

TENTATIVE AGENDA
RAYTOWN BOARD OF ALDERMEN
APRIL 12, 2022
REGULAR SESSION NO. 24
RAYTOWN CITY HALL
10000 EAST 59TH STREET
RAYTOWN, MISSOURI 64133
AND
ONLINE ZOOM WEBINAR
7:00 P.M.

The meeting will be streamed live and can be accessed on the City's website at www.raytown.mo.us. In addition, a video recording of the meeting will be available within 48 hours on the City's website. For questions, contact City Clerk, Teresa Henry at (816) 737-6004 or thenry@raytown.mo.us.

Public comments can be made in-person by signing in before the meeting using the sign-in sheet available in the City Hall Council Chamber. To make public comments remotely, please use the Zoom Webinar ID and Passcode below and notify the Clerk, using the contact information above, of your intent to give a Public Comment remotely during the live online meeting, or send your Public Comments to the City Clerk at the email address above by 12:00 p.m. (noon) on Monday, April 11, 2022 so that your comments can be presented in writing to the Board of Aldermen during the Public Comments section of the April 12, 2022 meeting agenda. All Public Comments received will be kept on file in the City Clerk's office.

zoom.us/join
Webinar ID: 880 0323 2142
Passcode: 361841

OPENING SESSION

Invocation/Pledge of Allegiance
Roll Call

Proclamations/Presentations

- ★ Proclamation recognizing Mary Jane Van Buskirk as Mayor Pro Tem 2021-2022

Public Comments

Comments from the Mayor
Comments from the City Administrator
Committee Reports

LEGISLATIVE SESSION

1. CONSENT AGENDA

All matters listed under the Consent Agenda are considered to be routine by the Board of Aldermen and will be enacted by one motion without separate discussion or debate. The Mayor or a member of the Board of Aldermen may request that any item be removed from the consent agenda.

Approval of the Regular March 15, 2022 Board of Aldermen meeting minutes.

REGULAR AGENDA

NEW BUSINESS

2. Public Hearing: A public hearing to consider a Conditional Use Permit for property located at 10028 East 63rd Street.
 - 2a. **FIRST READING: Bill No. 6601-22, Section XIII. AN ORDINANCE** APPROVING ISSUANCE OF A CONDITIONAL USE PERMIT TO JESUS AND GEORGINA AGUILERA OF LEE'S SUMMIT, MISSOURI, TO OPERATE AN ASSEMBLY USE IN THE FORM OF AN EVENT SPACE, AT 10028 E. 63rd STREET IN AN NC, NEIGHBORHOOD COMMERCIAL, DISTRICT WITHIN THE CITY OF RAYTOWN, JACKSON COUNTY, MISSOURI. Point of Contact: Chris Gilbert, Planning & Zoning Coordinator.
3. **FIRST READING: Bill No. 6602-22, Section V-A. AN ORDINANCE** AUTHORIZING AND APPROVING A SERVICE AGREEMENT AND A DISCONNECT/RECONNECT SEWER SERVICE AGREEMENT WITH PUBLIC WATER SUPPLY DISTRICT NO. 2 OF JACKSON COUNTY, MISSOURI. Point of Contact: Damon Hodges, City Administrator.
4. **FIRST READING: Bill No. 6603-22, Section XXXIII-A. AN ORDINANCE** AMENDING CHAPTER 18-ENVIRONMENT WITH THE ADDITION OF ARTICLE I, IN GENERAL; ARTICLE II-STORMWATER; DIVISION I-EROSION AND SEDIMENT CONTROL; DIVISION II-ILLICIT DISCHARGE AND DETECTION REGULATIONS; AND DIVISION III-STORMWATER RUNOFF CONTROL REGULATIONS TO THE RAYTOWN MUNICIPAL CODE. Point of Contact: Jose Leon, Public Works Director.
5. **R-3448-22: A RESOLUTION** APPOINTING A MEMBER OF THE BOARD OF ALDERMEN TO THE POSITION OF ACTING PRESIDENT FOR A TERM OF ONE YEAR OR UNTIL A SUCCESSOR IS APPOINTED. Point of Contact: Teresa Henry, City Clerk.
6. **R-3449-22: A RESOLUTION** APPROVING THE LAND AND LOT DELINQUENT LIST AND THE PERSONAL DELINQUENT LIST OF DELINQUENT TAXES REMAINING DUE AND UNCOLLECTED RECEIVED FROM JACKSON COUNTY, MISSOURI. Point of Contact: Damon Hodges, City Administrator.
7. **R-3450-22: A RESOLUTION** AUTHORIZING THE CITY ADMINISTRATOR TO ENTER INTO AN AGREEMENT WITH MCANANY CONSTRUCTION INC FOR THE 2022 ULTRATHIN BONDED ASPHALT SURFACE PROJECT IN AN AMOUNT NOT TO EXCEED \$360,000.00 FOR FISCAL YEAR 2021-2022. Point of Contact: Jose Leon, Public Works Director.
8. **R-3451-22: A RESOLUTION** AUTHORIZING THE CITY ADMINISTRATOR TO ENTER INTO AN AGREEMENT WITH MCCONNELL & ASSOCIATES CORP. FOR THE 2022 NEIGHBORHOOD STREET RECONSTRUCTION PROJECT IN AN AMOUNT NOT TO EXCEED \$372,354.08 FOR FISCAL YEAR 2021-2022. Point of Contact: Jose Leon, Public Works Director.
9. **R-3452-22: A RESOLUTION** AUTHORIZING AND APPROVING THE APPLICATION FOR CONGRESSIONAL EARMARKED FUNDS THROUGH THE U.S. HOUSE OF REPRESENTATIVES. Point of Contact: Damon Hodges, City Administrator and Dave Turner, Parks and Recreation Director.

ADJOURNMENT

MINUTES
RAYTOWN BOARD OF ALDERMEN
MARCH 15, 2022
REGULAR SESSION NO. 3
RAYTOWN CITY HALL
10000 EAST 59TH STREET
RAYTOWN, MISSOURI 64133
AND
ONLINE ZOOM WEBINAR
7:00 P.M.

OPENING SESSION

Mayor Michael McDonough called the March 15, 2022, Board of Aldermen Regular meeting to order at 7:01 p.m. Donnette Siems of the River Church provided the invocation and led the pledge of allegiance.

Roll was called by Teresa Henry, City Clerk, and the attendance was as follows:

Present: Alderman Derek Ward, Alderman Bonnaye Mims, Alderman Bill Van Buskirk, Alderman Mary Jane Van Buskirk, Alderman Janet Emerson, Alderman Ryan Myers, Alderman Loretha Hayden, Alderman Jim Aziere, Alderman Ian Scott, Alderman Greg Walters

Absent: None

Public Comments

Public comments were given by:

Alan Thompson, 8723 Ridgeway, Raytown, Missouri
Jeanette Gentry, Raytown, Missouri
Ryan Hoffman, 6201 Hedges Avenue, Raytown, Missouri

Communication from the Mayor

Mayor McDonough spoke on recent events and City business.

Communication from the City Administrator

None

Committee Reports

Comments were given by Aldermen Aziere and Bill Van Buskirk.

LEGISLATIVE SESSION

1. CONSENT AGENDA

All matters listed under the Consent Agenda are considered to be routine by the Board of Aldermen and will be enacted by one motion without separate discussion or debate. The Mayor or a member of the Board of Aldermen may request that any item be removed from the consent agenda.

Approval of the Regular March 1, 2022 Board of Aldermen meeting minutes.

Approval of the Special March 8, 2022 Board of Aldermen meeting minutes.

Alderman Mims, seconded by Alderman Hayden, made a motion to adopt. The motion as approved by a vote of 10-0.

Ayes: Aldermen Mims, Hayden, Bill Van Buskirk, Scott, Mary Jane Van Buskirk, Aziere, Walters, Emerson, Myers, Ward

Nays: None

REGULAR AGENDA

OLD BUSINESS

2. Public Hearing: A public hearing to consider a Conditional Use Permit for property located at 6204 Arlington Avenue.

2a. **SECOND READING: Bill No. 6597-22, Section XIII. AN ORDINANCE APPROVING ISSUANCE OF A CONDITIONAL USE PERMIT TO MONOPOLY ACQUISITIONS, LLC, OF RAYMORE, MISSOURI, TO OPERATE AN ANIMAL KENNEL FACILITY PROVIDING ANIMAL RESCUE, ANIMAL TRAINING, AND ANIMAL ADOPTION SERVICES, AT 6204 ARLINGTON AVENUE IN AN NC, NEIGHBORHOOD COMMERCIAL, ZONE WITHIN THE CITY OF RAYTOWN, JACKSON COUNTY, MISSOURI.** Point of Contact: Chris Gilbert, Planning & Zoning Coordinator.

The item was read by title only by Teresa Henry, City Clerk.

The public hearing continued.

Chris Gilbert, Planning & Zoning Coordinator, presented the item and remained for any discussion along with Stacey Payne, the applicant, and Melody Huff, a representative of The Pet Connection.

Alderman Bill Van Buskirk stated that he had ex parte communication regarding the item.

Mayor McDonough closed the public hearing.

Alderman Myers, seconded by Alderman Scott, made a motion to adopt. The motion was approved by a vote of 10-0.

Ayes: Aldermen Myers, Scott, Hayden, Bill Van Buskirk, Mary Jane Van Buskirk, Aziere, Mims, Walters, Emerson, Ward

Nays: None

Became Ordinance 5692-22.

3. **SECOND READING: Bill No. 6598-22, Section III-A-10. AN ORDINANCE CALLING AN ELECTION IN THE CITY OF RAYTOWN, JACKSON COUNTY, MISSOURI TO BE HELD ON THE 2ND DAY OF AUGUST, 2022 FOR THE PURPOSE OF SUBMITTING A QUESTION TO THE QUALIFIED VOTERS OF THE CITY OF RAYTOWN, MISSOURI, OF WHETHER THE CITY SHALL ISSUE GENERAL OBLIGATION BONDS FOR STREET, ROAD, BRIDGE AND SIDEWALK PURPOSES, PRESCRIBING THE FORM OF THE BALLOT TO BE USED THEREAT, SETTING OUT THE FORM OF NOTICE OF SAID ELECTION AND DIRECTING ITS PUBLICATION.** Point of Contact: Damon Hodges, City Administrator and Ryan Myers, Alderman Ward 3.

The item was read by title only by Teresa Henry, City Clerk.

Alderman Myers presented the item.

Alderman Bill Van Buskirk stated that he had ex parte communication regarding the item.

Alderman Myers, seconded by Alderman Aziere, made a motion to adopt. The motion was approved by a vote of 9-1.

Ayes: Aldermen Myers, Aziere, Mims, Mary Jane Van Buskirk, Scott, Ward, Hayden, Emerson, Bill Van Buskirk

Nays: Alderman Walters

Became Ordinance 5693-22.

4. **SECOND READING: Bill No. 6599-22, Section III-A-10. AN ORDINANCE CALLING AN ELECTION IN THE CITY OF RAYTOWN, JACKSON COUNTY, MISSOURI TO BE HELD ON THE 2ND DAY OF AUGUST, 2022 FOR THE PURPOSE OF SUBMITTING A QUESTION TO THE QUALIFIED VOTERS OF THE CITY OF RAYTOWN, MISSOURI, OF WHETHER THE CITY SHALL ISSUE GENERAL OBLIGATION BONDS FOR STORM SEWER PURPOSES, PRESCRIBING THE FORM OF THE BALLOT TO BE USED THEREAT, SETTING OUT THE FORM OF NOTICE OF SAID ELECTION AND DIRECTING ITS PUBLICATION.** Point of Contact: Damon Hodges, City Administrator and Ryan Myers, Alderman Ward 3.

The item was read by title only by Teresa Henry, City Clerk.

Alderman Myers presented the item.

Alderman Bill Van Buskirk stated that he had ex parte communication regarding the item.

Mayor McDonough called for a short break at 8:48 p.m.

Mayor McDonough reconvened the meeting at 9:00 p.m.

Alderman Scott, seconded by Alderman Myers, made a motion to adopt. The motion was approved by a vote of 9-1.

Ayes: Aldermen Scott, Myers, Aziere, Mims, Hayden, Mary Jane Van Buskirk, Ward, Bill Van Buskirk, Emerson

Nays: Alderman Walters

Became Ordinance 5694-22.

5. **SECOND READING: Bill No. 6600-22, Section VIII. AN ORDINANCE CALLING AN ELECTION IN THE CITY OF RAYTOWN, JACKSON COUNTY, MISSOURI TO BE HELD ON THE 2ND DAY OF AUGUST, 2022 FOR THE PURPOSE OF SUBMITTING A QUESTION TO THE QUALIFIED VOTERS OF THE CITY OF RAYTOWN TO INCREASE THE GENERAL PROPERTY TAX RATE FOR ALL SUBCLASSES OF PROPERTY BY \$0.30 PER ONE HUNDRED DOLLARS OF ASSESSED VALUATION IN COMPLIANCE WITH STATE LAW, PRESCRIBING THE FORM OF BALLOT TO BE USED THERE AT, SETTING OUT THE FORM OF NOTICE OF SAID ELECTION AND DIRECTING ITS PUBLICATION.** Point of Contact: Damon Hodges, City Administrator and Ryan Myers, Alderman Ward 3.

The item was read by title only by Teresa Henry, City Clerk.

Alderman Myers presented the item.

Alderman Bill Van Buskirk stated that he had ex parte communication regarding the item.

Alderman Scott, seconded by Alderman Aziere, made a motion to amend by striking the word “cent” from the ballot question language:

“Shall there be a \$0.30 ~~cent~~ increase in tax levy on one hundred dollars valuation for general municipal purposes in the City of Raytown, Missouri?”

The motion to amend was approved by a vote of 10-0.

Ayes: Aldermen Scott, Aziere, Emerson, Ward, Mims, Bill Van Buskirk, Walters, Mary Jane Van Buskirk, Hayden, Myers

Nays: None

Alderman Scott, seconded by Alderman Aziere, made a motion to adopt as amended. The motion was approved by a vote of 7-3.

Ayes: Aldermen Scott, Aziere, Myers, Emerson, Hayden, Mims, Ward

Nays: Aldermen Mary Jane Van Buskirk, Greg Walters, Bill Van Buskirk

Became Ordinance 5695-22.

NEW BUSINESS

6. **R-3446-22: A RESOLUTION** SUPPORTING THE RAYTOWN FARMERS MARKET IN THE CENTRAL BUSINESS DISTRICT. Point of Contact: Damon Hodges, City Administrator.

The item was read by title only by Teresa Henry, City Clerk.

Alderman Mims left the meeting at 9:20 p.m.

Mayor McDonough called for a short break at 9:21 p.m.

Mayor McDonough reconvened the meetings at 9:22 p.m.

Joey Carley, Engineering Technician, presented the item and remained for any discussion.

Alderman Myers, seconded by Alderman Scott, made a motion to adopt. The motion was approved by a vote of 8-1-1.

Ayes: Aldermen Myers, Scott, Mary Jane Van Buskirk, Aziere, Bill Van Buskirk, Hayden, Emerson, Walters

Nays: Alderman Ward

Absent: Alderman Mims

7. **R-3447-22: A RESOLUTION** AUTHORIZING AND APPROVING FINAL ENGINEERING SERVICES WITH GEORGE BUTLER ASSOCIATES FOR A SANITARY SEWER INFLOW AND INFILTRATION REDUCTION PROGRAM PROJECT IN AN AMOUNT NOT TO EXCEED \$233,498.00 FOR FISCAL YEAR 2021-2022. Point of Contact: Jose Leon, Public Works Director.

The item was read by title only by Teresa Henry, City Clerk.

Jose Leon, Public Works Director, presented the item and remained for any discussion.

Alderman Bill Van Buskirk, seconded by Alderman Hayden, made a motion to adopt. The motion was approved by a vote of 9-0-1.

Ayes: Aldermen Bill Van Buskirk, Hayden, Emerson, Ward, Aziere, Scott, Walters, Mary Jane Van Buskirk, Myers

Nays: None

Absent: Alderman Mims

ADJOURNMENT

Alderman Myers, seconded by Alderman Mary Jane Van Buskirk, made a motion to adjourn. The motion was approved unanimously.

The meeting adjourned at 10:04 p.m.

Teresa M. Henry, City Clerk, MRCC

DRAFT

CITY OF RAYTOWN
Request for Board Action

Date: April 7, 2022

Bill No.: 6601-22

To: Mayor and Board of Aldermen

Section No.: XIII

From: Chris Gilbert, Planning & Zoning Coordinator

Department Head Approval: _____

Finance Director Approval: _____ (Only if funding is requested)

City Administrator Approval: _____

Action Requested: Board of Aldermen consideration and approval of an application filed by Jesus and Georgina Aguilera, seeking approval of a Conditional Use Permit for an Assembly Use in the form of an Event Space, to be located at 10028 E. 63rd Street in an NC, Neighborhood Commercial District. This property has most recently hosted other event spaces, including KZZ from 2016 to 2020 and previous to that, Wal-Nic's, dating back to 2003.

Recommendation: Staff recommends approval as submitted. The Planning & Zoning Commission voted (7-0-1) on March 3, 2022, to recommend approval of the application with all conditions as contained in the staff report and the attached Ordinance. The applicant was present as the Conditions of Approval were individually explained during the public hearing and did agree to the Conditions.

Analysis: The proposed Assembly Use can only be performed with a valid Conditional Use Permit in the NC, Neighborhood Commercial District. The subject property was purchased over a year ago by the applicants who were performing interior cosmetic renovations not requiring permits since and are now seeking a CUP to approve the use. The applicants have some private parking available at the back of their building that will be properly marked and have a signed notarized lease agreement with a nearby owner with excess parking to meet the remainder of the parking requirement. The applicant stated to the Planning Commission, when asked, that he would make exterior improvements to the front façade after completing the internal improvements. These improvements would need to be consistent with the Central Business District design guidelines. The applicant held a neighborhood meeting as required by code and two of the nearby commercial owners either appeared for the meeting with their concerns stated in the synopsis contained in the PC staff report attachments, or provided written comment, also attached. The Planning Commission meeting had no persons from the public or nearby business owners attend regarding this application Staff has received one additional call regarding this application from a nearby business owner and information on the application was provided to the caller.

Alternatives: Alternatives to the recommendation of the Planning & Zoning Commission would be to conditionally approve or deny the Conditional Use Permit.

Budgetary Impact:

Not Applicable

Additional Reports Attached:

- Ordinance
- Staff Report from March 3, 2022, Planning Commission meeting
- Draft Minutes of the March 3, 2022, Planning Commission meeting

AN ORDINANCE APPROVING ISSUANCE OF A CONDITIONAL USE PERMIT TO JESUS AND GEORGINA AGUILERA OF LEE'S SUMMIT, MISSOURI, TO OPERATE AN ASSEMBLY USE IN THE FORM OF AN EVENT SPACE, AT 10028 E. 63RD STREET IN AN NC, NEIGHBORHOOD COMMERCIAL, DISTRICT WITHIN THE CITY OF RAYTOWN, JACKSON COUNTY, MISSOURI

WHEREAS, Application PZ-2022-03, was duly submitted on or about January 10, 2022 by Jesus and Georgina Aguilera of Lee's Summit, Missouri, requesting approval of a Conditional Use Permit to operate an Assembly Use, in the form of an Event Space, at 10028 E. 63rd Street in an NC, Neighborhood Commercial, District in the City of Raytown, Jackson County, Missouri (the "Application"); and

WHEREAS, the Application was considered by the Planning Commission on March 3, 2022, and by a vote of 7 in favor, 0 against, and 1 abstention, rendered a report to the Board of Aldermen recommending that the Application be approved; and

WHEREAS, after opening the public hearing, considering all testimony and the record, and then closing the public hearing, the Board of Aldermen finds and declares that the provisions hereinafter contained and enacted are in pursuant of and for the purpose of securing and promoting the public safety, health, and general welfare of persons in the City of Raytown and rendered a decision to approve the Application.

NOW THEREFORE, BE IT ORDAINED BY THE BOARD OF ALDERMEN OF THE CITY OF RAYTOWN, MISSOURI, AS FOLLOWS:

SECTION 1 – APPROVAL OF CONDITIONAL USE PERMIT. That the Application for approval of a Conditional Use Permit to operate an Assembly Use, in the form of an Event Space, at 10028 E. 63rd Street in an NC, Neighborhood Commercial, District in the City of Raytown, Jackson County, Missouri, is hereby approved and issued to Jesus and Georgina Aguilera.

SECTION 2 – CONDITIONS OF APPROVAL. That the Application for approval of a Conditional Use Permit to operate an Assembly Use, in the form of an Event Space, at 10028 E. 63rd Street in an NC, Neighborhood Commercial, District in the City of Raytown, Jackson County, Missouri, be approved and issued to Jesus and Georgina Aguilera subject to the following conditions as contained in the staff report and as approved by the Planning Commission:

The following Conditions of Approval of this CUP shall be satisfied within 30 days of approval of the Ordinance and prior to approval of the Commercial Use Permit. In exceptional circumstances, such as seasonal weather constraints, the Director of Community Development may grant an extension:

1. Ensure rear parking lot is properly striped to include a single handicapped "Van Accessible" parking space accessible to the main entrance of the building that meets all Americans with Disabilities Act (ADA) standards regarding striping and signage.
2. Prove through signed and notarized cross-parking easement agreements with property owners possessing extra parking not required for their needs within 300 feet that the required 24 parking spaces to serve this use are fully under the control of the applicant.
3. Remove all reference to "Wal-Nic's" from the Building Façade.

The following conditions are required to be met on an ongoing basis:

4. Any future intent to serve alcohol by the drink on the premises shall require an application be filed with the City and a permit be issued for such activity before any drinks are served.
5. The occupant load of the building shall be kept under 100 persons per the submitted architectural analysis.
6. The exterior areas of the building and property shall be illuminated in such a manner as to ensure the safety of the public before, during, and after events.
7. Parking area behind the building shall be maintained in good condition at all times.
8. Ensure the entire building exterior is maintained in good condition at all times, including paint, doors, windows, foundation, roof, and storage areas.
9. Ensure the site is maintained in good condition at all times, including trimming of weeds and grass growing in cracks. All junk, trash, and debris that collects on the site to be removed immediately and not permitted to remain.
10. All signage for the use shall be issued under separate permit process and shall meet Municipal Code requirements.
11. Any trash dumpster placed on site needs to be either within a fully enclosed dumpster enclosure or stored indoors, except on trash pickup day.

General Conditions of Approval:

12. A Commercial Use Permit or business license shall not be issued until Items #1 to #3 under Conditions of Approval are completed. The property shall not be occupied and used for Assembly Use until the Commercial Use Permit and/or a Business License to operate are issued.
13. Compliance with all applicable local, state and federal regulations, codes, ordinances, and laws.

SECTION 3 – REPEAL OF ORDINANCES IN CONFLICT. All ordinances or parts of ordinances in conflict with this ordinance are hereby repealed.

SECTION 4 – SEVERABILITY CLAUSE. The provisions of this ordinance are severable and if any provision hereof is declared invalid, unconstitutional or unenforceable, such determination shall not affect the validity of the remainder of this ordinance.

SECTION 5 – EFFECTIVE DATE. This ordinance shall be in full force and effect from and after the date of its passage and approval.

BILL NO. 6601-22

ORDINANCE NO. _____

SECTION NO. XIII

BE IT REMEMBERED that the above was read two times by heading only, **PASSED and ADOPTED** by a majority of the Board of Aldermen and **APPROVED** by the Mayor of the City of Raytown, Jackson County, Missouri, this ____ day of April, 2022.

Michael McDonough, Mayor

ATTEST:

Teresa M. Henry, City Clerk

Approved as to Form:

Jennifer M. Baird, City Attorney

PZ 2022-03

To: City of Raytown Planning and Zoning Commission

From: Chris Gilbert, Planning & Zoning Coordinator

Date: March 3, 2022

Re: Application for Conditional Use Permit

CONDITIONAL USE PERMIT APPLICATION SUMMARY

Applicant: Jesus and Georgina Aguilera

Property Owner: Jesus and Georgina Aguilera

Property Location: 10028 E. 63rd Street

Request: Conditional Use Permit approval for "Assembly" Use in the form of an Event Space, to be Located at 10028 E. 63rd Street in an NC, Neighborhood Commercial District

The applicants, Jesus and Georgina Aguilera, are requesting Conditional Use Permit (CUP) approval to open an Assembly Use in the form of an Event Space at 10028 E. 63rd Street on the downtown block of Raytown, within both the Neighborhood Commercial (NC) zoning district and the Central Business District Overlay. Per the statement of intent from the applicants included as an attachment to this staff report, they purchased this property about a year ago and have been remodeling it inside to modernize the space for a small family-run event center in what used to be known as Wal-Nic's. Per the city's land use table, this type of use can only be conditionally approved in the NC, Neighborhood Commercial, zoning district.



Figure 1 – Location and Vicinity Map – Downtown Raytown

The subject property is the largest property on the north side of 63rd Street in the Downtown block of Raytown where all the businesses open directly onto the public sidewalk and share common walls, anchored at the west end by Fox Drugs and the east end by Robert Atkins' Farmer's Insurance Office. The applicant has provided a conceptual layout for how the interior and exterior areas can be set up for this use that is included in the attachments to this staff report.

SURROUNDING ZONING AND LAND USES

Property's Zoning Classification	Neighborhood Commercial (NC)
Surrounding Properties' Zoning	Neighborhood Commercial (NC)
Surrounding Overlay	Central Business District (CBD)
Surrounding Land Use	Commercial
Designated Future Land Use	Downtown District
Ward	Ward 2
Approximate Land Area	0.2 Acres
Roadway Classification	Arterial w/ City Alley along the back side

SITE DESCRIPTION, HISTORY, AND PRESENT USE

This building, which shares common walls with neighbors to the east and west, has been licensed as an event space multiple times in the past, including as Wal-Nic's from 2003 to 2014, then as KZZ from 2016 to 2020, when, shortly thereafter, was purchased by the applicants. Prior to 2003 there were a variety of tenants, including BBQ restaurant, sales outlet, and used furniture store. Copies of CUP Ordinances for event spaces approved in 2008 and 2014 are included in the attachments to this report. The approximate usable floor space for assembly purposes that is not bathrooms, storage areas, hallways, and the kitchen, in this building is 2400 square feet based upon the architectural analysis attached to this report.



Figure 2 – Site Photos – (L) Storefront on 63rd Street. (R) Rear of Property on Public Alley



SURROUNDING PROPERTIES AND NEIGHBORHOOD

The subject property is surrounded by the following types of development:

To the West: Zero-lot-line businesses, including a bar, insurance agency, barber shop, and Fox Drugs.

To the South: Raytown Water Company Headquarters, shoe repair, fitness center, with upper floor loft residential.

To the East: Insurance agency and cigar lounge.

To the North: The Town Square property owned by the City and used for seasonal performance events. Used to be the First Baptist Church site until it moved to 350 Highway and the old buildings and lots demolished and is now a grass field.

PUBLIC COMMENTS

The public hearing notice was published in *The Daily Record* on February 14, 2022. Public notice letters were sent to property owners within 185 feet of the property by the applicant. The Neighborhood Information Meeting was held on February 22, 2022 (had to be rescheduled due to winter weather emergency to this date and new letters were hand carried to businesses within 185 feet as there was not enough time to mail new letters). A sign-in sheet from this meeting and a detailed synopsis of the discussions held with the attendees, as prepared by the applicant following the meeting, is attached to this staff report. To date, the Community Development Department has received two additional letters/calls/emails regarding this application, in the form of a letter of support (attached to this report) from Neal Clevenger, who owns a lot of property in the vicinity of this application. The second inquiry came in the form of questions asked by the Sue Frank Insurance Agency. The property was posted by the applicant with the required public hearing sign on February 16, 2022.

ANALYSIS

Evaluating an application for a conditional use permit requires consideration to be given by the City of Raytown to the health, safety, morals, comfort and general welfare of the inhabitants of the City, including but not limited to, the following factors:

1. Stability and integrity of the various zoning districts

The parcel and all adjacent lots are shown as "Downtown District" or "Commercial" on the Future Land Use Map incorporated in the Raytown Comprehensive Plan and also presently zoned Neighborhood Commercial (NC).

Section 50-185 of the Raytown Municipal Code, describing the NC zoning district, states it is designed to "provide a location for miscellaneous retail, wholesale, and businesses serving the consumer public and business". This application meets this intent for the NC zone as it is a business serving the consumer public by providing a gathering and entertainment venue, not too unlike the public venue on the adjacent Town Square tract to the north.

The proposed use would maintain the stability and integrity of the Neighborhood Commercial zoning district as assembly uses can generate increased revenues for nearby businesses



during events and the small size of the assembly area will not lead to excessive overcrowding in the downtown area during events as the applicant is being required to provide a minimum amount of dedicated parking required by Ordinance that is not inclusive of all on-street "extra" parking on 63rd Street along this block.

2. Conservation of property values

Due to the significant amount of money put into upgrading the property, there should be a beneficial impact on property values. The Downtown Raytown block between Raytown Road and Blue Ridge Blvd. has existed for over 70 years and has hosted a variety of uses and tenants during this time of which the current applicants' building was formerly an event space itself for many years between 2003 and 2020, so the proposed application would be re-introducing this use.

3. Protection against fire and casualties

The applicant has submitted an architectural analysis as required, and all internal modifications in accordance with the architect's recommendations shall be completed in accordance with Raytown Fire District requirements and City of Raytown Building Codes.

4. Observation of general police regulations

The proposed business will not violate any general police regulations if the events are handled in an orderly manner. Nightclubs, dance halls, and discotheque style assembly which has a greater chance of generating situations requiring police response is not permitted under the requested "assembly" use which includes Event Spaces. There is a specific separate Conditional Use required for the Nightclub category, which the applicant is not intending to operate.

5. Prevention of traffic congestion

Multiple access points out to Blue Ridge Blvd. and Raytown Road from the parking area in back should be sufficient to handle the event traffic for the requested use, particularly given its small size. Additionally, the overflow parking on 63rd Street is available as well.

6. Promotion of traffic safety and the orderly parking of motor vehicles

The applicants are required to provide 24 parking spaces uniquely under their control, of which 11 are shown directly behind their building including handicapped parking. The additional 13 are required to be provided within 300 feet and the applicant is still attempting to confirm control of these spaces. Initially he had them lined up with adjacent owners but due to how the spaces were accounted for was unable to include them in the count and is still looking.

7. Promotion of the safety of individuals and property

The Applicant will be required to ensure the Assembly activities are managed in a manner that observes proper decorum, providing a safe environment for all patrons and their property.

8. Provision for adequate light and air

The proposed business will not affect the air quality of the area beyond what is normal for a commercial district. All activities are to be contained inside the building.



9. Prevention of overcrowding and excessive intensity of land uses

The proposed business will affect the intensity of land uses in the area but only for short periods during events. It is an existing commercial area that has hosted events for years in the past thus the proposed use can easily be compatible with the other uses in the downtown area if the required committed parking is available.

10. Provision for public utilities and schools

The proposed business will not affect any public utilities or schools and could generate revenues that benefit the taxing entities including the school district and encourage additional ancillary spending in the community by attendees at events both before and after the events are held.

11. Invasion by inappropriate uses

Staff does not view the proposed business as an inappropriate use at this location. The proposed Assembly use is a commercial use that has twice been approved at this location in the past by CUP Ordinance, in 2008 and 2015. This would be a continuation of similar activities by a different owner.

12. Value, type and character of existing or authorized improvements and land uses

The proposed use will require interior improvements in accordance with the architects recommendations to meet Building and Fire Code for group events but no exterior improvements other than striping and properly marking the parking in the rear of the building. Requiring Central Business District (CBD) Overlay standards for a reuse of an existing commercial structure will be extremely difficult to enforce as the site is not being modified, expanded, reconstructed, etc., so as such does not require application of such standards at the present time with this application. Any new signage required for the business, however, will have to meet the channel lettering design style requirement of the CBD standards. Signage is approved under a separate permit process.

13. Encouragement of improvements and land uses in keeping with overall planning

As the property is a currently existing developed commercial building and the use is a commercial use consistent with approved uses over the past 20 years, the proposed business is consistent with overall planning principles.

14. Provision for orderly and proper renewal, development and growth

The proposed business, if approved and managed properly by the applicant, will contribute to the orderly and proper renewal, development and growth of the City. The proposed business should not affect the orderly and proper renewal, development or growth of the city. The applicant's proposed re-use of a vacant building, combined with the recommended conditions of approval, will contribute to the orderly renewal of the city by continuing occupancy in a structure that risks remaining vacant for an extended period otherwise, which is already being experienced by the building on the immediate west side of this property.

The view can also be taken that the property might be better utilized as a pure retail use. By taking this approach, there is no guarantee that the building will get an interested party that would invest the significant sums needed to redevelop a building designed as an event space into a retail-viable facility. The possibility exists if this application is turned down, the subject



property would remain vacant for a much longer time, delaying site improvements and maintenance, and creating a significant appearance issue, while also lowering surrounding property values and potentially creating a target for vandalism and other forms of crime.

RECOMMENDATION

Staff recommends CONTINUANCE of Case No. PZ 2022-03 to the April 7, 2022, Planning Commission Meeting to provide the applicant additional time to secure 13 parking spaces

Based upon the present situation, this Request for Conditional Use Permit approval for an "Assembly" Use in the form of an Event Space, to be located at 10028 E. 63rd Street, in an NC, Neighborhood Commercial District, should only be approved with the following conditions:

The following Conditions of Approval of this CUP shall be satisfied within 30 days of approval of the Ordinance and prior to approval of the Commercial Use Permit. In exceptional circumstances, such as seasonal weather constraints, the Director of Community Development may grant an extension:

1. Ensure rear parking lot is properly striped to include a single handicapped "Van Accessible" parking space accessible to the main entrance of the building that meets all Americans with Disabilities Act (ADA) standards regarding striping and signage.
2. Prove through signed and notarized cross-parking easement agreements with property owners possessing extra parking not required for their needs within 300 feet that the required 24 parking spaces to serve this use are fully under the control of the applicant.
3. Remove all reference to "Wal-Nic's" from the Building Façade.

The following conditions are required to be met on an ongoing basis:

4. Any future intent to serve alcohol by the drink on the premises shall require an application be filed with the City and a permit be issued for such activity before any drinks are served.
5. The occupant load of the building shall be kept under 100 persons per the submitted architectural analysis.
6. The exterior areas of the building and property shall be illuminated in such a manner as to ensure the safety of the public before, during, and after events.
7. Parking area behind the building shall be maintained in good condition at all times.



Staff Report

Community Development
Planning and Development Services

8. Ensure the entire building exterior is maintained in good condition at all times, including paint, doors, windows, foundation, roof, and storage areas.
9. Ensure the site is maintained in good condition at all times, including trimming of weeds and grass growing in cracks. All junk, trash, and debris that collects on the site to be removed immediately and not permitted to remain.
10. All signage for the use shall be issued under separate permit process and shall meet Municipal Code requirements.
11. Any trash dumpster placed on site needs to be either within a fully enclosed dumpster enclosure or stored indoors, except on trash pickup day.

General Conditions of Approval:

12. A Commercial Use Permit or business license shall not be issued until Items #1 to #3 under Conditions of Approval are completed. The property should not be occupied and used for private or public auto repair until the Commercial Use Permit and/or a Business License to operate are issued.
13. Compliance with all applicable local, state and federal regulations, codes, ordinances, and laws.

Case Number _____
Date Received _____
Map Page _____

CITY OF RAYTOWN
APPLICATION FOR CONDITIONAL USE PERMIT

PART I Background Information

1. This request applies to property at the following address:
10028 E 63rd St Raytown, MO 64133

2. The name(s), address(es), and phone number(s) of the property owners: (As listed on the deed)

Name	Address	Phone
<u>Jesus Aguilera</u>	<u>541 NE Summit Dr</u>	<u>816-585-5787</u>
<u>Georgina Aguilera</u>	<u>Blue Springs 64014</u>	<u>816-328-7630</u>

3. We, the property owner(s), do hereby appoint the following person as our agent during consideration of our request:

Name	Address	Phone/Email
<u>JESUS AGUILERA</u>	<u>SAME IS ABOUT</u>	

4. The property is currently being used for the following purposes:

Event Center

5. Zoning classification of the property: NC

6. Specify the use desired for the property: FAMILY/ADULT EVENT CENTER

7. Please list all existing structures and their heights located on the property:

<u>Structure</u>	<u>Height</u>

8. We, the undersigned, do hereby authorize the submission of this application and associated documents, and do hereby certify that all the information contained therein is true and correct. (Signatures of property owners)

<u>JESUS AGUILERA</u>	<u>Georgina Aguilera</u>
<u>Geo Aguilera</u>	<u>Georgina Aguilera</u>

Jesus & Georgina Aguilera
541 NE Summit Drive
Blue Springs MO 64014
Aguileragto@vahoo.com
(816) 585-5787

January 10, 2022

Mr. Ray Haydaripoor, Community Development Director
Raytown MO, city of
Community Development Department
Planning and Development Services
1000 East 59th Street
Raytown, MO 64133

Sir:

We are Georgina and Jesus Aguilera. We presently reside at 541 NE Summit Drive, Blue Springs MO 64014. We came to the United States in 1994 as a young couple in search of opportunity and a better life. We aspired to one day own a business and start a family. We worked hard and saved money. Here we are today with teenage children and having purchased a piece of commercial property in Raytown.

We purchased the property here in Raytown at 10028 E 63rd Street about a year ago. This property had been an event center for some fifteen years but fell into decline. We saw an opportunity to continue to build upon our dream. We invested most of our saving in the property acquisition and poured in a lot of sweat equity. The vision begin to come into focus for a nice place for small graduation and wedding receptions, birthday parties and other special events for less than one hundred people. The old was being made new and inviting.

We have already spent most of our savings to purchase the building and over \$8,000 on new flooring, repainting the inside, and replacing light and bathroom fixtures. When you approve the site plan, we will repaint the outside of the building and restripe the parking lot according to municipal code. We will complete all recommended improvements to ensure the new event centers meets all municipal building standards and has that special curb appeal.

We will certainly listen to the wisdom of the Council to help us continue to build our dream and help make Raytown the best it can be.

Thank you for considering our application. We will attempt to answer all of your questions.

Kind regards,

AN ORDINANCE GRANTING A CONDITIONAL USE PERMIT SUBJECT TO CERTAIN CONDITIONS TO OPERATE A BANQUET HALL IN DISTRICT N-C (NEIGHBORHOOD COMMERCIAL) ON LAND LOCATED AT 10020 – 10030 EAST 63RD STREET, ALL IN ACCORDANCE WITH THE PROVISIONS OF COMPREHENSIVE ZONING REGULATIONS, FOR THE CITY OF RAYTOWN, MISSOURI.

WHEREAS, pursuant to City Code Chapter 26, Section 20 of the Zoning Ordinance, Application No. PZ-2008-011, submitted by Regina Walters and Shawna Nicholls on behalf of Siatta Investments LLC, requesting a conditional use permit to use property located in a Neighborhood Commercial (NC) District at 10020-10030 East 63rd Street for operation of a commercial banquet hall was referred to the Planning Commission to hold a public hearing; and

WHEREAS, after due public notice in the manner prescribed by law, the Planning Commission held a public hearing on June 5, 2008, and rendered a report to the Board of Aldermen containing findings of fact and a recommendation that the conditional use permit requested be approved; and

WHEREAS, after due public notice in the manner prescribed by law, the Board of Aldermen held a public hearing on July 1, 2008 and July 15, 2008, and rendered a decision to grant said conditional use permit.

NOW THEREFORE, BE IT ORDAINED BY THE BOARD OF ALDERMEN OF THE CITY OF RAYTOWN, MISSOURI, AS FOLLOWS:

SECTION 1 – GRANT OF CONDITIONAL USE PERMIT. That pursuant to City Code Chapter 26, Section 20 of the Zoning Ordinance of the City of Raytown, Missouri, a Conditional Use Permit, subject to the conditions set forth herein, is hereby granted to Siatta Investments, LLC to allow property located at 10020-10030 East 63rd Street to be used as a banquet hall in the Neighborhood Commercial (NC) District, on said property legally described as follows:

Lots 11, 12 and 13, Rieder's Subdivision, Jackson County, Missouri.

SECTION 2 – CONDITIONS OF APPROVAL AND OPERATION. That the following conditions of approval shall apply and be followed during the operation of the business allowed by this Conditional Use Permit:

1. The occupant load within the assembly area inside the building shall not exceed 297 persons.
2. Loitering or the creation of a public nuisance or disturbance of the peace by any patron of the banquet hall on the premises or in the immediate vicinity of the banquet hall shall be prohibited. Loitering shall not include walking between the banquet hall building and the patron's vehicle, nor shall it include the act of waiting in line to gain admission to the hall as long as the patrons are not creating a public nuisance or disturbing the peace while waiting in line.
3. The premises shall be kept free from litter resulting from the operation of the banquet hall.
4. No controlled substances shall be offered for sale or consumed on the premises.

5. The premises shall be illuminated adequately to ensure the safety of the public.
6. The business shall remove, or have removed, from the premises any person who is or appears to be under the influence or affected by the use of alcohol and/or drugs, or whose conduct poses a physical danger to the safety of others present.
7. The business shall comply with all applicable local, state, and federal laws and regulations.
8. The business shall enter into and maintain off-street parking sufficient to provide at least 110 off-street parking spaces. Failure to maintain the minimum number of parking spaces at any time during the period of time the conditional use permit is effective shall result in immediate revocation of the right to utilize the property as a banquet hall.
9. The conditional use permit shall be valid only as long as the applicants, Regina Walters and Shawna Nicholls operate the use at the specified location. Any change of ownership in Siatta Investments shall also require issuance of a new conditional use permit to use the property as allowed herein.

SECTION 3 – FAILURE TO COMPLY. That failure to comply with all of the provisions contained in this ordinance shall constitute violations of both this ordinance and the City’s Comprehensive Zoning Regulations.

SECTION 4 – REPEAL OF ORDINANCES IN CONFLICT. All ordinances or parts of ordinances in conflict with this ordinance are hereby repealed.

SECTION 5 – SEVERABILITY CLAUSE. The provisions of this ordinance are severable and if any provision hereof is declared invalid, unconstitutional or unenforceable, such determination shall not affect the validity of the remainder of this ordinance.

SECTION 6 – EFFECTIVE DATE. This ordinance shall be in full force and effect from and after the date of its passage and approval.

BE IT REMEMBERED that the above was read two times, and upon final vote taken the 16th day of September, 2008, was approved by the Board of Aldermen of the City of Raytown, Jackson County, Missouri upon the following vote:

Alderman	Aye	Nay	Absent/Abstain
Walters			✓
Creamer	✓		
Aziere	✓		
White	✓		
Hamilton	✓		
Melson			✓
Schlapia	✓		
Ertz	✓		
Fleming	✓		
Sargeon	✓		
Tie Vote: Mayor Bower			

SUBSTITUTE BILL NO. 6150-08

ORDINANCE NO. 5298-08 SECTION NO. XIII

Teresa Henry, City Clerk

APPROVED BY THE MAYOR the 18th day of September, 2008.

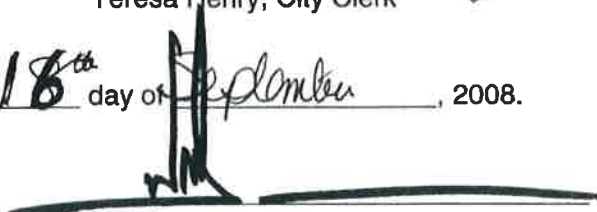
David Bower, Mayor

or, APPROVED without the Mayor's signature the ___ day of _____, 2008.

or, APPROVED over the Mayor's veto the ___ day of _____, 2008.

ATTEST:

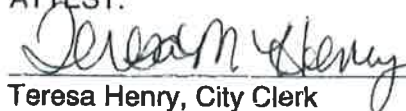
Teresa Henry, City Clerk

APPROVED AS TO FORM:

Nancy Thompson, City Attorney

Sponsor(s): The Planning Commission

AN ORDINANCE GRANTING A CONDITIONAL USE PERMIT SUBJECT TO CERTAIN CONDITIONS TO OPERATE AN EVENT SPACE ON PROPERTY LOCATED AT 10028 EAST 63RD STREET IN RAYTOWN, MISSOURI

WHEREAS, Nathan Prather, on behalf of Siatta Investments, LLC, is seeking approval of a conditional use permit application for operation of an event space at 10028 East 63rd Street; and

WHEREAS, pursuant to City Code Chapter 50, Article V of the City of Raytown Code of Ordinances, application no. PZ-2014-008, was referred to the Planning Commission to hold a public hearing; and

WHEREAS, after due public notice in the manner prescribed by law, the Planning Commission held said public hearing on December 11, 2014; and

WHEREAS, at the conclusion of said public hearing the Planning Commission by a vote of six (6) in favor and zero (0) against rendered a report to the Board of Aldermen recommending that the Conditional Use Permit Application be approved subject to certain conditions; and

WHEREAS, after due public notice in the manner prescribed by law, the Board of Aldermen held public hearings on January 6, 2015 and January 20, 2015; and

WHEREAS, based on all of the information presented the Board of Aldermen finds it is in the best interest of the citizens of the City of Raytown to grant said Conditional Use Permit subject to certain conditions;

NOW THEREFORE, BE IT ORDAINED BY THE BOARD OF ALDERMEN OF THE CITY OF RAYTOWN, MISSOURI, AS FOLLOWS:

SECTION 1 – GRANT OF CONDITIONAL USE PERMIT. That a Conditional Use Permit is hereby granted to Siatta Investments, LLC, for operation of an event space / banquet hall at 10028 East 63rd Street, as legally described in Exhibit "A", subject to the conditions set forth in Section 2.

SECTION 2 – CONDITIONS OF APPROVAL AND OPERATION. That the following conditions of approval shall apply to the granting of this Conditional Use Permit.

- A. The occupant load within assembly area inside building shall not exceed 100 persons.
- B. It shall be the obligation of the operator of the banquet facility to prevent loitering or the creation of public nuisances or disturbances of the peace by any patrons of the banquet hall on the premises of the banquet hall or the immediate vicinity of the same. Loitering, however, shall not include walking between the banquet hall building and the patron's vehicle, nor shall it include the act of waiting in line to gain admission to the banquet hall as long as the patrons are not creating public nuisance or disturbing the peace.
- C. It shall be the obligation of the operator of the banquet facility to clean up all litter on the premises resulting from the banquet hall operations.
- D. It shall be the obligation of the operator of the banquet facility to insure that no controlled substances are offered for sale or consumed on the club premises.
- E. It shall be the obligation of the operator of the banquet facility to remove, or have removed, from the banquet premises any person who is or appears to be under the influence of or affected by the use of alcohol and/or drugs, or whose conduct poses a physical danger to the safety of others present.

- F. It shall be the obligation of the operator of the banquet facility to provide proper and adequate illumination.
- G. Compliance with all applicable local, state and federal laws and regulations.

SECTION 3 – FAILURE TO COMPLY. That failure to comply with any of the conditions or provisions contained in this ordinance shall constitute violations of both this ordinance and the City's Comprehensive Zoning Code and shall be cause for revocation of the Conditional Use Permit granted herein in addition to other penalties contained in the City Code.

SECTION 4 – REPEAL OF ORDINANCES IN CONFLICT. All ordinances or parts of ordinances in conflict with this ordinance are hereby repealed.

SECTION 5 – SEVERABILITY CLAUSE. The provisions of this ordinance are severable and if any provision hereof is declared invalid, unconstitutional or unenforceable, such determination shall not affect the validity of the remainder of this ordinance.

SECTION 6 – EFFECTIVE DATE. This ordinance shall be in full force and effect from and after the date of its passage and approval.

BE IT REMEMBERED that the above was read two times by heading only, **PASSED AND ADOPTED** by a majority of the Board of Aldermen and **APPROVED** by the Mayor of the City of Raytown, Jackson County, Missouri, this 20th day of January, 2015.

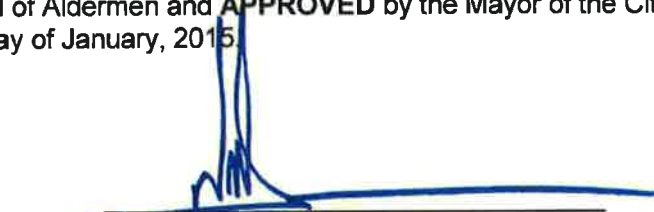

David W. Bower, Mayor

ATTEST:

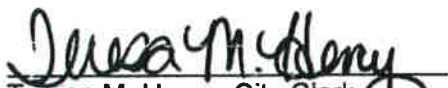

Teresa M. Henry, City Clerk

Approved as to Form:



Joe Willerth, City Attorney

Exhibit "A"

Lots 11, 12 and 13, Rieder's Subdivision, Jackson County, Missouri.

AFFIDAVIT OF PUBLICATION

STATE OF MISSOURI
COUNTY OF JACKSON

} S.S.

Page 1 of 1

Before the undersigned Notary Public personally appeared **Brandon Crail** on behalf of **THE DAILY RECORD, KANSAS CITY** who, being duly sworn, attests that said newspaper is qualified under the provisions of Missouri law governing public notices to publish, and did so publish, the notice annexed hereto, starting with the **February 14, 2022** edition and ending with the **February 14, 2022** edition, for a total of 1 publications:

02/14/2022

Notice of Public Hearings

Affected Property: 10028 E. 63rd Street, Raytown, Missouri
Jackson County Parcel ID # 45-120-09-19-00-0-00-000

A public hearing to consider a Conditional Use Permit application to operate an "Assembly" Use in the form of an Event Center, filed by Jesus Aguilera of Blue Springs, Missouri, will be held by the Raytown Planning & Zoning Commission at 7:00pm on Thursday, March 3, 2022. The packet and agenda should be available for view on the City of Raytown website on Friday, February 25, 2022.

The Raytown Board of Aldermen will also hold a public hearing to consider this Conditional Use Permit, tentatively scheduled for 7:00pm on Tuesday, April 19, 2022.

All public hearings will take place in the Council Chambers at Raytown City Hall located at 10000 E. 59th St. Raytown, MO 64133.

The public is invited to attend the public hearings to ask questions and provide comment. Additional information can be obtained from the Department of Community Development located in Raytown City Hall at 10000 East 59th Street, by telephone at (816) 737-6059 or by e-mail at chrisg@raytown.mo.us.

If you will require any special accommodation (i.e., qualified interpreter, large print, reader, hearing assistance) to attend either of these public hearings, please notify the Department of Community Development at Raytown City Hall at (816) 737-6014 no later than 48 hours prior to the applicable public hearing date.

12086374 Jackson Feb. 14, 2022



Brandon Crail

Subscribed & sworn before me this 14th day of Feb., 2022
(SEAL)



Notary Public

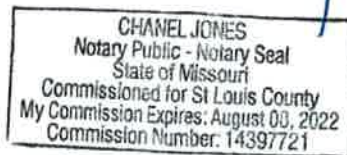

February 9, 2022

Dear Property Owner/Tenant:

Notice of Neighborhood Meeting and Public Hearings in Your Area

The Raytown Community Development Department is processing an application for a Conditional Use Permit for an Assembly Use, filed by Jesus Aguilera of Blue Springs, MO, to be located at 10028 E. 63rd Street in Raytown, Missouri. The applicant intends to operate an event center from the subject property, which requires a Conditional Use Permit per the City of Raytown Municipal Code. As a nearby owner or tenant, you are entitled to appear and provide comment at any of the public hearings on this matter or to provide written comment.

The applicant will be holding a neighborhood information meeting in the City Council Chambers at 4:00 PM on Thursday, February 17, 2022, to which you are invited to discuss the application directly with them. City staff will not be present at this time. If you have any concerns or need more information about the application, this is a good meeting to attend.

A public hearing to consider this application will be held by the Raytown Planning & Zoning Commission **at 7:00 PM on Thursday, March 3, 2022.** The full packet and agenda should be available for view on the City of Raytown website on Friday, February 25, 2022.

The Raytown Board of Aldermen will also hold a public hearing regarding the above-described application, tentatively scheduled for **7:00 PM on Tuesday, April 19, 2022.**

All public hearings will take place in the Council Chambers at Raytown City Hall located at 10000 E. 59th St. Raytown, MO 64133.

The public is invited to attend the public hearings to ask questions and provide comment regarding this application. Additional information regarding this application can be obtained from the Department of Community Development located in Raytown City Hall at 10000 East 59th Street, by phone at (816) 737-6059 or by e-mail at chrisg@raytown.mo.us.

If you will require any special accommodation (i.e., qualified interpreter, large print, reader, hearing assistance) to attend either of these public hearings, please notify the Department of Community Development at Raytown City Hall at (816) 737-6014 no later than 48 hours prior to the applicable public hearing date.

February 18, 2022

Dear Property Owner/Tenant:

Notice of Neighborhood Meeting and Public Hearings in Your Area

The Raytown Community Development Department is processing an application for a Conditional Use Permit for an Assembly Use, filed by Jesus Aguilera of Blue Springs, MO, to be located at 10028 E. 63rd Street in Raytown, Missouri. The applicant intends to operate an event center from the subject property, which requires a Conditional Use Permit per the City of Raytown Municipal Code. As a nearby owner or tenant, you are entitled to appear and provide comment at any of the public hearings on this matter or to provide written comment.

The applicant will be holding a neighborhood information meeting in the City Council Chambers at 4:00 PM on Tuesday, February 22, 2022, to which you are invited to discuss the application directly with them. City staff will not be present at this time. If you have any concerns or need more information about the application, this is a good meeting to attend.

A public hearing to consider this application will be held by the Raytown Planning & Zoning Commission **at 7:00 PM on Thursday, March 3, 2022.** The full packet and agenda should be available for view on the City of Raytown website on Friday, February 25, 2022.

The Raytown Board of Aldermen will also hold a public hearing regarding the above-described application, tentatively scheduled for **7:00 PM on Tuesday, April 19, 2022.**

All public hearings will take place in the Council Chambers at Raytown City Hall located at 10000 E. 59th St. Raytown, MO 64133.

The public is invited to attend the public hearings to ask questions and provide comment regarding this application. Additional information regarding this application can be obtained from the Department of Community Development located in Raytown City Hall at 10000 East 59th Street, by phone at (816) 737-6059 or by e-mail at chrisg@raytown.mo.us.

If you will require any special accommodation (i.e., qualified interpreter, large print, reader, hearing assistance) to attend either of these public hearings, please notify the Department of Community Development at Raytown City Hall at (816) 737-6014 no later than 48 hours prior to the applicable public hearing date.

Raytown, MO

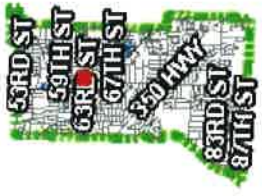

- Legend**
- Road
 - Parcel
 - Address Point
 - ▭ City Limit



1 in. = 94ft.

This Cadastral Map is for informational purposes only. It does not purport to represent a property boundary survey of the parcels shown and shall not be used for conveyances or the establishment of property boundaries.
THIS MAP IS NOT TO BE USED FOR NAVIGATION

Notes

Chris Gilbert

From: Erica Baier <ebaier@raytownwater.net>
Sent: Friday, February 18, 2022 10:15 AM
To: Chris Gilbert
Subject: Neal Clevenger Commercial Shops & Garages LLC

Good morning Raytown Community Development,

From: Commercial Shops & Garages LLC/Retail Centers LLC/ Owner Neal Clevenger

Thank you for the notice on "assembly use" use at 10028 E 63rd St.

With properties about the area, we welcome new business owners to Raytown. The building has assembly use prior to Jesus Aguilera's applications.

I've heard some comment about parking issues but a lot of downtown Raytown has that same problem.

Kindest Regards,

Commercial Shops & Garages LLC/Retail Centers LLC/Owner Neal Clevenger

Erica Baier

Admin. Sr. CSR Supervisor

Raytown Water Company

10017 E. 63rd St.

Raytown, MO 64133

P: 816-356-0333 Ext 105

F: 816-356-0331

Have a good day!!

Based on the Neighborhood Meeting last Tuesday/22/2022 where I, Georgina Aguilera, held this meeting and where only the SR attended. Doug Brink owner of Raytown Rec Pool Hall at 10012 E. 63rd street.

We shared ideas and comments and he mentioned to me that he agreed that more businesses should open in the area, especially to help the growth of the city of Raytown MO., and he also told me that he agrees with the ideas that Georgina and my husband have. Jesus Aguilera for our GSD Event Venue business. My responses to SR. Doug Brink were very appreciative because I could see that he really understood our purpose of growing the Raytown MO community. and of course also being able to see our dream of having our own business for the Aguilera family.

Thanks

Georgina and Jesus Aguilera.

ELECTRONICALLY RECORDED
JACKSON COUNTY, MISSOURI

10/12/2021 11:06 AM

FEE: \$24.00 2 PGS



INSTRUMENT NUMBER

2021E0112256

Assured Quality Title Company
MJ115254

Deed of Release

(Full)

This Deed of Release Witnesseth, That

Saitta Investments, LLC

GRANTOR(S), owner and holder of the note evidencing the debt secured by deed of trust excuted by

Jesus and Georgina Aguilera

GRANTEE(S), dated **July 1, 2020,** and recorded **July 2, 2020,**

in the office of Recorder of Deeds for Jackson County, Missouri, at Jackson as

Document No. 2020E0056194

does hereby acknowledge satisfaction of said deed of trust and releases the property described herein from the lien and effect of the same.

Lots 11, 12 and 13, RIEDER'S SUBDIVISION, a subdivision in Raytown, Jackson County, Missouri.

Saitta Investments, LLC

By: Joseph Saitta

Dated: 09/30/2021

STATE OF missouri
COUNTY OF jackson

On this 30 day, of September, 2021, before me, the undersigned, a Notary Public, in and for said state, personally appeared Joseph Saitta, to me personally known, who being duly sworn, did say that he/she is of Saitta Investments, LLC, a corporation, and that said instrument was executed on behalf of said corporation by authority of its Board of Directors, and said authorized officer acknowledged said instrument to be the free act and deed of said corporation.

Witness my hand and Notarial Seal subscribed and affixed in said County and State, the day and year first above written. missour

My term expires: 9-26-2022

Print Name: James Krueger
Notary Public in and for said County and State



JAMES KRUEGER
My Commission Expires
September 26, 2022
Clay County
Commission #17068141



Official Receipt

Jackson County, MO

2021 Property Tax

Paid December 30th, 2021

Receipt Details

Receipt Number
12948242

Amount Applied
\$6,262.01

Payer Name
AGUILERA JESUS

Tender Type
PAYIT ONLINE

Payer Address
541 NE SUMMIT DR
BLUE SPRINGS, MO 64014

Real Property

Property Account Number 45-120-09-19-00-0-00-000

Name
AGUILERA JESUS & GEORGINA

Address
10028 E 63RD ST
RAYTOWN, MO 64133

Since
2020-06-30

To
--

Legal Line
RIEDERS SUB ALL OF LOTS 11 12 & 13

Tax Year 2021

Receipt Details

Amount Applied
\$4,379.84

Unpaid Balance
\$0.00

Description
A/V Principal-Commer

Amount Applied
\$666.77

Unpaid Balance
\$0.00

Description
Replacement Tax

Amount Applied
\$755.00

Unpaid Balance
\$0.00

Description
Certified City

Distribution of Districts

STATE BLIND PENSION

\$13.92

BOARD OF DISABLED SERVICES

\$30.76

MENTAL HEALTH

\$49.97
 METRO JUNIOR COLLEGE
 \$94.10
 MID-CONTINENT LIBRARY
 \$160.92
 CITY - RAYTOWN
 \$221.10
 JACKSON COUNTY
 \$270.23
 FIRE DISTRICT - RAYTOWN
 \$606.36
 RAYTOWN SCHOOL C-II
 \$2,932.48

Personal Property

Property Account Number 100411123

Name
 AGUILERA JESUS & GEORGINA

Address
 541 NE SUMMIT DR
 BLUE SPRINGS, MO 64014

Since 2006-01-01 **To** --

**Tax Year 2021
Receipt Details**

Type TRUCK	Make HUMMER	Model H2
Series 4D 4WD V8	Model Year 2005	
Item ID 5GRGN23U95H127959	Plate Number --	

Type AUTO	Make MITSUBISHI	Model ECLIPSE
Series 2D GS SPYDER CV I4	Model Year 2012	
Item ID 4A37L2EF2CE003839	Plate Number --	

Type TRUCK	Make LINCOLN	Model NAVIGATOR
Series 4D 4WD V8	Model Year 2006	
Item ID 5LMFU285X6LJ17014	Plate Number --	

Amount Applied \$450.90	Unpaid Balance \$0.00	Description A/V Principal-Regular
-----------------------------------	---------------------------------	---

Amount Applied \$9.50	Unpaid Balance \$0.00	Description City Sticker Fee
---------------------------------	---------------------------------	--

Distribution of Districts
 STATE BLIND PENSION

\$1.50
BOARD OF DISABLED SERVICES
\$3.31
MENTAL HEALTH
\$5.37
METRO JUNIOR COLLEGE
\$10.11
MID-CONTINENT LIBRARY
\$17.29
JACKSON COUNTY
\$29.03
CITY - BLUE SPRINGS
\$31.73
FIRE DISTRICT - CENTRAL JACKSON
\$67.00
BLUE SPRINGS SCHOOLR-IV
\$285.57

Any unpaid balance will continue to accumulate interest, penalties, and fees.

This receipt reflects the amount of any current unpaid balance at the time this receipt is generated. It does not include any such interest, penalties and fees that are later accrued. Changes to the account may change the unpaid balance amount.

If this payment does not clear your financial institution, this receipt is void and you may receive a returned item fee and late penalty. Please verify with your financial institution that this payment has cleared.

**+CITY OF RAYTOWN
PLANNING & ZONING COMMISSION
REGULAR MEETING
MINUTES**

**March 3, 2022
7:00 pm
Council Meeting Chambers**

1. Welcome by Chairman Wilson. Chairman Wilson called the meeting to order at 7:00 PM.

2. Call meeting to order and Roll Call.

Wilson:	Present	Thurman:	Present	Emerson:	Present
Stock:	Present	Frazier:	Present	Hunt:	Present
Meyers:	Present	Bruenger:	Present		

3. Approval of Minutes: Minutes of February 3, 2022, were approved 7-0-1 (Frazier abstaining due to absence at the February 3 meeting) upon motion by Ms. Stock and second by Ms. Thurman.

4. Old Business: None.

5. New Business:

A. Case No.: PZ 2022-03: Application filed by Jesus and Georgina Aguilera for Approval of a Conditional Use Permit for an “Assembly” Use in the Form of an Event Space, to be Located at 10028 E. 63rd Street in an NC, Neighborhood Commercial District.

1. Introduction of Application by Chairman.

Chairman Wilson opened the public hearing and introduced the application. All persons providing testimony were sworn in by Jennifer Baird, City Attorney.

2. Explanation of any Ex Parte Communications Regarding the Application.

Mr. Meyers noted ex-parte contacts with the parties involved in this case but stated it would not affect his decision on the matter.

3. Enter Relevant Exhibits into the Record.

Chairman Wilson entered the staff report and supporting documents into the record.

4. Applicant Presentation of Application.

Jesus Aguilera presented his application, describing he and his wife's efforts to acquire and operate a small family oriented event space and the year-long remodeling efforts already put into the property to prepare it as such.

5. Staff Presentation of Application.

Chris Gilbert, Planning & Zoning Coordinator provided the staff report, reviewing the location of the application, surrounding zoning and uses of property, compliance with factors to be considered, in addition to the detailed Conditions of Approval for the application.

6. Request for Public Comment by Chairman.

Chairman Wilson asked if anyone was present to speak on this application. No one presented themselves to speak at this public hearing.

7. Commission Discussion.

The commissioners asked several questions of the applicant. The applicant agreed to all staff conditions of approval. Mr. Frazier encouraged the applicant to extend the interior renovations to the exterior front façade on 63rd Street.

8. Commission Decision to Approve, Conditionally Approve, or Deny Application.

Ms. Stock moved, and Mr. Hunt seconded, to recommend approval of the Conditional Use Permit to the Board of Aldermen with the conditions contained in the staff report.

VOTE: Motion passed 7-0-1, Ms. Emerson abstained.

6. Other Business- None.

7. Set Future Meeting Date – Next scheduled meeting date is April 7, 2022.

8. Meeting was Adjourned at 7:59 upon motion by Ms. Emerson and second by Ms. Thurman.

CITY OF RAYTOWN
Request for Board Action

Date: April 12, 2022
To: Mayor and Board of Aldermen
From: John Bales, Treasury Analyst

Bill No.: 6602-22
Section No.: V-A

Department Head Approval: _____

Finance Director Approval: _____

City Administrator Approval: _____

Action Requested: Board of Aldermen approval of a Disconnect/Reconnect Sewer Service Agreement with Public Water Supply District #2 of Jackson County setting rates and terms for charges to be made by Public Water Supply District #2 of Jackson County to the City of Raytown for disconnection/reconnection of services, uninstall/reinstall meters, and other obligations in the cooperative agreement between the parties. In addition, execution of a Service Agreement providing for charges to be made by Public Water Supply District #2 of Jackson County to the City of Raytown to provide information regarding new customer files, final customer files, meter agreements, adjustment reports, and other inquiries with respect to ownership accounts and outlining services charges of Two Hundred Dollars (\$200.00) per month for ten (10) files per month and Fifteen Dollars (\$15.00) per file thereafter.

Recommendation: Approval of the Ordinance authorizing the Service Contract and Disconnect/Reconnect Sewer Service Agreement between the City of Raytown and Public Water Supply District #2 of Jackson County is recommended.

Analysis: The last modification of this agreement was April 11, 2012 in which the City of Raytown and Public Water Supply District #2 of Jackson County entered into a Service Agreement provided for by Missouri Statute §393.015 by which the City was to reimburse the Water District for certain services including the connection and disconnection of water service during regular hours, late hours, and other charges; and, on May 8, 1996 an Addendum to the Contract providing for disconnection of water service for delinquent sewer accounts.

Now the Public Water Supply District #2 of Jackson County has requested a review and creation of a new reimbursement schedule in the Disconnect and Service Contract and charges submitted thereunder to provide them reimbursement for actual costs incurred by the Public Water Supply District #2 of Jackson County in providing disconnect and reconnect services during regular and after regular office hours and fees for pulling, setting, and unlocking of meters, all of which shall be reimbursed pursuant to the District's costs and expenses pursuant to §393.016.4(7) RSMo.

In addition, the Public Water Supply District #2 of Jackson County has sought reimbursement under the Service Agreement with respect to services provided by the Water District essential to the City of Raytown in carrying out and updating customer accounts, including the provision of new customer files, final customer files, meter readings, meter change information, adjustment files, and others which will be provided on a monthly basis at the rate of Two Hundred Dollars (\$200.00) per month for ten (10) files. In addition thereto, additional requests for information by the City of Raytown made in writing may be charged at the rate of Fifteen Dollars (\$15.00) per file request with up to fifteen (15) names or accounts permitted.

The relationship between Public Water Supply District #2 of Jackson County and the City of Raytown is authorized and required by state law and Public Water Supply District #2 of Jackson County is entitled to reimbursement of their direct costs for provision of these services.

Service Agreement between the City and District by Missouri Statute §249.640 RS Mo. 249.640. Any private water company, public water supply district, or municipality supplying water to the premises located within a sewer district shall, upon reasonable request, make available to such sewer district its records and books so that such sewer district may obtain therefrom such data as may be necessary to calculate the charges for sewer service. Prior to establishing any such sewer charges, public hearings shall be held thereon and at least thirty days' notice shall be given thereof.

In addition to the non-reimbursable fees listed above the Water Department is proposing the following increases to fees passed directly to our sewer customers.

District Fees Passed Directly to Sewer Customer		
	Current Fees	Proposed Fees
Service Requests During Business Hours		
Disconnect Service Request	N/A	\$2.00
Disconnect Service	\$25.00	\$35.00
Reconnect Service	\$25.00	\$35.00
Recheck as required by District	N/A	\$25.00
Administrative Fee	\$26.31/hour	\$42.87/hour
Service Requests After Business Hours		
Reconnect Service	\$40.00	\$50.00
Rechecks at City's Request	\$40.00	\$50.00
Additional Fees assessed from City's Requests		
Pull Meter (Uninstall Meter)	\$25.00	\$35.00
Set Meter (Reinstall Meter)	\$25.00	\$35.00
Lock Meter	\$15.00	\$25.00
Unlock Meter	\$15.00	\$25.00
Meters Greater than 1"	Actual Cost	Actual Cost

The agreement between the City of Raytown and the Public Water Supply District #2 of Jackson County is substantially the same as the agreement approved for Raytown Water Company. It is staff's opinion that this agreement is reasonable, and approval of the Service Contract and Disconnect/Reconnect Sewer Service Agreement is recommended.

Budgetary Impact: Staff does believe that the proposed changes will increase the non-reimbursable costs to the City Sewer Fund of estimated \$12,000.00 per year and an estimated 40% increase for the Raytown sewer customers that services have been disconnected.

During Fiscal Year 2020-2021, \$30,702.68 was spent for & Administrative charges

Additional Reports Attached: Service Agreement
Disconnect/Reconnect Sewer Service Agreement

AN ORDINANCE AUTHORIZING AND APPROVING A SERVICE AGREEMENT AND A DISCONNECT/RECONNECT SEWER SERVICE AGREEMENT WITH PUBLIC WATER SUPPLY DISTRICT NO. 2 OF JACKSON COUNTY, MISSOURI

WHEREAS, the City of Raytown desires to enter into an agreement with Public Water Supply District No. 2 of Jackson County, Missouri, for disconnect/reconnect sewer services; and

WHEREAS, it is necessary to enter into an agreement with Public Water Supply District No. 2 of Jackson County, Missouri, as set forth in Exhibit "A" and Exhibit "B" attached hereto.

NOW THEREFORE, BE IT ORDAINED BY THE BOARD OF ALDERMEN OF THE CITY OF RAYTOWN, MISSOURI, AS FOLLOWS:

SECTION 1 – APPROVAL OF AGREEMENT. That the Service Agreement and the Disconnect/Reconnect Sewer Services Agreement, by and between Public Water Supply District No. 2 of Jackson County, Missouri, and the City of Raytown, Missouri, in substantially the same form as attached hereto Exhibit "A" and Exhibit "B", are hereby authorized and approved.

SECTION 2 – EXECUTION OF AGREEMENT. That the City Administrator is hereby authorized to execute the Agreements, and all documents necessary to the Agreements, and the City Clerk is authorized to attest to the same.

SECTION 3 – REPEAL OF ORDINANCE IN CONFLICT. That all ordinances or parts of ordinances in conflict with this ordinance are hereby repealed.

SECTION 4 – SEVERABILITY CLAUSE. The provisions of this ordinance are severable and if any provision hereof is declared invalid, unconstitutional or unenforceable, such determination shall not affect the validity of the remainder of this ordinance.

SECTION 5 – EFFECTIVE DATE. This ordinance shall be in full force and effect from and after the date of its passage and approval.

BE IT REMEMBERED that the above was read two times by heading only, **PASSED and ADOPTED** by a majority of the Board of Aldermen and **APPROVED** by the Mayor of the City of Raytown, Jackson County, Missouri, this ___ day of April, 2022.

Michael McDonough, Mayor

ATTEST:

Approved as to Form:

Teresa M. Henry, City Clerk

Jennifer M.Baird, City Attorney



**PUBLIC WATER SUPPLY DISTRICT NO. 2
OF JACKSON COUNTY, MISSOURI**

6945 Blue Ridge Blvd • Raytown, MO 64133-5695

Phone: (816) 353-5550 • Fax: (816) 353-6000

E-mail: pwsd2@pwsd2.org • Website: www.pwsd2.org



January 28, 2022

City of Raytown
Mr. Damon Hodges, City Administrator
10000 E 59 Street
Raytown, Missouri 64133

cc: Mr. John Bales, Treasury Analyst
Ms. Missy Wilson, Assistant City Administrator

Dear all concerned:

We are writing you about the Disconnect/Reconnect Sewer Service Agreement between the City and the District dated April 12, 2012. Paragraph 8(e) of the Agreement provides that the district's costs and expenses be recalculated annually. Although we have not raised the fees in the past, recent events and inflation have convinced us that a recalculation is in order this year in order to fulfill our responsibilities to our customers. Accordingly, we have attached a schedule showing the new fees that will be billed to the City under the Agreement for periods after April 12, 2022. The new fee schedule will be in effect until our next recalculation of fees pursuant to the contract.

Best regards,

Patrick J. Ertz, District Manager
Public Water Supply District No. 2
Of Jackson County, Missouri

DISCONNECT/RECONNECT SEWER SERVICE AGREEMENT

City of Raytown – Public Water Supply District No. 2 of Jackson County

Schedule of Fees Effective April 12, 2022

(a) Services during District's regular business hours. ¹

(i)	Disconnect Service Request	\$ 2.00/per occurrence
(ii)	Disconnect Services	\$35.00/per occurrence
(iii)	Reconnect Services	\$35.00/per occurrence
(iv)	Rechecks as required by District	\$25.00/per occurrence
(v)	Administrative Fee ²	\$42.87/per hour

(b) Services after District's regular business hours:

(i)	Reconnect Services	\$50.00/per occurrence
(ii)	Rechecks at City's Request	\$50.00/per occurrence

(c) The following additional fees will be assessed upon City's request for the following services:

(i)	Pull Meter (uninstall meter)	\$35.00/per occurrence
(ii)	Set Meter (reinstall meter)	\$35.00/per occurrence
(iii)	Lock Meter	\$25.00/ per occurrence
(iv)	Unlock Meter	\$25.00/ per occurrence
(v)	Meters greater than 1" will be pulled and set at actual cost.	

¹ District's regular business hours shall be defined as 7:30 a.m. to 3:00 p.m., Monday through Friday, excluding District recognized holidays. Work performed after District's regular business hours and on weekends and holidays shall be billed under paragraph 8 section b.

² The Administrative Fee shall include all reimbursable expenses provided in section 393.016.4(8), including, but not limited to expenses for wages, employment taxes, benefits, equipment, computer, office space and insurance. The services considered in calculating the Administrative Fee shall include all office activity (e.g. phone calls, emails, faxes, record keeping, new customer and final customer reports, turning customers off and on, etc.) required during the month to perform this Agreement.

EXHIBIT A
SERVICE AGREEMENT

This Agreement, entered into this ____ day of _____, 2022 by and between the City of Raytown, Missouri, a municipal corporation, acting by and through its Mayor, (hereinafter referred to as “City”) and Public Water Supply District No. 2 of Jackson County, Missouri, a municipal corporation formed and existing under the laws of the State of Missouri (hereinafter referred to as “District”).

WITNESSETH:

WHEREAS, City provides sewer service to certain persons within its corporate limits for a fee; and

WHEREAS, District has contracted with City to provide water shut-off services to City; and

WHEREAS, City request certain information regarding its customers from District, and District agrees to provide such information;

NOW THEREFORE, the parties hereto do mutually agree as follows:

1. District agrees, in accordance with the terms of this Agreement, to provide up to ten (10) files of information per month to City. The District is, at the City’s request, currently providing five (5) of these ten (10) files on a regular monthly basis.

Requests by City for additional information, including but not limited to identifiers such as drivers license numbers, phone numbers or addresses, shall be made in writing via email or fax and may include up to fifteen (15) service addresses per email or fax. Each such email or fax containing no more than fifteen (15) service addresses shall be treated as one (1) additional file request to be included in the (10) monthly file requests or charged extra as defined below.

The parties may amend the Agreement to cover such additional requests so that District’s costs for producing the requested information and files (including programming) are adequately covered by the fee.

2. In exchange for the services provided by District hereunder, City shall pay District according to the following schedule:
 - (a) Two Hundred Dollars (\$200.00) per month for up to ten (10) files per month;
 - (b) Fifteen Dollars (\$15.00) per file for each emailed or faxed request for information requested above ten (10) files per month/or District's actual cost, whichever is greater.
3. District shall bill City for the Services contained in this Agreement on a monthly basis and City agrees to pay District within ten (10) days of receipt of such billing statement.
4. This Agreement contains the complete agreement of the parties and shall, as of the effective date hereof, supersede all other agreements (written or verbal) between the parties related to the subject matter of this Agreement.
5. Any modification of this Agreement or additional obligation assumed by either party in connection with this Agreement shall be binding only if evidenced in writing, signed by each party or a duly authorized representative of each party.
6. The invalidity of any portion of this Agreement will not and shall not be deemed to affect the validity of any other provision. In the event that any provision of this Agreement is held to be invalid, the parties agree that the remaining provisions shall be deemed in full force and effect as if they had been signed by both parties subsequent to the removal of the invalid provision.
7. This Agreement shall be construed and enforced in accordance with the laws of the State of Missouri. The court of the State of Missouri shall have jurisdiction over any dispute which arises under this Agreement, and each of the parties shall submit and hereby consents to such court's exercise of jurisdiction.
8. The failure of either party to this Agreement to insist upon the performance of any of the terms and conditions of this Agreement, or the waiver of any breach of terms of this Agreement, shall not be construed as thereafter waiving any such terms and conditions, but the same shall continue and remain in full force and effect as if no such forbearance had occurred.
9. The provisions of this Agreement shall not be deemed to create any third party benefit hereunder for any member of the public or to authorize anyone not a party hereto, to maintain suit pursuant to the terms of this Agreement.

10. This Agreement shall become effective upon execution by the parties herein and authorization or confirmation by ordinance of Board of Aldermen of the City of Raytown. It shall continue for a term of twelve months hereafter, and shall automatically renew for successive one year terms unless either party gives written notice to the other at least 60 (sixty) days prior to expiration of that party's intent not to renew this Agreement.

IN WITNESS WHEREOF, the parties hereto have executed this Agreement as of the date first above written.

PUBLIC WATER SUPPLY DISTRICT NO. 2
PRESIDENT/DISTRICT MANAGER

CITY OF RAYTOWN, MISSOURI
CITY ADMINISTRATOR

Attest:

Attest:

CORPORATE SECRETARY

CITY CLERK

EXHIBIT B

DISCONNECT/RECONNECT SEWER SERVICE AGREEMENT

This Agreement, entered into this ____ day of _____, 2022 by and between the City of Raytown, Missouri, a municipal corporation, acting by and through its Mayor, (hereinafter referred to as “City”) and Public Water Supply District No. 2 of Jackson County, Missouri, a municipal corporation formed and existing under the laws of the State of Missouri (hereinafter referred to as “District”).

WITNESSETH:

WHEREAS, City provides sewer service to certain persons within its corporate limits for a fee; and

WHEREAS, City desires to continue to promote the efficient and economic provision of sanitary sewer service for the citizens of the City of Raytown according to its powers granted by law; and

WHEREAS, City pursuant to Section 393.016 RSMo (copy attached), requires a method of enforcing payment of its sewer bills and District is able to provide this service by disconnecting water service for nonpayment of sewer bills; and

WHEREAS, District was formed for the purpose of supplying water to the citizens of the City; and

WHEREAS, the parties believe it is in the best interest of City to utilize the services of District to assist in the collection of sewer service charges, for which reasons City desires to engage District and District consents to be engaged, for the performance of said functions and services; and

WHEREAS, 393.015 RSMo (copy attached), authorizes City and District to enter into this Agreement to terminate water services for nonpayment of sewer bills;

NOW THEREFORE, the parties hereto do mutually agree as follows:

1. District agrees, in accordance with the terms of this Agreement, to terminate water services to any sewer service customer premises within its service area for nonpayment of City’s sewer service charges, and agrees not to restore water service to the sewer service customer until City has notified District in writing that all past due sewer amounts and charges have been paid in full.

2. Prior to the request for termination of water services hereunder, City shall send written notice to its delinquent sewer service customer in accordance with State Law, advising such customer that termination of water service may occur at any time not less than thirty days thereafter, if such delinquency continues.
3. Following expiration of the above mentioned thirty day period, City shall make written request upon District to terminate water service, providing District with a copy of the notice and a statement of the amount due City for sewer services, including all applicable disconnection and reconnection fees, pursuant to 250.236 RSMo. (copy attached)
4. On one mutually agreeable day each month, City shall deliver to the District a list of its sewer customers that are to have water service terminated for nonpayment of sewer bills. Upon receipt of the request from City to terminate water services, District shall proceed with all reasonable diligence to terminate water services. Absent work stoppage by District's employees, or acts of God, such as emergency line breaks, District shall terminate water services within 5 (five) business days from the date said request is received.
5. City shall provide to District a "door hanger" in a color distinctive from District's door hanger, which shall advise the sewer service customer that water services have been terminated due to nonpayment of City's sewer service charges. Such notice shall include provisions informing the customer of the requirements to reestablish water service, the appropriate address and telephone number for further information and such other data as the parties may agree.
6. District shall not collect delinquent sewer service charges at its offices or in the field. All such payments shall be collected by City. Upon payment of such charges as City may require, City shall issue a written notice to District to reinstate water service and shall provide a copy of such notice to the sewer service customer. District shall not reinstate water service until it receives a copy of such notice from the City in writing via facsimile or email.
7. If, at the time District institutes interruption of water service, a sewer service customer contends that City's sewer service charges have been satisfied, District, nevertheless, shall proceed to terminate water services, unless District has been provided a copy of the reinstatement notice as set forth in paragraph 6.

8. In exchange for the services provided by District hereunder, City shall pay District according to the following schedule:

(a) Services during District's regular business hours. ¹

(i)	Disconnect Service Request	\$ 2.00/per occurrence
(ii)	Disconnect Services	\$35.00/per occurrence
(iii)	Reconnect Services	\$35.00/per occurrence
(iv)	Rechecks as required by District	\$25.00/per occurrence
(v)	Administrative Fee ²	\$42.87/per hour

(b) Services after District's regular business hours:

(i)	Reconnect Services	\$50.00/per occurrence
(ii)	Rechecks at City's Request	\$50.00/per occurrence

(c) The following additional fees will be assessed upon City's request for the following services:

(i)	Pull Meter (uninstall meter)	\$35.00/per occurrence
(ii)	Set Meter (reinstall meter)	\$35.00/per occurrence
(iii)	Lock Meter	\$25.00/ per occurrence
(iv)	Unlock Meter	\$25.00/ per occurrence
(v)	Meters greater than 1" will be pulled and set at actual cost.	

(d) All fees shall be billed monthly by District and shall be payable by City by the 10th day after receipt.

(e) Pursuant to section 363.016.4(7) RSMo, District's costs and expenses in fulfilling its obligations under this Agreement shall be recalculated annually, and the amount due District during each subsequent year shall be increased or decreased according to any change occurring in District's costs and expenses.

¹ District's regular business hours shall be defined as 7:30 a.m. to 3:00 p.m., Monday through Friday, excluding District recognized holidays. Work performed after District's regular business hours and on weekends and holidays shall be billed under paragraph 8 section b.

² The Administrative Fee shall include all reimbursable expenses provided in section 393.016.4(8), including, but not limited to expenses for wages, employment taxes, benefits, equipment, computer, office space and insurance. The services considered in calculating the Administrative Fee shall include all office activity (e.g. phone calls, emails, faxes, record keeping, new customer and final customer reports, turning customers off and on, etc.) required during the month to perform this Agreement.

9. Pursuant to Section 393.016.2 RSMo (copy attached), District shall be exempt from any and all civil liability whatsoever arising from or related to termination of water service pursuant to this Agreement.
10. Pursuant to Section 393.016.4(3) RSMo, City shall at all times keep in force a general comprehensive public liability and property damage policy issued by a District authorized to do business in Missouri with policy limits equal to or in excess of those set forth in section 537.610, which shall include District as an additional insured and shall furnish District with a certificate of insurance evidencing such insurance is in effect. If at any time City fails to do so, District may cease to make water service terminations until such requirement is satisfied.
11. City shall reimburse District for any loss of revenue incurred by District as a result of its discontinuing water service because of the failure of any sewer service customer to pay the City sewer charges, including, but not limited to loss of revenue, when the customer's water bill is not delinquent.
12. In the event District incurs attorney fees or other costs not covered by insurance as a result of any claim, litigation, or threatened litigation against District which exceeds the limits of insurance coverage provided to District by City, City shall reimburse such amounts to District.
13. This Agreement contains the complete agreement of the parties and shall, as of the effective date hereof; supersede all other agreements (written or verbal) between the parties related to the subject matter of this Agreement.
14. Any modification of this Agreement or additional obligation assumed by either party in connection with this Agreement shall be binding only if evidenced in writing, signed by each party or a duly authorized representative of each party.
15. The invalidity of any portion of this Agreement will not and shall not be deemed to affect the validity of any other provision. In the event that any provision of this Agreement is held to be invalid, the parties agree that the remaining provisions shall be deemed in full force and effect as if they had been signed by both parties subsequent to the removal of the invalid provision.
16. This Agreement shall be construed and enforced in accordance with the laws of the State of Missouri. The court of the State of Missouri shall have jurisdiction over any dispute which arises under this Agreement, and each of the parties shall submit and hereby consents to such courts exercise of Jurisdiction.

17. The failure of either party to this Agreement to insist upon the performance of any of the terms and conditions of this Agreement, or the waiver of any breach of the terms of this Agreement, shall not be construed as thereafter waiving any such terms and conditions, but the same shall continue and remain in full force and effect as if no such forbearance had occurred.
18. The provisions of this Agreement shall not be deemed to create any third party benefit hereunder for any member of the public or to authorize anyone not a party hereto, to maintain suit pursuant to the terms of this Agreement.
19. This Agreement shall become effective upon execution by the parties herein and authorization or confirmation by ordinance of Board of Alderman of the City of Raytown. It shall continue for a term of twelve months hereafter, and shall automatically renew for successive one year terms unless either party gives written notice to the other at least 60(sixty) days prior to expiration of that party's intent not to renew this Agreement.

IN WITNESS WHEREOF, the parties hereto have executed this Agreement as of the date first above written.

PUBLIC WATER SUPPLY DISTRICT NO. 2
PRESIDENT/DISTRICT MANAGER

CITY OF RAYTOWN, MISSOURI
CITY ADMINISTRATOR

Attest:

Attest:

CORPORATE SECRETARY

CITY CLERK

CITY OF RAYTOWN
Request for Board Action

Date: April 8, 2022
To: Mayor and Board of Aldermen
From: Jason Hanson, City Engineer

Bill No.: 6603-22
Section No.: XXXIII-A

Department Head Approval: _____

Finance Director Approval: _____ (only if funding is requested)

City Administrator Approval: _____



Action Requested: Board of Aldermen approval of amendments to Chapter 18-Environment, addressing Erosion and Sediment Control Regulations, Illicit Discharge and Detection, and Stormwater Runoff Control.

Recommendation: Staff recommends approval as submitted.

Analysis: This ordinance adopts new Erosion and Sediment Control Regulations, Illicit Discharge and Detection, and Stormwater Runoff Control regulations. Our community is required to adopt 3 new stormwater management regulations that meet the standards of the Missouri Clean Water Law. Staff recommends adoption of the proposed ordinance in its entirety.

The Missouri Department of Natural Resources issued a letter of warning on October 29, 2021 to the City of Raytown that stated Raytown Small Municipal Separate Storm Sewer System (MS4) is lacking the 3 required stormwater ordinances and must have these adopted within 6 months or the City will be issued a Notice of Violation. Staff has been in contact with MDNR personnel, and this ordinance will satisfy the violations. MDNR has evaluated the proposed Raytown ordinance and it complies with all of their regulations.

The Erosion and Sediment Control Regulations Division's purpose is to control or eliminate stormwater pollution along with soil erosion & sedimentation within the City. It establishes standards & specifications for conservation practices and planning activities which minimize stormwater pollution, soil erosion & sedimentation. This will require work sites that are larger than 1000 square feet to have an approved land disturbance permit and incorporate erosion & sediment control devices.

The Illicit Discharge and Detection Division's purpose is to provide for the health, safety, and general welfare of the citizens of Raytown through the regulation of non-stormwater discharges to the storm drainage system to the maximum extent practicable as required by federal and state law. This division establishes methods for controlling the introduction of pollutants into the City stormwater system in order to comply with requirements of the National Pollutant Discharge Elimination System (NPDES) permit process.

The Stormwater Runoff Control Division's purpose is to establish minimum post-construction stormwater management requirements and controls to protect and safeguard the general health, safety, and welfare of the public residing in watersheds within Raytown. This is an extension of the erosion and sediment control ordinance for development sites to keep their stormwater pollution prevention plan in operation through the end and completion of their project.

Alternatives: We need to add this to our ordinances or the City will be in violation of the Missouri Clean Water Law.

Budgetary Impact: None.

Additional Reports Attached: Proposed ordinance and Exhibit

AN ORDINANCE AMENDING CHAPTER 18-ENVIRONMENT WITH THE ADDITION OF ARTICLE I-IN GENERAL; ARTICLE II-STORMWATER; DIVISION I-EROSION AND SEDIMENT CONTROL; DIVISION II-ILLICIT DISCHARGE AND DETECTION REGULATIONS; AND DIVISION III-STORMWATER RUNOFF CONTROL REGULATIONS TO THE RAYTOWN MUNICIPAL CODE

WHEREAS, to establish stormwater management requirements and control to protect and safeguard the general health, safety, and welfare of the public residing within the City of Raytown, it is necessary to amend the Raytown Municipal Code;

NOW THEREFORE, BE IT RESOLVED BY THE BOARD OF ALDERMEN OF THE CITY OF RAYTOWN, MISSOURI, AS FOLLOWS:

SECTION 1 – AMENDMENT. Chapter 18-Environment is hereby amended with the addition of Article I-In General; Article II-Stormwater; Division I-Erosion and Sediment Control; Division II-Illicit Discharge and Detection Regulations; and Division III-Stormwater Runoff Control Regulations as attached hereto as Exhibit “A” to the Raytown Municipal Code.

SECTION 2 – REPEAL OF ORDINANCES IN CONFLICT. All ordinances or parts of ordinances in conflict with this ordinance are hereby repealed.

SECTION 3 – SEVERABILITY CLAUSE. The provisions of this ordinance are severable and if any provision hereof is declared invalid, unconstitutional or unenforceable, such determination shall not affect the validity of the remainder of this ordinance.

SECTION 4 – EFFECTIVE DATE. This ordinance shall be in full force and effect from and after the date of its passage and approval.

BE IT REMEMBERED that the above was read two times by heading only, **PASSED and ADOPTED** by a majority of the Board of Aldermen and **APPROVED** by the Mayor of the City of Raytown, Jackson County, Missouri, this ____, April, 2022.

Michael McDonough, Mayor

ATTEST:

Teresa M. Henry, City Clerk

Approved as to Form:

Jennifer M. Baird, City Attorney

EXHIBIT A

CHAPTER 18, ENVIRONMENT

ARTICLE I - IN GENERAL

- **Sec. 18-1. - Definitions.**

For the purposes of this division, the following terms, phrases, words and their derivatives shall have the meanings stated below.

Accelerated erosion. Erosion caused by development activities that exceeds the natural processes by which the surface of the land is worn away by the action of water, wind, or chemical action.

Applicant. A property owner or agent of a property owner who has filed an application for a stormwater management permit.

Best management practices (BMPs). Schedules of activities, prohibitions of practices, general good housekeeping practices, pollution prevention and educational practices, maintenance procedures, and other management practices to prevent or reduce the discharge of pollutants directly or indirectly to stormwater, receiving waters, or stormwater conveyance systems. BMPs also include treatment practices, operating procedures, and practices to control site runoff, spillage or leaks, sludge or water disposal, or drainage from raw materials storage.

Building. Any structure, either temporary or permanent, having walls and a roof, designed for the shelter of any person, animal, or property, and occupying more than one hundred (100) square feet of area.

Channel. A natural or artificial watercourse with a definite bed and banks that conducts flowing water continuously or periodically.

Clean Water Act. The federal Water Pollution Control Act (33 U.S.C. § 1251 et seq.), and any subsequent amendments thereto.

Construction activity. Activities subject to NPDES construction permits. Currently these include construction projects resulting in land disturbance of one (1) acre or more.

Dedication. The deliberate appropriation of property by its owner for general public use.

Detention. The temporary storage of storm runoff in a stormwater management practice with the goals of controlling peak discharge rates and providing gravity settling of pollutants.

Detention basin. A temporary or a permanent natural or manmade structure that provides for the temporary storage of stormwater runoff.

Detention facility. A detention basin or alternative structure designed for the purpose of temporary storage of stream flow or surface runoff and gradual release of stored water at controlled rates.

Developer. A person who undertakes land disturbance activities.

Disturbed area. An area of land subject to erosion due to the removal of vegetative cover and/or soil disturbing activities.

Drainage. The removal of excess surface water or groundwater from land by surface or subsurface drains.

Drainage easement. A legal right granted by a landowner to a grantee allowing the use of private land for stormwater management purposes.

Erosion. The process by which the land surface is worn away as a result of the land disturbance activities, movement of wind, water, ice, gravity or any combination of those forces.

Erosion and sediment control. The control of sediment and soil, to minimize the removal of soil from the land surface and to prevent its transport from a disturbed area by means of wind, water, ice, gravity or a combination of those forces. Practices include silt fences, sediment traps, earth dikes, drainage swales, check dams, subsurface drains, pipe slope drains, storm drain inlet protection, and temporary or permanent sedimentation basins.

Excavate. Any act by which soil is cut into, dug, quarried, uncovered, removed, displaced, relocated, tunneled, bored or altered in any way.

Fee in lieu. A payment of money in place of meeting all or part of the stormwater performance standards required by this division.

Fill. A deposit of soil or other earth materials placed by artificial means.

Final stabilization. Means that all land disturbing activities at the site have been completed and a uniform perennial vegetative cover for the area has been established or equivalent stabilization measures, such as the use of mulches or geotextiles, have been employed.

Hazardous materials. Any material, including any substance, waste, or combination thereof, which because of its quantity, concentration, or physical, chemical, or infectious characteristics may cause, or significantly contribute to, a substantial present or potential hazard to human health, safety, property, or the environment when improperly treated, stored, transported, disposed of, or otherwise managed.

Hotspot. An area where land use or activities generate highly contaminated runoff, with concentrations of pollutants in excess of those typically found in stormwater.

Hydrologic soil group (HSG). A natural resource conservation service classification system in which soils are categorized into four (4) runoff potential groups. The groups range from "A" soils, with high permeability and little runoff production, to "D" soils, which have low permeability rates and produce much more runoff.

Illegal discharge. Any direct or indirect non-stormwater discharge to the storm drain system.

Illicit connections. An illicit connection is defined as either of the following: Any drain or conveyance, whether on the surface or subsurface, which allows an illegal discharge in violation to enter the storm drain system including but not limited to any conveyances which allow any non-stormwater discharge storm drain system from indoor drains and sinks, regardless of whether said drain or connection had been previously allowed, permitted, or approved by an authorized enforcement agency or, any drain or conveyance connected from a commercial or industrial land use to the storm drain system which has not been documented in plans, maps, or equivalent records and approved by an authorized enforcement agency.

Impervious cover. Those surfaces that cannot effectively infiltrate rainfall (e.g., building rooftops, pavement, sidewalks, driveways, etc.).

Industrial activity. Activities subject to NPDES industrial permits as defined in 40 CFR, Section 122.26(b)(14), and as the same may be amended.

Industrial stormwater permit. A National Pollutant Discharge Elimination System permit issued to a commercial industry or group of industries which regulates the pollutant levels associated with industrial stormwater discharges or specifies on-site pollution control strategies.

Infiltration. The process of percolating stormwater into the subsoil.

Infiltration facility. Any structure or device designed to infiltrate retained water to the subsurface. These facilities may be above grade or below grade.

Jurisdictional wetland. An area that is inundated or saturated by surface water or groundwater at a frequency and duration sufficient to support a prevalence of vegetation typically adapted for life in saturated soil conditions, commonly known as hydrophytic vegetation.

Land disturbance activity. Any land change that may result in soil erosion and the movement of sediments into or upon waters, lands, or rights-of-way within the City.

Land disturbance permit. A permit issued by the City authorizing disturbance of the land at a specific site or disturbed area subject to conditions stated in the permit.

Landowner. The legal or beneficial owner of land, including those holding the right to purchase or lease the land, or any other person holding proprietary rights in the land.

Maintenance agreement. A legally recorded document that acts as a property deed restriction, and which provides for long-term maintenance of stormwater management practices.

Municipal Separate Storm Sewer System (MS4) is a conveyance or system of conveyances (roads with drainage systems, municipal streets, catch basins, curbs, gutters, ditches, man-made channels, storm drains, etc.)

National Pollutant Discharge Elimination System (NPDES) stormwater discharge permit. A permit issued by EPA (or by a state under authority delegated pursuant to 33 USC § 1342(b)) that authorizes the discharge of pollutants to waters of the United States, whether the permit is applicable on an individual, group, or general area-wide basis.

Nonpoint source pollution. Pollution from any source other than from any discernible, confined, and discrete conveyances, and shall include, but not be limited to, pollutants from agricultural, silvicultural, mining, construction, subsurface disposal and urban runoff sources.

Non-stormwater discharge. Any discharge to the storm drainage system that is not composed entirely of stormwater.

Offset fee. A monetary compensation paid to a local government for failure to meet pollutant load reduction targets.

Off-site facility. A stormwater management measure located outside the subject property boundary described in the permit application for land development activity.

On-site facility. A stormwater management measure located within the subject property boundary described in the permit application for land development activity.

Permit holder. Any person or entity who receives an excavation permit approved by the City. This term includes that person's agents, employees, and anyone acting under their direction.

Person. Any individual, association, organization, partnership, firm, corporation or other entity.

Pollutant. Anything which causes or contributes to pollution. Pollutants may include, but are not limited to: paints, varnishes, and solvents; oil and other automotive fluids; non-hazardous liquid and solid wastes and yard wastes; refuse, rubbish, garbage, litter, other discarded or abandoned objects, ordinances, and accumulations, so that same may cause or contribute to pollution; floatables; pesticides, herbicides, and fertilizers; hazardous substances and wastes; sewage, fecal coliform and pathogens; dissolved and particulate metals; animal wastes; wastes and residues that result from constructing a building or structure; and noxious or offensive matter of any kind.

Premises. Any building, lot, parcel of land, or portion of land whether improved or unimproved including adjacent sidewalks and parking strips.

Recharge. The replenishment of underground water reserves.

Redevelopment. Any construction, alteration or improvement in areas where existing land use is high density commercial, industrial, institutional or multi-family residential.

Sediment. The soils or other surface materials, mineral and organic, that are transported or deposited by the action of wind, water, ice, gravity or any combination of those forces, as a product of erosion.

Silt. A solid material consisting of very fine particles that become part of the erosion process when moved by water, air or ice.

Site. The entire area of land on which the land disturbance activity is proposed in the permit application.

Soil. The unconsolidated mineral and organic material including earth, sand, gravel, rock or other similar material, that is on the immediate surface of the earth serving as a natural medium for the growth of land plants.

Stop work order. An order issued which requires that all construction activity on a site be stopped.

Storm drainage system. Publicly owned facilities by which stormwater is collected and/or conveyed, including but not limited to any roads with drainage systems, municipal streets, gutters, curbs, inlets, piped storm drains pumping facilities, retention and detention basins, natural and human-made or altered drainage channels, reservoirs, and other drainage structures.

Stormwater. Any surface flow, runoff, and drainage consisting entirely of water from any form of natural precipitation and resulting from such precipitation.

Stormwater design manual. Refers to the current edition of the American Public Works Association's Manual of Best Management Practices for Stormwater Quality.

Stormwater management. The use of structural or non-structural practices that are designed to reduce stormwater runoff pollutant loads, discharge volumes, peak flow discharge rates and detrimental changes in stream temperature that affect water quality and habitat.

Stormwater management facility. A facility or installation designed solely to handle stormwater discharge from a specific project.

Stormwater pollution prevention plan (SWPPP). A management plan, the purpose of which is to ensure the design, implementation, management and maintenance of erosion and sediment control measures in order to reduce the amount of sediments, soil, silt and other pollutants in stormwater runoff associated with land disturbance activities.

Stormwater retrofit. A stormwater management practice designed for an existing development site that previously had either no stormwater management practice in place or a practice inadequate to meet the stormwater management requirements of the site.

Stormwater runoff. The portion of rainfall, melted snow, or irrigation water that flows across the ground or impervious surface and is eventually conveyed to water resources or wetland.

Stormwater treatment practices (STPs). Measures, either structural or nonstructural, that are determined to be the most effective, practical means of preventing or reducing point source or nonpoint source pollution inputs to stormwater runoff and water bodies.

Wastewater. Any water or other liquid, other than uncontaminated stormwater, discharged from a facility.

Water quality volume (WQ_v). The storage needed to capture and treat ninety (90) percent of the average annual stormwater runoff volume. Numerically (WQ_v) will vary as a function of long-term rainfall statistical data.

Watercourse. A permanent or intermittent stream or other body of water, either natural or man-made, which gathers or carries surface water.

ARTICLE II - STORMWATER

DIVISION I - EROSION AND SEDIMENT CONTROL REGULATIONS

- **Sec. 18-2. - Generally.**

(a) *Title.* This division shall be known as the erosion and sediment control regulations.

(b) *Purpose.* The purpose of this division is to control or eliminate stormwater pollution along with soil erosion and sedimentation within the City. It establishes standards and specifications for conservation practices and planning activities which minimize stormwater pollution, soil erosion and sedimentation.

(c) *Scope.* Any person, entity, agency, or political subdivision proposing a land disturbance activity within the City shall apply to the City for the approval of a stormwater pollution prevention plan. No land shall be disturbed prior to the issuance of a land disturbance permit and approval of a plan by the City that conforms to the standards set forth herein and in the stormwater design manual approved by the City from time to time.

(d) *Design and construction manual.* In order to implement the provisions of this division, a City design and construction manual shall be updated/approved by separate resolution from time to time to implement these regulations. In the event of conflict between this division and the manual, the stricter requirement shall control.

- **Sec. 18-3. - Land disturbance permitting process.**

(a) *Permit required.* No person or entity may clear, grub, grade, fill, excavate, store, stockpile, transport, or dispose of earth materials or perform any other land disturbing activity (less than 1 acre in size, or part of a larger common area and at least 1 acre will be disturbed) including such activity related to the demolition of any structure without a land disturbance permit. For land disturbance activities greater than 1 acre, a land disturbance permit will be obtained from the Missouri Department of Natural Resources. A land disturbance permit is required whether or not a building permit or right-of-way permit is

required. Land disturbance activities not requiring land disturbance permits are limited to the following activities:

(b) *Exceptions:*

- (1) Minor land disturbance activities such as private home gardens, an individual's home landscaping, repairs and maintenance work.
- (2) Installation of fence, sign, telephone and electric poles and other kinds of posts or poles.
- (3) Tilling, planting or harvesting of agricultural, horticultural or silvicultural crops.
- (4) Emergency work performed to protect life, limb, or property that would have otherwise required an approved stormwater pollution prevention plan.
- (5) Other disturbances where the total square footage is less than 1000 square feet.

(c) *Application.* Application for a land disturbance permit shall be filed with the City. At a minimum, the form shall contain the name(s) and address(es) of the owner or developer of the site, and of any consulting firm retained by the permit holder together with the name of the permit holder's principal contact at such firm. Incomplete applications will be returned to the applicant and will not be processed until the form and all of the following items are submitted:

- (1) The estimated starting and completion dates for the proposed land disturbance activities schedule and permit term.
- (2) Two (2) copies of a site plan showing the following information:
 - a. Property lines and dimensions of the site;
 - b. The location of any existing buildings or structures on the site and the location of any building or structure on the land of adjacent property which is within fifty (50) feet of the property boundary;
 - c. The elevations, dimensions, locations, extent, and slopes of all proposed land disturbance activities shown by contours or other means;
 - d. Graphic representation of proposed excavations and fills, of on-site storage of soil and other earthen material, and of on-site disposal or spoil areas;
 - e. Graphic representation, including design details, of each temporary and permanent erosion, surface runoff and sediment control measure and structure;
 - f. Graphic representation of the location of all existing and proposed natural and man-made drainage facilities;
 - g. A clear and definite delineation of any wetlands, natural or artificial water storage detention areas, and drainage ditches on the site, or a statement that there are no wetlands, detention areas or drainage ditches located on the property; and
 - h. A clear and definite delineation of any drainage, sanitary, utility, or other easement(s) on or near the site.

(3) A stormwater pollution prevention plan (SWPPP) prepared for the disturbed area and site along with a pdf set of all supporting plans, specifications, reports, and documentation. This plan must be sufficient to evaluate the environmental characteristics of the affected area; assess the potential impacts of the proposed land disturbance on water resources; and, assess proposed methods to minimize on-site soil erosion and prevent off-site sedimentation to the maximum extent practicable, including disturbance of topsoil and limitation on disturbance.

a. For any site where one (1) acre or more of land will be disturbed, including sites of less than one (1) acre that are part of a larger common plan that will ultimately disturb one (1) acre or more, the SWPPP is required to be prepared by a design professional recognized by the State of Missouri as qualified to prepare a SWPPP.

(4) A Land Disturbance Permit issued by the Missouri Department of Natural Resources for any site where one (1) acre or more of land will be disturbed, before beginning any site work authorized by a City permit. This requirement includes sites of less than one (1) acre that are part of a larger common plan that will ultimately disturb one (1) acre or more.

a. A performance guaranty in accordance to Section 18-9.

b. Qualified cost estimates of work to be performed under the SWPPP.

(d) *Review and approval.* The City will review all applications to determine their conformance with the provisions of this Section 18-3 and the erosion and sediment control design criteria. After receiving all required submissions, the City shall notify the applicant in writing of his or her intention to:

(1) If a building permit is otherwise required:

a. Approve the plan and notify the building official that all requirements of this division have been met and that the permit may be issued; or

b. Conditionally approve the plan and notify the building official that the requirements of this division have been met and that the building permit may be issued, subject to conditions as may be necessary to substantially secure the objectives of this division, prevent the creation of a nuisance or an unreasonable hazard to persons or to a public or private property; or

c. Disapprove the plan and notify the building official that the requirements of this division have not been met, indicating those requirement(s) that have not been met and the procedure for submitting revised information and/or submittals.

(2) If a building permit is not otherwise required:

a. Approve the plan and issue a land disturbance permit; or

b. Conditionally approve the plan and issue a land disturbance permit subject to conditions as may be necessary to substantially secure the objectives of this division, prevent the creation of a nuisance or an unreasonable hazard to persons or to a public or a private property; or

c. Disapprove the plan and inform the applicant in writing of those requirement(s) that have not been met and the procedure for submitting revised information and/or submittals.

(e) Design standards. All work done under a permit issued under this chapter shall be done in conformity with the currently adopted City design and construction manual. The manual shall be approved by the City Council by resolution from time to time and kept on file with the department of public works. In the event of any conflict between this division and the manual, the stricter requirement shall control.

(f) Violation. Any person or entity violating the terms of this chapter, or of the design and construction manual, shall be guilty of an offense punishable under Chapter 1 General Provisions, Section 1-22 General Penalty; Continuing Violations.

- **Sec. 18-4. - Inspections.**

In making application for a land disturbance permit, the permit holder consents to allow City representatives to enter the site or disturbed area for the purpose of inspection and enforcement of the provisions of this division during any period that a land disturbance permit is in place, until closure of the permit by City approval. After the permit is issued, the permit holder shall be responsible for the following:

(a) A Copy of the land disturbance permit must be available on the site for inspection by the City prior to any inspections being conducted.

(b) Field markings showing limits of disturbance must be on site during all installation of erosion and sediment control measures, construction or other land disturbance activities.

(c) The permit holder shall call for and be approved for any or all of the following inspections:

(1) After a land disturbance permit has been issued and before any land disturbance activity begins;

(2) During the construction of sediment basins or stormwater management structures;

(3) During rough grading, including hauling of imported or wasted materials;

(4) Prior to the removal or substantial modification of any erosion and sediment control measure or practice;

(5) Upon completion of final grading, including establishment of ground covers and planting, installation of all vegetative measures and all other work;

(6) Additional inspections as required by the City to abate erosion control failures not addressed in the stormwater pollution and prevention plan.

- **Sec. 18-5. - Standards of performance and maintenance of structures, measures and devices.**

All structures, measures and devices installed or used for erosion and sediment control practices at a site or disturbed area must meet the criteria and performance standards set forth in the design and construction manual.

- **Sec. 18-6. - Enforcement.**

(a) The City shall serve a notice of violation upon any person responsible in whole or in part for the construction, alteration, repair, maintenance, or removal of drainage improvements in violation of a building permit, right-of-way permit, land disturbance permit or any permit issued under this Code. In the event work does not conform to the plans and specifications of an approved SWPPP, this division or to any instructions of the City, a notice of violation shall be served upon the permit holder. The notice of violation shall state the work to be done and the specified period of time by which corrective action shall be completed. After a notice of

violation to comply is given, the permit holder shall commence corrective measures within twenty-four (24) hours.

(b) If corrective action is not completed by the end of the time specified on a notice of violation, the City may issue a stop work order.

(c) The City may require all work on a site or disturbed area which is being performed contrary to the provisions of this division or in an unsafe or dangerous manner, be immediately stopped. The City may issue a stop work order for the entire project or any specified part thereof if any of the following conditions exist:

(1) Any land disturbance activity regulated under this division is being undertaken without an excavation permit.

(2) The SWPPP is not being fully implemented.

(3) Any of the conditions of the land disturbance permit are not being met.

(4) The work is being performed in a dangerous and unsafe manner.

(d) The stop-work order shall be in writing and shall be issued by posting a copy at the site or disturbed area and by serving a copy upon the permit holder. A copy of the stop work order shall be posted on the site of the land disturbing activity in reasonable proximity to a location where the land disturbing activity is taking place. In the case of work for which there is a land disturbance permit, a permit holder shall be properly served by mailing a copy of the order by first class mail to the address listed for the permit holder on the permit application. In the case of work for which there is not a land disturbance permit, a copy of the order shall be mailed to the owner of record. In addition, a copy of the stop work order may be given to any person in charge of or performing work on drainage improvements at the site or disturbed area, or to an agent of any of the foregoing.

(e) The stop work order shall state the conditions under which work may be resumed. No person, entity or permit holder shall continue any work after a stop work order has been issued except such work as is directed to be performed to remove a violation or dangerous or unsafe condition, as provided in the order.

(f) Ten (10) days after issuing a stop work order, the City may issue a notice of intent to the owner of record or permit holder of the City's intent to perform work necessary to comply with these regulations. If the permit holder wishes to contest the City's determination to enter and complete the work at the expense of the permit holder, the permit holder may request a hearing on the matter before the director of public works by requesting the same in writing delivered to the director of public works during the ten-day notice period. If a hearing is requested, the director of public works will, after a hearing on the record, determine whether the permit holder has complied with the provisions of this division, and shall issue written findings of fact and conclusions of law. If the director of public works determines that the provisions of this chapter have not been complied with, they shall order the permit holder to comply within a period of time specified in the order. Should the permit holder fail to comply within that time, or fail to request a hearing, the City may go on the land and commence work. The costs incurred by the City to perform this work shall be paid by the owner of record or permit holder out of the performance guaranty required by Section 18-9 of this division to the extent the amount is covered thereby, with the remainder being directly due and owing by the owner of record or permit holder. In the event no permit was issued or no performance guaranty was posted, the cost, plus interest at the rate authorized by the issuing authority, plus a reasonable administrative fee shall be billed to the owner of record.

- **Sec. 18-7. - Completion certificate.**

Upon completion of the land disturbance activity and after final stabilization of the site has occurred and all other requirements of the land disturbance permit are satisfied and approved by the City, a completion certificate shall be issued to the permit holder by the City.

- **Sec. 18-8. - Liability.**

The permit holder is responsible for safely and legally completing the project. Neither the issuance of a land disturbance permit under the provisions of this division, nor compliance with the provisions hereto or with any conditions imposed by the City, shall relieve any person from responsibility for damage to persons or property resulting there from, or as otherwise imposed by law, nor impose any liability upon the City for damages to persons or property.

- **Sec. 18-9. - Performance guaranty.**

(a) The applicant shall post a performance guaranty in the form of a cash bond, performance bond or letter of credit. The guaranty shall be in such form and amount as is necessary to assure the work, if not completed in accordance with this division, will be corrected. The amount of the performance guaranty shall be determined by the public works director to secure the costs for improvements required by this division, and this amount shall be in addition to any other amounts necessary to secure the faithful performance of other acts required of the permit holder by the City that the performance guaranty is intended to cover. The public works director may grant a partial or complete waiver of the performance guaranty, upon application, for governmental or quasi-governmental entities or state regulated utilities or where the public works director finds minimal impairment of existing surface drainage, minimal erosion hazard, minimal sedimentation hazard upon any adjacent land or watercourse, and no hazard to human life or property. All performance guaranties shall be accompanied by a pledge and performance agreement that shall grant the City the right to enter onto the applicant's property and utilize the security to either complete stormwater control measures or to correct deficiencies in the work to assure compliance with the performance standards set forth in this chapter and in the stormwater design manual.

(b) In the event of any alleged default in the performance of any term or condition of the performance guaranty, the City, the surety, the issuing organization or entity, or any person employed or engaged on its behalf has a right to go upon the site or disturbed area to complete the required work necessary to control erosion and sedimentation or to protect properties, watercourses and persons. In the event the City undertakes this work with the funds from a forfeited performance guaranty, the funds must be used to pay the cost of contracting, including engineering and administration, for necessary restoration of the site to control erosion and sediment within the requirements set forth in this division, permit, or performance guaranty. If the cost of the work necessary to control erosion and sediment or to protect properties, watercourses and persons exceeds the amount of the performance guaranty, the permit holder shall continue to be firmly bound under a continuing obligation for payment of all excess costs and expenses incurred by the City. The cost of necessary work in excess of the performance guaranty shall be certified by the City Clerk of the City of Raytown and shall, to the extent authorized by law, become a lien upon all property and all rights to property, real or personal, of any person liable to pay that cost. The cost of removal shall be listed on the tax bill and be collected in the manner of ordinary taxes to the extent authorized by law.

(c) A performance guaranty remains in full force and effect until a completion certificate is issued and all other permit holder's acts covered by the performance guaranty have been determined to be complete in accordance with the applicable City code provisions. Failure to renew the performance guaranty fourteen (14) days prior to expiration shall be deemed default by the City.

(d) The City shall issue a notice of violation or stop work order upon failure of any permit holder to maintain the performance guaranty.

- **Sec. 18-10. - Penalties.**

Any violation of the codes adopted by this division shall be an offense punishable under Chapter 1 General Provisions, Section 1-22 General Penalty; Continuing Violations of this Code. Each day such violation continues shall be considered a separate offense. Nothing herein contained shall prevent the City of Raytown or other appropriate authority from taking such other lawful action as is necessary to prevent or remedy any violation.

- **Secs. 18-11 to 18-20. – Reserved**

DIVISION II - ILLICIT DISCHARGE DETECTION AND ELIMINATION REGULATIONS

- **Sec. 18-21. - Generally.**

(a) *Title.* This division shall be known as the illicit discharge detection and elimination regulations.

(b) *Purpose.* The purpose of this division is to provide for the health, safety, and general welfare of the citizens of the City through the regulation of non-stormwater discharges to the storm drainage system to the maximum extent practicable as required by federal and state law. This division establishes methods for controlling the introduction of pollutants into the municipal separate storm sewer system (MS4) in order to comply with requirements of the National Pollutant Discharge Elimination System (NPDES) permit process.

(c) *Design and construction manual.* Additional performance and discharge criteria can be found in the Raytown Design & Construction Manual, section DC-4 design criteria for storm drainage facilities. In the event of any conflict between the manual and this chapter, the stricter requirement shall control.

- **Sec. 18-22. - Applicability.**

This division shall apply to all water entering the storm drain system generated on any developed and undeveloped lands unless explicitly exempted by the City.

- **Sec. 18-23. - Responsibility for administration.**

The City shall administer, implement, and enforce the provisions of this division.

- **Sec. 18-24. - Severability.**

The provisions of this division are hereby declared to be severable. If any provision, clause, sentence or paragraph of this division or the application thereof to any person, establishment, or circumstances shall be held invalid, such invalidity shall not affect the other provisions or application of this division.

- **Sec. 18-25. - Ultimate responsibility.**

The standards set forth herein and promulgated pursuant to this division are minimum standards; therefore this division does not intend nor imply that compliance by any person will ensure that there will be no contamination, pollution, nor unauthorized discharge of pollutants.

- **Sec. 18-26. - Discharge prohibitions.**

(a) *Prohibition of illegal discharges.* No person shall discharge or permit or allow to permit to be discharged into the municipal storm drain system or watercourses any materials, including but not limited to pollutants or waters containing any pollutants that cause or contribute to a violation of applicable water quality standards, other than stormwater.

The commencement, conduct or continuance of any illegal discharge to the storm drain system is prohibited except as described as follows:

(1) The following discharges are exempt from discharge prohibitions established by this division: water line flushing or other potable water sources, landscape irrigation or lawn watering, diverted stream flows, rising ground water, ground water infiltration to storm drains, uncontaminated pumped ground water, foundation or footing drains (not including active groundwater dewatering systems), crawl space pumps, air conditioning condensation, springs, noncommercial washing of vehicles, natural riparian habitat or wetland flows, swimming pools (if dechlorinated - typically less than one (1) PPM chlorine), fire-fighting activities, and any other water source not containing pollutants.

(2) Discharges specified in writing by the authorized enforcement agency as being necessary to protect public health and safety.

(3) Dye testing is an allowable discharge, but requires a verbal notification to the City prior to the time of the test.

(4) The prohibition shall not apply to any non-stormwater discharge permitted under an NPDES permit, waiver, or waste discharge order issued to the discharger and administered under the authority of the Federal Environmental Protection Agency, provided that the discharger is in full compliance with all requirements of the permit, waiver, or order and other applicable laws and regulations, and provided that written approval has been granted for any discharge to the storm drain system.

(b) *Prohibition of illicit connections.*

(1) The construction, use, maintenance or continued existence of illicit connections to the storm drain system is prohibited.

(2) This prohibition expressly includes, without limitation, illicit connections made in the past, regardless of whether the connection was permissible under law or practices applicable or prevailing at the time of connection.

(3) A person is considered to be in violation of this division if the person connects a line conveying sewage to the MS4, or allows such a connection to continue.

- **Sec. 18-27. - Industrial or construction activity discharges.**

Any person subject to an industrial or construction activity NPDES stormwater discharge permit shall comply with all provisions of such permit. Proof of compliance with said permit may be required in a form acceptable to the City prior to the allowing of discharges to the MS4.

- **Sec. 18-28. - Monitoring of discharges.**

(a) *Applicability.* This section applies to all facilities that have stormwater discharges associated with industrial activity, including construction activity.

(b) *Access to facilities.*

(1) The City shall be permitted to enter and inspect facilities subject to regulation under the NPDES and this division as often as may be necessary to determine compliance with this division. If a discharger has security measures in force which require proper identification and clearance before entry into its premises, the discharger shall make the necessary arrangements to allow access to representatives of the City.

(2) Facility operators shall allow the City ready access to all parts of the premises for the purposes of inspecting, sampling, examination and copying of records that must be kept under the conditions of an NPDES permit to discharge stormwater, and the performance of any additional duties as defined by state and federal law.

(3) The City shall have the right to set up on any NPDES permitted industrial facility, land disturbance or construction activity such devices as are necessary in the opinion of the City to conduct monitoring and/or sampling of the facility's stormwater discharge.

(4) The City has the right to require the discharger to install monitoring equipment as necessary. The facility's sampling and monitoring equipment shall be maintained at all times in a safe and proper operating condition by the discharger at its own expense. All devices used to measure stormwater flow and quality shall be calibrated to ensure their accuracy.

(5) Any temporary or permanent obstruction to safe and easy access to the facility to be inspected and/or sampled shall be promptly removed by the operator at the written or oral request of the City and shall not be replaced. The costs of clearing such access shall be borne by the operator.

(6) Unreasonable delays in allowing the City access to a NPDES permitted facility is a violation of this division. A person who is the operator of a facility with a NPDES permit to discharge stormwater associated with industrial activity commits an offense if the person denies the City reasonable access to the permitted facility for the purpose of conducting any activity authorized or required by this division.

(7) If the City has been refused access to any part of the premises from which stormwater is discharged, and he/she is able to demonstrate probable cause to believe that there may be a violation of this division, or that there is a need to inspect and/or sample as part of a routine inspection and sampling program designed to verify compliance with this division or any order issued hereunder, or to protect the overall public health, safety, and welfare of the community, then the City may seek issuance of a search warrant from any court of competent jurisdiction.

- **Sec. 18-29. - Requirement to prevent, control, and reduce stormwater pollutants by the use of best management practices.**

The City has adopted requirements identifying best management practices for any activity, operation, or facility which may cause or contribute to pollution or contamination of stormwater, the storm drain system, or waters of the U.S. The owner or operator of a commercial or industrial establishment shall provide, at their own expense, reasonable protection from accidental discharge of prohibited materials or other wastes into the

municipal storm drain system or watercourses through the use of these structural and non-structural BMPs. Further, any person responsible for a property or premise, which is, or may be, the source of an illicit discharge, may be required to implement, at said person's expense, additional structural and non-structural BMPs to prevent the further discharge of pollutants to the municipal separate storm sewer system. Compliance with all terms and conditions of a valid NPDES permit authorizing the discharge of stormwater associated with industrial activity, to the extent practicable, shall be deemed compliance with the provisions of this section. These BMPs shall be part of a stormwater pollution prevention plan (SWPP) as necessary for compliance with requirements of the NPDES permit.

- **Sec. 18-30. - Watercourse protection.**

Every person owning property through which a watercourse passes, or such person's lessee, shall keep and maintain that part of the watercourse within the property free of trash, debris, excessive vegetation, and other obstacles that would pollute, contaminate, or significantly retard the flow of water through the watercourse. In addition, the owner or lessee shall maintain existing privately owned structures within or adjacent to a watercourse, so that such structures will not become a hazard to the use, function, or physical integrity of the watercourse.

- **Sec. 18-31. - Notification of spills.**

Notwithstanding other requirements of law, as soon as any person responsible for a facility or operation, or responsible for emergency response for a facility or operation has information of any known or suspected release of materials which are resulting or may result in illegal discharges or pollutants discharging into stormwater, the storm drain system, or water of the U.S., said person shall take all necessary steps to ensure the discovery, containment, and cleanup of such release. In the event of such a release of hazardous materials, said person shall immediately notify emergency response agencies of the occurrence via emergency dispatch services. In the event of a release of nonhazardous materials, said person shall notify the authorized enforcement agency in person or by phone, email, or facsimile no later than the next business day. Notifications in person or by phone shall be confirmed by written notice addressed and mailed to the City within three (3) business days of the phone notice. If the discharge of prohibited materials emanates from a commercial or industrial establishment, the owner or operator of such establishment shall also retain an on-site written record of the discharge and the actions taken to prevent its recurrence. Such records shall be retained for at least three (3) years.

- **Sec. 18-32. - Enforcement.**

(1) The City shall serve a notice of violation upon any person responsible in whole or part for an illicit discharge to the MS4 in violation of this division or any permit issued under this Code. The notice shall state the specified period of time by which corrective action shall be completed. After a notice is given, the violator shall commence corrective measures within twenty-four (24) hours. Such notice may require without limitation:

- (a) The performance of monitoring, analysis and reporting;
- (b) The elimination of illicit connections or discharges;
- (c) That violating discharges, practices, or operations shall cease and desist;
- (d) The abatement or remediation of stormwater pollution or contamination hazards and the restoration of any affected property;

- (e) Payment of remediation costs; and
- (f) The implementation of source control or treatment BMPs.

Said notice shall further advise that, should the violator fail to remediate or restore within the established deadline, the work will be done by the City or a contractor and the expense thereof shall be charged to the violator. Illicit discharges in violation of this division are declared a nuisance under Chapter 1 General Provisions, Section 1-22 General Penalty; Continuing Violations of this Code and costs of abatement by the City may be recovered as set forth in the same section.

(2) If the illicit discharge is caused by construction activity, the City may require all work being performed contrary to the provisions of this division or any permit issued under this Code in an unsafe or dangerous manner, be immediately stopped. The City may issue a stop work order in addition to the notice of violation for the entire project or any specified part thereof if any of the following conditions exist:

- (a) Any illicit discharge activity regulated under this division is being undertaken without a land disturbance permit or any permit issued under this Code.
- (b) The stormwater pollution and prevention plan is not being fully implemented.
- (c) Any of the conditions of the land disturbance permit are not being met.
- (d) The work is being performed in a dangerous and unsafe manner.

(3) The stop-work order or notice of violation shall be in writing and shall be issued by posting a copy at the site and by serving a copy upon the owner of record. A copy of the stop work order or notice of violation shall be posted on the site in reasonable proximity to a location where the illicit discharge activity is taking place. In the case of work for which there is a land disturbance permit, a permit holder shall be properly served by mailing a copy of the order by first class mail to the address listed for the permit holder on the permit application. In the case of work for which there is not a land disturbance permit or any permit issued under this Code, a copy of the order shall be mailed to the owner of record as reflected in the records of the county assessor. In addition, a copy of the stop work order or notice of violation may be given to any person in charge of or performing work on the site or illicit discharge area, or to an agent of any of the foregoing.

(4) The stop work order or notice of violation shall state the conditions under which discharge into the City's MS4 may resume. No person, entity or permit holder shall continue any discharge after a stop work order or notice of violation has been issued except such work as is directed to be performed to remove a violation or dangerous or unsafe condition, as provided in the order.

(5) Ten (10) days after issuing a stop work order or notice of violation, the City may issue a notice of intent to the owner of record of the City's intent to perform work necessary to comply with these regulations. If the owner of record wishes to contest the City's determination to enter and complete the work at the expense of the permit holder, the owner of record may request a hearing on the matter before the Director of Public Works, or their representative, by requesting the same in writing delivered to the Director of Public Works, or their representative, during the ten-day notice period. If a hearing is requested, the Director of Public Works, or their representative, will, after a hearing on the record, determine whether the owner of record has complied with the provisions of this division, and shall issue written findings of fact and conclusions of law. If the Director of Public Works, or their

representative, determines that the provisions of this chapter have not been complied with, they shall order the owner of record to comply within a period of time specified in the order. Should the owner of record fail to comply within that time, or fail to request a hearing, the City may go on the land and commence work. The costs incurred by the City to perform this work shall be paid by the owner of record, plus interest at the rate authorized by the issuing authority, plus a reasonable administrative fee shall be billed to the owner of record, and may be filed as a lien against the property under the provisions for abatement of a nuisance under Chapter 1 General Provisions, Section 1-22 General Penalty; Continuing Violations of this Code.

- **Sec. 18-33. - Completion certificate.**

Upon abatement of a violation and/or restoration of the affected property and approval by the City, a completion certificate shall be issued to the person in violation or the owner of record by the City.

- **Sec. 18-34. - Liability.**

The violator is responsible for safely and legally completing the project. Neither the issuance of a land disturbance permit under the provisions of this division, nor compliance with the provisions hereto or with any conditions imposed by the City, shall relieve any person from responsibility for damage to persons or property resulting there from, or as otherwise imposed by law, nor impose any liability upon the City for damages to persons or property.

- **Sec. 18-35. - Penalties.**

Any violation of the Codes adopted by this division shall be an offense punishable under Chapter 1 General Provisions, Section 1-22 General Penalty; Continuing Violations of this Code. Each day such violation continues shall be considered a separate offense. Nothing herein contained shall prevent the City of Raytown or other appropriate authority from taking such other lawful action as is necessary to prevent or remedy any violation.

- **Secs. 18-36 to 18-50. - Reserved**

DIVISION III - STORMWATER RUNOFF CONTROL REGULATIONS

- **Sec. 18-51. - General.**

(a) *Title.* This division shall be known as the post-construction stormwater runoff control regulations.

(b) *Purpose.* The purpose of this division is to establish minimum post-construction stormwater management requirements and controls to protect and safeguard the general health, safety, and welfare of the public residing in watersheds within the City.

(c) *Scope.* Any person, entity, agency, or political subdivision proposing a land disturbance activity within the City shall apply to the City for the approval of a stormwater pollution prevention plan. No land shall be disturbed prior to the issuance of a land disturbance permit and approval of a plan by the City that conforms to the standards set forth herein.

(d) *Design and construction manual.* All work done under a permit issued under this chapter shall function in conformity with the currently adopted City design and construction manual. The manual shall be updated/approved by the City council by resolution from time to time and kept on file with the department of public works. In the event of any conflict between this division and the manual, the stricter requirement shall control.

(e) *Violation.* Any person or entity violating the terms of this chapter, or of the stormwater design manual, shall be guilty of an offense punishable under Chapter 1 General Provisions, Section 1-22 General Penalty; Continuing Violations.

- **Sec. 18-52. - Land disturbance permitting process.**

The permit and stormwater pollution prevention plan (SWPPP) requirements for post-construction land disturbance activities are set forth in Section 18-3 of this Code.

- **Sec. 18-53. - Inspections.**

In making application for a land disturbance permit, the permit holder consents to allow City representatives to enter the site or disturbed area for the purpose of inspection and enforcement of the provisions of this division during any period that a land disturbance permit is in place, until closure of the permit by City approval and thereafter for inspection to verify compliance with all post-construction requirements for the stormwater pollution prevention plan pursuant to Section 18-3 of this Code. After the permit is issued, the permit holder shall be responsible for the following:

(a) A copy of the land disturbance permit must be available on the site for inspection by the City prior to any inspections being conducted.

(b) Field markings showing limits of disturbance must be on site during all installation of erosion and sediment control measures, construction or other land disturbance activities.

(c) The permit holder shall call for and be approved for any or all of the following inspections:

(1) After a land disturbance permit has been issued and before any land disturbance activity begins;

(2) During the construction of sediment basins or stormwater management structures;

(3) During rough grading, including hauling of imported or wasted materials;

(4) Prior to the removal or substantial modification of any erosion and sediment control measure or practice;

(5) Upon completion of final grading, including establishment of ground covers and planting, installation of all vegetative measures and all other work;

(6) Additional inspections as required by the City to abate erosion control failures not addressed in the stormwater pollution and prevention plan.

- **Sec. 18-54. - Waivers to stormwater management requirements.**

Waivers to the requirements of this division shall be granted pursuant to Section 18-3 of this Code. Every applicant shall provide for stormwater management as required by this division, unless a written request is filed to waive this requirement. Requests to waive the stormwater management plan requirements shall be submitted to the City for approval. The City is not authorized to grant any waiver of state or federal requirements and no waiver granted by the City hereunder shall be interpreted to grant such authority.

The minimum requirements for stormwater management may be waived in whole or in part upon written request of the applicant, provided that at least one (1) of the following conditions applies:

(a) It can be demonstrated that the proposed development is not likely to impair attainment of the objectives of this division.

(b) Alternative minimum requirements for onsite management of stormwater discharges have been established in a stormwater management plan that has been approved by the City and the implementation of the plan is required by local division.

(c) Provisions are made to manage stormwater by an offsite facility. The offsite facility is required to be in place, to be designed and adequately sized to provide a level of stormwater control that is equal to or greater than that which would be afforded by onsite practices and there is a legally obligated entity responsible for long-term operation and maintenance of the stormwater practice.

(d) The City finds that meeting the minimum onsite management requirements is not feasible due to the natural or existing physical characteristics of a site.

(e) Non-structural practices will be used on the site that reduce:

(1) The generation of stormwater from the site;

(2) The size and cost of stormwater storage;

(3) The pollutants generated at the site.

These non-structural practices are explained in detail in the design and construction manual and the amount of credit available for using such practices shall be determined by the City.

In instances where one (1) of the conditions above applies, the City may grant a waiver from strict compliance with these stormwater management provisions, as long as acceptable mitigation measures are provided. However, to be eligible for a variance, the applicant must demonstrate to the satisfaction of the City that the variance will not result in the following impacts to downstream waterways:

(a) Deterioration of existing culverts, bridges, dams, and other structures;

(b) Degradation of biological functions or habitat;

(c) Accelerated stream bank or stream bed erosion or siltation;

(d) Increased threat of flood damage to public health, life, property.

Furthermore, where compliance with minimum requirements for stormwater management is waived, the applicant will satisfy the minimum requirements by meeting one (1) of the mitigation measures selected by the jurisdictional stormwater authority. Mitigation measures may include, but are not limited to, the following:

(a) The purchase and donation of privately owned lands, or the grant of an easement to be dedicated for preservation and/or reforestation. These lands should be located adjacent to the stream corridor in order to provide permanent buffer areas to protect water quality and aquatic habitat;

(b) The creation of a stormwater management facility or other drainage improvements on previously developed properties, public or private, that currently lack stormwater management facilities designed and constructed in accordance with the purposes and standards of this division;

(c) Monetary contributions (fee-in-lieu) to fund stormwater management activities such as research and studies (e.g., regional wetland delineation studies, stream monitoring studies for water quality and macroinvertebrates, stream flow monitoring, threatened and endangered species studies, hydrologic studies, and monitoring of stormwater management practices).

Where the City waives all or part of the minimum stormwater management requirements, or where the waiver is based on the provision of adequate stormwater facilities provided downstream of the proposed development, the applicant shall be required to pay a fee in an amount as determined by the City.

When an applicant obtains a waiver of the required stormwater management, the monetary contribution required shall be in accordance with a fee schedule (unless the developer and the stormwater authority agree on a greater alternate contribution) established by the City, and based on the cubic feet of storage required for stormwater management of the development in question. All of the monetary contributions shall be credited to an appropriate capital improvements program project, and shall be made by the developer prior to the issuance of any building permit for the development.

In lieu of a monetary contribution, an applicant may obtain a waiver of the required stormwater management by entering into an agreement with the City for the granting of an easement or the dedication of land by the applicant, to be used for the construction of an offsite stormwater management facility. The agreement shall be entered into by the applicant and the City prior to the recording of plats or, if no record plat is required, prior to the issuance of the building permit.

- **Sec. 18-55. - General performance criteria for stormwater management.**

All structures, measures and devices installed or used for erosion and sediment control practices at a site or disturbed area must, after construction, meet the criteria and performance standards set forth in the stormwater design manual.

- **Sec. 18-56. - Basic stormwater management design criteria.**

All stormwater management practices will be designed so that the specific storm frequency storage volumes (e.g., recharge, water quality, channel protection, ten (10) year, one hundred (100) year) as identified in the current stormwater design manual are met, unless the City grants the applicant a waiver or the applicant is exempt from such requirements.

In addition, if hydrologic or topographic conditions warrant greater control than that provided by the minimum control requirements, the City reserves the right to impose any and all additional requirements deemed necessary to control the volume, timing, and rate of runoff.

At a minimum, the requirements and performance standards of the stormwater design manual shall be adhered to.

- **Sec. 18-57. - Requirements for stormwater management plan approval.**

No application for development will be approved unless it includes a stormwater management plan detailing in concept how runoff and associated water quality impacts resulting from the development will be controlled or managed. This plan must be prepared by an individual approved by the City and must indicate whether stormwater will be managed on-site or off-site and, if on-site, the general location and type of practices. The stormwater management plan(s) shall be referred for comment to all other interested agencies, and any comments must be addressed in a final stormwater management plan. No building or land disturbance permit shall be issued until a satisfactory stormwater management plan, or a waiver thereof, shall have undergone a review and been approved by the City after determining that the plan or waiver is consistent with the requirements of this division. Stormwater management plans must meet the requirements of section 18-3 of this Code.

- **Sec. 18-58. - Maintenance and repair of stormwater facilities.**

Prior to the issuance of any permit that has a stormwater management facility as one (1) of the requirements of the permit, the applicant or owner of the site must execute a maintenance agreement that shall be binding on all subsequent owners of land served by the stormwater management facility. The agreement shall provide for access to the facility at reasonable times for periodic inspection by the City, or their contractor or agent, and for regular or special assessments of property owners to ensure that the facility is maintained in proper working condition to meet design standards and any other provisions established by this division. The maintenance agreement shall be recorded by the City in the land records.

Maintenance of all stormwater management facilities shall be ensured through the creation of a formal maintenance agreement that must be approved by the City and recorded into the land record prior to final plan approval. As part of the agreement, a schedule shall be developed for when and how often maintenance will occur to ensure proper function of the stormwater management facility. The agreement shall also include plans for periodic inspections to ensure proper performance of the facility between scheduled cleanouts. The City, in lieu of a maintenance agreement, may accept dedication of any existing or future stormwater management facility for maintenance, provided such facility meets all the requirements of this chapter and includes adequate and perpetual access and sufficient area, by easement or otherwise, for inspection and regular maintenance.

All stormwater management facilities must undergo, at the minimum, an annual inspection to document maintenance and repair needs and ensure compliance with the requirements of this division and accomplishment of its purposes. These needs may include:

- (a) Removal of silt, litter and other debris from all catch basins, inlets and drainage pipes;
- (b) Grass cutting and vegetation removal; and
- (c) Necessary replacement of landscape vegetation.

Any maintenance needs found must be addressed in a timely manner, as determined by the City, and the inspection and maintenance requirement may be increased as deemed necessary to ensure proper functioning of the stormwater management facility.

Inspection programs may be established on any reasonable basis, including but not limited to:

- (a) Routine inspections;
- (b) Random inspections;
- (c) Inspections based upon complaints or other notice of possible violations;
- (d) Inspection of drainage basins or areas identified as higher than typical sources of sediment or other contaminants or pollutants;
- (e) Inspections of businesses or industries of a type associated with higher than usual discharges of contaminants or pollutants or with discharges of a type which are more likely than the typical discharge to cause violations of state or federal water or sediment quality standards or the NPDES stormwater permit; and

(f) Joint inspection with other agencies inspecting under environmental or safety laws. Inspections may include, but are not limited to:

- (1) Reviewing maintenance and repair records;
- (2) Sampling discharges, surface water, groundwater, and material or water in drainage control facilities; and
- (3) Evaluating the condition of drainage control facilities and other stormwater treatment practices.

When any new drainage control facility is installed on private property, or when any new connection is made between private property and a public drainage control system, sanitary sewer or combined sewer, the property owner shall grant to the City the right to enter the property at reasonable times and in a reasonable manner for the purpose of inspection. This includes the right to enter a property when it has a reasonable basis to believe that a violation of this division is occurring or has occurred, and to enter when necessary for abatement of a public nuisance or correction of a violation of this division.

Parties responsible for the operation and maintenance of a stormwater management facility shall make records of the installation and of all maintenance and repairs, and shall retain the records permanently. These records shall be made available to the City during inspection of the facility and at other reasonable times upon request.

If a responsible party fails or refuses to meet the requirements of the maintenance agreement, the City, after reasonable notice, may correct a violation of the design standards or maintenance needs by performing all necessary work to place the facility in proper working condition. In the event that the stormwater management facility becomes a danger to public safety or public health, the City shall notify the party responsible for maintenance of the stormwater management facility in writing. Upon receipt of that notice, the responsible person shall have ten (10) days to effect maintenance and repair of the facility in an approved manner pursuant to the requirements set forth in this section 18-59 of this Code.

- **Sec. 18-59. - Enforcement.**

(a) The City shall serve a notice of violation upon any person responsible in whole or in part for the construction, alteration, repair, maintenance, or removal of drainage improvements in violation of a building permit, right-of-way permit, land disturbance permit or any permit issued under this Code. In the event work does not conform to the plans and specifications of an approved stormwater pollution prevention plan, this division or to any instructions of the City, a notice of violation shall be served upon the permit holder. The notice of violation shall state the work to be done and the specified period of time by which corrective action shall be completed. After a notice of violation to comply is given, the permit holder shall commence corrective measures within twenty-four (24) hours.

(b) The City may require all work on a site or disturbed area which is being performed contrary to the provisions of this division or in an unsafe or dangerous manner, be immediately stopped. The City may issue a notice of violation for the entire project or any specified part thereof if any of the following conditions exist:

- (1) Any land disturbance activity regulated under this division is being undertaken without a land disturbance permit.
- (2) The stormwater pollution prevention plan is not being fully implemented.

(3) Any of the conditions of the land disturbance permit are not being met.

(4) The work is being performed in a dangerous and unsafe manner.

(c) The notice of violation shall be in writing and shall be issued by posting a copy at the site or disturbed area and by serving a copy upon the permit holder. A copy of the notice of violation shall be posted on the site of the land disturbing activity in reasonable proximity to where the land disturbing activity is taking place. In the case of work for which there is a land disturbance permit, a permit holder shall be properly served by mailing a copy of the order by first class mail to the address listed for the permit holder on the permit application. In the case of work for which there is not a land disturbance permit, a copy of the order shall be mailed to the owner of record. In addition, a copy of the notice of violation may be given to any person in charge of or performing work on drainage improvements at the site or disturbed area, or to an agent of any of the foregoing.

(d) The notice of violation shall state the conditions under which work may be resumed. No person, entity or permit holder shall continue any work after a notice of violation has been issued except such work as is directed to be performed to remove a violation or dangerous or unsafe condition, as provided in the order.

(e) Ten (10) days after issuing a notice of violation, the City may issue a notice of intent to the owner of record or permit holder of the City's intent to perform work necessary to comply with these regulations. If the permit holder wishes to contest the City's determination to enter and complete the work at the expense of the permit holder, the permit holder may request a hearing on the matter before the Director of Public Works by requesting the same in writing delivered to the Director of Public Works during the ten-day notice period. If a hearing is requested, the Director of Public Works will, after a hearing on the record, determine whether the permit holder has complied with the provisions of this division, and shall issue written findings of fact and conclusions of law. If the Director of Public Works determines that the provisions of this chapter have not been complied with, they shall order the permit holder to comply within a period of time specified in the order. Should the permit holder fail to comply within that time, or fail to request a hearing, the City may go on the land and commence work. The costs incurred by the City to perform this work shall be paid by the owner of record or permit holder out of the performance guaranty required by Section 18-9 of this Code to the extent the amount is covered thereby, with the remainder being directly due and owing by the owner of record or permit holder. In the event no permit was issued or no performance guaranty was posted, the cost, plus interest at the rate authorized by the issuing authority, plus a reasonable administrative fee shall be billed to the owner of record and assessed against the property pursuant to Chapter 1 General Provisions, Section 1-22 General Penalty; Continuing Violations of this Code.

- **Sec. 18-60. - Completion certificate.**

Upon completion of the land disturbance activity and after final stabilization of the site has occurred and all other requirements of the land disturbance permit are satisfied and approved by the City, a completion certificate shall be issued to the permit holder by the City.

- **Sec. 18-61. - Liability.**

The permit holder is responsible for safely and legally completing the project. Neither the issuance of a land disturbance permit under the provisions of this division, nor compliance with the provisions hereto or with any conditions imposed by the City, shall relieve any person from responsibility for damage to persons or property resulting there from, or as otherwise imposed by law, nor impose any liability upon the City for damages to persons or property.

- **Sec. 18-62. - Penalties.**

Any violation of the codes adopted by this division shall be an offense punishable under Chapter 1 General Provisions, Section 1-22 General Penalty; Continuing Violations of this Code. Each day such violation continues shall be considered a separate offense. Nothing herein contained shall prevent the City of Raytown or other appropriate authority from taking such other lawful action as is necessary to prevent or remedy any violation.

- **Secs. 18-63 to 18-80. - Reserved**

CITY OF RAYTOWN
Request for Board Action

Date: April 7, 2022
To: Mayor and Board of Aldermen
From: Teresa Henry, City Clerk

Resolution No.: R-3448-22

Department Head Approval: _____

City Administrator Approval: _____

=====

Action Requested: Appointment of a member of the Board of Aldermen to serve as Acting President during the upcoming year of 2022-2023.

Recommendation: None.

Analysis: The appointment of an Acting President of the Board of Aldermen may be done by motion established by **RSMo. Section 79.090, Board to select an acting president, term.**

79.090. The board shall elect one of their own number who shall be styled "acting president of the board of aldermen" and who shall serve for a term of one year.

The duties of the Acting President are established by **RSMo. Section 79.100, Acting president to perform duties of mayor, when.**

79.100. When any vacancy shall happen in the office of mayor by death, resignation, removal from the city, removal from office, refusal to qualify, or from any other cause whatever, the acting president of the board of aldermen shall, for the time being, perform the duties of mayor, with all the rights, privileges, powers and jurisdiction of the mayor, until such vacancy be filled or such disability be removed; or, in case of temporary absence, until the mayor's return.

Budgetary Impact:

Not Applicable

A RESOLUTION APPOINTING A MEMBER OF THE BOARD OF ALDERMEN TO THE POSITION OF ACTING PRESIDENT FOR A TERM OF ONE YEAR OR UNTIL A SUCCESSOR IS APPOINTED

WHEREAS, Section 79.090 RSMo. provides that the Board of Aldermen elect one of their own number as Acting President of the Board of Aldermen to serve for a term of one year; and

WHEREAS, the duties of the Acting President of the Board of Aldermen are established by Section 79.100 RSMo., which provides that the Acting President shall perform the duties of the Mayor in the absence or inability of the Mayor to act; and

WHEREAS, the Board of Aldermen find it is in the best interest of the City to appoint _____ to serve as the Acting President of the Board of Aldermen during the next year;

NOW THEREFORE, BE IT RESOLVED BY THE BOARD OF ALDERMEN OF THE CITY OF RAYTOWN, MISSOURI, AS FOLLOWS:

THAT _____ is hereby appointed to serve as the Acting President of the Board of Aldermen of the City of Raytown for a term of one year;

PASSED AND ADOPTED by the Board of Aldermen and **APPROVED** by the Mayor of the City of Raytown, Missouri, the 12th day of April, 2022.

Michael McDonough, Mayor

ATTEST:

Teresa M. Henry, City Clerk

Approved as to Form:

Jennifer M. Baird, City Attorney

CITY OF RAYTOWN
Request for Board Action

Date: April 7, 2022

Resolution No.: R-3449-22

To: Mayor and Board of Aldermen

From: Damon Hodges, City Administrator/Interim Finance Director

Department Head Approval: _____

Finance Director Approval: _____

City Administrator Approval: _____

Action Requested: Staff requests Approval of Collector's Report obtained from Jackson County per Revised Statute of Missouri 94.320.

Analysis: 94.320. Collector to make delinquent lists — board to approve — collection of delinquent taxes. — 1. The board of aldermen shall require the collector, at the first meeting of the board in April of each year, or as soon thereafter as may be, to make out, under oath, lists of delinquent taxes remaining due and uncollected for each year, to be known as "the land and lot delinquent list" and "the personal delinquent list".

2. The board of aldermen, at the meeting at which the delinquent lists are returned or as soon as may be thereafter, shall examine the lists carefully, and if it appear that all property and taxes contained in the lists are properly returned as delinquent, the board shall approve the lists, enter a record thereof in the journal and credit the amount thereof to the account of the city collector.

3. The board shall return the delinquent lists to the collector, charging him therewith, and he shall proceed to collect the same in the same manner as provided by law for state and county taxes.

It should be noted that the City Collector, nor any City employee, collects property tax due. This is a function of Jackson County.

Budgetary Impact:

Not Applicable

Additional Reports Attached: Lists of Delinquency

A RESOLUTION APPROVING THE LAND AND LOT DELINQUENT LIST AND THE PERSONAL DELINQUENT LIST OF DELINQUENT TAXES REMAINING DUE AND UNCOLLECTED RECEIVED FROM JACKSON COUNTY, MISSOURI

WHEREAS, pursuant to Section 2-247 of the Raytown City Code and Sections 79.310 and 94.320, RSMo, at the first meeting of the board in April of each year, or as soon thereafter as may be, to make out, under oath, lists of delinquent taxes remaining due and uncollected for each year, to be known as "the land and lot delinquent list" and "the personal delinquent list; and

WHEREAS, the land and lot delinquent list and the personal delinquent list of delinquent taxes remaining due and uncollected has been received from Jackson County, Missouri and are attached hereto as Exhibit "A" and incorporated herein; and

WHEREAS, after examination of the lists, the Board of Aldermen find that all taxes contained in the lists are properly returned as delinquent and the Board finds it is in the best interest of the citizens of the City of Raytown to approve the attached lists referred to as "the land and lot delinquent list" and "the personal delinquent list" as attached hereto;

NOW THEREFORE, BE IT RESOLVED BY THE BOARD OF ALDERMEN OF THE CITY OF RAYTOWN, MISSOURI, AS FOLLOWS:

THAT the attached lists referred to as "the land and lot delinquent list" and "the personal delinquent list" as attached hereto as Exhibit "A" and incorporated herein, are hereby approved; and

FURTHER THAT the Collector, or her designee, is hereby charged with proceeding to collect the delinquent tax in the same manner as provided by law.

PASSED AND ADOPTED by the Board of Aldermen and **APPROVED** by the Mayor of the City of Raytown, Missouri, the 12th day of April, 2022.

Michael McDonough, Mayor

ATTEST:

Teresa M. Henry, City Clerk

Approved as to Form:

Jennifer M. Baird, City Attorney

Exhibit A

[See Attached Delinquent Lists]

Parcel Number	Yr(s) of Delinq	Pact Code	Current Taxpayer Name	Last Known Physical Address				
009701128	2009	BUSINESS PERSONAL PROPERTY	BOY SCOUT TROOP #341	7400 BLUE RIDGE BLVD	088196478	2021	BUSINESS PERSONAL PROPERTY	AMERICAN FAMILY MUTUAL INSURANCE CO S I
00970635C	2020	BUSINESS PERSONAL PROPERTY	MACEDONIA BAPTIST CHURCH	11409 E 71ST ST	088305008	2011-2021	BUSINESS PERSONAL PROPERTY	KAHRS REPAIR INC
010627008	2010	BUSINESS PERSONAL PROPERTY	ACCENT INTERIORS INC	11501 E 63RD ST	088348168	2005	BUSINESS PERSONAL PROPERTY	G&E CONSTRUCTION
018655708	2012	BUSINESS PERSONAL PROPERTY	BOWEN APARTMENTS LLC	6140 RAYTOWN RD APT 204	088401098	2015	BUSINESS PERSONAL PROPERTY	SECURITY 4 CHEMICAL COMPANY
020046578	2001-2004	BUSINESS PERSONAL PROPERTY	PRIME MECHANICAL	9906 E 53RD ST	088402128	2001-2004	BUSINESS PERSONAL PROPERTY	BELL BONDING CO
020047128	2002-2004	BUSINESS PERSONAL PROPERTY	PHYSICIANS SLENDER CONCEPTS	7600 RAYTOWN RD	088524818	2005	BUSINESS PERSONAL PROPERTY	H&H REPAIR
020047578	2012	BUSINESS PERSONAL PROPERTY	L P G VENTURES INC	9611 E 53RD ST	088830878	2004-2005	BUSINESS PERSONAL PROPERTY	CLASSIC CARPET CARE
020050878	2016	BUSINESS PERSONAL PROPERTY	INTEGRITY ACCOUNTING SERVICES INC	9029 E M 350 HWY	089146848	2021	BUSINESS PERSONAL PROPERTY	C&L HEATING AND A C SERVICE
020068408	2002-2004	BUSINESS PERSONAL PROPERTY	ZOLLARS MASONRY	10118 E 78TH TER	089195778	2013	BUSINESS PERSONAL PROPERTY	ROBERTS CHEVROLET INC
020935808	2000	BUSINESS PERSONAL PROPERTY	GIBBY	10205 E 71ST TER	089402018	2008-2009	BUSINESS PERSONAL PROPERTY	JACKSON COUNTY JANITORIAL SERV
021203008	2011	BUSINESS PERSONAL PROPERTY	CANINE FASHIONS	6218 ARLINGTON AVE	089402758	2000-2007	BUSINESS PERSONAL PROPERTY	W T RAWLEIGH DISTRIBUTOR
023101508	2009	BUSINESS PERSONAL PROPERTY	CHRYSLER MOTORS LLC	9401 E M 350 HWY	089413428	2011	BUSINESS PERSONAL PROPERTY	BLOCKBUSTER VIDEO # 29031
023470008	2019	BUSINESS PERSONAL PROPERTY	CITY DISTRIBUTORS	7926 DITZLER AVE	089960378	2010-2011	BUSINESS PERSONAL PROPERTY	ORTHO CARE INC
023930008	2020-2021	BUSINESS PERSONAL PROPERTY	CLIFFORD MFG CO	5631 RAYTOWN RD	089981528	1999-2003	BUSINESS PERSONAL PROPERTY	PHILLIPS CONSTRUCTION
029321008	2018-2019	BUSINESS PERSONAL PROPERTY	DONS BARGAIN CENTER SALES	9700 E 56TH ST	09003734K	2021	BUSINESS PERSONAL PROPERTY	SMITH GARY L DDS
032845008	2007-2009	BUSINESS PERSONAL PROPERTY	FARMERS INSURANCE GROUP	9800 E 87TH ST UNIT A	090527598	2009-2010	BUSINESS PERSONAL PROPERTY	TOYOTA MOTOR CREDIT CORP
035005008	1998-2001	BUSINESS PERSONAL PROPERTY	FREDS BARBER SHOP	9224 E US 350 HWY	090781108	2015	BUSINESS PERSONAL PROPERTY	DESIGNERS & COMPANY INC
037610008	2002	BUSINESS PERSONAL PROPERTY	GRAHAM RESTAURANT SALES INC	9124 E US 350 HWY	090781118	2019-2021	BUSINESS PERSONAL PROPERTY	GREEN LAWN FERTILIZER CO INC
038556008	2001-2007	BUSINESS PERSONAL PROPERTY	H&L CARPET SERVICE INC	8317 MAYWOOD AVE	090876578	2020-2021	BUSINESS PERSONAL PROPERTY	RAYTOWN LAWNMOWER PTS & SERV
038672508	2008	BUSINESS PERSONAL PROPERTY	HAAKE CONSTRUCTION CO INC	10029 E 63RD ST	091271638	2003	BUSINESS PERSONAL PROPERTY	NEPTUNES GALLEY
042623008	2015-2018	BUSINESS PERSONAL PROPERTY	IDA & BEAS DRAPERY	6805 VERMONT AVE	091789288	2021	BUSINESS PERSONAL PROPERTY	J CS AUTOMOTIVE REPAIR
043643508	2012	BUSINESS PERSONAL PROPERTY	I B C SALES CORPORATION	6631 RAYTOWN RD	091791318	1997	BUSINESS PERSONAL PROPERTY	E M I
045361008	2011-2016	BUSINESS PERSONAL PROPERTY	JOHNSON CONSTRUCTION	5408 RAYTOWN RD	091793118	2009	BUSINESS PERSONAL PROPERTY	AMERICAN LAMINATORS
047425008	2020	BUSINESS PERSONAL PROPERTY	KEN A VISION MFG CO INC	5615 RAYTOWN RD	091793128	2009-2012	BUSINESS PERSONAL PROPERTY	LAUREL LANES INC
047777508	2004-2005	BUSINESS PERSONAL PROPERTY	KIM DO KHAN U S A	6121 BLUE RIDGE BLVD	091793308	2017-2018	BUSINESS PERSONAL PROPERTY	STRATFORD DEVELOPMENT CORP
051402508	2006-2011	BUSINESS PERSONAL PROPERTY	LOVING WAY CHURCH INC THE & CHRISTIAN SC	8904 E 83RD ST	09212314C	2001-2003	BUSINESS PERSONAL PROPERTY	ANIMAL DAMAGE & NUISANCE
052250008	2011	BUSINESS PERSONAL PROPERTY	MAIS E A CO	6129 HUNTER ST	092172538	1998	BUSINESS PERSONAL PROPERTY	GELCO CORPORATION
056494008	2012-2020	BUSINESS PERSONAL PROPERTY	MISSOURI LEADED GLASS	9717 E 68TH TER	092229928	2016	BUSINESS PERSONAL PROPERTY	JIM GOS OF RAYTOWN LLC
056570008	2005-2007	BUSINESS PERSONAL PROPERTY	MISSOURI INFORMATION SOLUTIONS	NO ADDRESS PROVIDED BY TAXPAYER	092342738	2012-2013	BUSINESS PERSONAL PROPERTY	R E & P MIDWEST INC
059946008	2013	BUSINESS PERSONAL PROPERTY	NORTHCRAFT CARPETS	5600 RAYTOWN RD	092465798	2005-2007	BUSINESS PERSONAL PROPERTY	FIVE STAR GAMES INC
064915008	2010	BUSINESS PERSONAL PROPERTY	PRISCILLAS	10301 E 63RD ST	092897648	2020	BUSINESS PERSONAL PROPERTY	EXPRESSIONS IN DANCE WEAR
066457508	2009	BUSINESS PERSONAL PROPERTY	RAYTOWN DODGE CO	10000 E M 350 HWY	092958558	2009	BUSINESS PERSONAL PROPERTY	TOMMYS TOW SERVICE INC
066940008	2009	BUSINESS PERSONAL PROPERTY	CHARLIES R/C	6215 BLUE RIDGE BLVD	092959058	2001-2007	BUSINESS PERSONAL PROPERTY	RIDLEY JANITORIAL SERVICE
067700008	2021	BUSINESS PERSONAL PROPERTY	RIDGEWOOD BARBER SHOP	5252 BLUE RIDGE BLVD	092962128	2011	BUSINESS PERSONAL PROPERTY	ALTERNATIVE INS MARKING INC
06966750H	2021	BUSINESS PERSONAL PROPERTY	SAFETY KLEEN SYSTEMS INC	9305 E M 350 HWY	092991958	2002-2003	BUSINESS PERSONAL PROPERTY	SERVICE OIL #9
070005008	2010	BUSINESS PERSONAL PROPERTY	MICHAEL A SAMPSON DDS INC	6530 RAYTOWN RD UNIT A	093090378	2014	BUSINESS PERSONAL PROPERTY	BRAKES AND MORE
071080008	2008-2016	BUSINESS PERSONAL PROPERTY	SERVICE PLUS	5861 RAYTOWN RD	093174328	2011-2020	BUSINESS PERSONAL PROPERTY	RICED PLUMBING
073715008	2005-2008	BUSINESS PERSONAL PROPERTY	SMITH BROS BLDG SUPPLY CO	NO ADDRESS PROVIDED BY TAXPAYER	093177618	2007-2008	BUSINESS PERSONAL PROPERTY	SENIOR CITIZENS LAWN SERVICES
077904708	2019	BUSINESS PERSONAL PROPERTY	SYSTEMATIC TEMPERATURE CONTROL	6312 HEDGES AVE	093203768	2008	BUSINESS PERSONAL PROPERTY	ACCENT LANDSCAPE INC
081736328	2014	BUSINESS PERSONAL PROPERTY	A&J SERVICE INC	8801 E 63RD ST	093247848	2005	BUSINESS PERSONAL PROPERTY	FIRST ASSEMBLY OF GOD
081738088	2021	BUSINESS PERSONAL PROPERTY	CORLISS V LITTLE LLC	9915 E 63RD ST	093251338	2007-2008	BUSINESS PERSONAL PROPERTY	GRAND TOOL
081836178	2004-2005	BUSINESS PERSONAL PROPERTY	CALI CARS	UNKNOWN	093255338	2010	BUSINESS PERSONAL PROPERTY	COLDWELL BANKER HOMETOWN RLTY
082169858	2003	BUSINESS PERSONAL PROPERTY	MIDWEST LANDSCAPING	6210 HUNTER ST	093252868	2021	BUSINESS PERSONAL PROPERTY	LAS CHILIS
082392928	2002-2003	BUSINESS PERSONAL PROPERTY	TRIM RITE LAWN SERVICE	6404 BLUE RIDGE CTO B	093334608	2019-2020	BUSINESS PERSONAL PROPERTY	MARY TYLER
082609928	2021	BUSINESS PERSONAL PROPERTY	COLE TERMITE & PEST CONTROL	11705 M 350 HWY E UNIT B	093334728	2019-2021	BUSINESS PERSONAL PROPERTY	POTTER ENTERPRISES
082717938	1998-2020	BUSINESS PERSONAL PROPERTY	MANFREDI CHIROPRACTIC	9010 E M 350 HWY SPC D	093334748	2018	BUSINESS PERSONAL PROPERTY	RAYTOWN TRANSMISSION
082800028	2011	BUSINESS PERSONAL PROPERTY	WILSON AUTO & BOAT SALES	10807 E M 350 HWY	093342098	2011	BUSINESS PERSONAL PROPERTY	VERTEC ASSOCIATES
083009688	2007-2015	BUSINESS PERSONAL PROPERTY	KEYSER DANIEL J PHD	NO ADDRESS PROVIDED BY TAXPAYER	093347948	2014-2016	BUSINESS PERSONAL PROPERTY	CHAPMAN DEWEY
083207988	2021	BUSINESS PERSONAL PROPERTY	MID AMERICA LAMINATING	6636 CEDAR AVE	093945628	2017	BUSINESS PERSONAL PROPERTY	PRIMERICA FINANCIAL SERVICES
083351808	2005	BUSINESS PERSONAL PROPERTY	F B C CONSOLIDATED INS SER	UNKNOWN	094231578	2001-2002	BUSINESS PERSONAL PROPERTY	DAVILA SHEET METAL INC
084278488	2002-2003	BUSINESS PERSONAL PROPERTY	RAYMOND DONALD E	9500 E 63RD ST	094231548	2005	BUSINESS PERSONAL PROPERTY	MARKETING DYNAMICS
084498498	2008	BUSINESS PERSONAL PROPERTY	AQUA ROD INC	9301 E 63RD ST	094232608	2004	BUSINESS PERSONAL PROPERTY	STERLING REMODELING
084540008	2003-2004	BUSINESS PERSONAL PROPERTY	WESTWOOD ORNAMENTAL IRON	6105 ARLINGTON ST	094280138	1999	BUSINESS PERSONAL PROPERTY	M D PLUMBING
084623958	2005-2009	BUSINESS PERSONAL PROPERTY	EVERGREEN FINANCIAL SERVICES	NO ADDRESS PROVIDED BY TAXPAYER	094354518	2004	BUSINESS PERSONAL PROPERTY	J B & CO AUTO GLASS REPLACEMENT
084887498	2009	BUSINESS PERSONAL PROPERTY	PHILLIPS PETROLEUM COMPANY	6024 BLUE RIDGE BLVD	094355038	2010-2020	BUSINESS PERSONAL PROPERTY	FRANKOS FLOOR CLEANING
085044958	2014-2018	BUSINESS PERSONAL PROPERTY	HAAKE FOUNDATIONS INC	10029 E 63RD TER	094391538	1999	BUSINESS PERSONAL PROPERTY	CENTRAL AUTOMOTIVE MARKET INC
085390008	2011-2012	BUSINESS PERSONAL PROPERTY	WILSON PLUMBING CO	5401 RAYTOWN RD	094431978	2008	BUSINESS PERSONAL PROPERTY	JERSEY BOYZ DELI
085641758	2003	BUSINESS PERSONAL PROPERTY	OWENSBY & SONS ROOFING	8501 LANE	094440218	2002	BUSINESS PERSONAL PROPERTY	THREE FIFTY COLLISION GROUP
08573127K	2021	BUSINESS PERSONAL PROPERTY	HALLMARK MARKETING CORP	9005 E M 350 HWY	094464188	1997	BUSINESS PERSONAL PROPERTY	APPLICATIONS PLUS
085896478	2017-2018	BUSINESS PERSONAL PROPERTY	K C AUTO PANEL	9620 E M 350 HWY UNIT 110	094468228	2004-2005	BUSINESS PERSONAL PROPERTY	CREATIVE GALLERY PHOTOGRAPHY
086062548	2017	BUSINESS PERSONAL PROPERTY	ROLLERS JIM BODY WORKS	8402 WESTRIDGE RD	094471198	2020	BUSINESS PERSONAL PROPERTY	RAYVIEW CONSTRUCTION INC
086263508	2018	BUSINESS PERSONAL PROPERTY	WYNN TWINS, LLC	10818 E 79TH ST	094473418	2007	BUSINESS PERSONAL PROPERTY	TRIPPNT INC
086747848	1998	BUSINESS PERSONAL PROPERTY	TRANS AMERICAN SECURITY	9509 E 63RD ST	094534218	2006-2016	BUSINESS PERSONAL PROPERTY	ELLENWOOD JEFF PHOTOGRAPHY
087064078	2009	BUSINESS PERSONAL PROPERTY	K&M SALES & SERVICE	11230 E M 350 HWY UNIT A	094534918	2008	BUSINESS PERSONAL PROPERTY	A BARGAIN INSURANCE AGENCY
087290978	2019-2021	BUSINESS PERSONAL PROPERTY	ELITE FINANCIAL SERVICES INC	9417 E 63RD ST	094560598	2003	BUSINESS PERSONAL PROPERTY	STADIUM AUTO REPAIR
087313978	2018-2020	BUSINESS PERSONAL PROPERTY	AUTO TRIM DESIGN OF MO	9206 E M 350 HWY	094579488	2008-2009	BUSINESS PERSONAL PROPERTY	DONS CONTRACTING & PRPTY DEVLPMNT INC
087716278	2018-2020	BUSINESS PERSONAL PROPERTY	JEONGS CANTON CHINESE RESTAURANT	5252 BLUE RIDGE BLVD	095120318	2021	BUSINESS PERSONAL PROPERTY	WILSON CHARLES D JR ATTY
087890348	2005	BUSINESS PERSONAL PROPERTY	RAYTOWN DISCOUNT APPLIANCES	UNKNOWN	095578618	2021	BUSINESS PERSONAL PROPERTY	MIDWEST TRANSMISSION
088126908	1999-2007	BUSINESS PERSONAL PROPERTY	C J ENTERPRISES	6004 BLUE RIDGE BLVD	095842008	2001-2004	BUSINESS PERSONAL PROPERTY	CONNELYS PRINTED IMAGE
088136558	2009	BUSINESS PERSONAL PROPERTY	CRAWFORDS RAYTOWN JEEP EAGLE	9401 E M 350 HWY	095842598	2021	BUSINESS PERSONAL PROPERTY	HEAD TA TOE
088193698	2017-2020	BUSINESS PERSONAL PROPERTY	SUN AVIATION INC	10010 E 87TH ST	095886668	2016	BUSINESS PERSONAL PROPERTY	WILSON & MCCABE PSYCHOLOGICAL
						2007	BUSINESS PERSONAL PROPERTY	BURGEN ACCOUNTING & TAX SRVC
								9504 E 63RD ST
								5533 RAYTOWN RD
								7620 HARRIS AVE
								5885 RAYTOWN RD
								11304 E US 350 HWY
								9011 E 53RD ST
								10208 E 71ST TER
								9919 E 63RD ST
								9617 E M 350 HWY
								12000 E 78TH ST
								9029 E M 350 HWY
								6115 BLUE RIDGE BLVD
								11911 E 83RD ST
								6718 HARRIS ST
								7600 RAYTOWN RD
								11701 E M 350 HWY
								6304 WILLOW AVE
								10011 E 61ST TER
								6122 BLUE RIDGE BLVD
								6633 RAYTOWN RD
								11730 E 83RD ST SPC A
								6206 RAYTOWN RD
								9814 E 53RD ST
								9628 E M 350 HWY
								8024 SPRING VALLEY RD
								EQUIP IN COUNTY
								6400 RAYTOWN RD
								5533 RALSTON AVE
								11000 E 63RD ST
								6215 BLUE RIDGE BLVD
								9801 E 82ND TER
								5241 HARDY CT
								10805 E 61ST TER
								NO ADDRESS PROVIDED BY TAXPAYER
								6301 RAYTOWN RD
								5401 RAYTOWN RD
								NO ADDRESS PROVIDED BY TAXPAYER
								5401 RAYTOWN RD
								UNKNOWN
								NO ADDRESS PROVIDED BY TAXPAYER
								6326 RAYTOWN RD
								6200 RAYTOWN TFWY
								7210 CRISP AVE
								11647 E M 350 HWY
								8838 E M 350 HWY
								7600 RAYTOWN RD
								8023 WILLOW WAY
								10312 E 63RD ST
								6212 ARLINGTON ST
								11214 E 76TH TER
								8905 RICHARDS DR
								10600 E 69TH TER
								16706 WOODSON RD

095887178	2007	BUSINESS PERSONAL PROPERTY	FARMERS INSURANCE	6124 BLUE RIDGE BLVD	098976878	2001-2003	BUSINESS PERSONAL PROPERTY	ALTER IMAGE PHOTOGRAPHY	12000 E 75TH ST
095946408	2011-2015	BUSINESS PERSONAL PROPERTY	MIDLAND ELECTRICAL CORP	10220 E 65TH ST	098976888	2008	BUSINESS PERSONAL PROPERTY	PARAGON DELIVERY	8001 HUNTER ST
096054788	2002	BUSINESS PERSONAL PROPERTY	WHITE STEPHEN INS AGT	14401 E 42ND ST	098977248	2003	BUSINESS PERSONAL PROPERTY	POST NET	9340 E US 350 HWY
096055658	2021	BUSINESS PERSONAL PROPERTY	SPECIALTY CONCEPTS FENCES INC	10920 E M 350 HWY	099086598	1999	BUSINESS PERSONAL PROPERTY	HARVEYS LAWN SERVICE	7200 E 127TH ST
096056918	2009	BUSINESS PERSONAL PROPERTY	CONOCO CIRCLE K #2706563	6903 BLUE RIDGE BLVD	099633988	2007	BUSINESS PERSONAL PROPERTY	DUNCAN BRAD STYLIST	11507 E 63RD ST
096074978	2013-2014	BUSINESS PERSONAL PROPERTY	TROTTER TRUCKING CO INC	NO ADDRESS PROVIDED BY TAXPAYER	099633998	2009-2020	BUSINESS PERSONAL PROPERTY	KALINKA SUSAN STYLIST	11539 E 63RD ST
096819008	2021	BUSINESS PERSONAL PROPERTY	MANDINA & SONS DISTRIBUTING	9902 E 53RD ST	099639298	2017-2018	BUSINESS PERSONAL PROPERTY	EXECUTIVE SECURITY INC	9509 E 63RD ST
096819068	2006	BUSINESS PERSONAL PROPERTY	BUSINESS INVESTIGATION SOLUTIONS	8622 E UTOPIA DR APT 5	099717498	2003-2005	BUSINESS PERSONAL PROPERTY	HOME IMPROVEMENT	6236 MANNING AVE
096819138	2010-2012	BUSINESS PERSONAL PROPERTY	ROYAL TREATMENT THE	10104 E 63RD TER	099717508	2003-2004	BUSINESS PERSONAL PROPERTY	CORPORATE ASSET SERVICES LLC	10101 E 65TH ST
096819768	2013-2016	BUSINESS PERSONAL PROPERTY	AUTO COOL	9100 E M 350 HWY	099717548	1999	BUSINESS PERSONAL PROPERTY	ENGLISH TOUCH NAIL SALON THE	6004 BLUE RIDGE BLVD
096819798	2010-2015	BUSINESS PERSONAL PROPERTY	BURLINGTON PERFORMANCE	9600 E 59TH ST	099717558	2009-2010	BUSINESS PERSONAL PROPERTY	SHEAR PRECISION	11507 E 63RD ST
096819968	2021	BUSINESS PERSONAL PROPERTY	PUBLIC STORAGE	7900 WOODSON RD	099717568	1999-2000	BUSINESS PERSONAL PROPERTY	TYSON CLEANING CONCEPTS	8620 E 87TH ST
096909708	2015-2017	BUSINESS PERSONAL PROPERTY	TERRACE GARDEN APARTMENTS	6307 ASH AVE APT 1	099717588	2004	BUSINESS PERSONAL PROPERTY	TERRYS ROOFING SYSTEMS	8417 LANE ST
096911078	2003-2004	BUSINESS PERSONAL PROPERTY	HUNTER CAR AUDIO INC	6627 BLUE RIDGE BLVD	099717678	2002-2004	BUSINESS PERSONAL PROPERTY	ROCKSOLID CONSTRUCTION	7408 HEDGES ST
096911128	2008	BUSINESS PERSONAL PROPERTY	COLE VISION CORPORATION	9370 E M 350 HWY	099726948	2002-2003	BUSINESS PERSONAL PROPERTY	SUPERIOR CARPET CLEANING	8320 WESTRIDGE AVE B
096911528	1998-2001	BUSINESS PERSONAL PROPERTY	NOW LIFE BAPTIST CHURCH OF	8614 RAYTOWN RD	099739078	2005	BUSINESS PERSONAL PROPERTY	ALL AMERICAN LAWN & TREE	7516 CRESCENT DR
096916088	2018-2020	BUSINESS PERSONAL PROPERTY	HOSIER CONST CO	8405 MARSH AVE	099739178	2010	BUSINESS PERSONAL PROPERTY	GOFORTH HOLMES DESIGN	6310 ASH AVE
096919618	2010-2011	BUSINESS PERSONAL PROPERTY	A&J GUNSMITHING	6530 RAYTOWN RD UNIT A	099739208	2001	BUSINESS PERSONAL PROPERTY	JUST MY TYPE	6644 MAYWOOD ST A
096943948	2003-2004	BUSINESS PERSONAL PROPERTY	ELECTRICAL CONTRACTORS INC OF	10220 E 65TH ST A	099739258	1999-2007	BUSINESS PERSONAL PROPERTY	MYERS & ASSOCIATES COUNSELING	NO ADDRESS PROVIDED BY TAXPAYER
096955098	2008-2010	BUSINESS PERSONAL PROPERTY	PERSONAL TAX & ACCOUNTING	9604 E 63RD ST	099837038	2000-2004	BUSINESS PERSONAL PROPERTY	LANDSCAPE ARTISTS	10228 E 63RD ST 1
096961778	2001-2003	BUSINESS PERSONAL PROPERTY	AMERICAN BETTER HOMES INC	9611 E 53RD ST	099837128	2003	BUSINESS PERSONAL PROPERTY	BLUE RIBBON CONVENTION	1400 HEDGES ST
096972098	1998-2007	BUSINESS PERSONAL PROPERTY	C B F	6128 DITZLER AVE	099838918	1999-2003	BUSINESS PERSONAL PROPERTY	FOUR SEASONS ROOFING & REPAIRS	9400 E 85TH ST
096972158	1998-2007	BUSINESS PERSONAL PROPERTY	KRYSTAL INC	7109 STERLING AVE	099840318	2002-2005	BUSINESS PERSONAL PROPERTY	BLOWN SMOKE BBQ INC	4087 SW MARLINE DR
096972478	2005-2006	BUSINESS PERSONAL PROPERTY	ROWLAND DENNIS R ATTY	6119 BLUE RIDGE BLVD	099938418	2010-2011	BUSINESS PERSONAL PROPERTY	RE MAX HEARTLAND RAYTOWN	10208 E M 350 HWY
096973658	2003	BUSINESS PERSONAL PROPERTY	J&S GLASSWORKS INC	8834 E US 350 HWY	099938688	2012-2017	BUSINESS PERSONAL PROPERTY	FAULCONER JIM & ASSOCIATES	9000 JAMES A REED RD
096973998	2015-2021	BUSINESS PERSONAL PROPERTY	SIMPSON KARRIE V	5313 KENTUCKY AVE	100000765	2003	BUSINESS PERSONAL PROPERTY	SELF DEFENSE ACADEMY INC THE	VEHICLE ONLY
096974068	1997-2005	BUSINESS PERSONAL PROPERTY	TOMS EXOTIC AQUARIUS	UNKNOWN	100001470	2000-2003	BUSINESS PERSONAL PROPERTY	R L J PRIVATE INVESTIGATION & SECURITY	8817 E 72ND ST
097080738	2007	BUSINESS PERSONAL PROPERTY	AMERICAN APPLIANCE	11909 E 78TH TER	100001548	2020-2021	BUSINESS PERSONAL PROPERTY	COMPLETE PROPERTY MAINTENANCE	9816 E 66TH ST
097080778	2017-2018	BUSINESS PERSONAL PROPERTY	FIT FOR LIFE INC	11500 E 53RD ST	100001986	2021	BUSINESS PERSONAL PROPERTY	ANASTASIAS BOOKS	10416 E 63RD ST
097080808	1997-2002	BUSINESS PERSONAL PROPERTY	TRANS TECH	6832 STERLING AVE	100002367	2000-2007	BUSINESS PERSONAL PROPERTY	D&AS FIVE STAR CLEANING SERVICE	8604 ELM AVE
097081008	1997-2007	BUSINESS PERSONAL PROPERTY	WOLF CALL GAMES	9003 E 68TH ST	100003217	2012	BUSINESS PERSONAL PROPERTY	AAMCO TRANSMISSION	7609 E M 350 HWY UNIT 101
097083158	2005	BUSINESS PERSONAL PROPERTY	M&M AUTO SALES	UNKNOWN	100003600	2004-2007	BUSINESS PERSONAL PROPERTY	IMPORTS PLUS	NO ADDRESS PROVIDED BY TAXPAYER
097083918	2006	BUSINESS PERSONAL PROPERTY	LYON COUNSELING & CONSULTING	9503 E 80TH TER	100037542	2007-2021	BUSINESS PERSONAL PROPERTY	BEST NAILS	11565 E 63RD ST
097152248	2020-2021	BUSINESS PERSONAL PROPERTY	EXPRESSIONS IN DANCE	6215 BLUE RIDGE BLVD	100377385	2008	BUSINESS PERSONAL PROPERTY	LEAFGUARD OF KANSAS CITY INC	5899 RAYTOWN RD UNIT 100
097152338	2012	BUSINESS PERSONAL PROPERTY	PARK AT WESTRIDGE LLC THE	11809 E 86TH ST	100889139	2001-2002	BUSINESS PERSONAL PROPERTY	BALL DORIS I	UNKNOWN
097804678	2001-2002	BUSINESS PERSONAL PROPERTY	TOUCHDOWN CONSTRUCTION	6608 WOODSON RD	100907312	2008	BUSINESS PERSONAL PROPERTY	KAIN CHARLES	9115 E 60TH ST
097811328	2003	BUSINESS PERSONAL PROPERTY	SNACK TIME OF K C	220 PINK HILL RD	199900068	2007-2008	BUSINESS PERSONAL PROPERTY	VICTORY IN PRAISE	7140 STERLING AVE
097911158	1998	BUSINESS PERSONAL PROPERTY	RAYTOWN MOTORS	11507 E US 350 HWY	200003338	2006-2007	BUSINESS PERSONAL PROPERTY	LYON ELECTRONIC BUSINESS SERVICES	9350 E 80TH TER
097912658	1999-2001	BUSINESS PERSONAL PROPERTY	S&K PAINTING	7321 ELM ST	200003498	2000	BUSINESS PERSONAL PROPERTY	CALLAHAN FLATWORK	8507 MANNING
097924318	2001	BUSINESS PERSONAL PROPERTY	WITHERSPOON SCHOOLS	10311 E 63RD ST	200100498	2012-2021	BUSINESS PERSONAL PROPERTY	ALL AMERICAN AUTO REPAIR	9305 E M 350 HWY
09797134F	2020-2021	BUSINESS PERSONAL PROPERTY	NORTHERN LEASING SYSTEMS INC	6113 BLUE RIDGE BLVD	200101368	2001-2002	BUSINESS PERSONAL PROPERTY	RACE DAY CAFE THE	7108 DITZLER ST
097984318	2009	BUSINESS PERSONAL PROPERTY	AMERICAN PRESS	9112 E M 350 HWY	200101598	2002	BUSINESS PERSONAL PROPERTY	SELL WELL MANUFACTURING	10400 E 63RD ST
097984398	1998-2007	BUSINESS PERSONAL PROPERTY	PRESTIGE PHOTOGRAPHY	NO ADDRESS PROVIDED BY TAXPAYER	200101638	2006-2007	BUSINESS PERSONAL PROPERTY	JAY MCNAMARA INC	NO ADDRESS PROVIDED BY TAXPAYER
097985398	2009-2015	BUSINESS PERSONAL PROPERTY	LADS & LASSIES	8814 E 67TH ST	200101928	2001	BUSINESS PERSONAL PROPERTY	TRAPPERS ROADSKINS	9505 E 69TH TER
097985898	1999	BUSINESS PERSONAL PROPERTY	ALLENS CONSTRUCTION	9063 E 65TH TER	200102758	2001-2002	BUSINESS PERSONAL PROPERTY	KANSAS CITY MAD HATTER	6606 BLUE RIDGE CTO
097986568	2008	BUSINESS PERSONAL PROPERTY	HEARTLAND MOTORS INC	10811 E M 350 HWY	200102918	2008-2020	BUSINESS PERSONAL PROPERTY	NEW MILLENIUM JANITORIAL SERVICE	7504 OVERTON AVE
098053038	1999-2004	BUSINESS PERSONAL PROPERTY	DOWNTOWN ASSEMBLY OF GOD	VEHICLE ONLY	200103178	2006	BUSINESS PERSONAL PROPERTY	PET PAMPER	6140 HUNTER ST
098085408	2000-2003	BUSINESS PERSONAL PROPERTY	WALLYS GRAPHIC IMAGES	10921 E 53RD ST	200103268	2007-2008	BUSINESS PERSONAL PROPERTY	R&R REMODELING	9012 E 57TH TER
098085428	1998-2007	BUSINESS PERSONAL PROPERTY	FARRELLS INVESTMENT CO	5732 CEDAR AVE	200103858	2001-2005	BUSINESS PERSONAL PROPERTY	TRAILBLAZERS	UNKNOWN
098085458	1998	BUSINESS PERSONAL PROPERTY	ACCESS RESIDENTIAL MORTGAGE CO	6448 RAYTOWN TFWY	200103998	2001	BUSINESS PERSONAL PROPERTY	WILLIES REPAIR SERVICE	9226 E 53RD ST
098086078	2008	BUSINESS PERSONAL PROPERTY	PSYCHIC & TAROT CARD READER	NO ADDRESS PROVIDED BY TAXPAYER	200104028	2001-2006	BUSINESS PERSONAL PROPERTY	YUM YUMS	8320 WILLOW WAY
098086128	2017-2019	BUSINESS PERSONAL PROPERTY	GUARDIAN ANGEL	6112 MANNING AVE	200107128	2002	BUSINESS PERSONAL PROPERTY	HAMPSHIRE BILL RICH TOP SOIL	4700 NORFLEET ST
098086138	2015-2016	BUSINESS PERSONAL PROPERTY	DISCOUNT SMOKE SHOP	7312 RAYTOWN RD UNIT A	200107728	2001-2003	BUSINESS PERSONAL PROPERTY	C & G CONSTRUCTION	9417 E 82ND ST
098095448	2007-2010	BUSINESS PERSONAL PROPERTY	SPORT PRINT	6105 ARLINGTON AVE	20010986C	2005	BUSINESS PERSONAL PROPERTY	NETWORK CAPITAL ALLIANCE	NO ADDRESS PROVIDED BY TAXPAYER
098691018	2009-2011	BUSINESS PERSONAL PROPERTY	DANNY THE PLUMBER	8619 GRANT DR	200110248	2007	BUSINESS PERSONAL PROPERTY	B&V LAUNDRY	6151 BLUE RIDGE BLVD
098694378	1998-1999	BUSINESS PERSONAL PROPERTY	DAVIDSON HOME IMPROVEMENT CO	10816 GREGORY LN	200110778	2002	BUSINESS PERSONAL PROPERTY	CARPENTRY #1 LTD	7007 LAKE SHORE DR
098694668	1999-2003	BUSINESS PERSONAL PROPERTY	T&J FLOORING	8416 JAMES A REED RD	200110848	2002-2003	BUSINESS PERSONAL PROPERTY	CHIAOJINSHI MARTIAL ARTS SUPPLY	9004 E 73RD ST
098694718	2006	BUSINESS PERSONAL PROPERTY	RUSSELLS CAR WASH	10805 E M 350 HWY	200110918	2001-2003	BUSINESS PERSONAL PROPERTY	CITY WIDE PRINTING	9112 E 74TH TER
098695008	1998-2004	BUSINESS PERSONAL PROPERTY	WILSON CURTIS ORNAMENTAL IRON	7922 MAPLE ST	200110998	2009	BUSINESS PERSONAL PROPERTY	CONOCO CIRCLE K #2706567	8100 WESTRIDGE RD
098695848	2003-2007	BUSINESS PERSONAL PROPERTY	K C COWBOY CUSTOM HATTERS	6530 RAYTOWN RD UNIT A	200111038	2002	BUSINESS PERSONAL PROPERTY	CRANBERRY HILL RECOVERY OUTLET	11505 E 63RD ST
098695928	2021	BUSINESS PERSONAL PROPERTY	DIAMOND CONTRACTING INC	9500 E 55TH ST	200111848	2008	BUSINESS PERSONAL PROPERTY	HOUSE MASTER HOME INSPECTIONS	6317 HEDGES AVE
098699078	2004	BUSINESS PERSONAL PROPERTY	IMAGETECH INC	6501 HADLEY ST	200112248	2003-2004	BUSINESS PERSONAL PROPERTY	C R S RECONSTRUCTION	9105 E 65TH TER
098735198	2002-2003	BUSINESS PERSONAL PROPERTY	TY D AND CLEAN JANITORIAL	7918 TENNESSEE AVE	200112738	2001-2002	BUSINESS PERSONAL PROPERTY	HEALTH AT HOME	10512 E 65TH ST
098824528	2002	BUSINESS PERSONAL PROPERTY	P S I IRRIGATION INC	7015 HEDGES	200113458	2001-2007	BUSINESS PERSONAL PROPERTY	GARY LACEY CONSTRUCTION	6603 RALSTON AVE
098825068	2003-2007	BUSINESS PERSONAL PROPERTY	BANCO ELECTRICAL CONST INC	8205 HARRIS AVE	200113958	2001	BUSINESS PERSONAL PROPERTY	BRIDGETS UPHOLSTERING & EXTRAS	10807 E 56TH TER
098837168	2015	BUSINESS PERSONAL PROPERTY	TAYLOR CARPET CLEANING INC	5707 MAYWOOD AVE	200114158	2001-2004	BUSINESS PERSONAL PROPERTY	EAGER HANDS CRAFTS	9008 E 61ST ST
098837818	2011-2013	BUSINESS PERSONAL PROPERTY	BRITTANY APARTMENTS	8622 E UTOPIA DR APT 5	200114168	2001	BUSINESS PERSONAL PROPERTY	EDUCATION SERVICE PROFESSIONALS INC	8821 E 85TH ST
098896668	2008-2010	BUSINESS PERSONAL PROPERTY	KARS PLUS	NO ADDRESS PROVIDED BY TAXPAYER	200114248	2002-2003	BUSINESS PERSONAL PROPERTY	GLOBAL PAGING & CELLULAR	6614 BLUE RIDGE BLVD D
098902758	2006-2007	BUSINESS PERSONAL PROPERTY	CADYS PLUMBING	8806 E 72ND ST	200114378	2002-2005	BUSINESS PERSONAL PROPERTY	QUALITY IMPROVEMENTS	7700 RAYTOWN RD APT 10
098903448	2003	BUSINESS PERSONAL PROPERTY	M&R CONSTRUCTION LLC	10110 E 63RD ST	200114448	2001-2002	BUSINESS PERSONAL PROPERTY	U S A AUTO	9400 E 53RD PL
098907668	2003-2007	BUSINESS PERSONAL PROPERTY	PARKER PLASTERING	NO ADDRESS PROVIDED BY TAXPAYER	200114478	2006	BUSINESS PERSONAL PROPERTY	YARD KARD MO	9701 E 77TH TER
098974018	1998-1999	BUSINESS PERSONAL PROPERTY	AMRON HOLDING	EQUIP IN COUNTY	200115920	2014	BUSINESS PERSONAL PROPERTY	MACKE WATER SYSTEMS INC	9915 E 63RD ST

200116268	2009	BUSINESS PERSONAL PROPERTY	PHILLIPS / CIRCLE K # 2706332	9805 E M 350 HWY	200331908	2008-2009	BUSINESS PERSONAL PROPERTY	RAYTOWN POST	10014 E 63RD ST
20011733G	2002-2003	BUSINESS PERSONAL PROPERTY	I P COMMUNICATIONS CORP	EQUIP IN COUNTY	200331918	2005	BUSINESS PERSONAL PROPERTY	CARIBBEAN VEHICLE EXPORT SALES & LEASING	UNKNOWN
200120198	2002-2003	BUSINESS PERSONAL PROPERTY	KIMBROUGH & SON DIST INC	10012 E 64TH ST	200332048	2009-2011	BUSINESS PERSONAL PROPERTY	DOVE STUDIOS	10305 S 68TH TER
200122788	2004-2007	BUSINESS PERSONAL PROPERTY	BIG DADDYS SMOKE PIT	NO ADDRESS PROVIDED BY TAXPAYER	200332058	2012-2016	BUSINESS PERSONAL PROPERTY	PROFESSIONAL ACCOUNTING SOLUTIONS	10113 E 70TH TER
200124318	2018-2019	BUSINESS PERSONAL PROPERTY	MAN ABOUT THE HOUSE	11700 E 86TH TER	200332078	2007-2013	BUSINESS PERSONAL PROPERTY	STREAMLINE TECHNOLOGY	5412 HUNTER ST
200124408	2011	BUSINESS PERSONAL PROPERTY	B&D INDUSTRIAL CONSTRUCTION INC	9900 E 56TH ST	200402348	2021	BUSINESS PERSONAL PROPERTY	WYATTS CATERING CO	8205 E 86TH TER
200200658	2003-2020	BUSINESS PERSONAL PROPERTY	ALTEK FINANCIAL INC	8605 ARLINGTON AVE	200420978	2019-2021	BUSINESS PERSONAL PROPERTY	EMERALD AUTOMOTIVE	6140 BLUE RIDGE BLVD
200201138	2015-2017	BUSINESS PERSONAL PROPERTY	CUSTOM WINDOW	NO ADDRESS PROVIDED BY TAXPAYER	200421248	2007	BUSINESS PERSONAL PROPERTY	FLEMING CORP OF KANSAS	5304 RAYTOWN RD
200202938	2012	BUSINESS PERSONAL PROPERTY	NESTING PLACE INC THE	9504 E 63RD RD	200422018	2006-2007	BUSINESS PERSONAL PROPERTY	PIPOS ITALIANO	6516 RAYTOWN RD
200203968	2008-2010	BUSINESS PERSONAL PROPERTY	SHANG HAI EXPRESS	6340 RAYTOWN RD	200422138	2010-2011	BUSINESS PERSONAL PROPERTY	PRIME DIGITAL	5717 WOODSON RD
200204148	2006-2007	BUSINESS PERSONAL PROPERTY	SUNGLASS GUY	9409 E 79TH TER	200422518	2007-2009	BUSINESS PERSONAL PROPERTY	SHADE TREE RECORDING ENTERTAINMENT	9909 E 63RD ST UNIT E
200204928	2004-2007	BUSINESS PERSONAL PROPERTY	XCEL CARPET CARE	8920 E 81ST ST	200422588	2021	BUSINESS PERSONAL PROPERTY	SHUPE DAYCARE	11715 E 76TH TER
200206848	2006-2007	BUSINESS PERSONAL PROPERTY	ASSURED QUALITY TITLE CO	NO ADDRESS PROVIDED BY TAXPAYER	200423928	2004	BUSINESS PERSONAL PROPERTY	L C B ENTERPRISES II LLC	6329 BLUE RIDGE BLVD STE B
200207108	2002	BUSINESS PERSONAL PROPERTY	CINDYS HAIR CARE	6612 HARDY ST	200425608	2006-2007	BUSINESS PERSONAL PROPERTY	W E PLUMBING	NO ADDRESS PROVIDED BY TAXPAYER
200208318	2013-2018	BUSINESS PERSONAL PROPERTY	CHISMS TRANSPORTATION	7824 WESTRIDGE RD	200425658	2016-2017	BUSINESS PERSONAL PROPERTY	YE OLDE SEW N SEW	5724 LANE AVE
200208548	2011-2020	BUSINESS PERSONAL PROPERTY	STARR SIDING & WINDOWS	8804 E 81ST TER	200426518	2006	BUSINESS PERSONAL PROPERTY	CONSIDER IT DONE	10805 LAKEVIEW BLVD
200209238	2020	BUSINESS PERSONAL PROPERTY	CONSUMERS DIGESTIBLES INC	6501 HADLEY ST	200440538	2006-2007	BUSINESS PERSONAL PROPERTY	ALLEN TOI OPERATIONS	11300 E 85TH TER
200209768	2003-2009	BUSINESS PERSONAL PROPERTY	KOLA INC	NO ADDRESS PROVIDED BY TAXPAYER	200441268	2009-2011	BUSINESS PERSONAL PROPERTY	DIAMOND SHAMROCK SNACK MART Z & T INC	5304 RAYTOWN RD
200211658	2002	BUSINESS PERSONAL PROPERTY	FAR AND WIDE TRANSPORTATION	VEHICLE ONLY	200441538	2010	BUSINESS PERSONAL PROPERTY	GRABBA TAN	6236 RAYTOWN TFWY
200211688	2005	BUSINESS PERSONAL PROPERTY	AMERICAN MEDIA OPERATIONS	UNKNOWN	200441758	2005-2020	BUSINESS PERSONAL PROPERTY	HENDRIX JOE PHOTOGRAPHY & DESIGN	6215 BLUE RIDGE BLVD
200220608	2004-2012	BUSINESS PERSONAL PROPERTY	BEVERLY SCOTT INC	8323 WOODSON DR	200443268	2008-2009	BUSINESS PERSONAL PROPERTY	RAYTOWN KARATE FOR KIDS	9000 E M 350 HWY
200242198	2021	BUSINESS PERSONAL PROPERTY	DESTINY INTERNATIONAL	11901 E 78TH TER	200443288	2013-2018	BUSINESS PERSONAL PROPERTY	READY SET GO	6311 EVANSTON AVE
200242278	2020-2021	BUSINESS PERSONAL PROPERTY	KATHYS ELECTROLYSIS	6313 HEDGES AVE	200444048	2010	BUSINESS PERSONAL PROPERTY	TOOL RENTAL COMPANY LLC	6532 BLUE RIDGE CUT OFF
200242318	2016-2020	BUSINESS PERSONAL PROPERTY	MARKET PLACE SALES LLC	6408 OVERTON AVE	200444288	2007	BUSINESS PERSONAL PROPERTY	U P S STORE THE	6236 RAYTOWN TFWY
200242738	2003-2007	BUSINESS PERSONAL PROPERTY	I M M E INC	NO ADDRESS PROVIDED BY TAXPAYER	200444668	2006-2007	BUSINESS PERSONAL PROPERTY	XCELLENT MEDICAL SERVICES LLC	NO ADDRESS PROVIDED BY TAXPAYER
200242748	2005-2007	BUSINESS PERSONAL PROPERTY	BURTON REALTY	2025 PROSPECT AVE	200500538	2005-2008	BUSINESS PERSONAL PROPERTY	WESTWIND FLYING CLUB INC	NO ADDRESS PROVIDED BY TAXPAYER
200251978	2004	BUSINESS PERSONAL PROPERTY	ELITE EXTERIORS	9413 E 66TH TER	200501808	2009	BUSINESS PERSONAL PROPERTY	GARRISON DEPOT	9004 RICHARDS DR
200252628	2006-2009	BUSINESS PERSONAL PROPERTY	SUPERIOR SALES & LEASING INC	NO ADDRESS PROVIDED BY TAXPAYER	200502018	2009	BUSINESS PERSONAL PROPERTY	MCCALLISTER STABLE	9400 E 63RD ST
200261928	2009	BUSINESS PERSONAL PROPERTY	HANDY JIM DANDY	9812 E 82ND ST	200505968	2007-2009	BUSINESS PERSONAL PROPERTY	CLARENCE A MARSHALL MORTGAGE	10200 E 63RD TER
200262478	2010	BUSINESS PERSONAL PROPERTY	MR SIGN	9124 E M 350 HWY	200521488	2005-2007	BUSINESS PERSONAL PROPERTY	DOMINOS PIZZA	7009 RAYTOWN RD
200262948	2004-2005	BUSINESS PERSONAL PROPERTY	MINDYS CHILDCARE	11208 E 62ND ST	200521518	2005	BUSINESS PERSONAL PROPERTY	DOUGH STOP BAKERY INC	6215 BLUE RIDGE BLVD
200264048	2002-2003	BUSINESS PERSONAL PROPERTY	PLATINUM & LACE	9804 E 87TH ST C	200523438	2006-2011	BUSINESS PERSONAL PROPERTY	CHASE ATLANTIC MORTGAGE	NO ADDRESS PROVIDED BY TAXPAYER
200265098	2006-2007	BUSINESS PERSONAL PROPERTY	STACEYS QUALITY CLEANING	8315 KENTUCKY AVE	200523818	2008	BUSINESS PERSONAL PROPERTY	NAGEL CUSTOM CONTRACTING LLC	6008 CLAREMONT AVE
200265548	2020-2021	BUSINESS PERSONAL PROPERTY	VICKYS KID KORNER	6321 CEDAR AVE	200526498	2020	BUSINESS PERSONAL PROPERTY	STRIBLING & PITCHER	10212 E 63RD ST
200268398	2007-2008	BUSINESS PERSONAL PROPERTY	ANCHOR COMPUTING	8419 WESTRIDGE RD	200529398	2007	BUSINESS PERSONAL PROPERTY	HAMPTON PAINT LLC	NO ADDRESS PROVIDED BY TAXPAYER
200269288	2018-2021	BUSINESS PERSONAL PROPERTY	RAYTOWN VILLA LLC	6553 RAYTOWN RD APT 1B	200530078	2007	BUSINESS PERSONAL PROPERTY	SECURITYCO INC	8800 E 81ST TER
200269578	2003	BUSINESS PERSONAL PROPERTY	A P AUTOSPORT	5424 NORTHERN AVE	200530198	2020	BUSINESS PERSONAL PROPERTY	CHAUDHURI TAPAN K MD	8325 RAYTOWN RD
200269758	2007	BUSINESS PERSONAL PROPERTY	CHASITYS BOOKKEEPING SERVICES	7701 RAYTOWN RD APT 10	200540868	2010-2012	BUSINESS PERSONAL PROPERTY	BICKERING TREE	10010 E 63RD ST
200300218	2013	BUSINESS PERSONAL PROPERTY	RAYS LIQUORS	11545 E 63RD ST	200541728	2008-2010	BUSINESS PERSONAL PROPERTY	CURVES	11529 E 63RD ST
200300418	2015	BUSINESS PERSONAL PROPERTY	COSENTINO ENTERPRISES INC	7506 RAYTOWN RD	200542308	2005-2007	BUSINESS PERSONAL PROPERTY	AMERICAN & IMPORTS	10807 E M 350 HWY
200301008	2005	BUSINESS PERSONAL PROPERTY	AUTO MALL LLC THE	UNKNOWN	200542318	2007-2008	BUSINESS PERSONAL PROPERTY	AFFORDABLE TRAPPING	5524 MANNING AVE
200301128	2004-2005	BUSINESS PERSONAL PROPERTY	DANAS DESIGNS INC	5221 CRISP ST	200542348	2005	BUSINESS PERSONAL PROPERTY	EDNA INVESTMENT GROUP	NO ADDRESS PROVIDED BY TAXPAYER
200310428	2005	BUSINESS PERSONAL PROPERTY	C W ALARMS	8309 SPRING VALLEY RD	200543578	2007-2020	BUSINESS PERSONAL PROPERTY	HAIR DIRECTION	6448 RAYTOWN RD
200310458	2010-2011	BUSINESS PERSONAL PROPERTY	CANDYS DAY CARE	7905 MAPLE AVE	200544378	2010	BUSINESS PERSONAL PROPERTY	JUDAH DENTAL LABORATORY LLC	11004 E 81ST TER
200310588	2007-2012	BUSINESS PERSONAL PROPERTY	CASTEEL TRUCKING	6728 VERMONT AVE	200544638	2007	BUSINESS PERSONAL PROPERTY	KANSAS CITY TAI CHI & KUNG FU CTR LLC	5252 BLUE RIDGE BLVD
200311408	2016	BUSINESS PERSONAL PROPERTY	LANDSCAPERS CHOICE	11507 E M 350 HWY	200545098	2005-2007	BUSINESS PERSONAL PROPERTY	LOVITTS DISTRIBUTING INC	7216 MAPLE AVE
200311798	2007-2008	BUSINESS PERSONAL PROPERTY	NAMASTE UNLIMITED	10215 E M 350 HWY SPC F	200545358	2009	BUSINESS PERSONAL PROPERTY	MAXIMUM FITNESS	11730 E 83RD ST SPC A
200311918	2007	BUSINESS PERSONAL PROPERTY	ODNEAL LAWN CARE	8917 E 75TH ST	200545538	2007-2008	BUSINESS PERSONAL PROPERTY	MCMANUS CONSULTING	6601 HARDY AVE
200313258	2007	BUSINESS PERSONAL PROPERTY	QUALITY DETAIL & AUTO SALES	NO ADDRESS PROVIDED BY TAXPAYER	20055002C	2019-2020	BUSINESS PERSONAL PROPERTY	LEASE PLAN USA INC	6709 BLUE RIDGE BLVD
200313278	2009-2010	BUSINESS PERSONAL PROPERTY	NURSES UNITED AFT HEALTHCARE	6301 EVANSTON AVE	200550408	2005-2007	BUSINESS PERSONAL PROPERTY	PREMIER MORTGAGE FUNDING	NO ADDRESS PROVIDED BY TAXPAYER
200313308	2003	BUSINESS PERSONAL PROPERTY	MARY GIFTS & TREASURES	8405 PERSHING RD	200550698	2012-2013	BUSINESS PERSONAL PROPERTY	INTERSTATE BRANDS CORPORATION	6631 RAYTOWN RD
200313908	2003-2005	BUSINESS PERSONAL PROPERTY	DOLLAR PLUS CITY INC	6200 RAYTOWN RD	200551128	2009-2010	BUSINESS PERSONAL PROPERTY	MIDWEST SUCCESS	10017 E 63RD ST
200314418	2008-2020	BUSINESS PERSONAL PROPERTY	DAVEL COMMUNICATIONS INC	6236 RAYTOWN TFWY	200555568	2008	BUSINESS PERSONAL PROPERTY	RESULTS BILLING SERVICE	9935 E 63RD ST
200315698	2006	BUSINESS PERSONAL PROPERTY	AVISION AUTOGLASS LLC	NO ADDRESS PROVIDED BY TAXPAYER	200560018	2015	BUSINESS PERSONAL PROPERTY	APPLEBEES INTERNATIONAL INC #4201	9310 E M 350 HWY
200315728	2015	BUSINESS PERSONAL PROPERTY	WOODS OIL CO #28	10901 E M 350 HWY	200600858	2007-2010	BUSINESS PERSONAL PROPERTY	MCCLEIN PRODUCTION INC	11901 E 78TH TER
200316218	2009	BUSINESS PERSONAL PROPERTY	CHRYSLER MOTORS LLC	9209 E M 350 HWY	200601058	2009-2011	BUSINESS PERSONAL PROPERTY	MICKEALAS	10216 E 87TH ST
200316258	2018	BUSINESS PERSONAL PROPERTY	AMERICAN GENERAL PROPERTY INSPECT LLC	9503 E 63RD ST	200601378	2013	BUSINESS PERSONAL PROPERTY	STREETSIDE CARWASH LLC	5318 RAYTOWN RD
200321278	2012	BUSINESS PERSONAL PROPERTY	J W CONSTRUCTION INC	7700 ELM ST	200601668	2012-2016	BUSINESS PERSONAL PROPERTY	WOLFE ELECTRIC INC	7620 HARRIS AVE
200321468	2006	BUSINESS PERSONAL PROPERTY	MIDWEST BAR B Q	6332 RAYTOWN RD	200601908	2010-2011	BUSINESS PERSONAL PROPERTY	TRUCK MASTERS	11230 E M 350 HWY UNIT A
200322618	2004	BUSINESS PERSONAL PROPERTY	GREGORY JEFF CO THE	7900 HARDY AVE	200603458	2018-2019	BUSINESS PERSONAL PROPERTY	VICKYS KID KORNER II	10311 E 63RD ST
200323588	2003	BUSINESS PERSONAL PROPERTY	HEARTLAND PAINTING	8605 EVERETT RD	200603558	2015-2016	BUSINESS PERSONAL PROPERTY	SIMPLE SOLUTIONS	9905 E 85TH TER
200324368	2006-2013	BUSINESS PERSONAL PROPERTY	TAX & ACCOUNTING SHOP LLC	6326 RAYTOWN RD	200603578	2013-2020	BUSINESS PERSONAL PROPERTY	A C S IMAGE SOLUTIONS INC	7522 ELM ST
20032467F	2004	BUSINESS PERSONAL PROPERTY	INTEGRATED LEASING CORPORATION	EQUIP IN COUNTY	200604768	2018-2021	BUSINESS PERSONAL PROPERTY	JALEES BARBER SHOP	7538 RAYTOWN RD
200325498	2004-2005	BUSINESS PERSONAL PROPERTY	EDWARDS CONSTRUCTION	6329 BLUE RIDGE BLVD	200605138	2007-2009	BUSINESS PERSONAL PROPERTY	RAYS TOWN DINER	9600 E M 350 HWY
200325518	2005-2007	BUSINESS PERSONAL PROPERTY	HAIR PALACE	10009 E 62ND ST	200605378	2007	BUSINESS PERSONAL PROPERTY	5 K CAFE	6225 BLUE RIDGE BLVD
200330828	2006-2020	BUSINESS PERSONAL PROPERTY	A&L BUFF & SHINE CUSTODIAL SERVICES	5732 LANE AVE	200605428	2012-2020	BUSINESS PERSONAL PROPERTY	AUTO GALLERY	10904 E M 350 HWY
200331068	2005	BUSINESS PERSONAL PROPERTY	ADAMS TOYOTA RAYTOWN INC	UNKNOWN	200605618	2011-2012	BUSINESS PERSONAL PROPERTY	A 1 STAFFING	6635 RAYTOWN RD
200331118	2011-2013	BUSINESS PERSONAL PROPERTY	SAY IT WITH SILK	9600 E 87TH ST	200605628	2010-2020	BUSINESS PERSONAL PROPERTY	CLEAN CUTS	9600 E 53RD PL
200331678	2012	BUSINESS PERSONAL PROPERTY	SAMRA MART INC	5220 BLUE RIDGE CUT OFF	200605658	2006-2008	BUSINESS PERSONAL PROPERTY	CUTTING EDGE LLC THE	11917 E 83RD ST
200331788	2009	BUSINESS PERSONAL PROPERTY	BOB WATTS AT SUITE D	10215 E M 350 HWY SPC D	200606938	2014-2018	BUSINESS PERSONAL PROPERTY	SLAUGHTER SERVICE	10511 E 80TH ST
200331798	2012-2013	BUSINESS PERSONAL PROPERTY	CHRISTINES NAIL SALON	9331 E M 350 HWY	200610368	2007	BUSINESS PERSONAL PROPERTY	SQUARE ONE COMPUTER CONSULTING INC	11801 E 78TH TER
200331838	2009	BUSINESS PERSONAL PROPERTY	PHOTOGRAPHY BY STARLA	10400 E 72ND ST	200620138	2009-2012	BUSINESS PERSONAL PROPERTY	HANGOUT THE	10002 E 63RD TER

200640048	2006	BUSINESS PERSONAL PROPERTY	A A A CASH FLOW SOLUTIONS INC	11901 E 78TH TER	200821608	2020	BUSINESS PERSONAL PROPERTY	DALE PROPERTY SERVICES LLC	6317 HEDGES AVE
200641658	2006-2007	BUSINESS PERSONAL PROPERTY	PAYLESS AUTO MALL LLC	8809 E M 350 HWY	200900168	2013	BUSINESS PERSONAL PROPERTY	S A R CONSULTING LLC	8611 KENTUCKY AVE
200651128	2010	BUSINESS PERSONAL PROPERTY	RIGHT WAY PLUMBING CO LLC THE	8801 E 72ND ST	200900538	2009-2011	BUSINESS PERSONAL PROPERTY	CITYLIGHTS ENTERPRISES LLC	7730 RAYTOWN RD
200651761	2008	BUSINESS PERSONAL PROPERTY	MAIL BOXES ETC INC	6222 RAYTOWN TFWY	200900578	2012	BUSINESS PERSONAL PROPERTY	D&B HANDYMAN SERVICES LLC	7213 RAYTOWN RD
200653648	2006-2007	BUSINESS PERSONAL PROPERTY	MIDWEST EQUITY MORTGAGE	10215 E M 350 HWY SPC D	200901538	2011-2012	BUSINESS PERSONAL PROPERTY	KANSAS CITY PATROL & PROTECTION UNIT LLC	9212 E 85TH ST
200653688	2010	BUSINESS PERSONAL PROPERTY	DEALER SERVICES CORPORATION	8801 E 63RD ST	200902108	2010-2012	BUSINESS PERSONAL PROPERTY	MATTRESS CONNECTION INC	10004 E M 350 HWY
200654518	2020-2021	BUSINESS PERSONAL PROPERTY	KEYPOINT COUNSELING SVC LLC	6220 BLUE RIDGE CUT OFF	200904238	2021	BUSINESS PERSONAL PROPERTY	HERMANS ADVANTAGE BAIL BONDS	9915 E 63RD ST
200654908	2009-2020	BUSINESS PERSONAL PROPERTY	E L CATRACHO	6530 RAYTOWN RD UNIT A	200904828	2009	BUSINESS PERSONAL PROPERTY	CITY GROUNDS COFFEE SHOP	6142 RAYTOWN TFWY
200655848	2008-2009	BUSINESS PERSONAL PROPERTY	BIG MOMMAS HOMEMADE ROLLS	11507 E 63RD ST	200905708	2009-2021	BUSINESS PERSONAL PROPERTY	B & B JANITORIAL SERVICE	8311 SPRING VALLEY RD
200656368	2006	BUSINESS PERSONAL PROPERTY	TRACS INC	10010 E 63RD ST	200908818	2009	BUSINESS PERSONAL PROPERTY	SURROUND SOUND MANGEMENT & PRODUCTIONS	9909 E 63RD ST UNIT F
200656458	2009	BUSINESS PERSONAL PROPERTY	INKWORKS	8114 MANNING AVE	200908828	2009	BUSINESS PERSONAL PROPERTY	PLAY IT STRAIGHT MUSIC ACADEMY	8220 HARRIS CT
200656668	2019	BUSINESS PERSONAL PROPERTY	TOP DISCOUNT SMOKE & C STORE	9033 E M 350 HWY	200909338	2021	BUSINESS PERSONAL PROPERTY	SPRUCE	6104 ARLINGTON AVE
20066815D	2009	BUSINESS PERSONAL PROPERTY	MOBILE STORAGE GROUP INC	9812 E 56TH ST	200909958	2011	BUSINESS PERSONAL PROPERTY	HILLCREST BANK	10212 E 85TH TER
200700178	2009-2013	BUSINESS PERSONAL PROPERTY	ANGIE JOHNSON PHOTOGRAPHY	8404 DITMAN AVE	200910508	2021	BUSINESS PERSONAL PROPERTY	ROYAL ENGINEERING CONSOLTANTS, INC	5400 ELM AVE
200700568	2008-2009	BUSINESS PERSONAL PROPERTY	CITY GROUNDS COFFEE SHOP	6142 RAYTOWN TFWY	200910698	2014-2018	BUSINESS PERSONAL PROPERTY	ALL OCCASION DESIGNS	8214 E 67TH ST
200700788	2009-2011	BUSINESS PERSONAL PROPERTY	EAST 350 CAR WASH	10805 E M 350 HWY	200911038	2013-2015	BUSINESS PERSONAL PROPERTY	WEE CARE INFANT & TODDLER CARE SERVICES	6218 RAYTOWN TFWY
200701088	2008	BUSINESS PERSONAL PROPERTY	J & J VENTURES	6304 STERLING AVE	200911538	2013	BUSINESS PERSONAL PROPERTY	CLEAR TALK COMMUNICATIONS LLC	11817 E 83RD ST
200701098	2007	BUSINESS PERSONAL PROPERTY	JUDGMENT JUSTIFICATION	9311 E 84TH ST	200911858	2016	BUSINESS PERSONAL PROPERTY	D & M SPECIALTIES LLC	6900 HAWTHORNE AVE
200701138	2011-2016	BUSINESS PERSONAL PROPERTY	KVHK MOBILE	7536 RAYTOWN RD	200913628	2011-2016	BUSINESS PERSONAL PROPERTY	C J L ENTERPRIZE	11010 E 63RD ST
200701308	2009	BUSINESS PERSONAL PROPERTY	NEELY CHRIS PAINTING	5508 HARDY AVE	200913828	2012-2020	BUSINESS PERSONAL PROPERTY	IESHA MCCULLOUGH	6450 RAYTOWN RD
200701548	2007-2009	BUSINESS PERSONAL PROPERTY	J C P III INC	7302 RAYTOWN RD	200914448	2012	BUSINESS PERSONAL PROPERTY	AWESOME DETAIL & ACCESSORIES	5616 RAYTOWN RD
200701728	2012-2016	BUSINESS PERSONAL PROPERTY	SALON MILAN	7302 RAYTOWN RD	200914658	2011-2020	BUSINESS PERSONAL PROPERTY	SHEAR PRECISION LLC	11539 E 63RD ST
200702288	2013-2020	BUSINESS PERSONAL PROPERTY	B S TAX INC	6520 RAYTOWN RD UNIT J	200915738	2012-2014	BUSINESS PERSONAL PROPERTY	JACKSON COUNTY SQUARE PROPERTIES INC	10208 E M 350 HWY
200703238	2010-2017	BUSINESS PERSONAL PROPERTY	UNIQUE QUALITY CARE LLC	6133 KENTUCKY AVE	201001468	2012-2013	BUSINESS PERSONAL PROPERTY	FIVE STAR COMPUTER SERVICES LLC	10005 E 67TH ST
200704288	2008	BUSINESS PERSONAL PROPERTY	MR BS SURPLUS	10004 E M 350 HWY	201001878	2011-2012	BUSINESS PERSONAL PROPERTY	DAMASCUS ROAD SHIELD OF FAITH INC	9933 E 56TH ST
200704798	2009-2021	BUSINESS PERSONAL PROPERTY	KC PROPERTY PRESERVATION LLC	6718 HARRIS AVE	201002518	2012	BUSINESS PERSONAL PROPERTY	GARY KIVETT	5600 NORTHERN AVE
200704828	2008	BUSINESS PERSONAL PROPERTY	RAYTOWN CLEANERS	10101 E 63RD ST	201003388	2011-2020	BUSINESS PERSONAL PROPERTY	PLAZA FORD-IDEAL	10101 E 63RD ST
200706808	2011-2018	BUSINESS PERSONAL PROPERTY	KIDDELAND DAYCARE	11601 E 51ST ST	201003868	2017-2020	BUSINESS PERSONAL PROPERTY	BROTHERS HOME IMPROVEMENT & LAWN CARE	6119 E 72ND TER
200706928	2009	BUSINESS PERSONAL PROPERTY	BROOKE AUTO INSURANCE AGENCY	6200 RAYTOWN TFWY	201004158	2021	BUSINESS PERSONAL PROPERTY	OMAHA TROPICAL MARKET	11601 RAYTOWN RD
200710178	2009-2010	BUSINESS PERSONAL PROPERTY	MODERN WOODMEN OF AMERICA	10001 E 67TH ST	201004278	2016-2017	BUSINESS PERSONAL PROPERTY	STCHARLES AMUSEMENT INC/AMOUR ONE AMUSE	11509 E 63RD ST
200711338	2021	BUSINESS PERSONAL PROPERTY	IRISH PUB HOUSE	6332 RAYTOWN RD	201004318	2011-2013	BUSINESS PERSONAL PROPERTY	SKL INSURANCE AGENCY LLC/DBA FARMER INSU	10215 E M 350 HWY SPC E
200711828	2020-2021	BUSINESS PERSONAL PROPERTY	GCN HOLDING LLC	SITUS VERIFICATION IN PROGRESS	201004368	2015-2020	BUSINESS PERSONAL PROPERTY	RAYTOWN LICENSE OFFICE	6138 RAYTOWN TFWY
200715598	2007-2010	BUSINESS PERSONAL PROPERTY	PREMIER REAL ESTATE INVESTMENTS	6335 BLUE RIDGE BLVD	201005588	2017-2021	BUSINESS PERSONAL PROPERTY	Z IMAGE HAIR SALON LLC	6614 A BLUE RIDGE BLVD
200717108	2011	BUSINESS PERSONAL PROPERTY	CYNSANTIONAL HAIR DESIGN	8647 RAYTOWN RD	201006428	2015-2021	BUSINESS PERSONAL PROPERTY	ON-TIME PATROL LLC	10900 E 58TH TER
200717128	2016	BUSINESS PERSONAL PROPERTY	BODY WISE SOLUTIONS LLC	8609 CRESCENT AVE	201006718	2014-2016	BUSINESS PERSONAL PROPERTY	J V TRUST	5420 BLUE RIDGE CUT OFF APT 309
200717218	2009-2020	BUSINESS PERSONAL PROPERTY	HEALTH E NET INC	9600 E 53RD ST	201006848	2010	BUSINESS PERSONAL PROPERTY	DUANES COMPLETE AUTO REPAIR	9800 E 87TH ST UNIT C
200717518	2007-2012	BUSINESS PERSONAL PROPERTY	TERI WEBER	5528 RAYTOWN RD	201007048	2013-2015	BUSINESS PERSONAL PROPERTY	RENEE'S RESUME SERVICE	9221 E 54TH TER
200717668	2007-2009	BUSINESS PERSONAL PROPERTY	MMPSMS CHILDRENS EDUCATION FUND TRUST	6220 BLUE RIDGE CUT OFF	201007658	2011-2015	BUSINESS PERSONAL PROPERTY	GOOD TIMES TWO LLC	6151 BLUE RIDGE BLVD
200717888	2016	BUSINESS PERSONAL PROPERTY	LINDAS JEWELRY	8407 EVERETT ST	201009208	2014-2015	BUSINESS PERSONAL PROPERTY	CAMELOT MARBLE & GRANITE COUNTERTOPS LL	8714 E 87TH ST
200717998	2019-2021	BUSINESS PERSONAL PROPERTY	NEW CHILD PUBLISHING	6807 LAKESHORE DR	201009588	2011-2013	BUSINESS PERSONAL PROPERTY	S&R PROFESSIONAL DRY CLEANERS	10014 E 67TH ST
200718128	2021	BUSINESS PERSONAL PROPERTY	ARCHITECTURAL CONCEPTIONS LLC	5637 BLUE RIDGE CUT OFF	201011278	2013	BUSINESS PERSONAL PROPERTY	IMAAN ALI II ENTERPRISES INC	7542 RAYTOWN RD
200802108	2011-2012	BUSINESS PERSONAL PROPERTY	NEPTUNES LAUNDRY	6121 BLUE RIDGE BLVD	201012818	2018-2021	BUSINESS PERSONAL PROPERTY	G E PLUMBING & MECHANICAL LLC	9907 E 76TH ST
200802138	2010-2012	BUSINESS PERSONAL PROPERTY	GEAR AUTOMOTIVE LLC	8910 E M 350 HWY	201013108	2017	BUSINESS PERSONAL PROPERTY	SANTOKU INC	6251 BLUE RIDGE BLVD
200802178	2019	BUSINESS PERSONAL PROPERTY	LEOS BARBER SHOP	612 SW 3RD ST UNIT C	201013538	2016-2021	BUSINESS PERSONAL PROPERTY	R E SUPREME LLC	11404 E 69TH ST
200802198	2009	BUSINESS PERSONAL PROPERTY	GODS FAVOR JEWELRY ACCESSORIES & MORE	9324 E 84TH TER	201013928	2011	BUSINESS PERSONAL PROPERTY	WOW DISCOUNT CLEANER	8701 A RAYTOWN RD
200802208	2009	BUSINESS PERSONAL PROPERTY	ALLIED HOME MORTGAGE	7318 RAYTOWN RD	201014728	2019-2021	BUSINESS PERSONAL PROPERTY	ALLIED CLEANING SERVICES	8400 DITMAN AVE
200802278	2009	BUSINESS PERSONAL PROPERTY	CLEAN AIR FOR LIFE	6317 RAYTOWN RD	201016018	2017-2018	BUSINESS PERSONAL PROPERTY	MID AMERICA COACH INC	8809 E M 350 HWY
200804388	2008	BUSINESS PERSONAL PROPERTY	SQUEAKY CLEAN CAR WASH	11308 E M 350 HWY	201018008	2013-2020	BUSINESS PERSONAL PROPERTY	SYLVESTER SISCO	7501 EVANSTON AVE
200804428	2019-2020	BUSINESS PERSONAL PROPERTY	AMERICAN PAYDAY LOANS #4312	7544 RAYTOWN RD	201018138	2010-2011	BUSINESS PERSONAL PROPERTY	RAYTOWN'S INK SPOT	7312 RAYTOWN RD UNIT A
200804728	2009	BUSINESS PERSONAL PROPERTY	ROY LEE HATS AND CAPS	8308 MANNING AVE	201100588	2017-2020	BUSINESS PERSONAL PROPERTY	PHEM LLC	11900 JESSICA LN
200805058	2021	BUSINESS PERSONAL PROPERTY	LUTIF'S FRIED FISH	9120 E M 350 HWY	201100838	2019	BUSINESS PERSONAL PROPERTY	INFRASOURCE UNDERGROUND SERVICES LLC	11701 E M 350 HWY
200805188	2012	BUSINESS PERSONAL PROPERTY	UNLIMITED PROFESSIONAL CLEANING SERVICE	10101 E 83RD ST	201102108	2017-2020	BUSINESS PERSONAL PROPERTY	S & R FUEL LLC	6701 BLUE RIDGE BLVD
200805528	2011-2012	BUSINESS PERSONAL PROPERTY	FASHION NAILS	6612 BLUE RIDGE BLVD	201102558	2014-2020	BUSINESS PERSONAL PROPERTY	ISABELL HOMES LLC	8600 E 81ST TER
200805548	2008	BUSINESS PERSONAL PROPERTY	GENES HAULING	9313 E 84TH ST	201105358	2012	BUSINESS PERSONAL PROPERTY	CELL PHONE WORLD AND DISCOUNT TOBACCO LL	6614 A BLUE RIDGE BLVD
200806488	2008-2009	BUSINESS PERSONAL PROPERTY	MASTEN OF STEEL	9600 E 53RD PL	201105748	2021	BUSINESS PERSONAL PROPERTY	STRIKE ZONE PRO SHOP THE	11400 E M 350 HWY
200807138	2010-2013	BUSINESS PERSONAL PROPERTY	J & D ENTERPRISES	11308 E 50TH TER	201106088	2021	BUSINESS PERSONAL PROPERTY	TRILOGY SPORTS AND FITNESS , INC	7046 WOODSON RD
200808358	2010-2017	BUSINESS PERSONAL PROPERTY	ARREDLA LAWN COMPANY & LANDSCAPING	6012 HARRIS AVE	201107488	2013-2016	BUSINESS PERSONAL PROPERTY	MINC STYLE CENTER	7304 RAYTOWN RD
200808378	2013-2019	BUSINESS PERSONAL PROPERTY	BEST NAIL SALON	11565 E 63RD ST	201107638	2021	BUSINESS PERSONAL PROPERTY	GOODE DEVELOPING & ASSOCIATES LLC	8809 E M 350 HWY
200808398	2009	BUSINESS PERSONAL PROPERTY	RANDES COLONIC DAY SPA	3923 EUCLID AVE	201107698	2015	BUSINESS PERSONAL PROPERTY	MIKES CYCLE CENTER LLC	9616 E 63RD ST
200810628	2010	BUSINESS PERSONAL PROPERTY	DAVID LEA TRAINING LLC	6217 BLUE RIDGE BLVD	201107908	2021	BUSINESS PERSONAL PROPERTY	KANDY SHOP THE	8832 E M 350 HWY
200810958	2008-2010	BUSINESS PERSONAL PROPERTY	J & J INVESTOR LLC	9804 E 87TH ST UNIT C	201108008	2012-2016	BUSINESS PERSONAL PROPERTY	DANIEL WELLS AND DELORIS WELLS	8315 LANE AVE
200811308	2010-2012	BUSINESS PERSONAL PROPERTY	PACE HOME SERVICES	10908 E 59TH TER	201109548	2018-2020	BUSINESS PERSONAL PROPERTY	PHOENIX DISASTER RECOVERY MGMT LLC	6217 ENGLEWOOD AVE
200813158	2008	BUSINESS PERSONAL PROPERTY	PHILLIPS/CIRCLE K #2706332	9805 E M 350 HWY	201110238	2021	BUSINESS PERSONAL PROPERTY	CLASSIC CATERING BY GOURMET GATHERINGS L	6631 RAYTOWN RD
200814018	2020	BUSINESS PERSONAL PROPERTY	SONIC REAL ESTATE PROPERTIES	6525 RAYTOWN RD	201110298	2015	BUSINESS PERSONAL PROPERTY	SALON 1101	6154 RAYTOWN TFWY
200815928	2008-2010	BUSINESS PERSONAL PROPERTY	STERLING PAYPHONES LLC	6210 RAYTOWN TFWY	201110978	2017-2021	BUSINESS PERSONAL PROPERTY	GREENBOY TRANSPORTATION LLC	6838 RAYTOWN RD
200820058	2009	BUSINESS PERSONAL PROPERTY	LOVE OF ANIMALS	6528 RAYTOWN RD UNIT H	201113348	2012	BUSINESS PERSONAL PROPERTY	PLEASANT HILL MAINTENANCE LLC	9500 E 63RD ST
200820208	2012-2021	BUSINESS PERSONAL PROPERTY	STRAIGHT LINE BARBER SHOP	9504 E 63RD ST	201114148	2013-2020	BUSINESS PERSONAL PROPERTY	A TOUCH OF ELEGANCE CATERING	5501 BLUE RIDGE BLVD
200820238	2021	BUSINESS PERSONAL PROPERTY	LOGAN STEVE DBA KCS CHIMNEY SERVICES	7903 HEDGES AVE	201114428	2012-2015	BUSINESS PERSONAL PROPERTY	EL MINI SUPER II LLC	6528 RAYTOWN RD UNIT G
200820258	2009-2013	BUSINESS PERSONAL PROPERTY	A CLEAN SOLUTION SERVICE	8205 E 86TH TER	201114488	2020-2021	BUSINESS PERSONAL PROPERTY	BLUE YUU INCORPORATED	9700 E 63RD ST
200820578	2009-2020	BUSINESS PERSONAL PROPERTY	MUELLER PAINTING LLC	9800 E 81ST ST	201112208	2019-2021	BUSINESS PERSONAL PROPERTY	MKF 2095 INC	10000 E M 350 HWY
200820618	2019-2021	BUSINESS PERSONAL PROPERTY	SUPERIOR AUTO SOUND & ELECTRONICS INC	9831 E M 350 HWY W	201113978	2016-2017	BUSINESS PERSONAL PROPERTY	STINGRAY MOTORS LLC	11780 E 83RD ST
200820638	2008-2013	BUSINESS PERSONAL PROPERTY	SALON TCB	9327 E M 350 HWY	201117628	2021	BUSINESS PERSONAL PROPERTY	METRO ON TIME DELIVERY LLC	6217 ENGLEWOOD AVE

201200968	2019-2021	BUSINESS PERSONAL PROPERTY	DENNISON MAHIN LLC	7054 NORTHERN AVE	201601538	2017-2021	BUSINESS PERSONAL PROPERTY	JILES TRANSCORP SERVICES LLC	8607 FORD AVE
201202728	2014-2017	BUSINESS PERSONAL PROPERTY	RUSSELL DILLON	6219 WILLOW AVE	201601608	2016	BUSINESS PERSONAL PROPERTY	NEWZROOM 2 CAFE LLC	6020 BLUE RIDGE BLVD
201203108	2018-2019	BUSINESS PERSONAL PROPERTY	MONOPOLY ACQUISITIONS LLC	SITUS VERIFICATION IN PROGRESS	20160165F	2017	BUSINESS PERSONAL PROPERTY	GENERAL WIRELESS OPERATIONS, INC	9041 E M 350 HWY
201203838	2020-2021	BUSINESS PERSONAL PROPERTY	ROBERT A AND GRACE MCCLOSKEY	9001 E 65TH TER	201602868	2017-2018	BUSINESS PERSONAL PROPERTY	BEAKEN INC	7101 NORWOOD AVE
201204258	2021	BUSINESS PERSONAL PROPERTY	SHOW-ME QUILTING	10215 E M 350 HWY SPC A	201603008	2017-2020	BUSINESS PERSONAL PROPERTY	CLEAN 1ST LLC	9706 E 82ND ST
20120454C	2021	BUSINESS PERSONAL PROPERTY	JPMORGAN CHASE BANK NA	9401 E M 350 HWY	201603298	2017	BUSINESS PERSONAL PROPERTY	ONE LOVE CARE AND TRANSPORTATION LLC	8607 FORD AVE
20120629G	2021	BUSINESS PERSONAL PROPERTY	SMUCKER FOODSERVICE, INC	11400 HIDDEN LAKE DR	201604458	2017-2018	BUSINESS PERSONAL PROPERTY	PRESTIGIOUS GREENS LLC	7405 CRISP AVE
20120629K	2021	BUSINESS PERSONAL PROPERTY	SMUCKER FOODSERVICE, INC	8745 JAMES A REED RD	201606018	2018-2019	BUSINESS PERSONAL PROPERTY	TERRY HARRIS	7509 APPLETON AVE
201206338	2016	BUSINESS PERSONAL PROPERTY	ALPHA & OMEGA MECHANICAL LLC	6204 HEDGES AVE	201606228	2019-2020	BUSINESS PERSONAL PROPERTY	CJS SYSTEMS LLC	9600 E 53RD PL
201206978	2008-2012	BUSINESS PERSONAL PROPERTY	DEVIONES'S MEDICAL SUPPLIER LLC	10011 E 67TH ST	201608998	2018-2021	BUSINESS PERSONAL PROPERTY	ICON EXTERIORS LLC	11404 E M 350 HWY A
201209538	2012	BUSINESS PERSONAL PROPERTY	AMERICA'S WATER HEATER RENTALS LLC	8421 ARLINGTON AVE	201609608	2019-2021	BUSINESS PERSONAL PROPERTY	VAPOR ROOM UNLIMITED LLC	9598 E 86TH ST
201211178	2020	BUSINESS PERSONAL PROPERTY	GINNERS RESTAURANTS LLC	11555 E M 63RD ST	201610038	2018	BUSINESS PERSONAL PROPERTY	FLIGHT TIME COURIERS LLC	5332 HUNTER ST
20121253M	2021	BUSINESS PERSONAL PROPERTY	PINNACLE PROPANE EXPRESS LLC	9005 E M 350 HWY	201610488	2019-2021	BUSINESS PERSONAL PROPERTY	COMPLETE IMAGE CONSTRUCTION LLC	5900 RAYTOWN TRFY
20121253T	2021	BUSINESS PERSONAL PROPERTY	PINNACLE PROPANE EXPRESS LLC	8701 A RAYTOWN RD	201610728	2019-2021	BUSINESS PERSONAL PROPERTY	ALL SEASONS LANDSCAPE SERVICES LLC	10013 E 86TH TER
201213238	2015-2017	BUSINESS PERSONAL PROPERTY	DOGGIE DO RIGHT LLC	11230 E M 350 HWY UNIT A	201610778	2020-2021	BUSINESS PERSONAL PROPERTY	SEMPER BLUE PROFESSIONALSERVICES	6222 RAYTOWN TFWY
201213348	2013-2017	BUSINESS PERSONAL PROPERTY	LASTING IMPRESSION BEAUTY SALON	9909 E 63RD ST UNIT E	20161100E	2021	BUSINESS PERSONAL PROPERTY	PERFECT OUTPUT LLC	9500 E 63RD ST
201213828	2015	BUSINESS PERSONAL PROPERTY	GWENDOLYN R WILLIAMS	6151 BLUE RIDGE BLVD	201700588	2020-2021	BUSINESS PERSONAL PROPERTY	OP AMIN LLC	6514 BLUE RIDGE BLVD UNIT A
201214278	2021	BUSINESS PERSONAL PROPERTY	JUNIE JUICE ENTERPRISES LLC	8600 E 81ST TER	201702968	2021	BUSINESS PERSONAL PROPERTY	RAYTOWN PLAZA LAUNDROMAT LLC	6121 BLUE RIDGE BLVD
201300878	2016	BUSINESS PERSONAL PROPERTY	TIC TAC TOW & RECOVERY LLC	11705 M 350 HWY E UNIT D	201703008	2018-2020	BUSINESS PERSONAL PROPERTY	D&D SECURITY SURVEILLANCE LLC	6222 RAYTOWN TFWY
201303148	2014-2020	BUSINESS PERSONAL PROPERTY	ALPHA & OMEGA CONSTRUCTION & TOWER SVCS	10905 E 81ST TER	201703088	2018-2021	BUSINESS PERSONAL PROPERTY	PRIME TIME TRANSPORTATION SERVICE LLC	11411 E 59TH TER
201303788	2020-2021	BUSINESS PERSONAL PROPERTY	ROK IT ADVERTISING INC	10009 E 67TH ST	201703098	2019-2020	BUSINESS PERSONAL PROPERTY	AROUND THE CLOCK TOWING LLC	10009 E 70TH TER
201303888	2016-2020	BUSINESS PERSONAL PROPERTY	JUDON SOFTWARE LLC	8403 DITMAN AVE	201703138	2014-2019	BUSINESS PERSONAL PROPERTY	EXTREME TRUCK AND TRAILER REPAIR LLC	11201 E 59TH ST
201305138	2021	BUSINESS PERSONAL PROPERTY	BAILEY PAIGE PHOTOGRAPHY LC	11404 E 38TH ST	201703688	2021	BUSINESS PERSONAL PROPERTY	JUDON PROPERTIES LLC	8403 DITMAN AVE
20130521D	2021	BUSINESS PERSONAL PROPERTY	BANK OF THE WEST	9315 E M 350 HWY	201703948	2017	BUSINESS PERSONAL PROPERTY	MUNJI INC	6701 BLUE RIDGE BLVD
201306448	2016	BUSINESS PERSONAL PROPERTY	123 MATTRESS LLC	9105 E M 350 HWY	201704118	2018-2019	BUSINESS PERSONAL PROPERTY	SPIKED WIRELESS KC LLC	9047 E M 350 HWY
201307438	2021	BUSINESS PERSONAL PROPERTY	KCTECHSOFTHE.NET INC	10227 E 61ST ST	201704198	2020	BUSINESS PERSONAL PROPERTY	BILL SEALS	7833 WESTRIDGE RD
201307808	2015-2019	BUSINESS PERSONAL PROPERTY	UTA DISTRIBUTION COMPANY INC	8015 TENNESSEE AVE	201705218	2014-2017	BUSINESS PERSONAL PROPERTY	EXQUISITE JEWELRY LLC	6127 BLUE RIDGE BLVD
201308488	2019-2020	BUSINESS PERSONAL PROPERTY	KELRY CO	11704 E M 350 HWY	201705718	2021	BUSINESS PERSONAL PROPERTY	SHOW ME FISH AND CHICKEN LLC	5220 BLUE RIDGE BLVD
201308758	2016-2020	BUSINESS PERSONAL PROPERTY	VARIETY BRANDS DISTRIBUTION LLC	11651 E M 350 HWY	201707018	2018	BUSINESS PERSONAL PROPERTY	AHMED ABDO	8801 E 63RD ST
201309728	2014	BUSINESS PERSONAL PROPERTY	MIKE LERNER	5444 ASH AVE	201707498	2018	BUSINESS PERSONAL PROPERTY	KULWHINDER SINGH	8801 E 63RD ST
201312938	2017-2018	BUSINESS PERSONAL PROPERTY	MINUTE KEY INC	10300 E M 350 HWY	201707508	2018	BUSINESS PERSONAL PROPERTY	WHOLESALE FINANCE & TRUCK	8801 E 63RD ST
201313198	2021	BUSINESS PERSONAL PROPERTY	SKY TRANSPORTATION LLC	5612 DITZLER AVE	201708158	2018	BUSINESS PERSONAL PROPERTY	COURTESY OF BB LLC	8627 GREENWOOD RD
20140027L	2021	BUSINESS PERSONAL PROPERTY	NPC QUALITY BURGERS INC	9708 E 63RD ST	201708358	2018-2021	BUSINESS PERSONAL PROPERTY	RENEE REEVES VISUALS	8810 E 59TH ST
201401628	2017	BUSINESS PERSONAL PROPERTY	C. HALL HOLDINGS LLC	7021 HAWTHORNE AVE	201708868	2018	BUSINESS PERSONAL PROPERTY	EXCLUSIVE CORVETTE CLUB LLC	6151 BLUE RIDGE BLVD
201404108	2015-2016	BUSINESS PERSONAL PROPERTY	A & F BEAUTY SUPPLY	8647 RAYTOWN RD	201710918	2021	BUSINESS PERSONAL PROPERTY	1ST ACCESS LLC	8801 E 63RD ST
201404298	2021	BUSINESS PERSONAL PROPERTY	SUMMIT HEALTH CARE, LLC	6033 RAYTOWN RD	201711768	2021	BUSINESS PERSONAL PROPERTY	MAYDELIN LABOR SERVICE LLC	8605 MAPLE AVE
201405148	2019-2021	BUSINESS PERSONAL PROPERTY	WAL MART STORES INC	10608 E 64TH TER	201712038	2021	BUSINESS PERSONAL PROPERTY	SECOND TO NONE LLC	11125 85TH ST
201406398	2021	BUSINESS PERSONAL PROPERTY	EMMA HACKNEY	6631 RAYTOWN RD	201800448	2018	BUSINESS PERSONAL PROPERTY	AD XPRESS INC	8801 E 63RD ST
201407048	2021	BUSINESS PERSONAL PROPERTY	PEMBRICK TRUCKING LLC	8523 STERLING AVE	201801128	2019-2020	BUSINESS PERSONAL PROPERTY	NARS LLC	6251 BLUE RIDGE BLVD
201407228	2015-2016	BUSINESS PERSONAL PROPERTY	PATRICIA MOORE	9919 E 63RD ST	201801798	2021	BUSINESS PERSONAL PROPERTY	TALLEY WILLIAMS FAMILY TRUCKING LLC	5829 FARLEY AVE
201407268	2015-2020	BUSINESS PERSONAL PROPERTY	DEJAUNA LOUIS	6218 ARLINGTON AVE	201803398	2021	BUSINESS PERSONAL PROPERTY	MARQUETTA FORBUSH & NICOLE CROSS	9909 E 63RD ST UNIT A
201407648	2015	BUSINESS PERSONAL PROPERTY	HOPE AND HEALING WORSHIP CENTER	9704 E 81ST TER	201803838	2018-2020	BUSINESS PERSONAL PROPERTY	RIVERA FOODS LLC	6225 BLUE RIDGE BLVD
201407838	2021	BUSINESS PERSONAL PROPERTY	DUNCAN PIES LLC	6204 RAYTOWN TFWY	201803918	2020	BUSINESS PERSONAL PROPERTY	W&G CONSTRUCTION LLC	6105 ARLINGTON AVE
201409588	2021	BUSINESS PERSONAL PROPERTY	DAKA INC	6520 RAYTOWN RD UNIT D	201804278	2019	BUSINESS PERSONAL PROPERTY	ROBINSON & SONS REMODELING LLC	7701 RAYTOWN RD APT 11
201410318	2018-2020	BUSINESS PERSONAL PROPERTY	EUNHEE LLC	6215 BLUE RIDGE BLVD	20180765E	2020	BUSINESS PERSONAL PROPERTY	SMILE DOCTORS OF MISSOURI LLC	9500 E M 350 HWY
201410388	2015-2020	BUSINESS PERSONAL PROPERTY	PATRICIA A MOORE	6206 RAYTOWN RD	201809168	2019-2020	BUSINESS PERSONAL PROPERTY	MISSOURI HAULERS LLC	8801 E 63RD ST
201410428	2018-2020	BUSINESS PERSONAL PROPERTY	KIMBERLY STEFFAN	6143 BLUE RIDGE BLVD	201810338	2021	BUSINESS PERSONAL PROPERTY	MOBILEDOTPHYSICAL LLC	6004 BLUE RIDGE BLVD
201411248	2021	BUSINESS PERSONAL PROPERTY	WESTRIDGE GARDENS NURSING & REHABILITATI	11901 JESSICA LN	201810538	2020-2021	BUSINESS PERSONAL PROPERTY	LAWN ENTERPRISE LLC	5741 STERLING AVE
201411658	2020	BUSINESS PERSONAL PROPERTY	BD TOOLS INC	9016 E 73RD ST	201811938	2021	BUSINESS PERSONAL PROPERTY	MOORE MARKETING AND COMMUNICATIONS LLC	8810 RICHARDS DR
201500528	2021	BUSINESS PERSONAL PROPERTY	EMERALD HOUSE INC	8809 E M 350 HWY	201900988	2019-2020	BUSINESS PERSONAL PROPERTY	MINI SMOKE & LIQUOR LLC	5236 BLUE RIDGE BLVD
20150100C	2015	BUSINESS PERSONAL PROPERTY	GAS MART USA INC	9805 E M 350 HWY	201901298	2021	BUSINESS PERSONAL PROPERTY	HEARTLAND GROUNDS LLC	5401 RAYTOWN RD
20150100D	2015	BUSINESS PERSONAL PROPERTY	GAS MART USA INC	6905 BLUE RIDGE BLVD UNIT A	201901398	2020	BUSINESS PERSONAL PROPERTY	SHIFT TRANSMISSION INC	5247 WOODSON RD
20150100E	2015	BUSINESS PERSONAL PROPERTY	GAS MART USA INC	6024 BLUE RIDGE BLVD	201901818	2019-2021	BUSINESS PERSONAL PROPERTY	KEMP CONSTRUCTION AND REMODEL LLC	9112 E M 350 HWY
20150100G	2015	BUSINESS PERSONAL PROPERTY	GAS MART USA INC	8100 WESTRIDGE RD	201903078	2021	BUSINESS PERSONAL PROPERTY	TOTAL OFFICE SOLUTIONS LLC	6304 WILLOW AVE
201501238	2016-2020	BUSINESS PERSONAL PROPERTY	BRANDON'S AUTO LLC	5247 WOODSON RD	201904138	2020	BUSINESS PERSONAL PROPERTY	ROOT DEALS LLC	6103 ARLINGTON AVE
201502108	2021	BUSINESS PERSONAL PROPERTY	GIPSON TRUCKING INC	8411 SPRING VALLEY RD	201905048	2021	BUSINESS PERSONAL PROPERTY	RHS LAWCARE LLC	11805 E 76TH TER
201502528	2018-2020	BUSINESS PERSONAL PROPERTY	MARLINA DE LA TORRE	6140 RAYTOWN RD APT 104	201905888	2021	BUSINESS PERSONAL PROPERTY	TITANIUM TRUCKING LLC	6112 DITZLER AVE
201503678	2021	BUSINESS PERSONAL PROPERTY	MONROE'S MARKET LLC	11545 E 63RD ST	201907648	2019-2021	BUSINESS PERSONAL PROPERTY	SRZ OP ALUTUMN LLC	6124 RAYTOWN RD
201504208	2019-2021	BUSINESS PERSONAL PROPERTY	XTRACARE ADULT DAY CARE CENTER LLC	6311 EVANSTON AVE	201908018	2021	BUSINESS PERSONAL PROPERTY	ALL ABOUT YOU ADULT DAY SERVICES LLC	7600 RAYTOWN RD
201506468	2020-2021	BUSINESS PERSONAL PROPERTY	DEDICATED INVESTIGATIONS LLC	5500 LANE AVE	201909438	2021	BUSINESS PERSONAL PROPERTY	LADYBIRD LLC	8611 E 83RD ST
201508508	2019-2021	BUSINESS PERSONAL PROPERTY	TYARKS CABLING LLC	6904 WILDWOOD DR	202020238	2020	BUSINESS PERSONAL PROPERTY	KROBES LLC	6151 BLUE RIDGE BLVD
201508968	2020-2021	BUSINESS PERSONAL PROPERTY	CRANE BREWING COMPANY LLC	6515 RAILROAD ST	202020251J	2021	BUSINESS PERSONAL PROPERTY	CERBERUS SFR HOLDINGS LP	7716 ENGLEWOOD AVE
201509538	2020	BUSINESS PERSONAL PROPERTY	KAY-BEE'S LLC	6625 RAYTOWN RD	202020290C	2021	BUSINESS PERSONAL PROPERTY	FUSA MARKETING	11503 E 63RD ST
201510718	2018-2020	BUSINESS PERSONAL PROPERTY	LADY'S SPORTS BAR LLC	6635 RAYTOWN RD	202003298	2021	BUSINESS PERSONAL PROPERTY	L R M LEASING COMPANY INC	8801 E 63RD ST
201511228	2019-2021	BUSINESS PERSONAL PROPERTY	PRODIGY PLUMBING & MECHANICAL INC	8402 WESTRIDGE RD	202003598	2021	BUSINESS PERSONAL PROPERTY	ASSUMPTA ALLIED HEALTH CAREER CENTER	6033 RAYTOWN RD
201511238	2018-2020	BUSINESS PERSONAL PROPERTY	BAMS SOLUTIONS INC	10920 E M 350 HWY	202003748	2021	BUSINESS PERSONAL PROPERTY	HERE TO THERE PROPERTIES LLC	6645 CEDAR AVE APT A
201512998	2017-2020	BUSINESS PERSONAL PROPERTY	LANDRY ATHLETICS LLC	11230 E M 350 HWY UNIT A	202004188	2021	BUSINESS PERSONAL PROPERTY	GOLD RUSH DELIVERY LLC	7204 CRISP AVE
201513388	2018-2020	BUSINESS PERSONAL PROPERTY	MONARCHS ON THE MOVE	7021 KENTUCKY AVE	202006838	2021	BUSINESS PERSONAL PROPERTY	JEMS TRANSPORT LLC	5709 LAUREL AVE
201514018	2016-2020	BUSINESS PERSONAL PROPERTY	KIC SERVICES INC	8304 MANNING AVE	202006858	2021	BUSINESS PERSONAL PROPERTY	SMART FOUNDATION SYSTEMS LLC	5614 RAYTOWN RD
201514268	2019-2021	BUSINESS PERSONAL PROPERTY	TONY'S REMODELING & CLEANING LLC	9705 E 84TH ST	202008408	2021	BUSINESS PERSONAL PROPERTY	J & C AUTO GLASS LLC	9909 E 63RD ST UNIT E
201600088	2019-2021	BUSINESS PERSONAL PROPERTY	USMAN & BROTHERS LLC	5220 BLUE RIDGE CUT OFF	202008538	2021	BUSINESS PERSONAL PROPERTY	SERENITY CAFE, LLC	6109 BLUE RIDGE BLVD
201600378	2021	BUSINESS PERSONAL PROPERTY	MIKE SAGER	8323 WOODSON DR	202076108	2011-2020	BUSINESS PERSONAL PROPERTY	THERMO SPAS INC	7703 CRESCENT AVE

202100198	2021	BUSINESS PERSONAL PROPERTY	DISABLED BUT NOT REALLY FOUNDATION	8400 STARK AVE	072689451	2003	INDIVIDUAL PERSONAL PROPERTY	BERG NORMA L	NO ADDRESS PROVIDED BY TAXPAYER
202101518	2021	BUSINESS PERSONAL PROPERTY	SW1 BRITTANY PLACE LP	8620 E UTOPIA DR	072689834	2002	INDIVIDUAL PERSONAL PROPERTY	BERGLUND JIMMIE D	NO ADDRESS PROVIDED BY TAXPAYER
202107938	2021	BUSINESS PERSONAL PROPERTY	ESSENTIAL EXTRAS INC	7114 EVANSTON AV	072690092	2005-2013	INDIVIDUAL PERSONAL PROPERTY	BERKEBILE RALPH S	8611 WESTRIDGE RD
202108568	2021	BUSINESS PERSONAL PROPERTY	VERLO PROPERTY LLC	6222 RAYTOWN TFWY	072690537	2014	INDIVIDUAL PERSONAL PROPERTY	FARRAND GAIL B	NO ADDRESS PROVIDED BY TAXPAYER
202110398	2021	BUSINESS PERSONAL PROPERTY	WESLEY HAMILTON LLC	8400 STARK AVE	072692492	2001-2012	INDIVIDUAL PERSONAL PROPERTY	BEUMER ANGELA M	9102 E 72ND TER
019404727	2012-2017	INDIVIDUAL PERSONAL PROPERTY	RADER BECKIE	9312 E 57TH TER	072692893	2009	INDIVIDUAL PERSONAL PROPERTY	BEYMER DORIS M	8405 E 85TH ST
019404741	2021	INDIVIDUAL PERSONAL PROPERTY	MASTIN BETTY L	8304 KENTUCKY AVE	072699306	2009	INDIVIDUAL PERSONAL PROPERTY	BLANTON ULDEAN	5508 CEDAR AVE
019504989	2013	INDIVIDUAL PERSONAL PROPERTY	JOHNSON DEXTER E	7624 CRISP AVE	072699734	2010-2011	INDIVIDUAL PERSONAL PROPERTY	BLEDSEO KENNETH A	9712 E 67TH TER
019605798	2021	INDIVIDUAL PERSONAL PROPERTY	HARRELL MITCHELL ALLEN	11805 E 78TH ST	072700394	2019	INDIVIDUAL PERSONAL PROPERTY	BLOCK TERENCE	NO ADDRESS PROVIDED BY TAXPAYER
019705262	2001	INDIVIDUAL PERSONAL PROPERTY	FRANK LYLE B	UNKNOWN	072702114	2015-2016	INDIVIDUAL PERSONAL PROPERTY	BODENSTAFF CAROLYN	5737 MANNING AVE
019705276	2001	INDIVIDUAL PERSONAL PROPERTY	DAVIS BARRY R	UNKNOWN	072703462	2004	INDIVIDUAL PERSONAL PROPERTY	BOLEJACK MARVIN L	8000 E 87TH ST
019705312	2001	INDIVIDUAL PERSONAL PROPERTY	BISHOP DENNIS K	UNKNOWN	072707351	2001	INDIVIDUAL PERSONAL PROPERTY	BORKOWSKI CASIMER	NO ADDRESS PROVIDED BY TAXPAYER
019706541	2004-2005	INDIVIDUAL PERSONAL PROPERTY	HANZEK CYNTHIA	7828 VASSAR AVE	072709153	2006	INDIVIDUAL PERSONAL PROPERTY	BOWEN G L	9308 E 82ND TER
019803448	2021	INDIVIDUAL PERSONAL PROPERTY	BELL MORRIS EARL JR	8603 MAPLE AVE	072713031	2012-2013	INDIVIDUAL PERSONAL PROPERTY	BRADEN JEANNE S	5421 HARRIS AVE
019803573	2014-2019	INDIVIDUAL PERSONAL PROPERTY	CRAWFORD CHARLES E	11716 E 85TH ST	072713264	2021	INDIVIDUAL PERSONAL PROPERTY	BRADFORD JAMES W	11720 E 87TH ST
019803758	2021	INDIVIDUAL PERSONAL PROPERTY	OLAWAYNE OLADELE OLUWAFEMI	10109 E 83RD ST	072714888	2020-2021	INDIVIDUAL PERSONAL PROPERTY	BRALEY PAUL E & KATHERINE	5204 RALSTON AVE
019804360	1999-2001	INDIVIDUAL PERSONAL PROPERTY	WHEELER HARRISON E JR	8027 MANNING	072714977	2003-2004	INDIVIDUAL PERSONAL PROPERTY	BRAMLETTE THOMAS D	6524 OXFORD AVE
019804397	2001	INDIVIDUAL PERSONAL PROPERTY	GUTIERREZ JOHN A	UNKNOWN	072715849	2010	INDIVIDUAL PERSONAL PROPERTY	BRANSTETTER ANDREW N	8203 SPRING VALLEY RD
019804442	2001	INDIVIDUAL PERSONAL PROPERTY	THUM J	072716136	2014	INDIVIDUAL PERSONAL PROPERTY	BRANUM MARY G	7400 MAPLE UNIT 419	
019804458	2001	INDIVIDUAL PERSONAL PROPERTY	BARNETT JOSEPH W	UNKNOWN	072716537	2006	INDIVIDUAL PERSONAL PROPERTY	BRATCHER RALPH B	9708 E 79TH TER
019804468	2001	INDIVIDUAL PERSONAL PROPERTY	DOWNTON JOHN B	UNKNOWN	072716644	2016	INDIVIDUAL PERSONAL PROPERTY	BRATON NELL	7408 HARRIS AVE
019804478	2001	INDIVIDUAL PERSONAL PROPERTY	FIKKI R	UNKNOWN	072719017	2019	INDIVIDUAL PERSONAL PROPERTY	BRUNING BERNARD W & E MAXI	9504 E 67TH TER
019804490	2001	INDIVIDUAL PERSONAL PROPERTY	RICKARD VERNON D	UNKNOWN	072721790	2009-2013	INDIVIDUAL PERSONAL PROPERTY	BROADUST EUGENE C	10809 E 64TH TER
019804491	2001	INDIVIDUAL PERSONAL PROPERTY	MORGAN P (MARGAN)	UNKNOWN	072722727	2013-2014	INDIVIDUAL PERSONAL PROPERTY	BROWN HAROLD L & MARY M	8401 GREENWOOD RD
019804510	2001	INDIVIDUAL PERSONAL PROPERTY	WADE JOHN ERIC/JENNIFER K	UNKNOWN	072727623	2007-2008	INDIVIDUAL PERSONAL PROPERTY	BROWN JACK	5323 HEDGES AVE
019804548	2001	INDIVIDUAL PERSONAL PROPERTY	MULHEARN ROBERT E	UNKNOWN	072727801	2001-2002	INDIVIDUAL PERSONAL PROPERTY	BROWN JAMES D	7332 HARVARD DR
019805318	2021	INDIVIDUAL PERSONAL PROPERTY	DAHDAI FATENA	10700 E 56TH TER	072729587	2010-2011	INDIVIDUAL PERSONAL PROPERTY	BROWN JOY D	8302 HUNTER ST
019806588	2013-2017	INDIVIDUAL PERSONAL PROPERTY	JOHNSON LINDA & LARRY	8520 HAWTHORNE AVE	072730192	2020-2021	INDIVIDUAL PERSONAL PROPERTY	BROWN VESTA JEAN	5501 HUNTER ST
019807007	2015-2016	INDIVIDUAL PERSONAL PROPERTY	PETERSON TAMMY	6654 MAYWOOD AVE APT B	072730281	2016-2019	INDIVIDUAL PERSONAL PROPERTY	BROWN RUDOLPH SR	9801 E 79TH TER
019807081	2003-2006	INDIVIDUAL PERSONAL PROPERTY	RING CONNIE	10805 E 58TH TER	072731137	2008-2012	INDIVIDUAL PERSONAL PROPERTY	BROWN BRENDA V	8504 EVANSTON AVE
019807507	2001	INDIVIDUAL PERSONAL PROPERTY	JONES DOUGLAS E	UNKNOWN	072737989	2011	INDIVIDUAL PERSONAL PROPERTY	BURD WAYNE A	5903 ENGLEWOOD AVE
019807603	2001	INDIVIDUAL PERSONAL PROPERTY	DICKINSON J	UNKNOWN	072739736	2010-2012	INDIVIDUAL PERSONAL PROPERTY	BURLESON FRANCES	10504 E 64TH TER
019807656	2001	INDIVIDUAL PERSONAL PROPERTY	MOSELEY GALEN P	UNKNOWN	072740118	2006	INDIVIDUAL PERSONAL PROPERTY	BURNETT MARGARET A	5809 RALSTON AVE
019807704	2001	INDIVIDUAL PERSONAL PROPERTY	STEURY HAROLD L	UNKNOWN	072741420	2010-2013	INDIVIDUAL PERSONAL PROPERTY	BURNS WILLIAM J	7225 STERLING AVE
019807717	2001	INDIVIDUAL PERSONAL PROPERTY	WOODS TIMOTHY	UNKNOWN	072742839	2006-2009	INDIVIDUAL PERSONAL PROPERTY	BURTON JAMES N	5728 ELM AVE
019807731	2001	INDIVIDUAL PERSONAL PROPERTY	GIBBENS ENGINEERING INC	UNKNOWN	072746283	2016	INDIVIDUAL PERSONAL PROPERTY	BYERS MARY A	9101 E 63RD ST APT 218
019807735	2001	INDIVIDUAL PERSONAL PROPERTY	WOODWARD JEFFREY L	UNKNOWN	072749057	2008	INDIVIDUAL PERSONAL PROPERTY	CALDWELL WILBUR E	5408 WILLOW AVE
019807753	2001	INDIVIDUAL PERSONAL PROPERTY	SCHAFER MICHAEL	UNKNOWN	072750044	2015	INDIVIDUAL PERSONAL PROPERTY	CALTON MARIE W	5604 MANNING AVE
019807765	2001	INDIVIDUAL PERSONAL PROPERTY	KILGORE JAMES R	UNKNOWN	072751034	2009-2010	INDIVIDUAL PERSONAL PROPERTY	CAMPBELL CAROL E	9110 E 63RD ST APT 209
019807770	2001	INDIVIDUAL PERSONAL PROPERTY	SUBURBAN JANITORIAL	UNKNOWN	072754736	2004	INDIVIDUAL PERSONAL PROPERTY	CAREY MARY A	NO ADDRESS PROVIDED BY TAXPAYER
019900484	2000	INDIVIDUAL PERSONAL PROPERTY	EARL MICHAEL L	UNKNOWN	072755021	2009	INDIVIDUAL PERSONAL PROPERTY	CARLETON ANGLINE	10808 E 66TH TER
019903292	2021	INDIVIDUAL PERSONAL PROPERTY	FRANCIS EDUARDO R	11001 E 54TH TER	072757163	2001-2002	INDIVIDUAL PERSONAL PROPERTY	CARR JOYCE	NO ADDRESS PROVIDED BY TAXPAYER
019903669	2001	INDIVIDUAL PERSONAL PROPERTY	ABBOTT JUSTIN A	NO ADDRESS PROVIDED BY TAXPAYER	072759937	2001	INDIVIDUAL PERSONAL PROPERTY	CARTER M D	UNKNOWN
019904047	2006	INDIVIDUAL PERSONAL PROPERTY	MEYER CHRIS J	NO ADDRESS PROVIDED BY TAXPAYER	072760685	2007-2008	INDIVIDUAL PERSONAL PROPERTY	CARTY KATHERINE	9404 E 68TH TER
019907735	2001-2002	INDIVIDUAL PERSONAL PROPERTY	BRISTOL MYERS SQUIBB/BURTON E	NO ADDRESS PROVIDED BY TAXPAYER	072762139	2011-2015	INDIVIDUAL PERSONAL PROPERTY	CASISI VINCENT	9313 E 69TH TER
072622898	2020-2021	INDIVIDUAL PERSONAL PROPERTY	COX CURTIS J	8906 E 74TH ST	072767492	2012	INDIVIDUAL PERSONAL PROPERTY	CHAPMAN SHIRLEY	11600 E 80TH DR
072625047	2001	INDIVIDUAL PERSONAL PROPERTY	KLEINSORGE JERRY L	NO ADDRESS PROVIDED BY TAXPAYER	072772681	2001-2008	INDIVIDUAL PERSONAL PROPERTY	CLARDY DELORES J	11204 E 63RD ST
072625760	2009	INDIVIDUAL PERSONAL PROPERTY	ACTON HELEN K	693 NE CLUBHOUSE DR	072775429	2020	INDIVIDUAL PERSONAL PROPERTY	CLARKSON RUTH M	7420 MAPLE UNIT 214
072632262	2021	INDIVIDUAL PERSONAL PROPERTY	WILSON THOMAS A	7409 APPLETON AVE	072775383	2013-2014	INDIVIDUAL PERSONAL PROPERTY	CLEVENGER JUEL D & NANCY K	11408 E 65TH ST
072638015	2021	INDIVIDUAL PERSONAL PROPERTY	WALLACE LARRY B & JANET	10131 E 79TH TER	072777702	2021	INDIVIDUAL PERSONAL PROPERTY	CLIFTON CAROL A	10400 E 65TH ST
072639425	2016	INDIVIDUAL PERSONAL PROPERTY	ADAMS RICHARD BRUCE	6607 HARRIS AVE	072779755	2018	INDIVIDUAL PERSONAL PROPERTY	COCHRAN JERRY L	11305 E 67TH ST
072641635	2001-2004	INDIVIDUAL PERSONAL PROPERTY	AHLSTROM ROBERT T	NO ADDRESS PROVIDED BY TAXPAYER	072782386	2002-2003	INDIVIDUAL PERSONAL PROPERTY	COLE HARRY G	6202 NORTHERN AVE
072644204	2003	INDIVIDUAL PERSONAL PROPERTY	ALEXOPOULOS NICK H	11300 E 61ST TER	072784507	2019	INDIVIDUAL PERSONAL PROPERTY	COLLINS DALE & DONNA R	10513 E 65TH ST
072645882	2012	INDIVIDUAL PERSONAL PROPERTY	ALLEN JAMES M	8419 JAMES A REED RD	072785819	2015-2021	INDIVIDUAL PERSONAL PROPERTY	COLTHARP ROBERT O & SHIRLEY J	5234 NORTHERN AVE
072645908	2014	INDIVIDUAL PERSONAL PROPERTY	ALLEN EULA	5580 BLUE RIDGE BLVD	072788825	2005-2008	INDIVIDUAL PERSONAL PROPERTY	CONRAD CHARVILLE & PATRICIA	10508 E 80TH ST
072647407	2020	INDIVIDUAL PERSONAL PROPERTY	ALLISON ARTHUR E & OLA R	5305 HARDY AVE	072789423	2012-2013	INDIVIDUAL PERSONAL PROPERTY	CONWAY GRANLEY P JR & MARY	9413 E 68TH TER
072652604	2018-2021	INDIVIDUAL PERSONAL PROPERTY	ANDES BRUCE D & CONNIE	7513 APPLETON AVE	072791571	2021	INDIVIDUAL PERSONAL PROPERTY	COOMBS PHILIP	10505 E 61ST TER
072656450	2013	INDIVIDUAL PERSONAL PROPERTY	ARN VIRGINIA R	9401 E 63RD ST APT 10	072791731	2017	INDIVIDUAL PERSONAL PROPERTY	COONCE CARL JR	7606 WOODSON RD
072663353	2013-2016	INDIVIDUAL PERSONAL PROPERTY	BAILEY ETHEL L	7720 ENGLEWOOD AVE	072793098	2005-2006	INDIVIDUAL PERSONAL PROPERTY	COOPER SANDRA K	11000 E 78TH ST
072664094	2001	INDIVIDUAL PERSONAL PROPERTY	BAILEY ROBERT D	NO ADDRESS PROVIDED BY TAXPAYER	072793267	2021	INDIVIDUAL PERSONAL PROPERTY	COOPER GRACIE ANN	6140 RAYTOWN RD APT 905
072665528	2016-2017	INDIVIDUAL PERSONAL PROPERTY	BAKER WILLIAM & MINA	9408 E 81ST TER	072802970	2010	INDIVIDUAL PERSONAL PROPERTY	CRAWFORD MARY M	11600 E 79TH DR
072669473	2018-2019	INDIVIDUAL PERSONAL PROPERTY	BANKSON GARY L & IVA J	8328 OXFORD AVE	072803309	2020-2021	INDIVIDUAL PERSONAL PROPERTY	CREAMER JOHN W	7306 HARVARD DR
072672593	2005-2007	INDIVIDUAL PERSONAL PROPERTY	BARNES LECIL H	11301 E 67TH ST	072804460	2021	INDIVIDUAL PERSONAL PROPERTY	CRIST LEO A & TAMEARA	5828 NORTHERN AVE
072673681	2009-2010	INDIVIDUAL PERSONAL PROPERTY	BARNHILL JEAN M	6709 ELM AVE	072806468	2001	INDIVIDUAL PERSONAL PROPERTY	CROW GEORGE T	NO ADDRESS PROVIDED BY TAXPAYER
072675242	2009-2012	INDIVIDUAL PERSONAL PROPERTY	BARTLETT HELEN M	10512 E 69TH ST	072808251	2001	INDIVIDUAL PERSONAL PROPERTY	CULLOTTA SIMON	NO ADDRESS PROVIDED BY TAXPAYER
072676811	2008	INDIVIDUAL PERSONAL PROPERTY	BATCHELOR ROBERT G	5521 RALSTON AVE	072810792	2006	INDIVIDUAL PERSONAL PROPERTY	CURTIS T GARY & KARLAN	7411 HARVARD DR
072676839	2020-2021	INDIVIDUAL PERSONAL PROPERTY	SHANAHAN KATHERINE	10808 E 64TH TER	072815779	2012	INDIVIDUAL PERSONAL PROPERTY	DAVENPORT BARBARA J	9228 E 92ND ST
072677589	2021	INDIVIDUAL PERSONAL PROPERTY	BATSON DAVID D	5521 NORTHERN AVE	072816402	2014	INDIVIDUAL PERSONAL PROPERTY	DAVIDSON VIOLET C	9305 E 81ST ST
072681191	2002-2003	INDIVIDUAL PERSONAL PROPERTY	BEAUCHAMP DOROTHY A	5600 LANE	072816894	2006	INDIVIDUAL PERSONAL PROPERTY	DAVIS LYDIA V	11020 E 57TH TER
072682797	2011	INDIVIDUAL PERSONAL PROPERTY	BEDELL FARRELL L	10109 E 77TH TER	072817063	2010	INDIVIDUAL PERSONAL PROPERTY	DAVIS LILLIAN L	9106 E 72ND TER
072683153	2012	INDIVIDUAL PERSONAL PROPERTY	BEEBE ROBERT E	9006 E 87TH ST	072817955	2007-2008	INDIVIDUAL PERSONAL PROPERTY	DAVIS DOROTHY R	NO ADDRESS PROVIDED BY TAXPAYER
072684018	2001	INDIVIDUAL PERSONAL PROPERTY	BEHNKE GEORGE & KAYE	NO ADDRESS PROVIDED BY TAXPAYER	072820004	2012	INDIVIDUAL PERSONAL PROPERTY	DAVIS MARY K	8115 DITZLER AVE

072820727	2004	INDIVIDUAL PERSONAL PROPERTY	DAVIS ROBERT W	UNKNOWN	072916606	2001	INDIVIDUAL PERSONAL PROPERTY	GOOS JACQUELINE H	NO ADDRESS PROVIDED BY TAXPAYER
072821209	2012-2013	INDIVIDUAL PERSONAL PROPERTY	DAVIS VIRGINIA R	6309 HARVARD AVE	072919523	2021	INDIVIDUAL PERSONAL PROPERTY	GRAF PATRICIA	9709 PLYMOUTH LN
072822627	2013-2017	INDIVIDUAL PERSONAL PROPERTY	DAY MARY V	8401 WILLOW WAY	072919827	2019-2020	INDIVIDUAL PERSONAL PROPERTY	GRAHAM CAROLYN	8950 E 60TH ST
072822716	2021	INDIVIDUAL PERSONAL PROPERTY	DAY JUANITA	6409 BLUE RIDGE BLVD	072922797	2021	INDIVIDUAL PERSONAL PROPERTY	GRAY LLOYD D	7409 HARRIS AVE
072823029	2004	INDIVIDUAL PERSONAL PROPERTY	DECAVELE JACK	NO ADDRESS PROVIDED BY TAXPAYER	072924170	2007	INDIVIDUAL PERSONAL PROPERTY	GREEN ELMER R	5728 WOODSON RD
072828033	2019	INDIVIDUAL PERSONAL PROPERTY	DENNY SHERRI C	717 NE BALL DR UNIT B	072924802	2015-2020	INDIVIDUAL PERSONAL PROPERTY	HILTON MARY	10412 E 82ND ST
072828328	2005-2007	INDIVIDUAL PERSONAL PROPERTY	FULLER NAOMI DENTON	8515 STERLING AVE	072926686	2010	INDIVIDUAL PERSONAL PROPERTY	JONES DUANE & NANCY	10000 E 68TH ST
072828603	2006	INDIVIDUAL PERSONAL PROPERTY	DERKS DAISY D	NO ADDRESS PROVIDED BY TAXPAYER	072929433	2001	INDIVIDUAL PERSONAL PROPERTY	GRIMES MARJORIE	9813 E 77TH ST
072834696	2020-2021	INDIVIDUAL PERSONAL PROPERTY	DODD RUFUS & OTHERINE A	5845 HUNTER CT	072929674	2004	INDIVIDUAL PERSONAL PROPERTY	GRINDEL WILLIAM R	UNKNOWN
072837933	2013-2017	INDIVIDUAL PERSONAL PROPERTY	DORSEY NATHANIEL SR	11702 E 80TH DR	072930181	2009	INDIVIDUAL PERSONAL PROPERTY	GRONER CLETUS T	9135 RICHARDS DR
072838264	2021	INDIVIDUAL PERSONAL PROPERTY	DOTSON EDDIE & KAREN L	6712 HARRIS AVE	072931037	2015	INDIVIDUAL PERSONAL PROPERTY	GROVES DANIEL W & KATHERINE A	8615 KENTUCKY AVE
072838772	2020-2021	INDIVIDUAL PERSONAL PROPERTY	DOUGHTY BETTY F	5900 CRESCENT AVE	072932134	2021	INDIVIDUAL PERSONAL PROPERTY	GUESS LONDELL	7046 LAKESHORE DR
072839325	2001	INDIVIDUAL PERSONAL PROPERTY	DOVE ANN L	UNKNOWN	072932483	2005	INDIVIDUAL PERSONAL PROPERTY	GUINN CAROL G	9805 E 71ST TER
072839628	2001	INDIVIDUAL PERSONAL PROPERTY	DOWDY HARRY E	NO ADDRESS PROVIDED BY TAXPAYER	072934686	2004	INDIVIDUAL PERSONAL PROPERTY	HAAS EUGENE A	NO ADDRESS PROVIDED BY TAXPAYER
072840778	2017-2019	INDIVIDUAL PERSONAL PROPERTY	DRACE RICHARD	11601 E 72ND ST	072934864	2012	INDIVIDUAL PERSONAL PROPERTY	HABBen STANLEY R	7201 OXFORD AVE
072844122	2014-2021	INDIVIDUAL PERSONAL PROPERTY	DUKE NORMAN D	8008 APPLETON AVE	072937111	2019-2021	INDIVIDUAL PERSONAL PROPERTY	HAIRSTON TANYA RENEE	11601 E 51ST ST
072845247	2021	INDIVIDUAL PERSONAL PROPERTY	DUNCAN JAMES F	7209 RALSTON AVE	072938316	2020	INDIVIDUAL PERSONAL PROPERTY	HALL DORTHEA M	6829 LAKESHORE DR
072846451	2019	INDIVIDUAL PERSONAL PROPERTY	DUNN ROGER L	18032 E 31ST TERRACE DR S	072941099	2012	INDIVIDUAL PERSONAL PROPERTY	HAMILTON EDWIN O	5402 HARDY AVE
072846460	2001	INDIVIDUAL PERSONAL PROPERTY	DUNN PAULA A	8101 ARLINGTON AVE	072941847	2017	INDIVIDUAL PERSONAL PROPERTY	HAMILTON WINSTON DOUGLAS	8004 HUNTER ST
072847815	2004-2005	INDIVIDUAL PERSONAL PROPERTY	DUTTON SHIRLEY M	NO ADDRESS PROVIDED BY TAXPAYER	072945335	2017	INDIVIDUAL PERSONAL PROPERTY	HANSEN JACQUELINE R	6001 HARRIS AVE
072849029	2001	INDIVIDUAL PERSONAL PROPERTY	EADEN DONALD J	NO ADDRESS PROVIDED BY TAXPAYER	072945460	2019	INDIVIDUAL PERSONAL PROPERTY	HANSEN PAUL L & SHARON G	9600 E 65TH TER
072851444	2013	INDIVIDUAL PERSONAL PROPERTY	EDD EVESTER	7421 MAPLE UNIT 114	072945790	2016-2021	INDIVIDUAL PERSONAL PROPERTY	HANSON MARTIN G & NANCY	11001 E 74TH ST
072852256	2002	INDIVIDUAL PERSONAL PROPERTY	EDMONSOND GLADYS	NO ADDRESS PROVIDED BY TAXPAYER	072946398	2004	INDIVIDUAL PERSONAL PROPERTY	HARDEN EDWARD L	12101 E BANNISTER RD UNIT 108
072852648	2005	INDIVIDUAL PERSONAL PROPERTY	EDWARDS GLORIA E	NO ADDRESS PROVIDED BY TAXPAYER	072948617	2012	INDIVIDUAL PERSONAL PROPERTY	HARMON KEITH	8206 E 83RD ST
072853059	2016-2021	INDIVIDUAL PERSONAL PROPERTY	EDWARDS JOHN B	10207 E 67TH ST APT 1	072949457	2018	INDIVIDUAL PERSONAL PROPERTY	HARPER JOSEPH	8301 OVERTON DR
072853095	2021	INDIVIDUAL PERSONAL PROPERTY	EDWARDS JOSEPH G & NATIVIDAD	8301 HAWTHORNE AVE	072950667	2013	INDIVIDUAL PERSONAL PROPERTY	HARRIS DALE & VIRGINIA	10010 E 70TH TER
072853139	2015-2017	INDIVIDUAL PERSONAL PROPERTY	EDWARDS LARRY & JANICE	10008 E 77TH TER	072951327	2021	INDIVIDUAL PERSONAL PROPERTY	HARRIS HENRY & ALEE W	6198 CRISP AVE
072854110	2017	INDIVIDUAL PERSONAL PROPERTY	EHRHARDT RONALD L	6014 FARLEY AVE	072953129	2005	INDIVIDUAL PERSONAL PROPERTY	HARRISON ANNA K	8505 E 86TH TER
072855137	2005	INDIVIDUAL PERSONAL PROPERTY	ESSINGER HAROLD	5817 LAUREL AVE	072958874	2020-2021	INDIVIDUAL PERSONAL PROPERTY	HAWLEY JULIA M	8924 E 74TH ST
072855529	2001	INDIVIDUAL PERSONAL PROPERTY	ELDER ELOSIA E	NO ADDRESS PROVIDED BY TAXPAYER	072958945	2008	INDIVIDUAL PERSONAL PROPERTY	HAWLEY LEONARD T & RUBY M	7203 OVERTON AVE
072856074	2016-2017	INDIVIDUAL PERSONAL PROPERTY	ELKINS ROBERT L	6509 WILLOW AVE	072959301	2016	INDIVIDUAL PERSONAL PROPERTY	HAYDEN O RANDALL JR	9401 E 69TH TER
072857359	2015	INDIVIDUAL PERSONAL PROPERTY	ELLIS DANNY E	8012 APPLETON AVE	072959436	2018	INDIVIDUAL PERSONAL PROPERTY	HAYES BENNY & GEORGIA	7517 ENGLEWOOD AVE
072858492	2010-2017	INDIVIDUAL PERSONAL PROPERTY	ELSLOO CAROLL	7608 HARRIS AVE	072962459	2016	INDIVIDUAL PERSONAL PROPERTY	HEARN ROY	9712 ENGLEWOOD AVE
072858642	2015	INDIVIDUAL PERSONAL PROPERTY	ELY ROSALEE A	NO ADDRESS PROVIDED BY TAXPAYER	072962565	2017	INDIVIDUAL PERSONAL PROPERTY	HEATH DANIEL G	8215 WILLOW WAY
072861763	2004	INDIVIDUAL PERSONAL PROPERTY	ERISMAN MARJORIE E	NO ADDRESS PROVIDED BY TAXPAYER	072962903	2007-2009	INDIVIDUAL PERSONAL PROPERTY	HEAVEY JAMES & GLORIA	10508 E 57TH TER
072862913	2011-2017	INDIVIDUAL PERSONAL PROPERTY	ESTERLEY ROBERT F	8506 FORD AVE	072962949	2021	INDIVIDUAL PERSONAL PROPERTY	HEAVNER HARROL L	5413 MAYWOOD AVE
072864270	2005-2006	INDIVIDUAL PERSONAL PROPERTY	EVANS DONALD L	9707 E 65TH ST	072962967	2016-2018	INDIVIDUAL PERSONAL PROPERTY	HEAVEY PATRICIA	6622 ELM AVE
072864314	2014-2018	INDIVIDUAL PERSONAL PROPERTY	EVANS CHRISTINE	9117 E 68TH ST	072963369	2005-2006	INDIVIDUAL PERSONAL PROPERTY	HEDENBERG DONALD	8513 ASH AVE
072865867	2001	INDIVIDUAL PERSONAL PROPERTY	EWBANK JON R	NO ADDRESS PROVIDED BY TAXPAYER	072964206	2007-2009	INDIVIDUAL PERSONAL PROPERTY	HEFFRON BETTY J	10704 E 84TH ST
072866054	2002-2008	INDIVIDUAL PERSONAL PROPERTY	EWING RONALD R	5928 STERLING AVE	072966669	2008-2010	INDIVIDUAL PERSONAL PROPERTY	HENDERSON ARTHUR J	9110 E 63RD ST APT 101
072866740	2001	INDIVIDUAL PERSONAL PROPERTY	FAIN LAURA MAY	UNKNOWN	072968685	2009	INDIVIDUAL PERSONAL PROPERTY	HENKE BETTY P	NO ADDRESS PROVIDED BY TAXPAYER
072868418	2009	INDIVIDUAL PERSONAL PROPERTY	FARNSWORTH WALTER E	8802 RICHARDS DR	072972064	2007-2009	INDIVIDUAL PERSONAL PROPERTY	HERRING DONALD F & ANNETTA F	5408 NORTHERN AVE
072871789	2005-2017	INDIVIDUAL PERSONAL PROPERTY	FERGUSON HERBERT B	11413 E 55TH TER	072973349	2011-2017	INDIVIDUAL PERSONAL PROPERTY	HESTON DONNA	8515 OXFORD AVE
072872680	2008-2009	INDIVIDUAL PERSONAL PROPERTY	FERRO LILLIE M	7209 RALSTON AVE	072975276	2014-2015	INDIVIDUAL PERSONAL PROPERTY	HICKS PEGGY	7840 WOODSON RD
072874045	2008-2013	INDIVIDUAL PERSONAL PROPERTY	FIELDS R B JR	6007 KENTUCKY AVE	072976514	2004	INDIVIDUAL PERSONAL PROPERTY	HILBURN EUNICE I	NO ADDRESS PROVIDED BY TAXPAYER
072874688	2012	INDIVIDUAL PERSONAL PROPERTY	FINCH THOMAS R & LINDA C	11109 E 75TH ST	072979218	2016	INDIVIDUAL PERSONAL PROPERTY	HILTON HOMER	6000 ARLINGTON AVE
072876178	2019	INDIVIDUAL PERSONAL PROPERTY	FISER CONNIE J	10125 E 79TH TER	072980260	2021	INDIVIDUAL PERSONAL PROPERTY	HINRICHS HERSCHEL H	5376 BLUE RIDGE BLVD
072878559	2005	INDIVIDUAL PERSONAL PROPERTY	FLAEN JOEL L	7921 DITZLER AVE	072981018	2018-2021	INDIVIDUAL PERSONAL PROPERTY	HITCHCOCK EDMOND A	7912 ARLINGTON AVE
072878568	2006-2009	INDIVIDUAL PERSONAL PROPERTY	FLACK NELLIE M	7921 ELM AVE	072984612	2001	INDIVIDUAL PERSONAL PROPERTY	HOLBROOK THOMAS G	UNKNOWN
072878577	2008	INDIVIDUAL PERSONAL PROPERTY	FLACK JAMES R & DOROTHY	NO ADDRESS PROVIDED BY TAXPAYER	072985924	2006-2007	INDIVIDUAL PERSONAL PROPERTY	SMITH RALPH H & LORENE	12006 E 75TH ST
072884917	2000	INDIVIDUAL PERSONAL PROPERTY	FOSTER EUGENE L	UNKNOWN	072990071	2019	INDIVIDUAL PERSONAL PROPERTY	HOOVER HOMER H	5380 BLUE RIDGE BLVD
072885248	2021	INDIVIDUAL PERSONAL PROPERTY	FOSTER JAMES T & JUDITH F	6714 RALSTON AVE	072994692	2006	INDIVIDUAL PERSONAL PROPERTY	HOWARD PAUL L	8312 HUNTER ST
072886826	2016-2021	INDIVIDUAL PERSONAL PROPERTY	FOX KAREN KAY	11201 E 59TH TER	072995557	2003-2004	INDIVIDUAL PERSONAL PROPERTY	HOWELL VIRGIL L	UNKNOWN
072887656	2021	INDIVIDUAL PERSONAL PROPERTY	FRANCISCO DALE Z	9403 E 85TH ST	072999330	2003	INDIVIDUAL PERSONAL PROPERTY	HULBERT DON L & SHIRLEY	NO ADDRESS PROVIDED BY TAXPAYER
072889235	2015-2018	INDIVIDUAL PERSONAL PROPERTY	FRAZIER DONALD R	9708 RICE AVE	073004386	2021	INDIVIDUAL PERSONAL PROPERTY	HYMER EDGAR L	6009 HEDGES AVE
072889903	2020-2021	INDIVIDUAL PERSONAL PROPERTY	FREED ANNA L	6224 ASH CT	073005438	2021	INDIVIDUAL PERSONAL PROPERTY	INGRAM TWILA EULENE	9355 E 67TH TER
072891311	2001	INDIVIDUAL PERSONAL PROPERTY	FREY ALBERT F	NO ADDRESS PROVIDED BY TAXPAYER	073005900	2008	INDIVIDUAL PERSONAL PROPERTY	IRELAND LAWRENCE J	7013 EVANSTON AVE
072892720	2013	INDIVIDUAL PERSONAL PROPERTY	FROGGE CAROL J	9301 E 82ND TER	073006151	2014-2015	INDIVIDUAL PERSONAL PROPERTY	IRVINE WILLIE J	6012 KENTUCKY AVE
072902513	2011-2012	INDIVIDUAL PERSONAL PROPERTY	GAUERT THEODORE B & WILMA J	10305 E 64TH ST	073006703	2005-2006	INDIVIDUAL PERSONAL PROPERTY	ISENHOWER GERALD R	5417 HEDGES AVE
072902755	2015	INDIVIDUAL PERSONAL PROPERTY	GAUSS WM R	6324 HARVARD AVE	073007347	2018-2021	INDIVIDUAL PERSONAL PROPERTY	JACK WILLIAM J	10805 E 57TH ST
072902906	2015	INDIVIDUAL PERSONAL PROPERTY	GAY DORSEY	7705 RAYTOWN RD APT 23	073010048	2021	INDIVIDUAL PERSONAL PROPERTY	JACKSON VIRGIL	11817 E 83RD ST APT 201
072904806	2004	INDIVIDUAL PERSONAL PROPERTY	GEORGIE LINDA	UNKNOWN	073011902	2021	INDIVIDUAL PERSONAL PROPERTY	JAMES PAUL R	8616 RIDGEWAY AVE
072907135	2011	INDIVIDUAL PERSONAL PROPERTY	GIBSON MARY E	9110 E 63RD ST APT 201	073012224	2008	INDIVIDUAL PERSONAL PROPERTY	JAMISON CHESTER L	5517 NORTHERN AVE
072907153	2009-2011	INDIVIDUAL PERSONAL PROPERTY	GIBSON DOROTHY M	9051 E 52ND TER	073013116	2021	INDIVIDUAL PERSONAL PROPERTY	JASS HENRY	7612 ENGLEWOOD AVE
072908919	2009-2010	INDIVIDUAL PERSONAL PROPERTY	GILL THILBURN W & DOROTHY	NO ADDRESS PROVIDED BY TAXPAYER	073014678	2007-2008	INDIVIDUAL PERSONAL PROPERTY	JENKINS ADRA L	9905 E 81ST ST
072909231	2013-2017	INDIVIDUAL PERSONAL PROPERTY	GILLESPIE ROBERT H	NO ADDRESS PROVIDED BY TAXPAYER	073014696	2021	INDIVIDUAL PERSONAL PROPERTY	JENKINS SHARON K	9304 E 60TH TER
072910103	2002-2003	INDIVIDUAL PERSONAL PROPERTY	GILMORE JAMES R	NO ADDRESS PROVIDED BY TAXPAYER	073015506	2002-2005	INDIVIDUAL PERSONAL PROPERTY	JENSEN KATHRYN R	7304 HARDY AVE
072910201	2011	INDIVIDUAL PERSONAL PROPERTY	GILMORE DOROTHY J	7401 CEDAR AVE	073015640	2007	INDIVIDUAL PERSONAL PROPERTY	JEPSON MATHEW L & MARYONNE E	500 NW VESPER ST
072910684	2005	INDIVIDUAL PERSONAL PROPERTY	GIPPERT ROBERT C	6321 RALSTON AVE	073016925	2004	INDIVIDUAL PERSONAL PROPERTY	JOHNSON ALBERT O	NO ADDRESS PROVIDED BY TAXPAYER
072911415	2005	INDIVIDUAL PERSONAL PROPERTY	GLADNEY VADA D	UNKNOWN	073017568	2006-2007	INDIVIDUAL PERSONAL PROPERTY	JOHNSON MARYBETH	5400 LAUREL AVE
072912076	2009-2011	INDIVIDUAL PERSONAL PROPERTY	GLENN W D & SHIRLEY	7920 ELM AVE	073020698	2010-2011	INDIVIDUAL PERSONAL PROPERTY	JOHNSON LAVADA	5404 LAUREL AVE
072913495	2003	INDIVIDUAL PERSONAL PROPERTY	GOERGEN WILLIAM M	NO ADDRESS PROVIDED BY TAXPAYER	073021072	2017	INDIVIDUAL PERSONAL PROPERTY	JOHNSON KENNETH & LOIS	9113 E 66TH TER

073021580	2005	INDIVIDUAL PERSONAL PROPERTY	JOHNSON LUTHER W & WANDA	7522 E 85TH TER APT 204	073141068	2011-2012	INDIVIDUAL PERSONAL PROPERTY	MILLBERN ERNEST & BETTY	6318 RALSTON AVE
073022749	2001	INDIVIDUAL PERSONAL PROPERTY	JOHNSON DOROTHY J	NO ADDRESS PROVIDED BY TAXPAYER	073143226	2008-2010	INDIVIDUAL PERSONAL PROPERTY	MILLER JACK L SR & LILLIAN	9409 E 84TH TER
073023427	2020-2021	INDIVIDUAL PERSONAL PROPERTY	JOHNSON TERESSA L	11816 E 79TH DR	073144779	2004	INDIVIDUAL PERSONAL PROPERTY	MILLER LANA	UNKNOWN
073024088	2009	INDIVIDUAL PERSONAL PROPERTY	JOHNSTON MARY E % NONA STRATTON	6436 BLUE RIDGE BLVD	073144804	2017-2018	INDIVIDUAL PERSONAL PROPERTY	MILLER RICHARD G	6308 HARVARD AVE
073025247	2021	INDIVIDUAL PERSONAL PROPERTY	JONES BOB	10319 E 83RD ST	073145885	2001-2002	INDIVIDUAL PERSONAL PROPERTY	MILLETT MARTHA E	NO ADDRESS PROVIDED BY TAXPAYER
073028565	2010-2015	INDIVIDUAL PERSONAL PROPERTY	JONES FRED A	8821 E 81ST ST	073150191	2001	INDIVIDUAL PERSONAL PROPERTY	MITCHENER JAMES G	NO ADDRESS PROVIDED BY TAXPAYER
073029582	2003-2008	INDIVIDUAL PERSONAL PROPERTY	JONES BETTY A	8504 GREENWOOD RD	073150431	2009	INDIVIDUAL PERSONAL PROPERTY	MIZER ROSEMARY	6504 CLAREMONT AVE
073030810	2006	INDIVIDUAL PERSONAL PROPERTY	JORDAN ARLENE L	8513 EVERETT ST	073151001	2021	INDIVIDUAL PERSONAL PROPERTY	MOELLER MARGARET	7301 WILLOW AVE
073031962	2003-2007	INDIVIDUAL PERSONAL PROPERTY	JUCHET RICHARD D & HELEN	5929 LAUREL AVE	073151332	2011	INDIVIDUAL PERSONAL PROPERTY	MOFFITT ARNOLD C	10912 E 59TH ST
073032104	2008	INDIVIDUAL PERSONAL PROPERTY	JUDY DONALD L	6300 HUNTER ST	073152938	2007	INDIVIDUAL PERSONAL PROPERTY	MONTESSANO SAM	NO ADDRESS PROVIDED BY TAXPAYER
073032532	2018-2019	INDIVIDUAL PERSONAL PROPERTY	JUNGERMAN DAVID G	4801 MAIN ST	073152738	2001	INDIVIDUAL PERSONAL PROPERTY	MOORHEAD MARTHA J	7321 IRWIN
073033023	2020-2021	INDIVIDUAL PERSONAL PROPERTY	KABELL FRED LEE	7026 LAKEHORE DR	073161508	2011-2013	INDIVIDUAL PERSONAL PROPERTY	MORRIS DELORES M & RONALD R	8216 STERLING AVE
073033158	2012	INDIVIDUAL PERSONAL PROPERTY	KADLEC KEITH M	NO ADDRESS PROVIDED BY TAXPAYER	073162534	2021	INDIVIDUAL PERSONAL PROPERTY	MORTON HENRIETTA	9108 E 69TH ST
073034273	2010	INDIVIDUAL PERSONAL PROPERTY	IRWIN (KAPLANIS) CAROLE SUE	8923 E 74TH ST	073162874	2017	INDIVIDUAL PERSONAL PROPERTY	MOSBY HAROLD	11615 E 80TH DR
073038153	2013	INDIVIDUAL PERSONAL PROPERTY	KELEMMEN GEZA	10011 E 78TH ST	073165274	2015	INDIVIDUAL PERSONAL PROPERTY	MUELLER FLORENCE V	NO ADDRESS PROVIDED BY TAXPAYER
073039937	2001	INDIVIDUAL PERSONAL PROPERTY	KELLY HAROLD E	NO ADDRESS PROVIDED BY TAXPAYER	073165425	2007	INDIVIDUAL PERSONAL PROPERTY	MUELLER PALMER P	5207 STANTON DR
073040337	2002	INDIVIDUAL PERSONAL PROPERTY	KELLY PAUL W	UNKNOWN	073165595	2005	INDIVIDUAL PERSONAL PROPERTY	MUIR WALTER F	7240 WOODSON RD
073040925	2003-2006	INDIVIDUAL PERSONAL PROPERTY	KELTON MAYNARD W	NO ADDRESS PROVIDED BY TAXPAYER	073166816	2011	INDIVIDUAL PERSONAL PROPERTY	MULVIHILL JOHN W	10209 E 68TH TER
073044155	2013	INDIVIDUAL PERSONAL PROPERTY	KESSINGER MILDRED M	5305 HARDY AVE	073169154	2001	INDIVIDUAL PERSONAL PROPERTY	MURRAY ISADORE (MOLLY)	UNKNOWN
073044823	2013-2014	INDIVIDUAL PERSONAL PROPERTY	KEYS JIM L	5501 WOODSON RD	073169528	2018-2019	INDIVIDUAL PERSONAL PROPERTY	MUSGRAVE BILL J	10409 E 69TH TER
073044850	2019-2021	INDIVIDUAL PERSONAL PROPERTY	KEYSER DANIEL J	1220 NE APPLEWOOD ST	073169715	2001	INDIVIDUAL PERSONAL PROPERTY	MUSSLYN KENNETH L	NO ADDRESS PROVIDED BY TAXPAYER
073046689	2004-2005	INDIVIDUAL PERSONAL PROPERTY	KINATEDER GEORGE H	9363 E 65TH ST	073169948	2012-2017	INDIVIDUAL PERSONAL PROPERTY	MYERS ARTHUR F	11505 E 62ND ST
073047839	2021	INDIVIDUAL PERSONAL PROPERTY	KING GEORGE D	11004 E 74TH ST	073171588	2001	INDIVIDUAL PERSONAL PROPERTY	NAGLE MARILEE R	NO ADDRESS PROVIDED BY TAXPAYER
073048197	2021	INDIVIDUAL PERSONAL PROPERTY	KING JAMES G	8410 FORB AVE	073172113	2021	INDIVIDUAL PERSONAL PROPERTY	NASH MARIE L	9709 RICE AVE
073050502	2006-2007	INDIVIDUAL PERSONAL PROPERTY	KIRK JOSEPH D	NO ADDRESS PROVIDED BY TAXPAYER	073173595	2004	INDIVIDUAL PERSONAL PROPERTY	NEATHERY BETTY	NO ADDRESS PROVIDED BY TAXPAYER
073053581	2005	INDIVIDUAL PERSONAL PROPERTY	KNAPP ROY D JR	6309 KENTUCKY AVE	073174068	2001	INDIVIDUAL PERSONAL PROPERTY	NEELY DONALD R	7201 HARDY AVE
073055776	2008	INDIVIDUAL PERSONAL PROPERTY	KOENNING MADELYN J	7305 RALSTON AVE	073177485	2017-2020	INDIVIDUAL PERSONAL PROPERTY	NEWCOMB BYRON D	6809 LAKEHORE DR
073061046	2006	INDIVIDUAL PERSONAL PROPERTY	KUEHN MARY S	6140 RAYTOWN RD APT 204	073180774	2002	INDIVIDUAL PERSONAL PROPERTY	NIEMEYER MARJORIE S	UNKNOWN
073061787	2005	INDIVIDUAL PERSONAL PROPERTY	KUNTZ JUDITH L	NO ADDRESS PROVIDED BY TAXPAYER	073181951	2007	INDIVIDUAL PERSONAL PROPERTY	NOE FRAZIE	NO ADDRESS PROVIDED BY TAXPAYER
073062456	2021	INDIVIDUAL PERSONAL PROPERTY	KYLE SHARON	11804 E 77TH ST	073181997	2007-2008	INDIVIDUAL PERSONAL PROPERTY	NOEL CHARLES L	10224 E 55TH ST
073063348	2016-2021	INDIVIDUAL PERSONAL PROPERTY	LADD HARLEY R & MAEL JO ANN	8907 E 75TH ST	073182870	2017-2019	INDIVIDUAL PERSONAL PROPERTY	NOLTE GERARD A	5743 WILLOW AVE
073064551	2007	INDIVIDUAL PERSONAL PROPERTY	LAMB BUFORD L	6222 ASH CT	073184093	2004	INDIVIDUAL PERSONAL PROPERTY	NORRIS ROBERT C & LOIS	10212 E 72ND ST
073066014	2002	INDIVIDUAL PERSONAL PROPERTY	LAND WAYNE L & DOROTHY J	9213 E 79TH ST	073185476	2014-2016	INDIVIDUAL PERSONAL PROPERTY	NUGENT ELLIS R & MARIE	8010 EVERETT ST
073066997	2007	INDIVIDUAL PERSONAL PROPERTY	LANE PENNY	5508 LANE AVE	073187018	2021	INDIVIDUAL PERSONAL PROPERTY	OBRIEN MICHAEL A	8529 ASH AVE
073071311	2021	INDIVIDUAL PERSONAL PROPERTY	LAVAL CALVIN C	8958 E 82ND TER	073190433	2020	INDIVIDUAL PERSONAL PROPERTY	OLEARY MARY O	11704 E 79TH DR
073071605	2010	INDIVIDUAL PERSONAL PROPERTY	LAWHEAD SHIRLEY A	8818 E 84TH TER	073190816	2020-2021	INDIVIDUAL PERSONAL PROPERTY	WARD FRANCES	6140 RAYTOWN RD APT 802
073071865	2020	INDIVIDUAL PERSONAL PROPERTY	LAWRENCE DOUGLAS	6829 CRISP AVE	073191110	2005	INDIVIDUAL PERSONAL PROPERTY	OLIVER RUTH E	8304 HARRIS AVE
073072098	2015	INDIVIDUAL PERSONAL PROPERTY	HORTON THERESA	5820 CEDAR AVE	073194199	2019	INDIVIDUAL PERSONAL PROPERTY	OSBORNE JAMES L JR	11108 E 74TH ST
073073131	2008	INDIVIDUAL PERSONAL PROPERTY	LEACH EDNA A	7801 RAYTOWN RD	073196936	2021	INDIVIDUAL PERSONAL PROPERTY	OWENSBY RICHARD D & SHARON S	8406 E 83RD ST
073079206	2005	INDIVIDUAL PERSONAL PROPERTY	LEWIS FLORENCE	8819 E 80TH TER	073197285	2003-2004	INDIVIDUAL PERSONAL PROPERTY	OXLEY JERRY E	8530 ARLINGTON AVE
073082201	2007-2008	INDIVIDUAL PERSONAL PROPERTY	LIGON A P	12305 E 63RD TER	073198863	2014	INDIVIDUAL PERSONAL PROPERTY	PAITH WILBERT T	5234 NORTHERN AVE
073085271	2016	INDIVIDUAL PERSONAL PROPERTY	LITTLE ELSIE M	6234 ASH CT	073203367	2015	INDIVIDUAL PERSONAL PROPERTY	PARRISH JOHN R	8428 WOODSON DR
073086895	2010	INDIVIDUAL PERSONAL PROPERTY	LOCKWOOD RUBY	9311 E 80TH ST	073204785	2007	INDIVIDUAL PERSONAL PROPERTY	PATRICK DONALD O	NO ADDRESS PROVIDED BY TAXPAYER
073089277	2009-2010	INDIVIDUAL PERSONAL PROPERTY	LONG JOSEPH M	11400 HIDDEN LAKE DR	073206131	2007-2008	INDIVIDUAL PERSONAL PROPERTY	PATTON MARY L	9809 E 59TH ST
073094243	2008-2009	INDIVIDUAL PERSONAL PROPERTY	LUECKENHOFF GEORGE F	NO ADDRESS PROVIDED BY TAXPAYER	073206426	2014-2019	INDIVIDUAL PERSONAL PROPERTY	PAUL LINDA K	8311 WOODSON DR
073095395	2018-2019	INDIVIDUAL PERSONAL PROPERTY	LUNNON WILLIAM D	5130 WOODSON RD	073207032	2021	INDIVIDUAL PERSONAL PROPERTY	BROWN JR MARK P	11213 E 62ND ST
073098098	2009	INDIVIDUAL PERSONAL PROPERTY	MAASEN JOHN J	7907 HEDGES AVE	073208549	2012-2017	INDIVIDUAL PERSONAL PROPERTY	PEARSON MELVIN W	5805 LAUREL AVE
073100637	2008	INDIVIDUAL PERSONAL PROPERTY	MAGGARD NADINE	10600 E 80TH ST	073210073	2001	INDIVIDUAL PERSONAL PROPERTY	PENCE GEORGE R	8400 E 67TH ST
073101789	2003	INDIVIDUAL PERSONAL PROPERTY	MAKER CHARLES A	10201 E 64TH ST	073213267	2021	INDIVIDUAL PERSONAL PROPERTY	PERRY ROBERT F	10604 E 79TH TER
073106757	2016-2021	INDIVIDUAL PERSONAL PROPERTY	MARKER JEFFREY S & GEORGIA A	6404 HARVARD AVE	073214355	2016	INDIVIDUAL PERSONAL PROPERTY	PETERS ROBERT E	7918 EVANSTON AVE
073106935	2001	INDIVIDUAL PERSONAL PROPERTY	MARKL FREDA H	NO ADDRESS PROVIDED BY TAXPAYER	073215293	2006-2009	INDIVIDUAL PERSONAL PROPERTY	PETERSON ROBERT F	5321 RALSTON AVE
073109371	2002-2003	INDIVIDUAL PERSONAL PROPERTY	MARTIN DOROTHY V	NO ADDRESS PROVIDED BY TAXPAYER	073217423	2007-2008	INDIVIDUAL PERSONAL PROPERTY	PHILLIPS GLEN L	7213 RAYTOWN RD
073110564	2017-2018	INDIVIDUAL PERSONAL PROPERTY	MARTIN JOHN D	10714 E 63RD ST	073217682	2017-2018	INDIVIDUAL PERSONAL PROPERTY	PHILLIPS JOHN L & M	8110 HARDY AVE
073112802	2010-2011	INDIVIDUAL PERSONAL PROPERTY	MASON PATRICIA A	8902 E 74TH ST	073218538	2014-2015	INDIVIDUAL PERSONAL PROPERTY	PHILPOT RALPH S	9301 E 79TH ST
073113259	2002	INDIVIDUAL PERSONAL PROPERTY	MASONER CHARLES E & UNA L	NO ADDRESS PROVIDED BY TAXPAYER	073219305	2003-2005	INDIVIDUAL PERSONAL PROPERTY	PICKERING JUNE O MRS	6007 FARLEY AVE
073118655	2021	INDIVIDUAL PERSONAL PROPERTY	MARTHUR DAVID A	9717 E 68TH TER	073219378	2014-2017	INDIVIDUAL PERSONAL PROPERTY	PICKETT FLOYD R	6142 ASH CT
073119315	2017-2021	INDIVIDUAL PERSONAL PROPERTY	MCCALL VERMA J	5813 FARLEY AVE	073220053	2009	INDIVIDUAL PERSONAL PROPERTY	PIERCE LENORA C	6013 RAYTOWN RD
073120517	2009	INDIVIDUAL PERSONAL PROPERTY	MCCLAINE ROMA J	7917 HARDY AVE	073220259	2004-2014	INDIVIDUAL PERSONAL PROPERTY	PIERATT MICHAEL R	9110 E 69TH TER
073120884	2021	INDIVIDUAL PERSONAL PROPERTY	MCCLENDON DONALD RAY	10101 E 83RD TER	073220598	2009	INDIVIDUAL PERSONAL PROPERTY	INGLISH HAZELLE	11600 E 80TH DR
073122169	2003	INDIVIDUAL PERSONAL PROPERTY	MCCOY RUTH E	UNKNOWN	073223096	2011	INDIVIDUAL PERSONAL PROPERTY	PLATZ CHARLES J	9114 E 87TH ST
073122285	2010-2011	INDIVIDUAL PERSONAL PROPERTY	MCCOY MARY M	6801 HUNTER ST	073225441	2012	INDIVIDUAL PERSONAL PROPERTY	POOL GARY D	8950 E 59TH TER
073122579	2003	INDIVIDUAL PERSONAL PROPERTY	MCCRARY LYNDA M	NO ADDRESS PROVIDED BY TAXPAYER	073225842	2006	INDIVIDUAL PERSONAL PROPERTY	POPE NELCIE E & SAVANINEA BRANDON	8806 E 57TH ST
073125674	2013	INDIVIDUAL PERSONAL PROPERTY	MCGEHEE CLAUD D	9600 E 68TH ST	073228055	2002	INDIVIDUAL PERSONAL PROPERTY	POTTS JACK W	NO ADDRESS PROVIDED BY TAXPAYER
073127468	2007-2011	INDIVIDUAL PERSONAL PROPERTY	MCKEE RONALD G	7241 CRISP AVE	073228929	2021	INDIVIDUAL PERSONAL PROPERTY	POWELL LEROY	9110 E 63RD ST APT 205
073128617	2006	INDIVIDUAL PERSONAL PROPERTY	MCLAUGHLIN KENNETH J	7303 DITZLER AVE	073233986	2011	INDIVIDUAL PERSONAL PROPERTY	PULLIAM IRMA L	5721 WOODSON RD
073129484	2003-2007	INDIVIDUAL PERSONAL PROPERTY	MCMILLIN L E	NO ADDRESS PROVIDED BY TAXPAYER	073234315	2016	INDIVIDUAL PERSONAL PROPERTY	PURDUM ZENA G	9100 E 82ND ST
073129723	2004-2009	INDIVIDUAL PERSONAL PROPERTY	MCMURRY WILLIAM H	6808 MAPLE AVE	073234805	2008	INDIVIDUAL PERSONAL PROPERTY	PUZZO ANTHONY	8409 STERLING AVE
073131907	2017-2021	INDIVIDUAL PERSONAL PROPERTY	MCMICHAEL RAYMOND G	11010 E 83RD TER	073237660	2011-2017	INDIVIDUAL PERSONAL PROPERTY	RAGSDALE ROBERT E	18002 E 61ST TER
073133031	2020	INDIVIDUAL PERSONAL PROPERTY	MEDLEY DARYL W	7400 MAPLE DR UNIT 408	073238115	2013	INDIVIDUAL PERSONAL PROPERTY	RAINEY L V	5240 HARVARD AVE
073134842	2011	INDIVIDUAL PERSONAL PROPERTY	MELTON STEVE C	8806 E 55TH ST	073241156	2007	INDIVIDUAL PERSONAL PROPERTY	RATHBUN PHILIP D	9807 E 79TH TER
073135431	2016-2021	INDIVIDUAL PERSONAL PROPERTY	MENTESANA WILMA E	7416 CRISP AVE	073241548	2018	INDIVIDUAL PERSONAL PROPERTY	RAUZI ROBERT D	5736 BLUE RIDGE BLVD
073140577	2014-2015	INDIVIDUAL PERSONAL PROPERTY	MILES DONALD	6707 ENGLEWOOD AVE	073241584	2006	INDIVIDUAL PERSONAL PROPERTY	BURR DELORES	7517 OVERTON AVE

073241628	2009-2011	INDIVIDUAL PERSONAL PROPERTY	RAW BETTY L	8307 E 86TH TER	073381478	2001-2003	INDIVIDUAL PERSONAL PROPERTY	THRONEBERRY ANTONETT	NO ADDRESS PROVIDED BY TAXPAYER
073246570	2021	INDIVIDUAL PERSONAL PROPERTY	REESE KENNETH M & WANDA	10408 E 68TH TER	073384947	2019	INDIVIDUAL PERSONAL PROPERTY	TODD RICHARD L	6201 ASH CT
073248284	2005	INDIVIDUAL PERSONAL PROPERTY	REITH ERICH W & HELMA L	6313 STERLING AVE	073385704	2019	INDIVIDUAL PERSONAL PROPERTY	TOMAN LORETTA	8207 WILLOW WAY
073248658	2005-2006	INDIVIDUAL PERSONAL PROPERTY	REMY ERNEST E	9810 E 80TH TER	073390850	2005	INDIVIDUAL PERSONAL PROPERTY	TROUP ROBERT L	NO ADDRESS PROVIDED BY TAXPAYER
073250458	2006-2017	INDIVIDUAL PERSONAL PROPERTY	REYNOLDS BRYAN K	9104 E 74TH TER	073391966	2009-2010	INDIVIDUAL PERSONAL PROPERTY	TUCK GARRETT L	11200 E 64TH TER
073253400	2008	INDIVIDUAL PERSONAL PROPERTY	RICHARDS VIRGINIA	6240 ASH CT	073398987	2008-2009	INDIVIDUAL PERSONAL PROPERTY	VANLANCKER HENRY O	6625 OXFORD AVE
073256755	2004	INDIVIDUAL PERSONAL PROPERTY	RIGDON MARCELLENE C	UNKNOWN	073400885	2015	INDIVIDUAL PERSONAL PROPERTY	VANZANT ROSALIE A	7512 ARLINGTON AVE
073260107	2005	INDIVIDUAL PERSONAL PROPERTY	ROATH ETHEL	9110 E 63RD ST APT 101	073401394	2001	INDIVIDUAL PERSONAL PROPERTY	VAUGHAN ELLA M & GEORGE E	NO ADDRESS PROVIDED BY TAXPAYER
073266227	2017-2019	INDIVIDUAL PERSONAL PROPERTY	ROE EUGENE T	8932 E 66TH ST	073402366	2006	INDIVIDUAL PERSONAL PROPERTY	VEGA CECIL L	5602 WOODSON RD
073267832	2004	INDIVIDUAL PERSONAL PROPERTY	ROHLFING FLORA	NO ADDRESS PROVIDED BY TAXPAYER	073402696	2019	INDIVIDUAL PERSONAL PROPERTY	VENTO JOSEPH J JR	9307 E 84TH ST
073269625	2004-2017	INDIVIDUAL PERSONAL PROPERTY	ROPER LUELLA M	5332 NORTHERN AVE	073403392	2002-2005	INDIVIDUAL PERSONAL PROPERTY	VEST MARY F	5465 NE WEDGEWOOD LN
073270445	2019	INDIVIDUAL PERSONAL PROPERTY	ROSELLI SHIRLEY S	8609 E 83RD ST	073404391	2021	INDIVIDUAL PERSONAL PROPERTY	VINCENT EUNICE M	11813 E 83RD ST APT 102
073272069	2019-2020	INDIVIDUAL PERSONAL PROPERTY	ROSS WILLARD H	9202 E 69TH ST	073405773	2008-2013	INDIVIDUAL PERSONAL PROPERTY	VONDERAHE HERMAN J	NO ADDRESS PROVIDED BY TAXPAYER
073273335	2003	INDIVIDUAL PERSONAL PROPERTY	ROUTON LUCILLE V	NO ADDRESS PROVIDED BY TAXPAYER	073405862	2012	INDIVIDUAL PERSONAL PROPERTY	VORBECK WILLIAM R	7505 APPLETON AVE
073279142	2016-2017	INDIVIDUAL PERSONAL PROPERTY	RYON EUGENE C & LOUISE P	6511 LANE AVE	073406120	2020-2021	INDIVIDUAL PERSONAL PROPERTY	VOYLES PATRICIA BELLE & DONNA H BRESSMAN	9412 E 85TH ST
073280522	2004-2017	INDIVIDUAL PERSONAL PROPERTY	SALLEE DAVID M	NO ADDRESS PROVIDED BY TAXPAYER	073406978	2008	INDIVIDUAL PERSONAL PROPERTY	WADE WILLIAM & LOIS	NO ADDRESS PROVIDED BY TAXPAYER
073284528	2018-2021	INDIVIDUAL PERSONAL PROPERTY	SARVER ROBERT B	8114 WILLOW WAY	073408563	2008-2009	INDIVIDUAL PERSONAL PROPERTY	WAKEFIELD EUGENE F	11500 HIDDEN LAKE DR
073284626	2011-2017	INDIVIDUAL PERSONAL PROPERTY	SATTERFIELD BERT L	9418 E 82ND ST	073410062	2005	INDIVIDUAL PERSONAL PROPERTY	WALKER HENRY L	10905 E 77TH TER
073287115	2004-2007	INDIVIDUAL PERSONAL PROPERTY	SCHAFFER MICHAEL L	9401 E 81ST ST	073410133	2016	INDIVIDUAL PERSONAL PROPERTY	WALKER HOYT	8001 HARRIS AVE
073287268	2008	INDIVIDUAL PERSONAL PROPERTY	SCHALLENBERG EUGENE & MARY	7409 RALSTON AVE	073413880	2011-2012	INDIVIDUAL PERSONAL PROPERTY	WAMPLER JEANETTE	10111 E 77TH TER
073290600	2020-2021	INDIVIDUAL PERSONAL PROPERTY	SCHNECK JAMES M	9221 E 52ND TER	073417902	2017	INDIVIDUAL PERSONAL PROPERTY	WATERS ALBERT B	6005 ENGLEWOOD AVE
073292573	2004	INDIVIDUAL PERSONAL PROPERTY	SCHROER FRANCES M	7423 ASH AVE	073418457	2014-2016	INDIVIDUAL PERSONAL PROPERTY	WATKINS LARRY DEAN	8821 E 61ST TER
073296105	2006-2008	INDIVIDUAL PERSONAL PROPERTY	SCOTT JESSE W	9110 E 63RD ST APT 101	073423959	2004	INDIVIDUAL PERSONAL PROPERTY	WEIGAND JUNE I	UNKNOWN
073297658	2011-2014	INDIVIDUAL PERSONAL PROPERTY	SEABOLDT JERRY L	5604 DITZLER AVE	073424609	2003	INDIVIDUAL PERSONAL PROPERTY	WEISE CARL A	UNKNOWN
073303473	2017	INDIVIDUAL PERSONAL PROPERTY	SHARP JAMES M & IOHN M	7420 MARLE UNIT 224	073426108	2009	INDIVIDUAL PERSONAL PROPERTY	MORRIS DANISE S	806 S CRANE ST
073304196	2011-2013	INDIVIDUAL PERSONAL PROPERTY	SHAW DARLENE R	6424 WOODSON RD	073427107	2010	INDIVIDUAL PERSONAL PROPERTY	WEMOTT ELEANOR R	7209 ASH AVE
073305088	2021	INDIVIDUAL PERSONAL PROPERTY	SHEARER DONOVAN	8525 EVANSTON AVE	073428142	2004	INDIVIDUAL PERSONAL PROPERTY	WESSLEY M SCOTT	1100 E 78TH PL
073306602	2003-2004	INDIVIDUAL PERSONAL PROPERTY	SHELTON ROGER D	NO ADDRESS PROVIDED BY TAXPAYER	073428160	2019-2020	INDIVIDUAL PERSONAL PROPERTY	WESSLEY LOYDE C	7601 ENGLEWOOD AVE
073307763	2001-2002	INDIVIDUAL PERSONAL PROPERTY	SHERMAN GEORGE O	NO ADDRESS PROVIDED BY TAXPAYER	073429551	2004	INDIVIDUAL PERSONAL PROPERTY	WESTING HENRY D	NO ADDRESS PROVIDED BY TAXPAYER
073307914	2001	INDIVIDUAL PERSONAL PROPERTY	SHERMAN ROBERT F	UNKNOWN	073430905	2006-2017	INDIVIDUAL PERSONAL PROPERTY	WHEELER MARGARET E	9108 E 68TH ST
073307969	2003	INDIVIDUAL PERSONAL PROPERTY	SHERMAN STANLEY C	NO ADDRESS PROVIDED BY TAXPAYER	073434787	2010-2011	INDIVIDUAL PERSONAL PROPERTY	WHITE SARAH & ESTES DAN	8518 E 65TH ST
073308049	2011	INDIVIDUAL PERSONAL PROPERTY	SHERRILL JAMES V SR & MARGARET	6140 RAYTOWN RD APT 101	073435269	2001	INDIVIDUAL PERSONAL PROPERTY	WHITEMAN CHARLES R	UNKNOWN
073311026	2004	INDIVIDUAL PERSONAL PROPERTY	SHORES DOROTHY E	NO ADDRESS PROVIDED BY TAXPAYER	073435385	2003	INDIVIDUAL PERSONAL PROPERTY	WHITESIDE GERALD L	UNKNOWN
073311142	2008	INDIVIDUAL PERSONAL PROPERTY	SHORT BETTY A	6214 ASH CT	073437846	2005-2007	INDIVIDUAL PERSONAL PROPERTY	WILCH LAURA	8800 E 66TH ST
073312374	2018-2021	INDIVIDUAL PERSONAL PROPERTY	SHULL CHARLES L	9011 E 72ND TER	073440208	2006	INDIVIDUAL PERSONAL PROPERTY	WILLCUTS DON A & NADINE	5517 MANNING AVE
073315399	2004-2005	INDIVIDUAL PERSONAL PROPERTY	SIMMONS OWEN & DOROTHY	11016 E 54TH ST	073440271	2016-2017	INDIVIDUAL PERSONAL PROPERTY	WILLEFORD ALTON L	9115 E 58TH TER
073317039	2018-2021	INDIVIDUAL PERSONAL PROPERTY	SIMS CHARLIE E JR	9115 E 73RD ST	073442064	2013-2017	INDIVIDUAL PERSONAL PROPERTY	WILLIAMS DOUGLAS L	6601 RALSTON AVE
073317217	2004-2011	INDIVIDUAL PERSONAL PROPERTY	SIMS JOHN B	9053 E 83RD ST	073445999	2005	INDIVIDUAL PERSONAL PROPERTY	WILLIAMS MARY J	NO ADDRESS PROVIDED BY TAXPAYER
073318154	2013	INDIVIDUAL PERSONAL PROPERTY	SIPPEL ROBERT D	11601 E 80TH DR	073446685	2005	INDIVIDUAL PERSONAL PROPERTY	WILLIAMS VAUGHN E	NO ADDRESS PROVIDED BY TAXPAYER
073318314	2006	INDIVIDUAL PERSONAL PROPERTY	SIRON KAY R & CATHERINE	8824 E 61ST ST	073446916	2016	INDIVIDUAL PERSONAL PROPERTY	WILLIAMS WILLIAM F	9508 E 66TH ST
073323068	2019	INDIVIDUAL PERSONAL PROPERTY	SMITH CARSON	4235 E 53RD ST	073448399	2020-2021	INDIVIDUAL PERSONAL PROPERTY	WILLOUGHBY JAMES	7864 WOODSON CIR
073327117	2019-2021	INDIVIDUAL PERSONAL PROPERTY	SMITH JAMES L & LETA	7913 APPLETON AVE	073449067	2013-2015	INDIVIDUAL PERSONAL PROPERTY	WILSON CHARLES D	5725 HARVARD AVE
073327563	2018	INDIVIDUAL PERSONAL PROPERTY	SMITH JOE D	6616 RALSTON AVE	073450205	2010	INDIVIDUAL PERSONAL PROPERTY	WILSON GERALD E	9025 E 62ND ST
073329133	2009	INDIVIDUAL PERSONAL PROPERTY	SMITH MARQUIS	10508 E 65TH TER	073450839	2018-2020	INDIVIDUAL PERSONAL PROPERTY	WILSON KENNETH W	8906 E 58TH ST
073333146	2020-2021	INDIVIDUAL PERSONAL PROPERTY	HEINRICH RICHARD G	8959 E 79TH DR	073451669	2018	INDIVIDUAL PERSONAL PROPERTY	WILSON ROBERT C	10510 E 72ND ST
073333468	2005-2008	INDIVIDUAL PERSONAL PROPERTY	SNIDOW CHARLES R	NO ADDRESS PROVIDED BY TAXPAYER	073456361	2003	INDIVIDUAL PERSONAL PROPERTY	BOND EDITH JOYCE	NO ADDRESS PROVIDED BY TAXPAYER
073334225	2021	INDIVIDUAL PERSONAL PROPERTY	SNYDER DAVID D	11804 E 77TH TER	073457547	2004-2007	INDIVIDUAL PERSONAL PROPERTY	WOLGAMOTT SHANNON C	6712 LAUREL AVE
073334500	2021	INDIVIDUAL PERSONAL PROPERTY	SNYDER FRANCES	8817 E 81ST ST	073460999	2021	INDIVIDUAL PERSONAL PROPERTY	WOODWARD WILLIAM P	6906 HAWTHORNE AVE
073335634	2009	INDIVIDUAL PERSONAL PROPERTY	SOMERS LEONA M	8606 E 83RD ST	073461514	2015	INDIVIDUAL PERSONAL PROPERTY	WOODSEY ESSEL L	11205 E 64TH TER
073337446	2013-2014	INDIVIDUAL PERSONAL PROPERTY	SPARKS RUTH L	8521 E 81ST TER	073463718	2002	INDIVIDUAL PERSONAL PROPERTY	WRIGHT LAVERNE MAY	UNKNOWN
073341342	2009-2010	INDIVIDUAL PERSONAL PROPERTY	STABE RUTH M	7400 MAPLE UNIT 423	073463861	2001	INDIVIDUAL PERSONAL PROPERTY	WRIGHT MARION F	NO ADDRESS PROVIDED BY TAXPAYER
073341841	2012-2015	INDIVIDUAL PERSONAL PROPERTY	STAFFORD JANINE M	10508 E 71ST TER	073464940	2019	INDIVIDUAL PERSONAL PROPERTY	GREGORY BARBARA	7302 HEDGES AVE
073342779	2015-2021	INDIVIDUAL PERSONAL PROPERTY	STANDING RICHARD B	11013 E 54TH ST	073465501	2014	INDIVIDUAL PERSONAL PROPERTY	WYMAN JAMES L	11205 E 83RD ST
073347300	2018	INDIVIDUAL PERSONAL PROPERTY	STEPHENS LEROY V	8307 SPRING VALLEY RD	073465958	2002	INDIVIDUAL PERSONAL PROPERTY	YAGER JACK B	NO ADDRESS PROVIDED BY TAXPAYER
073347738	2020	INDIVIDUAL PERSONAL PROPERTY	STEPHENSON NORMAN R	9300 E 69TH TER	073467260	2020-2021	INDIVIDUAL PERSONAL PROPERTY	YETTER CLARICE E	11204 E 60TH ST
073349442	2013-2015	INDIVIDUAL PERSONAL PROPERTY	STEWART BILLY E	5544 BLUE RIDGE BLVD	073467563	2002	INDIVIDUAL PERSONAL PROPERTY	YODER CLEO G & MARGIE	NO ADDRESS PROVIDED BY TAXPAYER
073351474	2009	INDIVIDUAL PERSONAL PROPERTY	STILLWELL JAMES A & EVELYN	7614 ELM ST	073468697	2016-2017	INDIVIDUAL PERSONAL PROPERTY	YOUNG KATHERINE	6109 WILLOW AVE
073351606	2008-2017	INDIVIDUAL PERSONAL PROPERTY	STIMPERT FERN R	11605 E 79TH DR	073469534	2017-2019	INDIVIDUAL PERSONAL PROPERTY	YOUNG DONNIA R	8304 HAWTHORNE AVE
073354961	2017	INDIVIDUAL PERSONAL PROPERTY	STOUT CAROLYN J	10808 E 58TH ST	073470933	2014-2016	INDIVIDUAL PERSONAL PROPERTY	ZAPIEN JOSEPH M	5444 WOODSON RD
073357352	2004-2006	INDIVIDUAL PERSONAL PROPERTY	STRODER WILLIAM E	8428 MARSH AVE	073470988	2011-2012	INDIVIDUAL PERSONAL PROPERTY	ZARKER CATHERINE J	11602 E 79TH DR
073358734	2012-2015	INDIVIDUAL PERSONAL PROPERTY	STUHLMAN ARTHUR F	9104 VAUGHN AVE	073472557	2010-2014	INDIVIDUAL PERSONAL PROPERTY	ZOLLARS DONALD E & NORMA L	10118 E 78TH TER
073359485	2005	INDIVIDUAL PERSONAL PROPERTY	SUFFRIDGE KATHLEEN	9815 E 77TH TER	073472762	2005	INDIVIDUAL PERSONAL PROPERTY	ZUBECK JOHN J	8509 SPRING VALLEY RD
073364772	2019	INDIVIDUAL PERSONAL PROPERTY	SWITZER SANDRA M	6140 ASH CT	073475732	2009-2010	INDIVIDUAL PERSONAL PROPERTY	ALLEN FRANCIS J	8413 HARRIS AVE
073367234	2012	INDIVIDUAL PERSONAL PROPERTY	TAPP ELMER C JR & OLIVE	8605 MAYWOOD AVE	073477302	2002	INDIVIDUAL PERSONAL PROPERTY	TALLY JON F	NO ADDRESS PROVIDED BY TAXPAYER
073370612	2012-2014	INDIVIDUAL PERSONAL PROPERTY	TAYLOR OLIVER & DORA LEE	NO ADDRESS PROVIDED BY TAXPAYER	073478917	2016	INDIVIDUAL PERSONAL PROPERTY	AYERS MARGARET C & CAMERON D	7017 ARLINGTON AVE
073370621	2008	INDIVIDUAL PERSONAL PROPERTY	TAYLOR CLETA	8313 HARVARD TER	073480370	2009-2011	INDIVIDUAL PERSONAL PROPERTY	BARGER MARIAN J	6123 ASH CT
073372111	2006	INDIVIDUAL PERSONAL PROPERTY	TEMPLETON NEVA	8308 MANNING AVE	073481397	2001-2005	INDIVIDUAL PERSONAL PROPERTY	BASSETT JERRY L	NO ADDRESS PROVIDED BY TAXPAYER
073374609	2005	INDIVIDUAL PERSONAL PROPERTY	THOMAS ALMA L	5806 FARLEY AVE	073485856	2003-2004	INDIVIDUAL PERSONAL PROPERTY	BOLINGER GARRY & ESTHER L	7620 HARRIS AVE
073375092	2003-2005	INDIVIDUAL PERSONAL PROPERTY	THOMAS DELBERT R	11408 E 65TH TER	073486677	2017	INDIVIDUAL PERSONAL PROPERTY	BOWEN DALE R	8120 SPRING VALLEY RD
073375298	2005	INDIVIDUAL PERSONAL PROPERTY	THOMAS ERBEN C	11513 E 66TH TER	073487015	2013	INDIVIDUAL PERSONAL PROPERTY	BOX LUCILLE	NO ADDRESS PROVIDED BY TAXPAYER
073376144	2003	INDIVIDUAL PERSONAL PROPERTY	THOMAS LARRY L	7928 HEDGES AVE	073487051	2005-2009	INDIVIDUAL PERSONAL PROPERTY	BOXWELL GLENN F	6500 STERLING AVE
073377722	2013-2017	INDIVIDUAL PERSONAL PROPERTY	THOMPSON BERT JR	6720 CRISP AVE	073489139	2020-2021	INDIVIDUAL PERSONAL PROPERTY	BROADUS ROY L	11427 E 71ST ST

073490626	2001	INDIVIDUAL PERSONAL PROPERTY	BROWN NORMAN E	NO ADDRESS PROVIDED BY TAXPAYER	073684702	2019	INDIVIDUAL PERSONAL PROPERTY	PETERSON GEORGE W	5431 HARVARD AVE
073491233	2016	INDIVIDUAL PERSONAL PROPERTY	BRUCE WENDELL H	7516 OVERTON AVE	073685186	2006	INDIVIDUAL PERSONAL PROPERTY	POLLARD MARIAN A (DORE)	6122 WILLOW AVE
073491411	2005-2007	INDIVIDUAL PERSONAL PROPERTY	BRUNSON MARGIE D	9101 E 72ND TER	073685541	2002	INDIVIDUAL PERSONAL PROPERTY	PRICE CHARLES E	NO ADDRESS PROVIDED BY TAXPAYER
073491448	2021	INDIVIDUAL PERSONAL PROPERTY	BRYAN ALICE J	5216 ELM PL	073690358	2004	INDIVIDUAL PERSONAL PROPERTY	SMITH EMERY DWAYNE	UNKNOWN
073491457	2001	INDIVIDUAL PERSONAL PROPERTY	DISTEFANO FREDA	UNKNOWN	073690429	2014-2021	INDIVIDUAL PERSONAL PROPERTY	SMITH GEORGE W & JULIA A	6828 STERLING AVE
073491475	2021	INDIVIDUAL PERSONAL PROPERTY	BRYAN KAROLYN J	5216 ELM PL	073690580	2011-2012	INDIVIDUAL PERSONAL PROPERTY	SMITH MARY ANN	10201 E 71ST TER
073494061	2001	INDIVIDUAL PERSONAL PROPERTY	CADY LOUISE M	8806 E 72ND ST	073692506	2003-2004	INDIVIDUAL PERSONAL PROPERTY	HEIM PATTY	7809 ARLINGTON AVE
073494150	2019-2021	INDIVIDUAL PERSONAL PROPERTY	CAIN LOUIS C III & O	8504 B ELM AVE	073696398	2003-2007	INDIVIDUAL PERSONAL PROPERTY	DIANE PUNIABI	6105 HUNTER ST
073494720	2019-2021	INDIVIDUAL PERSONAL PROPERTY	CAMPBELL JUDITH LYNN	7608 CRESCENT DR	073699572	2021	INDIVIDUAL PERSONAL PROPERTY	COLLIER ELVA CLAUDENE	9606 E 77TH TER
073495408	2010	INDIVIDUAL PERSONAL PROPERTY	CAPRA SAMUEL J	9708 BROOKLANE ST	073702657	2010-2012	INDIVIDUAL PERSONAL PROPERTY	BROWN JAMES EDMOND	11126 E 84TH TER
073497291	2008	INDIVIDUAL PERSONAL PROPERTY	CAVANAUGH FRANK E	11311 E 58TH TER	073707046	2006	INDIVIDUAL PERSONAL PROPERTY	MUNHOLLAND IRENE	NO ADDRESS PROVIDED BY TAXPAYER
073498548	2008	INDIVIDUAL PERSONAL PROPERTY	CHRISTENSEN CHRIS A	5229 CRISP AVE	073708401	2020-2021	INDIVIDUAL PERSONAL PROPERTY	ROWE TONI C (GIBBS)	10012 E 83RD TER
073504915	2021	INDIVIDUAL PERSONAL PROPERTY	CREAMER DOUGLAS E	10700 E 66TH ST	073710737	2021	INDIVIDUAL PERSONAL PROPERTY	PIKE GREG J & JUDY A	8907 E 84TH ST
073505157	2018	INDIVIDUAL PERSONAL PROPERTY	CROPP DONNA M	7910 APPLETON AVE	073713173	2015	INDIVIDUAL PERSONAL PROPERTY	BERKEBIE DAVID KEIT	8611 WESTRIDGE RD
073507663	2003-2004	INDIVIDUAL PERSONAL PROPERTY	DAVIS ANNAMARIE	10504 E 70TH TER	073719337	2014	INDIVIDUAL PERSONAL PROPERTY	WILLIAMS EUGENE D & KIMBERLY	5812 ELM AVE
073510579	2004	INDIVIDUAL PERSONAL PROPERTY	DICKEY HELEN	6709 VERMONT AVE	073720539	2021	INDIVIDUAL PERSONAL PROPERTY	MCCAULEY MICHAEL J	8108 MANNING AVE
073511952	2005-2006	INDIVIDUAL PERSONAL PROPERTY	DOSS DWIGHT & CAMILLA	NO ADDRESS PROVIDED BY TAXPAYER	073720833	2021	INDIVIDUAL PERSONAL PROPERTY	LIPPS ARLTON D	5820 LANE AVE
073515770	2009	INDIVIDUAL PERSONAL PROPERTY	ELLIS JOAN M	7501 HAWTHORNE AVE	073724296	2006-2011	INDIVIDUAL PERSONAL PROPERTY	VILLEGAS CAROLYN S	9400 E 83RD ST
073515805	2012-2017	INDIVIDUAL PERSONAL PROPERTY	ELLIS WAYNE A	9304 E 70TH TER	073731929	2015-2021	INDIVIDUAL PERSONAL PROPERTY	ZIMMERMAN EDWARD	5707 CEDAR AVE
073519197	2008-2009	INDIVIDUAL PERSONAL PROPERTY	FIELDS MICHAEL & CYNTHIA	8312 HEDGES AVE	073734649	2021	INDIVIDUAL PERSONAL PROPERTY	JOHNSON GLENDORA	11801 E 85TH ST
073519598	2017-2019	INDIVIDUAL PERSONAL PROPERTY	FISCHBACH GARY W	11305 E 69TH ST	073750541	2005	INDIVIDUAL PERSONAL PROPERTY	BROWN JOHN	9708 E 71ST TER
073520443	2008	INDIVIDUAL PERSONAL PROPERTY	FLEENER VIRGINIA	9305 E 82ND TER	073751005	2007	INDIVIDUAL PERSONAL PROPERTY	PICKRELL LAVONA	5900 ARLINGTON AVE
073520648	2013-2015	INDIVIDUAL PERSONAL PROPERTY	FLORAY LAURA	6716 APPLETON AVE	073760521	2006-2007	INDIVIDUAL PERSONAL PROPERTY	STONEKING MEREDITH L & KRISTI C MEYER	7541 WESTRIDGE RD
073535255	2021	INDIVIDUAL PERSONAL PROPERTY	HARRIS WILLIAM B & SHARON K	6216 ENGLEWOOD AVE	073761995	2008	INDIVIDUAL PERSONAL PROPERTY	DUDLEY EVA M	15004 SE DALTON DR
073540074	2020	INDIVIDUAL PERSONAL PROPERTY	HICKS JERRY LEE	10012 E 86TH TER	073763396	2016-2019	INDIVIDUAL PERSONAL PROPERTY	LIVINGSTON AARON & HALL ERIC	7505 ENGLEWOOD AVE
073543954	2013-2014	INDIVIDUAL PERSONAL PROPERTY	HORTON ROBERT M	NO ADDRESS PROVIDED BY TAXPAYER	073764420	2009-2010	INDIVIDUAL PERSONAL PROPERTY	GATSCHE RETA	11701 E 83RD ST APT 101
073543990	2021	INDIVIDUAL PERSONAL PROPERTY	HOSIER LESLIE E & DOROTHY	8010 E 91ST ST	073766464	2005-2006	INDIVIDUAL PERSONAL PROPERTY	RATLIFF HENDERSOHN L & CHERYL LY	7517 RIDGEWAY AVE
073547512	2015	INDIVIDUAL PERSONAL PROPERTY	HURSMAN R C	5419 WOODSON RD	073773713	2008	INDIVIDUAL PERSONAL PROPERTY	WOOD RANDELL	8809 E 62ND TER
073545494	2009	INDIVIDUAL PERSONAL PROPERTY	JUERGENS DOROTHY	7032 HUNTER ST	073773857	2021	INDIVIDUAL PERSONAL PROPERTY	SCHMIDT RUTH A	11000 E 78TH ST
073559456	2001	INDIVIDUAL PERSONAL PROPERTY	KRUEGER RALPH L	UNKNOWN	073774543	2021	INDIVIDUAL PERSONAL PROPERTY	CASS GEORGE & HELLEN	11212 LAKEVIEW BLVD
073561452	2009	INDIVIDUAL PERSONAL PROPERTY	LASALA CARL J	8311 MANNING AVE	073775383	2015	INDIVIDUAL PERSONAL PROPERTY	SMITH CLIFFORD	8614 E UTOPIA DR APT 71
073563021	2021	INDIVIDUAL PERSONAL PROPERTY	LENHART DONNA SUE	11704 E 76TH TER	073776104	2005	INDIVIDUAL PERSONAL PROPERTY	RIDLEY CARLTON JR	5244 HARDY CT
073564850	2019	INDIVIDUAL PERSONAL PROPERTY	LITRELL LEILA	11016 E 57TH ST	073778068	2021	INDIVIDUAL PERSONAL PROPERTY	ROWLES RONALD L & OR	9901 E 76TH TER
073565056	2006	INDIVIDUAL PERSONAL PROPERTY	LOCASCIO RUBY P	NO ADDRESS PROVIDED BY TAXPAYER	073779977	2007-2012	INDIVIDUAL PERSONAL PROPERTY	SMITH LAURA H	NO ADDRESS PROVIDED BY TAXPAYER
073565859	2017	INDIVIDUAL PERSONAL PROPERTY	LONG NORMAN R	10505 E 65TH TER	073780162	2019-2021	INDIVIDUAL PERSONAL PROPERTY	ADAIR JOHN JR & BETTY A	9317 E 85TH ST
073567134	2015-2019	INDIVIDUAL PERSONAL PROPERTY	LEWIS SUGAR LEE & LUSTER YOLANDA D	10009 E 70TH TER	073781553	2005-2017	INDIVIDUAL PERSONAL PROPERTY	CHATMON DONNIE M & DELORES	9312 E 84TH TER
073574611	2004	INDIVIDUAL PERSONAL PROPERTY	MCGHEE ROBERT K	UNKNOWN	073784006	2010-2017	INDIVIDUAL PERSONAL PROPERTY	LEE GARY M & ALICE M	9922 E 77TH ST
073580262	2019	INDIVIDUAL PERSONAL PROPERTY	MOFFETT SHIRLEY J	5712 BLUE RIDGE CUT OFF	073788164	2005-2017	INDIVIDUAL PERSONAL PROPERTY	THOMAS SCOTT & BRENDA	8528 ASH AVE
073581332	2011-2012	INDIVIDUAL PERSONAL PROPERTY	MOORE HARVEY J	NO ADDRESS PROVIDED BY TAXPAYER	073789911	2002-2004	INDIVIDUAL PERSONAL PROPERTY	BALLANCE DAVID	9107 E 87TH ST
073586408	2009-2011	INDIVIDUAL PERSONAL PROPERTY	RAMSEY MARY O	NO ADDRESS PROVIDED BY TAXPAYER	073794736	2021	INDIVIDUAL PERSONAL PROPERTY	SIMPSON HERBERT	7918 TENNESSEE AVE
073587906	2008-2017	INDIVIDUAL PERSONAL PROPERTY	NUCCIO PETE	7418 ASH AVE	073795913	2001	INDIVIDUAL PERSONAL PROPERTY	KELTON ADA MARIE	NO ADDRESS PROVIDED BY TAXPAYER
073593409	2020-2021	INDIVIDUAL PERSONAL PROPERTY	PENCE LARRY AND RUTH AND JOHN	5433 RALSTON AVE	073796155	2001	INDIVIDUAL PERSONAL PROPERTY	MARTIN GEORGE C	NO ADDRESS PROVIDED BY TAXPAYER
073594079	2010-2011	INDIVIDUAL PERSONAL PROPERTY	PIRNIE TERRI JO	7137 RAYTOWN RD	073796681	2021	INDIVIDUAL PERSONAL PROPERTY	JOHNSON JOYCE A & CECIL	7408 WOODSON RD
073595158	2009	INDIVIDUAL PERSONAL PROPERTY	PHILLIPS DOROTHY M	11308 E 77TH TER	073796896	2021	INDIVIDUAL PERSONAL PROPERTY	SCOTT ALEX	6116 WOODSON RD
073595933	2020-2021	INDIVIDUAL PERSONAL PROPERTY	PINNEY MALCOLM G & ELEANOR L	10901 E 58TH TER	073800033	2005	INDIVIDUAL PERSONAL PROPERTY	COOMBS HARRY E	4531 TERRACE ST
073596870	2005	INDIVIDUAL PERSONAL PROPERTY	PORTER ANNA RUTH	10117 E 68TH TER	073800505	2021	INDIVIDUAL PERSONAL PROPERTY	COWAN JAMES L & SALLY	6005 CLAREMONT AVE
073596978	2008-2017	INDIVIDUAL PERSONAL PROPERTY	MORGAN BILLY J	5712 MANNING AVE	073800667	2021	INDIVIDUAL PERSONAL PROPERTY	SHEEHY MARCELLA K	6709 ELM AVE
073602300	2013-2017	INDIVIDUAL PERSONAL PROPERTY	REYNOLDS DARYLE E	7911 MAPLE AVE	073803780	2014-2015	INDIVIDUAL PERSONAL PROPERTY	QUEEN DONALD R & QUEEN ROBERTA	5745 BLUE RIDGE BLVD
073612282	2010-2013	INDIVIDUAL PERSONAL PROPERTY	SCHUCH NEAL R & NANCY J	10400 E 79TH TER	073808268	2003	INDIVIDUAL PERSONAL PROPERTY	FANNON AARON G & PHYLLIS	UNKNOWN
073612638	2019-2020	INDIVIDUAL PERSONAL PROPERTY	KIMREY DONALD L & MARY K	9700 E 84TH ST	073808348	2009-2010	INDIVIDUAL PERSONAL PROPERTY	BENNETT JUDITH	6647 CEDAR AVE APT A
073622235	2014	INDIVIDUAL PERSONAL PROPERTY	SPICKELMIER WARREN C	11411 HIDDEN LAKE DR APT 707	073810638	2015	INDIVIDUAL PERSONAL PROPERTY	HICKERSON MARLENA	6205 HUNTER ST
073623323	2009	INDIVIDUAL PERSONAL PROPERTY	STARK LOU ANN	9110 E 63RD ST APT 325	073814359	2010	INDIVIDUAL PERSONAL PROPERTY	WOODSON JACK T	NO ADDRESS PROVIDED BY TAXPAYER
073625802	2020	INDIVIDUAL PERSONAL PROPERTY	STONE CAROL	9209 VALIUGHN AVE	073815900	2001-2017	INDIVIDUAL PERSONAL PROPERTY	COLLINS LEOTA M	5809 WOODSON RD
073628989	2010	INDIVIDUAL PERSONAL PROPERTY	TATE WILLIAM E & FLORENE	8804 E 67TH ST	073817873	2000	INDIVIDUAL PERSONAL PROPERTY	HARKER CHRISTIAN S	UNKNOWN
073633722	2010	INDIVIDUAL PERSONAL PROPERTY	TRIPP DENISE G	11320 E 56TH TER	073818916	2006-2017	INDIVIDUAL PERSONAL PROPERTY	KING LEWIS E JR & KIM	6639 NORTHERN AVE
073636275	2002-2003	INDIVIDUAL PERSONAL PROPERTY	VANHORN RALPH D	NO ADDRESS PROVIDED BY TAXPAYER	073820397	2019-2021	INDIVIDUAL PERSONAL PROPERTY	GRUBB WILLIAM D & VANITA J	7012 ENGLEWOOD TER
073640313	2002	INDIVIDUAL PERSONAL PROPERTY	WARD VIRGINIA	NO ADDRESS PROVIDED BY TAXPAYER	073825686	2009-2010	INDIVIDUAL PERSONAL PROPERTY	REYNOLDS HAROLD E SR	9504 E 65TH ST
073640634	2001-2002	INDIVIDUAL PERSONAL PROPERTY	WARNEKEN LOIS Y	UNKNOWN	073826060	2021	INDIVIDUAL PERSONAL PROPERTY	GASSEN MICHAEL C	6400 HUNTER ST
073640652	2018	INDIVIDUAL PERSONAL PROPERTY	WARREN SALLY A	11411 HIDDEN LAKE DR APT 702	073826097	2006	INDIVIDUAL PERSONAL PROPERTY	ERWIN THOMAS V JR	NO ADDRESS PROVIDED BY TAXPAYER
073643828	2013	INDIVIDUAL PERSONAL PROPERTY	WHITAKER JOHN E	6812 LANE AVE	073827755	2014	INDIVIDUAL PERSONAL PROPERTY	PERKINS BILLIE J	5204 STERLING AVE
073647799	2021	INDIVIDUAL PERSONAL PROPERTY	WILLS JUDITH D	6140 RAYTOWN RD APT 1012	073829922	2001	INDIVIDUAL PERSONAL PROPERTY	LENINGTON PEARL M	NO ADDRESS PROVIDED BY TAXPAYER
073649261	2002-2003	INDIVIDUAL PERSONAL PROPERTY	WISDOM WILLIAM R	UNKNOWN	073830448	2016	INDIVIDUAL PERSONAL PROPERTY	WHITE WALTER E & KAREN	5507 HUNTER ST
073652041	2013-2015	INDIVIDUAL PERSONAL PROPERTY	WYATT NORMA L	8817 E 57TH TER	073831125	2012	INDIVIDUAL PERSONAL PROPERTY	SMITH MARSHALL W	8503 KENTUCKY AVE
073652513	2008-2016	INDIVIDUAL PERSONAL PROPERTY	YATES SHIRLEY A	8405 PERSHING RD	073831722	2010-2015	INDIVIDUAL PERSONAL PROPERTY	SALES BARBARA J	5111 WILLOW AVE
073662245	2017	INDIVIDUAL PERSONAL PROPERTY	CUSHMAN BARBARA L	11701 E 77TH TER	073834257	2017-2021	INDIVIDUAL PERSONAL PROPERTY	JACKSON MARGARET W	10612 E 60TH TER
073673207	2009-2011	INDIVIDUAL PERSONAL PROPERTY	IBERS MARJORIE	6707 CRISP AVE	073834300	2018-2021	INDIVIDUAL PERSONAL PROPERTY	KEISTER JERALDINE	10801 E 60TH TER
073675428	2004	INDIVIDUAL PERSONAL PROPERTY	LAWMAN RICHARD	NO ADDRESS PROVIDED BY TAXPAYER	073835899	2002	INDIVIDUAL PERSONAL PROPERTY	HOLLEY BARBARA A	NO ADDRESS PROVIDED BY TAXPAYER
073675865	2014-2016	INDIVIDUAL PERSONAL PROPERTY	LINDMARK DONALD G	7401 MAPLE UNIT 306	073842480	2016-2017	INDIVIDUAL PERSONAL PROPERTY	VERLANDER MARTHA	7416 WILLOW AVE
073677541	2014-2021	INDIVIDUAL PERSONAL PROPERTY	MATTHEWS JOHN	7521 ENGLEWOOD AVE	073846805	2001-2004	INDIVIDUAL PERSONAL PROPERTY	BROWN HAROLD TOM	UNKNOWN
073678862	2008	INDIVIDUAL PERSONAL PROPERTY	MCDERMAND ANITA M	9512 E 68TH ST	073852619	2009-2011	INDIVIDUAL PERSONAL PROPERTY	JOURDAN G JOY	11001 E 59TH ST
073679031	2006-2010	INDIVIDUAL PERSONAL PROPERTY	MCDUGAL IVAL M	6140 RAYTOWN RD APT 504	073852771	2019	INDIVIDUAL PERSONAL PROPERTY	HENDRIX THOMAS L	8816 E 85TH TER
073683339	2005-2008	INDIVIDUAL PERSONAL PROPERTY	OLARTE E MICHAEL & JOAN	10617 E 69TH TER	073855787	2001	INDIVIDUAL PERSONAL PROPERTY	GRAHAM LUTHERS	NO ADDRESS PROVIDED BY TAXPAYER

073856802	2013-2017	INDIVIDUAL PERSONAL PROPERTY	MATHEWS ANN	5536 HUNTER TER	074093894	2012-2017	INDIVIDUAL PERSONAL PROPERTY	SIMPSON TOMMY R & CAROL	11015 E 78TH TER
073857197	2020-2021	INDIVIDUAL PERSONAL PROPERTY	ULGENER KATHY J	7418 OVERTON AVE UNIT 1	074094349	2006-2007	INDIVIDUAL PERSONAL PROPERTY	CHERNOFF SELBERT G & WANDA L	7031 LAKEHORE DR
073858472	2021	INDIVIDUAL PERSONAL PROPERTY	BARTLETT ARTHUR C JR & LINDA	10204 E 72ND ST	074095286	2004-2005	INDIVIDUAL PERSONAL PROPERTY	HUNT JOYCE A	9105 E 66TH TER
073859168	2021	INDIVIDUAL PERSONAL PROPERTY	HARRIS LANCE	NO ADDRESS PROVIDED BY TAXPAYER	074099291	2006	INDIVIDUAL PERSONAL PROPERTY	PARSONS LINDA	5402 ELM AVE
073859195	2018-2021	INDIVIDUAL PERSONAL PROPERTY	THOMAS WILLIAM D & LINDA	5145 WESTRIDGE CIR	074099601	2013-2015	INDIVIDUAL PERSONAL PROPERTY	PACE STEVEN L	5406 HARDY AVE
073873687	2004-2005	INDIVIDUAL PERSONAL PROPERTY	STIMPERT DAVID L	NO ADDRESS PROVIDED BY TAXPAYER	074100733	2021	INDIVIDUAL PERSONAL PROPERTY	PORCH BRIAN K	10800 E 60TH TER
073878165	2020-2021	INDIVIDUAL PERSONAL PROPERTY	BRADLEY RONALD R & SANDRA	11217 E 55TH TER	074104356	2005	INDIVIDUAL PERSONAL PROPERTY	OXFORD JOHN B	4008 HARVARD CIR APT 1
073887173	2006	INDIVIDUAL PERSONAL PROPERTY	BROWN CLYDE L JR	8405 DITMAN AVE	074108110	2019	INDIVIDUAL PERSONAL PROPERTY	BROWN DAVID L	5420 BLUE RIDGE CUT OFF APT 703
073890445	2011-2012	INDIVIDUAL PERSONAL PROPERTY	OBER LOUIS J	8330 WESTRIDGE RD	074117048	2021	INDIVIDUAL PERSONAL PROPERTY	ROBINSON VERLENE	6007 HUNTER ST
073892675	2019-2021	INDIVIDUAL PERSONAL PROPERTY	COLLINS RONALD	11707 E 75TH ST	074119082	2021	INDIVIDUAL PERSONAL PROPERTY	ASHLEY JOSEPH & LONITA	11714 E 80TH DR
073896653	2014	INDIVIDUAL PERSONAL PROPERTY	HARPER WANDA	7401 MAPLE UNIT 301	074121097	2011	INDIVIDUAL PERSONAL PROPERTY	PIPKIN MARION & JEWELL	11606 E 80TH DR
073904546	2018-2019	INDIVIDUAL PERSONAL PROPERTY	EASLEY HAROLD L	3615 BLUE RIDGE EXT APT 4	074123095	2011-2012	INDIVIDUAL PERSONAL PROPERTY	RICHARDSON LONNIE L	6812 VERMONT AVE
073905215	2021	INDIVIDUAL PERSONAL PROPERTY	ERMELING EVELYN C	9109 E 55TH ST	074135527	2003-2012	INDIVIDUAL PERSONAL PROPERTY	YOUNG JODENE M	5713 STERLING AVE
073908132	2013-2014	INDIVIDUAL PERSONAL PROPERTY	GRIEGER DWAYNE E	8221 HARRIS CT	074135965	2021	INDIVIDUAL PERSONAL PROPERTY	REILLY KENNETH W	7917 ARLINGTON AVE
073910343	2014	INDIVIDUAL PERSONAL PROPERTY	ANDERSON GAYLORD & JANET A	6912 WILDWOOD DR	074137339	2021	INDIVIDUAL PERSONAL PROPERTY	CONWAY PHILLIP W JR	10704 E 83RD ST
073910744	2006-2011	INDIVIDUAL PERSONAL PROPERTY	WOLF LAWRENCE A	7908 TENNESSEE AVE	074140414	2009-2013	INDIVIDUAL PERSONAL PROPERTY	PHILLIPS RALPH D	9800 E 79TH TER
073910824	2009-2010	INDIVIDUAL PERSONAL PROPERTY	NELSON PHYLLIS D	10004 E 77TH TER	074142430	2001-2005	INDIVIDUAL PERSONAL PROPERTY	WALKER BONNIE	6524 E 53RD ST
073918292	2007	INDIVIDUAL PERSONAL PROPERTY	HANCOCK JO ANNE	9019 E 79TH ST	074143135	2003	INDIVIDUAL PERSONAL PROPERTY	DALTON FLOYD JR	NO ADDRESS PROVIDED BY TAXPAYER
073918755	2020-2021	INDIVIDUAL PERSONAL PROPERTY	NEVIUS LARRY E & PATRICIA	9102 E 72ND TER	074149727	2018-2019	INDIVIDUAL PERSONAL PROPERTY	HERRELL B KENT	7913 MAPLE AVE
073922759	2009-2017	INDIVIDUAL PERSONAL PROPERTY	OBRLEN LYNN R	6636 MAYWOOD AVE APT A	074151063	2021	INDIVIDUAL PERSONAL PROPERTY	GRUBBS MARGARET A	7201 RAYTOWN RD
073923286	2013-2017	INDIVIDUAL PERSONAL PROPERTY	MCMANUS VICKI	9008 E 87TH ST	074154970	2021	INDIVIDUAL PERSONAL PROPERTY	SLAUGHTER MICHAEL E & PATRICIA J	6409 HARRIS AVE
073927040	2001	INDIVIDUAL PERSONAL PROPERTY	MATTLAGE MARIAN E & SCOTT STEP	NO ADDRESS PROVIDED BY TAXPAYER	074156111	2008-2015	INDIVIDUAL PERSONAL PROPERTY	CATON PAUL	NO ADDRESS PROVIDED BY TAXPAYER
073928593	2011-2013	INDIVIDUAL PERSONAL PROPERTY	COOK JOSEPH R	6101 HARDY AVE	074161105	2011	INDIVIDUAL PERSONAL PROPERTY	DAME LINDA J	5827 KENTUCKY AVE
073938145	2020-2021	INDIVIDUAL PERSONAL PROPERTY	BALDWIN GAYLEN	6304 HUNTER ST	074161560	2001-2002	INDIVIDUAL PERSONAL PROPERTY	LOCKWOOD MILDRED L	8521 ARLINGTON AVE
073938957	2015-2021	INDIVIDUAL PERSONAL PROPERTY	ELLIS MARY L (BURRESS) & JOHN H JR	6120 ASH CT	074173352	2021	INDIVIDUAL PERSONAL PROPERTY	WILLIAMS MARK E & BARBARA G	10404 E 59TH ST
073940267	2020-2021	INDIVIDUAL PERSONAL PROPERTY	KOURY J PATRICK	10604 E 57TH TER	074179793	2020-2021	INDIVIDUAL PERSONAL PROPERTY	WILKINS KATHERINE	8508 SPRING VALLEY RD
073945235	2014	INDIVIDUAL PERSONAL PROPERTY	LONG GEORGE	10116 E 70TH TER APT 1	074183047	2004-2011	INDIVIDUAL PERSONAL PROPERTY	RICHARDSON ROBERT L	5713 STERLING AVE
073945645	2001	INDIVIDUAL PERSONAL PROPERTY	PALGUTA RUDOLPH J	NO ADDRESS PROVIDED BY TAXPAYER	074184554	2006-2011	INDIVIDUAL PERSONAL PROPERTY	WILLIAMS TOMMY E	3218 BENTON BLVD
073945663	2010	INDIVIDUAL PERSONAL PROPERTY	WILLIAMS GARY & WF	7205 OVERTON AVE	074186053	2017	INDIVIDUAL PERSONAL PROPERTY	FREEMON NAOMI M	5420 BLUE RIDGE CUT OFF APT 108
073947901	2021	INDIVIDUAL PERSONAL PROPERTY	MELTON SANDRA R	8516 EVANSTON AVE	074195908	2001	INDIVIDUAL PERSONAL PROPERTY	CHITTY LAURENCE K & M J	NO ADDRESS PROVIDED BY TAXPAYER
073949829	2003	INDIVIDUAL PERSONAL PROPERTY	SARGENT JERRE & DANA	10805 E 61ST TER	074196792	2007-2009	INDIVIDUAL PERSONAL PROPERTY	GARCIA THERESA	6307 ASH AVE APT 1
073950120	2021	INDIVIDUAL PERSONAL PROPERTY	ARMSTRONG LINDA K	9809 E 73RD ST APT B	074205835	2010-2012	INDIVIDUAL PERSONAL PROPERTY	COTTON BESSIE MAE	5821 LAUREL AVE
073955018	2015	INDIVIDUAL PERSONAL PROPERTY	ZIEGENHORN GARY P	6328 HUNTER ST	074207753	2014-2018	INDIVIDUAL PERSONAL PROPERTY	GARRETT HOMER F	5402 BLUE RIDGE CUT OFF APT 602
073955438	2006-2015	INDIVIDUAL PERSONAL PROPERTY	SCHAEFER STEVEN L	10108 E 68TH ST	074208547	2020-2021	INDIVIDUAL PERSONAL PROPERTY	SMITH LEUNICE	10900 E 58TH ST
073955759	2021	INDIVIDUAL PERSONAL PROPERTY	WALDRAM WARD A	7320 HARVARD DR	074214969	2002	INDIVIDUAL PERSONAL PROPERTY	JAMES JANET S	UNKNOWN
073955857	2014	INDIVIDUAL PERSONAL PROPERTY	KOVACHEVICH ALAN	5400 HEDGES AVE	074216093	2003	INDIVIDUAL PERSONAL PROPERTY	GRIESHABER ESTHER A	NO ADDRESS PROVIDED BY TAXPAYER
073968157	2002	INDIVIDUAL PERSONAL PROPERTY	JEFFERSON LEROY	5328 DITZLER AVE	074219125	2009	INDIVIDUAL PERSONAL PROPERTY	ROGERS WILLIAM H	11900 E 86TH ST
073971081	2001-2003	INDIVIDUAL PERSONAL PROPERTY	CORDER JAMES L & CANDICE	NO ADDRESS PROVIDED BY TAXPAYER	074219820	2012-2014	INDIVIDUAL PERSONAL PROPERTY	JACKSON MILTON W	5713 LAUREL AVE
073974319	2017	INDIVIDUAL PERSONAL PROPERTY	HINTON Q D	9904 E 59TH TER	074223263	2010	INDIVIDUAL PERSONAL PROPERTY	HOOGENRAAD LANEISA K	7236 RAYTOWN RD APT D
073977398	2007-2010	INDIVIDUAL PERSONAL PROPERTY	HOUSTON RUBYE M	7419 ENGLEWOOD LN	074229935	2020	INDIVIDUAL PERSONAL PROPERTY	WILSON JOEL WALTER	8906 E 58TH ST
073979788	2021	INDIVIDUAL PERSONAL PROPERTY	SCHOUTEN LAWRENCE K	8800 E 59TH ST	074231263	2016-2021	INDIVIDUAL PERSONAL PROPERTY	COALE DWIGHT	6105 HARDY AVE
073980366	2021	INDIVIDUAL PERSONAL PROPERTY	HINESLEY CAROL A & DANNY N	6400 HARRIS AVE	074234689	2018-2019	INDIVIDUAL PERSONAL PROPERTY	BROOKS JOHNNY L JR	8902 E 87TH ST
073980963	2001	INDIVIDUAL PERSONAL PROPERTY	TULLY JAMES D & JUNE	NO ADDRESS PROVIDED BY TAXPAYER	074237230	2021	INDIVIDUAL PERSONAL PROPERTY	SCHREIBER JERRY L	8808 E 72ND ST
073984656	2001	INDIVIDUAL PERSONAL PROPERTY	BEAVER BARBARA A	UNKNOWN	074238079	2019	INDIVIDUAL PERSONAL PROPERTY	FELICI MARCIA	9018 E 72ND TER
073986039	2005-2007	INDIVIDUAL PERSONAL PROPERTY	LOCASCIO JANET K	11409 E 78TH TER	074247906	2003-2008	INDIVIDUAL PERSONAL PROPERTY	SEABOLDT BRIAN L	5604 DITZLER AVE
073988741	2015-2021	INDIVIDUAL PERSONAL PROPERTY	LEVY RAYMOND L	11900 E 76TH TER	074256012	2021	INDIVIDUAL PERSONAL PROPERTY	SLINKARD JEFFREY W	1104 KEAGON AVE
073989697	2009-2016	INDIVIDUAL PERSONAL PROPERTY	REESE GLEN	10408 E 68TH TER	074256236	2011	INDIVIDUAL PERSONAL PROPERTY	SELLE JEFFREY L	8858 E 59TH TER
073991069	2019-2021	INDIVIDUAL PERSONAL PROPERTY	JONES STAN E & ADELE R	7512 STERLING AVE	074260882	2007-2011	INDIVIDUAL PERSONAL PROPERTY	SHATTUCK ORRIS M	11205 E 60TH ST
073995216	2021	INDIVIDUAL PERSONAL PROPERTY	ROBINSON EARNESTINE	8329 OXFORD AVE	074263585	2006-2015	INDIVIDUAL PERSONAL PROPERTY	STALLINGS FERN F	11705 E 87TH ST
074010331	2019	INDIVIDUAL PERSONAL PROPERTY	BROWN BANITA	11609 E 79TH DR	074270498	2008-2010	INDIVIDUAL PERSONAL PROPERTY	BROWN MAGALINE	11005 E 56TH TER
074018583	2012	INDIVIDUAL PERSONAL PROPERTY	RAMSAY CYNTHIA A	11601 E 75TH ST	074275019	2010	INDIVIDUAL PERSONAL PROPERTY	HALL BETTY K	11825 E 80TH DR
074019699	2020	INDIVIDUAL PERSONAL PROPERTY	BOEHM ANTHONY J JR	5533 HUNTER TER	074275126	2019	INDIVIDUAL PERSONAL PROPERTY	SUNDERLAND RICHARD G	7403 HEDGES AVE
074029321	2018	INDIVIDUAL PERSONAL PROPERTY	LITIG BARBARA J	7851 WOODSON CIR	074276394	2021	INDIVIDUAL PERSONAL PROPERTY	DYE DEE W	11420 E 55TH TER
074031318	2017-2021	INDIVIDUAL PERSONAL PROPERTY	MARTINEZ LEO (ELIGIO)	9000 E 66TH ST	074278114	2006-2007	INDIVIDUAL PERSONAL PROPERTY	BOOTH OLGA	10201 E 69TH TER
074039409	2007-2011	INDIVIDUAL PERSONAL PROPERTY	CRANEY THURMAN D	5512 MAYWOOD AVE	074279925	2017-2021	INDIVIDUAL PERSONAL PROPERTY	FRAZIER CHARLES E	9400 E 66TH ST
074047579	2021	INDIVIDUAL PERSONAL PROPERTY	LINN JON W	7900 HEDGES AVE	074281119	2004	INDIVIDUAL PERSONAL PROPERTY	TILLMAN WANDA M	NO ADDRESS PROVIDED BY TAXPAYER
074052679	2003	INDIVIDUAL PERSONAL PROPERTY	NOEL HARRIET M	10604 E 56TH ST	074288345	2020-2021	INDIVIDUAL PERSONAL PROPERTY	ROBINSON RONALD	15205 GRAND SUMMIT BLVD APT 203
074057718	2021	INDIVIDUAL PERSONAL PROPERTY	ROWE PETER L	8705 E 81ST TER	074293614	2018-2021	INDIVIDUAL PERSONAL PROPERTY	DUROS STEVEN	6540 RAYTOWN RD APT 1
074061641	2021	INDIVIDUAL PERSONAL PROPERTY	LEWIS LINDA	8109 KENTUCKY AVE	074294374	2013-2017	INDIVIDUAL PERSONAL PROPERTY	NICHOLS DENTON J	6202 ASH CT
074061785	2019-2021	INDIVIDUAL PERSONAL PROPERTY	REED ALTHEA	9107 E 7TH TER	074296461	2021	INDIVIDUAL PERSONAL PROPERTY	NELSON CYNTHIA	8817 E 85TH ST
074062686	2001	INDIVIDUAL PERSONAL PROPERTY	BURGGRAF TIMOTHY R	NO ADDRESS PROVIDED BY TAXPAYER	074301856	2021	INDIVIDUAL PERSONAL PROPERTY	KNOLES DOUGLAS W	7012 EVANSTON AVE
074064309	2014-2017	INDIVIDUAL PERSONAL PROPERTY	THOMAS ARCHIE E	6000 CRESCENT AVE	074304032	2021	INDIVIDUAL PERSONAL PROPERTY	HERBERT DAVID & MARCORDIA	5812 MANNING AVE
074065576	2021	INDIVIDUAL PERSONAL PROPERTY	WHITE RAYMOND	5821 ELM AVE	074310873	2019-2021	INDIVIDUAL PERSONAL PROPERTY	KELLY SAMUEL	8410 WOODSON PL
074066986	2020-2021	INDIVIDUAL PERSONAL PROPERTY	HOWARD ARVIA J	9109 E 62ND ST	074311113	2004-2014	INDIVIDUAL PERSONAL PROPERTY	GOETZ ROGER & EILEEN	5902 E 75TH ST
074068369	2018-2021	INDIVIDUAL PERSONAL PROPERTY	MEYER JEFFREY L	10400 E 69TH TER	074328187	2021	INDIVIDUAL PERSONAL PROPERTY	ESTIS KAREN ANN	8607 SPRING VALLEY RD
074071015	2002	INDIVIDUAL PERSONAL PROPERTY	SEYMOUR WAUNEITA	NO ADDRESS PROVIDED BY TAXPAYER	074333260	2003-2017	INDIVIDUAL PERSONAL PROPERTY	MCCANDLESS W L & VIVIAN	5921 NORTHERN AVE
074083878	2018-2021	INDIVIDUAL PERSONAL PROPERTY	ASHLOCK NORMA I	9014 E 85TH PL	074336409	2020-2021	INDIVIDUAL PERSONAL PROPERTY	COMPTON WILLIAM	8300 KENTUCKY AVE
074087393	2006	INDIVIDUAL PERSONAL PROPERTY	GALATE SALVATORE V J	9110 E 63RD ST APT 101	074337809	2021	INDIVIDUAL PERSONAL PROPERTY	STREET RICHARD M	6828 CRISP AVE
074090389	2020-2021	INDIVIDUAL PERSONAL PROPERTY	ROBLES BEULAH ANN	7909 EVANSTON AVE	074338755	2018	INDIVIDUAL PERSONAL PROPERTY	SPRINKLE DIANE	5212 S UNION ST
074091440	2006-2007	INDIVIDUAL PERSONAL PROPERTY	HAMMOND GREGORY D	10108 E 56TH TER	074341643	2006-2012	INDIVIDUAL PERSONAL PROPERTY	ALBERS CATHERINE J	8605 HAWTHORNE AVE
074092332	2020-2021	INDIVIDUAL PERSONAL PROPERTY	FRANCIS JOSEPH BRYAN	9216 VAUGHN AVE	074346014	2021	INDIVIDUAL PERSONAL PROPERTY	PRICE JAMES B & MARCIA KAY	8329 MAYWOOD AVE
074092528	2020-2021	INDIVIDUAL PERSONAL PROPERTY	KEELER WANDA DIANE	9111 E 72ND TER	074346416	2005-2006	INDIVIDUAL PERSONAL PROPERTY	MORENO LUCILLE M	9804 E 68TH ST

074352042	2019	INDIVIDUAL PERSONAL PROPERTY	WESSLEY BRADLEY SCOTT	11804 E 75TH ST	074759087	2013-2017	INDIVIDUAL PERSONAL PROPERTY	KELLY PHYLIS A	11901 E 85TH ST
074355370	2016	INDIVIDUAL PERSONAL PROPERTY	FORBES ROSE M	9600 E 69TH ST	074776736	2021	INDIVIDUAL PERSONAL PROPERTY	SLONE MARY K	6140 RAYTOWN RD APT 303
074375090	2021	INDIVIDUAL PERSONAL PROPERTY	JACKSON IVORY J	11800 E 78TH PL	074778173	2011	INDIVIDUAL PERSONAL PROPERTY	HUNLEY CHARLOTTE J	10510 E 80TH ST
074386373	2001	INDIVIDUAL PERSONAL PROPERTY	LASLEY CRAIG CLIFTON	4743 KENSINGTON AVE	0747793101	2001	INDIVIDUAL PERSONAL PROPERTY	POSNER MARK A & TAMMY	UNKNOWN
074389584	2016-2020	INDIVIDUAL PERSONAL PROPERTY	HUEBNER EUFRECINA E	11716 E 87TH ST	074801450	2018	INDIVIDUAL PERSONAL PROPERTY	CHAPPELL STEVE	10309 E 61ST ST APT 3
074396139	2001-2002	INDIVIDUAL PERSONAL PROPERTY	SLOAN KELLY L	6838 RAYTOWN RD	074802440	2021	INDIVIDUAL PERSONAL PROPERTY	BERRY DANIEL	5127 STERLING AVE
074398351	2021	INDIVIDUAL PERSONAL PROPERTY	HOPKINS DEEDRA	11710 E 79TH DR	074807481	2017-2021	INDIVIDUAL PERSONAL PROPERTY	DOWD ROBIN B	10809 E 66TH ST
074402097	2021	INDIVIDUAL PERSONAL PROPERTY	HIRSCH PAUL E	11705 E 77TH TER	074809666	2019-2021	INDIVIDUAL PERSONAL PROPERTY	PALMER CHESTER	11200 E 76TH ST
074418918	2020-2021	INDIVIDUAL PERSONAL PROPERTY	FRAME WILLIAM	11900 JESSICA LN	074822035	2005-2007	INDIVIDUAL PERSONAL PROPERTY	LANE JOHN R	5508 LANE AVE
074426927	2021	INDIVIDUAL PERSONAL PROPERTY	JOHNSON RUTH	5812 FARLEY AVE	074822277	2020-2021	INDIVIDUAL PERSONAL PROPERTY	WRIGHT ANTHONY	6016 FARLEY AVE
074431733	2021	INDIVIDUAL PERSONAL PROPERTY	SIMS STEVEN L	5712 HUNTER ST	074822614	2021	INDIVIDUAL PERSONAL PROPERTY	HATFIELD RAYMOND P	8605 E 81ST TER
074435061	2021	INDIVIDUAL PERSONAL PROPERTY	RIDDLE JAMES E JR	5626 LAUREL AVE	074823720	2007	INDIVIDUAL PERSONAL PROPERTY	BANKS STEPHEN B	11601 E 74TH TER
074435098	2021	INDIVIDUAL PERSONAL PROPERTY	SEBASTIANO DELORES L	8950 E 60TH ST	074829939	2014-2015	INDIVIDUAL PERSONAL PROPERTY	WAGNER JOHNNY H	8421 SPRING VALLEY RD
074437924	2013	INDIVIDUAL PERSONAL PROPERTY	MOON LANNY B	8813 E 84TH ST	074834567	2015-2016	INDIVIDUAL PERSONAL PROPERTY	WILCOX DOLORES	9717 E 76TH TER
074437988	2009	INDIVIDUAL PERSONAL PROPERTY	SEMONICK PAULINE	10508 E 66TH ST	074834585	2015-2016	INDIVIDUAL PERSONAL PROPERTY	COYLE MARY H	7324 CEDAR AVE
074444541	2018	INDIVIDUAL PERSONAL PROPERTY	COLLETTE BRUCE W	10409 E 65TH ST	074835370	2007	INDIVIDUAL PERSONAL PROPERTY	MONSEES PEGGY L (HILL)	8504 HARRIS AVE
074448967	2006	INDIVIDUAL PERSONAL PROPERTY	MARSHALL EVELYN D	NO ADDRESS PROVIDED BY TAXPAYER	074835591	2006-2007	INDIVIDUAL PERSONAL PROPERTY	FRYE JUDY A	708 NE 3RD ST
074449458	2003-2005	INDIVIDUAL PERSONAL PROPERTY	WRIGHT HAVIS L & CHONITA M	UNKNOWN	074835833	2021	INDIVIDUAL PERSONAL PROPERTY	LANNING LINDA L	8215 E 85TH TER
074451989	2021	INDIVIDUAL PERSONAL PROPERTY	THOMAS STACEY R	7816 RIDGEWAY AVE	074847802	2021	INDIVIDUAL PERSONAL PROPERTY	YOUNG PHYLIS E	7224 STERLING AVE
074452021	2021	INDIVIDUAL PERSONAL PROPERTY	DAVIS MARGUERITE	8401 HAWTHORNE PL	074850067	2012	INDIVIDUAL PERSONAL PROPERTY	KANNBLEY NORMA	8311 ELM AVE
074455431	2002-2017	INDIVIDUAL PERSONAL PROPERTY	JONES FELICIA L	5805 LAUREL AVE	074862633	2021	INDIVIDUAL PERSONAL PROPERTY	GOFORTH MARGARET (PICHELMAN)	5912 ELM AVE
074457402	2021	INDIVIDUAL PERSONAL PROPERTY	ADAMS ALAN D & KAY	5500 HEDGES AVE	074864034	2021	INDIVIDUAL PERSONAL PROPERTY	SAYLORS MONICA Y & BILLY J	8819 E 52ND TER
074459393	2001	INDIVIDUAL PERSONAL PROPERTY	SMITH DEBRA A	NO ADDRESS PROVIDED BY TAXPAYER	074875282	2021	INDIVIDUAL PERSONAL PROPERTY	PALETAOGA TAO V & CHRISTINE	11316 E 77TH ST
074461807	2017	INDIVIDUAL PERSONAL PROPERTY	WASHINGTON IOHN L	6140 RAYTOWN RD APT 704	074891068	2015-2016	INDIVIDUAL PERSONAL PROPERTY	MCLANAHAN DELLA	7923 HARRIS AVE
074471994	2021	INDIVIDUAL PERSONAL PROPERTY	RIDEN CHARLES & TERESA	9804 E 77TH ST	074902528	2018-2019	INDIVIDUAL PERSONAL PROPERTY	CLARK KAYE	9238 HARRIS AVE
074484631	2010	INDIVIDUAL PERSONAL PROPERTY	FIRUCCIA JOHN J & PATRICIA	7111 RALSTON AVE	074925825	2021	INDIVIDUAL PERSONAL PROPERTY	ORO VINCENT J JR	5300 RALSTON AVE
074487184	2014-2015	INDIVIDUAL PERSONAL PROPERTY	HAMON GLORIA J	9806 E 61ST ST APT 2	074934897	2021	INDIVIDUAL PERSONAL PROPERTY	SPARKS ROBERT & REGINA	7208 STERLING AVE
074495488	2013	INDIVIDUAL PERSONAL PROPERTY	COOPER KARYL	6810 HAWTHORNE AVE	074941521	2021	INDIVIDUAL PERSONAL PROPERTY	REEDS LYDIA MARIE	8928 E 74TH ST
074495549	2004-2005	INDIVIDUAL PERSONAL PROPERTY	SHUPERT LAURA LEE	11401 E 77TH TER	074942931	2003-2004	INDIVIDUAL PERSONAL PROPERTY	HINTON IRIS (JACKSON)	11804 E 78TH ST
074497413	2002-2003	INDIVIDUAL PERSONAL PROPERTY	MARTIN DANE W	NO ADDRESS PROVIDED BY TAXPAYER	074947357	2020-2021	INDIVIDUAL PERSONAL PROPERTY	RAY PAULA (MARSHALL)	7804 IRWIN RD
074500166	2008-2014	INDIVIDUAL PERSONAL PROPERTY	LAVAL MIKE P	8958 E 62ND TER	074966567	2020-2021	INDIVIDUAL PERSONAL PROPERTY	WOOLLEY GREGORY	9000 E 66TH TER
074503594	2021	INDIVIDUAL PERSONAL PROPERTY	DENNY KELLY A	9003 E 72ND TER	074970026	2018	INDIVIDUAL PERSONAL PROPERTY	YORK TERESA	10208 E 71ST TER
074509534	2010	INDIVIDUAL PERSONAL PROPERTY	MCCORD GREG S	8413 E 85TH TER	074976486	2020	INDIVIDUAL PERSONAL PROPERTY	O'BRIEN THOMAS J	7208 RAYTOWN RD
074509570	2021	INDIVIDUAL PERSONAL PROPERTY	HUBBARD ROBERT L & WILMA	11201 E 85TH TER	074977895	2013	INDIVIDUAL PERSONAL PROPERTY	BROOKS SHERYL D	5717 BLUE RIDGE BLVD
074518016	2021	INDIVIDUAL PERSONAL PROPERTY	JONES TRACEY R	8501 EVERETT ST	074977902	2015-2021	INDIVIDUAL PERSONAL PROPERTY	RUBY ROBERT E	7819 WOODSON DR
074518524	2020-2021	INDIVIDUAL PERSONAL PROPERTY	PALMISANO GINA LOUISE	8709 FORO AVE	074979839	2021	INDIVIDUAL PERSONAL PROPERTY	BEASLEY RAYMOND E & SANDRA K	6110 NORTHERN AVE
074525721	2017	INDIVIDUAL PERSONAL PROPERTY	DUTT ROD L & KATHY	11709 E 86TH ST	074979982	2018-2019	INDIVIDUAL PERSONAL PROPERTY	BOGERT MARK W	11100 E 74TH TER
074532152	2015-2016	INDIVIDUAL PERSONAL PROPERTY	MCMILLIAN STANLEY E	8858 E 59TH TER	074988534	2013-2014	INDIVIDUAL PERSONAL PROPERTY	SPRINGER LINDA	7236 RAYTOWN RD APT E
074532198	2021	INDIVIDUAL PERSONAL PROPERTY	BRANDT CARL E	5200 STERLING AVE	074989560	2019-2021	INDIVIDUAL PERSONAL PROPERTY	JOHNSON GARRY V	5804 LANE AVE
074532544	2021	INDIVIDUAL PERSONAL PROPERTY	FREEMAN SHARON M	8603 CRESCENT AVE	074994830	2006-2007	INDIVIDUAL PERSONAL PROPERTY	DEWOLF TED E	9800 E 80TH TER
074541703	2019	INDIVIDUAL PERSONAL PROPERTY	FORRESTER RICHARD D & GLENDA	9808 E 67TH TER	075007495	2001	INDIVIDUAL PERSONAL PROPERTY	PACKER JANIS	UNKNOWN
074542374	2018-2021	INDIVIDUAL PERSONAL PROPERTY	MOORE TERRI L	8617 E 83RD ST	075010481	2009	INDIVIDUAL PERSONAL PROPERTY	IVERSON RUTH MAE	10905 E 71ST TER
074549206	2007-2017	INDIVIDUAL PERSONAL PROPERTY	SELLARS JOHN R	NO ADDRESS PROVIDED BY TAXPAYER	075014101	2013	INDIVIDUAL PERSONAL PROPERTY	PERKINS HERMINE E	9108 E 66TH ST
074551041	2018-2020	INDIVIDUAL PERSONAL PROPERTY	MAXWELL JAMES E & ANN M	5909 CLAREMONT AVE	075018456	2021	INDIVIDUAL PERSONAL PROPERTY	SEALS WILLIAM L & DENISE	7833 WESTRIDGE RD
074558357	2001-2002	INDIVIDUAL PERSONAL PROPERTY	BROWN RANDY L	NO ADDRESS PROVIDED BY TAXPAYER	075029998	2005-2007	INDIVIDUAL PERSONAL PROPERTY	PIPPENGER RICKY	8602 E 87TH ST
074565081	2021	INDIVIDUAL PERSONAL PROPERTY	WHEELDON ALLEN L & CHRISTINE A	9304 E 80TH TER	075031832	2017-2021	INDIVIDUAL PERSONAL PROPERTY	WEIGMAN NANCY L & HENRY NELLIE F	9009 STARK AVE
074573580	2009	INDIVIDUAL PERSONAL PROPERTY	BRAMLETTE MARK R	6524 OXFORD AVE	075033563	2004-2005	INDIVIDUAL PERSONAL PROPERTY	ALLEE WILLIAM E	9016 E 73RD ST
074574188	2021	INDIVIDUAL PERSONAL PROPERTY	FLANSBURG MARK A & CHERYL A	5532 APPLETON AVE	075058108	2021	INDIVIDUAL PERSONAL PROPERTY	LONG STEVE & KIMBERLY L	6700 HARRIS AVE
074580732	2021	INDIVIDUAL PERSONAL PROPERTY	BELL BRENDA	6021 KENTUCKY AVE	075064128	2014	INDIVIDUAL PERSONAL PROPERTY	GRINDSTAFF CHARLES E	9302 VAUGHN AVE
074592783	2007	INDIVIDUAL PERSONAL PROPERTY	COTTON SHARON	8950 E 61ST ST	075072173	2019-2021	INDIVIDUAL PERSONAL PROPERTY	WRIGHT KELLI K & ROBERT D	10909 E 72ND TER
074621484	2020-2021	INDIVIDUAL PERSONAL PROPERTY	WOLFE JOHN	9908 E 71ST TER	075074750	2001-2009	INDIVIDUAL PERSONAL PROPERTY	STANSBURY JAMES T	8412 WOODSON DR
074622714	2014-2021	INDIVIDUAL PERSONAL PROPERTY	SHELTON MICHAEL W	7000 KENTUCKY AVE	075080527	2021	INDIVIDUAL PERSONAL PROPERTY	ALEXANDER KATHY A	5508 LANE AVE
074636399	2004-2017	INDIVIDUAL PERSONAL PROPERTY	JACKSON CLAUDIA N	11104 E 74TH ST	075082894	2002-2006	INDIVIDUAL PERSONAL PROPERTY	LANE JAMES G	8604 SPRING VALLEY RD
074640231	2020-2021	INDIVIDUAL PERSONAL PROPERTY	WOODS MARY C	7862 WOODSON CIR	075083973	2021	INDIVIDUAL PERSONAL PROPERTY	RAMSEY RICHARD LEE JR	9203 E 64TH TER
074640543	2004-2005	INDIVIDUAL PERSONAL PROPERTY	BERGMAN EDWARD L	9201 E 68TH ST	075091009	2020-2021	INDIVIDUAL PERSONAL PROPERTY	PARRISH LORETTA A	11215 E 53RD TER
074643247	2006-2017	INDIVIDUAL PERSONAL PROPERTY	FORD ARTHUR D	8506 EVERETT ST	075091054	2016	INDIVIDUAL PERSONAL PROPERTY	TANN PATRICIA L	6424 LANE AVE
074658230	2021	INDIVIDUAL PERSONAL PROPERTY	WILLIAMS ERIC D & BRENDA	10108 E 72ND ST	075092730	2017	INDIVIDUAL PERSONAL PROPERTY	HICKS MICHAEL E	10811 E 62ND TER
074659355	2009	INDIVIDUAL PERSONAL PROPERTY	MCNEILL JEFF T	5420 BLUE RIDGE CUT OFF APT G01	075098244	2009-2017	INDIVIDUAL PERSONAL PROPERTY	FARRELL GARY D	NO ADDRESS PROVIDED BY TAXPAYER
074659685	2020-2021	INDIVIDUAL PERSONAL PROPERTY	HAMILTON JOHNSON CYNTHIA LEVERA	8858 E 57TH TER	075099582	2003	INDIVIDUAL PERSONAL PROPERTY	ROCHA DAVID G & MARSHA	UNKNOWN
074679672	2021	INDIVIDUAL PERSONAL PROPERTY	CRISWELL BARBARA ANN	8925 E 81ST ST	075106119	2003	INDIVIDUAL PERSONAL PROPERTY	BETHUREM KAREN A	9416 E 55TH ST
074685255	2006-2007	INDIVIDUAL PERSONAL PROPERTY	MILLAM TODD E	5825 CEDAR AVE	075107706	2021	INDIVIDUAL PERSONAL PROPERTY	DALE PHILIP R	7908 ARLINGTON AVE
074692522	2003-2004	INDIVIDUAL PERSONAL PROPERTY	WILLIAMS JAMES L & SHA	11008 E 81ST TER	075113691	2021	INDIVIDUAL PERSONAL PROPERTY	ROPER DOUGLAS & DEBRA	10705 E 80TH ST
074692675	2003	INDIVIDUAL PERSONAL PROPERTY	SHIRLEY SCOTT	10216 E 70TH TER	075151715	2021	INDIVIDUAL PERSONAL PROPERTY	STEPHENSON PATRICIA A	10413 E 65TH ST
074693086	2021	INDIVIDUAL PERSONAL PROPERTY	GIBSON JENNIFER S	8529 VASSAR AVE	075120031	2021	INDIVIDUAL PERSONAL PROPERTY	SINGLETON SONYA R	8529 VASSAR AVE
074695798	2009-2010	INDIVIDUAL PERSONAL PROPERTY	PLANCHOCK HERBERT	9000 E 65TH ST	075121879	2015-2016	INDIVIDUAL PERSONAL PROPERTY	GIBSON JUANITA M	11424 E 75TH ST
074704332	2013	INDIVIDUAL PERSONAL PROPERTY	PATTERSON JAMES & WANDA	5804 MAYWOOD AVE	075124439	2018-2021	INDIVIDUAL PERSONAL PROPERTY	MARSHALL SHEILA PERKINS	9132 E 85TH ST
074711397	2021	INDIVIDUAL PERSONAL PROPERTY	FINN ERIC B	10323 E 78TH ST	075133973	2021	INDIVIDUAL PERSONAL PROPERTY	HARTMAN LINDA DIANE	7204 WOODSON DR
074722553	2021	INDIVIDUAL PERSONAL PROPERTY	CONNITE AUDREY M	7306 ELM ST	075135221	2006-2009	INDIVIDUAL PERSONAL PROPERTY	HOLLOWELL JUANITA	2120 HEDGES AVE
074730768	2021	INDIVIDUAL PERSONAL PROPERTY	ARMSTRONG JAMES L	8105 WILLOW WAY	075141198	2005-2007	INDIVIDUAL PERSONAL PROPERTY	MCCORMICK ALAN A	7415 WILLOW WAY
074743031	2002	INDIVIDUAL PERSONAL PROPERTY	DUCKWORTH FRANK C	UNKNOWN	075149706	2020-2021	INDIVIDUAL PERSONAL PROPERTY	ABBOTT ROBERT L	2120 NW HIDDEN POINTE CT
074752841	2006-2007	INDIVIDUAL PERSONAL PROPERTY	HARTWIG RONALD P	8507 GREENWOOD RD	075151701	2016	INDIVIDUAL PERSONAL PROPERTY	ALEXANDER ROBERT R	8954 E 59TH TER
074758667	2014	INDIVIDUAL PERSONAL PROPERTY	DALY BILLY E	6553 RAYTOWN RD APT 1B	075151872	2012	INDIVIDUAL PERSONAL PROPERTY	ALLEN CHARLES S	6457 BLUE RIDGE BLVD

075152210	2003	INDIVIDUAL PERSONAL PROPERTY	ALLEN ROY B	UNKNOWN	075338574	2015-2021	INDIVIDUAL PERSONAL PROPERTY	SNIDER JUDITH	7624 STERLING AVE
075152354	2013-2014	INDIVIDUAL PERSONAL PROPERTY	ALLINDER DOROTHY H	6709 CRISP AVE	075339500	2003-2004	INDIVIDUAL PERSONAL PROPERTY	SPAETH RICHARD R JR	NO ADDRESS PROVIDED BY TAXPAYER
075157484	2020-2021	INDIVIDUAL PERSONAL PROPERTY	BALL VIOLET J & REITER PATRICIA J	5729 MANNING AVE	075341105	2021	INDIVIDUAL PERSONAL PROPERTY	SAMMON ROBERT H & MARLA (STAHL)	8512 DITZLER AVE
075158526	2006-2008	INDIVIDUAL PERSONAL PROPERTY	BARNES B G & MARY NADINE	8314 HUNTER ST	075343096	2012-2017	INDIVIDUAL PERSONAL PROPERTY	STEVENSON RONALD E	9916 E 85TH ST
075158599	2002-2004	INDIVIDUAL PERSONAL PROPERTY	BARNES JAMES A	11301 E 67TH ST	075343309	2004-2008	INDIVIDUAL PERSONAL PROPERTY	STEWART EUGENE D	8904 RICHARDS DR
075159990	2005	INDIVIDUAL PERSONAL PROPERTY	BATSON R C	5109 WOODSON RD	075365482	2019	INDIVIDUAL PERSONAL PROPERTY	WHITE CARL & CAROLYN	9001 E 66TH ST
075161228	2012-2013	INDIVIDUAL PERSONAL PROPERTY	FRANKLIN ROXANNA & ROY	807 S LOGAN ST	075372143	2021	INDIVIDUAL PERSONAL PROPERTY	WOLFE BOBBY D	6107 HARVARD AVE
075167080	2016-2021	INDIVIDUAL PERSONAL PROPERTY	BOONE FRANK M	8540 E 81ST TER	075375514	2007-2008	INDIVIDUAL PERSONAL PROPERTY	YOUNG JAMES D	5428 STERLING AVE
075167302	2001	INDIVIDUAL PERSONAL PROPERTY	BOREN ERVIN D	UNKNOWN	075380884	2016-2017	INDIVIDUAL PERSONAL PROPERTY	ROTH ROSEMARY	8602 BOOTH AVE
075168784	2009	INDIVIDUAL PERSONAL PROPERTY	HARRIS PHILLIP A	10001 E 84TH ST	075479387	2001	INDIVIDUAL PERSONAL PROPERTY	MANDL ZENITH	8514 SPRING VALLEY RD
075171887	2013	INDIVIDUAL PERSONAL PROPERTY	BROOKS DAVID E	5717 BLUE RIDGE BLVD	075497376	2005	INDIVIDUAL PERSONAL PROPERTY	MAYS DONALD	7502 HAWTHORNE AVE
075175561	2017	INDIVIDUAL PERSONAL PROPERTY	BURKE CHRISTINE K	6140 RAYTOWN RD APT 410	075513492	2010	INDIVIDUAL PERSONAL PROPERTY	MASSEY HOWARD	9059 E 65TH ST
075183277	2021	INDIVIDUAL PERSONAL PROPERTY	CHILES KAREN JEAN	5449 ASH AVE	075514758	2018-2021	INDIVIDUAL PERSONAL PROPERTY	COATES TONNIE (YOUNG) & COATES ROBERT E	7605 OVERTON AVE
075187282	2014-2021	INDIVIDUAL PERSONAL PROPERTY	COMPTON DAVID L & DEBBIE L	11101 E 72ND ST	075529617	2015-2018	INDIVIDUAL PERSONAL PROPERTY	LEE ALICE M	9534 CHARLOTTE ST
075188209	2015	INDIVIDUAL PERSONAL PROPERTY	ALLISON JEFFREY K	7816 ELM ST	075533069	2018	INDIVIDUAL PERSONAL PROPERTY	BELWARD ROBERT	9505 E 84TH ST
075188691	2019-2021	INDIVIDUAL PERSONAL PROPERTY	COOPER TRUSSELL HELEN JOAN	8851 E 54TH ST	075541844	2017	INDIVIDUAL PERSONAL PROPERTY	SMITH MARY S	8863 E 54TH ST
075190731	2021	INDIVIDUAL PERSONAL PROPERTY	CRABB RICHARD CHARLES	7700 ELM ST	075585119	2003-2004	INDIVIDUAL PERSONAL PROPERTY	BRALIN KATHY A	NO ADDRESS PROVIDED BY TAXPAYER
075191543	2019	INDIVIDUAL PERSONAL PROPERTY	CREASON CHERYL	7609 HAWTHORNE AVE	075601495	2021	INDIVIDUAL PERSONAL PROPERTY	MORIN MARY C	7501 ELM ST
075193140	2021	INDIVIDUAL PERSONAL PROPERTY	CURRY JOHN H & FRANCES	11013 E 78TH ST	075603493	2009-2010	INDIVIDUAL PERSONAL PROPERTY	BARHAM ROSE (MCKINLEY)	5409 STERLING AVE
075194611	2003	INDIVIDUAL PERSONAL PROPERTY	DAUB MICHAEL & LINDA	UNKNOWN	075604090	2021	INDIVIDUAL PERSONAL PROPERTY	WATSON WILLIE JR	6805 VERMONT AVE
075196227	2021	INDIVIDUAL PERSONAL PROPERTY	DAY RANDY L	5932 CRESCENT AVE	075612027	2021	INDIVIDUAL PERSONAL PROPERTY	WERLING E KAY	7141 STERLING AVE
075203317	2009-2010	INDIVIDUAL PERSONAL PROPERTY	DUNLAP DAVID	9212 E 65TH TER	075615729	2016-2017	INDIVIDUAL PERSONAL PROPERTY	MUNGER HARRY W & MARILYN	10106 E 79TH ST
075204370	2005	INDIVIDUAL PERSONAL PROPERTY	EAGLE DONALD R	NO ADDRESS PROVIDED BY TAXPAYER	075639785	2021	INDIVIDUAL PERSONAL PROPERTY	HICKMAN DAVID O	9404 E 85TH ST
075205324	2002	INDIVIDUAL PERSONAL PROPERTY	EDMONDSON ROBERT E	6404 HARDY AVE	075646072	2001	INDIVIDUAL PERSONAL PROPERTY	SCHLUP DARRELL L	NO ADDRESS PROVIDED BY TAXPAYER
075206895	2019-2021	INDIVIDUAL PERSONAL PROPERTY	ASHLEY MOSIE LEE (ELLIS)	6140 RAYTOWN RD APT 703	075650545	2014	INDIVIDUAL PERSONAL PROPERTY	TORRELLO JERRY & EDNA	6122 WILLOW AVE
075208054	2004	INDIVIDUAL PERSONAL PROPERTY	ESPINOSA MARY ANN	UNKNOWN	075650887	2015	INDIVIDUAL PERSONAL PROPERTY	GRIFFIN MARTHA (SNOW)	10010 E 69TH ST
075209099	2017-2021	INDIVIDUAL PERSONAL PROPERTY	STEWART MARY ALICE	6101 LAUREL AVE	075653688	2021	INDIVIDUAL PERSONAL PROPERTY	BROWN MARCUS A	11212 E 62ND ST
075215885	2012-2013	INDIVIDUAL PERSONAL PROPERTY	FREEDLE OTIS WAYNE	10208 E 71ST TER	075688142	2001	INDIVIDUAL PERSONAL PROPERTY	PLATT CARMELETE	UNKNOWN
075225124	2013-2014	INDIVIDUAL PERSONAL PROPERTY	GRAYBILL JERALD A	11001 E 57TH ST	075693305	2020-2021	INDIVIDUAL PERSONAL PROPERTY	CHRISTENSEN PAMELA K	8529 ARLINGTON AVE
075234515	2017-2021	INDIVIDUAL PERSONAL PROPERTY	HUBER ANN M	7419 MAYWOOD AVE	075697374	2019-2021	INDIVIDUAL PERSONAL PROPERTY	BROWN DANIEL CLIFTON	11300 E 53RD ST
075235747	2021	INDIVIDUAL PERSONAL PROPERTY	HEDRICK RONALD L	11709 E 78TH ST	075699933	2014-2015	INDIVIDUAL PERSONAL PROPERTY	SAMPSON SAM	5224 DITZLER AVE
075241543	2004-2005	INDIVIDUAL PERSONAL PROPERTY	HOLLIS LEE A	7224 CRISP AVE	075703189	2019-2021	INDIVIDUAL PERSONAL PROPERTY	SCHMIDT LORA L	6162 CLAREMONT AVE
075241856	2020-2021	INDIVIDUAL PERSONAL PROPERTY	HOLMES RHONDA	10000 E 83RD TER	075711107	2021	INDIVIDUAL PERSONAL PROPERTY	WASHINGTON LORETTA	8508 OVERTON DR
075245763	2004-2017	INDIVIDUAL PERSONAL PROPERTY	HUNT EUGENE F	7605 ENGLEWOOD AVE	075716585	2006	INDIVIDUAL PERSONAL PROPERTY	ALLEN BARBARA L	NO ADDRESS PROVIDED BY TAXPAYER
075246361	2016-2021	INDIVIDUAL PERSONAL PROPERTY	HURST WILLIAM H	11100 E 75TH ST	075730603	2001-2002	INDIVIDUAL PERSONAL PROPERTY	DUNCAN LUCIEL	9900 E 85TH ST
075249386	2006-2017	INDIVIDUAL PERSONAL PROPERTY	JARVIS WANDA J	11100 E 75TH ST	075741165	2020-2021	INDIVIDUAL PERSONAL PROPERTY	CLIFFORD STEVEN W & KIMBERLY	9500 E 65TH TER
075251309	2016-2021	INDIVIDUAL PERSONAL PROPERTY	JOHNSON JOYCE ANN	8301 LAUREL AVE	075742495	2016	INDIVIDUAL PERSONAL PROPERTY	KROENKE ARTHUR JOHN JR & LETA	11224 E 75TH TER
075255902	2011-2012	INDIVIDUAL PERSONAL PROPERTY	KELLY ALVIN	11603 S 80TH DR	075747052	2016	INDIVIDUAL PERSONAL PROPERTY	EVANS BOBBY G	8917 E 74TH ST
075257651	2020-2021	INDIVIDUAL PERSONAL PROPERTY	KIMBLE OZELL	11603 E 61ST ST	075757371	2012-2013	INDIVIDUAL PERSONAL PROPERTY	VOLPE JOSEPH M	7901 TENNESSEE AVE
075259347	2018	INDIVIDUAL PERSONAL PROPERTY	KLINE ULH & JEAN	6524 HARDY AVE	075762089	2019	INDIVIDUAL PERSONAL PROPERTY	EISERER RUTH E	6200 RALSTON AVE
075261325	2006-2007	INDIVIDUAL PERSONAL PROPERTY	KUHNHOFF CLARA N	10000 E 83RD TER	075765834	2009-2010	INDIVIDUAL PERSONAL PROPERTY	DAVIS DOLORES M	8341 HARVARD AVE
075263476	2009	INDIVIDUAL PERSONAL PROPERTY	LARSON MARJORIE L	NO ADDRESS PROVIDED BY TAXPAYER	075768350	2001	INDIVIDUAL PERSONAL PROPERTY	MAHONEY DONNA M	NO ADDRESS PROVIDED BY TAXPAYER
075267098	2011	INDIVIDUAL PERSONAL PROPERTY	LIGGINS JOE L	7521 APPLETON AVE	075770301	2021	INDIVIDUAL PERSONAL PROPERTY	RATTERMAN THOMAS HUGH II & VALERIE	8403 E 86TH TER
075271831	2005-2010	INDIVIDUAL PERSONAL PROPERTY	STEVENSON SHERYL E	10311 E 78TH ST	075770356	2021	INDIVIDUAL PERSONAL PROPERTY	JAKOBE STEVE B	7012 KENTUCKY AVE
075273642	2005-2012	INDIVIDUAL PERSONAL PROPERTY	MANLEY CAROLYN	7325 HARDY AVE	075774478	2020-2021	INDIVIDUAL PERSONAL PROPERTY	LAMAR COLLETTE V	8801 E 54TH ST
075281090	2021	INDIVIDUAL PERSONAL PROPERTY	NELSON (GUESS) PALZETTA	7046 LAKESHORE DR	075777965	2021	INDIVIDUAL PERSONAL PROPERTY	BENNETT ALBERT M & LAUREL	8301 HARVARD AVE
075282044	2006	INDIVIDUAL PERSONAL PROPERTY	MCENTEE EDWARD E	NO ADDRESS PROVIDED BY TAXPAYER	075787794	2019-2021	INDIVIDUAL PERSONAL PROPERTY	HAINES LARRY D	9416 E 82ND ST
075284408	2001	INDIVIDUAL PERSONAL PROPERTY	MCKINZIE CONNIE	NO ADDRESS PROVIDED BY TAXPAYER	075793527	2006-2008	INDIVIDUAL PERSONAL PROPERTY	SEMLER RONALD L	9401 E 68TH TER
075288299	2004	INDIVIDUAL PERSONAL PROPERTY	MIESSE DORIS	5440 BLUE RIDGE CUTOFF	075818528	2021	INDIVIDUAL PERSONAL PROPERTY	HAZEZ SLIP LINDA	10404 E 69TH TER
075288351	2014	INDIVIDUAL PERSONAL PROPERTY	MILBURN HENRY LEE	8330 WESTRIDGE RD	075831086	2010-2015	INDIVIDUAL PERSONAL PROPERTY	HOWELL GLORIA	11713 E 87TH ST
075291043	2007	INDIVIDUAL PERSONAL PROPERTY	MOCK VIVIAN A	9110 E 63RD ST APT 319	075839373	2021	INDIVIDUAL PERSONAL PROPERTY	ROLAND STEVEN W	11418 E 58TH ST
075294184	2019	INDIVIDUAL PERSONAL PROPERTY	MOSEY RAY	10905 E 81ST ST	075846374	2005-2006	INDIVIDUAL PERSONAL PROPERTY	BARNES KEVIN LEE	NO ADDRESS PROVIDED BY TAXPAYER
075294380	2011-2021	INDIVIDUAL PERSONAL PROPERTY	MOTHERSBAUGH DAVID SR & MARTINA D	6717 HARVARD AVE	075848176	2021	INDIVIDUAL PERSONAL PROPERTY	GARVIN EDWARD P	9409 E 69TH TER
075296226	2003	INDIVIDUAL PERSONAL PROPERTY	MYERS RAYMOND L SR	UNKNOWN	075854845	2004-2007	INDIVIDUAL PERSONAL PROPERTY	WEBB ROBERT & JUDITH A	9303 E 82ND TER
075298144	2003	INDIVIDUAL PERSONAL PROPERTY	NEWELL FREEDA	3917 SW LINDEN LN	075873343	2001	INDIVIDUAL PERSONAL PROPERTY	ARNOLD HARVEY R	UNKNOWN
075301844	2001	INDIVIDUAL PERSONAL PROPERTY	OLSON ROBERT	UNKNOWN	075874137	2021	INDIVIDUAL PERSONAL PROPERTY	SUMPTER DAVID E	5329 HUNTER ST
075307651	2017-2021	INDIVIDUAL PERSONAL PROPERTY	PETERSEN PAUL R & DONN	11411 E 78TH ST	075878053	2020-2021	INDIVIDUAL PERSONAL PROPERTY	REESE LISA D	10408 E 68TH TER
075307802	2001	INDIVIDUAL PERSONAL PROPERTY	PETTYJOHN MARY	NO ADDRESS PROVIDED BY TAXPAYER	075880264	2009	INDIVIDUAL PERSONAL PROPERTY	RODGERS ROSIE M	9110 E 63RD ST APT 101
075308400	2002	INDIVIDUAL PERSONAL PROPERTY	PICARD DON F	UNKNOWN	075884812	2020-2021	INDIVIDUAL PERSONAL PROPERTY	ALLEN ROGER V	8004 MANNING AVE
075309445	2015-2019	INDIVIDUAL PERSONAL PROPERTY	PLANTZ ROGER	7617 HARRIS AVE	075897808	2002	INDIVIDUAL PERSONAL PROPERTY	FOSTER MICHAEL K	UNKNOWN
075311771	2017-2021	INDIVIDUAL PERSONAL PROPERTY	PRETTYMAN LE	7512 WOODSON RD	075908244	2021	INDIVIDUAL PERSONAL PROPERTY	ROSE ROBERT J JR	10600 E 56TH ST
075318523	2019-2021	INDIVIDUAL PERSONAL PROPERTY	RIDEAU FLANORD J	6140 RAYTOWN TFWY	075917252	2018-2019	INDIVIDUAL PERSONAL PROPERTY	KESSLER JENNIFER	10922 E 74TH ST
075322867	2006-2008	INDIVIDUAL PERSONAL PROPERTY	DUFFEY JOHN W JR	11205 E 58TH TER	075927768	2016-2017	INDIVIDUAL PERSONAL PROPERTY	BLACKWELL JO ANN	NO ADDRESS PROVIDED BY TAXPAYER
075325141	2006	INDIVIDUAL PERSONAL PROPERTY	SAIA CHRISTINE F	6213 ASH CT	075936133	2018-2019	INDIVIDUAL PERSONAL PROPERTY	DUTTON WILLIAM B JR & JOANN	9429 E 67TH TER
075327951	2011-2017	INDIVIDUAL PERSONAL PROPERTY	SCHNEIDER GARY LEE	7705 RAYTOWN RD	075947461	2003	INDIVIDUAL PERSONAL PROPERTY	DILTS JAMES M & MARILYN A	UNKNOWN
075327997	2021	INDIVIDUAL PERSONAL PROPERTY	SCHNEIDER JOEL A & HELEN	8110 MANNING AVE	075949021	2021	INDIVIDUAL PERSONAL PROPERTY	SCHNEIDER LYNETTE R	10916 E 82ND ST
075328059	2021	INDIVIDUAL PERSONAL PROPERTY	SCHNELL RUSSELL R	8514 STARK AVE	075954639	2008	INDIVIDUAL PERSONAL PROPERTY	MORRIS THOMAS E	NO ADDRESS PROVIDED BY TAXPAYER
075329735	2021	INDIVIDUAL PERSONAL PROPERTY	SEARCY HERBERT A & CAROL L	8119 MANNING AVE	075958467	2020-2021	INDIVIDUAL PERSONAL PROPERTY	CASS PATRICIA F	10304 E 69TH TER
075330331	2009	INDIVIDUAL PERSONAL PROPERTY	THONEN JOHN & CANDY & ZACHARY	7905 MAPLE AVE	075963923	2020-2021	INDIVIDUAL PERSONAL PROPERTY	ALLEN SALLY A	8004 MANNING AVE
075332268	2021	INDIVIDUAL PERSONAL PROPERTY	SHEPHEARD VICKIE LOU	10608 E 67TH ST	075967411	2020-2021	INDIVIDUAL PERSONAL PROPERTY	MURPHY KATHLEEN A	10212 E 59TH ST
075334738	2008	INDIVIDUAL PERSONAL PROPERTY	SIMPSON STANLEY J	10400 E 79TH ST	075969008	2003-2010	INDIVIDUAL PERSONAL PROPERTY	MOFFETT EDWARD JOHN & VICKI	10304 E 70TH TER
075337101	2016	INDIVIDUAL PERSONAL PROPERTY	SMITH JIMMY VIRGIL	8617 E 83RD ST	075971987	2017	INDIVIDUAL PERSONAL PROPERTY	CUBLEY MARK & JODY	11417 E 56TH TER

075975108	2013	INDIVIDUAL PERSONAL PROPERTY	EVANS CONSTANCE LEE	9051 E 66TH ST	076422837	2021	INDIVIDUAL PERSONAL PROPERTY	WHITLEY LEONARD	9103 E 66TH ST
075975885	2008	INDIVIDUAL PERSONAL PROPERTY	PENDERGRAFT DEL R	7200 CEDAR AVE	076432988	2020-2021	INDIVIDUAL PERSONAL PROPERTY	SMITH JOSEPH O	5307 HEDGES AVE
075978935	2021	INDIVIDUAL PERSONAL PROPERTY	CRISS VERONICA RENEE (WATERS)	9117 E 65TH ST	076448383	2019-2021	INDIVIDUAL PERSONAL PROPERTY	KREISSLER TROY A	9600 E 67TH TER
075980389	2003-2004	INDIVIDUAL PERSONAL PROPERTY	CONNELY DARREN D	11701 E 83RD ST 202	076452849	2020-2021	INDIVIDUAL PERSONAL PROPERTY	SEWARD RALPH V	9110 E 63RD ST APT 206
075990314	2008-2017	INDIVIDUAL PERSONAL PROPERTY	SPURGEON OLLIVNE	8616 E 87TH ST	076455846	2015	INDIVIDUAL PERSONAL PROPERTY	WILLIAMS ALMA J	328 SE GREYSTONE DR
076023741	2019-2020	INDIVIDUAL PERSONAL PROPERTY	MARLOUDAS DENNIS H	10416 E 70TH TER	076461848	2021	INDIVIDUAL PERSONAL PROPERTY	MADDEN RICK D	10704 E 67TH ST
076029772	2009	INDIVIDUAL PERSONAL PROPERTY	REEDER JEFF C	5917 CRESCENT AVE	076466335	2021	INDIVIDUAL PERSONAL PROPERTY	DAVIDSON PAUL A & CRUTCHER ROSEMARY M	5923 HARVARD AVE
076036602	2021	INDIVIDUAL PERSONAL PROPERTY	MOORE DEREK	11009 E 57TH ST	076467398	2021	INDIVIDUAL PERSONAL PROPERTY	ASHLEY KEVIN L	6112 KENTUCKY AVE
076038218	2019-2021	INDIVIDUAL PERSONAL PROPERTY	SHIELDS ARVIS	10319 E 78TH ST	076467986	2020-2021	INDIVIDUAL PERSONAL PROPERTY	NICHOLSON BIRDIE F	6005 BLUE RIDGE CUT OFF
076066927	2016-2017	INDIVIDUAL PERSONAL PROPERTY	BURAU CARL W	7918 HEDGES AVE	076474102	2021	INDIVIDUAL PERSONAL PROPERTY	CROFT TIMOTHY S	9309 E 60TH TER
076074179	2021	INDIVIDUAL PERSONAL PROPERTY	ELLIOTT GEOFFREY S	7904 SPRING VALLEY RD	076483959	2015-2019	INDIVIDUAL PERSONAL PROPERTY	GERDING JENNIFER A & MICHAEL J	9502 E 79TH TER
076077693	2005	INDIVIDUAL PERSONAL PROPERTY	HARRIS HARRY J	7021 ENGLEWOOD TER	076484379	2012	INDIVIDUAL PERSONAL PROPERTY	RILEY BRIAN L	11005 E 72ND TER
076079192	2020-2021	INDIVIDUAL PERSONAL PROPERTY	TESCH JANIE P	11413 E 57TH TER	076488507	2021	INDIVIDUAL PERSONAL PROPERTY	YOUNG SHERI & DOUGLAS	7512 OVERTON AVE
076079753	2016	INDIVIDUAL PERSONAL PROPERTY	WAIT HERBERT M	10200 E 58TH TER	076493939	2021	INDIVIDUAL PERSONAL PROPERTY	STAFFORD DANIEL J & HELEN B	7923 TENNESSEE AVE
076087129	2005-2007	INDIVIDUAL PERSONAL PROPERTY	SANTAMARIA JUANITA M	11600 E 61ST TER	076502475	2014	INDIVIDUAL PERSONAL PROPERTY	ERWIN CECIL C & ROZELLA	9110 E 63RD ST APT 213
076095361	2021	INDIVIDUAL PERSONAL PROPERTY	HESS KIM J	9304 E 54TH ST	076522523	2020-2021	INDIVIDUAL PERSONAL PROPERTY	NEWCOMB VIRGINIA	6807 LAKESHORE DR
076097528	2003	INDIVIDUAL PERSONAL PROPERTY	HUDSON DAVID L	UNKNOWN	076530131	2005	INDIVIDUAL PERSONAL PROPERTY	MANN HAZEL M & GEORGE F	NO ADDRESS PROVIDED BY TAXPAYER
076098974	2021	INDIVIDUAL PERSONAL PROPERTY	FOUNTAIN LEONARD M	10000 E 83RD TER	076535449	2021	INDIVIDUAL PERSONAL PROPERTY	GREEN THOMAS E & HELEN	7409 MAYWOOD AVE
076103245	2018	INDIVIDUAL PERSONAL PROPERTY	PRIEST KEN	9257 E 60TH TER	076542869	2021	INDIVIDUAL PERSONAL PROPERTY	SHAFFER RICHARD W & DONNA	2240 NE MAYBROOK DR
076110987	2020-2021	INDIVIDUAL PERSONAL PROPERTY	OZBURN LISA K	7014 WOODSON RD	076550065	2011-2017	INDIVIDUAL PERSONAL PROPERTY	YSLAS BENITO C	6901 LAUREL AVE
076120477	2010-2011	INDIVIDUAL PERSONAL PROPERTY	LEAKE LINDA SUE	9801 E 61ST ST APT 3	076550751	2002	INDIVIDUAL PERSONAL PROPERTY	NGUYEN HIEP	UNKNOWN
076126630	2003	INDIVIDUAL PERSONAL PROPERTY	REINMILLER DAVID L	UNKNOWN	076550993	2021	INDIVIDUAL PERSONAL PROPERTY	WILLIAMS REGINA V & ALLEN D	8915 E 56TH TER
076131358	2002	INDIVIDUAL PERSONAL PROPERTY	BANISTER JAMES G	NO ADDRESS PROVIDED BY TAXPAYER	076555346	2020	INDIVIDUAL PERSONAL PROPERTY	HOFFMAN RETA B	8402 BOOTH AVE
076132570	2020-2021	INDIVIDUAL PERSONAL PROPERTY	THOMAS STEPHEN WAYNE	11408 E 65TH TER	076556461	2019	INDIVIDUAL PERSONAL PROPERTY	BURTON JANETTE L	11115 E 77TH TER
076159088	2021	INDIVIDUAL PERSONAL PROPERTY	BROOKS TONIA L	8902 E 87TH ST	076562203	2021	INDIVIDUAL PERSONAL PROPERTY	DILLARD WINSTON L	5844 HUNTER CT
076159710	2010-2011	INDIVIDUAL PERSONAL PROPERTY	ROBERTS CHARLES EVERETT	9001 E 52ND TER	076563195	2018	INDIVIDUAL PERSONAL PROPERTY	COLLINS DANIEL J	10920 E 71ST TER
076168773	2006-2017	INDIVIDUAL PERSONAL PROPERTY	WILSON JERRY & BRENDA	10101 E 84TH ST	076588463	2006	INDIVIDUAL PERSONAL PROPERTY	GRUBBS MICHAEL V & ALLISON K	6723 ENGLEWOOD AVE
076169237	2007-2009	INDIVIDUAL PERSONAL PROPERTY	STIEGEMEYER STEVE C	7509 HARVARD AVE	076595311	2008-2011	INDIVIDUAL PERSONAL PROPERTY	JENKINS ROBERT E	5826 HEDGES AVE
076169460	2021	INDIVIDUAL PERSONAL PROPERTY	ALEXANDER STEVEN L & DANETTE K	9827 E 68TH TER	076599861	2021	INDIVIDUAL PERSONAL PROPERTY	CULBERTSON CHARLES P	6136 NORTHERN AVE
076180759	2012-2014	INDIVIDUAL PERSONAL PROPERTY	TRICE MARSHA D (FIELDS)	NO ADDRESS PROVIDED BY TAXPAYER	076600172	2019	INDIVIDUAL PERSONAL PROPERTY	NGUYEN MY	6717 VERMONT AVE
076188323	2021	INDIVIDUAL PERSONAL PROPERTY	DARTHARD WINFRED G	9204 E 64TH TER	076642751	2021	INDIVIDUAL PERSONAL PROPERTY	MOORE DONNA M	11008 E 72ND TER
076189661	2020	INDIVIDUAL PERSONAL PROPERTY	VANORMER ROBERT C	9810 E 60TH ST	076647863	2019-2021	INDIVIDUAL PERSONAL PROPERTY	ELLISON SANDRA	10905 E 57TH ST
076189796	2009-2012	INDIVIDUAL PERSONAL PROPERTY	YATES SHARON KAY	8405 PERSHING RD	076650689	2007-2010	INDIVIDUAL PERSONAL PROPERTY	LANIUS ANNETTE C & HIBBS CARRISSA L	6140 HUNTER ST
076193326	2010	INDIVIDUAL PERSONAL PROPERTY	FABERY JOSEPH M	7612 WOODSON RD	076653301	2003-2004	INDIVIDUAL PERSONAL PROPERTY	ECHO JOHN E	UNKNOWN
076193692	2011-2012	INDIVIDUAL PERSONAL PROPERTY	GUY L ELAINE	5831 FARLEY AVE	076660320	2020-2021	INDIVIDUAL PERSONAL PROPERTY	MEDINA LISA M	6605 STERLING AVE
076196261	2019-2021	INDIVIDUAL PERSONAL PROPERTY	TURNER JEANNE M & JAMES W	7141 CRISP AVE	076660428	2006-2007	INDIVIDUAL PERSONAL PROPERTY	BEDSOLE JAMES	11329 E 72ND ST
076210110	2018-2019	INDIVIDUAL PERSONAL PROPERTY	ORANGE DANNY G	3601 SW JACKSON ST	076669553	2020-2021	INDIVIDUAL PERSONAL PROPERTY	HARDY NANCY S	9406 E 80TH ST
076220617	2018-2021	INDIVIDUAL PERSONAL PROPERTY	SIMS BOBBY G & MARY F	8604 ARLINGTON AVE	076675546	2004-2006	INDIVIDUAL PERSONAL PROPERTY	TENNISON LLOYD M & PEGGY	11008 E 72ND TER
076222919	2014	INDIVIDUAL PERSONAL PROPERTY	BRISCOE BILLIE	6324 FARLEY AVE	076682501	2014-2015	INDIVIDUAL PERSONAL PROPERTY	TAYLOR JOSEPH C & MILDRED	10709 E 84TH ST
076223954	2016-2021	INDIVIDUAL PERSONAL PROPERTY	STEPHENS KENNETH & FLORENCE	10904 E 58TH ST	076686687	2017-2019	INDIVIDUAL PERSONAL PROPERTY	ALLEN TERRANCE LEE	8717 E 61ST TER APT 17
076225006	2020-2021	INDIVIDUAL PERSONAL PROPERTY	GOODWIN LANELL	8959 E 60TH TER	076700536	2020-2021	INDIVIDUAL PERSONAL PROPERTY	VERDICT JONNA (SHARP)	7143 STERLING AVE
076225890	2020-2021	INDIVIDUAL PERSONAL PROPERTY	ROSS THERRESSA (JOHNSON)	11529 E 74TH STREET CT	076713513	2009-2017	INDIVIDUAL PERSONAL PROPERTY	JONES GENE A	8851 E 57TH TER
076238092	2019-2020	INDIVIDUAL PERSONAL PROPERTY	CHRISTMAN LINDA SUE	5818 ELM AVE	076717877	2020-2021	INDIVIDUAL PERSONAL PROPERTY	JOHNSON VICTORIA L	6321 CEDAR AVE
076242737	2006	INDIVIDUAL PERSONAL PROPERTY	WOOLVERTON ROBERT	8807 E 59TH ST	076718331	2019-2021	INDIVIDUAL PERSONAL PROPERTY	TYSON MATA J	5701 ELM AVE
076255018	2021	INDIVIDUAL PERSONAL PROPERTY	WOODS VANESSA	6144 ASH CT	076719642	2015	INDIVIDUAL PERSONAL PROPERTY	GRIFFIN LINDA	8812 E 84TH ST
076270377	2004	INDIVIDUAL PERSONAL PROPERTY	EAGLE MARILYN S	NO ADDRESS PROVIDED BY TAXPAYER	076724912	2021	INDIVIDUAL PERSONAL PROPERTY	CAUGHRON WILLIAM & LANI	8419 SPRING VALLEY RD
076270475	2001	INDIVIDUAL PERSONAL PROPERTY	WALL RODNEY	NO ADDRESS PROVIDED BY TAXPAYER	076744491	2021	INDIVIDUAL PERSONAL PROPERTY	GROSS MICHAEL RENNY	10131 E 78TH TER
076275522	2012-2013	INDIVIDUAL PERSONAL PROPERTY	COOK JEFFERY S & BATSON PAMELA	7211 BLUE RIDGE BLVD	076759260	2012-2014	INDIVIDUAL PERSONAL PROPERTY	COLEMAN JUDITH A (WHITE) & ORLANDO	11300 E 85TH TER
076294262	2015-2016	INDIVIDUAL PERSONAL PROPERTY	HORTON MAY GLADYS	5424 RALSTON AVE	076760098	2020-2021	INDIVIDUAL PERSONAL PROPERTY	FUGATE KRISTINE S	6341 HARVARD AVE
076294832	2007-2008	INDIVIDUAL PERSONAL PROPERTY	VANNICE JAY	1833 SW TWINCREEK PL	076761970	2016	INDIVIDUAL PERSONAL PROPERTY	WALTER ROBERT	6204 WILLOW AVE
076295798	2020-2021	INDIVIDUAL PERSONAL PROPERTY	MURRAY LYNNE (HALE)	10809 E 57TH TER	076762023	2017	INDIVIDUAL PERSONAL PROPERTY	MAASEN DANIEL J	10909 E 58TH TER
076298366	2006	INDIVIDUAL PERSONAL PROPERTY	WETZEL DONNA D	7008 HUNTER ST	076772110	2020-2021	INDIVIDUAL PERSONAL PROPERTY	FANN CHRISTOPHER W	5337 HEDGES AVE
076302547	2006	INDIVIDUAL PERSONAL PROPERTY	HILL ROSETTA	9003 E 74TH TER	076774485	2021	INDIVIDUAL PERSONAL PROPERTY	FOX KEVIN	8404 DITAMM AVE
076303145	2010	INDIVIDUAL PERSONAL PROPERTY	LOVEALL CHARLES T	8506 E 86TH TER	076774573	2003	INDIVIDUAL PERSONAL PROPERTY	DALEY IRMA	1704 NW O BRIEN RD APT 110
076305394	2021	INDIVIDUAL PERSONAL PROPERTY	FITZWATER RAYMOND A	10404 E 79TH ST	076782403	2003-2004	INDIVIDUAL PERSONAL PROPERTY	LEMONS ILENE	NO ADDRESS PROVIDED BY TAXPAYER
076305704	2021	INDIVIDUAL PERSONAL PROPERTY	POORMAN DIANA K & RONALD	7208 HARDY AVE	076794640	2020-2021	INDIVIDUAL PERSONAL PROPERTY	GAMBER KEVIN L & MINDY	9303 E 81ST ST
076308328	2018-2021	INDIVIDUAL PERSONAL PROPERTY	FRIEDMAN BARTON J	5323 ASH AVE	076807342	2001	INDIVIDUAL PERSONAL PROPERTY	CAIN GLENDA R (MEACHUM)	NO ADDRESS PROVIDED BY TAXPAYER
076310985	2009-2010	INDIVIDUAL PERSONAL PROPERTY	CRITES BRIAN D	3909 HARDY AVE	076809251	2009-2011	INDIVIDUAL PERSONAL PROPERTY	BROWN LAURIE J	9706 E 65TH TER
076312572	2012	INDIVIDUAL PERSONAL PROPERTY	BARBER CARY R	6533 LAUREL AVE	076816804	2021	INDIVIDUAL PERSONAL PROPERTY	LEGGIO STEVE C & DEBORAH L	6314 NORWOOD CT
076319575	2003-2005	INDIVIDUAL PERSONAL PROPERTY	FELLS ALVESTER JR	5209 STERLING AVE	076830101	2018	INDIVIDUAL PERSONAL PROPERTY	RAYFIELD DONNA L	7016 EVANSTON AVE
076322516	2021	INDIVIDUAL PERSONAL PROPERTY	BENNETT DARREN & DONNA (ROBINSON)	5647 BLUE RIDGE BLVD	076832458	2021	INDIVIDUAL PERSONAL PROPERTY	BERGMANN JOHN P & ANDREA L	9705 E GREGORY BLVD
076329261	2002-2017	INDIVIDUAL PERSONAL PROPERTY	RAMOND (NEVLS) YVETTE	NO ADDRESS PROVIDED BY TAXPAYER	076833073	2016-2021	INDIVIDUAL PERSONAL PROPERTY	CORBIN KELLY M	6136 NE TUDOR RD APT 6
076336413	2014-2017	INDIVIDUAL PERSONAL PROPERTY	YOUNG EDWARD	6117 KENTUCKY AVE	076833867	2006-2013	INDIVIDUAL PERSONAL PROPERTY	HEDRICK WILLIAM M	9904 E 69TH ST
076338421	2008	INDIVIDUAL PERSONAL PROPERTY	HAMPTON JOHN A	NO ADDRESS PROVIDED BY TAXPAYER	076838292	2003-2004	INDIVIDUAL PERSONAL PROPERTY	CHATFIELD MATT & SOPHIA	11311 E 60TH TER
076339376	2010	INDIVIDUAL PERSONAL PROPERTY	FULLER GENEVIEVE O	5714 WOODSON RD	076846032	2008-2012	INDIVIDUAL PERSONAL PROPERTY	KANE GAIL M	6612 HARVARD AVE
076347731	2018-2020	INDIVIDUAL PERSONAL PROPERTY	WINSTON TERRY L	6009 OXFORD AVE	076852088	2020-2021	INDIVIDUAL PERSONAL PROPERTY	ANDERSON REBECCA	8611 W UTOPIA DR APT 82
076387607	2017-2021	INDIVIDUAL PERSONAL PROPERTY	MONROE WILLIE M	6218 ARLINGTON AVE	076853121	2008	INDIVIDUAL PERSONAL PROPERTY	SAUNDERS PRISCILLA M	9609 E 65TH TER
076395466	2012-2014	INDIVIDUAL PERSONAL PROPERTY	WATERS BERNICE E	1770 CITADEL DR	076855557	2020-2021	INDIVIDUAL PERSONAL PROPERTY	SWINNEY GREGORY A	6101 DITZLER AVE
076402822	2021	INDIVIDUAL PERSONAL PROPERTY	MADDEN KELLY & RUSSELL	5911 NORTHERN AVE	076870558	2020-2021	INDIVIDUAL PERSONAL PROPERTY	REIFF DAVID L & BRENDA	6011 STERLING AVE
076404722	2021	INDIVIDUAL PERSONAL PROPERTY	WHITE JEAN C	8401 E 85TH TER	076875027	2016-2018	INDIVIDUAL PERSONAL PROPERTY	MASONER RON A	8609 EVERETT ST
076419342	2020	INDIVIDUAL PERSONAL PROPERTY	BILES WANDA L	8001 WESTRIDGE RD	076885775	2021	INDIVIDUAL PERSONAL PROPERTY	WEBSTER MARTHA	11512 E 66TH TER
076422230	2014-2015	INDIVIDUAL PERSONAL PROPERTY	ALLEN PRESTON JR & ELOISE	11901 JESSICA LN	076892017	2002	INDIVIDUAL PERSONAL PROPERTY	SWOPE MICHAEL L	NO ADDRESS PROVIDED BY TAXPAYER

076893800	2021	INDIVIDUAL PERSONAL PROPERTY	HAWLEY CHARLES R	8924 E 74TH ST	086030216	2021	INDIVIDUAL PERSONAL PROPERTY	GRIFFIN YOLANDA DENISE	11724 E 85TH ST
076898191	2002	INDIVIDUAL PERSONAL PROPERTY	GERLACH ADA M	NO ADDRESS PROVIDED BY TAXPAYER	086032956	2016	INDIVIDUAL PERSONAL PROPERTY	HUDSON DANIEL & DENISE	8502 PERSHING RD
076900954	2007-2008	INDIVIDUAL PERSONAL PROPERTY	WILLIAMS PAMELA J	11801 E 78TH TER	086038654	2014-2015	INDIVIDUAL PERSONAL PROPERTY	PREWITT DOROTHY J (BANKS)	6311 HARRIS AVE
076906716	2016	INDIVIDUAL PERSONAL PROPERTY	WRIGHT STEPHEN M	7601 WOODSON RD	086040551	2019-2021	INDIVIDUAL PERSONAL PROPERTY	ETTER BRYCE C	10401 E 57TH TER
076909562	2021	INDIVIDUAL PERSONAL PROPERTY	BROWN EMMA	7025 KENTUCKY AVE	086040650	2008-2009	INDIVIDUAL PERSONAL PROPERTY	MYERS SHERYL KAY	NO ADDRESS PROVIDED BY TAXPAYER
076912068	2004	INDIVIDUAL PERSONAL PROPERTY	BARKER SUSAN	UNKNOWN	086041601	2014-2021	INDIVIDUAL PERSONAL PROPERTY	SHROPSHIRE SPELLMAN JR & BOBBI	11616 E 80TH DR
076916199	2021	INDIVIDUAL PERSONAL PROPERTY	GLOR ROY C	9204 E 65TH TER	086064782	2004	INDIVIDUAL PERSONAL PROPERTY	MOURNING JAMES B & MARLA	UNKNOWN
076921076	2021	INDIVIDUAL PERSONAL PROPERTY	GRAHAM BARBARA J	7619 WESTRIDGE RD	086065439	2003	INDIVIDUAL PERSONAL PROPERTY	DAWE GINA	UNKNOWN
076925928	2021	INDIVIDUAL PERSONAL PROPERTY	BATES DALE L & KAREN	6908 WILDWOOD DR	086067901	2021	INDIVIDUAL PERSONAL PROPERTY	PATRICK DENISE A (FOSTER)	5244 HEDGES AVE
076931920	2016-2019	INDIVIDUAL PERSONAL PROPERTY	BELSER EVELYN J	8615 BLUE RIDGE RD	086073720	2020-2021	INDIVIDUAL PERSONAL PROPERTY	MILES LADONNA	5513 ASH AVE
076955556	2016-2021	INDIVIDUAL PERSONAL PROPERTY	SCHUERMANN SHERRY J	5420 BLUE RIDGE CUT OFF APT 103	086073970	2011	INDIVIDUAL PERSONAL PROPERTY	TRAXLER STEVE M	8303 BOOTH AVE
076964252	2021	INDIVIDUAL PERSONAL PROPERTY	PONESSA DEANNA	9354 E 55TH ST	086075739	2007	INDIVIDUAL PERSONAL PROPERTY	LANG THEA M	NO ADDRESS PROVIDED BY TAXPAYER
076967632	2017-2018	INDIVIDUAL PERSONAL PROPERTY	BLACKBURN SUSANNE R & CURTIS	5319 GREENWOOD AVE	086075871	2016-2018	INDIVIDUAL PERSONAL PROPERTY	DOANE WILLIAM & JEANNE	10217 E 70TH TER
076971119	2019-2021	INDIVIDUAL PERSONAL PROPERTY	JOHNSON VIRGIL C	8432 GREENWOOD RD	086080220	2021	INDIVIDUAL PERSONAL PROPERTY	LOCKARD VALORIE A	7704 APPLETON AVE
076973750	2002	INDIVIDUAL PERSONAL PROPERTY	DELLAGUARDIA KARYL	UNKNOWN	086081265	2020-2021	INDIVIDUAL PERSONAL PROPERTY	MAYCOCK JUDY	5915 KENTUCKY AVE
076975071	2021	INDIVIDUAL PERSONAL PROPERTY	JONES MCKINLEY & KATHLEEN	8612 ARLINGTON AVE	086088418	2017-2019	INDIVIDUAL PERSONAL PROPERTY	MEYER JOHN H	11426 E 71ST ST
084460931	2013	INDIVIDUAL PERSONAL PROPERTY	HUDSON EDGAR K	7521 EVANSTON AVE	086090297	2004-2017	INDIVIDUAL PERSONAL PROPERTY	COOPER LINETTE M	NO ADDRESS PROVIDED BY TAXPAYER
084532550	2021	INDIVIDUAL PERSONAL PROPERTY	VANNI LEONARD A & WILLA	7605 CRISP AVE	086098828	2021	INDIVIDUAL PERSONAL PROPERTY	BLACK MARK & KAREN	9416 E 69TH ST
084532554	2015-2018	INDIVIDUAL PERSONAL PROPERTY	ADAMS RONALD C	6416 STERLING AVE	086109150	2002-2004	INDIVIDUAL PERSONAL PROPERTY	RUFF SHANNON L	7523 LEWIS
084590486	2007-2011	INDIVIDUAL PERSONAL PROPERTY	JOURDAN JOY R	11001 E 59TH ST	086109262	2018	INDIVIDUAL PERSONAL PROPERTY	GARCIA STELLA D	7216 RAYTOWN RD APT D
084617874	2021	INDIVIDUAL PERSONAL PROPERTY	NIGRO MICHELLE M	11009 E 57TH ST	086110495	2021	INDIVIDUAL PERSONAL PROPERTY	RICE STEVEN KENT & MARY LOU	6317 ASH AVE
084695904	2013-2014	INDIVIDUAL PERSONAL PROPERTY	MCWILLIAMS PAULINE E	7505 ARLINGTON AVE	086112005	2010-2013	INDIVIDUAL PERSONAL PROPERTY	DOWNS TRACY J	8609 E 84TH TER
084697512	2017	INDIVIDUAL PERSONAL PROPERTY	MAYES JIMMIE L	5440 BLUE RIDGE CUT OFF APT 609	086119590	2021	INDIVIDUAL PERSONAL PROPERTY	NEAL LOUIS C	8508 ARLINGTON AVE
085007511	2020-2021	INDIVIDUAL PERSONAL PROPERTY	WESTBROOK BETTY L	5100 BLUE RIDGE BLVD	086123003	2016	INDIVIDUAL PERSONAL PROPERTY	ALKA RICHARD	8805 E 53RD TER
085061722	2008-2017	INDIVIDUAL PERSONAL PROPERTY	BOONE TIMOTHY EUGENE	8112 STERLING AVE	086123429	2003-2004	INDIVIDUAL PERSONAL PROPERTY	ALDER KATHY	NO ADDRESS PROVIDED BY TAXPAYER
085064764	2006-2007	INDIVIDUAL PERSONAL PROPERTY	BULLARD JOHN	5405 MAYWOOD AVE	086129513	2013	INDIVIDUAL PERSONAL PROPERTY	ODELL RICHARD A	8911 E 79TH ST
085065306	2003-2005	INDIVIDUAL PERSONAL PROPERTY	ROSTON CALVIN	5509 BLUE RIDGE BLVD	086132473	2013-2015	INDIVIDUAL PERSONAL PROPERTY	GREESON RICK	7200 RAYTOWN RD
085065336	2004-2005	INDIVIDUAL PERSONAL PROPERTY	GRAY ROBERT WALLACE	11200 E 67TH ST	086134133	2021	INDIVIDUAL PERSONAL PROPERTY	JURGESON CHRISTOPHER	7913 RAYTOWN RD
085068684	2014-2016	INDIVIDUAL PERSONAL PROPERTY	LESSNER PHIL W & KAREN	932 E 79TH ST	086134144	2006	INDIVIDUAL PERSONAL PROPERTY	DORE JAMES L	6122 WILLOW AVE
085089832	2006	INDIVIDUAL PERSONAL PROPERTY	DIECKMAN CATHERINE	NO ADDRESS PROVIDED BY TAXPAYER	086156348	2001-2002	INDIVIDUAL PERSONAL PROPERTY	RYAN TIMOTHY W & DEBORAH	NO ADDRESS PROVIDED BY TAXPAYER
085098215	2018-2020	INDIVIDUAL PERSONAL PROPERTY	ALDEN STEVEN L & DIANA J	8023 SPRING VALLEY RD	086156537	2016-2019	INDIVIDUAL PERSONAL PROPERTY	BURDETTE ANNA M	6656 BALES AVE
085108482	2011	INDIVIDUAL PERSONAL PROPERTY	LEMPE JILL P	10800 E 66TH TER	086167680	2021	INDIVIDUAL PERSONAL PROPERTY	WHITE EARNESTINE	11917 S EAGLE CREST DR
085108517	2021	INDIVIDUAL PERSONAL PROPERTY	CONWAY PHILIP	7905 HUNTER ST	086170528	2021	INDIVIDUAL PERSONAL PROPERTY	ROBINSON KEITH CLINE	9026 E 85TH TER
085123443	2005-2006	INDIVIDUAL PERSONAL PROPERTY	CHRISTIE HOWARD W	10205 E 63RD TER APT A	086170907	2021	INDIVIDUAL PERSONAL PROPERTY	CATTIN PATRICK J	8716 E 79TH ST
085126369	2012-2017	INDIVIDUAL PERSONAL PROPERTY	HARPER ANDRE D	8301 OVERTON DR	086171024	2021	INDIVIDUAL PERSONAL PROPERTY	SCHINZE LARRY ALLAN & PITTS ANGELA M	8708 E 80TH TER
085164789	2021	INDIVIDUAL PERSONAL PROPERTY	JACKSON RICHARD B	10113 E 68TH TER	086184096	2012	INDIVIDUAL PERSONAL PROPERTY	ZIBUNG ROBERT A	5308 WILLOW AVE
085303985	2010-2011	INDIVIDUAL PERSONAL PROPERTY	BEARD MARILYN L	NO ADDRESS PROVIDED BY TAXPAYER	086184295	2002-2003	INDIVIDUAL PERSONAL PROPERTY	BURNETT SHARON N	NO ADDRESS PROVIDED BY TAXPAYER
085438998	2021	INDIVIDUAL PERSONAL PROPERTY	REFFITT JOSEPH PAUL	113 SW MCCLENDON DR UNIT 219	086186712	2021	INDIVIDUAL PERSONAL PROPERTY	ONONYE ANTHONY C	9101 E 84TH CT
085499051	2007-2013	INDIVIDUAL PERSONAL PROPERTY	FIELDS STEPHEN	6007 KENTUCKY AVE	086197266	2018-2021	INDIVIDUAL PERSONAL PROPERTY	ANTWINE MARK A	10111 E 77TH TER
085503492	2011-2013	INDIVIDUAL PERSONAL PROPERTY	AVIS LACANA	8904 E 73RD ST	086197307	2021	INDIVIDUAL PERSONAL PROPERTY	YOUNG ANGELIA F	5704 BLUE RIDGE CUT OFF
085512898	2021	INDIVIDUAL PERSONAL PROPERTY	PLUMMER MAVIS E	6704 LAKESHORE DR	086206111	2002	INDIVIDUAL PERSONAL PROPERTY	LEWIS WILLIAM G	NO ADDRESS PROVIDED BY TAXPAYER
085536055	2011-2017	INDIVIDUAL PERSONAL PROPERTY	YOUNG JESSE I & LAURA F	8500 DITZLER AVE	086216028	2004-2008	INDIVIDUAL PERSONAL PROPERTY	MCPACK JEFF	7018 WOODSON RD
085541946	2021	INDIVIDUAL PERSONAL PROPERTY	SMITH KELLI N	8504 STERLING AVE	086221751	2021	INDIVIDUAL PERSONAL PROPERTY	CANADAY SARAH A	8704 E 84TH ST
085563614	2006	INDIVIDUAL PERSONAL PROPERTY	STEVENSON DENNIS R	NO ADDRESS PROVIDED BY TAXPAYER	086232883	2005	INDIVIDUAL PERSONAL PROPERTY	BURRELL CHERYL A	8305 NORTHERN ST
085571156	2010-2012	INDIVIDUAL PERSONAL PROPERTY	PAYTON GREG	7317 ASH AVE	086235345	2021	INDIVIDUAL PERSONAL PROPERTY	UPTON LEAH LYNNE	9019 E 75TH ST
085576208	2021	INDIVIDUAL PERSONAL PROPERTY	EICHELBERGER MARIA S	6806 LAUREL AVE	086243119	2021	INDIVIDUAL PERSONAL PROPERTY	LAWRENCE BRIAN W	9023 E 73RD ST
085582079	2004-2008	INDIVIDUAL PERSONAL PROPERTY	CRUM JEFFRY R	8401 HEDGES AVE	086290991	2021	INDIVIDUAL PERSONAL PROPERTY	HEFLIN LARRY & SHIRLEY	9704 E 71ST TER
085590784	2001	INDIVIDUAL PERSONAL PROPERTY	JOBE RICHARD V	8501 E 92ND ST	086303460	2006-2017	INDIVIDUAL PERSONAL PROPERTY	ARCANO BENJAMIN J JR	10702 E 75TH ST
085595762	2021	INDIVIDUAL PERSONAL PROPERTY	MAIS CURTIS P & KELLY A	6215 CRISP AVE	086499273	2010	INDIVIDUAL PERSONAL PROPERTY	PEOPLES LINDA	NO ADDRESS PROVIDED BY TAXPAYER
085595986	2020-2021	INDIVIDUAL PERSONAL PROPERTY	PERRY GLEN	9505 E 65TH ST	086510683	2005	INDIVIDUAL PERSONAL PROPERTY	FLEEMAN JILL L	NO ADDRESS PROVIDED BY TAXPAYER
085623272	2020-2021	INDIVIDUAL PERSONAL PROPERTY	MORGAN TIFFANY R	5712 MANNING AVE	086512859	2013-2014	INDIVIDUAL PERSONAL PROPERTY	HARTER BRUCE L	6515 HUNTER ST UNIT B
085640245	2015-2016	INDIVIDUAL PERSONAL PROPERTY	PENN KENNETH W	11401 E 71ST ST	086513384	2007-2008	INDIVIDUAL PERSONAL PROPERTY	JOHNSON RODNEY	9063 E 66TH ST
085659600	2021	INDIVIDUAL PERSONAL PROPERTY	DOVER RICHARD JR	5304 HARDY AVE	086518499	2013	INDIVIDUAL PERSONAL PROPERTY	BERGEN WILLIAM A III	8629 E UTOPIA PKWY APT 10
085903891	2018-2019	INDIVIDUAL PERSONAL PROPERTY	MYERS SHEILA Y	3709 INDIANA AVE	086530044	2004	INDIVIDUAL PERSONAL PROPERTY	CASON ROSITA A	UNKNOWN
085906738	2007	INDIVIDUAL PERSONAL PROPERTY	JACKSON JERRY L	7804 E 86TH ST	086574358	2002-2003	INDIVIDUAL PERSONAL PROPERTY	GENERAUX SHARI	UNKNOWN
085911078	2019	INDIVIDUAL PERSONAL PROPERTY	STANSBURY JAMES G	10909 E 72ND TER	086582103	2010-2017	INDIVIDUAL PERSONAL PROPERTY	THOMPSON GREGORY A & LINDA J	10136 E 80TH ST
085915070	2002-2003	INDIVIDUAL PERSONAL PROPERTY	WILSON LARRY H	11312 E 78TH TER	086582239	2021	INDIVIDUAL PERSONAL PROPERTY	HARGREAVES TERRY K	2625 W PASEO BLVD
085918077	2002	INDIVIDUAL PERSONAL PROPERTY	ROHL MARQUITA S	NO ADDRESS PROVIDED BY TAXPAYER	086586100	2021	INDIVIDUAL PERSONAL PROPERTY	FOSTER THOMAS & JANINE	6714 RALSTON AVE
085926578	2006-2008	INDIVIDUAL PERSONAL PROPERTY	SUMMERS GORDON	8501 GRANT DR	086586266	2021	INDIVIDUAL PERSONAL PROPERTY	DIGGS PATRICIA A & WILLIAM S	11708 E 78TH TER
085926870	2009	INDIVIDUAL PERSONAL PROPERTY	DAVIS GEORGE L & JACQUELINE	8901 E 57TH ST	086590949	2018	INDIVIDUAL PERSONAL PROPERTY	SNOW LEONARD R	8328 LAUREL AVE
085926873	2005	INDIVIDUAL PERSONAL PROPERTY	CREEL ANNETTE M & ROBIN	5122 BOOTH AVE	086648894	2010-2014	INDIVIDUAL PERSONAL PROPERTY	GEROW JOHANNA C	10916 E 56TH TER
085928316	2004	INDIVIDUAL PERSONAL PROPERTY	MORRIS GARY A	UNKNOWN	086655163	2021	INDIVIDUAL PERSONAL PROPERTY	SPENCER LORETTA (MCCALOP)	5300 HUNTER ST
085929524	2002	INDIVIDUAL PERSONAL PROPERTY	BARCKLEY JYE	NO ADDRESS PROVIDED BY TAXPAYER	086682304	2019	INDIVIDUAL PERSONAL PROPERTY	STICKNEY SYLVIA	267 SW CARSON DR
085930949	2021	INDIVIDUAL PERSONAL PROPERTY	POTTER RON D	5712 ELM AVE	086694751	2006	INDIVIDUAL PERSONAL PROPERTY	HIGGINS BETH	5424 HUNTER ST
085939036	2017-2020	INDIVIDUAL PERSONAL PROPERTY	WALKINSHAW CRIS	6622 ENGLEWOOD AVE	086697225	2021	INDIVIDUAL PERSONAL PROPERTY	STARKS CHARLES E	8609 SPRING VALLEY RD
085942744	2012-2013	INDIVIDUAL PERSONAL PROPERTY	RAW EDWARD S & TERESA S	8307 E 86TH TER	086904463	2020-2021	INDIVIDUAL PERSONAL PROPERTY	SOK LAY	9113 E 66TH TER
085943069	2008	INDIVIDUAL PERSONAL PROPERTY	UNGER WILLIS C F & MARLENE	11311 E 61ST TER	086906796	2019-2021	INDIVIDUAL PERSONAL PROPERTY	GILMORE PATRICIA	8818 E 80TH TER
086002219	2021	INDIVIDUAL PERSONAL PROPERTY	HENDERSON RICHARD A	10017 E 56TH TER	086908239	2020-2021	INDIVIDUAL PERSONAL PROPERTY	JEFFERIES BARBARA	9113 E 66TH TER
086002705	2021	INDIVIDUAL PERSONAL PROPERTY	WILLENER CAROLYN D & GERALD	5512 ASH AVE	086913670	2002	INDIVIDUAL PERSONAL PROPERTY	GEREN MICHELLE A	5328 HEDGES AVE
086003321	2019	INDIVIDUAL PERSONAL PROPERTY	LACY DIANE M	8954 E 83RD TER	086923865	2003	INDIVIDUAL PERSONAL PROPERTY	SMITH CHARLES F	6208 HEDGES AVE
086004684	2021	INDIVIDUAL PERSONAL PROPERTY	HAYES TOMMY D & KATHY	9206 E 79TH ST	086928173	2016-2021	INDIVIDUAL PERSONAL PROPERTY	LATERRA CARL	5804 ASH AVE
086005731	2017-2018	INDIVIDUAL PERSONAL PROPERTY	SLAUGHTER CHRIS L	10511 E 80TH ST	086929880	2021	INDIVIDUAL PERSONAL PROPERTY	CARTER SONYA R	10401 E 79TH ST

086939864	2008	INDIVIDUAL PERSONAL PROPERTY	DRENNAN GRACE L	6704 ELM AVE	087912444	2011-2012	INDIVIDUAL PERSONAL PROPERTY	COOK DONALD RAY	9910 E 61ST ST APT 1
086944374	2008	INDIVIDUAL PERSONAL PROPERTY	JOHNSON SHIRLEY A	9404 E 84TH TER	087917767	2021	INDIVIDUAL PERSONAL PROPERTY	JACKSON JOYCE A (ADMIRE)	7020 HUNTER ST
086944542	2001-2002	INDIVIDUAL PERSONAL PROPERTY	EICHELBERGER THOMAS	9911 E 80TH ST	087918387	2010-2012	INDIVIDUAL PERSONAL PROPERTY	CONRAD CYNTHIA D	9805 E 69TH ST
086944833	2012-2016	INDIVIDUAL PERSONAL PROPERTY	WILCOX JEFFREY M	9717 E 76TH TER	087921429	2020-2021	INDIVIDUAL PERSONAL PROPERTY	WILLIAMS WILLIE GENE JR	5825 FARLEY AVE
086946694	2019-2021	INDIVIDUAL PERSONAL PROPERTY	OUTLAW FREDDIE B & JAMET	10505 E 66TH ST	087924107	2017-2021	INDIVIDUAL PERSONAL PROPERTY	PERKINS JEFFERY EUGENE	8622 EVANSTON AVE
086946769	2009-2017	INDIVIDUAL PERSONAL PROPERTY	ESCOE PERCY A	9010 E 87TH ST APT A1	087924402	2011-2013	INDIVIDUAL PERSONAL PROPERTY	WALKER JULIA A	7313 RAYTOWN RD
086948354	2001	INDIVIDUAL PERSONAL PROPERTY	CAMPBELL CRAIG C	NO ADDRESS PROVIDED BY TAXPAYER	087926225	2019-2021	INDIVIDUAL PERSONAL PROPERTY	HAMMONS MICKI S	NO ADDRESS PROVIDED BY TAXPAYER
087006817	2018-2021	INDIVIDUAL PERSONAL PROPERTY	AUSTIN LUCIUS S	11712 E 87TH ST	087926629	2002	INDIVIDUAL PERSONAL PROPERTY	LINGERFELT RUTH R	NO ADDRESS PROVIDED BY TAXPAYER
087008514	2021	INDIVIDUAL PERSONAL PROPERTY	HOLLOWAY ANDREW J	8800 E 59TH ST	087937081	2021	INDIVIDUAL PERSONAL PROPERTY	LOONEY EUGENE KERWIN	9417 E 82ND ST
087029604	2021	INDIVIDUAL PERSONAL PROPERTY	JACKSON MARY	NO ADDRESS PROVIDED BY TAXPAYER	087941227	2008-2017	INDIVIDUAL PERSONAL PROPERTY	WILLYARD HOWARD S SR	9408 E 65TH ST
087032818	2002	INDIVIDUAL PERSONAL PROPERTY	JESTER OLLIE M	NO ADDRESS PROVIDED BY TAXPAYER	087941302	2021	INDIVIDUAL PERSONAL PROPERTY	MAKADANZ DAVID WESLEY JR	11017 E 66TH TER
087033513	2011-2015	INDIVIDUAL PERSONAL PROPERTY	HOWELL WESLEY G	8468 LANE DR	087944160	2020-2021	INDIVIDUAL PERSONAL PROPERTY	EAGLE BRENT M	8520 HARVARD TER
087033526	2017	INDIVIDUAL PERSONAL PROPERTY	PILKENTON THEODORE R & JANELLE E	5549 HUNTER TER	087944804	2021	INDIVIDUAL PERSONAL PROPERTY	HAMBY DERRILL	10704 E 83RD TER
087040364	2021	INDIVIDUAL PERSONAL PROPERTY	MITCHELL ERIC S	6316 HUNTER ST	087948222	2009-2011	INDIVIDUAL PERSONAL PROPERTY	OWENS LARRY C	5945 RAYTOWN RD
087044974	2021	INDIVIDUAL PERSONAL PROPERTY	MCCONNELL BRIAN	5409 MAYWOOD AVE	088001078	2016-2018	INDIVIDUAL PERSONAL PROPERTY	WAGNER ROBERT E & TRACY	11415 E 77TH ST
087051299	2003	INDIVIDUAL PERSONAL PROPERTY	CRISP JASON P & JACQUELYN A	UNKNOWN	088002277	2020-2021	INDIVIDUAL PERSONAL PROPERTY	ARTERBERY REBECCA A	6633 MAYWOOD AVE
087055823	2017	INDIVIDUAL PERSONAL PROPERTY	ANDERSON JAMES T	9104 E 84TH ST	088002377	2021	INDIVIDUAL PERSONAL PROPERTY	MCCLENAHAN MELVIN TODD & SHELLY D	5425 HARVARD AVE
087057246	2003	INDIVIDUAL PERSONAL PROPERTY	BROWN EVERETT G	6140 RAYTOWN RD	088002916	2002-2017	INDIVIDUAL PERSONAL PROPERTY	MAGEE LINA L	NO ADDRESS PROVIDED BY TAXPAYER
087057872	2007-2008	INDIVIDUAL PERSONAL PROPERTY	NOZMDE WILLIAM M	NO ADDRESS PROVIDED BY TAXPAYER	088004618	2016-2021	INDIVIDUAL PERSONAL PROPERTY	JETT CYNTHIA M	7208 HEDGES AVE
087060798	2011	INDIVIDUAL PERSONAL PROPERTY	SARGENT HOWARD D	NO ADDRESS PROVIDED BY TAXPAYER	088008639	2021	INDIVIDUAL PERSONAL PROPERTY	ZAKOVICH CINDY	9801 E 73RD ST APT B
087064957	2021	INDIVIDUAL PERSONAL PROPERTY	HEAGY CHRISTINA L	5409 MAYWOOD AVE	088015224	2019-2021	INDIVIDUAL PERSONAL PROPERTY	EDWARDS BILLY L & JEAN M	5500 WOODSON RD
087065513	2021	INDIVIDUAL PERSONAL PROPERTY	TUBBS TRACY A & BRENDA	8704 E 87TH ST	088017725	2021	INDIVIDUAL PERSONAL PROPERTY	GASSEN CONNIE R	6400 HUNTER ST
087069882	2017-2018	INDIVIDUAL PERSONAL PROPERTY	SHERROW JAMES L	5416 WILLOW AVE	088024327	2019-2021	INDIVIDUAL PERSONAL PROPERTY	SCHULTZ KAREN	5912 ENGLEWOOD AVE
087071603	2007	INDIVIDUAL PERSONAL PROPERTY	KILGORE SUSAN L	9308 E 81ST ST	088026474	2021	INDIVIDUAL PERSONAL PROPERTY	CANNON RODNEY	7713 RAYTOWN RD APT 12
087071640	2021	INDIVIDUAL PERSONAL PROPERTY	SCHRANZ KARLENA (ECHO)	10805 E 57TH TER	088028576	2011	INDIVIDUAL PERSONAL PROPERTY	HUTCHINSON LEANETTE	8604 OXFORD AVE
087071996	2003-2004	INDIVIDUAL PERSONAL PROPERTY	MCCLEON ISAAC L	NO ADDRESS PROVIDED BY TAXPAYER	088032470	2021	INDIVIDUAL PERSONAL PROPERTY	DEAN KAREN D	11010 E 75TH ST
087072419	2003-2005	INDIVIDUAL PERSONAL PROPERTY	HOSCH MARY ANNE	10702 E 63RD ST	088033230	2014-2015	INDIVIDUAL PERSONAL PROPERTY	PETHWERS JAMES & DELENE	6510 BLUE RIDGE BLVD
087073389	2004	INDIVIDUAL PERSONAL PROPERTY	RICE DAVE F	NO ADDRESS PROVIDED BY TAXPAYER	088035418	2009-2010	INDIVIDUAL PERSONAL PROPERTY	JARMIN JEANNE M	1821 MAYWOOD AVE
087077328	2021	INDIVIDUAL PERSONAL PROPERTY	BIDWELL ROBERT J & KAREN	11209 E 83RD ST	088036908	2020-2021	INDIVIDUAL PERSONAL PROPERTY	BURMASTER DAVID A	10102 E 69TH TER
087080962	2007-2008	INDIVIDUAL PERSONAL PROPERTY	FRAYLING FRED A	10105 E 81ST ST	088037031	2020-2021	INDIVIDUAL PERSONAL PROPERTY	MCDEFERS VYONNE A	7814 ARLINGTON AVE
087081035	2002	INDIVIDUAL PERSONAL PROPERTY	BOATMAN JACQUELINE	NO ADDRESS PROVIDED BY TAXPAYER	088037089	2010	INDIVIDUAL PERSONAL PROPERTY	VERSER CRYSTAL LYNN	8403 OVERTON AVE
087082500	2021	INDIVIDUAL PERSONAL PROPERTY	CHRISMAN MICHAEL R & PAULA R	5908 CEDAR AVE	088040331	2013-2015	INDIVIDUAL PERSONAL PROPERTY	BLUM ELLEN	9005 E 74TH ST
087083305	2017	INDIVIDUAL PERSONAL PROPERTY	BARRERA ROBERT J	5512 HARDY AVE	088040338	2014-2021	INDIVIDUAL PERSONAL PROPERTY	DAVIS ROBERT W & BONNIE S	7703 CRESCENT AVE
087085171	2021	INDIVIDUAL PERSONAL PROPERTY	HENNEFORTH CAROLYN A	5729 ELM AVE	088040403	2004	INDIVIDUAL PERSONAL PROPERTY	FREEMYER HARRY E	UNKNOWN
087093258	2020	INDIVIDUAL PERSONAL PROPERTY	COOKS ANNETTA B	6616 WOODSON RD	088040765	2016	INDIVIDUAL PERSONAL PROPERTY	PALMS HARRY R & CHER P	5529 NORTHERN AVE
087096792	2021	INDIVIDUAL PERSONAL PROPERTY	DAVIS JULIUS LEE	9401 E 63RD ST APT 210	088040805	2004-2007	INDIVIDUAL PERSONAL PROPERTY	ESTEP DONALD R	8800 E 66TH ST
087100280	2011	INDIVIDUAL PERSONAL PROPERTY	WRIGHT CHERYL A & JEFFREY	11301 INDIANA AVE	088053059	2006	INDIVIDUAL PERSONAL PROPERTY	KNAPP ANN	7401 DITZLER AVE
087110392	2002	INDIVIDUAL PERSONAL PROPERTY	RAVENSRAFT DONALD B	UNKNOWN	088053295	2021	INDIVIDUAL PERSONAL PROPERTY	CLANAHAN MARGERIE	8927 E 74TH ST
087110674	2009-2012	INDIVIDUAL PERSONAL PROPERTY	PETTET TERRY D	11700 E 78TH PL	088056614	2014-2021	INDIVIDUAL PERSONAL PROPERTY	ARMSTRONG ROSELINE (MOSLEY)	1803 E 97TH ST
087111218	2007-2017	INDIVIDUAL PERSONAL PROPERTY	GLOR MARY L (WOOLFOLK)	9204 E 65TH TER	088057327	2011	INDIVIDUAL PERSONAL PROPERTY	PETERS JOHN JR	NO ADDRESS PROVIDED BY TAXPAYER
087111274	2020-2021	INDIVIDUAL PERSONAL PROPERTY	VIAL JOAN E	11131 E 84TH TER	088057397	2021	INDIVIDUAL PERSONAL PROPERTY	BARRETT RITA	7913 APPLETON AVE
087111463	2014-2021	INDIVIDUAL PERSONAL PROPERTY	PEARSON RODERICK I	8920 E 81ST ST	088060475	2020-2021	INDIVIDUAL PERSONAL PROPERTY	GARDENHIRE WILLIAM MAC DONALD 3RD	9118 E 85TH PL
087112496	2009	INDIVIDUAL PERSONAL PROPERTY	DARK JOHNNY E	7206 CRISP AVE	088070175	2002	INDIVIDUAL PERSONAL PROPERTY	BELL ORVILLE A & ROSE M	10209 E 86TH TER
087119699	2001	INDIVIDUAL PERSONAL PROPERTY	STRONG LEVSTER R & SHELLY J	5329 KENTUCKY	088071785	2021	INDIVIDUAL PERSONAL PROPERTY	MOFFIT DARRELL R	5906 CLAREMONT AVE
087132677	2004-2009	INDIVIDUAL PERSONAL PROPERTY	FREEMAN MARY Y (DANIEL)	7200 STREILING AVE	088075329	2021	INDIVIDUAL PERSONAL PROPERTY	HENSLEY STEVEN M	6244 RALSTON AVE
087142868	2021	INDIVIDUAL PERSONAL PROPERTY	GARCIA MISCHLA A	11704 E 77TH ST	088076124	2001	INDIVIDUAL PERSONAL PROPERTY	RIGGS CAROL A	8703 E 79TH ST
087143453	2020-2021	INDIVIDUAL PERSONAL PROPERTY	STANDSBERRY MARY C	7915 CRESCENT AVE	088078242	2021	INDIVIDUAL PERSONAL PROPERTY	MORRIS WAYNE THEODIS	9357 E 77TH ST
087144690	2021	INDIVIDUAL PERSONAL PROPERTY	TODD BEVERLY D	5825 BLUE RIDGE CUT OFF	088079791	2005	INDIVIDUAL PERSONAL PROPERTY	PARKER GRIFF & DONNA	NO ADDRESS PROVIDED BY TAXPAYER
087146452	2011	INDIVIDUAL PERSONAL PROPERTY	HEAVENER MICHAEL D	9204 E 69TH ST	088080712	2009-2010	INDIVIDUAL PERSONAL PROPERTY	SUTTON STUART A & MICHELE	7902 APPLETON AVE
087148540	2002-2004	INDIVIDUAL PERSONAL PROPERTY	SNYDER JOHN EUGENE	NO ADDRESS PROVIDED BY TAXPAYER	088081419	2004	INDIVIDUAL PERSONAL PROPERTY	KRAPE VICKIE	9355 E 69TH ST
087152229	2002	INDIVIDUAL PERSONAL PROPERTY	COE RICHARD GENE	8709 E 84TH TER	088081820	2021	INDIVIDUAL PERSONAL PROPERTY	VANDYKE JACK M & PATRICIA D	11804 E 79TH DR
087156228	2010-2011	INDIVIDUAL PERSONAL PROPERTY	MOSS (LUNGREEN) MARY F & KENNARD M	5552 BLUE RIDGE BLVD	088092805	2003-2004	INDIVIDUAL PERSONAL PROPERTY	ATCHISON LYNN	UNKNOWN
087156789	2021	INDIVIDUAL PERSONAL PROPERTY	HAMPTON VICKI L	11810 E 85TH ST	088099242	2001-2003	INDIVIDUAL PERSONAL PROPERTY	HUNTER ERIC S	UNKNOWN
087172871	2020-2021	INDIVIDUAL PERSONAL PROPERTY	BALDWIN DANNY M & CORA MARIE	7413 HEDGES AVE	088099245	2014	INDIVIDUAL PERSONAL PROPERTY	HASSLER GERALD E & WILMA A	11709 E 86TH ST
087183788	2012-2013	INDIVIDUAL PERSONAL PROPERTY	CIPOLLA TONY J	10208 E 56TH ST	088110944	2004-2005	INDIVIDUAL PERSONAL PROPERTY	CENKUS PAULA A	8715 E 77TH ST
087189601	2015	INDIVIDUAL PERSONAL PROPERTY	SMITH KIMIKO	9917 E 81ST TER	088123332	2020-2021	INDIVIDUAL PERSONAL PROPERTY	WALKER LAWRENCE P JR & ANGELA	9009 E 77TH TER
087190666	2019-2021	INDIVIDUAL PERSONAL PROPERTY	MEZZACASA JEFFERY KENT	9403 E 64TH ST	088132834	2021	INDIVIDUAL PERSONAL PROPERTY	CUTCHLOW AARON D & MICHELENA	10401 E 82ND TER
087191676	2011-2013	INDIVIDUAL PERSONAL PROPERTY	TYLER HERMAN L	9010 E 87TH ST APT A1	088135750	2009	INDIVIDUAL PERSONAL PROPERTY	HOGAN PATRICK J	113 S HAWTHORNE AVE
087202456	2015	INDIVIDUAL PERSONAL PROPERTY	VITTETOE GARY W & BONNIE C	8808 E 53RD TER	088136687	2007-2008	INDIVIDUAL PERSONAL PROPERTY	MIDDLEBROOKS JEROME	9031 E 85TH TER
087219264	2006	INDIVIDUAL PERSONAL PROPERTY	LONG STEVEN A	8611 KENTUCKY AVE	088137091	2020	INDIVIDUAL PERSONAL PROPERTY	BYRD MELINDA K	10101 HICKMAN MILLS DR APT 11
087232925	2009-2010	INDIVIDUAL PERSONAL PROPERTY	WHITE SUSAN ANNETTE	8314 MARSH AVE	088137420	2019	INDIVIDUAL PERSONAL PROPERTY	BREWSTER KENNY E	9801 APPLETON AVE
087245809	2021	INDIVIDUAL PERSONAL PROPERTY	BUTLER ELTON JR	9408 E 81ST TER	088137613	2015-2016	INDIVIDUAL PERSONAL PROPERTY	MIKEL BONNIE A	5606 E GREGORY BLVD
087247797	2020-2021	INDIVIDUAL PERSONAL PROPERTY	MORALES PATRICK B & CINDY	9816 E 66TH ST	088138329	2021	INDIVIDUAL PERSONAL PROPERTY	ALLEN GEORGE E JR & MARY M	9717 RICE AVE
087249598	2002	INDIVIDUAL PERSONAL PROPERTY	THOMPSON ROBERT W	UNKNOWN	088149310	2001	INDIVIDUAL PERSONAL PROPERTY	SHERWOOD NELLIE E	6818 LANE AVE
087352010	2007-2014	INDIVIDUAL PERSONAL PROPERTY	MORRISON JEANINE	9115 E 85TH ST	088149428	2001-2005	INDIVIDUAL PERSONAL PROPERTY	COCHRAN CLARENCE A	12200 E 60TH TER
087457676	2021	INDIVIDUAL PERSONAL PROPERTY	DICKEY CHARLOTTE R	8809 E 61ST TER	088149992	2018	INDIVIDUAL PERSONAL PROPERTY	SHELTON VIRGIA M	7331 NORTON AVE
087475803	2005-2006	INDIVIDUAL PERSONAL PROPERTY	ECKENROED EDITH M	NO ADDRESS PROVIDED BY TAXPAYER	088163501	2013	INDIVIDUAL PERSONAL PROPERTY	PODRAZA JOHN R & SUSAN	9401 E 63RD ST APT 207
087483816	2013	INDIVIDUAL PERSONAL PROPERTY	OTT RICHARD	7156 WOODSON RD	088168348	2021	INDIVIDUAL PERSONAL PROPERTY	BANKS DIANE M	8417 WESTRIDGE RD
087504348	2017-2021	INDIVIDUAL PERSONAL PROPERTY	COLTHARP JOSEPH	5324 NORTHERN AVE	088168531	2001-2003	INDIVIDUAL PERSONAL PROPERTY	MORGAN LATONYA	NO ADDRESS PROVIDED BY TAXPAYER
087900960	2017-2021	INDIVIDUAL PERSONAL PROPERTY	MCCLENTON FRANK & CLARA	7510 ELM ST	088168817	2006	INDIVIDUAL PERSONAL PROPERTY	MCKINZY MICHAEL E	9705 E 81ST TER
087909617	2020	INDIVIDUAL PERSONAL PROPERTY	COLE ETHEL F	8617 W UTOPIA DR APT 36	088175425	2020-2021	INDIVIDUAL PERSONAL PROPERTY	FORD JAMES WILLIAM 3RD	3218 BRIGHTON AVE
087911987	2014-2018	INDIVIDUAL PERSONAL PROPERTY	GRIFFITH JEANETTE & PAUL	NO ADDRESS PROVIDED BY TAXPAYER	088178393	2012	INDIVIDUAL PERSONAL PROPERTY	WIEDERSBERG PAULA	7911 MAPLE AVE

088179764	2003-2011	INDIVIDUAL PERSONAL PROPERTY	MANSFIELD ROBERT L	5800 BLUE RIDGE BLVD	089058100	2018	INDIVIDUAL PERSONAL PROPERTY	FARRELL CHARLENE	6738 STERLING AVE
088180463	2001	INDIVIDUAL PERSONAL PROPERTY	PERKINS CARL E	8517 S BUCKNER TARSNEY RD	089060565	2020-2021	INDIVIDUAL PERSONAL PROPERTY	ULSHAFAER MARION A & JEANA	11312 E 56TH TER
088181813	2007	INDIVIDUAL PERSONAL PROPERTY	FRENCH MICHAEL J	10107 E 78TH TER	089071546	2005-2006	INDIVIDUAL PERSONAL PROPERTY	MILLER NANCY ANN	NO ADDRESS PROVIDED BY TAXPAYER
088182315	2021	INDIVIDUAL PERSONAL PROPERTY	CAVANAGH FRANK & DELAINE	8853 E 59TH ST	089072608	2021	INDIVIDUAL PERSONAL PROPERTY	HORNER STEPHEN D	9002 E GREGORY BLVD
088183748	2008-2010	INDIVIDUAL PERSONAL PROPERTY	WILTFONG BRYAN S	11309 E 62ND ST	089077317	2003-2007	INDIVIDUAL PERSONAL PROPERTY	HAHN LAURA BETH	5709 ASH AVE
088183759	2009	INDIVIDUAL PERSONAL PROPERTY	QUALLS LINDA	5420 BLUE RIDGE CUT OFF APT 617	089084979	2007-2008	INDIVIDUAL PERSONAL PROPERTY	BUTLER SHARON K	NO ADDRESS PROVIDED BY TAXPAYER
088184303	2013-2017	INDIVIDUAL PERSONAL PROPERTY	MARTIN JOHN J	9400 E 65TH TER	089147722	2001	INDIVIDUAL PERSONAL PROPERTY	CURTIS FREDRICK D & DOROTHY V	NO ADDRESS PROVIDED BY TAXPAYER
088184344	2015-2016	INDIVIDUAL PERSONAL PROPERTY	CARLSON KAREN L	8609 E 85TH ST	089149371	2014-2018	INDIVIDUAL PERSONAL PROPERTY	TURNER MARK A & CYNTHIA D	5412 HUNTER ST
088190144	2021	INDIVIDUAL PERSONAL PROPERTY	HOLLOWAY ELIZABETH A	8800 E 59TH ST	089149839	2020-2021	INDIVIDUAL PERSONAL PROPERTY	STEAKLE DEBORAH	6718 MAPLE AVE
088196065	2001	INDIVIDUAL PERSONAL PROPERTY	BRYAN TERESA F	NO ADDRESS PROVIDED BY TAXPAYER	089150127	2004	INDIVIDUAL PERSONAL PROPERTY	MCCORMICK DENNIS E	UNKNOWN
088197159	2007	INDIVIDUAL PERSONAL PROPERTY	PREBLE MARGARET Q	NO ADDRESS PROVIDED BY TAXPAYER	089151350	2020-2021	INDIVIDUAL PERSONAL PROPERTY	THOMPSON KARIS L	6420 EVANSTON AVE
088197602	2005-2007	INDIVIDUAL PERSONAL PROPERTY	OLBERT JOHN L	5228 WOODSON RD	089155646	2021	INDIVIDUAL PERSONAL PROPERTY	SCARCELLO ROCCO C & DIANA	10413 E 69TH TER
088197703	2019	INDIVIDUAL PERSONAL PROPERTY	EDWARDS JON CHRISTIAN ALEXA	3919 S CEDAR CREST CIR APT 512	089155657	2021	INDIVIDUAL PERSONAL PROPERTY	PARKER CHARLES L	7220 RAYTOWN RD APT A
088199965	2019-2021	INDIVIDUAL PERSONAL PROPERTY	CASE JACK & JUDY	7200 HARDY AVE	089158242	2021	INDIVIDUAL PERSONAL PROPERTY	CLARK SHERRY R (HARRIS)	8924 E 90TH TER
088205415	2005-2017	INDIVIDUAL PERSONAL PROPERTY	CHADD VICKEY J (CLARDY)	11204 E 63RD ST	089159721	2021	INDIVIDUAL PERSONAL PROPERTY	POOL ERIC M & NATALIE L	10700 E 69TH TER
088206176	2020-2021	INDIVIDUAL PERSONAL PROPERTY	SMITH PERCY L	8618 E 83RD TER	089161519	2021	INDIVIDUAL PERSONAL PROPERTY	GINSBERG THOMAS E	6225 HALSTON AVE
088207359	2008-2009	INDIVIDUAL PERSONAL PROPERTY	SEAWOOD LUCILLE	5420 BLUE RIDGE CUT OFF APT G01	089162928	2021	INDIVIDUAL PERSONAL PROPERTY	BLAKE TODD H	8577 GREENWOOD RD
088211502	2017	INDIVIDUAL PERSONAL PROPERTY	HENRY NELLIE	8602 E 87TH ST	089164632	2002	INDIVIDUAL PERSONAL PROPERTY	WINDSOR CHRISTA A	6812 LAKESHORE CRT
088215061	2020	INDIVIDUAL PERSONAL PROPERTY	GILLOOLY KAREN	11513 E 74TH STREET CT	089164906	2021	INDIVIDUAL PERSONAL PROPERTY	BOONE SUSAN	7915 TENNESSEE AVE
088216200	2021	INDIVIDUAL PERSONAL PROPERTY	PEFFLY RHONDA (EDWARDS)	5529 HUNTER TER	089165178	2016	INDIVIDUAL PERSONAL PROPERTY	MILLER LOREN L	5305 WILLOW AVE
088218660	2008	INDIVIDUAL PERSONAL PROPERTY	PAYNE JANICE	5204 MAYWOOD AVE	089195372	2006-2017	INDIVIDUAL PERSONAL PROPERTY	SCHLOTZHAUER GARY J & SUSAN	10019 E 78TH ST
088220297	2006-2007	INDIVIDUAL PERSONAL PROPERTY	FRIENDS CHARLISA A	7430 WOODSON RD	089215139	2021	INDIVIDUAL PERSONAL PROPERTY	MCCHAN GEORGIA A (ROEHR) & MAURICE	9112 E 58TH TER
088229829	2005	INDIVIDUAL PERSONAL PROPERTY	HILL LARRY A SR	NO ADDRESS PROVIDED BY TAXPAYER	089219944	2018-2020	INDIVIDUAL PERSONAL PROPERTY	MORTON LINDA LYNETTE	10019 E 78TH ST
088237884	2008-2010	INDIVIDUAL PERSONAL PROPERTY	WARREN LESTER A JR	NO ADDRESS PROVIDED BY TAXPAYER	089244696	2019-2021	INDIVIDUAL PERSONAL PROPERTY	REED VICKIE	7224 RAYTOWN RD APT C
088240583	2017-2021	INDIVIDUAL PERSONAL PROPERTY	COLEMAN LYL R & LARRY D	6837 LAKESHORE DR	089245414	2021	INDIVIDUAL PERSONAL PROPERTY	PASCHAL DAVID K & JOANN	6401 EGGLEWOOD AVE
088244401	2009-2014	INDIVIDUAL PERSONAL PROPERTY	ANDREWS WILLIAM & STOLLENWERK	7505 WESTRIDGE RD	089248001	2002-2003	INDIVIDUAL PERSONAL PROPERTY	PIXLER DANIEL R	8501 GRANT DR
088245383	2021	INDIVIDUAL PERSONAL PROPERTY	CAMPBELL ROWENA	NO ADDRESS PROVIDED BY TAXPAYER	089248015	2021	INDIVIDUAL PERSONAL PROPERTY	MUDD DONALD W	8006 EVANSTON AVE
088278526	2002-2003	INDIVIDUAL PERSONAL PROPERTY	ANTHUIS CATHY J	10504 E 57TH TER	089256494	2011	INDIVIDUAL PERSONAL PROPERTY	KELLY GEORGENE S	11105 E 78TH ST
088279670	2020	INDIVIDUAL PERSONAL PROPERTY	ROBINSON LARRY E & DIANNA K	9107 E 74TH TER	089259522	2007-2012	INDIVIDUAL PERSONAL PROPERTY	ROBERSON ROBERT KEVIN	8404 STARK AVE
088280504	2021	INDIVIDUAL PERSONAL PROPERTY	DAVIS PAMELA E	8730 E 61ST ST	089270755	2005-2008	INDIVIDUAL PERSONAL PROPERTY	WILEY KIMBERLY D	7409 APPLETON AVE
088290205	2021	INDIVIDUAL PERSONAL PROPERTY	SYKES MAURICE R	11312 E 61ST ST	089278913	2016-2021	INDIVIDUAL PERSONAL PROPERTY	HILL BILLY G	6641 MAYWOOD AVE
088291357	2021	INDIVIDUAL PERSONAL PROPERTY	THOMAS GINNY S	6805 MAPLE AVE	089279031	2021	INDIVIDUAL PERSONAL PROPERTY	ADDISON ANGELA & RODNEY	8031 TENNESSEE AVE
088303215	2001-2006	INDIVIDUAL PERSONAL PROPERTY	BRATCHER LAWRENCE	9023 E 74TH TER	089301110	2012-2016	INDIVIDUAL PERSONAL PROPERTY	STAFFORD LILIANE	9620 E 66TH TER
088303231	2021	INDIVIDUAL PERSONAL PROPERTY	MADU FRANCIS & BLESSING	1601 SW WHISTLE DR	089303264	2007	INDIVIDUAL PERSONAL PROPERTY	UNIANDEYE KEVIN	7306 HEDGES AVE
088304756	2009	INDIVIDUAL PERSONAL PROPERTY	WALKER ROGER A	10705 E 51ST ST	089303402	2003-2004	INDIVIDUAL PERSONAL PROPERTY	ELY KIM	6328 KENTUCKY
088306776	2020-2021	INDIVIDUAL PERSONAL PROPERTY	MULWEE CLARENCE L	5307 STERLING AVE	089303569	2019	INDIVIDUAL PERSONAL PROPERTY	LANCASTER PEGGY A	8609 HAWTHORNE AVE
088323459	2020	INDIVIDUAL PERSONAL PROPERTY	MCMILLAN MARK E	NO ADDRESS PROVIDED BY TAXPAYER	089326682	2005	INDIVIDUAL PERSONAL PROPERTY	ODONNELL LORENE	NO ADDRESS PROVIDED BY TAXPAYER
088370842	2021	INDIVIDUAL PERSONAL PROPERTY	HOOTMAN BILLY D & JUANITA	8709 E 84TH ST	089327372	2020-2021	INDIVIDUAL PERSONAL PROPERTY	GUMINGER JOHN & JANIS	8325 HEDGES AVE
088410294	2013-2014	INDIVIDUAL PERSONAL PROPERTY	SHROYER DOUGLAS N	NO ADDRESS PROVIDED BY TAXPAYER	08931231	2012-2015	INDIVIDUAL PERSONAL PROPERTY	LATTIN CAROLYN L	9001 RICHARDS DR
088419107	2020-2021	INDIVIDUAL PERSONAL PROPERTY	SMITH NEAL D	9009 E 68TH ST	089341668	2006-2008	INDIVIDUAL PERSONAL PROPERTY	MATTHEWS DAVID P	8118 MANNING AVE
088419341	2007	INDIVIDUAL PERSONAL PROPERTY	LAMER JANICE	NO ADDRESS PROVIDED BY TAXPAYER	089341948	2007	INDIVIDUAL PERSONAL PROPERTY	MALLINSON MICHELLE MCCRARY	NO ADDRESS PROVIDED BY TAXPAYER
088428757	2021	INDIVIDUAL PERSONAL PROPERTY	MASON STEVEN & BRENDA	8408 EVERETT ST	089353917	2004-2008	INDIVIDUAL PERSONAL PROPERTY	RATLIFF MYRTLE	NO ADDRESS PROVIDED BY TAXPAYER
088432286	2015-2020	INDIVIDUAL PERSONAL PROPERTY	MOORE IDA A	6805 VERMONT AVE	089371421	2016-2021	INDIVIDUAL PERSONAL PROPERTY	SMITH DANIEL R & LINDA S	3331 SW KESSLER DR UNIT 3100
088444343	2018-2019	INDIVIDUAL PERSONAL PROPERTY	FOX SHELLY D	9107 E 69TH ST	089371684	2020	INDIVIDUAL PERSONAL PROPERTY	MARTIN GENE F & INEZ CHARLENE	7421 MAPLE DR UNIT 108
088456985	2017-2021	INDIVIDUAL PERSONAL PROPERTY	PITTS MARY A	9401 E 63RD ST APT 10	089377758	2016	INDIVIDUAL PERSONAL PROPERTY	CZINCZOLL-LEHMANN TRACY	7427 OVERTON AVE UNIT 6
088459604	2007	INDIVIDUAL PERSONAL PROPERTY	WILLIAMS JACK D	11710 E 71ST CT	089382187	2021	INDIVIDUAL PERSONAL PROPERTY	WEEKS KANDY L (VOLYLES) ROSS	5920 HARRIS AVE
088460197	2006-2008	INDIVIDUAL PERSONAL PROPERTY	WRIGLEY JERRY C	8309 STERLING AVE	089393603	2011-2014	INDIVIDUAL PERSONAL PROPERTY	WYATT JANELLE & THOMPSON DEONTÉ	8205 E 86TH TER
088463008	2018-2021	INDIVIDUAL PERSONAL PROPERTY	CARTER BERT B & ROSERITA F	7501 HARRIS AVE	089395353	2020-2021	INDIVIDUAL PERSONAL PROPERTY	RANDOLPH TRACY C	8600 E 81ST TER
088475124	2001	INDIVIDUAL PERSONAL PROPERTY	HEUMANN HARRIETT L	NO ADDRESS PROVIDED BY TAXPAYER	089411739	2010-2012	INDIVIDUAL PERSONAL PROPERTY	MUNKERS CHARLES E	9001 E 79TH ST
088493416	2020-2021	INDIVIDUAL PERSONAL PROPERTY	SPURGEON CURTIS & BANKSON-HEINZE PATRICI	8328 OXFORD AVE	089411967	2020-2021	INDIVIDUAL PERSONAL PROPERTY	THOMAS DONNA L	11408 E 65TH TER
088493560	2001	INDIVIDUAL PERSONAL PROPERTY	HINKLEY LINDA G	NO ADDRESS PROVIDED BY TAXPAYER	089422919	2021	INDIVIDUAL PERSONAL PROPERTY	OLDHAM SHARON L	11409 E 83RD ST
088559367	2003-2004	INDIVIDUAL PERSONAL PROPERTY	BANISTER BETH	NO ADDRESS PROVIDED BY TAXPAYER	089418111	2015-2016	INDIVIDUAL PERSONAL PROPERTY	LASATER KEITH B & GLENDA	5420 BLUE RIDGE CUT OFF APT 610
088792738	2021	INDIVIDUAL PERSONAL PROPERTY	SHEARD PATRICK W & DARLENE	8496 LANE DR APT 2	089421636	2021	INDIVIDUAL PERSONAL PROPERTY	GAUTREAU WALLACE E & LINDA	6357 BLUE RIDGE BLVD
088913617	2021	INDIVIDUAL PERSONAL PROPERTY	GREEN REX A	8802 E 85TH ST	089429226	2008	INDIVIDUAL PERSONAL PROPERTY	REDMOND WILLIAM J	7207 MAYWOOD AVE
088953476	2020-2021	INDIVIDUAL PERSONAL PROPERTY	WILLIAMS PRESTON J	6140 RAYTOWN RD APT 101	089436350	2005	INDIVIDUAL PERSONAL PROPERTY	HINKLE THOMAS & SHARON	8409 BOOTH AVE
089008951	2012-2013	INDIVIDUAL PERSONAL PROPERTY	SATTARIN DELANA (SMITH)	8801 E 72ND ST	089436651	2021	INDIVIDUAL PERSONAL PROPERTY	EDWARDS JOY D	8925 E 81ST ST
089014567	2021	INDIVIDUAL PERSONAL PROPERTY	THORNTON DARRROYCE	6916 ENGLEWOOD AVE	089436818	2009-2012	INDIVIDUAL PERSONAL PROPERTY	ECKENROD WALTER & ANGELA	8907 E 74TH ST
089021491	2021	INDIVIDUAL PERSONAL PROPERTY	BARLOW RANDY S	9804 E 71ST TER	089437488	2009-2011	INDIVIDUAL PERSONAL PROPERTY	LONG REBECCA N	11422 E 71ST ST
089025544	2021	INDIVIDUAL PERSONAL PROPERTY	SALDANA ROBERT LOYOLA	8209 WOODSON DR	089437698	2021	INDIVIDUAL PERSONAL PROPERTY	ROBINSON BETTY JANE (BRYANT)	7236 RAYTOWN RD APT E
089028247	2021	INDIVIDUAL PERSONAL PROPERTY	BURKE MORGANA J	10305 E 68TH TER	089438188	2014-2018	INDIVIDUAL PERSONAL PROPERTY	DAWSON LINDA K	9616 E 66TH TER
089029782	2008	INDIVIDUAL PERSONAL PROPERTY	NICHOLS NICK JAMES SR	5513 HARDY AVE	089444941	2018-2019	INDIVIDUAL PERSONAL PROPERTY	HOMLER RACHEL E (GLINN)	9806 E 60TH ST
089030133	2007-2010	INDIVIDUAL PERSONAL PROPERTY	ERTER THELMA L	11005 E 56TH TER	089474963	2002	INDIVIDUAL PERSONAL PROPERTY	STEWART ROBERT & LESA (BLACK)	NO ADDRESS PROVIDED BY TAXPAYER
089039901	2005-2007	INDIVIDUAL PERSONAL PROPERTY	MURRAY CHERITA K	6620 HARDY AVE	089478851	2010	INDIVIDUAL PERSONAL PROPERTY	TJARDÉS JUDY	8800 E 71ST TER
089045208	2003	INDIVIDUAL PERSONAL PROPERTY	GOODNER THOMAS D & CANICE	NO ADDRESS PROVIDED BY TAXPAYER	089482356	2001-2002	INDIVIDUAL PERSONAL PROPERTY	GAMMILL DEBORAH L	NO ADDRESS PROVIDED BY TAXPAYER
089046923	2001-2003	INDIVIDUAL PERSONAL PROPERTY	MCKIM LYNN I	11912 E 63RD TER	089482917	2003	INDIVIDUAL PERSONAL PROPERTY	SMITH JOCELYN E	5307 HEDGES AVE
089047133	2018	INDIVIDUAL PERSONAL PROPERTY	AUSTIN LAURIE (SCOTT)	11712 E 87TH ST	089491483	2021	INDIVIDUAL PERSONAL PROPERTY	ROGERS ELIZABETH A	11900 E 86TH ST
089049512	2001	INDIVIDUAL PERSONAL PROPERTY	WEST PERRY A	NO ADDRESS PROVIDED BY TAXPAYER	089049360	2021	INDIVIDUAL PERSONAL PROPERTY	NOU DARA V	6925 LAUREL AVE
089052598	2021	INDIVIDUAL PERSONAL PROPERTY	UWAEKE PETER UCHE	10104 E 67TH ST APT B	089581163	2015-2021	INDIVIDUAL PERSONAL PROPERTY	ROBINSON MYRTLE R (MOORE)	11812 E 79TH DR
089053049	2006	INDIVIDUAL PERSONAL PROPERTY	DUCKWORTH DANIELLE JO	11405 E 78TH ST	089682298	2021	INDIVIDUAL PERSONAL PROPERTY	BECKER MARTHA A	14610 E BANNISTER RD
089053249	2021	INDIVIDUAL PERSONAL PROPERTY	HARDY JAMES B	9406 E 80TH ST	089642989	2020-2021	INDIVIDUAL PERSONAL PROPERTY	HOOD LISA RENEE	11908 E 85TH ST
089054214	2021	INDIVIDUAL PERSONAL PROPERTY	GORDON SCOTT	7401 WILLOW AVE	089647085	2000	INDIVIDUAL PERSONAL PROPERTY	DURBIN ROBERT P & GERRI D	UNKNOWN
089055975	2005-2016	INDIVIDUAL PERSONAL PROPERTY	GIDLEY TINA G	NO ADDRESS PROVIDED BY TAXPAYER	090029695	2020-2021	INDIVIDUAL PERSONAL PROPERTY	WEST LANEZ	7312 ASH AVE

090029934	2006	INDIVIDUAL PERSONAL PROPERTY	OSBORNE DANA L	NO ADDRESS PROVIDED BY TAXPAYER	090428763	2021	INDIVIDUAL PERSONAL PROPERTY	BROWN DAWN M	6329 RALSTON AVE
090029961	2019	INDIVIDUAL PERSONAL PROPERTY	TAYLOR REBECCA L	6714 RALSTON AVE	090428858	2011-2013	INDIVIDUAL PERSONAL PROPERTY	KELOW STEVEN F	NO ADDRESS PROVIDED BY TAXPAYER
090030050	2009-2017	INDIVIDUAL PERSONAL PROPERTY	GRAVES AARON A	NO ADDRESS PROVIDED BY TAXPAYER	090428892	2020	INDIVIDUAL PERSONAL PROPERTY	BOOTH RAYMOND C	5623 ASH AVE
090106377	2021	INDIVIDUAL PERSONAL PROPERTY	WASHINGTON ERIC R	5108 STERLING AVE	090429229	2021	INDIVIDUAL PERSONAL PROPERTY	OBRIEN DANIEL P	7525 CRESCENT DR
090109880	2020-2021	INDIVIDUAL PERSONAL PROPERTY	WILLIAMS FELICIA	5807 KENTUCKY AVE	090429294	2021	INDIVIDUAL PERSONAL PROPERTY	BOSELL SHENICE M	6209 KENTUCKY AVE
090136371	2009	INDIVIDUAL PERSONAL PROPERTY	STACER ROBIN GAIL	6212 ENGLEWOOD AVE	090429558	2020-2021	INDIVIDUAL PERSONAL PROPERTY	TOWNSEND SHIRLEY J & BERYL	10008 E 79TH ST
090200510	2001	INDIVIDUAL PERSONAL PROPERTY	DOWDALL DEBORAH LU	11608 E 75TH ST	090432522	2021	INDIVIDUAL PERSONAL PROPERTY	TURNER ROYCE L	6608 CLAREMONT AVE
090202778	2021	INDIVIDUAL PERSONAL PROPERTY	OWENS GEORGE E JR	9612 E 67TH TER	090434088	2021	INDIVIDUAL PERSONAL PROPERTY	CAMPBELL BILL RAY & JENNIFER	7608 CRESCENT DR
090217219	2001	INDIVIDUAL PERSONAL PROPERTY	BOWMAN DANIEL W & PAULA J	413 NE CAMBRIDGE DR	090434780	2021	INDIVIDUAL PERSONAL PROPERTY	THOME DENNIS F	UNKNOWN
090229280	2008-2017	INDIVIDUAL PERSONAL PROPERTY	JORDAN HAZEL & DONALD LOONEY	10005 E 77TH TER	090436515	2016-2017	INDIVIDUAL PERSONAL PROPERTY	MINOR CLARESA	11217 E 58TH TER
090245141	2020-2021	INDIVIDUAL PERSONAL PROPERTY	JONES WADE & CYNTHIA L	8601 BOOTH AVE	090443864	2021	INDIVIDUAL PERSONAL PROPERTY	COLLIER COURTNEY	5540 HUNTER ST
090250040	2001-2003	INDIVIDUAL PERSONAL PROPERTY	TAYLOR JANICE K	9707 E 65TH ST	090443934	2001	INDIVIDUAL PERSONAL PROPERTY	SORRELL KENNETH R	UNKNOWN
090251434	2020-2021	INDIVIDUAL PERSONAL PROPERTY	LENZY BRUCE S	7608 WESTRIDGE RD	090445102	2014-2015	INDIVIDUAL PERSONAL PROPERTY	SCHESSER ELENA	6140 RAYTOWN RD APT 811
090259699	2011	INDIVIDUAL PERSONAL PROPERTY	CUNNINGHAM TERESA	9027 E 74TH TER	090451177	2004-2005	INDIVIDUAL PERSONAL PROPERTY	KEMPSON TERRY W	NO ADDRESS PROVIDED BY TAXPAYER
090262232	2021	INDIVIDUAL PERSONAL PROPERTY	DILLON HEATHER LYNNE	5420 RAYTOWN RD	090451295	2004	INDIVIDUAL PERSONAL PROPERTY	FRANCIS SCOTT A & DAVID	UNKNOWN
090263515	2011	INDIVIDUAL PERSONAL PROPERTY	CRUDEN WILLIAM	10409 E 71ST TER	090456398	2021	INDIVIDUAL PERSONAL PROPERTY	DEWEY EVERETTE P	6015 HUNTER ST
090266025	2021	INDIVIDUAL PERSONAL PROPERTY	HAMPTON JOHN & KRISTI L	NO ADDRESS PROVIDED BY TAXPAYER	090459163	2006-2013	INDIVIDUAL PERSONAL PROPERTY	BRUMFIELD LAURIE L	NO ADDRESS PROVIDED BY TAXPAYER
090268774	2003-2005	INDIVIDUAL PERSONAL PROPERTY	MINNIS MARILYN S	9105 E 66TH TER	090462862	2021	INDIVIDUAL PERSONAL PROPERTY	WALLACE LOUISE	9215 E 85TH ST
090269267	2018	INDIVIDUAL PERSONAL PROPERTY	CURRY ROSEMARIE K & CHARLES J	6213 ASH CT	090463257	2021	INDIVIDUAL PERSONAL PROPERTY	MASON TERRY D	8220 HARRIS CT
090269896	2021	INDIVIDUAL PERSONAL PROPERTY	CHILES KAREN J	5445 ASH AVE	090464281	2010-2017	INDIVIDUAL PERSONAL PROPERTY	BISHOP SAMUEL LEE JR	6212 RALSTON AVE
090269926	2007-2008	INDIVIDUAL PERSONAL PROPERTY	JONES JOSEPH P	11205 E 59TH TER	090465098	2021	INDIVIDUAL PERSONAL PROPERTY	YORK MARY C	8609 STARK AVE
090269986	2021	INDIVIDUAL PERSONAL PROPERTY	ROBINSON YOLANDA	8602 E 84TH TER	090465117	2015-2021	INDIVIDUAL PERSONAL PROPERTY	LOMAX L C	11307 E 78TH ST
090282650	2003-2004	INDIVIDUAL PERSONAL PROPERTY	MONTGOMERY H D	9613 E 68TH ST	090465721	2006	INDIVIDUAL PERSONAL PROPERTY	TURNER SECREE	6497 BLUE RIDGE BLVD
090289794	2017-2018	INDIVIDUAL PERSONAL PROPERTY	MEEHAN MICHAEL & ROHAN KAREN	7708 BLUE RIDGE BLVD	090478931	2021	INDIVIDUAL PERSONAL PROPERTY	HARRIS EDWARD A & BOBBIE E	7304 CEDAR AVE
090296699	2011	INDIVIDUAL PERSONAL PROPERTY	JOURDAN RAY & FRANK	11001 E 74TH TER	090479286	2018-2020	INDIVIDUAL PERSONAL PROPERTY	MYRICK WENDELL	6137 HARVARD AVE
090300153	2021	INDIVIDUAL PERSONAL PROPERTY	BOBADILLA JOSEPH	9027 VAUGHN AVE	090479950	2006-2010	INDIVIDUAL PERSONAL PROPERTY	SIMPSON NORMAN N	9009 E 66TH TER
090302645	2020-2021	INDIVIDUAL PERSONAL PROPERTY	ANDERSON ANGELO JASON	11111 E 78TH ST	090479967	2014	INDIVIDUAL PERSONAL PROPERTY	CARROL VANESSA	7707 ARLINGTON AVE
090309648	2019-2021	INDIVIDUAL PERSONAL PROPERTY	SCHMUTZLER JANET M	8310 BOOTH AVE	090481656	2021	INDIVIDUAL PERSONAL PROPERTY	ALLEN JAMES F III	6105 WILLOW AVE
090311429	2006	INDIVIDUAL PERSONAL PROPERTY	MONTOYA EMMA (VANNEVELE)	9116 E 85TH ST	090482634	2004	INDIVIDUAL PERSONAL PROPERTY	SHEETS LISA M	NO ADDRESS PROVIDED BY TAXPAYER
090311933	2021	INDIVIDUAL PERSONAL PROPERTY	EPP JERRY & EPP LOVE JD	10400 E 56TH ST	090492859	2021	INDIVIDUAL PERSONAL PROPERTY	SCHAUFFLER MARJORIE B	9015 E 72ND TER
090313965	2008	INDIVIDUAL PERSONAL PROPERTY	GARRISON NANCY M	10505 E 69TH ST	090493123	2014	INDIVIDUAL PERSONAL PROPERTY	MILLER SHARON R	7428 HARDY AVE
090315339	2021	INDIVIDUAL PERSONAL PROPERTY	TOBY PAMELA & LEAUNA J	10607 E 80TH ST	090493197	2012-2013	INDIVIDUAL PERSONAL PROPERTY	STANGLE KELLI	7422 E 57TH ST
090317227	2021	INDIVIDUAL PERSONAL PROPERTY	INMAN RANDY	5425 HARDY AVE	090493249	2021	INDIVIDUAL PERSONAL PROPERTY	SUBIDO MELANIO JR	8208 WILLOW WAY
090319156	2002-2003	INDIVIDUAL PERSONAL PROPERTY	HILL JAMES B	UNKNOWN	090493481	2013	INDIVIDUAL PERSONAL PROPERTY	SWENSON DANIEL R	6016 ELM AVE
090319973	2009	INDIVIDUAL PERSONAL PROPERTY	BOX STANLEY E	5328 HUNTER ST	090497812	2001	INDIVIDUAL PERSONAL PROPERTY	HARMON JENI (CHRISTAIN)	NO ADDRESS PROVIDED BY TAXPAYER
090320183	2020-2021	INDIVIDUAL PERSONAL PROPERTY	LIBEER TONI J (HARVEY)	11819 E 83RD ST APT 101	090510583	2021	INDIVIDUAL PERSONAL PROPERTY	WALTERS KEVIN J & PHYLLIS L	8701 E 79TH TER
090323870	2021	INDIVIDUAL PERSONAL PROPERTY	BROWN JAMES M	7332 HARVARD DR	090914881	2017-2019	INDIVIDUAL PERSONAL PROPERTY	LEWIS JANNIS	8511 KENTUCKY AVE
090323969	2016	INDIVIDUAL PERSONAL PROPERTY	CAMPION CLARENCE J JR	5401 OXFORD AVE	091000246	2021	INDIVIDUAL PERSONAL PROPERTY	KILGORE GLEN V	8701 MANCHESTER AVE
090324548	2020-2021	INDIVIDUAL PERSONAL PROPERTY	RICARD STEVEN E	12000 E 78TH ST	091093109	2021	INDIVIDUAL PERSONAL PROPERTY	OVERTUR LORA (FRANKO)	11701 E 78TH ST
090324584	2018-2021	INDIVIDUAL PERSONAL PROPERTY	MCDONNELL MICHELLE	10110 E 69TH ST	091158264	2014	INDIVIDUAL PERSONAL PROPERTY	MORENO BETTY E	9005 E 74TH TER
090327103	2017	INDIVIDUAL PERSONAL PROPERTY	ROBERTSON WANDA L	5616 CRESCENT AVE	091243661	2004-2017	INDIVIDUAL PERSONAL PROPERTY	SULLIVAN BARBARA	NO ADDRESS PROVIDED BY TAXPAYER
090330798	2001	INDIVIDUAL PERSONAL PROPERTY	RANDAZZO PATRICIA A	NO ADDRESS PROVIDED BY TAXPAYER	091246633	2005-2017	INDIVIDUAL PERSONAL PROPERTY	SKUBINNA DIANE M	9018 E 85TH TER
090335942	2005	INDIVIDUAL PERSONAL PROPERTY	PANGBORN STEPHEN D	NO ADDRESS PROVIDED BY TAXPAYER	091244370	2007-2017	INDIVIDUAL PERSONAL PROPERTY	MONTGOMERY TRAVIS C	NO ADDRESS PROVIDED BY TAXPAYER
090336711	2004-2005	INDIVIDUAL PERSONAL PROPERTY	WESSLEY MICHAEL E	7601 ENGLEWOOD AVE	091244508	2001	INDIVIDUAL PERSONAL PROPERTY	DONOVAN CHERYL L	NO ADDRESS PROVIDED BY TAXPAYER
090337662	2018-2019	INDIVIDUAL PERSONAL PROPERTY	SULLIVAN DARRYL A & LOUWINDA L	7423 HARRIS AVE	091244731	2021	INDIVIDUAL PERSONAL PROPERTY	YOUNG AARON A	5404 NORTHERN AVE
090341836	2017	INDIVIDUAL PERSONAL PROPERTY	NORDVYKE KENNETH A	9605 E 65TH TER	091249201	2012-2017	INDIVIDUAL PERSONAL PROPERTY	HORNBECK EARL P & LUCY	9115 VAUGHN AVE
090348205	2001	INDIVIDUAL PERSONAL PROPERTY	HERZOG THOMAS P	NO ADDRESS PROVIDED BY TAXPAYER	091249455	2002	INDIVIDUAL PERSONAL PROPERTY	GREEN FREIDA M	NO ADDRESS PROVIDED BY TAXPAYER
090348973	2008-2010	INDIVIDUAL PERSONAL PROPERTY	DEHONEY BARBARA J	7205 RALSTON AVE	091249987	2021	INDIVIDUAL PERSONAL PROPERTY	DUCKWORTH KEN & TERI	6020 HUNTER ST
090350557	2001-2006	INDIVIDUAL PERSONAL PROPERTY	EMERY SHERRI L	NO ADDRESS PROVIDED BY TAXPAYER	091251055	2021	INDIVIDUAL PERSONAL PROPERTY	FRANKLIN BOOKER T JR	8625 E UTOPIA PKWY APT 12
090353265	2021	INDIVIDUAL PERSONAL PROPERTY	SELKEN BRIAN D	6309 HARVARD AVE	091251712	2008	INDIVIDUAL PERSONAL PROPERTY	SPOONER VALERIE D	7924 HARRIS AVE
090353687	2018	INDIVIDUAL PERSONAL PROPERTY	BEACHNER RICHARD D	8615 CRESCENT AVE	091251802	2021	INDIVIDUAL PERSONAL PROPERTY	PENO DAVID & AMY	7611 WESTRIDGE RD
090355499	2005	INDIVIDUAL PERSONAL PROPERTY	LAITSBERGER DAVID	2835 GARY ST	091259606	2013	INDIVIDUAL PERSONAL PROPERTY	MEIRATH WAYNE	5325 RALSTON AVE
090358126	2021	INDIVIDUAL PERSONAL PROPERTY	SIMPSON YVONNE A	9709 E 77TH TER	091265780	2009-2010	INDIVIDUAL PERSONAL PROPERTY	MCDERMOTT HELEN M	6140 RAYTOWN RD APT 402
090359673	2010	INDIVIDUAL PERSONAL PROPERTY	BROOKS MICHAEL L	7401 ELM ST	091265788	2021	INDIVIDUAL PERSONAL PROPERTY	BARTEE TRACEY DUANE	11216 E 59TH ST
090360420	2021	INDIVIDUAL PERSONAL PROPERTY	STREVER CHRISTOPHER M	5421 HARRIS AVE	091268075	2015-2018	INDIVIDUAL PERSONAL PROPERTY	CHAPMAN DEWEY J	8023 WILLOW WAY
090361352	2005-2013	INDIVIDUAL PERSONAL PROPERTY	VANDYKE EUGENE E	11200 E 59TH TER	091271163	2021	INDIVIDUAL PERSONAL PROPERTY	THOMPSON JOHN & LINDA	10403 E 78TH TER
090364746	2009-2015	INDIVIDUAL PERSONAL PROPERTY	FAULCONER JAMES M	8300 JAMES A REED RD	091276132	2015	INDIVIDUAL PERSONAL PROPERTY	WILLIAMS ALONZO	8313 SPRING VALLEY RD
090366734	2004-2006	INDIVIDUAL PERSONAL PROPERTY	GARZA MIKE	8312 BOOTH AVE	091277459	2018-2021	INDIVIDUAL PERSONAL PROPERTY	BURNSIDE GARY R JR	10408 E 79TH ST
090368209	2021	INDIVIDUAL PERSONAL PROPERTY	BURFORD STANFORD W	9002 E 73RD ST	091286187	2011-2013	INDIVIDUAL PERSONAL PROPERTY	LIPPITT CURT A	11303 E 58TH TER
090371910	2006	INDIVIDUAL PERSONAL PROPERTY	COLSON LINDA S	NO ADDRESS PROVIDED BY TAXPAYER	091293243	2021	INDIVIDUAL PERSONAL PROPERTY	SMITH ROYLENE L	9205 E 64TH TER
090380552	2005-2006	INDIVIDUAL PERSONAL PROPERTY	HUFFSTUTTER MARJORIE	NO ADDRESS PROVIDED BY TAXPAYER	091301295	2021	INDIVIDUAL PERSONAL PROPERTY	TREAT GARY D & AMY	5820 KENTUCKY AVE
090388871	2021	INDIVIDUAL PERSONAL PROPERTY	MURRY DANIELLE A	9112 E 57TH TER	091301587	2014-2015	INDIVIDUAL PERSONAL PROPERTY	COCKRUM JO ELLEN	9006 E 87TH ST
090393120	2003	INDIVIDUAL PERSONAL PROPERTY	MCDANIEL VALDAZE J	7913 ELM	091302173	2003-2004	INDIVIDUAL PERSONAL PROPERTY	YARGES ANNETTE	UNKNOWN
090406360	2020-2021	INDIVIDUAL PERSONAL PROPERTY	LEDGERWOOD SEAN M & SHANNON K	6405 HARDY AVE	091308605	2014	INDIVIDUAL PERSONAL PROPERTY	HANSBERRY WENDY J (ROE)	9109 E 83RD PL
090406988	2003	INDIVIDUAL PERSONAL PROPERTY	BOTLEY MARSHALL & BRENDA	7815 IRWIN RD	091309344	2001-2002	INDIVIDUAL PERSONAL PROPERTY	CAUDILL GORDON C	10909 NEWTON AVE
090412060	2001	INDIVIDUAL PERSONAL PROPERTY	LAROSE SHIRLEY J	10400 E 69TH TER	091310266	2011	INDIVIDUAL PERSONAL PROPERTY	BEESON RAYMOND G	7925 MANNING AVE
090414012	2002	INDIVIDUAL PERSONAL PROPERTY	COFFMAN LAWANDA ELDER	UNKNOWN	091310316	2005	INDIVIDUAL PERSONAL PROPERTY	HUNTSMAN JENNIFER A	1419 LIBERTY ST
090419143	2005-2006	INDIVIDUAL PERSONAL PROPERTY	OWEN WILLIAM J	9003 E 85TH TER	091311474	2018-2021	INDIVIDUAL PERSONAL PROPERTY	LICKTEIG RONALD & KIMBERLY	7522 ELM ST
090419346	2014-2021	INDIVIDUAL PERSONAL PROPERTY	HEIM CHARLES R	7705 RAYTOWN RD	091317785	2021	INDIVIDUAL PERSONAL PROPERTY	WHEELER TERRY & CRYSTAL WALLEEN	9108 E 68TH ST
090419848	2019-2021	INDIVIDUAL PERSONAL PROPERTY	LADD HARLEY A	8501 GREENWOOD RD	091318065	2021	INDIVIDUAL PERSONAL PROPERTY	SWINDLE PATRICIA L & RONNIE	9110 VAUGHN AVE
090424130	2017-2021	INDIVIDUAL PERSONAL PROPERTY	KELLY BRIAN P	6128 HARVARD AVE	091320155	2004-2006	INDIVIDUAL PERSONAL PROPERTY	PETERSON JAMES E	6801 RAYTOWN RD
090427613	2009	INDIVIDUAL PERSONAL PROPERTY	ROSS JIMMIE	9201 E 68TH ST	091320737	2001	INDIVIDUAL PERSONAL PROPERTY	CIAFULLO MICHELLE	NO ADDRESS PROVIDED BY TAXPAYER

091329938	2021	INDIVIDUAL PERSONAL PROPERTY	HAMILTON MARY J	11307 E 72ND ST	091508176	2005	INDIVIDUAL PERSONAL PROPERTY	BROWN JEFFREY A & CHRISTY	7939 MANNING AVE
091330524	2001-2005	INDIVIDUAL PERSONAL PROPERTY	STEPHENS PATRICK L	9908 E 81ST ST	091510780	2003	INDIVIDUAL PERSONAL PROPERTY	MARTIN MICHAEL & SUZANNE	8309 MANNING AVE
091330760	2021	INDIVIDUAL PERSONAL PROPERTY	FURROW TAMMY JEAN	9813 S 73RD ST APT A	091514705	2018-2021	INDIVIDUAL PERSONAL PROPERTY	UPTON GLEN ARTHUR	9019 E 75TH ST
091330890	2011	INDIVIDUAL PERSONAL PROPERTY	GOODFELLOW LINDA	10315 E 70TH TER	091526755	2007-2008	INDIVIDUAL PERSONAL PROPERTY	BATLINER CAROL	9017 E 72ND TER
091331004	2021	INDIVIDUAL PERSONAL PROPERTY	JONES MICHAEL DWAYNE	8851 E 57TH TER	091528973	2009-2010	INDIVIDUAL PERSONAL PROPERTY	SPRATT RONALD W & KATHY S	8505 KENTUCKY AVE
091331200	2020-2021	INDIVIDUAL PERSONAL PROPERTY	THOMAS RAMONA K	9301 E 69TH TER	091530394	2014-2015	INDIVIDUAL PERSONAL PROPERTY	WHEELER ROBERT A	8958 E 54TH ST
091331282	2021	INDIVIDUAL PERSONAL PROPERTY	BOX LAURA A	7420 ENGLEWOOD LN	091532996	2004	INDIVIDUAL PERSONAL PROPERTY	WHITE PENNY D	NO ADDRESS PROVIDED BY TAXPAYER
091331518	2018-2021	INDIVIDUAL PERSONAL PROPERTY	PERRINO CHARLES L & MARGARET S	11411 HIDDEN LAKE DR APT 711	091539842	2002-2009	INDIVIDUAL PERSONAL PROPERTY	FRANKLIN PAUL S & JANICE	NO ADDRESS PROVIDED BY TAXPAYER
091335930	2021	INDIVIDUAL PERSONAL PROPERTY	LINDLEY JERRY W & LEVETA J	9425 E 67TH TER	091552444	2021	INDIVIDUAL PERSONAL PROPERTY	THOMAS ANDREA ANITA	5537 HUNTER TER
091336039	2010	INDIVIDUAL PERSONAL PROPERTY	MCGLADE TOM	10812 E 56TH ST	091880613	2008-2009	INDIVIDUAL PERSONAL PROPERTY	WORDEN BRENDA S	8412 E 85TH TER
091336081	2008-2017	INDIVIDUAL PERSONAL PROPERTY	GRAY LARRY J	11705 E 76TH TER	091898623	2020-2021	INDIVIDUAL PERSONAL PROPERTY	GUINN DANIEL ERIC	11713 E 83RD ST APT 202
091336159	2019	INDIVIDUAL PERSONAL PROPERTY	BURCH FONVILLE BRENDA	9912 E 61ST ST APT 2	091942604	2003	INDIVIDUAL PERSONAL PROPERTY	HAMMOND OLIVE JANE	NO ADDRESS PROVIDED BY TAXPAYER
091336175	2021	INDIVIDUAL PERSONAL PROPERTY	LANG RHONDA	11811 E 83RD ST APT 202	092125429	2021	INDIVIDUAL PERSONAL PROPERTY	BURKS ROBERTA A	10006 E 83RD ST
091336243	2019-2021	INDIVIDUAL PERSONAL PROPERTY	WRIGHT MARY ANN	9516 E 57TH ST	092127258	2019-2020	INDIVIDUAL PERSONAL PROPERTY	MINOR DANA	9006 E 85TH TER
091336254	2002-2004	INDIVIDUAL PERSONAL PROPERTY	HART CHRISTOPHER W	UNKNOWN	092132696	2021	INDIVIDUAL PERSONAL PROPERTY	MORGAN EDWARD & BETTY	6508 BLUE RIDGE BLVD
091337675	2004-2005	INDIVIDUAL PERSONAL PROPERTY	MCNAMARA CATHERINE	7424 WOODSON RD	092200755	2021	INDIVIDUAL PERSONAL PROPERTY	BURCH ERIC	8208 E 85TH TER
091341949	2003-2006	INDIVIDUAL PERSONAL PROPERTY	WILLIAMS DORIS J	NO ADDRESS PROVIDED BY TAXPAYER	092223411	2019	INDIVIDUAL PERSONAL PROPERTY	GORDON EVERETTE E & ROZELLA	19301 E 50TH TER S
091342021	2004	INDIVIDUAL PERSONAL PROPERTY	STROUT RODGERS & SANDRA	NO ADDRESS PROVIDED BY TAXPAYER	092247526	2007	INDIVIDUAL PERSONAL PROPERTY	ELLIOTT ARSANAS	9305 E 73RD ST
091342437	2021	INDIVIDUAL PERSONAL PROPERTY	BOX MATTHEW RANDALL & VALORIE ANN	7704 APPLETON AVE	092249259	2019-2021	INDIVIDUAL PERSONAL PROPERTY	PHILLIPS LORETTA A	7177 CRISP AVE
091344518	2021	INDIVIDUAL PERSONAL PROPERTY	WOFFORD DEARMOND DENISE	8512 SPRING VALLEY RD	092249324	2007-2012	INDIVIDUAL PERSONAL PROPERTY	DILLON CLIFFORD	5520 HEDGES AVE
091344558	2021	INDIVIDUAL PERSONAL PROPERTY	ELLIOTT RENAE	7608 WOODSON RD	092250003	2002-2004	INDIVIDUAL PERSONAL PROPERTY	HERR MICHAEL W	NO ADDRESS PROVIDED BY TAXPAYER
091344817	2021	INDIVIDUAL PERSONAL PROPERTY	GORDON RENNIE JR & SARAH A	8325 HARVARD TER	092250278	2016-2017	INDIVIDUAL PERSONAL PROPERTY	LESLIE CHRISTINA M	8531 E 81ST TER
091347778	2012-2013	INDIVIDUAL PERSONAL PROPERTY	CASEY LOUISE	9830 E 61ST ST APT 1	092254335	2013-2015	INDIVIDUAL PERSONAL PROPERTY	DAVIS LESLIE DAWN	NO ADDRESS PROVIDED BY TAXPAYER
091348677	2016-2017	INDIVIDUAL PERSONAL PROPERTY	TILLMAN DIANA L (WHITE)	7913 ELM AVE	092258888	2019-2020	INDIVIDUAL PERSONAL PROPERTY	HUBBARD WILLIAM HL & PATRICIA N	7719 RAYTOWN RD
091349038	2020-2021	INDIVIDUAL PERSONAL PROPERTY	GRIMES MARTHA J	8605 SPRING VALLEY RD	092260562	2019-2021	INDIVIDUAL PERSONAL PROPERTY	WATERS BRIAN A	8708 E 81ST TER
091357445	2005	INDIVIDUAL PERSONAL PROPERTY	HARRIS STELLA	3755 FLORA AVE	092262588	2014	INDIVIDUAL PERSONAL PROPERTY	KELLEY DAVID M	6140 RAYTOWN RD APT 506
091357639	2012-2017	INDIVIDUAL PERSONAL PROPERTY	WILLIAMS MELISSA	6718 WOODSON RD	092268540	2014-2016	INDIVIDUAL PERSONAL PROPERTY	TETER ERIC R	10006 E 77TH TER
091358898	2017-2020	INDIVIDUAL PERSONAL PROPERTY	MORGAN MARQUETTE	7145 STERLING AVE	092273119	2012	INDIVIDUAL PERSONAL PROPERTY	CUMMINS SUSAN R	5420 BLUE RIDGE CUT OFF APT 617
091359971	2007-2008	INDIVIDUAL PERSONAL PROPERTY	COLEMAN WANDA	9808 E 76TH TER	092299941	2005	INDIVIDUAL PERSONAL PROPERTY	OVERMAN KELLY A & NEIL	NO ADDRESS PROVIDED BY TAXPAYER
091363003	2021	INDIVIDUAL PERSONAL PROPERTY	BLACK ANTHONY T	8109 HEDGES AVE	092300027	2008	INDIVIDUAL PERSONAL PROPERTY	ZIEGENHORN CHARLES	7500 OVERTON AVE
091364447	2003	INDIVIDUAL PERSONAL PROPERTY	FRANKLIN VICTOR	NO ADDRESS PROVIDED BY TAXPAYER	092300327	2005	INDIVIDUAL PERSONAL PROPERTY	FALCONER WALTER & MAUDE	5729 MANNING AVE
091364842	2005-2014	INDIVIDUAL PERSONAL PROPERTY	BIRMINGHAM JOHN D JR	6140 RAYTOWN RD APT 204	092300536	2003	INDIVIDUAL PERSONAL PROPERTY	OWSLEY KATHLEEN G	NO ADDRESS PROVIDED BY TAXPAYER
091371258	2001-2003	INDIVIDUAL PERSONAL PROPERTY	KELLY RONNIE S	NO ADDRESS PROVIDED BY TAXPAYER	092300650	2005	INDIVIDUAL PERSONAL PROPERTY	GOODMAN BRYAN	11213 E 71ST ST
091371387	2005-2008	INDIVIDUAL PERSONAL PROPERTY	FRANCISCO ERIC D	NO ADDRESS PROVIDED BY TAXPAYER	092300828	2019-2021	INDIVIDUAL PERSONAL PROPERTY	BURGESS DIANA	5817 KENTUCKY AVE
091371784	2018-2021	INDIVIDUAL PERSONAL PROPERTY	SMITH ROBERT MICHAEL	7308 CEDAR AVE	092309405	2020-2021	INDIVIDUAL PERSONAL PROPERTY	WHITE MICHELLE	8407 BOOTH AVE
091372113	2021	INDIVIDUAL PERSONAL PROPERTY	BROWN TIMOTHY P	7332 HARVARD DR	092309592	2007-2009	INDIVIDUAL PERSONAL PROPERTY	PHILLIPS RODNEY E	1904 S OVERTON AVE
091376855	2017-2019	INDIVIDUAL PERSONAL PROPERTY	LALLY TRAVIS	9050 E 68TH TER	092309712	2001	INDIVIDUAL PERSONAL PROPERTY	MAXON MATTHEW SCOTT	NO ADDRESS PROVIDED BY TAXPAYER
091381200	2021	INDIVIDUAL PERSONAL PROPERTY	LARGENT LINNA E	7703 RAYTOWN RD APT 21	092310198	2005-2007	INDIVIDUAL PERSONAL PROPERTY	VANHORN MICHELLE R	NO ADDRESS PROVIDED BY TAXPAYER
091386006	2019	INDIVIDUAL PERSONAL PROPERTY	BARNES CHRISTOPHER A	9801 E 61ST ST APT 6	092310226	2013	INDIVIDUAL PERSONAL PROPERTY	COLLINS ROBERT D	9701 BROOKLANE ST
091390537	2003-2004	INDIVIDUAL PERSONAL PROPERTY	HUGHES THELMA I	NO ADDRESS PROVIDED BY TAXPAYER	092310244	2019	INDIVIDUAL PERSONAL PROPERTY	ASKREN GERTRUDE	11412 E 69TH ST
091390643	2021	INDIVIDUAL PERSONAL PROPERTY	JOHNSON STEVEN A	6312 KENTUCKY AVE	092310350	2004	INDIVIDUAL PERSONAL PROPERTY	HARRIS FREDERICK J	NO ADDRESS PROVIDED BY TAXPAYER
091391180	2020-2021	INDIVIDUAL PERSONAL PROPERTY	ROWE LARRY E	10012 E 83RD TER	092310355	2021	INDIVIDUAL PERSONAL PROPERTY	COHEE YULUNDA S	11717 E 85TH ST
091397167	2005	INDIVIDUAL PERSONAL PROPERTY	FAIRLIE JEFFREY S & CATHY L	NO ADDRESS PROVIDED BY TAXPAYER	092318121	2002-2003	INDIVIDUAL PERSONAL PROPERTY	DILL DENISE (MCCLUSTON)	6325 HEDGES AVE
091402871	2021	INDIVIDUAL PERSONAL PROPERTY	MANIS SUSAN K (CLAY)	9808 E 79TH PL	092318133	2021	INDIVIDUAL PERSONAL PROPERTY	MCKENZIE KENNETH & ETTA	8324 HEDGES AVE
091407412	2021	INDIVIDUAL PERSONAL PROPERTY	KAGARICE TAMMY	5509 BLUE RIDGE BLVD	092318664	2013-2017	INDIVIDUAL PERSONAL PROPERTY	JAMES WILLIAM E	6104 HARDY AVE
091407827	2005	INDIVIDUAL PERSONAL PROPERTY	MCKELVY KIMBERLY A	NO ADDRESS PROVIDED BY TAXPAYER	092318665	2018-2019	INDIVIDUAL PERSONAL PROPERTY	HENDERSON MICHAEL D	6009 CRESCENT AVE
091408459	2011	INDIVIDUAL PERSONAL PROPERTY	GIBBS MARGARET L	8801 E GREGORY BLVD	092321491	2021	INDIVIDUAL PERSONAL PROPERTY	ELLENWOOD JEFF	9402 E 84TH ST
091411607	2005	INDIVIDUAL PERSONAL PROPERTY	FINNEY TIFFINELY	NO ADDRESS PROVIDED BY TAXPAYER	092330301	2001	INDIVIDUAL PERSONAL PROPERTY	STRATTON DARIN V & KATHY J	UNKNOWN
091411789	2003-2004	INDIVIDUAL PERSONAL PROPERTY	SPAETH MAXINE	NO ADDRESS PROVIDED BY TAXPAYER	092334942	2002-2003	INDIVIDUAL PERSONAL PROPERTY	WOOD PARKER	NO ADDRESS PROVIDED BY TAXPAYER
091412040	2021	INDIVIDUAL PERSONAL PROPERTY	TYLER THOMAS W & MARY M	7206 CRISP AVE	092337867	2007	INDIVIDUAL PERSONAL PROPERTY	FUNK ROBERT K & CYNTHIA	8622 E UTOPIA DR APT 5
091421314	2021	INDIVIDUAL PERSONAL PROPERTY	WASHINGTON MAREO A	1101 NW ARLINGTON PL UNIT 1	092338377	2001-2002	INDIVIDUAL PERSONAL PROPERTY	BAILEY KENNETH E	NO ADDRESS PROVIDED BY TAXPAYER
091422503	2021	INDIVIDUAL PERSONAL PROPERTY	LOTHAMER ANGELA	11205 E 64TH TER	092338669	2008-2010	INDIVIDUAL PERSONAL PROPERTY	LATHROM JAMES H & JOHN H	11900 JESSICA LN
091425609	2021	INDIVIDUAL PERSONAL PROPERTY	JONES CHRISTOPHER	10101 E 83RD ST	092339448	2021	INDIVIDUAL PERSONAL PROPERTY	ELDRIDGE LACY	8606 FORD AVE
091426491	2010	INDIVIDUAL PERSONAL PROPERTY	FRIEDERICH ALECIA J & LAWHORN ANDRE	6808 LANE AVE	092339700	2005	INDIVIDUAL PERSONAL PROPERTY	TURNER MERRY JO (DAVIS)	10411 E 78TH TER
091432696	2015	INDIVIDUAL PERSONAL PROPERTY	VANHOUTEN BUDDY L	9408 E GREGORY BLVD	092350861	2021	INDIVIDUAL PERSONAL PROPERTY	BEETS DONALD	11611 E 77TH ST
091437283	2007	INDIVIDUAL PERSONAL PROPERTY	KELLA ROBYN B	5311 ASH AVE	092357197	2018-2019	INDIVIDUAL PERSONAL PROPERTY	CARTER ROBERT H JR	8622 LANE AVE
091441610	2008-2009	INDIVIDUAL PERSONAL PROPERTY	MARLATT MORTON L	NO ADDRESS PROVIDED BY TAXPAYER	092357360	2021	INDIVIDUAL PERSONAL PROPERTY	BRANDON LATRICE A & JONATHAN	6609 HARVARD AVE
091442318	2016-2017	INDIVIDUAL PERSONAL PROPERTY	WELCHON NANCY G & JACK L	10700 E 84TH TER	092357778	2017-2021	INDIVIDUAL PERSONAL PROPERTY	WASHINGTON VENUS R	7923 HEDGES AVE
091444858	2003-2004	INDIVIDUAL PERSONAL PROPERTY	CESAR JOAN	NO ADDRESS PROVIDED BY TAXPAYER	092358397	2020	INDIVIDUAL PERSONAL PROPERTY	BAGBY SHARON M	5548 HUNTER TER
091445023	2001-2017	INDIVIDUAL PERSONAL PROPERTY	SCHUMACHER KIM K	NO ADDRESS PROVIDED BY TAXPAYER	092359194	2021	INDIVIDUAL PERSONAL PROPERTY	CHABINO CARTER & TRICIA	6617 HARVARD AVE
091451186	2013	INDIVIDUAL PERSONAL PROPERTY	OVERBAY SHANNON PATRICE	8109 HEDGES AVE	092359664	2005	INDIVIDUAL PERSONAL PROPERTY	CRANFILL EUNICE	10016 E 68TH ST
091451681	2008	INDIVIDUAL PERSONAL PROPERTY	WHITE MARK A	542 C PARK AVE	092361166	2014-2015	INDIVIDUAL PERSONAL PROPERTY	TOMPKINS LOUIS D	7512 EVANSTON AVE
091473730	2005-2015	INDIVIDUAL PERSONAL PROPERTY	DEGUZMAN REGALADO C	10209 E 69TH ST	092361190	2021	INDIVIDUAL PERSONAL PROPERTY	LANTSBERGER LARNEL	10408 E 80TH ST
091476635	2020-2021	INDIVIDUAL PERSONAL PROPERTY	HOWARD JACQUE	9202 E 74TH TER	092362998	2020-2021	INDIVIDUAL PERSONAL PROPERTY	WALTERS MAYVIS	5804 HEDGES AVE
091476819	2005-2006	INDIVIDUAL PERSONAL PROPERTY	DUKEK JEFFERY	8612 E 81ST TER	092363888	2021	INDIVIDUAL PERSONAL PROPERTY	ROPER NICHOLE M & NEIL E	9359 E 65TH TER
091487384	2016	INDIVIDUAL PERSONAL PROPERTY	MCDOWELL JAMES A	7232 CRISP AVE	092393078	2010-2017	INDIVIDUAL PERSONAL PROPERTY	JONES WINIFRED (WILSON)	11613 E 78TH TER
091487405	2020	INDIVIDUAL PERSONAL PROPERTY	TURNER MICHAEL G	5904 ARLINGTON AVE	092393250	2020-2021	INDIVIDUAL PERSONAL PROPERTY	COPPAGE (BRADLEY) SHALONDA	8610 ARLINGTON AVE
091492763	2001	INDIVIDUAL PERSONAL PROPERTY	KRABBE JAMES F	NO ADDRESS PROVIDED BY TAXPAYER	092396314	2021	INDIVIDUAL PERSONAL PROPERTY	KURTZ BRIAN E	9310 E 54TH ST
091493920	2005	INDIVIDUAL PERSONAL PROPERTY	CAMPBELL ELAINE M	NO ADDRESS PROVIDED BY TAXPAYER	092416540	2020-2021	INDIVIDUAL PERSONAL PROPERTY	ROBINSON BARBARA J	9207 E 74TH TER
091496180	2021	INDIVIDUAL PERSONAL PROPERTY	WOODRUM DAVID M & PATRICIA E	7319 ELM ST	092416648	2021	INDIVIDUAL PERSONAL PROPERTY	HIGGINS JEREMY W	8305 NORTHERN ST
091499711	2002-2004	INDIVIDUAL PERSONAL PROPERTY	KAPKE RICHARD	11215 E 53RD TER	092416912	2011-2017	INDIVIDUAL PERSONAL PROPERTY	GRAVES JULIE LYNN	5932 STERLING AVE
091504156	2002-2003	INDIVIDUAL PERSONAL PROPERTY	MOORE TERESA (ELLSWORTH)	8300 KENTUCKY AVE	092416917	2008-2009	INDIVIDUAL PERSONAL PROPERTY	FLANNERY ROY THOMAS	5721 MANNING AVE

092421121	2009-2010	INDIVIDUAL PERSONAL PROPERTY	FRAZIER CASSANDRA D	8312 ELM AVE	093159287	2015-2021	INDIVIDUAL PERSONAL PROPERTY	CORUM HAROLD C & ALMA P	9109 E 68TH TER
092422976	2021	INDIVIDUAL PERSONAL PROPERTY	MARTIN TAINA M	8411 EVERETT ST	093195121	2003-2004	INDIVIDUAL PERSONAL PROPERTY	SHEDD DEBBIE L	9000 E 59TH ST
092451731	2021	INDIVIDUAL PERSONAL PROPERTY	HANKINS ALBERT L & JANICE L	8618 E 84TH ST	093242968	2021	INDIVIDUAL PERSONAL PROPERTY	GERSTNER ROBIN	8712 E 79TH TER
092451860	2017-2018	INDIVIDUAL PERSONAL PROPERTY	ALPOUGH JANICE L	6832 STERLING AVE	093362835	2002	INDIVIDUAL PERSONAL PROPERTY	WILSON SHARLYN KATHRYN	E 56TH TER
092464007	2002-2005	INDIVIDUAL PERSONAL PROPERTY	OHRMUND TAMMY	NO ADDRESS PROVIDED BY TAXPAYER	093442024	2011	INDIVIDUAL PERSONAL PROPERTY	FENIMORE L MILDRED	8505 E 81ST ST
092466347	2019-2020	INDIVIDUAL PERSONAL PROPERTY	COFFEY MAXINE	8440 EVANSTON AVE	093455932	2006	INDIVIDUAL PERSONAL PROPERTY	ELLIS JERRY D AND PAULA J	8212 HARRIS CT
092466365	2005-2006	INDIVIDUAL PERSONAL PROPERTY	BALLARD ROBIN L	7808 CRESCENT AVE	093466236	2017-2018	INDIVIDUAL PERSONAL PROPERTY	CLAY MELVIN JR	8405 JAMES A REED RD
092467853	2017	INDIVIDUAL PERSONAL PROPERTY	WARD SPENCER	NO ADDRESS PROVIDED BY TAXPAYER	093493719	2021	INDIVIDUAL PERSONAL PROPERTY	WOLFGHEHR CYNTHIA & RICHARD	9124 RICHARDS DR
092468960	2021	INDIVIDUAL PERSONAL PROPERTY	SPENCE LINDA S	8001 WESTRIDGE RD	093493869	2016-2017	INDIVIDUAL PERSONAL PROPERTY	THOMPSON KATHERINA T	10207 E 63RD TER APT C
092471878	2001	INDIVIDUAL PERSONAL PROPERTY	DAVIS TIMOTHY A	7925 RAYTOWN RD	093495294	2001-2002	INDIVIDUAL PERSONAL PROPERTY	ROSS TERESA J	NO ADDRESS PROVIDED BY TAXPAYER
092473679	2008	INDIVIDUAL PERSONAL PROPERTY	MCMANAMIN MICHAEL J	8816 E 85TH ST	093496245	2008-2012	INDIVIDUAL PERSONAL PROPERTY	KOJESKI FRANK P	7915 ELM AVE
092481400	2013	INDIVIDUAL PERSONAL PROPERTY	JORDISON PAUL W & MARY A	7705 RAYTOWN RD	093496821	2021	INDIVIDUAL PERSONAL PROPERTY	TOWNSEND JAMIE R	11726 E 85TH ST
092481400	2018-2021	INDIVIDUAL PERSONAL PROPERTY	SABE RAMON F	6508 BLUE RIDGE CUT OFF	093497124	2002-2003	INDIVIDUAL PERSONAL PROPERTY	ONEIL DOUGLAS E	NO ADDRESS PROVIDED BY TAXPAYER
092481555	2002	INDIVIDUAL PERSONAL PROPERTY	NORMAN GLEN	UNKNOWN	093497161	2008-2017	INDIVIDUAL PERSONAL PROPERTY	YEISLEY DONNA K	8913 E 59TH ST
092482325	2021	INDIVIDUAL PERSONAL PROPERTY	MEURET MARIA C	7001 RAYTOWN RD	093497967	2001	INDIVIDUAL PERSONAL PROPERTY	MORRIS BOB L & KAREN S	NO ADDRESS PROVIDED BY TAXPAYER
092488328	2009-2010	INDIVIDUAL PERSONAL PROPERTY	SCROGGINS DEANNA (ORR)	9101 E 55TH ST	093498235	2019-2021	INDIVIDUAL PERSONAL PROPERTY	PARKER YOLANDA Y	10407 E 78TH TER
092493258	2021	INDIVIDUAL PERSONAL PROPERTY	MITCHELL DEBBI L	6316 HUNTER ST	093499040	2002-2003	INDIVIDUAL PERSONAL PROPERTY	BEHMER CHRISTOPHER C	NO ADDRESS PROVIDED BY TAXPAYER
092497077	2020-2021	INDIVIDUAL PERSONAL PROPERTY	ANTWINE RENETTA JEAN (TOOLEY)	19400 E 37TH TERRACE CT S	093499161	2004-2006	INDIVIDUAL PERSONAL PROPERTY	BRACKMAN EARL L III	513 NE GRAND AVE
092497303	2008	INDIVIDUAL PERSONAL PROPERTY	JOSLIN DONALD L	9902 E 80TH TER	093499471	2003	INDIVIDUAL PERSONAL PROPERTY	KILGORE MINDY P	UNKNOWN
092497697	2001	INDIVIDUAL PERSONAL PROPERTY	FOSTER ROGER	UNKNOWN	093501672	2021	INDIVIDUAL PERSONAL PROPERTY	PRATT PAUL D	9914 E 60TH ST
092508113	2018-2021	INDIVIDUAL PERSONAL PROPERTY	BATTLE EUGENE	7913 ELM AVE	093505581	2007	INDIVIDUAL PERSONAL PROPERTY	ROBINSON MARJORIE L	9404 E 80TH TER
092515715	2009-2010	INDIVIDUAL PERSONAL PROPERTY	DARR-RODRIGUEZ FRANCES L	9815 E 61ST ST APT 1	093508200	2021	INDIVIDUAL PERSONAL PROPERTY	BISHOP JAMES W & KELLY A	9504 E 70TH TER
092518091	2018	INDIVIDUAL PERSONAL PROPERTY	COVINGTON LEEVERLIE	5900 LARSON AVE	093508314	2005-2006	INDIVIDUAL PERSONAL PROPERTY	THOMAS GREGORY	8502 E 83RD ST
092518313	2021	INDIVIDUAL PERSONAL PROPERTY	WEATHERS OZIE	11840 E 80TH DR	093512788	2006	INDIVIDUAL PERSONAL PROPERTY	JONES ANTHONY C	NO ADDRESS PROVIDED BY TAXPAYER
092518331	2015-2021	INDIVIDUAL PERSONAL PROPERTY	CONNELL ROBERT L & MARY C	9355 E 64TH TER	093513922	2006-2007	INDIVIDUAL PERSONAL PROPERTY	WIGGINS GREGORY	11405 E 78TH TER
092521906	2021	INDIVIDUAL PERSONAL PROPERTY	SIMMONS JEFFREY D	8903 E 74TH ST	093513996	2009	INDIVIDUAL PERSONAL PROPERTY	JACKSON ROY V	8613 HAWTHORNE AVE
092529248	2021	INDIVIDUAL PERSONAL PROPERTY	KING DAVID M	10106 E 69TH TER	093519248	2014-2015	INDIVIDUAL PERSONAL PROPERTY	COOPER HERBERT E & MARTHA	8904 RICHARDS DR
092532528	2015-2021	INDIVIDUAL PERSONAL PROPERTY	HALL DAWN M	8611 E 84TH TER	093523492	2007-2010	INDIVIDUAL PERSONAL PROPERTY	ROBERTS CHERRI L & RONALD W	8905 E 67TH PL APT 111
092574612	2017-2019	INDIVIDUAL PERSONAL PROPERTY	HAUS WILLIAM J	9205 E 64TH TER	093554866	2021	INDIVIDUAL PERSONAL PROPERTY	HUNTER DENISE A	9005 RICHARDS DR
092881737	2001	INDIVIDUAL PERSONAL PROPERTY	DELGADO MARIA C	NO ADDRESS PROVIDED BY TAXPAYER	093558567	2020-2021	INDIVIDUAL PERSONAL PROPERTY	OBAYA DONNA	5506 STERLING AVE
092888560	2021	INDIVIDUAL PERSONAL PROPERTY	SIMON KENNETH & JAQUELINE	9003 E GREGORY BLVD	093560670	2016-2017	INDIVIDUAL PERSONAL PROPERTY	NOWELL HEATHER L	5612 STERLING AVE
092894911	2021	INDIVIDUAL PERSONAL PROPERTY	BLOCK REX L & KAREN (BROOKS)	8612 OXFORD AVE	093584429	2021	INDIVIDUAL PERSONAL PROPERTY	UMBACH HEATHER NIELSEN	8904 E 72ND ST
092900177	2021	INDIVIDUAL PERSONAL PROPERTY	MORRISON FRANK E & PATTY	11521 E 74TH STREET CT	093619001	2008-2017	INDIVIDUAL PERSONAL PROPERTY	MCCRURTER DENNIS R	8515 E 81ST TER
092900650	2018-2021	INDIVIDUAL PERSONAL PROPERTY	COLE MARCEL G	8617 W UTOPIA DR APT 38	093619352	2021	INDIVIDUAL PERSONAL PROPERTY	JOHNSON NINA & AARON	6112 ENGLEWOOD AVE
092905470	2005-2006	INDIVIDUAL PERSONAL PROPERTY	LEE JAMES A JR & GRACE Y	5101 HARDY CT	093798929	2021	INDIVIDUAL PERSONAL PROPERTY	HILTON ANTHONIA (PACHECO)	9105 E 74TH TER
092905309	2014	INDIVIDUAL PERSONAL PROPERTY	HEIDLER JOSEPH H & ELIZEBETH M	6140 RAYTOWN RD APT 305	093880319	2008-2009	INDIVIDUAL PERSONAL PROPERTY	MOORE GABRIELLE	7208 HARDY AVE
092906713	2008-2009	INDIVIDUAL PERSONAL PROPERTY	DECKER KELLY J	7508 OVERTON AVE	093881317	2020-2021	INDIVIDUAL PERSONAL PROPERTY	MCDANIEL DANIEL	7508 APPLETON AVE
092915061	2021	INDIVIDUAL PERSONAL PROPERTY	FAULKNER MARY E	8109 KENCKY AVE	093882261	2001	INDIVIDUAL PERSONAL PROPERTY	ARMSTRONG JON R	UNKNOWN
092919676	2015-2016	INDIVIDUAL PERSONAL PROPERTY	MCDONALD DALE L	9401 E 63RD ST APT 209	093882336	2015	INDIVIDUAL PERSONAL PROPERTY	MCDANIEL HAROLD T	9408 E 68TH ST
092920854	2020-2021	INDIVIDUAL PERSONAL PROPERTY	SMITH MICHAEL K & KATHERINE & JOSHUA LOG	5540 HUNTER ST	093882979	2021	INDIVIDUAL PERSONAL PROPERTY	NELLENBACH MICHAEL F & JULITA	NO ADDRESS PROVIDED BY TAXPAYER
092921514	2012-2014	INDIVIDUAL PERSONAL PROPERTY	LYNCH JULIE G	6515 BLUE RIDGE CUT OFF	093883232	2003-2004	INDIVIDUAL PERSONAL PROPERTY	PORTER BRENDA K	NO ADDRESS PROVIDED BY TAXPAYER
092924985	2007	INDIVIDUAL PERSONAL PROPERTY	MORLAN ANNA (DUNN)	NO ADDRESS PROVIDED BY TAXPAYER	093887788	2015-2019	INDIVIDUAL PERSONAL PROPERTY	BACHOFER JOHN B	6121 LANE AVE
092925116	2007-2011	INDIVIDUAL PERSONAL PROPERTY	GEEDING MARK E	7608 ELM AVE	093887869	2009-2013	INDIVIDUAL PERSONAL PROPERTY	ANDERSON CHERI	11308 E 78TH TER
092925419	2014-2017	INDIVIDUAL PERSONAL PROPERTY	TAYLOR KAREN E (MITCHELL)	9501 E 65TH TER	093890378	2004-2005	INDIVIDUAL PERSONAL PROPERTY	SHAW BLANCHE L	NO ADDRESS PROVIDED BY TAXPAYER
092929475	2021	INDIVIDUAL PERSONAL PROPERTY	SMITH REGINA (REFFITT)	10107 E 63RD TER	093890830	2004	INDIVIDUAL PERSONAL PROPERTY	STANGLE DONALD G & IRMA A	92 FAIRVIEW ST
092946305	2001	INDIVIDUAL PERSONAL PROPERTY	ELLIOTT MARGARET (GREGOR)	NO ADDRESS PROVIDED BY TAXPAYER	093891263	2005-2006	INDIVIDUAL PERSONAL PROPERTY	TRYON VICKI E	NO ADDRESS PROVIDED BY TAXPAYER
092951288	2020-2021	INDIVIDUAL PERSONAL PROPERTY	SLAUGHTER ERIC LEE	6011 HUNTER ST	093891785	2001-2011	INDIVIDUAL PERSONAL PROPERTY	POSEY JUDY	NO ADDRESS PROVIDED BY TAXPAYER
092955477	2013	INDIVIDUAL PERSONAL PROPERTY	WOOD CHRISTIE	11278 E 71ST TER	093892065	2007	INDIVIDUAL PERSONAL PROPERTY	DOUGLAS BRAD S & AMY SUE M	11419 E 58TH ST
093008997	2013	INDIVIDUAL PERSONAL PROPERTY	BECHER SHERRY G	5316 HEDGES AVE	093892842	2001	INDIVIDUAL PERSONAL PROPERTY	WALLACE CURTIS E	NO ADDRESS PROVIDED BY TAXPAYER
093009018	2001	INDIVIDUAL PERSONAL PROPERTY	MARTIN MISA L (DAVIS)	7925 RAYTOWN RD	093893431	2004-2006	INDIVIDUAL PERSONAL PROPERTY	MANDINA LORINE L	NO ADDRESS PROVIDED BY TAXPAYER
093009897	2021	INDIVIDUAL PERSONAL PROPERTY	TAYLOR SHEILA R	8526 RAYTOWN RD	093893629	2021	INDIVIDUAL PERSONAL PROPERTY	EIKEN ALLEN	8904 ROSE LN
093021744	2010	INDIVIDUAL PERSONAL PROPERTY	MCCLUER ROLAND D & DEBRA D	8619 E 83RD TER	093894207	2012-2017	INDIVIDUAL PERSONAL PROPERTY	MURRAY MICHELLE R	9006 E 85TH ST
093023516	2005	INDIVIDUAL PERSONAL PROPERTY	BROWN DIANNA L	10809 E 57TH TER	093896292	2020-2021	INDIVIDUAL PERSONAL PROPERTY	WOODRUFF MATTHEW W	9509 E 66TH TER
093023826	2005	INDIVIDUAL PERSONAL PROPERTY	ABUSAADA BENALI T & ADRIENNE N	9708 E 83RD TER	093896567	2008	INDIVIDUAL PERSONAL PROPERTY	BRANSON MICHAEL	7236 RAYTOWN RD APT B
093031611	2001	INDIVIDUAL PERSONAL PROPERTY	LONEY DAVID W	UNKNOWN	093897712	2001-2002	INDIVIDUAL PERSONAL PROPERTY	EDWARDS AARON A	UNKNOWN
093030828	2021	INDIVIDUAL PERSONAL PROPERTY	GEORGE CYNTHIA L	7009 HUNTER ST	093898306	2008	INDIVIDUAL PERSONAL PROPERTY	NOONER JOHN H & IDA ALLEN	NO ADDRESS PROVIDED BY TAXPAYER
093036250	2021	INDIVIDUAL PERSONAL PROPERTY	HOGAN PAMELA D	9732 PLYMOUTH LN	093898364	2020-2021	INDIVIDUAL PERSONAL PROPERTY	WYATT KAREN S	11422 E 71ST ST
093046312	2004	INDIVIDUAL PERSONAL PROPERTY	MYNATT JOHN A	NO ADDRESS PROVIDED BY TAXPAYER	093898424	2021	INDIVIDUAL PERSONAL PROPERTY	TSCHIRHART WENDY	5732 OXFORD AVE
093048586	2009-2017	INDIVIDUAL PERSONAL PROPERTY	BOYLE SONIA E	10015 E 74TH TER	093898539	2021	INDIVIDUAL PERSONAL PROPERTY	MOORE CYNTHIA M	7515 HAWTHORNE AVE
093048948	2012-2015	INDIVIDUAL PERSONAL PROPERTY	SHUPE JULIE (GAUTREAUX)	11715 E 76TH TER	093898686	2001-2004	INDIVIDUAL PERSONAL PROPERTY	WALSH MARK B & OR	NO ADDRESS PROVIDED BY TAXPAYER
093049383	2011	INDIVIDUAL PERSONAL PROPERTY	CORNWELL ELAINE (LEVALLEE)	5217 ELM PL	093898774	2001	INDIVIDUAL PERSONAL PROPERTY	BENSON JOHN K	UNKNOWN
093051522	2021	INDIVIDUAL PERSONAL PROPERTY	BROCK STEPHANIE M & WILLIAM A	7611 HARVARD AVE	093898979	2020-2021	INDIVIDUAL PERSONAL PROPERTY	ELLIS ARZILA	8913 E 59TH ST
093054572	2019-2021	INDIVIDUAL PERSONAL PROPERTY	PAUL ROBERT C & HEATHER D	9705 E GREGORY BLVD	093899102	2021	INDIVIDUAL PERSONAL PROPERTY	HOPKINS WENDY JOYCE (HURN)	9204 E 69TH TER
093055297	2018-2019	INDIVIDUAL PERSONAL PROPERTY	PARRISH CHARLES E SR	5508 HUNTER ST	093900433	2020-2021	INDIVIDUAL PERSONAL PROPERTY	FORD GREGORY S & D MICHELL	11301 LANE AVE
093062741	2001	INDIVIDUAL PERSONAL PROPERTY	COOPER HESTER S	11700 E 83RD ST	093900652	2004	INDIVIDUAL PERSONAL PROPERTY	NOLAN LOU ELLA	NO ADDRESS PROVIDED BY TAXPAYER
093068476	2009-2010	INDIVIDUAL PERSONAL PROPERTY	REYNOLDS LARRY L & RUTH A	6419 STERLING AVE	093900994	2021	INDIVIDUAL PERSONAL PROPERTY	COX CHRISTOPHER A	9108 E 58TH TER
093073426	2004-2005	INDIVIDUAL PERSONAL PROPERTY	TORIAN JOAN M	8700 LANE AVE	093901559	2007	INDIVIDUAL PERSONAL PROPERTY	HERNANDEZ TAMMY ONKA	8923 E 79TH ST
093089973	2001-2004	INDIVIDUAL PERSONAL PROPERTY	CLEVENGER CURTIS	6012 RAYTOWN RD	093901563	2021	INDIVIDUAL PERSONAL PROPERTY	SELLON JEFF & SUSAN	11301 E 56TH TER
093091448	2005-2008	INDIVIDUAL PERSONAL PROPERTY	MOORE KENNETH W	9201 E 79TH ST	093903521	2007	INDIVIDUAL PERSONAL PROPERTY	WATERS CHRISTINE L (BARRETT)	5304 LAUREL AVE
093095733	2020-2021	INDIVIDUAL PERSONAL PROPERTY	JACKSON EUGENIA TAMMY (GRIGSBY)	10401 E 64TH ST	093903578	2009	INDIVIDUAL PERSONAL PROPERTY	WEATHERSPOON EVELYN J	NO ADDRESS PROVIDED BY TAXPAYER
093097501	2021	INDIVIDUAL PERSONAL PROPERTY	FREDERICK DAWN	8576 GREENWOOD RD	093903738	2007-2013	INDIVIDUAL PERSONAL PROPERTY	HARTMAN CINDY	10027 E 67TH ST
093108050	2001	INDIVIDUAL PERSONAL PROPERTY	MEZA DONNA J(COFFMAN) & JOSUE	NO ADDRESS PROVIDED BY TAXPAYER	093905206	2004-2007	INDIVIDUAL PERSONAL PROPERTY	BUSSARD SHAUN E	8512 KENTUCKY AVE

093905249	2017-2019	INDIVIDUAL PERSONAL PROPERTY	HUGHES ROBERT J	11029 E 54TH ST	094049431	2001-2009	INDIVIDUAL PERSONAL PROPERTY	ALVAREZ JUDY L	7923 WESTRIDGE RD
093909050	2007-2015	INDIVIDUAL PERSONAL PROPERTY	STAFFORD PATRICK	10508 E 71ST TER	094049686	2003	INDIVIDUAL PERSONAL PROPERTY	WALKER HOWARD L	11012 E 54TH ST
093909539	2021	INDIVIDUAL PERSONAL PROPERTY	DOBSON KENT L & JULIE M	6333 HARVARD AVE	094049694	2018-2020	INDIVIDUAL PERSONAL PROPERTY	MOURNING JAMES J	7725 ARLINGTON AVE
093910349	2017-2019	INDIVIDUAL PERSONAL PROPERTY	GRAY PATRICIA D	8909 E 72ND TER	094049764	2006	INDIVIDUAL PERSONAL PROPERTY	SEIGLAR CHRISTI J	10528 E 46TH TER
093912127	2021	INDIVIDUAL PERSONAL PROPERTY	LEDDO JULIA A	5416 WILLOW AVE	094050395	2021	INDIVIDUAL PERSONAL PROPERTY	HENDERSON TOYA R	7619 IRWIN RD
093912434	1998-2009	INDIVIDUAL PERSONAL PROPERTY	HAM JERRY	6211 HADLEY ST	094050454	2008	INDIVIDUAL PERSONAL PROPERTY	GROSS PAMELA & EDWARD T JR	9307 E 81ST TER
093914501	2005-2006	INDIVIDUAL PERSONAL PROPERTY	MOORE MARILYN K	5328 HUNTER ST	094050495	2002-2004	INDIVIDUAL PERSONAL PROPERTY	EKLUND LEE E	6733 STERLING
093915644	2020-2021	INDIVIDUAL PERSONAL PROPERTY	BROWN DENISE	NO ADDRESS ASSIGNED BY CITY	094050599	2007	INDIVIDUAL PERSONAL PROPERTY	MELCHER CHRIS E	NO ADDRESS PROVIDED BY TAXPAYER
093916004	2021	INDIVIDUAL PERSONAL PROPERTY	HASSEN TELISA D	11905 E 87TH TER	094052576	2021	INDIVIDUAL PERSONAL PROPERTY	DAWSON MICHELE DENISE (MCFEDERS)	8301 E 86TH TER
093916371	2008	INDIVIDUAL PERSONAL PROPERTY	JAMES ROBERT E	11811 E 83RD ST	094052807	2020-2021	INDIVIDUAL PERSONAL PROPERTY	RUCKS ROBIN J	8407 STERLING AVE
093917786	2016-2021	INDIVIDUAL PERSONAL PROPERTY	ROBINSON DONNIE E	10316 E 63RD ST APT 4	094053354	2021	INDIVIDUAL PERSONAL PROPERTY	YATES DARREL	11609 E 72ND ST
093917993	2019-2021	INDIVIDUAL PERSONAL PROPERTY	GILMORE KENNETH R	8427 WOODSON DR	094053360	2012-2015	INDIVIDUAL PERSONAL PROPERTY	HUGHES JEFF EARL JR	8208 EVANSTON CT
093918335	2002-2008	INDIVIDUAL PERSONAL PROPERTY	GENTRY JUANITA F	10204 E 56TH ST	094053633	2021	INDIVIDUAL PERSONAL PROPERTY	CLAY ALTON BROYLES III	1206 EVANSTON AVE
093918438	2007-2017	INDIVIDUAL PERSONAL PROPERTY	WILLIAMS VINCENT P	8538 E 81ST TER	094053691	2019-2021	INDIVIDUAL PERSONAL PROPERTY	JULIE JAMES D & RUTH E	8012 NW BOXELDER CT
093918621	2019-2021	INDIVIDUAL PERSONAL PROPERTY	LANDIS MICHELLE R	5420 BLUE RIDGE CUT OFF APT 618	094053944	2004-2007	INDIVIDUAL PERSONAL PROPERTY	WHITEBEAR ARLENE E	8611 E 83RD ST
093918715	2021	INDIVIDUAL PERSONAL PROPERTY	SLAUGHTER MARCUS BRYON	6409 HARRIS AVE	094054436	2021	INDIVIDUAL PERSONAL PROPERTY	KRAMER JOHN N	8619 OXFORD ST
093919256	2014	INDIVIDUAL PERSONAL PROPERTY	FOX ROBERT D	6641 CEDAR AVE	094054890	2004	INDIVIDUAL PERSONAL PROPERTY	MCDANIEL JANNIFER	NO ADDRESS PROVIDED BY TAXPAYER
093921125	2021	INDIVIDUAL PERSONAL PROPERTY	KRAMER KRISTEN Y	8619 OXFORD AVE	094055895	2021	INDIVIDUAL PERSONAL PROPERTY	MATHEWS LISA D	10509 E 79TH TER
093922168	2021	INDIVIDUAL PERSONAL PROPERTY	BAGBY DIANA M	8927 E 57TH ST	094060980	2005-2008	INDIVIDUAL PERSONAL PROPERTY	SCHWARTZ MICHAEL & AMANDA	9800 E 81ST ST
093922982	2020-2021	INDIVIDUAL PERSONAL PROPERTY	BUSH PAMELA S BRYANT	8525 ARLINGTON AVE	094062176	2012-2017	INDIVIDUAL PERSONAL PROPERTY	WHITE ERICA M	8812 E 87TH ST
093923284	2004	INDIVIDUAL PERSONAL PROPERTY	MITCHELL ROSE MARIE	8500 ELM B	094062207	2021	INDIVIDUAL PERSONAL PROPERTY	TYSON PHYLIS D	5701 ELM AVE
093923366	2021	INDIVIDUAL PERSONAL PROPERTY	HAMILTON-BEY LIONELL	8472 LANE DR	094068864	2011-2013	INDIVIDUAL PERSONAL PROPERTY	RICKY JEAN (LEWIS)	9350 E 69TH TER
093923806	2018-2021	INDIVIDUAL PERSONAL PROPERTY	CRAWFORD SCOTT S	9355 E 69TH ST	094070489	2010	INDIVIDUAL PERSONAL PROPERTY	SMART TIMOTHY L	NO ADDRESS PROVIDED BY TAXPAYER
093924220	2011	INDIVIDUAL PERSONAL PROPERTY	GARTH ANGELA R	8313 PERSHING RD	094079678	2001-2002	INDIVIDUAL PERSONAL PROPERTY	BELTCH SANDRA JO	748 SW LEMANS LN
093924356	2021	INDIVIDUAL PERSONAL PROPERTY	ALBERTY SHERRIE	6638 MAYWOOD AVE APT B	094085855	2012-2014	INDIVIDUAL PERSONAL PROPERTY	MCCNEAL MARK E	8501 EVERETT ST
093924487	2020-2021	INDIVIDUAL PERSONAL PROPERTY	STEVENSON LATANYA D	10204 E 86TH TER	094086420	2014	INDIVIDUAL PERSONAL PROPERTY	HENDERSON TAMMY R JOHNSON	5123 RALSTON AVE
093924898	2010-2012	INDIVIDUAL PERSONAL PROPERTY	SCOTT FAYE E	10407 E 82ND ST	094090227	2021	INDIVIDUAL PERSONAL PROPERTY	BILLUPS CECIL A & JACKSON MENIA	8601 ELM AVE
093924975	2021	INDIVIDUAL PERSONAL PROPERTY	DEDMON IYABO	8803 E 59TH ST	094090258	2021	INDIVIDUAL PERSONAL PROPERTY	DILLON ROBIN G	6837 RAYTOWN RD
093924977	2010	INDIVIDUAL PERSONAL PROPERTY	STEVENSON LASHONDA A (CANADY)	7919 HARRIS AVE	094091146	2012-2017	INDIVIDUAL PERSONAL PROPERTY	ROBINSON JACQUELYN A	11304 E 71ST ST
093925019	2021	INDIVIDUAL PERSONAL PROPERTY	HARDY NEMI JR	7143 CRISP AVE	094094750	2021	INDIVIDUAL PERSONAL PROPERTY	EDGIN MARK A	5501 APPLETON AVE
093925299	2005-2009	INDIVIDUAL PERSONAL PROPERTY	EVANS ROSETTA	7513 ENGLEWOOD AVE	094096675	2021	INDIVIDUAL PERSONAL PROPERTY	PARRIS CYNTHIA DENISE	7401 HARDY AVE
093926081	2016	INDIVIDUAL PERSONAL PROPERTY	RICHARDSON ROBERT D	9803 E 79TH TER	094096931	2016-2021	INDIVIDUAL PERSONAL PROPERTY	JOHNSON DOUGLAS W	11529 E 74TH STREET CT
093927078	2010	INDIVIDUAL PERSONAL PROPERTY	TUTTLE BRENDA	9205 VAUGHN AVE	094097248	2001	INDIVIDUAL PERSONAL PROPERTY	SLOAN DAVID K & MELINDA	NO ADDRESS PROVIDED BY TAXPAYER
093927471	2015	INDIVIDUAL PERSONAL PROPERTY	BLEDSE CLARENCE T & ANDREA D	5936 STERLING AVE	094097380	2002-2004	INDIVIDUAL PERSONAL PROPERTY	PAUL MARGARET CRAWFORD	UNKNOWN
093929152	2015-2018	INDIVIDUAL PERSONAL PROPERTY	DOWNUM KEITH A	8442 LANE DR	094097682	2019-2021	INDIVIDUAL PERSONAL PROPERTY	HATFIELD MARK ALLEN	9900 E 82ND TER
093929363	2021	INDIVIDUAL PERSONAL PROPERTY	JEFFERIES DAVID W & CYNTHIA M	9113 E 66TH TER	094098979	2007	INDIVIDUAL PERSONAL PROPERTY	OLIVER PATRICIA A	8505 KENTUCKY AVE
093929393	2003-2004	INDIVIDUAL PERSONAL PROPERTY	ALPOUGH SONYA RAE	NO ADDRESS PROVIDED BY TAXPAYER	094104909	2012	INDIVIDUAL PERSONAL PROPERTY	EVANS CAROLYN E & BRIAN K	8313 E 85TH TER
093929439	2017-2021	INDIVIDUAL PERSONAL PROPERTY	JONES FINLEY F & NANCY ALICE	6101 LAUREL AVE	094127699	2012-2013	INDIVIDUAL PERSONAL PROPERTY	THROCKMORTON MELVIN R	8640 JAMES A REED RD
093954043	2006	INDIVIDUAL PERSONAL PROPERTY	CHACON BETTIE K & DAVID	6808 VERMONT AVE	094114963	2007	INDIVIDUAL PERSONAL PROPERTY	CLARK JENELL M	1386 SW MANOR LAKE DR
093958370	2002	INDIVIDUAL PERSONAL PROPERTY	POOLE TWANETTE L	NO ADDRESS PROVIDED BY TAXPAYER	094118297	2017-2018	INDIVIDUAL PERSONAL PROPERTY	ALPOUGH RONALD K	6832 STERLING AVE
093962312	2011-2012	INDIVIDUAL PERSONAL PROPERTY	WALTER JOYCE S	NO ADDRESS PROVIDED BY TAXPAYER	094127552	2021	INDIVIDUAL PERSONAL PROPERTY	MASTERS JANICE K	10609 E 70TH ST
093962812	2002	INDIVIDUAL PERSONAL PROPERTY	DICKSON ANN C	NO ADDRESS PROVIDED BY TAXPAYER	094131629	2006-2007	INDIVIDUAL PERSONAL PROPERTY	PELLERITO FRED L & LYNDA	NO ADDRESS PROVIDED BY TAXPAYER
093965005	2020-2021	INDIVIDUAL PERSONAL PROPERTY	WILSON JENNIFER L (SMITH)	6720 STERLING AVE	094131808	2003-2006	INDIVIDUAL PERSONAL PROPERTY	BROWN KENNETH H & KATIA L (SHIELDS)	6129 KENTUCKY AVE
093965294	2002	INDIVIDUAL PERSONAL PROPERTY	KETCHUM JAY W	5420 BLUE RIDGE CUTOFF	094132786	2002	INDIVIDUAL PERSONAL PROPERTY	GROSS MICHAEL L	UNKNOWN
093968876	2001-2002	INDIVIDUAL PERSONAL PROPERTY	HENDERSON CHARLES	NO ADDRESS PROVIDED BY TAXPAYER	094139237	2004-2005	INDIVIDUAL PERSONAL PROPERTY	BAGSHAW CRYSTAL	7229 HARRIS AVE
093968949	2021	INDIVIDUAL PERSONAL PROPERTY	HORTON ANGELA C	9110 RICHARDS DR	094141493	2001	INDIVIDUAL PERSONAL PROPERTY	CRANK SUE A	UNKNOWN
094000067	2021	INDIVIDUAL PERSONAL PROPERTY	BRYANT MITCHELL L JR	8958 E 83RD TER	094141583	2017	INDIVIDUAL PERSONAL PROPERTY	SARNA JENNIFER G GILNER (GONZAGOWSKI)	10005 E 69TH TER
094000074	2005	INDIVIDUAL PERSONAL PROPERTY	KURZWEL JENNIFER ANN	10900 E 58TH TER	094147106	2003	INDIVIDUAL PERSONAL PROPERTY	HINER JOHN S	UNKNOWN
094000819	2016-2018	INDIVIDUAL PERSONAL PROPERTY	ROBINSON MARY A	11811 E 83RD ST	094175567	2004	INDIVIDUAL PERSONAL PROPERTY	BROADHEAD SARA K	9010 E 87TH ST
094001743	2021	INDIVIDUAL PERSONAL PROPERTY	LEWIS RODNEY E & JENNIFER L	7402 HEDGES AVE	094224562	2020-2021	INDIVIDUAL PERSONAL PROPERTY	ROBINSON CYRUS	9004 E 68TH ST
094004532	2021	INDIVIDUAL PERSONAL PROPERTY	DAVIS BRIDGETT RENEE (SHELTON)	9200 E 94TH TER	094305090	2020-2021	INDIVIDUAL PERSONAL PROPERTY	WHITE JUNE V	9016 E 55TH TER
094004861	2020-2021	INDIVIDUAL PERSONAL PROPERTY	SLAUGHTER MARK EUGENE	6409 HARRIS AVE	094313869	2021	INDIVIDUAL PERSONAL PROPERTY	ALBERTY DIANE	5301 LAUREL AVE
094005007	2012	INDIVIDUAL PERSONAL PROPERTY	TURNER CHRISTINA M (AILSHIRE)	9703 E 80TH TER	094370312	2007-2013	INDIVIDUAL PERSONAL PROPERTY	BOATWRIGHT DANIELLE J	5212 CRISP AVE
094005051	2017-2018	INDIVIDUAL PERSONAL PROPERTY	AGUIRRE CHRISTINA	145 M LAKE SHORE DR	094445271	2001-2002	INDIVIDUAL PERSONAL PROPERTY	FALKE ALBERT L & SHIRLEY L	UNKNOWN
094006272	2012	INDIVIDUAL PERSONAL PROPERTY	BROCE WILLIAM MARK & CHRISTY	7602 CRESCENT DR	094493399	2011	INDIVIDUAL PERSONAL PROPERTY	BUSBY BOBBY D JR & KIMBERLY	9709 E 68TH ST
094009003	2003-2004	INDIVIDUAL PERSONAL PROPERTY	VICKERS JACQUETTA (GAMBLIN)	10813 E 59TH TER	094495330	2018-2019	INDIVIDUAL PERSONAL PROPERTY	BENNETT VERNITA JOLENE	5420 BLUE RIDGE CUT OFF APT G01
094012996	2015-2020	INDIVIDUAL PERSONAL PROPERTY	BROOKS REGINA R	10612 E 56TH ST	094513100	2012-2020	INDIVIDUAL PERSONAL PROPERTY	ONUZRUIKHA PAUL	8717 E 61ST TER APT 16
094014681	2021	INDIVIDUAL PERSONAL PROPERTY	ELDRIDGE ZSHUZANNAH C	8606 FORD AVE	094531846	2007	INDIVIDUAL PERSONAL PROPERTY	WARREN JAMES	6723 CRISP AVE
094018206	2021	INDIVIDUAL PERSONAL PROPERTY	CARAHER RAYMOND F & WENDY (STEVENS)	5206 BLUE RIDGE BLVD	094540360	2006	INDIVIDUAL PERSONAL PROPERTY	BISHOP ANGELA R (ROBINSON)	8311 BOOTH AVE
094018235	2021	INDIVIDUAL PERSONAL PROPERTY	DORSETT MICHAEL P & TAMARA	8613 CRESCENT AVE	094577424	2019	INDIVIDUAL PERSONAL PROPERTY	HIXSON BARBARA S	NO ADDRESS PROVIDED BY TAXPAYER
094021872	2021	INDIVIDUAL PERSONAL PROPERTY	HENDERSON MICHAEL J	16712 E 43RD ST S	094614382	2021	INDIVIDUAL PERSONAL PROPERTY	FULLER SUZANNE C	8714 E 87TH ST
094022693	2021	INDIVIDUAL PERSONAL PROPERTY	DUNCAN CHRISTOPHER L	11208 E 59TH TER	094618639	2017	INDIVIDUAL PERSONAL PROPERTY	ALDERTON REGINA	9814 E 61ST ST APT 4
094023151	2021	INDIVIDUAL PERSONAL PROPERTY	PALMAS JOSE LUIS & BEATRICE	10107 E 80TH ST	094622215	2001	INDIVIDUAL PERSONAL PROPERTY	WELSH HAROLD E & DENISE (THOMP)	NO ADDRESS PROVIDED BY TAXPAYER
094024656	2021	INDIVIDUAL PERSONAL PROPERTY	FISCUS MICHAEL J & MARY ANN	11044 E 53RD TER	094789539	2021	INDIVIDUAL PERSONAL PROPERTY	SMITH LISA MICHELLE	7301 HARVARD AVE
094028155	2021	INDIVIDUAL PERSONAL PROPERTY	ST CLAIR JAMES A & EVELYN E (ANDERSON)	10605 E 78TH TER	094881359	2006-2007	INDIVIDUAL PERSONAL PROPERTY	CARSON ROYCE	8704 ARLINGTON AVE
094029466	2020-2021	INDIVIDUAL PERSONAL PROPERTY	GROOMS LORI M	10809 LEWIS AVE	094883178	2019-2021	INDIVIDUAL PERSONAL PROPERTY	QUINN RICHARD F	9909 E 77TH TER
094033150	2010-2012	INDIVIDUAL PERSONAL PROPERTY	MENDENHALL DANIEL V	5621 STERLING AVE	094889373	2001-2003	INDIVIDUAL PERSONAL PROPERTY	COOPER NICOLE D	NO ADDRESS PROVIDED BY TAXPAYER
094034555	2021	INDIVIDUAL PERSONAL PROPERTY	YODER JAMES L & SANDRA	8833 E 57TH ST	094889693	2021	INDIVIDUAL PERSONAL PROPERTY	JACKSON JAMES H & AMY A	6117 ELM AVE
094036194	2021	INDIVIDUAL PERSONAL PROPERTY	BEITLING JENNIFER L	10627 E 56TH ST	094889724	2008	INDIVIDUAL PERSONAL PROPERTY	PETREE REBECCA A	5703 HUNTER ST
094037465	2008-2009	INDIVIDUAL PERSONAL PROPERTY	PHELPS WILLIAM C & MARY S GAILEY	5420 BLUE RIDGE CUT OFF APT 204	094889977	2015-2019	INDIVIDUAL PERSONAL PROPERTY	RIGGS WILLIAM E	5311 MAYWOOD AVE
094038142	2020-2021	INDIVIDUAL PERSONAL PROPERTY	BURKE GASET E	11415 E 58TH TER	094889995	2021	INDIVIDUAL PERSONAL PROPERTY	HUBBARD CHERIE L	8514 CRESCENT AVE
094039151	2021	INDIVIDUAL PERSONAL PROPERTY	HERBERT TIMOTHY R	5420 BLUE RIDGE CUT OFF APT G02	094892182	2010-2017	INDIVIDUAL PERSONAL PROPERTY	YOUNG VALARIE (HARRIS)	11305 E 62ND ST

094894445	2012	INDIVIDUAL PERSONAL PROPERTY	MATTHEWS CHANDRA	6301 HARRIS AVE	094966874	2006-2007	INDIVIDUAL PERSONAL PROPERTY	MOORE MCDOLE	6117 DITZLER AVE
094895838	2021	INDIVIDUAL PERSONAL PROPERTY	INGRAM TEISHA C	9010 E 74TH TER	094967292	2016-2017	INDIVIDUAL PERSONAL PROPERTY	STILLWELL CLIFFORD E	10300 E 69TH TER
094896229	2021	INDIVIDUAL PERSONAL PROPERTY	BEAVER JASON C	7204 WILLOW AVE	094969245	2008	INDIVIDUAL PERSONAL PROPERTY	FULLER RICHARD JR	6503 BLUE RIDGE CUT OFF
094897059	2015-2017	INDIVIDUAL PERSONAL PROPERTY	BOWEN CHRISTOPHER M	6509 WILLOW AVE	094970026	2021	INDIVIDUAL PERSONAL PROPERTY	BOX LORI M	5943 RAYTOWN RD UNIT E
094898574	2016	INDIVIDUAL PERSONAL PROPERTY	HASTON TERRY W	7000 HUNTER ST	094972554	2004-2007	INDIVIDUAL PERSONAL PROPERTY	GILLIANS RODNEY M JR	7324 HARDY AVE
094898641	2003-2009	INDIVIDUAL PERSONAL PROPERTY	LATTIN RONNIE	9001 RICHARDS DR	094974626	2021	INDIVIDUAL PERSONAL PROPERTY	EDWARDS MICHELE L	6200 WOODSON RD
094898695	2018-2019	INDIVIDUAL PERSONAL PROPERTY	GROUNDS OTTIS V JR	10501 E 65TH ST	094975459	2013-2017	INDIVIDUAL PERSONAL PROPERTY	BROWN TAMELA Y	5500 WILLOW AVE
094899169	2002-2007	INDIVIDUAL PERSONAL PROPERTY	GREEN CYNTHIA KAY	7328 WILLOW AVE	094976625	2021	INDIVIDUAL PERSONAL PROPERTY	DEASON ROBERT L	6703 HARRIS AVE
094908082	2006-2007	INDIVIDUAL PERSONAL PROPERTY	COOK LAWANDA M	8466 LANE DR	094976944	2001-2003	INDIVIDUAL PERSONAL PROPERTY	MARTIN PONSER R & MARIA R	NO ADDRESS PROVIDED BY TAXPAYER
094909490	2010-2017	INDIVIDUAL PERSONAL PROPERTY	MUNFORD JACK R & PAMELA	9409 E 81ST ST	094978761	2020-2021	INDIVIDUAL PERSONAL PROPERTY	JONES DWIGHT B	6140 RAYTOWN RD APT 702
094909555	2004	INDIVIDUAL PERSONAL PROPERTY	REFFETT JOHN J & PHYLLIS	NO ADDRESS PROVIDED BY TAXPAYER	094980256	2002-2017	INDIVIDUAL PERSONAL PROPERTY	DAVIDSON TODD & GORDON	NO ADDRESS PROVIDED BY TAXPAYER
094909672	2007	INDIVIDUAL PERSONAL PROPERTY	HOGAN - MCCALL BRENDA S	8300 BOOTH AVE	094981438	2015	INDIVIDUAL PERSONAL PROPERTY	RICE CHARLETTA	7708 IRWIN RD
094911617	2021	INDIVIDUAL PERSONAL PROPERTY	SCOTT TAWONIA L	9916 E 85TH ST	094981537	2021	INDIVIDUAL PERSONAL PROPERTY	CLEMMONS NICOLE R	8809 E 59TH ST
094912319	2006-2007	INDIVIDUAL PERSONAL PROPERTY	STRICKLAND BRIAN	9410 E 81ST TER	095000046	2015	INDIVIDUAL PERSONAL PROPERTY	CRANMORE DONALD REX & MELINDA A	9704 E 81ST ST
094912337	2021	INDIVIDUAL PERSONAL PROPERTY	BRIGGS KEVIN PATRICK	6340 HARRIS AVE	095000204	2001	INDIVIDUAL PERSONAL PROPERTY	TILLMAN SHOMARI	NO ADDRESS PROVIDED BY TAXPAYER
094912523	2021	INDIVIDUAL PERSONAL PROPERTY	GIBSON SEAN D	8529 MASSAR AVE	095000234	2005-2007	INDIVIDUAL PERSONAL PROPERTY	MEYER CHARLES R & SCHERYL	5901 BLUE RIDGE BLVD
094915021	2012-2017	INDIVIDUAL PERSONAL PROPERTY	CONWAY KEVIN	9413 E 68TH TER	095000480	2006	INDIVIDUAL PERSONAL PROPERTY	NEEL JARED	9024 E 73RD ST
094915040	2021	INDIVIDUAL PERSONAL PROPERTY	MURPHY KIM T	8809 E 84TH ST	095000946	2021	INDIVIDUAL PERSONAL PROPERTY	JOHNSON RANDY STEVEN	8928 E 59TH ST
094915066	2021	INDIVIDUAL PERSONAL PROPERTY	MCMILLAN BARBARA J	5525 RALSTON AVE	095000979	2002-2005	INDIVIDUAL PERSONAL PROPERTY	HOWELL SONIA PEARLANE	12719 E 47TH TERRACE CT
094920380	2009-2010	INDIVIDUAL PERSONAL PROPERTY	ROBINSON SHARON D	8223 WOODSON DR	095001644	2015-2017	INDIVIDUAL PERSONAL PROPERTY	DEMEKE JOHN F	6647 RAYTOWN RD APT 2
094921421	2016	INDIVIDUAL PERSONAL PROPERTY	HALL STACEY E	5721 HUNTER ST	095001685	2009-2014	INDIVIDUAL PERSONAL PROPERTY	GEEDING KENNETH J	7608 ELM ST
094927218	2007-2009	INDIVIDUAL PERSONAL PROPERTY	MANLOVE KATHERINE DAYTON) & HAROLD J SR	11600 E 60TH ST	095001789	2018-2020	INDIVIDUAL PERSONAL PROPERTY	DAVIDSON MICHELLE LEE	11026 E 53RD TER
094929243	2018-2021	INDIVIDUAL PERSONAL PROPERTY	KEMP CHERRIE N	9223 E 54TH TER	095002127	2021	INDIVIDUAL PERSONAL PROPERTY	MATLOCK JAMIE & GRACHECK TAMMY	8206 E 83RD ST
094943262	2021	INDIVIDUAL PERSONAL PROPERTY	WAKILI JEROME & JEMILA GARBA-WAKILI	5722 STERLING AVE	095002159	2009-2012	INDIVIDUAL PERSONAL PROPERTY	ADAMS DARON T	11601 E 60TH TER
094950869	2008	INDIVIDUAL PERSONAL PROPERTY	LEWIS NANCY MAE	8720 E 61ST ST	095002543	2013	INDIVIDUAL PERSONAL PROPERTY	HOLLEY DEANNA M	5420 BLUE RIDGE CUT OFF APT 101
094950960	2018-2019	INDIVIDUAL PERSONAL PROPERTY	STONE CHRISTIE	5188 FARLEY AVE	095005252	2006-2016	INDIVIDUAL PERSONAL PROPERTY	SHEETS LAWRENCE & PATRICIA J	1118 WILLOW WAY
094950984	2006-2007	INDIVIDUAL PERSONAL PROPERTY	FRY CAROLYN	9901 E 81ST TER	095006494	2003-2017	INDIVIDUAL PERSONAL PROPERTY	STRICKLAND ANTONIO	6604 HARVARD AVE
094951012	2001	INDIVIDUAL PERSONAL PROPERTY	STOREY NATALIE	NO ADDRESS PROVIDED BY TAXPAYER	095007201	2014-2020	INDIVIDUAL PERSONAL PROPERTY	TILLMAN-HUGHEY JOI A	11209 E 75TH ST
094951044	2001-2002	INDIVIDUAL PERSONAL PROPERTY	PARIS PAMELA S	UNKNOWN	095008857	2019	INDIVIDUAL PERSONAL PROPERTY	JOHNSON CURLEY JR	8431 ARLINGTON AVE
094951323	2007-2008	INDIVIDUAL PERSONAL PROPERTY	HUANGAL SANDRA	8813 E 81ST ST	095009217	2021	INDIVIDUAL PERSONAL PROPERTY	MERCER SHELLY R	6046 E 125TH ST APT 3
094951694	2021	INDIVIDUAL PERSONAL PROPERTY	LUGENBEEL CURTIS A & ALCIA K	8621 W UTOPIA DR APT 15	095009459	2019-2021	INDIVIDUAL PERSONAL PROPERTY	JONES FRANKLIN D SR	10512 E 72ND ST
094951921	2001	INDIVIDUAL PERSONAL PROPERTY	WILLIAMS SCOTT M	10116 E 83RD ST	095009748	2021	INDIVIDUAL PERSONAL PROPERTY	DOWNTON HOWARD	8409 HARRIS AVE
094951979	2001-2003	INDIVIDUAL PERSONAL PROPERTY	MARTIN SHARYN E	NO ADDRESS PROVIDED BY TAXPAYER	095010622	2006-2007	INDIVIDUAL PERSONAL PROPERTY	SMITH GAIL DELORES	8808 CRYSTAL LN APT 101
094952784	2005	INDIVIDUAL PERSONAL PROPERTY	EICHMAN JOSEPH E & STACY	6700 APPLETON AVE	095011028	2005	INDIVIDUAL PERSONAL PROPERTY	PERRINE LYNETTE	505 NE BROOKWOOD CIR UNIT B
094952823	2003	INDIVIDUAL PERSONAL PROPERTY	HANSON MARTIN GARTZ JR	UNKNOWN	095012419	2016-2017	INDIVIDUAL PERSONAL PROPERTY	WILLIAMS ANNA LAURA	540 HARDY AVE
094952869	2001	INDIVIDUAL PERSONAL PROPERTY	EMERY TAMMY MARIE	UNKNOWN	095012490	2011-2015	INDIVIDUAL PERSONAL PROPERTY	CHOLAK DONNA L	NO ADDRESS PROVIDED BY TAXPAYER
094953307	2021	INDIVIDUAL PERSONAL PROPERTY	LOVE BERNARD G	7155 CRISP AVE	095014433	2021	INDIVIDUAL PERSONAL PROPERTY	FRASER JOSEPH & ELIZABETH	8204 ELM AVE
094953856	2006-2015	INDIVIDUAL PERSONAL PROPERTY	MORRIS DENNIS W	9712 E 66TH TER	095014661	2021	INDIVIDUAL PERSONAL PROPERTY	KOEHLER DAVID W II & JENNIFER LYNN	6012 CLAREMONT AVE
094953890	2021	INDIVIDUAL PERSONAL PROPERTY	HUGH BRENT	5916 ARLINGTON AVE	095015847	2021	INDIVIDUAL PERSONAL PROPERTY	MAY ERICA L	7517 OVERTON AVE
094954051	2015	INDIVIDUAL PERSONAL PROPERTY	AUSTIN RUBY E & THEODORE R	9314 E 84TH TER	095021079	2005	INDIVIDUAL PERSONAL PROPERTY	TUCKER JOSEPH C	NO ADDRESS PROVIDED BY TAXPAYER
094954204	2017-2018	INDIVIDUAL PERSONAL PROPERTY	LIDDELL MICHAEL	6553 RAYTOWN RD APT 1	095021325	2004-2005	INDIVIDUAL PERSONAL PROPERTY	WELSH JAMES E JR	10501 E 56TH ST
094954496	2019-2021	INDIVIDUAL PERSONAL PROPERTY	GRIGSBY MELISSA & KENNETH JR	6518 STERLING AVE	095023001	2021	INDIVIDUAL PERSONAL PROPERTY	THURMAN TERESE YVETTE	9017 E 74TH TER
094954761	2012-2013	INDIVIDUAL PERSONAL PROPERTY	GASTON LATRISHA Y	1604 E 40TH ST	095023306	2007	INDIVIDUAL PERSONAL PROPERTY	(BARTLETT) HESS JENNIFER	7404 HEDGES AVE
094954857	2006-2011	INDIVIDUAL PERSONAL PROPERTY	LUNGREN JONI	5552 BLUE RIDGE BLVD	095026146	2019	INDIVIDUAL PERSONAL PROPERTY	MATTSON VICKI L	8008 DITZLER AVE
094954964	2021	INDIVIDUAL PERSONAL PROPERTY	MEYERS ROLAND N	9809 E 79TH PL	095027696	2016-2018	INDIVIDUAL PERSONAL PROPERTY	MASSE KENNETH G	10408 E 69TH ST
094955347	2020-2021	INDIVIDUAL PERSONAL PROPERTY	BLAZEK KAREN	7518 ELM ST	095030536	2021	INDIVIDUAL PERSONAL PROPERTY	ARNOLD JASON W	8307 E 85TH ST
094956616	2021	INDIVIDUAL PERSONAL PROPERTY	ROUSE MYRON E & JOANN	6120 DITZLER AVE	095030575	2008	INDIVIDUAL PERSONAL PROPERTY	WRIGHT DACIA L	7834 HARDY AVE
094957267	2004-2005	INDIVIDUAL PERSONAL PROPERTY	COMBS CANDICE	NO ADDRESS PROVIDED BY TAXPAYER	095031667	2019-2021	INDIVIDUAL PERSONAL PROPERTY	KRIESEL DANIEL L & LINDA	7876 WOODSON CIR
094958061	2019-2021	INDIVIDUAL PERSONAL PROPERTY	BRUCE OJIA H	9317 E 84TH ST	095032580	2009-2011	INDIVIDUAL PERSONAL PROPERTY	FERGUSON LARRY	10019 E 63RD TER
094958095	2017	INDIVIDUAL PERSONAL PROPERTY	CAIN WILLIAMS RITA	8504 ELM AVE UNIT B	095033186	2021	INDIVIDUAL PERSONAL PROPERTY	LOPEZ FRANK G & JEANETTE S	11319 E 72ND ST
094958219	2007-2015	INDIVIDUAL PERSONAL PROPERTY	HARDIMAN THOMAS GENE	8925 E 81ST ST	095033715	2014-2015	INDIVIDUAL PERSONAL PROPERTY	MAYHEW TERESA M	6821 CRISP AVE
094958259	2006	INDIVIDUAL PERSONAL PROPERTY	RICHARDS GERALDINE	9201 VAUGHN AVE	095033722	2020-2021	INDIVIDUAL PERSONAL PROPERTY	GARLINGTON DERRICK EUGENE	6501 ARLINGTON AVE
094959061	1998-2007	INDIVIDUAL PERSONAL PROPERTY	THORP PATTY	NO ADDRESS PROVIDED BY TAXPAYER	095035525	1999	INDIVIDUAL PERSONAL PROPERTY	BARKINS ROBERT	NO ADDRESS PROVIDED BY TAXPAYER
094959081	2011	INDIVIDUAL PERSONAL PROPERTY	COMBS ERIN & CHRISTINA	8905 E 75TH ST	095035594	2005	INDIVIDUAL PERSONAL PROPERTY	SIMORTE DEBORAH LYNN	NO ADDRESS PROVIDED BY TAXPAYER
094959143	2004-2006	INDIVIDUAL PERSONAL PROPERTY	MCNEILL NINA FRANCES	10414 E 81ST TER	095035768	2006-2007	INDIVIDUAL PERSONAL PROPERTY	RYAN BETTY J	9312 E 70TH TER
094959161	2003-2008	INDIVIDUAL PERSONAL PROPERTY	BRYAN STACY J	9100 E 84TH ST	095036003	2004	INDIVIDUAL PERSONAL PROPERTY	PEARSON DONNA	NO ADDRESS PROVIDED BY TAXPAYER
094959185	2021	INDIVIDUAL PERSONAL PROPERTY	HALL THEODORE DANIEL	11212 E 71ST ST	095036045	2017-2018	INDIVIDUAL PERSONAL PROPERTY	BURNS BRUCE & RUCKER ANITA	9323 E 83RD ST
094959298	2020-2021	INDIVIDUAL PERSONAL PROPERTY	BROWN ROSILAND D	7605 HAWTHORNE AVE	095036244	2017-2021	INDIVIDUAL PERSONAL PROPERTY	COLDSNOW NATHAN M	11513 E 75TH ST
094961419	2003	INDIVIDUAL PERSONAL PROPERTY	BLAIR JANE	NO ADDRESS PROVIDED BY TAXPAYER	095036275	2012-2013	INDIVIDUAL PERSONAL PROPERTY	SIMONS DOUGLAS J	9000 E 75TH ST
094962197	2002	INDIVIDUAL PERSONAL PROPERTY	VANBIBBER RICHARD	NO ADDRESS PROVIDED BY TAXPAYER	095037732	2020-2021	INDIVIDUAL PERSONAL PROPERTY	CRAWFORD JONATHAN	10088 E 86TH TER
094962415	2021	INDIVIDUAL PERSONAL PROPERTY	MERRILL JEANNETTE & CHRIS	10815 E 58TH ST	095038395	2014-2020	INDIVIDUAL PERSONAL PROPERTY	HOWRY DUANE G	6310 RAYTOWN RD
094962639	2009-2015	INDIVIDUAL PERSONAL PROPERTY	BAGGETT JOHN C	11605 E 61ST ST	095047359	2009	INDIVIDUAL PERSONAL PROPERTY	MCFADDEN PATRICK LYNN	8614 LANE AVE APT 1
094962797	2020-2021	INDIVIDUAL PERSONAL PROPERTY	JAMES CARA M (LARKIN)	8019 HARDY AVE	095048530	2012	INDIVIDUAL PERSONAL PROPERTY	HARRINGTON THOMAS	NO ADDRESS PROVIDED BY TAXPAYER
094962908	2005	INDIVIDUAL PERSONAL PROPERTY	OLLMANN MARIA (ALUMBALUGH)	6553 RAYTOWN RD APT 18	095048536	2021	INDIVIDUAL PERSONAL PROPERTY	TURNER ANGELA D	10908 E 81ST TER
094964396	2019	INDIVIDUAL PERSONAL PROPERTY	NORRIS DEANNA	8611 E 81ST TER	095048632	2018-2021	INDIVIDUAL PERSONAL PROPERTY	FLANERY AARON	7238 WOODSON DR
094965666	2009-2011	INDIVIDUAL PERSONAL PROPERTY	ANDERSON ERIC TYREANE	8204 WOODSON DR	095048678	2021	INDIVIDUAL PERSONAL PROPERTY	SHAW AMANDA	8420 WOODSON RD
094965963	2017-2021	INDIVIDUAL PERSONAL PROPERTY	HUGHES JOHN A	9003 E GREGORY BLVD	095048711	2021	INDIVIDUAL PERSONAL PROPERTY	BELL VALERIA A	8811 E 61ST ST
094966240	2021	INDIVIDUAL PERSONAL PROPERTY	FARLEY WILLIAM D & MICHELLE	7916 ARLINGTON AVE	095048874	2006-2008	INDIVIDUAL PERSONAL PROPERTY	WILLIAMS CHARLIE D	7404 HARDY AVE
094966378	2020-2021	INDIVIDUAL PERSONAL PROPERTY	BRISTOW-FOSTER STELLA KAYE	8908 RICHARDS DR	095049238	2001	INDIVIDUAL PERSONAL PROPERTY	KEIM WILLIAM L & CHADD M	8315 MARSH AVE
094966590	2019-2020	INDIVIDUAL PERSONAL PROPERTY	GREEN CANDICE R	9109 E 55TH ST	095049628	2009	INDIVIDUAL PERSONAL PROPERTY	FRANCISCO JAMES P	8204 STERLING AVE
094966641	2012-2013	INDIVIDUAL PERSONAL PROPERTY	SHERWIN DEAN C	6907 LAUREL AVE	095049699	2004-2005	INDIVIDUAL PERSONAL PROPERTY	POE MICHAEL J	NO ADDRESS PROVIDED BY TAXPAYER
094966672	2014-2021	INDIVIDUAL PERSONAL PROPERTY	CARAWAY KEVIN AND JESSICA	5804 MANNING AVE	095049827	2004-2017	INDIVIDUAL PERSONAL PROPERTY	BROWN SANDI E	9408 E 82ND ST

095049960	2008	INDIVIDUAL PERSONAL PROPERTY	TAYLOR RALPH E	7705 RAYTOWN RD	095097546	2019	INDIVIDUAL PERSONAL PROPERTY	DICKEY RASHONDA	8809 E 61ST TER
095050003	2011-2013	INDIVIDUAL PERSONAL PROPERTY	TRIPP L D	7317 WOODSON RD	095097603	2001	INDIVIDUAL PERSONAL PROPERTY	CAPPS TWILA R	UNKNOWN
095050029	2004	INDIVIDUAL PERSONAL PROPERTY	ZARKER JACQUELINE J	NO ADDRESS PROVIDED BY TAXPAYER	095097644	2005-2007	INDIVIDUAL PERSONAL PROPERTY	ANDERSON ROOSEVELT J JOYCE	NO ADDRESS PROVIDED BY TAXPAYER
095050174	2009-2011	INDIVIDUAL PERSONAL PROPERTY	ROUTH ROBERT & VENITA KIM	7820 RIDGEWAY AVE	095097668	2017	INDIVIDUAL PERSONAL PROPERTY	BROOKS MICHAEL	8825 E 57TH ST
095050185	2008-2011	INDIVIDUAL PERSONAL PROPERTY	SIMS RENA G	9053 E 83RD ST	095097857	2020-2021	INDIVIDUAL PERSONAL PROPERTY	YATES BERNA D	6709 HUNTER ST
095050203	2021	INDIVIDUAL PERSONAL PROPERTY	BASSO ROBERT A	8910 E 74TH ST	095098074	2006	INDIVIDUAL PERSONAL PROPERTY	WILLIAMS CARL	6142 ASH CT
095050667	2021	INDIVIDUAL PERSONAL PROPERTY	BOWERSOCK CHARLOTTE R	5219 STERLING AVE	095095669	2021	INDIVIDUAL PERSONAL PROPERTY	CARNES KEVIN O	6729 STERLING AVE
095051039	2021	INDIVIDUAL PERSONAL PROPERTY	FRAZIER ROBIN L	8911 E 67TH ST APT 124	095100907	2020-2021	INDIVIDUAL PERSONAL PROPERTY	STEWART REBA B	5321 KENTUCKY AVE
095051236	2021	INDIVIDUAL PERSONAL PROPERTY	ADKINS JAMESETTA EUGENIA	1119 STERLING AVE	095102873	2021	INDIVIDUAL PERSONAL PROPERTY	DAVILA HERMAN S	11405 E 69TH ST
095051554	2017-2020	INDIVIDUAL PERSONAL PROPERTY	OGLETREE ANDREA M	5420 BLUE RIDGE CUT OFF APT 415	095104232	2006-2009	INDIVIDUAL PERSONAL PROPERTY	WALTER CHERYL L	8600 MAPLE AVE
095051590	2002	INDIVIDUAL PERSONAL PROPERTY	NGUYEN THANG H	NO ADDRESS PROVIDED BY TAXPAYER	095104234	2017-2021	INDIVIDUAL PERSONAL PROPERTY	MOSS VAVECA	8816 E 61ST ST
095051882	2007-2009	INDIVIDUAL PERSONAL PROPERTY	WILSON NAKIA D	9600 E 87TH ST	095104242	2012-2013	INDIVIDUAL PERSONAL PROPERTY	HARMS LARRY V II & MICHELLE	6604 RALSTON AVE
095051941	2008	INDIVIDUAL PERSONAL PROPERTY	SIMMON CHARLOTTE M	NO ADDRESS PROVIDED BY TAXPAYER	095104382	2013	INDIVIDUAL PERSONAL PROPERTY	LEIBER DORIS	NO ADDRESS PROVIDED BY TAXPAYER
095052360	2021	INDIVIDUAL PERSONAL PROPERTY	HORNE ROBERT L & LAURI A	9317 E 64TH TER	095104585	2004-2005	INDIVIDUAL PERSONAL PROPERTY	HEISE VERA S	NO ADDRESS PROVIDED BY TAXPAYER
095053222	2020-2021	INDIVIDUAL PERSONAL PROPERTY	MCCRAY JAMES B	6209 BLUE RIDGE CUT OFF	095110569	2021	INDIVIDUAL PERSONAL PROPERTY	ROBINSON PHYLLIS LEE	7200 WILLOW AVE
095053531	2020-2021	INDIVIDUAL PERSONAL PROPERTY	LATHROM CARRIE L	6300 HARRIS AVE	095113281	2010	INDIVIDUAL PERSONAL PROPERTY	BOIS LAVINA N	6210 HUNTER ST
095054485	2001	INDIVIDUAL PERSONAL PROPERTY	CHADWICK THELMA	NO ADDRESS PROVIDED BY TAXPAYER	095114470	2021	INDIVIDUAL PERSONAL PROPERTY	SMALL ROY L & DENISE	8802 E 73RD ST
095056390	2006	INDIVIDUAL PERSONAL PROPERTY	KING MELISSA A	NO ADDRESS PROVIDED BY TAXPAYER	095115888	2021	INDIVIDUAL PERSONAL PROPERTY	WILSON CYNTHIA & CHRISTOPHER	8212 E 83RD TER
095056430	2007-2008	INDIVIDUAL PERSONAL PROPERTY	TRUSLER MARY L	6017 KENTUCKY AVE	095116098	2007	INDIVIDUAL PERSONAL PROPERTY	JONES JENEANE ROCHELLE	1225 NE MAGNOLIA ST
095056518	2009	INDIVIDUAL PERSONAL PROPERTY	BROCK PATTY J (WILSON)	7713 RAYTOWN RD APT 10	095116898	2001	INDIVIDUAL PERSONAL PROPERTY	KRAUSS MICHELLE M	UNKNOWN
095057460	2021	INDIVIDUAL PERSONAL PROPERTY	WILSON CYNTHIA	9800 E 79TH TER	095117307	2006-2007	INDIVIDUAL PERSONAL PROPERTY	BRZUCHALSKI SUSAN D	10621 E 56TH ST
095058062	2006-2017	INDIVIDUAL PERSONAL PROPERTY	PARKER EVANGELINA	7504 EVANSTON AVE	095120615	2021	INDIVIDUAL PERSONAL PROPERTY	PARKER EDWARD T	7304 WILLOW AVE
095058178	2019-2021	INDIVIDUAL PERSONAL PROPERTY	JACKSON DANIEL C	6501 STERLING AVE	095123682	2021	INDIVIDUAL PERSONAL PROPERTY	POLLARD COSMOSIC T	6813 HAWTHORNE AVE
095058746	2001-2002	INDIVIDUAL PERSONAL PROPERTY	FURLONG PAUL N	UNKNOWN	095123696	2021	INDIVIDUAL PERSONAL PROPERTY	STEWART DANIEL & SHAUNTELL	7320 CEDAR AVE
095061688	2021	INDIVIDUAL PERSONAL PROPERTY	WILLIAMS ANGELA Y	11011 E 83RD ST	095124329	2021	INDIVIDUAL PERSONAL PROPERTY	NORTON GARY L	9800 E 60TH ST
095062225	2002-2009	INDIVIDUAL PERSONAL PROPERTY	GATZKE DEBORA A (SAVIANO)	NO ADDRESS PROVIDED BY TAXPAYER	095124331	2007-2016	INDIVIDUAL PERSONAL PROPERTY	HARSHBERGER JOSEPH D	NO ADDRESS PROVIDED BY TAXPAYER
095062354	2006-2012	INDIVIDUAL PERSONAL PROPERTY	JORDAN RICHARD J & PATRICIA	8812 E 72ND ST	095124597	2021	INDIVIDUAL PERSONAL PROPERTY	BOYD CLARENCE A JR	5529 HUNTER ST
095062382	2011-2017	INDIVIDUAL PERSONAL PROPERTY	PARRISH CHARLES E JR	8701 GLENWOOD AVE	095125064	2015-2019	INDIVIDUAL PERSONAL PROPERTY	MCINTOSH TERRI D (TOWSENDD)	1753 KANSAS AVE UNIT 5
095063018	2021	INDIVIDUAL PERSONAL PROPERTY	BURKE LEONARD & DEANNA	6114 WILLOW AVE	095125228	2021	INDIVIDUAL PERSONAL PROPERTY	DORCH CYNTHIA D	NO ADDRESS PROVIDED BY TAXPAYER
095063158	2003	INDIVIDUAL PERSONAL PROPERTY	GAROUTTE KIMBERLEE J LOOMIS	NO ADDRESS PROVIDED BY TAXPAYER	095125235	2018-2021	INDIVIDUAL PERSONAL PROPERTY	EDWARDS JANICE E & KENNETH J	7304 ELM ST
095063509	2001	INDIVIDUAL PERSONAL PROPERTY	HILL REBECCA F	NO ADDRESS PROVIDED BY TAXPAYER	095126549	2004-2010	INDIVIDUAL PERSONAL PROPERTY	DAVIS DARREN L & RENEE	10415 E 81ST TER
095063661	2013-2017	INDIVIDUAL PERSONAL PROPERTY	NGEGA EMMANUEL S	9313 E 84TH TER	095127347	2021	INDIVIDUAL PERSONAL PROPERTY	WHITE BRANDI L & DONOVAN E	11005 E 71ST TER
095063800	2021	INDIVIDUAL PERSONAL PROPERTY	JENKINS TRISHA R	6431 EVANSTON AVE	095127642	2021	INDIVIDUAL PERSONAL PROPERTY	THOMPSON CHAD M	9000 E 74TH ST
095063847	2017-2018	INDIVIDUAL PERSONAL PROPERTY	WILSON INGRID & WILSON LAMAR	6721 STERLING AVE	095127995	2021	INDIVIDUAL PERSONAL PROPERTY	CONNOR ORBUS E JR	7600 HARVARD AVE
095065116	2004-2011	INDIVIDUAL PERSONAL PROPERTY	PALMER JONATHAN T	9209 E 83RD PL	095128056	2010-2011	INDIVIDUAL PERSONAL PROPERTY	HEARD DANIEL R & MELISSA	7512 CRESCENT DR
095068648	2021	INDIVIDUAL PERSONAL PROPERTY	KIRBY JERRY PATRICK	5333 NORTHERN AVE	095131130	2017-2021	INDIVIDUAL PERSONAL PROPERTY	SINGLETON HARLAN N JR	10413 E 65TH ST
095069121	2002-2004	INDIVIDUAL PERSONAL PROPERTY	VALENTINE MELESSA	NO ADDRESS PROVIDED BY TAXPAYER	095131405	2003	INDIVIDUAL PERSONAL PROPERTY	REFFITT DEBRA K	7919 HUNTER ST
095069583	2009-2012	INDIVIDUAL PERSONAL PROPERTY	GILBERT BRENT C	10012 E 78TH ST	095132453	2009	INDIVIDUAL PERSONAL PROPERTY	RUSSELL CODY JR	5733 ASH AVE
095069751	2013	INDIVIDUAL PERSONAL PROPERTY	HINRICH'S DEAN A	444 W 12TH ST	095133217	2021	INDIVIDUAL PERSONAL PROPERTY	LANG REGINA ANN	1806 WESTRIDGE RD
095070134	2001	INDIVIDUAL PERSONAL PROPERTY	ADAMS GORDON	9801 E 61ST ST	095133700	2013	INDIVIDUAL PERSONAL PROPERTY	HENSLEY MARVIN E	5812 HEDGES AVE
095075203	2021	INDIVIDUAL PERSONAL PROPERTY	STRAWS DWAYNE & THERESA	11316 E 57TH TER	095134784	2004-2007	INDIVIDUAL PERSONAL PROPERTY	CARTWRIGHT CHRISTINA R	8606 E 83RD TER
095078621	2021	INDIVIDUAL PERSONAL PROPERTY	FRANK GREGORY E	10208 E 70TH TER	095135591	2007-2008	INDIVIDUAL PERSONAL PROPERTY	WASHINGTON KRISTIN	11012 E 72ND ST
095078813	2017-2019	INDIVIDUAL PERSONAL PROPERTY	GLUNT MARTIN D	10104 E 63RD TER	095137989	2004	INDIVIDUAL PERSONAL PROPERTY	BERNAL BRENDA JANE	5409 WILLOW AVE
095079006	2016-2021	INDIVIDUAL PERSONAL PROPERTY	REDMOND DORIS L	8407 SPRING VALLEY RD	095138291	2019	INDIVIDUAL PERSONAL PROPERTY	ABRAHAM JAMES SHANNON	8201 KENTUCKY AVE
095079098	2020	INDIVIDUAL PERSONAL PROPERTY	THOMAS SANDRA KAY	8136 DITZLER AVE	095138311	2005	INDIVIDUAL PERSONAL PROPERTY	GRAVES KEVIN	NO ADDRESS PROVIDED BY TAXPAYER
095079740	2006-2008	INDIVIDUAL PERSONAL PROPERTY	CROSDALE ROHAN M	11811 E 83RD ST	095138375	2018-2019	INDIVIDUAL PERSONAL PROPERTY	REID RONALD P	11216 E 64TH ST
095080111	2008-2010	INDIVIDUAL PERSONAL PROPERTY	FOLLEY DEBRA DIENECE	NO ADDRESS PROVIDED BY TAXPAYER	095140410	2001	INDIVIDUAL PERSONAL PROPERTY	STATHAM PAULA J BAHL	11038 E 53RD TER
095080185	2021	INDIVIDUAL PERSONAL PROPERTY	STEVENSON CURTIS T	7209 HARVARD AVE	095141235	2000-2001	INDIVIDUAL PERSONAL PROPERTY	LEWALLEN DARRELL E	9358 E 65TH ST
095084265	2016-2021	INDIVIDUAL PERSONAL PROPERTY	MORGAN SHARON K	7501 ENGLEWOOD AVE	095141926	2005-2007	INDIVIDUAL PERSONAL PROPERTY	BELEER DANIEL D	NO ADDRESS PROVIDED BY TAXPAYER
095085021	2001	INDIVIDUAL PERSONAL PROPERTY	ERISMAN JUSTIN	9603 E 79TH TER	095142158	2019-2021	INDIVIDUAL PERSONAL PROPERTY	MATHEWS ARDETH	10200 E 69TH ST
095086767	2021	INDIVIDUAL PERSONAL PROPERTY	WATSON PERTRISE A	6805 VERMONT AVE	095166657	2018	INDIVIDUAL PERSONAL PROPERTY	LOVELL CAMILLA J	5701 BLUE RIDGE CUT OFF
095089267	1999	INDIVIDUAL PERSONAL PROPERTY	CATLIN DEBORAH A	8814 E 86TH ST	095223761	2021	INDIVIDUAL PERSONAL PROPERTY	PELLETIER REBECCA S & BERNARD G	11104 E 83RD TER
095089732	2002	INDIVIDUAL PERSONAL PROPERTY	NICHOLSON DEBORAH A	10205 E 63RD TER APT A	095408927	2007-2008	INDIVIDUAL PERSONAL PROPERTY	HUMMEL JON A & BRANDIE	10420 E 56TH ST
095089956	2003	INDIVIDUAL PERSONAL PROPERTY	LAVENBARG RANDALL T	UNKNOWN	095419059	2016-2021	INDIVIDUAL PERSONAL PROPERTY	CARVER GLENN	10812 E 58TH ST
095090059	2021	INDIVIDUAL PERSONAL PROPERTY	GOODLOE TAMMY & HOOK MICHELLE	10225 E 56TH ST	095427563	2003-2004	INDIVIDUAL PERSONAL PROPERTY	HOWARD BETTY A (LEGGETT)	NO ADDRESS PROVIDED BY TAXPAYER
095090073	2012	INDIVIDUAL PERSONAL PROPERTY	CHENAULT TODD A	11604 E 56TH ST	095440951	2021	INDIVIDUAL PERSONAL PROPERTY	HALLIBURTON JAMES	8609 MAYWOOD AVE
095090111	2004	INDIVIDUAL PERSONAL PROPERTY	JONES LARRY F	9107 E 55TH ST	095573033	2021	INDIVIDUAL PERSONAL PROPERTY	JACKSON JANET E	11608 E 77TH ST
095090271	2013	INDIVIDUAL PERSONAL PROPERTY	KING INEZ	8406 SPRING VALLEY RD	095577365	2019	INDIVIDUAL PERSONAL PROPERTY	HILTNER DONALD B	7703 RAYTOWN RD APT 23
095090293	2001-2002	INDIVIDUAL PERSONAL PROPERTY	PATTERSON KENT E & LANA D	UNKNOWN	095586134	2021	INDIVIDUAL PERSONAL PROPERTY	RICHARDSON GLEN M	9808 E 126TH ST APT 1
095090308	2019-2021	INDIVIDUAL PERSONAL PROPERTY	DOWNUM KARL W	8442 LANE DR	095586229	2019-2020	INDIVIDUAL PERSONAL PROPERTY	DESSEST ROBERT F	5201 E 74TH TER
095090347	2021	INDIVIDUAL PERSONAL PROPERTY	ROBERSON SHARON D	8606 CRESCENT AVE	095586721	2009-2017	INDIVIDUAL PERSONAL PROPERTY	JOHNSON QUINCEY	8460 LANE DR
095090379	2020-2021	INDIVIDUAL PERSONAL PROPERTY	HARTER ANTHONY R	8902 E GREGORY BLVD	095596717	2007-2009	INDIVIDUAL PERSONAL PROPERTY	SHERILL DAVID J	9611 E 77TH TER
095090804	2011	INDIVIDUAL PERSONAL PROPERTY	NEWMAN KIMBERLY	8472 LANE DR	095597789	2004	INDIVIDUAL PERSONAL PROPERTY	KESSLER STEVEN R & LYNDA L	UNKNOWN
095091181	2017-2019	INDIVIDUAL PERSONAL PROPERTY	GANOTE ROBERT D	8517 WESTRIDGE RD	095597869	2006	INDIVIDUAL PERSONAL PROPERTY	BRANDON CHRISTINE	9101 E 74TH ST
095091464	2021	INDIVIDUAL PERSONAL PROPERTY	SYKES TERRY E & VICKIE L	9103 E 69TH TER	095681996	2020-2021	INDIVIDUAL PERSONAL PROPERTY	HOFFMAN TERESA MICHELLE	8406 SPRING VALLEY RD
095091489	2004	INDIVIDUAL PERSONAL PROPERTY	ROCKWELL GREGORY M	UNKNOWN	095685707	2021	INDIVIDUAL PERSONAL PROPERTY	JASS ELFRIEDE	7621 ENGLEWOOD AVE
095091750	2017-2021	INDIVIDUAL PERSONAL PROPERTY	EVERLENER THOMAS	8616 OXFORD AVE	095859375	2012	INDIVIDUAL PERSONAL PROPERTY	EMORY BENNY J	6224 HUNTER ST
095091800	2005-2009	INDIVIDUAL PERSONAL PROPERTY	WALKER DOROTHY T	5912 KENTUCKY AVE	095911375	2004	INDIVIDUAL PERSONAL PROPERTY	GARDNER RYAN J	NO ADDRESS PROVIDED BY TAXPAYER
095091934	2008-2009	INDIVIDUAL PERSONAL PROPERTY	KILBANE TAMMY R & TIM	10220 E 68TH ST	095918626	2003	INDIVIDUAL PERSONAL PROPERTY	CARTER CLARENCE JR	5633 E 39TH TER
095096993	2007-2010	INDIVIDUAL PERSONAL PROPERTY	HAWKINS DANIE (TOOMBS)	8816 E 61ST TER	095953112	2004	INDIVIDUAL PERSONAL PROPERTY	GOODE WARREN C	UNKNOWN
095097386	2016	INDIVIDUAL PERSONAL PROPERTY	WRIGHT TARSHISH D	5819 FARLEY AVE	095956461	2020-2021	INDIVIDUAL PERSONAL PROPERTY	GIBBS PHILLIP E SR	10104 E 74TH TER
095097505	2018-2021	INDIVIDUAL PERSONAL PROPERTY	MARKER JOSHUA S	6404 HARVARD AVE	095964055	2021	INDIVIDUAL PERSONAL PROPERTY	HEENAN LARRY A & PAULA	800 SW APPLE GROVE CT

095967107	2005-2006	INDIVIDUAL PERSONAL PROPERTY	GRIFFIN DAVID W	NO ADDRESS PROVIDED BY TAXPAYER	096038611	2021	INDIVIDUAL PERSONAL PROPERTY	NEWMAN DANIEL A	6140 RAYTOWN RD APT 911
095967419	2001	INDIVIDUAL PERSONAL PROPERTY	MCKINNEY LORA A	NO ADDRESS PROVIDED BY TAXPAYER	096039630	2010	INDIVIDUAL PERSONAL PROPERTY	VANN DARRICK E	8633 E UTOPIA PKWY APT 6
095974032	2005	INDIVIDUAL PERSONAL PROPERTY	SMITH ADAM C	1615 SE BROME CIR	096039654	2021	INDIVIDUAL PERSONAL PROPERTY	JOHNSON ELIZABETH ANN	6008 NORTHERN AVE
095986187	2017-2019	INDIVIDUAL PERSONAL PROPERTY	ANDERSON LLOYD REX	9705 E 67TH TER	096041043	2006-2007	INDIVIDUAL PERSONAL PROPERTY	TORRES ENRIQUE	8211 MAYWOOD AVE
096000141	2020-2021	INDIVIDUAL PERSONAL PROPERTY	BRASS JOHNNY HUBERT	8102 STERLING AVE	096041146	2006	INDIVIDUAL PERSONAL PROPERTY	MARTINEZ GABRIEL	NO ADDRESS PROVIDED BY TAXPAYER
096000177	2001	INDIVIDUAL PERSONAL PROPERTY	DIAL SUSAN A	NO ADDRESS PROVIDED BY TAXPAYER	096041574	2021	INDIVIDUAL PERSONAL PROPERTY	COWLEY PATRICK E	8614 E UTOPIA DR APT 74
096000277	2020	INDIVIDUAL PERSONAL PROPERTY	WILLIS HORTENSE (BRYANT)	5609 NE HIDDEN MEADOW CIR	096042410	2006-2007	INDIVIDUAL PERSONAL PROPERTY	DUTCHER DAWN M (BELL)	9127 RICHARDS DR
096000374	2021	INDIVIDUAL PERSONAL PROPERTY	BUSH CHARLENE RENEE	8633 E UTOPIA PKWY APT 3	096042555	2006-2007	INDIVIDUAL PERSONAL PROPERTY	POWELL GALEN & CHRISTENE E	6711 HARRIS AVE
096000618	2020-2021	INDIVIDUAL PERSONAL PROPERTY	WHITE JAMES W	7420 HARDY AVE	096044475	2010	INDIVIDUAL PERSONAL PROPERTY	ZAYAS FERMIN	8492 LANE DR APT 1
096000626	2008	INDIVIDUAL PERSONAL PROPERTY	RESTREPO ALFONSO D	8625 GREENWOOD RD	096044553	2020-2021	INDIVIDUAL PERSONAL PROPERTY	WILLARD RODNEY BERNARD	8829 E 58TH ST
096000706	2004	INDIVIDUAL PERSONAL PROPERTY	RASHAD KIM Y	NO ADDRESS PROVIDED BY TAXPAYER	096044654	2019-2021	INDIVIDUAL PERSONAL PROPERTY	HILL CAROLYN J	7036 WOODSON RD
096000750	2017-2018	INDIVIDUAL PERSONAL PROPERTY	GIBBS MARTHA N	5305 RALSTON AVE	096044726	2019	INDIVIDUAL PERSONAL PROPERTY	TATUM SHERYL R	8701 E 84TH TER
096000792	2004-2008	INDIVIDUAL PERSONAL PROPERTY	BRITT CHARLES	NO ADDRESS PROVIDED BY TAXPAYER	096044847	2021	INDIVIDUAL PERSONAL PROPERTY	JONES PATSY A	7516 WOODSON RD
096000834	2003-2005	INDIVIDUAL PERSONAL PROPERTY	KELLER LEON L & DIANA J	8511 JAMES A REED RD	096045116	2021	INDIVIDUAL PERSONAL PROPERTY	SCHNEIDER JASON M & ERIN J	7321 WOODSON RD
096000901	2021	INDIVIDUAL PERSONAL PROPERTY	MIZELL TINA M (WRIGHT)	7610 CRESCENT DR	096045269	2001	INDIVIDUAL PERSONAL PROPERTY	LEE LLOYD C	NO ADDRESS PROVIDED BY TAXPAYER
096000921	2010	INDIVIDUAL PERSONAL PROPERTY	BALLARD DAMON EUGENE	9421 E 67TH TER	096045790	2007-2009	INDIVIDUAL PERSONAL PROPERTY	PATTERSON ROBERT D	7925 MANNING AVE
096001018	2004-2005	INDIVIDUAL PERSONAL PROPERTY	GRAFF HEATHER R	9366 E 64TH TER	096045845	2004	INDIVIDUAL PERSONAL PROPERTY	DOWNING WILLIAM R	5420 BLUE RIDGE CUTOFF 211
096001267	2019-2021	INDIVIDUAL PERSONAL PROPERTY	LAMERS GARY L & WRIGHT BRADLEY S	11603 E 60TH TER	096046663	2021	INDIVIDUAL PERSONAL PROPERTY	TOOLEY CECIL G & ANGELA M	10000 E 63RD ST
096001375	2018	INDIVIDUAL PERSONAL PROPERTY	MUETZEL FORREST W	11909 E 78TH TER	096046757	2019-2021	INDIVIDUAL PERSONAL PROPERTY	HARRINGTON APRIL L	10705 E 62ND TER
096001411	2003	INDIVIDUAL PERSONAL PROPERTY	GILBORNE JOSEPH R	UNKNOWN	096047949	2013-2017	INDIVIDUAL PERSONAL PROPERTY	GARRETT ROBERT & SARAH	9001 E 57TH ST
096001570	2017	INDIVIDUAL PERSONAL PROPERTY	DAVIDSON HARRY R	8204 ASH AVE	096048572	2006-2008	INDIVIDUAL PERSONAL PROPERTY	JACKSON ANTHONY G	500 E 3RD ST
096001734	2007-2008	INDIVIDUAL PERSONAL PROPERTY	GLASGOW LAURA M	6637 MAYWOOD AVE	096049325	2002	INDIVIDUAL PERSONAL PROPERTY	PROBST CHRISTOPHER	5608 LANE AVE
096001785	2010	INDIVIDUAL PERSONAL PROPERTY	WILLIAMS KAREN SUE	6425 EVANSTON AVE	096049403	2005-2008	INDIVIDUAL PERSONAL PROPERTY	CONRAD TERESA A	7705 RAYTOWN RD
096001843	2018-2021	INDIVIDUAL PERSONAL PROPERTY	DAVIS RICHARD LEE & SUSAN	8709 E 79TH ST	096053652	2005	INDIVIDUAL PERSONAL PROPERTY	THOMPSON JACQUELINE C (BAKER)	10601 E 70TH ST
096001881	2003	INDIVIDUAL PERSONAL PROPERTY	WATSKY ELDON D	NO ADDRESS PROVIDED BY TAXPAYER	096056096	2004	INDIVIDUAL PERSONAL PROPERTY	CYPRET LEHMAN	NO ADDRESS PROVIDED BY TAXPAYER
096001937	2004	INDIVIDUAL PERSONAL PROPERTY	MCCURTER LISA L	UNKNOWN	096057296	2014-2018	INDIVIDUAL PERSONAL PROPERTY	GATES JANET L	5817 ELM AVE
096002076	2019-2021	INDIVIDUAL PERSONAL PROPERTY	HAWLEY BART P & LISA	8512 JAMES A REED RD	096057946	2014	INDIVIDUAL PERSONAL PROPERTY	PARVIN CHARLES SCOTT	6311 FARLEY AVE
096002917	2008-2010	INDIVIDUAL PERSONAL PROPERTY	SANDERS LAKEORA	10014 E 78TH TER	096058169	2021	INDIVIDUAL PERSONAL PROPERTY	HANVELT ANGELA & ERIK R	10127 56TH ST
096003367	2021	INDIVIDUAL PERSONAL PROPERTY	BUTLER CHRISTINA A	9505 E 77TH ST	096058198	2019-2020	INDIVIDUAL PERSONAL PROPERTY	BREWER GIBRAN R	4917 APPLETON AVE
096003702	2017-2021	INDIVIDUAL PERSONAL PROPERTY	OLVERA LISA M	9708 E 65TH TER	096058906	2011-2012	INDIVIDUAL PERSONAL PROPERTY	KEARNEY DAVID III & MELISSA	9001 E 66TH TER
096003718	2019-2020	INDIVIDUAL PERSONAL PROPERTY	GUNION ROBERT W JR	7431 OVERTON AVE UNIT 7	096058911	1999	INDIVIDUAL PERSONAL PROPERTY	RENO BRIAN W	NO ADDRESS PROVIDED BY TAXPAYER
096003962	2021	INDIVIDUAL PERSONAL PROPERTY	PARKER PAMELA M	5420 BLUE RIDGE CUT OFF APT 405	096058991	2000-2011	INDIVIDUAL PERSONAL PROPERTY	JOHNSON PATRICIA A	8717 E 61ST TER APT 1
096004099	2014-2019	INDIVIDUAL PERSONAL PROPERTY	NGUYEN NINH KHAC	6706 E 17TH ST	096059077	2013-2014	INDIVIDUAL PERSONAL PROPERTY	HOLMES MELANIE	9612 E 66TH ST
096004147	2021	INDIVIDUAL PERSONAL PROPERTY	BARTLEY ANTONIO M	7232 RAYTOWN RD APT C	096059945	2008-2011	INDIVIDUAL PERSONAL PROPERTY	OCNONOR EDWARD T	5636 STERLING AVE
096006655	2002	INDIVIDUAL PERSONAL PROPERTY	POTTER LYNN	10113 E 79TH TER	096064437	2020-2021	INDIVIDUAL PERSONAL PROPERTY	BOUWIE TABITHA R	7508 APPLETON AVE
096006807	2018-2021	INDIVIDUAL PERSONAL PROPERTY	BOYD WYLENA LUCILLE	9000 E 57TH ST	096064511	2005	INDIVIDUAL PERSONAL PROPERTY	MOZEE DOROTHY H	NO ADDRESS PROVIDED BY TAXPAYER
096006942	2021	INDIVIDUAL PERSONAL PROPERTY	GONZALEZ ROSALIA	10500 E 79TH ST	096064632	2021	INDIVIDUAL PERSONAL PROPERTY	MEEKES TAWONIA L (BURRELL)	9903 E 60TH ST
096007238	2019	INDIVIDUAL PERSONAL PROPERTY	PETERSON FARLEY ALBERT	10404 E 69TH ST	096065014	2021	INDIVIDUAL PERSONAL PROPERTY	WELLS LAMONT T	5504 HARRIS AVE
096007731	2012-2017	INDIVIDUAL PERSONAL PROPERTY	SMITH OLIVIA D	5414 DITZLER AVE	096065258	2021	INDIVIDUAL PERSONAL PROPERTY	TANKERSLEY MICHAEL K	18085 E 64TH TER
096008039	2020-2021	INDIVIDUAL PERSONAL PROPERTY	JOHNSON TIMOTHY K	5715 MANNING AVE	096066339	2017	INDIVIDUAL PERSONAL PROPERTY	BOGGS TABATHA L	11821 E 83RD ST APT 102
096008258	2020	INDIVIDUAL PERSONAL PROPERTY	BROWN VEOLA R	6817 HUNTER ST UNIT A	096073080	2020-2021	INDIVIDUAL PERSONAL PROPERTY	TUCKER MARCELLA L	7724 IRWIN RD
096008750	2021	INDIVIDUAL PERSONAL PROPERTY	DANIEL DOROTHY M	5121 WESTRIDGE CIR	096074052	2021	INDIVIDUAL PERSONAL PROPERTY	BOTTORFF ARIEL	9216 E 54TH TER
096010806	2020-2021	INDIVIDUAL PERSONAL PROPERTY	BANKS ANTHONY D	9104 E 72ND TER	096074290	2020-2021	INDIVIDUAL PERSONAL PROPERTY	OWENS RONNIE LEE	5816 NORTHERN AVE
096013511	2021	INDIVIDUAL PERSONAL PROPERTY	SMITH BRIAN D	5601 STERLING AVE	096074930	2010-2011	INDIVIDUAL PERSONAL PROPERTY	MOORE KIRSTEN M	7705 RAYTOWN RD
096013710	2001	INDIVIDUAL PERSONAL PROPERTY	MONCRIEF GLORIA S	UNKNOWN	096075304	2018-2019	INDIVIDUAL PERSONAL PROPERTY	PERRY LESLIE MEREDITH (LOUIS)	8419 WOODSON DR
096013817	2019-2021	INDIVIDUAL PERSONAL PROPERTY	EDMOND ELIE & KELLY CHRISTOPHER MICHAEL	5235 BLUE RIDGE BLVD	096075350	2021	INDIVIDUAL PERSONAL PROPERTY	FOWLER CHRYSTEL	5712 MAYWOOD AVE
096014385	2021	INDIVIDUAL PERSONAL PROPERTY	CADY STEVE C	10315 E 70TH TER	096075444	2012-2013	INDIVIDUAL PERSONAL PROPERTY	KING ROBERT P	9016 E 59TH ST
096014454	2002	INDIVIDUAL PERSONAL PROPERTY	BENDURE GENE L	NO ADDRESS PROVIDED BY TAXPAYER	096075797	2016	INDIVIDUAL PERSONAL PROPERTY	BROWN KAREN A	7516 CRESCENT DR
096014526	2016-2019	INDIVIDUAL PERSONAL PROPERTY	KERMER RICHARD K JR & AMY L	8611 E 83RD TER	096075974	2007-2009	INDIVIDUAL PERSONAL PROPERTY	JACQUES ROBERT C	11209 E 53RD TER
096015064	2004	INDIVIDUAL PERSONAL PROPERTY	WILLIS KATHIE ANN	6725 HAWTHORNE AVE	096076145	2017-2021	INDIVIDUAL PERSONAL PROPERTY	DAWSON CHARLA ROBERTS & SAMUEL GERD	6800 HAWTHORNE AVE
096015758	2016	INDIVIDUAL PERSONAL PROPERTY	PENN NARVIS L	13926 E 49TH TER APT K	096076190	2017	INDIVIDUAL PERSONAL PROPERTY	EDMISTEN ELLIE	10405 E 69TH TER
096015861	2021	INDIVIDUAL PERSONAL PROPERTY	LOGAN STEVEN	7903 HEDGES AVE	096076223	2012-2015	INDIVIDUAL PERSONAL PROPERTY	BAKER TIM J	8217 HARRIS AVE
096016217	2001	INDIVIDUAL PERSONAL PROPERTY	MORRIS FRANK A	NO ADDRESS PROVIDED BY TAXPAYER	096076967	2021	INDIVIDUAL PERSONAL PROPERTY	ROBINSON PATRICIA A	7221 RAYTOWN RD
096016431	2003	INDIVIDUAL PERSONAL PROPERTY	BREWER HELEN	UNKNOWN	096077489	2007	INDIVIDUAL PERSONAL PROPERTY	BRASHEARS ANDREA	9305 E 80TH TER
096016748	2004-2010	INDIVIDUAL PERSONAL PROPERTY	PIKE SUSAN	9177 RICE AVE	096077586	2021	INDIVIDUAL PERSONAL PROPERTY	GREIFE TODD A	6521 HARDY AVE
096017285	2002	INDIVIDUAL PERSONAL PROPERTY	BLAKE LAVON L	7054 LAKESHORE DR	096078653	2021	INDIVIDUAL PERSONAL PROPERTY	GREEN DANIEL D & STACY R	9712 E 69TH ST
096017640	2003-2005	INDIVIDUAL PERSONAL PROPERTY	STEPHENSON CARLA L	7140 E 69TH TER	096078654	2021	INDIVIDUAL PERSONAL PROPERTY	WASHINGTON DARNELL S	11903 E 85TH ST
096022843	2020-2021	INDIVIDUAL PERSONAL PROPERTY	LEIBER STEVEN D	11272 E 71ST DR	096079046	2020-2021	INDIVIDUAL PERSONAL PROPERTY	HARDIMAN SHANEKA (MOORE)	6015 FARLEY AVE
096022876	2003	INDIVIDUAL PERSONAL PROPERTY	WOODY AARON L	UNKNOWN	096079054	2021	INDIVIDUAL PERSONAL PROPERTY	EAGLE MICHELE RENE	8520 HARVARD TER
096022899	2021	INDIVIDUAL PERSONAL PROPERTY	COMMACK YOLANDA	8330 OXFORD AVE	096079097	2009	INDIVIDUAL PERSONAL PROPERTY	PETERS JAMES M	9708 E 83RD ST
096024321	2021	INDIVIDUAL PERSONAL PROPERTY	YATES JERALD A	7316 ASH AVE	096079140	2021	INDIVIDUAL PERSONAL PROPERTY	BURROFF PHILIP STEVEN	7705 RAYTOWN RD
096027083	2004	INDIVIDUAL PERSONAL PROPERTY	BERRY JILL	7915 HEDGES	096079149	2019-2021	INDIVIDUAL PERSONAL PROPERTY	ALLEN WILLIE L JR	10111 E 69TH TER
096027273	2020-2021	INDIVIDUAL PERSONAL PROPERTY	STUART TODD L	7511 HAWTHORNE AVE	096079351	2005-2007	INDIVIDUAL PERSONAL PROPERTY	PACE ANTHONY P	9401 E 63RD ST APT 10
096027903	2021	INDIVIDUAL PERSONAL PROPERTY	JACKSON PATSY A	11800 E 78TH PL	096079355	2000	INDIVIDUAL PERSONAL PROPERTY	ANDERSON DAVID W	UNKNOWN
096028388	2020-2021	INDIVIDUAL PERSONAL PROPERTY	BUTLER SHANNON R	6345 BLUE RIDGE BLVD	096079402	2020	INDIVIDUAL PERSONAL PROPERTY	GOINES BRIAN VILDEZ SR	7301 HARDY AVE
096028701	2020-2021	INDIVIDUAL PERSONAL PROPERTY	GIDDENS EARL	11405 E 78TH TER	096079476	2006-2013	INDIVIDUAL PERSONAL PROPERTY	STODDARD ANGIE M	8607 E 83RD ST
096028751	2021	INDIVIDUAL PERSONAL PROPERTY	JONES HEATHER A (WRIGHT)	8601 FORD AVE	096079602	2020-2021	INDIVIDUAL PERSONAL PROPERTY	MANLEY TERESA JEAN	9812 E 69TH ST
096029016	2021	INDIVIDUAL PERSONAL PROPERTY	ALEXANDER EUGENE C & JAIME M	8408 E 85TH TER	096079897	2005-2007	INDIVIDUAL PERSONAL PROPERTY	NICHOLSON AARON F	NO ADDRESS PROVIDED BY TAXPAYER
096029719	2010-2012	INDIVIDUAL PERSONAL PROPERTY	DOBROW KATHERINE A	8420 PERSHING RD	096079910	2005	INDIVIDUAL PERSONAL PROPERTY	DICKSON MARIAN S	10205 E 63RD ST
096030073	2000-2004	INDIVIDUAL PERSONAL PROPERTY	HUMPHREY DAVID ALAN	NO ADDRESS PROVIDED BY TAXPAYER	096079979	2002-2004	INDIVIDUAL PERSONAL PROPERTY	LULL NORMA ELAINE	UNKNOWN
096032209	2004-2005	INDIVIDUAL PERSONAL PROPERTY	WEED DEBORAH	NO ADDRESS PROVIDED BY TAXPAYER	096080006	2021	INDIVIDUAL PERSONAL PROPERTY	ESTRADA SIMON THOMAS	6825 RAYTOWN RD
096036693	2001	INDIVIDUAL PERSONAL PROPERTY	CLARK PATRICK DURELL	8311 STERLING	096080264	2021	INDIVIDUAL PERSONAL PROPERTY	WILLIAMS CLARISSA A	12211 E 68TH ST

096081275	2002-2008	INDIVIDUAL PERSONAL PROPERTY	RITTER RICHARD G & SHERRIE	9112 E 84TH ST	096135166	2003	INDIVIDUAL PERSONAL PROPERTY	BREWER JOHN ROBERT	UNKNOWN
096084207	2002-2005	INDIVIDUAL PERSONAL PROPERTY	QUILLEN RONALD F	NO ADDRESS PROVIDED BY TAXPAYER	096135626	2018-2021	INDIVIDUAL PERSONAL PROPERTY	CHILDS STACY R	11604 E 61ST ST
096084315	2021	INDIVIDUAL PERSONAL PROPERTY	WILLIAMS KEIVELA L TARKINGTON	7625 STERLING AVE	096135688	2001-2002	INDIVIDUAL PERSONAL PROPERTY	TAUSCH HAROLD W	UNKNOWN
096084354	2019-2021	INDIVIDUAL PERSONAL PROPERTY	LATHROP TIM A & CYNTHIA B	10805 E 65TH ST	096136005	2003-2005	INDIVIDUAL PERSONAL PROPERTY	GLENN OSBORN	9612 E 68TH ST
096084489	2008-2015	INDIVIDUAL PERSONAL PROPERTY	FOX PHILIP MICHAEL	NO ADDRESS PROVIDED BY TAXPAYER	096136038	2008-2012	INDIVIDUAL PERSONAL PROPERTY	BURCH KEVIN & KRISTINA	10008 E 69TH TER
096084500	2002	INDIVIDUAL PERSONAL PROPERTY	EGGLESTON OWEN L	NO ADDRESS PROVIDED BY TAXPAYER	096136810	2013-2015	INDIVIDUAL PERSONAL PROPERTY	KAPPLER KATHRYN A	5812 ASH AVE
096084612	2020-2021	INDIVIDUAL PERSONAL PROPERTY	MEADE THOMAS R	10008 E 72ND ST	096136977	2021	INDIVIDUAL PERSONAL PROPERTY	BUTENES SAMANTHA L	10334 E 63RD ST APT 2
096084910	2001-2002	INDIVIDUAL PERSONAL PROPERTY	ALLDAFFER RACHEL C	UNKNOWN	096137077	2021	INDIVIDUAL PERSONAL PROPERTY	TILFORD PAUL L SR	7924 DITZLER AVE
096085039	2017-2021	INDIVIDUAL PERSONAL PROPERTY	AUTREY JAMES	6622 WILLOW AVE	096137165	2021	INDIVIDUAL PERSONAL PROPERTY	WISHUR MICHAEL & JANET	7115 EVANSTON AVE
096085071	2020-2021	INDIVIDUAL PERSONAL PROPERTY	EDWARDS LAVERNE	10207 E 63RD TER APT A	096138241	2014-2015	INDIVIDUAL PERSONAL PROPERTY	ADKINS KIMBERLY D	130 E COLLEGE AVE APT 151
096085086	2003-2004	INDIVIDUAL PERSONAL PROPERTY	ROBINS GLIN & LATONYA D	9704 E 65TH ST	096138338	2018-2021	INDIVIDUAL PERSONAL PROPERTY	RAWLINGS CARLA L	8828 E 62ND ST
096085303	2019	INDIVIDUAL PERSONAL PROPERTY	BURGESS ROBERT JAMES	6700 VERMONT AVE	096138342	2020-2021	INDIVIDUAL PERSONAL PROPERTY	HARPER NATALIE J	7420 HARDY AVE
096085529	2002-2003	INDIVIDUAL PERSONAL PROPERTY	LITTLE ROBERT M	NO ADDRESS PROVIDED BY TAXPAYER	096138445	2006-2007	INDIVIDUAL PERSONAL PROPERTY	LAESSIG VICKI RAE	6825 ENGLEWOOD AVE
096085665	2004-2010	INDIVIDUAL PERSONAL PROPERTY	HARDY ADAM J	9412 E 68TH TER	096138474	2021	INDIVIDUAL PERSONAL PROPERTY	LAESSIG VICKI RAE	8823 E 57TH ST
096087024	2000-2001	INDIVIDUAL PERSONAL PROPERTY	ROUSH MELODY	10909 E 81ST ST	096141061	2001	INDIVIDUAL PERSONAL PROPERTY	CASON AMY R	11117 E 56TH TER
096087165	2006	INDIVIDUAL PERSONAL PROPERTY	BAUER CHRISTOPHER R	NO ADDRESS PROVIDED BY TAXPAYER	096141591	2007	INDIVIDUAL PERSONAL PROPERTY	LYONS ROBERT R	7224 WOODSON RD
096087392	1998-2000	INDIVIDUAL PERSONAL PROPERTY	DADO ROCHELLE (SHELLY)	900 MONTANA RIDGE DR	096141606	2001	INDIVIDUAL PERSONAL PROPERTY	ALLEE JAYNE H	UNKNOWN
096088551	2020-2021	INDIVIDUAL PERSONAL PROPERTY	ANDERSON EDNA L	11411 E 58TH TER	096141861	2020-2021	INDIVIDUAL PERSONAL PROPERTY	WALKER JERALYNNE	5912 KENTUCKY AVE
096089410	2021	INDIVIDUAL PERSONAL PROPERTY	QUESADA MAGALY P	5911 KENTUCKY AVE	096141901	2002-2005	INDIVIDUAL PERSONAL PROPERTY	BRADLEY DAVID M	7200 ASH AVE
096089505	2019	INDIVIDUAL PERSONAL PROPERTY	WHITNEY FREDERICK L	11332 COLORADO AVE UNIT 339	096141987	2007	INDIVIDUAL PERSONAL PROPERTY	WILLIAMS RICK	11801 E 78TH TER
096089545	2021	INDIVIDUAL PERSONAL PROPERTY	POSEY DARYLE LAMAR	8324 HARVARD TER	096141992	2001	INDIVIDUAL PERSONAL PROPERTY	CHITWOOD WILLIAM G	NO ADDRESS PROVIDED BY TAXPAYER
096090542	2001-2005	INDIVIDUAL PERSONAL PROPERTY	DOWNES MICHAEL J	NO ADDRESS PROVIDED BY TAXPAYER	096142086	2008-2011	INDIVIDUAL PERSONAL PROPERTY	CAIN HEATHER (PARKER)	NO ADDRESS PROVIDED BY TAXPAYER
096090637	2001	INDIVIDUAL PERSONAL PROPERTY	CANTU HECTOR	NO ADDRESS PROVIDED BY TAXPAYER	096142347	2009-2012	INDIVIDUAL PERSONAL PROPERTY	BLUE MICHELLE DIANE	10424 E 56TH ST
096091852	2003	INDIVIDUAL PERSONAL PROPERTY	TAYLOR-TINDALL KARLA & GARY	10615 E 78TH TER	096142502	2001-2002	INDIVIDUAL PERSONAL PROPERTY	CANTWELL CANDIE	9305 E 69TH ST
096099937	2001	INDIVIDUAL PERSONAL PROPERTY	DAY KEVIN A	NO ADDRESS PROVIDED BY TAXPAYER	096142661	2009-2011	INDIVIDUAL PERSONAL PROPERTY	MCCOWAN RONNIE D	9919 E 85TH ST
096100687	2021	INDIVIDUAL PERSONAL PROPERTY	MCCOMAS KIM DENISE	9608 E 66TH TER	096142970	2020-2021	INDIVIDUAL PERSONAL PROPERTY	HUNTER DETRICE LASHAWN	7408 ENGLEWOOD LN
096101967	2017-2021	INDIVIDUAL PERSONAL PROPERTY	WEBBER MARK P	8616 E 84TH ST	096143001	2021	INDIVIDUAL PERSONAL PROPERTY	LOCKETT CHRISTOPHER M	1720 RAYTOWN RD APT C
096102828	2021	INDIVIDUAL PERSONAL PROPERTY	TANN KYLE & CHRISTINA	7724 CRISP AVE	096143226	2021	INDIVIDUAL PERSONAL PROPERTY	BOYD LATREASE L	8618 OXFORD AVE
096102844	2008-2010	INDIVIDUAL PERSONAL PROPERTY	MCHENRY MIKE E	11305 E 67TH ST	096143283	2021	INDIVIDUAL PERSONAL PROPERTY	GORENFLO MICHELLE R	8615 E 87TH ST
096103685	2008	INDIVIDUAL PERSONAL PROPERTY	HATFIELD ALECIA K	NO ADDRESS PROVIDED BY TAXPAYER	096143793	2021	INDIVIDUAL PERSONAL PROPERTY	SMALLS JEANNA	8616 E UTOPIA DR APT 54
096103917	2005-2006	INDIVIDUAL PERSONAL PROPERTY	STEINLEY GANE D & SANDRINA (BOULDIN)	NO ADDRESS PROVIDED BY TAXPAYER	096145124	2003	INDIVIDUAL PERSONAL PROPERTY	MCCULLOUGH JAMES M	UNKNOWN
096104136	2017-2020	INDIVIDUAL PERSONAL PROPERTY	FILLMORE KERLEE A (WOHLER)	9307 E 80TH ST	096145190	2021	INDIVIDUAL PERSONAL PROPERTY	WILSON BEVERLEY S	5420 BLUE RIDGE CUT OFF APT 711
096104233	2021	INDIVIDUAL PERSONAL PROPERTY	ROBINSON DORIS A	8813 E 61ST TER	096145239	2006	INDIVIDUAL PERSONAL PROPERTY	FOSTER JAMES H	8200 WILLOW WAY
096104359	2001	INDIVIDUAL PERSONAL PROPERTY	RINEHOLT MELVIN P	NO ADDRESS PROVIDED BY TAXPAYER	096145254	2008-2009	INDIVIDUAL PERSONAL PROPERTY	HICKS JEFFREY B	NO ADDRESS PROVIDED BY TAXPAYER
096104389	2021	INDIVIDUAL PERSONAL PROPERTY	DINKEL WILLIAM P	11012 E 66TH TER	096145310	2019-2021	INDIVIDUAL PERSONAL PROPERTY	BRISCIANO PHILLIP III	8700 GLENWOOD AVE
096104500	2021	INDIVIDUAL PERSONAL PROPERTY	PAGE WARNELIA	8538 E 81ST TER	096145366	2017-2018	INDIVIDUAL PERSONAL PROPERTY	LEONARD MATTHEW W & JENNIFER	11016 E 56TH TER
096106283	2007	INDIVIDUAL PERSONAL PROPERTY	PACATTE DENNIS W & CHANELL (BATES)	11102 E 67TH ST	096145399	2010-2011	INDIVIDUAL PERSONAL PROPERTY	JONES LEANDREW	6005 ARLINGTON AVE
096106288	2019-2021	INDIVIDUAL PERSONAL PROPERTY	SINGLETON KENLYNN L	7900 HARDY AVE	096145462	2002	INDIVIDUAL PERSONAL PROPERTY	LYNN BRIAN S	5218 CRISP AVE
096106475	2003-2005	INDIVIDUAL PERSONAL PROPERTY	WILLARD JIMMY	10400 E 71ST TER	096145530	2021	INDIVIDUAL PERSONAL PROPERTY	DRAKE TAMEKA L	5221 WOODSON RD
096106993	2018-2021	INDIVIDUAL PERSONAL PROPERTY	SCHACKELFORD STACEY J	8902 E GREGORY BLVD	096145533	2003-2005	INDIVIDUAL PERSONAL PROPERTY	COCHRAN CHRISTIAN J	7228 CRISP AVE
096107686	2021	INDIVIDUAL PERSONAL PROPERTY	MCKINNEY CHARLETTE E	8510 FORD AVE	096145556	2002	INDIVIDUAL PERSONAL PROPERTY	VIGIL CANDICE J	10704 E 67TH ST
096110081	2008	INDIVIDUAL PERSONAL PROPERTY	MURRAY MARTHA A	11400 HIDDEN LAKE DR	096145603	2021	INDIVIDUAL PERSONAL PROPERTY	JIMENEZ GABRIEL E	11213 E 62ND ST
096110684	2001-2011	INDIVIDUAL PERSONAL PROPERTY	JOHNSON PATRICIA	8717 E 61ST TER APT 1	096303030	2005	INDIVIDUAL PERSONAL PROPERTY	FLINT ANTHONY	NO ADDRESS PROVIDED BY TAXPAYER
096112440	2020-2021	INDIVIDUAL PERSONAL PROPERTY	SALISBURY GAYLORD II	10809 LEWIS AVE	096317958	2021	INDIVIDUAL PERSONAL PROPERTY	DIETERICH DARRELL A	6311 HARRIS AVE
096115535	2001	INDIVIDUAL PERSONAL PROPERTY	ABEL WENDY	NO ADDRESS PROVIDED BY TAXPAYER	096319515	2021	INDIVIDUAL PERSONAL PROPERTY	MARTIN WILLIS TEANDRA LEVETTA	8707 E 83RD ST
096115784	2021	INDIVIDUAL PERSONAL PROPERTY	EKENGREN BENJAMIN & VALERIE	8809 E 66TH ST	096438366	2010	INDIVIDUAL PERSONAL PROPERTY	TANGBLADE JESSICA A (CAMPBELL)	8930 E 74TH ST
096115802	2013-2015	INDIVIDUAL PERSONAL PROPERTY	DILWORTH RICKY	11238 E 71ST TER	096444882	2003	INDIVIDUAL PERSONAL PROPERTY	HOWELL LISA A	5525 BLUE RIDGE BLVD
096115864	2004	INDIVIDUAL PERSONAL PROPERTY	PENCE RUSSELL L	NO ADDRESS PROVIDED BY TAXPAYER	096484447	2017-2021	INDIVIDUAL PERSONAL PROPERTY	BISHOP PATRICIA J	6008 OXFORD AVE
096116124	2009	INDIVIDUAL PERSONAL PROPERTY	HARRIS BENJAMIN T & HANNA	5625 ASH AVE	096578925	2001	INDIVIDUAL PERSONAL PROPERTY	BILYEU NEIL & ABIGAIL	7204 HARRIS AVE
096116849	2006-2008	INDIVIDUAL PERSONAL PROPERTY	GREGORY ROBIN C	9137 RICHARDS DR	096578926	2021	INDIVIDUAL PERSONAL PROPERTY	HOFFMAN RYAN C & AMY R	6201 HEDGES AVE
096116999	2021	INDIVIDUAL PERSONAL PROPERTY	BURNS SHAWNIA	6001 NORTHERN AVE	096592961	2007	INDIVIDUAL PERSONAL PROPERTY	DODD JENNIFER L	9058 E 66TH TER
096118770	2014	INDIVIDUAL PERSONAL PROPERTY	DABELSTEIN SUSAN E	7308 APPLETON AVE	096593654	2020-2021	INDIVIDUAL PERSONAL PROPERTY	WHITE LAVERNE	8306 MANNING AVE
096118812	2020-2021	INDIVIDUAL PERSONAL PROPERTY	RUNER JACK DEE	5521 HEDGES AVE	096603636	2021	INDIVIDUAL PERSONAL PROPERTY	FINDLAY JEFFERY LAMAR	9106 E 74TH ST
096119984	2021	INDIVIDUAL PERSONAL PROPERTY	BANES SCOT & CAROL	8611 STARK AVE	096604303	2001	INDIVIDUAL PERSONAL PROPERTY	GOODE LILA	7608 STERLING AVE
096120533	2006	INDIVIDUAL PERSONAL PROPERTY	EVANS JAMIE N	9051 E 66TH TER	096617324	2004-2006	INDIVIDUAL PERSONAL PROPERTY	MOORE KATHLEEN	9704 RICE AVE
096120671	2011	INDIVIDUAL PERSONAL PROPERTY	SACKLIVICH JAMES C	9800 E 53RD ST	096620573	2008	INDIVIDUAL PERSONAL PROPERTY	JONES JERI L	9118 VAUGHN AVE
096120850	2020-2021	INDIVIDUAL PERSONAL PROPERTY	HARRIS, ANTOYA L	9213 E 52ND TER	096626637	2021	INDIVIDUAL PERSONAL PROPERTY	BAGBY SHELLEY	5548 HUNTER TER
096122040	2003-2007	INDIVIDUAL PERSONAL PROPERTY	HOUSTON DANNY R & CYNTHIA J	NO ADDRESS PROVIDED BY TAXPAYER	096682423	2005-2011	INDIVIDUAL PERSONAL PROPERTY	TINCH KIMBERLY	NO ADDRESS PROVIDED BY TAXPAYER
096122068	2004	INDIVIDUAL PERSONAL PROPERTY	MCLELLAND JEFFREY D & CHRISIE	UNKNOWN	096683509	2021	INDIVIDUAL PERSONAL PROPERTY	NOLAN WILMA J	5806 STERLING AVE
096122353	2021	INDIVIDUAL PERSONAL PROPERTY	COODY ALICE M & SLAYTON TOVA	7303 RAYTOWN RD	096714216	2021	INDIVIDUAL PERSONAL PROPERTY	COLLINS JONENE & RYLAND COLE COLLINS	8955 E 60TH ST
096126769	2006-2010	INDIVIDUAL PERSONAL PROPERTY	CASELMAN JASON & MICHELLE L	9804 E 67TH TER	096777889	2018-2021	INDIVIDUAL PERSONAL PROPERTY	JONES ANTWONE L	7224 CRISP AVE
096126809	2001	INDIVIDUAL PERSONAL PROPERTY	YATES JEFFREY S	10804 BRISTOL TER	096884686	2010	INDIVIDUAL PERSONAL PROPERTY	FOSTER CANDICE	10905 E 60TH TER
096131565	2002	INDIVIDUAL PERSONAL PROPERTY	BYERS JOE F SR	7317 HEDGES AVE	096889164	2005-2008	INDIVIDUAL PERSONAL PROPERTY	SNODGRASS ROBIN & CHRISTINE	NO ADDRESS PROVIDED BY TAXPAYER
096131605	2015-2016	INDIVIDUAL PERSONAL PROPERTY	TAIWO SHERRIE LYNN	10600 E 72ND ST	096967166	2005-2006	INDIVIDUAL PERSONAL PROPERTY	BECKHOFF BETTY	7808 CRESCENT AVE
096131715	2006-2012	INDIVIDUAL PERSONAL PROPERTY	PETERSON GREGORY A	11412 E 77TH ST	096977508	2020-2021	INDIVIDUAL PERSONAL PROPERTY	LEWIS AVION DANIELLE	8959 E 62ND TER
096131755	2011-2017	INDIVIDUAL PERSONAL PROPERTY	COOPER BILL D	8851 E 54TH ST	096978383	2015-2019	INDIVIDUAL PERSONAL PROPERTY	MYERS CAROLYN S	11801 E 77TH ST
096131792	2020	INDIVIDUAL PERSONAL PROPERTY	WRIGHT JERRY LEE	12504 E 54TH TER	097002709	2021	INDIVIDUAL PERSONAL PROPERTY	ARMSTRONG MICHAEL & VICTORIA	9204 E 69TH ST
096133093	2020	INDIVIDUAL PERSONAL PROPERTY	COOPER LONNETTE CHERISE (TINDALL)	6408 WILLOW AVE	097003366	2004-2007	INDIVIDUAL PERSONAL PROPERTY	PILCHER KAREN L	10105 E 64TH ST
096133667	2003	INDIVIDUAL PERSONAL PROPERTY	BERSUCH SHANNON	NO ADDRESS PROVIDED BY TAXPAYER	097004271	2013	INDIVIDUAL PERSONAL PROPERTY	PHILLIPS VAN	8824 E 61ST ST
096134306	2016	INDIVIDUAL PERSONAL PROPERTY	MCMILLIN VICKIE L	5420 BLUE RIDGE CUT OFF APT 512	097004346	2021	INDIVIDUAL PERSONAL PROPERTY	WOOD PARK	8322 STERLING AVE
096134369	2016	INDIVIDUAL PERSONAL PROPERTY	MOORE PEGGY D	9317 E 64TH TER	097004731	2004	INDIVIDUAL PERSONAL PROPERTY	TRADER RAYMOND	6104 HARRIS AVE
096134726	2019-2021	INDIVIDUAL PERSONAL PROPERTY	CAFFEY CHERYL R	8625 GREENWOOD RD	097005443	2004-2005	INDIVIDUAL PERSONAL PROPERTY	IRWIN REUBEN A	NO ADDRESS PROVIDED BY TAXPAYER

097005483	2020-2021	INDIVIDUAL PERSONAL PROPERTY	RIEBESSELL LARRY M	7906 ARLINGTON AVE	097031418	2004	INDIVIDUAL PERSONAL PROPERTY	GRIFFITH KAREN L	8814 E 80TH TER
097005615	2003-2004	INDIVIDUAL PERSONAL PROPERTY	LANE BRADLEY	NO ADDRESS PROVIDED BY TAXPAYER	097032782	2007	INDIVIDUAL PERSONAL PROPERTY	AHMADI MIKE	8404 E 86TH TER
097005669	2021	INDIVIDUAL PERSONAL PROPERTY	PARRISH JANET S	8810 E 72ND TER	097033553	2021	INDIVIDUAL PERSONAL PROPERTY	WHITWORTH KIMBERLY	9002 E 73RD ST
097005856	2005-2014	INDIVIDUAL PERSONAL PROPERTY	MINEART ANTHONY L	9212 E 68TH TER	097033758	2020-2021	INDIVIDUAL PERSONAL PROPERTY	PORTER BARBARA A	7412 ENGLEWOOD LN
097006249	2001	INDIVIDUAL PERSONAL PROPERTY	WALKER DAVID J	NO ADDRESS PROVIDED BY TAXPAYER	097033825	2003-2007	INDIVIDUAL PERSONAL PROPERTY	JONES CURTIS J	11216 E 59TH ST
097006279	2003	INDIVIDUAL PERSONAL PROPERTY	DAVIS RUSSELL R & KARL L	UNKNOWN	097034112	2004	INDIVIDUAL PERSONAL PROPERTY	JACKSON GARY R JR	NO ADDRESS PROVIDED BY TAXPAYER
097006299	2020-2021	INDIVIDUAL PERSONAL PROPERTY	HAMPTON JUSTIN M	8606 STARK AVE	097034868	2020-2021	INDIVIDUAL PERSONAL PROPERTY	STONE KENNETH WALDO JR	11209 E 71ST ST
097006643	2020-2021	INDIVIDUAL PERSONAL PROPERTY	CARTER JOHN L	10913 E 82ND ST	097034895	2006-2008	INDIVIDUAL PERSONAL PROPERTY	BEST MARK R	12000 E 77TH TER
097007771	2008	INDIVIDUAL PERSONAL PROPERTY	MAROON ROBERT	9811 E 60TH ST	097035132	2004	INDIVIDUAL PERSONAL PROPERTY	ROUNTREE LAKELA T	9039 E 85TH TER
097008922	2016-2019	INDIVIDUAL PERSONAL PROPERTY	DOWDY DIAM	7309 RAYTOWN RD	097035761	2020-2021	INDIVIDUAL PERSONAL PROPERTY	MCKINZY ELMER C	8209 HARDY AVE
097009395	2021	INDIVIDUAL PERSONAL PROPERTY	CLARK DARREN K	8502 EVERTT ST	097036599	2019-2021	INDIVIDUAL PERSONAL PROPERTY	LIGHTFOOT JOYCE	8416 PERSHING RD
097009436	2019	INDIVIDUAL PERSONAL PROPERTY	GONZALEZ-REYES ELEAZAR	9504 E 68TH TER	097037004	2002	INDIVIDUAL PERSONAL PROPERTY	ONWILER DAVID M JR	7715 ELM AVE
097009865	2012-2013	INDIVIDUAL PERSONAL PROPERTY	CARPENTER RALPH E	6803 LAKESHORE DR	097037094	2005-2006	INDIVIDUAL PERSONAL PROPERTY	BISHOP ROBERT M	8136 DITZLER AVE
097010882	2006-2007	INDIVIDUAL PERSONAL PROPERTY	ALBERTY JERMINIE D	5918 LAUREL AVE	097038317	2012-2013	INDIVIDUAL PERSONAL PROPERTY	TUCKER RICKY L	8200 WITZLER WAY
097010902	2020-2021	INDIVIDUAL PERSONAL PROPERTY	JONES DENITA L	7305 CRISP AVE	097039101	2012	INDIVIDUAL PERSONAL PROPERTY	JONES MAURICE & PATRICIA	7917 WESTRIDGE RD
097011111	2006-2007	INDIVIDUAL PERSONAL PROPERTY	ROBINSON ANGEL N	11811 E 83RD ST	097039437	2017-2020	INDIVIDUAL PERSONAL PROPERTY	ICART JACQUES	10105 E 84TH ST
097011845	2009-2016	INDIVIDUAL PERSONAL PROPERTY	COEN MYNDI (GLOVER)	8517 DITZLER AVE	097040034	2009-2012	INDIVIDUAL PERSONAL PROPERTY	JACKSON LYRIS J & PATSY R	8515 STERLING AVE
097011934	2011	INDIVIDUAL PERSONAL PROPERTY	GENTRY JAMES	7902 APPLETON AVE	097040200	2021	INDIVIDUAL PERSONAL PROPERTY	CRUMP ROBIN R (PRICE)	9324 E 84TH TER
097014102	2009-2010	INDIVIDUAL PERSONAL PROPERTY	HAYNES DAVID N & STEVEN J	10234 E 63RD ST APT 3	097040275	2021	INDIVIDUAL PERSONAL PROPERTY	RUPE JEFFREY D	8206 HUNTER ST
097014894	2019-2021	INDIVIDUAL PERSONAL PROPERTY	HOOPER SANDRA K	5520 STERLING AVE	097040447	2021	INDIVIDUAL PERSONAL PROPERTY	WALLACE EUGENE E	11100 E 78TH TER
097015039	2021	INDIVIDUAL PERSONAL PROPERTY	FLORA ANGELIA L	10617 E 69TH TER	097040480	2004-2013	INDIVIDUAL PERSONAL PROPERTY	KELLY THOMAS A	NO ADDRESS PROVIDED BY TAXPAYER
097015439	2002-2003	INDIVIDUAL PERSONAL PROPERTY	ATKINS JAMISON K	9001 E 73RD ST	097040882	2002-2004	INDIVIDUAL PERSONAL PROPERTY	CREAGER JACKSON T & CINDY D	NO ADDRESS PROVIDED BY TAXPAYER
097015773	2021	INDIVIDUAL PERSONAL PROPERTY	ROACH DEBRA D	11613 E 79TH DR	097041726	2019-2021	INDIVIDUAL PERSONAL PROPERTY	CARVALLO SAUL ROMERO	7501 CRESCENT DR
097015794	2021	INDIVIDUAL PERSONAL PROPERTY	HUDGINS GARY W	9800 E 79TH TER	097041999	2005	INDIVIDUAL PERSONAL PROPERTY	WILLIAMS TIMOTHY J	9004 E 74TH ST
097016266	2021	INDIVIDUAL PERSONAL PROPERTY	STEWART RAMONA I (RANDOLPH)	8617 W UTOPIA DR APT 26	097042789	2001	INDIVIDUAL PERSONAL PROPERTY	BLACKMON DARLA	NO ADDRESS PROVIDED BY TAXPAYER
097016772	2001	INDIVIDUAL PERSONAL PROPERTY	CARLSON RALPH H	NO ADDRESS PROVIDED BY TAXPAYER	097044217	2021	INDIVIDUAL PERSONAL PROPERTY	HUNT BRIAN M	6353 BLUE RIDGE BLVD
097017033	2001	INDIVIDUAL PERSONAL PROPERTY	RUSSELL NEIL C	NO ADDRESS PROVIDED BY TAXPAYER	097045130	2006-2010	INDIVIDUAL PERSONAL PROPERTY	LASKY BECKY L	10601 78TH TER
097017106	2021	INDIVIDUAL PERSONAL PROPERTY	BUSTER MICHAEL DELANO	6505 STERLING AVE	097045200	2001	INDIVIDUAL PERSONAL PROPERTY	SVADIN GERALD	UNKNOWN
097017311	2007	INDIVIDUAL PERSONAL PROPERTY	DANIEL SOPHIA G	NO ADDRESS PROVIDED BY TAXPAYER	097045309	2021	INDIVIDUAL PERSONAL PROPERTY	STEWART BARBARA L	7108 NORWOOD AVE
097017401	2021	INDIVIDUAL PERSONAL PROPERTY	LONG PAULETTE DENISE	8310 LANE AVE	097045352	2009-2012	INDIVIDUAL PERSONAL PROPERTY	JONES DWAYNE & DORIS	5816 NORTHERN AVE
097017833	2004	INDIVIDUAL PERSONAL PROPERTY	CONNOR LYNISE M & COURTNEY E	UNKNOWN	097046319	2014-2015	INDIVIDUAL PERSONAL PROPERTY	FISCHER ROGER L	9801 E 61ST ST APT 1
097017840	2003-2005	INDIVIDUAL PERSONAL PROPERTY	GAINES DOUGLAS W	NO ADDRESS PROVIDED BY TAXPAYER	097046720	2002	INDIVIDUAL PERSONAL PROPERTY	GILLIAND CYNTHIA ANN	417 NE STATION DR
097018439	2008	INDIVIDUAL PERSONAL PROPERTY	GRIFFITH GLEN D	NO ADDRESS PROVIDED BY TAXPAYER	097046799	2021	INDIVIDUAL PERSONAL PROPERTY	WAINRIGHT VINCENT L	9801 E 73RD ST APT B
097018937	2008-2010	INDIVIDUAL PERSONAL PROPERTY	CORNIELS JEFFREY	5422 STERLING AVE	097047057	2021	INDIVIDUAL PERSONAL PROPERTY	WIGFALL DARLENE E	8108 WILLOW WAY
097019743	2008-2021	INDIVIDUAL PERSONAL PROPERTY	WADE FELICIA R	5401 WILLOW AVE	097047095	2010-2012	INDIVIDUAL PERSONAL PROPERTY	KIRKWOOD ADEL J	9804 E 79TH ST
097020874	2021	INDIVIDUAL PERSONAL PROPERTY	HIGH JULIE L	7918 OVERTON DR	097047258	2012	INDIVIDUAL PERSONAL PROPERTY	BROWN ROGER C	7929 HEDGES AVE
097020875	2010-2017	INDIVIDUAL PERSONAL PROPERTY	SCOTT CINDY	5724 OXFORD AVE	097047284	2003-2006	INDIVIDUAL PERSONAL PROPERTY	KING TIFFANY L (GAVY)	5301 CRISP AVE
097020876	2003-2005	INDIVIDUAL PERSONAL PROPERTY	GILMORE JEANNINE	NO ADDRESS PROVIDED BY TAXPAYER	097047322	2001-2009	INDIVIDUAL PERSONAL PROPERTY	WINN FLOYD	7325 HARDY AVE
097021096	2020-2021	INDIVIDUAL PERSONAL PROPERTY	BOURDESS HOWARD L	8935 E 57TH ST	097047406	2006-2007	INDIVIDUAL PERSONAL PROPERTY	DRAKE BILLY D JR	1817 LAUREL AVE
097022748	2002-2005	INDIVIDUAL PERSONAL PROPERTY	GREEN JASON M	4423 RIDGEWAY AVE	097047580	2021	INDIVIDUAL PERSONAL PROPERTY	MCCARTHY DANIEL R	7203 HEDGES AVE
097022749	2001-2002	INDIVIDUAL PERSONAL PROPERTY	JONES MELISSA	NO ADDRESS PROVIDED BY TAXPAYER	097047618	2017	INDIVIDUAL PERSONAL PROPERTY	SPANDETT CINDI S (SPROUSE)	6102 NORTHERN AVE
097022750	2001	INDIVIDUAL PERSONAL PROPERTY	THOMAS DOROTHY M	6314 NORWOOD CT	097047710	2021	INDIVIDUAL PERSONAL PROPERTY	SERVILLE GARY & ZONA J	6104 WILLOW WAY
097022844	2007	INDIVIDUAL PERSONAL PROPERTY	TARWATER SUSAN A & BRIAN E	7506 CRESCENT DR	097047880	2021	INDIVIDUAL PERSONAL PROPERTY	FARRIS THOMAS & KRISTEN M	11505 E 66TH TER
097022934	2021	INDIVIDUAL PERSONAL PROPERTY	SMITH SHELDA A	5605 HUNTER TER	097048841	2015-2016	INDIVIDUAL PERSONAL PROPERTY	FEDERICO JOHNNIE J	9901 E 85TH ST
097023034	2015-2018	INDIVIDUAL PERSONAL PROPERTY	CASEY CRYSTAL E	5341 ASH AVE	097048940	2011-2017	INDIVIDUAL PERSONAL PROPERTY	MAY LISA M	9129 E 85TH PL
097023075	2004	INDIVIDUAL PERSONAL PROPERTY	WILSON CARA L	NO ADDRESS PROVIDED BY TAXPAYER	097049058	2016	INDIVIDUAL PERSONAL PROPERTY	OLVER KEVIN O	9104 E 82ND ST
097023137	1998-1999	INDIVIDUAL PERSONAL PROPERTY	OLDENBURG MARGO R	UNKNOWN	097049345	2009-2010	INDIVIDUAL PERSONAL PROPERTY	STOWERS KATHRYN PEARL	5417 HARRIS AVE
097023171	2021	INDIVIDUAL PERSONAL PROPERTY	SAUL KATHERINE (OYLER) & MICHAEL	9119 RICHARDS DR	097049392	2010	INDIVIDUAL PERSONAL PROPERTY	PHILLIPS D REX	NO ADDRESS PROVIDED BY TAXPAYER
097023175	2008	INDIVIDUAL PERSONAL PROPERTY	HICKS ADAM	NO ADDRESS PROVIDED BY TAXPAYER	097049461	2005-2006	INDIVIDUAL PERSONAL PROPERTY	DOZIER GARY D L	11408 E 69TH ST
097023208	2021	INDIVIDUAL PERSONAL PROPERTY	LANE MEGAN & MCKINLEY JOSHUA	6208 ELM AVE	097049766	2003-2005	INDIVIDUAL PERSONAL PROPERTY	CARGO RICHARD E JR	NO ADDRESS PROVIDED BY TAXPAYER
097023312	2003-2004	INDIVIDUAL PERSONAL PROPERTY	YOUNG VIRGIL O	NO ADDRESS PROVIDED BY TAXPAYER	097050230	2021	INDIVIDUAL PERSONAL PROPERTY	WHITE ERIC	5234 NORTHERN AVE
097023333	2021	INDIVIDUAL PERSONAL PROPERTY	HEDRICK MARK ALLEN	6009 FARLEY AVE	097051394	2021	INDIVIDUAL PERSONAL PROPERTY	ASBERRY CAMICA N (RAMSEY)	8812 E 81ST ST
097023658	2021	INDIVIDUAL PERSONAL PROPERTY	HUNTLEY DOUGLAS C	8618 E UTOPIA DR APT 45	097051806	2004	INDIVIDUAL PERSONAL PROPERTY	BURGESS TAYLOR MARK	9110 E 73RD ST
097023921	2018	INDIVIDUAL PERSONAL PROPERTY	ROWE MICHAEL	7501 CRISP AVE	09705158	2019-2021	INDIVIDUAL PERSONAL PROPERTY	THOMPSON JAMES GERALD	8010 TENNESSEE AVE
097024167	2020-2021	INDIVIDUAL PERSONAL PROPERTY	PATTERSON CATHY E (ARNOLD)	8400 DITMAN AVE	09705318	2020-2021	INDIVIDUAL PERSONAL PROPERTY	GARRETT GARNAIT T	8490 LANE DR
097025006	2015	INDIVIDUAL PERSONAL PROPERTY	ALLEN SHELLI R	6518 STERLING AVE	097053715	2021	INDIVIDUAL PERSONAL PROPERTY	PERKINS OZELL DARLENE	7212 CEDAR AVE
097027012	2021	INDIVIDUAL PERSONAL PROPERTY	FRANKLIN CHARLES HARVEY	9105 E 66TH TER	097054554	2004-2013	INDIVIDUAL PERSONAL PROPERTY	WIGMAN JOHANNA T	NO ADDRESS PROVIDED BY TAXPAYER
097027020	2008-2010	INDIVIDUAL PERSONAL PROPERTY	HENDERSON MUNEEA A	11800 E 78TH PL	097055441	2010-2017	INDIVIDUAL PERSONAL PROPERTY	STEPHENS ROBERT C &/OR	8705 E 83RD TER
097027101	2009-2010	INDIVIDUAL PERSONAL PROPERTY	BARTELLI LAURIE	5817 BLUE RIDGE BLVD	097056207	2015-2021	INDIVIDUAL PERSONAL PROPERTY	COCAYNE KEVIN R	6101 HARDY AVE
097027111	2016-2021	INDIVIDUAL PERSONAL PROPERTY	CHURCHILL CHRISTY L	10200 E 57TH ST	097056977	2003-2005	INDIVIDUAL PERSONAL PROPERTY	RUBY SCOTT E	NO ADDRESS PROVIDED BY TAXPAYER
097027546	2009	INDIVIDUAL PERSONAL PROPERTY	YOUNG JERRY L	9350 E 64TH TER	097058781	2001	INDIVIDUAL PERSONAL PROPERTY	HALE MONICA L	NO ADDRESS PROVIDED BY TAXPAYER
097027706	2006-2009	INDIVIDUAL PERSONAL PROPERTY	KUHN BRIAN	9120 RICHARDS DR	097058822	2009	INDIVIDUAL PERSONAL PROPERTY	ELLIOTT FRIEDEL	8601 E 84TH ST
097027830	2021	INDIVIDUAL PERSONAL PROPERTY	RICHARDSON DAVID A	11904 E 86TH ST	097059213	2004	INDIVIDUAL PERSONAL PROPERTY	LALICH BENJAMIN	9359 E 64TH ST
097027866	2012-2017	INDIVIDUAL PERSONAL PROPERTY	NELSON FRED M & VIRGIE L	9712 E 82ND ST	097059257	2009	INDIVIDUAL PERSONAL PROPERTY	CAHILL TRAVIS	9106 VAUGHN AVE
097027896	2002-2004	INDIVIDUAL PERSONAL PROPERTY	NEWKIRK JOSEPH E	NO ADDRESS PROVIDED BY TAXPAYER	097059271	2010-2013	INDIVIDUAL PERSONAL PROPERTY	WYMAN BRIAN E	11205 E 83RD ST
097027941	2001-2003	INDIVIDUAL PERSONAL PROPERTY	ALLEN CARRIE	NO ADDRESS PROVIDED BY TAXPAYER	097059275	2007-2017	INDIVIDUAL PERSONAL PROPERTY	ASBERRY FREDDIE B JR	7520 STERLING AVE
097027950	2003	INDIVIDUAL PERSONAL PROPERTY	SCHINZE JOHN	11400 E 77TH ST	097059377	2001	INDIVIDUAL PERSONAL PROPERTY	KOEHLI GARY L JR & CANDACE D	NO ADDRESS PROVIDED BY TAXPAYER
097028024	2002	INDIVIDUAL PERSONAL PROPERTY	RAINEY ROBERT LEE	10117 E 56TH ST	097059524	2010-2011	INDIVIDUAL PERSONAL PROPERTY	BATES AARON B	9705 E 79TH PL
097028126	2019-2021	INDIVIDUAL PERSONAL PROPERTY	RUDAITS DAVID R	7603 WESTRIDGE RD	097059655	2003-2004	INDIVIDUAL PERSONAL PROPERTY	MOLINE HEATHER	UNKNOWN
097029098	2010-2012	INDIVIDUAL PERSONAL PROPERTY	CRUZ CARLOS R & MENJIVAR MARIA	5521 BLUE RIDGE CUT OFF	097059669	2010	INDIVIDUAL PERSONAL PROPERTY	WAYT RAY O & ALENE	NO ADDRESS PROVIDED BY TAXPAYER
097030194	2020-2021	INDIVIDUAL PERSONAL PROPERTY	MCROY ELAINE	6650 LANE AVE	097059709	2003	INDIVIDUAL PERSONAL PROPERTY	PALMER MICHELLE (WASHINGTON)	NO ADDRESS PROVIDED BY TAXPAYER
097030468	2021	INDIVIDUAL PERSONAL PROPERTY	DAVIDSON CHARLES E	5729 MANNING AVE	097059867	2019-2021	INDIVIDUAL PERSONAL PROPERTY	WEAVER DANIEL A	10708 E 65TH TER

097059907	2021	INDIVIDUAL PERSONAL PROPERTY	BENDER SUSAN D	1410 NW FOXBORO RD	097101952	2008	INDIVIDUAL PERSONAL PROPERTY	LINTON DAWN (STAGGS)	6009 ENGLEWOOD AVE
097059950	2008-2014	INDIVIDUAL PERSONAL PROPERTY	LOVEJOY ERNEST M	6008 ARLINGTON AVE	097101981	2018	INDIVIDUAL PERSONAL PROPERTY	FANN ROBERT	7715 WOODSON RD
097059984	2012-2013	INDIVIDUAL PERSONAL PROPERTY	SOUZA TRUDY JEAN	7525 HAWTHORNE AVE	097101990	2021	INDIVIDUAL PERSONAL PROPERTY	GUTIERREZ CHRISTOPER & CHRISTINA	8613 CRESCENT AVE
097060028	2021	INDIVIDUAL PERSONAL PROPERTY	RUNYAN TROY S & BRIDGET	10807 E 56TH TER	097102067	2008-2013	INDIVIDUAL PERSONAL PROPERTY	WOODS KAREN M	8619 KENTUCKY AVE
097060258	2001-2002	INDIVIDUAL PERSONAL PROPERTY	LINTON GREGORY A	UNKNOWN	097102069	2021	INDIVIDUAL PERSONAL PROPERTY	CARTNER ERIC C	6825 CRISP AVE
097060297	2021	INDIVIDUAL PERSONAL PROPERTY	PINKSTON MISTY L (DEWITT)	7412 CRISP AVE	097102154	2006-2016	INDIVIDUAL PERSONAL PROPERTY	MORRISON KAUNDRIA	5704 BLUE RIDGE BLVD
097060341	2021	INDIVIDUAL PERSONAL PROPERTY	NULL CORY & PEGGY J	11304 E 61ST ST	097103945	2021	INDIVIDUAL PERSONAL PROPERTY	EDMOND DAVID L & LISA MICHELLE	9617 E 66TH TER
097060363	2020	INDIVIDUAL PERSONAL PROPERTY	LISS DANIEL B	11520 HOLIDAY DR APT 1203	097108287	2021	INDIVIDUAL PERSONAL PROPERTY	JONES BRYAN L	9920 E 61ST ST
097060366	2019	INDIVIDUAL PERSONAL PROPERTY	GARRISON LARRY C	6005 FARLEY AVE	097108631	2017-2018	INDIVIDUAL PERSONAL PROPERTY	CUNNINGHAM JOSEPH E SR & EBONY	9103 E 72ND TER
097060409	2020-2021	INDIVIDUAL PERSONAL PROPERTY	BOWEN ROBERT C	9720 E 65TH ST	097110000	2021	INDIVIDUAL PERSONAL PROPERTY	ANDERSON DEBRA LYNETTE	9112 E 85TH ST
097060424	2011-2014	INDIVIDUAL PERSONAL PROPERTY	PARKER CHAD	9033 E 85TH TER	097112855	2001	INDIVIDUAL PERSONAL PROPERTY	TOWNER JAMES W SR	UNKNOWN
097062221	2021	INDIVIDUAL PERSONAL PROPERTY	BEDSWORTH ELISA R E & TERRY	6140 RAYTOWN RD APT 109	097113545	2021	INDIVIDUAL PERSONAL PROPERTY	MILLER SHANNON K & TIERRA	9612 E GREGORY BLVD
097062483	2021	INDIVIDUAL PERSONAL PROPERTY	THOMAS MARVIN D	10205 E 63RD TER APT D	097113724	2020-2021	INDIVIDUAL PERSONAL PROPERTY	TATUM TONI LYNN	11413 E 77TH ST
097062601	2021	INDIVIDUAL PERSONAL PROPERTY	HEAVENER KELLY L	406 S 21ST ST	097114128	2021	INDIVIDUAL PERSONAL PROPERTY	GORDON CHAD E	6906 RALSTON AVE
097062640	2017-2021	INDIVIDUAL PERSONAL PROPERTY	DICKERSON DIRK & TERRY	11800 E 77TH TER	097114330	2021	INDIVIDUAL PERSONAL PROPERTY	CRAYFORD HENRY	9701 E 81ST TER
097062659	2002	INDIVIDUAL PERSONAL PROPERTY	BUILDERSBACK WILLIAM C	NO ADDRESS PROVIDED BY TAXPAYER	097114889	2016	INDIVIDUAL PERSONAL PROPERTY	RILEY SUZANNE M	10310 E 69TH TER
097062784	2015-2021	INDIVIDUAL PERSONAL PROPERTY	LAIRD SHEILA (HOSKINS)	9411 E 80TH TER	097114824	2006	INDIVIDUAL PERSONAL PROPERTY	MORENO ANDREW J	NO ADDRESS PROVIDED BY TAXPAYER
097062839	2021	INDIVIDUAL PERSONAL PROPERTY	MORGASON ROBERT L & PAMELA	8304 KENTUCKY AVE	097115629	2016-2021	INDIVIDUAL PERSONAL PROPERTY	STARKS BRIDGETTE	8609 SPRING VALLEY RD
097063474	2002	INDIVIDUAL PERSONAL PROPERTY	KALLENBERGER DARYL W & DR	NO ADDRESS PROVIDED BY TAXPAYER	097115693	2015-2018	INDIVIDUAL PERSONAL PROPERTY	HANCOCK CHRISTOPHER L	9008 E 67TH TER
097064101	2019-2021	INDIVIDUAL PERSONAL PROPERTY	JACKSON CLEMENSTENE	6420 ELM AVE	097115794	2020-2021	INDIVIDUAL PERSONAL PROPERTY	BENNETT REBECCA L	7701 WOODSON RD
097064451	2001	INDIVIDUAL PERSONAL PROPERTY	CHIN MARY	6200 ASH CRT	097116145	2016-2021	INDIVIDUAL PERSONAL PROPERTY	FOX WILLIAM G & STACIE R	9804 E 79TH PL
097065010	2001-2002	INDIVIDUAL PERSONAL PROPERTY	JORDAN JOHN J & BETTY J	UNKNOWN	097119416	2019-2020	INDIVIDUAL PERSONAL PROPERTY	MOUSSEAU VICKI	7421 MAPLE DR UNIT 119
097065085	2021	INDIVIDUAL PERSONAL PROPERTY	PENCE RUTH D	5433 RALSTON AVE	097120057	2003-2006	INDIVIDUAL PERSONAL PROPERTY	SMITH DAVID W	SMITH DAVID W
097071550	2021	INDIVIDUAL PERSONAL PROPERTY	ANDERSON JAMES & AMY	8012 ELM AVE	097120675	2003-2004	INDIVIDUAL PERSONAL PROPERTY	PALMISANO JOHN	NO ADDRESS PROVIDED BY TAXPAYER
097071952	2005	INDIVIDUAL PERSONAL PROPERTY	MORGAN SUZETTE	184 E 68TH TER	097120888	2016-2021	INDIVIDUAL PERSONAL PROPERTY	BROWN RHONDA S	11212 E 62ND ST
097072571	2021	INDIVIDUAL PERSONAL PROPERTY	MCKINZY MARVIN D	5730 MANNING AVE	097121038	2021	INDIVIDUAL PERSONAL PROPERTY	ANDERSON DIONA S	8321 NORTHERN ST
097072647	2011	INDIVIDUAL PERSONAL PROPERTY	HIRE JOHN E	10301 E 63RD TER	097121251	2021	INDIVIDUAL PERSONAL PROPERTY	TERRY TIMOTHY A & TONI F	8818 E 58TH TER
097072665	2021	INDIVIDUAL PERSONAL PROPERTY	DECOOK GRETCHEN	6108 WOODSON DR	097121359	2021	INDIVIDUAL PERSONAL PROPERTY	SMITH YOLANDA C	8618 E 83RD TER
097073208	2008-2017	INDIVIDUAL PERSONAL PROPERTY	GRIFFIN CHARLES LEE JR	7205 WOODSON RD	097121601	2011-2013	INDIVIDUAL PERSONAL PROPERTY	LITTLEBEAR SUSAN F	10817 E 57TH ST
097073471	2021	INDIVIDUAL PERSONAL PROPERTY	MUDD GERALD DELORIS	8006 EVANSTON AVE	097123755	2021	INDIVIDUAL PERSONAL PROPERTY	PAYTON NICOLE L	7200 RAYTOWN RD
097073612	2001-2002	INDIVIDUAL PERSONAL PROPERTY	HOBBS MICHAEL L	7200 OVERTON	097130056	2020-2021	INDIVIDUAL PERSONAL PROPERTY	LEMBERGER PAULA	5512 APPLETON AVE
097077025	2021	INDIVIDUAL PERSONAL PROPERTY	JOHNSON ADELLA ELIZABETH & PENDELTON LANDIS	5715 MANNING AVE	097132034	2015-2017	INDIVIDUAL PERSONAL PROPERTY	MOORHEAD JASON	8307 MANNING AVE
097077419	2011-2013	INDIVIDUAL PERSONAL PROPERTY	JOHNSON ANISSA L	9200 E 87TH ST	097132930	2021	INDIVIDUAL PERSONAL PROPERTY	SPAKE KATHRYN	9205 E 69TH TER
097077437	2009	INDIVIDUAL PERSONAL PROPERTY	RUPARD ELISHIA	5244 HARDY CT	097133874	2018-2019	INDIVIDUAL PERSONAL PROPERTY	LOZANO OSWALD & JAMIE	8800 E 81ST TER
097077447	2001	INDIVIDUAL PERSONAL PROPERTY	MCCLAIN AKESHA K	5618 LAUREL AVE	097134631	2020	INDIVIDUAL PERSONAL PROPERTY	SIMMONS KELLY R	300 NE TIMBERCREEK CT
097077612	2005-2006	INDIVIDUAL PERSONAL PROPERTY	TRIPP CORY J	8600 EVERETT ST	097134742	2012-2013	INDIVIDUAL PERSONAL PROPERTY	LENGQUIST MARJORIE L	10908 E 60TH TER
097078213	2021	INDIVIDUAL PERSONAL PROPERTY	QUINN DAVID & JOHNETTA	8320 STERLING AVE	097134894	2021	INDIVIDUAL PERSONAL PROPERTY	DOWNUM KEVIN	4642 LANE DR
097078607	2020-2021	INDIVIDUAL PERSONAL PROPERTY	SHELBY JOSEPH S	8525 MAPLE AVE	097135738	2002	INDIVIDUAL PERSONAL PROPERTY	DORSEY PENNY S	NO ADDRESS PROVIDED BY TAXPAYER
097078881	2020-2021	INDIVIDUAL PERSONAL PROPERTY	MOORHEAD JEFF L	9401 E 65TH TER	097135806	2020-2021	INDIVIDUAL PERSONAL PROPERTY	LYNN PATRICIA A	8525 DITZLER AVE
097078906	2016	INDIVIDUAL PERSONAL PROPERTY	HARRIS CELESTA D	10501 E 60TH TER	097136358	2021	INDIVIDUAL PERSONAL PROPERTY	HINTON DIANE	11615 E 80TH DR
097078949	2007-2015	INDIVIDUAL PERSONAL PROPERTY	ROBERTS TONY MICHAEL JR	7604 WOODSON RD	097136395	2012	INDIVIDUAL PERSONAL PROPERTY	LINSEY LETICIA C	7520 CRISP AVE
097079000	2007-2015	INDIVIDUAL PERSONAL PROPERTY	COLLIER BARRY	NO ADDRESS PROVIDED BY TAXPAYER	097136540	2021	INDIVIDUAL PERSONAL PROPERTY	MULLIS DANIELLE	6712 NORTHERN AVE
097083885	2021	INDIVIDUAL PERSONAL PROPERTY	BATES JEREMY	9609 E 69TH ST	097136675	2001	INDIVIDUAL PERSONAL PROPERTY	NEWMAN LYNN	11014 LAKEVIEW RD
097084101	2010	INDIVIDUAL PERSONAL PROPERTY	BRANSCOM JOHN E L	9108 RICHARDS DR	097136950	2008	INDIVIDUAL PERSONAL PROPERTY	CLAYCOMB KEVIN	10106 E 79TH TER
097084524	2011-2012	INDIVIDUAL PERSONAL PROPERTY	JONES JANICE MARIE	5420 BLUE RIDGE CUT OFF APT 312	097136971	2018	INDIVIDUAL PERSONAL PROPERTY	SALINAS BRENDA J	7224 RAYTOWN RD APT D
097084622	2006	INDIVIDUAL PERSONAL PROPERTY	LYON BARBARA ANNE	9503 E 80TH TER	097136989	2019-2021	INDIVIDUAL PERSONAL PROPERTY	HENDERSON DAMON E	5635 LAUREL AVE
097084695	2004	INDIVIDUAL PERSONAL PROPERTY	EAVES MARTH J & TERRY E (RHODES)	UNKNOWN	097137029	2020-2021	INDIVIDUAL PERSONAL PROPERTY	GADT DWIGHT ALLEN	9201 E 65TH TER
097085532	2003-2004	INDIVIDUAL PERSONAL PROPERTY	MARION CHAUNCY D	NO ADDRESS PROVIDED BY TAXPAYER	097137169	2021	INDIVIDUAL PERSONAL PROPERTY	HADJUSE MARY ANN	9807 E 61ST ST APT 11
097085789	2002-2003	INDIVIDUAL PERSONAL PROPERTY	CRAYTON MARK E	UNKNOWN	097137201	2014-2017	INDIVIDUAL PERSONAL PROPERTY	MOORE RYAN D	8110 WOODSON DR
097086132	2019-2021	INDIVIDUAL PERSONAL PROPERTY	AGNEW SHARICE	7520 LEWIS AVE	097137517	2011	INDIVIDUAL PERSONAL PROPERTY	CLARK CRYSTAL I	10855 STATE LINE RD UNIT 5
097086643	2007	INDIVIDUAL PERSONAL PROPERTY	SCHROEDER CHRISTOPHER	10900 E 82ND ST	097137565	2001-2002	INDIVIDUAL PERSONAL PROPERTY	OJEDA TERRY	UNKNOWN
097089232	2019	INDIVIDUAL PERSONAL PROPERTY	DOWDY LINDA	7309 RAYTOWN RD	097137632	2007-2009	INDIVIDUAL PERSONAL PROPERTY	DEW MICHAEL T & STEPHANIE	6228 KENTUCKY AVE
097089638	2001-2002	INDIVIDUAL PERSONAL PROPERTY	AUSTIN WILLIAM	7520 CRISP AVE	097137666	2004	INDIVIDUAL PERSONAL PROPERTY	ROBINSON CYNTHIA L	NO ADDRESS PROVIDED BY TAXPAYER
097092867	2008-2009	INDIVIDUAL PERSONAL PROPERTY	HANKE BARBARA	600 NE MEADOWVIEW DR	097137814	2003-2005	INDIVIDUAL PERSONAL PROPERTY	HEAVENER AMANDA K	5912 CLAREMONT AVE
097093493	2002-2014	INDIVIDUAL PERSONAL PROPERTY	POINDEXTER CONRAD	6317 ASH AVE	097137884	2021	INDIVIDUAL PERSONAL PROPERTY	HUTSON CHRISTOPHER	8509 FORD AVE
097093818	2001	INDIVIDUAL PERSONAL PROPERTY	DORRELL STEVEN M	8737 E 96TH ST	097138130	2019-2021	INDIVIDUAL PERSONAL PROPERTY	DAVIS NANCY	7226 RAYTOWN RD APT C
097093836	2012	INDIVIDUAL PERSONAL PROPERTY	MACARTHUR FRANK J	8301 STERLING AVE	097138432	2020-2021	INDIVIDUAL PERSONAL PROPERTY	BLADE MARVIN GLENN	8330 OXFORD AVE
097098643	2019	INDIVIDUAL PERSONAL PROPERTY	SIMMONS LEON	9212 E 85TH ST	097138433	2012	INDIVIDUAL PERSONAL PROPERTY	WOODS BIANCA AVE	10809 E 66TH TER
097098757	2021	INDIVIDUAL PERSONAL PROPERTY	JOHNSTON SHAWN M	6441 BLUE RIDGE BLVD	097138884	2017-2018	INDIVIDUAL PERSONAL PROPERTY	CALVIN APRIL L	9050 E 84TH ST
097099922	2008-2017	INDIVIDUAL PERSONAL PROPERTY	ESCAGNE DENNIS	7305 CRISP AVE	097140429	2005-2006	INDIVIDUAL PERSONAL PROPERTY	PRITCHARD RAY E	8610 ENGLEWOOD AVE
097099952	2017-2021	INDIVIDUAL PERSONAL PROPERTY	SHEPHARD MARQUIS D	8819 E 61ST ST	097140628	2005	INDIVIDUAL PERSONAL PROPERTY	CLINE MELISSA	9514 E 64TH TER
097100277	2006-2007	INDIVIDUAL PERSONAL PROPERTY	FITZGEREL ALLISON KAY	4834 CRESCENT DR	097140700	2021	INDIVIDUAL PERSONAL PROPERTY	RAHM MICHAEL D	11613 E 78TH TER
097100510	2019-2021	INDIVIDUAL PERSONAL PROPERTY	HEDRICK GAYLE K	7305 DITZLER AVE	097141060	2021	INDIVIDUAL PERSONAL PROPERTY	DAVIS TAMMIE L (LONG) & LEE	7224 MAPLE AVE
097100533	2021	INDIVIDUAL PERSONAL PROPERTY	WHITE ANGELA KAY	11201 E 58TH TER	097142134	2021	INDIVIDUAL PERSONAL PROPERTY	ANAYA GENA NADINE	6210 HUNTER ST
097100658	2018-2021	INDIVIDUAL PERSONAL PROPERTY	AMES ALAN ADAIR	10201 E 58TH TER	097149694	2013-2017	INDIVIDUAL PERSONAL PROPERTY	LESTER JAMES	7209 WOODSON DR
097100710	2011	INDIVIDUAL PERSONAL PROPERTY	EDKIN DAVID	8225 HARRIS CT	097177611	2021	INDIVIDUAL PERSONAL PROPERTY	HERBERT MIRRAND A	5812 MANNING AVE
097100731	2002-2004	INDIVIDUAL PERSONAL PROPERTY	MCANANY RHIANDA A	NO ADDRESS PROVIDED BY TAXPAYER	097187159	2021	INDIVIDUAL PERSONAL PROPERTY	HARREL KYMBERLI	8130 STERLING AVE
097100787	2007-2017	INDIVIDUAL PERSONAL PROPERTY	KING CHARLES G	6004 BLUE RIDGE BLVD	097216946	2002-2004	INDIVIDUAL PERSONAL PROPERTY	MOORE RAYMOND G	UNKNOWN
097100976	2021	INDIVIDUAL PERSONAL PROPERTY	HUDNALL AMY MARIE	8205 KENTUCKY AVE	097239411	2021	INDIVIDUAL PERSONAL PROPERTY	RICE ANTOINETTE L (BRUCE)	8316 WILLOW WAY
097100984	2003	INDIVIDUAL PERSONAL PROPERTY	MALLEY SHERRYL A	NO ADDRESS PROVIDED BY TAXPAYER	097340351	2017-2019	INDIVIDUAL PERSONAL PROPERTY	LAGRANT JERI D	6140 RAYTOWN RD APT 210
097101247	2021	INDIVIDUAL PERSONAL PROPERTY	WHITING KELLY MICHELLE	6400 HARVARD AVE	097342884	2001	INDIVIDUAL PERSONAL PROPERTY	GUNN JAMES M & MARCIA J	7512 HARRIS AVE
097101648	2018	INDIVIDUAL PERSONAL PROPERTY	HENDRIX JOE E JR	5500 BLUE RIDGE BLVD	097510434	2015-2021	INDIVIDUAL PERSONAL PROPERTY	AGNEW YOLANDA	6422 ELM AVE

097526972	2002	INDIVIDUAL PERSONAL PROPERTY	AUSTIN TIFFANEY M (GRAHAM)	7601 CRISP	098032892	2003-2005	INDIVIDUAL PERSONAL PROPERTY	BRADLEY BARRY W	1700 S TRAIL RIDGE DR
097543874	2004-2017	INDIVIDUAL PERSONAL PROPERTY	HORNED DANIEL S & SUSAN M	NO ADDRESS PROVIDED BY TAXPAYER	098032943	2004	INDIVIDUAL PERSONAL PROPERTY	CAMPBELL CHRISTY L	5420 BLUE RIDGE CUTOFF
097566409	2004	INDIVIDUAL PERSONAL PROPERTY	LYTTON WILLIAM M & ROCHELLE	UNKNOWN	098037840	2020-2021	INDIVIDUAL PERSONAL PROPERTY	GREEN KENNETH S	6600 HARDY AVE
097570320	2002-2003	INDIVIDUAL PERSONAL PROPERTY	SALCHOW PETER J	NO ADDRESS PROVIDED BY TAXPAYER	098037869	2016-2018	INDIVIDUAL PERSONAL PROPERTY	NEAL RAY LISA R	11311 E 77TH TER
097620427	2021	INDIVIDUAL PERSONAL PROPERTY	SHAW REGINA	6002 KENTUCKY AVE	098037870	2008-2009	INDIVIDUAL PERSONAL PROPERTY	BINDER WES	8958 E 60TH TER
097681546	2006	INDIVIDUAL PERSONAL PROPERTY	LASS GLENN H	NO ADDRESS PROVIDED BY TAXPAYER	098042858	2011-2013	INDIVIDUAL PERSONAL PROPERTY	PORTER SHAWN KRISTINE	9117 E 85TH ST
097702165	2009-2017	INDIVIDUAL PERSONAL PROPERTY	MEGGS ROGER & MEGGS CHRISTINA	5900 HEDGES AVE	098042977	2004	INDIVIDUAL PERSONAL PROPERTY	BAUM ELIZABETH	NO ADDRESS PROVIDED BY TAXPAYER
097702509	2009	INDIVIDUAL PERSONAL PROPERTY	PERKINS TIMOTHY J	8910 E 72ND ST	098042984	2002-2003	INDIVIDUAL PERSONAL PROPERTY	BARCLAY DOWELL	10408 E 59TH ST
097714708	2020-2021	INDIVIDUAL PERSONAL PROPERTY	BRAGER ROY L	11211 E 77TH ST	098043635	2009	INDIVIDUAL PERSONAL PROPERTY	WILSON LEONARD G II	9351 E 69TH ST
097726267	2021	INDIVIDUAL PERSONAL PROPERTY	RAMSEY BRENDA K & DENNIS (BRENDA WHITE)	6605 HARVARD AVE	098044065	2011-2012	INDIVIDUAL PERSONAL PROPERTY	ELLIS BRIAN	11918 E 59TH TERRACE CIR
097873400	2002	INDIVIDUAL PERSONAL PROPERTY	ALLEN NINA N	NO ADDRESS PROVIDED BY TAXPAYER	098044302	2003	INDIVIDUAL PERSONAL PROPERTY	LANGFORD JOSH M	NO ADDRESS PROVIDED BY TAXPAYER
097939871	2005-2006	INDIVIDUAL PERSONAL PROPERTY	RENO TRACEY	NO ADDRESS PROVIDED BY TAXPAYER	098044779	2021	INDIVIDUAL PERSONAL PROPERTY	WILLIAMS RICK H & CHRISTAL	11804 E 76TH TER
098000769	2019-2021	INDIVIDUAL PERSONAL PROPERTY	BURCH GLENDA LORAIN	11411 E 58TH TER	098044787	2021	INDIVIDUAL PERSONAL PROPERTY	COONS CARL J	NO ADDRESS PROVIDED BY TAXPAYER
098001952	2021	INDIVIDUAL PERSONAL PROPERTY	THOMPSON RONALD C & CAROL L	5830 FARLEY AVE	098045346	2011-2017	INDIVIDUAL PERSONAL PROPERTY	HEDRICK WILLIAM L & SUSANNE B	10805 E 58TH ST
098004541	2008-2015	INDIVIDUAL PERSONAL PROPERTY	DYER SARAH	10317 E 78TH ST	098045363	2011-2017	INDIVIDUAL PERSONAL PROPERTY	COLLINS WILLIAM E JR	9110 VAUGHN AVE
098004694	2009	INDIVIDUAL PERSONAL PROPERTY	DELL GERALD M	NO ADDRESS PROVIDED BY TAXPAYER	098045466	2005-2006	INDIVIDUAL PERSONAL PROPERTY	INGOLD MICKEY	7001 RAYTOWN RD
098004718	2005-2008	INDIVIDUAL PERSONAL PROPERTY	LUNSFORD DAVID F	6800 LAUREL AVE	098045468	2005-2006	INDIVIDUAL PERSONAL PROPERTY	BATY RACHELLE J	8401 WOODSON DR
098004813	2017-2021	INDIVIDUAL PERSONAL PROPERTY	BRYANT SAUNDRA	UNKNOWN	098046544	2021	INDIVIDUAL PERSONAL PROPERTY	REED SHARON D	6437 BLUE RIDGE CUT OFF
098004853	2017-2021	INDIVIDUAL PERSONAL PROPERTY	KOGER JESSE & LAURIE A	7029 HUNTER ST	098046568	2008-2010	INDIVIDUAL PERSONAL PROPERTY	HOERL DAVID JR	NO ADDRESS PROVIDED BY TAXPAYER
098004996	2001	INDIVIDUAL PERSONAL PROPERTY	BRACKMAN JOHNETTA	NO ADDRESS PROVIDED BY TAXPAYER	098046642	2009	INDIVIDUAL PERSONAL PROPERTY	TAYLOR LEVON M	14200 E 49TH ST APT 408
098004997	2001	INDIVIDUAL PERSONAL PROPERTY	GELHAUS GREGORY B	UNKNOWN	098046647	2005-2011	INDIVIDUAL PERSONAL PROPERTY	THOMAS KENDALL W	7611 WOODSON RD
098005043	2014-2015	INDIVIDUAL PERSONAL PROPERTY	MCMILLAN WILLIAM CJR	9019 E 79TH ST	098046759	2006-2012	INDIVIDUAL PERSONAL PROPERTY	SHIELDS NELSON M II	8306 KENTUCKY AVE
098005065	2004	INDIVIDUAL PERSONAL PROPERTY	LINCOLN MARILYN D	9314 E 83RD ST	098047733	2005-2011	INDIVIDUAL PERSONAL PROPERTY	COOPER MILTON & ROSEMARY	6420 ELM AVE
098005087	2021	INDIVIDUAL PERSONAL PROPERTY	POTTS TONIA R	8440 EVANSTON AVE	098048056	2004	INDIVIDUAL PERSONAL PROPERTY	OBRIST JENNIFER K	UNKNOWN
098005154	2004	INDIVIDUAL PERSONAL PROPERTY	STOCKMAN ERIN	UNKNOWN	098048136	2007	INDIVIDUAL PERSONAL PROPERTY	MCDUFFY KRISTOPHER J	9808 E 77TH TER
098005324	2005-2011	INDIVIDUAL PERSONAL PROPERTY	WAGNER DEBORAH E	8421 SPRING VALLEY RD	098048348	2021	INDIVIDUAL PERSONAL PROPERTY	SHIREMAN STEVEN & LORA	8917 E 58TH ST
098005460	2011-2015	INDIVIDUAL PERSONAL PROPERTY	RAMBO SHANEA K	7906 ARLINGTON AVE	098049374	2018-2021	INDIVIDUAL PERSONAL PROPERTY	CREAGER JASON D	7324 HARVARD DR
098005480	2001-2007	INDIVIDUAL PERSONAL PROPERTY	CRAWFORD CASSANDRA	8484 LANE DR	098049439	2019	INDIVIDUAL PERSONAL PROPERTY	STEPHENSON MICHELLE L	10504 E 57TH TER
098005545	2021	INDIVIDUAL PERSONAL PROPERTY	BURTON JASON MICHAEL	8601 ARLINGTON AVE	098049568	2018-2021	INDIVIDUAL PERSONAL PROPERTY	WRIGHT JOYCE M	6133 STERLING AVE
098005572	2001	INDIVIDUAL PERSONAL PROPERTY	GEORGE DON R	NO ADDRESS PROVIDED BY TAXPAYER	098049758	2021	INDIVIDUAL PERSONAL PROPERTY	ADAMS BRIAN K	8600 SPRING VALLEY RD
098005595	2021	INDIVIDUAL PERSONAL PROPERTY	RUFFIN TERRI	8702 E 83RD TER	098050903	2005-2010	INDIVIDUAL PERSONAL PROPERTY	PARKS MATT R	6804 ENGLEWOOD AVE
098005882	2013	INDIVIDUAL PERSONAL PROPERTY	CLOSSON CAROL M	6205 CLAREMONT AVE	098052484	2005-2008	INDIVIDUAL PERSONAL PROPERTY	WEST LUCRICIA R	7908 CRESCENT AVE
098005926	2001	INDIVIDUAL PERSONAL PROPERTY	FUSSELL STACY L	NO ADDRESS PROVIDED BY TAXPAYER	098053865	2017-2021	INDIVIDUAL PERSONAL PROPERTY	WHITE VERPLE	5508 HUNTER ST
098006186	2014	INDIVIDUAL PERSONAL PROPERTY	TAYLOR MEGUIAL R	19201 E 117H TER S	098053930	2003-2007	INDIVIDUAL PERSONAL PROPERTY	FORD TAMMI	10508 E 79TH ST
098006370	2019-2021	INDIVIDUAL PERSONAL PROPERTY	GREEN FILLIS A	9222 E 54TH TER	098054743	2004	INDIVIDUAL PERSONAL PROPERTY	WEED VIRGIL K & NANCY L	NO ADDRESS PROVIDED BY TAXPAYER
098006371	2007	INDIVIDUAL PERSONAL PROPERTY	HARRIS FREDRICK M & MINDY	9808 E 77TH TER	098055271	2003-2016	INDIVIDUAL PERSONAL PROPERTY	LATTIN RANDY	9001 RICHARDS DR
098006375	2017-2021	INDIVIDUAL PERSONAL PROPERTY	RUPPRECHT BRIAN D	8007 MANNING AVE	098055406	2021	INDIVIDUAL PERSONAL PROPERTY	SCHULTZ RONALD D	8640 JAMES A REED RD
098006439	2021	INDIVIDUAL PERSONAL PROPERTY	HATTAWAY STEPHANIE D	11209 E 78TH TER	098056870	2001	INDIVIDUAL PERSONAL PROPERTY	YANEZ RUBEN	6717 HUNTER ST
098006487	2019	INDIVIDUAL PERSONAL PROPERTY	LEWIS ELISHA Y	13313 E 51ST ST S	098057148	2006-2017	INDIVIDUAL PERSONAL PROPERTY	KLEIST JOHN M	5424 LAUREL AVE
098006565	2005	INDIVIDUAL PERSONAL PROPERTY	JONES JAMES E	5529 DITZLER AVE	098057537	2015	INDIVIDUAL PERSONAL PROPERTY	GLOVER LINDA D	9405 E 69TH ST
098007048	2021	INDIVIDUAL PERSONAL PROPERTY	TURNER NIGEL W & BRISCOE ERIC T	10109 E 77TH TER	098057848	2002-2005	INDIVIDUAL PERSONAL PROPERTY	HEDRICK ROBERT D	NO ADDRESS PROVIDED BY TAXPAYER
098007355	2015-2017	INDIVIDUAL PERSONAL PROPERTY	SHUMATE ANTHONY & RONEE M	10604 E 79TH ST	098060743	2020-2021	INDIVIDUAL PERSONAL PROPERTY	FOWLER RAYMOND & RHETT	9803 E 85TH ST
098007365	2009	INDIVIDUAL PERSONAL PROPERTY	MALONE MARY C (DAVIS)	8620 E UTOPIA DR	098060841	2021	INDIVIDUAL PERSONAL PROPERTY	STINSON ALANNAH D	10309 E 61ST ST APT 3
098007419	2007-2013	INDIVIDUAL PERSONAL PROPERTY	JONES KACI L	8701 TENNESSEE AVE	098062710	2006-2008	INDIVIDUAL PERSONAL PROPERTY	FLAKE ANDREA L	6232 MANNING AVE
098007779	2012-2015	INDIVIDUAL PERSONAL PROPERTY	HENDERSON TEEMON B	11425 E 71ST ST	098063299	2001-2004	INDIVIDUAL PERSONAL PROPERTY	BRIEM DENVER III	NO ADDRESS PROVIDED BY TAXPAYER
098014257	2021	INDIVIDUAL PERSONAL PROPERTY	LAMASTER JOVONN O	6309 HEDGES AVE	098063472	2002-2008	INDIVIDUAL PERSONAL PROPERTY	HIGGINS MELISSA A & PENCE RUSS	10004 E 53RD ST
098014898	2021	INDIVIDUAL PERSONAL PROPERTY	HARNESS MELISSA A & ERIC	9708 E 71ST TER	098063533	2011	INDIVIDUAL PERSONAL PROPERTY	JOHNSON THERESA	6029 LAUREL AVE
098016022	2021	INDIVIDUAL PERSONAL PROPERTY	VAN WYE PAUL BRENT	9109 E 64TH TER	098063728	2011-2013	INDIVIDUAL PERSONAL PROPERTY	COLYER DEBRA G	6515 BLUE RIDGE BLVD
098016122	2021	INDIVIDUAL PERSONAL PROPERTY	PATRICK STEVEN C	11501 E 58TH ST	098063926	2021	INDIVIDUAL PERSONAL PROPERTY	AGGREY REATHA P (GOLSTON)	8805 E 62ND TER
098016218	2015-2021	INDIVIDUAL PERSONAL PROPERTY	BUSH PAULA R	8815 E 52TH TER	098063958	2008	INDIVIDUAL PERSONAL PROPERTY	BRADFORD JENIFER R	8604 E 83RD ST
098016581	2005-2008	INDIVIDUAL PERSONAL PROPERTY	ANDERSON LARRY D	8407 KENTUCKY AVE	098063985	2001	INDIVIDUAL PERSONAL PROPERTY	NEWELL NIKOLAS	9016 E 59TH ST
098016627	2020-2021	INDIVIDUAL PERSONAL PROPERTY	DAVIS NICHOLAS R	10026 E 78TH TER	098064035	2020	INDIVIDUAL PERSONAL PROPERTY	ROBERTS KENNY L	9405 E 65TH TER
098016689	2019	INDIVIDUAL PERSONAL PROPERTY	JONES MARY M	8814 E 80TH TER	098064160	2001-2005	INDIVIDUAL PERSONAL PROPERTY	WOODS LINDA F	NO ADDRESS PROVIDED BY TAXPAYER
098016971	2020-2021	INDIVIDUAL PERSONAL PROPERTY	ALBRIGHT ANNE M	NO ADDRESS PROVIDED BY TAXPAYER	098064255	2002	INDIVIDUAL PERSONAL PROPERTY	VLOEDMAN PATRICIA	6024 STERLING AVE
098016992	2007-2008	INDIVIDUAL PERSONAL PROPERTY	PRUITT ROBIN L	8804 RICHARDS DR	098064525	2008	INDIVIDUAL PERSONAL PROPERTY	CUFFLE DENNIS L	9617 E 65TH ST
098017186	2002	INDIVIDUAL PERSONAL PROPERTY	MCDANIEL (BELL) TAMMY	UNKNOWN	098064643	2002-2004	INDIVIDUAL PERSONAL PROPERTY	COTTER JOHN	NO ADDRESS PROVIDED BY TAXPAYER
098017255	2018-2021	INDIVIDUAL PERSONAL PROPERTY	SAGE STEVEN ROYCE SR	7921 DITZLER AVE	098064674	2012-2014	INDIVIDUAL PERSONAL PROPERTY	BROWN FREDERICK E	11329 E 72ND ST
098017286	2001-2002	INDIVIDUAL PERSONAL PROPERTY	FELZIEN JEFFREY D	11006 E 57TH ST	098064946	2004-2011	INDIVIDUAL PERSONAL PROPERTY	BULLARD JOHN G	5528 HUNTER TER
098017328	2005-2006	INDIVIDUAL PERSONAL PROPERTY	GROTH WILLIAM J	NO ADDRESS PROVIDED BY TAXPAYER	098065119	2002	INDIVIDUAL PERSONAL PROPERTY	SMITH ROGER DALE	UNKNOWN
098017407	1998-2001	INDIVIDUAL PERSONAL PROPERTY	MALONE JOSEPH M	NO ADDRESS PROVIDED BY TAXPAYER	098065200	2010-2011	INDIVIDUAL PERSONAL PROPERTY	PATRICK TAMARA E	9054 E 68TH TER
098017547	2019-2021	INDIVIDUAL PERSONAL PROPERTY	TALBERT TAMIKA C	9306 E 81ST ST	098068208	2008	INDIVIDUAL PERSONAL PROPERTY	RICHARDSON KARLA	6705 HUNTER ST APT 113
098017748	2007	INDIVIDUAL PERSONAL PROPERTY	OWSIANY GARY & CAROL	11904 E 78TH TER	098069968	2003-2004	INDIVIDUAL PERSONAL PROPERTY	HIRSCH RAHMEEN B	NO ADDRESS PROVIDED BY TAXPAYER
098017850	2004-2013	INDIVIDUAL PERSONAL PROPERTY	HEINDEL KEVIN	NO ADDRESS PROVIDED BY TAXPAYER	098073362	2007	INDIVIDUAL PERSONAL PROPERTY	JOHNSTON ALLISON M	9024 E 85TH PL
098017981	2016-2021	INDIVIDUAL PERSONAL PROPERTY	VANWYE ROSALE E	6606 WILLOW AVE	098073713	2001	INDIVIDUAL PERSONAL PROPERTY	MLOSEVICH LEAH (PLANTE)	UNKNOWN
098021353	2014-2017	INDIVIDUAL PERSONAL PROPERTY	MOORE RORY ALLEN	7220 OXFORD AVE	098073758	2021	INDIVIDUAL PERSONAL PROPERTY	BRAY ANTOINETTE (GREEN)	9300 E 82ND TER
098021454	2005-2007	INDIVIDUAL PERSONAL PROPERTY	NEWTON DANA M	NO ADDRESS PROVIDED BY TAXPAYER	098074295	2021	INDIVIDUAL PERSONAL PROPERTY	WILSON WAYNE A	7824 IRWIN RD
098021918	2009-2011	INDIVIDUAL PERSONAL PROPERTY	ELMORE CLARA M	6600 WILLOW AVE	098074731	2021	INDIVIDUAL PERSONAL PROPERTY	YEARBY JAMES JUNIOR III	6816 WILDWOOD DR
098024943	2019-2021	INDIVIDUAL PERSONAL PROPERTY	CARTER QUENTIN M	11504 E 62ND TER	098075889	2010	INDIVIDUAL PERSONAL PROPERTY	ANDERSON WALTER R	6657 MAYWOOD AVE
098025136	2019-2020	INDIVIDUAL PERSONAL PROPERTY	BULK BRIAN J	6920 HUNTER ST	098076712	2004	INDIVIDUAL PERSONAL PROPERTY	JOHNSON ANDRE	NO ADDRESS PROVIDED BY TAXPAYER
098026664	2011-2012	INDIVIDUAL PERSONAL PROPERTY	LAVENDER TRAVIS P	8329 NORTHERN ST	098078476	2000-2001	INDIVIDUAL PERSONAL PROPERTY	RODRRIQUEZ DANIEL & MARIA V	NO ADDRESS PROVIDED BY TAXPAYER
098031850	2006	INDIVIDUAL PERSONAL PROPERTY	STROEDE MICHAEL S	10909 E 59TH ST	098078564	2021	INDIVIDUAL PERSONAL PROPERTY	MALIK KHALID & SHAZIA P	8511 OXFORD AVE
098032161	2007-2015	INDIVIDUAL PERSONAL PROPERTY	GRIGSBY MICHAEL D	6706 NORTHERN AVE	098079426	2009-2012	INDIVIDUAL PERSONAL PROPERTY	ELLIOTT NICK	612 NE MULBERRY ST

098080826	2020-2021	INDIVIDUAL PERSONAL PROPERTY	WYMAN KELLY J	9516 E 69TH ST	098120219	2006-2009	INDIVIDUAL PERSONAL PROPERTY	INFIELD ANNA M	7424 ENGLEWOOD LN
098080988	2019-2021	INDIVIDUAL PERSONAL PROPERTY	TRIPP JOHN ELIAS	7315 WOODSON RD	098120300	2016-2017	INDIVIDUAL PERSONAL PROPERTY	MATHEIS DOUGLAS	7216 RAYTOWN RD APT B
098081034	2020-2021	INDIVIDUAL PERSONAL PROPERTY	PODSCHWIT AARON J & KARA	8617 OXFORD AVE	098120353	2000	INDIVIDUAL PERSONAL PROPERTY	ARNOLD GARY E	UNKNOWN
098081132	2003-2007	INDIVIDUAL PERSONAL PROPERTY	AGEE ROSEMARY	8705 STARK AVE	098120659	2020-2021	INDIVIDUAL PERSONAL PROPERTY	HILL CHRISTOPHER SEAN & JENNIFER LYNN	7824 WESTRIDGE RD
098082930	2021	INDIVIDUAL PERSONAL PROPERTY	MADSEN DEBORAH	8811 E 72ND ST	098120808	2021	INDIVIDUAL PERSONAL PROPERTY	DUNN DOROTHY & ROY	6813 CRISP AVE
098083388	2015-2016	INDIVIDUAL PERSONAL PROPERTY	MORTZ EUGENE A	5520 ASH AVE	098121048	2020-2021	INDIVIDUAL PERSONAL PROPERTY	NORWOOD MALCOLM E	8807 E 72ND TER
098083415	2005-2009	INDIVIDUAL PERSONAL PROPERTY	DUNLAP RESSIE S	NO ADDRESS PROVIDED BY TAXPAYER	098122378	2016-2019	INDIVIDUAL PERSONAL PROPERTY	HALL CHRIS L	9825 E 64TH TER
098083882	2021	INDIVIDUAL PERSONAL PROPERTY	BRALY JOSEPH A	10501 E 63RD ST	098122492	2021	INDIVIDUAL PERSONAL PROPERTY	ADAMS KEARRA B	5816 ELM AVE
098083894	2011	INDIVIDUAL PERSONAL PROPERTY	MCCLANAHAN WILLIAM	6716 LAKESHORE DR	098123008	2016-2018	INDIVIDUAL PERSONAL PROPERTY	BENNETT PHILLIP W	5505 HARRIS AVE
098084142	2020-2021	INDIVIDUAL PERSONAL PROPERTY	WORKCUFF PAULA M	8308 ELM AVE	098123085	2021	INDIVIDUAL PERSONAL PROPERTY	MOORE NEVA J	8402 WOODSON CT
098084195	2016-2018	INDIVIDUAL PERSONAL PROPERTY	MASON TRACY S	8431 ARLINGTON AVE	098123536	2019-2021	INDIVIDUAL PERSONAL PROPERTY	CLARK DEWANDA C	6500 BLUE RIDGE CUT OFF
098084918	2003	INDIVIDUAL PERSONAL PROPERTY	WILSON ORION JASON	6501 HARVARD AVE	098123684	2021	INDIVIDUAL PERSONAL PROPERTY	FORD PHILLIP TYRON	8508 CRESCENT AVE
098085110	2001-2004	INDIVIDUAL PERSONAL PROPERTY	PECK EDWARD C & CHARLOTTE	NO ADDRESS PROVIDED BY TAXPAYER	098123794	2019-2021	INDIVIDUAL PERSONAL PROPERTY	OMOREGIE GODWIN	11301 E 61ST ST
098085137	2021	INDIVIDUAL PERSONAL PROPERTY	POUNCEL GAYNELL	11307 E 78TH ST	098123903	2016-2021	INDIVIDUAL PERSONAL PROPERTY	SALINAS ALEJANDRO R & VICTORIA A	5821 FARLEY AVE
098085327	2021	INDIVIDUAL PERSONAL PROPERTY	HENDERSON CARLOS MAURICE	9709 E 79TH TER	098124410	2021	INDIVIDUAL PERSONAL PROPERTY	SAULS HAROLD D JR	9014 E 73RD ST
098086130	2001	INDIVIDUAL PERSONAL PROPERTY	GORDANIER MARIANNE	NO ADDRESS PROVIDED BY TAXPAYER	098124753	2021	INDIVIDUAL PERSONAL PROPERTY	RUSSELL MOTINA M	5709 WOODSON RD
098086178	2007	INDIVIDUAL PERSONAL PROPERTY	BRIDGEWATER JAY A	6400 HEDGES AVE	098124981	2007	INDIVIDUAL PERSONAL PROPERTY	GUYHAN REGINALD JR	8505 JAMES A REED RD
098086418	2002	INDIVIDUAL PERSONAL PROPERTY	TESKE TIMOTHY W	UNKNOWN	098125039	2020-2021	INDIVIDUAL PERSONAL PROPERTY	GRAHAM STEVE A & ANGELA L	10905 E 77TH TER
098087120	2001	INDIVIDUAL PERSONAL PROPERTY	SMITH WILBUR L & SHERRY C	NO ADDRESS PROVIDED BY TAXPAYER	098125652	2005-2013	INDIVIDUAL PERSONAL PROPERTY	HAGGARD BEN	11000 E 83RD ST
098088138	2020-2021	INDIVIDUAL PERSONAL PROPERTY	WILLIAMS MARILYN ROSE	8510 EVERETT ST	098126203	2021	INDIVIDUAL PERSONAL PROPERTY	MAYBERRY TANYA A	WOODS JENNIFER
098089147	2020-2021	INDIVIDUAL PERSONAL PROPERTY	ARNOLD CRYSTAL (ROBINSON)	6323 ASH AVE	098126687	2021	INDIVIDUAL PERSONAL PROPERTY	GOSSEY MELEA	8416 BOOTH AVE
098089347	2005-2006	INDIVIDUAL PERSONAL PROPERTY	RAMEY CATHERINE	NO ADDRESS PROVIDED BY TAXPAYER	098127883	2003-2004	INDIVIDUAL PERSONAL PROPERTY	KING AMBER D	5408 LAUREL AVE
098091258	2000-2001	INDIVIDUAL PERSONAL PROPERTY	SMITH BOSEDE A	NO ADDRESS PROVIDED BY TAXPAYER	098129623	2005	INDIVIDUAL PERSONAL PROPERTY	SPEAD ANTHONY & YOLANDA	MICKELSON RYAN M
098091510	2021	INDIVIDUAL PERSONAL PROPERTY	HOLLISTER JOSEPH JR	4513 ELMWOOD AVE	098129642	2020-2021	INDIVIDUAL PERSONAL PROPERTY	DANIELS PHILOMENA F	8311 MARSH AVE
098091823	2021	INDIVIDUAL PERSONAL PROPERTY	HARRIS LUAWANA LYNN	8617 W UTOPIA DR APT 36	098130323	2004-2007	INDIVIDUAL PERSONAL PROPERTY	TAYLOR JENNIFER L	10800 E 58TH ST
098093564	2004	INDIVIDUAL PERSONAL PROPERTY	ROBINSON MARGO D	3024 HIGHLAND AVE	098131868	2003-2004	INDIVIDUAL PERSONAL PROPERTY	WADDY CLEATHUS & ROEZEATHER	5220 STERLING AVE
098093952	2007-2014	INDIVIDUAL PERSONAL PROPERTY	GALES ANTONIO	9303 E 82ND TER	098132310	2006-2008	INDIVIDUAL PERSONAL PROPERTY	MOORE TRESSIE	NO ADDRESS PROVIDED BY TAXPAYER
098094900	2020-2021	INDIVIDUAL PERSONAL PROPERTY	HIBDON RONNY RACHELLE	5425 RALSTON AVE	098132600	2021	INDIVIDUAL PERSONAL PROPERTY	ALLEN ANTOINETTE C & DURHAM GLORIA J	5521 HUNTER TER
098096827	2021	INDIVIDUAL PERSONAL PROPERTY	SCHNEBELN NICHOLAS R	9309 E 69TH ST	098132976	2002-2006	INDIVIDUAL PERSONAL PROPERTY	HENDERSON CYNTHIA	11261 CALICO DR
098097120	2007	INDIVIDUAL PERSONAL PROPERTY	BEIGHLEY LEONARD C	5324 RALSTON AVE	098133051	2009-2017	INDIVIDUAL PERSONAL PROPERTY	ROWLAND TRACY L & GORDON	5332 NORTHERN AVE
098097121	2021	INDIVIDUAL PERSONAL PROPERTY	MURRAY TOBIE LOUISE	8102 EVANSTON AVE	098133085	2001	INDIVIDUAL PERSONAL PROPERTY	DAWKINS WILLIE	5120 CLEVELAND AVE APT 301
098097514	2002	INDIVIDUAL PERSONAL PROPERTY	LATSON DENISE	NO ADDRESS PROVIDED BY TAXPAYER	098133120	2011-2017	INDIVIDUAL PERSONAL PROPERTY	PIEPER RAYMOND R & REGINA K	5204 STERLING AVE
098097622	2021	INDIVIDUAL PERSONAL PROPERTY	SALAZAR ENRIQUE L & LISA C	9821 E 64TH TER	098133192	2002	INDIVIDUAL PERSONAL PROPERTY	MILLS GEOFFREY W	NO ADDRESS PROVIDED BY TAXPAYER
098097833	2021	INDIVIDUAL PERSONAL PROPERTY	BRUCE MARY ANN	9533 E 57TH TER	098133301	2002-2011	INDIVIDUAL PERSONAL PROPERTY	REESE CALVIN EUGENE	8809 E 62ND TER
098098057	2007-2009	INDIVIDUAL PERSONAL PROPERTY	MOHR JOHN S	7724 ELM ST	098133320	2001-2002	INDIVIDUAL PERSONAL PROPERTY	SZCZYGLI WENDY C	5501 BLUE RIDGE BLVD
098098117	2013-2017	INDIVIDUAL PERSONAL PROPERTY	ROSS JAMES M	8124 APPLETON AVE	098133326	2015-2021	INDIVIDUAL PERSONAL PROPERTY	EIKER CHRISTINA & DAVID	7811 E 75TH ST
098098482	2010-2014	INDIVIDUAL PERSONAL PROPERTY	PAYNE ROCHELLE M	8301 ELM AVE	098133355	2016-2017	INDIVIDUAL PERSONAL PROPERTY	ALLEN DAVID L & MARTHA L	8202 STERLING AVE
098098553	2014	INDIVIDUAL PERSONAL PROPERTY	HAMPTON CARMELITA W	9505 MANCHESTER AVE	098133420	2021	INDIVIDUAL PERSONAL PROPERTY	WESTMORELAND CHRIS	10900 E 66TH ST
098102239	2020-2021	INDIVIDUAL PERSONAL PROPERTY	FERBET MARK G	6917 WILDWOOD DR	098133428	2004	INDIVIDUAL PERSONAL PROPERTY	SPRADLEY DONALD E	5336 NORTHERN AVE
098102251	2009	INDIVIDUAL PERSONAL PROPERTY	DUNN ADRIAN L	6813 CRISP AVE	098133455	2013-2014	INDIVIDUAL PERSONAL PROPERTY	ROE TONYA	5801 BLUE RIDGE BLVD
098102625	2018	INDIVIDUAL PERSONAL PROPERTY	BELL TERESA LYNN	5408 WOODSON RD	098133457	2020-2021	INDIVIDUAL PERSONAL PROPERTY	MURRAY KIELE R	6620 HARDY AVE
098103164	2009-2011	INDIVIDUAL PERSONAL PROPERTY	HOLLER THOMAS E JR	5416 RAYTOWN RD	098133577	2001-2005	INDIVIDUAL PERSONAL PROPERTY	JENKINS TAMEISHA L	9047 E 82ND ST
098103500	2007	INDIVIDUAL PERSONAL PROPERTY	DAVIS GEORGE W IV	10318 E 63RD ST APT 1	098133607	2003-2017	INDIVIDUAL PERSONAL PROPERTY	BYRD JIM	9011 E 68TH ST
098103631	2021	INDIVIDUAL PERSONAL PROPERTY	EDMONDSON RICHARD L JR & BARBARA	7509 MAPLE LN	098133680	2007-2009	INDIVIDUAL PERSONAL PROPERTY	LEE TAMARA	UNKNOWN
098103919	2007	INDIVIDUAL PERSONAL PROPERTY	BISHOP ARDIS L	12017 E 51ST ST S	098133814	2002	INDIVIDUAL PERSONAL PROPERTY	BETTS MICHAEL J & GENELLE J	NO ADDRESS PROVIDED BY TAXPAYER
098104045	2013-2014	INDIVIDUAL PERSONAL PROPERTY	ADAMS DEBRA K (GIORDANO) & ADAMS JACK	NO ADDRESS PROVIDED BY TAXPAYER	098133900	2001-2002	INDIVIDUAL PERSONAL PROPERTY	RAINES FRANK	8115 WILLOW WAY
098104282	2020-2021	INDIVIDUAL PERSONAL PROPERTY	LEWIS NAKITA JANNI & FORBES AARON DWYANE	10808 E 79TH ST	098133912	2003	INDIVIDUAL PERSONAL PROPERTY	HOPPE CHRISTOPHER	NO ADDRESS PROVIDED BY TAXPAYER
098104326	2009-2010	INDIVIDUAL PERSONAL PROPERTY	MAIDEN VONDA	900A E 68TH ST	098134024	2004-2007	INDIVIDUAL PERSONAL PROPERTY	MENTOCK JAMES	NO ADDRESS PROVIDED BY TAXPAYER
098104592	2021	INDIVIDUAL PERSONAL PROPERTY	RAMSEY D DENNIS	6605 HARVARD AVE	098134049	2009-2010	INDIVIDUAL PERSONAL PROPERTY	BOGUE LARRY & PAMELA	5520 LANE AVE
098104805	2007-2017	INDIVIDUAL PERSONAL PROPERTY	JONES MICHAEL A JR	8460 LANE DR	098134069	2001	INDIVIDUAL PERSONAL PROPERTY	MIESSE KELLI	NO ADDRESS PROVIDED BY TAXPAYER
098105658	2017-2021	INDIVIDUAL PERSONAL PROPERTY	WHITE VERNELL	8306 MANNING AVE	098134232	2017-2018	INDIVIDUAL PERSONAL PROPERTY	KRIDNER MARY B & RICHARD A	NO ADDRESS PROVIDED BY TAXPAYER
098106207	2014	INDIVIDUAL PERSONAL PROPERTY	ARTIS KELLY L (GIOVANNETTI)	6408 HARDY AVE	098134364	2021	INDIVIDUAL PERSONAL PROPERTY	BANEY MARY C	6140 RAYTOWN RD APT 905
098106607	2007-2015	INDIVIDUAL PERSONAL PROPERTY	CAUTION RICHARD & SMIRNOFF JOAN	5608 CRESCENT AVE	098134504	2002-2004	INDIVIDUAL PERSONAL PROPERTY	MCCLURE WILLIE J	8815 E 85TH TER
098107203	2019-2021	INDIVIDUAL PERSONAL PROPERTY	ADAMS CARMEN D	10019 E 78TH ST	098134512	2015	INDIVIDUAL PERSONAL PROPERTY	DENATALE MICHAEL	UNKNOWN
098110099	2002	INDIVIDUAL PERSONAL PROPERTY	TAYLOR LORI A	13209 WORNALL RD UNIT E	098134723	2021	INDIVIDUAL PERSONAL PROPERTY	TORELLO PATRICK	NO ADDRESS PROVIDED BY TAXPAYER
098110376	2013	INDIVIDUAL PERSONAL PROPERTY	WOOTEN VANESSA	7600 CRISP AVE	098134724	2002-2003	INDIVIDUAL PERSONAL PROPERTY	SHAW DEBORAH S	5500 HARRIS AVE
098110905	2013	INDIVIDUAL PERSONAL PROPERTY	HACK LAVETA D	8900 E 59TH ST	098134866	2004-2005	INDIVIDUAL PERSONAL PROPERTY	MURPHY CULLEN M	7705 RAYTOWN RD
098111079	2002	INDIVIDUAL PERSONAL PROPERTY	HUDSPETH AMIE CAROL	NO ADDRESS PROVIDED BY TAXPAYER	098134887	2010-2011	INDIVIDUAL PERSONAL PROPERTY	FISHER EDGAR L	NO ADDRESS PROVIDED BY TAXPAYER
098111568	2021	INDIVIDUAL PERSONAL PROPERTY	KUYKENDALL LACRESHA T	8304 MANNING AVE	098134944	2014	INDIVIDUAL PERSONAL PROPERTY	HARDAWAY WILLIE E JR	5813 CEDAR AVE
098111623	2020	INDIVIDUAL PERSONAL PROPERTY	WALLS ROLAND	7709 E 90TH TER	098134990	2001	INDIVIDUAL PERSONAL PROPERTY	SNELL CARL P	NO ADDRESS PROVIDED BY TAXPAYER
098111634	2011	INDIVIDUAL PERSONAL PROPERTY	WITHERS CYNTHIA A	8622 E UTOPIA DR APT 9	098135233	2014-2016	INDIVIDUAL PERSONAL PROPERTY	BILLITER BRIAN C	6800 ENGLEWOOD AVE
098111789	2010-2012	INDIVIDUAL PERSONAL PROPERTY	ARMSTRONG DONALD E	9353 E 69TH ST	098135276	2002	INDIVIDUAL PERSONAL PROPERTY	GOODFELLOW JAMES L	NO ADDRESS PROVIDED BY TAXPAYER
098111802	2008	INDIVIDUAL PERSONAL PROPERTY	NILSEN KEITH W	2416 S HAWTHORNE AVE	098135481	2004-2005	INDIVIDUAL PERSONAL PROPERTY	HENKE MALLORIE A	9901 E 82ND TER
098111882	2021	INDIVIDUAL PERSONAL PROPERTY	GARRETSON KAREN E	9813 E 73RD ST APT E	098135492	2011	INDIVIDUAL PERSONAL PROPERTY	CARNETT SHAWN & BETH	NO ADDRESS PROVIDED BY TAXPAYER
098112347	2021	INDIVIDUAL PERSONAL PROPERTY	MILLS BRIAN J	11404 E 78TH ST	098135495	2007	INDIVIDUAL PERSONAL PROPERTY	DAWSON DOUGLAS T	UNKNOWN
098112413	2001	INDIVIDUAL PERSONAL PROPERTY	HUSTON KERRI B	6412 ELM	098135660	2001	INDIVIDUAL PERSONAL PROPERTY	SUMMERVILLE RENITA	900A E 74TH TER
098113615	2021	INDIVIDUAL PERSONAL PROPERTY	HERMES DAVID LEE	8306 E 86TH TER	098135678	2002	INDIVIDUAL PERSONAL PROPERTY	QUINTANILLA MATTHIAS A	9000 E 55TH ST
098114001	2020-2021	INDIVIDUAL PERSONAL PROPERTY	BRYANT CHARLES JR	5512 NORTHERN AVE	098135719	2015-2018	INDIVIDUAL PERSONAL PROPERTY	KEPPEL CHRISTOPHER C & RACHEL KEPPEL	11416 E 78TH TER
098114387	2020	INDIVIDUAL PERSONAL PROPERTY	BURRESS LOWELL E & DANA	5806 BLUE RIDGE CUT OFF	098135759	2021	INDIVIDUAL PERSONAL PROPERTY	JOHNSON JALITA M	NO ADDRESS PROVIDED BY TAXPAYER
098117247	2002	INDIVIDUAL PERSONAL PROPERTY	BRACY ROCHELLE (DAY)	10117 E 56TH ST	098135878	2021	INDIVIDUAL PERSONAL PROPERTY	TRAVIS LEO L	6609 OXFORD AVE
098119949	2021	INDIVIDUAL PERSONAL PROPERTY	PROTSMAN JAMES E	8810 E 72ND TER	098135958	2004-2008	INDIVIDUAL PERSONAL PROPERTY		
098120163	2002-2004	INDIVIDUAL PERSONAL PROPERTY	DUDEN DIRK J	NO ADDRESS PROVIDED BY TAXPAYER	098135978	2003-2006	INDIVIDUAL PERSONAL PROPERTY		

098136001	2020-2021	INDIVIDUAL PERSONAL PROPERTY	FORTNEY JOHN PHILLIP	7409 BLUE RIDGE BLVD	098966907	2020-2021	INDIVIDUAL PERSONAL PROPERTY	GILMORE MELONIE M	9037 E 85TH TER
098136087	2011-2017	INDIVIDUAL PERSONAL PROPERTY	HARTER DAVID C & MARTHA L (COMBS)	7311 BLUE RIDGE BLVD	098984408	2004	INDIVIDUAL PERSONAL PROPERTY	HOHIMER KIMBERLY D	6128 DITZLER AVE
098136169	2001-2003	INDIVIDUAL PERSONAL PROPERTY	YOUNG THOMAS J	NO ADDRESS PROVIDED BY TAXPAYER	099051707	2015	INDIVIDUAL PERSONAL PROPERTY	MOYER JEANETTE	NO ADDRESS PROVIDED BY TAXPAYER
098136194	2018-2021	INDIVIDUAL PERSONAL PROPERTY	KRAMER KRISTEN R	9909 E 60TH ST	099054106	2020-2021	INDIVIDUAL PERSONAL PROPERTY	HARRISON WILLIAM J	8462 LANE DR
098136295	2021	INDIVIDUAL PERSONAL PROPERTY	MOORE MICHAEL S	7817 ARLINGTON AVE	099054144	2001-2003	INDIVIDUAL PERSONAL PROPERTY	STARBUCK STEVEN D	11200 E 67TH ST
098136326	2020-2021	INDIVIDUAL PERSONAL PROPERTY	STOCKDALE LATISHA R	10021 E 67TH ST	099054175	2006	INDIVIDUAL PERSONAL PROPERTY	BARCLAY TERESA L	8833 E 57TH ST
098136350	2001	INDIVIDUAL PERSONAL PROPERTY	BOND WILLIAM G	6160 KENWOOD AVE	099054262	2001	INDIVIDUAL PERSONAL PROPERTY	GREY ANITA Q	10901 E 66TH ST
098136539	2003	INDIVIDUAL PERSONAL PROPERTY	WILSON MARLO	NO ADDRESS PROVIDED BY TAXPAYER	099054312	2012	INDIVIDUAL PERSONAL PROPERTY	CANDILLO JOHN JOSEPH	7324 CEDAR AVE
098136621	2011-2012	INDIVIDUAL PERSONAL PROPERTY	HARRISON GERALD D	6615 WILLOW AVE	099054351	2011	INDIVIDUAL PERSONAL PROPERTY	COYLE DAN & MARY	5817 RALSTON AVE
098136663	2019-2021	INDIVIDUAL PERSONAL PROPERTY	OSTROM BRUCE A	8324 PERSHING RD	099054353	2010-2011	INDIVIDUAL PERSONAL PROPERTY	HALL-MILLER-ESTES LISA KAY	7324 CEDAR AVE
098136797	2021	INDIVIDUAL PERSONAL PROPERTY	DAWSON CHAUNCEY	11614 E 72ND ST	099054359	2000-2002	INDIVIDUAL PERSONAL PROPERTY	WILLHOIT AARON H	5817 RALSTON AVE
098136821	2021	INDIVIDUAL PERSONAL PROPERTY	MILLIGAN JUAN K	8618 OXFORD AVE	099054562	2000-2005	INDIVIDUAL PERSONAL PROPERTY	SMITH MARCUS C	NO ADDRESS PROVIDED BY TAXPAYER
098136949	2021	INDIVIDUAL PERSONAL PROPERTY	FROGGE STEPHEN M	10007 E 60TH TER	099054596	2006-2017	INDIVIDUAL PERSONAL PROPERTY	GUIDO TERRY T	7424 HARDY AVE
098136995	2012-2017	INDIVIDUAL PERSONAL PROPERTY	HULL ADAM J	8312 PERSHING RD	099054792	2021	INDIVIDUAL PERSONAL PROPERTY	LUHNING ARNETT C	11300 E 55TH TER
098137000	2016-2021	INDIVIDUAL PERSONAL PROPERTY	SEBASTIANO BECKY J	6200 WILLOW AVE	099054822	2003	INDIVIDUAL PERSONAL PROPERTY	TYLER ERIK & BERNADETTES	11304 E 65TH ST
098137120	2010-2014	INDIVIDUAL PERSONAL PROPERTY	HAMLIN JASON	9511 E 64TH ST	099054850	2020-2021	INDIVIDUAL PERSONAL PROPERTY	NELSON CYNAMON	5431 DITZLER AVE
098137260	2014	INDIVIDUAL PERSONAL PROPERTY	SMITH RANDALL W	9050 E 65TH ST	099054993	2004-2008	INDIVIDUAL PERSONAL PROPERTY	INGLISH TINA R	8609 FORD AVE
098137472	2001-2002	INDIVIDUAL PERSONAL PROPERTY	MILTON WENDOLYN	UNKNOWN	099055081	2000-2001	INDIVIDUAL PERSONAL PROPERTY	ALLEN STACIE L	9809 E 60TH TER
098137543	2020-2021	INDIVIDUAL PERSONAL PROPERTY	SEARCY PETE B	8119 MANNING AVE	099055094	2001	INDIVIDUAL PERSONAL PROPERTY	STRIEGEL JAMES	112 N KENDALL DR
098137681	2004-2006	INDIVIDUAL PERSONAL PROPERTY	MICKELSON DUSTIN	11304 E 85TH TER	099055153	2000	INDIVIDUAL PERSONAL PROPERTY	BROWN APRIL L	NO ADDRESS PROVIDED BY TAXPAYER
098137828	1999	INDIVIDUAL PERSONAL PROPERTY	ALDRICH STEVEN	5828 WOODSON RD	099055249	2012-2016	INDIVIDUAL PERSONAL PROPERTY	ROYAL MICHELLE LYNN	1850 OXFORD AVE
098137902	2006-2008	INDIVIDUAL PERSONAL PROPERTY	HAM PETNER & IASINDA R SOSWIE	7509 HAMWORTHORNE AVE	099055493	2000	INDIVIDUAL PERSONAL PROPERTY	SMITH KRISTA A (EDWARDS)	UNKNOWN
098138272	2005-2006	INDIVIDUAL PERSONAL PROPERTY	MYERS PERCY C IV	8600 ASH AVE	099055577	2017-2021	INDIVIDUAL PERSONAL PROPERTY	SHOCKLEY LISA A	5403 WOODSON RD
098138372	2021	INDIVIDUAL PERSONAL PROPERTY	CHAMBERS PATRICK R	11412 E 77TH ST	099055581	2001-2003	INDIVIDUAL PERSONAL PROPERTY	KELLER BRENDA & GONSALVES	UNKNOWN
098138865	2011-2012	INDIVIDUAL PERSONAL PROPERTY	GEORGE LAURA S	9912 E 60TH ST	099055636	2004-2006	INDIVIDUAL PERSONAL PROPERTY	SMITH LAURA E	11214 I 76TH TER
098139581	2020-2021	INDIVIDUAL PERSONAL PROPERTY	JOHNSON MARSHA D	5429 DITZLER AVE	099055664	2021	INDIVIDUAL PERSONAL PROPERTY	MORALES JOSHUA D & SARAH H	4712 E 81ST ST
098145160	2011-2018	INDIVIDUAL PERSONAL PROPERTY	RICH TAMMY L	9404 E 65TH ST	099055791	2000	INDIVIDUAL PERSONAL PROPERTY	RICHWINE GARY L	9300 CARLISLE AVE
098146158	2021	INDIVIDUAL PERSONAL PROPERTY	REINE CAMILLE E	11219 E 51ST ST	099055877	2002-2005	INDIVIDUAL PERSONAL PROPERTY	COOPER JAMES E & CAROLYN L	NO ADDRESS PROVIDED BY TAXPAYER
098151355	2020-2021	INDIVIDUAL PERSONAL PROPERTY	DICKMANN WARD & AMY	10013 E 78TH ST	099055914	2021	INDIVIDUAL PERSONAL PROPERTY	YOCUM JEREMIAH C	9810 E 80TH TER
098152996	2018-2019	INDIVIDUAL PERSONAL PROPERTY	COCHRANE KARA & JOHN	5741 ASH AVE	099055936	2021	INDIVIDUAL PERSONAL PROPERTY	DOUGLAS ANDREW	5704 HUNTER ST
098154942	2001-2011	INDIVIDUAL PERSONAL PROPERTY	REDELLE REBECCA G	NO ADDRESS PROVIDED BY TAXPAYER	099060646	2007	INDIVIDUAL PERSONAL PROPERTY	MCDOWEL BRANDON C	21 W 10TH ST UNIT 9A
098155443	2010-2011	INDIVIDUAL PERSONAL PROPERTY	MUELLER CHRISTY L	11100 E 57TH TER	099060608	2006-2007	INDIVIDUAL PERSONAL PROPERTY	PARUIN CARL E 111	6331 FARLEY AVE
098155533	2001-2002	INDIVIDUAL PERSONAL PROPERTY	BAKER MARIE H	NO ADDRESS PROVIDED BY TAXPAYER	099065180	2000	INDIVIDUAL PERSONAL PROPERTY	CHASE JANET	UNKNOWN
098155664	2020-2021	INDIVIDUAL PERSONAL PROPERTY	WALLEY CYNTHIA J	7604 HARVARD AVE	099062600	2001-2002	INDIVIDUAL PERSONAL PROPERTY	YOUNG SCOTT A & JAIME	UNKNOWN
098156214	2001-2011	INDIVIDUAL PERSONAL PROPERTY	BROWN DAVID C	NO ADDRESS PROVIDED BY TAXPAYER	099057908	2001-2002	INDIVIDUAL PERSONAL PROPERTY	REAM BARBARA	NO ADDRESS PROVIDED BY TAXPAYER
098157911	2021	INDIVIDUAL PERSONAL PROPERTY	CRUMP LAMAR L	9324 E 84TH TER	099060608	2014-2021	INDIVIDUAL PERSONAL PROPERTY	SCARLETT JOHN ANDREW	9431 CEDAR AVE
098176194	2013-2014	INDIVIDUAL PERSONAL PROPERTY	PRUDEN SHERRI L	10005 E 72ND ST	099060931	2021	INDIVIDUAL PERSONAL PROPERTY	LAMBERT WILLIAM S	5205 E 52ND TER
098176508	2002	INDIVIDUAL PERSONAL PROPERTY	WESTERMAN KAREN	8521 ARLINGTON AVE	099061574	2015	INDIVIDUAL PERSONAL PROPERTY	RAMOS MARGARITA	11116 E 75TH ST
098176563	2005-2006	INDIVIDUAL PERSONAL PROPERTY	MCAFFEE PRECIOUS	9200 E 54TH ST	099061577	2000-2002	INDIVIDUAL PERSONAL PROPERTY	SAMPSON LEONA C	NO ADDRESS PROVIDED BY TAXPAYER
098177119	2017-2021	INDIVIDUAL PERSONAL PROPERTY	MCDOWELL PAULA N	9812 E 79TH PL	099061809	2021	INDIVIDUAL PERSONAL PROPERTY	BEDFORD GLORIA J	6221 ASH CT
098177120	2021	INDIVIDUAL PERSONAL PROPERTY	KATHY L DAVIS LEWIS	8609 ARLINGTON AVE	099061868	2016-2021	INDIVIDUAL PERSONAL PROPERTY	HARPER GREGORY	9303 E 82ND TER
098178280	2000-2001	INDIVIDUAL PERSONAL PROPERTY	HAALAND ANGELA K (STRONG)	NO ADDRESS PROVIDED BY TAXPAYER	099062072	2006-2008	INDIVIDUAL PERSONAL PROPERTY	SHEETS SHANNON K	5325 WOODSON RD
098179206	2013-2014	INDIVIDUAL PERSONAL PROPERTY	PUHL CAROL L	9801 E 61ST ST APT 9	099062536	2012-2014	INDIVIDUAL PERSONAL PROPERTY	HEATH CHRISTOPHER J	8725 E 60TH TER
098179722	2021	INDIVIDUAL PERSONAL PROPERTY	NICHOLSON DONALD	8621 LANE AVE	099062745	2004	INDIVIDUAL PERSONAL PROPERTY	CALDWELL ALI	NO ADDRESS PROVIDED BY TAXPAYER
098185724	2006-2015	INDIVIDUAL PERSONAL PROPERTY	HAKE MARVIN L	8700 E 87TH ST	099062855	2006	INDIVIDUAL PERSONAL PROPERTY	PRATT IRIS L	5419 OXFORD AVE
098186317	2020-2021	INDIVIDUAL PERSONAL PROPERTY	BOYLE ROBERT M	11009 E 66TH TER	099062865	1999-2001	INDIVIDUAL PERSONAL PROPERTY	FISHER JAMES C	NO ADDRESS PROVIDED BY TAXPAYER
098186445	2016-2019	INDIVIDUAL PERSONAL PROPERTY	ELLIS KASEY M	10413 E 65TH ST	099062935	2020-2021	INDIVIDUAL PERSONAL PROPERTY	LOTSPEICH JAMES C	11212 E 75TH TER
098186573	2012	INDIVIDUAL PERSONAL PROPERTY	GUTHRIE TRYSTON E	409 SW WESTMINISTER RD	099063138	2017	INDIVIDUAL PERSONAL PROPERTY	BRADBERRY ANITA	9815 E 61ST ST APT 1
098186663	2004	INDIVIDUAL PERSONAL PROPERTY	LEIGH LORI A & CHRISTOPHER E	9306 E 82ND ST	099063219	2021	INDIVIDUAL PERSONAL PROPERTY	FRISBEE JENNIFER LYNN	8232 LAUREL AVE
098189289	2005-2007	INDIVIDUAL PERSONAL PROPERTY	WILSON MICHAEL L	5424 NORTHERN AVE	099063240	2000-2004	INDIVIDUAL PERSONAL PROPERTY	COPENHAVER MICHAEL JESSE	NO ADDRESS PROVIDED BY TAXPAYER
098189291	2005-2006	INDIVIDUAL PERSONAL PROPERTY	BOWERSOCK DAMIEN R	8801 E 72ND TER	099063259	2021	INDIVIDUAL PERSONAL PROPERTY	HARRIS PHILLIP D	6510 BLUE RIDGE BLVD
098190082	2007	INDIVIDUAL PERSONAL PROPERTY	JONES KENNETH R & DEBI J	7200 WOODSON DR	099063303	2004-2006	INDIVIDUAL PERSONAL PROPERTY	RAINES JENNIFER	NO ADDRESS PROVIDED BY TAXPAYER
098190933	2002-2003	INDIVIDUAL PERSONAL PROPERTY	CUNDIFF GARY W II	6909 RAYTOWN RD	099063318	2009-2012	INDIVIDUAL PERSONAL PROPERTY	STEELE THOMAS W & RENE Y	5322 HARDY AVE
098204766	2002	INDIVIDUAL PERSONAL PROPERTY	NGUNJURI MARY N	5520 RALSTON	099063401	2001-2003	INDIVIDUAL PERSONAL PROPERTY	COOPER CAROLYN (HERVEY)	8720 E 61ST ST
098211989	2010-2012	INDIVIDUAL PERSONAL PROPERTY	BROWN SASHA ILENE E	9401 E 65TH TER	099063414	2006-2007	INDIVIDUAL PERSONAL PROPERTY	EUBANKS CHRISTOPHER	11218 E 58TH TER
098216506	2001	INDIVIDUAL PERSONAL PROPERTY	LUSTER CAROL	NO ADDRESS PROVIDED BY TAXPAYER	099063740	2000-2001	INDIVIDUAL PERSONAL PROPERTY	NOTHNAGEL MELISSA L	8504 E 86TH TER
098219957	2003-2011	INDIVIDUAL PERSONAL PROPERTY	BARNETTE BYRDELLA A	7924 CEDAR AVE	099063772	2018-2019	INDIVIDUAL PERSONAL PROPERTY	WILKERSON MAMIE	9525 E GREGORY BLVD
098221941	2012	INDIVIDUAL PERSONAL PROPERTY	HOUCHEN JEFFREY D	7405 ASH AVE	099063775	2002	INDIVIDUAL PERSONAL PROPERTY	GATZ AMY	NO ADDRESS PROVIDED BY TAXPAYER
098222478	2001	INDIVIDUAL PERSONAL PROPERTY	STRONG ERIC M	NO ADDRESS PROVIDED BY TAXPAYER	099063827	2021	INDIVIDUAL PERSONAL PROPERTY	JENKINS LEON & FRIEDA L	8436 LANE DR
098222646	2003	INDIVIDUAL PERSONAL PROPERTY	LAUGHLIN GAYLE A	5226 NORTHERN AVE	099063869	2010	INDIVIDUAL PERSONAL PROPERTY	HAROLD TERESA	7420 WOODSON RD
098223117	2014-2015	INDIVIDUAL PERSONAL PROPERTY	HUNT (JONES) TAMARA A	8820 E 61ST TER	099063921	2000-2002	INDIVIDUAL PERSONAL PROPERTY	ANDREWS GREGORY J	5525 STERLING AVE
098223582	2004	INDIVIDUAL PERSONAL PROPERTY	THOMAS DENISE L	12004 E 78TH ST	099064012	2006	INDIVIDUAL PERSONAL PROPERTY	RODRIGUEZ CONSUELO	7201 MAYWOOD AVE
098252076	2013-2018	INDIVIDUAL PERSONAL PROPERTY	WILLIAMS JAMES A JR	9109 E 72ND TER	099064333	2008-2012	INDIVIDUAL PERSONAL PROPERTY	PARKSEL REGINALD D	9122 E 68TH TER
098326410	2016-2018	INDIVIDUAL PERSONAL PROPERTY	WRIGHT CHARLOTTE	7914 HARDY AVE	099064574	2018-2019	INDIVIDUAL PERSONAL PROPERTY	RICHARDSON BRYAN KEITH	7604 ELM ST
098407655	2006	INDIVIDUAL PERSONAL PROPERTY	WAGNER JOHN HAROLD	7204 RAYTOWN RD	099064757	2000	INDIVIDUAL PERSONAL PROPERTY	HENDRIX JAMES L	NO ADDRESS PROVIDED BY TAXPAYER
098692733	2005	INDIVIDUAL PERSONAL PROPERTY	ROSE DEMETA J	8519 WESTRIDGE RD	099064764	2021	INDIVIDUAL PERSONAL PROPERTY	MAY DAVID F	5705 WOODSON RD
098693196	2021	INDIVIDUAL PERSONAL PROPERTY	NOLEN ZANA JENEE	7300 STERLING AVE	099064863	2000	INDIVIDUAL PERSONAL PROPERTY	GEBHARDT JESSICA & AUTUMN	NO ADDRESS PROVIDED BY TAXPAYER
098694329	2020-2021	INDIVIDUAL PERSONAL PROPERTY	MAYS LYNDELL	10103 E 67TH ST	099064915	2021	INDIVIDUAL PERSONAL PROPERTY	DILWORTH ERIC V	11801 E 78TH PL
098695412	2021	INDIVIDUAL PERSONAL PROPERTY	ZAGAR JOSEPH O & MINDY K	8603 E 79TH PL	099064924	2008	INDIVIDUAL PERSONAL PROPERTY	SCOTT CHANTAY D	CA RESIDENTIAL
098704098	2008	INDIVIDUAL PERSONAL PROPERTY	CRAWFORD CHANDRA D	8817 E 83RD TER	099065024	2000	INDIVIDUAL PERSONAL PROPERTY	MORAVCIK (WEATHERS) BRUNILDA A	UNKNOWN
098798084	2007-2011	INDIVIDUAL PERSONAL PROPERTY	COWAN ROBERTA C	7204 OXFORD AVE	099065029	2018	INDIVIDUAL PERSONAL PROPERTY	RAW ANTHONY C	10021 E 78TH TER
098964623	2003	INDIVIDUAL PERSONAL PROPERTY	BOX THERESA	6908 RAYTOWN RD	099065046	2017	INDIVIDUAL PERSONAL PROPERTY	WIKLUND REBECCA & TAYLER & HUNTER MARK	10600 E 59TH ST

099065095	2019-2020	INDIVIDUAL PERSONAL PROPERTY	WILSON MARK W	8906 E 58TH ST	099106216	2017-2021	INDIVIDUAL PERSONAL PROPERTY	AUTHORLEE WILLIS R	11804 E 78TH PL
099065131	2021	INDIVIDUAL PERSONAL PROPERTY	RAW DUSTIN	9106 E 65TH TER	099106650	2006-2007	INDIVIDUAL PERSONAL PROPERTY	WEINZIRL SCOTT T	8712 E 85TH ST
099065202	2021	INDIVIDUAL PERSONAL PROPERTY	EATON DONALD E (LEMMONS)	137 S FULLER ST	099107196	2008	INDIVIDUAL PERSONAL PROPERTY	WEBB ROBERT E	NO ADDRESS PROVIDED BY TAXPAYER
099066452	2004-2007	INDIVIDUAL PERSONAL PROPERTY	JOHNSON LARIE R JR	8806 E 71ST TER	099107307	2017	INDIVIDUAL PERSONAL PROPERTY	FRAZIER PAMELA	10608 E 79TH TER
099066486	2008	INDIVIDUAL PERSONAL PROPERTY	HUNT JESSICA (MCCRAY)	5416 LAUREL AVE	099108055	2004	INDIVIDUAL PERSONAL PROPERTY	JONES ALMEDA	6702 APPLETON AVE
099067678	2010-2011	INDIVIDUAL PERSONAL PROPERTY	DESHAZER ROY W & MICHELLE	4325 SW WESTBOUND US 40 HWY	099108357	2007	INDIVIDUAL PERSONAL PROPERTY	HANDLEY AARON A	9307 E 82ND ST
099068539	2002	INDIVIDUAL PERSONAL PROPERTY	BUTLER LYNN	10708 E 84TH ST	099108397	2021	INDIVIDUAL PERSONAL PROPERTY	MAXWELL SHAUN ANTONIO	8604 FORD AVE
099069167	2017-2019	INDIVIDUAL PERSONAL PROPERTY	BOWERSOCK DEVON R	7420 WOODSON RD	099108570	2001	INDIVIDUAL PERSONAL PROPERTY	STEWART ISAAC E	1456 E 77TH ST
099070614	2021	INDIVIDUAL PERSONAL PROPERTY	BROWN BRANDON CHRISTOPHER	7416 HARRIS AVE	099109032	2021	INDIVIDUAL PERSONAL PROPERTY	IVY KEISA SHERRI	7205 OXFORD AVE
099072083	2021	INDIVIDUAL PERSONAL PROPERTY	SALDANA SHEILA O	8209 WOODSON DR	099109388	2021	INDIVIDUAL PERSONAL PROPERTY	CAPELTON ROSEATTA	1715 RAYTOWN RD APT 13
099077980	2021	INDIVIDUAL PERSONAL PROPERTY	BOLDEN LOIS J	8200 E 85TH ST	099109393	2021	INDIVIDUAL PERSONAL PROPERTY	CRUM ANNA	10323 E 78TH ST
099078201	2015	INDIVIDUAL PERSONAL PROPERTY	HARRIS BENJAMIN JR	5625 ASH AVE	099111820	2007-2011	INDIVIDUAL PERSONAL PROPERTY	DAVIS JOHNNEL JR	7116 NORWOOD AVE
099078297	2000-2003	INDIVIDUAL PERSONAL PROPERTY	LAMBERT HUBERT JR	8409 HEDGES AVE	099111947	2021	INDIVIDUAL PERSONAL PROPERTY	JONES ADRIANNE NICOLE	6011 BLUE RIDGE CUT OFF
099078800	2002	INDIVIDUAL PERSONAL PROPERTY	FOSTER RANDY E & MINA E	NO ADDRESS PROVIDED BY TAXPAYER	099113997	2016	INDIVIDUAL PERSONAL PROPERTY	STANSBURY CHRISTINA MARIE	7042 WOODSON RD
099078815	2014-2015	INDIVIDUAL PERSONAL PROPERTY	NESBITT KEVIN & TINA	12009 E 78TH TER	099113995	2021	INDIVIDUAL PERSONAL PROPERTY	WELCH CHRISTA R	9509 E 77TH ST
099078819	2002-2009	INDIVIDUAL PERSONAL PROPERTY	OWENS GREGORY S	NO ADDRESS PROVIDED BY TAXPAYER	099114008	2021	INDIVIDUAL PERSONAL PROPERTY	MCGILL LUANITA	7021 WILLOW AVE
099078932	2018-2021	INDIVIDUAL PERSONAL PROPERTY	DOVER BRIAN L	5925 CRESCENT AVE	099114933	2021	INDIVIDUAL PERSONAL PROPERTY	ANDERSON MYRTICE & CAIN KEVIN JR	8320 WILLOW WAY
099079035	2007-2010	INDIVIDUAL PERSONAL PROPERTY	EVANS MARY	5225 CRISP AVE	099114945	2021	INDIVIDUAL PERSONAL PROPERTY	YZAGUIRE NICKOLAS	6305 HEDGES AVE
099079660	2001-2004	INDIVIDUAL PERSONAL PROPERTY	HAMLIN GARY	NO ADDRESS PROVIDED BY TAXPAYER	099115003	2004	INDIVIDUAL PERSONAL PROPERTY	KEITH CYNTHIA D	9212 E 54TH TER
099079923	2012-2013	INDIVIDUAL PERSONAL PROPERTY	EASTER PAULA S	10710 E 63RD ST	099115745	2000	INDIVIDUAL PERSONAL PROPERTY	CARTER RASHAWN N & OTIS T	1601 NE VIVION RD
099080942	2002	INDIVIDUAL PERSONAL PROPERTY	DELANO DON A	9003 E 84TH ST	099115851	2021	INDIVIDUAL PERSONAL PROPERTY	BREWSTER LATOASHA MARIE	10601 E 70TH ST
099081914	2013	INDIVIDUAL PERSONAL PROPERTY	NUBINE KARRI	6645 CEDAR AVE APT A	099116101	2013-2017	INDIVIDUAL PERSONAL PROPERTY	HOOD ALONZO E	7214 CRISP AVE
099082068	2019	INDIVIDUAL PERSONAL PROPERTY	PINKEPANK SCOTT B	210 W 100TH TER APT 215	099116195	2021	INDIVIDUAL PERSONAL PROPERTY	CUNNINGHAM EBONY RASHION (WATSON)	9108 E 72ND TER
099082169	2009-2011	INDIVIDUAL PERSONAL PROPERTY	EARL MELISSA L	8701 E 80TH TER	099116295	2018-2021	INDIVIDUAL PERSONAL PROPERTY	FUHR STEVEN D	8713 OXFORD AVE
099082983	2019	INDIVIDUAL PERSONAL PROPERTY	PERKINS BRAD	10500 E 66TH ST	099117475	2004-2005	INDIVIDUAL PERSONAL PROPERTY	TRAN CHRISTINA CLUNG XUAN	6600 BLUE RIDGE BLVD
099083420	2010-2011	INDIVIDUAL PERSONAL PROPERTY	CASTRO STARLA MARIE	2917 JARBOE ST	099118077	2021	INDIVIDUAL PERSONAL PROPERTY	KOOZMITCH REBECCA L	6703 HARRIS AVE
099084514	2020-2021	INDIVIDUAL PERSONAL PROPERTY	DACE EMANUEL	9201 E 84TH CT	099118133	2010	INDIVIDUAL PERSONAL PROPERTY	OWENS JENNIFER M & PATRICK	9808 E 85TH ST
099084772	2004-2006	INDIVIDUAL PERSONAL PROPERTY	FUENTES TAMMY	NO ADDRESS PROVIDED BY TAXPAYER	099118783	2019-2020	INDIVIDUAL PERSONAL PROPERTY	MCCALLISTER LISA M	9709 RICE AVE
099085155	2005-2007	INDIVIDUAL PERSONAL PROPERTY	NICHOLS NICOLE	9513 E 69TH ST	099119405	2010-2011	INDIVIDUAL PERSONAL PROPERTY	WEAVER CAROLYN J	10900 E 59TH ST
099085864	2019	INDIVIDUAL PERSONAL PROPERTY	ADAMS RICHARD J	6009 BLUE HILLS RD APT 2	099119969	2001	INDIVIDUAL PERSONAL PROPERTY	INGLISH TINA	635 DOVER
099086240	2007	INDIVIDUAL PERSONAL PROPERTY	SAXTON MICHAEL L	8306 STERLING AVE	099120216	2021	INDIVIDUAL PERSONAL PROPERTY	ZOLLARS STEVEN C	1504 SW 22ND ST
099086356	2010-2016	INDIVIDUAL PERSONAL PROPERTY	UNGER TODD A	NO ADDRESS PROVIDED BY TAXPAYER	099120228	2021	INDIVIDUAL PERSONAL PROPERTY	LENGQUIST KATHY J	10512 E 81ST TER
099086378	2003-2017	INDIVIDUAL PERSONAL PROPERTY	LIMBACH KACEE M	11601 E 62ND ST	099120272	2020-2021	INDIVIDUAL PERSONAL PROPERTY	STOECKER LINDA	5400 HUNTER ST
099086672	2005-2012	INDIVIDUAL PERSONAL PROPERTY	DRIVER SHIRLEY I	NO ADDRESS PROVIDED BY TAXPAYER	099120280	2021	INDIVIDUAL PERSONAL PROPERTY	VENTON DIANE	8504 ELM AVE UNIT A
099086675	2004-2007	INDIVIDUAL PERSONAL PROPERTY	YOUNG GEORGE C S & DIANE R	NO ADDRESS PROVIDED BY TAXPAYER	099120290	2000	INDIVIDUAL PERSONAL PROPERTY	MANKEY CHERYL	NO ADDRESS PROVIDED BY TAXPAYER
099086701	2021	INDIVIDUAL PERSONAL PROPERTY	MALLEN GLENDA J	11012 E 54TH ST	099120488	2021	INDIVIDUAL PERSONAL PROPERTY	GARDNER RONALD	6137 ELM AVE
099086763	2000	INDIVIDUAL PERSONAL PROPERTY	WENING KRISTEN J & BRIAN A	UNKNOWN	099120509	2014-2015	INDIVIDUAL PERSONAL PROPERTY	GORDON DAVID	6906 RALSTON AVE
099087096	2002-2005	INDIVIDUAL PERSONAL PROPERTY	ELLIS TIMOTHY T	10413 E 66TH ST	099120515	2003-2007	INDIVIDUAL PERSONAL PROPERTY	PARVIN CARL E III	6331 FARLEY AVE
099087155	2005-2017	INDIVIDUAL PERSONAL PROPERTY	THOMAS SUZANNE L	7928 HEDGES AVE	099120520	2004-2006	INDIVIDUAL PERSONAL PROPERTY	CUMMINGS RICKIE	5411 BLUE RIDGE BLVD
099087202	2016-2017	INDIVIDUAL PERSONAL PROPERTY	ONEAL FRANCES V	8305 E 85TH TER	099120552	2010	INDIVIDUAL PERSONAL PROPERTY	HAYNES MILLICENT	10111 E 67TH ST
099087229	2000	INDIVIDUAL PERSONAL PROPERTY	KILGORE JAMIE H	3953 MERCIER ST	099120565	2001	INDIVIDUAL PERSONAL PROPERTY	STEFFENS KATHLEEN	UNKNOWN
099087386	2013	INDIVIDUAL PERSONAL PROPERTY	HORNPOSTEL JAMES A	9509 E 79TH ST	099120610	2000	INDIVIDUAL PERSONAL PROPERTY	RAFFEY TODD E	7217 CEDAR AVE
099087459	2021	INDIVIDUAL PERSONAL PROPERTY	OAKES JAMES R	8309 WOODSON DR	099120728	2003	INDIVIDUAL PERSONAL PROPERTY	PENNINGTON DOUGLAS E	NO ADDRESS PROVIDED BY TAXPAYER
099087517	2010-2017	INDIVIDUAL PERSONAL PROPERTY	FOSTER KEVIN E	6104 HARVARD AVE	099120735	2017	INDIVIDUAL PERSONAL PROPERTY	SMALLEY BURK & SHIRLEY J	NO ADDRESS PROVIDED BY TAXPAYER
099087793	2005	INDIVIDUAL PERSONAL PROPERTY	REID ERICK E	1712 SE RIDGEWOOD DR	099120789	2019-2021	INDIVIDUAL PERSONAL PROPERTY	WEST CHERLY	6208 WILLOW AVE
099087860	2002	INDIVIDUAL PERSONAL PROPERTY	TOWNS GARRY R	1807 S HEDGES AVE	099120791	2002-2004	INDIVIDUAL PERSONAL PROPERTY	REIL TROY D & TERI J	NO ADDRESS PROVIDED BY TAXPAYER
099088249	2000	INDIVIDUAL PERSONAL PROPERTY	KRUEGER JANE(SIMMONS)	NO ADDRESS PROVIDED BY TAXPAYER	099120864	2021	INDIVIDUAL PERSONAL PROPERTY	SCOTT KARLISS R	9801 PLYMOUTH LN
099088305	2021	INDIVIDUAL PERSONAL PROPERTY	DITTON RANDY R	8601 WESTRIDGE RD	099120942	2002-2005	INDIVIDUAL PERSONAL PROPERTY	JONES DEBORAH J	1453 E 66TH TER
099088402	2020-2021	INDIVIDUAL PERSONAL PROPERTY	SERNA GUILLERMO	7916 MANNING AVE	099120961	2017	INDIVIDUAL PERSONAL PROPERTY	WALL MALINDA K	9900 E 60TH ST
099088899	2005-2007	INDIVIDUAL PERSONAL PROPERTY	HAY MARK W	5402 BLUE RIDGE BLVD	099121006	2000-2002	INDIVIDUAL PERSONAL PROPERTY	NELSON PHILLIP M	NO ADDRESS PROVIDED BY TAXPAYER
099088919	2003	INDIVIDUAL PERSONAL PROPERTY	HAIRFIELD JENNIFER L	NO ADDRESS PROVIDED BY TAXPAYER	099121147	2019	INDIVIDUAL PERSONAL PROPERTY	SCHULTZ DONALD G	10501 E 60TH TER
099089000	2021	INDIVIDUAL PERSONAL PROPERTY	CAMPBELL JESSIE III	8815 E 85TH ST	099121224	2018-2020	INDIVIDUAL PERSONAL PROPERTY	CRAYTON DICARLOS E	8315 WOODSON DR
099089597	2021	INDIVIDUAL PERSONAL PROPERTY	DAVIS TEAL Q (RASHAW)	11701 E 85TH ST	099121347	2005	INDIVIDUAL PERSONAL PROPERTY	KINGREY MICHAEL J	6020 STERLING AVE
099089678	2019-2021	INDIVIDUAL PERSONAL PROPERTY	JOHNSON CHARLENE F (GRAYSON)	9906 E 76TH TER	099121494	2014-2019	INDIVIDUAL PERSONAL PROPERTY	HULL CHRISTOPHER B	9802 E 60TH ST
099089799	2021	INDIVIDUAL PERSONAL PROPERTY	HALLUMS SABRINA R	NO ADDRESS PROVIDED BY TAXPAYER	099121509	2002-2004	INDIVIDUAL PERSONAL PROPERTY	MOTHERSBAUGH DESTINY D	6717 HARVARD AVE
099090166	2001-2003	INDIVIDUAL PERSONAL PROPERTY	INNIS SHARON D	6550 SCENIC DR	099121658	2000-2014	INDIVIDUAL PERSONAL PROPERTY	YATES GERALDINE	NO ADDRESS PROVIDED BY TAXPAYER
099090450	2021	INDIVIDUAL PERSONAL PROPERTY	CALDERON JOSE M	8506 SPRING VALLEY RD	099121671	2021	INDIVIDUAL PERSONAL PROPERTY	TAYLOR LORENE (HARBIN)	8403 WOODSON DR
099090509	2021	INDIVIDUAL PERSONAL PROPERTY	SMITH TERRIE J (BOLTON)	11808 E 86TH TER	099121707	2006-2007	INDIVIDUAL PERSONAL PROPERTY	MARGERUM DESIREE D	NO ADDRESS PROVIDED BY TAXPAYER
099090539	2020-2021	INDIVIDUAL PERSONAL PROPERTY	EVANS BETTINA	9108 E 64TH TER	099121715	2000	INDIVIDUAL PERSONAL PROPERTY	Haugen Leila	UNKNOWN
099093990	2006	INDIVIDUAL PERSONAL PROPERTY	CLAPPER DAWNA F	5909 HUNTER ST	099121725	2021	INDIVIDUAL PERSONAL PROPERTY	KURZ CHRISTOPHER D	10404 E 83RD ST
099094272	2000	INDIVIDUAL PERSONAL PROPERTY	KNOTT MARJORIE	UNKNOWN	099121802	2000	INDIVIDUAL PERSONAL PROPERTY	FOX RONALD V	UNKNOWN
099094503	2002	INDIVIDUAL PERSONAL PROPERTY	WINSTON SHARRON M	NO ADDRESS PROVIDED BY TAXPAYER	099121806	2016-2019	INDIVIDUAL PERSONAL PROPERTY	HADLEY FREIDA M	9713 E 82ND TER
099094555	2017	INDIVIDUAL PERSONAL PROPERTY	BROWNING HAYES WILLYE DENISE	9410 E 81ST ST	099121855	2015-2021	INDIVIDUAL PERSONAL PROPERTY	ZEVECKE RACHAEL	8127 WILLOW WAY
099095659	2001-2002	INDIVIDUAL PERSONAL PROPERTY	PEARSON SHARI J	NO ADDRESS PROVIDED BY TAXPAYER	099121983	2000-2017	INDIVIDUAL PERSONAL PROPERTY	TATUM MICHAEL	6912 HAWTHORNE AVE
099095724	2002	INDIVIDUAL PERSONAL PROPERTY	GUSHEE JENNIFER	6000 WOODSON RD	099122005	2002	INDIVIDUAL PERSONAL PROPERTY	BYRD ANGEL	12431 SUMMIT ST
099095854	2021	INDIVIDUAL PERSONAL PROPERTY	TASKER BERNARD & DEBORAH	5712 BLUE RIDGE BLVD	099122019	2004	INDIVIDUAL PERSONAL PROPERTY	BLANKS AUSTON	NO ADDRESS PROVIDED BY TAXPAYER
099095902	2002-2003	INDIVIDUAL PERSONAL PROPERTY	CARPENTER CHAD S	7429 ENGLEWOOD LN	099122101	2000	INDIVIDUAL PERSONAL PROPERTY	DAVENPORT JENNIFER	NO ADDRESS PROVIDED BY TAXPAYER
099095958	2000	INDIVIDUAL PERSONAL PROPERTY	WERNER MANDY J	NO ADDRESS PROVIDED BY TAXPAYER	099122199	2009-2012	INDIVIDUAL PERSONAL PROPERTY	DURHAM GLORIA J	5521 HUNTER TER
099099601	2013-2014	INDIVIDUAL PERSONAL PROPERTY	MALEY RANDY R JR	5524 CRESCENT AVE	099122254	2018-2019	INDIVIDUAL PERSONAL PROPERTY	KELLY DEDERICK D	10613 E 56TH TER
099099860	2002	INDIVIDUAL PERSONAL PROPERTY	DELANO NICOLE M	9003 E 84TH ST	099122319	2021	INDIVIDUAL PERSONAL PROPERTY	CUSICK MICHELLE K	7310 BLUE RIDGE BLVD
099099963	2013-2016	INDIVIDUAL PERSONAL PROPERTY	ANDERSON TOM	6811 HUNTER ST	099122325	2021	INDIVIDUAL PERSONAL PROPERTY	ROUSE CHRISTEL R	9504 E 67TH TER
099100810	2020-2021	INDIVIDUAL PERSONAL PROPERTY	TIEMEYER RANDALL J & JULIE	10204 E 70TH TER	099122335	2021	INDIVIDUAL PERSONAL PROPERTY	MILLER ROBIN	9811 E 80TH TER

099122392	2000	INDIVIDUAL PERSONAL PROPERTY	ROBERTS JEFFREY T	UNKNOWN	099207265	2010-2011	INDIVIDUAL PERSONAL PROPERTY	PELTON BRIAN P	11312 E 56TH TER
099129885	2021	INDIVIDUAL PERSONAL PROPERTY	EVANS DAWN D (ALEXANDER)	10912 E 57TH TER	099208832	2002	INDIVIDUAL PERSONAL PROPERTY	HEDRICK SHARLOT M	NO ADDRESS PROVIDED BY TAXPAYER
099134611	2017-2021	INDIVIDUAL PERSONAL PROPERTY	SPRUCELL NICHOLAS K	10108 E 83RD ST	099209660	2021	INDIVIDUAL PERSONAL PROPERTY	ANDERSON WANDA MARIA	11520 E 74TH STREET CT
099134657	2001	INDIVIDUAL PERSONAL PROPERTY	ALDRIDGE MIKE	NO ADDRESS PROVIDED BY TAXPAYER	099210063	2021	INDIVIDUAL PERSONAL PROPERTY	BOOZE TANESE & TURNER	6100 HARVARD AVE
099134698	2021	INDIVIDUAL PERSONAL PROPERTY	ANDRE JOSE PAUL	8521 MAPLE AVE	099210285	2014	INDIVIDUAL PERSONAL PROPERTY	ORCUTT KATHERINE R	7021 RAYTOWN RD
099134775	2021	INDIVIDUAL PERSONAL PROPERTY	EVERETTE LEAH	10008 E 83RD TER	099210457	2020-2021	INDIVIDUAL PERSONAL PROPERTY	EVANS JERMAINE L	9400 E 84TH ST
099140538	2021	INDIVIDUAL PERSONAL PROPERTY	CURRY CHARLENE (WASHINGTON) & KAVVEA	8304 ELM AVE	099210498	2021	INDIVIDUAL PERSONAL PROPERTY	FOCKLER JUSTIN L	9708 E 66TH ST
099141392	2010-2015	INDIVIDUAL PERSONAL PROPERTY	GRAY JR OREN L	10009 E 69TH ST	099210511	2003-2004	INDIVIDUAL PERSONAL PROPERTY	ELLIOTT KIMBERLY R	8900 OLD SANTA FE RD
099145043	2008	INDIVIDUAL PERSONAL PROPERTY	WOODSON ROBERT Q JR	5420 BLUE RIDGE CUT OFF APT 111	099210553	2020-2021	INDIVIDUAL PERSONAL PROPERTY	CANADY LORNA M (ARNETT)	7315 HARRIS AVE
099145379	2021	INDIVIDUAL PERSONAL PROPERTY	LAMB BOBBY LEWIS	11305 E 56TH TER	099210766	2021	INDIVIDUAL PERSONAL PROPERTY	NELSON ANDREW J & SARA E	10125 E 79TH ST
099145533	2011	INDIVIDUAL PERSONAL PROPERTY	HOLLAND LATRICE	11216 E 56TH TER	099211048	2008	INDIVIDUAL PERSONAL PROPERTY	NELSON DELORIS (STOLLER) & JAMES	9908 E 79TH PL
099146059	2021	INDIVIDUAL PERSONAL PROPERTY	SEARS FRANK L	11001 E 53RD TER	099211096	2020-2021	INDIVIDUAL PERSONAL PROPERTY	TELLIS (BRADFORD) ERICKA D	9546 E 57TH TER
099146554	2006-2007	INDIVIDUAL PERSONAL PROPERTY	HOYER SHAWN B	6411 HARVARD AVE	099211291	2020-2021	INDIVIDUAL PERSONAL PROPERTY	REED PATSY	5301 CRISP AVE
099146909	2017	INDIVIDUAL PERSONAL PROPERTY	HARVEY LISA M	11424 E 77TH ST	099211342	2019-2020	INDIVIDUAL PERSONAL PROPERTY	RAWLINGS LARRY F & STACY L	8111 DITZLER AVE
099147804	2018-2019	INDIVIDUAL PERSONAL PROPERTY	SPRAGUE BRIAN J	10601 E 78TH TER	099211460	2002	INDIVIDUAL PERSONAL PROPERTY	GIFFIN AARON W	8124 HARDY
099148119	2021	INDIVIDUAL PERSONAL PROPERTY	JONES PAMELA F	10909 E 53RD ST	099211463	2020	INDIVIDUAL PERSONAL PROPERTY	ADAMS LORENZO VONZELL	10400 E 79TH ST
099148277	2015-2017	INDIVIDUAL PERSONAL PROPERTY	HOPFINGER SCOTT	9711 E 81ST ST	099211823	2005-2008	INDIVIDUAL PERSONAL PROPERTY	ENGL E BRIAN F	7712 CRESCENT AVE
099151409	2012	INDIVIDUAL PERSONAL PROPERTY	DENNY LORA B	8815 E 72ND ST	099219769	2009	INDIVIDUAL PERSONAL PROPERTY	CARR LATONYA	9414 E 55TH ST
099151740	2001-2002	INDIVIDUAL PERSONAL PROPERTY	MOORE LEAH	5218 DITZLER	099219879	2019-2021	INDIVIDUAL PERSONAL PROPERTY	ROLAND DAVID J	8105 CRESCENT AVE
099153546	2021	INDIVIDUAL PERSONAL PROPERTY	TRUSTY WILLIAM J & TWYLA D	9803 E 61ST ST APT 5	099219957	2011	INDIVIDUAL PERSONAL PROPERTY	BARNETTE BYRDLEA A	9928 E 61ST ST
099154607	2018-2019	INDIVIDUAL PERSONAL PROPERTY	LEWIS MYRON I	7236 CRISP AVE	099221639	2002	INDIVIDUAL PERSONAL PROPERTY	STOREY GREGORY D	3616 E 10TH ST
099155369	2006	INDIVIDUAL PERSONAL PROPERTY	FRIDAY ROBIN L	NO ADDRESS PROVIDED BY TAXPAYER	099221862	2018	INDIVIDUAL PERSONAL PROPERTY	ZACHARY SHAYA R	5820 OXFORD AVE
099155580	2000	INDIVIDUAL PERSONAL PROPERTY	KELLERMAN KELVIN D	NO ADDRESS PROVIDED BY TAXPAYER	099221944	2000	INDIVIDUAL PERSONAL PROPERTY	BERRY VICTORIA L (SEALS)	NO ADDRESS PROVIDED BY TAXPAYER
099156319	2000	INDIVIDUAL PERSONAL PROPERTY	WRIGHT SUSAN	NO ADDRESS PROVIDED BY TAXPAYER	099222703	2002-2003	INDIVIDUAL PERSONAL PROPERTY	EVANS LESLIE E	UNKNOWN
099156482	2011-2014	INDIVIDUAL PERSONAL PROPERTY	GREEN CLAUDIA	6912 LAUREL AVE	099222758	2000	INDIVIDUAL PERSONAL PROPERTY	REDMOND JANETTE M	NO ADDRESS PROVIDED BY TAXPAYER
099176951	2021	INDIVIDUAL PERSONAL PROPERTY	POTTS CHARLES C	5419 OXFORD AVE	099223055	2013-2015	INDIVIDUAL PERSONAL PROPERTY	EDWARDS FRANKLIN E & CINDY A	9701 E 66TH ST
099182262	2005	INDIVIDUAL PERSONAL PROPERTY	OLENDER JONATHAN S	105 SW 8TH ST	099223240	2000	INDIVIDUAL PERSONAL PROPERTY	DELEMAN TRACY S	NO ADDRESS PROVIDED BY TAXPAYER
099182378	2021	INDIVIDUAL PERSONAL PROPERTY	ENGLAND NICHOLAS A	8106 EVANSTON AVE	099223268	2011	INDIVIDUAL PERSONAL PROPERTY	KNIPP BETTY	6924 RAYTOWN RD
099185626	2021	INDIVIDUAL PERSONAL PROPERTY	HAYES MARK O	7517 ENGLEWOOD AVE	099223419	2012-2019	INDIVIDUAL PERSONAL PROPERTY	BELSER-PATTON CECILIA E & PATTON PARIS S	8615 WESTRIDGE RD
099185638	2000-2002	INDIVIDUAL PERSONAL PROPERTY	GERTL CHRIS	NO ADDRESS PROVIDED BY TAXPAYER	099223908	2003	INDIVIDUAL PERSONAL PROPERTY	ALDRIDGE DAVIS E	UNKNOWN
099185680	2004	INDIVIDUAL PERSONAL PROPERTY	MORA EDDY G & MARY BETH	1113 SLEPPY HOLLOW	099225738	2004	INDIVIDUAL PERSONAL PROPERTY	ARNOLD RICHARD G	UNKNOWN
099185707	2021	INDIVIDUAL PERSONAL PROPERTY	BENNETT RUBY B	9103 E 73RD ST	099239699	2021	INDIVIDUAL PERSONAL PROPERTY	ALLEN ANGELA D	8109 WOODSON DR
099185843	2005	INDIVIDUAL PERSONAL PROPERTY	SANDY STEVEN K	5916 HARVARD AVE	099240098	2021	INDIVIDUAL PERSONAL PROPERTY	BEACH JOHNNIE	6015 LAUREL AVE
099185860	2004	INDIVIDUAL PERSONAL PROPERTY	ASBELL PAMELA K	UNKNOWN	099240153	2004	INDIVIDUAL PERSONAL PROPERTY	CARPENTER JENNIFER	NO ADDRESS PROVIDED BY TAXPAYER
099185897	2001	INDIVIDUAL PERSONAL PROPERTY	MILLS KIMBERLY I	NO ADDRESS PROVIDED BY TAXPAYER	099245686	2007-2010	INDIVIDUAL PERSONAL PROPERTY	SCOTT JOHN J	NO ADDRESS PROVIDED BY TAXPAYER
099185981	2013-2016	INDIVIDUAL PERSONAL PROPERTY	TUBBS ADAM	7405 WILLOW	099246834	2021	INDIVIDUAL PERSONAL PROPERTY	STONER SCOTT E & DAWN	9500 E 80TH TER
099185995	2007-2008	INDIVIDUAL PERSONAL PROPERTY	JORDAN ANTHONY D	9824 E 61ST ST APT 1	099246988	2002	INDIVIDUAL PERSONAL PROPERTY	SMITH SAMUEL G	5639 CEDAR AVE
099186017	2021	INDIVIDUAL PERSONAL PROPERTY	RAMIREZ BRIGIDA B	8207 E 86TH TER	099247092	2003-2004	INDIVIDUAL PERSONAL PROPERTY	WALKER HOLLIS E II	NO ADDRESS PROVIDED BY TAXPAYER
099186088	2021	INDIVIDUAL PERSONAL PROPERTY	YOUNG MICHAEL	3117 CHARLOTTE ST	099247673	2007-2009	INDIVIDUAL PERSONAL PROPERTY	PENNINGTON NICKOLAS	8412 JAMES A REED RD
099186124	2013-2014	INDIVIDUAL PERSONAL PROPERTY	MUSACCHIO DOMINICK	10220 E 68TH ST	099247720	2021	INDIVIDUAL PERSONAL PROPERTY	ROGERS MAE R	9008 E 74TH ST
099186442	2005-2006	INDIVIDUAL PERSONAL PROPERTY	LANG CYNTHIA E (SMITH)	NO ADDRESS PROVIDED BY TAXPAYER	099250504	2000	INDIVIDUAL PERSONAL PROPERTY	REITH DONALD JR	UNKNOWN
099186469	2019-2021	INDIVIDUAL PERSONAL PROPERTY	ROWLES PATRICIA C	1005 NE BANNER ST	099251283	2021	INDIVIDUAL PERSONAL PROPERTY	DALE JENNIFER S	6710 HARVARD AVE
099186503	2021	INDIVIDUAL PERSONAL PROPERTY	BREDVOLD MARTIN	8308 HEDGES AVE	099251383	2014	INDIVIDUAL PERSONAL PROPERTY	GORE JANEANE J (DICKAU)	7319 ELM ST
099186554	2009-2010	INDIVIDUAL PERSONAL PROPERTY	SHELLY SARAH J	5409 OXFORD AVE	099251547	2020-2021	INDIVIDUAL PERSONAL PROPERTY	MORROW LERITA	7512 ARLINGTON AVE
099186646	2000	INDIVIDUAL PERSONAL PROPERTY	WILLIMETZ GINA L	UNKNOWN	099252279	2001-2013	INDIVIDUAL PERSONAL PROPERTY	EVANS BRIAN KEITH	8313 E 84TH ST
099186757	2009-2011	INDIVIDUAL PERSONAL PROPERTY	SAMS JEREMIAH P	NO ADDRESS PROVIDED BY TAXPAYER	099252648	2004-2006	INDIVIDUAL PERSONAL PROPERTY	ASHLEY WILSON L JR & LAURIE K	9912 E 84TH ST
099186763	2000	INDIVIDUAL PERSONAL PROPERTY	BJOREM JEREMY D	13300 CORRINGTON	099508474	2000-2002	INDIVIDUAL PERSONAL PROPERTY	STEVENSON (SCHMIIT) JULIE A	UNKNOWN
099186821	2006-2007	INDIVIDUAL PERSONAL PROPERTY	HARVEY RONALD N	NO ADDRESS PROVIDED BY TAXPAYER	099512254	2009-2017	INDIVIDUAL PERSONAL PROPERTY	LAMPING RICHARD	8805 E 71ST TER
099186871	2009-2010	INDIVIDUAL PERSONAL PROPERTY	STRAHLE-LOCKLER AUSTIN J	8406 WOODSON CT	099923703	2019-2021	INDIVIDUAL PERSONAL PROPERTY	RUFF DONZELL L	7208 WILLOW AVE
099186986	2004-2017	INDIVIDUAL PERSONAL PROPERTY	ROBINSON PATRICE Y	11418 E 58TH ST	099981297	2018	INDIVIDUAL PERSONAL PROPERTY	WILLIAMS DAMON D	8313 HARRIS AVE
099187039	2007	INDIVIDUAL PERSONAL PROPERTY	SMELSER BARBARA J	9519 OXFORD AVE	100000140	2002	INDIVIDUAL PERSONAL PROPERTY	ANNEN ALECIA J	5553 HUNTER
099187043	2003	INDIVIDUAL PERSONAL PROPERTY	KELLY MARTLA L	10400 E 80TH ST	100000169	2021	INDIVIDUAL PERSONAL PROPERTY	JOHNSON KRystal M	9805 E 79TH TER
099187046	2000	INDIVIDUAL PERSONAL PROPERTY	BEAMON SHARI K	UNKNOWN	100000182	2004-2006	INDIVIDUAL PERSONAL PROPERTY	RECH RICHARD L & COLLEEN K	9111 E 73RD ST
099187067	2010-2014	INDIVIDUAL PERSONAL PROPERTY	WHITE RICHARD G	8407 800TH AVE	100000505	2000-2003	INDIVIDUAL PERSONAL PROPERTY	BALLEU DEBORAH J	10617 E 53RD ST
099187211	2009-2011	INDIVIDUAL PERSONAL PROPERTY	WATHEN MICHAEL W	6110 WILLOW AVE	100000555	2021	INDIVIDUAL PERSONAL PROPERTY	RAY KERRY D	7804 IRWIN RD
099187214	2001-2017	INDIVIDUAL PERSONAL PROPERTY	FULLER TRACI L	10400 E 71ST TER	100000687	2020-2021	INDIVIDUAL PERSONAL PROPERTY	WATSON THERESA L	10117 E 64TH ST
099187248	2002-2004	INDIVIDUAL PERSONAL PROPERTY	REED BRENDA I	7420 WOODSON	100000892	2014-2016	INDIVIDUAL PERSONAL PROPERTY	LOWE MAXINE A-TRUSTEE	8407 FORD AVE
099187263	2000-2002	INDIVIDUAL PERSONAL PROPERTY	CARPENTER JOLYNN	NO ADDRESS PROVIDED BY TAXPAYER	100001307	2021	INDIVIDUAL PERSONAL PROPERTY	MARTIN NICHOLAS D	5215 STERLING AVE
099187481	2011-2016	INDIVIDUAL PERSONAL PROPERTY	JACKSON DONMEANO	8601 ELM AVE	100001329	2003-2005	INDIVIDUAL PERSONAL PROPERTY	QUEDNOW SCOTT M	NO ADDRESS PROVIDED BY TAXPAYER
099187620	2001	INDIVIDUAL PERSONAL PROPERTY	SERR KERI LYNN (TAYLOR)	UNKNOWN	100001516	2016	INDIVIDUAL PERSONAL PROPERTY	HOLMAN JAMES EDWARD	9000 E 67TH TER
099187661	2016-2021	INDIVIDUAL PERSONAL PROPERTY	MANLEY KRISTAL	5613 MANNING AVE	100001578	2021	INDIVIDUAL PERSONAL PROPERTY	WELLS WAIT KIMBERLY ANN	5805 ELM AVE
099187745	2000	INDIVIDUAL PERSONAL PROPERTY	HARRIS PAUL & SPRAWLS JULIE	UNKNOWN	100001594	2021	INDIVIDUAL PERSONAL PROPERTY	MORALES PATSY J	9000 E 69TH ST
099187790	2005-2006	INDIVIDUAL PERSONAL PROPERTY	SIMON TROY L & LASHAWAN M	15804 E 77TH PL	100001664	2021	INDIVIDUAL PERSONAL PROPERTY	BYRD LAYLA T	8108 WOODSON DR
099187833	2007-2009	INDIVIDUAL PERSONAL PROPERTY	HATCH VENITA M	8508 E 85TH TER	100002095	2010-2014	INDIVIDUAL PERSONAL PROPERTY	WILLIAMS ROGER	9504 E 68TH TER
099187967	2015	INDIVIDUAL PERSONAL PROPERTY	WESTERFIELD DIANE L	NO ADDRESS PROVIDED BY TAXPAYER	100002576	2021	INDIVIDUAL PERSONAL PROPERTY	BURRESS BRIAN S	5319 HEDGES AVE
099188964	2021	INDIVIDUAL PERSONAL PROPERTY	MILES VERNA JEAN	8622 LANE AVE	100003158	2011-2015	INDIVIDUAL PERSONAL PROPERTY	CANN JANICE M	7619 ELM ST
099189290	2001-2004	INDIVIDUAL PERSONAL PROPERTY	SLATER FRED W	NO ADDRESS PROVIDED BY TAXPAYER	100003211	2015	INDIVIDUAL PERSONAL PROPERTY	RUIZ GARCIA MARIO ALBERTO	8414 BOOTH AVE
099191122	2021	INDIVIDUAL PERSONAL PROPERTY	MASONER JAY D	6600 WILLOW AVE	100004026	2020-2021	INDIVIDUAL PERSONAL PROPERTY	MASON CHRISTOPHER M	5528 APPLETON AVE
099192208	2000	INDIVIDUAL PERSONAL PROPERTY	SCHMALTZ DONALD L	UNKNOWN	100004127	2021	INDIVIDUAL PERSONAL PROPERTY	MELGAR JOSE ORLANDO	9219 E 54TH TER
099198375	2018-2021	INDIVIDUAL PERSONAL PROPERTY	BROWN TYRONE & JOYCE	6104 ENGLEWOOD AVE	100004494	2003-2005	INDIVIDUAL PERSONAL PROPERTY	GREENFIELD TIMOTHY H	NO ADDRESS PROVIDED BY TAXPAYER
099198593	2005-2017	INDIVIDUAL PERSONAL PROPERTY	AKERS DALE E	10601 E 71ST TER	100354313	2021	INDIVIDUAL PERSONAL PROPERTY	FRANTA DOMINIQUE	9900 E 81ST TER
099198848	2005	INDIVIDUAL PERSONAL PROPERTY	HUNT HOLLY A	3009 SE 6TH ST	100372932	2021	INDIVIDUAL PERSONAL PROPERTY	JONES MERLE	7301 STERLING AVE

100373452	2021	INDIVIDUAL PERSONAL PROPERTY	WEATHERLY GARY W	10905 E 53RD ST	100384695	2021	INDIVIDUAL PERSONAL PROPERTY	BOONE RICHARD D	7915 TENNESSEE AVE
100373613	2021	INDIVIDUAL PERSONAL PROPERTY	GROSS LISA	7704 WESTRIDGE RD	100384818	2021	INDIVIDUAL PERSONAL PROPERTY	JACKSON CHERYL J	7906 CEDAR AVE
100373733	2011-2014	INDIVIDUAL PERSONAL PROPERTY	WILLIAMS RONALD LEE	8513 OXFORD AVE	100385046	2018-2019	INDIVIDUAL PERSONAL PROPERTY	STEVENSON MARCUS A	11205 E 53RD TER
100374016	2010-2011	INDIVIDUAL PERSONAL PROPERTY	LUTMAN MICHAEL L	6900 LANE AVE	100385111	2019-2021	INDIVIDUAL PERSONAL PROPERTY	WRIGHT TERE L	6217 CLAREMONT AVE
100374350	2001	INDIVIDUAL PERSONAL PROPERTY	MCMAHAN MITCHELL M	8405 NORTHERN	100385219	2001-2002	INDIVIDUAL PERSONAL PROPERTY	ROYSTON CHARLES D & SHEILA O	NO ADDRESS PROVIDED BY TAXPAYER
100374626	2021	INDIVIDUAL PERSONAL PROPERTY	CHILDRESS CURTIS	5724 MAYWOOD AVE	100385718	2019-2021	INDIVIDUAL PERSONAL PROPERTY	TOWNSEND MICAH FALON ROSE	9000 E 63RD ST
100374887	2005-2006	INDIVIDUAL PERSONAL PROPERTY	HENDRIX VIRGINIA A	10010 E 78TH ST	100385765	2005-2008	INDIVIDUAL PERSONAL PROPERTY	BROWN JON T	7315 APPLETON AVE
100374892	2019-2021	INDIVIDUAL PERSONAL PROPERTY	HATFIELD CATHERINE HEATHER	10119 E 79TH TER	100385775	2021	INDIVIDUAL PERSONAL PROPERTY	SCOTT LEGITA M	10100 E 84TH ST
100374952	2007-2010	INDIVIDUAL PERSONAL PROPERTY	MC GEE PHILLIP G & MARILYN	10408 E 72ND ST	100385973	2002	INDIVIDUAL PERSONAL PROPERTY	WILSON PAMELA SUE	8111 WOODSON DR
100375459	2019-2021	INDIVIDUAL PERSONAL PROPERTY	SWENSON KATHY M	6510 BLUE RIDGE BLVD	100385979	2014-2016	INDIVIDUAL PERSONAL PROPERTY	CARTER LAURIE J (SCOTT)	9354 E 70TH TER
100375803	2021	INDIVIDUAL PERSONAL PROPERTY	BROWN RUTH HELEN	8618 E 83RD TER	100386045	2017-2019	INDIVIDUAL PERSONAL PROPERTY	WEAVER AMY K	8326 OXFORD AVE
100376397	2008-2016	INDIVIDUAL PERSONAL PROPERTY	OSMUS AMY	6011 FARLEY AVE	100386075	2021	INDIVIDUAL PERSONAL PROPERTY	THOMPSON COLETTE M	9000 E 63RD ST
100376854	2021	INDIVIDUAL PERSONAL PROPERTY	STEARNS DANNY L JR	8324 WOODSON DR	100386137	2001	INDIVIDUAL PERSONAL PROPERTY	WHITED LUCAS K	8401 E 86TH TER
100376855	2021	INDIVIDUAL PERSONAL PROPERTY	THOMAS DEBRA	9704 E 79TH PL	100386265	2001-2004	INDIVIDUAL PERSONAL PROPERTY	BRYANT STEPHEN L	9205 E 65TH ST
100377230	2002-2003	INDIVIDUAL PERSONAL PROPERTY	BREWSTER MATTHEW J & MARY	NO ADDRESS PROVIDED BY TAXPAYER	100386291	2004	INDIVIDUAL PERSONAL PROPERTY	HEPPLER LEO L & GRACE	9719 E 68TH TER
100377585	2021	INDIVIDUAL PERSONAL PROPERTY	HAMBLY COLLEEN R & BRENT	8526 ARLINGTON AVE	100386366	2021	INDIVIDUAL PERSONAL PROPERTY	FRAZIER KNIKKIA	8701 E 79TH ST
100377561	2021	INDIVIDUAL PERSONAL PROPERTY	COTTONHAM TANYA RENEE	9010 E 87TH ST APT A4	100386647	2021	INDIVIDUAL PERSONAL PROPERTY	GLYNNER RAQUEL	6700 APPLETON AVE
100377915	2011-2013	INDIVIDUAL PERSONAL PROPERTY	NEITCH DIANE M	9907 E 76TH ST	100386671	2020-2021	INDIVIDUAL PERSONAL PROPERTY	WRIGHT ELIEEN	6016 FARLEY AVE
100378183	2008-2009	INDIVIDUAL PERSONAL PROPERTY	WALTON FRED J	7314 RALSTON AVE	100386812	2004	INDIVIDUAL PERSONAL PROPERTY	CRISWELL PEGGIE	4131 VIRGINIA
100378239	2019-2021	INDIVIDUAL PERSONAL PROPERTY	DUPREE CYNTHIA L	8321 WOODSON DR	100386933	2001-2002	INDIVIDUAL PERSONAL PROPERTY	REAM CHARLES JR	7909 HUNTER
100378321	2005-2017	INDIVIDUAL PERSONAL PROPERTY	COOPER SHERRI	8207 WOODSON DR	100386940	2021	INDIVIDUAL PERSONAL PROPERTY	ZANER LAURA	7009 ARLINGTON AVE
100378399	2021	INDIVIDUAL PERSONAL PROPERTY	STALEY QUATREZ T	6000 FARLEY AVE	100387464	2002	INDIVIDUAL PERSONAL PROPERTY	SETZER CLYDE	UNKNOWN
100378710	2021	INDIVIDUAL PERSONAL PROPERTY	ABELL MELISSA J	9005 E GREGORY BLVD	100387491	2018-2019	INDIVIDUAL PERSONAL PROPERTY	BLANKENBAKER RYAN D	7149 CRISP AVE
100379117	2008-2010	INDIVIDUAL PERSONAL PROPERTY	BROWN WADE B & TARA L	10112 E 56TH ST	100387942	2020-2021	INDIVIDUAL PERSONAL PROPERTY	HENDERSON REBECCA (ALLEN)	10619 E 78TH TER
100379294	2001	INDIVIDUAL PERSONAL PROPERTY	WOODROME VERONICA	11217 E 83RD ST	100388028	2010-2017	INDIVIDUAL PERSONAL PROPERTY	WHITE SAUNDRA	7406 RALSTON AVE
100379300	2003	INDIVIDUAL PERSONAL PROPERTY	TURNHAM MAKALA M	9104 E 69TH TER	100388043	2016-2021	INDIVIDUAL PERSONAL PROPERTY	HARVEY CARLA M	5427 DITZLER AVE
100379594	2003-2008	INDIVIDUAL PERSONAL PROPERTY	LANG CHRIS M	8402 STARK AVE	100388148	2018	INDIVIDUAL PERSONAL PROPERTY	LOUNCE JAMES E	9816 E 67TH TER
100379613	2020-2021	INDIVIDUAL PERSONAL PROPERTY	MORRIS DANIELLE	8720 E 61ST ST	100388191	2001-2007	INDIVIDUAL PERSONAL PROPERTY	PLOMBOY RUDY	9516 DITZLER AVE
100379841	2010	INDIVIDUAL PERSONAL PROPERTY	CAMPBELL ELIZABETH	9204 E 53RD TER	100388403	2020-2021	INDIVIDUAL PERSONAL PROPERTY	STEINER BRIAN	8107 E 74TH ST
100379977	2021	INDIVIDUAL PERSONAL PROPERTY	ADMIRE BILLY JOE	7020 HUNTER ST	100388488	2021	INDIVIDUAL PERSONAL PROPERTY	CORNLEY WILLIE	6320 FARLEY AVE
100380280	2000-2001	INDIVIDUAL PERSONAL PROPERTY	THOMAS KRISSIE L	306 SKY VIEW DR APT B	100388521	2005	INDIVIDUAL PERSONAL PROPERTY	ADAMS BRAD	8203 E 85TH ST
100380396	2012-2017	INDIVIDUAL PERSONAL PROPERTY	LAHMERS TIM O	10301 E 69TH ST	100388566	2021	INDIVIDUAL PERSONAL PROPERTY	MOORE SONYA	8602 FORD AVE
100380412	2007	INDIVIDUAL PERSONAL PROPERTY	LEMONS JOSEPH	11252 E 71ST DR	100388641	2009-2010	INDIVIDUAL PERSONAL PROPERTY	TAYLOR JASON T	10008 E 83RD TER
100380771	2013	INDIVIDUAL PERSONAL PROPERTY	MILLER NANCY R	16201 E 48TH TER APT 215	100388699	2021	INDIVIDUAL PERSONAL PROPERTY	STAAB JOSEPH K	6616 HARVARD AVE
100380785	2019-2021	INDIVIDUAL PERSONAL PROPERTY	BLAND CORTEZ	8402 EVERETT ST	100388700	2001	INDIVIDUAL PERSONAL PROPERTY	ERICSON THERESA M	8915 ROSE LN
100380789	2005-2006	INDIVIDUAL PERSONAL PROPERTY	BERGLUND THOMAS L	NO ADDRESS PROVIDED BY TAXPAYER	100388753	2020	INDIVIDUAL PERSONAL PROPERTY	DAVIS ELFREIDA	3919 WABASH AVE
100380931	2001-2005	INDIVIDUAL PERSONAL PROPERTY	SCHNEIDLER JANE A	NO ADDRESS PROVIDED BY TAXPAYER	100388793	2021	INDIVIDUAL PERSONAL PROPERTY	MORALES MEAGHAN MARIE	9801 E 79TH ST
100381237	2001-2017	INDIVIDUAL PERSONAL PROPERTY	GRAFF PATRICIA S	8708 E 80TH TER	100388800	2021	INDIVIDUAL PERSONAL PROPERTY	DOUGLASS JESSICA R	5520 HUNTER TER
100381240	2021	INDIVIDUAL PERSONAL PROPERTY	GILBERT (CUMMINGS) ANGELIC	11217 E 83RD ST	100388981	2021	INDIVIDUAL PERSONAL PROPERTY	LOCKE DONNY	9001 E GREGORY BLVD
100381269	2001-2002	INDIVIDUAL PERSONAL PROPERTY	MCKLENY BYRON L	9601 E 80TH TER	100389226	2003-2005	INDIVIDUAL PERSONAL PROPERTY	MC GILL ISHMAEL SR	5212 CRISP AVE
100381371	2001	INDIVIDUAL PERSONAL PROPERTY	EARLY RONNIE	NO ADDRESS PROVIDED BY TAXPAYER	100389345	2010-2011	INDIVIDUAL PERSONAL PROPERTY	PEELER DENISER L	11708 E 78TH PL
100381639	2021	INDIVIDUAL PERSONAL PROPERTY	GUNN LINDA S	7408 HARVARD DR	100389379	2011	INDIVIDUAL PERSONAL PROPERTY	ALSTON SHANAE R	7208 STERLING AVE
100381935	2020-2021	INDIVIDUAL PERSONAL PROPERTY	ANDERSON MALISSIA QUEEN	8611 W UTOPIA DR APT 82	100389399	2021	INDIVIDUAL PERSONAL PROPERTY	COTHRAN TENEKA L	6408 HARVARD AVE
100381977	2020	INDIVIDUAL PERSONAL PROPERTY	SMITH MARVIN M	10504 E 71ST TER	100389477	2002	INDIVIDUAL PERSONAL PROPERTY	MORAVCIK-WEATHERS BRUNILDA A	9709 E GREGORY BLVD
100381993	2021	INDIVIDUAL PERSONAL PROPERTY	SHELBY HAROLD EDWARD II	8959 E 83RD TER	100389488	2018-2019	INDIVIDUAL PERSONAL PROPERTY	PADILLA LORRAINE	8402 E 86TH TER
100382013	2006	INDIVIDUAL PERSONAL PROPERTY	DUFFEE CHRISTOPHER J	NO ADDRESS PROVIDED BY TAXPAYER	100389587	2021	INDIVIDUAL PERSONAL PROPERTY	ASHBY ANDREA D	11813 E 83RD ST APT 101
100382029	2001	INDIVIDUAL PERSONAL PROPERTY	INGERSOLL GEORGIA C	NO ADDRESS PROVIDED BY TAXPAYER	100389591	2007-2010	INDIVIDUAL PERSONAL PROPERTY	BOWERS SYLVIA	8801 E GREGORY BLVD
100382033	2003-2005	INDIVIDUAL PERSONAL PROPERTY	VAUGHN DENNIS A	10907 E 62ND TER	100389618	2004-2005	INDIVIDUAL PERSONAL PROPERTY	SACKUVICH LINDA L	5916 HARVARD AVE
100382083	2020-2021	INDIVIDUAL PERSONAL PROPERTY	FARMER WC III	7908 ELM AVE	100389692	2021	INDIVIDUAL PERSONAL PROPERTY	GARDNER CANDICE D	8801 E 81ST TER
100382146	2006	INDIVIDUAL PERSONAL PROPERTY	LUCAS DOROTHY H	11807 E 54TH ST	100389791	2007	INDIVIDUAL PERSONAL PROPERTY	RIVERA NANCY K	5413 OXFORD AVE
100382161	2018-2021	INDIVIDUAL PERSONAL PROPERTY	SMITH ALLIEAN	8906 E 73RD ST	100389843	2019	INDIVIDUAL PERSONAL PROPERTY	MC MILLON ROY III	8500 ELM AVE UNIT B
100382163	2021	INDIVIDUAL PERSONAL PROPERTY	SCOTT KEITH ANTONIO	8850 E 59TH TER	100389852	2018-2021	INDIVIDUAL PERSONAL PROPERTY	SCOTT DONNA R & HOLMES CHARLES N	8901 E 74TH ST
100382369	2021	INDIVIDUAL PERSONAL PROPERTY	BOLTON LASANDRA R	8400 WOODSON CT	100389919	2001	INDIVIDUAL PERSONAL PROPERTY	WALLACE KIM L	5622 LAUREL
100382472	2015-2018	INDIVIDUAL PERSONAL PROPERTY	CLEMMONS KEVIN MICHAEL	8809 E 59TH ST	100389995	2004	INDIVIDUAL PERSONAL PROPERTY	KILGORE CHRYSYAL M & MATHIS ROBERT C	UNKNOWN
100382486	2020-2021	INDIVIDUAL PERSONAL PROPERTY	THOMAS FREDERICK & LEWIS D HURTT-THOMAS	12004 E 78TH ST	100390064	2021	INDIVIDUAL PERSONAL PROPERTY	WEIR NEIL	7705 RAYTOWN RD
100382508	2021	INDIVIDUAL PERSONAL PROPERTY	GARCIA REBECCA D & RAOUL C JR	11309 E 67TH TER	100390113	2008-2017	INDIVIDUAL PERSONAL PROPERTY	NUNEZ ANGELA S	7901 CRESCENT AVE
100382735	2001	INDIVIDUAL PERSONAL PROPERTY	PATTERSON STEPHANIE D	9208 E 57TH ST	100390287	2001	INDIVIDUAL PERSONAL PROPERTY	BREWER SHERRY M	7321 ASH AVE
100382999	2021	INDIVIDUAL PERSONAL PROPERTY	FLUSS LUANNE L	11312 E 78TH TER	100390326	2008	INDIVIDUAL PERSONAL PROPERTY	PAYNE MICHAEL	5304 MAYWOOD AVE
100383175	2000	INDIVIDUAL PERSONAL PROPERTY	NICHOLS NANCY K	8754 E 83RD ST	100390460	2020-2021	INDIVIDUAL PERSONAL PROPERTY	WILSON AYAH	8405 SPRING VALLEY RD
100383191	2000	INDIVIDUAL PERSONAL PROPERTY	THOMAS FREDRICK V & HURT	8809 E 61ST TER	100390508	2005-2008	INDIVIDUAL PERSONAL PROPERTY	GOUDEAUX NOLON	8405 E 83RD ST
100383494	2002	INDIVIDUAL PERSONAL PROPERTY	EDWARDS SALLIE M	9808 E 76TH TER	100390630	2021	INDIVIDUAL PERSONAL PROPERTY	HOLMES ANGELA L (ROBINSON)	7516 ARLINGTON AVE
100383687	2001	INDIVIDUAL PERSONAL PROPERTY	GOSSAGE CHRIS S	8802 E 71ST TER	100390726	2021	INDIVIDUAL PERSONAL PROPERTY	PHILLIPS SHERI E	10112 E 83RD ST
100383731	2002	INDIVIDUAL PERSONAL PROPERTY	MUSGRAVE BILLY W	10409 E 69TH TER	100390789	2015-2021	INDIVIDUAL PERSONAL PROPERTY	RANDLE TYLER W	11701 E 83RD ST APT 101
100383848	2015-2017	INDIVIDUAL PERSONAL PROPERTY	HAYES ALISHA M	8424 LANE PL	100391020	2001	INDIVIDUAL PERSONAL PROPERTY	OWENS PATRICK B	9017 E 66TH TER
100383918	2021	INDIVIDUAL PERSONAL PROPERTY	FOSTER SHANDRA L	7811 E 87TH ST	100391070	2021	INDIVIDUAL PERSONAL PROPERTY	ESTERLEY GABRIEL T	7507 HAWTHORNE AVE
100384103	2017-2018	INDIVIDUAL PERSONAL PROPERTY	STALLINGS SONSERAE	7919 MAPLE AVE	100391103	2006	INDIVIDUAL PERSONAL PROPERTY	KHALSA KARTA PURNIK	8572 JAMES A REED RD
100384253	2021	INDIVIDUAL PERSONAL PROPERTY	LEWIS JONATHAN W AND DESIREE L	8420 ARLINGTON AVE	100391263	2021	INDIVIDUAL PERSONAL PROPERTY	DALE WALLACE REED JR	9420 E 55TH ST
100384295	2013-2015	INDIVIDUAL PERSONAL PROPERTY	JONES NATALIE J	9204 E 84TH ST	100391387	2007-2017	INDIVIDUAL PERSONAL PROPERTY	MATNEY HOLLIE J	9015 E 74TH TER
100384448	2001	INDIVIDUAL PERSONAL PROPERTY	CLAGGETT AARON	10301 E 78TH ST	100391403	2004-2006	INDIVIDUAL PERSONAL PROPERTY	CROCKETT LAURIE	6517 HARDY AVE
100384461	2007-2017	INDIVIDUAL PERSONAL PROPERTY	HUGHES THELMA J & VAUGHAN CAREY	7317 RALSTON AVE	100391434	2001	INDIVIDUAL PERSONAL PROPERTY	TUCKER WILLIAM F III	5413 RAYTOWN RD
100384548	2021	INDIVIDUAL PERSONAL PROPERTY	MORRIS JOHN L	9912 E 60TH ST	100391463	2010	INDIVIDUAL PERSONAL PROPERTY	JOHNSON ANGIE B	9413 E 80TH TER
100384640	2002-2005	INDIVIDUAL PERSONAL PROPERTY	OSMAN SADIK AHMED	NO ADDRESS PROVIDED BY TAXPAYER	100391676	2004-2005	INDIVIDUAL PERSONAL PROPERTY	STEINER BRIAN T	9103 E 74TH ST

100391788	2012-2013	INDIVIDUAL PERSONAL PROPERTY	ALBERT MERLYNN & REINSTER MARTIN	6525 ELM AVE	100396227	2021	INDIVIDUAL PERSONAL PROPERTY	RAY TORRANCE JR	11307 E 78TH ST
100391810	2001	INDIVIDUAL PERSONAL PROPERTY	WEST KRIS E & TOD	9302 E 82ND ST	100396379	2002	INDIVIDUAL PERSONAL PROPERTY	MURPHY KIM T	UNKNOWN
100391846	2001-2002	INDIVIDUAL PERSONAL PROPERTY	SNOW MICHAEL R & JANICE S	UNKNOWN	100396543	2021	INDIVIDUAL PERSONAL PROPERTY	MCLENAHAN KRISTINA LYNN	11609 E 72ND ST
100391900	2005-2014	INDIVIDUAL PERSONAL PROPERTY	JONES KENNETH KELLY	8801 E 85TH ST	100396596	2001-2002	INDIVIDUAL PERSONAL PROPERTY	WHETSTONE LORI & MIKE	8212 E 83RD TER
100391984	2002	INDIVIDUAL PERSONAL PROPERTY	DAVIS JASON REECE	NO ADDRESS PROVIDED BY TAXPAYER	100396653	2014-2021	INDIVIDUAL PERSONAL PROPERTY	THOMPSON BRANDI	6407 BLUE RIDGE BLVD
100392050	2001	INDIVIDUAL PERSONAL PROPERTY	FORD CR TLT TR % BRENNER	6628 OXFORD AVE	100396749	2003	INDIVIDUAL PERSONAL PROPERTY	HETZLER JEREMIAH J	8608 E 87TH ST
100392080	2001-2002	INDIVIDUAL PERSONAL PROPERTY	GILMORE PEEGY L	NO ADDRESS PROVIDED BY TAXPAYER	100396761	2006-2008	INDIVIDUAL PERSONAL PROPERTY	DELEON MICHAEL	8309 STARK AVE
100392097	2008-2009	INDIVIDUAL PERSONAL PROPERTY	LIGON TERESA L	10105 E 84TH ST	100396817	2001-2005	INDIVIDUAL PERSONAL PROPERTY	WILLIAMS AL R	9517 E 67TH TER
100392150	2001	INDIVIDUAL PERSONAL PROPERTY	YASA CRYSTAL M	8225 WOODSON DR	100396959	2015	INDIVIDUAL PERSONAL PROPERTY	MEYER CHRIS A	8130 STERLING AVE
100392155	2006-2017	INDIVIDUAL PERSONAL PROPERTY	CHANCE SHAUN & SARAH	8110 MANNING AVE	100396965	2021	INDIVIDUAL PERSONAL PROPERTY	REVELES DE BROWN AIDA	6000 BLUE RIDGE CUT OFF
100392200	2016-2021	INDIVIDUAL PERSONAL PROPERTY	ROBINSON EDDIE JR III	8812 E 87TH ST	100397052	2002	INDIVIDUAL PERSONAL PROPERTY	DUNBAR VINCENT E & LORI J	8915 E 74TH ST
100392218	2004	INDIVIDUAL PERSONAL PROPERTY	JEYS WARREN	NO ADDRESS PROVIDED BY TAXPAYER	100397074	2010	INDIVIDUAL PERSONAL PROPERTY	LANE RICHARD N	8011 HARRIS AVE
100392226	2021	INDIVIDUAL PERSONAL PROPERTY	DELA TORRE CHAD M	10606 E 70TH TER	100397395	2003	INDIVIDUAL PERSONAL PROPERTY	ADAMS JACK & GIORDANO	NO ADDRESS PROVIDED BY TAXPAYER
100392227	2020	INDIVIDUAL PERSONAL PROPERTY	BUFORD RICHARD & TEENA	9801 E 61ST ST APT 1	100397640	2021	INDIVIDUAL PERSONAL PROPERTY	PETTY JENNIFER	9801 E 61ST ST APT 6
100392287	2005-2006	INDIVIDUAL PERSONAL PROPERTY	REDMON RUSSELL A	NO ADDRESS PROVIDED BY TAXPAYER	100397795	2002	INDIVIDUAL PERSONAL PROPERTY	TANG JING QING	7415 ASH AVE
100392439	2001	INDIVIDUAL PERSONAL PROPERTY	THOMAS STEPHANIE	6523 BLUE RIDGE BLVD	100397806	2018-2021	INDIVIDUAL PERSONAL PROPERTY	HOWARD MICHAEL J	5713 ELM AVE
100392451	2012-2013	INDIVIDUAL PERSONAL PROPERTY	HOBAN MICHAEL	935 E 69TH TER	100397855	2019-2021	INDIVIDUAL PERSONAL PROPERTY	WEST BRIAN J	6208 WILLOW AVE
100392487	2007	INDIVIDUAL PERSONAL PROPERTY	LOCKARD TROY & AMY B	7520 HARVARD AVE	100397960	2016	INDIVIDUAL PERSONAL PROPERTY	CRANMORE DANIEL	5725 ELM AVE
100392494	2021	INDIVIDUAL PERSONAL PROPERTY	ROBERTS JOANNA BETH	8908 E 74TH ST	100397961	2005	INDIVIDUAL PERSONAL PROPERTY	WALSH NIKKI	NO ADDRESS PROVIDED BY TAXPAYER
100392513	2016-2017	INDIVIDUAL PERSONAL PROPERTY	GONNELLO MARY	9106 E 74TH ST	100397967	2020-2021	INDIVIDUAL PERSONAL PROPERTY	WEST TRACY	7226 RAYTOWN RD APT D
100392561	2007	INDIVIDUAL PERSONAL PROPERTY	OLIVER DAVID	8505 KENTUCKY AVE	100398029	2005-2006	INDIVIDUAL PERSONAL PROPERTY	DOUGHTY DIMITRI	5712 HUNTER ST
100392580	2006-2014	INDIVIDUAL PERSONAL PROPERTY	HILL CHRISTINE	850 E 85TH ST	100398037	2001	INDIVIDUAL PERSONAL PROPERTY	TAYLOR WENDY	NO ADDRESS PROVIDED BY TAXPAYER
100392612	2021	INDIVIDUAL PERSONAL PROPERTY	KING ELLIOTT TRUOY M	5134 WESTRIDGE CIR	100398107	2010-2012	INDIVIDUAL PERSONAL PROPERTY	WILLIAMS KEVIN R	8819 E 75TH ST
100392661	2001	INDIVIDUAL PERSONAL PROPERTY	CHURCH GARY O	NO ADDRESS PROVIDED BY TAXPAYER	100398423	2007	INDIVIDUAL PERSONAL PROPERTY	GRAY DONALD C	5814 KENTUCKY AVE
100392692	2008	INDIVIDUAL PERSONAL PROPERTY	JOHNSON-COLLINS TANISHA & COLLINS ROOSEV	9200 E 54TH ST	100398538	2021	INDIVIDUAL PERSONAL PROPERTY	BOLDEN REGINALD L	8416 WOODSON DR
100392834	2002	INDIVIDUAL PERSONAL PROPERTY	ROCHA DAVID A	5304 LAUREL	100398545	2001	INDIVIDUAL PERSONAL PROPERTY	RICHARDS KIMBERLY V	NO ADDRESS PROVIDED BY TAXPAYER
100392854	2001	INDIVIDUAL PERSONAL PROPERTY	MORRIS SHANNON	PO BOX 18303	100398802	2001	INDIVIDUAL PERSONAL PROPERTY	STEINLY GARY D & SANDRINA	NO ADDRESS PROVIDED BY TAXPAYER
100392972	2004	INDIVIDUAL PERSONAL PROPERTY	BRYANT MELISSA S	11305 E 78TH TER	100398923	2014	INDIVIDUAL PERSONAL PROPERTY	SERAFIN ROMAN	11520 E 74TH STREET CT
100392993	2003	INDIVIDUAL PERSONAL PROPERTY	CROY SCOTT	UNKNOWN	100398941	2011-2012	INDIVIDUAL PERSONAL PROPERTY	BURKHART TODD A	7718 WOODSON
100393045	2001-2002	INDIVIDUAL PERSONAL PROPERTY	PRINCE LARRY	NO ADDRESS PROVIDED BY TAXPAYER	100398990	2016	INDIVIDUAL PERSONAL PROPERTY	WALDEN KIMMIE L	7903 MAPLE AVE
100393065	2020-2021	INDIVIDUAL PERSONAL PROPERTY	COLEMAN ADRIAN LEVELL	811 GRAND BLVD	100399014	2002	INDIVIDUAL PERSONAL PROPERTY	GOODSON MICHELLE M	7207 WOODSON DR
100393118	2004-2007	INDIVIDUAL PERSONAL PROPERTY	HESS ROBERT & SCHNEIDER VIRGINIA(OLDSON)	9102 E 74TH ST	100399047	2021	INDIVIDUAL PERSONAL PROPERTY	CHAPPLE JAMIE A & PHILBRICK DUSTIN R	7112 EVANSTON AVE
100393209	2019-2021	INDIVIDUAL PERSONAL PROPERTY	GILDEHAUS VICKI ANN	5541 AGNES AVE	100399179	2021	INDIVIDUAL PERSONAL PROPERTY	HUTCHINSON CLAYTON SHANE	9508 E 68TH ST
100393294	2018-2021	INDIVIDUAL PERSONAL PROPERTY	DAVIS DAMON	9108 E 58TH ST	100399605	2019	INDIVIDUAL PERSONAL PROPERTY	LESURE LATRICE	8610 JAMES A REED RD
100393462	2001	INDIVIDUAL PERSONAL PROPERTY	BRUMMITT LARRY	6440 RAYTOWN RD	100399666	2004-2005	INDIVIDUAL PERSONAL PROPERTY	GILL MICHELLE L	8704 E 83RD TER
100393471	2021	INDIVIDUAL PERSONAL PROPERTY	BEDFORD KAREEM	9807 E 61ST ST APT 2	100399668	2018-2021	INDIVIDUAL PERSONAL PROPERTY	GATLIN REGINALD B	8612 ELM AVE
100393546	2003	INDIVIDUAL PERSONAL PROPERTY	KEEN CHRISTY	NO ADDRESS PROVIDED BY TAXPAYER	100399746	2012-2013	INDIVIDUAL PERSONAL PROPERTY	FUGLE JAMES	6037 MAYWOOD AVE
100393636	2021	INDIVIDUAL PERSONAL PROPERTY	CRUZ WALTER O & HEATHER	10405 E 56TH ST	100399994	2001	INDIVIDUAL PERSONAL PROPERTY	EDWARDS ERIN E	9709 E 66TH ST
100393643	2004-2008	INDIVIDUAL PERSONAL PROPERTY	RUSSELL REBECCA H	NO ADDRESS PROVIDED BY TAXPAYER	100400023	2001	INDIVIDUAL PERSONAL PROPERTY	SMITH AMY	10713 E 66TH ST
100393682	2021	INDIVIDUAL PERSONAL PROPERTY	LAWRENCE MARY E	5825 CEDAR AVE	100400077	2021	INDIVIDUAL PERSONAL PROPERTY	WELLS AMBER	6711 HUNTER ST
100393712	2001	INDIVIDUAL PERSONAL PROPERTY	LOCKE FELICE (HERNANDEZ	642 NE CLUBHOUSE DR	100400411	2002	INDIVIDUAL PERSONAL PROPERTY	LABOI CARRIE L	NO ADDRESS PROVIDED BY TAXPAYER
100393783	2021	INDIVIDUAL PERSONAL PROPERTY	MORGAN FRANKIE	6811 PROCTOR AVE	100400433	2001-2013	INDIVIDUAL PERSONAL PROPERTY	LEMO CHRISTOPHER A	NO ADDRESS PROVIDED BY TAXPAYER
100393865	2021	INDIVIDUAL PERSONAL PROPERTY	COBB WILLIAM LOUIS & IRENE	11100 E 61ST	100400442	2017-2019	INDIVIDUAL PERSONAL PROPERTY	LAY TROY	8600 STARK AVE
100393979	2002	INDIVIDUAL PERSONAL PROPERTY	REYLEA AMY	8622 LANE AVE	100400446	2016-2021	INDIVIDUAL PERSONAL PROPERTY	SIMPSON DAVID A JR	6412 STERLING AVE
100394048	2009-2017	INDIVIDUAL PERSONAL PROPERTY	PENCE DANIEL	5448 ASH AVE	100400463	2001-2004	INDIVIDUAL PERSONAL PROPERTY	LOVICK DREW	8208 STERLING
100394241	2002	INDIVIDUAL PERSONAL PROPERTY	BOURDESS REBECCA S	8935 E 57TH ST	100400570	2002-2003	INDIVIDUAL PERSONAL PROPERTY	WYATT MICHELLE L	8817 E 57TH TER
100394254	2021	INDIVIDUAL PERSONAL PROPERTY	THATCHER COREY WILLIAM	6134 ASH CT	100400576	2001	INDIVIDUAL PERSONAL PROPERTY	GLADIEUX MARTHA M	9404 E 66TH ST
100394263	2001	INDIVIDUAL PERSONAL PROPERTY	PETTY MIKE	8219 LAUREL	100400720	2003-2006	INDIVIDUAL PERSONAL PROPERTY	MCDERMOTT KRIS	8505 GREENWOOD RD
100394277	2001-2004	INDIVIDUAL PERSONAL PROPERTY	TAYLOR DANIEL R	NO ADDRESS PROVIDED BY TAXPAYER	100400790	2005	INDIVIDUAL PERSONAL PROPERTY	BULLIS KERRY & DEBORAH L	6706 HARRIS AVE
100394403	2004	INDIVIDUAL PERSONAL PROPERTY	MARTIN MOSES	6525 ELM AVE	100400884	2007-2009	INDIVIDUAL PERSONAL PROPERTY	MCCALLISTER JASON	9709 RICE AVE
100394793	2004-2010	INDIVIDUAL PERSONAL PROPERTY	MCDUGALL KIM CRANDAL	9706 E 80TH TER	100400918	2001	INDIVIDUAL PERSONAL PROPERTY	GOOCH NICOLE	7909 HUNTER ST
100394860	2004-2005	INDIVIDUAL PERSONAL PROPERTY	BULLIS DEBORAH L	6706 HARRIS AVE	100400971	2013	INDIVIDUAL PERSONAL PROPERTY	WILLIAMS JANIS V	NO ADDRESS PROVIDED BY TAXPAYER
100394887	2003-2007	INDIVIDUAL PERSONAL PROPERTY	NEWKIRK DAVID E	NO ADDRESS PROVIDED BY TAXPAYER	100401104	2003	INDIVIDUAL PERSONAL PROPERTY	LEE VERNIA & NICOLE	UNKNOWN UNKNOWN
100394918	2004	INDIVIDUAL PERSONAL PROPERTY	RICKARD SEAN L	8608 KENTUCKY	100401405	2011-2012	INDIVIDUAL PERSONAL PROPERTY	NEIGHBORS WAYNE	NO ADDRESS PROVIDED BY TAXPAYER
100394970	2010-2012	INDIVIDUAL PERSONAL PROPERTY	RIFE STEVE A	6008 BLUE RIDGE BLVD	100401831	2015-2017	INDIVIDUAL PERSONAL PROPERTY	EDWARDS ZINA	8700 E 79TH TER
100394991	2004-2017	INDIVIDUAL PERSONAL PROPERTY	JENKINS JAMES M	NO ADDRESS PROVIDED BY TAXPAYER	100401858	2005-2010	INDIVIDUAL PERSONAL PROPERTY	COOPER JASON M	NO ADDRESS PROVIDED BY TAXPAYER
100395033	2017-2021	INDIVIDUAL PERSONAL PROPERTY	CAIN BRIAN T	5388 BLUE RIDGE BLVD	100402101	2021	INDIVIDUAL PERSONAL PROPERTY	FERGUSON DORIAN	8424 MARSH AVE
100395098	2021	INDIVIDUAL PERSONAL PROPERTY	DORSEY RAYMOND	7401 MAPLE UNIT 322	100402216	2007-2009	INDIVIDUAL PERSONAL PROPERTY	LEONARD AMANDA J	5416 HEDGES AVE
100395140	2017-2019	INDIVIDUAL PERSONAL PROPERTY	REYNOLDS HELEN L	9001 E 72ND TER	100402607	2002	INDIVIDUAL PERSONAL PROPERTY	WEAVER CHRISTOPHER M & DIANA	9823 E 68TH TER
100395225	2019	INDIVIDUAL PERSONAL PROPERTY	WILLIAMS MARVIN CLEO	8625 E UTOPIA PKWY APT 12	100402709	2007-2008	INDIVIDUAL PERSONAL PROPERTY	BROWN STERLING L	9113 E 52ND TER
100395271	2009-2014	INDIVIDUAL PERSONAL PROPERTY	MC DUFFY RYAN	8311 STERLING AVE	100402750	2001	INDIVIDUAL PERSONAL PROPERTY	DONALDSON MICHELLE R	6710 LANE
100395289	2001	INDIVIDUAL PERSONAL PROPERTY	KENNEDY VALARI	7900 HARDY	100402755	2021	INDIVIDUAL PERSONAL PROPERTY	ZACHARY TYESHA	5329 KENTUCKY AVE
100395352	2001-2004	INDIVIDUAL PERSONAL PROPERTY	DILLINGER JAMES	9600 E 69TH ST	100402769	2009-2010	INDIVIDUAL PERSONAL PROPERTY	SPILLER LEO KENT	8617 E 83RD TER
100395400	2016-2017	INDIVIDUAL PERSONAL PROPERTY	DENNEY MICHAEL B SR	8800 E 71ST TER	100402981	2011-2013	INDIVIDUAL PERSONAL PROPERTY	HOWARD JOANN	NO ADDRESS PROVIDED BY TAXPAYER
100395485	2015	INDIVIDUAL PERSONAL PROPERTY	FORTUNE IRENE E	6140 RAYTOWN RD APT 404	100403166	2021	INDIVIDUAL PERSONAL PROPERTY	CARBAJAL OMAR & ARENIVAS MARIZA	8800 RICHARDS DR
100395684	2021	INDIVIDUAL PERSONAL PROPERTY	FIGG DANIEL J	8204 HEDGES AVE	100403172	2021	INDIVIDUAL PERSONAL PROPERTY	SEARCY MICHAEL T	8712 E 79TH ST
100395775	2021	INDIVIDUAL PERSONAL PROPERTY	ALEXANDER CHERIE	9900 E 60TH ST	100403392	2004	INDIVIDUAL PERSONAL PROPERTY	BYBEE SEAN	8111 DITZLER
100395784	2002	INDIVIDUAL PERSONAL PROPERTY	DEES DUANE N	9804 E 77TH ST	100403468	2021	INDIVIDUAL PERSONAL PROPERTY	ESTERLEY DAVID CHARLES	8506 FORD AVE
100396051	2006-2015	INDIVIDUAL PERSONAL PROPERTY	VAUGHN GLEN W	5809 WOODSON DR	100403576	2006-2013	INDIVIDUAL PERSONAL PROPERTY	WILLIAMS DERRICK A	NO ADDRESS PROVIDED BY TAXPAYER
100396054	2021	INDIVIDUAL PERSONAL PROPERTY	SIMPSON CODY D	7905 APPLETON AVE	100403748	2011	INDIVIDUAL PERSONAL PROPERTY	SCHWARTZ MIKE T	9018 E 74TH TER
100396093	2019-2021	INDIVIDUAL PERSONAL PROPERTY	AVERY XANTHE YVONNE	7800 E 119TH ST	100403984	2019-2021	INDIVIDUAL PERSONAL PROPERTY	SCOTT REGINA R	9025 E 73RD ST
100396200	2004-2011	INDIVIDUAL PERSONAL PROPERTY	HANNAHS STEVEN C	9320 E 84TH TER	100403988	2001-2002	INDIVIDUAL PERSONAL PROPERTY	CLEAVES LAKISHA D	7811 E 86TH ST

100404188	2001-2002	INDIVIDUAL PERSONAL PROPERTY	BARNES DAVID L	UNKNOWN	100415868	2019-2021	INDIVIDUAL PERSONAL PROPERTY	HAWTHORNE SHANDA MARIE	8209 WOODSON DR
100404342	2010-2012	INDIVIDUAL PERSONAL PROPERTY	BURNS RAHMAAN	7225 VIRGINIA AVE	100415887	2001	INDIVIDUAL PERSONAL PROPERTY	JOHNS OTELIA E	5509 ASH AVE
100404901	2021	INDIVIDUAL PERSONAL PROPERTY	KITRELL KIMBERLY R	8509 HARVARD TER	100416074	2020-2021	INDIVIDUAL PERSONAL PROPERTY	HERNANDEZ AYESHA	5824 BLUE RIDGE BLVD
100404913	2006	INDIVIDUAL PERSONAL PROPERTY	THOMPSON MICHAEL E	9949 E 61ST ST APT 1	100416082	2016-2021	INDIVIDUAL PERSONAL PROPERTY	BYRD CAROLYN	909 S KISNER DR
100404992	2006	INDIVIDUAL PERSONAL PROPERTY	WILLIAMS FRANK	8903 E GREGORY BLVD	100416102	2016-2021	INDIVIDUAL PERSONAL PROPERTY	GOODWIN REGINA	11314 E 72ND ST
100405369	2001-2004	INDIVIDUAL PERSONAL PROPERTY	OAKES CHRISTOPHER J	11200 E 63RD ST	100416472	2007	INDIVIDUAL PERSONAL PROPERTY	LEWIS VERINNA M	11810 E 75TH ST
100405601	2013	INDIVIDUAL PERSONAL PROPERTY	SHEPARD ROBERT L	9909 E 60TH ST	100416932	2003	INDIVIDUAL PERSONAL PROPERTY	FOSTER MICHELE L	UNKNOWN
100405615	2014-2018	INDIVIDUAL PERSONAL PROPERTY	WILMURTH NICK	8518 OXFORD AVE	100417127	2020-2021	INDIVIDUAL PERSONAL PROPERTY	LESTER IMELDA	7407 BLUE RIDGE BLVD
100405641	2021	INDIVIDUAL PERSONAL PROPERTY	GILLESPIE CRAIG L	5221 CRISP AVE	100417398	2000-2001	INDIVIDUAL PERSONAL PROPERTY	PHIPPS KATY	10500 E 59TH ST
100405645	2021	INDIVIDUAL PERSONAL PROPERTY	GONZALEZ TONIA MARIE (QUARLES)	6810 HAWTHORNE AVE	100417642	2001-2017	INDIVIDUAL PERSONAL PROPERTY	MCCLUNG SANDRA F	6001 NORTHERN AVE
100405776	2010	INDIVIDUAL PERSONAL PROPERTY	WARCHOLA REBECCA	8307 DITZLER AVE	100417844	2020-2021	INDIVIDUAL PERSONAL PROPERTY	JACKSON MONICA LATRICE	7313 RAYTOWN RD
100405787	2006-2007	INDIVIDUAL PERSONAL PROPERTY	HARRIS JASON M	6609 HARVARD AVE	100417845	2007	INDIVIDUAL PERSONAL PROPERTY	DAVIS JOSEPH W	9813 E 60TH ST
100405868	2020-2021	INDIVIDUAL PERSONAL PROPERTY	FOSTER JACQUELINE M & DWIGHT E	11901 E 77TH TER	100417927	2001	INDIVIDUAL PERSONAL PROPERTY	CRAWFORD BRIAN	8404 EVANSTON AVE
100405873	2017-2018	INDIVIDUAL PERSONAL PROPERTY	SMITH CAROL LYNN	9807 E 61ST ST APT 4	100418205	2005-2007	INDIVIDUAL PERSONAL PROPERTY	HARRIS BRIANNA E	6609 HARVARD AVE
100406004	2021	INDIVIDUAL PERSONAL PROPERTY	REVES ROBIN FAITH	9215 E 65TH TER	100418269	2012-2015	INDIVIDUAL PERSONAL PROPERTY	GIPSON NACOMI	8608 OXFORD AVE
100406010	2006-2009	INDIVIDUAL PERSONAL PROPERTY	MATHIS TIM	NO ADDRESS PROVIDED BY TAXPAYER	100418497	2005-2013	INDIVIDUAL PERSONAL PROPERTY	DAVILA BABETTE M	11405 E 69TH ST
100406024	2018-2021	INDIVIDUAL PERSONAL PROPERTY	ROSS TAMIKIA P (BELLARD)	11113 E 74TH ST	100418640	2021	INDIVIDUAL PERSONAL PROPERTY	HENGGELER LEONARD JR & HENGGELER SARA M	5309 WILLOW AVE
100406202	2021	INDIVIDUAL PERSONAL PROPERTY	LAVALAIS RONALD O	9062 E 65TH ST	100418641	2005-2006	INDIVIDUAL PERSONAL PROPERTY	HAYES E W	6512 WOODSON RD
100406253	2016-2017	INDIVIDUAL PERSONAL PROPERTY	PHILLIPS JOHNNY L	8613 E 83RD ST	100418675	2003-2004	INDIVIDUAL PERSONAL PROPERTY	ELLIOTT KATY C & EVANS	8908 E 66TH ST
100406264	2021	INDIVIDUAL PERSONAL PROPERTY	POWELL HEWITT	5837 BLUE RIDGE CUT OFF	100418739	2013-2019	INDIVIDUAL PERSONAL PROPERTY	ALICEA JOSHUA R	8517 DITZLER AVE
100406435	2002	INDIVIDUAL PERSONAL PROPERTY	PAWLAK BARBRA	7430 ENGLEWOOD LN	100418748	2012	INDIVIDUAL PERSONAL PROPERTY	BROCKER COLLEEN & KEVIN	11314 E 71ST DR
100406444	2001	INDIVIDUAL PERSONAL PROPERTY	VECEA DANIEL	9504 DRURY AVE APT 205	100418870	2006	INDIVIDUAL PERSONAL PROPERTY	WILDE JOSEPH W & HEATHER L	NO ADDRESS PROVIDED BY TAXPAYER
100406499	2001-2002	INDIVIDUAL PERSONAL PROPERTY	WILLIAMS GREGORY S & TRACY D	9801 WILLOW #1B	100418894	2018-2019	INDIVIDUAL PERSONAL PROPERTY	MADDOX SHARON MERCYNE	9351 BALES DR APT 1101
100406962	2009	INDIVIDUAL PERSONAL PROPERTY	LUNDIN NICOL	8328 HARRIS AVE	100418921	2004	INDIVIDUAL PERSONAL PROPERTY	STEELE DELANIA D	UNKNOWN
100407089	2017-2021	INDIVIDUAL PERSONAL PROPERTY	RHYNE CANECE M	7605 HAWTHORNE AVE	100418943	2021	INDIVIDUAL PERSONAL PROPERTY	DENNIS GINA R	7815 IRWIN RD
100407133	2002	INDIVIDUAL PERSONAL PROPERTY	PAYNE PRECIOUS R	10716 BELLAIRE	100419036	2001-2004	INDIVIDUAL PERSONAL PROPERTY	GALLAGHER GEORGE W	10505 CORRINGTON AVE
100407179	2015-2016	INDIVIDUAL PERSONAL PROPERTY	LAIR JASON E	8825 E 61ST TER	100419166	2007-2008	INDIVIDUAL PERSONAL PROPERTY	FINCH ERIK W	10800 E 58TH ST
100407318	2016-2017	INDIVIDUAL PERSONAL PROPERTY	BAKER JEFFREY G & LESLIE	9116 E 58TH TER	100419464	2001	INDIVIDUAL PERSONAL PROPERTY	PETERSON PAUL A	UNKNOWN
100407439	2010-2011	INDIVIDUAL PERSONAL PROPERTY	WESTON EUGENE L	6812 MARLE AVE	100420040	2002	INDIVIDUAL PERSONAL PROPERTY	MCADAMS JIMMY J	6508 WOODSON RD
100407668	2021	INDIVIDUAL PERSONAL PROPERTY	KINNEY RAYMOND	8121 WOODSON DR	100420172	2021	INDIVIDUAL PERSONAL PROPERTY	BUTLER TODD W	6716 ENGLEWOOD AVE
100407680	2004-2005	INDIVIDUAL PERSONAL PROPERTY	LEE NEKITA L	8403 BOOTH AVE	100420864	2000	INDIVIDUAL PERSONAL PROPERTY	AMBROSE AARON D	2429 SE 7TH ST
100407736	2008-2017	INDIVIDUAL PERSONAL PROPERTY	HERNANDEZ MIGUEL M	8207 E 86TH TER	100421703	2019-2021	INDIVIDUAL PERSONAL PROPERTY	SURRATT DELECIA M	8300 E 83RD ST
100407910	2021	INDIVIDUAL PERSONAL PROPERTY	FUE JEREMY	12527 E 58TH ST	100422086	2002	INDIVIDUAL PERSONAL PROPERTY	COURNOYER ANGELINE C	UNKNOWN
100407922	2001-2004	INDIVIDUAL PERSONAL PROPERTY	NELSON DAVID L & RASHEED NOWARA	6317 BLUE RIDGE CUTOFF	100422128	2007	INDIVIDUAL PERSONAL PROPERTY	HINTON JARRAD	713 MAPLE LN
100407985	2003	INDIVIDUAL PERSONAL PROPERTY	STALLINGS BECKY J	NO ADDRESS PROVIDED BY TAXPAYER	100422303	2005-2006	INDIVIDUAL PERSONAL PROPERTY	DANIELS KATHERINE J	NO ADDRESS PROVIDED BY TAXPAYER
100408020	2021	INDIVIDUAL PERSONAL PROPERTY	HEARD OLLIS A & TISA	8967 E 62ND TER	100422308	2003-2006	INDIVIDUAL PERSONAL PROPERTY	LINCOLN VARETHIA	5304 DITZLER AVE
100408118	2020	INDIVIDUAL PERSONAL PROPERTY	WATERS DAVID O JR	10112 E 70TH TER	100422309	2000-2001	INDIVIDUAL PERSONAL PROPERTY	LANA DAMON	UNKNOWN
100408555	2021	INDIVIDUAL PERSONAL PROPERTY	CONWAY MICHAEL E	7301 HARVARD AVE	100422426	2005-2007	INDIVIDUAL PERSONAL PROPERTY	BROWN OTIS C JR	9007 E 75TH ST
100408927	2007	INDIVIDUAL PERSONAL PROPERTY	COOPER BRIAN P	9912 E 60TH ST	100422448	2016-2017	INDIVIDUAL PERSONAL PROPERTY	FOSTER RICHARD E	10816 E 81ST TER
100409324	2019-2021	INDIVIDUAL PERSONAL PROPERTY	HOLLOWELL CHRIS R	8700 STARK AVE	100422560	2002	INDIVIDUAL PERSONAL PROPERTY	KERMAN ADELINO	UNKNOWN
100409502	2021	INDIVIDUAL PERSONAL PROPERTY	MILLER CHARLES L	5720 MAYWOOD	100422634	2007-2009	INDIVIDUAL PERSONAL PROPERTY	LORD JEFFREY & KAREN	8602 STARK AVE
100409590	2002-2005	INDIVIDUAL PERSONAL PROPERTY	ANDERSON JANELLE	NO ADDRESS PROVIDED BY TAXPAYER	100422639	2003	INDIVIDUAL PERSONAL PROPERTY	KLUSMAN DANNA (NIXON)	NO ADDRESS PROVIDED BY TAXPAYER
100409699	2021	INDIVIDUAL PERSONAL PROPERTY	RANDOLPH LISA L	10908 E 81ST ST	100422757	2006	INDIVIDUAL PERSONAL PROPERTY	THOMASON RUTH A	NO ADDRESS PROVIDED BY TAXPAYER
100410331	2011	INDIVIDUAL PERSONAL PROPERTY	KOONTZ LINDA E	8928 E 59TH ST	100422824	2003	INDIVIDUAL PERSONAL PROPERTY	WEST CHARLOTTE M	UNKNOWN
100410478	2002-2005	INDIVIDUAL PERSONAL PROPERTY	BURKE DIANE	NO ADDRESS PROVIDED BY TAXPAYER	100422873	2021	INDIVIDUAL PERSONAL PROPERTY	BUIE ERAINA	6701 APPLETON AVE
100410534	2004-2005	INDIVIDUAL PERSONAL PROPERTY	RUSSI REBECCA	8805 E 59TH ST	100422996	2002-2004	INDIVIDUAL PERSONAL PROPERTY	BROWN JERALD R II	10005 E 84TH ST
100410597	2021	INDIVIDUAL PERSONAL PROPERTY	RODRIGUEZ ALVARO	11833 E 83RD ST APT 202	100423067	2012-2013	INDIVIDUAL PERSONAL PROPERTY	BROWN YOLESNA & BRENTON	7823 WOODSON RD
100410607	2005	INDIVIDUAL PERSONAL PROPERTY	BOOKER MELISSA	NO ADDRESS PROVIDED BY TAXPAYER	100423092	2021	INDIVIDUAL PERSONAL PROPERTY	BLUFORD KIMBERLY ANNETTE	10303 E 78TH ST
100410788	2021	INDIVIDUAL PERSONAL PROPERTY	GALLE DWAIN ALBERT	9906 E 60TH ST	100423105	2004	INDIVIDUAL PERSONAL PROPERTY	MCCAMISH DAWN M	NO ADDRESS PROVIDED BY TAXPAYER
100410866	2021	INDIVIDUAL PERSONAL PROPERTY	SIMMONS MICHAEL R	7705 RAYTOWN RD	100423245	2001	INDIVIDUAL PERSONAL PROPERTY	RAMEY ROY G	7517 HARVARD
100411195	2021	INDIVIDUAL PERSONAL PROPERTY	LOCKETT CHRISTOPHER B	11500 E 62ND ST	100423319	2003	INDIVIDUAL PERSONAL PROPERTY	LEAL JOSEPH R	3800 VIRGINIA AVE
100411400	2020-2021	INDIVIDUAL PERSONAL PROPERTY	AVILES CRYSTAL L	6132 LAUREL AVE	100423456	2005	INDIVIDUAL PERSONAL PROPERTY	HAMM BRIAN JAMES	NO ADDRESS PROVIDED BY TAXPAYER
100411427	2003	INDIVIDUAL PERSONAL PROPERTY	CANADY PEGGY L	3128 KENSINGTON AVE	100423464	2013	INDIVIDUAL PERSONAL PROPERTY	JONES DAVID W & JENNIFER	6300 HARVARD AVE
100411883	2019-2021	INDIVIDUAL PERSONAL PROPERTY	EDWARDS MARILYN D	11509 E 74TH STREET CT	100423765	2005-2006	INDIVIDUAL PERSONAL PROPERTY	MANG PHILIPPE R	5801 STERLING AVE
100411884	2001-2003	INDIVIDUAL PERSONAL PROPERTY	TUBBS JEFFERY	5601 LANE	100423877	2020-2021	INDIVIDUAL PERSONAL PROPERTY	BATTLE VERONICA	10005 E 83RD TER
100412594	2021	INDIVIDUAL PERSONAL PROPERTY	SIMPSON KRIS L	5577 BLUE RIDGE BLVD	100423889	2001	INDIVIDUAL PERSONAL PROPERTY	WORBOYS B	8031 TENNESSEE
100412630	2021	INDIVIDUAL PERSONAL PROPERTY	WILLIAMS GLEN D	5409 STERLING AVE	100423900	2021	INDIVIDUAL PERSONAL PROPERTY	SHAW DONNA S (GIANDALLIA)	11044 E 54TH ST
100412948	2001	INDIVIDUAL PERSONAL PROPERTY	COAN JOHN W	9404 E 66TH ST	100424092	2008-2013	INDIVIDUAL PERSONAL PROPERTY	GONZALES A HELEN	5911 BLUE RIDGE CUT OFF
100413248	2006-2011	INDIVIDUAL PERSONAL PROPERTY	BITTLE CHRIS	9201 E 79TH ST	100424107	2021	INDIVIDUAL PERSONAL PROPERTY	BEARLY DON & REBEKAH	10812 E 79TH ST
100413617	2002-2003	INDIVIDUAL PERSONAL PROPERTY	SHAUGHNESSY JEFF	4505 BEVERLY AVE	100425635	2013	INDIVIDUAL PERSONAL PROPERTY	LOWERY SECRET	5809 LANE AVE
100414010	2011	INDIVIDUAL PERSONAL PROPERTY	KEDDY CHARLES A	11400 E 62ND TER	100453117	2005-2006	INDIVIDUAL PERSONAL PROPERTY	KIRKSEY LORRIE	7415 APPLETON AVE
100414116	2001	INDIVIDUAL PERSONAL PROPERTY	BRAY DAVID E & BRENDA E	8863 E 52ND TER	100453134	2005-2006	INDIVIDUAL PERSONAL PROPERTY	MACK DOROTHY	NO ADDRESS PROVIDED BY TAXPAYER
100414388	2007-2011	INDIVIDUAL PERSONAL PROPERTY	GILMORE PEGGY L	9354 E 70TH TER	100453253	2012-2017	INDIVIDUAL PERSONAL PROPERTY	WALKER ANGELA	10608 E 65TH ST
100414425	2006	INDIVIDUAL PERSONAL PROPERTY	WILKINSON RONALD L & VIRGINIA M	8307 MANNING AVE	100453319	2002-2007	INDIVIDUAL PERSONAL PROPERTY	JACKSON RICHARD A	NO ADDRESS PROVIDED BY TAXPAYER
100414427	2007	INDIVIDUAL PERSONAL PROPERTY	RIDDLE JOHN A & JENNIFER A	5708 MAYWOOD AVE	100453343	2008	INDIVIDUAL PERSONAL PROPERTY	MCNEAL JACQUELYN WILLIAMS	9708 E 69TH ST
100414436	2002	INDIVIDUAL PERSONAL PROPERTY	BUNDY CLARA	9112 VAUGHN	100453472	2001	INDIVIDUAL PERSONAL PROPERTY	BALLEW DEBORAH	UNKNOWN
100414726	2004-2005	INDIVIDUAL PERSONAL PROPERTY	BLACKLEY JASON DANIEL	7308 APPLETON AVE	100453562	2006-2007	INDIVIDUAL PERSONAL PROPERTY	HOWARD ROBERT K	11000 E 54TH ST
100414737	2002	INDIVIDUAL PERSONAL PROPERTY	BOGAN ROY III	5400 DITZLER	100453622	2004-2005	INDIVIDUAL PERSONAL PROPERTY	STINE SARAH A	5415 BENNINGTON AVE
100414804	2003	INDIVIDUAL PERSONAL PROPERTY	STUART PHILLIP L	8017 MANNING AVE	100453828	2021	INDIVIDUAL PERSONAL PROPERTY	PACE SHARON	7300 APPLETON AVE
100414867	2021	INDIVIDUAL PERSONAL PROPERTY	WALTERS ANDERSON M	8121 HEDGES AVE	100453849	2010-2011	INDIVIDUAL PERSONAL PROPERTY	SINBAUGH GEORGIA BELLE	NO ADDRESS PROVIDED BY TAXPAYER
100415252	2002	INDIVIDUAL PERSONAL PROPERTY	OMER SABINE M	UNKNOWN	100453867	2021	INDIVIDUAL PERSONAL PROPERTY	MACK DAVIS L	7827 RIDGEWAY AVE
100415740	2016-2018	INDIVIDUAL PERSONAL PROPERTY	SMITH DORETHA	6929 RAYTOWN RD	100454011	2005	INDIVIDUAL PERSONAL PROPERTY	ANDERSON KEISHA R	4112 HIGHLAND AVE

100454176	2007-2010	INDIVIDUAL PERSONAL PROPERTY	ERVIN BILLY JOE	5432 STERLING AVE	100463869	2014	INDIVIDUAL PERSONAL PROPERTY	JORDAN TROY	11709 E 78TH PL
100454604	2006	INDIVIDUAL PERSONAL PROPERTY	FOMBON ATTABONG N	8220 WOODSON DR	100464148	2021	INDIVIDUAL PERSONAL PROPERTY	DAVIS DARRRELL	11808 E 79TH DR
100454618	2021	INDIVIDUAL PERSONAL PROPERTY	STINSON NOEL	9914 E 60TH ST	100464414	2013-2016	INDIVIDUAL PERSONAL PROPERTY	SMITH DARRYLE WAYNE	10900 E 65TH ST
100454631	2006	INDIVIDUAL PERSONAL PROPERTY	POE CHRISTY & DAN	7010 WOODSON RD	100464418	2017-2019	INDIVIDUAL PERSONAL PROPERTY	WELLS SHANEKA	11811 E 85TH ST
100454727	2006-2007	INDIVIDUAL PERSONAL PROPERTY	MEYER KRISTI C	7541 WESTRIDGE RD	100464499	2017-2021	INDIVIDUAL PERSONAL PROPERTY	GRAVES SANDRA J	8301 KENTUCKY AVE
100454750	2021	INDIVIDUAL PERSONAL PROPERTY	CRABTREE MICHELLE MARGARET	8810 E 72ND TER	100464613	2000	INDIVIDUAL PERSONAL PROPERTY	HARGROVE DUSTIN & MICHELLE	16513 E 51ST ST CRT
100455015	2004-2005	INDIVIDUAL PERSONAL PROPERTY	PEZZULO MICHAEL A	NO ADDRESS PROVIDED BY TAXPAYER	100464641	2021	INDIVIDUAL PERSONAL PROPERTY	HAYSLETT WYNETTA L	5512 CEDAR AVE
100455101	2002	INDIVIDUAL PERSONAL PROPERTY	WAEVER JOENDA	6140 RAYTOWN RD # 1009	100464645	2017-2020	INDIVIDUAL PERSONAL PROPERTY	HALL ELIZABETH J & JEREMIAH A	7504 HARVARD AVE
100455233	2002	INDIVIDUAL PERSONAL PROPERTY	JOHNSON PETER	UNKNOWN	100464613	2011-2017	INDIVIDUAL PERSONAL PROPERTY	BRADBURY LINDA	10600 E 79TH TER
100455288	2021	INDIVIDUAL PERSONAL PROPERTY	LANGFORD BELINDA L	8958 E 60TH TER	100465004	2021	INDIVIDUAL PERSONAL PROPERTY	VARGAS SHERRY	5512 CEDAR AVE
100455466	2001-2002	INDIVIDUAL PERSONAL PROPERTY	FORRISTAL JAMES A	11609 E 77TH TER	100465062	2021	INDIVIDUAL PERSONAL PROPERTY	RUFFIN JOHNETTA SHANINE (JOHNNETA)	11000 E 83RD ST
100455469	2001-2002	INDIVIDUAL PERSONAL PROPERTY	MATLOCK JARED L	5305 RIDGEWAY	100465155	2002-2004	INDIVIDUAL PERSONAL PROPERTY	ORTMAN SHANNON M	11000 E 83RD ST
100455615	2021	INDIVIDUAL PERSONAL PROPERTY	RICHMOND BREANNA K (CUSICK)	8205 HEDGES AVE	100465174	2002-2007	INDIVIDUAL PERSONAL PROPERTY	SCHAFFER APRIL	NO ADDRESS PROVIDED BY TAXPAYER
100456242	2021	INDIVIDUAL PERSONAL PROPERTY	REDINGER JAMES T	8920 E 74TH ST	100465212	2019-2021	INDIVIDUAL PERSONAL PROPERTY	MESSER JOHN R & TERRY E	8600 E 84TH ST
100456319	2004	INDIVIDUAL PERSONAL PROPERTY	GRAVINO JOE	UNKNOWN	100465598	2020-2021	INDIVIDUAL PERSONAL PROPERTY	JONES MARQUAN DEANDRE	8460 LANE DR
100456367	2000-2017	INDIVIDUAL PERSONAL PROPERTY	JONES GEORGIANNA & ANDERSON	9126 RICHARDS DR	100465569	2004-2006	INDIVIDUAL PERSONAL PROPERTY	ANDERSON WILBERT E	NO ADDRESS PROVIDED BY TAXPAYER
100456512	2021	INDIVIDUAL PERSONAL PROPERTY	MORRIS SHANTIE M	9916 E 61ST ST	100465750	2008-2017	INDIVIDUAL PERSONAL PROPERTY	HOUSER JULIE	5801 KENTUCKY AVE
100456581	2001-2002	INDIVIDUAL PERSONAL PROPERTY	PICARD DONALD F	NO ADDRESS PROVIDED BY TAXPAYER	100465833	2005-2012	INDIVIDUAL PERSONAL PROPERTY	MORRIS RAY A	9362 E 65TH TER
100456710	2021	INDIVIDUAL PERSONAL PROPERTY	DUNCAN CHRISTINE L	9718 E 53RD ST	100465907	2002-2004	INDIVIDUAL PERSONAL PROPERTY	JAMSEK LISA	11329 E 72ND ST
100456873	2005-2013	INDIVIDUAL PERSONAL PROPERTY	LONG STEVE	9007 E 67TH TER	100465963	2018-2021	INDIVIDUAL PERSONAL PROPERTY	REED LAMAR MONTEZ	9107 E 67TH TER
100456999	2020-2021	INDIVIDUAL PERSONAL PROPERTY	PIGGIE VALERIE LORETTA	9020 E 74TH TER	100466082	2007-2012	INDIVIDUAL PERSONAL PROPERTY	PURIFOY ANDREA & TODD	8912 E 52ND TER
100457499	2012	INDIVIDUAL PERSONAL PROPERTY	LEVI KENDALL D	9109 E 73RD ST	100466165	2012-2013	INDIVIDUAL PERSONAL PROPERTY	CARMAN SUMIE	5716 MAYWOOD AVE
100457528	2021	INDIVIDUAL PERSONAL PROPERTY	LEWIS DUSTIN	6406 ELM AVE	100466491	2014-2016	INDIVIDUAL PERSONAL PROPERTY	HOWARD STANLEY & GERRE K	7042 WOODSON RD
100457565	2009	INDIVIDUAL PERSONAL PROPERTY	MORRIS DONALD ROBERT	10813 E 66TH TER	100466503	2021	INDIVIDUAL PERSONAL PROPERTY	JAMES ALTA	5732 WESTRIDGE CIR
100458052	2004-2010	INDIVIDUAL PERSONAL PROPERTY	GREEN PERRY J & PAULLETTE	7444 BLUE RIDGE BLVD	100466521	2006-2010	INDIVIDUAL PERSONAL PROPERTY	CLOUGHLEY ROBYN	5145 BLUE RIDGE BLVD
100458106	2003-2005	INDIVIDUAL PERSONAL PROPERTY	WHITE WALLACE	NO ADDRESS PROVIDED BY TAXPAYER	100466612	2002	INDIVIDUAL PERSONAL PROPERTY	ESTABROOKS JAMES RICHARD	UNKNOWN
100458198	2001-2003	INDIVIDUAL PERSONAL PROPERTY	MERRITT JAMES B & VICKIE M	5203 SYCAMORE AVE	100466958	2010	INDIVIDUAL PERSONAL PROPERTY	SURRELL NATHEN M	8508 E 85TH ST
100458262	2005-2006	INDIVIDUAL PERSONAL PROPERTY	PETTYJOHN ANITA R	2038 BRIGHTON AVE	100466964	2008	INDIVIDUAL PERSONAL PROPERTY	JENKINS ROBERT E	10205 E 58TH TER
100458283	2001	INDIVIDUAL PERSONAL PROPERTY	WILSON MATHWE	UNKNOWN	100466970	2015-2016	INDIVIDUAL PERSONAL PROPERTY	CAUGHNOR CATHI J (FOSTER)	5428 RALSTON AVE
100458309	2012	INDIVIDUAL PERSONAL PROPERTY	DEAN TIFFANY J	9012 E 85TH ST	100466972	2006-2008	INDIVIDUAL PERSONAL PROPERTY	MCKINNEY MATTHEW R	11004 E 54TH ST
100458391	2001-2004	INDIVIDUAL PERSONAL PROPERTY	STRONG CRAIG L & LATOSHA	9012 STARK AVE	100467298	2021	INDIVIDUAL PERSONAL PROPERTY	DUDLEY KENYA C	7920 MAPLE AVE
100458429	2008-2013	INDIVIDUAL PERSONAL PROPERTY	RODRIGUEZ LASHAWNDA	8101 E 87TH ST	100467357	2021	INDIVIDUAL PERSONAL PROPERTY	ADAMS ERIKA D	5333 HUNTER ST
100458483	2020-2021	INDIVIDUAL PERSONAL PROPERTY	BARNES SHERRI MONAE	7024 WOODSON RD	100467367	2017-2021	INDIVIDUAL PERSONAL PROPERTY	ROBERTS HAROLD TEEN 3RD	7238 STERLING AVE
100458494	2006	INDIVIDUAL PERSONAL PROPERTY	LYNN JAMES	7050 LAKEHORE DR	100467423	2011-2016	INDIVIDUAL PERSONAL PROPERTY	WILSON CHALONDA M	9325 E 85TH ST
100458524	2016-2019	INDIVIDUAL PERSONAL PROPERTY	JORDAN ANISSA	6133 KENTUCKY AVE	100467509	2001-2003	INDIVIDUAL PERSONAL PROPERTY	GREGORY FRANCIS L	11901 JESSICA LN
100458629	2007-2011	INDIVIDUAL PERSONAL PROPERTY	HOOD MILA B	NO ADDRESS PROVIDED BY TAXPAYER	100467512	2021	INDIVIDUAL PERSONAL PROPERTY	WARD JOZETTA MARIE	9020 E 85TH PL
100459165	2004-2006	INDIVIDUAL PERSONAL PROPERTY	CANADY BRYAN K	NO ADDRESS PROVIDED BY TAXPAYER	100467781	2003-2004	INDIVIDUAL PERSONAL PROPERTY	JONES CAROLYN	UNKNOWN
100459243	2007-2009	INDIVIDUAL PERSONAL PROPERTY	GOFF CASSANDRA N	8142 DITZLER AVE	100467848	2007-2010	INDIVIDUAL PERSONAL PROPERTY	GUVNN JENNIFER M (STUCKER)	8712 E 79TH ST
100459273	2001-2003	INDIVIDUAL PERSONAL PROPERTY	HATCHER SHARON	UNKNOWN	100467868	2011-2017	INDIVIDUAL PERSONAL PROPERTY	ORTIZ ALEJANDRO	7309 ELM ST
100459275	2006-2007	INDIVIDUAL PERSONAL PROPERTY	MORGAN STEVEN D & JAMIE K	11005 E 72ND ST	100467880	2020-2021	INDIVIDUAL PERSONAL PROPERTY	PICARD J D	9718 E 53RD ST
100459385	2001-2002	INDIVIDUAL PERSONAL PROPERTY	WILLIAMS KATHLEEN M	10907 E 60TH TER	100468088	2003-2005	INDIVIDUAL PERSONAL PROPERTY	CABRERA ROBERT S	10109 E 83RD TER
100459435	2021	INDIVIDUAL PERSONAL PROPERTY	ROSS JACINDA R	5623 LAUREL AVE	100468218	2001	INDIVIDUAL PERSONAL PROPERTY	GONZALES AMANDA MARIE	UNKNOWN
100459447	2004	INDIVIDUAL PERSONAL PROPERTY	THOMPSON VALERIE	UNKNOWN	100468307	2005	INDIVIDUAL PERSONAL PROPERTY	TAYLOR CORICIA	8909 E 57TH ST
100459662	2021	INDIVIDUAL PERSONAL PROPERTY	WILCOX BRADLEY J & REBECCA	9701 E 82ND TER	100468365	2017-2018	INDIVIDUAL PERSONAL PROPERTY	HIGGINS PATRICIA	10217 E 70TH TER
100459701	2021	INDIVIDUAL PERSONAL PROPERTY	HERNANDEZ DARRAH	8863 E 54TH ST	100468450	2001-2004	INDIVIDUAL PERSONAL PROPERTY	VILLEGAS JUAN L HERNANDEZ	UNKNOWN
100459802	2004-2011	INDIVIDUAL PERSONAL PROPERTY	HERRING BRANDY M	8809 E 85TH TER	100468532	2001	INDIVIDUAL PERSONAL PROPERTY	PHILLIPS ANDY B	10217 E 70TH TER
100459820	2002	INDIVIDUAL PERSONAL PROPERTY	FLORES ANTONIO	6117 RAYTOWN RD	100468548	2021	INDIVIDUAL PERSONAL PROPERTY	VILLEGAS JUAN L HERNANDEZ	UNKNOWN
100459839	2021	INDIVIDUAL PERSONAL PROPERTY	BARSOTTI WILLIAM	5915 CLAREMONT AVE	100468717	2001	INDIVIDUAL PERSONAL PROPERTY	ROYSTON CHARLES D	5408 BLUE RIDGE BLVD
100460310	2005-2007	INDIVIDUAL PERSONAL PROPERTY	WEST BRENDA	8908 E 83RD ST	100468757	2001	INDIVIDUAL PERSONAL PROPERTY	GREEN IFETAYO TAKIYAH	UNKNOWN
100460374	2014-2017	INDIVIDUAL PERSONAL PROPERTY	CHRISTENSEN JAMES G & BARBARA	7105 HUNTER ST	100468798	2003-2004	INDIVIDUAL PERSONAL PROPERTY	ALLEN LISA K	UNKNOWN
100460486	2021	INDIVIDUAL PERSONAL PROPERTY	MCLENDON WILLIAM A & DOROTHY L	6325 CEDAR AVE	100468811	2021	INDIVIDUAL PERSONAL PROPERTY	MYERS KATHLEEN F	9212 E 68TH TER
100460535	2001-2009	INDIVIDUAL PERSONAL PROPERTY	HEAVEY CHRISTOPHER	10508 E 57TH TER	100468894	2009	INDIVIDUAL PERSONAL PROPERTY	TORIAN ALFRED & MIA	8700 LANE AVE
100461107	2002	INDIVIDUAL PERSONAL PROPERTY	HITA MARIA L	6117 RAYTOWN RD	100469115	2009-2017	INDIVIDUAL PERSONAL PROPERTY	HENSLEY (QUINN) SHARON & RANDY	9017 E 75TH ST
100461367	2007-2008	INDIVIDUAL PERSONAL PROPERTY	MCKINNEY ALICE M	7319 HARRIS AVE	100469194	2009-2010	INDIVIDUAL PERSONAL PROPERTY	MCBRYER DEBBIE L	NO ADDRESS PROVIDED BY TAXPAYER
100461419	2020-2021	INDIVIDUAL PERSONAL PROPERTY	STAGGS JARRED & NATASHA	11805 E 87TH ST	100469276	2009-2010	INDIVIDUAL PERSONAL PROPERTY	MCCORMICK SHELLY A	7739 MCGEE
100461439	2009-2011	INDIVIDUAL PERSONAL PROPERTY	ALLARD KLARISA M	10005 E 78TH ST	100469378	2005	INDIVIDUAL PERSONAL PROPERTY	GLEN DANIEL W & JENNIFER	9051 E 52ND ST
100461824	2020-2021	INDIVIDUAL PERSONAL PROPERTY	STARLING-REEVES SHUNEKA S	6307 ASH AVE APT 10	100469611	2016-2017	INDIVIDUAL PERSONAL PROPERTY	PILKINTON WAYNE N	5444 ASH AVE
100462112	2005	INDIVIDUAL PERSONAL PROPERTY	HONEYCLUTT TIM	10002 E 77TH TER	100469834	2019-2021	INDIVIDUAL PERSONAL PROPERTY	BURRESS RODNEY S	5319 HEDGES AVE
100462332	2006	INDIVIDUAL PERSONAL PROPERTY	PITT PAUL M & COSSINS MIKE C	NO ADDRESS PROVIDED BY TAXPAYER	100469940	2021	INDIVIDUAL PERSONAL PROPERTY	MONTOYA RODRIGUEZ MANUEL	7001 CRISP AVE
100462535	2010-2011	INDIVIDUAL PERSONAL PROPERTY	IBERS RONALD	6707 CRISP AVE	100470361	2021	INDIVIDUAL PERSONAL PROPERTY	ROSS PAMELA J & ROSS ERIC R	6309 HARVARD AVE
100462537	2006	INDIVIDUAL PERSONAL PROPERTY	RING CONLEY	10805 E 58TH TER	100470418	2001-2002	INDIVIDUAL PERSONAL PROPERTY	SPAINHOUR EMORY LJR	UNKNOWN
100462718	2001	INDIVIDUAL PERSONAL PROPERTY	CALLEJA RICHARD	6128 E 129TH ST	100470491	2019-2020	INDIVIDUAL PERSONAL PROPERTY	WILSON SHAWN T	7414 OVERTON AVE UNIT 2
100462732	2011	INDIVIDUAL PERSONAL PROPERTY	KING DAVID O & ELLIS JEAN	5805 KENTUCKY AVE	100470736	2021	INDIVIDUAL PERSONAL PROPERTY	PRATT LAVENA N	8512 E 85TH ST
100462998	2011-2012	INDIVIDUAL PERSONAL PROPERTY	HUGHES DAVID J	6907 RALSTON AVE	100471423	2021	INDIVIDUAL PERSONAL PROPERTY	WHITE LEE CHARLES	9822 E 60TH ST
100463390	2021	INDIVIDUAL PERSONAL PROPERTY	JOHNSON LAVONIE	9400 E 84TH TER	100471440	2018-2019	INDIVIDUAL PERSONAL PROPERTY	MAGITT TELLY	109 SE KEYSTONE CIR
100463525	2016-2021	INDIVIDUAL PERSONAL PROPERTY	STEPHENS KENNETH L	8116 STERLING AVE	100471470	2001-2003	INDIVIDUAL PERSONAL PROPERTY	AWUNUNUMA ELIZABETH	UNKNOWN
100463640	2001-2017	INDIVIDUAL PERSONAL PROPERTY	LIGHT LORI A	NO ADDRESS PROVIDED BY TAXPAYER	100471512	2006	INDIVIDUAL PERSONAL PROPERTY	MURDICK ROSEANN	7909 EVANSTON AVE
100463683	2008	INDIVIDUAL PERSONAL PROPERTY	BROWN DONTAY	8300 E 85TH ST	100472015	2001	INDIVIDUAL PERSONAL PROPERTY	GEMMELL JEFFREY & CUMMINGS HARRIETTE	7500 ARLINGTON AVE
100463706	2001	INDIVIDUAL PERSONAL PROPERTY	ARCEGA JORGE	UNKNOWN	100472055	2021	INDIVIDUAL PERSONAL PROPERTY	FENDER EDITH BERNICE (BROTHERS)	11117 E 52TH TER
100463830	2001-2002	INDIVIDUAL PERSONAL PROPERTY	BECKER JOAN F	11021 E 53RD TER	100472105	2017	INDIVIDUAL PERSONAL PROPERTY	ANDERSON TERRY L	9603 E 77TH ST
100463845	2001	INDIVIDUAL PERSONAL PROPERTY	ROBINSON DWIGHT	10517 E 60TH TER	100472107	2001	INDIVIDUAL PERSONAL PROPERTY	RITCHESON LINDA C	6210 RAYTOWN RD A
100463849	2002	INDIVIDUAL PERSONAL PROPERTY	GETZ DANIEL & ANGELA	UNKNOWN	100472136	2021	INDIVIDUAL PERSONAL PROPERTY	WRIGHT MAXINE	6333 HUNTER ST

100472169	2019-2021	INDIVIDUAL PERSONAL PROPERTY	JAMES JENNIFER LYNNE	8100 ELM AVE	100844750	2004	INDIVIDUAL PERSONAL PROPERTY	ROUSH JAMES T	6627 BLUE RIDGE BLVD
100472236	2006-2007	INDIVIDUAL PERSONAL PROPERTY	WILLIAMS STACY	NO ADDRESS PROVIDED BY TAXPAYER	100844922	2021	INDIVIDUAL PERSONAL PROPERTY	ROSCHER PATRICK	11225 E 60TH TER
100472273	2001-2002	INDIVIDUAL PERSONAL PROPERTY	NORRIS BARBARA	64111 EVANSTON RD	100845328	2011	INDIVIDUAL PERSONAL PROPERTY	HIRSCHMAN EDNA S	7525 ARLINGTON AVE
100472322	2001-2003	INDIVIDUAL PERSONAL PROPERTY	SIMS CHERYL R	7813 E 86TH ST	100845405	2020-2021	INDIVIDUAL PERSONAL PROPERTY	LARSON MARGARET ESTELLE	5400 BLUE RIDGE CUT OFF APT 213
100472378	2019	INDIVIDUAL PERSONAL PROPERTY	MCLEERY TAMMY	8526 CRESCENT AVE	100845463	2005	INDIVIDUAL PERSONAL PROPERTY	FREEMAN LORAN F & KELI R	9612 E 68TH ST
100472607	2007-2009	INDIVIDUAL PERSONAL PROPERTY	ALHAYDAR AHMAD	6523 BLUE RIDGE BLVD	100850360	2011-2013	INDIVIDUAL PERSONAL PROPERTY	MARTIN REBECCA (WHITE)	7612 ELM ST
100472768	2010	INDIVIDUAL PERSONAL PROPERTY	TILLMON DAVID R JR	8612 E UTOPIA DR APT 78	100850440	2021	INDIVIDUAL PERSONAL PROPERTY	FOSTER JILL A	7209 STERLING AVE
100472892	2021	INDIVIDUAL PERSONAL PROPERTY	FINCH JEANA M	11209 E 53RD TER	100850465	2013-2015	INDIVIDUAL PERSONAL PROPERTY	TALLEY COURTNEY	5829 FARLEY AVE
100472960	2021	INDIVIDUAL PERSONAL PROPERTY	JOHNSON BRANDON C	5901 HEDGES AVE	100850709	2018	INDIVIDUAL PERSONAL PROPERTY	JOHNSON STEVEN W	8609 STARK AVE
100473075	2021	INDIVIDUAL PERSONAL PROPERTY	GILMORE DONALD D	6129 HUNTER ST	100850837	2021	INDIVIDUAL PERSONAL PROPERTY	LOCKHEART ROGER JR	8625 E UTOPIA PKWY APT 4
100473094	2003	INDIVIDUAL PERSONAL PROPERTY	BRADLEY CONSTANCE M & DONALD V	9514 E 64TH TER	100851364	2001-2010	INDIVIDUAL PERSONAL PROPERTY	BOWEN LEONARD L & CECILIA J	8120 SPRING VALLEY RD
100473164	2000-2001	INDIVIDUAL PERSONAL PROPERTY	SMITH MELLISSA L	UNKNOWN	100851683	2002	INDIVIDUAL PERSONAL PROPERTY	SPOUSE RUTH ANNE	8118 E WOODSON DR
100473210	2021	INDIVIDUAL PERSONAL PROPERTY	OSCIAK NICHOLAS & VANESSA	9211 E 79TH ST	100851748	2013-2017	INDIVIDUAL PERSONAL PROPERTY	GAIN KEVIN C	7915 ARLINGTON AVE
100473221	2002	INDIVIDUAL PERSONAL PROPERTY	CRAWFORD LAURA F	6647 CEDAR	100852011	2021	INDIVIDUAL PERSONAL PROPERTY	ARENDOS DEVIN LEE	10005 E 53RD ST
100473721	2004	INDIVIDUAL PERSONAL PROPERTY	NGUYEN RHEA LYN	1021 E 5TH ST	100852162	2019	INDIVIDUAL PERSONAL PROPERTY	CANTWELL AMY B	213 SW 67TH ST
100473827	2019	INDIVIDUAL PERSONAL PROPERTY	CROSS DALE & PATRICIA H	7420 MAPLE UNIT 213	100852359	2021	INDIVIDUAL PERSONAL PROPERTY	DIALLO ALPHA O	11918 E 85TH ST
100473900	2005-2006	INDIVIDUAL PERSONAL PROPERTY	EVERS WALTER C	7018 WOODSON RD	100852392	2021	INDIVIDUAL PERSONAL PROPERTY	BETHANY LINDA J & BRUCE B	7527 HAWTHORNE AVE
100474247	2007-2016	INDIVIDUAL PERSONAL PROPERTY	SALINAS ROGELIO G	10317 E 61ST ST APT 2	100852481	2019-2021	INDIVIDUAL PERSONAL PROPERTY	LEWIS DERRICK W	8345 HARVARD AVE
100474263	2013-2017	INDIVIDUAL PERSONAL PROPERTY	MILLER ADEREMI T	11105 E 73RD ST	100852672	2004-2007	INDIVIDUAL PERSONAL PROPERTY	SMITH DAVID TODD	NO ADDRESS PROVIDED BY TAXPAYER
100476675	2003	INDIVIDUAL PERSONAL PROPERTY	COTTER LOIS	UNKNOWN	100852918	2002	INDIVIDUAL PERSONAL PROPERTY	GOODEN NOBIE O	5821 FARLEY
100476729	2004	INDIVIDUAL PERSONAL PROPERTY	REFFITT ELISA	NO ADDRESS PROVIDED BY TAXPAYER	100853420	2005	INDIVIDUAL PERSONAL PROPERTY	CHRISHOLM THERSA L	6488 BLUE RIDGE BLVD
100477008	2002	INDIVIDUAL PERSONAL PROPERTY	CALLIS SONIA	UNKNOWN	100854404	2018-2021	INDIVIDUAL PERSONAL PROPERTY	AL MALIKY THOURAYA	9909 E 77TH ST
100477010	2021	INDIVIDUAL PERSONAL PROPERTY	BURRELL EVA BOBBETTE	12401 E 49TH ST S	100854412	2021	INDIVIDUAL PERSONAL PROPERTY	HALL JAMIE D	11413 E 69TH ST
100477114	2008	INDIVIDUAL PERSONAL PROPERTY	BONAVIA LAWRENCE III	602 NE 2ND ST	100854430	2001	INDIVIDUAL PERSONAL PROPERTY	MONTANA LEIGH	UNKNOWN
100477153	2008-2011	INDIVIDUAL PERSONAL PROPERTY	PRICE TERRANCE T	8313 KENTUCKY AVE	100855354	2020-2021	INDIVIDUAL PERSONAL PROPERTY	RHINEHART WILLIAM M	8204 HEDGES AVE
100477211	2001-2003	INDIVIDUAL PERSONAL PROPERTY	HANKINS LAURA J	10008 FREMONT AVE	100855887	2012-2017	INDIVIDUAL PERSONAL PROPERTY	MCINTYRE SCOTT B	5333 NORTHERN AVE
100504305	2001	INDIVIDUAL PERSONAL PROPERTY	CARROLL KATHY	UNKNOWN	100856003	2010	INDIVIDUAL PERSONAL PROPERTY	MARIE SANTA	10603 E 79TH TER
100833598	2005	INDIVIDUAL PERSONAL PROPERTY	SAMPLE MICHELLE LEIGH	601 NE NEWPORT DR	100856363	2021	INDIVIDUAL PERSONAL PROPERTY	BURRESS WILLIAM G	5319 HEDGES AVE
100833932	2021	INDIVIDUAL PERSONAL PROPERTY	STEWART GARY W	5705 LAUREL AVE	100856398	2021	INDIVIDUAL PERSONAL PROPERTY	HENDERSON JOE A	7409 CRISP AVE
100834253	2021	INDIVIDUAL PERSONAL PROPERTY	PECINA CHRISTINA MARIE	5820 ELM AVE	100856542	2018	INDIVIDUAL PERSONAL PROPERTY	GILLESPIE ROBBY LEE	6112 HUNTER ST
100834404	2021	INDIVIDUAL PERSONAL PROPERTY	COX KESHAWN MECHELLE	5429 HARDY AVE	100856960	2006-2017	INDIVIDUAL PERSONAL PROPERTY	POST DAVID M	9143 E 82ND ST
100834480	2003-2008	INDIVIDUAL PERSONAL PROPERTY	NDUM PHILIP N	NO ADDRESS PROVIDED BY TAXPAYER	100856976	2019-2021	INDIVIDUAL PERSONAL PROPERTY	GOODMAN DEBRA	8324 PERSHING RD
100834772	2011-2012	INDIVIDUAL PERSONAL PROPERTY	BAUER RACHELLE J	8907 E 72ND TER	100857021	2013-2021	INDIVIDUAL PERSONAL PROPERTY	BLANCO BRITNI MAE	9109 E 72ND TER
100835089	2010	INDIVIDUAL PERSONAL PROPERTY	KERSHNER AARON W	9908 E 80TH ST	100857318	2012-2017	INDIVIDUAL PERSONAL PROPERTY	ALLRED-BRYANT CONSTANCE S	7124 NORWOOD AVE
100835171	2005-2017	INDIVIDUAL PERSONAL PROPERTY	BEEBE HANS	NO ADDRESS PROVIDED BY TAXPAYER	100857411	2005-2007	INDIVIDUAL PERSONAL PROPERTY	OLSON JEREMY	9013 E 85TH TER
100835233	2008-2009	INDIVIDUAL PERSONAL PROPERTY	MCKINNON TRACY L (FLANNERY)	10812 E 59TH ST	100857568	2021	INDIVIDUAL PERSONAL PROPERTY	VONLEGGETT KHOREA T	8314 HUNTER ST
100835256	2021	INDIVIDUAL PERSONAL PROPERTY	OLSON SHELLEY M	11704 E 77TH TER	100880344	2003	INDIVIDUAL PERSONAL PROPERTY	MEISENBACH JOYCE E	7213 ASH AVE
100835354	2001-2002	INDIVIDUAL PERSONAL PROPERTY	DUNIGAN LAVONDA D & RICKY	UNKNOWN	100880431	2012-2017	INDIVIDUAL PERSONAL PROPERTY	DUNMORE GLEN A II & GLEN A	8320 HARRIS AVE
100835371	2006	INDIVIDUAL PERSONAL PROPERTY	MCKINNEY EDWARD	11423 E 71ST ST	100880556	2005	INDIVIDUAL PERSONAL PROPERTY	HENIK BARBARA G	NO ADDRESS PROVIDED BY TAXPAYER
100835841	2007-2009	INDIVIDUAL PERSONAL PROPERTY	THOMAS FRED A	7424 WOODSON RD	100881240	2002-2004	INDIVIDUAL PERSONAL PROPERTY	MARTIN BARRERA	8812 E 84TH TER
100835984	2002	INDIVIDUAL PERSONAL PROPERTY	HOLLIMAN DWAYNE L	UNKNOWN	100881852	2002-2010	INDIVIDUAL PERSONAL PROPERTY	SPENCE JULIA ANN	NO ADDRESS PROVIDED BY TAXPAYER
100836043	2003-2004	INDIVIDUAL PERSONAL PROPERTY	DELACRUZ ARNOLD	9207 MANCHESTER AVE	100882108	2017	INDIVIDUAL PERSONAL PROPERTY	SHERMAN HARLAN J	8701 TENNESSEE AVE
100836667	2000	INDIVIDUAL PERSONAL PROPERTY	MARTIN PONSER	6501 BLUE RIDGE CUTOFF	100882135	2021	INDIVIDUAL PERSONAL PROPERTY	LUSK THOMAS W	11401 E 77TH TER
100836829	2000	INDIVIDUAL PERSONAL PROPERTY	FAISE MIHAI & LILIANA	5420 BLUE RIDGE CTO 804	100882210	2021	INDIVIDUAL PERSONAL PROPERTY	VOGAN EDITH M	7236 RAYTOWN RD APT D
100836867	2005	INDIVIDUAL PERSONAL PROPERTY	ELLIOTT DANIEL J	NO ADDRESS PROVIDED BY TAXPAYER	100882378	2021	INDIVIDUAL PERSONAL PROPERTY	KLINE JAMES & ZIDEK JOHN	6121 DITZLER AVE
100836997	2019-2021	INDIVIDUAL PERSONAL PROPERTY	HUNTER ROCHELLE	5837 MAYWOOD AVE	100882404	2007-2012	INDIVIDUAL PERSONAL PROPERTY	GIBSON LINDA /OR ANGELA	8105 MANNING AVE
100837093	2018	INDIVIDUAL PERSONAL PROPERTY	BROWN KATHERINE E	4701 SYCAMORE AVE	100882983	2021	INDIVIDUAL PERSONAL PROPERTY	BAILEY DARRELL	8108 RAYTOWN RD
100837118	2013	INDIVIDUAL PERSONAL PROPERTY	JOHNSON JAMES SOLOMON III	6345 BLUE RIDGE BLVD	100883145	2021	INDIVIDUAL PERSONAL PROPERTY	SANDERS MONICA MARIE	7444 BLUE RIDGE BLVD
100837193	2021	INDIVIDUAL PERSONAL PROPERTY	RUTH ANDREA L	8812 E 83RD ST	100883577	2021	INDIVIDUAL PERSONAL PROPERTY	GREENE ADRIAN L	7224 RAYTOWN RD APT A
100837228	2020-2021	INDIVIDUAL PERSONAL PROPERTY	COLE RODNEY D	8003 E 87TH ST	100883813	2008	INDIVIDUAL PERSONAL PROPERTY	LATTA KRISTINE E	8114 MANNING AVE
100837401	2000	INDIVIDUAL PERSONAL PROPERTY	HARREL KIMBERLY ANN	10912 83RD ST	100884054	2011	INDIVIDUAL PERSONAL PROPERTY	WRIGHT CISSY	8315 MARSH AVE
100837531	2000	INDIVIDUAL PERSONAL PROPERTY	HUCKBAY JAQUELINE	9411 E 80 TERR	100884121	2020-2021	INDIVIDUAL PERSONAL PROPERTY	MILLER JOHNELLA S	7234 RAYTOWN RD APT B
100837539	2021	INDIVIDUAL PERSONAL PROPERTY	JOHNSON JACQUELINE F	8027 MANNING AVE	100884195	2020-2021	INDIVIDUAL PERSONAL PROPERTY	SIMMONS KYLE L	7513 HAWTHORNE AVE
100837574	2012-2013	INDIVIDUAL PERSONAL PROPERTY	STERLING MICAL L	8315 DITZLER AVE	100884312	2017-2021	INDIVIDUAL PERSONAL PROPERTY	WILLIAMS OTHA	8505 HARVARD TER
100837576	2006-2010	INDIVIDUAL PERSONAL PROPERTY	KING THOMAS C & KARENA A	9409 E 79TH TER	100884378	2020-2021	INDIVIDUAL PERSONAL PROPERTY	MCCEE STEPHANIE LAURA	5615 HARRIS AVE
100838288	2004	INDIVIDUAL PERSONAL PROPERTY	VACA RIGOBERTO J	UNKNOWN	100885155	2021	INDIVIDUAL PERSONAL PROPERTY	GILL TAMIESHA	6009 CRESCENT AVE
100838354	2002-2003	INDIVIDUAL PERSONAL PROPERTY	BENDER MICHAEL A	NO ADDRESS PROVIDED BY TAXPAYER	100885263	2021	INDIVIDUAL PERSONAL PROPERTY	ROULETTE CENTORIA K	7617 ENGLEWOOD AVE
100838769	2019	INDIVIDUAL PERSONAL PROPERTY	GRAY MELISSA A	9805 E 61ST ST APT 9	100885453	2006	INDIVIDUAL PERSONAL PROPERTY	FARRIS VISNICH MELISSA	2455 POPLAR AVE
100839365	2021	INDIVIDUAL PERSONAL PROPERTY	MOIKOEDOE ANDRE	7305 HARVARD DR	100885540	2011	INDIVIDUAL PERSONAL PROPERTY	LEMENS MICHELLE	7705 SNI-A-BAR RD
100839477	2001-2002	INDIVIDUAL PERSONAL PROPERTY	CUELLA JORGE A & JUANITA	UNKNOWN	100885974	2021	INDIVIDUAL PERSONAL PROPERTY	CHILDS DANIELLE E	8309 WILLOW WAY
100839660	2009	INDIVIDUAL PERSONAL PROPERTY	BURGESS JEROME T	5717 STERLING AVE	100886180	2001	INDIVIDUAL PERSONAL PROPERTY	PURCELL (HILZENDAGER) CYNTHIA	UNKNOWN
100840638	2021	INDIVIDUAL PERSONAL PROPERTY	MONDAINE ZENOBIA	6617 ELM AVE	100886206	2021	INDIVIDUAL PERSONAL PROPERTY	JOHNSON MARQUITA	9313 E 67TH TER
100841616	2021	INDIVIDUAL PERSONAL PROPERTY	SWADLEY JASON D	8315 MARSH AVE	100886321	2019	INDIVIDUAL PERSONAL PROPERTY	MITCHELL IRA M	6416 ELM AVE
100842230	2021	INDIVIDUAL PERSONAL PROPERTY	BLISS MARY C	8506 ARLINGTON AVE	100886333	2001	INDIVIDUAL PERSONAL PROPERTY	MONTEZ JOE R	UNKNOWN
100843493	2021	INDIVIDUAL PERSONAL PROPERTY	WIDMEYER MICHAEL & AMEE ROBERTS WIDMEYER	8919 E 74TH ST	100886463	2003-2005	INDIVIDUAL PERSONAL PROPERTY	ROBERSON JOHN S & HAST GARY	NO ADDRESS PROVIDED BY TAXPAYER
100843539	2017	INDIVIDUAL PERSONAL PROPERTY	SCHORGL THOMAS J	5813 LANE AVE	100886665	2005-2006	INDIVIDUAL PERSONAL PROPERTY	BRUNNER KENT C	NO ADDRESS PROVIDED BY TAXPAYER
100843795	2021	INDIVIDUAL PERSONAL PROPERTY	MCCAY TOBE M	9109 E 58TH ST	100886666	2021	INDIVIDUAL PERSONAL PROPERTY	SULLIVAN PATRICIA A (KING)	8622 E UTOPIA DR APT 10
100844057	2001	INDIVIDUAL PERSONAL PROPERTY	MCMILLIAN LYONA KAY	NO ADDRESS PROVIDED BY TAXPAYER	100886740	2014-2016	INDIVIDUAL PERSONAL PROPERTY	GALLOWAY DENNIS D	7316 APPLETON AVE
100844140	2021	INDIVIDUAL PERSONAL PROPERTY	GLOVER BRIAN P	10004 E 69TH TER	100886753	2006-2017	INDIVIDUAL PERSONAL PROPERTY	PALLMER SHANNON A & EWING JEROME F	7509 CRISP AVE
100844181	2001	INDIVIDUAL PERSONAL PROPERTY	MONK SHIRLEY	8914 NEWTON 3406	100886781	2021	INDIVIDUAL PERSONAL PROPERTY	SANTORO ALBERTO & KATHERINE	8400 SPRING VALLEY RD
100844281	2019-2021	INDIVIDUAL PERSONAL PROPERTY	SISCO SLYVESTER R	8704 EVANSTON AVE	100886861	2001	INDIVIDUAL PERSONAL PROPERTY	SANDERS JAMMIE L	NO ADDRESS PROVIDED BY TAXPAYER
100844336	2002-2003	INDIVIDUAL PERSONAL PROPERTY	BOYCE MOLLY B (KRUGGER)	3009 NW KINGSRIDGE DR	100886863	2021	INDIVIDUAL PERSONAL PROPERTY	POINTER DONALD WAYNE	10308 E 56TH ST

100886904	2002	INDIVIDUAL PERSONAL PROPERTY	TYLER PATRICK A JR	8620 U TOPIA DR	100891575	2001	INDIVIDUAL PERSONAL PROPERTY	REFFITT DAVID	8604 E 83RD TER
100887007	2017	INDIVIDUAL PERSONAL PROPERTY	KING RYAN C	9808 E 60TH TER	100891580	2001-2003	INDIVIDUAL PERSONAL PROPERTY	REYES ALFREDO	10309 E 61ST ST
100887070	2001	INDIVIDUAL PERSONAL PROPERTY	CALDWELL DUSTIN	9912 E 85TH TER	100891592	2001	INDIVIDUAL PERSONAL PROPERTY	KING REGINAL	6132 BLUE RIDGE BLVD
100887114	2001	INDIVIDUAL PERSONAL PROPERTY	SMITH TONYA	UNKNOWN	100891667	2001	INDIVIDUAL PERSONAL PROPERTY	THOMAS KRISSIE L	8604 E 91ST TER
100887144	2013-2014	INDIVIDUAL PERSONAL PROPERTY	HAMLIN LINNA S	NO ADDRESS PROVIDED BY TAXPAYER	100891674	2001	INDIVIDUAL PERSONAL PROPERTY	SPOTWOOD AL-TRINA	8508 E 91ST ST
100887188	2006	INDIVIDUAL PERSONAL PROPERTY	TERHUNE TAMI J	9354 E 68TH ST	100891677	2005	INDIVIDUAL PERSONAL PROPERTY	ROBINSON MELISSA	8608 SPRING VALLEY RD
100887220	2003	INDIVIDUAL PERSONAL PROPERTY	BRYAN STEVEN	9354 E 68TH ST	100891836	2006-2017	INDIVIDUAL PERSONAL PROPERTY	NGUYEN BE T	8404 WOODSON CT
100887237	2001	INDIVIDUAL PERSONAL PROPERTY	BURNETT STACEY A	8424 HIGHLAND AVE	100891905	2018-2021	INDIVIDUAL PERSONAL PROPERTY	RIVERA ELIZABETH	11501 E 58TH ST
100887301	2001	INDIVIDUAL PERSONAL PROPERTY	CUMMINGS GEORGE	UNKNOWN	100891925	2009-2011	INDIVIDUAL PERSONAL PROPERTY	HILL JR LEO W	7033 ARLINGTON AVE
100887527	2001-2002	INDIVIDUAL PERSONAL PROPERTY	CALLAHAN JERRY	9801 E 79TH ST	100891955	2006	INDIVIDUAL PERSONAL PROPERTY	MC MILLAN SENEVA S	905 S EMERY ST
100887580	2004-2005	INDIVIDUAL PERSONAL PROPERTY	LEE CHARLEY & BEVERLY LEE	7836 WOODSON RD	100892015	2001-2002	INDIVIDUAL PERSONAL PROPERTY	ANDERSON STEPHEN E	7402 HEDGES
100887610	2014	INDIVIDUAL PERSONAL PROPERTY	JONES JOHN E	7900 WESTRIDGE RD	100892131	2013	INDIVIDUAL PERSONAL PROPERTY	PARISH MYRON	9200 E 54TH ST
100887689	2006	INDIVIDUAL PERSONAL PROPERTY	OSENTON MARY E (REARICK)	NO ADDRESS PROVIDED BY TAXPAYER	100892167	2001	INDIVIDUAL PERSONAL PROPERTY	HUGHLEY LENTON L JR	NO ADDRESS PROVIDED BY TAXPAYER
100887722	2001	INDIVIDUAL PERSONAL PROPERTY	HUSTON MONTGOMERY	5424 LAUREL	100892284	2006	INDIVIDUAL PERSONAL PROPERTY	LOGAN GLORIA R	NO ADDRESS PROVIDED BY TAXPAYER
100887820	2012-2016	INDIVIDUAL PERSONAL PROPERTY	KOLB SANDRA J	5418 HARDY AVE	100892342	2003	INDIVIDUAL PERSONAL PROPERTY	GRESAFE ANTHONY	NO ADDRESS PROVIDED BY TAXPAYER
100887880	2016	INDIVIDUAL PERSONAL PROPERTY	MC KINZEY JOSH	9716 E 69TH ST	100892415	2001-2007	INDIVIDUAL PERSONAL PROPERTY	PARVIN SCOTT	6331 FARLEY AVE
100887882	2009-2017	INDIVIDUAL PERSONAL PROPERTY	ROWE PETE THOMAS	NO ADDRESS PROVIDED BY TAXPAYER	100892550	2002-2021	INDIVIDUAL PERSONAL PROPERTY	BARLEY ROBERT BROWN SR	9021 E 72ND TER
100887907	2001-2005	INDIVIDUAL PERSONAL PROPERTY	BBOXWELL CHRISTINA	6500 STERLING AVE	100892771	2001	INDIVIDUAL PERSONAL PROPERTY	ESTRADA JOSEFINA M	6825 RAYTOWN RD
100887951	2003-2004	INDIVIDUAL PERSONAL PROPERTY	LANAUIZE MISHA M	6203 OLIVE	100892776	2001	INDIVIDUAL PERSONAL PROPERTY	DALL JEREMY M	10620 E 56TH TER
100887967	2020-2021	INDIVIDUAL PERSONAL PROPERTY	WILLIAMS JONEISHA I & JASIAH B	6402 ELM AVE	100892802	2010-2015	INDIVIDUAL PERSONAL PROPERTY	WALTON-LEWIS SHELLEY	5815 KENTUCKY AVE
100888034	2020-2021	INDIVIDUAL PERSONAL PROPERTY	SMITH JUSTEN GERARD	7148 CRISP AVE	100892826	2021	INDIVIDUAL PERSONAL PROPERTY	HALTOM LAVADA (FREEMAN)	11501 E 57TH TER
100888096	2001	INDIVIDUAL PERSONAL PROPERTY	MCMAHAN MITCHELL M	8405 NORTHERN	100892947	2003-2004	INDIVIDUAL PERSONAL PROPERTY	WILLIS THOMAS D & DAWN M	9405 E 85TH ST
100888179	2001	INDIVIDUAL PERSONAL PROPERTY	AAMALD BRIAN W & TAMERA L	UNKNOWN	100892984	2004	INDIVIDUAL PERSONAL PROPERTY	DUCKWORTH JR JACKIE A & TYSON K	7616 SNI A BAR RD
100888197	2001	INDIVIDUAL PERSONAL PROPERTY	SCOTT FINLEY J	UNKNOWN	100893250	2001-2004	INDIVIDUAL PERSONAL PROPERTY	PASTRAMA HERIBERTO	UNKNOWN
100888211	2001	INDIVIDUAL PERSONAL PROPERTY	BAKER GARY L JR	5524 MANNING	100893522	2012-2013	INDIVIDUAL PERSONAL PROPERTY	KEELER RANDY C & SHEILA A	8417 WOODSON PL
100888241	2010-2011	INDIVIDUAL PERSONAL PROPERTY	EARLY REGINALD M	5639 CEDAR AVE	100893870	2020-2021	INDIVIDUAL PERSONAL PROPERTY	ORISTR MISTI M	10912 E 72ND ST
100888384	2002	INDIVIDUAL PERSONAL PROPERTY	DEANE DAVID J	7600 ENGLEWOOD	100895155	2001-2003	INDIVIDUAL PERSONAL PROPERTY	LANGDON JAMES D	6311 HARRIS
100888512	2001-2002	INDIVIDUAL PERSONAL PROPERTY	PYONG ANK& RIEGLE RICHARD W	8814 E 57TH TER	100895199	2020-2021	INDIVIDUAL PERSONAL PROPERTY	GILMORE MARILYN	7401 CEDAR
100888564	2004	INDIVIDUAL PERSONAL PROPERTY	CLARK MATTHEW	8603 MARPLE	100895347	2014-2020	INDIVIDUAL PERSONAL PROPERTY	HARDING PETRICE M	8700 EVANSTON AVE
100888648	2020-2021	INDIVIDUAL PERSONAL PROPERTY	SEYMOUR JODI	6121 HEDGES AVE	100895463	2018-2021	INDIVIDUAL PERSONAL PROPERTY	NIXON CHRISTOPHER	8218 WOODSON DR
100888654	2015	INDIVIDUAL PERSONAL PROPERTY	WILLIAMS MONICA M	10901 E 57TH TER	100895712	2001	INDIVIDUAL PERSONAL PROPERTY	CROSS REATHY & STEPHANIE	UNKNOWN
100888654	2001-2007	INDIVIDUAL PERSONAL PROPERTY	LINDSAY DAVID W	UNKNOWN	100895816	2010-2013	INDIVIDUAL PERSONAL PROPERTY	BROWNE MICHAEL R & MARYANN	7517 OVERTON AVE
100888717	2001-2004	INDIVIDUAL PERSONAL PROPERTY	ROGERS JIMMIE P	UNKNOWN	100896097	2006-2008	INDIVIDUAL PERSONAL PROPERTY	MCCULLOUGH DEBRA A	8806 CRESCENT AVE
100888718	2019-2021	INDIVIDUAL PERSONAL PROPERTY	COOPER SHANTEL R	9805 E 84TH ST	100896256	2021	INDIVIDUAL PERSONAL PROPERTY	SIMS CHERIL	10005 E 77TH TER
100888740	2021	INDIVIDUAL PERSONAL PROPERTY	RATHBUN YVONNE	8905 E GREGORY BLVD	100896417	2006-2007	INDIVIDUAL PERSONAL PROPERTY	BABBITT CRYSTAL DAWN	8805 E 53RD TER
100888741	2007-2011	INDIVIDUAL PERSONAL PROPERTY	OBIHOA LISA C	5811 FARLEY AVE	100896507	2021	INDIVIDUAL PERSONAL PROPERTY	HOWELL TONY L & MICHELLE M	5310 HARDY AVE
100888745	2001-2010	INDIVIDUAL PERSONAL PROPERTY	CREECH SHEILA	7321 ASH AVE	100896530	2001	INDIVIDUAL PERSONAL PROPERTY	HUSSAIN KHALIL	UNKNOWN
100888759	2002-2015	INDIVIDUAL PERSONAL PROPERTY	BEACH MICHELE LEE	7020 RAYTOWN RD	100896663	2021	INDIVIDUAL PERSONAL PROPERTY	WOBBE NICHOLAS G	6400 KENTUCKY AVE
100888773	2011-2014	INDIVIDUAL PERSONAL PROPERTY	PARKER JOSEPH W	7114 EVANSTON AVE	100896686	2001-2002	INDIVIDUAL PERSONAL PROPERTY	WILSON JOSHUA J	8620 E UTOPIA DR
100888775	2005-2006	INDIVIDUAL PERSONAL PROPERTY	PETERS DEBI A	NO ADDRESS PROVIDED BY TAXPAYER	100896706	2007	INDIVIDUAL PERSONAL PROPERTY	SOLAR JENNIFER E & JOSHUA	9700 E 66TH TER
100888806	2001	INDIVIDUAL PERSONAL PROPERTY	BLACK MARK A	UNKNOWN	100896785	2005-2007	INDIVIDUAL PERSONAL PROPERTY	WILLIAMS DORTHY JEAN	10019 E 67TH ST
100888875	2002-2004	INDIVIDUAL PERSONAL PROPERTY	NEWMAN LAMONT	UNKNOWN	100896938	2013	INDIVIDUAL PERSONAL PROPERTY	HANSEN DOROTHY L	9812 E 71ST TER
100888914	2007-2009	INDIVIDUAL PERSONAL PROPERTY	MORROW DAVETTA	8525 MAYWOOD AVE	100897227	2020	INDIVIDUAL PERSONAL PROPERTY	HARRIS CINDY R	9401 E 63RD ST APT 304
100888939	2001-2002	INDIVIDUAL PERSONAL PROPERTY	SHOCKEY SARA	6723 ENGLEWOOD	100897227	2002-2003	INDIVIDUAL PERSONAL PROPERTY	PATTERSON KEITH A	9705 E 81ST ST
100888946	2001	INDIVIDUAL PERSONAL PROPERTY	MARTINEZ RAUL DURAN	UNKNOWN	100897515	2004-2005	INDIVIDUAL PERSONAL PROPERTY	WRIGHT CRYSTAL M	8315 MARSH AVE
100889228	2021	INDIVIDUAL PERSONAL PROPERTY	BURCIAGA MARTIN & ALMA	6300 RALSTON AVE	100897746	2001	INDIVIDUAL PERSONAL PROPERTY	MORI NICOLE S	9811 E 56TH ST
100889236	2021	INDIVIDUAL PERSONAL PROPERTY	DIXON APRIL S	5805 MAYWOOD AVE	100897748	2005-2007	INDIVIDUAL PERSONAL PROPERTY	SMITH PATRICIA KAY	NO ADDRESS PROVIDED BY TAXPAYER
100889365	2001	INDIVIDUAL PERSONAL PROPERTY	WEBER ROSS A & SCARLETT	UNKNOWN	100897758	2008-2010	INDIVIDUAL PERSONAL PROPERTY	ZOELLERS WILLIS E	11301 E 62ND ST
100889681	2001	INDIVIDUAL PERSONAL PROPERTY	DOUGHTY DMITRI	8913 E 55TH ST	100897795	2005	INDIVIDUAL PERSONAL PROPERTY	COLBURN RYAN	7718 WOODSON RD
100889723	2020-2021	INDIVIDUAL PERSONAL PROPERTY	MITCHELL ROBERT A	8614 E 85TH ST	100897915	2005-2015	INDIVIDUAL PERSONAL PROPERTY	THORNTON DIANNA L	10615 E 78TH TER
100889884	2021	INDIVIDUAL PERSONAL PROPERTY	FILMORE ROBERT C	11001 E 72ND ST	100898074	2002-2004	INDIVIDUAL PERSONAL PROPERTY	SZILVASY KEVIN	8504 PERSHING RD
100889926	2002-2007	INDIVIDUAL PERSONAL PROPERTY	HERNANDEZ RUBEN	NO ADDRESS PROVIDED BY TAXPAYER	100898181	2006-2007	INDIVIDUAL PERSONAL PROPERTY	WALSH JEFF	NO ADDRESS PROVIDED BY TAXPAYER
100889975	2002	INDIVIDUAL PERSONAL PROPERTY	HOPKINS MICHAEL R	NO ADDRESS PROVIDED BY TAXPAYER	100898257	2021	INDIVIDUAL PERSONAL PROPERTY	SEAGRAVES CHRISTOPHER ALLEN	8806 E 66TH ST
100890204	2001	INDIVIDUAL PERSONAL PROPERTY	DURDEN EARL C	9605 E 67TH TER	100898374	2021	INDIVIDUAL PERSONAL PROPERTY	VAUGHN JAMES R JR	5431 CEDAR AVE
100890277	2001	INDIVIDUAL PERSONAL PROPERTY	NELSON RONALD	1411 N WARD RD	100898478	2021	INDIVIDUAL PERSONAL PROPERTY	BALAGNA JAMES M & JULIE A	8931 E 74TH ST
100890320	2001	INDIVIDUAL PERSONAL PROPERTY	ALEXANDER VIDAL J	5500 LANE AVE	100898519	2001	INDIVIDUAL PERSONAL PROPERTY	MILOM MATTHEW C	8308 STERLING
100890486	2003	INDIVIDUAL PERSONAL PROPERTY	ESONG FLORA EMANGA	8205 WOODSON DR	100898604	2002	INDIVIDUAL PERSONAL PROPERTY	SWIGART CAROL L	UNKNOWN
100890492	2002	INDIVIDUAL PERSONAL PROPERTY	WRIGHT FRANCES L	7828 IRWIN RD	100898611	2002-2003	INDIVIDUAL PERSONAL PROPERTY	STARK PAMBI K	8955 E 60TH ST
100890515	2013-2014	INDIVIDUAL PERSONAL PROPERTY	ROBILLARD JASON	9807 E 61ST ST APT 6	100898744	2021	INDIVIDUAL PERSONAL PROPERTY	MURRELL DELMAR	10620 E 56TH TER
100890815	2021	INDIVIDUAL PERSONAL PROPERTY	ROBINSON MILLIE	7211 CEDAR AVE	100898886	2001	INDIVIDUAL PERSONAL PROPERTY	LUCAS DEBRA D & ROBERT	UNKNOWN
100890927	2001	INDIVIDUAL PERSONAL PROPERTY	BUCK KEVIN & KATHRYN	9903 E 60 ST APT 11	100898927	2021	INDIVIDUAL PERSONAL PROPERTY	JOHNSON ROSE ANN	7901 E 87TH ST
100891150	2001	INDIVIDUAL PERSONAL PROPERTY	HIGDON BRYAN K	10200 E 69TH TER	100898998	2002	INDIVIDUAL PERSONAL PROPERTY	SMITH ALLISON M	9312 E 85TH ST
100891177	2001	INDIVIDUAL PERSONAL PROPERTY	JAMES KATRINA	UNKNOWN	100899036	2008-2017	INDIVIDUAL PERSONAL PROPERTY	WHITE LINDA D	5732 LANE AVE
100891184	2001	INDIVIDUAL PERSONAL PROPERTY	MEDLOCK STEPHANIE K	8600 SPRING VALLEY RD	100899130	2021	INDIVIDUAL PERSONAL PROPERTY	MC SHANN LOLITA	9800 E 61ST ST APT 11
100891185	2001-2010	INDIVIDUAL PERSONAL PROPERTY	BLACKEY SWONCEI	8700 KENTUCKY AVE	100899168	2006-2007	INDIVIDUAL PERSONAL PROPERTY	LEE JAIME D	9000 E 85TH TER
100891204	2011-2021	INDIVIDUAL PERSONAL PROPERTY	RICE RAY N	8316 WILLOW WAY	100899193	2001	INDIVIDUAL PERSONAL PROPERTY	CANTRELL DEBORAH D	7821 ELM
100891212	2021	INDIVIDUAL PERSONAL PROPERTY	MERRIOTT JAMES M	5805 ELM AVE	100899205	2001-2003	INDIVIDUAL PERSONAL PROPERTY	SCOTT LESHODRA R	2454 SPRUCE AVE
100891214	2001-2002	INDIVIDUAL PERSONAL PROPERTY	RANSBURG WILLIAM M & NASH MAXINE E	8912 E 66TH ST	100899224	2018-2019	INDIVIDUAL PERSONAL PROPERTY	WALTON VONDELL	10640 BALES AVE
100891264	2008	INDIVIDUAL PERSONAL PROPERTY	MANION ALICE L	7016 HUNTER ST	100899249	2002	INDIVIDUAL PERSONAL PROPERTY	DARTHARD ANGELO	9204 E 64TH ST
100891329	2001	INDIVIDUAL PERSONAL PROPERTY	DAVIS RITA M	NO ADDRESS PROVIDED BY TAXPAYER	100899262	2001-2002	INDIVIDUAL PERSONAL PROPERTY	BEVERLY JAMES D	7834 HARDY
100891345	2001-2005	INDIVIDUAL PERSONAL PROPERTY	MCCLAIN LORA A	5618 LAUREL AVE	100899386	2002-2017	INDIVIDUAL PERSONAL PROPERTY	MCCURTER ELIZABETH	8515 E 81ST TER
100891353	2014	INDIVIDUAL PERSONAL PROPERTY	COTTRELL JUSTIN M	9005 E 74TH ST	100899520	2007-2009	INDIVIDUAL PERSONAL PROPERTY	ASBURY WAYNE JR & KIMBERLY	9309 E 68TH TER

100899528	2002-2004	INDIVIDUAL PERSONAL PROPERTY	DRAVES JOHN M	UNKNOWN	100904189	2002	INDIVIDUAL PERSONAL PROPERTY	SAWEIKIS PAULA A	8918 ROSE LN
100899568	2004-2006	INDIVIDUAL PERSONAL PROPERTY	MONTGOMERY RITA M	10915 E 72ND ST	100904212	2001-2002	INDIVIDUAL PERSONAL PROPERTY	FINCH DESSIE MAE	8700 NEWTON AVE APT 4008
100899660	2001	INDIVIDUAL PERSONAL PROPERTY	LAWSON JAMES S	5621 BLUE RIDGE CUTOFF	100904261	2001	INDIVIDUAL PERSONAL PROPERTY	MAXON BILL	9105 E 52ND TER
100899711	2021	INDIVIDUAL PERSONAL PROPERTY	MCCLOSKEY ROBERT A	9001 E 65TH TER	100904286	2007-2009	INDIVIDUAL PERSONAL PROPERTY	CHRISTOPHERSON LONNIE L	9350 E 67TH TER
100899741	2001	INDIVIDUAL PERSONAL PROPERTY	MORAINÉ MICHAEL	UNKNOWN	100904307	2021	INDIVIDUAL PERSONAL PROPERTY	MILLER SHERRI A	8521 VASSAR AVE
100900019	2020-2021	INDIVIDUAL PERSONAL PROPERTY	DAVIS KRystal	10026 E 78TH TER	100904341	2002	INDIVIDUAL PERSONAL PROPERTY	TANNER ROBERT H	6124 WILLOW AVE
100900020	2001-2011	INDIVIDUAL PERSONAL PROPERTY	GREB JOHN	7200 HARDY AVE	100904370	2001	INDIVIDUAL PERSONAL PROPERTY	CLARK MICHAEL S	8701 E 84TH TER
100900029	2001	INDIVIDUAL PERSONAL PROPERTY	HENLEY ANGELA	11215 E 53RD TER	100904428	2003-2004	INDIVIDUAL PERSONAL PROPERTY	HAND TODD	6124 HEDGES AVE
100900352	2005	INDIVIDUAL PERSONAL PROPERTY	EAVES NICOLE	NO ADDRESS PROVIDED BY TAXPAYER	100904470	2021	INDIVIDUAL PERSONAL PROPERTY	JONES MERRIAM LANE	9813 E 61ST ST APT 5
100900412	2002-2003	INDIVIDUAL PERSONAL PROPERTY	BRACKMANN JENNIFER	10005 E 59TH ST	100904471	2001	INDIVIDUAL PERSONAL PROPERTY	RAY VICK	10812 E 57TH TER
100900435	2021	INDIVIDUAL PERSONAL PROPERTY	FREEMAN TERRY L	8717 E 61ST TER APT 10	100904481	2005-2006	INDIVIDUAL PERSONAL PROPERTY	FRANCKE DORIS A	8615 E 80TH TER
100900490	2021	INDIVIDUAL PERSONAL PROPERTY	JANNER SKY R	9904 E 60TH TER	100904588	2021	INDIVIDUAL PERSONAL PROPERTY	MONTROSE NEIL	6217 RALSTON AVE
100900743	2001-2002	INDIVIDUAL PERSONAL PROPERTY	DOZIER JEROLD J	8607 E 61ST TER APT 84	100904624	2006	INDIVIDUAL PERSONAL PROPERTY	BEASON THOMAS E	9201 E 84TH ST
100900904	2019-2021	INDIVIDUAL PERSONAL PROPERTY	REESE KIZZY D	8406 LANE PL	100904651	2001-2017	INDIVIDUAL PERSONAL PROPERTY	BOYCE MARK W	8500 E 87TH ST
100901190	2016-2017	INDIVIDUAL PERSONAL PROPERTY	GARRETT CATRINA D	10401 E 79TH ST	100904665	2001-2004	INDIVIDUAL PERSONAL PROPERTY	JAMES KATRINA	8320 LAUREL AVE
100901248	2020-2021	INDIVIDUAL PERSONAL PROPERTY	CRAMER TODD B	6029 ARLINGTON AVE	100904671	2010-2017	INDIVIDUAL PERSONAL PROPERTY	BROWN CHANEL	5730 MAHNING AVE
100901338	2004-2005	INDIVIDUAL PERSONAL PROPERTY	KNAPP JESSICA B	8006 ARLINGTON AVE	100904681	2001	INDIVIDUAL PERSONAL PROPERTY	LANEY JASON J	10312 E 70TH TER
100901604	2005	INDIVIDUAL PERSONAL PROPERTY	ANDJALI RYAN	2611 S SCOTT AVE	100904778	2011-2017	INDIVIDUAL PERSONAL PROPERTY	FERRARA ANTHONY JR & CECILIA	7032 LAKESHORE DR
100901619	2015	INDIVIDUAL PERSONAL PROPERTY	MOORE SHENETTER	9708 E 85TH ST	100904868	2014	INDIVIDUAL PERSONAL PROPERTY	ROSE TRAVIS DEMETRIUS	11303 E 58TH TER
100901684	2005-2008	INDIVIDUAL PERSONAL PROPERTY	BELL WES E	11007 E 60TH TER	100904876	2006	INDIVIDUAL PERSONAL PROPERTY	MEADOR ANGELA	5310 HARBOR AVE
100901742	2002-2004	INDIVIDUAL PERSONAL PROPERTY	GILLESPIE IRENE R	5836 WOODSON	100904912	2014-2019	INDIVIDUAL PERSONAL PROPERTY	DYSON DAVID B	10068 E 65TH TER
100901805	2017	INDIVIDUAL PERSONAL PROPERTY	JENKINS STEPHANIE L	9007 E 85TH TER	100905000	2001	INDIVIDUAL PERSONAL PROPERTY	MCDONAKD TERRI & GREGORY HENRICK	7307 ELM
100902014	2001-2002	INDIVIDUAL PERSONAL PROPERTY	HUFFMAN SHIRLEY J	8805 E 71ST TER	100905035	2001-2004	INDIVIDUAL PERSONAL PROPERTY	MANN MORRIS	UNKNOWN
100902162	2002	INDIVIDUAL PERSONAL PROPERTY	LOPEZ ALMA	8404 E 86TH TER	100905070	2001	INDIVIDUAL PERSONAL PROPERTY	CRISPE AMANDA J	UNKNOWN
100902191	2003-2004	INDIVIDUAL PERSONAL PROPERTY	HARESDAPE JULIE	10405 E 59TH ST	100905081	2002	INDIVIDUAL PERSONAL PROPERTY	REINFELD LARRY S	NO ADDRESS PROVIDED BY TAXPAYER
100902270	2002	INDIVIDUAL PERSONAL PROPERTY	MOHR TYSON	NO ADDRESS PROVIDED BY TAXPAYER	100905196	2002	INDIVIDUAL PERSONAL PROPERTY	FLORES ROSENDO	7611 RAYTOWN RD
100902417	2021	INDIVIDUAL PERSONAL PROPERTY	BUSH ANTHONY	8525 ARLINGTON AVE	100905204	2001	INDIVIDUAL PERSONAL PROPERTY	GATEWOOD JAMES M	9204 E 74TH TER
100902485	2003	INDIVIDUAL PERSONAL PROPERTY	WILLIAMS LESLIE	1721 MEWS DR	100905279	2007-2008	INDIVIDUAL PERSONAL PROPERTY	AUSTIN ROBERT E	6619 HARRIS AVE
100902495	2004	INDIVIDUAL PERSONAL PROPERTY	WEST JEANNIE	8820 E 61ST TER	100905298	2004-2010	INDIVIDUAL PERSONAL PROPERTY	COLE JERA J	6022 NORTHERN AVE
100902497	2002-2004	INDIVIDUAL PERSONAL PROPERTY	WILLIAMS LESLIE	UNKNOWN	100905308	2004	INDIVIDUAL PERSONAL PROPERTY	MAHMOUD NIZER	NO ADDRESS PROVIDED BY TAXPAYER
100902511	2001-2003	INDIVIDUAL PERSONAL PROPERTY	SCHWARK DEVIN	UNKNOWN	100905312	2002	INDIVIDUAL PERSONAL PROPERTY	WARD JANET S	7200 CRISP AVE
100902529	2001	INDIVIDUAL PERSONAL PROPERTY	MINSHALL NATHAN R	8400 STERLING	100905324	2001	INDIVIDUAL PERSONAL PROPERTY	RICHARDSON ANGELA B	7501 CRESCENT DR
100902545	2020-2021	INDIVIDUAL PERSONAL PROPERTY	ROSS GARY A SR	7509 CRISP AVE	100905345	2021	INDIVIDUAL PERSONAL PROPERTY	BASTON TODD C & WINONA M	7216 RAYTOWN RD APT B
100902587	2001	INDIVIDUAL PERSONAL PROPERTY	CARDARELLIE JENNIFER	UNKNOWN	100905405	2001	INDIVIDUAL PERSONAL PROPERTY	BOND WILLIAM	6160 KENWOOD AVE
100902867	2021	INDIVIDUAL PERSONAL PROPERTY	GARCIA FRANK D	6504 STERLING AVE	100905412	2008	INDIVIDUAL PERSONAL PROPERTY	SWEANEY LINDA R	1116 NE INDEPENDENCE AVE APT 311
100902937	2004	INDIVIDUAL PERSONAL PROPERTY	PATTON TURNER RASHAUNDA	1438 MEWS DR D	100905486	2021	INDIVIDUAL PERSONAL PROPERTY	COX TONI	9050 E 65TH ST
100902950	2002	INDIVIDUAL PERSONAL PROPERTY	HOBERG NANCY J	5426 HARRIS	100905501	2011	INDIVIDUAL PERSONAL PROPERTY	MCCOY RYAN E	10107 E 69TH ST
100902958	2002-2004	INDIVIDUAL PERSONAL PROPERTY	COLLINS PAUL	8803 E 59TH ST	100905543	2009	INDIVIDUAL PERSONAL PROPERTY	FLOWERS ANNETTE	8955 E 83RD TER
100902967	2001-2002	INDIVIDUAL PERSONAL PROPERTY	LONG JEREMY L	UNKNOWN	100905553	2005	INDIVIDUAL PERSONAL PROPERTY	PENLAND STACI L	10109 E 71ST TER
100903024	2012	INDIVIDUAL PERSONAL PROPERTY	THOMPSON JOHN M	8319 PERSHING RD	100905559	2019-2021	INDIVIDUAL PERSONAL PROPERTY	MURPHY DONALD C	7410 OVERTON AVE UNIT 1
100903031	2004-2005	INDIVIDUAL PERSONAL PROPERTY	LUDWIG MICHAEL J & KATHLEEN S	6236 MANNING AVE	100905594	2021	INDIVIDUAL PERSONAL PROPERTY	RAGLAND APRIL L	11003 E 53RD TER
100903097	2001	INDIVIDUAL PERSONAL PROPERTY	FULLER TAMARA L	UNKNOWN	100905625	2004-2008	INDIVIDUAL PERSONAL PROPERTY	LUNSFORD APRIL C	NO ADDRESS PROVIDED BY TAXPAYER
100903133	2021	INDIVIDUAL PERSONAL PROPERTY	LENER ROSANNE	9008 E 66TH TER	100905638	2001	INDIVIDUAL PERSONAL PROPERTY	AMLERRE OSCAR G	UNKNOWN
100903178	2021	INDIVIDUAL PERSONAL PROPERTY	HOLLEY TAMEKKA (CROCKETT)	9609 E 86TH TER	100905827	2001-2002	INDIVIDUAL PERSONAL PROPERTY	AGUIRRE JOSE M	9812 BENNINGTON AVE
100903211	2010-2011	INDIVIDUAL PERSONAL PROPERTY	BRADLEY JEFFREY	9212 E 68TH TER	100905908	2013-2017	INDIVIDUAL PERSONAL PROPERTY	CARPENTER MISTY	4747 CEDAR ST
100903237	2002	INDIVIDUAL PERSONAL PROPERTY	WEBER RICHARD F	UNKNOWN	100905929	2021	INDIVIDUAL PERSONAL PROPERTY	DILLON JEFF E & OLDENBURG BRANDY	9216 E 68TH ST
100903248	2003-2004	INDIVIDUAL PERSONAL PROPERTY	JOHNSON JENNIFER E	UNKNOWN	100905936	2001	INDIVIDUAL PERSONAL PROPERTY	CORNER JERRIE LYNNE	9308 E 69TH TER
100903276	2013-2017	INDIVIDUAL PERSONAL PROPERTY	BROWN-STEVENSON STEPHANIE R	5809 KENTUCKY AVE	100905943	2009-2012	INDIVIDUAL PERSONAL PROPERTY	HENDERSON BRIAN	8306 KENTUCKY AVE
100903325	2004	INDIVIDUAL PERSONAL PROPERTY	CANFIELD KAREN J	NO ADDRESS PROVIDED BY TAXPAYER	100905970	2010	INDIVIDUAL PERSONAL PROPERTY	VIRCHOW ERIN	11006 E 57TH ST
100903326	2001	INDIVIDUAL PERSONAL PROPERTY	CKINLEY CORY D	UNKNOWN	100905996	2001	INDIVIDUAL PERSONAL PROPERTY	KLINE MARISSA	7516 OVERTON AVE
100903408	2010-2013	INDIVIDUAL PERSONAL PROPERTY	ZOLLER ROBERT SCOTT	8108 ELM AVE	100906000	2007	INDIVIDUAL PERSONAL PROPERTY	HANNA BRANDON	10912 E 56TH TER
100903419	2007-2008	INDIVIDUAL PERSONAL PROPERTY	HILBUS AMBER C & BAXTER CHRISTOPHER	8012 HUNTER ST	100906077	2001	INDIVIDUAL PERSONAL PROPERTY	MILAM MATHEW C	8308 STERLING
100903555	2002-2003	INDIVIDUAL PERSONAL PROPERTY	KLEIMAN ANTHONY	11220 E 59TH ST	100906121	2009	INDIVIDUAL PERSONAL PROPERTY	WILLIAMS VINCENT S	8400 STARK AVE
100903568	2006	INDIVIDUAL PERSONAL PROPERTY	JOHNSON CAROL JEAN M	5906 ENGLEWOOD AVE	100906123	2002-2005	INDIVIDUAL PERSONAL PROPERTY	REYES STEPHEN M	8121 HEDGES AVE
100903656	2021	INDIVIDUAL PERSONAL PROPERTY	HANKINS JAMES	9307 E 81ST TER	100906139	2001	INDIVIDUAL PERSONAL PROPERTY	RAY VICK	UNKNOWN
100903683	2001	INDIVIDUAL PERSONAL PROPERTY	MARTIN BRENDA	6804 LAUREL	100906183	2005-2006	INDIVIDUAL PERSONAL PROPERTY	TOMPKINS TOBY	NO ADDRESS PROVIDED BY TAXPAYER
100903695	2002-2010	INDIVIDUAL PERSONAL PROPERTY	LATIMER TYRONE	8600 JAMES A REED RD	100906251	2009	INDIVIDUAL PERSONAL PROPERTY	CHAFFIN RODGER N	6304 STERLING AVE
100903715	2001-2002	INDIVIDUAL PERSONAL PROPERTY	TAYLOR WAYNE	10008 E 83RD TER	100906253	2005	INDIVIDUAL PERSONAL PROPERTY	SUL MAX	6012 ARLINGTON AVE
100903746	2010-2015	INDIVIDUAL PERSONAL PROPERTY	KUHLMAN ERIK & LUZ VIMINDA	6204 CLAREMONT AVE	100906361	2021	INDIVIDUAL PERSONAL PROPERTY	GILLAND KEIARA K	7908 CRESCENT AVE
100903749	2001	INDIVIDUAL PERSONAL PROPERTY	MURPHY FRANK & DENISE	UNKNOWN	100906362	2001	INDIVIDUAL PERSONAL PROPERTY	LEGLEITER MAUREEN	7209 HARRIS AVE
100903756	2001	INDIVIDUAL PERSONAL PROPERTY	FUSON TRAVIS	UNKNOWN	100906376	2020	INDIVIDUAL PERSONAL PROPERTY	WEST PEGGY	8908 E 83RD ST
100903786	2001-2017	INDIVIDUAL PERSONAL PROPERTY	MACIEL MANUEL	8521 MAPLE AVE	100906381	2021	INDIVIDUAL PERSONAL PROPERTY	LAIR ANDRETTA LACHERYL	328 NE FIDDLEWOOD AVE
100903805	2016-2021	INDIVIDUAL PERSONAL PROPERTY	SMITH PENNY	9009 E 68TH ST	100906433	2010	INDIVIDUAL PERSONAL PROPERTY	ALLEN KELLY A (MEYERS)	7125 BLUE RIDGE BLVD
100903810	2019-2021	INDIVIDUAL PERSONAL PROPERTY	DOLSON DAVID B & SAGER B	7307 ASH AVE	100906447	2001	INDIVIDUAL PERSONAL PROPERTY	BUCKHALZ DONALD E	5440 BLUE RIDGE CUTOFF
100903819	2001	INDIVIDUAL PERSONAL PROPERTY	RUSSELL BRETT LEE	9404 E 66TH ST	100906571	2002-2008	INDIVIDUAL PERSONAL PROPERTY	BELL MICHAEL	9905 E 76TH ST
100903826	2001	INDIVIDUAL PERSONAL PROPERTY	CLARK SHARRITTA L	8620 E UTOPIA DR	100906629	2014	INDIVIDUAL PERSONAL PROPERTY	TOOOKER LEEANN RAE	11025 E 63RD ST
100903831	2002-2003	INDIVIDUAL PERSONAL PROPERTY	VESSELY RICHARD J	7923 ELM AVE	100906640	2001-2004	INDIVIDUAL PERSONAL PROPERTY	ECHELMEYER AMY S	5421 HARDY
100903951	2021	INDIVIDUAL PERSONAL PROPERTY	WESSLEY TIMOTHY A & TINA M	7508 WOODSON RD	100906644	2004-2005	INDIVIDUAL PERSONAL PROPERTY	CORNELIUS DEBBIE	7403 BLUE RIDGE BLVD
100904013	2001	INDIVIDUAL PERSONAL PROPERTY	BURTON MICHELLE	UNKNOWN	100906655	2006-2008	INDIVIDUAL PERSONAL PROPERTY	KABER KATHY	8307 DITZLER AVE
100904064	2001	INDIVIDUAL PERSONAL PROPERTY	VICK RAY	UNKNOWN	100906701	2009	INDIVIDUAL PERSONAL PROPERTY	WEST JAMES D	PRIVATE STREET
100904094	2001	INDIVIDUAL PERSONAL PROPERTY	SHAFFER CRISTI R	UNKNOWN	100906710	2020-2021	INDIVIDUAL PERSONAL PROPERTY	LAMASTER CHARVON	6309 HEDGES AVE
100904172	2001-2003	INDIVIDUAL PERSONAL PROPERTY	SCARCELLO YONG M	6720 RAYTOWN RD	100906719	2008-2010	INDIVIDUAL PERSONAL PROPERTY	PARKER LOIS M	NO ADDRESS PROVIDED BY TAXPAYER

100906748	2002-2017	INDIVIDUAL PERSONAL PROPERTY	MEZA JUAN MANUEL	NO ADDRESS PROVIDED BY TAXPAYER	100909182	2001-2004	INDIVIDUAL PERSONAL PROPERTY	SANDERS MONIQUE & WHITE BARBARA	UNKNOWN
100906755	2006-2007	INDIVIDUAL PERSONAL PROPERTY	ELLIS NANCY M	5420 BLUE RIDGE CUT OFF APT G01	100909223	2003-2004	INDIVIDUAL PERSONAL PROPERTY	JOHNSON CHERLYN	5505 WILLOW AVE
100906770	2002	INDIVIDUAL PERSONAL PROPERTY	SMITH LABECKA M	7316 MAYWOOD	100909290	2006-2007	INDIVIDUAL PERSONAL PROPERTY	ELLIOTT LARESA (LEWIS)	9305 E 73RD ST
100906795	2001	INDIVIDUAL PERSONAL PROPERTY	MARTINEZ CAMERON	UNKNOWN	100909306	2008	INDIVIDUAL PERSONAL PROPERTY	QUEEN ROBERTA J & DONALD	5745 BLUE RIDGE BLVD
100906819	2001	INDIVIDUAL PERSONAL PROPERTY	HUDSON DONALD M	8828 E 62ND ST	100909315	2001-2004	INDIVIDUAL PERSONAL PROPERTY	OROURKE COREY M & SEAN M	UNKNOWN
100906847	2021	INDIVIDUAL PERSONAL PROPERTY	NEWSOM GERALD	8115 HARDY AVE	100909418	2020-2021	INDIVIDUAL PERSONAL PROPERTY	MCBURNEY KATIE E	7411 ASH AVE
100906850	2003-2004	INDIVIDUAL PERSONAL PROPERTY	EBERSOLE ELIZABETH	UNKNOWN	100909429	2001	INDIVIDUAL PERSONAL PROPERTY	HENDRICKS SHARON D	UNKNOWN
100906851	2002	INDIVIDUAL PERSONAL PROPERTY	CHUON ANTHONY	8600 E 81ST ST	100909460	2001	INDIVIDUAL PERSONAL PROPERTY	JACKSON ELMER	UNKNOWN
100906922	2001	INDIVIDUAL PERSONAL PROPERTY	JELINEK JASI J	5244 RALSTON AVE	100909473	2003	INDIVIDUAL PERSONAL PROPERTY	VILLEMURE PHYLLIS M	4212 S COTTAGE AVE
100906978	2001	INDIVIDUAL PERSONAL PROPERTY	MORAINÉ PENELOPE D	8204 HARRIS CRT	100910692	2021	INDIVIDUAL PERSONAL PROPERTY	MARKS SANDRA	10104 E 77TH TER
100906981	2012	INDIVIDUAL PERSONAL PROPERTY	CARNETT JANET S & SHAWN	7511 CRESCENT DR	100911815	2001	INDIVIDUAL PERSONAL PROPERTY	BORIS JOHN STANLEY	UNKNOWN
100906982	2002-2005	INDIVIDUAL PERSONAL PROPERTY	MOORE JOSHUA	8478 LANE DR	100911979	2006-2017	INDIVIDUAL PERSONAL PROPERTY	WHEELER HARRY L	9108 E 68TH ST
100907007	2002	INDIVIDUAL PERSONAL PROPERTY	JACOBSON VIRGINIA A	6140 RAYTOWN RD	100912174	2002	INDIVIDUAL PERSONAL PROPERTY	QUEDNOW SCOTT M	NO ADDRESS PROVIDED BY TAXPAYER
100907018	2001-2008	INDIVIDUAL PERSONAL PROPERTY	MAGGARD DOUGLAS L	10600 E 80TH ST	100912508	2001	INDIVIDUAL PERSONAL PROPERTY	WATSON DIETRA R	NO ADDRESS PROVIDED BY TAXPAYER
100907036	2003	INDIVIDUAL PERSONAL PROPERTY	MASONER DANIEL A	8609 EVERETT ST	100912510	2005-2006	INDIVIDUAL PERSONAL PROPERTY	BARKER MICHAEL W	9115 E 65TH ST
100907083	2001-2002	INDIVIDUAL PERSONAL PROPERTY	CROY PATRICIA	10005 E 56TH ST	100912528	2003-2006	INDIVIDUAL PERSONAL PROPERTY	COOPER ANDREA	8409 JAMES A REED RD
100907148	2004-2007	INDIVIDUAL PERSONAL PROPERTY	WISNER JOSHUA	NO ADDRESS PROVIDED BY TAXPAYER	100912812	2019-2021	INDIVIDUAL PERSONAL PROPERTY	STEWART DANIELLE C	5321 KENTUCKY AVE
100907150	2002-2003	INDIVIDUAL PERSONAL PROPERTY	DONNINI TAD P	5816 LANE	100912962	2009-2017	INDIVIDUAL PERSONAL PROPERTY	SCHAEFER DANIEL B	10514 E 70TH ST
100907157	2002	INDIVIDUAL PERSONAL PROPERTY	COSTALES KATHERINE & DON J	UNKNOWN	100913673	2005	INDIVIDUAL PERSONAL PROPERTY	GREEN JENNIFER A	NO ADDRESS PROVIDED BY TAXPAYER
100907203	2021	INDIVIDUAL PERSONAL PROPERTY	RATLIFF SARA M	5521 HARDY AVE	100913926	2020	INDIVIDUAL PERSONAL PROPERTY	BUNNING CHRIS & JENIFER	7212 OXFORD AVE
100907209	2001	INDIVIDUAL PERSONAL PROPERTY	THOMAS ARRON L	UNKNOWN	100914135	2021	INDIVIDUAL PERSONAL PROPERTY	MIRANDA SHERRY LYNN	7930 CEDAR AVE
100907335	2021	INDIVIDUAL PERSONAL PROPERTY	ESSEX SOLOMON III	6497 BLUE RIDGE BLVD	100914569	2005	INDIVIDUAL PERSONAL PROPERTY	CHASTAIN CAROLYN S	7406 ELM ST
100907422	2001-2002	INDIVIDUAL PERSONAL PROPERTY	KILBANE TIMOTHY	10220 E 68TH ST	100914574	2005	INDIVIDUAL PERSONAL PROPERTY	FANN MELISSA M	7715 WOODSON RD
100907479	2003-2004	INDIVIDUAL PERSONAL PROPERTY	MOSSELLO BRAD	7922 MAPLE	100914877	2016	INDIVIDUAL PERSONAL PROPERTY	MCDOWELL SHERRIE L	9311 E 83RD ST
100907522	2020	INDIVIDUAL PERSONAL PROPERTY	LESLIE MAE & BAKKEN DIANE	5728 LANE AVE	100914935	2005-2006	INDIVIDUAL PERSONAL PROPERTY	PALMER MIKE	NO ADDRESS PROVIDED BY TAXPAYER
100907659	2001-2002	INDIVIDUAL PERSONAL PROPERTY	OWEN BARLOW	11409 E 71ST ST	100915308	2004	INDIVIDUAL PERSONAL PROPERTY	MUTRUX REBECCA A	10014 E 71ST TER
100907717	2001-2004	INDIVIDUAL PERSONAL PROPERTY	BABICKE ROBERT G III	7427 ENGLEWOOD	100915428	2002-2003	INDIVIDUAL PERSONAL PROPERTY	REECE JASON R	9024 E 79TH ST
100907879	2014	INDIVIDUAL PERSONAL PROPERTY	HENDERSON MICHAEL L	5312 RALSTON AVE	100915462	2002-2003	INDIVIDUAL PERSONAL PROPERTY	PWDERSON BRENDA E	UNKNOWN
100907916	2011	INDIVIDUAL PERSONAL PROPERTY	BUTLER LEON	9917 E 85TH ST	100916063	2016-2021	INDIVIDUAL PERSONAL PROPERTY	TAYLOR SAMUEL D & SHERRIE LYNNE	8609 GREENWOOD RD
100907934	2021	INDIVIDUAL PERSONAL PROPERTY	KLENOWSKI JODIE A	8908 E 73RD ST	100916335	2001	INDIVIDUAL PERSONAL PROPERTY	ZOELLERS WILLIS	115 S HARDY AVE
100907960	2011-2017	INDIVIDUAL PERSONAL PROPERTY	FREEMER CONNIE L	10413 E 81ST TER	100916431	2003-2017	INDIVIDUAL PERSONAL PROPERTY	WHEELER MICHAEL J	9108 E 68TH ST
100907965	2020-2021	INDIVIDUAL PERSONAL PROPERTY	CORTEZ SUSANNE M & ROY G	7900 CRESCENT AVE	100916524	2003-2005	INDIVIDUAL PERSONAL PROPERTY	SMITH KRISTEN N	NO ADDRESS PROVIDED BY TAXPAYER
100907970	2009-2013	INDIVIDUAL PERSONAL PROPERTY	BROWN SAMUEL	5809 KENTUCKY AVE	100916726	2019-2021	INDIVIDUAL PERSONAL PROPERTY	ROGERS MELISSA	9513 E 83RD ST
100908009	2001	INDIVIDUAL PERSONAL PROPERTY	MILLER CHAD E	UNKNOWN	100916849	2021	INDIVIDUAL PERSONAL PROPERTY	DANIELS DAVID B	11100 E 74TH ST
100908010	2009	INDIVIDUAL PERSONAL PROPERTY	SMITH MARY A (RICHARDSON)	6808 RAYTOWN RD	100917045	2006-2010	INDIVIDUAL PERSONAL PROPERTY	MELLENDEZ MOISES	NO ADDRESS PROVIDED BY TAXPAYER
100908051	2018-2020	INDIVIDUAL PERSONAL PROPERTY	JACKSON ANGELA G	10204 E 68TH TER	100917050	2015	INDIVIDUAL PERSONAL PROPERTY	MCCALL STACI J	9109 E 58TH ST
100908053	2001	INDIVIDUAL PERSONAL PROPERTY	CAMPELL TAMARA S & DANIEL	10514 E 70TH ST	100917075	2021	INDIVIDUAL PERSONAL PROPERTY	BOLES LORENZO M	5803 KENTUCKY AVE
100908121	2021	INDIVIDUAL PERSONAL PROPERTY	WHITTAKER ARTHUR P & GLENNIE M	8614 E 85TH ST	100917217	2008-2009	INDIVIDUAL PERSONAL PROPERTY	KEEN APRIL	4911 APPLETON AVE
100908158	2021	INDIVIDUAL PERSONAL PROPERTY	BECKER NIA FRANCES	9712 E 66TH TER	100917298	2012	INDIVIDUAL PERSONAL PROPERTY	GREEN DANIEL E	5428 RALSTON AVE
100908203	2001-2002	INDIVIDUAL PERSONAL PROPERTY	SHORT RHONDA E & MICHAEL	8405 JAMES A REED RD	100917680	2019	INDIVIDUAL PERSONAL PROPERTY	KEATON DENNY D	6808 LANE AVE
100908215	2001	INDIVIDUAL PERSONAL PROPERTY	JARMAN ELIZABETH J & DANIEL E	8914 NEWTON 3406	100917707	2008-2009	INDIVIDUAL PERSONAL PROPERTY	HARRISON CHERYL	6821 CRISP AVE
100908292	2021	INDIVIDUAL PERSONAL PROPERTY	WARREN SHARON KAY	9713 E 82ND TER	100918052	2008-2009	INDIVIDUAL PERSONAL PROPERTY	THOMPSON HERLEY	9357 E 77TH ST
100908329	2001-2002	INDIVIDUAL PERSONAL PROPERTY	DRUMMEL SARAH J	7328 ASH	100918327	2017-2018	INDIVIDUAL PERSONAL PROPERTY	SANDERS MICHAEL & KELLY DANA	6217 ENGLEWOOD AVE
100908444	2005	INDIVIDUAL PERSONAL PROPERTY	DELATORRE JUAN	9800 E 61ST ST	100918405	2003	INDIVIDUAL PERSONAL PROPERTY	HEALY ERIN	8454 LANE DR
100908449	2001-2004	INDIVIDUAL PERSONAL PROPERTY	CLARK STEVEN D	10104 E 86TH TER	100918646	2001-2003	INDIVIDUAL PERSONAL PROPERTY	LUKEHART JULIE	NO ADDRESS PROVIDED BY TAXPAYER
100908463	2013	INDIVIDUAL PERSONAL PROPERTY	PACHECO ANDRES	7709 RAYTOWN RD APT 13	100918679	2002-2003	INDIVIDUAL PERSONAL PROPERTY	GIBSON MICHELLE L OR MARSHALL WILLIAM F	8405 WOODSON
100908486	2001	INDIVIDUAL PERSONAL PROPERTY	SHIRMEMAN CRYSTAL	UNKNOWN	100919472	2002	INDIVIDUAL PERSONAL PROPERTY	SWOPE ERIC	7701 ELM AVE
100908506	2020-2021	INDIVIDUAL PERSONAL PROPERTY	DOWDELL CLEMENT LEWIS	8201 HARRIS AVE	100919523	2007	INDIVIDUAL PERSONAL PROPERTY	RIZEK KEVIN	8312 WILLOW WAY
100908522	2019-2021	INDIVIDUAL PERSONAL PROPERTY	HANSON GEORGE E & ANDREA L	11001 E 74TH ST	100919736	2021	INDIVIDUAL PERSONAL PROPERTY	WEAVER WILLIAM & JULIE	8509 E 85TH TER
100908600	2012	INDIVIDUAL PERSONAL PROPERTY	NELSON JO ELIZABETH	11315 E 58TH TER	100919926	2002-2006	INDIVIDUAL PERSONAL PROPERTY	LEE DAVID	NO ADDRESS PROVIDED BY TAXPAYER
100908657	2002-2008	INDIVIDUAL PERSONAL PROPERTY	WEAVER KRISTON	6720 LAKESHORE DR	100919951	2020-2021	INDIVIDUAL PERSONAL PROPERTY	MACE MATTHEW & RACHELLE	10406 E 82ND TER
100908698	2003-2007	INDIVIDUAL PERSONAL PROPERTY	FAUNTLERAY TWYLLA MCDOWELL	10013 E 56TH TER	100919970	2002	INDIVIDUAL PERSONAL PROPERTY	DIXSON SAMUEL H	8826 RICHARDS DR
100908739	2002	INDIVIDUAL PERSONAL PROPERTY	CONLEN MICHAEL E	NO ADDRESS PROVIDED BY TAXPAYER	100919989	2005-2007	INDIVIDUAL PERSONAL PROPERTY	BUSH TIMOTHY	9806 E 60TH TER
100908774	2017-2018	INDIVIDUAL PERSONAL PROPERTY	MOORE LATRISHA L	8620 E UTOPIA DR	100919991	2004	INDIVIDUAL PERSONAL PROPERTY	WRIGHT DUSTIN & KELLY	7303 APPLETON AVE
100908780	2018-2021	INDIVIDUAL PERSONAL PROPERTY	DILLON MICHELLE L	9101 E 73RD ST	100920004	2002-2003	INDIVIDUAL PERSONAL PROPERTY	KELLEY KATIE L	UNKNOWN
100908785	2002-2011	INDIVIDUAL PERSONAL PROPERTY	ROBLES FREDERICK	NO ADDRESS PROVIDED BY TAXPAYER	100920020	2002	INDIVIDUAL PERSONAL PROPERTY	BARNES SHAWNDELL & SHERRI	11215 E 76TH ST
100908827	2001-2007	INDIVIDUAL PERSONAL PROPERTY	MANDRELL BRADBERRY	10409 E 67TH ST	100920047	2008	INDIVIDUAL PERSONAL PROPERTY	WILLIAMS TANGELA	6551 RAYTOWN RD APT 6
100908830	2001-2003	INDIVIDUAL PERSONAL PROPERTY	EWING TODD	6109 STERLING AVE	100920066	2003-2017	INDIVIDUAL PERSONAL PROPERTY	ANDRE PAUL JR	8521 MAPLE AVE
100908852	2013-2017	INDIVIDUAL PERSONAL PROPERTY	SMITH CHARLES R SR	8809 RICHARDS DR	100920767	2002	INDIVIDUAL PERSONAL PROPERTY	BRUNK CRAIG S	UNKNOWN
100908872	2001-2002	INDIVIDUAL PERSONAL PROPERTY	IKNER ELLAREY V SR	UNKNOWN	101264027	2011-2013	INDIVIDUAL PERSONAL PROPERTY	POUR JERRY L	8613 MAPLE AVE
100908875	2001	INDIVIDUAL PERSONAL PROPERTY	EVANS KELLY J	8504 BOOTH AVE	101264058	2002-2009	INDIVIDUAL PERSONAL PROPERTY	AIKEN CALVEN	NO ADDRESS PROVIDED BY TAXPAYER
100908895	2001	INDIVIDUAL PERSONAL PROPERTY	GUTHRIE LARRY B	8115 WOODSON DR	101264309	2006	INDIVIDUAL PERSONAL PROPERTY	CARMICHAEL MATTHEW E	NO ADDRESS PROVIDED BY TAXPAYER
100908902	2001	INDIVIDUAL PERSONAL PROPERTY	BARNETT TREVA S	6204 NORTHERN	101264476	2008-2009	INDIVIDUAL PERSONAL PROPERTY	HILL ERICA D	4814 E 51ST TER
100908947	2001	INDIVIDUAL PERSONAL PROPERTY	JONES TANYA	3100 WOODS CHAPEL CRT	101265535	2004	INDIVIDUAL PERSONAL PROPERTY	MARSH SARAH K	6231 NORTHERN AVE
100908994	2021	INDIVIDUAL PERSONAL PROPERTY	MCCLENTON BRENDA J	5941 RAYTOWN RD UNIT C	101265544	2002	INDIVIDUAL PERSONAL PROPERTY	OMOHUNDRO FELICIA L	7922 MAPLE
100909021	2020-2021	INDIVIDUAL PERSONAL PROPERTY	HILLS RALPH L	9701 E GREGORY BLVD	101265571	2021	INDIVIDUAL PERSONAL PROPERTY	GLENN CHRISTOPHER	8211 E 64TH TER
100909054	2012	INDIVIDUAL PERSONAL PROPERTY	VANDERPOOL JULIE A	9604 E 68TH TER	101265634	2006-2007	INDIVIDUAL PERSONAL PROPERTY	KENYON AMY R & JOEL L	8211 E 85TH ST
100909068	2001-2009	INDIVIDUAL PERSONAL PROPERTY	ESONG CHARLES A	NO ADDRESS PROVIDED BY TAXPAYER	101266154	2002-2004	INDIVIDUAL PERSONAL PROPERTY	CROMLEY BRIAN R & RICHARD L	10700 W 59TH ST
100909107	2001	INDIVIDUAL PERSONAL PROPERTY	RHODES CHARLIE L	5420 BLUE RIDGE CUTOFF	101266579	2021	INDIVIDUAL PERSONAL PROPERTY	HILLS MICAH C	5409 WOODSON RD
100909119	2001-2004	INDIVIDUAL PERSONAL PROPERTY	RISON KATHRYNE A	5801 BLUE RIDGE BLVD	101266614	2002	INDIVIDUAL PERSONAL PROPERTY	SHANKLEIN EBONY A	UNKNOWN
100909140	2001-2005	INDIVIDUAL PERSONAL PROPERTY	PATRICK STEVEN	4827 VERMONT AVE	101266674	2001-2002	INDIVIDUAL PERSONAL PROPERTY	HARRIS ERICA L	9225 E 53RD TER
100909143	2021	INDIVIDUAL PERSONAL PROPERTY	SACCARDI THOMAS L & ERIKA L	11408 E 65TH ST	101266688	2011	INDIVIDUAL PERSONAL PROPERTY	SMITH STEVE	10901 E 62ND TER

101267030	2011-2014	INDIVIDUAL PERSONAL PROPERTY	MOORE HAROLD A	10336 E 63RD ST APT 4	101284128	2002-2003	INDIVIDUAL PERSONAL PROPERTY	THOMAS ROBERT L	8307 KENTUCKY AVE
101267206	2008-2009	INDIVIDUAL PERSONAL PROPERTY	DETAR NEWBERT DAVID	NO ADDRESS PROVIDED BY TAXPAYER	101284149	2016-2018	INDIVIDUAL PERSONAL PROPERTY	GUENIN JAMES L	10404 E 72ND ST
101267416	2021	INDIVIDUAL PERSONAL PROPERTY	WILKERSON ALEXIS L	8309 HARRIS AVE	101284161	2002	INDIVIDUAL PERSONAL PROPERTY	HERRINGTON CONNIE S	UNKNOWN
101268939	2002-2004	INDIVIDUAL PERSONAL PROPERTY	VIELBIG JO L & ELLIOTT RICHARD	7840 WOODSON RD	101284491	2021	INDIVIDUAL PERSONAL PROPERTY	HUNTER STEVE	9005 RICHARDS DR
101268969	2013	INDIVIDUAL PERSONAL PROPERTY	SALAZAR JAIME ANDRES	9362 E 64TH ST	101284492	2011	INDIVIDUAL PERSONAL PROPERTY	JOHNSON PHILIP M	12940 WORNALL RD
101269036	2021	INDIVIDUAL PERSONAL PROPERTY	TOLBERT ERIC	11204 E 78TH ST	101284709	2002-2003	INDIVIDUAL PERSONAL PROPERTY	SCHELLHORN CHRISTINA	UNKNOWN
101270058	2004-2005	INDIVIDUAL PERSONAL PROPERTY	MCMURRAY EDWARD J	NO ADDRESS PROVIDED BY TAXPAYER	101284712	2002	INDIVIDUAL PERSONAL PROPERTY	LEE VANCE	8623 PERSHING RD
101270109	2009-2010	INDIVIDUAL PERSONAL PROPERTY	YOUNG VICKIE R	8106 ASH AVE	101284745	2011	INDIVIDUAL PERSONAL PROPERTY	GIRON MARY ANN	8604 FORD AVE
101270332	2008-2009	INDIVIDUAL PERSONAL PROPERTY	AUSTIN ROBERT & HINDS ANGELA D	11000 E 83RD ST	101284771	2002	INDIVIDUAL PERSONAL PROPERTY	RADER JOSEPH E	UNKNOWN
101271434	2021	INDIVIDUAL PERSONAL PROPERTY	HENDERSON MICHAEL ERIC	8300 MANNING AVE	101284821	2007	INDIVIDUAL PERSONAL PROPERTY	VOLLMER GLENDA G	10908 E 60TH TER
101271627	2019-2021	INDIVIDUAL PERSONAL PROPERTY	FAILS KENNETH D	9010 E 87TH ST APT C3	101284824	2002-2004	INDIVIDUAL PERSONAL PROPERTY	AMIN SHAILESH	11205 E 64TH ST
101272244	2021	INDIVIDUAL PERSONAL PROPERTY	CARTER CECELIA R	7709 CRESCENT AVE	101284842	2021	INDIVIDUAL PERSONAL PROPERTY	HENDRIX JILLIAN D	7505 ENGLEWOOD AVE
101272688	2007	INDIVIDUAL PERSONAL PROPERTY	KOPP LIDIA	9009 E 73RD ST	101284891	2002-2003	INDIVIDUAL PERSONAL PROPERTY	COLE DEAN L	UNKNOWN
101272862	2006	INDIVIDUAL PERSONAL PROPERTY	GODLEY MARLENE J	6553 RAYTOWN RD APT 1B	101284895	2016	INDIVIDUAL PERSONAL PROPERTY	FANN MATTHEW M	7715 WOODSON RD
101272938	2016-2021	INDIVIDUAL PERSONAL PROPERTY	BRADLEY SABRIYA A	6825 STERLING AVE	101284905	2017-2021	INDIVIDUAL PERSONAL PROPERTY	COX ANN M	8906 E 74TH ST
101272984	2004-2005	INDIVIDUAL PERSONAL PROPERTY	ESCOBAR CARLOS	NO ADDRESS PROVIDED BY TAXPAYER	101284968	2002	INDIVIDUAL PERSONAL PROPERTY	LOONG TITUS W	UNKNOWN
101273231	2003-2006	INDIVIDUAL PERSONAL PROPERTY	FRANCIS KENNETH	5916 HARVARD AVE	101285129	2002	INDIVIDUAL PERSONAL PROPERTY	TOINEFF CHRISTOPHER	8815 RICHARDS DR
101273348	2020-2021	INDIVIDUAL PERSONAL PROPERTY	CLEARY VIRGINIA L	8745 JAMES A REED RD	101285176	2002-2004	INDIVIDUAL PERSONAL PROPERTY	SIMS AMERICA R & HAILE K	UNKNOWN
101273531	2006-2008	INDIVIDUAL PERSONAL PROPERTY	DAVIDSON AQUAILA N	11704 E 76TH TER	101285177	2002-2004	INDIVIDUAL PERSONAL PROPERTY	NORMAN DONNA	9001 E 73RD ST
101273758	2020-2021	INDIVIDUAL PERSONAL PROPERTY	ERTEL SCOTT ASHER	7401 MAPLE DR UNIT 311	101285191	2002	INDIVIDUAL PERSONAL PROPERTY	SMITH PRESKY	UNKNOWN
101273940	2015	INDIVIDUAL PERSONAL PROPERTY	MCCOLLOR DANIEL D	9801 E 73RD ST APT A	101285195	2002-2004	INDIVIDUAL PERSONAL PROPERTY	MEGINN MICHELE M	7716 ARLINGTON
101274114	2003-2005	INDIVIDUAL PERSONAL PROPERTY	TUCKER WILLIAM F III	8601 E 47TH ST	101285198	2002-2012	INDIVIDUAL PERSONAL PROPERTY	WILLIAMS CARLA D	NO ADDRESS PROVIDED BY TAXPAYER
101274552	2008-2013	INDIVIDUAL PERSONAL PROPERTY	BIGGS NORMAN A	8911 E 66TH ST	101285201	2009	INDIVIDUAL PERSONAL PROPERTY	ABBOTT BRUCE D	8912 E 66TH ST
101274626	2018-2019	INDIVIDUAL PERSONAL PROPERTY	HENDERSON SHERMANE N	5313 LEWIS AVE	101285263	2002	INDIVIDUAL PERSONAL PROPERTY	PENELTON BERNARD	5905 RAYTOWN RD
101275213	2006-2010	INDIVIDUAL PERSONAL PROPERTY	MEYER ADAM G	11422 E 71ST ST	101285275	2006	INDIVIDUAL PERSONAL PROPERTY	ANDRESEN THEODORE R	5813 HARVARD AVE
101275305	2008-2009	INDIVIDUAL PERSONAL PROPERTY	BAKER RANDALL B	5401 OXFORD AVE	101285289	2002	INDIVIDUAL PERSONAL PROPERTY	SCHIEDT RICHARD K	UNKNOWN
101275587	2003-2006	INDIVIDUAL PERSONAL PROPERTY	STEPHENS JOHN J	NO ADDRESS PROVIDED BY TAXPAYER	101285294	2004	INDIVIDUAL PERSONAL PROPERTY	HICKS PATRICIA	UNKNOWN
101276031	2020-2021	INDIVIDUAL PERSONAL PROPERTY	LAUCK AMANDA M	7810 E 86TH ST	101285330	2004-2005	INDIVIDUAL PERSONAL PROPERTY	LERETTE NICHOLAS E	6107 NORTHERN AVE
101276163	2021	INDIVIDUAL PERSONAL PROPERTY	WILLIAMS MARK A & TANIA BAKER WILLIAMS	10904 E 72ND ST	101285368	2003	INDIVIDUAL PERSONAL PROPERTY	BROWN LINDE Y	8825 E 57TH ST
101276199	2014	INDIVIDUAL PERSONAL PROPERTY	MEANS WANDA R	NO ADDRESS PROVIDED BY TAXPAYER	101285440	2002	INDIVIDUAL PERSONAL PROPERTY	TOINEFF CHRISTOPHER	UNKNOWN
101276299	2017-2019	INDIVIDUAL PERSONAL PROPERTY	MARTIN JEANNETTE	9311 E 80TH TER	101285444	2002-2003	INDIVIDUAL PERSONAL PROPERTY	BOYCE RICHARD G	8412 GREENWOOD RD
101276387	2013-2017	INDIVIDUAL PERSONAL PROPERTY	CLAY MYRON JR	6345 BLUE RIDGE BLVD	101285452	2006-2007	INDIVIDUAL PERSONAL PROPERTY	CARPINO CAROL & POPE RONALD	NO ADDRESS PROVIDED BY TAXPAYER
101276447	2010-2017	INDIVIDUAL PERSONAL PROPERTY	KOBEL JEFFREY	6405 KENTUCKY AVE	101285523	2002-2017	INDIVIDUAL PERSONAL PROPERTY	MINSHALL GEANE M & NATHAN	NO ADDRESS PROVIDED BY TAXPAYER
101277147	2004-2005	INDIVIDUAL PERSONAL PROPERTY	RHODES DIANA M & COOK RICKY A	5605 DITZLER AVE	101285526	2019-2021	INDIVIDUAL PERSONAL PROPERTY	TIPTON ALFREDIA T	11613 E 78TH TER
101277164	2021	INDIVIDUAL PERSONAL PROPERTY	WADE EDGAR WILFORD	5420 BLUE RIDGE CUT OFF APT G01	101285556	2004	INDIVIDUAL PERSONAL PROPERTY	WATTS KATHRYN J	UNKNOWN
101278100	2021	INDIVIDUAL PERSONAL PROPERTY	PALMER-LEE ERIKA MONIQUE	6911 RALSTON AVE	101285565	2002	INDIVIDUAL PERSONAL PROPERTY	SUAZO KAREN M	11700 E 75TH ST
101278242	2003-2007	INDIVIDUAL PERSONAL PROPERTY	COWAN EVERETT D JR & CAROL L	9933 E 56TH ST	101285595	2002	INDIVIDUAL PERSONAL PROPERTY	BAKER TANIA V	10904 E 72ND ST
101278498	2016-2021	INDIVIDUAL PERSONAL PROPERTY	RUIZ MARGARET C	5 NW OBRINE RD APT 15	101285631	2009	INDIVIDUAL PERSONAL PROPERTY	GILLING LAWRENCE D	8611 CRESCENT AVE
101278788	2021	INDIVIDUAL PERSONAL PROPERTY	MCDANIELS RAYMOND C	5615 HARRIS AVE	101285656	2021	INDIVIDUAL PERSONAL PROPERTY	PREWITT JAMIE L & DELBERT	8609 E 81ST TER
101278843	2021	INDIVIDUAL PERSONAL PROPERTY	LAUDERDALE VANESSA	7311 RAYTOWN RD	101285687	2012	INDIVIDUAL PERSONAL PROPERTY	GREENE BONNIE	9951 E 61ST ST APT 1
101279137	2012-2013	INDIVIDUAL PERSONAL PROPERTY	CARTER KENNETH A JR	5525 LANE AVE	101285717	2002	INDIVIDUAL PERSONAL PROPERTY	MARTIN GWEN	6130 BLUE RIDGE CUTOFF
101279157	2021	INDIVIDUAL PERSONAL PROPERTY	SMITH YVONNDA L	8611 E 83RD ST	101285724	2002	INDIVIDUAL PERSONAL PROPERTY	NANCY HOBERG J	UNKNOWN
101279545	2009-2011	INDIVIDUAL PERSONAL PROPERTY	WILLIAMS JAMES R	9413 E 66TH TER	101285730	2019-2021	INDIVIDUAL PERSONAL PROPERTY	DOUGLAS ADAM JAMES	8701 E 83RD TER
101279606	2004	INDIVIDUAL PERSONAL PROPERTY	SLATER CHERYL	10117 E 56TH ST	101285756	2003-2007	INDIVIDUAL PERSONAL PROPERTY	CHAMBERS MIKE	9108 VAUGHN AVE
101279691	2021	INDIVIDUAL PERSONAL PROPERTY	PADEN DANNY & CANADY BESSIE	11117 E 53RD ST	101285836	2002	INDIVIDUAL PERSONAL PROPERTY	MARK & KELLY WRIGHT	UNKNOWN
101280275	2003-2004	INDIVIDUAL PERSONAL PROPERTY	SULLIVAN DOUGLAS M	UNKNOWN	101285853	2005	INDIVIDUAL PERSONAL PROPERTY	TANCK KEVIN	10118 E 79TH ST
101280319	2019-2021	INDIVIDUAL PERSONAL PROPERTY	JACKSON ANTHONY DUANE	9002 RICHARDS DR	101285868	2002	INDIVIDUAL PERSONAL PROPERTY	WAWERER NJORGE	UNKNOWN
101280584	2012-2017	INDIVIDUAL PERSONAL PROPERTY	LAUER JAMES C	6521 STERLING AVE	101285913	2002	INDIVIDUAL PERSONAL PROPERTY	HENG TAN CHOUN	UNKNOWN
101280626	2021	INDIVIDUAL PERSONAL PROPERTY	HURT LAJEANNA	9011 E 73RD ST	101285919	2002	INDIVIDUAL PERSONAL PROPERTY	BUNKER JOSHUA W	7901 HEDGES AVE
101281564	2002	INDIVIDUAL PERSONAL PROPERTY	LUCENTE ANTHONY J JR	10613 E 53RD ST	101285952	2002-2005	INDIVIDUAL PERSONAL PROPERTY	THOMPSON MICHAEL	10702 E 63RD ST
101281758	2021	INDIVIDUAL PERSONAL PROPERTY	BROWN TRAVINA L (JARVIS)	7601 HAWTHORNE AVE	101286042	2013	INDIVIDUAL PERSONAL PROPERTY	HUBBLE SHIRLEE	6210 ASH CT
101282133	2016-2021	INDIVIDUAL PERSONAL PROPERTY	BURSON DAVID	5716 HUNTER ST	101286047	2002-2005	INDIVIDUAL PERSONAL PROPERTY	HAZLETT KEVIN E	9420 E 67TH TER
101282331	2010-2012	INDIVIDUAL PERSONAL PROPERTY	CHATFIELD KELLY S	8206 EVANSTON AVE	101286127	2021	INDIVIDUAL PERSONAL PROPERTY	GETHERS TYRONE E JR	8821 E 81ST TER
101282461	2020-2021	INDIVIDUAL PERSONAL PROPERTY	KRIESEL KELLY A	5733 ELM AVE	101286128	2015	INDIVIDUAL PERSONAL PROPERTY	ANDERSON KATEISHA D	8812 E 62ND ST
101282533	2004	INDIVIDUAL PERSONAL PROPERTY	LUTT JOHANN ROBERT	UNKNOWN	101286134	2002	INDIVIDUAL PERSONAL PROPERTY	BOGDON JON ERIC & MAC MILLEN ALUCE BETH	UNKNOWN
101282551	2020-2021	INDIVIDUAL PERSONAL PROPERTY	DOWNTON JOHN B JR	8409 HARRIS AVE	101286136	2002-2003	INDIVIDUAL PERSONAL PROPERTY	CHARAY CHRISTY LEE	UNKNOWN
101282556	2011-2012	INDIVIDUAL PERSONAL PROPERTY	KARN RONALD F	9200 E 68TH TER	101286299	2002	INDIVIDUAL PERSONAL PROPERTY	QUINTANILLO MATTHIAS A	UNKNOWN
101282617	2012	INDIVIDUAL PERSONAL PROPERTY	BIRD ROBERT B	11216 E 71ST DR	101286317	2002	INDIVIDUAL PERSONAL PROPERTY	HOBGOOD-CHITTIK NATHAN	UNKNOWN
101282569	2005	INDIVIDUAL PERSONAL PROPERTY	CLARK JOSHUA P	11314 MONTGALL AVE APT 1507	101286401	2011-2017	INDIVIDUAL PERSONAL PROPERTY	NELSON RACHEL	10101 E 69TH ST
101282619	2003	INDIVIDUAL PERSONAL PROPERTY	STURGEON DAVID P	UNKNOWN	101286416	2003	INDIVIDUAL PERSONAL PROPERTY	MELTON BEN	11409 E 65TH TER
101282625	2011	INDIVIDUAL PERSONAL PROPERTY	MUKTIKAR AJAY & NEELA	6728 RAYTOWN RD	101286520	2003-2005	INDIVIDUAL PERSONAL PROPERTY	COPPENBARGER BRAD	12104 E 78TH TER
101282667	2021	INDIVIDUAL PERSONAL PROPERTY	WILLIS JOSEPH & JENNIFER	6100 HUNTER ST	101286603	2005	INDIVIDUAL PERSONAL PROPERTY	WHITE HENRY & ANELLEN	11501 E 62ND TER
101283062	2005-2006	INDIVIDUAL PERSONAL PROPERTY	GILE MICHELE & BRYAN E	9017 E 74TH TER	101286618	2019-2020	INDIVIDUAL PERSONAL PROPERTY	KEISTER EMERY L	10801 E 60TH TER
101283069	2019-2021	INDIVIDUAL PERSONAL PROPERTY	STEPHENS BONNIE S	10407 E 82ND TER	101286665	2002	INDIVIDUAL PERSONAL PROPERTY	KIOUS CHRISTOPHER	8509 E 85TH TER
101283262	2008	INDIVIDUAL PERSONAL PROPERTY	NEWTON YODONDA	6608 HARDY AVE	101286860	2009-2013	INDIVIDUAL PERSONAL PROPERTY	SAMM DEBORAH	9112 E 69TH ST
101283555	2011	INDIVIDUAL PERSONAL PROPERTY	CLEMONS BARRY L	10703 E 69TH TER	101286943	2007-2008	INDIVIDUAL PERSONAL PROPERTY	WIGGINS WANDA E	8920 E 57TH ST
101283629	2014-2021	INDIVIDUAL PERSONAL PROPERTY	OJEDA BARBARA	7108 WOODSON RD	101287001	2002	INDIVIDUAL PERSONAL PROPERTY	HERMIDA ABEL & MARTINEZ ANNE	UNKNOWN
101283659	2002-2003	INDIVIDUAL PERSONAL PROPERTY	CHAMBRIS DANIEL R	8905 E 72ND TER	101287205	2021	INDIVIDUAL PERSONAL PROPERTY	RISLER JENNIFER L	10005 E 86TH TER
101283696	2002	INDIVIDUAL PERSONAL PROPERTY	RIPEL JASON C	UNKNOWN	101287283	2002	INDIVIDUAL PERSONAL PROPERTY	KALSTAD NICOLE S JASON E	NO ADDRESS PROVIDED BY TAXPAYER
101283756	2014	INDIVIDUAL PERSONAL PROPERTY	CAIN HENRY	5516 MAYWOOD AVE	101287500	2008	INDIVIDUAL PERSONAL PROPERTY	WILSON BROOKE R	10101 E 84TH ST
101283853	2005-2006	INDIVIDUAL PERSONAL PROPERTY	TAIT ANSON V	6412 OVERTON AVE	101287533	2006-2009	INDIVIDUAL PERSONAL PROPERTY	RYAN RONALD L	NO ADDRESS PROVIDED BY TAXPAYER
101283956	2020-2021	INDIVIDUAL PERSONAL PROPERTY	PARKER DAVID	11602 E 60TH TER	101287552	2002-2004	INDIVIDUAL PERSONAL PROPERTY	HOOTEN CRAIG A & TASHA M	UNKNOWN

101287560	2006-2007	INDIVIDUAL PERSONAL PROPERTY	AIKEN RICHARD L	6106 NORTHERN AVE	101291942	2014	INDIVIDUAL PERSONAL PROPERTY	SMITH BARRETT J	6726 APPLETON AVE
101287613	2016-2021	INDIVIDUAL PERSONAL PROPERTY	FRANKLIN ROBERT L	8423 ARLINGTON AVE	101291955	2006-2007	INDIVIDUAL PERSONAL PROPERTY	GUTIERREZ VERONICA	NO ADDRESS PROVIDED BY TAXPAYER
101287709	2009-2012	INDIVIDUAL PERSONAL PROPERTY	MAZZA MELISSA JEAN	11400 E 58TH TER	101291965	2002	INDIVIDUAL PERSONAL PROPERTY	STEPHENS SHIRLEY L & JAMES	NO ADDRESS PROVIDED BY TAXPAYER
101287710	2016-2021	INDIVIDUAL PERSONAL PROPERTY	BLACKWOOD SATIRAN	5420 BLUE RIDGE CUT OFF APT 217	101291973	2002-2006	INDIVIDUAL PERSONAL PROPERTY	ELLIOT ELMWOOD T	5437 RAYTOWN RD
101287777	2002	INDIVIDUAL PERSONAL PROPERTY	FERNANDEZ STEVEN	9108 E 85TH PL	101291975	2003-2004	INDIVIDUAL PERSONAL PROPERTY	SIMMONS KIMBERLY D	UNKNOWN
101287864	2002-2003	INDIVIDUAL PERSONAL PROPERTY	SPAULDING MICHAEL	8405 KENTUCKY	101291980	2003	INDIVIDUAL PERSONAL PROPERTY	CONNOR BLAKE M	UNKNOWN
101287911	2021	INDIVIDUAL PERSONAL PROPERTY	BLUM NICOLE	11604 E 60TH ST	101291986	2021	INDIVIDUAL PERSONAL PROPERTY	RAINEY SEANTEE	5504 LANE AVE
101287944	2011-2014	INDIVIDUAL PERSONAL PROPERTY	HARRIS DUSTIN	10001 E 77TH TER	101292011	2006-2007	INDIVIDUAL PERSONAL PROPERTY	TURNER JOSHUA D & REGINA S	NO ADDRESS PROVIDED BY TAXPAYER
101287977	2003	INDIVIDUAL PERSONAL PROPERTY	QUERY BRENDA L	NO ADDRESS PROVIDED BY TAXPAYER	101292023	2002	INDIVIDUAL PERSONAL PROPERTY	ANDREWS LONI A	UNKNOWN
101287981	2004	INDIVIDUAL PERSONAL PROPERTY	SALEEM MUHAMMAD A	UNKNOWN	101292029	2008-2012	INDIVIDUAL PERSONAL PROPERTY	BAILEY JENNIFER L	6808 VERMONT AVE
101288000	2021	INDIVIDUAL PERSONAL PROPERTY	BROOKS TAJAREE	9202 VAUGHN AVE	101292060	2002-2017	INDIVIDUAL PERSONAL PROPERTY	BUSH DAVID B	NO ADDRESS PROVIDED BY TAXPAYER
101288021	2002	INDIVIDUAL PERSONAL PROPERTY	FUSON TRAVIS H	5909 FARLEY	101292099	2009-2010	INDIVIDUAL PERSONAL PROPERTY	SPIELMAN TERRI & TYRONE	9400 E 85TH ST
101288122	2007	INDIVIDUAL PERSONAL PROPERTY	KOEHLER JAY	NO ADDRESS PROVIDED BY TAXPAYER	101292107	2002-2003	INDIVIDUAL PERSONAL PROPERTY	SMITH ANTON C	10730 E 53RD ST
101288172	2003	INDIVIDUAL PERSONAL PROPERTY	KAMERIS EVANTROS	9901 E 61ST ST	101292169	2004	INDIVIDUAL PERSONAL PROPERTY	UNDERWOOD CHANDA	UNKNOWN
101288196	2021	INDIVIDUAL PERSONAL PROPERTY	WHEELDON GREGORY	9304 E 80TH TER	101292230	2002	INDIVIDUAL PERSONAL PROPERTY	DEBOOT SHAUN	5443 BRISTOL AVE
101288378	2002	INDIVIDUAL PERSONAL PROPERTY	SIERRA DANILO O & LOURDES	UNKNOWN	101292275	2021	INDIVIDUAL PERSONAL PROPERTY	HAMBRICK ROBETTE LEONETTA	9517 E 83RD ST
101288416	2002	INDIVIDUAL PERSONAL PROPERTY	MOSELY KARL	UNKNOWN	101292282	2002-2012	INDIVIDUAL PERSONAL PROPERTY	THOMPSON CARROLL JOSEPH	NO ADDRESS PROVIDED BY TAXPAYER
101288588	2020-2021	INDIVIDUAL PERSONAL PROPERTY	ESTES DEIDRE N	9908 E 60TH ST	101292323	2003	INDIVIDUAL PERSONAL PROPERTY	GAMMILL APRIL R	UNKNOWN
101288589	2002	INDIVIDUAL PERSONAL PROPERTY	KANE MARGARET E	UNKNOWN	101292380	2009	INDIVIDUAL PERSONAL PROPERTY	MIGEIZA TIMOTHY A	NO ADDRESS PROVIDED BY TAXPAYER
101288666	2002-2006	INDIVIDUAL PERSONAL PROPERTY	MALONEY ROBERT A	NO ADDRESS PROVIDED BY TAXPAYER	101292484	2016-2017	INDIVIDUAL PERSONAL PROPERTY	ROSS WILLIAM S & TERESA O	9501 E 70TH TER
101288681	2003-2004	INDIVIDUAL PERSONAL PROPERTY	TOWNSEND ELIZABETH	NO ADDRESS PROVIDED BY TAXPAYER	101292718	2003-2004	INDIVIDUAL PERSONAL PROPERTY	PISCIOTTA JOSEPH R	UNKNOWN
101288741	2002	INDIVIDUAL PERSONAL PROPERTY	DANNENBURG NANCY	8634 LANE AVE	101292781	2002-2003	INDIVIDUAL PERSONAL PROPERTY	BRADLEY KENT D	11601 E 72ND ST
101288929	2013-2014	INDIVIDUAL PERSONAL PROPERTY	HOPEWELL SCOTT M	5528 HUNTER TER	101292784	2006-2008	INDIVIDUAL PERSONAL PROPERTY	MCCLEUR MATTHEW	NO ADDRESS PROVIDED BY TAXPAYER
101289046	2004	INDIVIDUAL PERSONAL PROPERTY	GIESFELD REBECCA S	8918 E 74TH ST	101292824	2021	INDIVIDUAL PERSONAL PROPERTY	HIBDON JOSEPH L	9502 E 79TH TER
101289052	2002	INDIVIDUAL PERSONAL PROPERTY	PASSAMANECK LINDA J	UNKNOWN	101292863	2002-2007	INDIVIDUAL PERSONAL PROPERTY	LONG GICO & HWANG	NO ADDRESS PROVIDED BY TAXPAYER
101289062	2002	INDIVIDUAL PERSONAL PROPERTY	WOOLFORD ARTHUR G	UNKNOWN	101292868	2002	INDIVIDUAL PERSONAL PROPERTY	PRUETT ELIZABETH	9901 E 61ST ST
101289104	2002-2004	INDIVIDUAL PERSONAL PROPERTY	HUNTER CYLISHA SHANTELL	8911 E 87TH ST	101292870	2002	INDIVIDUAL PERSONAL PROPERTY	THOMPSON COREY D	UNKNOWN
101289110	2003	INDIVIDUAL PERSONAL PROPERTY	POPE RONALD & CARPINO CAROL	NO ADDRESS PROVIDED BY TAXPAYER	101292881	2003	INDIVIDUAL PERSONAL PROPERTY	VICKY LEWIS	UNKNOWN
101289209	2006-2008	INDIVIDUAL PERSONAL PROPERTY	HANNA RUSTY J & DEBBIE L	NO ADDRESS PROVIDED BY TAXPAYER	101292896	2002	INDIVIDUAL PERSONAL PROPERTY	MARTIN RICHARD R	UNKNOWN
101289269	2011-2017	INDIVIDUAL PERSONAL PROPERTY	RHODES RAYMOND E SR	7424 HARDY AVE	101292906	2021	INDIVIDUAL PERSONAL PROPERTY	MORGAN MICHAEL RAY	7205 OVERTON AVE
101289451	2002	INDIVIDUAL PERSONAL PROPERTY	PRIEL GUY A	UNKNOWN	101293051	2002-2005	INDIVIDUAL PERSONAL PROPERTY	ANDERSON FRANCIS	NO ADDRESS PROVIDED BY TAXPAYER
101289458	2020	INDIVIDUAL PERSONAL PROPERTY	JONES JERRY DEXTER	9813 E 60TH ST	101293066	2002	INDIVIDUAL PERSONAL PROPERTY	DUCKSON DAINEL G	UNKNOWN
101289526	2004-2006	INDIVIDUAL PERSONAL PROPERTY	CALDWELL MICHAEL & TAMI	NO ADDRESS PROVIDED BY TAXPAYER	101293078	2002	INDIVIDUAL PERSONAL PROPERTY	MITCHELL DAVID O	UNKNOWN
101289576	2006	INDIVIDUAL PERSONAL PROPERTY	SHORE LESLIE E	7601 WOODSON RD	101293115	2002-2003	INDIVIDUAL PERSONAL PROPERTY	RYAN WILLIAM	5712 HUNTER ST
101289611	2002	INDIVIDUAL PERSONAL PROPERTY	MURRAY ANDREA R	UNKNOWN	101293216	2021	INDIVIDUAL PERSONAL PROPERTY	SMITH RICHARD J	11829 E 80TH DR
101289666	2002	INDIVIDUAL PERSONAL PROPERTY	GRAHAM JAMES L	UNKNOWN	101293219	2002	INDIVIDUAL PERSONAL PROPERTY	KELLEY REGINALD F II	NO ADDRESS PROVIDED BY TAXPAYER
101289815	2020-2021	INDIVIDUAL PERSONAL PROPERTY	SPENCER ALICA	8325 WILLOW WAY	101293223	2021	INDIVIDUAL PERSONAL PROPERTY	SMITH ARMAND R	7522 HAWTHORNE AVE
101290098	2002-2011	INDIVIDUAL PERSONAL PROPERTY	RANDALL JORDAN	6124 BLUE RIDGE BLVD	101293278	2002	INDIVIDUAL PERSONAL PROPERTY	IRVINE JAMES L C/O PLAZA CT APTS	UNKNOWN
101290111	2002	INDIVIDUAL PERSONAL PROPERTY	KELLAR JAMIE D	UNKNOWN	101293285	2002	INDIVIDUAL PERSONAL PROPERTY	IRVINE JAMES L C/O PLAZA CT APTS	UNKNOWN
101290255	2002-2016	INDIVIDUAL PERSONAL PROPERTY	NAULT KAREN L	7423 HARRIS AVE	101293293	2002-2004	INDIVIDUAL PERSONAL PROPERTY	JONES DANIEL M	9104 TENNESSEE
101290263	2006	INDIVIDUAL PERSONAL PROPERTY	WILLIAMS TASICIA	6553 RAYTOWN RD APT 18	101293295	2002-2017	INDIVIDUAL PERSONAL PROPERTY	BULSON LEO L	NO ADDRESS PROVIDED BY TAXPAYER
101290301	2004-2005	INDIVIDUAL PERSONAL PROPERTY	WIGFALL CLINT JR	8604 LONGVIEW RD	101293419	2002	INDIVIDUAL PERSONAL PROPERTY	PATRICIA JEAN	UNKNOWN
101290315	2004	INDIVIDUAL PERSONAL PROPERTY	EDWARDS FRANKLIN E JR	9701 E 66TH ST	101293421	2002	INDIVIDUAL PERSONAL PROPERTY	CRAWFORD ROBERT D	UNKNOWN
101290381	2021	INDIVIDUAL PERSONAL PROPERTY	JACKSON DYLAN	7101 WILLOW AVE	101293445	2011	INDIVIDUAL PERSONAL PROPERTY	INGRAHAM ERIC	5613 STERLING AVE
101290392	2003-2004	INDIVIDUAL PERSONAL PROPERTY	MORALES RITA	6649 MAYWOOD AVE	101293458	2002	INDIVIDUAL PERSONAL PROPERTY	JAMES ROSS W	UNKNOWN
101290456	2002-2007	INDIVIDUAL PERSONAL PROPERTY	JONES ROBERT A	8800 E 62ND TER	101293469	2005	INDIVIDUAL PERSONAL PROPERTY	ATKESON SHARON S	NO ADDRESS PROVIDED BY TAXPAYER
101290503	2003-2008	INDIVIDUAL PERSONAL PROPERTY	LONG GARY W	9007 E 67TH TER	101293485	2002	INDIVIDUAL PERSONAL PROPERTY	SMITH OLIVIA D	UNKNOWN
101290515	2007	INDIVIDUAL PERSONAL PROPERTY	CRADDOCK MICHAEL & MICHELLE	8126 STERLING AVE	101293566	2021	INDIVIDUAL PERSONAL PROPERTY	NEER EVAN & TIFFANY	9111 E 58TH TER
101290524	2002-2007	INDIVIDUAL PERSONAL PROPERTY	STARR EDNA & WOLANOLA	7312 ELM ST	101293569	2009-2012	INDIVIDUAL PERSONAL PROPERTY	VILLA J D	6500 BLUE RIDGE CUT OFF
101290527	2021	INDIVIDUAL PERSONAL PROPERTY	CAIN MATTHEW P & TIFFANY (BURNETT)	6316 HARVARD AVE	101293685	2014	INDIVIDUAL PERSONAL PROPERTY	PASSWATER NANCY R	5420 BLUE RIDGE CUT OFF APT 105
101290537	2008-2011	INDIVIDUAL PERSONAL PROPERTY	MOURNING LORRAINE M	5311 LEWIS AVE	101293733	2002	INDIVIDUAL PERSONAL PROPERTY	WILLIAMS JENEA L	UNKNOWN
101290562	2002-2004	INDIVIDUAL PERSONAL PROPERTY	QUISEP IJUAN C	11411 E 78 TH ST	101293745	2004-2005	INDIVIDUAL PERSONAL PROPERTY	ENGMANN RUSSELL H & SUSAN	5908 ENGLEWOOD AVE
101290573	2002	INDIVIDUAL PERSONAL PROPERTY	EVANS BRITTANI R	5717 HUNTER	101293754	2002-2004	INDIVIDUAL PERSONAL PROPERTY	LEE TINA	16602 LARKSPUR LN APT 5
101290610	2002	INDIVIDUAL PERSONAL PROPERTY	SMITH CARRIE H	6553 RAYTOWN RD APT 18	101293759	2002	INDIVIDUAL PERSONAL PROPERTY	SALZILLO TIMOTHY J	UNKNOWN
101290625	2002-2003	INDIVIDUAL PERSONAL PROPERTY	ELLIS FELICIA R	1845 E 76TH ST	101293816	2003-2004	INDIVIDUAL PERSONAL PROPERTY	JOHNSON ANDRE R	UNKNOWN
101290686	2005-2006	INDIVIDUAL PERSONAL PROPERTY	SUTTER MATTHEW A	5324 DITZLER AVE	101293828	2002-2005	INDIVIDUAL PERSONAL PROPERTY	BROOKS LAWRENCE II	1827 E 75TH TER
101290923	2003	INDIVIDUAL PERSONAL PROPERTY	ROTHROCK MELISSA	7719 ELM ST	101293898	2002	INDIVIDUAL PERSONAL PROPERTY	ABBOTT BRUCE	8912 E 66TH ST
101290926	2002	INDIVIDUAL PERSONAL PROPERTY	MARSHALL WILLIAM F	8405 WOODSON DR	101293901	2006	INDIVIDUAL PERSONAL PROPERTY	AULGUR JOLIE	NO ADDRESS PROVIDED BY TAXPAYER
101290945	2003	INDIVIDUAL PERSONAL PROPERTY	CAMERON NATHAN D	UNKNOWN	101293903	2002-2003	INDIVIDUAL PERSONAL PROPERTY	PAGE MICHAEL C & MICHELLE	2542 DRURY AVE
101291000	2018-2021	INDIVIDUAL PERSONAL PROPERTY	SMITH DESMA JEAN	6205 KENTUCKY AVE	101293914	2002	INDIVIDUAL PERSONAL PROPERTY	JOYCE FRIX	UNKNOWN
101291013	2003-2017	INDIVIDUAL PERSONAL PROPERTY	KILBURN BRANDY M	9201 E 65TH TER	101293935	2018	INDIVIDUAL PERSONAL PROPERTY	ROUCHKA DOMINICK	9205 E 79TH ST
101291026	2003-2005	INDIVIDUAL PERSONAL PROPERTY	REESE TIFFANY	UNKNOWN	101293958	2002-2008	INDIVIDUAL PERSONAL PROPERTY	FOSTER CHARLES A	6103 HADLEY ST
101291085	2016-2018	INDIVIDUAL PERSONAL PROPERTY	JAMES REGINALD VERNIE JR	6241 BLUE RIDGE BLVD	101294003	2002-2003	INDIVIDUAL PERSONAL PROPERTY	KLEIMAN ANTHONY	UNKNOWN
101291144	2002	INDIVIDUAL PERSONAL PROPERTY	HAYES ROBERT	6019 HEDGES AVE	101294058	2002	INDIVIDUAL PERSONAL PROPERTY	LUNDSTROM CHRIS	UNKNOWN
101291338	2002	INDIVIDUAL PERSONAL PROPERTY	WATSON PAULA S	UNKNOWN	101294130	2015-2016	INDIVIDUAL PERSONAL PROPERTY	MITCHELL CHARLES E	6724 LAKESHORE DR
101291372	2018	INDIVIDUAL PERSONAL PROPERTY	MASTERS RYAN	6129 KENTUCKY AVE	101294190	2002-2004	INDIVIDUAL PERSONAL PROPERTY	SMITH WILLIAM C	10409 E 39TH TER
101291382	2004-2005	INDIVIDUAL PERSONAL PROPERTY	COLEMAN ALEX JEROME	9204 E 61ST ST	101294194	2003	INDIVIDUAL PERSONAL PROPERTY	EVANSON DONALD D	6553 RAYTOWN RD APT 18
101291484	2002-2008	INDIVIDUAL PERSONAL PROPERTY	HOAG LANCE C & COLLEEN J	7325 WILLOW AVE	101294207	2002	INDIVIDUAL PERSONAL PROPERTY	BARNETT STEPHEN	UNKNOWN
101291613	2002	INDIVIDUAL PERSONAL PROPERTY	GUTTER RONALD J & LESLIE R	11020 E 53RD TER	101294256	2002-2003	INDIVIDUAL PERSONAL PROPERTY	WEBSTER THERESSA	UNKNOWN
101291716	2003	INDIVIDUAL PERSONAL PROPERTY	MYERS LOVELLA K	UNKNOWN	101294291	2003-2004	INDIVIDUAL PERSONAL PROPERTY	FINNELL RICHARD	UNKNOWN
101291730	2004	INDIVIDUAL PERSONAL PROPERTY	NEW LIFE BAPTIST CHURCH	NO ADDRESS PROVIDED BY TAXPAYER	101294424	2011-2017	INDIVIDUAL PERSONAL PROPERTY	JACKSON CHRISTY L	6320 WILLOW AVE
101291858	2002-2004	INDIVIDUAL PERSONAL PROPERTY	SZILVASY KEVIN	8504 PERSHING RD	101294441	2002	INDIVIDUAL PERSONAL PROPERTY	EARL DONALD L	UNKNOWN

101294506	2015	INDIVIDUAL PERSONAL PROPERTY	JOHNSON CHRISTINA MARIE	8609 E 87TH ST	101297453	2002-2004	INDIVIDUAL PERSONAL PROPERTY	GERING MARK	UNKNOWN
101294520	2002-2003	INDIVIDUAL PERSONAL PROPERTY	JOHNSON SHAVONNE L	543 BLUE RIDGE BLVD	101297496	2002	INDIVIDUAL PERSONAL PROPERTY	BURGEMAN ROBERT C	UNKNOWN
101294527	2002	INDIVIDUAL PERSONAL PROPERTY	MOORE JOSHUA	UNKNOWN	101297655	2002	INDIVIDUAL PERSONAL PROPERTY	ORTHMAN ROBERT M	UNKNOWN
101294583	2002	INDIVIDUAL PERSONAL PROPERTY	WHITESIDE ROBERT M (SMITH)	UNKNOWN	101297694	2004-2007	INDIVIDUAL PERSONAL PROPERTY	WILSON MIKE A SR	NO ADDRESS PROVIDED BY TAXPAYER
101294589	2016-2021	INDIVIDUAL PERSONAL PROPERTY	SPRATT BOBBY	7316 HEDGES AVE	101297699	2002	INDIVIDUAL PERSONAL PROPERTY	WOOLSEY TIA L	502 S CRESCENT AVE
101294667	2002-2004	INDIVIDUAL PERSONAL PROPERTY	VENUGOPAL KUMAR & CHRISTINA	UNKNOWN	101297738	2017-2021	INDIVIDUAL PERSONAL PROPERTY	PETERSON LINDA J	5420 BLUE RIDGE CUT OFF APT 107
101294688	2002	INDIVIDUAL PERSONAL PROPERTY	MOHAMMAD BSHARAT	UNKNOWN	101297801	2002	INDIVIDUAL PERSONAL PROPERTY	YOUSUFF MOHAMED	UNKNOWN
101294719	2021	INDIVIDUAL PERSONAL PROPERTY	RACKERS CAROLYN JEAN	7909 APPLETON AVE	101297871	2004-2005	INDIVIDUAL PERSONAL PROPERTY	LUKEHART RENEE L	NO ADDRESS PROVIDED BY TAXPAYER
101294729	2002-2005	INDIVIDUAL PERSONAL PROPERTY	HAZLETT JESSICA	9420 E 67TH TER	200294554	2019-2021	INDIVIDUAL PERSONAL PROPERTY	HASSLER JASON D	10208 E 69TH ST
101294745	2002-2005	INDIVIDUAL PERSONAL PROPERTY	COMBS LISA D	12616 E 58TH ST	200294795	2002	INDIVIDUAL PERSONAL PROPERTY	MCCORNECK DENNIS A JR	UNKNOWN
101294748	2019-2021	INDIVIDUAL PERSONAL PROPERTY	MEYER SCOTT W	NO ADDRESS PROVIDED BY TAXPAYER	200294984	2002	INDIVIDUAL PERSONAL PROPERTY	GRUETER JESSICA	9401 E 70TH TER
101294864	2002-2003	INDIVIDUAL PERSONAL PROPERTY	PENAYER AMY M	UNKNOWN	200295136	2021	INDIVIDUAL PERSONAL PROPERTY	MILLER (GLISE) AMBER	8705 E 79TH ST
101294892	2004	INDIVIDUAL PERSONAL PROPERTY	ARMBURST ERIC F	8705 E 74TH ST	200295175	2011-2012	INDIVIDUAL PERSONAL PROPERTY	FRAZIER CHRISTOPHER C	812 E 84TH ST
101294912	2014-2021	INDIVIDUAL PERSONAL PROPERTY	LIGHTSEY BRYANT K	7316 MAYWOOD AVE	200295178	2021	INDIVIDUAL PERSONAL PROPERTY	RENDON BRANDY & RICHARD	UNKNOWN
101294919	2010-2011	INDIVIDUAL PERSONAL PROPERTY	BLAKES JESSE L & SWONCEL M	8700 KENTUCKY AVE	200295186	2002	INDIVIDUAL PERSONAL PROPERTY	ROUTH STEVEN N	9039 E 75TH ST
101294969	2019-2021	INDIVIDUAL PERSONAL PROPERTY	ELLSWORTH PRESTON D	6821 CRISP AVE	200295188	2013-2017	INDIVIDUAL PERSONAL PROPERTY	UPTON MARK & GLEN	8720 E 61ST ST
101295120	2021	INDIVIDUAL PERSONAL PROPERTY	MORGAN SHARON H	5840 HUNTER CT	200295210	2004-2007	INDIVIDUAL PERSONAL PROPERTY	COOPER JAMES E & CARYLYN L	10700 E 65TH TER
101295187	2002-2005	INDIVIDUAL PERSONAL PROPERTY	BIBBS FRANK II	7024 BELLEFONTAINE AVE	200295231	2002	INDIVIDUAL PERSONAL PROPERTY	SHARBONO CLAUDE	9113 E 83RD PL
101295198	2002	INDIVIDUAL PERSONAL PROPERTY	SIERRA DARILO	UNKNOWN	200295246	2020-2021	INDIVIDUAL PERSONAL PROPERTY	GUNNELS GLEN A JR	6641 HARDY AVE
101295206	2002	INDIVIDUAL PERSONAL PROPERTY	SCHRANZ ANDREW J	UNKNOWN	200295248	2020-2021	INDIVIDUAL PERSONAL PROPERTY	HARALSON MICHAEL	NO ADDRESS PROVIDED BY TAXPAYER
101295225	2006-2009	INDIVIDUAL PERSONAL PROPERTY	BOSS CHRISTOPHER J	5921 LAUREL AVE	200295258	2002	INDIVIDUAL PERSONAL PROPERTY	COCHRAN RICK L	UNKNOWN
101295335	2021	INDIVIDUAL PERSONAL PROPERTY	SOLOMON DEBORAH	9411 E 64TH TER	200295265	2002	INDIVIDUAL PERSONAL PROPERTY	BELL CRYSTAL L	7725 ARLINGTON AVE
101295343	2007	INDIVIDUAL PERSONAL PROPERTY	HEGGIE ROGER II	NO ADDRESS PROVIDED BY TAXPAYER	200295270	2013-2015	INDIVIDUAL PERSONAL PROPERTY	WILLIAMS SHENELLE N	11011 E 78TH ST
101295344	2002	INDIVIDUAL PERSONAL PROPERTY	BRADFORD BELLZORE J	UNKNOWN	200295450	2021	INDIVIDUAL PERSONAL PROPERTY	DARKS LAVANDEN	7727 ENGLEWOOD AVE
101295361	2012-2014	INDIVIDUAL PERSONAL PROPERTY	PATTON KRISHINNA M	12009 E 28TH TER	200295497	2021	INDIVIDUAL PERSONAL PROPERTY	FORD JOHNNY R	8208 HARDY AVE
101295403	2002	INDIVIDUAL PERSONAL PROPERTY	JAMES BRIAN L	6608 ELM	200295595	2011-2012	INDIVIDUAL PERSONAL PROPERTY	JONES RYAN D	9616 E 65TH TER
101295451	2010-2013	INDIVIDUAL PERSONAL PROPERTY	GRANT ROBERT E	7140 STERLING AVE	200295678	2011-2012	INDIVIDUAL PERSONAL PROPERTY	LAWRENCE CHRISTOPHER S & KIMBERLY S	UNKNOWN
101295497	2002	INDIVIDUAL PERSONAL PROPERTY	VOSA ANGELA	5604 WOODSON RD	200295679	2002	INDIVIDUAL PERSONAL PROPERTY	GREGORY JACQUILYN	NO ADDRESS PROVIDED BY TAXPAYER
101295533	2002-2005	INDIVIDUAL PERSONAL PROPERTY	COLLIER MICHELLE R	8216 STERLING AVE	200295692	2006-2007	INDIVIDUAL PERSONAL PROPERTY	IVY SHERITHA R	8510 PERSHING RD
101295600	2004	INDIVIDUAL PERSONAL PROPERTY	ANANT FADI Y	UNKNOWN	200295742	2002-2010	INDIVIDUAL PERSONAL PROPERTY	GREEN KIMBERLY D	10808 E 81ST TER
101295643	2003	INDIVIDUAL PERSONAL PROPERTY	HEALY SARA J	UNKNOWN	200295752	2012	INDIVIDUAL PERSONAL PROPERTY	HIGGINBOTHAM L E & GERALDINE	8111 E 87TH ST
101295648	2002	INDIVIDUAL PERSONAL PROPERTY	BROWN CHERRI	UNKNOWN	200295839	2007-2008	INDIVIDUAL PERSONAL PROPERTY	KHAWAJA MOHAMMAD K & BUSHRA E	6125 WILLOW AVE
101295696	2003	INDIVIDUAL PERSONAL PROPERTY	TRAGER STARR	UNKNOWN	200295855	2021	INDIVIDUAL PERSONAL PROPERTY	BAXTER SHAWN & CINDY	UNKNOWN
101295737	2002-2013	INDIVIDUAL PERSONAL PROPERTY	HERMANDEZ JOSE A	NO ADDRESS PROVIDED BY TAXPAYER	200295861	2002	INDIVIDUAL PERSONAL PROPERTY	GOPAL SAMPATH K	6255 BLUE RIDGE BLVD
101295787	2002	INDIVIDUAL PERSONAL PROPERTY	DRURY CHARLES E II & DAVIDSON LOIS W	11016 E 57TH TER	200295901	2002	INDIVIDUAL PERSONAL PROPERTY	ALVARO RUEDAS	6208 RIDGEWAY AVE
101295804	2002-2005	INDIVIDUAL PERSONAL PROPERTY	CARTER CORETHA A	2204 E 75TH ST	200295912	2002	INDIVIDUAL PERSONAL PROPERTY	STEWART NATALIE M	8601 E 81ST TER
101295822	2002	INDIVIDUAL PERSONAL PROPERTY	YOCUM JAMES	UNKNOWN	200295970	2021	INDIVIDUAL PERSONAL PROPERTY	LOGEMAN MATTHEW A & JENNIFER M	8908 E 66TH ST
101295954	2013-2014	INDIVIDUAL PERSONAL PROPERTY	WINTERS LATASHA M	9405 E 83RD ST	200295999	2021	INDIVIDUAL PERSONAL PROPERTY	PARKINSON JAMES	UNKNOWN
101295955	2002-2004	INDIVIDUAL PERSONAL PROPERTY	SLOAN SAMANTHA	6600 HARRIS AVE	200296004	2003	INDIVIDUAL PERSONAL PROPERTY	FISHER EDWARD M	UNKNOWN
101296050	2007	INDIVIDUAL PERSONAL PROPERTY	HENRY ROBERT Y & CHERIKA	9506 E 79TH TER	200296011	2002	INDIVIDUAL PERSONAL PROPERTY	WILSON DAVID D	UNKNOWN
101296140	2002	INDIVIDUAL PERSONAL PROPERTY	LILE ANDREW G	UNKNOWN	200296016	2002-2003	INDIVIDUAL PERSONAL PROPERTY	LANDAVERDE ALEX	5801 LAUREL AVE
101296152	2002-2017	INDIVIDUAL PERSONAL PROPERTY	WASTON BENJAMIN T	7904 ARLINGTON AVE	200296020	2021	INDIVIDUAL PERSONAL PROPERTY	STONE KENDALL S	UNKNOWN
101296175	2021	INDIVIDUAL PERSONAL PROPERTY	SEXTON KRISTFER DALE	8606 EVERETT ST	200296021	2002-2004	INDIVIDUAL PERSONAL PROPERTY	PRESTON MENGES	6833 LAUREL AVE
101296186	2002	INDIVIDUAL PERSONAL PROPERTY	MATTY DANIEL	UNKNOWN	200296035	2003	INDIVIDUAL PERSONAL PROPERTY	WOODARD CHARLES W	UNKNOWN
101296201	2002	INDIVIDUAL PERSONAL PROPERTY	RYSER ERICKA	10620 E 56TH ST	200296124	2007	INDIVIDUAL PERSONAL PROPERTY	JARVIS SEAN	9504 E 63RD ST
101296250	2002	INDIVIDUAL PERSONAL PROPERTY	BROWN CHRISTOPHER & TAMMY	UNKNOWN	200296141	2002-2004	INDIVIDUAL PERSONAL PROPERTY	PETRON ERIC L	8620 E UTOPIA DR
101296255	2003-2005	INDIVIDUAL PERSONAL PROPERTY	ANDARA SANDRO A	8510 OLDHAM RD	200296152	2005	INDIVIDUAL PERSONAL PROPERTY	HARRIS CARMEN T	9020 E 85TH PL
101296292	2002	INDIVIDUAL PERSONAL PROPERTY	RIVERA LUIS M	UNKNOWN	200296193	2010-2011	INDIVIDUAL PERSONAL PROPERTY	DAILEY SHAWN & CHRISTINE (LATHROP)	8309 HARRIS AVE
101296492	2020-2021	INDIVIDUAL PERSONAL PROPERTY	DOUGLAS JR WADE & SHAWNTA	10500 E 59TH ST	200296335	2008	INDIVIDUAL PERSONAL PROPERTY	BLAIR DARREN L	UNKNOWN
101296578	2002	INDIVIDUAL PERSONAL PROPERTY	KELLY MONICA (MICHELLE)	UNKNOWN	200296457	2002	INDIVIDUAL PERSONAL PROPERTY	HULL BARROW ANTHONY	5212 E 54TH ST
101296632	2007	INDIVIDUAL PERSONAL PROPERTY	ROHR JASON M	NO ADDRESS PROVIDED BY TAXPAYER	200296480	2006	INDIVIDUAL PERSONAL PROPERTY	JACKSON DAVID R	8701 KENTUCKY AVE
101296766	2006	INDIVIDUAL PERSONAL PROPERTY	DESHONG SHIRLEY	NO ADDRESS PROVIDED BY TAXPAYER	200296523	2002-2005	INDIVIDUAL PERSONAL PROPERTY	VANBIBBER RICHARD	5940 CRESCENT AVE
101296773	2003-2007	INDIVIDUAL PERSONAL PROPERTY	KINGREY STEPHANIE M & DEBORAH M	6020 STERLING AVE	200296546	2003-2004	INDIVIDUAL PERSONAL PROPERTY	MCGRATH STEPHEN J	8812 E 84TH TER
101296782	2002-2003	INDIVIDUAL PERSONAL PROPERTY	TOWNSEND BETH	UNKNOWN	200296668	2002-2004	INDIVIDUAL PERSONAL PROPERTY	SANTOS FELIPE	5713 ELM AVE
101296804	2011-2015	INDIVIDUAL PERSONAL PROPERTY	GREENLEE BRIAN M & BEN C JR	5401 STERLING AVE	200296743	2007-2009	INDIVIDUAL PERSONAL PROPERTY	CHEFFEY MILES	UNKNOWN
101296833	2003-2004	INDIVIDUAL PERSONAL PROPERTY	WILSON STEPHON M	5813 CEDAR AVE	200296779	2002	INDIVIDUAL PERSONAL PROPERTY	ESTABROOKS BRANDY	7429 HARDY AVE
101296888	2018-2021	INDIVIDUAL PERSONAL PROPERTY	BOYD KENDE J	10009 E 77TH TER	200296839	2002	INDIVIDUAL PERSONAL PROPERTY	HODGES JANA	8305 MANNING AVE
101296892	2007-2011	INDIVIDUAL PERSONAL PROPERTY	LEWIS STEPHEN B	6721 HAWTHORNE AVE	200296876	2021	INDIVIDUAL PERSONAL PROPERTY	MATZELLE RYAN S	8955 E 84TH ST
101296942	2002	INDIVIDUAL PERSONAL PROPERTY	FAKMER TRICIA L	UNKNOWN	200297077	2012	INDIVIDUAL PERSONAL PROPERTY	KRAMER KELLI & CYNTHIA	10000 E 77TH TER
101296976	2021	INDIVIDUAL PERSONAL PROPERTY	STEPHENS WAYNE E	8308 E 85TH ST	200297085	2019-2021	INDIVIDUAL PERSONAL PROPERTY	SANDERS SHAUN A	5701 BLUE RIDGE CUT OFF
101297024	2005-2008	INDIVIDUAL PERSONAL PROPERTY	ALFONS RICKNARD	6525 ELM AVE	200297102	2021	INDIVIDUAL PERSONAL PROPERTY	COTTON YOLANDA	8309 NORTHERN ST
101297069	2004	INDIVIDUAL PERSONAL PROPERTY	KELLY -HUBBARD TWYLIAH	4503 E 56TH TER	200297289	2017-2021	INDIVIDUAL PERSONAL PROPERTY	BLUETT CEDRIC L	9404 E 70TH TER
101297183	2002	INDIVIDUAL PERSONAL PROPERTY	LEMMONS CANDICE	UNKNOWN	200297364	2021	INDIVIDUAL PERSONAL PROPERTY	RAMIREZ PAUL M	6600 HARRIS AVE
101297206	2003-2004	INDIVIDUAL PERSONAL PROPERTY	KELLY LATONIA S	UNKNOWN	200297390	2002-2004	INDIVIDUAL PERSONAL PROPERTY	SLOAN SAMANTHA	8633 E UTOPIA PKWY APT 7
101297236	2002	INDIVIDUAL PERSONAL PROPERTY	CURTON DAVID S	UNKNOWN	200297413	2020-2021	INDIVIDUAL PERSONAL PROPERTY	BROWN VERONICA	9920 E 85TH ST
101297240	2003	INDIVIDUAL PERSONAL PROPERTY	OBIKOYA OLUFEMI A	UNKNOWN	200297446	2019-2021	INDIVIDUAL PERSONAL PROPERTY	SPURGEON PAUL & KAY KENDRA	11600 E 61ST TER
101297245	2002	INDIVIDUAL PERSONAL PROPERTY	STILES ROBERT & HOPE MEGAN	UNKNOWN	200297447	2005	INDIVIDUAL PERSONAL PROPERTY	SANTAMARIA GUSTEND A	UNKNOWN
101297262	2002	INDIVIDUAL PERSONAL PROPERTY	LIEBAU RUTH	UNKNOWN	200297458	2002-2004	INDIVIDUAL PERSONAL PROPERTY	OSBORNE EMMETT	11009 E 74TH ST
101297287	2021	INDIVIDUAL PERSONAL PROPERTY	BLACK WILFRED	5420 BLUE RIDGE CUT OFF APT 809	200297488	2002-2006	INDIVIDUAL PERSONAL PROPERTY	WRIGLEY SHONDRA G	8900 E 64TH ST
101297290	2002	INDIVIDUAL PERSONAL PROPERTY	FOURMIER MICHAEL B & LAURIE R TROMPETER	UNKNOWN	200297540	2002	INDIVIDUAL PERSONAL PROPERTY	WILLIAMSON KATRINA	NO ADDRESS PROVIDED BY TAXPAYER
101297405	2003	INDIVIDUAL PERSONAL PROPERTY	FLOSSCHOEN JEFF P & APRIL	UNKNOWN	200297640	2002-2007	INDIVIDUAL PERSONAL PROPERTY	YANG YI Y & POON WAI Y	10105 E 64TH ST
101297443	2009-2010	INDIVIDUAL PERSONAL PROPERTY	SIMMONS SHERRIE	10313 E 71ST TER	200297770	2002-2003	INDIVIDUAL PERSONAL PROPERTY	KING LORI A	

200297838	2021	INDIVIDUAL PERSONAL PROPERTY	COLLINS ERNEST U	11209 E 62ND ST	200305080	2021	INDIVIDUAL PERSONAL PROPERTY	JAMES WILLIAM R	5610 NORTHERN AVE
200298217	2008	INDIVIDUAL PERSONAL PROPERTY	DAY SUSAN	8720 E 97TH TER	200305088	2010-2011	INDIVIDUAL PERSONAL PROPERTY	MCCEE GARETH	11004 E 83RD ST
200298247	2009-2011	INDIVIDUAL PERSONAL PROPERTY	PANGBURN CHRIS	8515 OXFORD AVE	200305122	2003-2017	INDIVIDUAL PERSONAL PROPERTY	STEVENS JOSEPH M	7315 HEDGES AVE
200298410	2015	INDIVIDUAL PERSONAL PROPERTY	FITZGEREL LUCILLE	6601 OXFORD AVE	200305231	2017-2018	INDIVIDUAL PERSONAL PROPERTY	COLEMAN CHARLES A	11705 E 51ST ST
200298493	2004-2006	INDIVIDUAL PERSONAL PROPERTY	BELLAMY KIM R	NO ADDRESS PROVIDED BY TAXPAYER	200305378	2020-2021	INDIVIDUAL PERSONAL PROPERTY	MARSHALL JANUARY E (HOLLEY)	11109 E 75TH ST
200298578	2003-2009	INDIVIDUAL PERSONAL PROPERTY	KENNEDY ROBERT J	NO ADDRESS PROVIDED BY TAXPAYER	200305517	2003-2004	INDIVIDUAL PERSONAL PROPERTY	EHLERS FRITZI	6713 HUNTER ST
200298697	2011	INDIVIDUAL PERSONAL PROPERTY	CARTER CARL ADAM	7405 HEDGES AVE	200305538	2007-2008	INDIVIDUAL PERSONAL PROPERTY	YEARMAN JEREMY A	8701 E 84TH TER
200298708	2019-2020	INDIVIDUAL PERSONAL PROPERTY	BARNES DEBBIE	7723 CRESCENT AVE	200305596	2003-2005	INDIVIDUAL PERSONAL PROPERTY	BREWER CHUCK D	6142 BROOKSIDE BLVD
200298734	2014	INDIVIDUAL PERSONAL PROPERTY	BROWN JASON D	11301 E 61ST TER	200305631	2020-2021	INDIVIDUAL PERSONAL PROPERTY	MARTIN CHERYL A	6328 HUNTER ST
200298737	2003-2004	INDIVIDUAL PERSONAL PROPERTY	MURRAY MICHELLE	UNKNOWN	200305658	2007-2011	INDIVIDUAL PERSONAL PROPERTY	FRENCH AMBER D	8531 VASSAR AVE
200298746	2006-2007	INDIVIDUAL PERSONAL PROPERTY	CHARLES CALVERT	9010 E 87TH ST APT A1	200305855	2021	INDIVIDUAL PERSONAL PROPERTY	BURNETT NICOLE LYNE	5312 DITZLER AVE
200298934	2021	INDIVIDUAL PERSONAL PROPERTY	JENSEN JOSHUA K	9400 E 69TH TER	200305856	2003-2004	INDIVIDUAL PERSONAL PROPERTY	HODGE M E & GREEN BILL	UNKNOWN
200299041	2003	INDIVIDUAL PERSONAL PROPERTY	SKAGGO MIKE	UNKNOWN	200305901	2004-2005	INDIVIDUAL PERSONAL PROPERTY	HOLLINGWORTH LUCIEN E	5428 WILLOW AVE
200299178	2003	INDIVIDUAL PERSONAL PROPERTY	NEWMAN VERA	5229 BLUE RIDGE BLVD	200305937	2009-2011	INDIVIDUAL PERSONAL PROPERTY	MIDKIFF RYAN A &/OR AIMEE J	11626 E 85TH ST
200299248	2011	INDIVIDUAL PERSONAL PROPERTY	HANZEL MICHAEL	9002 E 85TH PL	200305967	2003-2004	INDIVIDUAL PERSONAL PROPERTY	THOMPSON-SETO PAMELIA	10620 E 56TH ST
200299297	2002	INDIVIDUAL PERSONAL PROPERTY	JAMES PATRICIA A	6713 RALSTON	200306001	2004	INDIVIDUAL PERSONAL PROPERTY	HEINEN MEAGAN & EMERICK SCOTT M	7205 HARVARD DR
200299422	2003	INDIVIDUAL PERSONAL PROPERTY	FISCHER MELISSA A	10009 E 83RD ST	200306022	2004	INDIVIDUAL PERSONAL PROPERTY	JACOBI JUSTIN L	9115 E 57TH ST
200299518	2003-2016	INDIVIDUAL PERSONAL PROPERTY	RODRIGUEZ DANIEL I & MARIA V	NO ADDRESS PROVIDED BY TAXPAYER	200306133	2004-2005	INDIVIDUAL PERSONAL PROPERTY	KRAUSE KEVIN & MICHELLE	NO ADDRESS PROVIDED BY TAXPAYER
200299630	2003	INDIVIDUAL PERSONAL PROPERTY	COX STEVE L	NO ADDRESS PROVIDED BY TAXPAYER	200306240	2003-2017	INDIVIDUAL PERSONAL PROPERTY	MARTENS CHAD P	6500 CLAREMONT AVE
200299636	2011-2012	INDIVIDUAL PERSONAL PROPERTY	WITHERS TERRELL	11315 E 60TH TER	200306249	2015	INDIVIDUAL PERSONAL PROPERTY	MCDONALD TERRI	1405 SW 3RD ST APT C-2
200299682	2021	INDIVIDUAL PERSONAL PROPERTY	HARRIS LAVERNE KENNY	11213 E 61ST TER	200306274	2003-2004	INDIVIDUAL PERSONAL PROPERTY	HICKS WILLIAM A	9500 E 65TH TER
200299787	2021	INDIVIDUAL PERSONAL PROPERTY	RICE KERILYNN E	8315 HUNTER ST	200306294	2020-2021	INDIVIDUAL PERSONAL PROPERTY	STEGNER JAMES ALLEN	11604 E 75TH ST
200299834	2005	INDIVIDUAL PERSONAL PROPERTY	GENTRY MARK	NO ADDRESS PROVIDED BY TAXPAYER	200306396	2003-2008	INDIVIDUAL PERSONAL PROPERTY	RIDDITT FELICITY	7133 CEDAR AVE
200299835	2010-2011	INDIVIDUAL PERSONAL PROPERTY	WALKER NATALIE	11702 E 85TH ST	200306421	2017-2021	INDIVIDUAL PERSONAL PROPERTY	ALTIS KENNETH & ROBIN	10902 E 62ND TER
200299852	2020	INDIVIDUAL PERSONAL PROPERTY	BROSCH KEVIN	9305 E 82ND ST	200306523	2002	INDIVIDUAL PERSONAL PROPERTY	MCIGHON JOY	9215 E 65TH TER
200299936	2021	INDIVIDUAL PERSONAL PROPERTY	POWELL CHERYL A	7911 TENNESSEE AVE	200306621	2015-2021	INDIVIDUAL PERSONAL PROPERTY	ROSS TAMELA	9108 E 58TH ST
200300019	2021	INDIVIDUAL PERSONAL PROPERTY	TAYLOR STEVEN S	8906 RICHARDS DR	200306656	2006-2010	INDIVIDUAL PERSONAL PROPERTY	SANDT MELISSA	6004 ARLINGTON AVE
200300171	2010-2011	INDIVIDUAL PERSONAL PROPERTY	SCOTT AUDREY L	9208 E 85TH ST	200306662	2010-2016	INDIVIDUAL PERSONAL PROPERTY	WHORTON RONALD	6004 ARLINGTON AVE
200300411	2004-2005	INDIVIDUAL PERSONAL PROPERTY	LAXSON TIMOTHY C	NO ADDRESS PROVIDED BY TAXPAYER	200306999	2021	INDIVIDUAL PERSONAL PROPERTY	POOLE VIRGIL	9355 E 60TH TER
200300555	2002	INDIVIDUAL PERSONAL PROPERTY	GORANOV SLANESLOV T	11032 E 54TH ST	200307013	2008-2013	INDIVIDUAL PERSONAL PROPERTY	BRITTON DANA L	11823 E 83RD ST APT 202
200300589	2005	INDIVIDUAL PERSONAL PROPERTY	PADILLA ANDREW & TERRI T	6913 WILDWOOD DR	200307016	2013-2015	INDIVIDUAL PERSONAL PROPERTY	BRITTON DEBORAH	NO ADDRESS PROVIDED BY TAXPAYER
200300621	2002	INDIVIDUAL PERSONAL PROPERTY	THOMAS DUE	UNKNOWN	200307026	2002	INDIVIDUAL PERSONAL PROPERTY	GRANTHAN RYAN B	8500 ARLINGTON AVE
200300745	2003-2007	INDIVIDUAL PERSONAL PROPERTY	BAUM ROBERT S & FRANK E	NO ADDRESS PROVIDED BY TAXPAYER	200307281	2021	INDIVIDUAL PERSONAL PROPERTY	CLIFTON STEVEN	1604 SE STRATFORD ST
200300775	2005-2017	INDIVIDUAL PERSONAL PROPERTY	STINE JASON A	8522 CRESCENT AVE	200307328	2019	INDIVIDUAL PERSONAL PROPERTY	ELLIOTT JEANETTE D	6224 MANNING AVE
200300837	2006-2008	INDIVIDUAL PERSONAL PROPERTY	JEFFERSON MONICA M	8217 WOODSON DR	200307333	2011-2012	INDIVIDUAL PERSONAL PROPERTY	LIANG THOMAS C III	9409 E 79TH TER
200300840	2008-2017	INDIVIDUAL PERSONAL PROPERTY	MASONER RHONDA N	8609 EVERETT ST	200307359	2012-2016	INDIVIDUAL PERSONAL PROPERTY	PIERCE JOSHUA S	6007 FARLEY AVE
200300854	2014-2018	INDIVIDUAL PERSONAL PROPERTY	MCCREARY RANDI	9100 VAUGHN AVE	200307380	2007	INDIVIDUAL PERSONAL PROPERTY	HENSLEY TAMMY	1211 HEDGES AVE
200300877	2003	INDIVIDUAL PERSONAL PROPERTY	PAGE BRIAN S	5316 KENTUCKY AVE	200307390	2004-2005	INDIVIDUAL PERSONAL PROPERTY	WATKINS CHRIS A & /OR BUTLER LYNN	7018 WOODSON RD
200300960	2003	INDIVIDUAL PERSONAL PROPERTY	DANIELSON RYAN	8427 MARSH AVE	200307391	2003-2004	INDIVIDUAL PERSONAL PROPERTY	BRIGGS KENDRA L	UNKNOWN
200300969	2011	INDIVIDUAL PERSONAL PROPERTY	DUNCAN MICHAEL A	9805 E 61ST ST APT 4	200307403	2016-2018	INDIVIDUAL PERSONAL PROPERTY	QUIGLEY EDIE	6712 LAKESHORE DR
200300983	2021	INDIVIDUAL PERSONAL PROPERTY	DAVIS NICHOLAS JUSTIN & LAWSON SUSAN H	7924 MAPLE AVE	200307480	2006-2007	INDIVIDUAL PERSONAL PROPERTY	HERMAN STEVE & LOIS L	9119 RICHARDS DR
200300994	2002-2003	INDIVIDUAL PERSONAL PROPERTY	LUCAS JANICE M	UNKNOWN	200307531	2006	INDIVIDUAL PERSONAL PROPERTY	KEYS FRANK & ALICE	9205 E 52ND TER
200301025	2002	INDIVIDUAL PERSONAL PROPERTY	MCKENZIE ERROL B	8808 E 84TH ST	200307740	2004-2005	INDIVIDUAL PERSONAL PROPERTY	MCCEE CARMAN R	8518 OXFORD AVE
200301114	2004	INDIVIDUAL PERSONAL PROPERTY	HARRIS ALEX	UNKNOWN	200307872	2021	INDIVIDUAL PERSONAL PROPERTY	CAMPBELL SHAWN MICHAEL	8402 STARK AVE
200301205	2007	INDIVIDUAL PERSONAL PROPERTY	CLAUSING RICKY D	8319 PERSHING RD	200308014	2003	INDIVIDUAL PERSONAL PROPERTY	CANO MICHAEL	8500 MAPLE
200301252	2021	INDIVIDUAL PERSONAL PROPERTY	HAYES KATHYRENE S	NO ADDRESS PROVIDED BY TAXPAYER	200308196	2021	INDIVIDUAL PERSONAL PROPERTY	SMITH RONICA & GLENDA M	8521 DITZLER AVE
200301300	2020	INDIVIDUAL PERSONAL PROPERTY	KLEIN JUSTIN	7313 HARDY AVE	200308303	2003-2017	INDIVIDUAL PERSONAL PROPERTY	SEYMOUR LASHODA ANNETTE	8305 EVANSTON AVE
200301308	2006-2007	INDIVIDUAL PERSONAL PROPERTY	DOUGLAS GREGORY & LINSEY	NO ADDRESS PROVIDED BY TAXPAYER	200308333	2013	INDIVIDUAL PERSONAL PROPERTY	CHACE CALLIE R	11201 E 59TH ST
200301340	2007	INDIVIDUAL PERSONAL PROPERTY	GRAY PHYLLIS B	8609 CRESCENT AVE	200308584	2002	INDIVIDUAL PERSONAL PROPERTY	JEFFERSON CLARA S	10117 E 56TH ST
200301459	2002	INDIVIDUAL PERSONAL PROPERTY	PERO AMY & FERBEZAR JUSTIN	UNKNOWN	200308619	2003-2005	INDIVIDUAL PERSONAL PROPERTY	EDER MAJURA P	6908 E 85TH TER
200301506	2003-2010	INDIVIDUAL PERSONAL PROPERTY	JOHNSON DANIEL S	8804 E 73RD ST	200308718	2003-2005	INDIVIDUAL PERSONAL PROPERTY	POWELL DARRYL D	NO ADDRESS PROVIDED BY TAXPAYER
200301519	2005-2009	INDIVIDUAL PERSONAL PROPERTY	HOSKINS DONALD W	7803 CRESCENT AVE	200308959	2010-2011	INDIVIDUAL PERSONAL PROPERTY	JONES ALESA BK	8405 ARLINGTON AVE
200301660	2004-2005	INDIVIDUAL PERSONAL PROPERTY	PEMBERTON LISA & MAXON ROBERT	5924 CRESCENT AVE	200309152	2006	INDIVIDUAL PERSONAL PROPERTY	STATES RONALD A	8492 LANE DR APT 1
200301711	2009	INDIVIDUAL PERSONAL PROPERTY	MAY LACRETIA D & THOMAS SR	8815 E 85TH TER	200309174	2007-2011	INDIVIDUAL PERSONAL PROPERTY	SCHMITT ANN R	8506 CRESCENT AVE
200301908	2009-2017	INDIVIDUAL PERSONAL PROPERTY	SIMPSON ERIN D	NO ADDRESS PROVIDED BY TAXPAYER	200309232	2004-2005	INDIVIDUAL PERSONAL PROPERTY	DUGGAN SANDRA J	9306 E 82ND ST
200301980	2013-2017	INDIVIDUAL PERSONAL PROPERTY	JONES BRIAN L	6608 ELM AVE	200309266	2003	INDIVIDUAL PERSONAL PROPERTY	WALRUFF ANN K	UNKNOWN
200302006	2021	INDIVIDUAL PERSONAL PROPERTY	GENTRY LINDSEY JO	8504 GREENWOOD RD	200309486	2021	INDIVIDUAL PERSONAL PROPERTY	WILLIAMS KAREN R	6329 CEDAR AVE
200302187	2004-2008	INDIVIDUAL PERSONAL PROPERTY	BAKER JOHN A	9612 E 66TH TER	200309598	2002	INDIVIDUAL PERSONAL PROPERTY	CLARK MARY KATHRYN	UNKNOWN
200302225	2021	INDIVIDUAL PERSONAL PROPERTY	VAUGHN SHELLEY ALEXANDRIA	7424 WILLOW AVE	200309644	2003-2004	INDIVIDUAL PERSONAL PROPERTY	DELAMETER ARON	10113 E 56TH ST
200302245	2003-2008	INDIVIDUAL PERSONAL PROPERTY	KABER JAMES M	8307 DITZLER AVE	200309649	2017-2019	INDIVIDUAL PERSONAL PROPERTY	NEAL CLIFFORD	7705 BAYTOWN RD
200302298	2003-2004	INDIVIDUAL PERSONAL PROPERTY	WOODROME CYNDA L	10328 E 56TH ST	200309722	2003-2013	INDIVIDUAL PERSONAL PROPERTY	FLEMING ELLENA M	8242 SPRING VALLEY RD
200302451	2004-2005	INDIVIDUAL PERSONAL PROPERTY	CARPENTER STEVEN P & JEAN	9313 E 83RD ST	200309743	2005	INDIVIDUAL PERSONAL PROPERTY	HERRON ROGER ALLEN	8585 FARLEY AVE
200302662	2021	INDIVIDUAL PERSONAL PROPERTY	HORTON JOHN SR & GRADY DONNA	6117 DITZLER AVE	200309913	2021	INDIVIDUAL PERSONAL PROPERTY	GARCIA GERARDO ROCHA	5329 NORTHERN AVE
200302897	2019	INDIVIDUAL PERSONAL PROPERTY	STAPLES RONALD B	10309 E 61ST ST APT 2	200310116	2021	INDIVIDUAL PERSONAL PROPERTY	MCINTOSH CLIFFORD L JR	8601 BOOTH AVE
200303012	2006	INDIVIDUAL PERSONAL PROPERTY	BRITT DESIREE	NO ADDRESS PROVIDED BY TAXPAYER	200310198	2004-2006	INDIVIDUAL PERSONAL PROPERTY	CORDUM MICHAEL G	11314 E 72ND ST
200303185	2021	INDIVIDUAL PERSONAL PROPERTY	BENNETT CHERYL L	6113 LANE AVE	200310452	2017-2021	INDIVIDUAL PERSONAL PROPERTY	ROLAND ELARA	7929 HEDGES AVE
200303204	2013-2014	INDIVIDUAL PERSONAL PROPERTY	JENNINGS MARY A	5728 CEDAR AVE	200310547	2002	INDIVIDUAL PERSONAL PROPERTY	WENING BRIAN A	UNKNOWN
200304168	2004	INDIVIDUAL PERSONAL PROPERTY	KENDRICK LYNDDOL L	11004 E 78TH ST	200310711	2007-2017	INDIVIDUAL PERSONAL PROPERTY	LOGAN MATTHEW S	5919 HARRIS AVE
200304264	2012-2014	INDIVIDUAL PERSONAL PROPERTY	NATION KIMBERLY	11215 E 51ST ST	200310921	2021	INDIVIDUAL PERSONAL PROPERTY	HILL CHELESE D	11005 E 83RD ST
200304638	2021	INDIVIDUAL PERSONAL PROPERTY	SMITH MARY KATHERINE	7427 HUNTER ST	200311097	2013	INDIVIDUAL PERSONAL PROPERTY	ALHAMAR MOHAMED T	11811 E 85TH ST
200304670	2016	INDIVIDUAL PERSONAL PROPERTY	LANE JUSTIN S	222 E EMANUEL CLEAVER I BLVD APT 1W	200311327	2004	INDIVIDUAL PERSONAL PROPERTY	LEE LORI ANNE	8317 WOODSON DR
200304819	2018-2021	INDIVIDUAL PERSONAL PROPERTY	WILLIAMS HEATHER N	9401 E 66TH ST	200311374	2003-2004	INDIVIDUAL PERSONAL PROPERTY	CARVER JOSHUA WAYNE	11811 E 83RD ST

200311535	2003-2007	INDIVIDUAL PERSONAL PROPERTY	FARRIS JOHNATHAN J	6720 APPLETON AVE	200318461	2003	INDIVIDUAL PERSONAL PROPERTY	FRANCIS DARYL	UNKNOWN
200311538	2003	INDIVIDUAL PERSONAL PROPERTY	BARNARD AMY J	11701 E 56TH ST	200318541	2003	INDIVIDUAL PERSONAL PROPERTY	GASTON BOBBI B	6212 WILLOW
200311655	2021	INDIVIDUAL PERSONAL PROPERTY	KHALIFAH ASYA HAMEEN	7321 CEDAR AVE	200318675	2003-2004	INDIVIDUAL PERSONAL PROPERTY	CLAUVIO SOTO ERNESTO R	9214 E 54TH ST
200312029	2021	INDIVIDUAL PERSONAL PROPERTY	ALEXANDER ARLEATHIA DENISE	8301 LANE AVE	200318840	2006	INDIVIDUAL PERSONAL PROPERTY	HERNOND VIVIAN L	5512 MAYWOOD AVE
200312257	2009-2017	INDIVIDUAL PERSONAL PROPERTY	MCINTOSH TIARA	8601 BOOTH AVE	200318963	2018-2021	INDIVIDUAL PERSONAL PROPERTY	MCCAY SHANISHA L	11424 E 75TH ST
200312345	2009-2012	INDIVIDUAL PERSONAL PROPERTY	CARTER BRITTANI R	10401 E 79TH TER	200319012	2011-2016	INDIVIDUAL PERSONAL PROPERTY	MORRIS MICHELE	8216 5TERLING AVE
200312375	2021	INDIVIDUAL PERSONAL PROPERTY	OGUNNIYI CHRISTOPHER OLABOWALE	8504 DITZLER AVE	200319021	2013	INDIVIDUAL PERSONAL PROPERTY	HOWARD HARVEY OR GRANT	5717 HUNTER ST
200312392	2003-2004	INDIVIDUAL PERSONAL PROPERTY	BROWN LINDA R	5420 OXFORD	200319034	2013-2014	INDIVIDUAL PERSONAL PROPERTY	SLINKARD SHELLEY D	8703 MANCHESTER AVE
200312403	2021	INDIVIDUAL PERSONAL PROPERTY	LEWIS MELBRA	7238 RAYTOWN RD APT C	200319047	2019-2021	INDIVIDUAL PERSONAL PROPERTY	WASSON RACHEL A	8919 E 56TH TER
200312550	2004	INDIVIDUAL PERSONAL PROPERTY	KINNEY DARENDA	UNKNOWN	200319099	2017-2021	INDIVIDUAL PERSONAL PROPERTY	OMALLEY KATHRINE L	6533 RAYTOWN RD APT 4
200312733	2021	INDIVIDUAL PERSONAL PROPERTY	MANSELL MICHAEL G	5403 BLUE RIDGE BLVD	200319189	2003-2010	INDIVIDUAL PERSONAL PROPERTY	DICKERSON KYLE W	11800 E 77TH TER
200312834	2021	INDIVIDUAL PERSONAL PROPERTY	DUNIGAN RICKY GENE	7620 STERLING AVE	200319198	2003-2009	INDIVIDUAL PERSONAL PROPERTY	ROTH JOY E	NO ADDRESS PROVIDED BY TAXPAYER
200313061	2003-2004	INDIVIDUAL PERSONAL PROPERTY	HARVEY JOHN R & FEIGHT T	10812 E 66TH TER	200319397	2003	INDIVIDUAL PERSONAL PROPERTY	FORD CORY J	5516 HARDY
200313232	2021	INDIVIDUAL PERSONAL PROPERTY	LOVELACE SHALISHIA D	8600 MAYWOOD AVE	200320241	2020-2021	INDIVIDUAL PERSONAL PROPERTY	RAGSDALE WILLIAM H	7226 RAYTOWN RD APT B
200313233	2013-2015	INDIVIDUAL PERSONAL PROPERTY	HAMILTON GRAVES PHILLIS	9707 E 80TH ST	200320959	2020	INDIVIDUAL PERSONAL PROPERTY	BELSHE JASON A	6616 WOODSON RD
200313247	2003	INDIVIDUAL PERSONAL PROPERTY	GONZAGOWSKI JOHN A	6805 ELM AVE	200321392	2003	INDIVIDUAL PERSONAL PROPERTY	ELLISON LISSA	8401 E 114TH TER
200313265	2021	INDIVIDUAL PERSONAL PROPERTY	OEHRRING TARA & GREG	7415 WILLOW AVE	200321461	2002-2005	INDIVIDUAL PERSONAL PROPERTY	APPLEMAN JACOB A & AUBREY M	3734 BIRCHWOOD DR
200313273	2021	INDIVIDUAL PERSONAL PROPERTY	SIMS THERESA R	7616 ENGLEWOOD AVE	200321591	2004	INDIVIDUAL PERSONAL PROPERTY	DRAKE ALICIA K & GREGORY D	5432 WILLOW
200313309	2006	INDIVIDUAL PERSONAL PROPERTY	DAVIDSON COURTNEY	5813 STERLING AVE	200322016	2014-2016	INDIVIDUAL PERSONAL PROPERTY	BROWN CHRIS M	5608 DITZLER AVE
200313316	2017	INDIVIDUAL PERSONAL PROPERTY	BROWN JERILYN	5336 HEDGES AVE	200322078	2021	INDIVIDUAL PERSONAL PROPERTY	JONES SHAVANNA RENEE	7828 RIDGEWAY AVE
200313340	2006-2007	INDIVIDUAL PERSONAL PROPERTY	FISHER CHAD & TANYA	9101 E 65TH ST	200322131	2003-2005	INDIVIDUAL PERSONAL PROPERTY	ELKINS EDWARD & BERNIE	6324 CEDAR AVE
200313415	2008-2017	INDIVIDUAL PERSONAL PROPERTY	YOUNG BRANDON A & ELLEXSON SHELBY D	8401 E 86TH TER	200322197	2008-2011	INDIVIDUAL PERSONAL PROPERTY	ORTIZ LUIS A	8114 MANNING AVE
200313446	2004-2005	INDIVIDUAL PERSONAL PROPERTY	STRICKLAND SHABREA M	2750 BRIGHTON AVE	200322198	2003	INDIVIDUAL PERSONAL PROPERTY	PARKER AMANDA	11408 E 59TH ST
200313469	2021	INDIVIDUAL PERSONAL PROPERTY	SEGARS JONATHAN & POPE CAROL A	7321 BLUE RIDGE BLVD	200322209	2005-2013	INDIVIDUAL PERSONAL PROPERTY	DAVIS GWENETTA	7316 HEDGES AVE
200313482	2019	INDIVIDUAL PERSONAL PROPERTY	BARTLETT LARRY E	5327 HARDY AVE	200322987	2006-2007	INDIVIDUAL PERSONAL PROPERTY	ESLICK MICHAEL S & WENDY M	8151 MAPLE AVE
200313632	2020-2021	INDIVIDUAL PERSONAL PROPERTY	HATCHITT JAMIE	6494 BLUE RIDGE BLVD	200323141	2020-2021	INDIVIDUAL PERSONAL PROPERTY	WILLIAMS BOBBIE E	8921 E 81ST ST
200313685	2003-2004	INDIVIDUAL PERSONAL PROPERTY	FLINN JEREMY D	UNKNOWN	200323273	2006-2016	INDIVIDUAL PERSONAL PROPERTY	FOSTER LASHAWN	10405 E 65TH ST
200313926	2005	INDIVIDUAL PERSONAL PROPERTY	SCHIENI CHRISTOPHER J	8609 ELM AVE	200323773	2020-2021	INDIVIDUAL PERSONAL PROPERTY	FREEMAN VERA	8410 WOODSON PL
200313958	2019-2021	INDIVIDUAL PERSONAL PROPERTY	FRIEDT MAUREN	5316 APPLETON AVE	200324073	2014-2016	INDIVIDUAL PERSONAL PROPERTY	SNELL LINDA A	11208 E 71ST DR
200314077	2020-2021	INDIVIDUAL PERSONAL PROPERTY	SMITH CAROLYN J & JOHN C	8129 WILLOW WAY	200324133	2021	INDIVIDUAL PERSONAL PROPERTY	BROWN ROSEMARY C	8401 GREENWOOD RD
200314089	2020-2021	INDIVIDUAL PERSONAL PROPERTY	HAYNES RONALD E	6817 HUNTER ST UNIT B	200324385	2002	INDIVIDUAL PERSONAL PROPERTY	ADAMS CHRIS M	UNKNOWN
200314121	2003-2005	INDIVIDUAL PERSONAL PROPERTY	LEWIS SANDRA A & JASON M	507 NE FOX TRAIL DR	200324474	2021	INDIVIDUAL PERSONAL PROPERTY	JENNINGS REX ALAN	10014 E 71ST TER
200314140	2014-2021	INDIVIDUAL PERSONAL PROPERTY	COLEMAN LARRY D	6837 LAKEHORE DR	200324492	2021	INDIVIDUAL PERSONAL PROPERTY	HART CHALESE J	11218 E 71ST TER
200314151	2021	INDIVIDUAL PERSONAL PROPERTY	COCHRAN TERRANCE J	7302 ELM ST	200324499	2012	INDIVIDUAL PERSONAL PROPERTY	MERCADO SIMEON	NO ADDRESS PROVIDED BY TAXPAYER
200314247	2003-2004	INDIVIDUAL PERSONAL PROPERTY	YOUNG SHANNON	7216 OXFORD AVE	200324678	2003	INDIVIDUAL PERSONAL PROPERTY	WARE RIQUISHA	NO ADDRESS PROVIDED BY TAXPAYER
200314351	2014	INDIVIDUAL PERSONAL PROPERTY	BURNSIDE CHARITY (SHIELDS)	10408 E 79TH ST	200324697	2003-2017	INDIVIDUAL PERSONAL PROPERTY	LUMBACH CURTIS & CLINTON	11601 E 62ND ST
200314657	2021	INDIVIDUAL PERSONAL PROPERTY	NELSON PENION	5410 OXFORD AVE	200324998	2002-2003	INDIVIDUAL PERSONAL PROPERTY	FRITZEL WILLIAM L	NO ADDRESS PROVIDED BY TAXPAYER
200314708	2001-2008	INDIVIDUAL PERSONAL PROPERTY	TALLEY SHALITHA	6117 DITZLER AVE	200325207	2009	INDIVIDUAL PERSONAL PROPERTY	REVELS KANESHIA	6314 BELLEFONTAINE AVE
200314820	2020-2021	INDIVIDUAL PERSONAL PROPERTY	JACKSON LAWANDA E	8808 E 58TH TER	200325270	2005	INDIVIDUAL PERSONAL PROPERTY	BACON JEFFREY W & TIA M	8427 ARLINGTON AVE
200315090	2021	INDIVIDUAL PERSONAL PROPERTY	STEGMAN DANIEL	7505 MAPLE LN	200325830	2015-2016	INDIVIDUAL PERSONAL PROPERTY	BELL RICKY B	11112 E 71ST TER
200315157	2011	INDIVIDUAL PERSONAL PROPERTY	FLETCHER CYNTHIA M	10900 E 67TH ST	200352466	2003-2004	INDIVIDUAL PERSONAL PROPERTY	MCMURRAY JUDY F	4907 OVERTON AVE
200315180	2021	INDIVIDUAL PERSONAL PROPERTY	RAMIREZ ESTHER & MANUEL H	8509 E 81ST ST	200353045	2021	INDIVIDUAL PERSONAL PROPERTY	JACKSON MICHELE M & DAVID R	5408 WILLOW AVE
200315189	2021	INDIVIDUAL PERSONAL PROPERTY	HACKER ROBERT W	11001 E 85TH ST	200353461	2003-2005	INDIVIDUAL PERSONAL PROPERTY	HUDDLESTON CHRIS J	5321 HEDGES AVE
200315225	2012	INDIVIDUAL PERSONAL PROPERTY	HANCOCK NICOLE A	8321 HEDGES AVE	200353529	2021	INDIVIDUAL PERSONAL PROPERTY	BRANSTETTER DAVID ALLEN	6916 HAWTHORNE AVE
200315254	2017	INDIVIDUAL PERSONAL PROPERTY	CALDWELL JOHN D	7625 STERLING AVE	200354145	2003	INDIVIDUAL PERSONAL PROPERTY	EALEY MELLISSA	7815 WOODSON
200315287	2021	INDIVIDUAL PERSONAL PROPERTY	NEWTON CASSANDRA EVETTE	10104 E 68TH TER	200354296	2003-2017	INDIVIDUAL PERSONAL PROPERTY	FORD ARTHUR D III	8506 EVERETT ST
200315377	2003	INDIVIDUAL PERSONAL PROPERTY	HOLTER JASON P	9912 E 60TH ST	200354334	2003	INDIVIDUAL PERSONAL PROPERTY	ROLAND TRAVIS	3294 CLEVELAND
200315389	2005-2006	INDIVIDUAL PERSONAL PROPERTY	BESTUL TROY	6553 RAYTOWN RD APT 1B	200354604	2020-2021	INDIVIDUAL PERSONAL PROPERTY	PARSONS RAY E & MELODY	8620 E 80TH TER
200315723	2003-2005	INDIVIDUAL PERSONAL PROPERTY	CRAWFORD TRAVIS J	NO ADDRESS PROVIDED BY TAXPAYER	200354615	2015-2021	INDIVIDUAL PERSONAL PROPERTY	CAIN CRYSTAL A (HILL)	5388 BLUE RIDGE BLVD
200315764	2004-2005	INDIVIDUAL PERSONAL PROPERTY	DANDO CHRISTOPHER B	8604 MAYWOOD AVE	200354618	2003	INDIVIDUAL PERSONAL PROPERTY	MUHAMMAD TARAR A	6709 HUNTER
200315992	2006	INDIVIDUAL PERSONAL PROPERTY	VANBIBBER ROBERT E JR	5420 BLUE RIDGE CUT OFF APT G01	200354620	2007-2008	INDIVIDUAL PERSONAL PROPERTY	FAZEL SARAH & BRANDON G	NO ADDRESS PROVIDED BY TAXPAYER
200316117	2011-2012	INDIVIDUAL PERSONAL PROPERTY	NEVILS DIANE R	8611 WESTRIDGE RD	200354628	2003-2009	INDIVIDUAL PERSONAL PROPERTY	COLE JEFF E	6202 NORTHERN AVE
200316267	2021	INDIVIDUAL PERSONAL PROPERTY	GONZALEZ APRIL M & JOSE L	5900 NORTHERN AVE	200354674	2021	INDIVIDUAL PERSONAL PROPERTY	GOODS SHANELLE RENEE	10505 E 66TH ST
200316536	2001	INDIVIDUAL PERSONAL PROPERTY	BOYCE RICHARD G	8412 GREENWOOD RD	200354739	2020	INDIVIDUAL PERSONAL PROPERTY	KEESLER DEBBIE	NO ADDRESS PROVIDED BY TAXPAYER
200316772	2005-2006	INDIVIDUAL PERSONAL PROPERTY	WALLACE TRACY L	NO ADDRESS PROVIDED BY TAXPAYER	200354816	2021	INDIVIDUAL PERSONAL PROPERTY	DILLMAN MATTHEW J	8416 BOOTH AVE
200316845	2003-2004	INDIVIDUAL PERSONAL PROPERTY	FARRAR SHAINA	8618 E 84TH ST	200354882	2008-2011	INDIVIDUAL PERSONAL PROPERTY	UTA TAMMY	8701 E 80TH TER
200316918	2021	INDIVIDUAL PERSONAL PROPERTY	BOKONICH JUDITH A	11818 E 47TH TER	200354911	2021	INDIVIDUAL PERSONAL PROPERTY	HAMILTON CAROL ANN	9030 E 85TH TER
200316988	2002-2004	INDIVIDUAL PERSONAL PROPERTY	MAGNANA RAMIRO	UNKNOWN	200354943	2004-2007	INDIVIDUAL PERSONAL PROPERTY	EARL DAVID A	5812 LANE AVE
200317058	2008	INDIVIDUAL PERSONAL PROPERTY	SLEVIN HOWARD JR & ELSIE	5328 ASH AVE	200355101	2002-2004	INDIVIDUAL PERSONAL PROPERTY	HINSON JESS G	5919 E 82ND ST
200317233	2005	INDIVIDUAL PERSONAL PROPERTY	ATKESON SHARON SUE	7701 RAYTOWN RD APT 10	200355449	2003-2004	INDIVIDUAL PERSONAL PROPERTY	SIERKS CHARLES H JR	8309 NORTHERN ST
200317355	2006-2007	INDIVIDUAL PERSONAL PROPERTY	OSBORNE CYNTHIA G	11212 E 75TH TER	200355529	2016-2021	INDIVIDUAL PERSONAL PROPERTY	WILSON DOROTHY M	NO ADDRESS PROVIDED BY TAXPAYER
200317554	2017-2018	INDIVIDUAL PERSONAL PROPERTY	WILSON SPARKLE LATORIA	8003 DITZLER AVE	200355538	2005	INDIVIDUAL PERSONAL PROPERTY	BRUCE EDWARD R & ALYSSA	9315 E US 350 HWY
200317600	2021	INDIVIDUAL PERSONAL PROPERTY	RIMMER DAVID W	8700 EVANSTON AVE	200355577	2003-2004	INDIVIDUAL PERSONAL PROPERTY	CARROLL PEGGY & EDWARD	8701 E 87TH ST APT D7
200317646	2013-2014	INDIVIDUAL PERSONAL PROPERTY	MILLER DAVID E	8863 E 52ND TER	200355647	2011-2012	INDIVIDUAL PERSONAL PROPERTY	KIRUI EDWARD C	5401 ELM AVE
200317681	2008-2009	INDIVIDUAL PERSONAL PROPERTY	NGUYEN CHISTITA B	7905 HEDGES AVE	200355655	2010-2012	INDIVIDUAL PERSONAL PROPERTY	MYERS CLAYTON & EDWARDS JESSICA	9945 E 61ST ST APT 1
200317777	2007-2011	INDIVIDUAL PERSONAL PROPERTY	FREE WILLIAM L & YETONDA L	5815 FARLEY AVE	200355758	2007-2008	INDIVIDUAL PERSONAL PROPERTY	PEREZ JOSE LUIS	8611 LANE AVE
200317831	2011-2017	INDIVIDUAL PERSONAL PROPERTY	GREGORY JERMAINE N	9137 RICHARDS DR	200355797	2008-2010	INDIVIDUAL PERSONAL PROPERTY	WHITE CHARLES K JR & MELINDA M	9106 VAUGHN AVE
200317873	2014	INDIVIDUAL PERSONAL PROPERTY	BROOKE TIM & CARRIE	8111 RAYTOWN RD	200682207	2018-2020	INDIVIDUAL PERSONAL PROPERTY	WALKER MARK CHRISTOPHER	7310 BLUE RIDGE BLVD
200317883	2013-2014	INDIVIDUAL PERSONAL PROPERTY	HEADLEY LESLIE E TERRY	5316 MAYWOOD AVE	200682346	2003-2007	INDIVIDUAL PERSONAL PROPERTY	MEYER MELINDA S	5732 LANE AVE
200318280	2005	INDIVIDUAL PERSONAL PROPERTY	KIRUI BETTY	NO ADDRESS PROVIDED BY TAXPAYER	200682547	2006-2008	INDIVIDUAL PERSONAL PROPERTY	NOONER TERRY JR	9206 E 79TH ST
200318301	2002	INDIVIDUAL PERSONAL PROPERTY	LE CLAIR PAMELA	NO ADDRESS PROVIDED BY TAXPAYER	200682932	2018-2021	INDIVIDUAL PERSONAL PROPERTY	FITZWATER BRANDI	919 E SEA AVE
200318306	2006-2008	INDIVIDUAL PERSONAL PROPERTY	JOHNSON BRIAN	7156 WOODSON RD	200683000	2004-2005	INDIVIDUAL PERSONAL PROPERTY	HANEY KENNETH L	

200683060	2021	INDIVIDUAL PERSONAL PROPERTY	RAMIREZ MANUEL H & RAMIREZ ANGEL M	8509 E 81ST ST	200693469	2007-2009	INDIVIDUAL PERSONAL PROPERTY	ZIPF MATTHEW L	5417 WOODSON RD
200683063	2015-2017	INDIVIDUAL PERSONAL PROPERTY	CANADY MISTY D & BELL VALERIA	8811 E 61ST ST	200694675	2020-2021	INDIVIDUAL PERSONAL PROPERTY	WISEMAN DONALD & JOANNE	10710 E 65TH TER
200683366	2006	INDIVIDUAL PERSONAL PROPERTY	LOMAX ZULEIKA M	5419 OXFORD AVE	200694814	2021	INDIVIDUAL PERSONAL PROPERTY	WADDELL KORY DALE	10009 E 83RD TER
200683395	2003-2005	INDIVIDUAL PERSONAL PROPERTY	WAITS MELISSA	5315 ASH AVE	200694830	2020-2021	INDIVIDUAL PERSONAL PROPERTY	PORTER BEIANCA	10712 E 83RD TER
200683427	2004	INDIVIDUAL PERSONAL PROPERTY	TEBBS SAUNDRA R	7213 RAYTOWN RD	200694859	2018-2021	INDIVIDUAL PERSONAL PROPERTY	MAIN KRISTEN & WILLIAM	5405 ELM AVE
200683462	2010	INDIVIDUAL PERSONAL PROPERTY	VILLEGAS MARTIN	9400 E 83RD ST	200694960	2009-2011	INDIVIDUAL PERSONAL PROPERTY	ARDITO GINA A	405 E 63RD TER
200683477	2005-2017	INDIVIDUAL PERSONAL PROPERTY	WEYGARTS JOHN & MARY	NO ADDRESS PROVIDED BY TAXPAYER	200695398	2009	INDIVIDUAL PERSONAL PROPERTY	HOOTZ JOANN	8814 E 85TH TER
200683489	2019	INDIVIDUAL PERSONAL PROPERTY	LEAPHART BERNARD & JEANINE	10311 E 78TH ST	200695931	2016	INDIVIDUAL PERSONAL PROPERTY	DEMOSS LAURA	1309 N REDWOOD DR
200683506	2008-2010	INDIVIDUAL PERSONAL PROPERTY	SANDERS LEONARD	10014 E 78TH TER	200696759	2010	INDIVIDUAL PERSONAL PROPERTY	SMITH KEITH P	2525 MAIN ST UNIT 308
200683577	2021	INDIVIDUAL PERSONAL PROPERTY	BARTELLI DAN	9208 E 68TH ST	200697043	2010-2017	INDIVIDUAL PERSONAL PROPERTY	PLAYTER MICHAEL	5420 BLUE RIDGE CUT OFF APT 513
200683578	2003	INDIVIDUAL PERSONAL PROPERTY	HEARD SHEILA F	UNKNOWN	200697232	2021	INDIVIDUAL PERSONAL PROPERTY	ICART JACKY	10105 E 84TH ST
200683589	2003-2017	INDIVIDUAL PERSONAL PROPERTY	WHITE CHERYLL Y	6604 ENGLEWOOD AVE	200697490	2020-2021	INDIVIDUAL PERSONAL PROPERTY	SIMMONS VERNAIL JR	8819 E 84TH TER
200683600	2006-2010	INDIVIDUAL PERSONAL PROPERTY	RUCKER FLOYD & KIZER VIVAN	8904 E 72ND ST	200697533	2017-2020	INDIVIDUAL PERSONAL PROPERTY	COOPER MONIQUE COLET	11303 E 61ST TER
200683619	2006	INDIVIDUAL PERSONAL PROPERTY	BURTON LISSA	SITUS VERIFICATION IN PROGRESS	200697538	2004-2006	INDIVIDUAL PERSONAL PROPERTY	STANLEY GARY A	NO ADDRESS PROVIDED BY TAXPAYER
200683623	2019	INDIVIDUAL PERSONAL PROPERTY	MCMANUS PHILLIP	9008 E 87TH ST	200697780	2012-2013	INDIVIDUAL PERSONAL PROPERTY	SPENCER DEBORAH A	9222 E 54TH ST
200683648	2021	INDIVIDUAL PERSONAL PROPERTY	SIMMONS CHAUNTEA N	6009 BLUE RIDGE CUT OFF	200697786	2020-2021	INDIVIDUAL PERSONAL PROPERTY	HOSKINS LEKEISHA L	7401 HEDGES AVE
200683723	2021	INDIVIDUAL PERSONAL PROPERTY	GOETZ MARY E	9012 E 75TH ST	200698503	2005-2006	INDIVIDUAL PERSONAL PROPERTY	FLOREZ-DUNCAN ESTELLA A	9420 E 55TH ST
200683734	2010-2011	INDIVIDUAL PERSONAL PROPERTY	REYNOLDS TIFFANY A (TURCOTTE)	9114 E 66TH TER	200698590	2019	INDIVIDUAL PERSONAL PROPERTY	VOCHATZER ANGELA (SHRIVER)	808 SE 11TH TER
200683785	2004	INDIVIDUAL PERSONAL PROPERTY	CHURCH GARY OLIN	11200 E 67TH ST	200698866	2003	INDIVIDUAL PERSONAL PROPERTY	PENNIMAN DANIELLE	9319 E 84TH ST
200683914	2012	INDIVIDUAL PERSONAL PROPERTY	POWELL ROBERT L	7705 RAYTOWN RD	200699138	2002	INDIVIDUAL PERSONAL PROPERTY	ROHLFS KEVIN G	5420 RALSTON
200684002	2007-2017	INDIVIDUAL PERSONAL PROPERTY	MCFARLAND CAROLE C	UNKNOWN	200699162	2003	INDIVIDUAL PERSONAL PROPERTY	KAIN CHARLES	UNKNOWN
200684101	2018	INDIVIDUAL PERSONAL PROPERTY	DUNN LASHAWN M	11024 E 54TH ST	200699185	2004-2005	INDIVIDUAL PERSONAL PROPERTY	SMITH SHANNON M (BROWN)	NO ADDRESS PROVIDED BY TAXPAYER
200684108	2004	INDIVIDUAL PERSONAL PROPERTY	MCDERMOTT APRIL & COCHRAN BRANDON	UNKNOWN	200699350	2003-2006	INDIVIDUAL PERSONAL PROPERTY	PORTER JOE	10511 MAPLE AVE
200684500	2011	INDIVIDUAL PERSONAL PROPERTY	BROWN VIRGINIA M	6015 LAUREL AVE	200699357	2021	INDIVIDUAL PERSONAL PROPERTY	SHIPLEY TIMOTHY L	5400 RALSTON AVE
200684508	2004	INDIVIDUAL PERSONAL PROPERTY	PHAM TRI H	UNKNOWN	200699450	2003	INDIVIDUAL PERSONAL PROPERTY	GRESS SAMANTHA & MICHAEL	11701 E 83RD ST APT 102
200684566	2014-2017	INDIVIDUAL PERSONAL PROPERTY	STRICKLAND SHARICE	10509 E 82ND ST	200699525	2007	INDIVIDUAL PERSONAL PROPERTY	WILLIAMS MONICA M	8492 LANE DR APT 1
200684623	2009	INDIVIDUAL PERSONAL PROPERTY	CALDWELL SAMANTHA	6600 HARRIS AVE	200699563	2009-2010	INDIVIDUAL PERSONAL PROPERTY	ANDERSON HEIDI J	7905 ARLINGTON AVE
200684625	2006-2007	INDIVIDUAL PERSONAL PROPERTY	PECHT VICTORIA	6408 HARDY AVE	200699665	2006-2009	INDIVIDUAL PERSONAL PROPERTY	MBAYOH FRANKELLA	9917 E 60TH ST
200684642	2003	INDIVIDUAL PERSONAL PROPERTY	CRUTH ANGELICA R	7508 MARLE LN	200699686	2021	INDIVIDUAL PERSONAL PROPERTY	HAWTHORNE EDRIC	8209 WOODSON DR
200684663	2005	INDIVIDUAL PERSONAL PROPERTY	LANGDON RICHARD JAMES	NO ADDRESS PROVIDED BY TAXPAYER	200699705	2003-2004	INDIVIDUAL PERSONAL PROPERTY	HARRIS NATHAN	8310 E 111TH TER
200684677	2015-2021	INDIVIDUAL PERSONAL PROPERTY	DAWSON WATONNA CAROL	9616 E 66TH TER	200699757	2004	INDIVIDUAL PERSONAL PROPERTY	MURPHY MATT L & SARAH J	8917 E 72ND ST
200684684	2004-2005	INDIVIDUAL PERSONAL PROPERTY	PURSER DAWN L	8414 WOODSON CT	200699766	2021	INDIVIDUAL PERSONAL PROPERTY	JOHNSON LARRY & LINDA F	8637 E UTOPIA PKWY APT 7
200684846	2004-2005	INDIVIDUAL PERSONAL PROPERTY	BORRA MOLLY J (STRAIT)	8918 E 59TH ST	200699855	2020-2021	INDIVIDUAL PERSONAL PROPERTY	WILLIAMS DIANA	4614 WILLOW AVE
200685022	2003	INDIVIDUAL PERSONAL PROPERTY	FALAH JEANELLE	6713 RALSTON	200699925	2009-2017	INDIVIDUAL PERSONAL PROPERTY	PARSONS LARRY	6718 HARRIS AVE
200685026	2012-2017	INDIVIDUAL PERSONAL PROPERTY	BROWN JULIE A	11413 E 77TH ST	200700038	2009	INDIVIDUAL PERSONAL PROPERTY	MORMAN JOHN W	5420 BLUE RIDGE CUT OFF APT G01
200685216	2003-2010	INDIVIDUAL PERSONAL PROPERTY	HUGHLEY JOI A	11209 E 75TH ST	200700206	2013-2016	INDIVIDUAL PERSONAL PROPERTY	SALGADO MARIO I	10317 E 61ST ST APT 1
200685236	2017	INDIVIDUAL PERSONAL PROPERTY	LAIDLIEY KALIE MARIAM	8806 E 72ND TER	200700228	2021	INDIVIDUAL PERSONAL PROPERTY	WILLIAMS RICKY A	8606 CRESCENT AVE
200685250	2008-2009	INDIVIDUAL PERSONAL PROPERTY	CLARDY JACOB L	11204 E 63RD ST	200700387	2004-2005	INDIVIDUAL PERSONAL PROPERTY	SARAHIA ALEJANDRT	NO ADDRESS PROVIDED BY TAXPAYER
200685257	2021	INDIVIDUAL PERSONAL PROPERTY	DAVIS AARON L (WOODS)	9021 E 85TH ST	200700396	2007-2008	INDIVIDUAL PERSONAL PROPERTY	AGGREY FELIX	8805 E 62ND TER
200685319	2019-2021	INDIVIDUAL PERSONAL PROPERTY	CROSS BRIAN D	6809 HUNTER ST	200700469	2006	INDIVIDUAL PERSONAL PROPERTY	HUNDALL SARA A	8205 KENTUCKY AVE
200685320	2020-2021	INDIVIDUAL PERSONAL PROPERTY	BUSH WARREN CROSBY III	8815 E 52ND TER	200700477	2019-2021	INDIVIDUAL PERSONAL PROPERTY	GAINES MICHAEL CHRISTOPHER	8917 E 72ND ST
200685402	2005	INDIVIDUAL PERSONAL PROPERTY	STOCKMANN DAWN	NO ADDRESS PROVIDED BY TAXPAYER	200700521	2020-2021	INDIVIDUAL PERSONAL PROPERTY	LEE PAMELA R	9213 E 65TH ST
200685450	2021	INDIVIDUAL PERSONAL PROPERTY	PEMBRICK PAUL D	8523 STERLING AVE	200700725	2015-2017	INDIVIDUAL PERSONAL PROPERTY	GOOD RYAN JOSEPH	9103 E 65TH ST
200685592	2021	INDIVIDUAL PERSONAL PROPERTY	WINSOR DUANE T & TAMMY LEE	6814 LAKESHORE CT	200701010	2003-2005	INDIVIDUAL PERSONAL PROPERTY	DAY ROLAND	8612 E 87TH ST
200686267	2020-2021	INDIVIDUAL PERSONAL PROPERTY	CARTER REGINA	6116 ARLINGTON AVE	200701018	2016-2018	INDIVIDUAL PERSONAL PROPERTY	PEEL TERESA	9330 E 83RD ST
200686289	2005	INDIVIDUAL PERSONAL PROPERTY	DRAKE JARRETT & CRYSTAL	7805 ENGLEWOOD AVE	200701237	2005-2015	INDIVIDUAL PERSONAL PROPERTY	HOLST SHAWN M	8421 ELM AVE
200686551	2003-2004	INDIVIDUAL PERSONAL PROPERTY	BROWN DAVID L	6209 KENTUCKY	200701259	2017	INDIVIDUAL PERSONAL PROPERTY	JEFFERS EARL	9116 RICHARDS DR
200686803	2003-2017	INDIVIDUAL PERSONAL PROPERTY	GATES FENISHEA & WAYNE	8421 SPRING VALLEY RD	200701283	2010-2011	INDIVIDUAL PERSONAL PROPERTY	MCENTIRE REBECCA	13701 11TH TER
200686896	2005-2006	INDIVIDUAL PERSONAL PROPERTY	CASHION JAMES H	NO ADDRESS PROVIDED BY TAXPAYER	200701343	2009-2010	INDIVIDUAL PERSONAL PROPERTY	DOUGLAS KYLE	8024 HUNTER ST
200687344	2019-2021	INDIVIDUAL PERSONAL PROPERTY	TUCKER DARIN	9346 E 55TH ST	200701347	2021	INDIVIDUAL PERSONAL PROPERTY	PARKER DEMETRIUS EARL	10108 E 68TH TER
200687462	2003-2004	INDIVIDUAL PERSONAL PROPERTY	SOUTHARD AMANDA K	6804 LAUREL	200701401	2003-2004	INDIVIDUAL PERSONAL PROPERTY	CLAUDIO ERNESTO	9212 E 54TH ST
200687514	2020-2021	INDIVIDUAL PERSONAL PROPERTY	LITENBERGER KRISTINA	6803 HUNTER ST	200701417	2009	INDIVIDUAL PERSONAL PROPERTY	JONES JAMES	8458 LANE DR
200687562	2005-2006	INDIVIDUAL PERSONAL PROPERTY	ADAMS ARDETH J	9420 E 67TH TER	200701457	2003	INDIVIDUAL PERSONAL PROPERTY	SPROWLS DONNA	NO ADDRESS PROVIDED BY TAXPAYER
200687611	2009	INDIVIDUAL PERSONAL PROPERTY	MCCALL STEVEN & HIEMAN JULIE	6808 RAYTOWN RD	200701478	2015	INDIVIDUAL PERSONAL PROPERTY	ALBERT JOHN N	5808 STERLING AVE
200687860	2009	INDIVIDUAL PERSONAL PROPERTY	GORDON RAQUEL	6730 STERLING AVE	200701492	2003-2017	INDIVIDUAL PERSONAL PROPERTY	FRANKLIN VICTOR	NO ADDRESS PROVIDED BY TAXPAYER
200688277	2014-2015	INDIVIDUAL PERSONAL PROPERTY	WALKER LYNDA (SALMON)	5512 HARDY AVE	200701581	2004	INDIVIDUAL PERSONAL PROPERTY	BROWN HAROLD J	11204 E 64TH ST
200688486	2017-2021	INDIVIDUAL PERSONAL PROPERTY	JONES WILLIS & TINA	9905 E 73RD ST APT E	200701627	2003	INDIVIDUAL PERSONAL PROPERTY	RODGERS JODY	8304 HUNTER ST
200688752	2021	INDIVIDUAL PERSONAL PROPERTY	ONEAL CECIL S II & MELESIA M	10914 E 56TH TER	200701650	2020-2021	INDIVIDUAL PERSONAL PROPERTY	CONNELY KATHY J	7200 OVERTON AVE
200689327	2017-2018	INDIVIDUAL PERSONAL PROPERTY	PENNY RONALD L	8916 E 81ST ST	200701714	2020	INDIVIDUAL PERSONAL PROPERTY	DRESSER JULIANNE E	6713 ENGLEWOOD AVE
200689397	2016-2017	INDIVIDUAL PERSONAL PROPERTY	MURRY STEVE D	10404 E 57TH TER	200701723	2006-2017	INDIVIDUAL PERSONAL PROPERTY	STRIKLAND ANTONIO	6604 HARVARD AVE
200689979	2005-2008	INDIVIDUAL PERSONAL PROPERTY	MARENGO JOSEPH & FLORENCE	6724 CRISP AVE	200701731	2014-2020	INDIVIDUAL PERSONAL PROPERTY	COX KRISTOFFER M	5248 HARDY CT
200689995	2019	INDIVIDUAL PERSONAL PROPERTY	ARNOLD JOHN E	8800 E 62ND TER	200701758	2007-2010	INDIVIDUAL PERSONAL PROPERTY	TAYLOR DENIA	NO ADDRESS PROVIDED BY TAXPAYER
200690043	2004-2005	INDIVIDUAL PERSONAL PROPERTY	CAMPBELL DOMINIC L	1765 SE SILKWOOD LN	200701767	2009	INDIVIDUAL PERSONAL PROPERTY	BLUE MARSHALL	4515 RIDGEWAY AVE
200690260	2021	INDIVIDUAL PERSONAL PROPERTY	JONES TIFFANY T	8704 E 84TH ST	200701773	2020-2021	INDIVIDUAL PERSONAL PROPERTY	BAILEY JAMEZETTA & LONZELL	8502 SPRING VALLEY RD
200690371	2004	INDIVIDUAL PERSONAL PROPERTY	YOUNG MONIQUE & MICHAEL L	6501 E 55TH TER	200701905	2004-2006	INDIVIDUAL PERSONAL PROPERTY	HAMMOND CARL D JR & JO ANN	7308 MAYWOOD AVE
200690873	2016-2019	INDIVIDUAL PERSONAL PROPERTY	WILLIAMS OLA J	9327 E 83RD ST	200702251	2004	INDIVIDUAL PERSONAL PROPERTY	TYNER MILDRED	NO ADDRESS PROVIDED BY TAXPAYER
200691009	2005	INDIVIDUAL PERSONAL PROPERTY	PENNIMAN DANIELLE	802 SW RYAN RD	200702777	2019-2021	INDIVIDUAL PERSONAL PROPERTY	JUDIE DELLA WAYNIECE	6021 LAUREL AVE
200691141	2021	INDIVIDUAL PERSONAL PROPERTY	WOODS DERRICK A & NICOLE L	11412 E 71ST ST	200702968	2003	INDIVIDUAL PERSONAL PROPERTY	YOUNG MARJORIE M	UNKNOWN
200691238	2010	INDIVIDUAL PERSONAL PROPERTY	BROWN DONALD C	7908 TENNESSEE AVE	200703071	2007-2008	INDIVIDUAL PERSONAL PROPERTY	NORRIS MAY ANN	9405 E 67TH TER
200691366	2021	INDIVIDUAL PERSONAL PROPERTY	HILTON MARY J	6913 RAYTOWN RD	200703509	2005-2006	INDIVIDUAL PERSONAL PROPERTY	BROWN ANGELA L	8205 WOODSON DR
200692436	2015-2021	INDIVIDUAL PERSONAL PROPERTY	GREENE CHERITA	11013 E 74TH ST	200703528	2021	INDIVIDUAL PERSONAL PROPERTY	EASTER JOSEPH RYAN	10710 E 63RD ST
200692513	2021	INDIVIDUAL PERSONAL PROPERTY	LEWIS RICHARD J	11500 E 63RD ST	200703587	2003	INDIVIDUAL PERSONAL PROPERTY	MOHIDDIN MAHNOUD R	UNKNOWN

200703869	2021	INDIVIDUAL PERSONAL PROPERTY	CROCKER SONYA ANN	6541 RAYTOWN RD APT 2	200713342	2017-2021	INDIVIDUAL PERSONAL PROPERTY	DAVIS TERRELL	8432 LANE PL
200704058	2007-2021	INDIVIDUAL PERSONAL PROPERTY	STACKHOUSE JIMMY & PATRICIA	8811 E 52ND TER	200713365	2003-2017	INDIVIDUAL PERSONAL PROPERTY	WEST KRIS E & JENNIFER D	8001 APPLETON AVE
200704336	2021	INDIVIDUAL PERSONAL PROPERTY	TORRES-FLORES KARIN SAAVEDRA	5747 RALSTON AVE	200713395	2021	INDIVIDUAL PERSONAL PROPERTY	KELLEY CHARLESTON GENE	8307 MANNING AVE
200704469	2011-2017	INDIVIDUAL PERSONAL PROPERTY	GRAY ROBIN Y	8506 JAMES A REED RD	200713448	2006	INDIVIDUAL PERSONAL PROPERTY	AURA SUSAN N	NO ADDRESS PROVIDED BY TAXPAYER
200704607	2020-2021	INDIVIDUAL PERSONAL PROPERTY	HILL LISA R	8401 E 85TH ST	200713545	2010-2011	INDIVIDUAL PERSONAL PROPERTY	ABU RUMMAN MAHER	9912 E 60TH TER
200705159	2003-2017	INDIVIDUAL PERSONAL PROPERTY	NEWMAN ARMOND	8301 E 86TH TER	200713674	2021	INDIVIDUAL PERSONAL PROPERTY	QUINTANILLA HOLLY ANN	9000 E 55TH ST
200705740	2004	INDIVIDUAL PERSONAL PROPERTY	GUTIERREZ SALVADOR & SANDOVAL MARIA	611 N HOCKER ST	200713877	2021	INDIVIDUAL PERSONAL PROPERTY	CLOUGHLEY TONI	5745 BLUE RIDGE BLVD
200706002	2004-2005	INDIVIDUAL PERSONAL PROPERTY	COLVIN JENNIFER K & TODD J	9055 E 67TH TER	200713954	2003	INDIVIDUAL PERSONAL PROPERTY	TAYLOR ANDREW	UNKNOWN
200707172	2021	INDIVIDUAL PERSONAL PROPERTY	JEFFERSON TRACEY	11320 E 58TH TER	200714014	2021	INDIVIDUAL PERSONAL PROPERTY	BROWN LAKISHA M	11701 E 83RD ST APT 102
200707334	2003	INDIVIDUAL PERSONAL PROPERTY	LYONS DENNIS C	UNKNOWN	200714026	2011	INDIVIDUAL PERSONAL PROPERTY	MATTOX DAVID D & JONEL M	10216 E 72ND ST
200707964	2007-2010	INDIVIDUAL PERSONAL PROPERTY	KELLY WILLIE L SR & BELINDA C	6217 ENGLEWOOD AVE	200714260	2015	INDIVIDUAL PERSONAL PROPERTY	ZIEGLER VAL J	8531 EVANSTON AVE
200708061	2005	INDIVIDUAL PERSONAL PROPERTY	ASBILL IRMA N	NO ADDRESS PROVIDED BY TAXPAYER	200714269	2019-2021	INDIVIDUAL PERSONAL PROPERTY	SCOTT RACHEL K (FIKES)	8310 HUNTER ST
200708144	2019-2020	INDIVIDUAL PERSONAL PROPERTY	LIVINGSTON-TANNER KINDRA DENISE	7505 ENGLEWOOD AVE	200714280	2003	INDIVIDUAL PERSONAL PROPERTY	COBB MARCUS R	414 E BLUE RIDGE BLVD APT A
200708316	2021	INDIVIDUAL PERSONAL PROPERTY	HILTON CAROLYN	6000 ARLINGTON AVE	200714307	2021	INDIVIDUAL PERSONAL PROPERTY	TUCKER BRENT W	9705 PLYMOUTH LN
200708439	2003-2004	INDIVIDUAL PERSONAL PROPERTY	THOVENELLE RAYMOND D	UNKNOWN	200714376	2017-2021	INDIVIDUAL PERSONAL PROPERTY	MAYOSKY MIKE	11032 E 53RD TER
200708482	2005-2007	INDIVIDUAL PERSONAL PROPERTY	COX JANA L	NO ADDRESS PROVIDED BY TAXPAYER	200714421	2021	INDIVIDUAL PERSONAL PROPERTY	PALMER ANGEL C	8900 E 57TH ST
200708794	2011-2013	INDIVIDUAL PERSONAL PROPERTY	MCINTOSH NOVA J JR	8859 E 54TH ST	200714466	2009	INDIVIDUAL PERSONAL PROPERTY	KENNEDY PETER J	8700 GLENWOOD AVE
200708877	2016	INDIVIDUAL PERSONAL PROPERTY	RODRIGUEZ SERGIO T	9949 E 61ST ST APT 1	200714480	2021	INDIVIDUAL PERSONAL PROPERTY	SISCO BRITTANY	8704 EVANSTON AVE
200708918	2004-2014	INDIVIDUAL PERSONAL PROPERTY	CARPENTER JASON L & RACHAEL A	9301 E 65TH TER	200714588	2004	INDIVIDUAL PERSONAL PROPERTY	WOODS ANTUWAN	8611 W UTOPIA DR APT 95
200708929	2020-2021	INDIVIDUAL PERSONAL PROPERTY	TAYLOR JOHN A	8706 GLENWOOD AVE	200714856	2020-2021	INDIVIDUAL PERSONAL PROPERTY	BLAIR NATHANIEL STEVEN	6714 WOODSON RD
200709075	2004-2017	INDIVIDUAL PERSONAL PROPERTY	COLEMAN RICK L	5245 WILLOW AVE	200714887	2021	INDIVIDUAL PERSONAL PROPERTY	REED JAMIE YARNELL	5824 FARLEY AVE
200709079	2005-2006	INDIVIDUAL PERSONAL PROPERTY	SEEM JENNIFER M	6816 LANE AVE	200714890	2015-2016	INDIVIDUAL PERSONAL PROPERTY	MITCHELL (THOMPSON) WYANDOTTA	1845 E 85TH ST
200709106	2009-2010	INDIVIDUAL PERSONAL PROPERTY	RODGERS STEVEN LEE & ANNA M	12802 E 57TH ST	200714906	2005	INDIVIDUAL PERSONAL PROPERTY	LA CROIX BRIAN J	NO ADDRESS PROVIDED BY TAXPAYER
200709130	2004	INDIVIDUAL PERSONAL PROPERTY	OATIS JENNIFER (DUPREE) & ROBERT	8650 JAMES A REED RD	200714936	2009	INDIVIDUAL PERSONAL PROPERTY	NELSON JERRY E	8341 HARVARD AVE
200709136	2003-2005	INDIVIDUAL PERSONAL PROPERTY	BELL JOHN E	NO ADDRESS PROVIDED BY TAXPAYER	200714967	2018-2019	INDIVIDUAL PERSONAL PROPERTY	DYE CARMEN	8619 KENTUCKY AVE
200709266	2018	INDIVIDUAL PERSONAL PROPERTY	CALKINS CAROL	6916 RAYTOWN RD	200714998	2017-2018	INDIVIDUAL PERSONAL PROPERTY	PAEZ RICARDO	5218 DITZLER AVE
200709374	2016-2017	INDIVIDUAL PERSONAL PROPERTY	MOTHERSBAUGH MARTINA J	NO ADDRESS PROVIDED BY TAXPAYER	200715007	2004-2009	INDIVIDUAL PERSONAL PROPERTY	WINGERT JOSHUA R	6324 HUNTER ST
200709389	2003-2006	INDIVIDUAL PERSONAL PROPERTY	ROBINSON LYNN M	9215 E 54TH ST	200715058	2007-2008	INDIVIDUAL PERSONAL PROPERTY	DALE SEAN M	NO ADDRESS PROVIDED BY TAXPAYER
200709392	2003-2004	INDIVIDUAL PERSONAL PROPERTY	TURNER MARQUAISA (CHATMAN)	11618 E 59TH TER	200715066	2020	INDIVIDUAL PERSONAL PROPERTY	MOORE MONIQUE D	2809 E 52ND ST
200709616	2003	INDIVIDUAL PERSONAL PROPERTY	DAVIS RONNIE L	UNKNOWN	200715133	2005-2007	INDIVIDUAL PERSONAL PROPERTY	HENSON NICOLE	5108 HARDY CT
200709694	2020-2021	INDIVIDUAL PERSONAL PROPERTY	HERRERA DAVID A	6212 WILLOW AVE	200715137	2013-2015	INDIVIDUAL PERSONAL PROPERTY	DORSETT CARL	8613 CRESCENT AVE
200709855	2021	INDIVIDUAL PERSONAL PROPERTY	JOHNSON JERMAINE K	5243 SYCAMORE AVE	200715172	2004	INDIVIDUAL PERSONAL PROPERTY	GARCIA ERIC P	11108 E 78TH TER
200709968	2003	INDIVIDUAL PERSONAL PROPERTY	MEADS CINDY	UNKNOWN	200715214	2014	INDIVIDUAL PERSONAL PROPERTY	THOMPSON KENDRICK	8605 FORD AVE
200710249	2010-2012	INDIVIDUAL PERSONAL PROPERTY	NEWTON LUCAS	8106 ASH AVE	200715216	2006-2017	INDIVIDUAL PERSONAL PROPERTY	PARKER JOHN THOMAS	5701 CEDAR AVE
200710278	2004	INDIVIDUAL PERSONAL PROPERTY	COX ROBERT L	5415 WOODSON RD	200715260	2004	INDIVIDUAL PERSONAL PROPERTY	GUERRA JANNA	UNKNOWN
200710289	2021	INDIVIDUAL PERSONAL PROPERTY	MONTANO JOHN F	8010 WILLOW WAY	200715290	2021	INDIVIDUAL PERSONAL PROPERTY	WALTON PATRICK	8325 OXFORD AVE
200710598	2021	INDIVIDUAL PERSONAL PROPERTY	CARLO ANGELA J	9610 E 80TH TER	200715303	2004-2007	INDIVIDUAL PERSONAL PROPERTY	BROWN SHALEECE M	7811 E 86TH ST
200710753	2021	INDIVIDUAL PERSONAL PROPERTY	YANCY TERRY L	8723 E 60TH TER	200715328	2007	INDIVIDUAL PERSONAL PROPERTY	MICKELSON MONICA	9824 E 61ST ST APT 1
200710784	2018	INDIVIDUAL PERSONAL PROPERTY	VILLINES DALE	7705 RAYTOWN RD	200715448	2021	INDIVIDUAL PERSONAL PROPERTY	LEDFORD DENISE	300 SW MORELAND SCHOOL RD STE 5
200710793	2004-2007	INDIVIDUAL PERSONAL PROPERTY	DANIELS MANDY H	NO ADDRESS PROVIDED BY TAXPAYER	200715502	2020-2021	INDIVIDUAL PERSONAL PROPERTY	MIXON DEBRA	6812 MAPLE AVE
200710910	2006-2021	INDIVIDUAL PERSONAL PROPERTY	JORDAN BETTY J	6133 KENTUCKY AVE	200715572	2021	INDIVIDUAL PERSONAL PROPERTY	SLOAN RYAN C	11605 E 60TH TER
200710936	2021	INDIVIDUAL PERSONAL PROPERTY	PHILLIPS TEMICKA N	4811 HEINTZ AVE	200715588	2010-2017	INDIVIDUAL PERSONAL PROPERTY	TROTTER MONIQUE N	10009 E 56TH TER
200710975	2005-2007	INDIVIDUAL PERSONAL PROPERTY	SINGLETON JOYCE L & SIMMONS LEE	NO ADDRESS PROVIDED BY TAXPAYER	200715638	2021	INDIVIDUAL PERSONAL PROPERTY	MOORE NATASHA J	11137 E 84TH TER
200711000	2021	INDIVIDUAL PERSONAL PROPERTY	WARREN VINCENT LEE JR	5408 NORTHERN AVE	200715758	2021	INDIVIDUAL PERSONAL PROPERTY	MCCEE ARLINDA D(HOPKINS)	11709 E 78TH PL
200711240	2016-2019	INDIVIDUAL PERSONAL PROPERTY	RUBELEE JANELLE M	7525 HAWTHORNE AVE	200715769	2006-2008	INDIVIDUAL PERSONAL PROPERTY	BROWN SAUNDRA D (BURNETT)	5809 KENTUCKY AVE
200711290	2004-2006	INDIVIDUAL PERSONAL PROPERTY	MUCHTLWA BREBBA	NO ADDRESS PROVIDED BY TAXPAYER	200715867	2012	INDIVIDUAL PERSONAL PROPERTY	REED PHILLIP W & GLENDA	5316 NORTHERN AVE
200711325	2021	INDIVIDUAL PERSONAL PROPERTY	MCCLINTON COREAN	6222 RAYTOWN TRFY	200715890	2020-2021	INDIVIDUAL PERSONAL PROPERTY	MAIER BENJAMIN M	7116 WOODSON RD
200711348	2013-2014	INDIVIDUAL PERSONAL PROPERTY	CALLIER MARLON L	8600 EVERETT ST	200715937	2004-2005	INDIVIDUAL PERSONAL PROPERTY	POTTS RHONDA	11215 E 51ST ST
200711564	2003	INDIVIDUAL PERSONAL PROPERTY	KAIN CAROL	UNKNOWN	200715950	2012	INDIVIDUAL PERSONAL PROPERTY	THOMPSON DANNY L	10702 E 63RD ST
200711621	2008-2010	INDIVIDUAL PERSONAL PROPERTY	WARREN ROGER C JR	13509 APPLEWOOD DR	200716080	2006	INDIVIDUAL PERSONAL PROPERTY	CUZICK CLIFTON	NO ADDRESS PROVIDED BY TAXPAYER
200711657	2005-2007	INDIVIDUAL PERSONAL PROPERTY	GOMEZ JOSE E	7517 LEWIS AVE	200716091	2019-2021	INDIVIDUAL PERSONAL PROPERTY	BROWN SHANIKIA T (WRIGHT)	10900 E 82ND ST
200711755	2020-2021	INDIVIDUAL PERSONAL PROPERTY	FISCH CHERYL K	11211 E 83RD ST	200716099	2008	INDIVIDUAL PERSONAL PROPERTY	HIERSCHE SHANIE E	11715 E 83RD ST APT 202
200711965	2021	INDIVIDUAL PERSONAL PROPERTY	LOWE ALICE MARIE	6234 RALSTON AVE	200716106	2005-2008	INDIVIDUAL PERSONAL PROPERTY	BOSTON CHERITA	8900 E 59TH ST
200712156	2002	INDIVIDUAL PERSONAL PROPERTY	DOWNING ERIC L	UNKNOWN	200716144	2004-2017	INDIVIDUAL PERSONAL PROPERTY	JONES WARREN E	7515 CRESCENT DR
200712242	2003-2005	INDIVIDUAL PERSONAL PROPERTY	ELLIS JEFF C	NO ADDRESS PROVIDED BY TAXPAYER	200716149	2005-2008	INDIVIDUAL PERSONAL PROPERTY	MOSELY WILLIE R & PEELER LOUISE	7827 VASSAR AVE
200712266	2003	INDIVIDUAL PERSONAL PROPERTY	ELLERBACK JACQUELINE A	UNKNOWN	200716191	2015-2017	INDIVIDUAL PERSONAL PROPERTY	TUCKER TAMARA L	6209 MANNING AVE
200712410	2008	INDIVIDUAL PERSONAL PROPERTY	LEWIS GARY M	5541 AGNES AVE	200716197	2013-2019	INDIVIDUAL PERSONAL PROPERTY	KING LONDELRO DEAN	8609 MAPLE AVE
200712449	2004-2008	INDIVIDUAL PERSONAL PROPERTY	JOHNSON DELORES M	NO ADDRESS PROVIDED BY TAXPAYER	200716200	2010	INDIVIDUAL PERSONAL PROPERTY	AUSTIN ROBERT A	7601 CRISP AVE
200712663	2012	INDIVIDUAL PERSONAL PROPERTY	SHEPHERD TERRY	8503 EVERETT ST	200716201	2004-2006	INDIVIDUAL PERSONAL PROPERTY	WORMSLEY PATRICK D & POLLYANNA A	NO ADDRESS PROVIDED BY TAXPAYER
200712668	2021	INDIVIDUAL PERSONAL PROPERTY	JOHNSON FRANK E	5125 WESTRIDGE CIR	200716212	2010	INDIVIDUAL PERSONAL PROPERTY	KING SHANNON W	9512 E 67TH TER
200712720	2003	INDIVIDUAL PERSONAL PROPERTY	VAN DUSKIRK KIMBERLY S & TROY J	7909 HEDGES AVE	200716214	2004-2005	INDIVIDUAL PERSONAL PROPERTY	GRIFFIN HEZEKIAH	9501 E 83RD ST
200712749	2021	INDIVIDUAL PERSONAL PROPERTY	DOUGLAS THOMAS J	8607 E 80TH AVE	200716259	2004-2005	INDIVIDUAL PERSONAL PROPERTY	BROWN MICHELLE R	NO ADDRESS PROVIDED BY TAXPAYER
200712773	2004	INDIVIDUAL PERSONAL PROPERTY	ECKSTINE MARK W & LORA M	4312 E 113TH TER	200716359	2009-2010	INDIVIDUAL PERSONAL PROPERTY	MUSICK JOHN	2914 S FOREST AVE
200712782	2021	INDIVIDUAL PERSONAL PROPERTY	SILLS JOHN C	6816 HUNTER ST	200716434	2004-2005	INDIVIDUAL PERSONAL PROPERTY	PRINCE GARY	4517 WOODSON RD
200712824	2007	INDIVIDUAL PERSONAL PROPERTY	ASHCRAFT CHAD G & LEWIS BONNIE	3809 BALTIMORE AVE	200716465	2005-2014	INDIVIDUAL PERSONAL PROPERTY	BUTLER SHAWNDR E	6412 STERLING AVE
200712854	2003	INDIVIDUAL PERSONAL PROPERTY	STRINGER JESSICA & JERRY E	UNKNOWN	200716469	2016-2021	INDIVIDUAL PERSONAL PROPERTY	WILKERSON EBONY	8506 FORD AVE
200712949	2003-2007	INDIVIDUAL PERSONAL PROPERTY	CANTY LOVE NICOLE	5817 FARLEY AVE	200716475	2021	INDIVIDUAL PERSONAL PROPERTY	BUYSEE RONALD A	10913 E 61ST TER
200712973	2013	INDIVIDUAL PERSONAL PROPERTY	GREEN EBONY L	8623 BRISTOL AVE	200716482	2020	INDIVIDUAL PERSONAL PROPERTY	GARCIA DARINEL	8710 E 87TH ST
200713182	2019-2021	INDIVIDUAL PERSONAL PROPERTY	DAVIS DONALD	5413 WILLOW AVE	200716489	2018-2021	INDIVIDUAL PERSONAL PROPERTY	KAYS RACHEL	6824 LAUREL AVE
200713187	2007-2008	INDIVIDUAL PERSONAL PROPERTY	OSÉNTON JACOB M	7309 HEDGES AVE	200716502	2007	INDIVIDUAL PERSONAL PROPERTY	GROSS ALAN G	9824 E 61ST ST APT 1
200713296	2013	INDIVIDUAL PERSONAL PROPERTY	RICHMOND ADELINE D	NO ADDRESS PROVIDED BY TAXPAYER	200716513	2004	INDIVIDUAL PERSONAL PROPERTY	ONASSIS CHANEL C	10005 E 77TH TER
200713316	2020-2021	INDIVIDUAL PERSONAL PROPERTY	MYERS TIFFANY M	9605 E 67TH TER	200716552	2005-2006	INDIVIDUAL PERSONAL PROPERTY	GARCIA YVONNE	8000 E 87TH ST

200716565	2003-2005	INDIVIDUAL PERSONAL PROPERTY	WESTMORELAND LEPARIA G	7914 HEDGES AVE	200721188	2021	INDIVIDUAL PERSONAL PROPERTY	GREEN ANGELA R	11309 E 50TH ST
200716596	2016-2020	INDIVIDUAL PERSONAL PROPERTY	HOBLEY JEANETTA MARIE	9200 E 87TH ST	200721255	2004	INDIVIDUAL PERSONAL PROPERTY	JONES DERRICK & GARY	5329 KENTUCKY
200716604	2004	INDIVIDUAL PERSONAL PROPERTY	BARNETT REGGIE	UNKNOWN	200721282	2010	INDIVIDUAL PERSONAL PROPERTY	BRACKSON-KELLY LULA	9824 E 61ST ST APT 1
200716636	2006-2012	INDIVIDUAL PERSONAL PROPERTY	GIVENS JAMES H JR	9404 E 69TH ST	200721402	2020-2021	INDIVIDUAL PERSONAL PROPERTY	HEDRICK JOSHUA	9802 E 80TH ST
200716661	2011-2017	INDIVIDUAL PERSONAL PROPERTY	PATTERSON VICTOR R	9404 E 81ST TER	200721475	2021	INDIVIDUAL PERSONAL PROPERTY	AARONSON MICHAEL	8609 FORD AVE
200716699	2004-2009	INDIVIDUAL PERSONAL PROPERTY	GILBERT KENNETH	7628 STERLING AVE	200721533	2003	INDIVIDUAL PERSONAL PROPERTY	DONETRAM DANIEL	8316 OXFORD
200716703	2007	INDIVIDUAL PERSONAL PROPERTY	BANNER MATTHEW S	11713 E 86TH TER	200721625	2003-2004	INDIVIDUAL PERSONAL PROPERTY	HALL TAMIKIA TASHA	UNKNOWN
200716746	2021	INDIVIDUAL PERSONAL PROPERTY	POPE STEPHEN A	10104 E 83RD ST	200721679	2004-2017	INDIVIDUAL PERSONAL PROPERTY	BALLARD JIMMY	NO ADDRESS PROVIDED BY TAXPAYER
200716756	2004-2006	INDIVIDUAL PERSONAL PROPERTY	DEATHREAGE DEREK	7320 CEDAR AVE	200721711	2004	INDIVIDUAL PERSONAL PROPERTY	VARNES JASON OR LEVI	4127 HAWTHORNE AVE
200716776	2004-2006	INDIVIDUAL PERSONAL PROPERTY	BRADBERRY MADORELL	NO ADDRESS PROVIDED BY TAXPAYER	200721745	2021	INDIVIDUAL PERSONAL PROPERTY	PHILLIPS GERRY & RESHANDIA	11116 E 85TH TER
200716908	2006	INDIVIDUAL PERSONAL PROPERTY	ALEXANDRE ALEC	NO ADDRESS PROVIDED BY TAXPAYER	200721771	2004	INDIVIDUAL PERSONAL PROPERTY	HATCH KENEISHA N & PENNY D	NO ADDRESS PROVIDED BY TAXPAYER
200716916	2007-2008	INDIVIDUAL PERSONAL PROPERTY	WORLEY TEMEKA	5512 RALSTON AVE	200721853	2003	INDIVIDUAL PERSONAL PROPERTY	GEORGIEVA SILVIA NEDEUR	UNKNOWN
200716939	2020-2021	INDIVIDUAL PERSONAL PROPERTY	ROSS CRYSTAL A	11313 E 72ND ST	200721864	2003-2005	INDIVIDUAL PERSONAL PROPERTY	DIXON RANDY M	7823 E 105TH ST
200717083	2014-2016	INDIVIDUAL PERSONAL PROPERTY	WEST ZACHARY	11005 E 85TH ST	200721908	2003	INDIVIDUAL PERSONAL PROPERTY	ROBINSON BRIAN B	UNKNOWN
200717124	2004-2005	INDIVIDUAL PERSONAL PROPERTY	GALLAGOS KELLY	NO ADDRESS PROVIDED BY TAXPAYER	200721915	2004-2008	INDIVIDUAL PERSONAL PROPERTY	JOHNSON WILLIAM IV	9026 E 85TH PL
200717264	2021	INDIVIDUAL PERSONAL PROPERTY	ECHOLS TANMIKA RACHEL	8605 FORD AVE	200722004	2003-2005	INDIVIDUAL PERSONAL PROPERTY	BLANCA'S JOSE F	6816 LAKE AVE
200717309	2005	INDIVIDUAL PERSONAL PROPERTY	SKINNER LINDA L	9001 E 57TH ST	200722025	2006	INDIVIDUAL PERSONAL PROPERTY	WARD AARON ANTHONY	9103 E 62ND TER
200717466	2020-2021	INDIVIDUAL PERSONAL PROPERTY	BERKSTRESSER STEPHEN D	7317 BLUE RIDGE BLVD	200722133	2003	INDIVIDUAL PERSONAL PROPERTY	COWDIN BRENDA A	UNKNOWN
200717484	2006-2008	INDIVIDUAL PERSONAL PROPERTY	LUKEHART TODD	NO ADDRESS PROVIDED BY TAXPAYER	200722271	2012	INDIVIDUAL PERSONAL PROPERTY	DAVIS CHARLES	9424 E 85TH ST
200717492	2008	INDIVIDUAL PERSONAL PROPERTY	NOEL CHARLES & JOANNE	10604 E 56TH ST	200722346	2003-2007	INDIVIDUAL PERSONAL PROPERTY	MCMANUS AMBER	NO ADDRESS PROVIDED BY TAXPAYER
200717516	2003-2004	INDIVIDUAL PERSONAL PROPERTY	TIONGSON MARYVA	UNKNOWN	200722378	2007	INDIVIDUAL PERSONAL PROPERTY	BAILEY CALVIN & MELANIE	5929 LAUREL AVE
200717537	2021	INDIVIDUAL PERSONAL PROPERTY	GILLESPIE GEORGE & MICHALLE	7611 ARLINGTON AVE	200722407	2021	INDIVIDUAL PERSONAL PROPERTY	GARCIA LETICIA & BARRRARA MIGUEL	8416 E 85TH TER
200717585	2021	INDIVIDUAL PERSONAL PROPERTY	ROBINSON LEANDER JR	11726 E 85TH ST	200722545	2004-2006	INDIVIDUAL PERSONAL PROPERTY	ROBINSON HENRY IV & BANKS IDA MARY	NO ADDRESS PROVIDED BY TAXPAYER
200717666	2016-2018	INDIVIDUAL PERSONAL PROPERTY	KING ARNOLD & ADRIENNE	11312 E 57TH TER	200722550	2005	INDIVIDUAL PERSONAL PROPERTY	HODGE JANESSA L	10617 E 78TH TER
200717679	2021	INDIVIDUAL PERSONAL PROPERTY	OKOJIE ISAAC E	11215 E 75TH ST	200722621	2021	INDIVIDUAL PERSONAL PROPERTY	CALHOON CODY	805 SW LIGGETT RD
200717702	2009	INDIVIDUAL PERSONAL PROPERTY	HELM APRIL L	10816 E 63RD ST	200722643	2010	INDIVIDUAL PERSONAL PROPERTY	MARSTON DANIELLE C	9805 E 76TH TER
200717779	2011-2012	INDIVIDUAL PERSONAL PROPERTY	SMITH AMY LEE	10709 E 66TH ST	200722648	2004	INDIVIDUAL PERSONAL PROPERTY	BELL CORDELL L	6391 MANCHESTER AVE APT 1
200717799	2005	INDIVIDUAL PERSONAL PROPERTY	MAMMEN DAVID	10509 E 67TH ST	200722661	2021	INDIVIDUAL PERSONAL PROPERTY	WHITE TRACY	4671 OVERTON TER
200717929	2011	INDIVIDUAL PERSONAL PROPERTY	WILLIAMS JANET	8606 EVERETT ST	200722727	2003-2004	INDIVIDUAL PERSONAL PROPERTY	YESERY ZEBIBA MOHAMMED	10207 E 63RD ST
200717990	2006-2010	INDIVIDUAL PERSONAL PROPERTY	JOYNER DAN W	NO ADDRESS PROVIDED BY TAXPAYER	200722740	2004	INDIVIDUAL PERSONAL PROPERTY	HAYES DENNIS C	8103 E 87TH ST
200718046	2015-2016	INDIVIDUAL PERSONAL PROPERTY	MITCHELL WILLIAM JOSEPH	9100 RICHARDS DR	200722747	2021	INDIVIDUAL PERSONAL PROPERTY	LARSON LISA A & ROGER K	6407 HARVARD AVE
200718080	2004-2006	INDIVIDUAL PERSONAL PROPERTY	WATERS ROBERT L	NO ADDRESS PROVIDED BY TAXPAYER	200722803	2021	INDIVIDUAL PERSONAL PROPERTY	FLORES CARMELO	8431 EVANSTON AVE
200718278	2004	INDIVIDUAL PERSONAL PROPERTY	SHOWENGEROT ZACHARY SCOTT	8134 STERLING AVE	200722840	2006-2007	INDIVIDUAL PERSONAL PROPERTY	CRISS ALEGRIA	9206 E 84TH TER
200718661	2021	INDIVIDUAL PERSONAL PROPERTY	JUDIE TANIKIA KIERRA	6021 LAUREL AVE	200722935	2004-2010	INDIVIDUAL PERSONAL PROPERTY	TINDALL AMBER	11911 E 85TH ST
200718670	2004	INDIVIDUAL PERSONAL PROPERTY	KERN REX A	9006 E 67TH ST	200723038	2004-2005	INDIVIDUAL PERSONAL PROPERTY	JOHNSON LINDA D	NO ADDRESS PROVIDED BY TAXPAYER
200718689	2004	INDIVIDUAL PERSONAL PROPERTY	AURA SUSAN N	7427 OVERTON	200723049	2012-2013	INDIVIDUAL PERSONAL PROPERTY	PETTYJOHN JAMES G	10205 E 71ST TER
200718706	2014-2015	INDIVIDUAL PERSONAL PROPERTY	OKAFOR IKECHUTWU P	10109 E 74TH TER	200723087	2011	INDIVIDUAL PERSONAL PROPERTY	ESPINO MARIA ROSA S	7804 E 87TH ST
200718730	2010	INDIVIDUAL PERSONAL PROPERTY	DILTHEY VICTORIA	NO ADDRESS PROVIDED BY TAXPAYER	200723176	2005	INDIVIDUAL PERSONAL PROPERTY	LOGSDON LEANDRA J	16816 LAUREL AVE
200718853	2014	INDIVIDUAL PERSONAL PROPERTY	SCHOBER KERA	9804 E 61ST ST APT 1	200723189	2008-2009	INDIVIDUAL PERSONAL PROPERTY	BIRCHLER RONALD	51501 E 42ND PL S
200718874	2009-2011	INDIVIDUAL PERSONAL PROPERTY	SCHINZE JEREMY A	8705 E 80TH TER	200723226	2004	INDIVIDUAL PERSONAL PROPERTY	LINNONE KRISTI L	6636 MAYWOOD AVE APT A
200718958	2003-2010	INDIVIDUAL PERSONAL PROPERTY	MATTOON LOUIS	6122 BLUE RIDGE BLVD	200723452	2007	INDIVIDUAL PERSONAL PROPERTY	AUXIER RONALD	6140 RAYTOWN RD APT 204
200718965	2004-2007	INDIVIDUAL PERSONAL PROPERTY	KRULIC ROBERT A	NO ADDRESS PROVIDED BY TAXPAYER	200723481	2011	INDIVIDUAL PERSONAL PROPERTY	EDENS LINDSEY M & WANETTA B	9240 E 55TH ST
200718981	2004-2007	INDIVIDUAL PERSONAL PROPERTY	SILTON SUSAN	7224 STERLING AVE	200723498	2020-2021	INDIVIDUAL PERSONAL PROPERTY	ERVIN MALLORY DOMINIQUE	11107 E M 350 HWY
200719016	2005	INDIVIDUAL PERSONAL PROPERTY	MADRID WILFEREDO	NO ADDRESS PROVIDED BY TAXPAYER	200723812	2008	INDIVIDUAL PERSONAL PROPERTY	JOHNSON JAMES & TIFFANY	8918 E 74TH ST
200719061	2021	INDIVIDUAL PERSONAL PROPERTY	ANDERSON ROBERT C	6415 HARVARD AVE	200723895	2007	INDIVIDUAL PERSONAL PROPERTY	SCOTT DAN JR	9351 E 68TH TER
200719063	2021	INDIVIDUAL PERSONAL PROPERTY	WILLIAMS BARRY & STEPHANIE	8316 DITZLER AVE	200724077	2011-2013	INDIVIDUAL PERSONAL PROPERTY	BROWN DANIEL E	5608 DITZLER AVE
200719102	2017-2018	INDIVIDUAL PERSONAL PROPERTY	RICH MICHAEL L	310 N CRYSLER AVE	200724087	2018-2021	INDIVIDUAL PERSONAL PROPERTY	DIR JAMES A	8414 E 85TH ST
200719491	2011-2012	INDIVIDUAL PERSONAL PROPERTY	WILLIAMS KIMBERLEY E	5928 ARLINGTON AVE	200724467	2009	INDIVIDUAL PERSONAL PROPERTY	BEASLEY MICHAEL I	NO ADDRESS PROVIDED BY TAXPAYER
200719529	2004	INDIVIDUAL PERSONAL PROPERTY	BOLTON TINA M	16602 LARKSPUR LN APT 5	200725228	2008-2010	INDIVIDUAL PERSONAL PROPERTY	SCHAEFER SUSAN K	7705 RAYTOWN RD
200719596	2014-2017	INDIVIDUAL PERSONAL PROPERTY	SASSER ARLICIA	8488 LANE DR	200725457	2021	INDIVIDUAL PERSONAL PROPERTY	WILLIAMS DION H	8101 E 87TH ST
200719751	2003	INDIVIDUAL PERSONAL PROPERTY	MORAN LEONARD J II	UNKNOWN	200725547	2007	INDIVIDUAL PERSONAL PROPERTY	BRADSHAW KAREN S	9708 E 80TH TER
200719882	2017-2021	INDIVIDUAL PERSONAL PROPERTY	RIMMER JANICE	11404 E 69TH ST	200725565	2006-2007	INDIVIDUAL PERSONAL PROPERTY	PUNJABI D DIANE	6105 HUNTER ST
200720176	2020-2021	INDIVIDUAL PERSONAL PROPERTY	ALEXANDER EVETTE L	8629 E UTOPIA PKWY APT 3	200726137	2009	INDIVIDUAL PERSONAL PROPERTY	HOBERECHT ALVERTA A	9110 E 63RD ST APT 101
200720193	2021	INDIVIDUAL PERSONAL PROPERTY	BLITZ KIMBERLY	9700 E 75TH ST	200726153	2005-2017	INDIVIDUAL PERSONAL PROPERTY	POWELL GLENDA S	9044 E 85TH ST
200720227	2013	INDIVIDUAL PERSONAL PROPERTY	WEATHERHOLT LEO J	10200 E 69TH ST	200726173	2021	INDIVIDUAL PERSONAL PROPERTY	OWENS JAMES L	7415 APPLETON AVE
200720240	2021	INDIVIDUAL PERSONAL PROPERTY	SCHUMACHER ROBERT F	9930 E 61ST ST	200726190	2004-2005	INDIVIDUAL PERSONAL PROPERTY	CARPENTER STEPHEN	9301 E 65TH TER
200720291	2007-2015	INDIVIDUAL PERSONAL PROPERTY	RISLEY BRIE LYN	8208 KENTUCKY AVE	200726230	2004	INDIVIDUAL PERSONAL PROPERTY	BELL CHARLOTTE MARIE	9002 RICHARDS DR
200720326	2011-2016	INDIVIDUAL PERSONAL PROPERTY	BYNUM-CRUMP CURTISTEAN	9010 E GREGORY BLVD	200726255	2004-2005	INDIVIDUAL PERSONAL PROPERTY	HOBBS TRAVIS	10100 E 68TH ST
200720714	2006-2011	INDIVIDUAL PERSONAL PROPERTY	MILLER IVY L	11116 E 57TH TER	200726258	2004	INDIVIDUAL PERSONAL PROPERTY	GRAZIANO ANTHONY JOHN	8201 SPRING VALLEY RD
200720775	2021	INDIVIDUAL PERSONAL PROPERTY	ARMSTRONG LAWRENCE	6545 RAYTOWN RD APT 4	200726351	2004	INDIVIDUAL PERSONAL PROPERTY	KERMER MINDY	8600 E 84TH ST
200720806	2005-2007	INDIVIDUAL PERSONAL PROPERTY	SMITH MICHAEL JOHN	NO ADDRESS PROVIDED BY TAXPAYER	200726377	2007	INDIVIDUAL PERSONAL PROPERTY	READ TAMMY M	5945 RAYTOWN RD
200720821	2008-2009	INDIVIDUAL PERSONAL PROPERTY	MOORE JOHN L	NO ADDRESS PROVIDED BY TAXPAYER	200726382	2009-2015	INDIVIDUAL PERSONAL PROPERTY	WARRINGTON CHRISTOPHER M	7914 ELM AVE
200720862	2020-2021	INDIVIDUAL PERSONAL PROPERTY	STROTHER ERI BLYON & VONDA K	7920 HARDY AVE	200726630	2020-2021	INDIVIDUAL PERSONAL PROPERTY	CARTER AMANDA L	9308 E 81ST ST
200720876	2020-2021	INDIVIDUAL PERSONAL PROPERTY	THOMPSON J CALEB	9012 E 55TH ST	200726755	2006	INDIVIDUAL PERSONAL PROPERTY	KING RONALD L	6488 BLUE RIDGE BLVD
200720915	2021	INDIVIDUAL PERSONAL PROPERTY	BROWN VINSON L	6423 HARRIS AVE	200726777	2014	INDIVIDUAL PERSONAL PROPERTY	WHITE BRIAN C	11308 E 78TH TER
200720950	2004	INDIVIDUAL PERSONAL PROPERTY	TURANO KEVIN G	7000 LAKESHORE DR	200726949	2005-2009	INDIVIDUAL PERSONAL PROPERTY	WASHINGTON KATHERINE R & HAMPTON JEROME	6415 HARVARD AVE
200720955	2003	INDIVIDUAL PERSONAL PROPERTY	MOYER SCOTT	NO ADDRESS PROVIDED BY TAXPAYER	200727121	2011-2017	INDIVIDUAL PERSONAL PROPERTY	SCARLETT JAMES C & JANENE	5431 CEDAR AVE
200720982	2004-2005	INDIVIDUAL PERSONAL PROPERTY	HOLLINS ANGELA P	NO ADDRESS PROVIDED BY TAXPAYER	200727144	2003-2005	INDIVIDUAL PERSONAL PROPERTY	TORAR MUHAMMAD A	NO ADDRESS PROVIDED BY TAXPAYER
200721015	2004-2005	INDIVIDUAL PERSONAL PROPERTY	SLOAN MATTHEW	6600 HARRIS AVE	200727241	2003-2004	INDIVIDUAL PERSONAL PROPERTY	HAMLETT JENNIFER	UNKNOWN
200721117	2004	INDIVIDUAL PERSONAL PROPERTY	HAYNES STEPHANIE A	UNKNOWN	200727331	2004-2005	INDIVIDUAL PERSONAL PROPERTY	KNOWLES MATTHEW A & RACHELA	8416 BOOTH AVE
200721118	2005	INDIVIDUAL PERSONAL PROPERTY	MILLER TIMOTHY	5816 ELM AVE	200727542	2004	INDIVIDUAL PERSONAL PROPERTY	HENKE TARA J	UNKNOWN
200721185	2004-2009	INDIVIDUAL PERSONAL PROPERTY	JACKSON LEA M	9358 E 68TH ST	200727559	2017-2020	INDIVIDUAL PERSONAL PROPERTY	KELLERMAN JONATHAN	8603 EVANSTON AVE

200727623	2021	INDIVIDUAL PERSONAL PROPERTY	CRISWELL COCO C	10408 E 79TH TER	200734414	2013-2017	INDIVIDUAL PERSONAL PROPERTY	RUFFIN RAPHEAL D	8701 TENNESSEE AVE
200727649	2011	INDIVIDUAL PERSONAL PROPERTY	HOLMES SYDNEE A & JAMAL	10801 E 66TH TER	200734417	2004-2005	INDIVIDUAL PERSONAL PROPERTY	TURPIN CORI D	9507 E 83RD ST
200727675	2007-2014	INDIVIDUAL PERSONAL PROPERTY	NEVIUS MICHELLE LYNN	9102 E 72ND TER	200734432	2021	INDIVIDUAL PERSONAL PROPERTY	COWAN CHANTA D	9401 E 82ND ST
200727696	2004	INDIVIDUAL PERSONAL PROPERTY	BROWN ANDRE	UNKNOWN	200734440	2004-2005	INDIVIDUAL PERSONAL PROPERTY	RAMIREZ GUADALUPE	8001 CAMPBELL ST APT 101
200727777	2006-2007	INDIVIDUAL PERSONAL PROPERTY	JOHNSON ADAM LEE & LILLIE G	11609 E 78TH ST	200734486	2021	INDIVIDUAL PERSONAL PROPERTY	NELSON MARK D	8808 E 72ND TER
200727816	2020-2021	INDIVIDUAL PERSONAL PROPERTY	MORTON CHARMINÉ C	9825 LINDEN CIR	200734517	2004	INDIVIDUAL PERSONAL PROPERTY	FARRELL SHANNON	UNKNOWN
200727994	2005	INDIVIDUAL PERSONAL PROPERTY	DUBLIN MICHAEL L & ROBIN R	NO ADDRESS PROVIDED BY TAXPAYER	200734532	2006-2008	INDIVIDUAL PERSONAL PROPERTY	WARNER TIMOTHY B & KRISTINA	10204 E 69TH ST
200728133	2021	INDIVIDUAL PERSONAL PROPERTY	AVERY ALFORD III	5322 DITZLER AVE	200734537	2007-2010	INDIVIDUAL PERSONAL PROPERTY	RITTER ANGELA N	304 NE FOREST AVE APT B
200728232	2005-2014	INDIVIDUAL PERSONAL PROPERTY	DURHAM ANTHONY J & SHARON A	11409 E 62ND ST	200734662	2017-2021	INDIVIDUAL PERSONAL PROPERTY	SMALL KASEY R	9601 E 68TH ST
200728233	2004	INDIVIDUAL PERSONAL PROPERTY	CHEVALIER PAUL L & KERRY L	9417 E 68TH TER	200734670	2010-2017	INDIVIDUAL PERSONAL PROPERTY	NOWICKI JOSEPH	7202 HARRIS AVE
200728285	2021	INDIVIDUAL PERSONAL PROPERTY	KERNS TRISTAIN	8505 E 85TH ST	200734705	2021	INDIVIDUAL PERSONAL PROPERTY	THOMAS DERRICK L	9011 E 85TH ST
200728292	2004-2017	INDIVIDUAL PERSONAL PROPERTY	DUGGAR SHELLY L	9001 E 65TH TER	200734775	2021	INDIVIDUAL PERSONAL PROPERTY	SMALL KYLE	8802 E 73RD ST
200728333	2010-2017	INDIVIDUAL PERSONAL PROPERTY	MORRIS GERRY	8216 STERLING AVE	200734784	2021	INDIVIDUAL PERSONAL PROPERTY	BLACK NATHAN ALLEN	9412 E 70TH TER
200728338	2021	INDIVIDUAL PERSONAL PROPERTY	PAEZ RICARDO JOSEPH	7224 WOODSON RD	200734962	2004-2006	INDIVIDUAL PERSONAL PROPERTY	BREWER GARY W &/OR PETERSON RACHEL	6401 KENTUCKY AVE
200728349	2004	INDIVIDUAL PERSONAL PROPERTY	COLLINS ROOSEVELT III & TANISHA	9200 E 54TH ST	200734987	2021	INDIVIDUAL PERSONAL PROPERTY	FLISS ROBERT T	5717 ASH AVE
200728372	2020-2021	INDIVIDUAL PERSONAL PROPERTY	ADAMS ERIN N	8810 CAMBRIDGE AVE APT 901	200735094	2015-2021	INDIVIDUAL PERSONAL PROPERTY	ROSE NICHOLAS	10708 E 65TH TER
200728399	2021	INDIVIDUAL PERSONAL PROPERTY	BRANDON JAMES W	9101 E 74TH ST	200735189	2005-2007	INDIVIDUAL PERSONAL PROPERTY	MCCOMBS BRANDON S	11009 E 74TH ST
200728407	2005	INDIVIDUAL PERSONAL PROPERTY	JEFFS ANGELA	NO ADDRESS PROVIDED BY TAXPAYER	200735202	2007-2008	INDIVIDUAL PERSONAL PROPERTY	LESLIE DONALD	9600 E 53RD PL
200728462	2005	INDIVIDUAL PERSONAL PROPERTY	ORTIZ JOSE G	9806 E 61ST ST	200735224	2010-2015	INDIVIDUAL PERSONAL PROPERTY	MADGE JAMAR H	8530 ARLINGTON AVE
200728477	2018-2021	INDIVIDUAL PERSONAL PROPERTY	HENDERSON TONY MAURICE	6420 ELM AVE	200735262	2004	INDIVIDUAL PERSONAL PROPERTY	TARTER ASHLEY	UNKNOWN
200728479	2007-2008	INDIVIDUAL PERSONAL PROPERTY	STALEY MARK & LAURIE	10509 E 65TH ST	200735264	2013	INDIVIDUAL PERSONAL PROPERTY	HARMON DANIEL	11044 E 53RD TER
200728523	2004	INDIVIDUAL PERSONAL PROPERTY	BAYER CHRISTOPHER	UNKNOWN	200735277	2004	INDIVIDUAL PERSONAL PROPERTY	NISHIKAWA TRAVIS	UNKNOWN
200728539	2005-2007	INDIVIDUAL PERSONAL PROPERTY	BRUDERS ASHTAN N	11705 E 86TH ST	200735305	2007	INDIVIDUAL PERSONAL PROPERTY	VANDAWALKER MICHELLE R	10105 E 81ST ST
200728547	2005	INDIVIDUAL PERSONAL PROPERTY	MONSHOWER JOHN J	6908 RAYTOWN RD	200735355	2021	INDIVIDUAL PERSONAL PROPERTY	DOSS TAMIKA L	6106 WILLOW AVE
200728580	2006-2010	INDIVIDUAL PERSONAL PROPERTY	CASTRO HECTOR & EDUARDO	8507 BOOTH AVE	200735378	2017-2021	INDIVIDUAL PERSONAL PROPERTY	GRIESHABER RUSSELL A	9020 CEDAR AVE APT A
200728605	2006	INDIVIDUAL PERSONAL PROPERTY	SHAFFER DENISE	9801 E 61ST ST APT 1	200735434	2007	INDIVIDUAL PERSONAL PROPERTY	POLLOCK LLOYD W	7305 CRISP AVE
200729157	2007	INDIVIDUAL PERSONAL PROPERTY	MATTHEWS LYNN	9200 E 85TH ST	200735482	2004-2007	INDIVIDUAL PERSONAL PROPERTY	GREEN JIMMIE & ARLENE	NO ADDRESS PROVIDED BY TAXPAYER
200729176	2021	INDIVIDUAL PERSONAL PROPERTY	VINEYARD FELECHIA	8800 E 53RD TER	200735488	2005-2006	INDIVIDUAL PERSONAL PROPERTY	WILSON ERIN	10517 E 60TH TER
200729330	2016-2018	INDIVIDUAL PERSONAL PROPERTY	MONROE THEOPHILUS & CARROLL ALEDA D	7809 E 87TH ST	200735597	2007-2009	INDIVIDUAL PERSONAL PROPERTY	PARKS DAMON L & STACY M	8521 ARLINGTON AVE
200729577	2005-2008	INDIVIDUAL PERSONAL PROPERTY	LINDSEY TERRY N	5932 STERLING AVE	200735627	2005	INDIVIDUAL PERSONAL PROPERTY	RANDLEN SABRINA R	8616 E 83RD TER
200729717	2020-2021	INDIVIDUAL PERSONAL PROPERTY	OWENS GREGORY	8512 EVANSTON AVE	200735756	2019-2021	INDIVIDUAL PERSONAL PROPERTY	SIXTA KIMBERLY	9456 E 64TH TER
200729764	2011-2014	INDIVIDUAL PERSONAL PROPERTY	GUESS JOHNNY D	9813 E 60TH ST	200735873	2019-2021	INDIVIDUAL PERSONAL PROPERTY	BATES BRETT	6908 WILLOWOOD DR
200729776	2016-2021	INDIVIDUAL PERSONAL PROPERTY	HUGHLEY WANSOLO	10190 E 79TH TER	200735929	2021	INDIVIDUAL PERSONAL PROPERTY	THOMAS DEWAYSON	9901 E 77TH ST
200729941	2012-2019	INDIVIDUAL PERSONAL PROPERTY	BRANTLEY ERIKA L	9118 E 85TH ST	200735938	2016	INDIVIDUAL PERSONAL PROPERTY	GARDNER GWENDOLYN Y	11100 E 74TH ST
200729952	2016-2021	INDIVIDUAL PERSONAL PROPERTY	ANDERSON REGINALD T	8812 E 62ND ST	200736003	2015	INDIVIDUAL PERSONAL PROPERTY	STRUM FREDERICK A JR & JOCELYN	5820 WOODSON RD
200730123	2003-2004	INDIVIDUAL PERSONAL PROPERTY	ALLEN BENAMIN	7201 STERLING AVE	200736043	2019-2021	INDIVIDUAL PERSONAL PROPERTY	MINER RODNEY	7308 MAYWOOD AVE
200730206	2019-2021	INDIVIDUAL PERSONAL PROPERTY	SWEET CANDACE	6724 LAUREL AVE	200736055	2005-2017	INDIVIDUAL PERSONAL PROPERTY	ASBERRY STEVEN	7502 STERLING AVE
200730229	2021	INDIVIDUAL PERSONAL PROPERTY	MARSHALL BRANDON L & DAVOYA M	206 NE COUNTRY LN	200736233	2007	INDIVIDUAL PERSONAL PROPERTY	TERRILL ANDREW W	NO ADDRESS PROVIDED BY TAXPAYER
200730385	2021	INDIVIDUAL PERSONAL PROPERTY	CURRY TAWANNA SHANTA	6705 HUNTER ST APT 213	200736617	2007	INDIVIDUAL PERSONAL PROPERTY	FRAZIER ROBERT L & JONES GEORGIE D	6643 CEDAR AVE APT A
200730406	2020-2021	INDIVIDUAL PERSONAL PROPERTY	BROUGHTON SANDRA	10407 E 82ND ST	200737074	2021	INDIVIDUAL PERSONAL PROPERTY	MOORE EULONDA	7308 ASH AVE
200730505	2012-2016	INDIVIDUAL PERSONAL PROPERTY	WHEAT FELICIA R & DALE PHILIP	8901 E 52ND TER	200737391	2016-2018	INDIVIDUAL PERSONAL PROPERTY	BENDET CHRISTOPHER & DAWNDY	9545 E 57TH TER
200730591	2005-2017	INDIVIDUAL PERSONAL PROPERTY	ASBERRY STEVEN T	7520 STERLING AVE	200737342	2015-2016	INDIVIDUAL PERSONAL PROPERTY	ROBERTSON TAFILI JR	9805 E 51ST TER
200730667	2021	INDIVIDUAL PERSONAL PROPERTY	BANKS LONI	6743 STERLING AVE	200737560	2020-2021	INDIVIDUAL PERSONAL PROPERTY	BROWN MARKCO DEANGELO	9612 E 65TH TER
200730758	2021	INDIVIDUAL PERSONAL PROPERTY	BRADFORD DIANE	11720 E 87TH ST	200737735	2002	INDIVIDUAL PERSONAL PROPERTY	TAYLOR TAMMY L	10612 E 79TH ST
200730938	2004-2008	INDIVIDUAL PERSONAL PROPERTY	ROUCHKA JOSEPH D	9205 E 79TH ST	200737778	2010-2012	INDIVIDUAL PERSONAL PROPERTY	GREEN TERRI D	9002 E 85TH ST
200731006	2005	INDIVIDUAL PERSONAL PROPERTY	BISHOP WILMA M	10215 E 56TH ST	200738147	2010	INDIVIDUAL PERSONAL PROPERTY	GASTINGER JEFF	NO ADDRESS PROVIDED BY TAXPAYER
200731022	2004	INDIVIDUAL PERSONAL PROPERTY	BALDWIN CHRISTOPHER	8909 E GREGORY BLVD	200738476	2017-2020	INDIVIDUAL PERSONAL PROPERTY	NAVARRO LUIS	7300 WILLOW AVE
200731026	2021	INDIVIDUAL PERSONAL PROPERTY	BARFIELD NICOLE	8208 KENTUCKY AVE	200738646	2017-2019	INDIVIDUAL PERSONAL PROPERTY	YOUNG RICHARD & EDEN	5301 HUNTER ST
200731296	2007-2009	INDIVIDUAL PERSONAL PROPERTY	GIBBS ANTONETTE	8801 E GREGORY BLVD	200738697	2003-2004	INDIVIDUAL PERSONAL PROPERTY	ELLIOTT CARRISSA	NO ADDRESS PROVIDED BY TAXPAYER
200731551	2012	INDIVIDUAL PERSONAL PROPERTY	PRESSLER GALE L	5325 WILLOW AVE	200739031	2005	INDIVIDUAL PERSONAL PROPERTY	GRAY YATTA A	9215 E 65TH TER
200731746	2017-2019	INDIVIDUAL PERSONAL PROPERTY	LANDRUM WAYNE L & CHERYL R	8408 E 85TH TER	200739276	2020-2021	INDIVIDUAL PERSONAL PROPERTY	BYAS MARLETTE	11823 E 83RD ST APT 102
200731821	2021	INDIVIDUAL PERSONAL PROPERTY	BLACKBURN AMBER L	11006 E 85TH ST	200739852	2014	INDIVIDUAL PERSONAL PROPERTY	TURNER TRIPP KARON	7317 WOODSON RD
200731823	2005-2010	INDIVIDUAL PERSONAL PROPERTY	TRINIDAD JOSE R	9104 E 67TH TER	200740154	2018-2021	INDIVIDUAL PERSONAL PROPERTY	CISNEROS ROCIO	7821 HEDGES AVE
200732018	2006-2011	INDIVIDUAL PERSONAL PROPERTY	ELMORE CHARLES	6600 WILLOW AVE	200740497	2017-2020	INDIVIDUAL PERSONAL PROPERTY	MCKIVERGAN KATHERINE & JOHN	8415 JAMES A REED RD
200732432	2010	INDIVIDUAL PERSONAL PROPERTY	WOOD RICHARD W	10908 E 87TH ST	200740518	2006	INDIVIDUAL PERSONAL PROPERTY	GREEN ANGELA C	8206 ELM AVE
200732636	2006	INDIVIDUAL PERSONAL PROPERTY	SMITH ROBIN R	NO ADDRESS PROVIDED BY TAXPAYER	200741219	2011-2013	INDIVIDUAL PERSONAL PROPERTY	WILLIAMS CLAUDE P	9017 E 85TH ST
200732672	2004-2005	INDIVIDUAL PERSONAL PROPERTY	STEBBINS RICHARD GLEN	NO ADDRESS PROVIDED BY TAXPAYER	200741398	2003-2008	INDIVIDUAL PERSONAL PROPERTY	PENDLETON-DORSEY STEPHANIE	8114 WOODSON DR
200732759	2007	INDIVIDUAL PERSONAL PROPERTY	GOFORTH AMY	7900 WOODSON RD	200741450	2005	INDIVIDUAL PERSONAL PROPERTY	GUNNELS ARTIS G	10619 E 43RD ST APT 1721
200732790	2013	INDIVIDUAL PERSONAL PROPERTY	MILLER JAMIE H	8863 E 52ND TER	200741726	2021	INDIVIDUAL PERSONAL PROPERTY	MARSALIS EDITH	9314 E 83RD ST
200732963	2003	INDIVIDUAL PERSONAL PROPERTY	JOHNSON MARVIN & JANICE	UNKNOWN	200741765	2004	INDIVIDUAL PERSONAL PROPERTY	MOSES MARIO	9200 E 67TH TER
200732970	2021	INDIVIDUAL PERSONAL PROPERTY	SMITH HENRY L	2317 ENGLEWOOD CRT	200741784	2005	INDIVIDUAL PERSONAL PROPERTY	KLINE MICHAEL W	NO ADDRESS PROVIDED BY TAXPAYER
200733176	2019-2021	INDIVIDUAL PERSONAL PROPERTY	ROBERTS JEFFREY T	10013 E 86TH TER	200741797	2021	INDIVIDUAL PERSONAL PROPERTY	SHULSE RICKY	9109 E 82ND ST
200733257	2010	INDIVIDUAL PERSONAL PROPERTY	DANIELS CHRISTOPHER SCOTT	11021 E 53RD TER	200741841	2020-2021	INDIVIDUAL PERSONAL PROPERTY	TUGGLE JOSHUA	8115 HEDGES AVE
200733492	2020-2021	INDIVIDUAL PERSONAL PROPERTY	MITCHELL MARTIN V	8611 CLANT DR	200741849	2021	INDIVIDUAL PERSONAL PROPERTY	WILLIAMS GREGORY VERNON	8460 LANE DR
200733625	2007-2010	INDIVIDUAL PERSONAL PROPERTY	DILLINGER DEBRA T	9600 E 69TH ST	200742035	2013	INDIVIDUAL PERSONAL PROPERTY	HOVAN TAYA L	11020 E 53RD TER
200733855	2021	INDIVIDUAL PERSONAL PROPERTY	POPE EDLISA	7827 WOODSON RD	200742090	2010-2011	INDIVIDUAL PERSONAL PROPERTY	HAFIZ ALIM	11006 E 85TH ST
200733999	2007-2010	INDIVIDUAL PERSONAL PROPERTY	GUFFEY STEVEN L	NO ADDRESS PROVIDED BY TAXPAYER	200742094	2006-2007	INDIVIDUAL PERSONAL PROPERTY	LAVENBARG WADE	6808 LANE AVE
200734042	2006	INDIVIDUAL PERSONAL PROPERTY	ARENIVAS LUIS	7208 HARVARD DR	200742114	2020-2021	INDIVIDUAL PERSONAL PROPERTY	HUBER SARAH	8316 HARVARD TER
200734159	2004-2007	INDIVIDUAL PERSONAL PROPERTY	HARDAWAY ELVIS	NO ADDRESS PROVIDED BY TAXPAYER	200742118	2004-2017	INDIVIDUAL PERSONAL PROPERTY	KOBEL PATTI	6403 KENTUCKY AVE
200734232	2021	INDIVIDUAL PERSONAL PROPERTY	JUAREZ YANDERI	4842 LANE DR	200742181	2021	INDIVIDUAL PERSONAL PROPERTY	LEE SEAN C	5909 CRESCENT AVE
200734291	2011	INDIVIDUAL PERSONAL PROPERTY	POMMERER SARAH L	8620 E 83RD TER	200742194	2004	INDIVIDUAL PERSONAL PROPERTY	GAMBLE AMBER	UNKNOWN
200734313	2003-2004	INDIVIDUAL PERSONAL PROPERTY	DUNCAN RODNEY & BRUCE MICALL L	UNKNOWN	200742195	2007-2013	INDIVIDUAL PERSONAL PROPERTY	KING ASHLEY D	5711 CEDAR AVE

200742218	2020-2021	INDIVIDUAL PERSONAL PROPERTY	BRANDON ROBERT L	7324 WILLOW AVE	200748559	2021	INDIVIDUAL PERSONAL PROPERTY	STOUT BETH J	10901 E 58TH ST
200742227	2009	INDIVIDUAL PERSONAL PROPERTY	LEWIS CURTIS W	8609 ARLINGTON AVE	200748571	2004	INDIVIDUAL PERSONAL PROPERTY	HOUCK DORTHY L	8512 PERSHING RD
200742356	2008	INDIVIDUAL PERSONAL PROPERTY	GUMBS DORIS	8525 HAWTHORNE AVE	200748616	2004-2006	INDIVIDUAL PERSONAL PROPERTY	COLEMAN ALEX & FIELDS RENEE	NO ADDRESS PROVIDED BY TAXPAYER
200742396	2003	INDIVIDUAL PERSONAL PROPERTY	HOPKINS STEVE	NO ADDRESS PROVIDED BY TAXPAYER	200748626	2010-2017	INDIVIDUAL PERSONAL PROPERTY	MATHIS SHIRLEY J	5300 LAUREL AVE
200742417	2018	INDIVIDUAL PERSONAL PROPERTY	WILSON DARON L	9815 E 73RD ST APT D	200748628	2021	INDIVIDUAL PERSONAL PROPERTY	SAULS CHANDRELETRIA	9110 E 74TH ST
200742535	2020-2021	INDIVIDUAL PERSONAL PROPERTY	PARHAM MORIAH CELESTE	8520 HAWTHORNE AVE	200748638	2004-2017	INDIVIDUAL PERSONAL PROPERTY	CHOWINS JANET L	8300 HEDGES AVE
200742561	2006-2007	INDIVIDUAL PERSONAL PROPERTY	PERSLEY DONALD R	9000 E 57TH ST	200748643	2015	INDIVIDUAL PERSONAL PROPERTY	WILLIAMS NICOLE M	6300 HARRIS AVE
200742597	2007-2010	INDIVIDUAL PERSONAL PROPERTY	JONES KENNIETH R JR	9620 LYDIA AVE APT C	201111637	2010	INDIVIDUAL PERSONAL PROPERTY	HOOVER ROBERT II	9908 E 71ST TER
200742689	2004	INDIVIDUAL PERSONAL PROPERTY	MURLARKEY TABITHA J	11811 E 83RD ST	201111755	2004-2005	INDIVIDUAL PERSONAL PROPERTY	WOLF JOHN R & JASON GILL	8219 E 57TH TER
200742883	2008-2012	INDIVIDUAL PERSONAL PROPERTY	SANDERS THOMAS ERIC	8309 PERSHING RD	201111834	2009	INDIVIDUAL PERSONAL PROPERTY	CHE TITUS A	9808 E 76TH TER
200742911	2008	INDIVIDUAL PERSONAL PROPERTY	JONES DAVID W AND BARBARA A	8822 E 74TH ST	201111849	2021	INDIVIDUAL PERSONAL PROPERTY	ODELL DANIEL W	10804 E 57TH TER
200743008	2021	INDIVIDUAL PERSONAL PROPERTY	JONES JANEL	8907 E 72ND TER	201111874	2008-2014	INDIVIDUAL PERSONAL PROPERTY	TAYLOR CAROL D	9808 E 76TH TER
200743063	2019	INDIVIDUAL PERSONAL PROPERTY	WESSON LANCE	9205 E 82ND ST	20112016	2004-2012	INDIVIDUAL PERSONAL PROPERTY	CLEAVER MONICA	NO ADDRESS PROVIDED BY TAXPAYER
200743179	2006-2012	INDIVIDUAL PERSONAL PROPERTY	SWEENEY ROGER J JR	5417 WOODSON RD	20112028	2004-2006	INDIVIDUAL PERSONAL PROPERTY	TUCKER KEISHA	8409 HARVARD TER
200743193	2006	INDIVIDUAL PERSONAL PROPERTY	SMITH PAMELA S	6324 HUNTER ST	20112039	2013-2017	INDIVIDUAL PERSONAL PROPERTY	SMITH KIMBERLY V & SMITH RICKY DALE	10508 E 65TH TER
200743210	2004-2006	INDIVIDUAL PERSONAL PROPERTY	SERVOS TINA L	9216 E 68TH ST	20112065	2021	INDIVIDUAL PERSONAL PROPERTY	RICHARDSON MARY E	10524 E 56TH ST
200743223	2006-2007	INDIVIDUAL PERSONAL PROPERTY	SANDER ANDREW T	7911 MANNING AVE	20112153	2019-2020	INDIVIDUAL PERSONAL PROPERTY	COBBINS JAMES D JR	5537 HUNTER TER
200743230	2004-2012	INDIVIDUAL PERSONAL PROPERTY	AL-NSOUR NUHA ABCLEL R	NO ADDRESS PROVIDED BY TAXPAYER	20112156	2004-2005	INDIVIDUAL PERSONAL PROPERTY	GOULAS GREG II	5910 WOODSON RD
200743244	2006	INDIVIDUAL PERSONAL PROPERTY	DIGGS ANDREA L	8601 WESTRIDGE RD	20112177	2006-2007	INDIVIDUAL PERSONAL PROPERTY	ROBERTS JERRY J	11201 E 85TH TER
200743468	2005-2007	INDIVIDUAL PERSONAL PROPERTY	BROWN DERRICO	7808 WOODSON RD	20112238	2015-2021	INDIVIDUAL PERSONAL PROPERTY	MCCLENTON FRANK E	7510 ELM ST
200743472	2004	INDIVIDUAL PERSONAL PROPERTY	RILEY BARBARA ANN	5400 DITZLER	20112259	2019-2021	INDIVIDUAL PERSONAL PROPERTY	LAWHEAD NEIL & TENLEY	9017 E 66TH TER
200743610	2004-2005	INDIVIDUAL PERSONAL PROPERTY	FRACKE JAMES	8615 E 80TH TER	20112283	2021	INDIVIDUAL PERSONAL PROPERTY	WILLIAMS STACY L	6120 LAUREL AVE
200743616	2018-2021	INDIVIDUAL PERSONAL PROPERTY	EDWARDS SHERRON ANTONIETTE	7504 ELM ST	20112368	2005-2017	INDIVIDUAL PERSONAL PROPERTY	BRAXTON BETTY J & JONES WARREN E	7515 CRESCENT DR
200743645	2019	INDIVIDUAL PERSONAL PROPERTY	DOWNUM SCOTT	8442 LANE DR	20112463	2004-2005	INDIVIDUAL PERSONAL PROPERTY	MCCAIN KENNETH RAY	NO ADDRESS PROVIDED BY TAXPAYER
200743651	2005-2006	INDIVIDUAL PERSONAL PROPERTY	MYNATT MENDY K	10009 E 69TH TER	20112611	2021	INDIVIDUAL PERSONAL PROPERTY	BLACKMAN RUSSELL D & DAWN M	7717 CRESCENT AVE
200743715	2007-2013	INDIVIDUAL PERSONAL PROPERTY	SWAYNE JILL A	7507 CRESCENT DR	20112631	2021	INDIVIDUAL PERSONAL PROPERTY	AMBS DAVID	6307 STERLING AVE
200743737	2004	INDIVIDUAL PERSONAL PROPERTY	DAILEY ERIC	UNKNOWN	20112668	2017	INDIVIDUAL PERSONAL PROPERTY	WALTON PASHA	10334 E 63RD ST APT 1
200743741	2004	INDIVIDUAL PERSONAL PROPERTY	BABAJIDE SHEKONI	UNKNOWN	20112686	2003-2004	INDIVIDUAL PERSONAL PROPERTY	CORNIELS MELISSA L	5422 STERLING AVE
200743759	2005	INDIVIDUAL PERSONAL PROPERTY	TURNER TIFFANY ANN	3600 E 10TH ST	20112750	2005-2009	INDIVIDUAL PERSONAL PROPERTY	CONSIDINE JESSICA	8508 E 85TH ST
200743760	2005	INDIVIDUAL PERSONAL PROPERTY	NITZ PAUL N	NO ADDRESS PROVIDED BY TAXPAYER	20113106	2006-2007	INDIVIDUAL PERSONAL PROPERTY	ODOM AARON M	9709 E 81ST TER
200743763	2006	INDIVIDUAL PERSONAL PROPERTY	BEACH JOANNE	7054 LAKEHORE DR	20113196	2007	INDIVIDUAL PERSONAL PROPERTY	HAGERMA RAYMOND L	7785 RAYTOWN RD
200743767	2007-2009	INDIVIDUAL PERSONAL PROPERTY	SMITH LEONARD J	6808 RAYTOWN RD	20113205	2007-2017	INDIVIDUAL PERSONAL PROPERTY	KUETHE CINDY L	NO ADDRESS PROVIDED BY TAXPAYER
200743857	2005	INDIVIDUAL PERSONAL PROPERTY	CARROLL WINIFRED ANN	NO ADDRESS PROVIDED BY TAXPAYER	20113210	2004	INDIVIDUAL PERSONAL PROPERTY	WHEELER TRACY	UNKNOWN
200743961	2012-2017	INDIVIDUAL PERSONAL PROPERTY	BURNMASTER BRUCE	6805 HAWTHORNE AVE	20113353	2005-2006	INDIVIDUAL PERSONAL PROPERTY	BELL TALITTA	8608 ASH AVE
200744000	2007-2015	INDIVIDUAL PERSONAL PROPERTY	STEPHENS VIRGINIA	8116 STERLING AVE	20113762	2004	INDIVIDUAL PERSONAL PROPERTY	TRANER MICHAEL W & CHARLES L	9067 E 55TH ST
200744021	2004-2005	INDIVIDUAL PERSONAL PROPERTY	DENTON JAMES E	4900 RAYTOWN RD	20113780	2021	INDIVIDUAL PERSONAL PROPERTY	SCHOFFSTALL JAMIE & MIKE	5424 HEDGES AVE
200744034	2007	INDIVIDUAL PERSONAL PROPERTY	ARDREY DAVID B	NO ADDRESS PROVIDED BY TAXPAYER	20113810	2005	INDIVIDUAL PERSONAL PROPERTY	HAGEN DAVID	NO ADDRESS PROVIDED BY TAXPAYER
200744119	2006-2017	INDIVIDUAL PERSONAL PROPERTY	AYALA RENE F	5217 CRISP AVE	20114016	2015-2019	INDIVIDUAL PERSONAL PROPERTY	GUMBS GILBERT	10600 CORRIINGTON AVE
200745373	2013-2017	INDIVIDUAL PERSONAL PROPERTY	FIFER AMY	7148 WOODSON DR	20114374	2010-2011	INDIVIDUAL PERSONAL PROPERTY	JACKSON LAKEISHA	7427 ENGLEWOOD LN
200745376	2014-2016	INDIVIDUAL PERSONAL PROPERTY	ALKA STEPHAN P	8805 E 53RD TER	20114451	2006	INDIVIDUAL PERSONAL PROPERTY	VILLALOBOS EDUARDO G	5905 CLAREMONT AVE
200746054	2021	INDIVIDUAL PERSONAL PROPERTY	KING TONI R	11408 E 77TH ST	20114632	2019-2021	INDIVIDUAL PERSONAL PROPERTY	JEFFERSON ROENA & CLINT	6914 E 114TH ST
200746214	2009-2016	INDIVIDUAL PERSONAL PROPERTY	SCHREIBER CARLA M	8413 OLIVE ST	20115070	2018-2021	INDIVIDUAL PERSONAL PROPERTY	HARRIS ROBERT CHRISTOPHER	10602 E 79TH TER
200746567	2005-2006	INDIVIDUAL PERSONAL PROPERTY	CLARY PAUL EDWARD	NO ADDRESS PROVIDED BY TAXPAYER	20115540	2017-2021	INDIVIDUAL PERSONAL PROPERTY	VALIANT LESLIE	8325 NORTHERN ST
200746574	2017	INDIVIDUAL PERSONAL PROPERTY	RODRIGUEZ MARILYN GOBEL	8614 OXFORD AVE	20115865	2010	INDIVIDUAL PERSONAL PROPERTY	WILLIAMS ANTONYO L	9104 RICHARDS DR
200746751	2021	INDIVIDUAL PERSONAL PROPERTY	DRAVES JOY E	16400 S COGAN DR	20116202	2021	INDIVIDUAL PERSONAL PROPERTY	RIGGS CYNTHIA JO & RIGGS CALLIE J	5515 HARRIS AVE
200747180	2004	INDIVIDUAL PERSONAL PROPERTY	HEAD MICHELLEA C	UNKNOWN	20116392	2009-2011	INDIVIDUAL PERSONAL PROPERTY	YOUNG CAIRA	8614 E 85TH ST
200747275	2003-2004	INDIVIDUAL PERSONAL PROPERTY	STANDEFER KRISTINA L	10339 E 61ST ST 3	20116401	2021	INDIVIDUAL PERSONAL PROPERTY	JOHNSON BRYANT JAMES	8301 LAUREL AVE
200747402	2006	INDIVIDUAL PERSONAL PROPERTY	CARTER ADAM J	7209 WOODSON RD	20116434	2021	INDIVIDUAL PERSONAL PROPERTY	LEAR ROBERT D	6220 HUNTER ST
200747633	2021	INDIVIDUAL PERSONAL PROPERTY	CARTER-ROBINSON DEMIKO A	8955 E 54TH ST	20116472	2005-2006	INDIVIDUAL PERSONAL PROPERTY	ALLSUP MARIE	9300 E 67TH TER
200747636	2021	INDIVIDUAL PERSONAL PROPERTY	ELLIOTT CARRIE LEE	8330 WESTRIDGE RD	20116519	2016-2017	INDIVIDUAL PERSONAL PROPERTY	WATKINS ROCKY & ESMERALDA	9054 E 59TH ST
200747692	2018-2019	INDIVIDUAL PERSONAL PROPERTY	WILLIAMS LINDA & MICHAEL & DESTINY	8402 STERLING AVE	20116640	2017	INDIVIDUAL PERSONAL PROPERTY	HUNTLEY STORMY L	6725 VERMONT AVE
200747699	2004	INDIVIDUAL PERSONAL PROPERTY	STANCIEER JOAN & ESTERA ANDERSEN	8808 E 61ST ST	20116904	2021	INDIVIDUAL PERSONAL PROPERTY	TUGGLE KELVIN II & ROSS BERNICE	5938 E 40TH TER
200747765	2005	INDIVIDUAL PERSONAL PROPERTY	BINNEY ROGER	NO ADDRESS PROVIDED BY TAXPAYER	20117134	2017-2018	INDIVIDUAL PERSONAL PROPERTY	BURRIS KEITH L & JANELLE	5516 HEDGES AVE
200747784	2005	INDIVIDUAL PERSONAL PROPERTY	THAXTON OLLIE M	9804 E 84TH ST	20117145	2004	INDIVIDUAL PERSONAL PROPERTY	WILLIAMS NICOLE R	UNKNOWN
200747873	2021	INDIVIDUAL PERSONAL PROPERTY	LAMMING KYLE	7519 HAWTHORNE AVE	20117238	2010-2017	INDIVIDUAL PERSONAL PROPERTY	COPENHAVER CHRISTINE M	9111 E 72ND TER
200747879	2005-2007	INDIVIDUAL PERSONAL PROPERTY	GARRISON RENEE	8310 STERLING AVE	20117298	2021	INDIVIDUAL PERSONAL PROPERTY	JONES JUSTIN LEE	9035 LEWIS AVE
200747942	2006	INDIVIDUAL PERSONAL PROPERTY	HIGHFILL JASON L	6637 MAYWOOD AVE	20117434	2011-2013	INDIVIDUAL PERSONAL PROPERTY	BUNGEI DAVID & LORTRIDGE MALISA	8326 STERLING AVE
200747952	2004-2005	INDIVIDUAL PERSONAL PROPERTY	CLAY MYRON III	4021 AGNES AVE	20117563	2004	INDIVIDUAL PERSONAL PROPERTY	WHITE SONIA E	1301 ARROWHEAD RIDGE DR
200747956	2004	INDIVIDUAL PERSONAL PROPERTY	RICE MICHAEL	6407 EVANSTON	20117604	2021	INDIVIDUAL PERSONAL PROPERTY	LADINES LEONIDA	10901 E 53RD ST
200747975	2008-2009	INDIVIDUAL PERSONAL PROPERTY	TAYLOR PAUL T	8337 HARVARD AVE	20117681	2007	INDIVIDUAL PERSONAL PROPERTY	DOUGLAS MYLA	NO ADDRESS PROVIDED BY TAXPAYER
200747985	2004-2006	INDIVIDUAL PERSONAL PROPERTY	EHPLE MELSIHDA	6900 RAYTOWN RD	20117831	2020-2021	INDIVIDUAL PERSONAL PROPERTY	CLEMMONS FELICIA D	8605 E 84TH TER
200747993	2004	INDIVIDUAL PERSONAL PROPERTY	ROBERIE NINA A	9501 E 65TH TER	20117927	2004	INDIVIDUAL PERSONAL PROPERTY	REYES GERARDO LOPEZ	8610 RAYTOWN RD
200747998	2021	INDIVIDUAL PERSONAL PROPERTY	BLAND DEMARIO RAMON	8209 HEDGES AVE	20118026	2012-2017	INDIVIDUAL PERSONAL PROPERTY	SHEPPARD KANDICE S	7607 ARLINGTON AVE
200748012	2020-2021	INDIVIDUAL PERSONAL PROPERTY	CUNNINGHAM JENNIFER LEIGH	8810 VANHOE TRL	20118378	2004	INDIVIDUAL PERSONAL PROPERTY	MEISTER JOLENE	UNKNOWN
200748014	2020-2021	INDIVIDUAL PERSONAL PROPERTY	PRUITT MAXINE L BRACKSON	7919 HARRIS AVE	20118933	2020-2021	INDIVIDUAL PERSONAL PROPERTY	GURLEY LANATASHA S	7209 ASH AVE
200748033	2004-2005	INDIVIDUAL PERSONAL PROPERTY	HILL PRECIOSUS	6391 MANCHESTER AVE APT 1	20119123	2021	INDIVIDUAL PERSONAL PROPERTY	SUBLETT MARY J	7154 CRISP AVE
200748219	2004	INDIVIDUAL PERSONAL PROPERTY	MAYBERRY SHOMARI	11700 E 83RD ST	20119201	2012-2013	INDIVIDUAL PERSONAL PROPERTY	ARMES KEITH E & LAURA S	8020 DITZLER AVE
200748227	2007-2009	INDIVIDUAL PERSONAL PROPERTY	HIGHFILL ANTHONY	9350 E 67TH TER	20119587	2020-2021	INDIVIDUAL PERSONAL PROPERTY	HOOD STEPHANIE C	7214 CRISP AVE
200748260	2004	INDIVIDUAL PERSONAL PROPERTY	SMITH BYRNN	5910 NORTHERN AVE	20119671	2019-2021	INDIVIDUAL PERSONAL PROPERTY	GEORGE ALISHA M	9213 E 84TH CT
200748283	2005	INDIVIDUAL PERSONAL PROPERTY	SCHWEITZER MATHEW	8014 MANNING AVE	20119769	2021	INDIVIDUAL PERSONAL PROPERTY	ANDERSON JENNIFER E	712 NE 3RD ST
200748308	2006-2010	INDIVIDUAL PERSONAL PROPERTY	POPLETT MATTHEW R	1825 S HOME AVE	20120399	2011	INDIVIDUAL PERSONAL PROPERTY	DAVENPORT ALLAN	11406 E 58TH TER
200748325	2004	INDIVIDUAL PERSONAL PROPERTY	CLARK WILLIAM A	UNKNOWN	20121328	2013-2015	INDIVIDUAL PERSONAL PROPERTY	SMITH LOUISE M	9215 E 54TH ST

201121439	2005	INDIVIDUAL PERSONAL PROPERTY	CROOKS ROGER & JANIS	5416 MAYWOOD AVE	201133841	2020-2021	INDIVIDUAL PERSONAL PROPERTY	FOSTER JAMES D & SHERRY M	9201 E 68TH ST
201121448	2004	INDIVIDUAL PERSONAL PROPERTY	HOLMAN MICHELLE LYNN	UNKNOWN	201133956	2008	INDIVIDUAL PERSONAL PROPERTY	MANLEY CAROLYN S	6816 VERMONT AVE
201121655	2008-2009	INDIVIDUAL PERSONAL PROPERTY	CURRIE MARION L	9010 E 87TH ST APT A1	201134039	2021	INDIVIDUAL PERSONAL PROPERTY	TAYLOR RAKETA & BRIAN	8020 HUNTER ST
201121658	2012	INDIVIDUAL PERSONAL PROPERTY	PATERSON MARC D & JAMIE	6305 HEDGES AVE	201134074	2012	INDIVIDUAL PERSONAL PROPERTY	MORGAN THELWOOD JR	9809 E 67TH TER
201121774	2005	INDIVIDUAL PERSONAL PROPERTY	HUNZIKER GAYLEN	NO ADDRESS PROVIDED BY TAXPAYER	201134276	2006-2010	INDIVIDUAL PERSONAL PROPERTY	HENRY GREGORY DONNELL	619 E 27TH ST
201122035	2020-2021	INDIVIDUAL PERSONAL PROPERTY	MARSHALL WILLIAM F III	8307 WOODSON DR	201134311	2005-2006	INDIVIDUAL PERSONAL PROPERTY	RENO JOHN W	7200 OXFORD AVE
201122153	2006-2007	INDIVIDUAL PERSONAL PROPERTY	MOON SARAH	10900 E 57TH TER	201134398	2021	INDIVIDUAL PERSONAL PROPERTY	BRICE TANEISHA RENEE	8609 CRESCENT AVE
201122161	2016-2021	INDIVIDUAL PERSONAL PROPERTY	BAKER TARA S & WEST SHAWN	9318 E 83RD ST	201134420	2021	INDIVIDUAL PERSONAL PROPERTY	MARTIN OVONJA EUGENE	7001 LAKESHORE DR
201122441	2007-2010	INDIVIDUAL PERSONAL PROPERTY	BOWLUS GARY L & DEBRA	5815 CEDAR AVE	201134511	2009-2017	INDIVIDUAL PERSONAL PROPERTY	HERRON CHARLES M SR	9309 E 73RD ST
201122488	2006	INDIVIDUAL PERSONAL PROPERTY	KELLY GARI STORM	11105 E 78TH ST	201134521	2013	INDIVIDUAL PERSONAL PROPERTY	SHUPERT FRANCES JOLENE	11401 E 77TH TER
201122566	2017	INDIVIDUAL PERSONAL PROPERTY	HENRIQUEZ NELSON W	7908 OVERTON DR	201134591	2004-2005	INDIVIDUAL PERSONAL PROPERTY	KING DAVID E	8409 BOOTH AVE
201122584	2011-2012	INDIVIDUAL PERSONAL PROPERTY	DOUGLAS LAWRENCE DEVERT	407 W WALNUT ST	201134630	2004-2007	INDIVIDUAL PERSONAL PROPERTY	VERNESS RYAN THOMAS	5401 OXFORD AVE
201122648	2017-2019	INDIVIDUAL PERSONAL PROPERTY	KIRKWOOD TERENCE	5713 OLIVE ST	201134713	2014	INDIVIDUAL PERSONAL PROPERTY	HENSLEY AARON & MICKY PRICILLA	10816 E 57TH ST
201122800	2004-2005	INDIVIDUAL PERSONAL PROPERTY	YVONNE COLEMAN	5220 E 39TH TER	201134750	2005	INDIVIDUAL PERSONAL PROPERTY	KAMARUDEEN MUSTAPHA M	10207 E 63RD ST
201122910	2021	INDIVIDUAL PERSONAL PROPERTY	CAMPBELL ALPHONSO & ADRIENE JOY	9017 E 66TH TER	201134853	2005-2008	INDIVIDUAL PERSONAL PROPERTY	SMITH STEPHEN	9405 E 83RD ST
201122971	2021	INDIVIDUAL PERSONAL PROPERTY	MORRIS DAVID J	6718 HARRIS AVE	201135033	2021	INDIVIDUAL PERSONAL PROPERTY	BRAICHA JERRALD	9507 E 69TH ST
201123106	2004	INDIVIDUAL PERSONAL PROPERTY	CARR ROY L	UNKNOWN	201135253	2005	INDIVIDUAL PERSONAL PROPERTY	WEST WYATT LUCRICIA R	NO ADDRESS PROVIDED BY TAXPAYER
201123160	2004-2005	INDIVIDUAL PERSONAL PROPERTY	KHAWAJA ADEEL	NO ADDRESS PROVIDED BY TAXPAYER	201135266	2017-2021	INDIVIDUAL PERSONAL PROPERTY	RIGG EDNA L	5409 RALSTON AVE
201123275	2005	INDIVIDUAL PERSONAL PROPERTY	EASTON PAUL S	13407 LITTLE BLUE RD	201135607	2007-2008	INDIVIDUAL PERSONAL PROPERTY	DOUGHERTY JESSIE D	8317 MAYWOOD AVE
201123253	2021	INDIVIDUAL PERSONAL PROPERTY	NORMAN DERECK EDWARD	12019 S EAGLE CREST DR	201135716	2021	INDIVIDUAL PERSONAL PROPERTY	MEADE RODNEY M	11008 E 72ND TER
201123446	2004-2006	INDIVIDUAL PERSONAL PROPERTY	ASHLAW MICHAEL J	5309 HARDY AVE	201135748	2021	INDIVIDUAL PERSONAL PROPERTY	HENSEL TIM & LATISHA M	7718 WOODSON RD
201123522	2005-2017	INDIVIDUAL PERSONAL PROPERTY	HILLIARD BRIAN & JEAN	9004 E 69TH ST	201135828	2019-2020	INDIVIDUAL PERSONAL PROPERTY	BENTE PATRICK B	10309 E 56TH ST
201124397	2006-2007	INDIVIDUAL PERSONAL PROPERTY	GAMMIL APRIL	NO ADDRESS PROVIDED BY TAXPAYER	201135975	2006	INDIVIDUAL PERSONAL PROPERTY	MOSES JENNIFER	5904 CLAREMONT AVE
201125497	2005-2006	INDIVIDUAL PERSONAL PROPERTY	BARNETT JAMES W	NO ADDRESS PROVIDED BY TAXPAYER	201136322	2020-2021	INDIVIDUAL PERSONAL PROPERTY	OLIVER KENNETH E	11901 E 76TH TER
201125719	2011-2013	INDIVIDUAL PERSONAL PROPERTY	ZEARLEY BONNIE	5517 HEDGES AVE	201136405	2005-2009	INDIVIDUAL PERSONAL PROPERTY	TARVIN LAURA S	5812 ASH AVE
201125865	2005	INDIVIDUAL PERSONAL PROPERTY	GRISOLANO MEGAN	980 E 67TH TER	201136452	2004-2005	INDIVIDUAL PERSONAL PROPERTY	ROBERTS WESLEY H	NO ADDRESS PROVIDED BY TAXPAYER
201125966	2019-2020	INDIVIDUAL PERSONAL PROPERTY	FRAZIER GARY D	9316 E 61ST ST APT 1	201136548	2007-2008	INDIVIDUAL PERSONAL PROPERTY	SINGLETON KENNETH E	10701 E 65TH TER
201126004	2021	INDIVIDUAL PERSONAL PROPERTY	HARDIMAN RASHANDA MARIE	10510 E 80TH ST	201136617	2010-2011	INDIVIDUAL PERSONAL PROPERTY	MAGEE LUCY MAE	8611 KENTUCKY AVE
201126106	2018-2019	INDIVIDUAL PERSONAL PROPERTY	THELANDER JOSEPH	9808 E 79TH ST	201138011	2009-2010	INDIVIDUAL PERSONAL PROPERTY	SMITH HANNAH	8323 OXFORD AVE
201126177	2004	INDIVIDUAL PERSONAL PROPERTY	WILLIAMS JANET R	UNKNOWN	201138214	2021	INDIVIDUAL PERSONAL PROPERTY	HART ROBIN LEANN (STANAR)	10005 E 71ST TER
201126404	2020-2021	INDIVIDUAL PERSONAL PROPERTY	DAVIS CINDY M	6811 HUNTER ST	201138287	2021	INDIVIDUAL PERSONAL PROPERTY	WALTER CAWTHON JOSHUA KENNETH	10004 E 78TH ST
201126820	2019-2021	INDIVIDUAL PERSONAL PROPERTY	TASKER WILLIAM CODY ALAN	5712 BLUE RIDGE CUT OFF	201138292	2021	INDIVIDUAL PERSONAL PROPERTY	BISHOP JAMIE L	11805 E 51ST ST
201127131	2009-2011	INDIVIDUAL PERSONAL PROPERTY	RICHARDSON LANESHA D	6812 VERMONT AVE	201138321	2004	INDIVIDUAL PERSONAL PROPERTY	CARPENTER STEPHEN R	9319 E 65TH TER
201127507	2015-2016	INDIVIDUAL PERSONAL PROPERTY	HOLLEY CHARLES O	10005 E 77TH TER	201138443	2021	INDIVIDUAL PERSONAL PROPERTY	LOVINGOOD TAMIKA	9319 E 84TH ST
201127677	2005	INDIVIDUAL PERSONAL PROPERTY	CAMPBELL THOMAS	7101 WILLOW AVE	201138482	2021	INDIVIDUAL PERSONAL PROPERTY	BROWN JULIAN MARCUS	5940 STERLING AVE
201127809	2017	INDIVIDUAL PERSONAL PROPERTY	LARSEN MEGAN	11517 E 67TH ST	201138512	2008	INDIVIDUAL PERSONAL PROPERTY	ABANGAN COLEEN K	8531 EVANSTON AVE
201127885	2005-2007	INDIVIDUAL PERSONAL PROPERTY	FRAYLING LLOYD WILLIAM	10105 E 81ST ST	201138539	2021	INDIVIDUAL PERSONAL PROPERTY	SHEDD DANIEL P	9000 E 59TH ST
201128027	2004	INDIVIDUAL PERSONAL PROPERTY	JOHNSON JOYCE M	NO ADDRESS PROVIDED BY TAXPAYER	201138585	2005-2007	INDIVIDUAL PERSONAL PROPERTY	WILLIAMS DONRIAL	NO ADDRESS PROVIDED BY TAXPAYER
201128259	2006	INDIVIDUAL PERSONAL PROPERTY	HUYNH MICHAEL	8516 HAWTHORNE AVE	201138619	2006-2008	INDIVIDUAL PERSONAL PROPERTY	WALTON CLINT M	7314 RALSTON AVE
201128332	2005-2006	INDIVIDUAL PERSONAL PROPERTY	BARTLETT WALTER ELVIN JR	8805 E 71ST TER	201138629	2021	INDIVIDUAL PERSONAL PROPERTY	JOHNSON REBECCA J	6436 OVERTON AVE
201128573	2005	INDIVIDUAL PERSONAL PROPERTY	RHOADS CHAD	8521 MAYWOOD AVE	201138790	2020-2021	INDIVIDUAL PERSONAL PROPERTY	DAVIS SHERON D	5152 WESTRIDGE CIR
201129049	2021	INDIVIDUAL PERSONAL PROPERTY	WILLIAMS AJUANA M	12001 E 78TH TER	201138813	2005	INDIVIDUAL PERSONAL PROPERTY	DALATORRE JUAN	9800 E 61ST ST
201129099	2012	INDIVIDUAL PERSONAL PROPERTY	DAVIS MARGARET L	5532 HUNTER TER	201138895	2021	INDIVIDUAL PERSONAL PROPERTY	HEARD IRVING KATRICE LASHANDA	7116 STERLING AVE
201129174	2003	INDIVIDUAL PERSONAL PROPERTY	LEWIS CORY	UNKNOWN	201138965	2021	INDIVIDUAL PERSONAL PROPERTY	ANDERSON JOSEPH R & MELANIE (MORRIS)	6517 STERLING AVE
201129361	2005-2006	INDIVIDUAL PERSONAL PROPERTY	DORSEY IVAN E	5426 DITZLER AVE	201139232	2005	INDIVIDUAL PERSONAL PROPERTY	CLINE JOHN & ANDMISTY	NO ADDRESS PROVIDED BY TAXPAYER
201129537	2021	INDIVIDUAL PERSONAL PROPERTY	MASONER THERESA	8609 EVERETT ST	201139241	2005-2017	INDIVIDUAL PERSONAL PROPERTY	SANTOS MARGARITO	8206 E 86TH TER
201129551	2016	INDIVIDUAL PERSONAL PROPERTY	AMBLER MIKEL CORTEZ	4435 ASKEW AVE	201139311	2021	INDIVIDUAL PERSONAL PROPERTY	SPURGEON DANIEL A	8714 E 87TH ST
201130136	2020-2021	INDIVIDUAL PERSONAL PROPERTY	JOHNSON JAMES B	9405 E 66TH ST	201139378	2017	INDIVIDUAL PERSONAL PROPERTY	COMMACK SHARON	7009 ARLINGTON AVE
201130146	2004-2013	INDIVIDUAL PERSONAL PROPERTY	HAWTHORNE ELTROUS	8925 E 81ST ST	201139852	2005	INDIVIDUAL PERSONAL PROPERTY	OTT SHERRY	11314 E 72ND ST
201130217	2019-2021	INDIVIDUAL PERSONAL PROPERTY	BURBANKS KIMMIEKA	9219 E 54TH ST	201139905	2015	INDIVIDUAL PERSONAL PROPERTY	HARRISON JOHRON	9105 E 66TH ST
201130307	2020-2021	INDIVIDUAL PERSONAL PROPERTY	CHAPMAN JOLENE MICHELLE	5945 RAYTOWN RD	201140070	2021	INDIVIDUAL PERSONAL PROPERTY	SPURGEON DANIEL A	8714 E 87TH ST
201130510	2009-2017	INDIVIDUAL PERSONAL PROPERTY	SHULER DAVID C	9112 RICHARDS DR	201140094	2010	INDIVIDUAL PERSONAL PROPERTY	COMBS DORIS	5104 HARDY CT
201130690	2021	INDIVIDUAL PERSONAL PROPERTY	MORRIS KIPPY JR	10804 E 79TH ST	201140262	2006-2007	INDIVIDUAL PERSONAL PROPERTY	KNURBEIN CINDY	NO ADDRESS PROVIDED BY TAXPAYER
201130899	2005	INDIVIDUAL PERSONAL PROPERTY	RODNEY BRONSON & KATHLEEN N	NO ADDRESS PROVIDED BY TAXPAYER	201140382	2009-2011	INDIVIDUAL PERSONAL PROPERTY	SNOW CHRIS	5321 LAUREL AVE
201130943	2021	INDIVIDUAL PERSONAL PROPERTY	TROW PERIS R	9809 E 73RD ST APT D	201140500	2005-2007	INDIVIDUAL PERSONAL PROPERTY	SCHAFER JESSICA	NO ADDRESS PROVIDED BY TAXPAYER
201130991	2004	INDIVIDUAL PERSONAL PROPERTY	WINSLOW JAIME	10109 E 68TH ST	201141044	2016-2021	INDIVIDUAL PERSONAL PROPERTY	HOLLOWAY WHITNEY (KUYKENDALL)	8808 E 86TH ST
201131216	2017-2019	INDIVIDUAL PERSONAL PROPERTY	DAVIS DEIATRA	11325 GRANDVIEW RD UNIT 327	201141122	2021	INDIVIDUAL PERSONAL PROPERTY	LUNA ANGEL M	10401 E 71ST TER
201131267	2021	INDIVIDUAL PERSONAL PROPERTY	DATTOLI SCOTT & SELENA N	5815 FARLEY AVE	201141130	2021	INDIVIDUAL PERSONAL PROPERTY	SMITH LARICE MARVETTE	11911 NEWTON AVE APT 64
201131393	2007	INDIVIDUAL PERSONAL PROPERTY	ASHBY EMMANUEL	NO ADDRESS PROVIDED BY TAXPAYER	201141233	2021	INDIVIDUAL PERSONAL PROPERTY	MYRES ANGELA D	10023 E 67TH ST
201131593	2020-2021	INDIVIDUAL PERSONAL PROPERTY	MANNING VICKI L	9400 E 55TH ST	201141273	2012-2014	INDIVIDUAL PERSONAL PROPERTY	ANDERSON MITCHELL A	11904 E 78TH TER
201131620	2020-2021	INDIVIDUAL PERSONAL PROPERTY	HILL JEANNE B & SESLEY DRAKE E	6117 WILLOW AVE	201141324	2012	INDIVIDUAL PERSONAL PROPERTY	BEASLEY CHANDRA	6608 OXFORD AVE
201131746	2020-2021	INDIVIDUAL PERSONAL PROPERTY	DECAMP SARA	10512 E 79TH ST	201141337	2017	INDIVIDUAL PERSONAL PROPERTY	SMITH TANDRA D	10100 E 83RD TER
201131819	2003-2004	INDIVIDUAL PERSONAL PROPERTY	WESCHE TRAVIS	7140 STERLING	201141347	2018-2019	INDIVIDUAL PERSONAL PROPERTY	POE GREGORY A	9000 E 75TH ST
201132085	2021	INDIVIDUAL PERSONAL PROPERTY	HULL JASON L	10705 E 62ND TER	201141426	2006-2008	INDIVIDUAL PERSONAL PROPERTY	LOEHR ERIN M	NO ADDRESS PROVIDED BY TAXPAYER
201132180	2009	INDIVIDUAL PERSONAL PROPERTY	HOGAN DOUG P & KELLY	10909 E 60TH TER	201141438	2015-2019	INDIVIDUAL PERSONAL PROPERTY	MARTIN JESSICA A & DREW C	10015 E 78TH ST
201132285	2014-2016	INDIVIDUAL PERSONAL PROPERTY	TOOLEY MICHAEL S	6549 RAYTOWN RD APT 3	201141494	2021	INDIVIDUAL PERSONAL PROPERTY	ANDERSON SARAH B	10005 E 53RD ST
201132466	2012	INDIVIDUAL PERSONAL PROPERTY	GRADY DENNIS M	8528 MAYWOOD AVE	201141532	2005-2006	INDIVIDUAL PERSONAL PROPERTY	STONEMAN JON W	12520 E 49TH ST S
201132522	2005-2007	INDIVIDUAL PERSONAL PROPERTY	BOWEN AMELIA	NO ADDRESS PROVIDED BY TAXPAYER	201141535	2019-2021	INDIVIDUAL PERSONAL PROPERTY	CHANDLER AARON JOSEPH	8409 JAMES A REED RD
201132678	2009-2011	INDIVIDUAL PERSONAL PROPERTY	CARLSON PAULA S	11209 E 62ND ST	201141752	2020-2021	INDIVIDUAL PERSONAL PROPERTY	SHOCKEY TRISH NICOLE	8808 E 86TH TER
201133051	2021	INDIVIDUAL PERSONAL PROPERTY	GRANT NICHOLAS	7328 WILLOW AVE	201141871	2021	INDIVIDUAL PERSONAL PROPERTY	TRINIDAD KRIS	10325 E 61ST ST APT 4
201133420	2007-2008	INDIVIDUAL PERSONAL PROPERTY	STREB GLENN	6622 WILLOW AVE	201141969	2014-2016	INDIVIDUAL PERSONAL PROPERTY	QUINN JESSICA	7510 WOODSON RD
201133423	2020-2021	INDIVIDUAL PERSONAL PROPERTY	BETTIS THOMAS III & MICHELLE	5525 WOODSON RD	201141998	2011	INDIVIDUAL PERSONAL PROPERTY	DENNY RAYMOND H	9903 E 60TH ST

201142012	2021	INDIVIDUAL PERSONAL PROPERTY	GARRETT DAVID	11604 E 58TH TER	201148841	2005	INDIVIDUAL PERSONAL PROPERTY	TOWNLEY ADAM D	6500 HARDY AVE
201142061	2005-2008	INDIVIDUAL PERSONAL PROPERTY	ANDERSON RICHARD	8328 OXFORD AVE	201148850	2014-2016	INDIVIDUAL PERSONAL PROPERTY	OWENS JANINE M	7415 APPLETON AVE
201142090	2019-2021	INDIVIDUAL PERSONAL PROPERTY	LILES ANGELA	10504 E 79TH ST	201148875	2021	INDIVIDUAL PERSONAL PROPERTY	SHEPHERD SABRINA	10600 E 59TH ST
201142092	2005-2006	INDIVIDUAL PERSONAL PROPERTY	BURNSIDE TENEAL A	NO ADDRESS PROVIDED BY TAXPAYER	201148912	2018-2021	INDIVIDUAL PERSONAL PROPERTY	NEAL APRIL & DOMINIQUE	5400 LAUREL AVE
201142152	2021	INDIVIDUAL PERSONAL PROPERTY	KINSEY ASHLEY N	827 SW PEACH TREE LN	201149138	2016	INDIVIDUAL PERSONAL PROPERTY	FRENCH GEORGE E	8505 SPRING VALLEY RD
201142201	2017-2018	INDIVIDUAL PERSONAL PROPERTY	COLDING ALEGRIA	9204 E 64TH TER	201149304	2016-2021	INDIVIDUAL PERSONAL PROPERTY	THOMAS AUDREY S	9112 E 84TH ST
201142232	2015-2019	INDIVIDUAL PERSONAL PROPERTY	ECHOLS RIVERO	8634 LANE AVE APT 4	201149403	2005-2008	INDIVIDUAL PERSONAL PROPERTY	CHASE MICHAEL R II	6110 ARLINGTON AVE
201142503	2007	INDIVIDUAL PERSONAL PROPERTY	RIVERA CARLOS L & CRESPO MARIA L	8315 LANE AVE	201149474	2020	INDIVIDUAL PERSONAL PROPERTY	BLANFORD GINA D	5420 BLUE RIDGE CUT OFF APT G06
201142577	2004	INDIVIDUAL PERSONAL PROPERTY	ROBERTSON MICHAEL	9404 LEWIS AVE	201149495	2005-2007	INDIVIDUAL PERSONAL PROPERTY	WEBSTER DANNY R	6507 BLUE RIDGE BLVD
201142947	2007-2008	INDIVIDUAL PERSONAL PROPERTY	AVERY REBECCA A	7317 RALSTON AVE	201149530	2005-2008	INDIVIDUAL PERSONAL PROPERTY	BARTON MAGEN D	10005 E 53RD ST
201142951	2021	INDIVIDUAL PERSONAL PROPERTY	SMITH TANYA R	9067 E 55TH ST	201149598	2009	INDIVIDUAL PERSONAL PROPERTY	GODINEZ JANICE	7204 OVERTON AVE
201142974	2009-2013	INDIVIDUAL PERSONAL PROPERTY	KYTE SHELLY R	9006 E GREGORY BLVD	201149639	2005	INDIVIDUAL PERSONAL PROPERTY	PRICE CHRISTINA LOUISE	NO ADDRESS PROVIDED BY TAXPAYER
201143153	2007-2008	INDIVIDUAL PERSONAL PROPERTY	KHAWAJA IMRAN	8111 E 87TH ST	201149688	2021	INDIVIDUAL PERSONAL PROPERTY	PIONIO BILLY J	7025 KENTUCKY AVE
201143382	2020-2021	INDIVIDUAL PERSONAL PROPERTY	COWANS SIR EDWARD	8812 E 71ST TER	201149791	2021	INDIVIDUAL PERSONAL PROPERTY	GLENN DONALD PAUL	NO ADDRESS PROVIDED BY TAXPAYER
201143475	2010-2011	INDIVIDUAL PERSONAL PROPERTY	TYSON FOREST E III	7432 ENGLEWOOD LN	201150006	2009	INDIVIDUAL PERSONAL PROPERTY	MORALES SANTA	5420 BLUE RIDGE CUT OFF APT 608
201143533	2010-2011	INDIVIDUAL PERSONAL PROPERTY	WILCOX MEGAN N	9001 E 94TH ST	201150013	2005-2006	INDIVIDUAL PERSONAL PROPERTY	JOHNSON JOHNNY	11314 E 72ND ST
201143551	2021	INDIVIDUAL PERSONAL PROPERTY	CRAWFORD MARCUS A & BAILEY COREAN K	9901 E 84TH ST	201150068	2005	INDIVIDUAL PERSONAL PROPERTY	WILLIAMS TANYA	NO ADDRESS PROVIDED BY TAXPAYER
201143897	2019-2021	INDIVIDUAL PERSONAL PROPERTY	MASON LETIA CHARLENE	9225 E 53RD TER	201150090	2020-2021	INDIVIDUAL PERSONAL PROPERTY	SMITH RYAN WILLIAM	9009 E 68TH ST
201144226	2007	INDIVIDUAL PERSONAL PROPERTY	WEAVER THERESA M	6412 ELM AVE	201150166	2021	INDIVIDUAL PERSONAL PROPERTY	DAWKINS KELLI	8316 STARK AVE
201144379	2021	INDIVIDUAL PERSONAL PROPERTY	HIGGINS FREDERICK S	9701 E 66TH ST	201150215	2017-2019	INDIVIDUAL PERSONAL PROPERTY	MOORE BRAD	9601 E 66TH ST
201144381	2018-2021	INDIVIDUAL PERSONAL PROPERTY	WILLIAMS RYAN D	8805 E 59TH ST	201150241	2020-2021	INDIVIDUAL PERSONAL PROPERTY	ELLSWORTH GARY C & SUSAN J	6821 VERMONT AVE
201144533	2005-2007	INDIVIDUAL PERSONAL PROPERTY	PEARSON LARRY	NO ADDRESS PROVIDED BY TAXPAYER	201150297	2007-2011	INDIVIDUAL PERSONAL PROPERTY	GUST LESLIE ANN	8114 SPRING VALLEY RD
201144590	2007-2008	INDIVIDUAL PERSONAL PROPERTY	TEMPLE COLUSHEON	10208 E 69TH TER	201150324	2017-2020	INDIVIDUAL PERSONAL PROPERTY	ALLEN REGINA	6928 HUNTER ST
201144634	2005	INDIVIDUAL PERSONAL PROPERTY	HOLDERMAN SARAH H	NO ADDRESS PROVIDED BY TAXPAYER	201150450	2007	INDIVIDUAL PERSONAL PROPERTY	GRAY ROBERT W	11200 E 67TH ST
201144665	2021	INDIVIDUAL PERSONAL PROPERTY	WAINRIGHT CALEESE CARZELL	6642 MAYWOOD AVE APT A	201150640	2012	INDIVIDUAL PERSONAL PROPERTY	JOHNSON RALPH L & LATTA VIRGINIA C	8613 WESTRIDGE RD
201144734	2021	INDIVIDUAL PERSONAL PROPERTY	HENDERSON LAKESHIA S	8412 E 85TH ST	201150648	2005	INDIVIDUAL PERSONAL PROPERTY	JONES KRISTLE D	NO ADDRESS PROVIDED BY TAXPAYER
201144757	2009-2011	INDIVIDUAL PERSONAL PROPERTY	ANDERSON BOBBIE F	10200 E 72ND ST	201150898	2020-2021	INDIVIDUAL PERSONAL PROPERTY	WELLS JOYCE D	5312 DITZLER AVE
201144869	2020-2021	INDIVIDUAL PERSONAL PROPERTY	ENAHOLE EBHEIREMEN E	11215 E 75TH ST	201151111	2006	INDIVIDUAL PERSONAL PROPERTY	SLATTON CHANTLEY L	NO ADDRESS PROVIDED BY TAXPAYER
201145108	2021	INDIVIDUAL PERSONAL PROPERTY	RELIFORD MADA NOEL	6706 LANE AVE APT 204	201151314	2021	INDIVIDUAL PERSONAL PROPERTY	STOKES RACHEL DION	10330 E 63RD ST APT 2
201145196	2004-2008	INDIVIDUAL PERSONAL PROPERTY	HANCOCK MELISSA	NO ADDRESS PROVIDED BY TAXPAYER	201151349	2017-2018	INDIVIDUAL PERSONAL PROPERTY	JOHANNESEN ROBERT E & JUDITH J	8202 E 85TH TER
201145201	2010-2017	INDIVIDUAL PERSONAL PROPERTY	HUGHES RACHELLE	9605 E 68TH TER	201151413	2004-2005	INDIVIDUAL PERSONAL PROPERTY	HARRISON WILLIAM J	6912 HAWTHORNE AVE
201145294	2007	INDIVIDUAL PERSONAL PROPERTY	GREENE ODELL JR & STACY A	8300 BOOTH AVE	201153171	2005	INDIVIDUAL PERSONAL PROPERTY	LOVE DELORES	10413 E 64TH ST
201145329	2021	INDIVIDUAL PERSONAL PROPERTY	WARREN SPENCER D	5420 RAYTOWN RD	201153274	2013-2016	INDIVIDUAL PERSONAL PROPERTY	MOORE JUSTIN M	8409 BOOTH AVE
201145336	2016-2021	INDIVIDUAL PERSONAL PROPERTY	JIMENEZ EULALIA	5432 MAYWOOD AVE	201153402	2015-2016	INDIVIDUAL PERSONAL PROPERTY	INOUE MAILE C	6106 WILLOW AVE
201145367	2004-2010	INDIVIDUAL PERSONAL PROPERTY	NORBREGA JONATHAN	11008 E 71ST TER	201153602	2009-2011	INDIVIDUAL PERSONAL PROPERTY	GHALE SANDRA	1315 MAYWOOD AVE
201145388	2005-2006	INDIVIDUAL PERSONAL PROPERTY	CANARY WILLIAM C	8812 RICHARDS DR	201153641	2005-2006	INDIVIDUAL PERSONAL PROPERTY	OLDHAM APRIL	11411 E 83RD ST
201145432	2004	INDIVIDUAL PERSONAL PROPERTY	HENDRIX MATT	UNKNOWN	201153852	2020-2021	INDIVIDUAL PERSONAL PROPERTY	PRUITT AARON L	11120 E 85TH ST
201145486	2007	INDIVIDUAL PERSONAL PROPERTY	WATSON JAMES E	9701 E 81ST ST	201153874	2021	INDIVIDUAL PERSONAL PROPERTY	POLLARD AARON	8202 E 87TH ST
201145511	2011-2012	INDIVIDUAL PERSONAL PROPERTY	GONZALEZ MARY ELLEN	11516 E 74TH STREET CT	201154074	2010-2011	INDIVIDUAL PERSONAL PROPERTY	VERLANDER BARD	NO ADDRESS PROVIDED BY TAXPAYER
201145522	2004	INDIVIDUAL PERSONAL PROPERTY	BORDERS TALLY	8305 E 86TH TER	201154182	2021	INDIVIDUAL PERSONAL PROPERTY	CALHOUN TRENELLE	8478 LANE DR
201145567	2007	INDIVIDUAL PERSONAL PROPERTY	BERNAL YVONNE	8000 E 87TH ST	201154257	2020-2021	INDIVIDUAL PERSONAL PROPERTY	COWLEY TANIESHA	5621 STERLING AVE
201145705	2020-2021	INDIVIDUAL PERSONAL PROPERTY	WILLIAMS CRAIG ANTHONY	6204 CLAREMONT AVE	201154308	2008	INDIVIDUAL PERSONAL PROPERTY	HALE ANDRE L	NO ADDRESS PROVIDED BY TAXPAYER
201145773	2021	INDIVIDUAL PERSONAL PROPERTY	JONES DEBRA A	7205 RALSTON AVE	201154310	2011	INDIVIDUAL PERSONAL PROPERTY	STEVENSON ANDREW V III	9116 E 85TH PL
201145780	2007	INDIVIDUAL PERSONAL PROPERTY	CREPO MARIA L	8315 LANE AVE	201154407	2014	INDIVIDUAL PERSONAL PROPERTY	JONES KARLEY A	8906 E 73RD ST
201145810	2015-2019	INDIVIDUAL PERSONAL PROPERTY	MILLER CHRISTOPHER C	8701 KENTUCKY AVE	201154471	2018-2021	INDIVIDUAL PERSONAL PROPERTY	FINNELL DENNIS A	5234 DITZLER AVE
201145858	2007-2011	INDIVIDUAL PERSONAL PROPERTY	JOHNSON KENNETH LANE JR	8012 E TRUMAN RD	201154530	2016-2021	INDIVIDUAL PERSONAL PROPERTY	OSBORNE DANA RV	9505 E 60TH TER
201145869	2006	INDIVIDUAL PERSONAL PROPERTY	HILL CHANELLE L	9503 E 80TH TER	201154598	2009-2012	INDIVIDUAL PERSONAL PROPERTY	ARAUJO JOEL & MARIA	8521 DITZLER AVE
201145885	2019-2021	INDIVIDUAL PERSONAL PROPERTY	LOGAN TAMIKA SHAYRON	8627 E 80TH TER	201154951	2021	INDIVIDUAL PERSONAL PROPERTY	KIZINE TERESA	10800 E 60TH TER
201145925	2004-2007	INDIVIDUAL PERSONAL PROPERTY	ROBINSON BEN L	10512 E 65TH ST	201155045	2008-2012	INDIVIDUAL PERSONAL PROPERTY	EISENLOHR JOSEPH	9102 E 74TH TER
201145929	2012-2017	INDIVIDUAL PERSONAL PROPERTY	STITT DANIEL P	9006 E GREGORY BLVD	201155061	2021	INDIVIDUAL PERSONAL PROPERTY	MC LAUGHLIN SHARDAY	8302 MANNING AVE
201145935	2004-2006	INDIVIDUAL PERSONAL PROPERTY	BURRELL BOBBY	NO ADDRESS PROVIDED BY TAXPAYER	201155396	2008-2010	INDIVIDUAL PERSONAL PROPERTY	MCALLISTER AMAZAIR JR	4667 BENTON BLVD
201145942	2021	INDIVIDUAL PERSONAL PROPERTY	SMITH REGINALD	5420 BLUE RIDGE CUT OFF APT G06	201155459	2016-2017	INDIVIDUAL PERSONAL PROPERTY	CARTER KATHERYN R	10324 E 63RD ST APT 4
201145975	2010-2011	INDIVIDUAL PERSONAL PROPERTY	BENNETT EMILY	8400 STARK AVE	201155500	2005	INDIVIDUAL PERSONAL PROPERTY	GOMEZ ENRIQUE RICKY	11014 E 85TH ST
201145984	2004	INDIVIDUAL PERSONAL PROPERTY	HOWARD SHANTA M	UNKNOWN	201155641	2021	INDIVIDUAL PERSONAL PROPERTY	MARTIN TIARA E	5816 RALSTON AVE
201145987	2004-2005	INDIVIDUAL PERSONAL PROPERTY	CORNELIUS DAREL JR	7404 BLUE RIDGE BLVD	201155735	2006-2007	INDIVIDUAL PERSONAL PROPERTY	MULLENIX ROCHELLE	10104 E 86TH TER
201146015	2014	INDIVIDUAL PERSONAL PROPERTY	THOMPSON LUCILLE	NO ADDRESS PROVIDED BY TAXPAYER	201155758	2005-2017	INDIVIDUAL PERSONAL PROPERTY	RODRIGUEZ GUERRO ANDRES GASTANO	7309 ELM ST
201146036	2021	INDIVIDUAL PERSONAL PROPERTY	FLOWERS JOHNSON MASHELL W	9803 E 61ST ST APT 12	201155777	2019-2021	INDIVIDUAL PERSONAL PROPERTY	BANDY SHANTIC REAON (LEMONS)	8607 MAPLE AVE
201146046	2005	INDIVIDUAL PERSONAL PROPERTY	THOMASON GARY D & CHERYL L	8822 RICHARDS DR	201155884	2008-2010	INDIVIDUAL PERSONAL PROPERTY	MADDIX DEANGELO P	9014 E 75TH ST
201146177	2005-2006	INDIVIDUAL PERSONAL PROPERTY	LARSEN LORA L	8305 DITZLER AVE	201155917	2007-2009	INDIVIDUAL PERSONAL PROPERTY	ENRIQUEZ SANDRA M & SANCHEZ JUAN & VASQU	10339 E 61ST ST APT 1
201146218	2007-2011	INDIVIDUAL PERSONAL PROPERTY	SPRING JEAN N	10206 E 68TH ST	201155974	2020-2021	INDIVIDUAL PERSONAL PROPERTY	CASEY LEKEISHA M	11831 E 83RD ST APT 202
201146656	2020-2021	INDIVIDUAL PERSONAL PROPERTY	GOODRICH JACOB M	11017 E 56TH TER	201156335	2021	INDIVIDUAL PERSONAL PROPERTY	JANS DONOVAN	10119 E 80TH ST
201146680	2004-2007	INDIVIDUAL PERSONAL PROPERTY	ORE KEVIN	7902 CRESCENT AVE	201156351	2006-2008	INDIVIDUAL PERSONAL PROPERTY	ACOSTA RONALD	9109 E 83RD PL
201147653	2010	INDIVIDUAL PERSONAL PROPERTY	SCOTT ERNEST A III	11919 E 85TH ST	201156387	2004	INDIVIDUAL PERSONAL PROPERTY	WALKER ANTHONY R & BAKER GEMEC	UNKNOWN
201147868	2021	INDIVIDUAL PERSONAL PROPERTY	WALKER JEAN MARIE	5718 STERLING AVE	201156413	2020-2021	INDIVIDUAL PERSONAL PROPERTY	OTIS LONDON S	9330 E 83RD ST
201148118	2014	INDIVIDUAL PERSONAL PROPERTY	BARNES CHARLES E	5322 ASH AVE	201156495	2005-2007	INDIVIDUAL PERSONAL PROPERTY	LANDOLT JAMES T	6818 LANE AVE
201148169	2005	INDIVIDUAL PERSONAL PROPERTY	CAROTHERS BRANDON S	3725 ASKEW AVE	201156579	2021	INDIVIDUAL PERSONAL PROPERTY	LATHROP ASHLEY M	10800 E 65TH ST
201148172	2017	INDIVIDUAL PERSONAL PROPERTY	DATTILO CHRISTOPHER M	7606 CRESCENT DR	201156630	2005-2010	INDIVIDUAL PERSONAL PROPERTY	SALINAS ALANA	5605 LANE AVE
201148301	2008	INDIVIDUAL PERSONAL PROPERTY	HOKENSON MICHAEL SCOTT	11909 E 76TH TER	201156695	2008-2009	INDIVIDUAL PERSONAL PROPERTY	WEBERLIST CHERYL L	7042 WOODSON RD
201148454	2006-2007	INDIVIDUAL PERSONAL PROPERTY	POE DONNA LOUISE	NO ADDRESS PROVIDED BY TAXPAYER	201156778	2007-2009	INDIVIDUAL PERSONAL PROPERTY	ORNELAS RAYLETTA C	5521 HUNTER TER
201148522	2007	INDIVIDUAL PERSONAL PROPERTY	JEFFREYS ERIC	8700 CAMBRIDGE AVE APT 502	201156779	2007-2008	INDIVIDUAL PERSONAL PROPERTY	NORTON YONAH ZANE V	8413 NORTHERN ST
201148655	2005	INDIVIDUAL PERSONAL PROPERTY	PHILLIPS FRANCIS R & GLADYS G	8219 E 85TH TER	201156813	2010-2011	INDIVIDUAL PERSONAL PROPERTY	WILSON DONNIE L JR	10304 E 81ST ST
201148829	2009-2010	INDIVIDUAL PERSONAL PROPERTY	PRESIDENT SHAUNTAY	CA RESIDENTIAL	201157338	2017-2021	INDIVIDUAL PERSONAL PROPERTY	GALLEGOS JOSE S	8202 E 85TH ST

201157415	2005-2007	INDIVIDUAL PERSONAL PROPERTY	REVELL ANDREA R	11214 E 76TH TER	201163530	2021	INDIVIDUAL PERSONAL PROPERTY	ROYAL DONNA K	9802 E 60TH ST
201157442	2020-2021	INDIVIDUAL PERSONAL PROPERTY	PORTER TAWON C	11401 E 61ST TER	201163626	2005	INDIVIDUAL PERSONAL PROPERTY	CLARK GEORGE JR	NO ADDRESS PROVIDED BY TAXPAYER
201157462	2011	INDIVIDUAL PERSONAL PROPERTY	EVANS WILLIAM R & THERESA	5225 CRISP AVE	201163654	2008	INDIVIDUAL PERSONAL PROPERTY	JACKSON KIMBERLY A	3521 WALNUT ST APT 1
201157683	2019	INDIVIDUAL PERSONAL PROPERTY	JOHNSON ROGER L	7307 RAYTOWN RD	201163926	2004-2007	INDIVIDUAL PERSONAL PROPERTY	CHERNOFF SLEBERT G & WANDA L	7031 LAKESHORE DR
201157705	2021	INDIVIDUAL PERSONAL PROPERTY	CLARK (POTTER) AMANDA N & ANTONIO L	8332 HARRIS AVE	201164087	2004	INDIVIDUAL PERSONAL PROPERTY	JEYS WARREN	UNKNOWN
201157805	2007-2009	INDIVIDUAL PERSONAL PROPERTY	MWANIA JOHN M & STEPHANIE A	10100 E 78TH TER	201164192	2016-2019	INDIVIDUAL PERSONAL PROPERTY	WILEY EBONY S	5815 KENTUCKY AVE
201157890	2020	INDIVIDUAL PERSONAL PROPERTY	SCHROETER VANESSA A	8400 E 86TH TER	201164197	2018-2021	INDIVIDUAL PERSONAL PROPERTY	MATHEWS CHANELLE A	5536 HUNTER TER
201158093	2021	INDIVIDUAL PERSONAL PROPERTY	COLLINS THERESA (WILSON)	7712 ARLINGTON AVE	201164244	2005	INDIVIDUAL PERSONAL PROPERTY	BURTON KATHRYN M	10112 E 83RD ST
201158144	2016-2018	INDIVIDUAL PERSONAL PROPERTY	BROOKS DEANDRE	9010 E 85TH ST	201164298	2021	INDIVIDUAL PERSONAL PROPERTY	HILL REGGIE	6424 WOODSON RD
201158159	2005-2012	INDIVIDUAL PERSONAL PROPERTY	JOHNSON JOSEPH	7624 CRISP AVE	201164399	2004	INDIVIDUAL PERSONAL PROPERTY	SEARCY AMY K & JOHNSON RICHARD	UNKNOWN
201158369	2006-2017	INDIVIDUAL PERSONAL PROPERTY	CARNOW TABITHA	9400 E 81ST ST	201164414	2005-2006	INDIVIDUAL PERSONAL PROPERTY	BENNETT ADAM	NO ADDRESS PROVIDED BY TAXPAYER
201158373	2020-2021	INDIVIDUAL PERSONAL PROPERTY	DICKERSON TERENCE L	7204 OVERTON AVE	201164425	2013-2015	INDIVIDUAL PERSONAL PROPERTY	GRAVES RAYMOND	9707 E 80TH ST
201158383	2021	INDIVIDUAL PERSONAL PROPERTY	WHIGHAM KYDRA S	5417 STERLING AVE	201164511	2005-2008	INDIVIDUAL PERSONAL PROPERTY	LINDSTEDT TERRY M	5437 RAYTOWN RD
201158588	2005	INDIVIDUAL PERSONAL PROPERTY	BROWN GAYE MARIE	8140 GREENWOOD RD	201164538	2020-2021	INDIVIDUAL PERSONAL PROPERTY	HOLLAND LAWRENCE	6140 RAYTOWN RD APT 301
201158637	2009	INDIVIDUAL PERSONAL PROPERTY	SZABO CHRISTINA	8303 BOOTH AVE	201164563	2021	INDIVIDUAL PERSONAL PROPERTY	BUTLER JOYCELYN R (JOYCE)	6140 RAYTOWN RD APT 203
201158894	2020-2021	INDIVIDUAL PERSONAL PROPERTY	PARKS RASHONDA J	8809 RICHARDS DR	201164605	2019	INDIVIDUAL PERSONAL PROPERTY	DOUGLAS REBECCA I	5704 HUNTER ST
201158923	2021	INDIVIDUAL PERSONAL PROPERTY	GILSTRAP KEVIN	6710 HARRIS AVE	201164650	2021	INDIVIDUAL PERSONAL PROPERTY	DAVIS WILMA V	8432 LANE PL
201158936	2014-2019	INDIVIDUAL PERSONAL PROPERTY	EASTON STEVEN E	9808 E 79TH PL	201164671	2017-2021	INDIVIDUAL PERSONAL PROPERTY	BATTAGLER RANDALL E	6610 WILLOW AVE
201159048	2006-2007	INDIVIDUAL PERSONAL PROPERTY	MOSS RICHARD A JR	7116 NORWOOD AVE	201164696	2005	INDIVIDUAL PERSONAL PROPERTY	GETTINGS GORDON KEITH	9712 E 65TH ST
201159242	2006	INDIVIDUAL PERSONAL PROPERTY	MILLER CORA C	6228 ASH CT	201164733	2021	INDIVIDUAL PERSONAL PROPERTY	PINSON SHAN D	9351 E 60TH TER
201159246	2017-2020	INDIVIDUAL PERSONAL PROPERTY	GILES JACQUELINE O	8413 SPRING VALLEY RD	201164926	2018-2021	INDIVIDUAL PERSONAL PROPERTY	DELAMETER AARON D	9112 E 56TH ST
201159324	2006-2007	INDIVIDUAL PERSONAL PROPERTY	LYONS BRUCE E	11412 E 78TH ST	201164989	2011-2012	INDIVIDUAL PERSONAL PROPERTY	GRAVES DOUGLAS M	8408 BOOTH AVE
201159327	2008-2009	INDIVIDUAL PERSONAL PROPERTY	WISEMAN MEGHAN	5305 LAUREL AVE	201164988	2021	INDIVIDUAL PERSONAL PROPERTY	VILLALBA CESAR A & JACQUELINE S	9112 E 73RD ST
201159369	2010	INDIVIDUAL PERSONAL PROPERTY	BENNETT EMAS	5712 HUNTER ST	201165067	2021	INDIVIDUAL PERSONAL PROPERTY	GRENIER ANTHONY	9709 E 68TH TER
201159390	2014-2015	INDIVIDUAL PERSONAL PROPERTY	PALMER AMANDA ROSE (HESCHMEYER)	7425 CRISP AVE	201165100	2005	INDIVIDUAL PERSONAL PROPERTY	ANDERSON APRIL N	NO ADDRESS PROVIDED BY TAXPAYER
201159458	2007-2017	INDIVIDUAL PERSONAL PROPERTY	HOWZE ARROL C	NO ADDRESS PROVIDED BY TAXPAYER	201165241	2006-2007	INDIVIDUAL PERSONAL PROPERTY	MEIER CYNTHIA E	NO ADDRESS PROVIDED BY TAXPAYER
201159499	2004-2006	INDIVIDUAL PERSONAL PROPERTY	EADS SHAWN	NO ADDRESS PROVIDED BY TAXPAYER	201165284	2007	INDIVIDUAL PERSONAL PROPERTY	MEDELIN ERICA A	7900 CRESCENT AVE
201159815	2020-2021	INDIVIDUAL PERSONAL PROPERTY	BERK JAMES L JR & MONTGOMERY YVONNE	5715 CEDAR AVE	201165288	2009-2010	INDIVIDUAL PERSONAL PROPERTY	BURRELL RYAN P	8305 NORTHERN ST
201159874	2005-2006	INDIVIDUAL PERSONAL PROPERTY	SAGE JAMES W & APRIL	5517 MANNING AVE	201165298	2021	INDIVIDUAL PERSONAL PROPERTY	JONES TUWYDNA L	9204 VAUGHN AVE
201160122	2018-2019	INDIVIDUAL PERSONAL PROPERTY	SMITH LATISHA	8226 WOODSON DR	201165370	2021	INDIVIDUAL PERSONAL PROPERTY	RUSSELL AMBER M	8121 HEDGES AVE
201160321	2015-2021	INDIVIDUAL PERSONAL PROPERTY	JOHNSON NICHELLE D	9202 E 54TH ST	201165433	2021	INDIVIDUAL PERSONAL PROPERTY	PIERCE LAURELYN	9045 E 59TH ST
201160390	2007	INDIVIDUAL PERSONAL PROPERTY	KERN ANDY R & SARAH L	11200 E 67TH ST	201165446	2009-2017	INDIVIDUAL PERSONAL PROPERTY	SEBELSKI CHRISTOPHER T	9424 E 84TH TER
201160429	2013-2015	INDIVIDUAL PERSONAL PROPERTY	WILLIAMS VICKI P	521 NE NEWPORT DR	201165497	2019-2021	INDIVIDUAL PERSONAL PROPERTY	BELTRAN LUIS E	NO ADDRESS PROVIDED BY TAXPAYER
201160447	2017-2018	INDIVIDUAL PERSONAL PROPERTY	WRIGHT BEVERLY J	11131 E 84TH TER	201165559	2021	INDIVIDUAL PERSONAL PROPERTY	JACKSON DERIC D & KELLY	8308 EVANSTON AVE
201160451	2014-2021	INDIVIDUAL PERSONAL PROPERTY	WATTS TERRY	7501 MAPLE LN	201172235	2006-2008	INDIVIDUAL PERSONAL PROPERTY	MCGLOTHEN KIMBERLY C	8818 E 80TH TER
201160526	2009-2010	INDIVIDUAL PERSONAL PROPERTY	MAWEU CARTER MUMO & DOREEN M	5801 HARVARD AVE	201172264	2019-2021	INDIVIDUAL PERSONAL PROPERTY	SLATER STEVEN W	10021 E 78TH TER
201160588	2006	INDIVIDUAL PERSONAL PROPERTY	NEATH MARK J & KELLY D	9901 E 80TH ST	201172617	2013-2014	INDIVIDUAL PERSONAL PROPERTY	GRAVES NADINE	9045 E 83RD ST
201160590	2005-2006	INDIVIDUAL PERSONAL PROPERTY	COLLINS LISA J	NO ADDRESS PROVIDED BY TAXPAYER	201172712	2016	INDIVIDUAL PERSONAL PROPERTY	WAKE TYLER & JOY	7909 TENNESSEE AVE
201160679	2020-2021	INDIVIDUAL PERSONAL PROPERTY	DURHAM JOCELYNN	37309 E HILLSIDE SCHOOL RD	201172848	2007-2008	INDIVIDUAL PERSONAL PROPERTY	JACOBS KRystal L	5524 HEDGES AVE
201160761	2021	INDIVIDUAL PERSONAL PROPERTY	BETANCOURT JUAN B	5233 NORTHERN AVE	201172938	2021	INDIVIDUAL PERSONAL PROPERTY	JOHNSON WILLIAM	9032 E 52ND TER
201160822	2008-2009	INDIVIDUAL PERSONAL PROPERTY	TIBBITTS NICOLE	8403 MARSH AVE	201173021	2021	INDIVIDUAL PERSONAL PROPERTY	HURST LOYD	8717 E 66TH TER
201160961	2011	INDIVIDUAL PERSONAL PROPERTY	WHEAT SUMMER R	8901 E 52ND TER	201173072	2009-2010	INDIVIDUAL PERSONAL PROPERTY	HUMPHERY ROBERT D	8717 E 61ST TER APT 3
201161031	2005-2007	INDIVIDUAL PERSONAL PROPERTY	CLEMENTS JEWERELL L & JUDITH A	11810 E 75TH ST	201173293	2019-2021	INDIVIDUAL PERSONAL PROPERTY	JONES DERIANITAE S	8618 E UTOPIA DR APT 52
201161069	2011	INDIVIDUAL PERSONAL PROPERTY	TISDALE PAMELA	10322 E 63RD ST APT 1	201173329	2007-2008	INDIVIDUAL PERSONAL PROPERTY	LANG FRANCIS	7410 OVERTON AVE UNIT 1
201161188	2011	INDIVIDUAL PERSONAL PROPERTY	PARRISH LESLIE	5420 BLUE RIDGE CUT OFF APT G03	201174374	2013	INDIVIDUAL PERSONAL PROPERTY	MABRIE ANGELA L	8600 E 81ST ST
201161240	2010-2011	INDIVIDUAL PERSONAL PROPERTY	KRAAS JAMES M	9018 E 74TH TER	201174532	2017-2019	INDIVIDUAL PERSONAL PROPERTY	HILL MICHAEL ANTHONY	6140 RAYTOWN RD APT 406
201161368	2021	INDIVIDUAL PERSONAL PROPERTY	GOODE TOMIQUITOS MORDECAI	9048 E 68TH ST	201174552	2005	INDIVIDUAL PERSONAL PROPERTY	TAYLOR DEJUAN	9008 MANCHESTER AVE
201161425	2021	INDIVIDUAL PERSONAL PROPERTY	HATTEN ALBERT L	10113 E 70TH TER	201175327	2010	INDIVIDUAL PERSONAL PROPERTY	WOODWARD TOM J	8704 CRESCENT AVE
201161517	2013-2017	INDIVIDUAL PERSONAL PROPERTY	BARNES ERNEST	8616 E UTOPIA DR APT 49	201175790	2005-2012	INDIVIDUAL PERSONAL PROPERTY	SCHNEIDER GERALD	NO ADDRESS PROVIDED BY TAXPAYER
201161628	2008	INDIVIDUAL PERSONAL PROPERTY	GOMOLETZ KLAUS	9009 RICHARDS DR	201175928	2016	INDIVIDUAL PERSONAL PROPERTY	ROWLAND TIM W	10111 E 69TH ST
201161787	2018-2020	INDIVIDUAL PERSONAL PROPERTY	CHAMBERS DAN	5921 ELM AVE	201176034	2021	INDIVIDUAL PERSONAL PROPERTY	HAGGER BETTY JO	8626 LANE AVE
201161870	2009-2012	INDIVIDUAL PERSONAL PROPERTY	KAHLAMAT DEREK	9350 E 69TH TER	201176389	2021	INDIVIDUAL PERSONAL PROPERTY	KING STEVEN E	8305 KENTUCKY AVE
201161915	2005	INDIVIDUAL PERSONAL PROPERTY	WHISEMONT MONTY & APRIL	4112 SW DUCK POND DR	201176920	2021	INDIVIDUAL PERSONAL PROPERTY	JONES LARRY DONELL	9351 E 77TH ST
201161937	2005-2017	INDIVIDUAL PERSONAL PROPERTY	LEDGERWOOD TIM T	10500 E 64TH TER	201177187	2005-2009	INDIVIDUAL PERSONAL PROPERTY	WINDLER BREN	8605 E 83RD TER
201162011	2010-2017	INDIVIDUAL PERSONAL PROPERTY	DUVALL LISA J	8803 RICHARDS DR	201177406	2021	INDIVIDUAL PERSONAL PROPERTY	EMERY KETURA LOUISE	9700 E GREGORY BLVD
201162126	2005-2013	INDIVIDUAL PERSONAL PROPERTY	PHILLIP CLARENCE	8828 RICHARDS DR	201177436	2019	INDIVIDUAL PERSONAL PROPERTY	BUTLER MARYUM E	9408 E 83RD ST
201162259	2021	INDIVIDUAL PERSONAL PROPERTY	LAW DEREK STEVEN	9050 E 84TH ST	201177446	2005-2006	INDIVIDUAL PERSONAL PROPERTY	REYES RUBEN B	7800 E 87TH ST
201162261	2005-2006	INDIVIDUAL PERSONAL PROPERTY	BERGMAN MATTHEW S	9050 HEDGES AVE	201177737	2005-2007	INDIVIDUAL PERSONAL PROPERTY	HARRIS BELINDA	7406 ENGLEWOOD LN
201162461	2006	INDIVIDUAL PERSONAL PROPERTY	CURPHY MELINDA D	8820 E 58TH TER	201178070	2021	INDIVIDUAL PERSONAL PROPERTY	MEYER CHAD M & ARIKA M	6924 WILLOW DR
201162489	2013-2017	INDIVIDUAL PERSONAL PROPERTY	PARRA EDER M	8436 EVANSTON AVE	201178225	2020-2021	INDIVIDUAL PERSONAL PROPERTY	RIDLEY KATHRYN	5241 HARDY CT
201162683	2008-2012	INDIVIDUAL PERSONAL PROPERTY	DELAMETER DELANA K	10113 E 56TH ST	201178236	2006-2010	INDIVIDUAL PERSONAL PROPERTY	WILLIAMS SUELLEN L	8801 E 59TH ST
201162690	2020-2021	INDIVIDUAL PERSONAL PROPERTY	WEST BROOKE MARIE (PARKER)	8202 LAUREL AVE	201178409	2021	INDIVIDUAL PERSONAL PROPERTY	STREET JILL (SAMLAND)	6282 CRISP AVE
201162819	2010	INDIVIDUAL PERSONAL PROPERTY	BRACKEEN ANGELA	8922 E 74TH ST	201178436	2007	INDIVIDUAL PERSONAL PROPERTY	MORRIS KEN E	7311 APPLETON AVE
201162932	2014-2017	INDIVIDUAL PERSONAL PROPERTY	YOUNG JADDA ISIS (BOARMAN)	8814 E 84TH TER	201178471	2021	INDIVIDUAL PERSONAL PROPERTY	BARRERA RAFAEL F NAVAS	7053 HUNTER ST
201162968	2005-2006	INDIVIDUAL PERSONAL PROPERTY	BERRY LINDA K	NO ADDRESS PROVIDED BY TAXPAYER	201179067	2009	INDIVIDUAL PERSONAL PROPERTY	LOTZ JEREMY C	5320 WILLOW AVE
201162973	2005	INDIVIDUAL PERSONAL PROPERTY	BOONE KAREN K	10503 E 87TH ST	201189232	2021	INDIVIDUAL PERSONAL PROPERTY	HOLMES ETHAN	8221 HARRIS CT
201162987	2017-2018	INDIVIDUAL PERSONAL PROPERTY	ALLEN KYSHA D	8809 E 73RD ST	201189369	2021	INDIVIDUAL PERSONAL PROPERTY	LOGERMAN JOHN T	7033 HUNTER ST
201163231	2011-2017	INDIVIDUAL PERSONAL PROPERTY	REYNOLDS JAMES C	7911 MAPLE AVE	201189825	2018-2021	INDIVIDUAL PERSONAL PROPERTY	WILLIAMS CLIFTON R SR	7511 MAPLE LN
201163385	2009	INDIVIDUAL PERSONAL PROPERTY	CLAUSEN RYAN	5400 ELM AVE	201189845	2021	INDIVIDUAL PERSONAL PROPERTY	ANDERSON PATRICIA	11001 E 33RD TER
201163499	2005-2006	INDIVIDUAL PERSONAL PROPERTY	LANGSTON SHIRLEY A	8401 ARLINGTON AVE	201189915	2015-2017	INDIVIDUAL PERSONAL PROPERTY	WILSON DAMIAN DESHAUN	10220 E 72ND ST
201163502	2008-2011	INDIVIDUAL PERSONAL PROPERTY	SCOTT ARMAJEAN	9006 E 85TH PL	201189955	2008-2011	INDIVIDUAL PERSONAL PROPERTY	WORDEN NICHOLAS	8412 E 85TH TER
201163529	2005-2010	INDIVIDUAL PERSONAL PROPERTY	BURTON JERA	7424 WOODSON RD	201189960	2020-2021	INDIVIDUAL PERSONAL PROPERTY	PRUITT PANSY ELAINE	9904 E 82ND ST

201189996	2005	INDIVIDUAL PERSONAL PROPERTY	RIOS-ZAPATA WILLIAMS	9312 LEWIS AVE	201574386	2005-2006	INDIVIDUAL PERSONAL PROPERTY	ALLISON TERRY & MELANIE	NO ADDRESS PROVIDED BY TAXPAYER
201190112	2005	INDIVIDUAL PERSONAL PROPERTY	HOLMES MICHAEL L	7705 ELM ST	201574392	2006-2008	INDIVIDUAL PERSONAL PROPERTY	SEXTON ANDREA	8809 RICHARDS DR
201190189	2004-2005	INDIVIDUAL PERSONAL PROPERTY	GRAVES QUINNEL	NO ADDRESS PROVIDED BY TAXPAYER	201574448	2021	INDIVIDUAL PERSONAL PROPERTY	GILLESPIE ROBIN GAIL	611 NE COLUMBUS ST UNIT B
201190194	2016	INDIVIDUAL PERSONAL PROPERTY	MCMILLAN JUDY	7901 MANNING AVE	201574502	2005	INDIVIDUAL PERSONAL PROPERTY	JACKSON JOYCE M & MONICA	NO ADDRESS PROVIDED BY TAXPAYER
201190524	2005-2007	INDIVIDUAL PERSONAL PROPERTY	JENKINS TIM W	5501 HARVARD AVE	201574515	2005-2006	INDIVIDUAL PERSONAL PROPERTY	CROOMS ERIKKA L	NO ADDRESS PROVIDED BY TAXPAYER
201190577	2005-2007	INDIVIDUAL PERSONAL PROPERTY	SMITH JEFFREY D	NO ADDRESS PROVIDED BY TAXPAYER	201574554	2005	INDIVIDUAL PERSONAL PROPERTY	DENNY COREY W	10708 E 65TH TER
201190634	2013-2014	INDIVIDUAL PERSONAL PROPERTY	MORGAN MICHELLE M	7824 ARLINGTON AVE	201574657	2021	INDIVIDUAL PERSONAL PROPERTY	DELLINGER MICHAEL J	1106 SE SCENIC DR
201190666	2005	INDIVIDUAL PERSONAL PROPERTY	NEWLAND SHELLY	8813 E 84TH TER	201574679	2005-2007	INDIVIDUAL PERSONAL PROPERTY	SHEARD MARLON BARNARD	NO ADDRESS PROVIDED BY TAXPAYER
201205591	2004-2005	INDIVIDUAL PERSONAL PROPERTY	SANDERS SHAWN L	8213 WOODSON DR	201574868	2021	INDIVIDUAL PERSONAL PROPERTY	MORGAN DANA	10923 E 81ST TER
201205613	2008-2010	INDIVIDUAL PERSONAL PROPERTY	DICKERSON CHARLES C	NO ADDRESS PROVIDED BY TAXPAYER	201574873	2005	INDIVIDUAL PERSONAL PROPERTY	MEJIA FRANCISCO	NO ADDRESS PROVIDED BY TAXPAYER
201205647	2014	INDIVIDUAL PERSONAL PROPERTY	DEUBNER (KATHKE) SABRINA	5728 OXFORD AVE	201574964	2005-2007	INDIVIDUAL PERSONAL PROPERTY	RAW CRYSTLE L	8307 E 86TH TER
201205817	2011-2012	INDIVIDUAL PERSONAL PROPERTY	MAZARI MERIEM	NO ADDRESS PROVIDED BY TAXPAYER	201575513	2009-2014	INDIVIDUAL PERSONAL PROPERTY	HAWKINS PAUL E JR	8518 ARLINGTON AVE
201205863	2009-2010	INDIVIDUAL PERSONAL PROPERTY	NOWACZYK HOLLI ANN	7311 APPLETON AVE	201575517	2007	INDIVIDUAL PERSONAL PROPERTY	ORTIZ BERTHA	NO ADDRESS PROVIDED BY TAXPAYER
201205920	2020-2021	INDIVIDUAL PERSONAL PROPERTY	SMITH ESSENCE M (SCOTT)	10108 E 55TH TER	201575789	2009	INDIVIDUAL PERSONAL PROPERTY	PORTER GREGORY S	10212 E 69TH ST
201205950	2020-2021	INDIVIDUAL PERSONAL PROPERTY	COSBY TERESA	7500 ARLINGTON AVE	201575964	2010	INDIVIDUAL PERSONAL PROPERTY	COCHRAN DENA A	NO ADDRESS PROVIDED BY TAXPAYER
201205952	2014-2018	INDIVIDUAL PERSONAL PROPERTY	FRONAS RICHARD	8909 RICHARDS DR	201576190	2008-2009	INDIVIDUAL PERSONAL PROPERTY	STUART KENDRA AMY	7511 HAWTHORNE AVE
201206035	2021	INDIVIDUAL PERSONAL PROPERTY	WHITE CHRISTOPHER R	5428 HARRIS AVE	201576729	2006	INDIVIDUAL PERSONAL PROPERTY	LAWSON JOHN A	9505 E 62ND ST
201206094	2021	INDIVIDUAL PERSONAL PROPERTY	HAYES WILLIAM J JR	8903 E 72ND ST	201576883	2019-2021	INDIVIDUAL PERSONAL PROPERTY	WARREN ANTHONY K	8112 ELM AVE
201206223	2006-2013	INDIVIDUAL PERSONAL PROPERTY	HERNANDEZ ERIK	NO ADDRESS PROVIDED BY TAXPAYER	201577230	2005	INDIVIDUAL PERSONAL PROPERTY	SANDOVAL MARIA	NO ADDRESS PROVIDED BY TAXPAYER
201206321	2021	INDIVIDUAL PERSONAL PROPERTY	HILL KAYLA LEE	7036 WOODSON RD	201577269	2005	INDIVIDUAL PERSONAL PROPERTY	JONES CYNTHIA A	8104 E 90TH TER
201206391	2005-2006	INDIVIDUAL PERSONAL PROPERTY	MOORE GLEN & REBECCA	6008 HEDGES AVE	201577298	2007-2008	INDIVIDUAL PERSONAL PROPERTY	WHITE ZACHARY L	8609 MAYWOOD AVE
201206484	2008-2009	INDIVIDUAL PERSONAL PROPERTY	COLIN DON E	NO ADDRESS PROVIDED BY TAXPAYER	201577490	2020	INDIVIDUAL PERSONAL PROPERTY	IYEWARUN BOSEDE A	8000 OVERTON DR
201206544	2004-2005	INDIVIDUAL PERSONAL PROPERTY	BYRD VIRGINIA G & HAYNES DENNIS	8703 E 92ND PL	201577497	2007	INDIVIDUAL PERSONAL PROPERTY	ERWIN TAMMY	10027 E 84TH TER
201207262	2005-2006	INDIVIDUAL PERSONAL PROPERTY	REEDS LAWANDA	NO ADDRESS PROVIDED BY TAXPAYER	201577513	2007	INDIVIDUAL PERSONAL PROPERTY	EWAN COURTNEY J	9713 E 84TH ST
201207303	2005	INDIVIDUAL PERSONAL PROPERTY	JOHNSON RACHEL R	11701 E 83RD ST APT 102	201577526	2005-2006	INDIVIDUAL PERSONAL PROPERTY	ZUMBRUNNEN RANDY	6636 MAYWOOD AVE APT A
201207307	2004	INDIVIDUAL PERSONAL PROPERTY	BEEBLE JUSTIN & ELIZABETH	9023 E 73RD ST	201577873	2021	INDIVIDUAL PERSONAL PROPERTY	SHEPHEARD TANISHA	8019 ARLINGTON AVE
201207322	2008-2017	INDIVIDUAL PERSONAL PROPERTY	CRUZ SALVADOR	10608 E 55TH TER	201578177	2018-2019	INDIVIDUAL PERSONAL PROPERTY	FRY LAVERN L	6144 ASH CT
201207452	2014	INDIVIDUAL PERSONAL PROPERTY	HERREN JAMES W JR & CAROLYN	9705 E 65TH TER	201578292	2021	INDIVIDUAL PERSONAL PROPERTY	BANKS BRIGETTE L (HARRIS)	10408 E 57TH TER
201207694	2006-2009	INDIVIDUAL PERSONAL PROPERTY	SMITH DOUGLAS R	9108 RICHARDS DR	201578544	2006-2007	INDIVIDUAL PERSONAL PROPERTY	MCFALL EMILY S	1028 BENNINGTON AVE
201207716	2004	INDIVIDUAL PERSONAL PROPERTY	MAURISIO RENSPER	UNKNOWN	201578555	2005	INDIVIDUAL PERSONAL PROPERTY	GREEN STEVE D	10520 E 40TH TER
201207744	2007-2011	INDIVIDUAL PERSONAL PROPERTY	COOPER CHARLES Q	5808 STERLING AVE	201578613	2008-2011	INDIVIDUAL PERSONAL PROPERTY	QUINTERO JOSE ROMULO	10405 E 67TH ST
201207957	2005	INDIVIDUAL PERSONAL PROPERTY	YANCE CARLTON	8603 BUCKINGHAM LN APT 17	201578677	2006	INDIVIDUAL PERSONAL PROPERTY	CAMPBELL THOMAS	5909 CRESCENT AVE
201208022	2010-2017	INDIVIDUAL PERSONAL PROPERTY	HERNANDEZ JOSE A	8431 EVANSTON AVE	201579074	2020-2021	INDIVIDUAL PERSONAL PROPERTY	WILLIAMS MONIQUE LASHAWN	8633 E UTOPIA PKWY APT 3
201208029	2013	INDIVIDUAL PERSONAL PROPERTY	ALLEN MARKIS J	9817 E 61ST ST APT 5	201579197	2002-2005	INDIVIDUAL PERSONAL PROPERTY	DAVIS CRYSTAL J	520 NW BEAU CIR
201208049	2008-2017	INDIVIDUAL PERSONAL PROPERTY	ROMAN LUIS	8416 E 85TH TER	201579833	2006	INDIVIDUAL PERSONAL PROPERTY	LEDFOV BRENDA	6813 LAKESHORE DR
201208080	2005-2007	INDIVIDUAL PERSONAL PROPERTY	AVERY WALISH C JR	9204 E 84TH ST	201579866	2010-2012	INDIVIDUAL PERSONAL PROPERTY	CARNEY JOSHUA A	10920 E 54TH TER
201208099	2017-2021	INDIVIDUAL PERSONAL PROPERTY	BROWN MARCUS A	9350 E 69TH ST	201579918	2021	INDIVIDUAL PERSONAL PROPERTY	PRATER SHIRLEY A	8708 E 79TH TER
201208143	2017	INDIVIDUAL PERSONAL PROPERTY	OLIVER JESSICA M	7703 ARLINGTON AVE	201580220	2006-2017	INDIVIDUAL PERSONAL PROPERTY	BEASLEY PAUL	5512 MANNING AVE
201208188	2018-2021	INDIVIDUAL PERSONAL PROPERTY	GAVIN DESHUAN & MILLIESHIA	8300 E 87TH ST	201580231	2019-2021	INDIVIDUAL PERSONAL PROPERTY	BALDWIN DANIEL E & ELIZABETH G	9006 E 72ND TER
201208282	2021	INDIVIDUAL PERSONAL PROPERTY	ROBERTSON ANGELA	8400 STERLING AVE	201580481	2021	INDIVIDUAL PERSONAL PROPERTY	SCHULT BARBARA	8704 E 81ST TER
201208582	2006-2017	INDIVIDUAL PERSONAL PROPERTY	FLORES DARIO	5432 MAYWOOD AVE	201580743	2021	INDIVIDUAL PERSONAL PROPERTY	GRAY PHILLIP	9312 E 84TH TER
201208607	2008	INDIVIDUAL PERSONAL PROPERTY	DANIELS STEPHONO L	6306 RALSTON AVE	201581183	2021	INDIVIDUAL PERSONAL PROPERTY	ELLIS-JORDAN SHAUNTEL MONIQUE	8705 E 83RD TER
201208632	2014-2021	INDIVIDUAL PERSONAL PROPERTY	BASAK MICHAEL	8957 E 60TH ST	201581693	2005-2007	INDIVIDUAL PERSONAL PROPERTY	TYSON WILLIS J	1108 ELM AVE
201208694	2005-2017	INDIVIDUAL PERSONAL PROPERTY	SKINNER ADRIENNE	9008 RICHARDS DR	201581791	2005-2006	INDIVIDUAL PERSONAL PROPERTY	PORTER DETRA	1108 LITTLE AVE
201208804	2005-2009	INDIVIDUAL PERSONAL PROPERTY	EMIRE WALTER	8116 DITZLER AVE	201582005	2016	INDIVIDUAL PERSONAL PROPERTY	RYAN CAROLYN S	7509 ARLINGTON AVE
201209039	2021	INDIVIDUAL PERSONAL PROPERTY	TURNER WENDY J (RICKEL)	9217 E 67TH TER	201582111	2020-2021	INDIVIDUAL PERSONAL PROPERTY	LEAHR DANA	5424 HARDY AVE
201209044	2016	INDIVIDUAL PERSONAL PROPERTY	LUALLEN SHANE	10106 E 64TH ST	201582223	2006-2007	INDIVIDUAL PERSONAL PROPERTY	THOMAS VANESSA B	NO ADDRESS PROVIDED BY TAXPAYER
201209048	2020-2021	INDIVIDUAL PERSONAL PROPERTY	GRIGSBY GEORGE H IV	8855 E 59TH ST	201582444	2021	INDIVIDUAL PERSONAL PROPERTY	JONES ALICIA LUCILLE	11500 E 58TH TER
201209055	2021	INDIVIDUAL PERSONAL PROPERTY	OSBORN MICHELLE RENEE	5425 APPLETON AVE	201582477	2021	INDIVIDUAL PERSONAL PROPERTY	HERNANDEZ ALVAREZ ELIAS	11900 E M 350 HWY
201209145	2005-2008	INDIVIDUAL PERSONAL PROPERTY	PENCE KENNETH D	9059 E 65TH TER	201582584	2016-2021	INDIVIDUAL PERSONAL PROPERTY	KING AMBER M	5711 CEDAR AVE
201209147	2015-2018	INDIVIDUAL PERSONAL PROPERTY	SCHUMACHER BELINDA J	5202 BLUE RIDGE BLVD	201591461	2006-2008	INDIVIDUAL PERSONAL PROPERTY	STONE ANTHONY D	8504 BOOTH AVE
201209160	2014-2019	INDIVIDUAL PERSONAL PROPERTY	WYATT RODNEY A JR	8909 E 88TH TER	201591577	2019	INDIVIDUAL PERSONAL PROPERTY	VANDERGRIFF ROBERT & VENUS C	NO ADDRESS PROVIDED BY TAXPAYER
201209177	2006-2007	INDIVIDUAL PERSONAL PROPERTY	ROBINSON MARY A	9058 E 65TH TER	201591620	2005-2007	INDIVIDUAL PERSONAL PROPERTY	HOLLOWELL BRIAN	9132 E 85TH ST
201209198	2007-2009	INDIVIDUAL PERSONAL PROPERTY	TOLEFREE SANDRA A	4714 HADEN CT	201591765	2014	INDIVIDUAL PERSONAL PROPERTY	HOLMES RICHARD J III	9612 E 66TH ST
201209217	2005-2010	INDIVIDUAL PERSONAL PROPERTY	LUCE JASON T	10901 E 65TH ST	201591904	2021	INDIVIDUAL PERSONAL PROPERTY	HILL JUNETTE (POWELL)	7320 CEDAR AVE
201209261	2011	INDIVIDUAL PERSONAL PROPERTY	WASHINGTON CAIRRA & DYE	9801 E 61ST ST APT 2	201591920	2006-2017	INDIVIDUAL PERSONAL PROPERTY	ROSAS RICARDO	8708 E 87TH ST
201209274	2005	INDIVIDUAL PERSONAL PROPERTY	LAMONTE DUSTIN W	8135 DITZLER AVE	201591972	2021	INDIVIDUAL PERSONAL PROPERTY	NUCKOLLS WILBER D	6816 VERMONT AVE
201573644	2021	INDIVIDUAL PERSONAL PROPERTY	BALLENGER CALLIE	6014 KENTUCKY AVE	201592028	2005	INDIVIDUAL PERSONAL PROPERTY	SMITH DONTÉ	NO ADDRESS PROVIDED BY TAXPAYER
201573655	2013	INDIVIDUAL PERSONAL PROPERTY	RHEA JOE E	5436 WOODSON RD	201592056	2006	INDIVIDUAL PERSONAL PROPERTY	SIMPSON RICKY	9007 E 72ND TER
201573682	2009	INDIVIDUAL PERSONAL PROPERTY	SMITH NEENA M	10612 E 80TH ST	201592197	2021	INDIVIDUAL PERSONAL PROPERTY	LICHTENAUER PAUL M	11401 E 67TH TER
201573702	2021	INDIVIDUAL PERSONAL PROPERTY	KELLER PAMILA S	8803 E 72ND TER	201592388	2007	INDIVIDUAL PERSONAL PROPERTY	CANNON JESSICA	10408 E 72ND ST
201573761	2021	INDIVIDUAL PERSONAL PROPERTY	SMITH JAMES ROBERT & CARRISSA KAYLEEN	9051 E 66TH ST	201592594	2021	INDIVIDUAL PERSONAL PROPERTY	WEBB APRIL D & RIDGE HAHN GENESIS LAMAR JR	8614 OXFORD AVE
201573992	2021	INDIVIDUAL PERSONAL PROPERTY	FRAZIER STEVEN D	11401 E 58TH ST	201592840	2009-2011	INDIVIDUAL PERSONAL PROPERTY	LOPEZ NICOLE L	9401 E 69TH ST
201574058	2005	INDIVIDUAL PERSONAL PROPERTY	SMITH JOSEPH FRANK	15329 FULLER AVE	201593070	2006	INDIVIDUAL PERSONAL PROPERTY	MICHALSKA EMILIAN	NO ADDRESS PROVIDED BY TAXPAYER
201574061	2020-2021	INDIVIDUAL PERSONAL PROPERTY	BURMASTER RANDALL K	10201 E 69TH TER	201593129	2007-2011	INDIVIDUAL PERSONAL PROPERTY	SMOCKS ORISKA	9007 E 54TH ST
201574084	2008-2017	INDIVIDUAL PERSONAL PROPERTY	FENNESY JAMES E	5905 HUNTER ST	201593407	2007	INDIVIDUAL PERSONAL PROPERTY	PARKER TINA MARIE	7201 RAYTOWN RD
201574090	2021	INDIVIDUAL PERSONAL PROPERTY	SURBER JAMES M	10124 E 79TH ST	201593466	2019-2021	INDIVIDUAL PERSONAL PROPERTY	SMITH KAREN	10900 E 65TH ST
201574113	2013-2017	INDIVIDUAL PERSONAL PROPERTY	MITCHELL JOHN	6316 HUNTER ST	201593509	2007	INDIVIDUAL PERSONAL PROPERTY	CRANMORE MELINDA A	9704 E 81ST ST
201574200	2005-2013	INDIVIDUAL PERSONAL PROPERTY	GAITHER CHRISTOPHER	8819 E 84TH TER	201593631	2005	INDIVIDUAL PERSONAL PROPERTY	AMBLER CORTNEY	11411 E 58TH TER
201574218	2009-2017	INDIVIDUAL PERSONAL PROPERTY	DABALUS JENALYN	8508 SPRING VALLEY RD	201593653	2006	INDIVIDUAL PERSONAL PROPERTY	ALLEN NASREEN & ALLEN RAYMOND	8219 E 85TH ST
201574293	2020-2021	INDIVIDUAL PERSONAL PROPERTY	SMITH ROBERT W	6205 KENTUCKY AVE	201593872	2021	INDIVIDUAL PERSONAL PROPERTY	JOHNSON SECILIE PAIGE	6307 ASH AVE APT 9
201574356	2005-2017	INDIVIDUAL PERSONAL PROPERTY	SPURGEON JONATHON D	8714 E 87TH ST	201593891	2005-2012	INDIVIDUAL PERSONAL PROPERTY	SULVER ANTHONY M	NO ADDRESS PROVIDED BY TAXPAYER

201594073	2019-2020	INDIVIDUAL PERSONAL PROPERTY	SCHULTZ CASSANDRA JOAN	10324 E 63RD ST APT 2	201611070	2021	INDIVIDUAL PERSONAL PROPERTY	SHAW PAULA L & DARRYL J	5837 FARLEY AVE
201594181	2011-2013	INDIVIDUAL PERSONAL PROPERTY	ADAMS KELLY L	2000 ROSE LN	201611114	2005-2007	INDIVIDUAL PERSONAL PROPERTY	HORAK MATTHEW A	7906 APPLETON AVE
201594428	2006-2009	INDIVIDUAL PERSONAL PROPERTY	RICE ANGELA M	10208 E 56TH ST	201611138	2012	INDIVIDUAL PERSONAL PROPERTY	LINDESE ERIC L	7520 CRISP AVE
201594450	2018-2019	INDIVIDUAL PERSONAL PROPERTY	MCDONALD HAJJI J	9004 E 74TH TER	201611291	2020-2021	INDIVIDUAL PERSONAL PROPERTY	STANFORD ELIZABETH	10512 E 79TH ST
201594529	2018-2019	INDIVIDUAL PERSONAL PROPERTY	SEXTON GEON	3539 NE INDEPENDENCE AVE	201611292	2021	INDIVIDUAL PERSONAL PROPERTY	RENERIA PIEDAD	8908 E 57TH ST
201594556	2006-2015	INDIVIDUAL PERSONAL PROPERTY	GARCIA DANIEL	8482 LANE DR	201611515	2012-2013	INDIVIDUAL PERSONAL PROPERTY	JEMERSON ANTOINETTE	9812 E 61ST ST APT 2
201594635	2021	INDIVIDUAL PERSONAL PROPERTY	HARBIN COLETTE	7600 EVANSTON AVE	201611574	2006-2012	INDIVIDUAL PERSONAL PROPERTY	MOSS RHONDA V	8609 E 84TH TER
201594986	2007	INDIVIDUAL PERSONAL PROPERTY	HOLST JACOB	9322 E 83RD ST	201611647	2010	INDIVIDUAL PERSONAL PROPERTY	ORTIZ MARIBEL	5432 MAYWOOD AVE
201595144	2005-2007	INDIVIDUAL PERSONAL PROPERTY	IVEY CAROLYN A	10712 E 83RD TER	201611782	2009-2010	INDIVIDUAL PERSONAL PROPERTY	HOPKINS ALFRED M	5618 E 39TH ST
201595324	2021	INDIVIDUAL PERSONAL PROPERTY	HILL DOROTHEA Y	9013 E 85TH ST	201611985	2008-2009	INDIVIDUAL PERSONAL PROPERTY	SANDERS TOYMEHSA N	8309 PERSHING RD
201595863	2013-2014	INDIVIDUAL PERSONAL PROPERTY	BELLAMY ANGELA	8416 WOODSON DR	201612304	2008-2010	INDIVIDUAL PERSONAL PROPERTY	COLE BERNADINE	9906 E 60TH ST
201596519	2019-2021	INDIVIDUAL PERSONAL PROPERTY	WILLIAMS DONALD LEE JR	7701 RAYTOWN RD APT 13	201612665	2021	INDIVIDUAL PERSONAL PROPERTY	ALEXANDER TONI	6506 BLUE RIDGE BLVD
201596772	2005-2006	INDIVIDUAL PERSONAL PROPERTY	STINSON ALLANNAH & JOHNNY	10309 E 61ST ST APT 1	201612834	2018-2021	INDIVIDUAL PERSONAL PROPERTY	ADAMS CHRIS A	5500 HEDGES AVE
201596777	2006	INDIVIDUAL PERSONAL PROPERTY	DIAZ ARMANDO ORTIA	NO ADDRESS PROVIDED BY TAXPAYER	201612859	2006	INDIVIDUAL PERSONAL PROPERTY	TALKINGTON SANDRA	10813 E 58TH TER
201596829	2021	INDIVIDUAL PERSONAL PROPERTY	ROBERSON MARKESHA & ROBERSON RASHAN	5907 CLAREMONT AVE	201612869	2021	INDIVIDUAL PERSONAL PROPERTY	MARTINEZ AMY M	5328 LAUREL AVE
201597311	2017-2019	INDIVIDUAL PERSONAL PROPERTY	BURCHETT MICHAEL E	5533 NORTHERN AVE	201613268	2021	INDIVIDUAL PERSONAL PROPERTY	FLACK STORM T	7921 ELM AVE
201597477	2021	INDIVIDUAL PERSONAL PROPERTY	RIGG MARCL	10607 E 70TH ST	201613281	2008	INDIVIDUAL PERSONAL PROPERTY	SMITH JEREMY	10612 E 80TH ST
201597657	2012-2013	INDIVIDUAL PERSONAL PROPERTY	CONYERS BILLIA	10619 E 56TH ST	201613289	2021	INDIVIDUAL PERSONAL PROPERTY	WALKER TWYLA N	7720 IRWIN RD
201597807	2012	INDIVIDUAL PERSONAL PROPERTY	COLA ANITA A	11303 E 58TH TER	201613446	2021	INDIVIDUAL PERSONAL PROPERTY	CARLO ROGER ERWIN	7722 CRESCENT AVE
201597854	2016-2021	INDIVIDUAL PERSONAL PROPERTY	ELMONIS RONY	5301 STERLING AVE	201613486	2021	INDIVIDUAL PERSONAL PROPERTY	HARPER BRANDI J	8201 HARRIS AVE
201598027	2005	INDIVIDUAL PERSONAL PROPERTY	ABUSAADA FARAH T	9608 E 69TH ST	201613577	2006-2008	INDIVIDUAL PERSONAL PROPERTY	DUPREE THOMAS EDWARD	8500 JAMES A REED RD
201598258	2007-2011	INDIVIDUAL PERSONAL PROPERTY	TURNER THOMAS N & MILLER SAMANTHA	NO ADDRESS PROVIDED BY TAXPAYER	201613735	2021	INDIVIDUAL PERSONAL PROPERTY	REYNOLDS CATHERINE	8907 E 66TH ST
201603710	2011-2012	INDIVIDUAL PERSONAL PROPERTY	COTHRAN PAUL	5420 BLUE RIDGE CUT OFF APT 608	201613909	2013-2017	INDIVIDUAL PERSONAL PROPERTY	BOGGS ROSZELL	8501 E 85TH TER
201603751	2011-2013	INDIVIDUAL PERSONAL PROPERTY	CROSBY DANIEL	9101 E 64TH TER	201613912	2009-2010	INDIVIDUAL PERSONAL PROPERTY	ZEDEK ANTHONY F & DOLAS F	9107 E 68TH TER
201604018	2005-2006	INDIVIDUAL PERSONAL PROPERTY	SYKES JA LIL	9007 E 75TH ST	201614052	2006	INDIVIDUAL PERSONAL PROPERTY	HANKINS SHELDON V	7705 RAYTOWN RD
201604019	2005-2017	INDIVIDUAL PERSONAL PROPERTY	BALSLY JEFF	7605 ENGLEWOOD AVE	201614265	2014	INDIVIDUAL PERSONAL PROPERTY	WIENKE DEBRA	402 SW MORELAND SCHOOL RD STE 3
201604042	2020	INDIVIDUAL PERSONAL PROPERTY	RIFFEY MARK W	11104 E 78TH TER	201614464	2021	INDIVIDUAL PERSONAL PROPERTY	GRAYSON ROMERO M	8498 LANE DR APT 1
201604290	2021	INDIVIDUAL PERSONAL PROPERTY	REED ANDRE J'VONE	9815 E 61ST ST APT 1	201614548	2006-2012	INDIVIDUAL PERSONAL PROPERTY	DELLAMANO CORY M	10812 E 66TH TER
201604390	2006	INDIVIDUAL PERSONAL PROPERTY	BADGER CHRISTINA M	9500 E 64TH TER	201614794	2005	INDIVIDUAL PERSONAL PROPERTY	LOPEZ CARMEN GINA	NO ADDRESS PROVIDED BY TAXPAYER
201604426	2008-2017	INDIVIDUAL PERSONAL PROPERTY	DAVILLA ANGELIC J	11405 E 69TH ST	201614888	2020-2021	INDIVIDUAL PERSONAL PROPERTY	HERZIG BOBBIE J (RANDALL) & PAUL D	10011 E 78TH ST
201604427	2007-2008	INDIVIDUAL PERSONAL PROPERTY	BURLISON TAMMI L	6212 WILLOW AVE	201615059	2006-2008	INDIVIDUAL PERSONAL PROPERTY	FRIAS MICHELLE L & GEORGE J	6403 HARVARD AVE
201604884	2021	INDIVIDUAL PERSONAL PROPERTY	MAGGARD RUSTY LYNN	6140 RAYTOWN RD APT 803	201615085	2007-2016	INDIVIDUAL PERSONAL PROPERTY	VANCASEY ERIN S	11601 E 61ST ST
201605145	2005	INDIVIDUAL PERSONAL PROPERTY	COOPER LEONARD L	NO ADDRESS PROVIDED BY TAXPAYER	201615102	2016-2018	INDIVIDUAL PERSONAL PROPERTY	FERRELL CHRISTOPHER RAY	6431 BLUE RIDGE CUT OFF
201605202	2021	INDIVIDUAL PERSONAL PROPERTY	HARRIS HOWARD L & KATHLEEN R	10602 E 79TH TER	201615228	2006-2010	INDIVIDUAL PERSONAL PROPERTY	RODRIGUEZ RONAL	7912 CEDAR AVE
201605449	2016-2017	INDIVIDUAL PERSONAL PROPERTY	TOWNSELL JOHN R JR	5535 LANE AVE	201615613	2020-2021	INDIVIDUAL PERSONAL PROPERTY	LEOPARD HEATHER LYNN	6325 KENTUCKY AVE
201605526	2006-2009	INDIVIDUAL PERSONAL PROPERTY	BUNBTON TANEYA	7439 OVERTON AVE	201615674	2021	INDIVIDUAL PERSONAL PROPERTY	BRYANT EDIE YVETTE	5728 ARLINGTON AVE
201606321	2019-2021	INDIVIDUAL PERSONAL PROPERTY	ATKINS CLAIR	9350 E 64TH TER	201615738	2009	INDIVIDUAL PERSONAL PROPERTY	BRADY PATRICIA L	NO ADDRESS PROVIDED BY TAXPAYER
201606440	2018-2019	INDIVIDUAL PERSONAL PROPERTY	KUSH KELLY D	7801 RAYTOWN RD	201616182	2005	INDIVIDUAL PERSONAL PROPERTY	NEYMAN SANDRA	8701 E 74TH TER
201606557	2008	INDIVIDUAL PERSONAL PROPERTY	GUARDADO STEPHANIE	9409 E 82ND TER	201616243	2021	INDIVIDUAL PERSONAL PROPERTY	MCDONALD ANGELA ARCHELLE	8904 E 81ST ST
201606610	2009-2013	INDIVIDUAL PERSONAL PROPERTY	JAMES JACQUELYN L	5700 BLUE RIDGE BLVD	201616343	2014	INDIVIDUAL PERSONAL PROPERTY	JOHNSON PATRICIA D	11906 E 61ST ST
201606649	2006-2007	INDIVIDUAL PERSONAL PROPERTY	GRANADOS DESIREE & HENRY	NO ADDRESS PROVIDED BY TAXPAYER	201616688	2020-2021	INDIVIDUAL PERSONAL PROPERTY	REEVES ANTHONY CURTIS	7816 RIVINGTON AVE
201606870	2008	INDIVIDUAL PERSONAL PROPERTY	STURDIVANT TREVIA	2248 NE TOWN CENTER BLVD APT 408	201616705	2006-2007	INDIVIDUAL PERSONAL PROPERTY	ORTIZ SALVADOR II	6650 MAYWOOD AVE APT B
201606992	2007-2008	INDIVIDUAL PERSONAL PROPERTY	LAROSE MARIE	5312 WILLOW AVE	201616749	2021	INDIVIDUAL PERSONAL PROPERTY	TAYLOR CAROL LYNN	8801 E 75TH ST
201607011	2016-2018	INDIVIDUAL PERSONAL PROPERTY	BRADLEY CLARENCE O	5312 WILLOW AVE	201616803	2006	INDIVIDUAL PERSONAL PROPERTY	KEESEE JOHN R	NO ADDRESS PROVIDED BY TAXPAYER
201607012	2021	INDIVIDUAL PERSONAL PROPERTY	MORTON ARLENE E	8633 E UTOPIA PKWY APT 4	201616820	2006-2007	INDIVIDUAL PERSONAL PROPERTY	CAMMISANO CATHY	7105 WILLOW AVE
201607023	2005-2006	INDIVIDUAL PERSONAL PROPERTY	JOHNSON JOHN E & CHARLENE F	11704 E 78TH TER	201617006	2012-2017	INDIVIDUAL PERSONAL PROPERTY	JORDAN CORTNEE D	6122 BLUE RIDGE CUT OFF
201607037	2009-2011	INDIVIDUAL PERSONAL PROPERTY	HERNANDEZ DEBORAH A	8321 WOODSON DR	201617121	2007	INDIVIDUAL PERSONAL PROPERTY	HOLMES LINDA	8505 E 86TH TER
201607472	2007-2008	INDIVIDUAL PERSONAL PROPERTY	BANKS KATHERINE J	9708 E 71ST TER	201617317	2008-2011	INDIVIDUAL PERSONAL PROPERTY	BAILEY LATASHA P	9055 E 68TH TER
201607944	2021	INDIVIDUAL PERSONAL PROPERTY	PETERSON STEPHANIE NICHOLE	11112 E 74TH ST	201617352	2021	INDIVIDUAL PERSONAL PROPERTY	THOMAS LATRESE EVONNE	11424 E 77TH ST
201608533	2021	INDIVIDUAL PERSONAL PROPERTY	WHITE THOMAS E	502 PROSPECT AVE	201617438	2007-2008	INDIVIDUAL PERSONAL PROPERTY	TUALA LEIFI	9208 VAUGHN AVE
201608561	2012-2013	INDIVIDUAL PERSONAL PROPERTY	VASSER LORINDA	5730 MANNING AVE	201617722	2005-2007	INDIVIDUAL PERSONAL PROPERTY	REZNICEK JOHN A & DAWN R	8816 E 58TH TER
201608692	2021	INDIVIDUAL PERSONAL PROPERTY	THORNBERG TIMOTHY ALAN	10504 E 70TH TER	201617755	2011-2017	INDIVIDUAL PERSONAL PROPERTY	AVILES DAVID R	11028 E 54TH ST
201608733	2011-2015	INDIVIDUAL PERSONAL PROPERTY	VOGT DEREK W	8808 E 84TH ST	201617787	2008	INDIVIDUAL PERSONAL PROPERTY	NORTON CARRAK D	8413 NORTHERN ST
201608900	2018-2020	INDIVIDUAL PERSONAL PROPERTY	YOUNG NICOLE G	10331 LULLY AVE	201617790	2020-2021	INDIVIDUAL PERSONAL PROPERTY	AGBEY MARTHA J	9811 E 61ST ST APT 5
201608978	2020	INDIVIDUAL PERSONAL PROPERTY	PAYNE SUSAN	8004 OVERTON DR	201617827	2020	INDIVIDUAL PERSONAL PROPERTY	MITCHELL WILLISHIA	10816 E 81ST TER
201609188	2007	INDIVIDUAL PERSONAL PROPERTY	OTTE DEREK WAYNE	6417 HARRIS AVE	201617920	2019-2021	INDIVIDUAL PERSONAL PROPERTY	ADAMS CHRISTOPHER A	5808 HARVARD AVE
201609289	2005-2007	INDIVIDUAL PERSONAL PROPERTY	VOGEL JASON R	6908 ENGLEWOOD AVE	201617998	2021	INDIVIDUAL PERSONAL PROPERTY	BROOKS JEREMY M & MICHAEL L	7401 ELM ST
201609347	2005-2009	INDIVIDUAL PERSONAL PROPERTY	PARKER KEITH E	NO ADDRESS PROVIDED BY TAXPAYER	201618005	2006-2014	INDIVIDUAL PERSONAL PROPERTY	PAULL PATRICK D	1811 E 84TH ST
201609513	2009-2016	INDIVIDUAL PERSONAL PROPERTY	VASSER CEDRIC D	8001 ELM AVE	201618088	2018-2021	INDIVIDUAL PERSONAL PROPERTY	JONES DOLORES W	7104 NORWOOD AVE
201610002	2017	INDIVIDUAL PERSONAL PROPERTY	WESLEY BRITTNEY MARIE (MILES)	6130 BLUE RIDGE CUT OFF	201618093	2014	INDIVIDUAL PERSONAL PROPERTY	ROBERTSON NATALIE C	6320 STERLING AVE
201610044	2009-2010	INDIVIDUAL PERSONAL PROPERTY	STANDIFER DANIEL E	9037 E 85TH TER	201618232	2006	INDIVIDUAL PERSONAL PROPERTY	ROE CHRISTOPHER	5324 HEDGES AVE
201610074	2012-2013	INDIVIDUAL PERSONAL PROPERTY	TONGA PAUL MAPA II	203 NW HIGHLAND LN	201618288	2006-2007	INDIVIDUAL PERSONAL PROPERTY	WEAVER SOLOMON	6008 FARLEY AVE
201610088	2007-2008	INDIVIDUAL PERSONAL PROPERTY	HICKS REBECCA	6004 HARRIS AVE	201618371	2005	INDIVIDUAL PERSONAL PROPERTY	JEFFERS LETHA	10208 E 70TH TER
201610133	2021	INDIVIDUAL PERSONAL PROPERTY	HINER JOSEPH WILLIAM SR	11200 E 64TH ST	201618389	2020-2021	INDIVIDUAL PERSONAL PROPERTY	YORK DERRICK HESTON & AVERY LINNAE	10616 E 70TH TER
201610211	2006-2009	INDIVIDUAL PERSONAL PROPERTY	ALLISON RASHAD & OR GRAY KYEELA	9901 E 77TH TER	201618460	2006-2007	INDIVIDUAL PERSONAL PROPERTY	MASON DAVID N SR	5608 STERLING AVE
201610237	2021	INDIVIDUAL PERSONAL PROPERTY	SIMPSON BRANDIE	5521 HUNTER TER	201618641	2006-2008	INDIVIDUAL PERSONAL PROPERTY	ALFONS BENITO JR	5408 DITZLER AVE
201610266	2021	INDIVIDUAL PERSONAL PROPERTY	KITCHEN SIFFERMAN SHELLY	NO ADDRESS PROVIDED BY TAXPAYER	201618670	2013	INDIVIDUAL PERSONAL PROPERTY	GRAY WILLIAM E	5808 LANE AVE
201610268	2019-2021	INDIVIDUAL PERSONAL PROPERTY	BLUM PETER MICHAEL	11604 E 60TH ST	201618683	2006	INDIVIDUAL PERSONAL PROPERTY	BOHANNON NANCY A	NO ADDRESS PROVIDED BY TAXPAYER
201610452	2020-2021	INDIVIDUAL PERSONAL PROPERTY	WEAVER JOHN W JR	11901 E 78TH TER	201618849	2020-2021	INDIVIDUAL PERSONAL PROPERTY	ALLAN ELIZABETH C	5401 HEDGES AVE
201610520	2021	INDIVIDUAL PERSONAL PROPERTY	COLLINS SHAQUITA SHANEE	8615 W UTOPIA DR APT 42	201618854	2005	INDIVIDUAL PERSONAL PROPERTY	HUNDLEY VIOLA S	NO ADDRESS PROVIDED BY TAXPAYER
201610874	2006-2007	INDIVIDUAL PERSONAL PROPERTY	HARDY RUTH	10207 E 78TH ST	201618857	2007-2008	INDIVIDUAL PERSONAL PROPERTY	PARENT CHRISTOPHER L	NO ADDRESS PROVIDED BY TAXPAYER
201610927	2007-2009	INDIVIDUAL PERSONAL PROPERTY	CLUNKINBEARD BRYSON A	7917 MAPLE AVE	201618866	2006-2008	INDIVIDUAL PERSONAL PROPERTY	MARENGO ROBERT	6724 CRISP AVE

201618906	2019-2021	INDIVIDUAL PERSONAL PROPERTY	REEVES DAVID P	6551 RAYTOWN RD APT 4	201626199	2021	INDIVIDUAL PERSONAL PROPERTY	SMITH HALEIGH BREANNE (CHRISMAN)	10016 E 68TH ST
201618908	2008	INDIVIDUAL PERSONAL PROPERTY	HAYNES CHRIS N	8626 E 84TH ST	201626282	2021	INDIVIDUAL PERSONAL PROPERTY	HENDRIX RANDY JR & LAURA LOUISA	7924 CEDAR AVE
201618933	2008	INDIVIDUAL PERSONAL PROPERTY	MCCLURE BRIAN	5409 OXFORD AVE	201626286	2006	INDIVIDUAL PERSONAL PROPERTY	NALLEY NICOLE & SANTOS BACA	7906 APPLETON AVE
201619024	2009	INDIVIDUAL PERSONAL PROPERTY	ANDERSON FRANCES D	8611 KENTUCKY AVE	201626406	2006-2007	INDIVIDUAL PERSONAL PROPERTY	OWENS NAIMAH	NO ADDRESS PROVIDED BY TAXPAYER
201619087	2006-2007	INDIVIDUAL PERSONAL PROPERTY	STRICKLAND BRAIN A JR	9410 E 81ST TER	201626452	2009	INDIVIDUAL PERSONAL PROPERTY	QUINN LARRY R	5941 RAYTOWN RD UNIT C
201619233	2005	INDIVIDUAL PERSONAL PROPERTY	CODR DAVID J	5805 OXFORD AVE	201626469	2010	INDIVIDUAL PERSONAL PROPERTY	MACKEY LEROY	5420 BLUE RIDGE CUT OFF APT 716
201619383	2006-2014	INDIVIDUAL PERSONAL PROPERTY	MC GILL KATHY L	7820 WESTRIDGE RD	201626649	2006	INDIVIDUAL PERSONAL PROPERTY	SMITH CHRISTOPHER LEE	108 N HUTTIG AVE
201619439	2021	INDIVIDUAL PERSONAL PROPERTY	WOODIN VERNON J	6204 STERLING AVE	201626739	2021	INDIVIDUAL PERSONAL PROPERTY	BROWN CHARLES E	8808 E 61ST ST
201619516	2020	INDIVIDUAL PERSONAL PROPERTY	MORRIS THOMAS V JR & HAMLIN KELLY J	9200 E 63RD ST	201626833	2019-2021	INDIVIDUAL PERSONAL PROPERTY	BONO AARON MICHAEL	8614 PERSHING RD
201619562	2014	INDIVIDUAL PERSONAL PROPERTY	VAILS CYNTHIA M	8307 E 86TH TER	201626834	2015-2016	INDIVIDUAL PERSONAL PROPERTY	KWIATKOWSKI LAURA ALYSON	6800 RAYTOWN RD
201619618	2014-2018	INDIVIDUAL PERSONAL PROPERTY	SLOAN MARGARET A	8108 EVANSTON AVE	201626963	2016	INDIVIDUAL PERSONAL PROPERTY	FORBIS JAMES	7512 LEWIS AVE
201619758	2021	INDIVIDUAL PERSONAL PROPERTY	THOMAS GWENDOLYN D	6015 FARLEY AVE	201627074	2021	INDIVIDUAL PERSONAL PROPERTY	MCCOLLOUGH REGINA SHAJAUJ	7125 RAYTOWN RD
201619902	2010-2011	INDIVIDUAL PERSONAL PROPERTY	PINION ANTHONY	7025 KENTUCKY AVE	201627140	2021	INDIVIDUAL PERSONAL PROPERTY	TAVAI ERIC	5512 DITZLER AVE
201620112	2021	INDIVIDUAL PERSONAL PROPERTY	BARRY ROXANNE	5504 WOODSON RD	201627358	2021	INDIVIDUAL PERSONAL PROPERTY	CAMPBELL MICHAEL DEAN	9009 E 84TH ST
201620172	2020-2021	INDIVIDUAL PERSONAL PROPERTY	DAVIS GWENDOLYN L	8302 HUNTER ST	201627414	2006-2007	INDIVIDUAL PERSONAL PROPERTY	FREEMAN ASHLEY D	9824 E 61ST ST APT 1
201620636	2006-2008	INDIVIDUAL PERSONAL PROPERTY	JACKSON TONY G	8903 E 72ND ST	201627622	2012-2013	INDIVIDUAL PERSONAL PROPERTY	ZOELLERS DAVID	5933 STERLING AVE
201620708	2007	INDIVIDUAL PERSONAL PROPERTY	WRIGHT STEVEN & WILLIAM	9021 E 79TH ST	201627826	2020-2021	INDIVIDUAL PERSONAL PROPERTY	GROVES ALECIA	5508 CEDAR AVE
201620893	2008	INDIVIDUAL PERSONAL PROPERTY	SHIRLEY CASEY E	8003 ARLINGTON AVE	201628239	2006-2010	INDIVIDUAL PERSONAL PROPERTY	WOOD PATRICIA ANN	9321 E 84TH ST
201621019	2009-2010	INDIVIDUAL PERSONAL PROPERTY	HALL DANIELLE R	8513 DITZLER AVE	201628378	2007-2008	INDIVIDUAL PERSONAL PROPERTY	WALKER CALEB	8211 HEDGES AVE
201621250	2012-2013	INDIVIDUAL PERSONAL PROPERTY	RUSSELL JUSTIN M	8307 STERLING AVE	201628580	2016	INDIVIDUAL PERSONAL PROPERTY	WEBB GARY E	5420 BLUE RIDGE CUT OFF APT G01
201621311	2020-2021	INDIVIDUAL PERSONAL PROPERTY	PERRY GABRIEL M	5433 WILLOW AVE	201628661	2006-2007	INDIVIDUAL PERSONAL PROPERTY	GONZALES SHANNON J	9153 E 70TH TER
201621395	2006-2008	INDIVIDUAL PERSONAL PROPERTY	HARMON JOSHUA & ELISA	6012 ENGLEWOOD AVE	201628809	2020-2021	INDIVIDUAL PERSONAL PROPERTY	BELL ALEXANDER	9809 E 66TH TER
201621449	2008	INDIVIDUAL PERSONAL PROPERTY	NICHOLS DONALD & HEATHER M	9003 RICHARDS DR	201628853	2021	INDIVIDUAL PERSONAL PROPERTY	POWELL JASMAA	9501 E 83RD ST
201621474	2006-2007	INDIVIDUAL PERSONAL PROPERTY	BAKER PAMELA ELIZABETH	NO ADDRESS PROVIDED BY TAXPAYER	201628991	2006	INDIVIDUAL PERSONAL PROPERTY	MCLEOD ALDRA L	7228 CRISP AVE
201621490	2005-2012	INDIVIDUAL PERSONAL PROPERTY	LEWIS WENDA (HOLMES)	8001 E 87TH ST	201629124	2018-2019	INDIVIDUAL PERSONAL PROPERTY	SPENCER JOHN R JR	5400 BLUE RIDGE CUT OFF
201621586	2011-2017	INDIVIDUAL PERSONAL PROPERTY	STAFFORD DANIEL J II	7923 TENNESSEE AVE	201629474	2008	INDIVIDUAL PERSONAL PROPERTY	OWENSBY JACQUELINE	8406 E 83RD ST
201621602	2006-2012	INDIVIDUAL PERSONAL PROPERTY	COX DEBORAH D	NO ADDRESS PROVIDED BY TAXPAYER	201629486	2007	INDIVIDUAL PERSONAL PROPERTY	LOUIZOU STEPHANIE	9700 E 65TH TER
201621617	2018-2019	INDIVIDUAL PERSONAL PROPERTY	PILAND DAVID R	9913 E 77TH TER	201629517	2021	INDIVIDUAL PERSONAL PROPERTY	GINES BRANDON E	6547 RAYTOWN RD APT 4
201621635	2006-2007	INDIVIDUAL PERSONAL PROPERTY	PARRISH KEVIN	NO ADDRESS PROVIDED BY TAXPAYER	201629580	2006-2007	INDIVIDUAL PERSONAL PROPERTY	FERGUSON MACY B	NO ADDRESS PROVIDED BY TAXPAYER
201621671	2009-2010	INDIVIDUAL PERSONAL PROPERTY	WASHINGTON CHRISTINE M	8717 E 61ST TER APT 1	201629700	2007-2010	INDIVIDUAL PERSONAL PROPERTY	RICHARDSON OLGA	NO ADDRESS PROVIDED BY TAXPAYER
201621723	2006-2009	INDIVIDUAL PERSONAL PROPERTY	BESS TALESE D	7926 DITZLER AVE	201629721	2006-2008	INDIVIDUAL PERSONAL PROPERTY	MCDANIEL MAALEK A	5705 WOODSON RD
201621797	2013-2014	INDIVIDUAL PERSONAL PROPERTY	KENNON TANISHA L	5312 DITZLER AVE	201629768	2010-2017	INDIVIDUAL PERSONAL PROPERTY	CROUCH LAURA	8110 MANNING AVE
201621834	2006-2010	INDIVIDUAL PERSONAL PROPERTY	HULETT BRANDON	9208 E 85TH ST	201629817	2007	INDIVIDUAL PERSONAL PROPERTY	SPOTZ HOLLY	9130 E 52ND TER
201621886	2017-2018	INDIVIDUAL PERSONAL PROPERTY	RUSH DEANGELA S	5430 DITZLER AVE	201629941	2008-2021	INDIVIDUAL PERSONAL PROPERTY	VICKERS LINDA R	8520 DITZLER AVE
201621974	2009	INDIVIDUAL PERSONAL PROPERTY	STRIGIN DAVID	7705 RAYTOWN RD	201629999	2007	INDIVIDUAL PERSONAL PROPERTY	CHASTAIN JIM	9500 E 63RD ST
201621983	2006-2008	INDIVIDUAL PERSONAL PROPERTY	BIERMANN MARK J	9003 RICHARDS DR	201630000	2011	INDIVIDUAL PERSONAL PROPERTY	MAXFIELD VONJA	5800 HEDGES AVE
201622181	2021	INDIVIDUAL PERSONAL PROPERTY	PARKER LAUNA J & LISA L	5701 CEDAR AVE	201630015	2009	INDIVIDUAL PERSONAL PROPERTY	DAWSON SAMUEL G	6800 HAWTHORNE AVE
201622332	2006-2012	INDIVIDUAL PERSONAL PROPERTY	MARTIN MAURICE L	NO ADDRESS PROVIDED BY TAXPAYER	201630022	2006-2008	INDIVIDUAL PERSONAL PROPERTY	ALFARO JOSE MARTIN	6553 RAYTOWN RD APT 18
201622352	2007-2010	INDIVIDUAL PERSONAL PROPERTY	CAMPBELL COREY CHRISTOPHER	5724 CEDAR AVE	201630079	2018-2021	INDIVIDUAL PERSONAL PROPERTY	SMITH JAMES A	9126 RICHARDS DR
201622357	2007	INDIVIDUAL PERSONAL PROPERTY	FORTINI JAMIE L	10409 E 67TH ST	201630102	2019	INDIVIDUAL PERSONAL PROPERTY	THOMAS BENJAMIN J	5245 EUCLID AVE
201622445	2012-2013	INDIVIDUAL PERSONAL PROPERTY	COSAR LINDA J	NO ADDRESS PROVIDED BY TAXPAYER	201630112	2008-2017	INDIVIDUAL PERSONAL PROPERTY	BROOKS DAVID H & LEAH D	10006 E 70TH TER
201622503	2011	INDIVIDUAL PERSONAL PROPERTY	EDKIN TYSON A	8225 HARRIS CT	201630331	2011-2013	INDIVIDUAL PERSONAL PROPERTY	THOMAS KETLEE M	5823 FARLEY AVE
201622527	2008-2017	INDIVIDUAL PERSONAL PROPERTY	GENTRY TRAVIS	11000 E 57TH ST	201630417	2021	INDIVIDUAL PERSONAL PROPERTY	BAKER LARITA SHANTE	8313 E 85TH TER
201622555	2006	INDIVIDUAL PERSONAL PROPERTY	JONES STANFORD LEE JR	8955 E 54TH ST	201630614	2006-2007	INDIVIDUAL PERSONAL PROPERTY	RILEY ALEX	8313 HAWTHORNE AVE
201622579	2006	INDIVIDUAL PERSONAL PROPERTY	BAER MICHAEL	7313 HARDY AVE	201630654	2007	INDIVIDUAL PERSONAL PROPERTY	ELLIS PAUL A & KATHRYN E	5732 NORTHERN AVE
201622598	2021	INDIVIDUAL PERSONAL PROPERTY	DAVILA MALLORY	11405 E 69TH ST	201630746	2007-2008	INDIVIDUAL PERSONAL PROPERTY	BUTTS DAMIAN M	11117 E 53RD ST
201622630	2006-2007	INDIVIDUAL PERSONAL PROPERTY	WILLIAMS DEANN	NO ADDRESS PROVIDED BY TAXPAYER	201630816	2021	INDIVIDUAL PERSONAL PROPERTY	JAMIS JAMES R	8963 E 54TH ST
201622631	2006	INDIVIDUAL PERSONAL PROPERTY	LORA JORGE G	NO ADDRESS PROVIDED BY TAXPAYER	201630962	2021	INDIVIDUAL PERSONAL PROPERTY	GREEN MICHAEL LEE JR	9905 E 82ND TER
201622670	2006	INDIVIDUAL PERSONAL PROPERTY	BORDONALLI ANTONIO	9700 E 65TH TER	201630963	2008-2011	INDIVIDUAL PERSONAL PROPERTY	ANDERSON TREMELL	NO ADDRESS PROVIDED BY TAXPAYER
201622732	2008-2009	INDIVIDUAL PERSONAL PROPERTY	ALWAN SAMAR	35510 E SPAINHOUR RD	201631004	2006-2008	INDIVIDUAL PERSONAL PROPERTY	REID CHRISTOPHER A	6500 HARDY AVE
201622830	2021	INDIVIDUAL PERSONAL PROPERTY	BARKER DAVID ALAN II	9117 E 73RD ST	201631114	2008-2014	INDIVIDUAL PERSONAL PROPERTY	REISNER DAVID J	6115 BLUE RIDGE BLVD
201622848	2008-2009	INDIVIDUAL PERSONAL PROPERTY	BOON TERRY L	NO ADDRESS PROVIDED BY TAXPAYER	201631164	2007	INDIVIDUAL PERSONAL PROPERTY	MITCHELL DANA M & ABOUGH ALAINA L	8402 LANE PL
201622956	2020-2021	INDIVIDUAL PERSONAL PROPERTY	ROBINSON FRANCES M	7307 APPLETON AVE	201631321	2020-2021	INDIVIDUAL PERSONAL PROPERTY	FONSECA DORA ANGELINA (MARTINEZ)	10109 E 86TH TER
201623022	2021	INDIVIDUAL PERSONAL PROPERTY	LARISON JANE	8306 HUNTER ST	201631632	2009	INDIVIDUAL PERSONAL PROPERTY	WATSON ODEAL O & MANHNEO TRACY	7831 WOODSON RD
201623351	2006-2011	INDIVIDUAL PERSONAL PROPERTY	LEE CHUNGHYUN	8905 E 66TH ST	201631697	2021	INDIVIDUAL PERSONAL PROPERTY	SCOTT BRYANT S & AMANDA SCIARA	10409 E 79TH TER
201623385	2021	INDIVIDUAL PERSONAL PROPERTY	BARRARA MIGUEL	8416 E 85TH ST	201631718	2006-2017	INDIVIDUAL PERSONAL PROPERTY	BARRERA MARK	9403 E 64TH ST
201623874	2017-2018	INDIVIDUAL PERSONAL PROPERTY	AUBREY LINDSEY SHARON D	10326 E 63RD ST APT 3	201631725	2009	INDIVIDUAL PERSONAL PROPERTY	WALTERS ERYN & MULLINS BILLY	8600 MAPLE AVE
201623922	2008-2010	INDIVIDUAL PERSONAL PROPERTY	COLLINS TANIEL	5912 LAUREL AVE	201631736	2012-2015	INDIVIDUAL PERSONAL PROPERTY	MCCARTY AMY ELLEN	8505 ARLINGTON AVE
201623989	2016-2017	INDIVIDUAL PERSONAL PROPERTY	YOUNT JACOB A & MEGAN P	7411 ELM ST	201631839	2006	INDIVIDUAL PERSONAL PROPERTY	ROBY COURTNEYA JETAIME	7505 HAWTHORNE AVE
201624018	2017	INDIVIDUAL PERSONAL PROPERTY	CLAUSEN SHANNA M & CLAUSEN LORI A	5400 ELM AVE	201631861	2006-2007	INDIVIDUAL PERSONAL PROPERTY	HILL CORTEZ	5732 LANE AVE
201624123	2021	INDIVIDUAL PERSONAL PROPERTY	DAVIS DEANNA LYNN	8958 E 62ND TER	201632084	2018-2021	INDIVIDUAL PERSONAL PROPERTY	GARCIA MAREBLE MARGARITA	5846 HUNTER CT
201624138	2021	INDIVIDUAL PERSONAL PROPERTY	YATES MISHA D	8301 LANE AVE	201632315	2006-2010	INDIVIDUAL PERSONAL PROPERTY	DEAN AUURHAU J	7817 E 113TH TER
201624198	2021	INDIVIDUAL PERSONAL PROPERTY	EDWARDS MARIO LORELL	7504 ELM ST	201632398	2011	INDIVIDUAL PERSONAL PROPERTY	SHORT PAUL LESTER	8804 E 72ND TER
201624717	2021	INDIVIDUAL PERSONAL PROPERTY	JENKINS CARLIN R	8436 LANE DR	201632419	2021	INDIVIDUAL PERSONAL PROPERTY	BRADSHAW MINDY D (DREES)	6824 LAKESHORE DR
201625095	2007	INDIVIDUAL PERSONAL PROPERTY	LISTER SHONDELL M	9911 E 77TH ST	201632424	2007	INDIVIDUAL PERSONAL PROPERTY	CELIS JAVIER L	11811 E 83RD ST
201625374	2017-2021	INDIVIDUAL PERSONAL PROPERTY	MOORE CATHY A	8110 WOODSON DR	201632480	2021	INDIVIDUAL PERSONAL PROPERTY	ARMSTRONG MELINDA C	9800 E 73RD ST APT B
201625418	2018	INDIVIDUAL PERSONAL PROPERTY	WISEMAN WILLIAM L III	5305 LAUREL AVE	201632589	2012-2016	INDIVIDUAL PERSONAL PROPERTY	FIRMIN ROMA L	6649 CEDAR AVE APT B
201625432	2021	INDIVIDUAL PERSONAL PROPERTY	LUCAS TANISHA CHANTE	6709 LAUREL AVE	201632710	2016	INDIVIDUAL PERSONAL PROPERTY	ELY SARAH & KIMBERLY (BOND)	8923 ROSE LN
201625736	2006-2008	INDIVIDUAL PERSONAL PROPERTY	PARKER RAEJON L	8823 E 62ND ST	201632756	2008-2011	INDIVIDUAL PERSONAL PROPERTY	MORRISON ANDREA D	9200 E 64TH TER
201625824	2010-2017	INDIVIDUAL PERSONAL PROPERTY	ARRINGTON DEREK L	8611 KENTUCKY AVE	201632759	2006-2007	INDIVIDUAL PERSONAL PROPERTY	COOPER GARY A & BRANDON MARIE	9824 E 61ST ST APT 1
201625984	2021	INDIVIDUAL PERSONAL PROPERTY	PENNINGTON KIMBERLY LOUISE	7203 RALSTON AVE	201632868	2020-2021	INDIVIDUAL PERSONAL PROPERTY	TATUM LATONYA S	6032 LAUREL AVE
201626142	2010	INDIVIDUAL PERSONAL PROPERTY	WEGENER JEFFREY	6622 RALSTON AVE	201632982	2015-2021	INDIVIDUAL PERSONAL PROPERTY	MORRIS RON R JR	8216 STERLING AVE

201633124	2021	INDIVIDUAL PERSONAL PROPERTY	MURDOCK CLYDE E & FRANCINE A	10629 E 56TH TER	201642615	2011	INDIVIDUAL PERSONAL PROPERTY	PIKE JOSEPH C	8219 E 85TH ST
201633290	2012-2017	INDIVIDUAL PERSONAL PROPERTY	FREEMAN DANIELLE B	6001 NORTHERN AVE	201642659	2007	INDIVIDUAL PERSONAL PROPERTY	TANNER MALEYAH	6828 CRISP AVE
201633342	2013	INDIVIDUAL PERSONAL PROPERTY	WOODS TYRONE M	6816 HUNTER ST	201642704	2006-2007	INDIVIDUAL PERSONAL PROPERTY	REED ROBERT A	NO ADDRESS PROVIDED BY TAXPAYER
201633523	2021	INDIVIDUAL PERSONAL PROPERTY	WEHNER AMANDA S	11204 E 64TH TER	201642820	2010-2011	INDIVIDUAL PERSONAL PROPERTY	THOMAS MONICE	9613 E 67TH TER
201633645	2006-2008	INDIVIDUAL PERSONAL PROPERTY	DACE EMANUEL	NO ADDRESS PROVIDED BY TAXPAYER	201642906	2014-2015	INDIVIDUAL PERSONAL PROPERTY	TURNER APRIL DAWN	5827 KENTUCKY AVE
201633798	2009-2013	INDIVIDUAL PERSONAL PROPERTY	MCCLINTON HAROLD JR	5725 ELM AVE	201643261	2021	INDIVIDUAL PERSONAL PROPERTY	SMITH DEBRA A	7522 HAWTHORNE AVE
201634040	2021	INDIVIDUAL PERSONAL PROPERTY	NEWCOMB DAVID V II & JESSICA	6832 STERLING AVE	201643311	2006-2017	INDIVIDUAL PERSONAL PROPERTY	DUNN DEANDRA L	8812 E 62ND ST
201634106	2006-2007	INDIVIDUAL PERSONAL PROPERTY	JOHNSON DARIN K	9131 E 85TH PL	201643424	2006-2007	INDIVIDUAL PERSONAL PROPERTY	SEARS DERRICK B	10117 E 64TH ST
201634108	2009	INDIVIDUAL PERSONAL PROPERTY	ADOKI NEMI M	11001 E 59TH ST	201643446	2021	INDIVIDUAL PERSONAL PROPERTY	GITTELMAN NEIL M & CHRISTY J	8609 OXFORD AVE
201634163	2009	INDIVIDUAL PERSONAL PROPERTY	DUNKER CRAIG T	9825 E 64TH TER	201643543	2006-2008	INDIVIDUAL PERSONAL PROPERTY	FURNEY FELICIA M	6705 HUNTER ST APT 113
201634170	2008-2009	INDIVIDUAL PERSONAL PROPERTY	OCONNOR GINDY	9026 E 74TH TER	201643546	2021	INDIVIDUAL PERSONAL PROPERTY	TRICE REGINA	7234 RAYTOWN RD B
201634238	2007-2008	INDIVIDUAL PERSONAL PROPERTY	ZEHRING AMANDA L	10600 E 70TH ST	201643550	2021	INDIVIDUAL PERSONAL PROPERTY	ASHBY ERIC & TANESH R & TURNER GREGORY	6104 HARVARD AVE
201634331	2008-2010	INDIVIDUAL PERSONAL PROPERTY	LONG KEITH A	9016 E 73RD ST	201643587	2008-2014	INDIVIDUAL PERSONAL PROPERTY	NATIONS TERRANCE L & NATIONS DIANA P	7123 HARVARD AVE
201634347	2011	INDIVIDUAL PERSONAL PROPERTY	STAMPS TOMMY D	8213 RAYTOWN RD	201643619	2017-2018	INDIVIDUAL PERSONAL PROPERTY	ABEL CHARLES M	6104 HARVARD AVE
201634778	2005-2007	INDIVIDUAL PERSONAL PROPERTY	HUTCHINSON KEYON M	5805 OXFORD AVE	201643628	2021	INDIVIDUAL PERSONAL PROPERTY	MITCHELL WILLIE	9911 E 77TH ST
201634939	2005-2006	INDIVIDUAL PERSONAL PROPERTY	CRAWFORD CHANDA	8617 E 83RD TER	201643735	2021	INDIVIDUAL PERSONAL PROPERTY	BRUMFIELD BERNITA M	9010 E 87TH ST APT D7
201635014	2011-2017	INDIVIDUAL PERSONAL PROPERTY	DOWDELL KIANA	NO ADDRESS PROVIDED BY TAXPAYER	201644022	2009	INDIVIDUAL PERSONAL PROPERTY	SURFACE DOUGLAS C	9205 E 84TH ST
201635051	2008-2012	INDIVIDUAL PERSONAL PROPERTY	CROFT MARGARET M	7611 HAWTHORNE AVE	201644166	2016	INDIVIDUAL PERSONAL PROPERTY	BOYLE JULIE	6729 HARRIS AVE
201635095	2007	INDIVIDUAL PERSONAL PROPERTY	TAYLOR AUBREE M & DARRIN E	9817 E 66TH TER	201644288	2011	INDIVIDUAL PERSONAL PROPERTY	ALLSUP GARY R	NO ADDRESS PROVIDED BY TAXPAYER
201635156	2005-2017	INDIVIDUAL PERSONAL PROPERTY	GOULDSMITH DAVID N	6809 CRISP AVE	201644486	2017-2021	INDIVIDUAL PERSONAL PROPERTY	AYERS CORINNE	7017 ARLINGTON AVE
201635161	2007	INDIVIDUAL PERSONAL PROPERTY	NOEL CORRINE E	NO ADDRESS PROVIDED BY TAXPAYER	201644560	2016-2017	INDIVIDUAL PERSONAL PROPERTY	THOMPSON ALTHEA F	11208 E 71ST DR
201635173	2005	INDIVIDUAL PERSONAL PROPERTY	WAGNER ROBERT A	8616 E 83RD TER	201645003	2017	INDIVIDUAL PERSONAL PROPERTY	BOREN KENT S	9712 E 66TH TER
201635249	2018	INDIVIDUAL PERSONAL PROPERTY	HOOTEN ROY L & JANE A	8505 B GREENWOOD RD	201645075	2006-2007	INDIVIDUAL PERSONAL PROPERTY	VELAZQUEZ ARNALDO R	NO ADDRESS PROVIDED BY TAXPAYER
201635370	2006	INDIVIDUAL PERSONAL PROPERTY	STEVENSON CARLOTTA R	NO ADDRESS PROVIDED BY TAXPAYER	201645422	2019	INDIVIDUAL PERSONAL PROPERTY	GOODE ANISSA	9716 STERLING AVE
201635499	2013-2016	INDIVIDUAL PERSONAL PROPERTY	DUNN LASHAUN L	8302 MANNING AVE	201645472	2008-2017	INDIVIDUAL PERSONAL PROPERTY	OBERG SCOTT D	8316 E 66TH ST
201635676	2007-2017	INDIVIDUAL PERSONAL PROPERTY	FERNANDES ROBERT C	10108 E 77TH TER	201645608	2007-2008	INDIVIDUAL PERSONAL PROPERTY	RACY HEATHER M	11601 E 73RD ST
201635769	2008	INDIVIDUAL PERSONAL PROPERTY	HILL IAN M	9705 E 81ST TER	201645801	2021	INDIVIDUAL PERSONAL PROPERTY	ESTRADA YENIS V	8109 WOODSON DR
201636010	2008	INDIVIDUAL PERSONAL PROPERTY	WILLIAMS DEBRAH M	7918 ELM AVE	201645812	2006-2017	INDIVIDUAL PERSONAL PROPERTY	HASTINGS BETTY N	5320 APPLETON AVE
201636292	2013	INDIVIDUAL PERSONAL PROPERTY	BRAS HARRY P OR DIANE K BRAS	11805 E 77TH ST	201645888	2021	INDIVIDUAL PERSONAL PROPERTY	FORD CALEB A	6715 APPLETON AVE
201636567	2009-2014	INDIVIDUAL PERSONAL PROPERTY	ELLIOT ANTHONY S	7405 HARDY AVE	201645903	2019-2020	INDIVIDUAL PERSONAL PROPERTY	HARRIS RODNEY GILBERT	7216 CRISP AVE
201636680	2011-2013	INDIVIDUAL PERSONAL PROPERTY	JOHNSON NIKKI N	10512 E 56TH ST	201645940	2012	INDIVIDUAL PERSONAL PROPERTY	NICHOLS JUSTINA E	NO ADDRESS PROVIDED BY TAXPAYER
201636902	2008	INDIVIDUAL PERSONAL PROPERTY	MAZE BRANDON & WOODIN VERONICA	8314 STERLING AVE	201646006	2014-2016	INDIVIDUAL PERSONAL PROPERTY	WEAKS ALLEN & DAWN	6516 CLAREMONT AVE
201637303	2006-2007	INDIVIDUAL PERSONAL PROPERTY	SMITH KAREY L	7705 RAYTOWN RD	201646034	2021	INDIVIDUAL PERSONAL PROPERTY	TURNER MICHAEL L	6606 RALSTON AVE
201637381	2021	INDIVIDUAL PERSONAL PROPERTY	MICKELSON ASHLEY B	11901 E 76TH TER	201646057	2006-2008	INDIVIDUAL PERSONAL PROPERTY	HERNDON FRANK L	NO ADDRESS PROVIDED BY TAXPAYER
201637388	2007-2008	INDIVIDUAL PERSONAL PROPERTY	SHUCKAHOSEE GARY J	2310 S FOREST AVE APT A	201646077	2019-2021	INDIVIDUAL PERSONAL PROPERTY	WALKER TAHISHA	11801 E 77TH TER
201637504	2006-2011	INDIVIDUAL PERSONAL PROPERTY	ROBINSON CHARLA L	8200 E 87TH ST	201646157	2017-2021	INDIVIDUAL PERSONAL PROPERTY	KIRBY SARA	8424 GREENWOOD RD
201637660	2020-2021	INDIVIDUAL PERSONAL PROPERTY	GUNN LATRISHA RENEE	7408 HARVARD DR	201646311	2006-2007	INDIVIDUAL PERSONAL PROPERTY	BURMASTER RODNEY & PIPER MARY	NO ADDRESS PROVIDED BY TAXPAYER
201637748	2021	INDIVIDUAL PERSONAL PROPERTY	HOPKINS ROBERT JAMES	11219 E 83RD ST	201646496	2010-2011	INDIVIDUAL PERSONAL PROPERTY	KHAN JOLYNN	8528 ASH AVE
201638166	2006-2017	INDIVIDUAL PERSONAL PROPERTY	CORONA MARIA F	8206 E 86TH TER	201646501	2007	INDIVIDUAL PERSONAL PROPERTY	HANSEN TYLER & THERESA	11125 E 84TH TER
201638167	2010	INDIVIDUAL PERSONAL PROPERTY	HUGHES WILLIAM A	9605 E 68TH TER	201646533	2014	INDIVIDUAL PERSONAL PROPERTY	TAYLOR QUINCY	7021 HUNTER ST
201638260	2007-2009	INDIVIDUAL PERSONAL PROPERTY	YEO ROBERT L & SKINNER JOEY	7923 TENNESSEE AVE	201646548	2021	INDIVIDUAL PERSONAL PROPERTY	BALLENGER RICHARD A	7420 ENGLEWOOD LN
201638277	2021	INDIVIDUAL PERSONAL PROPERTY	HAHN LYNNISA ANN	10404 E 72ND ST	202022429	2007-2009	INDIVIDUAL PERSONAL PROPERTY	IRVINE MIKE	18002 E 18TH ST N
201638288	2007	INDIVIDUAL PERSONAL PROPERTY	MERIDITH JADE M	7505 HAWTHORNE AVE	202023030	2017-2018	INDIVIDUAL PERSONAL PROPERTY	MARSHALL WILLIAM	7854 WOODSON CIR
201638456	2007-2009	INDIVIDUAL PERSONAL PROPERTY	BRUMFIELD JOYCELYN M	7839 ELM ST	202023140	2021	INDIVIDUAL PERSONAL PROPERTY	TRUE KATHERINE A	9301 E 65TH TER
201638489	2021	INDIVIDUAL PERSONAL PROPERTY	VEAL ALFONSO B	6900 CRISP AVE	202023363	2020-2021	INDIVIDUAL PERSONAL PROPERTY	COBBINS MONIQUE	5537 HUNTER TER
201638568	2010	INDIVIDUAL PERSONAL PROPERTY	KOENIG NATALIE E	8336 LAUREL AVE	202024244	2006-2008	INDIVIDUAL PERSONAL PROPERTY	ADESANYA FEMI	5420 BLUE RIDGE CUT OFF APT G01
201639216	2010	INDIVIDUAL PERSONAL PROPERTY	MCVEY JONAS	11513 E 74TH STREET CT	202024474	2021	INDIVIDUAL PERSONAL PROPERTY	BARNHILL BRIAN	5704 ARLINGTON AVE
201639334	2021	INDIVIDUAL PERSONAL PROPERTY	FARQUHARSON LEMORE A	11415 E 58TH TER	202024685	2020-2021	INDIVIDUAL PERSONAL PROPERTY	ZAPIEN LISA MARIE	5444 WOODSON RD
201639366	2006-2007	INDIVIDUAL PERSONAL PROPERTY	SIMS CHRISTINE	NO ADDRESS PROVIDED BY TAXPAYER	202024743	2021	INDIVIDUAL PERSONAL PROPERTY	SMITH ANDREA R	9000 E 68TH TER
201639722	2007-2017	INDIVIDUAL PERSONAL PROPERTY	OROURKE JOHN J	11517 E 67TH ST	202024914	2017-2021	INDIVIDUAL PERSONAL PROPERTY	SPAHN CAYLA	5901 E 77TH ST
201640097	2013	INDIVIDUAL PERSONAL PROPERTY	ARMITAGE TORI D	9106 E 67TH TER	202024928	2021	INDIVIDUAL PERSONAL PROPERTY	VERNER MALACHI	9805 E 84TH ST
201640152	2006-2017	INDIVIDUAL PERSONAL PROPERTY	WHITE CARWOFORD MANON	5936 STERLING AVE	202025021	2007-2016	INDIVIDUAL PERSONAL PROPERTY	CAIN ANTONIO D	5516 MAYWOOD AVE
201640600	2009	INDIVIDUAL PERSONAL PROPERTY	UNGER NICHOLE	11311 E 61ST TER	202025178	2021	INDIVIDUAL PERSONAL PROPERTY	VONLEGGETT BYRON	8314 HUNTER ST
201640647	2009-2011	INDIVIDUAL PERSONAL PROPERTY	HAWKINS ISAAC C	5907 KENTUCKY AVE	202025295	2010-2011	INDIVIDUAL PERSONAL PROPERTY	STICKEN CHRIS & RACHELLE	8908 E GREGORY BLVD
201640916	2021	INDIVIDUAL PERSONAL PROPERTY	MILLER RICHARD J & RENEE A (BRANN)	7220 OXFORD AVE	202025651	2019	INDIVIDUAL PERSONAL PROPERTY	HYDARA FODAY	8312 JAMES A REED RD
201641029	2011-2012	INDIVIDUAL PERSONAL PROPERTY	SIMMONS CASSANDRA L	NO ADDRESS PROVIDED BY TAXPAYER	202025954	2021	INDIVIDUAL PERSONAL PROPERTY	LEFTWICH BETTY	9809 E 59TH TER
201641113	2006-2007	INDIVIDUAL PERSONAL PROPERTY	HOWE MELISSA A	8324 LAUREL AVE	202026135	2021	INDIVIDUAL PERSONAL PROPERTY	STRINGER WILLIE LEE JR	8800 E 53RD TER
201641212	2021	INDIVIDUAL PERSONAL PROPERTY	EDWARDS TONIA	5719 KENTUCKY AVE	202026275	2012-2016	INDIVIDUAL PERSONAL PROPERTY	GRADY DONNA K	6117 DITZLER AVE
201641226	2021	INDIVIDUAL PERSONAL PROPERTY	MOLZHON LORRAINE M	6012 HEDGES AVE	202026444	2020-2021	INDIVIDUAL PERSONAL PROPERTY	HOWARD TERRI L	10607 E 80TH ST
201641264	2019-2021	INDIVIDUAL PERSONAL PROPERTY	MCMICHAEL MELISSA	7005 HUNTER ST	202026804	2006	INDIVIDUAL PERSONAL PROPERTY	LACY DOUGLAS C	7420 WOODSON RD
201641265	2006-2008	INDIVIDUAL PERSONAL PROPERTY	MCLAUGHLIN SHAWN W	8108 WILLOW WAY	202026925	2009	INDIVIDUAL PERSONAL PROPERTY	WEGMANN UDO P	7708 IRWIN RD
201641408	2020-2021	INDIVIDUAL PERSONAL PROPERTY	ESTRADA JAIRO OCANA	9010 E 87TH ST APT A1	202026963	2015-2016	INDIVIDUAL PERSONAL PROPERTY	MORAST RALPH E JR	9102 E 68TH TER
201641635	2010	INDIVIDUAL PERSONAL PROPERTY	BENNETT ANTHONY R	6225 WOODSON RD	202027045	2010	INDIVIDUAL PERSONAL PROPERTY	CONNELL CRYSTAL	6724 CRISP AVE
201641718	2009-2014	INDIVIDUAL PERSONAL PROPERTY	MORRIS RAYNE K	8307 E 85TH ST	202027108	2007	INDIVIDUAL PERSONAL PROPERTY	FERGUSON JESSICA L	9119 RICHARDS DR
201641728	2006-2007	INDIVIDUAL PERSONAL PROPERTY	MCFADDEN BRENDA J	10612 E 80TH ST	202027236	2019	INDIVIDUAL PERSONAL PROPERTY	GREEN TOI LASHON	8325 OLIVE ST
201641741	2021	INDIVIDUAL PERSONAL PROPERTY	HAUN RODNEY E JR & GIBSON AMBER R	9503 E 64TH TER	202027250	2006	INDIVIDUAL PERSONAL PROPERTY	SEE JOHN E	10504 E 70TH TER
201641744	2021	INDIVIDUAL PERSONAL PROPERTY	GARRISON LARENCE III	7827 VASSAR AVE	202027305	2013-2016	INDIVIDUAL PERSONAL PROPERTY	SOLOMON LATASHA	9310 E 54TH ST
201641985	2012	INDIVIDUAL PERSONAL PROPERTY	WILLIAMS ERIC J	NO ADDRESS PROVIDED BY TAXPAYER	202027497	2008-2009	INDIVIDUAL PERSONAL PROPERTY	MIDKIFF HARLEY R	NO ADDRESS PROVIDED BY TAXPAYER
201641993	2006-2008	INDIVIDUAL PERSONAL PROPERTY	BAKER ZACHARY A	NO ADDRESS PROVIDED BY TAXPAYER	202027717	2007	INDIVIDUAL PERSONAL PROPERTY	GULLETT MATTHEW L	11105 E 87TH ST
201642050	2020-2021	INDIVIDUAL PERSONAL PROPERTY	STARR ERIC JOSEPH	7325 HARDY AVE	202027799	2010-2017	INDIVIDUAL PERSONAL PROPERTY	WHITE MANON	5936 STERLING AVE
201642186	2006-2008	INDIVIDUAL PERSONAL PROPERTY	LAMIN JOBE	NO ADDRESS PROVIDED BY TAXPAYER	202027945	2006-2009	INDIVIDUAL PERSONAL PROPERTY	MCCARTHY CHERI MARIE (WAGNER)	8955 E 83RD TER
201642525	2013-2017	INDIVIDUAL PERSONAL PROPERTY	CRAWFORD DENISE Y (BRANDON)	11716 E 85TH ST	202027967	2018	INDIVIDUAL PERSONAL PROPERTY	SCHROEDER SEAN	7311 RAYTOWN RD

202027983	2020	INDIVIDUAL PERSONAL PROPERTY	JONES JESSE R JR	10324 E 63RD ST APT 3	202038414	2021	INDIVIDUAL PERSONAL PROPERTY	REID KMESHA LATRICE	8705 STARK AVE
202028016	2006	INDIVIDUAL PERSONAL PROPERTY	MCKINNEY KENNETH D JR	NO ADDRESS PROVIDED BY TAXPAYER	202038422	2018-2021	INDIVIDUAL PERSONAL PROPERTY	ST CLAIR CRAIG S	9705 E 69TH ST
202028239	2008-2009	INDIVIDUAL PERSONAL PROPERTY	JACKSON FRANK DEAN	9117 E 65TH ST	202038423	2021	INDIVIDUAL PERSONAL PROPERTY	BARRERA DAVID OR TINA	9719 E 68TH TER
202028580	2010-2013	INDIVIDUAL PERSONAL PROPERTY	STOCKMAN KIM	8656 E 53RD ST	202038696	2010-2011	INDIVIDUAL PERSONAL PROPERTY	SACCO NICK & ALISA	7514 MAPLE LN
202028640	2007-2021	INDIVIDUAL PERSONAL PROPERTY	SYKES LATONYA D	9007 E 75TH ST	202038857	2021	INDIVIDUAL PERSONAL PROPERTY	HOLMAN PHINITA	11605 E 60TH ST
202028776	2021	INDIVIDUAL PERSONAL PROPERTY	WINCHESTER FREDDIE J	7406 OVERTON AVE UNIT 2	202038955	2010-2016	INDIVIDUAL PERSONAL PROPERTY	KELLER TAYLOR R	514 NE CHURCHILL ST
202028865	2007-2017	INDIVIDUAL PERSONAL PROPERTY	GOMEZ MARIA	NO ADDRESS PROVIDED BY TAXPAYER	202039310	2018-2021	INDIVIDUAL PERSONAL PROPERTY	GASTON ALYSHA	8832 E 57TH ST
202029136	2007	INDIVIDUAL PERSONAL PROPERTY	HARRISON SHARRI I	11701 E 83RD ST APT 101	202039799	2020	INDIVIDUAL PERSONAL PROPERTY	JOHNSON TYSHIA	8306 E 81ST ST
202029282	2021	INDIVIDUAL PERSONAL PROPERTY	CARULLO LEE ELAINA M	11201 E 59TH TER	202039800	2019-2021	INDIVIDUAL PERSONAL PROPERTY	DUNSON SHILOH	7233 STERLING AVE
202029485	2015	INDIVIDUAL PERSONAL PROPERTY	WHETSTONE JAWON A	9204 VAUGHN AVE	202039895	2010-2011	INDIVIDUAL PERSONAL PROPERTY	DAUGHERTY PETER J	9306 E 81ST ST
202029545	2021	INDIVIDUAL PERSONAL PROPERTY	GRIFFIN BRANDI N	8325 NORTHERN ST	202040021	2021	INDIVIDUAL PERSONAL PROPERTY	MCCHAN JENNIFER M	9112 E 58TH TER
202029639	2012-2017	INDIVIDUAL PERSONAL PROPERTY	FRUITT MICHAEL D	5809 HARVARD AVE	202040075	2021	INDIVIDUAL PERSONAL PROPERTY	RICHARD TIM	8520 PERSHING RD
202029890	2010-2017	INDIVIDUAL PERSONAL PROPERTY	THOMPSON LAUREL & AARON	11112 E 78TH ST	202040490	2021	INDIVIDUAL PERSONAL PROPERTY	CENICEROS SAUL	5520 HUNTER ST
202029949	2007-2008	INDIVIDUAL PERSONAL PROPERTY	DURON MARIA E & RODOLFO	NO ADDRESS PROVIDED BY TAXPAYER	202040549	2021	INDIVIDUAL PERSONAL PROPERTY	JACK IESHA	9122 RICHARDS DR
202030033	2016-2021	INDIVIDUAL PERSONAL PROPERTY	WARD KYLE	11104 E 78TH ST	202040567	2021	INDIVIDUAL PERSONAL PROPERTY	WELLS JOEL M	8915 ROSE LN
202030133	2006	INDIVIDUAL PERSONAL PROPERTY	MEYER RICHARD M	9603 E 80TH TER	202040747	2021	INDIVIDUAL PERSONAL PROPERTY	ASHBY MICHAEL	8968 E 55TH ST
202030317	2014-2015	INDIVIDUAL PERSONAL PROPERTY	DIJUNGAN D LOGAN	10117 E 56TH ST	202040750	2021	INDIVIDUAL PERSONAL PROPERTY	MURPHY MATT	6807 HUNTER ST
202030456	2020-2021	INDIVIDUAL PERSONAL PROPERTY	WILLIAMS MIRIAM (BOUNDS)	10405 E 82ND TER	202040900	2012	INDIVIDUAL PERSONAL PROPERTY	FOLTZ ROBERT BRANDON	9401 E 70TH TER
202030674	2018-2021	INDIVIDUAL PERSONAL PROPERTY	COWLEY MILTON	11335 E 72ND ST	202041039	2014-2019	INDIVIDUAL PERSONAL PROPERTY	WILLIAMS WILLARD C JR	9010 E 87TH ST APT D6
202030783	2006-2012	INDIVIDUAL PERSONAL PROPERTY	TATE JAESON LAWRENCE	8612 ARLINGTON AVE	202041049	2008-2009	INDIVIDUAL PERSONAL PROPERTY	HODGES DAYLE J	8971 E 66TH ST
202030980	2021	INDIVIDUAL PERSONAL PROPERTY	GOFORTH MICHAEL L	5912 ELM AVE	202041175	2021	INDIVIDUAL PERSONAL PROPERTY	BELTZ JOHN F II	11304 E 56TH TER
202031126	2008-2009	INDIVIDUAL PERSONAL PROPERTY	VANSICKEL AMANDA	11805 E 77TH TER	202042083	2019-2021	INDIVIDUAL PERSONAL PROPERTY	SPANN NASIA MELA	11045 E 53RD TER
202031193	2020-2021	INDIVIDUAL PERSONAL PROPERTY	SWINTON DANA L	7926 HEDGES AVE	202042086	2012-2014	INDIVIDUAL PERSONAL PROPERTY	REEDY SARAH	6508 BLUE RIDGE CUT OFF
202031397	2007-2009	INDIVIDUAL PERSONAL PROPERTY	SNYDER DAVID A	10001 E 77TH TER	202042202	2010-2011	INDIVIDUAL PERSONAL PROPERTY	ARTIS MOSES	6408 HARDY AVE
202031681	2021	INDIVIDUAL PERSONAL PROPERTY	JONES MARCUS ZURI	8403 BOOTH AVE	202042405	2006-2008	INDIVIDUAL PERSONAL PROPERTY	RICE MIKE	9597 TAYTOWN RD APT 1B
202031748	2021	INDIVIDUAL PERSONAL PROPERTY	BOLTON GERRY J & BOLTON ANGELA D	7148 WOODSON DR	202042419	2007	INDIVIDUAL PERSONAL PROPERTY	SHEAF SANDRA R	7613 CRESCENT AVE
202031783	2007	INDIVIDUAL PERSONAL PROPERTY	SWANSON TOVA M	6907 LAUREL AVE	202042440	2012	INDIVIDUAL PERSONAL PROPERTY	UPDEGRAFF JAMES & LEANN UPDEGRAFF	8912 HUNTER ST
202031972	2007-2011	INDIVIDUAL PERSONAL PROPERTY	ARNOLD GERALD W	10514 E 70TH ST	202042492	2005	INDIVIDUAL PERSONAL PROPERTY	CARSON JENNIFER L	8405 STERLING AVE
202031998	2008	INDIVIDUAL PERSONAL PROPERTY	STANGLE DON & ASHLEY	5628 DITZLER AVE	202042517	2008-2009	INDIVIDUAL PERSONAL PROPERTY	WALLACE LATONYA D	8601 E 85TH ST
202032186	2007-2011	INDIVIDUAL PERSONAL PROPERTY	SCOTT ANGELA M	9208 E 85TH ST	202042982	2006	INDIVIDUAL PERSONAL PROPERTY	TAYLOR DOUGLAS R	11212 E 61ST TER
202032462	2021	INDIVIDUAL PERSONAL PROPERTY	MOSBY ANTONIA	9110 E 85TH ST	202043228	2007	INDIVIDUAL PERSONAL PROPERTY	SHORNIK JAMES M	11007 E 60TH TER
202032654	2017-2018	INDIVIDUAL PERSONAL PROPERTY	WALKER LATONYA M	8624 E 83RD ST	202043394	2006-2008	INDIVIDUAL PERSONAL PROPERTY	TURNER JERMON E	10908 E 81ST TER
202032836	2007-2009	INDIVIDUAL PERSONAL PROPERTY	WILLIS MATTHEW C	9203 E 54TH ST	202043493	2019-2021	INDIVIDUAL PERSONAL PROPERTY	RODRIGUEZ SHERON L	7455 MAYWOOD AVE
202032845	2021	INDIVIDUAL PERSONAL PROPERTY	PAXTON MICHAEL L & REBECCA	6723 ENGLEWOOD AVE	202043521	2010	INDIVIDUAL PERSONAL PROPERTY	BRADFORD ALBERT	5947 TAYTOWN RD UNIT G
202032877	2021	INDIVIDUAL PERSONAL PROPERTY	MORRIS JEFFREY	10212 E 68TH TER	202043720	2006-2009	INDIVIDUAL PERSONAL PROPERTY	KEYS BRADLEY	9205 E 52ND TER
202033188	2007	INDIVIDUAL PERSONAL PROPERTY	HAHN RAYMOND & CRYSTAL	11315 E 72ND ST	202043769	2013	INDIVIDUAL PERSONAL PROPERTY	WILSON NATHANIEL S	7511 MAPLE LN
202033330	2012-2013	INDIVIDUAL PERSONAL PROPERTY	CARTY STEVEN C	6204 HEDGES AVE	202043837	2009-2017	INDIVIDUAL PERSONAL PROPERTY	GARCIA ARNOLD	11704 E 77TH ST
202033359	2010-2016	INDIVIDUAL PERSONAL PROPERTY	JARVIS WILLIAM R JR	5508 ASH AVE	202044050	2015-2016	INDIVIDUAL PERSONAL PROPERTY	MCPHERRIN CONSTANCE I	6222 ASH CT
202034163	2011	INDIVIDUAL PERSONAL PROPERTY	HASKELL KEITYSHIA	9401 E 83RD ST	202044314	2008-2009	INDIVIDUAL PERSONAL PROPERTY	PHILLIPS TANYA	10023 E 67TH ST
202034179	2020-2021	INDIVIDUAL PERSONAL PROPERTY	PARVIN ANDREA	8204 HARDY AVE	202044342	2009	INDIVIDUAL PERSONAL PROPERTY	MAMMEN PHILIP	9611 E 77TH ST
202034358	2015-2021	INDIVIDUAL PERSONAL PROPERTY	WEATHERS AARON	5810 KENTUCKY AVE	202044382	2007	INDIVIDUAL PERSONAL PROPERTY	MORTAYA WILLIAN	6705 HUNTER ST APT 113
202034382	2021	INDIVIDUAL PERSONAL PROPERTY	WILSON VICTORIA NAIPAH	8613 MAPLE AVE	202044563	2014-2015	INDIVIDUAL PERSONAL PROPERTY	GATES JAMELLE P	9316 BALES DR APT 302
202034432	2007	INDIVIDUAL PERSONAL PROPERTY	CASEY TOMMY D	8531 EVANSTON AVE	202044724	2019-2021	INDIVIDUAL PERSONAL PROPERTY	BAYLIFF CARLENA JANELL	5901 HEDGES AVE
202034553	2018-2019	INDIVIDUAL PERSONAL PROPERTY	DOSS DENISHA	8426 LANE PL	202044856	2020-2021	INDIVIDUAL PERSONAL PROPERTY	MCCULLOUGH QRAN C	7410 OVERTON AVE UNIT 1
202034733	2017-2018	INDIVIDUAL PERSONAL PROPERTY	CALDWELL MARKITA D	6628 OXFORD AVE	202044868	2013-2015	INDIVIDUAL PERSONAL PROPERTY	HARMIS CHRISTOPHER & AMANDA PITTS	8708 E 80TH TER
202034919	2007	INDIVIDUAL PERSONAL PROPERTY	CONNALLY JOCELYN	9204 E 54TH TER	202044975	2014-2016	INDIVIDUAL PERSONAL PROPERTY	JOHNSON COREY LYN	10407 E 82ND ST
202034933	2021	INDIVIDUAL PERSONAL PROPERTY	SIMMONS ANDREW DAVID	9018 E 72ND TER	202045197	2015	INDIVIDUAL PERSONAL PROPERTY	DOWDELL MARVIN	11617 E 72ND ST
202035074	2006	INDIVIDUAL PERSONAL PROPERTY	JESTER JENNIFER	9912 E 60TH ST	202045203	2006	INDIVIDUAL PERSONAL PROPERTY	GAVRILOVA NATALYA	8700 E 87TH ST
202035304	2007-2008	INDIVIDUAL PERSONAL PROPERTY	POOLE ANDREW	10705 E 62ND TER	202045210	2006	INDIVIDUAL PERSONAL PROPERTY	KOUTS PATRICK W	9624 E M 350 HWY
202035388	2008-2010	INDIVIDUAL PERSONAL PROPERTY	BRADLEY EDWARD D	7309 BLUE RIDGE BLVD	202045683	2020-2021	INDIVIDUAL PERSONAL PROPERTY	DUNLAP DAVID R & KUMPFER MILDRED	11405 E 55TH TER
202035434	2013-2016	INDIVIDUAL PERSONAL PROPERTY	VANLANKER SHANNON	5248 WOODSON RD	202045862	2021	INDIVIDUAL PERSONAL PROPERTY	LOPEZ EUCEDA JOMER YADIR	8328 ELM AVE
202035577	2021	INDIVIDUAL PERSONAL PROPERTY	ALSALMAN SAHAR MAHMOUD	5935 STERLING AVE	202045977	2014-2015	INDIVIDUAL PERSONAL PROPERTY	CROTTY DEBRA (UEHLING)	8211 HEDGES AVE
202035715	2007-2008	INDIVIDUAL PERSONAL PROPERTY	MARTINEZ GABRIELA	8440 WESTRIDGE RD	202046022	2008-2009	INDIVIDUAL PERSONAL PROPERTY	LAIRD JAMES C III	15175 POLLARD AVE
202035820	2021	INDIVIDUAL PERSONAL PROPERTY	THROCKMORTON TERESA	10809 E 58TH TER	202046136	2009-2010	INDIVIDUAL PERSONAL PROPERTY	JARNEY ETHELYNE R	5309 KENTUCKY AVE
202035926	2019-2021	INDIVIDUAL PERSONAL PROPERTY	BROOKS ROGER LEE	9905 E 73RD ST APT F	202046200	2009	INDIVIDUAL PERSONAL PROPERTY	LYONS JOAN ARLENE	9121 RICHARDS DR
202035939	2021	INDIVIDUAL PERSONAL PROPERTY	JONES KRISTEN R	8801 E 85TH ST	202046214	2020-2021	INDIVIDUAL PERSONAL PROPERTY	VITNER MICHAEL EDWARD	9808 E 79TH ST
202036074	2010	INDIVIDUAL PERSONAL PROPERTY	BLUNNIE PAUL B	7212 CEDAR AVE	202046257	2007	INDIVIDUAL PERSONAL PROPERTY	KASIVISWANATHAN ARAVINDAN	6705 HUNTER ST APT 113
202036264	2021	INDIVIDUAL PERSONAL PROPERTY	STORY ALFRED T	9214 E 54TH ST	202046262	2014	INDIVIDUAL PERSONAL PROPERTY	SMITH ANGELA CHRISTINE	6106 E 152ND TER APT A
202036552	2021	INDIVIDUAL PERSONAL PROPERTY	SIPHO LARREGUI & SHIRLEY	6840 STERLING AVE	202046381	2007-2009	INDIVIDUAL PERSONAL PROPERTY	SWIFT HILLERY EURICA	11412 E 71ST ST
202036651	2014-2016	INDIVIDUAL PERSONAL PROPERTY	ST CLAIR HEATHER D	9705 E 69TH ST	202046757	2018-2020	INDIVIDUAL PERSONAL PROPERTY	DRIMMEL NICHOLAS	6708 APPLETON AVE
202036653	2007-2008	INDIVIDUAL PERSONAL PROPERTY	AARON GARY W JR	600 E 74TH TER	202046798	2010-2013	INDIVIDUAL PERSONAL PROPERTY	TRANER DONNA J	9811 E 60TH ST
202036789	2010-2017	INDIVIDUAL PERSONAL PROPERTY	JACKSON OMARI S	8515 STERLING AVE	202046833	2007	INDIVIDUAL PERSONAL PROPERTY	ERAZO CRISTOBAL	9805 HUNTER ST APT 113
202036795	2021	INDIVIDUAL PERSONAL PROPERTY	BASAK ANTHONY R	8957 E 60TH ST	202046861	2007-2009	INDIVIDUAL PERSONAL PROPERTY	THOMAS ASHLEY L	1104 CONCORD CIR
202037109	2007-2011	INDIVIDUAL PERSONAL PROPERTY	WALKER SHALONDA	5516 MAYWOOD AVE	202046872	2010	INDIVIDUAL PERSONAL PROPERTY	ELAM JESSE	6425 EVANSTON AVE
202037187	2013	INDIVIDUAL PERSONAL PROPERTY	BARRICK JENNIFER	8018 ELM AVE	202046956	2008	INDIVIDUAL PERSONAL PROPERTY	FOXWORTHY ANN	11601 E 58TH TER
202037212	2020-2021	INDIVIDUAL PERSONAL PROPERTY	MARRIOTT TRACY J	8001 APPLETON AVE	202046974	2007-2012	INDIVIDUAL PERSONAL PROPERTY	GIVENS JAMES MICHAEL	9404 E 69TH ST
202037296	2008-2013	INDIVIDUAL PERSONAL PROPERTY	BOHRER SANDRA M	9026 E 74TH TER	202047075	2021	INDIVIDUAL PERSONAL PROPERTY	EDEMANN JEFF D & EDEMANN KERRI	6610 ELM AVE
202037393	2014	INDIVIDUAL PERSONAL PROPERTY	JORDAN KASSONDRA P & BEATY MARTY F	11412 E 55TH TER	202047079	2013	INDIVIDUAL PERSONAL PROPERTY	JOHNSON DUANE L & ANDREA B	9408 E 84TH TER
202037445	2007	INDIVIDUAL PERSONAL PROPERTY	ORTIZ MARLON (ALEMAN)	10309 E 61ST ST APT 1	202047148	2016-2021	INDIVIDUAL PERSONAL PROPERTY	PALMER GREGORY L	6107 EVANSTON AVE
202037612	2007-2013	INDIVIDUAL PERSONAL PROPERTY	ROWDEN KENNETH LEE JR	11708 E 78TH PL	202047366	2021	INDIVIDUAL PERSONAL PROPERTY	HAMPTON CONSUERO R	9500 E 60TH TER
202037682	2012-2017	INDIVIDUAL PERSONAL PROPERTY	BROWN CHRISTOPHER L	8142 DITZLER AVE	202047423	2004-2008	INDIVIDUAL PERSONAL PROPERTY	ARMSTRONG GUY W & CELIA A	8220 HARRIS AVE
202037754	2008	INDIVIDUAL PERSONAL PROPERTY	HOLLCROFT LINA	7025 KENTUCKY AVE	202047496	2021	INDIVIDUAL PERSONAL PROPERTY	MCCON JASON	6428 OVERTON AVE

202047581	2021	INDIVIDUAL PERSONAL PROPERTY	SCIDA ANN	400 W 109TH TER	202055752	2021	INDIVIDUAL PERSONAL PROPERTY	ROSS BRIAN L	5920 HARRIS AVE
202047592	2007	INDIVIDUAL PERSONAL PROPERTY	DE JESUS CUEVAS GERMAN	9006 RICHARDS DR	202055779	2007	INDIVIDUAL PERSONAL PROPERTY	WEDDLE JERRET	7311 RAYTOWN RD
202047660	2017	INDIVIDUAL PERSONAL PROPERTY	NOLEN TAMIKA	9004 E 75TH ST	202056050	2021	INDIVIDUAL PERSONAL PROPERTY	SAXTON DANIEL LEE	6808 RAYTOWN RD
202047674	2021	INDIVIDUAL PERSONAL PROPERTY	MORGAN JAMES L	5404 RALSTON AVE	202056220	2014	INDIVIDUAL PERSONAL PROPERTY	CURRAN KATHLEEN ANN & GARRY JAMES	6711 HARVARD AVE
202047914	2021	INDIVIDUAL PERSONAL PROPERTY	PARKER JACOB	10908 E 57TH ST	202056421	2007	INDIVIDUAL PERSONAL PROPERTY	ESPARSA JOSÉ MEZA	10212 E 68TH TER
202048136	2012-2021	INDIVIDUAL PERSONAL PROPERTY	ROSS GAVIN C	11113 E 74TH ST	202056442	2006	INDIVIDUAL PERSONAL PROPERTY	VAILS BOBBY L	8307 E 68TH TER
202048217	2018	INDIVIDUAL PERSONAL PROPERTY	BOWMAN LATANYA R	5920 WESTRIDGE RD	202056468	2007	INDIVIDUAL PERSONAL PROPERTY	ANDREWS JACQUELINE D	11513 E 75TH ST
202048347	2007	INDIVIDUAL PERSONAL PROPERTY	SMITH RONALD L	11314 E 72ND ST	202056714	2021	INDIVIDUAL PERSONAL PROPERTY	PORREVECCHIO DANIEL R	12004 E 75TH ST
202048727	2007-2017	INDIVIDUAL PERSONAL PROPERTY	ZAMORA KRISTIAN A	10309 E 61ST ST APT 1	202056731	2021	INDIVIDUAL PERSONAL PROPERTY	WRIGHT IVA & MEDINA KYLE	9030 E 85TH PL
202048792	2017-2021	INDIVIDUAL PERSONAL PROPERTY	PLOMBOY VANESA	8607 WESTRIDGE RD	202056817	2007	INDIVIDUAL PERSONAL PROPERTY	BOWLIN MARK D	9919 E 63RD ST
202048882	2011-2012	INDIVIDUAL PERSONAL PROPERTY	ODANIEL DEIDRA & ROBERT	9900 E 80TH ST	202057104	2019	INDIVIDUAL PERSONAL PROPERTY	WALLGREN TIFFANY LEA	6523 BLUE RIDGE BLVD
202048992	2012	INDIVIDUAL PERSONAL PROPERTY	MITCHELL TERRY V	10914 E 71ST TER	202057128	2007	INDIVIDUAL PERSONAL PROPERTY	JACKSON CONSTANCE MM	9117 E 65TH ST
202049022	2007-2013	INDIVIDUAL PERSONAL PROPERTY	STAKE CENTER LOCATING	8309 KENTUCKY AVE	202057365	2007-2008	INDIVIDUAL PERSONAL PROPERTY	FLORES HECTOR M & ROMERO RAUL	8414 BOOTH AVE
202049205	2012-2017	INDIVIDUAL PERSONAL PROPERTY	BARBA JACK J	8610 KENTUCKY AVE	202057519	2007-2009	INDIVIDUAL PERSONAL PROPERTY	HALE SAMUEL & KATRINA	8200 E 87TH ST
202049223	2006-2007	INDIVIDUAL PERSONAL PROPERTY	BRADFORD CAMILLE D	6003 BLUE HILLS RD APT 7	202057547	2009-2012	INDIVIDUAL PERSONAL PROPERTY	HORNE DEBORAH J	10612 E 59TH ST
202049373	2007	INDIVIDUAL PERSONAL PROPERTY	WRIGHT CHEKESIA	6029 INDIANA AVE	202057583	2011	INDIVIDUAL PERSONAL PROPERTY	TRIANOS JESSE	11910 NEWTON AVE APT 11
202049446	2021	INDIVIDUAL PERSONAL PROPERTY	CONLEY GREGORY J & BONITA	8407 SPRING VALLEY RD	202057591	2021	INDIVIDUAL PERSONAL PROPERTY	LEWIS IRVIN JR	13216 CRYSTAL AVE
202049453	2021	INDIVIDUAL PERSONAL PROPERTY	RAMIREZ ANGEL & ALMA	8509 E 81ST ST	202057711	2012-2013	INDIVIDUAL PERSONAL PROPERTY	YOUN DAVID HYUN	7705 RAYTOWN RD
202049463	2020-2021	INDIVIDUAL PERSONAL PROPERTY	GLEASON CRAIG S	8101 RAYTOWN RD	202057754	2008-2010	INDIVIDUAL PERSONAL PROPERTY	HAAKE KATHRYN	8011 MANNING AVE
202049470	2015-2021	INDIVIDUAL PERSONAL PROPERTY	BRITNEY ROENIA M & TOMMY ERIC SR	8508 EVERETT ST	202057841	2007-2009	INDIVIDUAL PERSONAL PROPERTY	PARKER JAKE	7913 ARLINGTON AVE
202049631	2007-2008	INDIVIDUAL PERSONAL PROPERTY	GREGORY MARK A	8408 GREENWOOD RD	202058051	2016	INDIVIDUAL PERSONAL PROPERTY	WITHERSPOON TENISHA	5825 FARLEY AVE
202049660	2010	INDIVIDUAL PERSONAL PROPERTY	CARTER DOROTHY & GARY	6105 HARDY AVE	202058075	2021	INDIVIDUAL PERSONAL PROPERTY	WERELY PASTORA	9001 E 52ND TER
202049749	2017-2019	INDIVIDUAL PERSONAL PROPERTY	WILLIAMS DELORES	6000 NORTHERN AVE	202058625	2021	INDIVIDUAL PERSONAL PROPERTY	REIFOLD YAWMESSIA R & LASHONE	5609 CRESCENT AVE
202049819	2021	INDIVIDUAL PERSONAL PROPERTY	LOYOLA THOMAS J & SALTER JR	6720 RAYTOWN RD	202058643	2021	INDIVIDUAL PERSONAL PROPERTY	NEWTON STEFFON	8812 E 62ND ST
202049868	2019-2021	INDIVIDUAL PERSONAL PROPERTY	STRAWDER ERIC & SHARA	6905 WILDWOOD DR	202058677	2018	INDIVIDUAL PERSONAL PROPERTY	MILLER LISA R	8304 HARRIS AVE
202050029	2007	INDIVIDUAL PERSONAL PROPERTY	HEDLEY THOMAS	9305 E M 350 HWY	202058715	2009-2013	INDIVIDUAL PERSONAL PROPERTY	CHAFFEE ALDEN A & WEXLER JESSICA	8409 WOODSON PL
202050119	2008	INDIVIDUAL PERSONAL PROPERTY	GARDNER AMANDA	6137 ELM AVE	202058841	2021	INDIVIDUAL PERSONAL PROPERTY	ALLEN AMBER L	8506 WESTRIDGE RD
202050165	2007-2008	INDIVIDUAL PERSONAL PROPERTY	TALAMANTES LUCILA DIAZ	8527 E 81ST TER	202058855	2007-2009	INDIVIDUAL PERSONAL PROPERTY	BOYNTON JEREMY	8417 SPRING VALLEY RD
202050414	2007	INDIVIDUAL PERSONAL PROPERTY	SAUNDERS AMBER	9801 E 61ST ST APT 1	202058867	2007-2009	INDIVIDUAL PERSONAL PROPERTY	BOYNTON JEREMY	8417 SPRING VALLEY RD
202050712	2007	INDIVIDUAL PERSONAL PROPERTY	CORTES ROJA MIGUEL	9006 RICHARDS DR	202058897	2008-2009	INDIVIDUAL PERSONAL PROPERTY	PIERCE MICHAEL M	10408 E 63RD ST
202050729	2007	INDIVIDUAL PERSONAL PROPERTY	MENDOZA ABEL ESPINEBARROS	9006 RICHARDS DR	202059168	2007	INDIVIDUAL PERSONAL PROPERTY	LAGUNA ALEJANDRO	6604 HARRIS AVE
202050757	2008-2009	INDIVIDUAL PERSONAL PROPERTY	BRANDES MICHELLE R & BARNHART AMANDA	6641 MAYWOOD AVE	202059246	2013	INDIVIDUAL PERSONAL PROPERTY	FLETCHER AIMEE R	8419 MARSH AVE
202050784	2010-2013	INDIVIDUAL PERSONAL PROPERTY	HAM HAMSON	6525 ELM AVE	202059324	2021	INDIVIDUAL PERSONAL PROPERTY	WILLIAMS LAUREN MICHAEL	9107 E 65TH ST
202050793	2020-2021	INDIVIDUAL PERSONAL PROPERTY	CASTLE MICHAEL ELIZABETH	6600 HARVARD AVE	202059485	2020-2021	INDIVIDUAL PERSONAL PROPERTY	JOHNSON CHARDAE	11529 74TH STREET CT
202050885	2010-2011	INDIVIDUAL PERSONAL PROPERTY	FROST CATHY	5420 BLUE RIDGE CUT OFF APT 603	202059549	2016-2021	INDIVIDUAL PERSONAL PROPERTY	FONDREN HAMP	8333 HARRIS AVE
202050932	2006-2007	INDIVIDUAL PERSONAL PROPERTY	WADDELL LINDSEY & SCHUYLER SHELLY	5432 HARVARD AVE	202059589	2006-2008	INDIVIDUAL PERSONAL PROPERTY	DUKE STEVEN L	8008 APPLETON AVE
202051012	2010-2013	INDIVIDUAL PERSONAL PROPERTY	FREEMAN LORENE	9305 CHARLOTTE ST APT C122	202059848	2007	INDIVIDUAL PERSONAL PROPERTY	BURNETT BEVERLEY S	8548 GRANT DR
202051225	2007	INDIVIDUAL PERSONAL PROPERTY	LIRA ARNULFO	9010 E GREGORY BLVD	202059947	2008-2017	INDIVIDUAL PERSONAL PROPERTY	HILL MICHAEL C	7417 WOODSON RD
202051555	2021	INDIVIDUAL PERSONAL PROPERTY	ARNOLD TIMOTHY L	10017 E 56TH TER	202059984	2016-2021	INDIVIDUAL PERSONAL PROPERTY	BRADFORD JUSTIN A	5925 MANNING AVE
202051629	2021	INDIVIDUAL PERSONAL PROPERTY	TRUE JAMES	8909 E 74TH ST	202060093	2011-2013	INDIVIDUAL PERSONAL PROPERTY	HOBLIA RAYMOND C	5911 KENTUCKY AVE
202051815	2021	INDIVIDUAL PERSONAL PROPERTY	WILLIAMS LACRETIA CHANELLE	7214 MAYWOOD AVE	202060165	2021	INDIVIDUAL PERSONAL PROPERTY	CUMMINGS ALMETA & ORLANDO	11104 E 63RD ST
202051933	2008	INDIVIDUAL PERSONAL PROPERTY	GARCIA RUTH I	7315 ELM ST	202060249	2009	INDIVIDUAL PERSONAL PROPERTY	MORENO JOSE CATALAN	9704 E GREGORY BLVD
202052053	2008-2011	INDIVIDUAL PERSONAL PROPERTY	ROBERTS JEFFREY A	6825 STERLING AVE	202060577	2020-2021	INDIVIDUAL PERSONAL PROPERTY	POLLARD VICTORIA RENEE (BURNETT)	6813 HAWTHORNE AVE
202052071	2020-2021	INDIVIDUAL PERSONAL PROPERTY	MASSEY TINA	10616 E 70TH ST	202061039	2006-2010	INDIVIDUAL PERSONAL PROPERTY	BROWN ANDY T II	9208 E 53RD TER
202052135	2021	INDIVIDUAL PERSONAL PROPERTY	TETER VIRGIL TOM	9127 RICHARDS DR	202061311	2007-2008	INDIVIDUAL PERSONAL PROPERTY	FLOWERS JOSEPH	7422 OVERTON AVE UNIT 2
202052138	2008	INDIVIDUAL PERSONAL PROPERTY	DRAKE MICHELLE	5229 CRISP AVE	202061373	2017-2020	INDIVIDUAL PERSONAL PROPERTY	THEXTON KENNETH RAY JR	5500 STERLING AVE
202052280	2021	INDIVIDUAL PERSONAL PROPERTY	PECINA HENRY A III	5820 ELM AVE	202061442	2020-2021	INDIVIDUAL PERSONAL PROPERTY	MATNEY JEREMIAH	5817 BLUE RIDGE BLVD
202052374	2007	INDIVIDUAL PERSONAL PROPERTY	HEFLIN JONATHAN	9116 E 85TH ST	202061480	2018-2021	INDIVIDUAL PERSONAL PROPERTY	SCOTT KAMARA T	7211 RAYTOWN RD
202052473	2017-2021	INDIVIDUAL PERSONAL PROPERTY	MANESS RUSSELL PAUL	11405 E 78TH TER	202061630	2012-2017	INDIVIDUAL PERSONAL PROPERTY	SALAZAR JAIME	9010 E 87TH ST APT A1
202052527	2019-2021	INDIVIDUAL PERSONAL PROPERTY	DUNN ERIKA L	6813 CRISP AVE	202061659	2021	INDIVIDUAL PERSONAL PROPERTY	WIJEDL JERRY V	6624 WILLOW AVE
202052665	2020-2021	INDIVIDUAL PERSONAL PROPERTY	FOSTER BETH ANN (GARRETT)	8727 E 60TH TER	202061879	2020-2021	INDIVIDUAL PERSONAL PROPERTY	BOWEN BRENDA L	9720 E 65TH ST
202052952	2010	INDIVIDUAL PERSONAL PROPERTY	STERNER KELLI J	8001 APPLETON AVE	202062006	2010-2012	INDIVIDUAL PERSONAL PROPERTY	KENNEDY DUSTIN & THERESA	11405 E 78TH TER
202052959	2021	INDIVIDUAL PERSONAL PROPERTY	PHILLIPS BRENDA L	6616 OXFORD AVE	202062050	2008-2009	INDIVIDUAL PERSONAL PROPERTY	SHARP ROGER J	10600 E 64TH TER
202053134	2015-2017	INDIVIDUAL PERSONAL PROPERTY	GILLESPIE NICHOLAS M	5304 HUNTER ST	202062178	2021	INDIVIDUAL PERSONAL PROPERTY	WALKER MARCUS J	5428 STERLING AVE
202053775	2011-2014	INDIVIDUAL PERSONAL PROPERTY	HUYCK FRANK B	9107 E 55TH ST	202062268	2007-2008	INDIVIDUAL PERSONAL PROPERTY	ETTER TONYA L	8308 JAMES A REED RD
202053817	2012-2017	INDIVIDUAL PERSONAL PROPERTY	WILLIAMSON SCOTT A	9404 E 83RD ST	202062305	2019	INDIVIDUAL PERSONAL PROPERTY	CASTEEL LOGAN	6728 VERMONT AVE
202053841	2011	INDIVIDUAL PERSONAL PROPERTY	HOLLAND NAOMI M	11407 E 57TH TER	202062532	2009-2011	INDIVIDUAL PERSONAL PROPERTY	ARBONDONO MEGAN	8624 E 80TH TER
202054046	2007	INDIVIDUAL PERSONAL PROPERTY	MACIAS DAVID	10309 E 61ST ST APT 1	202062579	2019-2020	INDIVIDUAL PERSONAL PROPERTY	ALDERTON SHANE	8512 PERSHING RD
202054225	2008-2010	INDIVIDUAL PERSONAL PROPERTY	HILL KELLY ANNE	8905 RICHARDS DR	202062709	2007	INDIVIDUAL PERSONAL PROPERTY	VAZQUEZ PETER B	9009 E 73RD ST
202054371	2015	INDIVIDUAL PERSONAL PROPERTY	ELLIS GARY A II & LINDA K	9901 E 82ND TER	202062747	2008	INDIVIDUAL PERSONAL PROPERTY	BATTEE RICKEY CORDELL	6306 RALSTON AVE
202054373	2021	INDIVIDUAL PERSONAL PROPERTY	RUSSELL JOHN D	1408 SE 3RD ST	202062798	2007	INDIVIDUAL PERSONAL PROPERTY	MILLER KIMBERLY RENEE	5910 CLAREMONT AVE
202054402	2007-2017	INDIVIDUAL PERSONAL PROPERTY	CLARK JOHNATHAN	9804 E 84TH ST	202062812	2007	INDIVIDUAL PERSONAL PROPERTY	NONDORF DAN	9102 E 60TH ST
202054595	2013-2017	INDIVIDUAL PERSONAL PROPERTY	SHELLEY JAMIE J	7204 RAYTOWN RD	202062928	2006-2008	INDIVIDUAL PERSONAL PROPERTY	ARMSTRONG CELIA & GUY	8220 HARRIS AVE
202054624	2006-2017	INDIVIDUAL PERSONAL PROPERTY	HENSON STEVEN L	8539 GRANT DR	202062980	2020-2021	INDIVIDUAL PERSONAL PROPERTY	DERKITS MICHAEL & SHARON	11700 E 79TH DR
202054687	2006-2007	INDIVIDUAL PERSONAL PROPERTY	BUNTON BARBARA J	5109 HARDESTY AVE	202062998	2021	INDIVIDUAL PERSONAL PROPERTY	MCLOUTH RUSTY W & KATHARINE	5908 CLAREMONT AVE
202054716	2012-2013	INDIVIDUAL PERSONAL PROPERTY	MCLEES LAURA & RYAN	8100 HARDY AVE	202063204	2007-2009	INDIVIDUAL PERSONAL PROPERTY	JONES MARKOS L	8205 WOODSON DR
202054896	2021	INDIVIDUAL PERSONAL PROPERTY	BAUTISTA GUTIERREZ CAROLINA (HORTENSIA)	7840 WOODSON RD	202063301	2012-2014	INDIVIDUAL PERSONAL PROPERTY	SAGER ROBERT MICHAEL	8323 WOODSON DR
202054987	2021	INDIVIDUAL PERSONAL PROPERTY	MARIN FELICIANO	9016 55TH ST	202063321	2012-2014	INDIVIDUAL PERSONAL PROPERTY	MCCLENDON NAKEISH NICOLE	6016 LAUREL AVE
202055256	2013-2017	INDIVIDUAL PERSONAL PROPERTY	SPARKMAN LARRY D	9704 E 68TH TER	202063432	2021	INDIVIDUAL PERSONAL PROPERTY	SHROPSHIRE CHRISTOPHER S & TINA	8401 KENTUCKY AVE
202055422	2007-2008	INDIVIDUAL PERSONAL PROPERTY	STANDLEY ERIC MARIE	8000 APPLETON AVE	202063622	2009	INDIVIDUAL PERSONAL PROPERTY	SCHAFER CONNIE S	9805 E 61ST ST APT 1
202055553	2021	INDIVIDUAL PERSONAL PROPERTY	PERKINS CARL R	8915 E 57TH ST	202063635	2011	INDIVIDUAL PERSONAL PROPERTY	SPEARS JULIA M	9808 E 81ST TER
202055571	2011-2012	INDIVIDUAL PERSONAL PROPERTY	TOLMAN BESSIE M	8206 EVANSTON AVE	202063878	2021	INDIVIDUAL PERSONAL PROPERTY	TYSON FOREST E JR	7516 CRISP AVE

202063940	2012	INDIVIDUAL PERSONAL PROPERTY	SANDER ELIZABETH	7911 MANNING AVE	202072662	2006-2007	INDIVIDUAL PERSONAL PROPERTY	GLENN JUNE E	10318 E 63RD ST APT 1
202063960	2006-2007	INDIVIDUAL PERSONAL PROPERTY	HAHN ADAM	7513 HAWTHORNE AVE	202072710	2007	INDIVIDUAL PERSONAL PROPERTY	WATTS JULIAN Q	6553 RAYTOWN RD APT 4
202064039	2007-2009	INDIVIDUAL PERSONAL PROPERTY	BRISCO BENITA L	7508 MAPLE LN	202073206	2007-2010	INDIVIDUAL PERSONAL PROPERTY	SCHWALL SCOTT H	8521 DITZLER AVE
202064175	2021	INDIVIDUAL PERSONAL PROPERTY	MCCLUNEY THERESA	11602 E 61ST ST	202073215	2014	INDIVIDUAL PERSONAL PROPERTY	ELLISON ELMER & PAMELA	5803 BLUE RIDGE CUT OFF
202064271	2021	INDIVIDUAL PERSONAL PROPERTY	WAGNER OMAR RASHID	1644 SW HIGHLAND DR	202073220	2013	INDIVIDUAL PERSONAL PROPERTY	MARTIN SAMUEL F	9000 E 57TH TER
202064446	2010	INDIVIDUAL PERSONAL PROPERTY	HOEGLER MILDRED	9117 E 68TH ST	202073337	2021	INDIVIDUAL PERSONAL PROPERTY	PERSON DENNIS C III	11317 E 77TH TER
202064725	2006-2007	INDIVIDUAL PERSONAL PROPERTY	ZAMORA JAMES	6711 HARRIS AVE	202073360	2009-2010	INDIVIDUAL PERSONAL PROPERTY	HUYCK AMBER ROSE	9107 E 55TH ST
202065025	2007	INDIVIDUAL PERSONAL PROPERTY	WATSON MARCUS L	11811 E 83RD ST	202073433	2021	INDIVIDUAL PERSONAL PROPERTY	TOLEFREE QUIANI LOUISE	11253 CALICO DR
202065043	2020-2021	INDIVIDUAL PERSONAL PROPERTY	MELANCON MALLORY LEE	9100 E 73RD ST	202073486	2008-2010	INDIVIDUAL PERSONAL PROPERTY	MORRIS MARCIA L	11811 E 83RD ST
202065075	2021	INDIVIDUAL PERSONAL PROPERTY	BROWN SHAUNVEL	5811 KENTUCKY AVE	202073634	2020-2021	INDIVIDUAL PERSONAL PROPERTY	FRAZIER MICHAEL L	5600 LANE AVE
202065132	2011-2017	INDIVIDUAL PERSONAL PROPERTY	BURRESS GREGORY A E	9513 E 83RD ST	202074178	2021	INDIVIDUAL PERSONAL PROPERTY	HARRISON CHARLES JR	6821 CRISP AVE
202065133	2009-2017	INDIVIDUAL PERSONAL PROPERTY	GIBSON LEO A	9503 E 64TH TER	202074182	2014-2015	INDIVIDUAL PERSONAL PROPERTY	MCDOWELL TIMOTHY T	9212 E 77TH TER
202065373	2007-2010	INDIVIDUAL PERSONAL PROPERTY	FORESTER SHAUNTE	5814 FARLEY AVE	202074536	2007-2009	INDIVIDUAL PERSONAL PROPERTY	BURTON WESLEY	7424 WOODSON RD
202065416	2021	INDIVIDUAL PERSONAL PROPERTY	BURNETTE CHARLOTTE	8725 E 60TH TER	202074667	2019-2021	INDIVIDUAL PERSONAL PROPERTY	PETERSON SHANNON M	10712 E 84TH TER
202065700	2019-2020	INDIVIDUAL PERSONAL PROPERTY	VIRTUE JULIE A	5725 ELM AVE	202074791	2021	INDIVIDUAL PERSONAL PROPERTY	HICKSICH CELIA	6820 CRISP AVE
202065746	2021	INDIVIDUAL PERSONAL PROPERTY	RANGEL CHELSEA LANE	8656 E 81ST TER	202074940	2021	INDIVIDUAL PERSONAL PROPERTY	KNOW TONYA	8607 E 84TH TER
202065763	2008-2014	INDIVIDUAL PERSONAL PROPERTY	MILLER GREG P	8204 E 86TH TER	202074980	2017-2019	INDIVIDUAL PERSONAL PROPERTY	JACKSON SCOTT A	9951 E 61ST ST APT 2
202065933	2010-2016	INDIVIDUAL PERSONAL PROPERTY	PHILLIPS BEN A	9601 E 67TH TER	202075019	2009	INDIVIDUAL PERSONAL PROPERTY	GREEVER BRUCE & NINA A	8116 DITZLER AVE
202065985	2007-2008	INDIVIDUAL PERSONAL PROPERTY	SKUBINNA RICK	9018 E 85TH TER	202075279	2021	INDIVIDUAL PERSONAL PROPERTY	JACKSON KARL L	8808 E 58TH TER
202066134	2015-2017	INDIVIDUAL PERSONAL PROPERTY	KREHL STEPHANIE & CHRISTIAN J	9006 RICHARDS DR	202075300	2008	INDIVIDUAL PERSONAL PROPERTY	ACEVEDO ERENDIRA B & ROJAS ISIDRO	9904 E 76TH TER
202066165	2021	INDIVIDUAL PERSONAL PROPERTY	HOOD JACI L	7909 HEDGES AVE	202075311	2011-2013	INDIVIDUAL PERSONAL PROPERTY	RULLODA SHERWIN & MEGAN	9212 HUNTER ST
202066447	2009	INDIVIDUAL PERSONAL PROPERTY	BROWN AARON M	11600 E 61ST ST	202075377	2009	INDIVIDUAL PERSONAL PROPERTY	SANTIAGO MORALES FRANCISCO J	10109 E 56TH TER
202066582	2010-2011	INDIVIDUAL PERSONAL PROPERTY	WEGMANN WENDY S (CHELBERG)	9111 RICHARDS DR	202075707	2011	INDIVIDUAL PERSONAL PROPERTY	GORHAM CASEY M	11208 E 61ST ST
202066800	2007-2009	INDIVIDUAL PERSONAL PROPERTY	ESTER BRANDON	5433 ASH AVE	202075782	2020-2021	INDIVIDUAL PERSONAL PROPERTY	FLOWERS TANESHA	7813 E 86TH ST
202066852	2007-2017	INDIVIDUAL PERSONAL PROPERTY	WHITE RONNIE E	9909 E 76TH TER	202075813	2007-2008	INDIVIDUAL PERSONAL PROPERTY	BURLISON THOMAS K	6140 RAYTOWN RD APT 204
202066883	2015	INDIVIDUAL PERSONAL PROPERTY	SLAUGHTER ASHLEY D	6011 HUNTER ST	202076042	2012-2013	INDIVIDUAL PERSONAL PROPERTY	HERNANDEZ ALEJANDRO & MARISELA	9210 E 68TH TER
202067203	2013-2017	INDIVIDUAL PERSONAL PROPERTY	CHAFFIN DAVID N	6809 CRISP AVE	202076141	2012	INDIVIDUAL PERSONAL PROPERTY	BOBBITT KAITLYNN	6825 LAUREL AVE
202067398	2018	INDIVIDUAL PERSONAL PROPERTY	CARPENTER COURTNEY N	9008 E 74TH ST	202076186	2007	INDIVIDUAL PERSONAL PROPERTY	RODRIGUEZ JUAN	10212 E 68TH TER
202067504	2009-2016	INDIVIDUAL PERSONAL PROPERTY	ZAMORA ALFONSO ROGELIO SALINAS	10309 E 61ST ST APT 1	202076228	2012-2014	INDIVIDUAL PERSONAL PROPERTY	COLLINS KAMALA	9400 E 82ND ST
202067570	2009-2015	INDIVIDUAL PERSONAL PROPERTY	COMSTOCK BRYAN	9359 E 60TH TER	202076322	2007	INDIVIDUAL PERSONAL PROPERTY	BAHENA ISRAEL	9006 RICHARDS DR
202067588	2021	INDIVIDUAL PERSONAL PROPERTY	WARFORD BRIANNA	6206 DITZLER AVE	202076382	2020-2021	INDIVIDUAL PERSONAL PROPERTY	DANIELS JAMES D	5312 NORTHERN AVE
202067766	2007	INDIVIDUAL PERSONAL PROPERTY	MCGINNIS MIKKI	9401 E 63RD ST APT 10	202076434	2016	INDIVIDUAL PERSONAL PROPERTY	LESLIE JESSICA N	11316 E 58TH ST
202068003	2007	INDIVIDUAL PERSONAL PROPERTY	BENITZ OSCAR AGUSTIN CAMPOS	6705 HUNTER ST APT 113	202076473	2020	INDIVIDUAL PERSONAL PROPERTY	SINGH SURINDER & CINDY	9105 E 69TH ST
202068052	2006	INDIVIDUAL PERSONAL PROPERTY	WILLIAMS WAYMON R	8615 E 80TH TER	202076577	2007-2011	INDIVIDUAL PERSONAL PROPERTY	TYSON JERMAINE	7430 ENGLEWOOD LN
202068136	2013	INDIVIDUAL PERSONAL PROPERTY	KING AMANDA (RICKETTS)	9517 E 67TH TER	202076659	2010	INDIVIDUAL PERSONAL PROPERTY	SCHUSSLER LARRY J	10201 E 69TH TER
202068142	2007	INDIVIDUAL PERSONAL PROPERTY	PACE MARK ANTHONY	9401 E 63RD ST APT 10	202076952	2019-2021	INDIVIDUAL PERSONAL PROPERTY	DUKES DONALD R	10330 E 63RD ST APT 3
202068144	2020-2021	INDIVIDUAL PERSONAL PROPERTY	MCDUFFY SHAWNA	10412 E 80TH ST	202077302	2007-2010	INDIVIDUAL PERSONAL PROPERTY	JAMES BILL	8622 EVANSTON AVE
202068266	2021	INDIVIDUAL PERSONAL PROPERTY	MARQUEZ CRYSTAL (BERNARD)	7427 OVERTON AVE UNIT 5	202077441	2007	INDIVIDUAL PERSONAL PROPERTY	BEASLEY EDWIN JR	UNKNOWN
202068299	2007	INDIVIDUAL PERSONAL PROPERTY	NUROZI SEEMA	8805 E 66TH ST	202077447	2012-2017	INDIVIDUAL PERSONAL PROPERTY	BROWN VERN RAY JR	5612 RAYTOWN RD
202068436	2007	INDIVIDUAL PERSONAL PROPERTY	ALEMAN MARLON A	10309 E 61ST ST APT 1	202102715	2010-2011	INDIVIDUAL PERSONAL PROPERTY	RANSBURG CEDRIC M	9908 E 84TH ST
202068457	2021	INDIVIDUAL PERSONAL PROPERTY	BEEYS COURTNEY & LANTSBERGER BRICE	9301 E 81ST ST	202102833	2010	INDIVIDUAL PERSONAL PROPERTY	LARSON ROBERT E	UNKNOWN
202068532	2007-2008	INDIVIDUAL PERSONAL PROPERTY	HINES KEITH D	8622 E UTOPIA DR APT 5	202102846	2015-2020	INDIVIDUAL PERSONAL PROPERTY	MOSS MICHAEL ANTHONY II	8816 E 61ST ST
202068735	2007-2008	INDIVIDUAL PERSONAL PROPERTY	WILSON DAVID L	8611 KENTUCKY AVE	202102858	2007	INDIVIDUAL PERSONAL PROPERTY	GLIDEWELL TERRY L	9506 E 60TH ST
202068743	2009	INDIVIDUAL PERSONAL PROPERTY	GREENFIELD CASSANDRA	9218 E 70TH TER	202102887	2021	INDIVIDUAL PERSONAL PROPERTY	DAUGHERTY NATALIE	805 NW DONOVAN RD
202068894	2007-2008	INDIVIDUAL PERSONAL PROPERTY	LOMAN MICHAEL D	5201 STERLING AVE	202103016	2008	INDIVIDUAL PERSONAL PROPERTY	LISUSHKIN DENIS	7705 RAYTOWN RD
202068924	2019-2021	INDIVIDUAL PERSONAL PROPERTY	ARTIS MICHELE J	7302 RALSTON AVE	202103143	2021	INDIVIDUAL PERSONAL PROPERTY	STOGNER KIMBERLY KAY	6124 ASH CT
202068950	2007	INDIVIDUAL PERSONAL PROPERTY	RASCON RAFAEL ARREOLA	11601 E 76TH TER	202103258	2007-2014	INDIVIDUAL PERSONAL PROPERTY	NELSON DONALD D	5410 OXFORD AVE
202069307	2010-2017	INDIVIDUAL PERSONAL PROPERTY	WENDEL HENRY L	9804 E 82ND ST	202103358	2007	INDIVIDUAL PERSONAL PROPERTY	BRUNSON VALERIE L	9101 E 72ND TER
202069418	2021	INDIVIDUAL PERSONAL PROPERTY	WOOD JONATHAN	10901 E 82ND ST	202103375	2010	INDIVIDUAL PERSONAL PROPERTY	CAIN KRISTIN L	10404 E 65TH ST
202069516	2011	INDIVIDUAL PERSONAL PROPERTY	GRAVITT VICKI	5416 DITZLER AVE	202103391	2018	INDIVIDUAL PERSONAL PROPERTY	WOOLEDRIDGE MATTHEW T	8200 E 86TH TER
202070277	2017-2018	INDIVIDUAL PERSONAL PROPERTY	WILSON BRITTANY NICOLE	8217 WOODSON DR	202103399	2009	INDIVIDUAL PERSONAL PROPERTY	MILLARD ERWIN & HEATHER	8605 SPRING VALLEY RD
202070348	2018-2021	INDIVIDUAL PERSONAL PROPERTY	RAHN SUSAN V	11310 E 71ST DR	202103508	2010-2017	INDIVIDUAL PERSONAL PROPERTY	GOSSEY SCOTT	5817 BLUE RIDGE BLVD
202070391	2008-2011	INDIVIDUAL PERSONAL PROPERTY	RAINEY TRAVIS	7050 LAKESHORE DR	202103532	2008	INDIVIDUAL PERSONAL PROPERTY	ROJAS ISIDRO M	9604 E 76TH TER
202070454	2007	INDIVIDUAL PERSONAL PROPERTY	HALLAK PATRICIA A	6308 BLUE RIDGE CUT OFF	202103552	2019-2021	INDIVIDUAL PERSONAL PROPERTY	GARRETT MICHAEL MONTAYE	8903 E 84TH TER
202070514	2010	INDIVIDUAL PERSONAL PROPERTY	ORTEGA VICTOR M	8440 WESTRIDGE RD	202103578	2007	INDIVIDUAL PERSONAL PROPERTY	MANG PAULINE M	5801 STERLING AVE
202070567	2007-2017	INDIVIDUAL PERSONAL PROPERTY	THORNTON ROY	8601 ELM AVE	202103582	2007	INDIVIDUAL PERSONAL PROPERTY	GARCIA SALDIVAR SAMUEL	10204 E 57TH ST
202070653	2008-2009	INDIVIDUAL PERSONAL PROPERTY	DUFF ANTONIO	11412 E 71ST ST	202103638	2007-2010	INDIVIDUAL PERSONAL PROPERTY	JONES JAMES CHARLTON	10109 E 68TH TER
202070748	2012-2013	INDIVIDUAL PERSONAL PROPERTY	GOERING KRISTOPHER & CRYSTAL	7712 CRESCENT AVE	202103659	2007	INDIVIDUAL PERSONAL PROPERTY	PHILLIPS PAUL V	4954 RIDGEWAY AVE
202070825	2008-2009	INDIVIDUAL PERSONAL PROPERTY	DANIELS JESSICA R	8506 ARLINGTON AVE	202103694	2006-2010	INDIVIDUAL PERSONAL PROPERTY	COX DARRELL G	10825 E 57TH ST
202071043	2008	INDIVIDUAL PERSONAL PROPERTY	SALAZAR BOLIVAR	8600 STARK AVE	202103709	2020-2021	INDIVIDUAL PERSONAL PROPERTY	WATKINS CHANEL D	5813 RALSTON AVE
202071076	2020-2021	INDIVIDUAL PERSONAL PROPERTY	WILLIAMS GREGORY	7709 RAYTOWN RD APT 30	202103712	2017-2018	INDIVIDUAL PERSONAL PROPERTY	WATKINS WILLIE JEROME JR	5772 COTTAGE AVE
202071147	2010-2014	INDIVIDUAL PERSONAL PROPERTY	DAUDA FUONBAI SAI	11300 INDIANA AVE	202103722	2019	INDIVIDUAL PERSONAL PROPERTY	CONNELY SARA	11007 E 60TH TER
202071171	2021	INDIVIDUAL PERSONAL PROPERTY	AMOS LISA R	9208 E 67TH TER	202103728	2007-2008	INDIVIDUAL PERSONAL PROPERTY	SMITH BRANDON	8210 LAUREL AVE
202071276	2007-2017	INDIVIDUAL PERSONAL PROPERTY	CARTER BERNARD C	5525 MANNING AVE	202103785	2007-2012	INDIVIDUAL PERSONAL PROPERTY	STOKES DANIELLE ANTIONETTE	5600 HUNTER TER
202071281	2021	INDIVIDUAL PERSONAL PROPERTY	SINGLETEARY CHARLES M	8409 ELM AVE	202103916	2007-2017	INDIVIDUAL PERSONAL PROPERTY	HERNANDEZ GARCIA CARLOS	8431 EVANSTON AVE
202071288	2013-2015	INDIVIDUAL PERSONAL PROPERTY	FREDERICK NICHOLE	6634 OXFORD AVE	202103922	2013	INDIVIDUAL PERSONAL PROPERTY	CRUZ GABRIEL VERA	5728 BLUE RIDGE CUT OFF
202071956	2010	INDIVIDUAL PERSONAL PROPERTY	FLEETWOOD DOUG L	10309 E 61ST ST APT 1	202103956	2020-2021	INDIVIDUAL PERSONAL PROPERTY	WRIGHT DONNISHA RENEE	8313 NORTHERN ST
202071996	2007-2008	INDIVIDUAL PERSONAL PROPERTY	CURRY LORI L	9400 E 55TH ST	202103988	2008-2009	INDIVIDUAL PERSONAL PROPERTY	BUSH BRENT	7705 RAYTOWN RD
202072128	2021	INDIVIDUAL PERSONAL PROPERTY	CRUICKSHANK GRAEME & MICHELLE	6522 STERLING AVE	202103989	2015-2021	INDIVIDUAL PERSONAL PROPERTY	DAVIS BRYCE C	7805 ELM ST
202072499	2016-2021	INDIVIDUAL PERSONAL PROPERTY	CLARK LASHEENA	417 E 85TH ST	202104076	2007	INDIVIDUAL PERSONAL PROPERTY	HARRIS NEAL A	414 W 33RD ST
202072623	2021	INDIVIDUAL PERSONAL PROPERTY	LEE JUWAN D & JANISE M (SIMPSON)	6901 RICHMOND AVE	202104083	2012-2013	INDIVIDUAL PERSONAL PROPERTY	SKIDMORE JOHN MICHAEL	6816 LAKESHORE CT
202072634	2007-2008	INDIVIDUAL PERSONAL PROPERTY	GRIFFIN CARTE	5322 HURDY AVE	202104088	2007	INDIVIDUAL PERSONAL PROPERTY	BUSH BRENT	7705 RAYTOWN RD

202104203	2008	INDIVIDUAL PERSONAL PROPERTY	PETTY JOHN GILBERT	10205 E 71ST TER	202434526	2013-2014	INDIVIDUAL PERSONAL PROPERTY	HOUSE CHRIS	11212 E 71ST ST
202104219	2021	INDIVIDUAL PERSONAL PROPERTY	JONES PATRICK D & MOORE GABRIELLE	7205 HARDY AVE	202434980	2017-2021	INDIVIDUAL PERSONAL PROPERTY	BOBO KAHTEA	6325 HARVARD AVE
202104221	2017-2021	INDIVIDUAL PERSONAL PROPERTY	JACKSON ANGELA N	9500 E 69TH TER	202435394	2014-2015	INDIVIDUAL PERSONAL PROPERTY	MOORE TINA MARIE	7400 HARVARD DR
202104299	2019-2021	INDIVIDUAL PERSONAL PROPERTY	BOUGHTON WINFORD E	8801 E 53RD TER	202435471	2009-2012	INDIVIDUAL PERSONAL PROPERTY	BOWLS VINCENT	9200 E 67TH TER
202104322	2007	INDIVIDUAL PERSONAL PROPERTY	ROBERSON SHELIA L	7400 HARVARD DR	202435527	2020-2021	INDIVIDUAL PERSONAL PROPERTY	CARROLL VERNA KENET	8402 LANE PL
202104346	2010-2011	INDIVIDUAL PERSONAL PROPERTY	BELL MONIQUA L	8617 EVANSTON AVE	202435531	2007-2009	INDIVIDUAL PERSONAL PROPERTY	SEMAAN BRITNEY	11309 E 71ST ST
202424259	2007	INDIVIDUAL PERSONAL PROPERTY	WALKER CHERISE T	7431 OVERTON AVE UNIT 1	202435594	2018-2021	INDIVIDUAL PERSONAL PROPERTY	SCHROEDER KODY	8417 ELM AVE
202424416	2017-2021	INDIVIDUAL PERSONAL PROPERTY	ROATH DERICK & TOOMBS TYRA	8905 E 81ST ST	202435707	2020-2021	INDIVIDUAL PERSONAL PROPERTY	LEWIS SHALIECE RAI'SHAWN	8400 ELM AVE
202424471	2021	INDIVIDUAL PERSONAL PROPERTY	LARRABEE SARAH COLETTE	9005 E 72ND TER	202435980	2008	INDIVIDUAL PERSONAL PROPERTY	MORROW DAVERICK	5609 STERLING AVE
202424490	2008	INDIVIDUAL PERSONAL PROPERTY	TRABLIK DAVID & TINA	9719 E 58TH TER	202436106	2008	INDIVIDUAL PERSONAL PROPERTY	PHELPS STEPHANIE K	10413 E 81ST TER
202424534	2020-2021	INDIVIDUAL PERSONAL PROPERTY	JEFFERSON LORI A	11320 E 58TH TER	202436222	2012	INDIVIDUAL PERSONAL PROPERTY	PADGETT CHRISTOPHER D	10112 E 56TH ST
202424569	2016-2017	INDIVIDUAL PERSONAL PROPERTY	WEBER REBECCA A	11604 E 75TH ST	202436380	2021	INDIVIDUAL PERSONAL PROPERTY	BELL KEVIN MICHAEL & HOLLEY KENDRA DIANN	8300 E 83RD ST
202424837	2020	INDIVIDUAL PERSONAL PROPERTY	SHELBY EBONY MARSHAN	8525 MAPLE AVE	202436384	2021	INDIVIDUAL PERSONAL PROPERTY	TURCK CALLIE PATRICIA	7236 RAYTOWN RD APT B
202425019	2007-2008	INDIVIDUAL PERSONAL PROPERTY	WILLIAM DERRICK	8329 HARVARD AVE	202436903	2011-2012	INDIVIDUAL PERSONAL PROPERTY	AUGUSTUS RANDY	10605 E 79TH TER
202425139	2021	INDIVIDUAL PERSONAL PROPERTY	ERWIN TIFFANY R	9367 E 68TH TER	202436909	2010-2012	INDIVIDUAL PERSONAL PROPERTY	JOHNSON TRINA & RICHARD D	8500 PERSHING RD
202425177	2008-2017	INDIVIDUAL PERSONAL PROPERTY	POWELL MARCO	8466 LANE DR	202436917	2008	INDIVIDUAL PERSONAL PROPERTY	MCCALL SAMANTHA	7401 MAYWOOD AVE
202425365	2012	INDIVIDUAL PERSONAL PROPERTY	BRAZELTON DAVID	8614 HAWTHORNE AVE	202436942	2009	INDIVIDUAL PERSONAL PROPERTY	HICKEN HEATHER L	8813 E 84TH TER
202425455	2010	INDIVIDUAL PERSONAL PROPERTY	POWER ELIZABETH	10401 E 63RD TER	202437009	2021	INDIVIDUAL PERSONAL PROPERTY	KUDER CHRISTRANA Q & KUDER BRYCE A	8224 WILLOW WAY
202425558	2013	INDIVIDUAL PERSONAL PROPERTY	LILLYGREN MICHAEL EARL	9004 E 57TH TER	202437156	2010-2011	INDIVIDUAL PERSONAL PROPERTY	ROCHA ENIA DELC	7005 HUNTER ST
202425683	2020	INDIVIDUAL PERSONAL PROPERTY	SHIPLEY STEFAN LASHAWN	327 W 77TH ST UNIT 2C	202437620	2012-2014	INDIVIDUAL PERSONAL PROPERTY	WINN NATALIE	9812 E 69TH ST
202425985	2014-2016	INDIVIDUAL PERSONAL PROPERTY	WILSON FRANCINE	8613 E 84TH TER	202438003	2012	INDIVIDUAL PERSONAL PROPERTY	GONZALEZ RAYMOND A	5708 ASH AVE
202426009	2013	INDIVIDUAL PERSONAL PROPERTY	ORR MICHAEL LEE	9950 E 61ST ST	202438310	2020-2021	INDIVIDUAL PERSONAL PROPERTY	WHEATON JOEL	11605 E 51ST ST
202426016	2019-2021	INDIVIDUAL PERSONAL PROPERTY	HARDY JUSTIN K	11254 E 71ST TER	202438329	2012	INDIVIDUAL PERSONAL PROPERTY	ROY DEIRDRE & ROY ETHAN	11407 E 85TH TER
202426462	2016-2021	INDIVIDUAL PERSONAL PROPERTY	ELMONIS DANY	5301 STERLING AVE	202438332	2021	INDIVIDUAL PERSONAL PROPERTY	FLORES JAIMES LINDA GRACIELA	7301 CRISP AVE
202426753	2014-2016	INDIVIDUAL PERSONAL PROPERTY	SMITH CHARLES PATRICK	7730 RAYTOWN RD	202438619	2021	INDIVIDUAL PERSONAL PROPERTY	TIDWELL JOHN A	7711 RAYTOWN RD APT 11
202426906	2006	INDIVIDUAL PERSONAL PROPERTY	WILLIAMS KRISTOPHER M	10808 E 57TH TER	202438678	2013-2017	INDIVIDUAL PERSONAL PROPERTY	WHITE SHELLY R	9508 HUNTER ST
202426963	2019	INDIVIDUAL PERSONAL PROPERTY	ROBERSON CEDRIC B	5310 HARRY S TRUMAN DR UNIT 102	202438758	2010-2017	INDIVIDUAL PERSONAL PROPERTY	MCKEE ROBERT	5000 E 74TH TER
202427302	2021	INDIVIDUAL PERSONAL PROPERTY	NOLEN LATORIA & MARK L	6409 HARDY AVE	202438950	2008	INDIVIDUAL PERSONAL PROPERTY	STAPLEY CLAUDIA E	9712 E 66TH TER
202428188	2021	INDIVIDUAL PERSONAL PROPERTY	BELL AMY E	7722 CRESCENT AVE	202438956	2008-2009	INDIVIDUAL PERSONAL PROPERTY	TAYLOR ANDRE	6133 KENTUCKY AVE
202428423	2012	INDIVIDUAL PERSONAL PROPERTY	FRITZAL MARY H	7306 HEDGES AVE	202438957	2006-2007	INDIVIDUAL PERSONAL PROPERTY	MEREDITH JADE M	7505 HAWTHORNE AVE
202428501	2021	INDIVIDUAL PERSONAL PROPERTY	ADAMS LATOYA MARIE	10005 E 78TH ST	202438985	2012	INDIVIDUAL PERSONAL PROPERTY	KLUSENER SCARLETT R (JENKINS)	8800 E 53RD TER
202428834	2008-2012	INDIVIDUAL PERSONAL PROPERTY	SMITH FELICIA R	8625 E UTOPIA PKWY APT 1	202439370	2008-2010	INDIVIDUAL PERSONAL PROPERTY	HASKELL KIETYSHIA	9401 E 83RD ST
202428839	2021	INDIVIDUAL PERSONAL PROPERTY	WESLEY FREDRICK J	7431 OVERTON AVE UNIT 1	202439602	2008	INDIVIDUAL PERSONAL PROPERTY	FLETCHER AMANDA	8919 MARSH AVE
202428911	2013-2017	INDIVIDUAL PERSONAL PROPERTY	MAXON JUSTIN	6828 ENGLEWOOD AVE	202439644	2007-2009	INDIVIDUAL PERSONAL PROPERTY	ALSALMAN SAHARM	6523 BLUE RIDGE BLVD
202428984	2015	INDIVIDUAL PERSONAL PROPERTY	MCCEE KYNA	4306 ELMWOOD AVE	202439783	2020-2021	INDIVIDUAL PERSONAL PROPERTY	MOORE ALAINA L	8300 E 85TH TER
202429853	2009-2017	INDIVIDUAL PERSONAL PROPERTY	MAYCOCK RYAN	9001 E 57TH ST	202439801	2021	INDIVIDUAL PERSONAL PROPERTY	PERKINS VICKIE	8516 OXFORD AVE
202430169	2021	INDIVIDUAL PERSONAL PROPERTY	VALLECILLO MORATAYA KARINA IVETH	10008 E 56TH TER	202439876	2009-2011	INDIVIDUAL PERSONAL PROPERTY	BANKS NATASHA L	6133 KENTUCKY AVE
202430246	2021	INDIVIDUAL PERSONAL PROPERTY	GERMAIN CHARLES C	9819 E 61ST ST APT 1	202439995	2017-2021	INDIVIDUAL PERSONAL PROPERTY	WHITE WILLIAMS L SR	8203 WOODSON DR
202430272	2008-2010	INDIVIDUAL PERSONAL PROPERTY	TUCKER BRANDON A	6008 ENGLEWOOD AVE	202440292	2009-2010	INDIVIDUAL PERSONAL PROPERTY	YATES MICHAEL A	8928 ROSE LN
202430489	2007-2012	INDIVIDUAL PERSONAL PROPERTY	LOUIS VITAL	9540 MANNING AVE	202440559	2021	INDIVIDUAL PERSONAL PROPERTY	SMITH DEBORAH KAY	8308 PERSHING RD
202430604	2012-2017	INDIVIDUAL PERSONAL PROPERTY	TURNER GARY & CARRIE J	9707 E 65TH ST	202440635	2012-2017	INDIVIDUAL PERSONAL PROPERTY	PARKER SASHA MARIE	8603 CRESCENT AVE
202430626	2007	INDIVIDUAL PERSONAL PROPERTY	HAMILTON DONNA	9611 E 77TH TER	202440711	2021	INDIVIDUAL PERSONAL PROPERTY	DAVIS TABATHA ANN-MARIE	9816 E 67TH TER
202430704	2009	INDIVIDUAL PERSONAL PROPERTY	MORALES MARIA L & ISMAEL	10217 E 57TH ST	202440814	2016-2021	INDIVIDUAL PERSONAL PROPERTY	WYRICK DAVID S	7715 RAYTOWN RD APT 33
202430710	2021	INDIVIDUAL PERSONAL PROPERTY	GRIFFITTS HEATHER GALE	9512 E 60TH TER	202441464	2021	INDIVIDUAL PERSONAL PROPERTY	DENNEY PATRICK H	8129 WILLOW WAY
202430751	2008	INDIVIDUAL PERSONAL PROPERTY	ARNOLD GREGORY	9007 E 68TH TER	202441526	2007-2008	INDIVIDUAL PERSONAL PROPERTY	FERRISS GREGORY S	9609 E 79TH ST
202430826	2007	INDIVIDUAL PERSONAL PROPERTY	COLEMAN SHARITA	8620 E UTOPIA DR	202441571	2021	INDIVIDUAL PERSONAL PROPERTY	STEELE PANTHEA L	5121 WESTRIDGE CIR
202431107	2009-2010	INDIVIDUAL PERSONAL PROPERTY	JOHNSON REGINA	8456 LANE DR	202441628	2009-2012	INDIVIDUAL PERSONAL PROPERTY	CURRY DAVID A	9058 E 65TH ST
202431178	2008	INDIVIDUAL PERSONAL PROPERTY	CHRISTIAN SEBASTION S	7509 HAWTHORNE AVE	202441896	2018-2021	INDIVIDUAL PERSONAL PROPERTY	GATES MICHAEL A	7040 HUNTER ST
202431317	2021	INDIVIDUAL PERSONAL PROPERTY	HAKE ROBERT E	11200 E 78TH ST	202441979	2009-2010	INDIVIDUAL PERSONAL PROPERTY	ALLEN GARRIN & BRITTANY	5357 BLUE RIDGE BLVD
202431502	2020-2021	INDIVIDUAL PERSONAL PROPERTY	HANGELOSE PHILLIP & TARA	6332 OVERTON AVE	202442014	2009-2010	INDIVIDUAL PERSONAL PROPERTY	ALLEN GARRIN & BRITTANY	8517 CRESCENT AVE
202431623	2021	INDIVIDUAL PERSONAL PROPERTY	HARDEN SONYA	10607 E 79TH ST	202442478	2021	INDIVIDUAL PERSONAL PROPERTY	KABER GLENN	7218 RAYTOWN RD APT A
202431858	2021	INDIVIDUAL PERSONAL PROPERTY	WALKER EASTER MAE	8001 TENNESSEE AVE	202442539	2008	INDIVIDUAL PERSONAL PROPERTY	MURFIN SAMANTHA & DAVIS TRAVIS	7305 CEDAR AVE
202431941	2010	INDIVIDUAL PERSONAL PROPERTY	WHITNEY MATTHEW & JESSICA	6500 HARDY AVE	202442629	2008-2009	INDIVIDUAL PERSONAL PROPERTY	THOMPSON SALIMAH	2324 BROOKLYN AVE
202432103	2014-2021	INDIVIDUAL PERSONAL PROPERTY	CHRISMAN SCOTT MICHAEL	5908 CEDAR AVE	202442641	2011-2012	INDIVIDUAL PERSONAL PROPERTY	CLIFTON WILLIAM ERIC	8306 PERSHING RD
202432202	2015	INDIVIDUAL PERSONAL PROPERTY	WILLIAMS MILTON	10222 E 63RD ST APT 2	202442693	2008-2017	INDIVIDUAL PERSONAL PROPERTY	RAMIREZ JESUS ANTONIO	8509 E 81ST ST
202432257	2021	INDIVIDUAL PERSONAL PROPERTY	CLEMONS GERARD	10208 E 69TH TER	202442905	2019	INDIVIDUAL PERSONAL PROPERTY	BICE LARRY	5825 KENTUCKY AVE
202432432	2008	INDIVIDUAL PERSONAL PROPERTY	ALARCON GLADIS	9212 E 54TH TER	202443397	2008	INDIVIDUAL PERSONAL PROPERTY	BANITZ OSCAR CAMPOS	CA RESIDENTIAL
202432499	2009	INDIVIDUAL PERSONAL PROPERTY	REYES JAVIER	7800 E 87TH ST	202443401	2011	INDIVIDUAL PERSONAL PROPERTY	MORATAYA WILLIAN	CA RESIDENTIAL
202432503	2020-2021	INDIVIDUAL PERSONAL PROPERTY	HENDERSON KRISTINA	8005 HUNTER ST	202444154	2014	INDIVIDUAL PERSONAL PROPERTY	BLACKSTOCK JANICE	5420 BLUE RIDGE CUT OFF APT 601
202432553	2021	INDIVIDUAL PERSONAL PROPERTY	HAEFS PATRICIA ANN	10401 E 71ST TER	202444162	2008	INDIVIDUAL PERSONAL PROPERTY	SMITH ERIC BRIAN	8807 E 72ND TER
202432592	2010-2017	INDIVIDUAL PERSONAL PROPERTY	CHADD SARAH	11204 E 63RD ST	202444233	2018-2019	INDIVIDUAL PERSONAL PROPERTY	WEBSTER LESLIE	10214 E 71ST TER
202432639	2021	INDIVIDUAL PERSONAL PROPERTY	NANCE MICHAEL TYRONE	9122 RICHARDS DR	202444452	2008-2012	INDIVIDUAL PERSONAL PROPERTY	DIXON BRIANA	9234 E 84TH ST
202432985	2008-2009	INDIVIDUAL PERSONAL PROPERTY	WILMOTH KELLERHALS MEGHAN	9812 E 69TH ST	202444649	2002-2017	INDIVIDUAL PERSONAL PROPERTY	JOYCE JULIA K	9007 E 87TH ST
202433091	2008-2009	INDIVIDUAL PERSONAL PROPERTY	BRISCO WILLIAM L	7508 MAPLE LN	202444766	2008-2015	INDIVIDUAL PERSONAL PROPERTY	MOORE JEFFREY LEWIS	8617 E 83RD ST
202433268	2013	INDIVIDUAL PERSONAL PROPERTY	MILLER PAUL F & HELEN M	9111 E 74TH ST	202444825	2017-2021	INDIVIDUAL PERSONAL PROPERTY	CASEY SANDRA KAYE	8805 E 81ST TER
202433270	2020-2021	INDIVIDUAL PERSONAL PROPERTY	TYARKS RICHARD WILLIAM JR	6904 WILDWOOD DR	202444831	2019	INDIVIDUAL PERSONAL PROPERTY	TART CANDICE N	9323 E 83RD ST
202433543	2021	INDIVIDUAL PERSONAL PROPERTY	WYATT WESLEY BERNARD JR	8332 WILLOW WAY	202444837	2021	INDIVIDUAL PERSONAL PROPERTY	DAMICO PAMELA	9807 E 61ST ST APT 12
202433637	2010-2013	INDIVIDUAL PERSONAL PROPERTY	REW PATRICK	10604 W 79TH ST	202444903	2016	INDIVIDUAL PERSONAL PROPERTY	WAXTER CHRISTOPHER TERELL	9526 HARRISON ST
202433666	2021	INDIVIDUAL PERSONAL PROPERTY	DAVIS SHANTA	11700 E 56TH ST	202445021	2008	INDIVIDUAL PERSONAL PROPERTY	MADISON KATHLEEN A	6300 HARRIS AVE
202433723	2020-2021	INDIVIDUAL PERSONAL PROPERTY	WROTEN JOYELL DIANNE	2233 E 70TH ST	202445177	2011	INDIVIDUAL PERSONAL PROPERTY	JEFFRIES VICTORIA F	9000 E 84TH ST
202433988	2021	INDIVIDUAL PERSONAL PROPERTY	MITCHELL BLAINE	7925 MANNING AVE	202445294	2021	INDIVIDUAL PERSONAL PROPERTY	COLLINS ZAIN & MARLISA M	10621 E 65TH ST
202434524	2007-2008	INDIVIDUAL PERSONAL PROPERTY	ROUTH ALICIA	7820 RIDGEWAY AVE	202445485	2021	INDIVIDUAL PERSONAL PROPERTY	DIXON ALETHIA M	11819 E 85TH ST

202445518	2018	INDIVIDUAL PERSONAL PROPERTY	JEFFERSON TROY LAMONT	8517 DITZLER AVE	202453137	2015-2016	INDIVIDUAL PERSONAL PROPERTY	CHANEY BILLY DAVID	5817 OXFORD AVE
202445536	2020-2021	INDIVIDUAL PERSONAL PROPERTY	BIGGINS HASSAN M	8504 SPRING VALLEY RD	202453367	2021	INDIVIDUAL PERSONAL PROPERTY	WEBB GEORGE EDWARD JR & JULIE ANN	11413 E 77TH ST
202445785	2021	INDIVIDUAL PERSONAL PROPERTY	BUFORD LORRAINE & KENNETH	11600 E 61ST ST	202453580	2019-2021	INDIVIDUAL PERSONAL PROPERTY	RAWSON EDWIN CLIFFORD	8125 WILLOW WAY
202445925	2021	INDIVIDUAL PERSONAL PROPERTY	BATES LATREASE	8634 LANE AVE APT 2	202453748	2020-2021	INDIVIDUAL PERSONAL PROPERTY	SPAINHOUR AMBER DAWN	9409 E 65TH TER
202446034	2009-2012	INDIVIDUAL PERSONAL PROPERTY	WILFORD TERESA C	9400 E 68TH ST	202453929	2021	INDIVIDUAL PERSONAL PROPERTY	EVENSEN KATHERINE ANNE	9801 E 59TH TER
202446068	2008-2017	INDIVIDUAL PERSONAL PROPERTY	JARRAD MIKEAL	9103 E 73RD ST	202454091	2020-2021	INDIVIDUAL PERSONAL PROPERTY	MORRISON BRUETTA T (ELLISON)	10933 E 54TH TER
202446175	2011-2012	INDIVIDUAL PERSONAL PROPERTY	NELSON ERICA R	6112 ELM AVE	202454340	2008	INDIVIDUAL PERSONAL PROPERTY	CERNA H JOSE A	8919 E 67TH ST APT 101
202446223	2014	INDIVIDUAL PERSONAL PROPERTY	DAVIS CRAIG	4520 NE KINGSTON DR	202454711	2017-2019	INDIVIDUAL PERSONAL PROPERTY	CROCKETT CHANDRA ANITA	5149 WESTRIDGE CIR
202446233	2007-2013	INDIVIDUAL PERSONAL PROPERTY	PRINGLE LINDSEY	8701 E 84TH TER	202454788	2021	INDIVIDUAL PERSONAL PROPERTY	REID KYLE	8004 OVERTON DR
202446372	2008	INDIVIDUAL PERSONAL PROPERTY	MAURICIO MANUEL	CA RESIDENTIAL	202454892	2016	INDIVIDUAL PERSONAL PROPERTY	RIEDEL JO ANNA	6109 ENGLEWOOD AVE
202446455	2018-2019	INDIVIDUAL PERSONAL PROPERTY	WALKER JUSTIN T	11006 E 59TH ST	202454960	2015	INDIVIDUAL PERSONAL PROPERTY	GORRES-MARTENS BRITTANY KAY & MARTENS JO	9401 E 84TH TER
202446523	2008-2009	INDIVIDUAL PERSONAL PROPERTY	MORRISON BRENT R	9900 E 80TH ST	202455046	2007-2009	INDIVIDUAL PERSONAL PROPERTY	FLOYD JEREMIAH J & BUENROSTRO ANGELICA	6625 RALSTON AVE
202446913	2021	INDIVIDUAL PERSONAL PROPERTY	GILMORE DONALD D JR	8121 HEDGES AVE	202455074	2009-2013	INDIVIDUAL PERSONAL PROPERTY	AGUILERA LOURDES	5520 HUNTER TER
202447014	2016-2021	INDIVIDUAL PERSONAL PROPERTY	TODD DONNELL	9308 E 81ST TER	202455130	2018-2021	INDIVIDUAL PERSONAL PROPERTY	HENDERSON JOSHUA M & DOLLY E	9009 E 52ND TER
202447116	2008-2009	INDIVIDUAL PERSONAL PROPERTY	BYWATER JEFFREY A	9732 PLYMOUTH LN	202455310	2021	INDIVIDUAL PERSONAL PROPERTY	ELLMAKER KIRK	10512 E 81ST TER
202447169	2011	INDIVIDUAL PERSONAL PROPERTY	CORUM KRISTIAN	9906 E 71ST TER	202455861	2007	INDIVIDUAL PERSONAL PROPERTY	ROETTGEN DANITA	10921 E 81ST ST
202447225	2008-2009	INDIVIDUAL PERSONAL PROPERTY	HATCH ANTHONY W	5628 DITZLER AVE	202455893	2010	INDIVIDUAL PERSONAL PROPERTY	MANDEFRO SENAAT & GEBRU MEKURIA	7109 HARVARD AVE
202447363	2010	INDIVIDUAL PERSONAL PROPERTY	CARTER JAMES JR	8704 STARK AVE	202455914	2008-2017	INDIVIDUAL PERSONAL PROPERTY	MCUNNER TRAVIS L & SARAH L	5907 CLAREMONT AVE
202447407	2008	INDIVIDUAL PERSONAL PROPERTY	BRAY ROY & BRAY OMA MAY	11802 E 73RD ST	202456206	2017-2021	INDIVIDUAL PERSONAL PROPERTY	KELLY PATRICK M & MARY ALICE KELLY	6128 HARVARD AVE
202447445	2019	INDIVIDUAL PERSONAL PROPERTY	PITTMAN MARILYN S	11105 E 77TH TER	202456269	2021	INDIVIDUAL PERSONAL PROPERTY	LACY KYLE	9000 E 57TH TER
202447534	2012	INDIVIDUAL PERSONAL PROPERTY	MIDDLEBROOKS WESLEY B	10101 E 59TH ST	202456393	2019-2020	INDIVIDUAL PERSONAL PROPERTY	HICKISCH BOBBY D	6820 CRISP AVE
202447918	2008-2009	INDIVIDUAL PERSONAL PROPERTY	ROSS SHANNON M	9615 E 66TH TER	202456483	2008-2009	INDIVIDUAL PERSONAL PROPERTY	DELGADO JOSE JULIAN	5412 DITZLER AVE
202448086	2008	INDIVIDUAL PERSONAL PROPERTY	JAMES SENEJA LASHELL	8923 ROSE LN	202456747	2021	INDIVIDUAL PERSONAL PROPERTY	WHELAN JAMES F & MARTHA S	8216 HARDY AVE
202448137	2014	INDIVIDUAL PERSONAL PROPERTY	BRITT SANDRA K	8855 E 57TH TER	202456830	2008-2009	INDIVIDUAL PERSONAL PROPERTY	PEREZ CARLOS	5812 HEDGES AVE
202448158	2017-2021	INDIVIDUAL PERSONAL PROPERTY	VANLANCKER RACHEL	6401 BLUE RIDGE BLVD	202457207	2008	INDIVIDUAL PERSONAL PROPERTY	HOLLAND JAMES K JR	11705 HOLIDAY DR APT 12
202448216	2008-2017	INDIVIDUAL PERSONAL PROPERTY	LOPEZ JOSE DEJESUS	5937 LAUREL AVE	202457225	2019-2021	INDIVIDUAL PERSONAL PROPERTY	FISHER BENJAMIN D	9062 E 64TH TER
202448269	2008-2009	INDIVIDUAL PERSONAL PROPERTY	SAWYER JOHN	10112 E 56TH ST	202457252	2008	INDIVIDUAL PERSONAL PROPERTY	BECKETT LATANYA & BERNARD	5416 RAYTOWN RD
202448415	2019-2021	INDIVIDUAL PERSONAL PROPERTY	HARRIS MICHAEL LEANARD	9006 E 73RD ST	202457268	2006-2007	INDIVIDUAL PERSONAL PROPERTY	VAUGHN ERIC	10921 E 53RD ST
202448492	2016-2019	INDIVIDUAL PERSONAL PROPERTY	TREVOR CRYSTAL S (JENKINS)	10805 BELLAIRE AVE	202457573	2009	INDIVIDUAL PERSONAL PROPERTY	GRAHAM MICO CEDETTE	9507 E 83RD ST
202448610	2008-2009	INDIVIDUAL PERSONAL PROPERTY	WINFIELD PATRICIA C	5400 BLUE RIDGE CUT OFF	202457805	2012	INDIVIDUAL PERSONAL PROPERTY	GARCIA ANNAMARIE R	7314 RALSTON AVE
202448633	2020-2021	INDIVIDUAL PERSONAL PROPERTY	FRISBEE MATTHEW	8232 LAUREL AVE	202457807	2010	INDIVIDUAL PERSONAL PROPERTY	BUCKLEY MARKA & RYAN	5516 WILLOW AVE
202448686	2008-2017	INDIVIDUAL PERSONAL PROPERTY	JONES TERESE R	8701 TENNESSEE AVE	202458045	2020-2021	INDIVIDUAL PERSONAL PROPERTY	GIVENS BRIDGETTE R	5410 DITZLER AVE
202448737	2017	INDIVIDUAL PERSONAL PROPERTY	TRIGGS WENDI M	8619 LANE AVE	202458428	2020	INDIVIDUAL PERSONAL PROPERTY	GONZALEZ FRANCISCO JAVIER	8301 E 60TH ST
202448756	2008	INDIVIDUAL PERSONAL PROPERTY	MARTINEZ POLICARPIO ORTIZ	6539 RAYTOWN RD APT 2	202458601	2008-2010	INDIVIDUAL PERSONAL PROPERTY	HAHN RAYMOND A	11319 E 72ND ST
202448874	2021	INDIVIDUAL PERSONAL PROPERTY	BARRERA PEDRO G	8517 ARLINGTON AVE	202458652	2009-2010	INDIVIDUAL PERSONAL PROPERTY	HAIN DENNIS G	10212 E 71ST TER
202449158	2017	INDIVIDUAL PERSONAL PROPERTY	STAYTON PRESTON A	9401 E 63RD ST APT 102	202458843	2021	INDIVIDUAL PERSONAL PROPERTY	QUINONEZ OSCAR	7936 CEDAR AVE
202449190	2010	INDIVIDUAL PERSONAL PROPERTY	KILBURG SARAH	9900 E 60TH ST	202459021	2017-2021	INDIVIDUAL PERSONAL PROPERTY	WILLIAMS WAYMOND D	7112 WOODSON RD
202449216	2008	INDIVIDUAL PERSONAL PROPERTY	PAYNE LESLIE J	11713 E 83RD ST APT 202	202459131	2010	INDIVIDUAL PERSONAL PROPERTY	MCCRIGHT TIMOTHY A	SITUS VERIFICATION IN PROGRESS
202449357	2016-2018	INDIVIDUAL PERSONAL PROPERTY	STIDHAM CRYSTAL	9301 E 69TH TER	202459547	2014	INDIVIDUAL PERSONAL PROPERTY	FOWLER PERRY D & JOSIE L	4814 E 51ST TER
202449520	2007	INDIVIDUAL PERSONAL PROPERTY	LARSON NATHANIEL L	6708 NORTHERN AVE	202459858	2021	INDIVIDUAL PERSONAL PROPERTY	YOUNG JEFFREY L	6233 RALSTON AVE
202449777	2021	INDIVIDUAL PERSONAL PROPERTY	COX DARALITA O	7910 SOUTH BENTON AVE	202459938	2021	INDIVIDUAL PERSONAL PROPERTY	HARPER ANDREA D	8301 OVERTON DR
202449807	2021	INDIVIDUAL PERSONAL PROPERTY	HANDLEY PERRY JR	9807 E 61ST ST APT 9	202460128	2021	INDIVIDUAL PERSONAL PROPERTY	BEELEY MARK S & JENNIFER BORROR	9709 E GREGORY BLVD
202449913	2008	INDIVIDUAL PERSONAL PROPERTY	HURBY COREY	9000 RICHARDS DR	202460971	2011-2016	INDIVIDUAL PERSONAL PROPERTY	MACHAUF HENRY	9100 E M 350 HWY
202450056	2020-2021	INDIVIDUAL PERSONAL PROPERTY	JOHNSON WILLIAM KEITH	9608 E 65TH ST	202461089	2016-2021	INDIVIDUAL PERSONAL PROPERTY	BOND ROSS E & CYNTHIA S	11000 GREGORY LN
202450066	2008-2009	INDIVIDUAL PERSONAL PROPERTY	BRISBIN STEPHEN EUGENE	9000 E 69TH ST	202461110	2008	INDIVIDUAL PERSONAL PROPERTY	MACK BRANDI E	8812 E 86TH ST
202450155	2014-2016	INDIVIDUAL PERSONAL PROPERTY	PENISTON NANCY J	6140 RAYTOWN RD APT 911	202461180	2007	INDIVIDUAL PERSONAL PROPERTY	BROWN JOSHUA D	8618 LANE AVE APT 1
202450280	2021	INDIVIDUAL PERSONAL PROPERTY	COGGINS ANDREA M	8917 E 75TH ST	202461218	2020-2021	INDIVIDUAL PERSONAL PROPERTY	HAWKINS WENDY	2101 VINE ST
202450360	2020-2021	INDIVIDUAL PERSONAL PROPERTY	THURMAN TIESHIA	8804 E 62ND ST	202461369	2014	INDIVIDUAL PERSONAL PROPERTY	LARSON CHRISTOPHER A	8609 E 50TH TER
202450450	2019-2021	INDIVIDUAL PERSONAL PROPERTY	PARKER KELVIN R JR	11804 E 87TH ST	202461480	2017-2019	INDIVIDUAL PERSONAL PROPERTY	NICHOLSON ANDRE	6004 BLUE RIDGE BLVD
202450748	2008-2010	INDIVIDUAL PERSONAL PROPERTY	WARDEN SHERRI	11200 E 78TH TER	202461533	2008-2014	INDIVIDUAL PERSONAL PROPERTY	PENCE STEPHEN BROOKE	11011 US 50 HWY
202450861	2021	INDIVIDUAL PERSONAL PROPERTY	SCHROEDER DEBRA & BRANDON	10713 E 84TH ST	202461555	2014-2015	INDIVIDUAL PERSONAL PROPERTY	JAMERSON PHILIP	6901 WILDWOOD DR
202450909	2008-2017	INDIVIDUAL PERSONAL PROPERTY	GRABER MARK A & PALMER NATOSHIA	8900 E 57TH ST	202461597	2012	INDIVIDUAL PERSONAL PROPERTY	RIPPEE STEVEN R	5420 BLUE RIDGE CUT OFF APT G01
202450924	2008	INDIVIDUAL PERSONAL PROPERTY	GOODS MALCOLM E	10505 E 66TH ST	202461643	2018-2021	INDIVIDUAL PERSONAL PROPERTY	CHRONISTER MARK J	5801 BLUE RIDGE BLVD
202451170	2009	INDIVIDUAL PERSONAL PROPERTY	BRADFORD RADELL A	4532 AGNES AVE	202461749	2008-2011	INDIVIDUAL PERSONAL PROPERTY	COCHRAN LUKE T	10601 E 80TH ST
202451184	2010-2012	INDIVIDUAL PERSONAL PROPERTY	BACH NANCY A	8413 HEDGES AVE	202461934	2020-2021	INDIVIDUAL PERSONAL PROPERTY	MEDLIN NICHOLAS J	11201 E 64TH ST
202451192	2021	INDIVIDUAL PERSONAL PROPERTY	MOORE MICHAEL A	9111 E 73RD ST	202461929	2008-2017	INDIVIDUAL PERSONAL PROPERTY	BRADLEY SHANICE BELL	8464 LANE DR
202451758	2021	INDIVIDUAL PERSONAL PROPERTY	BROOKS JEFFREY D	8529 CRESCENT AVE	202461971	2017-2021	INDIVIDUAL PERSONAL PROPERTY	OCAMPO GUILLEN GERARDO	9010 E 87TH ST APT D5
202451934	2007-2013	INDIVIDUAL PERSONAL PROPERTY	PEARLSON MARY ELLA	9818 E 61ST ST APT 2	202462352	2008	INDIVIDUAL PERSONAL PROPERTY	CERNECH ROBERT G	9915 E 60TH TER
202451960	2008-2011	INDIVIDUAL PERSONAL PROPERTY	KATES ANTHONY	9811 E 61ST ST APT 6	202462420	2010	INDIVIDUAL PERSONAL PROPERTY	CERVACIO MARIO C & DUARTE JOSE P	8909 E 67TH PL APT 209
202451976	2008	INDIVIDUAL PERSONAL PROPERTY	BLANSETT LOGAN	10803 E 67TH ST	202462568	2021	INDIVIDUAL PERSONAL PROPERTY	MUNOZ DONACIANO	8600 STARK AVE
202452034	2017-2019	INDIVIDUAL PERSONAL PROPERTY	DOWNEY WILLIAM IV	8570 JAMES A REED RD	202462696	2008	INDIVIDUAL PERSONAL PROPERTY	FUENTES FELIX NIETO	9218 E 54TH TER
202452115	2016-2017	INDIVIDUAL PERSONAL PROPERTY	FOWLER JOHNSON TAMIKA	8210 WOODSON DR	202462837	2011-2014	INDIVIDUAL PERSONAL PROPERTY	LEWIS GARY H	8615 E 83RD TER
202452204	2019-2021	INDIVIDUAL PERSONAL PROPERTY	DAVIS DEA LYNAE	5709 LAUREL AVE	202463039	2011-2014	INDIVIDUAL PERSONAL PROPERTY	STEWART DANNY R	6706 LAUREL AVE
202452212	2020-2021	INDIVIDUAL PERSONAL PROPERTY	FORD DENNIS & KATHY	6715 APPLETON AVE	202463142	2009-2017	INDIVIDUAL PERSONAL PROPERTY	PHILLIPS MELISSA R	7600 ARLINGTON AVE
202452214	2015-2016	INDIVIDUAL PERSONAL PROPERTY	GRIGSBY REVA D & HORTON ERICA L	5941 RAYTOWN RD UNIT C	202463218	2019-2021	INDIVIDUAL PERSONAL PROPERTY	BLACKMAN JAMILLA ROSE	6204 ENGLEWOOD AVE
202452258	2021	INDIVIDUAL PERSONAL PROPERTY	LEE BARRETT J	10700 E 56TH ST	202463234	2013-2014	INDIVIDUAL PERSONAL PROPERTY	OSWALD MICHAEL E	9020 E 74TH TER
202452419	2009-2012	INDIVIDUAL PERSONAL PROPERTY	JACKSON JEREMY A	5912 BLUE RIDGE CUT OFF	202463278	2018-2019	INDIVIDUAL PERSONAL PROPERTY	BAKER JOSEPH LEE	7716 ARLINGTON AVE
202452619	2018-2019	INDIVIDUAL PERSONAL PROPERTY	PARKS KIMBERLY JOY	8414 E 85TH ST	202463641	2019-2021	INDIVIDUAL PERSONAL PROPERTY	BLEWETT SHARON K	7505 OVERTON AVE
202452809	2009-2012	INDIVIDUAL PERSONAL PROPERTY	WOODFIN AMELIA	8121 WOODSON DR	202463645	2016	INDIVIDUAL PERSONAL PROPERTY	PETERS ROBBY	7918 EVANSTON AVE
202452861	2008-2010	INDIVIDUAL PERSONAL PROPERTY	HENRY EDWARD E	6011 ENGLEWOOD AVE	202463841	2020-2021	INDIVIDUAL PERSONAL PROPERTY	ALEXANDER MICHAEL	13511 E 54TH TER
202453056	2020-2021	INDIVIDUAL PERSONAL PROPERTY	MELENDEZ JUAN CARLOS	10337 E 61ST ST APT 2	202463932	2021	INDIVIDUAL PERSONAL PROPERTY	THOMPSON RYAN ALLEN	9200 E 68TH ST
202453065	2021	INDIVIDUAL PERSONAL PROPERTY	WILLIAMS CHANNELL NICOLE	5978 BLUE HILLS RD	202463963	2021	INDIVIDUAL PERSONAL PROPERTY	MCURTREY SANDRA K	8650 JAMES A REED RD

202464170	2020-2021	INDIVIDUAL PERSONAL PROPERTY	CAMPBELL CATHERINE M	8402 STARK AVE	202471792	2011-2012	INDIVIDUAL PERSONAL PROPERTY	WALZ CAROL	7216 RAYTOWN RD APT E
202464783	2010-2013	INDIVIDUAL PERSONAL PROPERTY	CLARK LESLIE S	6825 STERLING AVE	202471993	2011-2012	INDIVIDUAL PERSONAL PROPERTY	HENDRIX AMBER	5500 BLUE RIDGE BLVD
202464798	2021	INDIVIDUAL PERSONAL PROPERTY	TATE MICHAEL H	7521 HAWTHORNE AVE	202471995	2019-2021	INDIVIDUAL PERSONAL PROPERTY	MASONER LINDA C & BELLAMY ELIZABETH	8008 HARRIS AVE
202464834	2020-2021	INDIVIDUAL PERSONAL PROPERTY	SMALLWOOD LISA	6828 VERMONT AVE	202472067	2018	INDIVIDUAL PERSONAL PROPERTY	KEEN CAROL J	11014 E 83RD TER
202464995	2017	INDIVIDUAL PERSONAL PROPERTY	SHANNON PHILLIP II	8311 SPRING VALLEY RD	202472116	2021	INDIVIDUAL PERSONAL PROPERTY	SEMENS KENSILYNN G	7238 RAYTOWN RD APT F
202465093	2008	INDIVIDUAL PERSONAL PROPERTY	WOODS WILLIAM RUBE	8508 E 85TH TER	202472131	2011	INDIVIDUAL PERSONAL PROPERTY	MCKINNEY AMY K	8900 E 59TH ST
202465229	2015-2017	INDIVIDUAL PERSONAL PROPERTY	AYALA MARCO & MONIQUE	5332 HEDGES AVE	202472132	2021	INDIVIDUAL PERSONAL PROPERTY	RIMPSON BRITTANYE	5304 MAYWOOD AVE
202465252	2014	INDIVIDUAL PERSONAL PROPERTY	AUTREY WILLIAM J	9101 E 72ND TER	202472213	2018-2020	INDIVIDUAL PERSONAL PROPERTY	MITCHELL DENIEJAI LASHAE	5910 ENGLEWOOD AVE
202465254	2012	INDIVIDUAL PERSONAL PROPERTY	WEINBERG RUTH	6021 STERLING AVE	202472924	2021	INDIVIDUAL PERSONAL PROPERTY	WEHNER RICHARD LEE	11204 E 64TH TER
202465434	2021	INDIVIDUAL PERSONAL PROPERTY	ADAMS RAYVELL MONTA	8408 E 5TH ST	202472945	2021	INDIVIDUAL PERSONAL PROPERTY	DAY SEAN TYLER	8110 ELM AVE
202465461	2021	INDIVIDUAL PERSONAL PROPERTY	WILSON ANDREW G	6613 CLAREMONT AVE	202473023	2017-2021	INDIVIDUAL PERSONAL PROPERTY	REDMON ASHLEY	350 E ARMOUR BLVD
202465567	2011	INDIVIDUAL PERSONAL PROPERTY	BUCK LANEVA & MEGAN	8325 NORTHERN ST	202473077	2021	INDIVIDUAL PERSONAL PROPERTY	KELLOGG DAWN M	6324 CEDAR AVE
202465678	2008	INDIVIDUAL PERSONAL PROPERTY	RIOS MEZA ALEXANDER	5412 DITZLER AVE	202473155	2018	INDIVIDUAL PERSONAL PROPERTY	BROGDON WHITNEY & HAND WESLEY	9905 E 73RD ST APT E
202465782	2010-2011	INDIVIDUAL PERSONAL PROPERTY	CASTORENA ANGELA	9137 RICHARDS DR	202473178	2017-2021	INDIVIDUAL PERSONAL PROPERTY	LIPPS LINNSEY M	5820 LANE AVE
202465925	2008	INDIVIDUAL PERSONAL PROPERTY	LAWSON RONDA J	5312 WILLOW AVE	202473203	2021	INDIVIDUAL PERSONAL PROPERTY	LUCAS MONTOYA D	6709 LAUREL AVE
202465959	2012-2014	INDIVIDUAL PERSONAL PROPERTY	KING RICEY L	8301 EVANSTON AVE	202473236	2008-2016	INDIVIDUAL PERSONAL PROPERTY	PRICE TRAVIS M	10808 E M 350 HWY
202466150	2018-2019	INDIVIDUAL PERSONAL PROPERTY	MCINTOSH JINA LAVETTE	9010 E 87TH ST APT A3	202473237	2021	INDIVIDUAL PERSONAL PROPERTY	ROSS CONSUELO L	3311 SW KESSLER DR UNIT 4400
202466157	2008-2009	INDIVIDUAL PERSONAL PROPERTY	DURHAM ANDRE	6815 HUNTER ST UNIT A	202473264	2008	INDIVIDUAL PERSONAL PROPERTY	HINDS LASHAE	9220 E 54TH ST
202466230	2012-2013	INDIVIDUAL PERSONAL PROPERTY	KONOPASEK KRISTIE L	9218 E 70TH TER	202473277	2020-2021	INDIVIDUAL PERSONAL PROPERTY	BRISCOE TYLAN	5234 HARRIS AVE
202466284	2007-2016	INDIVIDUAL PERSONAL PROPERTY	SALINAS ALFONSO	10317 E 61ST ST APT 1	202473285	2016	INDIVIDUAL PERSONAL PROPERTY	BEAMAN MELISSA	8604 OXFORD AVE
202466307	2009-2011	INDIVIDUAL PERSONAL PROPERTY	DAYTON JEFFREY	11602 E 60TH ST	202473611	2008	INDIVIDUAL PERSONAL PROPERTY	DOMINQUEZ-MARTINEZ JUAN	5916 HARVARD AVE
202466334	2011	INDIVIDUAL PERSONAL PROPERTY	HAFIZ CARLIN	11006 E 85TH ST	202473703	2021	INDIVIDUAL PERSONAL PROPERTY	VICTORINO-GRIFFIN JERMAINE DARNELL	7906 ELM AVE
202466415	2010-2011	INDIVIDUAL PERSONAL PROPERTY	BRAMLETTE MICHAEL R & THOMAS	1013 SE GRANADA DR	202473854	2009	INDIVIDUAL PERSONAL PROPERTY	TOUPS APRIL M	7006 KENTUCKY AVE
202466417	2016-2019	INDIVIDUAL PERSONAL PROPERTY	BARMORE CODY G	5728 WOODSON RD	202473892	2008	INDIVIDUAL PERSONAL PROPERTY	MARKRAY RICHARD	4901 E 77TH TER
202466477	2018	INDIVIDUAL PERSONAL PROPERTY	COOK BENNY L	13404 BRISTOL AVE	202473947	2012-2017	INDIVIDUAL PERSONAL PROPERTY	CLARK MADELINE	5409 ASH AVE
202466557	2007-2011	INDIVIDUAL PERSONAL PROPERTY	WILKINS SHAMMIETTA M	7307 ELM ST	202474242	2010-2011	INDIVIDUAL PERSONAL PROPERTY	BRIGGS TRENT A	5806 FARLEY AVE
202466668	2011	INDIVIDUAL PERSONAL PROPERTY	HANSEN MICHELLE S	6825 STERLING AVE	202474468	2018-2019	INDIVIDUAL PERSONAL PROPERTY	SPROWLS ZACHARY RYAN	1531 APPLETON AVE
202466792	2008-2010	INDIVIDUAL PERSONAL PROPERTY	DAVIS RUSSELL LEE	8912 E 66TH ST	202474656	2015	INDIVIDUAL PERSONAL PROPERTY	MAYHEW RONNIE D	5420 BLUE RIDGE CUT OFF APT 711
202466812	2017-2019	INDIVIDUAL PERSONAL PROPERTY	BROOKS ANTHONY ARVELL	5808 KENTUCKY AVE	202474709	2008	INDIVIDUAL PERSONAL PROPERTY	GOEBEL JAMES O	9624 E M 350 HWY
202466944	2021	INDIVIDUAL PERSONAL PROPERTY	MORGAN ONICA	7501 ENGLEWOOD AVE	202474814	2021	INDIVIDUAL PERSONAL PROPERTY	PROUTY DUSTIN	7216 OXFORD AVE
202467251	2008-2013	INDIVIDUAL PERSONAL PROPERTY	MARTIN RODERICK	10108 E 83RD TER	202474838	2008-2009	INDIVIDUAL PERSONAL PROPERTY	MOORE NICHOLE J	10324 E 63RD ST APT 1
202467352	2009	INDIVIDUAL PERSONAL PROPERTY	THELANDER DOROTHY J	5828 CEDAR AVE	202474890	2019	INDIVIDUAL PERSONAL PROPERTY	PLANTZ IRMA I	1617 HARRIS AVE
202467356	2014-2019	INDIVIDUAL PERSONAL PROPERTY	BOOTH LISA M	1917 S ELIZABETH AVE	202474902	2007-2010	INDIVIDUAL PERSONAL PROPERTY	SNOW CONRAD W	7600 KENTUCKY AVE
202467395	2016	INDIVIDUAL PERSONAL PROPERTY	GATLIN KAMISHA	11008 E 63RD ST	202474988	2021	INDIVIDUAL PERSONAL PROPERTY	GEORGE KELLY LEI	7701 RAYTOWN RD APT 32
202467637	2019-2021	INDIVIDUAL PERSONAL PROPERTY	DEWITT LEASIA A	8502 PERSHING RD	202475005	2008-2010	INDIVIDUAL PERSONAL PROPERTY	OSBORNE DARRYL D & SONYA R	6416 ELM AVE
202467641	2008-2017	INDIVIDUAL PERSONAL PROPERTY	LESLIE DENNIS J	5400 BLUE RIDGE BLVD	202475142	2008-2009	INDIVIDUAL PERSONAL PROPERTY	HARRIS SHARONDA L	9704 E 68TH TER
202467705	2008	INDIVIDUAL PERSONAL PROPERTY	ROUSSEY KERRY W & SUSAN J	10300 E 81ST ST	202475148	2021	INDIVIDUAL PERSONAL PROPERTY	GREEN AMBER NASHAY	7520 LEWIS AVE
202467772	2009-2017	INDIVIDUAL PERSONAL PROPERTY	CASE JEREMY W & TINA L	11100 E 78TH TER	202475234	2017	INDIVIDUAL PERSONAL PROPERTY	RYMER DARBY H	5329 RALSTON AVE
202467792	2011-2013	INDIVIDUAL PERSONAL PROPERTY	SCROGGINS ALVIN EARL	6539 RAYTOWN RD APT 4	202475247	2010	INDIVIDUAL PERSONAL PROPERTY	SCHAEFER DANIEL	11511 E 57TH TER
202467808	2021	INDIVIDUAL PERSONAL PROPERTY	JOHNSON JOANN	8909 RICHARDS DR	202475284	2014	INDIVIDUAL PERSONAL PROPERTY	SMITH LARRY T & JOYCE K	10504 E 79TH ST
202467828	2018-2021	INDIVIDUAL PERSONAL PROPERTY	ROOZENBOOM KAREN N	8410 EVERETT ST	202475444	2018-2021	INDIVIDUAL PERSONAL PROPERTY	SPERANZA JAMES	5716 MAYWOOD AVE
202467854	2020-2021	INDIVIDUAL PERSONAL PROPERTY	JOHNSON MAURICE A	9105 E 73RD ST	202475476	2021	INDIVIDUAL PERSONAL PROPERTY	GOODWIN MARIO & MCKINZY MARVIN D	5730 MANNING AVE
202467908	2020-2021	INDIVIDUAL PERSONAL PROPERTY	HALL BRIAN S JR	11407 GREENWOOD RD	202475535	2021	INDIVIDUAL PERSONAL PROPERTY	BOTTLEY ANTRENISE M	10211 E 78TH ST
202467929	2017	INDIVIDUAL PERSONAL PROPERTY	JUDON WILLIE LEE III	8403 DITMAN AVE	202475790	2008-2010	INDIVIDUAL PERSONAL PROPERTY	WOODS LISA C & FRED E	8634 LANE AVE APT 4
202468321	2019-2021	INDIVIDUAL PERSONAL PROPERTY	ALBERTY CLARENCE EDWARD IV	5301 LAUREL AVE	202475821	2021	INDIVIDUAL PERSONAL PROPERTY	COLLINS TROY MITCHELL	4307 VERMONT AVE
202468384	2008-2011	INDIVIDUAL PERSONAL PROPERTY	MAYCROFT PAUL R	7839 ELM ST	202475843	2013-2014	INDIVIDUAL PERSONAL PROPERTY	JENNINGS DIANA K	5728 CEDAR AVE
202468395	2010-2012	INDIVIDUAL PERSONAL PROPERTY	FEYZULLAYEV AHMAD Z	6307 ASH AVE APT 12	202475876	2008	INDIVIDUAL PERSONAL PROPERTY	BROOKS MICHAEL A	6318 NORWOOD CT
202468457	2016	INDIVIDUAL PERSONAL PROPERTY	SIEFERT RYAN C	1100 S NOLAND RD	202475878	2016	INDIVIDUAL PERSONAL PROPERTY	GAMMILL MAXWELL	6104 ELM AVE
202468590	2008-2011	INDIVIDUAL PERSONAL PROPERTY	ALCARAZ JOB GARCIA	9400 E 83RD ST	202476044	2017-2018	INDIVIDUAL PERSONAL PROPERTY	FLORES KENIA	8436 EVANSTON AVE
202468654	2021	INDIVIDUAL PERSONAL PROPERTY	WRIGHT AVONA E	9815 E 61ST ST APT 7	202476375	2008-2009	INDIVIDUAL PERSONAL PROPERTY	HANSON MISTY M	7414 ENGLEWOOD LN
202468732	2005-2009	INDIVIDUAL PERSONAL PROPERTY	GIBBS ADRIAN YVETTE	5808 FARLEY AVE	202476584	2009-2010	INDIVIDUAL PERSONAL PROPERTY	MAYO BARBARA	7030 WOODSON RD
202468793	2008-2009	INDIVIDUAL PERSONAL PROPERTY	WILLIS JUSTIN & AMBER	8819 E 84TH TER	202476598	2021	INDIVIDUAL PERSONAL PROPERTY	GREEN STEVEN L SR	11805 E 78TH ST
202468856	2008	INDIVIDUAL PERSONAL PROPERTY	BENNETT BERNADETTE T	6545 RAYTOWN RD APT 4	202476606	2012	INDIVIDUAL PERSONAL PROPERTY	ANJADI OMD	10004 E M 350 HWY
202469207	2008	INDIVIDUAL PERSONAL PROPERTY	BARBOZA CARMONA RODRIGO	5412 DITZLER AVE	202476608	2019-2021	INDIVIDUAL PERSONAL PROPERTY	MCCRACKEN SHADOW & REEVES BROOKE	11000 E 74TH TER
202469360	2009	INDIVIDUAL PERSONAL PROPERTY	WEAVER ROBERT L	6817 RAYTOWN RD	202476760	2010	INDIVIDUAL PERSONAL PROPERTY	HALL ANDRE T	10901 E 53RD ST
202469410	2008	INDIVIDUAL PERSONAL PROPERTY	THOMPSON TYLER L	9704 E 81ST TER	202476864	2009-2015	INDIVIDUAL PERSONAL PROPERTY	GARCIA-SALDIVAR SAMUEL	10209 E 57TH ST
202469422	2008	INDIVIDUAL PERSONAL PROPERTY	CRUZ DANYEL ALFREDO	12004 E 75TH ST	202476883	2021	INDIVIDUAL PERSONAL PROPERTY	WILEY ERWIN & SUSAN	8605 E 83RD TER
202469443	2021	INDIVIDUAL PERSONAL PROPERTY	FLORES LUIS JR	9209 E 83RD PL	202476890	2017-2021	INDIVIDUAL PERSONAL PROPERTY	SIMMONS JEFFERY L	9915 E 60TH ST
202469790	2021	INDIVIDUAL PERSONAL PROPERTY	BREWER JON M	10803 E 60TH TER	202477199	2008	INDIVIDUAL PERSONAL PROPERTY	CHRONISTER AUSTIN	8863 E 52ND TER
202470177	2002-2021	INDIVIDUAL PERSONAL PROPERTY	BARLOW TERESA	9712 E 81ST TER	202477200	2008	INDIVIDUAL PERSONAL PROPERTY	LARA JUAN GABIEL DONIS	10321 E 61ST ST APT 1
202470232	2014	INDIVIDUAL PERSONAL PROPERTY	RENICK MELISSA L	11120 E 57TH ST	202477303	2008	INDIVIDUAL PERSONAL PROPERTY	FERRISS PATRICIA G	9609 E 79TH ST
202470277	2010-2012	INDIVIDUAL PERSONAL PROPERTY	TAFT DAMOND	8823 E 62ND ST	202477635	2008-2017	INDIVIDUAL PERSONAL PROPERTY	AGUILERA LORESLY	10317 E 61ST ST APT 1
202470332	2007-2008	INDIVIDUAL PERSONAL PROPERTY	MEADOWS ROBERT JOE	11128 E 84TH TER	202477858	2015	INDIVIDUAL PERSONAL PROPERTY	HIGGINS LATOYA A	7430 WOODSON RD
202470484	2021	INDIVIDUAL PERSONAL PROPERTY	MASSEY WAYNE CHRISTOPHER	6515 CLAREMONT AVE	202477923	2008-2009	INDIVIDUAL PERSONAL PROPERTY	STAHL JANET L & SAMMON MARLA L	8512 DITZLER AVE
202470605	2008	INDIVIDUAL PERSONAL PROPERTY	QUINN JESSICA D	8637 E UTOPIA PKWY APT 10	202478026	2020-2021	INDIVIDUAL PERSONAL PROPERTY	MELTON LORI S (COOK)	11701 E 75TH ST
202471196	2008	INDIVIDUAL PERSONAL PROPERTY	FLORES ECTOR	8414 BOOTH AVE	202478187	2019-2021	INDIVIDUAL PERSONAL PROPERTY	PERRY SEAN MICHAEL	10604 E 79TH TER
202471390	2021	INDIVIDUAL PERSONAL PROPERTY	GARRETT CHRISTOPHER E & JACINDA N	11109 E 78TH ST	202478317	2013-2014	INDIVIDUAL PERSONAL PROPERTY	LAVELLE ALEXANDRA	8301 DITZLER AVE
202471437	2020-2021	INDIVIDUAL PERSONAL PROPERTY	TAYLOR JOHNNY E	7013 HUNTER ST	202478742	2020-2021	INDIVIDUAL PERSONAL PROPERTY	MORRIS BILLY JOE JR & MCDOWELL JESSICA C	6517 STERLING AVE
202471588	2008-2014	INDIVIDUAL PERSONAL PROPERTY	SHELBY GARY JR	8314 STARK AVE	202478913	2020-2021	INDIVIDUAL PERSONAL PROPERTY	MOORE JAIBREE	9236 E 85TH ST
202471648	2008-2010	INDIVIDUAL PERSONAL PROPERTY	MAHBOBI FARZIN &/OR SINA	8819 E M 350 HWY	202479139	2008-2011	INDIVIDUAL PERSONAL PROPERTY	CHASE ROBERT T	6646 MAYWOOD AVE APT A
202471721	2014-2021	INDIVIDUAL PERSONAL PROPERTY	WESLEY LASHONDA	9412 E 81ST TER	202479161	2017-2021	INDIVIDUAL PERSONAL PROPERTY	INMAN JERRY LEE III	7604 WOODSON RD
202471762	2008	INDIVIDUAL PERSONAL PROPERTY	TAYLOR LATONYA	11600 E 61ST TER	202479527	2008	INDIVIDUAL PERSONAL PROPERTY	JOHNSON CHRISTOPHER & MILLER LEE	11116 E 57TH TER

202479746	2021	INDIVIDUAL PERSONAL PROPERTY	GUINN TEAIRA	8615 KENTUCKY AVE	202844038	2021	INDIVIDUAL PERSONAL PROPERTY	HEARD PATRICIA	5601 WOODSON RD
202479890	2010	INDIVIDUAL PERSONAL PROPERTY	SILAS RODNISHA	8812 E 84TH TER	202844070	2009-2011	INDIVIDUAL PERSONAL PROPERTY	SALVADOR LYDIA	7509 HAWTHORNE AVE
202479909	2009-2020	INDIVIDUAL PERSONAL PROPERTY	AYON SOTO ISRAEL	4807 E 20TH ST	202844086	2016-2018	INDIVIDUAL PERSONAL PROPERTY	CAMPBELL PATRICK W	8502 KENTUCKY AVE
202479924	2008-2010	INDIVIDUAL PERSONAL PROPERTY	WEBB DONOVAN AND ROBERT	9413 E 82ND ST	202844213	2021	INDIVIDUAL PERSONAL PROPERTY	BARDWELL JACE DAVID	9322 E 85TH ST
202479979	2011-2017	INDIVIDUAL PERSONAL PROPERTY	ANDERSON DAVID M	9821 E 60TH ST	202844357	2021	INDIVIDUAL PERSONAL PROPERTY	BROWN RAECHARD & RYAN	7625 ENGLEWOOD AVE
202479982	2010-2013	INDIVIDUAL PERSONAL PROPERTY	DACY DANIEL M & FREEMYER DACY SHEILA Y	11500 E 67TH ST	202844405	2020-2021	INDIVIDUAL PERSONAL PROPERTY	COLLINS PAULETTE E	5161 WESTRIDGE CIR
202480123	2021	INDIVIDUAL PERSONAL PROPERTY	FAILS LEONA CAROL	8707 E 85TH ST	202844530	2017-2019	INDIVIDUAL PERSONAL PROPERTY	DUNCAN DAMON	8305 HAWTHORNE AVE
202480287	2008-2011	INDIVIDUAL PERSONAL PROPERTY	NOEL JOHN R	10209 E 57TH ST	202844778	2021	INDIVIDUAL PERSONAL PROPERTY	GRIDDINE MARVETTE & ARNOLD RODERICK	5161 WESTRIDGE CIR
202480384	2020-2021	INDIVIDUAL PERSONAL PROPERTY	ADDIS JORDAN L	10205 E 69TH TER	202844799	2021	INDIVIDUAL PERSONAL PROPERTY	MILLS MICHAEL & LAURA	8904 E 83RD ST
202480598	2008-2012	INDIVIDUAL PERSONAL PROPERTY	LUTMAN MIKE L	6900 LANE AVE	202844930	2021	INDIVIDUAL PERSONAL PROPERTY	MCCOY JULIUS M	864 LAKEVIEW DR
202820600	2010	INDIVIDUAL PERSONAL PROPERTY	CERVACIO VAZQUEZ IRMA	8911 E 67TH ST APT 125	202844992	2010	INDIVIDUAL PERSONAL PROPERTY	DOBBINS DONNA JANEAN	9009 E 68TH ST
202820903	2013-2017	INDIVIDUAL PERSONAL PROPERTY	HOGLEN CHAD	5639 ASH AVE	202845061	2018-2021	INDIVIDUAL PERSONAL PROPERTY	STEVENS SHONTAY & STEVENSON JACK	6641 HARDY AVE
202835270	2014	INDIVIDUAL PERSONAL PROPERTY	STROBEL RANDY	7705 RAYTOWN RD APT 31	202845366	2018	INDIVIDUAL PERSONAL PROPERTY	FORD EBONIE JAUIQUE	9812 E 61ST ST APT 5
202835593	2008	INDIVIDUAL PERSONAL PROPERTY	GILLILAND DEBORA	11005 E 60TH TER	202845484	2008	INDIVIDUAL PERSONAL PROPERTY	CLARK LOJIE L	8614 W UTOPIA DR APT 39
202836027	2021	INDIVIDUAL PERSONAL PROPERTY	SELLERS DAVID E	7705 RAYTOWN RD	202845526	2021	INDIVIDUAL PERSONAL PROPERTY	THARP HOLLY (WILEY)	7054 NORTHERN AVE
202836029	2011	INDIVIDUAL PERSONAL PROPERTY	KILGORE DOUGLAS G & BRESSETTE SHANNA K	6812 ENGLEWOOD AVE	202845666	2021	INDIVIDUAL PERSONAL PROPERTY	MYERS JOETTA V (SCOTT)	8610 E 84TH TER
202836094	2021	INDIVIDUAL PERSONAL PROPERTY	PARKS STEVIE	5420 BLUE RIDGE CUT OFF APT 716	202845858	2011-2014	INDIVIDUAL PERSONAL PROPERTY	LUTON PATRICIA L	7803 E 85TH ST
202836493	2009-2016	INDIVIDUAL PERSONAL PROPERTY	SCANLAN DEVLIN & ANGIE	8955 E 60TH ST	202845914	2021	INDIVIDUAL PERSONAL PROPERTY	DANLEY LOUIS EDWARD JR	8903 RICHARDS DR
202836518	2021	INDIVIDUAL PERSONAL PROPERTY	JOHNSON SHERRY D	7328 ASH AVE	202846065	2008	INDIVIDUAL PERSONAL PROPERTY	JOHNSON LADONNA	5905 KENTUCKY AVE
202836861	2014	INDIVIDUAL PERSONAL PROPERTY	CHIBOGWU ALEX I	300 W ARMOUR BLVD	202846127	2009-2017	INDIVIDUAL PERSONAL PROPERTY	BOSSSELL NICOLE R	11811 E 83RD ST APT 201
202836938	2010	INDIVIDUAL PERSONAL PROPERTY	MARTIN JAMESSETTA C	8900 E 59TH ST	202846452	2021	INDIVIDUAL PERSONAL PROPERTY	FOSTER JAME M & PEGGY E	11201 E 83RD ST
202837049	2010-2013	INDIVIDUAL PERSONAL PROPERTY	OWEN TYLER D	9904 E 60TH ST	202846474	2008	INDIVIDUAL PERSONAL PROPERTY	HUDSON DAVID L	8523 BLUE RIDGE BLVD
202837148	2008-2013	INDIVIDUAL PERSONAL PROPERTY	GODFIRNON JEFFREY DAVID	9805 E 71ST TER	202846660	2021	INDIVIDUAL PERSONAL PROPERTY	JACKSON LINDA MARIE	6328 STERLING AVE
202837172	2021	INDIVIDUAL PERSONAL PROPERTY	VANDYKE DREW AKAMAI & AIMEE LADON	6608 ENGLEWOOD AVE	202846743	2021	INDIVIDUAL PERSONAL PROPERTY	ADAMS LAKISHA	11823 E 83RD ST APT 102
202837465	2008	INDIVIDUAL PERSONAL PROPERTY	BARFIELD ROBERT A	9500 E GREGORY BLVD	202846885	2009-2010	INDIVIDUAL PERSONAL PROPERTY	DANIEL R TRUSLOR LLC	8539 GRANT DR
202837587	2020-2021	INDIVIDUAL PERSONAL PROPERTY	HARDY CRASHAWNDA M	8306 STARK AVE	202846951	2010	INDIVIDUAL PERSONAL PROPERTY	SCROGGS KATIE G	9012 E 55TH ST
202837685	2008	INDIVIDUAL PERSONAL PROPERTY	WILLIAMS MARLENE	8621 E UTOPIA DR APT 2	202847126	2019-2021	INDIVIDUAL PERSONAL PROPERTY	SMITH ERICA N	9405 E 83RD ST
202838419	2021	INDIVIDUAL PERSONAL PROPERTY	WALKER SPENCER LEE	10212 E 69TH ST	202847150	2014	INDIVIDUAL PERSONAL PROPERTY	BAILES ROGER M	5425 HARRIS AVE
202838534	2021	INDIVIDUAL PERSONAL PROPERTY	LENOIR DEBRA EUGENA	9112 E 82TH ST	202847627	2009-2010	INDIVIDUAL PERSONAL PROPERTY	ARMSTRONG PATRICIA L & HEYER WENDY	1813 RALSTON AVE
202838647	2021	INDIVIDUAL PERSONAL PROPERTY	HASKINS LASHIKA M & MATRIE CRUTCHER	6353 BLUE RIDGE BLVD	202847828	2020-2021	INDIVIDUAL PERSONAL PROPERTY	CHRISTOPHERSON PATRICK A	11038 E 53RD TER
202838656	2013-2017	INDIVIDUAL PERSONAL PROPERTY	LATHROP BRANDON M	10805 E 65TH ST	202847867	2021	INDIVIDUAL PERSONAL PROPERTY	UNGER KURT	11311 E 61ST TER
202838906	2008-2011	INDIVIDUAL PERSONAL PROPERTY	THOMAS DANETRA N	5428 DITZLER AVE	202848008	2012-2013	INDIVIDUAL PERSONAL PROPERTY	SANDERS BRANDON	8311 DITZLER AVE
202838933	2021	INDIVIDUAL PERSONAL PROPERTY	HIGHTOWER ASHLEY M	8629 E UTOPIA PKWY APT 12	202848023	2011-2012	INDIVIDUAL PERSONAL PROPERTY	VIRTUE JESSICA MARIE	10123 E 67TH ST
202839176	2013-2015	INDIVIDUAL PERSONAL PROPERTY	RASBERRY STACY	11411 E 78TH TER	202848150	2012	INDIVIDUAL PERSONAL PROPERTY	REEVES JESSICA R & DUTY ANNA M	6708 STERLING AVE
202839348	2021	INDIVIDUAL PERSONAL PROPERTY	SIMONS WAYNE	6007 BLUE RIDGE CUT OFF	202848420	2008-2009	INDIVIDUAL PERSONAL PROPERTY	GRIFFING DANIEL STEPHEN	8819 E 84TH TER
202839753	2009	INDIVIDUAL PERSONAL PROPERTY	ELDER LYNETTE	7234 RAYTOWN RD APT B	202848489	2016	INDIVIDUAL PERSONAL PROPERTY	ROBERSON CHINA D	8311 PERSHING RD
202839809	2020-2021	INDIVIDUAL PERSONAL PROPERTY	MENOUGH BRANDON L	8607 BOOTH AVE	202848612	2021	INDIVIDUAL PERSONAL PROPERTY	GREEN TERRELL A & GREEN HELEN J	7409 MAYWOOD AVE
202840091	2010-2012	INDIVIDUAL PERSONAL PROPERTY	WALKER VICTORIA E & DONOVANE	7804 E 86TH ST	202848626	2021	INDIVIDUAL PERSONAL PROPERTY	BROWN JOHNNIE MATTHEWS	9029 E 80TH TER
202840233	2013	INDIVIDUAL PERSONAL PROPERTY	WILLINGHAM FREDERICK M	8955 E 83RD ST	202848750	2020-2021	INDIVIDUAL PERSONAL PROPERTY	STUMP EDWARD A	5692 BLUE RIDGE BLVD
202840754	2008	INDIVIDUAL PERSONAL PROPERTY	MARTINEZ RENE	8803 E 73RD ST	202848796	2020-2021	INDIVIDUAL PERSONAL PROPERTY	SIMS CHRISTY LYNN	11101 E M 350 HWY
202840758	2021	INDIVIDUAL PERSONAL PROPERTY	JENSON JUANITA	8422 STERLING AVE	202848813	2017	INDIVIDUAL PERSONAL PROPERTY	AHMADI SANDRA	10717 E 71ST TER
202840809	2017-2019	INDIVIDUAL PERSONAL PROPERTY	SMITH MIKE EUGENE	11304 E 62ND ST	202848932	2008-2017	INDIVIDUAL PERSONAL PROPERTY	HOUSE FORRESTINE	9019 E 72ND TER
202840850	2021	INDIVIDUAL PERSONAL PROPERTY	MASON CONTRELL & ERICA R	6011 BLUE RIDGE CUT OFF	202848939	2021	INDIVIDUAL PERSONAL PROPERTY	PHILLIPS DENISE A	11808 E 85TH ST
202840877	2017-2021	INDIVIDUAL PERSONAL PROPERTY	MASTERS BRANDON	5709 LAUREL AVE	202848950	2021	INDIVIDUAL PERSONAL PROPERTY	BANKSTON SARAH	8809 E 62ND TER
202841052	2021	INDIVIDUAL PERSONAL PROPERTY	SNOWDEN JAMIL	8610 E 83RD TER	202849020	2021	INDIVIDUAL PERSONAL PROPERTY	PARENT CHAD STEPHEN	9800 E 79TH PL
202841324	2009	INDIVIDUAL PERSONAL PROPERTY	PRINCE BRENTIS M JR	8316 DITZLER AVE	202849103	2011-2013	INDIVIDUAL PERSONAL PROPERTY	MCDONALD JAMES A JR	9354 E GREGORY BLVD
202841337	2021	INDIVIDUAL PERSONAL PROPERTY	MITCHELL JAMAL ANTHONY	8408 JAMES A REED RD	202849610	2017-2021	INDIVIDUAL PERSONAL PROPERTY	BROOKS NOVA M	8424 MARSH AVE
202841372	2017-2018	INDIVIDUAL PERSONAL PROPERTY	LAW DAVID ANTHONY	9808 E 81ST TER	202849856	2010-2012	INDIVIDUAL PERSONAL PROPERTY	MACHAMER DOUGLAS & MARTIN REBECCA	9505 E 57TH TER
202841471	2009	INDIVIDUAL PERSONAL PROPERTY	EWING CAROL	7021 RAYTOWN RD	202849964	2009	INDIVIDUAL PERSONAL PROPERTY	SMITH MILDRED D	7406 ENGLEWOOD LN
202841483	2021	INDIVIDUAL PERSONAL PROPERTY	WINSTEAD ROSHANDA S	9101 E 72ND TER	202850174	2021	INDIVIDUAL PERSONAL PROPERTY	BLAIR DANIEL E SR	9900 E GREGORY BLVD
202841781	2021	INDIVIDUAL PERSONAL PROPERTY	WOODS LATOYA N	7615 ELM ST	202850343	2010	INDIVIDUAL PERSONAL PROPERTY	HUTCHINSON KRISTLE ANN	8854 E 59TH TER
202841918	2015	INDIVIDUAL PERSONAL PROPERTY	JUMP JAMES M	10824 E 66TH TER	202850379	2008	INDIVIDUAL PERSONAL PROPERTY	LANG CHRISSELL M	8402 STARK AVE
202841941	2021	INDIVIDUAL PERSONAL PROPERTY	MANNING KENDRA	8311 MANNING AVE	202850643	2012-2015	INDIVIDUAL PERSONAL PROPERTY	ADAMS ALBERTA C	1738 E 97TH ST
202842027	2010	INDIVIDUAL PERSONAL PROPERTY	MCNERNEY TIM & SARAH	5916 ELM ST	202850907	2012	INDIVIDUAL PERSONAL PROPERTY	NAVE TOISHEONA M	10609 E 65TH ST
202842059	2020-2021	INDIVIDUAL PERSONAL PROPERTY	WILLIAMS LATRICE R	5604 MANNING AVE	202850924	2009	INDIVIDUAL PERSONAL PROPERTY	RICE-WALKER MATHEW E	10207 E 63RD ST
202842092	2020-2021	INDIVIDUAL PERSONAL PROPERTY	BARNES KAMESHA DEWAN	11100 E 75TH ST	202850936	2009	INDIVIDUAL PERSONAL PROPERTY	HAWKINS PAUL JR	5609 STERLING AVE
202842126	2012	INDIVIDUAL PERSONAL PROPERTY	BOYER PATRICIA L	5720 HARVARD AVE	202851263	2017-2018	INDIVIDUAL PERSONAL PROPERTY	GARZA OSCAR JR	8801 RICHARDS DR
202842228	2008	INDIVIDUAL PERSONAL PROPERTY	BLANDIN MICHAEL	6612 LANE AVE	202851316	2020-2021	INDIVIDUAL PERSONAL PROPERTY	JOHNSON JT JR	5408 DITZLER AVE
202842301	2009	INDIVIDUAL PERSONAL PROPERTY	MCMICHAEL STEVEN A	6740 STERLING AVE	202851542	2012-2013	INDIVIDUAL PERSONAL PROPERTY	BREWER DAWN	6007 BLUE RIDGE CUT OFF
202842309	2021	INDIVIDUAL PERSONAL PROPERTY	BRADLEY CHRISTINA LASHOYA	9010 E 75TH ST	202851658	2021	INDIVIDUAL PERSONAL PROPERTY	MURRAY JARED J	7512 HARRIS AVE
202842443	2011-2012	INDIVIDUAL PERSONAL PROPERTY	CARTER RAYMOND E	7705 RAYTOWN RD	202851741	2009-2010	INDIVIDUAL PERSONAL PROPERTY	BERRY LAURIE ANNETTE	8023 HARRIS AVE
202842829	2019	INDIVIDUAL PERSONAL PROPERTY	YOAKUM STEPHEN F	8316 E 85TH TER	202851774	2009-2012	INDIVIDUAL PERSONAL PROPERTY	WILSON JESSICA	6117 RALSTON AVE
202842890	2010	INDIVIDUAL PERSONAL PROPERTY	ANDERSON JOHNNY W	10915 E 72ND ST	202851810	2014	INDIVIDUAL PERSONAL PROPERTY	HARRIS RUSSELL M III	6720 WOODSON RD
202842894	2020-2021	INDIVIDUAL PERSONAL PROPERTY	WILLIAMS CHRISTEL & WILLIAM L	8303 BOOTH AVE	202851818	2020-2021	INDIVIDUAL PERSONAL PROPERTY	BARNES LUKE	11411 E 78TH TER
202842956	2016	INDIVIDUAL PERSONAL PROPERTY	BOWDEN LINDA FAY	9119 E 85TH ST	202851821	2014	INDIVIDUAL PERSONAL PROPERTY	BONHAM ANTHONY RAY	8512 E 85TH TER
202843050	2008-2009	INDIVIDUAL PERSONAL PROPERTY	WESTMORELAND VIRGIE & GATES TERRENCE	11137 E 84TH TER	202851869	2021	INDIVIDUAL PERSONAL PROPERTY	WRIGHT AYANA D (HEARRON)	8600 FORD AVE
202843205	2021	INDIVIDUAL PERSONAL PROPERTY	HAYNES-DANIELS ANGELA R	11100 E 74TH ST	202852053	2019-2021	INDIVIDUAL PERSONAL PROPERTY	HILES BRITTNEY L	10916 E 81ST TER
202843264	2021	INDIVIDUAL PERSONAL PROPERTY	BYRNE MARK & SUSAN	8001 TENNESSEE AVE	202852289	2009	INDIVIDUAL PERSONAL PROPERTY	BAKER MICHAEL ENENG JR	7030 WOODSON RD
202843646	2012	INDIVIDUAL PERSONAL PROPERTY	VARGAS CARINA MARISOL	7309 ELM ST	202852546	2021	INDIVIDUAL PERSONAL PROPERTY	HARDIN RODERICK TYRONE	9125 MYRTLE AVE APT 131
202843702	2010-2021	INDIVIDUAL PERSONAL PROPERTY	HRONSKI GAIL ANN (YAW) & YAW CHARLES	8911 E 59TH ST	202852617	2020	INDIVIDUAL PERSONAL PROPERTY	FLETCHER IVY	11834 E 80TH DR
202843942	2009	INDIVIDUAL PERSONAL PROPERTY	BRAVO RAMON JR	11516 E 74TH STREET CT	202852738	2014-2016	INDIVIDUAL PERSONAL PROPERTY	ROBINSON MARVINA A	9819 E 61ST ST APT 7
202844008	2020-2021	INDIVIDUAL PERSONAL PROPERTY	WALKER TYRON	8524 OXFORD AVE	202852741	2009-2010	INDIVIDUAL PERSONAL PROPERTY	LONG JAMES A	7300 RALSTON AVE

202852782	2009	INDIVIDUAL PERSONAL PROPERTY	BRAVO MARICELA	11516 E 74TH STREET CT	202864158	2015	INDIVIDUAL PERSONAL PROPERTY	MADDEN JOHN L	6631 HARDY AVE
202853197	2021	INDIVIDUAL PERSONAL PROPERTY	HYDEMAN ANDREW	5202 BLUE RIDGE BLVD	202864498	2021	INDIVIDUAL PERSONAL PROPERTY	STERLING TYLER	8141 DITZLER AVE
202853204	2019-2020	INDIVIDUAL PERSONAL PROPERTY	SIMPSON APRIL M	7705 RAYTOWN RD APT 30	202864573	2015-2017	INDIVIDUAL PERSONAL PROPERTY	ROMERO BRIGIDO A	11809 E 78TH PL
202853388	2009-2011	INDIVIDUAL PERSONAL PROPERTY	THOMAS RONNIE L	11400 E 58TH ST	202864655	2020-2021	INDIVIDUAL PERSONAL PROPERTY	PEW DAVID D & LARA	6012 STERLING AVE
202853671	2015	INDIVIDUAL PERSONAL PROPERTY	CARLTON CAROL ANN	8017 E 87TH ST	202864788	2010	INDIVIDUAL PERSONAL PROPERTY	TAMEZ PEDRO JESUS	6805 LAUREL AVE
202853772	2009-2014	INDIVIDUAL PERSONAL PROPERTY	HAYES CORTEZ	11300 E 85TH TER	202864860	2018	INDIVIDUAL PERSONAL PROPERTY	WYATT ALLEN Q	6607 RALSTON AVE
202853993	2020-2021	INDIVIDUAL PERSONAL PROPERTY	ROSS CHRISTOPHER LEE	8615 ARLINGTON AVE	202864910	2019-2021	INDIVIDUAL PERSONAL PROPERTY	KRIEGER BRINDA L	10004 E 77TH TER
202854129	2011-2012	INDIVIDUAL PERSONAL PROPERTY	RUCKER DARNELL	12803 14TH ST APT 167	202864978	2009	INDIVIDUAL PERSONAL PROPERTY	ZAMORA JOSE LUIS	10313 E 61ST ST APT 1
202854215	2009-2017	INDIVIDUAL PERSONAL PROPERTY	CAMPBELL CODY J	5724 CEDAR AVE	202865139	2021	INDIVIDUAL PERSONAL PROPERTY	FARRAND FREDERICK W JR	7517 HARVARD AVE
202854265	2016-2021	INDIVIDUAL PERSONAL PROPERTY	ANDERSON SHAUNISE L	302 N MAIN ST	202865153	2013	INDIVIDUAL PERSONAL PROPERTY	TERRELL MELINDA M	8815 E 61ST ST
202854373	2018-2019	INDIVIDUAL PERSONAL PROPERTY	KRAXNER DAVID W	6029 ARLINGTON AVE	202865377	2021	INDIVIDUAL PERSONAL PROPERTY	PARKISON ASHLEY N	8119 HEDGES AVE
202854428	2011-2012	INDIVIDUAL PERSONAL PROPERTY	FAJRI KAMAL WAZIR	9350 E 84TH ST	202865423	2021	INDIVIDUAL PERSONAL PROPERTY	SALMON RUBY DELLA	5512 HARDY AVE
202854654	2012	INDIVIDUAL PERSONAL PROPERTY	BECK JELEY	NO ADDRESS ASSIGNED BY CITY	202865427	2010	INDIVIDUAL PERSONAL PROPERTY	MCKINNEY ANDRE	8900 E 59TH ST
202854794	2010-2017	INDIVIDUAL PERSONAL PROPERTY	OWENS REBECCA L	7415 APPLETON AVE	202865643	2020-2021	INDIVIDUAL PERSONAL PROPERTY	MOORE JENNIFER RENEE	9111 E 73RD ST
202855018	2013-2017	INDIVIDUAL PERSONAL PROPERTY	WILLIAMSON BRANDON	5820 LANE AVE	202865724	2008	INDIVIDUAL PERSONAL PROPERTY	MOULTRIE JARRED	7422 OVERTON AVE UNIT 2
202855476	2010-2011	INDIVIDUAL PERSONAL PROPERTY	ALLEN DOMINIQUE	8605 ARLINGTON AVE	202865819	2021	INDIVIDUAL PERSONAL PROPERTY	RICKS RALPH B	5329 WILLOW AVE
202855782	2018	INDIVIDUAL PERSONAL PROPERTY	ANGIER TIFFANY N	6000 HEDGES AVE	202865885	2012-2013	INDIVIDUAL PERSONAL PROPERTY	HARRIS DENNIS LEE	5420 BLUE RIDGE CUT OFF APT 205
202861828	2017-2021	INDIVIDUAL PERSONAL PROPERTY	EDENFIELD BARBARA	9400 E 55TH ST	202865959	2010	INDIVIDUAL PERSONAL PROPERTY	WOODS KYLE	6720 LAKESHORE DR
202865146	2021	INDIVIDUAL PERSONAL PROPERTY	HOPKINS PHYLLIS	9902 E 80TH TER	202866109	2021	INDIVIDUAL PERSONAL PROPERTY	TYSON LEON MARKIESE	8015 SPRING VALLEY RD
202865158	2014-2021	INDIVIDUAL PERSONAL PROPERTY	ROE ADRIAN	7403 VIRGINIA AVE	202866136	2008-2012	INDIVIDUAL PERSONAL PROPERTY	MEINERS NICOLE L	9018 E 74TH TER
202865285	2009	INDIVIDUAL PERSONAL PROPERTY	SICKLER CINDY A	8905 E 67TH PL APT 210	202866151	2021	INDIVIDUAL PERSONAL PROPERTY	TAFT MICHAEL A	6240 RALSTON AVE
202865482	2021	INDIVIDUAL PERSONAL PROPERTY	WAYMAN JENNIFER C	512 NW FALK DR	202866222	2017-2019	INDIVIDUAL PERSONAL PROPERTY	ROSS DEONE	5623 LAUREL AVE
202865752	2021	INDIVIDUAL PERSONAL PROPERTY	SMITH LASEANDA	8420 JAMES A REED RD	202866536	2015-2016	INDIVIDUAL PERSONAL PROPERTY	MONROE D/MITRIA	9203 B E 53RD TER
202865806	2017-2021	INDIVIDUAL PERSONAL PROPERTY	GOODMAN REGINA D	8464 LANE DR	202866572	2011-2016	INDIVIDUAL PERSONAL PROPERTY	GREEN ALISHA	7409 MAYWOOD AVE
202865915	2015	INDIVIDUAL PERSONAL PROPERTY	KOONS NEURIVA L	5420 BLUE RIDGE CUT OFF APT 806	202866584	2021	INDIVIDUAL PERSONAL PROPERTY	HARPER MILES M JR & MAREE	9504 E 57TH ST
20287059	2011	INDIVIDUAL PERSONAL PROPERTY	HOLTZ MELISSA	5320 WILLOW AVE	202866592	2012-2013	INDIVIDUAL PERSONAL PROPERTY	KUMPFER MILDRED L	6617 ELM AVE
20287470	2019-2020	INDIVIDUAL PERSONAL PROPERTY	BENNETT JOSHUA J	6825 LAUREL AVE	202866614	2012-2014	INDIVIDUAL PERSONAL PROPERTY	MCGIMPSEY JOSH	10904 E 56TH TER
20287571	2011-2017	INDIVIDUAL PERSONAL PROPERTY	BANKS KWAME A	11012 E 72ND ST	202866689	2021	INDIVIDUAL PERSONAL PROPERTY	WILLIAMS ARICA L	8460 LANE DR
20287805	2019-2021	INDIVIDUAL PERSONAL PROPERTY	HARRISON SHAUN A	10110 E 77TH TER	202866760	2009	INDIVIDUAL PERSONAL PROPERTY	MAARELS ALMANZA GUZMAN	9140 E 63RD ST
20287809	2009-2014	INDIVIDUAL PERSONAL PROPERTY	DRYER JASON M	9105 E 72ND TER	202866828	2015-2021	INDIVIDUAL PERSONAL PROPERTY	OPPENHEIMER KATY K	9115 E 58TH ST
202880017	2015	INDIVIDUAL PERSONAL PROPERTY	DYKMAN DANIEL	5528 MANNING AVE	202866894	2009-2011	INDIVIDUAL PERSONAL PROPERTY	CUNNINGHAM THERESA (MURRAY)	6620 HARDY AVE
202880032	2009-2011	INDIVIDUAL PERSONAL PROPERTY	DARTHARD ANGELO G	9133 E 85TH PL	202866967	2011-2012	INDIVIDUAL PERSONAL PROPERTY	DYER SANDRA V	7709 RAYTOWN RD APT 22
202880054	2010	INDIVIDUAL PERSONAL PROPERTY	PETERSON STEPHEN D	11704 E 78TH PL	202867274	2018-2021	INDIVIDUAL PERSONAL PROPERTY	WILLIAMS ROBERT LESLIE	9129 RICHARDS DR
202881111	2012	INDIVIDUAL PERSONAL PROPERTY	DIAMOND JESSIE L & OR HUNTINGTON MICHELL	8911 E 67TH ST APT 220	202867391	2021	INDIVIDUAL PERSONAL PROPERTY	CASTILLO CECILIA ANA	7800 E 87TH ST
20288492	2014	INDIVIDUAL PERSONAL PROPERTY	LAWLER BRIAN T	9405 E 66TH ST	202867507	2021	INDIVIDUAL PERSONAL PROPERTY	SMITH JEREMY RYAN	10009 S 53RD ST
20288727	2014-2015	INDIVIDUAL PERSONAL PROPERTY	SPENCER CHARLES	9224 E 61ST ST	202867598	2014-2021	INDIVIDUAL PERSONAL PROPERTY	BAI LAVOUCHER	5305 LEWIS AVE
20288764	2013-2014	INDIVIDUAL PERSONAL PROPERTY	QUINN JOHN	5316 MAYWOOD AVE	202867711	2008	INDIVIDUAL PERSONAL PROPERTY	THOMPSON SHAUN L	8719 E 57TH ST
202888002	2012-2013	INDIVIDUAL PERSONAL PROPERTY	WOHLETT JILL	7300 HARDY AVE	202867719	2010	INDIVIDUAL PERSONAL PROPERTY	WILSON HARRY C	7121 NORWOOD AVE
20288838	2021	INDIVIDUAL PERSONAL PROPERTY	TAYLOR JESSICA L	10508 E 79TH ST	202867898	2007-2010	INDIVIDUAL PERSONAL PROPERTY	KOROLOVICZ JEREMY & MAJOR MARY J	6005 FARLEY AVE
202892525	2009-2010	INDIVIDUAL PERSONAL PROPERTY	MENDEZ ROY QUIROS	5412 DITZLER AVE	202867925	2019	INDIVIDUAL PERSONAL PROPERTY	HANSON SCOTT	9002 E 68TH ST
202892527	2021	INDIVIDUAL PERSONAL PROPERTY	CAFFEY LARRY R JR	8625 GREENWOOD RD	202867996	2020-2021	INDIVIDUAL PERSONAL PROPERTY	DAVIS TASHAL I	8915 E 74TH ST
20289310	2021	INDIVIDUAL PERSONAL PROPERTY	HOWARD ERNEST T III	7417 HARDY AVE	202868230	2010-2017	INDIVIDUAL PERSONAL PROPERTY	MCKEE RHANNON	9004 E 74TH ST
20289455	2015-2018	INDIVIDUAL PERSONAL PROPERTY	PAUL DON H JR	6325 KENTUCKY AVE	202868266	2012-2017	INDIVIDUAL PERSONAL PROPERTY	CHEGE FAITH NJERI	8486 LANE DR
20289459	2021	INDIVIDUAL PERSONAL PROPERTY	ROBERSON TIERRA SHANA	15218 GRAND SUMMIT EXT	202868310	2014-2019	INDIVIDUAL PERSONAL PROPERTY	COUNTY DEVON M	9063 E 66TH TER
202895786	2013-2015	INDIVIDUAL PERSONAL PROPERTY	SHREVE JOSEPH A	6906 LAUREL AVE	202868355	2012	INDIVIDUAL PERSONAL PROPERTY	GUESS VADA B	8607 ELM AVE
202895856	2010-2013	INDIVIDUAL PERSONAL PROPERTY	JOHNSON ERIC	9019 E 72ND TER	202868391	2009	INDIVIDUAL PERSONAL PROPERTY	CANNON MARCI	5521 HARDY AVE
202860150	2019-2021	INDIVIDUAL PERSONAL PROPERTY	EASON RONNIE MITCHELL SR	8629 E UTOPIA PKWY APT 7	202868427	2021	INDIVIDUAL PERSONAL PROPERTY	CONWAY DAVID J	6706 HARRIS AVE
202860228	2008	INDIVIDUAL PERSONAL PROPERTY	BLACKBURN JAMES D	6222 RAYTOWN TFWY	202868461	2012-2017	INDIVIDUAL PERSONAL PROPERTY	WRIGHT WILLIAM J	7601 WOODSON RD
202860335	2020-2021	INDIVIDUAL PERSONAL PROPERTY	LOVE RONNELL	11524 E 75TH ST	202868466	2020-2021	INDIVIDUAL PERSONAL PROPERTY	PRINNINGTON DUSTIN	7203 RALSTON AVE
202860356	2009	INDIVIDUAL PERSONAL PROPERTY	UDAGBULMAN LACY	11108 E 74TH ST	202868499	2020-2021	INDIVIDUAL PERSONAL PROPERTY	CAIN CAMILLE	6349 BLUE RIDGE BLVD
202860929	2016	INDIVIDUAL PERSONAL PROPERTY	ALEXANDER MICHAEL C	10324 E 63RD ST APT 4	202868565	2019-2021	INDIVIDUAL PERSONAL PROPERTY	NELSON EBE J	8817 E 85TH ST
202861372	2021	INDIVIDUAL PERSONAL PROPERTY	WILLIAMS DENEICA DONTRESHA & KITCHEN GEORGE M	8951 E 94TH ST	202868727	2008-2009	INDIVIDUAL PERSONAL PROPERTY	GIBBS NICHOLAS D	5357 BLUE RIDGE BLVD
202861688	2009-2010	INDIVIDUAL PERSONAL PROPERTY	GOODMAN VERNON F JR	10804 E 63RD ST	202868831	2005-2021	INDIVIDUAL PERSONAL PROPERTY	GIBSON STACEY D	11708 E 77TH TER
202861850	2013	INDIVIDUAL PERSONAL PROPERTY	LACEY EBONI N	8411 DITMAN AVE	202868921	2021	INDIVIDUAL PERSONAL PROPERTY	MANN DANTE LEVANCE	9355 E 68TH ST
202861863	2020-2021	INDIVIDUAL PERSONAL PROPERTY	NORWOOD KENNETH D	8302 HUNTER ST	202868925	2021	INDIVIDUAL PERSONAL PROPERTY	DONAHUE JESSICA KAY	9219 E 54TH TER
202862040	2009-2015	INDIVIDUAL PERSONAL PROPERTY	HAWKINS SHAUN T	8824 E 81ST TER	202869143	2010-2011	INDIVIDUAL PERSONAL PROPERTY	PARKER BEVERLY A	6112 HUNTER ST
202862176	2020-2021	INDIVIDUAL PERSONAL PROPERTY	COTTER KIM L	11104 E 59TH ST	202869360	2012-2013	INDIVIDUAL PERSONAL PROPERTY	COLEMAN NINA CHARISSE	11827 E 83RD ST APT 101
202862240	2019-2020	INDIVIDUAL PERSONAL PROPERTY	EDENFIELD BENJAMIN J	7809 RAYTOWN RD	202869471	2009	INDIVIDUAL PERSONAL PROPERTY	DURAN MARIN	9214 E 54TH TER
202862297	2019-2021	INDIVIDUAL PERSONAL PROPERTY	QUINN FRANCIS ARTHUR	9909 E 77TH TER	202869626	2013	INDIVIDUAL PERSONAL PROPERTY	WILLIS JAYMIE J	8707 E 83RD ST
202862428	2012-2013	INDIVIDUAL PERSONAL PROPERTY	GRESHAM BENNIE D & BRENDA RANAE	6816 LANE AVE	202869886	2021	INDIVIDUAL PERSONAL PROPERTY	BLACKMON LINDA S	10109 E 71ST TER
202862813	2021	INDIVIDUAL PERSONAL PROPERTY	MESSER MATTHEW C	8513 EVERETT ST	202869892	2009	INDIVIDUAL PERSONAL PROPERTY	GUZMAN VALENTIN ZAVALA	8309 SPRING VALLEY RD
202863122	2013-2014	INDIVIDUAL PERSONAL PROPERTY	WORNELL JEANIE L	11411 E 53RD ST	202869963	2009-2010	INDIVIDUAL PERSONAL PROPERTY	SMITH TERESA L	7504 MARLE LN
202863204	2013	INDIVIDUAL PERSONAL PROPERTY	SLEDGE KEISHA	6328 STERLING AVE	202870133	2021	INDIVIDUAL PERSONAL PROPERTY	JOHNSON ANTONIO V	11713 E 78TH TER
202863263	2020-2021	INDIVIDUAL PERSONAL PROPERTY	KELLEY KEITH DANIEL	9008 E 72ND TER	202870256	2009-2011	INDIVIDUAL PERSONAL PROPERTY	CHANDLER ANNIE M	9326 E 85TH ST
202863425	2019-2021	INDIVIDUAL PERSONAL PROPERTY	NOBLE MALISA R	9038 MANNING AVE	202870308	2016-2021	INDIVIDUAL PERSONAL PROPERTY	PATIENCE BRANDAN JAMES & NUKKI JO	8527 E 81ST TER
202863526	2018-2021	INDIVIDUAL PERSONAL PROPERTY	NICOLL JESSE T	8400 E 83RD ST	202870374	2012-2017	INDIVIDUAL PERSONAL PROPERTY	TRAVIS SEAN M	6609 OXFORD AVE
202863539	2009	INDIVIDUAL PERSONAL PROPERTY	BLACKBURN JOSEPH	5941 RAYTOWN RD UNIT C	202870416	2012-2017	INDIVIDUAL PERSONAL PROPERTY	ROWE MARCUS ALLISON	8705 E 81ST TER
202863855	2009-2012	INDIVIDUAL PERSONAL PROPERTY	RAYBURN BRENDA LEE	9005 E GREGORY BLVD	202870430	2021	INDIVIDUAL PERSONAL PROPERTY	CAREY MICHAEL A	5409 HARDY AVE
202863914	2020	INDIVIDUAL PERSONAL PROPERTY	LAI HANG THI	6216 CLAREMONT AVE	202870478	2009-2010	INDIVIDUAL PERSONAL PROPERTY	HINES-SANDERS RYAN CEDRIC	10900 E 58TH TER
202863998	2021	INDIVIDUAL PERSONAL PROPERTY	BALLANCE CORRINA & DAVID II	3415 APPLETON AVE	202870495	2011-2013	INDIVIDUAL PERSONAL PROPERTY	KELTNER CATHERINE MARTINA	7509 E 107TH ST
202864093	2014-2016	INDIVIDUAL PERSONAL PROPERTY	BROWN MELANIE ANNE & BROWN MICHAEL	7201 WILLOW AVE	202870824	2009	INDIVIDUAL PERSONAL PROPERTY	MINGUS MARTY J	11130 E 84TH TER
202864118	2009	INDIVIDUAL PERSONAL PROPERTY	SMITH MILDRED DIANE	7406 ENGLEWOOD LN	202870987	2012	INDIVIDUAL PERSONAL PROPERTY	GALLOWAY ROSE M	9902 E 77TH ST

202871095	2010-2011	INDIVIDUAL PERSONAL PROPERTY	COPELAND LENORA	8611 W UTOPIA DR APT 85	202878913	2008-2009	INDIVIDUAL PERSONAL PROPERTY	LINARES JOSE M	5804 BLUE RIDGE BLVD
202871269	2009-2010	INDIVIDUAL PERSONAL PROPERTY	KAMMERICH BRIDGET L	8812 E 84TH ST	202879086	2020	INDIVIDUAL PERSONAL PROPERTY	BRISCIANO JOHN A	6659 MAYWOOD AVE
202871494	2011-2015	INDIVIDUAL PERSONAL PROPERTY	GARCES BERTATRE MARION	8026 MANNING AVE	202879109	2019-2021	INDIVIDUAL PERSONAL PROPERTY	JOHNSON SAMIRA	8002 CRESCENT AVE
202871529	2009-2015	INDIVIDUAL PERSONAL PROPERTY	COLEMAN EVAN J	10712 E 83RD TER	202879277	2010	INDIVIDUAL PERSONAL PROPERTY	YOON SUHYUN	8903 E 66TH ST
202871542	2016	INDIVIDUAL PERSONAL PROPERTY	THOMAS LAQUANDA R	9701 E 77TH ST	202880148	2015	INDIVIDUAL PERSONAL PROPERTY	PARRIE ADAM B	11308 E 65TH ST
202871635	2009-2010	INDIVIDUAL PERSONAL PROPERTY	MEYER RAYMOND C	5901 BLUE RIDGE BLVD	202880253	2021	INDIVIDUAL PERSONAL PROPERTY	STANGLE JASON & STANGLE JENNIFER	9003 E 66TH ST
202871736	2012	INDIVIDUAL PERSONAL PROPERTY	MAGANA MIGUEL ANGEL & MAGANA ALICIA	10013 E 71ST TER	202880340	2009-2016	INDIVIDUAL PERSONAL PROPERTY	EUBANKS ARNOLD WHITNEY	8400 DITMAN AVE
202871756	2021	INDIVIDUAL PERSONAL PROPERTY	VOYLES PHILLIP DEAN	8909 RICHARDS DR	202880379	2011-2012	INDIVIDUAL PERSONAL PROPERTY	MATTHEWS JOHN RICHARD	11403 E 83RD ST
202871873	2011	INDIVIDUAL PERSONAL PROPERTY	ACOSTA ANDRES	5512 HUNTER ST	202880380	2019-2020	INDIVIDUAL PERSONAL PROPERTY	EWING UNIQUA SHANIQUE	6539 RAYTOWN RD APT 1
202872009	2018-2021	INDIVIDUAL PERSONAL PROPERTY	ZAMORA DANIEL E	6011 FARLEY AVE	202880479	2015-2021	INDIVIDUAL PERSONAL PROPERTY	MOORE WILLIAM RAY	5409 HAYTON AVE
202872017	2021	INDIVIDUAL PERSONAL PROPERTY	FULLER AMBER LYNN	8300 ELM AVE	202880561	2011	INDIVIDUAL PERSONAL PROPERTY	CONTRERAS ANA DAISY	11304 E 55TH TER
202872074	2021	INDIVIDUAL PERSONAL PROPERTY	GREEN GABRIELLE	6400 HEDGES AVE	202880563	2009-2017	INDIVIDUAL PERSONAL PROPERTY	LANE CARY RUSSELL	5412 ELM AVE
202872185	2021	INDIVIDUAL PERSONAL PROPERTY	SKINNER JAKOB & BLAKEY DANIELLE	7509 HARRARD AVE	202880598	2021	INDIVIDUAL PERSONAL PROPERTY	GARY DONALD L	9819 E 61ST ST APT 3
202872216	2021	INDIVIDUAL PERSONAL PROPERTY	HENDRICKSON BRIAN N JR	9007 E 79TH ST	202880616	2021	INDIVIDUAL PERSONAL PROPERTY	EDGAR IOANIS & EDGAR ROSLINA	7709 RAYTOWN RD APT 11
202872241	2021	INDIVIDUAL PERSONAL PROPERTY	CRISS WAYNE	9117 E 65TH ST	202880645	2012-2017	INDIVIDUAL PERSONAL PROPERTY	BERGSTRAND MATHEW	5815 WOODSON RD
202872632	2012-2013	INDIVIDUAL PERSONAL PROPERTY	BOOKER EUGENE & KEISHA L	4515 LISTER AVE	202880723	2009-2010	INDIVIDUAL PERSONAL PROPERTY	WILMESHERR MELISSA L (BLACKMON)	11312 E 77TH ST
202872932	2014	INDIVIDUAL PERSONAL PROPERTY	LEE WILLIAM H	5329 WILLOW AVE	202880743	2009-2011	INDIVIDUAL PERSONAL PROPERTY	TEANEY JASON & TEANEY DEBBIE	11100 E 57TH TER
202873020	2018	INDIVIDUAL PERSONAL PROPERTY	OSBORN ASHLEY RENEE	8501 RAYTOWN RD	202880808	2009-2010	INDIVIDUAL PERSONAL PROPERTY	LOPEZ JOSE MICHELL	7418 OVERTON AVE UNIT 8
202873085	2018-2021	INDIVIDUAL PERSONAL PROPERTY	MANNING ROBERT JOHN	7616 HARRIS AVE	202880975	2009-2010	INDIVIDUAL PERSONAL PROPERTY	YATES ZACH W	8001 APPLETON AVE
202873175	2021	INDIVIDUAL PERSONAL PROPERTY	TAYLOR WILLIAM REGINALD II	7718 ARLINGTON AVE	202881038	2016-2019	INDIVIDUAL PERSONAL PROPERTY	GRAVES LARISHA	10201 E 42ND ST
202873248	2021	INDIVIDUAL PERSONAL PROPERTY	MOON CAMILLE MELINDA	8105 HEDGES AVE	202881082	2021	INDIVIDUAL PERSONAL PROPERTY	MOSBY STEVEN EUGENE JR	7430 WOODSON RD
202873319	2021	INDIVIDUAL PERSONAL PROPERTY	FOUST JEFF	11500 E 62ND TER	202881170	2018-2021	INDIVIDUAL PERSONAL PROPERTY	MANNING SAMANTHA BEATRICE	6231 NORTHERN AVE
202873329	2021	INDIVIDUAL PERSONAL PROPERTY	LONG SUSAN RALPHEAL	9813 E 73RD ST APT G	202881247	2021	INDIVIDUAL PERSONAL PROPERTY	BLUE KAYLA M	5406 HEDGES AVE
202873377	2021	INDIVIDUAL PERSONAL PROPERTY	NEAL STEPHANIE MYCHALE	9214 E 54TH TER	202881270	2009	INDIVIDUAL PERSONAL PROPERTY	ROBINSON EVA M	5406 DITZLER AVE
202873804	2018	INDIVIDUAL PERSONAL PROPERTY	PARKER SIMONE E	8309 E 85TH ST	202881298	2019-2021	INDIVIDUAL PERSONAL PROPERTY	GOOLSBY MELVIN L	6304 HEDGES AVE
202873920	2021	INDIVIDUAL PERSONAL PROPERTY	LARRY CASSANDRA	7032 HUNTER ST	202881354	2009	INDIVIDUAL PERSONAL PROPERTY	HELM KRISTAL	5733 STERLING AVE
202874048	2010-2011	INDIVIDUAL PERSONAL PROPERTY	GARTON SASCHA	NO ADDRESS PROVIDED BY TAXPAYER	202881431	2010-2016	INDIVIDUAL PERSONAL PROPERTY	HOOVER JOSHUA A	917 E 64TH TER
202874170	2021	INDIVIDUAL PERSONAL PROPERTY	CREAMER PATRICIA STARR	8808 E 66TH ST	202881511	2019	INDIVIDUAL PERSONAL PROPERTY	VENTURA JOSE B	8414 STARK AVE
202874357	2021	INDIVIDUAL PERSONAL PROPERTY	HART RACHEL &/OR CRUSE JASON	8504 FORA AVE	202881523	2017-2021	INDIVIDUAL PERSONAL PROPERTY	HARDIN JOSEPH	9052 E 82ND ST
202874411	2021	INDIVIDUAL PERSONAL PROPERTY	ALLADICE JOHN	9014 E 87TH ST	202881841	2018-2021	INDIVIDUAL PERSONAL PROPERTY	CALLOWAY BRANDON	8505 KENTUCKY AVE
202874669	2009	INDIVIDUAL PERSONAL PROPERTY	DAVIS EDWARD L	6637 MAYWOOD AVE	202881848	2020-2021	INDIVIDUAL PERSONAL PROPERTY	MAHURIN MARY A	8508 ARLINGTON AVE
202874806	2009-2010	INDIVIDUAL PERSONAL PROPERTY	MITI DAWN	8413 NORTHERN ST	202881875	2021	INDIVIDUAL PERSONAL PROPERTY	SMITH YALONDA	8830 RICHARDS DR
202874821	2021	INDIVIDUAL PERSONAL PROPERTY	MATLOCK ASHLEY K	9101 E 55TH ST	202881936	2009	INDIVIDUAL PERSONAL PROPERTY	SMITH NATHAN T & SMITH ELIZABETH A	11808 E 86TH TER
202874850	2020-2021	INDIVIDUAL PERSONAL PROPERTY	LOPEZ NANCY	10804 E 67TH ST	202881940	2020-2021	INDIVIDUAL PERSONAL PROPERTY	STRICKLAND BRIAN ALLEN	6700 E 87TH ST APT 5205
202875011	2016-2018	INDIVIDUAL PERSONAL PROPERTY	RUPP SPENCER G	10704 E 69TH TER	202881982	2009-2017	INDIVIDUAL PERSONAL PROPERTY	HUYNH JEANNIE	8516 HAWTHORNE AVE
202875029	2021	INDIVIDUAL PERSONAL PROPERTY	JONES DONNELL V	9603 E 77TH ST	202882242	2021	INDIVIDUAL PERSONAL PROPERTY	SIMPSON BRAD L	5131 KENTUCKY AVE
202875032	2010	INDIVIDUAL PERSONAL PROPERTY	MAGRUDER CONNIE & MAGRUDER KENNETH W	10326 E 63RD ST APT 1	202882243	2013-2017	INDIVIDUAL PERSONAL PROPERTY	OMORODION JAMES	8705 EVANSTON AVE
202875181	2009-2017	INDIVIDUAL PERSONAL PROPERTY	GRANTT CARLA	5326 DITZLER AVE	202882404	2021	INDIVIDUAL PERSONAL PROPERTY	JORDAN MARIO JAREL	11404 E 71ST ST
202875235	2019	INDIVIDUAL PERSONAL PROPERTY	RAYNER CONNIE NICOLE	8304 MANNING AVE	202882410	2010-2017	INDIVIDUAL PERSONAL PROPERTY	REYES GABRIELA	5416 RAYTOWN RD
202875587	2021	INDIVIDUAL PERSONAL PROPERTY	EASTEP JANET L & ERTER JEFFERY L	9725 E 56TH ST	202882485	2009-2011	INDIVIDUAL PERSONAL PROPERTY	JACKSON LANAE M	7228 CRISP AVE
202875674	2017-2021	INDIVIDUAL PERSONAL PROPERTY	COODY DAMETRÉ D	11707 E 83RD ST APT 101	202882486	2021	INDIVIDUAL PERSONAL PROPERTY	SCOTT DENISE L	8807 E 73RD ST
202876103	2008-2011	INDIVIDUAL PERSONAL PROPERTY	WHITAKER NICOLE L	708 SE SOUTHBROOKE CT	202882488	2020-2021	INDIVIDUAL PERSONAL PROPERTY	SCHNEBELLEN DANIELLE NICOLE	1050 BERKLEY PKWY
202876137	2009	INDIVIDUAL PERSONAL PROPERTY	KITTSLESON ANN MARIE	11305 E 72ND ST	202882542	2011	INDIVIDUAL PERSONAL PROPERTY	SHIRLEY ALLISON M	8101 SPRING VALLEY RD
202876168	2018-2020	INDIVIDUAL PERSONAL PROPERTY	PONDER JASMINE CAPRI	5816 HEDGES AVE	202882584	2010	INDIVIDUAL PERSONAL PROPERTY	LANE TYLER K	8428 GREENWOOD RD
202876500	2020-2021	INDIVIDUAL PERSONAL PROPERTY	BAILEY LORENZO JR	8502 SPRING VALLEY RD	202882631	2016	INDIVIDUAL PERSONAL PROPERTY	RIDDLE RYANE M	8921 E 81ST ST
202876509	2008-2009	INDIVIDUAL PERSONAL PROPERTY	MILLER JAMES R JR	8308 STERLING AVE	202882686	2018	INDIVIDUAL PERSONAL PROPERTY	MORGAN BONNIE J	6231 ASH CT
202876632	2009-2012	INDIVIDUAL PERSONAL PROPERTY	EZELL ALLISON M	8316 HEDGES AVE	202882749	2010	INDIVIDUAL PERSONAL PROPERTY	GILES MICHAEL J JR	7036 WOODSON RD
202876707	2021	INDIVIDUAL PERSONAL PROPERTY	BARTLETT JAMIE	8909 E 74TH ST	202882816	2011-2012	INDIVIDUAL PERSONAL PROPERTY	DENNALP LAURA E	8732 E 73RD TER
202876816	2011	INDIVIDUAL PERSONAL PROPERTY	SIMMONS CAROLYN A	7400 MAPLE UNIT 401	202882918	2014	INDIVIDUAL PERSONAL PROPERTY	COBBINS RYAN TERRELL	10309 E 61ST ST APT 1
202876851	2011-2012	INDIVIDUAL PERSONAL PROPERTY	KHALSA GURJAMRIT	8572 JAMES A REED RD	202883146	2015	INDIVIDUAL PERSONAL PROPERTY	SEATS DONZELL M	8410 LANE PL
202876922	2018	INDIVIDUAL PERSONAL PROPERTY	MACK ANTHONY E JR	11540 HOLIDAY DR APT 3101	202883204	2010-2011	INDIVIDUAL PERSONAL PROPERTY	BOBBITT MATTHEW W & KAITLYNN	8709 E 79TH TER
202876923	2013-2017	INDIVIDUAL PERSONAL PROPERTY	TIEMAN JEAN	7832 WOODSON RD	202883254	2016-2021	INDIVIDUAL PERSONAL PROPERTY	COURTNEY SHAWNA RENEE	8326 OXFORD AVE
202876941	2020-2021	INDIVIDUAL PERSONAL PROPERTY	DUGGAN APRIL	5310 BLUE RIDGE BLVD	202883315	2018-2019	INDIVIDUAL PERSONAL PROPERTY	STARNES COURTNEY A	11401 E 71ST ST
202876989	2010-2017	INDIVIDUAL PERSONAL PROPERTY	LEE MARY JEAN & HAYES TACHAI	11300 E 85TH TER	202883480	2011-2013	INDIVIDUAL PERSONAL PROPERTY	FOSTER JEROME I & EVELYN J	7419 ASH AVE
202877093	2010	INDIVIDUAL PERSONAL PROPERTY	HALL ALLEN ANDREW	7504 HARRARD AVE	202883485	2021	INDIVIDUAL PERSONAL PROPERTY	WHITE CHRISTOPHER S	11805 E 51ST ST
202877099	2013-2017	INDIVIDUAL PERSONAL PROPERTY	HURLEY JERRY M	5405 RALSTON AVE	202883592	2019-2021	INDIVIDUAL PERSONAL PROPERTY	JEFFRIES DANIELLE YVONNE (WALKER)	11027 W 101ST TER APT A
202877199	2010-2011	INDIVIDUAL PERSONAL PROPERTY	ADAMS QUALANDRIA	9208 E 85TH ST	202883661	2021	INDIVIDUAL PERSONAL PROPERTY	VILANE KIMBERLY & BOUBACAR	11603 E 75TH ST
202877417	2012-2017	INDIVIDUAL PERSONAL PROPERTY	CRABTREE TROY S	8001 BLUE RIDGE BLVD	202883686	2021	INDIVIDUAL PERSONAL PROPERTY	TAYLOR JONES NATIJUAN	7413 ENGLEWOOD LN
202877501	2008-2009	INDIVIDUAL PERSONAL PROPERTY	ADAMS SHANNON W	9101 E 82ND TER	202883728	2005-2017	INDIVIDUAL PERSONAL PROPERTY	FERGUSON IOAN	8318 STERLING AVE
202877518	2009	INDIVIDUAL PERSONAL PROPERTY	WEBSTER KELLY	10716 E 84TH ST	202883763	2012	INDIVIDUAL PERSONAL PROPERTY	LYCAN CONNIE L	6124 RAYTOWN RD
202877671	2021	INDIVIDUAL PERSONAL PROPERTY	GIRARD MIGUEL	10333 E 61ST ST APT 2	202883919	2021	INDIVIDUAL PERSONAL PROPERTY	HUDGENS JANELLE NICOLE	5708 ELM AVE
202877753	2015	INDIVIDUAL PERSONAL PROPERTY	MOLT CHERYL A	9304 E 69TH TER	202884123	2010-2011	INDIVIDUAL PERSONAL PROPERTY	BULLARD RACHEL N (WOODARD)	5528 HUNTER TER
202877867	2011-2012	INDIVIDUAL PERSONAL PROPERTY	REEVES SHANNON N (CAREY)	8306 PERSHING RD	202884273	2021	INDIVIDUAL PERSONAL PROPERTY	KING CARNELL LEFORD	8815 E 72ND ST
202877956	2011-2012	INDIVIDUAL PERSONAL PROPERTY	FRAZIER NATASHA	8705 E 79TH ST	202884283	2009-2010	INDIVIDUAL PERSONAL PROPERTY	DICKEY DIANE M	9709 E 68TH ST
202877961	2009-2010	INDIVIDUAL PERSONAL PROPERTY	COLLINS FREDERICK ALEX	9944 E 61ST ST	202884285	2021	INDIVIDUAL PERSONAL PROPERTY	WATERMAN MIKE	10617 E 69TH TER
202877967	2010	INDIVIDUAL PERSONAL PROPERTY	PAYNE BUDDY L JR OR PAYNE MARY J	10401 E 70TH TER	202884319	2021	INDIVIDUAL PERSONAL PROPERTY	BARTLETT MICHAEL A	10204 E 72ND ST
202877994	2016-2017	INDIVIDUAL PERSONAL PROPERTY	WEAVER CARRY NICOLE	9112 E 61ST ST	202884331	2021	INDIVIDUAL PERSONAL PROPERTY	LEONARD SCOTT A	3605 N OSAGE ST
202878292	2008-2010	INDIVIDUAL PERSONAL PROPERTY	ELLIOT TIFFANY P	7608 WOODSON RD	202884533	2021	INDIVIDUAL PERSONAL PROPERTY	WAYMAN JEFFERY BRETT	7516 HARRIS AVE
202878319	2021	INDIVIDUAL PERSONAL PROPERTY	ANDERSON LETICIA L	8320 WILLOW WAY	202884618	2009-2014	INDIVIDUAL PERSONAL PROPERTY	MORENO ANDRES	10333 E 61ST ST APT 4
202878365	2013-2014	INDIVIDUAL PERSONAL PROPERTY	SIMON BECKY J	8401 E 86TH TER	202884715	2009-2017	INDIVIDUAL PERSONAL PROPERTY	MONTOYA-DIAZ SIXTO RICARDO	5937 LAUREL AVE
202878430	2010-2014	INDIVIDUAL PERSONAL PROPERTY	WINTERS CEDIL EDWARD	11274 E 71ST TER	202884800	2018-2021	INDIVIDUAL PERSONAL PROPERTY	LOLLAS JONATHAN SCOTT	8808 E 81ST TER
202878473	2016-2021	INDIVIDUAL PERSONAL PROPERTY	MAROUDES JAMES D	10416 E 70TH TER	202885050	2009-2012	INDIVIDUAL PERSONAL PROPERTY	THOMAS RAYMOND	9326 E 85TH ST

202885083	2020-2021	INDIVIDUAL PERSONAL PROPERTY	FENSKE FRANKLIN	6701 HARVARD AVE	202245568	2021	INDIVIDUAL PERSONAL PROPERTY	MOORE JOSHUA KEVIN	5612 RIDGEWAY AVE
202885248	2018-2021	INDIVIDUAL PERSONAL PROPERTY	AUTHORLEE MONIQUE	11804 E 78TH PL	202245788	2009	INDIVIDUAL PERSONAL PROPERTY	CUBIE KEISHA M	8618 E UTOPIA DR APT 52
202885705	2021	INDIVIDUAL PERSONAL PROPERTY	HEDRICK SHANNON	6009 FARLEY AVE	202246089	2009-2012	INDIVIDUAL PERSONAL PROPERTY	WWITHERS CORDELL III	8600 E 84TH TER
202885782	2012	INDIVIDUAL PERSONAL PROPERTY	GOW THOMAS F	10019 E 78TH ST	202246175	2019-2021	INDIVIDUAL PERSONAL PROPERTY	JOHNSON KOURTNI JAUANA & TAMYCA DYANNA	5408 RALSTON AVE
202885861	2021	INDIVIDUAL PERSONAL PROPERTY	LATORE THOMAS S	11805 E 83RD ST APT 202	202246325	2014	INDIVIDUAL PERSONAL PROPERTY	ARMSTRONG RUSSELL	11205 E 58TH TER
202885937	2019-2021	INDIVIDUAL PERSONAL PROPERTY	HARVEY RAYMOND L II	9812 E 60TH ST	202246375	2009-2011	INDIVIDUAL PERSONAL PROPERTY	OLDENBURG SIERRA ELAINE	9508 E 66TH TER
202886017	2011	INDIVIDUAL PERSONAL PROPERTY	PENNINGTON BRITINI TEKELIA	6609 HARVARD AVE	202246419	2017-2018	INDIVIDUAL PERSONAL PROPERTY	TOWNSEND CHRISTOPHER	11425 E 71ST ST
202886165	2021	INDIVIDUAL PERSONAL PROPERTY	DEMORE WILLIAM IAN	5317 HUNTER ST	202246594	2019-2021	INDIVIDUAL PERSONAL PROPERTY	WILLIAMS SOPHORINA M	8307 E 86TH TER
202886467	2009-2011	INDIVIDUAL PERSONAL PROPERTY	RODRIQUEZ GERARDO RENE GARCIA	7705 APPLETON AVE	202246773	2010	INDIVIDUAL PERSONAL PROPERTY	KING LINDA K	8315 MANNING AVE
202886542	2016-2017	INDIVIDUAL PERSONAL PROPERTY	BIGELOW MATTHEW	8925 E 74TH ST	202246958	2009-2011	INDIVIDUAL PERSONAL PROPERTY	GILL DESMOND J & TANNER BRITTANY J	8832 E 57TH ST
202886669	2009	INDIVIDUAL PERSONAL PROPERTY	ACHEAMPONG STEPHANIE	9201 E 54TH ST	202247055	2021	INDIVIDUAL PERSONAL PROPERTY	TRAVIS WILLIAM DEMAR	5402 ELM AVE
202886717	2019-2021	INDIVIDUAL PERSONAL PROPERTY	PORTER JESSIE MAY	6739 STERLING AVE	202247084	2014	INDIVIDUAL PERSONAL PROPERTY	HENBEST JARROD & NATALIA	10909 E 82ND ST
202886845	2011-2014	INDIVIDUAL PERSONAL PROPERTY	CHEVALIER JOSEPH	10710 E 65TH TER	202247258	2011	INDIVIDUAL PERSONAL PROPERTY	SUTHERLAN TYRAN	10029 E 67TH ST
202886869	2021	INDIVIDUAL PERSONAL PROPERTY	FLORES ANGEL	8431 EVANSTON AVE	202247292	2020-2021	INDIVIDUAL PERSONAL PROPERTY	MANSANG RODERICK T	10204 E 86TH TER
202887167	2021	INDIVIDUAL PERSONAL PROPERTY	ELLIS MARK S	5500 BLUE RIDGE BLVD	202247486	2015	INDIVIDUAL PERSONAL PROPERTY	BRADEN KIRANDA	9708 E 82ND ST
202887204	2021	INDIVIDUAL PERSONAL PROPERTY	WEBB DRACLISHA MARIE	7909 CRESCENT AVE	202247756	2021	INDIVIDUAL PERSONAL PROPERTY	PERRINE LEANN M	8404 E 85TH ST
202887270	2021	INDIVIDUAL PERSONAL PROPERTY	MACKENZIE EMILY	10920 E 32ND ST	202247993	2021	INDIVIDUAL PERSONAL PROPERTY	SMALL DANIELLE R & TINA THOMPSON	8328 STERLING AVE
202887288	2009-2010	INDIVIDUAL PERSONAL PROPERTY	HOLMES EARL JOSEPH	8404 HARVARD TER	202248797	2009-2010	INDIVIDUAL PERSONAL PROPERTY	MCKINN LASTRONIA D	9801 E 61ST ST APT 1
202887750	2011	INDIVIDUAL PERSONAL PROPERTY	MCPHERRIN CINDY	6209 CLAREMONT AVE	202249247	2011	INDIVIDUAL PERSONAL PROPERTY	WILLIAMS DAVID A	1020 VERMONT AVE
202887755	2011-2016	INDIVIDUAL PERSONAL PROPERTY	HARRIS ARLENE	7209 RAYTOWN RD	202249442	2021	INDIVIDUAL PERSONAL PROPERTY	ABDALLAH AEREN J	9013 E 85TH ST
202887771	2014	INDIVIDUAL PERSONAL PROPERTY	WARD MATTHEW	5613 STERLING AVE	202250093	2018-2020	INDIVIDUAL PERSONAL PROPERTY	PENNY ELGIN H	10325 E 61ST ST APT 1
202888051	2012	INDIVIDUAL PERSONAL PROPERTY	PORTILLO GUADALUPE	9710 E 66TH TER	202250279	2009-2011	INDIVIDUAL PERSONAL PROPERTY	ELSTON LAKEISHA	8620 E UTOPIA DR
202888087	2011	INDIVIDUAL PERSONAL PROPERTY	SWITZER JENNIFER L	5805 ASH AVE	202250536	2011	INDIVIDUAL PERSONAL PROPERTY	ABRAHAM JUDY K & KERRI M	10408 E 57TH TER
202888129	2012-2013	INDIVIDUAL PERSONAL PROPERTY	YOUNG DEMETRIA C M	7502 HAWTHORNE AVE	202250742	2019-2021	INDIVIDUAL PERSONAL PROPERTY	MORGAN MICHAEL	8302 MANNING AVE
202888251	2017-2019	INDIVIDUAL PERSONAL PROPERTY	MASON CHRISTOPHER	5724 MANNING AVE	202251607	2021	INDIVIDUAL PERSONAL PROPERTY	THIEDE MARCIA LEE (SHORE) & BARRY THOMAS	9021 E 72ND TER
202888329	2021	INDIVIDUAL PERSONAL PROPERTY	BROOKS ROBERT & ROSALYNE	11800 E 86TH TER	202251679	2021	INDIVIDUAL PERSONAL PROPERTY	MCALLISTER MARK C	6700 WOODSON RD
202888396	2021	INDIVIDUAL PERSONAL PROPERTY	BREWINGTON ANGELA CHRISTINE & BREWINGTON	212 PEBBLEBROOK LN	202251866	2018	INDIVIDUAL PERSONAL PROPERTY	SEYMOUR SHAWN JACOB	8305 EVANSTON AVE
202888404	2013-2014	INDIVIDUAL PERSONAL PROPERTY	HANKINS MELISSA	10805 E 58TH ST	202252107	2009-2017	INDIVIDUAL PERSONAL PROPERTY	ROBINSON HUSHA A	9408 E 82ND ST
202888638	2020-2021	INDIVIDUAL PERSONAL PROPERTY	HANLON JACOB THOMAS	5721 MANNING AVE	202252779	2017	INDIVIDUAL PERSONAL PROPERTY	BAIRES OSCAR A	8825 E 57TH ST
202888756	2010-2011	INDIVIDUAL PERSONAL PROPERTY	WHEAT-LUNN BRIEANNA	8901 E 52ND TER	202253076	2017	INDIVIDUAL PERSONAL PROPERTY	ANDERSON KENDRICK	10331 E 61ST ST APT 3
202888881	2018	INDIVIDUAL PERSONAL PROPERTY	WILLIS JAMES CLAY JR	8406 E 83RD ST	202253156	2016-2021	INDIVIDUAL PERSONAL PROPERTY	ALLEN TINA LAVONNE	6700 E 87TH ST APT 5201
202888905	2011-2014	INDIVIDUAL PERSONAL PROPERTY	GEMMELL ANDREA J & BILLY BRANDENBURG	8412 BOOTH AVE	202253264	2021	INDIVIDUAL PERSONAL PROPERTY	LAWRENCE CHARLES K & MICHELLE D	10013 E 83RD TER
202889179	2015-2017	INDIVIDUAL PERSONAL PROPERTY	MEDINA JOSE VARGAS	6549 RAYTOWN RD APT 2	202253491	2011	INDIVIDUAL PERSONAL PROPERTY	BOZEMAN SHERRILYN	10313 E 61ST ST APT 4
202889186	2009	INDIVIDUAL PERSONAL PROPERTY	STAIR MARK	9309 E 81ST ST	202253627	2011-2014	INDIVIDUAL PERSONAL PROPERTY	ATAY PATRICIA K	5524 HEDGES AVE
202889309	2014-2015	INDIVIDUAL PERSONAL PROPERTY	JACKSON LOLEITA M	5325 KENTUCKY AVE	202253687	2021	INDIVIDUAL PERSONAL PROPERTY	DENSON TERRY B	6302 RALSTON AVE
202889312	2018-2019	INDIVIDUAL PERSONAL PROPERTY	RODRIGUEZ ARIANNA M	7804 E 87TH ST	202253786	2010-2012	INDIVIDUAL PERSONAL PROPERTY	FRANKLIN KESHAWNA	11128 E 84TH TER
202889387	2021	INDIVIDUAL PERSONAL PROPERTY	THOMAS DEBORAH R	19301 E EASTLAND CENTER CT	202254092	2021	INDIVIDUAL PERSONAL PROPERTY	ZIMMERMAN SYBIL	8420 E 66TH ST
202889459	2021	INDIVIDUAL PERSONAL PROPERTY	TOTTEN JESSICA	5708 CEDAR AVE	202254118	2009	INDIVIDUAL PERSONAL PROPERTY	STANSBURY CHRISTOPHER	6412 HARDY AVE
203241410	2021	INDIVIDUAL PERSONAL PROPERTY	TUBBS EDGAR A	5601 LANE AVE	202254157	2010-2017	INDIVIDUAL PERSONAL PROPERTY	RAMIREZ VICTOR	8509 E 81ST ST
203241435	2020-2021	INDIVIDUAL PERSONAL PROPERTY	NELSON CAMERON LAMARR	1503 E 97TH ST	202254182	2012-2017	INDIVIDUAL PERSONAL PROPERTY	COLLINS AMANDA TIFFANY	6212 MANNING AVE
203241643	2010-2017	INDIVIDUAL PERSONAL PROPERTY	DAVENPORT SHANE MICHAEL	5436 APPLETON AVE	202254319	2015	INDIVIDUAL PERSONAL PROPERTY	TRAVIS JERRY D	8405 ARLINGTON AVE
203242521	2016-2018	INDIVIDUAL PERSONAL PROPERTY	TROTTER JOANN	10009 E 56TH TER	202254335	2010-2017	INDIVIDUAL PERSONAL PROPERTY	LAW BRIANA R	9319 E 83RD ST
203242647	2013-2017	INDIVIDUAL PERSONAL PROPERTY	KINNARD MICHAEL DENNIS	5816 OXFORD AVE	202254476	2014	INDIVIDUAL PERSONAL PROPERTY	MCKINNEY DEBORAH S	5420 BLUE RIDGE CUT OFF APT 613
203242782	2019-2021	INDIVIDUAL PERSONAL PROPERTY	MONTANO TYLER	8010 WILLOW WAY	202254521	2020-2021	INDIVIDUAL PERSONAL PROPERTY	BRADLEY JAMES C JR	8911 E 67TH ST APT 125
203242834	2011-2017	INDIVIDUAL PERSONAL PROPERTY	MORGAN ANDREW S	7309 CEDAR AVE	202254668	2011-2013	INDIVIDUAL PERSONAL PROPERTY	SAMUELS MONIKA	9811 E 61ST ST APT 5
203242920	2021	INDIVIDUAL PERSONAL PROPERTY	TOEWS CLAIR E	10412 E 87TH ST	202254714	2021	INDIVIDUAL PERSONAL PROPERTY	DANIELS CEAIRA D	9019 E 85TH ST
203242935	2021	INDIVIDUAL PERSONAL PROPERTY	MORAN JORGE	10333 E 61ST ST APT 4	202254727	2009	INDIVIDUAL PERSONAL PROPERTY	BRAVO JOSE TOMAS	10317 E 61ST ST APT 1
203243032	2015	INDIVIDUAL PERSONAL PROPERTY	NGUYEN VINCENT	9011 E 74TH TER	202254792	2010-2017	INDIVIDUAL PERSONAL PROPERTY	DIXON PORSHA	8215 WOODSON DR
203243044	2021	INDIVIDUAL PERSONAL PROPERTY	NELSON SHAWNETTA DENISE	9301 VAUGHN AVE	202254803	2017-2018	INDIVIDUAL PERSONAL PROPERTY	SLOAN RACHEL E	8108 EVANSTON AVE
203243081	2021	INDIVIDUAL PERSONAL PROPERTY	CARTER TAJAE	7918 ELM AVE	202254910	2010-2012	INDIVIDUAL PERSONAL PROPERTY	KENNEDY ARTHUR	8612 KENTUCKY AVE
203243139	2013-2020	INDIVIDUAL PERSONAL PROPERTY	BATTLE LATONIA RENEE	417 SE 5TH ST	202254917	2021	INDIVIDUAL PERSONAL PROPERTY	DOSS SHORDA	3226 JACKSON AVE
203243156	2009-2010	INDIVIDUAL PERSONAL PROPERTY	SCOTT STEVEN C	11212 E 64TH TER	202254955	2020-2021	INDIVIDUAL PERSONAL PROPERTY	PRICE REGINALD ALEXANDER II	9201 E 84TH ST
203243288	2021	INDIVIDUAL PERSONAL PROPERTY	RAY TERREANCE TERRELL	10708 E 84TH ST	202254997	2011-2017	INDIVIDUAL PERSONAL PROPERTY	POWELL CHRISTOPHER	9404 E 85TH ST
203243457	2021	INDIVIDUAL PERSONAL PROPERTY	HENDERSON FELICIA C	9812 E 60TH ST	202255146	2009	INDIVIDUAL PERSONAL PROPERTY	NAO XIAXIONG	6636 MAYWOOD AVE APT A
203243579	2013-2017	INDIVIDUAL PERSONAL PROPERTY	GAMMILL WILLIAM J	7608 APPLETON AVE	202255159	2021	INDIVIDUAL PERSONAL PROPERTY	WEAVER DONALD JR	7308 APPLETON AVE
203243584	2009	INDIVIDUAL PERSONAL PROPERTY	HART STEPHANIE LYNETTE	8611 LANE AVE	202255441	2020	INDIVIDUAL PERSONAL PROPERTY	SMITH DANIEL ELI	10254 E 71ST TER
203243678	2003-2008	INDIVIDUAL PERSONAL PROPERTY	SHEPARD JACOB & JACQUIE POWELL	5713 ELM AVE	202255686	2010-2017	INDIVIDUAL PERSONAL PROPERTY	CLINTON DENIELLE CAPRICE (FERGUSON)	9221 E 54TH ST
203243828	2009	INDIVIDUAL PERSONAL PROPERTY	NOVACK TYLOR D	7237 CRISP AVE	202255712	2016-2019	INDIVIDUAL PERSONAL PROPERTY	NICHOLSON JESSE L	8611 LANE AVE
203244008	2009-2010	INDIVIDUAL PERSONAL PROPERTY	TRIPLETT PRECIOUS J	9811 E 61ST ST APT 8	202256617	2018-2021	INDIVIDUAL PERSONAL PROPERTY	SANCHEZ JESSICA DYANN	9424 E 64TH ST
203244123	2009-2010	INDIVIDUAL PERSONAL PROPERTY	TUCKER MICHAEL S	7328 HARDY AVE	202256670	2016-2021	INDIVIDUAL PERSONAL PROPERTY	KING KRISLYN J	9014 E 85TH ST
203244254	2015	INDIVIDUAL PERSONAL PROPERTY	HARRIS ANGEL S	11276 E 71ST DR	202257116	2018-2020	INDIVIDUAL PERSONAL PROPERTY	STANLEY ROGER LYNN	124 COURT DR
203244296	2009-2010	INDIVIDUAL PERSONAL PROPERTY	SAVELY DONALD R	8409 JAMES A REED RD	202257148	2018-2021	INDIVIDUAL PERSONAL PROPERTY	PETERS JACQUELINE C	7404 MAYWOOD AVE
203244380	2018	INDIVIDUAL PERSONAL PROPERTY	PRICE DEEDRA M	8217 WOODSON DR	202257435	2018-2021	INDIVIDUAL PERSONAL PROPERTY	FOWLER LASHONDA CYMONE	7300 HARDY AVE
203244904	2018-2021	INDIVIDUAL PERSONAL PROPERTY	COMPANY JANISE NASHLE (RAY)	5819 CEDAR AVE	202257471	2011	INDIVIDUAL PERSONAL PROPERTY	SPRATT BRIANA A	3716 HEDGES AVE
203245041	2021	INDIVIDUAL PERSONAL PROPERTY	BAKER TEREASA C	1016 NE BRYCO DR UNIT A	202257566	2021	INDIVIDUAL PERSONAL PROPERTY	DAMERON LASHAWNA	8436 LANE DR
203245066	2019-2020	INDIVIDUAL PERSONAL PROPERTY	BOYD CRAIG JR	9908 E 60TH ST	202257827	2017-2018	INDIVIDUAL PERSONAL PROPERTY	JOHNSON SHREE	9035 RICE AVE
203245077	2010	INDIVIDUAL PERSONAL PROPERTY	MONTELEONE DEBORAH K	5524 HUNTER TER	202258033	2011-2015	INDIVIDUAL PERSONAL PROPERTY	MAASEN THOMAS JOSEPH	7907 HEDGES AVE
203245097	2016	INDIVIDUAL PERSONAL PROPERTY	TALBERT ANDREW J	8805 E 54TH ST	202258101	2010	INDIVIDUAL PERSONAL PROPERTY	AYALA EDWIN	7192 CEDAR AVE
203245147	2015	INDIVIDUAL PERSONAL PROPERTY	GARCIA WHITNY	8704 W LONGVIEW PKWY	202258275	2010-2011	INDIVIDUAL PERSONAL PROPERTY	MCGOWAN CATRINA	8622 E UTOPIA PKWY APT 1
203245298	2016	INDIVIDUAL PERSONAL PROPERTY	CHABINO KERMIT C	9008 E 66TH ST	202258320	2020-2021	INDIVIDUAL PERSONAL PROPERTY	WILLIAMS EBONY R	6230 STERLING AVE
203245387	2021	INDIVIDUAL PERSONAL PROPERTY	GRAYSON CHONTEL DELORIS	11705 E 77TH TER	202258693	2015-2016	INDIVIDUAL PERSONAL PROPERTY	MCAFEY KENJAY	10609 E 80TH ST
203245567	2020-2021	INDIVIDUAL PERSONAL PROPERTY	DIZER CAMITRA	7614 E 112TH ST	202258868	2021	INDIVIDUAL PERSONAL PROPERTY	NICHOLS TRACY	10301 E 63RD TER

203258932	2012	INDIVIDUAL PERSONAL PROPERTY	TATOM LINDA C	6411 HARVARD AVE	203269202	2021	INDIVIDUAL PERSONAL PROPERTY	LAUTNER WILLIAM	9800 E 67TH TER
203259050	2016-2021	INDIVIDUAL PERSONAL PROPERTY	LORD LAUREN M	9904 E 71ST TER	203269239	2021	INDIVIDUAL PERSONAL PROPERTY	MURPHY GARRICK D JR	7520 HAWTHORNE AVE
203259063	2017-2021	INDIVIDUAL PERSONAL PROPERTY	HALL LAWANDA	8135 DITZLER AVE	203269376	2020-2021	INDIVIDUAL PERSONAL PROPERTY	STEINMETZ JEREMY J	6804 HAWTHORNE AVE
203259070	2021	INDIVIDUAL PERSONAL PROPERTY	DIXON MICHAELA RE'NAE (JACKSON)	7105 STERLING AVE	203269466	2009-2013	INDIVIDUAL PERSONAL PROPERTY	HAWTHORNE JENA N	7918 TENNESSEE AVE
203259473	2021	INDIVIDUAL PERSONAL PROPERTY	DOUGLAS JENNIFER	5520 HUNTER TER	203269749	2019	INDIVIDUAL PERSONAL PROPERTY	PENROSE DORIS L & GRANT	5432 APPLETON AVE
203259716	2012-2017	INDIVIDUAL PERSONAL PROPERTY	DUPREE MAURICE	7208 STERLING AVE	203269907	2010-2012	INDIVIDUAL PERSONAL PROPERTY	CAPLES CORTEZ J	8719 E 79TH TER
203259857	2019-2021	INDIVIDUAL PERSONAL PROPERTY	ARNOLD DEVIN WAYNE	9719 E 65TH TER	203269926	2021	INDIVIDUAL PERSONAL PROPERTY	VILLARREAL MICHAEL AUSTIN	6037 LAUREL AVE
203259915	2020-2021	INDIVIDUAL PERSONAL PROPERTY	STUBBS AMY E	5316 KENTUCKY AVE	203269956	2010-2013	INDIVIDUAL PERSONAL PROPERTY	HORNBECK SARA ANN	9008 RICHARDS DR
203260045	2021	INDIVIDUAL PERSONAL PROPERTY	GUINN CHARLESO WALLETTA	9800 E 61ST ST APT 1	203269983	2020-2021	INDIVIDUAL PERSONAL PROPERTY	RUSHING SHAWN TA C	10505 E 74TH ST
203260047	2009	INDIVIDUAL PERSONAL PROPERTY	BRENNAN GEORGE P	11104 E 67TH ST	203270060	2009-2010	INDIVIDUAL PERSONAL PROPERTY	DAVIS SHAUNTA	8625 E UTOPIA PKWY APT 1
203260049	2014-2020	INDIVIDUAL PERSONAL PROPERTY	HUNLEY DOUGLAS M JR	8223 HARDY AVE	203270201	2010-2014	INDIVIDUAL PERSONAL PROPERTY	BARTON JAMES K & BARTON STEPHANIE A	5827 KENTUCKY AVE
203260183	2010-2013	INDIVIDUAL PERSONAL PROPERTY	JAMES RIAN	8411 DITMAN AVE	203270339	2012-2015	INDIVIDUAL PERSONAL PROPERTY	HANKO MEREDITH D	5509 BLUE RIDGE BLVD
203260392	2012-2016	INDIVIDUAL PERSONAL PROPERTY	MORFORD SARA & CHAD	11301 E 78TH TER	203270409	2021	INDIVIDUAL PERSONAL PROPERTY	EWING-WILLIAMS DEBORAH	8818 RICHARDS DR
203260405	2012	INDIVIDUAL PERSONAL PROPERTY	JOHNSON JOHN EDWARD	5310 ASH AVE	203270438	2011-2017	INDIVIDUAL PERSONAL PROPERTY	GRAHAM TIFFANY D	5409 ASH AVE
203260506	2009	INDIVIDUAL PERSONAL PROPERTY	DOBSON BRANDON L	7311 HEDGES AVE	203270517	2010-2017	INDIVIDUAL PERSONAL PROPERTY	WALKER MARRKL & ANGELA	10608 E 65TH ST
203260616	2013-2014	INDIVIDUAL PERSONAL PROPERTY	PALMER JEREMY ALLEN	8312 JAMES A REED RD	203270784	2011	INDIVIDUAL PERSONAL PROPERTY	COLTER SETH	7701 ELM ST
203260854	2011	INDIVIDUAL PERSONAL PROPERTY	SOMERS BRADLEY A & JONI	8606 E 83RD ST	203271052	2021	INDIVIDUAL PERSONAL PROPERTY	JORDAN BRITNEY R	5601 WOODSON RD
203261032	2010	INDIVIDUAL PERSONAL PROPERTY	GILKEY LEE E	6117 LAUREL AVE	203271168	2010-2011	INDIVIDUAL PERSONAL PROPERTY	MEKURIAGEBRU AACHAMYEEESH MERETU	7109 HARVARD AVE
203261694	2016-2020	INDIVIDUAL PERSONAL PROPERTY	FOELSK LUKE A	6101 ENGLEWOOD AVE	203271392	2013	INDIVIDUAL PERSONAL PROPERTY	SARTAIN MATTHEW	10905 E 53RD ST
203261760	2021	INDIVIDUAL PERSONAL PROPERTY	CANNON QUIANTE S	1116 NW DOWNING CIR	203271458	2017-2021	INDIVIDUAL PERSONAL PROPERTY	HARVEY WILLIAM CHARLES JR	6404 ELM AVE
203261792	2009-2010	INDIVIDUAL PERSONAL PROPERTY	CLEMOENS BRANDON R	9112 E 58TH ST	203271469	2014-2018	INDIVIDUAL PERSONAL PROPERTY	FLETCHER BRANDON H & LINDSAY L	9425 MARSH AVE
203261807	2010-2011	INDIVIDUAL PERSONAL PROPERTY	MARSHALL KENNETH MICHAEL	SITUS VERIFICATION IN PROGRESS	203271635	2021	INDIVIDUAL PERSONAL PROPERTY	VALET SETH A AND MELODY A	9304 E 68TH TER
203261838	2021	INDIVIDUAL PERSONAL PROPERTY	DUNCAN MICHAEL EUGENE JR	8901 E 52ND TER	203271918	2015-2021	INDIVIDUAL PERSONAL PROPERTY	RAVENS CROFT ROBERT W	7517 OVERTON AVE
203261922	2010-2011	INDIVIDUAL PERSONAL PROPERTY	PEREZ JOEL R	5728 BLUE RIDGE CUT OFF	203271982	2009-2012	INDIVIDUAL PERSONAL PROPERTY	CRAWFORD MATTHEW MICHAEL	11818 E 62ND TER
203261937	2019-2021	INDIVIDUAL PERSONAL PROPERTY	JOHNSON TORION R	8633 UTOPIA PKWY APT 2	203271995	2010	INDIVIDUAL PERSONAL PROPERTY	PERCY JULIA V	6553 RAYTOWN RD APT 1
203261939	2021	INDIVIDUAL PERSONAL PROPERTY	CHASTAIN PAUL HENRY	6140 RAYTOWN RD APT 111	203272065	2021	INDIVIDUAL PERSONAL PROPERTY	FOX JENNAFER	6123 HARVARD AVE
203261974	2021	INDIVIDUAL PERSONAL PROPERTY	STEPHENS AMANDA	9809 E 60TH TER	203272194	2021	INDIVIDUAL PERSONAL PROPERTY	MONTGOMERY MICHAEL D & SHAYLA M	312 SW GREENWICH DR
203262262	2012	INDIVIDUAL PERSONAL PROPERTY	BAKER DEDRA R	10339 E 61ST ST APT 4	203272207	2020-2021	INDIVIDUAL PERSONAL PROPERTY	JONES DAVID LEE JR	8704 TENNESSEE AVE
203262265	2020-2021	INDIVIDUAL PERSONAL PROPERTY	GRIFFIN STACEE RENEE	8504 SPRING VALLEY RD	203272238	2020-2021	INDIVIDUAL PERSONAL PROPERTY	WEST NICHOLAS L	11305 E 77TH ST
203262319	2010	INDIVIDUAL PERSONAL PROPERTY	SUADY GAIL	5245 HARDY CT	203272317	2011-2013	INDIVIDUAL PERSONAL PROPERTY	WILLIAMS DAINA M & CROSBY DIONNA L	9010 E 87TH ST APT C1
203262519	2010-2016	INDIVIDUAL PERSONAL PROPERTY	HULSHOF JOHN A JR	9609 E 82ND TER	203272423	2015-2017	INDIVIDUAL PERSONAL PROPERTY	HUGHLEY LYNTON L JR	8404 STARK AVE
203262524	2021	INDIVIDUAL PERSONAL PROPERTY	SIMS CHARLIE CURTIS	10327 E 61ST ST APT 4	203272506	2010	INDIVIDUAL PERSONAL PROPERTY	DUFFIELD ZETTIE M	9901 E 60TH ST
203262842	2018	INDIVIDUAL PERSONAL PROPERTY	PARVIN CRYSTAL D	6204 STERLING AVE	203272735	2020-2021	INDIVIDUAL PERSONAL PROPERTY	BRIGHT KAREE	8802 E 53RD TER
203262870	2021	INDIVIDUAL PERSONAL PROPERTY	LEHENY TREVOR SCOTT & DURON LEHENY FABIOLA BERENI	5923 HARRIS AVE	203272945	2010	INDIVIDUAL PERSONAL PROPERTY	DOUGLASS BRANDY	8494 LANE DR APT 2
203262884	2019	INDIVIDUAL PERSONAL PROPERTY	PRUITT KRISTALL L	8629 E UTOPIA PKWY APT 1	203272966	2011	INDIVIDUAL PERSONAL PROPERTY	MUSYOKI ALEX K	UNKNOW
203263064	2020-2021	INDIVIDUAL PERSONAL PROPERTY	HOLDER-PIGGIE TAMIKKA LASHON	9003 E 85TH ST	203272984	2021	INDIVIDUAL PERSONAL PROPERTY	HAMILTON JOSHUA LEE	7038 WOODSON RD
203263589	2010	INDIVIDUAL PERSONAL PROPERTY	APPLEBERRY JILLIAM M & APPLEBERRY RICHAR	6925 LAKESHORE DR	203272994	2011-2012	INDIVIDUAL PERSONAL PROPERTY	JONES TRACY J	8933 E 74TH ST
203263645	2020-2021	INDIVIDUAL PERSONAL PROPERTY	MORRIS LESTER L & PAMELA D	11405 E 62ND ST	203273006	2018-2020	INDIVIDUAL PERSONAL PROPERTY	FALCON JODIE L & MCKINNEY ALLEN L II	11500 E 58TH TER
203263842	2013-2016	INDIVIDUAL PERSONAL PROPERTY	TURLEY ROBERT J	6800 LANE AVE	203273058	2010-2012	INDIVIDUAL PERSONAL PROPERTY	KEATON KESHIA N	10921 E 53RD ST
203264095	2010	INDIVIDUAL PERSONAL PROPERTY	RAINS SHAWN M	5223 STERLING AVE	203273138	2021	INDIVIDUAL PERSONAL PROPERTY	KING KAMILAH	10318 E 63RD ST APT 4
203264142	2010-2012	INDIVIDUAL PERSONAL PROPERTY	HYATT ROHAN V	8325 HARVARD AVE	203273285	2021	INDIVIDUAL PERSONAL PROPERTY	SHEELEY JOSEPH LEE	821 SE 19TH ST
203264276	2010	INDIVIDUAL PERSONAL PROPERTY	THORP RYAN N	9107 E 68TH TER	203273758	2009-2010	INDIVIDUAL PERSONAL PROPERTY	LIMBAUGH ASHLIE	NO ADDRESS PROVIDED BY TAXPAYER
203264646	2010-2017	INDIVIDUAL PERSONAL PROPERTY	ARMSTRONG WILLIAM J	5813 RALSTON AVE	203273759	2018-2021	INDIVIDUAL PERSONAL PROPERTY	LOVELACE GARREN L JR	5321 KENTUCKY AVE
203264678	2011-2012	INDIVIDUAL PERSONAL PROPERTY	KEARNEY STACIE	8615 E 83RD TER	203273855	2020-2021	INDIVIDUAL PERSONAL PROPERTY	DAVENPORT KAYLA J	10309 E 63RD ST
203264808	2020-2021	INDIVIDUAL PERSONAL PROPERTY	HOTCHKISS DAVID T & AMBER B	7828 WESTRIDGE RD	203273935	2012	INDIVIDUAL PERSONAL PROPERTY	NATIONS PATRICIA A	8808 E 84TH ST
203265220	2010-2013	INDIVIDUAL PERSONAL PROPERTY	JOHNSON DEVIN T	9200 E 87TH ST	203274244	2012	INDIVIDUAL PERSONAL PROPERTY	WARREN SHAWN D & SALLY A	6002 KENTUCKY AVE
203265366	2021	INDIVIDUAL PERSONAL PROPERTY	COOPER GREGORY CARTER	7324 ASH AVE	203274247	2012	INDIVIDUAL PERSONAL PROPERTY	PAPIS EVA	6002 KENTUCKY AVE
203265769	2011-2017	INDIVIDUAL PERSONAL PROPERTY	STODDARD SEAN ANTHONY	8607 E 83RD ST	203274272	2014-2021	INDIVIDUAL PERSONAL PROPERTY	ALLEN DAWN RACHELLE	11100 E 63RD ST
203265829	2018	INDIVIDUAL PERSONAL PROPERTY	HALE EDWIN L JR	7401 MAPLE 64133 UNIT 309	203274276	2021	INDIVIDUAL PERSONAL PROPERTY	HOLGUIN MORALES HUGO	621 MYRTLE AVE
203265856	2009	INDIVIDUAL PERSONAL PROPERTY	HETZEL JASON A	11129 E 84TH TER	203274644	2020-2021	INDIVIDUAL PERSONAL PROPERTY	HINK RENEE J	8500 SPRING VALLEY RD
203265921	2014-2019	INDIVIDUAL PERSONAL PROPERTY	CARTER THOMAS W & CARTER JANE C	7813 CRESCENT AVE	203274648	2020-2021	INDIVIDUAL PERSONAL PROPERTY	LOVE TWDYELL D JR	5200 HARDY CT
203266075	2010-2011	INDIVIDUAL PERSONAL PROPERTY	BANKS RODNEY LEE	10401 E 83RD ST	203274664	2010-2017	INDIVIDUAL PERSONAL PROPERTY	HENRY JOHNATHEN G	8803 RICHARDS DR
203266078	2010	INDIVIDUAL PERSONAL PROPERTY	MARTIN LATONYA	8450 LANE DR	203274695	2021	INDIVIDUAL PERSONAL PROPERTY	LONG KERI ANN	7001 HAWTHORNE AVE
203266145	2016-2021	INDIVIDUAL PERSONAL PROPERTY	BANKS KRISTIN RENEE	717 NE TUDOR RD UNIT 9	203274744	2019	INDIVIDUAL PERSONAL PROPERTY	WILLIAMS LESLIE WALKER	8641 W UTOPIA DR APT 4
203266230	2021	INDIVIDUAL PERSONAL PROPERTY	MONTGOMERY CURTIS	7504 ELM ST	203274837	2016-2021	INDIVIDUAL PERSONAL PROPERTY	HARDIN JOHN WESLEY	9051 E 82ND ST
203266236	2021	INDIVIDUAL PERSONAL PROPERTY	LAMMING KODY	8509 BOOTH AVE	203275282	2010-2016	INDIVIDUAL PERSONAL PROPERTY	JONES VEVERLY ANN	8704 E 83RD TER
203266400	2010-2014	INDIVIDUAL PERSONAL PROPERTY	PALMER JERRY MACK JR	8305 STARK AVE	203275535	2021	INDIVIDUAL PERSONAL PROPERTY	UZUETA CAROL	5025 S MARION AVE
203266524	2014-2015	INDIVIDUAL PERSONAL PROPERTY	CAUGHRON DAVID E	8419 SPRING VALLEY RD	203275955	2013	INDIVIDUAL PERSONAL PROPERTY	MCCLEAN ALESHA	8407 SPRING VALLEY RD
203266584	2021	INDIVIDUAL PERSONAL PROPERTY	BICKHAM MICHELLE & TIMOTHY A	9508 E 68TH TER	203276249	2011	INDIVIDUAL PERSONAL PROPERTY	SHELBY DMONIKA M	10200 W 72ND ST
203266638	2021	INDIVIDUAL PERSONAL PROPERTY	WHITCOMB BARBARA A	5908 RAYTOWN RD	203276394	2013	INDIVIDUAL PERSONAL PROPERTY	ESTES CHARLENE & DIETZ BRIAN	9358 E 65TH ST
203266867	2021	INDIVIDUAL PERSONAL PROPERTY	MORGAN MARIA ANN	11827 E 83RD ST APT 101	203276777	2021	INDIVIDUAL PERSONAL PROPERTY	CAIN CHRISTOPHER MICHAEL	7711 RAYTOWN RD APT 32
203266901	2009-2011	INDIVIDUAL PERSONAL PROPERTY	TUCKER DAMON R	8317 NORTHERN ST	203276842	2013	INDIVIDUAL PERSONAL PROPERTY	WILSON KENSON	9820 E 60TH ST
203267015	2014	INDIVIDUAL PERSONAL PROPERTY	PORTER DEANNE NICOLE	8406 STERLING AVE	203276867	2016-2021	INDIVIDUAL PERSONAL PROPERTY	BOTTS JERRY R	8306 MANNING AVE
203267035	2010-2014	INDIVIDUAL PERSONAL PROPERTY	PALMER AUTUMN NICOLE	8305 STARK AVE	203277508	2015-2018	INDIVIDUAL PERSONAL PROPERTY	OLSEN JENNIFER ANNE	11216 E 59TH ST
203267050	2019-2020	INDIVIDUAL PERSONAL PROPERTY	TAYLOR DANIEL LEE	11201 E 59TH TER	203277552	2021	INDIVIDUAL PERSONAL PROPERTY	MORENO FERNANDO ANTONIO	5432 MAYWOOD AVE
203267395	2018-2021	INDIVIDUAL PERSONAL PROPERTY	DELUCA ANTHONY J	8606 MAPLE AVE	203277612	2021	INDIVIDUAL PERSONAL PROPERTY	COPELAND JONATHAN BRUCE	6717 ARLINGTON AVE
203267489	2021	INDIVIDUAL PERSONAL PROPERTY	FARR BRANDON R	9220 E 61ST ST	203277799	2016	INDIVIDUAL PERSONAL PROPERTY	KING DONALD EUGENE	7717 RAYTOWN RD APT 12
203267588	2015-2016	INDIVIDUAL PERSONAL PROPERTY	MCCOLLUM PATRICIA & BILLY	9803 E 61ST ST APT 5	203278002	2021	INDIVIDUAL PERSONAL PROPERTY	BAZZLE CANDACE A	6509 STERLING AVE
203267606	2021	INDIVIDUAL PERSONAL PROPERTY	BAYLON GUILLERMO	2533 BRIGHTON AVE	203278049	2021	INDIVIDUAL PERSONAL PROPERTY	TELFORD ROCHELLE D	7945 BLUE RIDGE BLVD
203268292	2010	INDIVIDUAL PERSONAL PROPERTY	JACKSON OLISHA R	9803 E 61ST ST APT 8	203278352	2010-2013	INDIVIDUAL PERSONAL PROPERTY	DUNN GERALD WESTLEY SR	11104 E 72ND ST
203268615	2012	INDIVIDUAL PERSONAL PROPERTY	HABERSAT PAULA	8201 SPRING VALLEY RD	203278822	2013-2016	INDIVIDUAL PERSONAL PROPERTY	MAZZA JOSHUA CONRAD	11400 E 58TH TER
203268661	2010-2013	INDIVIDUAL PERSONAL PROPERTY	APPLEBERRY JOHN J	11401 E 71ST ST	203278956	2009-2011	INDIVIDUAL PERSONAL PROPERTY	DYE CHRISTY K	8916 E 81ST ST

203279170	2010-2013	INDIVIDUAL PERSONAL PROPERTY	SALDIVAR DAVID P	10804 E 63RD ST	203288779	2010	INDIVIDUAL PERSONAL PROPERTY	CAREY CASSANDRA B	9605 E 69TH ST
203279664	2019-2021	INDIVIDUAL PERSONAL PROPERTY	ZOELLERS KRISTINA MARIE	11301 E 62ND ST	203288955	2017	INDIVIDUAL PERSONAL PROPERTY	PLATT MARK K	9308 E 85TH ST
203279804	2018-2021	INDIVIDUAL PERSONAL PROPERTY	MILLER ERICA & ERIC	10303 E 78TH ST	203289133	2019-2021	INDIVIDUAL PERSONAL PROPERTY	GREEN JOSEPH CHRISTOPHER	12912 MANCHESTER AVE
203280016	2011	INDIVIDUAL PERSONAL PROPERTY	LAMM JAMES K & GLENDA E	6013 STERLING AVE	203289234	2021	INDIVIDUAL PERSONAL PROPERTY	LOVE JOSEPH L	7304 WOODSON RD
203280226	2010-2013	INDIVIDUAL PERSONAL PROPERTY	MCPHERRIN CASEY B	8706 STARK AVE	203289396	2010-2017	INDIVIDUAL PERSONAL PROPERTY	HENRY JOHNATHEN	8803 RICHARDS DR
203280259	2013-2017	INDIVIDUAL PERSONAL PROPERTY	MANN LITICIA D	5353 BLUE RIDGE BLVD	203289425	2018	INDIVIDUAL PERSONAL PROPERTY	NAVE CHERYL K	8508 FORD AVE
203280621	2009	INDIVIDUAL PERSONAL PROPERTY	KAUMANS JOHN	8819 E 84TH TER	203289497	2021	INDIVIDUAL PERSONAL PROPERTY	YOUNG CAROLYN F	10104 E 67TH ST APT A
203280664	2016-2017	INDIVIDUAL PERSONAL PROPERTY	BYRAM JILL D	11825 E 83RD ST APT 201	203289660	2020-2021	INDIVIDUAL PERSONAL PROPERTY	HART ROCHELLE LASHAN	8512 JAMES A REED RD
203280673	2021	INDIVIDUAL PERSONAL PROPERTY	EDGERSON BRANDON B	6905 E 143RD ST	203289818	2021	INDIVIDUAL PERSONAL PROPERTY	HAWLEY JOSEPH P	7036 HUNTER ST
203280737	2020-2021	INDIVIDUAL PERSONAL PROPERTY	THOMPSON MONET CHERIE	8629 E UTOPIA PKWY APT 10	203289900	2010-2011	INDIVIDUAL PERSONAL PROPERTY	HARDEN CARRIE D	11801 E 76TH TER
203280754	2018-2021	INDIVIDUAL PERSONAL PROPERTY	SIMPKINS RENOIL III	8808 E 62ND ST	203289930	2021	INDIVIDUAL PERSONAL PROPERTY	TEN-HUE CHARLES MICHAEL	9022 E 87TH ST
203280772	2018	INDIVIDUAL PERSONAL PROPERTY	MCNUTT MELISSA M & MATTHEW	10110 E 69TH ST	203289990	2009-2017	INDIVIDUAL PERSONAL PROPERTY	STANFORD JEROME E	10007 E 60TH TER
203280847	2015-2021	INDIVIDUAL PERSONAL PROPERTY	VOGT SANDRA ELIZABETH (BANKSTON)	8809 E 62ND TER	203290142	2010-2017	INDIVIDUAL PERSONAL PROPERTY	MYERS SUSAN M	5506 WILLOW AVE
203280879	2021	INDIVIDUAL PERSONAL PROPERTY	ALONZO JULIA CATHERINE	9354 E 64TH ST	203290265	2021	INDIVIDUAL PERSONAL PROPERTY	MATHISON MARY JO	6009 ELM AVE
203280894	2015	INDIVIDUAL PERSONAL PROPERTY	MILES TALESHA T	7216 CRISP AVE	203290303	2021	INDIVIDUAL PERSONAL PROPERTY	TORRENCE LESLIE ANN	9208 E 54TH ST
203280922	2010-2013	INDIVIDUAL PERSONAL PROPERTY	YORK JABOIAK K	8424 MARSH AVE	203290418	2011	INDIVIDUAL PERSONAL PROPERTY	JOHNSON PRINCESS CABRINA	8505 JAMES A REED RD
203280935	2010	INDIVIDUAL PERSONAL PROPERTY	SHUMAKER JASON	9500 E 66TH TER	203290420	2017-2019	INDIVIDUAL PERSONAL PROPERTY	GRAHAM STEVEN R	8212 E 85TH TER
203281036	2015	INDIVIDUAL PERSONAL PROPERTY	BANAI NEJAD SAMERA	8926 ROSE LN	203290725	2019-2021	INDIVIDUAL PERSONAL PROPERTY	HIBDON NATHANIEL S	8055 JAMES A REED RD
203281286	2019	INDIVIDUAL PERSONAL PROPERTY	FAGGETT ROSHONDA ADRIENNE (MCCOWAN)	933 S KISNER DR	203290866	2010-2014	INDIVIDUAL PERSONAL PROPERTY	MAN MICHAEL A	9055 E 55TH ST
203281426	2011-2013	INDIVIDUAL PERSONAL PROPERTY	LAUDERDALE KENDRA	8907 E 67TH ST APT 118	203290884	2021	INDIVIDUAL PERSONAL PROPERTY	PHILLIPS CRAIG ALAN	10007 E 63RD ST
203281956	2010-2011	INDIVIDUAL PERSONAL PROPERTY	GONZALEZ CORONA SANDRA B	8717 E 61ST TER APT 11	203291028	2021	INDIVIDUAL PERSONAL PROPERTY	HUNT KATHRYN JAMESIAN	8302 HUNTER ST
203281962	2013	INDIVIDUAL PERSONAL PROPERTY	MORRIS JERRY L	8216 STERLING AVE	203291139	2021	INDIVIDUAL PERSONAL PROPERTY	VICK AMANDA MARIE	9204 E 53RD TER
203281993	2010-2017	INDIVIDUAL PERSONAL PROPERTY	JONES PHYLLIS K	11214 E 71ST DR	203291146	2021	INDIVIDUAL PERSONAL PROPERTY	JARVIS CARMELLA D	11100 E 53RD TER
203282026	2011-2013	INDIVIDUAL PERSONAL PROPERTY	MOLINA MECA CHATAMARIA	8143 DITZLER AVE	203291199	2012-2014	INDIVIDUAL PERSONAL PROPERTY	MCDONALD IASON D	8203 WILLOW WAY
203282105	2020-2021	INDIVIDUAL PERSONAL PROPERTY	GORDON BRYTTANI	8717 E 61ST TER APT 3	203291223	2010	INDIVIDUAL PERSONAL PROPERTY	RODRIGUEZ MARIA J	7804 E 87TH ST
203282130	2020-2021	INDIVIDUAL PERSONAL PROPERTY	ANDERS JAMES MARION	4712 APPLETON AVE	203291260	2021	INDIVIDUAL PERSONAL PROPERTY	DONOVAN NANCY E	6201 HARRIS AVE
203282171	2021	INDIVIDUAL PERSONAL PROPERTY	RAYBURN GARY LEE	9705 E 69TH ST	203291452	2021	INDIVIDUAL PERSONAL PROPERTY	THOMPSON JAMES E & QUEVETTA	6602 OXFORD AVE
203283034	2016-2021	INDIVIDUAL PERSONAL PROPERTY	MCBEE AUSTIN J	8410 BOOTH AVE	203291469	2021	INDIVIDUAL PERSONAL PROPERTY	EBERT BRITTANY	6625 ELM AVE
203283146	2020-2021	INDIVIDUAL PERSONAL PROPERTY	RIEGER CARL W	8402 DITMAN AVE	203291602	2015	INDIVIDUAL PERSONAL PROPERTY	MADGE PSHYRA	8711 E 83RD ST
203283320	2010-2013	INDIVIDUAL PERSONAL PROPERTY	FORRISTAL RONALD P	8919 E 57TH ST	203291737	2010-2014	INDIVIDUAL PERSONAL PROPERTY	GILES MELINDA S	5308 DITZLER AVE
203283333	2017-2018	INDIVIDUAL PERSONAL PROPERTY	NOWELL TANNER C	5612 STERLING AVE	203292749	2021	INDIVIDUAL PERSONAL PROPERTY	KNIGHT ASHLEY CHE'VAUGHN	11413 E 77TH ST
203283451	2010-2014	INDIVIDUAL PERSONAL PROPERTY	ELLIS BRITTANY SHANTEL	5730 MANNING AVE	203293158	2017	INDIVIDUAL PERSONAL PROPERTY	RICKS SIMON P III	7423 ASH AVE
203283535	2016-2018	INDIVIDUAL PERSONAL PROPERTY	FOLGER JINI K	7713 RAYTOWN RD APT 32	203293160	2021	INDIVIDUAL PERSONAL PROPERTY	TAYLOR REGINALD E	9070 STARK AVE
203283847	2016-2017	INDIVIDUAL PERSONAL PROPERTY	BAKER JESSICA NICOLE	6200 E 153RD ST APT B	203293300	2011-2012	INDIVIDUAL PERSONAL PROPERTY	SHRADER ANNA R	9056 E 66TH ST
203283870	2021	INDIVIDUAL PERSONAL PROPERTY	ALLEN LESTER E JR	8605 ARLINGTON AVE	203293541	2020	INDIVIDUAL PERSONAL PROPERTY	TAYLOR ALEA LORRAINE	9212 E 55TH ST
203283928	2019-2021	INDIVIDUAL PERSONAL PROPERTY	CANADAY DORIS	10100 E 83RD TER	203293981	2010-2016	INDIVIDUAL PERSONAL PROPERTY	RIGGS RONALD H	8600 FORD AVE
203283937	2019-2021	INDIVIDUAL PERSONAL PROPERTY	LINZY JEREMY	9221 E 54TH ST	203294092	2018-2021	INDIVIDUAL PERSONAL PROPERTY	LOONEY KERWIN C	9417 E 82ND ST
203284171	2012-2013	INDIVIDUAL PERSONAL PROPERTY	SHEAFER ASHLEY C	6201 WILLOW AVE	203294112	2010-2011	INDIVIDUAL PERSONAL PROPERTY	DELEON NICHOLAS M	8309 STARK AVE
203284346	2018-2021	INDIVIDUAL PERSONAL PROPERTY	TRAMMEL LASHANDA	5416 DITZLER AVE	203294207	2020	INDIVIDUAL PERSONAL PROPERTY	LUCAS CORY M	9805 E 67TH TER
203284369	2016-2017	INDIVIDUAL PERSONAL PROPERTY	CANNON-TOLLIVER MORGAN N	10015 E 74TH TER	203294577	2012	INDIVIDUAL PERSONAL PROPERTY	WALLER BRIAN D	6328 OVERTON AVE
203284411	2010-2012	INDIVIDUAL PERSONAL PROPERTY	JOHNSON ADRIANNE	8805 E 75TH ST	203294655	2010-2011	INDIVIDUAL PERSONAL PROPERTY	TURNER CARLA J	5314 DITZLER AVE
203284685	2018	INDIVIDUAL PERSONAL PROPERTY	GEBBEKEN DAIN Z & TERRIL BRANDY M	9410 E 80TH TER	203294780	2009-2010	INDIVIDUAL PERSONAL PROPERTY	CLARK (BADER) BETHENY L	6124 RALSTON AVE
203284804	2021	INDIVIDUAL PERSONAL PROPERTY	LARSON JESSICA L	5420 RALSTON AVE	203295349	2020	INDIVIDUAL PERSONAL PROPERTY	FARLEY EUGENE & PATRICIA A	8901 E 57TH ST
203284920	2009-2010	INDIVIDUAL PERSONAL PROPERTY	BENITEZ AUGOSTIN	8919 E 67TH ST APT 228	203295639	2007-2009	INDIVIDUAL PERSONAL PROPERTY	BURY ERIC	8933 GRAND AVE
203284984	2010	INDIVIDUAL PERSONAL PROPERTY	MASON ALEXIS M	9815 E 61ST ST APT 2	203295732	2020-2021	INDIVIDUAL PERSONAL PROPERTY	NETTERVILLE PORSHA NECHE'	11512 E 74TH STREET CT
203285032	2021	INDIVIDUAL PERSONAL PROPERTY	WARD ADAM R & KORTNEY K	8816 E 61ST ST	203295823	2014-2015	INDIVIDUAL PERSONAL PROPERTY	WARREN BRIAN S	11216 E 62ND ST
203285049	2010-2017	INDIVIDUAL PERSONAL PROPERTY	VALDEZ MERIS ANTONIA	9218 E 54TH TER	203296625	2015-2017	INDIVIDUAL PERSONAL PROPERTY	FREAR TRINA T	6333 BLUE RIDGE CUT OFF
203285346	2019-2021	INDIVIDUAL PERSONAL PROPERTY	GABRIEL CAMILLE MICHELLE	10109 E 71ST TER	203296684	2011	INDIVIDUAL PERSONAL PROPERTY	STOKES RACHEL	9813 E 73RD ST APT E
203285389	2021	INDIVIDUAL PERSONAL PROPERTY	TARTAGLIA JENNIFER J	6804 VERMONT AVE	203296800	2016-2017	INDIVIDUAL PERSONAL PROPERTY	TALBOTT EMILY RENEE	10613 E 70TH ST
203285461	2021	INDIVIDUAL PERSONAL PROPERTY	KURBISTA JULIA A	7009 BLUE RIDGE BLVD	203296825	2019-2021	INDIVIDUAL PERSONAL PROPERTY	PRESLEY ELIZABETH A	5317 WILLOW AVE
203285633	2019	INDIVIDUAL PERSONAL PROPERTY	VELEZ MEDELLIN PEDRO	5246 FOREST AVE	203296918	2009	INDIVIDUAL PERSONAL PROPERTY	WRIGHT JOE J	8400 DITMAN AVE
203286075	2019-2021	INDIVIDUAL PERSONAL PROPERTY	WHITE BRANDY N	7611 E 85TH ST	203296996	2015-2017	INDIVIDUAL PERSONAL PROPERTY	SALMEN COURTNEY M	7919 RAYTOWN RD
203286464	2013-2017	INDIVIDUAL PERSONAL PROPERTY	BARNES JESSE BRIAN	9036 E 85TH TER	203297027	2013-2014	INDIVIDUAL PERSONAL PROPERTY	MCINTYRE MAGEN FAITH A	8708 E 84TH ST
203286604	2021	INDIVIDUAL PERSONAL PROPERTY	WATKINS KIMBERLY ELIZABETH	5407 OXFORD AVE	203297036	2011-2015	INDIVIDUAL PERSONAL PROPERTY	BROWN JR BENJAMIN J	7823 WOODSON RD
203286898	2017	INDIVIDUAL PERSONAL PROPERTY	STANLEY TRACY MARIE	6610 WILLOW AVE	203297129	2021	INDIVIDUAL PERSONAL PROPERTY	STREET GREG DEAN II	10602 E 72ND ST
203287074	2014-2017	INDIVIDUAL PERSONAL PROPERTY	HYLTON KAMERON L	6821 CRISP AVE	203297591	2021	INDIVIDUAL PERSONAL PROPERTY	BURNETT DAJUAN DELVON DEWAYNE	8622 EVANSTON AVE
203287251	2019	INDIVIDUAL PERSONAL PROPERTY	BLANKSHIP JALITA M & MARCUS D	6547 RAYTOWN RD APT 4	203297756	2021	INDIVIDUAL PERSONAL PROPERTY	GLENN EDDIE J	6303 HARRIS AVE
203287308	2011-2015	INDIVIDUAL PERSONAL PROPERTY	GILPIN RICHARD	10324 E 63RD ST APT 3	203298046	2021	INDIVIDUAL PERSONAL PROPERTY	WALDON YOLANDA	7308 CRISP AVE
203287441	2019-2021	INDIVIDUAL PERSONAL PROPERTY	PAIGE VONDALE B	11408 E 62ND TER	203298113	2015-2016	INDIVIDUAL PERSONAL PROPERTY	RODRIGUEZ ELMER	5425 HEDGES AVE
203287756	2015	INDIVIDUAL PERSONAL PROPERTY	BARTON DOYLE E	5130 WOODSON RD	203298528	2011-2013	INDIVIDUAL PERSONAL PROPERTY	ALLEN COREY B	11400 E 65TH ST
203287797	2014	INDIVIDUAL PERSONAL PROPERTY	BRADBURY TREVORWAYNE W	8516 DITZLER AVE	203298828	2021	INDIVIDUAL PERSONAL PROPERTY	YOUNG CHRISTOPHER & KARIN	8415 MARSH AVE
203287971	2012-2016	INDIVIDUAL PERSONAL PROPERTY	MCCLENDON DANDRE	3021 MERSINGTON AVE	203299102	2021	INDIVIDUAL PERSONAL PROPERTY	BLANFORD JUSTIN L	6112 ELM AVE
203287973	2021	INDIVIDUAL PERSONAL PROPERTY	MARTIN ERIC LAMONT JR	7602 CRESCENT DR	203299732	2021	INDIVIDUAL PERSONAL PROPERTY	SLAUGHTER MONTELE & ABERNATHY CANDICE	8401 E 86TH TER
203287995	2021	INDIVIDUAL PERSONAL PROPERTY	RINEHART ZECHARIAH A	9051 E 52ND TER	203299826	2021	INDIVIDUAL PERSONAL PROPERTY	TONEY JENNY MAE	10013 E 81ST ST
203288183	2021	INDIVIDUAL PERSONAL PROPERTY	JOHNSON DARELLE ANTOINE	6332 STERLING AVE	203299872	2020-2021	INDIVIDUAL PERSONAL PROPERTY	OSBORNE NEIL	9115 E 72ND TER
203288200	2020-2021	INDIVIDUAL PERSONAL PROPERTY	ALEXANDER KESHAUN D	7110 WOODSON RD	203299986	2021	INDIVIDUAL PERSONAL PROPERTY	LEFEBURE JAMIE	9333 BALES DR APT 3109
203288404	2021	INDIVIDUAL PERSONAL PROPERTY	ALLEN JEANESE	11220 E 71ST DR	203300085	2013	INDIVIDUAL PERSONAL PROPERTY	MILLER MICHAEL CHADWICK	6225 RALSTON AVE
203288430	2021	INDIVIDUAL PERSONAL PROPERTY	MARTURELOS RODRIGUEZ YUDIESKY	11092 E 53RD TER	203300154	2021	INDIVIDUAL PERSONAL PROPERTY	THOMAS LEONARD N	5909 RAYTOWN RD
203288458	2010-2011	INDIVIDUAL PERSONAL PROPERTY	MORRISON JR FRANKLIN E	11521 E 74TH STREET CT	203300234	2010-2013	INDIVIDUAL PERSONAL PROPERTY	PAYTON DARIN SCOTT	7209 RAYTOWN RD APT D
203288485	2017-2021	INDIVIDUAL PERSONAL PROPERTY	PENA SANDRA MARIE	9012 E 73RD ST	203300312	2021	INDIVIDUAL PERSONAL PROPERTY	BASKIN ANTOINETTE	11008 E 81ST TER
203288593	2010-2012	INDIVIDUAL PERSONAL PROPERTY	LEHR KENDRA A	10318 E 63RD ST APT 4	203300468	2010-2011	INDIVIDUAL PERSONAL PROPERTY	LOWELL LAFAVE L JR	8412 STARK AVE
203288722	2016-2021	INDIVIDUAL PERSONAL PROPERTY	PARKS DOMINIQUE	8448 LANE DR	203300470	2017	INDIVIDUAL PERSONAL PROPERTY	BEAVER BARBARA A	

203300634	2014-2015	INDIVIDUAL PERSONAL PROPERTY	OLIVER TANISHA K	10811 E 58TH ST	203665343	2011-2016	INDIVIDUAL PERSONAL PROPERTY	BANCROFT DIANA	9401 E 63RD ST APT 101
203300794	2010-2012	INDIVIDUAL PERSONAL PROPERTY	NANCE JEFFREY E	8124 SPRING VALLEY RD	203665426	2017-2021	INDIVIDUAL PERSONAL PROPERTY	TAYLOR LUANN DESHAWNETTE	7415 ASH AVE
203301446	2021	INDIVIDUAL PERSONAL PROPERTY	McDANIEL VALERIE	8313 E 85TH TER	203665486	2021	INDIVIDUAL PERSONAL PROPERTY	ROBERTS REVA R	11730 E 83RD ST SPC A
203301466	2016-2019	INDIVIDUAL PERSONAL PROPERTY	NELSON DEWITT S	7216 RAYTOWN RD APT B	203665800	2016-2021	INDIVIDUAL PERSONAL PROPERTY	BEARD SARAH E	7512 WOODSON DR
203301809	2010-2012	INDIVIDUAL PERSONAL PROPERTY	OKAFOR IFEANYI	10204 E 69TH TER	203666051	2021	INDIVIDUAL PERSONAL PROPERTY	ROWE EVELYN RENEE	7300 HARDY AVE
203301810	2010-2011	INDIVIDUAL PERSONAL PROPERTY	COHEN BARRY ADAM	8903 E 67TH ST APT 217	203666060	2017	INDIVIDUAL PERSONAL PROPERTY	SMITH KENNON	7100 STERLING AVE
203301913	2021	INDIVIDUAL PERSONAL PROPERTY	WEDEL ZACHARY DOUGLAS	7309 STERLING AVE	203666251	2020-2021	INDIVIDUAL PERSONAL PROPERTY	COURTNEY POWELL LAKIA RENE	8326 OXFORD AVE
203302099	2010-2011	INDIVIDUAL PERSONAL PROPERTY	FRANKLIN TERRONE	8612 E UTOPIA DR APT 67	203666358	2011-2017	INDIVIDUAL PERSONAL PROPERTY	PORTER CHARLES E JR	5709 BLUE RIDGE CUT OFF
203302222	2010	INDIVIDUAL PERSONAL PROPERTY	GAU CURTIS	8844 E 83RD ST	203666388	2019-2021	INDIVIDUAL PERSONAL PROPERTY	LIBRERA TODRIA	8605 MAYWOOD AVE
203302329	2011-2017	INDIVIDUAL PERSONAL PROPERTY	LEE MICHAEL	6011 HUNTER ST	203666480	2020	INDIVIDUAL PERSONAL PROPERTY	ROBINSON MIA M	7813 E 86TH ST
203302546	2012	INDIVIDUAL PERSONAL PROPERTY	SCHWIETERMAN STEPHANIE J	10312 E 81ST ST	203666668	2011-2013	INDIVIDUAL PERSONAL PROPERTY	CLAY VARETHIA	6345 BLUE RIDGE BLVD
203302711	2011-2012	INDIVIDUAL PERSONAL PROPERTY	WRIGHT DENISE L	5240 DITZLER AVE	203666694	2016-2017	INDIVIDUAL PERSONAL PROPERTY	MILLER BRIAN RICHARD	9205 E 67TH TER
203302945	2011-2012	INDIVIDUAL PERSONAL PROPERTY	LEGG GARY R	8923 E 74TH ST	203666749	2021	INDIVIDUAL PERSONAL PROPERTY	LEGGS KEELA MARIE	9821 E 60TH ST
203303326	2021	INDIVIDUAL PERSONAL PROPERTY	BREWER STACY M	1019 SW LAKEVIEW BLVD	203666788	2012	INDIVIDUAL PERSONAL PROPERTY	POMPEY AMBER AMINA	9322 E 83RD ST
203303432	2017-2021	INDIVIDUAL PERSONAL PROPERTY	QUITMAN JEREMIAH	11108 E 78TH TER	203666981	2018-2021	INDIVIDUAL PERSONAL PROPERTY	MARSHALL JACQUE D	9024 E 85TH TER
203304096	2020-2021	INDIVIDUAL PERSONAL PROPERTY	CARRASQUILLO ALBERTO & GRACIELA	4611 S EASTLAND CENTER DR UNIT 611	203667541	2019-2021	INDIVIDUAL PERSONAL PROPERTY	SLAUGHTER BENJAMIN D	6011 HUNTER ST
203655233	2021	INDIVIDUAL PERSONAL PROPERTY	RODRIGUEZ DAVID T	8505 KENTUCKY AVE	203667613	2011	INDIVIDUAL PERSONAL PROPERTY	LANGSTON SABRINA	10201 E 69TH TER
203655300	2018	INDIVIDUAL PERSONAL PROPERTY	JABAGAT FERNANDO D & CRISTITA B	7905 HEDGES AVE	203667623	2016	INDIVIDUAL PERSONAL PROPERTY	PERCELL MELISSA K	8600 SPRING VALLEY RD
203655546	2020-2021	INDIVIDUAL PERSONAL PROPERTY	VEGA KELLY A	11400 E 78TH ST	203667628	2012-2017	INDIVIDUAL PERSONAL PROPERTY	GOLDEN ELIJAHUAN	9909 E 76TH TER
203655992	2019-2021	INDIVIDUAL PERSONAL PROPERTY	HUTTON NICHOLAS C	6029 LAUREL AVE	203668156	2012	INDIVIDUAL PERSONAL PROPERTY	JASPER STOCKMAN FERRAN	8656 E 53RD ST
203656024	2014-2015	INDIVIDUAL PERSONAL PROPERTY	MAYS RACHELLE MARIE	9007 E 53RD TER	203668158	2016-2018	INDIVIDUAL PERSONAL PROPERTY	JACKSON DANIELLE MARIE	9406 E 84TH TER
203656186	2016-2021	INDIVIDUAL PERSONAL PROPERTY	STEWART MARQUETTA B ERIC	7915 CRESCENT AVE	203668369	2021	INDIVIDUAL PERSONAL PROPERTY	GORDON EBONY LATRECE	8704 E 84TH ST
203656608	2011-2017	INDIVIDUAL PERSONAL PROPERTY	CAMPBELL EDWARD V	8809 E 84TH ST	203668379	2021	INDIVIDUAL PERSONAL PROPERTY	HOLLAND KECIA L (HARRISON)	11916 E 85TH ST
203656613	2015-2018	INDIVIDUAL PERSONAL PROPERTY	ANDERSON ANGELA M	8005 TENNESSEE AVE	203668957	2011-2014	INDIVIDUAL PERSONAL PROPERTY	PAYTON LATIQUE	8705 E 61ST TER APT 56
203656691	2021	INDIVIDUAL PERSONAL PROPERTY	NEWNUM KRISTIAN R	11115 E 75TH ST	203669279	2013	INDIVIDUAL PERSONAL PROPERTY	BESSARD HEATHER A	10321 E 61ST ST APT 1
203656795	2021	INDIVIDUAL PERSONAL PROPERTY	BROWN SIMONE A	7430 ENGLEWOOD LN	203669378	2014-2019	INDIVIDUAL PERSONAL PROPERTY	THOMAS META	15208 GRAND SUMMIT BLVD
203656956	2020-2021	INDIVIDUAL PERSONAL PROPERTY	GARTH JAYMIE	8741 CHESTNUT CIR APT 302	203669427	2021	INDIVIDUAL PERSONAL PROPERTY	BASKIN SHANQUALA	10137 E 80TH ST
203657140	2012	INDIVIDUAL PERSONAL PROPERTY	MENZE FELICIA M	11420 E 55TH TER	203669447	2021	INDIVIDUAL PERSONAL PROPERTY	BRALY EMILY SUE	5101 WOODSON RD
203657156	2018-2019	INDIVIDUAL PERSONAL PROPERTY	BOSTON BISHIBA T	6306 RALSTON AVE	203669587	2011-2014	INDIVIDUAL PERSONAL PROPERTY	JARVIS KORY	11100 E 75TH ST
203657341	2012-2014	INDIVIDUAL PERSONAL PROPERTY	ARMSTRONG WESLEY	6912 LAUREL AVE	203669605	2018	INDIVIDUAL PERSONAL PROPERTY	SINGLETON TERRY DIANE	5804 HEDGES AVE
203657427	2015-2021	INDIVIDUAL PERSONAL PROPERTY	COPPAGE TYRA	6204 CLAREMONT AVE	203669643	2020-2021	INDIVIDUAL PERSONAL PROPERTY	PETERSON TANISHA	7212 CEDAR AVE
203657637	2011	INDIVIDUAL PERSONAL PROPERTY	WOODS PENNY D	4545 COLONIAL TER	203669779	2021	INDIVIDUAL PERSONAL PROPERTY	SHELTON DIANNE L	8202 WOODSON DR
203657799	2021	INDIVIDUAL PERSONAL PROPERTY	JAMISON JESSICA EVE	9226 E 53RD TER	203670140	2014-2015	INDIVIDUAL PERSONAL PROPERTY	ALLEN SHAYLA R	6112 KENTUCKY AVE
203657847	2015-2021	INDIVIDUAL PERSONAL PROPERTY	JOHNSON LEOTIS JORDAN	8405 WOODSON DR	203670144	2018-2020	INDIVIDUAL PERSONAL PROPERTY	CAMPOS RAUL ENOC	8208 E 83RD TER
203658134	2010	INDIVIDUAL PERSONAL PROPERTY	ROBINSON EVA	5404 RAYTOWN RD	203670279	2010	INDIVIDUAL PERSONAL PROPERTY	OLEARY ERIC D	8717 E 61ST TER APT 20
203658136	2011	INDIVIDUAL PERSONAL PROPERTY	KINCEY JAMEY & SCHAEFER ANNIE	9811 E 61ST ST APT 12	203670529	2021	INDIVIDUAL PERSONAL PROPERTY	COBY RODRICK S	8504 PERSHING RD
203658142	2011-2012	INDIVIDUAL PERSONAL PROPERTY	DRAKE KENYA D	5813 FARLEY AVE	203670564	2017-2018	INDIVIDUAL PERSONAL PROPERTY	BAIRES YOHALMO ALFRED	8829 E 57TH ST
203658423	2018-2021	INDIVIDUAL PERSONAL PROPERTY	NELSON TREAWNA	10608 E 59TH ST	203670626	2012-2015	INDIVIDUAL PERSONAL PROPERTY	JOHNSON CHRISTY	5336 NORTHERN AVE
203658478	2011-2012	INDIVIDUAL PERSONAL PROPERTY	LEE JOSLYN NICOLE	8324 LAUREL AVE	203670680	2021	INDIVIDUAL PERSONAL PROPERTY	BANKS DIANE	5818 KENTUCKY AVE
203658513	2021	INDIVIDUAL PERSONAL PROPERTY	PRICE EBONY Y	9003 E 84TH ST	203670681	2019-2021	INDIVIDUAL PERSONAL PROPERTY	PINEDA KATHLEEN SUZANNE	10507 E 67TH ST
203659188	2021	INDIVIDUAL PERSONAL PROPERTY	ANDERSON DOMINIQUE	8622 E UTOPIA DR APT 7	203670798	2011	INDIVIDUAL PERSONAL PROPERTY	VALLANT TARON	9517 E 83RD ST
203659963	2020-2021	INDIVIDUAL PERSONAL PROPERTY	MATLOCK KEONNA	6001 BLUE RIDGE CUT OFF	203670823	2021	INDIVIDUAL PERSONAL PROPERTY	ELLIOTT BRITTANY R	8417 E 85TH ST
203660413	2017-2021	INDIVIDUAL PERSONAL PROPERTY	BROWN DONALD E	8819 E 80TH TER	203670908	2018	INDIVIDUAL PERSONAL PROPERTY	NORRIS NAKIWA M	8005 TENNESSEE AVE
203660658	2021	INDIVIDUAL PERSONAL PROPERTY	McCLAIN MYRON	10916 E 82ND ST	203671130	2017-2021	INDIVIDUAL PERSONAL PROPERTY	SALMOND MARQUES & SIMS STEFANIE	7616 ENGLEWOOD AVE
203660856	2014-2015	INDIVIDUAL PERSONAL PROPERTY	MARTIN ROBERT C	8811 E 71ST TER	203671344	2019-2021	INDIVIDUAL PERSONAL PROPERTY	ABDUL HAQQ WALI T	8701 E 87TH ST
203660898	2010	INDIVIDUAL PERSONAL PROPERTY	CHEVALIER ERICA (RUBY)	10710 E 65TH TER	203671409	2011-2013	INDIVIDUAL PERSONAL PROPERTY	WHITNEY BRIAN	8816 E 85TH ST
203660919	2012	INDIVIDUAL PERSONAL PROPERTY	SAULSBERRY KWAMAIN L	5747 RALSTON AVE	203671518	2015-2021	INDIVIDUAL PERSONAL PROPERTY	LOCKARD TERRANCE W	9108 VAUGHN AVE
203661068	2021	INDIVIDUAL PERSONAL PROPERTY	WYATT NICOLE MARIE	8412 FORD AVE	203671761	2019-2021	INDIVIDUAL PERSONAL PROPERTY	MOORE NIKKIALA Y	8613 E 84TH TER
203661967	2011	INDIVIDUAL PERSONAL PROPERTY	SHAW WILLIAM MICHAEL	8912 E 66TH ST	203671872	2011-2017	INDIVIDUAL PERSONAL PROPERTY	ALEXANDER MARK E	11810 E 85TH ST
203662467	2010-2017	INDIVIDUAL PERSONAL PROPERTY	TUCKER JOHNAH JORDAN	6209 MANNING AVE	203672238	2010	INDIVIDUAL PERSONAL PROPERTY	BETHA MARK ELLIOTT & NICOLE L	6101 KENTUCKY AVE
203662547	2011	INDIVIDUAL PERSONAL PROPERTY	HEIDEMAN ASHLEY M	6732 RAYTOWN RD	203672240	2011	INDIVIDUAL PERSONAL PROPERTY	WELLS SHERBI LYNN	5409 WILLOW AVE
203662709	2021	INDIVIDUAL PERSONAL PROPERTY	GRIFFIN LADONNA MARIE	8513 FORD AVE	203672258	2011-2017	INDIVIDUAL PERSONAL PROPERTY	FLUGER CAROLYN B	11313 E 62ND ST
203662725	2021	INDIVIDUAL PERSONAL PROPERTY	KING TAKELAH J	5918 LAUREL AVE	203672261	2021	INDIVIDUAL PERSONAL PROPERTY	RATHBONE CHRISTOPHER M	9313 E 69TH TER
203662965	2019-2021	INDIVIDUAL PERSONAL PROPERTY	JONES EBONY MONIQUE	8614 E 85TH ST	203672410	2019-2021	INDIVIDUAL PERSONAL PROPERTY	MICK JOSEPH B & STACEY HEDRICK	11709 E 78TH ST
203663166	2013	INDIVIDUAL PERSONAL PROPERTY	GREEN HAWAN T	5422 MARION AVE	203672505	2012	INDIVIDUAL PERSONAL PROPERTY	BELL RAYTMON DEONDR	705 PARK AVE UNIT F
203663608	2011	INDIVIDUAL PERSONAL PROPERTY	JACKSON TAESHA L	8602 BUCKINGHAM LN APT 19	203672735	2013	INDIVIDUAL PERSONAL PROPERTY	HUEBL JOSEPH & BUILT ESTELLE	7123 HARVARD AVE
203663686	2010-2014	INDIVIDUAL PERSONAL PROPERTY	GIVHAN JR REGINALD	5709 WOODSON RD	203672865	2021	INDIVIDUAL PERSONAL PROPERTY	ELLINGTON CURTISS L	8214 WOODSON DR
203663689	2017-2021	INDIVIDUAL PERSONAL PROPERTY	MC GEE TERRANCE L	8328 STERLING AVE	203672929	2011	INDIVIDUAL PERSONAL PROPERTY	BURNS JONATHAN M	8414 WOODSON CT
203663710	2012-2014	INDIVIDUAL PERSONAL PROPERTY	THOMAS SHANNON A	9112 E 84TH ST	203672940	2021	INDIVIDUAL PERSONAL PROPERTY	DILLARD CARTHESA	8509 FORD AVE
203663724	2013-2014	INDIVIDUAL PERSONAL PROPERTY	WILLIAMS JOSHUA & ERIC	10021 E 78TH ST	203673280	2016-2021	INDIVIDUAL PERSONAL PROPERTY	OSENTON CHARLES & MELISSA (BISHOP)	8402 E 86TH TER
203663814	2021	INDIVIDUAL PERSONAL PROPERTY	HAMMONDS PERRY	8509 BOOTH AVE	203673417	2010-2017	INDIVIDUAL PERSONAL PROPERTY	LANDRUM WAYNE M	8404 E 85TH TER
203663861	2020-2021	INDIVIDUAL PERSONAL PROPERTY	STARR NIKISHA MARIE (BUTLER)	7901 MANNING AVE	203673760	2020-2021	INDIVIDUAL PERSONAL PROPERTY	DAVIS PAMELA JANE	9106 E 72ND TER
203664062	2021	INDIVIDUAL PERSONAL PROPERTY	FARR ANDREA LEIGH (WILLIAMS)	8503 JAMES A REED RD	203673880	2021	INDIVIDUAL PERSONAL PROPERTY	BRYANT CHRISTA L (MOORE)	6904 CRISP AVE
203664110	2020-2021	INDIVIDUAL PERSONAL PROPERTY	LEWIS LATRISE Y	9813 E 60TH TER	203673889	2010-2014	INDIVIDUAL PERSONAL PROPERTY	RUNNELS MICHAEL R	8600 EVERETT ST
203664413	2012-2014	INDIVIDUAL PERSONAL PROPERTY	SCHMITT JACOB	7209 HARVARD AVE	203674031	2021	INDIVIDUAL PERSONAL PROPERTY	SCLAUGHTER CHRISTOPHER D	9704 E 85TH ST
203664517	2010	INDIVIDUAL PERSONAL PROPERTY	SIERRA NELLY	9214 E 54TH TER	203674341	2019-2021	INDIVIDUAL PERSONAL PROPERTY	MCCUISTON FRANK G III	1812 E 61ST ST APT 2
203664780	2010-2017	INDIVIDUAL PERSONAL PROPERTY	ROBERTS MELISSA L	5101 WOODSON RD	203674909	2015-2016	INDIVIDUAL PERSONAL PROPERTY	WILLIAMS SHERRIE A	8204 HARDY AVE
203664847	2014-2019	INDIVIDUAL PERSONAL PROPERTY	BOYD BRANDON	9317 E 83RD ST	203675236	2011-2015	INDIVIDUAL PERSONAL PROPERTY	FULLER BRENNIA J	9106 E 73RD ST
203664885	2010-2011	INDIVIDUAL PERSONAL PROPERTY	HENDERSON LONNIE L	8850 E 59TH TER	203675399	2021	INDIVIDUAL PERSONAL PROPERTY	HOWARD HEATHER L	11305 E 77TH ST
203665115	2021	INDIVIDUAL PERSONAL PROPERTY	DENEAU DAVID J JR & VERONICA J	9004 E 55TH ST	203675498	2012	INDIVIDUAL PERSONAL PROPERTY	MILLER GARY D	302 CONCORD CIR
203665202	2021	INDIVIDUAL PERSONAL PROPERTY	BAYLESS JOSHUA & EVANS DESTINY	1501 CYPRESS DR	203675506	2012	INDIVIDUAL PERSONAL PROPERTY	BARNES DOROTHY	9812 E 61ST ST APT 1
203665204	2020-2021	INDIVIDUAL PERSONAL PROPERTY	XIONG CHANCE BEE & KHOSHA KUE	8307 DITZLER AVE	203675695	2014-2015	INDIVIDUAL PERSONAL PROPERTY	HART JOSANDA	9404 E 81ST TER

203675780	2010-2013	INDIVIDUAL PERSONAL PROPERTY	MARTINETTE CAROLYN A	7815 WOODSON RD	203683950	2020-2021	INDIVIDUAL PERSONAL PROPERTY	HAMILTON DELAIAH	6048 LAUREL AVE
203675797	2011-2017	INDIVIDUAL PERSONAL PROPERTY	MCCLUNEY TORINO	11602 E 61ST ST	203684338	2018-2021	INDIVIDUAL PERSONAL PROPERTY	NOLEN MARK L JR	6409 HARRIS AVE
203675827	2011	INDIVIDUAL PERSONAL PROPERTY	RUANO,VINCENT P	8622 E UTOPIA DR APT 22	203684368	2020-2021	INDIVIDUAL PERSONAL PROPERTY	JONES EILEEN DELORIS	5148 WESTRIDGE CIR
203676206	2018-2021	INDIVIDUAL PERSONAL PROPERTY	PURNELL MIKAYLA	8929 E 58TH ST	203684556	2021	INDIVIDUAL PERSONAL PROPERTY	JACKSON MAURICE O	8600 MAYWOOD AVE
203676421	2020	INDIVIDUAL PERSONAL PROPERTY	VAN BUSKIRK TIMOTHY E	7812 WOODSON RD	203684916	2021	INDIVIDUAL PERSONAL PROPERTY	GORDON DONOVAN NATHANIEL	11804 E 76TH TER
203676439	2011-2017	INDIVIDUAL PERSONAL PROPERTY	MWANGI JENNIFER L	5520 STERLING AVE	203685219	2013-2017	INDIVIDUAL PERSONAL PROPERTY	CLARK KEITH T	9611 E 66TH ST
203676479	2020-2021	INDIVIDUAL PERSONAL PROPERTY	SHUAIB WILLIAM ALVIN	5417 STERLING AVE	203685504	2019-2021	INDIVIDUAL PERSONAL PROPERTY	ADDISON SHARON	8621 W UTOPIA DR APT 13
203676502	2011-2013	INDIVIDUAL PERSONAL PROPERTY	BROOKS CLARISSA	6829 WILDWOOD DR	203685819	2011	INDIVIDUAL PERSONAL PROPERTY	JACKSON AMALIKA TAHIRIH	6302 RALSTON AVE
203676508	2010-2017	INDIVIDUAL PERSONAL PROPERTY	ASHBY DELLA J	8514 CRESCENT AVE	203685862	2015-2017	INDIVIDUAL PERSONAL PROPERTY	ELLIS MARY & HAYNES MARK	8626 E 84TH ST
203676565	2016-2021	INDIVIDUAL PERSONAL PROPERTY	WILSON SHELLEY R	8515 WESTRIDGE RD	203686054	2011-2013	INDIVIDUAL PERSONAL PROPERTY	NYQUIST KALEE	9020 E 74TH TER
203676737	2011-2014	INDIVIDUAL PERSONAL PROPERTY	CASSIDY MEGAN	9100 RICHARDS DR	203686077	2013-2014	INDIVIDUAL PERSONAL PROPERTY	DAVIS VERNON L JR	9355 E 60TH TER
203676761	2020-2021	INDIVIDUAL PERSONAL PROPERTY	KRUEGER ROBERT	8500 E 87TH ST	203686242	2017-2018	INDIVIDUAL PERSONAL PROPERTY	GIBBINS MARK A	10520 E 60TH TER
203676815	2011	INDIVIDUAL PERSONAL PROPERTY	MOUNGED SEFEDDINE	5301 RALSTON AVE	203686508	2021	INDIVIDUAL PERSONAL PROPERTY	BANNISTER ROBERT JACOB	7713 RAYTOWN RD APT 32
203677264	2011-2012	INDIVIDUAL PERSONAL PROPERTY	ALLEN LEMARIO D	8605 ARLINGTON AVE	203686643	2015	INDIVIDUAL PERSONAL PROPERTY	TEMPLETON DELISA & RONALD	9800 E 61ST ST APT 1
203677285	2011-2013	INDIVIDUAL PERSONAL PROPERTY	WILSON JR ARCHIE L	8713 E 85TH ST	203686659	2015-2016	INDIVIDUAL PERSONAL PROPERTY	BLAIR ELIZABETH	7412 E 52ND TER
203677450	2011-2012	INDIVIDUAL PERSONAL PROPERTY	BARRY THOMAS ET	7424 WILLOW ST	203686762	2020-2021	INDIVIDUAL PERSONAL PROPERTY	MIGGS TRAVIS	5900 HEDGES AVE
203677564	2010	INDIVIDUAL PERSONAL PROPERTY	MOLINA ANDREW	8114 MANNING AVE	203686770	2013	INDIVIDUAL PERSONAL PROPERTY	BOWMAN LINDA S	8618 E UTOPIA DR APT 53
203677683	2013	INDIVIDUAL PERSONAL PROPERTY	DAVIS LONNIE EDWARD II	8500 PERSHING RD	203686893	2021	INDIVIDUAL PERSONAL PROPERTY	FUNDERBURK JANELLE	7312 ASH AVE
203677734	2009-2010	INDIVIDUAL PERSONAL PROPERTY	SHACKLEFORD MICHELLE E	10008 E 83RD ST	203686916	2014	INDIVIDUAL PERSONAL PROPERTY	SPARKMAN JERALD	10109 E 70TH TER
203677982	2011	INDIVIDUAL PERSONAL PROPERTY	CLAY DEETA & WILLIAM	6201 HARRIS AVE	203687060	2021	INDIVIDUAL PERSONAL PROPERTY	ADAMS ALVESTER II	8406 FORD AVE
203678111	2012-2013	INDIVIDUAL PERSONAL PROPERTY	BUSSEY BENJAMIN	8623 E 61ST TER APT 67	203687251	2021	INDIVIDUAL PERSONAL PROPERTY	JOHNSON THOMAS J & FOSTER ABBY A	8803 E 72ND ST
203678637	2011-2012	INDIVIDUAL PERSONAL PROPERTY	COLLINS KIMBERLY S	9362 E 64TH ST	203687321	2021	INDIVIDUAL PERSONAL PROPERTY	GADDY LORRI SUZANNE	10500 E 87TH ST
203678656	2021	INDIVIDUAL PERSONAL PROPERTY	GOKE CHRISTOPHER J & AMANDA L	8320 HARRIS AVE	203687632	2009-2013	INDIVIDUAL PERSONAL PROPERTY	SIMONS MICHAEL J	9008 E 75TH ST
203678817	2011-2013	INDIVIDUAL PERSONAL PROPERTY	PATTERSON AMAJ	11400 E 58TH TER	203687649	2015-2021	INDIVIDUAL PERSONAL PROPERTY	HARDING JAMES R	8413 HARRIS AVE
203679098	2017-2019	INDIVIDUAL PERSONAL PROPERTY	BUTLER CRYSTAL L	9800 E 57TH TER	203687717	2021	INDIVIDUAL PERSONAL PROPERTY	CHRISMAN ARIEL M	5418 DITZLER AVE
203679204	2012	INDIVIDUAL PERSONAL PROPERTY	MOORE CHANIECE ROSHA	10321 E 61ST ST APT 2	203687831	2011-2017	INDIVIDUAL PERSONAL PROPERTY	SANDERS VIRGINIA & WALLACE ALLISON R	10000 E 77TH TER
203679248	2012-2015	INDIVIDUAL PERSONAL PROPERTY	WOODBURY RYANN	9708 E 75TH ST	203687963	2020-2021	INDIVIDUAL PERSONAL PROPERTY	BRAY CAMERON ARVELL	9300 E 82ND TER
203679361	2021	INDIVIDUAL PERSONAL PROPERTY	HENRY MICKEY	9900 E 71ST TER	203688077	2011	INDIVIDUAL PERSONAL PROPERTY	IVORY MARCUS J	9014 E 73RD ST
203679483	2021	INDIVIDUAL PERSONAL PROPERTY	CLIFFORD ARTHUR MORTON	10616 E 56TH TER	203688359	2014	INDIVIDUAL PERSONAL PROPERTY	HOPKINS VICTORIA	9406 E 82ND ST
203679570	2021	INDIVIDUAL PERSONAL PROPERTY	HIGGARD TIMOTHY D	8814 E 80TH TER	203688370	2010-2012	INDIVIDUAL PERSONAL PROPERTY	RUSSELL MANESS	6019 KENTUCKY AVE
203679696	2018	INDIVIDUAL PERSONAL PROPERTY	FICKLEN TONJA SAMONE	12506 E 46TH PL S	203689062	2015-2016	INDIVIDUAL PERSONAL PROPERTY	WASHINGTON NINA	6900 PERSHING RD
203679862	2021	INDIVIDUAL PERSONAL PROPERTY	HAMILTON HAKIM	6312 STERLING AVE	203689123	2018-2019	INDIVIDUAL PERSONAL PROPERTY	SILAS RODNIKIA J & TEMPLE DORRICE S	8812 E 84TH TER
203679967	2019-2021	INDIVIDUAL PERSONAL PROPERTY	WESTON TIMOTHY	9512 E 69TH TER	203689175	2010-2017	INDIVIDUAL PERSONAL PROPERTY	HERNANDEZ JOSE A	9112 E 61ST ST
203680086	2011	INDIVIDUAL PERSONAL PROPERTY	HURT KENNETH MICHAEL	5528 LANE AVE	203689178	2011-2012	INDIVIDUAL PERSONAL PROPERTY	BRIGGS LARON D	8605 ELM AVE
203680283	2017-2019	INDIVIDUAL PERSONAL PROPERTY	WESLEY TIAUNDRAL LEATRICE	9130 E 85TH ST	203689207	2021	INDIVIDUAL PERSONAL PROPERTY	LEWIS RESHENA LASHEA	6600 E 135TH ST
203680350	2021	INDIVIDUAL PERSONAL PROPERTY	IVY NECHELLE NICOLE	619 NE LYNN ST UNIT B	203689295	2019	INDIVIDUAL PERSONAL PROPERTY	BUSBY JESSICA RENEE	6117 DITZLER AVE
203680397	2011-2017	INDIVIDUAL PERSONAL PROPERTY	TREJOS BELLA S	5724 ELM AVE	203689537	2019-2021	INDIVIDUAL PERSONAL PROPERTY	ELLIOTT BRITTNEY CIARRA LYNN	11315 COLORADO AVE UNIT 345
203680535	2021	INDIVIDUAL PERSONAL PROPERTY	ROSS ROBERT & DIANA	10601 E 79TH TER	203689541	2011-2017	INDIVIDUAL PERSONAL PROPERTY	STREET EMMA	7909 HEDGES AVE
203680556	2020-2021	INDIVIDUAL PERSONAL PROPERTY	RESSEGUE MICHAEL & EMILY	9317 E 68TH TER	203689717	2012	INDIVIDUAL PERSONAL PROPERTY	DESANTO KELSEY	8909 E 73RD ST
203680623	2011-2013	INDIVIDUAL PERSONAL PROPERTY	CARPENTER COURTNEY H	6803 LAKESHORE DR	203690025	2012-2017	INDIVIDUAL PERSONAL PROPERTY	HONEYCUTT DAVID W	7300 APPLETON AVE
203680646	2011	INDIVIDUAL PERSONAL PROPERTY	DENNETT EMILY L	8400 STARK AVE	203690109	2011-2013	INDIVIDUAL PERSONAL PROPERTY	PHILLIPS MAXFIELD	9800 E 79TH TER
203680685	2021	INDIVIDUAL PERSONAL PROPERTY	MITTS ORVILLE L	6118 BLUE RIDGE CUT OFF	203690635	2014-2019	INDIVIDUAL PERSONAL PROPERTY	LUTHER KAITLYN M & PATRICIA M	9101 E 64TH TER
203681126	2016-2019	INDIVIDUAL PERSONAL PROPERTY	EASLEY MARENDA	10201 E 70TH TER	203690673	2021	INDIVIDUAL PERSONAL PROPERTY	WILLIS JAYMIE J	8707 E 83RD ST
203681195	2012-2014	INDIVIDUAL PERSONAL PROPERTY	ISAIAH DEWAYNE II	8610 LANE AVE	203690763	2012-2013	INDIVIDUAL PERSONAL PROPERTY	TANNER RAY A	8808 E 85TH TER
203681397	2018	INDIVIDUAL PERSONAL PROPERTY	LOBDELL GREGORY & CHRISTINA	7800 WESTRIDGE RD	203691017	2011-2014	INDIVIDUAL PERSONAL PROPERTY	CONWAY DONNIE	11904 E 78TH TER
203681449	2020-2021	INDIVIDUAL PERSONAL PROPERTY	GARDNER BREANNA C	11412 E 77TH ST	203691161	2010	INDIVIDUAL PERSONAL PROPERTY	BYERS JERRY RAY JR	5720 BLUE RIDGE BLVD
203681532	2011-2013	INDIVIDUAL PERSONAL PROPERTY	BATTON SHANIC	8113 WOODSON DR	203691632	2010	INDIVIDUAL PERSONAL PROPERTY	HOERL BRENT DAVID	11008 E 72ND ST
203681669	2017	INDIVIDUAL PERSONAL PROPERTY	ALZATE MELCHIZEDEK	8816 E 81ST ST	203691710	2012	INDIVIDUAL PERSONAL PROPERTY	KENDRICK JIMMY D II	8627 E 80TH TER
203681696	2021	INDIVIDUAL PERSONAL PROPERTY	SANCHEZ MORI MELISSA ANNETTE	6310 RAYTOWN RD	203691792	2011-2012	INDIVIDUAL PERSONAL PROPERTY	IRONS CAROL	12200 E 62ND TER
203681729	2013	INDIVIDUAL PERSONAL PROPERTY	TAYLOR BRITTANY L	8621 W UTOPIA DR APT 4	203691797	2021	INDIVIDUAL PERSONAL PROPERTY	RAY VICIE	10708 E 84TH ST
203681760	2015-2020	INDIVIDUAL PERSONAL PROPERTY	RHONE JARESHA	7207 MAYWOOD AVE	203691974	2021	INDIVIDUAL PERSONAL PROPERTY	REYES JOHN JOE P	5100 E 83RD ST
203681824	2011	INDIVIDUAL PERSONAL PROPERTY	THOMPSON TERRANCE	7422 OVERTON AVE UNIT 6	203692031	2011	INDIVIDUAL PERSONAL PROPERTY	CARTER EDWINA	8923 E 56TH TER
203682025	2013-2015	INDIVIDUAL PERSONAL PROPERTY	DAVIS LASHEILA L	7412 HARDY AVE	203692073	2017	INDIVIDUAL PERSONAL PROPERTY	MCCLINTON QADEERA	6222 RAYTOWN FWY
203682132	2014-2015	INDIVIDUAL PERSONAL PROPERTY	ZELSNICK FRANK	5521 HEDGES AVE	203692138	2021	INDIVIDUAL PERSONAL PROPERTY	DREHER BRANDEN LEWIS	16400 E COGAN DR
203682178	2016-2020	INDIVIDUAL PERSONAL PROPERTY	BARRETT FRANKLIN MONTEZ	6217 CLAREMONT AVE	203692352	2021	INDIVIDUAL PERSONAL PROPERTY	KING DELIA M	7905 E 87TH ST
203682211	2017-2021	INDIVIDUAL PERSONAL PROPERTY	FLORES JOSEPH NOEL	8521 BLUE RIDGE BLVD	203692356	2015	INDIVIDUAL PERSONAL PROPERTY	SANDERS DY ESHA	7148 CRISP AVE
203682393	2015-2016	INDIVIDUAL PERSONAL PROPERTY	HERNANDEZ BEATRIZ PENA	NO ADDRESS ASSIGNED BY CITY	203692490	2011-2012	INDIVIDUAL PERSONAL PROPERTY	HUTCHINSON DAVID W	8854 E 59TH TER
203682410	2019-2021	INDIVIDUAL PERSONAL PROPERTY	HICKS DONALD F	9801 E 81ST TER	203692515	2011-2012	INDIVIDUAL PERSONAL PROPERTY	TAYLOR NATHAN E JR	6309 E 109TH TER
203682553	2021	INDIVIDUAL PERSONAL PROPERTY	RAY SHAUN E & MARIAH K	1914 N YORK RD	203692578	2021	INDIVIDUAL PERSONAL PROPERTY	REX ERIC D	7408 ELM ST
203682575	2017-2021	INDIVIDUAL PERSONAL PROPERTY	GREEN JERRY L	9200 E 67TH TER	203692751	2012	INDIVIDUAL PERSONAL PROPERTY	JOHNSON YVONNE MARIE	11827 E 83RD ST APT 102
203682748	2021	INDIVIDUAL PERSONAL PROPERTY	DAY JOEL F	6314 RALSTON AVE	203692773	2011-2012	INDIVIDUAL PERSONAL PROPERTY	BROWNING BRYAN T	11105 E 72ND TER
203682839	2013	INDIVIDUAL PERSONAL PROPERTY	PETWAY JESSE D	9709 E 81ST ST	203693054	2021	INDIVIDUAL PERSONAL PROPERTY	HALL LISA	9621 HOWARD RD
203682889	2021	INDIVIDUAL PERSONAL PROPERTY	SAMPSON NEIA S	9900 E HEDGES BLVD	203693088	2011-2017	INDIVIDUAL PERSONAL PROPERTY	MANN ALISA	6401 HEDGES AVE
203682900	2018-2020	INDIVIDUAL PERSONAL PROPERTY	MCDANIEL ALISHA & PATRICIA	8317 HEDGES AVE	203693623	2020-2021	INDIVIDUAL PERSONAL PROPERTY	CARTAGENA WILFREDO	6002 MANNING AVE
203683183	2020-2021	INDIVIDUAL PERSONAL PROPERTY	CURIEL-RODRIGUEZ PATRICIA	10604 E 80TH ST	203693833	2011-2012	INDIVIDUAL PERSONAL PROPERTY	IRONS JR STEPHAN G	9813 E 73RD ST APT F
203683260	2015-2019	INDIVIDUAL PERSONAL PROPERTY	GARLINGTON MICHAEL A	9612 E 86TH TER	203693905	2015-2017	INDIVIDUAL PERSONAL PROPERTY	BROWN TEQUILA	9900 E 61ST ST
203683349	2021	INDIVIDUAL PERSONAL PROPERTY	BRIGHT BRIANA L	8701 E 83RD TER	203694155	2011	INDIVIDUAL PERSONAL PROPERTY	BROWN ASHLEY M	9619 E 65TH TER
203683464	2018	INDIVIDUAL PERSONAL PROPERTY	JACKSON JOVOAN MICHELLE	8808 E 86TH ST	203694178	2011	INDIVIDUAL PERSONAL PROPERTY	FRANKLIN KIMBERLY L	6510 OVERTON AVE
203683634	2021	INDIVIDUAL PERSONAL PROPERTY	MCLURG ANGEL	8201 BLUE RIDGE BLVD	203694405	2018-2019	INDIVIDUAL PERSONAL PROPERTY	KABINGA GEORGE N	9416 E 84TH TER
203683823	2011	INDIVIDUAL PERSONAL PROPERTY	DICKERSON SHEILA	9206 VAUGHN AVE	203694484	2014-2021	INDIVIDUAL PERSONAL PROPERTY	BIELSKI KATHERINE J	7705 ELM ST
203683876	2009-2010	INDIVIDUAL PERSONAL PROPERTY	ENGLISH TED D	9363 E 64TH ST	203694550	2020	INDIVIDUAL PERSONAL PROPERTY	LOPEZ KATIE M	10500 E 69TH TER
203683909	2019-2021	INDIVIDUAL PERSONAL PROPERTY	CLARK KRISTIE D	9201 E 67TH TER	203694647	2013-2015	INDIVIDUAL PERSONAL PROPERTY	RAMEY KRISTINE LEE	8604 SPRING VALLEY RD

203709482	2015-2016	INDIVIDUAL PERSONAL PROPERTY	CAMPBELL KEVIN C	7207 MAYWOOD AVE	203719329	2011-2017	INDIVIDUAL PERSONAL PROPERTY	JACKSON KAMESHA	11019 E 72ND TER
203709699	2010	INDIVIDUAL PERSONAL PROPERTY	WEST BRIAN & CHERYL	6208 WILLOW AVE	203719379	2013-2017	INDIVIDUAL PERSONAL PROPERTY	HUFFMAN COURTNEY J	9309 E 82ND ST
203709765	2011	INDIVIDUAL PERSONAL PROPERTY	PITTMAN DAVID L	5528 LANE AVE	204077247	2008-2011	INDIVIDUAL PERSONAL PROPERTY	CUNNETUBBY AMANDA L	8614 E UTOPIA DR APT 75
203709794	2011	INDIVIDUAL PERSONAL PROPERTY	GROOMS STEWART	9001 E 85TH TER	204077335	2012-2013	INDIVIDUAL PERSONAL PROPERTY	ENYART JACOB	11605 E 61ST ST
203709964	2012-2017	INDIVIDUAL PERSONAL PROPERTY	DAVIS RUSSELL E	8513 OXFORD AVE	204077360	2011	INDIVIDUAL PERSONAL PROPERTY	WILLIAMS ANGEL N (ROBINSON)	9104 RICHARDS DR
203710433	2019-2021	INDIVIDUAL PERSONAL PROPERTY	HOFFMAN MICHAEL RYAN	9005 E 67TH TER	204077549	2012	INDIVIDUAL PERSONAL PROPERTY	VAZQUEZ DAVID MARTIN	8632 E 84TH ST
203710665	2019-2020	INDIVIDUAL PERSONAL PROPERTY	MILLER STEVEN R	5408 BLUE RIDGE BLVD	204077749	2019	INDIVIDUAL PERSONAL PROPERTY	NEVIUS AMANDA	8801 RICHARDS DR
203711179	2011	INDIVIDUAL PERSONAL PROPERTY	WRIGHT MATTHEW E	9424 E 64TH ST	204077800	2011	INDIVIDUAL PERSONAL PROPERTY	DAVIS TYCHELL JANAY	2615 E 22ND ST
203711370	2021	INDIVIDUAL PERSONAL PROPERTY	HANNA CARLA L	5440 BLUE RIDGE CUT OFF APT 706	204077839	2014-2016	INDIVIDUAL PERSONAL PROPERTY	MCCULLOUTH CHARLES ALBERT JR	11316 E 62ND ST
203711406	2011-2017	INDIVIDUAL PERSONAL PROPERTY	KOLBE JAMIE J	5618 HARVARD AVE	204078003	2021	INDIVIDUAL PERSONAL PROPERTY	PARKER RAYMOND LOUIS & JERROLYN KAY	6140 RAYTOWN RD APT 902
203711515	2020-2021	INDIVIDUAL PERSONAL PROPERTY	STILL JAHLEEL	7301 HEDGES AVE	204078290	2014-2015	INDIVIDUAL PERSONAL PROPERTY	CHAFFIN LEE S	9410 E 81ST ST
203711563	2018-2021	INDIVIDUAL PERSONAL PROPERTY	MCCLUNG BRETT	6001 NORTHERN AVE	204078302	2011	INDIVIDUAL PERSONAL PROPERTY	VILLEDA BRENDA OLIVIA	6329 ASH AVE
203711675	2013	INDIVIDUAL PERSONAL PROPERTY	TURNER ELLEN M	7405 ASH AVE	204078526	2021	INDIVIDUAL PERSONAL PROPERTY	NEAL SHAWN	10405 E 82ND TER
203711691	2020-2021	INDIVIDUAL PERSONAL PROPERTY	AIRIHOUDION EMMANUEL	8629 E UTOPIA PKWY APT 11	204078600	2020	INDIVIDUAL PERSONAL PROPERTY	GREEN STAN & BARBARA	609 SW GENTRY LN
203711704	2018-2021	INDIVIDUAL PERSONAL PROPERTY	SOWLE ELIZABETH A	9205 E 84TH CT	204078666	2021	INDIVIDUAL PERSONAL PROPERTY	GREEN IFETAYO T	7400 HARRIS AVE
203711951	2021	INDIVIDUAL PERSONAL PROPERTY	FREEMAN MICHAEL L	10300 E 81ST ST	204078748	2021	INDIVIDUAL PERSONAL PROPERTY	NEWTON LAKESHIA	8602 STARX AVE
203712176	2013	INDIVIDUAL PERSONAL PROPERTY	BAILEY TAMIKA L	8620 E 87TH ST	204078855	2020-2021	INDIVIDUAL PERSONAL PROPERTY	CUBLEY JONTY K	10328 E 53RD ST APT 4
203712196	2021	INDIVIDUAL PERSONAL PROPERTY	SPAULDING COREY ALAN	11017 E 56TH TER	204078952	2014-2021	INDIVIDUAL PERSONAL PROPERTY	SIEBERT CHRYSYLL M	9310 E 79TH ST
203712230	2021	INDIVIDUAL PERSONAL PROPERTY	ECKFORD JEFFREY ALAN	7201 OXFORD AVE	204078999	2020-2021	INDIVIDUAL PERSONAL PROPERTY	PRICE KIRTISHA LANEE	9706 E 75TH ST
203712266	2012-2013	INDIVIDUAL PERSONAL PROPERTY	PEDARITHANGAL SABARI K	9104 E 73RD ST	204079009	2021	INDIVIDUAL PERSONAL PROPERTY	JAMISON MIA MICHELLE	9018 E 85TH ST
203712303	2011-2017	INDIVIDUAL PERSONAL PROPERTY	RAINS RICHARD DEAN	11044 E 54TH ST	204079011	2011-2013	INDIVIDUAL PERSONAL PROPERTY	GOLDMAN MARY	7022 WOODSON RD
203712307	2017	INDIVIDUAL PERSONAL PROPERTY	HATHAWAY SUSAN	11900 E 76TH TER	204079267	2020-2021	INDIVIDUAL PERSONAL PROPERTY	MARTIN VELDA	8038 E 87TH ST
203712401	2011	INDIVIDUAL PERSONAL PROPERTY	VICK JAMES DEAN	9010 E 87TH ST APT C5	204079314	2013-2017	INDIVIDUAL PERSONAL PROPERTY	HUFFMAN FRANK E	9509 E 66TH ST
203712548	2019-2021	INDIVIDUAL PERSONAL PROPERTY	PURNELL CHAVONNE	9021 E 85TH ST	204079330	2014	INDIVIDUAL PERSONAL PROPERTY	BECKER HEATHER	7021 HUNTER ST
203712978	2011-2012	INDIVIDUAL PERSONAL PROPERTY	JONES COREY	8301 ELM AVE	204079433	2018-2021	INDIVIDUAL PERSONAL PROPERTY	RHODES LESLIE & PATRICIA	8427 ARLINGTON AVE
203713070	2020-2021	INDIVIDUAL PERSONAL PROPERTY	BRADLEY BREANNA	10121 E 67TH ST	204079501	2015	INDIVIDUAL PERSONAL PROPERTY	ACCIOLY DANIELA	11708 E 86TH TER
203713281	2019-2021	INDIVIDUAL PERSONAL PROPERTY	QUICK TIA	9344 E 55TH ST	204079952	2011	INDIVIDUAL PERSONAL PROPERTY	LUO XI	9819 E 61ST ST APT 8
203713418	2011	INDIVIDUAL PERSONAL PROPERTY	JONES RENEE DIANE	10119 E 67TH ST	204080338	2021	INDIVIDUAL PERSONAL PROPERTY	BAKER KEISA	7716 ARLINGTON AVE
203713441	2021	INDIVIDUAL PERSONAL PROPERTY	HILL MELINDA ROCHELLE	1712 MISSOURI AVE	204080391	2021	INDIVIDUAL PERSONAL PROPERTY	HARRIS TYRONE	6201 E 154TH TER APT A
203713854	2011-2016	INDIVIDUAL PERSONAL PROPERTY	PALMER WILLIAM C	8312 JAMES A REED RD	204080527	2015	INDIVIDUAL PERSONAL PROPERTY	SCOTT SARA DONNELL	9808 E 76TH TER
203714215	2020-2021	INDIVIDUAL PERSONAL PROPERTY	ROSS LATOSHA	11617 E 72ND ST	204080651	2021	INDIVIDUAL PERSONAL PROPERTY	SMITH MAURITA	7519 HAWTHORNE AVE
203714405	2021	INDIVIDUAL PERSONAL PROPERTY	BURTON LAUREN DANIELLE	8131 HARRIS AVE	204080652	2013	INDIVIDUAL PERSONAL PROPERTY	CLARY BRENDA L	9357 E 77TH ST
203714530	2021	INDIVIDUAL PERSONAL PROPERTY	COY MIRANDA L	5423 BLUE RIDGE BLVD	204080804	2020	INDIVIDUAL PERSONAL PROPERTY	GRAYSON COLLETTE J	9185 E 60TH ST
203714731	2010-2011	INDIVIDUAL PERSONAL PROPERTY	SMITH JESSE W	9811 E 61ST ST APT 2	204081115	2012-2014	INDIVIDUAL PERSONAL PROPERTY	PETER MARIA & JOHNSON FELIX	9148 E 55TH ST
203714781	2016-2021	INDIVIDUAL PERSONAL PROPERTY	ROWLAND DONNA L	5332 NORTHERN AVE	204081164	2012-2014	INDIVIDUAL PERSONAL PROPERTY	HARRISON ISAAC	9104 E 64TH TER
203714803	2011-2012	INDIVIDUAL PERSONAL PROPERTY	DEPRIEST GEORGE E II	7705 RAYTOWN RD	204081291	2011-2012	INDIVIDUAL PERSONAL PROPERTY	LARA CARLA E	7621 HARVARD AVE
203714819	2012-2017	INDIVIDUAL PERSONAL PROPERTY	SALAZAR SAM	10331 E 61ST ST APT 1	204081346	2011-2015	INDIVIDUAL PERSONAL PROPERTY	CLINKINGBEARD KRISTIN K	9719 RICE AVE
203714908	2021	INDIVIDUAL PERSONAL PROPERTY	MILLER DEENA LYNN MARIE	9100 E 69TH TER	204081355	2019-2021	INDIVIDUAL PERSONAL PROPERTY	SMITH DARON TOSHAYE	5418 DITZLER AVE
203715001	2021	INDIVIDUAL PERSONAL PROPERTY	SHIRLEY TINA T	5529 HUNTER ST	204081474	2014	INDIVIDUAL PERSONAL PROPERTY	BEAN DAVID	7103 STERLING AVE
203715005	2021	INDIVIDUAL PERSONAL PROPERTY	BRANDON CAIRA IMAN	6609 HARVARD AVE	204081586	2021	INDIVIDUAL PERSONAL PROPERTY	MITCHELL PATRICIA MARIE	8816 E 85TH TER
203715014	2020-2021	INDIVIDUAL PERSONAL PROPERTY	SIRLS CALITHA	5300 HUNTER ST	204081605	2020-2021	INDIVIDUAL PERSONAL PROPERTY	WILEY RANESHA	7215 WILLOW AVE
203715030	2011	INDIVIDUAL PERSONAL PROPERTY	BELCHER JOHN RAY JR	9806 E 61ST ST APT 2	204081706	2012	INDIVIDUAL PERSONAL PROPERTY	ELLIOTT MAXWELL C II	7300 HARVARD AVE
203715040	2020-2021	INDIVIDUAL PERSONAL PROPERTY	PATILLO WALTER L JR	9212 VAUGHN AVE	204081730	2021	INDIVIDUAL PERSONAL PROPERTY	HILL UNEDA C	2284 NE TOWN CENTER BLVD UNIT 701
203715096	2016	INDIVIDUAL PERSONAL PROPERTY	CUNNINGHAM ERINN	9066 E 65TH TER	204081887	2011	INDIVIDUAL PERSONAL PROPERTY	PERKINS RICHARD & WANDA	9919 E 60TH ST
203715097	2017-2018	INDIVIDUAL PERSONAL PROPERTY	RUEDAS SANTOS MAYQUEL OMAR	7913 DITZLER AVE	204082094	2021	INDIVIDUAL PERSONAL PROPERTY	WALKER TIFFANY MARIE	8509 EVERETT ST
203715133	2012	INDIVIDUAL PERSONAL PROPERTY	STANGER JACQUELINE A	6521 ENGLEWOOD AVE	204082161	2021	INDIVIDUAL PERSONAL PROPERTY	GOINES VENUS N	7301 HARDY AVE
203715177	2012-2013	INDIVIDUAL PERSONAL PROPERTY	LEUTY DAWNA & MOON LANNY	8813 E 84TH ST	204082295	2011	INDIVIDUAL PERSONAL PROPERTY	WATSON BRIDGETT	6320 HUNTER ST
203715287	2012	INDIVIDUAL PERSONAL PROPERTY	CUNNINGHAM II SCOTT W	6709 APPLETON AVE	204082421	2016-2018	INDIVIDUAL PERSONAL PROPERTY	LOWE SETH A	8813 E 85TH TER
203715298	2012-2013	INDIVIDUAL PERSONAL PROPERTY	WALKER NICHOLLE	1804 E 83RD TER	204082453	2017	INDIVIDUAL PERSONAL PROPERTY	OHNRUMUND MATTHEW M	6533 LAUREL AVE
203715318	2018	INDIVIDUAL PERSONAL PROPERTY	WILLIAMS JULIE A	7902 CRESCENT AVE	204082785	2021	INDIVIDUAL PERSONAL PROPERTY	MURPHY ASHLEY R	7512 APPLETON AVE
203715336	2013	INDIVIDUAL PERSONAL PROPERTY	HETRICK ERIN	10909 E 60TH TER	204083103	2021	INDIVIDUAL PERSONAL PROPERTY	BLUNT JACQUELINE M	7511 MAPLE LN
203715497	2016-2017	INDIVIDUAL PERSONAL PROPERTY	SMITH DELEECE RENEE	11127 E 84TH TER	204083414	2021	INDIVIDUAL PERSONAL PROPERTY	COLLINS KEVIN	7712 ARLINGTON AVE
203715584	2011	INDIVIDUAL PERSONAL PROPERTY	GEORGE LAURA J	9813 E 60TH TER	204083454	2019-2021	INDIVIDUAL PERSONAL PROPERTY	KIPPER KENNETH	9014 E 73RD ST
203715591	2012	INDIVIDUAL PERSONAL PROPERTY	STUART ROBERT M JR & ANGELA	6500 ELM AVE	204083634	2014-2016	INDIVIDUAL PERSONAL PROPERTY	ELLIS FRANK E	8913 E 59TH ST
203716470	2021	INDIVIDUAL PERSONAL PROPERTY	MOSBY LARRELL A	5412 OXFORD AVE	204083752	2021	INDIVIDUAL PERSONAL PROPERTY	FORD LAUREN K	8311 LANE AVE
203716653	2021	INDIVIDUAL PERSONAL PROPERTY	HELMS THERESA E & JESSE C	8215 HARRIS CT	204083790	2012-2013	INDIVIDUAL PERSONAL PROPERTY	FERGUSON JARELL LAMAR	8111 HARRIS AVE
203716808	2020-2021	INDIVIDUAL PERSONAL PROPERTY	RAMIREZ LUIS S	8509 E 81ST ST	204084310	2019	INDIVIDUAL PERSONAL PROPERTY	CALLIS STUCKEY TIFFANY	5418 OXFORD AVE
203716826	2016-2017	INDIVIDUAL PERSONAL PROPERTY	BAXTER ALICIA	8311 MANNING AVE	204084506	2015	INDIVIDUAL PERSONAL PROPERTY	BROWN BYRON	9807 E 61ST ST APT 8
203716849	2021	INDIVIDUAL PERSONAL PROPERTY	BLACKMAN JERROD M	6204 ENGLEWOOD AVE	204084608	2020-2021	INDIVIDUAL PERSONAL PROPERTY	WASHINGTON JEFFERY B	10600 E 70TH ST
203716874	2017	INDIVIDUAL PERSONAL PROPERTY	DENNEY CHEYENNE D & WEHNER RICHARD L	8915 ROSE LN	204084742	2012-2013	INDIVIDUAL PERSONAL PROPERTY	BRITLEY MADDIX	8637 E UTOPIA PKWY APT 9
203717187	2012	INDIVIDUAL PERSONAL PROPERTY	FELIX HIME	8311 PERSHING RD	204085035	2013-2015	INDIVIDUAL PERSONAL PROPERTY	RICHEY JUSTINA	10321 E 61ST ST APT 2
203717538	2011-2015	INDIVIDUAL PERSONAL PROPERTY	WHITE NATHANIEL JR	8201 WOODSON DR	204085177	2016	INDIVIDUAL PERSONAL PROPERTY	WALKER BRANDAN	8621 W UTOPIA DR APT 1
203717690	2021	INDIVIDUAL PERSONAL PROPERTY	ROBBINS ELIZABETH A	7515 HAWTHORNE AVE	204085587	2019	INDIVIDUAL PERSONAL PROPERTY	WIGFALL GERALDINE	10740 GREENWOOD RD
203718154	2012-2014	INDIVIDUAL PERSONAL PROPERTY	WOODRUM CHRISTOPHER J	8517 ASH AVE	204085655	2012-2013	INDIVIDUAL PERSONAL PROPERTY	CARR DERRICK E	9336 E 67TH TER
203718318	2020-2021	INDIVIDUAL PERSONAL PROPERTY	DALE LOYANA MARLEASE	2256 NE TOWN CENTER BLVD UNIT 1805	204085811	2016-2017	INDIVIDUAL PERSONAL PROPERTY	MURPHY MARK EDWARD	9008 E 85TH TER
203718417	2015-2016	INDIVIDUAL PERSONAL PROPERTY	KELLEY MEGAN ELIZABETH ANN	8024 HUNTER ST	204085952	2012-2017	INDIVIDUAL PERSONAL PROPERTY	COLLAZO TAFUYA TALAH M	9205 E 67TH TER
203718513	2015	INDIVIDUAL PERSONAL PROPERTY	HARMON MAX	11319 E 57TH TER	204086153	2021	INDIVIDUAL PERSONAL PROPERTY	BAI GEORGE	5305 LEWIS AVE
203718963	2011-2012	INDIVIDUAL PERSONAL PROPERTY	HAJI HAMZIYA HASSAN	8416 PERSHING RD	204086163	2012-2013	INDIVIDUAL PERSONAL PROPERTY	LEWIS DAVIA A & BASIL	10911 E 72ND ST
203719002	2010	INDIVIDUAL PERSONAL PROPERTY	CAMPBELL KEVIN C	7207 MAYWOOD AVE	204086342	2021	INDIVIDUAL PERSONAL PROPERTY	FEE IAN GEOFFREY	5417 RALSTON AVE
203719016	2016-2021	INDIVIDUAL PERSONAL PROPERTY	HUFFMAN AMBER M	9509 E 66TH ST	204086373	2012	INDIVIDUAL PERSONAL PROPERTY	ZAPATA HENRY OMAR & MARIA PAZMINO	5433 WILLOW AVE
203719024	2020	INDIVIDUAL PERSONAL PROPERTY	NOBLES SHEILA G	8217 HARRIS AVE	204086578	2011	INDIVIDUAL PERSONAL PROPERTY	REEVES TITONYA CAMELYA	9904 E 60TH ST
203719126	2011	INDIVIDUAL PERSONAL PROPERTY	CASTILLO MICHAEL R	6537 RAYTOWN RD APT 2	204086598	2021	INDIVIDUAL PERSONAL PROPERTY	WOOD STEPHEN L	5420 BLUE RIDGE CUT OFF APT 206

204086600	2021	INDIVIDUAL PERSONAL PROPERTY	TURNER MATTHEW M	1311 N REDWOOD DR	204099662	2021	INDIVIDUAL PERSONAL PROPERTY	JAMES MICHAEL W	8019 HARDY AVE
204086771	2012	INDIVIDUAL PERSONAL PROPERTY	MOORE MICHAEL & MOORE SMITH DIANA	6511 WILLOW AVE	204099686	2019	INDIVIDUAL PERSONAL PROPERTY	COBB CHRISTOPHER GLEN JR	7153 CRISP AVE
204086795	2021	INDIVIDUAL PERSONAL PROPERTY	ALLEN ASHLEY C	8531 EVANSTON AVE	204099891	2018-2019	INDIVIDUAL PERSONAL PROPERTY	OLIVER DANA DENAE	8732 E 73RD TER
204086911	2012	INDIVIDUAL PERSONAL PROPERTY	BERNARD ISAAC	7406 OVERTON AVE UNIT 4	204100003	2021	INDIVIDUAL PERSONAL PROPERTY	LORD LUKE & CLEASON	9904 E 71ST TER
204087129	2012	INDIVIDUAL PERSONAL PROPERTY	ARBELO DANNY	5805 LANE AVE	204100112	2020-2021	INDIVIDUAL PERSONAL PROPERTY	BROWN SHAVONNE M	7717 ENGLEWOOD AVE
204087304	2015	INDIVIDUAL PERSONAL PROPERTY	HAMILTON TIFFANY DAWN	5433 ASH AVE	204100118	2015-2021	INDIVIDUAL PERSONAL PROPERTY	ROBINSON CHAKENA TANEA	16805 E 29TH ST S
204087368	2013-2014	INDIVIDUAL PERSONAL PROPERTY	DIAMOND TANDRA DENISE	7408 E 112TH ST	204100379	2016	INDIVIDUAL PERSONAL PROPERTY	BIGGS SANDRA L	8911 E 66TH ST
204087407	2021	INDIVIDUAL PERSONAL PROPERTY	WILSON SARAH A	5509 BLUE RIDGE BLVD	204100387	2020-2021	INDIVIDUAL PERSONAL PROPERTY	SMITH LARRY E	7101 NORWOOD AVE
204087451	2021	INDIVIDUAL PERSONAL PROPERTY	MCCALLOP ANDRE SCHAUN	8404 E 93RD ST	204100760	2020-2021	INDIVIDUAL PERSONAL PROPERTY	FINCH STEVEN C JR	11209 E 53RD TER
204087681	2021	INDIVIDUAL PERSONAL PROPERTY	MERRIMAN CASSY	11116 E 75TH ST	204100892	2012-2017	INDIVIDUAL PERSONAL PROPERTY	ZMUODA GREGORY DAVID	9205 E 67TH TER
204087683	2012-2014	INDIVIDUAL PERSONAL PROPERTY	HAROLD AKILAH	11008 E 75TH ST	204101011	2021	INDIVIDUAL PERSONAL PROPERTY	MCCOY JENNIFER D	8816 E 72ND TER
204087714	2015-2021	INDIVIDUAL PERSONAL PROPERTY	JEFFERSON ELTIC & JENNIFER	9320 E 84TH TER	204101101	2014-2017	INDIVIDUAL PERSONAL PROPERTY	NOLTE DAVID C JR	7808 E 87TH ST
204087867	2014-2015	INDIVIDUAL PERSONAL PROPERTY	MARSH JAMES R	6231 NORTHERN AVE	204101121	2013	INDIVIDUAL PERSONAL PROPERTY	HICKS STEVEN P	9306 E 81ST ST
204088065	2021	INDIVIDUAL PERSONAL PROPERTY	HOOKHAM ANGELA	10807 E 56TH TER	204101167	2021	INDIVIDUAL PERSONAL PROPERTY	FRITZ ASHLEY M	8120 WILLOW WAY
204088160	2019-2021	INDIVIDUAL PERSONAL PROPERTY	HAROLD ROBERT DALLAS COLTON	9705 E 67TH TER	204101217	2021	INDIVIDUAL PERSONAL PROPERTY	PIGG LADONNA LEE (LARSON)	10305 E 70TH TER
204088174	2017	INDIVIDUAL PERSONAL PROPERTY	SIMPSON KARRIE & BRAD	5313 KENTUCKY AVE	204101293	2011	INDIVIDUAL PERSONAL PROPERTY	RANEY ROBERT J	6019 FARLEY AVE
204088482	2020-2021	INDIVIDUAL PERSONAL PROPERTY	MATNEY AMANDA NICOLE (CHOATE)	5817 BLUE RIDGE BLVD	204101731	2019	INDIVIDUAL PERSONAL PROPERTY	PADAKH ROBERT & WEITAL MAGDALINA	6720 RAYTOWN RD
204088511	2012	INDIVIDUAL PERSONAL PROPERTY	KLEMENZ HEATHER	5324 RALSTON AVE	204101767	2012	INDIVIDUAL PERSONAL PROPERTY	BEDSAUL STEPHEN	5402 DITZLER AVE
204088721	2013	INDIVIDUAL PERSONAL PROPERTY	SMALLWOOD JOSHUA	8918 E 74TH ST	204102013	2018-2021	INDIVIDUAL PERSONAL PROPERTY	EWING JEROME F	7509 CRISP AVE
204088829	2021	INDIVIDUAL PERSONAL PROPERTY	VAN BUSKIRK TYLER JON	7812 WOODSON RD	204102144	2021	INDIVIDUAL PERSONAL PROPERTY	ISUM NYLA	10106 E 69TH TER
204089001	2021	INDIVIDUAL PERSONAL PROPERTY	MCMEANS SHERRI DAWN	7820 RIDGEWAY AVE	204102154	2019-2021	INDIVIDUAL PERSONAL PROPERTY	SMITH DARNELL JOSHUA	6120 RALSTON AVE
204089211	2021	INDIVIDUAL PERSONAL PROPERTY	WRIGHT CATRINA	8505 KENTUCKY AVE	204102252	2017-2018	INDIVIDUAL PERSONAL PROPERTY	PAREDES OBADIAH	10611 E 78TH TER
204089230	2021	INDIVIDUAL PERSONAL PROPERTY	BEACHAM ASHLEY L	11504 E 67TH TER	204102279	2011	INDIVIDUAL PERSONAL PROPERTY	CARR KURTRESS	9363 E 67TH TER
204089668	2020-2021	INDIVIDUAL PERSONAL PROPERTY	SMITH MICHAEL RENARD	8308 PERSHING RD	204102404	2021	INDIVIDUAL PERSONAL PROPERTY	RANSBURG JOSHUA	10116 E 70TH TER APT 2
204089744	2020-2021	INDIVIDUAL PERSONAL PROPERTY	FERGERSON RANDALL KEITH	10601 E 57TH TER	204102428	2021	INDIVIDUAL PERSONAL PROPERTY	TURNER ISAIAH	9309 E 84TH ST
204089835	2012-2014	INDIVIDUAL PERSONAL PROPERTY	GREENLEE ZACHERY	6440 BLUE RIDGE BLVD	204102471	2017	INDIVIDUAL PERSONAL PROPERTY	DAVIS CIERRA JAMESETTA	8619 E 83RD TER
204089990	2018-2019	INDIVIDUAL PERSONAL PROPERTY	LEE GLADYES	6920 RAYTOWN RD	204102477	2020-2021	INDIVIDUAL PERSONAL PROPERTY	SMITH DARION	7623 STERLING AVE
204090115	2013-2014	INDIVIDUAL PERSONAL PROPERTY	BROWN SHERRALL J	8955 E 83RD ST	204102697	2021	INDIVIDUAL PERSONAL PROPERTY	ROBINSON-KING DEWYNN LAKETRA	7602 E 85TH TER APT 300
204090227	2021	INDIVIDUAL PERSONAL PROPERTY	TAYLOR BRITNEY D	9105 E 74TH ST	204102719	2020-2021	INDIVIDUAL PERSONAL PROPERTY	PARIES LATORIA D	8107 WOODSON DR
204090250	2015	INDIVIDUAL PERSONAL PROPERTY	ZIMMERSCHIED JUNIOR & VITULA	11400 HIDDEN LAKE DR	204102758	2012-2017	INDIVIDUAL PERSONAL PROPERTY	SINCERE GLENN F	8717 E 61ST TER APT 12
204090926	2020	INDIVIDUAL PERSONAL PROPERTY	EDMONDS SANDRA Y	7308 ASH AVE	204103025	2020-2021	INDIVIDUAL PERSONAL PROPERTY	GRAVITT JEAN MARIE (CHESHIRE)	9200 E 84TH ST
204090983	2010	INDIVIDUAL PERSONAL PROPERTY	COUNTERMAN TIFFANY	8705 E 81ST TER	204103030	2020-2021	INDIVIDUAL PERSONAL PROPERTY	CARTER ANASTACIA ETCH	9020 E 67TH TER
204091305	2020-2021	INDIVIDUAL PERSONAL PROPERTY	SMITH CHIQUITA T	9368 E 68TH ST	204103064	2015-2017	INDIVIDUAL PERSONAL PROPERTY	SMITH AARON B	10812 E 65TH ST
204091591	2021	INDIVIDUAL PERSONAL PROPERTY	BAGBY ALONZO (STEPHANIE)	9354 E 64TH ST	204103094	2021	INDIVIDUAL PERSONAL PROPERTY	CHAMBERS TERESA LYNN	8621 W UTOPIA DR APT 20
204092006	2018-2021	INDIVIDUAL PERSONAL PROPERTY	GAUTNEY JOSHUA M	10504 E 79TH TER	204103135	2018-2021	INDIVIDUAL PERSONAL PROPERTY	BETTS DAVID J	1823 HEDGES AVE
204092053	2016-2018	INDIVIDUAL PERSONAL PROPERTY	GUHR MARISSA	10905 E 75TH ST	204103423	2021	INDIVIDUAL PERSONAL PROPERTY	SWAN TONY TYRELL III	10400 E 79TH TER
204092397	2012-2017	INDIVIDUAL PERSONAL PROPERTY	BRENTON DEBRA	9050 E 68TH TER	204103703	2019-2021	INDIVIDUAL PERSONAL PROPERTY	WOODS ORLANDO C	8607 GREENWOOD RD
204092547	2012-2013	INDIVIDUAL PERSONAL PROPERTY	NEDLIC AILYNN	6525 ELM AVE	204103899	2017	INDIVIDUAL PERSONAL PROPERTY	FLOWERS RICHARD D & SOPHIA	7604 ARLINGTON AVE
204092571	2011-2014	INDIVIDUAL PERSONAL PROPERTY	MORELAND DANA L & SUMMER	5400 NORTHERN AVE	204103934	2021	INDIVIDUAL PERSONAL PROPERTY	CABINE VERNELL	5911 CLAREMONT AVE
204092657	2016	INDIVIDUAL PERSONAL PROPERTY	DAVIS GREG L	5429 HARVARD AVE	204104068	2021	INDIVIDUAL PERSONAL PROPERTY	SMITH SUZANNE (THEIBAUET)	7904 SPRING VALLEY RD
204093121	2021	INDIVIDUAL PERSONAL PROPERTY	GRAHAM JONATHAN JOSEPH	8820 E 80TH TER	204104856	2009-2012	INDIVIDUAL PERSONAL PROPERTY	GARRETT TISHA	9108 RICHARDS DR
204093132	2014	INDIVIDUAL PERSONAL PROPERTY	COMPANY CHRISTOPHER LAVERN	9305 E 85TH ST	204104907	2014-2020	INDIVIDUAL PERSONAL PROPERTY	GUERRERO DANIEL A	10012 E 56TH TER
204093161	2013-2017	INDIVIDUAL PERSONAL PROPERTY	MILLER JOSEPH V	9904 E 80TH ST	204105133	2019	INDIVIDUAL PERSONAL PROPERTY	HENSLEY KELLY	1230 S PEARL ST
204093250	2012-2013	INDIVIDUAL PERSONAL PROPERTY	WILLIAMS VICTORIA	8403 DITMAN AVE	204105399	2013	INDIVIDUAL PERSONAL PROPERTY	LIGHT JR MICHAEL D	8010 WILLOW WAY
204093395	2012	INDIVIDUAL PERSONAL PROPERTY	MEIER JOEL D	8016 HARVEY AVE	204105401	2014	INDIVIDUAL PERSONAL PROPERTY	ERWIN JAMES	6646 MAYWOOD AVE APT A
204093774	2019-2021	INDIVIDUAL PERSONAL PROPERTY	COOPER CAMILLE D	11209 E 61ST ST	204105624	2018-2019	INDIVIDUAL PERSONAL PROPERTY	SANCHEZ DEBORAH J	9005 E 74TH ST
204093840	2017	INDIVIDUAL PERSONAL PROPERTY	CALAME XOCHITL A	7505 ARLINGTON AVE	204105670	2019	INDIVIDUAL PERSONAL PROPERTY	KEPPEL KATHRYN M	10917 E 82ND ST
204093977	2012-2014	INDIVIDUAL PERSONAL PROPERTY	HADSON II ANTONIO D	9012 E 85TH TER	204105806	2012-2017	INDIVIDUAL PERSONAL PROPERTY	PUENTE JESUS	8206 E 86TH TER
204094203	2013-2017	INDIVIDUAL PERSONAL PROPERTY	WOOLRIDGE REGAN	8200 E 86TH TER	204105906	2012-2016	INDIVIDUAL PERSONAL PROPERTY	STRIKLAND NICOLE L	6212 MANNING AVE
204094339	2021	INDIVIDUAL PERSONAL PROPERTY	BANKS DAVID R	5905 ELM AVE	204105944	2012-2019	INDIVIDUAL PERSONAL PROPERTY	BISHOP DOROTHY J	5304 DITZLER AVE
204094568	2021	INDIVIDUAL PERSONAL PROPERTY	JOHNSON ANDRE	6837 LAKESHORE DR	204105949	2016	INDIVIDUAL PERSONAL PROPERTY	HARROLD-ESKRIDGE RASHEEDA	11008 E 75TH ST
204094746	2014	INDIVIDUAL PERSONAL PROPERTY	PHILLIP SHIRLEY R	6620 HARDY AVE	204106025	2011-2013	INDIVIDUAL PERSONAL PROPERTY	DUVAL ALESSA	8803 RICHARDS DR
204094818	2019-2021	INDIVIDUAL PERSONAL PROPERTY	GORDON DOMINIC	11804 E 78TH PL	204106026	2020-2021	INDIVIDUAL PERSONAL PROPERTY	FLOWERS ROBERT LARON	8404 MARSH AVE
204095482	2015-2021	INDIVIDUAL PERSONAL PROPERTY	VELEZ PADILLA ALBERTO	4611 EASTLAND CENTER DR UNIT 622	204106079	2021	INDIVIDUAL PERSONAL PROPERTY	BERNHARD JEREMIAH PHILLIP	10104 E 67TH ST APT A
204095778	2021	INDIVIDUAL PERSONAL PROPERTY	TODD RONEIL	6408 HARDY AVE	204106118	2020-2021	INDIVIDUAL PERSONAL PROPERTY	KEELING ANDREA NICOLE	10908 E 81ST ST
204095866	2019-2021	INDIVIDUAL PERSONAL PROPERTY	CAIN CONNIE MAGNOLIA	5804 NORTHERN AVE	204106136	2021	INDIVIDUAL PERSONAL PROPERTY	JONES DOROTHY J	11600 E 61ST ST
204096115	2021	INDIVIDUAL PERSONAL PROPERTY	ORTEGO TERRIE	9002 RICHARDS DR	204106183	2021	INDIVIDUAL PERSONAL PROPERTY	WHITELAW MALCOLM	9001 E 62ND TER
204096331	2019-2021	INDIVIDUAL PERSONAL PROPERTY	CROSS ANGEL M	7903 MARPLE AVE	204106185	2012-2017	INDIVIDUAL PERSONAL PROPERTY	JOHNSON SANDRA	7628 STERLING AVE
204097219	2021	INDIVIDUAL PERSONAL PROPERTY	WILLIAMS JAMAHL	8602 STARK AVE	204106212	2018-2020	INDIVIDUAL PERSONAL PROPERTY	EPERLY DOUGLAS	6004 NORTHERN AVE
204097871	2017-2018	INDIVIDUAL PERSONAL PROPERTY	HAYNES SWIYYAH	11016 E 72ND TER	204106298	2015-2020	INDIVIDUAL PERSONAL PROPERTY	BARRETT-JONES TAEOR	7413 WOODSON DR
204097972	2012-2017	INDIVIDUAL PERSONAL PROPERTY	MURRAY LISA	1520 MEWS DR	204106317	2012	INDIVIDUAL PERSONAL PROPERTY	BURKE RUSSELL	7415 HARVARD DR
204098052	2020	INDIVIDUAL PERSONAL PROPERTY	HUNT SARAH N	9003 E 74TH TER	204106326	2012	INDIVIDUAL PERSONAL PROPERTY	MITTCHER SHERRI D	7208 WILLOW AVE
204098293	2011-2012	INDIVIDUAL PERSONAL PROPERTY	GRAVES JASMIN	8430 LANE PL	204106846	2017-2021	INDIVIDUAL PERSONAL PROPERTY	GREEN PATRICK A	9351 E 77TH ST
204098355	2021	INDIVIDUAL PERSONAL PROPERTY	REYNA RENE L	6008 NORTHERN AVE	204107064	2012-2016	INDIVIDUAL PERSONAL PROPERTY	RYUNYAN BRANDON	18007 E 56TH TER
204098392	2021	INDIVIDUAL PERSONAL PROPERTY	SULLIVAN KILIA MONEA	9218 E 54TH ST	204107132	2012-2017	INDIVIDUAL PERSONAL PROPERTY	TURNER GORDON A	9707 E 65TH ST
204098406	2021	INDIVIDUAL PERSONAL PROPERTY	JOHNSON JERMIE & CANDI	12301 E 78TH ST	204107301	2016	INDIVIDUAL PERSONAL PROPERTY	BOWMAN FABIAN	7508 STERLING AVE
204098502	2015-2021	INDIVIDUAL PERSONAL PROPERTY	BENNINGTON GERALD E	10608 E 71ST TER	204107310	2021	INDIVIDUAL PERSONAL PROPERTY	GIPSON BILLY RAY JR	8011 SPRING VALLEY RD
204098638	2012	INDIVIDUAL PERSONAL PROPERTY	WILLIAMS JAMIE	5520 HEDGES AVE	204107347	2021	INDIVIDUAL PERSONAL PROPERTY	RUDAITIS DULINDA J	7603 WESTRIDGE RD
204098701	2021	INDIVIDUAL PERSONAL PROPERTY	SHUPE JEFFREY & JULIE	11715 E 76TH TER	204107396	2011-2013	INDIVIDUAL PERSONAL PROPERTY	GARRETT BRANDON	8604 E 87TH ST
204098732	2018-2021	INDIVIDUAL PERSONAL PROPERTY	COAN RICHARD L & LISA K	7909 BLUE RIDGE BLVD	204107586	2012-2013	INDIVIDUAL PERSONAL PROPERTY	YOUNG JAYME	8629 E UTOPIA PKWY APT 1
204099479	2015-2016	INDIVIDUAL PERSONAL PROPERTY	MILLS ALFRED JR	10600 E 66TH ST	204107639	2012-2017	INDIVIDUAL PERSONAL PROPERTY	COIN JOSEPH	5828 CEDAR AVE
204099620	2021	INDIVIDUAL PERSONAL PROPERTY	LANGFORD AMBER	10105 E 83RD TER	204107645	2020-2021	INDIVIDUAL PERSONAL PROPERTY	CEINE MELINDA	9203 E 74TH TER

204108018	2021	INDIVIDUAL PERSONAL PROPERTY	SPEARS DUSTIN	11605 E 62ND ST	204118854	2021	INDIVIDUAL PERSONAL PROPERTY	MCGEER REGINALD DEWAYNE	7825 HEDGES AVE
204108051	2020-2021	INDIVIDUAL PERSONAL PROPERTY	HARRIS DEONTAY	8907 RICHARDS DR	204118939	2016	INDIVIDUAL PERSONAL PROPERTY	VASQUEZ SANTOS	9219 E 54TH TER
204108187	2014-2021	INDIVIDUAL PERSONAL PROPERTY	WILLIAMS ALLEN III	8409 ELM AVE	204119097	2021	INDIVIDUAL PERSONAL PROPERTY	MESSINGER JULIE	9612 E 68TH ST
204108293	2016-2021	INDIVIDUAL PERSONAL PROPERTY	NEWBILL CHRISTOPHER	8805 E 71ST TER	204119192	2017-2021	INDIVIDUAL PERSONAL PROPERTY	HILL ALI ANTHONY	10000 E 86TH TER
204108368	2012-2015	INDIVIDUAL PERSONAL PROPERTY	ROARK BRANDI J	8209 HARDY AVE	204119210	2011-2012	INDIVIDUAL PERSONAL PROPERTY	MCCULLOUGH RONALD S	10505 E 60TH TER
204108623	2016-2019	INDIVIDUAL PERSONAL PROPERTY	LAWSON KALEN K	9316 E 84TH TER	204119294	2019-2021	INDIVIDUAL PERSONAL PROPERTY	ESSEX SARA J	9804 E 77TH TER
204108669	2021	INDIVIDUAL PERSONAL PROPERTY	ELLIS CARRI A	6101 KENTUCKY AVE	204119429	2013-2016	INDIVIDUAL PERSONAL PROPERTY	COLE ELLEN A	8492 LANE DR APT 2
204108815	2021	INDIVIDUAL PERSONAL PROPERTY	MAHNKE LOGAN EDWARD	6019 HARVARD AVE	204119537	2021	INDIVIDUAL PERSONAL PROPERTY	JONES DARELL TYRON	9351 E 70TH TER
204109146	2011-2012	INDIVIDUAL PERSONAL PROPERTY	MONTGOMERY BRIAN	9708 E 71ST TER	204119553	2012	INDIVIDUAL PERSONAL PROPERTY	COLLINS PATRICK S	10322 E 63RD ST APT 4
204109203	2014	INDIVIDUAL PERSONAL PROPERTY	WAITHAKA PAUL	9010 E 87TH ST APT A5	204119718	2015-2021	INDIVIDUAL PERSONAL PROPERTY	ARTERBERY SYDNEY	8750 E 59TH ST
204109213	2020	INDIVIDUAL PERSONAL PROPERTY	BLANTON DEVLIN MICHAEL	9106 E 65TH TER	204119733	2012-2017	INDIVIDUAL PERSONAL PROPERTY	TURNER CARRIE JO	9707 E 65TH ST
204109344	2020	INDIVIDUAL PERSONAL PROPERTY	ERNSTMANN AMELIA	24911 E TIMBERLAKE DR	204119798	2021	INDIVIDUAL PERSONAL PROPERTY	LINDSEY JESS	6502 STERLING AVE
204109409	2016	INDIVIDUAL PERSONAL PROPERTY	SALINAS MARISOL	10322 HILLCREST RD APT 22	204119803	2012	INDIVIDUAL PERSONAL PROPERTY	BUTLER LATUNDRA R	10000 E 83RD TER
204109463	2017-2018	INDIVIDUAL PERSONAL PROPERTY	WAGNER ALYSSA N & TRACY A	11415 E 77TH ST	204119936	2017-2021	INDIVIDUAL PERSONAL PROPERTY	RENZ ROBERT F & ZAPIEN JESSICA N	5427 DITZLER AVE
204109474	2012	INDIVIDUAL PERSONAL PROPERTY	HARVEY ASHLEY N	9805 E 61ST ST APT 9	204119939	2020-2021	INDIVIDUAL PERSONAL PROPERTY	HARRIS EDWARD ERIC L	9805 E 61ST ST APT 9
204109509	2016-2018	INDIVIDUAL PERSONAL PROPERTY	WILLIAMS MICHELLE SARINA ROSE	11422 E 75TH ST	204119984	2013	INDIVIDUAL PERSONAL PROPERTY	TILLMAN VERONICA	10318 E 63RD ST APT 4
204109803	2012	INDIVIDUAL PERSONAL PROPERTY	RAMIREZ ONOFRE	5428 HARRIS AVE	204119994	2019-2021	INDIVIDUAL PERSONAL PROPERTY	MAHUBJ WAKASS S	10905 E 60TH TER
204109847	2021	INDIVIDUAL PERSONAL PROPERTY	PODDIG-JENKINS RAMONA ANNE	8506 EVERETT ST	204120102	2021	INDIVIDUAL PERSONAL PROPERTY	PASCHAL SHANTAYE M	7613 ENGLEWOOD AVE
204109901	2021	INDIVIDUAL PERSONAL PROPERTY	HAYES NANCY E	101 N LEE ST UNIT 24	204120129	2014-2016	INDIVIDUAL PERSONAL PROPERTY	HUNT JIMMY D JR	8802 E 61ST TER
204109963	2012-2018	INDIVIDUAL PERSONAL PROPERTY	WADE ANTONIO	5401 WILLOW AVE	204120335	2020-2021	INDIVIDUAL PERSONAL PROPERTY	PETERSON GERALD W	5300 RALSTON AVE
204110087	2016	INDIVIDUAL PERSONAL PROPERTY	HADI MAHER SAIED	11415 HIDDEN LAKE DR APT 807	204120596	2012-2017	INDIVIDUAL PERSONAL PROPERTY	RAINS JAMES LEE	10012 E 68TH TER
204110546	2021	INDIVIDUAL PERSONAL PROPERTY	RANDLE DENNIS JR	8318 STARK AVE	204120620	2013-2014	INDIVIDUAL PERSONAL PROPERTY	MAYO ROBERT R	9318 E 85TH ST
204110612	2017-2019	INDIVIDUAL PERSONAL PROPERTY	LORTRIDGE MALISA RAMONA	8326 STERLING AVE	204120819	2012-2014	INDIVIDUAL PERSONAL PROPERTY	CLEMONS BRANDON DEVIN T	6228 KENTUCKY AVE
204110766	2012-2013	INDIVIDUAL PERSONAL PROPERTY	LEWIS HERBERT D	5825 FARLEY AVE	204121136	2012	INDIVIDUAL PERSONAL PROPERTY	MERRIN SHARLENE	5412 E 80TH TER
204110851	2021	INDIVIDUAL PERSONAL PROPERTY	BUSH PAIGE	8525 ARLINGTON AVE	204121204	2012-2017	INDIVIDUAL PERSONAL PROPERTY	STEVENSON ANTWAN MAURICE	9809 KENTUCKY AVE
204111457	2016-2017	INDIVIDUAL PERSONAL PROPERTY	MILLER ZSA ZSA M	9107 VAUGHN AVE	204121414	2021	INDIVIDUAL PERSONAL PROPERTY	FUGITT MICHAEL C	8315 DITZLER AVE
204111752	2012-2014	INDIVIDUAL PERSONAL PROPERTY	HENLEY RIDDELSPRIGER DOMINICK	8523 VASSAR AVE	204121423	2012-2013	INDIVIDUAL PERSONAL PROPERTY	SHUPERT NATHAN L	11401 E 77TH TER
204111756	2012-2017	INDIVIDUAL PERSONAL PROPERTY	AUSTIN BRYAN R	7601 CRISP AVE	204121557	2021	INDIVIDUAL PERSONAL PROPERTY	RICE RAY NORVEL JR	8315 WILLOW WAY
204111902	2018-2021	INDIVIDUAL PERSONAL PROPERTY	HARMON REGINALD T	5746 WILLOW AVE	204121597	2015-2021	INDIVIDUAL PERSONAL PROPERTY	BOUIWE RONNELL	7508 APPLETON AVE
204121115	2012	INDIVIDUAL PERSONAL PROPERTY	KING RICKY A	9032 E 85TH PL	204122055	2020-2021	INDIVIDUAL PERSONAL PROPERTY	CARTER BRITTNEY	7001 WOODSON RD
204121290	2020-2021	INDIVIDUAL PERSONAL PROPERTY	VANBEBBER COLBY	6011 STERLING AVE	204122133	2020-2021	INDIVIDUAL PERSONAL PROPERTY	MOORE NORMA J & JACKSON WELLS M	608 HARVARD AVE
204121288	2011-2012	INDIVIDUAL PERSONAL PROPERTY	HAMBY DEHLIA	8609 FORD AVE	204122225	2019-2021	INDIVIDUAL PERSONAL PROPERTY	CLAIBORNE RONALD A	8603 E 114TH TER
20413018	2016-2021	INDIVIDUAL PERSONAL PROPERTY	ELLENWOOD ANNALIE	9402 E 84TH ST	204122263	2014-2015	INDIVIDUAL PERSONAL PROPERTY	HEARRON CIARA	5309 CRISP AVE
20413022	2012-2017	INDIVIDUAL PERSONAL PROPERTY	GONZALEZ PORFIRIO JR	10505 E 64TH TER	204122333	2019-2020	INDIVIDUAL PERSONAL PROPERTY	ARNEY ALAINA B	9901 E 82ND TER
20413073	2012-2017	INDIVIDUAL PERSONAL PROPERTY	LITTLE CHERYL	9205 E 67TH TER	204122336	2017-2021	INDIVIDUAL PERSONAL PROPERTY	EVANS JACQUARD L	5311 BLUE RIDGE BLVD
204131343	2013	INDIVIDUAL PERSONAL PROPERTY	GOSS PATRICK	9116 E 57TH ST	204122346	2014-2019	INDIVIDUAL PERSONAL PROPERTY	GIBOYEAUX ANTHONY	6007 FARLEY AVE
204133380	2017-2021	INDIVIDUAL PERSONAL PROPERTY	BOLEY CARL E	7310 ELM ST	204122370	2012-2017	INDIVIDUAL PERSONAL PROPERTY	KENDRICK ALLISON PAIGE	5808 STERLING AVE
204133566	2018-2019	INDIVIDUAL PERSONAL PROPERTY	KABINGA CANDACE	9416 E 84TH TER	204122730	2012-2015	INDIVIDUAL PERSONAL PROPERTY	PULLUAIM STEVEN RYAN	11208 E 62ND ST
204133661	2018-2021	INDIVIDUAL PERSONAL PROPERTY	MOUNT JEREMY	10104 E 86TH TER	204122918	2015-2017	INDIVIDUAL PERSONAL PROPERTY	PERRY JOY & ISAIAH DEWAYNE	8600 LANE AVE
204133835	2012	INDIVIDUAL PERSONAL PROPERTY	CHASTAIN JAMES M	10007 E 63RD ST	204122970	2012-2013	INDIVIDUAL PERSONAL PROPERTY	RUTH MARY A	6140 HUNTER ST
204133842	2017-2018	INDIVIDUAL PERSONAL PROPERTY	STEVENS ALLARY J & MEGAN D	11517 E 67TH ST	204123038	2011-2013	INDIVIDUAL PERSONAL PROPERTY	BENNETT ERIK L	6412 KENTUCKY AVE
204133913	2013-2016	INDIVIDUAL PERSONAL PROPERTY	NUNGESTER KIRK A & JENNIFER F	5524 HEDGES AVE	204123113	2019	INDIVIDUAL PERSONAL PROPERTY	FATTY SAIKOU	8312 JAMES A REED RD
204134196	2021	INDIVIDUAL PERSONAL PROPERTY	PALETAOGA SINA C	16000 E 28TH TER S APT 2301	204123145	2017-2020	INDIVIDUAL PERSONAL PROPERTY	ROBINSON ROCHELLE D	6415 BLUE RIDGE CUT OFF
204134219	2013-2015	INDIVIDUAL PERSONAL PROPERTY	WEBER MICHELLE J	10136 E 80TH ST	204123225	2021	INDIVIDUAL PERSONAL PROPERTY	BURNSIDE STACEY	6501 BLUE RIDGE CUT OFF
204134592	2018-2021	INDIVIDUAL PERSONAL PROPERTY	ANDREWS WILLETTA MARIE (RICHARDSON)	8717 E 61ST TER APT 7	204123970	2015-2021	INDIVIDUAL PERSONAL PROPERTY	BRADEN HEATHER & BERGEN DAMION	8629 E UTOPIA PKWY APT 10
204134807	2012	INDIVIDUAL PERSONAL PROPERTY	BRADFORD DARREN	10608 E 70TH ST	204124272	2021	INDIVIDUAL PERSONAL PROPERTY	HOGGATT JZAQUASMYN J	8423 ARLINGTON AVE
204134953	2017-2021	INDIVIDUAL PERSONAL PROPERTY	LAVALAIS RONALD OBRIEN	9062 E 65TH ST	204124488	2020	INDIVIDUAL PERSONAL PROPERTY	PTACEK LARRY	9515 E 64TH ST
204135173	2015	INDIVIDUAL PERSONAL PROPERTY	BURASCO STEVEN & BROOKE	11004 E 54TH ST	204124509	2013-2014	INDIVIDUAL PERSONAL PROPERTY	YOUNG CHRISTOPHER M	9803 E 73RD ST APT A
204135372	2021	INDIVIDUAL PERSONAL PROPERTY	CHAVIRA TIFFANY MICHELLE	10600 E 79TH TER	204124753	2021	INDIVIDUAL PERSONAL PROPERTY	HERMAN WESLEY MICHAEL	11101 E 62ND ST
204135431	2019-2021	INDIVIDUAL PERSONAL PROPERTY	SHELTON ELIZABETH & CHARLES	7021 RAYTOWN RD	204124816	2013	INDIVIDUAL PERSONAL PROPERTY	JOHNSON NATHANIEL D	9408 E 84TH TER
204135555	2021	INDIVIDUAL PERSONAL PROPERTY	MURRAY DION LAMONT	10213 E 78TH ST	204124824	2011-2012	INDIVIDUAL PERSONAL PROPERTY	AVERY MICHELE	8716 E 81ST TER
204135575	2019-2021	INDIVIDUAL PERSONAL PROPERTY	REFITTT DERRICK	10107 E 63RD TER	204125227	2021	INDIVIDUAL PERSONAL PROPERTY	WILLIAMS CHARLENE C	9816 E 61ST ST APT 2
204135582	2015-2018	INDIVIDUAL PERSONAL PROPERTY	PURIFOY TODD J	8917 E 52ND TER	204125257	2014-2015	INDIVIDUAL PERSONAL PROPERTY	CRAWFORD ANTHONY RAY	436 E 81ST ST
204135629	2021	INDIVIDUAL PERSONAL PROPERTY	LARSEN ROBERT	8204 E 83RD TER	204125341	2013-2017	INDIVIDUAL PERSONAL PROPERTY	HADLEY BILHTER	6732 RAYTOWN RD
204135697	2019-2021	INDIVIDUAL PERSONAL PROPERTY	GARDENHIRE ALANNA	9131 RICHARDS DR	204125462	2012-2016	INDIVIDUAL PERSONAL PROPERTY	MCCLOUD WILLIAM A	11310 E 71ST DR
204135821	2012	INDIVIDUAL PERSONAL PROPERTY	STUTZMAN GERLAD	10316 E 63RD ST APT 2	204125711	2014-2019	INDIVIDUAL PERSONAL PROPERTY	STANIUNAS SARAH	5809 RALSTON AVE
204135929	2012	INDIVIDUAL PERSONAL PROPERTY	CLAYTON VALARIE N	10711 E 56TH TER	204125834	2015-2021	INDIVIDUAL PERSONAL PROPERTY	BOYD MARTHA E	8612 OXFORD AVE
204135941	2013-2014	INDIVIDUAL PERSONAL PROPERTY	THOMAS LAKEISHA SHONTA	10416 PERSHING RD	204126319	2014-2016	INDIVIDUAL PERSONAL PROPERTY	ATKINSON NATHANAE L	6128 RALSTON AVE
204136120	2012-2013	INDIVIDUAL PERSONAL PROPERTY	POWERS JUSTIN A	7509 HARVARD AVE	204126456	2021	INDIVIDUAL PERSONAL PROPERTY	DILLON JOHN M JR & JOLENE W	11204 E 60TH ST
204136591	2017	INDIVIDUAL PERSONAL PROPERTY	TEEL DERRICK	8101 RAYTOWN RD	204126487	2021	INDIVIDUAL PERSONAL PROPERTY	ROLAND VANESSA NICOLE	8538 E 81ST TER
204136849	2013	INDIVIDUAL PERSONAL PROPERTY	JOHNSON CHARLES TIMOTHY	10708 BRISTOL ST	204126510	2012-2017	INDIVIDUAL PERSONAL PROPERTY	WASHINGTON CHARLES V	8304 ELM AVE
204136899	2017	INDIVIDUAL PERSONAL PROPERTY	MILES MICHAEL PAUL	11200 E 64TH ST	204126535	2021	INDIVIDUAL PERSONAL PROPERTY	LUSTER ROY ANTHONY	10009 E 70TH TER
204137040	2019	INDIVIDUAL PERSONAL PROPERTY	DEVAYNES MARY (BOGERT)	5724 MANNING AVE	204126550	2017-2019	INDIVIDUAL PERSONAL PROPERTY	ELMORE BRITTANY S	6600 WILLOW AVE
204137292	2020-2021	INDIVIDUAL PERSONAL PROPERTY	SIMMONS JASON DAVID	8903 E 74TH ST	204126597	2021	INDIVIDUAL PERSONAL PROPERTY	VASSER TURQUOISE	8108 ELM AVE
204137439	2021	INDIVIDUAL PERSONAL PROPERTY	(YOUNG) GODSEY SAMANTHA & MARK	9301 E 73RD ST	204126615	2021	INDIVIDUAL PERSONAL PROPERTY	YARBOUGH DONTÉ	9816 E 61ST ST APT 1
204137468	2021	INDIVIDUAL PERSONAL PROPERTY	BURHANS RACHEL R	6204 CRISP AVE	204126653	2021	INDIVIDUAL PERSONAL PROPERTY	SMITH MISTY A	10408 E 82ND ST
204137767	2017-2018	INDIVIDUAL PERSONAL PROPERTY	CRITTON KOWAISKI KARREN	10615 E 43RD ST APT 1511	204126663	2012	INDIVIDUAL PERSONAL PROPERTY	DANNAR BRANDEE	8328 WILLOW WAY
204137784	2017-2021	INDIVIDUAL PERSONAL PROPERTY	STANGLE HANNA	5431 CEDAR AVE	204126665	2012-2013	INDIVIDUAL PERSONAL PROPERTY	COOK NORA L & DONALD A JR	9012 E 87TH ST
204137942	2019-2021	INDIVIDUAL PERSONAL PROPERTY	KING SARAH NICOLE	9508 E 69TH TER	204126667	2015	INDIVIDUAL PERSONAL PROPERTY	RILEY JOHN	8313 HAWTHORNE AVE
204138065	2016	INDIVIDUAL PERSONAL PROPERTY	RIVETTE BRENDA M	6140 RAYTOWN RD APT 404	204126696	2012	INDIVIDUAL PERSONAL PROPERTY	BRITTON BONNIE & PRATT ROBERT	5529 DITZLER AVE
204138228	2016-2019	INDIVIDUAL PERSONAL PROPERTY	JENKINS DANIEL	7411 WOODSON RD	204126715	2012-2017	INDIVIDUAL PERSONAL PROPERTY	ZAPIEN ROSA M	10900 LAKEVIEW BLVD
204138420	2019-2021	INDIVIDUAL PERSONAL PROPERTY	WILLIAMS JACQUELINE A	8700 E 79TH TER	204126819	2016-2017	INDIVIDUAL PERSONAL PROPERTY	HENRY ANTHONY E	10517 E 43RD ST APT 424

204127015	2012-2013	INDIVIDUAL PERSONAL PROPERTY	BRADFORD JEREMY & PIRNIE MARY	7137 RAYTOWN RD	204134946	2021	INDIVIDUAL PERSONAL PROPERTY	CONNOR ROBERT L	8401 WILLOW WAY
204127095	2013	INDIVIDUAL PERSONAL PROPERTY	FARNEN CYRENA J	10703 E 69TH TER	204135299	2017-2021	INDIVIDUAL PERSONAL PROPERTY	HOFFMAN DAKOTA & ALLEN NATASHA F	6202 HEDGES AVE
204127117	2012-2013	INDIVIDUAL PERSONAL PROPERTY	MESSBARGER WAYNE M	7902 APPLETON AVE	204135583	2013	INDIVIDUAL PERSONAL PROPERTY	WELSH TIMOTHY PATRICK	7200 OVERTON AVE
204127132	2021	INDIVIDUAL PERSONAL PROPERTY	SAWYER STEPHAN	9204 E 64TH TER	204136086	2020-2021	INDIVIDUAL PERSONAL PROPERTY	WIETRICK ALEXANDER M	8211 HEDGES AVE
204127151	2019	INDIVIDUAL PERSONAL PROPERTY	RIEDEL AARON	9024 N LISTON ST	204136088	2021	INDIVIDUAL PERSONAL PROPERTY	WILLIAMS TAYLOR ALICIA MARIE	9130 E 85TH ST
204127165	2013-2019	INDIVIDUAL PERSONAL PROPERTY	ROBINSON JAVONNE L & AYENI PAUL BUNMI	8408 PERSHING RD	204136153	2013-2014	INDIVIDUAL PERSONAL PROPERTY	AMES MICHAEL G & JENNIFER L	5315 BLUE RIDGE BLVD
204127169	2021	INDIVIDUAL PERSONAL PROPERTY	MCNUTT MINDY	8820 E 85TH ST	204272765	2021	INDIVIDUAL PERSONAL PROPERTY	SHEPHARD MARIO	8819 E 61ST ST
204127185	2012-2013	INDIVIDUAL PERSONAL PROPERTY	FIELDS DENISA	8521 DITZLER AVE	204496675	2021	INDIVIDUAL PERSONAL PROPERTY	BRYANT JAMES MCCORMICK	9206 E 64TH TER
204127197	2012-2013	INDIVIDUAL PERSONAL PROPERTY	HERRERA MICHAEL CHRISTOPHER	9903 E 60TH ST	204497961	2021	INDIVIDUAL PERSONAL PROPERTY	WILLENER ALEA M	5512 ASH AVE
204127262	2020	INDIVIDUAL PERSONAL PROPERTY	RILEY PATRICK LEE	3909 E 60TH TER	204498013	2013	INDIVIDUAL PERSONAL PROPERTY	BLACK RUSSELL	7839 ELM ST
204127281	2018-2021	INDIVIDUAL PERSONAL PROPERTY	JENKINS LESLIE	9712 E 66TH TER	204498028	2012-2015	INDIVIDUAL PERSONAL PROPERTY	DOMINGUEZ MIGUEL	8482 LANE DR
204127307	2021	INDIVIDUAL PERSONAL PROPERTY	RICHARDSON TARA M	10813 E 65TH ST	204498060	2013-2017	INDIVIDUAL PERSONAL PROPERTY	STANFIELD JACOB E	9612 E 69TH ST
204127427	2013	INDIVIDUAL PERSONAL PROPERTY	SEKONA TUPOU	5704 MAYWOOD AVE	204498389	2020-2021	INDIVIDUAL PERSONAL PROPERTY	THOMAS ERICA R	9112 E 84TH ST
204127591	2021	INDIVIDUAL PERSONAL PROPERTY	PICARD DONNA RAYLENE	9718 E 53RD ST	204498928	2019	INDIVIDUAL PERSONAL PROPERTY	BEEBE JASON	7309 DITZLER AVE
204127592	2019-2021	INDIVIDUAL PERSONAL PROPERTY	TYARRS RYAN	6904 WILDWOOD DR	204498984	2017-2021	INDIVIDUAL PERSONAL PROPERTY	HUDSON BONNIE S	6610 ELM AVE
204127640	2012-2017	INDIVIDUAL PERSONAL PROPERTY	FARRIN JAMES & HEATHER	11305 E 55TH TER	204499118	2013	INDIVIDUAL PERSONAL PROPERTY	PHILLIPS RUSSEL & VICKIE	11609 E 72ND ST
204127667	2015-2017	INDIVIDUAL PERSONAL PROPERTY	ROWLAND MELISSA	8906 E 73RD ST	204499141	2021	INDIVIDUAL PERSONAL PROPERTY	HARRISON DOMINIQUE	8515 E 85TH ST
204127897	2018	INDIVIDUAL PERSONAL PROPERTY	STUBBS ROBERT	7213 WOODSON RD	204499578	2012	INDIVIDUAL PERSONAL PROPERTY	EVANS ERICA	8500 EVANSTON AVE
204127909	2017-2019	INDIVIDUAL PERSONAL PROPERTY	RAY BRYCE A & SARAH M	10615 E 80TH ST	204499958	2020-2021	INDIVIDUAL PERSONAL PROPERTY	BASS CRISTIN J	11412 E 71ST ST
204128041	2020-2021	INDIVIDUAL PERSONAL PROPERTY	JACKSON SHEILA FAYE	9200 E 54TH ST	204500116	2013-2014	INDIVIDUAL PERSONAL PROPERTY	HILTON JUSTIN	11208 E 76TH TER
204128287	2014-2015	INDIVIDUAL PERSONAL PROPERTY	LYONS CAYSON DAJUAN	8603 CRESCENT AVE	204500303	2021	INDIVIDUAL PERSONAL PROPERTY	KAHLER DUANE STEPHAN	5620 WOODSON DR
204128365	2012	INDIVIDUAL PERSONAL PROPERTY	MORFITT DESIRREE A	6533 RAYTOWN RD APT 1	204500340	2016	INDIVIDUAL PERSONAL PROPERTY	GLADNEY SHAWANA V	6547 RAYTOWN RD APT 3
204128423	2016-2017	INDIVIDUAL PERSONAL PROPERTY	YOUNGBLOOD JAVLEN DEMETRIUS	8113 WOODSON DR	204500479	2021	INDIVIDUAL PERSONAL PROPERTY	PAIGE RANDY MILLARD	5118 WESTRIDGE CIR
204128454	2021	INDIVIDUAL PERSONAL PROPERTY	VELARDE DANIEL	8405 JAMES A REED RD	204500610	2021	INDIVIDUAL PERSONAL PROPERTY	WILLIAMS LAYCE	7204 HEDGES AVE
204128538	2020-2021	INDIVIDUAL PERSONAL PROPERTY	FERGUSON BRIAN K	6011 ENGLEWOOD AVE	204501052	2021	INDIVIDUAL PERSONAL PROPERTY	ONUZRUIKE JANE N	8717 E 61ST TER APT 6
204128787	2018-2021	INDIVIDUAL PERSONAL PROPERTY	JONES DENISHA	19805 E 17TH TER N	204501110	2009-2011	INDIVIDUAL PERSONAL PROPERTY	LUCAS KARL E & ARLA J	6709 LAUREL AVE
204128789	2020-2021	INDIVIDUAL PERSONAL PROPERTY	FOSTER ANTHONY L	10816 E 81ST TER	204501146	2021	INDIVIDUAL PERSONAL PROPERTY	HODGES CHARLES A & SARAH D	7512 CRESCENT DR
204128961	2016-2021	INDIVIDUAL PERSONAL PROPERTY	STAFFORD JESSE	7923 TENNESSEE AVE	204501205	2019-2021	INDIVIDUAL PERSONAL PROPERTY	MITCHELL MICHELLE	6108 NORTHERN AVE
204128910	2018-2019	INDIVIDUAL PERSONAL PROPERTY	WALTERS JANIS	11307 E 58TH TER	204501570	2014-2017	INDIVIDUAL PERSONAL PROPERTY	CAMPBELL RICHARD	8304 HAWTHORNE AVE
204129221	2012	INDIVIDUAL PERSONAL PROPERTY	CAMPBELL TEVIN	9803 E 61ST ST APT 9	204501769	2013	INDIVIDUAL PERSONAL PROPERTY	SMITH TRE	7800 IRWIN RD
204129235	2015-2016	INDIVIDUAL PERSONAL PROPERTY	MCCARTY SHEENA	9205 E 81TH ST	204502113	2013	INDIVIDUAL PERSONAL PROPERTY	FRANCO ALMA	9016 55TH ST
204129507	2012-2017	INDIVIDUAL PERSONAL PROPERTY	LAMPING TABITHA L	8805 E 71ST TER	204502137	2018-2019	INDIVIDUAL PERSONAL PROPERTY	GRAFFAM ERIC J & SARAH	10904 E 72ND ST
204129749	2016-2021	INDIVIDUAL PERSONAL PROPERTY	LOGAN MARQUITA E	9128 E 85TH ST	204502275	2020	INDIVIDUAL PERSONAL PROPERTY	RANSBURG LAMAR EARL	9325 E 85TH ST
204129955	2021	INDIVIDUAL PERSONAL PROPERTY	OVERLY ROMIA D	6485 BLUE RIDGE BLVD	204502428	2014	INDIVIDUAL PERSONAL PROPERTY	VILLEGAS JORGE I	10111 E 74TH TER
204129957	2012-2013	INDIVIDUAL PERSONAL PROPERTY	SEE LAURA M	9108 E 74TH ST	204502661	2021	INDIVIDUAL PERSONAL PROPERTY	TURNER JUSTIN M	8505 E 85TH ST
204130015	2018-2021	INDIVIDUAL PERSONAL PROPERTY	DRYER BARBARA J	10208 E 58TH TER	204502858	2012-2017	INDIVIDUAL PERSONAL PROPERTY	THOMAS GREGORY A JR	7829 HEDGES AVE
204130129	2012-2017	INDIVIDUAL PERSONAL PROPERTY	THEOBALD KARALYN S	7711 RAYTOWN RD APT 30	204502975	2014-2016	INDIVIDUAL PERSONAL PROPERTY	DILLON RUSSELL	6219 WILLOW AVE
204130227	2012-2017	INDIVIDUAL PERSONAL PROPERTY	HUTSON MATT	11906 E 75TH ST	204503042	2016	INDIVIDUAL PERSONAL PROPERTY	DILLARD BRENDA	11408 E 69TH ST
204130341	2012	INDIVIDUAL PERSONAL PROPERTY	WATSON TAMICIA	6112 HARDY AVE	204503140	2021	INDIVIDUAL PERSONAL PROPERTY	WASHINGTON MARILYN T	10033 E 67TH ST
204130360	2012-2017	INDIVIDUAL PERSONAL PROPERTY	DUVALL MEGAN J	8803 RICHARDS DR	204503191	2020-2021	INDIVIDUAL PERSONAL PROPERTY	JAMES JUSTIN A	7115 EVANSTON AVE
204130477	2021	INDIVIDUAL PERSONAL PROPERTY	ANDREWS JALESA M	7915 HEDGES AVE	204503204	2021	INDIVIDUAL PERSONAL PROPERTY	JAMES WILLIAM E II	7115 EVANSTON AVE
204130526	2021	INDIVIDUAL PERSONAL PROPERTY	COLE SHARAE ELISE	7148 CRISP AVE	204503395	2018-2021	INDIVIDUAL PERSONAL PROPERTY	JOHNSON ADRIANNE M	10604 E 65TH TER
204130596	2012-2017	INDIVIDUAL PERSONAL PROPERTY	WRIGHT DAVID V JR	8302 KENTUCKY AVE	204503485	2018	INDIVIDUAL PERSONAL PROPERTY	OWENS LORRAINE A	7516 ENGLEWOOD AVE
204130616	2015	INDIVIDUAL PERSONAL PROPERTY	WIETRICK THERESE	9003 E 74TH TER	204503753	2019-2021	INDIVIDUAL PERSONAL PROPERTY	STINSON ANTHONY C	7312 ASH AVE
204130682	2013-2016	INDIVIDUAL PERSONAL PROPERTY	PAGE BRANDON M & MILLER DOROTHY W	5902 BLUE RIDGE BLVD	204503985	2012-2013	INDIVIDUAL PERSONAL PROPERTY	BARTON THOMAS	5718 STERLING AVE
204130917	2017	INDIVIDUAL PERSONAL PROPERTY	HUNTINGTON BOYD S JR & SHARON K	8002 DITZLER AVE	204504035	2018-2019	INDIVIDUAL PERSONAL PROPERTY	CLINE CODY	9811 E 60TH ST
204130930	2021	INDIVIDUAL PERSONAL PROPERTY	JONES MARK & ANTONIA	11313 E 58TH ST	204504048	2012-2013	INDIVIDUAL PERSONAL PROPERTY	FRANCO SAUL	8428 GREENWOOD RD
204131283	2021	INDIVIDUAL PERSONAL PROPERTY	TAPP MARK CARWIN	8625 E UTOPIA PKWY APT 1	204504242	2013	INDIVIDUAL PERSONAL PROPERTY	WILPREDO JOSE C	7804 E 87TH ST
204131476	2014-2017	INDIVIDUAL PERSONAL PROPERTY	LEWIS SHERRY A	9805 E 73RD ST APT C	204504531	2018-2020	INDIVIDUAL PERSONAL PROPERTY	WILLIAMS DEON L	8434 LANE PL
204131525	2012	INDIVIDUAL PERSONAL PROPERTY	GRUBB BERNARD C JR	9704 E GREGORY BLVD	204504556	2021	INDIVIDUAL PERSONAL PROPERTY	GREEN TAUSHA	6704 ELM AVE
204131608	2019-2020	INDIVIDUAL PERSONAL PROPERTY	MOORE HILL MICHAEL	11708 E 78TH TER	204504639	2013	INDIVIDUAL PERSONAL PROPERTY	YATES ALISHA	8405 PERSHING RD
204131751	2012	INDIVIDUAL PERSONAL PROPERTY	BOALES MARLETTE J	11312 E 78TH ST	204504660	2012	INDIVIDUAL PERSONAL PROPERTY	HOPKINS CYDNEY	9406 E 82ND ST
204131775	2015	INDIVIDUAL PERSONAL PROPERTY	WASHINGTON LESLIE	5833 MAYWOOD AVE	204504664	2012-2013	INDIVIDUAL PERSONAL PROPERTY	GRAHAM NINA M	8109 WOODSON DR
204131817	2020-2021	INDIVIDUAL PERSONAL PROPERTY	RANA SAMRAJE	9912 E 60TH ST	204504702	2019-2021	INDIVIDUAL PERSONAL PROPERTY	MORALES PEREZ ROMUALDO	8625 E 81ST TER
204132051	2014	INDIVIDUAL PERSONAL PROPERTY	BAKER JUSTIN B	7201 OXFORD AVE	204504869	2018-2019	INDIVIDUAL PERSONAL PROPERTY	SCHMIDT MATTHEW B	9511 E 64TH ST
204132347	2020-2021	INDIVIDUAL PERSONAL PROPERTY	GOCHENOUR TROY J	10401 E 79TH ST	204504918	2021	INDIVIDUAL PERSONAL PROPERTY	PINEDA MANUEL L III	10507 E 67TH ST
204132370	2012	INDIVIDUAL PERSONAL PROPERTY	HAYES JEFF R	8249 WARD PKWY	204504969	2019-2020	INDIVIDUAL PERSONAL PROPERTY	WILSON MICHAEL L JR & WASH CHIKAYLA M	10107 E 67TH ST
204132387	2021	INDIVIDUAL PERSONAL PROPERTY	KNOX MAKINZIE	9823 E 60TH ST	204505283	2014	INDIVIDUAL PERSONAL PROPERTY	CARTER ALYCIA MONIQUE NICOLE	9003 E 85TH ST
204132524	2020-2021	INDIVIDUAL PERSONAL PROPERTY	AUTHORLEE CIERA	11804 E 78TH PL	204505356	2019-2021	INDIVIDUAL PERSONAL PROPERTY	NORWOOD VEJAY XAVIER	5109 PALMER DR
204132125	2012	INDIVIDUAL PERSONAL PROPERTY	BUFFINGTON DAVID BRYAN	8412 E 83RD ST	204505687	2014	INDIVIDUAL PERSONAL PROPERTY	BISCHOFF LYNN (CHURCH)	6712 LAUREL AVE
204133319	2012-2013	INDIVIDUAL PERSONAL PROPERTY	CARROLL RUBY	8223 WOODSON DR	204505802	2012	INDIVIDUAL PERSONAL PROPERTY	BARTON STEVEN & GIDDENS JOANNE G	11405 E 78TH TER
204133402	2012	INDIVIDUAL PERSONAL PROPERTY	JANET CLARE M & SUSAN M	8400 HARVARD AVE	204505807	2012	INDIVIDUAL PERSONAL PROPERTY	BARTON STEVEN & GIDDENS JOANNE G	11405 E 78TH TER
204133515	2021	INDIVIDUAL PERSONAL PROPERTY	THOMAS STEPHANIE L	7907 APPLETON AVE	204505907	2021	INDIVIDUAL PERSONAL PROPERTY	SMITH PATRICK R & TONI R	9000 RICHARDS DR
204133737	2021	INDIVIDUAL PERSONAL PROPERTY	KANE ELISHA M	11001 E 83RD ST	204505979	2021	INDIVIDUAL PERSONAL PROPERTY	KLUEPELF CHRISTINE	5609 STERLING AVE
204133822	2020-2021	INDIVIDUAL PERSONAL PROPERTY	HUFF TAQUILA	8420 GREENWOOD RD	204506509	2014	INDIVIDUAL PERSONAL PROPERTY	WHITLEY CHEEZAH & ARRON	5315 BLUE RIDGE BLVD
204133931	2012-2017	INDIVIDUAL PERSONAL PROPERTY	BURNAM PHILLIP	5525 LANE AVE	204506658	2015	INDIVIDUAL PERSONAL PROPERTY	WILLARD TRUDY	9099 E 65TH TER
204133950	2012	INDIVIDUAL PERSONAL PROPERTY	SPENCER LEE	8617 W UTOPIA DR APT 37	204506768	2021	INDIVIDUAL PERSONAL PROPERTY	HAYES JORDAN MATTHEW	10137 E 80TH ST
204134101	2013-2014	INDIVIDUAL PERSONAL PROPERTY	THOME ROBIN E	11134 E 84TH TER	204506854	2021	INDIVIDUAL PERSONAL PROPERTY	MCNURLIN SAMONE A	11403 E 51ST ST
204134235	2021	INDIVIDUAL PERSONAL PROPERTY	BUTNER JOHN E JR	5329 RALSTON AVE	204507165	2020-2021	INDIVIDUAL PERSONAL PROPERTY	HARVEY SHERRELL	5427 DITZLER AVE
204134274	2014	INDIVIDUAL PERSONAL PROPERTY	BUTLER BRIAN O & MOORE TIEDRA L	6612 OXFORD AVE	204507233	2020-2021	INDIVIDUAL PERSONAL PROPERTY	DAWKINS ARRIS ALGER	8033 MANNING AVE
204134310	2021	INDIVIDUAL PERSONAL PROPERTY	KUENSTLER CHRISTA L	7200 STERLING AVE	204508077	2014-2015	INDIVIDUAL PERSONAL PROPERTY	LUMPKIN LAMONT	9203 E 79TH ST
204134828	2021	INDIVIDUAL PERSONAL PROPERTY	WEBSTER JOHNIE L	9909 E 85TH ST	204508208	2021	INDIVIDUAL PERSONAL PROPERTY	HAMMOND WILSON F & UNETA	5528 DITZLER AVE

204508662	2011-2014	INDIVIDUAL PERSONAL PROPERTY	JONES LISA JEANETTE	7714 E 111TH TER	204520851	2021	INDIVIDUAL PERSONAL PROPERTY	CHASE YOLANDA & DEREK T	6422 ELM AVE
204508691	2019-2021	INDIVIDUAL PERSONAL PROPERTY	MERRITT JAMIE	6500 E 125TH ST APT 1	204521855	2015	INDIVIDUAL PERSONAL PROPERTY	PAULSON CLIFFORD R	5516 LANE AVE
204508904	2012	INDIVIDUAL PERSONAL PROPERTY	BUCKLEY FRANCINA A & STARCHER GINA L	8201 SPRING VALLEY RD	204521973	2015-2021	INDIVIDUAL PERSONAL PROPERTY	PITRE JACK	11800 E 77TH TER
204508910	2021	INDIVIDUAL PERSONAL PROPERTY	GOODWIN ROSETTA KEOSHA BREEAWN	6341 BLUE RIDGE BLVD	204522139	2013-2014	INDIVIDUAL PERSONAL PROPERTY	MARQUEZ RAUL E	5840 BLUE RIDGE BLVD
204509167	2014-2015	INDIVIDUAL PERSONAL PROPERTY	TISDALE MELISSA	10322 E 63RD ST APT 1	204522413	2015-2021	INDIVIDUAL PERSONAL PROPERTY	TURNER BROOK	9309 E 84TH ST
204509429	2017	INDIVIDUAL PERSONAL PROPERTY	JOHNSON JERRETTE	9212 E 54TH TER	204522622	2012-2013	INDIVIDUAL PERSONAL PROPERTY	JOHNSON AKARI	7712 IRWIN RD
204509794	2018-2021	INDIVIDUAL PERSONAL PROPERTY	GRAVES WAYNETTA MICHELLE Y (RICHARDSON)	9011 E 73RD ST	204522779	2016-2021	INDIVIDUAL PERSONAL PROPERTY	CAPLES WENDELL L SR	7309 BLUE RIDGE BLVD
204509824	2013	INDIVIDUAL PERSONAL PROPERTY	DIELEMAN BRITTANY	8007 TENNESSEE AVE	204522841	2013	INDIVIDUAL PERSONAL PROPERTY	COWAN DONALD L	9709 E 80TH ST
204509905	2013-2016	INDIVIDUAL PERSONAL PROPERTY	POWELL BUSBY CHRISTINA M	7911 TENNESSEE AVE	204523245	2021	INDIVIDUAL PERSONAL PROPERTY	NICHOLSON LASHAYLA M	9226 E 54TH ST
204509921	2021	INDIVIDUAL PERSONAL PROPERTY	MORATAYA MARIA	8919 E 67TH ST APT 128	204523302	2018-2020	INDIVIDUAL PERSONAL PROPERTY	TAYLOR CHRISTINA BROOKE	8817 E 85TH ST
204509974	2016	INDIVIDUAL PERSONAL PROPERTY	VANBECELAERE BOB	10409 E 67TH ST	204523602	2013-2017	INDIVIDUAL PERSONAL PROPERTY	CALLISON THOMAS AARON	8511 SPRING VALLEY RD
204510279	2012-2013	INDIVIDUAL PERSONAL PROPERTY	SMITH ELIZABETH M	5604 CRESCENT AVE	204523681	2021	INDIVIDUAL PERSONAL PROPERTY	RAMEY LEAH KATHERINE	5520 CRESCENT AVE
204510307	2013	INDIVIDUAL PERSONAL PROPERTY	PANKIEWICZ LYNETTE	11608 E 75TH ST	204523706	2013-2017	INDIVIDUAL PERSONAL PROPERTY	POOL CHRIS L	8204 HARDY AVE
204510438	2019	INDIVIDUAL PERSONAL PROPERTY	CONSTANCE CHERYL OR STEVEN	8621 WESTRIDGE RD	204524032	2019-2021	INDIVIDUAL PERSONAL PROPERTY	BELL GLEN R	7308 BLUE RIDGE BLVD
204510622	2021	INDIVIDUAL PERSONAL PROPERTY	GARRETT KIMBERLY R	7509 ARLINGTON AVE	204524035	2021	INDIVIDUAL PERSONAL PROPERTY	CARTER CHRISTIAN	7504 ARLINGTON AVE
204510743	2020	INDIVIDUAL PERSONAL PROPERTY	MUNKERS KATHERINE IRENE (KAMMERICH)	507 N SEMINOLE DR	204524042	2013-2017	INDIVIDUAL PERSONAL PROPERTY	CONTREAS GUADALUPE	7936 CEDAR AVE
204510759	2013	INDIVIDUAL PERSONAL PROPERTY	RYAN JOSEPH E	11513 E 75TH ST	204524095	2013-2017	INDIVIDUAL PERSONAL PROPERTY	GRIMES DOUGLAS MR	8605 SPRING VALLEY RD
204511062	2021	INDIVIDUAL PERSONAL PROPERTY	SMITH KIMBERLY	10405 E 78TH TER	204524190	2020-2021	INDIVIDUAL PERSONAL PROPERTY	DUNN HELEN M	9709 BROOKLANE ST
204511098	2010-2015	INDIVIDUAL PERSONAL PROPERTY	FORTNEY MARC	5512 CEDAR AVE	204524319	2021	INDIVIDUAL PERSONAL PROPERTY	PALMER NATOSHIA	8900 E 57TH ST
204511230	2019-2021	INDIVIDUAL PERSONAL PROPERTY	BROWN IVORY	5817 KENTUCKY AVE	204524372	2013-2015	INDIVIDUAL PERSONAL PROPERTY	TRUETOVE JAY J	9101 E 73RD ST
204511333	2021	INDIVIDUAL PERSONAL PROPERTY	WINKLEY DARIUS	8618 E UTOPIA DR APT 43	204524511	2021	INDIVIDUAL PERSONAL PROPERTY	DORSEY CHERRI DENISE [SCOTT] & CLIFFORD	6733 STERLING AVE
204511529	2013	INDIVIDUAL PERSONAL PROPERTY	DOUGLAS DARRYL A	11301 E 72ND ST	204524724	2021	INDIVIDUAL PERSONAL PROPERTY	TOWNSEND MONIQUE LASHA	6609 OXFORD AVE
204511594	2021	INDIVIDUAL PERSONAL PROPERTY	ANDERSON BONNIQUECA	9004 E 61ST TER	204525088	2016-2021	INDIVIDUAL PERSONAL PROPERTY	MARION CRYSTAL J	8595 E 83RD TER
204511630	2017-2021	INDIVIDUAL PERSONAL PROPERTY	JOHNSON CAMERON DENISE (RANDLE)	8496 LANE DR APT 3	204525200	2013	INDIVIDUAL PERSONAL PROPERTY	FOSTER KRISHAWN	8011 E 72ND ST
204511801	2018-2021	INDIVIDUAL PERSONAL PROPERTY	WOODS LACRESHA JEAN	10407 E 78TH TER	204525242	2019-2021	INDIVIDUAL PERSONAL PROPERTY	TODD MONICA B	9810 E 65TH TER
204512019	2021	INDIVIDUAL PERSONAL PROPERTY	HAIGHT JOHN M JR	5609 BLUE RIDGE BLVD	204525588	2018-2021	INDIVIDUAL PERSONAL PROPERTY	HASTIE DEVON M	8408 WOODSON CT
204512022	2013	INDIVIDUAL PERSONAL PROPERTY	GRIMMETT TEANIA	9814 E 61ST ST APT 1	204525624	2014	INDIVIDUAL PERSONAL PROPERTY	WALLACE GENE PAUL	8328 HARVARD AVE
204512118	2020-2021	INDIVIDUAL PERSONAL PROPERTY	ELLIOTT TIFFANY P	7608 WOODSON DR	204525781	2021	INDIVIDUAL PERSONAL PROPERTY	BUCHOLTZ CARL ROGER	10005 E 84TH ST
204512272	2013	INDIVIDUAL PERSONAL PROPERTY	LEMONS ERICA	8218 WOODSON RD	204526044	2015	INDIVIDUAL PERSONAL PROPERTY	KING ANTHONY M	8300 HEDGES AVE
204512337	2012-2017	INDIVIDUAL PERSONAL PROPERTY	GIBOYEAUX CASANDRA	6002 FARLEY AVE	204526172	2020-2021	INDIVIDUAL PERSONAL PROPERTY	WENTZ MICHAEL	8135 DITZLER AVE
204512618	2021	INDIVIDUAL PERSONAL PROPERTY	MCKINZY BRANDON STEWART	8820 E 61ST TER	204526360	2012-2017	INDIVIDUAL PERSONAL PROPERTY	MITCHELL THERESA	11401 E 61ST TER
204512806	2017-2021	INDIVIDUAL PERSONAL PROPERTY	HALTOM CANDACE N	11407 E 57TH TER	204526447	2021	INDIVIDUAL PERSONAL PROPERTY	WILSON CLAY A	6015 HARVARD AVE
204512817	2013	INDIVIDUAL PERSONAL PROPERTY	ROBINSON KANDE MARIE	9204 E 61ST TER	204526626	2019-2021	INDIVIDUAL PERSONAL PROPERTY	TOLIVER LONZETTA E	5121 STERLING AVE
204513171	2020-2021	INDIVIDUAL PERSONAL PROPERTY	TURPIN SARAH	8529 EVANSTON AVE	204526689	2013	INDIVIDUAL PERSONAL PROPERTY	WILLIAMS KEVIN W & ROLFE ELMYRA E	11700 E 77TH ST
204513255	2017-2021	INDIVIDUAL PERSONAL PROPERTY	WATKINS JOYCE E	7148 CRISP AVE	204526740	2021	INDIVIDUAL PERSONAL PROPERTY	LACY STACY	7018 WOODSON RD
204513489	2018-2021	INDIVIDUAL PERSONAL PROPERTY	EASTERLA CHELSEA	17405 E 21ST ST N	204527010	2021	INDIVIDUAL PERSONAL PROPERTY	BERRYMAN BONNIE	9003 E 72ND TER
204514252	2021	INDIVIDUAL PERSONAL PROPERTY	THOMAS BRYAN & CRYSTAL	8962 E 54TH ST	204527149	2019-2021	INDIVIDUAL PERSONAL PROPERTY	BEALS KENNESHA	9322 E 83RD ST
204514450	2013-2014	INDIVIDUAL PERSONAL PROPERTY	BRAND NICHOLAS	6509 HARVARD AVE	204527211	2013	INDIVIDUAL PERSONAL PROPERTY	GROOMES IVORY	6821 LAKESHORE DR
204514579	2017	INDIVIDUAL PERSONAL PROPERTY	GEORGE DIANE M	8605 E 83RD RD	204527516	2012-2016	INDIVIDUAL PERSONAL PROPERTY	WADE PAMELA L	8100 MANNING AVE
204515236	2021	INDIVIDUAL PERSONAL PROPERTY	LOVE ANDREA	12700 MANCHESTER AVE	204527560	2016-2017	INDIVIDUAL PERSONAL PROPERTY	JUSTICE NATHAN	7301 HARRIS AVE
204515242	2013-2017	INDIVIDUAL PERSONAL PROPERTY	WATSON VERNAE NEKOLE	10809 E 57TH TER	204527573	2020	INDIVIDUAL PERSONAL PROPERTY	EWING THOMAS L	10327 E 61ST ST APT 1
204515647	2017-2021	INDIVIDUAL PERSONAL PROPERTY	SMITH DWANN D	8633 E UTOPIA PKWY APT 1	204527785	2017-2021	INDIVIDUAL PERSONAL PROPERTY	REED DIANA	8505 DITZLER AVE
204516037	2013-2017	INDIVIDUAL PERSONAL PROPERTY	DRAPER DEDRA DIYAN	9004 E 74TH ST	204528044	2021	INDIVIDUAL PERSONAL PROPERTY	GRIFFIN GINGER	8812 E 87TH ST
204516131	2020-2021	INDIVIDUAL PERSONAL PROPERTY	KELLEY DRAMONTE	12009 E 78TH TER	204528155	2018-2021	INDIVIDUAL PERSONAL PROPERTY	JOHNSON DANIELLE N	10619 E 87TH ST
204516455	2016-2021	INDIVIDUAL PERSONAL PROPERTY	JONES FELICIA E	5820 ELM AVE	204528717	2017-2018	INDIVIDUAL PERSONAL PROPERTY	MARSHALL THOMAS W	5612 DITZLER AVE
204516463	2021	INDIVIDUAL PERSONAL PROPERTY	GLASSLEY MORGAN N	8401 WILLOW WAY	204528878	2020-2021	INDIVIDUAL PERSONAL PROPERTY	FORSTER HEATHER COLE	6415 EVANSTON AVE
204516809	2020-2021	INDIVIDUAL PERSONAL PROPERTY	BROCKINGTON JERAYLE	6705 HUNTER ST APT 212	204528975	2013	INDIVIDUAL PERSONAL PROPERTY	BURTON KENDRICK JAMIE	8806 E 80TH TER
204517271	2013	INDIVIDUAL PERSONAL PROPERTY	SCOTT JEREMY	7401 HARDY AVE	204529096	2013-2014	INDIVIDUAL PERSONAL PROPERTY	SNELLINGS KEVIN M	8800 E 72ND ST
204517469	2017-2019	INDIVIDUAL PERSONAL PROPERTY	BECKHAM JEFFREY A	5408 ELM AVE	204529252	2017	INDIVIDUAL PERSONAL PROPERTY	STARR WILLIE	6649 CEDAR AVE APT A
204517584	2013-2017	INDIVIDUAL PERSONAL PROPERTY	LAMBERT HUBERT JR	8409 HEDGES AVE	204529297	2017-2019	INDIVIDUAL PERSONAL PROPERTY	DAVIS KATLYAN	6811 HUNTER ST
204517724	2012-2017	INDIVIDUAL PERSONAL PROPERTY	MAJOR MARY J	6005 FARLEY AVE	204529412	2014-2021	INDIVIDUAL PERSONAL PROPERTY	CUSHMAN MATTHEW	10400 E 72ND ST
204517725	2019-2021	INDIVIDUAL PERSONAL PROPERTY	LAWRENCE TIFFANY LYNN	7606 WOODSON RD	204529694	2018-2019	INDIVIDUAL PERSONAL PROPERTY	PERKEY SHAWN THOMAS	11306 E 61ST TER
204517909	2021	INDIVIDUAL PERSONAL PROPERTY	YSLAS JESUE CHRISTOPHER	6901 LAUREL AVE	204529935	2015	INDIVIDUAL PERSONAL PROPERTY	WILSON JASON A	8703 MANCHESTER AVE
204518026	2013	INDIVIDUAL PERSONAL PROPERTY	HIBBS JEREMY	5701 ASH AVE	204529936	2013-2017	INDIVIDUAL PERSONAL PROPERTY	BARRERA MEGAN GABRIELLA	9408 HARVARD AVE
204518066	2013	INDIVIDUAL PERSONAL PROPERTY	BROWN RONALD D JR	8405 DITMAN AVE	204529953	2012	INDIVIDUAL PERSONAL PROPERTY	ROBLES FRANCISCO	9116 E 85TH ST
204518325	2013-2014	INDIVIDUAL PERSONAL PROPERTY	CLEMONS BRENT	10703 E 69TH TER	204530046	2021	INDIVIDUAL PERSONAL PROPERTY	DOWDELL DANIEL	8315 MANNING AVE
204518490	2021	INDIVIDUAL PERSONAL PROPERTY	JUAREZ NANCY	7709 RAYTOWN RD APT 32	204530190	2013-2017	INDIVIDUAL PERSONAL PROPERTY	BURCH CHEVIS	8531 VASSAR AVE
204518535	2021	INDIVIDUAL PERSONAL PROPERTY	SHIPMAN AMANDA	9707 E 79TH PL	204530200	2015-2016	INDIVIDUAL PERSONAL PROPERTY	GERALD BRENDON L	8301 HEDGES AVE
204518590	2013-2014	INDIVIDUAL PERSONAL PROPERTY	CARTER SHAUNTAY M	9003 E 85TH ST	204530392	2019-2021	INDIVIDUAL PERSONAL PROPERTY	BERRERA JULIA V & MIGUEL A	8416 E 85TH TER
204518722	2013-2017	INDIVIDUAL PERSONAL PROPERTY	GOODIN JAMES D	7916 MANNING AVE	204530586	2013-2017	INDIVIDUAL PERSONAL PROPERTY	MACK MARCUS BRANDON	8701 E 84TH TER
204518947	2013-2014	INDIVIDUAL PERSONAL PROPERTY	FARR DAVONNA	7834 SPRING VALLEY RD	204530723	2021	INDIVIDUAL PERSONAL PROPERTY	MCLAUGHLIN BARRY MARTIN	7205 ASH AVE
204519010	2018	INDIVIDUAL PERSONAL PROPERTY	WAYMAN JENNIFER A & SHAWN F	5804 HEDGES AVE	204530874	2021	INDIVIDUAL PERSONAL PROPERTY	GASTON SAMANTHA NICHOLE (BUSBY)	7236 RAYTOWN RD APT A
204519067	2015-2021	INDIVIDUAL PERSONAL PROPERTY	BELL BRIANA MARIE	11413 E 77TH ST	204530989	2016	INDIVIDUAL PERSONAL PROPERTY	LOCKETT ALMEDA M	8001 WESTRIDGE RD UNIT 3
204519110	2015-2021	INDIVIDUAL PERSONAL PROPERTY	TUCK GARY	11200 E 64TH TER	204531041	2018	INDIVIDUAL PERSONAL PROPERTY	VENTO ALEXANDRA R	9307 E 84TH ST
204519345	2021	INDIVIDUAL PERSONAL PROPERTY	HAROLD WILLIAM MICHAEL DILLON	8018 ELM AVE	204531186	2016	INDIVIDUAL PERSONAL PROPERTY	ARNOLD CHELSEA N	9904 E 81ST ST
204519364	2017-2021	INDIVIDUAL PERSONAL PROPERTY	FORTUNE TYRONE	9209 E 65TH ST	204531304	2021	INDIVIDUAL PERSONAL PROPERTY	WRIGHT JR MARCUS M	5917 HARVARD AVE
204520034	2021	INDIVIDUAL PERSONAL PROPERTY	REIFF LEEANN M & TAYLOR LEESA A	6107 HADLEY ST	204531316	2013	INDIVIDUAL PERSONAL PROPERTY	BAILEY YATTA L	5936 STERLING AVE
204520137	2015	INDIVIDUAL PERSONAL PROPERTY	DOLBEARE CHUCK M	7720 IRWIN RD	204531564	2021	INDIVIDUAL PERSONAL PROPERTY	EASLEY PHILLIP A	6708 LANE AVE
204520168	2016-2017	INDIVIDUAL PERSONAL PROPERTY	DOSS ALONZO	8928 E 57TH ST	204531870	2018-2021	INDIVIDUAL PERSONAL PROPERTY	BANKS CORNELIUS RONNIE H	5501 WOODSON RD
204520257	2019	INDIVIDUAL PERSONAL PROPERTY	HARRIS KEESHA	10604 E 70TH TER	204532258	2021	INDIVIDUAL PERSONAL PROPERTY	VANDAL REBECCA	7705 WOODSON RD
204520432	2013-2021	INDIVIDUAL PERSONAL PROPERTY	GRANGER RENEE S	11130 E 84TH TER	204532405	2014-2021	INDIVIDUAL PERSONAL PROPERTY	MCLEOD SANDRA	8817 E 84TH ST
204520557	2021	INDIVIDUAL PERSONAL PROPERTY	RENDER MAURICE & ROSS TRACEY M	2260 NE TOWN CENTER BLVD UNIT 1907	204532434	2019-2021	INDIVIDUAL PERSONAL PROPERTY	DAVIS ANNA MARIE	7918 HEDGES AVE

204532457	2017	INDIVIDUAL PERSONAL PROPERTY	MILLER RICHARD GARY	11408 E 71ST ST	204542293	2020-2021	INDIVIDUAL PERSONAL PROPERTY	FORD BRANDON P	5800 BLUE RIDGE CUT OFF
204532477	2021	INDIVIDUAL PERSONAL PROPERTY	PORCHIA VIRGIL	5304 DITZLER AVE	204542307	2014-2015	INDIVIDUAL PERSONAL PROPERTY	CARRINGTON ERIKA L	6400 BLUE RIDGE CUT OFF
204532514	2017-2019	INDIVIDUAL PERSONAL PROPERTY	JOHNSON EVERETT & AMY	5320 LAUREL AVE	204542324	2013-2017	INDIVIDUAL PERSONAL PROPERTY	CARAVEO BRISA	11601 E 76TH TER
204532588	2013-2017	INDIVIDUAL PERSONAL PROPERTY	BEASON ANDREW	7425 CRISP AVE	204542391	2018-2019	INDIVIDUAL PERSONAL PROPERTY	HALL NEIL K	11300 HIDDEN LAKE DR APT 503
204532659	2021	INDIVIDUAL PERSONAL PROPERTY	HUNTLEY MARQUITA VIRGINIA	9500 E 69TH ST	204542650	2021	INDIVIDUAL PERSONAL PROPERTY	JOHNSON JOAN JONES	8616 CRESCENT AVE
204532677	2021	INDIVIDUAL PERSONAL PROPERTY	LIENHARD VIRGIL & DEBORAH	8000 E 87TH ST	204542798	2021	INDIVIDUAL PERSONAL PROPERTY	ROSS COLBY L	7501 HARVARD AVE
204532711	2014-2015	INDIVIDUAL PERSONAL PROPERTY	HOFFMAN ASHLEY ANN NIKOLE	7920 HEDGES AVE	204542898	2013-2017	INDIVIDUAL PERSONAL PROPERTY	SEMINARA MARK D	8006 ARLINGTON AVE
204532741	2021	INDIVIDUAL PERSONAL PROPERTY	MAGEE KEVIN M & KURZWEIL JENNIFER	7311 APPELTON AVE	204542958	2015	INDIVIDUAL PERSONAL PROPERTY	NOCE DEANNA C	6116 BLUE RIDGE AVE
204532759	2014-2017	INDIVIDUAL PERSONAL PROPERTY	PARKER PATRICE ROCHELLE	10600 E 79TH TER	204542987	2013	INDIVIDUAL PERSONAL PROPERTY	TUCKER JESSIE	8504 SPRING VALLEY RD
204533252	2015	INDIVIDUAL PERSONAL PROPERTY	NOBLE JOHNATHAN W	7207 OVERTON AVE	204543111	2016-2021	INDIVIDUAL PERSONAL PROPERTY	DAVIDSON CHEYENNE M	5813 STERLING AVE
204533556	2021	INDIVIDUAL PERSONAL PROPERTY	RUHGE MATTHEW	6601 OXFORD AVE	204543148	2021	INDIVIDUAL PERSONAL PROPERTY	WILKERSON TIFFANY D	8621 W UTOPIA DR APT 4
204533800	2021	INDIVIDUAL PERSONAL PROPERTY	KUYKENDALL CLEVELAND	8304 MANNING AVE	204543185	2012-2013	INDIVIDUAL PERSONAL PROPERTY	ALFREDO EDWIN	7804 E 87TH ST
204533826	2013-2017	INDIVIDUAL PERSONAL PROPERTY	YOUNG KEVIN CHARLES	8322 PERSHING RD	204543838	2012	INDIVIDUAL PERSONAL PROPERTY	SNEED RICHARD LUCAS	6537 RAYTOWN RD APT 3
204534043	2018	INDIVIDUAL PERSONAL PROPERTY	SHOLAJA MORAYONLA O	8514 CRESCENT AVE	204543988	2012	INDIVIDUAL PERSONAL PROPERTY	ORTIZ DANIEL	9000 E 84TH ST
204534066	2012-2014	INDIVIDUAL PERSONAL PROPERTY	DEDMON ANTHONY T	8803 E 59TH ST	204544147	2019-2021	INDIVIDUAL PERSONAL PROPERTY	CARNEY EMMITT CLAYTON	5615 CRESCENT AVE
204534378	2012-2013	INDIVIDUAL PERSONAL PROPERTY	TRUDE JASMINE J	9508 E 64TH ST	204544534	2021	INDIVIDUAL PERSONAL PROPERTY	KENNE JOSHUA	8808 E 84TH ST
204534493	2017	INDIVIDUAL PERSONAL PROPERTY	QUINN RONALD EUGENE	5420 BLUE RIDGE CUT OFF APT 601	204544535	2019-2020	INDIVIDUAL PERSONAL PROPERTY	GAMMAGE WILLIE EARL	8014 HARDY AVE
204534742	2014-2015	INDIVIDUAL PERSONAL PROPERTY	FULLILOVE CESLEY C	8900 E 59TH ST	204544567	2017-2021	INDIVIDUAL PERSONAL PROPERTY	HOPPER CRYSTAL D	14622 E 96TH ST
204534813	2017	INDIVIDUAL PERSONAL PROPERTY	DOTSON LARISSA A	6716 ENGLEWOOD AVE	204544598	2014-2016	INDIVIDUAL PERSONAL PROPERTY	DELLAMANO DANIEL & JESSICA	10812 E 66TH TER
204535013	2019	INDIVIDUAL PERSONAL PROPERTY	LEVINGSTON BOBBIE LAVETT	8802 E 72ND ST	204544726	2018-2021	INDIVIDUAL PERSONAL PROPERTY	DESHAZER PEGGY A	10007 E 77TH TER
204535244	2015	INDIVIDUAL PERSONAL PROPERTY	DOBBINS DEMARKIS D	3406 S OVERTON TER	204544796	2021	INDIVIDUAL PERSONAL PROPERTY	DIXON MICHAEL	7905 HEDGES AVE
204535256	2013-2017	INDIVIDUAL PERSONAL PROPERTY	SHOFNER BRET	7801 RAYTOWN AVE	204544812	2021	INDIVIDUAL PERSONAL PROPERTY	THOMPSON ISRAEL C & DOMINIQUE N	10104 E 86TH TER
204535438	2021	INDIVIDUAL PERSONAL PROPERTY	BOWERS MATT T	8619 WESTRIDGE RD	204544977	2017-2019	INDIVIDUAL PERSONAL PROPERTY	KIRKPATRICK JENNIFER MARIE	8629 E UTOPIA PKWY APT 6
204536111	2015	INDIVIDUAL PERSONAL PROPERTY	LARRY DEONDREA	8706 STARK AVE	204545471	2017	INDIVIDUAL PERSONAL PROPERTY	SWANSON BREANNA	8534 CRESCENT AVE
204536163	2020	INDIVIDUAL PERSONAL PROPERTY	SCHMIDT KARL	10605 E 65TH TER	204545513	2016-2018	INDIVIDUAL PERSONAL PROPERTY	DUNCAN JERRY L JR	9409 E 79TH TER
204536284	2013-2014	INDIVIDUAL PERSONAL PROPERTY	CRAWFORD JOY L	8319 LAUREL AVE	204545725	2018	INDIVIDUAL PERSONAL PROPERTY	PARKER TANIYAH D	7707 RAYTOWN RD APT 32
204536316	2021	INDIVIDUAL PERSONAL PROPERTY	CARSON ROSE M	6409 BLUE RIDGE CUT OFF	204545740	2013	INDIVIDUAL PERSONAL PROPERTY	SCOTT WAYNE & TIA	6503 RAYTOWN RD APT 3
204536437	2013	INDIVIDUAL PERSONAL PROPERTY	OLSON MICHAEL JAMES	8509 E 85TH TER	204545861	2010-2016	INDIVIDUAL PERSONAL PROPERTY	CARTER DENISE	12201 E 55TH TER
204536681	2017	INDIVIDUAL PERSONAL PROPERTY	POLDRUGO TANYA R & RUDROFF TODD A	5919 HARVARD AVE	204546280	2014-2021	INDIVIDUAL PERSONAL PROPERTY	JONES LAMONT D	9704 E 65TH ST
204537078	2018-2019	INDIVIDUAL PERSONAL PROPERTY	YOUNG JULIAN	8614 E 85TH ST	204546386	2014	INDIVIDUAL PERSONAL PROPERTY	DOWNING VIRGINIA R	11108 E 57TH TER
204537252	2013-2017	INDIVIDUAL PERSONAL PROPERTY	REEDY TIMOTHY D	6508 BLUE RIDGE CUT OFF	204546467	2019	INDIVIDUAL PERSONAL PROPERTY	NEASHAM SHELLY L	1131 S GLENWOOD AVE
204537383	2021	INDIVIDUAL PERSONAL PROPERTY	GOMES HELEN JOHANNA	7306 RALSTON AVE	204546571	2017-2021	INDIVIDUAL PERSONAL PROPERTY	CEARLEY CASEY N	7238 RAYTOWN RD APT F
204537492	2015-2016	INDIVIDUAL PERSONAL PROPERTY	FLECKENSTINE LEIGH ANN	9321 E 85TH ST	204546601	2014-2015	INDIVIDUAL PERSONAL PROPERTY	BLATT MICHELLE L	6300 HARRIS AVE
204537510	2021	INDIVIDUAL PERSONAL PROPERTY	LEE JACKIE	6810 LAKE SHORE CT	204546801	2013-2016	INDIVIDUAL PERSONAL PROPERTY	SHIELDS MICHAEL R	5215 STERLING AVE
204537512	2014-2016	INDIVIDUAL PERSONAL PROPERTY	FLOREZ ASHLEY L	7525 LEWIS AVE	204546802	2013	INDIVIDUAL PERSONAL PROPERTY	SOSA JOSE A	8202 E 85TH TER
204537610	2021	INDIVIDUAL PERSONAL PROPERTY	KINNAMAN BRAD S & JESSIE L	445 NW CHATEAU DR	204546986	2021	INDIVIDUAL PERSONAL PROPERTY	WILCOX BEN	7900 WOODSON RD
204537629	2013-2014	INDIVIDUAL PERSONAL PROPERTY	COOPER KHRISTIAN S	11713 E 58TH ST	204546994	2013	INDIVIDUAL PERSONAL PROPERTY	SCHUSSLER CATRINA L	8200 WOODSON RD
204537830	2020-2021	INDIVIDUAL PERSONAL PROPERTY	KARNES ROBERT L	11405 E 56TH TER	204547173	2014-2016	INDIVIDUAL PERSONAL PROPERTY	CLANTON LARANDA SHAWNITA	9400 E 68TH TER
204537852	2013	INDIVIDUAL PERSONAL PROPERTY	ANDERSON ALICIA M	7032 HUNTER ST	204547195	2021	INDIVIDUAL PERSONAL PROPERTY	SMITH DANIEL LEE	6828 STERLING AVE
204538224	2020-2021	INDIVIDUAL PERSONAL PROPERTY	SKINNER VIOLETTE IRENE	11411 E 78TH TER	204547311	2020	INDIVIDUAL PERSONAL PROPERTY	CROWELL DAVID C	9503 E 60TH TER
204538280	2019-2021	INDIVIDUAL PERSONAL PROPERTY	WHITE SYDNEY	7923 HEDGES AVE	204547476	2021	INDIVIDUAL PERSONAL PROPERTY	BRADLEY MONICA K & MMAYUMI I	6515 BLUE RIDGE CUT OFF
204538292	2015	INDIVIDUAL PERSONAL PROPERTY	BROWN AMBER M	9363 E 70TH TER	204547510	2020-2021	INDIVIDUAL PERSONAL PROPERTY	CROOKSHANK JEANINE P	9600 E 68TH TER
204538445	2015	INDIVIDUAL PERSONAL PROPERTY	CALVIN TONYIA	9000 E 74TH ST	204547594	2013-2014	INDIVIDUAL PERSONAL PROPERTY	PALMER KENNETH EUGENE JR	7501 ARLINGTON AVE
204538615	2021	INDIVIDUAL PERSONAL PROPERTY	MCCOY KENNETH WAYNE	10409 E 64TH ST	204547858	2013-2014	INDIVIDUAL PERSONAL PROPERTY	SEXTON CHAITEZ AHMAR JR	8801 E 81ST TER
204538734	2018-2021	INDIVIDUAL PERSONAL PROPERTY	TARRANT ALEX	9429 E 67TH TER	204548288	2013	INDIVIDUAL PERSONAL PROPERTY	JACOBS DONYELL	10331 E 61ST ST APT 4
204538740	2021	INDIVIDUAL PERSONAL PROPERTY	MCKINNEY MICHAEL L	10609 E 70TH ST	204548481	2021	INDIVIDUAL PERSONAL PROPERTY	HANCOCK HOLLY	10208 E 56TH ST
204538780	2020-2021	INDIVIDUAL PERSONAL PROPERTY	EDEMANN DAKOTA JACOB	6610 ELM AVE	204548512	2021	INDIVIDUAL PERSONAL PROPERTY	ROSE MALLORY KATHARINE	10600 E 56TH ST
204538831	2021	INDIVIDUAL PERSONAL PROPERTY	GUENTHER URIAH	5516 CEDAR AVE	204548573	2013-2014	INDIVIDUAL PERSONAL PROPERTY	BOWERS MATTHEW & DANELLE	11724 E 85TH ST
204539009	2018-2021	INDIVIDUAL PERSONAL PROPERTY	ABBOTT ROYANNE L	10208 E 56TH ST	204548579	2021	INDIVIDUAL PERSONAL PROPERTY	HILL CLINTON J	16102 E 49TH ST
204539321	2013-2017	INDIVIDUAL PERSONAL PROPERTY	STALLINGS JANICE I	7919 MAPLE AVE	204548585	2021	INDIVIDUAL PERSONAL PROPERTY	PARKINSON ROBIN ELIZABETH	8908 E 66TH ST
204539428	2020-2021	INDIVIDUAL PERSONAL PROPERTY	DENNIS IRAYA LYNN	9713 E 82ND TER	204548677	2011-2012	INDIVIDUAL PERSONAL PROPERTY	SANCHEZ MIGUEL A	9508 E 62ND ST
204539535	2014-2016	INDIVIDUAL PERSONAL PROPERTY	MORI CHRISTY L	11013 E 74TH ST	204548888	2013-2015	INDIVIDUAL PERSONAL PROPERTY	BROWN BRENTON	7823 WOODSON RD
204539658	2016-2021	INDIVIDUAL PERSONAL PROPERTY	WILLIAMS GARY L	7311 BLUE RIDGE BLVD	204548891	2018-2021	INDIVIDUAL PERSONAL PROPERTY	WILLIAMS TROUSA A	8440 EVANSTON AVE
204539988	2013	INDIVIDUAL PERSONAL PROPERTY	CASTELO RICHARD G	11809 E 86TH ST	204548915	2021	INDIVIDUAL PERSONAL PROPERTY	WRIGLEY FRANKIE	10109 E 71ST TER
204540079	2021	INDIVIDUAL PERSONAL PROPERTY	REDMON MONIKA	11821 E 83RD ST APT 202	204549178	2013-2014	INDIVIDUAL PERSONAL PROPERTY	LAWSON KELLI R	5808 HARVARD AVE
204540135	2016	INDIVIDUAL PERSONAL PROPERTY	GALEN MACK JR	9508 E 57TH TER	204549224	2015	INDIVIDUAL PERSONAL PROPERTY	MERRIN SIMON J	9412 E 80TH TER
204540198	2020-2021	INDIVIDUAL PERSONAL PROPERTY	LEWIS DANIEL EDWIN & RILEY CHRISTINE	7800 ARLINGTON AVE	204549227	2020	INDIVIDUAL PERSONAL PROPERTY	SMITH KAREEMA LANISE	8612 E UTOPIA DR APT 77
204540578	2021	INDIVIDUAL PERSONAL PROPERTY	LUCAS KARLAYSHA DASHYA	6709 LAUREL AVE	204549230	2019-2021	INDIVIDUAL PERSONAL PROPERTY	VERNON KARA K	11301 E 58TH TER
204540753	2021	INDIVIDUAL PERSONAL PROPERTY	HAYWARD BETTY L	7421 MAPLE UNIT 111	204549292	2015-2016	INDIVIDUAL PERSONAL PROPERTY	GRAHAM MARGARET J	6551 RAYTOWN RD APT 1
204540795	2015-2016	INDIVIDUAL PERSONAL PROPERTY	WILLIAMS CARLA D	10332 E 63RD ST APT 3	204549369	2015-2019	INDIVIDUAL PERSONAL PROPERTY	SULLIVAN CASEY S & YDIA A	10504 E 81ST TER
204540892	2015	INDIVIDUAL PERSONAL PROPERTY	WYNN MEGAN	5604 LANE AVE	204549516	2012-2014	INDIVIDUAL PERSONAL PROPERTY	ANDERSON MITCH	11904 E 78TH TER
204540992	2013-2014	INDIVIDUAL PERSONAL PROPERTY	ROACH KENIE	9351 E 60TH TER	204549517	2019-2021	INDIVIDUAL PERSONAL PROPERTY	STERLING NICHOLAS	10412 E 81ST TER
204541049	2020-2021	INDIVIDUAL PERSONAL PROPERTY	OWENS TAYLOR LEE	5816 NORTHERN AVE	204549641	2021	INDIVIDUAL PERSONAL PROPERTY	MAXWELL LASHAUNDA NAOMI	9212 E 54TH ST
204541271	2012-2013	INDIVIDUAL PERSONAL PROPERTY	JONES NICOLE & EDWARDS EARL LONZO	7414 OVERTON AVE UNIT 4	204549739	2019	INDIVIDUAL PERSONAL PROPERTY	FRANKLIN JOSEPH L	11415 E 58TH TER
204541286	2017	INDIVIDUAL PERSONAL PROPERTY	SPILLER LATASHA	8819 E 84TH TER	204549829	2013-2017	INDIVIDUAL PERSONAL PROPERTY	COOPER CHELENA	8600 E 81ST TER
204541659	2018-2021	INDIVIDUAL PERSONAL PROPERTY	DRIVER JESSICA E	8622 LANE AVE	204549830	2013	INDIVIDUAL PERSONAL PROPERTY	EMERY BETTIE G	8605 GREENWOOD RD
204541705	2019	INDIVIDUAL PERSONAL PROPERTY	JONES RANDALL D	4312 NORTHERN AVE APT 2421	204549929	2019-2021	INDIVIDUAL PERSONAL PROPERTY	MAY LELAND DWIGHT	9000 E 57TH TER
204541874	2014	INDIVIDUAL PERSONAL PROPERTY	SANDERS JESSE BRIAN	5803 BLUE RIDGE CUT OFF	204550008	2018-2021	INDIVIDUAL PERSONAL PROPERTY	LEE MICHELLE DECARLA	11415 E 58TH TER
204541912	2014-2015	INDIVIDUAL PERSONAL PROPERTY	BYRD ANDRE L	8855 E 52ND TER	204550220	2021	INDIVIDUAL PERSONAL PROPERTY	EDWARDS ZINE RENA	8700 E 79TH TER
204542142	2021	INDIVIDUAL PERSONAL PROPERTY	CROCKETT DARNISHA ALEXANDRIA A	5149 WESTRIDGE CIR	204550372	2015-2020	INDIVIDUAL PERSONAL PROPERTY	SWANSON JUSTIN	7701 RAYTOWN RD APT 11
204542189	2013-2014	INDIVIDUAL PERSONAL PROPERTY	WORLEY JAMES ANTHONY JR	11007 E 83RD ST	204550566	2014-2016	INDIVIDUAL PERSONAL PROPERTY	HERNANDEZ JOHN M	5745 BLUE RIDGE BLVD
204542250	2021	INDIVIDUAL PERSONAL PROPERTY	RELIFORD MICHELLE ELIZABETH	8413 HARRIS AVE	204550596	2020-2021	INDIVIDUAL PERSONAL PROPERTY	WARREN BRIAN A	10915 E 81ST TER

204550693	2017-2018	INDIVIDUAL PERSONAL PROPERTY	SHAVER SARA MICHELLE	8716 E 81ST TER	204559787	2013-2014	INDIVIDUAL PERSONAL PROPERTY	WAGNER KEITH V	8932 E 57TH ST
204550782	2021	INDIVIDUAL PERSONAL PROPERTY	SMITHERS AMBER NACOEL	1504 SE ABBEY ST	204560036	2018	INDIVIDUAL PERSONAL PROPERTY	HUGHES DIANE G	1815 E 73RD ST APT F
204551213	2021	INDIVIDUAL PERSONAL PROPERTY	WILLIAMS TREY MAJOR	6117 LAUREL AVE	204560236	2019-2021	INDIVIDUAL PERSONAL PROPERTY	GRAY KEIA	6133 KENTUCKY AVE
204551520	2015-2021	INDIVIDUAL PERSONAL PROPERTY	DOBSON BRANDON L & SAMANTHA J	7608 HARRIS AVE	204560327	2013-2014	INDIVIDUAL PERSONAL PROPERTY	DANIELS STEPHONS	6306 RALSTON AVE
204551696	2015	INDIVIDUAL PERSONAL PROPERTY	SANDERS DYESHA	7148 CRISP AVE	204560551	2013	INDIVIDUAL PERSONAL PROPERTY	MACIEL IVAN	7320 APPLETON AVE
204551841	2013-2017	INDIVIDUAL PERSONAL PROPERTY	LAVVORN KRISTIN NICHOLE	9708 BROOKLANE ST	204560728	2017	INDIVIDUAL PERSONAL PROPERTY	BRADFORD RONDAL E	9546 E 57TH TER
204551894	2020-2021	INDIVIDUAL PERSONAL PROPERTY	WHITED DEBORAH MARIE	9104 E 66TH TER	204560956	2013-2016	INDIVIDUAL PERSONAL PROPERTY	MILES OSCAR	11208 E 60TH ST
204552146	2014	INDIVIDUAL PERSONAL PROPERTY	MARCURELLA JENNIFER N	10616 E 70TH ST	204561175	2015	INDIVIDUAL PERSONAL PROPERTY	SEGOVIA ROBERTO E	5521 MANNING AVE
204552230	2013-2015	INDIVIDUAL PERSONAL PROPERTY	VEGA MONARRES ROBERTO	8409 STERLING AVE	204561434	2018	INDIVIDUAL PERSONAL PROPERTY	THOMAS ELDA M	10504 E 57TH PL
204552388	2021	INDIVIDUAL PERSONAL PROPERTY	WIDENER JOYCE J	5420 BLUE RIDGE CUT OFF APT G05	204561920	2019-2021	INDIVIDUAL PERSONAL PROPERTY	BECKER AMY E	9800 E 80TH TER
204552413	2021	INDIVIDUAL PERSONAL PROPERTY	REX KADISHIA JANNICE L C	9401 E 83RD ST	204561963	2013	INDIVIDUAL PERSONAL PROPERTY	WEAVER ASHLEY NICOLE	11815 E 83RD ST APT 102
204552427	2021	INDIVIDUAL PERSONAL PROPERTY	MERRIOTT TRINA	4908 APPLETON AVE	204916887	2021	INDIVIDUAL PERSONAL PROPERTY	MONTROSE AMERICAN M	6217 RALSTON AVE
204552498	2021	INDIVIDUAL PERSONAL PROPERTY	HARDIN ANDRE CHARLES II	9004 E 85TH ST	204917841	2015	INDIVIDUAL PERSONAL PROPERTY	GILES DOMINIQUE J	6116 HARRIS AVE
204552728	2021	INDIVIDUAL PERSONAL PROPERTY	BROWN MICHELLE DENISE	8634 LANE AVE APT 3	204917928	2021	INDIVIDUAL PERSONAL PROPERTY	BALLEW JEFFREY SCOTT	7044 WOODSON RD
204552935	2014-2021	INDIVIDUAL PERSONAL PROPERTY	WHITLOW JAZMYNE N	8314 HUNTER ST	204917943	2018-2019	INDIVIDUAL PERSONAL PROPERTY	COYLE JASON	8915 E 75TH ST
204552948	2021	INDIVIDUAL PERSONAL PROPERTY	HOPKINS JAMON RAY II & TRACY ANN	8816 E 61ST ST	204918142	2016	INDIVIDUAL PERSONAL PROPERTY	SCHNEIDER STANLEY ALAN	6107 STERLING AVE
204552972	2015-2016	INDIVIDUAL PERSONAL PROPERTY	LEWIS CHRISTOPHER	6208 KENTUCKY AVE	204918495	2018-2020	INDIVIDUAL PERSONAL PROPERTY	SMITH AY SHAWN RAMAL & VANZAN QWENTOLIA	9916 E 61ST ST
204553037	2016-2018	INDIVIDUAL PERSONAL PROPERTY	ROSE JOHN L	7324 WILLOW AVE	204918580	2017-2021	INDIVIDUAL PERSONAL PROPERTY	HEMKENS RACHEL CHRISTINA	8704 W LONGVIEW PKWY
204553276	2021	INDIVIDUAL PERSONAL PROPERTY	FLOWERS ELBERT	9815 E 73RD ST APT A	204918701	2014-2021	INDIVIDUAL PERSONAL PROPERTY	MINOR DEANGILO E	11217 E 58TH TER
204553420	2021	INDIVIDUAL PERSONAL PROPERTY	JOHNSON AMBER NICOLE	9724 E 79TH ST	204919038	2015-2016	INDIVIDUAL PERSONAL PROPERTY	WILLIAM GRACE ISAISH THEODORE	8405 ARLINGTON AVE
204553603	2013-2017	INDIVIDUAL PERSONAL PROPERTY	SIMS AMANDA LEE	9245 E 53RD TER	204919217	2014-2016	INDIVIDUAL PERSONAL PROPERTY	LOVEALL CRAIG E	9408 E 61ST ST APT 7
204553723	2014	INDIVIDUAL PERSONAL PROPERTY	SINKCLAR JILL	5724 MANNING AVE	204919254	2018-2021	INDIVIDUAL PERSONAL PROPERTY	GRAY KENNETH CHAVELLE	6342 INDIANA AVE
204553789	2014	INDIVIDUAL PERSONAL PROPERTY	QUALLS JEFFREY S	11703 E 83RD ST APT 201	204919757	2014	INDIVIDUAL PERSONAL PROPERTY	HARRIS CHRISTOPHER	9813 E 61ST ST APT 7
204553803	2021	INDIVIDUAL PERSONAL PROPERTY	GREEN ANNETTE DALIA	10408 E 65TH ST	204919830	2014-2021	INDIVIDUAL PERSONAL PROPERTY	STEWART SHEENA M	9010 E 87TH ST APT D7
204553837	2014-2015	INDIVIDUAL PERSONAL PROPERTY	EIKEL DENISE G	5321 HUNTER ST	204919971	2021	INDIVIDUAL PERSONAL PROPERTY	PELER THOMAS KAYLA MARIAH	9808 E 61ST ST APT 2
204554007	2013-2016	INDIVIDUAL PERSONAL PROPERTY	MILES THOMAS	11208 E 60TH ST	204920042	2016-2021	INDIVIDUAL PERSONAL PROPERTY	VARELA OVLSON JOEL	5416 RAYTOWN RD
204554142	2019-2021	INDIVIDUAL PERSONAL PROPERTY	KHAN VICTORIA ELAINE	8904 E 58TH ST	204920078	2014	INDIVIDUAL PERSONAL PROPERTY	GOMEZ ERIC	9100 E 87TH ST APT C1
204554213	2020-2021	INDIVIDUAL PERSONAL PROPERTY	CUNNINGHAM KORTNEY LYNN	6016 STERLING AVE	204920528	2018	INDIVIDUAL PERSONAL PROPERTY	FENECK FELICIA M	8805 E 81ST TER
204554309	2017-2021	INDIVIDUAL PERSONAL PROPERTY	LETTERMAN RAE A	5229 CRISP AVE	204920680	2019-2021	INDIVIDUAL PERSONAL PROPERTY	FORD NAKIA J	11405 E 61ST TER
204554318	2013	INDIVIDUAL PERSONAL PROPERTY	BURNES ALBERT M	10318 E 63RD ST APT 3	204920753	2015-2016	INDIVIDUAL PERSONAL PROPERTY	BRANDON ADLEANA & EVANS CHRISTOPHER	7211 RAYTOWN RD
204554439	2013-2014	INDIVIDUAL PERSONAL PROPERTY	MAHAN CHARLES GLENN	7509 HAWTHORNE AVE	204920842	2015	INDIVIDUAL PERSONAL PROPERTY	ST CLAIR ROBERT N & LAURA L	8472 LANE DR
204554453	2016	INDIVIDUAL PERSONAL PROPERTY	REED OLIVIA C	11801 E 77TH ST	204920886	2020-2021	INDIVIDUAL PERSONAL PROPERTY	WHITE RAYMOND DEWAYNE & SH'NEL	9109 E 85TH ST
204554676	2020-2021	INDIVIDUAL PERSONAL PROPERTY	OKOJIE FRANCISCA ADESUWA	11215 E 75TH ST	204921224	2021	INDIVIDUAL PERSONAL PROPERTY	HEROLD JASON LEE	9107 E 74TH TER
204554731	2013-2014	INDIVIDUAL PERSONAL PROPERTY	ROSE TIFFANY H	7324 WILLOW AVE	204921318	2019-2021	INDIVIDUAL PERSONAL PROPERTY	RACY SHQLUA	8629 E UTOPIA PKWY APT 6
204554734	2015-2019	INDIVIDUAL PERSONAL PROPERTY	BROOKS MARSHALL D	11100 E 67TH ST	204921358	2016	INDIVIDUAL PERSONAL PROPERTY	BRADLEY SHASHANDA DORCEYA	9319 PERSHING RD
204554755	2013	INDIVIDUAL PERSONAL PROPERTY	VANCAMP TARA	9401 E 63RD ST APT 204	204921802	2014-2019	INDIVIDUAL PERSONAL PROPERTY	JACKSON ELVIN	8614 E UTOPIA DR APT 73
204554890	2017-2021	INDIVIDUAL PERSONAL PROPERTY	CROW GEOFFREY	6700 CRISP AVE	204921966	2014-2017	INDIVIDUAL PERSONAL PROPERTY	SANDERS THERESA	9205 E 82ND ST
204554927	2020	INDIVIDUAL PERSONAL PROPERTY	GRAYSON JOYCE M	5420 BLUE RIDGE CUT OFF APT 208	204922077	2021	INDIVIDUAL PERSONAL PROPERTY	HARRIS KEYANA DIANE	8621 W UTOPIA DR APT 35
204555088	2020-2021	INDIVIDUAL PERSONAL PROPERTY	OLIVER PAUL C	6719 APPLETON AVE	204922111	2013	INDIVIDUAL PERSONAL PROPERTY	MUHAMMAD NAJMAH A	7202 CRISP AVE
204555426	2015-2021	INDIVIDUAL PERSONAL PROPERTY	EHLEY WHITNEY	9521 E 67TH TER	204922145	2020	INDIVIDUAL PERSONAL PROPERTY	GODDARD HESPER JEAN	8005 HARRIS AVE
204555428	2021	INDIVIDUAL PERSONAL PROPERTY	YOUNGS ROBERT R II	10400 E 70TH TER	204922431	2013-2015	INDIVIDUAL PERSONAL PROPERTY	AKINS JANET M	10341 E 61ST ST APT 4
204555473	2021	INDIVIDUAL PERSONAL PROPERTY	GRIDDINE KYLER MARNETT	8307 WOODSON DR	204922495	2020-2021	INDIVIDUAL PERSONAL PROPERTY	SIMMS CHRISTINA L	6926 EWING AVE
204555531	2014	INDIVIDUAL PERSONAL PROPERTY	KELLEHER ANN L	11021 E 57TH ST	204922503	2015	INDIVIDUAL PERSONAL PROPERTY	BERRY WAYNE E	7807 E 87TH ST
204555979	2013	INDIVIDUAL PERSONAL PROPERTY	PARTRIDGE KELLY RENAE	7915 HUNTER ST	204922616	2018-2019	INDIVIDUAL PERSONAL PROPERTY	HUNTINGTON KEVIN	9024 E 74TH TER
204556060	2021	INDIVIDUAL PERSONAL PROPERTY	CAMPBELL MAURICE LAKEITH	7224 RAYTOWN RD APT C	204922772	2020-2021	INDIVIDUAL PERSONAL PROPERTY	WINN LAMONT C	9808 E 57TH ST
204556123	2016-2021	INDIVIDUAL PERSONAL PROPERTY	WAGNER KEITH OR YOLANDA C	8932 E 57TH ST	204923156	2021	INDIVIDUAL PERSONAL PROPERTY	BROWN RONNISHA	8474 LANE DR
204556152	2013	INDIVIDUAL PERSONAL PROPERTY	WASHINGTON ANTWOINE D	9005 E 65TH ST	204923250	2016-2019	INDIVIDUAL PERSONAL PROPERTY	CRUTHIRD MICHAEL E	8466 LANE DR
204556186	2019-2021	INDIVIDUAL PERSONAL PROPERTY	HAMILTON SEAN	11211 E 50TH ST	204923323	2021	INDIVIDUAL PERSONAL PROPERTY	WILLIAMS MARSHINNA KAYE	10609 E 80TH ST
204556304	2020-2021	INDIVIDUAL PERSONAL PROPERTY	LYNCH TEVIN MATHEW	8325 HEDGES AVE	204923393	2021	INDIVIDUAL PERSONAL PROPERTY	COX CASSANDRA	9106 RICHARDS DR
204556513	2020-2021	INDIVIDUAL PERSONAL PROPERTY	SHIELDS JOSEPH D & AMANDA A	10520 E 60TH TER	204923565	2013-2014	INDIVIDUAL PERSONAL PROPERTY	WATTS RICK	7501 MAPLE LN
204556554	2013-2017	INDIVIDUAL PERSONAL PROPERTY	LEATON PATRICK DAKOTA	7624 STERLING AVE	204923599	2013-2015	INDIVIDUAL PERSONAL PROPERTY	WILLIAMS KAREN T	6118 BLUE RIDGE CUT OFF
204557122	2021	INDIVIDUAL PERSONAL PROPERTY	TOWNER JAMES W & CORALYN E	6609 KENTUCKY AVE	204923790	2020-2021	INDIVIDUAL PERSONAL PROPERTY	DOUGLAS TWONNA R	9313 E 83RD ST
204557225	2015-2017	INDIVIDUAL PERSONAL PROPERTY	TAYLOR WESLYNN	6015 KENTUCKY AVE	204924017	2020	INDIVIDUAL PERSONAL PROPERTY	SMITH EBONY S	9801 E 71ST TER
204557423	2013-2017	INDIVIDUAL PERSONAL PROPERTY	ROSE JACQUELYN E	11303 E 58TH TER	204924499	2016	INDIVIDUAL PERSONAL PROPERTY	FORD THOMASTINE L	11833 E 83RD ST APT 102
204557455	2021	INDIVIDUAL PERSONAL PROPERTY	HENDERSON CARLOS KAPEL SR	6100 BLUE RIDGE CUT OFF	204924504	2021	INDIVIDUAL PERSONAL PROPERTY	WILLIAMS OLIVIA H	8604 STARK AVE
204557463	2019-2021	INDIVIDUAL PERSONAL PROPERTY	HARRIS JOHN MICHAEL	10113 E 55TH ST	204924764	2019	INDIVIDUAL PERSONAL PROPERTY	PEREZ ARMANDO B	9213 E 54TH TER
204557612	2013-2017	INDIVIDUAL PERSONAL PROPERTY	PITRE PAUL M	11800 E 77TH TER	204925085	2013-2014	INDIVIDUAL PERSONAL PROPERTY	ROBERTSON SHEMARIO J & COURTNEY	11701 E 83RD ST APT 201
204557831	2016	INDIVIDUAL PERSONAL PROPERTY	OHLMAN NATHAN	8408 SPRING VALLEY RD	204925094	2018-2021	INDIVIDUAL PERSONAL PROPERTY	BAILEY LATASHA D	8907 E 73RD ST
204557843	2021	INDIVIDUAL PERSONAL PROPERTY	MEIER CHASE	1210 SPRUCE DR	204925317	2021	INDIVIDUAL PERSONAL PROPERTY	MCGLOTHEN CAROLYN K	9118 WESTRIDGE CIR
204558021	2019	INDIVIDUAL PERSONAL PROPERTY	COLE AMBER R & BISIG ALFREDO S	6520 HARBOR AVE	204925417	2015-2016	INDIVIDUAL PERSONAL PROPERTY	WILEY DEANTHONY	5055 E 68TH TER
204558032	2021	INDIVIDUAL PERSONAL PROPERTY	HINESLEY DARREN KAYE	9350 E 64TH TER	204925505	2020	INDIVIDUAL PERSONAL PROPERTY	BUDD RAYMOND W	6140 RAYTOWN RD APT 511
204558351	2021	INDIVIDUAL PERSONAL PROPERTY	TERRY SAMARA	6133 KENTUCKY AVE	204925600	2014-2021	INDIVIDUAL PERSONAL PROPERTY	FALES ASHLEY J	7908 HARRIS AVE
204558403	2013-2017	INDIVIDUAL PERSONAL PROPERTY	BROCKMAN MISTY	10113 E 56TH ST	204926053	2014-2015	INDIVIDUAL PERSONAL PROPERTY	RAZI HOSEIN	6341 HARVARD AVE
204558514	2021	INDIVIDUAL PERSONAL PROPERTY	CARLSON MICHAEL S	3413 NW DUNCAN RD APT 3	204926241	2021	INDIVIDUAL PERSONAL PROPERTY	STEVENS TIANDRIA SHONTAY	9808 E 59TH TER
204558804	2017-2018	INDIVIDUAL PERSONAL PROPERTY	UZUETA CARLOS ENRIQUE	9812 E 60TH ST	204926632	2021	INDIVIDUAL PERSONAL PROPERTY	SILLS JEVON C	11329 E 72ND ST
204558810	2014-2021	INDIVIDUAL PERSONAL PROPERTY	JACOBS TIMOTHY CHRISTIAN A JR	9505 E 62ND ST	204926658	2013	INDIVIDUAL PERSONAL PROPERTY	ROULETTE JUDAUN	8633 E UTOPIA PKWY APT 1
204559099	2013-2014	INDIVIDUAL PERSONAL PROPERTY	SANTIAGO JORGE LUIS	8414 LANE PL	204926733	2018-2019	INDIVIDUAL PERSONAL PROPERTY	THOMAS ERIKA K	9806 E 80TH TER
204559255	2021	INDIVIDUAL PERSONAL PROPERTY	ABDULLAH MUSTAFA	9030 E 85TH TER	204926961	2015	INDIVIDUAL PERSONAL PROPERTY	MILES SHANEA K	9363 E 64TH ST
204559257	2018	INDIVIDUAL PERSONAL PROPERTY	CUMMINGS CONRAD JOSEF NOEL	5825 FARLEY AVE	204927086	2013	INDIVIDUAL PERSONAL PROPERTY	LAFFEY SHIRLEY J	8816 RICHARDS DR
204559258	2018	INDIVIDUAL PERSONAL PROPERTY	NGUYEN TUYEN K	11408 E 62ND TER	204927154	2015-2018	INDIVIDUAL PERSONAL PROPERTY	CLARK JASON A & THOMAS SARA M	8182 E 72ND TER
204559774	2020-2021	INDIVIDUAL PERSONAL PROPERTY	PERSONETTE CHRISTOPHER D	5916 ELM ST	204927337	2014	INDIVIDUAL PERSONAL PROPERTY	MORRIS PATRICIA ANTOINETTE	10341 E 61ST ST APT 1
204559778	2020-2021	INDIVIDUAL PERSONAL PROPERTY	STASI JOE	6300 KENTUCKY AVE	204927340	2018	INDIVIDUAL PERSONAL PROPERTY	MARCHBANKS BERKINZ & MECHELL	8316 MANNING AVE

204927356	2020-2021	INDIVIDUAL PERSONAL PROPERTY	PRUITT DENASIA R	9023 E 85TH ST	204937145	2020-2021	INDIVIDUAL PERSONAL PROPERTY	BUIE GENE LEWIS JR	6701 APPLETON AVE
204927359	2021	INDIVIDUAL PERSONAL PROPERTY	WILLIAMS DANIELLE J	11119 E 85TH TER	204937282	2020-2021	INDIVIDUAL PERSONAL PROPERTY	CHASE TUKESA LANAY	5943 RAYTOWN RD
204927500	2013	INDIVIDUAL PERSONAL PROPERTY	RAINEY MICHELE L	5240 HARVARD AVE	204937403	2017	INDIVIDUAL PERSONAL PROPERTY	MOANANU LEILANI SIUTUMEA	6529 OXFORD AVE
204928218	2016-2018	INDIVIDUAL PERSONAL PROPERTY	TATUM CHAUNCEY	9905 E 60TH ST	204937441	2014-2021	INDIVIDUAL PERSONAL PROPERTY	ZAMBRANO CLAUDIA B	5416 RAYTOWN RD
204928374	2014	INDIVIDUAL PERSONAL PROPERTY	BROWNLEE DANIELLE S	9100 E 64TH TER	204937481	2021	INDIVIDUAL PERSONAL PROPERTY	HUBER WESLEY ROY & ANGELOVA HUBER ANNA NIKOLAEVA	8904 E 55TH ST
204928426	2016-2017	INDIVIDUAL PERSONAL PROPERTY	ATWELL KASEY	9112 E 61ST ST	204937701	2021	INDIVIDUAL PERSONAL PROPERTY	COLLINS SHAMICA M	8618 E UTOPIA DR APT 52
204928570	2019-2021	INDIVIDUAL PERSONAL PROPERTY	SMITH TANNER R	7309 CEDAR AVE	204938074	2014	INDIVIDUAL PERSONAL PROPERTY	PEARSON LONNIE	9104 E 64TH TER
204928628	2013-2014	INDIVIDUAL PERSONAL PROPERTY	LANDIS MICHAEL	5420 BLUE RIDGE CUT OFF APT 106	204938091	2013-2014	INDIVIDUAL PERSONAL PROPERTY	NEVIUS MEGAN ANN	9102 E 72ND TER
204928668	2015	INDIVIDUAL PERSONAL PROPERTY	TREJO CARLOS R	8508 EVERETT ST	204938162	2014	INDIVIDUAL PERSONAL PROPERTY	ALMONOR NEHEMIE	8812 E 72ND TER
204928854	2014	INDIVIDUAL PERSONAL PROPERTY	STEVENS RAVEON	8421 ELM AVE	204938257	2019-2021	INDIVIDUAL PERSONAL PROPERTY	JONES CHARLES RAMON	8321 WOODSON DR
204928892	2018-2021	INDIVIDUAL PERSONAL PROPERTY	WELLS CHRISTOPHER D	1306 W 27TH ST S	204938408	2016-2021	INDIVIDUAL PERSONAL PROPERTY	COLEMAN LARHONDA & MYESHA	9005 E 65TH TER
204928988	2014-2018	INDIVIDUAL PERSONAL PROPERTY	COLLINS ERNEST M	11209 E 62ND ST	204938760	2015	INDIVIDUAL PERSONAL PROPERTY	PODRAZA MICHAELA R	10701 E 69TH TER
204928995	2021	INDIVIDUAL PERSONAL PROPERTY	BULLIS JUSTIN	9705 PLYMOUTH LN	204938780	2017	INDIVIDUAL PERSONAL PROPERTY	MITCHEM TERREL	7208 WILLOW AVE
204929094	2014-2019	INDIVIDUAL PERSONAL PROPERTY	GARRETT LILLIE A	7329 HARDY AVE	204939054	2014-2019	INDIVIDUAL PERSONAL PROPERTY	TRICE DALTON	7028 WOODSON RD
204929450	2017-2020	INDIVIDUAL PERSONAL PROPERTY	WOOLERY ROMIA JEAN	11814 E 79TH DR	204939068	2014-2017	INDIVIDUAL PERSONAL PROPERTY	SMITH WYLYESTER WELLESLEY	8303 WOODSON DR
204929460	2021	INDIVIDUAL PERSONAL PROPERTY	MYERS CHRISTINA G	7608 HARRIS AVE	204939120	2020-2021	INDIVIDUAL PERSONAL PROPERTY	PARKER EVELYN	10108 E 68TH ST
204929611	2015-2021	INDIVIDUAL PERSONAL PROPERTY	LOYOLA JACKSON & WENSON	8311 PERSHING RD	204939302	2014	INDIVIDUAL PERSONAL PROPERTY	DONLEY QUINTIN EUGENE	11500 E 57TH TER
204929651	2013	INDIVIDUAL PERSONAL PROPERTY	MBOTE CAROLINE W	11011 E 59TH ST	204939489	2014	INDIVIDUAL PERSONAL PROPERTY	HUSTEDDE CAROLYN	9005 E 74TH ST
204930029	2014-2015	INDIVIDUAL PERSONAL PROPERTY	FITZGERALD JONATHAN	6547 RAYTOWN RD APT 3	204939523	2018-2019	INDIVIDUAL PERSONAL PROPERTY	GORMAN JOSEPH R	7116 STERLING AVE
204930101	2013-2017	INDIVIDUAL PERSONAL PROPERTY	JONES LARRY W	7709 RAYTOWN RD APT 32	204939886	2015	INDIVIDUAL PERSONAL PROPERTY	GRIFFIN JONATHON M	9823 E 60TH ST
204930184	2021	INDIVIDUAL PERSONAL PROPERTY	JOHNSON MICHELLE R	7719 ELM ST	204940006	2021	INDIVIDUAL PERSONAL PROPERTY	HARRIS NATHAN L	9107 E 85TH PL
204930327	2014-2021	INDIVIDUAL PERSONAL PROPERTY	CLYCE LINDA & CRAWFORD NATASHA	8603 FORD AVE	204940094	2014-2021	INDIVIDUAL PERSONAL PROPERTY	LINDSAY RYAN A & MICHELE M	5332 WILLOW AVE
204930374	2017-2020	INDIVIDUAL PERSONAL PROPERTY	WHITE JAMES L	5420 BLUE RIDGE CUT OFF APT 804	204940207	2021	INDIVIDUAL PERSONAL PROPERTY	ARNOLD RYAN D	5312 HUNTER ST
204930506	2017-2020	INDIVIDUAL PERSONAL PROPERTY	NUGENT THADDEUS III	8211 E 85TH TER	204940441	2013	INDIVIDUAL PERSONAL PROPERTY	ROBERTSON MARLON	8814 E 84TH ST
204930544	2014-2015	INDIVIDUAL PERSONAL PROPERTY	LAWSON KATELYN	8622 EVANSTON AVE	204940646	2018	INDIVIDUAL PERSONAL PROPERTY	PIERCE TIMOTHY R	9106 E 74TH ST
204930590	2014	INDIVIDUAL PERSONAL PROPERTY	STRATTON NONA K	6436 BLUE RIDGE BLVD	204940906	2019-2021	INDIVIDUAL PERSONAL PROPERTY	DOMINGOS MANUEL A	7222 RAYTOWN RD APT C
204930685	2020-2021	INDIVIDUAL PERSONAL PROPERTY	ARTH JULIE ANNETTE	513 NW WESTVALE CIR UNIT A	204941322	2020-2021	INDIVIDUAL PERSONAL PROPERTY	PEARSON RODERICK IVAN JR	8920 E 81ST ST
204930760	2012-2019	INDIVIDUAL PERSONAL PROPERTY	BEAVER CRYSTAL L	7204 WILLOW AVE	204941328	2014	INDIVIDUAL PERSONAL PROPERTY	LUSTER EDDIE L	8813 E 84TH ST
204930880	2020-2021	INDIVIDUAL PERSONAL PROPERTY	WILLIAMS ADRIAN JERRON	8200 GREENWOOD RD	204941383	2015-2019	INDIVIDUAL PERSONAL PROPERTY	FENDER JULIE R	9708 E 79TH PL
204930910	2017-2018	INDIVIDUAL PERSONAL PROPERTY	LAMBERT KRISTIE	5415 OXFORD AVE	204941434	2021	INDIVIDUAL PERSONAL PROPERTY	WILLIAMS RONALD EUGENE	9611 E 66TH ST
204931138	2014	INDIVIDUAL PERSONAL PROPERTY	HORTON NATHAN	9811 E 60TH ST	204941484	2021	INDIVIDUAL PERSONAL PROPERTY	HILL CHRISTOPHER YAN	7917 ARLINGTON AVE
204931181	2018	INDIVIDUAL PERSONAL PROPERTY	DENSON DIONNA T	8405 ELM AVE	204941763	2014-2021	INDIVIDUAL PERSONAL PROPERTY	MARTINEZ VIVIANA	8206 E 86TH TER
204931541	2013	INDIVIDUAL PERSONAL PROPERTY	BARKSDALE CRAIG JR	7110 WOODLAND AVE	204941973	2020	INDIVIDUAL PERSONAL PROPERTY	STROTHER CELESTINE J	6225 WOODSON RD
204931618	2013-2015	INDIVIDUAL PERSONAL PROPERTY	INMAN ZACHERY R	7917 ELM AVE	204941982	2018-2021	INDIVIDUAL PERSONAL PROPERTY	CARPENTER TOBY R	7236 RAYTOWN RD APT F
204931659	2020-2021	INDIVIDUAL PERSONAL PROPERTY	MAUCH RACHEL R	11215 E 56TH TER	204942324	2018-2019	INDIVIDUAL PERSONAL PROPERTY	CASE JENNIFER LYNN & JACOB LEVI	7601 ARLINGTON AVE
204931659	2021	INDIVIDUAL PERSONAL PROPERTY	LEWIS MARCUS SHANNON LORENZO	8621 E 83RD TER	204942448	2013-2016	INDIVIDUAL PERSONAL PROPERTY	WALTERS GREG & VICTORIA (LEWIS)	7917 MAPLE AVE
204931879	2021	INDIVIDUAL PERSONAL PROPERTY	ANGUIANO GOMEZ JOSE LUIS	8522 ARLINGTON AVE	204942610	2020-2021	INDIVIDUAL PERSONAL PROPERTY	JAMES BARRY L JR	11313 E 58TH ST
204932149	2017	INDIVIDUAL PERSONAL PROPERTY	HERNANDEZ-MORENO JOSEPH P	9601 E 68TH ST	204942661	2018-2019	INDIVIDUAL PERSONAL PROPERTY	TUCKER JERON	8904 E 73RD ST
204932160	2016	INDIVIDUAL PERSONAL PROPERTY	RANEY MELANIE N (WEDOW)	8816 E 85TH ST	204942887	2015-2021	INDIVIDUAL PERSONAL PROPERTY	MACHIGUA JAIME J & IVONNE L	7911 HARRIS AVE
204932237	2021	INDIVIDUAL PERSONAL PROPERTY	WILSON JAMES JR & WILSON JAMES SR	11819 E 83RD ST APT 201	204943017	2014-2016	INDIVIDUAL PERSONAL PROPERTY	CUNNINGHAM BRYANT E	8605 GREENWOOD RD
204932355	2013-2017	INDIVIDUAL PERSONAL PROPERTY	AYADI ADIL	9801 E 82ND TER	204943049	2020	INDIVIDUAL PERSONAL PROPERTY	SEGULA ELIZABETH A	5420 BLUE RIDGE CUT OFF APT 406
204932436	2018-2021	INDIVIDUAL PERSONAL PROPERTY	STOVALL QUENTIN & SIMMONS ELIZABETH A	8605 STARK AVE	204943135	2021	INDIVIDUAL PERSONAL PROPERTY	CHAPPEL LATERESA (WILLIAMS)	5325 KENTUCKY AVE
204932488	2015-2021	INDIVIDUAL PERSONAL PROPERTY	GARCIA ANTONIO & ALICIA	8002 MANNING AVE	204943311	2017-2020	INDIVIDUAL PERSONAL PROPERTY	BADUA BRANDON L	7444 BLUE RIDGE BLVD
204932691	2021	INDIVIDUAL PERSONAL PROPERTY	HODGE DANNIELLE DENISE	8605 MANNING AVE	204943348	2017	INDIVIDUAL PERSONAL PROPERTY	HECKELBECK BRITTANY	5323 BLUE RIDGE BLVD
204933072	2014-2017	INDIVIDUAL PERSONAL PROPERTY	LYNN ERIN	5305 KENTUCKY AVE	204943374	2016-2021	INDIVIDUAL PERSONAL PROPERTY	ZOELLERS DONALD D	11301 E 62ND ST
204933153	2020-2021	INDIVIDUAL PERSONAL PROPERTY	GARDNER MARY SUSAN	8401 WILLOW WAY	204943460	2015-2016	INDIVIDUAL PERSONAL PROPERTY	OLSON ELIZABETH ANN	8112 MANNING AVE
204933225	2021	INDIVIDUAL PERSONAL PROPERTY	BROWN WALTER R	5608 CRESCENT AVE	204943614	2021	INDIVIDUAL PERSONAL PROPERTY	HENDRIX LOGAN E	8820 E 85TH ST
204933249	2021	INDIVIDUAL PERSONAL PROPERTY	HAMMOND THOMAS R	6137 DITZLER AVE	204943763	2015-2016	INDIVIDUAL PERSONAL PROPERTY	APPLETOFT JOSHUA J	8627 E 80TH TER
204933441	2017-2018	INDIVIDUAL PERSONAL PROPERTY	WATKINS BRUCE R III	9709 E 77TH TER	204944308	2014	INDIVIDUAL PERSONAL PROPERTY	COON CATHERINE LYNN	6641 MAYWOOD AVE
204933550	2017-2018	INDIVIDUAL PERSONAL PROPERTY	MARCURELLA NICHOLAS A	8513 E 47TH ST	204944708	2019-2021	INDIVIDUAL PERSONAL PROPERTY	LESUE MYNDI HOLT	10505 E 82ND ST
204933890	2021	INDIVIDUAL PERSONAL PROPERTY	CHAMPION CATINA	9710 E 75TH ST	204944723	2016-2021	INDIVIDUAL PERSONAL PROPERTY	MILES STEVEN MOURICE	9508 E 66TH ST
204933990	2016-2021	INDIVIDUAL PERSONAL PROPERTY	RINGGOLD ELIZABETH & MOORE HANNAH	9113 E 83RD PL	204944819	2014-2015	INDIVIDUAL PERSONAL PROPERTY	CARTER SHANISHA D	7409 RALSTON AVE
204934050	2014-2017	INDIVIDUAL PERSONAL PROPERTY	BELL CHRISTOPHER DIJON	8052 BOOTH AVE	204945128	2021	INDIVIDUAL PERSONAL PROPERTY	STOWERS LINDSAY R (CRUMP)	9036 E 85TH PL
204934083	2020-2021	INDIVIDUAL PERSONAL PROPERTY	AL SAL BASHEER MOHAMMED	8950 E 83RD TER	204945177	2014-2021	INDIVIDUAL PERSONAL PROPERTY	PEREIRA ALEXANDRE ALVES	7322 ASH AVE
204934228	2021	INDIVIDUAL PERSONAL PROPERTY	WILSON LESLIEANN LACOLE	7724 IRWIN RD	204945428	2015	INDIVIDUAL PERSONAL PROPERTY	MITCHELL RICKY R	8815 E 75TH ST
204934266	2020-2021	INDIVIDUAL PERSONAL PROPERTY	RAINER CARTER JAMES	9304 VAUGHN AVE	204945462	2021	INDIVIDUAL PERSONAL PROPERTY	JONES JESSICA DEANN	5616 DITZLER AVE
204934393	2014-2017	INDIVIDUAL PERSONAL PROPERTY	CARTER JOSEPH B	9211 E 53RD TER	204945720	2017-2019	INDIVIDUAL PERSONAL PROPERTY	FREELAND LEWIS DEE	7705 APPLETON AVE
204934607	2021	INDIVIDUAL PERSONAL PROPERTY	JAGETZ ALEXIS ANN	9101 E 55TH ST	204946024	2016	INDIVIDUAL PERSONAL PROPERTY	PIERSCHBACHER HAZEL L	5609 DITZLER AVE
204934617	2014	INDIVIDUAL PERSONAL PROPERTY	PARKS TERESA W	6004 ARLINGTON AVE	204946178	2014-2016	INDIVIDUAL PERSONAL PROPERTY	LOZIER DAVID	9404 E 68TH ST
204935150	2020-2021	INDIVIDUAL PERSONAL PROPERTY	HAMPTON ALEXIS	8606 STARK AVE	204946635	2014	INDIVIDUAL PERSONAL PROPERTY	NICHOLS SAMANTHA D	8928 E 57TH ST
204935308	2015-2016	INDIVIDUAL PERSONAL PROPERTY	TAYLOR AMBIE	5520 HEDGES AVE	204947046	2017-2020	INDIVIDUAL PERSONAL PROPERTY	BADUA BRANDON	7444 BLUE RIDGE BLVD
204935474	2015-2017	INDIVIDUAL PERSONAL PROPERTY	NAIL CHARLES B	6602 HARDY AVE	204947048	2021	INDIVIDUAL PERSONAL PROPERTY	ROSS ERICA N	9025 E 73RD ST
204935499	2014-2021	INDIVIDUAL PERSONAL PROPERTY	FLORES PHILLIP M	8520 PERSHING RD	204947327	2019-2021	INDIVIDUAL PERSONAL PROPERTY	BUTLER BRADLEY W	8408 BOOTH AVE
204935507	2017	INDIVIDUAL PERSONAL PROPERTY	PROUGH ORSINI DAWN E	9410 E 82ND ST	204947768	2014-2015	INDIVIDUAL PERSONAL PROPERTY	REYNOLDS JOHN DAVIS	9025 E 73RD ST
204935775	2013	INDIVIDUAL PERSONAL PROPERTY	GERSTNER JESSICA	9805 E 61ST ST APT 5	204947801	2014-2021	INDIVIDUAL PERSONAL PROPERTY	BUTT DENNIS R	11313 E 62ND ST
204935809	2015-2021	INDIVIDUAL PERSONAL PROPERTY	ERICKSON MELANIE	10000 E 68TH ST	204947981	2019-2021	INDIVIDUAL PERSONAL PROPERTY	ABRAHAM KIVA LACELLA	8201 KENTUCKY AVE
204935953	2014	INDIVIDUAL PERSONAL PROPERTY	CUTCHLOW NATOSHA	9704 E 79TH PL	204948010	2020-2021	INDIVIDUAL PERSONAL PROPERTY	CARADINE CRYSTAL	9818 E 61ST ST APT 2
204935991	2021	INDIVIDUAL PERSONAL PROPERTY	HERNANDEZ CHRISTOPHER P	11313 RIDGE DR	204948057	2014-2021	INDIVIDUAL PERSONAL PROPERTY	VAUGHN KENNETH CARL	8871 E 52ND TER
204936029	2021	INDIVIDUAL PERSONAL PROPERTY	SARVER APRIL C	1404 S OSAGE ST	204948135	2021	INDIVIDUAL PERSONAL PROPERTY	NIXON DANIELLE NICOLE	10405 E 80TH ST
204936211	2020-2021	INDIVIDUAL PERSONAL PROPERTY	SMALL ANGELA DENICE	10803 E 60TH TER	204948222	2013	INDIVIDUAL PERSONAL PROPERTY	CROSBY JON	7411 ASH AVE
204936711	2021	INDIVIDUAL PERSONAL PROPERTY	ROSS CASSANDRA L	5502 HARDY AVE	204948414	2014-2021	INDIVIDUAL PERSONAL PROPERTY	SHANNON LACRECIA DENISE (TAYLOR)	8118 WOODSON DR
204936867	2020-2021	INDIVIDUAL PERSONAL PROPERTY	GETMAN BLAKE	9809 E 73RD ST APT C	204948507	2021	INDIVIDUAL PERSONAL PROPERTY	REID JASON MICHAEL	11105 E 78TH TER

204948513	2020-2021	INDIVIDUAL PERSONAL PROPERTY	TURNER LARISHA N	9404 E 67TH TER	204960353	2021	INDIVIDUAL PERSONAL PROPERTY	CUSHON MIA JANEEN	8304 MANNING AVE
204948557	2016-2021	INDIVIDUAL PERSONAL PROPERTY	MILES CARRIE LYNN	9005 E 68TH TER	204961421	2020-2021	INDIVIDUAL PERSONAL PROPERTY	JUPITER RENIEL	5301 STERLING AVE
204948599	2021	INDIVIDUAL PERSONAL PROPERTY	TUBBS ELLIOTT DUANE	8917 E 67TH PL APT 107	204961507	2014	INDIVIDUAL PERSONAL PROPERTY	KIRBY CHRISTOPHER & CASARES CHRISTINA	10600 E 66TH ST
204948619	2014-2016	INDIVIDUAL PERSONAL PROPERTY	SARRATT JENNIFER & JOHNSON JEREMY K	8607 EVANSTON AVE	204961591	2017-2018	INDIVIDUAL PERSONAL PROPERTY	OKOJIE PATRICK EHIABHI	11215 E 75TH ST
204948827	2021	INDIVIDUAL PERSONAL PROPERTY	WRIGHT-POOLER SYLVIA SELENE	9001 E 66TH TER	204961600	2014-2015	INDIVIDUAL PERSONAL PROPERTY	COULTER BILLY JACK	9009 E 52ND TER
204949466	2013-2017	INDIVIDUAL PERSONAL PROPERTY	SMITH ANTHONY J	11205 E 61ST ST	204962042	2014-2015	INDIVIDUAL PERSONAL PROPERTY	JACKSON RONNIE L	9356 E 77TH ST
204949605	2021	INDIVIDUAL PERSONAL PROPERTY	GRAY KIMBERLY A	8707 E 80TH TER	204962324	2021	INDIVIDUAL PERSONAL PROPERTY	COPRIDGE CARISHA	9204 E 53RD TER
204949631	2020-2021	INDIVIDUAL PERSONAL PROPERTY	POTTER KRISTIN D	11015 E 78TH TER	204962377	2021	INDIVIDUAL PERSONAL PROPERTY	WAYNE CARTER A	10401 E 56TH ST
204949753	2021	INDIVIDUAL PERSONAL PROPERTY	SIMONDS SHEILA D	8617 E 83RD TER	204962537	2021	INDIVIDUAL PERSONAL PROPERTY	HUSKEY BILLY D JR & WHITNEY R	8452 LANE DR
204949758	2020-2021	INDIVIDUAL PERSONAL PROPERTY	BEAN MICHELLE	11605 E 61ST TER	204962867	2021	INDIVIDUAL PERSONAL PROPERTY	CLARKE RUBEN	7248 BLUE RIDGE BLVD
204949868	2019-2021	INDIVIDUAL PERSONAL PROPERTY	PENCE ALEX MICHAEL	30705 E ATHERTON SIBLEY RD	204963086	2021	INDIVIDUAL PERSONAL PROPERTY	WLEH TARPLOH & DIXON TASHEANA J M	5724 MANNING AVE
204949964	2014-2021	INDIVIDUAL PERSONAL PROPERTY	MARTIN MARIA R	6525 ELM AVE	204963321	2019-2021	INDIVIDUAL PERSONAL PROPERTY	SMITH JAYUAN J	9108 E 58TH ST
204950067	2021	INDIVIDUAL PERSONAL PROPERTY	YUN FRED	8905 E 66TH ST	204963328	2021	INDIVIDUAL PERSONAL PROPERTY	BATTLE JAMEEL R & EUGENE	7907 APPLETON AVE
204950160	2021	INDIVIDUAL PERSONAL PROPERTY	ROBB SHEILA A (BAKER)	10905 E 62ND TER	204963629	2020-2021	INDIVIDUAL PERSONAL PROPERTY	WESSLEY RONALD R	11700 E 78TH TER
204950192	2014	INDIVIDUAL PERSONAL PROPERTY	COKER THOMAS & MARTINA MOTHERSBOUGH	11701 E 51ST ST	204963730	2019-2021	INDIVIDUAL PERSONAL PROPERTY	RICHARDSON HOSEA A	11705 E 77TH ST
204950205	2015	INDIVIDUAL PERSONAL PROPERTY	RUPLE JOHN HENRY JR & SHAWNA MARIE	10117 E 64TH ST	204963897	2019-2021	INDIVIDUAL PERSONAL PROPERTY	CLIFFORD STEPHEN RAY & STEVEN W	9500 E 65TH TER
204950272	2021	INDIVIDUAL PERSONAL PROPERTY	EDMONDS WILLIAM R & CINDY S	5165 WESTRIDGE CIR	204964732	2021	INDIVIDUAL PERSONAL PROPERTY	LESLIE CHRISTOPHER ARTIS	10505 E 82ND ST
204950662	2017	INDIVIDUAL PERSONAL PROPERTY	DAVIS JOHNNIE RUTH	7308 CRISP AVE	204965189	2014	INDIVIDUAL PERSONAL PROPERTY	SMITH DANTE J	7632 STERLING AVE
204950803	2021	INDIVIDUAL PERSONAL PROPERTY	HIGGS ARVETA JJ	10113 E 74TH TER	204965433	2017	INDIVIDUAL PERSONAL PROPERTY	HENSLEY RICKEY D	9708 E 77TH ST
204950809	2021	INDIVIDUAL PERSONAL PROPERTY	MARKS DANIEL M	10104 E 77TH TER	204965697	2019-2021	INDIVIDUAL PERSONAL PROPERTY	FOLAK JOHN MICHAEL	11320 E 72ND ST
204950927	2021	INDIVIDUAL PERSONAL PROPERTY	KLINGE FRANCES S	11811 E 80TH DR	204965832	2019	INDIVIDUAL PERSONAL PROPERTY	WEBB SYDNEY A	9505 E 57TH ST
204950955	2021	INDIVIDUAL PERSONAL PROPERTY	BEATTY REGINALD & EHRHARAT NATALEA	8413 E 85TH TER	204965886	2016	INDIVIDUAL PERSONAL PROPERTY	ODGERS GAIL ANN	8509 BOOTH AVE
204951287	2020-2021	INDIVIDUAL PERSONAL PROPERTY	JENKINS LEON III	8436 LANE DR	204965917	2015-2017	INDIVIDUAL PERSONAL PROPERTY	BUTTERFIELD GARRETT A	1820 E 11TH ST
204951323	2020	INDIVIDUAL PERSONAL PROPERTY	WINGATE SANTINAE ARMONDA V	8308 E 85TH TER	204966109	2014-2017	INDIVIDUAL PERSONAL PROPERTY	DAVIS WORTHINGTON ANDREW HALL	4906 E 61ST ST
204951468	2020	INDIVIDUAL PERSONAL PROPERTY	JOHNSON SEVAUN EMANUEL	8600 SPRING VALLEY RD	204966189	2020-2021	INDIVIDUAL PERSONAL PROPERTY	FORD ELISHA D	5244 HARDY CT
204951547	2019-2021	INDIVIDUAL PERSONAL PROPERTY	MOCK DOROTHY	5709 HUNTER ST	204966367	2021	INDIVIDUAL PERSONAL PROPERTY	MCCULLOUGH BRIAN J	11702 E 85TH ST
204951630	2013-2015	INDIVIDUAL PERSONAL PROPERTY	GILLESPIE ROBBY L	7505 WOODSON RD	204966392	2014	INDIVIDUAL PERSONAL PROPERTY	DAVIS JOHN TRENT	5420 BLUE RIDGE CUT OFF APT 715
204951771	2014-2021	INDIVIDUAL PERSONAL PROPERTY	JAMES EDWARD BRYANT	7316 MAYWOOD AVE	204966493	2014	INDIVIDUAL PERSONAL PROPERTY	RODARTE MARIA	11220 E 71ST DR
204952113	2015	INDIVIDUAL PERSONAL PROPERTY	HAMILTON BREIONA S	9221 E 54TH ST	204966977	2021	INDIVIDUAL PERSONAL PROPERTY	MELTON ELIZABETH I & KEVIN D	10200 E 64TH ST
204952272	2021	INDIVIDUAL PERSONAL PROPERTY	KOPP KARI LYNN	7148 STERLING AVE	204966982	2021	INDIVIDUAL PERSONAL PROPERTY	MCKAY MICHAEL W	7408 APPLETON AVE
204952366	2019-2020	INDIVIDUAL PERSONAL PROPERTY	THURMAN TAMEKA NICOLE	9138 E 87TH TER	204967029	2010-2017	INDIVIDUAL PERSONAL PROPERTY	WALKER EASTER	8001 TENNESSEE AVE
204953061	2014	INDIVIDUAL PERSONAL PROPERTY	BIGGS BRANDY R	7901 OLDHAM RD	204967224	2017-2021	INDIVIDUAL PERSONAL PROPERTY	SMERK ANTHONY	9800 E GREGORY BLVD
204953147	2019-2021	INDIVIDUAL PERSONAL PROPERTY	VANDERPOOL KEITH	6640 MAYWOOD AVE APT A	204967287	2021	INDIVIDUAL PERSONAL PROPERTY	JOHNSON SEQUOIA	9808 STARK AVE
204953180	2017-2019	INDIVIDUAL PERSONAL PROPERTY	MCMILLIAN ARKEYA JARAY	7717 ENGLEWOOD AVE	204967394	2017-2018	INDIVIDUAL PERSONAL PROPERTY	WAHLERS JOANN C	5524 DITZLER AVE
204953395	2014-2016	INDIVIDUAL PERSONAL PROPERTY	POWELL RUSSELL EUGENE II	10412 E 72ND ST	204967615	2014-2015	INDIVIDUAL PERSONAL PROPERTY	DUNLAP ALEXIS J	10000 E 68TH ST
204953856	2014-2015	INDIVIDUAL PERSONAL PROPERTY	GONZALEZ SALVADOR A	9418 E 82ND ST	204967692	2021	INDIVIDUAL PERSONAL PROPERTY	LOVE JEFFREY L	8905 E GREGORY BLVD
204953865	2017-2021	INDIVIDUAL PERSONAL PROPERTY	PENNINGTON CLIFTON J	8303 HUNTER ST	204968072	2014-2021	INDIVIDUAL PERSONAL PROPERTY	FITZGERALD JENNIFER M	8614 PERSHING RD
204953923	2014	INDIVIDUAL PERSONAL PROPERTY	FOSTER ANTWAIN D	7226 RAYTOWN RD APT C	204968463	2021	INDIVIDUAL PERSONAL PROPERTY	MELSON MATTHEW C	10905 E 77TH TER
204953969	2015	INDIVIDUAL PERSONAL PROPERTY	KENEMORE JACOB P	11001 E 71ST TER	204968482	2020-2021	INDIVIDUAL PERSONAL PROPERTY	WALKER SHERRIE	9205 E 82ND ST
204954374	2016-2019	INDIVIDUAL PERSONAL PROPERTY	JONES NICKLAS	4728 E 39TH ST	204968491	2021	INDIVIDUAL PERSONAL PROPERTY	ADDISON FELICIA RENEA (CLINTON)	8901 E 57TH ST
204954384	2018	INDIVIDUAL PERSONAL PROPERTY	PARKS RAEVEN ALLYSA	11829 E 83RD ST APT 101	204968562	2014-2019	INDIVIDUAL PERSONAL PROPERTY	TSCHIRHART STEPHEN	5416 RALSTON AVE
204954653	2014	INDIVIDUAL PERSONAL PROPERTY	RUDROFF DEREK L	5919 HARVARD AVE	204968784	2014	INDIVIDUAL PERSONAL PROPERTY	TALLEY JOHN R	7511 HAWTHORNE AVE
204954766	2020	INDIVIDUAL PERSONAL PROPERTY	SPRATT BRITTNEY MARIE	7316 HEDGES AVE	204968825	2021	INDIVIDUAL PERSONAL PROPERTY	THOMPSON DAVASHAE ALICEANN	6406 ELM AVE
204955472	2020-2021	INDIVIDUAL PERSONAL PROPERTY	HARRIS CHIQUITA RENEE	8812 E 72ND ST	204969064	2016-2021	INDIVIDUAL PERSONAL PROPERTY	CAIN MICHAEL LEE JR	9058 E 65TH ST
204955516	2014	INDIVIDUAL PERSONAL PROPERTY	MILLER CARDELL	8305 HARVARD AVE	204969462	2019-2021	INDIVIDUAL PERSONAL PROPERTY	MEYER JONAE S	11532 E 74TH STREET CT
204955520	2021	INDIVIDUAL PERSONAL PROPERTY	FELICIONE NICOLE R	9406 E 77TH ST	204969686	2018-2019	INDIVIDUAL PERSONAL PROPERTY	BROWN D/MARCO D/JUAN	8400 LANE PL
204955539	2014-2015	INDIVIDUAL PERSONAL PROPERTY	GILL FONNESHA LATRECE	9819 E 61ST ST APT 7	204969766	2019-2021	INDIVIDUAL PERSONAL PROPERTY	WERNER JESSIE L	10125 E 78TH TER
204955751	2019	INDIVIDUAL PERSONAL PROPERTY	DONAHUE JASMINE NASHA	9202 E 53RD TER	204970234	2018-2019	INDIVIDUAL PERSONAL PROPERTY	KOLBEK TESSA MARIE	8211 E 85TH TER
204956199	2018	INDIVIDUAL PERSONAL PROPERTY	HINKEL CAMERON J	9306 E 81ST TER	204970272	2014-2015	INDIVIDUAL PERSONAL PROPERTY	JONES BRADLEY LYNN	6140 RAYTOWN RD APT 406
204956348	2018	INDIVIDUAL PERSONAL PROPERTY	SHAW MADELINE DIANA JOY	8622 E UTOPIA DR APT 23	204970384	2019-2021	INDIVIDUAL PERSONAL PROPERTY	FREEMAN ALBERT A	11407 E 57TH TER
204956475	2019	INDIVIDUAL PERSONAL PROPERTY	NICHOLSON BRITTANY NICOLE	6800 CRABAPPLE CIR APT 2	204970603	2019-2021	INDIVIDUAL PERSONAL PROPERTY	LEWIS AMANDA JO	9706 E 65TH TER
204957020	2021	INDIVIDUAL PERSONAL PROPERTY	WAIT JAMES ISAAC	7804 CRESCENT AVE	204970630	2016-2017	INDIVIDUAL PERSONAL PROPERTY	WALBURN KORIE	9803 E 61ST ST APT 1
204957267	2018	INDIVIDUAL PERSONAL PROPERTY	COONEY KELLY DAWN	9103 E 84TH ST	204970685	2013	INDIVIDUAL PERSONAL PROPERTY	DORTCH ROBERT L & CYNTHIA R	8408 PERSHING RD
204957887	2021	INDIVIDUAL PERSONAL PROPERTY	WILSON CALEY S	8903 RICHARDS DR	204970799	2015-2016	INDIVIDUAL PERSONAL PROPERTY	KIRK JACOB DANIEL	5404 ELM AVE
204957387	2019	INDIVIDUAL PERSONAL PROPERTY	SIMINGTON LAVELL	9205 E 84TH ST	204971028	2014	INDIVIDUAL PERSONAL PROPERTY	WALKER TIM & TRINA	8400 E 85TH ST
204957526	2014-2015	INDIVIDUAL PERSONAL PROPERTY	HENSLEY JOSEPH E	9003 E 69TH ST	204971229	2015	INDIVIDUAL PERSONAL PROPERTY	MATTHEWS DESMOND C	6000 BLUE RIDGE CUT OFF
204957578	2021	INDIVIDUAL PERSONAL PROPERTY	RIDS MELODY	8328 LAUREL AVE	204971346	2015-2021	INDIVIDUAL PERSONAL PROPERTY	BAILEY LONZELL D	8052 SPRING VALLEY RD
204957600	2015-2016	INDIVIDUAL PERSONAL PROPERTY	WILLEY LESLIE A	8409 JAMES A REED RD	204971349	2021	INDIVIDUAL PERSONAL PROPERTY	JOHNSON ADRIAN	10604 E 65TH TER
204957658	2015-2017	INDIVIDUAL PERSONAL PROPERTY	RELIFORD MICHAEL L	8316 MANNING AVE	204971412	2021	INDIVIDUAL PERSONAL PROPERTY	PORTER TERRAE	7412 ENGLEWOOD LN
204957708	2013-2014	INDIVIDUAL PERSONAL PROPERTY	MICUCCI MELANIE F & (BRIA A)	7715 RAYTOWN RD APT 33	204971451	2021	INDIVIDUAL PERSONAL PROPERTY	WINDER ALFRED M	7229 STERLING AVE
204957769	2018-2021	INDIVIDUAL PERSONAL PROPERTY	WEAVER LINDA K	8509 E 85TH TER	204971605	2018-2019	INDIVIDUAL PERSONAL PROPERTY	CARPENTER PATRICK	9415 E 81ST ST
204957903	2021	INDIVIDUAL PERSONAL PROPERTY	RUPP KRystal K	11104 E 78TH ST	204972115	2018	INDIVIDUAL PERSONAL PROPERTY	STUBBLEFIELD DONTAE N	9914 E 61ST ST APT 2
204958115	2021	INDIVIDUAL PERSONAL PROPERTY	LOCKLER TYLER D	10810 E 58TH TER	204972175	2021	INDIVIDUAL PERSONAL PROPERTY	HOPKINS STEVEN L	9204 E 69TH TER
204958321	2014-2017	INDIVIDUAL PERSONAL PROPERTY	COLIN JORDAN ELAINE & ROBERT JR	10801 E 66TH TER	204972199	2021	INDIVIDUAL PERSONAL PROPERTY	TOLEFREE LARRY	10809 E 57TH TER
204958559	2018	INDIVIDUAL PERSONAL PROPERTY	LUKER RUFUS E	7220 RAYTOWN RD APT E	204972296	2014-2018	INDIVIDUAL PERSONAL PROPERTY	COLEMAN JACQUELAN M	11209 E 53RD TER
204958560	2016	INDIVIDUAL PERSONAL PROPERTY	SHOCKEY KERRI RENEE & HARRIS RODNEY G	6013 LARSON AVE	204972297	2021	INDIVIDUAL PERSONAL PROPERTY	COOK CLAY M	5730 WOODSON RD
204958770	2020-2021	INDIVIDUAL PERSONAL PROPERTY	FANNING RORY	11315 E 77TH TER	204972340	2014-2017	INDIVIDUAL PERSONAL PROPERTY	EVANS SHANNON M	9058 E 66TH ST
204958800	2014-2021	INDIVIDUAL PERSONAL PROPERTY	NEWTON ANAYA DIONNE	9508 E 57TH ST	204972364	2012-2014	INDIVIDUAL PERSONAL PROPERTY	JACKSON LAKENDRA MONIQUE	9216 E 54TH ST
204959753	2015-2021	INDIVIDUAL PERSONAL PROPERTY	AUSTIN KAYLA MARIE	9708 E 71ST TER	204972509	2021	INDIVIDUAL PERSONAL PROPERTY	BRITTON NAOMI JESSICA	8014 HARDY AVE
204959883	2018-2021	INDIVIDUAL PERSONAL PROPERTY	SMITH MAKAYLA RENEE	8211 E 85TH ST	204972675	2015-2021	INDIVIDUAL PERSONAL PROPERTY	SHAFFER PAUL W	6123 ASH CT
204960102	2021	INDIVIDUAL PERSONAL PROPERTY	EMBAH JUSTIN I	11309 E 71ST ST	204973053	2021	INDIVIDUAL PERSONAL PROPERTY	MCGUIRE JENNIFER K	9055 E 67TH TER
204960290	2014-2015	INDIVIDUAL PERSONAL PROPERTY	LUNGAYAN HERMAN JR	8200 WILLOW WAY	204973541	2017-2021	INDIVIDUAL PERSONAL PROPERTY	SHIRLEY JONES FRANKIE	7224 CRISP AVE

204973702	2021	INDIVIDUAL PERSONAL PROPERTY	VETRUSHKA ANJULI (TREAT)	5528 LANE AVE	204984671	2014-2015	INDIVIDUAL PERSONAL PROPERTY	BERZUNZA CRISTIAN GEOVANY	9509 E 60TH TER
204974049	2017-2018	INDIVIDUAL PERSONAL PROPERTY	MOORE PATRICIA A	6206 RAYTOWN RD	204984688	2016-2021	INDIVIDUAL PERSONAL PROPERTY	YABLONSKI ANGELA M	931 E 65TH TER
204974181	2014	INDIVIDUAL PERSONAL PROPERTY	TOLBERT REBECCA ARCOLA RENEE	5223 STERLING AVE	204985079	2021	INDIVIDUAL PERSONAL PROPERTY	PALMER SEAN ERIC & FUEL LATRICE DANIELLE	8305 WOODSON DR
204974304	2014-2018	INDIVIDUAL PERSONAL PROPERTY	PEARSON WENDELL CARL	5805 LAUREL AVE	204985116	2020-2021	INDIVIDUAL PERSONAL PROPERTY	GLOVER MARK V	10608 E 70TH ST
204974306	2014-2021	INDIVIDUAL PERSONAL PROPERTY	RAMIREZ ROCHA FERMIN	6328 KENTUCKY AVE	204985216	2017	INDIVIDUAL PERSONAL PROPERTY	VIELBIG WILLIAM	5431 HARVARD AVE
204974676	2021	INDIVIDUAL PERSONAL PROPERTY	BREDVOLD JOSEPH ALLEN	8308 HEDGES AVE	204985274	2014-2020	INDIVIDUAL PERSONAL PROPERTY	LUEVANO GARCIA SILVIA LISET	5937 LAUREL AVE
204974801	2021	INDIVIDUAL PERSONAL PROPERTY	HERNANDEZ FRANCISCO MANUEL & DAMARIS M	9705 E 84TH ST	204986454	2014-2016	INDIVIDUAL PERSONAL PROPERTY	ROTHSCHILD SHANEQUEEA DEBORAH	11408 E 69TH ST
204974836	2021	INDIVIDUAL PERSONAL PROPERTY	NWAKOLAM KECHUKWU	6635 CEDAR AVE	204986687	2015-2021	INDIVIDUAL PERSONAL PROPERTY	GRIFFIN BEVERLY M	7205 WOODSON DR
204974884	2017	INDIVIDUAL PERSONAL PROPERTY	MCGLONE CATHERINE ANN	11116 E 59TH ST	204986689	2020-2021	INDIVIDUAL PERSONAL PROPERTY	SAUNDERS TRACY DALE	11215 E 56TH TER
204974946	2017-2021	INDIVIDUAL PERSONAL PROPERTY	TAYLOR KEITH A	8807 E 59TH ST	204986728	2020	INDIVIDUAL PERSONAL PROPERTY	HAMILTON ALEX R	5713 WOODSON RD
204975042	2019-2021	INDIVIDUAL PERSONAL PROPERTY	WATSON TYLEN MONTE	7723 CRESCENT AVE	204986921	2021	INDIVIDUAL PERSONAL PROPERTY	LARA KATHIA ESMERALDA	NO ADDRESS ASSIGNED BY CITY
204975155	2017-2018	INDIVIDUAL PERSONAL PROPERTY	MONTGOMERY ARTHUR & BETTY	9805 E 61ST ST APT 11	204986929	2021	INDIVIDUAL PERSONAL PROPERTY	CAVINDER JEREMY SCOTT	9109 E 68TH TER
204975285	2021	INDIVIDUAL PERSONAL PROPERTY	BROWN JACQUELINE RENEE	8633 E UTOPIA PKWY APT 12	204987025	2017-2018	INDIVIDUAL PERSONAL PROPERTY	PETERSON EVAN MILES	6202 NORTHERN AVE
204975712	2015-2018	INDIVIDUAL PERSONAL PROPERTY	RUIZ ELAINE	6715 HARRIS AVE	204987069	2015-2016	INDIVIDUAL PERSONAL PROPERTY	COX DEREK TYLER	9108 E 58TH TER
204976131	2016-2021	INDIVIDUAL PERSONAL PROPERTY	BUSS ALLYSHIA	8308 MANNING AVE	204987182	2015-2019	INDIVIDUAL PERSONAL PROPERTY	BREVAR ARIANA	9811 E 61ST ST APT 9
204976176	2021	INDIVIDUAL PERSONAL PROPERTY	ORTEGA MACARENA C	8305 LANE AVE	204987406	2016-2021	INDIVIDUAL PERSONAL PROPERTY	LOPEZ JOHN L	6140 RAYTOWN RD APT 411
204976210	2020-2021	INDIVIDUAL PERSONAL PROPERTY	MASON CHARLES M	5521 HARDY AVE	204987479	2016-2018	INDIVIDUAL PERSONAL PROPERTY	HILDSON KRISTAL	8404 E 66TH ST
204976626	2020-2021	INDIVIDUAL PERSONAL PROPERTY	HOFFMAN WILLIAM III	10312 E 58TH TER	204987573	2021	INDIVIDUAL PERSONAL PROPERTY	BENTLEY TAMMY	9125 E 85TH PL
204976646	2014-2021	INDIVIDUAL PERSONAL PROPERTY	FALUK MARIO JERMICA	8909 E 57TH ST	204987800	2020-2021	INDIVIDUAL PERSONAL PROPERTY	SUMULIN MARTIN TERRON II	6217 CLAREMONT AVE
204976757	2020	INDIVIDUAL PERSONAL PROPERTY	PARKER TYRONE G	7224 RAYTOWN RD APT B	204988028	2021	INDIVIDUAL PERSONAL PROPERTY	JOHNSON CARMEN LEIGH-ANN	9201 E 54TH TER
204976810	2014-2016	INDIVIDUAL PERSONAL PROPERTY	DILLARD JAMOND	8509 FORD AVE	204988051	2014	INDIVIDUAL PERSONAL PROPERTY	JORDAN JESSIE	8633 E UTOPIA PKWY APT 11
204977304	2014	INDIVIDUAL PERSONAL PROPERTY	HAWKINS WILL HODGES III	9350 E 70TH TER	204988150	2015-2016	INDIVIDUAL PERSONAL PROPERTY	WILCHER TREVOR C	11320 E 72ND ST
204977314	2021	INDIVIDUAL PERSONAL PROPERTY	CORNWELL JULIE ANN	8119 HARDY AVE	204988308	2020-2021	INDIVIDUAL PERSONAL PROPERTY	LOCKARD LAUREN	7704 APPLETON AVE
204977482	2015	INDIVIDUAL PERSONAL PROPERTY	DAUGHERTY IAN S & CYNTHIA C	8911 E 79TH ST	205346196	2021	INDIVIDUAL PERSONAL PROPERTY	MCCOART DEREK	885 E 72ND ST
204977605	2021	INDIVIDUAL PERSONAL PROPERTY	RITTER BELINDA JOY	7107 NORTHERN JOY	205346333	2019-2021	INDIVIDUAL PERSONAL PROPERTY	MCCEE PRENTHIA	3826 E 80TH TER
204977894	2014	INDIVIDUAL PERSONAL PROPERTY	BENNETT ANDRE C	1447 CRISP AVE	205346388	2021	INDIVIDUAL PERSONAL PROPERTY	VINCENT DOMINIQUE L	9806 E 80TH TER
204978142	2015-2016	INDIVIDUAL PERSONAL PROPERTY	JACKSON DEANDRE M	7509 E 57TH TER	205347115	2020-2021	INDIVIDUAL PERSONAL PROPERTY	ROSS CHRISTOPHER J	8717 E 61ST TER APT 14
204978312	2015	INDIVIDUAL PERSONAL PROPERTY	WARREN TIMOTHY D & MARGOT T	321 SE GREYSTONE DR	205347373	2021	INDIVIDUAL PERSONAL PROPERTY	COCHRAN FRED D & ESTHER J	6206 DITZLER AVE
204978418	2014	INDIVIDUAL PERSONAL PROPERTY	DANNER SARAH M	6004 CLAREMONT AVE	205347473	2021	INDIVIDUAL PERSONAL PROPERTY	JOHNSON KELLY N	8956 HEDGES AVE
204978470	2021	INDIVIDUAL PERSONAL PROPERTY	BUTLER TAMARA Y	9201 E 87TH ST	205347675	2021	INDIVIDUAL PERSONAL PROPERTY	SMIDDY SAMANTHA JO	5529 HUNTER TER
204978480	2020-2021	INDIVIDUAL PERSONAL PROPERTY	SANTOS-MONICO EMMANUEL	8509 KENTUCKY AVE	205347948	2014	INDIVIDUAL PERSONAL PROPERTY	ALDIS LARSON	9904 E 60TH ST
204978850	2015-2017	INDIVIDUAL PERSONAL PROPERTY	SANDER DAVID MARTIN	7911 MANNING AVE	205347964	2021	INDIVIDUAL PERSONAL PROPERTY	KEEN ALLEN R	9612 E 66TH ST
204979139	2016-2020	INDIVIDUAL PERSONAL PROPERTY	TROUT JANE ANN	9405 E 66TH ST	205348014	2021	INDIVIDUAL PERSONAL PROPERTY	PORRAS SALGADO LAURA JANETH	11209 E 53RD ST
204979154	2014-2015	INDIVIDUAL PERSONAL PROPERTY	ESPINOZA ROBERT	9904 E 60TH ST	205348223	2014	INDIVIDUAL PERSONAL PROPERTY	BROOKS ROBYN	9101 E 85TH ST
204979170	2014-2021	INDIVIDUAL PERSONAL PROPERTY	MURPHY ROBERT WESLEY & JIMMIE D	6741 STERLING AVE	205348985	2021	INDIVIDUAL PERSONAL PROPERTY	JONES PAUL A	6200 MANNING AVE
204979246	2019-2021	INDIVIDUAL PERSONAL PROPERTY	GILES TRERAHN JERMARVIN	6316 HARRIS AVE	205349018	2015	INDIVIDUAL PERSONAL PROPERTY	SANTOS REINALDO SOLIS	895 E 84TH ST
204979272	2021	INDIVIDUAL PERSONAL PROPERTY	GARDNER MASON DANE	9805 E 82ND ST	205349163	2021	INDIVIDUAL PERSONAL PROPERTY	PARSON ANTHONY E JR	6428 OVERTON AVE
204979289	2021	INDIVIDUAL PERSONAL PROPERTY	LINDLEY GABRIELLE H	9001 E 67TH TER	205349260	2021	INDIVIDUAL PERSONAL PROPERTY	KELLEY JULI ANNE	11329 E 72ND ST
204979429	2014	INDIVIDUAL PERSONAL PROPERTY	SCOTT KELVIN E	8000 DITZLER AVE	205349374	2021	INDIVIDUAL PERSONAL PROPERTY	MIDDLEBROOK BRITTANY N	6005 HARRIS AVE
204979460	2015	INDIVIDUAL PERSONAL PROPERTY	THOMAS LAKEISHA M	8907 RICHARDS DR	205349759	2020-2021	INDIVIDUAL PERSONAL PROPERTY	DIXON MAREAE DONTAE	10004 E 86TH TER
204979592	2014-2016	INDIVIDUAL PERSONAL PROPERTY	HARRISON TAYLOR MICHELLE	9301 E 64TH ST	205350080	2020-2021	INDIVIDUAL PERSONAL PROPERTY	ROBERTS ERIC D	6104 ENGLEWOOD AVE
204979610	2017	INDIVIDUAL PERSONAL PROPERTY	ABDUL HAQQ ABDULLAH BAIS	6329 ASH AVE	205350189	2021	INDIVIDUAL PERSONAL PROPERTY	THEUS MELODY	11606 E 60TH ST
204980039	2016-2017	INDIVIDUAL PERSONAL PROPERTY	SHEARER PATRICIA E & JASON W	9024 E 74TH TER	205350642	2017	INDIVIDUAL PERSONAL PROPERTY	STRICKLAND ERIC J JR	10609 E 64TH TER
204980053	2014-2015	INDIVIDUAL PERSONAL PROPERTY	STEWART NATHAN C	5420 RALSTON AVE	205351204	2016-2018	INDIVIDUAL PERSONAL PROPERTY	BURGIN TYREE & SCOTT LASHANHEY	9900 E 60TH ST
204980240	2015	INDIVIDUAL PERSONAL PROPERTY	RAMIREZ-ALFARO MARIA DEL CARMEN	10212 E 71ST TER	205351319	2021	INDIVIDUAL PERSONAL PROPERTY	HUNT LESLIE TIARA	6102 BLUE RIDGE CUT OFF
204980265	2018-2019	INDIVIDUAL PERSONAL PROPERTY	PAUL ANGELA KATRINA	8629 E UTOPIA PKWY APT 12	205351325	2014-2015	INDIVIDUAL PERSONAL PROPERTY	HAIRSTON DIANA R	8315 PERSHING RD
204980439	2014-2015	INDIVIDUAL PERSONAL PROPERTY	PIERCE CAROL	6004 ENGLEWOOD AVE	205351496	2016	INDIVIDUAL PERSONAL PROPERTY	WHITE LETESHA N (JONES)	11216 E 71ST DR
204980440	2021	INDIVIDUAL PERSONAL PROPERTY	WATSON JENISHA	10320 E 63RD ST APT 3	205351578	2014-2015	INDIVIDUAL PERSONAL PROPERTY	LEE MARIA J	5333 NORTHERN AVE
204980563	2014-2015	INDIVIDUAL PERSONAL PROPERTY	WOODS APRIL MICHELLE	11604 E 58TH TER	205351838	2021	INDIVIDUAL PERSONAL PROPERTY	VROMAN JASON & AUDRA	5235 HARRIS AVE
204980658	2021	INDIVIDUAL PERSONAL PROPERTY	MCCARTY MEGAN	127 SW MCCLUNDEN DR APT 305	205352012	2021	INDIVIDUAL PERSONAL PROPERTY	PORTER CARLOTTA K	11522 E 75TH ST
204980741	2021	INDIVIDUAL PERSONAL PROPERTY	SCOTT KENNETH II	5317 NORTHERN AVE	205352096	2019-2021	INDIVIDUAL PERSONAL PROPERTY	CASTILLO JEWEL	7800 E 87TH ST
204980993	2019-2021	INDIVIDUAL PERSONAL PROPERTY	RATTERMAN THOMAS	5531 LANE AVE	205352193	2021	INDIVIDUAL PERSONAL PROPERTY	DOTTIS ASIA	9909 E 76TH TER
204981009	2015-2017	INDIVIDUAL PERSONAL PROPERTY	BOYD JORDAN REECE	118 E WOODLAND AVE	205352404	2019-2021	INDIVIDUAL PERSONAL PROPERTY	ROBERTS MARQUIS A	8624 E 83RD ST
204981210	2021	INDIVIDUAL PERSONAL PROPERTY	DAVIS BESSIE MARIE	10109 E 67TH ST	205352751	2020-2021	INDIVIDUAL PERSONAL PROPERTY	NEAL BRANDON MALIK	8719 FORD AVE
204981294	2020-2021	INDIVIDUAL PERSONAL PROPERTY	HANSBERRY AARON J	9109 E 83RD PL	205352885	2016	INDIVIDUAL PERSONAL PROPERTY	BUCK HOLLY ANN	9808 BROOKLANE ST
204981349	2014-2015	INDIVIDUAL PERSONAL PROPERTY	BOX SELMA LURDEEN	8704 EVANSTON AVE	205353037	2017	INDIVIDUAL PERSONAL PROPERTY	RUECKERT CHRISTOPHER D	10317 E 78TH ST
204981603	2016	INDIVIDUAL PERSONAL PROPERTY	KEITHLEY DAVID PAUL	9004 E 75TH ST	205353062	2021	INDIVIDUAL PERSONAL PROPERTY	COHENS STEVE	8321 NORTHERN ST
204981653	2021	INDIVIDUAL PERSONAL PROPERTY	LOVE LAMISHA	9409 E 79TH TER	205353138	2015-2021	INDIVIDUAL PERSONAL PROPERTY	SHAUCK DENNIS & ELIZABETH	8115 DITZLER AVE
204981675	2021	INDIVIDUAL PERSONAL PROPERTY	MACIAS KAREN B (MOLINA)	11601 E 76TH TER	205353369	2021	INDIVIDUAL PERSONAL PROPERTY	MANNING LATOYA & WILBURN	10608 E 80TH ST
204981784	2017-2019	INDIVIDUAL PERSONAL PROPERTY	ACOSTA YAJAIRA LISBETH (PICKETT)	17318 E SUSUQUEHANNA DR	205353615	2019-2021	INDIVIDUAL PERSONAL PROPERTY	BEACH ALICIA	6105 LAUREL AVE
204981850	2020-2021	INDIVIDUAL PERSONAL PROPERTY	JENNINGS WILLIAM BRENT	8001 WESTRIDGE RD UNIT 33	205353638	2016	INDIVIDUAL PERSONAL PROPERTY	BRISBIN CHLOE E	9905 E 73RD ST APT B
204981908	2021	INDIVIDUAL PERSONAL PROPERTY	BRACY JERRON C JR	5703 HUNTER ST	205353647	2021	INDIVIDUAL PERSONAL PROPERTY	WALLACE ADAM GABRIEL	10923 E 81ST TER
204982029	2021	INDIVIDUAL PERSONAL PROPERTY	SANCHEZ MIRIAM	8202 E 85TH ST	205353652	2017-2021	INDIVIDUAL PERSONAL PROPERTY	BAKER MESA ALEXANDRA	10203 BELMONT AVE
204982046	2014	INDIVIDUAL PERSONAL PROPERTY	95 MERCURY GRAND MARQUIS VEHICLE TRUST	10909 E 64TH TER	205353771	2021	INDIVIDUAL PERSONAL PROPERTY	COOPER WILLIAM JR	9507 E 83RD ST
204982275	2021	INDIVIDUAL PERSONAL PROPERTY	COLLIER DAVID ALLEN	9208 E 67TH TER	205354057	2021	INDIVIDUAL PERSONAL PROPERTY	JOHNSON MONICA	8221 WOODSON DR
204982443	2017-2020	INDIVIDUAL PERSONAL PROPERTY	HOLMES LEVI J	7116 STERLING AVE	205354241	2021	INDIVIDUAL PERSONAL PROPERTY	HINES THELMA	8411 SPRING VALLEY RD
204982799	2020-2021	INDIVIDUAL PERSONAL PROPERTY	RHOADES ROBYN E	6400 HUNTER ST	205354296	2019-2021	INDIVIDUAL PERSONAL PROPERTY	TODD DAVID L	9059 E 65TH ST
204982878	2016-2021	INDIVIDUAL PERSONAL PROPERTY	ELVIN JAMES	7918 HEDGES AVE	205354361	2021	INDIVIDUAL PERSONAL PROPERTY	PATTERSON KELLI	6100 LANE AVE
204983069	2020-2021	INDIVIDUAL PERSONAL PROPERTY	CARTER MICHAEL PRESTON & LEONORA ROBLES	7823 WOODSON DR	205354375	2015	INDIVIDUAL PERSONAL PROPERTY	BOLES RAYMOND A	7205 WOODSON DR
204983159	2021	INDIVIDUAL PERSONAL PROPERTY	ZHAKUPOVA NAZIRA	7324 HARVARD RD	205354559	2015	INDIVIDUAL PERSONAL PROPERTY	JONES REBECCA R	8703 E 86TH TER
204983712	2014-2016	INDIVIDUAL PERSONAL PROPERTY	WISNIEWSKI HOLLY M	9107 E 68TH TER	205355107	2018-2021	INDIVIDUAL PERSONAL PROPERTY	MCCAULEY SAMON APRIL	5501 WOODSON DR
204984156	2021	INDIVIDUAL PERSONAL PROPERTY	GARCIA DIANA	8700 KENTUCKY AVE	205355118	2018-2019	INDIVIDUAL PERSONAL PROPERTY	MITCHELL QUINSHUNNA SHANELL	10130 E 79TH TER

205355531	2014	INDIVIDUAL PERSONAL PROPERTY	MORRIS JEFF L	11704 E 78TH ST	205368005	2015-2021	INDIVIDUAL PERSONAL PROPERTY	WHITE EMMA LEE	8407 WOODSON DR
205355661	2017-2021	INDIVIDUAL PERSONAL PROPERTY	SNOWBERRY RUSSELL B JR	9109 E 73RD ST	205368341	2019-2021	INDIVIDUAL PERSONAL PROPERTY	BURGIN JONTAE ANTHONY	8608 ELM AVE
205355745	2016	INDIVIDUAL PERSONAL PROPERTY	YANG FUCHEN	9815 E 73RD ST APT G	205368663	2020-2021	INDIVIDUAL PERSONAL PROPERTY	WILLNER SHELLY LYNN	5512 ASH AVE
205355902	2019-2021	INDIVIDUAL PERSONAL PROPERTY	RANSOM-WILEY BIANCA	8615 ELM AVE	205368859	2020-2021	INDIVIDUAL PERSONAL PROPERTY	PITNER RORY VON	11901 E 76TH TER
205364608	2016-2021	INDIVIDUAL PERSONAL PROPERTY	BARNES ISIAH F	5512 RALSTON AVE	205368908	2016-2018	INDIVIDUAL PERSONAL PROPERTY	COMBS DONALD	2716 NW OLMSTEAD DR
205366658	2020-2021	INDIVIDUAL PERSONAL PROPERTY	BRICE ARNETTA M & FRAZIER CLARENCE	8609 CRESCENT AVE	205369005	2015-2016	INDIVIDUAL PERSONAL PROPERTY	MALDONADO NATHAN ROBERT	8315 LANE AVE
205357238	2014	INDIVIDUAL PERSONAL PROPERTY	HAWKINS CHEESTER A	9052 E 59TH ST	205369062	2016	INDIVIDUAL PERSONAL PROPERTY	SY PAPA E BELLY	11603 E 75TH ST
205357384	2019-2021	INDIVIDUAL PERSONAL PROPERTY	WHEELER MONICA L & HENDERSON RYAN S	11212 E 59TH TER	205369161	2015-2021	INDIVIDUAL PERSONAL PROPERTY	DOUGAN JAMIE A	7401 WOODSON RD
205357409	2015	INDIVIDUAL PERSONAL PROPERTY	ABNEY JOSEPH KENNETH	7323 MAYWOOD AVE	205369285	2015-2021	INDIVIDUAL PERSONAL PROPERTY	GORANTLA ANIL	6553 RAYTOWN RD APT 3
205357448	2020-2021	INDIVIDUAL PERSONAL PROPERTY	ETGAR ROSLINA & KEVIN	9902 E 61ST ST	205369297	2015-2021	INDIVIDUAL PERSONAL PROPERTY	HILL CARLA JANICE	10000 E 86TH TER
205357728	2020-2021	INDIVIDUAL PERSONAL PROPERTY	CONRICK SETH	8406 EVERETT ST	205369515	2021	INDIVIDUAL PERSONAL PROPERTY	CONSOLVER MELINDA S	6000 OXFORD AVE
205357746	2018	INDIVIDUAL PERSONAL PROPERTY	BETZ ELBERT L & JODI K	9363 E 64TH ST	205370275	2015-2016	INDIVIDUAL PERSONAL PROPERTY	JIMENEZ ESMERALDA VERENISE	11116 E 75TH ST
205358100	2021	INDIVIDUAL PERSONAL PROPERTY	BLACKMON TASHA MARIE	2284 NE TOWN CENTER BLVD UNIT 702	205370282	2016-2021	INDIVIDUAL PERSONAL PROPERTY	EUBANKS DON STEVEN	7404 ELM ST
205358169	2021	INDIVIDUAL PERSONAL PROPERTY	THACKER HEATHER J	6622 WILLOW AVE	205370557	2021	INDIVIDUAL PERSONAL PROPERTY	PILKINTON ANN M	5444 ASH AVE
205358345	2021	INDIVIDUAL PERSONAL PROPERTY	SHAVERS DENISE COLLETTE	11831 E 83RD ST APT 102	205370750	2021	INDIVIDUAL PERSONAL PROPERTY	PERSON KURT M	7505 HARRIS AVE
205358398	2021	INDIVIDUAL PERSONAL PROPERTY	SHERMAN CHRISTOPHER EUGENE	8661 E 108TH TER	205370887	2021	INDIVIDUAL PERSONAL PROPERTY	WALTERS LEVI	5816 HEDGES AVE
205358458	2020-2021	INDIVIDUAL PERSONAL PROPERTY	MAYS LYNTAEYA VONAE	8725 BRISTOL AVE	205370978	2021	INDIVIDUAL PERSONAL PROPERTY	HENDRICKSON RUSSELL T & ANN M	6301 KENTUCKY AVE
205358517	2021	INDIVIDUAL PERSONAL PROPERTY	DAVILA KRISTLE A	11405 E 69TH ST	205371109	2019-2021	INDIVIDUAL PERSONAL PROPERTY	CARTER AARON M	8506 ELM AVE
205358995	2021	INDIVIDUAL PERSONAL PROPERTY	MAUPIN BRIAN P & KYRA B	7420 MURKINS RD	205371362	2015-2021	INDIVIDUAL PERSONAL PROPERTY	MCKINZY LACHELLE M	8802 E 61ST TER
205359429	2021	INDIVIDUAL PERSONAL PROPERTY	BRUNTMYER ZACHARY	11711 E 83RD ST APT 101	205371870	2021	INDIVIDUAL PERSONAL PROPERTY	DODSON OLIVER E JR & GERALDINE L	7400 MAPLE UNIT 424
205359592	2021	INDIVIDUAL PERSONAL PROPERTY	KELLEY JAMES A	7315 APPLETON AVE	205371931	2019-2021	INDIVIDUAL PERSONAL PROPERTY	MILLER COLTON	8328 STERLING AVE
205359680	2020-2021	INDIVIDUAL PERSONAL PROPERTY	COYNE PATRICIA M	6116 BLUE RIDGE CUT OFF	205372086	2021	INDIVIDUAL PERSONAL PROPERTY	OROZCO ANDRES ALEJANDRO	6420 HARRIS AVE
205359942	2015-2016	INDIVIDUAL PERSONAL PROPERTY	LOPEZ NUÑEZ OLVIN ALFONSO	8956 E 84TH ST	205372144	2019-2021	INDIVIDUAL PERSONAL PROPERTY	WIESE THOMAS DRAKE	11140 WASHINGTON ST
205359956	2021	INDIVIDUAL PERSONAL PROPERTY	WATSON JARON LEE	10511 E 80TH ST	205372311	2015	INDIVIDUAL PERSONAL PROPERTY	COX TYRONE D	7431 OVERTON AVE UNIT 9
205360066	2014	INDIVIDUAL PERSONAL PROPERTY	ADKINS TRAVAIL L	9700 E 67TH TER	205372336	2014	INDIVIDUAL PERSONAL PROPERTY	SUMMERS DANIEL ELLIS	8403 WOODSON DR
205360186	2017-2021	INDIVIDUAL PERSONAL PROPERTY	MEYER BETH ANN	8704 W LONGVIEW PKWY	205372404	2016-2018	INDIVIDUAL PERSONAL PROPERTY	WICKHAM ALLEN E	9000 E 72ND TER
205360340	2015	INDIVIDUAL PERSONAL PROPERTY	FITZGERALD DEBORAH LYNN	5525 LANE AVE	205372410	2015-2016	INDIVIDUAL PERSONAL PROPERTY	JONES GARY MICHAEL	8000 E 84TH ST
205360469	2021	INDIVIDUAL PERSONAL PROPERTY	SHEPHERD TATIANA TYNEISHA C	7418 ENGLEWOOD LN	205372462	2016-2017	INDIVIDUAL PERSONAL PROPERTY	MCDONALD REGINA E & BYRD STEVEN D	10825 BEACON AVE
205360479	2019-2021	INDIVIDUAL PERSONAL PROPERTY	HOFFMAN MICHAEL P	12805 8TH ST	205372818	2021	INDIVIDUAL PERSONAL PROPERTY	WILLIAMS CINNAMON	10106 E 69TH ST
205360569	2021	INDIVIDUAL PERSONAL PROPERTY	HOBBY TAREZ	8605 HAWTHORNE AVE	205372924	2020-2021	INDIVIDUAL PERSONAL PROPERTY	BRYANT TENELL DANTE	8112 RAYTOWN RD
205360719	2015	INDIVIDUAL PERSONAL PROPERTY	WIKLUND AARON DANIEL	10600 E 59TH ST	205372986	2014	INDIVIDUAL PERSONAL PROPERTY	STINSON TERRANCE	8518 HARVARD TER
205360861	2021	INDIVIDUAL PERSONAL PROPERTY	ELMONIS NADIA	5301 STERLING AVE	205373146	2019-2021	INDIVIDUAL PERSONAL PROPERTY	MURRELL KEITH LAMONT	8717 E 79TH ST
205360902	2015-2017	INDIVIDUAL PERSONAL PROPERTY	CHRISMAN AMANDA J & RADSPINNER SHELLY	6108 NORTHERN AVE	205373188	2020-2021	INDIVIDUAL PERSONAL PROPERTY	MARSHALL GLORIA	11026 E 63RD ST
205360946	2021	INDIVIDUAL PERSONAL PROPERTY	HARRIS NICHELLE NICOLE	5430 DITZLER AVE	205373382	2021	INDIVIDUAL PERSONAL PROPERTY	STEPHENS LAUREN COURTNEY	11420 E 77TH ST
205361022	2019-2021	INDIVIDUAL PERSONAL PROPERTY	ICART PIERRE	10105 E 84TH ST	205373545	2015-2017	INDIVIDUAL PERSONAL PROPERTY	STILL JAHMAI KENAN	7330 HEDGES AVE
205361035	2016-2021	INDIVIDUAL PERSONAL PROPERTY	MILLS CYNTHIA D	5513 HARDY AVE	205373548	2019-2021	INDIVIDUAL PERSONAL PROPERTY	WYMAN CLINT	11205 E 83RD ST
205361265	2015-2021	INDIVIDUAL PERSONAL PROPERTY	LIMO HENRY K	8401 WOODSON PL	205373570	2021	INDIVIDUAL PERSONAL PROPERTY	GUMMINGER CORY C	6833 ELM AVE
205361607	2017-2021	INDIVIDUAL PERSONAL PROPERTY	BARBER STEPHEN LEE	7601 ARLINGTON AVE	205373931	2015-2021	INDIVIDUAL PERSONAL PROPERTY	CRIDER JOSHUA MATTHEW	9000 E 65TH TER
205361744	2014	INDIVIDUAL PERSONAL PROPERTY	NORRIS KEITH ANDRE	11015 E 85TH ST	205374435	2018-2019	INDIVIDUAL PERSONAL PROPERTY	STEVENS MICHELLE AMI	10336 E 63RD ST APT 2
205361995	2014	INDIVIDUAL PERSONAL PROPERTY	GOUDEAU QUAN	10328 E 63RD ST APT 3	205374475	2021	INDIVIDUAL PERSONAL PROPERTY	CARTER SHERRI D	7606 WESTRIDGE RD
205362077	2021	INDIVIDUAL PERSONAL PROPERTY	THOMPSON LEVI D	6420 EVANSTON AVE	205374573	2018-2021	INDIVIDUAL PERSONAL PROPERTY	ROMAN DANIEL	6000 NORTHERN AVE
205362386	2019-2021	INDIVIDUAL PERSONAL PROPERTY	SMITH BROOKE R	8909 E 67TH PL APT 109	205374677	2021	INDIVIDUAL PERSONAL PROPERTY	HAMILTON JERRY DEAN JR	10900 E 58TH TER
205362849	2015-2021	INDIVIDUAL PERSONAL PROPERTY	BIBBY JOSHUA	8815 E 71ST TER	205374695	2018-2021	INDIVIDUAL PERSONAL PROPERTY	KOBAYASHI KEN & ROBYNN BUSHNER	8612 RIDGeway AVE
205362880	2020	INDIVIDUAL PERSONAL PROPERTY	BENAVIDEZ ALLISON LEIGH	10007 E 63RD ST	205374816	2015-2017	INDIVIDUAL PERSONAL PROPERTY	MARTIN R MICHELLE	11112 E 83RD TER
205362901	2020-2021	INDIVIDUAL PERSONAL PROPERTY	BROWN JADAIA DASHANEA	8621 W UTOPIA DR APT 14	205375219	2015-2019	INDIVIDUAL PERSONAL PROPERTY	CROSE WILLIAM J & JIL N	10705 E 84TH TER
205363340	2021	INDIVIDUAL PERSONAL PROPERTY	PRETTYMAN JAMES	7512 WOODSON RD	205375701	2015-2021	INDIVIDUAL PERSONAL PROPERTY	TOSCANO MARES RUBEN	8206 E 86TH TER
205363353	2017	INDIVIDUAL PERSONAL PROPERTY	NICHOLSON NAOMI J	5721 MANNING AVE	205375946	2016-2021	INDIVIDUAL PERSONAL PROPERTY	GEIMER MEGAN ANNE	5816 OXFORD AVE
205363572	2015-2017	INDIVIDUAL PERSONAL PROPERTY	COWLEY PATRICK JR	6209 RALSTON AVE	205376077	2020-2021	INDIVIDUAL PERSONAL PROPERTY	THIBEAUX MARDAE	8959 E 62ND TER
205364010	2016-2017	INDIVIDUAL PERSONAL PROPERTY	OROZCO LUIS MANUEL	9713 E 76TH TER	205376111	2017-2021	INDIVIDUAL PERSONAL PROPERTY	MASONER ANTHONY M	5305 ASH AVE
205364276	2021	INDIVIDUAL PERSONAL PROPERTY	MILLER FARLEY EMERALD RENEE	7916 ARLINGTON AVE	205376399	2021	INDIVIDUAL PERSONAL PROPERTY	MISENHILTER GREGORY D	7900 CRESCENT AVE
205364292	2015-2019	INDIVIDUAL PERSONAL PROPERTY	BARFIELD ERIC	9800 E 61ST ST APT 1	205376477	2016-2017	INDIVIDUAL PERSONAL PROPERTY	HARDWAY SHAKEELAH	5813 CEDAR AVE
205364328	2021	INDIVIDUAL PERSONAL PROPERTY	GEREN MICHAEL A	5328 HEDGES AVE	205376602	2021	INDIVIDUAL PERSONAL PROPERTY	SHANNON RANDY L	9707 E 79TH TER
205364368	2021	INDIVIDUAL PERSONAL PROPERTY	THURMAN KEVIN & ERIN MARIE	8616 E 87TH ST	205377021	2015-2021	INDIVIDUAL PERSONAL PROPERTY	ARATEA MARC	9708 BROOKLANE ST
205364437	2021	INDIVIDUAL PERSONAL PROPERTY	KALUTZ CEDAR AVE	5809 CEDAR AVE	205377054	2020-2021	INDIVIDUAL PERSONAL PROPERTY	BANKS BRIAN KEITH	8311 SPRING VALLEY RD
205364607	2021	INDIVIDUAL PERSONAL PROPERTY	BECKLUND MARIANNE PRICE	9107 E 74TH TER	205377171	2015	INDIVIDUAL PERSONAL PROPERTY	DAVIS KOREY S	6011 ENGLEWOOD AVE
205364636	2021	INDIVIDUAL PERSONAL PROPERTY	RIDDLE KYLE J & SCHENKE COURTNEY	5626 LAUREL AVE	205377380	2021	INDIVIDUAL PERSONAL PROPERTY	CHASE JADA	9102 E 72ND TER
205364639	2019	INDIVIDUAL PERSONAL PROPERTY	HARRIS MICHAEL D	5618 HARVARD AVE	205377885	2014-2021	INDIVIDUAL PERSONAL PROPERTY	WILEY RANISHA M	7214 CRISP AVE
205364746	2018	INDIVIDUAL PERSONAL PROPERTY	WOOLEN ADONIS MARCELL	9826 E 61ST ST APT 1	205377988	2020-2021	INDIVIDUAL PERSONAL PROPERTY	SALINAS GONZALEZ MIGUEL A	10205 E 53RD ST
205364807	2017-2020	INDIVIDUAL PERSONAL PROPERTY	LEATHERMAN MELISSA S	8703 E 79TH ST	205378016	2021	INDIVIDUAL PERSONAL PROPERTY	WASHINGTON JR VERNON LAMARE	8208 WOODSON DR
205364869	2018-2021	INDIVIDUAL PERSONAL PROPERTY	MITCHELL SHAUN L	11606 E 60TH ST	205378061	2015-2017	INDIVIDUAL PERSONAL PROPERTY	COWAN RICHARD W JR	8310 KENTUCKY AVE
205364933	2014-2018	INDIVIDUAL PERSONAL PROPERTY	SNYDER MARK A	9418 E 82ND ST	205378098	2021	INDIVIDUAL PERSONAL PROPERTY	TABRON ANTIONETTE	11205 MONTGALL AVE APT 205
205365366	2019-2021	INDIVIDUAL PERSONAL PROPERTY	HENDRICKSON RENEE M	6301 KENTUCKY AVE	205378181	2015	INDIVIDUAL PERSONAL PROPERTY	FRANKLIN TONIESHA	9820 E 66TH ST
205365634	2021	INDIVIDUAL PERSONAL PROPERTY	WARD TODD G	8314 BOOTH AVE	205378188	2021	INDIVIDUAL PERSONAL PROPERTY	MOORE KALONDA & EULONDA	7308 ASH AVE
205365645	2016-2021	INDIVIDUAL PERSONAL PROPERTY	TABRON DIAMOND A	10909 E 60TH TER	205378230	2021	INDIVIDUAL PERSONAL PROPERTY	MADDOCK TIFFANY MARIE	8181 HUNTER ST
205365749	2020	INDIVIDUAL PERSONAL PROPERTY	COLLINS JASON WILLIAM	8812 E 84TH ST	205378270	2020-2021	INDIVIDUAL PERSONAL PROPERTY	SMITH NAKIELA	7100 STERLING AVE
205365957	2021	INDIVIDUAL PERSONAL PROPERTY	ALVAREZ NIETO ANTONIA	8405 JAMES A REED RD	205378391	2017-2019	INDIVIDUAL PERSONAL PROPERTY	AHMED SARMED S	11006 E 83RD TER
205366005	2015	INDIVIDUAL PERSONAL PROPERTY	EDWARDS KITARA	11128 E 84TH TER	205378484	2021	INDIVIDUAL PERSONAL PROPERTY	LOVINGOOD RAEHEL	5409 OXFORD AVE
205366623	2017-2021	INDIVIDUAL PERSONAL PROPERTY	KLEINBECK MARY LOUISE	8717 E 61ST TER APT 2	205378579	2015	INDIVIDUAL PERSONAL PROPERTY	OCNNER PHILIP R	9608 E 79TH TER
205366636	2017-2019	INDIVIDUAL PERSONAL PROPERTY	BLACK RICHARD CARTHILL JR	11215 E 71ST DR	205378884	2021	INDIVIDUAL PERSONAL PROPERTY	COPELAND CLINTON TERRY	6624 OXFORD AVE
205366899	2015	INDIVIDUAL PERSONAL PROPERTY	DAVIDSON L C	7315 HARDY AVE	205379327	2015-2018	INDIVIDUAL PERSONAL PROPERTY	CLARK WILL E SR	9401 E 63RD ST APT 201
205367082	2015-2017	INDIVIDUAL PERSONAL PROPERTY	LEE DENNIS CHARLES	9805 E 53RD ST UNIT A	205379492	2021	INDIVIDUAL PERSONAL PROPERTY	DOBBS KAYLA	10010 E 69TH ST
205368001	2015-2017	INDIVIDUAL PERSONAL PROPERTY	SUTHERLIN TERRELL EUGENE JR	9004 E 55TH ST	205380165	2021	INDIVIDUAL PERSONAL PROPERTY	WILLIAMS NATASHA M	10021 E 78TH ST

205381095	2015	INDIVIDUAL PERSONAL PROPERTY	MINTON LOGAN C	7439 OVERTON AVE	205390417	2015-2021	INDIVIDUAL PERSONAL PROPERTY	PADILLA VELASQUEZ OLMAN MAURICIO	9354 E 69TH TER
205381187	2018-2020	INDIVIDUAL PERSONAL PROPERTY	WEITAL MAGDALINA	6720 RAYTOWN RD	205390420	2016	INDIVIDUAL PERSONAL PROPERTY	REAGAN ASHLEY LYNN	8314 JAMES A REED RD
205381209	2015	INDIVIDUAL PERSONAL PROPERTY	LONG JESSICA MARGUERITE	9901 E 59TH TER	205390641	2014-2015	INDIVIDUAL PERSONAL PROPERTY	EVANS KENNETH V	8600 SPRING VALLEY RD
205381247	2020-2021	INDIVIDUAL PERSONAL PROPERTY	JAMES LAWRENCE RICHARD	10311 E 78TH ST	205390746	2015	INDIVIDUAL PERSONAL PROPERTY	LUKER LELIANI	7220 RAYTOWN RD APT B
205381578	2016	INDIVIDUAL PERSONAL PROPERTY	ROJAS JOSEPH	8808 E 84TH TER	205390788	2015	INDIVIDUAL PERSONAL PROPERTY	DENNIS KEVIN	6004 ENGLEWOOD AVE
205381807	2016-2017	INDIVIDUAL PERSONAL PROPERTY	WISE JARRETT E	6407 EVANSTON AVE	205391663	2020-2021	INDIVIDUAL PERSONAL PROPERTY	CAPLES JASMINE DESHAWN	6116 WOODSON RD
205381833	2015-2021	INDIVIDUAL PERSONAL PROPERTY	TOWNSEND JAMES HENRY JR	8222 WOODSON DR	205391814	2020-2021	INDIVIDUAL PERSONAL PROPERTY	GIBSON RONNIE EUGENE	9051 E 52ND TER
205381964	2014-2021	INDIVIDUAL PERSONAL PROPERTY	HILL PAIGE	10902 E 62ND TER	205391822	2015-2021	INDIVIDUAL PERSONAL PROPERTY	BEATTY DENISHA CHENE	11513 E M 350 HWY
205382030	2017-2021	INDIVIDUAL PERSONAL PROPERTY	HILL STACY LEE	10902 E 62ND TER	205391991	2015-2016	INDIVIDUAL PERSONAL PROPERTY	TREINARY MELINDA MARIE & WHITE K CHARLES	6840 STERLING AVE
205382079	2021	INDIVIDUAL PERSONAL PROPERTY	MARTIN JAMES E	12009 E 84TH TER	205392280	2014-2015	INDIVIDUAL PERSONAL PROPERTY	DESMOND REBECCA L	6102 NORTHERN AVE
205382435	2020-2021	INDIVIDUAL PERSONAL PROPERTY	PATTON-THOMPSON LYNETTE	12009 E 84TH TER	205392536	2016	INDIVIDUAL PERSONAL PROPERTY	SPOUSE SAMANTHA S	6122 WILLOW AVE
205382606	2014-2015	INDIVIDUAL PERSONAL PROPERTY	THORNBURG SHARON	8315 HUNTER ST	205392597	2021	INDIVIDUAL PERSONAL PROPERTY	METCALF SANDRA LATRICE	10907 E 60TH TER
205382747	2018	INDIVIDUAL PERSONAL PROPERTY	GUEVARA NAYEN ZURISADAI	7504 OVERTON AVE	205392621	2015-2021	INDIVIDUAL PERSONAL PROPERTY	HENERY LACI	9541 E 70TH TER
205382790	2014-2015	INDIVIDUAL PERSONAL PROPERTY	COOPER CHEYENNE DAVONAE	8031 TENNESSEE AVE	205393014	2020-2021	INDIVIDUAL PERSONAL PROPERTY	FOLTZ ROBERT B	5332 HUNTER ST
205382876	2019	INDIVIDUAL PERSONAL PROPERTY	STARINES COREY & COURTNEY	11401 E 71ST ST	205393491	2019-2021	INDIVIDUAL PERSONAL PROPERTY	ADAMS JADE MONISE	5704 ELM AVE
205382904	2018-2020	INDIVIDUAL PERSONAL PROPERTY	SCHNOEBELN JACOB RYAN	6812 ENGLEWOOD AVE	205393682	2019-2021	INDIVIDUAL PERSONAL PROPERTY	FOSTER ALEXANDER J	8617 E 81ST TER
205382946	2020-2021	INDIVIDUAL PERSONAL PROPERTY	MACIAS ZAPATA JUAN MANUEL	10400 E 72ND ST	205393787	2018	INDIVIDUAL PERSONAL PROPERTY	CRAWFORD BRITTANY	11425 E 71ST ST
205383051	2015-2016	INDIVIDUAL PERSONAL PROPERTY	MCKNIGHT OCTAVENO RAQUEN	8909 E 66TH ST	205393887	2021	INDIVIDUAL PERSONAL PROPERTY	TOWNSEND ROBERT D	8719 E 79TH TER
205383080	2021	INDIVIDUAL PERSONAL PROPERTY	JONES KHALIL ROBERT	8303 PERSHING RD	205393959	2021	INDIVIDUAL PERSONAL PROPERTY	CARTER DEXTER ANTHONY	11007 E 60TH TER
205383091	2020-2021	INDIVIDUAL PERSONAL PROPERTY	CURTIS LONNIE	9908 E 60TH ST	205394128	2015-2016	INDIVIDUAL PERSONAL PROPERTY	TYSON DOMINIC L	11708 E 78TH ST
205383156	2020-2021	INDIVIDUAL PERSONAL PROPERTY	PRICE DEAIRA ROYE'	11139 E 84TH TER	205394813	2020-2021	INDIVIDUAL PERSONAL PROPERTY	JONES BRANDON	7512 STERLING AVE
205383167	2021	INDIVIDUAL PERSONAL PROPERTY	PATTERSON NOEL CANDACE	9802 E 79TH PL	205394858	2015-2016	INDIVIDUAL PERSONAL PROPERTY	MARCHBANKS DIAMOND TAWON	8805 E 62ND TER
205383273	2016	INDIVIDUAL PERSONAL PROPERTY	SALINAS BARTOLO ARVIZU	9500 E 77TH ST	205395364	2021	INDIVIDUAL PERSONAL PROPERTY	WILLIAMS RODNEY	8814 E 58TH TER
205383333	2015	INDIVIDUAL PERSONAL PROPERTY	GASTON TALIB & KLUGE KALIE L	10101 E 83RD TER	205395593	2018	INDIVIDUAL PERSONAL PROPERTY	ADDISON JARON	8405 DRURY CIR
205383339	2018-2021	INDIVIDUAL PERSONAL PROPERTY	KIZER STANFORD ALEXANDER	8904 E 72ND ST	205395607	2018-2019	INDIVIDUAL PERSONAL PROPERTY	CAMPBELL DINA LASHAWNE	11206 E 71ST DR
205383672	2017	INDIVIDUAL PERSONAL PROPERTY	HARWELL ROBERT JESSE	7408 MAYWOOD AVE	205395614	2019	INDIVIDUAL PERSONAL PROPERTY	OLDS LOLA JEAN	6140 RAYTOWN RD APT 306
205383899	2019	INDIVIDUAL PERSONAL PROPERTY	NIEGSCH JOANNA	9810 E 60TH ST	205395642	2017-2018	INDIVIDUAL PERSONAL PROPERTY	HOOVER ROBERT WAYNE	6300 HARRIS AVE
205384055	2020	INDIVIDUAL PERSONAL PROPERTY	GIVHAN JARRET ANRAE	5709 WOODSON RD	205395739	2021	INDIVIDUAL PERSONAL PROPERTY	MAYO ROLITTA	5316 KENTUCKY AVE
205384141	2017-2021	INDIVIDUAL PERSONAL PROPERTY	BUSHNELL VICKIE	5828 CEDAR AVE	205395801	2019-2021	INDIVIDUAL PERSONAL PROPERTY	MAJEED FARAH N	9300 VAUGHN AVE
205384383	2017	INDIVIDUAL PERSONAL PROPERTY	STRIANO GRACIE MARIE	7220 RAYTOWN RD APT B	205395840	2020-2021	INDIVIDUAL PERSONAL PROPERTY	HARVEY CARL ALLEN	12017 E 51ST ST S
205384540	2016	INDIVIDUAL PERSONAL PROPERTY	XU HAIYANG	9805 E 73RD ST APT G	205395879	2020-2021	INDIVIDUAL PERSONAL PROPERTY	MAYNARD ASIA	9801 E 61ST ST APT 5
205384615	2015-2018	INDIVIDUAL PERSONAL PROPERTY	LYON JENNIFER L	9015 E 74TH TER	205395955	2021	INDIVIDUAL PERSONAL PROPERTY	LENOIR JAMESETTA MARIE	8726 E 61ST ST
205384692	2020-2021	INDIVIDUAL PERSONAL PROPERTY	PALMER WILLIE & GARRETT	11200 E 76TH ST	205396010	2014-2015	INDIVIDUAL PERSONAL PROPERTY	TYLER SAVANNAH L & MARCO D	10207 E 78TH ST
205384804	2021	INDIVIDUAL PERSONAL PROPERTY	RICHARDS SHANAGAY A	9705 E 76TH TER	205396097	2015-2021	INDIVIDUAL PERSONAL PROPERTY	ROACH KENYASHAE MONAE	8104 HARDY AVE
205384955	2018-2019	INDIVIDUAL PERSONAL PROPERTY	SCHARNHORST CRYSTAL	5810 BLUE RIDGE CUT OFF	205396229	2021	INDIVIDUAL PERSONAL PROPERTY	KUHN DESTINY	6212 RALSTON AVE
205385246	2015	INDIVIDUAL PERSONAL PROPERTY	SMITH SHAUN M	9004 E 69TH ST	205396271	2021	INDIVIDUAL PERSONAL PROPERTY	ALBIREZ ANGELICA MARIE	5317 HUNTER ST
205385276	2019-2021	INDIVIDUAL PERSONAL PROPERTY	FLACK AMANDA L	7317 ELM ST	205396392	2015	INDIVIDUAL PERSONAL PROPERTY	KROGH TYLER	9322 E 85TH ST
205385442	2019-2021	INDIVIDUAL PERSONAL PROPERTY	BELL STEPHANIE LYNN	7308 BLUE RIDGE BLVD	205396852	2016-2018	INDIVIDUAL PERSONAL PROPERTY	ALLEN JAMES LORAN	5717 BLUE RIDGE BLVD
205385704	2019	INDIVIDUAL PERSONAL PROPERTY	ALLEN STEPHON L AND SONIA J	8522 ARLINGTON AVE	205396864	2020	INDIVIDUAL PERSONAL PROPERTY	MADDEN BEAU J	11330 E TRUMAN RD
205385752	2015-2016	INDIVIDUAL PERSONAL PROPERTY	EISENLOHR LINDA S	9102 E 74TH TER	205396934	2020-2021	INDIVIDUAL PERSONAL PROPERTY	CLARK LEONA LANNETTE	5512 RALSTON AVE
205385934	2014	INDIVIDUAL PERSONAL PROPERTY	WELCH WENDI S	8732 E 73RD TER	205396940	2020-2021	INDIVIDUAL PERSONAL PROPERTY	LOCKE TYLER	5229 BLUE RIDGE BLVD APT C
205385956	2019-2021	INDIVIDUAL PERSONAL PROPERTY	MCINTYRE CHESTER Z II	9708 E 84TH ST	205397021	2016	INDIVIDUAL PERSONAL PROPERTY	LOCKE MALCOLM	7315 DITZLER AVE
205386001	2021	INDIVIDUAL PERSONAL PROPERTY	BASS HALEY	10501 E 55TH ST	205397042	2014-2015	INDIVIDUAL PERSONAL PROPERTY	VAUGHN WILLIE EARL	8812 E 84TH TER
205386058	2021	INDIVIDUAL PERSONAL PROPERTY	WALLINGFORD NICK ERIC	9808 E 85TH PL	205397480	2018-2019	INDIVIDUAL PERSONAL PROPERTY	GOODALL CAROL	12508 MONROE AVE
205386214	2015-2021	INDIVIDUAL PERSONAL PROPERTY	LEWIS OMAR	8400 ELM AVE	205397562	2014-2017	INDIVIDUAL PERSONAL PROPERTY	SILAS RODSHA'E SAWAN	9508 E 60TH TER
205386255	2021	INDIVIDUAL PERSONAL PROPERTY	MYERS MICHELLE R & WESLEY A	11006 E 60TH TER	205397591	2019	INDIVIDUAL PERSONAL PROPERTY	MEDGYESI DOUGLAS S	10600 E 75TH ST
205386361	2015	INDIVIDUAL PERSONAL PROPERTY	CARTER CA'RON WILL	8204 WOODSON DR	205397645	2015-2016	INDIVIDUAL PERSONAL PROPERTY	ANGUIANO JESSE	8127 WILLOW WAY
205386434	2021	INDIVIDUAL PERSONAL PROPERTY	ARDUSER MATTHIAS C	6812 VERMONT AVE	205397803	2016-2018	INDIVIDUAL PERSONAL PROPERTY	HEYBODER MOLLY	8206 E 86TH TER
205386457	2020-2021	INDIVIDUAL PERSONAL PROPERTY	JAMES TONI L	7154 CRISP AVE	205397827	2015-2021	INDIVIDUAL PERSONAL PROPERTY	BRIZUELA JUAN J	11821 E 83RD ST APT 101
205386792	2016	INDIVIDUAL PERSONAL PROPERTY	HAMILTON LARONN D	9816 E 61ST ST APT 1	205397983	2020-2021	INDIVIDUAL PERSONAL PROPERTY	ALLEN SEAN E JR	9708 E 67TH TER
205387258	2021	INDIVIDUAL PERSONAL PROPERTY	ROSS DAMARKO RAMON	9825 E 60TH ST	205398023	2016-2021	INDIVIDUAL PERSONAL PROPERTY	WASHAM KAYLEIGH	6909 RAYTOWN RD
205387290	2021	INDIVIDUAL PERSONAL PROPERTY	JENKINS BRITTANY	7615 WOODSON RD	205398059	2020-2021	INDIVIDUAL PERSONAL PROPERTY	ELLIS MCCLENDON	6900 LANE AVE
205387336	2015-2017	INDIVIDUAL PERSONAL PROPERTY	OWENS JESSICA LYNN	7415 APPLANT AVE	205388236	2015-2021	INDIVIDUAL PERSONAL PROPERTY	DIAZ JOHN JOSEPH III	6728 RAYTOWN RD
205387444	2021	INDIVIDUAL PERSONAL PROPERTY	CURNAL ANTHONY & BURTON CARL D	8907 E GREGORY BLVD	205398480	2016-2018	INDIVIDUAL PERSONAL PROPERTY	BELKNAP JENNIFER	8811 E 84TH ST
205387454	2019-2021	INDIVIDUAL PERSONAL PROPERTY	SHARP JOSEPHINE LEE	10204 E 83RD ST	205398837	2021	INDIVIDUAL PERSONAL PROPERTY	ORELLANA SANCHEZ MAYNOR R	9112 E 69TH TER
205387483	2014	INDIVIDUAL PERSONAL PROPERTY	CARUTHERS AUDREY M	10405 E 69TH ST	205398978	2021	INDIVIDUAL PERSONAL PROPERTY	WHITE WALKESHIA	9301 E 64TH ST
205387709	2016	INDIVIDUAL PERSONAL PROPERTY	BAYLON-PALMA JESUS DAVID & CONTRERAS ESM	11801 E 77TH ST	205399058	2021	INDIVIDUAL PERSONAL PROPERTY	WILLIAMS VONTREZ TYRELL	8609 MAYWOOD AVE
205387797	2019	INDIVIDUAL PERSONAL PROPERTY	MCCOLLOM SAVANNAH	5724 CEDAR AVE	205399091	2015-2021	INDIVIDUAL PERSONAL PROPERTY	COOPER FEALT GARY III & ASHLEY D PEARL	5501 BLUE RIDGE CUT OFF
205387865	2020-2021	INDIVIDUAL PERSONAL PROPERTY	ABEND SARAH H	9002 E 69TH ST	205399575	2015-2016	INDIVIDUAL PERSONAL PROPERTY	WILSON JAUAN	7241 STERLING AVE
205388148	2019	INDIVIDUAL PERSONAL PROPERTY	VAUGHN LUKE PRESTON (JOHNSON)	8001 ARLINGTON AVE	205399605	2017-2021	INDIVIDUAL PERSONAL PROPERTY	GOODWIN TYRONE TREMAINE	10107 E 80TH ST
205388224	2015-2016	INDIVIDUAL PERSONAL PROPERTY	HAUK ADRIENNE	8128 APPLETON AVE	205399779	2021	INDIVIDUAL PERSONAL PROPERTY	PALMAS LUIS	8609 EVERETT ST
205388267	2019-2021	INDIVIDUAL PERSONAL PROPERTY	HUNT ROBERT LONZELL JR	10116 E 83RD ST	205399884	2018-2021	INDIVIDUAL PERSONAL PROPERTY	HICKERSON KIMBERLY	7329 WILLOW AVE
205388396	2018-2021	INDIVIDUAL PERSONAL PROPERTY	GARCIA ISAAC J & ELISA B	10021 E 79TH ST	205400001	2021	INDIVIDUAL PERSONAL PROPERTY	JORDAN KEVIN DAUNDRAE	6650 MAYWOOD AVE APT A
205388548	2014-2020	INDIVIDUAL PERSONAL PROPERTY	ADDISON KEVIN GERARD	3312 E 73RD ST	205400047	2021	INDIVIDUAL PERSONAL PROPERTY	TAVERNARO COLBY CHRISTIAN	9716 BROOKLANE ST
205388851	2021	INDIVIDUAL PERSONAL PROPERTY	MCREE LAURA E	6137 MANNING AVE	205400158	2021	INDIVIDUAL PERSONAL PROPERTY	COLLINS TONEEK LATRAYLE	9600 E 77TH TER
205388922	2019-2021	INDIVIDUAL PERSONAL PROPERTY	POLSON LATOYA SHANELL	5720 ELM AVE	205400370	2021	INDIVIDUAL PERSONAL PROPERTY	LIVINGSTON JOSEPH DANIEL	11000 E 74TH TER
205389350	2018	INDIVIDUAL PERSONAL PROPERTY	FLESCH JOSETE KM	9919 E 60TH ST	205400523	2021	INDIVIDUAL PERSONAL PROPERTY	REEVES CHRISTOPHER A	6232 MANNING AVE
205389554	2018	INDIVIDUAL PERSONAL PROPERTY	PATTON GERALD JERRY	6140 RAYTOWN RD APT 802	205400620	2021	INDIVIDUAL PERSONAL PROPERTY	SMITH EARL D SR	10131 E 79TH ST
205389937	2018	INDIVIDUAL PERSONAL PROPERTY	STARK TINA F	7007 LAKESHORE DR	205400855	2019	INDIVIDUAL PERSONAL PROPERTY	SAWYER DIAMOND M	8613 W UTOPIA DR APT 89
205390145	2015	INDIVIDUAL PERSONAL PROPERTY	DANIELY DIONDRE	5816 ELM AVE	205401117	2015-2019	INDIVIDUAL PERSONAL PROPERTY	BOWERS TIA NICOLE	7204 HARVARD DR
205390194	2017	INDIVIDUAL PERSONAL PROPERTY	PAYNE LARRY B JR	9104 RICHARDS DR	205401195	2015-2016	INDIVIDUAL PERSONAL PROPERTY		
205390375	2021	INDIVIDUAL PERSONAL PROPERTY	BOUSMAN JASON M & ERIN N	1001 NW PENNINGTON PL	205401407	2021	INDIVIDUAL PERSONAL PROPERTY		

205401545	2017-2021	INDIVIDUAL PERSONAL PROPERTY	RENNER JORDAN	10800 E 60TH TER	205411634	2021	INDIVIDUAL PERSONAL PROPERTY	DREW RODNEY	8622 EVANSTON AVE
205401812	2020-2021	INDIVIDUAL PERSONAL PROPERTY	PATTERSON TERESSA JEANNINE	5416 NORTHERN AVE	205411871	2020-2021	INDIVIDUAL PERSONAL PROPERTY	GRAY ROSALINA ANNETTE	7234 RAYTOWN RD APT A
205402303	2021	INDIVIDUAL PERSONAL PROPERTY	BARCLAY CLINT	8138 STERLING AVE	205412026	2021	INDIVIDUAL PERSONAL PROPERTY	BUTLER ANTOINE MAURICE JR	7153 CRISP AVE
205402418	2017-2019	INDIVIDUAL PERSONAL PROPERTY	ROHAN GAGE CHRISTIAN	9009 E 73RD ST	205412124	2015-2016	INDIVIDUAL PERSONAL PROPERTY	VEST WILLIAM E	8907 E 72ND ST
205402454	2015-2017	INDIVIDUAL PERSONAL PROPERTY	REDDICK ARYSSA BRIANNA	11105 E 78TH TER	205412344	2017-2021	INDIVIDUAL PERSONAL PROPERTY	JOHNSON BRIAN	9401 E 66TH ST
205402491	2018	INDIVIDUAL PERSONAL PROPERTY	RENFRO VIRGINIA	6140 RAYTOWN RD APT 304	205413384	2016	INDIVIDUAL PERSONAL PROPERTY	CLETCHER YVONNE G	9732 PLYMOUTH LN
205402548	2018-2019	INDIVIDUAL PERSONAL PROPERTY	BARAHONA RIVERA JOSE RAMON	11201 E 75TH TER	205413514	2021	INDIVIDUAL PERSONAL PROPERTY	NIXON SUDDENLY SHARON PHAE	8218 WOODSON DR
205402598	2020-2021	INDIVIDUAL PERSONAL PROPERTY	TEVES SUSY LIMCO	8515 E 85TH ST	205413561	2016-2020	INDIVIDUAL PERSONAL PROPERTY	RIVERA ADAM MICHAEL	8322 PERSHING RD
205402664	2015	INDIVIDUAL PERSONAL PROPERTY	MOORE GARY P	9919 E 63RD ST	205413611	2017-2021	INDIVIDUAL PERSONAL PROPERTY	KRAPES RONALD P	10509 E 59TH ST
205402754	2015-2019	INDIVIDUAL PERSONAL PROPERTY	MITCHELL MEAGHAN	10412 E 64TH ST	205413815	2016-2017	INDIVIDUAL PERSONAL PROPERTY	COX KENNETH LEE	8400 GREENWOOD RD
205402773	2021	INDIVIDUAL PERSONAL PROPERTY	FULFORD KAREN	10122 E 71ST TER	205414021	2016-2021	INDIVIDUAL PERSONAL PROPERTY	WILSON BARRY ANDRE	7214 CRISP AVE
205402935	2021	INDIVIDUAL PERSONAL PROPERTY	MEINDERS ALEXANDRA D & CHRISTOPHER C	7031 LAKESHORE DR	205414256	2021	INDIVIDUAL PERSONAL PROPERTY	WILEY WRIGHT MARCUS REGINALD	1909 TENNESSEE AVE
205402949	2021	INDIVIDUAL PERSONAL PROPERTY	RICHARDSON REGINALD KEITH	10201 E 68TH ST	205414345	2021	INDIVIDUAL PERSONAL PROPERTY	HENDERSON ANDREA KAY	8300 MANNING AVE
205402964	2020-2021	INDIVIDUAL PERSONAL PROPERTY	THONEN AMANDA M	10916 E 72ND ST	205414435	2015-2017	INDIVIDUAL PERSONAL PROPERTY	BOONE REUBEN W	7807 E 87TH ST
205402981	2021	INDIVIDUAL PERSONAL PROPERTY	BURTON TYSHANA LANAY	10130 E 79TH ST	205414646	2015	INDIVIDUAL PERSONAL PROPERTY	RANDLE DENNIS JEROME JR	8496 LANE DR APT 3
205403071	2020-2021	INDIVIDUAL PERSONAL PROPERTY	WOLF KIZZIE E	7924 DITZLER AVE	205414757	2016	INDIVIDUAL PERSONAL PROPERTY	REID DWIGHT SILVESTER	9312 E 64TH ST
205403213	2016	INDIVIDUAL PERSONAL PROPERTY	SMITH KAREEM AHMAD RASHAD	11419 E 71ST ST	205414791	2020-2021	INDIVIDUAL PERSONAL PROPERTY	WINKLEY MAURICE T	9213 E 84TH CT
205403261	2015	INDIVIDUAL PERSONAL PROPERTY	HOPPER DAVID	8515 OXFORD AVE	205414816	2021	INDIVIDUAL PERSONAL PROPERTY	COOPER KELSEY	7801 ENGLEWOOD AVE
205403491	2021	INDIVIDUAL PERSONAL PROPERTY	COSIO MICHELE	7900 WOODSON RD	205415172	2015	INDIVIDUAL PERSONAL PROPERTY	LACEY ELLANDIS	9010 E 87TH ST APT D7
205403518	2017	INDIVIDUAL PERSONAL PROPERTY	SHEPHERD FELICA	11208 E 76TH TER	205415236	2019-2021	INDIVIDUAL PERSONAL PROPERTY	CHAMBERS PHILLIP A	9001 E 66TH TER
205403678	2021	INDIVIDUAL PERSONAL PROPERTY	ORTEGA HILARIO SALVADOR	6543 RAYTOWN RD APT 1	205415425	2020	INDIVIDUAL PERSONAL PROPERTY	LEIGHTY HANNA	8905 E 67TH PL APT 211
205403683	2015-2021	INDIVIDUAL PERSONAL PROPERTY	MCKINLEY CAMERON J	10008 E 68TH ST	205415430	2020	INDIVIDUAL PERSONAL PROPERTY	MATTOX IONA R & DICKEY KATELYNN M	6912 WILDWOOD DR
205403934	2015-2019	INDIVIDUAL PERSONAL PROPERTY	GUTHRIDGE MONICA	9816 E 61ST ST APT 1	205415442	2015-2021	INDIVIDUAL PERSONAL PROPERTY	EVERETT RAYMOND E	7904 ARLINGTON AVE
205404073	2021	INDIVIDUAL PERSONAL PROPERTY	HOSIER NICOLE JO	8403 MARSH AVE	205415643	2021	INDIVIDUAL PERSONAL PROPERTY	ECKHOFF ERIC A & SARAH L	6001 HARRIS AVE
205404114	2021	INDIVIDUAL PERSONAL PROPERTY	THOMAS CATHERINE D	7521 ENGLEWOOD AVE	205415703	2017	INDIVIDUAL PERSONAL PROPERTY	WOODS KRISHINNA M	12009 78TH TER
205404125	2020-2021	INDIVIDUAL PERSONAL PROPERTY	SIMS FREDDIE ALEXANDRA	7616 ENGLEWOOD AVE	205415913	2019	INDIVIDUAL PERSONAL PROPERTY	GARDNER TERRI L	8305 KENTUCKY AVE
205404162	2015-2019	INDIVIDUAL PERSONAL PROPERTY	GURLEY CHELSEA R	9109 E 74TH ST	205416102	2021	INDIVIDUAL PERSONAL PROPERTY	DIGIOVANNI WANDA	11305 E 55TH TER
205404171	2017-2021	INDIVIDUAL PERSONAL PROPERTY	BOYD ZACHARY TYLER	5520 HEDGES AVE	205416268	2021	INDIVIDUAL PERSONAL PROPERTY	MCKINNEY JAMES HENRY JR	9804 E 79TH ST
205404209	2020-2021	INDIVIDUAL PERSONAL PROPERTY	REED GLENDA SUE	5316 NORTHERN AVE	205416332	2021	INDIVIDUAL PERSONAL PROPERTY	WOLFF SEAN M	7505 CRISP AVE
205404232	2016-2019	INDIVIDUAL PERSONAL PROPERTY	SISEMORE KATHERINE	9416 E 67TH TER	205416398	2021	INDIVIDUAL PERSONAL PROPERTY	VOLSEN ANDREA FRANCES	8500 E 83RD ST
205404494	2015	INDIVIDUAL PERSONAL PROPERTY	JORDAN MAKAILA	7206 CRISP AVE	205416478	2015	INDIVIDUAL PERSONAL PROPERTY	PHELPS RASHAWN	8503 BROTHER AVE
205404658	2017-2021	INDIVIDUAL PERSONAL PROPERTY	SOLOMON KATHERINE LEIGH	8618 GRANT DR	205416767	2021	INDIVIDUAL PERSONAL PROPERTY	GONZALEZ MARTIN LUIS PEDRO	8810 E 67TH ST
205404687	2021	INDIVIDUAL PERSONAL PROPERTY	RICHARDSON ANTOINCE	8808 E 54TH ST	205416814	2015-2016	INDIVIDUAL PERSONAL PROPERTY	LICHT ROBERT DEAN JR	7808 WOODSON RD
205404718	2021	INDIVIDUAL PERSONAL PROPERTY	WILLIAMS CELESTE CHARIS	8306 JAMES A REED RD	205416827	2020-2021	INDIVIDUAL PERSONAL PROPERTY	SMITH BRANDY LEE	9944 E 61ST ST
205404829	2014-2017	INDIVIDUAL PERSONAL PROPERTY	SERIAL DEMONAE	11803 E 83RD ST APT 102	205416852	2015-2021	INDIVIDUAL PERSONAL PROPERTY	LANE MAURI RASHAWN	8701 ARLINGTON AVE
205404886	2015-2017	INDIVIDUAL PERSONAL PROPERTY	SMITH RICKY P	8804 RICHARDS DR	205416942	2021	INDIVIDUAL PERSONAL PROPERTY	SHULTS JUSTIN	11012 E 78TH ST
205405311	2021	INDIVIDUAL PERSONAL PROPERTY	NEWHOUSE JOSEPH P	10921 E 81ST TER	205417389	2016-2021	INDIVIDUAL PERSONAL PROPERTY	REED KIMBERLY ANN	8602 STARK AVE
205405475	2021	INDIVIDUAL PERSONAL PROPERTY	HUTT JEANNE MARIE	10315 E 70TH TER	205417859	2020-2021	INDIVIDUAL PERSONAL PROPERTY	LANE DERAN MORRIS	11408 E 62ND TER
205405509	2021	INDIVIDUAL PERSONAL PROPERTY	SHIRLEY BRYAN RANDALL	9116 VAUGHN AVE	205417931	2021	INDIVIDUAL PERSONAL PROPERTY	BARBER JERELL MOSES	7907 BLUE RIDGE BLVD
205405658	2020-2021	INDIVIDUAL PERSONAL PROPERTY	GREEN ERIC A	6404 KENTUCKY AVE	205417957	2020-2021	INDIVIDUAL PERSONAL PROPERTY	SEXTON WHITNEY MARIE	7601 HAWTHORNE AVE
205405665	2020-2021	INDIVIDUAL PERSONAL PROPERTY	WALTERS RONALD LEE	6730 STERLING AVE	205417984	2021	INDIVIDUAL PERSONAL PROPERTY	BOCKHAHN JOSHUA DAVID	7007 LAKESHORE DR
205405785	2016	INDIVIDUAL PERSONAL PROPERTY	NESTELL JENNIFER LEE	9508 E 60TH TER	205418200	2021	INDIVIDUAL PERSONAL PROPERTY	BARDWELL CHRISTINA ELIZABETH	5512 NORTHERN AVE
205405942	2016-2021	INDIVIDUAL PERSONAL PROPERTY	CRABTREE KIRA	5800 MAYWOOD AVE	205418964	2021	INDIVIDUAL PERSONAL PROPERTY	ATKINSON DIANA LYNN	10711 MARSH AVE APT 2
205405946	2018-2020	INDIVIDUAL PERSONAL PROPERTY	GULLY BARBRA	9100 E 72ND TER	205419161	2021	INDIVIDUAL PERSONAL PROPERTY	FLOHR JOHN K 2ND	9001 E 66TH TER
205406014	2015-2021	INDIVIDUAL PERSONAL PROPERTY	GAZLAY JEFFREY LEE II	8910 RICHARDS DR	205419433	2015	INDIVIDUAL PERSONAL PROPERTY	SIRNA HANNAH	10812 GREGORY LN
205406330	2019-2021	INDIVIDUAL PERSONAL PROPERTY	SMITH SHAWNA LYNN	6725 STERLING AVE	205780914	2021	INDIVIDUAL PERSONAL PROPERTY	COOK ROSE M	9601 E 69TH ST
205406354	2017-2019	INDIVIDUAL PERSONAL PROPERTY	DAVIS BEATRICE EILEEN	7224 MAPLE AVE	205781625	2015	INDIVIDUAL PERSONAL PROPERTY	HAYES ROBERT JR	7802 LANE AVE
205406576	2020-2021	INDIVIDUAL PERSONAL PROPERTY	TILLARD JUSTIN D	9808 E 81ST TER	205781889	2019	INDIVIDUAL PERSONAL PROPERTY	LOONEY KATHERINE G	530 GLADSTONE BLVD
205406665	2021	INDIVIDUAL PERSONAL PROPERTY	STONEKING CHRISTINE	6720 LAUREL AVE	205781898	2020	INDIVIDUAL PERSONAL PROPERTY	ARZATE LUIS ANGEL	8733 FORD AVE
205406891	2017	INDIVIDUAL PERSONAL PROPERTY	HUGHES MARLAND RAYNARD & TAMELA MASHONNE	10512 E 60TH TER	205782020	2015-2021	INDIVIDUAL PERSONAL PROPERTY	WOLKEN KEITH ALLEN	5513 HARDY AVE
205406926	2015-2021	INDIVIDUAL PERSONAL PROPERTY	CRANER PAULLETTE M	6600 WILLOW AVE	205782299	2020-2021	INDIVIDUAL PERSONAL PROPERTY	ROSS SHANE	7509 CRISP AVE
205407178	2015-2021	INDIVIDUAL PERSONAL PROPERTY	BADWIN JAKOBB NATHAN	6304 HUNTER ST	205782443	2020-2021	INDIVIDUAL PERSONAL PROPERTY	MUN HWISOOK	7810 IRWIN RD
205407283	2021	INDIVIDUAL PERSONAL PROPERTY	MOHAMMED SALIH MUSTAFA	8704 W LONGVIEW PKWY	205782503	2020-2021	INDIVIDUAL PERSONAL PROPERTY	PHILLIPS CYNTHIA	8472 LANE DR
205407370	2015-2021	INDIVIDUAL PERSONAL PROPERTY	MAXON TRISHA C	6828 ENGLEWOOD AVE	205782919	2021	INDIVIDUAL PERSONAL PROPERTY	GALAN ANA L	5741 BLUE RIDGE BLVD
205407510	2021	INDIVIDUAL PERSONAL PROPERTY	THOMAS TRACY LATASHIA	5218 DITZLER AVE	205783449	2021	INDIVIDUAL PERSONAL PROPERTY	PAYNE RUSSEL P & DANA	7916 HUNTER ST
205407564	2021	INDIVIDUAL PERSONAL PROPERTY	BROWNING JAMIE	11105 E 72ND TER	205783499	2021	INDIVIDUAL PERSONAL PROPERTY	MONTOYA MANCERA JESUS FERNANDO	8632 E 84TH ST
205407922	2018	INDIVIDUAL PERSONAL PROPERTY	GOOLD JIMMY W	7007 LAKESHORE DR	205783556	2021	INDIVIDUAL PERSONAL PROPERTY	STANTON SHAWN MARCUS	301 W ARMOUR BLVD APT 115
205408009	2020-2021	INDIVIDUAL PERSONAL PROPERTY	LINEBACK JESSE	6515 HEDGES AVE	205784017	2018-2019	INDIVIDUAL PERSONAL PROPERTY	GRAY ADRIAN	9903 E 60TH ST
205408678	2021	INDIVIDUAL PERSONAL PROPERTY	BRAUN JOSEPH	9119 RICHARDS DR	205784346	2021	INDIVIDUAL PERSONAL PROPERTY	MEDLEY KYLAH R	10336 E 63RD ST APT 4
205408695	2018-2019	INDIVIDUAL PERSONAL PROPERTY	BROWN ANDREW	8309 E 85TH TER	205784594	2021	INDIVIDUAL PERSONAL PROPERTY	SAMUELS SHALYNN RENE	9900 E 61ST ST
205408812	2020-2021	INDIVIDUAL PERSONAL PROPERTY	MCKINNEY RAFIQ JAWAN JR	11007 E 83RD TER	205784660	2021	INDIVIDUAL PERSONAL PROPERTY	JONES LARHONDA ROCHELLE	11220 E 71ST DR
205409090	2021	INDIVIDUAL PERSONAL PROPERTY	MCCRAY LERON	5316 KENTUCKY AVE	205784707	2016-2021	INDIVIDUAL PERSONAL PROPERTY	BRUNDAGE SHAWN R	11323 E 60TH TER
205409227	2019-2021	INDIVIDUAL PERSONAL PROPERTY	SCHAFFER CHRISTOPHER SCOTT	7105 NORWOOD AVE	205784730	2018-2019	INDIVIDUAL PERSONAL PROPERTY	GONZALEZ DANIEL	10313 E 71ST TER
205409278	2019-2021	INDIVIDUAL PERSONAL PROPERTY	CARTER LARRY CURTIS III	11724 E 85TH ST	205784837	2021	INDIVIDUAL PERSONAL PROPERTY	HERRINGTON JEANNIE S & LUKE M	8311 DITZLER AVE
205409308	2016-2021	INDIVIDUAL PERSONAL PROPERTY	KELLEY ARNETT DETOINE	8113 KENTUCKY AVE	205785201	2019-2021	INDIVIDUAL PERSONAL PROPERTY	JONES KIMBERLY L	9905 E 73RD ST APT E
205409396	2021	INDIVIDUAL PERSONAL PROPERTY	LEMEN AARON CHASE	5520 STERLING AVE	205785218	2021	INDIVIDUAL PERSONAL PROPERTY	PENCE MINDY & STEINER SUSAN	11011 US 50 HWY
205409590	2021	INDIVIDUAL PERSONAL PROPERTY	VERKINDEREN MATHEW	11108 E 59TH ST	205785429	2019-2021	INDIVIDUAL PERSONAL PROPERTY	MOORE ANITA E	11409 E 65TH ST
205409724	2021	INDIVIDUAL PERSONAL PROPERTY	COOLEY AMOS TERRELL	7229 CRISP AVE	205785695	2020-2021	INDIVIDUAL PERSONAL PROPERTY	GOULDEN WILLIAM J	8605 MAYWOOD AVE
205409919	2015	INDIVIDUAL PERSONAL PROPERTY	PLATT LYNDIA JOYCE	6541 RAYTOWN RD APT 4	205785744	2015-2019	INDIVIDUAL PERSONAL PROPERTY	SCHELSTRATE JUSTIN DAVID	9521 E 67TH TER
205410796	2015-2016	INDIVIDUAL PERSONAL PROPERTY	WASHINGTON ALEXIS	8317 HARVARD AVE	205785787	2021	INDIVIDUAL PERSONAL PROPERTY	WILLIAMS KAMIKA KESHAWN (EWING)	7511 MAPLE LN
205411614	2021	INDIVIDUAL PERSONAL PROPERTY	PLUMLEE JOHANNA	11611 E 77TH ST	205785791	2016-2021	INDIVIDUAL PERSONAL PROPERTY	SANDERS MATTIE	11611 E 80TH DR
205411620	2019	INDIVIDUAL PERSONAL PROPERTY	CHARLES ED LEANTHONY	8813 E 84TH TER	205785832	2021	INDIVIDUAL PERSONAL PROPERTY	ELLIS BRANDY S	6114 BLUE RIDGE CUT OFF

205786126	2019-2021	INDIVIDUAL PERSONAL PROPERTY	MILLER ANNA MARIE	10812 GREGORY LN	205800815	2016-2021	INDIVIDUAL PERSONAL PROPERTY	LLOPEX NICOLAS ADOLPH	6809 HUNTER ST
205786146	2015	INDIVIDUAL PERSONAL PROPERTY	LAGRANT KELLY CHRISTINE	5915 FARLEY AVE	205800980	2021	INDIVIDUAL PERSONAL PROPERTY	LOPEZ ERICA M	9107 E 74TH TER
205786155	2015	INDIVIDUAL PERSONAL PROPERTY	JIMENEZ MEGAN L	5521 HEDGES AVE	205801033	2019-2021	INDIVIDUAL PERSONAL PROPERTY	WILLIAMS SHARAE KEIANNE	7414 OVERTON AVE UNIT 6
205786859	2020	INDIVIDUAL PERSONAL PROPERTY	MULLANE MARISA J	1417 SW 3RD ST APT A-4	205801063	2015-2016	INDIVIDUAL PERSONAL PROPERTY	YOUNG CALEB DAN	8303 BOOTH AVE
205787195	2021	INDIVIDUAL PERSONAL PROPERTY	SHADDEN AMY	8501 KENTUCKY AVE	205801169	2021	INDIVIDUAL PERSONAL PROPERTY	THOMAS AKAYA KAYE	10205 E 63RD TER APT D
205787418	2016-2018	INDIVIDUAL PERSONAL PROPERTY	COOPER TOMIEKA MICHELLE	9807 E 61ST ST APT 10	205801372	2016-2017	INDIVIDUAL PERSONAL PROPERTY	RANSBURG RAYMOND D JR	8634 LANE AVE APT 3
205787584	2020-2021	INDIVIDUAL PERSONAL PROPERTY	SMITH DEANN P	11008 E 83RD ST	205801790	2021	INDIVIDUAL PERSONAL PROPERTY	FITHIAN KELSEA D	8517 EVANSTON AVE
205787901	2017-2019	INDIVIDUAL PERSONAL PROPERTY	YOUNG NICO M	7616 ENGLEWOOD AVE	205802045	2015-2019	INDIVIDUAL PERSONAL PROPERTY	BURTON BREANNA LATRICE	10100 E 68TH ST
205787919	2017	INDIVIDUAL PERSONAL PROPERTY	BACA ASHLEY & BRANSON KYLE J	9409 E 81ST ST	205802307	2021	INDIVIDUAL PERSONAL PROPERTY	SIMPSON LISA MARIE	8424 LANE PL
205787976	2018-2021	INDIVIDUAL PERSONAL PROPERTY	AMOS DASHAY A VIANCE	5205 STERLING AVE	205802576	2020-2021	INDIVIDUAL PERSONAL PROPERTY	PEARSON BRIANNA F	7703 CRESCENT AVE
205788273	2021	INDIVIDUAL PERSONAL PROPERTY	DRESSER COREY	8112 MANNING AVE	205802595	2019-2021	INDIVIDUAL PERSONAL PROPERTY	FISO AH-LOON RODERICK	11104 E 57TH ST
205788557	2018-2021	INDIVIDUAL PERSONAL PROPERTY	KLUEPFEL TAMIRA	5609 STERLING AVE	205802758	2016-2017	INDIVIDUAL PERSONAL PROPERTY	TODD HENSE JR	8416 PERSHING RD
205788777	2016-2021	INDIVIDUAL PERSONAL PROPERTY	HAVRUM TYLER F	8509 GREENWOOD RD	205802981	2016-2018	INDIVIDUAL PERSONAL PROPERTY	ORTIZ KEVIN A	5416 RAYTOWN RD
205788785	2021	INDIVIDUAL PERSONAL PROPERTY	PERKINS TRAVIS G	1026 NW WILLOW DR	205803316	2020-2021	INDIVIDUAL PERSONAL PROPERTY	COLLINS SEAN L	8904 ROSE LN
205788891	2016-2021	INDIVIDUAL PERSONAL PROPERTY	CAMILLO GONZALEZ-JIMENEZ	6328 KENTUCKY AVE	205803966	2020-2021	INDIVIDUAL PERSONAL PROPERTY	FRAZIER JUAN MONDRE	9816 E 60TH ST
205788948	2017-2021	INDIVIDUAL PERSONAL PROPERTY	LONGIE COURTNEY ANN	10004 E 77TH TER	205803967	2021	INDIVIDUAL PERSONAL PROPERTY	VARELA EMMA EDITH	6804 LAKESHORE DR
205788954	2021	INDIVIDUAL PERSONAL PROPERTY	WASHINGTON VICTORIA FAITH (PHILLIPS)	8500 EVANSTON AVE	205804118	2021	INDIVIDUAL PERSONAL PROPERTY	EIKEN KARA JORDAN	9109 E 67TH TER
205789151	2021	INDIVIDUAL PERSONAL PROPERTY	ALLEN ANTONIO	847 E 85TH ST	205804218	2015	INDIVIDUAL PERSONAL PROPERTY	SMITH ADAM DAVID	6100 DITZLER AVE
205789216	2020-2021	INDIVIDUAL PERSONAL PROPERTY	BLEDSOE ANDRES D & TONIESHA N	9826 E 60TH ST	205804269	2020-2021	INDIVIDUAL PERSONAL PROPERTY	JAKOBE JEROME & AURORA	9804 LAKESHORE DR
205790338	2021	INDIVIDUAL PERSONAL PROPERTY	CARRERE DIAMOND LASHAY	4002 INDIANA AVE	205804434	2021	INDIVIDUAL PERSONAL PROPERTY	GRASHER KENNETH & GRASHER BRITTNEY	8806 E 57TH ST
205790522	2016	INDIVIDUAL PERSONAL PROPERTY	DAVIS JOSHUA	8505 BOOTH AVE	205804499	2017	INDIVIDUAL PERSONAL PROPERTY	BRENETT GLENN KYLE	9109 E 67TH TER
205790593	2015-2020	INDIVIDUAL PERSONAL PROPERTY	TERRELL DWIGHT E	6302 RALSTON AVE	205804535	2021	INDIVIDUAL PERSONAL PROPERTY	NEWMAN ASHLEY N	6100 DITZLER AVE
205790864	2021	INDIVIDUAL PERSONAL PROPERTY	RUSNAK JAKE	6801 ENGLEWOOD AVE	205804626	2018-2021	INDIVIDUAL PERSONAL PROPERTY	WINFIELD ERICKA L	9101 HUNTER ST
205790865	2021	INDIVIDUAL PERSONAL PROPERTY	ROCK TIMOTHY ALAN	7909 HUNTER ST	205804922	2021	INDIVIDUAL PERSONAL PROPERTY	WHEELER JAQUAL	9605 E 65TH ST
205791092	2016-2017	INDIVIDUAL PERSONAL PROPERTY	COUNTINHO JOSE CELSO CARVALHO	7238 RAYTOWN RD APT A	205804931	2017-2021	INDIVIDUAL PERSONAL PROPERTY	OSBY ANDREA RAMON	8008 E 85TH ST
205791193	2020-2021	INDIVIDUAL PERSONAL PROPERTY	MILLS YVONNE S	9408 E 68TH TER	205805088	2017-2021	INDIVIDUAL PERSONAL PROPERTY	SISCO ANTHONY DANVLI II	7513 EVANSTON AVE
205791563	2021	INDIVIDUAL PERSONAL PROPERTY	WILLINGHAM BEATRICE RENEE	9311 E 83RD ST	205805552	2019	INDIVIDUAL PERSONAL PROPERTY	DAWLEY AMANDA MARIE	7918 HEDGES AVE
205791653	2015	INDIVIDUAL PERSONAL PROPERTY	MATTHEWS TERRY T	6000 BLUE RIDGE CUT OFF	205805596	2019	INDIVIDUAL PERSONAL PROPERTY	BETANCOURT MADISON	8409 ELM AVE
205791856	2021	INDIVIDUAL PERSONAL PROPERTY	ANGUS BILLY J & FRANCO VERONICA A	9200 VAUGHN AVE	205805815	2016	INDIVIDUAL PERSONAL PROPERTY	WILSON SAMMIE LEE JR	6124 HARVARD AVE
205792540	2016-2020	INDIVIDUAL PERSONAL PROPERTY	WOODARD MAURICE & SUMMERS PATRICA	8307 HEDGES AVE	205805855	2021	INDIVIDUAL PERSONAL PROPERTY	OLVERA SIERRA AIYANNA	9708 E 65TH TER
205793331	2015	INDIVIDUAL PERSONAL PROPERTY	FITZWATER DONNA S	7400 MAPLE UNIT 416	205806183	2016-2019	INDIVIDUAL PERSONAL PROPERTY	BAYLON PENA ERICK CRISTOBAL	11801 E 77TH TER
205793440	2021	INDIVIDUAL PERSONAL PROPERTY	RIDDICK JOSEPH DEMETRIUS JR	10101 E 83RD ST	205806190	2020-2021	INDIVIDUAL PERSONAL PROPERTY	RUMSOWER TIMOTHY A	9355 E 60TH TER
205793650	2019-2020	INDIVIDUAL PERSONAL PROPERTY	SHIRLEY DYLAN LENOLD	4818 NORWOOD AVE	205806657	2020-2021	INDIVIDUAL PERSONAL PROPERTY	CERTAIN TAKAYLA GABRIELLE REYANA	6428 CEDAR AVE APT B
205793994	2021	INDIVIDUAL PERSONAL PROPERTY	JONES BRANDON RAYON	9808 E 85TH ST	205807093	2016-2021	INDIVIDUAL PERSONAL PROPERTY	GATES FERNANDUS ANTHONY JR	11238 E 71ST DR
205794044	2020-2021	INDIVIDUAL PERSONAL PROPERTY	WHITE BILLY J	5821 APPLETON AVE	205807395	2021	INDIVIDUAL PERSONAL PROPERTY	MCCOLLUM CHRISTOPHER STEPHEN	6153 RAYTOWN RD APT 4
205794293	2017-2021	INDIVIDUAL PERSONAL PROPERTY	MORRISON CARL DYLAN	11521 E 74TH STREET CT	205807569	2021	INDIVIDUAL PERSONAL PROPERTY	WARD SHAUN M	11705 E 78TH ST
205794359	2021	INDIVIDUAL PERSONAL PROPERTY	MURPHY ZACKREY	7512 APPLETON AVE	205807870	2019-2020	INDIVIDUAL PERSONAL PROPERTY	ROWELL FALYN	6405 KENTUCKY AVE
205794402	2015	INDIVIDUAL PERSONAL PROPERTY	GEORGES GRESHAN	9209 E 53RD TER	205807871	2016-2021	INDIVIDUAL PERSONAL PROPERTY	TONASKET JAIME ANNALISE	8609 EVERETT ST
205794503	2020-2021	INDIVIDUAL PERSONAL PROPERTY	GOODIN TYRONE	9401 E 63RD ST APT 305	205808005	2016-2017	INDIVIDUAL PERSONAL PROPERTY	ST LOUIS VINCENT V	2012 STERLING AVE
205794893	2021	INDIVIDUAL PERSONAL PROPERTY	ALI AMINAH ZAHIRRAH	5402 OXFORD AVE	205808027	2016-2021	INDIVIDUAL PERSONAL PROPERTY	MILLER LAWRENCE LARONNE	6501 BLUE RIDGE CUT OFF
205795016	2017-2021	INDIVIDUAL PERSONAL PROPERTY	WHITE DIAMOND LENAEE	8325 NORTHERN ST	205808079	2019	INDIVIDUAL PERSONAL PROPERTY	HART MICHAEL JAMES	11400 E 58TH ST
205795250	2020-2021	INDIVIDUAL PERSONAL PROPERTY	TURNER DESHANNON DARNELL	8501 SPRING VALLEY RD	205808092	2021	INDIVIDUAL PERSONAL PROPERTY	MEFFORD JOSHUA ROBERT	9516 E 68TH ST
205795999	2021	INDIVIDUAL PERSONAL PROPERTY	SANCHEZ DAVID MICHAEL	8530 CRESCENT AVE	205808337	2021	INDIVIDUAL PERSONAL PROPERTY	DAWKINS AREL A	8303 MANNING AVE
205796181	2021	INDIVIDUAL PERSONAL PROPERTY	JOHNSON RODNEY DEMETRIUS JR	9513 E 83RD ST	205808549	2016	INDIVIDUAL PERSONAL PROPERTY	MOORE REBECCA A	5508 DITZLER AVE
205796354	2021	INDIVIDUAL PERSONAL PROPERTY	EVANS RACHAEL RENEE	7213 HARVARD AVE	205808585	2018-2019	INDIVIDUAL PERSONAL PROPERTY	DEISHER DUSTIN D	8802 E 72ND ST
205796526	2016-2017	INDIVIDUAL PERSONAL PROPERTY	HARMS TRAVIS D	6140 RAYTOWN RD APT 601	205808941	2013-2017	INDIVIDUAL PERSONAL PROPERTY	MANNING KENESHA DYNAE	6008 ENGLEWOOD AVE
205796873	2016	INDIVIDUAL PERSONAL PROPERTY	GARRETT NATASHA MARY	10405 E 82ND TER	205809256	2017-2019	INDIVIDUAL PERSONAL PROPERTY	STAZEN ADAMS JAMES	9500 E 65TH ST
205797213	2021	INDIVIDUAL PERSONAL PROPERTY	HENDERSON SHARELE SHANTE	8136 DITZLER AVE	205809605	2016-2021	INDIVIDUAL PERSONAL PROPERTY	CONROY TINA	9709 E GREGORY BLVD
205797257	2021	INDIVIDUAL PERSONAL PROPERTY	WILSON DESTINEE JADE	15314 GRAND SUMMIT LN	205809943	2021	INDIVIDUAL PERSONAL PROPERTY	CARTER RICHARD EDWARD	9104 E 67TH TER
205797319	2021	INDIVIDUAL PERSONAL PROPERTY	HORNBECK MICHAEL JAMES	9008 RICHARDS DR	205809997	2017-2018	INDIVIDUAL PERSONAL PROPERTY	MOLDEN TAMOI AUSAHAIE	8828 E 61ST ST
205797385	2019-2021	INDIVIDUAL PERSONAL PROPERTY	MELEY JENNIFER M	8513 OXFORD AVE	205810067	2019	INDIVIDUAL PERSONAL PROPERTY	WRIGHT TIFFANY CHARRAL	6417 BLUE RIDGE CUT OFF
205797922	2016-2021	INDIVIDUAL PERSONAL PROPERTY	BROCKMAN MICHELLIE JOANN	5824 FARLEY AVE	205810306	2017-2021	INDIVIDUAL PERSONAL PROPERTY	COCKRELL STEPHEN WILLIAM	11208 E 75TH TER
205797998	2021	INDIVIDUAL PERSONAL PROPERTY	MURPHY KERI	9802 E 60TH ST	205810316	2019-2021	INDIVIDUAL PERSONAL PROPERTY	KIRK RICHARD JOSEPH	5421 HARRIS AVE
205798207	2016	INDIVIDUAL PERSONAL PROPERTY	WENRICK CHAD LEWIS JR	9813 E 73RD ST APT D	205810320	2021	INDIVIDUAL PERSONAL PROPERTY	ROBINSON KIMBROUGH PAMELA R	8321 WILLOW WAY
205798285	2021	INDIVIDUAL PERSONAL PROPERTY	REDICK DANIELLE N & QUANLI C	11021 E 66TH TER	205810333	2019-2021	INDIVIDUAL PERSONAL PROPERTY	WOLGAMOTT RODNEY	6712 LAUREL AVE
205798656	2021	INDIVIDUAL PERSONAL PROPERTY	DEVINE ANTHONY WILLIAM	5336 HEDGES AVE	205810353	2016	INDIVIDUAL PERSONAL PROPERTY	BATTISTE RONALD S	6801 HUNTER ST
205798740	2017-2021	INDIVIDUAL PERSONAL PROPERTY	LYTLE GERALD LEON JR	11045 E 53RD TER	205810449	2021	INDIVIDUAL PERSONAL PROPERTY	RICHARDSON JOSEPH LINDSEY	6212 RALSTON AVE
205798778	2020-2021	INDIVIDUAL PERSONAL PROPERTY	HARTMAN CHARLES & DAWN	5513 HUNTER ST	205810657	2021	INDIVIDUAL PERSONAL PROPERTY	ATKISON JOEL CAMERON	9104 E 82ND TER
205798921	2021	INDIVIDUAL PERSONAL PROPERTY	GONZALEZ JOHN RUDOLPH	6215 WILLOW AVE	205810659	2017-2021	INDIVIDUAL PERSONAL PROPERTY	NEWSOME CEDRICK D	3505 LEWIS AVE
205798922	2016-2021	INDIVIDUAL PERSONAL PROPERTY	BIGGS JOHN DUNCAN IV	6113 HUNTER ST	205810741	2016-2021	INDIVIDUAL PERSONAL PROPERTY	HOUSH JUSTIN T	39314 E US 50 HWY
205799124	2021	INDIVIDUAL PERSONAL PROPERTY	ALEXANDER SANAY RENE	4547 S SAVILLE CT	205811063	2018	INDIVIDUAL PERSONAL PROPERTY	SYDOW MATTHEW RYAN	7030 WOODSON RD
205799243	2017-2021	INDIVIDUAL PERSONAL PROPERTY	STANBROUGH BRANDON	10108 E 68TH TER	205811259	2017-2020	INDIVIDUAL PERSONAL PROPERTY	MORGAN SHON NESHA DUJOUR	9906 E 60TH ST
205799474	2021	INDIVIDUAL PERSONAL PROPERTY	MEADOWS CHARLES LEON JR	6509 LANE AVE	205811290	2018-2021	INDIVIDUAL PERSONAL PROPERTY	MUNTER JULIE MARIE	9413 E 83RD ST
205799536	2019-2021	INDIVIDUAL PERSONAL PROPERTY	GASKIN KEITH ANDRE	9905 E 73RD ST APT B	205811390	2021	INDIVIDUAL PERSONAL PROPERTY	GIER KRISTINE L	9104 RICHARDS DR
205799538	2020-2021	INDIVIDUAL PERSONAL PROPERTY	DUNNELL CURTIS JOE JR	5837 MAYWOOD AVE	205811473	2016	INDIVIDUAL PERSONAL PROPERTY	MCCRAY BELL BELYNDA S & BELL NOELLE ANAI	11112 E 71ST TER
205799577	2020-2021	INDIVIDUAL PERSONAL PROPERTY	GARRETT KELLIE MICHELLE	9021 E 74TH TER	205811857	2021	INDIVIDUAL PERSONAL PROPERTY	HINSHAW GLADYS L	7000 HUNTER ST
205799808	2015	INDIVIDUAL PERSONAL PROPERTY	MOORE JOE	10201 E 86TH TER	205812412	2017-2018	INDIVIDUAL PERSONAL PROPERTY	KOONTZ ELLA	10115 E 67TH ST
205800087	2021	INDIVIDUAL PERSONAL PROPERTY	FLIPPIN ANDREW S	9708 E 79TH PL	205812617	2020-2021	INDIVIDUAL PERSONAL PROPERTY	PRICE MAKAYLA SHANA	8611 OXFORD AVE
205800343	2015	INDIVIDUAL PERSONAL PROPERTY	HERRON RICARDO LEROY III	11606 E 60TH ST	205812969	2019	INDIVIDUAL PERSONAL PROPERTY	ROBBINS TRENTON	3916 NW CIMARRON ST
205800385	2021	INDIVIDUAL PERSONAL PROPERTY	HODLE KEVIN ROBERT	8100 MANNING AVE	205813118	2021	INDIVIDUAL PERSONAL PROPERTY	CANDLER DESTINY ELAINE	5312 RALSTON AVE
205800515	2015	INDIVIDUAL PERSONAL PROPERTY	FORD ALVIS BYRON	6659 MAYWOOD AVE	205813503	2016-2017	INDIVIDUAL PERSONAL PROPERTY	FLINT ERIC L	8608 E 83RD TER
205800634	2021	INDIVIDUAL PERSONAL PROPERTY	HENDERSON CYRIL L	5299 WILLOW AVE	205813669	2016	INDIVIDUAL PERSONAL PROPERTY	WALKER BRYAN A	9712 BROOKLANE ST

205813683	2020	INDIVIDUAL PERSONAL PROPERTY	WESSLEY CHANTZ JERMAINE	11700 E 78TH TER	205824734	2016-2021	INDIVIDUAL PERSONAL PROPERTY	GUZMAN JOEL III	9200 VAUGHN AVE
205813789	2019	INDIVIDUAL PERSONAL PROPERTY	EVERSON ZACHARY Q	10335 E 61ST ST APT 3	205824833	2019-2021	INDIVIDUAL PERSONAL PROPERTY	GONZAGOWSKI MASON JORDAN	11009 E 57TH TER
205813904	2017-2021	INDIVIDUAL PERSONAL PROPERTY	FOWLER EVAN T	3200 SW LONGVIEW RD	205824876	2021	INDIVIDUAL PERSONAL PROPERTY	JONES THEODUS JR	9006 E 85TH PL
205814282	2016-2017	INDIVIDUAL PERSONAL PROPERTY	GIBBS NICHOLAS	5357 BLUE RIDGE BLVD	205825018	2021	INDIVIDUAL PERSONAL PROPERTY	HUSKEY MARLESHA LE'BORAH (HARDEN)	606 NE HOWARD ST UNIT 7
205814787	2017-2021	INDIVIDUAL PERSONAL PROPERTY	WHITE RICHARD LEE	7914 HARDY AVE	205825021	2020-2021	INDIVIDUAL PERSONAL PROPERTY	AKHTAR PARVIZ	6140 RAYTOWN RD APT 101
205814998	2019-2021	INDIVIDUAL PERSONAL PROPERTY	HOLLOWAY JESSICA M	8918 E 74TH ST	205825469	2021	INDIVIDUAL PERSONAL PROPERTY	HAWKINS RICKEY ALLAN	5301 WILLOW AVE
205815154	2017	INDIVIDUAL PERSONAL PROPERTY	HUGHES CHRISTINE	6801 HUNTER ST	205825672	2021	INDIVIDUAL PERSONAL PROPERTY	GREEN PHILLIP LEVI & REX	8802 E 85TH ST
205815324	2015	INDIVIDUAL PERSONAL PROPERTY	MOTZ DORA JANE	11003 E 53RD ST	205825777	2016-2018	INDIVIDUAL PERSONAL PROPERTY	ANDERSON GABRIELLE AMANDA	5903 ENGLEWOOD AVE
205815551	2015	INDIVIDUAL PERSONAL PROPERTY	CUMMINS KELLY D	12018 E 75TH ST	205825841	2020-2021	INDIVIDUAL PERSONAL PROPERTY	ALLEN JORDAN MIKEL	5301 WILLOW AVE
205815652	2017	INDIVIDUAL PERSONAL PROPERTY	HERNANDEZ CARLOS & STEPHANIE F	8863 E 54TH ST	205825998	2018-2021	INDIVIDUAL PERSONAL PROPERTY	SMITH KYLA JO	5823 APPLETON AVE
205815697	2021	INDIVIDUAL PERSONAL PROPERTY	HILLIARD SEAN TREVEL	5504 LANE AVE	205826279	2017-2021	INDIVIDUAL PERSONAL PROPERTY	BRANDON XAVIER TREMON	6609 HARVARD AVE
205815787	2019	INDIVIDUAL PERSONAL PROPERTY	CARNER JUSTIN MICHAEL	7608 EVANSTON AVE	205826568	2016-2021	INDIVIDUAL PERSONAL PROPERTY	BRAND MARTOINE L	9608 E 77TH ST
205815803	2020-2021	INDIVIDUAL PERSONAL PROPERTY	CRAIG-WALKER CAMERON DEWAYNE	7230 RAYTOWN RD APT D	205826753	2017-2020	INDIVIDUAL PERSONAL PROPERTY	SHURN KIMBERLY VENETTE	8101 WILLOW WAY
205815872	2021	INDIVIDUAL PERSONAL PROPERTY	LANG KOURTNEE TIARA	8621 W UTOPIA DR APT 2	205826966	2021	INDIVIDUAL PERSONAL PROPERTY	HUNTINGTON MICHELLE LYNN	6704 LANE AVE APT 103
205815963	2021	INDIVIDUAL PERSONAL PROPERTY	SHERMAN JUDITH H	9018 E 74TH TER	205827338	2017-2019	INDIVIDUAL PERSONAL PROPERTY	SEAMANDS MADALYN	7839 ELM ST
205816038	2017-2018	INDIVIDUAL PERSONAL PROPERTY	RODGERS SIMONE REANN	5909 BLUE RIDGE CUT OFF	205827825	2020	INDIVIDUAL PERSONAL PROPERTY	SCHMITT ADISON MERRITT	11603 E 60TH ST
205816330	2020-2021	INDIVIDUAL PERSONAL PROPERTY	STARR DANIEL D	7901 MANNING AVE	205827931	2016	INDIVIDUAL PERSONAL PROPERTY	STARR KELVIN L	9204 E 84TH ST
205816397	2021	INDIVIDUAL PERSONAL PROPERTY	WILLIAMS YVONNE ELAINE	11701 E 83RD ST APT 102	205828033	2021	INDIVIDUAL PERSONAL PROPERTY	MITCHEM MIKALE JAYLEN	5425 DITZLER AVE
205816498	2019-2021	INDIVIDUAL PERSONAL PROPERTY	WOFFORD ROBERT SR	7907 ARLINGTON AVE	205828162	2015-2020	INDIVIDUAL PERSONAL PROPERTY	OAKS MARK A	9802 E 60TH ST
205816648	2019-2021	INDIVIDUAL PERSONAL PROPERTY	STEVENS KARI JO	9906 E 61ST ST	205828292	2021	INDIVIDUAL PERSONAL PROPERTY	CLAWSON TIFFANY LE ANN	9112 E 61ST ST
205816730	2020-2021	INDIVIDUAL PERSONAL PROPERTY	WAGNER STEFAN C	11418 E 71ST ST	205828434	2016-2017	INDIVIDUAL PERSONAL PROPERTY	MOEN KASSANDRA	5416 WILLOW AVE
205816901	2021	INDIVIDUAL PERSONAL PROPERTY	BENDER AMANDA RYANN	10800 E 60TH TER	205828486	2017-2021	INDIVIDUAL PERSONAL PROPERTY	GALBEARTH GLORIA A	894 E 83RD ST
205817194	2015	INDIVIDUAL PERSONAL PROPERTY	MCILWAIN SHANE	8496 LANE DR APT 6	205828717	2016-2021	INDIVIDUAL PERSONAL PROPERTY	HUNT BRIAN JUWAN JR	6353 BLUE RIDGE BLVD
205817503	2016	INDIVIDUAL PERSONAL PROPERTY	SOCIALO JAMES HEPRONA	8800 E 62ND ST	205828789	2015	INDIVIDUAL PERSONAL PROPERTY	PENNINGTON TREVOR RICHARD	8108 SPRING VALLEY RD
205817676	2020-2021	INDIVIDUAL PERSONAL PROPERTY	MCLEAN KIARA S	9803 E 61ST ST APT 6	205829033	2020-2021	INDIVIDUAL PERSONAL PROPERTY	WASHINGTON MEEYAH RAE	9112 E 84TH CT
205817778	2016	INDIVIDUAL PERSONAL PROPERTY	CHONLANAH MICHAEL	5321 WILLOW AVE	205829278	2021	INDIVIDUAL PERSONAL PROPERTY	SPARKS RACQUEL JENAE	5414 DITZLER AVE
205817978	2021	INDIVIDUAL PERSONAL PROPERTY	HOWARD SARA S	8208 ASH AVE	205829646	2016	INDIVIDUAL PERSONAL PROPERTY	FERRER MARIBEL	5520 HEDGES AVE
205818134	2021	INDIVIDUAL PERSONAL PROPERTY	WITHERSPOON ANGELA JOYCE	5831 FARLEY AVE	205829966	2018	INDIVIDUAL PERSONAL PROPERTY	PASTOR-ALVAREZ MARIA GUADALUPE	10906 E 62ND TER
205818336	2021	INDIVIDUAL PERSONAL PROPERTY	JACKSON MIA JANNA	11208 E 64TH ST	205830228	2021	INDIVIDUAL PERSONAL PROPERTY	BEASLEY LATASHA MARIE	5821 LAUREL AVE
205818638	2018-2021	INDIVIDUAL PERSONAL PROPERTY	TREWHITT BRADLEY D & MEGAN A (BARNES)	5416 MAYWOOD AVE	205830239	2021	INDIVIDUAL PERSONAL PROPERTY	PENDARVIS LARRY	4377 SW BREEZY POINT LN
205818719	2020-2021	INDIVIDUAL PERSONAL PROPERTY	RAMEY SHERYL ANN	8604 SPRING VALLEY RD	205830283	2021	INDIVIDUAL PERSONAL PROPERTY	HOLT GEORGIA LEE	1032 DEAN DR
205818915	2015	INDIVIDUAL PERSONAL PROPERTY	EDWARDS DARIUS DAWAN	6000 BLUE RIDGE CUT OFF	205830357	2019-2021	INDIVIDUAL PERSONAL PROPERTY	JAUDON LATHAN THOMAS	5815 WOODSON RD
205819009	2019-2021	INDIVIDUAL PERSONAL PROPERTY	JOHNSON EDWARD	6312 HUNTER ST	205831084	2021	INDIVIDUAL PERSONAL PROPERTY	BACHSTEIN ANDREW RUSSELL	9205 E 67TH TER
205819043	2016-2021	INDIVIDUAL PERSONAL PROPERTY	ROBINSON THOMAS A	7724 IRWIN RD	205831140	2021	INDIVIDUAL PERSONAL PROPERTY	BUMCON RODERICK TRIMICHAEL	5316 DITZLER AVE
205819126	2021	INDIVIDUAL PERSONAL PROPERTY	MORCHA MAX	9712 E 67TH TER	205831155	2021	INDIVIDUAL PERSONAL PROPERTY	ELLENWOOD TRAVIS JAMES	9402 E 84TH ST
205819183	2017-2019	INDIVIDUAL PERSONAL PROPERTY	HILL BRENDONNICA DELIAH	6521 STERLING AVE	205831315	2018-2019	INDIVIDUAL PERSONAL PROPERTY	CLAYTON KESHUNIK TEOSH	5920 WESTRIDGE RD
205819314	2016	INDIVIDUAL PERSONAL PROPERTY	BRITTON ABRAM MICHAEL	9800 E 80TH TER	205831356	2020-2021	INDIVIDUAL PERSONAL PROPERTY	ELLIOTT TORY SHATON	9805 E 61ST ST APT 8
205819576	2020	INDIVIDUAL PERSONAL PROPERTY	HERNANDEZ LEONA L	8514 ARLINGTON AVE	205831424	2016-2019	INDIVIDUAL PERSONAL PROPERTY	FITZGERALD ADAM	10915 E M 350 HWY
205819632	2021	INDIVIDUAL PERSONAL PROPERTY	MILLER RYLENN H	8424 JAMES A REED RD	205831750	2021	INDIVIDUAL PERSONAL PROPERTY	SIMS-WALTON CHRISTOPHER SEAN	11815 E 83RD ST APT 201
205819729	2021	INDIVIDUAL PERSONAL PROPERTY	HARRIS CARRIE LEE	7216 RAYTOWN RD APT F	205831855	2016	INDIVIDUAL PERSONAL PROPERTY	YOUNG GARY B & WALKUP ELIZABETH ANN	8417 WOODSON PL
205819750	2017	INDIVIDUAL PERSONAL PROPERTY	CLARK JAMES F	10613 E 70TH ST	205832254	2016	INDIVIDUAL PERSONAL PROPERTY	BENES JAMES R	8967 E 62ND TER
205820071	2019	INDIVIDUAL PERSONAL PROPERTY	HAYMAKER DEREK	6515 CLAREMONT AVE	205832272	2020-2021	INDIVIDUAL PERSONAL PROPERTY	DAVIS PEGGY ANN	11029 E 53RD TER
205820120	2017-2019	INDIVIDUAL PERSONAL PROPERTY	HARRIS SHELBY COLEEN	10909 E 64TH TER	205832450	2019-2021	INDIVIDUAL PERSONAL PROPERTY	ANTUNEZ REYES BLANCA E	6107 STERLING AVE
205820362	2015	INDIVIDUAL PERSONAL PROPERTY	CONLEN STEPHANIE ANN	5418 HARDY AVE	205832577	2021	INDIVIDUAL PERSONAL PROPERTY	POWELL CALVIN A	9609 E GREGORY BLVD
205820451	2016-2021	INDIVIDUAL PERSONAL PROPERTY	TAVERA-GARCIA MIGUEL ANGEL	8603 E 81ST ST	205832614	2020-2021	INDIVIDUAL PERSONAL PROPERTY	ROCHA JIMENEZ RODRIGO	5329 NORTHERN AVE
205820464	2021	INDIVIDUAL PERSONAL PROPERTY	HAVNER CHADWICK LEE	10200 E 83RD ST	205832792	2021	INDIVIDUAL PERSONAL PROPERTY	BAQUEDANO NOEL ARMANDO JR	6820 CRISP AVE
205820557	2021	INDIVIDUAL PERSONAL PROPERTY	STOKES DAVID PAUL	5420 BLUE RIDGE CUT OFF APT 516	205832918	2020-2021	INDIVIDUAL PERSONAL PROPERTY	RIVERS KENNETH LAMONT	8200 E 87TH ST
205820615	2016-2021	INDIVIDUAL PERSONAL PROPERTY	WILSON PHILLIP C SR	7824 IRWIN RD	205833109	2020	INDIVIDUAL PERSONAL PROPERTY	POWELL DAVID O	6140 RAYTOWN RD APT 707
205820806	2019-2020	INDIVIDUAL PERSONAL PROPERTY	MOSLEY CORNELIUS JAVAN	9063 E 65TH ST	205833314	2021	INDIVIDUAL PERSONAL PROPERTY	WEBSTER DANNY RAY JR	9321 E 84TH ST
205821314	2020-2021	INDIVIDUAL PERSONAL PROPERTY	INMAN ZACHARY RYAN	7604 WOODSON RD	205833329	2020-2021	INDIVIDUAL PERSONAL PROPERTY	HOOPER KESHIA MONIQUE	9000 E 85TH ST
205821335	2021	INDIVIDUAL PERSONAL PROPERTY	WEST JAMES DEAN	7728 CRISP AVE	205833404	2021	INDIVIDUAL PERSONAL PROPERTY	GALBEARTH LB	8914 E 83RD ST
205821367	2017	INDIVIDUAL PERSONAL PROPERTY	PATTERSON MATTHEW LLOYD	10505 E 79TH ST	205833638	2017-2020	INDIVIDUAL PERSONAL PROPERTY	MOORE WILLIAM REDELL JR	5420 BLUE RIDGE CUT OFF APT G01
205821406	2021	INDIVIDUAL PERSONAL PROPERTY	SARVER NICHOLAS	7201 HARDY AVE	205833917	2021	INDIVIDUAL PERSONAL PROPERTY	MANUEL JASON BERNARD	10905 E 82ND ST
205821407	2021	INDIVIDUAL PERSONAL PROPERTY	POWELL LADONNA L	11408 E 69TH ST	205834014	2019-2021	INDIVIDUAL PERSONAL PROPERTY	SNOW LEALAND	7046 WOODSON RD
205821507	2019	INDIVIDUAL PERSONAL PROPERTY	THE ETC TRUST	5932 BLUE RIDGE CUT OFF	205835006	2020-2021	INDIVIDUAL PERSONAL PROPERTY	MEYER ALLISON MARY	10122 E 71ST TER
205821540	2017-2018	INDIVIDUAL PERSONAL PROPERTY	LARIMER STEPHEN DEXTER	6108 NORTHERN AVE	205835053	2021	INDIVIDUAL PERSONAL PROPERTY	HAYES BENNIE	6509 HARDY AVE
205821606	2021	INDIVIDUAL PERSONAL PROPERTY	YOUNG KAREN	9021 E 79TH ST	205836073	2019	INDIVIDUAL PERSONAL PROPERTY	CONRICK BONNIE M	6008 CLAREMONT AVE
205821864	2020-2021	INDIVIDUAL PERSONAL PROPERTY	WALKER DANIELLE SHANTE	11319 E 81TH TER	205836117	2016-2018	INDIVIDUAL PERSONAL PROPERTY	RANSBURG MALYK J	7418 WOODSON RD
205821990	2021	INDIVIDUAL PERSONAL PROPERTY	DAVILLA CHRISTIAN LUCAS	11405 E 69TH ST	205836368	2021	INDIVIDUAL PERSONAL PROPERTY	TANNER MAUREEN LANETTE	5331 HARDY AVE
205822433	2021	INDIVIDUAL PERSONAL PROPERTY	RUHMAN ELISHA NATHANIEL	9611 E 77TH TER	205836455	2021	INDIVIDUAL PERSONAL PROPERTY	HICKS ANDREA J	9001 E 73RD ST
205822527	2019-2021	INDIVIDUAL PERSONAL PROPERTY	HOLMES KEITH TYRONE JR	8498 LANE DR APT 3	205836788	2017-2021	INDIVIDUAL PERSONAL PROPERTY	JONES SARAH MICHELLE	9501 E 68TH TER
205822564	2016-2019	INDIVIDUAL PERSONAL PROPERTY	MORRIS TIMOTHY MICHAEL	11029 E 81ST ST	205836997	2019-2021	INDIVIDUAL PERSONAL PROPERTY	DAVIS KYEELA JOZETTE	9905 E 77TH ST
205822578	2021	INDIVIDUAL PERSONAL PROPERTY	PARKS DENESHA MARSHAE	9920 E 61ST ST	205837077	2017-2019	INDIVIDUAL PERSONAL PROPERTY	THOMAS STACEY RENEE	6431 BLUE RIDGE CUT OFF
205822909	2017-2021	INDIVIDUAL PERSONAL PROPERTY	JOHANSEN BAILEY A	10505 E 79TH TER	205837319	2020	INDIVIDUAL PERSONAL PROPERTY	LOCKETT JORDAN DEONDRE	11500 E 62ND ST
205823091	2012-2017	INDIVIDUAL PERSONAL PROPERTY	COUNCE JENESIS SADE	6424 WOODSON RD	205837497	2016	INDIVIDUAL PERSONAL PROPERTY	OGUIN JENNIFER MARIE	7820 ARLINGTON AVE
205823212	2021	INDIVIDUAL PERSONAL PROPERTY	FRANCIS KYRA SHAREE	7716 ARLINGTON AVE	205837666	2018-2019	INDIVIDUAL PERSONAL PROPERTY	ADAMS BRANDON LEE	5455 ASH AVE
205823218	2020-2021	INDIVIDUAL PERSONAL PROPERTY	COLLINS MARCUS JOHN	7324 WILLOW AVE	205837835	2019-2021	INDIVIDUAL PERSONAL PROPERTY	WILSON DEKAYLA M & MOORE KALONDA T	7308 ASH AVE
205823336	2015-2017	INDIVIDUAL PERSONAL PROPERTY	ARNOLD ALEXIS I	10717 E 84TH ST	205837952	2020-2021	INDIVIDUAL PERSONAL PROPERTY	VERNON KAYLA KRISTINE	11301 E 58TH TER
205823641	2020-2021	INDIVIDUAL PERSONAL PROPERTY	LATTIN CHELSEY M	5945 RAYTOWN RD	205838645	2021	INDIVIDUAL PERSONAL PROPERTY	HAMPTON PEYTON MICHAEL	8606 STARK AVE
205824140	2017-2019	INDIVIDUAL PERSONAL PROPERTY	DOUGLAS DANNESHA LASHA	6308 STERLING AVE	205838996	2020-2021	INDIVIDUAL PERSONAL PROPERTY	JOHNSON DASHALA R	8517 CRESCENT AVE
205824562	2018-2021	INDIVIDUAL PERSONAL PROPERTY	HERNANDEZ ROBLEDO JESUS A	7516 APPLETON AVE	205838998	2016-2018	INDIVIDUAL PERSONAL PROPERTY	PARKER BRENDA	10605 E 78TH TER
205824577	2017	INDIVIDUAL PERSONAL PROPERTY	DRAKE ANDRUA DE'MEL	7315 HARDY AVE	205839167	2021	INDIVIDUAL PERSONAL PROPERTY	MIKA CALEB & CHLOE	9819 E 68TH TER

205839291	2019-2021	INDIVIDUAL PERSONAL PROPERTY	POWELL TROY	11408 E 69TH ST	205850044	2021	INDIVIDUAL PERSONAL PROPERTY	HOWARD TATEUANA MARIE	9211 E 54TH TER
205839303	2017-2021	INDIVIDUAL PERSONAL PROPERTY	JOHNSON ALBERT A JR	10904 E 81ST ST	205850195	2016	INDIVIDUAL PERSONAL PROPERTY	COLEMAN JORDAN TYLER	6840 STERLING AVE
205839315	2016-2017	INDIVIDUAL PERSONAL PROPERTY	RYAN CASEY	7612 WOODSON RD	205850250	2019-2021	INDIVIDUAL PERSONAL PROPERTY	EDWARDS HUNTER RAY	5529 HUNTER ST
205839510	2020-2021	INDIVIDUAL PERSONAL PROPERTY	EVERHART BRANDI M	9709 E 68TH TER	205850578	2021	INDIVIDUAL PERSONAL PROPERTY	KONOMOS ERIN L	10908 E 59TH TER
205839555	2021	INDIVIDUAL PERSONAL PROPERTY	BAHENA CARLOS ANTONIO	7541 WESTRIDGE RD	205850719	2021	INDIVIDUAL PERSONAL PROPERTY	POWELL-UNDERHILL SARAH DAWN	5909 CRESCENT AVE
205839795	2021	INDIVIDUAL PERSONAL PROPERTY	HIGGINS ALICE LARAINE	9701 E 66TH ST	205850756	2016-2018	INDIVIDUAL PERSONAL PROPERTY	SHEPHERD DANIEL P	7406 ELM ST
205839837	2018	INDIVIDUAL PERSONAL PROPERTY	EVERETT JAMES C	5809 LAUREL AVE	205851201	2021	INDIVIDUAL PERSONAL PROPERTY	BEAMAN STEPHON DELEIGH	9327 E 83RD ST
205839925	2016	INDIVIDUAL PERSONAL PROPERTY	PASCOE ELIZABETH A	8967 E 62ND TER	205851387	2016-2017	INDIVIDUAL PERSONAL PROPERTY	MEINDERS SAMUEL	7031 LAKESHORE DR
205840014	2017-2021	INDIVIDUAL PERSONAL PROPERTY	PENNINGTON KATHRYN LUANN	8303 HUNTER ST	205851390	2016-2018	INDIVIDUAL PERSONAL PROPERTY	BLACK JACOB LEONARD	7234 RAYTOWN RD APT C
205840123	2021	INDIVIDUAL PERSONAL PROPERTY	ARENIVAS ARTURO EDUARDO	9705 E 79TH ST	205851402	2016-2020	INDIVIDUAL PERSONAL PROPERTY	COLBERT DOUGLAS	10603 S 10TH ST
205840277	2021	INDIVIDUAL PERSONAL PROPERTY	WINCHELL KENT	9808 BROOKLANE ST	205851728	2021	INDIVIDUAL PERSONAL PROPERTY	CARPENTER LOUISE MARIE	9215 E 80TH ST
205840655	2018-2020	INDIVIDUAL PERSONAL PROPERTY	WOODS RODNEY EUGENE	11226 E 71ST DR	205851818	2016	INDIVIDUAL PERSONAL PROPERTY	LUTMER JOAN MARY	9215 E 85TH ST
205840684	2021	INDIVIDUAL PERSONAL PROPERTY	COVARRUBIAS LANCE NICHOLAS	11613 E 76TH TER	205851961	2017-2021	INDIVIDUAL PERSONAL PROPERTY	LYONS CAYSON DAJUAN DOMINIC	8603 CRESCENT AVE
205840880	2021	INDIVIDUAL PERSONAL PROPERTY	AYELE RIBKA	9818 E 60TH ST	205852006	2019-2021	INDIVIDUAL PERSONAL PROPERTY	WHITING DANA JO	9500 HARRISON ST
205841123	2021	INDIVIDUAL PERSONAL PROPERTY	BAILEY DAMIAN CRISTIAN	7420 MAYWOOD AVE	205852408	2020-2021	INDIVIDUAL PERSONAL PROPERTY	OWENS BRIANNA RAE	6816 ENGLEWOOD AVE
205841519	2019	INDIVIDUAL PERSONAL PROPERTY	STRAUGE BRANDON R & LOURDES	9013 E 52ND TER	205852560	2016	INDIVIDUAL PERSONAL PROPERTY	WALKER TABITHA E	5837 BLUE RIDGE CUT OFF
205841734	2021	INDIVIDUAL PERSONAL PROPERTY	LAMBERT TYLER HARRISON	10010 E 78TH ST	205852908	2016-2018	INDIVIDUAL PERSONAL PROPERTY	GODDARD ANDREA NINA	8911 E 59TH ST
205841740	2016-2017	INDIVIDUAL PERSONAL PROPERTY	TALIFERRO JAYDE LATRICE	9514 E 64TH TER	205852912	2016-2021	INDIVIDUAL PERSONAL PROPERTY	ZOELLERS DONALD D SR	11301 E 62ND ST
205841871	2018-2021	INDIVIDUAL PERSONAL PROPERTY	MOORE JACOB RYAN	7927 HEDGES AVE	205853188	2021	INDIVIDUAL PERSONAL PROPERTY	BLACK DENNIS R	11205 E 78TH TER
205842070	2021	INDIVIDUAL PERSONAL PROPERTY	REED KEN'DRICK GREGORY	5301 CRISP AVE	205876334	2021	INDIVIDUAL PERSONAL PROPERTY	BROOKS ROMEL DEVANTE	6517 HARVARD AVE
205842107	2020-2021	INDIVIDUAL PERSONAL PROPERTY	GREEN ALEXANDER JR	205876477	205876477	2019-2021	INDIVIDUAL PERSONAL PROPERTY	ZAMORA MOISES	8954 E 60TH TER
205842201	2017-2021	INDIVIDUAL PERSONAL PROPERTY	DIEGO JUAN HIGINIO	5525 LANE AVE	205876558	2021	INDIVIDUAL PERSONAL PROPERTY	PRUNEDA OZIEL O	10908 E 60TH TER
205842272	2021	INDIVIDUAL PERSONAL PROPERTY	MURRAY JACQUELINE MARIE	5824 FARLEY AVE	205876681	2021	INDIVIDUAL PERSONAL PROPERTY	FERRELL AUSTIN D	10604 65TH ST
205842281	2021	INDIVIDUAL PERSONAL PROPERTY	HIGH KATRINA CLAIRE	5426 HARVARD AVE	205877128	2020-2021	INDIVIDUAL PERSONAL PROPERTY	DAVIS DAKOTA LEE	5413 WILLOW AVE
205842306	2021	INDIVIDUAL PERSONAL PROPERTY	YOUNG KAILY ELIZABETH	5520 CRESCENT AVE	205877215	2021	INDIVIDUAL PERSONAL PROPERTY	DOWNES MICHAEL STEPHEN	10895 65TH ST
205842444	2016	INDIVIDUAL PERSONAL PROPERTY	RODRIGUEZ CIARA CORSHHEENA	5732 LANE AVE	205877509	2021	INDIVIDUAL PERSONAL PROPERTY	CASTRO ZUNIGA ANDRO F	9062 E 65TH TER
205842463	2020-2021	INDIVIDUAL PERSONAL PROPERTY	BELL MARCEDES B	8608 ASH AVE	205877681	2019-2021	INDIVIDUAL PERSONAL PROPERTY	LAMB ADRIANA ROSHELLE	5406 ELM AVE
205842720	2021	INDIVIDUAL PERSONAL PROPERTY	YOUNG BRIAN RONNELL & BROWN LORN	7300 STERLING AVE	205877707	2021	INDIVIDUAL PERSONAL PROPERTY	SMITH KELCIE RENEE & OWENS LESLIE RACHEL	10812 E 65TH ST
205842753	2019-2021	INDIVIDUAL PERSONAL PROPERTY	MCDONALD ALEXIS BRIANNA	10811 E 58TH ST	205877826	2017-2021	INDIVIDUAL PERSONAL PROPERTY	ROLDAN JEFFREY LUIS JR	7419 ASH AVE
205842838	2021	INDIVIDUAL PERSONAL PROPERTY	POWELL ESSENCE RENEE	10413 E 65TH ST	205878238	2021	INDIVIDUAL PERSONAL PROPERTY	HAGGINS SHARICE NICOLE	8630 LANE AVE
205843050	2016	INDIVIDUAL PERSONAL PROPERTY	RUIZ CASTANEDA MELISSA	5747 RALSTON AVE	205878467	2017	INDIVIDUAL PERSONAL PROPERTY	REID KIMESHIA LATRICE	8701 STARK AVE
205843212	2021	INDIVIDUAL PERSONAL PROPERTY	FOREMAN SHARON LEE & DAVIS VENIA K	9409 E 65TH ST	205878705	2021	INDIVIDUAL PERSONAL PROPERTY	FANGMAN RICHARD W	8617 E 83RD TER
205843407	2019	INDIVIDUAL PERSONAL PROPERTY	HAMBRICK DOMINICK GILES	9517 E 83RD ST	205878767	2021	INDIVIDUAL PERSONAL PROPERTY	JACKSON MARCUS CHRISTOPHER	6328 STERLING AVE
205844221	2017-2021	INDIVIDUAL PERSONAL PROPERTY	CLARK PERRY EUGENE JR	8958 E 60TH TER	205878911	2017-2019	INDIVIDUAL PERSONAL PROPERTY	RILEY MICHAEL DALE JR	8605 E 84TH TER
205844241	2016-2021	INDIVIDUAL PERSONAL PROPERTY	VORBECK HAILEY N	8414 BOOTH AVE	205879032	2017-2021	INDIVIDUAL PERSONAL PROPERTY	GARCIA JOSE REFUGIO	8954 E 60TH TER
205844430	2018-2021	INDIVIDUAL PERSONAL PROPERTY	HOOVER SKYLAR	6300 HARRIS AVE	205879091	2018-2021	INDIVIDUAL PERSONAL PROPERTY	VARGAS-GARCIA JUAN CARLOS	8804 E 81ST TER
205844776	2016-2017	INDIVIDUAL PERSONAL PROPERTY	GODDARD KAYLA ANN	5301 DITZLER AVE	205879184	2017	INDIVIDUAL PERSONAL PROPERTY	KOHLER DEVON MICHAEL	10601 E 65TH TER
205845053	2020	INDIVIDUAL PERSONAL PROPERTY	THOMPSON VERNICE N	11600 E 60TH ST	205879332	2020-2021	INDIVIDUAL PERSONAL PROPERTY	MATTHEWS EMANUEL MAURICE SR	11600 HOLIDAY DR APT 110A
205845106	2021	INDIVIDUAL PERSONAL PROPERTY	HARRIS RAKEITA DAWNNEA	9308 E 81ST TER	205879613	2020	INDIVIDUAL PERSONAL PROPERTY	DAVIS HALEY DAWN	7305 HARRIS AVE
205845188	2019-2021	INDIVIDUAL PERSONAL PROPERTY	BOWENS LAMONICA AISHA	9204 E 61ST ST	206221708	2016-2021	INDIVIDUAL PERSONAL PROPERTY	NIEVES MELISSA MARIE	5621 BLUE RIDGE BLVD
205845448	2021	INDIVIDUAL PERSONAL PROPERTY	ANDERSON JAMES D	9004 E 84TH ST	206221757	2016	INDIVIDUAL PERSONAL PROPERTY	MENDOZA JULIANN MARIE	9404 E 65TH ST
205845576	2021	INDIVIDUAL PERSONAL PROPERTY	HENDERSON DOUGLAS TROY ALLEN	9009 E 52ND TER	206222202	2021	INDIVIDUAL PERSONAL PROPERTY	RICHARDSON KAITLYN MICHELLE	9914 E 60TH ST
205845811	2017-2020	INDIVIDUAL PERSONAL PROPERTY	SAMUEL WELDEN & SEMENS ANNARHKA	9918 E 61ST ST	206222509	2017-2021	INDIVIDUAL PERSONAL PROPERTY	KRIVULKA MICHAEL P	8704 STARK AVE
205845948	2017	INDIVIDUAL PERSONAL PROPERTY	HAYMOND JEFF	6617 OXFORD AVE	206222988	2019-2021	INDIVIDUAL PERSONAL PROPERTY	HONKOMP GERHARD FREDRICK 5TH	7816 ELM ST
205846076	2018	INDIVIDUAL PERSONAL PROPERTY	COPKNEY ABDUL SHABAZZ	10321 E 61ST ST APT 4	206223016	2019-2021	INDIVIDUAL PERSONAL PROPERTY	TAYLOR NICHOLAS CHRISTIAN	8825 E 61ST TER
205846255	2020-2021	INDIVIDUAL PERSONAL PROPERTY	COLTER BRENNAN	11132 E 84TH TER	206223332	2016	INDIVIDUAL PERSONAL PROPERTY	LAIR JOSEPH CALEB	10409 E 63RD TER
205846282	2019-2021	INDIVIDUAL PERSONAL PROPERTY	MENDOZA MARISSA	8850 E 53RD TER	206223458	2021	INDIVIDUAL PERSONAL PROPERTY	HENSLEY ELIZABETH LOUISE	11513 E 75TH ST
205846421	2016	INDIVIDUAL PERSONAL PROPERTY	BEEMER NICOLAS WAYNE	11609 E 72ND ST	206223737	2019-2021	INDIVIDUAL PERSONAL PROPERTY	COLDSNOW MASON TAYLOR	9131 RICHARDS DR
205846891	2017-2021	INDIVIDUAL PERSONAL PROPERTY	LUKE AMY L	7406 OVERTON AVE UNIT 6	206223817	2021	INDIVIDUAL PERSONAL PROPERTY	LASSICH CANDICE	9717 E 76TH TER
205846972	2021	INDIVIDUAL PERSONAL PROPERTY	BROWN MELANIE ALYSE	10603 E 78TH TER	206224057	2016	INDIVIDUAL PERSONAL PROPERTY	LASSICH PATRICIA DIANE	11701 E 77TH TER
205847344	2018-2020	INDIVIDUAL PERSONAL PROPERTY	TALLEY TIFFANY CHEREE	10207 E 67TH ST APT 4	206224113	2021	INDIVIDUAL PERSONAL PROPERTY	CUSHMAN PATRICK C	8622 EVANSTON AVE
205847404	2020-2021	INDIVIDUAL PERSONAL PROPERTY	WILLIAMS RAE SHAUN M	9102 E 67TH TER	206224129	2017	INDIVIDUAL PERSONAL PROPERTY	LAHSON VERNON J III	9801 PLYMOUTH LN
205847598	2017-2021	INDIVIDUAL PERSONAL PROPERTY	WALL WILLIAM A & AMANDA E	6405 BLUE RIDGE BLVD	206224167	2019-2021	INDIVIDUAL PERSONAL PROPERTY	KONE ISABELLE MAKOUMBA	6711 ANDREA C
205847613	2017-2021	INDIVIDUAL PERSONAL PROPERTY	MERONEY CHARLES W	5503 RALSTON AVE	206224762	2021	INDIVIDUAL PERSONAL PROPERTY	CRUZ ANDREA C	7317 HARDY AVE
205847673	2016	INDIVIDUAL PERSONAL PROPERTY	DUGGINS VALERIE	6900 RAYTOWN RD	206225149	2021	INDIVIDUAL PERSONAL PROPERTY	BARNES ANTWONE D'RAY	9409 E 66TH TER
205847776	2021	INDIVIDUAL PERSONAL PROPERTY	BURNS RAYLENE MARIE	9914 E 61ST ST APT 2	206225809	2016	INDIVIDUAL PERSONAL PROPERTY	HOLLAND STANLEY E	8012 TENNESSEE AVE
205847825	2021	INDIVIDUAL PERSONAL PROPERTY	RILEY DEVIN PATRICK	10400 E 70TH TER	206225813	2021	INDIVIDUAL PERSONAL PROPERTY	FOSTER CALEB J	5715 MANNING AVE
205847871	2020-2021	INDIVIDUAL PERSONAL PROPERTY	ROBERSON MARCIA M	9104 E 74TH ST	206225816	2020-2021	INDIVIDUAL PERSONAL PROPERTY	JOHNSON TIMOTHY KEITH II	6012 BLUE RIDGE BLVD
205847980	2016	INDIVIDUAL PERSONAL PROPERTY	CHASTAIN DYLAN	9504 E 64TH TER	206226045	2017-2018	INDIVIDUAL PERSONAL PROPERTY	ZUROWSKI TYLER STEPHEN	5417 MAYWOOD AVE
205848227	2021	INDIVIDUAL PERSONAL PROPERTY	IYEWARUN OLUFEMI ANDRE DANIEL	8803 E 59TH ST	206226446	2021	INDIVIDUAL PERSONAL PROPERTY	SILVERS BRANDON MICHAEL	6301 HEDGES AVE
205848244	2019-2020	INDIVIDUAL PERSONAL PROPERTY	ANDREWS JOE ALLEN	8717 E 61ST TER APT 1	206226961	2021	INDIVIDUAL PERSONAL PROPERTY	STANLEY RODNEY C	7211 RAYTOWN RD
205848251	2018-2021	INDIVIDUAL PERSONAL PROPERTY	GREEN RYAN W	10209 E 72ND ST	206227350	2017	INDIVIDUAL PERSONAL PROPERTY	MILLER SADE MONIQUE	11201 E 75TH TER
205849001	2020	INDIVIDUAL PERSONAL PROPERTY	NEAL PETER EMMANUEL II	5400 LAUREL AVE	206227362	2018-2019	INDIVIDUAL PERSONAL PROPERTY	ACOSTA FERNANDO DAVID	7604 ELM ST
205849052	2018-2019	INDIVIDUAL PERSONAL PROPERTY	BRYAN DAVID E & LAURA H	811 W JACK ST	206227408	2018-2020	INDIVIDUAL PERSONAL PROPERTY	RICHARDSON JANICE DARLENE	7517 LEWIS AVE
205849143	2016	INDIVIDUAL PERSONAL PROPERTY	GALLAGHER GARY S	5316 HUNTER ST	206227512	2020-2021	INDIVIDUAL PERSONAL PROPERTY	CALIFORNIA JOSEPH	7216 RAYTOWN RD APT A
205849228	2021	INDIVIDUAL PERSONAL PROPERTY	REDETZKE ERIKA L	10205 E 78TH ST	206227564	2020-2021	INDIVIDUAL PERSONAL PROPERTY	ROBINSON TRESA D	6425 BLUE RIDGE CUT OFF
205849556	2021	INDIVIDUAL PERSONAL PROPERTY	CUESTA PEDRO PABLO	7527 CRESCENT DR	206227641	2021	INDIVIDUAL PERSONAL PROPERTY	RENDON RICHARD ALLEN III	9825 E 60TH ST
205849567	2021	INDIVIDUAL PERSONAL PROPERTY	BONIN JESSE & ALAINA	7315 HARVARD AVE	206227965	2017-2018	INDIVIDUAL PERSONAL PROPERTY	SUA RITA MARIE	9409 E 66TH TER
205849704	2016-2021	INDIVIDUAL PERSONAL PROPERTY	KELLEY MARTYSEON QUINTRELL	10331 E 61ST ST APT 4	206227974	2021	INDIVIDUAL PERSONAL PROPERTY	GREEN JERRY LEE JR & GREEN JERRY L	6704 ELM AVE
205850011	2018-2019	INDIVIDUAL PERSONAL PROPERTY	OLIVER SUZANNE CHEREE	11513 E 75TH ST	206228147	2021	INDIVIDUAL PERSONAL PROPERTY	WILLIAMS ERICA R	9950 E 61ST ST
205850041	2017-2019	INDIVIDUAL PERSONAL PROPERTY	ROBBINS JASON JOHN	5323 ASH AVE	206228180	2021	INDIVIDUAL PERSONAL PROPERTY	JERMAIAH AB LYNN E	6620 HARDY AVE
			GADDY T'YHANA DANIELLE	10100 E 84TH ST	206228250	2019	INDIVIDUAL PERSONAL PROPERTY	GORDON MELVIN LEROY	10412 E 69TH ST

206228412	2017	INDIVIDUAL PERSONAL PROPERTY	CLOPPER JEFFREY C	8402 STARK AVE	206243388	2017-2021	INDIVIDUAL PERSONAL PROPERTY	ROSE ROCHELL LYNNET	11303 E 58TH TER
206229048	2020-2021	INDIVIDUAL PERSONAL PROPERTY	STONE DANZELL D'MONTE	11831 E 83RD ST APT 102	206243600	2017-2020	INDIVIDUAL PERSONAL PROPERTY	WADE ANTONIO	5401 WILLOW AVE
206229667	2016-2017	INDIVIDUAL PERSONAL PROPERTY	JENKINS DONTAY JAVON	8816 E 61ST TER	206243614	2017	INDIVIDUAL PERSONAL PROPERTY	DIXON SUMMER CELESTE	5908 BLUE RIDGE CUT OFF
206229830	2018	INDIVIDUAL PERSONAL PROPERTY	SCOTT BRYAN TEREEL	6115 HADLEY ST	206243619	2021	INDIVIDUAL PERSONAL PROPERTY	NORMAN CHRISTINA ROBIN LEIGH	9015 E 74TH TER
206229866	2016-2021	INDIVIDUAL PERSONAL PROPERTY	EGGLESTON JOSEPH JEROME	9504 E 57TH ST	206243652	2018-2019	INDIVIDUAL PERSONAL PROPERTY	HICKS LEA ANN	9400 E 68TH ST
206230452	2021	INDIVIDUAL PERSONAL PROPERTY	MORRISON CHARLES E JR	10800 WORNALL RD	206243695	2017	INDIVIDUAL PERSONAL PROPERTY	PAYNE AMY LYNN	9104 RICHARDS DR
206230479	2017	INDIVIDUAL PERSONAL PROPERTY	LANE AUDREY DORTHEA	8420 MARSH AVE	206243847	2020-2021	INDIVIDUAL PERSONAL PROPERTY	MOORE TONY	11500 E 75TH ST
206230549	2021	INDIVIDUAL PERSONAL PROPERTY	LOWERY KORTINI ALEXIS	11700 E 77TH TER	206243942	2021	INDIVIDUAL PERSONAL PROPERTY	HOWAYEK ELISA M	11012 E 56TH TER
206230699	2021	INDIVIDUAL PERSONAL PROPERTY	NGUYEN MARY TRANG	8612 HAWTHORNE AVE	206244251	2017	INDIVIDUAL PERSONAL PROPERTY	GILLIAM STEPHEN L	7310 ELM ST
206230861	2017-2021	INDIVIDUAL PERSONAL PROPERTY	GUEVARA DIANELIS KARILIN	8614 OXFORD AVE	206244592	2021	INDIVIDUAL PERSONAL PROPERTY	GARRETT TEARRA ARIANE	5517 HUNTER TER
206231762	2021	INDIVIDUAL PERSONAL PROPERTY	YATES EBONY MICHELLE	7408 RALSTON AVE	206244907	2021	INDIVIDUAL PERSONAL PROPERTY	FRANKS DEBORAH JEAN	5420 BLUE RIDGE CUT OFF APT 418
206231959	2021	INDIVIDUAL PERSONAL PROPERTY	MARSHALL RHEGAN CHEVELLE	5929 LAUREL AVE	206245028	2017-2018	INDIVIDUAL PERSONAL PROPERTY	COLGROVE JACOB JEFFREY IAN	6803 HUNTER ST
206232045	2018-2021	INDIVIDUAL PERSONAL PROPERTY	MCGUIRE KIERRA MONIQUE	10808 E 79TH ST	206245225	2021	INDIVIDUAL PERSONAL PROPERTY	MCGEE NYLES ANTONIO	7600 WOODSON RD
206232166	2017-2021	INDIVIDUAL PERSONAL PROPERTY	SIMPSON ROMONE V	10005 E 77TH TER	206245393	2019-2021	INDIVIDUAL PERSONAL PROPERTY	BARTON AMANDA J	9912 E 60TH ST
206232238	2020-2021	INDIVIDUAL PERSONAL PROPERTY	BELL RAYMOND O	10910 LAKEVIEW BLVD	206245492	2021	INDIVIDUAL PERSONAL PROPERTY	WATSON LENORA VICTORIA (MORALES)	10117 E 64TH ST
206232359	2017-2018	INDIVIDUAL PERSONAL PROPERTY	KAMPMIEER CHRISTOPHER L	9809 E 61ST ST APT 5	206245495	2018-2021	INDIVIDUAL PERSONAL PROPERTY	BROWN RICKAM	5222 E 54TH TER
206232396	2020-2021	INDIVIDUAL PERSONAL PROPERTY	AUTHORLEE ERICA JAMEI CHANTE	11804 E 78TH PL	206245524	2021	INDIVIDUAL PERSONAL PROPERTY	FULLER KAYLA DAWN	7032 WOODSON RD
206233302	2019	INDIVIDUAL PERSONAL PROPERTY	BERONIA GABRIEL THOMAS	9400 E 70TH TER	206245564	2017	INDIVIDUAL PERSONAL PROPERTY	PICKEL FAYE E	8505 GREENWOOD RD UNIT B
206233567	2017-2021	INDIVIDUAL PERSONAL PROPERTY	ARRINGTON MATTHEW CAMERON	6820 VERMONT AVE	206245628	2021	INDIVIDUAL PERSONAL PROPERTY	TOBAY MAKAYLA ANIYA	7049 MANCHESTER AVE APT 21
206233839	2021	INDIVIDUAL PERSONAL PROPERTY	TAYLOR OTIS III	11105 E 57TH TER	206245670	2021	INDIVIDUAL PERSONAL PROPERTY	ATTY TRACY M (SHOCKLEY)	9005 E 65TH ST
206233909	2021	INDIVIDUAL PERSONAL PROPERTY	BUSH WAYNESHA DASHAY	7408 ENGLEWOOD LN	206245758	2021	INDIVIDUAL PERSONAL PROPERTY	HEATH NATHANIEL SCOTT	8709 E 83RD ST
206234205	2018-2021	INDIVIDUAL PERSONAL PROPERTY	FARRUGIA JEANA JULIA	7715 ELM ST	206245894	2021	INDIVIDUAL PERSONAL PROPERTY	STRICKER NICOLAS ROBERT	9800 E 53RD ST
206234268	2017-2018	INDIVIDUAL PERSONAL PROPERTY	JACKSON KELLECIA KIANE	8308 EVANSTON AVE	206246010	2016-2017	INDIVIDUAL PERSONAL PROPERTY	REDDING SARA ELIZABETH	10404 E 82ND TER
206234579	2021	INDIVIDUAL PERSONAL PROPERTY	DEAN CATERA A	7241 CRISP AVE	206246255	2021	INDIVIDUAL PERSONAL PROPERTY	BALLENGER TRENTON ANDREW	5625 BLUE RIDGE CUT OFF
206234580	2021	INDIVIDUAL PERSONAL PROPERTY	PARKS WALLACE TAYLOR RENAE	8321 MAWWOOD AVE	206246388	2021	INDIVIDUAL PERSONAL PROPERTY	VAZQUEZ LEYLA	11301 E 53RD ST
206234866	2017	INDIVIDUAL PERSONAL PROPERTY	WILLIAMS DIAMOND SIERRA	8121 WOODSON DR	206246403	2017-2019	INDIVIDUAL PERSONAL PROPERTY	COX MILEEN JUANITA	8015 CAMPBELL ST APT 101
206235000	2016-2021	INDIVIDUAL PERSONAL PROPERTY	KENNEDY BILLY	8409 FORD AVE	206246505	2021	INDIVIDUAL PERSONAL PROPERTY	MORRIS SAMANTHA MARIAH	6730 STERLING AVE
206235039	2021	INDIVIDUAL PERSONAL PROPERTY	JOB KATRINA LYNN	6722 HARRIS AVE	206246563	2021	INDIVIDUAL PERSONAL PROPERTY	ERBY ARNISHA L	8209 HARDY AVE
206235074	2016	INDIVIDUAL PERSONAL PROPERTY	SPOTZ TYLER EUGENE	8814 E 84TH ST	206246689	2021	INDIVIDUAL PERSONAL PROPERTY	MURRAY CHRISTINA	8626 E UTOPIA PKWY APT 8
206235131	2019	INDIVIDUAL PERSONAL PROPERTY	MARCUS LAWRENCE PETER	8610 LANE AVE	206246724	2021	INDIVIDUAL PERSONAL PROPERTY	LAMPING JEFFREY STEVEN	8805 E 71ST TER
206235619	2019-2021	INDIVIDUAL PERSONAL PROPERTY	KITCHENER ANDREW LANCE	11801 E 67TH TER	206246858	2021	INDIVIDUAL PERSONAL PROPERTY	LATHROP SARAH ELIZABETH	10805 E 65TH ST
206235649	2021	INDIVIDUAL PERSONAL PROPERTY	MEADE DEMETRIUS OTHELLO	9003 E 73RD ST	206247035	2021	INDIVIDUAL PERSONAL PROPERTY	ELLIS LANEISHA MARLENE	6929 RAYTOWN RD
206235898	2021	INDIVIDUAL PERSONAL PROPERTY	GARCIA-OROZCO VICTOR ALFANSO	11012 E 83RD ST	206247173	2017-2018	INDIVIDUAL PERSONAL PROPERTY	ROBINSON KRISTA EPIPHANY	7500 HAWTHORNE AVE
206236038	2019-2021	INDIVIDUAL PERSONAL PROPERTY	SAAD SONJA L	9106 E 74TH TER	206247814	2021	INDIVIDUAL PERSONAL PROPERTY	FROST BRIENA ANN	5933 STERLING AVE
206236162	2017	INDIVIDUAL PERSONAL PROPERTY	JONES TRAVIS LAVELLE	5600 STERLING AVE	206248016	2021	INDIVIDUAL PERSONAL PROPERTY	KASERMAN EMLI ORRICE III	10600 E 65TH ST
206236164	2021	INDIVIDUAL PERSONAL PROPERTY	ELKINS ANDREW EDWARD	8711 E 80TH TER	206248020	2020	INDIVIDUAL PERSONAL PROPERTY	ORTIZ GARY JAVIER	7703 CRESCENT AVE
206236241	2019-2020	INDIVIDUAL PERSONAL PROPERTY	BARNES MELANIE ELIZABETH	11021 E 53RD TER	206248336	2017-2021	INDIVIDUAL PERSONAL PROPERTY	GRIFFIN FALLON GABRIEL	7216 HARDY AVE
206236317	2021	INDIVIDUAL PERSONAL PROPERTY	SHIELDS THOMAS WAYNE	9712 E 67TH TER	206248637	2017-2021	INDIVIDUAL PERSONAL PROPERTY	JACKSON NICOLE L	9206 E 54TH ST
206236469	2017-2021	INDIVIDUAL PERSONAL PROPERTY	JONES FRANKLIN DELANO JR	10824 E 66TH TER	206248813	2018-2021	INDIVIDUAL PERSONAL PROPERTY	CLEVENGER LISA RAE	5520 STERLING AVE
206236637	2021	INDIVIDUAL PERSONAL PROPERTY	COYLE KATHERINE LEE	8915 E 75TH ST	206249145	2017-2019	INDIVIDUAL PERSONAL PROPERTY	SMITH AVERY LEVELL	5815 KENTUCKY AVE
206237099	2016	INDIVIDUAL PERSONAL PROPERTY	MOORE TYLERWHITNEY EDWIN & SARIAH GERALD	11121 E 56TH TER	206249565	2021	INDIVIDUAL PERSONAL PROPERTY	DOUGLAS DAMON CHRISTOPHER	9116 E 53RD TER
206237193	2020-2021	INDIVIDUAL PERSONAL PROPERTY	NEWTON MAYA NICHOLE	9508 E 57TH ST	206250600	2021	INDIVIDUAL PERSONAL PROPERTY	EDMONDS ANTHONY CHARLES	9209 E 53RD TER
206237417	2017-2021	INDIVIDUAL PERSONAL PROPERTY	WILLIAMS-MARSH RICHARD ARNEZ	11422 E 75TH ST	206250772	2021	INDIVIDUAL PERSONAL PROPERTY	LOVE LARRY LEE	6812 ENGLEWOOD AVE
206237929	2021	INDIVIDUAL PERSONAL PROPERTY	EDWARDS CONSUELO LOUISA	7609 APPLETON AVE	206251550	2021	INDIVIDUAL PERSONAL PROPERTY	CUTLER BRIANNA NICHOLE	10915 E 81ST TER
206237936	2017-2018	INDIVIDUAL PERSONAL PROPERTY	CRUZ GARCIA OMAR DE JESUS	7804 E 87TH ST	206251630	2021	INDIVIDUAL PERSONAL PROPERTY	ANDERSON CHRISTOPHER JAMES	8012 ELM AVE
206238046	2016-2021	INDIVIDUAL PERSONAL PROPERTY	JONES RITA YOYONNIE	10824 E 66TH TER	206251700	2021	INDIVIDUAL PERSONAL PROPERTY	CORREIA MICHAEL SEAN	11408 E 69TH ST
206238131	2018-2019	INDIVIDUAL PERSONAL PROPERTY	TRUE JENNIFER	8617 W UTOPIA DR APT 27	206251913	2021	INDIVIDUAL PERSONAL PROPERTY	PHILLIPS JEANETTE L	6244 ASH CT
206238261	2017	INDIVIDUAL PERSONAL PROPERTY	WOODS BRIAN L & MCDONALD MICHELLE A	6407 HARVARD AVE	206251936	2021	INDIVIDUAL PERSONAL PROPERTY	JOHNSON APHELIA RAINE	8615 W UTOPIA DR APT 41
206238531	2017-2021	INDIVIDUAL PERSONAL PROPERTY	COE BARBARA JEAN	10320 E 63RD ST APT 2	206252107	2021	INDIVIDUAL PERSONAL PROPERTY	NELSON MATTHEW CECIL VANDEL	9112 E 85TH ST
206238684	2021	INDIVIDUAL PERSONAL PROPERTY	RANDALL DARRIENNE LASEAN	9007 E 85TH TER	206252480	2021	INDIVIDUAL PERSONAL PROPERTY	CLINTON TAMIKA S	7609 STERLING AVE
206239081	2017-2019	INDIVIDUAL PERSONAL PROPERTY	FRANKLIN TYREIK DELSHALIN	10143 E 80TH ST	206253194	2016-2017	INDIVIDUAL PERSONAL PROPERTY	HUNT RICHARD L	9005 E 66TH TER
206239124	2019-2021	INDIVIDUAL PERSONAL PROPERTY	WELLS ODEMIS ANITA ROSE	6312 HUNTER ST	206253233	2019	INDIVIDUAL PERSONAL PROPERTY	JONES TABITHA L	7716 ENGLEWOOD AVE
206239158	2021	INDIVIDUAL PERSONAL PROPERTY	FLETCHER KACHAE JEANAE	7507 CRESCENT DR	206253308	2021	INDIVIDUAL PERSONAL PROPERTY	MARSH CAROL ANN JR	5901 CLAREMONT AVE
206239284	2018-2021	INDIVIDUAL PERSONAL PROPERTY	GALE DANIEL LOUIS	6549 RAYTOWN RD APT 4	206253401	2021	INDIVIDUAL PERSONAL PROPERTY	HAMILTON HAYDEN JOSEPH	6904 WILDWOOD DR
206239579	2018-2021	INDIVIDUAL PERSONAL PROPERTY	COBBINS CLEOTIS III	10600 E 59TH ST	206253440	2021	INDIVIDUAL PERSONAL PROPERTY	BENOIT BRIAN DAVID	10813 E 66TH TER
206239667	2021	INDIVIDUAL PERSONAL PROPERTY	GARRISON BRITTANY RAE ANN	9808 E 79TH ST	206253664	2020-2021	INDIVIDUAL PERSONAL PROPERTY	VICTORINO JUAN ANTONIO	7906 ELM AVE
206239759	2020-2021	INDIVIDUAL PERSONAL PROPERTY	BROCKHOUSE BRIAN ANDREW	5616 HARVARD AVE	206254262	2017-2019	INDIVIDUAL PERSONAL PROPERTY	STRICKLAND TAYA JAMILL	6102 NORLIND AVE
206240627	2020-2021	INDIVIDUAL PERSONAL PROPERTY	GRAHAM KALEB MARCUS	9051 E 66TH TER	206254364	2020-2021	INDIVIDUAL PERSONAL PROPERTY	DUNIGAN RICKI GENE	7620 STERLING AVE
206240631	2017-2020	INDIVIDUAL PERSONAL PROPERTY	BYBEE CHRISTOPHER LOGAN	6533 LAUREL AVE	206254454	2020-2021	INDIVIDUAL PERSONAL PROPERTY	HENDERSON KYLA NICOLE	9812 E 69TH ST
206240944	2021	INDIVIDUAL PERSONAL PROPERTY	SONGONY CHAPHNI JESSICA	11401 E 51ST ST	206254455	2021	INDIVIDUAL PERSONAL PROPERTY	OWENS CHRISTOPHER JAMES	8201 ELM AVE
206241037	2018-2019	INDIVIDUAL PERSONAL PROPERTY	EDDINGTON SARAH SHELBY	7746 LOMA VISTA DR	206254512	2018-2021	INDIVIDUAL PERSONAL PROPERTY	SALINAS ARVIZU ALFONSO	9500 E 77TH ST
206241287	2021	INDIVIDUAL PERSONAL PROPERTY	WRIGHT TERI ALLENE	7112 EVANSTON AVE	206254887	2021	INDIVIDUAL PERSONAL PROPERTY	JENNINGS KALIAH LAVONNE	8603 E UTOPIA PKWY APT 7
206241670	2021	INDIVIDUAL PERSONAL PROPERTY	CARROLL CIERRA BARBARA J	10700 E 56TH TER	206254935	2019-2021	INDIVIDUAL PERSONAL PROPERTY	FARLEY KYLIE GRACE	10921 E 53RD ST
206241765	2021	INDIVIDUAL PERSONAL PROPERTY	FERGUSON MONEE TOREA	8424 MARSH AVE	206255026	2020-2021	INDIVIDUAL PERSONAL PROPERTY	RUBY MATHEW EUGENE	5209 STERLING AVE
206241855	2018-2021	INDIVIDUAL PERSONAL PROPERTY	REDMER DERRICK C L	10512 E 56TH ST	206255054	2021	INDIVIDUAL PERSONAL PROPERTY	GOMEZ ANGELES ALFREDO	5430 HARDY AVE
206242000	2021	INDIVIDUAL PERSONAL PROPERTY	JOHNSON PETRA DANIELLE	5706 WOODSON RD	206255140	2017-2018	INDIVIDUAL PERSONAL PROPERTY	HURLEY VALDO RUBIN II	8911 E 67TH ST APT 124
206242321	2019	INDIVIDUAL PERSONAL PROPERTY	BLACKWOOD DAVIS ALTON	5940 STERLING AVE	206255204	2018	INDIVIDUAL PERSONAL PROPERTY	MENDOZA CECILIA BEATRIZ	10912 E 60TH ST
206242787	2021	INDIVIDUAL PERSONAL PROPERTY	RITTER AMANDA DAUN	5221 ELM PL	206255269	2017	INDIVIDUAL PERSONAL PROPERTY	WATSON FRANKLIN M	9926 E 61ST ST
206242836	2018-2021	INDIVIDUAL PERSONAL PROPERTY	STOUT TONYA L	8412 LANE PL	206255400	2020-2021	INDIVIDUAL PERSONAL PROPERTY	RUSSELL CHRISTOPHER ALAN	8311 LAUREL AVE
206243108	2017-2019	INDIVIDUAL PERSONAL PROPERTY	MEYER REBECCA ANN	8130 STERLING AVE	206256320	2017-2018	INDIVIDUAL PERSONAL PROPERTY	PARK MARTINA LOUISE	10008 E 79TH ST
206243302	2016	INDIVIDUAL PERSONAL PROPERTY	CLINE CHRISTY LYNN	5412 RALSTON AVE	206256407	2018	INDIVIDUAL PERSONAL PROPERTY	GEORGE SHELBY B	11132 E 84TH TER
206243310	2017-2021	INDIVIDUAL PERSONAL PROPERTY	ANTUNEZ REYES RUBEN ANTONIO	6000 KENTUCKY AVE	206256477	2021	INDIVIDUAL PERSONAL PROPERTY	STRIPLING CHRISTOPHER D	8702 EVERETT ST

206256787	2019-2021	INDIVIDUAL PERSONAL PROPERTY	GONZALES DAVID EDIBERTO	8002 MANNING AVE	206269058	2017-2018	INDIVIDUAL PERSONAL PROPERTY	KEELING CLIFFORD LEE	5635 LAUREL AVE
206256967	2017-2018	INDIVIDUAL PERSONAL PROPERTY	BRADFORD STAR LEE	10216 E 72ND ST	206269133	2018	INDIVIDUAL PERSONAL PROPERTY	HOOKS MARCIUS VENTURE	9809 E 82ND ST
206257395	2018-2021	INDIVIDUAL PERSONAL PROPERTY	WEBER BRADLEY D	8108 SPRING VALLEY RD	206269285	2016-2019	INDIVIDUAL PERSONAL PROPERTY	ROSS NICOLE R	7801 RAYTOWN RD
206257819	2016-2020	INDIVIDUAL PERSONAL PROPERTY	LEWIS JAMES RUBEN IV	9138 E 85TH ST	206269535	2018	INDIVIDUAL PERSONAL PROPERTY	HARRISON SHANA RENAE	6840 STERLING AVE
206258066	2021	INDIVIDUAL PERSONAL PROPERTY	DOEDTMAN DANIEL R	10808 LEWIS AVE	206269622	2020-2021	INDIVIDUAL PERSONAL PROPERTY	JONES DONOVAN MICHAEL	8509 FORD AVE
206258174	2021	INDIVIDUAL PERSONAL PROPERTY	FREEMAN HARLAN L JR & HARRIS EDNA MAE	5308 RALSTON AVE	206269626	2018-2019	INDIVIDUAL PERSONAL PROPERTY	JONES NIKKATTA RACHELLE	11301 E 61ST ST
206258650	2021	INDIVIDUAL PERSONAL PROPERTY	FLEURY SHANE MATHREW	8200 WOODSON DR	206269883	2021	INDIVIDUAL PERSONAL PROPERTY	MITCHELL SHERRI D	7215 WILLOW AVE
206258707	2020	INDIVIDUAL PERSONAL PROPERTY	KYSER JR ROBERT CECIL	8503 OVERTON DR	206270063	2017-2019	INDIVIDUAL PERSONAL PROPERTY	CHABINO WILLIAM JOSEPH	6509 STERLING AVE
206258743	2017	INDIVIDUAL PERSONAL PROPERTY	LARABEE DUSTIN DEAN	9362 E 64TH ST	206270280	2018-2021	INDIVIDUAL PERSONAL PROPERTY	HYATT TRENTON L	5737 ELM AVE
206258998	2017-2018	INDIVIDUAL PERSONAL PROPERTY	STOCKDALE TAMARA SANTESHA	9404 E 75TH TER	206270393	2017-2018	INDIVIDUAL PERSONAL PROPERTY	JOHNSON SHREE MONIQUE	8614 E UTOPIA DR APT 73
206259074	2019-2021	INDIVIDUAL PERSONAL PROPERTY	TOOLEY DEAJIA LENYEA	9708 E 77TH ST	206270660	2018-2019	INDIVIDUAL PERSONAL PROPERTY	STILES CHRISTOPHER BLAINE	5628 DITZLER AVE
206259123	2017-2021	INDIVIDUAL PERSONAL PROPERTY	HORTON DARRIEN DEWAYNE	8311 MARSH AVE	206270803	2021	INDIVIDUAL PERSONAL PROPERTY	JENKINS SHEILA ANN	7525 ARLINGTON AVE
206259215	2020-2021	INDIVIDUAL PERSONAL PROPERTY	LOTHAMER CHANCE D	11205 E 64TH TER	206271003	2021	INDIVIDUAL PERSONAL PROPERTY	BALAGNA PATRICK JAMES	8931 E 74TH ST
206259350	2021	INDIVIDUAL PERSONAL PROPERTY	BENNETT CHARLES R II	8801 E 71ST TER	206271140	2017	INDIVIDUAL PERSONAL PROPERTY	RAMSEY CHRISTOPHER D JR	7303 RALSTON AVE
206259435	2020-2021	INDIVIDUAL PERSONAL PROPERTY	BREWER JESSICA NICOLE	8403 BOOTH AVE	206271253	2017-2021	INDIVIDUAL PERSONAL PROPERTY	ROBERTS PATRICK RAYNARD	9001 E 52ND TER
206259499	2021	INDIVIDUAL PERSONAL PROPERTY	ROSS RYAN H	6708 HARVARD AVE	206271273	2018	INDIVIDUAL PERSONAL PROPERTY	OGUIN LUKIA D	8405 STERLING AVE
206259505	2021	INDIVIDUAL PERSONAL PROPERTY	GONZALEZ PATRICIA JEANNINE	9919 E 60TH ST	206271315	2021	INDIVIDUAL PERSONAL PROPERTY	BURKS JARON	9809 E 73RD ST APT D
206259616	2021	INDIVIDUAL PERSONAL PROPERTY	PARKER MYA JOSHPHINE	8616 E UTOPIA DR APT 60	206271317	2018	INDIVIDUAL PERSONAL PROPERTY	BURKS JARON	7209 RAYTOWN RD
206259689	2019-2021	INDIVIDUAL PERSONAL PROPERTY	VANG DON & DONNA	7922 DITZLER AVE	206271324	2020-2021	INDIVIDUAL PERSONAL PROPERTY	JACKSON STACY	10113 E 68TH ST
206259835	2021	INDIVIDUAL PERSONAL PROPERTY	OSBORNE CRYSTAL M	6622 ENGLEWOOD AVE	206271371	2020-2021	INDIVIDUAL PERSONAL PROPERTY	DEVERA CHRISTINE MUN	7810 IRWIN RD
206259859	2017	INDIVIDUAL PERSONAL PROPERTY	ICART JEANNOT	10105 E 84TH ST	206271491	2021	INDIVIDUAL PERSONAL PROPERTY	BELL JOSIAH N HALL MEGAN	8309 LANE AVE
206260179	2019-2021	INDIVIDUAL PERSONAL PROPERTY	JENNINGS MARIAH SYMONE	11709 E 87TH ST	206271810	2020-2021	INDIVIDUAL PERSONAL PROPERTY	ALLEN COREY B	11404 E 65TH ST
206260215	2021	INDIVIDUAL PERSONAL PROPERTY	BETANCOURT BRYAN ALEXIS	5233 NORRTHEN AVE	206271932	2018	INDIVIDUAL PERSONAL PROPERTY	MOORE GARY PAUL	6206 RAYTOWN RD
206260216	2016-2017	INDIVIDUAL PERSONAL PROPERTY	DRESSELHAUS JOSEPH SCOTT	2600 NW 6TH ST	206272012	2017	INDIVIDUAL PERSONAL PROPERTY	MACDONALD KENDALL M	9001 E 69TH ST
206260272	2021	INDIVIDUAL PERSONAL PROPERTY	CABRERA MARTINEZ JOSE TOMAS	8600 STARK AVE	206272090	2021	INDIVIDUAL PERSONAL PROPERTY	BERGMANN KATHRYN P & PRICE MARY	10905 E 59TH ST
206260316	2018-2021	INDIVIDUAL PERSONAL PROPERTY	HERRIFORD THOMAS CORINTHIAN	8412 HARRIS AVE	206272138	2021	INDIVIDUAL PERSONAL PROPERTY	MURPHY ANTHONY C & CHERYL	11104 E 72ND TER
206260350	2017	INDIVIDUAL PERSONAL PROPERTY	HENDERSON ALISHA DIONNE	9905 E 83RD TER	206272316	2017-2018	INDIVIDUAL PERSONAL PROPERTY	ABBOTT-SAMPLE TALINA	8862 E 52ND TER
206260430	2021	INDIVIDUAL PERSONAL PROPERTY	MARTINEZ SARAVIA ALEXANDER	9805 E GREGORY BLVD	206272337	2017	INDIVIDUAL PERSONAL PROPERTY	SANDERS DARRELL D	9813 E 61ST ST APT 4
206260906	2021	INDIVIDUAL PERSONAL PROPERTY	KILGORE DONALD JAY	8701 MANCHESTER AVE	206272635	2019	INDIVIDUAL PERSONAL PROPERTY	RATLIFF KIMBERLEE ANN	10330 E 63RD ST APT 1
206261130	2017	INDIVIDUAL PERSONAL PROPERTY	TIGER SHELIA RENEE	5336 DITZLER AVE	206272727	2019	INDIVIDUAL PERSONAL PROPERTY	WASHINGTON ADRIAN	11912 E 63RD TER
206261650	2019-2021	INDIVIDUAL PERSONAL PROPERTY	RICE RASHAD ANTONIO	8316 WILLOW WAY	206272832	2021	INDIVIDUAL PERSONAL PROPERTY	BUSCHHORN RICHARD	5323 HARDY AVE
206261944	2021	INDIVIDUAL PERSONAL PROPERTY	GRAYS QUENTIN RON'L	8313 E 85TH TER	206272869	2019-2021	INDIVIDUAL PERSONAL PROPERTY	INGRAM DARIS HENRY	9014 E 74TH TER
206262317	2021	INDIVIDUAL PERSONAL PROPERTY	GRASHER BRITTNEY N	8806 E 57TH ST	206272898	2020-2021	INDIVIDUAL PERSONAL PROPERTY	MEHL COREY ANDREW	10124 E 78TH TER
206262574	2018	INDIVIDUAL PERSONAL PROPERTY	CHASE HOWARD RASHAD	9400 E 68TH TER	206272924	2021	INDIVIDUAL PERSONAL PROPERTY	OWENS LAUREN	5816 NORTHERN AVE
206262596	2020-2021	INDIVIDUAL PERSONAL PROPERTY	WILSON DOMINIQUE LACHELLE	9102 E 73RD ST	206272949	2017	INDIVIDUAL PERSONAL PROPERTY	FEARS BRIAN K	8815 E 59TH ST
206262631	2017-2021	INDIVIDUAL PERSONAL PROPERTY	DOSTAL JIRI	11705 E 86TH ST	206273171	2021	INDIVIDUAL PERSONAL PROPERTY	MCINTOSH SHARRA L	9413 HARRIS AVE
206262875	2021	INDIVIDUAL PERSONAL PROPERTY	FINNEY RAHSAAN M	11208 E 60TH ST	206273229	2019	INDIVIDUAL PERSONAL PROPERTY	REID IMANI JAE'LEE	8115 E 58TH ST
206262990	2021	INDIVIDUAL PERSONAL PROPERTY	LINDLEY LEVI MALACHI	6621 MAYWOOD AVE	206273502	2019-2021	INDIVIDUAL PERSONAL PROPERTY	VERNER JOSHUA	9805 E 84TH ST
206263015	2016	INDIVIDUAL PERSONAL PROPERTY	DOWNING KIMBERLY K	8514 ARLINGTON AVE	206273587	2017-2018	INDIVIDUAL PERSONAL PROPERTY	REYNOLDS MARKUS W	7808 MANNING AVE
206263188	2017	INDIVIDUAL PERSONAL PROPERTY	GUZAN JOSEPH A	10401 E 69TH ST	206273642	2019-2020	INDIVIDUAL PERSONAL PROPERTY	HENSLEY CHARLES LEE	9017 E 75TH ST
206263189	2017	INDIVIDUAL PERSONAL PROPERTY	THOMSON KAYLA	10401 E 69TH ST	206273838	2021	INDIVIDUAL PERSONAL PROPERTY	RICHARDS PAMELA J	5912 HEDGES AVE
206263191	2019	INDIVIDUAL PERSONAL PROPERTY	WADE ERIK LEROY	8401 WOODSON PL	206274139	2017-2018	INDIVIDUAL PERSONAL PROPERTY	HUGHES YVONNE M	5420 BLUE RIDGE CUT OFF APT G01
206263448	2021	INDIVIDUAL PERSONAL PROPERTY	LOISELLE AMBER NICOLE	5815 WOODSON RD	206274147	2021	INDIVIDUAL PERSONAL PROPERTY	BREWINGTON KACIE L	6124 RALSTON AVE
206263520	2021	INDIVIDUAL PERSONAL PROPERTY	HERMESCH EMILY BETH	8700 STARK AVE	206274452	2017-2018	INDIVIDUAL PERSONAL PROPERTY	CARNEY CAROL A & DANIEL J	6122 WILLOW AVE
206263846	2016-2018	INDIVIDUAL PERSONAL PROPERTY	VIERRA CHRISTOPHER J	9006 E 69TH ST	206274483	2017-2020	INDIVIDUAL PERSONAL PROPERTY	BONHAM JESSICA K	10213 E 71ST TER
206264055	2017-2021	INDIVIDUAL PERSONAL PROPERTY	CHEN GUANG HUI	7025 ARLINGTON AVE	206274491	2021	INDIVIDUAL PERSONAL PROPERTY	PUGH NYESHA SANTIARA	6604 RALSTON AVE
206264202	2021	INDIVIDUAL PERSONAL PROPERTY	JONES YOLANDA M	9010 E 87TH ST APT A2	206274551	2017	INDIVIDUAL PERSONAL PROPERTY	MAY EDWIN L	7929 HEDGES AVE
206264314	2020-2021	INDIVIDUAL PERSONAL PROPERTY	COLLINS KEYERA MONAE	5223 STERLING AVE	206274872	2018-2021	INDIVIDUAL PERSONAL PROPERTY	DOMINGUEZ-ESPINOZA FELIX ENRIQUE	9705 E 82ND ST
206264523	2017	INDIVIDUAL PERSONAL PROPERTY	HILTON LEONARD	9401 E 63RD ST APT 304	206274972	2018-2021	INDIVIDUAL PERSONAL PROPERTY	ROWE MICHAEL II	7501 CRISP AVE
206264534	2021	INDIVIDUAL PERSONAL PROPERTY	LANGENDORFER HEATHER	9006 E GREGORY BLVD	206275120	2018	INDIVIDUAL PERSONAL PROPERTY	LEWIS KYLE EDWARD	5417 STERLING AVE
206264535	2017-2021	INDIVIDUAL PERSONAL PROPERTY	LEGRAND TAAIAN	8313 HARRIS AVE	206275166	2018-2021	INDIVIDUAL PERSONAL PROPERTY	MONDANE BREGANNA LATRICE	6617 ELM AVE
206264864	2020	INDIVIDUAL PERSONAL PROPERTY	DILLARD FRANCES MARIE	7226 RAYTOWN RD APT A	206275530	2017-2018	INDIVIDUAL PERSONAL PROPERTY	KELLEY SAMUEL JACOB	8730 E 81ST TER
206264942	2017	INDIVIDUAL PERSONAL PROPERTY	MOORE FARRIS CYNTHIA D	9115 E 85TH ST	206275584	2020-2021	INDIVIDUAL PERSONAL PROPERTY	MILLAN JUAREZ CANDIDO	6725 STERLING AVE
206265361	2017-2018	INDIVIDUAL PERSONAL PROPERTY	PARKS QUENTIN MAURICE JR	8606 OXFORD AVE	206275670	2017	INDIVIDUAL PERSONAL PROPERTY	RICHARDSON RA'KIAH DE-ANN	10405 E 78TH TER
206265552	2017-2020	INDIVIDUAL PERSONAL PROPERTY	DAVIS AMANDA LYNN	10125 E 78TH TER	206275959	2021	INDIVIDUAL PERSONAL PROPERTY	THURMAN KEVIN	8616 E 87TH ST
206265563	2018	INDIVIDUAL PERSONAL PROPERTY	MARTIN JANAE MICHELLE	9808 E 84TH ST	206276286	2019	INDIVIDUAL PERSONAL PROPERTY	SWOPE DALENE RENEE	11004 E 72ND TER
206265625	2018	INDIVIDUAL PERSONAL PROPERTY	MONSLOW GEORGE CHRISTOPHER 2ND	9106 E 74TH TER	206276395	2017	INDIVIDUAL PERSONAL PROPERTY	NICHOLS STANLEY W	8001 DITZLER AVE
206265793	2017	INDIVIDUAL PERSONAL PROPERTY	SANDERS KATHERINE M & JAMISON GEORGEEN	5332 HEDGES AVE	206276748	2021	INDIVIDUAL PERSONAL PROPERTY	CIZA ANTOINE	11064 E 77TH TER
206266012	2020-2021	INDIVIDUAL PERSONAL PROPERTY	MACKENZIE RYAN LACHLAN	10920 E 82ND ST	206276835	2017	INDIVIDUAL PERSONAL PROPERTY	AMAYA ANETT	9803 E 79TH ST
206266042	2018-2020	INDIVIDUAL PERSONAL PROPERTY	WILLIAMS DION LAMONT	7112 WOODSON RD	206277178	2019-2021	INDIVIDUAL PERSONAL PROPERTY	KELLY TIMOTHY MATTHEW	7600 ELM ST
206266162	2021	INDIVIDUAL PERSONAL PROPERTY	LANEAR HENRY LEE JR	7900 HEDGES AVE	206277474	2021	INDIVIDUAL PERSONAL PROPERTY	FOSTER JAMES DAVID III	9201 E 68TH ST
206266316	2021	INDIVIDUAL PERSONAL PROPERTY	FAUST SARAH E	8322 STERLING AVE	206277553	2017-2018	INDIVIDUAL PERSONAL PROPERTY	RIVETTE JULIAN BRANDON	6140 RAYTOWN RD APT 405
206266824	2018-2020	INDIVIDUAL PERSONAL PROPERTY	BRADLEY JEREMY FARLE	11412 E 71ST ST	206277705	2017-2021	INDIVIDUAL PERSONAL PROPERTY	HARMS ROBYN JUSTINE & MORGAN DARRIN RAY	11611 E 77TH ST
206266978	2016-2017	INDIVIDUAL PERSONAL PROPERTY	HALL STEVEN R	9026 E 85TH PL	206277986	2019-2021	INDIVIDUAL PERSONAL PROPERTY	LOYOLA KIMBERLY	6702 RAYTOWN RD
206267430	2018	INDIVIDUAL PERSONAL PROPERTY	HOLT CAMP TRISTON J & JEFFREY L	10109 E 81ST ST	206278164	2020-2021	INDIVIDUAL PERSONAL PROPERTY	FLORIO JASMINE NICOLE	8625 E UTOPIA PKWY APT 4
206268277	2021	INDIVIDUAL PERSONAL PROPERTY	BENITEZ GARCIA PILAR ALEXANDER	6232 RALSTON AVE	206278305	2020-2021	INDIVIDUAL PERSONAL PROPERTY	ZAMORA QUIROZ ROSA E	10317 E 61ST ST APT 2
206268342	2018-2021	INDIVIDUAL PERSONAL PROPERTY	WEHNER HALEY	6416 STERLING AVE	206278367	2017-2019	INDIVIDUAL PERSONAL PROPERTY	CANADY REIGIS OMNI	11000 HARVARD AVE
206268428	2017-2018	INDIVIDUAL PERSONAL PROPERTY	EHLERS RICHARD BRIAN JR	6205 HEDGES AVE	206278414	2017-2021	INDIVIDUAL PERSONAL PROPERTY	GARCIA EDWIN LEON	5804 BLUE RIDGE BLVD
206268881	2021	INDIVIDUAL PERSONAL PROPERTY	CARROLL DANNY PHILIP	8301 KENTUCKY AVE	206278466	2017-2021	INDIVIDUAL PERSONAL PROPERTY	BROWN DARYL A	8905 E 67TH PL APT 210
206268920	2017	INDIVIDUAL PERSONAL PROPERTY	WELDON DEMETRIUS	9904 E 60TH ST	206278948	2021	INDIVIDUAL PERSONAL PROPERTY	WOODWARD SAMANTHA NICHOLE	120 SW KINGS CROSS RD
206268979	2019-2020	INDIVIDUAL PERSONAL PROPERTY	HAROLD DENON	11201 E 78TH TER	206279437	2021	INDIVIDUAL PERSONAL PROPERTY	GRIGGS TYLER & LONALYN	5629 STERLING AVE
206269038	2021	INDIVIDUAL PERSONAL PROPERTY	NEILSON TIMOTHY ADAM	9115 E 57TH TER	206279560	2020-2021	INDIVIDUAL PERSONAL PROPERTY	ROGERS KAMICHA DASI & PEELER KEVIN L	8511 EVERETT ST

206279881	2021	INDIVIDUAL PERSONAL PROPERTY	COUGHENOWER TODD A	8621 WESTRIDGE RD	206290676	2017	INDIVIDUAL PERSONAL PROPERTY	BIRDO MARCUS LEE	9300 E 70TH TER
206279978	2021	INDIVIDUAL PERSONAL PROPERTY	WILLIS THERESA A	8719 E 60TH TER	206290780	2021	INDIVIDUAL PERSONAL PROPERTY	CALDWELL TATE	8707 NEWTON AVE
206280092	2017-2021	INDIVIDUAL PERSONAL PROPERTY	WEBER ALLYSON L	8108 SPRING VALLEY RD	206290985	2018-2019	INDIVIDUAL PERSONAL PROPERTY	HART JAMES RONALD	10501 E 81ST TER
206280239	2021	INDIVIDUAL PERSONAL PROPERTY	MURPHY MELISSA LYNN	10813 E 66TH TER	206291249	2021	INDIVIDUAL PERSONAL PROPERTY	WALLACE KATHERINE ELIZABETH	11109 E 78TH ST
206280445	2020-2021	INDIVIDUAL PERSONAL PROPERTY	MIERITZ JOEL M & WARD TAMAKI N	8622 E UTOPIA DR APT 24	206291316	2017-2021	INDIVIDUAL PERSONAL PROPERTY	GERMANN MERSADEZ	10547 E 56TH ST
206280991	2017-2019	INDIVIDUAL PERSONAL PROPERTY	BRANCH NATHAN C	9107 E 73RD ST	206291546	2017	INDIVIDUAL PERSONAL PROPERTY	GRANT JOHNNIE DONTALE JR	8704 TENNESSEE AVE
206281045	2021	INDIVIDUAL PERSONAL PROPERTY	CRUZ GUANDIQUIL PATRICIO	9521 E 67TH TER	206292348	2021	INDIVIDUAL PERSONAL PROPERTY	KNISLEY BRANDON K	9013 E 65TH TER
206281483	2017-2019	INDIVIDUAL PERSONAL PROPERTY	ARNOLD ALEXANDER ROGER	11900 E 86TH ST	206292541	2017-2019	INDIVIDUAL PERSONAL PROPERTY	COPEL RONELL LAMONT	8716 E 81ST TER
206281612	2017-2018	INDIVIDUAL PERSONAL PROPERTY	REVADA STEPHANIE LYNN	9135 RICHARDS DR	206292651	2021	INDIVIDUAL PERSONAL PROPERTY	OSBORNE CAMERON	9505 E 60TH TER
206281667	2020-2021	INDIVIDUAL PERSONAL PROPERTY	ATKISON KAITLYN SUE MARIE	9809 E 85TH ST	206292949	2019	INDIVIDUAL PERSONAL PROPERTY	SMITH GABRIEL RENEE	8507 GREENWOOD RD
206281703	2021	INDIVIDUAL PERSONAL PROPERTY	RULE ERIN ALEXIS	11808 E 82ND ST	206293057	2018-2021	INDIVIDUAL PERSONAL PROPERTY	HENRY ARMOND JAMAHL	11505 E 62ND ST
206282217	2017-2018	INDIVIDUAL PERSONAL PROPERTY	WILLIAMS PAMELA ELAINE & DEREK K	7234 STERLING AVE	206293127	2017-2021	INDIVIDUAL PERSONAL PROPERTY	MOORE KIANA K'NAI	11200 E 75TH TER
206282234	2016-2018	INDIVIDUAL PERSONAL PROPERTY	KNAPP CAREY KAY (PETTEGREW)	8504 HARRIS AVE	206293483	2017-2020	INDIVIDUAL PERSONAL PROPERTY	WATSON DUANE MARCELLOUS	8627 GREENWOOD RD
206282272	2021	INDIVIDUAL PERSONAL PROPERTY	PAYNE TYLER P	7916 HUNTER ST	206293553	2017-2018	INDIVIDUAL PERSONAL PROPERTY	COLEMAN WENDY L	11209 E 53RD ST
206282358	2021	INDIVIDUAL PERSONAL PROPERTY	CAPLES STEPHANIE MICHELLE & SAWYER JAMES	7021 ENGLEWOOD TER	206293605	2016-2017	INDIVIDUAL PERSONAL PROPERTY	GORDON WILLIAM ELZY	7927 HEDGES AVE
206282373	2016-2019	INDIVIDUAL PERSONAL PROPERTY	RICHARDSON DAVID AND MARY	5601 LANE AVE	206294076	2019-2021	INDIVIDUAL PERSONAL PROPERTY	CEEDING LAURA N	5512 WOODSON RD
206282494	2021	INDIVIDUAL PERSONAL PROPERTY	PEARSON ERIC	8818 RICHARDS DR	206294240	2017-2019	INDIVIDUAL PERSONAL PROPERTY	SMITH TARA LYNN	7713 RAYTOWN RD APT 33
206282602	2019	INDIVIDUAL PERSONAL PROPERTY	HARLIN JARVON D'MARIO	5813 HARVARD AVE	206294533	2021	INDIVIDUAL PERSONAL PROPERTY	MORGAN VICKY LYNN	6104 ELM AVE
206282751	2021	INDIVIDUAL PERSONAL PROPERTY	ROBERSON EBONY S	5815 KENTUCKY AVE	206294548	2021	INDIVIDUAL PERSONAL PROPERTY	ELDRIDGE LACY QUANTE	8606 FORD AVE
206282771	2017-2021	INDIVIDUAL PERSONAL PROPERTY	WOLLSHLAGER DUSTIN DANIEL	6622 ENGLEWOOD AVE	206294684	2017-2020	INDIVIDUAL PERSONAL PROPERTY	MOORE ZAVIOR H	8507 MAPLE AVE
206282778	2019	INDIVIDUAL PERSONAL PROPERTY	WILLIAMS TAKAYLA MORIANNA	8818 E 80TH TER	206294835	2020-2021	INDIVIDUAL PERSONAL PROPERTY	BENNETT OLIVIA L	8301 HARVARD AVE
206282881	2018	INDIVIDUAL PERSONAL PROPERTY	TRIBBLE JOHN	10409 E 69TH TER	206294947	2017-2018	INDIVIDUAL PERSONAL PROPERTY	DESANTIS JOSEPH THOMAS	11004 E 83RD ST
206282914	2016-2018	INDIVIDUAL PERSONAL PROPERTY	BAYNHAM TYRONE II	11212 E 53RD ST	206295076	2021	INDIVIDUAL PERSONAL PROPERTY	DOTTREY CLARENCE II	8301 HEDGES AVE
206282920	2020-2021	INDIVIDUAL PERSONAL PROPERTY	TOWNSEND CLARENCE R JR	7902 SPRING VALLEY RD	206295235	2018	INDIVIDUAL PERSONAL PROPERTY	MARKOVICH BRIAN PETER	8405 E 86TH TER
206283242	2017-2018	INDIVIDUAL PERSONAL PROPERTY	HARRISON COLLAN A	8504 ELM AVE UNIT A	206295270	2018	INDIVIDUAL PERSONAL PROPERTY	CHAPPEL GEORGE W	6651 MAYWOOD AVE
206283311	2020-2021	INDIVIDUAL PERSONAL PROPERTY	SMITH LAWRENCE COLBY & SMITH SUZY	6500 STERLING AVE	206295348	2020-2021	INDIVIDUAL PERSONAL PROPERTY	OWENS LAVETTE MARIE	9600 E 68TH TER
206283559	2017-2018	INDIVIDUAL PERSONAL PROPERTY	DEVORE BRANDON ANDREW	9912 E 60TH ST	206295500	2017	INDIVIDUAL PERSONAL PROPERTY	JONES LARRY WAYNE	6638 MAYWOOD AVE APT A
206283708	2017	INDIVIDUAL PERSONAL PROPERTY	POTTS JOSEPH WESLEY	7415 ASH AVE	206295622	2017-2021	INDIVIDUAL PERSONAL PROPERTY	BELTON ORLANDO MAURICE	8300 E 83RD ST
206283744	2017-2019	INDIVIDUAL PERSONAL PROPERTY	WEAVER LAURA NICOLE	7720 ELM ST	206295627	2020	INDIVIDUAL PERSONAL PROPERTY	CHAMBERS TRAVIONE	5724 HARVARD AVE
206283761	2019	INDIVIDUAL PERSONAL PROPERTY	PARENT NEALY ANN	9111 RICHARDS DR	206295628	2017	INDIVIDUAL PERSONAL PROPERTY	THOMPSON NAKASHA	10401 E 80TH ST
206283878	2020-2021	INDIVIDUAL PERSONAL PROPERTY	PALMER LOIS ANN	11200 E 76TH ST	206295921	2021	INDIVIDUAL PERSONAL PROPERTY	HITE MARILYNNE GENE	5613 MANNING AVE
206284026	2017-2018	INDIVIDUAL PERSONAL PROPERTY	HALEY ROBERT	9346 E 55TH ST	206296000	2017	INDIVIDUAL PERSONAL PROPERTY	HERNANDEZ BRANDON LEE	5707 CEDAR AVE
206284046	2021	INDIVIDUAL PERSONAL PROPERTY	HATCH CHRISTIAN & STERBIK DAVID	10608 E 71ST TER	206296196	2019-2021	INDIVIDUAL PERSONAL PROPERTY	MAY DAVID F JR	5405 RALSTON AVE
206284199	2017-2021	INDIVIDUAL PERSONAL PROPERTY	NEWMAN LAURIE LEE	6821 CRISP AVE	206296214	2021	INDIVIDUAL PERSONAL PROPERTY	DEAN MICHAEL A	9206 VAUGHN AVE
206284227	2020	INDIVIDUAL PERSONAL PROPERTY	BOBADILLA ANN ELIZABETH	9207 VAUGHN AVE	206296312	2020-2021	INDIVIDUAL PERSONAL PROPERTY	WOODS JENAY A	9221 E 54TH TER
206284480	2017-2021	INDIVIDUAL PERSONAL PROPERTY	WATSON DENNI M	9926 E 61ST ST	206296321	2021	INDIVIDUAL PERSONAL PROPERTY	STEPHENS FRD & SHIRLEY	9205 E 74TH TER
206284481	2021	INDIVIDUAL PERSONAL PROPERTY	ARMSTRONG BRIAN DANIEL	9223 E 54TH TER	206296379	2018-2019	INDIVIDUAL PERSONAL PROPERTY	DETTLAFF CHRISTOPHER	10907 E 87TH ST BLDG 1
206284851	2021	INDIVIDUAL PERSONAL PROPERTY	HARDAWAY KHADIJAH & HARDAWAY ALEAH	5813 CEDAR AVE	206296736	2020-2021	INDIVIDUAL PERSONAL PROPERTY	BRAFFORD DEVIN	8623 E 84TH ST
206285004	2017-2021	INDIVIDUAL PERSONAL PROPERTY	WILSON TYRONE EVERETT	8637 E UTOPIA PKWY APT 12	206297073	2017-2021	INDIVIDUAL PERSONAL PROPERTY	STRIKLAND RAMON B	8959 E 62ND TER
206285086	2016-2021	INDIVIDUAL PERSONAL PROPERTY	HENDERSON KINESHEYA R	9211 E 53RD TER	206297432	2017-2021	INDIVIDUAL PERSONAL PROPERTY	KESSELL VICTOR R	6628 OXFORD AVE
206285245	2021	INDIVIDUAL PERSONAL PROPERTY	WALKER FRANK GARY	10400 E 71TH ST	206297539	2017	INDIVIDUAL PERSONAL PROPERTY	BURRUS BRIAN CHRISTOPHER	6201 RALSTON AVE
206285283	2021	INDIVIDUAL PERSONAL PROPERTY	HILL WILLIE JOHN JOSEPH	9006 E 69TH ST	206297692	2021	INDIVIDUAL PERSONAL PROPERTY	WEBB DERRICK TYWAN	10109 E 74TH TER
206285467	2021	INDIVIDUAL PERSONAL PROPERTY	EDWARDS SAMUEL DALE	10704 E 65TH TER	206320515	2017-2021	INDIVIDUAL PERSONAL PROPERTY	MAY BRITTANI LYNN	9418 E 55TH ST
206285999	2019	INDIVIDUAL PERSONAL PROPERTY	RENDON KAYLYNN DIANN-MARIE	8812 E 84TH ST	206320517	2021	INDIVIDUAL PERSONAL PROPERTY	CRAWFORD DENISE	7716 CRISP AVE
206286207	2021	INDIVIDUAL PERSONAL PROPERTY	RICHARDS SUSAN J	7015 HEDGES AVE	206321110	2019-2021	INDIVIDUAL PERSONAL PROPERTY	MACK ERIKA NICOLE	8604 ASH AVE
206286273	2021	INDIVIDUAL PERSONAL PROPERTY	GREEN JENNIFER SUE	8106 ASH AVE	206321136	2017	INDIVIDUAL PERSONAL PROPERTY	ROSS TODD E	5803 BLUE RIDGE CUT OFF
206286732	2021	INDIVIDUAL PERSONAL PROPERTY	MCDOWELL KAYLA DENISE	9812 E 79TH PL	206321188	2020-2021	INDIVIDUAL PERSONAL PROPERTY	PALMAS JOSE	10107 E 80TH ST
206286739	2017	INDIVIDUAL PERSONAL PROPERTY	BRYANT EUGENE N ROBINSON	10104 E 67TH ST APT A	206321243	2021	INDIVIDUAL PERSONAL PROPERTY	CACEDO DARIN MICHAEL	6620 HARDY AVE
206286852	2019-2021	INDIVIDUAL PERSONAL PROPERTY	MASON JUSTIN RYAN	5521 HARDY AVE	206321629	2021	INDIVIDUAL PERSONAL PROPERTY	ALCORN RACHEL JUEL	11300 E 62ND ST
206286874	2021	INDIVIDUAL PERSONAL PROPERTY	FIGUEREDO CHAVIANO PABLO	5416 RAYTOWN RD	206321856	2021	INDIVIDUAL PERSONAL PROPERTY	GREEN GABRIELLE NICOLE	8329 LAUREL AVE
206287284	2018-2020	INDIVIDUAL PERSONAL PROPERTY	STEFANI COHENS	8321 NORTHERN ST	206322371	2021	INDIVIDUAL PERSONAL PROPERTY	MORGAN BRIANA GABRIELLE	8206 WOODSON DR
206287334	2020-2021	INDIVIDUAL PERSONAL PROPERTY	THOMAS ANNETTE D	5415 OXFORD AVE	206322455	2018-2021	INDIVIDUAL PERSONAL PROPERTY	ANDERSON JOHNOLA & SAMUEL	9126 E 85TH ST
206287568	2021	INDIVIDUAL PERSONAL PROPERTY	ROLLINS PRETT III	9117 E 68TH ST	206671741	2017-2021	INDIVIDUAL PERSONAL PROPERTY	LAWTON-BROWN KYLE CHRISTIAN SR	7300 STERLING AVE
206287653	2017	INDIVIDUAL PERSONAL PROPERTY	MCKINNEY DESIRAE RUBY MAE	6317 RALSTON AVE	206671823	2017-2018	INDIVIDUAL PERSONAL PROPERTY	GROSEKEMPER BRIDE DALIS MAKAYLA	9007 E 74TH ST
206287907	2020-2021	INDIVIDUAL PERSONAL PROPERTY	MURDOCK ROSEANN E	10629 E 56TH TER	206672122	2021	INDIVIDUAL PERSONAL PROPERTY	SCOTT KALEY MARIE	6006 FARLEY AVE
206287961	2019-2021	INDIVIDUAL PERSONAL PROPERTY	JOHNSON CALVIN L	8806 E 72ND ST	206672134	2020-2021	INDIVIDUAL PERSONAL PROPERTY	STEBBINS NICHOLAS G	11104 E 67TH ST
206288058	2017-2019	INDIVIDUAL PERSONAL PROPERTY	TOLLIVER ARIANNA & CAREY ELIZABETH	9932 E 61ST ST	206672439	2020-2021	INDIVIDUAL PERSONAL PROPERTY	GILBERT MARION DENISE & UTA TUNI	8604 E 83RD TER
206288513	2019-2021	INDIVIDUAL PERSONAL PROPERTY	MOORE TAILER MARIE (ENGLISH)	9804 E 69TH ST	206673276	2020	INDIVIDUAL PERSONAL PROPERTY	CLARK CHELSEY FRANCES (POWERS)	10025 E 67TH ST
206288728	2017-2021	INDIVIDUAL PERSONAL PROPERTY	ROBERSON JAMES DYLAN	9104 E 74TH TER	206673520	2021	INDIVIDUAL PERSONAL PROPERTY	MASON CHRISTINA JAMES (LANDRY)	6009 ELM AVE
206288739	2020-2021	INDIVIDUAL PERSONAL PROPERTY	KRIESEL MICHAEL ALLEN	5733 ELM AVE	206673731	2021	INDIVIDUAL PERSONAL PROPERTY	MCMEANS MARK ALLEN	1270 SW ARBOR PARK DR
206288914	2020	INDIVIDUAL PERSONAL PROPERTY	EALY SHANITA & SMOCKS BRANNON	8700 E 87TH ST	206673771	2021	INDIVIDUAL PERSONAL PROPERTY	RAIL EMAREE TAYLOR	10317 E 61ST ST APT 1
206289076	2017-2019	INDIVIDUAL PERSONAL PROPERTY	IRAHETA MELENDEZ EDWIN ALBERT	10337 E 61ST ST APT 2	206673827	2021	INDIVIDUAL PERSONAL PROPERTY	STELLER JENNIFER L MORRIS	6803 LAUREL AVE
206289202	2017-2018	INDIVIDUAL PERSONAL PROPERTY	MURRAY BIONCA SHEREE	5824 FARLEY AVE	206673993	2018-2021	INDIVIDUAL PERSONAL PROPERTY	VANG THI TONG	7922 DITZLER AVE
206289280	2020-2021	INDIVIDUAL PERSONAL PROPERTY	ROMAN YOLANDA LUCILLE	6000 NORTHERN AVE	206674011	2018-2021	INDIVIDUAL PERSONAL PROPERTY	LEWIS SHANE M	9122 DITZLER AVE
206289330	2017-2018	INDIVIDUAL PERSONAL PROPERTY	LANSDOWN TAYLOR MICHAELE	5625 HARVARD AVE	206674122	2018-2021	INDIVIDUAL PERSONAL PROPERTY	GARCIA ROMAN	5310 ASH AVE
206289660	2018-2019	INDIVIDUAL PERSONAL PROPERTY	GREEN KIMBERLY LATASHA	8951 E 83RD ST	206674489	2017-2018	INDIVIDUAL PERSONAL PROPERTY	OHL JACQUELIN AMANDA	5803 BLUE RIDGE CUT OFF
206289767	2018-2019	INDIVIDUAL PERSONAL PROPERTY	SCROGGINS MARIAH D	6321 ASH AVE	206674854	2017-2019	INDIVIDUAL PERSONAL PROPERTY	TAYLOR APRIL RACHELLE	12001 LANE AVE
206289948	2017-2021	INDIVIDUAL PERSONAL PROPERTY	BECERRA JESSE DON & KATRINA MARIE	5420 LAUREL AVE	206674864	2018	INDIVIDUAL PERSONAL PROPERTY	EDWARDS LEAH BETH	10600 E 79TH ST
206290026	2018-2019	INDIVIDUAL PERSONAL PROPERTY	GAHM SAMUEL MARK	5227 BLUE RIDGE BLVD	206674880	2018-2019	INDIVIDUAL PERSONAL PROPERTY	KAYS AUSTIN L	6824 LAUREL AVE
206290406	2021	INDIVIDUAL PERSONAL PROPERTY	WATSON DONOVAN C	11705 E 76TH TER	206674918	2019-2020	INDIVIDUAL PERSONAL PROPERTY	DELGADO DEVIN JOSE	5332 RALSTON AVE
206290430	2020	INDIVIDUAL PERSONAL PROPERTY	FLETCHER BALDWIN PATRICE	7325 HARDY AVE	206674957	2021	INDIVIDUAL PERSONAL PROPERTY	ANDERSON LUKE WESLEY	8012 ELM AVE
206290509	2018-2021	INDIVIDUAL PERSONAL PROPERTY	THOMAS ROZENER	9010 E 87TH ST APT D1	206675015	2021	INDIVIDUAL PERSONAL PROPERTY	GRAVITT LEWIS P	9200 E 84TH ST

206675166	2020-2021	INDIVIDUAL PERSONAL PROPERTY	WILLIS NOLA FRANCINE	11202 LAKEVIEW RD	206686903	2018-2019	INDIVIDUAL PERSONAL PROPERTY	WILLIAMS BRITTANY S	9946 E 61ST ST
206675294	2021	INDIVIDUAL PERSONAL PROPERTY	KIRKWOOD DALTON JAMES	9116 E 84TH ST	206687047	2021	INDIVIDUAL PERSONAL PROPERTY	CROXELL JOHNATHAN ANDREW	9004 E GREGORY BLVD
206675486	2016-2021	INDIVIDUAL PERSONAL PROPERTY	HINEMAN LARRY DEAN	8535 GRANT DR	206687110	2018-2020	INDIVIDUAL PERSONAL PROPERTY	SMITH EMILY NICHOLE	6329 ASH AVE
206675538	2021	INDIVIDUAL PERSONAL PROPERTY	MONTROYA-MENDEZ JOSE R	7804 E 87TH ST	206687324	2018-2019	INDIVIDUAL PERSONAL PROPERTY	WHITE VICTOR V	3611 KENSINGTON AVE
206676468	2021	INDIVIDUAL PERSONAL PROPERTY	BROWN KESHAEDA K	6828 AGNES AVE	206687366	2021	INDIVIDUAL PERSONAL PROPERTY	TWITCHEL TIFFANY AN	10904 E 62ND TER
206677071	2020-2021	INDIVIDUAL PERSONAL PROPERTY	KUYKENDALL CLEVELAND T II	6001 NORTHERN AVE	206687426	2018-2020	INDIVIDUAL PERSONAL PROPERTY	MITCHELL DYMOND RAY	7215 WILLOW AVE
206677279	2018	INDIVIDUAL PERSONAL PROPERTY	MORALES ROBERT JR	7000 BLUE RIDGE BLVD	206687572	2021	INDIVIDUAL PERSONAL PROPERTY	FISCHER-KIETRYS SEAN DAVID	7017 HUNTER ST
206677312	2021	INDIVIDUAL PERSONAL PROPERTY	OEHRRING DAVID LEE	7415 WILLOW AVE	206687635	2018-2020	INDIVIDUAL PERSONAL PROPERTY	KELLEY KYLIE LYNNE	9008 E 72ND TER
206677446	2021	INDIVIDUAL PERSONAL PROPERTY	DETAR ELMIRA M	6612 OXFORD AVE	206687671	2021	INDIVIDUAL PERSONAL PROPERTY	REED ADAM J	8492 LANE DR APT 6
206677556	2017-2021	INDIVIDUAL PERSONAL PROPERTY	FRIEDT VINCENT R	5805 BLUE RIDGE BLVD	206687717	2018	INDIVIDUAL PERSONAL PROPERTY	CARTER EYVETTE	5823 FARLEY AVE
206677562	2021	INDIVIDUAL PERSONAL PROPERTY	ROCHA JIMENEZ MARIO	5329 NORTHERN AVE	206688025	2020-2021	INDIVIDUAL PERSONAL PROPERTY	WHITESIDE JAVIN NICOLE	9201 E 53RD TER UNIT A
206677646	2017	INDIVIDUAL PERSONAL PROPERTY	HATLEY ANASAZI LANE	7408 HARRIS AVE	206688100	2020-2021	INDIVIDUAL PERSONAL PROPERTY	STAFFORD JAMES PATRICK	7923 TENNESSEE AVE
206677854	2021	INDIVIDUAL PERSONAL PROPERTY	MCKINNEY REBECCA LYNN	6317 RALSTON AVE	206688151	2020-2021	INDIVIDUAL PERSONAL PROPERTY	MERRIOTT DAKODA MICHAEL	5805 ELM AVE
206677891	2021	INDIVIDUAL PERSONAL PROPERTY	SANDERS TAYLOR MARIE	9507 E 62ND ST	206688206	2021	INDIVIDUAL PERSONAL PROPERTY	PEEK LORI JEAN	9012 E 85TH PL
206678068	2021	INDIVIDUAL PERSONAL PROPERTY	BATES CASEY SCOTT	10708 E 83RD TER	206688295	2021	INDIVIDUAL PERSONAL PROPERTY	GRIFFIN TAYLOR LA'NAE	8102 EVANSTON AVE
206678222	2018	INDIVIDUAL PERSONAL PROPERTY	JOHNSON DAVID JONATHON	5816 KENTUCKY AVE	206688539	2021	INDIVIDUAL PERSONAL PROPERTY	GROFF TRISTON JOSEPH	8514 BOOTH AVE
206678396	2021	INDIVIDUAL PERSONAL PROPERTY	SANTIAGO CARYN C	7819 IRWIN RD	206688947	2021	INDIVIDUAL PERSONAL PROPERTY	KELLY JAMES LAMONT	8901 E 81ST ST
206678506	2021	INDIVIDUAL PERSONAL PROPERTY	AZEHI PATRICIA A	10409 E 59TH ST	206689274	2018-2021	INDIVIDUAL PERSONAL PROPERTY	MARTIN TANISHA TYANA	9819 E 61ST ST APT 9
206678543	2019	INDIVIDUAL PERSONAL PROPERTY	ANDERSON CASEY D	10112 E 87TH ST	206689343	2017	INDIVIDUAL PERSONAL PROPERTY	THOMPSON JESSICA ROSE	9807 E 61ST ST APT 5
206678584	2017	INDIVIDUAL PERSONAL PROPERTY	BAKER BRADLEY EVAN	10508 E 65TH TER	206689373	2021	INDIVIDUAL PERSONAL PROPERTY	PATRICK GABRIEL MICHAEL	6320 KENTUCKY AVE
206678835	2020-2021	INDIVIDUAL PERSONAL PROPERTY	LEWIS BRITTANY BRESHAWN	6608 OXFORD AVE	206689757	2018-2020	INDIVIDUAL PERSONAL PROPERTY	FUZFA AUSTIN JANOS	6703 CRISP AVE
206679261	2021	INDIVIDUAL PERSONAL PROPERTY	ROGERS RHONDA KAE	9000 E 57TH ST	206689890	2017-2021	INDIVIDUAL PERSONAL PROPERTY	BACHMAN JESSICA ARIELLE	8312 EVANSTON AVE
206679461	2017-2021	INDIVIDUAL PERSONAL PROPERTY	DUPREE CHRISTOPHER M	7228 STERLING AVE	206690187	2020-2021	INDIVIDUAL PERSONAL PROPERTY	SCOTT AARON VAUGHN	8710 HUNTER ST
206679896	2021	INDIVIDUAL PERSONAL PROPERTY	YOUNG KELLEY MONIQUE	7927 HEDGES AVE	206690267	2021	INDIVIDUAL PERSONAL PROPERTY	KLEY GABRIELLA N	7601 HARVARD AVE
206679926	2020-2021	INDIVIDUAL PERSONAL PROPERTY	RODRIGUEZ RAMIREZ ERNESTO	8002 MANNING AVE	206690428	2020-2021	INDIVIDUAL PERSONAL PROPERTY	COX JESSICA COURTNEY	9101 E 58TH TER
206680062	2018-2019	INDIVIDUAL PERSONAL PROPERTY	HINDS MACENZIE MARIE	8246 SPRING VALLEY RD	206690527	2017-2018	INDIVIDUAL PERSONAL PROPERTY	FINNEY OLEN BRYAN	9809 E 73RD ST APT A
206680283	2019	INDIVIDUAL PERSONAL PROPERTY	DOOLEY TINA	8121 KENTUCKY AVE	206690577	2019	INDIVIDUAL PERSONAL PROPERTY	BURNS RHONDA S	8400 SPRING VALLEY RD
206680459	2018	INDIVIDUAL PERSONAL PROPERTY	RACY SHQUILA	8900 E 59TH ST	206690856	2017	INDIVIDUAL PERSONAL PROPERTY	EMERY SIERRA MARIE	6317 ASH AVE
206680579	2021	INDIVIDUAL PERSONAL PROPERTY	ZAMORANO-HERNANDEZ ANTONIO	8606 LANE AVE	206691055	2021	INDIVIDUAL PERSONAL PROPERTY	REEVES SHANIECE RENEE	7186 RIDGEWAY AVE
206680956	2018-2021	INDIVIDUAL PERSONAL PROPERTY	COMAS TRE MARCEL	6324 HUNTER ST	206691134	2017	INDIVIDUAL PERSONAL PROPERTY	PUSKAC CANDY LYNN	6645 MAYWOOD AVE
206680964	2019	INDIVIDUAL PERSONAL PROPERTY	HUMPHREY DANILLA K	6706 LANE AVE APT 104	206691156	2020-2021	INDIVIDUAL PERSONAL PROPERTY	BAKER SAMANTHA RENAE	7605 CEDAR AVE
206681321	2021	INDIVIDUAL PERSONAL PROPERTY	THOMPSON JANAE JAVONNE	5428 DITZLER AVE	206691396	2021	INDIVIDUAL PERSONAL PROPERTY	STINE RACHEL LUANN	6916 E 69TH ST
206681350	2020-2021	INDIVIDUAL PERSONAL PROPERTY	NAVE CHARISSE R	11428 E 71ST ST	206691480	2020-2021	INDIVIDUAL PERSONAL PROPERTY	BEAMAN TREVEAN	9725 E 93RD ST APT 35
206681398	2018-2021	INDIVIDUAL PERSONAL PROPERTY	BOLDEN DESIREE L	8817 E 85TH TER	206691996	2020	INDIVIDUAL PERSONAL PROPERTY	MCLELLAND NATHAN DANIEL	10309 E 61ST ST APT 4
206681567	2016-2021	INDIVIDUAL PERSONAL PROPERTY	SANDOVAL MATTHEW JOSEPH	5232 DITZLER AVE	206692004	2020-2021	INDIVIDUAL PERSONAL PROPERTY	BEASLEY BRANDON DANIEL	6110 NORTHERN AVE
206681745	2019-2021	INDIVIDUAL PERSONAL PROPERTY	TYUS DARYL WILLIAM	7317 RAYTOWN RD	206692191	2017	INDIVIDUAL PERSONAL PROPERTY	GREEN TERWEY TANESHA LASHAWN	8617 W UTOPIA DR APT 33
206681939	2021	INDIVIDUAL PERSONAL PROPERTY	DEVOL CLARENCE WILLIAM	6511 BLUE RIDGE BLVD	206692336	2017-2021	INDIVIDUAL PERSONAL PROPERTY	TURNER DENNIS DARON	9309 E 84TH ST
206682019	2019-2021	INDIVIDUAL PERSONAL PROPERTY	BROWN VILMA	9409 E 85TH ST	206692373	2021	INDIVIDUAL PERSONAL PROPERTY	WARREN JASMINE C	5914 ENGLEWOOD AVE
206682205	2021	INDIVIDUAL PERSONAL PROPERTY	HARTMAN NICOLE J	7204 WOODSON DR	206692630	2019-2021	INDIVIDUAL PERSONAL PROPERTY	RUCH CRAIG AARON	9708 E 68TH ST
206682298	2017-2018	INDIVIDUAL PERSONAL PROPERTY	ETSE MIHNA & BENSTER JR	6720 RAYTOWN RD	206693185	2021	INDIVIDUAL PERSONAL PROPERTY	SONNIER MARIETTA	9216 E 54TH ST
206682404	2021	INDIVIDUAL PERSONAL PROPERTY	ABELL GERALDINE	9705 E 69TH ST	206693229	2018-2019	INDIVIDUAL PERSONAL PROPERTY	BRISCOE WAYNE LESTER	6404 EVANSTON AVE
206682479	2021	INDIVIDUAL PERSONAL PROPERTY	SIMINGTON DIAMOND SADA JALEGIA	9205 E 84TH ST	206693491	2021	INDIVIDUAL PERSONAL PROPERTY	MACKENZIE LISA DARLENE	10920 E 82ND ST
206682800	2020-2021	INDIVIDUAL PERSONAL PROPERTY	DAVIS RAUCHELLE R	11120 E 85TH ST	206693849	2019-2020	INDIVIDUAL PERSONAL PROPERTY	JOHNSON-RAMSEY TYLER KEATON	8812 E 81ST ST
206682864	2019	INDIVIDUAL PERSONAL PROPERTY	BLAIR LLOYD W	8305 STERLING AVE	206694069	2021	INDIVIDUAL PERSONAL PROPERTY	GARLAND TYLER JENNISON & TALIA JANE	7329 HARDY AVE
206682883	2019	INDIVIDUAL PERSONAL PROPERTY	BALL JASMINE MARIE	6800 RAYTOWN RD	206694202	2021	INDIVIDUAL PERSONAL PROPERTY	MCCOY KC	9005 E GREGORY BLVD
206682901	2018	INDIVIDUAL PERSONAL PROPERTY	LIVINGSTON AARON	7505 ENGLEWOOD AVE	206694476	2018-2020	INDIVIDUAL PERSONAL PROPERTY	MULLEN SHANE & PIRNIE MARY ANN MARIE	7137 RAYTOWN RD
206682991	2017	INDIVIDUAL PERSONAL PROPERTY	SANDEE TRAVON EUGENE LAMONTE	5642 WABASH AVE	206694624	2018-2021	INDIVIDUAL PERSONAL PROPERTY	BAKER THOMAS MICHAEL	8101 ARLINGTON AVE
206683050	2017-2021	INDIVIDUAL PERSONAL PROPERTY	ROUDEBUSH STEVEN CURTIS & CANDICE MICHEL	10505 E 69TH ST	206694805	2020-2021	INDIVIDUAL PERSONAL PROPERTY	JIMENEZ SORIA NOEMII ALEJANDRA	7804 E 87TH ST
206683119	2017-2019	INDIVIDUAL PERSONAL PROPERTY	POCOCK JEREMY JOHN	10921 E 53RD ST	206695285	2018-2021	INDIVIDUAL PERSONAL PROPERTY	SOLOWMON CHRISTOPHER B	8129 WILLOW WAY
206683165	2018-2021	INDIVIDUAL PERSONAL PROPERTY	VORBECK HAILEY NOEL	8414 BOOTH AVE	206695489	2019-2021	INDIVIDUAL PERSONAL PROPERTY	DANIEL TAMON D	9916 E 85TH ST
206683218	2017-2021	INDIVIDUAL PERSONAL PROPERTY	COOK MILFORD WESLEY & DENEEN M	7725 CRESCENT AVE	206695533	2021	INDIVIDUAL PERSONAL PROPERTY	THOMPSON TOSHA N	8529 CRESCENT AVE
206683387	2020-2021	INDIVIDUAL PERSONAL PROPERTY	MACKLIN BRITTANY R	9947 E 61ST ST APT 2	206695708	2020	INDIVIDUAL PERSONAL PROPERTY	WILSON PAMELA	9900 E 59TH TER
206683819	2018-2019	INDIVIDUAL PERSONAL PROPERTY	ALLEN JESSICA D	5717 BLUE RIDGE BLVD	206695826	2019-2021	INDIVIDUAL PERSONAL PROPERTY	MITCHELL THERESA A	8919 E 67TH ST APT 228
206683825	2018	INDIVIDUAL PERSONAL PROPERTY	SUBLETT BRANDON-MICHAEL LEE	8617 W UTOPIA DR APT 37	206695932	2018	INDIVIDUAL PERSONAL PROPERTY	MADRID JESSICA RAY	6105 HUNTER ST
206683849	2020-2021	INDIVIDUAL PERSONAL PROPERTY	SHAW FELICIA M	8404 DITMAN AVE	206696004	2018-2021	INDIVIDUAL PERSONAL PROPERTY	FENTON BRIAN ORAN	5809 HEDGES AVE
206683905	2021	INDIVIDUAL PERSONAL PROPERTY	BAILEY CHENOA GABRIELLE	8047 COTTAGE CT	206696057	2018-2019	INDIVIDUAL PERSONAL PROPERTY	HAWS JOHN CHRISTOPHER S	11420 E 56TH TER
206684000	2019	INDIVIDUAL PERSONAL PROPERTY	MYRES DEMONT D	10023 E 67TH ST	206696084	2018-2020	INDIVIDUAL PERSONAL PROPERTY	ESTRADA GARDUNO DANIEL	9051 E 66TH ST
206684187	2021	INDIVIDUAL PERSONAL PROPERTY	FORD SHANDRIEKA MARIE (THOMAS)	11405 E 61ST TER	206696089	2021	INDIVIDUAL PERSONAL PROPERTY	ELLIS WALTERNE	6921 RAYTOWN RD
206684306	2020-2021	INDIVIDUAL PERSONAL PROPERTY	ELAM CASANDRA & JACOB	8213 KENTUCKY AVE	206696377	2020	INDIVIDUAL PERSONAL PROPERTY	AYADI FATIMA E	1311 VOLKER BLVD
206684416	2019-2021	INDIVIDUAL PERSONAL PROPERTY	BLADE ANGELA LINNETTE (HALL)	8505 ENGLEWOOD RD	206696490	2018-2021	INDIVIDUAL PERSONAL PROPERTY	GARRETT VICTOR UGENE	5517 HUNTER ST
206684536	2020-2021	INDIVIDUAL PERSONAL PROPERTY	CARPENTER NICHOLAS W & MARIAH M	5405 LAUREL AVE	206696883	2019-2021	INDIVIDUAL PERSONAL PROPERTY	EDWARDS METZIE M IV	6200 WOODSON RD
206684855	2019-2021	INDIVIDUAL PERSONAL PROPERTY	MELEY SHOEMAKER DEBORAH A	8513 OXFORD AVE	206697108	2020-2021	INDIVIDUAL PERSONAL PROPERTY	CLAWSON TIMOTHY A	6541 RAYTOWN RD APT 4
206685098	2018	INDIVIDUAL PERSONAL PROPERTY	PATILLO TIFFANY L	7418 WOODSON RD	206697442	2021	INDIVIDUAL PERSONAL PROPERTY	SWOPE GERI ANN	7222 RAYTOWN RD APT B
206685126	2020	INDIVIDUAL PERSONAL PROPERTY	JOHNSON DAVIS JONNAE DEANN	10604 E 53RD TER	206697560	2020-2021	INDIVIDUAL PERSONAL PROPERTY	IRONIS ANGELA J	8140 OXFORD AVE
206685395	2021	INDIVIDUAL PERSONAL PROPERTY	WILLIAMSON EDNA M	9809 E 61ST ST APT 6	206697673	2019	INDIVIDUAL PERSONAL PROPERTY	GOLD MICHELLE MCNABB	5516 HARDY AVE
206685448	2018	INDIVIDUAL PERSONAL PROPERTY	KEITH TIA	8310 GREENWOOD RD	206697943	2020-2021	INDIVIDUAL PERSONAL PROPERTY	LEE ARTORIA TAHISHA	9010 E 53RD TER UNIT A
206686201	2021	INDIVIDUAL PERSONAL PROPERTY	DAVIS MARKITA LYNN	7905 ARLINGTON AVE	206697947	2020-2021	INDIVIDUAL PERSONAL PROPERTY	KOELLIKER BREANNA D	9017 E 52ND TER
206686304	2021	INDIVIDUAL PERSONAL PROPERTY	SHARP KYMBUR ANN	6018 FARLEY AVE	206698016	2021	INDIVIDUAL PERSONAL PROPERTY	COX ABIGAIL ROBERTA	1140 E 60TH ST
206686560	2021	INDIVIDUAL PERSONAL PROPERTY	JOHNSON CHRISTOPHER DION	8700 TENNESSEE AVE	206698062	2019	INDIVIDUAL PERSONAL PROPERTY	CONRICK SYDNEY MARIE	7529 CRESCENT DR
206686705	2020-2021	INDIVIDUAL PERSONAL PROPERTY	LOCKE MELISSA ANN	5231 BLUE RIDGE BLVD	206698081	2021	INDIVIDUAL PERSONAL PROPERTY	BEITLING ALYSSA RENNE	10627 E 56TH ST
206686850	2020-2021	INDIVIDUAL PERSONAL PROPERTY	KIMBLE CLINTON	7308 MAYWOOD AVE	206698438	2021	INDIVIDUAL PERSONAL PROPERTY	CARTER DANIKA NICOLE	11504 E 62ND TER
206686858	2018	INDIVIDUAL PERSONAL PROPERTY	HOKI TAYLOR M	7114 EVANSTON AVE	206698517	2021	INDIVIDUAL PERSONAL PROPERTY	WOLFGHEER RICHARD D JR	9124 RICHARDS DR

206698570	2018-2021	INDIVIDUAL PERSONAL PROPERTY	HILLSTROM DEBORAH LYNN	9823 E 60TH ST	206711934	2019-2021	INDIVIDUAL PERSONAL PROPERTY	MILEY DAVID A	8124 APPLETON AVE
206698861	2018	INDIVIDUAL PERSONAL PROPERTY	SHEPPARD ZACHARY L	7509 ARLINGTON AVE	206711939	2019	INDIVIDUAL PERSONAL PROPERTY	GODDARD AUNDREA	7919 MANCHESTER AVE APT 10
206699323	2020-2021	INDIVIDUAL PERSONAL PROPERTY	POWELL AISHA LASHON	11700 E 77TH TER	206712057	2021	INDIVIDUAL PERSONAL PROPERTY	SCHANK CHRISTOPHER J	8612 GRANT DR
206699379	2021	INDIVIDUAL PERSONAL PROPERTY	LAMB MEGHAN S & AADAM M	6820 VERMONT AVE	206712732	2020-2021	INDIVIDUAL PERSONAL PROPERTY	WILLIAMS SHANTERIA NICOLE	8915 E 56TH TER
206699442	2018-2019	INDIVIDUAL PERSONAL PROPERTY	DOWDEN PATRIA PATRICE VENEIA	11821 E 83RD ST APT 101	206712896	2020-2021	INDIVIDUAL PERSONAL PROPERTY	STOCKDALE SWAN JAMAL	9112 E 85TH ST
206699934	2019	INDIVIDUAL PERSONAL PROPERTY	HARRIS NEIL PATRICK JR	7213 EASTERN AVE	206713260	2018-2020	INDIVIDUAL PERSONAL PROPERTY	BUNCH KEYONTAE ALEXANDER	5604 CRESCENT AVE
206699979	2020-2021	INDIVIDUAL PERSONAL PROPERTY	PIERCE HAZEL EVELYN	6423 STERLING AVE	206713541	2021	INDIVIDUAL PERSONAL PROPERTY	HAWKINS PATRICE YVETTE	9052 E 59TH ST
206700108	2021	INDIVIDUAL PERSONAL PROPERTY	HELMS IVANA KATHLEEN NOEL	8750 E 83RD ST	206713569	2018-2019	INDIVIDUAL PERSONAL PROPERTY	RIDDICK MYLO DEION JR	5920 WESTRIDGE RD
206700186	2020-2021	INDIVIDUAL PERSONAL PROPERTY	MOURNING NATHANIEL II	6020 STERLING AVE	206714024	2021	INDIVIDUAL PERSONAL PROPERTY	HARVEY WILLIAM JAMES	7005 HUNTER ST
206700533	2018	INDIVIDUAL PERSONAL PROPERTY	ROBINSON DONNIE	5302 DITZLER AVE	206714316	2019-2020	INDIVIDUAL PERSONAL PROPERTY	NICHOLLS CONNOR BERNARD RONGO	10504 E 59TH ST
206700814	2020	INDIVIDUAL PERSONAL PROPERTY	DIEDIKER TIMOTHY S	11708 E 77TH TER	206714811	2020-2021	INDIVIDUAL PERSONAL PROPERTY	CAPLES LEWIS JOSUE	8719 E 79TH TER
206701056	2020-2021	INDIVIDUAL PERSONAL PROPERTY	COPPAGE WALTER ALVA	8610 ARLINGTON AVE	206714926	2021	INDIVIDUAL PERSONAL PROPERTY	PAGE ELAINE ELIZABETH JR	9707 E 65TH ST
206701394	2018-2020	INDIVIDUAL PERSONAL PROPERTY	CAGLE PHILLIP ANTHONY	9919 E 63RD ST	206715046	2018	INDIVIDUAL PERSONAL PROPERTY	CARDON BENJAMIN S & MARIA D	8858 E 53RD RD
206701472	2021	INDIVIDUAL PERSONAL PROPERTY	CLARK FREDRICK L	5401 OXFORD AVE	206715300	2019	INDIVIDUAL PERSONAL PROPERTY	BERRY TYLER J	1700 SW MCARTHUR ST APT A
206701683	2021	INDIVIDUAL PERSONAL PROPERTY	CUNNINGHAM SIERRA RENEIA	10012 E 68TH TER	206715440	2019-2020	INDIVIDUAL PERSONAL PROPERTY	LOPEZ LUIS FERNANDO	6310 E RED BRIDGE RD
206701806	2018-2021	INDIVIDUAL PERSONAL PROPERTY	VALENTINE ALEXIA ADRIEAN N	9303 E 82ND TER	206715714	2020-2021	INDIVIDUAL PERSONAL PROPERTY	GARCIA ANDRES JESUS	8819 E 80TH TER
206701849	2021	INDIVIDUAL PERSONAL PROPERTY	BOOKER JAMAUN MORRIS	8500 STARK AVE	206715737	2018-2019	INDIVIDUAL PERSONAL PROPERTY	SONNER STEPHEN & DEBRA	8600 RIDGEWAY AVE
206701930	2021	INDIVIDUAL PERSONAL PROPERTY	WALKER MAIN MORGAN LINDZEE	4505 ELM AVE	206715765	2021	INDIVIDUAL PERSONAL PROPERTY	WARD LAKENBEAL	7239 CRISP AVE
206701961	2018-2021	INDIVIDUAL PERSONAL PROPERTY	DAVIS AARON BRETT	8301 STARK AVE	206716219	2020-2021	INDIVIDUAL PERSONAL PROPERTY	TARR EMMANUEL	8613 MAPLE AVE
206702169	2021	INDIVIDUAL PERSONAL PROPERTY	HERT MONTERRELL DAVID	10029 E 67TH ST	206716239	2021	INDIVIDUAL PERSONAL PROPERTY	NESSBIT KEVIN LAWRENCE	11008 E 74TH ST
206702489	2021	INDIVIDUAL PERSONAL PROPERTY	CULTER SAMANTHA JO	10805 E 65TH ST	206716331	2017-2018	INDIVIDUAL PERSONAL PROPERTY	GRECHUS JOSEPH AARON	7501 HAWTHORNE AVE
206702672	2018-2021	INDIVIDUAL PERSONAL PROPERTY	TOTTRESS BRIANNA	8313 E 85TH TER	206716884	2019	INDIVIDUAL PERSONAL PROPERTY	HELM DARYL LEE	5813 STERLING AVE
206702692	2021	INDIVIDUAL PERSONAL PROPERTY	DILLARD EZEKIEL DEWYONE	11005 E 74TH ST	206717160	2021	INDIVIDUAL PERSONAL PROPERTY	HENRY DIANE DENISE	9822 E 60TH ST
206703018	2020-2021	INDIVIDUAL PERSONAL PROPERTY	WILLIAMS GIOVANNI RICHARD	4014 S DELAWARE AVE	206717238	2019-2021	INDIVIDUAL PERSONAL PROPERTY	HARTMAN DUSTIN RAYMOND	7204 WOODSON DR
206703259	2018	INDIVIDUAL PERSONAL PROPERTY	WORTHAM WILLARD III	8712 E 85TH ST	206718028	2021	INDIVIDUAL PERSONAL PROPERTY	WILSON RACHAEL LADAWN	8514 BOOTH AVE
206703286	2021	INDIVIDUAL PERSONAL PROPERTY	WINGATE D'LEXIS LASHAUN	8308 E 85TH TER	206718159	2018-2019	INDIVIDUAL PERSONAL PROPERTY	CRISWELL BARBARA	8925 E 81ST ST
206703289	2019	INDIVIDUAL PERSONAL PROPERTY	WINGATE ANNOREA MARSHAUN	8308 E 85TH TER	206718236	2018	INDIVIDUAL PERSONAL PROPERTY	SMITH ENRIQUE & ROSALYN	7917 HARDY AVE
206703502	2021	INDIVIDUAL PERSONAL PROPERTY	MCDONALD TIMOTHY PAUL	9813 E 73RD ST APT D	206718275	2019	INDIVIDUAL PERSONAL PROPERTY	WILKINSON MARCUS JOHN	9604 E 69TH ST
206703725	2018-2019	INDIVIDUAL PERSONAL PROPERTY	SIMPSON KAYLEE CHEYENNE	7820 ARLINGTON AVE	206718289	2019-2021	INDIVIDUAL PERSONAL PROPERTY	SIMMONS ASHLEY LESHAE	5409 ASH AVE
206703915	2018-2021	INDIVIDUAL PERSONAL PROPERTY	ANDERSON STEPHEN A	9126 E 85TH ST	206718308	2019-2020	INDIVIDUAL PERSONAL PROPERTY	WHITE APRIL RENEE	10108 E 77TH TER
206703928	2021	INDIVIDUAL PERSONAL PROPERTY	MOON SUNDIATA ARTHUR	10101 E 74TH TER	206718490	2018	INDIVIDUAL PERSONAL PROPERTY	PICOLET AMY LYNN	8856 E 59TH TER
206704392	2018	INDIVIDUAL PERSONAL PROPERTY	DANIELY MICHAEL JOHN	10007 E 63RD ST	206718516	2020-2021	INDIVIDUAL PERSONAL PROPERTY	HENDERSON COMAL PERRY SR	8430 LANE PL
206704504	2021	INDIVIDUAL PERSONAL PROPERTY	HORN WILLIE PAUL JR & USA S	8900 NEWTON AVE APT 3115	206718585	2020-2021	INDIVIDUAL PERSONAL PROPERTY	HERNANDEZ KAREN TATIANA HERNANDEZ	9821 E 60TH ST
206704545	2017	INDIVIDUAL PERSONAL PROPERTY	CLARK JOHNNY DEAN JR	9904 E 60TH TER	206719033	2017	INDIVIDUAL PERSONAL PROPERTY	SMITH DEYON JR & SERENA	8750 E 59TH ST
206704753	2021	INDIVIDUAL PERSONAL PROPERTY	BELCHER-ALLEN TAMARA MICHELLE L	7042 WOODSON RD	206719116	2018-2019	INDIVIDUAL PERSONAL PROPERTY	AUSTIN MEGAN LYNN	5733 CEDAR AVE
206705051	2019-2021	INDIVIDUAL PERSONAL PROPERTY	HUMPHRESS HARLEY D R	9806 E 60TH ST	206719343	2021	INDIVIDUAL PERSONAL PROPERTY	MEINDERS SAMUEL TODD	7003 LAKESHORE DR
206705617	2018-2021	INDIVIDUAL PERSONAL PROPERTY	BELL MARKUS LARON	8608 ASH AVE	206719352	2017	INDIVIDUAL PERSONAL PROPERTY	GOMEZ LAUREN M	10000 CEDAR AVE
206705693	2018-2021	INDIVIDUAL PERSONAL PROPERTY	ZOELLERS ROBERT EUGENE	11301 E 62ND ST	206719818	2020-2021	INDIVIDUAL PERSONAL PROPERTY	LAIZURE JOHNNY L II & DAWN M	8119 HARRIS AVE
206705806	2018-2019	INDIVIDUAL PERSONAL PROPERTY	TOWNSEND MONIQUE	9803 E 61ST ST APT 10	206720247	2021	INDIVIDUAL PERSONAL PROPERTY	JONES JAMES E & DOROTHY H	8503 OVERTON DR
206705885	2019-2021	INDIVIDUAL PERSONAL PROPERTY	BATES BRANDON M	6300 HARRIS AVE	206720312	2020-2021	INDIVIDUAL PERSONAL PROPERTY	ROMANAS PETER JAMES	10509 E 81ST TER
206705950	2021	INDIVIDUAL PERSONAL PROPERTY	SOLOMON DEANDRE K & TIFFANY C (WRIGHT)	5604 HUNTER TER	206720376	2021	INDIVIDUAL PERSONAL PROPERTY	SIRETT ROBERT M	7312 APPLETON AVE
206706157	2018-2021	INDIVIDUAL PERSONAL PROPERTY	SMITH AALIYAH YASMEEN	8723 E 60TH TER	206720772	2021	INDIVIDUAL PERSONAL PROPERTY	GONZALEZ RAYMOND ANTHONY	8959 E 54TH ST
206706529	2021	INDIVIDUAL PERSONAL PROPERTY	CALLISON MARIA LOUISA	7935 HEDGES AVE	206720783	2021	INDIVIDUAL PERSONAL PROPERTY	LOPEZ MEDINA FERNANDO	9816 MANNING AVE
206706841	2017-2021	INDIVIDUAL PERSONAL PROPERTY	VANG GARY	7922 DITZLER AVE	206721317	2018-2019	INDIVIDUAL PERSONAL PROPERTY	KENNEDY ADAM RICHARD	8613 E GREGORY BLVD
206707007	2021	INDIVIDUAL PERSONAL PROPERTY	TAYLOR BIRAN ERIC JR	9904 E 60TH TER	206721380	2018-2021	INDIVIDUAL PERSONAL PROPERTY	HAWTHORNE SOLOMON BEN	9801 EVERETT ST
206707040	2018	INDIVIDUAL PERSONAL PROPERTY	WOJTWICA MERCEDES ANN	7509 ARLINGTON AVE	206721478	2021	INDIVIDUAL PERSONAL PROPERTY	GARRETT ZADA ANNE	5915 KENTUCKY AVE
206707065	2020-2021	INDIVIDUAL PERSONAL PROPERTY	BOYD SHERRY MICHELLE (FLOWERS)	11604 E 61ST TER	206721589	2017-2021	INDIVIDUAL PERSONAL PROPERTY	ALLEN JOHN D JR	7240 WOODSON RD
206707071	2018-2020	INDIVIDUAL PERSONAL PROPERTY	BURKS JONICE DASUJAN	7238 RAYTOWN RD APT C	206721771	2018	INDIVIDUAL PERSONAL PROPERTY	JONES JOCELYN MAURISE	7900 HEDGES AVE
206707072	2020-2021	INDIVIDUAL PERSONAL PROPERTY	JACKSON SUZANNE CAROLYNE	10105 E 56TH TER	206722132	2021	INDIVIDUAL PERSONAL PROPERTY	SEATON KATHLEEN	5725 ELM AVE
206707260	2021	INDIVIDUAL PERSONAL PROPERTY	GROPPER ZAKARY EKAN	8304 KENTUCKY AVE	206722170	2018-2021	INDIVIDUAL PERSONAL PROPERTY	BEAVER CAIN JUSTIN	7204 WILLOW AVE
206707435	2018-2021	INDIVIDUAL PERSONAL PROPERTY	BLEWETT NIVA SHANAE	10305 E 64TH ST	206722296	2018	INDIVIDUAL PERSONAL PROPERTY	WHITE RICHARD LEE JR	7913 ELM AVE
206707466	2021	INDIVIDUAL PERSONAL PROPERTY	MCKINNEY CHARLESIA T C	8510 FORD AVE	206722797	2018	INDIVIDUAL PERSONAL PROPERTY	BOX WILLIAM CLAYTON	7001 KENTUCKY AVE
206707901	2021	INDIVIDUAL PERSONAL PROPERTY	KLASSEN NICOLE LEE	8010 WILLOW WAY	206723029	2021	INDIVIDUAL PERSONAL PROPERTY	MORRIS ELIZABETH ANN	7431 OVERTON AVE UNIT 7
206708189	2017-2021	INDIVIDUAL PERSONAL PROPERTY	SHELL WANDA M & GREGORY A	6304 STERLING AVE	206723044	2021	INDIVIDUAL PERSONAL PROPERTY	SMITH MERCEDEE N	8236 WOODSON DR
206708541	2020	INDIVIDUAL PERSONAL PROPERTY	LEMUS GARCIA CARLOS A	8700 W LONGVIEW PKWY	206724236	2020-2021	INDIVIDUAL PERSONAL PROPERTY	POTTER NICHOLE MICHELLE	8416 MARSH AVE
206708544	2020-2021	INDIVIDUAL PERSONAL PROPERTY	BLEDSOE AERICKA VAE'JON	5936 STERLING AVE	206724297	2021	INDIVIDUAL PERSONAL PROPERTY	JONES SE AIRA SHA RON	10816 E 81ST TER
206708937	2018-2021	INDIVIDUAL PERSONAL PROPERTY	BAKER LUCAS BRANDON	11312 E 58TH ST	206724340	2019	INDIVIDUAL PERSONAL PROPERTY	SURRATT ANDREA MONETTE	11012 E 75TH ST
206708950	2021	INDIVIDUAL PERSONAL PROPERTY	WHEELER TIFFANY MICHELLE	8404 STARK AVE	206724557	2019-2021	INDIVIDUAL PERSONAL PROPERTY	MCINTYRE MICHAEL JAMES-ALBERT	9708 E 84TH ST
206709054	2018-2021	INDIVIDUAL PERSONAL PROPERTY	LONG TIFFANY RENEE	8604 FORD AVE	206724704	2020-2021	INDIVIDUAL PERSONAL PROPERTY	BAXLEY BRADEN S	10905 E 82ND ST
206709108	2020-2021	INDIVIDUAL PERSONAL PROPERTY	SMITH SAWYER N	8615 MARPLE AVE	206724870	2021	INDIVIDUAL PERSONAL PROPERTY	BRACHAK TYLAR A	7016 HUNTER ST
206709658	2020-2021	INDIVIDUAL PERSONAL PROPERTY	SAUNDERS-CLAY LAUREN T	8400 MARSH AVE	206725017	2019	INDIVIDUAL PERSONAL PROPERTY	JONES BAILEY PAGE	8606 OXFORD AVE
206709720	2021	INDIVIDUAL PERSONAL PROPERTY	GEORGE CHRISTOPHER MARTIN & PEGGY ANNETT	8315 PERSHING RD	206725209	2021	INDIVIDUAL PERSONAL PROPERTY	CHITWOOD NIKKI D	9420 E 67TH TER
206709961	2019-2021	INDIVIDUAL PERSONAL PROPERTY	TROYER MEGAN DAWN	7513 HAWTHORNE AVE	206725241	2021	INDIVIDUAL PERSONAL PROPERTY	ELLIS JORDWAUN BO	7709 RAYTOWN RD APT 20
206710002	2018-2021	INDIVIDUAL PERSONAL PROPERTY	MOSBY-SHEARD ARMONI LANAYA	9131 RICHARDS DR	206725615	2021	INDIVIDUAL PERSONAL PROPERTY	ROBISON NICHOLAS JAMES	8309 STARK AVE
206710246	2018	INDIVIDUAL PERSONAL PROPERTY	DUNN RONDALE A	9213 E 52ND TER	206725768	2018-2020	INDIVIDUAL PERSONAL PROPERTY	KERMER MELINDA RAE	8322 BOOTH AVE
206710281	2021	INDIVIDUAL PERSONAL PROPERTY	HILL MATTHEW ARLO	7320 CEDAR AVE	206725996	2018	INDIVIDUAL PERSONAL PROPERTY	WROTTEN SHELBY	10304 E 70TH TER
206710348	2018	INDIVIDUAL PERSONAL PROPERTY	CROCKER STEPHANIE MARIE	9110 E 85TH ST	206726258	2019-2021	INDIVIDUAL PERSONAL PROPERTY	HANSEN ROBERT ARNE	5900 RAYTOWN TFWY
206710589	2018-2019	INDIVIDUAL PERSONAL PROPERTY	ANDREWS DAVID CHRISTOPHER	1308 NE DEPOT DR	206726477	2020-2021	INDIVIDUAL PERSONAL PROPERTY	SOTO LUZ ESTHELA	10401 E 56TH ST
206710784	2018-2021	INDIVIDUAL PERSONAL PROPERTY	PHILLIPS DYLAN M	10004 E 63RD ST	206726695	2021	INDIVIDUAL PERSONAL PROPERTY	RAHM KATHERINE I	9600 E 65TH ST
206711221	2020-2021	INDIVIDUAL PERSONAL PROPERTY	MADRID DIAMOND DAKOTA	8811 E 52ND TER	206727107	2021	INDIVIDUAL PERSONAL PROPERTY	LUGENBEEL MICHAEL JAMES	8124 W UTAPIA DR APT 15
206711724	2020-2021	INDIVIDUAL PERSONAL PROPERTY	WASINGER BREANNE LARAE	5433 WILLOW AVE	206727286	2020-2021	INDIVIDUAL PERSONAL PROPERTY	HILL DEMARCUS LAMONTE	5322 HARDY AVE
206711932	2019-2021	INDIVIDUAL PERSONAL PROPERTY	MILEY ALICE ANNAMAY	8124 APPLETON AVE	206727377	2018-2021	INDIVIDUAL PERSONAL PROPERTY	JENKINS DOMINIQUE JERMON	8506 EVERETT ST

206727448	2018	INDIVIDUAL PERSONAL PROPERTY	SHARP ROBERT ERNEST JR	5508 HARVARD AVE	206739262	2021	INDIVIDUAL PERSONAL PROPERTY	CHAPMAN RYAN JOHN	8618 LANE AVE
206727690	2020-2021	INDIVIDUAL PERSONAL PROPERTY	MCMULLEN JULIAN ARMAN	10909 S 53RD ST	206739345	2020-2021	INDIVIDUAL PERSONAL PROPERTY	HAMPTON STEPHANIE	8806 STARK AVE
206727785	2021	INDIVIDUAL PERSONAL PROPERTY	ROBINSON JOHN PATRICK	8215 WILLOW WAY	206739606	2020-2021	INDIVIDUAL PERSONAL PROPERTY	THOMAS STACEY R II	8502 STARK AVE
206727925	2017-2019	INDIVIDUAL PERSONAL PROPERTY	GRIFFIN ALEXANDER AMER	10301 E 56TH ST	206739737	2019	INDIVIDUAL PERSONAL PROPERTY	MORRIS DEMOND MARCELLE	9704 E 79TH PL
206728251	2020-2021	INDIVIDUAL PERSONAL PROPERTY	SHANAHAN CRAIG MICHAEL	5425 APPLETON AVE	206739764	2019-2020	INDIVIDUAL PERSONAL PROPERTY	GIBBS MICHELLE RENEE	8915 E 74TH ST
206728521	2019	INDIVIDUAL PERSONAL PROPERTY	YOUNG STEPHANIE LYNNAE	8415 MARSH AVE	206739899	2021	INDIVIDUAL PERSONAL PROPERTY	MAYO-WARD ROBYN BROOKS & WARD DERRIK	11208 E 61ST ST
206728546	2021	INDIVIDUAL PERSONAL PROPERTY	PASHMAN DEBRA KAY	5229 CRISP AVE	206739982	2019	INDIVIDUAL PERSONAL PROPERTY	KIMBRO LAUREN MELISSA	6328 OVERTON AVE
206728794	2021	INDIVIDUAL PERSONAL PROPERTY	NASH CHANCE G	6121 LAUREL AVE	206740213	2019-2021	INDIVIDUAL PERSONAL PROPERTY	TAYLOR JUANITA M	8014 HARDY AVE
206728815	2021	INDIVIDUAL PERSONAL PROPERTY	KING MARTINA LASHAE	8717 E 61ST TER APT 15	206740290	2018-2021	INDIVIDUAL PERSONAL PROPERTY	CELLA MARC ANTHONY	9066 E 65TH TER
206728996	2018-2019	INDIVIDUAL PERSONAL PROPERTY	LONG TISHAWN	3230 TRACY AVE APT 15	206740407	2017-2018	INDIVIDUAL PERSONAL PROPERTY	PRATT JAONA BRESHAE	10408 E 64TH ST
206729243	2021	INDIVIDUAL PERSONAL PROPERTY	GANT ALEXIS ANTWON	11516 E 74TH STREET CT	206740600	2018	INDIVIDUAL PERSONAL PROPERTY	SMITH MARK ANTHONY	10100 E 83RD TER
206729416	2020	INDIVIDUAL PERSONAL PROPERTY	TURNER MARCUS	7708 ARLINGTON AVE	206740719	2021	INDIVIDUAL PERSONAL PROPERTY	DESLOUCHES GAUDINO & SHEBA M (STEPNAY)	9401 E 69TH ST
206729605	2019-2020	INDIVIDUAL PERSONAL PROPERTY	THON AROK	6535 RAYTOWN RD APT 2	206740723	2018-2019	INDIVIDUAL PERSONAL PROPERTY	PERKINS JUANITA E	5521 MANNING AVE
206729621	2018-2021	INDIVIDUAL PERSONAL PROPERTY	POWELL JACHELLE L	7320 CEDAR AVE	206740727	2021	INDIVIDUAL PERSONAL PROPERTY	BLEVINS DAKOTA L	9712 E 67TH TER
206730040	2018-2019	INDIVIDUAL PERSONAL PROPERTY	FINLEY LADIAMOND DANIELLE	8717 E 61ST TER APT 2	206740832	2021	INDIVIDUAL PERSONAL PROPERTY	PRICE JAMESHA RAVON	11833 E 83RD ST APT 102
206730209	2018	INDIVIDUAL PERSONAL PROPERTY	MILLER JACOB AUSTIN	10812 E 59TH ST	206740837	2021	INDIVIDUAL PERSONAL PROPERTY	COTTER MEGAN A	9062 E 67TH TER
206730909	2021	INDIVIDUAL PERSONAL PROPERTY	ROE LEAH ANN	9413 E 83RD ST	206740944	2021	INDIVIDUAL PERSONAL PROPERTY	COLLINS CHELSEA J & BROCKER SEAN M	11314 E 71ST DR
206730921	2021	INDIVIDUAL PERSONAL PROPERTY	WIDNER DAVID OWEN	5817 LAUREL AVE	206740945	2021	INDIVIDUAL PERSONAL PROPERTY	LOCKWOOD MEGAN AMBER	8812 E 72ND TER
206730984	2018-2021	INDIVIDUAL PERSONAL PROPERTY	RINCON MORENO KERLY CAROLINA (MURDOCK)	8207 E 86TH TER	206741236	2021	INDIVIDUAL PERSONAL PROPERTY	MESSINGER ELIJAH CHRISTIAN	9612 E 68TH ST
206731137	2021	INDIVIDUAL PERSONAL PROPERTY	TORAN SYDNEE JANA E	8618 E UTOPIA DR APT 55	206741335	2020	INDIVIDUAL PERSONAL PROPERTY	PAYNE CHARLES DANIEL JR	11516 E 74TH STREET CT
206731344	2018-2021	INDIVIDUAL PERSONAL PROPERTY	SMITH DEWAYNE LAVANCE	8222 WOODSON DR	206741418	2020	INDIVIDUAL PERSONAL PROPERTY	VIPOND HEATHER M	9220 E 54TH ST
206731398	2020	INDIVIDUAL PERSONAL PROPERTY	WRIGHT ANGEL	8446 LANE DR	206741482	2018-2021	INDIVIDUAL PERSONAL PROPERTY	WILLIAMS DARRON LAVELL	5732 LANE AVE
206731404	2020	INDIVIDUAL PERSONAL PROPERTY	EMANUEL KRYSHONNA	6621 MAYWOOD AVE	206741589	2018-2021	INDIVIDUAL PERSONAL PROPERTY	SMITH THELMA MAY	8904 E 83RD ST
206731732	2017-2019	INDIVIDUAL PERSONAL PROPERTY	STANIUNAS SARAH ELIZABETH	8404 MARSH AVE	206741752	2018	INDIVIDUAL PERSONAL PROPERTY	STARR DANIEL DEE JR	8310 LANE ST
206731862	2021	INDIVIDUAL PERSONAL PROPERTY	MCFERRIN JENNIFER	5524 HEDGES AVE	206742030	2018-2019	INDIVIDUAL PERSONAL PROPERTY	DRAKE CIERRA SHYANNE	9928 E 61ST ST
206732136	2018-2019	INDIVIDUAL PERSONAL PROPERTY	ROMERO MARTINEZ JULIO CESAR	9913 E 60TH TER	206742248	2021	INDIVIDUAL PERSONAL PROPERTY	SMITH SAMUEL JACOB	7170 MAPLE LN
206732137	2018	INDIVIDUAL PERSONAL PROPERTY	SWYGETR PRECIOUS LENCIA	6436 BLUE RIDGE BLVD	206742338	2020-2021	INDIVIDUAL PERSONAL PROPERTY	WILLIAMS MONAE BYRDELL	11804 E 76TH TER
206732257	2018-2021	INDIVIDUAL PERSONAL PROPERTY	LUTSJO ARACELI	9401 E 82ND TER	206742399	2020	INDIVIDUAL PERSONAL PROPERTY	BURNS CHRISTINA	11418 E 71ST ST
206732355	2020-2021	INDIVIDUAL PERSONAL PROPERTY	COTTRELL JOELLEN K	9708 BROOKLANE ST	206742503	2021	INDIVIDUAL PERSONAL PROPERTY	TREECE MELISA DAWN	8311 LAUREL AVE
206732517	2019-2021	INDIVIDUAL PERSONAL PROPERTY	POPEJOY CODY C	9716 E 84TH ST	206742604	2018	INDIVIDUAL PERSONAL PROPERTY	FERRARA CECILIA C	7032 LAKESHORE DR
206732699	2021	INDIVIDUAL PERSONAL PROPERTY	SEALS RUBBIE	10409 E 81ST TER	206743001	2018	INDIVIDUAL PERSONAL PROPERTY	CROFT MARGARET MARIE	5224 DITZLER AVE
206732921	2019	INDIVIDUAL PERSONAL PROPERTY	COSTA SHEA ANTONE	8637 E UTOPIA PKWY APT 3	206743008	2019-2021	INDIVIDUAL PERSONAL PROPERTY	TONCHUK ROBERT	5416 STERLING AVE
206732932	2021	INDIVIDUAL PERSONAL PROPERTY	DAVIS LATICIA EILEEN	5827 FALCON AVE	206743036	2019-2020	INDIVIDUAL PERSONAL PROPERTY	LEWIS ZAUCHEAUNA	8600 EVERETT ST
206733126	2021	INDIVIDUAL PERSONAL PROPERTY	HINKEL SCOTT THOMAS	7907 ELM AVE	206743149	2021	INDIVIDUAL PERSONAL PROPERTY	NEWMAN JACKIE N	9066 E 65TH TER
206733870	2019	INDIVIDUAL PERSONAL PROPERTY	CROW KELLI BRYNN	6700 CRISP AVE	206743380	2017-2018	INDIVIDUAL PERSONAL PROPERTY	CLIPPERTON GABRIELLA SIERA	8304 WOODSON DR
206733882	2019	INDIVIDUAL PERSONAL PROPERTY	REYNOLDS ERIN STARR	11111 E 85TH ST	206743554	2019	INDIVIDUAL PERSONAL PROPERTY	SMITH KYRAH LASHA	8829 E 85TH ST
206734253	2020-2021	INDIVIDUAL PERSONAL PROPERTY	AKINS BRIDGETTE MONIQUE	8310 STERLING AVE	206743578	2021	INDIVIDUAL PERSONAL PROPERTY	POPE JASMINE ANNETTE	7217 WOODSON RD
206734289	2021	INDIVIDUAL PERSONAL PROPERTY	HOUPT COREY ALLAN	7145 CRISP AVE	206743626	2021	INDIVIDUAL PERSONAL PROPERTY	GARMAN BRIANNA KAY	7905 APPLETON AVE
206734512	2018-2020	INDIVIDUAL PERSONAL PROPERTY	BATISTA ANDREW DAYON	9909 E 60TH TER	206743864	2018-2020	INDIVIDUAL PERSONAL PROPERTY	FLESCH DEVON CORTEZ	9915 E 60TH ST
206734707	2019-2021	INDIVIDUAL PERSONAL PROPERTY	BOZARTH JOEL C	8801 E 73RD ST	206743901	2020	INDIVIDUAL PERSONAL PROPERTY	SIMMONS ZAIBUNISSA ZEBBIE	8811 E 84TH ST
206734805	2021	INDIVIDUAL PERSONAL PROPERTY	SOLOMON BERNARD ELDON	9210 E 53RD TER	206743946	2020-2021	INDIVIDUAL PERSONAL PROPERTY	BROWN LEE EDWARD JR	8632 E UTOPIA PKWY APT 12
206735198	2021	INDIVIDUAL PERSONAL PROPERTY	POWERS ABRIANNA RAIGH	9109 E 67TH TER	206743971	2021	INDIVIDUAL PERSONAL PROPERTY	VICTORY COLIN J	7808 E 87TH ST
206735256	2018	INDIVIDUAL PERSONAL PROPERTY	CARREON KEVIN D	9240 E 55TH ST	206744168	2019	INDIVIDUAL PERSONAL PROPERTY	WRIGHT EDDIE JR	11315 HERRICK AVE
206735373	2021	INDIVIDUAL PERSONAL PROPERTY	JONES TAYLOR JAY	11209 E 64TH ST	206744239	2019	INDIVIDUAL PERSONAL PROPERTY	MILLER JEFFERY A	8605 MAPLE AVE
206735390	2020-2021	INDIVIDUAL PERSONAL PROPERTY	ELLIS MYLES ANDERSON	8113 WOODSON DR	206744504	2018-2020	INDIVIDUAL PERSONAL PROPERTY	MASSIE ARAYA HOPE B	9804 E 77TH TER
206735579	2021	INDIVIDUAL PERSONAL PROPERTY	WEINZATL DEREK AUSTIN	7427 OVERTON AVE UNIT 3	206744671	2018	INDIVIDUAL PERSONAL PROPERTY	OLIVER STEPHANIE DENISE	9805 E 61ST ST APT 12
206735899	2021	INDIVIDUAL PERSONAL PROPERTY	CASTANEDA JACOB EDWARD	7515 ARLINGTON AVE	206744901	2019-2021	INDIVIDUAL PERSONAL PROPERTY	TIEMEYER CHANDLER ANN	10204 E 70TH TER
206735983	2018-2019	INDIVIDUAL PERSONAL PROPERTY	AUNE KAREN KAY	5804 ARLINGTON AVE	206745039	2018	INDIVIDUAL PERSONAL PROPERTY	ANGUANO TIMOTHY ANDREW	7411 ELM ST
206735988	2018	INDIVIDUAL PERSONAL PROPERTY	HOLMES DAVID ANTHONY	5741 STERLING AVE	206745142	2021	INDIVIDUAL PERSONAL PROPERTY	COLLINS SUSAN RENE	5448 ASH AVE
206736023	2020-2021	INDIVIDUAL PERSONAL PROPERTY	PRAKSHAK DANIEL JAMES	9712 E 84TH ST	206745311	2021	INDIVIDUAL PERSONAL PROPERTY	LONG ANTONIO MAURICE MONROE	8604 FORD AVE
206736117	2021	INDIVIDUAL PERSONAL PROPERTY	MCMINN JON COLLIN HARRIS	11003 E 53RD ST	206745566	2021	INDIVIDUAL PERSONAL PROPERTY	DAILY LYNN F	6012 HEDGES AVE
206736205	2021	INDIVIDUAL PERSONAL PROPERTY	PETERSON VERN R II	11112 E 74TH ST	206745741	2021	INDIVIDUAL PERSONAL PROPERTY	ROBERTS PAUL V JR	7224 STERLING AVE
206736283	2017	INDIVIDUAL PERSONAL PROPERTY	HILAVATY ANGELA NICOLE	7611 CRESCENT DR	206745860	2018-2019	INDIVIDUAL PERSONAL PROPERTY	HERMAN CUSTIER	6703 APPLETON AVE
206736304	2018-2020	INDIVIDUAL PERSONAL PROPERTY	WILBURN KENNETH ALLEN	8609 MARPLE AVE	206745929	2018-2019	INDIVIDUAL PERSONAL PROPERTY	OGLTREE JARON	0218 RAYTOWN RD APT D
206736305	2021	INDIVIDUAL PERSONAL PROPERTY	STEWART DAVID LEE	5419 WOODSON RD	206745972	2018-2021	INDIVIDUAL PERSONAL PROPERTY	ROMAN JONATHAN LEROI	6000 NORTHERN AVE
206736374	2021	INDIVIDUAL PERSONAL PROPERTY	JONES KEELAN R	7205 KALSTON AVE	206746065	2018-2021	INDIVIDUAL PERSONAL PROPERTY	NELSON TYRIN TAYLOR	7046 LAKESHORE DR
206736405	2021	INDIVIDUAL PERSONAL PROPERTY	ROY ALISON ELIZABETH	7823 VASSAR AVE	206746069	2021	INDIVIDUAL PERSONAL PROPERTY	WILLIAMS KENYA SYMONE	9912 E 60TH ST
206736458	2020-2021	INDIVIDUAL PERSONAL PROPERTY	MEEKES QUIANNA DESHON	9903 E 60TH ST	206746163	2021	INDIVIDUAL PERSONAL PROPERTY	FRENDEL KELSEY MARIE	8309 STARK AVE
206736463	2018-2020	INDIVIDUAL PERSONAL PROPERTY	RICHARDSON RAKIAH D	10405 E 78TH TER	206746326	2018	INDIVIDUAL PERSONAL PROPERTY	FOSTER BRANDY NICOLE	8474 LANE DR
206736537	2018	INDIVIDUAL PERSONAL PROPERTY	CARAWAY TONI SHALON	8800 E 73RD TER	206746333	2018	INDIVIDUAL PERSONAL PROPERTY	DECK CODY JAMES	8427 JAMES A REED RD
206736570	2018-2021	INDIVIDUAL PERSONAL PROPERTY	EVERSON DEDRA R	10335 E 61ST ST APT 3	206746753	2021	INDIVIDUAL PERSONAL PROPERTY	PUGH DAVID MICHAEL	7806 RAYTOWN RD
206736665	2021	INDIVIDUAL PERSONAL PROPERTY	RANDLE TERRY T & HOLLY A	11810 E 75TH ST	206769035	2018	INDIVIDUAL PERSONAL PROPERTY	MITCHELL BRITTANY	5928 LAUREL AVE
206736998	2021	INDIVIDUAL PERSONAL PROPERTY	SCHRADER KYLIE ELIZABETH	8409 NORTHERN ST	206769061	2018-2019	INDIVIDUAL PERSONAL PROPERTY	HENDERSON DENISE	8806 E 73RD ST
206737185	2019	INDIVIDUAL PERSONAL PROPERTY	BRYANT JOHN LORNN	9104 E 82ND ST	206769371	2021	INDIVIDUAL PERSONAL PROPERTY	YANG SANDY	5202 BLUE RIDGE BLVD
206737401	2019-2021	INDIVIDUAL PERSONAL PROPERTY	BLACKMON LAWRENCE CHRISTOPHER	8009 APPLETON AVE	206769387	2019-2020	INDIVIDUAL PERSONAL PROPERTY	KIDWELL AMBER M (FRANCIS)	10212 E 71ST TER
206737762	2020-2021	INDIVIDUAL PERSONAL PROPERTY	TAYLOR JASMINE RAE	10100 E 83RD ST	206769786	2018-2019	INDIVIDUAL PERSONAL PROPERTY	THOMPSON KENYISHA MICHELLE	6201 KENTUCKY AVE
206738323	2019-2021	INDIVIDUAL PERSONAL PROPERTY	AUTHORLEE WILLIAM JAY	11804 E 78TH PL	206769943	2018	INDIVIDUAL PERSONAL PROPERTY	SILVEY JEFFREY C & HANNAH M	6148 ELM AVE
206738531	2021	INDIVIDUAL PERSONAL PROPERTY	HUGHES DOMINIQUE EBONY	8416 WOODSON DR	206770008	2019-2021	INDIVIDUAL PERSONAL PROPERTY	GORENCE RANDY DUANE	11105 E 57TH ST
206738697	2018-2019	INDIVIDUAL PERSONAL PROPERTY	BYERS DERRON T & THOMAS BIANCA O	11206 CORRINGTON AVE	206770107	2020-2021	INDIVIDUAL PERSONAL PROPERTY	DIHEL ARIANA L	8713 E 85TH ST
206739110	2019	INDIVIDUAL PERSONAL PROPERTY	LEMMER ADAM	818 SE 13TH TER	206770272	2018-2019	INDIVIDUAL PERSONAL PROPERTY	WOLKEN HAYLEY RENEE	10005 E 71ST TER
206739201	2021	INDIVIDUAL PERSONAL PROPERTY	JORDAN BREAUINNA DNAME	627 SW SHADOW GLEN DR	206770734	2019-2020	INDIVIDUAL PERSONAL PROPERTY	LEONE JENNIFER	7033 ARLINGTON AVE
206739230	2018-2020	INDIVIDUAL PERSONAL PROPERTY	LAY MARK TYLER	9415 E 67TH TER	206771086	2018	INDIVIDUAL PERSONAL PROPERTY	PENNINGTON DUSTIN	7429 ENGLEWOOD LN

206771124	2021	INDIVIDUAL PERSONAL PROPERTY	MAPLES CINDY ANN	8601 WESTRIDGE RD	207141760	2019	INDIVIDUAL PERSONAL PROPERTY	PICKENS DELRON MONTREZ	5428 WILLOW AVE
206771498	2019-2021	INDIVIDUAL PERSONAL PROPERTY	TUCKER RIDGE THERAN	11501 E 78TH TER	207141877	2021	INDIVIDUAL PERSONAL PROPERTY	BERRYMAN BRITNEY RENAE	900 E 73RD ST
206771533	2021	INDIVIDUAL PERSONAL PROPERTY	REDMER BOBBY J & BARBARA ANN	10512 E 56TH ST	207141910	2020-2021	INDIVIDUAL PERSONAL PROPERTY	SMITH CHRISTOPHER LEE	10709 E 66TH ST
206771642	2021	INDIVIDUAL PERSONAL PROPERTY	MUNOZ JIMENEZ CHRISTINA P	8436 EVANSTON AVE	207142072	2019-2021	INDIVIDUAL PERSONAL PROPERTY	SMART MARIAH CAPRICE	12001 E 78TH TER
206771944	2020-2021	INDIVIDUAL PERSONAL PROPERTY	DESHAZER CHLOE DIANNE	10007 E 77TH TER	207142086	2021	INDIVIDUAL PERSONAL PROPERTY	BOYD MONEISHA DAVENE	8618 OXFORD AVE
206772428	2018-2020	INDIVIDUAL PERSONAL PROPERTY	WANMER PENNY JEANENE	8316 DITZLER AVE	207142596	2020-2021	INDIVIDUAL PERSONAL PROPERTY	NOVAK JORDAN J	9054 E 59TH ST
206772440	2020-2021	INDIVIDUAL PERSONAL PROPERTY	LEWIS LAMAR S	8409 JAMES A REED RD	207142661	2019-2021	INDIVIDUAL PERSONAL PROPERTY	JONES BRIAN E	5537 HUNTER TER
206772726	2019	INDIVIDUAL PERSONAL PROPERTY	GREVE CHRISTOPHER GENE	10807 E 75TH ST	207143164	2021	INDIVIDUAL PERSONAL PROPERTY	ROSS TERENCE E & NOLA J	8808 RICHARDS DR
206773009	2019-2020	INDIVIDUAL PERSONAL PROPERTY	HUSSEY BENJAMIN T	8820 E 54TH ST	207143177	2019-2021	INDIVIDUAL PERSONAL PROPERTY	BAILEY DARRELL LAMONT JR	8108 RAYTOWN RD
207127818	2021	INDIVIDUAL PERSONAL PROPERTY	CLARK ROBERT JORDAN	5572 BLUE RIDGE BLVD	207143188	2021	INDIVIDUAL PERSONAL PROPERTY	COX JABRIL ABDUL-MALIK	9505 E 83RD ST
207128074	2021	INDIVIDUAL PERSONAL PROPERTY	ROBERTS HAYDEN THOMAS	10013 E 86TH TER	207143312	2020-2021	INDIVIDUAL PERSONAL PROPERTY	BEASLEY SUSAN MICHELE	5413 MAYWOOD AVE
207128163	2021	INDIVIDUAL PERSONAL PROPERTY	COOPER MCKAELA MICHELLE	11101 E 71ST TER	207143596	2021	INDIVIDUAL PERSONAL PROPERTY	POEHL GERRI ANNA	6007 HUNTER ST
207128320	2020	INDIVIDUAL PERSONAL PROPERTY	FRAZIER KERISSA JENELL	10600 E 66TH ST	207144023	2019	INDIVIDUAL PERSONAL PROPERTY	FINES ZACHARY MICHAEL	8508 FORD AVE
207128463	2021	INDIVIDUAL PERSONAL PROPERTY	SHICK BETH K & RAY B	8515 HARVARD TER	207144234	2019-2021	INDIVIDUAL PERSONAL PROPERTY	HAYWOOD DALSHAQNN LAREE	9355 E 60TH TER
207129355	2018-2020	INDIVIDUAL PERSONAL PROPERTY	GAMMAGE TAJAI RASHAD	8014 HARDY AVE	207144237	2021	INDIVIDUAL PERSONAL PROPERTY	BARTON THOMAS L JR	5718 STERLING AVE
207129475	2021	INDIVIDUAL PERSONAL PROPERTY	FARROW DAVANTE JAMAL	7715 RAYTOWN RD APT 33	207144696	2019	INDIVIDUAL PERSONAL PROPERTY	BARBER JONATHAN LUKE	6716 CRISP AVE
207129544	2021	INDIVIDUAL PERSONAL PROPERTY	FITZPATRICK NICHOLAS CONRAD	10614 E 70TH TER	207144703	2017-2019	INDIVIDUAL PERSONAL PROPERTY	WILLIAMS LATUERRA MON'AE	6019 FARLEY AVE
207129966	2019-2021	INDIVIDUAL PERSONAL PROPERTY	MCQUIRE AUSTIN PADRAIG	7910 SPRING VALLEY RD	207144870	2020-2021	INDIVIDUAL PERSONAL PROPERTY	JOPLIN ISAJAH THOMAS	7701 RAYTOWN RD APT 23
207130221	2018	INDIVIDUAL PERSONAL PROPERTY	WILLIAMS LACRETIA	11803 E 83RD ST APT 202	207145660	2019	INDIVIDUAL PERSONAL PROPERTY	HUTCHINSON BRUCE THOMAS	2412 BLUE RIDGE BLVD
207130236	2018	INDIVIDUAL PERSONAL PROPERTY	BUTLER LEGACY	11817 E 83RD ST APT 102	207145870	2019	INDIVIDUAL PERSONAL PROPERTY	DODSON JORDAN ANTHONY	6424 LANE AVE
207130359	2019-2021	INDIVIDUAL PERSONAL PROPERTY	GICINTO DOMINIC R	5836 BLUE RIDGE BLVD	207145872	2021	INDIVIDUAL PERSONAL PROPERTY	KIRK SEAN A	3493 WYOMING ST UNIT B
207130394	2021	INDIVIDUAL PERSONAL PROPERTY	KATZ REGAN EMILY MARY	980 E GREGORY BLVD	207146241	2018-2021	INDIVIDUAL PERSONAL PROPERTY	ALLRED BOBBI JO	8535 GRANT DR
207130438	2021	INDIVIDUAL PERSONAL PROPERTY	BRIDGEWATER CHERYL KAY	6310 NORWOOD CT	207146634	2019	INDIVIDUAL PERSONAL PROPERTY	MURRAY CHESNEY MARIE	9904 E 84TH ST
207131518	2019	INDIVIDUAL PERSONAL PROPERTY	HENDERSON CAMONTE P	8430 LANE PL	207146679	2018-2021	INDIVIDUAL PERSONAL PROPERTY	BRIGHT STEPHEN EUGENE	11809 E 78TH PL
207131792	2021	INDIVIDUAL PERSONAL PROPERTY	HOLMES DARIAN MARCELLUS	7815 WOODSON RD	207146683	2021	INDIVIDUAL PERSONAL PROPERTY	ROBERTS SARAH ELIZABETH	10311 E 78TH ST
207131887	2019	INDIVIDUAL PERSONAL PROPERTY	MORTON BARRY	10811 E M 350 HWY	207146774	2021	INDIVIDUAL PERSONAL PROPERTY	ROMERO SONIA IBEL	9014 E 77TH TER
207131932	2021	INDIVIDUAL PERSONAL PROPERTY	GREENLEE MEGAN L	5401 STERLING AVE	207146931	2019-2021	INDIVIDUAL PERSONAL PROPERTY	BRINSON TERESA RENEE	9901 E 74TH TER
207132020	2019	INDIVIDUAL PERSONAL PROPERTY	STONE GERRAN DEANGEULIQUE	5820 FARLEY AVE	207147196	2020-2021	INDIVIDUAL PERSONAL PROPERTY	HARDY CLIFFORD EUGENE	5928 LAUREL AVE
207132110	2021	INDIVIDUAL PERSONAL PROPERTY	VARELA TESLA EDITH	5416 RAYTOWN RD	207147207	2020-2021	INDIVIDUAL PERSONAL PROPERTY	FRANKLIN MARIAH MARSHAY	7808 E 87TH ST
207132145	2021	INDIVIDUAL PERSONAL PROPERTY	BROOKS DOMINIC SEBASTIAN	7502 HAWTHORNE AVE	207147233	2019	INDIVIDUAL PERSONAL PROPERTY	MITCHELL BRITTANY RENEE	9100 E 74TH TER
207132968	2021	INDIVIDUAL PERSONAL PROPERTY	HARRIS TOYE A	8521 DITZLER AVE	207147427	2021	INDIVIDUAL PERSONAL PROPERTY	GRANT DIANE ATLENE	7719 VAUGHN AVE
207133688	2020-2021	INDIVIDUAL PERSONAL PROPERTY	WHEATLEY GARRY DEAN	11309 E 67TH TER	207147573	2020-2021	INDIVIDUAL PERSONAL PROPERTY	PAUL TRISTAN DAY	9705 E GREGORY BLVD
207133691	2019	INDIVIDUAL PERSONAL PROPERTY	EHRlich JASON S	7314 RALSTON AVE	207147599	2021	INDIVIDUAL PERSONAL PROPERTY	BINION DANIELLE DENISE	8009 APPLETON AVE
207133848	2019-2020	INDIVIDUAL PERSONAL PROPERTY	LANDRUM NATASHA LEIGH	8404 E 85TH TER	207147632	2021	INDIVIDUAL PERSONAL PROPERTY	AMRINE VICTORIA MICHELLE	7816 WOODSON RD
207134057	2018-2019	INDIVIDUAL PERSONAL PROPERTY	JACKSON THOMAS E	6037 SOUTH BENTON AVE	207147789	2020-2021	INDIVIDUAL PERSONAL PROPERTY	GAROZZO GENO ANTHONY	8509 STERLING AVE
207134108	2021	INDIVIDUAL PERSONAL PROPERTY	DYER DAVID MICHAEL	10009 E 78TH ST	207147886	2021	INDIVIDUAL PERSONAL PROPERTY	WOODWARD SHELBY D	9219 VAUGHN AVE
207134597	2021	INDIVIDUAL PERSONAL PROPERTY	BORDERS NATHANIAL DAVID	8832 E 57TH ST	207147904	2021	INDIVIDUAL PERSONAL PROPERTY	SIMMERSON SEAN JUSTIN	7716 ENGLEWOOD AVE
207134694	2018	INDIVIDUAL PERSONAL PROPERTY	TURNER SYDNI RENEE	6305 FARLEY AVE	207147996	2021	INDIVIDUAL PERSONAL PROPERTY	CASTILLO MURCIA MARIA DE JESUS	8316 MANNING AVE
207135408	2019-2021	INDIVIDUAL PERSONAL PROPERTY	FOSTER JEROME JR	6048 LAUREL AVE	207148049	2021	INDIVIDUAL PERSONAL PROPERTY	ALLRED JESSICA MARIE	7713 RAYTOWN RD APT 13
207135567	2018-2021	INDIVIDUAL PERSONAL PROPERTY	FLEMMING SHARON LYNN	6800 LANE AVE	207148271	2021	INDIVIDUAL PERSONAL PROPERTY	PHILLIPS BRIANNA NICOLE	5534 HUNTER ST
207135763	2021	INDIVIDUAL PERSONAL PROPERTY	COX KELSEY ANN	9108 E 58TH TER	207148315	2019-2021	INDIVIDUAL PERSONAL PROPERTY	GARDNER DEBRA ANN	9710 E 75TH ST
207136100	2018	INDIVIDUAL PERSONAL PROPERTY	SINGLETON JACOB BRIAN	9000 E 58TH ST	207148393	2021	INDIVIDUAL PERSONAL PROPERTY	VALDES JIMMY	8010 EVANSTON AVE
207136105	2021	INDIVIDUAL PERSONAL PROPERTY	ALLEN DELEAH JAKHARI MONIQUE	5703 E 96TH PL APT 207	207148820	2021	INDIVIDUAL PERSONAL PROPERTY	BARTLETT HEATHER K (BLASCHE)	5716 RIDGEVIEW AVE
207136115	2019-2021	INDIVIDUAL PERSONAL PROPERTY	JACKSON EBED-MELECH	8214 WOODSON DR	207148967	2021	INDIVIDUAL PERSONAL PROPERTY	HAMPTON BRYNDAN EDWIN LEE	11005 E 53RD TER
207136240	2018-2021	INDIVIDUAL PERSONAL PROPERTY	MILLER DARRELL	8010 ELM AVE	207149097	2020-2021	INDIVIDUAL PERSONAL PROPERTY	PICKINGS SANTHONY J	6009 OXFORD AVE
207136379	2019-2021	INDIVIDUAL PERSONAL PROPERTY	VEAL KYLA TAIRA ELAINE	11108 E 57TH TER	207149389	2019	INDIVIDUAL PERSONAL PROPERTY	WOLF BREANA DAYZANIQUE	8301 ELM AVE
207136895	2019-2021	INDIVIDUAL PERSONAL PROPERTY	MARSHALL LAURA SMOUELLA	8637 E UTOPIA PKWY APT 8	207149428	2019-2021	INDIVIDUAL PERSONAL PROPERTY	WHITEHEAD KRISTINA C	9103 E 72ND TER
207136901	2020-2021	INDIVIDUAL PERSONAL PROPERTY	THOMAS DARIUS LEUJAN	10621 E 65TH ST	207149595	2018-2021	INDIVIDUAL PERSONAL PROPERTY	RAMIREZ RUTH NOEMI	8509 E 81ST ST
207137075	2020-2021	INDIVIDUAL PERSONAL PROPERTY	MARTINEZ SUSAN STEPHANIE	11001 E 72ND ST	207149754	2020-2021	INDIVIDUAL PERSONAL PROPERTY	CHAVEZ JAZMIN	14530 E BANNISTER RD
207137429	2020-2021	INDIVIDUAL PERSONAL PROPERTY	MANNING DANIELLE LEIGH	8101 ARLINGTON AVE	207149935	2020-2021	INDIVIDUAL PERSONAL PROPERTY	MIDDLEBROOKS JEROME QUINTON 2ND	9031 E 85TH TER
207137459	2019	INDIVIDUAL PERSONAL PROPERTY	HUMPHREY TERRI	5316 NORTHERN AVE	207150075	2021	INDIVIDUAL PERSONAL PROPERTY	REED ELIZABETH ANNIE & KALEB CHASE	9425 E 67TH TER
207137470	2019-2021	INDIVIDUAL PERSONAL PROPERTY	WALLACE CRISTINA M	6611 OVERTON AVE	207150343	2020	INDIVIDUAL PERSONAL PROPERTY	HARPER RACHEL CHRISTINE	8811 RICHARDS DR
207138081	2018-2021	INDIVIDUAL PERSONAL PROPERTY	COX JALIAH	9400 E 83RD ST	207150345	2018-2019	INDIVIDUAL PERSONAL PROPERTY	DORRELL TAVIA C	10137 E 80TH ST
207138089	2018-2021	INDIVIDUAL PERSONAL PROPERTY	COX JAMAAL ABDUL-MALIK	9505 E 83RD ST	207150377	2020-2021	INDIVIDUAL PERSONAL PROPERTY	SWANSON TESSA ELIZABETH	10701 E 62ND TER
207138131	2021	INDIVIDUAL PERSONAL PROPERTY	NEWELL MELISSA	6401 HEDGES AVE	207150388	2019-2021	INDIVIDUAL PERSONAL PROPERTY	DICKERSON GABRIELLA LIZABETH	6205 LANE AVE
207138355	2021	INDIVIDUAL PERSONAL PROPERTY	BLAND MARQUISE LAMAR	8216 E 85TH TER	207150394	2020	INDIVIDUAL PERSONAL PROPERTY	NELSON ARTHUR BRIAN	6501 HARRIS AVE
207138403	2021	INDIVIDUAL PERSONAL PROPERTY	JONES CHRISTINA ELAINE	7504 OVERTON AVE	207150453	2020-2021	INDIVIDUAL PERSONAL PROPERTY	CRAIG-WALKER VOLANAE BRITAE	7230 RAYTOWN RD APT D
207139046	2019	INDIVIDUAL PERSONAL PROPERTY	GARCIA JOSHUA LEE	7612 ELM ST	207150459	2021	INDIVIDUAL PERSONAL PROPERTY	BEGGS TERRI LYNN	9359 E 60TH TER
207139347	2021	INDIVIDUAL PERSONAL PROPERTY	MCGREW AUDRY ANN	9608 E 66TH ST	207150570	2019-2021	INDIVIDUAL PERSONAL PROPERTY	MCKNIGHT SARAH ELIZABETH	6821 LAKESHORE DR
207139520	2019	INDIVIDUAL PERSONAL PROPERTY	ALLEN LESTER E	8605 ARLINGTON AVE	207150701	2018-2021	INDIVIDUAL PERSONAL PROPERTY	MARTIN TERRIONE JOYLN	8531 VASSAR AVE
207139732	2019-2021	INDIVIDUAL PERSONAL PROPERTY	KUHN DYMOND MONIQUE	6212 RALSTON AVE	207150712	2021	INDIVIDUAL PERSONAL PROPERTY	MORALES CASTILLO SINDY CECILIA	7800 E 87TH ST
207139779	2020-2021	INDIVIDUAL PERSONAL PROPERTY	HARRIS AMANDA NICOLE	8903 E 74TH ST	207150858	2019	INDIVIDUAL PERSONAL PROPERTY	TRAMMELL TONI L	9107 E 68TH TER
207139794	2021	INDIVIDUAL PERSONAL PROPERTY	LACY SARAH ANN	9000 E 57TH TER	207151168	2021	INDIVIDUAL PERSONAL PROPERTY	EDLIN LINNEA MARIE	7905 HARDY AVE
207139816	2021	INDIVIDUAL PERSONAL PROPERTY	HEDGES KALEB SCOTT	9904 E 81ST ST	207151437	2019	INDIVIDUAL PERSONAL PROPERTY	LEE ARTHUR CELESTAN JR	7425 ENGLEWOOD LN
207140201	2020-2021	INDIVIDUAL PERSONAL PROPERTY	HAMPTON SHANNON NICOLE	10908 E 56TH TER	207151705	2021	INDIVIDUAL PERSONAL PROPERTY	HAYNES JOHN BRADFORD	7401 DITZLER AVE
207140290	2019-2021	INDIVIDUAL PERSONAL PROPERTY	MARTIN JAMES EDWARD JR	8531 VASSAR AVE	207151859	2020-2021	INDIVIDUAL PERSONAL PROPERTY	SMITH ANGELA MARIE	10009 E 56TH TER
207140474	2019	INDIVIDUAL PERSONAL PROPERTY	WALKER DYSHAMEL DEZIJON	8620 E UTOPIA DR	207151963	2019-2021	INDIVIDUAL PERSONAL PROPERTY	IYEWARUN ABAYOMI DEJI	11105 E 73RD ST
207140719	2020-2021	INDIVIDUAL PERSONAL PROPERTY	BATTS BRIDGETTE DENISE	8717 E 61ST TER APT 12	207152385	2021	INDIVIDUAL PERSONAL PROPERTY	KEPLER STEVEN JAY JR	7704 HARRIS AVE
207141187	2019	INDIVIDUAL PERSONAL PROPERTY	DOTSON CHRISTOPHER J	6712 HARRIS AVE	207152462	2021	INDIVIDUAL PERSONAL PROPERTY	MCNEAL THEODORE E	6009 CLAREMONT AVE
207141483	2019	INDIVIDUAL PERSONAL PROPERTY	BROWN DEE ANN	7021 HUNTER ST	207152487	2019	INDIVIDUAL PERSONAL PROPERTY	SCHMIDT JAY CHRISTOPHER	5413 MAYWOOD AVE
207141529	2021	INDIVIDUAL PERSONAL PROPERTY	MATTOX JONEL MARI	7200 ASH AVE	207152754	2021	INDIVIDUAL PERSONAL PROPERTY	BUTLER BRIANA NICHOLE	6013 E 84TH ST
207141660	2020-2021	INDIVIDUAL PERSONAL PROPERTY	MEYER MARK A	5521 HEDGES AVE	207152850	2020-2021	INDIVIDUAL PERSONAL PROPERTY	KERR BRANDI NICOLLE	6645 CEDAR AVE APT A

2017152941	2019	INDIVIDUAL PERSONAL PROPERTY	COWAN PHILLIP A	9016 E 59TH ST	2017167126	2021	INDIVIDUAL PERSONAL PROPERTY	RELAFORD GABRIEL K	10609 E 64TH TER
2017152986	2021	INDIVIDUAL PERSONAL PROPERTY	PEW CECIL W	6012 STERLING AVE	2017167237	2019-2021	INDIVIDUAL PERSONAL PROPERTY	EVANS KHALILAH IMAN	11126 E 84TH TER
2017153256	2019	INDIVIDUAL PERSONAL PROPERTY	DICKEY RASHONDA	8809 E 61ST TER	2017167340	2020-2021	INDIVIDUAL PERSONAL PROPERTY	BROWN STEPHEN L & DIANE M	10012 E 83RD ST
2017153544	2019-2021	INDIVIDUAL PERSONAL PROPERTY	ALAZZEH ELHAM AWNI	9804 E 82ND ST	2017167596	2021	INDIVIDUAL PERSONAL PROPERTY	ROWE ALISHA L	11011 E 78TH ST
2017153551	2020-2021	INDIVIDUAL PERSONAL PROPERTY	ROBERTS ARTHUR LEE JR	8624 E 83RD ST	2017167773	2021	INDIVIDUAL PERSONAL PROPERTY	MCKINNEY CATLIN ROSE	6022 FARLEY AVE
2017153645	2018	INDIVIDUAL PERSONAL PROPERTY	ROJAS CARLOS PEDRO	8216 HARVARD AVE	2017167932	2020-2021	INDIVIDUAL PERSONAL PROPERTY	ROSS LATOYA MICHELLE	1103 S BROOKSIDE AVE APT 3C
2017153824	2018	INDIVIDUAL PERSONAL PROPERTY	WATKINS BRENDA FAY	7238 RAYTOWN RD APT A	2017168069	2019-2021	INDIVIDUAL PERSONAL PROPERTY	OCCIL SIMONE ALLYSE	9013 E 85TH ST
2017154034	2021	INDIVIDUAL PERSONAL PROPERTY	FERRER JAVIER	1404 NW BURR OAK CT	2017168307	2021	INDIVIDUAL PERSONAL PROPERTY	CUNNINGHAM TYLARRAH MARIE	6204 CLAREMONT AVE
2017154210	2018	INDIVIDUAL PERSONAL PROPERTY	JONES BREAWN N K	8622 E UTOPIA DR APT 9	2017168552	2021	INDIVIDUAL PERSONAL PROPERTY	YEATES SARAH ALLISON	8926 E 74TH ST
2017154367	2021	INDIVIDUAL PERSONAL PROPERTY	RAY GENIA KWAN	7241 CRISP AVE	2017168655	2020-2021	INDIVIDUAL PERSONAL PROPERTY	LEIGHTY PARKS DOROTHY	5215 BLUE RIDGE BLVD
2017154658	2019	INDIVIDUAL PERSONAL PROPERTY	TRAMMELL TONI	9107 E 68TH TER	2017168831	2021	INDIVIDUAL PERSONAL PROPERTY	ROTHERMICH THOMAS ROBERT	8012 HARDY AVE
2017154935	2021	INDIVIDUAL PERSONAL PROPERTY	DEBUSK RYAN MATTHEW	8415 MARSH AVE	2017168896	2018-2020	INDIVIDUAL PERSONAL PROPERTY	HUGHES SAMUEL ROBERT	610 NW YENNIE AVE
2017155214	2019	INDIVIDUAL PERSONAL PROPERTY	HINKLE LYNDI LEE	6621 CLAREMONT AVE	2017169013	2019-2021	INDIVIDUAL PERSONAL PROPERTY	WILLIAMS RICK HAYDEN JR	11804 E 76TH TER
2017155323	2021	INDIVIDUAL PERSONAL PROPERTY	ROATH JADA	5521 WOODSON RD	2017169285	2021	INDIVIDUAL PERSONAL PROPERTY	KINNEY HAROLD M	8504 EVANSTON AVE
2017155369	2019	INDIVIDUAL PERSONAL PROPERTY	DAVIS ALIZE N	9226 E 53RD TER	2017169300	2019	INDIVIDUAL PERSONAL PROPERTY	BECKER MERCEDES MARIE	7309 ELM ST
2017155617	2019-2020	INDIVIDUAL PERSONAL PROPERTY	MCGEE ANTONIO L	10301 E 68TH TER	2017169332	2020	INDIVIDUAL PERSONAL PROPERTY	KILGORE MAGGIE MAE	8701 MANCHESTER AVE
2017156269	2020-2021	INDIVIDUAL PERSONAL PROPERTY	STROTHER KELLY R	8519 HARVARD TER	2017169383	2021	INDIVIDUAL PERSONAL PROPERTY	MOORE KIANA LATRICE	9804 E 69TH ST
2017156710	2021	INDIVIDUAL PERSONAL PROPERTY	WONISHI CHE NOELA	7711 RAYTOWN RD APT 22	2017169430	2020-2021	INDIVIDUAL PERSONAL PROPERTY	GREGORY MALCOM LUTHER	10825 E 57TH ST
2017156737	2021	INDIVIDUAL PERSONAL PROPERTY	GABRIEL MAIKEL DENG	9401 E 63RD ST APT 209	2017169703	2021	INDIVIDUAL PERSONAL PROPERTY	GEORGE DALE EUGENE	5234 RALSTON AVE
2017157177	2018-2020	INDIVIDUAL PERSONAL PROPERTY	BATTLE GINA R	7314 RALSTON AVE	2017169774	2020-2021	INDIVIDUAL PERSONAL PROPERTY	ALLEN DE'AJAH JAKBAELL MONNET	9300 E 70TH TER
2017157200	2019	INDIVIDUAL PERSONAL PROPERTY	HAVELKA JAMES D	10109 E 68TH TER	2017169921	2021	INDIVIDUAL PERSONAL PROPERTY	GRIGGS MARLENE K	10617 E 70TH TER
2017157220	2019-2021	INDIVIDUAL PERSONAL PROPERTY	CLEVELAND TIM L	8128 APPLETON AVE	2017170220	2021	INDIVIDUAL PERSONAL PROPERTY	FANN CURTIS WESLEY	5337 HEDGES AVE
2017157954	2019-2021	INDIVIDUAL PERSONAL PROPERTY	POWELL TERESA E	6917 WILDWOOD DR	2017170485	2021	INDIVIDUAL PERSONAL PROPERTY	DANIELS JEREMIAH A	5940 CRESCENT AVE
2017158088	2021	INDIVIDUAL PERSONAL PROPERTY	CURTIS CALVIN JEFFREY	5404 RALSTON AVE	2017171124	2021	INDIVIDUAL PERSONAL PROPERTY	WAGGONER ANDREW JAMES & KIMBERLY JANE	6708 STERLING AVE
2017158306	2019	INDIVIDUAL PERSONAL PROPERTY	WRIGHT MARCUS Q	9905 E 73RD ST APT A	2017171438	2021	INDIVIDUAL PERSONAL PROPERTY	JENKINS DE'ANDRE KEITH	8506 EVERETT ST
2017158674	2020	INDIVIDUAL PERSONAL PROPERTY	TAYLOR MILTON ANDREW III	8801 E GREGORY BLVD	2017171441	2021	INDIVIDUAL PERSONAL PROPERTY	JAMES-HILL DIAMOND	8637 E UTOPIA PKWY APT 4
2017158734	2021	INDIVIDUAL PERSONAL PROPERTY	ALLEN KELLIE RENE	6905 RAYTOWN RD	2017171482	2021	INDIVIDUAL PERSONAL PROPERTY	COSTELLO MARY ANNE	6704 69TH TER
2017158929	2021	INDIVIDUAL PERSONAL PROPERTY	CHIEKWU MARY JANE A	9905 E 60TH ST	2017171602	2021	INDIVIDUAL PERSONAL PROPERTY	BRAUN JOHN H 2ND	9100 E 73RD ST
2017159239	2019	INDIVIDUAL PERSONAL PROPERTY	ANZORA WILMER A MANCIA	9521 E 67TH TER	2017171766	2021	INDIVIDUAL PERSONAL PROPERTY	SWEET KALEB ZANE	6730 STERLING AVE
2017159339	2020-2021	INDIVIDUAL PERSONAL PROPERTY	MULWEE JOYCE A	5307 STERLING AVE	2017171805	2019-2021	INDIVIDUAL PERSONAL PROPERTY	PAIGE KAELYN DOMINIQUE	5425 STERLING AVE
2017159511	2019-2021	INDIVIDUAL PERSONAL PROPERTY	LUNA RHONDA M	6900 RAYTOWN RD	2017171830	2021	INDIVIDUAL PERSONAL PROPERTY	LOVE TEAUNNA	7115 CRISP AVE
2017159951	2019	INDIVIDUAL PERSONAL PROPERTY	ROGERS JESSE HALE	8801 E 73RD ST	2017171853	2021	INDIVIDUAL PERSONAL PROPERTY	MOORE YAKIRA ARAI	7315 HARDY AVE
2017160216	2021	INDIVIDUAL PERSONAL PROPERTY	TRAN JESSICA MARIE	8637 E UTOPIA PKWY APT 3	2017172161	2018-2021	INDIVIDUAL PERSONAL PROPERTY	RUTHLEDGE TYLER J	8004 HARVARD AVE
2017160313	2018	INDIVIDUAL PERSONAL PROPERTY	SAMPLE JASMINE	7915 CRESCENT AVE	2017172353	2021	INDIVIDUAL PERSONAL PROPERTY	HIMBROOK SHANON KAY (MCNUTT)	7909 ELM AVE
2017160465	2019	INDIVIDUAL PERSONAL PROPERTY	WILLIAMS TAMEKA NICOLE	11703 E 83RD ST APT 201	2017172626	2019-2020	INDIVIDUAL PERSONAL PROPERTY	SCHREIMANN KENNETH EUGENE II	10608 E 65TH TER
2017160967	2021	INDIVIDUAL PERSONAL PROPERTY	HARSHFIELD NORMAN LAYTON	8637 E UTOPIA PKWY APT 9	2017172778	2020-2021	INDIVIDUAL PERSONAL PROPERTY	TAFOLLA MICHELLE ADRIENNE	8115 HARDY AVE
2017161156	2021	INDIVIDUAL PERSONAL PROPERTY	CROFT TIMOTHY EDWARD	9309 E 60TH TER	2017173060	2021	INDIVIDUAL PERSONAL PROPERTY	WADE RENEE KC	8101 RAYTOWN RD
2017161640	2019-2021	INDIVIDUAL PERSONAL PROPERTY	TOWNSHEND MICHAEL JOSEPH	6609 RALSTON AVE	2017173062	2019-2021	INDIVIDUAL PERSONAL PROPERTY	DUGGAN BRADLEY WARREN	9708 E 85TH ST
2017161942	2018-2019	INDIVIDUAL PERSONAL PROPERTY	TAYLOR COLBY JAMALL	10214 E 71ST TER	2017173077	2020-2021	INDIVIDUAL PERSONAL PROPERTY	PECK DANIEL E	8418 HARRIS AVE
2017162096	2020-2021	INDIVIDUAL PERSONAL PROPERTY	GOMEZ MICHAEL D & ROSEMARY	9001 E 75TH ST	2017173224	2021	INDIVIDUAL PERSONAL PROPERTY	ROGERS RENEE ALLEAN	6609 WILLOW AVE
2017162186	2020-2021	INDIVIDUAL PERSONAL PROPERTY	WHITE SHANNON R	8605 ELM AVE	2017173328	2021	INDIVIDUAL PERSONAL PROPERTY	BORIA STEPHANIE N	5432 MAYWOOD AVE
2017162498	2019-2021	INDIVIDUAL PERSONAL PROPERTY	HARRIS TERRILL ARGNES JR	9918 E 61ST ST	2017173395	2019	INDIVIDUAL PERSONAL PROPERTY	NORTHCUTT RIKAYLA LASHA	11100 E 72ND TER
2017162866	2019-2020	INDIVIDUAL PERSONAL PROPERTY	LUM CARINE NEBA	8000 E 90TH ST	2017173573	2020-2021	INDIVIDUAL PERSONAL PROPERTY	SMALL MADELINE MACKENZIE	7504 MAPLE LN
2017162955	2021	INDIVIDUAL PERSONAL PROPERTY	CHANDLER IRA	6310 RAYTOWN RD	2017173941	2020-2021	INDIVIDUAL PERSONAL PROPERTY	GRAY LEWIS ANTHONY JR	8707 E 80TH TER
2017162995	2018-2019	INDIVIDUAL PERSONAL PROPERTY	SCOTT TRAVIS IAN	8817 E 85TH ST	2017174445	2020	INDIVIDUAL PERSONAL PROPERTY	EDWARDS PRICE JAMONT MARQUAN	6140 RAYTOWN RD APT 512
2017163476	2021	INDIVIDUAL PERSONAL PROPERTY	CLARK KHOBI RHAE	7800 WOODSON RD	2017174661	2021	INDIVIDUAL PERSONAL PROPERTY	BAUR JASON MICHAEL	9321 E 85TH ST
2017163605	2019-2021	INDIVIDUAL PERSONAL PROPERTY	DICKMANN JOHN JOSEPH	10417 E 43RD ST APT 134	2017174833	2021	INDIVIDUAL PERSONAL PROPERTY	JUAREZ EDUARDO MAGDALENO	6004 HARVARD AVE
2017163900	2019-2021	INDIVIDUAL PERSONAL PROPERTY	TURCIOS MANDY	8411 MARSH AVE	2017174979	2021	INDIVIDUAL PERSONAL PROPERTY	ANDERSON CRAIG MICHAEL	5727 CEDAR AVE
2017163937	2018-2019	INDIVIDUAL PERSONAL PROPERTY	PLUMMER JON PAUL	8468 LANE DR	2017174982	2021	INDIVIDUAL PERSONAL PROPERTY	DODD DOYNE JAMES JR	10804 E 59TH ST
2017164043	2021	INDIVIDUAL PERSONAL PROPERTY	SORRELLS TYREE D'ANTE	8118 WILLOW WAY	2017175121	2021	INDIVIDUAL PERSONAL PROPERTY	DODD DOYNE JAMES JR	7300 STERLING AVE
2017164106	2018-2021	INDIVIDUAL PERSONAL PROPERTY	JACKSON KAYLA MARIE	8308 EVANSTON AVE	2017175302	2020-2021	INDIVIDUAL PERSONAL PROPERTY	NOLEN JASMINE LANEAR	10613 E 56TH TER
2017164282	2019	INDIVIDUAL PERSONAL PROPERTY	WILLIAMS TINA MARIE	9358 E 67TH TER	2017175363	2021	INDIVIDUAL PERSONAL PROPERTY	MERTEN JENNIFER LYNN	7701 CRESCENT AVE
2017164293	2021	INDIVIDUAL PERSONAL PROPERTY	WHITNEY YUCHETCH CATHERINE E	8717 E 61ST TER APT 4	2017175373	2021	INDIVIDUAL PERSONAL PROPERTY	RYAN CORRIE ANN	7612 WOODSON RD
2017164308	2020	INDIVIDUAL PERSONAL PROPERTY	HERNANDEZ VALENTIN YUHALEXIS	7617 ENGLEWOOD AVE	2017175541	2021	INDIVIDUAL PERSONAL PROPERTY	WILLIAMS KRystal A	8215 GRANT DR
2017164713	2020-2021	INDIVIDUAL PERSONAL PROPERTY	ROBERTS MCKENZIE LEIGH	7212 HARRIS AVE	2017175744	2019-2021	INDIVIDUAL PERSONAL PROPERTY	HERNANDEZ REYMUNDO S	5824 BLUE RIDGE BLVD
2017164733	2018	INDIVIDUAL PERSONAL PROPERTY	WEYANT HAROLD EVAN	7720 ELM ST	2017175806	2019	INDIVIDUAL PERSONAL PROPERTY	STROUD MATTHEW WAYNE	10621 E 56TH ST
2017164738	2021	INDIVIDUAL PERSONAL PROPERTY	ADAMS SHAKAYLA MARIE	10027 E 67TH ST	2017176026	2021	INDIVIDUAL PERSONAL PROPERTY	GOMEZ OJEDA MARIA DELCARMEN	8612 KENTUCKY AVE
2017165001	2019	INDIVIDUAL PERSONAL PROPERTY	SMITH RAE LAND NEKEIDRA	9204 E 53RD TER	2017176294	2021	INDIVIDUAL PERSONAL PROPERTY	JOHNSON PAUL ANTHONY	5353 BLUE RIDGE BLVD
2017165078	2020-2021	INDIVIDUAL PERSONAL PROPERTY	CASTRO JAVIER A	9063 E 65TH TER	2017176338	2019-2021	INDIVIDUAL PERSONAL PROPERTY	SELLERS SUNNI TA	7220 CRISP AVE
2017165186	2021	INDIVIDUAL PERSONAL PROPERTY	STONEKING BRITNEY CAROL LYNN	6720 LAUREL AVE	2017176356	2021	INDIVIDUAL PERSONAL PROPERTY	MILLER-FARLEY NOAH WILLIAM	7916 ARLINGTON AVE
2017165209	2021	INDIVIDUAL PERSONAL PROPERTY	ROUSE RYAN ALLAN LEE	6120 DITZLER AVE	2017176514	2021	INDIVIDUAL PERSONAL PROPERTY	ALEXANDRIA VINCENT RAY	8001 WESTRIDGE RD UNIT 9
2017165308	2019-2021	INDIVIDUAL PERSONAL PROPERTY	BRIGGS OLEN K	10205 E 56TH ST	2017176609	2020-2021	INDIVIDUAL PERSONAL PROPERTY	CAMPBELL ANNIE R	7145 CRISP AVE
2017165472	2018-2021	INDIVIDUAL PERSONAL PROPERTY	EWING NELSON K JR	5512 MANNING AVE	2017176694	2019-2020	INDIVIDUAL PERSONAL PROPERTY	MORGAN BRITNEY DANIELLE	8406 STERLING AVE
2017165525	2019-2021	INDIVIDUAL PERSONAL PROPERTY	ROSS GARY ALLEN JR	7509 CRISP AVE	2017176842	2019-2021	INDIVIDUAL PERSONAL PROPERTY	CHILDS EMMANUEL MYNIAL	9505 E 79TH ST
2017165571	2019	INDIVIDUAL PERSONAL PROPERTY	BURROUGHS RYAN RUSSELL	8505 CRESCENT AVE	2017176843	2019-2021	INDIVIDUAL PERSONAL PROPERTY	RIZQ ABDELLATIF FAROUQ	8801 E 63RD ST
2017165856	2021	INDIVIDUAL PERSONAL PROPERTY	BRUCE LEAH RENE	11004 E 81ST TER	2017176960	2019-2021	INDIVIDUAL PERSONAL PROPERTY	MCCULLY KATELYNN MAE	8215 E 85TH ST
2017165941	2021	INDIVIDUAL PERSONAL PROPERTY	MARTIN DEJUAN DAVID JR	8529 VASSAR AVE	2017177008	2021	INDIVIDUAL PERSONAL PROPERTY	LOUX JOSEPH HENRY	8909 E 66TH ST
2017165959	2018	INDIVIDUAL PERSONAL PROPERTY	FONSECA MARISA MIEKO	7406 ELM ST	2017177264	2018-2019	INDIVIDUAL PERSONAL PROPERTY	BURKETT HOLLY	6002 FARLEY AVE
2017166012	2018-2021	INDIVIDUAL PERSONAL PROPERTY	WILLIAMS AALIYAH NICOLE	8618 E UTOPIA DR APT 43	2017177514	2018	INDIVIDUAL PERSONAL PROPERTY	GANT REGINALD	11516 E 74TH STREET CT
2017166132	2019-2021	INDIVIDUAL PERSONAL PROPERTY	BARNETT ELIJAH M	5223 STERLING AVE	2017177690	2019-2020	INDIVIDUAL PERSONAL PROPERTY	LEWIS JAMES	9118 E 85TH TER
2017166355	2021	INDIVIDUAL PERSONAL PROPERTY	GERHARDT TINA L	210 S HIGH ST	2017177798	2018-2019	INDIVIDUAL PERSONAL PROPERTY	STARK ASHLEY DAWN	11109 E 78TH TER
2017166498	2019-2021	INDIVIDUAL PERSONAL PROPERTY	ARMSTRONG DAN EE KRISTINA	7632 STERLING AVE	2017177914	2018	INDIVIDUAL PERSONAL PROPERTY	JOHNSON CURLEY	6904 CRISP AVE

207178095	2018	INDIVIDUAL PERSONAL PROPERTY	ENGLISH THOMAS	9303 E 81ST TER	207188358	2021	INDIVIDUAL PERSONAL PROPERTY	BAYLISS BONNA KAY	8005 EVANSTON AVE
207178210	2021	INDIVIDUAL PERSONAL PROPERTY	BRALY ABIGALE SUE	5101 WOODSON RD	207188461	2020	INDIVIDUAL PERSONAL PROPERTY	ALLEN RYLIE NICOLE	5400 NORTHERN AVE
207178231	2021	INDIVIDUAL PERSONAL PROPERTY	MURPHY DAMIEN ARMON	6508 CLAREMONT AVE	207188463	2018	INDIVIDUAL PERSONAL PROPERTY	WILLIAMS OLA J	9327 E 83RD ST
207178264	2018	INDIVIDUAL PERSONAL PROPERTY	BROOKS MICHALLE	9001 RICHARDS DR	207188945	2021	INDIVIDUAL PERSONAL PROPERTY	HALL DAVID M & KIEREN LUCAS	6311 HARRIS AVE
207178590	2021	INDIVIDUAL PERSONAL PROPERTY	SHERRY GREGORY P	11020 E 57TH TER	207188961	2021	INDIVIDUAL PERSONAL PROPERTY	SLAUGHTER LINDA LESHELLE	8458 LANE DR
207178672	2021	INDIVIDUAL PERSONAL PROPERTY	SMITH DANTE GUADALUPE	8700 E 87TH ST	207189153	2019-2021	INDIVIDUAL PERSONAL PROPERTY	HOPKINS JORDAN CHRISTOPHER	8815 E 61ST ST
207179088	2021	INDIVIDUAL PERSONAL PROPERTY	PLACK FERNINAND	7304 APPLETON AVE	207189288	2021	INDIVIDUAL PERSONAL PROPERTY	HAYS JUSTIN M	9615 E 66TH TER
207179182	2021	INDIVIDUAL PERSONAL PROPERTY	ASH CHRISTOPHER SHANE	10404 E 69TH TER	207189350	2019-2021	INDIVIDUAL PERSONAL PROPERTY	RYKALSKY RONALD M III	5708 MAYWOOD AVE
207179266	2019	INDIVIDUAL PERSONAL PROPERTY	ELLIS JA SHAWN AHMAD	9006 E 85TH ST	207189514	2019	INDIVIDUAL PERSONAL PROPERTY	JARQUIO VICTORIANO	8600 KENTUCKY AVE
207179356	2019	INDIVIDUAL PERSONAL PROPERTY	SIMPSON D'ANTHONY LAVERIAL	6201 KENTUCKY AVE	207189554	2021	INDIVIDUAL PERSONAL PROPERTY	THOMAS TOISHEONA MONET	11422 E 71ST ST
207179447	2021	INDIVIDUAL PERSONAL PROPERTY	BAUR MEGAN NICOLE	9321 E 85TH ST	207189769	2020	INDIVIDUAL PERSONAL PROPERTY	GONZALEZ GARDENAZ MARIA E	8603 E 81ST ST
207179477	2019	INDIVIDUAL PERSONAL PROPERTY	PAUL ANGELA KATRINA	8629 E UTOPIA PKWY APT 12	207189913	2021	INDIVIDUAL PERSONAL PROPERTY	WILLIAMS GALVIN H & WILLIAMS MARRISA H	6703 APPLETON AVE
207179534	2021	INDIVIDUAL PERSONAL PROPERTY	GARRETT WAYNE ARNEAL	5517 HUNTER ST	207189923	2021	INDIVIDUAL PERSONAL PROPERTY	LICHTEN MARA	9105 E 62ND ST
207179762	2019	INDIVIDUAL PERSONAL PROPERTY	VASQUEZ LISSETH S & SOTRES FARIAS CESAR	6541 RAYTOWN RD APT 3	207189960	2021	INDIVIDUAL PERSONAL PROPERTY	COONCE SANDRA K	7606 WOODSON RD
207179770	2020	INDIVIDUAL PERSONAL PROPERTY	LENLEY VERA KALISSE	5306 GARFIELD AVE	207189980	2020-2021	INDIVIDUAL PERSONAL PROPERTY	STROTHER ELI BYRON HARRISON JR	7920 HARDY AVE
207180057	2019-2021	INDIVIDUAL PERSONAL PROPERTY	MILLER KATHLEEN E	9824 E 61ST ST APT 1	207190374	2021	INDIVIDUAL PERSONAL PROPERTY	DALE WILLIAM JOSEPH	9224 E 61ST ST
207180210	2019	INDIVIDUAL PERSONAL PROPERTY	HARVEY TOMIEKA	11919 E 85TH ST	207190458	2021	INDIVIDUAL PERSONAL PROPERTY	MCCLAIN RUIQUIYA S	5521 BLUE RIDGE CUT OFF
207180232	2018	INDIVIDUAL PERSONAL PROPERTY	CLINCY BRADFORD	6433 BLUE RIDGE CUT OFF	207190824	2019-2021	INDIVIDUAL PERSONAL PROPERTY	THOMAS UNIQUA MONAY SS	11422 E 71ST ST
207180265	2019-2020	INDIVIDUAL PERSONAL PROPERTY	HERNANDEZ SALLY	6405 BLUE RIDGE CUT OFF	207190892	2021	INDIVIDUAL PERSONAL PROPERTY	ESPINOSA JOHN JOSEPH JR	6803 LAUREL AVE
207180620	2018	INDIVIDUAL PERSONAL PROPERTY	GOODMAN REGINA	8466 LANE DR	207190954	2021	INDIVIDUAL PERSONAL PROPERTY	VICKERS CHEYENNE RENEE	10113 E 68TH TER
207180648	2018-2019	INDIVIDUAL PERSONAL PROPERTY	RANDALL DORIS	10011 E 78TH ST	207191227	2020-2021	INDIVIDUAL PERSONAL PROPERTY	YORK KEIA ZHANE	8404 ELM AVE
207180652	2020	INDIVIDUAL PERSONAL PROPERTY	LENTELL HANNAH ALEXIS	5309 HUNTER ST	207191326	2021	INDIVIDUAL PERSONAL PROPERTY	REYNOLDS WILLIAM ROBERT	11309 E 67TH ST
207180653	2018	INDIVIDUAL PERSONAL PROPERTY	DAVIS SHARESE	19000 N M 350 HWY	207191341	2019-2021	INDIVIDUAL PERSONAL PROPERTY	ROBINSON DEREGINENE LLAIOIYA	8314 STERLING AVE
207181015	2019-2021	INDIVIDUAL PERSONAL PROPERTY	DIXON TYRA PATRICE	8611 E 85TH ST	207191415	2021	INDIVIDUAL PERSONAL PROPERTY	HUILMAN KEVIN MATTHEW	8009 SPRING VALLEY RD
207181021	2021	INDIVIDUAL PERSONAL PROPERTY	BOND ERIC MICHAEL	6123 HARVARD AVE	207191461	2018-2019	INDIVIDUAL PERSONAL PROPERTY	REGIS CANADY OMNI	11023 US 50 HWY
207181153	2021	INDIVIDUAL PERSONAL PROPERTY	MARTIN JACOB ADAM	11708 E 78TH PL	207191531	2021	INDIVIDUAL PERSONAL PROPERTY	ROBERTS ARTHUR L	8604 E 83RD ST
207181169	2019-2020	INDIVIDUAL PERSONAL PROPERTY	BELL FAITH SIMONE	8609 E 84TH ST	207191650	2019-2021	INDIVIDUAL PERSONAL PROPERTY	WASHINGTON JAMMI LASHAUN	8825 E 75TH ST
207181396	2021	INDIVIDUAL PERSONAL PROPERTY	CARTER SHALISHA LAMEA IREAN	8018 WILLOW WAY	207191683	2019-2020	INDIVIDUAL PERSONAL PROPERTY	WALKER RAYSHOD RONCELL	9121 E 85TH ST
207181415	2021	INDIVIDUAL PERSONAL PROPERTY	HENDERSON CAMERON PERKEL	8430 LANE PL	207191694	2017	INDIVIDUAL PERSONAL PROPERTY	THOMPSON SAVANNAH DAWN	10801 E 57TH TER
207181452	2019-2021	INDIVIDUAL PERSONAL PROPERTY	YOCUM TYLER CHRISTOPHER	9810 E 80TH TER	207191797	2021	INDIVIDUAL PERSONAL PROPERTY	COILLOT ALLYSSA C	10328 E 63RD ST APT 2
207181735	2019-2021	INDIVIDUAL PERSONAL PROPERTY	ARTEAGA HENRIQUEZ JOSE CARLOS	8900 E 72ND ST	207191987	2019-2021	INDIVIDUAL PERSONAL PROPERTY	LYTLE ASIAIANA MELA	11045 E 53RD TER
207182464	2019-2021	INDIVIDUAL PERSONAL PROPERTY	OLINGER JOSEPH MICHAEL	5910 WOODSON RD	207192094	2018-2020	INDIVIDUAL PERSONAL PROPERTY	KERMER RAYN N	8600 E 84TH ST
207182532	2020	INDIVIDUAL PERSONAL PROPERTY	PETERSON JESSIE L	10208 E 69TH ST	207192391	2019-2021	INDIVIDUAL PERSONAL PROPERTY	WILLIAMS JESSE DWAYNE	8700 E 79TH TER
207182548	2021	INDIVIDUAL PERSONAL PROPERTY	DUKE ETHAN PATRICK	8008 APPLETON AVE	207192503	2019-2021	INDIVIDUAL PERSONAL PROPERTY	HAWTHORNE ABRAHAM ELIJAH	8601 EVERETT ST
207182764	2021	INDIVIDUAL PERSONAL PROPERTY	LOVE CURTIS LAMON	7155 CRISP AVE	207192606	2019-2021	INDIVIDUAL PERSONAL PROPERTY	HELETT JAMES LEE DANIEL	8300 HUNTER ST
207182824	2021	INDIVIDUAL PERSONAL PROPERTY	BARRY LANNA K & VICTOR P	7424 WILLOW AVE	207192723	2019-2020	INDIVIDUAL PERSONAL PROPERTY	WASHINGTON VICTORIA CHANTAE	10617 E 78TH TER
207182895	2021	INDIVIDUAL PERSONAL PROPERTY	WILLINGHAM SIERRA ELIZABETH	5328 DITZLER AVE	207192774	2021	INDIVIDUAL PERSONAL PROPERTY	LEWIS WILBUR JR	10617 ARLINGTON AVE
207182955	2019-2020	INDIVIDUAL PERSONAL PROPERTY	FOSTER OMNI CHEYENNE RAJEENE	9000 E 63RD ST	207193114	2019	INDIVIDUAL PERSONAL PROPERTY	PHILLIP ALLARD	5604 DITZLER AVE
207183235	2020	INDIVIDUAL PERSONAL PROPERTY	HONKOMP JAMEL DOMINIQUE	5604 CRESCENT AVE	207193334	2019-2021	INDIVIDUAL PERSONAL PROPERTY	THOMAS JASJIA LE'NEA	9300 HARTZ AVE
207183555	2020-2021	INDIVIDUAL PERSONAL PROPERTY	ANDERSON BURGESS JACOB AEKEM	7117 STERLING AVE	207193523	2019	INDIVIDUAL PERSONAL PROPERTY	LAWRENCE SMITH SERENA	9212 E 54TH TER
207183582	2019-2021	INDIVIDUAL PERSONAL PROPERTY	MOORE KIANA D'NAI	11200 E 75TH TER	207193548	2019-2020	INDIVIDUAL PERSONAL PROPERTY	COOK DURELLE MONTE	8902 E 74TH ST
207184054	2019	INDIVIDUAL PERSONAL PROPERTY	MANTONYA JESSICA LYNN	10019 E 78TH ST	207193724	2021	INDIVIDUAL PERSONAL PROPERTY	KROLL BETHANY PAIGE	9900 E 60TH TER
207184276	2021	INDIVIDUAL PERSONAL PROPERTY	YORK TRAVIS LAMONT	7808 ARLINGTON AVE	207193766	2021	INDIVIDUAL PERSONAL PROPERTY	SWEETSER GANZ AUTYMN ELAINE	8608 SPRING VALLEY RD
207184358	2020	INDIVIDUAL PERSONAL PROPERTY	FOUTCH MATTHEW KEVIN	11304 E 55TH TER	207193770	2020-2021	INDIVIDUAL PERSONAL PROPERTY	BROWN ALBERTA JOAN	7325 HARDY AVE
207184562	2021	INDIVIDUAL PERSONAL PROPERTY	SMITH CARLTON EDWIN	8123 SPRING VALLEY RD	207193771	2018-2019	INDIVIDUAL PERSONAL PROPERTY	TORRES QUENTIN ROBERT	8601 GREENWOOD RD
207184868	2019-2020	INDIVIDUAL PERSONAL PROPERTY	SOTRES PARTAS CESAR JONATHAN	11209 E 59TH ST	207193907	2021	INDIVIDUAL PERSONAL PROPERTY	STEWART JOSIAH	8908 E GREGORY BLVD
207185107	2019-2021	INDIVIDUAL PERSONAL PROPERTY	RICHCREEK ZACHARY DAY SHARP	5805 KENTUCKY AVE	207194348	2019	INDIVIDUAL PERSONAL PROPERTY	FRANCIS KIMBERLY R	9415 E 81ST ST
207185283	2021	INDIVIDUAL PERSONAL PROPERTY	MOORE LACY ANN	5301 RIDGEWAY AVE	207194389	2020-2021	INDIVIDUAL PERSONAL PROPERTY	BROWN PATRICIA ANN	7500 CRISP AVE
207185378	2019	INDIVIDUAL PERSONAL PROPERTY	WATSON JERI L	11819 E 83RD ST APT 202	207194462	2021	INDIVIDUAL PERSONAL PROPERTY	MCGILL SETH M	10409 E 70TH TER
207185386	2021	INDIVIDUAL PERSONAL PROPERTY	ROCK JOSHUA SAMUEL	6807 HUNTER ST	207194548	2021	INDIVIDUAL PERSONAL PROPERTY	ARRINGTON DEREK LAMONT JR	8611 KENTUCKY AVE
207185589	2019-2021	INDIVIDUAL PERSONAL PROPERTY	TOMLINSON DAVID PAUL	7100 STERLING AVE	207195067	2020-2021	INDIVIDUAL PERSONAL PROPERTY	MCBRAY SHANNEN J	6209 BLUE RIDGE CUT OFF
207185737	2019-2021	INDIVIDUAL PERSONAL PROPERTY	GREGORY MALCOLM LUTHER	10625 E 57TH ST	207195308	2021	INDIVIDUAL PERSONAL PROPERTY	JAGGERS DOMINIQUE NICOLE	8507 WESTRIDGE RD
207185914	2019	INDIVIDUAL PERSONAL PROPERTY	GREEN ALEX JADE	7240 AGNES AVE	207195322	2020-2021	INDIVIDUAL PERSONAL PROPERTY	BIGGS LEONARD LEE	10904 E 67TH ST
207186250	2021	INDIVIDUAL PERSONAL PROPERTY	HILL ANDRE DUANE JR	9204 VAUGHN AVE	207195465	2019-2020	INDIVIDUAL PERSONAL PROPERTY	JOYNER LAVANDRIS TRAMAE	6816 ENGLEWOOD AVE
207186388	2021	INDIVIDUAL PERSONAL PROPERTY	MIDDLETON ERIC MATTHEW	13205 E 50TH ST	207195467	2021	INDIVIDUAL PERSONAL PROPERTY	AUSTIN MEGAN MARIE (SIPU)	10508 E 75TH ST
207186472	2020-2021	INDIVIDUAL PERSONAL PROPERTY	GREENSTREET BOBBY OLIANA	7821 ELM ST	207195530	2020-2021	INDIVIDUAL PERSONAL PROPERTY	WILLMORE KEVIN WILLIAM	8001 BLUE RIDGE BLVD
207186473	2018-2021	INDIVIDUAL PERSONAL PROPERTY	HERNANDEZ FLORES DE SANTIAGO DANNA	10908 E 60TH TER	207195677	2019	INDIVIDUAL PERSONAL PROPERTY	PETTIT VIRGINIA L	7711 ELM ST
207186635	2021	INDIVIDUAL PERSONAL PROPERTY	HEDGES KATELYN KATHLEEN	9904 E 81ST ST	207195738	2019-2020	INDIVIDUAL PERSONAL PROPERTY	PAYNE ESSENCE DANIEL	11516 E 74TH STREET CT
207186647	2021	INDIVIDUAL PERSONAL PROPERTY	MCNACK ELAINE N	7410 OVERTON AVE UNIT 1	207195755	2021	INDIVIDUAL PERSONAL PROPERTY	RICHMOND JAMES MICHAEL	7725 CRESCENT AVE
207186673	2021	INDIVIDUAL PERSONAL PROPERTY	KEY AMIYA CHEYENNE	6425 BLUE RIDGE CUT OFF	207195778	2021	INDIVIDUAL PERSONAL PROPERTY	CLARK DEYASHIA ROSE CAROL	6209 HARVARD AVE
207186752	2021	INDIVIDUAL PERSONAL PROPERTY	KEOGH BARBARA LEA	9358 E 68TH ST	207195916	2021	INDIVIDUAL PERSONAL PROPERTY	HASLAR JONATHAN ROBERT JR	10800 LEWIS AVE
207186840	2019-2021	INDIVIDUAL PERSONAL PROPERTY	FARMER MICHAEL ANTWON	11504 E 62ND ST	207196026	2021	INDIVIDUAL PERSONAL PROPERTY	TILLMAN LILLIAN GENICE	6140 RAYTOWN RD APT 707
207186960	2019-2021	INDIVIDUAL PERSONAL PROPERTY	THOMAS TYESHA R	8502 STARK AVE	207196124	2021	INDIVIDUAL PERSONAL PROPERTY	TUCKER DEBRA RENEE	8306 STERLING AVE
207187380	2018	INDIVIDUAL PERSONAL PROPERTY	JACKSON ARIANA DOROTHEA	10808 GREGORY LN	207196442	2019	INDIVIDUAL PERSONAL PROPERTY	WILLIAMS JACQUELYN SUE	11418 DELMAR ST
207187426	2021	INDIVIDUAL PERSONAL PROPERTY	SIMMONS LAUREN ELIZABETH	8605 STARK AVE	207196659	2020-2021	INDIVIDUAL PERSONAL PROPERTY	ISEMAN JULIE MARIE	5516 CEDAR AVE
207187427	2018-2019	INDIVIDUAL PERSONAL PROPERTY	PETERSON TAMMY SUE	9809 E 73RD ST APT A	207196689	2021	INDIVIDUAL PERSONAL PROPERTY	MICHAUX KENNADI T	11315 E 58TH TER
207187460	2018-2020	INDIVIDUAL PERSONAL PROPERTY	WATTS SAMANTHA MICHELLE	8508 E 85TH TER	207196955	2019-2021	INDIVIDUAL PERSONAL PROPERTY	FULTON KEELIN D	8909 E 57TH ST
207187611	2021	INDIVIDUAL PERSONAL PROPERTY	PARKER SHERRY LORICE	10907 E 62ND TER	207197048	2019-2021	INDIVIDUAL PERSONAL PROPERTY	TALLEY MARVIN LEON	5517 HEDGES AVE
207187653	2021	INDIVIDUAL PERSONAL PROPERTY	MILLER ANGELIA DAWN	10812 GREGORY LN	207197110	2019-2020	INDIVIDUAL PERSONAL PROPERTY	ROBERTSON DITREONNA EVETTE	8200 KENTUCKY AVE
207187929	2019	INDIVIDUAL PERSONAL PROPERTY	CLAYTON DESIREE Y	9354 E GREGORY BLVD	207197125	2019-2020	INDIVIDUAL PERSONAL PROPERTY	NACHEL BEVERLY J	5420 BLUE RIDGE CUT OFF APT 712
207188206	2021	INDIVIDUAL PERSONAL PROPERTY	KUBACH MAGARRETT D	11809 E 78TH PL	207197360	2021	INDIVIDUAL PERSONAL PROPERTY	DENG PETER B	9914 E 61ST ST APT 2
207188275	2021	INDIVIDUAL PERSONAL PROPERTY	ECHEVERRY FLAMENCO GILMA VANESSA	9620 E 66TH TER	207197598	2021	INDIVIDUAL PERSONAL PROPERTY	DEGASE CLINTON & GABRIELLE	9405 E 80TH ST

207197625	2019-2021	INDIVIDUAL PERSONAL PROPERTY	WARRIOR QUEEN ANASTASIA	5520 HEDGES AVE	207582177	2021	INDIVIDUAL PERSONAL PROPERTY	ROCHA JIMENEZ ANDRES	11328 E 59TH ST
207197802	2019-2021	INDIVIDUAL PERSONAL PROPERTY	PARSONS REECE	9508 E 69TH ST	207582387	2021	INDIVIDUAL PERSONAL PROPERTY	MAPLES ERIKA MARIE	7605 ENGLEWOOD AVE
207197932	2021	INDIVIDUAL PERSONAL PROPERTY	KREISSLER SAMANTHA JO	7500 EVANSTON AVE	207582694	2021	INDIVIDUAL PERSONAL PROPERTY	BROWN LA'NAY LYNN	8820 E 61ST TER
207197941	2021	INDIVIDUAL PERSONAL PROPERTY	COX DAMONE EUGENE	4210 E 67TH TER	207582813	2020-2021	INDIVIDUAL PERSONAL PROPERTY	TAYLOR SAXTON MCCALL	10214 E 71ST TER
207198012	2021	INDIVIDUAL PERSONAL PROPERTY	ENKE TANNER JACKSON	7522 MAPLE LN	207582953	2019-2021	INDIVIDUAL PERSONAL PROPERTY	HOSTERT DANIEL JOSEPH	11601 E 78TH TER
207198030	2021	INDIVIDUAL PERSONAL PROPERTY	BIVENS ROBERT J	9804 E 17TH TER	207582984	2019-2021	INDIVIDUAL PERSONAL PROPERTY	WALKER LINDA F	8500 STARK AVE
207198074	2021	INDIVIDUAL PERSONAL PROPERTY	HIMBROOK ERIK VAUGHN	7909 ELM AVE	207583491	2020-2021	INDIVIDUAL PERSONAL PROPERTY	MILLER XAVIER CORTEZ	6209 KENTUCKY AVE
207198387	2021	INDIVIDUAL PERSONAL PROPERTY	GRAYSON LACONA JANAY	8900 E 59TH ST	207583564	2021	INDIVIDUAL PERSONAL PROPERTY	BOULWARE TIFFANY N& HAYES CHRISTIAN N	9900 E 82ND ST
207198659	2019-2021	INDIVIDUAL PERSONAL PROPERTY	WILLIAMS JACK L	9545 E 57TH TER	207584030	2019-2021	INDIVIDUAL PERSONAL PROPERTY	STONEKING NELSON LEE JR	6720 LAUREL AVE
207198660	2019-2021	INDIVIDUAL PERSONAL PROPERTY	NEWTON FRED MICHAEL JR	11846 E 80TH DR	207584046	2019	INDIVIDUAL PERSONAL PROPERTY	GRAFF KEVIN MICHAEL	9708 E 81ST TER
207198869	2018-2019	INDIVIDUAL PERSONAL PROPERTY	CRABTREE SANDRA J	8001 BLUE RIDGE BLVD	207584268	2021	INDIVIDUAL PERSONAL PROPERTY	SCHNAKENBERG DANIEL ERIC	6307 ASH AVE APT 3
207198999	2020-2021	INDIVIDUAL PERSONAL PROPERTY	HOGAN SABRINA SADE	7509 HAWTHORNE AVE	207584622	2020	INDIVIDUAL PERSONAL PROPERTY	JENKINS TERELLE LA MAR	9010 E 87TH ST APT B5
207199113	2020	INDIVIDUAL PERSONAL PROPERTY	BAME JONATHAN C & MORGAN DEANDREA (MICHE	9800 PLYMOUTH LN	207584630	2019-2021	INDIVIDUAL PERSONAL PROPERTY	WOODS KYMAN CEPEDA	8607 GREENWOOD RD
207199214	2019-2021	INDIVIDUAL PERSONAL PROPERTY	DETRICH KANDIS L	8709 E 79TH ST	207584756	2021	INDIVIDUAL PERSONAL PROPERTY	BLEWETT DONTAE ARMOND	10305 E 64TH ST
207199451	2021	INDIVIDUAL PERSONAL PROPERTY	HICKMON TONNIE ALLEN	8412 WOODSON DR	207584788	2019	INDIVIDUAL PERSONAL PROPERTY	SEXTON MYKIECE DANAE	3539 NE INDEPENDENCE AVE
207199583	2021	INDIVIDUAL PERSONAL PROPERTY	RUTH A CHACE GRANTOR UTA DTD	10909 E 89TH TER	207584888	2021	INDIVIDUAL PERSONAL PROPERTY	HALLMAN BRITTNEY JAYNA	9358 E 67TH TER
207199719	2019	INDIVIDUAL PERSONAL PROPERTY	SIMMS DEMONTAE LEON	7305 CRISP AVE	207584910	2020-2021	INDIVIDUAL PERSONAL PROPERTY	SCHECHTER JAY MICHAEL	8611 GRANT DR
207199791	2020-2021	INDIVIDUAL PERSONAL PROPERTY	HINEMAN ZACHARY ALLEN	8535 GRANT DR	207585521	2019	INDIVIDUAL PERSONAL PROPERTY	BURROUGH LOVIE	6644 MAYWOOD AVE APT A
207200011	2021	INDIVIDUAL PERSONAL PROPERTY	BRYLA MARY B & KEVIN R	5520 RALSTON AVE	207585940	2021	INDIVIDUAL PERSONAL PROPERTY	PETERSON SIERRA MICHELLE	8316 HARRIS AVE
207200119	2021	INDIVIDUAL PERSONAL PROPERTY	JACKSON TRENTON CCEEL	10305 E 78TH ST	207586471	2019-2021	INDIVIDUAL PERSONAL PROPERTY	MURPHY WILLIAM CHASE	7410 OVERTON AVE UNIT 7
207200178	2019	INDIVIDUAL PERSONAL PROPERTY	MCCULLY NANCY JEANETTE	8719 E 67TH ST	207586840	2021	INDIVIDUAL PERSONAL PROPERTY	BARRERA NOAH ANDRES	9403 E 81ST TER
207200285	2019	INDIVIDUAL PERSONAL PROPERTY	EPERSON BILLY DEAN II	8007 HARDY AVE	207586928	2019	INDIVIDUAL PERSONAL PROPERTY	SHEPHERD MORGAN LEE	5528 HUNTER TER
207200331	2019	INDIVIDUAL PERSONAL PROPERTY	CUNNINGHAM DANIEL ANTHONY	9813 E 61ST ST APT 11	207587052	2021	INDIVIDUAL PERSONAL PROPERTY	RANDALL RANDY JACOB	9403 E 81ST ST
207200434	2019-2021	INDIVIDUAL PERSONAL PROPERTY	BETTS LANAE ANETTE	7615 ELM ST	207587106	2021	INDIVIDUAL PERSONAL PROPERTY	GRANT MARQUASHA DAY'QUELLE	8315 LANE AVE
207200496	2020-2021	INDIVIDUAL PERSONAL PROPERTY	HALL MIKHILA DENISE	11413 E 69TH ST	207587204	2021	INDIVIDUAL PERSONAL PROPERTY	BROWN TIANA LACHELLE	BROWN TIANA LACHELLE
207200650	2021	INDIVIDUAL PERSONAL PROPERTY	COCHRAN LATASHA LYNN	11533 E 74TH STREET CT	207587220	2021	INDIVIDUAL PERSONAL PROPERTY	ANDERSON WILLIAM AMOS JR	9126 E 85TH ST
207200678	2021	INDIVIDUAL PERSONAL PROPERTY	JOHNSON LAQUANNA	11833 E 83RD ST APT 101	207587406	2019	INDIVIDUAL PERSONAL PROPERTY	SANCHEZ KASSANDRA NOELLE & DANIEL JOHN	5524 LANE AVE
207200699	2021	INDIVIDUAL PERSONAL PROPERTY	GEREN AUSTIN ALLAN	5328 HEDGES AVE	207587498	2021	INDIVIDUAL PERSONAL PROPERTY	JONES KURTIS DREW	7519 CRESCENT DR
207200787	2018-2020	INDIVIDUAL PERSONAL PROPERTY	OSBORNE ANTHONY J	9505 E 68TH ST	207587532	2019-2021	INDIVIDUAL PERSONAL PROPERTY	JONES TONETTE D	8500 ELM AVE UNIT A
207200821	2021	INDIVIDUAL PERSONAL PROPERTY	BAILEY RALPH J	10007 E 63RD ST	207587547	2020-2021	INDIVIDUAL PERSONAL PROPERTY	WRIGHT CHRISTOPHER D	9101 RICHARDS DR
207200880	2021	INDIVIDUAL PERSONAL PROPERTY	MATTHEW MELINDA	7905 HEDGES AVE	207587571	2021	INDIVIDUAL PERSONAL PROPERTY	FOUNTAIN SABRINA MARIE	8324 HARRIS AVE
207200968	2019-2021	INDIVIDUAL PERSONAL PROPERTY	DEAN JALEA JABRE	11201 E 63RD ST	207587644	2020-2021	INDIVIDUAL PERSONAL PROPERTY	CHO NFOYA HARIS	7400 MAYWOOD AVE
207201168	2019-2021	INDIVIDUAL PERSONAL PROPERTY	TOMMY AARON JACKLEY	8830 E M 350 HWY	207587760	2021	INDIVIDUAL PERSONAL PROPERTY	PRATT MICHAEL DEVIN JR	7840 SPRING VALLEY RD
207201302	2021	INDIVIDUAL PERSONAL PROPERTY	THOMAS LAVERN	9326 E 85TH ST	207588636	2020	INDIVIDUAL PERSONAL PROPERTY	MCKINZY BILLY RAY	7316 HARVARD DR
207201390	2019	INDIVIDUAL PERSONAL PROPERTY	VICKERS HANNAH CHRISTINE	8322 PERSHING RD	207589119	2019	INDIVIDUAL PERSONAL PROPERTY	FRILLMAN ANGIE KAY	7230 RAYTOWN RD APT F
207201425	2019-2020	INDIVIDUAL PERSONAL PROPERTY	FUEL MACHAEL LATRICE	7615 ELM ST	207589148	2021	INDIVIDUAL PERSONAL PROPERTY	LACEY MICHELLE G	10811 E 58TH ST
207201489	2021	INDIVIDUAL PERSONAL PROPERTY	MONTOYA MEDINA JORGE ALBERTO	7301 CRISP AVE	207589187	2019-2021	INDIVIDUAL PERSONAL PROPERTY	WALTON JERRICK PERRYN	8325 OXFORD AVE
207201746	2019	INDIVIDUAL PERSONAL PROPERTY	WURTZ ALICIA LIAN	9800 E 82ND ST	207589223	2019	INDIVIDUAL PERSONAL PROPERTY	ANDERSON AHNYA ANI	8104 E 90TH TER
207201882	2019-2021	INDIVIDUAL PERSONAL PROPERTY	CRAWLEY VELMA JEAN	10007 E 68TH TER	207589345	2021	INDIVIDUAL PERSONAL PROPERTY	CALTON KIMBERLEE ANNE	8412 JAMES A REED RD
207224816	2020-2021	INDIVIDUAL PERSONAL PROPERTY	GODDARD JADA MARIE	9113 E 52ND TER	207589508	2019-2020	INDIVIDUAL PERSONAL PROPERTY	DAWSON MICHAEL KEITH	9616 E 66TH ST
207224973	2021	INDIVIDUAL PERSONAL PROPERTY	BAUDER JASON C	7402 OVERTON AVE UNIT 9	207589828	2020-2021	INDIVIDUAL PERSONAL PROPERTY	EDWARDS SUSAN KATHELEN	7414 OVERTON AVE UNIT 6
207225413	2021	INDIVIDUAL PERSONAL PROPERTY	TEZNER TANYA NICHOLE	6212 MANNING AVE	207589830	2021	INDIVIDUAL PERSONAL PROPERTY	DAVIS HEATHER ALANA	6911 RALSTON AVE
207225456	2021	INDIVIDUAL PERSONAL PROPERTY	SHERWOOD ANDREW JAMES	9911 E 80TH ST	207590014	2019-2021	INDIVIDUAL PERSONAL PROPERTY	GREEN TIERRA ALEXIS	6704 ELM AVE
207225609	2019	INDIVIDUAL PERSONAL PROPERTY	HOY JONAS MICHAEL	8316 BOOTH AVE	207590031	2021	INDIVIDUAL PERSONAL PROPERTY	CODNER DOMINGO	5605 WOODSON RD
207225644	2021	INDIVIDUAL PERSONAL PROPERTY	WILSON JERRY DAN	7319 MAYWOOD AVE	207590263	2019	INDIVIDUAL PERSONAL PROPERTY	PETRIE TAWANA MONIQUE	8616 E UTOPIA DR APT 59
207225877	2021	INDIVIDUAL PERSONAL PROPERTY	JONES SIRJULIAN D	10409 E 81ST TER	207590817	2021	INDIVIDUAL PERSONAL PROPERTY	WILLIAMS KELLIE RENA	8148 DITZLER AVE
207225969	2020-2021	INDIVIDUAL PERSONAL PROPERTY	CHALMERS JAZMYN LYNETTE	11246 E 71ST TER	207591079	2020-2021	INDIVIDUAL PERSONAL PROPERTY	PACHECO-CRESS TRAVIS GLEN JR	9111 E 73RD ST
207226185	2021	INDIVIDUAL PERSONAL PROPERTY	ROBINSON ERIC L	11304 E 71ST ST	207591186	2021	INDIVIDUAL PERSONAL PROPERTY	ATTY RANDY LEE	9005 E 65TH ST
207226221	2021	INDIVIDUAL PERSONAL PROPERTY	HERDMAN JEFFREY NATHANIEL	9301 E 68TH ST	207591448	2019	INDIVIDUAL PERSONAL PROPERTY	BURROUGH CHRISTOPHER MOSES	6644 MAYWOOD AVE APT A
207226713	2021	INDIVIDUAL PERSONAL PROPERTY	HALE ZACKARY CHRISTOPHER	NO ADDRESS ASSIGNED BY CITY	207591512	2021	INDIVIDUAL PERSONAL PROPERTY	WATSON MORGAN ELIZABETH	9600 E 68TH TER
207226756	2021	INDIVIDUAL PERSONAL PROPERTY	CLARK DIONNA RAE	9809 E 82ND TER	207592129	2020	INDIVIDUAL PERSONAL PROPERTY	KIRLYO CALESHSHEA	6323 ASH AVE
207226832	2019	INDIVIDUAL PERSONAL PROPERTY	KRUISE CAMERON VAUGHN	12230 E 63RD TER	207592293	2021	INDIVIDUAL PERSONAL PROPERTY	TRUMBULE ZACHARY ROBERT	5833 MAYWOOD AVE
207226958	2021	INDIVIDUAL PERSONAL PROPERTY	YODER ASHTON JAMES	8833 E 57TH ST	207593149	2021	INDIVIDUAL PERSONAL PROPERTY	PINGLETON TIMOTHY WAYNE	5809 ELM AVE
207226999	2021	INDIVIDUAL PERSONAL PROPERTY	STOLBERG CHRISTOPHER PAUL	8412 HAWTHORNE PL	207593155	2020	INDIVIDUAL PERSONAL PROPERTY	WALL BRANDI NICHOLE	8813 E 85TH TER
207227118	2020-2021	INDIVIDUAL PERSONAL PROPERTY	DYER MICHAELA ALAMA	17310 E 48TH ST CT S	207593743	2020-2021	INDIVIDUAL PERSONAL PROPERTY	SAMPLE AMBER SEMMON	7915 CRESCENT AVE
207227498	2021	INDIVIDUAL PERSONAL PROPERTY	TRIPLETT CAITLYN G	8024 HUNTER ST	207593780	2021	INDIVIDUAL PERSONAL PROPERTY	BENARD JULIEANNE MARIE	7906 APPLETON AVE
207227912	2021	INDIVIDUAL PERSONAL PROPERTY	BROOKS ELIJAH WADE	8011 STERLING AVE	207594191	2020-2021	INDIVIDUAL PERSONAL PROPERTY	HOLLIDAY MAEGAN RENAE ANN	5102 WOODSON RD
207228095	2020-2021	INDIVIDUAL PERSONAL PROPERTY	NELSON KORRIN RAE LYNN	5650 BLUE RIDGE BLVD	207594403	2020-2021	INDIVIDUAL PERSONAL PROPERTY	WRIGHT LASHAWNA S	6302 HARRIS AVE
207228113	2020-2021	INDIVIDUAL PERSONAL PROPERTY	WILLIAMS TIFFANEE JOY	8913 E 55TH ST	207594426	2021	INDIVIDUAL PERSONAL PROPERTY	COWART KORTNI ERIN	9218 E 68TH ST
207228378	2021	INDIVIDUAL PERSONAL PROPERTY	MCCLLUNG MAGEE JAYNE	6001 NORTHERN AVE	207594842	2020-2021	INDIVIDUAL PERSONAL PROPERTY	HARRIS MARIONNA MARIE	9508 E 62ND ST
207228390	2019-2020	INDIVIDUAL PERSONAL PROPERTY	KINNEY JORDAN ANTHONY	16068 E 80TH ST	207594977	2019-2020	INDIVIDUAL PERSONAL PROPERTY	RUNYON SARAH MARIE	5909 CLAREMONT AVE
207228431	2019-2021	INDIVIDUAL PERSONAL PROPERTY	TIEMEYER TUCKER NATHANIEL	10204 E 70TH TER	207595156	2021	INDIVIDUAL PERSONAL PROPERTY	MUNOZ NICOLAS RAY	5908 RAYTOWN RD
207228448	2019-2021	INDIVIDUAL PERSONAL PROPERTY	DUNCAN DAMON MARCEL JR	6124 HARVARD AVE	207595330	2021	INDIVIDUAL PERSONAL PROPERTY	SEMENS ANNARIKHA	8901 E 80TH ST
207580315	2021	INDIVIDUAL PERSONAL PROPERTY	RINALDI VALERIE JEAN	5432 HARVARD AVE	207595513	2019-2020	INDIVIDUAL PERSONAL PROPERTY	RODRIGUEZ KRystal DANIELLE	8505 KENTUCKY AVE
207580587	2019	INDIVIDUAL PERSONAL PROPERTY	SAULSBERRY CORTEZ L	10205 E 63RD TER APT B	207595780	2021	INDIVIDUAL PERSONAL PROPERTY	DANNER BRILEIGH RACHELLE	7408 ELM ST
207580773	2020-2021	INDIVIDUAL PERSONAL PROPERTY	MOZINGO MANASSEH GRACIE & JESSICA ANN	11701 E 76TH TER	207595833	2020-2021	INDIVIDUAL PERSONAL PROPERTY	WESLEY LATARA DANIELLE	8814 E 84TH ST
207580903	2019-2020	INDIVIDUAL PERSONAL PROPERTY	HARRIS NIKKIA RASHAY	8633 E UTOPIA PKWY APT 10	207595872	2021	INDIVIDUAL PERSONAL PROPERTY	WEBB NAKISHA R	9821 E 60TH ST
207581067	2021	INDIVIDUAL PERSONAL PROPERTY	SEXTON JOHN ROBERT	8911 E 81ST TER	207595967	2020-2021	INDIVIDUAL PERSONAL PROPERTY	BORDEN MILES WILLIAM	8000 HARRIS AVE
207581335	2020-2021	INDIVIDUAL PERSONAL PROPERTY	RICE EVAN NATHNIEL	8817 E 81ST TER	207596213	2021	INDIVIDUAL PERSONAL PROPERTY	JORDAN HEATHER ELLEN	8206 E 83RD ST
207581883	2019	INDIVIDUAL PERSONAL PROPERTY	MILLS ARYE RYDELL	8412 MARSH AVE	207596393	2019-2021	INDIVIDUAL PERSONAL PROPERTY	KLEIN JUSTIN BRETT	10912 E 56TH TER
207582045	2020-2021	INDIVIDUAL PERSONAL PROPERTY	DONNELL MICHAEL DUANE	5842 HUNTER CT	207596869	2020-2021	INDIVIDUAL PERSONAL PROPERTY	BATTLE ALFRED CORTEZ JR	6343 BLUE RIDGE BLVD
207582169	2021	INDIVIDUAL PERSONAL PROPERTY	TROY CLARK R	7406 OVERTON AVE UNIT 3	207597528	2021	INDIVIDUAL PERSONAL PROPERTY	WEATHERS JA'LET NICOLE	7223 RAYTOWN RD

207597569	2019-2021	INDIVIDUAL PERSONAL PROPERTY	WILLIAMS KIRA DEON	8600 EVERETT ST	207612678	2021	INDIVIDUAL PERSONAL PROPERTY	LEE JAEYEU	5501 BLUE RIDGE CUT OFF
207597744	2021	INDIVIDUAL PERSONAL PROPERTY	HOWE DACODA DANIELLE	5524 HUNTER ST	207612871	2021	INDIVIDUAL PERSONAL PROPERTY	JENNINGS DANIEL D	10404 E 69TH TER
207597908	2020-2021	INDIVIDUAL PERSONAL PROPERTY	ROULETTE JAMES EVERETTE III	7617 ENGLEWOOD AVE	207613044	2019-2021	INDIVIDUAL PERSONAL PROPERTY	WOLFORD-PEREZ ANNA ELIZABETH	8413 HARRIS AVE
207598115	2020-2021	INDIVIDUAL PERSONAL PROPERTY	BUCHANAN DRAPER ANTHON	5609 CRESCENT AVE	207613064	2021	INDIVIDUAL PERSONAL PROPERTY	FRANKLIN MARC D	7509 OVERTON AVE
207599339	2020-2021	INDIVIDUAL PERSONAL PROPERTY	GODDALE JENIFER R	8508 STARK AVE	207613136	2020-2021	INDIVIDUAL PERSONAL PROPERTY	ROGERS LATRICE ROCHELLE	8223 WOODSON DR
207599456	2020-2021	INDIVIDUAL PERSONAL PROPERTY	SHUPE NICHOLAS ALAN	11715 E 76TH TER	207613258	2020-2021	INDIVIDUAL PERSONAL PROPERTY	ROBINSON JANET FAY	7811 ENGLEWOOD AVE
207599472	2019	INDIVIDUAL PERSONAL PROPERTY	DISON ERROL LEIGH JR	10330 E 63RD ST APT 2	207613456	2019-2021	INDIVIDUAL PERSONAL PROPERTY	VOGLER CYNTHIA LYNN	5521 RALSTON AVE
207600025	2020-2021	INDIVIDUAL PERSONAL PROPERTY	CHAPPLE STEVEN ANDRE JR	5325 KENTUCKY AVE	207613569	2021	INDIVIDUAL PERSONAL PROPERTY	MELGAR PORTILLO WILLFERD ERNEST	7840 WOODSON RD
207600089	2019	INDIVIDUAL PERSONAL PROPERTY	KELLY TARA MICHELLE (MCCANN)	7912 ELM AVE	207613767	2021	INDIVIDUAL PERSONAL PROPERTY	CAMPBELL CARLOS DEMICHAEL D	7846 LANE DR
207600444	2021	INDIVIDUAL PERSONAL PROPERTY	DOODY MARY ANGELA	6140 RAYTOWN RD APT 901	207613829	2020-2021	INDIVIDUAL PERSONAL PROPERTY	LITTLES SAMANTHA JAY	6600 HARRIS AVE
207600718	2021	INDIVIDUAL PERSONAL PROPERTY	SEARCY CHRISTINA D	5557 BLUE RIDGE BLVD	207613861	2020-2021	INDIVIDUAL PERSONAL PROPERTY	RODRIGUEZ JAIME ALFREDO	11009 E 57TH TER
207601002	2020-2021	INDIVIDUAL PERSONAL PROPERTY	MCCRACKEN PAUL ERIC	9705 E 71ST TER	207613922	2020-2021	INDIVIDUAL PERSONAL PROPERTY	EDWARDS SHAWNNA NICOLE	5221 ELM PL
207601063	2020	INDIVIDUAL PERSONAL PROPERTY	HENDERSON RONNIE EARL III	8951 E 83RD ST	207614118	2020-2021	INDIVIDUAL PERSONAL PROPERTY	MICHAEL MATTHEW ALAN	8000 ELM AVE
207601277	2021	INDIVIDUAL PERSONAL PROPERTY	RICH JESSICA BRIANNA	5324 APPLETON AVE	207614162	2019-2021	INDIVIDUAL PERSONAL PROPERTY	BLEVINS SHANNON M	8615 ELM AVE
207601366	2020-2021	INDIVIDUAL PERSONAL PROPERTY	COLEMAN JAMEL E & MISTY D	5733 CEDAR AVE	207614225	2021	INDIVIDUAL PERSONAL PROPERTY	ROLAND FRANKLIN JOSEPH SR	7412 WOODSON RD
207601850	2020-2021	INDIVIDUAL PERSONAL PROPERTY	BROOKS MICHAEL JANETTE	9001 RICHARDS DR	207614348	2020-2021	INDIVIDUAL PERSONAL PROPERTY	JUAREZ-MORALES OLGA LIDIA	8408 WILLOW WAY
207602444	2021	INDIVIDUAL PERSONAL PROPERTY	HILL KEANDRE R	9204 VAUGHN AVE	207614503	2020-2021	INDIVIDUAL PERSONAL PROPERTY	PEARSON RHIANN ELIZABETH	7230 RAYTOWN RD APT F
207602566	2020-2021	INDIVIDUAL PERSONAL PROPERTY	BAGBY MATHEW EUGENE	9000 E 57TH ST	207615040	2017-2018	INDIVIDUAL PERSONAL PROPERTY	JONES ANDREA D	14580 E BANNISTER RD
207602567	2021	INDIVIDUAL PERSONAL PROPERTY	WILLIAMS PRECIOUS JANELL	8508 EVERETT ST	207615163	2021	INDIVIDUAL PERSONAL PROPERTY	COOPER RAS AARON	8601 EVERETT ST
207602728	2020-2021	INDIVIDUAL PERSONAL PROPERTY	GEORGE ZAIC ANTHNEE	9213 E 84TH CT	207615686	2021	INDIVIDUAL PERSONAL PROPERTY	SHIREMAN CATLYN JEWELL	10009 E 68TH ST
207602844	2021	INDIVIDUAL PERSONAL PROPERTY	RONZZO NICHOLAS EUGENE & RONZZO LAURA LY	9026 E 82ND ST	207615764	2020-2021	INDIVIDUAL PERSONAL PROPERTY	BEAM LEIGH ANN	6700 ENGLEWOOD AVE
207602934	2021	INDIVIDUAL PERSONAL PROPERTY	GRAVES KELLY LACHELLE	5803 KENTUCKY AVE	207615828	2021	INDIVIDUAL PERSONAL PROPERTY	THORNTON TRACI MARIE	6009 HARVARD AVE
207602998	2021	INDIVIDUAL PERSONAL PROPERTY	GOARD MICHAEL JEROME SR	11200 E 64TH TER	207615851	2021	INDIVIDUAL PERSONAL PROPERTY	BLAIR TYLER ALCANTER	5608 CRESCENT AVE
207603824	2021	INDIVIDUAL PERSONAL PROPERTY	PARKS DATHAN LEE II	10505 E 69TH TER	207615914	2020	INDIVIDUAL PERSONAL PROPERTY	HINSON LORICA SHANNON	6808 RAYTOWN RD
207603902	2020	INDIVIDUAL PERSONAL PROPERTY	BURNSIDE NOAH JONATHON	9908 E 82ND TER	207616402	2020	INDIVIDUAL PERSONAL PROPERTY	WHITE BREYANA DANAE	3834 MERSINGTON AVE
207604115	2021	INDIVIDUAL PERSONAL PROPERTY	JOHNSON ANGEL ELIZABETH	5715 MANNING AVE	207616475	2020-2021	INDIVIDUAL PERSONAL PROPERTY	DAY QUINTON LARON	7827 WASSAR AVE
207604223	2019-2021	INDIVIDUAL PERSONAL PROPERTY	JOHNSON BOBBY ISAIAH EUGENE	6537 RAYTOWN RD APT 2	207616725	2021	INDIVIDUAL PERSONAL PROPERTY	RAWLINGS LILY ELAINE	8111 DITZLER AVE
207604233	2020-2021	INDIVIDUAL PERSONAL PROPERTY	LYTLE JESSICA LYNN	5801 OXFORD AVE	207616766	2020	INDIVIDUAL PERSONAL PROPERTY	ARROYO FELICIANO HECTOR ENRIQUE	6535 RAYTOWN RD APT 2
207604306	2020-2021	INDIVIDUAL PERSONAL PROPERTY	COOPER DARELL LEE	9415 E 81ST ST	207616963	2020-2021	INDIVIDUAL PERSONAL PROPERTY	DAVIS STEPHEN JEREMY	1309 NE BURGANDY CT
207604380	2021	INDIVIDUAL PERSONAL PROPERTY	MILLER EMERY LAYNE	8204 HARVARD AVE	207617524	2021	INDIVIDUAL PERSONAL PROPERTY	HIGGINS STEPHANIE LYNN	8400 MARSH AVE
207604723	2019	INDIVIDUAL PERSONAL PROPERTY	CRANON KENNETH SAMUAL ZEMERIAH	11109 E 78TH ST	207617538	2021	INDIVIDUAL PERSONAL PROPERTY	MCCNEAL DANIEL JOSHUA-LEE	7508 APPLETON AVE
207604821	2020-2021	INDIVIDUAL PERSONAL PROPERTY	GIST CAIN ANITA	9058 E 65TH TER	207617587	2021	INDIVIDUAL PERSONAL PROPERTY	HERRERA ESTHER	7501 CRESCENT DR
207605055	2020-2021	INDIVIDUAL PERSONAL PROPERTY	THOMAS TAMIA JA'NEA	9307 E 84TH TER	207617773	2021	INDIVIDUAL PERSONAL PROPERTY	DORITY CHRISTIAN OWEN	5804 OXFORD AVE
207605131	2021	INDIVIDUAL PERSONAL PROPERTY	BOYD ANDREW MICHAEL	8004 HUNTER ST	207617988	2020-2021	INDIVIDUAL PERSONAL PROPERTY	FIELDS JAMIE CAMRON	8216 HARRIS AVE
207605153	2020-2021	INDIVIDUAL PERSONAL PROPERTY	CLAXTON DEJA RENAE	1031 N ELIZABETH AVE	207618089	2021	INDIVIDUAL PERSONAL PROPERTY	DONOHUE SEAN ALBERT	8615 CRESCENT AVE
207605174	2020	INDIVIDUAL PERSONAL PROPERTY	MEDINA DE VILLATORO TESLA LARISSA	5416 RAYTOWN RD	207618203	2020-2021	INDIVIDUAL PERSONAL PROPERTY	RICE KEONN RASHAWD	6418 ELM AVE
207605436	2021	INDIVIDUAL PERSONAL PROPERTY	BODENHAMER JONATHAN ROSS	11401 E 51ST ST	207618368	2020-2021	INDIVIDUAL PERSONAL PROPERTY	KONOMOS BRETT COLIN	10908 E 59TH TER
207605453	2021	INDIVIDUAL PERSONAL PROPERTY	POSTLEWAIT JUSTIN SCOTT	7105 HARVARD AVE	207618599	2021	INDIVIDUAL PERSONAL PROPERTY	BRYANT DANIEL A	8512 FORD AVE
207605767	2019-2021	INDIVIDUAL PERSONAL PROPERTY	PEBWORTH JASON RAY	8700 LANE AVE	207618832	2021	INDIVIDUAL PERSONAL PROPERTY	CALVIN SHAYLA JANAE	9027 E 85TH TER
207606001	2020-2021	INDIVIDUAL PERSONAL PROPERTY	REYNA LLOLANDA	8819 E 80TH TER	207618841	2019	INDIVIDUAL PERSONAL PROPERTY	GRIFFEN BREANA SHEREE	6539 RAYTOWN RD APT 2
207606370	2020	INDIVIDUAL PERSONAL PROPERTY	CAMPBELL CHARLES CREIGHTON II	11274 E 71ST TER	207618967	2020-2021	INDIVIDUAL PERSONAL PROPERTY	ESPARZA ROCIO	6205 HUNTER ST
207606737	2021	INDIVIDUAL PERSONAL PROPERTY	CAUTION KEAGAN DALLAS WAYLON	5312 HEDGES AVE	207619074	2021	INDIVIDUAL PERSONAL PROPERTY	TOOKER CAILENE REBECCA	7313 CRISP AVE
207607309	2019-2021	INDIVIDUAL PERSONAL PROPERTY	RICE LOGAN THORN PATRICK	8315 HUNTER ST	207619867	2021	INDIVIDUAL PERSONAL PROPERTY	LAUDERDALE TITUS DEVENTA	7311 RAYTOWN RD
207607328	2021	INDIVIDUAL PERSONAL PROPERTY	GRAY KRISLYN NOEL	7509 ARLINGTON AVE	207619928	2020-2021	INDIVIDUAL PERSONAL PROPERTY	CLAYTON DUANE CARLTON 2ND	8204 WOODSON DR
207607610	2020-2021	INDIVIDUAL PERSONAL PROPERTY	CAMAS SALAZAR JAIME ALBERTO	8312 JAMES A REED RD	207620020	2020-2021	INDIVIDUAL PERSONAL PROPERTY	WILSON TAMARA ALANE	7916 SUNSET CIR
207607687	2020-2021	INDIVIDUAL PERSONAL PROPERTY	HARRIS TERRILL ARGNES JR	9918 E 61ST ST	207620472	2021	INDIVIDUAL PERSONAL PROPERTY	JOLLY STACY NICHOLE	8601 CRESCENT AVE
207607715	2021	INDIVIDUAL PERSONAL PROPERTY	MONTGOMERY SHAUNTE LOUISE	2165 SW TIMBERTRACE LN	207620527	2020-2021	INDIVIDUAL PERSONAL PROPERTY	SIMMONS RAIVYANA LASHAWN	5601 MANNING AVE
207607940	2019	INDIVIDUAL PERSONAL PROPERTY	WEINBERG JOHN MICHAEL	7617 HARRIS AVE	207620889	2021	INDIVIDUAL PERSONAL PROPERTY	OXLEY BRANDON SEAN	9000 E 68TH ST
207607998	2020-2021	INDIVIDUAL PERSONAL PROPERTY	MARTIN JERMALE ROOSEVELT	8615 KENTUCKY AVE	207621017	2020-2021	INDIVIDUAL PERSONAL PROPERTY	NEVELS MARRISHA SHA MONT	9331 E 83RD ST
207608128	2021	INDIVIDUAL PERSONAL PROPERTY	PATTERSON JALIJAH NICHOLE	7206 CRISP AVE	207621055	2021	INDIVIDUAL PERSONAL PROPERTY	GOAD ELIZABETH ALAINE	9103 E 69TH ST
207608482	2019-2020	INDIVIDUAL PERSONAL PROPERTY	SPENCER ANDREW LEE	6423 BLUE RIDGE CUT OFF	207621357	2020-2021	INDIVIDUAL PERSONAL PROPERTY	BOBADILLA GRACE ANN	9207 VAUGHN AVE
207608918	2020-2021	INDIVIDUAL PERSONAL PROPERTY	SALAZAR EMA ESTHER	9821 E 64TH TER	207621473	2020-2021	INDIVIDUAL PERSONAL PROPERTY	WILLIAMS ELIZABETH ANN	8806 E 73RD ST
207609015	2021	INDIVIDUAL PERSONAL PROPERTY	OGBIAGU AUSTIN C	10006 E 70TH TER	207621476	2021	INDIVIDUAL PERSONAL PROPERTY	LAWNS AMY JO	7304 CRISP AVE
207609819	2020-2021	INDIVIDUAL PERSONAL PROPERTY	TAYLOR ANASTASIA UNIQUE	9705 E 80TH TER	207622513	2020	INDIVIDUAL PERSONAL PROPERTY	GOLDMAN CHARLES A III	8609 ELM AVE
207609958	2020-2021	INDIVIDUAL PERSONAL PROPERTY	FLYNN HAILEY RHEA	7309 HARVARD DR	207622525	2020-2021	INDIVIDUAL PERSONAL PROPERTY	LANE TREVALLE M	7236 RAYTOWN RD APT E
207610014	2021	INDIVIDUAL PERSONAL PROPERTY	BUCHANAN BILLIE JOE JR	8513 CRESCENT AVE	207622589	2020-2021	INDIVIDUAL PERSONAL PROPERTY	RICHARD TIARA DEON	7420 WILLOW AVE
207610200	2021	INDIVIDUAL PERSONAL PROPERTY	MCLIN BRIANNA NICOLE	11134 E 84TH TER	207622690	2020-2021	INDIVIDUAL PERSONAL PROPERTY	TREVINO DONOVAN WILLIAM	5901 CLAREMONT AVE
207610220	2020-2021	INDIVIDUAL PERSONAL PROPERTY	DOOLEY MICHELA JOY	8720 E 79TH TER	207622894	2021	INDIVIDUAL PERSONAL PROPERTY	LAWRENCE MONTERALA TRANE E	9314 E 85TH ST
207610521	2021	INDIVIDUAL PERSONAL PROPERTY	WHITEHAIR LEVINA ROSE	6600 WILLOW AVE	207622986	2020-2021	INDIVIDUAL PERSONAL PROPERTY	GILMORE AERIYANA TARSE E	8819 E 85TH ST
207610607	2020-2021	INDIVIDUAL PERSONAL PROPERTY	BURGOS FRANCO JOSE MARTIN	8312 JAMES A REED RD	207623174	2019	INDIVIDUAL PERSONAL PROPERTY	TRAMMELL TONI	9107 E 68TH TER
207610803	2020	INDIVIDUAL PERSONAL PROPERTY	WALKER JOSEPH HUFF	8814 E 84TH ST	207623188	2021	INDIVIDUAL PERSONAL PROPERTY	WATSON HARRY P III & SUSAN A	10010 E 78TH ST
207611017	2020-2021	INDIVIDUAL PERSONAL PROPERTY	COLLINS POWERS LAYNE	9109 E 67TH TER	207623210	2021	INDIVIDUAL PERSONAL PROPERTY	ROTHERMICH MONICA ELAINE	8012 HARDY AVE
207611087	2020-2021	INDIVIDUAL PERSONAL PROPERTY	ARMSTRONG DANEE KRISTYNA	7632 STERLING AVE	207623656	2021	INDIVIDUAL PERSONAL PROPERTY	SAUNDERS MASON LUKE	11215 E 56TH TER
207611124	2020-2021	INDIVIDUAL PERSONAL PROPERTY	CLAYPOOL ASHLEY DAWN	9362 E 69TH TER	207623866	2021	INDIVIDUAL PERSONAL PROPERTY	WOODS TIMOTHY LAMONT JR	7165 ELM ST
207611194	2021	INDIVIDUAL PERSONAL PROPERTY	NIMROD RICO	8423 WOODSON DR	207624244	2021	INDIVIDUAL PERSONAL PROPERTY	DAVISON ROBERT L	6743 STERLING AVE
207611404	2020-2021	INDIVIDUAL PERSONAL PROPERTY	YOUNG CRYSTAL DANIELLE	7213 HARRIS AVE	207624318	2020-2021	INDIVIDUAL PERSONAL PROPERTY	BELTRAN LINDSEY DANIELLE	8828 RICHARDS DR
207611806	2021	INDIVIDUAL PERSONAL PROPERTY	BUGENHAGEN STEVEN ALEXANDER	9105 E 72ND TER	207624552	2021	INDIVIDUAL PERSONAL PROPERTY	FALK JUDY LYNN	7705 APPLETON AVE
207612088	2020-2021	INDIVIDUAL PERSONAL PROPERTY	WHITE STACI EILEEN	7420 HARDY AVE	207624572	2021	INDIVIDUAL PERSONAL PROPERTY	MCCLAIN ANTHONY REGINALD	5521 BLUE RIDGE CUT OFF
207612236	2021	INDIVIDUAL PERSONAL PROPERTY	COMBS TANYA KAY	7539 WESTRIDGE RD	207624781	2020	INDIVIDUAL PERSONAL PROPERTY	PAYNE MARQUISE MARIEA	6809 COLLEGE AVE
207612259	2020-2021	INDIVIDUAL PERSONAL PROPERTY	MAYS TAVVIYEA DALSHAWN	11125 E 84TH TER	207624922	2021	INDIVIDUAL PERSONAL PROPERTY	BARNEY SEAN WINFIELD	7145 RAYTOWN RD
207612290	2020-2021	INDIVIDUAL PERSONAL PROPERTY	TURNER REBECCA LYNETTE	11409 E 65TH TER	207625271	2020-2021	INDIVIDUAL PERSONAL PROPERTY	CRUZ REBECCA JOAN	10824 E 66TH TER
207612396	2021	INDIVIDUAL PERSONAL PROPERTY	JOHNSON LISA YVONNE	2716 ENGLEWOOD TER	207625272	2020-2021	INDIVIDUAL PERSONAL PROPERTY	LOVE JONTE RENARDO	10824 E 66TH TER

207625350	2019-2021	INDIVIDUAL PERSONAL PROPERTY	PETERS EMILY ANN	7201 CEDAR AVE	207638022	2020	INDIVIDUAL PERSONAL PROPERTY	MICHAEL CALEB SILAS	9919 E 63RD ST
207625562	2020	INDIVIDUAL PERSONAL PROPERTY	HAYS SAMATHA VIVIAN	10108 E 77TH TER	207638072	2020-2021	INDIVIDUAL PERSONAL PROPERTY	BROOKS HEATHER NICOLE	11100 E 67TH ST
207625869	2020-2021	INDIVIDUAL PERSONAL PROPERTY	DEAN JALEN JAMAL D	11201 E 63RD ST	207638335	2019-2021	INDIVIDUAL PERSONAL PROPERTY	ONEAL SHAVON J	9022 E 61ST ST
207626023	2021	INDIVIDUAL PERSONAL PROPERTY	REYNOLDS JAMES REX III	5717 BLUE RIDGE BLVD	207638540	2021	INDIVIDUAL PERSONAL PROPERTY	NEAL KELE MIKEL	9977 E 87TH ST
207626251	2021	INDIVIDUAL PERSONAL PROPERTY	DEMERY DARRIAN DESHAUN	11011 E 83RD ST	207638581	2021	INDIVIDUAL PERSONAL PROPERTY	JONES LAUREN CHRISTINE	10408 E 79TH ST
207626329	2020	INDIVIDUAL PERSONAL PROPERTY	BROOKS BOBBI A	9021 E 74TH TER	207638603	2020-2021	INDIVIDUAL PERSONAL PROPERTY	VANG KABAO THOR & KAO LEE	7922 DITZLER AVE
207626556	2021	INDIVIDUAL PERSONAL PROPERTY	LIVINGSTON CIERRA CHANTELL	6000 BLUE RIDGE CUT OFF	207638675	2021	INDIVIDUAL PERSONAL PROPERTY	HILL LINDA DIANE	9815 E 77TH TER
207626795	2020	INDIVIDUAL PERSONAL PROPERTY	SCHEPCOFF MICHAEL ERIC	11124 E 85TH ST	207638986	2020-2021	INDIVIDUAL PERSONAL PROPERTY	STOVALL JAYLEN KYLE	8605 STARK AVE
207627061	2021	INDIVIDUAL PERSONAL PROPERTY	SOUTHERS DAWN CHRISTINE	8409 NORTHERN ST	207639240	2019-2020	INDIVIDUAL PERSONAL PROPERTY	HIBDON NICOLE L	11308 E 67TH TER
207627368	2020	INDIVIDUAL PERSONAL PROPERTY	ALLEN MATTHEW REX	5400 NORTHERN AVE	207639617	2021	INDIVIDUAL PERSONAL PROPERTY	DAVIS THOMAS LEE	7224 MAPLE AVE
207627422	2020-2021	INDIVIDUAL PERSONAL PROPERTY	ARCHER SAMANTHA JO	6444 BLUE RIDGE BLVD	207639990	2020-2021	INDIVIDUAL PERSONAL PROPERTY	CROSS KEVIN O	9904 E 61ST ST
207627670	2020	INDIVIDUAL PERSONAL PROPERTY	BUTLER CASEY WAYNE	7512 CRESCENT DR	207640373	2020-2021	INDIVIDUAL PERSONAL PROPERTY	PENNINGTON SAMUEL LEGUS JR	11901 E 85TH ST
207627799	2021	INDIVIDUAL PERSONAL PROPERTY	CATTELL MALLOREIGH RENEE	9512 E 57TH ST	207640392	2021	INDIVIDUAL PERSONAL PROPERTY	JOHNSON ILLYA HYMES	6545 RAYTOWN RD APT 2
207627977	2021	INDIVIDUAL PERSONAL PROPERTY	MARSHALL VINCENT ANTHONY	5323 BLUE RIDGE BLVD	207640397	2020-2021	INDIVIDUAL PERSONAL PROPERTY	YOUNGBLOOD DANNITA RENEE	8113 WOODSON DR
207628210	2021	INDIVIDUAL PERSONAL PROPERTY	LAMB ELIJAH JARON	10401 E 82ND TER	207640576	2020-2021	INDIVIDUAL PERSONAL PROPERTY	BEASON LESTER NEWELL III	5601 WOODSON RD
207628281	2020	INDIVIDUAL PERSONAL PROPERTY	AREVALO CASTRO MARVIN OVED	9806 E 60TH ST	207640585	2021	INDIVIDUAL PERSONAL PROPERTY	DUGAN KENNETH LEE III	8136 DITZLER AVE
207628487	019	INDIVIDUAL PERSONAL PROPERTY	MCWILLIN KASEY L	5904 ARLINGTON AVE	207640723	2020	INDIVIDUAL PERSONAL PROPERTY	SANDERS PATRICK DON'TAY	9816 E 67TH ST
207628641	019	INDIVIDUAL PERSONAL PROPERTY	SALUBEAER SHEILA LEE	7402 OVERTON AVE UNIT 8	207641039	2021	INDIVIDUAL PERSONAL PROPERTY	HINOJOSA ADDISON MARIE	6720 LAUREL AVE
207628650	2019	INDIVIDUAL PERSONAL PROPERTY	LOPEZ VICTORIA ROSE MARIE & JAMISON AUSTIN L	6004 FARLE AVE	207641068	2021	INDIVIDUAL PERSONAL PROPERTY	JACKSON JOHN PAUL	6501 STERLING AVE
207629028	2021	INDIVIDUAL PERSONAL PROPERTY	SEATON GALEN TOBIAS T	5725 ELM AVE	207641346	2020-2021	INDIVIDUAL PERSONAL PROPERTY	HOOKS CEDRIC L III	10006 E 70TH TER
207629276	2020-2021	INDIVIDUAL PERSONAL PROPERTY	ANRADE ABRAHAM LOPEZ	8605 MAPLE AVE	207641528	2021	INDIVIDUAL PERSONAL PROPERTY	WATSON DILLON CAMDEN	6805 VERMONT AVE
207629345	2021	INDIVIDUAL PERSONAL PROPERTY	FOX BOND KIMBERLYNNE JENNETTE MICHELLE	6123 HARVARD AVE	207641718	2020-2021	INDIVIDUAL PERSONAL PROPERTY	PLYCOR ALEXIS NICOLE	8412 WOODSON CT
207629545	2020	INDIVIDUAL PERSONAL PROPERTY	WASHINGTON TINAYIA L	8421 SPRING VALLEY RD	207641765	2020	INDIVIDUAL PERSONAL PROPERTY	YARBRO WILLIAM ANTHONY	5605 STERLING AVE
207629988	2020-2021	INDIVIDUAL PERSONAL PROPERTY	SPINSKI TRENT M	6620 RALSTON AVE	207642027	2020-2021	INDIVIDUAL PERSONAL PROPERTY	ZECHEL BROOKE ASHLEY	9210 E 79TH ST
207630137	2021	INDIVIDUAL PERSONAL PROPERTY	BRISCOE WENDELL D III	5700 BLUE RIDGE BLVD	207642042	2021	INDIVIDUAL PERSONAL PROPERTY	DISMUKE RENITA NICHELLE	9909 E 82ND ST
207630211	2020-2021	INDIVIDUAL PERSONAL PROPERTY	LOYOLA JENTRY	7200 RAYTOWN RD	207642233	019	INDIVIDUAL PERSONAL PROPERTY	MCCLURE WILLIE	13309 WINCHESTER AVE
207630214	2020-2021	INDIVIDUAL PERSONAL PROPERTY	ROGERS JEFFREY LYNN	8906 E 74TH ST	207642246	2020	INDIVIDUAL PERSONAL PROPERTY	RYMES SYLVIA	8610 EVERETT ST
207630401	2020	INDIVIDUAL PERSONAL PROPERTY	ROCHA-GONZALEZ LUIS DAVID	8603 E 81ST ST	207642261	019	INDIVIDUAL PERSONAL PROPERTY	WILLIAMS RONALD	7800 EVERETT ST
207630404	2019-2021	INDIVIDUAL PERSONAL PROPERTY	HASEGAWA ALEXANDER SCOTT	6634 OXFORD AVE	207642448	2021	INDIVIDUAL PERSONAL PROPERTY	MALLORY KAYTLYN MACKENZIE	7412 CRISP AVE
207630542	2020	INDIVIDUAL PERSONAL PROPERTY	MCCLAIN JOHN EDWARD	9411 E 83RD ST	207642659	2020-2021	INDIVIDUAL PERSONAL PROPERTY	GOKE SETH CHRISTOPHER	8320 HARRIS AVE
207630574	019	INDIVIDUAL PERSONAL PROPERTY	LEE TERRANCE DEMOND	9032 E 85TH PL	207642738	019	INDIVIDUAL PERSONAL PROPERTY	SMITH ELLA	6416 ELM AVE
207630723	019-2021	INDIVIDUAL PERSONAL PROPERTY	VICE ASHLEY NICHOLE (BENNETT)	5520 DITZLER AVE	207642875	2021	INDIVIDUAL PERSONAL PROPERTY	SHOALS DELBERT EUGENE JR	8524 ASH AVE
207630990	2021	INDIVIDUAL PERSONAL PROPERTY	KENNER SHARON KAYE	8421 ELM AVE	207642922	2021	INDIVIDUAL PERSONAL PROPERTY	DAVIS GWENDOLYN	7513 ENGLEWOOD AVE
207631330	2020	INDIVIDUAL PERSONAL PROPERTY	TAYLOR MARKES DAMON	6405 BLUE RIDGE CUT OFF	207643066	2020-2021	INDIVIDUAL PERSONAL PROPERTY	MARSHALL CHRISTOPHER SCOTT & RACHEL RENE	7910 MANNING AVE
207632045	2020-2021	INDIVIDUAL PERSONAL PROPERTY	JOHNSON BRIANNA MIKALLE	9806 E 74TH ST	207643147	2019	INDIVIDUAL PERSONAL PROPERTY	WILLIAMS MONICA	9705 E 72TH TER
207632403	2021	INDIVIDUAL PERSONAL PROPERTY	SCOGGIN NAOMI LOREE	8812 E 81ST TER	207643167	019	INDIVIDUAL PERSONAL PROPERTY	HERVEY ENRIQUE	7917 HARDY AVE
207632508	2020	INDIVIDUAL PERSONAL PROPERTY	EDWARDS JACOB A	5305 RIDGEWAY AVE	207643379	2021	INDIVIDUAL PERSONAL PROPERTY	TRACY JOHNNY CHARLES	8619 KENTUCKY AVE
207632636	2020-2021	INDIVIDUAL PERSONAL PROPERTY	JOHNSON CHRISTIAN LAMONTE	5336 NORTHERN AVE	207643527	2021	INDIVIDUAL PERSONAL PROPERTY	NOLEN MARCHELLE LANAE	7614 CRESCENT DR
207632690	2021	INDIVIDUAL PERSONAL PROPERTY	HANNAH DALLAS CURTIS	7221 HARRIS AVE	207643568	2021	INDIVIDUAL PERSONAL PROPERTY	RILEY RISHAWN ALI GARNETT	8515 OXFORD AVE
207632717	2020-2021	INDIVIDUAL PERSONAL PROPERTY	GOMEZ WALKER NICOLE LOUISE	7202 OVERTON AVE	207643753	2020-2021	INDIVIDUAL PERSONAL PROPERTY	ELLISON JEROME J	5324 RALSTON AVE
207632814	2020-2021	INDIVIDUAL PERSONAL PROPERTY	HARRIS KIMBERLY RUTH	10901 E 66TH ST	207643848	019	INDIVIDUAL PERSONAL PROPERTY	PRICE ROLANDA	8621 W UTOPIA DR APT 1
207632890	2020-2021	INDIVIDUAL PERSONAL PROPERTY	HOPPE CAROLE ANN	9712 E 84TH ST	207643969	2021	INDIVIDUAL PERSONAL PROPERTY	NICHOLAS ZITAYA LESLIE	9401 E 83RD ST
207632903	2021	INDIVIDUAL PERSONAL PROPERTY	MILLER HANNAH LARHEA	6210 DITZLER AVE	207644393	2020-2021	INDIVIDUAL PERSONAL PROPERTY	VELASQUEZ PINTO WALTER GABRIEL	7703 RAYTOWN RD APT 21
207633017	2021	INDIVIDUAL PERSONAL PROPERTY	WATTS DEION MARQUIS	9306 VAUGHN AVE	207644402	2021	INDIVIDUAL PERSONAL PROPERTY	REED WILLIAM ANTHONY	6551 RAYTOWN RD APT 3
207633040	2021	INDIVIDUAL PERSONAL PROPERTY	SMITH AARON QUARNELL	11709 E 83RD ST APT 202	207644413	2020-2021	INDIVIDUAL PERSONAL PROPERTY	MCCLENDON KEVIN ALAN	9404 E 81ST ST
207633389	2020-2021	INDIVIDUAL PERSONAL PROPERTY	ARAMBULA ANAIS ANGELINA	6016 BLUE RIDGE BLVD	207644536	019	INDIVIDUAL PERSONAL PROPERTY	KNIGHT ASHLEY	11413 E 77TH ST
207633996	2020-2021	INDIVIDUAL PERSONAL PROPERTY	WYATT ABREANNA N	8858 E 53RD TER	207644549	019	INDIVIDUAL PERSONAL PROPERTY	AVERY XANTHE	9812 E 61ST ST APT 1
207633733	019-2021	INDIVIDUAL PERSONAL PROPERTY	CREACY KIESHA CHYNAE	7412 WOODSON RD	207644578	2020-2021	INDIVIDUAL PERSONAL PROPERTY	SANCHEZ DANIELLE ROSA	6721 STERLING AVE
207634237	2021	INDIVIDUAL PERSONAL PROPERTY	GREGORY DENNIS ROY	8808 E 86TH ST	207644580	2020-2021	INDIVIDUAL PERSONAL PROPERTY	REBOULICH RUSSELL J	7200 WILLOW AVE
207634421	2020-2021	INDIVIDUAL PERSONAL PROPERTY	MANIFREDONIA LUCIANO JR & ANDREA	11104 E 74TH ST	207644630	019	INDIVIDUAL PERSONAL PROPERTY	TAYLOR STEWART RONDINE MONIQUE	9308 E 69TH TER
207634707	2021	INDIVIDUAL PERSONAL PROPERTY	ISACKSON MARCY DIANE	9904 E 59TH TER	207644824	2020-2021	INDIVIDUAL PERSONAL PROPERTY	PARKER STAN & DEVIN	9406 E 80TH TER
207634752	2020-2021	INDIVIDUAL PERSONAL PROPERTY	WILLIAMS KENNETH LAVELL	8605 E 84TH TER	207644920	2020-2021	INDIVIDUAL PERSONAL PROPERTY	RYMES ROSEMARY	5505 WILLOW AVE
207634798	2020-2021	INDIVIDUAL PERSONAL PROPERTY	SHIRLEY ANTWON CHARLTON	7224 CRISP AVE	207644992	2020-2021	INDIVIDUAL PERSONAL PROPERTY	GRAY MAYA CHARNAE	6222 RAYTOWN FWY
207634968	2021	INDIVIDUAL PERSONAL PROPERTY	RODRIGUEZ NAJARRO CONCEPCION	9415 E 67TH ST	207645802	2021	INDIVIDUAL PERSONAL PROPERTY	EUCEDA MEJIA JOSE OMAR	7922 DITZLER AVE
207635396	2020-2021	INDIVIDUAL PERSONAL PROPERTY	LAMASTER LA'ARION SHA'COR	8312 STERLING AVE	207645858	2021	INDIVIDUAL PERSONAL PROPERTY	BANKS TYRESE LEE	8407 KENTUCKY AVE
207635592	2020	INDIVIDUAL PERSONAL PROPERTY	LUCAS EMILY ANNE	9809 E 67TH TER	207645999	2020	INDIVIDUAL PERSONAL PROPERTY	ARITA URBINA WILLIAM EDGARDO	9809 E 61ST ST APT 4
207635716	2020-2021	INDIVIDUAL PERSONAL PROPERTY	WASHINGTON-CURRY CAMEO O	8304 ELM AVE	207646071	019-2021	INDIVIDUAL PERSONAL PROPERTY	MILES REMMI RACHELLE	9809 E 61ST TER
207636055	2021	INDIVIDUAL PERSONAL PROPERTY	GLADNEY DEBORAH LYNN	9109 E 84TH CT	207646585	2019-2021	INDIVIDUAL PERSONAL PROPERTY	DONALESKI SABRINA GWEN	5801 ELM AVE
207636354	2020-2021	INDIVIDUAL PERSONAL PROPERTY	HUSSAIN BLAZE CHRISTOPHER	7312 HARDY AVE	207646777	2021	INDIVIDUAL PERSONAL PROPERTY	URBANEX DEIGHTON	8006 ARLINGTON AVE
207636397	2020-2021	INDIVIDUAL PERSONAL PROPERTY	PRATT JACQUELINE	5420 BLUE RIDGE CUT OFF APT 507	207647213	2021	INDIVIDUAL PERSONAL PROPERTY	BEAM DAVID J	6706 ENGLEWOOD AVE
207636410	2021	INDIVIDUAL PERSONAL PROPERTY	VANG CHENG PEDER	7922 DITZLER AVE	207647288	2021	INDIVIDUAL PERSONAL PROPERTY	CASTRO HECTOR JR	9808 E 85TH ST
207636891	2021	INDIVIDUAL PERSONAL PROPERTY	BROOKS MOLLY MARGARET	5528 BLUE RIDGE BLVD	207647532	2021	INDIVIDUAL PERSONAL PROPERTY	JOHNSON ALEXIS SHARAE	9808 E 85TH ST
207636996	2020-2021	INDIVIDUAL PERSONAL PROPERTY	LANDRUM KRISTA ALISE	10611 E 78TH TER	207647582	2017-2019	INDIVIDUAL PERSONAL PROPERTY	SHULTS DEBORAH KAY (BRAVERMAN)	11012 E 78TH ST
207637169	2020-2021	INDIVIDUAL PERSONAL PROPERTY	SCHEIDER BRANDON LAMONT JR	7905 HEDGES AVE	207648091	2020-2021	INDIVIDUAL PERSONAL PROPERTY	EICHELBERER CHARLES	5715 KENTUCKY AVE
207637246	2021	INDIVIDUAL PERSONAL PROPERTY	COLLINS HELEN ANN	9005 E 68TH ST	207648481	2020-2021	INDIVIDUAL PERSONAL PROPERTY	HATLES JACKSON	6724 RAYTOWN RD
207637311	2021	INDIVIDUAL PERSONAL PROPERTY	VANG CHOUA DER	7922 DITZLER AVE	207649454	2020-2021	INDIVIDUAL PERSONAL PROPERTY	EVANS JYON D	8428 WOODSON DR
207637408	2021	INDIVIDUAL PERSONAL PROPERTY	HAYES CODY MICHAEL	10101 E 80TH ST	207649586	2020-2021	INDIVIDUAL PERSONAL PROPERTY	REYNOLD SANCHEZ RUTHANN KATHIE	5901 ELM AVE
207637483	2019-2021	INDIVIDUAL PERSONAL PROPERTY	COWLEY MILAEENE KEION	11335 E 72ND ST	207649872	2021	INDIVIDUAL PERSONAL PROPERTY	RIDLEY LESTER T JR	9809 E 79TH ST
207637712	2021	INDIVIDUAL PERSONAL PROPERTY	ALFARO PERAZA MARIA	8002 MANNING AVE	207650221	2021	INDIVIDUAL PERSONAL PROPERTY	HIRST COY THOMAS	5924 CRESCENT AVE
207637803	2021	INDIVIDUAL PERSONAL PROPERTY	LAVENDER TRAVIS PAUL	8001 ARLINGTON AVE	207650281	2021	INDIVIDUAL PERSONAL PROPERTY	CLEMMONS KALEB DUPRE	8002 E 59TH ST
207637987	2021	INDIVIDUAL PERSONAL PROPERTY	REYNOLDS STEVE MICHAEL	8407 WOODSON CT	207650394	2021	INDIVIDUAL PERSONAL PROPERTY	RUSSELL LASHAY BREANN	5408 BLUE RIDGE BLVD
207637990	2021	INDIVIDUAL PERSONAL PROPERTY	THOLE RACHEL LEIGH	9320 E 84TH TER	207650612	2020-2021	INDIVIDUAL PERSONAL PROPERTY	DARRINGTON ROY LEE	5610 NORTHERN AVE

207650771	2020-2021	INDIVIDUAL PERSONAL PROPERTY	DENNIS BREYON SKYY	9412 E 81ST TER	208042519	2021	INDIVIDUAL PERSONAL PROPERTY	CLARK MARY L	7137 CRISP AVE
207650795	2021	INDIVIDUAL PERSONAL PROPERTY	SOUTHWARD JASON LEE	10500 E 69TH TER	208042843	2021	INDIVIDUAL PERSONAL PROPERTY	HOWARD JASON JOSEPH	9710 E 77TH ST
207651071	2021	INDIVIDUAL PERSONAL PROPERTY	MILLER TANIA PATRICE	9333 E 83RD ST	208042845	2020	INDIVIDUAL PERSONAL PROPERTY	WALKER JACOREY ANTHONY	7321 HARDY AVE
207651126	2021	INDIVIDUAL PERSONAL PROPERTY	MORTON HANNAH BETH	6208 ENGLEWOOD AVE	208043170	2020-2021	INDIVIDUAL PERSONAL PROPERTY	GREEN ASHLYN ROSE	6905 RAYTOWN RD
207651219	2021	INDIVIDUAL PERSONAL PROPERTY	BRAGG HAILEY DEMETRIA MARIE	10600 E 72ND ST	208043688	2020-2021	INDIVIDUAL PERSONAL PROPERTY	WATSON MIYA RENEE SIMONE	8450 LANE DR
207651518	2021	INDIVIDUAL PERSONAL PROPERTY	REED KE'ANDRA G	5301 CRISP AVE	208043978	2021	INDIVIDUAL PERSONAL PROPERTY	RESSEL MAKILA KAYTLYN	9109 E 74TH ST
207651937	2020-2021	INDIVIDUAL PERSONAL PROPERTY	SIMINGTON MEGHAN FRANCIS	5909 CRESCENT AVE	208044125	2021	INDIVIDUAL PERSONAL PROPERTY	NORRIS EMMA LEE ROSE	9904 E 60TH ST
207652096	2020-2021	INDIVIDUAL PERSONAL PROPERTY	SEIDEN LUCAS TAYLOR	11301 E 78TH TER	208044314	2021	INDIVIDUAL PERSONAL PROPERTY	CARTER DANIELLE L (LITRELL)	6701 CRISP AVE
207652447	2020-2021	INDIVIDUAL PERSONAL PROPERTY	CLARK DAQUAN MONTES	8502 EVERETT ST	208044371	2021	INDIVIDUAL PERSONAL PROPERTY	JONES MARISSA LAUREN	5580 BLUE RIDGE BLVD
207652506	2021	INDIVIDUAL PERSONAL PROPERTY	WATSON JOHN M 3RD	8951 E 83RD ST	208044680	2020-2021	INDIVIDUAL PERSONAL PROPERTY	GARCIA MATTHEW ADRIAN	5716 LANE AVE
207652689	2020	INDIVIDUAL PERSONAL PROPERTY	JOHNSON TERRANCE ANTHONY	6307 ASH AVE APT 6	208044770	2021	INDIVIDUAL PERSONAL PROPERTY	BLAKE ELISABETH ANNE	6004 FARLEY AVE
207652698	2021	INDIVIDUAL PERSONAL PROPERTY	SMITH-GRAY ELISSIA JONAE	6222 RAYTOWN TRFY	208044902	2021	INDIVIDUAL PERSONAL PROPERTY	CUEVAS PABLO MIGUEL	9133 E 85TH PL
207652971	2020-2021	INDIVIDUAL PERSONAL PROPERTY	LE FLORE KENDALL JERMEL	9805 E 61ST ST APT 6	208045129	2021	INDIVIDUAL PERSONAL PROPERTY	MURPHY SAMUEL CODY	8208 HEDGES AVE
207653088	2020	INDIVIDUAL PERSONAL PROPERTY	GENTZ SABRINA M	6625 MAYWOOD AVE	208045267	2021	INDIVIDUAL PERSONAL PROPERTY	STIEPP LESIA K	6140 RAYTOWN RD APT 1002
207653326	2020-2021	INDIVIDUAL PERSONAL PROPERTY	THONMPSON DAISHANE TANIQUE	8916 E 81ST ST	208045558	2020	INDIVIDUAL PERSONAL PROPERTY	MANFIELD TAMMY JO	5905 RAYTOWN RD
207653376	2020-2021	INDIVIDUAL PERSONAL PROPERTY	OWENS STEPHEN C	10512 E 69TH ST	208045596	2020-2021	INDIVIDUAL PERSONAL PROPERTY	JOHNSON KYLE MICHAEL	7720 ELM ST
207653486	2020-2021	INDIVIDUAL PERSONAL PROPERTY	LARSON SETH HARLEN	9001 E 85TH ST	208045629	2021	INDIVIDUAL PERSONAL PROPERTY	KING DEVONTAE LEE	8512 E 85TH ST
207653767	2020-2021	INDIVIDUAL PERSONAL PROPERTY	BROWN DEVONTE JORSHON	5817 KENTUCKY AVE	208045848	2021	INDIVIDUAL PERSONAL PROPERTY	JOHNSON ANTHONY RAYE	8803 HILLWOOD DR APT 203
207654083	2021	INDIVIDUAL PERSONAL PROPERTY	WHITE DENZEL T	8809 E 59TH ST	208046111	2020-2021	INDIVIDUAL PERSONAL PROPERTY	MCDONALD DAYVON JEREMIAH	9804 E 79TH ST
207654312	2019-2021	INDIVIDUAL PERSONAL PROPERTY	TAYLOR BRIAN ERIC JR	9904 E 60TH TER	208046261	2020-2021	INDIVIDUAL PERSONAL PROPERTY	GUZMAN JIMENEZ CARLOS ANTONIO	11209 E 59TH ST
207654572	2021	INDIVIDUAL PERSONAL PROPERTY	HOBBS JACOB DONALD	5721 HUNTER ST	208046693	2020-2021	INDIVIDUAL PERSONAL PROPERTY	WILLIAMS MARTEZ LARELLE	6711 KENTUCKY AVE
207654800	2019-2021	INDIVIDUAL PERSONAL PROPERTY	SILL VICKIE LYNN	6625 OXFORD AVE	208046739	2021	INDIVIDUAL PERSONAL PROPERTY	WHIGHAM HARDIMAN KEVIONTE EARL	5417 STERLING AVE
207655216	2021	INDIVIDUAL PERSONAL PROPERTY	NEWMAN HEATHER JOAN	9066 E 67TH TER	208046764	2021	INDIVIDUAL PERSONAL PROPERTY	WILLINGHAM SHAKAYLA MARIE	10105 E 56TH TER
207655408	2021	INDIVIDUAL PERSONAL PROPERTY	BURNS HARLAN JAMES	5512 NORTHERN AVE	208047823	2020-2021	INDIVIDUAL PERSONAL PROPERTY	ARNOLD ALEXIS BRIANNA	8400 DITMAN AVE
207655567	2021	INDIVIDUAL PERSONAL PROPERTY	GONZALES JORDAN LEE & PATTI DANIELLE LEIGH	6112 HARVARD AVE	208048603	2021	INDIVIDUAL PERSONAL PROPERTY	FITHIAN AARON A	8517 EVANSTON AVE
207655568	2018-2019	INDIVIDUAL PERSONAL PROPERTY	PADILLA BRANDON LEE	5720 CEDAR AVE	208049405	2021	INDIVIDUAL PERSONAL PROPERTY	PURNELL KYANNE ELEXIAH DURAN	9408 E 69TH TER
207655576	2021	INDIVIDUAL PERSONAL PROPERTY	FORBES DUSTIN P	6701 HARVARD AVE	208049434	2021	INDIVIDUAL PERSONAL PROPERTY	VANEATON HEATHER LYNN	9017 E 85TH TER
207655771	2021	INDIVIDUAL PERSONAL PROPERTY	HENRY SAMANTHA JO	9009 E 74TH TER	208049519	2021	INDIVIDUAL PERSONAL PROPERTY	BOYD JAMES MICHAEL	9416 E 84TH TER
207655929	2020-2021	INDIVIDUAL PERSONAL PROPERTY	JAIMIE BARBARA JEAN	9208 E 54TH ST	208049545	2021	INDIVIDUAL PERSONAL PROPERTY	CUELLAR ORTIZ LUIS ANGEL	10212 E 63RD TER
207656111	2020	INDIVIDUAL PERSONAL PROPERTY	CASTANEDA OSCAR DANIEL JR	7515 ARLINGTON AVE	208049986	2021	INDIVIDUAL PERSONAL PROPERTY	DENEAU JOHNATHAN DAVID	9004 E 55TH ST
207656384	2020-2021	INDIVIDUAL PERSONAL PROPERTY	BARNES SHAYLA KEMANI	11258 E 71ST TER	208050087	2021	INDIVIDUAL PERSONAL PROPERTY	STRICKLAND TAMIYA RHAEEANN	7711 RAYTOWN RD APT 30
207656516	2020	INDIVIDUAL PERSONAL PROPERTY	MELENDREZ KODY ROBERT	9400 E 83RD ST	208050114	2021	INDIVIDUAL PERSONAL PROPERTY	KING JESSE DUNNELL	9813 E 60TH ST
207656969	2020-2021	INDIVIDUAL PERSONAL PROPERTY	MCLAUGHLIN BRIDGETTE ARIEL	6504 BLUE RIDGE BLVD	208050420	2021	INDIVIDUAL PERSONAL PROPERTY	MIRANDA CRISTIAN FABIAN	5905 CLAREMONT AVE
207657028	2020	INDIVIDUAL PERSONAL PROPERTY	SOLOMON RAMON	5400 LAUREL AVE	208050558	2021	INDIVIDUAL PERSONAL PROPERTY	KEELING AMANDA ANALISE	10908 E 81ST TER
207657031	2020-2021	INDIVIDUAL PERSONAL PROPERTY	LEWIS LEONARD DORELL II	8959 E 62ND TER	208050559	2021	INDIVIDUAL PERSONAL PROPERTY	VON LEGGETT JADE DARIYAN	8314 HUNTER ST
207657095	2021	INDIVIDUAL PERSONAL PROPERTY	COX BRANDON CHRISTOPHER	5805 HARVARD AVE	208050607	2021	INDIVIDUAL PERSONAL PROPERTY	KRIPPS RICHARD KEITH	7307 ELM ST
207657113	2020-2021	INDIVIDUAL PERSONAL PROPERTY	ROSS DERRICK MICHAEL JR	5400 DITZLER AVE	208051034	2021	INDIVIDUAL PERSONAL PROPERTY	SPRATLEY RICKY RALSTON	5126 STERLING AVE
207657287	2021	INDIVIDUAL PERSONAL PROPERTY	MILIAN GARY DEAN	11301 E 72ND ST	208051201	2020-2021	INDIVIDUAL PERSONAL PROPERTY	VANEATON CHAD MICHAEL	9917 E 85TH TER
207657394	2020-2021	INDIVIDUAL PERSONAL PROPERTY	THOMAS KARENETH W JR	5904 CLAREMONT AVE	208051255	2021	INDIVIDUAL PERSONAL PROPERTY	WELSON CRAYDON	5403 OXFORD AVE
207657462	2021	INDIVIDUAL PERSONAL PROPERTY	FREICHS SCOTT ALLEN	6111 WOODSON RD	208051481	2021	INDIVIDUAL PERSONAL PROPERTY	WILLIAMS AVIANA VONNETTE	8538 E 81ST TER
207657501	2020-2021	INDIVIDUAL PERSONAL PROPERTY	BROWN SARA ANN	5821 HEDGES AVE	208051699	2021	INDIVIDUAL PERSONAL PROPERTY	FISHER SHANNON L	6108 NORTHERN AVE
207657782	2020-2021	INDIVIDUAL PERSONAL PROPERTY	WASHINGTON TYNELL LARRON	8508 OVERTON DR	208052075	2021	INDIVIDUAL PERSONAL PROPERTY	DAVIS SHONDA M	9912 E 60TH ST
207657880	2020	INDIVIDUAL PERSONAL PROPERTY	MORRISON LEITH A	8706 E 80TH TER	208052082	2021	INDIVIDUAL PERSONAL PROPERTY	SHERMAN KERRIA LANELL	8608 ELM AVE
207680311	2021	INDIVIDUAL PERSONAL PROPERTY	GENTRY JASMINE RAKEL	6313 STERLING AVE	208052302	2020-2021	INDIVIDUAL PERSONAL PROPERTY	BURGGRAF BRADEN MATTHEW	7044 WOODSON RD
207680351	2021	INDIVIDUAL PERSONAL PROPERTY	BLACK RONALD LEE	11024 E 54TH ST	208052424	2020-2021	INDIVIDUAL PERSONAL PROPERTY	CATRINA RENEE KENNEDY	10411 E 78TH TER
207680515	2020-2021	INDIVIDUAL PERSONAL PROPERTY	REFFITT DUSTIN LEE	10107 E 63RD TER	208052593	2021	INDIVIDUAL PERSONAL PROPERTY	BULLER STEPHEN & GRACE	8210 LAUREL AVE
207680718	2021	INDIVIDUAL PERSONAL PROPERTY	LEE MERCEDES DRIEL	9214 E 54TH ST	208052637	2021	INDIVIDUAL PERSONAL PROPERTY	TRABLICK BARRERA DAVID VIDAL	9719 E 68TH TER
207680779	2019-2021	INDIVIDUAL PERSONAL PROPERTY	BOLTON SHAQUETT DOLVEON	8400 WOODSON CT	208052741	2021	INDIVIDUAL PERSONAL PROPERTY	BOOKER VONTRAE MARQUEZ	8500 STARK AVE
207681261	2020	INDIVIDUAL PERSONAL PROPERTY	RINDOLPH ANASTASIA R	8812 E 72ND ST	208053149	2021	INDIVIDUAL PERSONAL PROPERTY	HOOVER ANTHONY ERIC	11300 HIDDEN LAKE DR APT 506
207681277	2021	INDIVIDUAL PERSONAL PROPERTY	SIMMONS KYLEE MICHELLE	8207 WOODSON DR	208053869	2020	INDIVIDUAL PERSONAL PROPERTY	MADISON ANGELA BENITA	8225 WOODSON DR
207681567	2021	INDIVIDUAL PERSONAL PROPERTY	MCMULLEN JUSTUS ANTHONY	10909 E 53RD ST	208054118	2021	INDIVIDUAL PERSONAL PROPERTY	THUN NICHOLAS ARMON II	7021 HAWTHORNE AVE
207681598	2021	INDIVIDUAL PERSONAL PROPERTY	DISMUKE BRANDON CORNELIUS	9909 E 82ND ST	208054248	2021	INDIVIDUAL PERSONAL PROPERTY	THUN SAVANNAH HAILEY	7216 RAYTOWN RD APT F
207681751	2021	INDIVIDUAL PERSONAL PROPERTY	LUCIDO DANIELLE DALESSANDRO	9416 E 84TH TER	208054282	2021	INDIVIDUAL PERSONAL PROPERTY	COLLINS DOROTHY A	9005 E 68TH TER
207681783	2021	INDIVIDUAL PERSONAL PROPERTY	ORTIZ VARGAS ELISET	5805 ELM AVE	208054533	2020	INDIVIDUAL PERSONAL PROPERTY	WOODS LAQUISHIA RONSHÉ	6100 E 154TH TER APT B
207681921	2021	INDIVIDUAL PERSONAL PROPERTY	CLAY BRYANT JAMES	8208 EVANSTON AVE	208054968	2021	INDIVIDUAL PERSONAL PROPERTY	GRISWOLD MACKENZIE DESIREE	9105 E 74TH TER
207682388	2020-2021	INDIVIDUAL PERSONAL PROPERTY	HORNBECK CLAUDIA CAROLINA	6720 CRISP AVE	208055375	2021	INDIVIDUAL PERSONAL PROPERTY	YOCUM SHANE CHARLES	9810 E 80TH TER
207682781	2021	INDIVIDUAL PERSONAL PROPERTY	HARRIS RONISHA RENAE	9314 E 83RD ST	208055682	2021	INDIVIDUAL PERSONAL PROPERTY	JOHNSON ANDRE DOMINIQUE	8610 E 84TH TER
207682987	2020-2021	INDIVIDUAL PERSONAL PROPERTY	DICKERSON KHALID ANTONIO	7310 ELM ST	208055755	2021	INDIVIDUAL PERSONAL PROPERTY	GILBERT EUFRANCA NECQUE	10113 E 56TH TER
207683108	2020-2021	INDIVIDUAL PERSONAL PROPERTY	LEWIS DESIREE DELL	9822 E 60TH ST	208055771	2020-2021	INDIVIDUAL PERSONAL PROPERTY	BAYNHAM TREIVA DESHA	9012 E 55TH TER
207683217	2020	INDIVIDUAL PERSONAL PROPERTY	JOHNSON BYRAN A	6008 NORTHERN AVE	208055960	2020-2021	INDIVIDUAL PERSONAL PROPERTY	BOZEMAN JAMES MICHAEL JR	11903 E 85TH ST
208039998	2020-2021	INDIVIDUAL PERSONAL PROPERTY	BROWN DEVIN ANTHONY	11614 E 72ND ST	208055965	2021	INDIVIDUAL PERSONAL PROPERTY	LEWIS DEVEON JODIE LAMAR SR	9355 E 60TH TER
208040080	2021	INDIVIDUAL PERSONAL PROPERTY	MEURET JASON THOMAS	9418 E 55TH ST	208056170	2021	INDIVIDUAL PERSONAL PROPERTY	KEMP AMAIYAH ALIANAH	6122 BLUE RIDGE CUT OFF
208040446	2021	INDIVIDUAL PERSONAL PROPERTY	UGWUMBA CHRISTINE CHINENYE	9908 E 71ST TER	208056390	2021	INDIVIDUAL PERSONAL PROPERTY	COOK SCOTTIE DEE JR	5421 STERLING AVE
208040678	2021	INDIVIDUAL PERSONAL PROPERTY	SCHWAB MARISSA JEANNERNE	6714 HARVARD AVE	208056394	2021	INDIVIDUAL PERSONAL PROPERTY	MORRIS BARBARA MICHELLE	6157 STERLING AVE
208041038	2021	INDIVIDUAL PERSONAL PROPERTY	WALKER DAVID EUGENE	10917 E 81ST ST	208056398	2021	INDIVIDUAL PERSONAL PROPERTY	LOVELESS DIAMOND MICHELLE H	7427 ASH AVE
208041104	2020-2021	INDIVIDUAL PERSONAL PROPERTY	FLOWERS BRICE DAVID	8308 MANNING AVE	208056439	2021	INDIVIDUAL PERSONAL PROPERTY	COWAN CHANTEZ' MONIQUE	9104 E 82ND ST
208041553	2020	INDIVIDUAL PERSONAL PROPERTY	SHANKLIN WILLIAM ALANDO	8311 LAUREL AVE	208056567	2021	INDIVIDUAL PERSONAL PROPERTY	WITTEN MATTHEW CLAYTON MITCHELL	9708 BROOKLANE ST
208041791	2021	INDIVIDUAL PERSONAL PROPERTY	JONES RAI LYNN	10808 GREGORY LN	208056759	2020-2021	INDIVIDUAL PERSONAL PROPERTY	SANDERS WILLIAM LEE	9218 E 70TH TER
208042027	2021	INDIVIDUAL PERSONAL PROPERTY	MCDERMOTT JACOB WINSTON	8202 LAUREL AVE	208057030	2021	INDIVIDUAL PERSONAL PROPERTY	PHILLIPS ERIC RAMON II	7900 CRESCENT AVE
208042211	2021	INDIVIDUAL PERSONAL PROPERTY	THOMAS GEORGE IV	5616 WOODSON RD	208057567	2021	INDIVIDUAL PERSONAL PROPERTY	DREYER REBEKAH GRACE	5240 DITZLER AVE
208042434	2021	INDIVIDUAL PERSONAL PROPERTY	GUZMAN ROXANNE	11709 E 77TH TER	208057769	2021	INDIVIDUAL PERSONAL PROPERTY	HEARD TAURREAN TYREE	7116 STERLING AVE
208042510	2020-2021	INDIVIDUAL PERSONAL PROPERTY	UNDERWORLD JOSHUA MICHAEL	5313 HUNTER ST	208057783	2021	INDIVIDUAL PERSONAL PROPERTY	BROWN ALEGRIA S	11315 E 58TH TER

208057810	2021	INDIVIDUAL PERSONAL PROPERTY	MARTIN CHRIS R	7820 ARLINGTON AVE	208074136	2021	INDIVIDUAL PERSONAL PROPERTY	DESHON JASON W & TIFFANY R	7305 STERLING AVE
208057843	2021	INDIVIDUAL PERSONAL PROPERTY	GREENWOOD AMY MICHELLE	8813 E 81ST TER	208074176	2021	INDIVIDUAL PERSONAL PROPERTY	HUBER AUSTIN LOUIS	8511 BOOTH AVE
208057928	2021	INDIVIDUAL PERSONAL PROPERTY	REEDY ANDREW WARREN	7409 APPLETON AVE	208074270	2021	INDIVIDUAL PERSONAL PROPERTY	SOLOMON IMANI AKAKIA	9129 WILLOW WAY
208058053	2021	INDIVIDUAL PERSONAL PROPERTY	THOMAS JANNETT LOUISE	11301 E 61ST TER	208074652	2021	INDIVIDUAL PERSONAL PROPERTY	REDELLE BRITTANY M	8366 E 68TH ST
208058055	2021	INDIVIDUAL PERSONAL PROPERTY	MIDDLETON SHAWMAYNE DAHYSHAPELL	9401 E 63RD ST APT 203	208074763	2021	INDIVIDUAL PERSONAL PROPERTY	HAWTHORNE AALIYAH ELISHEVA	8601 EVERETT ST
208058079	2020-2021	INDIVIDUAL PERSONAL PROPERTY	JOHNSON RIAN ASHLEY	5336 NORTHERN AVE	208075045	2021	INDIVIDUAL PERSONAL PROPERTY	SCHNEIDER BRIAN'NA LARIE	7905 HEDGES AVE
208058183	2021	INDIVIDUAL PERSONAL PROPERTY	GEORGE ROGER WAYNE	9415 E 69TH ST	208075739	2021	INDIVIDUAL PERSONAL PROPERTY	INGRAM KARRINGTON JOI REQUEL	7604 CRISP AVE
208059084	2020-2021	INDIVIDUAL PERSONAL PROPERTY	HUGHLON JASMAINE CATHERINE	7018 WOODSON RD	208075741	2021	INDIVIDUAL PERSONAL PROPERTY	HENDERSON BRIANNA DHARREN	9037 E 85TH TER
208059141	2021	INDIVIDUAL PERSONAL PROPERTY	ADAMS STEVEN JOSEPH	8713 E 83RD ST	208076030	2020-2021	INDIVIDUAL PERSONAL PROPERTY	CECIL JOSEPH BENJAMIN & LORI S	8412 STARK AVE
208059624	2021	INDIVIDUAL PERSONAL PROPERTY	LINGENFELSER MICHAEL RAY	9009 E 74TH TER	208076289	2021	INDIVIDUAL PERSONAL PROPERTY	KUGLER MICHAEL WILLIAM & GENA CHRISTINE	10008 E 86TH TER
208060681	2021	INDIVIDUAL PERSONAL PROPERTY	PRATT DEYSHAUN EUGENE	8512 E 85TH ST	208076613	2020-2021	INDIVIDUAL PERSONAL PROPERTY	SIMMS CHARLESETTA J	9014 E 74TH TER
208061000	2021	INDIVIDUAL PERSONAL PROPERTY	MCDONNELL GABRIELLE ALEXIS	9102 VAUGHN AVE	208076806	2021	INDIVIDUAL PERSONAL PROPERTY	CLARK CHRISTOPHER J	10311 E 78TH ST
208061024	2021	INDIVIDUAL PERSONAL PROPERTY	ROSALEZ ALEXANDRIA	9225 E 53RD TER	208077355	2021	INDIVIDUAL PERSONAL PROPERTY	DUFFIN CAMERON RILEY	9513 E 69TH ST
208061148	2020-2021	INDIVIDUAL PERSONAL PROPERTY	BLEVINS IVY LEE	8424 JAMES A REED RD	208077424	2021	INDIVIDUAL PERSONAL PROPERTY	HARRIS NIKKOLIS CHRISTIAN	8638 E UTOPIA PKWY APT 10
208061596	2021	INDIVIDUAL PERSONAL PROPERTY	BOOKER LYRSESE D	8500 STARK AVE	208077569	2021	INDIVIDUAL PERSONAL PROPERTY	GREEN HAILEY NICOLE	9808 E 69TH ST
208062060	2021	INDIVIDUAL PERSONAL PROPERTY	RODDEN HOLLIDAY JENNIFER DENISE	5102 WOODSON RD	208077744	2021	INDIVIDUAL PERSONAL PROPERTY	NURN TIFFANY M	9401 E 63RD ST APT 305
208062538	2021	INDIVIDUAL PERSONAL PROPERTY	BROOKS STEVEN DON	11100 E 67TH ST	208077776	2021	INDIVIDUAL PERSONAL PROPERTY	TANDY RACHELLE ELIZABETH	7415 ELM ST
208062646	2021	INDIVIDUAL PERSONAL PROPERTY	GIBBS PHILLIP EUGENE JR	10104 E 74TH TER	208077881	2021	INDIVIDUAL PERSONAL PROPERTY	SMITH MAKALA CHERLYN	8616 E UTOPIA DR APT 48
208062865	2021	INDIVIDUAL PERSONAL PROPERTY	CRUTHIRD JUSTIN LAMAR E	8466 LANE DR	208077959	2021	INDIVIDUAL PERSONAL PROPERTY	VAUGHN ASHLEY MARIE NICHOLE	6422 ELM AVE
208062870	2020-2021	INDIVIDUAL PERSONAL PROPERTY	SHELTON LESLIE PATRICE	5122 WESTRIDGE CIR	208078114	2020-2021	INDIVIDUAL PERSONAL PROPERTY	JENKINS GEORGE WESLEY III	9313 E 83RD ST
208062873	2021	INDIVIDUAL PERSONAL PROPERTY	STRONG ALLYSSA MAUREEN	9106 RICHARDS DR	208078221	2021	INDIVIDUAL PERSONAL PROPERTY	BELL MYESHA SHENELL	8300 E 83RD ST
208062881	2021	INDIVIDUAL PERSONAL PROPERTY	WILLIAMS ANDREA MARIA	9913 E 85TH ST	208078253	2021	INDIVIDUAL PERSONAL PROPERTY	PARTAIN DAVID W	11016 LAKEVIEW RD
208062890	2021	INDIVIDUAL PERSONAL PROPERTY	JONES LOLA ESTELITA	11807 E 83RD ST APT 102	208078333	2021	INDIVIDUAL PERSONAL PROPERTY	HILLIARD ZARIA BRENAE	9309 E 81ST TER
208063316	2020-2021	INDIVIDUAL PERSONAL PROPERTY	LEWIS STEPHANIE ANN	9817 E 64TH TER	208078660	2021	INDIVIDUAL PERSONAL PROPERTY	CANADY IOSHUA DEANTHONY	9912 E 60TH ST
208063321	2021	INDIVIDUAL PERSONAL PROPERTY	CALTON JACOB DUSTIN	8412 JAMES A REED RD	208079003	2021	INDIVIDUAL PERSONAL PROPERTY	KAHMEYER KARLA JANAM	7313 RAYTOWN RD
208063325	2021	INDIVIDUAL PERSONAL PROPERTY	DONOVAN DAVID	10318 E 63RD ST APT 4	208079041	2020-2021	INDIVIDUAL PERSONAL PROPERTY	LAKAY JENNIFER M	6415 BLUE RIDGE CUT OFF
208063475	2021	INDIVIDUAL PERSONAL PROPERTY	MCCONVILLE CLAYTON GEORGE	10738 CEDAR AVE	208079170	2021	INDIVIDUAL PERSONAL PROPERTY	CUNNINGHAM NA'KEEA CHAMPHELLE	6504 CLAREMONT AVE
208063483	2021	INDIVIDUAL PERSONAL PROPERTY	NICHOLS JESSE LEONARD	11004 E 53RD TER	208079211	2021	INDIVIDUAL PERSONAL PROPERTY	ESKRIDGE ANDREW EUGENE	11831 E 83RD ST APT 201
208063485	2021	INDIVIDUAL PERSONAL PROPERTY	DESHAZER MIKAYLA NICOLE	6718 LAKESHORE DR	208079825	2021	INDIVIDUAL PERSONAL PROPERTY	PERRY JESSICA LYNN	8500 MANNING AVE
208063625	2021	INDIVIDUAL PERSONAL PROPERTY	BROOKS RAKAYLA MARIE	11800 E 86TH TER	208080339	2021	INDIVIDUAL PERSONAL PROPERTY	WILSON JARRED CHRISTOPHER	8132 STERLING AVE
208063930	2021	INDIVIDUAL PERSONAL PROPERTY	COOPER SEAN MICHAEL	8412 LANE PL	208080553	2020-2021	INDIVIDUAL PERSONAL PROPERTY	LESTER JASON RALPH	7319 MAYWOOD AVE
208064077	2020-2021	INDIVIDUAL PERSONAL PROPERTY	HENDERSON BAILEY MARIE	8608 E 81ST TER	208080808	2021	INDIVIDUAL PERSONAL PROPERTY	WEBB DAWN RENEE	7906 CEDAR AVE
208064080	2021	INDIVIDUAL PERSONAL PROPERTY	HARDY WINSTON RONALD JR	8720 E 61ST ST	208080989	2021	INDIVIDUAL PERSONAL PROPERTY	MIRANDA SALVADOR JR & ELVIRA ANN	5816 NORTHERN AVE
208064453	2021	INDIVIDUAL PERSONAL PROPERTY	LEONARD JULIA ANN	9804 E 69TH ST	208081665	2021	INDIVIDUAL PERSONAL PROPERTY	GOLD COURTNEY MARIE	5912 CLAREMONT AVE
208064488	2020	INDIVIDUAL PERSONAL PROPERTY	PETERS CRYSTAL AMARA	11008 E 63RD ST	208081841	2021	INDIVIDUAL PERSONAL PROPERTY	CIAMBRIELLO LAUREN PATRICE	10109 E 68TH TER
208064697	2021	INDIVIDUAL PERSONAL PROPERTY	RIDLEY KOHSI RAJAN	9509 E 79TH ST	208082065	2020-2021	INDIVIDUAL PERSONAL PROPERTY	VASSOL LINDA FAYE	7713 RAYTOWN RD APT 33
208065313	2020-2021	INDIVIDUAL PERSONAL PROPERTY	LUNA DOMINIC MANUEL	8148 DITZLER AVE	208082224	2021	INDIVIDUAL PERSONAL PROPERTY	BULLOCK LACHELLE DENISE	9102 E 73RD ST
208065455	2020-2021	INDIVIDUAL PERSONAL PROPERTY	JACKSON KELLECIA KIANE	8308 EVANSTON AVE	208082258	2021	INDIVIDUAL PERSONAL PROPERTY	GLOR RYR ANTHONY	9204 E 65TH TER
208065827	2021	INDIVIDUAL PERSONAL PROPERTY	MITCHELL ALEXIS R	5901 HARVARD AVE	208082330	2021	INDIVIDUAL PERSONAL PROPERTY	ADETUNJI MICHAEL ADEWALE	8803 E 59TH ST
208065849	2021	INDIVIDUAL PERSONAL PROPERTY	WEBER DENNIS WILLIAM	10012 E M 350 HWY	208082478	2021	INDIVIDUAL PERSONAL PROPERTY	PORTER DEREK JONES	8506 E 87TH ST
208065855	2021	INDIVIDUAL PERSONAL PROPERTY	GARCIA ARIANA GABRIELA	8700 KENTUCKY AVE	208082564	2021	INDIVIDUAL PERSONAL PROPERTY	MILLER BAILEY ELIZABETH	8950 E 60TH ST
208065904	2021	INDIVIDUAL PERSONAL PROPERTY	MORIN MANDI LYNNE	5906 ENGLEWOOD AVE	208082680	2021	INDIVIDUAL PERSONAL PROPERTY	AKTAA WASEM A	9609 E 67TH TER
208065957	2021	INDIVIDUAL PERSONAL PROPERTY	LEWIS KEVIN KAYLEN	7608 ELM ST	208082758	2021	INDIVIDUAL PERSONAL PROPERTY	FULTON JAIMAR CORDELL	5916 HEDGES AVE
208066028	2021	INDIVIDUAL PERSONAL PROPERTY	SNOW-SAPPINGTON ANGEL LATRIECE	8600 MAPLE AVE	208083477	2021	INDIVIDUAL PERSONAL PROPERTY	TRUJILLO TRUJILLO RAFAEL	6325 BLUE RIDGE CUT OFF
208066090	2020-2021	INDIVIDUAL PERSONAL PROPERTY	WIEGAND KYLA ANN MONNIQUE	8412 JAMES A REED RD	208083982	2021	INDIVIDUAL PERSONAL PROPERTY	FERNANDEZ APRIL NICOLE	8409 WOODSON CT
208066120	2021	INDIVIDUAL PERSONAL PROPERTY	COURTNEY DAYSHAWNA RENEE	8326 OXFORD AVE	208084192	2021	INDIVIDUAL PERSONAL PROPERTY	MARCUS KATIE LYNN	9600 E 65TH ST
208066488	2021	INDIVIDUAL PERSONAL PROPERTY	SIMMONS RACYA DARYONA MICHELLE	11315 E 72ND ST	208084213	2021	INDIVIDUAL PERSONAL PROPERTY	ALSHAZI IBRAHIM WALID AHMED	9010 E 87TH ST APT D1
208067119	2021	INDIVIDUAL PERSONAL PROPERTY	MOORE ZANAY T	8725 E 60TH TER	208084223	2021	INDIVIDUAL PERSONAL PROPERTY	HOUSTON BOWIE RAQUEL MONYE	9302 E 82ND TER
208067401	2021	INDIVIDUAL PERSONAL PROPERTY	LINDSAY DANIEL LEE	5312 WILLOW AVE	208085117	2021	INDIVIDUAL PERSONAL PROPERTY	NELSON PATRICK JEROME	11300 E 61ST ST
208067657	2021	INDIVIDUAL PERSONAL PROPERTY	MORRIS MORGAN L	10110 E 69TH ST	208085143	2021	INDIVIDUAL PERSONAL PROPERTY	JOHNSON JEREMIAH KEYON	6545 RAYTOWN RD APT 2
208067933	2020-2021	INDIVIDUAL PERSONAL PROPERTY	THORNTON KENDALL DARROYCE	6916 ENGLEWOOD AVE	208085169	2021	INDIVIDUAL PERSONAL PROPERTY	LEWIS RYAN DOMINIQUE	11305 E 69TH ST
208068106	2021	INDIVIDUAL PERSONAL PROPERTY	JACKSON JOSEPH CHRISTOPHER JR	6328 STERLING AVE	208085298	2021	INDIVIDUAL PERSONAL PROPERTY	BLAKE JOHNNY B (2ND)	8618 OXFORD AVE
208068190	2021	INDIVIDUAL PERSONAL PROPERTY	WAFER BUFORD JHIRAYON	9310 E 83RD ST	208085302	2021	INDIVIDUAL PERSONAL PROPERTY	LUCAS MYECIA MARIE	8609 BOOTH AVE
208068278	2021	INDIVIDUAL PERSONAL PROPERTY	CLEMONS BRYAN THOMAS JR	9822 E 60TH ST	208085751	2021	INDIVIDUAL PERSONAL PROPERTY	JONES TYLIAH	7234 RAYTOWN RD APT C
208068305	2020-2021	INDIVIDUAL PERSONAL PROPERTY	HOPKINS MARVIN JAMAL	8610 E 83RD TER	208085806	2021	INDIVIDUAL PERSONAL PROPERTY	COLINDRES PEREZ JOSE LUIS	9404 E GREGORY BLVD
208068575	2020-2021	INDIVIDUAL PERSONAL PROPERTY	STEVENSON LANAE ROVONNE	5929 CRESCENT AVE	208085933	2021	INDIVIDUAL PERSONAL PROPERTY	TOWNER CRAIG S	6609 KENTUCKY AVE
208068837	2021	INDIVIDUAL PERSONAL PROPERTY	WEST HANNA ILENE	11305 E 77TH ST	208086102	2021	INDIVIDUAL PERSONAL PROPERTY	MAGANA JONAS M & DIAZ DIAZ ANGELICA	10013 E 71ST TER
208069056	2021	INDIVIDUAL PERSONAL PROPERTY	MORRIS STEPHANIE LATASHA	9705 E 80TH ST	208086142	2021	INDIVIDUAL PERSONAL PROPERTY	HARRIS KARINNE DEATRICE	11005 E 72ND ST
208069152	2021	INDIVIDUAL PERSONAL PROPERTY	ARNOLD NICHOLAS DEANTHONY	5824 BLUE RIDGE BLVD	208086156	2020-2021	INDIVIDUAL PERSONAL PROPERTY	ROBINSON CHARLES RAY	8814 E 84TH TER
208069310	2021	INDIVIDUAL PERSONAL PROPERTY	TAYLOR TRAMBA M	11408 E 59TH ST	208086232	2021	INDIVIDUAL PERSONAL PROPERTY	CUNNINGHAM JAMYA MONAE	10505 E 65TH TER
208069338	2020-2021	INDIVIDUAL PERSONAL PROPERTY	HAYES SAMANTHA VIVIAN	10108 E 77TH TER	208086233	2021	INDIVIDUAL PERSONAL PROPERTY	JACKSON OLIVIA MARIE	8005 TENNESSEE AVE
208069664	2021	INDIVIDUAL PERSONAL PROPERTY	MONGE GAVARRETE JOSE GUSTAVO	9620 E 66TH TER	208086467	2021	INDIVIDUAL PERSONAL PROPERTY	MCGILL TIFFANY M	8114 WOODSON DR
208070139	2021	INDIVIDUAL PERSONAL PROPERTY	BORDEN CHRISTOPHER JOHN	6216 CLAREMONT AVE	208086845	2021	INDIVIDUAL PERSONAL PROPERTY	GORDON KESHA RHODES	8506 E 87TH ST
208070204	2021	INDIVIDUAL PERSONAL PROPERTY	BOLTON OSHONDA EVON	9314 E 83RD ST	208086907	2021	INDIVIDUAL PERSONAL PROPERTY	VELEZ-GIBSON BRANDON MILES	7628 ENGLEWOOD AVE
208070210	2021	INDIVIDUAL PERSONAL PROPERTY	ADA ALEXIS MUNA	7713 RAYTOWN RD APT 13	208087041	2021	INDIVIDUAL PERSONAL PROPERTY	AKINS ZARIA MAKAYLA	15407 GRAND SUMMIT BLVD
208071634	2020-2021	INDIVIDUAL PERSONAL PROPERTY	DESHAZER CLARISSA MICHELLE	10007 E 77TH TER	208087337	2021	INDIVIDUAL PERSONAL PROPERTY	ROBINSON ALAISIA SIERRA	8314 STERLING AVE
208072327	2021	INDIVIDUAL PERSONAL PROPERTY	DILWORTH AARON CHRISTOPHER	11801 E 78TH PL	208087559	2020	INDIVIDUAL PERSONAL PROPERTY	LEE RACHEL YVONNE	9603 E 68TH ST
208072404	2021	INDIVIDUAL PERSONAL PROPERTY	WINCHELL MARTHA KAY	9808 BROOKLANE ST	208087627	2021	INDIVIDUAL PERSONAL PROPERTY	SCOFIELD ELIJAH OWEN	9913 E 77TH TER
208072545	2021	INDIVIDUAL PERSONAL PROPERTY	RAYTOWN SCHOOLS SUPERINTENDENT	6608 RAYTOWN RD	208087784	2021	INDIVIDUAL PERSONAL PROPERTY	EWING EMILY MORGAN	5512 MANNING AVE
208072823	2021	INDIVIDUAL PERSONAL PROPERTY	EDWARDS CARDELL & KATHERINE MARIE	8312 KENTUCKY AVE	208087831	2021	INDIVIDUAL PERSONAL PROPERTY	PADEN DAMARTY VONDELL	11117 E 53RD ST
208072847	2021	INDIVIDUAL PERSONAL PROPERTY	WASHINGTON DAKAYLA USHAH	8304 ELM AVE	208088194	2021	INDIVIDUAL PERSONAL PROPERTY	HERRERA MENDOZA LETICIA IVONNE	7201 RALSTON AVE
208072906	2021	INDIVIDUAL PERSONAL PROPERTY	LAMASTER TYON CHARLES	6309 HEDGES AVE	208088264	2021	INDIVIDUAL PERSONAL PROPERTY	KLEY ZOE RAQUEL	7601 HARVARD AVE

208088279	2021	INDIVIDUAL PERSONAL PROPERTY	EVANS IEISHA LACHAN	8634 LANE AVE APT 4	208100741	2021	INDIVIDUAL PERSONAL PROPERTY	BRANHAM KAYLA RENEE	8807 RICHARDS DR
208088384	2021	INDIVIDUAL PERSONAL PROPERTY	ALCANTER LAVANDIS LOUIS JR	9321 E 84TH ST	208101146	2021	INDIVIDUAL PERSONAL PROPERTY	POWELL JAI SHON LARIE	11803 E 83RD ST APT 201
208088437	2021	INDIVIDUAL PERSONAL PROPERTY	KNIGHTON CHRISTOPHER E	5309 HARDY AVE	208101160	2021	INDIVIDUAL PERSONAL PROPERTY	HOOK JARRED WAYNE	8301 E 85TH ST
208088556	2021	INDIVIDUAL PERSONAL PROPERTY	DOOLEY RYAN JAMES	8720 E 79TH TER	208101656	2021	INDIVIDUAL PERSONAL PROPERTY	MILES ANTONIO MAURICE	8123 HARRIS AVE
208088643	2020-2021	INDIVIDUAL PERSONAL PROPERTY	CABINE VERNELL LASHAN JR	5911 CLAREMONT AVE	208102009	2021	INDIVIDUAL PERSONAL PROPERTY	CIAFULLO EMMA A	5928 ARLINGTON AVE
208089290	2021	INDIVIDUAL PERSONAL PROPERTY	MOORE HAROLD ALLEN YOUNG	8919 E 67TH ST APT 128	208102065	2021	INDIVIDUAL PERSONAL PROPERTY	MCROBERTS NICOLE ANN	10505 E 79TH ST
208089675	2021	INDIVIDUAL PERSONAL PROPERTY	GORDON JADE BIANCA	9405 E 66TH ST	208102234	2021	INDIVIDUAL PERSONAL PROPERTY	BIGGS VICTORIA MARIE	6113 HUNTER ST
208089691	2021	INDIVIDUAL PERSONAL PROPERTY	JAMIESON JOSELYN JEAN	8604 EVERETT ST	208102532	2021	INDIVIDUAL PERSONAL PROPERTY	DOUGLAS ALLYSSIA MONAE	10500 E 59TH ST
208089861	2020-2021	INDIVIDUAL PERSONAL PROPERTY	SLEDD GARRETT THOMAS	5412 WILLOW AVE	208102839	2021	INDIVIDUAL PERSONAL PROPERTY	BAKUNAS WESTON JACK	9007 E 68TH TER
208090194	2021	INDIVIDUAL PERSONAL PROPERTY	BARRAGAN NAVAS LAURA CECILIA	8517 ARLINGTON AVE	208103175	2021	INDIVIDUAL PERSONAL PROPERTY	WILLIAMS HOPKINS GEORGE JUSTIN	7206 CRISP AVE
208090196	2021	INDIVIDUAL PERSONAL PROPERTY	FRATE JEREMY J	11308 E 85TH TER	208103230	2021	INDIVIDUAL PERSONAL PROPERTY	JOHNSON TAYLER PATRICE	8405 SPRING VALLEY RD
208090208	2020-2021	INDIVIDUAL PERSONAL PROPERTY	CORNELIUS BENJAMIN ALLYN	5326 DITZLER AVE	208103472	2021	INDIVIDUAL PERSONAL PROPERTY	BAUTISTA ROSA ADOLFO ERNESTO	7840 WOODSON RD
208090456	2021	INDIVIDUAL PERSONAL PROPERTY	MCCURRY JOHN E	5612 DITZLER AVE	208103803	2021	INDIVIDUAL PERSONAL PROPERTY	TOWNES TYANN PRECIOUS KAY	7204 OVERTON AVE
208090724	2021	INDIVIDUAL PERSONAL PROPERTY	PELLETIER CLAIRE LAURENE	11104 E 83RD TER	208103807	2021	INDIVIDUAL PERSONAL PROPERTY	WILLIAMS, BAYLIE	10901 E 57TH TER
208090804	2021	INDIVIDUAL PERSONAL PROPERTY	GROPPER GIOVANNI F	8301 E 85TH TER	208103838	2021	INDIVIDUAL PERSONAL PROPERTY	SALAZAR KAYLA LYNN	7131 HARRIS AVE
208090990	2021	INDIVIDUAL PERSONAL PROPERTY	DABBS FONTANA RENEE	7228 CRISP AVE	208104098	2021	INDIVIDUAL PERSONAL PROPERTY	STEWART COYA	8246 SPRING VALLEY RD
208091090	2021	INDIVIDUAL PERSONAL PROPERTY	WILLIAMS ANTONIO LAMAR JR	6021 LAUREL AVE	208104806	2021	INDIVIDUAL PERSONAL PROPERTY	HILL SHELBY MAY	9006 E 69TH ST
208091539	2021	INDIVIDUAL PERSONAL PROPERTY	ROBERTSON CINDY LOUISE	11252 E 71ST TER	208104848	2020-2021	INDIVIDUAL PERSONAL PROPERTY	SMITH MICHAEL	8301 E 85TH TER
208091884	2021	INDIVIDUAL PERSONAL PROPERTY	BOSTON JORDAN E	9357 E 67TH TER	208105516	2021	INDIVIDUAL PERSONAL PROPERTY	FLETCHER MICHAEL	9810 E 60TH ST
208091996	2021	INDIVIDUAL PERSONAL PROPERTY	MARTINEZ ADAN	10505 E 67TH ST	208105672	2021	INDIVIDUAL PERSONAL PROPERTY	EDWARDS ORLANDO RAY	10612 E 56TH TER
208092047	2021	INDIVIDUAL PERSONAL PROPERTY	CLARK JANESE LASHAY	8502 EVERETT ST	208105825	2021	INDIVIDUAL PERSONAL PROPERTY	COLEMAN NYREE' MICHELLE	8108 WOODSON DR
208092177	2021	INDIVIDUAL PERSONAL PROPERTY	PRICE TAJASHA M	5504 STERLING AVE	208105884	2021	INDIVIDUAL PERSONAL PROPERTY	JOHNSON DARRION ELIJAH	7605 ENGLEWOOD AVE
208092231	2021	INDIVIDUAL PERSONAL PROPERTY	KONOMOS CHASE ALAN	10908 E 59TH TER	208106321	2021	INDIVIDUAL PERSONAL PROPERTY	JONES TERRENCE LAMONT JR	10501 E 60TH TER
208092443	2021	INDIVIDUAL PERSONAL PROPERTY	SHEEHY JORDAN L	11300 E 62ND ST	208106743	2021	INDIVIDUAL PERSONAL PROPERTY	FLETCHER MICHAEL NELSON	5431 DITZLER AVE
208092489	2021	INDIVIDUAL PERSONAL PROPERTY	ABERNATHY KEIANDRA DENAE	8404 LANE PL	208102582	2021	INDIVIDUAL PERSONAL PROPERTY	LEE JACOB WADE	7917 DITZLER AVE
208092683	2021	INDIVIDUAL PERSONAL PROPERTY	THE RAM TRUST BY ROBERT MARTIN TRUSTEE	8402 WESTRIDGE RD	208130538	2020-2021	INDIVIDUAL PERSONAL PROPERTY	MASONER OLJANA MARIA	7821 ELM ST
208093246	2021	INDIVIDUAL PERSONAL PROPERTY	CISNEROS ALEXIS RAEAL	8406 LANE PL	208131838	2021	INDIVIDUAL PERSONAL PROPERTY	SHERRY MADISON	10200 E 57TH TER
208093274	2021	INDIVIDUAL PERSONAL PROPERTY	LEWIS VIRJA NOVELLA	8524 OXFORD AVE	208132151	2021	INDIVIDUAL PERSONAL PROPERTY	BROWN TIA ASHANTE	11000 E 53RD TER
208093427	2021	INDIVIDUAL PERSONAL PROPERTY	ERBY ARTAY DEMON	8209 HARDY AVE	208133359	2021	INDIVIDUAL PERSONAL PROPERTY	DIEHM TAYLOR CHARLES	8602 E 87TH ST
208093435	2021	INDIVIDUAL PERSONAL PROPERTY	GLOR COOPER BETH RENEE	9606 E 77TH TER	208133472	2021	INDIVIDUAL PERSONAL PROPERTY	CAMPLIN STEFAN MARQUIS	11607 E 60TH ST
208093602	2021	INDIVIDUAL PERSONAL PROPERTY	WILLIAMS DASHA DANESEE ERICKA ANNE	6644 MAYWOOD AVE APT A	208134966	2021	INDIVIDUAL PERSONAL PROPERTY	MATHER SAMUEL ROBERT	6310 RAYTOWN RD
208094082	2021	INDIVIDUAL PERSONAL PROPERTY	FRANCO CLAUDIA & ELIZARDO P	5524 LANE AVE	208135010	2021	INDIVIDUAL PERSONAL PROPERTY	DOLEZAL CLAUDIA L	7309 HARVARD AVE
208094329	2020-2021	INDIVIDUAL PERSONAL PROPERTY	PEARSON SAUNDRA OLIVIA	8304 E 86TH TER	208488890	2021	INDIVIDUAL PERSONAL PROPERTY	CROCKER RITA BETH	8500 RALSTON AVE
208094342	2021	INDIVIDUAL PERSONAL PROPERTY	BRUCE KARINA GABRIELLE	7412 HARDY AVE	208488983	2021	INDIVIDUAL PERSONAL PROPERTY	FORESTER SHAUNTE PATRICE	6808 VERMONT AVE
208094755	2021	INDIVIDUAL PERSONAL PROPERTY	PARKER VADNAIS TYRONE	7620 STERLING AVE	208490093	2021	INDIVIDUAL PERSONAL PROPERTY	VALERIO BURCIAGA ALEXANDRA	6833 LAUREL AVE
208094770	2021	INDIVIDUAL PERSONAL PROPERTY	GUZMAN REYES ANA LIZETH	11209 E 59TH ST	208490206	2021	INDIVIDUAL PERSONAL PROPERTY	MORRIS ADRIAN LAMONTE CAMERON	9192 E 60TH ST
208095077	2021	INDIVIDUAL PERSONAL PROPERTY	HEARD NATHAN WAYNE	10812 GREGORY LN	208490344	2021	INDIVIDUAL PERSONAL PROPERTY	TANNER TRISHA COLLEEN	7439 OVERTON AVE
208095320	2021	INDIVIDUAL PERSONAL PROPERTY	LEWIS KEITH DOUGLASS JR	9012 E 59TH ST	208490445	2021	INDIVIDUAL PERSONAL PROPERTY	RANDALL ALEXANDRA LYNN	6702 APPLETON AVE
208095400	2021	INDIVIDUAL PERSONAL PROPERTY	BOYD LAWRENCE ALEXANDER	5806 FARLEY AVE	208490450	2021	INDIVIDUAL PERSONAL PROPERTY	NORWOOD NADEN KENDRICK	8302 HUNTER ST
208095414	2021	INDIVIDUAL PERSONAL PROPERTY	APPLEBERRY JIMMY LEE JR	8908 E 73RD ST	208490688	2021	INDIVIDUAL PERSONAL PROPERTY	COLLINS MIKISHA SHREE	8903 W LONGVIEW PKWY
208095481	2021	INDIVIDUAL PERSONAL PROPERTY	BUTLER CHANDLER C	11801 E 77TH TER	208490807	2020-2021	INDIVIDUAL PERSONAL PROPERTY	ZWEIFEL MARCOUIS LAUJAN	8805 E 61ST TER
208095629	2021	INDIVIDUAL PERSONAL PROPERTY	HETLAGE KELLY NICHOLE	7605 OVERTON AVE	208490977	2021	INDIVIDUAL PERSONAL PROPERTY	HUTCHERSON KARI LYNN	9010 E 87TH ST APT C8
208096108	2021	INDIVIDUAL PERSONAL PROPERTY	TAYLOR JORDAN SYMONE	7929 HEDGES AVE	208491652	2021	INDIVIDUAL PERSONAL PROPERTY	FAIELLA STEVEN G	5919 NORTHERN AVE
208096711	2021	INDIVIDUAL PERSONAL PROPERTY	JOHNSON ISAAH ALEXZAVIER	8517 CRESCENT AVE	208491724	2020	INDIVIDUAL PERSONAL PROPERTY	COLLINS INNIS LEE JR	8805 E 61ST TER
208096721	2021	INDIVIDUAL PERSONAL PROPERTY	FARR COURTNEY LEE	11412 E 71ST ST	208491963	2021	INDIVIDUAL PERSONAL PROPERTY	ELLIOTT BROOKE DANIELLE	9616 E 86TH TER
208096733	2021	INDIVIDUAL PERSONAL PROPERTY	FIARFIELD KIMBERY	8607 MAPLE AVE	208492370	2021	INDIVIDUAL PERSONAL PROPERTY	BAHENA RICHARD	7541 WESTRIDGE RD
208096830	2021	INDIVIDUAL PERSONAL PROPERTY	THOMAS LYNTOVIA MAESHEL	11424 E 77TH TER	208492460	2021	INDIVIDUAL PERSONAL PROPERTY	SCHUMAN BETHANY MARIE	6209 CLAREMONT AVE
208097005	2021	INDIVIDUAL PERSONAL PROPERTY	YAMAGUCHI FREDRICK	8607 MAPLE AVE	208492532	2021	INDIVIDUAL PERSONAL PROPERTY	PRUIITT CHASE EVERETTE	10900 E 72ND ST
208097028	2021	INDIVIDUAL PERSONAL PROPERTY	PHILLIPS VONNEISHA ANTONICE JOYCE	8317 NORTHERN ST	208492701	2021	INDIVIDUAL PERSONAL PROPERTY	KELTNER AMBER ANN	7402 OVERTON AVE UNIT 9
208097112	2020-2021	INDIVIDUAL PERSONAL PROPERTY	HARPER AVILA MONIQUE	10301 E 68TH TER	208493199	2021	INDIVIDUAL PERSONAL PROPERTY	OSBORN KALEN ONYON	5835 BLUE RIDGE CUT OFF
208097141	2021	INDIVIDUAL PERSONAL PROPERTY	MAY DARREL E JR	6108 LAUREL AVE	208493464	2021	INDIVIDUAL PERSONAL PROPERTY	NORWOOD SHANNON CHENNELLE	8302 HUNTER ST
208097266	2021	INDIVIDUAL PERSONAL PROPERTY	LYONS HAROLD BERGER	11301 HIDDEN LAKE DR APT 608	208493650	2021	INDIVIDUAL PERSONAL PROPERTY	RICHMOND SEAN MICHAEL	8205 HEDGES AVE
208097284	2020-2021	INDIVIDUAL PERSONAL PROPERTY	WHITE WILLARD DON OZELL	5887 RAYTOWN RD	208494300	2021	INDIVIDUAL PERSONAL PROPERTY	JOHNSON MARISSA ANN	6008 NORTHERN AVE
208097294	2021	INDIVIDUAL PERSONAL PROPERTY	FIENE DEVIN MICHAEL	11513 E 75TH ST	208494378	2021	INDIVIDUAL PERSONAL PROPERTY	HICKS BILLEE JEANETTE	9801 E 81ST TER
208097580	2021	INDIVIDUAL PERSONAL PROPERTY	BRADFORD TRAIPELL MALIK	8301 HEDGES AVE	208494431	2021	INDIVIDUAL PERSONAL PROPERTY	BOGDANOVIC BOJAN	6533 RAYTOWN RD APT 2
208097942	2021	INDIVIDUAL PERSONAL PROPERTY	JACKMAN LARON SANTANA MARCELLE	8610 E 84TH TER	208494796	2021	INDIVIDUAL PERSONAL PROPERTY	WILSON TRACY BERNARD	8404 E 85TH ST
208098144	2021	INDIVIDUAL PERSONAL PROPERTY	FRANCO RODRIGUEZ CARLA	5524 LANE AVE	208497207	2021	INDIVIDUAL PERSONAL PROPERTY	ADAMS JADE LAKIA	10215 E 56TH ST
208098633	2020-2021	INDIVIDUAL PERSONAL PROPERTY	NORWOOD NAKHI KENSEAN	8302 HUNTER ST	208497518	2021	INDIVIDUAL PERSONAL PROPERTY	GIBBS JUSTIN ANTHONY	5520 HEDGES AVE
208098794	2021	INDIVIDUAL PERSONAL PROPERTY	GONZALES MARIO	10113 E 78TH TER	208497667	2021	INDIVIDUAL PERSONAL PROPERTY	DRAFFEN TAYLOR ALEXANDR	6820 LAKESHORE DR
208098910	2021	INDIVIDUAL PERSONAL PROPERTY	CASTILLO RODRIGUEZ FLOR DE MARIA	7713 RAYTOWN RD APT 32	208497677	2021	INDIVIDUAL PERSONAL PROPERTY	BRADLEY CHRISTOPHER DEWAYNE LUSTE JR	8610 ARLINGTON AVE
208099059	2021	INDIVIDUAL PERSONAL PROPERTY	CARDOZA MORENO SANTIAGO MANUEL	7310 ELM ST	208499107	2021	INDIVIDUAL PERSONAL PROPERTY	ALEXANDER RICHARD	5418 OXFORD AVE
208099261	2021	INDIVIDUAL PERSONAL PROPERTY	ESCOBAR CARDOZA GREGIA	7310 ELM ST	208499948	2021	INDIVIDUAL PERSONAL PROPERTY	CARADINE JADA SIMONE	9818 E 61ST ST APT 2
208099440	2021	INDIVIDUAL PERSONAL PROPERTY	PORTER JEREMY DAVID & KYRA KAY	5820 WOODSON RD	208500056	2021	INDIVIDUAL PERSONAL PROPERTY	BRYANT WILLIAM WALTER III	7713 RAYTOWN RD APT 13
208099519	2021	INDIVIDUAL PERSONAL PROPERTY	PASCHAL KIERRA LYNN	7613 ENGLEWOOD AVE	208500118	2021	INDIVIDUAL PERSONAL PROPERTY	WILLIAMS KA'NESHIA D'ARA	9000 E 84TH ST
208099705	2021	INDIVIDUAL PERSONAL PROPERTY	WILSON-HANCOCK AZANDREA L'AZIA	7405 HARDY AVE	208500265	2021	INDIVIDUAL PERSONAL PROPERTY	MOOREHEAD IRVING QUATELL JR	8618 E UTOPIA DR APT 55
208099777	2021	INDIVIDUAL PERSONAL PROPERTY	LOPEZ JACOBO MIGUEL ANGEL	11041 E 54TH ST	208501786	2021	INDIVIDUAL PERSONAL PROPERTY	BALLARD AMANDA LEE	9800 E 60TH ST
208100433	2021	INDIVIDUAL PERSONAL PROPERTY	HOLMES MARTERRIO LEELYNN	11124 E 84TH TER	208502461	2021	INDIVIDUAL PERSONAL PROPERTY	JONES LONZE LENESE	7303 RALSTON AVE
208100485	2020-2021	INDIVIDUAL PERSONAL PROPERTY	LOVETT KEITH C	10412 E 82ND ST	208502801	2021	INDIVIDUAL PERSONAL PROPERTY	VANN LEONARD ALVIN JR	7605 CRISP AVE
208100494	2021	INDIVIDUAL PERSONAL PROPERTY	CARTER JANIKKIA L	7311 BLUE RIDGE BLVD	208502814	2021	INDIVIDUAL PERSONAL PROPERTY	STEELE TRE ANA LYNETTE	5500 STERLING AVE
208100535	2021	INDIVIDUAL PERSONAL PROPERTY	YOUAMAN QUINTAE KENNETTE	11810 E 101ST ST	208502849	2021	INDIVIDUAL PERSONAL PROPERTY	REYNOLDS DOMINIC EUGENE	6801 VERMONT AVE
208100615	2021	INDIVIDUAL PERSONAL PROPERTY	MONARREZ NICOLAS ANTONIO	8223 JAMES A REED RD	208503363	2021	INDIVIDUAL PERSONAL PROPERTY	SMITH JORDIE DANIEL	9205 E 82ND ST
208100632	2021	INDIVIDUAL PERSONAL PROPERTY	MASON DWAUNAH L	8005 APPLETON AVE	208503645	2021	INDIVIDUAL PERSONAL PROPERTY	WALKER JAYQUAN D	10603 E 80TH ST

208503699	2021	INDIVIDUAL PERSONAL PROPERTY	KING-DIAL DEJA ARIANNA LAVAL	11701 E 83RD ST APT 201	208543475	2021	INDIVIDUAL PERSONAL PROPERTY	PHILLIPS DYLAN M	10007 E 63RD ST
208505609	2021	INDIVIDUAL PERSONAL PROPERTY	BROADWAY MICHELLE DENISE	8732 E 73RD TER	208545723	2021	INDIVIDUAL PERSONAL PROPERTY	BYRAM CHRISTINE DARLEACE	9811 E 73RD ST APT B
208505854	2021	INDIVIDUAL PERSONAL PROPERTY	STROTHER KEISHA LETICE	9948 E 61ST ST	208546974	2021	INDIVIDUAL PERSONAL PROPERTY	COLE AALAZIA ANAIS	11200 E 74TH TER
208505991	2021	INDIVIDUAL PERSONAL PROPERTY	TAYLOR BRENDA JALISE (ANDERSON)	8304 WOODSON DR	208547061	2021	INDIVIDUAL PERSONAL PROPERTY	BABIN CHAD PATRICK	9023 E 75TH TER
208506955	2019-2021	INDIVIDUAL PERSONAL PROPERTY	BANKS ERNIE RENALDO	8811 E 75TH ST	208547430	2021	INDIVIDUAL PERSONAL PROPERTY	GADDY T'YHANA DANIELLE	9916 E 85TH TER
208507565	2021	INDIVIDUAL PERSONAL PROPERTY	HUGHLON JADE	7018 WOODSON RD	208547874	2021	INDIVIDUAL PERSONAL PROPERTY	COOKS(SHEPPARD) ANN M & COOKS MALCOLM S	9608 E 80TH TER
208508481	2021	INDIVIDUAL PERSONAL PROPERTY	PEARSON DEANDREA MONIQUE	7913 ELM AVE	208550020	2021	INDIVIDUAL PERSONAL PROPERTY	WILLIAMS QUORDRECE MONTAE	9314 E 68TH TER
208509846	2021	INDIVIDUAL PERSONAL PROPERTY	JOHNSON COREAN DIASHELL QUOSHAE	8618 E UTOPIA DR APT 44	208552196	2021	INDIVIDUAL PERSONAL PROPERTY	BALCH JOHN DAWSON	11308 E 65TH ST
208510174	2021	INDIVIDUAL PERSONAL PROPERTY	HJOHNSON TYRA MARSHAY	9803 E 61ST ST APT 10	208552411	2021	INDIVIDUAL PERSONAL PROPERTY	HAYTON CURTIS LLOYD	10508 E 72ND ST
208511636	2021	INDIVIDUAL PERSONAL PROPERTY	METZGER SEAN PAUL	8306 PERSHING RD	208552761	2021	INDIVIDUAL PERSONAL PROPERTY	WILSON TYLER ANEECE	7154 CRISP AVE
208512268	2021	INDIVIDUAL PERSONAL PROPERTY	GARTH MIKKOS RONNELL	5616 DITZLER AVE	208553211	2021	INDIVIDUAL PERSONAL PROPERTY	DUFFEY RUBY ANN	6804 LAKESHORE DR
208512635	2021	INDIVIDUAL PERSONAL PROPERTY	STEWART AUSTIN RYAN	10919 E 81ST TER	208553593	2021	INDIVIDUAL PERSONAL PROPERTY	SEARCY GAVIN MICHAEL TODD	5557 BLUE RIDGE BLVD
208512769	2021	INDIVIDUAL PERSONAL PROPERTY	SCOTT ARLANDO DONNELL	8506 WESTRIDGE RD	208554087	2021	INDIVIDUAL PERSONAL PROPERTY	HILL MICHAEL SCOTT	9109 E 74TH ST
208512802	2021	INDIVIDUAL PERSONAL PROPERTY	RASH BRANDON KYLE	7402 BLUE RIDGE BLVD	208554667	2021	INDIVIDUAL PERSONAL PROPERTY	HABBIT KATINA	9115 E 84TH ST
208513039	2021	INDIVIDUAL PERSONAL PROPERTY	GARRETT VICTORIA ELIZABETH	5517 HUNTER ST	208555029	2021	INDIVIDUAL PERSONAL PROPERTY	WEST CHRISTINE LEOILA MAE	9104 E 82ND ST
208513968	2021	INDIVIDUAL PERSONAL PROPERTY	BINGHAM DAVID RAY	6007 HUNTER ST	208555584	2021	INDIVIDUAL PERSONAL PROPERTY	BANKS DORIAN CHRISTIAN	10408 E 57TH TER
208514089	2021	INDIVIDUAL PERSONAL PROPERTY	COPELAND JUSTICE F	6624 OXFORD AVE	208556434	2021	INDIVIDUAL PERSONAL PROPERTY	DIKONI CAROL MARIE	11604 E 58TH TER
208514143	2021	INDIVIDUAL PERSONAL PROPERTY	BROWN KAREN ANN	8494 LANE DR APT 4	208558576	2021	INDIVIDUAL PERSONAL PROPERTY	OJEDA RALPH JOSEPH	7403 ELM ST
208514619	2021	INDIVIDUAL PERSONAL PROPERTY	KALTZ BENJAMIN WESLEY	5809 CEDAR AVE	208558824	2021	INDIVIDUAL PERSONAL PROPERTY	MICROBERTS NICHOLAS ANDREW	7324 CEDAR AVE
208515188	2021	INDIVIDUAL PERSONAL PROPERTY	LAUDERDALE JAMESTREVONE	8614 OXFORD AVE	208558877	2021	INDIVIDUAL PERSONAL PROPERTY	JACKSON CEDERICK RAIMAHN JAMES	7406 OVERTON AVE UNIT 2
208515270	2021	INDIVIDUAL PERSONAL PROPERTY	BILLINGTON JOHN JUSTIN	7832 SPRING VALLEY RD	208559417	2021	INDIVIDUAL PERSONAL PROPERTY	BROWN MORGAN ASHLEY	8300 E 83RD ST APT 102
208515646	2021	INDIVIDUAL PERSONAL PROPERTY	WASHINGTON CAIRRA RENAY	5704 MAYWOOD AVE	208559631	2021	INDIVIDUAL PERSONAL PROPERTY	JONES DAVID MICHAEL	8412 WOODSON DR
208516324	2021	INDIVIDUAL PERSONAL PROPERTY	TANNER ALEXANDER MICHAEL	6007 HUNTER ST	208559907	2021	INDIVIDUAL PERSONAL PROPERTY	CARLOS MACARENA	8305 LANE AVE
208516336	2021	INDIVIDUAL PERSONAL PROPERTY	OKONGWU JASMINE LOUISA	8325 NORTHERN ST	208560147	2020-2021	INDIVIDUAL PERSONAL PROPERTY	SPENCER REBECCA IMOGEN	9404 E 67TH TER
208517089	2021	INDIVIDUAL PERSONAL PROPERTY	BAILEY JAMES IR	6535 RAYTOWN RD APT 3	208561228	2021	INDIVIDUAL PERSONAL PROPERTY	WEATHERSPOON DEIDRE LEIGH	8000 STERLING AVE
208517209	2021	INDIVIDUAL PERSONAL PROPERTY	BUZEK ANDREA NICHOLE	9321 E 84TH ST	208563440	2021	INDIVIDUAL PERSONAL PROPERTY	WILLIAMS RENAE ELISABETH	11701 E 83RD ST APT 101
208517545	2021	INDIVIDUAL PERSONAL PROPERTY	HARDIMAN AQUAILLA M	10510 E 80TH ST	208563897	2021	INDIVIDUAL PERSONAL PROPERTY	KANGETHE ELANA N	8801 E 83RD ST
208518358	2021	INDIVIDUAL PERSONAL PROPERTY	JONES ANTONIO MARQUETTE	10507 E 78TH TER	208564371	2021	INDIVIDUAL PERSONAL PROPERTY	LEAPHEART ADRIAN DEWAYNE & SHAUNA LEIGH	8205 WOODSON DR
208519025	2021	INDIVIDUAL PERSONAL PROPERTY	DANNER LAWILLIAM U	9010 E 87TH ST APT A5	208564727	2021	INDIVIDUAL PERSONAL PROPERTY	CARLOCK SHAWNTR E ANN MONIQUE	8825 E 57TH ST
208519119	2021	INDIVIDUAL PERSONAL PROPERTY	MORRIS DIANA DAWN	7236 RAYTOWN RD APT D	208589509	2021	INDIVIDUAL PERSONAL PROPERTY	TURNER MYNESHEY K	8444 LANE DR
208520022	2021	INDIVIDUAL PERSONAL PROPERTY	ZWEIFEL MARCUS LEESEAN	8805 E 61ST TER	208589776	2021	INDIVIDUAL PERSONAL PROPERTY	COLLINS TONIA J & JARED DAMON T	11819 E 83RD ST APT 202
208521004	2021	INDIVIDUAL PERSONAL PROPERTY	REAL KIMBERLY MARIE	9200 E 63RD ST	208594033	2019-2021	INDIVIDUAL PERSONAL PROPERTY	RAMIREZ DIANA DOLORES	8509 E 81ST ST
208521411	2021	INDIVIDUAL PERSONAL PROPERTY	THOMAS LAVERN	9326 E 85TH ST	208960914	2021	INDIVIDUAL PERSONAL PROPERTY	WILLIAMS ROWENA LYNN	9405 E 66TH TER
208521547	2021	INDIVIDUAL PERSONAL PROPERTY	LAUDERDALE JEFFREY	7311 RAYTOWN RD	208963435	2019-2021	INDIVIDUAL PERSONAL PROPERTY	ENG SAHRICHA CHRISTINA	6314 STERLING AVE
208521570	2021	INDIVIDUAL PERSONAL PROPERTY	SCHUH JONATHAN	5401 NORTHERN AVE	208972118	2021	INDIVIDUAL PERSONAL PROPERTY	LEWIS DILLON TAYLOR	6022 FARLEY AVE
208521626	2021	INDIVIDUAL PERSONAL PROPERTY	THOMAS TERESA	8404 BOOTH AVE	32-640-15-54-00-0-00-000	2021	REAL PROPERTY	JG HOMES LLC	11400 E 51ST ST
208521628	2021	INDIVIDUAL PERSONAL PROPERTY	BUTLER MARCUS	9611 E 80TH TER	32-710-01-27-00-0-00-000	2021	REAL PROPERTY	CASNER JACK L & HANCOCK JOAN T	5244 CRISP AVE
208521825	2021	INDIVIDUAL PERSONAL PROPERTY	SPRAGG RYAN DARYL	7509 ENGLEWOOD AVE	32-710-01-53-00-0-00-000	2020	REAL PROPERTY	THE OASIS CHURCH INTERNATIONAL	11500 E 53RD ST
208522146	2021	INDIVIDUAL PERSONAL PROPERTY	WILLIAMS TORANADA	9404 E 84TH TER	32-710-05-17-00-0-00-000	2021	REAL PROPERTY	WILSON THOMAS & TERRI	5240 HARRIS AVE
208522189	2021	INDIVIDUAL PERSONAL PROPERTY	LORICK JASMINE YVONNE	10019 E 78TH ST	32-710-08-07-00-0-00-000	2021	REAL PROPERTY	EAST DOUGLAS D	11301 E 53RD TER
208522325	2021	INDIVIDUAL PERSONAL PROPERTY	MORGAN KANESHA JOY ROCHELLE	6306 RALSTON AVE	32-710-09-05-00-0-00-000	2021	REAL PROPERTY	JPC PROPERTY HOLDINGS LLC	11029 E 53RD TER
208522334	2021	INDIVIDUAL PERSONAL PROPERTY	LANDOWN CONDREAL D SR	6306 RALSTON AVE	32-710-09-10-00-0-00-000	2021	REAL PROPERTY	CONREX RESIDENTIAL PROPERTY GROUP	11009 E 53RD TER
208523459	2021	INDIVIDUAL PERSONAL PROPERTY	LAW R'MONTE' RACHON	5809 KENTUCKY AVE	32-710-09-16-00-0-00-000	2021	REAL PROPERTY	MALLEN GLENDA J	11012 E 54TH ST
208523532	2021	INDIVIDUAL PERSONAL PROPERTY	EISENHART ZION DANIEL	8121 KENTUCKY AVE	32-710-09-21-00-0-00-000	2019-2021	REAL PROPERTY	MONTIEL NAYELI PORTUGAL	11032 E 54TH ST
208525331	2021	INDIVIDUAL PERSONAL PROPERTY	CAMPFIELD CONSTANCE ANN	7220 RAYTOWN RD APT B	32-710-10-40-00-0-00-000	2020-2021	REAL PROPERTY	ROACH DONA LEE & THOENI VICKI L	11026 E 53RD TER
208525351	2021	INDIVIDUAL PERSONAL PROPERTY	THOMAS L'ESSENCE MARIE	11424 E 77TH TER	32-710-12-01-00-0-00-000	2021	REAL PROPERTY	DURST MICHAEL K	5420 HARRIS AVE
208525598	2020-2021	INDIVIDUAL PERSONAL PROPERTY	WILSON KRISTA N	8404 E 85TH ST	32-710-12-04-00-0-00-000	2021	REAL PROPERTY	ARVM 5 LLC	5425 APPLETON AVE
208525980	2021	INDIVIDUAL PERSONAL PROPERTY	GARCIA KATHERINE IRENE	7718 ARLINGTON AVE	32-710-12-05-00-0-00-000	2021	REAL PROPERTY	GEORGE PAULA A	5429 APPLETON AVE
208526086	2021	INDIVIDUAL PERSONAL PROPERTY	MURRELL MARIAH MONIQUE	8200 ELM AVE	32-710-14-04-00-0-00-000	2021	REAL PROPERTY	MCCLLENAHAN MELVIN T & SHELLY D	5425 HARVARD AVE
208526419	2021	INDIVIDUAL PERSONAL PROPERTY	MCGUIRE LESLIE RENEE	5940 STERLING AVE	32-720-02-12-00-0-00-000	2021	REAL PROPERTY	LINDEMAN CYNTHIA R	5501 CEDAR AVE
208526997	2021	INDIVIDUAL PERSONAL PROPERTY	AMBAM ANYE LAWRENCE	9205 E 84TH ST	32-720-02-30-03-0-00-000	2021	REAL PROPERTY	SCOFFIELD MARK W	5414 MAYWOOD AVE
208527113	2021	INDIVIDUAL PERSONAL PROPERTY	WENDLETON MASSON STORM	8701 GLENWOOD AVE	32-720-03-09-00-0-00-000	2021	REAL PROPERTY	HEAGY CHRISTINA LYNN	5409 MAYWOOD AVE
208527114	2021	INDIVIDUAL PERSONAL PROPERTY	BEACH DYLAN TYLER	7004 HUNTER ST	32-720-03-10-00-0-00-000	2021	REAL PROPERTY	HEAVNER HARROL L & MARJORIE	5413 MAYWOOD AVE
208528380	2021	INDIVIDUAL PERSONAL PROPERTY	SAAVEDRA MANZUR JUAN MAURICIO	11405 E 56TH TER	32-720-04-02-00-0-00-000	2021	REAL PROPERTY	CARLETON SUSAN M & FERRELL ALBERT A	5301 ASH AVE
208529671	2021	INDIVIDUAL PERSONAL PROPERTY	LESTER JOSHUA MICHAEL	8601 GREENWOOD RD	32-720-05-02-00-0-00-000	2020-2021	REAL PROPERTY	BUFFA SHEILA A	5301 HARDY AVE
208530501	2021	INDIVIDUAL PERSONAL PROPERTY	BANKS KENYA Y	9802 E 60TH ST	32-720-05-17-00-0-00-000	2021	REAL PROPERTY	INMAN RANDY LAVERNE	5425 HARDY AVE
208531573	2021	INDIVIDUAL PERSONAL PROPERTY	WILSON COURTNEY LACONNE	9529 E GREGORY BLVD	32-720-05-37-00-0-00-000	2019	REAL PROPERTY	SLEDD JULIA A	5416 WILLOW AVE
208531586	2021	INDIVIDUAL PERSONAL PROPERTY	PETRIE GLENDA ADRIANNA	8951 E 52ND TER	32-720-06-30-00-0-00-000	2021	REAL PROPERTY	RIMER ALBERT DALE & EULA FAYE	5328 RALSTON AVE
208532775	2021	INDIVIDUAL PERSONAL PROPERTY	MONTIELONGO ANGELA MARIA	11252 E 71ST TER	32-720-07-26-00-0-00-000	2021	REAL PROPERTY	GEREN MICHAEL A	5328 HEDGES AVE
208533054	2021	INDIVIDUAL PERSONAL PROPERTY	BERNHARDT ALICIA DAWN	11003 E 60TH TER	32-720-08-07-00-0-00-000	2020-2021	REAL PROPERTY	OLDENBURG HOWARD P & JOANN	5321 HEDGES AVE
208535292	2021	INDIVIDUAL PERSONAL PROPERTY	MALCOLM JESSICA R	6612 OXFORD AVE	32-720-08-10-00-0-00-000	2020-2021	REAL PROPERTY	FANN SHARON M	5337 HEDGES AVE
208536984	2021	INDIVIDUAL PERSONAL PROPERTY	SCOFFIELD BAILEY J	9913 E 77TH TER	32-720-08-21-00-0-00-000	2020-2021	REAL PROPERTY	COLTHARP JOSEPH A	5324 NORTHERN AVE
208537563	2021	INDIVIDUAL PERSONAL PROPERTY	MOEN DONALD PAUL & CHERI CAROLYN	8308 KENTUCKY AVE	32-720-08-28-00-0-00-000	2021	REAL PROPERTY	PRIEST PAUL DAVID & MARCIA S	5413 HEDGES AVE
208537884	2021	INDIVIDUAL PERSONAL PROPERTY	TOWNSEND JHERMAYNE DSHAUN	8858 E 63RD ST	32-730-06-02-00-0-00-000	2021	REAL PROPERTY	INVEST SUCCESS	10214 E 56TH ST
208538060	2021	INDIVIDUAL PERSONAL PROPERTY	HOKE DARRYL H & BARBARA J	6725 LAUREL AVE	32-730-07-09-00-0-00-000	2021	REAL PROPERTY	PADGETT DAVID D JR & LEONG SIEW KEW	10112 E 56TH ST
208538181	2021	INDIVIDUAL PERSONAL PROPERTY	DEATHERAGE RHYS EIRANN J	9121 E 68TH ST	32-730-07-11-00-0-00-000	2019-2021	REAL PROPERTY	BMT RENTAL ENTERPRISES LLC	10116 E 56TH ST
208539720	2021	INDIVIDUAL PERSONAL PROPERTY	POOL MADISON LEIGH	7205 RAYTOWN RD	32-730-09-12-00-0-00-000	2021	REAL PROPERTY	INGLE BEVERLY J	10228 E 56TH ST
208540306	2021	INDIVIDUAL PERSONAL PROPERTY	BREWSTER KYLE ANDREW	10916 E 56TH TER	32-730-10-13-00-0-00-000	2020-2021	REAL PROPERTY	DAYLONG LARRY	5516 HARDY AVE
208542283	2021	INDIVIDUAL PERSONAL PROPERTY	EIDSON RANDY FRED JR & LINDBERG SAVANNAH MARIE	9805 E 53RD ST UNIT A	32-730-11-13-00-0-00-000	2019-2021	REAL PROPERTY	MATHISON JAMES C & MARY JO	5506 WILLOW AVE
208542320	2021	INDIVIDUAL PERSONAL PROPERTY	KOLSTAD JESSICA KRISTAL	6805 LAUREL AVE	32-730-12-07-00-0-00-000	2019-2021	REAL PROPERTY	REDMER BOBBY JOE & BARBARA	10512 E 56TH ST
208542339	2021	INDIVIDUAL PERSONAL PROPERTY	EWING RHONDA MAE	9804 E 59TH TER	32-730-12-17-00-0-00-000	2019-2021	REAL PROPERTY	REDMER BOBBY JOE & BARBARA	10512 E 56TH ST
208543316	2021	INDIVIDUAL PERSONAL PROPERTY	SEARCY TAJHCHEL REEL LAMETRICE	8427 WOODSON DR	32-730-13-15-00-0-00-000	2021	REAL PROPERTY	MCFFERNY JENNIFER	5524 HEDGES AVE

32-730-15-14-00-0-00-000	2020-2021	REAL PROPERTY	CRUZ HEATHER MARIE	10405 E 56TH ST	32-820-12-02-00-0-00-000	2020	REAL PROPERTY	SANDERS CANDACE	8599 E 54TH ST
32-730-15-28-01-0-00-000	2021	REAL PROPERTY	JEFFERSON CHARLES J	NO ADDRESS ASSIGNED BY CITY	32-820-12-08-00-0-00-000	2021	REAL PROPERTY	JAMESON JERRY R & VERA E	5425 HUNTER ST
32-730-15-51-00-0-00-000	2021	REAL PROPERTY	JORDAN RILLIE ANN	10620 E 56TH TER	32-830-01-14-00-0-00-000	2021	REAL PROPERTY	BETH SHALOM CONGREGATION	5529 DITZLER AVE
32-730-15-52-00-0-00-000	2020-2021	REAL PROPERTY	CLIFFORD ARTHUR M-TRUSTEE	10616 E 56TH TER	32-830-02-27-00-0-00-000	2021	REAL PROPERTY	THOMPSON SAUNDRA L	9006 E 55TH TER
32-730-16-02-00-0-00-000	2021	REAL PROPERTY	PLUM STREET MANAGEMENT LLC	10215 E 56TH ST	32-830-02-42-00-0-00-000	2019-2021	REAL PROPERTY	RIDDLE DEANN D	5626 LAUREL AVE
32-730-16-04-01-0-00-000	2018-2021	REAL PROPERTY	MCILWAIN PAULINE F & DELAMETER DELANA K	10113 E 56TH ST	32-830-02-64-00-0-00-000	2019-2021	REAL PROPERTY	MAZE MARGARET	5623 LAUREL AVE
32-730-16-04-02-0-00-000	2020-2021	REAL PROPERTY	HANVELT ERIK & ANGELA	10117 E 56TH ST	32-830-03-06-00-0-00-000	2020-2021	REAL PROPERTY	SIMPSON BRANDIE	5521 HUNTER ST
32-730-16-08-00-0-00-000	2021	REAL PROPERTY	CHURCHILL SHARON K	10200 E 57TH ST	32-830-03-13-00-0-00-000	2021	REAL PROPERTY	ANNEN PAMELA J	5553 KENTUCKY ST
32-730-16-28-00-0-00-000	2021	REAL PROPERTY	TROTTER JOANN	10009 E 56TH TER	32-830-03-26-00-0-00-000	2021	REAL PROPERTY	PROBST DAVID R & NANCY K	5608 LANE AVE
32-730-16-38-01-0-00-000	2019-2021	REAL PROPERTY	HOOK MICHELLE	10225 E 56TH ST	32-830-03-37-00-0-00-000	2021	REAL PROPERTY	WILLIAMS ALLEN D & REGINA Y	8915 E 56TH TER
32-730-16-38-02-0-00-000	2020-2021	REAL PROPERTY	GOODLOE TAMMY RENEE	10225 E 56TH ST	32-830-04-13-00-0-00-000	2020-2021	REAL PROPERTY	SMITH MICHAEL K & KATHERINE L	5540 HUNTER ST
32-730-17-15-00-0-00-000	2019-2021	REAL PROPERTY	ULGENER KATHLEEN J	5707 CEDAR AVE	32-830-05-14-00-0-00-000	2021	REAL PROPERTY	GREGO JANET C	5637 BLUE RIDGE CUT OFF
32-730-17-24-00-0-00-000	2019-2021	REAL PROPERTY	KAUTZ BENJAMIN W & CARRIE	5809 CEDAR AVE	32-830-05-23-00-0-00-000	2021	REAL PROPERTY	WILSON JOEL W	8906 E 58TH ST
32-730-17-34-00-0-00-000	2021	REAL PROPERTY	HASTINGS CHRYSTEL	5712 MAYWOOD AVE	32-830-05-38-00-0-00-000	2021	REAL PROPERTY	BROOKS THERESA A	8828 E 57TH ST
32-730-18-15-00-0-00-000	2020-2021	REAL PROPERTY	DRYER GERALD D	10208 E 55TH TER	32-830-07-03-00-0-00-000	2018-2021	REAL PROPERTY	EWIC PROPERTIES LLC	8817 E 57TH TER
32-730-19-09-00-0-00-000	2021	REAL PROPERTY	HEAVNER ROBERT THEODORE II	5725 ASH AVE	32-830-07-10-02-0-00-000	2021	REAL PROPERTY	HOLLOWAY ANDREW J	8800 E 59TH ST
32-730-19-15-00-0-00-000	2019-2021	REAL PROPERTY	HOFFMAN WILLIAM F III	10312 E 58TH TER	32-830-07-13-00-0-00-000	2021	REAL PROPERTY	SHELTON VICKIE E	5826 FARLEY AVE
32-730-19-27-00-0-00-000	2021	REAL PROPERTY	ETTER ALICE M	10401 E 57TH TER	32-830-08-25-00-0-00-000	2021	REAL PROPERTY	QUIASON MARIO G & AIDA E	8920 E 59TH ST
32-730-19-44-00-0-00-000	2021	REAL PROPERTY	SOSNA EDWARD T & DOMENICA R	10508 E 57TH PL	32-830-08-43-00-0-00-000	2021	REAL PROPERTY	CRITES JEFFREY DEAN	5700 MANNING AVE
32-730-19-53-00-0-00-000	2019-2021	REAL PROPERTY	HARMON REGINALD T & BERRYMAN JOHNETTA	5746 WILLOW AVE	32-830-08-45-00-0-00-000	2019-2021	REAL PROPERTY	MORGAN KENNETH V & TIFFANY R	5712 MANNING AVE
32-730-19-56-00-0-00-000	2021	REAL PROPERTY	JONES CLIFFORD D & DIANE C	10501 E 57TH PL	32-830-08-50-00-0-00-000	2019-2021	REAL PROPERTY	BOYKIN COURTNEY D	5513 KENTUCKY AVE
32-730-20-02-00-0-00-000	2021	REAL PROPERTY	CARTER CARL V JR & MELODY JO	5703 BLUE RIDGE BLVD	32-830-08-63-00-0-00-000	2019-2021	REAL PROPERTY	FOUR GEM HOMES LLC	5810 HUNTER CT
32-730-20-05-00-0-00-000	2021	REAL PROPERTY	DUFF KAREN & PAUL	5729 BLUE RIDGE BLVD	32-830-08-64-00-0-00-000	2019-2021	REAL PROPERTY	FOUR GEM HOMES LLC	5812 HUNTER CT
32-730-20-15-00-0-00-000	2021	REAL PROPERTY	HILLEBRAND JOSEPH HENRY	5809 HEDGES AVE	32-830-08-65-00-0-00-000	2019-2021	REAL PROPERTY	FOUR GEM HOMES LLC	5814 HUNTER CT
32-740-01-03-00-0-00-000	2021	REAL PROPERTY	DONOVAN JASON & MONICA	11408 E 55TH TER	32-830-08-66-00-0-00-000	2019-2021	REAL PROPERTY	FOUR GEM HOMES LLC	5816 HUNTER CT
32-740-01-09-00-0-00-000	2020-2021	REAL PROPERTY	LOCKETT ROBERT J III	5505 BLUE RIDGE BLVD	32-830-08-67-00-0-00-000	2019-2021	REAL PROPERTY	FOUR GEM HOMES LLC	5820 HUNTER CT
32-740-01-15-00-0-00-000	2020-2021	REAL PROPERTY	BROCK GLENN A II	5504 WOODSON RD	32-830-08-68-00-0-00-000	2019-2021	REAL PROPERTY	FOUR GEM HOMES LLC	5822 HUNTER CT
32-740-04-06-00-0-00-000	2021	REAL PROPERTY	MEYER ANNABELLE	5552 BLUE RIDGE BLVD	32-830-08-69-00-0-00-000	2019-2021	REAL PROPERTY	FOUR GEM HOMES LLC	5824 HUNTER CT
32-740-05-05-00-0-00-000	2021	REAL PROPERTY	HOMEZONE LLC	5525 APPLETON AVE	32-830-08-70-00-0-00-000	2019-2021	REAL PROPERTY	FOUR GEM HOMES LLC	5826 HUNTER CT
32-740-09-06-00-0-00-000	2021	REAL PROPERTY	MURDOCK SHANNON LEE	5615 HARRIS AVE	32-830-08-71-00-0-00-000	2019-2021	REAL PROPERTY	FOUR GEM HOMES LLC	5830 HUNTER CT
32-740-10-10-00-0-00-000	2021	REAL PROPERTY	IRELAND MATTHEW W & MARY J	5616 STERLING AVE	32-830-08-72-00-0-00-000	2019-2021	REAL PROPERTY	FOUR GEM HOMES LLC	5832 HUNTER CT
32-740-11-08-00-0-00-000	2018-2021	REAL PROPERTY	BRADLEY SANDRA K	11217 E 55TH TER	32-830-08-73-00-0-00-000	2019-2021	REAL PROPERTY	FOUR GEM HOMES LLC	5834 HUNTER CT
32-740-11-34-00-0-00-000	2021	REAL PROPERTY	MAYSE RICHARD	5521 STERLING AVE	32-830-08-74-00-0-00-000	2019-2021	REAL PROPERTY	FOUR GEM HOMES LLC	5836 HUNTER CT
32-740-14-02-00-0-00-000	2021	REAL PROPERTY	SANTEE JUDY L	11117 E 56TH TER	32-830-08-75-00-0-00-000	2021	REAL PROPERTY	MORGAN SHARON H	5840 HUNTER CT
32-740-14-19-00-0-00-000	2020-2021	REAL PROPERTY	POINT CAPITAL 401(K) PLAN	11120 E 57TH ST	32-830-08-76-00-0-00-000	2021	REAL PROPERTY	FOUR GEM HOMES LLC	5842 HUNTER CT
32-740-16-18-00-0-00-000	2021	REAL PROPERTY	EMERSON R JANET	10920 E 57TH TER	32-830-08-81-00-0-00-000	2019-2021	REAL PROPERTY	FOUR GEM HOMES LLC	5813 HUNTER CT
32-740-23-16-00-0-00-000	2021	REAL PROPERTY	MAXWELL HOLLY ANN	10812 E 58TH ST	32-830-08-82-00-0-00-000	2019-2021	REAL PROPERTY	FOUR GEM HOMES LLC	5815 HUNTER CT
32-740-23-18-00-0-00-000	2020-2021	REAL PROPERTY	STEPHENS FLORENCE E	10904 E 58TH ST	32-830-08-83-00-0-00-000	2019-2021	REAL PROPERTY	FOUR GEM HOMES LLC	5817 HUNTER CT
32-740-23-25-00-0-00-000	2021	REAL PROPERTY	WHITE BILLY J & GABRIELLE L	5821 APPLETON AVE	32-830-08-84-00-0-00-000	2019-2021	REAL PROPERTY	FOUR GEM HOMES LLC	5819 HUNTER CT
32-740-23-29-00-0-00-000	2021	REAL PROPERTY	GAME BRIANNA K	10817 E 58TH TER	32-830-08-85-00-0-00-000	2019-2021	REAL PROPERTY	FOUR GEM HOMES LLC	5821 HUNTER CT
32-740-23-44-00-0-00-000	2021	REAL PROPERTY	THUNDER PROPERTIES LLC	11006 E 59TH ST	32-830-08-86-00-0-00-000	2019-2021	REAL PROPERTY	FOUR GEM HOMES LLC	5823 HUNTER CT
32-740-24-08-00-0-00-000	2019-2021	REAL PROPERTY	DAVIS TERESA L	5801 HARVARD AVE	32-830-08-87-00-0-00-000	2019-2021	REAL PROPERTY	FOUR GEM HOMES LLC	5825 HUNTER CT
32-740-24-14-00-0-00-000	2021	REAL PROPERTY	RHS HOLDINGS LLC	11104 E 59TH ST	32-830-08-88-00-0-00-000	2019-2021	REAL PROPERTY	FOUR GEM HOMES LLC	5827 HUNTER CT
32-740-27-29-00-0-00-000	2019-2021	REAL PROPERTY	BURCH GLENDA L	11411 E 58TH TER	32-830-08-89-00-0-00-000	2019-2021	REAL PROPERTY	FOUR GEM HOMES LLC	5829 HUNTER CT
32-740-28-07-00-0-00-000	2021	REAL PROPERTY	KLEIMAN WILLIAM J	11220 E 59TH ST	32-830-08-90-00-0-00-000	2019-2021	REAL PROPERTY	FOUR GEM HOMES LLC	5831 HUNTER CT
32-810-02-40-00-0-00-000	2019-2021	REAL PROPERTY	PICARD DONNA R	9718 E 53RD ST	32-830-08-91-00-0-00-000	2019-2021	REAL PROPERTY	FOUR GEM HOMES LLC	5833 HUNTER CT
32-810-02-42-00-0-00-000	2021	REAL PROPERTY	DAHL DOUGLAS E	9808 E 53RD ST	32-830-08-92-00-0-00-000	2019-2021	REAL PROPERTY	FOUR GEM HOMES LLC	5835 HUNTER CT
32-810-02-48-00-0-00-000	2021	REAL PROPERTY	REAL ESTATE TO FREEDOM LLC	9912 E 53RD ST	32-830-08-93-00-0-00-000	2019-2021	REAL PROPERTY	FOUR GEM HOMES LLC	5837 HUNTER CT
32-810-02-83-00-0-00-000	2021	REAL PROPERTY	NATIONWIDE PROPERTIES LLC	9814 E 53RD ST	32-830-08-94-00-0-00-000	2019-2021	REAL PROPERTY	FOUR GEM HOMES LLC	5839 HUNTER CT
32-810-06-04-00-0-00-000	2021	REAL PROPERTY	RUPE JAMES L & PATRICIA A	5225 ELM PL	32-830-08-95-00-0-00-000	2019-2021	REAL PROPERTY	FOUR GEM HOMES LLC	5841 HUNTER CT
32-810-06-05-00-0-00-000	2020-2021	REAL PROPERTY	BRYAN ALICE & KAROLYN J	5216 ELM PL	32-830-09-09-00-0-00-000	2020-2021	REAL PROPERTY	SCHORGL JAMES J & SCHORGL THOMAS J	5813 LANE AVE
32-810-06-40-00-0-00-000	2020-2021	REAL PROPERTY	5318 LLC	5318 RAYTOWN RD	32-830-10-01-00-0-00-000	2021	REAL PROPERTY	SLATER EDWARD R & ROSE K-TRUSTEES	5636 LAUREL AVE
32-810-06-45-00-0-00-000	2021	REAL PROPERTY	EDMUND NORTH LLC	5408 RAYTOWN RD	32-830-10-30-00-0-00-000	2021	REAL PROPERTY	NELSON LARRY E & NORMA J	9115 E 57TH TER
32-810-06-46-00-0-00-000	2021	REAL PROPERTY	BURTON LOREN KEITH	5412 RAYTOWN RD	32-830-11-17-00-0-00-000	2021	REAL PROPERTY	COTTON BESSIE MAE	5821 LAUREL AVE
32-810-06-47-00-0-00-000	2021	REAL PROPERTY	VARELA TESLA EDITH	5416 RAYTOWN RD	32-840-03-16-00-0-00-000	2019-2021	REAL PROPERTY	DS MORGAN LLC	5539 RAYTOWN RD
32-810-07-30-00-0-00-000	2021	REAL PROPERTY	CURRY AUTUMN M	5433 RAYTOWN RD	32-840-03-22-00-0-00-000	2017-2021	REAL PROPERTY	ARTHUR M CLIFFORD TRUST DATED 10-12-2000 AMEND 4-27	NO ADDRESS ASSIGNED BY CITY
32-810-07-47-00-0-00-000	2019-2021	REAL PROPERTY	DS MORGAN LLC	9513 E 53RD ST	32-840-04-79-00-0-00-000	2021	REAL PROPERTY	FRASER CHRISTIN M	5526 CRESCENT AVE
32-810-07-54-00-0-00-000	2019-2021	REAL PROPERTY	DS MORGAN LLC	NO ADDRESS ASSIGNED BY CITY	32-840-04-80-00-0-00-000	2019-2021	REAL PROPERTY	HARTLEIN AMY JO	5737 ELM AVE
32-810-07-55-00-0-00-000	2019-2021	REAL PROPERTY	DS MORGAN LLC	NO ADDRESS ASSIGNED BY CITY	32-840-05-05-00-0-00-000	2021	REAL PROPERTY	STEWART GILBERT L & WF	5900 RAYTOWN TRFY
32-810-08-06-00-0-00-000	2021	REAL PROPERTY	LEE JASON M	9805 E 53RD ST UNIT A	32-840-09-01-00-0-00-000	2021	REAL PROPERTY	HEDGER JOHN W	5709 CRESCENT AVE
32-810-09-02-00-0-00-000	2019-2021	REAL PROPERTY	QUALITY INVESTMENTS LLC	5401 ELM AVE	32-840-10-05-00-0-00-000	2020-2021	REAL PROPERTY	VERTICAL DESIGN LLC	5717 CRESCENT AVE
32-820-07-08-00-0-00-000	2021	REAL PROPERTY	FISHER GERALD D & CLARA MAY	5305 LAUREL AVE	32-840-10-06-00-0-00-000	2020-2021	REAL PROPERTY	VERTICAL DESIGN LLC	5712 ARLINGTON AVE
32-820-08-07-00-0-00-000	2021	REAL PROPERTY	LADINES GLORIA F & NEWMAN LAURILEE L	9013 E 52ND TER	32-840-10-22-00-0-00-000	2020-2021	REAL PROPERTY	VERTICAL DESIGN LLC	5716 ARLINGTON AVE
32-820-08-11-00-0-00-000	2020-2021	REAL PROPERTY	MAHL DUSTIN W	8963 E 52ND TER	32-840-10-23-00-0-00-000	2020-2021	REAL PROPERTY	VERTICAL DESIGN LLC	5720 ARLINGTON AVE
32-820-08-13-00-0-00-000	2019-2021	REAL PROPERTY	TONEY HAZEL CARSON	8955 E 52ND TER	32-840-10-24-00-0-00-000	2020-2021	REAL PROPERTY	VERTICAL DESIGN LLC	5724 ARLINGTON AVE
32-820-08-46-00-0-00-000	2021	REAL PROPERTY	TRUE DAVID R & MARY K TRUSTEES	9004 E 55TH ST	32-840-10-25-00-0-00-000	2020-2021	REAL PROPERTY	VERTICAL DESIGN LLC	5725 CRESCENT AVE
32-820-09-06-00-0-00-000	2021	REAL PROPERTY	PROVIDENT TRUST GROUP LLC	8855 E 52ND TER	32-840-10-27-00-0-00-000	2020-2021	REAL PROPERTY	VERTICAL DESIGN LLC	NO ADDRESS ASSIGNED BY CITY
32-820-09-20-00-0-00-000	2020-2021	REAL PROPERTY	SIMPSON KARRIE VAUN	5313 KENTUCKY AVE	32-840-10-28-00-0-00-000	2020-2021	REAL PROPERTY	VERTICAL DESIGN LLC	NO ADDRESS ASSIGNED BY CITY
32-820-10-08-00-0-00-000	2021	REAL PROPERTY	EDWARDS NANCY K	8812 E 54TH ST	32-840-11-15-00-0-00-000	2020-2021	REAL PROPERTY	VERTICAL DESIGN LLC	NO ADDRESS ASSIGNED BY CITY
32-820-10-12-00-0-00-000	2020-2021	REAL PROPERTY	STUBBS AMY E	5316 KENTUCKY AVE	32-840-11-16-00-0-00-000	2020-2021	REAL PROPERTY	VERTICAL DESIGN LLC	NO ADDRESS ASSIGNED BY CITY
32-820-11-03-00-0-00-000	2021	REAL PROPERTY	HERNANDEZ DARRAH & CARLOS JR	8863 E 54TH ST	32-840-11-17-00-0-00-000	2020-2021	REAL PROPERTY	VERTICAL DESIGN LLC	NO ADDRESS ASSIGNED BY CITY
32-820-11-06-00-0-00-000	2021	REAL PROPERTY	COOPER HELEN JOAN	8851 E 54TH ST	32-840-11-18-00-0-00-000	2020-2021	REAL PROPERTY	VERTICAL DESIGN LLC	NO ADDRESS ASSIGNED BY CITY

32-840-11-19-00-0-00-000	2020-2021	REAL PROPERTY	VERTICAL DESIGN LLC	NO ADDRESS ASSIGNED BY CITY	44-920-04-04-00-0-00-000	2021	REAL PROPERTY	POPE 401K PLAN	7722 WOODSON RD
32-840-11-20-00-0-00-000	2020-2021	REAL PROPERTY	VERTICAL DESIGN LLC	NO ADDRESS ASSIGNED BY CITY	44-920-05-03-00-0-00-000	2019-2021	REAL PROPERTY	SUTTER BRIDGETTE M	11801 E 77TH TER
32-840-11-21-00-0-00-000	2020-2021	REAL PROPERTY	VERTICAL DESIGN LLC	NO ADDRESS ASSIGNED BY CITY	44-920-05-16-00-0-00-000	2021	REAL PROPERTY	FRITZ GERALD D & ANNELLA J-TR	11712 E 78TH ST
32-840-11-22-00-0-00-000	2020-2021	REAL PROPERTY	VERTICAL DESIGN LLC	NO ADDRESS ASSIGNED BY CITY	44-920-05-17-00-0-00-000	2021	REAL PROPERTY	PERKINS HERMINIE E	11716 E 78TH ST
32-840-11-23-00-0-00-000	2020-2021	REAL PROPERTY	VERTICAL DESIGN LLC	NO ADDRESS ASSIGNED BY CITY	44-920-07-04-00-0-00-000	2019-2021	REAL PROPERTY	HEDRICK RONALD L & JACQUELINE	11709 E 78TH ST
32-840-13-01-00-0-00-000	2020-2021	REAL PROPERTY	VERTICAL DESIGN LLC	NO ADDRESS ASSIGNED BY CITY	44-920-07-10-00-0-00-000	2021	REAL PROPERTY	CARPINO MIKE J & MARY J	7809 WOODSON RD
32-840-13-11-00-0-00-000	2020-2021	REAL PROPERTY	VERTICAL DESIGN LLC	NO ADDRESS ASSIGNED BY CITY	44-920-08-04-00-0-00-000	2021	REAL PROPERTY	VAN BUSKIRK WILLIAM E & MARY J	7812 WOODSON RD
32-840-13-12-00-0-00-000	2020-2021	REAL PROPERTY	VERTICAL DESIGN LLC	NO ADDRESS ASSIGNED BY CITY	44-920-09-05-00-0-00-000	2021	REAL PROPERTY	MACK DAVIS L & STACEY A	7827 RIDGEWAY AVE
32-840-13-14-00-0-00-000	2020-2021	REAL PROPERTY	VERTICAL DESIGN LLC	5796 CRESCENT AVE	44-920-11-06-00-0-00-000	2021	REAL PROPERTY	CRADDOCK JUDITH LEE	11805 E 78TH TER
32-840-13-15-00-0-00-000	2020-2021	REAL PROPERTY	VERTICAL DESIGN LLC	5792 CRESCENT AVE	44-920-12-10-00-0-00-000	2019-2021	REAL PROPERTY	BENNETT REBECCA L	7701 WOODSON RD
32-840-13-16-00-0-00-000	2020-2021	REAL PROPERTY	VERTICAL DESIGN LLC	5788 CRESCENT AVE	44-920-12-23-00-0-00-000	2021	REAL PROPERTY	MOORE MICHELE	7712 IRWIN RD
32-840-13-17-00-0-00-000	2020-2021	REAL PROPERTY	VERTICAL DESIGN LLC	5784 CRESCENT AVE	44-930-04-02-01-1-00-000	2021	REAL PROPERTY	QUALITY PROPERTY LLC	NO ADDRESS ASSIGNED BY CITY
32-840-13-18-00-0-00-000	2020-2021	REAL PROPERTY	VERTICAL DESIGN LLC	5780 CRESCENT AVE	44-930-04-02-01-3-00-000	2021	REAL PROPERTY	QUALITY PROPERTY LLC	NO ADDRESS ASSIGNED BY CITY
32-840-13-19-00-0-00-000	2020-2021	REAL PROPERTY	VERTICAL DESIGN LLC	5776 CRESCENT AVE	44-930-04-17-00-0-01-018	2020-2021	REAL PROPERTY	ALEXANDRIA VINCENT R	8001 WESTRIDGE RD UNIT 9
32-840-13-20-00-0-00-000	2020-2021	REAL PROPERTY	VERTICAL DESIGN LLC	5772 CRESCENT AVE	44-930-04-17-00-0-03-002	2021	REAL PROPERTY	NG HOI TING	8001 WESTRIDGE RD UNIT 29
32-840-13-21-00-0-00-000	2020-2021	REAL PROPERTY	VERTICAL DESIGN LLC	5768 CRESCENT AVE	44-930-04-17-00-0-03-008	2021	REAL PROPERTY	GILLILAND LOIS E	8001 WESTRIDGE RD UNIT 23
32-840-14-02-00-0-00-000	2020-2021	REAL PROPERTY	WILLIAMS JACK & ADRIENNE	9545 E 57TH TER	44-930-04-17-00-0-03-013	2021	REAL PROPERTY	SNOW HOLLY	8001 WESTRIDGE RD UNIT 32
32-840-14-10-00-0-00-000	2020-2021	REAL PROPERTY	VERTICAL DESIGN LLC	9521 E 57TH TER	44-930-04-20-00-0-00-000	2021	REAL PROPERTY	QUALITY PROPERTY LLC	NO ADDRESS ASSIGNED BY CITY
32-840-14-17-00-0-00-000	2020-2021	REAL PROPERTY	VERTICAL DESIGN LLC	NO ADDRESS ASSIGNED BY CITY	44-930-05-17-00-0-00-000	2021	REAL PROPERTY	QUALITY HOLDINGS LLC	NO ADDRESS ASSIGNED BY CITY
32-840-14-18-00-0-00-000	2020-2021	REAL PROPERTY	VERTICAL DESIGN LLC	NO ADDRESS ASSIGNED BY CITY	44-930-06-03-01-5-00-000	2021	REAL PROPERTY	JENSEN DANNY L & SANDRA K	11730 E 83RD ST SPC A
32-840-14-19-00-0-00-000	2020-2021	REAL PROPERTY	VERTICAL DESIGN LLC	NO ADDRESS ASSIGNED BY CITY	44-930-06-03-02-0-00-000	2021	REAL PROPERTY	JENSEN DANNY L	11820 E 83RD ST
32-840-14-20-00-0-00-000	2020-2021	REAL PROPERTY	VERTICAL DESIGN LLC	9516 E 58TH ST	44-930-06-21-00-0-00-000	2021	REAL PROPERTY	JENSEN DANNY L & SANDRA K	11730 E 83RD TER
32-840-14-21-00-0-00-000	2020-2021	REAL PROPERTY	VERTICAL DESIGN LLC	9520 E 58TH ST	45-110-02-08-00-0-00-000	2021	REAL PROPERTY	QUERO ENTERPRISE LLC	5907 CLAREMONT AVE
32-840-14-22-00-0-00-000	2020-2021	REAL PROPERTY	VERTICAL DESIGN LLC	9524 E 58TH ST	45-110-02-15-00-0-00-000	2021	REAL PROPERTY	HUDSON PAUL L & JO ANN	6011 CLAREMONT AVE
32-840-14-23-00-0-00-000	2020-2021	REAL PROPERTY	VERTICAL DESIGN LLC	9528 E 58TH ST	45-110-02-17-00-0-00-000	2021	REAL PROPERTY	MORALES ELLARD	6008 ENGLEWOOD AVE
32-840-14-24-00-0-00-000	2020-2021	REAL PROPERTY	VERTICAL DESIGN LLC	9532 E 58TH ST	45-110-03-16-00-0-00-000	2021	REAL PROPERTY	BALL BETTY M	5915 STERLING AVE
32-840-14-26-00-0-00-000	2020-2021	REAL PROPERTY	VERTICAL DESIGN LLC	9536 E 58TH ST	45-110-03-60-00-0-00-000	2021	REAL PROPERTY	ABBEY TOMMY W & SUN C	11504 E 62ND ST
32-840-14-27-00-0-00-000	2020-2021	REAL PROPERTY	VERTICAL DESIGN LLC	9540 E 58TH ST	45-110-03-86-00-0-00-000	2021	REAL PROPERTY	HANRATTY LINDA W	6101 ENGLEWOOD AVE
32-840-14-29-00-0-00-000	2020-2021	REAL PROPERTY	VERTICAL DESIGN LLC	9501 E 57TH TER	45-110-04-06-00-0-00-000	2021	REAL PROPERTY	TAGUE MICHAEL L & SHERRY L	5911 HARVARD AVE
32-840-15-01-00-0-00-000	2020-2021	REAL PROPERTY	VERTICAL DESIGN LLC	NO ADDRESS ASSIGNED BY CITY	45-110-04-16-00-0-00-000	2021	REAL PROPERTY	SCHAEER MARK W & ANN E	11005 E 60TH TER
32-840-15-02-00-0-00-000	2020-2021	REAL PROPERTY	VERTICAL DESIGN LLC	NO ADDRESS ASSIGNED BY CITY	45-110-04-33-00-0-00-000	2021	REAL PROPERTY	WRIGHT KATHERINE C	10809 E 62ND TER
32-840-15-04-00-0-00-000	2020-2021	REAL PROPERTY	VERTICAL DESIGN LLC	NO ADDRESS ASSIGNED BY CITY	45-110-04-71-00-0-00-000	2020-2021	REAL PROPERTY	DILLS JAY E & KAREN S	5928 STERLING AVE
32-840-15-05-00-0-00-000	2020-2021	REAL PROPERTY	VERTICAL DESIGN LLC	NO ADDRESS ASSIGNED BY CITY	45-110-04-78-00-0-00-000	2021	REAL PROPERTY	MERINO JESSE A & VICKIE L	10900 E 63RD ST
32-840-15-06-00-0-00-000	2020-2021	REAL PROPERTY	VERTICAL DESIGN LLC	NO ADDRESS ASSIGNED BY CITY	45-110-04-79-00-0-00-000	2021	REAL PROPERTY	ALDRICH JAMES C & EVA L TRUSTEES	10816 E 63RD ST
32-840-15-07-00-0-00-000	2020-2021	REAL PROPERTY	VERTICAL DESIGN LLC	NO ADDRESS ASSIGNED BY CITY	45-110-05-13-00-0-00-000	2021	REAL PROPERTY	ECKHOFF ERIC & SARAH	6001 HARRIS AVE
32-840-15-08-00-0-00-000	2020-2021	REAL PROPERTY	VERTICAL DESIGN LLC	NO ADDRESS ASSIGNED BY CITY	45-110-06-05-00-0-00-000	2021	REAL PROPERTY	BUFFA MICHAEL D & SHEILA A	5919 NORTHERN AVE
32-840-15-09-00-0-00-000	2020-2021	REAL PROPERTY	VERTICAL DESIGN LLC	NO ADDRESS ASSIGNED BY CITY	45-110-07-23-00-0-00-000	2021	REAL PROPERTY	EICHLER KENNETH R & JUDY L	10808 E 62ND TER
32-840-15-10-00-0-00-000	2020-2021	REAL PROPERTY	VERTICAL DESIGN LLC	NO ADDRESS ASSIGNED BY CITY	45-110-11-20-00-0-00-000	2019-2021	REAL PROPERTY	PONDS JAMES A	6104 ENGLEWOOD AVE
32-840-15-11-00-0-00-000	2020-2021	REAL PROPERTY	VERTICAL DESIGN LLC	NO ADDRESS ASSIGNED BY CITY	45-110-13-12-00-0-00-000	2021	REAL PROPERTY	MCPHERRIN WILLIAM S	6209 CLAREMONT AVE
32-840-16-03-00-0-00-000	2020-2021	REAL PROPERTY	VERTICAL DESIGN LLC	NO ADDRESS ASSIGNED BY CITY	45-110-13-14-00-0-00-000	2020-2021	REAL PROPERTY	WRIGHT TERE L	6217 CLAREMONT AVE
32-840-16-05-00-0-00-000	2020-2021	REAL PROPERTY	VERTICAL DESIGN LLC	NO ADDRESS ASSIGNED BY CITY	45-110-13-15-00-0-00-000	2020-2021	REAL PROPERTY	HARRIS WILLIAM B & SHARON K	6216 ENGLEWOOD AVE
32-840-16-06-00-0-00-000	2020-2021	REAL PROPERTY	VERTICAL DESIGN LLC	NO ADDRESS ASSIGNED BY CITY	45-110-13-18-00-0-00-000	2020-2021	REAL PROPERTY	BLACKMAN JERROD & JAMILLA	6204 ENGLEWOOD AVE
32-840-16-07-00-0-00-000	2020-2021	REAL PROPERTY	VERTICAL DESIGN LLC	NO ADDRESS ASSIGNED BY CITY	45-110-13-24-00-0-00-000	2019-2021	REAL PROPERTY	LEONARD ED & DIANA	6204 WOODSON RD
32-840-16-08-00-0-00-000	2020-2021	REAL PROPERTY	VERTICAL DESIGN LLC	NO ADDRESS ASSIGNED BY CITY	45-110-16-12-01-0-00-000	2017-2021	REAL PROPERTY	CHADD VICKEY J CLARDY	11204 E 63RD ST
32-840-17-10-00-0-00-000	2021	REAL PROPERTY	WYNNE HOMES INC	9326 E 57TH ST	45-120-01-10-00-0-00-000	2021	REAL PROPERTY	HYMER EDGAR L	6009 HEDGES AVE
32-910-07-38-00-0-00-000	2021	REAL PROPERTY	ICNA RELIEF USA PROGRAMS	5310 BLUE RIDGE CUT OFF	45-120-01-22-00-0-00-000	2020-2021	REAL PROPERTY	YOUNG DORIS J	6109 WILLOW AVE
32-910-07-39-00-0-00-000	2012-2021	REAL PROPERTY	ABBASI ROSS RASOUL	5309 LEWIS AVE	45-120-01-24-00-0-00-000	2021	REAL PROPERTY	RMATIC GROUP LLC	6117 WILLOW AVE
32-910-09-28-00-0-00-000	2021	REAL PROPERTY	BROWN THOMAS B & CECELIA B	5330 BLUE RIDGE CUT OFF	45-120-01-56-00-0-00-000	2021	REAL PROPERTY	MARTIN DANIEL K	10714 E 63RD ST
32-940-08-16-00-0-00-000	2018-2021	REAL PROPERTY	FALLS STEPHEN TROY	8721 E 57TH ST	45-120-02-03-00-0-00-000	2021	REAL PROPERTY	CHO ADELINE	10409 E 59TH ST
33-920-03-11-00-0-00-000	2021	REAL PROPERTY	REPINE ERIC	5225 BLUE RIDGE BLVD	45-120-02-20-00-0-00-000	2020-2021	REAL PROPERTY	FELEN HOLDINGS 2 LLC	5924 HEDGES AVE
33-920-04-25-00-0-00-000	2019-2021	REAL PROPERTY	CARAHER RAYMOND F & WENDY LYNN	5206 BLUE RIDGE BLVD	45-120-04-02-00-0-00-000	2020-2021	REAL PROPERTY	ROLLEN MICHAEL	10009 E 59TH ST
33-920-04-36-01-0-00-000	2021	REAL PROPERTY	A22 TITOL CAR CARE LLC	5270 BLUE RIDGE BLVD	45-120-04-40-00-0-00-000	2019-2021	REAL PROPERTY	BRANDAN MICHAEL	6013 RAYTOWN RD
33-920-09-06-00-0-00-000	2020-2021	REAL PROPERTY	GRAHAM DALE W	5321 WOODSON RD	45-120-04-53-00-0-00-000	2021	REAL PROPERTY	THURMAN PAUL W II & PENNY A	NO ADDRESS ASSIGNED BY CITY
33-920-09-10-00-0-00-000	2020-2021	REAL PROPERTY	SHOCKLEY USA A & BUCHER DAVID A	5403 WOODSON RD	45-120-06-06-00-0-00-000	2021	REAL PROPERTY	WILKINSON JAMES LEE	6113 HARDY AVE
33-920-09-17-00-0-00-000	2020-2021	REAL PROPERTY	HILLS MICAH C	5409 WOODSON RD	45-120-07-42-00-0-00-000	2021	REAL PROPERTY	SHASTA GG INVESTMENT GROUP, LLC	6216 WILLOW AVE
33-920-09-45-00-0-00-000	2021	REAL PROPERTY	WEDEL BRUCE D	5336 RIDGEWAY AVE	45-120-07-48-00-0-00-000	2021	REAL PROPERTY	COOMBS PATRICA K	10505 E 61ST TER
33-920-09-48-00-0-00-000	2018-2021	REAL PROPERTY	LERENBERG DANA J	5312 RIDGEWAY AVE	45-120-08-02-00-0-00-000	2019-2021	REAL PROPERTY	MATTOON LOUIS E	10011 E 61ST TER
33-930-03-14-00-0-00-000	2020-2021	REAL PROPERTY	JONES DAVID MICHAEL	5509 WOODSON RD	45-120-08-03-00-0-00-000	2019-2021	REAL PROPERTY	MATTOON LOUIS E	10007 E 61ST TER
33-930-04-05-00-0-00-000	2021	REAL PROPERTY	MCCOY GERTRUDE	5605 WOODSON RD	45-120-08-05-00-0-00-000	2021	REAL PROPERTY	FEBBAT LLC	6117 RAYTOWN RD
33-930-14-06-00-0-00-000	2021	REAL PROPERTY	ALBRIGHT TERRY E & VICTORIA A	5805 WOODSON RD	45-120-08-10-00-0-00-000	2021	REAL PROPERTY	LAROSE ANTHONY	6132 BLUE RIDGE BLVD
33-930-14-07-00-0-00-000	2021	REAL PROPERTY	COLLINS JESSE LOREN	5809 WOODSON RD	45-120-08-12-00-0-00-000	2021	REAL PROPERTY	MATTOON LOUIS E	6122 BLUE RIDGE BLVD
44-320-15-16-00-0-00-000	2021	REAL PROPERTY	SCHMITT DONALD E	11601 E 60TH ST	45-120-09-16-00-0-00-000	2021	REAL PROPERTY	BRINK DOUGLAS E	10010 E 63RD ST
44-330-11-03-00-0-00-000	2021	REAL PROPERTY	DANNER DANIEL H & MICKIE A	6504 WOODSON RD	45-120-11-12-00-0-00-000	2021	REAL PROPERTY	ALL ABOUT YOU HEALTH SERVICES LLC	6119 BLUE RIDGE BLVD
44-330-99-15-00-0-00-000	2021	REAL PROPERTY	USSERY MELISSA & BRIAN	6503 WOODSON RD	45-120-11-26-00-0-00-000	2021	REAL PROPERTY	JACKSON BRUCE	10212 E 63RD ST
44-400-22-06-00-0-00-000	2021	REAL PROPERTY	WILSON CHARLES A JR	11722 E 71ST CT	45-120-11-27-00-0-00-000	2021	REAL PROPERTY	JACKSON BRUCE	10212 E 63RD ST
44-430-02-31-00-0-00-000	2021	REAL PROPERTY	WALLEN GARY C & MARY A	7209 WOODSON DR	45-120-11-32-00-0-00-000	2021	REAL PROPERTY	MOORE IDA A	6246 ASH CT
44-430-03-16-00-0-00-000	2021	REAL PROPERTY	ROWLAND NORMA J ET AL	11600 E 75TH ST	45-120-11-60-00-0-00-000	2020	REAL PROPERTY	MIDWEST ANIMAL RESQ	10312 E 63RD ST
44-430-05-07-00-0-00-000	2019-2021	REAL PROPERTY	DABBAGH FEHER	7409 IRWIN RD	45-120-11-86-00-0-00-000	2021	REAL PROPERTY	MACHAL-TITUS CLARICE	6126 ASH CT
44-430-05-12-00-0-00-000	2020-2021	REAL PROPERTY	PORREVECCHIO DANIEL R	12004 W 75TH ST	45-130-02-01-00-0-00-000	2021	REAL PROPERTY	JOHNSON ROBERT L	6300 HEDGES AVE
44-920-02-04-00-0-00-000	2021	REAL PROPERTY	HUFF DAVID A & CHRISTINE	7513 WESTRIDGE RD	45-130-02-12-00-0-00-000	2020-2021	REAL PROPERTY	MILLBERN CHRISTOPHER S & NEELY L	6138 RALSTON AVE
44-920-03-17-00-0-00-000	2021	REAL PROPERTY	KYLE LARRY J AND SHARON A	11804 E 77TH ST	45-130-02-17-00-0-00-000	2021	REAL PROPERTY	LEDGERWOOD MICHAEL L	10500 E 64TH TER
44-920-03-35-00-0-00-000	2020-2021	REAL PROPERTY	GARNER VALERIE SUE	11613 E 76TH TER	45-130-03-14-00-0-00-000	2021	REAL PROPERTY	DANIEL NANCY L-TR	10201 E 63RD TER

45-130-03-15-00-0-00-000	2021	REAL PROPERTY	TATUM LINDA S	10109 E 63RD TER	45-220-01-24-02-0-00-000	2020-2021	REAL PROPERTY	NEDS WILLIAM & MCKENZIE	6000 ELM AVE
45-130-03-22-00-0-00-000	2021	REAL PROPERTY	ANZIANO ELIZABETH	10110 E 64TH ST	45-220-01-29-01-0-00-000	2020-2021	REAL PROPERTY	JUNGERMAN ANGELIA & DAVID	6000 ELM AVE
45-130-03-32-00-0-00-000	2021	REAL PROPERTY	GILMORE NOELLE-TRUSTEE	10404 E 64TH ST	45-220-01-29-02-0-00-000	2020-2021	REAL PROPERTY	NEDS WILLIAM & MCKENZIE	6000 ELM AVE
45-130-04-11-00-0-00-000	2021	REAL PROPERTY	TAYLOR SHARON JUNE & TAYLOR EDWARD R	10104 E 63RD TER	45-220-01-31-00-0-00-000	2020-2021	REAL PROPERTY	NEDS WILLIAM & MCKENZIE	6000 ELM AVE
45-130-04-13-00-0-00-000	2021	REAL PROPERTY	LEM CONTRACTING LLC	10200 E 63RD TER	45-220-02-16-00-0-00-000	2021	REAL PROPERTY	ROBERSON MARY J	8959 E 60TH TER
45-130-04-15-00-0-00-000	2021	REAL PROPERTY	LEM LING	10208 E 63RD TER	45-220-02-21-00-0-00-000	2021	REAL PROPERTY	EVERETT AGNES E	9000 E 61ST ST
45-130-04-17-00-0-00-000	2020-2021	REAL PROPERTY	PEWTERS DELENE	10216 E 63RD TER	45-220-03-32-00-0-00-000	2021	REAL PROPERTY	TERRANOVA PROPERTIES LLC	6000 FARLEY AVE
45-130-06-03-00-0-00-000	2020-2021	REAL PROPERTY	HAAKE DAN M & JOANNE M	10019 E 63RD TER	45-220-03-39-00-0-00-000	2021	REAL PROPERTY	KC ASSET GROUP LLC	6001 BLUE RIDGE CUT OFF
45-130-06-04-00-0-00-000	2021	REAL PROPERTY	MENTESANA CHRISTOPHER W	NO ADDRESS ASSIGNED BY CITY	45-220-03-76-00-0-00-000	2021	REAL PROPERTY	MANNING KENNETH L & FRAN P	6132 HUNTER ST
45-130-06-13-00-0-00-000	2021	REAL PROPERTY	MENTESANA CHRISTOPHER W	NO ADDRESS ASSIGNED BY CITY	45-220-04-03-00-0-00-000	2021	REAL PROPERTY	CAVANAGH FRANK R & ELIZABETH D	8853 E 59TH ST
45-130-06-14-00-0-00-000	2021	REAL PROPERTY	HAAKE DAN M & JOANNE M	6324 CEDAR AVE	45-220-04-04-00-0-00-000	2021	REAL PROPERTY	WILSON TERESA L	8851 E 59TH ST
45-130-08-03-00-0-00-000	2021	REAL PROPERTY	JOHNSON DAVID W & MARILYN L-TRUSTEES	10405 E 64TH ST	45-220-04-08-00-0-00-000	2021	REAL PROPERTY	DEDMON IYABO	8803 E 59TH ST
45-130-09-13-00-0-00-000	2021	REAL PROPERTY	KASERMAN EMIL ORRICE III	10600 E 65TH ST	45-220-04-16-00-0-00-000	2020-2021	REAL PROPERTY	HUTCHINSON DAVID W & MARSHA K	8854 E 59TH TER
45-130-09-15-00-0-00-000	2021	REAL PROPERTY	CHEEK RICHARD & MARY LOU	10608 E 65TH ST	45-220-04-17-00-0-00-000	2021	REAL PROPERTY	PADILLA THOMAS N & JUDITH A	8856 E 59TH TER
45-130-10-05-00-0-00-000	2021	REAL PROPERTY	VANCE WARTHA L	10613 E 65TH ST	45-220-05-01-00-0-00-000	2019-2021	REAL PROPERTY	LE TAN MAI	5908 KENTUCKY AVE
45-130-11-13-00-0-00-000	2021	REAL PROPERTY	JONES MARGARET L	6516 WILLOW AVE	45-220-05-04-00-0-00-000	2021	REAL PROPERTY	HORTON REI LLC	5915 FARLEY AVE
45-130-11-14-00-0-00-000	2019-2021	REAL PROPERTY	BOWEN CHRISTOPHER MICHAEL	6500 WILLOW AVE	45-220-06-01-00-0-00-000	2021	REAL PROPERTY	NEWSOME JANICE MARIE	8823 E 61ST ST
45-130-13-19-00-0-00-000	2021	REAL PROPERTY	MID AMERICA LAMINATING INC	6636 CEDAR AVE	45-220-06-02-00-0-00-000	2021	REAL PROPERTY	SHEPARD MICHAEL W & ANNIE F	8819 E 61ST ST
45-130-15-01-00-0-00-000	2021	REAL PROPERTY	REYNOLDS JOHN T	10705 E 65TH TER	45-220-06-04-00-0-00-000	2021	REAL PROPERTY	BELL VALERIA	8811 E 61ST ST
45-130-15-02-00-0-00-000	2021	REAL PROPERTY	CONREX RES PROP GROUP 2016-01 OP CO LLC	10701 E 65TH TER	45-220-07-06-00-0-00-000	2020-2021	REAL PROPERTY	PETTY EMMANUEL & BENITA	8813 E 61ST TER
45-130-15-07-00-0-00-000	2020-2021	REAL PROPERTY	SALES BARBARA JOAN	6511 WILLOW AVE	45-220-09-04-00-0-00-000	2021	REAL PROPERTY	JOSLIN GAIL A	6117 LANE AVE
45-130-15-10-00-0-00-000	2021	REAL PROPERTY	SEMONICK PAULINE	10508 E 66TH ST	45-220-09-05-00-0-00-000	2021	REAL PROPERTY	THOMPSON LAURA L HENDLEY	6121 LANE AVE
45-130-16-05-00-0-00-000	2020-2021	REAL PROPERTY	WILLIAMS CAROLEE & REQUENES LUIS	6601 RALSTON AVE	45-220-11-03-00-0-00-000	2019-2021	REAL PROPERTY	KLINE JAMES L & SARAH	6209 BLUE RIDGE CUT OFF
45-130-16-07-00-0-00-000	2019-2021	REAL PROPERTY	ANDERSON BRANDON	6607 RALSTON AVE	45-220-13-04-00-0-00-000	2020-2021	REAL PROPERTY	MCCRAY DIANE CECILIA	6300 HUNTER ST
45-130-16-12-00-0-00-000	2020-2021	REAL PROPERTY	MADDEN RICKY D	10704 E 67TH ST	45-230-03-01-00-0-00-000	2019-2021	REAL PROPERTY	WILSON DEWAYNE D & GWEN Y	6200 HUNTER ST
45-130-17-01-00-0-00-000	2021	REAL PROPERTY	OUTLAW FREDDIE & JAMET	10505 E 66TH ST	45-230-03-20-00-0-00-000	2019-2021	REAL PROPERTY	MITCHELL ERIC S & DEBBI	6316 HUNTER ST
45-130-17-07-00-0-00-000	2021	REAL PROPERTY	REPPER RICHARD D	6617 WILLOW AVE	45-230-04-06-00-0-00-000	2021	REAL PROPERTY	MCCLAIN MARK S & MARY T	6327 FARLEY AVE
45-130-17-09-00-0-00-000	2021	REAL PROPERTY	SCHAFFER KAREN	6623 WILLOW AVE	45-230-04-18-00-0-00-000	2021	REAL PROPERTY	UNDERWOOD CHRISTINE J	6515 BLUE RIDGE CUT OFF
45-130-17-12-00-0-00-000	2021	REAL PROPERTY	ROLLING HILLS INVESTMENTS LLC	6620 RALSTON AVE	45-230-04-19-00-0-00-000	2021	REAL PROPERTY	HARRIS PHILLIP D & BILLIE J-TR	6510 BLUE RIDGE BLVD
45-130-18-15-00-0-00-000	2021	REAL PROPERTY	TETLOW GERALDINE R	6614 WILLOW AVE	45-230-04-28-00-0-00-000	2018-2021	REAL PROPERTY	SHALIMAR INVESTMENTS LLC	6404 KENTUCKY AVE
45-130-19-17-01-0-00-000	2020-2021	REAL PROPERTY	BM CONSULTING LLC	6608 HARDY AVE	45-230-04-34-00-0-00-000	2021	REAL PROPERTY	JOHNSON STEVEN	6312 KENTUCKY AVE
45-140-01-07-00-0-00-000	2021	REAL PROPERTY	WRIGHT JOYCE	6313 STERLING AVE	45-230-05-05-00-0-00-000	2021	REAL PROPERTY	FRANKLIN VICTOR	6317 BLUE RIDGE CUT OFF
45-140-01-28-00-0-00-000	2021	REAL PROPERTY	TYLER JOHN E & BERNADETTE S	11304 E 65TH ST	45-230-06-07-02-0-00-000	2019-2021	REAL PROPERTY	BAKER GEORGE H	9501 BLUE RIDGE BLVD
45-140-02-17-00-0-00-000	2021	REAL PROPERTY	WEHNER HALEY	6416 STERLING AVE	45-230-06-27-00-0-00-000	2021	REAL PROPERTY	KADLEC KEITH M & KADLIC MADELON	8930 ROSE LN
45-140-03-25-00-0-00-000	2021	REAL PROPERTY	KENNY JAMES E & GAYLE L	6608 HARVARD AVE	45-230-08-06-00-0-00-000	2021	REAL PROPERTY	SCIOTO PROPERTIES SP-16 LLC	9115 E 65TH ST
45-140-04-08-00-0-00-000	2021	REAL PROPERTY	SHANAHAN ELLA K	10808 E 64TH TER	45-230-09-07-00-0-00-000	2021	REAL PROPERTY	RAYMONT REI HOLDINGS INC	6509 LANE AVE
45-140-05-14-00-0-00-000	2021	REAL PROPERTY	GILDEWELL TIMOTHY R	6504 HARRIS AVE	45-230-09-12-00-0-00-000	2021	REAL PROPERTY	SMITH WAYNE J & ROSA F	9050 E 65TH TER
45-140-05-19-00-0-00-000	2020-2021	REAL PROPERTY	LATHROP TIMOTHY ALAN & CYNTHIA BABETTE	10805 E 65TH ST	45-230-12-06-00-0-00-000	2020-2021	REAL PROPERTY	POINT CAPITAL 401X PLAN	6533 LAUREL AVE
45-140-05-26-00-0-00-000	2019-2021	REAL PROPERTY	SUMNER NANCY & PENNINGTON DELORES (BECKE	10908 E 66TH ST	45-230-14-06-00-0-00-000	2021	REAL PROPERTY	STANGLE JASON R & JENNIFER M	9003 E 66TH ST
45-140-06-02-00-0-00-000	2020-2021	REAL PROPERTY	ALLEN RICHARD E & IVONNE J	10905 E 66TH ST	45-230-15-04-00-0-00-000	2021	REAL PROPERTY	CAMBRIC KIMBERLY M	8911 E 66TH ST
45-140-06-30-00-0-00-000	2019-2021	REAL PROPERTY	HUGHES LEROY	6602 HARRIS AVE	45-230-15-30-00-0-00-000	2021	REAL PROPERTY	CHERRY TIMOTHY A	6650 LANE AVE
45-140-06-32-00-0-00-000	2021	REAL PROPERTY	HUGHES LEROY & EDITH	6602 HARRIS AVE	45-230-16-05-00-0-00-000	2020-2021	REAL PROPERTY	COLVIN JASON	9009 E 66TH TER
45-140-07-08-00-0-00-000	2021	REAL PROPERTY	RAMSEY DONALD DENNIS	6605 HARVARD AVE	45-240-04-09-00-0-00-000	2021	REAL PROPERTY	STAUFFER PROPERTIES LLC	NO ADDRESS ASSIGNED BY CITY
45-140-07-15-00-0-00-000	2021	REAL PROPERTY	EVINGER ALLEN D & APRIL PAMELA	11013 E 66TH TER	45-240-04-10-00-0-00-000	2021	REAL PROPERTY	STAUFFER PROPERTIES LLC	NO ADDRESS ASSIGNED BY CITY
45-140-07-16-00-0-00-000	2020-2021	REAL PROPERTY	BOYLE ROBERT MICHAEL	11009 E 66TH TER	45-240-04-11-00-0-00-000	2021	REAL PROPERTY	STAUFFER PROPERTIES LLC	NO ADDRESS ASSIGNED BY CITY
45-140-07-36-00-0-00-000	2020-2021	REAL PROPERTY	REINSEL LAURA	6504 STERLING AVE	45-240-04-34-00-0-00-000	2021	REAL PROPERTY	STEPHENSON KEITH	NO ADDRESS ASSIGNED BY CITY
45-140-08-08-00-0-00-000	2021	REAL PROPERTY	VERMILLION-FOSTER CYNTHIA & DONALD K	6601 STERLING AVE	45-240-05-11-00-0-00-000	2021	REAL PROPERTY	PALMER JULIAN E & PATRICIA R	9355 E 64TH ST
45-140-08-12-00-0-00-000	2021	REAL PROPERTY	CHANDLER MARY JO	6617 STERLING AVE	45-240-05-22-00-0-00-000	2021	REAL PROPERTY	HINESLEY BERNIS N AND ANNA M	9358 E 64TH TER
45-140-08-14-00-0-00-000	2021	REAL PROPERTY	WASHINGTON DEBORAH M & RAYMOND S	6620 CLAREMONT AVE	45-240-05-31-00-0-00-000	2021	REAL PROPERTY	CARMER DAVID C	9312 E 64TH TER
45-140-09-02-00-0-00-000	2021	REAL PROPERTY	CARPENTER NEAL B	11405 E 65TH TER	45-240-05-32-00-0-00-000	2021	REAL PROPERTY	FINNEY VERA J	9306 E 64TH TER
45-140-09-09-00-0-00-000	2021	REAL PROPERTY	DIETZEL CHARLES R-TRUSTEE	6617 CLAREMONT AVE	45-240-06-05-01-0-00-000	2021	REAL PROPERTY	CRD REAL ESTATE HOLDINGS LLC	6301 EVANSTON AVE
45-140-10-06-00-0-00-000	2021	REAL PROPERTY	ARVIM S LLC	11500 E 67TH ST	45-240-06-18-00-0-00-000	2019-2021	REAL PROPERTY	GLENN DONALD PAUL & KATZ LISA GLENN	6424 OVERTON AVE
45-210-02-02-00-0-00-000	2018-2021	REAL PROPERTY	DREW SHOLANDA N	9711 E 59TH ST	45-240-07-24-00-0-00-000	2020-2021	REAL PROPERTY	LIFE CHANGERS CHRISTIAN CENTER OF KC	6420 RAYTOWN TREV
45-210-02-10-00-0-00-000	2021	REAL PROPERTY	SCHNEIDER CAROLYN D	9813 E 59TH TER	45-240-08-20-00-0-00-000	2021	REAL PROPERTY	P&Q LLC	NO ADDRESS ASSIGNED BY CITY
45-210-03-09-00-0-00-000	2017-2021	REAL PROPERTY	GARRETT DAVID	5900 RAYTOWN TREV	45-240-08-21-00-0-00-000	2021	REAL PROPERTY	P&Q LLC	6322 RAYTOWN RD
45-210-03-17-01-0-00-000	2020-2021	REAL PROPERTY	HOUSER HENRY J	6101 ARLINGTON AVE	45-240-09-16-00-0-00-000	2021	REAL PROPERTY	SCHNEIDER JOEL A & HELEN M	6521 OVERTON AVE
45-210-03-25-00-0-00-000	2021	REAL PROPERTY	WENDYS PROPERTIES LLC	9708 E 63RD ST	45-240-10-02-00-0-00-000	2020-2021	REAL PROPERTY	STEWART CHARLES B	9501 E 65TH ST
45-210-04-07-00-0-00-000	2017-2019	REAL PROPERTY	FOGLESONG SUSAN LYNN MINGES	5921 CRESCENT AVE	45-240-10-19-00-0-00-000	2020-2021	REAL PROPERTY	CLIFFORD STEVEN W & KIMBERLY A	9500 E 65TH TER
45-210-04-23-00-0-00-000	2020-2021	REAL PROPERTY	ESPARZA JOSE ANTONIO	5920 ARLINGTON AVE	45-240-11-14-00-0-00-000	2021	REAL PROPERTY	WISLEY RICHARD	9702 E 65TH TER
45-210-05-04-00-0-00-000	2019-2021	REAL PROPERTY	BANKS DAVID R & GLENN REBECCA M	5905 ELM AVE	45-240-13-03-00-0-00-000	2020-2021	REAL PROPERTY	WALKER CATHY	9709 E 65TH TER
45-210-05-10-00-0-00-000	2020-2021	REAL PROPERTY	STITH STEVEN R	5923 OXFORD AVE	45-240-14-13-00-0-00-000	2021	REAL PROPERTY	BLACKMAN DAVID G	NO ADDRESS ASSIGNED BY CITY
45-210-06-03-00-0-00-000	2021	REAL PROPERTY	HEENE WILLIAM R	6001 ELM AVE	45-240-14-14-00-0-00-000	2019-2021	REAL PROPERTY	KESSELL VICTOR	6628 OXFORD AVE
45-210-06-05-00-0-00-000	2021	REAL PROPERTY	JENKINS SHARON KAYE	9304 E 60TH TER	45-240-15-30-00-0-00-000	2021	REAL PROPERTY	SHEHAN MICHAEL C & EULA M	9501 E 66TH ST
45-210-07-03-00-0-00-000	2021	REAL PROPERTY	REEVES DUSTIN & TANNER TORIE	6116 ELM AVE	45-240-16-13-00-0-00-000	2021	REAL PROPERTY	MCCOMAS KIM	9608 E 66TH TER
45-210-08-02-00-0-00-000	2020-2021	REAL PROPERTY	VANCE RICHARD A & MARY ANN	9505 E 60TH TER	45-240-17-12-00-0-00-000	2020-2021	REAL PROPERTY	WOODRUFF TERRY L A TRUST	9509 E 66TH TER
45-210-08-06-00-0-00-000	2021	REAL PROPERTY	BEGGS TERRI L	9359 E 60TH TER	45-240-19-09-00-0-00-000	2021	REAL PROPERTY	HJERPE DEBORAH L	9363 E 64TH TER
45-210-08-09-00-0-00-000	2021	REAL PROPERTY	CROFT TIMOTHY S & BARBETTA	9309 E 60TH TER	45-240-19-19-00-0-00-000	2020-2021	REAL PROPERTY	HARRISON LINDA RAY	9404 E 65TH ST
45-210-08-20-00-0-00-000	2021	REAL PROPERTY	BARKER J CAROL (HUBBARD)	6205 ELM AVE	45-310-03-01-00-0-00-000	2021	REAL PROPERTY	THE ETC IRREVOCABLE TRUST	5932 BLUE RIDGE CUT OFF
45-210-10-02-00-0-00-000	2020-2021	REAL PROPERTY	MISSOURI REGENCY ASSOCIATES	6124 RAYTOWN RD	45-340-01-42-00-0-00-000	2017-2021	REAL PROPERTY	LAVADORES ADRIAN	6412 BLUE RIDGE CUT OFF
45-210-10-32-00-0-00-000	2021	REAL PROPERTY	MISSOURI REGENCY ASSOC L P	6124 RAYTOWN RD	45-340-01-48-00-0-00-000	2019-2021	REAL PROPERTY	SLOAN R M-TRUSTEE	6332 BLUE RIDGE CUT OFF
45-220-01-05-00-0-00-000	2021	REAL PROPERTY	BRUENGER ROGER M & DONNA LOU	5913 LAUREL AVE	45-440-05-17-00-0-00-000	2019-2021	REAL PROPERTY	BELL GLEN RICHARD & STEPHANIE LYNN	7308 BLUE RIDGE BLVD
45-220-01-23-00-0-00-000	2020-2021	REAL PROPERTY	NEDS WILLIAM & MCKENZIE	6000 ELM AVE	45-440-05-18-00-0-00-000	2019-2021	REAL PROPERTY	BELL GLEN RICHARD & STEPHANIE LYNN	7308 BLUE RIDGE BLVD

45-440-06-02-00-0-00-000	2021	REAL PROPERTY	PLAGMAN JEREMY A	8711 E 74TH TER	45-530-19-17-00-0-00-000	2018-2021	REAL PROPERTY	GW GOLDEN ENTERPRISES INC	9023 E 75TH ST
45-440-06-17-01-0-00-000	2021	REAL PROPERTY	F1 SERVICES INC	7448 BLUE RIDGE BLVD	45-530-19-34-00-0-00-000	2020-2021	REAL PROPERTY	LADD MAEL J	8907 E 75TH ST
45-510-01-08-00-0-00-000	2021	REAL PROPERTY	BLEVINS ANGELA RENEE	9712 E 67TH TER	45-530-20-02-00-0-00-000	2019-2021	REAL PROPERTY	HORNBECK EARL P	9115 VAUGHN AVE
45-510-03-07-00-0-00-000	2021	REAL PROPERTY	CONREX RESIDENTIAL PROPERTY GROUP	9358 E 67TH TER	45-530-20-10-00-0-00-000	2020-2021	REAL PROPERTY	GOETZ MARY ELLEEN	9012 E 75TH ST
45-510-05-03-00-0-00-000	2021	REAL PROPERTY	INGRAM TWILA E	9355 E 67TH TER	45-540-02-11-00-0-00-000	2021	REAL PROPERTY	SEYFARTH REALTY CORP	9330 E M 350 HWY
45-510-06-03-00-0-00-000	2020-2021	REAL PROPERTY	DUTTON WILLIAM B & JOANNE M	9429 E 67TH TER	45-540-02-14-00-0-00-000	2021	REAL PROPERTY	SEYFARTH REALTY CORP	9330 E M 350 HWY
45-510-06-04-00-0-00-000	2020-2021	REAL PROPERTY	REED KALEB & ELIZABETH	9425 E 67TH TER	45-540-02-28-00-0-00-000	2020-2021	REAL PROPERTY	MORGAN NANCY K	7205 OVERTON AVE
45-510-07-14-00-0-00-000	2021	REAL PROPERTY	MILLICAN LEONA M JONES	9608 E 68TH ST	45-540-02-54-00-0-00-000	2020-2021	REAL PROPERTY	O BRIEN THOMAS J	7208 RAYTOWN RD
45-510-09-04-00-0-00-000	2021	REAL PROPERTY	HUMPHREY DANA DEB	9709 PLYMOUTH LN	45-540-02-80-00-0-00-000	2020-2021	REAL PROPERTY	CITYVIEW REAL ESTATE SERVICES LLC	9620 E M 350 HWY UNIT 101
45-510-09-06-00-0-00-000	2021	REAL PROPERTY	HYDEMAN AMY B	9704 E 68TH ST	45-540-02-85-00-0-00-000	2021	REAL PROPERTY	BROADWAY PLAZA PARTNERS III LLC	9598 E M 350 HWY A
45-510-11-10-00-0-00-000	2020-2021	REAL PROPERTY	BRYANT THOMAS C	6817 ELM AVE	45-540-03-06-00-0-00-000	2021	REAL PROPERTY	O DELL LINDA L	9300 E 75TH ST
45-510-11-11-00-0-00-000	2021	REAL PROPERTY	VALET MELODY A	9304 E 68TH TER	45-540-03-53-00-0-00-000	2020-2021	REAL PROPERTY	ELLIOT PLACE INVESTORS LLC	7311 MAPLE AVE
45-510-12-37-00-0-00-000	2020-2021	REAL PROPERTY	DAVIS KRISTAL JEAN	9308 E 69TH ST	45-610-01-06-00-0-00-000	2019-2021	REAL PROPERTY	WENDEGATZ JANICE KAY	6721 VERMONT AVE
45-510-13-04-00-0-00-000	2021	REAL PROPERTY	CONRICK LEONARD J & LYNNE-TRUSTEES	6909 HAWTHORNE AVE	45-610-02-01-00-0-00-000	2021	REAL PROPERTY	BURGESS REVA	6700 VERMONT AVE
45-510-13-05-00-0-00-000	2021	REAL PROPERTY	TATUM THEO A	6913 HAWTHORNE AVE	45-610-02-31-00-0-00-000	2021	REAL PROPERTY	JUNOD PAUL S & SUSAN D	6720 VERMONT AVE
45-510-14-12-00-0-00-000	2021	REAL PROPERTY	SHALIMAR INVESTMENTS LLC	9808 BROOKLANE ST	45-610-04-01-00-0-00-000	2021	REAL PROPERTY	NILE RIVER VALLEY HOMES LLC	6700 CRISP AVE
45-510-14-13-00-0-00-000	2019-2021	REAL PROPERTY	HERNDON LEWIS M & OLETA M	6916 HAWTHORNE AVE	45-610-04-09-00-0-00-000	2020-2021	REAL PROPERTY	ROCK CREEK INVESTMENT PROPERTIES LLC	6729 STERLING AVE
45-510-14-14-00-0-00-000	2020-2021	REAL PROPERTY	TATUM MARY M	6912 HAWTHORNE AVE	45-610-04-13-00-0-00-000	2020-2021	REAL PROPERTY	YOUNG PHYLLIS	6737 STERLING AVE
45-510-15-12-00-0-00-000	2021	REAL PROPERTY	WHITWORTH DAVID B & ALICE K -TRUSTEE	9609 E 69TH ST	45-610-04-16-00-0-00-000	2020-2021	REAL PROPERTY	WEDEL BRUCE	6743 STERLING AVE
45-510-15-30-00-0-00-000	2021	REAL PROPERTY	BAY KRISTINA L	9312 E 69TH TER	45-610-05-02-00-0-00-000	2019-2021	REAL PROPERTY	FENSKÉ KATHERINE R	6701 HARVARD AVE
45-510-15-40-00-0-00-000	2021	REAL PROPERTY	WONSER STEPHEN R & SHARON K	9500 E 69TH TER	45-610-05-27-00-0-00-000	2021	REAL PROPERTY	OVERFIELD LARRY A & CAROLYN	11018 LAKEVIEW RD
45-510-15-48-00-0-00-000	2021	REAL PROPERTY	KC 1 PROPERTY GROUP LLC	7033 ARLINGTON AVE	45-610-06-06-00-0-00-000	2021	REAL PROPERTY	MILLARD DECATUR C III AND ANITA J	6713 HARRIS AVE
45-510-15-63-00-0-00-000	2021	REAL PROPERTY	FRAZIER BRENDA J	9708 RICE AVE	45-610-08-17-00-0-00-000	2021	REAL PROPERTY	WREF II LOAN 1 LLC	18033 E 67TH ST
45-510-16-03-00-0-00-000	2021	REAL PROPERTY	GARVIN EDWARD PATRICK	9409 E 69TH TER	45-610-09-27-02-0-00-000	2021	REAL PROPERTY	LANDRY PAUL L	NO ADDRESS ASSIGNED BY CITY
45-510-17-19-00-0-00-000	2021	REAL PROPERTY	MIRANDA NORMA	9404 E GREGORY BLVD	45-610-10-06-00-0-00-000	2021	REAL PROPERTY	PATTON KEITH	6825 STERLING AVE
45-510-19-05-00-0-00-000	2021	REAL PROPERTY	CLOUSER DELBERT A & JULIA ANN	7013 HAWTHORNE AVE	45-610-10-20-00-0-00-000	2021	REAL PROPERTY	HICKSICH CAROLIN M	6820 CRISP AVE
45-520-01-01-00-0-00-000	2019-2021	REAL PROPERTY	MCCOLM NANCY ANN	6704 ELM AVE	45-610-12-15-00-0-00-000	2019-2021	REAL PROPERTY	SMITH LARRY E	7101 NORWOOD AVE
45-520-02-05-00-0-00-000	2021	REAL PROPERTY	LEMBERGER PATRICK J	9004 E 67TH TER	45-610-12-17-00-0-00-000	2021	REAL PROPERTY	GLASGOW JAMES E JR	6935 WOODSDR AVE
45-520-04-33-00-0-00-000	2021	REAL PROPERTY	STRIPLING SISTEN M	6816 HUNTER ST	45-610-16-22-00-0-00-000	2021	REAL PROPERTY	GUESS LONDELL & PALZETA	7046 LAKESHORE DR
45-520-05-17-00-0-00-000	2021	REAL PROPERTY	JAKOBE STEVEN & KAREN	7012 KENTUCKY AVE	45-610-16-26-00-0-00-000	2020-2021	REAL PROPERTY	KABELL FRED L	7026 LAKESHORE DR
45-520-05-41-00-0-00-000	2021	REAL PROPERTY	HINSHAW GLADYS L	7000 HUNTER ST	45-610-17-14-00-0-00-000	2021	REAL PROPERTY	THORN ELISABETH M-TRUSTEE	6904 EDGEWOOD AVE
45-520-05-44-00-0-00-000	2020-2021	REAL PROPERTY	AGUIRRE CALIXTO D	6920 HUNTER ST	45-620-02-05-00-0-00-000	2021	REAL PROPERTY	SCHROEDER LESLIE W	10600 LAKEVIEW BLVD
45-520-07-10-00-0-00-000	2019-2021	REAL PROPERTY	ROBERSON CYRUS MARK	9004 E 68TH ST	45-620-02-07-00-0-00-000	2021	REAL PROPERTY	SCHROEDER ROBERT W & LESLIE	10600 LAKEVIEW BLVD
45-520-07-16-00-0-00-000	2020-2021	REAL PROPERTY	WOLGAMOTT DAVID S & WOLGAMOTT RODNEY L	6712 LAUREL AVE	45-620-02-11-00-0-00-000	2020-2021	REAL PROPERTY	POINT CAPITAL 401(K) PLAN	6708 NORTHERN AVE
45-520-08-10-00-0-00-000	2021	REAL PROPERTY	HOKE DARRYL & TALLEY BARBARA	6725 LAUREL AVE	45-620-02-13-00-0-00-000	2020-2021	REAL PROPERTY	SARTAIN PROPERTY MANAGEMENT CO LLC	6704 NORTHERN AVE
45-520-11-12-00-0-00-000	2021	REAL PROPERTY	JAKOBE SARAH E & CHRISTOPHER A	9008 E 69TH ST	45-620-02-14-00-0-00-000	2021	REAL PROPERTY	SCHROEDER LESLIE W	10600 LAKEVIEW BLVD
45-520-12-19-00-0-00-000	2020-2021	REAL PROPERTY	MORTON CHARLEY A	9108 E 69TH ST	45-620-03-19-00-0-00-000	2021	REAL PROPERTY	SMITH EMMA LORRAINE	6841 LAKESHORE DR
45-520-13-03-00-0-00-000	2021	REAL PROPERTY	DANNER WALTER GARY & TERRI ANN	9201 E 69TH ST	45-620-03-27-00-0-00-000	2021	REAL PROPERTY	FOSTER THOMAS J & JANINE D	6714 RALSTON AVE
45-520-13-06-00-0-00-000	2021	REAL PROPERTY	FRENCH MEMOREE & LIMBACH KELEE JENE	9103 E 69TH ST	45-620-04-03-00-0-00-000	2021	REAL PROPERTY	PLUMMER MAX D & PLUMMER MAVIS E	6704 LAKESHORE DR
45-520-13-13-00-0-00-000	2021	REAL PROPERTY	BROSKOW BRUCE EDWARD	9104 E 69TH TER	45-620-04-06-00-0-00-000	2021	REAL PROPERTY	BYRNES ROBERT W & KELLY T	6716 LAKESHORE DR
45-520-15-07-00-0-00-000	2021	REAL PROPERTY	THE ANIMAL RESCUE ALLIANCE	6921 HUNTER ST	45-620-04-15-00-0-00-000	2020-2021	REAL PROPERTY	WINSOR THOMAS DUANE JR	6814 LAKESHORE CT
45-520-15-08-00-0-00-000	2021	REAL PROPERTY	VALLADARES ANTONIO & SONIA	7001 HUNTER ST	45-620-04-16-00-0-00-000	2021	REAL PROPERTY	DUTOIT MICHAEL J & ARLENE J	6816 LAKESHORE CT
45-520-15-16-00-0-00-000	2021	REAL PROPERTY	BANKS ANTHONY MICHAEL	7033 HUNTER ST	45-620-04-19-00-0-00-000	2021	REAL PROPERTY	BRADSHAW PATRICIA G	6824 LAKESHORE DR
45-520-17-08-00-0-00-000	2021	REAL PROPERTY	NOU DARA V-TRUSTEE	6925 LAUREL AVE	45-620-07-54-00-0-00-000	2020-2021	REAL PROPERTY	REESE KENNETH M & WANDA L	10408 E 68TH TER
45-530-01-23-00-0-00-000	2020-2021	REAL PROPERTY	LEDGERWOOD RICK & TERESA	9300 VAUGHN AVE	45-620-07-62-00-0-00-000	2021	REAL PROPERTY	RUFY PATRICIA J	10416 E 69TH ST
45-530-01-24-00-0-00-000	2019-2021	REAL PROPERTY	WRIGHT ROBERT D & KELLI K	9302 VAUGHN AVE	45-620-08-20-00-0-00-000	2020-2021	REAL PROPERTY	ARNOLD BARBARA G	10100 E 69TH ST
45-530-02-31-00-0-00-000	2015-2021	REAL PROPERTY	DAVIS LARRY D& ROE JOYCE E& FRY RHONDA K	9106 E 72ND TER	45-620-08-30-00-0-00-000	2020-2021	REAL PROPERTY	DILLON ROBIN G	6837 RAYTOWN RD
45-530-06-09-00-0-00-000	2021	REAL PROPERTY	ROUDEBUSH CAROLYN SUE & FORREST LEE-TRS	8800 E 72ND ST	45-620-09-02-00-0-00-000	2021	REAL PROPERTY	FISHER EDWARD & PAMILA	10505 E 69TH ST
45-530-07-08-00-0-00-000	2021	REAL PROPERTY	ROUDEBUSH FORREST L & CAROLYN-TRUSTEES	8801 E 72ND ST	45-620-09-16-00-0-00-000	2020-2021	REAL PROPERTY	CHRISTENSON CLEON B	10005 E 69TH ST
45-530-08-03-00-0-00-000	2021	REAL PROPERTY	CHAMBERS DAVID H & BARBARA J	8905 E 72ND TER	45-620-09-37-00-0-00-000	2021	REAL PROPERTY	MOORE SANDRA K BAKER - & SCHRAM GEORGE T	6906 RALSTON AVE
45-530-08-04-00-0-00-000	2021	REAL PROPERTY	LANGER PHIL	8903 E 72ND TER	45-620-10-06-00-0-00-000	2019-2021	REAL PROPERTY	SCARCELLO ROCCO C & DIANA M	10413 E 69TH TER
45-530-08-06-00-0-00-000	2018-2021	REAL PROPERTY	JSI HOLDINGS LLC	8809 E 72ND TER	45-620-10-09-00-0-00-000	2019-2021	REAL PROPERTY	HAZELSP LINDA LOUISE	10401 E 69TH TER
45-530-08-23-00-0-00-000	2021	REAL PROPERTY	BURFORD MERRILL LESLIE	9002 E 73RD ST	45-620-10-16-00-0-00-000	2021	REAL PROPERTY	FICKEN DALLAS	10107 E 69TH TER
45-530-11-07-00-0-00-000	2020-2021	REAL PROPERTY	LAPINE LLC	9105 E 73RD ST	45-620-10-52-01-0-00-000	2021	REAL PROPERTY	SALARY EVELYN-TRUSTEE	10603 E 70TH ST
45-530-11-09-00-0-00-000	2021	REAL PROPERTY	DILLON MICHELLE LYNN	9101 E 73RD ST	45-620-10-63-00-0-00-000	2021	REAL PROPERTY	HOELZEL DAVID & LAURA	10200 E 70TH TER
45-530-11-25-00-0-00-000	2020-2021	REAL PROPERTY	AKINS TARRON	9116 RICHARDS DR	45-620-13-26-00-0-00-000	2020-2021	REAL PROPERTY	ALLARD CONSTANTIA	10005 E 70TH TER
45-530-12-26-00-0-00-000	2021	REAL PROPERTY	BRIDENSTINE KAREN	7409 BLUE RIDGE BLVD	45-630-02-09-00-0-00-000	2021	REAL PROPERTY	JENNINGS REX	10014 E 71ST TER
45-530-12-34-00-0-00-000	2021	REAL PROPERTY	MAURICIO LLC	8812 RICHARDS DR	45-630-03-01-00-0-00-000	2020-2021	REAL PROPERTY	JACKSON JOSEPH	10417 E 71ST TER
45-530-12-37-00-0-00-000	2021	REAL PROPERTY	PEARSON ERIC & DEBORAH	8818 RICHARDS DR	45-630-03-07-00-0-00-000	2020-2021	REAL PROPERTY	BARKER BRET A	10301 E 71ST TER
45-530-13-34-00-0-00-000	2020-2021	REAL PROPERTY	HAWLEY JULIA M	8924 E 74TH ST	45-630-03-24-00-0-00-000	2021	REAL PROPERTY	ALLEN JANE C	10112 E 72ND ST
45-530-15-02-00-0-00-000	2021	REAL PROPERTY	SHELLY MICHAELS LLC	9109 E 74TH ST	45-630-03-26-00-0-00-000	2019-2021	REAL PROPERTY	PETTYJOHN GILBERT F SR & AMALIA A	10205 E 71ST TER
45-530-15-10-00-0-00-000	2019-2021	REAL PROPERTY	BLUM ELLEN T	9003 E 74TH ST	45-630-03-32-00-0-00-000	2021	REAL PROPERTY	WOODROW H WEBB & JEFFERY JANET V	10300 E 72ND ST
45-530-15-15-00-0-00-000	2021	REAL PROPERTY	VELDHOUSE JERRY M & SHIRLEY K	9106 E 74TH TER	45-630-03-36-00-0-00-000	2020-2021	REAL PROPERTY	WILLIAMS ARTHUR L	10408 E 72ND ST
45-530-15-18-00-0-00-000	2020-2021	REAL PROPERTY	HOWARD JACQUE E	9202 E 74TH TER	45-630-03-44-00-0-00-000	2020-2021	REAL PROPERTY	PIRNIE TERRI J & PIRNIE MARY ANN MARIE	7317 RAYTOWN RD
45-530-16-05-00-0-00-000	2021	REAL PROPERTY	CLANAHAN MARGERY E	8927 E 74TH ST	45-630-03-46-00-0-00-000	2020-2021	REAL PROPERTY	JACKSON JOE	10409 E 71ST TER
45-530-17-06-00-0-00-000	2021	REAL PROPERTY	FEBBAT LLC	9017 E 74TH TER	45-630-04-09-00-0-00-000	2021	REAL PROPERTY	KELSEY INVESTMENT PROPERTY LLC	7301 RAYTOWN RD
45-530-17-19-00-0-00-000	2019-2021	REAL PROPERTY	COLLINS LAURA J & BLAKE HARRY	9110 VAUGHN AVE	45-630-04-24-00-0-00-000	2021	REAL PROPERTY	MASON GARY D & BEVERLY A	7204 CEDAR AVE
45-530-17-22-00-0-00-000	2021	REAL PROPERTY	SHIRLEY PAULA K & BRYAN R	9116 VAUGHN AVE	45-630-05-15-00-0-00-000	2020-2021	REAL PROPERTY	GILMORE WILLIAM JOHN & DOROTHY J	7401 CEDAR AVE
45-530-18-01-00-0-00-000	2018-2021	REAL PROPERTY	ROBINSON BARBARA J	9207 E 74TH TER	45-630-06-18-00-0-00-000	2021	REAL PROPERTY	GREEN THOMAS E & HELEN J	7409 MAYWOOD AVE
45-530-18-13-00-0-00-000	2021	REAL PROPERTY	ROSS KEVIN & LYDIA ROSS	9206 VAUGHN AVE	45-630-07-01-00-0-00-000	2020-2021	REAL PROPERTY	GREB KATHERINE (DECEASED)	7200 HARDY AVE
45-530-19-04-00-0-00-000	2021	REAL PROPERTY	LAUGHLIN RUTH MARIE	9221 VAUGHN AVE	45-630-07-03-00-0-00-000	2021	REAL PROPERTY	MCLAUGHLIN BARRY	7205 ASH AVE
45-530-19-09-00-0-00-000	2021	REAL PROPERTY	STONE CAROL	9209 VAUGHN AVE	45-630-07-09-00-0-00-000	2021	REAL PROPERTY	PROPERTIES BY J & R LLC	7317 ASH AVE

45-630-07-16-00-0-00-000	2021	REAL PROPERTY	ENGL LYNN W & PATRICIA D	7409 ASH AVE	45-740-02-02-00-0-00-000	2021	REAL PROPERTY	BESHORE ALLAN	7880 HARRIS AVE
45-630-09-01-00-0-00-000	2021	REAL PROPERTY	HUNT ROBERT ALAN & BARBER-HUNT DIXIE	7200 RALSTON AVE	45-740-07-12-00-0-00-000	2021	REAL PROPERTY	GLENN R H & JO ANN	8271 HARRIS CT
45-630-09-07-00-0-00-000	2019-2021	REAL PROPERTY	WALTERS ANDERSON	7215 WILLOW AVE	45-740-07-27-00-0-00-000	2021	REAL PROPERTY	KO SHARON ANN MATHIS	8120 APPLETON AVE
45-630-10-04-00-0-00-000	2021	REAL PROPERTY	OPENDOOR PROPERTY C LLC	7205 RALSTON AVE	45-810-03-15-00-0-00-000	2021	REAL PROPERTY	DECKER CONNIE J	7508 OVERTON AVE
45-630-10-11-00-0-00-000	2021	REAL PROPERTY	GROSS MARK E & CHARLENE A	7309 RALSTON AVE	45-810-04-08-00-0-00-000	2019-2021	REAL PROPERTY	JENKINS SHEILA	7525 ARLINGTON AVE
45-630-10-15-00-0-00-000	2021	REAL PROPERTY	SPRATT BOBBY	7316 HEDGES AVE	45-810-04-32-00-0-00-000	2019-2021	REAL PROPERTY	ROWLES RONALD L	9901 E 76TH TER
45-630-11-27-00-0-00-000	2021	REAL PROPERTY	STEVENS KAREN T	7315 HEDGES AVE	45-810-05-24-00-0-00-000	2020-2021	REAL PROPERTY	WALTERS ANDERSON	9356 E 77TH ST
45-630-14-05-00-0-00-000	2021	REAL PROPERTY	LEVER JEFFERSON G	7409 WILLOW AVE	45-810-06-09-00-0-00-000	2021	REAL PROPERTY	TINAMISAN ARSENIO A & SAMANTHA L R	7517 MAPLE LN
45-630-16-01-00-0-00-000	2020-2021	REAL PROPERTY	HIGGS VELMINY B	10113 E 74TH TER	45-810-08-03-00-0-00-000	2021	REAL PROPERTY	JONES EILEAN D	7506 ELM ST
45-630-16-22-00-0-00-000	2016-2021	REAL PROPERTY	BARLOW ROBERT W & DONNA R	NO ADDRESS ASSIGNED BY CITY	45-810-09-06-00-0-00-000	2021	REAL PROPERTY	WILSON JAMES DEAN	7701 ELM ST
45-640-01-06-01-0-00-000	2020-2021	REAL PROPERTY	JOHNSON SCOTT	11609 E 72ND ST	45-810-09-15-00-0-00-000	2021	REAL PROPERTY	WAIT JAMES	7805 ELM ST
45-640-06-15-00-0-00-000	2021	REAL PROPERTY	TYLER THOMAS W & MARY M	7210 CRISP AVE	45-810-09-32-00-0-00-000	2021	REAL PROPERTY	MOON MARK A & M LINDA	7708 CRESCENT AVE
45-640-07-09-00-0-00-000	2021	REAL PROPERTY	HARTMAN LINDA D	7204 WOODSON DR	45-810-10-08-00-0-00-000	2020-2021	REAL PROPERTY	BLACKMAN RUSSELL D III	7717 CRESCENT AVE
45-640-08-06-00-0-00-000	2021	REAL PROPERTY	CLATANOFF REBECCA S & CLATANOFF GINGER A	7217 CRISP AVE	45-810-11-21-00-0-00-000	2021	REAL PROPERTY	HUNT HERBERT L AND LINDA IRENE	9600 E 77TH TER
45-640-08-30-00-0-00-000	2021	REAL PROPERTY	NICHOLSON LARRY B JR AND DORINDA M	7236 WOODSON RD	45-810-11-33-00-0-00-000	2019-2021	REAL PROPERTY	SIGALA LILIA SELENE	9900 E 77TH TER
45-640-08-76-00-0-00-000	2019-2021	REAL PROPERTY	LEGGS DARRYL	11508 E 74TH STREET CT	45-810-12-01-00-0-00-000	2021	REAL PROPERTY	SCOFIELD CHRISTOPHER H & PEPPER J	9913 E 77TH TER
45-640-08-78-00-0-00-000	2021	REAL PROPERTY	AMERICASA LLC	11516 E 74TH STREET CT	45-810-12-02-00-0-00-000	2021	REAL PROPERTY	QUINN STEPHEN P	9909 E 77TH TER
45-640-10-23-00-0-00-000	2021	REAL PROPERTY	IYEWARUN ROSE ABIODUN	11105 E 73RD ST	45-830-01-10-00-0-00-000	2021	REAL PROPERTY	JULO JACK R & SHEILA M	8119 DITZLER AVE
45-640-11-09-00-0-00-000	2021	REAL PROPERTY	GRACE RAYMOND C & CONNIE K	7304 HARVARD AVE	45-830-01-11-00-0-00-000	2021	REAL PROPERTY	STUEVEN MATTHIAS S & SHARON G	8123 DITZLER AVE
45-640-13-03-00-0-00-000	2021	REAL PROPERTY	MAGEE KEVIN M & JENNIFER A	7311 APPLETON AVE	45-830-01-18-00-0-00-000	2021	REAL PROPERTY	WERNER CHARLES S	8149 DITZLER AVE
45-640-13-09-00-0-00-000	2020-2021	REAL PROPERTY	WEDEL BRUCE	7409 APPLETON AVE	45-830-02-14-00-0-00-000	2021	REAL PROPERTY	AL-ANSARE CLAUDIA & TAAIB UD DIN	8025 MANNING AVE
45-640-13-10-00-0-00-000	2020-2021	REAL PROPERTY	OWENS JANINE M & JAMES L JR	7415 APPLETON AVE	45-830-02-23-00-0-00-000	2021	REAL PROPERTY	SEARCY HERBERT A & CAROL	8119 MANNING AVE
45-640-15-09-00-0-00-000	2019-2021	REAL PROPERTY	STEVENSON CURTIS T	7209 HARVARD AVE	45-830-02-29-00-0-00-000	2020-2021	REAL PROPERTY	BROWN BRENDA K	8142 DITZLER AVE
45-640-16-04-00-0-00-000	2021	REAL PROPERTY	SMALLRIDGE FREDERIKA S	7109 STERLING AVE	45-830-02-42-00-0-00-000	2021	REAL PROPERTY	XIONG NHIA	7922 DITZLER AVE
45-640-16-20-00-0-00-000	2020-2021	REAL PROPERTY	WARE ALAN R	7137 CRISP AVE	45-830-02-51-00-0-00-000	2021	REAL PROPERTY	VERTICAL DESIGN LLC	7900 DITZLER AVE
45-640-16-25-00-0-00-000	2021	REAL PROPERTY	BROCKER KEVIN WILLIAM & COLLEEN DEANNA	11314 E 71ST DR	45-830-03-03-00-0-00-000	2021	REAL PROPERTY	ODELL MARK A & NANCY A	9001 E 79TH ST
45-640-16-59-00-0-00-000	2021	REAL PROPERTY	WILKINSON JAMES	11222 E 71ST DR	45-830-03-38-00-0-00-000	2021	REAL PROPERTY	MCCAULEY MICHAEL J & KATHY S	8108 MANNING AVE
45-640-16-61-00-0-00-000	2021	REAL PROPERTY	DOUGLAS CHERYL J	11226 E 71ST DR	45-830-04-20-00-0-00-000	2021	REAL PROPERTY	HAUS BENNY L & HAZEL M	8004 TENNESSEE AVE
45-640-17-06-00-0-00-000	2021	REAL PROPERTY	BOSNAK MICHAEL J & JENNIFER	7311 HARRIS AVE	45-830-05-27-00-0-00-000	2014-2021	REAL PROPERTY	GMAC MORTGAGE LLC	8825 E 81ST ST
45-640-17-13-00-0-00-000	2021	REAL PROPERTY	GRAY LLOYD D	7409 HARRIS AVE	45-830-05-39-00-0-00-000	2021	REAL PROPERTY	RIMMER DAVID L & RITA M	8016 HUNTER ST
45-640-17-30-00-0-00-000	2021	REAL PROPERTY	CREAGER JASON & ZHAKUPOVA NAZIRA E	7324 HARVARD DR	45-830-05-45-00-0-00-000	2020-2021	REAL PROPERTY	PAYNE COURTNEY J & TYLER P	7916 HUNTER ST
45-640-18-07-00-0-00-000	2021	REAL PROPERTY	SCHNOOR GAROLD L & LISA D	11101 E 74TH ST	45-830-05-54-01-0-00-000	2018-2021	REAL PROPERTY	WILLEFORD REBECCA LYNN	8813 E 81ST ST
45-640-18-11-00-0-00-000	2019-2021	REAL PROPERTY	HANSON MARTIN G	11001 E 74TH ST	45-830-06-47-00-0-00-000	2020-2021	REAL PROPERTY	PRICE JASON & LEILIANE	804 E 83RD ST
45-640-21-03-00-0-00-000	2021	REAL PROPERTY	CANTOR ROBERT	7124 NORWOOD AVE	45-830-07-04-00-0-00-000	2018-2021	REAL PROPERTY	MILLS LAURA	8200 E 83RD ST
45-640-23-02-00-0-00-000	2021	REAL PROPERTY	WALDON YOLANDA	11709 E 71ST CT	45-830-08-22-00-0-00-000	2021	REAL PROPERTY	SHELL LARRY G & BETTY L	9901 E 79TH TER
45-710-01-08-00-0-00-000	2021	REAL PROPERTY	HAYES MARK O	7517 ENGLEWOOD AVE	45-840-01-14-00-0-00-000	2021	REAL PROPERTY	HARMS PATRICIA A	7612 MAPLE AVE
45-710-01-09-00-0-00-000	2020-2021	REAL PROPERTY	FOSTER CATHERINE DIANE	7521 ENGLEWOOD AVE	45-840-03-07-00-0-00-000	2019-2021	REAL PROPERTY	REYNOLDS DARYLE E & TERRY A	9901 E 79TH TER
45-710-01-34-00-0-00-000	2021	REAL PROPERTY	WRIGHT PERRY R	11416 E 77TH TER	45-840-04-01-00-0-00-000	2021	REAL PROPERTY	FERRARA MARY M	7900 MAPLE AVE
45-710-01-35-00-0-00-000	2018-2021	REAL PROPERTY	HAUSER FREDRICK W	11420 E 77TH TER	45-840-06-14-00-0-00-000	2021	REAL PROPERTY	KANSAS CITY REAL ESTATE INVESTMENT SERVICES LLC	7912 ARLINGTON AVE
45-710-01-42-00-0-00-000	2021	REAL PROPERTY	COONCE CARL	7606 WOODSON RD	45-840-07-05-00-0-00-000	2021	REAL PROPERTY	WOFFORD ROBERT W JR	7907 ARLINGTON AVE
45-710-03-13-00-0-00-000	2021	REAL PROPERTY	WAYMAN SHERYL MARLENE	7516 HARRIS AVE	45-840-12-04-00-0-00-000	2021	REAL PROPERTY	MIDWEST INVEST LLC	9601 E 80TH TER
45-710-03-14-00-0-00-000	2021	REAL PROPERTY	CRAWFORD ROBERT D & LAURA F	7512 HARRIS AVE	45-840-12-17-00-0-00-000	2019-2021	REAL PROPERTY	MILLER RICHARD J & TERESA	9616 E 80TH TER
45-710-04-07-00-0-00-000	2021	REAL PROPERTY	PRUETT BROTHER PROPERTIES LLC	7520 APPLETON AVE	45-840-12-46-00-0-00-000	2021	REAL PROPERTY	HAINES LARRY D	9416 E 82ND ST
45-710-04-09-00-0-00-000	2019-2021	REAL PROPERTY	IRELAND SHANNON D	7604 APPLETON AVE	45-840-13-14-00-0-00-000	2021	REAL PROPERTY	DAVIS FRANCES L	9306 E 81ST ST
45-710-06-16-00-0-00-000	2021	REAL PROPERTY	BOOKER EUGENE	7520 HARVARD AVE	45-840-13-17-00-0-00-000	2021	REAL PROPERTY	TALBERT TAMIKA	9306 E 81ST ST
45-710-08-13-00-0-00-000	2021	REAL PROPERTY	SCHMIDT RUTH A & COOPER LINDA	11000 E 78TH ST	45-840-14-04-00-0-00-000	2021	REAL PROPERTY	MILLER CLIFFORD C & LINDA J	9407 E 81ST ST
45-710-11-02-00-0-00-000	2021	REAL PROPERTY	BROGDON SHERRY L & DAVID M	11201 E 78TH ST	45-840-14-09-00-0-00-000	2021	REAL PROPERTY	TAMFU WILFRED NFOR	9305 E 81ST ST
45-710-12-19-02-0-00-000	2021	REAL PROPERTY	HOLMES TROY	11311 E 78TH ST	45-840-14-12-00-0-00-000	2021	REAL PROPERTY	THOMAS DAWN C	8105 ELM AVE
45-710-13-15-00-0-00-000	2021	REAL PROPERTY	WOOD MARTHA C	11309 E 78TH TER	45-840-14-19-00-0-00-000	2021	REAL PROPERTY	MAD BEAR ENTERPRISES LLC	9408 E 81ST TER
45-710-13-26-00-0-00-000	2019-2021	REAL PROPERTY	SHIPP HOMES LLC	11100 E M 350 HWY	45-840-15-15-00-0-00-000	2021	REAL PROPERTY	SFR3-000 LLC	9804 E 81ST TER
45-710-17-02-00-0-00-000	2021	REAL PROPERTY	AUSTIN OBIE A & TIFFANY M	7601 CRISP AVE	45-840-16-20-00-0-00-000	2021	REAL PROPERTY	HATFIELD MARK ALLEN	9900 E 82ND TER
45-710-18-12-00-0-00-000	2021	REAL PROPERTY	SHAHER RONALD L	7513 HARVARD AVE	45-840-19-03-00-0-00-000	2020-2021	REAL PROPERTY	WHITE MICHAEL EUGENE	9901 E 82ND TER
45-710-18-23-00-0-00-000	2021	REAL PROPERTY	EASLEY DANNY & LYNETTE	11108 E 77TH TER	45-910-08-07-00-0-00-000	2021	REAL PROPERTY	VARGAS CARINA	8708 E 79TH ST
45-710-18-41-00-0-00-000	2021	REAL PROPERTY	ASBERRY FREDDIE B SR & GENOVA	7520 STERLING AVE	45-940-01-18-00-0-00-000	2021	REAL PROPERTY	KEYS COLEMAN O	7949 BLUE RIDGE BLVD
45-710-18-47-00-0-00-000	2021	REAL PROPERTY	BROWN CYRILL & DIXIE	11208 E 75TH TER	45-940-01-25-00-0-00-000	2020-2021	REAL PROPERTY	PARSONS MELODY J & RAY	8620 E 80TH TER
45-710-18-51-00-0-00-000	2021	REAL PROPERTY	HOLMES HARRIETT DIAN	11224 E 75TH TER	45-940-01-37-00-0-00-000	2021	REAL PROPERTY	LIBBY NORMA E (HATFIELD)	8711 E 79TH TER
45-720-09-04-00-0-00-000	2021	REAL PROPERTY	AMERICASA II LLC	10113 E 78TH TER	45-940-01-41-00-0-00-000	2021	REAL PROPERTY	MILLER JOHN LESTER AND NORMA JEAN	7917 BLUE RIDGE BLVD
45-720-09-15-00-0-00-000	2020-2021	REAL PROPERTY	BUCZINSKI SHARON R	10020 E 79TH ST	45-940-01-43-00-0-00-000	2021	REAL PROPERTY	SULZEN KENNETH F & ANTONIA V	7911 BLUE RIDGE BLVD
45-720-09-21-00-0-00-000	2021	REAL PROPERTY	SURBER JAMES M	10124 E 79TH ST	45-940-04-11-00-0-00-000	2021	REAL PROPERTY	WEBB ROY J	8615 E 80TH TER
45-730-01-01-00-0-00-000	2021	REAL PROPERTY	AMERICASA PLATINUM LLC	7821 HEDGES AVE	45-940-04-61-00-0-00-000	2016-2021	REAL PROPERTY	EADS MELISSA	8604 E 81ST TER
45-730-03-12-00-0-00-000	2021	REAL PROPERTY	HEDRICK JOHN D & CAROL J	7907 CEDAR AVE	45-940-04-70-00-0-00-000	2021	REAL PROPERTY	PHILLIPS JAMES W & GEORGIA A	8604 E 81ST TER
45-730-04-03-00-0-00-000	2021	REAL PROPERTY	WEDEL BRUCE D	7907 RAYTOWN RD	45-940-04-85-00-0-00-000	2019-2021	REAL PROPERTY	RANGEL CHELSEA LANE	8616 E 81ST TER
45-730-04-09-00-0-00-000	2021	REAL PROPERTY	SPECK JAMES EDWARD	8007 RAYTOWN RD	45-940-05-04-00-0-00-000	2020-2021	REAL PROPERTY	ROWE PETER L & DONNA J	8705 E 81ST TER
45-730-04-44-00-0-00-000	2021	REAL PROPERTY	PLATTNER JOHN	8006 HARDY AVE	45-940-05-06-00-0-00-000	2021	REAL PROPERTY	YOUNG KEVIN W	8625 E 81ST TER
45-730-04-56-00-0-00-000	2016-2021	REAL PROPERTY	HENDRIX RANDY JR & LAURA	7924 CEDAR AVE	45-940-05-35-00-0-00-000	2019-2021	REAL PROPERTY	MONARREZ MARTHA & JUAN	8223 JAMES A REED RD
45-730-07-01-00-0-00-000	2021	REAL PROPERTY	BEELER DAVID L JR & EDYTHE	7910 HEDGES AVE	45-940-05-39-00-0-00-000	2019-2021	REAL PROPERTY	VANG CHENG	8200 E 83RD ST
45-730-07-31-00-0-00-000	2020-2021	REAL PROPERTY	ELVIN JIM	7918 HEDGES AVE	45-940-05-42-00-0-00-000	2018-2021	REAL PROPERTY	WISEMAN INVESTMENTS LLC	8620 E 83RD ST
45-730-14-14-00-0-00-000	2021	REAL PROPERTY	CUTCHLOW AARON D & MICHELENA R	10401 E 82ND TER	45-940-05-58-00-0-00-000	2020-2021	REAL PROPERTY	FETTEROLF ERIC M & SHERYL L	8200 E 83RD ST
45-730-14-16-00-0-00-000	2021	REAL PROPERTY	KURZ JACQUELINE M	10404 E 83RD ST	45-940-05-62-00-0-00-000	2021	REAL PROPERTY	NICHOLS ROGER W & K SUE	8705 E 83RD ST
45-740-01-02-00-0-00-000	2019-2021	REAL PROPERTY	KEYS COLEMAN O	11308 E M 350 HWY	45-940-05-73-00-0-00-000	2021	REAL PROPERTY	US DEN TOOLS INC	8209 BLUE RIDGE BLVD
45-740-01-05-00-0-00-000	2021	REAL PROPERTY	OWENSBY PHILLIP D & NADINE R	11222 E M 350 HWY	50-110-01-04-00-0-00-000	2021	REAL PROPERTY	MILLER BARBARA J	11405 E 83RD ST
45-740-02-01-00-0-00-000	2021	REAL PROPERTY	BESHORE ALLAN	7884 HARRIS AVE	50-110-01-16-00-0-00-000	2021	REAL PROPERTY	CUNNINGHAM JUSTIN & HOPE	8419 PERSHING RD

50-110-01-17-00-0-00-000	2021	REAL PROPERTY	CUNNINGHAM JUSTIN & HOPE	NO ADDRESS ASSIGNED BY CITY	50-220-06-10-00-0-00-000	2019-2021	REAL PROPERTY	BRYANT MITCHELL LJR	8958 E 83RD TER
50-110-01-51-00-0-00-000	2019-2021	REAL PROPERTY	DENNINGSON MAHIN LLC	8616 GRANT DR	50-220-08-11-00-0-00-000	2021	REAL PROPERTY	KEUHN MADLYN ANN	8317 KENTUCKY AVE
50-110-02-16-00-0-00-000	2021	REAL PROPERTY	VAUGHN ORETA F	8403 STERLING AVE	50-220-09-18-00-0-00-000	2021	REAL PROPERTY	BLANKENSHIP KATELYNN	8306 KENTUCKY AVE
50-110-02-18-00-0-00-000	2021	REAL PROPERTY	YATES DARREL EUGENE	8407 STERLING AVE	50-220-09-22-00-0-00-000	2021	REAL PROPERTY	MASTIN BETTY LOU	8304 KENTUCKY AVE
50-110-02-44-00-0-00-000	2021	REAL PROPERTY	CONREX RESIDENTIAL PROPERTY GROUP	8502 PERSHING RD	50-220-10-06-00-0-00-000	2021	REAL PROPERTY	HILL OTTO B	8310 STARK AVE
50-110-02-48-00-0-00-000	2019-2021	REAL PROPERTY	MICKELSON DENNIS H & HEATHER A	11304 E 85TH TER	50-220-11-09-00-0-00-000	2019-2021	REAL PROPERTY	MICAH RIGGS	8818 E 84TH TER
50-110-03-22-00-0-00-000	2021	REAL PROPERTY	PROWELL RICHARD & CYNTHIA	11116 E 85TH ST	50-220-13-03-00-0-00-000	2021	REAL PROPERTY	NELSON CYNTHIA & DAVID K	8817 E 85TH ST
50-110-03-45-00-0-00-000	2021	REAL PROPERTY	KONCAL ROBERT	11139 E 84TH TER	50-220-14-05-00-0-00-000	2020-2021	REAL PROPERTY	PITTMAN LARRY R & PAULA	8508 STARK AVE
50-110-04-15-00-0-00-000	2021	REAL PROPERTY	EAGLE RONALD D	8520 HARVARD TER	50-220-14-08-00-0-00-000	2021	REAL PROPERTY	SCHNELL RUSSELL R	8514 STARK AVE
50-110-04-18-00-0-00-000	2021	REAL PROPERTY	SHAFFER LARRY	8508 HARVARD TER	50-220-14-12-00-0-00-000	2020-2021	REAL PROPERTY	HAMPTON JUSTIN M & STEPHANIE	8606 STARK AVE
50-110-04-47-00-0-00-000	2021	REAL PROPERTY	MORRIS PERRY J	8408 HARRIS AVE	50-220-16-12-00-0-00-000	2021	REAL PROPERTY	DEHART BRIAN A	8608 KENTUCKY AVE
50-110-05-03-00-0-00-000	2019-2021	REAL PROPERTY	SUMMERS NOEL W	8501 GRANT DR	50-220-17-21-02-0-00-000	2019-2021	REAL PROPERTY	CARTER JULIE M & DWIGHT D	8526 LANE AVE
50-110-05-14-00-0-00-000	2021	REAL PROPERTY	TRUSLER DAN R & KAREN J	8539 GRANT DR	50-220-18-27-01-0-00-000	2021	REAL PROPERTY	BONILLA CANDIDA VELASQUEZ	NO ADDRESS ASSIGNED BY CITY
50-110-07-09-00-0-00-000	2021	REAL PROPERTY	MONTGOMERY ROGER L & KATHY	8332 HARVARD AVE	50-220-19-07-00-0-00-000	2021	REAL PROPERTY	ARVM 5 LLC	8903 E 84TH ST
50-110-08-01-00-0-00-000	2021	REAL PROPERTY	JACQUES CHARLES R	8316 HARVARD TER	50-220-19-21-00-0-00-000	2021	REAL PROPERTY	MYRTIL PEIRE & KETTELY	8480 LANE DR
50-120-01-08-00-0-00-000	2021	REAL PROPERTY	LAVENDER LAWRENCE JR & SUZANNE	8329 NORTHERN ST	50-220-19-48-00-0-00-000	2021	REAL PROPERTY	HINES WILMA V	8432 LANE PL
50-120-01-16-00-0-00-000	2020	REAL PROPERTY	DEMAREE BRIAN	10709 E 84TH TER	50-220-19-70-00-0-00-000	2021	REAL PROPERTY	ENDGAME VENTURES 4 SERIES LLC	8448 LANE DR
50-120-01-21-00-0-00-000	2019-2021	REAL PROPERTY	VANCE RICHARD A & MARY A	8404 WILLOW WAY	50-220-20-01-00-0-00-000	2021	REAL PROPERTY	HOWARD HARRY ARTHUR	8400 ELM AVE
50-120-01-62-00-0-00-000	2021	REAL PROPERTY	CLARK CHRISTOPHER JUDE SR & JOYCE ELAINE	8300 WILLOW WAY	50-220-20-10-00-0-00-000	2019-2021	REAL PROPERTY	MITCHELL ERIC S & DEBBI	9105 E 84TH ST
50-120-04-06-00-0-00-000	2021	REAL PROPERTY	KIWI HOMES LLC	10009 E 83RD TER	50-220-20-75-00-0-00-000	2020-2021	REAL PROPERTY	DACE EMANUEL	9100 E 84TH CT
50-120-04-12-00-0-00-000	2021	REAL PROPERTY	RAYMONT REI HOLDINGS INC	10012 E 84TH ST	50-220-20-77-00-0-00-000	2020-2021	REAL PROPERTY	DACE EMANUEL	9100 E 84TH CT
50-120-06-01-00-0-00-000	2021	REAL PROPERTY	SCHUETTE JAMES D	10717 E 84TH ST	50-220-20-79-00-0-00-000	2020-2021	REAL PROPERTY	DACE EMANUEL	9105 E 84TH CT
50-120-06-05-00-0-00-000	2020-2021	REAL PROPERTY	GARDNER MARY SUSAN	8401 WILLOW WAY	50-220-21-67-00-0-00-000	2021	REAL PROPERTY	GREENLAND HOLDINGS LLC	9107 E 85TH ST
50-120-07-03-00-0-00-000	2021	REAL PROPERTY	CARPER THOMAS H & MICHELINE T	8513 MAYWOOD AVE	50-220-21-74-01-0-00-000	2021	REAL PROPERTY	SBD CAPITAL DEVELOPMENT LLC	NO ADDRESS ASSIGNED BY CITY
50-120-07-06-00-0-00-000	2019-2021	REAL PROPERTY	JOHNSON CARL L	8525 MAYWOOD AVE	50-220-22-24-00-0-00-000	2021	REAL PROPERTY	PEEK LORI J	9012 E 85TH PL
50-120-07-07-00-0-00-000	2019-2021	REAL PROPERTY	WILLIAMS ELLEN D	8601 MAYWOOD AVE	50-220-22-36-00-0-00-000	2021	REAL PROPERTY	TINKSHELL BARBARA T	9019 E 85TH TER
50-120-07-18-00-0-00-000	2021	REAL PROPERTY	STEVENSON LATANYA D	NO ADDRESS ASSIGNED BY CITY	50-220-22-50-00-0-00-000	2021	REAL PROPERTY	JONES FRANCES A	9038 E 85TH PL
50-120-09-06-00-0-00-000	2021	REAL PROPERTY	HAGLUND PATRICIA	8313 MAYWOOD AVE	50-230-02-03-00-0-00-000	2021	REAL PROPERTY	JONES VIVIAN & JONES KACI L	8701 TENNESSEE AVE
50-120-10-25-00-0-00-000	2021	REAL PROPERTY	OBRIEN MICHAEL A	8529 ASH AVE	50-230-02-43-00-0-00-000	2021	REAL PROPERTY	SBD PROPERTY ACQUISITIONS LLC	8705 TENNESSEE AVE
50-130-01-01-00-0-00-000	2021	REAL PROPERTY	PAUL KEVIN C & LINDA S	10624 E 87TH ST	50-310-01-14-00-0-00-000	2020-2021	REAL PROPERTY	1 CASH FLOW SOURCE LLC	8413 SPRING VALLEY RD
50-140-01-42-00-0-00-000	2021	REAL PROPERTY	DERKS MARY ANN	10908 E 87TH ST	50-310-02-15-00-0-00-000	2021	REAL PROPERTY	DEHART PROPERTIES LLC	8303 BOOTH AVE
50-210-01-11-00-0-00-000	2021	REAL PROPERTY	ROBINSON EARNESTINE	8329 OXFORD AVE	50-310-02-23-00-0-00-000	2021	REAL PROPERTY	NOLKE JOSEPH E AND ELAINE N	8614 E 83RD TER
50-210-01-56-01-0-00-000	2021	REAL PROPERTY	WILLIAMS BARBARA	9315 E 83RD ST	50-310-02-25-00-0-00-000	2021	REAL PROPERTY	BAYNHAM STACY M	8618 E 83RD TER
50-210-02-01-00-0-00-000	2021	REAL PROPERTY	WHITMORE BYRON	8320 OXFORD AVE	50-310-02-29-00-0-00-000	2021	REAL PROPERTY	TLLD HOLDINGS LLC	8704 E 83RD TER
50-210-02-08-00-0-00-000	2019-2021	REAL PROPERTY	RAYMONT REI HOLDINGS INC	9304 E 84TH ST	50-310-03-07-00-0-00-000	2021	REAL PROPERTY	KLINE JOAN F	8204 E 83RD TER
50-210-03-21-00-0-00-000	2021	REAL PROPERTY	CLARK V KAYE-TRUSTEE	9308 E 84TH TER	50-310-03-12-00-0-00-000	2021	REAL PROPERTY	RUTHERFORD GEORGE A & KATHLEEN J	8401 MARSH AVE
50-210-03-35-00-0-00-000	2021	REAL PROPERTY	FITZGERALD RICHARD E & DEBORAH J	9424 E 84TH TER	50-310-03-42-00-0-00-000	2021	REAL PROPERTY	CRUMM CHARLOTTE BRIGGS	8400 BOOTH AVE
50-210-04-02-00-0-00-000	2021	REAL PROPERTY	MOCK GARY S & JANICE D	9417 E 84TH TER	50-310-03-45-00-0-00-000	2019-2021	REAL PROPERTY	MESSER JOHN RAYMOND & MESSER TERRY	8312 BOOTH AVE
50-210-04-14-00-0-00-000	2021	REAL PROPERTY	DANIEL J HOSTERT REVOCABLE LIVING TRUST DATED 07-11-21	9309 E 84TH TER	50-310-05-17-00-0-00-000	2019-2021	REAL PROPERTY	MESSER JOHN & TERRY	8600 E 84TH ST
50-210-05-05-00-0-00-000	2020-2021	REAL PROPERTY	FEDERICO JOHNNIE J	9901 E 85TH ST	50-310-05-30-00-0-00-000	2021	REAL PROPERTY	LOEST GLENN E & ANNE	8708 E 84TH ST
50-210-06-19-00-0-00-000	2021	REAL PROPERTY	VAN DOLAH DOROTHY D	9807 E 85TH ST	50-310-07-01-00-0-00-000	2021	REAL PROPERTY	CLINE CLIFFORD	8402 FORD AVE
50-210-06-36-00-0-00-000	2021	REAL PROPERTY	MELTON SANDRA R TR-SANDRA R MELTON REVTR	8516 EVANSTON AVE	50-310-09-09-00-0-00-000	2020-2021	REAL PROPERTY	LANDMARK EQUITY GROUP LLC	8604 E 84TH TER
50-210-06-53-00-0-00-000	2021	REAL PROPERTY	SHIPMAN JAMES M & SHEILA JUNE	9608 E 86TH TER	50-310-12-17-00-0-00-000	2021	REAL PROPERTY	TUBBS TRACY A & BRENDA A	8704 E 87TH ST
50-210-06-81-00-0-00-000	2021	REAL PROPERTY	STEWART DOROTHY	8604 RAYTOWN RD	50-310-13-04-00-0-00-000	2021	REAL PROPERTY	JONES TRACEY R	8501 EVERETT ST
50-210-09-02-00-0-00-000	2020	REAL PROPERTY	ENGLAND NICHOLAS AARON	9417 E 85TH ST	50-310-13-11-00-0-00-000	2021	REAL PROPERTY	HAWTHORNE DEBRA Y	8601 EVERETT ST
50-210-09-06-00-0-00-000	2021	REAL PROPERTY	FRANCISCO DALE Z & S SUE - TRUSTEES	9403 E 85TH ST	50-310-13-15-00-0-00-000	2019-2021	REAL PROPERTY	MASONER RONALD ALLEN	8609 EVERETT ST
50-210-09-14-00-0-00-000	2019-2021	REAL PROPERTY	VARGAS JORGE & ANDRE PAUL	8521 MAPLE AVE	50-310-14-14-00-0-00-000	2021	REAL PROPERTY	BRINK DOUGLAS K	8600 E 87TH ST
50-210-09-26-00-0-00-000	2021	REAL PROPERTY	JOHNSON JOAN J	8616 CRESCENT AVE	50-310-15-12-00-0-00-000	2021	REAL PROPERTY	120 INVESTMENTS LLC	8309 E 85TH ST
50-210-09-49-00-0-00-000	2021	REAL PROPERTY	BELL MORRIS & BEVERLY	8603 MAPLE AVE	50-310-15-20-00-0-00-000	2021	REAL PROPERTY	CUMMINS ROBERT L & MAGDA L TRUSTEES	8503 JAMES A REED RD
50-210-10-02-00-0-00-000	2021	REAL PROPERTY	CROWN PROPERTIES MISSOURI LLC	8513 OXFORD AVE	50-310-16-04-00-0-00-000	2021	REAL PROPERTY	NEVILLE JOANNE C	8501 E 85TH TER
50-210-10-07-00-0-00-000	2019-2021	REAL PROPERTY	HORIZON TRUST COMPANY CUSTODIAN	8607 OXFORD AVE	50-310-17-12-00-0-00-000	2021	REAL PROPERTY	MALURO PARRA EFREN	8207 E 86TH TER
50-210-10-12-00-0-00-000	2019-2021	REAL PROPERTY	PODSCHWIT AARON J	8617 OXFORD AVE	50-310-17-20-00-0-00-000	2021	REAL PROPERTY	WEBB ROY J	8300 E 87TH ST
50-210-11-02-00-0-00-000	2021	REAL PROPERTY	PINK HILL PROPERTIES LLC	9325 E 85TH ST	50-310-17-25-00-0-00-000	2021	REAL PROPERTY	BROOKE ALVA W & MADELYN D	8402 E 87TH ST
50-210-11-08-00-0-00-000	2021	REAL PROPERTY	WHEELER JESSTIN K & SHELIA M	8517 ELM AVE	50-310-17-28-00-0-00-000	2019-2021	REAL PROPERTY	SNYDER JEFFREY W	8500 E 87TH ST
50-210-11-17-00-0-00-000	2021	REAL PROPERTY	LONG ADRIAN F & ELBERTA E-TRUSTEES	8613 ELM AVE	50-320-07-04-00-0-00-000	2020-2021	REAL PROPERTY	UPWARD MOBILITY SOAR TRUST DATED 11/16/2019	8325 BLUE RIDGE BLVD
50-210-11-19-00-0-00-000	2021	REAL PROPERTY	ZELLERS MARY V	8617 ELM AVE	50-320-07-06-00-0-00-000	2020-2021	REAL PROPERTY	ADCIP LLC	8401 BLUE RIDGE BLVD
50-210-11-20-00-0-00-000	2021	REAL PROPERTY	PIERCE JOANN	8619 ELM AVE	50-320-07-08-00-0-00-000	2020-2021	REAL PROPERTY	SFR3 LLC	8407 BLUE RIDGE BLVD
50-210-12-02-00-0-00-000	2021	REAL PROPERTY	HARPER JOSEPH & DOLLIE M	8301 OVERTON DR	50-320-07-09-00-0-00-000	2019-2021	REAL PROPERTY	NATHAN DAVID A	8409 BLUE RIDGE BLVD
50-210-14-02-00-0-00-000	2021	REAL PROPERTY	STEWART DORA L	8305 HAWTHORNE AVE	50-320-07-32-00-0-00-000	2020-2021	REAL PROPERTY	HOBBS AMANDA	8529 BLUE RIDGE BLVD
50-210-14-03-00-0-00-000	2021	REAL PROPERTY	GROFF DANTON D & CAROL JANE	8309 HAWTHORNE AVE	50-320-07-40-00-0-00-000	2020-2021	REAL PROPERTY	HETHERINGTON RON W	7810 E 87TH ST
50-210-14-08-00-0-00-000	2021	REAL PROPERTY	SWIAM JASMIN L	9805 E 83RD TER	50-320-07-50-00-0-00-000	2020-2021	REAL PROPERTY	JUAREZ GLORIA ERIKA TREJO	8432 GREENWOOD RD
50-210-14-17-01-0-00-000	2021	REAL PROPERTY	MARTIN DORIS J	9900 E 84TH ST	50-320-07-56-00-0-00-000	2021	REAL PROPERTY	ASSET INVESTMENTS LLC	8408 GREENWOOD RD
50-210-14-19-00-0-00-000	2021	REAL PROPERTY	MARTIN RICHARD B & TERESEEA M	9808 E 84TH ST	50-320-07-62-00-0-00-000	2021	REAL PROPERTY	NICKELL DENNIS W	8576 GREENWOOD RD
50-210-15-27-00-0-00-000	2021	REAL PROPERTY	FEIK ELEANOR R	8439 EVANSTON AVE	50-320-08-06-00-0-00-000	2020-2021	REAL PROPERTY	BANKER ARNIE M	8427 GREENWOOD RD
50-210-15-30-00-0-00-000	2019-2021	REAL PROPERTY	DUGGAN BRADLEY	9708 E 85TH ST	50-320-09-06-00-0-00-000	2021	REAL PROPERTY	HETHERINGTON ROGER	7807 E 86TH ST
50-220-02-01-00-0-00-000	2021	REAL PROPERTY	CORBIN JACKIE LEE	8300 DITZLER AVE	50-320-09-18-00-0-00-000	2019-2021	REAL PROPERTY	BMT RENTAL ENTERPRISES LLC	8009 E 87TH ST
50-220-04-06-00-0-00-000	2020-2021	REAL PROPERTY	MATZELLE RYAN SCOTT	8305 MANNING AVE	50-320-09-32-00-0-00-000	2018-2021	REAL PROPERTY	FRAZIER BRENDA J	8602 GREENWOOD RD
50-220-04-08-00-0-00-000	2021	REAL PROPERTY	8309 MANNING	8309 MANNING AVE	50-330-01-06-00-0-00-000	2021	REAL PROPERTY	HUGHES IDELLA	8009 E 87TH ST
50-220-04-15-00-0-00-000	2021	REAL PROPERTY	HOFFMAN RICHARD E & LINDA M	8332 LAUREL AVE	50-330-01-15-00-0-00-000	2021	REAL PROPERTY	KING DELIA M	7905 E 87TH ST
50-220-04-22-00-0-00-000	2021	REAL PROPERTY	CARTER WILLIAM H & JANICE L	8304 LAUREL AVE	50-330-01-20-00-0-00-000	2019-2021	REAL PROPERTY	TITUS TONIA L	7807 E 87TH ST
50-220-05-07-00-0-00-000	2019-2021	REAL PROPERTY	FORD GREGORY S & DEBRA M	8311 LANE AVE	50-340-03-02-00-0-00-000	2021	REAL PROPERTY	JUSTICE DAVID	8615 E 87TH ST
50-220-05-15-00-0-00-000	2021	REAL PROPERTY	MCCLENDON KENNETH L	8312 MANNING AVE	50-340-03-06-00-0-00-000	2021	REAL PROPERTY	ROEGES CLAUDIA	8705 BOOTH AVE

50-340-06-25-00-0-00-000	2021	REAL PROPERTY	PRATT MANON	NO ADDRESS ASSIGNED BY CITY
51-320-02-02-00-0-00-000	2021	REAL PROPERTY	SALZ & LIGHT LLC	11911 E 83RD ST
51-320-02-13-00-0-00-000	2020-2021	REAL PROPERTY	BEVERLY SCOTT INC	8323 WOODSON DR
51-320-02-22-00-0-00-000	2021	REAL PROPERTY	HENCE MAE O-TRUSTEE	8400 WOODSON CT
51-320-02-62-00-0-00-000	2020-2021	REAL PROPERTY	COURTNEY SCOTT M & KRISTEN RILEY	8402 WESTRIDGE CT
51-320-03-36-00-0-00-000	2021	REAL PROPERTY	GREEN CHARLAN & RODNEY K SR	11701 E 86TH TER
51-320-03-73-00-0-00-000	2021	REAL PROPERTY	BUMGARDNER RICHARD	11627 E 85TH ST
51-320-04-16-00-0-00-000	2021	REAL PROPERTY	GAVIN PATRICIA M	8503 WESTRIDGE RD
51-320-08-11-00-0-00-000	2021	REAL PROPERTY	DILLARD PATRICIA L	11803 E 85TH ST
51-320-08-12-00-0-00-000	2021	REAL PROPERTY	JOHNSON GLENDORA	11801 E 85TH ST
51-320-08-15-00-0-00-000	2020-2021	REAL PROPERTY	MARTIN CHERYL-TRUSTEE	8529 VASSAR AVE
51-320-08-16-00-0-00-000	2020-2021	REAL PROPERTY	MARTIN CHERYL-TRUSTEE	8531 VASSAR AVE

CITY OF RAYTOWN
Request for Board Action

Date: April 7, 2022
To: Mayor and Board of Aldermen
From: Jason Hanson, City Engineer

Resolution No.: R-3450-22

Department Head Approval: _____

Finance Director Approval: _____ (only if funding is requested)

City Administrator Approval: _____



Action Requested: Authorization to approve an agreement with McAnany Construction Inc. for street maintenance improvements at a cost not to exceed \$360,000.00.

Recommendation: Staff recommends approval as submitted.

Analysis: The Public Works Department received 2 sealed bids that were opened on Wednesday, March 30, 2022, at 2:00 pm.

McAnany Construction Inc. - \$360,000.00
Superior Bowen Asphalt Company, LLC - \$389,301.73

This project will improve (1) one street section:
83rd Street, from Spring Valley Road to Raytown Road

This work will consist of spot curb/gutter repairs, 3" asphalt repairs, sidewalk repairs, ADA improvements, utility lid adjustments, and pavement markings. The whole section of road will receive UBAS surface over it.

Ultra-Thin Bonded Asphalt Surface (UBAS) is a hot mix asphalt overlay (0.5-inch) placed over a heavy asphalt emulsion layer or membrane. The system is placed on a structurally sound flexible pavement that may exhibit minor amounts of raveling or cracking. The primary function of the ultra-thin bonded wearing course is to provide a durable, friction resistant surface on an existing flexible pavement to restore a smooth surface.

The current Transportation Sales Tax Fund budget has \$400,000.00 budgeted in Repairs and Maintenance Services for contracted street maintenance.

Alternatives: Do not do the project and leave the roadways as is.

Budgetary Impact:

- Not Applicable
- Budgeted item with available funds
- Non-Budgeted item with available funds through prioritization
- Non-Budgeted item with additional funds requested

Fund: Transportation Sales Tax Fund, 204-62-00-100-53600
Amount to Spend: not to exceed \$360,000.00

Additional Reports Attached: Bid results, project location map, and bid recommendation letter from Lamp Rynearson Engineers.

RESOLUTION NO.: R-3450-22

A RESOLUTION AUTHORIZING THE CITY ADMINISTRATOR TO ENTER INTO AN AGREEMENT WITH MCANANY CONSTRUCTION INC FOR THE 2022 ULTRATHIN BONDED ASPHALT SURFACE PROJECT IN AN AMOUNT NOT TO EXCEED \$360,000.00 FOR FISCAL YEAR 2021-2022

WHEREAS, the City of Raytown (the "City") issued a invitation to bid on its 2022 Ultrathin Bonded Asphalt Surface Project for street maintenance within the City; and

WHEREAS, the Public Works Department received two (2) bids in response to the invitation and has determined that the bid submitted by McAnany Construction Inc. in the amount of \$360,000.00 for the 2022 Ultrathin Bonded Asphalt Surface Project was the most advantageous bid received; and

WHEREAS, the City finds McAnany Construction Inc. meets all of the qualifications as the lowest and best bidder for the project; and

WHEREAS, the Board of Aldermen find it is in the best interest of the City to enter into an agreement with McAnany Construction Inc. in the amount of \$360,000.00 for such purposes; and

NOW THEREFORE, BE IT RESOLVED BY THE BOARD OF ALDERMEN OF THE CITY OF RAYTOWN, MISSOURI, AS FOLLOWS:

THAT the Agreement by and between the City of Raytown and McAnany Construction Inc. in the amount of \$360,000.00 for the 2022 Ultrathin Bonded Asphalt Surface Project within the City, attached hereto as Exhibit "A" and incorporated herein, is hereby authorized and approved; and

FURTHER THAT the City Administrator is hereby authorized to execute any and all documents and to take any and all actions necessary to effectuate the terms of the Agreement and exercise the authority granted herein on behalf of the City.

PASSED AND ADOPTED by the Board of Aldermen and **APPROVED** by the Mayor of the City of Raytown, Missouri, the 12th day of April, 2022.

Michael McDonough, Mayor

ATTEST:

Approved as to Form:

Teresa M. Henry, City Clerk

Jennifer M. Baird, City Attorney



BID RESULTS

2022 UBAS Project

Wed., March 30, 2022 -- 2:00pm

CONTRACTOR	Total Bid
1. McAnany Construction	\$360,000.00
2. Superior Bowen Asphalt Co., LLC	\$389,301.73
Engineer's Estimate	\$462,908.60

UBAS Project Location Map

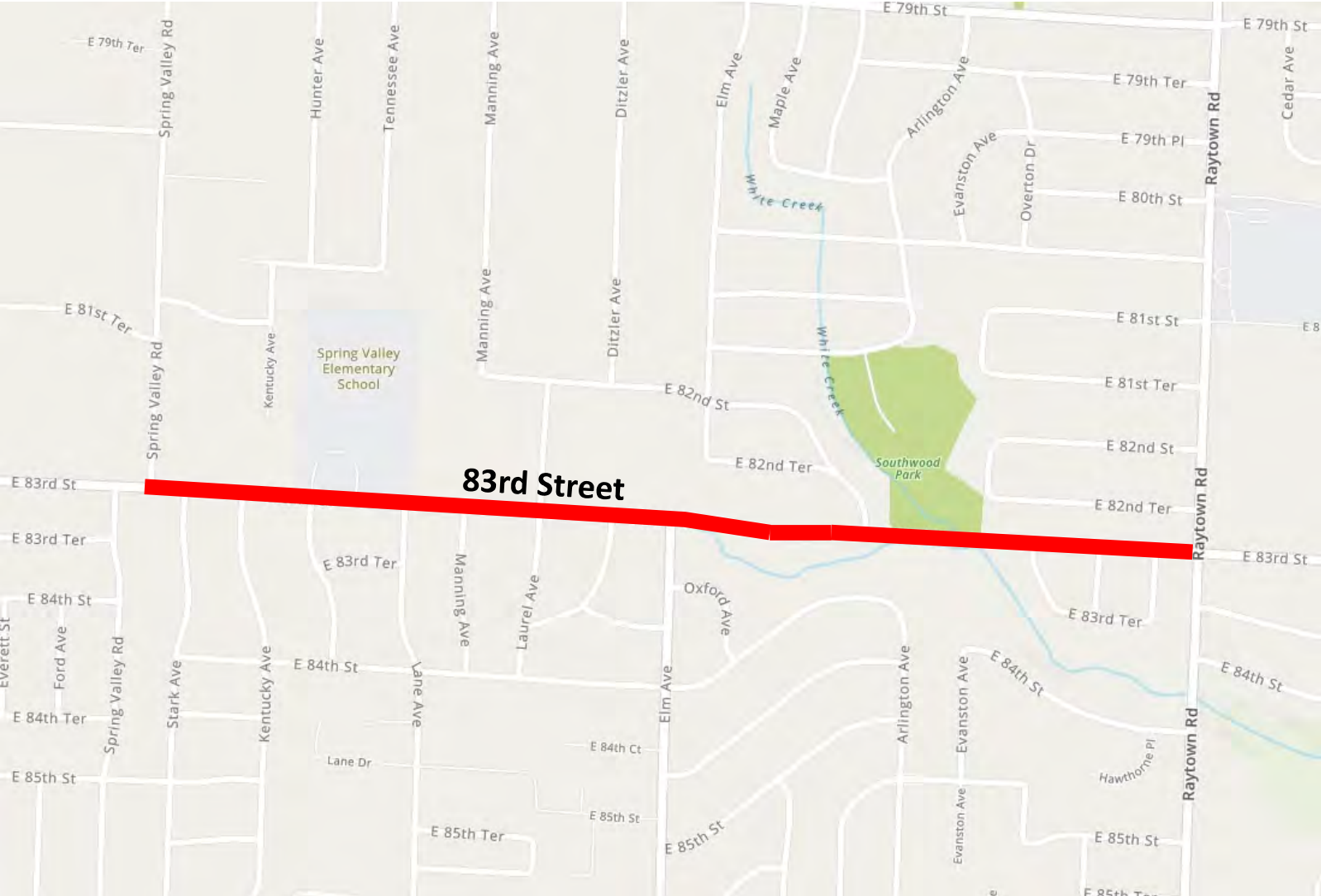

March 31, 2022

Jose M. Leon Jr.
Director of Public Works
City of Raytown, MO
10000 E 59th Street
Raytown, Missouri 64133

**Re: 2022 UBAS Project
Bid Recommendation Letter**

Dear Mr. Leon:

Bids were received for the above referenced project on Wednesday March 30, 2022.

A total of two bids were received. The low bid was submitted by McAnany Construction in the amount of \$360,000.00. The engineers estimate for the project was \$462,908.60.

We have frequently worked with McAnany included on the 2021 Base Repair project in Raytown and found them to be a qualified contractor. I have attached the bid tabulation and they have supplied and the have supplied their subcontractor list. After consultation with City staff we recommend that McAnany Construction be awarded the contract.

You may contact me with any questions, or if you need additional information.

Sincerely,
LAMP RYNEARSON



Greg Van Patten, P.E.
Senior Project Engineer

CC:
Email C: Project File
Jason Hanson, P.E. – City Engineer, City of Raytown
Dan Miller, P.E. – Civil Design Group Leader

COMPLETED BID TAB											
2022 UBAS PROJECT											
RAYTOWN, MISSOURI											
March 30, 2022											
				ENGINEERS ESTIMATE		MCANANY CONSTRUCTION INC.		SUPERIOR BOWEN CO. LLC		AVERAGE MINUS ENGINEERS ESTIMATE	
Item No.	Item Description	Unit	Estimated Quantity	Unit Price	Total	Unit Price	Total	Unit Price	Total	Unit Price	Total
1	Mobilization	LS	1	\$ 20,000.00	\$ 20,000.00	\$ 13,106.97	\$ 13,106.97	\$ 9,600.00	\$ 9,600.00	\$ 11,353.49	\$ 11,353.49
2	Traffic Control	LS	1	\$ 8,589.60	\$ 8,589.60	\$ 6,562.50	\$ 6,562.50	\$ 7,500.00	\$ 7,500.00	\$ 7,031.25	\$ 7,031.25
3	Concrete Blockout (Water Valve) (Manhole)	EA	13	\$ 2,600.00	\$ 33,800.00	\$ 2,467.50	\$ 32,077.50	\$ 1,565.00	\$ 20,345.00	\$ 2,016.25	\$ 26,211.25
4	Base Asphalt Repair (3")	SY	924	\$ 60.00	\$ 55,440.00	\$ 35.00	\$ 32,340.00	\$ 49.80	\$ 46,015.20	\$ 42.40	\$ 39,177.60
5	Curb and Gutter (Combined) (CG-2) (Remove and Replace) (KCMMB4K)	LF	1049	\$ 55.00	\$ 57,695.00	\$ 43.75	\$ 45,893.75	\$ 63.85	\$ 66,978.65	\$ 53.80	\$ 56,436.20
6	Sidewalk (4") (Remove and Replace) (KCMMB4K)	SF	1401	\$ 15.00	\$ 21,015.00	\$ 10.75	\$ 15,060.75	\$ 16.40	\$ 22,976.40	\$ 13.58	\$ 19,018.58
7	Sidewalk Ramp with Detectable Warnings (6") (Remove and Replace) (KCMMB4K)	SF	315	\$ 16.00	\$ 5,040.00	\$ 33.00	\$ 10,395.00	\$ 28.30	\$ 8,914.50	\$ 30.65	\$ 9,654.75
8	Detectable Warnings	SF	49	\$ 65.00	\$ 3,185.00	\$ 63.00	\$ 3,087.00	\$ 60.00	\$ 2,940.00	\$ 61.50	\$ 3,013.50
9	Macrotecture	SY	21217	\$ 2.50	\$ 53,042.50	\$ 1.55	\$ 32,886.35	\$ 1.50	\$ 31,825.50	\$ 1.53	\$ 32,355.93
10	UBAS, Residential	SY	21217	\$ 7.00	\$ 148,519.00	\$ 5.65	\$ 119,876.05	\$ 5.80	\$ 123,058.60	\$ 5.73	\$ 121,467.33
11	Sign Assembly	EA	6	\$ 500.00	\$ 3,000.00	\$ 472.50	\$ 2,835.00	\$ 530.00	\$ 3,180.00	\$ 501.25	\$ 3,007.50
12	Restore Pavement Markings (White) (24") (Stop Bar) (Thermoplastic)	LF	28	\$ 15.00	\$ 420.00	\$ 16.80	\$ 470.40	\$ 16.80	\$ 470.40	\$ 16.80	\$ 470.40
13	Restore Pavement Markings (Double Yellow) (4") (Centerline) (Thermoplastic)	LF	4259	\$ 2.00	\$ 8,518.00	\$ 1.44	\$ 6,132.96	\$ 1.45	\$ 6,175.55	\$ 1.45	\$ 6,154.26
14	Restore Pavement Markings (White) (4") (Thermoplastic)	LF	9550	\$ 1.00	\$ 9,550.00	\$ 0.72	\$ 6,876.00	\$ 0.73	\$ 6,971.50	\$ 0.73	\$ 6,923.75
15	Restore Pavement Markings (White) (4") (Dashed) (Thermoplastic)	LF	216	\$ 1.00	\$ 216.00	\$ 0.72	\$ 155.52	\$ 0.73	\$ 157.68	\$ 0.73	\$ 156.60
16	Restore Pavement Markings (White) (6") (Crosswalk) (Thermoplastic)	LF	199	\$ 1.50	\$ 298.50	\$ 5.25	\$ 1,044.75	\$ 5.25	\$ 1,044.75	\$ 5.25	\$ 1,044.75
17	Restore Pavement Markings (White) (24") (Piano Keys) (Preformed Thermoplastic)	LF	60	\$ 18.00	\$ 1,080.00	\$ 16.80	\$ 1,008.00	\$ 16.80	\$ 1,008.00	\$ 16.80	\$ 1,008.00
18	Restore Pavement Markings (Yield Triangles) (Preformed Thermoplastic)	EA	6	\$ 200.00	\$ 1,200.00	\$ 120.75	\$ 724.50	\$ 120.00	\$ 720.00	\$ 120.38	\$ 722.25
19	Restore Pavement Markings (Bike Lane Symbols) (Preformed Thermoplastic)	EA	43	\$ 500.00	\$ 21,500.00	\$ 441.00	\$ 18,963.00	\$ 440.00	\$ 18,920.00	\$ 440.50	\$ 18,941.50
20	Restore Pavement Markings (Turn Arrow) (Preformed Thermoplastic)	EA	2	\$ 400.00	\$ 800.00	\$ 252.00	\$ 504.00	\$ 250.00	\$ 500.00	\$ 251.00	\$ 502.00
21	Force Account	Set	1	\$ 10,000.00	\$ 10,000.00	\$ 10,000.00	\$ 10,000.00	\$ 10,000.00	\$ 10,000.00	\$ 10,000.00	\$ 10,000.00
				TOTAL	\$ 462,908.60		\$ 360,000.00		\$ 389,301.73		\$ 374,650.87

Greg VanPatten

From: Eric Vossman <ericv@mcananyconstruction.com>
Sent: Thursday, March 31, 2022 4:17 PM
To: Greg VanPatten; Ben McAnany
Subject: Re: Raytown

[EXTERNAL EMAIL]

Concrete – Lantel Construction
Traffic Control/Striping – Twin Traffic



McANANY

ERIC VOSSMAN

President

ericv@mcananyconstruction.com

m (913) 207-3516

o (913) 631-5440

mcananyconstruction.com

CITY OF RAYTOWN
Request for Board Action

Date: April 7, 2022
To: Mayor and Board of Aldermen
From: Jason Hanson, City Engineer

Resolution No.: R-3451-22

Department Head Approval: _____

Finance Director Approval: _____ (only if funding is requested)

City Administrator Approval: _____

Action Requested: Authorization to approve an agreement with McConnell & Associates Corp. for street improvements at a cost not to exceed \$372,354.08.

Recommendation: Staff recommends approval as submitted.

Analysis: The Public Works Department received 5 sealed bids that were opened on Wednesday, March 30, 2022, at 2:00 pm.

McConnell & Associates - \$372,354.08
J.M. Fahey Construction - \$372,783.00
Amino Brothers - \$402,563.03
Gunter Construction - \$497,126.00
Leavenworth Excavating - \$539,884.65

This project will improve (4) four street sections:
83rd Terrace, Evanston, Overton, and Hawthorne

This neighborhood street reconstruction project work will consist of complete asphalt street reconstruction with some spot curb repair and inlet lids replacement. The whole section of the 4 roads will be completely removed and replaced from bottom to top with an engineered subgrade (6"), asphalt street base (4"), and an asphalt street surface (2").

The current Transportation Sales Tax Fund budget has \$675,000.00 budgeted in Capital Expenditures for street reconstruction.

Alternatives: Do not do the project and leave the roadways as is.

Budgetary Impact:

- Not Applicable
- Budgeted item with available funds
- Non-Budgeted item with available funds through prioritization
- Non-Budgeted item with additional funds requested

Fund: Transportation Sales Tax Fund, 204-62-00-100-57000
Amount to Spend: not to exceed \$372,354.08

Additional Reports Attached: Bid results, project location map, core samples, proposed street section, example pictures and bid recommendation letter from Lamp Rynearson Engineers.

A RESOLUTION AUTHORIZING THE CITY ADMINISTRATOR TO ENTER INTO AN AGREEMENT WITH MCCONNELL & ASSOCIATES CORP. FOR THE 2022 NEIGHBORHOOD STREET RECONSTRUCTION PROJECT IN AN AMOUNT NOT TO EXCEED \$372,354.08 FOR FISCAL YEAR 2021-2022

WHEREAS, the City of Raytown (the "City") issued a invitation to bid on the 2022 Neighborhood Street Reconstruction Project for completed asphalt street reconstruction with some spot curb repair and inlet lid replacement within the City; and

WHEREAS, the Public Works Department received five (5) bids in response to the invitation and has determined that the bid submitted by McConnell & Associates Corp. in the amount \$372,354.08 was the most advantageous bid received; and

WHEREAS, the City finds McConnell & Associates Corp. meets all of the qualifications as the lowest and best bidder for the project; and

WHEREAS, the City desires to enter into an agreement with McConnell & Associates Corp. in the amount of \$372,354.08 for the 2022 Neighborhood Street Reconstruction Project; and

NOW THEREFORE, BE IT RESOLVED BY THE BOARD OF ALDERMEN OF THE CITY OF RAYTOWN, MISSOURI, AS FOLLOWS:

THAT an Agreement by and between the City of Raytown and McConnell & Associates Corp. in the amount of \$372,354.08 for the 2022 Neighborhood Street Reconstruction Project within the City, attached hereto as Exhibit "A" and incorporated herein, is hereby approved; and

FURTHER THAT the City Administrator is hereby authorized to execute any and all documents and to take any and all actions necessary to effectuate the terms of the Agreement and exercise the authority granted herein on behalf of the City.

PASSED AND ADOPTED by the Board of Aldermen and **APPROVED** by the Mayor of the City of Raytown, Missouri, the 7th day of April, 2022.

Michael McDonough, Mayor

ATTEST:

Teresa M. Henry, City Clerk

Approved as to Form:

Jennifer M. Baird, City Attorney



BID RESULTS

2022 Neighborhood Street Reconstruction Project

Wed., March 30, 2022 -- 2:00pm

CONTRACTOR	Total Bid
1. McConnell & Associates Corp.	\$372,354.08
2. J.M. Fahey Construction Co.	\$372,783.00
3. Amino Brothers Co., Inc.	\$402,563.03
4. Gunter Construction Company	\$497,126.00
5. Leavenworth Excavating & Equipment Co., Inc.	\$539,884.65
Engineer's Estimate	\$433,922.50

Neighborhood Street Reconstruction Project Location Map

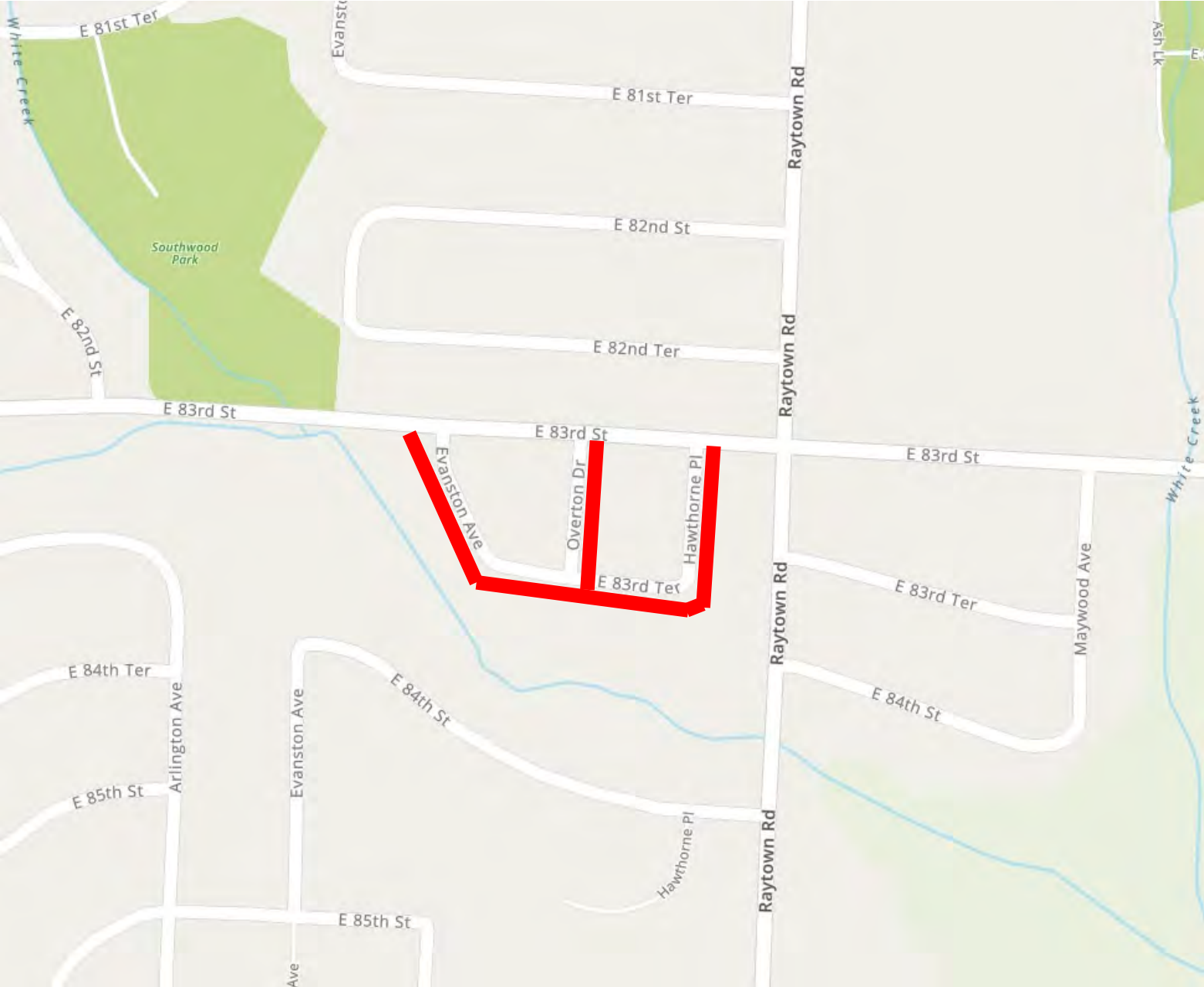

Neighborhood Street Reconstruction Project

Core sample pictures



Neighborhood Street Reconstruction Project

New Street Section Design

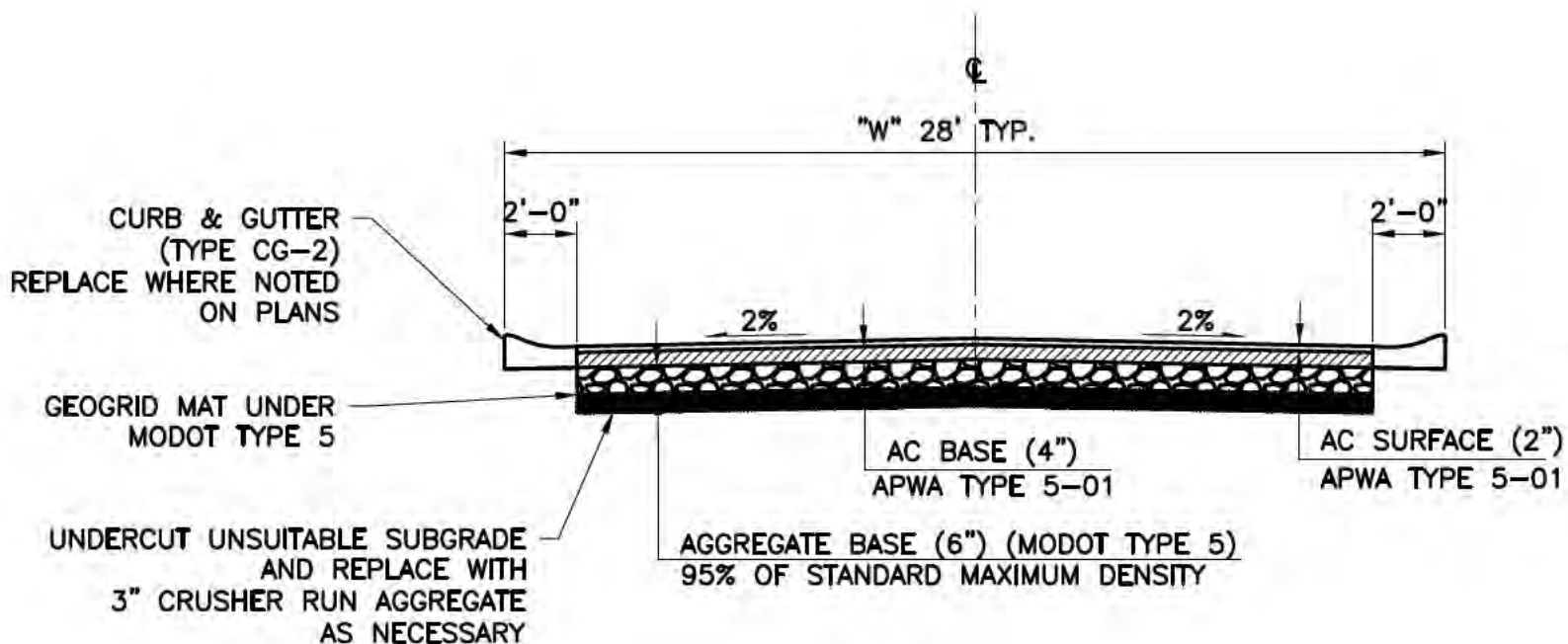

TYPICAL STREET SECTION



Public Works Department

10000 East 59th Street
Raytown, Missouri 64133
(816) 737-6012
www.raytown.mo.us



Examples of similar work:



Established in 1849 as Ray's Town
On the Santa Fe, California and Oregon Trail

March 31, 2022

Jose M. Leon Jr.
Director of Public Works
City of Raytown, MO
10000 E 59th Street
Raytown, Missouri 64133

**Re: 2022 Neighborhood Street Reconstruction Project
Bid Recommendation Letter**

Dear Mr. Leon:

Bids were received for the above referenced project on Wednesday March 30, 2022.

A total of five bids were received. The low bid was submitted by McConnell and Associates in the amount of \$372,354.08. The engineers estimate for the project was \$433,922.50.

We have worked with McConnell and Associates several times over the last two years and found them to be a qualified contractor. I have attached the bid tabulation and they have supplied project references and subcontractors. After consultation with City staff we recommend that McConnell and Associates be awarded the contract.

You may contact me with any questions, or if you need additional information.

Sincerely,
LAMP RYNEARSON



Greg Van Patten, P.E.
Senior Project Engineer

CC:
Email C: Project File
Jason Hanson, P.E. – City Engineer, City of Raytown
Dan Miller, P.E. – Civil Design Group Leader

COMPLETED BID TAB																	
2022 NEIGHBORHOOD STREET RECONSTRUCTION PROJECT																	
RAYTOWN, MISSOURI																	
March 30, 2022																	
Item No.	Item Description	Unit	Estimated Quantity	ENGINEERS ESTIMATE		MCCONNELL AND ASSOCIATES CORP.		J.M. FAHEY CONSTRUCTION		AMINO BROTHERS		GUNTER CONSTRUCTION COMPANY		LEAVENWORTH EXCAVATING & EQUIPMENT CO. INC.		AVERAGE MINUS ENGINEERS ESTIMATE AND HIGH BID	
				Unit Price	Total	Unit Price	Total	Unit Price	Total	Unit Price	Total	Unit Price	Total	Unit Price	Total	Unit Price	Total
1	Mobilization	L.S.	1	\$ 30,000.00	\$ 30,000.00	\$ 11,100.00	\$ 11,100.00	\$ 20,000.00	\$ 20,000.00	\$ 12,571.00	\$ 12,571.00	\$ 37,070.00	\$ 37,070.00	\$ 61,000.00	\$ 61,000.00	\$ 20,185.25	\$ 20,185.25
2	Traffic Control	L.S.	1	\$ 5,000.00	\$ 5,000.00	\$ 3,000.00	\$ 3,000.00	\$ 5,500.00	\$ 5,500.00	\$ 3,020.00	\$ 3,020.00	\$ 2,500.00	\$ 2,500.00	\$ 2,200.00	\$ 2,200.00	\$ 3,505.00	\$ 3,505.00
3	Erosion Control	L.S.	1	\$ 3,000.00	\$ 3,000.00	\$ 600.00	\$ 600.00	\$ 2,000.00	\$ 2,000.00	\$ 550.00	\$ 550.00	\$ 750.00	\$ 750.00	\$ 1,120.00	\$ 1,120.00	\$ 975.00	\$ 975.00
4	Clearing, Grubbing, Demolition	L.S.	1	\$ 84,878.30	\$ 84,878.30	\$ 61,000.00	\$ 61,000.00	\$ 83,000.00	\$ 83,000.00	\$ 67,000.00	\$ 67,000.00	\$ 115,950.00	\$ 115,950.00	\$ 77,900.00	\$ 77,900.00	\$ 81,737.50	\$ 81,737.50
5	Inlet Lid (Remove and Replace) (6'x4')	E.A.	5	\$ 2,500.00	\$ 12,500.00	\$ 2,240.00	\$ 11,200.00	\$ 2,500.00	\$ 12,500.00	\$ 3,300.00	\$ 16,500.00	\$ 2,500.00	\$ 12,500.00	\$ 4,460.00	\$ 22,300.00	\$ 2,635.00	\$ 13,175.00
6	Unsuitable Subgrade (Remove and Replace with 3" Crusher Run Aggreg	TON	200	\$ 50.00	\$ 10,000.00	\$ 65.00	\$ 13,000.00	\$ 55.00	\$ 11,000.00	\$ 121.00	\$ 24,200.00	\$ 90.00	\$ 18,000.00	\$ 65.00	\$ 13,000.00	\$ 82.75	\$ 16,550.00
7	Geogrid Subgrade Reinforcement	S.Y.	4351	\$ 8.00	\$ 34,808.00	\$ 3.27	\$ 14,227.77	\$ 5.00	\$ 21,755.00	\$ 5.75	\$ 25,018.25	\$ 8.00	\$ 34,808.00	\$ 6.20	\$ 26,976.20	\$ 5.51	\$ 23,952.26
8	Aggregate Base (6") (MoDOT Type 5)	S.Y.	4351	\$ 12.20	\$ 53,082.20	\$ 8.21	\$ 35,721.71	\$ 10.00	\$ 43,510.00	\$ 15.00	\$ 65,265.00	\$ 15.00	\$ 65,265.00	\$ 14.70	\$ 63,959.70	\$ 12.05	\$ 52,440.43
9	Temporary Aggregate	L.S.	1	\$ 10,000.00	\$ 10,000.00	\$ 1,200.00	\$ 1,200.00	\$ 2,500.00	\$ 2,500.00	\$ 5,200.00	\$ 5,200.00	\$ 19,000.00	\$ 19,000.00	\$ 96,140.00	\$ 96,140.00	\$ 6,975.00	\$ 6,975.00
10	Curb and Gutter (Combined) (CG-2)	L.F.	105	\$ 70.00	\$ 7,350.00	\$ 50.00	\$ 5,250.00	\$ 125.00	\$ 13,125.00	\$ 110.00	\$ 11,550.00	\$ 95.00	\$ 9,975.00	\$ 82.80	\$ 8,694.00	\$ 95.00	\$ 9,975.00
11	Asphaltic Concrete Base (4") (APWA Type 5 MOD)	TON	1028	\$ 90.00	\$ 92,520.00	\$ 112.74	\$ 115,896.72	\$ 73.00	\$ 75,044.00	\$ 82.54	\$ 84,851.12	\$ 86.00	\$ 88,408.00	\$ 78.30	\$ 80,492.40	\$ 88.57	\$ 91,049.96
12	Asphaltic Concrete Surface (2") (APWA Type 5 MOD)	TON	529	\$ 96.00	\$ 50,784.00	\$ 113.72	\$ 60,157.88	\$ 81.00	\$ 42,849.00	\$ 88.54	\$ 46,837.66	\$ 100.00	\$ 52,900.00	\$ 87.15	\$ 46,102.35	\$ 95.82	\$ 50,686.14
13	Force Account	SET	1	\$ 40,000.00	\$ 40,000.00	\$ 40,000.00	\$ 40,000.00	\$ 40,000.00	\$ 40,000.00	\$ 40,000.00	\$ 40,000.00	\$ 40,000.00	\$ 40,000.00	\$ 40,000.00	\$ 40,000.00	\$ 40,000.00	\$ 40,000.00
				TOTAL	\$ 433,922.50		\$ 372,354.08		\$ 372,783.00		\$ 402,563.03		\$ 497,126.00		\$ 539,884.65		\$ 411,206.53

REFERENCES ATTACHMENT

OWNER: CITY OF RAYTOWN, MISSOURI

CONTRACTOR: _____

WORK: 2022 Neighborhood Street Reconstruction Project

BID NO.: _____

REFERENCE

Public Owner: Roeland Park KS

Project/Contract Name: CARS 2020 Roe Blvd

Location of Project: Roe Boulevard, Roeland Park

Contract Price: \$734,155.48

Project Started: 3/2021 Completed: 7/2021

Owner's Representative (Name and Telephone):
Donnie Scharff 913-722-2600

Bidder's Representative (Name and Telephone):
Jared Dakin 816-518-8724

Scope of Project: _____
Concrete, Asphalt, Landscaping, Striping

REFERENCE

Public Owner: Platte County MO

Project/Contract Name: 2021 Concrete Curb Repair

Location of Project: Highlands of Weatherby Subdivision

Contract Price: \$63,069.00

Project Started: 4/13/21 Completed: 4/23/21

Owner's Representative (Name and Telephone):
Bob Heim 816-858-2223

Bidder's Representative (Name and Telephone):
Jared Dakin 816-518-8724

Scope of Project: Curb Replacement

REFERENCE

Public Owner: Westwood Hills KS

Project/Contract Name: CARS 2021 50th & State Line

Location of Project: 50th & State Line, Westwood Hills KS

Contract Price: \$85,012.00

Project Started: 8/2021 Completed: 9/2021

Owner's Representative (Name and Telephone):
Paula Schwach 913-262-6622

Bidder's Representative (Name and Telephone):
Jared Dakin 816-518-8724

Scope of Project: _____
Concrete, Trench Drain, Landscaping, Street Light

REFERENCE

Public Owner: Liberty MO

Project/Contract Name: City Park Parking Lot Project

Location of Project: Liberty City Park

Contract Price: \$535,028.00

Project Started: 6/2020 Completed: 10/2021

*delayed by other projects concurrently at the park and COVID

Owner's Representative (Name and Telephone):
Tom Garland 816-439-4384

Bidder's Representative (Name and Telephone):
Jared Dakin 816-518-8724

Scope of Project: _____
Storm, Site Grading, Concrete, Asphalt, Striping

LIST OF SUBCONTRACTORS

In the following spaces please list the required information for all sub-contractors working on this project:

Contractor Name: Erosion Specialists, LLC
Street Address: 681599 PO BOX
City, State, Zip: Riverside, MO 64168
Phone Number: 816-321-1847
Number of years in business performing this type of work: _____

Contractor Name: _____
Street Address: _____
City, State, Zip: _____
Phone Number: _____
Number of years in business performing this type of work: _____

Contractor Name: _____
Street Address: _____
City, State, Zip: _____
Phone Number: _____
Number of years in business performing this type of work: _____

Contractor Name: _____
Street Address: _____
City, State, Zip: _____
Phone Number: _____
Number of years in business performing this type of work: _____

CITY OF RAYTOWN
Request for Board Action

Date: April 7, 2022 **Resolution No.:** R-3452-22
To: Mayor and Board of Aldermen
From: Damon Hodges, City Administrator and
Dave Turner, Parks and Recreation Director

Department Head Approval: _____

Finance Director Approval: _____

City Administrator Approval: _____



Action Requested: Board of Aldermen approval directing City staff to seek non-matching 100% federal funding for various qualified City of Raytown projects as permitted through the United States House of Representatives, and a letter of support for the funding request.

Recommendation: Staff recommends approval to apply for 100% federal project funding, with no local matching funds.

Analysis: Recently, the City was contacted by Congressman Cleaver's office about a new source of grant funding through the U.S. House of Representatives. The City of Raytown staff would like to apply for Congressional earmarked funds to be spent on Parks and Recreation projects; infrastructure and redevelopment projects and Community Development projects. The process will be to communicate with Congressman Cleaver's office to show the need for federal financial assistance. Initial projects will be the improvement to the condition of the Kenagy Pond and ADA accessibility at that location, and for phase 2 of the 53rd Street redevelopment project. The application deadline for this round of grant projects through the U.S. House of Representatives is April 15, 2022.

This would provide funds for a project in FY2023 that would be fully funded by Congressional earmarked spending projects.

Alternatives: Do not approve the application and direct staff to seek alternate methods for project funding.

Budgetary Impact:

Not Applicable

Additional Reports Attached: Supporting documents attached.

A RESOLUTION AUTHORIZING AND APPROVING THE APPLICATION FOR CONGRESSIONAL EARMARKED FUNDS THROUGH THE U.S. HOUSE OF REPRESENTATIVES

WHEREAS, the City of Raytown (the “City”) will apply for congressional earmark funds through the U.S. House of Representatives to be spent on Parks and Recreation projects; infrastructure and redevelopment projects and Community Development projects; and

WHEREAS, the Board of Aldermen find it is in the best interests of the City to authorize and approve the application for the Congressional earmarked funding;

NOW THEREFORE, BE IT RESOLVED BY THE BOARD OF ALDERMEN OF THE CITY OF RAYTOWN, MISSOURI, AS FOLLOWS:

THAT the application for congressional earmark funds through the U.S. House of Representatives to be spent on Parks and Recreation projects; infrastructure and redevelopment projects and Community Development projects is hereby authorized and approved; and

FURTHER THAT the City Administrator is hereby authorized to execute any and all other documents necessary or incidental thereto and to take any and all actions necessary to effectuate the terms of the grant on behalf of the City and the City Clerk is authorized to attest thereto.

PASSED AND ADOPTED by the Board of Aldermen and **APPROVED** by the Mayor of the City of Raytown, Missouri, the 12th day of April, 2022.

Michael McDonough, Mayor

ATTEST:

Teresa M. Henry, City Clerk

Approved as to Form:

Jennifer M. Baird, City Attorney