

# Xerox Versant 180 Press Customer Expectation & Installation Guide

Xerox Versant 180 Press with  
Xerox<sup>®</sup> EX-i 180 Print Server powered by EFI  
Xerox<sup>®</sup> EX-180 Print Server powered by EFI



Copyright 2016 Xerox Corporation

Copyright protection claimed includes all forms and matters of copyrighted material and information now allowed by statutory or judicial law or hereinafter granted, including without limitation, material generated from the software programs that are displayed on the screen such as styles, templates, icons, screen displays, looks, etc.

XEROX®, sphere symbol, and all Xerox product names and product numbers mentioned in this publication are trademarks of XEROX CORPORATION. All non-Xerox brands and product names may be trademarks or registered trademarks of the respective companies, and are hereby acknowledged.

Product appearance, build status and/or specifications are subject to change without notice.

# Table of Contents

## Product Overview ..... 1

- Introduction* ..... 1
- Productivity ..... 1
- Cost Control ..... 1
- System/Product Configuration ..... 1
- Options ..... 2

## Detailed Specifications..... 6

- Product Specifications* ..... 6
- System Specifications ..... 6
- Device Specifications ..... 7
- Operating Environment ..... 7
- Electrical Requirements ..... 8
- Feature Specifications ..... 8
- Device Management ..... 10
- Tray Switching and Mixed Media Test Results* ..... 13
- Press Productivity Modes ..... 13
- Integrated Scanner Productivity Charts ..... 13
- Printer Server / Controller* ..... 14
- EX-i 180 / EX 180 Print Server Options ..... 14
- Responsibility Matrix ..... 22
- Feeding Specifications* ..... 23
- Finishing Specifications* ..... 24
- Offset Catch Tray (OCT) ..... 24
- GBC Advanced Punch Pro ..... 24
- High Capacity Stacker (HCS) ..... 27
- Production Ready Finisher ..... 28
- C-Z Folder ..... 31
- SquareFold Trimmer Module ..... 31
- Business Ready Finisher (BR Finisher) ..... 36
- Business Ready Booklet Maker Finisher (BR Booklet Marker Finisher) ..... 37
- 2-Knife Trimmer Module\* ..... 38
- Third Party Finishing Options ..... 38
- Media and Substrate* ..... 38

## Maintenance and Support..... 40

- Customer / Operator Maintenance* ..... 40
- Automated Color Quality Suite (ACQS) (Optional Performance Package) ..... 40
- SIQA ..... 41
- Support Services* ..... 41

Call Procedure .....	41
Product Sustainability .....	41
Supplies and Consumables .....	41
Recommended Supplies .....	42
Initial Supplies .....	42

## Installation Planning ..... 43

<i>Main Components</i> .....	43
Press Components (Base Configuration) .....	43
Optional Feeding / Finishing .....	43
<i>Module Dimensions and Weights</i> .....	43
Dimension and Weights for the Press .....	43
Dimensions and Weights for Optional Devices .....	43
Dimensions and Weights for the EX-i 80 Print Server .....	44
Dimensions and Weights for the EX-80 Print Server .....	44
Print Server Cables (common for print servers) .....	44
Module Dimensions for Optional Third Party Finishing Devices .....	44
<i>Space Requirements / Service Space Envelope</i> .....	45
Movable Configurations and Minimizing Space Requirements .....	45
Service / Operational Space Chart .....	45
Service Space Envelope .....	45
<i>Floor Information</i> .....	46
<i>Electrical Requirements</i> .....	47
Press Electrical Requirements .....	47
Electrical Requirements for Optional Devices .....	47
Electrical Requirements for the Print Servers .....	48
Determining Circuit Requirements .....	48
<i>Electrical Installation Considerations</i> .....	48
Press Electrical Considerations .....	49
Electrical Considerations for Optional Devices .....	49
Electrical Considerations for Print Servers .....	49
Information Applicable to All Electrical Devices .....	49
Other Installation Considerations .....	50
<i>Environmental Requirements</i> .....	50
Environmental Requirements & Performance for the Press .....	50
<i>Customer Site Survey</i> .....	51
Pre-installation Worksheet .....	51
Customer Site Description .....	52
Site Preparation Checklist .....	54

## Operational Considerations ..... 56

<i>Image Quality Expectations</i> .....	56
Image Quality .....	56
<i>Printing Expectations</i> .....	56
Product Limitations and Caveats .....	56
Integrated Fiery and EX Print Server: .....	57
Factors Affecting Productivity and Rated Print Speed .....	57

<i>Envelopes</i> .....	57
Envelope Feeding Guidelines and Limitations .....	57
<i>Customer Expectations Agreement</i> .....	59



# Product Overview

## Introduction

This document is intended to help you understand the performance and capabilities of the Xerox® Versant 180 Press, including information on optional accessories. Installation planning information is provided later in this document and contains specifications and guidelines for installing your press. Specifications and data in this document include Xerox and customer proprietary information. The customer will use all reasonable efforts to safeguard the document, will not disclose its contents to third parties, and should only circulate it within the organization on a need-to-know basis.

## Product Highlights

### Productivity

- Improvements in imaging and fusing technology enable more sellable prints to more customers
  - New compact belt fuser drives up to 80 ppm speeds (single-sided letter/A4).
  - New Ultra HD Resolution that produces incredibly smooth sweeps and spectacularly sharp images, graphics and text.
  - New low gloss, low melt EA dry ink/toner that provides brilliant, vibrant and powerful images.
- Simple Image Quality Adjustment (SIQA) tool utilizes the on-board scanner to ensure that you spend more time printing and less time adjusting the press.
  - Create registration profiles by stock and tray, making the registration front to back better aligned.
  - Perform density adjustments to correct slight variations inboard to outboard (“smile” correction).
  - Adjust transfer settings to improve mottle on textured stocks

### Cost Control



- Remote Services helps ensure market-leading press availability
- Longer-life components
- Scalable and modular solutions simplify workflows for one or many presses
- Automated Color Quality Suite delivers consistent, accurate, and automated color, which reduces waste, cost and time (optional with Performance Package)





### System/Product Configuration









Base Configuration	
Feeding	Press with three main trays and control panel with touch screen
Output	(Not shown) Choice of Finishing Options
Print Server	(Not shown) Choice of Print Server Options
Multi-sheet Inserter (MSI)	<ul style="list-style-type: none"> <li>• Tray is also referred to as Tray 5 / Bypass</li> <li>• Mounts on top of optional 1-Tray OHCF or Advanced HCF</li> <li>• Maximum 250 sheet capacity</li> </ul>
Scanner	Duplex Automatic Document Feeder



## Options

Feeding Options	
 High Capacity Feeder (letter)	<ul style="list-style-type: none"> <li>• Single tray, holds up to 2,000 sheets</li> <li>• 8.5 x 11 in / A4 – Long Edge Feed (LEF)</li> </ul>
 1-Tray Oversized High Capacity Feeder	<ul style="list-style-type: none"> <li>• Single tray holds up to 2,000 sheets and size up to 13 x 19.2 in / 330 x 487.7mm</li> </ul>
 Advanced High Capacity Feeder	<ul style="list-style-type: none"> <li>• Two tray, holds up to 2,000 sheets each (4,000 total) and sizes up to 13 x 19.2 in / 330 x 487.7mm</li> <li>• An additional Dual Advanced High Capacity Feeder can be optionally added to the 2-Tray Advanced High Capacity Feeder</li> </ul>

Finishing Options	
<b>IMPORTANT:</b> Refer to Configuration Dependencies for information on configuration requirements for the finishing devices.	
 Offset Catch Tray (OCT)	Holds a maximum of 500 sheets
 BR Finisher	The BR Finisher features include basic stapling and hole punching.
 BR Booklet Finisher	The BR Booklet Finisher adds saddle stitching capability
 Interface Decurler Module	The Interface Decurler Module acts as a paper path from the press to the finishing device; it allows communication between the press and the finishing device. The Interface Module also cools and decurls paper as it exits the press and before it enters the finishing device.
Interface Decurler ILS Module	The Interface Decurler ILS Module is required to enable the Performance Package configuration of the Versant 180 Press. It contains additional cooling technology to enable the press to run all stock weights at rated speed, as well as housing the Inline Spectrophotometer (ILS) which is used to automate calibration and profiling at the DFE.
 GBC® AdvancedPunch® Pro	The GBC AdvancedPunch Pro is an inline die punch that utilizes modular die sets to enable a variety of hole-punch patterns from A4/8.5 x 11 in. (LTR/letter) Long-Edge-Feed (LEF) to 12x18 or SRA3 media. LTR die punch ships with a 21-hole die set which can be used on A4 sheets or can be customized by removing 2 pins create a 19-hole die for use with letter sheets.



Finishing Options	
<b>IMPORTANT:</b> Refer to Configuration Dependencies for information on configuration requirements for the finishing devices.	
<p>High Capacity Stacker (HCS)</p> 	<p>The HCS is designed for long production runs:</p> <ul style="list-style-type: none"> <li>• Top tray has a maximum 500 sheet capacity</li> <li>• Stacking a maximum of 5,000 sheets (based on 80 gsm centerline paper) and offsetting the output in the stack tray/cart</li> <li>• The movable stack tray/cart provides easy transition of the output to off-line finishing</li> <li>• An additional stack tray/cart is available for the customer to order</li> <li>• Sample prints are additional prints that are directed to the top tray for inspection. Sample prints are not produced by redirecting sheets from the stack tray/cart to the top tray; therefore the contents in the stack tray/cart are complete</li> </ul>
<p>Production Ready Finisher</p> 	<p>The Production Ready Finisher features include a stapler, stacker tray, and top exit tray. It also includes a built-in decurler unit that corrects the curl on paper output from the print engine.</p> <p>Options for the Production Ready Finisher:</p> <ul style="list-style-type: none"> <li>- C/Z Folder</li> <li>- Basic Punch</li> <li>- Inserter</li> </ul>
<p>Production Ready Booklet Maker Finisher</p> 	<p>The Production Ready Booklet Maker Finisher features include a stapler, the stacker tray, top exit tray, and a booklet unit capable of saddle stapling and bi-fold. It also includes a built-in decurler unit that corrects the curl on paper output from the print engine.</p> <p>Options for the Production Ready Booklet Maker Finisher:</p> <ul style="list-style-type: none"> <li>- C/Z Folder</li> <li>- Basic Punch</li> <li>- Inserter</li> </ul>
<p>Production Ready Finisher Plus</p> 	<p>The Production Ready Finisher Plus includes the functionality of the Production Ready Finisher and adds interface/trans- port module to enable connection to third party finishing solutions. An optional C/Z Folder is available which includes the C-Fold, Z-Fold, and Z-Fold Half Sheet. Refer to C/Z Folder for more information.</p>
<p>C/Z Folder</p> 	<p>This optional unit can perform C-Fold, Z-fold, and Z- Fold Half-Sheet (also called Engineering Z-Fold). The C/Z Folder can be added to these finishing devices:</p> <ul style="list-style-type: none"> <li>• Production Ready Finisher</li> <li>• Production Ready Booklet Maker</li> <li>• Production Ready Finisher Plus</li> </ul>
<p>Basic Punch</p>	<p>This optional module can perform a basic in-line punch function. The Basic Punch can be added to these finishing devices:</p> <ul style="list-style-type: none"> <li>• Production Ready Finisher</li> <li>• Production Ready Booklet Maker Finisher</li> <li>• Production Ready Finisher Plus</li> </ul>
<p>Inserter</p> 	<p>This optional unit can be used to insert sheets into jobs to be finished without having to go through the print engine (e.g. pre-printed covers, etc.). The Inserter can be added to these finishing devices:</p> <ul style="list-style-type: none"> <li>• Production Ready Finisher</li> <li>• Production Ready Booklet Maker Finisher</li> <li>• Production Ready Finisher Plus</li> <li>• High Capacity Stacker</li> </ul>

Finishing Options	
<b>IMPORTANT:</b> Refer to Configuration Dependencies for information on configuration requirements for the finishing devices.	
Two-sided Trimmer 	This optional device can perform a two sided trim to the top and bottom of finished sets. The Two-sided Trimmer can be added to these finishing devices: <ul style="list-style-type: none"> <li>• Production Ready Finisher</li> <li>• Production Ready Booklet Maker Finisher</li> <li>• Production Ready Finisher Plus</li> </ul>
SquareFold® Trimmer Module 	This optional device is available only with the Production Ready Booklet Maker Finisher (with or without the C/Z Folder). The SquareFold Trimmer Module flattens the spine of the booklet and trims the face of the booklet.
2-Knife Timmer ( <i>unavail. in North America</i> ) 	This optional device is available only with the SquareFold Trimmer module. Provides full-bleed trim up to 3/16" (5mm) thickness, adjustable trim dimensions, no DFA required.

Other Options	
Foreign Interface Kit	The Foreign Interface Kit enables the connection of external devices such as audiotrons or coin-op devices. This will perform in copy and print modes.
Convenience Stapler	Staple up to 50 sheets of 90 gsm/24 lb media.
Common Access Card Enablement Kit	Security feature to identify user based on two-factor identification requirement – access card plus user PIN.
Network Accounting Kit	Enables reporting and user/device management in combination with optional accounting solutions.
USB Enablement Kit	Enables scan-to-USB functionality.

Configuration Dependencies	
The following dependencies are required for all or certain configurations:	
Performance Package	Not compatible with: <ul style="list-style-type: none"> <li>• EFI Integrated</li> <li>• BR Finisher</li> <li>• OCT</li> </ul>
Interface Module	The Interface Module is required with any system configuration that has one or more finishing devices, except the OCT or either BR Finishers. Required on system configurations with: <ul style="list-style-type: none"> <li>• HCS</li> <li>• Production Ready Finisher</li> <li>• Production Ready Booklet Maker Finisher</li> <li>• Production Ready Finisher Plus</li> <li>• GBC AdvancePunch Pro</li> </ul>
GBC AdvancedPunch Pro	Requires Interface Module plus: <ul style="list-style-type: none"> <li>• HCS and / or</li> <li>• Production Ready Finisher</li> <li>• Production Ready Booklet Maker Finisher</li> <li>• Production Ready Finisher Plus</li> </ul>
SquareFold Trimmer Module	This device requires the Interface Module and the Production Ready Booklet Maker Finisher. The SquareFold Trimmer Module is not available with any other finishing device.
Two-sided Trimmer, Basic Punch, & Inserter	These devices require the Interface Decurler Module and the Production Ready Finisher, Production Ready Booklet Maker Finisher, or the Production Ready Finisher Plus.
Production Ready Finisher Plus	This device requires the Interface Module and a third-party finishing device.
BR Finisher BR Booklet Finisher	<ul style="list-style-type: none"> <li>• Must be ordered with V-Tra module</li> <li>• Not compatible with any other finisher</li> <li>• Does not require Interface Module</li> </ul>
2-Knife Trimmer ( <i>unavail. in North America</i> )	This device requires the Interface Module, the Production Ready Finisher Booklet Maker and the SquareFold Trimmer.

Versant 180 Press

Print Server Options -- North America	EX-i 80	EX 80	EX 80 w/ PP
Fiery Graphic Arts Premium Edition	N/A	O	O
Fiery Compose license	N/A	O	S
Fiery Impose license	O	S	S
FACI Kit	N/A	O	S
EFI Color Profiler Suite	O	O	S
ES-2000 Spectro (Incl. w/ color prof. suite)	O	O	S
Removable HDD	N/A	O	O

Standard – S, Optional – O, Not Applicable – NA

Print Server Options -- Europe	EX-i 80	EX 80	EX 80 w/ PP
Fiery Graphic Arts Premium Edition	N/A	O	O
Fiery Compose license	N/A	S	O
Fiery Impose license	O	S	S
FACI Kit	N/A	O	O
EFI Color Profiler Suite	O	O	O
ES-2000 Spectro (Incl. w/ color prof. suite)	O	S	S
Removable HDD	N/A	N/A	N/A

Standard – S, Optional – O, Not Applicable – NA

# Detailed Specifications

## Product Specifications

All references to media capacity are based on the Xerox Centerline Paper. Centerline Paper identifies the stock at the middle of the range of stocks that will deliver optimum performance for a given characteristic. Other paper weights and brands may alter performance (for example, paper tray capacities).

Media Type	Xerox Versant® 180 Press Centerline Paper
Uncoated paper	North America - Xerox Color Xpressions Plus (24 lb / 90 gsm) Europe – Xerox Colotech+
Coated paper	North America - Xerox Digital Color Elite Gloss (80 lb / 120 gsm) Europe - Xerox Digital Color Elite Gloss (80 lb / 120 gsm)

## System Specifications

Print Speed and Monthly Volume	Xerox Versant® 180 Press
Print Speed	<u>With</u> Performance Package: <ul style="list-style-type: none"> <li>Up to 80 ppm all paper weights.</li> </ul> <u>Without</u> Performance Package: <ul style="list-style-type: none"> <li>Up to 80 ppm 52 – 220 gsm</li> <li>Up to 60 ppm 221-350 gsm</li> </ul>
Recommended Average Monthly Print Volume <sup>1</sup>	25,000 to 80,000 pages
Maximum Monthly Duty Cycle <sup>2</sup>	Up to 750,000 pages

1 The Average Monthly Print Volume is the expected regular monthly throughput for 8.5x11/A4 paper.

2 The Monthly Duty Cycle is the maximum volume capacity expected in any one month. This volume is supported under standard vendor supplied service for any single month but is not expected to be sustained on a regular basis. Customers should consider higher volume machines or multiple machines if average monthly volume approaches the maximum duty cycle on a continual basis.

**NOTE:** Refer to the following for more detailed specification information: [Feature Specifications](#), [Print Engine Productivity Charts](#), and [Feeding from the Bypass Tray 5](#).

The press is designed to operate in the range of 25,000 – 80,000 prints per month. At an average usage of 43,000 prints per month using centerline paper, it is expected that service will be required about once every 3.5 weeks. Prints between service calls on a digital color press depend upon individual customer requirements for quality, volume, applications, and throughput material. Generally, customers who participate in formal operator training from Xerox experience better performance, improved productivity, and reduced service activity.

The recommended maximum Black-only (K-only) volume is 20 % of total monthly volume, or up to 8,600 K-only AMPV.

Service Rates	Xerox Versant © 180 Press	
Service Call	Approximately one call every 3.5 weeks.	At average usage of 43,000 prints per month on centerline paper  Actual service call rate is influenced by total print volume, environmental conditions, area coverage, and media characteristics.
Shutdown	On average, less than 1 fault per week requiring a power-recycle to recover.	Based on 43,000 AMPV, one 8-hour shift per day, using centerline papers.

Customers will also achieve improved system uptime and elimination of certain service calls through the Technical Key Operator Replaceable Units (TKORU) program. TKORU is a self-maintenance program that will enable trained operators to replace certain parts (Fuser Belt Module, Pressure Roll, Stripper Finger Assembly, and Pressure Roll Cleaning Pad) and perform other service and diagnostic tasks. The TKORU program will provide supplies, documentation, and Technical Key Operator training, which will be scheduled with the Xerox Customer Service Engineer at, or shortly after, installation. Following the initial TKORU training, if the customer requires additional people to be trained it may be chargeable or the service pricing maybe adjusted. If the customer fails to perform the TKORU maintenance tasks, the service entity will be able to charge the customer for the service labor performing these tasks.

**Technology**

- Simple Image Quality Adjustment (SIQA)
- Ultra HD Resolution for extremely fine details from rendering and VCSEL ROS technologies
- Automated Color Quality Suite (ACQS) (optional)
- Closed-loop color process controls
- Xerox® EA Low Melt Dry Ink
- Bias Charge Rolls with auto cleaning technology
- Compact Belt Fuser technology
- Smart Decurler Module built into paper path resulting in flat sheets
- Long life photoreceptors
- Modular feeding and finishing
- Advanced Customer Care Design

**Connectivity**

Refer to Print Server [Network Specifications](#) section.

## Device Specifications

**Control Panel Language Support**

US English, Brazilian Portuguese, Catalan, Czech, Danish, Dutch, Finnish, German, Greek, Hungarian, International English, International French, International Spanish, Italian, Norwegian, Polish, Romanian, Russian, Swedish, Turkish

**Certifications**

- FCC Class A Compliant (US)
- ICES Class A Compliant (Canada)
- CSA Listed (UL 60950-1, Second Edition)
- CB Certified (IEC 60950-1, Second Edition)
- ENERGY STAR®
- Environmental Choice
- CE Marked
- IPv6
- EPEAT Silver

**Dimensions and Weights**

Configuration	Width	Depth	Height	Weight
Base Configuration	67.5 in / 1714 mm	33 in / 831 mm	57 in / 1714 mm	651 lb / 295 kg





For a detailed configurations table refer to the [Installation](#) section.

## Operating Environment

Operating Environment	Xerox Versant® 180 Press
Required Temperature Range	50° to 90° F (10° to 32° C)
Required Relative Humidity	15% to 85% RH
Altitude (above sea level)	Max of 8,200 feet (2,500 meters)
Sound Pressure Levels	Running: 63.0 dBA Standby: 36.1 dBA

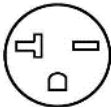
For detailed information, refer to [Environmental Requirements for the Press](#).

## Electrical Requirements

Electrical	Xerox Versant® 180 Press
Press	<p>North America Receptacle: 208–240 VAC, 50/60 Hz, NEMA 6-20R</p>  <p>Europe: receptacle that mates to the PCE Shark 023-6 plug (shown below) 220 – 240 VAC, 50Hz</p>  
Additional electrical required for print server, feeding / finishing devices. (Note: HCF, BR Finisher and BR Booklet Finisher plug directly into press and require no additional receptacle.)	<p>Nema 5-15R or 5-20R</p>  

For detailed information refer to [Electrical Requirements](#).

Power Consumption	Xerox Versant® 180 Press
Voltage	<p>XC – 208 - 240 V XE – 220 - 40 V</p>
Power Consumption	<p>XC – 208 – 3.66 kW or less 240 – 4.224 kW or less XE – 220 – 4.4 kW or less 240 – 4.8 kW or less</p>
Standby Mode	1,400 watts
Warm up Time from Power off	≤ 5 minutes

## Feature Specifications

Print	Xerox Versant® 180 Press * Using Centerline Paper	
First Print Out Time (FPOT)	<ul style="list-style-type: none"> <li>In “Ready Mode” the FPOT is on average less than 8 sec. for color and less than 10 sec. for B/W.</li> <li>At initial power on copy/print, the system requires between 30 and 45 seconds to produce the first print.</li> <li>Switching from a Color Mode job to a B/W job or the reverse requires on average between 30-60 seconds.</li> <li>60 seconds is always needed after a paper jam to ensure the system is recovered from possible contamination, and ensure that the image quality is optimized.</li> </ul>	<p>FPOT is measured from the time the Printer starts to the time the trail edge of the sheet exits the Offset Catch Tray.</p> <p>Note: If the system is equipped with various types of finishing devices, the FPOT time will vary depending on the length of the paper path needed to transport that paper.</p>
Resolution	<ul style="list-style-type: none"> <li>2400 x 2400 x 1 dpi** (Print Engine Addressability)</li> <li>1200x1200 dpi RIP resolution</li> <li>10 bits per pixel bit depth</li> </ul> <p>**dpi = dots per inch</p>	<p>Halftones Screens supported:</p> <p>300 dot, 200 line, 175 dot 150 dot, 200 dot, and stochastic</p>

Versant 180 Press

Print	Xerox Versant © 180 Press * Using Centerline Paper	
Line Screens	Halftone Screens <ul style="list-style-type: none"> <li>• 150, 175, 200, 300, 600 Clustered Dot</li> <li>• 150, 200 Rotated Line Screen</li> <li>• FM Screen</li> </ul>	
Front to Back Registration	<ul style="list-style-type: none"> <li>• Internal trays: 64 – 256 gsm: +/- 1.0 mm</li> <li>• 1-Tray OHCF: 64 – 300 gsm: +/-1.0 mm</li> <li>• Advanced HCF: 52 – 300 gsm: +/- 1.0 mm</li> </ul>	Specification applies only to Xerox Versant © 180 Press centerline paper measured on an 11 x 17" (A3) sheet. To achieve registration results with paper other than centerline paper, Xerox recommends that you use SIQA to create custom media profiles. Note that custom cut media may adversely impact registration performance.
Color to Color Registration	≤70 microns	Specification applies on either Color Xpressions or Colotech+ 90 gsm paper.  Specification may vary on papers above 90 gsm.

Print	Xerox Versant © 180 Press * Using Centerline Paper	
Max Printable Area	12.83 in x 18.98 in (326 mm x 482 mm)  (12.83 in. x 25.75 in / 326 mm x 654 mm for Extra Long sheets out of the Bypass Tray)	Guaranteed Image Quality: 12.48 in x 18.98 in (317 mm x 482 mm)  Minimum image distance to edge of sheet: Lead edge = 4mm Side edges = 2mm Trail edge = 2mm
Print Features	See Print Server section.	
Print Solutions	See Print Server section.	
Optional	See Print Server section.	

## Device Management

Features	Xerox Versant © 180 Press
Workflow	
Variable Information Solutions	<ul style="list-style-type: none"> <li>• XMPie®</li> <li>• Xerox® FreeFlow® Variable Information Suite</li> <li>• Other industry partners</li> </ul>
Automation	<ul style="list-style-type: none"> <li>• Xerox® FreeFlow® Core</li> <li>• Xerox® IntegratedPLUS Finishing Solution for Booklets</li> <li>• Xerox® IntegratedPLUS automated Color Management</li> </ul>
Remote Services	
Xerox® Connect Advantage Services	<ul style="list-style-type: none"> <li>• Sophisticated diagnostic technology</li> <li>• Analysis of real-time device performance data, allowing for reactive and proactive problem resolution</li> <li>• Dedicated, highly skilled specialists</li> <li>• Parts prediction</li> <li>• Fault code interpretation and diagnosis</li> <li>• Extensive array of tool and information quickly accessible via the web</li> </ul>
Meters: <ul style="list-style-type: none"> <li>• Color Impressions</li> <li>• Black Impressions</li> <li>• Total Impressions</li> <li>• Color Large Impressions</li> <li>• Extra Long Impressions</li> </ul>	<p>Large Size Definition: For the Versant © 180 Press, a large sheet is defined as having greater than or equal to 145 square inches in total area. For example:</p> <ul style="list-style-type: none"> <li>• 8.5 x 14 in is NOT oversize (119 sq. in)</li> <li>• 11 x 17 in is oversize (187 sq. in)</li> <li>• A3 is oversize (124740 sq. mm)</li> <li>• A4 is NOT oversize (62370 sq. mm)</li> </ul> <p>Extra Long Definition: For billing* on the Versant 180 Press, an extra long sheet is defined as having a length that is greater than 19.33 inches / 491mm.</p> <p><i>(*note: the definition of an Extra Long Sheet for billing purposes (19.33in/491mm) is slightly longer than the technical definition of an Extra Long Sheet (19.2in/488mm) used in the rest of this document.)</i></p>

The following tables show the maximum print speed of the press across the full range of paper sizes that the press supports. Unless otherwise noted, the print speed is identical for full-color or black-only prints. Paper weights are stated in grams per square meter (gsm), the references to Bond and Cover weight ranges are approximations based on conversion to the nearest standard paper weight and type.

**NOTE:** The print speeds cited in the charts below are for jobs with one media weight only. The print speeds for mixed media jobs depends on the job itself in addition to the productivity mode that is selected. Please see the tray switching and mixed media results section for more information.

### **Without** Performance Package

Media Size	Paper Feed Length			Media Type / Weight	Press Speed (ppm)		Press Speed from Bypass Tray 5 (ppm)	
	Feed Direction*	Min (in / mm)	Max (in / mm)		Simplex	Duplex	Simplex	Duplex
8.5x11 in / A4	LEF	7.2 / 182.0	8.5 / 216.0	Uncoated and Coated Paper	80	40	53	27



Media Size	Paper Feed Length			Media Type / Weight	Press Speed (ppm)		Press Speed from Bypass Tray 5 (ppm)	
	Feed Direction*	Min (in / mm)	Max (in / mm)		Simplex	Duplex	Simplex	Duplex
8.5x11 in / A4	SEF	8.51 / 216.1	11.7 / 298.0	<b>(52 - 220 gsm)</b> (18 lb. Bond -80 lb. Cover)  <b>NOTE:</b> Papers heavier than 256 gsm (90 lb. Cover) cannot be fed from internal Trays 1-3	64	32	46	23
8.5x14 in / B4	SEF	11.71 / 298.1	14.3 / 365		51	26	39	20
11x17 in / A3	SEF	14.4 / 366	17 / 432.0		44	22	34	17
12x18 in / SRA3	SEF	17.1 / 431.9	19 / 486.2		37	19	32	16
13x19.2 in	SEF	19.1 / 482.7	19.2 / 488		37	19	31	16
8.5x11 in / A4	LEF	7.2 / 182.0	8.5 / 216.0	Uncoated and Coated Paper <b>221-350 gsm*</b> (110 lb. Cover- 130 lb. Cover)  <b>NOTE:</b> Papers heavier than 300 gsm (110 lb. Cover) cannot be auto-duplexed	60	30	48	24
8.5x11 in / A4	SEF	8.51 / 216.1	11.7 / 298.0		48	24	40	20
8.5x14 in / B4	SEF	11.71 / 298.1	14.3 / 365		38	19	33	17
11x17 in / A3	SEF	14.4 / 366	17 / 432.0		32	16	28	14
12x18 in / SRA3	SEF	17.1 / 431.9	19 / 482.6		29	15	26	13
13x19.2 in	SEF	19.1 / 482.7	19.2 / 488	29	15	26	13	
8.5x11 in / A4	LEF	7.2 / 182.0	8.5 / 216.0	Labels and Transparencies (106 - 300 gsm)	40	20	39	20
8.5x11 in / A4	SEF	8.51 / 216.1	11.7 / 298.0		32	16	32	16
8.5x14 in / B4	SEF	11.71 / 298.1	14.3 / 365		25	13	25	13
11x17 in / A3	SEF	14.4 / 366	17 / 432.0		22	11	21	11
12x18 in / SRA3	SEF	17.1 / 431.9	19 / 482.6		20	10	19	10
8.5x11 in / A4	LEF	7.2 / 182.0	8.5 / 216.0	Tab Paper (106 - 176 gsm)	64	-	53	-

\* LEF = Long edge feed; SEF = Short edge feed

**With Performance Package**

Media Size	Paper Feed Length			Media Type / Weight	Press Speed (ppm)		Press Speed Feeding from Bypass Tray 5 (ppm)	
	Feed Direction*	Min (in / mm)	Max (in / mm)		Simplex	Duplex	Simplex	Duplex
8.5x11 in / A4	LEF	7.2 / 182.0	8.5 / 216.0	Uncoated and Coated Paper <b>(52 - 220 gsm)</b> (18 lb. Bond -80 lb. Cover)  <b>NOTE:</b> Papers heavier than 256 gsm (90 lb. Cover) cannot be fed from internal Trays 1-3	80	40	53	27
8.5x11 in / A4	SEF	8.51 / 216.1	11.7 / 298.0		64	32	46	23
8.5x14 in / B4	SEF	11.71 / 298.1	14.3 / 365		51	26	39	20
11x17 in / A3	SEF	14.4 / 366	17 / 432.0		44	22	34	17
12x18 in / SRA3	SEF	17.1 / 431.9	19 / 482.6		37	19	32	16
13x19.2 in	SEF	19.1 / 482.7	19.2 / 488	37	19	31	16	
8.5x11 in / A4	LEF	7.2 / 182.0	8.5 / 216.0	Uncoated and Coated Paper <b>221-350gsm</b> (110 lb. Cover- 130 lb. Cover)  <b>NOTE:</b> Papers heavier than 300 gsm (110 lb. Cover) cannot be auto-duplexed	80	40	53	27
8.5x11 in / A4	SEF	8.51 / 216.1	11.7 / 298.0		64	32	46	23
8.5x14 in / B4	SEF	11.71 / 298.1	14.3 / 365		51	26	39	20
11x17 in / A3	SEF	14.4 / 366	17 / 432.0		44	22	34	17
12x18 in / SRA3	SEF	17.1 / 431.9	19 / 482.6		37	19	32	16
13x19.2 in	SEF	19.1 / 482.7	19.2 / 488	37	19	31	16	
8.5x11 in / A4	LEF	7.2 / 182.0	8.5 / 216.0	Labels and Transparencies (106 - 300 gsm)	40	20	39	16
8.5x11 in / A4	SEF	8.51 / 216.1	11.7 / 298.0		32	16	32	16
8.5x14 in / B4	SEF	11.71 / 298.1	14.3 / 365		25	13	25	13
11x17 in / A3	SEF	14.4 / 366	17 / 432.0		22	11	21	11
12x18 in / SRA3	SEF	17.1 / 431.9	19 / 482.6		20	10	19	10

Media Size	Paper Feed Length			Media Type / Weight	Press Speed (ppm)		Press Speed Feeding from Bypass Tray 5 (ppm)	
	Feed Direction*	Min (in / mm)	Max (in / mm)		Simplex	Duplex	Simplex	Duplex
8.5x11 in / A4	LEF	7.2 / 182.0	8.5 / 216.0	Tab Paper (106 - 176 gsm)	64	-	53	-

\* LEF = Long edge feed; SEF = Short edge feed

# Tray Switching and Mixed Media Test Results

## Press Productivity Modes

The Xerox Versant 180 Press allows the user to select from 2 Productivity Modes that impact the print speed of mixed media jobs. Descriptions of these modes and test results are cited below. Note – test results refer to Versant 180 speeds without the Performance Package. Performance Package test results will be released in a future edition of this document.

**Optimized for Speed:** (Default mode) This mode uses the maximum temperature for the heaviest stock within the job and won't stop to adjust the fuser temperature.

**Optimized for Quality:** This mode adjusts the fuser temperature for each stock weight range and the system productivity will slow down to allow the press to adjust the fuser temperature when necessary.

The following table provides test results on several job types that utilize mixed media and that require paper tray switching. These jobs were tested by Xerox to provide representative productivity. Results for similar jobs may vary depending on the Print Server, specific media, paper trays, and print mode that are used.

Job Description	Configuration or Settings	Optimized for Speed	Optimized for Quality
10 sheets: <ul style="list-style-type: none"> <li>All 8.5 x 11 in LEF 90 gsm</li> <li>Alternating between two trays; 1 sheet per tray</li> </ul>	<ul style="list-style-type: none"> <li>Run to HCS and Production Ready Finisher Stacker Tray with set offset</li> <li>Auto Tray Switch Timing set to Tray Near Empty</li> </ul>	80	80
10 sheets: <ul style="list-style-type: none"> <li>All 8.5 x 11 in LEF</li> <li>Sheets 1 and 10, 210 gsm</li> <li>Sheets 2-9, 90 gsm</li> </ul>	<ul style="list-style-type: none"> <li>Run to Production Ready Finisher Stacker Tray with set offset</li> <li>Auto Tray Switching defined in the job</li> <li>1-Sided</li> </ul>	80	13
3 sheets from different trays: <ul style="list-style-type: none"> <li>All 8.5 x 11 in LEF</li> <li>Sheet 1: 200gsm (Tray 1)</li> <li>Sheet 2: 90gsm (Tray 2)</li> <li>Sheet 3: 90gsm (Tray 3)</li> </ul>	<ul style="list-style-type: none"> <li>Run to Production Ready Finisher Stacker Tray with set offset</li> <li>Auto Tray Switching defined in the job</li> <li>1-Sided</li> </ul>	80	4
30 sheets: <ul style="list-style-type: none"> <li>All 11 x 17 in</li> <li>90 gsm uncoated</li> <li>Sheets 1-10: Tray 1</li> <li>Sheets 11-20: Tray 2</li> <li>Sheets 21-30: Tray 3</li> </ul>	<ul style="list-style-type: none"> <li>Run to Production Ready Finisher Stacker Tray with set offset</li> <li>Auto Tray Switching defined in the job</li> <li>1-Sided</li> </ul>	44	44
23 sheets: <ul style="list-style-type: none"> <li>All 8.5 x 11 in LEF</li> <li>90gsm</li> <li>4 from tray 1, 1 from tray 3, repeat 3 times</li> <li>Then 1 from tray 1, 1 from tray 3, repeat 4 times</li> </ul>	<ul style="list-style-type: none"> <li>Run to Production Ready Finisher Stacker Tray with set offset</li> <li>Auto Tray Switching defined in the job</li> <li>1-Sided</li> </ul>	80	80
225 pages: <ul style="list-style-type: none"> <li>8.5 x 11 in</li> <li>210gsm cover</li> <li>90 gsm body with 13</li> <li>9 x 11 in tabs</li> <li>15 sheets between tabs: Cover, 15 sheets, Tab, 15 sheets, Tab, 15 sheets, Cover</li> </ul>	<ul style="list-style-type: none"> <li>Run to Production Ready Finisher Stacker Tray with set offset</li> <li>Auto Tray Switching defined in the job</li> </ul>	75	75

## Integrated Scanner Productivity Charts

The Integrated scanner performs color or black and white scanning at 200 x 200, 300 x 300, 400 x 400, or 600 x 600 dpi resolutions. Expected scanning speeds by document size are shown in the table. Note that the scanner can image both sides of an original simultaneously. Each side of an original is referred to as an "impression", and therefore scan speeds are shown in "Impression Per Minute" (IPM).

## Expected scan speed at 400 dpi or lower:

Document Size and Orientation	1-side B/W Scan Speed (IPM)	1-side Color Scan Speed (IPM)	2-sided B/W Scan Speed (IPM)	2-sided Color Scan Speed (IPM)
A4 LEF	100	100	200	200
A4 SEF	71	71	44	44
A3 SEF	57	57	114	114
8.5" x 11 LEF	100	100	200	200
8.5" x 11 " SEF	75	75	130	130
8.5" x 14 SEF	65	65	130	130
11" x 17"	56	56	112	112

## Expected scan speed at 600 dpi:

Document Size and Orientation	1-side B/W Scan Speed (IPM)	1-side Color Scan Speed (IPM)	2-sided B/W Scan Speed (IPM)	2-sided Color Scan Speed (IPM)
A4 LEF	100	75	200	150
A4 SEF	71	58	142	116
A3 SEF	57	44	114	88
8.5" x 11 LEF	100	75	200	150
8.5" x 11 " SEF	75	61	150	122
8.5" x 14 SEF	65	51	130	102
11" x 17"	56	43	112	86

## Printer Server / Controller

### EX-i 180 / EX 180 Print Server Options

#### Introduction

The purpose of this section is to provide information about the capabilities and potential limitations of the EX-i/EX 180 Print Server for the Xerox Versant 180 Press.

Please see the EX-i/EX Print Server Customer Release Notes document for the Versant 180 Press for additional information and software usage tips.

This chart is a guide of hardware specifications matched to the Press. Minor hardware variations within the model may occur as upgrades take place in the manufacturing process. Any difference in the delivered product will provide functional equivalence to the performance and feature set described herein.

#### Support

Software and hardware support of your print server may vary in regions. Refer to the Terms and Conditions for definitions for software and/or hardware support.

#### Surge Protection

Xerox recommends protecting the EX-i/EX Print Server from surges or spikes in electrical power that can damage the server and result in extended downtime. In areas that tend to experience brownouts or blackouts with more frequency, installation of an Uninterruptible Power Supply (UPS) is suggested. This protection is the responsibility of the customer.

A surge protector is strongly recommended for the network controller installation. This should be provided by the customer.

**Microsoft Windows Certificate of Authenticity (COA)** Microsoft® Windows® 8.1 Professional FES OS License is part of the EX 180 Print Server. Every Xerox EX 180 Print Server includes Software DVDs, an individual Windows 8.1 Professional Certificate of Authenticity (COA) license number that is preprinted on a label placed on the back cover of the EX 180 Print Server. It is the responsibility of the customer to place the booklet and all software DVD/CDs in a secure, but accessible area. The EX 180 Print Server System Software, Windows 8.1 and User Software DVDs along with the license number might be required when performing a complete EX 180 Print Server software installation. The Xerox Service Representative will use the DVDs and the license in case a full system software re- installation is recommended.

EFI may make available system updates to the operating system. These are downloadable from the EX 180 Print Server and are customer installable.

**NOTE:** If the license is lost or misplaced, the customer will be required to purchase a replacement license at his or her own expense.

## Environmental and Electrical Requirements

Refer to [Electrical Requirements](#) and [Environmental Requirements](#) for detailed information.

**NOTE:** The EX-i/EX Print Server requires an electrical outlet.

## Product Recycling and Disposal

Xerox operates a worldwide equipment take back and reuse/recycle program. Contact your sales or service representative to determine whether this Xerox product is part of the program. For more information about Xerox environmental programs, visit [www.xerox.com/environment](http://www.xerox.com/environment).

**NOTE:** This product meets the RoHS standards (Restriction of Hazardous Substances) required for products being installed in the European Union.

## Space Requirements

All standard Xerox space requirements apply to this installation including overhead, shared, aisle or hallway, and operator space. The customer is responsible to provide appropriate floor spacing and placement surface. Refer to [Space Requirements/Service Space Envelope](#) for space requirements that are matched to your Xerox EX-i/EX Print Server.

To enable a Service Representative to safely repair the system, the work area must measure at least 36 inches (91.44 cm) square around the server. There must be a minimum of 78 inches (198.12 cm) clearance from the floor to the nearest overhead obstructions.

The work surface of the network controller must not infringe on the space requirements by the press and any attached accessories unless the work surface is a table that has wheels and can easily be moved. Storage and future availability of software that ships with the color server is a customer responsibility. Xerox personnel do not carry replacement materials.

**NOTE:** Power cord for the EX-i/EX Print Server is approximately 7.5 feet (2.3 meters).

## Specifications

Hardware	EX-i Print Server	EX Print Server
Processors	Intel G1820 2.7 GHz	Intel i5-4570S GHz
Number of Cores	2	4
Bus Speed	5.0 GT/s	5.0 GT/s
Platform OS	Linux	Windows 8.1 Professional FES
System Memory (Minimum)	2 GB	4 GB
Hard Drives Size / RPM (Minimum)	500 GB/7200	1 TB/7200
DVD Drive	No	DVD R/W
Serial Interface	No	No
USB Interfaces (Rear, Front, Internal)	6 (6 – 4 USB 2.0 & 2 USB 3.0,0,0)	9 (6 – 4 USB 3.0 & 2 USB 2.0, 0,3 – USB 3.0, 0)
Monitor Size	No	Optional – 19 in/482.6 mm Flat
EX-i/EX Print Server Software	FS200	FS200 Pro
Stand	No	Optional

Hardware	EX-i Print Server	EX Print Server
Removable Hard Drive	No	Frame is an Option: additional drives are ordered via the TXC (Not avail. in Europe)
Electrical	Refer to <a href="#">Electrical Requirements for the Print Servers</a>	Refer to <a href="#">Electrical Requirements for the Print Servers</a>
BTU/Hour	Refer to <a href="#">Environmental Requirements</a>	Refer to <a href="#">Environmental Requirements</a>
Module Dimensions	Refer to <a href="#">Module Dimensions for the EX-i 80 Print Server</a>	Refer to <a href="#">Module Dimensions for the EX 80 Print Server</a>

## Running Antivirus Software

The EX-i/EX Print Server has not provided testing on any specific anti-virus software. One should refer to the Fiery Security White Paper on how best to choose appropriate antivirus software and what settings should or should not be enabled on the EX-i/EX Print Server.

Commercially available software programs (with the exception of Virus Protection Software) should not be loaded onto the EX-i/EX Print Server.

Additional programs will limit the available disk space the color server requires to operate efficiently.

## Security

Security threats are defined as issues that compromise the integrity of the system, hampering the integrity of job data, compromising secured feature access, or allowing unauthorized data access. The installation of network devices should be done in accordance with existing security paradigms. The EX-i/EX Print Server core software includes security features. To create a more secure network environment, end-users will need to combine the EX-i/EX Print Server security features with other security safeguards. Customers should review the Fiery Security White Paper. This can be made available from your Xerox representative. In addition, one can review EFI or Xerox Products and Anti-Virus Software on [www.xerox.com](http://www.xerox.com) where it states EFI tested compatibility and found no adverse effects when run as described.

The EX-i/EX Print Server for the Xerox Versant® 180 Press offers Secure Erase to ensure the safety of the data on the server hard drive.

- This feature is enabled by default on the EX-i/EX Print Server, but can be disabled by adjusting your settings.

Some IT communities may request a Statement of Volatility (SOV). This document is available. Ask your sales representative for further details.

## Non-standard Paper Size Support

The Press supports non-standard paper sizes. However, due to rounding and unit conversions that occur in the client applications, print server, and printer, some mismatch may occur between the paper size entered at the application and the paper size that must be entered at the printer. The operator may need to adjust the entered paper dimensions by up to 0.1 in (2.5 mm) in order for the printer to detect that the requested paper size has been loaded. In addition, the printer interprets some paper sizes included in the PPD as non-standard sizes.

## Customer Service and Support

Periodically, Xerox will make available bug fixes and other software releases. Some of these bug fixes and upgrades are designed to be customer installable. Updates can be obtained by using the Fiery automatic updates service or going to [www.xerox.com/support](http://www.xerox.com/support). Future upgrades may have costs associated with them.

## Software Replacement

If lost or misplaced, replacement software and documentation is available to be purchased. For the United States, you can access replacements through the Software Services web site <http://www.xdss.com>. If you reside outside the United States, work with your local Xerox Representative. Xerox personnel may not be able to provide services unless these materials are available.

## Professional Support Services

Xerox offers a rich set of value-added services designed to help you plan, implement, and operate your solution in addition to migrate and build your key applications, analyze and optimize your workflow. Your local sales representative and analyst can discuss and demonstrate to you that their professional services can make your business more effective. Professional services are billable by the hour and/or job based depending on the geographic region.

## Adobe PDF Print Engine

The EX 80 Print Server now supports APPE\* v3.0 (Adobe PDF Print Engine) offering native end-to-end pdf workflows. This technology provides important features:

- Improves the consistency and flexibility of PDF output from design to print.
- Supports live transparency and spot color rendering.
- Adobe Common Rendering Engine (ACR): Adobe® Creative Suite and RIP technologies now use a single rendering engine.

The EX 80 Print Server can process CPSI and APPE workflows simultaneously, helps jobs meet customer demands, appearance and performance.

## File Creation

Even with the ability to process files through the Adobe PDF Print Engine there can be variations in processing times and color when comparing this to the traditional CPSI PostScript pathway. It is always best to create files appropriate for the intended production workflow. Image source color profiles, common color conversion working spaces, live vs. flattened transparency should all be considered prior to creation for best end results.

Images that are scaled and rotated to their appropriate angle, size and resolution prior to being placed in a design program will typically process better. Always refer to a design guide for advice.

Xerox offers two booklets as guidelines to help you and your customers. They are The Art & Science of Digital Printing, The Parsons Guide to Getting it Right, and The Xerox Job Preparation Guide for Designers. These items are part of the Xerox ProfitAccelerator® Program. Further information can be found at [www.xerox.com](http://www.xerox.com) under Business Development, or from your local sales representative.

Always read the full documentation and understand how PDFs affect color paths with the print engine. There are many online resources available to help optimize PDF's for printed output.

## File Formats

The following file formats are supported:

- PostScript level 1, 2, or 3 per the PostScript language Reference Manual Supplement v3019 and PDFLib9
- Adobe Portable Document Format version up to 1.9 (Acrobat 11). Supports native PDF processing
- PDF/X-1a, PDF/X-3 and PDF/X-4\*
- PDF/VT-1\* and PDF/VT-2\*
- JPEG\*\*, TIFF, TIFF/IT-P1\*\*, DCS 2.0\*\*, EPS
- PCL 6/C (can be processed by the EX-i/EX Print Server but cannot be selected as an output from the driver)
- Jobs that have been RIPPed
- Fiery FreeForm 1 enhanced, and FreeForm 2.1 VDP
- Xerox VI Compose 11\* (VIPP); license required (available at an additional cost)
- Personalized Print Markup Language (PPML) Version 3.0 Graphic Arts subset\*
- VPS compatible\*
- Jobs submitted from Xerox FreeFlow Workflow Offerings.
- CT/LW\*\*
- Hot Folders, Microsoft Native Formats (DOCX, XLSX, PUB, PPTX) supported through filters for Hot Holders on EX-i/EX

\* EX 180 Only

\*\* Supported with the Graphic Arts Package, Premium Edition, EX 180 Only

## Key Features and Considerations

The following features are available and operate per specification, unless otherwise noted in the customer documentation.

Feature	Description	Comments
EX Print Server JDF v1.5	<ul style="list-style-type: none"> <li>Enables EX Print Server integration with JDF workflow</li> <li>Resides on EX Print Server</li> </ul>	<ul style="list-style-type: none"> <li>Basic JDF/JMF commands are supported. These commands are those that reference the stock, weight, size and color.</li> <li>Not available on the EX-i Print Server.</li> </ul>
EFI Color Profiler Suite	<ul style="list-style-type: none"> <li>A complete, integrated color management tool to ensure color quality control in the printing workflow. The flexible suite is based on EFIs color management solutions.</li> <li>Color Profiler Suite (CPS) consists of the following 4 modules:               <ol style="list-style-type: none"> <li>Profile Creation</li> <li>Profile Evaluation</li> <li>Quality Assurance</li> <li>Profile Editing</li> </ol> </li> <li>Support for the In-Line Sensor</li> </ul>	<ul style="list-style-type: none"> <li>Optional with EX-i/EX printer servers</li> <li>Standard with Performance Package (Optional w/ Performance Package in Europe)</li> <li>Generate Monitor &amp; Printer Profiles, Create Device Links, Inspect &amp; Edit profiles</li> <li>EFI Color Verifier</li> <li>ES2000 Spectrophotometer hardware</li> <li>CPS includes the first year of a Support and Maintenance Agreement. This agreement entitles customers to all updates &amp; upgrades to CPS software. Additional Years of Maintenance can be purchased for a nominal fee.</li> </ul>
Fiery Compose	<ul style="list-style-type: none"> <li>Preview and Edit Jobs easily</li> <li>Compose provides a visual representation of the job so users can confirm the correctness of the job before printing, or modify it as necessary.</li> </ul>	<ul style="list-style-type: none"> <li>Not available with EX-i print server</li> <li>Optional with EX print server</li> <li>Included with Performance Package (Optional w/ Performance Package in Europe)</li> <li>Also handles last-minute editing of text and images with powerful PDF editing capabilities</li> <li>Uses a license activation code for full s/w functionality.</li> </ul>
Fiery Impose	<ul style="list-style-type: none"> <li>A WYSIWYG tool to enable easy creation of imposition layouts.</li> <li>Create unlimited user definable imposition templates.</li> </ul>	<ul style="list-style-type: none"> <li>Standard with Performance Package</li> <li>Standard with EX Print Server</li> <li>Optional on the EX-i Print Server</li> </ul>
Fiery Graphic Arts Package, Premium Edition	Includes: ImageViewer, Paper Simulation Editing, Pre- and Post-flight, Custom Control Bars and other advanced features.	<ul style="list-style-type: none"> <li>Optional with EX Print Server</li> <li>Optional with Performance Package</li> </ul>
Remote Operation	<ul style="list-style-type: none"> <li>Command Workstation 5.8</li> <li>Log into multiple servers.</li> <li>Manipulate jobs from any connected server without having to look at separate applications, or separate windows.</li> <li>Preview print jobs from several different servers at one time.</li> <li>Proof print</li> <li>Use and save EX-i/EX Print Server presets for commonly used settings.</li> <li>Constantly monitor activity on one selected server, or on all connected servers.</li> </ul>	<ul style="list-style-type: none"> <li>Command Workstation is included. A more current version of CWS may be available to download from <a href="http://www.efi.com">www.efi.com</a>.</li> <li>Can run multiple color or monochrome systems from one central site</li> <li>Client memory may limit the number of remote GUIs; 512 Mb minimum of memory required.</li> </ul>
Tab Wizard/ Insert Tab Wizard	<ul style="list-style-type: none"> <li>Set up tabs sets and controls in an easy to use interface.</li> <li>Can choose forward or reverse tabs and a set number of banks of tabs</li> </ul>	<ul style="list-style-type: none"> <li>The user can set up tabs as</li> <li>8.5x11 Tab LEF or A4 Tab</li> <li>LEF in Tab Wizard.</li> </ul>
Booklet Maker 4.0	Easily create booklets in a user friendly environment without trying to program a job ticket	



Feature	Description	Comments
Passes both Altona Suite and Ghent Output Suite	<ul style="list-style-type: none"> <li>• These are two different tests to help a printer comprehend how the EX-i/EX Print Server manages color, PostScript Overprint and other common color print issues.</li> <li>• The tests suites test and verify both PDFX-1A, PD- FX-3 and PDFX-4 capabilities (EX 80 only).</li> <li>• The files are specially designed for testing digital output devices primarily proofing systems as well as conventional and digital printing systems.</li> </ul>	<ul style="list-style-type: none"> <li>• In customer environments where tight color controls are requirements, and/or passing of the Altona Suite, Fogra Media Wedge and Ghent Suite, it is highly recommended to have EFI Profiler to help maintain color consistency.</li> <li>• More information on the Altona Test Suite can be found at: <a href="http://www.altona-atestsuite.de/en/index.php">http://www.altona-atestsuite.de/en/index.php</a></li> <li>• More information on the Ghent Output Suite can be found at: <a href="http://www.gwg.org/">http://www.gwg.org/</a></li> </ul>
Fogra Media Wedge (EX-i/EX Print Server)	<ul style="list-style-type: none"> <li>• The Fogra Media Wedge is a color proofing bar used to monitor and measure color.</li> <li>• It is a comparison tool, designed for checking digital proofs against print standards.</li> </ul>	<ul style="list-style-type: none"> <li>• To maintain tight consistency for this industry standard requires EFI Color Profiler Suite to calibrate and profile engine.</li> <li>• Profiler is recommended to calibrate and profile both the monitor and press and to inspect and measure the output.</li> </ul>
Virtual Printers	<ul style="list-style-type: none"> <li>• Supports ability to create Hot Folders and Virtual Printers</li> <li>• The hot folder relieves the user of the repetitive task of configuring print set- tings for multiple jobs and allows the direct printing of files without need for an application.</li> <li>• Supports native printing through hot folders for Microsoft applications: Microsoft Word, Excel, Publisher and PowerPoint</li> </ul>	<ul style="list-style-type: none"> <li>• Standard feature</li> </ul>
Mixed Media Support	<ul style="list-style-type: none"> <li>• Dynamic media pulls</li> <li>• Recognizes the PostScript command for any stock-related parameter to enable mixed stock jobs</li> <li>• Supports imposed and non-imposed</li> <li>• Paper Catalog</li> </ul>	<ul style="list-style-type: none"> <li>• Tabs are not supported with any imposed job</li> <li>• For imposed jobs, sheet size for that job is fixed and cannot be changed</li> <li>• Mixed media cannot be applied as a record-based attribute inside FreeForm jobs.</li> <li>• Mixed Media settings for FreeForm jobs must be applied to the variable component file.</li> </ul>
Security	<ul style="list-style-type: none"> <li>• User password control</li> <li>• EX Print Server security (log-in) protocol makes shared locations accessible only to authorized users</li> </ul>	<ul style="list-style-type: none"> <li>• Included on EFI Print Server</li> <li>• Microsoft Windows 8.1 operating system and security features are available on EX Print Server</li> </ul>
Secure Erase	<ul style="list-style-type: none"> <li>• The ability to rewrite the hard drive data three times to destroy data.</li> <li>• Department of Defense 5220.22M</li> </ul>	<ul style="list-style-type: none"> <li>• Included on EX-i/EX Print Server</li> </ul>
EX Print Server FACI / Furniture bundle	Furniture stand, GUI Kit (display, keyboard and mouse)	<ul style="list-style-type: none"> <li>• Optional with EX print server</li> <li>• Standard with Performance Package (optional in Europe)</li> </ul>

## Purchasable Options

The following features are available as purchasable options on the EX-i/EX Print Server unless otherwise noted. Speak to your Xerox Sales representative for more information.

Option	Includes	Comments
Removable Hard Disk Drive Kit (not avail. in Europe)	Hardware to enable removable hard disk drives.	<ul style="list-style-type: none"> <li>• Optional on the EX Print Server</li> <li>• This kit will provide a casing that will house the hard disk drive for the DFE. This will allow for the HDD to be removed and locked up if desired.</li> </ul>

## Variable Information

**Note:** This is not supported on the EX-i Print Server

If a customer is successfully running a Xerox® FreeFlow® Variable Information Suite 11.0 (Variable data Intelligent PostScript

Printware) workflow, it will work similarly across the Xerox portfolio when using the EX Print Server. The same Xerox infrastructure in place today will support existing applications on the EX Print Server.

Variable information is a very complex subject. Many variables exist that impact a file. File creation, emitters, PostScript code and type of server, are just a few of the things that will affect Variable Code. It is advisable to test a file prior to gain an understanding of any possible issues in the workflow. A Xerox Analyst can help in the process and there is always opportunity for a customer to correct and develop an efficient workflow to gain the best throughput.

## Network Specifications

The EX-i / EX 180 Print Servers use the following protocols and frame types:

- HTTP and HTTPS browser submission support
- Support for 10/100/1000 Ethernet
- NFS file sharing
- Microsoft Vista®, Windows 7, Windows Server 2008 and Windows 8 support.

**NOTE:** If a DHCP server is not available the Server IP address must be entered manually.

## Printing Services

The EX-i/EX Print Server supports the following printing services and drivers:

- SMB print sharing (over TCP/IP)
- FreeFlow® Print Manager (FFPM is an optional workflow solution) support
- Microsoft® Windows® WHQL (Windows Hardware Quality Labs) printer drivers with Dynamic tray and Status reporting
- Macintosh® OS X full feature drivers
- Adobe PostScript® Printers Descriptions (PPD)
- LPD (Line Printer Daemon) Allows printing in TCP/IP networks using an LPR client and supporting RFC 1179, the Berkeley LPR protocol. Supports direct socket interface via port 9100.
- PAP (Printer Access Protocol) Allows printing in AppleTalk networks.
- NetBIOS printing over TCP/IP
- IPv6 support
- SMB (Server Message Block) Allows printing in Windows networks over TCP/ IP.
- Port 9100 Supports direct socket interface through direct, print and hold queues. Note: Disabling the Port 9100 service also disables the associated IP ports
- FTP Printing Supports printing from an FTP client to the EX-i/EX Print Server.
- IPP Support Internet Printing Protocol (IPP) is an application level protocol that can be used for distributed printing using Internet tools and technologies. This would allow end-user to print to a remote printer on the Internet, as if it were attached to its local area network, by specifying the URL. IPP uses HTTP protocol to provide the underlying communication between the client and the server.

**NOTE:** Disabling the IPP service also blocks port 631.

## Client Specifications

Client	Specifications
Apple® Macintosh®	<ul style="list-style-type: none"> <li>• G4 Power Macintosh or better is strongly recommended</li> <li>• Operating system: OS 10.6 or higher</li> <li>• Protocols: TCP/IP, Bonjour</li> <li>• Recommended memory: A minimum of 500 MB is recommended</li> </ul>
PC	<ul style="list-style-type: none"> <li>• Required platform: PC platform capable of running supported operating system</li> <li>• Operating system: Microsoft Windows Vista*, Windows 7*, and Windows 8*</li> <li>• Protocols: TCP/IP</li> <li>• Recommended memory: Operating system dependent, e.g., Windows 7, 1 GB (32-bit) 2 GB (64-bit)</li> <li>• *Supports both 32 &amp; 64-bit operating systems</li> </ul>
UNIX®	<ul style="list-style-type: none"> <li>• A workstation with standard TCP/IP connectivity</li> <li>• TCP/IP printing software that conforms to RFC1179 (Berkeley lpd protocol)</li> </ul>

## PPDs and Print Drivers

PPDs are provided for Windows Vista, Server 2008, Windows 7 and Windows 8 (Windows Hardware Quality Laboratories tested, [WHQL]) and Apple Macintosh 10.5 or higher. The PC drivers are automatically installed when the printers are installed in the respective PC platforms. Please refer to the user's manual for further installation information. The EX-i/EX 180 Print Servers support the following drivers:

- Microsoft Windows WHQL (Windows Hardware Quality Labs) printer drivers with Dynamic tray and Status reporting
- Macintosh OS 10 full feature drivers
- Adobe PostScript Printers Descriptions (PPD)

**NOTE:** PCL Print Server Drivers are not included.

## EX-i / EX Print Server Software Limitations

### System

- When Secure Erase is enabled (in Configure), certain tasks take longer to complete. These tasks include:
  - Deleting multiple jobs
  - Setting Job Properties for multiple jobs
  - Backup and Restore.

**NOTE:** When Secure Erase is enabled, do not let the hard disk drive fill to maximum capacity. To keep disk storage at a manageable level, delete the jobs in the Hold queue frequently.

- When printing from the EX Print Server via the EX Print Server Advanced Controller Interface (FACI), if you want the default printer of the EX Print Server to be one of the EX Print Server queues, you must set the default printer manually from the FACI.
- Login from Remote Desktop; the login name for the administrator when accessing the EX Print Server from Remote Desktop is admin and must be lowercase.
- Media type **Tab stock** lists paper size selection **161.0 x 210.0 mm LEF** as an option. The option is not supported and will be removed from the list of available options in a future software release.

### Printing

- If a job based on specific media type/weight (for example heavyweight paper) exceeds page limit for selected finishing options (for example: staple) the job is processed and canceled and the error is displayed.
- Half Z-fold finishing option is ignored (without the warning message) for unsupported media size/weight/type. Combination of supported and unsupported media (Mixed Media based jobs) with selected Half Z-fold finishing option is allowed
- If you suspend and then resume printing a job, and then print a second job, Suspend Printing is unavailable. In fact, Resume Printing can still be selected, which is incorrect because the job is being printed. To correct this issue, press Resume printing twice and the Suspend Printing option will become available.

### Print Options

- You cannot print on coated paper if Paper Source is set to Auto Tray Select and Media Type is set to Any. You must choose a specific tray or a specific coated media type.
- If the punch edge is selected not according to the job orientation the job will still be printed without the punch and without the error message.
- If the staple finishing option is selected not according to the job orientation the job will not be printed, instead it will be canceled with an error message.
- To use the Paper Catalog option in Windows 7 when Two-Way Communication is enabled, you must have Administrator privileges. Go to **Control Panel > Administrative Tools > Print Management** and choose **Run As Administrator**. For more information, see [Printing](#).

### Command Workstation

- For color devices, if using the getTIFF macro, commonly used on monochrome devices, the recommendation is to use getFORM. Using getTIFF macros may impair performance. The macro, getFORM, has a wider PDL format support and caching performance.
- If the EX Print Server does not have a static IP address and you want to connect to the EX Print Server with Command WorkStation running on the EX Print Server, enter 127.0.0.1 for the IP address or localhost.
- In Image Enhance Visual Editor, changes are applied to both the selected job and any duplicates of the selected job.
- The maximum copy count in the PPD and Command WorkStation job properties is 9999.
- The maximum number of spot colors per page in a composite overprint file is 32. The maximum number of spot colors is

250 per page with CMYK.

- When the hard disk of the color server is full, jobs sent to the server will not print until the current job is finished and completed jobs are removed from the Printer Queue.
- Jobs archived using any previous version of software may not be backward compatible to other Fiery Print Servers.
- If any Tab or Insert sheet is inserted into a job using the Compose Utility and that particular Tab/Insert is not loaded in the press, the job will error out and move to the Printed Jobs Queue highlighted in pink. If double-clicked this job will say no trays are associated with the media
- inserted through Compose. Load this media in the press and re-submit the job and it will print successfully.

### Print Drivers and Printing

- Windows Print Server printer driver installed with Point and Print: If you install the Windows Print Server printer driver with Point and Print you may receive an error when you view the printer driver properties.
- Printing a job with incompatible Finishing print options: If you try to print a job with incompatible Finishing print options you will receive a message that Finishing could not be completed as selected.
- Correct paper not loaded in the printer: If you print a job and the correct paper is not loaded in the printer, the load paper message may not specify the paper weight you need to load to complete your job. The paper weights are listed in the Customer Release Notes and the paper needed is displayed in the EFI Command Workstation Information panel.
- If you print an APPE job with many spot colors and select Composite Overprint, your job may not print correctly.

### Fiery Impose

Saving APPE jobs in Fiery Impose: When you have imposed a job in Fiery Impose with APPE (Adobe PDF Print Engine) selected in Print Server Job Properties, and saved the job, you cannot go back and make further imposition changes to the imposed job. The default for saving APPE imposed jobs is as a flattened PDF, which does not allow further changes. If you are not satisfied with the imposition choices you have made, start over with the original job.

**NOTE:** If you save the job in .dbp format, you can make further imposition changes, but the job will be RIPped as a PostScript job, not as an APPE job.

### Applications

- If you print a job from Microsoft Word with the page size set to A4 and the EX-i/EX Print Server displays a message indicating that you must load 8.5x11 paper, you must do one of the following:
  - Reprint the job from Microsoft Word and set the paper size to A4 on the Fiery Printing tab of the printer driver.

or

  - Set the paper size for the job to A4 in Command WorkStation Job Properties and reprint the job.
- In general, if print options that are selectable from an application are similar to print options that are specific to the EX-i/EX Print Server and the digital press (on the Fiery Printing tab), use the print options that are specific to the EX-i/EX Print Server and the digital press
- The EX-i/EX Print Server does not support printing from Adobe FreeHand
- If you print a job to the EX-i/EX Print Server from Adobe InDesign after setting the number of copies and selecting the media in the printer driver, the settings might not be applied to the job. If this happens, edit the Job Properties in Command WorkStation and reprint the job
- Internet Explorer 8 and 9; when you display Help files for the EX-i/EX Print Server utilities, all steps start with the number 1. To view Help files correctly, use another browser or an earlier version of Internet Explorer

## Responsibility Matrix

Action	Customer	Carrier	Xerox
Ensure adequate space and power to configure the EX-i/EX Print Server to the print engine.	X		
Unpack system / components		X <sup>3</sup>	
Install server hardware		X <sup>3</sup>	
Connect all System Components prior to powering up the system		X <sup>3</sup>	
Install the printer description files, utilities, and printer drivers on client PCs	X <sup>2</sup>		
Ensure network configuration	X <sup>2</sup>		

Action	Customer	Carrier	Xerox
Confirm network integrity	X		
Acquire and install client workstation network hardware and software	X <sup>2</sup>		
Monitor and Adjust calibration for color matching of color management systems	X		
Load any additional fonts	X		
Procure BNC transceiver for network connection (if required)	X		
Set up and administer client workstations	X		
Provide Helpline Support (when FSMA is purchased)			X <sup>1</sup>
Provide spared parts (when FSMA is purchased)			X <sup>1</sup>
Provide service (when FSMA is purchased)			X <sup>1</sup>
Install all software options designated as customer installable	X		
Secure all system software	X		
Assess site security requirements and configure the print server as needed to satisfy customers IT/Security department	X		
Ensure all sensitive customer data is removed from the server and print engine hard drive before return to Xerox	X		

<sup>1</sup> Field Service Maintenance Agreement (FSMA) is required for these services, for more information, contact your Xerox representative.

<sup>2</sup> A customer can purchase professional consulting hours to have a systems analyst assist in planning and implementing these activities.

<sup>3</sup> The Xerox Versant® 180 Press is delivered and installed by Carriers. The carrier unpacks, installs the hardware, connects the print server to the press, and prints a job from the sample jobs folder. The customer installs all software options.

## Feeding Specifications

Bypass Tray	
Capacity	250 sheet capacity (using Centerline Paper)
Sizes	Min: 3.9 x 5.8 in (100 x 148) SEF Max: 13 x 26 in (330 x 660) SEF
Weights	52 to 350* gsm uncoated, 64 to 350* gsm coated <i>(*note – recommended max weight is 300gsm)</i>  Greater than 19.2 inches in length: 52-220gsm uncoated, 64-220gsm coated.
Supported Media Types	Plain, uncoated, coated, transparencies, heavyweight, lightweight, predrilled, tabs, envelopes, hole punched, labels, letterhead
Trays 1 -3	
Capacity	550 sheets (per tray); combined capacity of 1,650 sheets (using Centerline Paper)
Sizes	Min: 5.5 x 7.2 in (140 x 182 mm) Max: 13 x 19.2 in (330 x 488 mm)
Weights	64 to 256 Note: Jam rates may be higher with coated stocks when feeding from trays 1-3.
Supported Media Types	Plain, uncoated, coated, transparencies, heavyweight, predrilled, tabs, hole punched, labels, letterhead
High Capacity Feeder (letter) (HCF)	
Capacity	2,000 sheets (using Centerline Paper)
Sizes	8.5 x 11 in (A4) LEF
Weights	64 to 220 gsm
Supported Media Types	Plain, uncoated, coated, transparencies, heavyweight, predrilled, hole punched, labels, letterhead
1 Tray Oversized High Capacity Feeder (OHCF)	
Capacity	2,000 sheets (using Centerline Paper)
Sizes	Min: 7.2 x 8.3 in (182 x 210 mm), w/postcard kit 4 x 6 in (100 x 148 mm) Max: 13 x 19.2 in (330 x 488 mm)
Weights	52 to 350* gsm <i>(*note – recommended max weight is 300gsm)</i>
Supported Media Types	Plain, uncoated, coated, transparencies, heavyweight, predrilled, tabs, hole punched, labels, letterhead, postcard (with Tray inserter)
Advanced High Capacity Feeder (Advanced HCF) – Single or Dual Configurations	

Capacity	2,000 sheets (per tray); combined capacity of 4,000 sheets (using Centerline Paper)
Sizes	Min: 7.2 x 7.2 in (182 x 182 mm), w/postcard kit 4 x 6 in (100 x 148 mm) Max: 13 x 19.2 in (330 x 488 mm)
Weights	52 to 350 gsm Note: Optimal performance for coated stocks is 64 – 350 gsm
Supported Media Types	Plain, uncoated, coated, transparencies, heavyweight, predrilled, tabs, hole punched, labels, letterhead, postcard (with Tray inserter)

## Finishing Specifications

### Offset Catch Tray (OCT)

The Catch Tray holds a maximum of 500 sheets.

#### Catch Tray Limitations:

- If utilizing the Catch Tray, overall productivity will decline if offsetting mode is selected. The print engine will pause printing to offset between sets, and then resume. Productivity loss depends on the number of sheets per set, with single-page jobs representing the worst case (approximately 50% productivity loss)
- Sheets smaller than 6.7 inches (170 mm) in the cross-process direction (e.g. the feed edge) cannot be offset
- Sheets larger than 11.7 inches (297 mm) in the cross-process direction (e.g. the feed edge) cannot be offset

With the EX-i/EX Fiery Print Server, the Offset Jobs box on the Finishing tab must be checked to enable offsetting.

#### Interface Module

**TIP:** The Interface Module is required with any system configuration that has one or more finishing devices, except the Offset Catch Tray (OCT), BR Finisher and BR Booklet Finisher. The Interface Module acts as a paper path from the press to the finishing device; it also allows communication between the press and the finishing device. The Interface Module also cools and decurls paper as it exits the press and before it enters the finishing device.

### GBC Advanced Punch Pro

The GBC AdvancedPunch Pro is an inline die punch that uses modular die sets to create a variety of hole punch patterns in a range of papers sizes, from A4 or 8.5 x 11 inch (LTR), long-edge-fed to 12x18 or SRA3 media, to support offline binding. The GBC AdvancedPunch Pro is supported by all print servers. The GBC AdvancedPunch Pro requires an Interface Module as well as a High Capacity Stacker, Production Ready Finisher, Production Ready Booklet Maker Finisher, or Production Ready Finisher Plus (and additional third-party device).

GBC AdvancedPunch Pro	
GBC AdvancedPunch Pro Specifications	<ul style="list-style-type: none"> <li>Supports media from 75-300 gsm, (120-300gsm coated)</li> <li>Supports tab stocks: letter (3, 4, 5, 8, 10 bank), ½ letter (3 and 5 bank), A4 (5 and 10 bank), and A5 (3 and 5 bank)</li> <li>The GBC AdvancedPunch Pro is able to bypass all coated and uncoated media sizes and weights that are printed on the Press</li> <li>Requires an additional electrical receptacle; refer to the Electrical Requirements for Optional Devices.</li> </ul>
GBC AdvancedPunch Pro Limitations	<ul style="list-style-type: none"> <li>GBC AdvancedPunch Pro punched sheets cannot be punched, stapled, folded, or converted into a booklet in a PR Finisher.</li> <li>Hole punch position from edge of paper is user adjustable using the AdvancedPunch Pro LCD User Interface</li> <li>Double punch capability is not available on GBC AdvancedPunch Pro.</li> <li>Opening the door of the GBC AdvancedPunch while the machine is running will cause the machine to jam and shut down</li> <li>Gloss coated media may not run as reliably as uncoated paper. Typically, coated papers and high area coverage exhibit increased variability in paper handling due to lower coefficients of friction, resulting in a broader distribution of punch registration and elevated jam rates</li> <li>Stacking may be misaligned on jobs containing tab stock; these jobs will require additional jogging before final finishing</li> <li>GBC AdvancedPunch Pro is not compatible with Extra Long Sheets (sheets longer than 19.2 in / 488 mm). It cannot punch Extra Long Sheets AND it cannot “bypass” Extra Long Sheets. Do <b>not</b> run Extra Long Sheets through a Versant 180 Press with a GBC AdvancedPunch Pro as it will cause a severe jam and may require a service call.</li> <li>Due to the nature of punching holes, each punched sheet is slightly deformed, and when stacked, the edge with the holes will have an increased height compared to the non-punched edge.                             <ul style="list-style-type: none"> <li>- Reduced stack quality may be experienced due to variability in the punch hole formation</li> <li>- When sending output to the stack tray of the High Capacity Stacker, if this stack height difference exceeds one inch, the machine will shut down and alert the operator to unload the stacker tray. This is done to prevent a jam and will result in a reduction of stack capacity depending on the die being used</li> </ul> </li> </ul>
GBC AdvancedPunch Pro	
Punch Dies	<p>The GBC AdvancedPunch Pro is capable of punching a variety of hole-punch patterns by simply changing the punch die. Punch dies can be changed in seconds without tools. The punch dies currently available are listed below. Each die set has a 90 day warranty from date of purchase. Punch dies are ordered using the Supplies ordering process.</p> <p>Punch die life will be maximized if lightly oiled every 100K punch cycles (approximately every 2 months) with light machine oil such as 3-in-1 Oil. Small deposits of oil will be observed around the perimeter of the punched holes until the excess oil is absorbed (usually within 20 sheets).</p>

GBC AdvancePunch Pro Punch Dies

**Die Set Description**

For Plastic Comb Binding:



For Twin Loop™ Binding:



For Color Coil™ Binding:



For Velo® Bind:

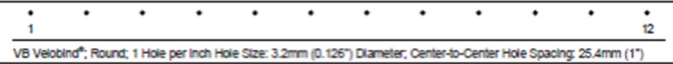
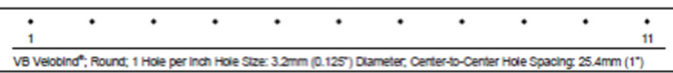

For Loose Leaf Binding:

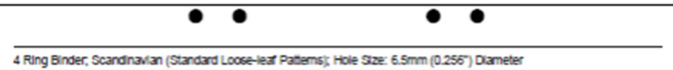
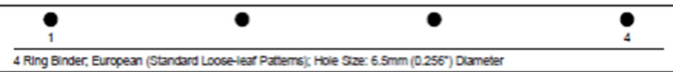
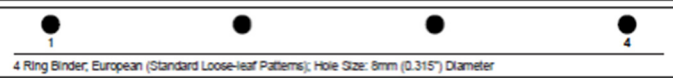

©2015 GBC, Lake Zurich, Illinois - All rights reserved.

Graphics do not represent actual punch pattern dimensions or spacing.

**Xerox Part Number**

Die, Xerox, Comb Bind	008R13190
-----------------------	-----------

Die, Xerox, Wire 3.1, Sq.	008R13192
---------------------------	-----------

Die, Xerox, Wire 2.1, Sq.	008R13191
---------------------------	-----------

Die, Xerox, Wire, 3:1, Rnd.	008R13181
-----------------------------	-----------

Die, Xerox, Wire, 2:1, Rnd.	008R13180
-----------------------------	-----------

Die, Xerox, Coil, Rnd.	008R13179
------------------------	-----------

Die, Xerox, Velobind®, 11 Holes, Ltr.	008R13187
---------------------------------------	-----------

Die, Xerox, Velobind®, 12 Holes, A4.	008R13188
--------------------------------------	-----------

Die, Xerox, 3 Hole, 8mm	008R13182
-------------------------	-----------

Die, Xerox, 3/5/7 Hole, 8mm	008R13183
-----------------------------	-----------

Die, Xerox, 4 Hole, 8mm	008R13184
-------------------------	-----------

Die, Xerox, 4 Hole, 6.5mm	008R13185
---------------------------	-----------

Die, Xerox, 4 Hole, Scan	008R13186
--------------------------	-----------



## High Capacity Stacker (HCS)

The HCS is designed for long production runs.

- Up to 5,000 sheets offsetting output stack tray with movable cart to move to off line finishing.
- 500 sheet top tray
- Sample Prints are additional prints directed to the top tray for inspection. Samples are not produced by redirecting sheets from the Stack to the Top Tray; therefore the contents in the Stack Tray are complete

High Capacity Stacker (HCS) Tray		
HCS Specifications	Feature	Specification (with centerline paper)
	Stacker Tray Capacity	5,000 sheets
	Top Tray Capacity	500 sheets
	Maximum Stack Weight	70KG (154 lb.)
	Maximum Paper Size	330 mm x 488 mm (13 x 19.2 in)
	Power requirement	Refer to Electrical Requirements for Optional Devices, for information.
HCS Limitations	<ul style="list-style-type: none"> <li>• The HCS is subject to stack weight limitations, and settings have been implemented to prevent damage to the unit caused by an excessively heavy stack. Please refer to this chart for approximate stack sizes for sheets larger than 8.5 x 11 in/A4.</li> <li>• Stack quality may degrade and jams may increase with 64-106 gsm coated paper stocks</li> <li>• Mixed stock sizes can be sent to the HCS. However, the HCS generally should be unloaded between jobs that utilize different stock sizes to prevent stack quality problems such as paper misalignment or stack integrity.</li> </ul>	

## Stacker Tray Specifications

Stacker Tray Capacity by weight and paper finish								
Paper type and weight		Paper Size						
		Smallest size 203 x 182 Min	A4 / 8.5 x 11 in	B4 / 8.5 x 14 in	A3 / 11 x 17 in	12 x 18 in	SRA3	13 x 19.2 in
Uncoated 52-350 gsm	Sheets	≤ 5,000	≤ 5,000	≤ 2,300	≤ 2,300	≤ 2,300	≤ 2,300	≤ 2,300
	Stack Height	H ≤ 570 mm (22.44 in)	H ≤ 570 mm (22.44 in)	H ≤ 460 mm (≤18.11 in)	H ≤ 460 mm (≤18.11 in)	H ≤ 460 mm (≤18.11 in)	H ≤ 460 mm (≤18.11 in)	H ≤ 460 mm (≤18.11 in)
Coated 64-350 gsm	Sheets	≤ 5,000	≤ 5,000	≤ 3,400	≤ 3,400	≤ 3,400	≤ 3,400	≤ 3,400
	Stack Height	H ≤ 570 mm (22.44 in)	H ≤ 570 mm (22.44 in)	H ≤ 412 mm (≤16.22 in)	H ≤ 412 mm (≤16.22 in)	H ≤ 412 mm (≤16.22 in)	H ≤ 412 mm (≤16.22 in)	H ≤ 412 mm (≤16.22 in)

## Production Ready Finisher

The Production Ready Finisher is an output device that can perform up to 100-sheets stapling and up to 3,000 sheets stacking. Additionally an optional C/Z-fold/three-fold, punch, and cover paper insertion modules may be added.

The Production Ready Finisher has an optional interposer (Tray T1 or 8 depending on your product) that feeds cover paper to the finisher for stapled sets. Other than the Top Tray, the Production Ready Finisher does not support the full paper weight range that can be printed on the press. Refer to Production Ready Finisher Specifications for details on the media that is supported.

## Production Ready Finisher Specifications

### Top Tray

Production Ready Finisher Top Tray Capacity by weight and paper finish								
Paper type and weight		Paper Size						
		Post Card 182x257 mm	A4 / 8.5 x 11 in	B4 / 8.5 x 14 in	A3 / 11 x 17 in	12 x 18 in*	SRA3*	13 x 19.2 in*
Uncoated	52-80 gsm	H=67mm (2.64 in)	500	500	500	500	500	500
	80-350 gsm	H=67mm (2.64 in)	H=67mm (2.64in)	H=67mm (2.64 in)	H=67mm (2.64 in)	H=67mm (2.64 in)	H=67mm (2.64 in)	H=67mm (2.64 in)
Coated	106-350 gsm	H=67mm (2.64 in)	H=67mm (2.64 in)	H=67mm (2.64 in)	H=67 mm (2.64 in)	H=67mm (2.64 in)	H=67 mm (2.64 in)	H=67mm (2.64 in)

\*Cannot be offset

Top Tray minimum sheet size: 98mm x 146mm (SEF)

Top Tray maximum sheet size: 330.2mm x 660.4mm

### Stacker Tray

Production Ready Finisher Stacker Tray Capacity by weight and paper finish								
Paper type and weight		Paper Size						
		B5 / 182 x 257 mm	A4 / 8.5 x 11 in	B4 / 8.5 x 14 in	A3 / 11 x 17 in	12 x 18 in*	SRA3*	13 x 19.2 in*
Uncoated	52-80 gsm	1,500	3,000	1,500	1,500	1,500	1,500	1,500
	80-300 gsm	H=180 mm (7.09 in)	H=378 mm (14.88 in)	H=180 mm (7.09 in)	H=180 mm (7.09 in)	H=180 mm (7.09 in)	H=180 mm (7.09 in)	H=180 mm (7.09 in)
Coated	106-300 gsm	H=180 mm (7.09 in)	H=378 mm (14.88 in)	H=180 mm (7.09 in)	H=180 mm (7.09 in)	H=180 mm (7.09 in)	H=180 mm (7.09 in)	H=180 mm (7.09 in)

\*Cannot be offset

Stacker Tray minimum sheet size: 148mm x 146mm (LEF)

Stacker Tray maximum sheet size: 330.2mm x 488mm

## Stapling

Production Ready Finisher Staple Capacity by weight and paper finish				
Paper type and weight	A4 or Letter Sized Stock		Smaller <b>OR</b> larger than A4 / Letter Sized Stock	
	Uncoated	Coated	Uncoated	Coated
52-80 gsm	100	35	65	35
81-90 gsm	100	35	65	35
91-105 gsm	50	30	50	30
106-128 gsm	50	30	45	30
129-150 gsm	20	20	20	20
151-176 gsm	20	20	20	20
177-220 gsm	20	20	20	20
221-256 gsm	20	20	20	20
257-300 gsm	10	10	10	10
301-350 gsm	10	10	10	10

## Inserter

The Production Ready Finisher has an optional Inserter (also called a Post-Process Inserter), used to insert preprinted stock into finished sets without having to go through the engine. This tray, on the Press Control Panel is called Tray T1 (on some products it is Tray 8).

**NOTE:** Labels, coated media, and envelopes are not supported.

Inserter Capacity by weight and paper finish					
Paper type and weight		Paper Size			
		B5 / 8 x 10 in	A4 / 8.5 x 11 in	B4 / 8.5 x 14 in	A3 / 11 x 17 in
Uncoated	52-80 gsm	250 sheets	250 sheets	250 sheets	250 sheets
	81-350 gsm	H=22 mm (0.87 in)	H=22 mm (0.87 in)	H=22 mm (0.87 in)	H=22 mm (0.87 in)

Inserter minimum sheet size: 182mm x 148mm (LEF)

Inserter maximum sheet size: 330.2 x 488mm

## Hole Punching

The Production Ready Finisher offers Hole Punching as an optional feature.

- Holes are created on the trail edge of the sheet.
- Hole punch capacity is equal to the regular capacity of the chosen output tray.
- For the USA, 2- and 3-hole punching is available; for Europe, 2- and 4- hole punch is available.
- Stacks can be punched on the left or right side, or on the top edge.

Hole Punch Capacity by weight and paper finish					
Paper type and weight		Paper Size			
		B5	A4 / 8.5 x 11 in	B4 / 8.5 x 14 in	A3 / 11 x 17 in
Uncoated	52-220 gsm	Applicable	Applicable	Applicable	Applicable
Coated	106-220 gsm	Applicable	Applicable	Applicable	Applicable
Production Ready Finisher Limitations		Productivity may be reduced by up to 50% when running multiple sets of a single sheet job to the Stacker Tray, due to the press being forced to wait while each single sheet set is ejected to the Stacker Tray.			

Punch minimum sheet size:

- 2 hole (LEF): 203.2mm x 182mm
- 3 hole (LEF): 254mm x 182mm
- 4 hole (LEF): 267mm x 182mm

Punch maximum sheet size: 297mm x 431.8mm

Production Ready Finisher Caveats	
Lightweight paper	Lightweight coated stocks may exhibit subtle gloss marking due to rollers. This may be more visible with high area coverage.
Stack capacity	Stacking multiple finished sized jobs will reduce the stack capacity.

### Production Ready Booklet Maker Finisher

The Production Ready Booklet Maker Finisher is a separate configuration that adds basic booklet making capability to all the same features as the Production Ready Finisher. The Production Ready Booklet Maker Finisher includes:

- Stapler
- Top Tray
- Stacker Tray
- Booklet Unit capable of saddle stapling and bi-folding

**NOTE:** Hole punching is not available to the Booklet Tray

Production Ready Booklet Maker Finisher	
Production Ready Booklet Maker Finisher Specifications	For specifications on the Top Tray, Stacker Tray, Stapling, Hole Punching, and the Interposer refer to Production Ready Finisher Specifications. The following provides specifications on the Booklet Maker.

### Booklet Capabilities by Weight and Paper Finish

Production Ready Finisher Booklet Capacity by weight and paper finish		
Paper type and weight	Paper Finish	
	Uncoated	Coated
60-80 gsm	30	-
81-90 gsm	30	25
91-105 gsm	20	20
106-128 gsm	15	15
129-150 gsm	10	10
151-176 gsm	10	10
177-220 gsm	5	5
221-256 gsm	4	4
257-300 gsm	3	3
301-350 gsm	3	3

### Bi-Fold Capability

Paper type and weight		Bi-Fold (Single Fold) **Capability by weight, size and paper finish				
		A4 / 8.5 x 11 in	B4/8.5 x 14 in	A3/11 x 17 in	12 x 18 in	SRA3
Uncoated	52-350 gsm	1	1	1	1	1
Coated	106-350 gsm	1	1	1	1	1
Fold Accuracy of Bi-Fold (Lead and Side Edges)		<ul style="list-style-type: none"> <li>• Fold accuracy (lead and side edge): ≤2.5 mm</li> <li>• Bi-Fold: 1 sheet/set, 64-300 gsm uncoated stock, 106-300 gsm coated stock</li> </ul>				
Booklet Marker Finisher Limitations		<ul style="list-style-type: none"> <li>• Productivity may be reduced by up to 50% when running multiple sets of a single sheet job to the Stacker Tray.</li> <li>• Higher jam rates may occur when running 280 gsm and above, tabloid sheets to the Booklet Maker.</li> <li>• After cancelling a job sent to the Booklet Maker, empty the purge tray before submitting another print job. This will ensure that purged sheets are not inadvertently inserted into the next booklet printed.</li> </ul>				

## C-Z Folder

The C/Z Folder is available with these finishing devices:

- Production Ready Finisher
- Production Ready Booklet Maker Finisher
- Production Ready Finisher Plus

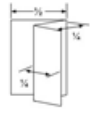
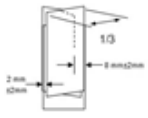
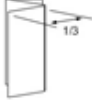
C/Z Folder		
<p>The C/Z Folder unit produces Tri-C fold, Z-fold, and Z-Fold half-sheet.</p> <ul style="list-style-type: none"> <li>• The C/Z folding tray accommodates 30 sheets of up to 24 lb. (64-90 gsm) uncoated media</li> <li>• Supported Paper size is 8.5 x 11 in (A4) to the bottom tray; 11 x 17 in (B4 and A3) to the top tray</li> <li>• Fold types, accuracy, and supported paper sizes are shown in the following table:</li> </ul>		
<p>Z-Fold Half-Sheet Also known as:</p> <ul style="list-style-type: none"> <li>• Engineering Z-Fold</li> <li>• Accordion Fold</li> <li>• Accordion Fold-out</li> </ul>		<p>Produces folded output 1/2 size of original:</p> <ul style="list-style-type: none"> <li>• B4 -&gt; B5</li> <li>• A3 -&gt; A4</li> <li>• 11 x 17 in -&gt; 8 1/2 x 11 in</li> </ul>
<p>C-Fold Also known as:</p> <ul style="list-style-type: none"> <li>• Letter Fold</li> <li>• Tri-fold</li> <li>• Envelope Fold</li> </ul>		<p>Produces folded output 1/3 size of original.</p> <p>For stock sizes:</p> <ul style="list-style-type: none"> <li>• A4**</li> <li>• 8 1/2 x 11 in **</li> </ul> <p>** Delivered to Envelope Folder</p>
<p>Z-Fold Also known as:</p> <ul style="list-style-type: none"> <li>• Accordion Fold</li> <li>• Concordia Fold</li> </ul>		<p>Produces folded output 1/3 size of original.</p> <p>For stock sizes:</p> <ul style="list-style-type: none"> <li>• A4**</li> <li>• 8 1/2 x 11 in **</li> </ul> <p>** Delivered to Envelope Folder Tray</p>

## SquareFold Trimmer Module

The SquareFold Trimmer is an optional finishing device that flattens the spine of a booklet and performs face trim of the booklet.

**IMPORTANT:** It is available with the Production Ready Booklet Maker Finisher; it is not available with any other finishing device. For information related to the SquareFold Trimmer Module, refer to Module Dimensions for Optional Devices and Electrical Requirements for Optional Devices.

SquareFold Trimmer Module		
Feature	Specification (with centerline paper)	
SquareFold Trimmer Specifications	Paper Types and Weights	52-350 gsm, Coated and Uncoated (18 lb. Bond - 110 lb. Cover)
	Paper Size	Minimum: 8.5 x 11 in SEF (216 mm x 279 mm) Maximum: 13 x 18 in SEF (330 mm x 457 mm)
	Booklet Receiving Tray Capacity	20 booklets
	Trim Dimensions	2 mm-20 mm, adjustable in 0.1 mm increments
Configuration	<p>This equipment is located after the Production Ready Booklet Maker Finisher, and the operation is as follows:</p> <ul style="list-style-type: none"> <li>• Receives the booklet from the booklet maker unit</li> <li>• Transports the received booklet to the square-fold unit to flatten the spine of the booklet and then to the trimmer unit to trim the face of the booklet</li> <li>• Deposits the finished booklet into the booklet tray.</li> </ul> <p>The SquareFold Trimmer Module is also able to face-trim without square-folding. All output from the Production Ready Booklet Maker Finisher can be passed through, square-folded, trimmed, or both squared-folded and trimmed, including custom sizes from 194x257mm – 330x488mm (SEF Letter through 13 x 18 in).</p>	
Auto Recognition of the SquareFold Trimmer Module	When the SquareFold Trimmer Module is docked to the Production Ready Booklet Maker Finisher via cable, the finisher automatically recognizes that the SquareFold Trimmer is installed.	
Booklet Size	Square-folding/trimming of non-stapled sets and square-folding of 4 or less sheets in a set are outside the specification and cannot be assured. Jams may occur frequently or wrinkles may occur on the square-folded side of paper.	
Caveats	<ul style="list-style-type: none"> <li>- When performing a face-trim of thicker booklets, the trimmed pieces of paper may not clear properly and result in jams, sensor errors, or other issues.</li> <li>- When creating a full-bleed booklet using both the Squarefold Trimmer and the Two Sided Trimmer together, face trim skew may be more obvious due to the contrast of imaged area on the cover next to white paper on the body stock.</li> <li>- Thicker square fold booklets may cause the default staple location to be misaligned. Booklet quality can be optimized by centering the staple position in the center of the square fold area OR by moving the staple position such that it is outside of the square fold area.</li> <li>- Thicker booklets may show a beveled or slanted trim at the default face trim setting of 2mm. This can be avoided by increasing this value at the DFE.</li> <li>- Face-trimming of specialty stocks such as scored or perforated stocks may show an increased amount of variation during a print run.</li> <li>- Tall and narrow booklets may exhibit more variation of face trimming during a print run</li> </ul>	

### SquareFold Trimmer Skew Specification

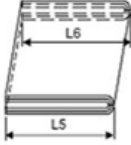
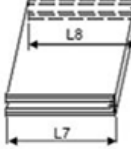
Booklet + trimming	<p>Measure both sides of the bottom sheet when the booklet is output.</p>  <p>Staple: <math> L5-L6  \leq 2</math> mm (Achievement rate: 95<sup>th</sup> percentile* within run )                  Bi-Fold/Non-staple: <math> L5-L6  \leq 3</math> mm (Achievement rate: 95<sup>th</sup> percentile within run)</p>
Booklet + trimming + square-folding	<p>Measure both sides of the bottom sheet when the booklet is output.</p>  <p>Staple: <math> L7-L8  \leq 2.5</math> mm (Achievement rate: 95<sup>th</sup> percentile* within run)                  Performance is not guaranteed at Bi-Fold/Non-staple.</p>

\*Note: face-trim skews beyond the 95<sup>th</sup> percentile may be as high as 5mm within run.

## Two-Sided Trimmer Module

The Two-Sided Trimmer is an optional finishing device that trims the top and bottom of a booklet. It also has a buffering function which can improve the productivity of bookletmaking with the Production Ready Booklet Maker Finisher for certain stock weights.

Two Sided Trimmer	
Trim Range (per side)	Minimum Trim: 6mm Maximum Trim: 25mm
Page Width	Minimum Width: <ul style="list-style-type: none"> <li>- Paper input: 194mm</li> <li>- Booklet output: 108.5</li> </ul> Maximum Width: <ul style="list-style-type: none"> <li>- Paper input: 330mm</li> <li>- Booklet output: 242mm</li> </ul>
Page Length	Minimum Length: 257mm <ul style="list-style-type: none"> <li>- Paper input: 257mm</li> <li>- Booklet output: 182mm</li> </ul> Maximum Length: <ul style="list-style-type: none"> <li>- Paper input: 488mm</li> <li>- Booklet output: 318mm</li> </ul>
Stock Weights	Uncoated: <ul style="list-style-type: none"> <li>- Weight Range: 52gsm – 350gsm</li> </ul> Coated: <ul style="list-style-type: none"> <li>- Weight Range*: 52gsm – 350gsm</li> </ul> <p><i>*Coated stocks between 52 and 105gsm can be trimmed however performance is not guaranteed.</i></p>

### Two Sided Trimmer Skew Specification

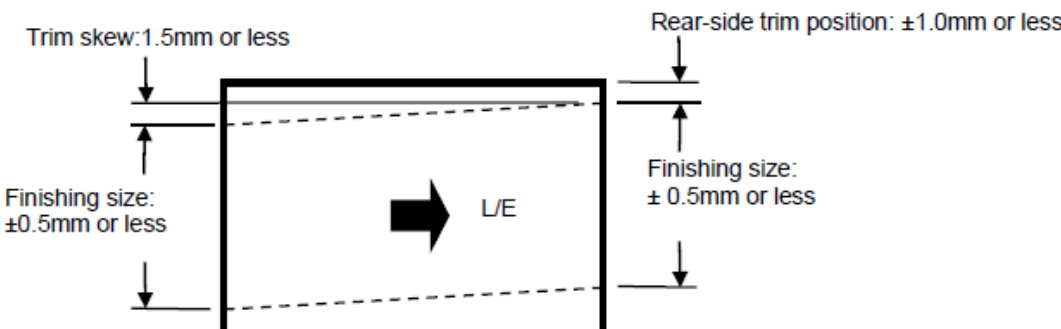
Booklet + trimming	<ul style="list-style-type: none"> <li>- Accuracy of the "rear side" (i.e. back of the machine) trim position <math>\leq \pm 1.0\text{mm}</math> against target trim value on paper leading edge.</li> <li>- Finished size <math>\leq \pm 0.5\text{mm}</math></li> <li>- Total trimming skew <math>\leq 1.5\text{mm}</math></li> </ul> 
--------------------	---

## Production Ready Finisher Functional Combinations

The following tables show the possible combination of functions and output locations for the Production Ready Finisher.

Function/ Combination of Functions	Staple	Offset	Booklet	Z-Fold	Envelope size C/Z	Punch	Inserter	Square Fold Trim	Two Sided Trim	GBC Punch
Staple	-	Y	N	Y	N	Y	Y	N	N	N
Offset	-	-	N	Y	N	Y	Y	N	N	N
Booklet	-	-	-	N	N	N	Y	Y	Y	N
Z-Fold	-	-	-	-	N	Y	Y	N	N	N
Envelope size C/Z	-	-	-	-	-	N	Y	N	N	N
Punch	-	-	-	-	-	-	Y	N	Y	N
Inserter	-	-	-	-	-	-	-	N	Y	Y
Square Fold Trim	-	-	-	-	-	-	-	-	Y	N
Two Sided Trim	-	-	-	-	-	-	-	-	-	N
GBC Punch	-	-	-	-	-	-	-	-	-	-
Staple + Punch	-	Y	N	Y	N	-	Y	N	N	N
Staple + Z Fold	-	Y	N	-	N	Y	Y	N	N	N
Staple + Inserter	-	Y	N	Y	N	Y	-	N	N	N
Punch + Z Fold	Y	Y	N	-	N	-	Y	N	N	N
Punch + Inserter	Y	Y	N	Y	N	-	-	N	Y	N
Inserter + Z Fold	Y	Y	N	-	N	Y	-	N	N	N
Inserter + Booklet	N	N	-	N	N	N	-	Y	Y	N
Inserter + Two Sided Trim	N	N	Y	N	N	N	-	Y	-	N
Inserter + GBC Punch	N	N	N	N	N	N	-	N	N	-
Booklet + Square Fold Trim	N	N	-	N	N	N	Y	-	Y	N
Booklet + Two Sided Trim	N	N	-	N	N	N	Y	Y	-	N



Function/ Combination of Functions	Output Location						
	Adv. High Cap. Stacker Top Tray	Adv. High Cap. Stacker Stacker Tray	PR Finisher Top Tray	PR Finisher Stacker Tray	PR Finisher Sq. Fold Trim Booklet Tray	C/Z Envelope Fold Tray	PR Finisher Plus Output
Staple	-	-	N	Y	N	N	N
Offset	-	-	N	Y	N	N	N
Booklet	-	-	Y	N	Y	N	N
Z-Fold	-	-	Y	Y	N	N	N
Envelope size C/Z	-	-	N	N	N	Y	N
Punch	-	-	Y	Y	N	N	N
Inserter	Y	Y	Y	Y	Y	Y	Y
Square Fold Trim	-	-	N	N	Y	N	N
Two Sided Trim	-	-	Y	N	Y	N	Y
GBC Punch	Y	Y	Y	Y	N	N	Y
Staple + Punch	-	-	N	Y	N	N	N
Staple + Z Fold	-	-	N	Y	N	N	N
Staple + Inserter	-	-	N	Y	N	N	N
Punch + Z Fold	-	-	Y	Y	N	N	N
Punch + Inserter	-	-	Y	Y	N	N	N
Inserter + Z Fold	-	-	Y	Y	N	N	N
Inserter + Booklet	-	-	Y	N	Y	N	N
Inserter + Two Sided Trim	-	-	Y	N	Y	N	Y
Inserter + GBC Punch	Y	Y	Y	Y	N	N	Y
Booklet + Square Fold Trim	-	-	N	N	Y	N	N
Booklet + Two Sided Trim	-	-	N	N	Y	N	N

## Production Ready Finisher Plus

The Production Ready Finisher Plus provides the same functions as the Production Ready Finisher, although Stacker Tray capacity is reduced from 3,000 sheets to a maximum of 2,000 sheets. The Production Ready Finisher Plus adds a Finishing Transport module which enables connection to available third-party finishing solutions.

**NOTE:** A Production Ready Finisher cannot be upgraded to a Production Ready Finisher Plus. Finishing solutions that can be connected to the Production Ready Finisher Plus include:

- Plockmatic Pro 35/50 Booklet Maker
- GBC E-wire.

Specifications and expectations for these devices are available in a Solutions Planning Guide which is available from your Xerox sales representative or analyst.

For information related to the Production Ready Finisher Plus, refer to Module Dimensions for Optional Devices.

## Top Tray

**NOTE:** These specifications are the **same** as the Production Ready Finisher.

Production Ready Finisher Plus Top Tray Capacity by weight and paper finish								
Paper type and weight		Paper Size						
		Post Card 182x257 mm	A4 / 8.5 x 11 in	B4 / 8.5 x 14 in	A3 / 11 x 17 in	12 x 18 in*	SRA3*	13 x 19.2 in*
Uncoated	52-80 gsm	H=67mm (2.64 in)	500	500	500	500	500	500
	80-350 gsm	H=67mm (2.64 in)	H=67mm (2.64 in)	H=67mm (2.64 in)	H=67mm (2.64 in)	H=67mm (2.64 in)	H=67mm (2.64 in)	H=67mm (2.64 in)
Coated	106-350 gsm	H=67mm (2.64 in)	H=67mm (2.64 in)	H=67mm (2.64 in)	H=67mm (2.64 in)	H=67mm (2.64 in)	H=67mm (2.64 in)	H=67mm (2.64 in)

## Stacker Tray

**IMPORTANT:** These specifications are **different** from the Production Ready Finisher.

Production Ready Finisher Plus Stacker Tray Capacity by weight and paper finish								
Paper type and weight		Paper Size						
		B5 / 182 x 257 mm	A4 / 8.5 x 11 in	B4 / 8.5 x 14 in	A3 / 11 x 17 in	12 x 18 in*	SRA3*	13 x 19.2 in*
Uncoated	52-80 gsm	1,500	2,000	1,500	1,500	1,500	1,500	1,500
	80-300 gsm	H=180 mm (7.09 in)	H=378 mm (14.88in)	H=180 mm (7.09 in)	H=180 mm (7.09 in)	H=180 mm (7.09 in)	H=180 mm (7.09 in)	H=180 mm (7.09 in)
Coated	106-300 gsm	H=180 mm (7.09 in)	H=378 mm (14.88 in)	H=180 mm (7.09 in)	H=180 mm (7.09 in)	H=180 mm (7.09 in)	H=180 mm (7.09 in)	H=180 mm (7.09 in)

\*Cannot be offset

## Stapling

**NOTE:** These specifications are the same as the Production Ready Finisher. See that section above for details.

## Inserter

The Production Ready Finisher Plus has an optional Inserter, used to insert pre-printed stock into finished sets without having to go through the print engine. Labels, coated media and envelopes are not supported.

The Inserter is also called the Post-Process Inserter, and depending on the product, it is either Tray T1 or Tray 8.

**NOTE:** The specifications are the same as the Production Ready Finisher. See that section above for details.

## Hole Punching

The Production Ready Finisher Plus has an optional punch,

**NOTE:** The punch specifications are the same as the Production Ready Finisher punch. See that section above for details.

## Business Ready Finisher (BR Finisher)

The Business Ready Finisher includes:

- Multi-position Stapling
- Hole Punch

Business Ready Finisher (BR Finisher)		
BR Finisher Specifications	Feature	Specification (with centerline paper)
	Top Tray Capacity	500 sheets of 8.5"x11" / A4, 20lb bond / 80 gsm uncoated paper. Accommodates up to 13"x19"/SRA3 size at 64-350 gsm.
	Stacker Tray Capacity	3,000 sheets of 8.5"x11" / A4, 20lb bond / 80 gsm uncoated paper. Accommodates up to 13"x19"/SRA3 size at 64-220 gsm.
	Paper weights	16 lb Bond to 100 lb Cover / 64 to 350 gsm
	Maximum Paper Size	SRA3 (13 x 19.2)
	Stapling	Up to 50 sheets uncoated / coated Quad stitch available through EX-i/EX print servers.
	Hole Punching	NA – 2 – 3 hole punch Europe – 2 – 4 hole punch
BR Finisher Limitations	<ul style="list-style-type: none"> <li>• Heavier weight stocks will result in reduced output tray capacity</li> </ul>	

## Business Ready Booklet Maker Finisher (BR Booklet Marker Finisher)

The Business Ready Finisher includes:

- Multi-position Stapling
- Hole Punch
- Bi-fold
- Booklet Maker
- Saddle stitching Short Edge Feed (SEF)

Business Ready Booklet Maker Finisher (BR Booklet Maker Finisher)																					
BR Booklet Maker Finisher Specifications	Feature	Specification (with centerline paper)																			
	Top Tray Capacity	500 sheets of 8.5"x11" / A4, 20lb bond / 80 gsm uncoated paper. Accommodates up to 13"x19"/SRA3 size at 64-350 gsm.																			
	Stacker Tray Capacity	1,500 sheets of 8.5"x11" / A4, 20lb bond / 80 gsm uncoated paper. Accommodates up to 13"x19"/SRA3 size at 64-220 gsm.																			
	Paper weights	16 lb Bond to 100 lb Cover / 64 to 350 gsm																			
	Maximum Paper Size	SRA3 (13 x 19.2)																			
	Stapling	Up to 50 sheets uncoated / coated Quad stitch available through EX-i/EX print servers.																			
	Hole Punching	NA: 2 – 3 hole punch Europe: 2 – 4 hole punch																			
	Booklet Maker Capacity	Up to 20 sets of a maximum of 16 stapled sheets and maximum size of 13 x 18 / SRA3. Coated /uncoated stocks 106-176 gsm up to 7 sheets Uncoated stock 177-220 gsm up to 5 sheets.																			
	Saddle Stapling	Supports sheet sizes from 182mm x 257mm to 330.2mm x 457.2mm																			
		<table border="1"> <thead> <tr> <th>Paper Weight (gsm)</th> <th>Number of sheets that can be stapled – UNCOATED</th> <th>Number of sheets that can be stapled - COATED</th> </tr> </thead> <tbody> <tr> <td>52 – 90</td> <td>16</td> <td>-</td> </tr> <tr> <td>91 – 105</td> <td>7</td> <td>-</td> </tr> <tr> <td>106 – 176</td> <td>7</td> <td>7</td> </tr> <tr> <td>177 – 220</td> <td>5</td> <td>5</td> </tr> <tr> <td>221 – 300</td> <td>3</td> <td>3</td> </tr> </tbody> </table>		Paper Weight (gsm)	Number of sheets that can be stapled – UNCOATED	Number of sheets that can be stapled - COATED	52 – 90	16	-	91 – 105	7	-	106 – 176	7	7	177 – 220	5	5	221 – 300	3	3
Paper Weight (gsm)	Number of sheets that can be stapled – UNCOATED	Number of sheets that can be stapled - COATED																			
52 – 90	16	-																			
91 – 105	7	-																			
106 – 176	7	7																			
177 – 220	5	5																			
221 – 300	3	3																			
	Bi-Fold	Unstapled sets of up to 5 sheets on 64-220 gsm media.																			
BR Booklet Maker Finisher Limitations	<ul style="list-style-type: none"> <li>• Offsetting is not enabled in Top Tray for paperweights above 350gsm or larger than 11" x 17" / A3.</li> <li>• Offsetting not enabled in Stack Tray for paperweights above 350gsm or larger than 11" x 17" / A3</li> <li>• Dual Staple 11x17/A3 SEF coated and uncoated stock is supported</li> <li>• Hole punch capacity is equal to the regular capacity of the chosen output tray. For the US, 2- and 3-hole punching is available; for Europe, 2- and 4- hole punch is available. Stacks can be punched on the left or right side, or on the top edge. If hole punching fails, ensure that the punch waste container is empty before calling for service.</li> <li>• Stapled booklets are limited to 16 sheets of uncoated 90gsm or 7 sheets of coated 106-176gsm.</li> <li>• The misregistration fold of a stapled booklet will not exceed 2.3mm for 95% of output.</li> </ul>																				

## 2-Knife Trimmer Module\*

\*note that 2-Knife Trimmer Module is not avail. in North America

2-Knife Trimmer Module		
<p>The 2-Knife Trimmer is an optional finishing device that provides full-bleed trim for square fold booklets.</p> <p><b>IMPORTANT:</b> It is only available with the Production Ready Booklet Maker Finisher with the SquareFold Trimmer; it is not available with any other finishing device.</p> <p>For information related to the 2-Knife Trimmer Module, refer to Module Dimensions for Optional Devices and Electrical Requirements for Optional Devices.</p>		
2-Knife Trimmer Specifications	Feature	Specification (with centerline paper)
	Paper Types and Weights	Coated and Uncoated Paper weights: 18 lb. Bond – 110 lb. Cover (64 gsm – 300 gsm) Cover weights: 45lb Cover – 110 lb Cover (120 gsm – 300 gsm)
	Paper Size	Minimum: 8.5 x 11 in. SEF (216 mm x 279 mm) Maximum: 13 x 18 in. SEF (330 mm x 457 mm)
	Trim Capacity	5—20 sheet booklet at 24 lb (90 gsm) 5—20 sheet booklet at 20 lb (80 gsm)
	Trim Dimensions	1/16" – 1 3/8" (2 – 35 mm) at 0.1 mm increments
2-Knife Trimmer Limitations	<p>When clearing a fault on the 2-Knife Trimmer, the SquareFold Trimmer will also need to be reset. The SquareFold Trimmer can be reset by opening and closing the waste bin.</p> <p>Always empty the waste bin for both the 2-Knife Trimmer and SquareFold Trimmer at the same time.</p> <p>The 2-Knife Trimmer can handle cover paper as low as 60 gsm, for best results, 120 gsm to 300 gsm is recommended.</p>	

## Third Party Finishing Options

Third-Party Finishing devices that can be connected to the Production Ready Finisher Plus include:

- Plockmatic Pro 55/50 Booklet Maker
- GBC e-Wire

Specifications and expectations for these devices are available in a Solutions Planning Guide which is available from your Xerox sales representative or analyst. For Xerox personnel, information may be found at <http://www.smartcentre.xerox.com/Portal/>

## Media and Substrate

Media Selection Guidelines and Media Support	
Media Type	Versant® 180 Press Centerline Paper
Uncoated Paper	North America - Xerox Color Xpressions Plus (90 gsm/24 lb.) Europe Colotech+ (90 gsm/24 lb.)
Coated Paper	North America Xerox Digital Color Elite Gloss 80 lb. Text (120 gsm) Europe Xerox Digital Color Elite Gloss 80 lb. Text (120 gsm)
<ul style="list-style-type: none"> <li>• Every effort has been made to ensure that the Press supports a broad range of media. Using only Xerox-recommended media helps maximize reliability and paper-handling performance. Furthermore, use of the Centerline papers is recommended to help ensure that you receive the best image quality from your Press.</li> <li>• Typically, heavy weight papers exhibit increased variability of formation and surface smoothness, which may result in degraded image quality.</li> <li>• Paper from all trays is printed topside first. It is recommended that Xerox branded paper be loaded with ream wrapper seam-side up.</li> <li>• Manufacturers of coated stock do not recommend use of their media when the ambient relative humidity exceeds 60%. Relative humidity greater than 40% may increase the misfeed rate from Trays 1, 2, 3 and 5 (Bypass).</li> <li>• All paper stretches to a certain extent during printing. The amount of stretch is dependent on paper type and environmental conditions. Stretch is most noticeable on coated stocks. This stretch can affect front-to-back image registration. Use the Alignment Profiles feature with the SIQA tool to minimize this effect.</li> <li>• Image registration, image quality (for example white spots), and machine reliability can be adversely affected when custom-cut paper is inaccurately cut, is of poor quality, or loose paper fibers are present on the cut edges.</li> <li>• Image registration, image quality (for example white spots), jam frequency and machine reliability can be adversely affected when punched or drilled paper is of poor quality and/or loose hole plugs are present in the ream.</li> </ul> <p>For further information and recommendations regarding media testing, selections, and handling, refer to the Recommended Media List (RML) available from your Xerox representative or downloaded at <a href="http://www.xerox.com">www.xerox.com</a>.</p>	

#### Press Output and Other Equipment

- The Press output (prints) should not be run through the printing path of Nuvera® or DocuTech® Production Publishing systems. However, the prints can be used with the Interposer module.
- Nuvera, DocuTech, and other technology output, including preprinted offset shells, should not be run through the printing path of a Versant® 180 Press.
- If you plan to run the Press output through other equipment, including finishing devices such as a coater or laminator, it is recommended you test the application before committing to the job. Many factors impact the success of running the Press output in other equipment.

#### Duplex (2-Sided Prints)

- Automatic duplex printing can be performed on recommended media up to 13 x 19 in (SRA3 320 x 450 mm/maximum 320 x 482 mm) from 52-300 gsm.
- Manual duplex can also be performed on recommended media up to 13 x 19 in (SRA3 320 x 450 mm/maximum 320 x 482 mm) from Tray 5 (Bypass).
- As with any printer or copier, duplex performance may not match the performance for single-sided printing or copying. Paper jam rates may be higher than the rate you will experience for the same throughput material in single-sided mode.
- In order to reduce paper jam frequency when duplex printing on stocks heavier than 220 gsm (80 lb. Cover), paper grain should be perpendicular to the print process direction (i.e. Short Grain).

#### Transparencies

- For optimum system performance and image projection, use Xerox removable stripe transparency materials. These premium transparencies are specifically designed to provide optimum print quality. Use of other transparencies may cause machine damage and result in excessive service calls.
- Due to the increased thickness of the removable stripe, no more than 100 transparencies should be loaded in a paper tray at one time. The maximum output stack height should not exceed 100 transparencies.

# Maintenance and Support

## Customer / Operator Maintenance

### Automated Color Quality Suite (ACQS) (Optional Performance Package)

The optional Performance Package for the Versant® 180 includes an Inline Spectrophotometer (ILS) and the Automated Color Quality Suite (ACQS). The ACQS suite is available on the Xerox EX Print Server Powered by Fiery. These tools can be used to perform automated DFE calibration and custom profiling. These procedures are automated in that they eliminate the need for an operator to manually scan target sheets using an external spectrophotometer. The operator must initiate the procedures at the print server. All target sheets are then generated and scanned automatically, and all measurements, calculations, and corrections are performed automatically. Following normal calibration or profiling, the ILS does not monitor or measure prints within an actual print job.

In order to ensure the best color quality, customers should always calibrate and then create a custom profile for each stock to ensure the best color quality.

An external (handheld) spectrophotometer can still be used for manual print server calibration and profiling, if preferred. In general, the external spectrophotometer will have a higher degree of color accuracy, however using the external spectrophotometer does not deliver automated measurements like the ILS does. Customers should always use a single device type for calibration and profiling measurements, i.e. do not calibrate with an external spectrophotometer and then profile using the ILS. The billing meter(s) will be incremented for pages generated by the ACQS procedures. This is not a change from the manual procedures.

### Automated Color Calibration Notes and Caveats

- All digital color presses require periodic image quality assessment and maintenance to deliver consistent color over time. Standard color maintenance procedures should include periodic Calibration to set gray balance, which returns the print engine to a nominal state.
- Automated Print Server Calibration must be initiated by an operator at the print server.
- Automated Calibration is accomplished in two to three minutes per halftone (line screen) using the ILS.
- Calibration frequency depends in part on customer preference; however, the following guidelines apply:
  - We recommend that Calibration be performed daily.
  - Calibration should always be performed after service procedures or if any drift in color is detected.
  - During a regular 8-hour shift, many customers calibrate at least once for each halftone that is used during that shift and many customers calibrate more frequently to mitigate potential drift.
  - Calibration should be performed using your most commonly used paper stock, or a “centerline” stock with mid-range weight and coating within the set of stocks you typically use.
- Each time Automated Calibration is activated, the target sheets are printed, scanned and ejected to the purge tray location (for example, the top tray of a High Capacity Stacker). If the purge tray is full, performing Automated Calibration will cause a jam to occur. In most cases, once the jam is cleared, the printer will be able to resume calibration. If the Automated Calibration procedure cannot recover, the current calibration job will be aborted, and the operator will need to close the calibration dialog box and reinitiate calibration.

### Advanced Profiling Notes and Caveats

- Advanced Profiling creates a superior, custom ICC-compliant Destination Profile for color critical applications that require a high degree of color accuracy. Using the ILS, this procedure will automatically print target sheets (measure the color patches on those sheets, and use those color measurements to generate a custom color profile for that specific press using that stock with that halftone dot). For optimal color accuracy, customers should create a custom profile for each stock that is used.
- Advanced Profiling must be initiated by the operator at the print server using Color Profiler Suite with Fiery EX color server.

- When creating new advanced profiles, customers should perform DFE calibration first, and then create profile, and ensure that you are linking the correct calibration curve to the correct destination profile.
- Once the target sheets are printed and scanned, the Advanced Profiling software takes approximately 5 minutes to generate a profile for the selected halftone.
- Calibrating routinely (to maintain gray balance) will extend the period of time for which an Advanced Profile can be used. If calibration is performed regularly, the profile should be accurate for up to a month; however some customers prefer to replace their profiles every 2 weeks to ensure accuracy.
- A new (replacement) Advanced Profile may need to be generated after certain service procedures such as photoreceptor drum replacement or charge corotron replacement.
- If a jam or other fault occurs during printing of the profile sheets, the Profiling operation will automatically be aborted and the operator will need to restart the Advanced Profile creation process.

## SIQA

The Versant 180 Press includes a number of procedures, collectively called Simple Image Quality Adjustments that use the on-press scanner to adjust image quality. The SIQA toolset can be used to adjust inboard-to-outboard uniformity (“smile” correction) and side-to-side registration, as well as image transfer settings. These adjustments are performed by initiating the process at the user interface which generates a set of prints. These prints are then scanned using the on-press scanner, which automatically feeds the measurement data back to the press where the necessary adjustments are made.

### SIQA Notes and Caveats

- In general, the inboard-to-outboard uniformity correction does not depend on which particular stock and tray is used. One correction will be sufficient for all stocks and trays.
- Side-to-side registration correction does depend on the specific stock and tray.
- Image transfer adjustment is dependent on the specific stock.

# Support Services

## Call Procedure

Contact your local sales and service team for details.

## Product Sustainability

### Packaging Take-Back Service for Xerox Branded Products

Whenever possible, we encourage you to recycle packaging locally as it reduces greenhouse gas emissions associated with transportation. However, if unable to recycle locally, please check with your local sales and service team for recycling instructions.

## Supplies and Consumables

Xerox supplies for your machine, including paper and CRUs, can be ordered from Xerox by going to [www.xerox.com](http://www.xerox.com) and clicking on either the Contact link for specific contact information/telephone numbers in your area or by clicking on the Supplies link and entering/selecting your specific machine information (product family and model type).

**NOTE:** Always refer to [www.xerox.com](http://www.xerox.com) for the latest Customer Replaceable Units (CRUs) part numbers.

It may be helpful to know the press serial number before calling for support. The press serial number can be accessed either by locating the serial number plate on the inside frame of Tray 1, or by accessing the Press Control Panel:

- Press the Machine Status button.
- From the Machine Status screen, ensure that the Machine Information tab is displayed.
- The press serial number is displayed under General Information.

## Recommended Supplies

Item	Reorder Number			Units per Carton	Yield
	WW Metered	WH / XE Sold	DMO Sold Toner		
Black <sup>1</sup>	6R01638	6R01642	6R01646	1	20k A4 at 7.5% AC
Cyan <sup>1</sup>	6R01639	6R01643	6R01647	1	22K A4 at 7.5% AC
Yellow <sup>1</sup>	6R01641	6R01645	6R01649	1	22K A4 at 7.5% AC
Magenta <sup>1</sup>	6R01640	6R01644	6R01648	1	21K A4 at 7.5% AC
Drum Cartridge <sup>2</sup>	13R00674			1	348K
Toner Waste Bottle	8R12290			1	70K
Suction Filter	8R13175			1	200K
Production Ready Finisher Staple Refills	8R13041			4 refills	5K per refill (20K total)
Production Ready Booklet Maker Finisher Staple Refills	8R12941			3 refills	5K per refill (20K total)
Production Ready Booklet Maker Finisher Staple Cartridge	8R13177			1	5K
Staple Refills for BR Finishers, BR Booklet Maker Finishers, & Convenience Staplers	008R12941			3 refills	5K per refill (15K total)
Staple Cartridge for BR Finishers & Convenience Staplers	008R12964			1	5K
Staple Cartridge for BR Booklet Maker Finishers	008R13177			1	5K
Advanced HCF Feed Roll Kits	8R13169			1	333K

1. The dry ink yield projections are based on the indicated area coverage at standardized conditions on 8.5 in x 11 in/A4 Versant® 180 Press centerline paper. Please note that actual yields vary greatly depending on color intensity, area coverage, paper stock, and mode selected.
2. Drum Cartridge replacement frequency noted above for 8.5 x 11 in/A4 images when using Versant® 180 Press centerline paper and other stocks with equivalent smoothness, cut quality and structure. Replacement rates may be more frequent for operations which use high percentages of coated stocks, have area coverage greater than 70% of each color, and/or larger than 8.5 x 11 in/A4 size throughputs, e.g., 11 x 17 in/A3.
3. Note – instructions on how to replace these supplies & CRU's can be found in the User Guide.

## Initial Supplies

Each Versant® 180 Press is delivered with an initial supply of Toner and all CRUs: Drum Cartridges, Waste Toner Container, and Staples (if applicable).

To order additional supplies or media (throughput materials), contact the Xerox Supplies Marketing Center or your local sales and service team for information



# Installation Planning

## Main Components

### Press Components (Base Configuration)



The press base configuration is delivered with the following components:

1. Press
2. MSI
3. User interface

### Optional Feeding / Finishing

Refer to [Options](#).

## Module Dimensions and Weights

**NOTE:** The dimensions listed in the following tables are provided to assist in the installation of the press and should not be used to calculate press space requirements. Refer to the [Space Requirements / Service Space Envelope](#) section for the press overall space requirements.

### Dimension and Weights for the Press

Module Name	Width	Depth	Height	Weight
Press	30 in / 760 mm	33 in / 831 mm	48 in / 1212 mm	651 lb. / 295 kg

### Dimensions and Weights for Optional Devices

Module Name	Width	Depth	Height	Weight
High Capacity Feeder (HCF)	15.5 in / 389 mm	24 in / 610 mm	15 in / 377 mm	64 lb. / 29 kg
OHCF	39.5 in / 998 mm	30 in / 762 mm	39 in / 992 mm	353 lb. / 160 kg
Advanced HCF	39.5 in / 998 mm	30 in / 762 mm	39 in / 992 mm	523 lb. / 237 kg
BR Finisher	21.5 in / 542 mm	25 in / 635 mm	39.5 in / 1002 mm	96 lb. / 44 kg
BR Booklet Finisher	21.5 in / 542 mm	25 in / 635 mm	39.5 in / 1002 mm	133 lb. / 60 kg
Interface Decurler Module	13.6 in / 323 mm	28.5 in / 724 mm	39 in / 992 mm	110 lb. / 50 kg
Insertor	6.7 in / 165 mm	28.5 in / 724 mm	39 in / 992 mm	99 lb. / 45 kg

Module Name	Width	Depth	Height	Weight
GBC AdvancedPunch Pro	17.5 in / 445 mm	28.5 in / 724 mm	39 in / 992 mm	220 lb. / 100 kg
High Capacity Stacker (HCS)	31.5 in / 800 mm	28.5 in / 724 mm	39 in / 992 mm	341 lb. / 155 kg
Production Ready Finisher	33.6 in / 855 mm	28.5 in / 724 mm	39 in / 992 mm	187 lb. / 85 kg
Production Ready Booklet Maker Finisher	34.8 in / 890 mm	28.5 in / 724 mm	39 in / 992 mm	231 lb. / 105 kg
Two-sided Trimmer	23.8 in / 605 mm	28.5 in / 724 mm	39 in / 992 mm	260 lb. / 118 kg
C/Z Folder	9.1 in / 232 mm	28.5 in / 724 mm	39 in / 992 mm	114 lb. / 52 kg
SquareFold Trimmer Module	42 in / 1066 mm	28.5 in / 724 mm	21.5 in / 546 mm	209 lb. / 95 kg
2-Knife Trimmer Module (outside NA only)	27.6 in / 700 mm	38.6 in / 980 mm	38.6 in / 980 mm	440 lb. / 200 kg

The Production Ready Finisher Plus is comprised of the Finisher Module and the Finishing Transport.

Module Name	Width	Depth	Height	Weight
Production Ready Finisher Plus	58.8 in / 1490 mm	28.5 in / 724 mm	39.5 in / 1003 mm	368 lb. / 167 kg
Finisher Module	34.8 in / 890 mm	28.5 in / 724 mm	39 in / 992 mm	231 lb. / 105 kg
Finishing Transport	24 in / 600 mm	25 in / 635 mm	39.5 in / 1003 mm	137 lb. / 62 kg

## Dimensions and Weights for the EX-i 80 Print Server

Module Name	Width	Depth	Height	Weight
Controller (hard drive)	3.6 in / 92 mm	11 in / 279 mm	11.6 in / 295 mm	12.8 lb. / 5.81 kg
This option adds 4 inches (100 mm) to overall Press depth. DFE mounts on rear of Press.				

## Dimensions and Weights for the EX-80 Print Server

Module Name	Width	Depth	Height	Weight
Controller (hard drive), no furniture	8.36 in / 212 mm	19 in / 482 mm	19.23 in / 488 mm	43.2 lb./ 19.6 kg
Optional Stand, furniture	31.5 in / 800 mm	31.5 in / 800 mm	62 in / 1575 mm	62 lb. / 28 kg

## Print Server Cables (common for print servers)

Item	Length
Communications cables (connecting the print server with the press)	16.4 feet/5 meters
Image cables (connecting the print server with the press)	19.69 feet/6 meters

## Module Dimensions for Optional Third Party Finishing Devices

**NOTE:** Always refer to the Finishing Solutions Planning Guide for the most up-to-date information on the optional, third-party finishing devices. The latest information can be found at: <http://www.thefic.xerox.com/View/Collection-113169>

# Space Requirements / Service Space Envelope

## Movable Configurations and Minimizing Space Requirements

Certain Press configurations are considered movable as long as they are on a hard surface (concrete, wood, and/or with mobility plates). A movable configuration enables the placement of the Press 29 inches (737 mm) closer to the rear wall or obstruction. A movable Press may require service break apart the Press apart into modules to service it, hence a movable configuration may take longer to service than a stationary configuration. No operator activities are compromised with a movable configuration. To determine which configurations are moveable and which may require mobility plates (and how many), review the data at the Xerox SMART Centre (<https://s3s.smartcentre.xerox.com/templates/AssetDetail.aspx?id=25769825116>).

**Note:** Larger configurations must be considered stationary due to the amount of force required to move the Press.

## Service / Operational Space Chart

Service/Operational Space	Stationary	Movable
Rear of Press	39.3 in / 1000 mm	10 in / 254 mm
Front of Press	37.3 in / 947 mm	37.3 / 947 mm
Sides of Press	29.5 in / 750 mm	29.5 in / 750 mm
Space above press	78 in / 1981 mm	78 in / 1981 mm
Space between Press and Print Server (as required)	24 in / 610 mm	24 in / 610 mm

## Service Space Envelope

### For stationary Presses

Space around the Press is required to both use and service it. The depth (front to back) of the service envelope (the space required to service all aspects of the Press) is:

Free space in front of Press: 37.3 in / 947 mm  
 Press depth: 30 in / 762 mm  
 Free space behind Press: 39.3 in / 1000 mm  
 Total depth: 106.6 in / 2709 mm

### For movable Presses

Free space in front of Press: 37.3 in / 947 mm  
 Press depth: 30 in / 762 mm  
 Free space behind Press: 10 in / 254 mm  
 Total depth: 77.3 in / 1963 mm

### For all Presses

The total width of the service envelope is determined by the options attached to the Press. Use the [Service Space Width Worksheet](#) to determine the total free width required for the Press. These two dimensions (Total Depth and Total Width) define the overall service space required for the Press, into which no obstruction may impinge. The dimensions the absolute minimums without sign-off by the local service district.

Service Space Worksheet					
Feeding Options	Press	Press (Base Configuration)	68 in	1713 mm	_____
		Press (with optional Feeding and Finishing Devices)	31 in	790 mm	_____
		High Capacity Feeder	16 in	389 mm	_____

	Dual Advanced High Capacity Feeder	39 in	998 mm	_____
	1 Tray Oversized HCF	39 in	998 mm	_____
	2 Tray Oversized HCF	39 in	998 mm	_____
Finishing Options	Interface Decurler Module	14 in	345 mm	_____
	Insertor	7 in	170 mm	_____
	GBC® Advanced Punch® Pro	18 in	450 mm	_____
	High Capacity Stacker (HCS)	32 in	805 mm	_____
	BR Finisher	36 in	914 mm	_____
	BR Booklet Maker	36 in	914 mm	_____
	C/Z Folder	10 in	237mm	_____
	Production Ready Finisher	34 in	860mm	_____
	Production Ready Booklet Maker Finisher	35 in	890 mm	_____
	Production Ready Finisher Plus	58 in	1455 mm	_____
	SquareFold® Trimmer Module	42 in	1066 mm	_____
	2-Knife Trimmer	28 in	700	_____
	Two-sided Trimmer	24 in	610 mm	_____
				Subtotal of module measurements
Required Service Space (left 29.5 in / 750 mm, right 29.5 in / 750 mm)		59 in	1500 mm	_____
<b>Add module measurements subtotal, plus required service space for the Total Service Space Envelope =</b>			_____	

## Floor Information

The customer site floor must safely support the weight of the entire machine and all its components. This includes the weight of any optional feeding and finishing devices that the customer intends to add.

Any installation on a carpeted surfaces requires the installation of mobility plates to allow the product to be moved during normal maintenance.



For product specification information on all third-party finishing devices, refer to the specific third-party customer documentation.

## Electrical Requirements

All machine optional accessories and print servers should be placed within 6 feet (1.8 meters) of wall outlets. Ensure that there are enough wall outlets available for optional accessories and the print server.

### Press Electrical Requirements

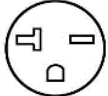
Electrical requirements must be satisfied prior to equipment delivery. The Press requires a dedicated 20 Amp service.



Item	Main processor
Nominal Voltage	<ul style="list-style-type: none"> <li>North America (NA): 208-240 VAC (XC) -10% /+6%</li> <li>Europe: 220-240 VAC (XE) ±10%</li> </ul>
Circuit Breaker	20 Amps
Maximum Typical Current	16 Amps
Frequency (Hz)	<ul style="list-style-type: none"> <li>NA: 50/60 ±3%</li> <li>Europe: 50 ±3%</li> </ul>
Power consumption	<ul style="list-style-type: none"> <li>NA: 208V, 3.66KW or less</li> <li>NA: 240V, 4.224KW or less</li> <li>Europe: 220V, 4.4KW or less</li> <li>Europe: 240V, 4.8KW or less</li> </ul>
Power Cord Length	10 feet/3 meters
Plug/Receptacle Diagram	<ul style="list-style-type: none"> <li>North American Plug: NEMA 6-20P</li> <li>North American Receptacle: NEMA 6-20R</li> </ul>  <p>A single power cord and receptacle is required for the press.</p> <ul style="list-style-type: none"> <li>Europe: PCE Shark 023-6 Plug</li> <li>Europe: receptacle that mates to the PCE Shark 023-6 plug</li> </ul> 

### Electrical Requirements for Optional Devices

**NOTE:** HCF, BR Finisher, and BR Booklet Finisher plug directly into the Press and require no additional power receptacle.

**NOTE:** Use surge protection only as required and is the responsibility of the customer.

Item	1-Tray OHCF / Advanced HCF	100-127 VAC	220-240 VAC
Current/run power		1-Tray OHCF – 2.5A Advanced HCF – 5A	1-Tray OHCF – 1.5A Advanced HCF – 3A
Power cord length		8.2 feet/2.5 meters	8.2 feet/2.5 meters
Receptacle NEMA part number		5-15R or 5-20R	

	 	
--	---	--

Optional finishing device		Current (amps) @ 125 VAC	Current (amps) @ 230 VAC	Power cord length	Receptacle NEMA part number (US Only)
1-Tray OHCF		2.5	1.5	8.2 feet / 2.5 meters	5-15R or 5-20R
Advanced HCF (Single or Dual Configuration)		5	3	8.2 feet / 2.5 meters	5-15R or 5-20R
Interface Module		1.5-1.9	0.8-1.0	8.2 feet / 2.5 meters	5-15R
Interface Module (with ILS)		3-3.9	1.6-2.0	8.2 feet / 2.5 meters	5-15R
GBC AdvancedPunch Pro		3.8	1.9	8.2 feet / 2.5 meters	5-15R
High Capacity Stacker (HCS)		1.2-1.5	0.8-1.0	8.2 feet / 2.5 meters	5-15R
Production Ready Finisher		2.4-3.0	1.5-1.8	8.2 feet / 2.5 meters	5-15R
PR Booklet Maker Finisher		2.4-3.0	1.5-1.8	8.2 feet / 2.5 meters	5-15R
SquareFold Trimmer Module		0.6-0.8	0.4-0.5	8.2 feet / 2.5 meters	5-15R
C/Z Folder		0.8	0.4	8.2 feet / 2.5 meters	5-15R
2-Knife Trimmer Module		4	2	14.8 feet / 4.5 meters	5-15R
Standard Finisher Plus	Finisher Module	2.4-3.0	1.5-1.8	8.2 feet / 2.5 meters	5-15R
	Finisher Transport	5 (max)	2.7 (max)	8.2 feet / 2.5 meters	5-15R

**NOTE:** The Standard Finisher Plus requires two receptacles, one for the Finisher and one for the Transport.

## Electrical Requirements for the Print Servers

### EX 180 Print Server

Print Server Item	Current (amps) @ 125 VAC	Current (amps) @ 240 VAC	Power cord length	Receptacle NEMA part number (US Only)
EX-i 180 Controller	0.8 (typical) 1.5 (max)	0.4 (typical) 0.8 (max)	7.5 feet/2.3 meters	5-15R
EX 180 Controller	0.8 (typical) 2.8 (max)	0.4 (typical) 1.5 (max)	7.5 feet/2.3 meters	5-15R

## Determining Circuit Requirements

The Press requires a dedicated 20 Amp service.

All modules require one receptacle except the Print Server that needs two, and the Inserter and HCF that need none. Based upon your system configuration and existing electrical infrastructure, discuss with your electrician the modules you will be installing along with the electrical information from this IPG to determine the best layout and number of circuits for your situation. All modules must be installed according to local code.

## Electrical Installation Considerations

## Press Electrical Considerations

- Ground Fault Protection is provided which meets Xerox internal safety requirements and exceeds the Industry Standards for Information Technology Equipment.
- The electrical outlet must be located within 6 feet (1.83 m) to the right of the right rear corner of the main processor, or no more than 3 feet (0.914 m) to the left of the left rear corner of the main processor (when facing the equipment)
- The power cord must have sole use of the circuit. The outlet/circuit cannot be shared with any other devices or equipment
- OHCF should be placed within 6 feet (1.83 meters) of wall outlets.
- OHCF have their own power cord and must be plugged into an outlet separate from the print engine. Ensure that there are enough wall outlets.

## Electrical Considerations for Optional Devices

- Electrical requirements and space requirements must be satisfied prior to equipment delivery.
- Optional accessories should be placed within 6 feet (1.83 meters) of wall outlets.
- Most optional devices have their own power cord and must be plugged into an outlet separate from the print engine. Ensure that there are enough wall outlets for each required accessory.

## Electrical Considerations for Print Servers

- Electrical requirements and space requirements must be satisfied prior to equipment delivery.
- The print server should be placed within 6 feet (1.83 m) of the wall outlet.
- Ensure that there is an available wall outlet for the print server.

## Information Applicable to All Electrical Devices

### Extension Cord Information

Periodically extension cords may be needed. Electrical and local building and fire codes must be adhered to in terms of length of cord, conductor size, and grounding. An extension cord may serve only one device. Plug strips are not extension cords and may be used for computer applications.

### Acceptable Circumstances for Using Extension Cords

Extension cords may be used under the following circumstances:

- Extension cords may be used to facilitate demo situations where the customer does not have an outlet receptacle at the location of the demo placement. All electrical and code requirements apply.
- Where a temporary condition exists (90 days) at the customer site before a permanent outlet receptacle is installed, an extension cord set may be used to get the customer up and running. Typical situations include customer moves, remodeling, and recovery from fires or other facility emergencies.
- For most copy and facsimile machines requiring 20 amp service or less and where permitted by the Authority Having Jurisdiction, extension cord sets may be used without regard to length of time in service.

### Extension Cord Requirements

Extension cords must meet the following requirements:

- The customer must notify the appropriate agencies (Authority Having Jurisdiction) such as the local building inspector, insurance inspector, and fire inspector of the use of any extension cord set if required by local law.
- The cord set used to supply power to our machine supplies power only to our machine.
- The cord set receptacle is a single outlet receptacle. The receptacle of the extension cord set must be compatible with the machine plug (no adapters permitted).
- The cord set is of proper amp voltage to carry the load over the distance/length needed. Length is not to exceed 25 feet/7.62 meters. Cord conductors shall be a minimum of AWG# 12 (16.1 to 20.0 amps), AWG # 14 for (12.1 to 16.0 amps), and AWG # 16 (7.1 to 12.0 amps) for 25 foot/7.62 meter lengths.

- The cord set has UL or CSA listing or both, and shall have appropriate markings or labels such as type (S, SO, ST, SJ, SJO, SJT for 20 amp capacity or less).
- The Plug and Connector are grounded and the polarity and continuity are checked prior to placing the cord set in service.
- The cord set does not cross any aisles or walkways that are required exits.
- Where the Authority Having Jurisdiction permits the use of extruded cord protectors, in an aisle or walk way, only extruded cord protectors shall be permitted as protection for the cord set. Cord sets shall not be run under carpet, through walls, floors, windows or doorways, or overhead in ceiling plenum space.
- The plug of the extension cord set must be compatible with the receptacle of the wall outlet (no adapters permitted).
- The cord set must be a continuous length without splices or in line switches.

## Other Installation Considerations

### Other Installation Considerations for the Press

- Physical delivery of the Press and Print Server will be by a Xerox authorized Carrier. The Carrier will physically install the Press. Depending on geography, either the Carrier or Xerox Service perform a functional check of the Press. The entity performing the functional test of the Press will review the software/documentation with the customer. The customer is responsible for connecting and configuring the Printer Server on their network.
- There should be a minimum of 78 inches (1981 mm) clearance from the floor to the nearest overhead obstruction.

### Other Installation Considerations for the Print Servers

- One network drop is required for installation of the print server.
- The customer is responsible for configuring the print server to the network.
- To enable system administrators and others to work at the print server, the work surface should be desk height.
- To enable the Xerox service representative to safely repair the system, the work surface should measure at least 41 in (1041 mm) by 30 in (762 mm).
- The work surface of the print server must not impede on the space required by the machine and any attached accessories unless the work surface is a table that has wheels and can be easily moved.
- A secure but accessible place near the print server must be established in which to store the print server media and software. Xerox personnel may not be able to provide services unless these materials are available.
- The communications cables, which connect the print server to the press, vary in length; refer to Module Dimensions section of this guide.

**NOTE:** If the available floor space is an issue, the print server components may be placed on the right side of the press.

**CAUTION:** Avoid placing the print server directly behind the press. Heat generated by the press may cause the print server to overheat and stop functioning properly.

## Environmental Requirements

### Environmental Requirements & Performance for the Press

Item	Minimum	Maximum	Recommended
Temperature	50° F/10° C	90° F/32° C NOTE: Temperatures above 90° F (32° C) require reduced relative humidity to maintain the specific/optimal performance.	68-76° F/20-24° C NOTE: Better performance is achieved when environmental conditions are maintained at these temperatures.
Relative Humidity (RH)	15%	85%	45%



Item	Minimum	Maximum	Recommended
Heat emission	See Product Safety Data Sheet at <a href="http://www.xerox.com/download/ehs/psds/Versant%2080%20Press.en-us.pdf">http://www.xerox.com/download/ehs/psds/Versant%2080%20Press.en-us.pdf</a>		
Power consumption			
Noise (system)			
Altitude	0 feet/0 meters	8,200 feet/2,500 meters NOTE: Altitudes above 6,500 feet (2,000 meters) may require field adjustment.	6,500 feet/2,000 meters

## Customer Site Survey

Customer General Information	
Company	
Location	
State/Province	
Country	
Zip/Postal Code	
Contact 1	
Contact 2	

## Pre-installation Worksheet

### Customer Interview and Physical Site Checklist

After the order for a Xerox Press has been placed, the Analyst, Customer Trainer, or designated Xerox person in the district must visit the customer site to complete a physical site check. Arrange for a meeting with the decision maker at the site and explain that it is the responsibility of the customer to ensure the site is ready for the delivery and installation of the equipment. This document contains the requirements for the delivery and the installation of the Xerox Press.

Discuss the installation requirements with the customer and explain the installation process. As each of the following items are completed, mark the check-off box to indicate its completion.

Checkbox	Item
<input type="checkbox"/>	Show the space requirement for the installation.
Checkbox	Item
<input type="checkbox"/>	Determine if Mobility Plates are required. A mobility plate is required for all movable installations on carpeting or rough surface flooring.
<input type="checkbox"/>	Stationary installations are generally acceptable on wooden, industrial linoleum over concrete, or concrete floors.
<input type="checkbox"/>	Ensure that the site meets electrical power requirements for all modules of the Xerox Press, the print server, and any other accessories that have been ordered.
<input type="checkbox"/>	Determine if the environmental conditions meet specifications for the Xerox Press and print server.
<input type="checkbox"/>	Measure the intended site to ensure that it meets space requirements.
<input type="checkbox"/>	Walk the delivery path from the dock/entry point to the install site. TIP: If there are any stairs in the delivery path, you must contact the carrier to perform a Delivery Site Inspection (coded JK1, Misc.). Do not commit to an install date until this inspection is completed.
<input type="checkbox"/>	Ask the customer if there are any questions at this point in the process.
<input type="checkbox"/>	If there are any problems that cannot be resolved, report them to the responsible team in the district.
<input type="checkbox"/>	Tape the floor in an "L" shape where the left rear corner of the print engine will be located.

### Follow-up

Visit the site and verify that all requirements have been met. If the site is not ready, attempt to resolve any readiness conflicts. Perform ongoing site check updates until the site is ready.

When the site is ready, begin the installation process used in the district. Ensure that any optional letters of agreement concerning space requirements are processed properly in the district.

## Customer Site Description

### Special Customer Site Considerations

- (USA only) Are union workers at the loading dock and/or the installation site?  
 Yes  No
- If yes, may the carrier move the equipment at the loading dock and/or the installation site?  
 Yes  No
- Can the delivery be made during normal business hours?  
 Yes  No
- If no, identify any special delivery instructions on the Analyst Site Worksheet, located later in this chapter.  
 Yes  No

### Docks

- Is there a loading dock?  
 Yes  No
- Is the dock accessible to a truck/trailer for delivery?  
 Yes  No

Write any special instructions for the truck driver:

---

---

---

---

3. Does the dock have load/dock levelers?  Yes  No

4. Does the dock area have adequate space for unloading the Press?  Yes  No

**NOTE:** If the answer to *any* of the above questions is **No**, then a fork lift will be required to unload the modules from the truck to the floor/ground level.

### Entrance Ways

Measure the entrance ways; they must be wide enough to accommodate the Press and the largest feeder and finisher in the configuration (see Weights and Dimensions section). Is there proper clearance?  Yes  No  
If No, try another entrance or the site must be modified.

### Stairs

Are there stairs anywhere in the delivery path?  Yes  No

**TIP:** If there are any stairs in the delivery path, the Carrier Delivery Site Inspection must be performed prior to delivery commitment.

**WARNING:** The Xerox Press should never be up-ended or serious damage will result.

### Elevator Requirements

#### Elevator Weight Requirements

An elevator capacity of 651 lb. (295 kg) or more is required to move the print engine and Print Server for an installation. If the elevator capacity is not adequate, options may exist for elevator modifications. Please contact the on-site maintenance support for more information on this process.

Does the elevator capacity equal or exceed 651 lb. (295 kg) capacity?  Yes  No

If no: Determine whether modifications can be made to the elevator to increase its maximum weight capacity to 651 lb. (295 kg). If modifications cannot be made, the elevator cannot be used.

#### Elevator Width Requirements

The elevator width requirements include the doorway entrance and the interior area. The elevator must meet the following width dimensions:

##### Elevator Doorway Entrance Width

Minimum 30 in/760 mm

##### Elevator Interior Width

Minimum 34 in/864 mm

Measure the elevator entrance dimensions. Is there sufficient space at the elevator opening?  Yes  No

If No and the elevator opening is too narrow, determine whether there is another means of transporting the press modules and installation location.

### Installation Site Space Requirements

Is the site cleared and ready for installation?  Yes  No

If No: When will the site be cleared?

---

Ensure that it will be cleared and ready prior to machine installation.

Is proper power available?  Yes  No

If No: When is power scheduled to be installed?

---

Is the date prior to machine installation?  Yes  No

If this is a Xerox Press and print server installation, is a functional network connection installed?  Yes  No

If No: When is the network connection scheduled to be installed?

---

Is the date prior to machine installation?  Yes  No

Do the site space requirements meet installation planning requirements?  Yes  No

If No: What steps are being taken to ensure they meet installation planning requirements?

---

Is the date prior to machine installation?  Yes  No

### Site Preparation Checklist

The following checklist provides a list of tasks that the customer and the Xerox/Partner personnel should complete in order to ensure a successful installation. When both the customer and Xerox/Partner tasks are completed, the Xerox/Partner personnel should send notification to the carrier. This informs the carrier to plan for the delivery of the machine and to accomplish the rigger installation.

	Responsibility (Enter the name of the person responsible in the area marked with the *)		Date Completed
	Customer	Xerox / Partner	
<b>Activity:</b> <b>Delivery route</b>			
Determine if the route between the delivery door/loading dock and the installation site meets all requirements for a successful delivery; includes: Entrance ways, doorways, passageways, turning radii, ramps, and elevators		X	
<b>Activity:</b> <b>Location</b>			
	Customer	Xerox / Partner	Date Completed

Create an installation site sketch using the correct template: Match the customer configuration (including possible future expansion)		X	
Determine the location of the system at the installation site by using the site installation sketch		X	
<b>Activity: Electrical</b>	<b>Customer</b>	<b>Xerox / Partner</b>	<b>Date Completed</b>
Ensure all electrical receptacles are installed at the site in accordance with local codes	X		
<b>Activity: Location</b>	<b>Customer</b>	<b>Xerox / Partner</b>	<b>Date Completed</b>
Order network cables and install internet connection	X		
Complete the network installation work sheets	X	X	

# Operational Considerations

## Image Quality Expectations

### Image Quality

- As with any printing process, artifacts will occur. These may include banding, streaks, mottle, spots, scratches in the process direction, and more. For most jobs and clients, the expected level of artifacts is within the normal operational and component quality ranges of the system and will not affect the acceptability of the job. Maintenance procedures are available to mitigate these artifacts.
  - Artifacts may occur with more frequency when running heavyweight coated media.
  - Certain jobs may show bands across the sheet when running ~350gsm media.
  - Edge deletions are most common when duplex printing on heavier (>220 gsm / 85 lb. Cover) stocks and when using the maximum available image area. Deletions can be mitigated by using less than the maximum imageable area, i.e. allowing extra blank space at the lead and trail edges of the paper
- Using products on the Recommended Materials List (RML) and maintaining your environment will help to minimize the occurrence of these artifacts.
- Color quality perception is subjective and will be affected by ambient lighting conditions.
- The customer is responsible for calibrating the Press. Refer to the Press customer documentation for guidelines.
- Image quality is strongly influenced by paper surface structure, texture, and color. To ensure satisfaction of your customers, key jobs should be printed on the Press using representative paper for review by the customer.
- The surface texture of some uncoated papers may cause increased graininess in halftone areas printed with only black toner. This effect may be minimized by using smooth or coated papers (refer to the Recommended Media List).
- Sheets in a job may exhibit slight variation in gloss within a page (variation across page in the process direction).
- Prints may exhibit random white spots caused by paper dust, stray developer beads, or other particles. You can reduce the occurrence of white spots by using Xerox approved paper. If you are cutting your own paper, ensure that cut edges are dust free, and keep the machine in a clean and dust/dirt reduced environment. Failure to do this will result in increased frequency of white spots.
- Xerox recommends use of the SIQA toolset to improve registration on certain media, correct density if inboard-to-outboard density variation is observed, or if mottle is observed on side or side 2.

## Printing Expectations

### Product Limitations and Caveats

- When printing a large number of one page jobs in a row a 45-310 fault could occur requiring a full system reboot.
- The maximum rated print speed may be affected by job types and job settings. Productivity may be affected by the press cycling down/cycle up within or between jobs, and finishing options that are selected for a particular job.
- Overall productivity may also decline due to the press pausing to make adjustments to maintain consistent image quality. More frequent image quality adjustments and more severe productivity loss may be seen for the following job types:
  - Low area coverage jobs (3 % area coverage per color or lower)
  - Mixed media jobs; refer to [Tray Switching and Mixed Media Test Results](#) and [Print Engine Productivity Charts](#)

**NOTE:** Impact to productivity depends on the specific attributes of each job.

- If utilizing the Offset Catch Tray (OCT), overall productivity will decline if offsetting mode is selected. The print engine will pause printing in order to offset between sets and then resume printing. Productivity loss depends on the number of sheets per set with single-page jobs representing the worst case (approximately 50 % productivity loss).
- In certain conditions (e.g. high temp., heavy media, high area coverage), printed sheets may stick to each other. In these situations, the operator should select the Ink Setoff Prevention setting to "Always On". This will slightly increase the gap

between pages as they are printed, allowing them more time to cool down. Print speed will be slightly reduced as a result. Note that this condition may be more likely when printing to the OCT or BR finisher.

- Tabs or Ordered/Sequenced stock will need to be confirmed by the operator when the printer is powered on and when exiting power save mode. This is done by opening the paper tray, verifying that the first tab or sheet in the series is on top, and then closing the paper tray.
- When printing a 2-sided job that utilizes Tabs, overall productivity will decline because the press must switch between 1-sided mode (for Tabs) and 2-sided mode (for body sheets). The severity of productivity loss depends on the number of Tabs in the job (more Tabs results in greater loss of productivity).
- If the operator changes the Auto Tray Switching from the default Near Empty to Empty the print engine will pause to switch the new tray.
- If the customer network is using a 100.100.100.x IP address series, conflicts will occur.
- Auto Supplies Replenishment (ASR) will not function through XDA clients, only direct connect will enable ASR.
- Stopping or cancelling a job that is utilizing a 3<sup>rd</sup> party DFA connected finisher while printing may cause some booklets to be incomplete and the user will not be notified of the situation.
- When printing with very lightweight papers, it is strongly recommended to use RML stocks whenever possible. Failure to do so may result in the output exhibiting wrinkled sheets. At a minimum, lightweight stocks should always be run in the short-grain direction.
- 3<sup>rd</sup> party devices connected via the optional Foreign Interface Device (FID) may cause delays between print jobs.

## Integrated Fiery and EX Print Server:

- When running a job that includes both coated and uncoated paper, the Output Profile (found in the advanced color management settings) must be changed from “default” to the “coated” profile.
- Only the 21 patch color calibration target should be used when calibrating the press. Calibrating with the 51 patch target will cause undesirable color rendition.
- Multiple single page jobs submitted in a large batch will cause the press to fault and require a power cycle. Running multi-page jobs in between the single page jobs will improve this problem.

## Factors Affecting Productivity and Rated Print Speed

The rated print speed refers to the maximum print or copy speed enabled for the press. Over the course of a print job, the press will perform automatic process adjustments in order to maintain consistent Image Quality. As a result, actual productivity for a job may be less than the rated speeds shown. The actual print speed (PPM) achieved depends on a number of factors including the stock type, stock size, and number of sheets in the job.

## Envelopes

Envelope	Size	Feed Direction
Monarch	3.875 x 7.5 inches	Short Edge Feed (SEF)
#10	4.125 x 9.5 inches	Short Edge Feed (SEF)
C4	229 x 324 mm	Short Edge Feed (SEF) or Long Edge Feed (LEF)
C5	162 x 229 mm	Short Edge Feed (SEF) or Long Edge Feed (LEF)

## Envelope Feeding Guidelines and Limitations

- Other size envelopes can be used, but performance is not guaranteed.
- Envelopes should be loaded in the feed direction shown in the table above, and must be run simplex only.
- The recommended tray for printing envelopes is the Bypass Tray – Tray 5. Recommended capacity is 30-40 envelopes. Capacity may vary based on envelope type and manufacturer.
- Tray 6 or Tray 7 can be used if the Postcard Bracket is mounted and the stack height is limited to no more than 100 envelopes. Capacity may vary based on envelope type and manufacturer.
- Always load envelopes with the **flaps closed** and flaps faced down.
- When loading SEF, place the flaps facing the front of the press;
- When loading LEF, place the flaps facing the lead edge.

- When submitting your print file, select a **custom paper** as the Paper Type and enter the dimensions of the envelope. The **Width** is measured from the **lead edge to the trail edge** of the envelope. This means that if you are loading the envelope SEF, you should enter the long dimension of the envelope as the Width. If you are loading the envelope LEF, you should enter the short dimension of the envelope as the Width.
- Enter a **heavy weight** for the media, such as **176 gsm** or greater for 24lb envelopes. Best results will vary based on envelope type and manufacturer.
- Select the **Bypass Tray, Tray 6, or Tray 7** as the Paper Source.
- Do not use padded envelopes.
- Store unused envelopes in their original packaging to avoid the excess moisture or dryness which can affect print quality and cause wrinkling. Excessive moisture can cause the envelopes to seal before or during printing.
- Some wrinkling or embossing may occur when printing on envelopes. Successful envelope printing depends on the quality and construction of the envelopes. Try another envelope brand if problems occur.
- Greater image registration variance may be experienced on envelopes.
- Removal of the envelopes from the top tray is recommended to minimize poor stack quality and possible jams.
- Envelopes can only be output to the OCT or the top tray of the BR or Production Ready Finishers.

Please note that there are many kinds and manufacturers of blank envelopes that are available on the market today – the combination of different sizes, paper stocks, windows, flap styles, envelope vendors, etc. translates into many thousands of envelope options that could be used for digital imaging. Due to this extremely wide variety of envelopes, Xerox Corporation does not guarantee the performance of any particular envelope or envelopes. If a desired envelope type is fed and performance is not optimal (e.g. frequent jams occur), we encourage you to try alternate types of envelopes to see if performance improves.

## Extra Long Sheets (longer than 19.2 in. / 488 mm)

### Configurations

- Feeding is only possible via the Bypass Tray, also called Tray 5, or Multisheet Inserter (MSI).
- Sheets greater than 488mm can only be output to the Offset Catch Tray (OCT), the top tray of the High Capacity Stacker, or the top tray of the Production Ready Finisher, Production Ready Booklet Maker Finisher, or Production Ready Finisher Plus. Stacking capacity and quality is not guaranteed.
- Sheets greater than 488mm cannot be stapled, punched, folded, or any other finishing option including any 3<sup>rd</sup> party DFA finishers.
- Extra Long Sheets are incompatible with the GBC AdvancedPunch Pro, even when the GBC module is not being used to punch the Extra Long Sheets. Running Extra Long Sheets will result in a severe jam and may result in a service call.

### Media Handling

- Sheets greater than 488mm can be printed single sided (simplex) only. Auto-duplex is not possible.
- Print speed of 660mm sheets is up to 9ppm.
- Media range is 52-220gsm for uncoated media, and 72-220gsm for coated media.

### Caveats

- Full Width Array features are not available for > 488mm sheets
- There is an increased risk of paper jams when running > 488mm sheets.
- When running long sheets, paper jams may span multiple modules within the engine and therefore may be more difficult to clear.
- Multi-feeds may occur when printing on coated media. Sheets may be fed individually to prevent this.
- Registration performance is not guaranteed on sheets greater than 488mm. Any registration specifications cited in the Versant 3100 CEIG do not apply to > 488mm sheets.
- There is an increased risk of print quality defects when running sheets greater than 488mm.
- Sheets greater than 488mm have an increased risk of creasing and wrinkle.
- More image quality adjustments during run-time are likely.
- Any machine problems identified when running >488mm sheets should be re-evaluated when running the same stock at less than 488mm. The user should validate that the problem persists on <488mm stock before calling for service.
- Any print engine hardware problems encountered that are unique to XLS length stock are unsupported.
- Use of the XLS printing feature that is outside of the scope of the products' intended use is the sole responsibility of the customer.
- Stock type, coating, quality of how it was cut to size, etc. have a large impact on performance. If problems occur running a given stock, alternate stocks should be attempted to evaluate whether performance improves.
- When cutting larger paper down to XLS format, stocks should be cut in the long grain direction when possible.



# Customer Expectations Agreement

Checkbox	Modules to be installed
	Xerox Versant® 180 Press
	HCF Feeder
	1-Tray OHCF
	Advanced HCF
	OCT
	BR Finisher
	BR Booklet Finisher
	Interface Module
	GBC AdvancedPunch Pro
	High Capacity Stacker
	Production Ready Finisher
	Production Ready Booklet Maker Finisher
	SquareFold Trimmer Module
	Production Ready Finisher Plus
	Other Third Party Finisher

Name of Third-Party Device \_\_\_\_\_

Additional Reference Material:

Inform/show customer where to find and download a complete set of customer documentation online at [www.xerox.com](http://www.xerox.com)

Primary Customer Applications:

---

---

---

---

Special considerations or performance limitations identified by Xerox/Partner and agreed to by the customer:

---

---

---

---

Upending and/or Stair Climbing Required and Reviewed:

Yes \_\_\_\_\_ Not Required \_\_\_\_

I have reviewed and understand the product specifications for each of the modules that will be installed, including those specified in the product Customer Expectation and Installation Guide: (Signatures Required)

Customer \_\_\_\_\_

Xerox/Partner Sales Representative \_\_\_\_\_

Xerox/Partner Analyst Representative \_\_\_\_\_

Xerox/Partner Service Representative \_\_\_\_\_

I have viewed a representative output sample from the Xerox Versant® 180 Press and the image quality is acceptable for the needs of my organization: (Signature required if Xerox Versant® 180 Press is included with Order)

Customer \_\_\_\_\_



