



# **REGAL LS4, LX4, LS6, LX6, LS9 OWNER'S MANUAL**

 **REGAL**

JULY 2023 REVISION

# Notes

## FUEL SYSTEMS

Boats manufactured for use in California for model year 2018 and after meet the California EVAP Emissions regulation for spark-ignition marine watercraft. Boats meeting this requirement will have a label affixed near the helm.



## WARNING

Operating, servicing and maintaining a recreational marine vessel can expose you to chemicals including engine exhaust, carbon monoxide, phthalates, and lead, which are known to the State of California to cause cancer and birth defects or other reproductive harm. To minimize exposure, avoid breathing exhaust, service your vessel in a well-ventilated area and wear gloves or wash your hands frequently when servicing this vessel. For more information go to: [www.P65warnings.ca.gov/marine](http://www.P65warnings.ca.gov/marine).

The fuel system in this boat complies with U.S. EPA mandated evaporative emission standards at time of manufacture using certified components.

### Typical Helm CARB Label-Trailerable Models

**EMISSIONS CONTROL SYSTEM INFORMATION  
MEETS U.S. EPA EVAP STANDARDS USING CERTIFIED  
COMPONENTS AND MEETS 2020 MY CALIFORNIA EVAP  
EMISSIONS REGULATIONS FOR SPARK-IGNITION  
MARINE WATERCRAFT**

**MANUFACTURER: REGAL MARINE INDUSTRIES, INC.  
MODEL:**

**CALIFORNIA EVAP FAMILY: LRMIPVSSL001  
EMISSION CONTROL SYSTEM: CM**

## MANUFACTURER'S WARRANTY COVERAGE

This evaporative emission control system is warranted for two years. If any evaporative emission-related part on your spark-ignition marine watercraft is defective, the part will be repaired by Regal Marine Industries, Inc.

## OWNER'S MANUAL RESPONSIBILITIES

- As the spark-ignition marine watercraft owner, you are responsible for the performance of the required maintenance listed in your owner's manual. Regal Marine Industries, Inc. recommends that you retain all receipts covering maintenance on your spark-ignition marine watercraft, but Regal Marine Industries, Inc. cannot deny warranty solely on the lack of receipts.
- As the owner, you should be aware that Regal Marine Industries, Inc. may deny you warranty coverage of your spark-ignition marine watercraft or a part has failed due to abuse, neglect, or improper maintenance or unapproved modifications.
- You are responsible for presenting your spark-ignition marine watercraft to a Regal Marine Industries, Inc. distribution center or a service center as soon as the problem exists. The warranty repairs should be completed in a reasonable amount of time, not to exceed 30 days. If you have any questions regarding your warranty coverage, you should contact Regal Marine Industries, Inc. at 407-851-4360.

# Introduction

Boating is becoming more popular each year. There are numerous types of recreational vessels on our waterways today involved in a growing number of activities. Therefore, as a Regal boat owner, it is of the highest priority to learn about general boating practices before operating your vessel.

Your Regal dealer will answer any questions and provide valuable “hands-on” information during the completion of the new boat delivery process. In addition, your dealer has received special factory training on the product line and his services should be employed to solve any technical problems and periodic maintenance beyond the scope of this manual. Your Regal dealer carries a line of factory-approved parts and accessories.

Your Regal dealer can provide information regarding national training organizations such as the U.S. Power Squadron and the United States Coast Guard Auxiliary. Along with other organizations and literature, they can help build your “boating savvy” by developing the necessary skills and awareness to be a safe and confident skipper.

Also, your local library can assist in providing recommended boating literature such as Chapman Piloting Seamanship & Boat Handling by Elbert S. Maloney. Also, boating information is available on the internet.

Remember, waterway conditions can change in a heartbeat. Knowing how to react quickly comes from experience and knowledge which can be gained through boating education.

Welcome aboard!

# Welcome to Regal

I know I speak for everyone at Regal when I welcome you to the ever-growing family of Regal boat owners. You've chosen a boat that is recognized worldwide for its standard of excellence. Each step in construction has been carefully scrutinized to assure safety, performance, reliability, and comfort for both your passengers and yourself.

Your yacht is certified by the National Marine Manufacturers Association. It also complies with the applicable standards set by the United States Coast Guard, American Boat and Yacht Council, and the International Marine Certification Institute. Your Regal boat was built with the same attention to detail and quality of construction that we would expect in a craft we would purchase ourselves.

Whether you're a veteran boater or a newcomer, we strongly urge you to read this owner's manual thoroughly. Familiarize yourself with the various components of your vessel, and heed the safety precautions noted herein.

If you have questions that are not covered in this manual, please consult your authorized Regal dealer for assistance, phone the Regal factory at 407-851-4360, or visit us at [www.regalboats.com](http://www.regalboats.com).

Thank you, and welcome to the "World of Regal!"

Duane Kuck  
President & CEO

## Our Mission

With God's Help and a Steadfast Commitment to Integrity, We will Develop a Team of Exceptional People and Relationships to Provide Exceptional Customer Satisfaction.



# Table Of Contents

<b>2</b>	Notes
<b>3</b>	Introduction
<b>4</b>	Welcome to Regal
<b>6</b>	Chapter 1 - Systems
<b>45</b>	Chapter 2 - Engine & Controls
<b>58</b>	LS4/LS6 Surf Engine & Systems
<b>62</b>	LS9 Surf Engine & Systems
<b>65</b>	Chapter 3 - Outboard Engine & Systems
<b>110</b>	Chapter 4 - Vessel Operation
<b>124</b>	Chapter 5 - Auxiliary Equipment Operation
<b>173</b>	Chapter 6 - Care & Maintenance
<b>194</b>	Chapter 7 - Troubleshooting
<b>203</b>	Chapter 8 - Storage & Winterization
<b>207</b>	Chapter 9 - Towing
<b>212</b>	Chapter 10 - Glossary & Index
<b>218</b>	Chapter 11 - Technical
<b>219</b>	LS Series Drawings (Stern Drive & Surf)
<b>253</b>	LX Series Drawings (Outboard)

# Chapter 1

# Systems

## Overview

In this chapter Regal on board standard systems are introduced. Information includes several main systems including electrical, fuel, waste, and entertainment. In short, this chapter is the “meat and potato” section for systems. Selected optional equipment and systems are found in Chapter 7.

A system description, location of components, and operational information is found in this section. Enhanced vendor component details and troubleshooting can be found in the owner’s information packet along with the troubleshooting chapter of this manual.

*Be sure to read and follow any danger, warning, or caution labels in reference to boat systems or individual equipment components.*

*Note that your Regal boat may not contain all of the equipment or systems shown. Regal has the right to modify, update or delete equipment and/or systems at anytime. Refer to the vendor documentation located in the owner’s information packet for more detailed information of individual system components. Also, use internet search agents.*



## WARNING

PREVENT INJURY OR DEATH!  
READ AND UNDERSTAND THE  
PROPULSION OWNER’S MANUAL  
BEFORE ATTEMPTING  
TO OPERATE THE VESSEL.



## WARNING

PREVENT INJURY, DEATH AND/OR  
PROPERTY DAMAGE!  
READ AND UNDERSTAND ALL  
EQUIPMENT OWNER’S MANUALS  
BEFORE ATTEMPTING  
TO OPERATE THE COMPONENT.

## Electrical System

### Introduction

In this section, basic DC (direct current) is introduced. Select electrical components are reviewed along with their location and function within the electrical system.

For more complicated issues outside the scope of this manual contact your closet Regal dealer. They have undergone extensive training on the Regal boat systems.

Be sure to read and follow any danger, warning, caution, or notice labels in reference to the vessel's electrical system or individual equipment components. Also, refer to the owner's information packet for further product information or the internet.

 **WARNING**

PREVENT SEVERE INJURY OR DEATH!  
DISCONNECT  
ALL ELECTRICAL POWER SOURCES  
BEFORE ATTEMPTING  
TO REPAIR OR REPLACE  
ANY ELECTRICAL COMPONENT.

 **CAUTION**

AVOID CHARGING SYSTEM DAMAGE!  
DO NOT TURN  
BATTERY SWITCH TO THE "OFF"  
POSITION WITH THE ENGINE RUNNING.

## DC Current

Your Regal boat uses 12 volt DC electricity otherwise known as direct current. It is called DC because it flows only one way in a circuit. Specifically to name a few, helm gauges, batteries, battery cables, engine electrical components, engine wiring harnesses, dash switches, selected lighting, shower sump, bilge pumps, and vacuum toilets are all components using a 12 volt DC system.

In the domestic DC system the red wire is designated as the "hot" or conductor wire and the black wire is referred to as the ground wire. At times other current carrying wires are color coded such as blue to identify their use as a low voltage conductor. This is especially helpful in troubleshooting and adding additional equipment. Be sure to review the wiring schematics in the drawing section of the technical chapter.

Direct current is stored in the ship's battery(ies) and produced through the engine alternator while the engine is running or by the battery charger at shore. Normal DC voltage is between 12 and 15 volts. Lower or higher readings could indicate a charging malfunction or a weak battery.

*Note that current specifications for alternator output is around 105 amps depending on engine model. The forward bilge pump and automatic float switch are continuously on with the bilge pump switch in the middle or "off" position. Should a leak develop with the operator away from the vessel the bilge pump will continue to pump bilge water overboard until of course the battery goes dead.*

TYPICAL DC (12 VOLT) WIRING COLOR CODE & SIZES		
BLACK	16,14,12,10,8,6,4,2,2/0,40	GROUNDS
BLACK/WHITE	16	HALON INDICATOR
BLACK/YELLOW	10,16	GRD. DIESEL TRANSFER PUMP, MERC DIESEL STOP CIRCUIT
BLACK/WHITE	10	HALON MAIN GRD. FEED
BROWN/BLACK	10	MACERATOR, SUN ROOF
BROWN	10	SUN ROOF
BROWN	14	AFT BILGE PUMP-MANUAL
BROWN/WHITE	14	AFT BILGE PUMP-AUTO
BROWN/RED	14	FWD. BILGE PUMP-AUTO
BROWN/BLUE	14	FWD. BILGE PUMP-MANUAL
BROWN/PINK	16	CO DETECTOR
BROWN/BLACK	16	SHOWER SUMP PUMP
YELLOW	12,10	BLOWER
YELLOW/WHITE	16	HEAD VENT FAN MOTOR
YELLOW/BLACK	16	STEREO MEMORY
YELLOW/RED	14	ENGINE START CIRCUIT

Note: The list above applies to a number of vessels. Vessel components/wiring specifications may vary depending on the model.



TYPICAL DC (12 VOLT) WIRING COLOR CODE & SIZES (CONTINUED)		
ORANGE	10,12	VACUUM TOILET, REFRIGERATOR, HATCH RAM
ORANGE	16	WIPER RUN
ORANGE/WHITE	16	WIPER PARK
ORANGE/BLACK	10,12,16	HORN, HATCH RAM
BLUE	14	INTERIOR LIGHTS, SWITCHED CIRCUIT
BLUE/RED	14	INTERIOR LIGHTS, CONSTANT HOT CIRCUIT
BLUE/BLACK	16	COCKPIT SOFT LIGHTS
BLUE/GREEN	16	INTERIOR SOFT LIGHTS
BLUE	10	CABIN LIGHT MAIN CIRCUIT FEED
GRAY	14	NAVIGATION LIGHTS, RUN- NING, BOW, TRANSOM LIGHTS
GRAY/BLACK	14	NAVIGATION LIGHTS, AFT AN- CHOR, MASTHEAD
GRAY/WHITE	14	NAVIGATION LIGHTS, MAST- HEAD, FWD. RUNNING LIGHTS
RED	16	POSITIVE FEED- ELECTRON- ICS, GAS VAPOR DETECTOR, BREAKER TO DASH SWITCH FEEDS

Note: The list above applies to a number of vessels. Vessel components/wiring may vary depending on the model.

TYPICAL DC (12 VOLT) WIRING COLOR CODE & SIZES (CONTINUED)		
RED/WHITE	16	WINDLASS CONTROL-DOWN
RED/BLACK	16	WINDLASS CONTROL-UP
RED/WHITE	14	BATTERY PARALLEL-LOAD
RED	14	POSITIVE FEED-ELECTRONICS
RED	12	POSITIVE FEED-ELECTRONICS
RED	10	POSITIVE FEED-AUTO PILOT
RED/VIOLET	10	FUEL TANK TRANSFER PUMP AMPLIFIER POWER
RED	8	POSITIVE FEED- MAIN ALTERNATOR CHARGE
RED	6	POSITIVE FEED- MAIN ALTERNATOR CHARGE
RED	4	POSITIVE FEED-MAIN
RED	2	POSITIVE FEED- MAIN STARTER, BATTERY, GENERATOR
RED	2/0	POSITIVE FEED- MAIN, START- ER, BATTERY
PURPLE	16	STBD. IGNITION, HOUR METER- WINDSHIELD VENT
PURPLE/WHITE	16	PORT IGNITION, HOUR METER, WINDSHIELD VENT
PINK	16	STBD. FUEL TANK SENDER
PINK/BLACK	16	PORT FUEL TANK SENDER
TAN/BLUE	16	ENGINE ALARM CIRCUIT
GREEN	16	TANK LEVEL MONITOR, SPOT- LIGHT
GREEN	10	SPOTLIGHT
GREEN	8	BONDING

Note: The list above applies to a number of vessels. Vessel components/wiring may vary depending on the model.

## Batteries

All vessel DC equipment and specifications are subject to change at any time, as part of Regal's commitment to product improvement. Equipment information here is up to date per the owner's manual printing date.

### Battery Terminology Descriptions

One battery is standard equipment on your vessel. A second battery is used when the dual battery switch option is chosen. All batteries include a battery box or tray along with fastening hardware. Be sure to periodically check maintenance style batteries for proper electrolyte levels and use only distilled water when filling cells.

Group- Batteries are divided into groups which identify the height, length, and width of the battery. This is useful information should a replacement battery become necessary. Note that the LS & LX vessels currently use 31 A series battery (ies).

Cold Cranking Amps (CCA)- This rating measures the cranking power of a full charged marine battery having the ability to start at 32 degrees F. Basically, the higher the rating the greater starting power of the battery.

Reserve Capacity (RC)- As usage on the boat increases so does the need for more reserve capacity. The reserve capacity represents the length of time in minutes a new fully charged battery can maintain the vessel's electrical needs without the engine running or in the event of alternator failure.

BATTERY SPECIFICATIONS			
Battery Type	Group	CCA @32 Degrees F.	Reserve Capacity
Engine Cranking & House	31 A	1260	195 min.

## Battery Problems/Solutions



1. Weak battery- This battery problem can be caused by low electrolyte cell levels.

Warm, bilge compartment temperatures will deteriorate a battery's life quicker by evaporating the water from the electrolyte, thus corroding and weakening the positive grids inside the battery.

Low electrolyte levels can be monitored by periodic inspection and filling as needed with distilled water.

Boaters in higher climate areas with longer stretches of hot weather will need to check their batteries more often.

“Maintenance free” engine cranking batteries require no water and cells are not accessible. They do feature a different chemistry that does consume less water. Inside the cells as gases are released condensation is formed which aids in maintaining the cell electrolyte level. These batteries incorporate a deeper layer of electrolyte over the plates, but eventually it can run dry. On the 31 series engine cranking batteries keep all terminals clean, connections tight and your electrical system in top shape to extend battery life.

2. Dead Battery- Either the battery will not accept a charge, hold a charge or the charging system is not supplying a charging current through the battery charging system and/or engine alternators.

The battery charger output can be checked by monitoring the lights on the charger front face.

To begin with check the battery post connections for tightness and corrosion.

With the engine running the displayed voltage of the battery should be between 12.5 up to 14.6 volts.

If less than 12 volts check for voltage across the battery terminals.

If less than 12 volts check with a hydrometer to locate faulty cells.

Maintenance free batteries they can be removed from the vessel if necessary and trickle charged. If readings after charging are still low replace the battery.



## Battery Switch

The engine cranking battery switch is located in the starboard bilge (sump) on the battery management panel. To access the panel lift up the starboard aft seat.

The dual battery switch designates “off”, “on” and “combine batteries” positions. This particular battery switch is connected to dual batteries and this set-up supplies additional reserve capacity to run higher average draw equipment on one battery bank and to supply cranking amperage to start the engine with the other battery bank.

To use the “combine batteries” feature for engine starting when one battery bank is weak turn the battery switch knob to the “combine batteries” detent (yellow labeled area). At this point you can start the engine.

As this particular battery switch features a “make before break” footprint once the engine starts you can reposition the battery switch to the “on” detent which will revert back to the engine starting battery. It is recommended not to leave the dual battery switch in the “combine batteries” position as under the right conditions a severe discharge could result in both batteries becoming “dead”.

*Never turn the battery switch to the “off” position with the engine running.*

Note that the battery charging system will recognize a low or weak battery and will send a charge to the weak battery when the outboard motor is running.



TYPICAL DUAL BATTERY SWITCH

The engine and house battery system is protected by a breaker at the battery management panel.

Be sure to turn the battery switch to the “off” position when leaving the vessel as the bilge pump (s) will remain active in the automatic position. In addition, the stereo memory system will be protected.

## Typical Battery Management Panel

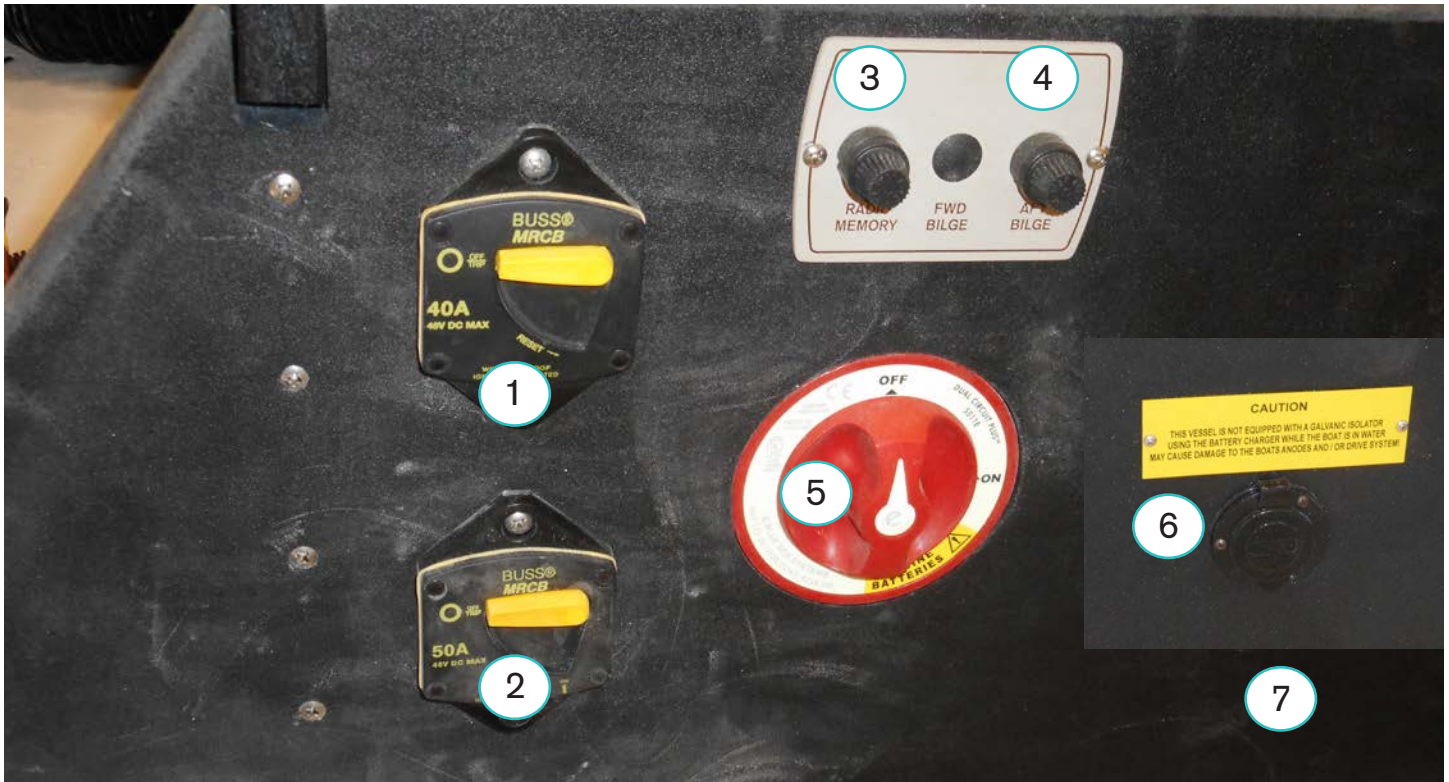

TYPICAL BATTERY MANAGEMENT PANEL (outside view) (OPT. DUAL BATTERY SWITCH SHOWN)

The battery management panel features key electrical components including battery switches, breakers, fuse panels and related battery charging components. The panel is accessed by lifting up the aft starboard cushion. Here are selected components you may find on the panel:

1. This 40 amp breaker controls power to the optional anchor windlass. An 80 amp breaker is used for optional PowerTower. There may be other similar breakers depending on the option protected.

2. This 50 amp breaker protects the dash or helm circuit.

*Note that the above breakers are shown in the "off" position. Activate the above breakers push the yellow lever down until it ratchets in the "on" position.*

3. This fuse protects the stereo memory circuit. This allows you to keep all your stereo program selections when you leave your vessel even with the battery switch turned off.

4. This fuse protects the aft bilge pump which is usually found in the bilge just forward of the engine. When you leave the vessel and turn off the battery switch as recommended the bilge pump circuit is still activated allowing the pump to work should a leak develop.

5. The battery switch when off disconnects any voltage to the dash including the engine key switch. Note that the standard battery switch instead of the dual switch may be present on your battery management panel.

6. This is the shore plug for the battery charger. It is recommended that you use a 3 prong extension cord rated for the amperage. Read and follow the label instructions below as we do not recommend using the shore cord while vessel is in the water.



## CAUTION

AVOID ANODE/DRIVE SYSTEM DAMAGE!  
THIS VESSEL IS NOT EQUIPPED WITH A GALVANIC ISOLATOR. USING THE BATTERY CHARGER WHILE THE VESSEL IS IN THE WATER MAY CAUSE DAMAGE OR CORROSION ISSUES WITH THE ANODE/DRIVE SYSTEM!

7. There is a label placed close to the battery charger shore plug. Read and understand the following label.



## WARNING

PREVENT SEVERE INJURY OR DEATH FROM FIRE, EXPLOSION OR ELECTRICAL SHOCK!

THIS DEVICE MUST BE CONNECTED TO A GROUND FAULT CIRCUIT INTERRUPT (GFCI) PROTECTED AC OUTLET.

WHEN USING AN EXTENSION CORD, CONNECT THE AC CHARGER PLUG BEFORE CONNECTING TO THE GFCI PROTECTED AC OUTLET!

MAKE CONNECTION IN AN OPEN ATMOSPHERE FREE OF EXPLOSIVE FUMES.

MAKE CORD AND CONNECTION IN A SECURE MANNER THAT WILL AVOID CONTACT WITH THE WATER.



## Battery Management Panel (Continued)

TYPICAL BATTERY MANAGEMENT PANEL (inside view)

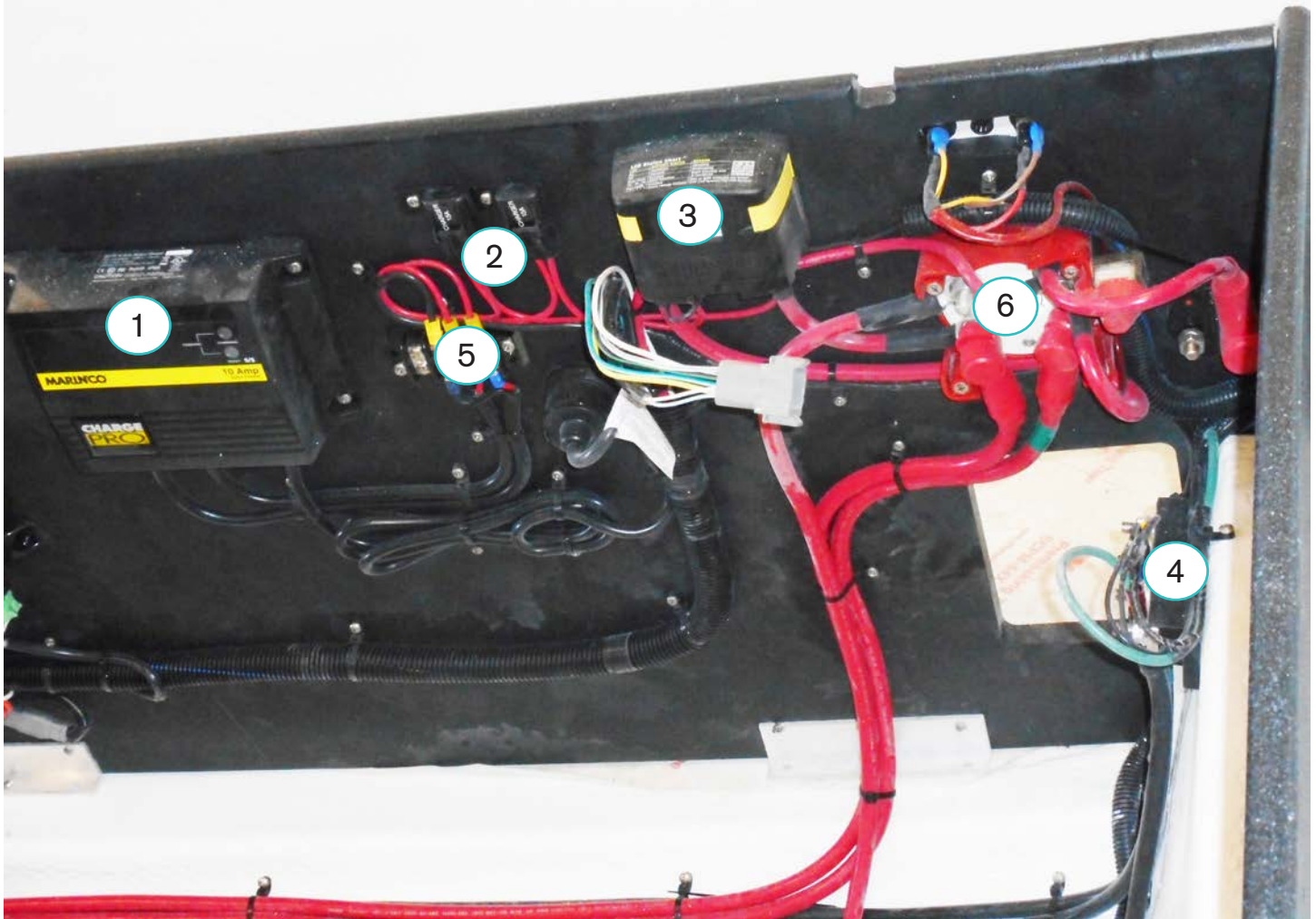

Above is the battery management panel shown as an inside view. This view would be facing the starboard side of the engine.

1. Shown is a 10 amp battery charger. It supplies DC current to assist in keeping the batteries charged at shore. Be sure to read and understand the recommendations on how and where to use the battery charger (see previous pages).

2. These 15 amp fuses protect each of the battery circuits. If the positive and negative battery cables are somehow reversed these breakers could trip.

3. The automatic charging relay (ACR) controls the flow of charge current from the battery charger to the appropriate battery. The ACR is only used on the dual battery switch system.

The ACR requires no maintenance and there are no adjustments since it is a digital component but check the wires periodically for tightness.



## Battery Management Panel (Continued)

4. The ground block is a home for a group of negative (black) wires. You may even find an earth ground on the block (green). This may be an additional ground area for added accessories. Periodically check to ensure all wires are fastened securely. When adding accessories never add more than 4 connectors to any stud on a ground block.

5. This bank provides a junction for wiring from the battery charger circuits and from the ACR unit. Periodically check wires for secure fastening.

6. Battery switch (rear view). See earlier information for additional details. Note the red boots on the rear of the battery switch. Periodically check to ensure the boots cover the nuts securely and that the connections and nuts are tight. Disconnect the battery (ies) positive or + wires before tightening the battery switch nuts.

## DC (Direct Current) Helm Fuse Panel

Lift up the starboard bow backrest to access the DC fuse panel. This panel protects many of the direct current devices along with their circuit wiring that are found on board your vessel. See the photo on this page.

Below we will acquaint the operator with the function of each fuse and information regarding the related component. These mini fuses can be purchased at most auto and marine supply houses. Never replace a fuse with a higher rated fuse to prevent possible fire or component damage. Always find the reason why the fuse “blew” before replacing it.

**NAV/ANC-** This 10 amp fuse protects the bow light located on front deck the deck mounted stern light. With the optional PowerTower an all around light is used verses the stern light.

**CPT/CAB LTS-** A 10 amp fuse protects the blue LED style blue cockpit lights which allows safer night maneuvering throughout the cockpit.

**DOCK LTS-** This 15 amp fuse protects the optional hull docking lights which are used for maneuvering in tight quarters at night. It is recommended that the docking lights be off when running above idle speeds at night since they might blind another boater from being able to see the bow light.

**GARMIN-** This 2.5 amp fuse protects the chartplotter(s) which show engine vitals along with GPS information.

**U/WTR LTS** The 10 amp fuse protects the stern mounted underwater lights.



## DC (Direct Current) Helm Fuse Panel (CONT)

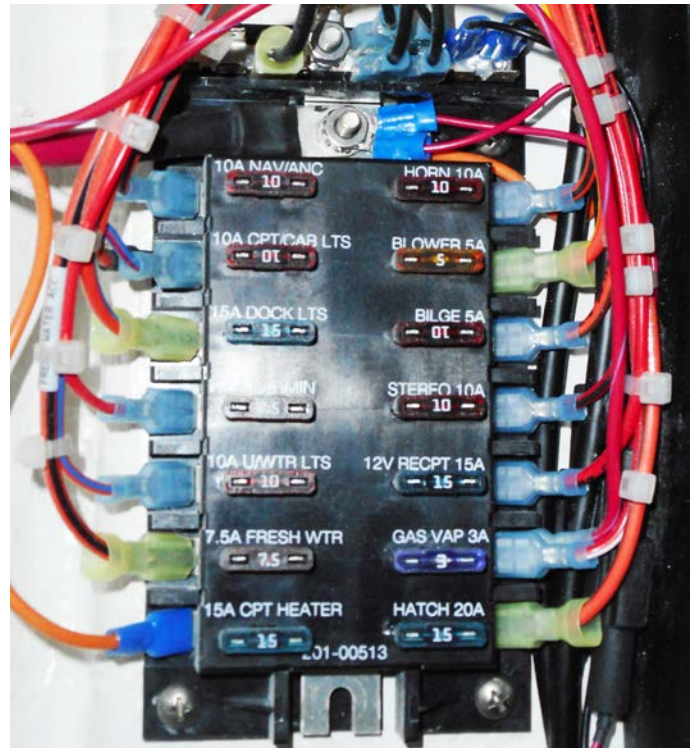

TYPICAL HELM DC FUSE PANEL

**FRESH WATER-** This 7.5 amp fuse protects the fresh water pressure pump and its wiring circuit. The pump is responsible for supplying potable water to the head faucet and transom shower if installed.

**CPT HEATER-** This 15 amp fuse protects the cockpit heater which is available on surf models.

**BLOWER-** This 5 amp fuse protects the ventilation blower. This powered system removes any fumes and bilge air and provides an exit to the atmosphere through ducting located in the lower third of the bilge. Check these 4" black hoses periodically for their condition and fastening of hardware.

**BILGE-** The fuse protects the bilge pump and its circuit wiring located in the bilge. This pump features a dash switch automatic center position. Remember that your vessels bilge pump system with the automatic position is "on" even with the main battery switch turned off at the battery management panel.

**STEREO-** This 10 amp fuse protects the Fusion stereo circuit. Note that if stereo performance and lighting package is ordered there are additional fuses located in the system such as at the amplifier unit.

**12 VOLT RECPT-** This 15 amp fuse protects the 12 volt receptacles on the vessel. These can be used to power accessories or with the correct adapters to charge phones and tablets.

**GAS VAP-** This 3 amp fuse protects the optional gas vapor detector system. There is a sensor mounted in the bilge and a head unit close to the helm. If the sensor finds gas fumes in the bilge it sounds an alarm.

**HATCH-** This fuse position is not currently being used. With that being said the operator could use this one for protecting an after market accessory. Always ensure your fuse amperage allows the component a safety margin.

## Gasoline Fuel System

In this section, a typical EPA approved domestic gasoline fuel system is introduced. The fuel system includes the fuel tank, fuel feed lines, fill and vent fittings along with fuel filters, emission devices, natural and powered ventilation systems.

Gasoline today is processed in a different manner than it was a few years ago. As a result it has become more unstable and the product shelf life has been shortened.

Stern drive engines in this size range normally utilize a metal fuel tank. A special EPA approved low permeability hose system is used as required to supply the engine.

Read and understand the stern drive engine owner's manual fuel section and safety information before attempting to use the vessel.

*Note that due to a possible fire or explosion danger never store flammable liquids and/or portable fuel tanks in any storage compartment aboard the vessel.*

### Gasoline Specifications/Octane Ratings:

Gasoline Requirements- Use premium non-leaded gasoline with the following minimum octane rating for stern drive engines:

**\*Minimum pump octane number is 89.**

The use of leaded fuels will damage the catalysts and can not be used with catalytic converters.

Gasoline in the United States and other areas is blended with 10% ethanol and is known as E-10 at the pumps. Marine engines used in your Regal boat shall be operated with premium unleaded

gasoline blended with no more than 10% ethanol and that meets the minimum 89 octane specification.

*Do not use ethanol blends greater than 10% such as a newer blend for select motor vehicles called E-15. Your marine engine may be damaged by more than 10% ethanol. A loss of performance may occur and the engine will not be covered by the engine manufacturer's warranty.*

Refer to your stern drive engine manufacturer's operation manual for additional information regarding fuel information for your engine model.

As an option contact your engine manufacturer's hot line or text on web with fuel related questions. Also, additional fuel system information may be as close as your Regal dealer. Your Regal dealer has special training on the propulsion and Regal vessel systems.



## Typical EPA Fuel System

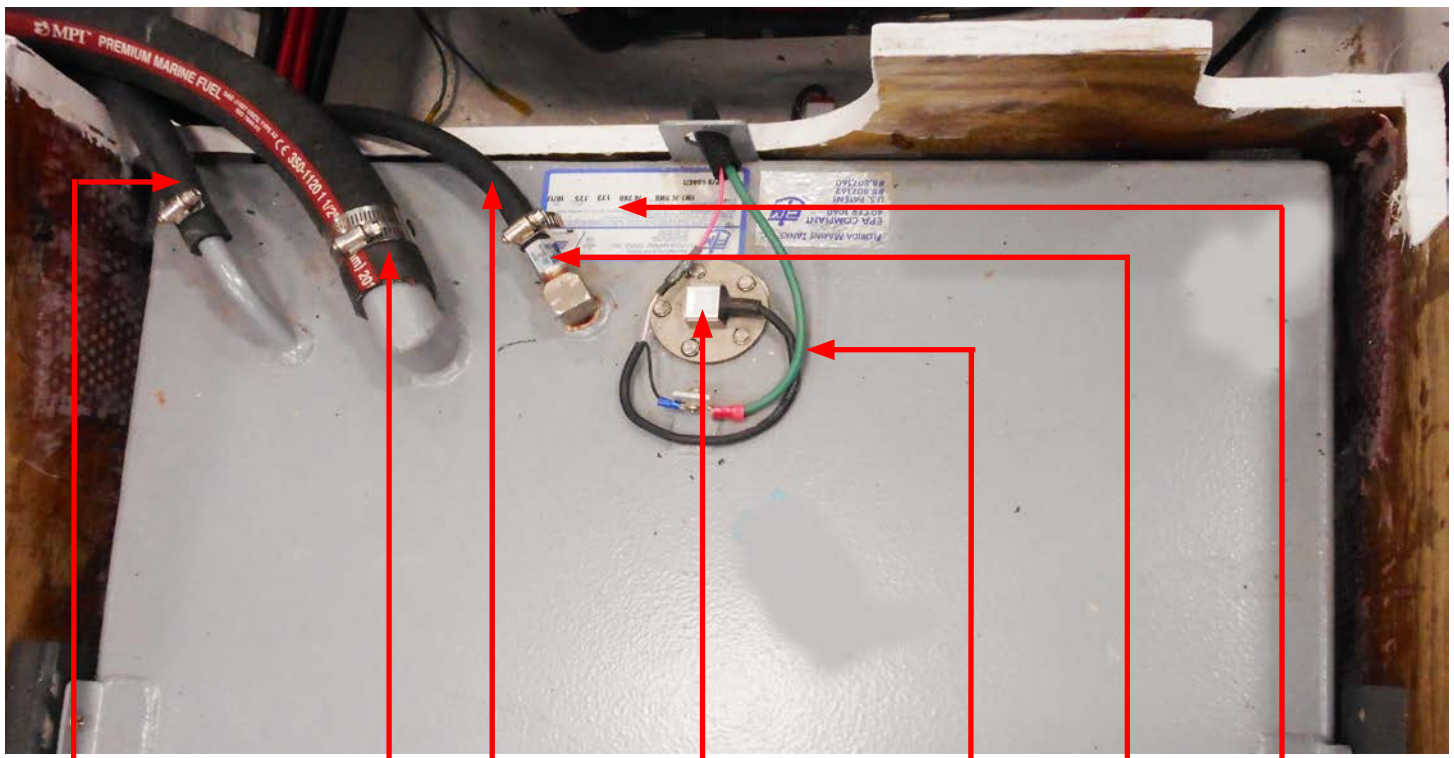

TANK VENT  
& HOSE

FUEL FILL  
& HOSE

ENGINE  
FEED/HOSE

FUEL  
SENDER UNIT

BONDING  
WIRE

ANTI SIPHON  
VALVE

TANK  
LABEL

## Typical Fuel Tank

Vessels manufactured for *domestic* use are now required to be outfitted with an EPA compliant fuel system using an aluminum tank that must pass a battery of tests. This system uses special valves and baffles located inside the fuel tank along with special hoses marked for low permeability. Also, there is a carbon canister in-line with the vent hose which functions much like the one in an automobile by filtering gas fumes. The carbon canister rarely needs to be replaced and is not a serviceable item.

These tanks are tested and inspected along with the complete fuel system several times for safety requirements and quality by the fuel tank supplier, in house personnel and independent inspections by National Marine Manufacturers Association personnel.

## Fuel Fill Fitting

The fuel fill fitting is labeled “gas” and in addition displays the international symbol (See the next page). When fueling the boat keep the fill nozzle in contact with the fuel fill pipe since it decreases effects of static electricity. Always use the recommended fuel octane rating as specified in your engine owner’s manual.

*Extinguish all flame producing agents before fueling!*

# WARNING

**AVOID SERIOUS INJURY OR DEATH FROM FIRE OR EXPLOSION, RESULTING FROM LEAKING FUEL. INSPECT SYSTEM FOR LEAKS AT LEAST ONCE A YEAR.**

## Fuel Vent Fitting - Typical



Currently, domestic EPA compliant fuel tanks vent fumes back into the fuel tank system. While the tank is filled, air displaced by the incoming fuel is vented through the fuel

COMBO FUEL FILL/ system charcoal canister.

INTERNAL VENT Your vessel uses a combo type (internal vented) fuel fill. Both the fuel fill and vent occupy the same cavity under a protective cover. If fuel overflows through the vent the design forces it back into the fuel fill hose and tank. Be sure to tighten the fuel fill cap to prevent water and debris from entering the fill system.

A seasoned skipper will hear a distinct sound as the tank nears the “top out” or full mode and may see fuel overflowing back into the fuel hose through the vent hole in the fill fitting. On select vessels not using an EPA fuel system there may be a separate vent fitting on the hull side. Periodically check this vent screen for debris and insect activity.

# NOTICE

DO NOT OVERFILL THE FUEL TANK!  
THIS HELPS AVOID ANY OVERBOARD  
SPILLS WHICH MAY HARM THE  
ENVIRONMENT!

## Anti-Siphon Valve

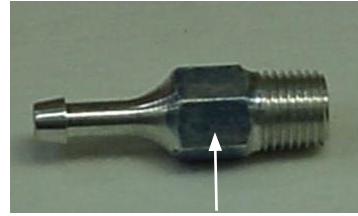

INTERNAL BALL/SPRING

The gasoline fuel tank feed line that runs from the fuel tank to an engine fuel component uses an anti-siphon valve.

The valve is threaded into the fuel tank fitting at the feed line. The valve is pulled off its seat by fuel pump pressure as the engine is cranking or running. There is a ball and spring assembly inside the valve that is activated by fuel pump impulses. It allows a one-way fuel roadway to the engine or generator fuel system. It prevents fuel from siphoning out of the tank in the event of a fuel line rupture or damaged fuel feed hose. When the engine fuel components stop the fuel from cycling the spring forces the ball against the valve opening to prohibit fuel flow.

Never remove an anti-siphon valve as it is a fuel system safety component. Also, never remove the ball and spring from the valve assembly. The anti-siphon valve requires no normal maintenance. Symptoms indicating possible valve problems may be fuel starvation at intermediate or high rpm or in extreme cases an engine that will not start.

Contact your Regal dealer for further information.

## Fuel Gauge & Sending Unit



# WARNING

PREVENT INJURY OR DEATH!  
READ AND UNDERSTAND THE  
PROPULSION OWNER'S MANUAL  
BEFORE ATTEMPTING  
TO OPERATE THE VESSEL.

## Fuel Filters

Spin on fuel filters found on stern drive engines function to remove moisture and impurities from the fuel supply before traveling through the engine fuel system. They should be serviced periodically per the stern drive engine manufacturer's instructions. It is a good idea to keep extra fuel filters on board along with a strap style filter wrench, catch container and clean rags for emergencies. Never use automotive style fuel filters on your vessel. Dispose of all fuel residue materials in an environmentally safe fashion.

These filters are available on-line, through marinas, retail marine outlets, or can be ordered via your closest Regal dealer.

## Fuel Storage On Board



# WARNING

PREVENT INJURY OR DEATH!  
FUEL VAPORS ARE A FIRE  
AND EXPLOSION HAZARD.  
DO NOT STORE FUELS, FLAMMABLE LIQUIDS  
OR PORTABLE FUEL TANKS ON BOARD!

Read and understand the label above regarding the storage of flammables on board the vessel. Also, do not store auxiliary portable fuel tanks on board the vessel since these portable tanks can emit vapors into the atmosphere through their vent.

## Helm Systems

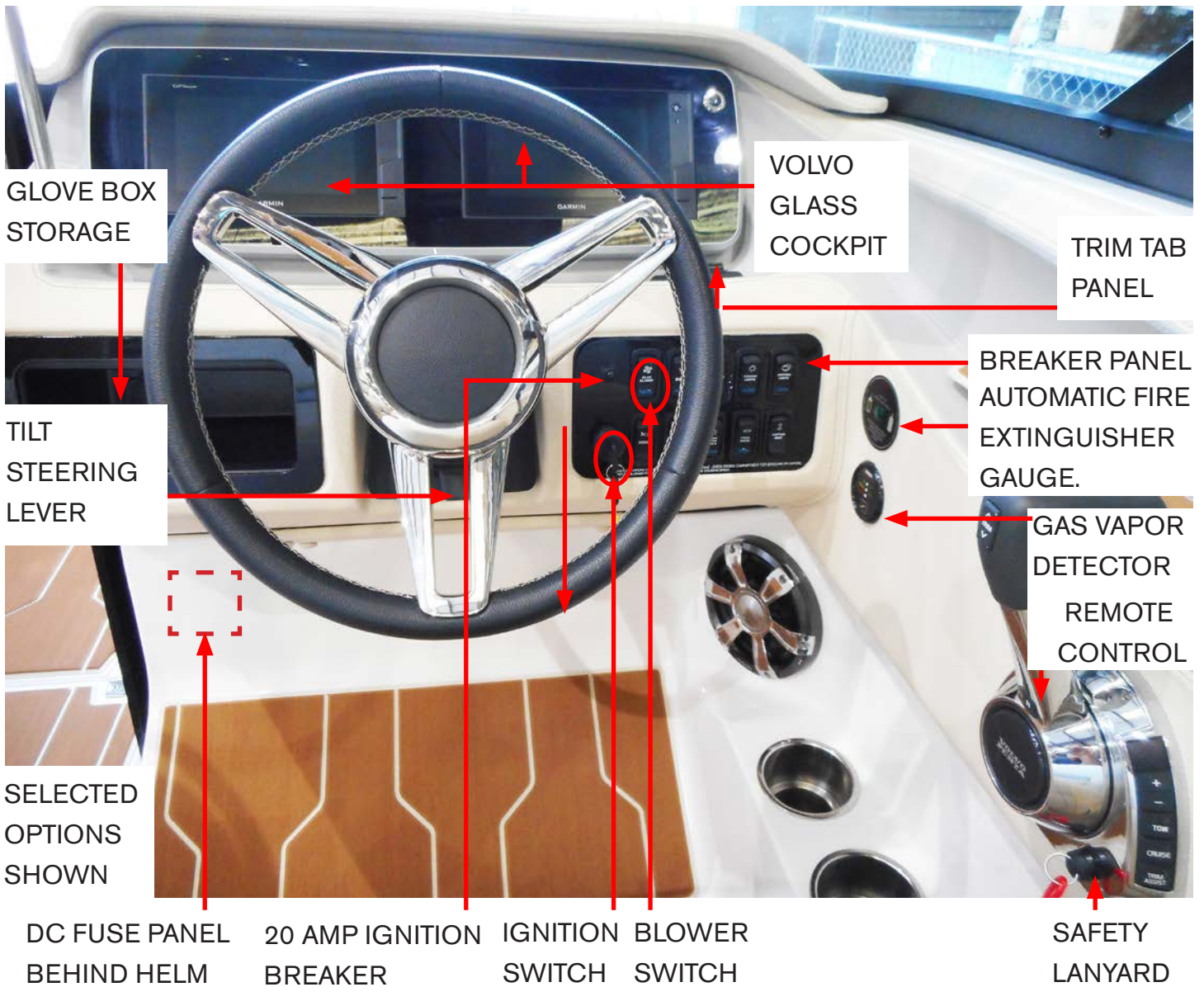

### Helm Overview- (Typical)

The helm station is equipped with the ability to monitor engine functions through a Garmin chart plotter. Close observation of the digital display is recommended throughout the trip as you can split the screen to accommodate GPS functions along with monitoring basic engine systems including fuel usage and hours for maintenance cycles. This works in addition to the engine manufacturer's information panel system.

Select models with the dual chart plotter option another whole dimension of information monitoring is achievable. Note that with the battery switches in the "off" position, there is no power to the helm and the ignition switch will not function.

All electrical features are protected by the main battery management panel located in the sump. Refer to earlier pages in this chapter for additional information. ***Note to read and understand the blower operation information on the bottom of the breaker panel.***



## Helm Switch Panel-Typical *Stern Drive*



Typical Switch Panel Shown

The helm switch panel controls various vessel electrical components. The main battery switch must be activated for most of the switch functions to work except for the automatic side of the aft bilge pump. When a particular component is activated the blue icon portion of the switch lights up. This feature is great for night cruising, too. Below is a brief description of each switch. *Note that select switches may represent optional equipment that is not installed on your vessel.*

### Bilge Blower

One of the most important components on board is the bilge blower. The blower switch controls the powered ventilation system (blower). Read and understand the following warning label.



## WARNING

GASOLINE VAPORS CAN EXPLODE  
CAUSING INJURY OR DEATH!  
BEFORE STARTING ENGINE, CHECK  
ENGINE COMPARTMENT  
FOR GASOLINE OR VAPORS.  
OPERATE BLOWER 4 MINUTES.  
RUN BLOWER BELOW CRUISING SPEEDS.



Typical Ventilation Blower with Hose

The powered ventilation system (blower) aids in removing any gas fumes from the engine compartment and any joined compartments. Also, the blower removes any polluted air. *Never obstruct or modify ventilation system!*

Periodically check the black “4” hoses connected to the blower for tightness. In addition, ensure there are no holes or tears in the hose since efficiency may be compromised. Also, make sure the attached hose extends into the lower third of the bilge. This is important since gasoline fumes are heavier than air and tend to gather in the lower bilge.

When the blower is activated any fumes will be drawn up the hose and dispersed overboard through the aft vent system.

*Note that there are other black hoses attached to the aft vents that may only extend a short distance from the vent not like the longer extending exhaust hoses. These shorter hoses bring fresh air into the engine compartment and allow the engine to “breathe” so it can run more efficiently. They comprise the “natural” ventilation system.*



## Bilge

This switch controls the bilge pump which is located below the front of the engine at the bilge floor. This bilge pump removes any accumulated water from the bilge.

*Note that with the bilge switch in the center position the pump circuit assumes an "automatic" position and will operate even with the battery switch in "off" position with the vessel unattended. This is a safety feature.*

Periodically check the bilge pump grate for debris that could effect the pumping efficiency. Also, never manually run the pump dry for extended periods as the impeller may develop premature wear.

## Nav/Anc

This on/off/on switch energizes the center bow red/green navigation light and all-around light as a standard configuration as the top portion of the switch is pressed. This is the position for nighttime headway navigation. The lower portion of the switch will energize the all-around light on the deck for anchored use only or vessels with PowerTower or hard top will have the all around light on top of the tower or hard top.

## Cockpit Lights

This switch controls the blue LED lighting which is normally found on vertical surfaces to aid in nighttime cockpit activity. They are especially useful to light stairways, deck walkways, and swim platforms.

## Docking Lights

This switch controls the optional hull docking lights. These lights are valuable for maneuvering around docks and tight waterways at night such as you might find at marinas and locks. Do not use these lights for navigation as other vessel may not be able to see your combination bow light especially for head on and crossing situations.

## Horn

This momentary switch controls the electric horn located at the starboard bow area. Make sure the horn is tested before each outing as it can be valuable in navigation situations and can be used for bridge communications. Normally there is an adjustment screw on the horn top to alter the tone. Periodically inspect the horn hardware for tightness and polish the horn grill.

## Tower

This switch controls the forward or aft tower movement. When the "up" switch position is pressed the PowerTower moves to the forward position which is useful for bridge navigation and storage opportunities.

When the "down" switch position is pressed the PowerTower moves to a vertical or run position. The vessel operator shall read this following label:



## Under Water Lights

This switch controls the hull mounted underwater lights. If installed these blue or white LED lights illuminate the water around the aft sides and transom areas. It is recommended that these lights not be activated at night with the vessel making headway.

## Fresh Water

This switch energizes the optional on board potable fresh water system. It permits the water pump to draw fresh water from the potable water tank to any faucets or showers/wash downs mounted aboard.

## Captain Seat

This switch activates the movement of the captain seat for more comfortable positioning and visibility enhancement. Press the upper portion of the switch to slide the seat forward. Press the lower portion of the switch to move the seat aft for additional leg room.

## Waste System

### Chemical Toilet

Selected models use a sanitation toilet with a 2.3 gallon freshwater tank and 2.6 gallon waste tank capacity. There is a prismatic tank level indicator which allows for easy tank level monitoring. The push button flush clears the bowl quickly.

Selected vessels feature optional pump-out fittings. There is waste deck plate fitted with a hose directly to the holding tank. Most marinas provide pump-out facilities. Their equipment screws onto the waste deck plate and with an adapter hose they pump out the waste into a dedicated container.

*Note to read and understand the vendor toilet operating manual before attempting to use the component.*



Typical Chemical Toilet Shown

# NOTICE

GENERAL INFORMATION SHOWN!  
NOTE THAT YOUR TOILET MAY APPEAR AND  
OPERATE SOMEWHAT DIFFERENT THAN  
THE COMPONENT SHOWN HERE.  
READ MANUAL FOR SPECIFIC INFORMATION.

### Helpful Hints- Chemical Toilet

- Changes in the ambient temperature or the actual height above sea level while traveling can cause rising or falling holding tank pressure. Before using, equalize the holding tank pressure by opening the flush grip (slide valve) completely by pulling out. Be sure the seat cover is down before opening the slide valve.
- Never fill the portable toilet with chemicals when the slide valve is closed.
- Do not let the flush water tank build up pressure ie; covering up the pressure relief valve.
- Do not pressurize the flush water tank if it is not connected to the holding tank.
- Never empty the holding tank by dumping it into the environment; use an approved disposal station
- Do not use caustic chemicals to clean the unit or wire brushes. Periodically, clean with a soft wet cloth and mild detergent.
- Use only sanitary chemicals approved by the toilet manufacturer.
- Provide children supervision when operating the toilet.

1

	Parts Description
1	Pump
2	Cap-Flush Water Tank
3	Flush Water Tank
4	Holding Tank
5	Fill Level Display
6	Flush Grip
7	Locking Grip
8	Flush Button

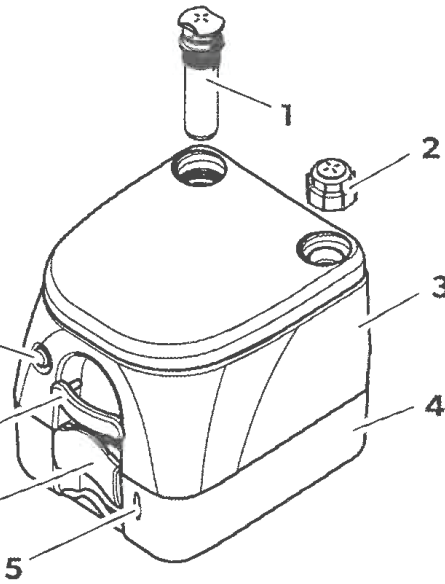

2

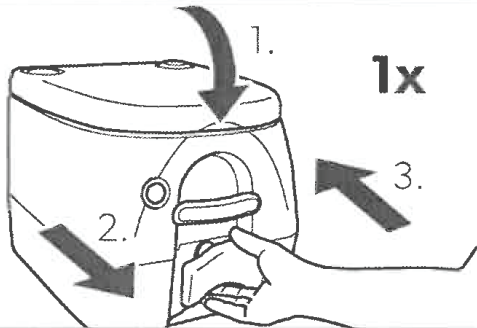

3

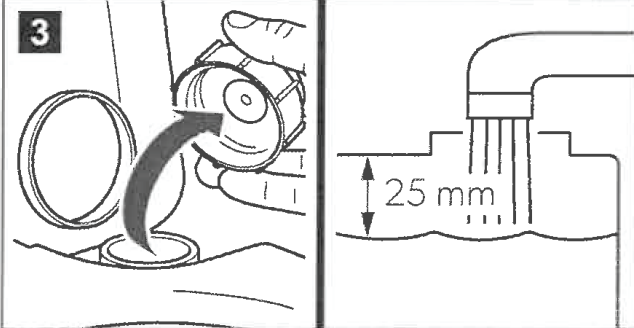

4

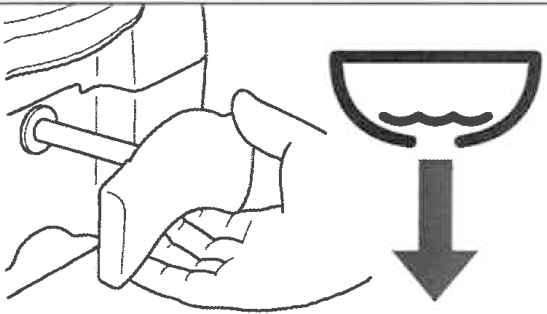

5

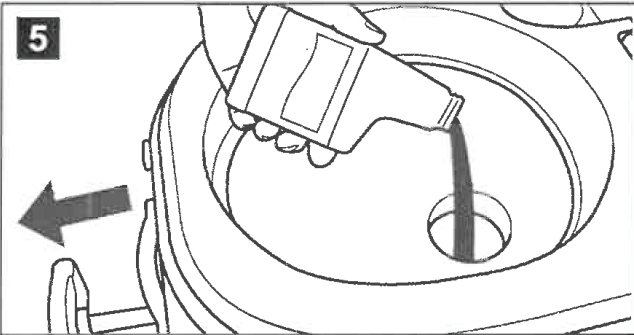

6

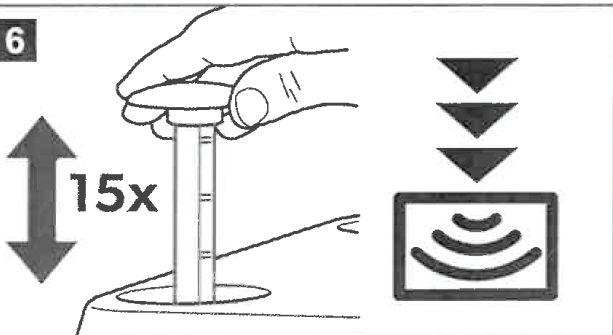

## Using Chemical Toilet

*Refer to the parts description and action #'s one page back. Note to ensure the pressure in the holding tank is equalized before usage. If needed, review earlier pages and carry out action #2.*

1. Remove flush water tank cap and fill the tank with fresh water until level is 1" below the top. Tighten the cap on flush water tank. Refer to action #3.
2. Pull the flush grip to open the slide valve. Refer to action #4.
3. Pour the recommended sanitation chemical directly into the holding tank. Close the slide valve. Refer to action #5.
4. Press the pump approximately 15 times or until air exits the cap of the flush water tank through the pressure relief valve. Refer to action #6.

*This completes the initial toilet set-up. Follow the up-coming instructions on flushing the portable toilet and emptying the holding tank.*

## Flushing Toilet

*Follow the action #'s on the following page.*

1. Pull out the flush grip to permit the waste to pass into the holding tank. Refer to action #8.
2. Press the flush button to flush the toilet. Push the flush grip to close the slide valve. Refer to action #9.

## Emptying Toilet (Without Pump-Out Fittings)

*Note that if your toilet includes the pump-out fittings by pass the steps below and have your tank pumped out by an appropriate service company or marina.*

1. When the filling display shows full the holding tank needs to be emptied. Pull the locking grip on the holding tank. To reach the aft bracket lift up the toilet and move it. Refer to action #10.
2. Pull up on the aft latch to disconnect the flush water tank from the holding tank. Refer to action #11.
3. Take the holding tank to a reliable disposal station or a normal toilet.
4. Turn the waste pipe away from the tank and open the pressure relief valve on top of the tank. Empty the tank. Refer to action #12.
5. After emptying holding tank rinse unit out with fresh water using a garden hose if available.
6. Reassemble unit and fill with water and chemical.



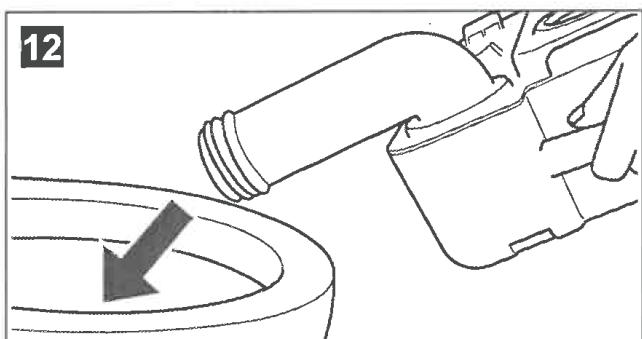
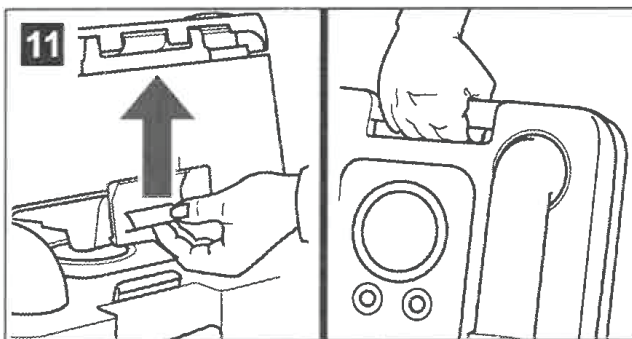
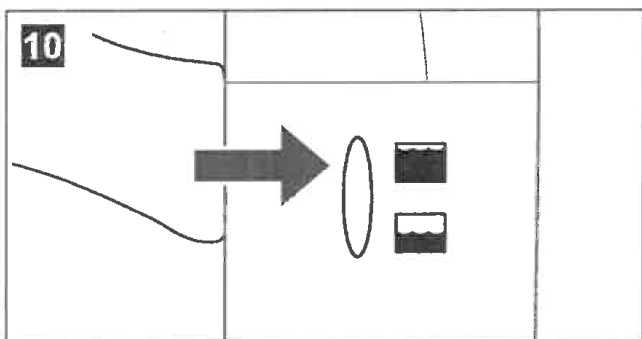
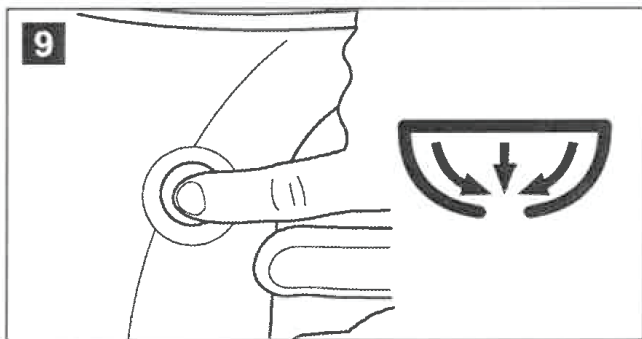
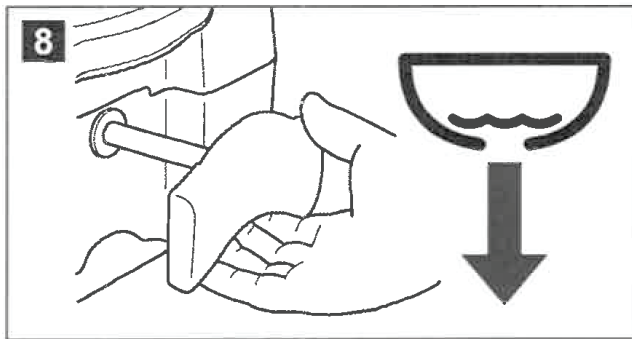
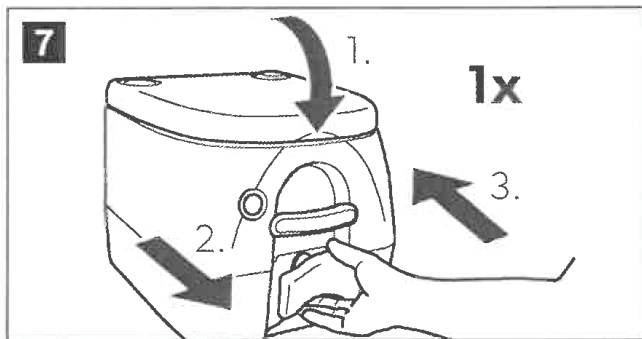

*Note that select vessels employ a deck mounted pump-out waste fitting. When the chemical toilet holding tank is full the system can be evacuated with a marina or facility pump-out mechanism that screws into the deck fitting.*

*This eliminates the need to manually disconnect the holding tank and dump it each time the holding tank is full.*

## Entertainment



### Fusion Stereo-Display Overview

#### Introduction

The Fusion stereo unit installed in your vessel is designed and engineered for the harsh marine environment. Head units are globally IPX6 & IPX7 rated against water ingress. Regal offers durable marine speakers and optional signature speaker units. The unit offers independent control of your audio entertainment including balance, sub woofer, and volume level from multiple audio zones as part of the optional stereo performance package. The stereo features Fusion-Link™ an entertainment integration process which permits Fusion to be displayed and controlled on your Garmin chart plotter using NMEA 2000 (N2K) technology. Unit is SiriusXM-ready. Note that optional subscription and tuner device required to activate Sirius XM. Bluetooth menu discovers other devices such as cell phones. There is a USB-2.0 aft port for charging and media playback.

In addition, the unit features DSP (digital signal processing). This system analyzes on board speaker system protocols to maximize speaker sound reproduction.

The head unit delivers a maximum 280 watts peak power with a class D amp.

## Quick Start Notes (Regal Systems)

To energize the Fusion display unit first rotate the vessel main battery switch knob to the “on” position. The main battery switch is located on the battery management panel.

Next, press the power button on the Fusion display to energize the unit. To select menus rotate the dial to navigate the menus. Press dial to select highlighted options. Press and hold the power button to turn the display off.

Note that the Fusion unit is protected by a breaker at the battery management panel. Should the unit “trip” the breaker find the cause of the malfunction before resetting the breaker. There is a troubleshooting chart available in the owner’s manual.

When you leave your boat after a cruise weekend you can count on all selections being saved through a stereo memory system featured on your vessel *even with the main battery switch turned off*. The stereo memory display is located on the battery management panel.

Use the information on the following page for stereo controls and playback functions.

***For further information refer to the Fusion owner’s manual or consult web address at:***

[www.fusionentertainment.com/marine](http://www.fusionentertainment.com/marine)

## Controls



Dial	<ul style="list-style-type: none"> <li>Turn to adjust the volume.</li> <li>When adjusting the volume, press to switch between zones.</li> <li>Turn to move through the menus or adjust a setting.</li> <li>When in a menu, press to select the highlighted option.</li> <li>Press and hold to activate certain functions such as opening the radio presets or muting all connected stereos from the mute screen (<i>Muting all Connected Stereos</i>, page 2).</li> </ul>
	<ul style="list-style-type: none"> <li>Press to turn on the stereo.</li> <li>Press to mute the audio.</li> <li>Press and hold to turn off the stereo.</li> <li>Press and hold to open the power menu.</li> </ul>
	<ul style="list-style-type: none"> <li>Press to open the menu.</li> <li>Press to return to the previous screen from the menu.</li> <li>Press and hold to exit the menu.</li> </ul>
	<p>Press to change the source.</p> <p><b>TIP:</b> You can turn the dial to browse, and press the dial to select the source.</p> <p>Press and hold to open the GROUPS menu.</p>
	<ul style="list-style-type: none"> <li>Press to skip to the beginning of the track or to the previous track, when using an applicable source.</li> <li>Press and hold to rewind the track, when using an applicable source.</li> <li>AM/FM source: <ul style="list-style-type: none"> <li>Press to tune to the previous station or preset.</li> <li>Press and hold for faster tuning, in Manual mode only.</li> </ul> </li> <li>SiriusXM source: <ul style="list-style-type: none"> <li>In Live Mode, press to tune to the previous station or preset.</li> <li>In Live Mode, press and hold for faster tuning, in Manual mode only.</li> <li>In Replay Mode, press to skip to the previous track.</li> <li>In Replay Mode, press and hold to rewind the current track.</li> </ul> </li> <li>DAB source: <ul style="list-style-type: none"> <li>Press to return to the previous DAB station in the ensemble. When you reach the beginning of the current ensemble, the stereo automatically changes to the last available station in the previous ensemble.</li> <li>Press and hold to change the ensemble.</li> </ul> </li> </ul>
	<ul style="list-style-type: none"> <li>Press to pause or resume media playback.</li> <li>AM/FM source: <ul style="list-style-type: none"> <li>Press to cycle through the tuning modes (Auto, Manual, and Preset).</li> <li>Press and hold to save the selected station as a preset.</li> </ul> </li> <li>SiriusXM source: <ul style="list-style-type: none"> <li>Press and hold to switch between Replay Mode and Live Mode.</li> <li>In Live Mode, press to cycle through the tuning modes (Manual, Category, and Preset).</li> <li>In Replay Mode, press to pause and play.</li> </ul> </li> <li>DAB source: press to scan for DAB stations.</li> </ul>
	<ul style="list-style-type: none"> <li>Press to pause or resume media playback.</li> <li>AM/FM source: <ul style="list-style-type: none"> <li>Press to cycle through the tuning modes (Auto, Manual, and Preset).</li> <li>Press and hold to save the selected station as a preset.</li> </ul> </li> <li>SiriusXM source: <ul style="list-style-type: none"> <li>Press and hold to switch between Replay Mode and Live Mode.</li> <li>In Live Mode, press to cycle through the tuning modes (Manual, Category, and Preset).</li> <li>In Replay Mode, press to pause and play.</li> </ul> </li> <li>DAB source: press to scan for DAB stations.</li> </ul>

applicable source.

- Press and hold to fast-forward, when using an applicable source.
- AM/FM:
  - Press to tune to the next station or preset.
  - Press and hold for faster tuning (Manual mode only).
- SiriusXM source:
  - In Live Mode, press to tune to the next station or preset.
  - In Live Mode, press and hold for faster tuning, in Manual mode only.
  - In Replay Mode, press to skip to the next track, if applicable.
  - In Replay Mode, press and hold to fast-forward the current track, if applicable.
- DAB source:
  - Press to advance to the next DAB station in the ensemble. When you reach the end of the current ensemble, the stereo automatically changes to the first available station in the ensemble.
  - Press and hold to change the ensemble.

## Display Screen ie., Stereo

The information displayed on the screen varies depending on the source selected. This example shows a track playing on a device connected using Bluetooth® wireless technology.

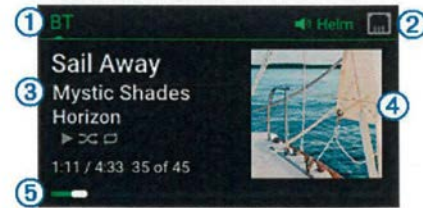

①	Source name
②	Active zone and status icons ( <i>Network Status Icons</i> , page 14)
③	Track details (if available)
④	Album art (if available from a compatible source)
⑤	Elapsed time, track duration, and the current track number out of the total number of tracks in the playlist (if available)

## Connecting Media Player Devices

The stereo accepts many media players including smartphones and other mobile devices. Connections such as Bluetooth wireless or USB are available for this unit.



# CAUTION

AVOID MEDIA PLAYER DAMAGE!  
REMOVE MEDIA PLAYER FROM STEREO  
WHEN NOT IN USE.  
REMOVE FROM VESSEL WHEN LEAVING  
TO REDUCE RISK OF THEFT  
AND EXTREME TEMPERATURE DAMAGE.



# Advanced Smart Battery Management System



Photo: Battery Management Box with “Engine”, “House Battery”, and “Bow Thruster” switches.

## Operation

The “House Battery” switch controls the power for most of the vessels Electronics, Audio & Lightmost Lighting. This switch controls the power distribuion ing. for two battery banks installed on the boat. The “House” and “Accy” Batteries. These two Batteries automatically combine when the voltage of either battery maintains over 12.5v. They will automatibattery automatically isolate from one another when either voltage cally maintains less than 11.7v. Estimated times are available on a chart in the Battery Maintenance section.

The “Engine” Switch controls the power for the Engine and all data related to the Engine that is available on the Garmin Display Units. Both switches are required to be ON in order to have full Operation of the the Engine(s) and related components, but the Engine switch is not required

to be ON to use any of the Electronics that are on the “House Battery” switch.

The “Bow Thruster” switch is an emergency cut-off switch that will disconnect power going to the Bow Thruster motor/fuse. For optimal performance, the Bow Thruster should only be used while the Engine(s) are running.

## Battery Management Box

Inside of this box is the majority of the boats removeable circuit protection and Battery Parallel switchswitches. es.

A “Circuit Protection Behind This Panel” label is installed next to the door handle of the battery management box. The door is firmly held shut usmanagement using Cabinet latches and can be opened by putting ing your hand in the hole and pulling towards the front of the boat and swinging the door inboard.

## Battery Parallel

In the case of a bad or fully discharged battery. Battery Parallel can be manually engaged using switches inside of the battery management box.

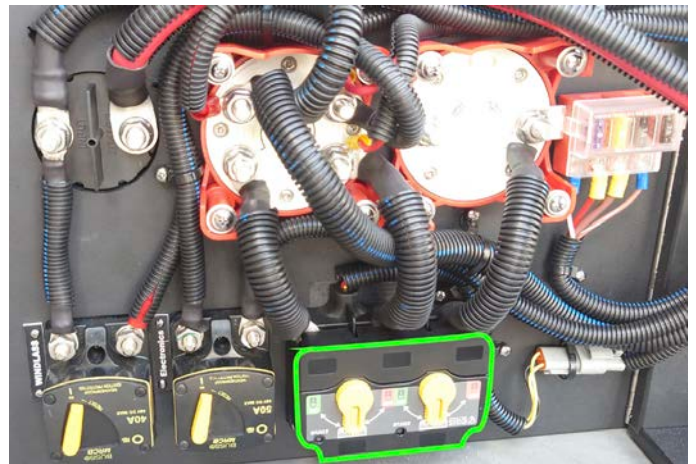

In the photo above, the EGIS device highlighted in Green is a voltage sensitive relay (VSR). This device is used to automatically combine and isolate the “House” + “Accy” bank together and the late “House” + “Engine” bank together. Either switch can be set to “OFF”, “AUTO” or “ON”. For normal smart battery management purposes, these should always be set to “AUTO”. For an emergency parallel situation, either of these can be set to “ON”, but should be reset to “AUTO” when the situation has been resolved.

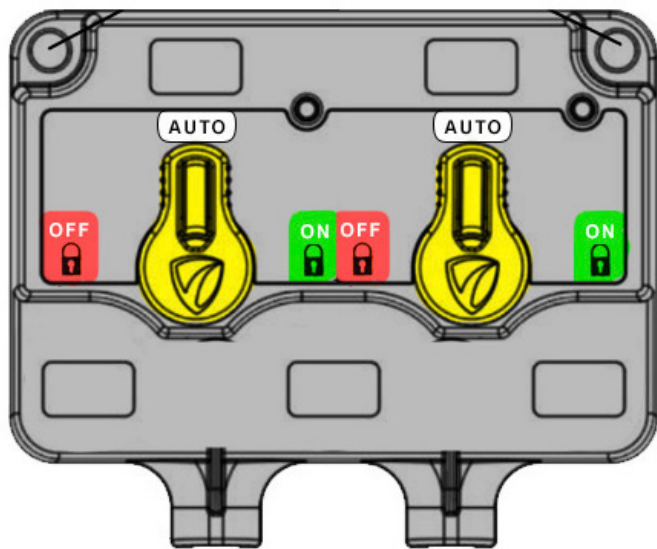

Illustration: EGIS Dual Flex Relay (VSR)

In the illustration above, the yellow handles are shown set to the “AUTO” position. The levers can be either moved to the left or right for “OFF” and “ON” functions.

**NOTICE**

THE BATTERY PARALLEL FEATURES ON THIS VESSEL ARE INTENDED FOR EMERGENCY INTERMITTENT USE ONLY! WHEN A PARALLEL FEATURE IS REQUIRED IT MAY INDICATE A SERVICE BATTERY IS NEAR THE END OF ITS USEFUL SERVICE LIFE.

REGAL # 381499

ABYC Compliant Notice Label/ABYC Label

## Battery Maintenance

Battery Voltages are visible on all of the Garmin Displays under the “Digital Switching” pages. When the voltages are good, the icons will appear Green. When the voltages are getting Low the icons will change to Yellow. Red indicates that the batteries have less than 25% remaining and must be recharged soon. Connecting a battery charger or running an Engine will activate the EGIS VSR and automatically combine all Battery banks to share the charge. The time it takes to combine banks will vary depending on the voltages of each Battery.

Auto Combine		
Banks	Voltage	ETA
House + Engine	>13.1v	30 secs
House + Engine	>13.7v	10 secs
House + ACCY	>12.5v	30 secs
House + ACCY	>13.1v	10 secs

Auto Isolate		
Banks	Voltage	ETA
House + Engine	<12.7v	30 secs
House + ACCY	<11.7v	30 secs

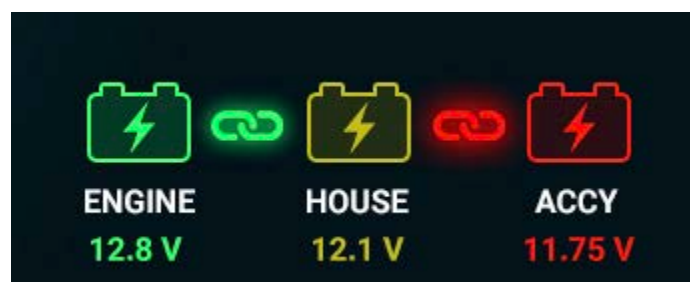

Graphic above is a snapshot of the gauges visible on the Digital Switching pages.



In addition to color-changing voltage indicators, there is color changing indicators that show whether the battery banks are combined or isolated. A Green link indicator appears in-between the ed. two batteries to show the banks are combined. A Grey indicator will appear between the “Engine” and “House” battery when they are not combined as these are only combined while charging and is not designed to be a constant connection point. If the vessels Battery Charger or Engine(s) are running, the voltage should reach over 13.1v and these two banks will automatically combine. This link Indicator will change from Grey to Green to help identify when this happens. For the link indicator between the “House” and “Accy” batteries, this should always be Green un“under normal conditions as these two battery banks der are designed to be connected until the batteries reach a low voltage. When this low voltage state is reached and the two battery banks isolate, the inreached indicator will go from Green to Red. This is because dicator this means there is less than 25% percent charge remaining on the two banks and that it is critical to apply a charge to the boat as soon as possible to avoid dead batteries.

### LED INDICATORS

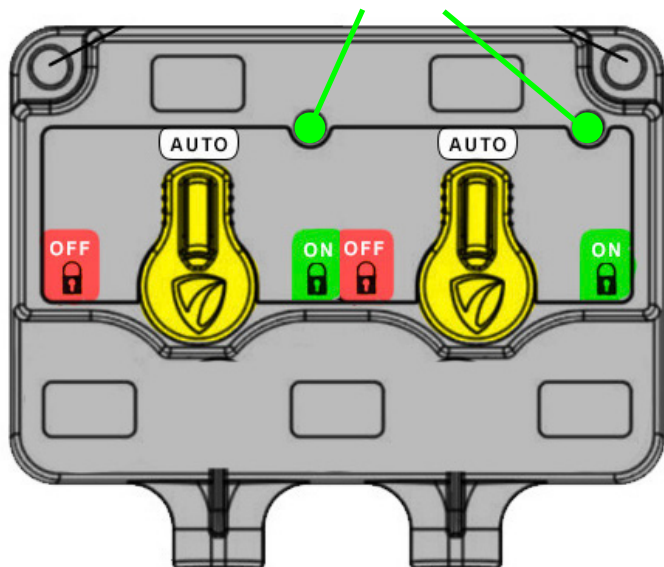

Illustration: EGIS VSR with Green Indicator Light  
Illustration: Light

## Troubleshooting

If the EGIS switches are manually set to the “ON” or “OFF” position, the indicator icon on the Digital Switching page will flash green twice quickly. This is a visual reminder that the EGIS device is not properly set to the auto position.

If the Link indicators are not switching to Green and the voltages + time have exceeded what is shown on the estimated chart, the EGIS part has LED's on the part that can be checked to see if they are combined or isolated.

The LED indicators on the physical unit have more LED sequences than what is displayed on the screen. In a pending ON/OFF state, the LED will flash 3 times rapidly. In a standby mode, the LED will flash once with a pause in between each flash. When powering up the device for the first time the LED will flash continuously. Also switching from “ON” or “OFF” back to “AUTO”, the LED may continuously flash indicating there is a pending Auto continuously On/Off event triggered due to voltage setting.

In the event that there is a suspected bad battery. Follow to these steps to help diagnose:

1. Turn both EGIS devices to the “ON” position.
2. Connect the battery charger inlet and allow the charger to run for at least 4 hours. Up to 10 hours or more may be required if all batteries are fully depleted.
3. Unplug the Battery charger
4. Switch both EGIS switches to the “OFF” position.
5. Allow batteries to rest for 1 hour.
5. On the front of the Battery Management Box, turn “ON” the “Engine” and “House Battery” switches and proceed to a Digital Switching page on one

of the Garmin Displays. A good battery should be able to maintain 12.6v to 12.7v. If a battery can only maintain 12.5v or less, it may need to be replaced. These steps may need to be repeated if adequate time was not allowed to fully recharge a batteries.

6. Turn both switches on the EGIS device back to "AUTO" to resume normal function.

### Terminology

ACR: Automatic Charging Relay

LVD: Low Voltage Disconnect (Relay)

# Digital Switching & Breakers

### Overview

The Digital Switching system is powered by an Empirbus Connect 50-10 module through Garmin

and includes a lot of smart features not available on an Analog boat. In this section we will go over the basic functions of each switch and indicators available in the Digital Switching System and the advanced features included within.

All of the Garmin Displays have a Digital Switching section that is selectable under "Home". For the Display units at the Helm, these pages are labeled as "Digital Switching" (shown above). For the optional Companion Display unit, this page is called "Companion Panel". The main helm units have full function over all Digital Switching items, while the companion panel is limited to essential features. The Port Display and optional Companion Display will automatically boot to their designated Digital Switching pages when the units power-up.



All of the Garmin Display touch-screen Digital Switching items are protected by Digital Breakers. If a device trips the Digital Breaker and can be conveniently reset by clicking the “Breaker Reset” page or on the Empirbus module located behind the Dash. How to reset the breakers on the physical module is available in the Empirbus Module section.



*Illustration: Companion Panel Digital page*

### Operation: Main Page

**Hardtop Up/Down** - Push and Hold. Activates the Hardtop Power Control Box up/down relays allowing the Hardtop to move up or down depending on direction that is pushed. Actual Breakers for each actuator are located on the Hardtop control box located in the sump area.

**Windlass Up/Down** - Push and Hold. Activates the Windlass Relay located in the Bow allowing high power to the Windlass motor to move up or down. Windlass lockout switch at the Bow must be in the “ON” position for this to work. “Enable” button is only designed to prevent accidental use at Garmin Displays. It does not disable the Physical up/down switch located in the Bow. As a safety feature, the Bow switch is an analog switch and is not tied to Digital Switching. It is wired parallel and has it's own fuse located in the Battery Management Box, along with the resettable Windlass motor breaker.

**Power Platform** - Push once for auto Up/Down. Both Actuators and physical switch are completely Digital and use logic to control amperage and time allowing the system to give Indicators when the Platform is either Up/Down. Digital Breakers.

**Horn** - Push and Hold. Digital Breaker. This is parallel with the physical Analog Horn switch on the Dash acrylic. The physical switch is Analog for emergency purposes and can be used without power to the Garmin units. A fuse for this analog switch is located in the Battery Management Box.

**Nav/Anchor Lights** - Push once for “all on”, Push again for “only Anchor On”, and push a third time for “all off”. Digital Breakers.

**Deck/Underwater Lights** - If RGBW option is installed, an “All Zones” ON/Off button, color slider and dimmer is available. If RGBW is not installed, a On/Off button for “Deck Lights” and an On/Off button for “Underwater Lights” will be shown instead. Underwater Lights are always powered by Empirbus, while only Non-RGBW “Deck Lights” are powered by Empirbus. RGBW “Deck Lights” are powered by an iTC controller and both Zones of RGBW are color controlled through iTC.

**FWD Bilge and Aft Bilge Indicators** - An indicator will flash slowly indicating if either Bilge pump is running, whether it was manually turned On through the Digital Switching page or if it turned On automatically because the internal float switch was activated by water.

Battery Indicators - Shows voltages of each battery and change colors based on voltages.

Grey = Not Connected Green = Good Voltage

Yellow/Red = Low Voltage

Battery Link Indicators - Show if either Battery banks are combined or isolated.

Green = Combined

Grey = Engine + House not combined due to no charge being present.

Red = House + Accy not combined, indicates low voltage and a charge should be applied soon.

Fire Supression Indicator - Status of onboard Fire Extinguisher.

Green - Fire supression bottle is charged and ready for use.

Flashing Red - Fire Supression bottle is discharged or defective and needs serviced.

# Accessory Page

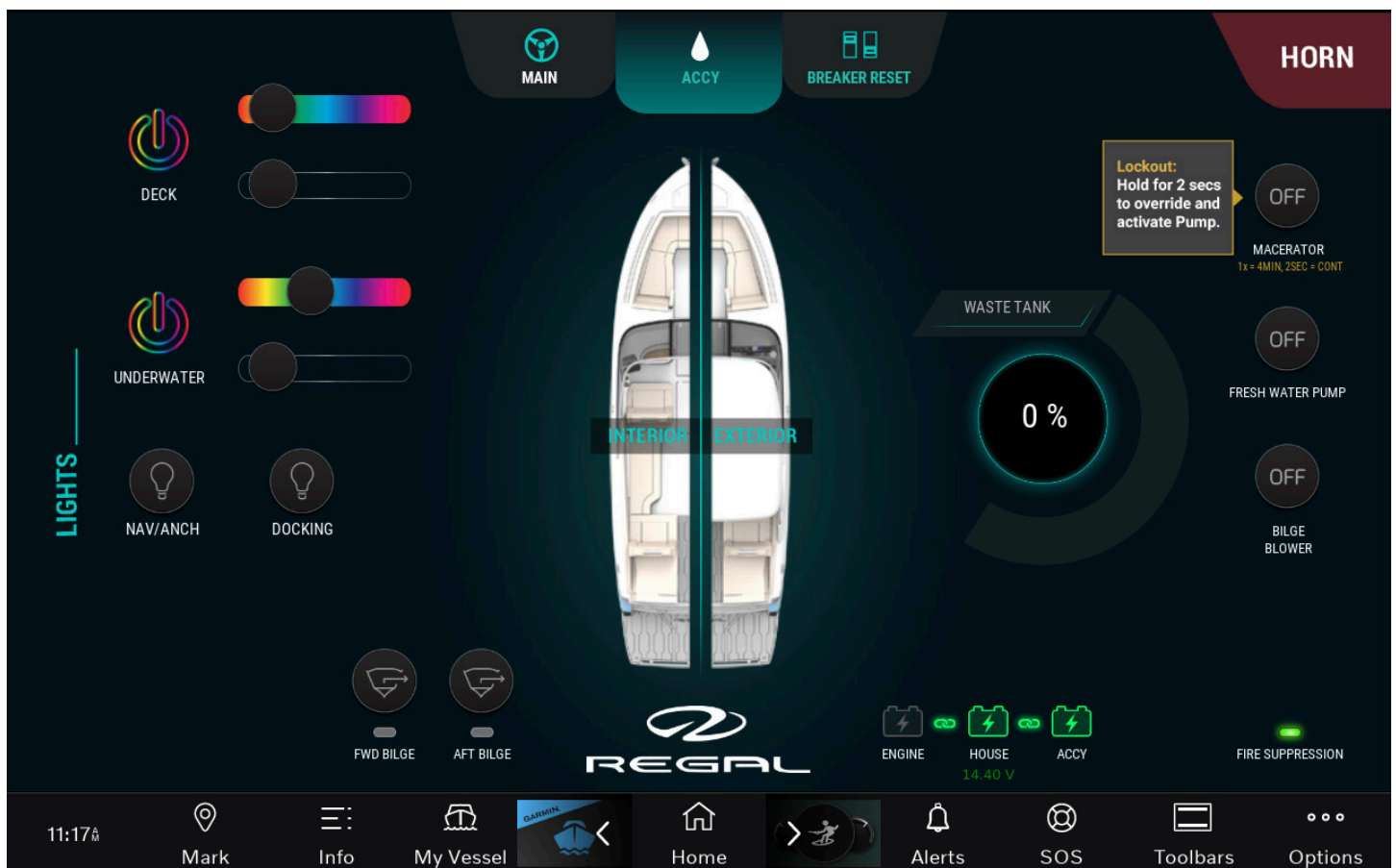

## Operation: Accessory Page

On this layout, we have a planned view of the boat. Unlike the main page, when certain devices are turned on, an icon indicator will appear on or around the boat rather than a realistic looking graphic. Other indicators such as Batteries and Fire Suppression remain the same as the Main page.

Deck/Underwater Lights - Similar to the Main page, an ON/Off button, color slider and dimmer are available for the RGBW option. On this page the two zones have separate controls. If RGBW is not installed on this boat, only a standard On/Off switch will appear for the two zones just like on the Main page.

Docking Lights - Push once for On/Off. Digital Breakers.

Companion Lockout - Push once for On/Off. Disables Hardtop/Platform on the companion display.

Fwd & Aft Bilge Pump - Push once for On/Off. On this page we not only have the indicators, but the manual On/Off switch. Note that if water activates the internal float switch of the pump, it can not be turned off here.

Waste Tank Level - How much poop in the tank. A common ground feeding the sender and returning to the Digital module for a tank level reading. Macerator - Push and Hold for 2 Secs to bypass lockout. Push once again for On/Off. Timer based and can be increased. Digital Breaker.

Fresh Water Pump - Push once for On/Off. Digital Breaker.

Bilge Blower - Push once for On/Off.

Automatically activates for 5 min when Ignition key is pushed. Auto On can be turned Off immediately. If Fire suppression is discharged, the blower will shutoff and a bypass switch will appear in order to use again.



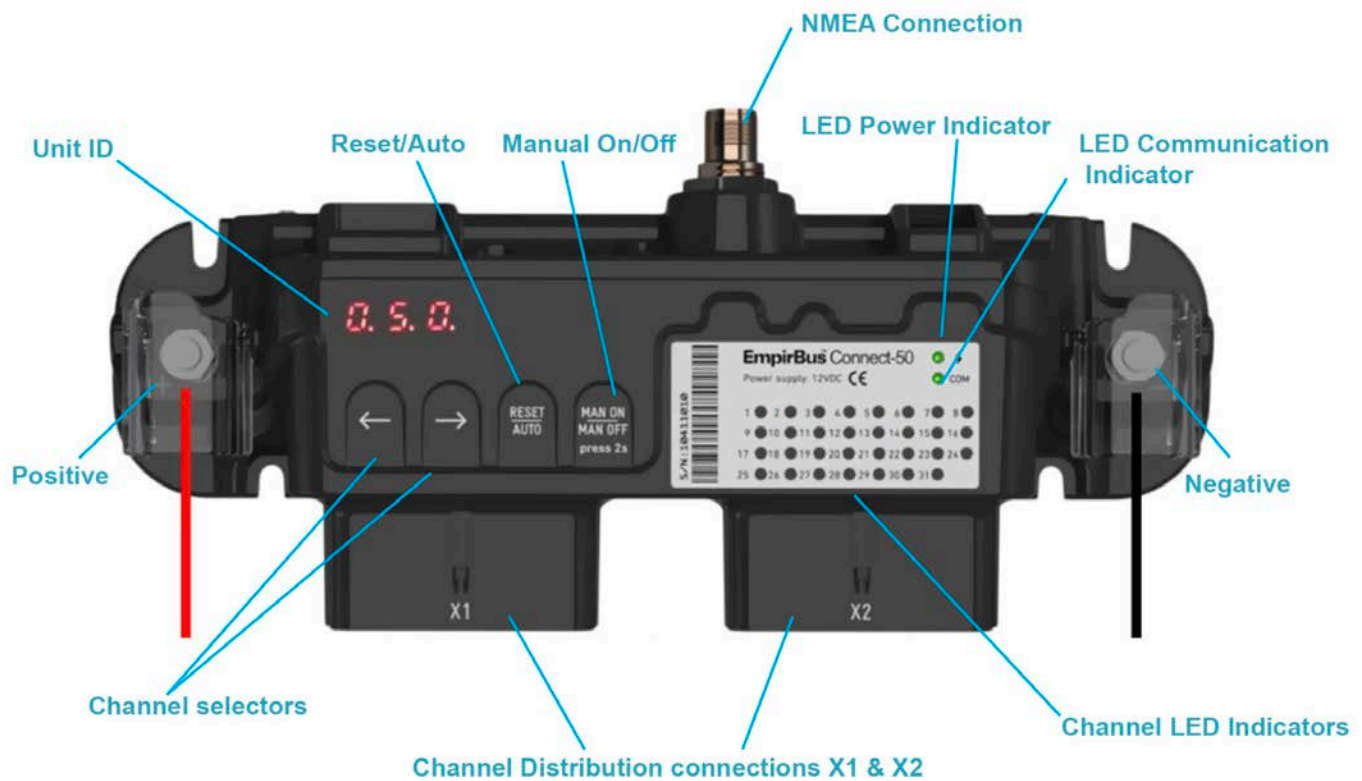

## Digital Switching/Breaker Module

*Empirbus Connect 50-10*

This Empirbus module features 32 channels.

- 20 Output Channels
- 11 Input Channels
- 1 Common Ground Channel (used for Tank send- ers and Close to Minus distribution)

All Output/Input channels are distributed through two 16 Pos Molex Caps labeled as X1 & X2 at the bottom of the device.

LED Indicators are available for channels 1-31. If a channel is Outputting or receiving an Input the LED indicator will be lit up Green for each channel with activity. If a channel is tripped, a Red indicator will be present. If there is no activity in the channel, the Indicator LED will be off.

A Green LED indicator for Power and Communications can be found above the channel indicators.

As well as a numerical Red indicator showing unit ID. This is helpful if multiple units are installed on the same vessel.

A channel can be manually turned ON/OFF or a breaker can be reset by using the keypad on the front of the device: Click on the right Arrow channel selector button and all channel Indicator lights will temporarily shutoff except channel 1. It is now possible to navigate through the channels using the two arrow buttons. Only the LED indicator of the channel selected will be on. To turn a selected channel ON/OFF, push the ON/OFF button. To reset a breaker, push the RESET/AUTO button.

The Module is powered by a positive and negative cable on each side of the unit as shown above.

The positive cable is connected to a 50A resettable circuit breaker that is located in the Battery Management Box and labeled as “Electronics”.

The Empirbus Connect 50-10 receives commands from the Garmins through a WDU (Web Display Unit) through the public NMEA 2000 Garmin Network. The WDU communicates with the Garmins through the private Garmin Ethernet Network.



## Garmin WDUv2

The WDU (Web Display Unit) is the device that stores and displays the Digital Switching pages seen on the Garmin Displays. The Empirbus Connect 50-10 module does not require this part to work, but it is impossible to see the Graphic pages on the Garmin Displays without this device. This device is powered through the public NMEA network and does not require an external power supply.

## Troubleshooting

If the Digital Switching Graphics page is not visible on any of the Garmin Displays,

the power to the WDU should be checked. To see if this device is receiving power, check the NMEA 2000 “Device List” under “Communications” on any of the connected Garmin Displays. If other Garmin devices such as the Fusion Stereo are not available either, there may be a problem with the power to the NMEA 2000 backbone. The fuse for this is located in the Battery Management Box.

A green LED Indicator is also visible on the WDU device next to the word “STATUS” if receiving power.

If the Graphics page is available on the displays, but all of the buttons are unresponsive, the Empirbus Connect-50-10 module should be checked to make sure it is powered on. If the device is not powered On, the “Electronics” breaker in the Battery Management Box should be checked to see if it is Off. If the module has power, the NMEA 2000 cable connected to the Empirbus module should be checked.

If the device is receiving power and the graphics page is not available on all of the plotters, the Network cable from the WDU to the Garmin Display should then be checked instead. If the the graphics are available on at least one of the units, the network cables that connect from one Garmin display to another display should be checked.

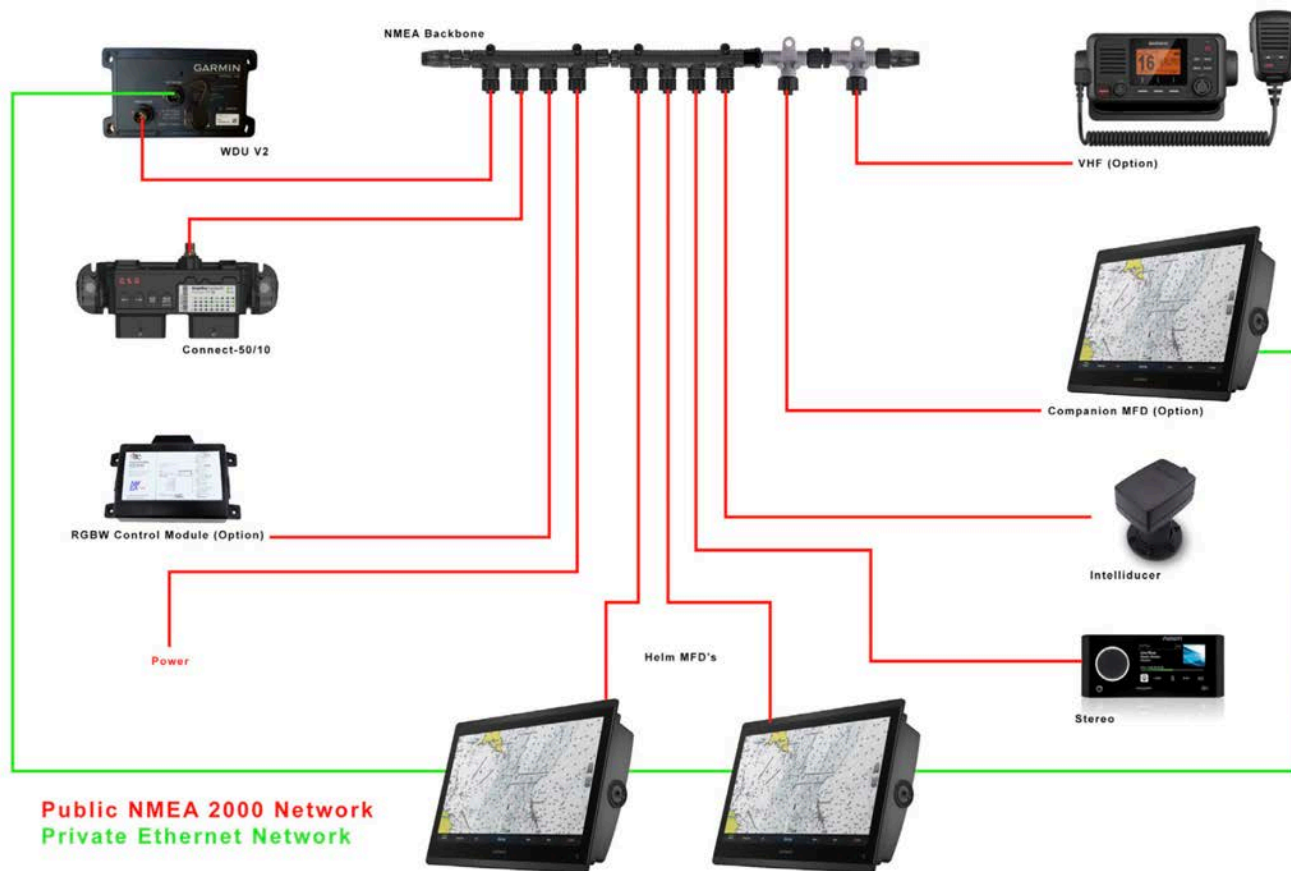

## Garmin Communications Network

In the pictorial diagram above, the entire Garmin communications network is illustrated. This shows the connection between Empirbus, Garmin, Fusion and the iTC RGBW Controller.

The Red lines represent the Public NMEA 2000 Network cables that are connected to the main NMEA 2000 backbone located inside of the Dash compartment. These cables are standard NMEA 2000 compliant cables and there are no other junction points in-between the devices and the NMEA backbone. On this particular vessel, the Fusion head unit NRX Power should always be disabled. NRX Power is specifically designed for Fusion Remotes and should not be used on NMEA 2000 backbones such as this one. The Power for the NMEA Network is supplied from the Battery Management Box and is protected by a 3A fuse.

The green line represents the Private Garmin OneHelm Network. This network is connected using Garmin Crossover Ethernet cables.

For information on connection points at the devices, refer to device specific manuals. These manuals can be found on [www.garmin.com](http://www.garmin.com), [www.empirbus.com](http://www.empirbus.com) and [www.itc-us.com](http://www.itc-us.com)

# Garmin Communications Network

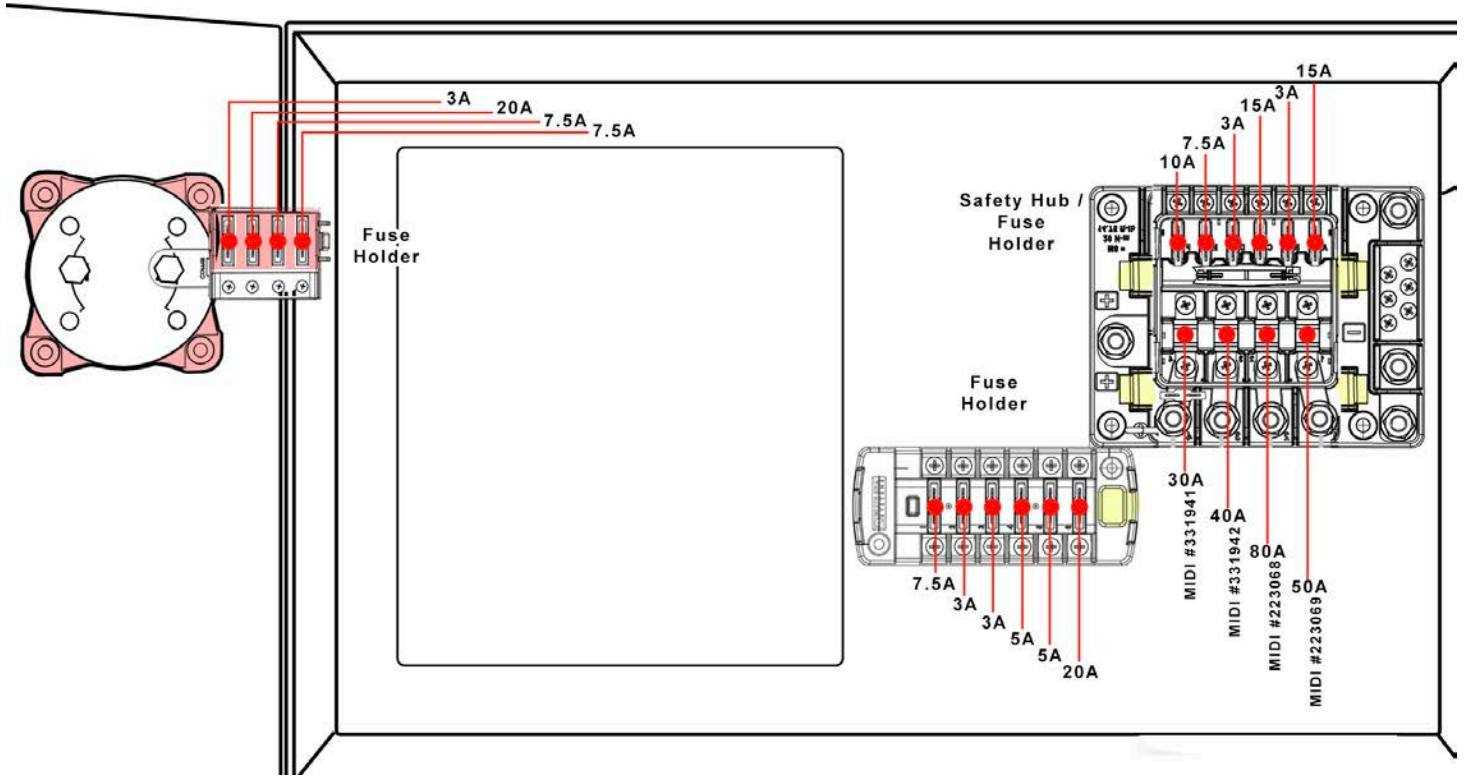

## Engine Battery Switch Fuse Holder

Wire	Fuse
Voltage - 16g Purple/White	3A
Battery Charger - 12g Red	20A
Aft Bilge Pump - 14g Brown/Red	7.5A
Fwd Bilge Pump - 14g Brown/White	7.5A

## House Battery 6 Pos Fuse Holder

Wire	Fuse
Horn/Windlass - 12g Orange/Black/16g Red	7.5A
NMEA - 16g Orange	3A
VHF - 14g Orange/White	3A
Stbd Plotter - 14g Orange/Green	5A
Port Plotter - 14g Orange/Red	5A
Battery Charger - 12g Red	20A



Sump Bow Thruster (Option)

## ANL Single Fuse Holder

Wire	Fuse
Bow Thruster Motor - 2/0g Red	200A

## Accy Battery Safety Hub Fuse Holder

Wire	Fuse
Horn/Windlass - 12g Orange/Black/16g Red	10A
NMEA - 16g Orange	7.5A
VHF - 14g Orange/White	3A
Stbd Plotter - 14g Orange/Green	15A
Port Plotter - 14g Orange/Red	3A
Battery Charger - 12g Red	15A
Head - 8g Red	30A
JL SPP Hardtop Amp - 8g Red	40A
JL SPP Standard Amp - 4g Red	80A
JL SPP Wake Sub Amp - 6g Red	50A



Sump Surf Board Assembly (Option)

## MIDI Double Fuse Holder

Wire	Fuse
Port Surf Module - 4g Red	50A
Stbd Surf Module - 4g Red	50A



# Chapter 2

## Stern Drive Engine/Systems

### Engine Checklist Before Each Outing

Every engine option may require different checks before each use, but a general **stern drive** engine checklist is included here as a guide.

- Check crankcase engine and stern drive oil levels.
- Check power steering fluid.
- Check power trim fluid/trim tab levels.

### At Helm/Deck

- Check power trim for operation.
- Check control lever for operational defects. Check the clip and safety lanyard for functionality.
- Check any gauges for accuracy.
- Check fuel level and ensure the level is sufficient for the trip with a 1/3 reserve.



TYPICAL STERN DRIVE ENGINE

### Engine Cooling System

Your typical engine normally utilizes a raw water system for cooling the engine with intakes at the gear case. It is important that this system continues to run unobstructed at all times to avoid hazardous situations and to ensure a safe voyage.

Raw water is drawn up into the vertical drive shaft housing through pick-up feeds above the gear case vicinity into a water pump and impeller and then into the engine itself. Water passes through a thermostat which controls how much water circulates through the engine. The cool water absorbs heat produced by the engine, before being circulated to the coolant exhaust system.

### Impeller/ Water Pump

Periodically, the coolant system impeller and water pump should be inspected for debris, damage or excessive wear due to wear, water chemistry such as mineral and/or silt conditions. Damaged parts will affect the system's ability to function, and may cause engine overheating or damage. Contact your closest Regal dealer for more information and maintenance schedules affecting the engine coolant system.



## Thermostat

If the temperature gauge starts yielding abnormal readings, it may become necessary to look at or replace the thermostat after determining whether it is functioning properly. The thermostat reads the temperature of coolant and determines whether to open or close a valve to allow warm sea water to pass into the exhaust manifold. The thermostat may recirculate hot coolant for the purposes of reaching standard operating temperatures. If standard operating temperatures have been reached, the thermostat will open a valve and allow hot raw water to exit through the exhaust manifold. For more information read your engine manual or contact the closest Regal dealer. Dealers have the necessary knowledge and tools to troubleshoot any engine related problems.



### **WARNING**

PREVENT INJURY DUE TO HOT SURFACE!  
AVOID TOUCHING THE THERMOSTAT  
OR ITS COMPONENTS WHILE THE ENGINE  
IS HOT.



### **CAUTION**

TO PREVENT ENGINE DAMAGE DUE TO  
OVERHEATING AVOID RUNNING THE  
ENGINE WITHOUT A FUNCTIONING  
THERMOSTAT.



### **CAUTION**

AVOID ENGINE DAMAGE OR FAILURE!  
DISCONTINUE ENGINE OPERATION  
AFTER AN ALARM HAS SOUNDED.  
ADDRESS MALFUNCTION BEFORE  
RESTARTING ENGINE.

## Engine Electrical System

Your engine utilizes a great deal of electronic equipment. Some equipment sends signals between the engine and the Garmin, while other systems set off alarms, and still others are used by the engine to generate a spark and ignite the fuel. The battery switch controls electrical power distribution to the boat systems.

To regularly maintain your DC electrical system, inspect battery condition before each trip. Test all gauges and control equipment prior to departure, and replace as necessary. Spark plugs should be replaced according to your engine owner's manual maintenance schedule.

### Gauge Electrical Signals

Your stern drive engine transmits signals through electrical harnesses to different components through the use of NMEA 2000 connections and a "backbone system". A Garmin plotter displays the engine functions. The fuel gauge and depth sounder use stand alone technology to display readings. Also, idiot lights are display tolerances that are classified as being abnormal.

### Alarms

If a malfunction with your engine occurs, the Garmin plotter alerts the skipper of a problem. Common engine problems include overheating, low oil pressure, or a miscommunication with equipment. Learn the alarm systems that apply to your engine by consulting your engine owner's manual. Engine manufacturer's feature their own engine display screen which may display rpm, engine hours, coolant temperatures and use alarms.

## Garmin Engine Monitoring Display



Typical Display Shown

A Garmin chart plotter may be installed on your vessel. The unit displays many GPS features along with the ability to monitor engine system functions including engine revolutions per minute (rpm's), GPS speed, voltage, fuel flow rate, trim, and temperature along with tracking engine hours.

Fusion uses its own display screen on the chart plotter for audio controls on the vessel.

Note that the Garmin and Fusion circuitry use individual DC sources to power up the system. The key switch does not power up these 2 systems.

1. To power up the Garmin GPS press the "on" button located at the upper chart plotter display.
2. The function AV/Gauges,Controls will appear as one of the choice boxes. Press the box. Another screen with engine will appear.
3. Press the engine box and the engine gauge displays will appear (oil pressure is engine code driven only).

For more information refer to the Garmin manual.

## Spark Plugs

The spark plugs are components that help make ignition occur. As electrical potential builds on one side of the gap based upon the energy distributed by the ignition system, the potential eventually grows large enough to cause the electric current to jump the gap on the spark plug. This spark is what ignites the compressed fuel generating a controlled explosion that will power the piston down and deliver power to the drive shaft.

## Alternator

Under normal circumstances, the starter battery would wear down after being used so often to generate a spark for the engine. This isn't an ideal setup because a strong battery is needed for continual operation. A weak battery does no good out on the water. The alternator recharges the batteries while the engines are running.

However, in an effort to conserve battery life, the battery switch should still be turned off after every trip and turned on at the start of every trip. This limits the drain on the battery while the boat is not in use. As optional equipment a 10 amp battery charging system charges batteries when the shore cord is connected to the vessel 3 prong grounded plug which must be connected to a GFCI outlet. Read and understand the following label!



## CAUTION

THIS VESSEL IS NOT EQUIPPED WITH A GALVANIC ISOLATOR. USING THE BATTERY CHARGER WHILE THE BOAT IS IN WATER MAY CAUSE DAMAGE TO THE BOAT'S ANODES AND/ OR DRIVE SYSTEM.

## Fuses

Your engine also comes equipped with fuses that will burn out or "blow" when engine components attempt to draw more power than the piece of equipment or wiring can handle. When the fuse blows, it breaks the circuit, and electricity stops flowing. Before replacing the fuse, investigate the cause of the problem, and why the equipment was overworked. Your engine uses a helm mounted fuse box which is accessible by lifting the starboard bow backrest while other engines feature in-line fuses, while still others feature a mixture of both. Refer to your engine owner's manual for complete details on your electrical system and the location of any engine mounted over current protection.

## Engine Exhaust System

Your engine expels the by-products of the engine operation through an exhaust system, just like automobiles do. In boats however, this exhaust system mixes the debris left over after the power stroke of the engine with the hot water that is expelled after cooling the engine.

Basically the exhaust flows through the engine before expelling the exhaust through the vertical drive housing either just above the propeller, or through the prop shaft.

## Engine Fuel System

Refer to the system chapter of this manual for fuel system specifics. Be sure to read and understand the warnings on the next page.



## WARNING

USE OF ALCOHOL ENHANCED FUEL, OR ANY FUEL OTHER THAN GASOLINE CAN LEAD TO DETERIORATION OF THE FUEL SYSTEM COMPONENTS. THIS CAN RESULT IN FIRE AND POSSIBLE EXPLOSION.



## WARNING

GASOLINE VAPORS CAN EXPLODE!  
BEFORE STARTING ENGINE  
CHECK BILGE COMPARTMENTS  
FOR GASOLINE LEAKS OR VAPORS.



## WARNING

PREVENT INJURY OR DEATH  
DUE TO FIRE OR EXPLOSION!  
RUN BLOWER AT LEAST 4  
MINUTES BEFORE STARTING ENGINE.

### Engine Lubrication System

Whenever two components rub together, friction causes wear on both components. To minimize the wear on your engine, a lubrication system has been put in place to help components slide next to each other easier. This is particularly important within the inner workings of an engine. It is important to ensure your lubrication system is working properly at all times.

Your Regal utilizes lubrication and fluids that need regular check ups. Refer to your engine owner's manual for specific details regarding the proper maintenance of the lubrication system.

*Note that your engine uses other lubricants in addition to engine oil such as power trim fluid and gear lubricants to reduce wear on moving components. These fluids should be checked according to the recommended maintenance procedures determined by the engine manufacturer.*

### Engine Oil

The purpose of engine oil is to lubricate the internal components of the engine and ensure parts that regularly move against each other have reduced friction to lessen wear and noise between components. An oil filter keeps metal particles and water out of the engine's interior.

Stern drive engines performing on regular oil should have the oil drained and replaced after the first 20 hours of operation or 3 months, and every 100 hours or at 1 year intervals thereafter.

### Stern Drive Oil

Stern drive oil keeps all the mechanical components of the prop shaft gear assembly functioning optimally. It reduces friction in the gear case as the gears revolve. Sometimes gear case oil is called gear lubricant. Gear case oil should be inspected periodically according to factory maintenance schedules. Use engine manufacturer's recommended oil.

### Power Trim Fluid

Power trim fluid allows your out drive to trim up or down. This is particularly useful when trying to get your boat to plane.

Power trim fluid is used in hydraulic rams that maneuver the stern drive unit. Power trim fluid should be checked regularly in the reservoir which is located in the bilge.

## Propeller System



Regal has carefully tested and chosen the propellers to give your vessel the best possible performance based on the engine and propulsion package you choose. We have allowed for the additional weight in equipment that might be added to the boat. It is a good idea to carry a spare set of propellers and hand tools onboard in order to handle emergency propeller changes.

Marine propellers may display the following information:

1. Propeller pitch shown by inches.
2. Propeller type (L for left or R for right).
3. Propeller diameter in inches

Refer to the engine manual for propeller removal and installation procedures, as the application is unique to the manufacturer. Call a marine professional or your Regal dealer for to order a spare propeller set.

## Propeller Checklist

At least twice a year, check the propeller for:

- Loose, missing, or corroded hardware.
- Nicks, dings, or missing propeller material
- Bent propeller blades.
- Objects wrapped around the prop (fish line)
- Decomposing propeller blades (electrolysis symptom).
- If equipped, check the propeller rubber hub for slippage

Contact a propeller shop or your closest Regal dealer if any of the above symptoms exist. They have purchased special equipment to refurbish both stainless steel and aluminum propellers.



## Starting Engine

### Before Starting Engine

*Note that it is important that you read and understand the engine operator's manual carefully and become completely familiar with the operation as well as required maintenance procedures on the engine and related propulsion systems.*

Before starting the engine check the guidelines below:

1. Open the engine hatch and sniff for fuel smells and visually check for fuel leaks. If gasoline vapors are sensed or leaks seen be sure to determine the cause and repair the source **before starting the engine**. If you can not locate a fuel leak contact a marine professional immediately or your closest Regal dealer.

1. Always run the bilge blower at least 4 minutes before attempting to start the engine. Continue to run the blower after the engine starts below cruising speeds.

2. Remove any loose canvas and store in a dry location.

3. Shut and secure all portholes and doors.

4. Make sure the swim ladder is secured in its folded position and that the cover if installed is in place.

5. Check fuel supply levels. Use the fuel "1/3" rule.

6. Turn battery switch to the "on" position at the battery panel.

7. Activate the VHF if installed and listen for the latest weather conditions along with performing a radio check.

8. Activate the plotter and check its function, set your cruise, and monitor engine read-outs once the engine has started.



Check to ensure that all ventilation duct grills are clear of foreign objects.

The natural and powered ducts provide a continual air supply to the engine compartment and evacuate any fumes along with warm air. Sometimes insects make nests in the vent ducts. Lift the aft cushion on both port and starboard sides to access the ventilation ducts/grilles.

### Starting Engine

After the preliminary checks are performed the engine is ready to start. Insert the ignition key into the ignition panel key switch hole. Note that the key switch shows three positions;



A) Straight Up= "Off"

B) 45 Degree Angle to Right= "Ignition" or "On"

C) Spring Loaded Furthest Right= "Start"

When you turn the key switch to the furthest right position you may feel a small resistance which is the spring loaded key switch position. This is normal.

Ensure that your remote control is in the idle neutral position before beginning the starter cranking process!

Crank the starter over until the engine starts. When the engine starts leave go of the key and it will spring back to the ignition or "on" position for normal running.

If the starter continues to crank and the engine does not start turn the key back to the "off" position and let the starter cool down between start attempts.

*Note to avoid possible starter damage do not crank over the starter more than 20 seconds on each start cycle.*

*Note that if a flooding condition should exist put the throttle in full throttle neutral gear position and crank the starter. If it does not start try it again in the same advanced neutral throttle position. When it starts return the throttle to the upright neutral idle position. If it does not start return to the neutral idle position and let it set a few minutes before re-cranking the starter. Never continuously pump the throttle.*

## After Starting

1. Allow the engines to idle for a short period as they warm up. Never race a cold engine!
2. Check the chart plotter and pay particular attention to volts, oil pressure and temperature display panel functions as they are key indicators of a proper performing engine. Also, check that no alarms are sounding, warning lights are flashing and no fault codes display on screens. See information display.
3. Open the engine compartment and listen to engine for unusual sounds.
4. Inspect the fuel, exhaust, and engine circulation system for leaks.
5. Visually check the entire sump (bilge) for any unusual conditions.
6. Visually check your passengers to ensure they are wearing the proper PFD, are sitting in a designated seat, boat load is balanced, and the operator has uninterrupted field of vision both forward and aft before shifting the remote control.
7. Make sure that all passengers have been informed on using the various seat hand holds should the sea conditions deteriorate.

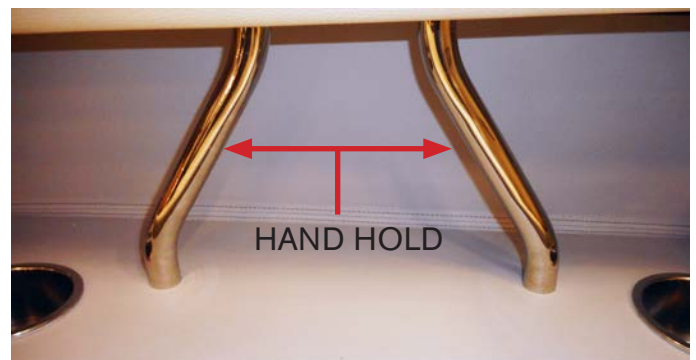



8. Select vessels feature an information display panel as part of the engine related components. This helm display shows engine and operational

information, messages and alarms. A portion of the same engine information could be displayed through the chart plotter display.

The basic settings show:

- Engine speed
- Oil Pressure
- Coolant Temperature
- Battery Voltage

One of the features on the information panel is the fault display. If the system finds a fault, the word fault and the number of them are shown on the display. By pressing the OK button the panel will display all detected faults.

Navigating to the Settings menu. Press OK to bring up sub menus. Use the arrows to seek the information. For more detailed information refer to the engine operation manual.

*Note that it is recommended to use the display cover on the unit when not in use. The prolonged rays of the sun and high temperatures over time may damage the screen.*

## Corrosion Protection Systems

Your vessel's engine either Volvo or MerCruiser may be equipped with a corrosion protection system. The Volvo system is called the active corrosion protection system (ACPS) and the MerCruiser system is called a MerCathode system. Refer to your engine manual for more information. We will cover the basic ACPS system here.

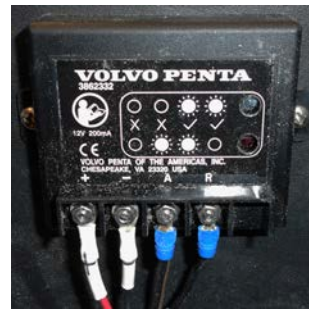

The ACPS works as an active anode and is programmed to reduce the galvanic corrosion in underwater stern drive parts. The system works along with the sacrificial drive

zinc anodes. Longer life for anodes is provided through the ACPS but periodic maintenance checks of anodes are still required. This system was designed to work only in salt water.

The system will not provide protection from stray currents emitted from a faulty AC power source on the dock, your boat, or other boats close to yours. The module is usually mounted aft of the engine. Note the red and green LED indicator lights. They indicate the system status.

1. Green LED only indicates the system is working.
2. Green and red LED's on, the system is working, but the system is drawing power.
3. Red LED only, the system has power but is not working (no protection).
4. No LED's, the system does not have power, and is not working (no protection).

## Remote Control

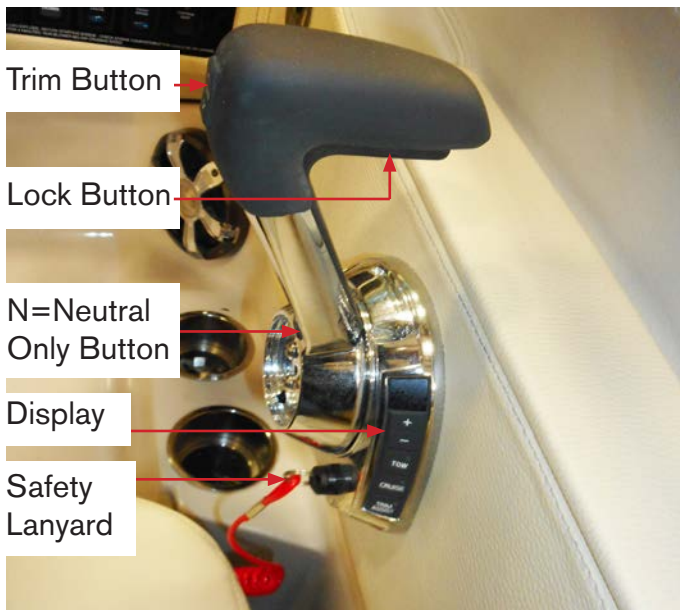

Typical Side Mount (EVC) Remote Control Shown Introduction

A majority of bow rider stern drive vessels use a single lever side mount control for shifting and throttle operations. The remote control handle controls forward, neutral and reverse shifting as well as throttle operations. A trim button permits raising and lowering the drive to provide an optimum ride and the best vessel position (angle) as it travels through the water. As there is a neutral safety switch in the system the control must be in neutral to start the engine.

Understand all remote control functions before operating the vessel. The single control handle makes it much easier to maneuver in tight quarters. See the information following for basic component description and operation. *Note to read and understand the engine manufacturer's manual before attempting to operate the vessel remote control.*

Practice docking operations using the remote control in a controlled environment to learn the basic functions and the vessel's response to them.

## Safety Lanyard

Locate the remote control handle in the neutral position. Advance the neutral throttle position as instructed in the engine owner's manual. The function of the safety lanyard is to shut down the ignition should the captain become separated from the steering position such as falling down or losing consciousness. Connect the safety lanyard to a belt or secure piece of clothing. Ensure the lanyard is securely fastened to the remote control post. Keep passengers seated and away from helm controls at all times. Never leave the helm unattended when the engines are running.



## WARNING

LANYARD MUST BE ATTACHED TO THE OPERATOR WHILE THE ENGINE IS RUNNING. A QUALIFIED OPERATOR MUST BE IN CONTROL AT ALL TIMES. READ AND UNDERSTAND THE OWNER'S MANUAL BEFORE OPERATING VESSEL.



## WARNING

AVOID POSSIBLE INJURY OR DEATH! BEFORE MAKING HEADWAY ENSURE THAT ALL PASSENGERS ARE OCCUPYING DESIGNATED SEATS. ENSURE THAT DRIVER HAS UNOBSTRUCTED VISIBILITY IN BOTH FORWARD AND AFT SECTORS.



## CAUTION

IF THE LANYARD IS IN THE "OFF" POSITION, THE ENGINE WILL CRANK OVER BUT WILL NOT START. ENSURE SAFETY LANYARD IS ATTACHED SECURELY TO A BELT OR SECURE PIECE OF CLOTHING AND THE REMOTE CONTROL PANEL.



## Remote Control Display Bar

There are several features found on the Volvo EVC or MerCruiser DTS remote control display. See the individual buttons on the display strip shown on the previous page. They include trim assist, cruise control and tow mode. A brief description is found below. Note that the MerCruiser DTS remote control uses similar features. For a complete guide refer to the engine operator's manual.

**Power Trim Assistant-** Activate the PTA by pressing the Trim Assist button on the remote control. When you press the button again you deactivate the PTA. It automatically adjusts the trim angle to the engine speed. This feature permits trim functions to be loaded to control the in and out movement of the drive unit which control the boat angle and ride conditions. It eliminates the need to use the trim button on the side of the remote control handle. When the throttle changes the trim servos automatically "pair" themselves with the control handle position; full speed or anywhere in between they will seek the optimum trim angle for that speed.

*Note that the power trim assistant will not move the stern drive if it is manually trimmed above 7 degrees.*

*Note to ensure the PTA function is "off" if the vessel needs to be removed from the water. This eliminates automatic trimming of the drive if any test runs are performed with the rig land locked.*

**Cruise Control-** Activate the cruise control by pressing the button. This feature controls the vessel speeds in increments of 50 revolutions per minute shown as + or - on the control display. Each time the + button is pressed the engine rpm's increases by 50 rpm's. Each time the - button is pressed the engine rpm's decreases by 50. You can hit the plus or minus 5 times from where you have the throttles set. Beyond that it is time to move the controls and start again.

You might find yourself using this feature in heavy seas where you can make changes as wave height, current and wind conditions change and you do not want to manually use the control handle.

**Tow Mode-** Activate the tow mode by pressing the button. This feature is especially useful in water sports where you can program the throttle to remain at a specified rpm. Once programmed the tow mode will take the engine to that preset rpm which is best suited for the rider.

**Triangle Symbol-** The triangle icon lights up if the EVC system has registered a fault; refer to the Fault Code Information in the engine owner's manual.

**Mil Light-** (indicator light) lights up if the engine's emission system has registered a fault. At engine start, with the ignition on and the engine not running, the MIL will light on the control. This is a system test. The light will disappear when the engine is running unless there are engine faults.



## Remote Control Operation

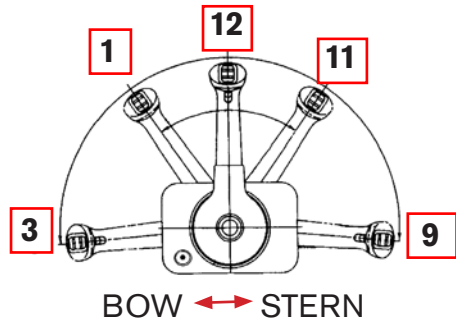

*Profile Of Typical Engine Control Lever Displaying Five Positions*



Shown here is the Volvo EVC (Electronic Vessel Control) remote control in a 12 o'clock or neutral position above with idle throttle control (left). This is the neutral position for starting and stopping the engine(s). Press the N button to activate the neutral position and a flashing light appears. Now depress the lock button (provides start in gear protection) upward and this will permit advancing the throttle in a neutral position to warm up a cold engine.



Depress the lock button. Push the throttle control lever forward from the neutral 12 o'clock position to the 1 o'clock position and you will reach forward gear with minimal throttle. From the 1 o'clock position to the 3 o'clock position, the vessel is in forward gear with differing levels of throttle selections.



Shown here is the remote control in a full throttle forward (3 o'clock) gear position.



Pulling the throttle control lever back from the neutral 12 o'clock position to the 11 o'clock position will engage the reverse gear with minimal throttle. From the 11 o'clock position to the 9 o'clock position, the vessel is in reverse gear with differing levels of throttle selections.



Shown here is the remote control in the full reverse position which shows as 9 o'clock.

See the diagram on the last page. This is a throttle position you would use for an emergency such as to avoid running aground or a collision. *Note that the operator needs to heed the warning that this throttle position under the right conditions could deposit large amounts of water over the swim platform or transom.*

The control lever features a *neutral safety switch* which ensures the engine and control are in the indented neutral position for starting the engine. You will hear a distinct tone and will feel the remote control's rotation lock in neutral when you shift from reverse or forward into neutral.

*Note that if you turn the key and the engine starter doesn't crank the engine, ensure the control lever is in the neutral position.*

*Note that the Volvo EVC stands for electronic vessel control and MerCruiser DTS stands for (digital throttle and shift). Both are known as "fly by wire" systems. Both systems assume similar control positions as shown above.*

## Hints For Shifting

- DO NOT shift quickly from forward to reverse gear positions. Drive system damage may occur.
- DO NOT “pump” the throttle in neutral as it is normally not needed since today’s engines use an enrichment valve system that requires very little starting throttle.
- DO NOT try to shift into forward or reverse gear at high rpm’s. Personal injury, drive system, or property damage may result.
- Only use idle throttle positions when docking or maneuvering in tight quarters.
- Wear your safety lanyard at all times.
- Never shift the controls with the engine not running.
- Always ensure you have unobstructed visibility before you shift into forward or reverse gears.
- For more information on remote controls and shifting read engine manufacturer’s operation manual before operating the remote control.

## Power Steering Operation

Both major engine manufacturer’s offer digital steering systems. The standard helm is replaced with a digital control wheel and instead of mechanical parts or hydraulic steering hoses connected to the steering helm/wheel the digital system transmits and communicates steering instructions from the steering wheel to the drive by electrical impulses in wires. They send a signal to the steering servo that control the hydraulic rams to steer the vessel. The wheel feels effortless and all controls are fingertip gentle.

*Note that whenever you check the engine oil is recommended at that point to check the power steering reservoir fluid level. Fill with correct type of power steering fluid. See the engine owner’s manual for more information regarding power steering specifications.*

# LS4 LS6 Surf Engine/Systems



The following pages outline the basic operation of the Regal Surf System. Read and understand the Regal owner's manual especially the stern drive sections as many systems overlap. Also read any surf system marketing materials in the owner's information packet before attempting to operate the surf system. Always use an on board spotter to watch and communicate with the surf rider.

Remember the captain is responsible for his crew, wake, and maintaining his vessel. Safety first!!

The Regal Surf System utilizes Volvo forward drive propulsion along with other integrated components to offer boater's wake surfing, wake boarding or cruising options. The components include ballast bags, wave shaping surf tabs, and rider preferences for full surf control at your fingertips.



## Introduction To Surf Components

### Volvo Forward Drive Propulsion

This cutting edge technology utilizes two-forward-facing counter-rotating propellers which actually pull the vessel through the water rather than push it (older technology). The forward drive delivers a smoother and quieter ride with little vibration. Of course coupled with surf tab technology, the drive unit permits equally shaped wake surfing on either side of the vessel. The dual propellers are placed forward of the gear case located for optimal performance for water sports activities. By reducing prop ventilation, the Volvo forward drive produces better overall fuel economy and higher top end speeds.

### TYPICAL FORWARD DRIVE



Also, by eliminating the exhaust passage in the prop hub it allows more propeller blade room which accentuates acceleration.

## Ballast Bags & Pump System



TYPICAL  
BALLAST BAG

An additional feature of the Regal surf system is the 3 ballast bags. Usually the bags are placed as follows: 1 bag aft starboard, 1 aft port and 1 at the center line.

These bags are activated by electronic controls inside the chart plotter through an engine compartment mounted node module to fill/empty the tanks.

The ballast bags feature Valmex PVC material, high end plasticizer and a welded process which produces bags with thermo-bonded seams. They are much stronger and durable than glued seams in the harsh marine environment.

Your vessel utilizes 3 reversible pumps to fill and empty the ballast bags. When the bags fill water is drawn through the hull bottom and sea cock to the desired bags pump. When the bags empty water exits through the sea cock and the hull bottom. The impeller that pulls water through the pump is a heavy duty polymer design and should provide longevity in a variety of water types. The impeller inside the pump spins around a cam which produces a low pressure area and pulls water through the pump.

The port and starboard bags use the port sea cock as a water source through the hull bottom. The top hose on port sea cock runs to the port bag.

The larger center bag uses the starboard sea cock.

*Note that the sea cock handle must be straight up (open position) to fill/empty the desired bag.*

*Note that the output pump hoses utilize a quick disconnect band (orange) for any maintenance needs.*



The surf water pump system requires little maintenance. It is a good idea to carry an extra replaceable impeller. Note that the pump O ring should be replaced and lubricated

when a new impeller is replaced.

## NOTICE

PREVENT WATER PUMP/IMPELLER DAMAGE!  
DO NOT RUN THE PUMP SYSTEM  
WITHOUT WATER OR WITH SEA COCK  
HANDLE CLOSED.

## Surf Tabs

The surf tabs operate using screw drive technology. This eliminates the possibility of hydraulic leaks as with fluid operated types. The surf tabs run independently of one another in 2 different positions; completely up or down. To begin you can choose the starting up position which will permit the boat to be evenly planed before you start wake surfing. At that point you choose your desired side to ride

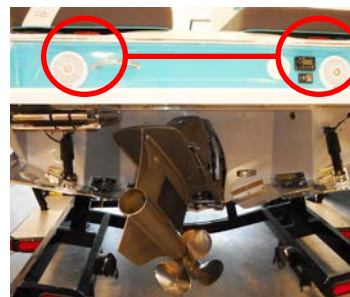

(usually a higher wake position) on the chart plotter screen and the transom mounted red light will initially flash for the rider to be prepared

TYPICAL SURF LIGHTS and then the boat will list to the desired side and the red light will stop flashing and stay on through that surf cycle.



## Typical Surf Boat Pump System

*Note: Equipment specification, location, and operation changes may occur over the vessel production life.*

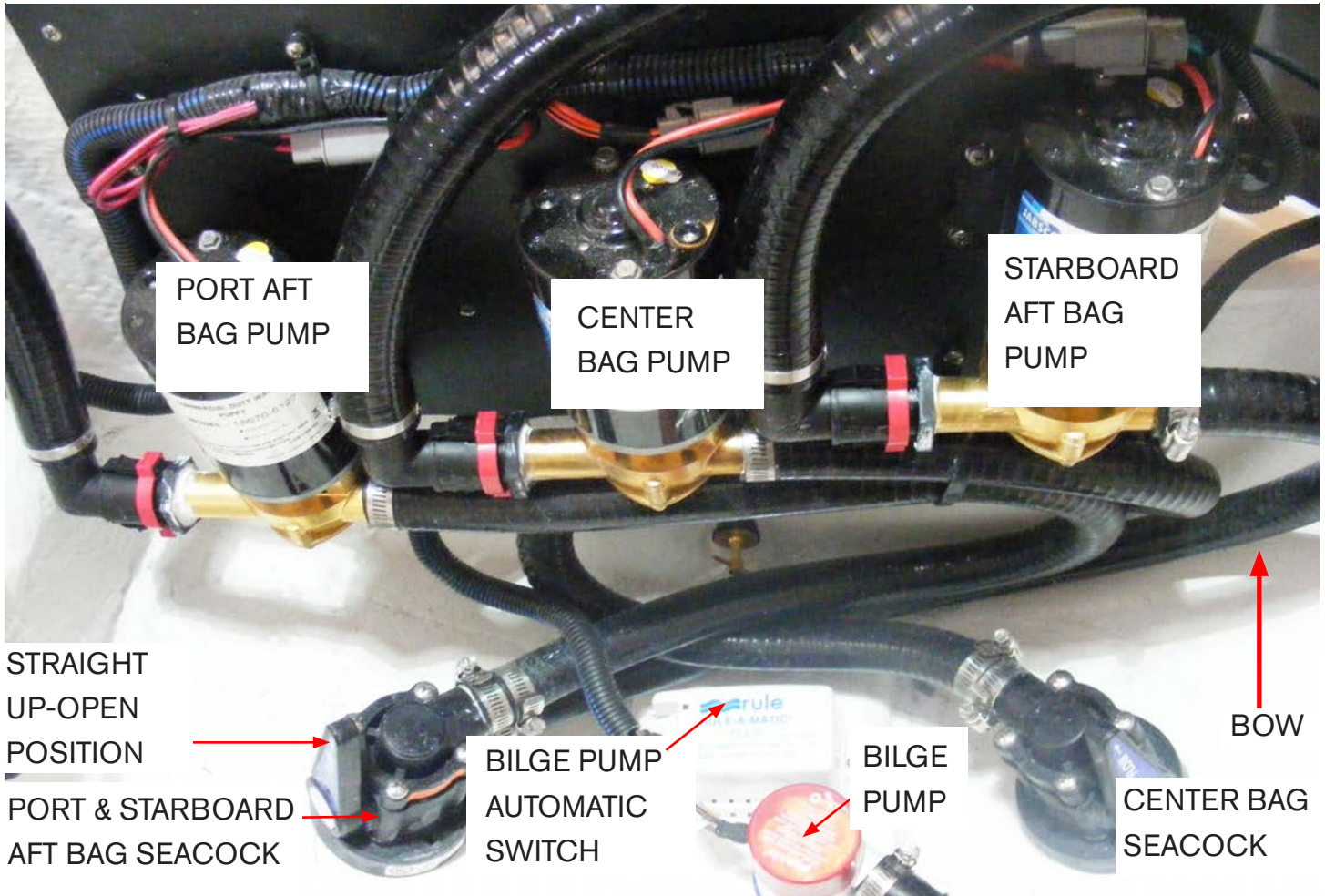

### Notes Regarding Wake Surf Pump System

1. In freezing climates contact your closest Regal dealer for winterizing the wake surf system along with the entire propulsion system. Dealers have the special tools and latest knowledge regarding these systems. Regal is not responsible for any damage due to improper winterization.
2. Periodically check the entire surf pump and ballast bag system for leaks and abrasions.
3. Never store anything in the bag compartments. Bag could fail due to heavy and/or sharp objects.

4. Periodically check all hoses and hose clamps are securely fastened. Do not operate the surf pumps out of water as pump/impeller damage will occur.
5. If leaving the vessel in the water for extended periods turn the surf pump sea cocks to the "off" position (90 degrees to the straight up position) and leave a note to yourself on the dash to turn sea cocks on before using the surf system again. Also, remove keys from the ignition switch.





Your Regal boat features a Garmin plotter system that is used for GPS, engine, and surf functions.

Refer to the plotter operator's manual for system rider profiles, surf tabs, ballast bag filling and emptying, surf rider optimum speed and quick launch perimeters.

The factory has set up the basic information on the plotter surf displays. Detailed and personal preferences can be set up under the preset perimeter guidelines.

### Surf Vessel Operator's Wake Responsibility

Read and understand the wake responsibility information below. Bottom line the vessel **operator** is responsible for the boat wake at all times.

## WAKE RESPONSIBLY

- 1 Stay at least 200 feet away** from the shoreline, docks, or other structures.
- 2 Keep music at reasonable levels.** Sound travels well over water. If it's loud enough to hear at 80 feet back, it is likely loud enough for homeowners to hear, too.
- 3 Minimize repetitive passes** on any one portion of shoreline. Once you've run the same line for a while, move on to another area.

**YOU ARE RESPONSIBLE FOR YOUR WAKE**

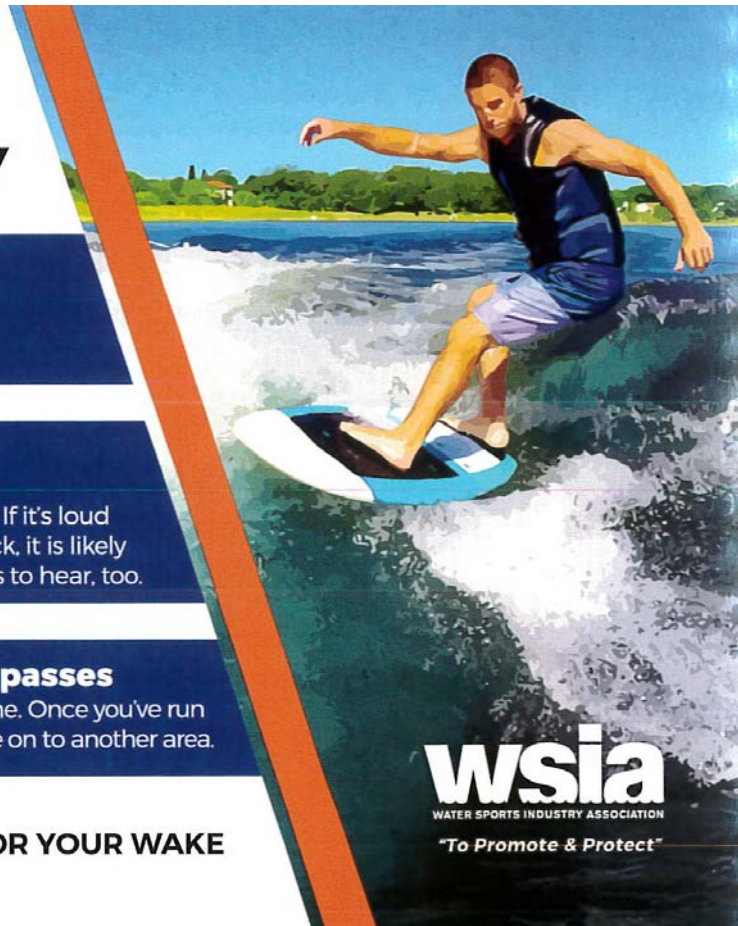

# LS9 Surf Engine/Systems

## Intro

The following pages outline the operation of the Regal Surf System on the LS9 Surf. Make sure to read all information prior to operating the surf system. Always use an on-board spotter to watch and communicate with the rider. Remember, the captain is responsible for his crew, wake, and maintaining vessel safety.

## Components

Regal's surf boats use Volvo Penta's forward drive technology. This drive uses two forward facing propellers that pull the boat through the water rather than push it, like a traditional outdrive would. The forward facing propellers allow for the surfer to ride closely behind the boat without the concern of being close to the rotating propellers. Unlike traditional straight-shaft surf boats, the forward drive enables the user to trim the drive up to enter shallower water, or to modify the surf wake, and provides better riding performance when not surfing.

Regal utilizes ballast bags to weigh down the boat to create the surf wave. There are three ballast bags on the LS9. Two bags are located in the engine room, one on the port side and one on the starboard side, and one is in the forward ski locker storage on the centerline. The two aft bags each can hold 550 pounds of ballast, and the center bag can hold 700 pounds of ballast, for a combined 1800 pounds

of total ballast. If the ballast bags are overflowed, they will discharge overboard through the vents located on the starboard hullside just forward of the windshield. The ballast bags each have a dedicated impeller pump that can fill and drain the bags, which are located in the engine room. Along the ballast hose line between each aft bag and its respective pump are siphon breaks that prevent the water from siphoning out of the bags.



In order to fill or drain the bags, the seacock (pictured above) must be in the open position. When the handle is rotated upwards, the valve is open and will allow water flow. Running the pumps without water can cause damage to the pump.

The LS9 uses an electric actuator system to move the trim tabs up and down for the surf function. Each trim tab has an independent actuator that is programmed to run all the way up or down depending on the surf orientation. When the "surf left" operation is selected, the starboard trim tab deploys down, and the port trim tab stays up. When "surf right" is selected, the starboard trim tab stays up, and the port trim tab deploys down. The brake lights on the back of the boat show the rider if surf right or surf left is selected.

The surf system uses two Garmin EmpirBus modules (located in the engine room) to control all of the surf functions. The actuators, pumps, and lights use the logic programmed in the EmpirBus module to operate the surf system.



## Operation - Surf Control

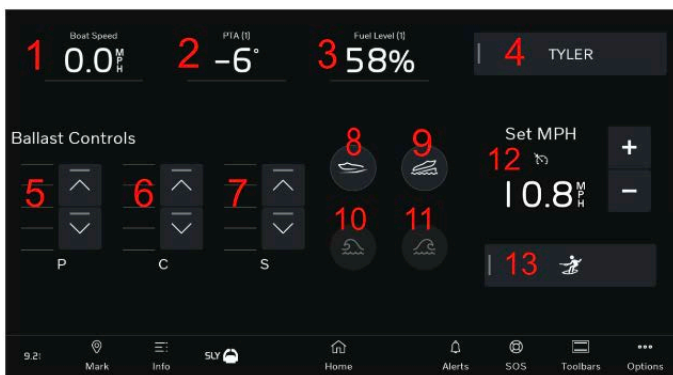

Refer to the image above for the functions of the Surf Control screen.

**Boat Speed** - The GPS speed that the boat is currently moving at.

**PTA** - The current angle that the forward drive is trimmed to.

**Fuel Level** - Current fuel level of the vessel

**Profile** - Programmable and selectable custom profile for surf control. Allows users to program different settings (surf side, ballast level, speed, trim) for surf control. Light is green when selected.

**Port Ballast Control** - Controls ballast of port bag. Up arrow will fill the bag. Down arrow will drain the bag. Column fills with blue to indicate water level. Bar near the arrows will light green to indicate activation.

**Center Ballast Control** - Controls ballast of center

bag. Up arrow will fill the bag. Down arrow will drain the bag. Column fills with blue to indicate water level. Bar near the arrows will light green to indicate activation.

**Starboard Ballast Control** - Controls ballast of starboard bag. Up arrow will fill the bag. Down arrow will drain the bag. Column fills with blue to indicate water level. Bar near the arrows will light green to indicate activation.

**Quick Launch** - Uses pre-programmed settings to get the boat on plane when full of ballast. Deploys the trim tabs at varying levels based on boat speed.

**Trailing Mode** - When pressed, immediately begins to drain bags and retract trim tabs. Used as a one touch button to get the boat ready to put back on the trailer.

**Surf Left** - Creates a surf wake on the port side of the boat by deploying the starboard tab.

**Surf Right** - Creates a surf wake on the starboard side of the boat by deploying the port tab.

**Set Speed** - Speed that the boat will maintain when surf control mode is activated. Even at full throttle, the boat will limit itself to this speed.

**Surf Control Mode** - Activates Surf Control, allowing the user to select surf left or right to surf the boat.

The LS9 Surf has rocker switches located on the dash that allow the user to individually deploy the tabs while underway and not in surf control mode. These act just like a standard pair of trim tabs would, but are now also available on a surf boat.

## Notes

In freezing climates, contact your closest Regal dealer for winterizing the surf system along with the entire propulsion system. Regal is not



responsible for any damage due to improper winterization.

Periodically check the entire surf pump and ballast bag system for leaks and abrasions.

Be mindful of the gear stored on top of the ballast bags when they are not in use. Sharp objects can cause damage to the bag. Never fill the bags with objects stored on top of them.

Periodically check that all hoses and hose clamps are properly secured.

### Surf Vessel Operator's Wake Responsibility

Read and understand the wake responsibility information below. Bottom line the vessel **operator** is responsible for the boat wake at all times.

## WAKE RESPONSIBLY

- 1 Stay at least 200 feet away** from the shoreline, docks, or other structures.
- 2 Keep music at reasonable levels.** Sound travels well over water. If it's loud enough to hear at 80 feet back, it is likely loud enough for homeowners to hear, too.
- 3 Minimize repetitive passes** on any one portion of shoreline. Once you've run the same line for a while, move on to another area.

**YOU ARE RESPONSIBLE FOR YOUR WAKE**

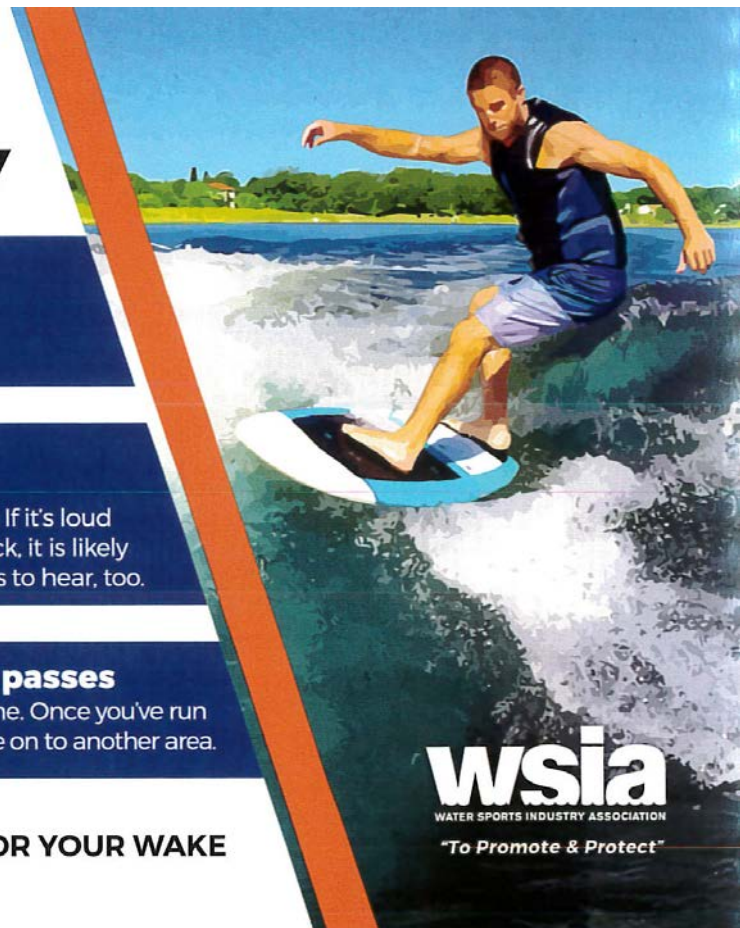

**wsia**  
WATER SPORTS INDUSTRY ASSOCIATION  
"To Promote & Protect"

# Chapter 3

## Outboard Engine Systems

### Introduction

This section covers selected topics unique to the LX4 & LX6 outboard systems including electrical, fuel, basic helm controls and equipment. More detailed information can be found in the outboard manufacturer's operator's manual covering that particular model. A portion of the information included in this outboard section overlaps both outboard types.

*Note that where possible related LX4 and LX6 information is in this beginning section.*

*Note that we encourage you to read the entire manual since there are differences in select systems such as electrical and propulsion.*

It is recommended that you become familiar with all the boat and engine systems before cruising. Be sure to read and understand all caution, warning and danger labels. Furthermore, pay close attention to all notices as they relate to the vessel, engine, systems, and or other on board components.

Finally, refer to the owner's information packet or contact your closest Regal dealer for further product information.

Note that equipment specifications, location, and operation may occur over the vessel production life.



TYPICAL OUTBOARD ENGINE OVERVIEW



## Engine Checklist Before Each Outing

Every engine option may require different checks before each use, but a general **outboard** engine checklist guide is included here. Read your Yamaha outboard owner's manual for more detailed information regarding start-up procedures.

### At Helm/Deck

- Check engine crankcase and gearcase oil levels. If needed refer to the outboard owner's manual for type and quantity.
- Check power steering fluid pump levels.
- Check power trim fluid/trim tab levels at the pump motor.
- Open the Lazarette compartment and preform a fuel sniff and visual test for leaks. If vapors are detected call for professional assistance. **Do not attempt to start the outboard engine!**
- **When all of the system checks above are completed preform the following:**
  - Activate the battery switch(es)
  - Start the engine and check for a steady stream of water from the pilot hole.
  - Check control lever for operational defects.
  - Check the clip and safety lanyard for proper operation.
- Check fuel level and ensure the level is sufficient for the trip with a 1/3 reserve.
- Check all gauges for functionality including your engine gauge panel located on the chart plotter screen.
- Check ignition panel. Make sure the outboard shuts down when key is turned to "off".

## Helm Controls

### Introduction to Mechanical Remote Control Box



#### SIDE MOUNT O/B REMOTE CONTROL BOX

1. Neutral Interlock Trigger (Mounted under handle)
2. Up and Down Trim Buttons (Trim O/B drive)
3. Remote Control (Side Mount-Single Lever)
4. Throttle Only Button
5. Safety Lanyard Switch
6. Safety Lanyard Cord w/ Attachment Device

The mechanical remote control box is standard equipment with the Yamaha outboard engine. With this system control cables are used for both shift and throttle modes. Read and understand the control box shift and throttle functions before venturing out in the water. At that point practice using the remote control until you understand its functions and how the vessel reacts to it. Practice maneuvering in an uncluttered environment.

For more detailed information refer to your Yamaha outboard owner's manual and the information packet along with the internet. Also, contact your closest authorized Regal dealer for technical service and advice.

### Functions Of Mechanical Control Box Components

#### Neutral Interlock Switch

To shift control make sure the remote control handle is straight up which is the neutral position and engine is started and in idle mode.

To engage forward gear squeeze the trigger up and hold trigger momentarily while shifting the remote control lever forward (toward bow). Once forward gear is reached by moving the remote control handle further forward increased throttle is obtained locked in forward gear.

To engage reverse gear squeeze the trigger up and hold trigger momentarily while shifting the remote control backward (toward stern). Once reverse gear is reached by moving the remote control handle further backward increased throttle is obtained locked in reverse gear.

To obtain a neutral position from a forward or reverse gear/throttle location use a crisp, even motion toward neutral with the remote control handle. The handle will only regress so far until the neutral interlock trigger is squeezed up. At this point the control handle will enter the neutral detent position.

### Trim Buttons

The “up” and “down” trim buttons control the trim angle of the outboard. Also, there is a trim/tilt switch located on the engine cowling. Use this switch for trim/tilt functions only when the vessel is completely stopped and the engine is shut off.

For further information on trim functions refer to chapter 6 of this manual and your Yamaha owner’s manual.

 **CAUTION**

THE BOAT TRIM SHOULD BE ADJUSTED TO PROVIDE BALANCED STEERING AS SOON AS POSSIBLE EACH TIME YOU GET UNDERWAY. SOME BOAT/ENGINE/ PROPELLER COMBINATIONS MAY CREATE BOAT INSTABILITY AND/OR HIGH STEERING TORQUE WHEN OPERATED AT OR NEAR THE LIMITS OF THE “BOW UP” OR “BOW DOWN” TRIM POSITIONS. BOAT STABILITY AND STEERING TORQUE CAN ALSO VARY DUE TO CHANGING WATER CONDITIONS. IF YOU EXPERIENCE BOAT INSTABILITY OR HIGH STEERING TORQUE SEE YOUR AUTHORIZED REGAL DEALER.

### Throttle Only Button

The throttle only button controls the engine speed while in the neutral position. Normally it is used to warm up a cold engine or for idling functions.

To use make sure the control handle is in neutral. Attach the safety lanyard and start the engine. Press the throttle only button and hold while advancing the control handle to the desired engine speed. See photo on previous page for throttle only button location.

### Safety Lanyard Switch/Attachment Cord

The safety lanyard switch when activated will disable the outboard ignition system causing the engine to stop. To use engine the spade shaped end to the lanyard switch. This will permit the engine to start. Connect the attachment device end around a belt or wrist and then connect around the lanyard cord.

*Note that a belt buckle is not recommended.*

The operator must keep the lanyard attached when underway. Should anything happen to the operator and the lanyard is disconnected the vessel will stop quickly.

**If the lanyard spade is not connected to the lanyard switch the engine will crank but will not start.**

## Digital Electronic Remote Control Box

The remote control actuates the shifter and throttle operations of the engine. The remote control box typically is a key player in electronic functions such as alerts and active indicators. It features a side mount design and includes safety components such as a safety lanyard.

Read and understand the control box shift and throttle functions before venturing out in the water. At that point practice using the remote control until you understand its functions and how the vessel reacts to it. Practice maneuvering in an uncluttered environment.

*Note the photo to the right with a description of the DEC remote control and its safety components.*

## Helm Controls

### Introduction to DEC Remote Control Box

This section covers select basic component operations for the digital electronic control. For more detailed information refer to the Yamaha outboard owner's manual and your information packet along with the earlier chapter using the stern drive remote control as many of the basic functions overlap.

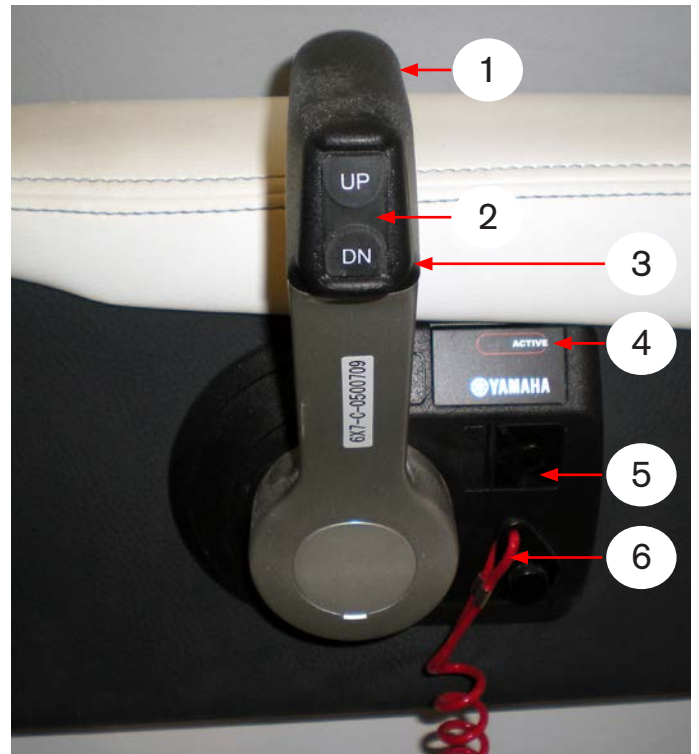

SIDE MOUNT O/B DEC CONTROL BOX

1. Neutral Interlock Trigger (Mounted under handle)
2. Up and Down Trim Buttons (Trim O/B drive)
3. Remote Control (Side Mount-Single Lever)
4. Active Indicator Icon ( Lights when engaged)
5. Throttle Only Button
6. Safety Lanyard (Disables engine ignition system)

## Functions of DEC Control Box Components

### Shifting To Forward, Reverse, Throttle Only

To shift control make sure the remote control handle is straight up which is the neutral position and engine is started and in idle mode. Activation icon should light blue.

To engage forward gear squeeze the trigger up and hold trigger momentarily while shifting the remote control lever forward (toward bow). Once forward gear is reached by moving the remote control handle further forward increased throttle is obtained locked in forward gear.

To engage reverse gear squeeze the trigger up and hold trigger momentarily while shifting the remote control backward (toward stern). Once reverse gear is reached by moving the remote control handle further backward increased throttle is obtained locked in reverse gear.

To obtain a neutral position from a forward or reverse gear/throttle location use a crisp, even motion toward neutral with the remote control handle. The handle will only regress so far until the neutral interlock trigger is squeezed up. At this point the control handle will enter the neutral detent position. Remember that the icon blinks only when the control box is in neutral.

To obtain a “throttle only” neutral position press and hold the throttle only button. The activation icon will begin blinking. Release the throttle only button. While the indicator blinks you can move the control handle to the desired neutral speed for engine warm up or idle positioning.

To obtain forward or reverse positions from the neutral position press the button to turn the neutral function “off”. The control is now ready to shift into a forward or reverse position.

See photo on previous pages or refer to the Yamaha owner’s manual for further detailed information.

### Trim Buttons

The “up” and “down” trim buttons control the trim angle of the outboard. Also, there is a trim/tilt switch located on the engine cowling. Use this switch for trim/tilt functions only when the vessel is completely stopped and the engine is shut off.

 **CAUTION**

THE BOAT TRIM SHOULD BE ADJUSTED TO PROVIDE BALANCED STEERING AS SOON AS POSSIBLE EACH TIME YOU GET UNDERWAY. SOME BOAT/ENGINE/ PROPELLER COMBINATIONS MAY CREATE BOAT INSTABILITY AND/OR HIGH STEERING TORQUE WHEN OPERATED AT OR NEAR THE LIMITS OF THE “BOW UP” OR “BOW DOWN” TRIM POSITIONS. BOAT STABILITY AND STEERING TORQUE CAN ALSO VARY DUE TO CHANGING WATER CONDITIONS. IF YOU EXPERIENCE BOAT INSTABILITY OR HIGH STEERING TORQUE SEE YOUR AUTHORIZED REGAL DEALER.

For further information on trim functions refer to chapter 6 of this manual and your Yamaha owner’s manual.

### Active Indicator Icon

*Note that when the indicator icon is lighted blue the remote control is active.*



## Safety Lanyard Switch/Attachment Cord

The safety lanyard switch when activated will disable the outboard ignition system causing the engine to stop. To use attach the clip (spade shaped end) to the lanyard switch. This will permit the engine to start. Connect the cord attachment device located at the other end around a belt or wrist and then connect around the lanyard cord.

*Note that a belt buckle is not recommended as it may be a weak connection point.*

The operator must keep the lanyard attached when underway. Should anything happen to the operator or there is an emergency on board the lanyard when pulled off the switch will deactivate the ignition system and the vessel will stop quickly.

**If the lanyard spade is not connected to the lanyard switch the engine will crank but will not start.**

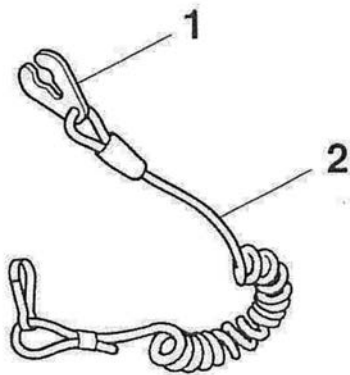

1. Clip
2. Engine shut-off cord (lanyard)

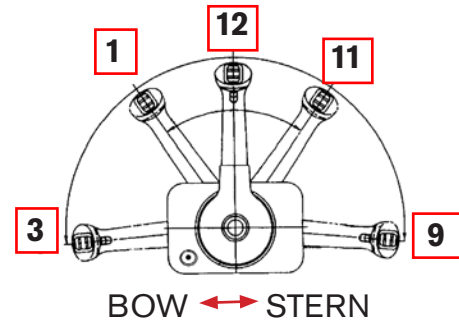

*Profile Of Typical Engine Control Lever Displaying Five Positions*

## Typical Remote Control Shift Position Descriptions

12- This is the straight-up or neutral position which is the starting position for all other operations.

1- This is the detent forward gear position.

3- This is full throttle in forward gear.

11- This is the detent reverse gear position.

9- This is full throttle in reverse gear.



Shown above is a typical LX series helm switch panel. It provides switching for various navigation aids and key vessel systems. Be sure to understand each switches function before embarking on the waterway! Each switch upon activation features a blue icon which could be helpful with night cruising. Check that the switches are deactivated when leaving the vessel. Below is a description and function of each switch.

## Switch Panel Operation

### Accessory

This switch is available for accessories.

### Aft Seat

This switch controls the rear slide-away seat feature which when positioned **fully aft** adds one foot to the cockpit space. **When cruising** always position the aft seat **fully aft or fully forward as** it will enable the water shedding dam to operate properly under the seat structure.



*Slide-away seat shown in full aft position.*

Before attempting to open the Lazarette storage hatch ensure that the slide-away seat mechanism is fully aft. This prevents the hatch from contacting the seat structure when opening.

## Switch Panel Operation (Continued)

### Docking Lights

This switch controls the optional hull docking lights. These lights are valuable for maneuvering around docks and tight waterways at night such as you might find at marinas and locks. Do not use these lights for navigation as other vessel may not be able to see your combination bow light especially for head on and crossing situations.

### Horn

This momentary switch controls the electric horn located at the starboard bow area. Make sure the horn is tested before each outing as it can be valuable in navigation situations and can be used for bridge communications. Normally there is an adjustment screw on the horn top to alter the tone. Periodically inspect the horn hardware for tightness and polish the horn grill.

### Tower

This switch controls the forward or aft tower movement. When the “up” switch position is pressed the PowerTower moves to the forward position which is useful for bridge navigation and storage opportunities.

When the “down” switch position is pressed the PowerTower moves to a vertical or run position.



## CAUTION

AVOID BODILY INJURY!  
WHEN OPERATING POWERTOWER  
KEEP ALL BODY PARTS CLEAR  
OF TOWER HINGE MECHANISMS.

## Typical Outboard Helm Switch Panel Continued

### Under Water Lights

This switch controls the hull mounted underwater lights. If installed these blue or white LED lights illuminate the water around the aft sides and transom areas. It is recommended that these lights not be activated at night with the vessel making headway.

### Fresh Water

This switch energizes the optional on board fresh water system. It permits the water pump to draw fresh water from the water tank to the head sink or transom shower. Note that the pressure water system is to be used for cleaning and not for drinking.

### Captain Seat

This switch activates the movement of the captain seat for more comfortable positioning and visibility enhancement. Press the upper portion of the switch to slide the seat forward. Press the lower portion of the switch to move the seat aft for additional leg room.

## Starting Outboard Engine

The following general information covers the starting and stopping of your outboard engine. Read and understand all previous information on remote controls, fueling and operational procedures. Pay particular attention to all danger, warning and caution labels. Refer to the engine owner's manual for in depth propulsion system information.

Review all pre-departure information. Before starting your engine make sure all canvas is stored.

Start engine only in a well ventilated location to avoid CO buildup.

Turn the battery switch to the "on" position.

Set the remote control handle in the neutral straight up position. Advance the neutral throttle position as earlier instructed or refer to the engine owner's manual.

Connect the safety lanyard to a belt or secure to the arm. Keep passengers seated and away from controls.

## Starting Outboard Engine Guidelines(Typical)



Refer to the key switch position photo above.

Turn the ignition key right to the "on" position. This is known as the "run" or ignition position. Turn the key further right to the momentarily "start" position. Since this key position is "spring loaded" you will need to hold it there. You will hear the starter cranking over the engine. When the engine starts release the key switch. It will automatically align itself in the run position (ignition).

If the engine does not start refrain from cranking the engine over 10-12 seconds. Allow the starter and battery a chance to recover.

Once the engine starts, advance the remote control in the neutral throttle position as recommended in the engine manual. Let the engine warm up for a few minutes. Do not race the remote control in the neutral position.



## After Starting Outboard Engine



1. Check for a steady stream from the cooling water pilot hole located on the starboard side of the outboard on a casting below the shroud. Water must be flowing at all speeds out of the pilot hole (see photo). A less than steady flow may indicate possibly one of the following:

- a. Obstruction in the power head water passages
- b. worn water pump or plate
- c. Weeds covering water intakes on vertical drive housing.
- d. Pilot hole is plugged with debris. Take a small solid core wire and move it in and out of the pilot hole several times while engine is running. If flow increases the take time to further clean the pilot hole.

2. Let the engine warm up for several minutes listening for any alarms or low oil pressure alerts along with watching the analog helm gauges on selected models. In another scenario the operator can activate the Garmin chartplotter and program the unit to the engine gauge screen and observe the gauge functions.



# WARNING

AVOID INTERNAL ENGINE DAMAGE!  
CHECK THE LOW OIL PRESSURE ALERT INDICATOR AFTER STARTING.  
IF BLINKING SHUT DOWN ENGINE AND INVESTIGATE THE PROBLEM.  
CALL YOUR CLOSEST REGAL DEALER OR MARINE PROFESSIONAL IF THE CAUSE OF THE PROBLEM CAN NOT BE FOUND.

WATER DISCHARGE PILOT HOLE

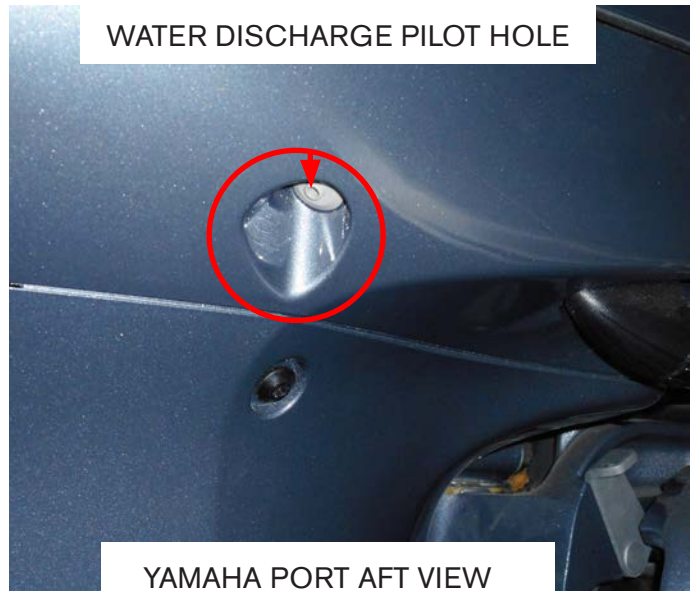

YAMAHA PORT AFT VIEW

## Helm Controls (Typical)

### Introduction

Your vessel may be outfitted with a Garmin single or dual chartplotter. Select units are either sonar capable or function as a GPS without sonar capability. Both types of chartplotters will display water depth and engine functions.

All units are feature a 7" touchscreen and are pre-loaded with US BlueChart® g3 and LakeVu g3 maps.

We will touch on basic start up procedures here. Refer to your Garmin manual for more detailed operating information or use the Garmin web-site at [support.garmin.com](http://support.garmin.com). Before venturing out be sure to read and become familiar with the chartplotter operation. Read and understand all warnings related to the use of the chartplotter.

*Note that all route and navigation lines displayed on the chartplotter are only intended to provide general route guidance or to identify proper channels and are not to be precisely followed. Always defer to the navigation aids and water conditions when navigating to avoid grounding or hazards that could result in vessel damage, other property damage, personal injury or death.*

## Quick Start Information

### Chartplotter Overview & Feature Description

5



1. This is the touchscreen indicator.

2. This is the power key. Press and hold to activate the unit.

3. This is the back light sensor. To change brightness you can repeatedly press the power button to scroll through the various brightness levels.

4 Under the cover are 2 micro SD memory card slots. Maximum card size is 32GB formatted to FAT32. To use slots lift the cover and insert card into slot until it clicks. Shut the door. If the card resists when inserted turn it 180 degrees and try again. Read more about memory card usage features in your Garmin manual which can be downloaded at [www.garmin.com/manuals/GPSMP702-902](http://www.garmin.com/manuals/GPSMP702-902).

Note that features may differ from model to model including equipment installed on your vessel.

## Hints & Tips Regarding Garmin 742

1. The units are protected by a 7.5 amp fuse located on the fuse block under the starboard helm which can be accessed by pulling the backrest up.
2. The Garmin system is controlled by the battery switch. With the battery switch in the “off” position the units can not be powered up.
3. This unit provides GPS and chartplotter information. Sonar readings are not available on this unit.
4. Fusion stereo entertainment functions can be controlled from the Home screen on the chartplotter. Read and understand the Fusion owner’s manual.
5. The chartplotter can be customized by accessing the Home screen. Once there use the Status bar, Pages buttons, Categories bar, and Menu bar to choose, add, and save your customized features.
6. Refer to the Garmin owner’s manual for information on the Active Captain App.
7. Select Home from any screen to return to the Home screen.
8. Select Menu to open more settings regarding that screen.
9. Select Menu to close the menu when completed.

12. Press the power button to open more options, such as locking the touchscreen or adjusting the back light.

13. Press the power button to deactivate the chart plotter.

14. If unit not operable first check for power to the helm, Garmin fuse, and NMEA 2000 network fuse.

15. As stated before all units display depth, fuel tank level, engine functions including warnings and alarm data.

16. Standard NMEA 2000 support for network conductivity including autopilots, digital switching, weather, Fusion-link, VHS, AIS and other sensors.

## TYPICAL GARMIN GAUGE DISPLAY



\* NOTE THAT YOUR GARMIN CHARTPLOTTER MAY SLIGHTLY DIFFERENT FROM DISPLAY ABOVE

As installed the Garmin chartplotter single or twin display features many GPS features along with the ability to monitor engine system functions which may include revolutions per minute (rpm's), GPS speed, voltage, fuel flow rate, trim, and temperature along with tracking engine hours.

*Note that the Garmin chartplotter can control the Fusion entertainment system through the NMEA 2000 backbone.*

1. To power up the Garmin GPS press the on button located on the upper right display.

2. The function AV/Gauges,Controls will appear as one of the choice boxes. Press the box. Another screen with engine will appear.

3. Press the engine box and the engine gauge displays will appear.



## Stopping Vessel

Allow your vessel to lose all headway before shifting from reverse or forward gear into neutral. Do not use the reverse gear function to stop the boat at speeds above idle as it could cause the operator to lose control, be ejected or impact steering wheel functions.

*Note that bodily injury could occur or damage to the shifting mechanism including the gear case gear unit. Do not shift into reverse at planing speeds as the operator could lose control, be ejected or the vessel could be swamped by taking water over the transom area.*

Remember that the operator is responsible for his passengers! The vessel cannot “stop on a dime” but requires a safe distance to stop headway. Of course this distance is effected by water current, wind velocity and direction, along with the weight of the boat and how it is balanced.

Passengers shall occupy designated seating positions while the vessel is making headway. Make sure everyone including the operator is wearing their life vests while cruising.

## Stopping Outboard Engine

If available it is always a plus to fill the vessel at the marina gas dock if vessel is moored there as you will be then ready for the next cruise.

After cruising and returning to your mooring let the engine cool down at an idle position for several minutes.

Turn the ignition key to the “off” position or pull on the safety lanyard cord to stop it. This last endeavor assures that the cut-off system is functioning properly.

Remove the key from the ignition switch. Do not leave the key on the vessel to avoid possible theft. Store at home on a key rack for future use. It is recommended that you put your boat key on a float to prevent submersion and subsequent loss.

When the engine has stopped turn off the single or dual battery switch at the aft located battery management panel.

Cover the vessel with appropriate bow and cockpit covers and/or mooring cover if installed.



## LX4 OUTBOARD

### Electrical System

#### Overview

In this section select outboard related electrical components are reviewed along with their location and function within the electrical system.

For more complicated issues outside the scope of this manual contact your closest Regal dealer. They have undergone extensive training and possess the tools for the Regal boat systems along with the engine and propulsion package.

Also, refer to the Yamaha outboard owner's manual for more detailed information.



## WARNING

TO PREVENT BODILY INJURY OR DEATH  
DUE TO FIRE OR EXPLOSION  
DO NOT STORE FLAMMABLE LIQUIDS  
OR PORTABLE GAS TANKS  
IN THE LAZARETTE COMPARTMENT  
OR ANY OTHER STORAGE AREA.

The electrical system operates from 12 volt direct current (DC) which originates at the batteries.

## Stacked Battery System

### Introduction

Integrated under the *starboard* cockpit seat at the forward end of the bilge is located a stacked battery system housing the engine and house batteries.

Note on select vessels higher amperage draw components may be installed such as a bow thruster. These components use the house battery for DC power requirements and leave the engine battery safely isolated for starting requirements.

The stacked battery system features a sliding tray, hold down system, and protective cover which permits increased storage room versus conventional battery systems using side-by-side battery trays or boxes.

### System Accessibility

The stacked system protective panel helps to prevent any loose equipment contact with the battery system and related components.



***Before removing the protective cover turn the battery switch(es) to the “off” position.***

To remove the protective cover first extract any screws holding the cover bottom on the angle hardware. Next, pull the cover aft which will free it from both port and starboard latches. Set cover aside to access batteries. See photo above.

To remove the top battery slide the positive boot off the positive battery cable (red wire) and loosen the battery cable positive terminal wiring. Move the cable out of the way.

Next, loosen the negative battery cable (black wire) and move the cable out of the way.

Remove the battery hold down hardware.

To remove the top battery slide the top tray out to a point where the battery can be safely lifted out of the tray.

With lead acid batteries make sure the battery remains positioned with the battery caps facing up to prevent electrolyte spillage when removing or installing batteries.



## WARNING

AVOID SERIOUS INJURY!

BATTERIES CONTAIN SULFURIC ACID (POISON) WHICH ALSO CAN CAUSE BURNS. AVOID CONTACT WITH THE SKIN, EYES, AND CLOTHING. IF CONTACTED, FLUSH WITH WATER FOR AT LEAST 15 MINUTES. IF SWALLOWED, DRINK LARGE AMOUNTS OF WATER, OR MILK. FOLLOW UP WITH MILK OF MAGNESIA, BEATEN EGG, OR VEGETABLE OIL. GET MEDICAL ATTENTION IMMEDIATELY!



## WARNING

AVOID SERIOUS INJURY!

WEAR GOGGLES, RUBBER GLOVES, AND A PROTECTIVE APRON WHEN WORKING WITH A BATTERY. BATTERY ELECTROLYTE CAUSES SEVERE EYE DAMAGE AND SKIN BURNS. IN CASE OF SPILLAGE, WASH AREA WITH A SOLUTION OF BAKING SODA AND WATER.

To remove the bottom battery we recommend removing the top battery sliding tray from the sliding channels to afford easier access.

Next, remove battery terminal hardware and stud hold down hardware to allow removal from tray. Lift the battery safely out of the tray. Make sure the battery remains positioned with the battery caps facing up to prevent electrolyte spillage. See photo below.

*Note that the battery box hold down studs can be removed as needed by turning counterclockwise.*

### STACKED BATTERY SYSTEM-TYPICAL

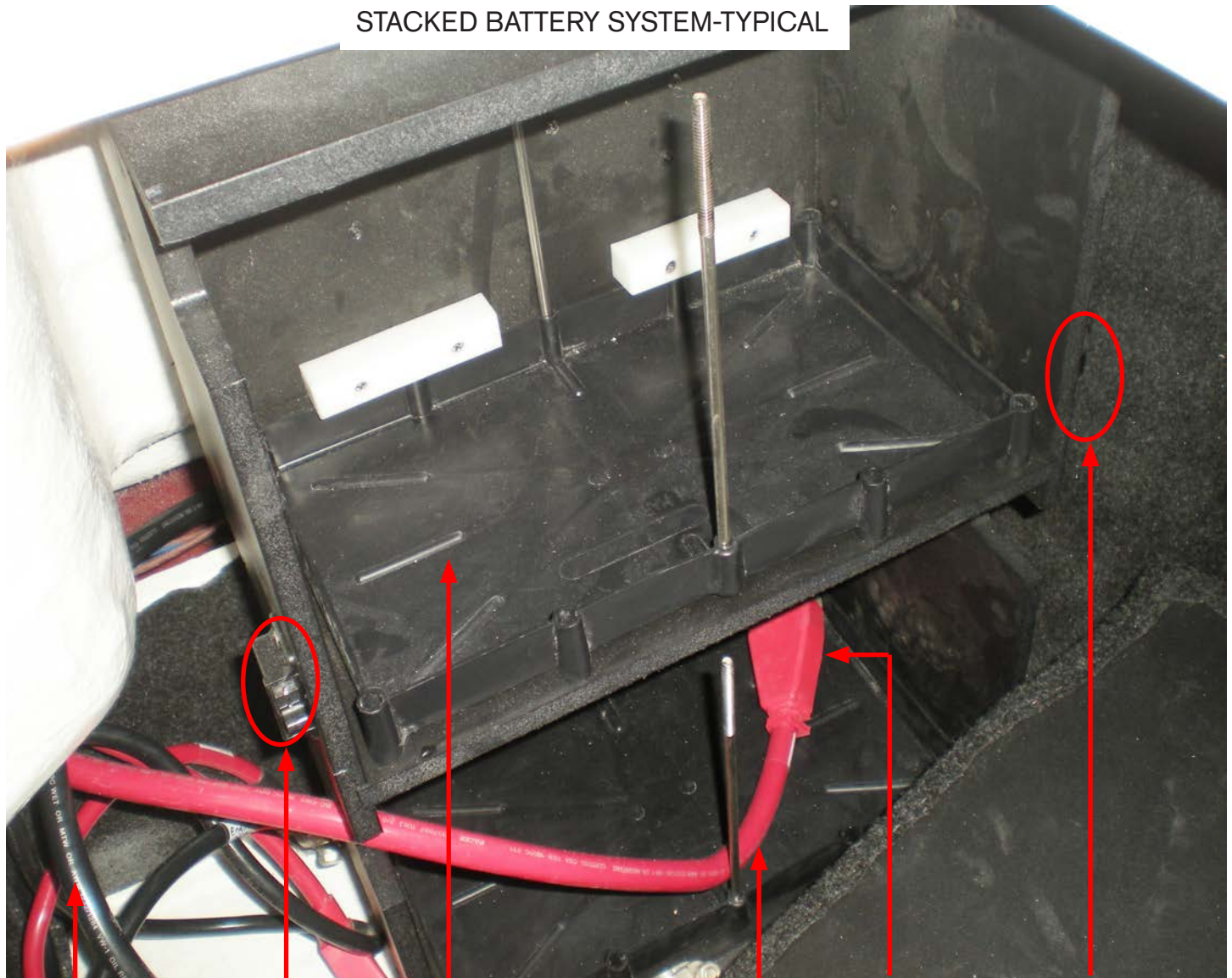

BATTERY CABLE (-) LATCH SLIDING TRAY HOLD DOWN STUD/HDWR. BATTERY BOOT (+) BATTERY CABLE (+) LATCH

## Battery System Tips

1. Do not use any battery that does not meet the minimum specifications as the electrical system may be overloaded and cause electric system damage. Never use a battery that exceeds the CCA specs.
2. Ensure that the charging system is operating properly as the engine will not start with low battery voltage.
3. Do not store flammable liquids on board the vessel. See warning label.
4. Do not store items on top or near the battery bank as it may keep battery vapors from venting through the cover top.
5. Never turn the battery switch off with the engine running as charging system damage will result.
6. When installing battery cables red goes to the positive (+) post & black goes to the negative (-) post.
7. Periodically check the positive/negative battery cables & terminal hardware for tightness/corrosion.
8. If flooded lead cell batteries are used periodically check the cell electrolyte level. Fill as needed with distilled water only. Do not overfill cells.
9. Wear protective eye gear and rubber gloves when servicing batteries.
10. Never smoke around batteries or bring any source of ignition near them.

11. Flooded lead, AGM, gel-cell, and maintenance free battery types are all approved for your outboard vessel.

Typically a battery similar to a group 31 A with a CCA around 1260 and a reserve capacity of 195 minutes will work adequately with your outboard engine and equipment.

*Note that when replacing batteries never mix types such as an AGM with flooded lead.*

For more battery information refer to your Yamaha outboard owner's manual or contact your closest Regal dealer.





AUTOMATIC CHARGING RELAY  
POWER STEERING BREAKER

DUAL BATTERY SWITCH

POWER INLET-CHARGER

### LX4 Battery Management Panel

Note that select items mentioned below or displayed above may not be installed on your vessel. Found under the starboard cockpit seat cushion is the battery management panel. Typically, this panel includes an m-ACR or VCR, ship's main system breaker(s), dual circuit battery switch, fuse panel, and battery charger cord power inlet.

### Automatic Charging Relay (m-ACR or ACR)

The m-ACR is designed to manage the charging current from outboard stators up to 65 amps. It includes a start isolation feature that protects sensitive electronics by temporarily isolating house loads from the engine circuit during engine cranking, protecting the house circuit from voltage spikes and sags.

The ACR works by sensing when the voltage of either battery rises to a level indicating that a charge source is active (13.0 volts for 2 minutes). At that point the ACR's contacts connect and the ACR applies to both batteries. If the voltage on both batteries subsequently drops to 12.75 volts for 30 seconds, the ACR disconnects and isolates the batteries.

ACR's use a relay combined with a circuit that senses when a charging source is being applied to either battery. Compared to battery isolators they create very little heat and consume little charging energy. Note that the ACR body encompasses a QR label which when connected through an app will take you to the web-site where you can find detailed operation and troubleshooting information beyond what is noted here.

### ACR Operating Hints

If the ACR does not disconnect when the engine is turned off it has not reached the low voltage threshold to isolate the circuit. It may take several minutes for the batteries to drop to this level. Since the ACR uses a delay, additional time up to 2 minutes may be required before the ACR disconnects.

A slow flashing LED indicates that the start isolation wire is energized.

A fast flashing LED indicates one or both batteries are below 9.5 volts DC. Refer to the table below.

LED	BATTERY STATUS	REASON
Solid ON	Combined	Charging
Single Flash (15 sec.)	Isolated	Standby
Double Flash	Isolated (Start Isolation)	Start Isolation wire is energized
Triple Flash	Isolated (Under Voltage Lockout)	One or both batteries are below 9.5V (12V System) 19V (24V System)



## Power Steering System Breaker

This 30 amp breaker protects the power assisted hydraulic steering system. This includes the pumps and the wiring circuitry.

*Note that if the breaker trips due to an overload find and correct the problem before resetting the circuit breaker.*

To reset push the breaker handle down until it reaches the “on” position at the bottom. A click will be heard as the breaker is reset.

## Dash Main System Breaker

This 50 amp breaker protects the wiring up to the dash.

*Note that if the breaker trips due to an overload find and correct the problem before resetting the circuit breaker.*

To reset push the breaker handle down until it reaches the “on” position at the bottom. A click will be heard as the breaker is reset.

## Dual Circuit Plus Battery Switch

This battery switch simultaneously switches two isolated battery banks or combines battery banks to all loads.

Optional dual battery switch designates “off”, “on” and “combine batteries” positions. This particular battery switch is connected to dual batteries and this set-up supplies additional reserve capacity to run extra accessories and to supply cranking amperage to start the engine with the other battery in a low charge condition.

To use this feature position turn the battery switch knob to the “combine batteries” detent (yellow labeled area). At this point you can start the engine. As this particular battery switch features a “make before break” footprint once the engine starts you can reposition the battery switch to the “on” detent to revert back to one battery for engine starting. It is recommended not to leave the dual battery switch in the “combine batteries” position as under the right conditions a severe discharge could result in both batteries becoming “dead”. An example of this condition existing would be anchoring your vessel without the engine running and playing the stereo for extended periods of time. In the combine batteries position both batteries could be drained completely.



## CAUTION

TO AVOID CHARGING SYSTEM FAILURE  
NEVER TURN THE BATTERY SWITCH  
TO THE OFF POSITION  
WITH THE ENGINE RUNNING!

## Fuse Panel

### Radio (Stereo) Memory)

This fuse protects the radio (stereo) memory circuit. This allows you to keep all your stereo program selections when you leave your vessel even with the battery switch turned off.

### Power Platform

This fuse protects the optional power platform mounted under the swim platform. This component is only available on stern drive models.

### Aft Bilge Pump

This fuse protects the aft bilge pump which is usually found in the sump just forward of the engine. When you leave the vessel and turn off the battery switch as recommended the bilge pump circuit is still activated allowing the pump to work should a leak develop. An icon on the bilge pump helm switch lights to alert the operator that the pump is activated.

Note that the battery switch in the “off” position disconnects any voltage to the dash including the engine key switch.

## Shore Power Inlet- Battery Charger Cord

The shore power inlet is part of the battery charger option. **Use a 15 amp 3 blade extension cord of the correct size and length to compensate for current draw and voltage drop.** Normally the longer distance traveled requires a higher amperage extension cord. Read and understand the warning below and the extension cord tips on next page.



# DANGER

AVOID POSSIBLE INJURY OR DEATH!  
DUE TO ELECTROCUTION!  
DO NOT OPERATE THE BATTERY CHARGER  
WITH A TWO BLADED ADAPTER PLUG  
OR EXTENSION CORD.



### 15 AMP 3 BLADE OUTDOOR EXTENSION CORD

*If in field charging is needed at most marinas today a 25 or 50 foot 15 amp 3 bladed outdoor extension cord will fit the needs of your on board battery charger. Make sure the outlet you are plugging into features 3 inputs and is a GFCI protected outlet. Note the earth ground rounded blade which provides a path for the “earth” ground wire. It reduces the risk of electrical shock and fire.*

## Extension Cord Usage Tips

1. Use a 15 amp 3 blade outdoor extension cord of the correct size and length to compensate for current draw and voltage drop.
2. Never modify an extension cord or the vessel power inlet for the battery charger.
3. Never use an indoor extension cord outdoors.
4. Never plug 2 extension cords together to make a longer single cord.
5. Never let an extension cord lay in water.
6. Always check to ensure both ends of the extension cord are completely plugged into the power outlet and the power supply.
7. Never use a wet extension cord.
8. Store extension cords in a cool, dry place.
9. Never use a damaged extension cord where the insulation has been compromised.
10. Roll up the extension cord when not in use.
11. Upon initial use plug the extension cord in the vessel power inlet then into the shore power supply. When done charging unplug the extension cord from the shore power supply first before disconnecting from the vessel power inlet.
12. Most importantly, use common sense with extension cords around water!



## CAUTION

THIS VESSEL IS NOT EQUIPPED WITH A GALVANIC ISOLATOR. USING THE BATTERY CHARGER WHILE THE BOAT IS IN WATER MAY CAUSE DAMAGE TO THE BOAT'S ANODES AND/ OR DRIVE SYSTEM.



## WARNING

PREVENT SEVERE INJURY OR DEATH FROM FIRE, EXPLOSION OR ELECTRICAL SHOCK!

THIS DEVICE MUST BE CONNECTED TO A GROUND FAULT CIRCUIT INTERRUPT (GFCI) PROTECTED AC OUTLET.

WHEN USING AN EXTENSION CORD, CONNECT THE AC CHARGER PLUG BEFORE CONNECTING TO THE GFCI PROTECTED AC OUTLET!

MAKE CONNECTION IN AN OPEN ATMOSPHERE FREE OF EXPLOSIVE FUMES.

MAKE CORD AND CONNECTION IN A SECURE MANNER THAT WILL AVOID CONTACT WITH THE WATER.

## Typical Battery Charging System Circuitry

*Note that the drawing below is for reference only as there are 2 battery switches on your vessel. Locations and components may vary by model.*

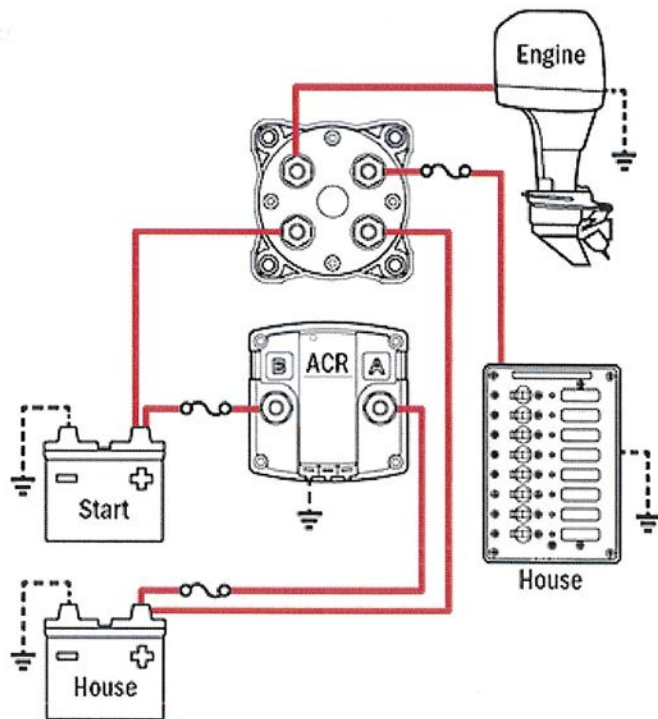

## LX4 Helm Overview

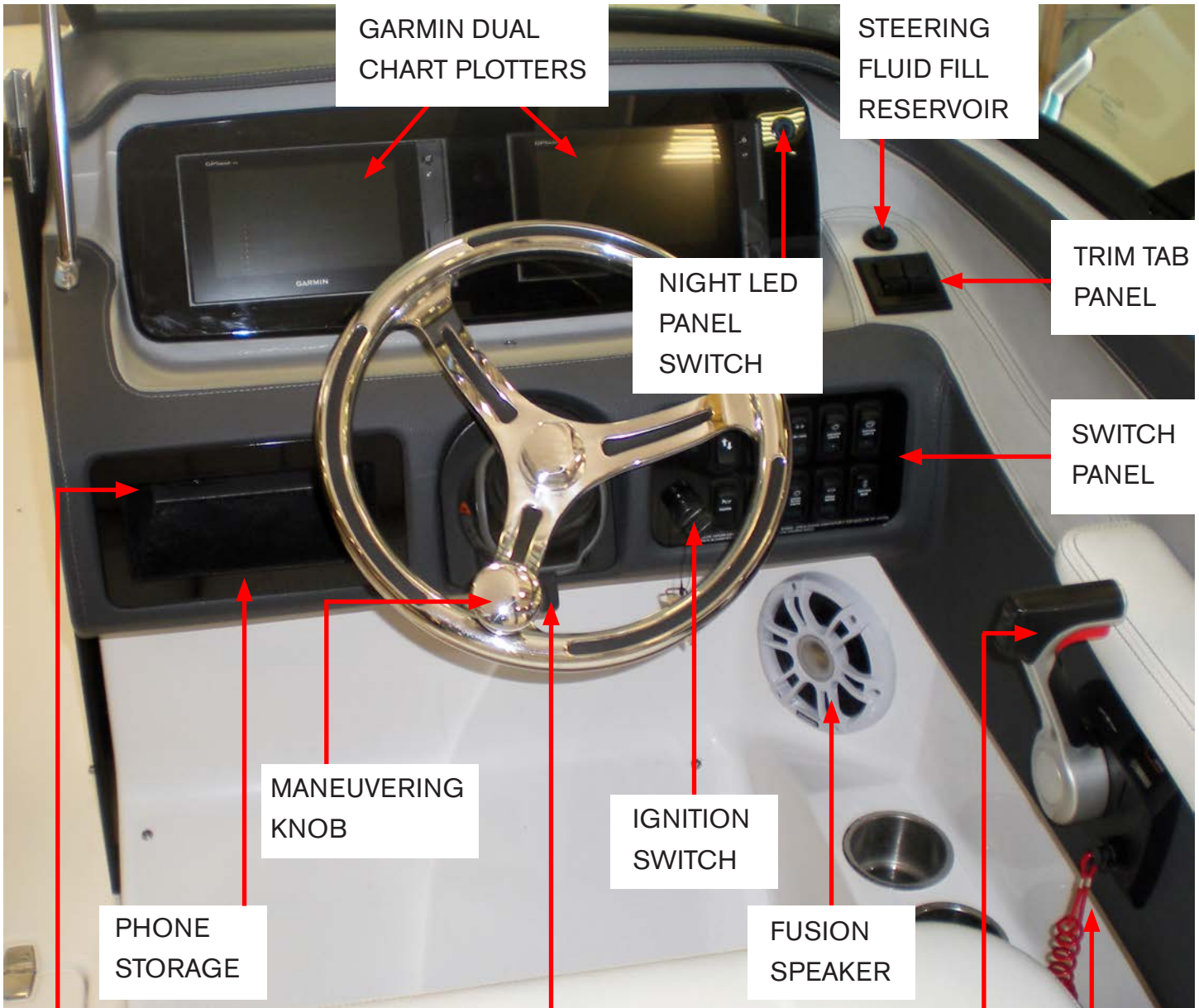

12 VOLT  
ACC.  
PLUG

TILT  
STEERING  
LATCH

REMOTE  
CONTROL SAFETY  
LANYARD

Shown above is a typical LX4 helm component layout. The key switch circuit is protected by a 20 amp breaker located above the key switch. The breaker is covered with a water resistant rubber boot. Should this breaker “trip” ignition for starting the engine will be interrupted. Always find the root cause of the problem before resetting the breaker.

Note that the Garmin plotter uses mini SD cards in the card reader slots on each plotter. The LED panel perimeter is lighted “blue” for night helm visibility. Familiarize yourself with the switch panel components and all the functions of the helm controls before embarking on a cruise. Safety first!

*Note that select components shown above may be optional and or may not be applicable to your vessel.*



## LX6 OUTBOARD

### Electrical System

#### Overview

In this section select outboard related electrical components are reviewed along with their location and function within the electrical system.

For more complicated issues outside the scope of this manual contact your closest Regal dealer. They have undergone extensive training and possess the tools for the Regal boat systems along with the engine and propulsion package.

Also, refer to the Yamaha outboard owner's manual for more detailed information.



## WARNING

TO PREVENT BODILY INJURY OR DEATH  
DUE TO FIRE OR EXPLOSION  
DO NOT STORE FLAMMABLE LIQUIDS  
OR PORTABLE GAS TANKS  
IN THE LAZARETTE COMPARTMENT  
OR ANY OTHER STORAGE AREA.

## LX6 Batteries

Batteries are not provided from the factory; normally the dealer will add the proper batteries on the vessel delivery. The group 31 battery is recommended by the factory for this vessel. The vessel standard components does include positive and negative battery cables for 3 batteries.

The vessel requires 3 batteries; one for engine starting, one as a house accessory battery for higher amperage drawing components and a house main battery to handle lower amperage draw components.

Battery boxes or other types of enclosures may cover batteries. Battery boxes or other enclosures are vented for hydrogen gas release. Flooded lead, AGM, gel-cell, and maintenance free battery types are all approved for your outboard vessel. The battery charging icon system and chart in this owners manual reflects flooded lead types which are still the most common types used today. Typically a battery with a CCA between 680 -1150 and a reserve capacity of 160 minutes will work adequately as a cranking battery for your engine.

Battery description and typical locations;

**House Main-** Accessible under portside cockpit cushion. Battery closest to hull.

**Engine Cranking-** Accessible under portside cockpit cushion. Battery closest to center line of hull.

**House Accessory-** Accessible by DC Management Panel

*Note that when replacing batteries never mix types such as an AGM with flooded lead.*

For more battery information refer to your Yamaha outboard owner's manual or Regal dealer.

## Battery System Tips

1. Do not use any battery that does not meet the minimum specifications as the electrical system may be overloaded and cause electric system damage. Never use a battery that exceeds the CCA specs.
2. Ensure that the charging system is operating properly as the engine will not start with low battery voltage.
3. Do not store flammable liquids on board the vessel. See warning label.
4. Do not store items on top or near the battery bank as it may keep battery vapors from venting through the cover top.
5. Never turn the battery switch off with the engine running as charging system damage will result.
6. When installing battery cables red goes to positive (+) post & black goes to negative (-) post.
7. Periodically check battery positive and negative leads and hardware for tightness/corrosion at terminals.
8. If flooded lead cell batteries are used periodically check the cell electrolyte level. Fill as needed with distilled water. Do not overfill cells.
9. Wear protective eye gear and rubber gloves when servicing batteries.
10. Never smoke around batteries or bring any source of ignition near them.

## LX6 BATTERY MANAGEMENT PANEL

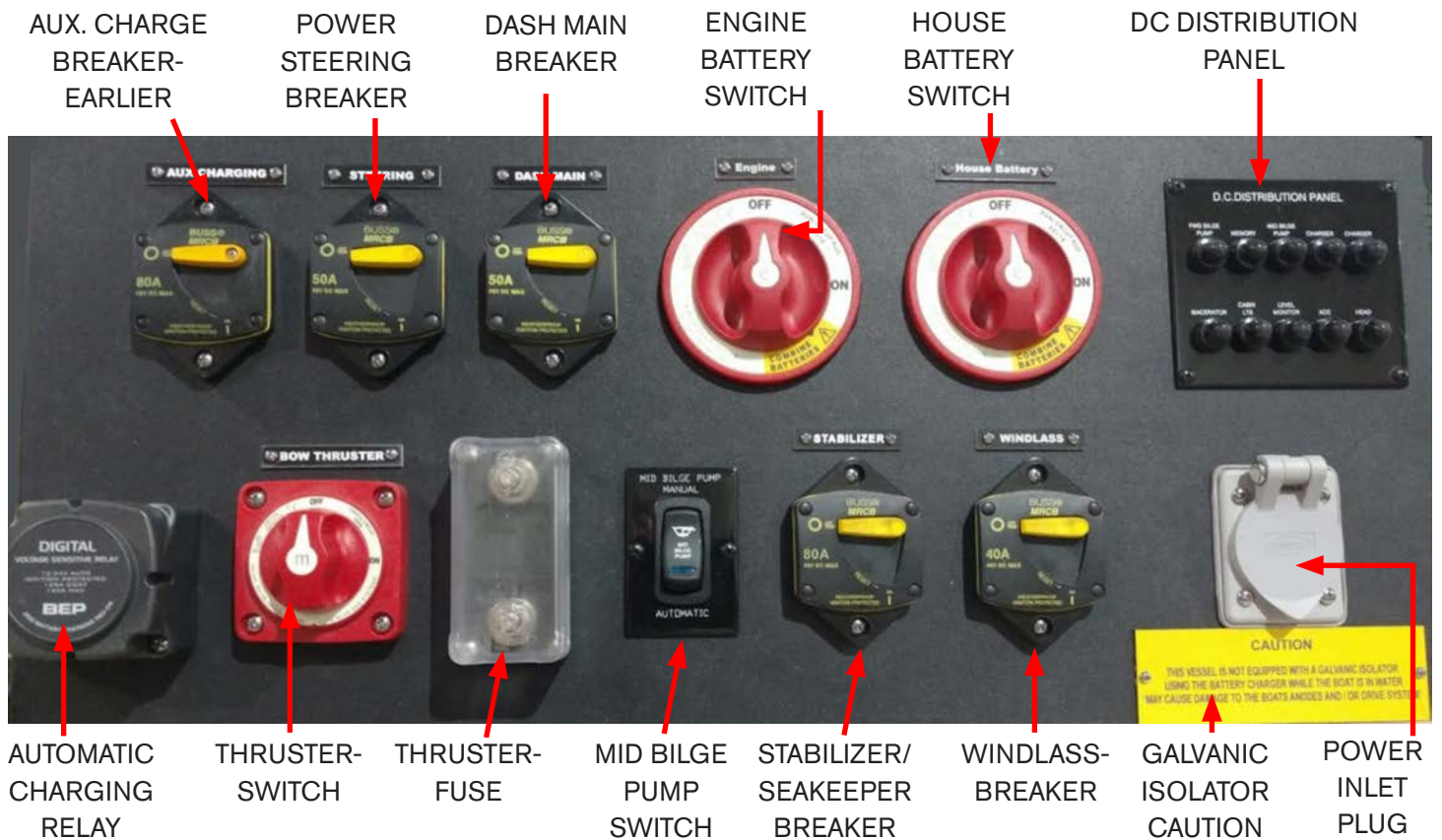

Note that select items mentioned above or displayed are optional equipment and may not be installed on your vessel. The battery management panel is found under the starboard cockpit seat cushion.

Since the battery management panel is the “heartbeat” of onboard components functions of each device will be found in the next pages. Refer to the owner’s information packet for more information.

## Aux. Charge

This 80 amp breaker controls the auxiliary charging wire which originates at the outboard stator charging system. Normal outboard stator output is 70 amps for mechanical engines and DEC engines. The current is distributed to the batteries by the ACR system. Note: Only found on earlier systems

## Power Steering Breaker

This 80 amp breaker controls the power steering pump and wiring circuitry. There is one per engine. This pump provides necessary fluid quantity and pressure to operate the steering system.

## Dash Main Breaker

This 50 amp breaker controls DC current running to the helm wiring and subsequent components.

## Engine Battery Switch

This “make before break” battery switch controls the engine DC cranking system. Day to day operation is to set this switch to the “on” position as you prepare for cruising. When disembarking turn the engine battery switch to the “off” position. If the battery should become discharged turn the engine battery switch to the “combine batteries” position to parallel with the house main and house accessory battery for cranking the engine. This additional feature is available as there is a link bar from the main battery switch to the accessory battery switch.

Never turn the engine battery switch to the “off” position with the engine running as charging system damage may occur.

Because of the “make before break” feature it permits turning the engine battery switch to the “combine batteries” position while the engine is running.

## House Battery Switch

This “make before break” battery switch controls the house main and house accessory battery.

The house main battery is connected to any **lower** amperage draw components such as the lighting, stereo, and bilge pump components.

The house accessory battery supports **higher** amperage draw components including (if installed) bow thruster, windlass and Seakeeper. These items use motors that to accomplish their functions require increased amperage. Day to day operation is to set this switch to the “on” position as you prepare for cruising. When disembarking turn the house battery switch to the “off” position.

If the battery should become discharged turn the house battery switch to the “combine batteries” position to parallel with the engine battery. Never turn the house battery switch to the “off” position with the engine running as charging system damage may occur. Note however that because of the “make before break” feature turning the house battery switch to the “combine batteries” position while the engine is running is possible.

## DC Distribution Panel

Below is a description of each distribution panel component located at the top right of the battery management panel.

Note that select breakers may be part of optional components not installed on your vessel.

**Mid Bilge Pump-** This breaker controls the optional bilge pump and float switch system mounted at amidships under the floor access.

**Memory-** This breaker controls the stereo memory circuit. The memory feature permits the stereo selected formats to remain even if the battery is disconnected for winter storage.

**Aft Bilge Pump-** This breaker controls the aft bilge pump and float switch system.

**Charger-** This breaker controls one leg of the battery charger to the engine battery at the engine battery switch.

**Charger-** This breaker controls the other leg of the battery charger to the main house and accessory house batteries as they are at the house battery switch.

**Macerator-** This breaker controls the macerator (overboard discharge pump). Remember to check and understand local, state, and country legislation regarding pumping waste overboard before activating the pump.

**Cabin Lts-** This breaker controls select LED lighting located in the cabin area including ceiling and reading lamps.

**Level monitor-** This breaker controls the water and waste monitor located in the head.

**Power platform-** This breaker controls the hydraulics which move the component up and down the transom area on select vessels.

**Head-** This breaker controls the DC head (toilet) flushing mechanism if installed.



## Automatic Charging Relay

The M-ACR is designed to manage the charging current from outboard stators up to 65 amps. It includes a start isolation feature that protects sensitive electronics by temporarily isolating house loads from the engine circuit during engine cranking, protecting the house circuit from voltage spikes and sags.

The ACR works by sensing when the voltage of either battery rises to a level indicating that a charge source is active (13.0 volts for 2 minutes). At that point the ACR's contacts connect and the ACR applies to both batteries. If the voltage on both batteries subsequently drops to 12.75 volts for 30 seconds, the ACR disconnects and isolates the batteries.

ACR's use a relay combined with a circuit that senses when a charging source is being applied to either battery. Compared to battery isolators they create very little heat and consume little charging energy. Note that the ACR body encompasses a QR label which when connected through an app will take you to the web-site where you can find detailed operation and troubleshooting information beyond what is noted here.

## ACR System Hints/Self Tests

If the ACR does not disconnect when the engine is turned off it has not reached the low voltage threshold to isolate the circuit. It may take several minutes for the batteries to drop to this level. Since the ACR uses a delay, additional time up to 2 minutes may be required before the ACR disconnects.

A slow flashing LED indicates that the start isolation wire is energized.

A fast flashing LED indicates one or both batteries are below 9.5 volts DC. Refer to the table below.

LED	BATTERY STATUS	REASON
Solid ON	Combined	Charging
Single Flash (15 sec.)	Isolated	Standby
Double Flash	Isolated (Start Isolation)	Start Isolation wire is energized
Triple Flash	Isolated (Under Voltage Lockout)	One or both batteries are below 9.5V (12V System) 19V (24V System)

## Thruster Switch

To activate the optional bow thruster DC system the switch needs to be placed in the “on” position. This provides power from the battery to the solenoid and to the thruster motor when energized by the bow thruster helm joystick.

## Thruster Fuse

This fuse located in a protective cover controls current through the bow thruster battery circuit to the bow thruster motor. Normally a 200 or 225 amp fuse is used. The size is notated on the fuse under the cover. It is recommended to carry an extra fuse which can be ordered through your closest Regal dealer.

If the fuse ever “blows” find the root cause of the problem before replacing it.

## Mid Bilge Pump Switch

If installed this switch controls the bilge pump located in the mid-ship bilge. This switch is only installed when an optional bow thruster is present. *Note that this switch does not control the aft bilge pump.* The mid bilge pump switch utilizes an automatic and off position. It is recommended to retain the switch in the auto position. In the auto position the bilge pump float will energize the pump if and when accumulating bilge water is present.

This bilge pump will continue to operate if the house battery switch is in the “off” position affording protection when the vessel is left unattended.

## Seakeeper Breaker

This 80 amp breaker controls the optional Seakeeper DC circuitry. This breaker is linked to the house accessory battery for higher amperage draw components.

## Windlass Breaker

This 40 amp breaker controls the optional windlass DC circuitry. It is sized to protect the windlass motor which is a high amperage type. This breaker is linked to the house accessory battery!

## Power Inlet Plug



This is the shore connection point for the battery charger operation. Read the section on the following pages regarding the battery charger cord for further information. Always ensure the power inlet plug cover is in place when not in use since it helps prevent corrosion and possible water intrusion.

**⚠ WARNING**

**Avoid serious injury or death from fire, explosion or electrical shock.**

- This device must be connected to a Ground Fault Circuit Interrupter (GFCI) protected AC outlet
- When using an extension cord, connect the AC charger plug before connecting to the GFCI protected AC outlet
- Make connection in an open atmosphere free from explosive fumes
- Make cord and connection in a secure manner that will avoid contact with the water

GFCI WARNING LABEL

## GFCI Warning Label

Read and understand the label shown at the left side of this page and found on the bulkhead across from the battery management panel.

Most marina moorings these days feature GFCI weatherproof outlet devices. When using the optional battery charger first plug in the 3 prong extension cord to the vessel AC power inlet plug. Then plug the male end in the dock GFCI.

Make sure there is no sign or smell of hydrogen gas fumes from the battery banks before using an approved extension cord. Check to make sure cord does not contact the water and cord length is considered especially in a tidal zone environment.

## Galvanic Isolator Caution Label

*Read and understand the following label information.*

**CAUTION**

• THIS VESSEL IS NOT EQUIPPED WITH A GALVANIC ISOLATOR USING THE BATTERY CHARGER WHILE THE BOAT IS IN WATER MAY CAUSE DAMAGE TO THE BOATS ANODES AND / OR DRIVE SYSTEM! •

You may moor your boat at a marina that could be labeled a “hot marina” which may attack your outboard zinc anodes or those on trim tabs, too.

This phenomena is due to leaking AC and DC current coursing through the water and around docked vessels. Normally the corrosion of underwater metals (props & drives) or rapid consumption of zinc anodes is a result of other vessels not the marina facilities. You can be docked next to a person who has not maintained his vessels' zincs.

With this situation in place if the marina is “hot” your zincs will protect both boats and your zincs will rapidly be depleted. The green safety ground wire is usually a contributing player to the above problem.

*Note that it is recommended that if necessary plug your extension into the vessel power inlet plug for just enough time to charge the batteries.*

*Do not leave the cord plugged in for extended periods of time as you may risk damage from galvanic corrosion.*

For additional information contact your closest Regal dealer or marine professional.

## Shore Power Inlet- Battery Charger Cord

The shore power inlet is part of the battery charger option. **Use a 15 amp 3 blade extension cord of the correct size and length to compensate for current draw and voltage drop.** Normally the longer distance traveled requires a higher amperage extension cord. Read the extension cord tip page earlier in this chapter.

 **DANGER**

**AVOID POSSIBLE INJURY OR DEATH!  
DUE TO ELECTROCUTION!  
DO NOT OPERATE THE BATTERY CHARGER  
WITH A TWO BLADED ADAPTER PLUG  
OR EXTENSION CORD.**



**15 AMP 3 BLADE OUTDOOR CORD**

*If in field charging is needed at most marinas today a 25 or 50 foot 15 amp 3 bladed outdoor extension cord will fit the needs of your on board battery charger. Make sure the outlet you are plugging into features 3 inputs and is a GFCI protected outlet. Note the earth ground rounded blade which provides a path for the “earth” ground wire. It reduces the risk of electrical shock and fire.*

## Battery Charger

If installed the battery charger delivers up to 20 amps of DC current and uses a 120 AC voltage input (extension cord/power inlet plug).

As a result of lightweight design it delivers faster charging through optimal cooling. It utilizes fully automatic multi-stage charging and enhances battery performance with 5 sequential stages with integrated easy to read monitor with LED bars. System check ok and battery status indicators result in accurate battery status feedback.

Battery charger utilizes 2 output legs one for each battery switch.

### Factory Set for Flooded/Lead-Acid Batteries

#### Stage 1 - Analyze & System Check OK

During this stage the ProSportHD Mode LED will pulse blue indicating it is analyzing all battery connections and ensuring each battery is capable of being charged. When completed successfully, the "System Check OK" indicator will illuminate green. This takes approximately 1 minute.

#### Stage 2 - Charge

During this stage the ProSportHD Mode LED will be solid red and the ProSportHD will use all of its available charging amps (as controlled by temperature) until the battery voltage is raised to the selected absorption voltage.

#### Stage 3 - Condition

During this stage the ProSportHD Mode LED will be solid amber. During this mode batteries will be held at the selected absorption voltage to complete charging while conditioning each battery connected for up to 3 hours as needed.

#### Stage 4 - Auto Maintain (Energy Saver Mode)

During this stage the Mode indicator will be solid green, indicating it is monitoring and auto maintaining your batteries as needed to maintain a full state of charge. At this time, the blue Power LED, green System OK and green Mode LEDs will remain on letting you know your batteries are ready when you are.

#### Stage 5 - Storage Recondition

During this stage the ProSportHD will enter into its once a month Storage Recondition mode. The green Mode LED will pulse indicating that while your batteries / boat are in storage, the ProSportHD is reconditioning all batteries for up to 3 hours once a month to extend battery life and provide maximum reserve power performance on the water.

## Lazarette Actuator Control Box

This component integrates a breaker to control the actuator cylinders used to open and close the Lazarette storage compartment. There are relays inside the control box. A breaker controls the upward cylinder travel and the other breaker controls the downward cylinder travel. The control breaker protects the relay circuit wiring.

## PowerTower Actuator Control Box

This component integrates a breaker to control the port and starboard actuator cylinders used to control the PowerTower angling forward and upright. There are relays inside the control box. One breaker controls the tower port actuator while a second breaker controls the starboard actuator. A separate breaker protects the entire relay wiring circuit.



# LX6 Helm Overview

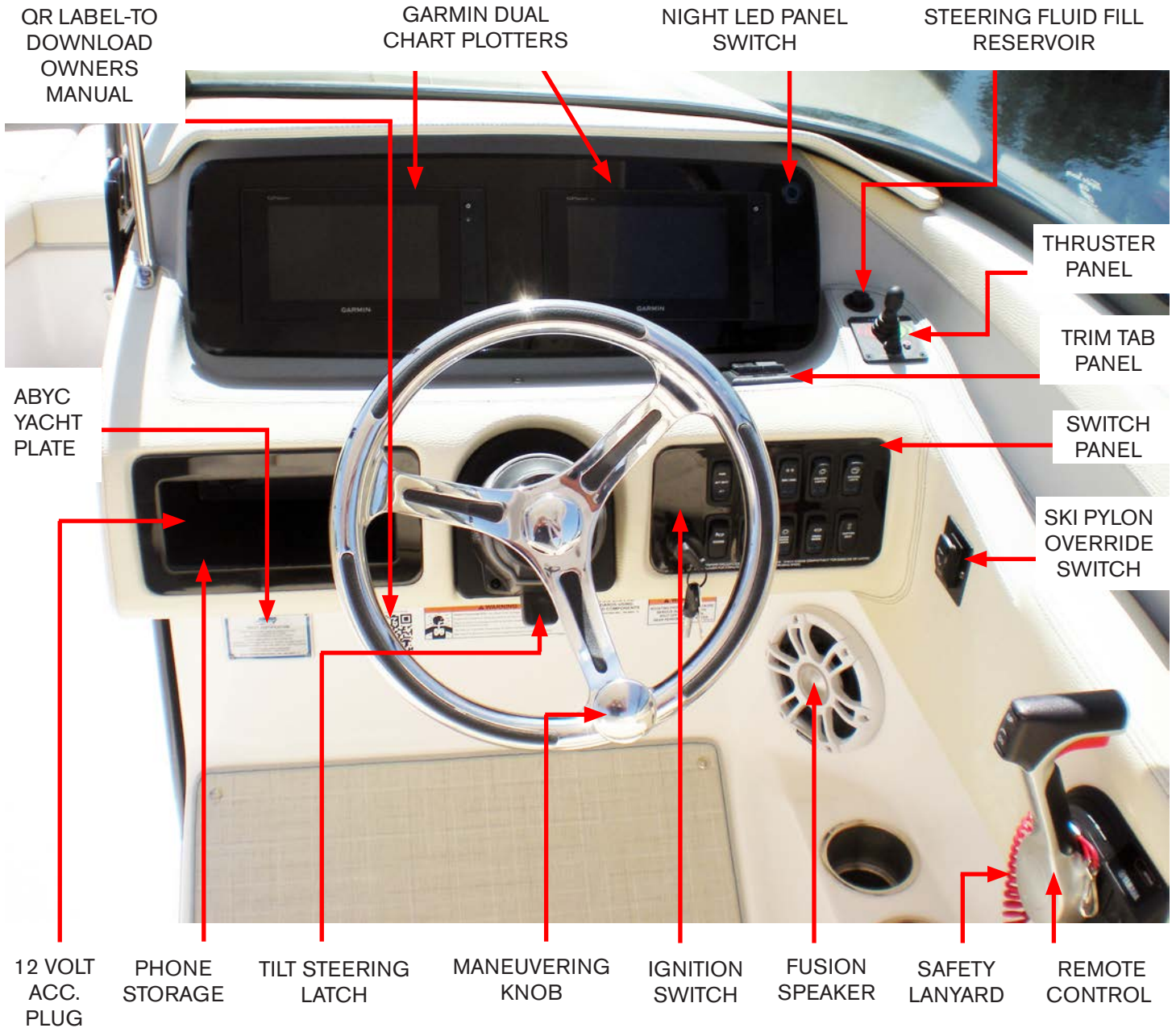

Shown above is a typical LX6 helm component layout. The key switch circuit is protected by a 20 amp breaker located above the key switch. The breaker is covered with a water resistant rubber boot. Should this breaker “trip” ignition for starting the engine will be interrupted. Always find the root cause of the problem before resetting the breaker.

Note that the Garmin plotter uses mini SD cards in the card reader slots on each plotter. The LED panel perimeter is lighted “blue” for night helm visibility. Familiarize yourself with the switch panel components and all the functions of the helm controls before starting a cruise. Safety first!

*Note that select components shown above may be optional and or may not be applicable to your vessel.*

## LX4, LX6 OUTBOARD ENGINE CONTROLS AND CHECKS

In this section we will explore various outboard systems and controls that are featured on your vessel.

Note that more detailed information can be found in the outboard engine owner's manual.

This segment of the manual follows a sequence in operations and checks including the following; before starting the engine, starting the engine, and after starting the engine.

### **Before Starting Engine**

#### **Remote Control**

Refer to the typical remote outboard remote control in chapter 5 for operating procedures.

*Note that your remote control may appear a bit different but the operation should be similar.*

Practice shifting the engine in low traffic areas to understand its motion and effects on the vessel. Be sure to use diligence and obey all no wake zones and other speed restrictions as they appear.

## **FUEL OCTANE NOTICE**

*Outboard engines depending on the model may require a mid-range octane level (89) versus a lower regular octane level (87). Refer to your outboard manufacturer's operation manual for correct information regarding the proper octane level for your outboard model.*

*Using the wrong octane level may cause permanent internal engine damage such as piston detonation. Problems with the incorrect octane fuel are not covered by the outboard motor manufacturer or Regal. Any questions relating to fuel requirements contact your outboard manufacturer's hot line, outboard owner's manual specifications, or contact your closest Regal or Yamaha dealer.*

## CHECKING CRANKCASE OIL LEVEL

Remove the shroud (cover) and check the crankcase for proper oil levels. Remember that a 4 cycle outboard uses crankcase oil to lubricate all internal engine components such as crankshaft, rods and pistons along with all related bearings and seals. For changing crankcase oil contact your closest Regal dealer for additional information since they have the special tools and knowledge for these maintenance procedures. Check your outboard owner's manual for correct oil type and viscosity. See figure 1 for dipstick location.

### FLYWHEEL COVER



FIGURE 1

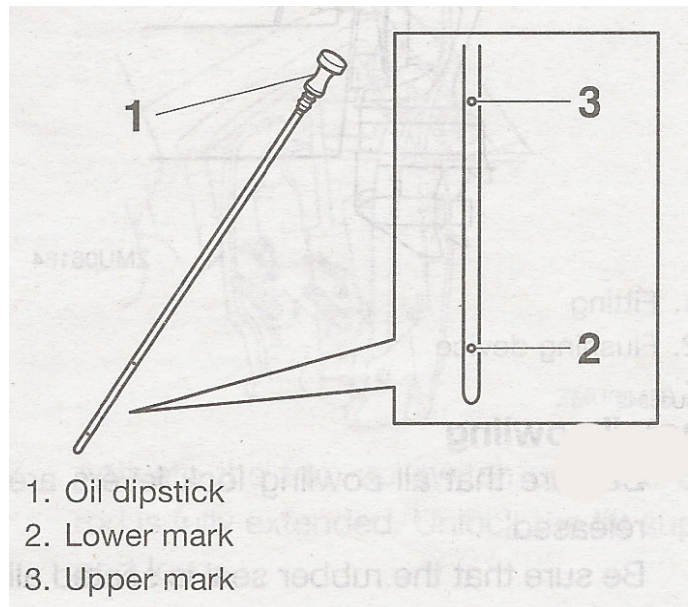

To check the crankcase oil do the following:

1. Ensure the outboard is setting in a flat vertical position or the dipstick may not display an accurate oil level.
2. Remove the crankcase oil dipstick and wipe it clean.
3. Reinstall the crankcase oil dipstick completely into the hole. Remove it again.
4. The oil level should be between the upper and lower dipstick holes. As needed add the manufacturer's recommended oil or contact your closest dealer especially if the oil is contaminated with water which will show a milky color verses a clear or light amber look.

TYPICAL EPA FUEL SYSTEM

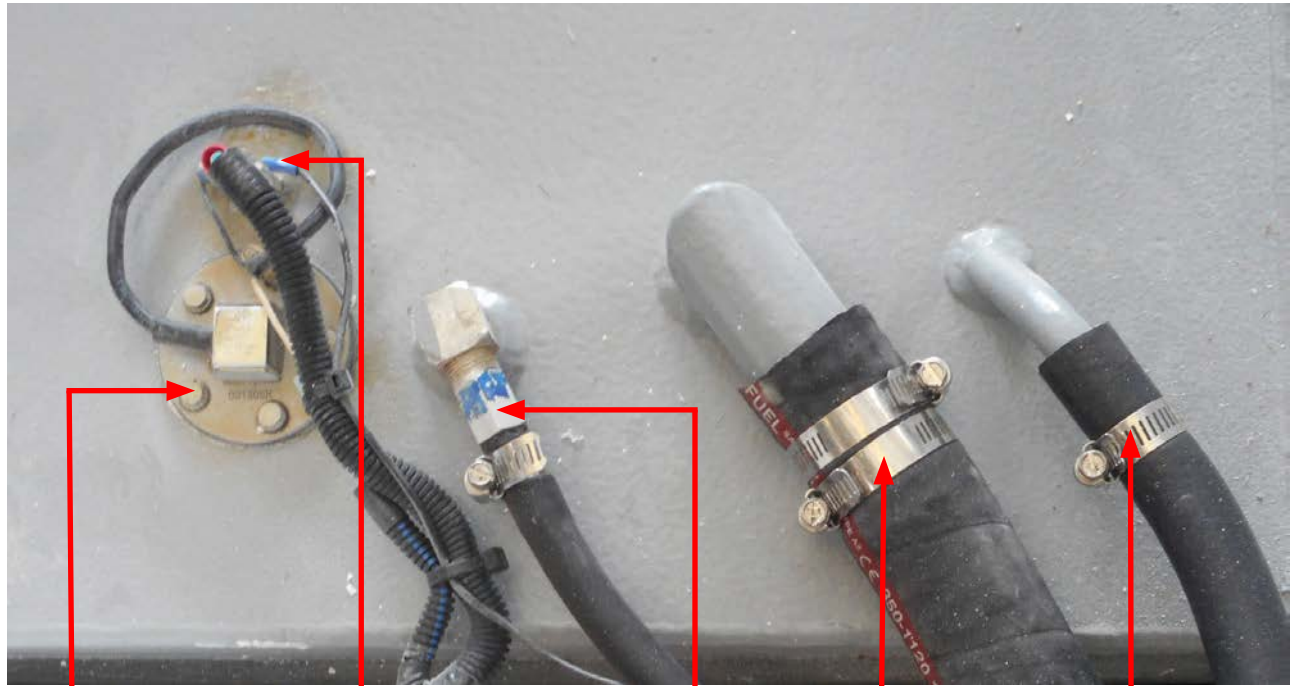

FUEL SENDER

TANK GROUND

ENGINE FEED

FUEL FILL

VENT

Before each outing check the fuel tank components including hoses and related clamps. Be sure to sniff for gasoline vapors in the process. If any vapors exist find the source of the leak and repair as needed. At that point ventilate the compartment until all vapor smell is gone.

Read and understand the following fuel system warning labels.



**WARNING**

AVOID SERIOUS INJURY OR DEATH  
FROM EXPLOSION OR FIRE!  
NEVER STORE FUEL  
OR FLAMMABLE LIQUIDS  
ON BOARD.



**WARNING**

AVOID SERIOUS INJURY OR DEATH  
FROM EXPLOSION OR FIRE  
RESULTING FROM LEAKING FUEL!  
INSPECT ENTIRE FUEL SYSTEM  
AT LEAST ONCE A YEAR.





### CHECKING ENGINE MOUNTED FUEL FILTER

As part of select outboards under the motor shroud (engine cover) on the lower port side of the outboard engine is a fuel filter. Periodically check to ensure the fuel filter is clean and free of water. When reinstalling the filter tighten to manufacturer's specifications. Check for leaks after starting the engine. For more information refer to the outboard manufacturer's owners manual or contact a Regal dealer or marine professional.

### CHECKING IN-LINE WATER SEPARATOR FILTER



Inside the Lazarette center cockpit storage area a 10 micron in-line water separator filter is installed. Use an oil spanner type wrench and turn the filter counterclockwise to remove the element. Using a clean pan

empty the filter contents and examine the fuel. Water in fuel tends to hug the bottom since it is heavier than fuel and will show a different color. At least yearly or on an as needed basis replace the filter element. Fill the element up with fresh unleaded fuel of the correct octane rating (assists with keeping air out of the fuel system) and turn it clockwise by hand until tight. As always check for leaks before starting the engine. It makes sense to keep extra fuel filters on board in protective wrap for emergency use.



## Checking Power-Assisted Power Steering System

Your outboard may feature a mechanical-hydraulic rack style power assisted steering system. The unit utilizes valves which permit hydraulic fluid to pass through the system allowing the steering arm at the outboard to turn the vessel to port or starboard. This check valve cluster is located behind the steering wheel. The hardware at both the helm and engine ends must be checked regularly for tightness, lubrication, and leaks. Check the steering system for full steering to port and starboard before disembarking. Typical hydraulic pump shown below. Locations may vary by model. Refer to your outboard motor operator's manual for adding fluid to the pump and type required.

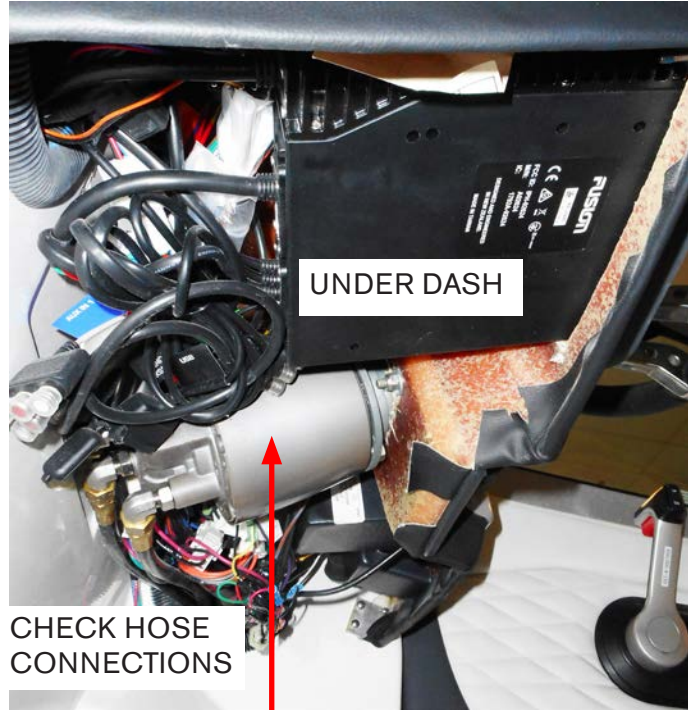

HYDRAULIC RACK STEERING CLUSTER

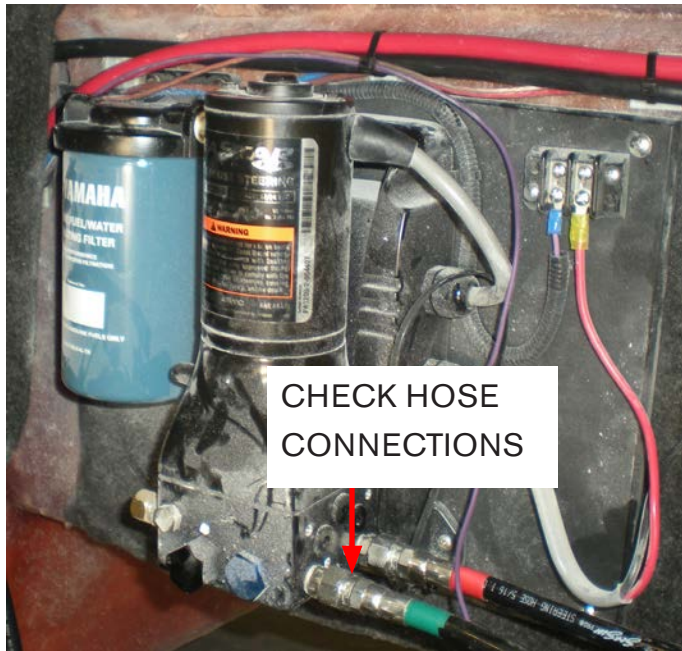

TYPICAL HYDRAULIC STEERING PUMP



STEERING HARDWARE & HOSES AT ENGINE

## Filling Helm Steering Reservoir



### FILLING HELM HYDRAULIC STEERING FLUID

There is a fill plug located at the starboard helm used to add hydraulic fluid to the steering system. There is a hose kit used to fill the system. Note that Sea Star Solutions recommends Seastar Hydraulic Steering Fluid for use with the filler kit.

Any non-approved fluid may cause serious damage to the steering system resulting in possible loss of steering, causing property damage, personal injury or death.

Contact your closest Regal dealer or marine professional for system filling instructions since the steering system may need to be purged of air by opening bleed fittings as the wheel is turned port and/or starboard.

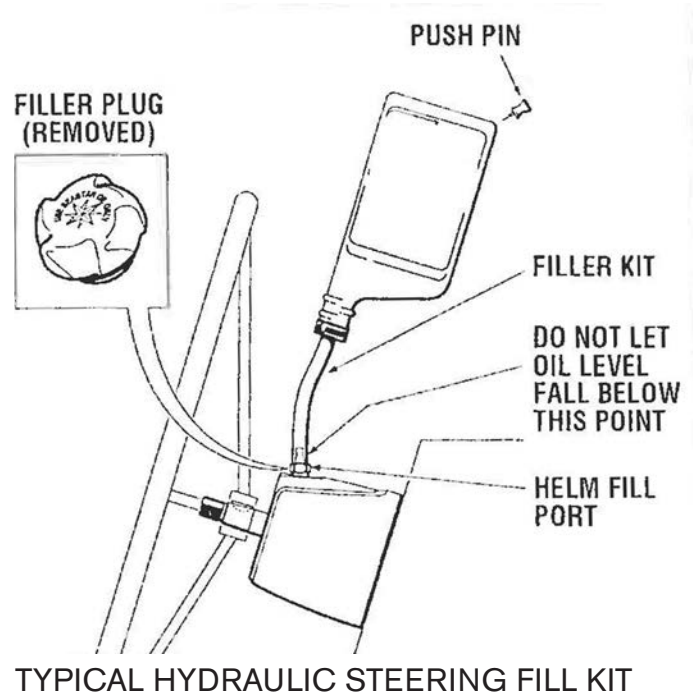

TYPICAL HYDRAULIC STEERING FILL KIT



## WARNING

AVOID SERIOUS INJURY OR DEATH!  
THE OPERATOR OF THE CRAFT  
MUST HAVE COMPLETE CONTROL  
OF THE HELM STEERING STATION  
WHILE THE VESSEL IS MOVING.  
NEVER LEAVE  
THE HELM STATION UNATTENDED  
WHILE THE VESSEL IS MOVING.

# SEA STAR STEERING SYSTEM SCHEMATIC OVERVIEW (TYPICAL)

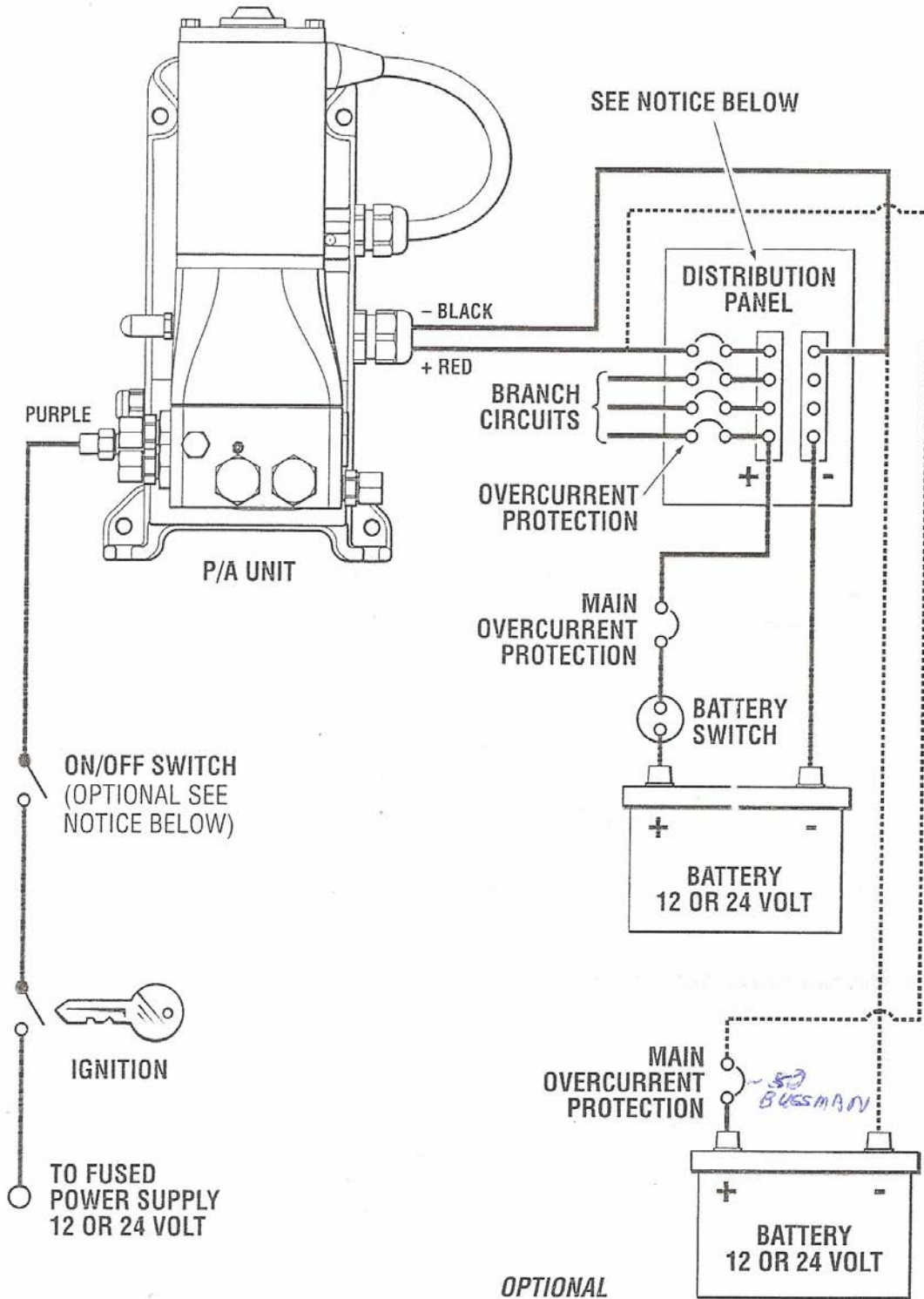

## Additional Outboard System Checks

Check these components/systems before starting engine:

1. Tilt the outboard drive and check the propeller for nicks and bent blades which will cause vibration.
2. While the outboard drive is tilted up check for any debris around the water intakes on the vertical drive shaft housing. These could cause the engine to overheat.
3. Check steering system fasteners at the engine and all related hydraulic hoses and connections for signs of leaks including the ones under the helm.
4. While the shroud is off check for any engine oil leakage or fuel puddling.
5. Check engine transom mounting fasteners for tightness.
6. Repair any signs of leakage and loose fasteners and hoses before attempting to start the engine.
7. Ensure that you use the 1/3 rule for determining if you have adequate supplies for the trip. Fill up as needed.
8. Check all throttle and shift cable linkages at power head for tightness.
9. When finished, reinstall the engine shroud ensuring all lock levers are secure.



# Chapter 4

## Vessel Operation

### Getting Underway

#### *Pre-departure Questionnaire*

- Have all fluid levels been topped off?
- Is the fuel tank full?
- Is all safety equipment accounted for and easily accessible?
- Are navigation lights and horn operating properly?
- Is the bilge free of water and does the bilge pump operate?
- Is the engine and propeller in good working condition?
- Is the drain plug in place ?
- Have all passengers been briefed on emergency procedures and seated for departure? Is the boat load balanced?
- Is the operator sober, alert and ready to skipper the vessel?
- Have all passengers been fitted for life jackets?
- Has a float plan been filed and left with a component person?

- Has the bilge been sniffed and the fuel system leak checked?
- Are sea cocks open (if applicable)?
- Is all communication equipment in good operating condition?
- Has a second person been briefed on operational procedures should the skipper become disabled?
- Are all gauges and electrical switches functioning properly?
- Has weather information been gathered and analyzed?

### Underway Questionnaire

- After casting off have all dock lines and fenders been stowed?
- Are all passengers seated and all doors closed and latched?
- As skipper are you monitoring the dash gauges and/or Garmin plotter for changes?
- As skipper are you on the lookout for changing weather?
- Is the remote control safety lanyard tightly secured to your belt or clothing?



## Disembarking Questionnaire

Have you removed the keys from the ignition and secured them?

- Have all systems been checked for leaks?
- Has the battery switch been turned to the “off” position?
- Are all sea cocks closed (if applicable)?
- Has the fuel tank been filled enough to prevent condensation?
- Is the vessel properly tied and covered with equipment stored?

## Fueling

 **DANGER**

AVOID SERIOUS INJURY OR DEATH!  
GASOLINE IS HIGHLY FLAMMABLE  
AND EXPLOSIVE MATERIAL.  
PRACTICE “NO SMOKING” AND EXTINGUISH  
ALL FLAMMABLE MATERIALS  
WITHIN 75 FEET  
OF THE FUEL DOCK

 **WARNING**

AVOID INJURY OR DEATH FROM FIRE  
OR EXPLOSION  
RESULTING FROM LEAKING FUEL!  
INSPECT ENTIRE FUEL SYSTEM AT  
LEAST ONCE PER YEAR.



## WARNING

SINCE GASOLINE IS AVAILABLE  
IN SEVERAL GRADES  
INCLUDING ETHANOL AND VARIOUS  
OCTANE LEVELS, REFER TO THE ENGINE  
MANUFACTURER'S OWNER'S MANUAL FOR THE  
CORRECT GAS TYPE/GRADE.  
USING THE IMPROPER OCTANE LEVEL  
OR THE WRONG GASOLINE TYPE CAN CAUSE  
ENGINE DAMAGE AND VOID THE WARRANTY!

### Before Fueling

- Make sure a working fire extinguisher is available.
- Stop engines and any device that can cause a spark.
- Disembark all passengers and crew not needed for fueling.
- Fuel if possible during the daylight hours.
- Check to ensure nobody is smoking in the boat or near the fueling dock.
- Close all portholes, hatches and doors to keep vapors from blowing aboard and settling in the bilge.
- Tie up your boat securely at the fuel dock.
- Identify the fuel fill. Unfortunately, people have mistakenly filled the water or waste with fuel.
- Visually inspect all fuel system components before each filling.
- Avoid using fuels with E-15 alcohol additives. It can attack fuel system parts along with hoses and cause deterioration.

## During Fueling

- Keep the fuel nozzle in contact with the fuel fill to guard against static sparks. The fuel fill pipe is grounded through the fuel system wiring to protect against static electricity.
- Avoid overfilling the fuel tank. Leave room for expansion. Also, if fuel exits the fuel vent indicating the tank is full, this situation is dangerous and unfriendly to the environment.
- Avoid spilling any fuel. Clean up any fuel accidentally spilled with a clean rag and dispose of it on shore.

## After Fueling

- Close all fuel fill openings tightly.
- Open all portholes, hatches and doors if applicable.
- Sniff in the bilge and engine area for gas fumes. If fumes are detected continue to let the area ventilate until the odor is gone. Look for any traces of fuel droplets or spillage. Do not start the engine(s), smoke or run any electrical components until the fumes can no longer be detected.

Strong Points- Read Warning Below

 **WARNING**

AVOID INJURY OR DEATH  
FROM STRONG POINT FAILURE!  
REPLACE ANY CLEAT, BOW  
OR STERN EYE IMMEDIATELY THAT SHOWS  
ANY TYPE OF DETERIORATION.

## Dock Line Basics

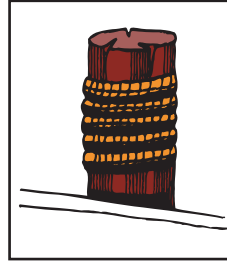

Most skippers use dock line terminology fairly loose but there is more to the basics than just bow or stern lines. There are several lines that can be secured to the bow and stern and depending on their direction and use, can be called other names. Remember that “forward” and “aft” refer to the direction that a spring line runs from the vessel, and not where it is secured on board.

### Bow/Stern Lines

There is only one true bow line. It is secured to the forward cleat and run forward along the dock to prevent the vessel from moving to the stern. The stern line leads from a rear cleat to a piling or cleat on the dock astern of the vessel. This line keeps the boat from moving ahead. For small vessels these are the only lines needed for normal wind and current conditions. If located in a tidal environment, keep slack in the lines.

### Breast Lines

These lines are attached to the bow and stern that lead to nearly right angles from the center of the vessel to the dock. They help keep larger vessels from moving away from the dock, or are pulled in to help people board the vessel. Larger vessels may use bow or quarter breast lines.

## Spring Lines

Most small boats use two spring lines although it is possible to have four. They are called the after bow spring and forward quarter spring.

Bow springs are secured at the vessels bow area. Forward spring lines lead forward from the boat to the dock and control movement toward the stern. After springs stem aft from the vessel, and stop movement ahead. Spring lines are used to prevent movement in a berth, ahead or astern. They are really useful in controlling the effects of a real active tidal surge. Spring lines are useful where fenders need to be kept in place against piles.

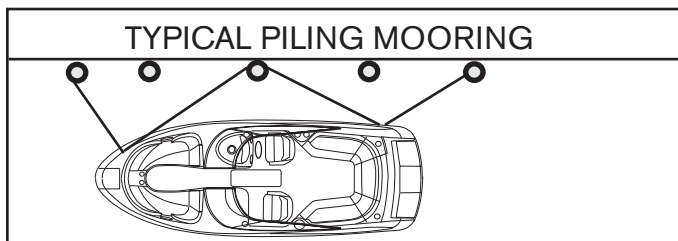
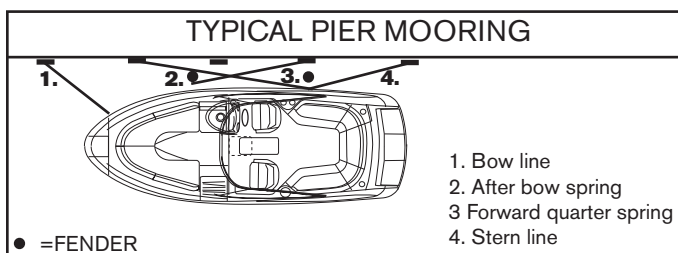

## Boat Mooring

Most boats can be secured to a dock using four lines. The after bow spring is crossed with the forward quarter spring and secured to individual dock cleats or pilings. This ensures longer springs and can be snugged up tighter for more efficient tidal control.

Remember, if you only have one piling available, position the vessel so this point is opposite amidships. Run both spring lines to it. These lines will be shorter but still useful. The bow and stern lines should be relatively at a 45 degree angle with the dock. The stern line can be attached to the near-shore quarter cleat, but will work more efficiently to the offshore quarter cleat. The longer line will allow the boat flow with the tide with less time checking the vessel.

## Dock Line Sizing

Most dock lines today are made of nylon, either of twisted rope or braided core and cover. The most often used material is nylon because of its stretching abilities absorbing shock loads. It is chafe resistant for extended life and is easier on bare hands.

The line's size varies with the vessel. Normally, a vessel in the 20' to 40' boats will use 1/2" diameter nylon lines. Larger yachts use 5/8" and 3/4" diameter nylon lines. Smaller boats can use 3/8" nylon lines.

Dock lines need to have the strength to hold the vessel and have enough density to resist chafing. They shouldn't be too heavy that they lose their shock-absorbing capabilities. Use the right size line for the vessel since a line too large for the boat will pull hard against the vessel since it won't be forced to stretch. If the line is too small for the vessel, there is no margin for wear and chafe when under strain.

## Securing Dock Lines

When mooring your boat, make sure the dock lines are secured at both ends. Depending on your situation you may need to loop the eye splice of the dock line around a piling.

Sometimes the mooring line will lead down sharply from the piling to the deck cleat. Loop the eye splice around the piling twice to keep it from being pulled up off the pile.

Pull the line through the looped eye if the mooring line is too small to go around the piling twice or too small to fit over once.

If you must drop a line over a piling that already holds another boat's line, run the eye of the line up through the first eye from below, then loop it over the pile. This will allow either line to be removed without disturbing the other. If another line is dropped over yours, simply reverse the process. Secure a little slack in the other dock line, then slip your eye up through its loop and over the top of the pile. Your line can be dropped through the other eye.

When debarking from a dock, it is easier to release the line from a cleat or piling, from on board the boat, as soon as you leave the dock. Loop a long line around the cleat or pier and leading both ends on board you can release the line easily. Slip one end around the cleat or pile, then pull it back on board. Release the line without the eye splice, so it will run freely from around the pile without hanging up on the splice.

## Fenders

Fenders are normally made of a rubberized plastic and are usually filled with air. Most have a fitting like a basketball so they can be inflated or deflated. Fenders are available in a wide range of sizes and shapes to fit both small and large vessels. Fenders are normally designated in inches. They are used between piers, docks, sea walls and the boat.

They protect the top sides of the boat from rubbing against rough objects. Most fenders have eyes of attachment which allow a line to be inserted vertically or horizontally. This will permit the fender to be tied off to fit a variety of marina, dock and tidal situations. Be sure the fender is correct for the vessel size. It is a good idea to carry extra fenders but half a dozen is normally an acceptable number. Remember to store fenders on board so they can be easily accessed. Some people incorrectly call fenders "bumpers".

*Note that optional fender clips are available for your vessel.*



There is a variety of fender styles and types, each selected for specified uses. When choosing fenders, contact a marine dealer or supply house. Explain how you moor and use your vessel so they can recommend the best fender type for you. We suggest the type with a fill plug so you can inflate them with a hand pump like the ones used for bicycles.

## Stern Drive Maneuvering

Directing propeller energy (thrust) makes slower speed maneuvering easier. The propeller discharge current is turned from one side to the other which results in turning forces. Rudder boats need water to flow by the rudder to be efficient. Stern drive units are designed to have reduced shaft angle, so the propeller does not produce as much unequal blade thrust and resistance. Large horsepower boats do produce more thrust and steering torque but your vessel has the advantage of a "fly by wire" steering.

Below is some basic information on how stern drive boats handle in normal conditions.

### Gathering Headway

When a stern drive is not moving forward or reverse in the water and the propeller is not turning, (shift in neutral) the boat will not react to the helm steering wheel.

As soon as the vessel is shifted into forward gear propeller action creates a discharge motion and generates energy in the form of thrust. If the drive is centered, the discharge motion is directed straight back causing the vessel to advance forward.

You may notice that if you advance the throttle quickly in initial take-off (make sure you have a firm grip on the wheel), the boat has a tendency to pull the stern of the vessel to starboard. There is a trim tab (also serves as a sacrificial anode) located on the drive housing. This trim tab helps compensate for the low speed steering torque. Once the boat increases headway and the propeller is operating in a faster water flow this torque effect decreases.

Sometimes the trim tab may need adjustment. Contact your Regal dealer for further information or consult your engine manufacturer's manual.

### Turning

Once the boat has gathered headway, with the boat planing at the correct bow angle and the outboard drive unit and helm straight the boat tends to stay on a uniform course heading. To assure the boat trim angle is correct use the chart plotter screen trim gauge as a guide while activating the trim button on the remote control panel.

When the helm wheel is turned to the right or starboard, the drive unit is turned in the same direction. The propeller's discharge force is directed to starboard forcing the boat's stern to port. Water flowing past the hull strikes the stern drive gear housing in its starboard side, creating additional turning torque. The stern starts a move to port, forcing the bow to starboard.

If the helm is turned to the left or port the drive turns to port, the stern of the boat goes starboard as the bow turns to port.

As the vessel operator gains experience, he will better gauge each maneuver and speed situation. In this way he will understand the handling characteristics of his boat. He needs to keep the safety of his passengers in the highest priority.

### Backing Down

If your boat has the steering wheel and drive straight with the control in reverse, the stern will be pushed a bit to port by the reversing propeller thrust. This tendency to back to port can be eliminated by turning the drive to starboard.



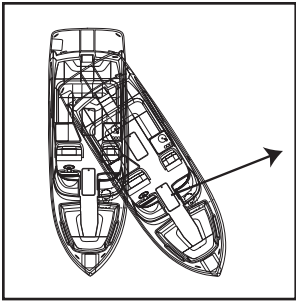

When the vessel begins to gather speed to stern, the water passing by the lower gear case housing will continue to increase steering torque. If the helm wheel is turned to

starboard, and will direct the propeller thrust to port, tracking the stern to starboard.

Wind and current will affect how a vessel backs. Stern drive boats tend to be light displacements and when backing down in a strong crosswind, the bow will tend to fall toward the windward. This may cause steering problems.

### Stopping

Remember that your boat does not have any brakes. It uses reverse thrust from the propellers to stop. If the vessel has headway, with the helm and propeller in reverse the propeller thrust is directed backwards, past the lower gear case. Depending on how far the throttle is advanced, the discharged thrust may not be strong enough to reverse the water flowing by the gear case. As the power is increased, the propeller thrust becomes strong enough to stop the flow of water past the lower unit, and, as the throttle is advanced it reverses its flow more completely.

When water is flowing past the gear case, steering torque is increased, but when the thrust stops the water flow, the boat will not respond to the helm. This is a short lived event and is overcome quickly when the water again flows past the gear case. Furthermore, added to the energy of the water hitting the lower gear case, the propeller thrust is directed by turning the stern drive unit which can add to the steering torque.

The prop tends to throw the stern to port. This is why experienced skippers undertake a port side landing when wind and current conditions permit. They allow the prop to move the stern to port toward the dock. With a forward motion when the helm wheel is turned hard to one side, the vessel pivots around a point about 1/3 its length abaft to stern.

## Power Trim/Trim Tabs

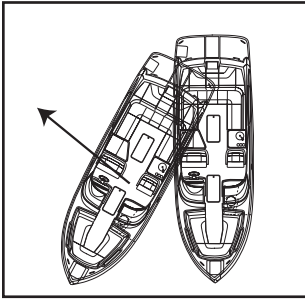

Stern drive boats have the ability to angle in or out their drive unit in relationship to the transom. This is accomplished by hydraulic shocks located on the lower unit housing

along with an electrical sender unit that reads the drive angle and sends information to the chart plotter showing a reading.

### Purpose of Power Trim

The purpose of the power trim/tilt is to enable the operator to change the angle of the drive while at the helm. Changing the angle of the drive or “trimming” provides the following benefits:

1. Improves acceleration onto a plane.
2. Maintains boat on plane at reduced throttle settings.
3. Increases fuel economy.
4. Provides smoother ride in choppy water.
5. Increases top speed.

In short, it is a way of fine-tuning the performance of your boat and will enable you to get the most efficient and comfortable ride possible, whatever the conditions.

### Using Power Trim

The power trim is normally used prior to accelerating onto a plane, after reaching the desired RPM or boat speed and when there is a change in water or boating conditions.

Position passengers and equipment in the boat so that the weight is balanced correctly fore and aft as well as side to side. Trimming will not compensate for an unbalanced load.

To operate the trim, push the switch until the desired bow position is reached. The trim may be operated at any boat speed or at rest. Avoid operating the trim system when running in reverse. Observe the trim/tilt gauge which indicates the boat's bow position achieved by the trim angle of the vertical drive unit. “Bow-Up” corresponds to the upper portion of the trim range on the gauge while “Bow Down” corresponds to the lower portion of the trim range on the gauge.

To determine the proper trim angle, experiment a little until you are familiar with the changes in your boat. The vessel will be properly trimmed when the trim angle provides the best boat performance for the particular operating conditions. A trim position that provides a balanced steering load is desirable. To familiarize yourself with the power trim, make test runs at slower speeds and at various trim positions to see the effect of trimming. Note the time it takes for the boat to plane. View the chart plotter screen, tachometer and speedometer readings as well as the ride action of the boat.

### Operation In “Bow Up”

The “Bow Up” or out position is normally used for cruising, running with a choppy wave condition, or running at full speed. Excessive “bow up” trim will cause propeller ventilation resulting in propeller slippage. Use caution when operating in rough water or crossing another boat's wake.

Excessive “bow up” trim may result in the boat’s bow rising rapidly, creating a hazardous condition.

#### Operation In “Bow Down” Position

The “Bow Down” or in position is normally used for acceleration onto a plane, operating at slow planning speeds, and running against a choppy wave condition. It is also used when pulling water skiers, tubers, knee boarders, etc. In this position the boats’ bow will want to go deeper into the water. If the boat is operated at high speed and/or against high waves, the bow of the boat will plow into the water.

#### Operation In ‘Level’ Position”

In normal running conditions, distribute passengers and gear so boat is level. At or below cruising speeds, trim the vessel for optimum performance. The trim gauge will show somewhere in the center of the gauge. This position will also enhance running visibility and overall stability. Again, each outing provides different wave, load and running conditions. Be prepared to make trim changes as needed.



## CAUTION

THE BOAT TRIM SHOULD BE ADJUSTED TO PROVIDE BALANCED STEERING AS SOON AS POSSIBLE EACH TIME YOU GET UNDERWAY. SOME BOAT/ENGINE/ PROPELLER COMBINATIONS MAY CREATE BOAT INSTABILITY AND/OR HIGH STEERING TORQUE WHEN OPERATED AT OR NEAR THE LIMITS OF THE “BOW UP”OR “BOW DOWN” POSITIONS. BOAT STABILITY AND STEERING TORQUE CAN ALSO VARY DUE TO CHANGING WATER CONDITIONS. IF YOU EXPERIENCE BOAT INSTABILITY OR HIGH STEERING TORQUE SEE YOUR AUTHORIZED REGAL DEALER.

#### Shallow Water Operation

Operating your vessel in shallow water presents various hazards. You are more apt to hit a submerged object such as a rock, sand bar, stump coral, or other unmarked objects.

Pay close attention to your chart plotter for descriptions of any shallow areas along with marked submerged objects. Always post a lookout when operating in shallow water. Trim your drive up as needed to provide adequate draft. If possible, set the alarm on your depth sounder and travel at a speed that will keep the boat level in these shallow areas.

**If your boat strikes a submerged object stop immediately and check for hull, drive, and propeller damage.**

### TRIMMED "TO FAR IN" POSITION



### TRIMMED "TOO FAR OUT" POSITION

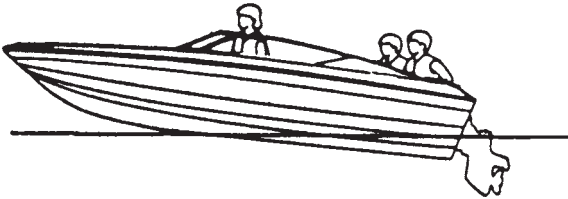

### WELL TRIMMED "LEVEL" POSITION

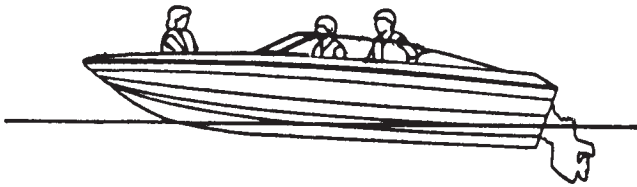

Typical Examples (Stern drive shown)

## Anchoring

Selecting the correct anchor is an important decision. The anchor style in part depends on the usage and boat type. Regal may designate an anchor type and or model. Some models incorporate chain, line with an optional windlass. Contact an authorized Regal dealer for more information.

Anchoring is easier with another person on board. First be certain that the line for the anchor is properly attached, to avoid losing the anchor and anchor line overboard.

For most anchors to perform more efficiently, you should attach 3 to 6 feet of chain. The chain will stand up to the abrasion of sand, rock, or mud on the bottom much better than a nylon line. It should be galvanized to reduce corrosion. Next, attach a length of nylon line to the other end of the chain.

The nylon will stretch under a heavy strain cushioning the impact of waves or wind on both the boat and the anchor.

To anchor, select a well protected area, preferably with a flat bottom. Contrary to modern belief, you do not throw the anchor over while the boat is making headway, or moving forward. In fact, the bow of the boat should be brought slowly backward, while easing the anchor slowly over the side of the boat until it hits the bottom. To "snub the line" means to stop its outward "pay" or movement. Usually the length of anchor line used should be 5 to 10 times the depth of the water.

After you have anchored, check your position with landmarks if possible. You need to continue to monitor landmarks to make sure you are not drifting.

Since anchoring can also be an emergency procedure, the anchor and line should be readily accessible.

For increased holding power in windy conditions, two anchors are sometimes set. If your primary anchor drags, you can run out your secondary anchor without picking up the primary one. The important thing is to lay them out at an angle. When setting two anchors, make sure they are fastened to separate rodes or cleats. This is done in case you need to adjust one later so the line is accessible. If two anchors are used ahead of a boat, make sure to set the rodes at an angle than in a straight line to reduce the chances of tangling as the boat moves in wind and current. See the illustration.

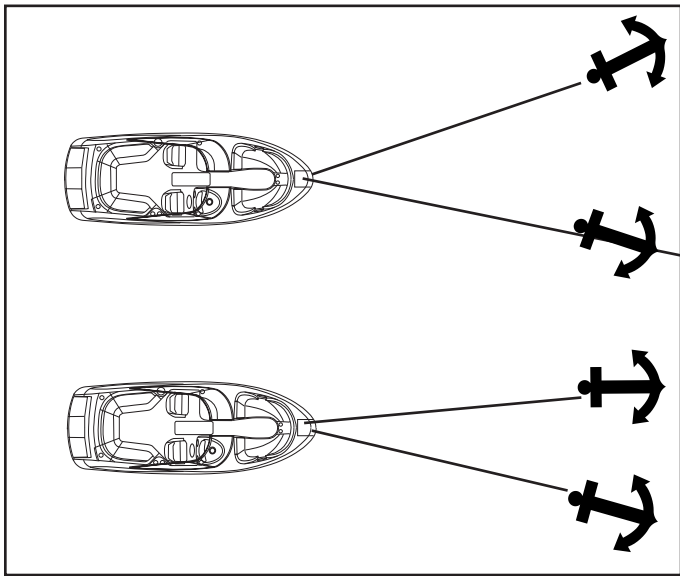

### The Law Of Salvage

The Admiralty law sometimes referred to as the salvage law was founded primarily on English law fundamentals and basically says that a vessel distressed, in danger of flounder, if rendered assistance from a towing company or private agency, can be forced to relinquish a portion of the vessels' worth for the assistance received.

# NOTICE

IN THE EVENT  
YOUR VESSEL IS IN DISTRESS,  
PRIOR TO ALLOWING ANY TOWING  
COMPANY OR PRIVATE AGENCY THE  
RIGHT TO PASS A LINE TO YOUR VESSEL,  
BE SURE TO ESTABLISH THAT YOU  
DO NOT AGREE TO SALVAGE RIGHTS.  
ESTABLISH WITH THE CAPTAIN  
OR OPERATOR THAT YOU WISH TO BE  
ASSISTED IN A CONTRACT BASIS AND  
ESTABLISH A PRICE.  
OF COURSE IN CERTAIN SITUATIONS, YOU  
MAY NOT HAVE THIS OPTION.

USE YOUR BEST JUDGEMENT!

### Towing

Read and understand the above notice! In case you find yourself aground or in need of a tow, or should you want to tow another vessel, keep in mind that you never use deck hardware or cleats to secure lines for towing!

Deck hardware is intended for mooring and anchoring, and is not designed to withstand the strain and pull of towing. Rather than tie the line to your cleats on deck, it is suggested that you tie a bridle by passing a line completely around the hull of your boat to avoid damage.

When towing, always stand clear of a taut line, as any type of line breaking under stress can be extremely dangerous. The preferred line for towing is double-braided nylon, as it has sufficient elasticity to cushion shock loads. Move slowly and cautiously.





# WARNING

AVOID INJURY OR DEATH!  
DO NOT USE DECK HARDWARE  
INCLUDING CLEATS  
FOR TOWING.

## Knots

Knots are useful in docking, towing and other emergency situations. Learning to tie knots requires practice. As they say “ Practice makes perfect”. Some of the knots used in boating are the square, bowline, anchor bend, clove hitch, figure eight and half hitch. There are several periodicals available that explain various knots and how to tie them effectively. An experienced skipper will know the basic nautical knots and will use them when on the water. Take the time to know the basic knots.

**Figure 8 Knot  
Tied To Cleat**



A useful knot to learn for general docking is the figure eight with one end reversed. By turning the free end of the line back under, the knot can be released without disturbing the boat. After some practice one person can secure a vessel easily to a dock or pier in a variety of weather conditions. This knot normally is used to tie the bow and stern. Then the vessel can further be fastened by tying the spring line in the figure eight knot. Wrap it around the cleat 2 or 3 times.

## Emergencies

Always be ready to help others on the water if possible, but do not take any unnecessary risks. Use equipment to save a life, but do not risk a life to save equipment. Consult earlier information in this manual concerning accidents, etc. Also, read other literature concerning on the water emergencies. Be alert and prepared!

### Fires

Fire aboard a vessel can spread quickly and can cause tremendous alarm among everyone. Most fires can be prevented by keeping the bilge free from oil and debris. Keep all equipment stowed and maintained in working order. Carry a backup fire extinguisher on board. If something becomes a possible fire hazard, remove that possibility at once. Never use water on gasoline, oil or electrical fires. When you dump water on an electrical fire you can be shocked since water conducts electricity.

Follow these instructions if a fire breaks out:

- A. Fit everyone aboard with a life jacket. Turn off the ignition.
- B. Try to keep the fire downwind. If the fire is to the stern, head the bow toward the wind. If forward, put the stern to the wind.
- C. If the engine should catch fire, shut off the fuel supply. Usually there is a fuel tank access that will enable you can crimp the fuel feed line.

D. Use a hand fire extinguisher. Make sure to point it at the base of the flames. Use short bursts and sweep the extinguisher side to side.

**Remember : (4 lb. extinguishers usually discharge in 20 seconds)**

These actions help prevent the fire from spreading to other parts of the boat. You can extinguish fires quickly if you act swiftly. Have a plan of action in motion in case a fire breaks out.

## First Aid

Knowing first aid can save lives. A first aid kit and the ability to use it are important ingredients for the safety of a skippers' passengers, crew and vessel. Having confidence and competence in handling medical emergencies on board is a must for the skipper. Invest your time in a first aid course available at the American Red Cross.

## CPR (Basic Life Support)

If someone is seriously injured have someone call for help while the injured person is being attended.

Check for possible danger signs; loss of breathing, unconsciousness, severe bleeding and heartbeat. If you determine the individual is not breathing or unconscious place the victim on their back on a hard surface and do the following:

1. If unconscious, open the airway. Neck lift, head lift or chin head lift.

2. If not breathing, begin artificial breathing. Pinch the nose. Give 4 quick breaths. If airway is blocked, try back blows, abdominal or chest thrusts and finger probe until airway is open.

3. Check for pulse. Begin artificial circulation. Depress sternum 2".

15 compressions rate 80 per minute. 2 quick breaths. Continue uninterrupted until advanced medical support is available.

## **Follow up immediately with medical authorities!**

## Hypothermia

Hypothermia is a condition where the body temperature decreases because the body can't generate enough heat to maintain its normal temperature. It can be serious and usually occurs where victims have been immersed in water (under 68 degrees) for extended periods of time. If you encounter a possible hypothermia victim call for help on the radio and get the person out of the water.

Symptoms are:

1. Shivering that if condition is advanced may stop.
2. Confusion, clumsiness or slurred speech.
3. Rigid muscles.
4. Semiconscious to unconscious.

Treat hypothermia by the following:

- Remove wet clothing.

- Monitor the victim's pulse and breathing.
- Rapidly apply heat to the body core by using blankets, naked bodies or warm water.
- Do not give the person any food or drink.
- Do not warm the arms and legs. Warming of these extremities can be fatal. Follow up immediately with medical authorities!

### Electric Shock Drowning (ESD)

ESD occurs when stray AC current enters the water either from marina or private docks and/or open grounding conductors on vessels. People caught in this dangerous electrical field in the water often drown as the body becomes paralyzed. ESD happens much more often in fresh or brackish water as salt water tends to conduct electricity and basically grounds it.

To aid in prevention of ESD do the following:

1. Never swim near a marina, dock, or boat yard or near a boat especially if it is running.
2. When in the water stay at least 150 feet away from boats or docks where electricity exists.
3. Always obey "no swimming signs."
4. If your vessel features a battery charger use a 3 prong electrical cord rated for the battery charger receptacle. Plug the male end into a functioning shore system GFCI. Do not let the cord dangle in the water. Allow for cord slack if in tidal zone.
5. Check with marina owner to ensure his electrical system has been recently inspected and up to code.
6. Yearly have a qualified marine electrician inspect your vessels electrical system.

### Environmental Awareness

There are numerous vessels operating on our waterways on a daily basis. Each boat has an impact on our environment. Boat operation habits, marine sanitation, and maintenance all play a role in a delicate battle to keep the ecosystem clean. Each of us has a role in doing our part as an environmentally conscious skipper to conserve our waterways. The National Marine Manufacturer's Association lists their top ten of Eco-Boating Practices as follows:

1. Observe all regulatory agency policies regarding marine toilets.
2. If equipped with a holding tank, use marina pump-out facilities.
3. If used, make sure bottom paints are legal and ecosystem friendly.
4. Use only biodegradable cleaning agents.
5. Dispose of all garbage and litter on shore properly.
6. Don't top off fuel tanks. Leave expansion room. Clean up spills.
7. Watch your wake and propeller wash.
8. Make sure your engines are well maintained.
9. Control your bilge water.
10. When fishing, practice the "catch and release" principle.

**Follow these basics practices when on the waterways. Treat the environment in a way that you would like to be treated.**

# Chapter 5

## Auxiliary Equipment Operation

\*Note that equipment specifications, location, and operation may occur over the vessel production life.

### Overview

This chapter will assist the boat operator in understanding selected standard and optional equipment components on the vessel. *Select equipment described may not be installed on your boat or the pictorials and/or instructions may not exactly fit equipment on your craft.* Remember that Regal is constantly improving its product line and therefore may make changes in vendor parts and specifications without notice. For detailed information on equipment, please refer to the owner's information packet. **Note that all chain windlasses use a chain stopper to remove tension from the windlass itself.**

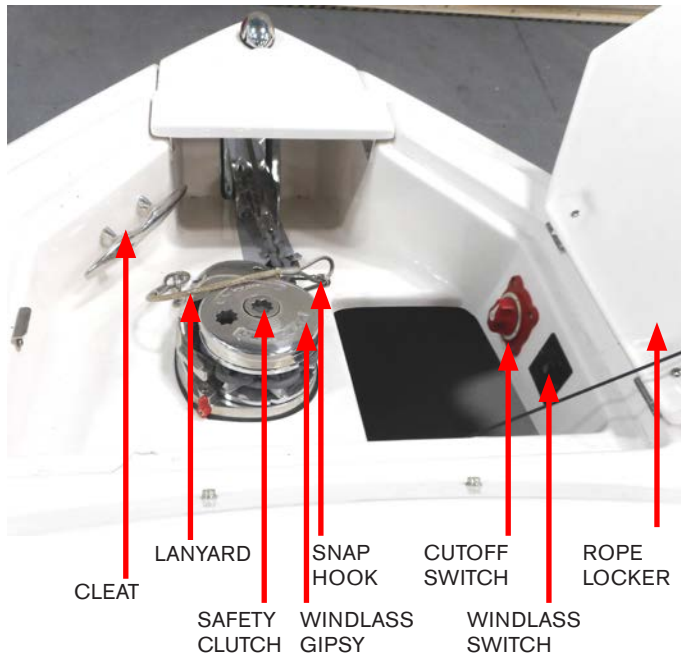
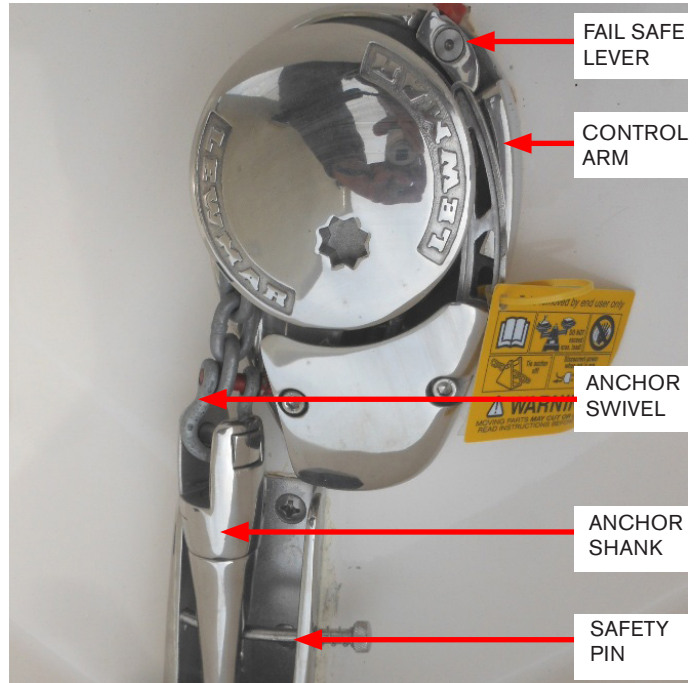

TYPICAL UNIT SHOWN

### Anchor Windlass Introduction

If installed the windlass *may* feature a stainless steel polished “claw” style anchor complete with swivel. This anchor has high holding power in most seabeds. Select windlass units offer all chain or a rope-chain combination.

A momentary windlass rocker switch located at the anchor locker controls the lowering and retrieving of the anchor through the windlass. A 40 amp breaker for windlass over current protection is located at the battery management panel. There is a lanyard with a snap hook to add holding power when the anchor is in the stored position. The cleat is for tying off the anchor rode rather than maintaining constant pressure on the windlass itself.

Note: Never use the windlass to break the anchor free from the bottom. This may cause excessive strain on the windlass motor and or hardware.

### Using Anchor Windlass

The windlass may be outfitted with a rode using 100' of 1/2" nylon rope along with 10' of galvanized chain. The chain is connected to the anchor shank which is next to the anchor. The chain acts as a safety margin to protect the rope rode from being damaged by sharp seabed objects such as coral that might sever the rope if it was next to the anchor. If needed for harsh sea bottoms the rode can be converted over to 100' of 6 mm. Galvanized chain with a small length of rope at the top for tying off the rode to a cleat.

The safety clutch is used to "pay out the windlass chain or to retrieve the anchor "rode". There is a handle in the anchor locker that inserts into the gypsy drive cap located on top of the windlass framework. With the handle inserted in the cap, turn the handle *clockwise* which grips the "gypsy", locks it and **tightens the clutch**. Remove the handle and store it after usage.

To **loosen the clutch** with the handle inserted in the cap, turn the handle *counterclockwise* which will free up the "gypsy" from the drive train. Remove the handle and store it.

Before attempting to "pay out" the anchor **ensure that the fail safe pawl is disengaged from the gypsy and held clear of it by the fail safe lever**. See windlass owner's manual for further information.

**Be sure to pull the safety pin from the anchor shank before using the system.** *The anchor will not pay out with this pin inserted.* This pin should be reinstalled after each anchor retrieval.



## WARNING

AVOID SERIOUS INJURY!  
ENSURE THAT ALL BODY PARTS & CLOTHING  
ARE KEPT CLEAR OF THE ANCHOR RODE  
AND WINDLASS DURING OPERATION.



## WARNING

AVOID SERIOUS INJURY!  
DO NOT "PAY OUT" ANCHOR UNTIL IT IS  
DETERMINED THAT THERE ARE NO  
SWIMMERS OR DIVERS NEAR THE AREA.

### Paying Out Anchor Using Gravity

To let out the anchor release any anchor locks, insert the clutch handle into the gypsy drive cap and turn it in a clockwise direction to tighten the clutch. When in a safe mode, pull back on the clutch until the anchor and rode begin to pay out. Control the rate of anchor descent by pushing the clutch lever forward. When the desired rode is paid out, tighten the gypsy drive cap.

### Paying Out Anchor Using Power

Make sure any anchor locks are disengaged and the pin through the anchor shank is pulled along with the lanyard hook. Stand clear of all windlass components when paying out. Using the windlass momentary switch, press and hold the lower portion of the switch.



When the proper ratio of anchor rode is paid out disengage the switch and tie off the rode to a cleat since it is not recommended to let the windlass mechanism be the only source holding the rode to the anchor on the sea bottom. Also, do not use the fail safe pawl to hold the anchor load as windlass damage could occur.

#### Hauling In Anchor-Manual Recovery

Insert clutch handle into the gipsy drive cap and turn clockwise until anchor is fully returned to the bow roller.

#### Hauling In Anchor-Using Power

When anchor rode is safe to haul in use the windlass momentary switch to haul in the anchor rode. Press and hold the upper portion of the switch until the anchor is returned to the bow roller position.

The fail safe pawl does not need to be disengaged during retrieval as it will act as a ratchet. When the anchor has been retrieved in the bow roller position the fail safe pawl should be left engaged in the gipsy to prevent accidental activation of the windlass while underway. Also, reinstall the pin through the anchor shank and the lanyard hook. Note that the fail safe pawl does not need to be disengaged from the gipsy before the anchor can be paid out again.

It is recommended that during the paying out process the engines be run to stern before full scope is reached. This will help prevent the rode from being tangled in the anchor on the sea bottom. It is recommended that during the retrieval process use the engine to gather headway.

Do not let the vessel sit directly on top or over the area where the anchor lies because the chain rode could damage the hull topside.

As the anchor raises toward the scuff plate area, retrieve the last few feet very carefully to eliminate any hull damage.

Once the anchor is retrieved, check to ensure the fail safe pawl is engaged in the gipsy which will help prevent accidental activation.

#### Windlass Safety Tips

1. Read the windlass owner's manual.
2. Keep all body parts and clothing away from an activated windlass.
3. Do not exceed the maximum load designated by specifications.
4. Always tie off the anchor rode to the designated cleat.
5. Do not use the windlass to pull or tow another vessel.
6. Always shut off windlass breaker or main battery switch before servicing the component.
7. Always use engine power to gain headway before retrieving anchor.
8. Always look for swimmers or divers before deploying anchor.
9. Always secure rode/anchor while cruising or pulling vessel on highway.

## Automatic Fire Extinguishing System



Stern drive engines use a powered ventilation (blower) system and may have installed an optional fire extinguishing system in the sump capable of automatic and manual activation. The dash monitor utilizes an instrument display unit light that provides the operator with a system status of a charged or

uncharged condition by an audible alarm and icons. With the ignition switch on and a no light condition it indicates that the system has been discharged.



If the fire extinguishing system should discharge the ignition system will be instantaneously interrupted and the engine will shut down. See the automatic fire

extinguisher manual in the owner's packet for additional details.



If a fire has started in the engine compartment the system will automatically discharge or the operator can manually discharge the extinguisher. Find the system manual cable assembly located in the cockpit. To use the manual remote remove the safety pin from the

“Fire T Handle” and pull firmly on the “Fire” handle which will activate the fire extinguisher unit in the engine compartment. A loud “rushing air” sound may be heard. Complete discharge will take several seconds. Keep the compartment closed for a period of time sufficient to permit the agent to soak all areas of the protected space. This allows hot metals and fuel time to cool. Refer to the automatic fire extinguisher owner’s manual for additional information.

*Note: The boat operator needs to educate the crew on fire protection and more specifically the automatic fire extinguishing system in the event that he becomes incapacitated. It is a good idea to practice by having a mock fire drill.*

# NOTICE

IF INSTALLED, FIXED FIRE EXTINGUISHER SYSTEM MUST BE SUITABLE FOR A COMPARTMENT VOLUME OF 135 CU. FT.

## Portable Fire Extinguishers

Clean agent extinguishers are primarily for Class B and C fires (gasoline is a flammable liquid under the Class B group). The extinguisher should be of the 5 lb. capacity and 2 are recommended based on the maximum capacity of the fuel tank onboard and the boat length. These extinguishers may be available from your dealer, marine speciality stores, or on the internet. It is recommended to have extra portable fire extinguishers to backup the automatic fire extinguisher system since a fire could take place in an area outside of the sump/ machinery space.

As noted above a clean agent type of liquefied gas used today is FE- 241. This gas is colorless and odorless, heavier than air and sinks to the lower parts of the sump to extinguish fires. Since the year 2000 ingredients have changed to a more environmental friendly formula (Chlorotetrafluoroethane or FE- 241). FE- 241 is used in portable-hand units.

The canister needs to be weighed once a year. Also, the canister is engraved with a date which is part of the canister life cycle. Refer to the information regarding fire prevention in this manual and on the internet.

Normally the clean agent fire extinguishers cost more than powdered or CO<sub>2</sub> extinguishers and they are more effective with fire ports than powder extinguishers. They work by suffocating the fire by removing the oxygen which is a key factor in any fire.

## Bilge Pump

Before each outing, check the operation of the bilge pump, automatic switch, and manual switch. The bilge pump should automatically activate when water reaches a pre-determined height in the engine compartment. Test the bilge pump manually at the dashboard with the switch. Periodically check for bilge debris around the grates of both the bilge pump and automatic switch.

The automatic mode for your bilge pump works similarly to the manual method. Both methods control the bilge pump by a switch, but the automatic mode utilizes a float switch. Float switches use a device that sits at water level, and when the float reaches a certain height, it trips the switch and activates the bilge pump.

Periodically you may need to disassemble the bilge pump from the grate in order to clean or access the inner mechanisms. To remove the bilge pump, utilize the quick disconnect tabs on either side of the bilge pump, squeezing them like a backpack clip while pulling up on the pump.

The bilge pump and float switch are normally located at the center hull bottom at the front of the engine. Open the engine hatch to access the aft bilge pump (See photo above right).

*Note that with the addition of a bow thruster option a second bilge pump and automatic switch is located at mid-ships. As with the aft bilge pump this optional unit uses an automatic switch which is active with the battery switch(es) in the off position thus protecting the vessel when unattended. See photo on this page.*

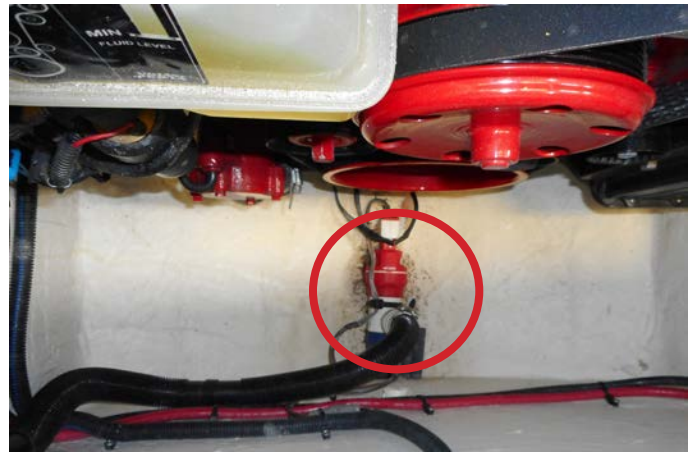

Typical Aft Bilge Pump & Automatic Switch

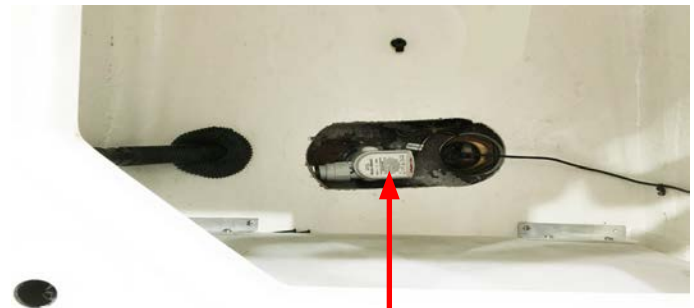

Optional Mid Ship Bilge Pump & Automatic Switch

## Bow Filler Cushion

Your vessel may include an a bow filler cushion. Your vessel's appearance may vary from below. To set up the filler cushion follow these steps:

1. Find the filler cushion which is stored in one of the bow storage compartments accessible by lifting the seat cushion.



2. Locate the support bars which normally are found in the bow storage compartment. Position shorter bar in the forward grooves. Position the longer bar in the aft grooves. See photo below.



1. Insert the hard back filler cushion in place and align as needed. This completes the installation.





## Bow Walk Through Doors

If installed the bow walk through doors provide a barrier for cockpit passengers in rough seas and wind gusts. They can also aid in colder climates as a blanket against lower air temperatures. Do use the doors follow these steps:

1. Pull the doors free from the magnetic catches and bring them near closing. Note the latch.

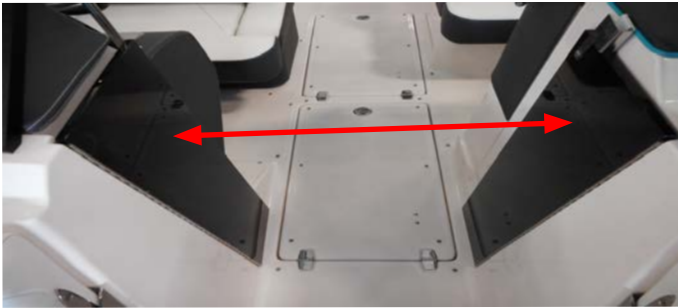

2. Lift the latch to clear both doors while bringing both doors to a closed position. Lower the hinged latch until it is completely down.

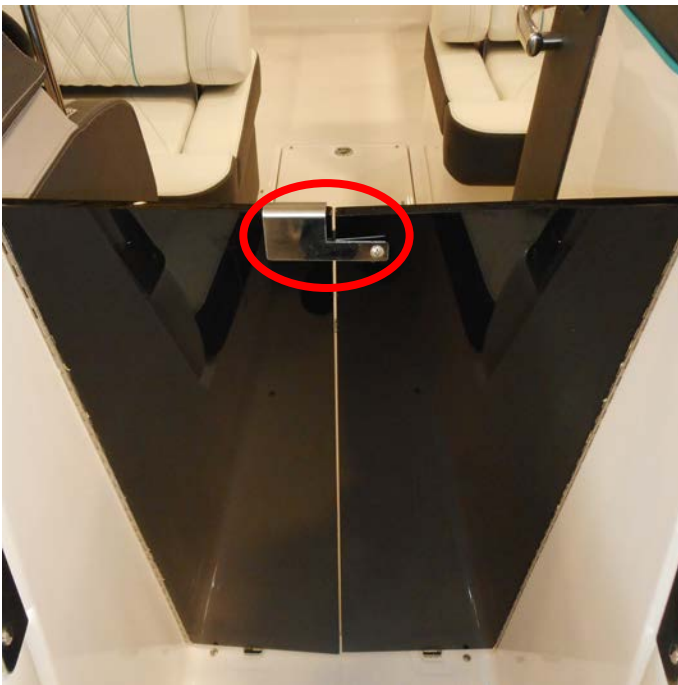

Note that these are acrylic doors and are tinted for UV protection. Clean with a soft cloth and mild soap. Rinse with plenty of water. Never use harsh chemicals or coarse cleaning implements or brushes. Periodically remove any scratches or dullness using products for acrylic. Buff with soft cloth o bring out the luster of the product.

## Canvas

There are canvas options available for your vessel including bow covers, cockpit covers, PowerTower and travel/storage covers. Let us look at the basic installation on each type. As general information many of our models use Sunbrella a solution dyed fabric well known for its ability to hold up in the harsh marine environment.

### Bow Cover

If installed a bow cover protects the front cockpit of the boat from weather and snaps to the deck.

*The bow cover is not be used for towing.* On select vessels when both the bow and cockpit cover options are purchased, the two halves snap and velcro together at the center windshield location.

Notice in the middle underside of your bow cover, you may find an area of reinforced canvas with an eyelet snap. This snap connects to a bow cover pole. This pole is adjustable and by opening the lock the pole can telescope out to the desired length. This pole should push the canvas up when positioned correctly on its rubber enclosed foot. The purpose here is to prevent the pooling of water.

### Cockpit Cover

If installed, the cockpit cover installs over the windshield and snaps to the deck. The cockpit cover is meant to protect the cockpit of the boat from weather elements. *The cockpit cover is not to be used for towing purposes.* Note that on the bow end of the cockpit cover, there may be a velcro strip used to attach to the bow cover.

COCKPIT COVER



BOW COVER

This strip can be used to align the covers with your boat. Line up the Velcro edge with the windshield. Ensure the center windshield is in the closed position. Start snapping the cover to the deck by use of the eyelet snaps, starting at the bow and working aft. Continue snapping the cockpit cover to the deck snaps. When you reach the rear corner, leave enough room for an exit point. Notice in the middle underside of your cover, you may find an area of reinforced canvas with an eyelet snap. This snap connects to a cockpit cover pole. This pole is adjustable, and by opening the lock, the pole can telescope out to the desired length. This pole should push the canvas up when standing straight up on its rubber enclosed foot. Again, the purpose is to shed water off of the top.

The cockpit cover and bow cover should be rolled up for storage inside the ski locker when towing or storing your boat. This canvas should not be used while the engines are running.

## Bimini Style Top (Typical)- PowerTower

If your vessel is fitted with the PowerTower it may feature a white top upgrade which covers the tower for increased resistance to water and leakage.

This bimini style top provides sun protection for the center cockpit and helm. Stainless steel bimini bows provide support as your bimini top extends forward. *Note to read, understand, and follow any warning labels attached to the bimini style top especially those regarding towing.*

*Note to read carefully any instructions from the canvas manufacturer regarding the installation, care, and maintenance of the white bimini style top that may be found in the owner's packet.*



### CAUTION

AVOID POSSIBLE BODILY INJURY AND PROPERTY DAMAGE!  
DO NOT USE THE BIMINI STYLE TOP CRUISING AT SPEEDS ABOVE 35 MILES PER HOUR.  
IF TOWING BOAT MAKE SURE TOP IS SECURELY ATTACHED TO HARDWARE AND INSIDE BOOT.



### CAUTION

AVOID POSSIBLE BODILY INJURY AND PROPERTY DAMAGE!  
DO NOT TOW VESSEL WITH BIMINI, BOW OR COCKPIT COVER IN PLACE!  
TOW WITH TRAVEL COVER ONLY!



### CAUTION

AVOID POSSIBLE BODILY INJURY AND PROPERTY DAMAGE!  
DO NOT TOW VESSEL WITH COCKPIT SEA-GRASS MATING IN PLACE.  
UNSNAP, ROLL, AND STORE IN LOCKER.

## NOTICE

CHECK YOUR STATE LAWS AND REGULATIONS BEFORE ATTEMPTING TO TOW THIS VESSEL. SPECIAL PERMITS AND EQUIPMENT MAY BE NEEDED. FOR HIGHWAY TOWING THE POWERTOWER SHALL BE IN THE COMPLETE FORWARD POSITION AND ALL CANVAS SHALL BE IN THEIR DEDICATED BOOTS. ALL ATTACHED CANVAS BOW HARDWARE SHALL BE CHECKED FOR TIGHTNESS BEFORE AND AFTER TOWING. SEA-GRASS MATING SHALL BE ROLLED UP AND STORED IN A DEDICATED LOCKER.

## Travel/Storage Cover- (Typical)



TYPICAL TRAVEL/STORAGE COVER



RATCHET STRAP

Ensure the ratchet strap is tight and the velcro flap is closed on the travel cover before pulling boat at highway speeds. Tie cover securely to bow and stern eyes. Once on the road periodically pull over and check cover, ratchet strap and pertinent hardware for tightness. Note that select covers use dual aft straps.

*Note not exceed manufacturer's miles per hour speed limit. See travel cover information for additional details or visit them on their web-site.*



## INSTALLING TRAVEL/STORAGE COVER

**▲ WARNING:** To prevent damage to your boat and/or cover please read and understand instructions before attempting to use cover.

It features:

1. **ON SOME MODELS:** A special anti-pooling system is included to prevent large puddles from ruining your cover.
2. The SurLast® all-weather fabric was chosen to allow stability, water repellency and breathe-ability.
3. The Vacu-Hold™ system allows trailering at highway speeds (65 mph) without billowing or buffeting.
4. The new ratchet and drawstrap type attachment will allow easy, tight and secure installation.

### CARE, WARRANTY AND INSTALLATION INSTRUCTIONS

**Hint-**To properly install ratchet strap system.

1. Pull the webbing through the channeled ratchet cylinder and tension while ratcheting to "start" the webbing.
2. Tension the ratchet with about 5 lbs. of pressure (pinky finger). Pull the sides of the cover to even the webbing throughout. Re-tension about 5 lbs. (the ratchet should be tight on the side of the boat lever, perpendicular to the hull).
3. Crank the ratchet approximately 5 full additional times to add tension (based on an 18' boat).
4. Check boat webbing for tension during stops while trailering. (webbing may stretch during first installation and use CHECK OFTEN).

**▲WARNING:** Readjust and retighten the cover after trailering and before storage. To prevent pooling do not allow snow and ice to accumulate on the cover. Never trailer at speeds above the speed limit.

**CARE INSTRUCTIONS-** Wash with warm soapy water (while installed if possible) and allow to air dry. For stubborn stains, mild detergent is recommended.

Storing the boat in constant direct sunlight will shorten the life of the cover and the components used to construct it. We recommend storing the boat in a location that exposes it to some sun and also shades it throughout the day. Preferably morning sun and afternoon shade.

**WARRANTY-** This cover includes a two-year warranty from date of purchase against any defects in material or workmanship. If you incur any problems or have any comments please contact your dealer or call Commercial Sewing Customer Service directly at (860) 482-5509.

#### PROPER INSTALLATION-

##### A. Pooling System Installation:

**Note:**

Install anti-pooling system as per illustration putting the front webbing to the cleats, standing pole upright. Pull the other two webbing straps to the two rear cleats. Tighten adjustable buckle strap, until the pole stands upright.

##### B. Proper Cover Installation:

- Place cover on boat starting at front, use cleats as buttons to keep cover in place, work toward back over pooling system until back cleats are "buttoned" in place.
- Maneuver in place until cover fits over gunwale. Check the symmetry. Connect the confidence straps through the openings on the swim platform to the "U" bolts. Disconnect velcro wrap around ratchet. Begin ratcheting by unzipping ratchet pocket(s) and pulling ratchet(s) handle in right-to-left motion until zippered ratchet pocket no longer sags but rests against the hull.
- Pull on webbing to even the tension around the cover and again tighten the ratchet until it does not sag but rests against the boat. Tighten ratchet four to five more times. The ratchet should be very hard to pull with your pinky finger. Zip ratchet pocket closed and connect velcro wrap around ratchet pocket. **On some models:** Connect the rear strap tiedowns in the back of the boat.

**Note:** Proper installation and operation of this cover requires that it be very tight at the gunwale. Retighten as necessary before, after and during stops while trailering. **BE SURE** cover is installed below gunwale before final ratchet adjustment. ZIP ratchet pocket closed for final installation.

**▲ Warning:** Zippered ratchet mechanism should be hand tightened only. Do not pry or attempt to operate ratchet mechanism with any type of tool.

#### REMOVAL-

- Disconnect velcro wrap & zip open ratchet pocket.
- Follow instructions on ratchet label to release pressure.
- Once pressure is released pull out webbing to allow simple future installation, then close handle and ZIP POCKET closed (this is important to prevent damage in future installation).
- Disconnect holddown straps. Remove and fold cover working from rear to front.

#### ANTI-POOLING POLE STORAGE-

- Disconnect anti-pooling pole from either the front (colored webbing) or back.
- After disconnecting collapse poles by pushing buttons and telescoping them down.
- Wrap webbing around poles.

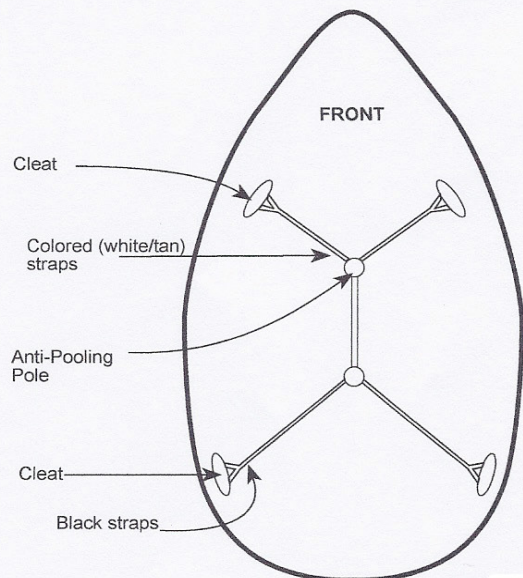

ISBLANKMOORING/R0



## Cockpit Sea-Grass Matting



If installed, cockpit sea grass mats feature urethane backing for marine environments. The mats provide style, comfort and durability as well as additional protection in environments where microbes are a concern.

Chilewich® products contain Microban®. This antimicrobial protection inhibits the growth of stain and odor-causing bacteria, mold and mildew for the product's life.

When storing your sea grass mats, always roll with the face of product out with the backing facing in. Do not fold or crease as the backing may split. Vacuum or hose off for regular cleaning. Dry face up or hang. Do not machine wash. Matting may be cleaned with a mild detergent and a sponge. Rinse with fresh water. Do not pull on material when removing from cockpit, but lift the snap instead to disengage it.

## Docking Lights



If installed docking lights are integrated into the hull near the bow on both port and starboard sides. They are very useful for night mooring approaches and maneuvering. To operate turn on the helm switch marked “docking lights”. It is recommended not to use the docking lights while navigating in open water at night since the illumination could cause a glare on the bow navigation light possibly causing visibility problems for other vessels.

LED type bulbs used in the docking lights are normally used known for long life and low lumen energy usage.

## Electronics



TYPICAL DUAL GARMIN PLOTTERS

Various electronic components are available on the vessel including single and dual chart plotters.

Each component utilizes individual operator's manuals. Refer to the appropriate electronic component operator's manual for detailed product information since the vast amount of information presented can not be covered here.

These Garmin manuals will cover features, operation, alarm and safety systems along with any cosmetic care and maintenance information.

## Fender Clips

The fender clip option features receivers integrated into the vessel hull side and quick release pins. The quick release pins attach to fenders with lines so they are ready to deploy as needed. When the vessel approaches a mooring the quick release pin with fender is attached to the receiver and pushed into place. This will help protect the boat from dock “rash” which could damage the rub rail or gel coat. When leaving the dock the pins feature a quick release mechanism which detach easily.



FENDER CLIP RECEIVER



FENDER CLIP RELEASE  
PIN

## Gas Vapor Detector



If equipped, a gas vapor detector is a state of the art fume monitoring and alarm system. It is a highly effective detector of engine compartment gasoline fumes from unburned hydrocarbons emitted from faulty exhaust systems and hydrogen battery vapors. The unit operates with a head unit at the helm, a sensor located in the bilge installed just above the normal accumulation of oily bilge water. A 3 amp fuse (for over current protection) is located behind the helm which can be accessed by lifting up the starboard bow backrest cushion.

The display panel at the helm features 3 windows. The top green window indicates the system is operational. The center yellow window indicates there is a fault in the system. This notifies the user to check the connections and wire runs of the sensor. There may be a break in the wire or the sensor may be disconnected. The lower window is the red warning indicator indicating a fume buildup of 20% of the LEL (Lower Explosive Limit) which is considered an alarm.

Should this condition last for longer than 10 seconds, the alarm horn will sound.

To check for fumes, turn the ignition key to the "on" position. the green power on LED will show on and the red warning LED may light momentarily to indicate a warm-up period for the sensor. The alarm horn will not sound during this period. The alarm will continue as long as vapors are present. The alarm horn may be silenced by pressing the "mute" switch, the the Red warning light will remain on until the vapor problem has been resolved. Note that the problem should never be considered corrected until red warning light is out.

If the red LED begins to glow softly and or intermittently, it is an indication that the gasoline vapor build-up is beginning to occur and you can anticipate a full alarm momentarily.

Immediately have all passengers and crew exit the passenger compartment. If an explosion or fire should occur, the probability of injury will be greatly reduced if no one is in a confined area of the vessel. In the event of an alarm it is important to understand that an alarm would not occur unless a problem existed. Carefully check all fuel lines, gas lines, and any other potential sources of gas leaks.

The head unit can be tested for electrical continuity by pressing the "Test" switch. The Red LED will come on. The light will glow as long as the switch is held down. If the test switch is held down longer than 10 seconds the horn will sound and the "MUTE" switch must be pushed to silence the horn. Unplug the sensor wire from the helm display head while the unit is powered up. The Red LED will illuminate and within 10-15 seconds the alarm horn will sound.

If warning Red LED fails to come on & horn fails to sound, remove display head & return to factory for repair. *Note that due to the harsh environmental conditions in marine applications, it is recommended to replace the gasoline fume sensors every 3 to 4 years.*

Refer to the equipment manufacturer's manual for additional operating information along with more troubleshooting.



## Ladder-Boarding



LADDER

The stern ladder is located under the port side of the swim platform. It is the recommended component for entering or exiting the vessel to and from the water. Be sure to use a hand hold for support as needed when on the ladder.

Never try to board using any part of the outboard motor as serious injury may occur.

When not using ladder be sure to keep the ladder locked in the framework as shown in top right photo. Insist that only one person use the ladder at a time. Periodically check the ladder hardware for tightness and corrosion. Replace fasteners and lubricate hinges as needed.

See the cosmetic care chapter regarding cleaning and preserving the stainless steel. Read and understand all warning and information labels found in the vicinity of the ladder.

To use the stern ladder grasp the ladder rung and push the ladder up and in until the ladder round pawl clears the spring loaded scalloped lock of the framework. Pull the ladder out to the end of the travel. Then flip the ladder over and let it down gently. Make sure you keep all body parts clear of any moving ladder parts especially the hinged top.

When reattaching pull the ladder up to retract the rungs. Then grasp the rung and push it into the scalloped lock and pull it down until the round pawl is secured. *Note that some resistance may be felt during both the releasing and attaching process as the ladder framework is spring loaded to complete the locking process.*



SCALLOPED LOCK



## WARNING

AVOID BODILY INJURY!  
ENSURE ALL BODY PARTS  
ARE KEPT CLEAR OF LADDER HINGING  
HARDWARE WHEN USING LADDER.

## Lazarette Storage

### FUEL SYSTEM ACCESS



The Lazarette compartment features bountiful storage for water toys, extra safety equipment, and cruising supplies. It operates through a set of actuators. It is accessed by using the hatch control switch located in the aft cockpit.



Always ensure the slide-away rear seat is in the fully aft position before activating the hatch switch.

This will prevent possible damage to the slide-away structure and the hatch.

Pressing the upper portion of the switch will lift the hatch. Pressing

the down portion of the switch will lower the hatch. Ensure that the hatch is completely down before making headway.

There is a hinged black locker in the forward center section of the Lazarette for accessing equipment including the fuel tank connections, hoses, and hardware. Fuel system components need to be inspected at least once annually,



## WARNING

AVOID SERIOUS INJURY OR DEATH FROM EXPLOSION OR FIRE RESULTING FROM LEAKING FUEL! INSPECT ENTIRE FUEL SYSTEM AT LEAST ONCE A YEAR.



## WARNING

AVOID SERIOUS INJURY OR DEATH FROM EXPLOSION OR FIRE! NEVER STORE FUEL OR FLAMMABLE LIQUIDS ON BOARD.



## CAUTION

AVOID BODILY INJURY! WHEN OPERATING HATCH KEEP ALL BODY PARTS CLEAR OF HATCH AND ALL HARDWARE.

### Lazarette Actuator Control Box

This component integrates a breaker to control the actuator cylinders used to open and close the Lazarette storage compartment. There are relays inside the control box. A breaker controls the upward cylinder travel and the other breaker controls the downward cylinder travel. The control breaker protects the relay circuit wiring.

## Port Light



If installed the D shaped head port light can be used to create cross ventilation and freshen head air. Note the locking devices located on the head side of the port light. Latch them in place when leaving the vessel.

Also, when at sea with inclement weather make sure the port light is latched to prevent water infusion.

## Power Platform



TYPICAL UNIT-UP POSITION



If installed on your vessel the power platform features the ability to lower a seat structure into the water and also extend it out a bit from the swim platform. It permits a person to sit on the seat of the platform while it is

submerged at varying degrees in the water.

There is a switch on the transom to control the movement of the platform.

*Note that the transom boarding ladder is recommended for entering and exiting the water.*

Make sure the drive is trimmed in as far as possible and the keys removed from the ignition switch before attempting to use the power platform. Use the platform for sitting only. Do not stand, jump, or dive from the device. There is a 20 amp fuse part of a fuse panel located on the battery management panel board accessible through the engine hatch.

*Supervise small children around power platform!*



## CAUTION

AVOID INJURY OR PROPERTY DAMAGE!  
ENSURE THAT POWER PLATFORM IS IN  
THE UP POSITION  
AND CLEAR OF ALL OBJECTS  
BEFORE STARTING THE ENGINE!



## CAUTION

AVOID INJURY OR PROPERTY DAMAGE  
DUE TO IMPROPER OPERATION!  
STERN DRIVE MUST BE TRIMMED  
BELOW 20 DEGREES  
OR FULLY CENTERED  
TO OPERATE POWER PLATFORM.  
ENGINE MUST BE OFF.



## PowerTower- Typical

The PowerTower hinges forward for tight overhead clearances such as bridges, restricted storage situations and towing opportunities. The PowerTower features an aluminum framework with a multi-layered powder coated finishing process. Read and understand the warning label on the following pages regarding PowerTower usage.

The PowerTower features an FRP framework, all around light, and the ability to anchor major electronic equipment. Select towers feature a pylon for water sports. Use the switch marked “tower” found on helm panel to energize the PowerTower. It connects to twin actuators that raise or lower the PowerTower.

Located at the aft starboard battery management



board (engine compartment) is the PowerTower actuator control box. The purpose of this device is to provide overload protection for the port and starboard actuators

that energize the rams to move the PowerTower forward and aft.

Facing the box the left reset breaker protects the port power tower lift actuator. The center reset breaker protects the starboard power tower lift actuator.

The far right breaker protects the entire circuit wiring including the helm. If the PowerTower fails to raise check the box for an “open” breaker. Always find the cause of an open breaker situation before resetting the device.



TYPICAL POWERTOWER



# CAUTION

WHEN OPERATING POWERTOWER  
KEEP ALL BODY PARTS CLEAR  
OF TOWER HINGE MECHANISMS.

Make sure the operator and all aboard read and understand the above warning.

As the operator energizes the switch to hinge the tower forward visually monitor the port and starboard aft deck to ensure all passengers are clear of the hinge mechanism. This same procedure applies for raising the mechanism to the cruise position.

For highway towing the PowerTower shall be in the complete forward position and all canvas shall be in their dedicated boots. All attached canvas bow hardware shall be checked for tightness before and after towing. Cockpit carpet shall be rolled up and stored in a dedicated cockpit locker.





**AVOID BODILY INJURY OR DEATH DUE TO MISUSE OF THE POWERTOWER!**

**READ AND UNDERSTAND THE FOLLOWING WARNING!**

DO NOT PULL MORE THAN ONE (1) PERSON AT A TIME FROM THE POWERTOWER. USE POWERTOWER ONLY FOR KNEEBOARDING, WATER SKIING, WAKEBOARDING OR WAKE SURFING. THIS POWERTOWER WAS NOT DESIGNED AND SHALL NOT BE USED FOR TUBING, TOWING OF BOATS, PERSONAL WATERCRAFTS, FLOATING DOCKS OR ANY OTHER TYPE OF FLOATING VESSEL OR CRAFT. THIS POWERTOWER SHALL NOT BE USED FOR PULLING PARASAILING OR ANY OTHER EQUIPMENT NOT APPROVED.

THIS POWERTOWER SHALL NOT BE USED TO PULL INFLATABLE WATER SPORTS TOYS OF ANY KIND. NEVER LET PASSENGERS SIT DIRECTLY BEHIND THE POWERTOWER ROPE ATTACHMENT POINT WHILE PULLING APPROVED WATER SPORTS ACTIVITIES. DO NOT LET LOOSE WATER SPORTS ROPE HANG FROM THE POWERTOWER. ALWAYS INSPECT THE POWERTOWER PRIOR TO USE TO ENSURE IT IS NOT DEFORMED, DEFLECTED, AND THAT ALL BOLTS ARE IN PLACE AND TIGHT. WATER LEVELS CAN VARY DAILY AND IN SOME CASES HOURLY.

BE AWARE OF MINIMUM CLEARANCE OF BRIDGES, TREE LIMBS, AND OTHER OBSTACLES, BEFORE ATTEMPTING TO PASS OR GO UNDER ANY OVERHEAD STRUCTURE. WHEN TOWING KEEP POWERTOWER IN THE FURTHEST FORWARD POSITION.

READ AND UNDERSTAND ALL SAFETY LABELS REGARDING THE POWERTOWER IN THIS OWNER'S MANUAL!

## PowerHardtop- Typical



TYPICAL POWERHARDTOP UP POSITION



TYPICAL POWERHARDTOP DOWN POSITION

The PowerHardtop up (rear) position features the ability to provide sun protection and increased cross ventilation while cruising or at dockside.

The down (forward) position provides increased cockpit shade and protection from the elements while cruising. If towing the lower positioning may aid mileage due to less friction.

The unit features the ability to balance itself while hinging forward or aft to a desired height. Note there are 2 handles on the port and starboard interior stanchions. When both unlocked and in a full open position provide the ability to lower or heighten the PowerHardtop.

## PowerHardtop Operation



To lower the unit pull out on either of the handles to unlock it. Turn the handle counterclockwise 270 degrees or about 3/4 of a turn to the left and the handle should be facing up.

Perform the same sequence with the other handle. Once both handles are in the up facing position the top can be physically moved to the desired position.



HANDLE UP FACING FULL OPEN POSITION

Once desired position is obtained reverse the process to lock the handles in place.

## Pressurized Water System

*Note that the water system is non-potable (not for drinking).* If installed the pressurized water system may include a deck fill plate, water tank, hoses, pressure pump and sediment filter, head sink w/ faucet and transom shower.

The aluminum water tank is located in the forward center bilge. The pressure pump and sediment filter are normally mounted in the bilge. Periodically clean the filter and screen if installed. Reinstall filter and check for leaks.

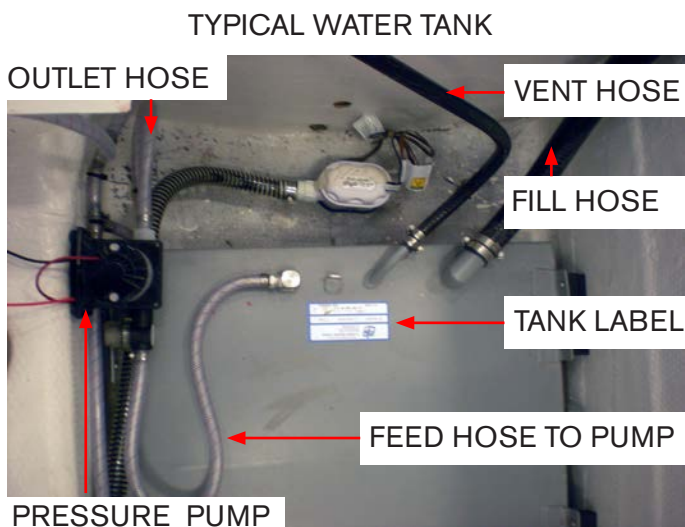

### Using Pressurized Water System

1. The tank capacity varies by model. Fill the water tank at the deck fill plate. You might want to use a white hose manufactured specifically for pressurized water. These hoses are available in 25, 50 and 100 foot increments at marinas, marine retailers, RV dealers and big box stores. They do not leave marks on the deck and do not carry a rubber odor. As you look into the deck fill you will see a vent hole. Once the tank is nearly full water will emerge from the vent hole and re-enter the fill.

Shut the fill cap and line up the two dimples on the cap and fill plate to seal the system from foreign debris.

2. At the helm switch panel activate the water system switch. This will energize the water pressure pump to send water from the water tank through the cold water lines terminating at the head faucet and transom shower.

3. Open the head faucet. Water pressure should be present. Opening the faucet for a few seconds will purge any air in the system especially in cases where the fresh water tank has run out of water. When water is running at a faucet it is not unusual to hear the water pump activate as it is trying to build up the pressure required in the system. Soon after the faucet is turned off the fresh water pump sound will end indicating the water system is now up to specified system pressure.

4. This entire water system is not meant for consumption (non-drinkable) and does not



meet the requirements of the U.S. Public Health Drinking Water Standards. This symbol found at the optional head and transom shower is a reminder to

passengers not to drink the water. It is for cleaning purposes only.

## Typical Water Pressure Pump



FILTER

A majority of these pressure pumps use a switch which disengages the water pump after it reaches a predetermined line pressure. If the water pump ever runs continuously it may be a result of the following:

- A faulty internal pressure relief valve
- A faucet on board not turned off
- A broken line or loose line connection

It is recommended that the water pressure pump switch be in the "off" position when leaving your vessel to help prevent damage should a leak develop in the cold water system.

## NOTICE

AVOID COMPONENT DAMAGE!  
NEVER RUN THE WATER PUMP  
WITHOUT WATER IN THE WATER  
TANK AS PRESSURIZED WATER SYSTEM  
DAMAGE MAY OCCUR.



## CAUTION

PREVENT PROPERTY DAMAGE!  
TURN OFF WATER SWITCH  
AT HELM PANEL  
BEFORE LEAVING THE VESSEL

## Sanitizing Water System

It is recommended to sanitize your vessel water system at least annually or more often when odors are detected.

1. Flush entire system thoroughly by allowing water to flow through it.
2. Drain system completely.
3. Fill entire system with a chlorine solution having a strength of at least 100 parts per million, and allow to stand for (1) hour. Shorter periods will require greater concentrations of chlorine solutions. See the table.  
As a rule of thumb quick reference without the use of the table to reach the recommended proportions use a quarter cup of household bleach for every 15 gallons of water the fresh water tank holds.
4. Drain chlorine solution from entire system.
5. Flush entire system thoroughly with water.
6. Fill system with fresh water.

TABLE I – CHLORINE CONCENTRATIONS

Amount of chlorine compound required for 100 ppm solution

Solution (Gallons)	Chlorinated Lime 25% (ounces)	High Test Calcium Hypochlorite 70% (ounces)	Liquid Sodium Hypochlorite 1% (quarts)
5	0.3	0.1	0.2
10	0.6	0.2	0.4
15	0.9	0.3	0.6
20	1.2	0.4	0.8
30	1.8	0.6	1.2
50	3.0	1.0	2.0
100	6.0	2.0	4.0

## Winterizing Water System

*Note that In freezing climates make sure the water system is winterized to prevent damage to hoses and components. Contact your Regal dealer since only special alcohol based products like “Winter Ban” are to be used in the system.*

DANGER

AVOID BODILY INJURY OR DEATH DUE TO POISON! NEVER USE AUTOMOTIVE TYPE ANTIFREEZE IN A WATER SYSTEM SINCE IT IS POISONOUS TO THE HUMAN BODY!



## Pressurized Water System-Helpful Hints



1. Water pressure pump cycles on and off. Normally this type of action indicates a water leak in the system.

Check all water system related equipment on the deck and engine compartment for leaks. Look for puddled or dripping water.

2. Using water system the water pressure is weak. Check the fresh water pressure pump filter for debris. Also, make sure the water tank level is sufficient.

3. Water at sink or transom shower is hammering and has air bubbles in it. Check for air leaks in the system along with low water levels in the water tank.

4. There is no water at any of the water related equipment including head faucet or transom shower. Check to make sure the water pressure pump switch is activated. Also, check for a blown fuse.

5. The water system has a bad odor. Use the pressurized water pressure pump to drain the water system. *Do not permit anyone to drink the water as it may be contaminated and it is not a potable water system. Sanitize the water system as needed.*

## SeaDek

As an option SeaDek® is featured on select vessel swim platform and walk through areas. The non-skid, closed cell material is derived from UV protected non-absorbent foam. You will find the product easy to clean with a high stain resistance.

Other features include noise reduction, great traction even when wet, body comfort when standing, walking or leaning on the swim platform.

To clean small dirt particles first try soap, hot water and a stiff brush.

For surface dirt and footprints use glass cleaner and a clean rag.

If a more thorough cleaning is needed you may use bleach, 409, Simple Green or Soft Scrub. Be sure to rinse thoroughly. Stay away from using any acid base cleaners.

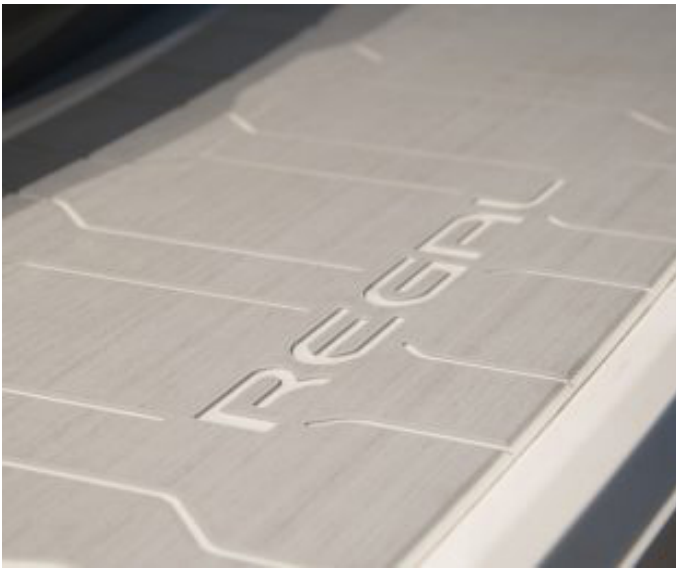

## Seakeeper (Typical) LX6

If installed, the Seakeeper 1 unit uses gyroscopic principles to reduce boat motions in waves and wakes independent of boat speeds. A typical unit consists of a Gyro assembly, a CAN communications cable, and displays.

The Seakeeper unit is located under the center Lazarette storage area of your vessel. The unit's cycling is regulated by an electronic controller and a hydraulic brake throughout each roll cycle to supply maximum anti-roll torque and limits mechanical contact with the hard stops that regulate gimbals angle travel. Seakeeper operates from 12 volt DC (direct current) and the unit is part of the **accessory house battery** circuitry. A dedicated 80 amp breaker is located at the battery management panel.

### Seakeeper Display

The **main** display is located in the Lazarette area for more *specific* maintenance/programming needs.

To use the Lazarette display do the following:

After 12 volt power is present the Seakeeper screen will energize and a home screen will appear. Here the ON/OFF touch screen button will appear grey (OFF). Once the button is pressed it will change to blue (ON) and menu button is used.

An **auxiliary** Seakeeper display is used for *basic* operation and shutdown at the Garmin helm chart plotter. The display provides information only in the event of an alarm. Select alarms can cause precession to stop and start the unit to coast down. Note that alarms can only in addressed at the Lazarette MFD panel.

To use the Seakeeper helm display the Garmin chartplotter needs to be activated. The home screen will appear. Choose the AV/Gauges display. The Seakeeper tab will appear. Activate the Seakeeper tab. Press the power button and it will turn color. A progress bar will appear and indicate the length of time before the Seakeeper unit is available for stabilization. Once the unit is initialized and up to stabilization RPM the STABILIZE button will illuminate and pulse. At this point the stabilization cycle is started by pressing the STABILIZE button.



## WARNING

AVOID SERIOUS INJURY!  
DO NOT REMOVE THE COVERS FROM  
THE UNIT OR CONTACT ANY PARTS  
WHILE THE UNIT IS PRECESSING.  
MAINTENANCE SHOULD NOT BE DONE  
UNLESS THE SEAKEEPER IS LOCKED AND  
FLYWHEEL HAS STOPPED SPINNING.



## WARNING

AVOID SERIOUS INJURY!  
ENSURE ALL BODY PARTS & CLOTHING  
ARE KEPT CLEAR OF THE SEAKEEPER  
WHILE IT IS CYCLING.

For further detailed information on Seakeeper 1 refer to the Seakeeper operator's manual or the manufacturer's web-site.

See Chapter 8 for recommended Seakeeper system maintenance plan and schedule.

## Seat- Aft Bench/Sun Lounge



The aft bench seats feature multi-function capability.

They can be converted to a sun lounge position and the aft seat fillers can be positioned to face aft.

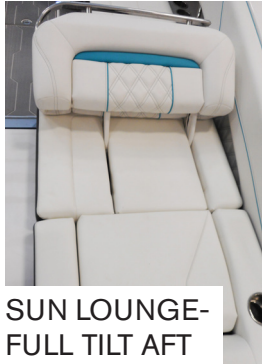

SUN LOUNGE-  
FULL TILT AFT

From the normal sitting position facing forward the seats can be converted to a sun lounge.

To convert find the seat latch on the vertical surface of the desired seat. Press the latch and while pulling back on the seat itself. It will tilt back to a partial lounge position. When latch is activated again and held down the seat will push down into a full tilt aft facing lounge.



*Note that these sun lounge aft facing positions are not to be occupied when the vessel is underway.*



To convert the seat to a sitting position *aft* pull up on the aft seat cushion. On the forward side of the cushion is a backrest support panel.

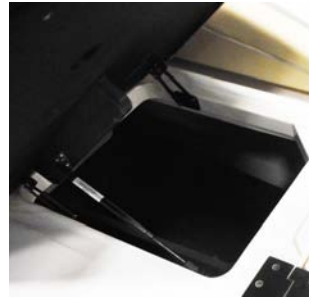

The panel holds the backrest in a pre-set position. Raise the panel until the it latches in the pre-fitted backrest grooves.

*Note that the port and starboard aft starboard cushions lift for accessibility to storage or equipment.*

The starboard aft cushion offers access to selected direct current components including the battery switch. When leaving the vessel it is recommended that the battery switch be turned to the “off” position. The automatic bilge pump and stereo memory circuits will still function with the battery switch deactivated.

## Seat- Captain/Helm



The captain's seat offers multiple features. The seat is double wide; enough room for two people comfortably. The seat structure permits the backrest to also serve as a lounge seat with the backrest in the forward position. In addition, select seats use a hydraulic system to lift the seat for enhanced visibility and body differences. On the helm switch panel if installed press the upper portion of the captain seat switch and hold it. The seat will start to elevate. The bottom portion of the switch will lower the seat. The captain's seat can be adjusted fore and aft with a lever under the front cushion. Push the lever to the right and move the seat to the desired detent. This accommodates shorter and taller body frames.

For the safety of the crew and captain never sit on the top of the seat as you could lose control of the throttle and/or the steering wheel. Either stand or use the leaning post especially when close maneuvering is required in tight quarters. Select seats offer storage under the chair cushion.

Note select passengers feature the leaning post.



*Note that it is the captain's responsibility when making headway to attach the safety lanyard and shall make sure all passengers are in designated seats and PFD's are worn by everyone aboard.*

### Bow Seat Arm Rests

*On selected models bow seating includes arm rests. To use pull the arm rest down until completely extended.*





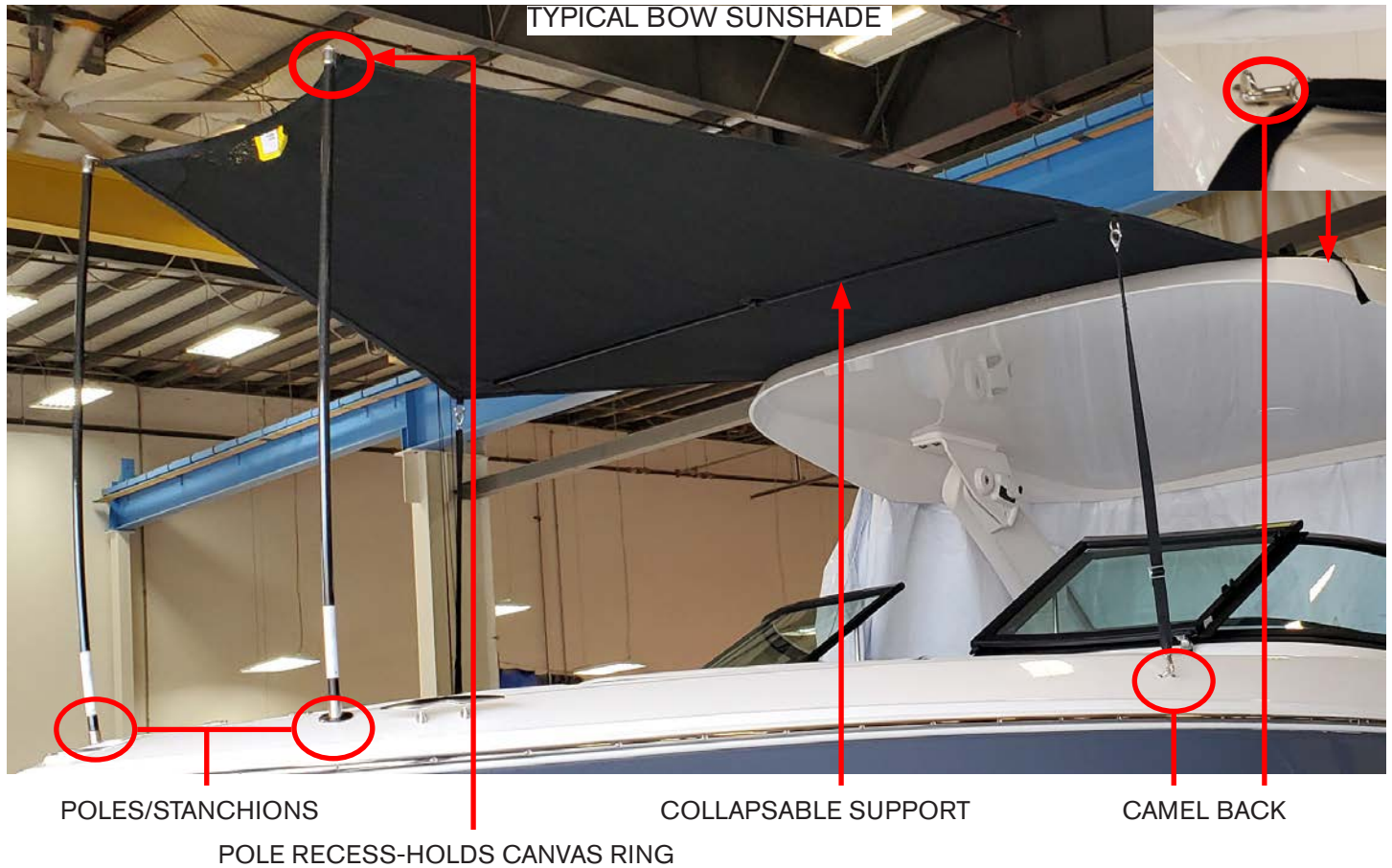

### Introduction

A manual sunshade system option is available on select models. On the LX4 the manual system is available for the bow location. On the LX6 the manual system is available for both both and stern locations. Note that the bow system shown above and the stern system when installed use similar parts and installation procedures.

Read and understand the safety label below.

	<b>WARNING</b>
AVOID SERIOUS INJURY AND/OR PROPERTY DAMAGE! ONLY USE THE MANUAL SUNSHADE SYSTEM WHEN ANCHORED OR ADRIFT.	

## System Installation

Refer to the photo on the previous page for installation tips. For further information contact your closest authorized Regal dealer.

The main system components integrate reinforced canvas with straps, carbon-fiber flexible poles, retainer rings, camel backs, and stanchions. Note that the sunshade system is only available on select vessels with hardtops.

To install the bow sunshade do the following:

1. Connect the hardtop canvas latches to the camel backs sewn into the canvas on both the port and starboard forward ends of the hardtop. See A.

2. Note that the carbon fiber poles are designed to be collapsable. To install open the poles to the fully extended position.

3. Install each of the poles in the forward sewn in rings at the forward canvas corners. Once the poles are inserted into the ring retainers check that they are positioned firmly. See B.

4. Raise each pole and insert the bottom end into the deck mounted stanchion. Note that the poles are normally in a bent position when installed which will assist additionally in holding the retaining ring at the top of each pole. See C.

5. Latch the collapsable support that extends across the sunshade canvas. This support adds stability to the sunshade and holds its shape while positioned. See the photo on the previous page.

5. Once the poles are positioned in the deck stanchions connect the port and starboard middle straps to the deck mounted camel backs and tighten each strap as needed. See D.

6. If installed use a similar installation procedure with the stern sunshade.

7. Store system components in a dry bilge location when not in use.

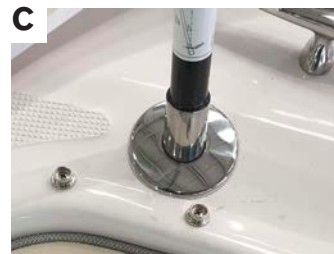
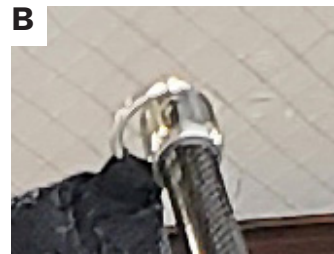

## Table-Teak

If installed the teak bow table is found in a cockpit locker. The table features teak a hardwood known for beauty and durability in the harsh marine environment.

1

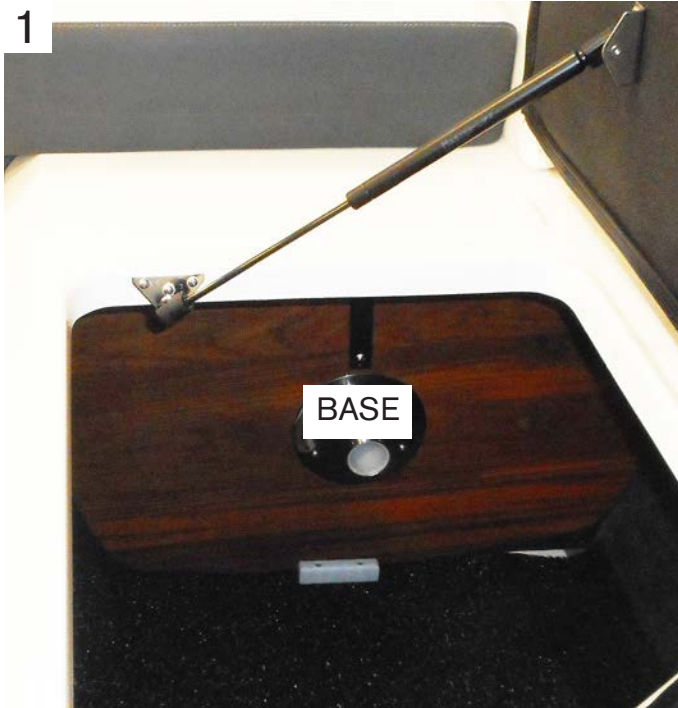

2

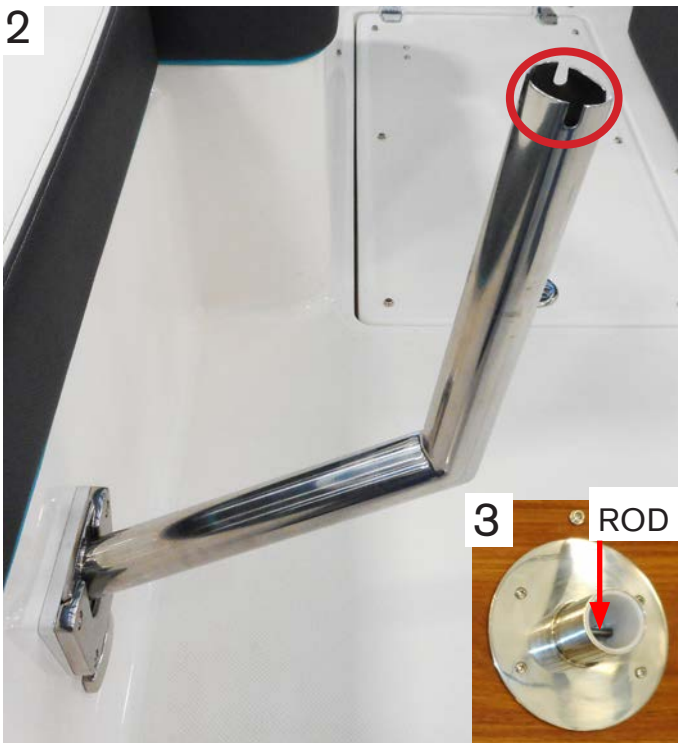

## Setting Up Table

1. Remove the table from the cockpit storage area. You will need to move the cooler for table access. Unsnap the holding strap and pull out the table.
2. Locate the table leg under the starboard cockpit seat. Unfasten it from the 2 hold down clamps. Insert the leg into a table holder. Note that the table leg features 4 cut outs at the top.
3. The table base features an alignment rod through the top of the base as shown.
4. The table must be inserted down into one of the two sets of holes depending on how the table fits the seating arrangement. The rod when attached to the table will prevent the table from turning while in use. Ensure that the table is down completely into the rod before placing items on the table.
5. To disassemble the table reverse the process.



*Note that it is recommended that the table assembly be stored before making a cruise due to possible rough seas or other adverse weather conditions.*

## Thruster-Bow



BOW THRUSTER- VIEW FROM SKI LOCKER

If installed the electric bow thruster provides increased maneuverability around the dock area. The composite 5 blade propeller design permits thrust in both port and starboard directions with the use of a helm controlled joy stick. The unit provides smooth, quiet, and efficient performance.

The bow thruster motor and hub assembly are located at the forward bow hull area accessible through the ski locker. See the photo above. An integrated exterior hull tunnel tube houses a propeller which assures efficient propulsion in port and starboard directions. The propeller and its hardware are accessible for maintenance purposes through the hull tunnel tube.

***Note to read and understand the bow thruster operator's manual before using the unit.***



## WARNING

AVOID SERIOUS INJURY  
DUE TO ROTATING PARTS!  
TURN OFF THE MAIN THRUSTER BATTERY  
SWITCH BEFORE PERFORMING ANY  
THRUSTER PROPELLER, MOTOR OR HUB  
MANINTENANCE!

## Thruster User Tips

1. Never operate the thruster out of the water.
2. Do not move the joystick to port and starboard in quick succession as the motor may become damaged.
3. When removing the propeller for maintenance or replacement purposes, make sure to reassemble parts in correct order. If unsure use the operator manual to guide you.
4. When inspecting propeller ensure it is centered in the tunnel and is not touching the tunnel itself
5. To prevent electrolytic corrosion of faults. the thruster motor body and assembly must remain isolated from any power supply or grounds. Check the operator manual for further details.
6. Periodically check the battery cable connections for correct torque. Always reinstall rubber boots to cover any exposed wires.
7. Check the propeller for debris especially in high salt areas as barnacles can build up especially during times of non-use.
8. Use the bow thruster in low density areas when learning to maneuver around docks and marinas.



## WARNING

AVOID SERIOUS INJURY!  
NEVER OPERATE IN THE VICINITY  
OF SWIMMERS  
AS POWERFUL SUCTIONIS GENERATED  
AS THRUSTER IS OPERATED.



## Thruster Joystick Operation

When activated the joystick is used to provide thrust to the bow thruster propeller in a port or starboard cycle.

1. To operate joystick the bow thruster main battery switch must be turned to the "on" position.

2. To activate the joystick panel press and release the ON/OFF button. The LED light on the panel will illuminate indicating the panel is activated. At this point you are ready to operate the joystick.

3. Ensure there are no swimmers, divers or debris in the nearby vicinity and the boat is in a balanced position with passengers in their seats. Ensure that the boat is not close to other vessels.

4. Positioning the joystick to port (left) will turn the thruster propeller in a counterclockwise direction resulting in the bow of the boat moving to port.

Positioning the joystick to starboard (right) will turn the thruster propeller in a clockwise direction resulting in the bow of the boat moving to starboard.

Note: As long as the joystick is held in the port or starboard position it will continue to maneuver the boat in that general direction. When the joystick is released it will assume a neutral (non-thrusting) position with power still retained at the panel.

5. To deactivate the joystick panel, press and release the ON/OFF button. At this point the LED light will turn off indicating the joystick panel is off.



TYPICAL BOW THRUSTER JOYSTICK

6. Note when the vessel main battery switch is deactivated (turned to the OFF position) the thruster switch is also deactivated even if it is in the ON position. It is recommended that when leaving the vessel after an outing ensure that all battery switches are turned to the OFF position.

***Remember with all battery switches in the OFF position both bilge pumps will remain active in the automatic position for extended periods.***



## Toilet- Electric (Typical)



TYPICAL ELECTRIC TOILET OVERVIEW

### Introduction

If installed the electric toilet (head) uses turbine technology to produce a clog-resistant, powerful flush. It integrates an efficient small footprint resulting in the same features of larger units.

The toilet draws clean water from the fresh water tank through a solenoid to fill the bowl. A wall rocker type switch operates toilet flushing cycle.



TYPICAL PUMP-OUT WASTE FITTING/VENT

As an option a deck mounted pump-out fitting is used and is labeled "waste". When the holding tank is full as indicated by the wall rocker switch a marina or pump out station can attach a hose to the waste fitting. When activated a pump will evacuate waste from the holding tank.

If installed a macerator system featuring an overboard discharge pump uses an impeller to grind up waste and send it to the holding tank or through the hull bottom via a seacock fitting during the overboard discharge process. Note the seacock must be in the "open" position to use the overboard discharge feature. It is recommended to secure the seacock in a closed position after an overboard discharge cycle. You might want to keep a pack of zip ties in the bilge tied to the seacock for this purpose. With the seacock secured closed it adds an extra layer of protection for following discharge regulations.

The macerator pump is integrated behind the toilet lower base. The pump is replaceable.



## WARNING

ALWAYS CHECK WITH LOCAL, STATE AND COUNTRY WASTE DUMPING REGULATIONS/AUTHORITIES BEFORE ATTEMPTING TO PUMP WASTE OVERBOARD!

The toilet (head) electrical system is connected to the *house battery system thus using a 12 volt DC power supply*. The head is protected by a 30 amp resettable breaker on the D.C. distribution panel located at the battery management panel.

If installed the macerator (overboard discharge pump) is protected by a 10 amp resettable breaker on the D.C. distribution panel located at the battery management panel.

## Operating Electric Toilet

The wall control switch is used to add water to the bowl and to flush the toilet. Select cycle information is noted here. For more complete information, refer to the electric toilet operator's manual located in the information packet.



1. To add water (est. 17 ounces per cycle) to the bowl before flushing human waste press the add water button momentarily and release. The system fills but prevents overfilling the bowl.

2. To flush the bowl press the flush button momentarily and release. The attached bowl motor will inject the waste and flush it. The cycle ends with a small amount of water being added to the bowl to help prevent odors. This completes the minimal water usage flush cycle.

## Wall Control Panel Blue Backlighting Description:

- The holding tank icon in the lower right hand corner of the control panel is not lighted. Toilet system is off or not receiving power.
- The holding tank icon is normally green. This means the holding tank is less than full.
- The holding tank icon is red. The holding tank is full or near full with the flush lockout (prevents Flush operation when holding tank is full) activated.
- Tank icon flashes.
- Sleep mode (non-use for 8 hours) causes the lights to go out. Pushing the fill or flush button momentarily will return lighting cycle.

## Single Flush Override of Flush Lockout

1. If the holding tank is full the flush lockout cycle will not allow the bowl to be flushed and the flush button will be lighted red.

2. **For emergency use only** the flush button can be held for 8 seconds and a flush will occur. This can be accomplished because the full sensor connected to the holding tank is usually placed a bit below the actual full capacity of the tank. Flushing more than 5 times using the override feature may force waste into plumbing system. Regal is not responsible for damage to equipment, injury or death due to overflow of waste when flush lockout is overridden.

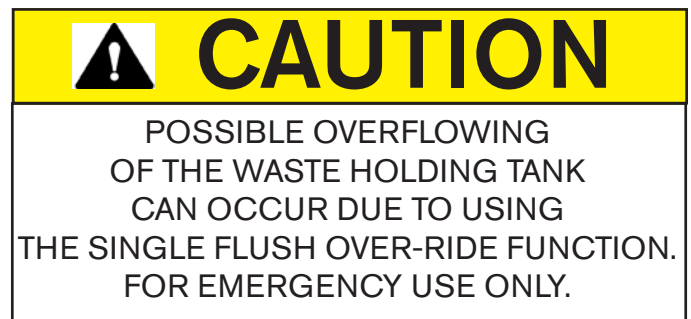

## Monitor Panel Option



KEY GAUGE MOMENTARY SWITCH  
PUMP-OUT BUTTON

The monitor panel normally is located on the head upper cabinetry. It is a multi-function component but also offers a check for the potable water and waste tanks. To check the waste tank black water level press the lower part of the momentary switch shown in the above photo and check the gauge.

It will help you determine when to pump out the waste tank. The top segment of the switch measures the fresh water tank level. Always check water and waste tank levels before each cruise.

HOSE FROM  
MACERATOR



SEA COCK IN  
CLOSED  
POSITION

MACERATOR SEACOCK AT  
HULL BOTTOM

## Operation- Overboard Discharge

As an option the vessel may be outfitted with an overboard discharge system including macerator. Waste will exit the hull through the macerator sea cock when turned to the open position.

To pump overboard notice there is a key switch and red button on the monitor panel. Turn the key to the "on" position. Next, press the red button and hold it as the macerator pumps the waste through the hull bottom sea cock. Check the waste portion of the monitor panel as the gauge should show empty. The reset breaker on the monitor panel protects the power to the gauge. The macerator grinds up the waste and sends it through the hull bottom via the open macerator sea cock. See the photo.

NOTE: The macerator seacock shown may not look identical to the one installed on your vessel.

In general when a seacock handle is in line (straight up) is in the open or "on" position. When the handle is at 90 degrees to a straight up position is considered closed or "off".



## WARNING

ALWAYS CHECK WITH LOCAL, STATE AND  
COUNTRY WASTE DUMPING REGULATIONS/  
AUTHORITIES  
BEFORE ATTEMPTING TO PUMP WASTE  
OVERBOARD!

## Waste Tank (Typical Electric Toilet System)

### Overview

The waste water system on your vessel is located in the starboard bilge. The system features a pump-out fitting mounted on the deck labeled “waste”.

A monitor panel shared with the fresh water system displays the waste tank level when activated. Press the lower portion of the switch and read the gauge waste level. The waste tank can be pumped out at select marine facilities. Normally a hose is attached to the deck waste fitting and the tank waste is then pumped into a dock side facility storage container.

After the pump out procedure use a garden hose and nozzle to rinse the pump out hose before recapping the waste fitting. This will assist in reducing residue build up in the inside of the waste hose.

### Overboard Discharge System

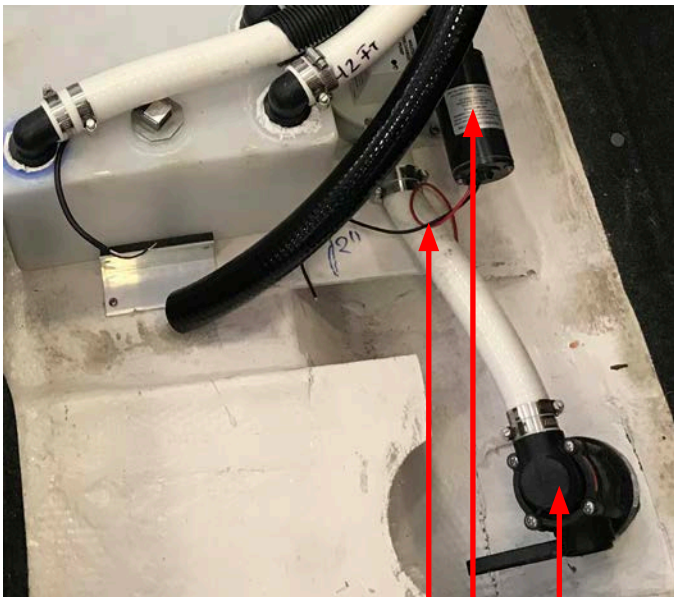

HOSE TO SEACOCK  
OVERBOARD DISCHARGE  
PUMP/MACERATOR  
SEACOCK

## Waste Tank (Hose Function)

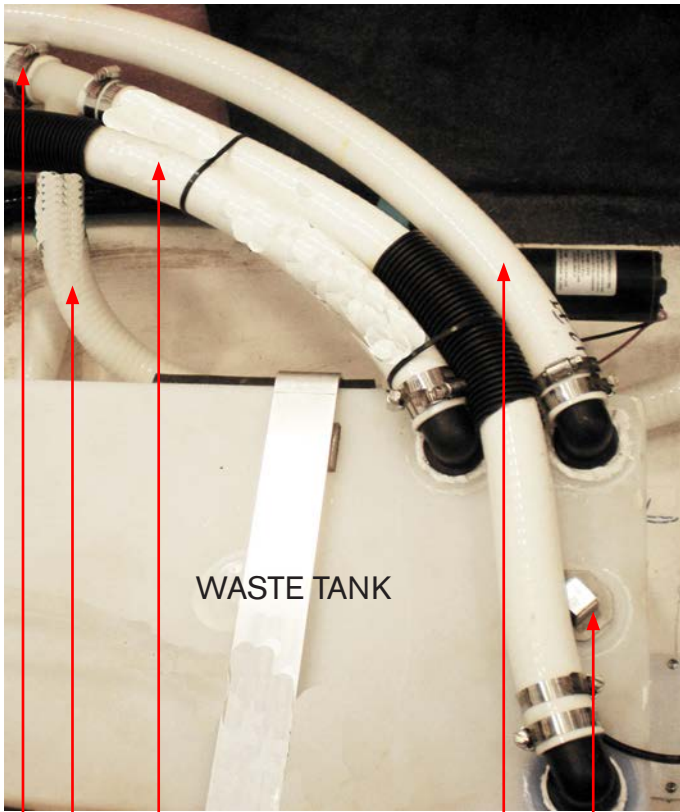

WASTE TANK

VENT HOSE

HOSE FROM TOILET

SENDER

HOSE (TEE) TO PUMP OUT/ OPTIONAL  
OVERBOARD DISCHARGE

HOSE TO DECK PUMP-OUT FITTING



## Vent Line Filter-Waste Tank



INLET UNION

UNION OUTLET

The waste (holding) tank filter is in-line between the holding tank vent and in this case a starboard routing to a waste vent exterior fitting (exit hose missing above).

As the holding tank fills up with waste it gives off odors. The vent filter breaks down the odors with its unique charcoal absorption system.

The waste filter is “customer friendly” as it is designed with a union at each end for changing out the filter. The unions unscrew counter clockwise for serviceability. It is recommended to change the filter yearly, normally at the end of your boating season. Mark the change date on the filter or on your vessel maintenance calendar.

It is a good habit to carry an extra filter onboard. For further information on availability contact your closest Regal dealer or maine retail outlet.

## A Few Notations About Marine Toilets

Only human waste and toilet paper should be put in the toilet. Never flush foreign materials such as paper towels, pre-moistened wipes, condoms, feminine hygiene products, dental floss or household garbage down the toilet.

- Always disconnect the dock side water system if boat is left unattended to avoid property damage due to leakage.
- Refill the toilet as soon as possible after emptying the bowl to prevent objectionable odors.
- Use only RV-Marine toilet tissues that disintegrate rapidly. Do not use household type tissues.
- If repairs are needed, use only a trained and qualified marine technician or electrician.

## Underwater Lighting



As an option light bars w/ blue or white LED clusters make up the underwater lighting system. The lights are located on the transom along with the port and starboard hull sides. There is a dash switch for energizing the lights and a breaker behind the dash to protect the system.



The underwater light option provides high output, long life and low heat emission.

The lights are made from a high impact resistant polycarbonate housing. The lights are installed under the transom for maximum efficiency. A blue beam increases underwater penetration.

These lights are based on LED technology which stands for light emitting diode which can produce various colors depending on the electron makeup inside the semiconductor body of the device.

## Water Sport Tow Pylon

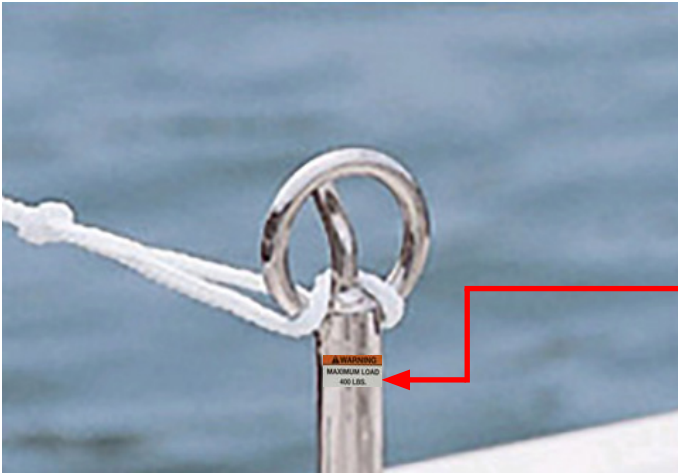

TYPICAL WATER SPORT TOW PYLON

As an option a water sports pylon may be installed on your vessel. Read and understand the warning label and installation instructions prior to using the pylon.



*Note the correct line end loop configuration above for water sports activity. Always use a 3rd person spotter to keep a constant lookout for the person engaged in water sports. Do not pull more than 1 person at a time from the pylon. Use pylon only for kneeboarding, water skiing, wakeboarding or wake surfing.*



Do not exceed the pylon maximum pull load of 400 pounds as stated in the above warning label.

## Ski Pylon Over Ride Switch



The ski pylon over ride switch is normally located at the helm area forward of the remote control on the gunnel bolster pad. When the outboard is trimmed/tilted to a set angle the trim/tilt switch stops to prevent the outboard shroud (cover) from contacting and possibly damaging the ski pylon.

To continue trimming/tilting press both the over ride switch and the outboard trim/tilt switch.

Note that if the ski pylon is not installed the above steps still must be followed to trim/tilt the drive beyond the stop angle.

## HardTop Wakeboard Storage

Storage solution for up to two wake surfboards to be stored on top of the hardtop. Complete with two EVA foam pads with integrated strap system to secure your boards.

To Use: Insert Board underneath strap system. Tighten both front and rear straps over the board. Shake board to check for fitment. If board feels loose, tighten straps accordingly. To remove the board, unbuckle rear strap and slide the board aft out of the strap. When not in use, remove straps from camelbacks and secure in storage. This prevents wind damage while trailering and driving.



## WakeSubs

Two ported subwoofer boxes that are integrated into the existing sound system. Each subwoofer box, one located on the port side and one on the starboard side in the sump, are ported into the aft tubs outboard of the rear facing transom seats.

To Use: WakeSubs are integrated into the existing sound system. They are controlled via the subwoofer outputs on both zones 2 and 3.

Troubleshooting: If WakeSubs are not working ensure that Zone 2 and Zone 3 both have subwoofer outputs on.



# Portside Handle Instructions Power Hardtop

## RESET PROCEDURE

FOR ISSUES LOCKING HANDLE IN EITHER POSITION (TRAILER LOCK AND/OR TOWER UP)

STEP 1 - ROTATE THE ROOF AWAY FROM BOTH UPRIGHT AND LOWERED STOPS.

STEP 2 - ROTATE THE HANDLE CLOCKWISE UNTIL IT STOPS. ALIGN HANDLE ARROW WITH RESET MARK.

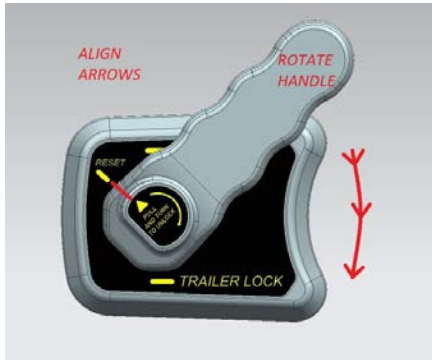

STEP 3 - ROTATE ROOF TO DESIRED POSITION (TOWER-UP OR TRAILER)

TOWER-UP - FOLLOW ADDITIONAL STEPS 2-4

TRAILER - FOLLOW ADDITIONAL STEPS 3-4

## TOWER-UP PROCEDURE

STARTING POSITION - TRAILER LOCK



STEP 1 - ROTATE THE HANDLE CLOCKWISE UNTIL IT STOPS. ALIGN HANDLE ARROW WITH RESET MARK.

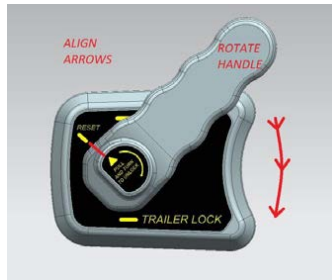

STEP 2 - MANUALLY ROTATE THE ROOF CLOCKWISE. FULLY ROTATE UNTIL IT STOPS.

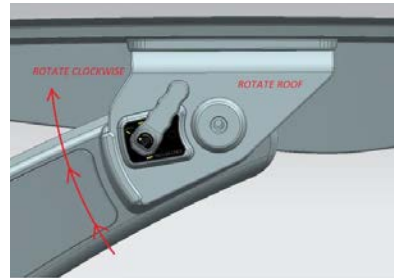

## TRAILER PROCEDURE

STARTING POSITION - OPERATING / TOWER UP



STEP 1 - PULL HANDLE OUT

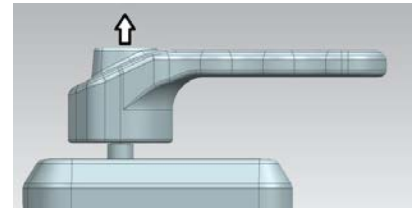

STEP 2 - ROTATE THE HANDLE CLOCKWISE UNTIL IT STOPS. ALIGN HANDLE ARROW WITH RESET MARK.

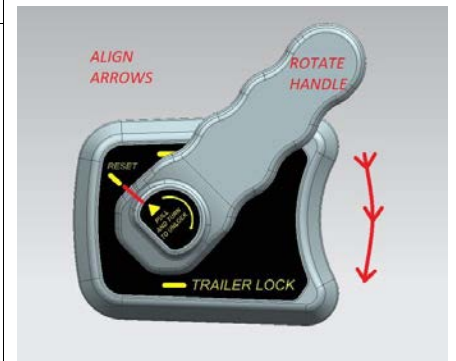

# Starboard Handle Instructions Power Hardtop

## RESET PROCEDURE

FOR ISSUES LOCKING HANDLE IN EITHER POSITION (TRAILER LOCK AND/OR TOWER UP)

STEP 1 - ROTATE THE ROOF AWAY FROM BOTH UPRIGHT AND LOWERED STOPS.

STEP 2 - ROTATE THE HANDLE COUNTER CLOCKWISE UNTIL IT STOPS. ALIGN HANDLE ARROW WITH RESET MARK.

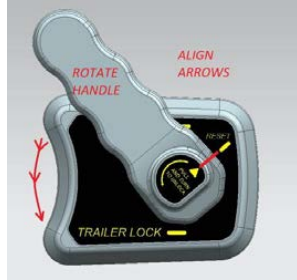

STEP 3 - ROTATE ROOF TO DESIRED POSITION (TOWER-UP OR TRAILER)

TOWER-UP - FOLLOW ADDITIONAL STEPS 2-4

TRAILER - FOLLOW ADDITIONAL STEPS 3-4

## TOWER-UP PROCEDURE

STARTING POSITION - TRAILER LOCK



STEP 1 - ROTATE THE HANDLE COUNTER CLOCKWISE UNTIL IT STOPS. ALIGN HANDLE ARROW WITH RESET MARK.

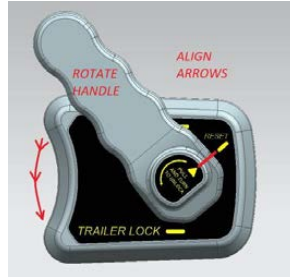

STEP 2 - MANUALLY ROTATE THE ROOF COUNTER CLOCKWISE. FULLY ROTATE UNTIL IT STOPS.



## TRAILER PROCEDURE

STARTING POSITION - OPERATING / TOWER UP



STEP 1 - PULL HANDLE OUT

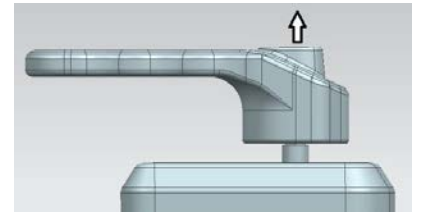

STEP 2 - ROTATE THE HANDLE COUNTER CLOCKWISE UNTIL IT STOPS. ALIGN HANDLE ARROW WITH RESET MARK.

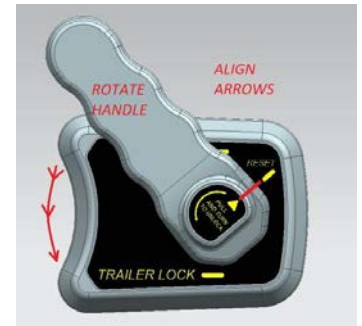

# Chapter 6

## Care & Maintenance

### Cosmetic Care

This section covers the care and maintenance of your Regal boat. Many cosmetic care topics including exterior hardware, upholstery, fiberglass and canvas are covered along with major equipment and systems. Refer to the owner's information packet and the appropriate engine manufacturer's manuals for further detailed instructions.

### Upholstery

Cockpit and interior vinyl require periodic cleaning to maintain a neat appearance and to prevent the build up of dirt, mildew and contaminants that may stain and reduce the vinyl life if they are not removed. The frequency of cleaning depends on the amount of use and conditions to which the vinyl is subjected. Most common stains can be cleaned using warm, soapy water and clear rinses. Scrubbing with a soft bristle brush will help loosen soiled material from embossed surfaces and under welting. If the stains are not removed with the above method use a mild cleaner such as Fantastic. This cleaner should be used only as needed and not the normal means.

With more stubborn stains, rubbing alcohol or mineral spirits may be tried cautiously. Widespread solvent use can severely damage or discolor vinyl. Try to remove stains immediately before they have a chance to penetrate the surface of the vinyl.

Powdered abrasives, steel wool, or industrial strength cleaners are not recommended for cleaning our vinyl. Lacquer solvents will cause immediate damage. Dilute chlorine bleach before using. Do not wax the vinyl as it may cause cracking. Always wear protective gloves and make sure there is sufficient ventilation when cleaning vinyl. Wear eye protection.

Remember that suntan oil will damage vinyl. Use suntan lotion instead of suntan oil. Exposure to the sun is a natural enemy of vinyl upholstery. Keep the vessel covered with a cover when not in use.

FREQUENT STAINS/CLEAN-UP STEPS	1	2	3
Coffee, Tea, Chocolate.....	B		
Permanent Marker* .....	E	B	C
Household Dirt.....	A	B	
Grease.....	D	B	
Ketchup, Tomato Products.....	A	B	
Latex Paint.....	A	B	
Oil Base Paint.....	D	B	
Mustard.....	A	B	C
Suntan Oil.....	A	B	
Asphalt/Road Tar.....	D	B	
Crayon.....	D	B	
Engine Oil.....	B		
Spray Paint.....	B		
Chewing Gum.....	D	A	
Shoe Polish* .....	D	B	
Ballpoint Pen* .....	E	B	A
Lipstick.....	A	B	
Eyeshadow.....	E	B	
Mildew*.....	C	B	A
Wet Leaves * .....	C	B	A
Mustard	A	B	C

A= Soft brush; warm soapy water/rinse/ dry

B= Fantastik cleaner

C= One tablespoon ammonia, 1/4 cup of hydrogen peroxide, 3/4 cup of warm water/ rinse/dry

D= Scrape off residue ( use ice to lift gum)

E= Denatured alcohol/rinse/dry

\* These products contain dyes which leave permanent stains.

## Acrylics

The optional walk-through doors are one item made from a heavy acrylic material. Use warm water and a couple drops of mild detergent. The cleaning rag should be lint free and thoroughly rinsed. Do not substitute paper towels, which could lead to fine scratching of the surface. With the right cleaning materials, you can easily remove most dust and grime without creating an additional static discharge.

Do not use an abrasive or scouring pad. Acrylic must not be exposed to organic, oil-based solvents. This includes:

- Acetone/nail polish remover
- Paint thinner or comparable
- Benzene
- Rubbing, denatured, or other alcohol-based solutions
- Carbon tetrachloride

For scratches and other marks that do not respond to basic cleaning, polishing is the way to renew your acrylic. Again, use a soft, lint-free cloth. You can hand polish or use a polishing machine.

Apply the polish in a snake like S pattern across the surface first horizontally and then vertically. Smaller polish jobs can use an L shape followed by a circular motion. If you are still not able to remove the blemish the scratch is probably too deep. In these situations, the only recourse is an incremental wet sanding, finishing with an #800 grit abrasive, and another coat of polish. After polishing any residual polish should be removed.

# NOTICE

AVOID CLEANING PLASTIC SURFACES WITH A DRY CLOTH OR GLASS CLEANING SOLUTIONS CONTAINING AMMONIA. NEVER USE SOLVENTS OR WIPE WITH ABRASIVES.

## Plastic

Use plastic cleaners and polishes recommended for marine use only. Use proper applicators. Read all instructions carefully. Test the product in a small area first. Use a soft rag and always rinse the surface with water. Ammonia based cleaners and abrasives will damage plastic parts.

## Spaghetti Mats

Spaghetti mat is used in most of our storage lockers. It is a thick black material that looks like pasta. It provides cushioned support for stored items along with the ability to weep water and condensation through its porous design.

To clean spaghetti mat remove from the storage area and use a hose and nozzle to remove debris. Air dry and reinstall in compartment. Material features ability to dry quickly. For heavier cleaning spray with a mild liquid soap and rinse with fresh water. Air dry.



## Interior Fabrics

Clean flat good interior fabrics with dry cleaning fluid style cleaners approved for use with soft fabrics. Allow adequate ventilation and follow the label instructions carefully. Use a soft cleanser with feldspar to clean stubborn marks or stains on wallpaper. Normal interior vinyl such as used on the headliner on cruisers and head clean up with a mild soap and water solution. Rinse immediately with clean water and wipe dry. Always test an area with a cleaner before applying it to a larger area.

## Fiberglass & Gel Coat



# DANGER

AVOID SERIOUS INJURY!  
WAXED GELCOAT SURFACES CAN BE VERY SLIPPERY! DO NOT WAX NORMALLY USED AREAS OF THE DECK, LINER, OR GUNWALES. DO NOT WAX ANY TEXTURED OR NONSKID SURFACES SUCH AS FLOORS, WALKWAYS, STEPS, LADDERS, OR SWIM PLATFORMS. WEAR NON-SLIP FOOTWEAR WHEN WALKING ON VESSEL SURFACES!

# NOTICE

WIRE BRUSHES, SCOURING PADS, OR OTHER ABRASIVE TYPE MATERIALS AND SOLUTIONS SHOULD NEVER BE USED ON THE HULL OR DECK. THEY CREATE SMALL SCRATCH THAT COLLECT MARINE GROWTH.

Routine maintenance is the only practical way to keep the surface of your boat looking shiny and new. Most objects left outdoors will gradually deteriorate from exposure to the sun, water, dust and pollution. Such outdoor exposure can cause your boat's gel coated surface to change or fade. Darker colors tend to fade more rapidly than lighter colors because they absorb more of the sun's rays (ultra-violet and infrared).

Basic maintenance includes monthly washing of the boat's surface to remove normal accumulation of soil and stain.

Use a mild detergent such as dishwasher powder or liquid. Do not use automatic dishwasher detergent. Avoid any kind of alkaline cleaners such as trisodium phosphate (TSP), abrasives, bleaches and ammonia. For best results use cleaners that are recommended for fiberglass.

It is recommended that you wax the gel coat surface twice yearly to prevent loss of gloss and to protect the finish. Use only waxes for fiberglass and follow the label instructions. Apply a 3' x 3' section at a time using clean applicator cloths or a buffing bonnet. When a haze develops, use a power buffer at low speeds (1200-2000 rpm) to remove the haze. Keep the buffer moving to avoid heat buildup. The power buffer is very efficient at removing contaminants from gel coat. Never wax gel coat in the direct sun.

When the washing and waxing as recommended does not restore the shine it may be necessary to use a fine rubbing compound. Do not apply rubbing compound in direct sunlight. A power buffer at low speed does an excellent job to remove impurities from the gel coat that cause dulling. Use light pressure and keep the buffer moving. Re-wax after compounding to buff the surface.

“Hairline cracks” or “spider webbing” could develop in the gelcoat surface of a hull or deck. This can be caused by impact or other factors. Small air pockets or gouges may also occur through normal wear.

These do not affect the strength of the hull or deck and can be repaired by yourself, a marine professional or a Regal dealer.

The affected area should be chipped or sanded away and a thin layer of color matched gel coat applied. This layer is then sanded smooth and buffed to its original luster.

Most minor scratches, nicks, and dents can be removed by compounding the surface. Marine type compounds can be found at most auto body supply stores. Specify a number 25 which is a coarser compound up to a number 55 being less coarse. Various glazes and polishes are available as needed. Ask your marine professional or Regal dealer for more information. Fiberglass hulls are strong but they can be damaged. A fiberglass hull has virtually no internal stresses. Thus when a part is broken or punctured, the rest of the hull retains its original shape. A severe blow will either be absorbed or result in a definite localized break. A break of this nature should be checked and repaired by a marine professional or a Regal dealer.

## Minor Repairs

You will need the following materials for minor repairs:

- Gel coat
- Clear Liquid Catalyst
- Putty Knife
- Razor Blade
- Fine Sandpaper (400,600,1000)
- Wax Paper (to cover repair area)



# DANGER

AVOID SERIOUS INJURY!  
GEL COAT AND FIBERGLASS RESIN ARE  
FLAMMABLE! WORK IN A WELL VENTILATED  
AREA FREE FROM OPEN FLAMES.  
DO NOT SMOKE!

For minor repairs refer to the following procedure:

1. Clean the area to be repaired and get rid of any wax or grease residues.
2. Clean out scratches, chips, and nicks.
3. Sand area to be repaired so gel coat will bond.
4. In a separate container, measure only the amount of gel coat you will need. Mix a ratio of 2% ratio of catalyst to the amount of gel coat being used (a spoonful of gel coat will require only a drop or two of catalyst). Do not pour any unused portions of the gel coat/catalyst mixture back into either original container.

5. Apply gel coat to area leaving a slight lift above the surface.
6. Cover the area with wax paper. It will help the mixture to set up faster.
7. Remove wax paper and shave off any extra gel coat with a razor blade.
8. After the area is shaved smooth, start with the 400, 600, and finally 1000 grit sand papers.
9. Buff the area with compound, polish and a finish wax. You may notice a difference between the repaired area and the original finish due to the natural weathering process.

## **Canvas**

Boat canvas is in most cases subjected to more severe punishment than practically any other type of material. Moisture, dirt and chemicals from industrial fallout, heat, ultraviolet rays and salt water are all factors which accelerate the deterioration of your boat canvas. These elements can cause serious damage if left unchecked.

The boat top and other canvas supplied on your Regal boat are manufactured from top quality materials to provide you with years of trouble free service. The following information on the care, cleaning and proper storage of the fabrics and fasteners that make up your marine canvas is being provided to help you maintain the appearance and ease of operation.

## **Sunbrella General Information**

Sunbrella is used on select bow, cockpit covers and bimini tops. Sunbrella is a woven fabric made from 100% solution dyed acrylic fiber. It is color fast and will withstand long term exposure to the sun (ultraviolet rays) without excessive fading.

Even though it is treated with water repellency some "misting" through the fabric is typical. With new canvas, the greatest potential for leakage is through any sewn seams. Because Sunbrella and the long term thread used is synthetic, the holes created by sewing will not swell up and seal when exposed to water as cotton does. Usually the movement of the fabric in use will move the fibers enough to seal the holes. You may apply Apseal or Uniseal to the seams to speed up this process.

When the canvas is new, the fit will normally be tight. It is designed this way because Sunbrella stretches as it ages. The initial tight fit allows for a suitable fit for the life of the canvas. The Sunbrella fit will vary slightly in the heat, cold, and rain.

Sunbrella canvas should be cleaned regularly before substances such as dirt, roof particles, etc., are allowed to accumulate on and become embedded in the fabric. The fabric can be cleaned without being removed from the boat. Simply brush off any loose dirt, hose down, and clean with a mild solution of natural soap in lukewarm water. Rinse thoroughly to remove soap. **DO NOT USE DETERGENTS!** Allow to air dry. For heavily soiled fabric, remove the top from the frame.

Soak the fabric in a solution that has been mixed to the following proportions.: 1/2 cup of bleach and 1/4 cup of Ivory or Lux soap (liquid or soap) per each gallon of lukewarm water. Allow the fabric to soak until the bleach has killed the mildew and the stains can be brushed out with a common kitchen scrub brush. Rinse the fabric thoroughly in cold water to remove all the soap. This may require several rinsings. Incomplete rinsing can cause deterioration of sewing threads and prohibit the fabric from being properly retreated. Allow the fabric to dry completely. **DO NOT STEAM PRESS OR DRY IN AN ELECTRIC OR GAS DRYER!** Excessive heat can damage and shrink the fabric since it is heat sensitive.

This method of cleaning may remove part of the water and stain repellent that was applied to the fabric during its manufacture. It is recommended to retreat with such water repellency products as Apseal and Uniseal. We do not recommend any wax based treatments such as Thompson's Water Seal or any of the silicone products such as SC-15 or Aqua-Tite. Wax based products prevent the fabric from breathing, and encourage mildew growth while the silicone products interact with the original fluorocarbon finish and seem to cause a rapid loss of water repellency.

### Clear Vinyl, Zipper & Snap Care

Never store canvas wet or in an unventilated, moist area. Always roll the canvas instead of folding. This is of particular importance on side curtains or any other part with the clear vinyl "glass". Roll the top carefully around the bows and cover with the storage boot provided.

The clear vinyl "glass" used in side curtains, aft curtains, visors, and camper enclosures is very susceptible to heat and cold. Keep vinyl curtains from touching metal tubing to minimize burning the vinyl. If the boat is stored with top, side curtains and aft curtain in place, heat build up inside the boat may discolor the vinyl. To clean the clear "vinyl" glass, use a solution of Ivory or Lux soap, liquid or flakes, and lukewarm water. Allow to air dry. Never use any type of abrasive cleaner as it will scratch the "vinyl" glass. There are many cleaners and scratch removers on the market specifically for clear vinyl. Handle the clear curtains carefully. They are soft and prone to scratching.

Canvas parts are designed with zippers. When zippers are new they can be a little difficult to use. Zip carefully without forcing the zipper or the material. They will loosen with use. A zipper lubricant may be used to help new zippers as well as maintaining used ones. The most vulnerable part of the zipper is the starts. Use care when beginning to close the zipper.

Canvas snap fasteners should be unsnapped as close to the button as possible. Never remove canvas by pulling roughly on the edge of the material. This can damage the canvas as well as the fasteners. Use petroleum jelly on snaps to keep them from developing corrosion especially in harsh environments.

### Metal

Keep all stainless steel and other metal parts rinsed and wiped dry. To maintain their finish annually polish the stainless steel and other bright works at least annually. Use commercially available metal products and read the labels carefully before use.

Refer to the flyer in the owners information pouch.  
Most marinas and boating retail outlets carry metal care products.

### **Hull Bottom**

Never use wire brushes or highly abrasive scouring pads on your hull bottom. It could damage the gel coat surface or the bottom paint. The bottom of your boat needs to be clean since the build up of natural coatings from water or marine life can potentially create drag and affect your boat's performance.



## Maintenance

### Propellers



Out-of-balance and nicked propellers will effect performance or cause vibration. Damaged props should be replaced, but those that are chipped

or bent can usually be reconditioned by a marine dealer or a propeller repair facility. When cruising, consider carrying a spare set of props on board because many marinas do not carry a full inventory of replacement propellers. Also, include an extra set of prop hardware. Refer to the engine manufacturer's manual for appropriate propeller replacement and installation assistance.

Write down the propeller diameter and pitch while the vessel is in dry dock. They are pressed into the prop for easy reading.

Also, note that propellers feature a rubber hub pressed into the center propeller that includes the hole for the prop shaft to slide through. Sometimes as a result of impact the rubber hub becomes damaged and the propeller will not let the boat perform up to the rated revolutions per minute (rpm).

In an emergency a stainless propeller blade may be straightened by laying the propeller blade on a 2 x 4 and hammering the bent portion of the blade until straight. This normally will result in the propeller creating a vibration and if this occurs reduce rpm until back at mooring.

It is advantageous to carry the needed tools to change propellers including pliers to pull cotter key and deep socket and ratchet to remove the propeller shaft nut. See the appropriate outboard manufacturer's owner's manual for further information.

Removing the propeller- Before removing the propeller make sure the remote control is in neutral and the ignition keys are removed to prevent the engine starting and possibly causing bodily injury. Always wear gloves when removing or installing propellers since the component blades are very sharp.

Note that special tools are required to remove the DPS style propellers. Contact your nearest Regal dealer for assistance in purchasing and procuring these tools.

Installing propeller- Before installing parts back on to the prop shaft make sure you lubricate the prop shaft with the recommended lube. Again, special tools are required for installation of propellers and hardware. Contact your closest Regal dealer for additional information.

On MerCruiser units, refer to your engine operation manual or contact your closest Regal dealer for propeller removal and installation parts, tools, and periodic maintenance schedules and information.

## Battery



Frequently check your battery terminals for corrosion build-up. If you find a greenish, powdery substance, remove the cable connections and clean

both the both the terminals and the connectors with a wire brush. When the cleaning is finished reconnect the battery cables and coat the terminal with an approved grease or petroleum jelly to help prevent further corrosion.

Check the electrolyte level at least every 30 days, more often in hot weather. The level should be maintained between the top of the battery plates and the bottom of the fill cap opening.

Add distilled water as needed after charging the batteries or periodically as needed. Do not over-fill because sulfuric acid could run over and cause burns or an explosion.

Batteries should be charged outside the boat. Do not smoke or bring flames near a battery that is being or has recently been charged. The hydrogen gas generated by battery charging is highly explosive. Set batteries on a block of wood rather than concrete since this procedure will help the batteries from losing their charge.

Do not allow a metal object or loose wires to spark across battery posts while working close to the battery. Contact across terminals will cause a short circuit and personal injury or fire may result.

Tighten all battery connectors securely. Check their tightness by pulling on the connectors. They should not move from their tightened position. Be sure to re-install the positive boot over the battery terminal after tightening the battery post connection. While using the boat, use the volt meter to monitor the charge level of the battery. Monitor the charge with the engines turned off (static condition).

The engine alternators recharge the batteries. A fully charged battery will indicate between 12.3 and 12.6 volts on the voltmeter. Readings below this could indicate a dead battery cell or a charging system malfunction which should be checked by a marine professional.



## WARNING

**AVOID SERIOUS INJURY!**  
BATTERIES CONTAIN SULFURIC ACID (POISON) WHICH ALSO CAN CAUSE BURNS. AVOID CONTACT WITH THE SKIN, EYES, AND CLOTHING. IF CONTACTED, FLUSH WITH WATER FOR AT LEAST 15 MINUTES. IF SWALLOWED, DRINK LARGE AMOUNTS OF WATER, OR MILK. FOLLOW UP WITH MILK OF MAGNESIA, BEATEN EGG, OR VEGETABLE OIL. GET MEDICAL ATTENTION IMMEDIATELY!



## WARNING

**AVOID SERIOUS INJURY!**  
WEAR GOGGLES, RUBBER GLOVES, AND A PROTECTIVE APRON WHEN WORKING WITH A BATTERY. BATTERY ELECTROLYTE CAUSES SEVERE EYE DAMAGE AND SKIN BURNS. IN CASE OF SPILLAGE, WASH AREA WITH A SOLUTION OF BAKING SODA AND WATER.

Make sure all terminals are clean. As discussed earlier, a battery cleaner tool along with a toothbrush should be used to clean both the positive and negative terminals. Use a small amount of baking soda and water. Remove any acid residue from the terminal area and battery top with a damp cloth. Be sure to wear plastic gloves and eye protection. See the illustration.

Install an anti-corrosion lubricant to the posts before reinstalling the terminals. This lubricant is available as a paste or spray type and can be found at most marina or auto supply stores.

Be sure to reinstall any red (+) battery (anti-short) boots on the battery terminals.

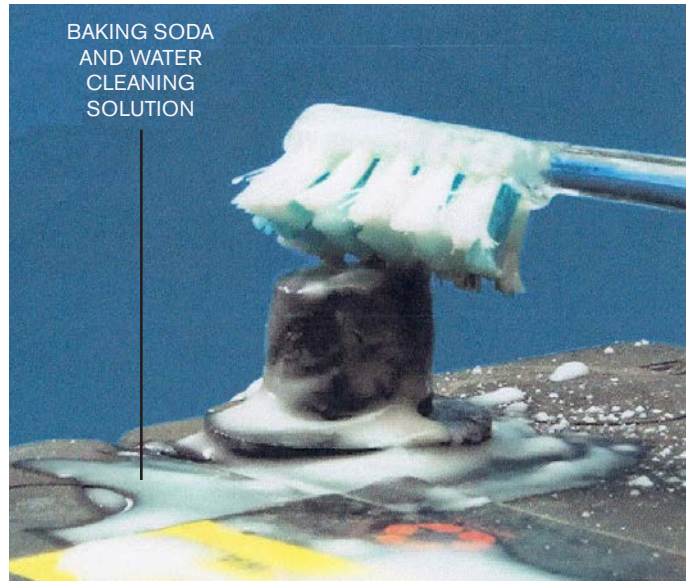

BAKING SODA  
AND WATER  
CLEANING  
SOLUTION

USE TOOTHBRUSH AND BAKING SODA TO CLEAN TERMINALS

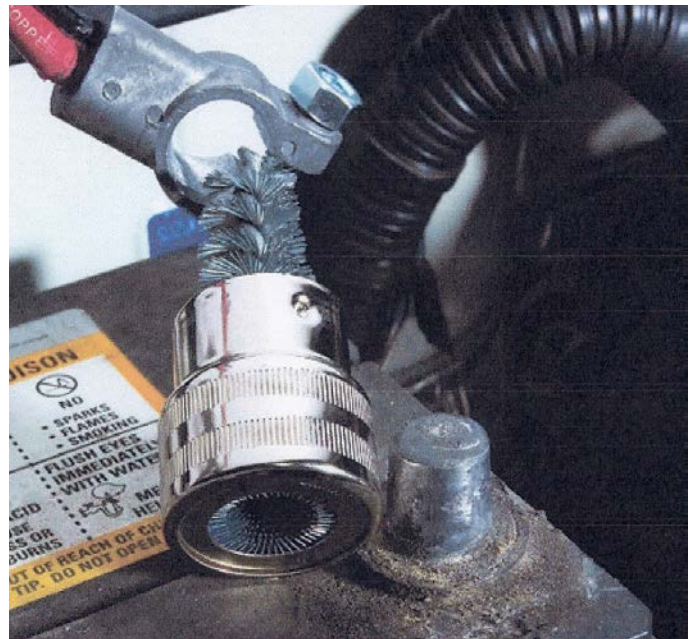

USE BATTERY TOOL TO CLEAN CONNECTORS & TERMINALS

## Controls-Typical



Check the helm remote control box and make sure there is no roughness or tightness when shifting. Also, check to make sure the control box hardware is tightly secured. The shifting is done by a

process called “fly by wire” Being the engines use electronics to shift it should be effortless. An application of silicone spray on the handles will help fight any corrosion. Remember there are no actual mechanical shift and throttle control cables on your vessel.

There is a friction control which may be altered to personal needs. To adjust the friction control on side mount remote controls it needs to be preformed by an authorized dealer. Contact your closest Regal dealer for further assistance or a marine professional.

## Fuel System

At least annually inspect all fuel system components for loose clamps at the vent, fill and feed locations. Examine each hose for signs of deterioration and leakage. Check the fuel sender for loose bolts, nuts, and leaks at all areas of contact. Also, inspect the fuel tank for signs of leakage or abrasion. Tighten all components as needed.



## WARNING

AVOID SERIOUS INJURY OR DEATH DUE TO FIRE OR EXPLOSION RESULTING FROM LEAKING FUEL!  
INSPECT ENTIRE FUEL SYSTEM AT LEAST ONCE PER YEAR.

TYPICAL EPA FUEL TANK

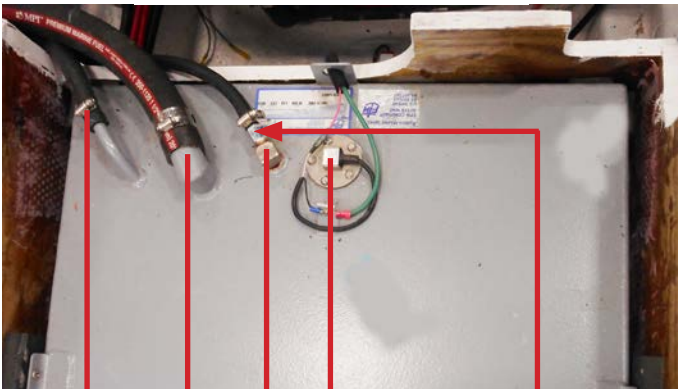

FUEL VENT

FUEL FEED

ANTI-SIPHON VALVE



## Galvanic Corrosion/Stray Current

Metal parts underwater can be subjected to two basic styles of electrolysis: galvanic corrosion and stray current corrosion. Both can damage the outboard drive, propeller, underwater parts, boat and motor if not correctly monitored (testing at 2 week intervals) and avoided.

Galvanic corrosion is an electrochemical reaction between two or more metals. Drive systems consist of several different metals. Some are more active than others.

Galvanic corrosion of the more chemically active metals can occur whenever two or more dissimilar metals that are “grounded” (connected by actually touching each other, or through a wire or metal part) are immersed in a conductive solution (any material that can conduct electricity). Anything but pure water is conductive. Saltwater, fresh water with a high mineral content and polluted freshwater are highly conductive. Conductivity increases with temperature. That is why Florida boats experience more corrosion than boats in Maine.

Specifically look at a typical marine drive unit with a stainless steel propeller. The aluminum is the more chemically active metal (called the anode) and the stainless steel propeller is the less chemically active metal (called the cathode).

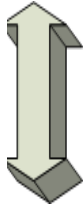
CORROSION TABLE	
Gold	 <p>Least Active</p> <p>Most Active</p>
Stainless Steel	
Bronze	
Copper	
Brass	
Steel	
Aluminum	
Zinc	
Magnesium	

Typically electrons flow from the anode (the aluminum drive unit), via the external conducting path to the cathode (stainless steel propeller). If there is a very large anode connected to a small cathode, the anode will corrode very slowly. If a very large cathode is connected to a small anode, the anode will corrode very quickly. Obviously, if you do not control galvanic corrosion, over time the aluminum will corrode away.

The first sign of galvanic corrosion is paint blistering (starting on sharp edges) below the water line- a white powdery substance forms on the exposed metal areas. As the corrosion advances, the exposed metal will become deeply pitted as the metal is actually eaten away.

Another condition which will increase galvanic corrosion is the removal or reduction in surface area of the sacrificial anodes. Never add aftermarket products that are connected to the engine ground such as stainless steel steering aids and trim planes. Zinc connected to aluminum will form a corrosion cell but the aluminum (drive) becomes the cathode and the zinc (anode) corrodes.

Even though your boat may not have shore power aboard current from nearby vessels with shore power can produce stray current galvanic corrosion. Stray current corrosion occurs when metal with an electrical current flowing into it is immersed in water that is grounded (lake, ocean, pond). The current can leave the metal and flow through the water to ground. This will cause rapid corrosion of the metal at the point where the current leaves.

When a vessel nearby is plugged into shore power, they can potentially tie your drive unit to their boat via the green grounding shore power lead. Your drive unit could be the receiving end of a large galvanic cell (a battery) interconnected with nearby vessels or even through the marina's metal structures via their electrical system.

The vessel should be tested every couple of weeks to determine the integrity of the anode protection system. Another way to test the system is to measure the hull potential. This is accomplished by immersing a reference electrode, usually a silver/silver chloride into the water about six inches behind the drive. With leads attached to a digital multimeter the hull potential is read on the DC scale and compared to recommended specifications for the water body type. See the owner's information vendor packet for more information or contact your nearest authorized Regal dealer.

#### Tips To Aid In Maintaining Galvanic Integrity

1. Test the galvanic integrity of your vessel every 2 weeks. Raise the drive and inspect anodes/parts for signs of galvanic corrosion, stray current corrosion or loose fasteners. Contact your closest Regal dealer/marine professional where signs of galvanic corrosion exist.
2. Never paint over anodes as they will become inoperative. Always leave at least one inch between bottom paint and any underwater fitting such as sea cocks, swim platform stanchions and all drive and propulsion related underwater parts.

3. Periodically remove vessel from water and clean/pressure wash all drive, anode and hull bottom areas to remove growth.

4. Ensure vessel is using the correct anode metal for the body of water that it is moored. See the engine manufacturer's manual for more information or contact an authorized dealer.

5. Ensure that the drive is completely "in" down to provide more complete anode protection when vessel is moored.

6. Do not attempt to use magnesium anodes in saltwater. They will provide over protection.

7. If marina moored, contact appropriate personnel if signs of galvanic corrosion appear on your drive system. Ask them to check for stray electrical current which may be originating from a nearby vessel's faulty DC wiring or from a marina pier, piling or dock carrying leaking marina ground wiring such as a dock side cord partially submerged.

<b>GALVANIC/STRAY CURRENT CORROSION</b>	
<b>Cause/Observed Condition</b>	<b>Corrective Action</b>
Sacrificial anodes consumed	Replace anodes when 30% consumed
Sacrificial anodes not grounded to drive	Remove anodes, clean contact surface, reinstall, check for continuity
Loss of continuity between underwater parts & ground	Provide good ground connections
Nearby vessel with stray current	Contact appropriate personnel Remove your vessel from water
Paint on drive heavily worn, exposing more metal	Prime and repaint or install additional anodes
Sacrificial anodes painted	Remove paint or replace anodes
Drive tilted/anodes out of water	Leave drive down, install additional anodes below water
Power trim cylinders only corroded	Provide a good ground to drive, all parts must be grounded
Corrosion in area of exhaust outlets	Remove deposits
Corrosion occurring after vessel is removed from saltwater	Wash exterior and flush interior with freshwater
Stainless steel parts corroding	Clean parts, remove foreign material, ensure continuity
Underwater drive parts corroded, sacrificial anodes OK	Oxide film on anode (fresh water only) Replace anode Poor ground. Scrape anode

## Seakeeper (Stabilizer)

If installed the Seakeeper 1 requires periodic maintenance. See suggested maintenance schedules below. **Read and understand the Seakeeper operator's manual before using the stabilizer or performing any maintenance.** Contact your authorized Regal dealer, Certified Seakeeper dealer, or Seakeeper on-line at: [www.seakeeper.com/find-us](http://www.seakeeper.com/find-us). Service intervals are based on "average" use.

### SEAKEEPER SCHEDULED MAINTENANCE PLAN



#### RECREATIONAL LINE

Brake System	Task	Running Hours	Period
Hydraulic Oil	Flush & Bleed	1000	Annually
Brake Bushings	Inspect	1000	Annually
Brake Bushings	Replace	2000/As Needed	----
Seakeeper 1 Mechanical/Safety Latch Assembly	Inspect	1000	Annually
Seakeeper 1 Mechanical/Safety Latch Assembly	Replace	2000/As Needed	----
Hydraulic Cylinders & Hoses	Inspect	1000	Annually
Hydraulic Accumulators	Inspect	1000	Annually
Hydraulic Accumulators	Replace	2000/As Needed	----
<b>Cooling System</b>			
Zinc Anode *N/A for Seakeeper 1, 2, 3	Inspect/Replace	150/As Needed	3 Months
Heat Exchanger	Inspect	1000	Annually
Heat Exchanger	Replace	2000/As Needed	----
Coolant Level - Glycol	Inspect/Fill	1000	Annually
Clean/Descale Heat Exchanger	Inspect/Clean	1000	Annually
Cooling Hoses	Inspect	1000	Annually
Cooling System Flush - Glycol	Inspect/Replace	1000	Annually
<b>Electronics System</b>			
Inspection of all electrical connections, cables, and components	Inspect	----	Annually
<b>Mechanical &amp; Foundation System</b>			
Inspect all mounting hardware/bolts	Inspect	----	Annually
Inspect isolation bushings, pins, and clips	Inspect	----	Annually
Clevis assemblies (4), hardware, isolation bushings, pins & clips	Inspect	1000	Annually

## Stereo

The Fusion® stereo head unit requires little maintenance as it meets global IPX6 and IPX7 waterproof standards. To protect the device display surface use a clean, soft, lint-free cloth with fresh water. Gently wipe the device. This process will help prevent debris from scratching the device display surface. Never use chemicals or harsh cleaners on the display device surface.

For further information, refer to your stereo owner's manual located in the owner's packet.



## Toilet- Electric

Read and understand the electric toilet operator's manual for further details on any cleaning and maintenance procedures.

### Maintenance Tips-

1. When cleaning the pump use only non-abrasive and those without a petroleum base. Recommended is Thetford's Aqua-Clean for all toilet components.
2. Abstain from using any type of household cleaners as they may contain bleach that can cause component damage.
3. Do not use toilet bowl cleaners on toilet system parts as they contain strong acids which again can damage the toilet system components.
4. To keep the toilet flushing properly use only toilet tissues specifically designed to decompose rapidly. Recommended tissues are Thetford's Aqua-Kem, EcoSmart, or Aqua-Clean.
5. Remember that only human waste and designated toilet paper should be put into the toilet. Never flush foreign materials such as household garbage, dental floss, paper towels, napkins, feminine hygiene products, wipes, condoms or etc. into the toilet.

## Thruster (Bow)

If installed the bow thruster requires a periodic maintenance schedule to maintain an optimum running unit. See recommended maintenance schedule below. ***Read and understand the electric bow thruster operator's manual before using the bow thruster.*** Contact your closest authorized Regal dealer or the bow thruster manufacturer on-line for additional product information.

### **BOW THRUSTER MAINTENANCE SCHEDULE**

#### **Annual Recommended Maintenance**

Remove any accumulated debris from tunnel, propeller, and hub.

\*Replace composite type propeller if it is heavily damaged or contaminated.

Apply marine grease to the exposed thruster shaft and seal.

Replace the tunnel gasket if the hub is removed.

Inspect the motor for tight electrical connections.

Check the torque specification on all bolts and nuts.

Ensure the motor assembly is dry and the compartment is water tight.

Clean and check out the thruster compartment.

Brush out any accumulated carbon dust from the top of the electric motor.

With thruster main switch off check the thruster fuse holder attachment points for corrosion and tightness.

\*Note- When ordering replacement propeller refer to the operator manual for correct part number or contact your closest authorized Regal dealer.

## Zinc Anodes



Sacrificial zinc anodes are located on the drive housing, trim tabs and/or prop shaft to protect softer metals exposed to the water. Electrolysis attacks the least noble

metals first. Because zinc is a less noble metal, it will decompose before other metals. Check these zinc anodes periodically and have them replaced when they are 30% consumed. Notwithstanding, zinc is the most popular metal used to protect parts that are exposed to saltwater, freshwater or brackish water. See the photos below for anode location on your stern drive.

Zinc anodes in brackish or salt water need to be checked more frequently. If the anodes seem to be requiring frequent replacement there may be a boat leaking DC current into the water taxing the anodes. This is especially possible around a marina environment. Contact a marine professional who can measure the galvanic activity with a special electrode and electric VOA meter. Refer to the engine manufacturer's manual for exact anode location and detailed information.

Inspect the ground leads for tightness if attached.

*Note that parts damage due to galvanic or stray current corrosion is not covered under warranty.*

# Chapter 7

## Troubleshooting

The following diagnostic information will assist you in identifying minor electrical, fuel, and mechanical problems. Some of the items listed require technical training and tools. Additional assistance is available in the engine manufacturer's owner's manual.

Also, you can contact your closest Regal dealer or marine professional for further information. Sometimes a problem can be solved by performing a logical sequence of elimination and/or root cause techniques.



### **WARNING**

AVOID SERIOUS INJURY OR DEATH!  
BEFORE PERFORMING ANY MAINTENANCE  
WORK, TURN OFF THE BATTERY SWITCH  
AND REMOVE THE IGNITION KEY  
FROM THE SWITCH.



### **WARNING**

AVOID SERIOUS INJURY OR DEATH!  
USE ONLY APPROVED MARINE  
REPLACEMENT PARTS THAT  
ARE IGNITION PROTECTED.

# ENGINE DIAGNOSTIC CHART

<b>Problem</b>	<b>Possible Cause</b>
Engine Overheating	<p>Water pick-up feeds are blocked by debris, especially plastic bag material.</p> <p>Cooling system leak</p> <p>Impeller is worn or blocked by debris</p> <p>Propeller is over propped for the circumstances, causing the engine to work extra hard</p> <p>Debris in oil is holding heat more than normal - bad oil filter</p> <p>Defective thermostat.</p>
Starter Will Not Crank	<p>Battery weak or dead</p> <p>Starter defective</p> <p>Fuse for electric start relay blown</p> <p>Control not in neutral</p> <p>Defective start panel button</p>
Excessive Steering Play	<p>Air in steering lines (Bleed)</p> <p>System low on steering fluid</p> <p>Mechanical parts-loose connection</p>



# ENGINE DIAGNOSTIC CHART

Problem	Possible Cause
No Power To Helm	Battery switch turned off  Batteries are weak or dead.  Main breaker tripped  Loose connection
Engine Cranks But Will Not Start  *Engine Will Not Crank Over	Fuel flow obstructed/water in fuel  Low battery voltage  Engine ignition system malfunction  Timing belt broken  Empty fuel tank  *Lanyard not attached properly  *Remote control not in neutral
Hard Starting	Vacuum In Fuel System  Fuel lines obstructed  Water in fuel  Debris in fuel/clogged fuel filter
Engine Idles/ Runs Rough	Old fuel  Faulty spark plugs  Fuel contaminated/ clogged anti-siphon

# ENGINE DIAGNOSTIC CHART

<b>Problem</b>	<b>Possible Cause</b>
Power Loss	Damaged propeller Improper trim angle Spark plugs fouled Fuel system malfunction Hull bottom fouled with debris Excess water in bilge (leak)
Excessive Vibration	Damaged propeller Damaged propeller shaft Loose/broken motor mount Steering pivot loose or damaged Debris caught on propeller Ignition malfunction Motor mount bolts loose (transom)

# ENGINE DIAGNOSTIC CHART

<b>Problem</b>	<b>Possible Cause</b>
Buzzer Sounds/Icon Lights	Cooling system malfunction Engine oil level low or incorrect type Wrong spark plug heat range Oil pump malfunction

# DC ELECTRICAL SYSTEM DIAGNOSTIC CHART

Problem	Possible Cause
No 12 Volt Power At Battery	Battery switch turned off  Weak or dead battery  Battery cables loose/disconnected
Battery Not Charging While Engine Is Running	Faulty alternator  Faulty circuit wiring
Battery Will Not Hold Charge	Faulty/old battery  Loose battery cables  Corroded battery terminals
12 Volt Equipment Not Working	Fuse blown-Take time to investigate why the equipment was drawing too much current or why it had a short circuit. Check fuses at fuse block and under the engine shroud Weak or dead battery if all 12 volt equipment fails to function.  Corroded / loose wire connection  Internal equipment short /failure

# SEAKEEPER DIAGNOSTIC CHART

<b>Problem</b>	<b>Possible Cause</b>
Seakeeper cannot generate anti-rolling torques-unit not functioning	<p>12 volt DC power failure controlling electronics and motor drive has caused the brake to lock the Seakeeper-Refer to Seakeeper manual</p> <p>12 volt DC power to the seawater cooling pump has been interrupted.</p> <p>Seakeeper breaker tripped</p> <p>Loose connection</p> <p>Seakeeper battery dead</p>
Sensors or alarms are energized	<p>Check the Seakeeper screen for alarm and sensor information since the controller sends alarm and sensor information to the display and locks the brake and shuts down the motor drive when an alarm situation is detected.</p> <p>Use the Seakeeper Application at the MFD lazarette compartment to address an alarm situation.</p> <p>* Note that the Reset alarm button is pressed to clear the alarm after the alarm situation is no longer present.</p> <p>Refer to the Seakeeper operator's manual for additional information on alarms and sensors.</p>
GPS signal is lost- check alarm history.	<p>NMEA 2000 connection interrupted.</p> <p>GPS antenna signal interrupted due to obstructions.</p>



# TOILET-ELECTRIC DIAGNOSTIC CHART

PROBLEM	CAUSE	ACTION/SOLUTION
Toilet does not flush or flush performance is poor	Waste tank is full	Empty waste tank before continuing to use toilet.
	Clog at pump inlet	Clear clog. DO NOT flush foreign objects.
	Solid object in macerator	DISABLE power. Attempt to remove object. If unsuccessful, contact Theftford Service. DO NOT flush foreign objects.
	Low voltage	Check that toilet supply voltage is 12V+/-2V (24V+/-2V) AND that there is no more than a 10% decrease in voltage when macerator is running. If voltage decreases more than this, there may be a wiring problem in the boat.
Water does not enter bowl during flush or water add cycle	Water supply line kinked or not connected	Check that supply line is properly connected to fresh water supply. Check for kinks in the supply line.
	No power to water pump	Check that fuse/circuit breaker has not tripped. Ensure all electrical connectors to water pump are fully mated.
	Water supply has been turned off	Open water supply valves or reconnect power to supply pump.
	Solenoid not plugged into relay module (where applicable)	Ensure wiring harness to solenoid is fully connected.
Water continues dripping briefly into bowl after flush cycle is complete	Toilet is installed below water line with vented loop in water supply line	Normal operation – if only a small amount of water drips from nozzle.
Bowl drains dry after flush	Water is siphoning out of bowl due to discharge hose pulled down	Discharge hose from macerator pump is pulled down. Straighten hose so that top of discharge hose is in line with toilet nozzle.

# THRUSTER DIAGNOSTIC CHART

Thrust in wrong direction?	Change contactor wires on motor solenoid
Breaker trips?	<ul style="list-style-type: none"><li>▶ Propeller restricted or jammed causing excessive load on motor - check and clear. Check that propeller washer is fitted</li></ul>
Control panel does not illuminate?	<p>Check</p> <ul style="list-style-type: none"><li>▶ Battery is connected.</li><li>▶ Main switch ON, check fuse.</li><li>▶ Control loom connections.</li><li>▶ Long operation has tripped thermal switch. Wait 20 minutes for motor to cool and reset.</li></ul> <p>⚠ DO NOT attempt to cool motor by any other means.</p>
Control panel illuminates but no thrust?	<ul style="list-style-type: none"><li>▶ Are batteries charged?</li><li>▶ Check main motor connections are tight.</li></ul>
Poor thrust or thrust in one direction only?	<ul style="list-style-type: none"><li>▶ Batteries not large enough or charged, cables not recommended size. Voltage at motor when running should be a minimum 10 V for 12 V and 21 V for 24 V units.</li><li>▶ Blockage in tunnel/propeller jammed with debris, switch off main power, inspect and clear.</li><li>▶ Propeller washers fitted wrong.</li><li>▶ Check motor brush springs are located properly, brushes should have good contact with the commutator.</li></ul>
Motor turns but no drive?	<p>⚠ DO NOT continue to run thruster.</p> <ul style="list-style-type: none"><li>▶ Shear pin broken, remove 4 motor bolts, drive out old pin and replace with new pin.</li><li>▶ Propeller blades broken. Replace with new.</li></ul>
Thruster noisy and vibrating?	<ul style="list-style-type: none"><li>▶ Check propeller is not touching the tunnel wall.</li><li>▶ Check hub height is correct</li></ul>

# Chapter 8

## Storage & Winterization



### Overview

Storage procedures are outlined in this chapter. These are general guidelines to follow before longer periods such as over the winter in colder/freezing climates. Be sure to familiarize yourself with all relevant information in the owner's sacht.

Special winterization procedures are necessary for the boat equipment and systems. Use the enclosed checklists to help you identify areas of concern and maintenance. Call a Regal dealer or marine professional for further information regarding storage/maintenance procedures.

Also, more specific information can be found in the engine manufacturer's owners manual and on line via equipment vendor web-sites.



### WARNING

AVOID SERIOUS INJURY OR DEATH  
DUE TO FIRE AND EXPLOSION!  
DO NOT FILL FUEL TANK TO RATED  
CAPACITY. LEAVE ROOM FOR EXPANSION.

### NOTICE

AVOID VESSEL AND/OR ENGINE DAMAGE!  
CONTACT A MARINE PROFESSIONAL  
FOR WINTERIZATION ASSISTANCE.  
DAMAGE CAUSED BY  
IMPROPER WINTERIZATION IS NOT  
COVERED BY VESSEL  
OR ENGINE MANUFACTURER.

### NOTICE

AVOID SERIOUS ENGINE DAMAGE!  
USE ONLY FACTORY APPROVED PRODUCTS  
FOR ENGINE AND DRIVE DURING STORAGE  
PERIODS.

### NOTICE

REMOVE BATTERIES WHEN VESSEL  
IS IN LONG PERIODS OF STORAGE  
ESPECIALLY IN COLD CLIMATES.  
BATTERIES CAN FREEZE AND POSSIBLY  
LOSE ELECTROLYTE.

## Decommissioning Checklist

### *Engine Winterization/Maintenance*

- Run engine. Pour approved fuel stabilizer/conditioner in the fuel tank. Allow time for it to circulate through the fuel system.
- Change all engine fluids as referenced in the engine manufacturer's owners manual. Contact a Regal dealer.
- Check engine hoses, clamps, and system wiring for loose connections, abrasion, and corrosion.
- Spray all exterior parts with a rust preventative.
- On surf models drain all ballast bags, hoses, and pumps of water. Check all related components.
- *Perform maintenance as referenced in the manufacturer's owners manual for any standard and/or optional equipment . Contact your Regal dealer.*
- Remove propellers. Refurbish as needed.

### Engine Care

- After cleaning use touch up paint on unit as needed.
- Apply coat of wax to stern drive exterior parts.

### *Boat*

- Check hull bottom for any fiberglass damage.
- After cleaning apply wax to hull and deck surfaces.

- Pour a pint of 50/50 antifreeze into bilge pump.
- Remove batteries. Use a trickle charger as needed.
- Remove all loose gear and electronics from boat. Inspect all equipment for wear and damage. Store in a clean, dry environment.
- Remove drain plug. Clean drain plug hole of debris as needed. Enclose drain plug in plastic bag and tie to steering wheel.
- Empty chemical toilet holding tank and rinse out. Add small amount of approved type of non-toxic anti-freeze. Refer to toilet owner's manual.
- Make sure bow is higher than stern to permit proper drainage.
- Clean all upholstery & store to promote "fabric breathing".
- Clean, rinse, and dry all spaghetti mats.
- Conduct a visual inspection to ensure boat is balanced properly on the trailer, cradle or blocks.
- Cover boat with appropriate cover. Tie down for protection from rain, snow and/or wind. Prop up cover to provide proper ventilation. Do not cover up the fuel vents.
- Drain the fresh water system.
- Use sling locations for lifting boat.
- **Never block up boat bottom as blocking may cause structural damage.**

## Boat (Continued)

***Note that select equipment including the toilet system and Seakeeper stabilizer may be installed on your vessel. These units require additional maintenance in cold/freezing climates including the following:***

- Pump-out fresh water and waste tanks when installed to prevent freeze damage in cold climates. Add non-toxic anti-freeze.
- Empty chemical toilet holding tank and add non-toxic anti-freeze.
- If installed drain Seakeeper sea water intake system including any sea water strainers along with the heat exchanger unit.

Note the more typical pressurized water system option instructions are found on this page. For further details refer to your equipment operator's manual or contact your closest authorized Regal dealer.

### ***Trailer***

- Repack all wheel bearings per manufacturer's specifications.
- Check all trailer parts for excessive wear. Replace/ refurbish as needed.
- Use touch up paint on trailer as needed.
- Lubricate all moving parts as needed.
- Check all lighting and brakes (if applicable).

## Typical Pressurized Water System

1. Activate the pressure water pump switch.
2. Open all faucets including transom shower (if equipped) and allow tank to empty.
3. Drain the water tank. Shut off water pump switch.
4. Mix nontoxic antifreeze with water in accordance with the manufacturer's recommendations. (Available at marina & RV stores)
5. Pour solution into the water tank.
6. Turn on pressure water pump switch.
7. Open water faucet and purge until a steady stream of nontoxic antifreeze flows from the faucet. If equipped, do the same to the transom shower. Turn the pressure water switch to the "off" position.

## Waste System

1. With chemical heads, make sure to dump both upper and lower tanks. Rinse well with fresh water. Sanitize chemical head as needed.
2. Toilets with overboard discharge require additional procedures including waste removal from the holding tank with a pump-out device found at select marine facility locations.



## Recommissioning Checklist

### **Engine**

- Check all components per engine manufacturer's owner's manual especially fluid levels.
- Run engine on "ear muffs" (flushette) before launching. Check for fuel, exhaust, oil, and water leaks.

### **Boat**

- Install drain plug.
- Install battery and tighten all terminals.
- Check all equipment, switches, alarms, gauges and breakers for proper operation.
- Add necessary chemicals and water to chemical head.
- Add water to water tank. Turn on faucet to purge tank. Refill water tank.
- Make sure all safety gear is on board and in excellent working condition.
- After launching, check controls and systems for proper operation through chart plotter screen/information panel.
- If electric toilet installed flush to check operation. Also, check toilet system for leaks.
- If thruster on board **after** launching check operation in both port and starboard direction w/ joystick.

### **Trailer**

- Make sure all equipment is in excellent working condition including all winch, tongue jack, brake actuator and lines.
- Check all trailer lighting including running, turn signals, and brake lights.

# Chapter 9

# Towing

## Overview

This chapter covers towing basics including equipment, maintenance, and techniques of using a trailer. Check with state and local agencies for detailed information on required equipment, safety issues, and licensing.

## BEFORE TOWING

Before towing your boat, be sure to check the air pressure of your tires for the recommended inflation rating. Also, be certain that your tow vehicle is in good working order.

Install bimini top in its boot before towing. Also, remove and store cockpit and bow cover. Store cockpit carpet along with cockpit/mooring/bow covers in ski locker.

This can make it especially difficult to drive safely, as the hitch may be in danger of striking the road. Also, this situation can be caused by worn vehicle rear shock absorbers. One option is to install a set of air shocks which will assist in supporting the load. As a rule of thumb 5 to 7 percent of the total trailer load should be on the trailer tongue.

Check all lights to ensure they all work properly. You may find it helpful to ask someone to check your turn signals, brake lights, and towing lights while you remain in the vehicle. Be certain that the trailer winch cable is securely attached to the boat's bow eye and the cable lock is engaged.

Make sure the bow of the boat is snug against the bow stop at the winch stand.

It is a good idea to tie another line or secure an extra cable to the winch stand and boat bow eye as a backup system.

Be certain that your trailer is of rated capacity for the size and weight of your boat, including the weight for all fuel, water and gear. Your authorized Regal dealer can advise you on the proper trailer capacity and tongue weight ( the weight exerted on the rear of your vehicle).

Never use a bumper mounted trailer hitch. Always use a bolted or welded frame-mounted hitch, class 2 or 3. Consult your Regal dealer for further information.

Should your trailer be equipped with surge brakes, that is brakes on the trailer that cut in with a very slight delay when your brakes are applied, be sure to follow recommended service and maintenance instructions. Be sure that the trailer master cylinder is filled with the recommended fluid before towing your boat. Inspect the trailer brake lines for any leakage. Also, if you notice brake fluid on the inside of the tires, you may have a wheel cylinder leaking. Consult a professional.

Never place your hands between the trailer hitch coupling and the hitch ball on your towing vehicle while hooking up. Be sure the tongue jack is in the full up position before departure. Be certain safety chains are crisscrossed and secured; do not allow them to drag on the road.

# TRAILER TERMINOLOGY

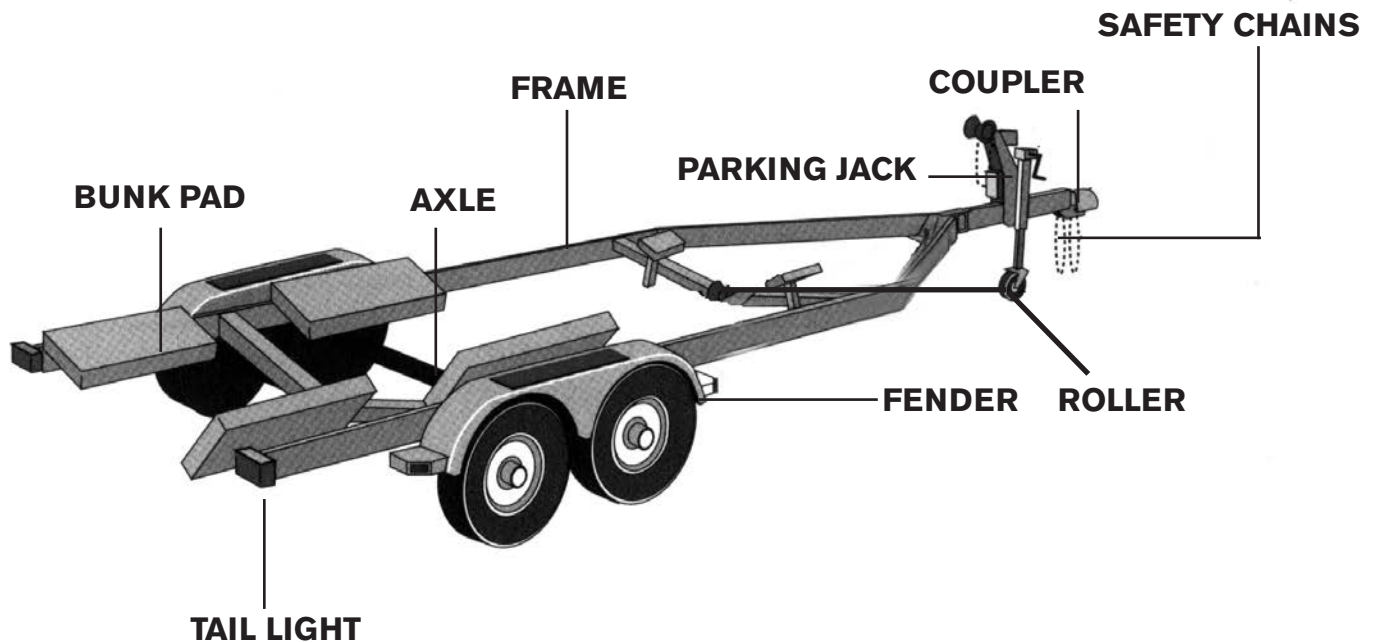

## TYPICAL TRAILER SHOWN

Be sure to buy a suitable set of tie downs which can be attached to the boats' stern eyes and the eyelets provided on most trailers. Tighten them securely and neatly fold up the extra strap material and secure it with tape so it doesn't loosen and dangle on the road.

Check the trailer lug nuts for the proper torque. Use a foot pound wrench and torque in a star sequence to the correct poundage as recommended by the trailer manufacturer. Torque the lug nuts at half the poundage on all nuts. Then set the torque wrench to the full poundage and fasten to the last foot poundage figure. Check the trailer tires often for voids, excessive wear or out of round tire conditions.

If the trailer seems to vibrate you may have a bad tire or one that is unbalanced. These wheels can be rebalanced at most automotive or tire shops. Never pull a boat on a patched tire. Buy a spare tire and wheel including a hub and wheel bearing assembly. Mount it on the trailer for speedy installation should a blow out occur.

Check the trailer harness often for signs of fraying. Check the harness connector for corrosion. Make sure the trailer harness when connected to the trailer has enough slack for turning

Check the wheel bearings for wear periodically by a professional.

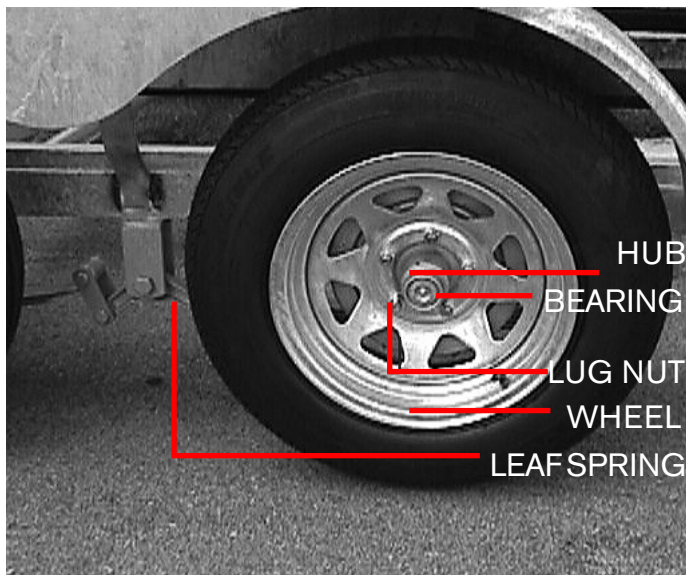

**TYPICAL WHEEL PARTS DESCRIPTION**

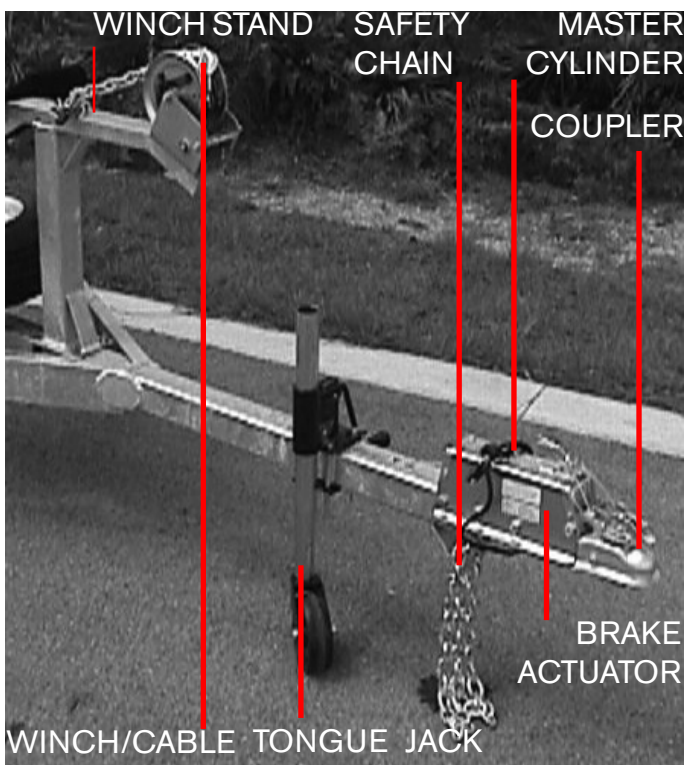

**TYPICAL TONGUE SECTION**

On most trailers, there is a zerk fitting on the wheel hub to add the proper lubricant to the wheel bearing with a grease gun. These wheel bearing waterproof covers for the bearings can be purchased at retail outlets.

## Spare Parts/Tools

Longer towing trips increase the need for special preparations. Sometimes these extended trips cover areas where it is difficult in locating repair parts due to a breakdown. Following is a checklist of recommended items to add a safety net to your trip.

### Trailer-

1. Trailer tire jack
2. Spare hub assembly including wheel bearings
3. Spare tire
4. Lug wrench
5. Jack stand
6. 12 volt air compressor-
7. Spare bearing protector
8. Extra tie-down straps
9. Trailer light bulbs
10. Brake pads and brake fluid
11. Grease gun

### Tow Vehicle-

1. Tool kit including necessary ratchet and sockets
2. Jumper cables
3. Extra fuses
4. Engine oil & transmission fluid
5. Wheel chocks
6. Highway flares
7. 12 volt spotlight- plugs into 12 volt acc. outlet
8. Flashlight & spare batteries
9. Waterless hand cleaner and rags
10. Electrical connectors and crimpers
11. Low voltage electrical tester

## Launching

Serious accidents can occur at the launching ramp. Therefore, it is imperative you be alert and attentive during launching and docking activities. Study the ramp area and surrounding water for any potential hazards, such as a short ramp or one with a drop off at the end. If you are uncertain of the conditions, ask someone else who has just used the ramp if there are any peculiarities to the area.

Install the drain plug. Attach 2 lines, one each at the bow and stern, to control your boat once it is off the trailer. If you need additional fenders to keep the sides of the boat from banging against the ramp walls, use those as well.

Unhook the stern tie-downs and the winch line to the bow. Unplug the trailer harness connector so the hot trailer light bulbs won't blow out when they come in contact with water.

When backing in, have someone assist, giving the palms up stop signal when the boat is in deep enough water to float off, or when the rear wheels of your vehicle approach the water's edge.

After your boat is floating freely, position it clear of the trailer before pulling out of the water. If there is no one to help you, secure one of the lines you've attached from the boat to the dock and use the other line to pull the boat off trailer. The process is easier with 2 people.



## WARNING

AVOID SERIOUS INJURY!  
BOAT RAMPS ARE VERY SLIPPERY.  
DO NOT ATTEMPT TO WALK OR STAND  
ON AN ANGLED BOAT RAMP!



## CAUTION

AVOID LOSING VEHICLE TRACTION!  
DO NOT ALLOW REAR WHEELS TO  
ENCOUNTER SAND OR SLIPPERY  
CONCRETE CONDITIONS!



## Loading



The most important thing to remember when pulling your boat out of the water is that often the ramp will be

crowded. As you approach the ramp, make a visual inspection of the traffic and people, both at the ramp and all around you. This is an important time to use caution, courtesy, and common sense. While you may feel it's your next turn, another boater may not be as courteous. Don't insist on your rightful place in line; it could lead to disastrous consequences in the confines of a crowded boat ramp. If there is any perceived danger, stand off until you can safely approach the ramp.

Back your trailer down to the water's edge. At this point it is a good idea to let a sufficient amount of line out of the winch to reach the bow eye. Make sure you disconnect the trailer harness to keep the hot bulbs from blowing out due to being subjected to cold water. When replacing lights if possible shop for LED's which are a sealed unit without any filament and they usually enjoy a extended life.

On roller or bunk style trailers back up until the aft roller is just at the water level. This allows you to hook up the winch cable and to start cranking the boat on to the trailer properly. This method gives you a good starting point and helps keep the boat centered on the trailer as it is reloaded. It may be necessary to further back the trailer into the water, permitting easier cranking of the boat on the trailer.

Once the boat is positioned correctly on the trailer have someone connect the winch cable hook to the bow eye. Also, this will help keep the boat bow against the trailer roller. Shut down the engine and run the stern drive up to the top of the trailer position.

With the bow snug against the roller start to crank the boat up on to the trailer. Make sure the hull bottom or keel stays in the center of each roller as it is being cranked on the trailer. Double check to ensure the hitch is locked tight on the vehicle ball.

TRANSOM LIGHT

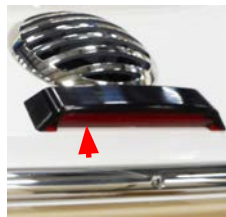

HARNESS/PLUG



MALE PLUG



RECEPTACLE



Before towing the vehicle connect up the wiring harness to the bow receptacle for the boat transom lights to operate. These lights are high on the boat transom providing additional visibility from the rear while towing in highway traffic, especially at night.

This harness features a raised alignment notch as shown in the male plug to the female receptacle. When plugging in the male plug to the female receptacle make sure the 2 notches line up before inserting the plug into the receptacle. *Note that the other end of the harness features wires without ends. Using for the first time requires these wires be spliced into the correct trailer wires (color coded) for the running and brake lights to function. Use connectors that permit removing the harness wire connectors from the trailer wires. Keep the receptacle protected with the cap when not in use.*

# Chapter 10

## Glossary & Index

### Overview

Below is a brief list of nautical terminology. For more detailed glossaries we recommend you check your local library, book retailer, marine store or internet.

### Glossary

**Abeam:** at right angles to the fore and aft line and off the boat

**Aboard:** on or in the boat

**Above:** the part of the boat on a vessel which is above the interior of the boat

**Aft, After:** aft is the boat section toward the stern or back of the boat

**Amidships:** toward the center of the boat from either side to side or rear to front

**Beam:** the width of a boat at its widest part

**Bilge:** the lower interior of the hull of the boat

**Bitter end:** the end of a line also the end of an anchor line

**Bow:** the front, or forward part of the boat

**Bulkhead:** the vertical partition or wall of a boat

**Cast off:** to let go or release

**Chine:** the line fore and aft formed by the intersection of the side and bottom of the boat

**Chock:** deck fitting used to secure or guide anchor or tie lines

**Cleat:** deck fitting with protruding arms around which lines are secured

**Cockpit:** the seating space used to accommodate passengers

**Cuddy:** a small cabin in the fore part of the boat

**Deck:** the open flooring surface on which crew and passengers walk

**Draft:** the depth from the waterline of the boat to the lowest part of the boat, which indicates how much water is required to float the boat

**FasTrac-** a proven hull bottom design which incorporates a full, mid-beam step that reduces drag by forcing air under the hull to decrease drag and friction.

**Fathom:** a measurement of depth; one fathom equals six feet

**Fender:** a cushion hung from the side of a boat to prevent it from rubbing against a dock or against other boats.

Fend off: to push off to avoid sharp contact with dock or other vessel

Fore: the part of the boat toward the bow or front

Freeboard: the height of the top side from the waterline to the deck at its shortest point (The distance from sheer or gunwale to the water).

Gunwale: rail or upper edge of the side of the boat

Head: toilet

Hull: the part of the hull from the deck down

Keel: the lowest point of a boat; the backbone of the vessel

Knots: a measurement of speed indicating nautical miles per hour

Lee: the side opposite that from which the wind is blowing; the side sheltered from the wind

Leeward: the direction toward which the wind is blowing

PFD: personal flotation device; required for each person aboard

Port: the left side of the boat when facing forward (an easy way to remember the difference between "port" and "starboard" is that both "port" and "left" have four letters)

Shank: the main body of an anchor

Sheer: the curve of the boat's deck from fore to aft when seen from the side

Starboard: the right side of the boat when facing forward

Stern: the aft end of the boat

Stern drive: an inboard/outboard (I/O) unit

Stringer: strengthening integral unit fastened from fore to aft inside the hull and fiberglass encapsulated for added strength: much like the skeleton system of our body

## INDEX

### A

Accidents	37
Accident Reporting	37
Acrylics	203
Anchor Light	29
Anchor Windlass	155
Anchoring	150
Audible Alarms	80
Automatic Fire Extinguisher	158

### B

Ballast Bags	93
Battery	56
	113
	122
	210
Battery Charger	61
Battery Switch	59
Bilge Pump	127
	160
Boating Under The Influence	36
Bottom Blocking	232
Bow Filler Cushion	161
Bow Walk Through Doors	162
Bridge Clearance	48
Buoys	45

### C

California EVAP Regulation	2
California Spark Ignition Information	2
Canvas	206
Carbon Monoxide	33
Cardiopulmonary Resuscitation (CPR)	153
Cockpit Sea-Grass Mat	167
Controls	88
	98
	212

### D

Dealer Responsibilities	12
Decommissioning	232
Direct Current Protection	59
Distress Signals	27
Diver's Flag	39
Docking Lights	168
Dock Line Basics	143
Drain Plug	141

### E

EPIRB	11
Electrical	52
Electronics	108
Emergencies	152
Engine (Stern Drive)	79
Engine (Forward Drive)	92
Engine (Outboard)	96
Engine-Starting	85
	106
Environmental Awareness	154
Exhaust	82

<b>F</b>		<b>I</b>	
Fender Clips	169	Ignition Panel/Switch	85
Fenders	145		103
Fiberglass	204	Index	242
Filters	68	Instruments	87
Fire Extinguishers	24	Interior Fabrics	204
	158		
First Aid	153	<b>K</b>	
Fishing	39	Knots	152
Float Plan	9		
Forward Drive Propulsion	92	<b>L</b>	
Fueling	142	Labels	18
Fuel System	66		248
Fuse Panel (DC)	63	Ladder	172
		Lighting	63
<b>G</b>		Life Raft	32
GFCI	60	Loading	20
Galvanic Corrosion	87		21
Galvanic Isolator	60	Law Of Salvage	151
Garbage Placard	31	Lubrication-Engine	83
Gas Vapor Detector	170		97
Gel Coat Maintenance	204		133
General Boating Safety	19	Lubrication- Stern Drive	121
Getting Underway	140		
Glossary	240	<b>M</b>	
		Maneuvering	145
<b>H</b>		Maintaining PFD'S	24
		Masthead Light	29
Helm Controls	69	Metal Cleaning	207
	81	Minimum Required Equipment	32
	87		
	108		
HIN	7		
Horn	28		
Hull Bottom	208		
Hypothermia	153		



N		S	
Navigational Aids	45	Safety Labels	18
Navigation Lights	28		248
	29	SeaDek	183
Navigation Rules	41	Seating	20
Neutral Safety Switch	90		103
Night Running	48		185
			186
O		Shallow Water Operation	149
Oil Spills	30	Signals-Navigation	42
Overloading	20	Sound Producing Devices	28
	21	Spaghetti Matts	203
Owner's Information Packet	7	Spring Line	144
Owner's Registration	12	Stopping	147
Owner's Responsibilities	12	Stern Line	143
		Stereo	77
P			218
Personal Flotation Devices	22	Surf Tabs	93
Plastics	203		
Pollution Regulations	30	T	
Portable Fire Extinguishers	159	Table	189
Port Light (Head)	174	Table Of Contents	5
Power Platform	175	Tachometer	81
PowerTower	176	Technical	246
Power Trim	148	Toilet	73
Pre-departure questionnaire	140	Towing	151
Propellers	84	Trim Angle	148
	209	Trim Switch	88
			101
R		Trim Tabs	148
Radio Communications	28	Troubleshooting	222
Recommissioning	234		
Required Safety Equipment	32	U	
Right Of Way	41	Underwater Lighting	199
Rules Of The Road	43	Upholstery	201
	44		

V	
Vent Line Filter (Waste Tank)	197
Ventilation	70
Visual Distress Signals	26
W	
Water System-Pressurized	179
Water Sports	39
Warning Labels	18
	248
Warranty	14
Weather	40
Winterizing	231
Wiring Color Codes	53
Y	
Yacht Plate	7
Z	
Zinc Anodes	221

# Chapter 11

## Technical

### NOTICE

The following technical information and drawings can be an aid in troubleshooting electrical and mechanical problems along with the charts located in the troubleshooting chapter.

Note that select drawings can be used for all models represented in this manual. Notwithstanding, there are separate sections for LS and LX series vessels.

*Note that all product specifications, models, standard and optional equipment, systems, along with technical information and drawings are subject to change without notice.*

For more information contact your nearest authorized Regal dealer. For the location of your nearest authorized dealer call 407-851-4360 or visit the web-site at [www.Regalboats.com](http://www.Regalboats.com).

Your Regal dealer has received special factory training on the entire product line and his services should be employed to solve technical problems.

# TYPICAL DOMESTIC COMPLIANT FUEL SYSTEM LS SERIES

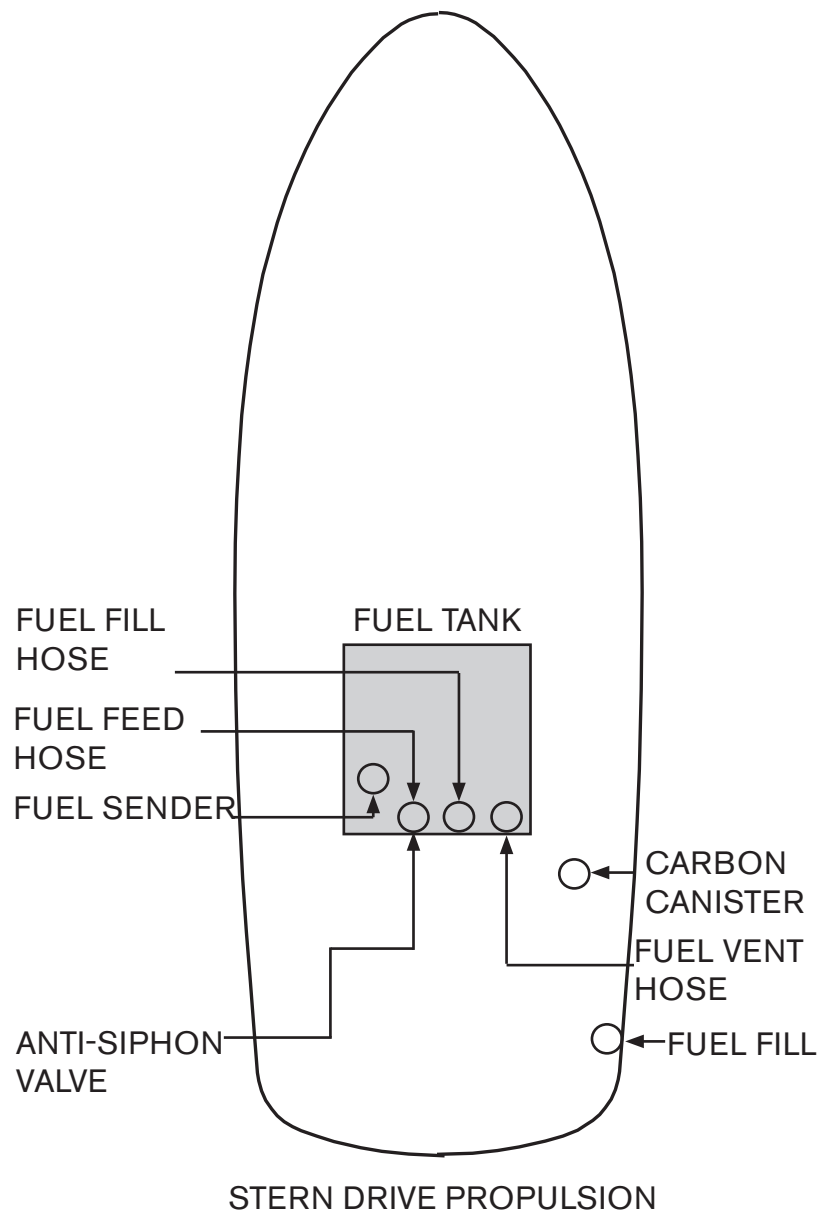

# TYPICAL LABELS & LOCATIONS

**WARNING**  
USE PROPER BLOCKING TECHNIQUES  
WHEN LIFTING BOAT

**NOTICE**  
**Retrieval of Windlass Chain**  
Winch operator may be required  
to periodically spread chain out  
within anchor locker

LIFETIME  
*Plus*  
WARRANTY  
REGAL BOATS



**WARNING**  
ROTATING PROPELLER MAY CAUSE  
SERIOUS INJURY OR DEATH.  
SHUT OFF ENGINE WHEN  
NEAR PERSONS IN THE WATER.  
NW-207-08

**WARNING**  
Carbon monoxide (CO) can cause brain damage or death.  
Engine and generator exhaust contains odorless and colorless carbon monoxide gas.  
Signs of carbon monoxide poisoning include nausea, headache, dizziness, drowsiness  
and lack of consciousness.  
Get fresh air if anyone shows signs of carbon monoxide poisoning.  
See Owner's Manual for information regarding carbon monoxide poisoning.

**WARNING**  
GASOLINE VAPORS CAN EXPLODE BEFORE STARTING  
ENGINE. OPERATE BLOWER 4 MIN. AND CHECK ENGINE  
COMPARTMENT FOR GASOLINE LEAKS OR VAPORS. RUN  
BLOWER BELOW CRUISING SPEED.

MEETS U.S. EPA EVAP  
STANDARDS USING  
CERTIFIED COMPONENTS  
REGAL MARINE INC., ORLANDO, FL



**WARNING**  
AVOID PERSONAL INJURY!  
INTERRUPT SWITCH MUST BE ATTACHED TO OPERATOR  
WHILE ENGINE IS RUNNING. QUALIFIED OPERATOR MUST  
BE IN CONTROL AT ALL TIMES.  
READ OWNER'S MANUAL BEFORE USE.

**WARNING**  
CARBON MONOXIDE IS A TASTELESS, ODORLESS, AND  
INVISIBLE GAS THAT CAN CAUSE DISCOMFORT, SEVERE  
AND EVEN DEATH. EXERCISE CAUTION WHILE OPERATING  
A GENERATOR OR ENGINE IN CONFINED SPACES OR AT  
DOCK SIDE. DO NOT ALLOW HULL EXHAUST OUTLETS TO  
BECOME BLOCKED OR EXHAUST FUMES CAN BECOME  
TRAPPED IN OR AROUND THE CONFINES OF YOUR VESSEL.

**CAUTION**  
WHEN OPERATING POWERTOWER  
KEEP ALL BODY PARTS CLEAR  
OF TOWER HINGE MECHANISMS.

**WARNING**  
AVOID SERIOUS INJURY OR DEATH  
FROM FIRE OR EXPLOSION  
RESULTING FROM LEAKING FUEL.  
INSPECT SYSTEM FOR LEAKS AT  
LEAST ONCE A YEAR.  
NW-201-01

**WARNING**  
ROTATING PROPELLER(S) MAY CAUSE  
SERIOUS INJURY OR DEATH!  
DO NOT APPROACH OR USE LADDER  
WHEN ENGINE IS RUNNING.

**CAUTION**  
THIS VESSEL IS NOT EQUIPPED WITH A  
GALVANIC ISOLATOR. USING THE BATTERY  
CHARGER WHILE THE VESSEL IS IN THE  
WATER MAY CAUSE DAMAGE TO THE  
BOAT'S ANODES AND/OR DRIVE SYSTEM!

**WARNING**  
PREVENT SEVERE INJURY OR DEATH  
FROM FIRE, EXPLOSION  
OR ELECTRICAL SHOCK!  
THIS DEVICE MUST BE CONNECTED TO A  
GROUND FAULT CIRCUIT INTERRUPT  
(GFCI) PROTECTED AC OUTLET.  
WHEN USING AN EXTENSION CORD,  
CONNECT THE AC CHARGER PLUG  
BEFORE CONNECTING TO THE GFCI  
PROTECTED AC OUTLET!  
MAKE CONNECTION IN AN OPEN  
ATMOSPHERE FREE OF EXPLOSIVE FUMES.  
MAKE CORD AND CONNECTION IN A  
SECURE MANNER THAT WILL AVOID  
CONTACT WITH THE WATER.

**DANGER**  
Carbon monoxide (CO) can cause brain damage  
or death.  
Engine and generator exhaust contains odorless  
and colorless carbon monoxide gas.  
Carbon monoxide will be around the back of the  
boat when engines or generators are running.  
Move to fresh air, if you feel nausea, headache,  
dizziness, or drowsiness.



# NOTICE

DRAWINGS TITLED AS LS4/LS6  
ARE MODEL SPECIFIC.

DRAWINGS THAT ARE TITLED LS  
ARE APPLICABLE FOR BOTH MODELS.

## LS SERIES DRAWINGS

# LS4 PROFILE

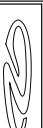

PROPERTY AND CONFIDENTIAL. THIS DRAWING IS THE SOLE PROPERTY OF REGAL MARINE INDUSTRIES AND IS NOT TO BE REPRODUCED OR TRANSMITTED IN ANY FORM OR BY ANY MEANS, ELECTRONIC OR MECHANICAL, INCLUDING PHOTOCOPYING, RECORDING, OR BY ANY INFORMATION STORAGE AND RETRIEVAL SYSTEM. PERMISSION OF REGAL MARINE INDUSTRIES IS PROHIBITED.

 <b>REGAL MARINE INDUSTRIES</b> <small>DESIGN AND CONSTRUCTION</small> <small>11111 W. 11TH AVENUE</small>		<small>ALL RIGHTS RESERVED</small>	
DATE:	11/10/17	DESIGNER:	-
DRAWN BY:	JPG	APPROVED BY:	Dennis R.
PROJECT TITLE:	LS4 (DH) Profile	FRAME:	1 OF 1
		DWG. NO.:	5

# LS6 PROFILE



PROPERTY AND CONFIDENTIAL. THIS DRAWING IS THE SOLE PROPERTY OF REGAL MARINE INDUSTRIES. ANY REPRODUCTION OR PARTIAL REPRODUCTION WITHOUT THE WRITTEN PERMISSION OF REGAL MARINE INDUSTRIES IS PROHIBITED.

<b>DATE</b>	11/10/17	<b>REVISION</b>		<b>PAGE</b>	1 OF 1
<b>FORMAT</b>	JPG	<b>APPROVED BY</b>	Dennis R.	<b>DRAWN BY</b>	5

**REGAL MARINE INDUSTRIES**  
 10000 W. CENTRAL EXPRESSWAY  
 SUITE 1000  
 FORT WORTH, TEXAS 76155  
 TEL: 817.433.8888  
 WWW.REGALMARINE.COM

ALL RIGHTS RESERVED

**LS6 (MH) Starboard Profile**

# LS4 DIMENSIONS

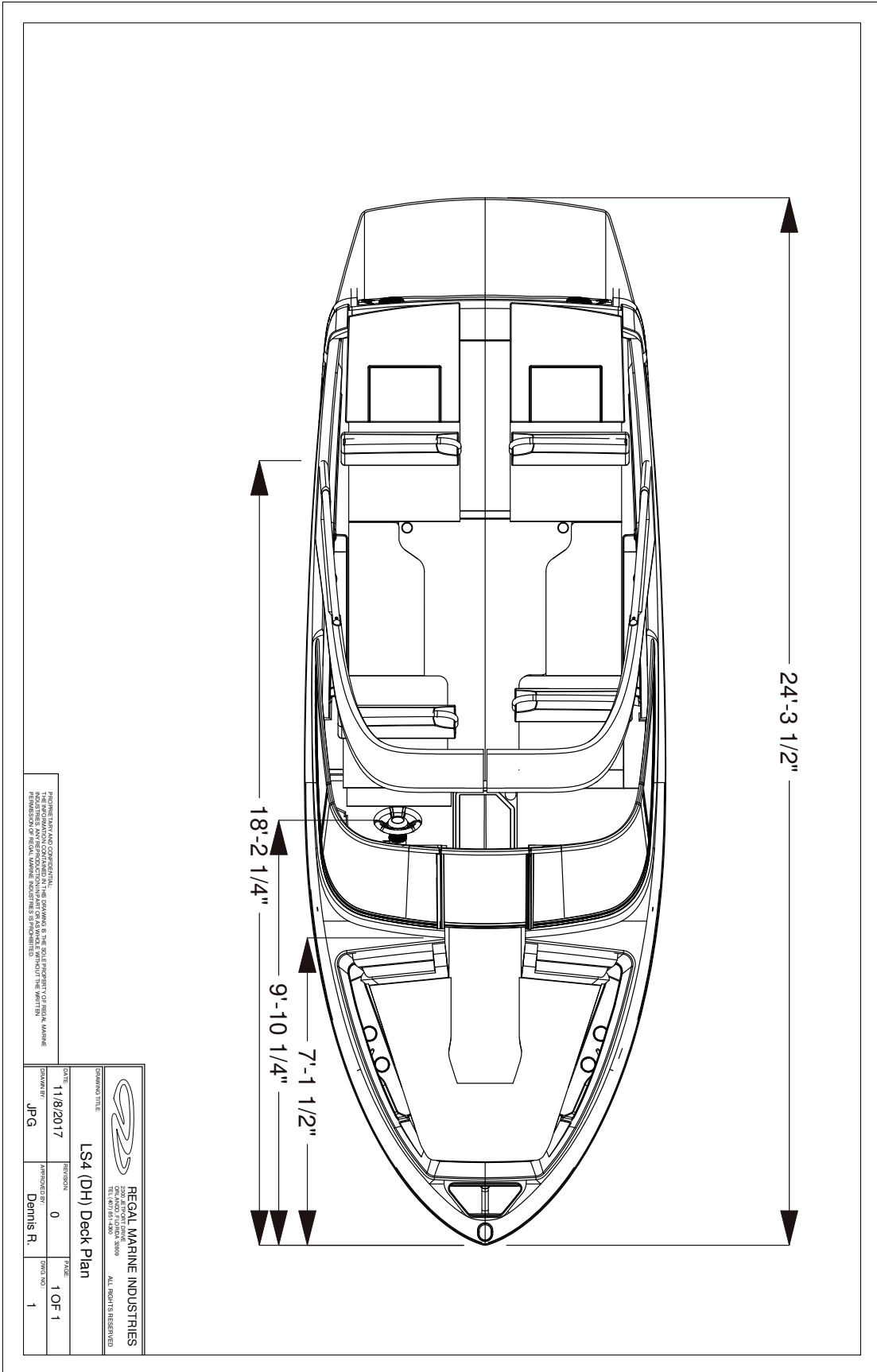

PROPRIETARY AND CONFIDENTIAL.  
 THE INFORMATION CONTAINED IN THIS DRAWING IS THE SOLE PROPERTY OF REGAL MARINE.  
 PERMISSION OF REGAL MARINE INDUSTRIES IS REQUIRED TO REPRODUCE THIS DRAWING.

 <b>REGAL MARINE INDUSTRIES</b> 6000 W. FLORIDA AVE. FORT LAUDERDALE, FL 33309 TEL: 954.776.4400		ALL RIGHTS RESERVED	
DRAWING TITLE	LS4 (DH) Deck Plan		
DATE	11/8/2017	REVISION	0
DRAWN BY	JPG	APPROVED BY	Dennis R.
		SCALE	1 OF 1
		DWG. NO.	1

# LS6 DIMENSIONS

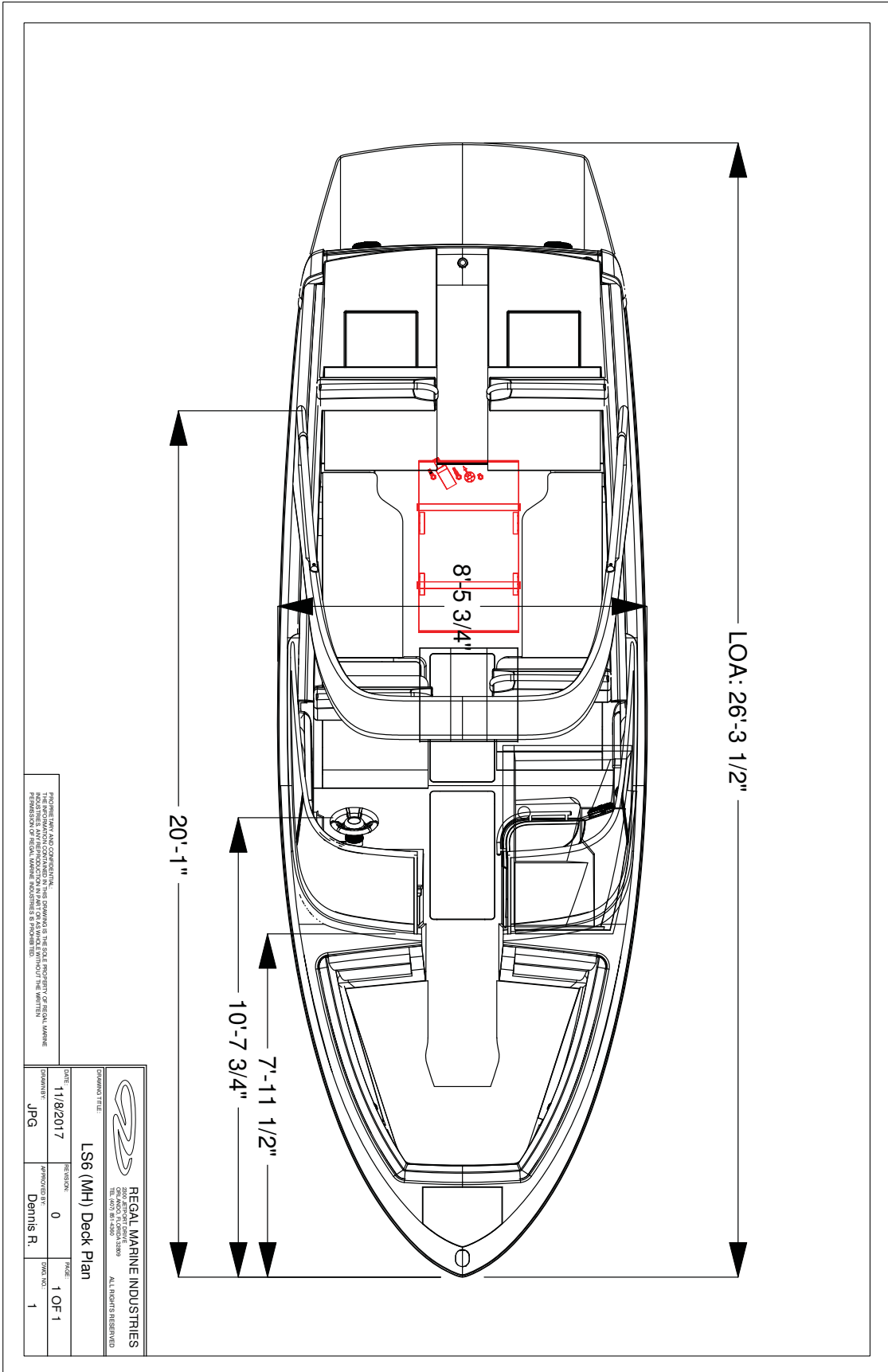

PROPRIETARY AND CONFIDENTIAL. THIS DRAWING IS THE SOLE PROPERTY OF REGAL MARINE INDUSTRIES. ANY REPRODUCTION OR PARTIAL REPRODUCTION OF THIS DRAWING WITHOUT THE WRITTEN PERMISSION OF REGAL MARINE INDUSTRIES IS PROHIBITED.

 <b>REGAL MARINE INDUSTRIES</b> 20000 W. STATE ROAD 100 BOCA RATON, FL 33433 TEL: 561-993-9300 FAX: 561-993-9301 ALL RIGHTS RESERVED					
DATE:	11/8/2017	REV. NO.:	0	PAGE:	1 OF 1
DRAWN BY:	JPG	APPROVED BY:	Dennis R.	SCALE:	1
<b>LS6 (MH) Deck Plan</b>					



# LS4 CE PERSONS/SEATING OCCUPANCY

\*Maximum persons based on seating and ISO stability calculations

15.5" W X 29.5" L  
Allowance Per Person

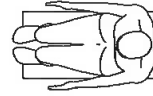

CE Persons Occupancy: 10 Persons

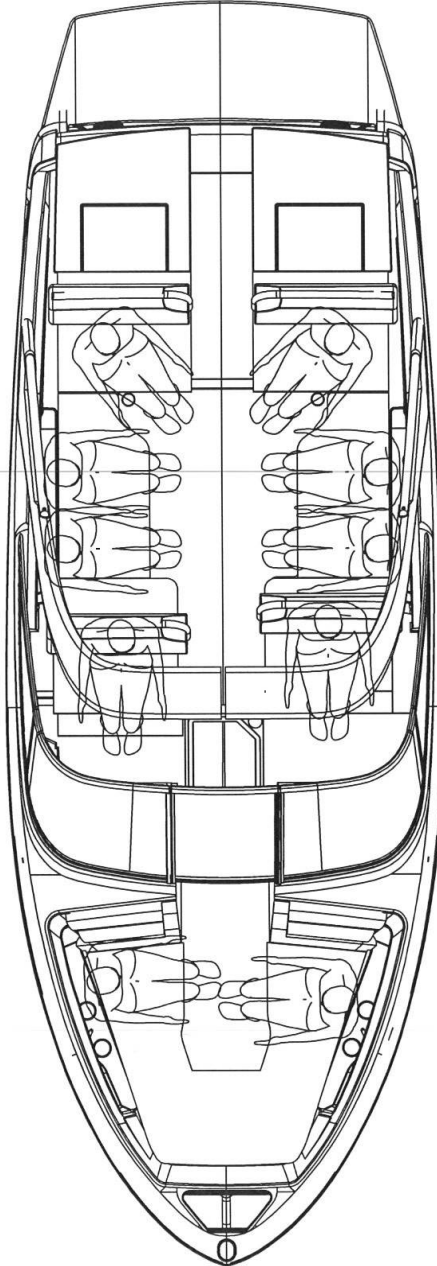

THE INFORMATION CONTAINED HEREIN IS THE PROPERTY OF REGAL MARINE INDUSTRIES. IT IS TO BE USED ONLY FOR THE SPECIFIC PURPOSES AND CONDITIONS OF THE ORIGINAL ORDER. REGAL MARINE INDUSTRIES ASSUMES NO LIABILITY FOR ANY DAMAGE OR LOSS OF PROFITS OR REVENUE RESULTING FROM THE USE OF THIS INFORMATION.

 <b>REGAL MARINE INDUSTRIES</b> 2000 AIRPORT DRIVE FORT WORTH, TEXAS 76117-4099 ALL RIGHTS RESERVED			
DATE:	11/8/2017	REVISED BY:	0
DESIGNED BY:	JPG	DESIGNED BY:	Dennis R.
ISSUED TITLE:	LS4 (DH) Deck Plan	TRAILER:	1 OF 1
		DRAWING NO.:	2

# LS6 CE PERSONS/SEATING OCCUPANCY

\*Maximum persons based on seating and ISO stability calculations

15.5" W X 29.5" L  
Allowance Per Person

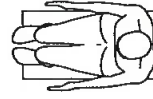

CE Persons Occupancy: 10 Persons

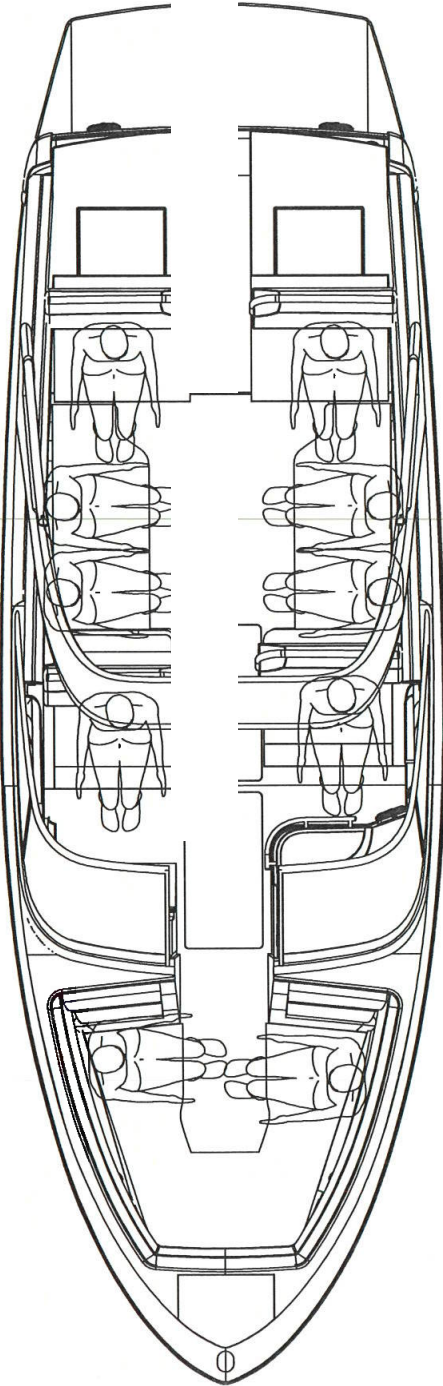

REGAL MARINE INDUSTRIES AND COMPANIES, THE DESIGNER OF THIS BOAT, ACCEPTS NO RESPONSIBILITY OR LIABILITY FOR ANY DAMAGE TO PERSONS OR PROPERTY, OR ANY DAMAGE TO THE BOAT, ARISING FROM THE USE OF THIS BOAT IN ANY MANNER, INCLUDING BUT NOT LIMITED TO, COLLISION, SINKING, OR OTHER ACCIDENTS, OR FROM THE USE OF THIS BOAT IN ANY MANNER THAT IS NOT INTENDED BY THE DESIGNER.

 <b>REGAL MARINE INDUSTRIES</b> 10000 W. 10th Street, Suite 100 Edina, MN 55425 Tel: 763-853-8600 Fax: 763-853-8601 www.regalmarine.com		
DRAWING TITLE: <b>LS6 (MH) Deck Plan</b>		
DATE: 11/8/2017	ISSUED: 0	PAGE: 1 OF 1
DESIGNED BY: JPG	APPROVED BY: Dennis R.	TRIAL: 2

# TYPICAL SURF SYSTEM HOSE ROUTING

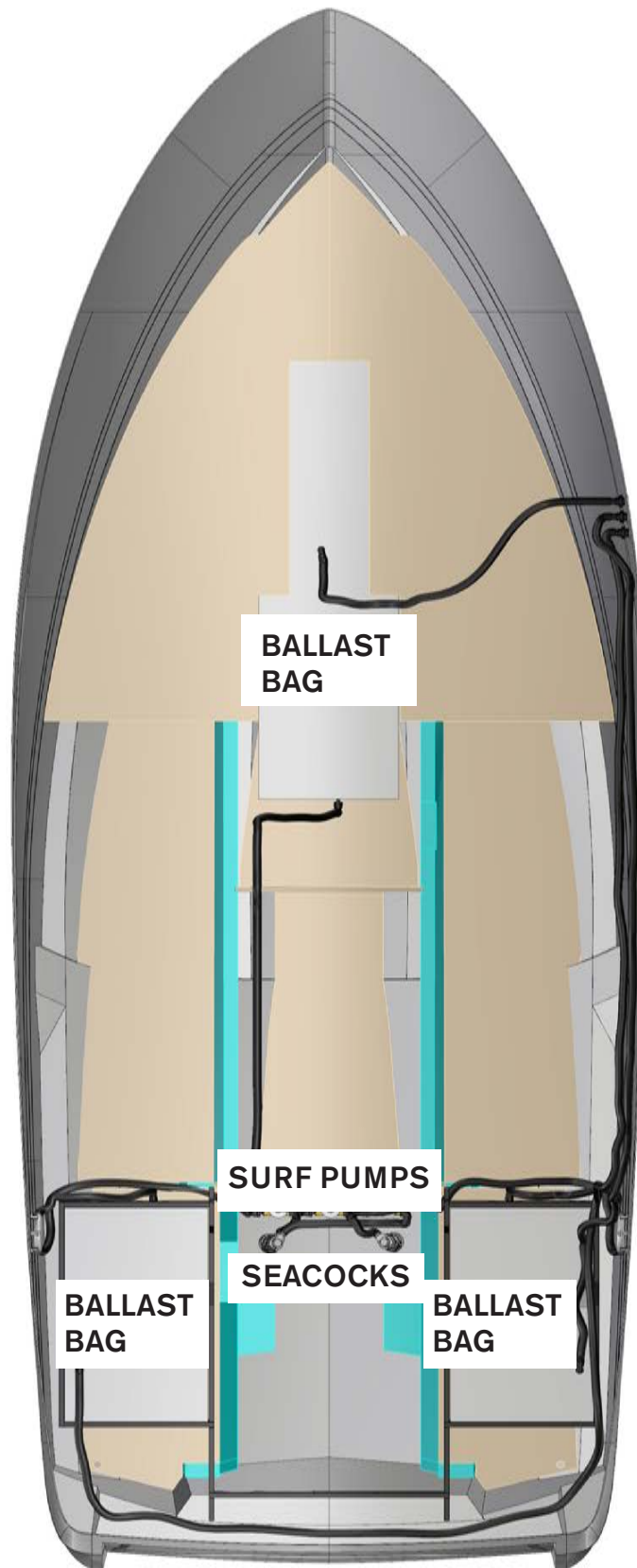

LS6 SHOWN

# TYPICAL SUMP LS SERIES WITH SURF PACKAGE

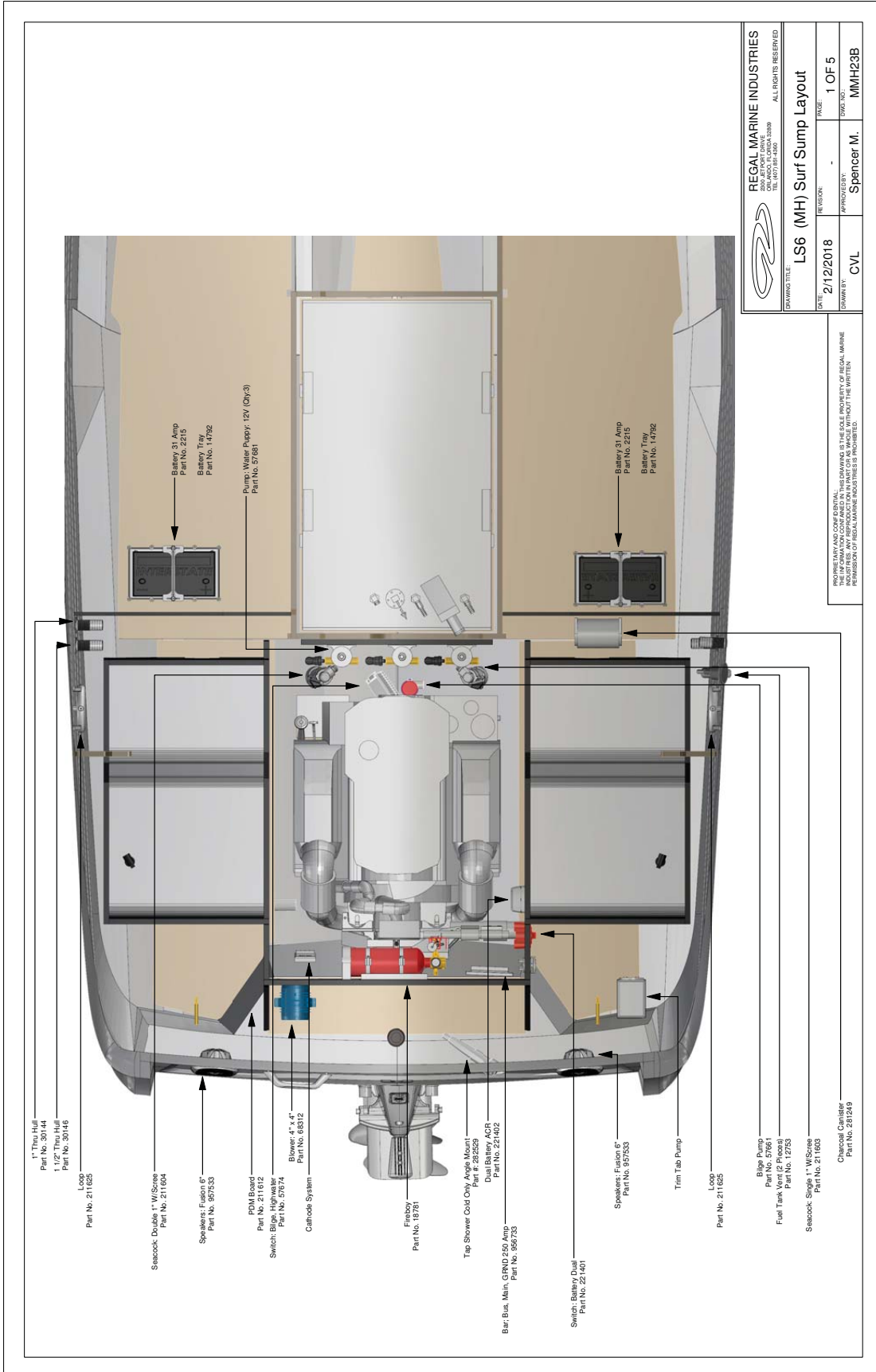

 <b>REGAL MARINE INDUSTRIES</b> <small>100 MARCO PL. CORONA, CA 92626          TEL: 949.255.6500</small>		<small>ALL RIGHTS RESERVED</small>	
<small>DATE:</small> 2/12/2018	<small>REVISION:</small> CVL	<small>APPROVED BY:</small> Spencer M.	<small>PAGE:</small> 1 OF 5
<small>DRAWING TITLE:</small> LS6 (MH) Surf Sump Layout		<small>COMPANY:</small> MMH23B	

PROPRIETARY AND CONFIDENTIAL. THIS DRAWING IS THE PROPERTY OF REGAL MARINE INDUSTRIES. ANY UNAUTHORIZED REPRODUCTION OR USE OF THIS DRAWING WITHOUT THE WRITTEN PERMISSION OF REGAL MARINE INDUSTRIES IS PROHIBITED.

# TYPICAL SUMP LS SERIES WITHOUT SURF PACKAGE



 <b>REGAL MARINE INDUSTRIES</b> 200 W. WILSON BLVD. DEERFIELD BEACH, FL 33442 TEL: 561-993-4800		ALL RIGHTS RESERVED	
DRAWING TITLE: <b>z5 (MH) Sump Layout</b>		REVISION: -	PAGE: 1 OF 5
DATE: 1/22/2018	DRAWN BY: CVL	APPROVED BY: Mike W.	DRAWN TO: MMH23B

PROHIBIT ANY AND ALL REPRODUCTION, DISTRIBUTION, OR SALE OF THIS DRAWING OR ANY PART THEREOF WITHOUT THE WRITTEN PERMISSION OF REGAL MARINE INDUSTRIES. PERMISSION OF REGAL MARINE INDUSTRIES IS PROHIBITED.

Charcoal Canister Part No. 261249







# LS VOLVO NETWORK GLASS COCKPIT SINGLE PLOTTER/ WATER SPORT DISPLAY (SURF MODELS)

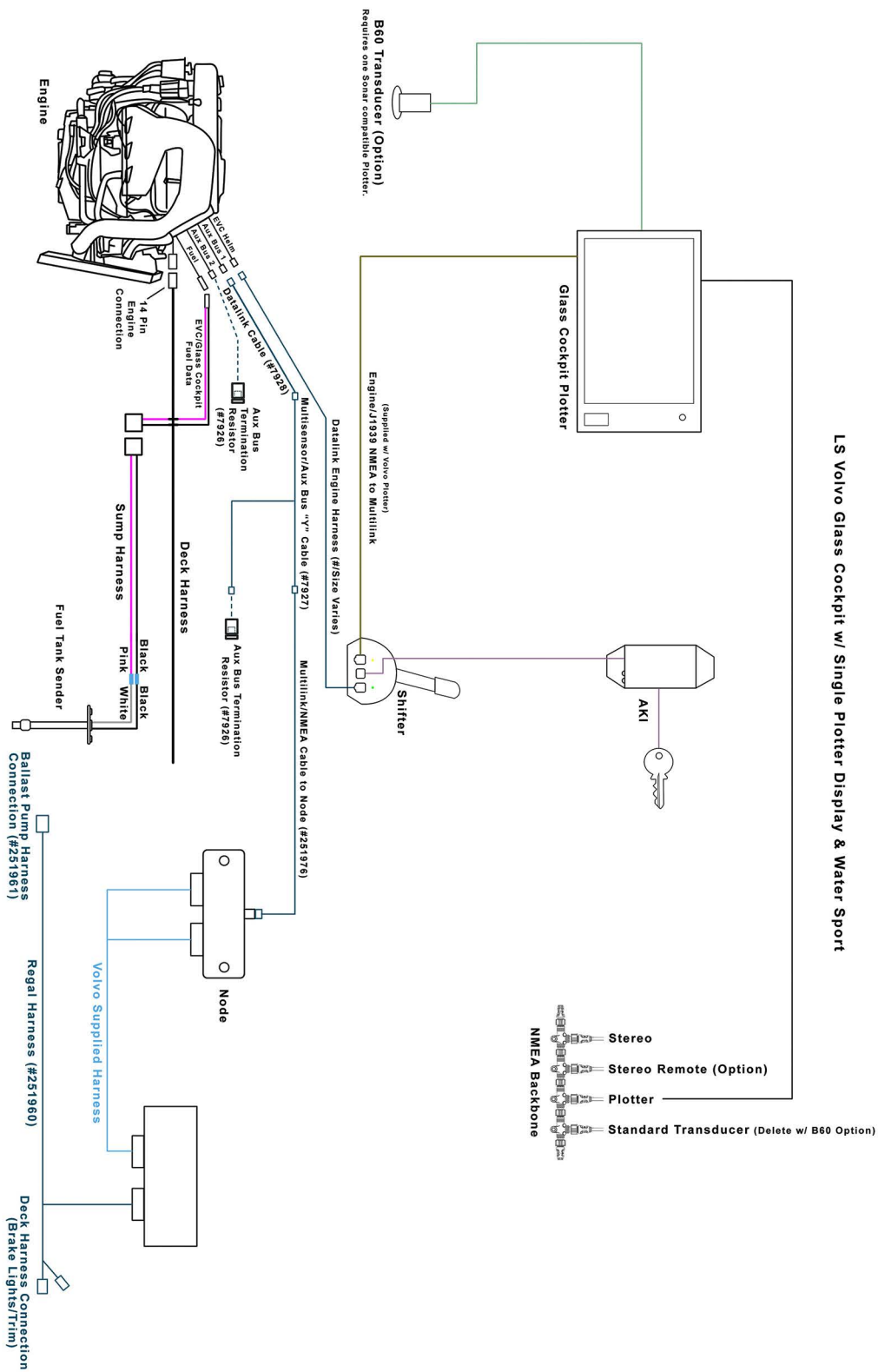

# LS VOLVO NETWORK GLASS COCKPIT DUAL PLOTTER/ WATER SPORT DISPLAY (SURF MODELS)

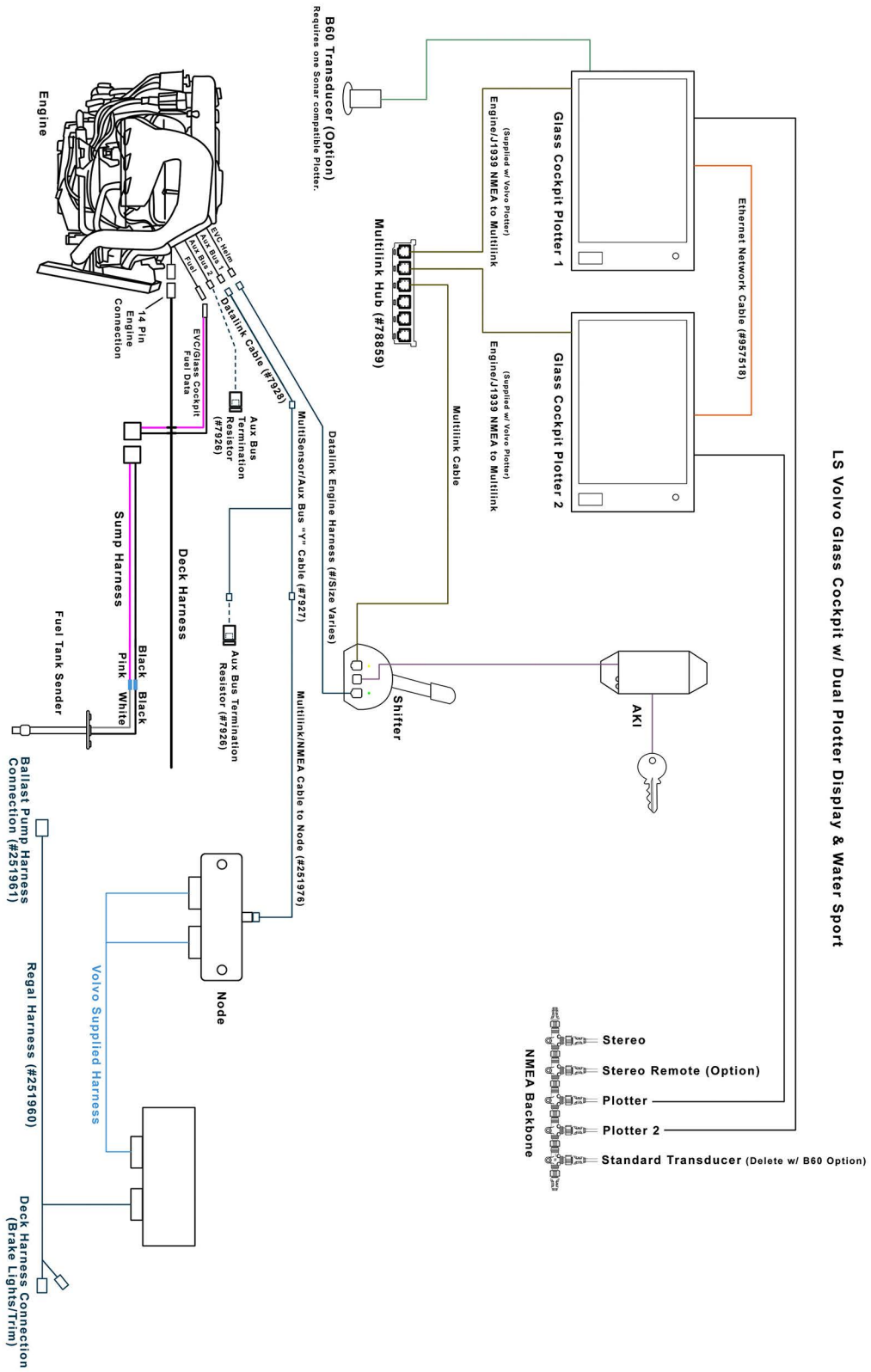

# SURF PACKAGE DUAL BATTERY SWITCH

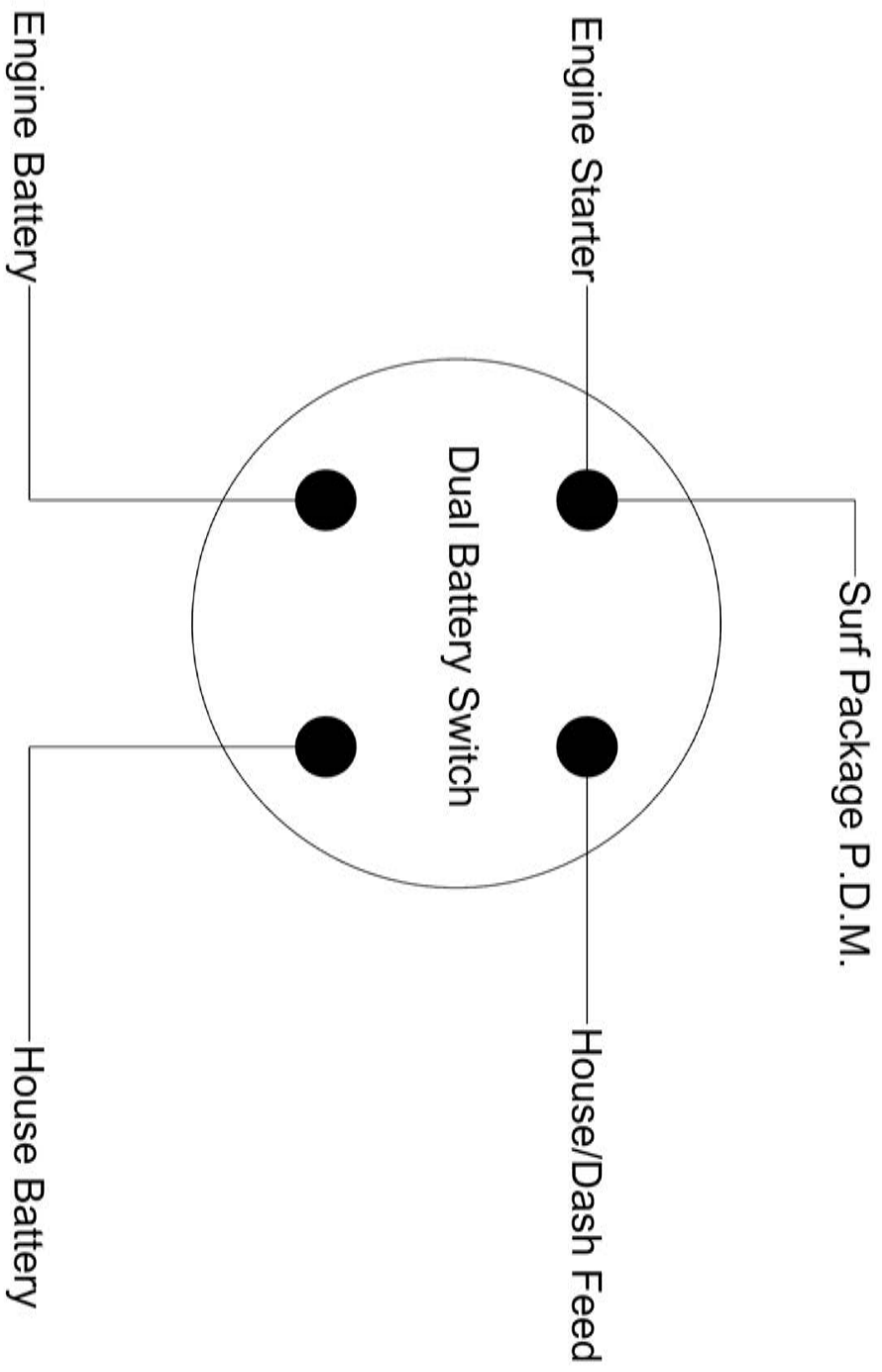

Note: Diagram specific to surf package with dual battery option. Additional connections may be required



# LS VOLVO NETWORK GLASS COCKPIT SINGLE PLOTTER

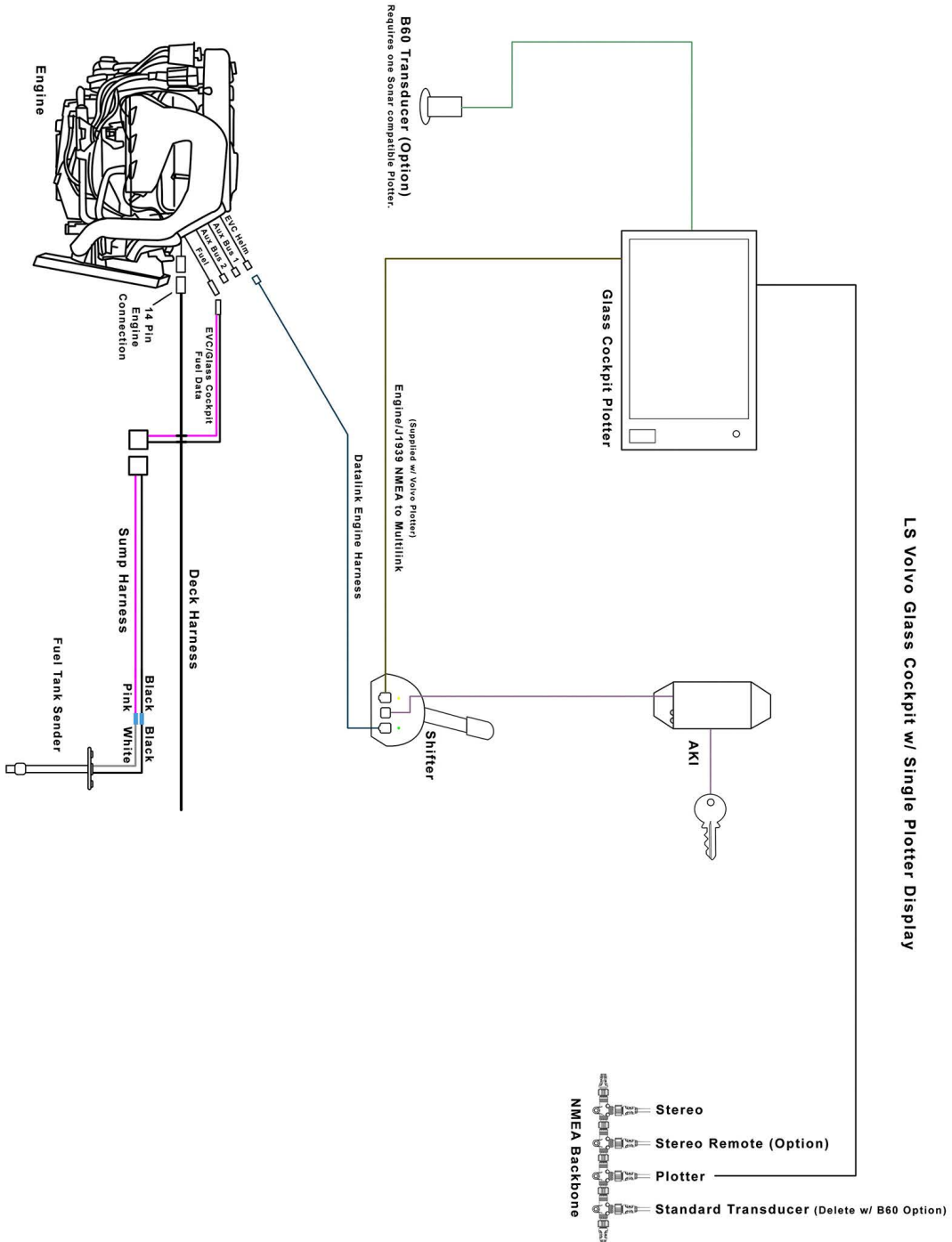

# LS VOLVO NETWORK GLASS COCKPIT DUAL PLOTTER

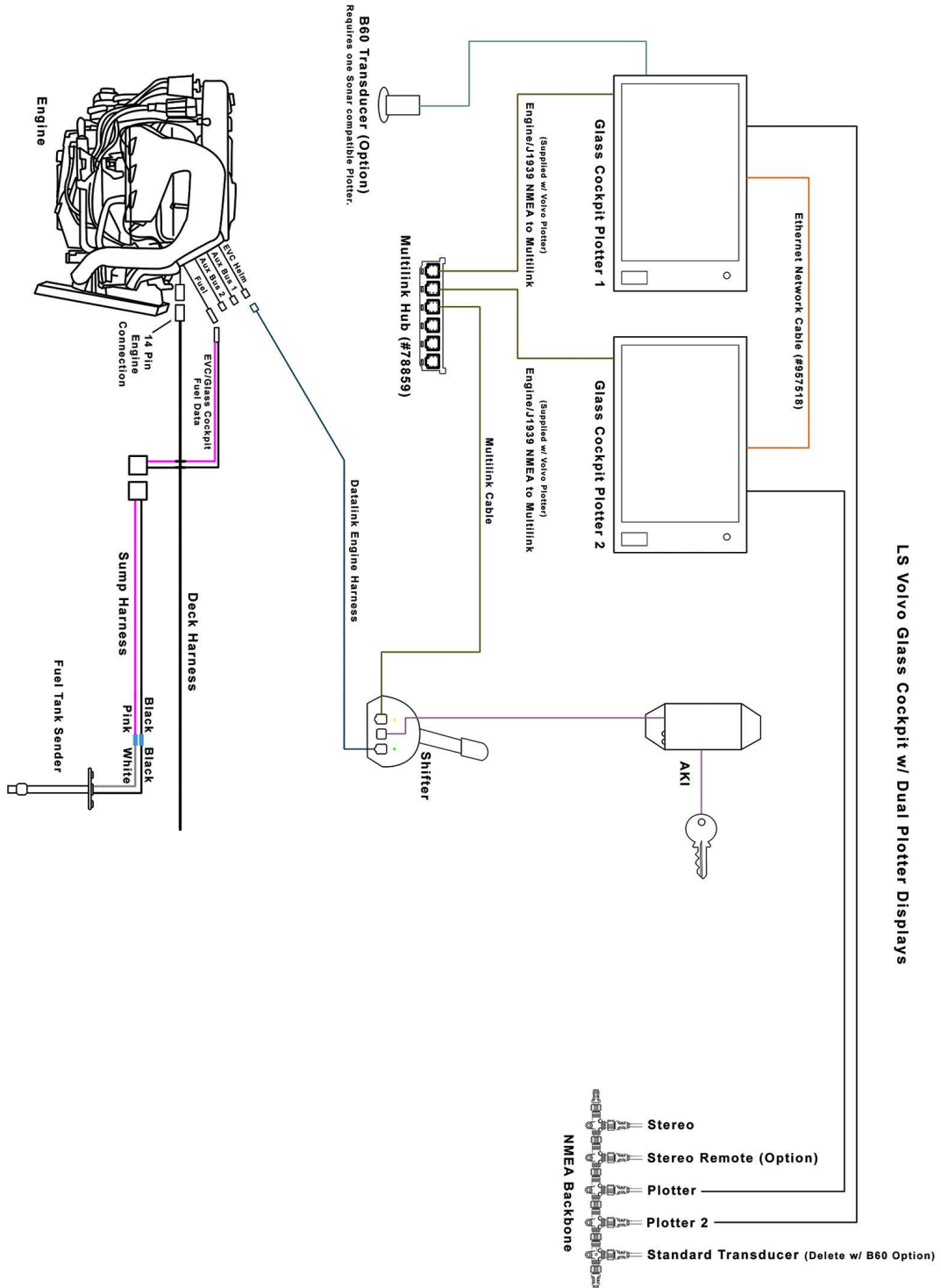

# LS VOLVO NETWORK WITH EVC/SINGLE PLOTTER

EVC= ELECTRONIC VESSEL CONTROL

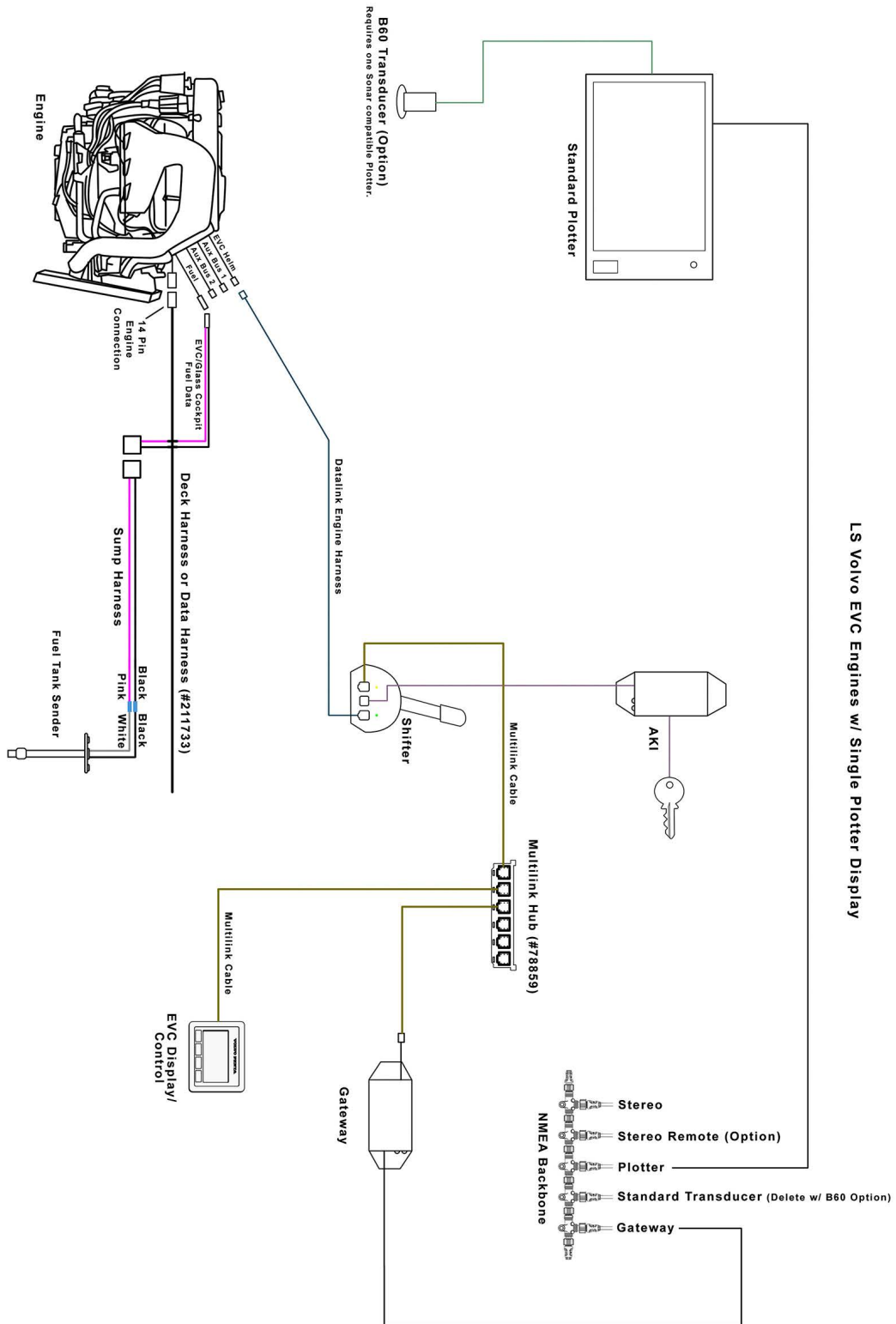

# LS VOLVO NETWORK WITH EVC/DUAL PLOTTER

EVC= ELECTRONIC VESSEL CONTROL

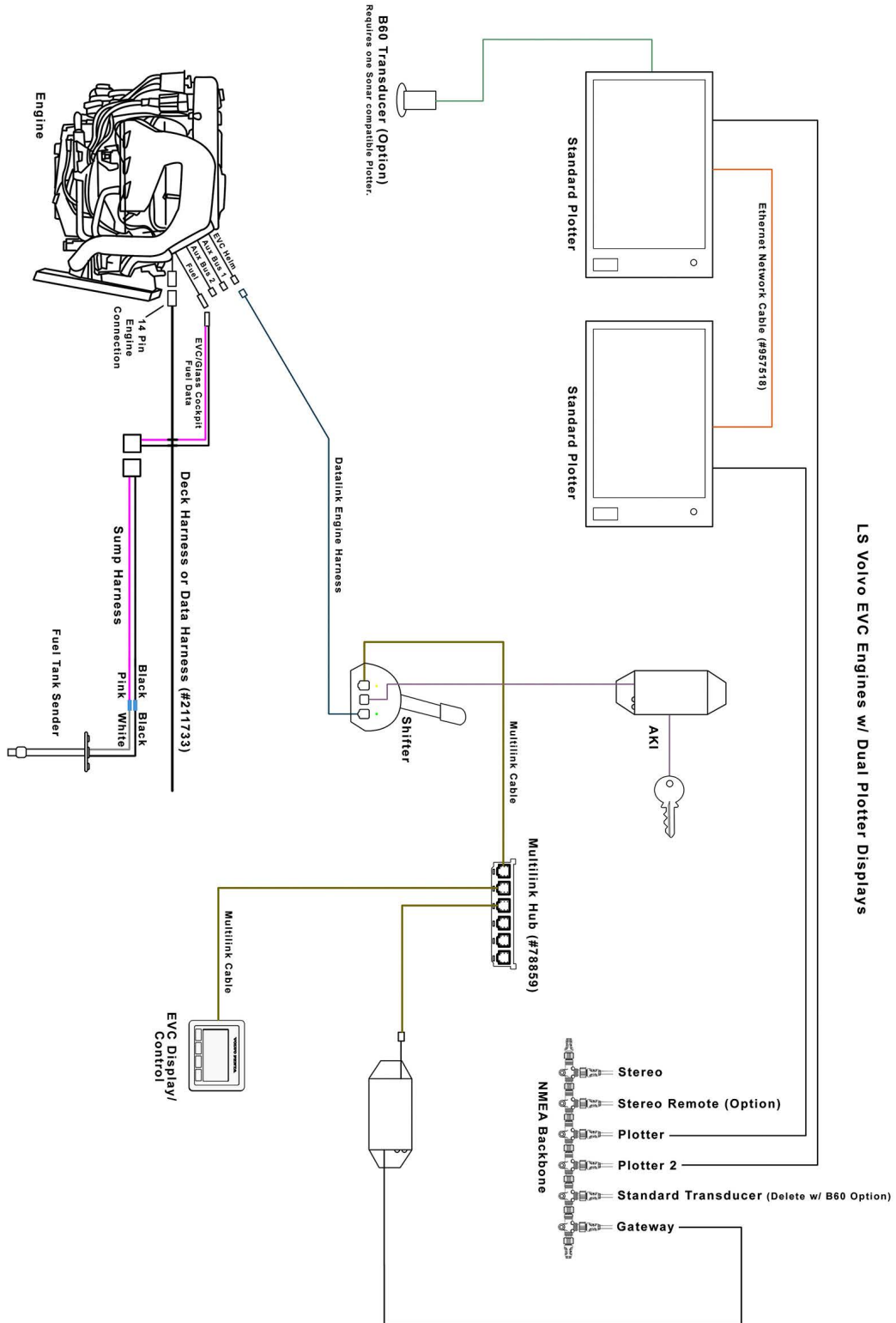

# LS VOLVO NETWORK WITH ANALOG ENGINES/SINGLE PLOTTER

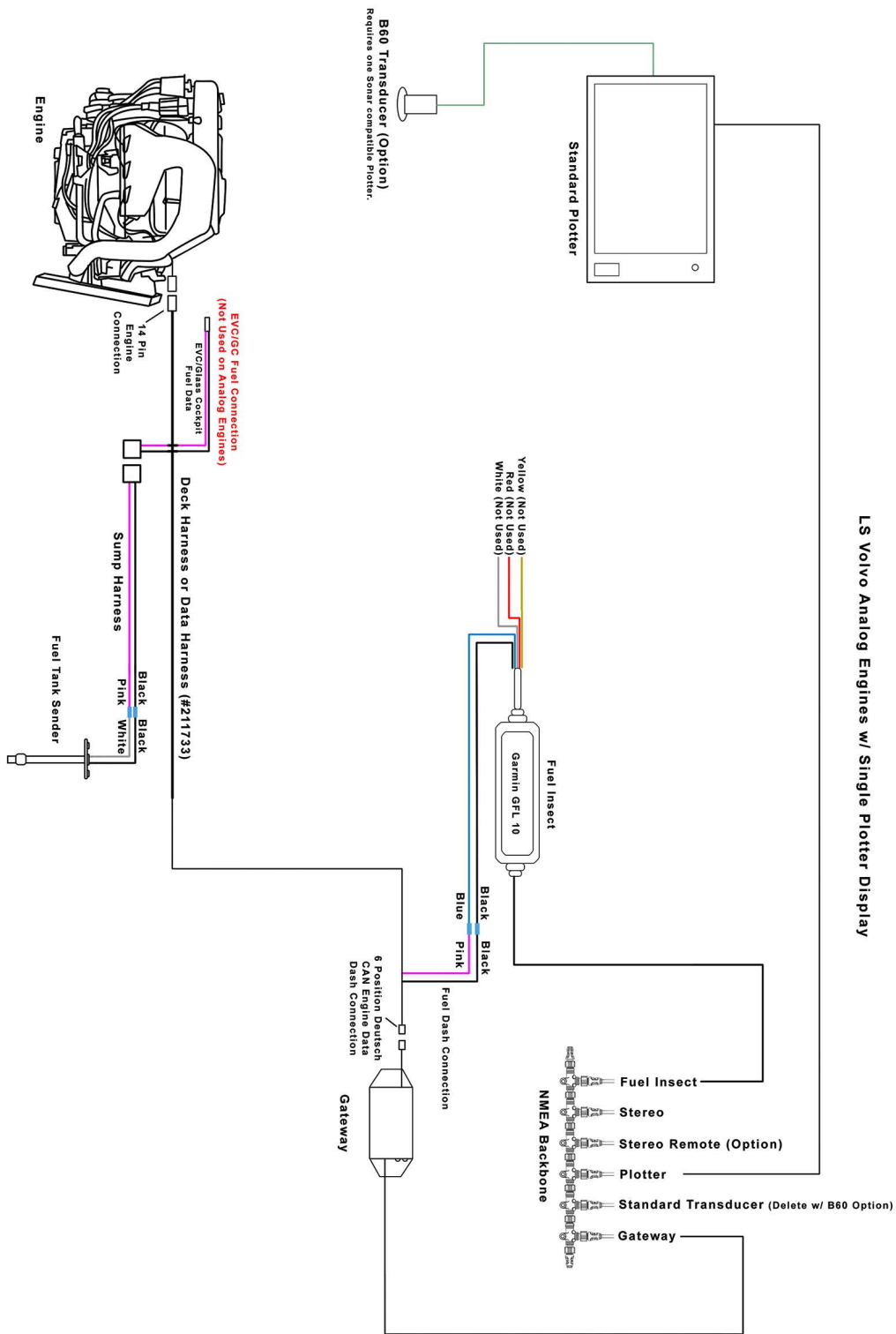



# LS VOLVO NETWORK WITH ANALOG ENGINES/DUAL PLOTTER

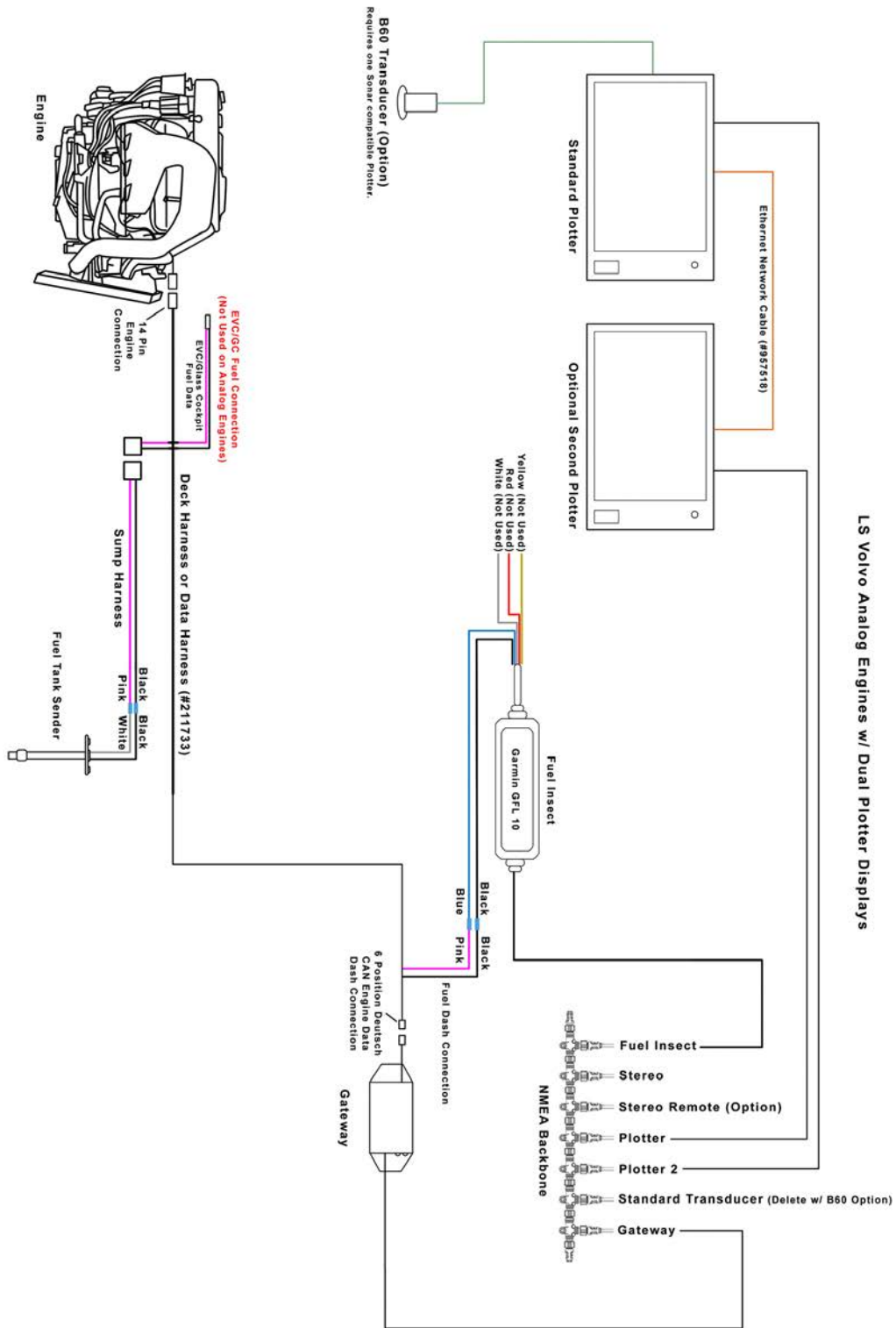

# TYPICAL LS SERIES STEREO PERFORMANCE PACKAGE

## LS Z5 Amplifier RCA Wiring/Settings

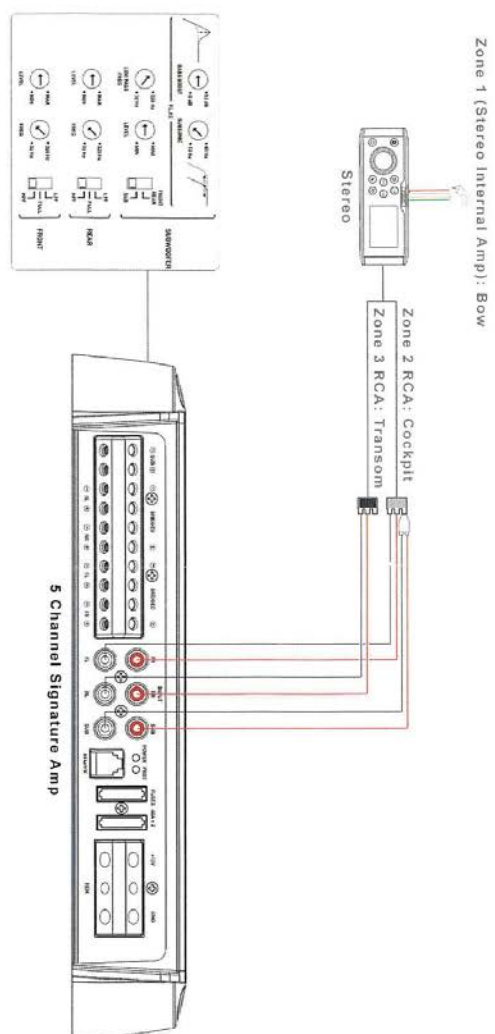

# TYPICAL LS SERIES STEREO PERFORMANCE PACKAGE

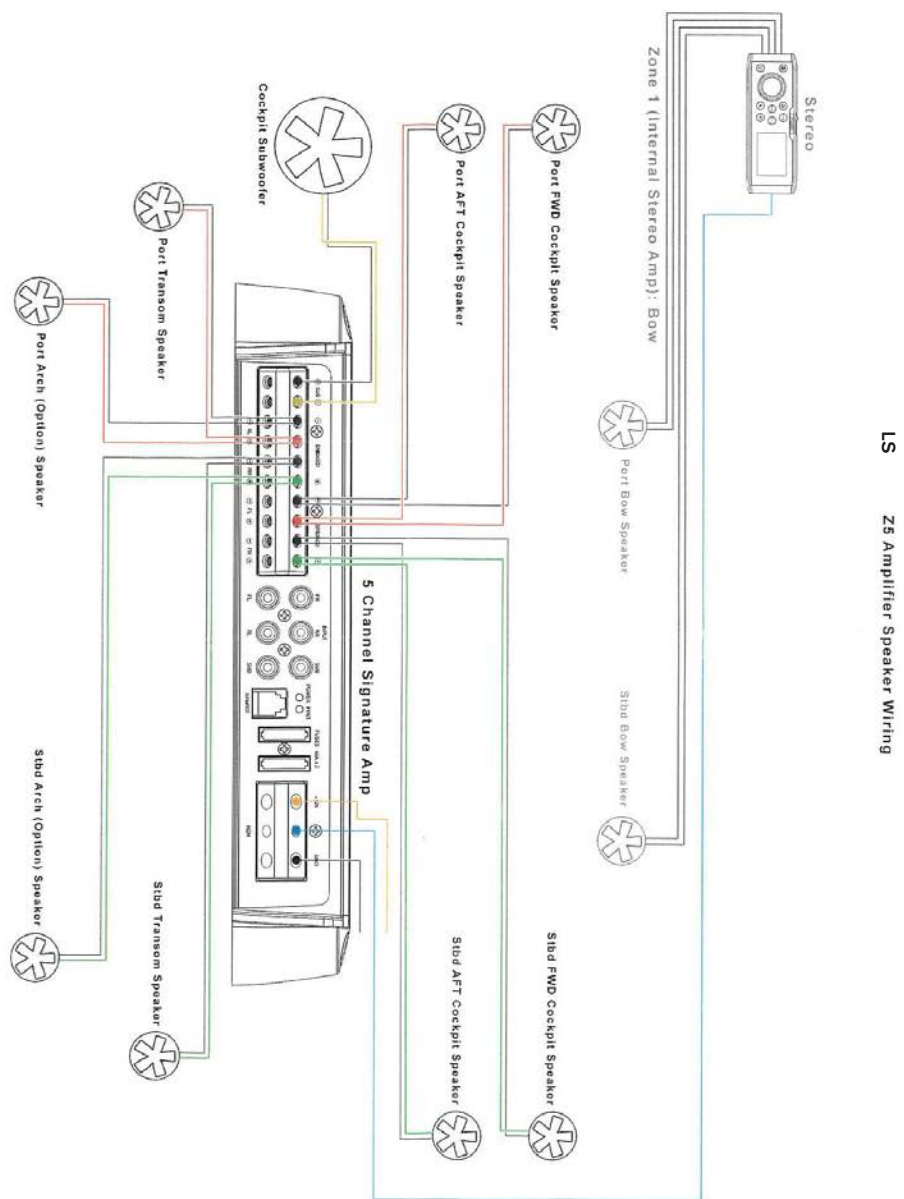



# LS6 SLING LOCATIONS

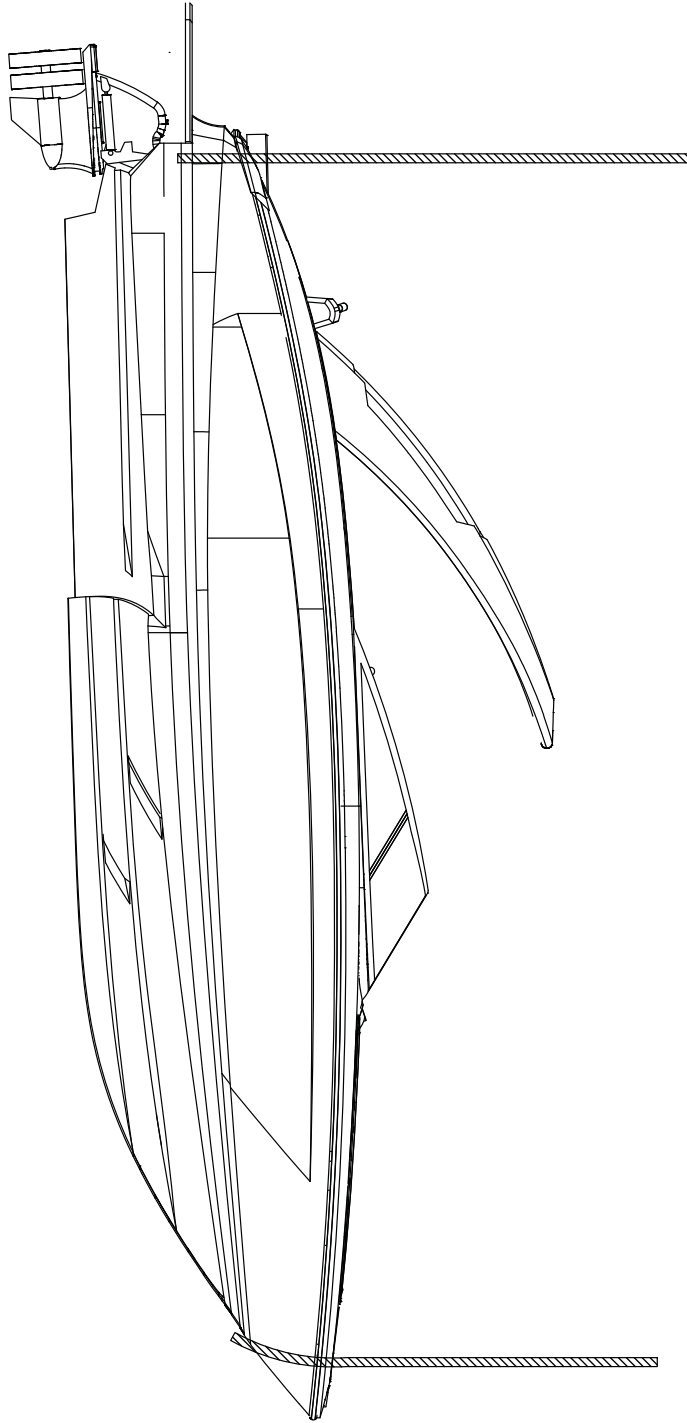

Note: Lifting locations are located at bow eye and aft stern eyes

REGAL MARINE INDUSTRIES, INC. AND COMPANIES, INC. IS THE SOLE PROPRIETOR OF REGAL MARINE INDUSTRIES, INC. AND COMPANIES, INC. ALL RIGHTS RESERVED. THIS DRAWING IS THE PROPERTY OF REGAL MARINE INDUSTRIES, INC. AND COMPANIES, INC. AND IS NOT TO BE REPRODUCED OR TRANSMITTED IN ANY FORM OR BY ANY MEANS, ELECTRONIC OR MECHANICAL, INCLUDING PHOTOCOPYING, RECORDING, OR BY ANY INFORMATION STORAGE AND RETRIEVAL SYSTEM, WITHOUT THE WRITTEN PERMISSION OF REGAL MARINE INDUSTRIES, INC. AND COMPANIES, INC.

 <b>REGAL MARINE INDUSTRIES</b> <small>10000 N. HIGHWAY 100, SUITE 1000          BOCA RATON, FL 33433</small>		<small>ALL RIGHTS RESERVED</small>	
<b>LS6 (MH) Slings Locations</b>			
DATE	REVISION	PKG#	
11/1/017	0	1 OF 1	
DRAWN BY	APPROVED BY	SCALE	
JPG	Dennis R.	30	





# TYPICAL LS SERIES HULL HARDWARE (LS6 SHOWN)

STBD Side

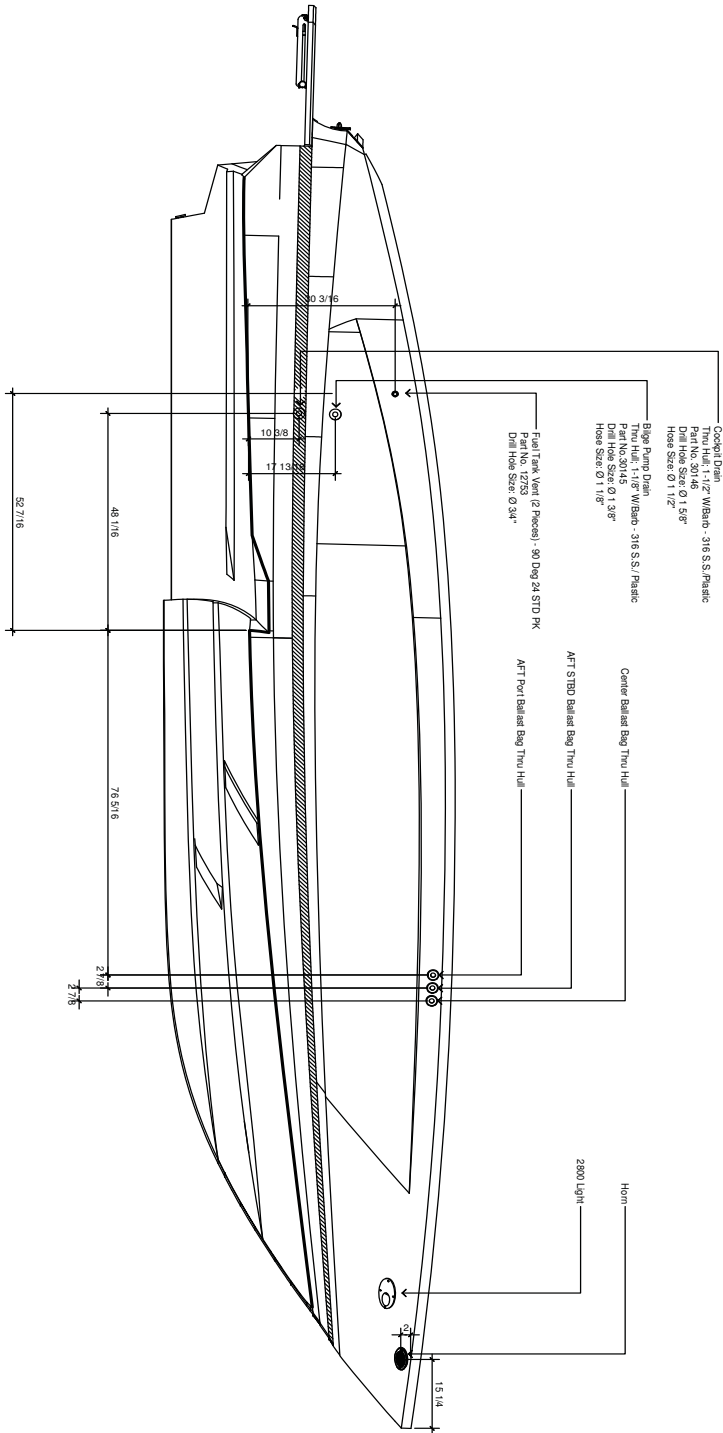

REGAL MARINE AND COMPONENTS  
 REGAL MARINE AND COMPONENTS IS THE SOLE IMPORTER OF REGAL MARINE  
 EQUIPMENT AND REPRODUCTION PARTS IN THE UNITED STATES AND CANADA.  
 REGAL MARINE AND COMPONENTS IS NOT RESPONSIBLE FOR ANY DAMAGE TO THE VESSEL OR  
 EQUIPMENT CAUSED BY THE USE OF REGAL MARINE EQUIPMENT.

 <b>REGAL MARINE INDUSTRIES</b> <small>ONE ANNO, FORT LAUDERDALE, FL 33308        TEL: 954.789.4800</small>		<small>ALL RIGHTS RESERVED</small>	
DRAWING TITLE: <b>LS6 (MH) Hull Hardware</b>			
DATE: 2/12/2018	DESIGNER: -	SCALE: 1 OF 4	TRNG NO: 35
DRAWN BY: CVL	APPROVED BY: Spencer M.		

# TYPICAL LS SERIES HULL HARDWARE (LS6 SHOWN)

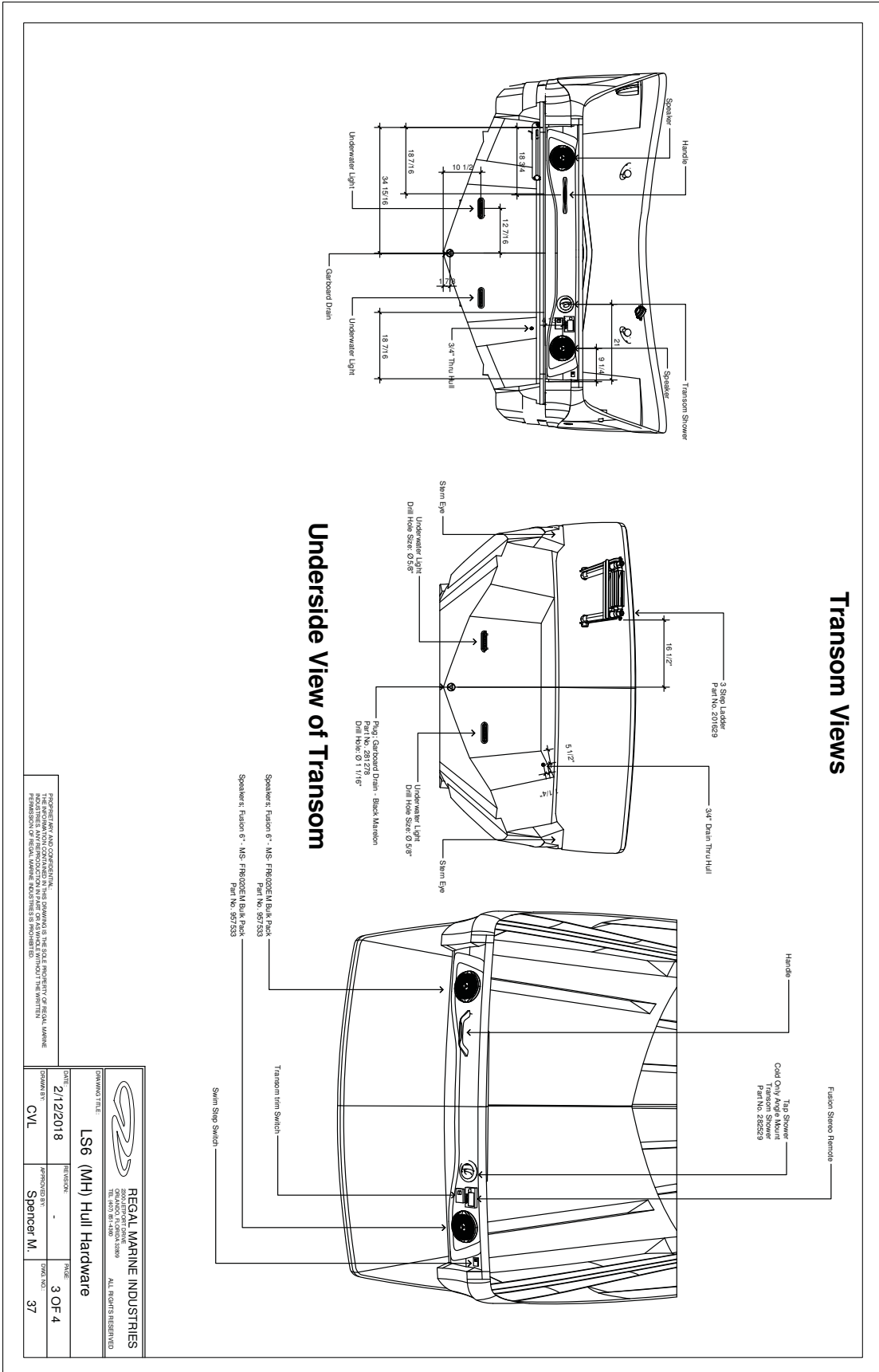







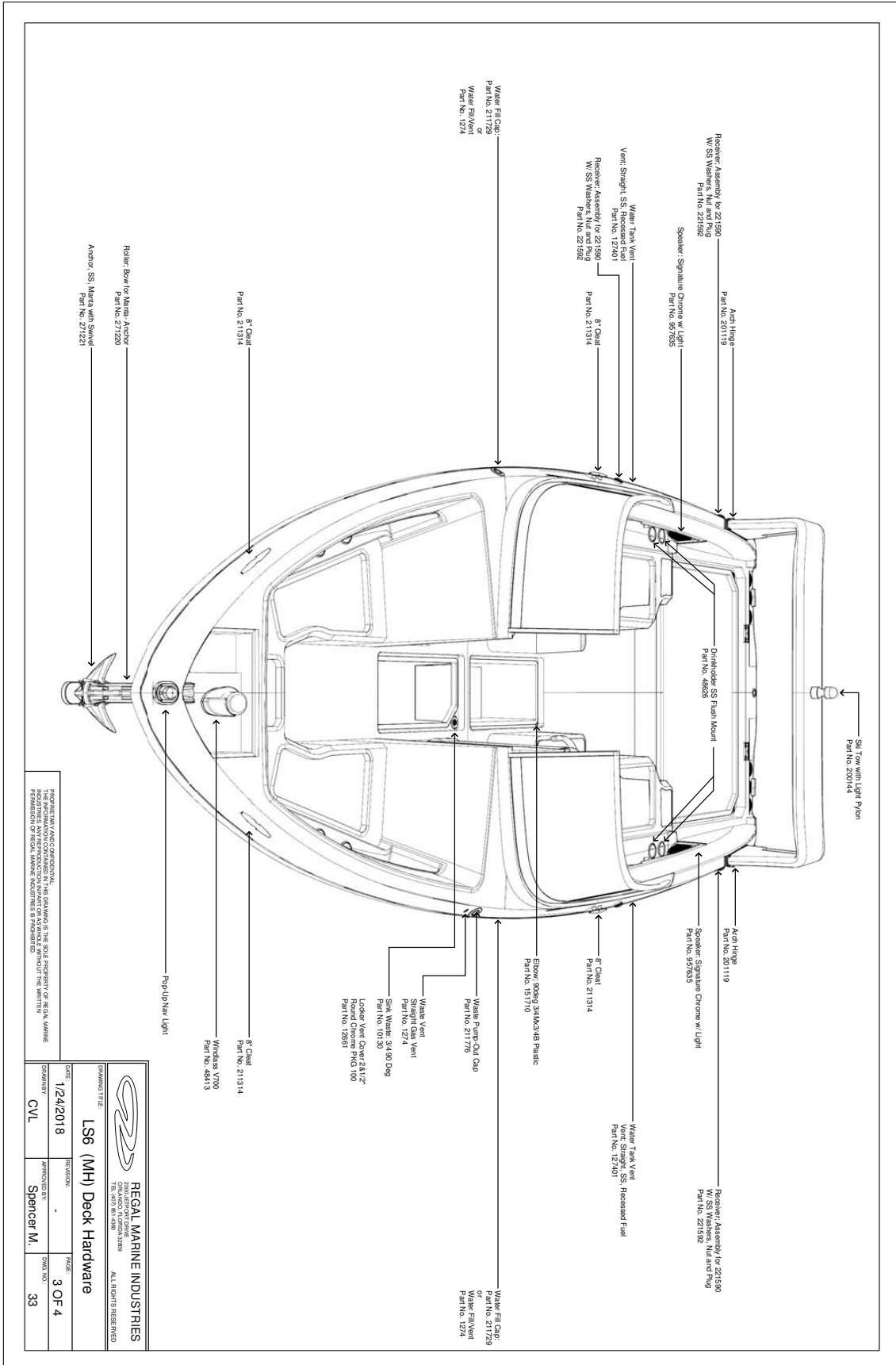

# TYPICAL LS SERIES DECK HARDWARE (LS6 SHOWN)



PREPARE THE VEHICLE AND COMPONENTS. USE DIMENSIONS IN THE BLUE SHADING OF ORIGINAL MANUFACTURER'S AND REPRODUCTION PARTS FOR ASSEMBLY. WITHOUT THE WRITTEN PERMISSION OF REGAL, REMOVE DIMENSIONS & PHOTOGRAPHS.

 <p><b>REGAL MARINE INDUSTRIES</b>                  22000 CENTRAL EXPRESS                  BOATLIFE CENTER                  BOATLIFE CENTER                  TEL: 407-861-4800                  ALL RIGHTS RESERVED</p>	
DATE:	1/24/2018
DESIGNED BY:	CVL
APPROVED BY:	Spencer M.
PAGE NO.:	33
<p><b>LS6 (MH) Deck Hardware</b></p> <p>3 OF 4</p>	



# NOTICE

DRAWINGS TITLED AS LX4/LX6  
ARE MODEL SPECIFIC.

DRAWINGS THAT ARE TITLED LX  
ARE APPLICABLE FOR BOTH MODELS.

## LX OUTBOARD SERIES DRAWINGS

# LX4 PROFILE



# LX6 PROFILE







# LX4 DIMENSIONS

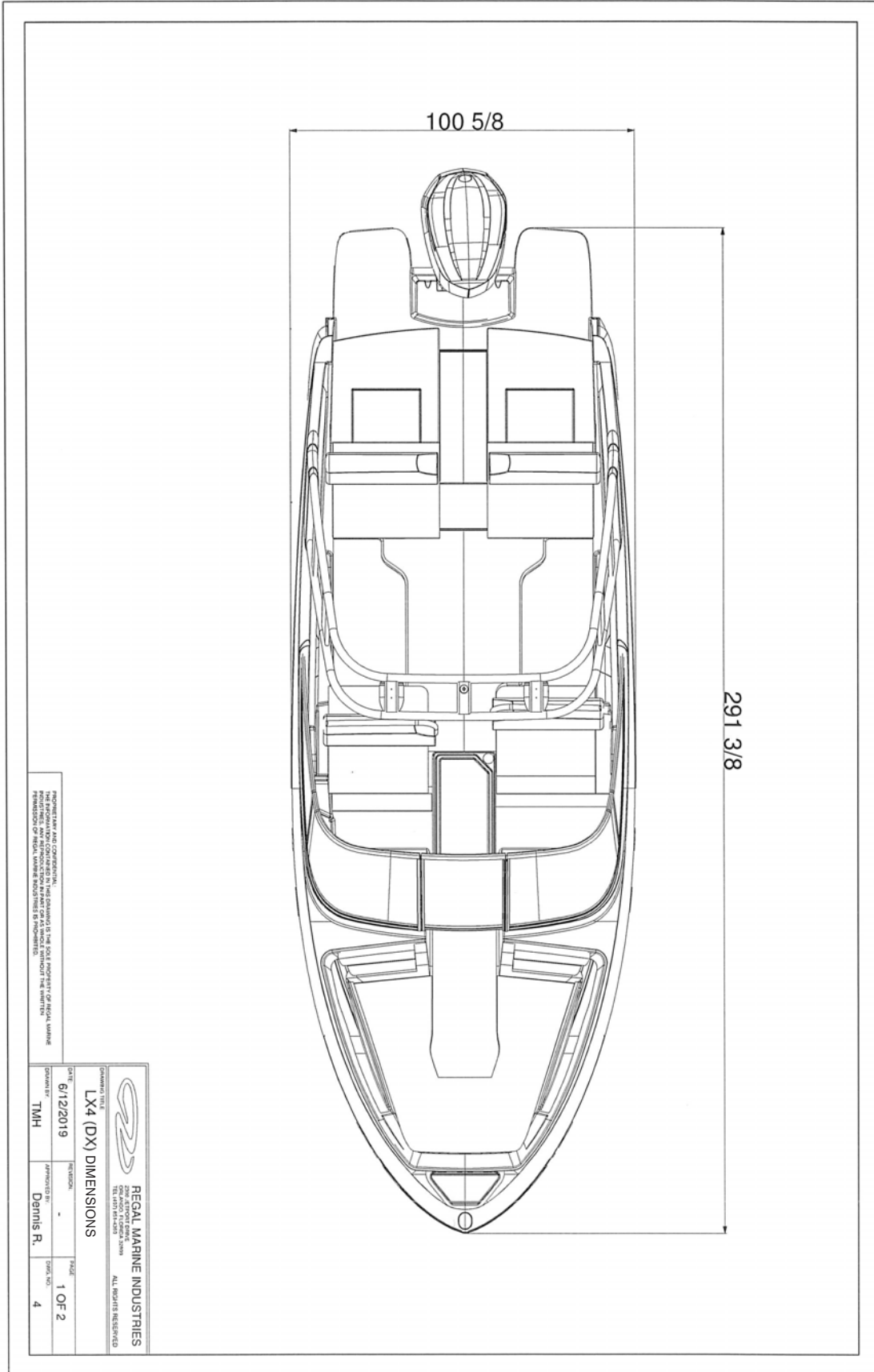

# LX6 DIMENSIONS

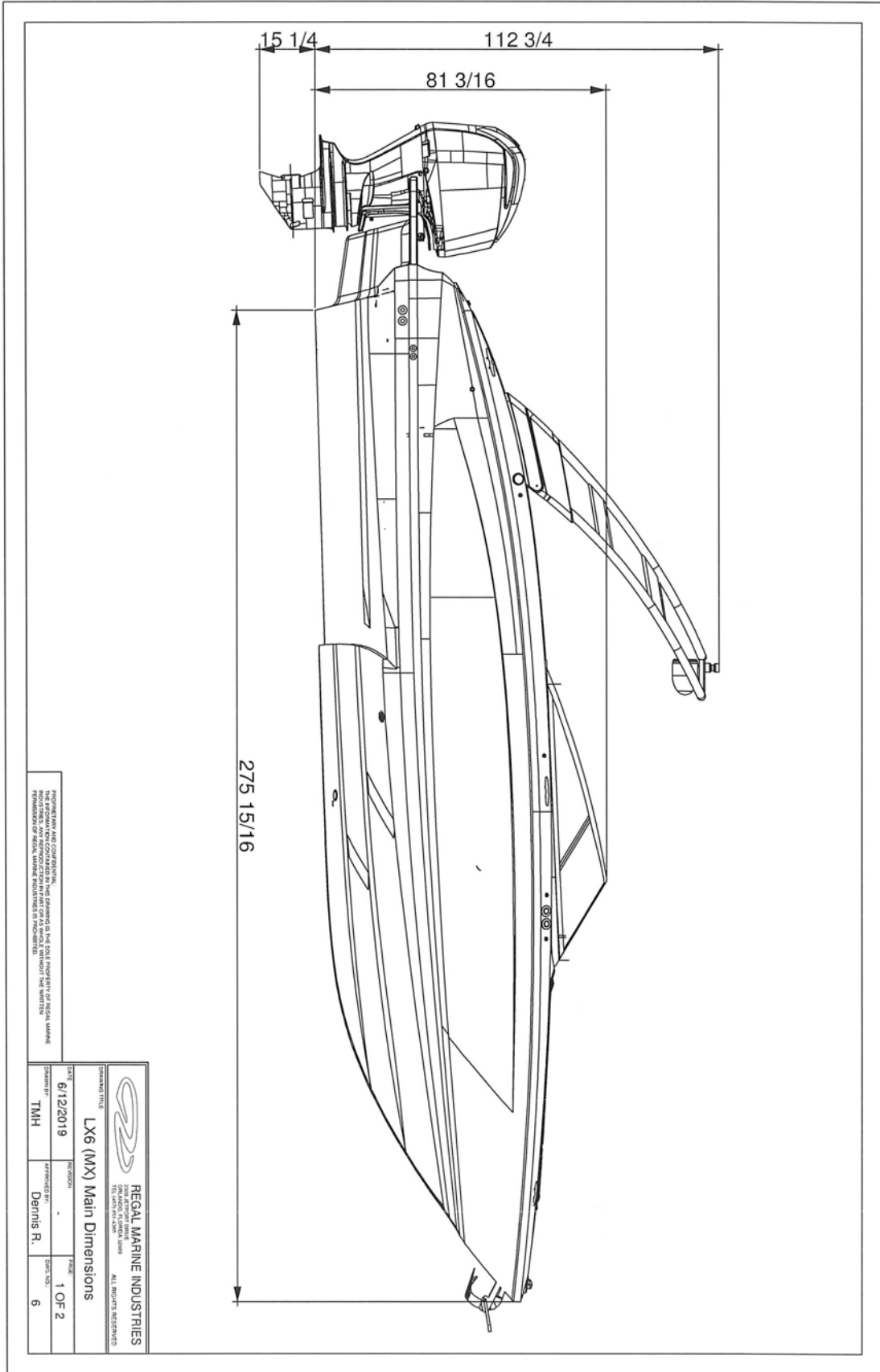

# LX6 DIMENSIONS

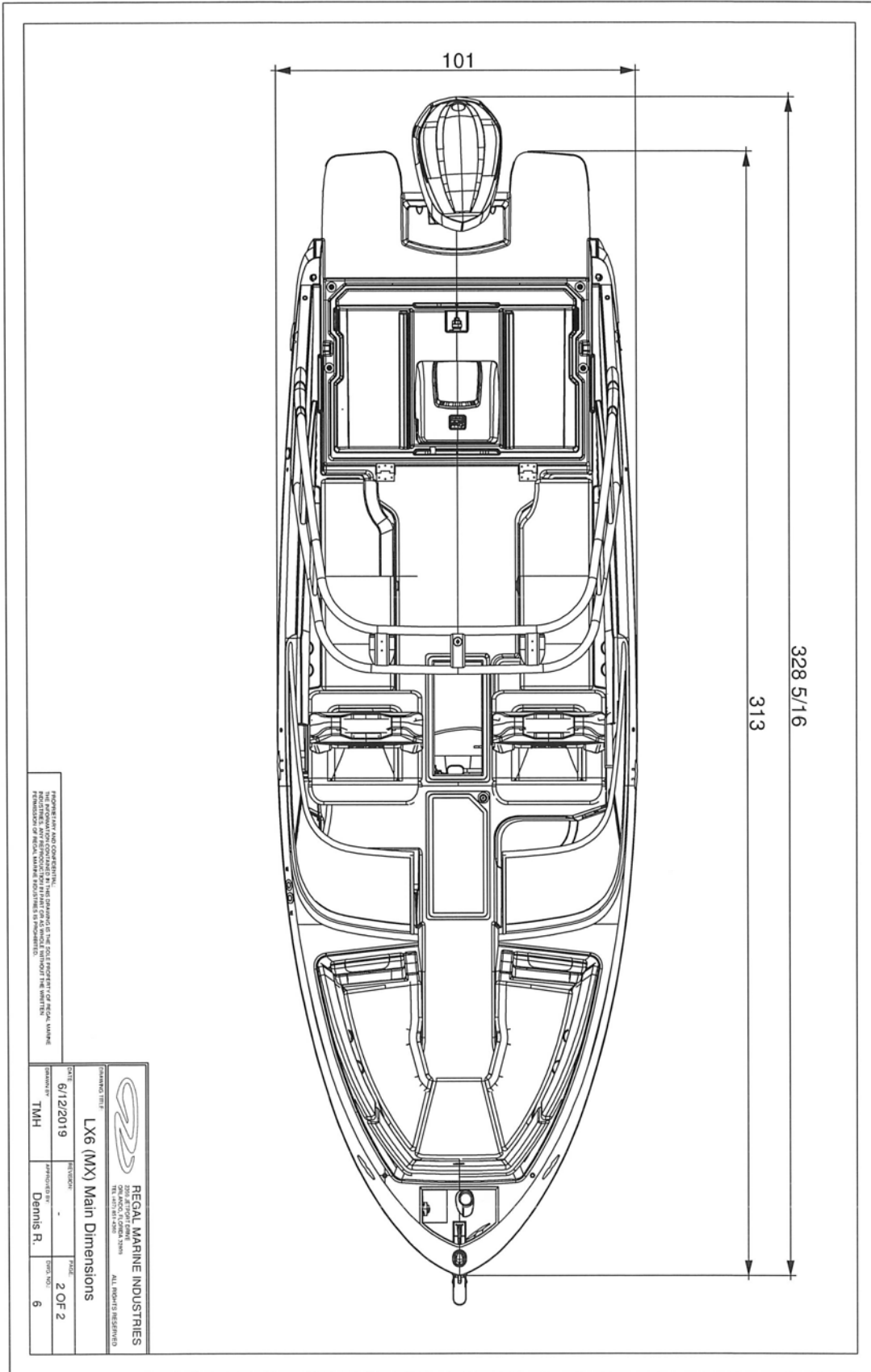

REGAL MARINE INDUSTRIES  
 2008 STONEY CREEK  
 10000 14TH AVENUE, SUITE 100  
 DENVER, CO 80231  
 TEL: 303.440.9400 FAX: 303.440.9401  
 WWW.REGALMARINE.COM

 <b>REGAL MARINE INDUSTRIES</b> 2008 STONEY CREEK 10000 14TH AVENUE, SUITE 100 DENVER, CO 80231 TEL: 303.440.9400 FAX: 303.440.9401 WWW.REGALMARINE.COM	
DRAWING TITLE <b>LX6 (MX) Main Dimensions</b>	
DATE	6/12/2019
DESIGNER	TMH
APPROVED BY	Dennis R.
PAGE	2 OF 2
DRAWING NO.	6

# LX4 CE PERSONS/SEATING OCCUPANCY

\*Number of persons based on seating and ISO stability calculations

15.5" W X 29.5" L  
Allowance Per Person

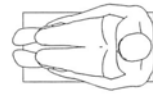

CE Seating Occupancy: 10 Persons

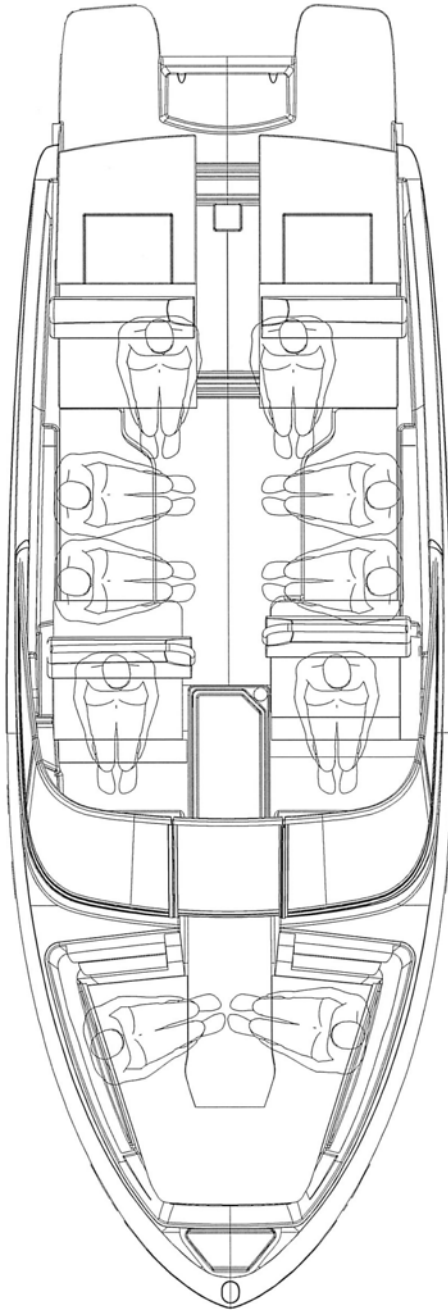

REGAL MARINE INDUSTRIES  
THE INFORMATION CONTAINED IN THIS DRAWING IS THE SOLE PROPERTY OF REGAL MARINE INDUSTRIES. IT IS TO BE USED ONLY FOR THE PROJECT AND VESSEL IDENTIFIED HEREIN.

 <b>REGAL MARINE INDUSTRIES</b> COMPANY OF LUMINA STAR TEL: (203) 891-8200		ALL RIGHTS RESERVED	
DRAWING TITLE <b>LX4 (DX) Seating Capacity</b>	REVISION -	DRAWN BY TMH	CHECKED BY Dennis R.
DATE 6/12/2019	SCALE 1 OF 1	SHEET NO. 3	



# LX4 CE WORKING DECK

\*Working deck= external areas of the boat to stand or walk during normal operations of the craft.

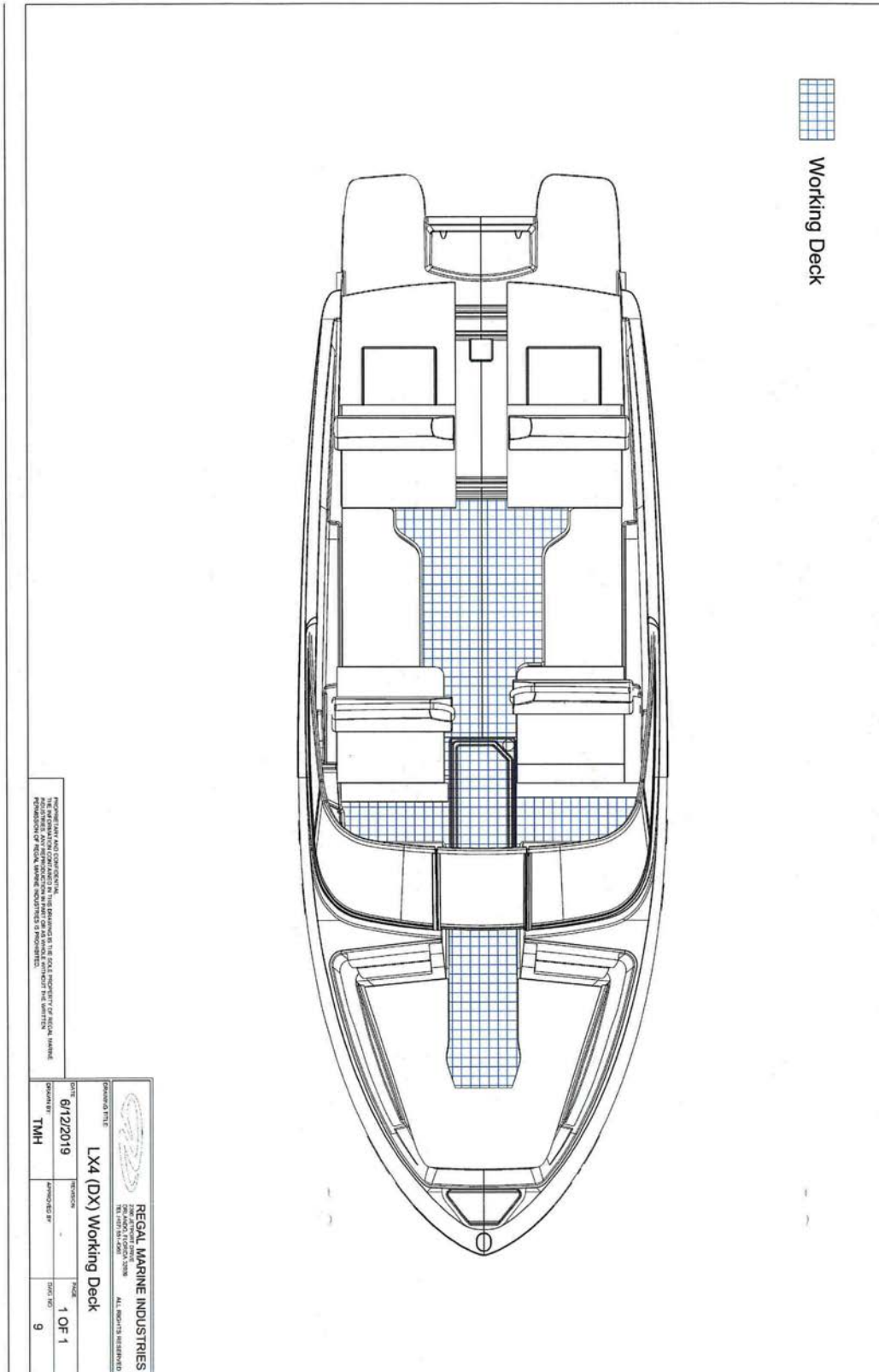

# LX4 NORTH AMERICA PERSONS/SEATING OCCUPANCY

\*Maximum persons based on seating and NMMA using ABYC standards

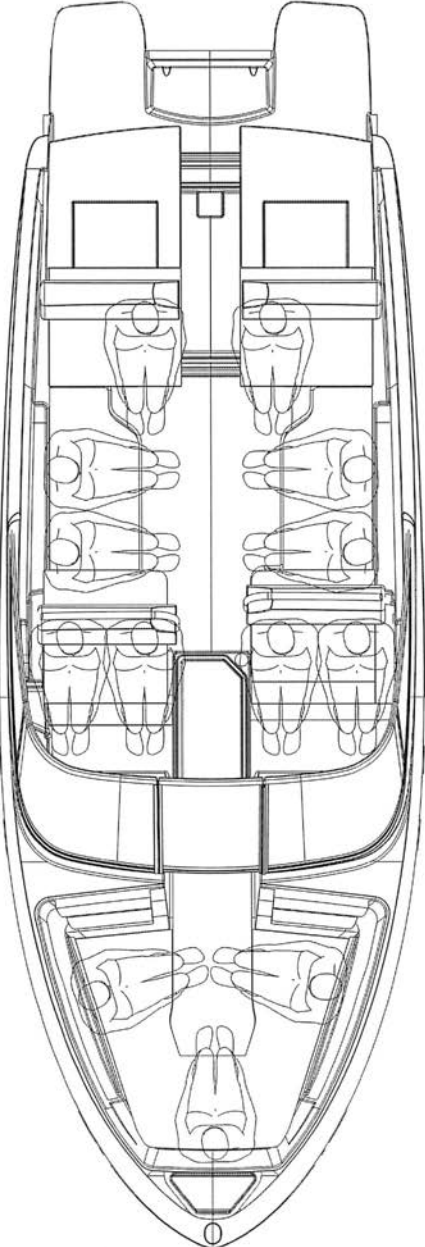

North America Seating Occupancy: 13 Persons

 <b>REGAL MARINE INDUSTRIES</b> 10000 W. Highway 100, Fort Lauderdale, FL 33308 TEL: 954.343.7000 FAX: 954.343.7001 WWW.REGALMARINE.COM			
EQUIPMENT TITLE: <b>LX4 (DX) Seating Capacity</b>			
DATE:	REVISED:		
6/12/2019			
DESIGNER:	DESIGNER'S TITLE:	SCALE:	TEXT SIZE:
TMH	Dennis R.	1 OF 1	3

REGAL MARINE INDUSTRIES, FORT LAUDERDALE, FLORIDA, IS THE SOLE PROPRIETOR OF REGAL MARINE INDUSTRIES. THE INFORMATION CONTAINED IN THIS DRAWING IS THE SOLE PROPERTY OF REGAL MARINE INDUSTRIES. NO PART OF THIS DRAWING IS TO BE REPRODUCED OR TRANSMITTED IN ANY FORM OR BY ANY MEANS, ELECTRONIC OR MECHANICAL, INCLUDING PHOTOCOPYING, RECORDING, OR BY ANY INFORMATION STORAGE AND RETRIEVAL SYSTEM, WITHOUT THE WRITTEN PERMISSION OF REGAL MARINE INDUSTRIES. IT IS RECOMMENDED THAT YOU CONSULT WITH A PROFESSIONAL DESIGNER FOR ASSISTANCE IN THE PROPER USE OF THIS DRAWING.

# LX6 CE WORKING DECK

\*Working deck= external areas of the boat to stand or walk during normal operations of the craft.

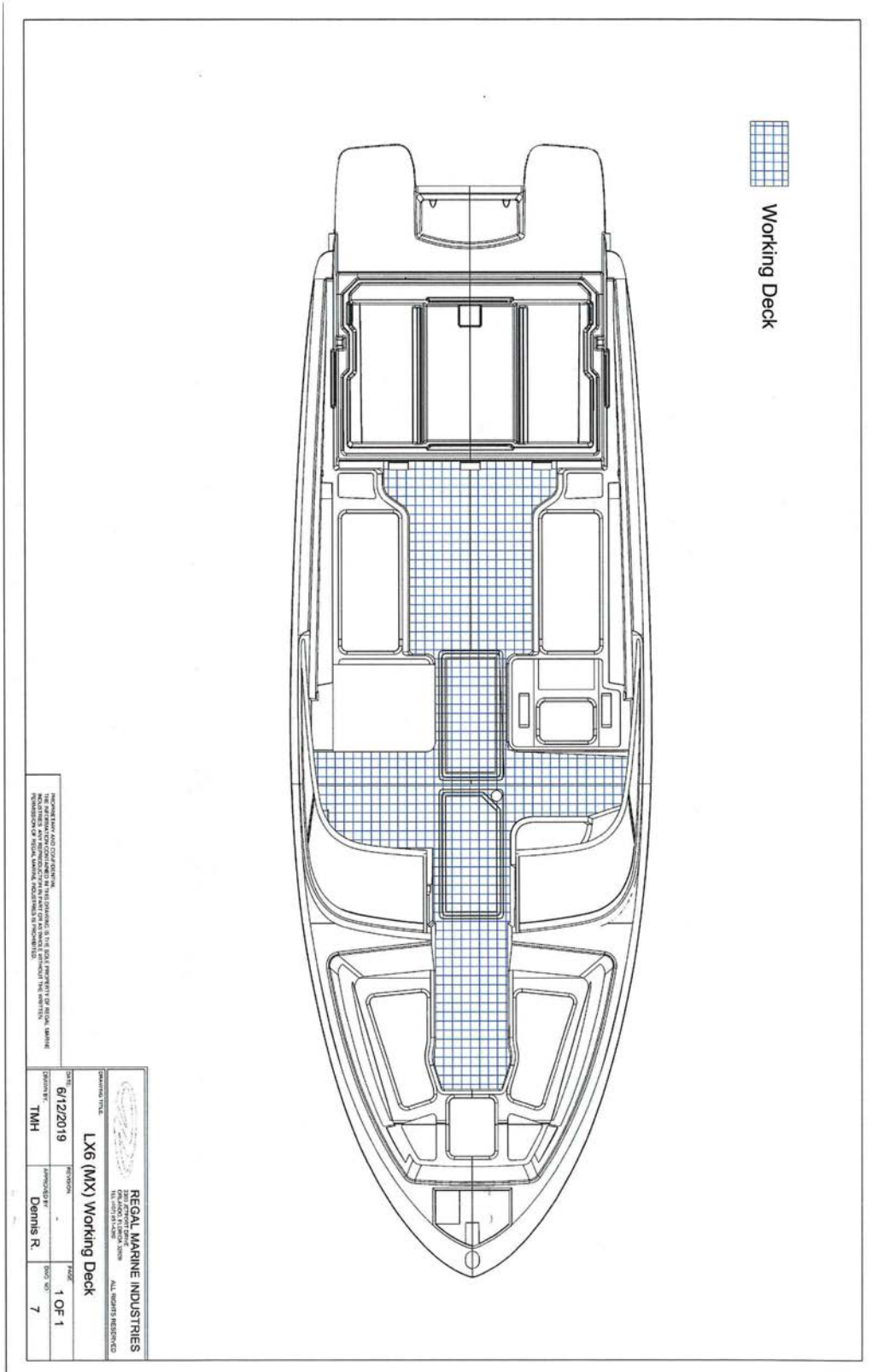

# LX4 SUMP

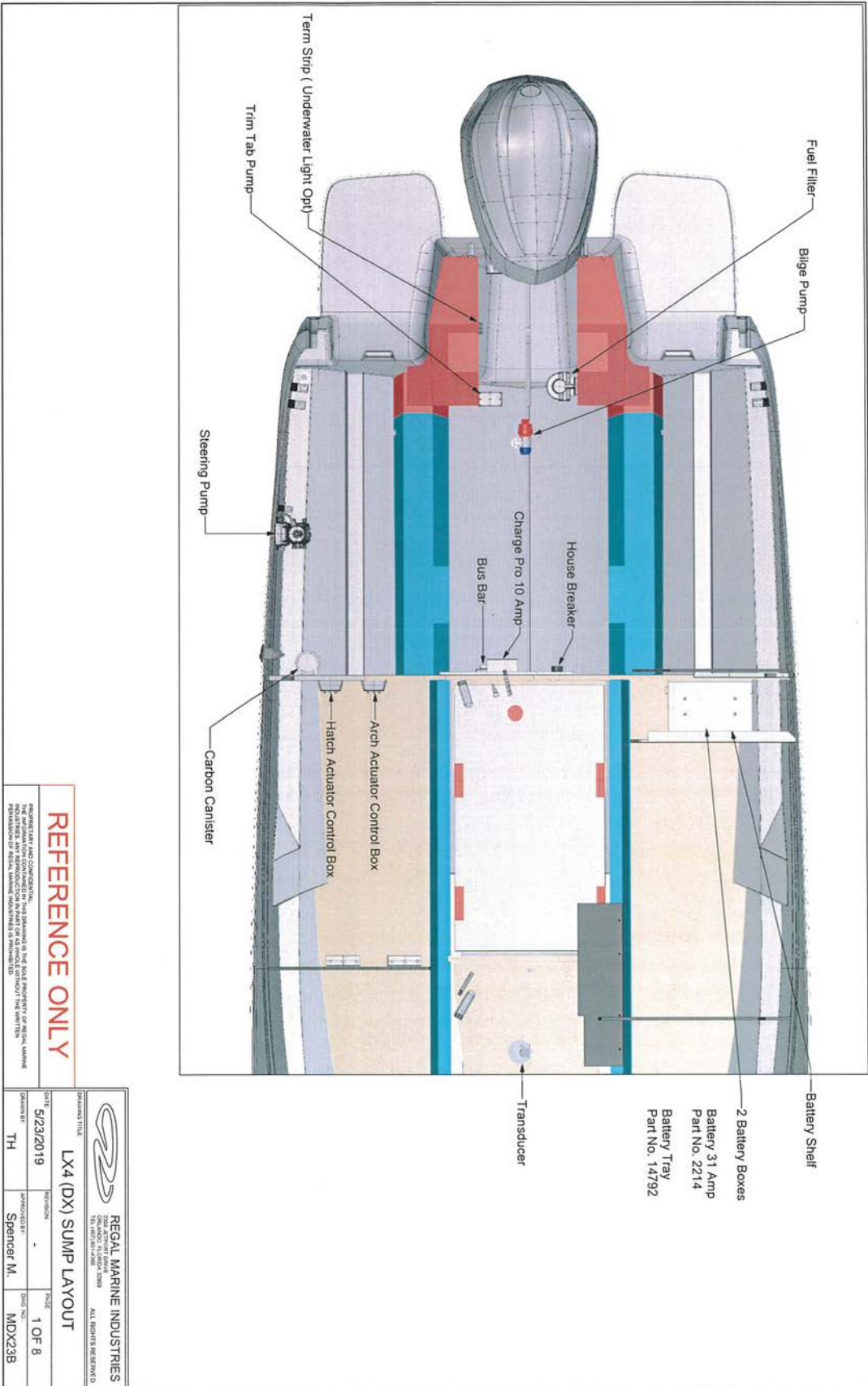

**REFERENCE ONLY**

REGAL MARINE AND COMPANY, THE DESIGN IS THE SOLE PROPERTY OF REGAL MARINE INDUSTRIES. ANY REPRODUCTION IN PART OR IN WHOLE WITHOUT THE WRITTEN PERMISSION OF REGAL MARINE INDUSTRIES IS PROHIBITED.

 <b>REGAL MARINE INDUSTRIES</b> 2008 Alton Road, Suite 1000 The Woodlands, Texas 77380 ALL RIGHTS RESERVED	
<b>DRAWING TITLE</b> LX4 (DX) SUMP LAYOUT	
<b>DATE</b> 5/23/2019	<b>REVISED</b> *
<b>DESIGNER</b> TH	<b>PAID</b> 1 OF 8
<b>APPROVED BY</b> Spencer M.	<b>POUR NO.</b> MDX23B



# LX6 SUMP

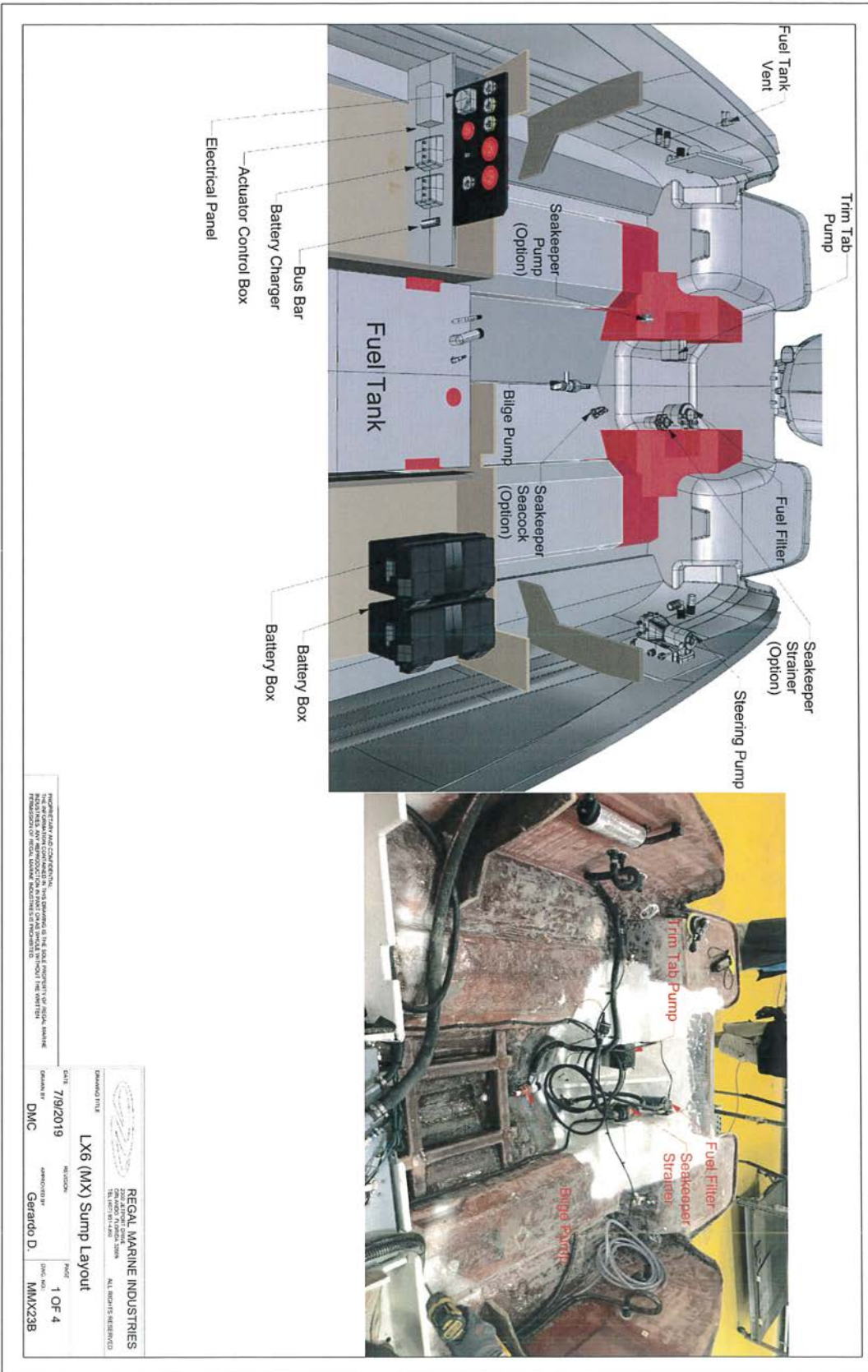

REGAL MARINE INDUSTRIES  
 2025 ALBERT DRIVE  
 TEL: 407.811.4100  
 FAX: 407.811.4101  
 WWW.REGALMARINE.COM

 <b>REGAL MARINE INDUSTRIES</b> 2025 ALBERT DRIVE TEL: 407.811.4100 FAX: 407.811.4101 WWW.REGALMARINE.COM	
DATE	7/9/2019
DRAWN BY	DMC
DESIGNED BY	Gerardo D.
NO. OF SHEETS	1 OF 4
DWG. NO.	MMX238



# LX4 HULL HARNESS

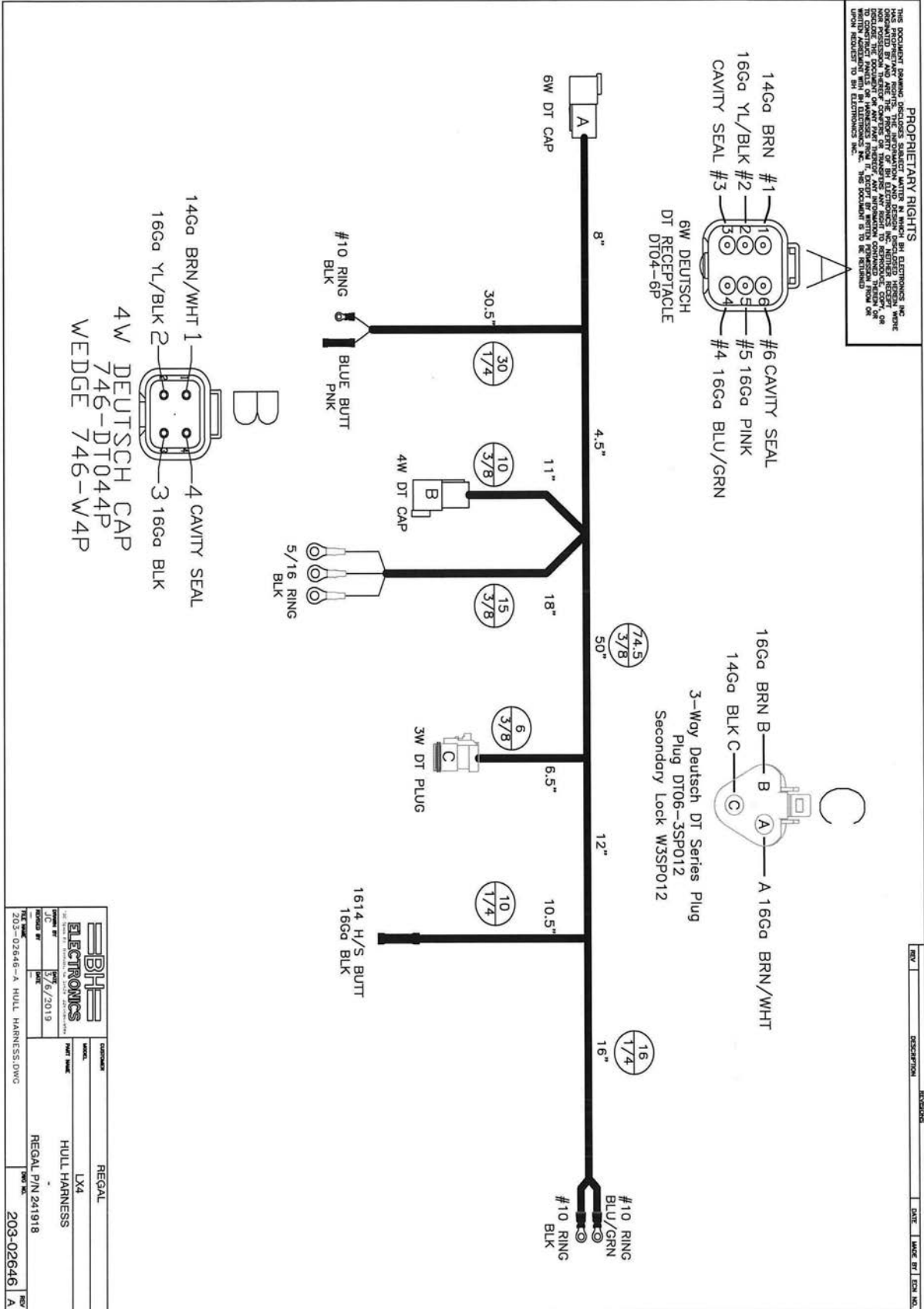



# LX SERIES POWERTOWER ACTUATOR CONTROL BOX-FRONT

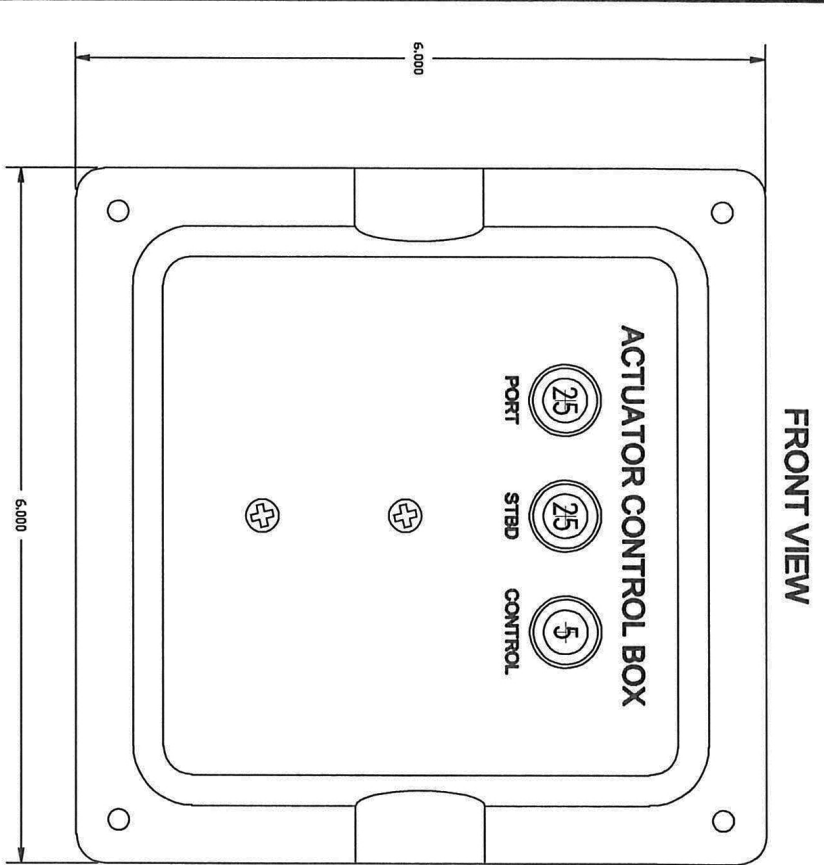

FRONT VIEW

**SHROUD**  
 P/N 740166026 A REV. A QTY. 1 DESCRIPTION SCREENED BLK BOX (12-0166-080)

**ORDERING INFORMATION:**

KE P/N 85064286 DESCRIPTION ACT Ctlr BOX CUST P/N 985055

REGAL 2300 to 3350 ACTUATOR CONTROL BOX

REV.	FCGN#	DESCRIPTION	DATE	BY
A		RELEASED FOR PRODUCTION	01-21-13 MD	
B	R24947	PNL HRNS BUILD IMPROVEMENT	03-01-17MEW	

**GENERAL INFORMATION:**

**CIRCUIT PROTECTION:** CARLING PUSH RESET SCREW TERM  
 P/N 042602005 QTY. 1 DESCRIPTION 5 AMP CKT BREAKER  
 042602025 QTY. 2 DESCRIPTION 25 AMP CKT BREAKER

**ACCESSORY ITEMS:**

P/N	QTY.	DESCRIPTION
080401007	2	#6 FLAT WASHER SS (RELAY)
080504003	2	#6-32 NYLOCK NUT (RELAY)
080602078	2	#6 X 1/2" BLK PPH SCREW
540503013	4	40A SEALED RELAY
080203012	4	RELAY MOUNTING CLIP
310102002	3	CB BLK BOOT
751000303	1	3 POS BUS BAR

**HARNESSES:**

P/N	REV.	QTY.	DESCRIPTION
900003476	B	1	PANEL WIRING

**NOTES:**

CREATED FROM 85064252



85064286

01-21-13 MD SHEET 1 OF 1





# LX6 BATTERY CABLE ROUTING 1

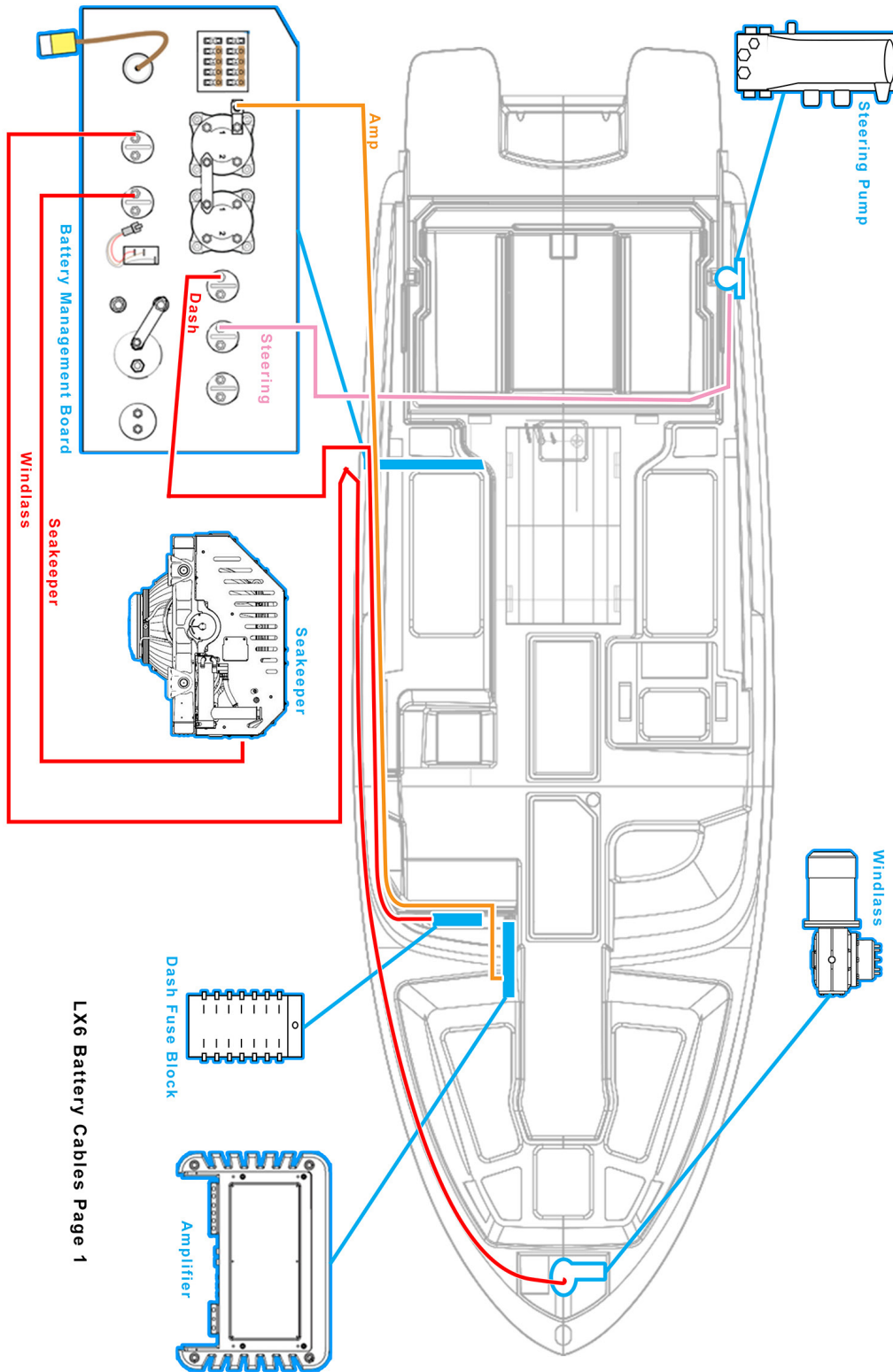

LX6 Battery Cables Page 1



# LX6 BATTERY CABLE ROUTING 2

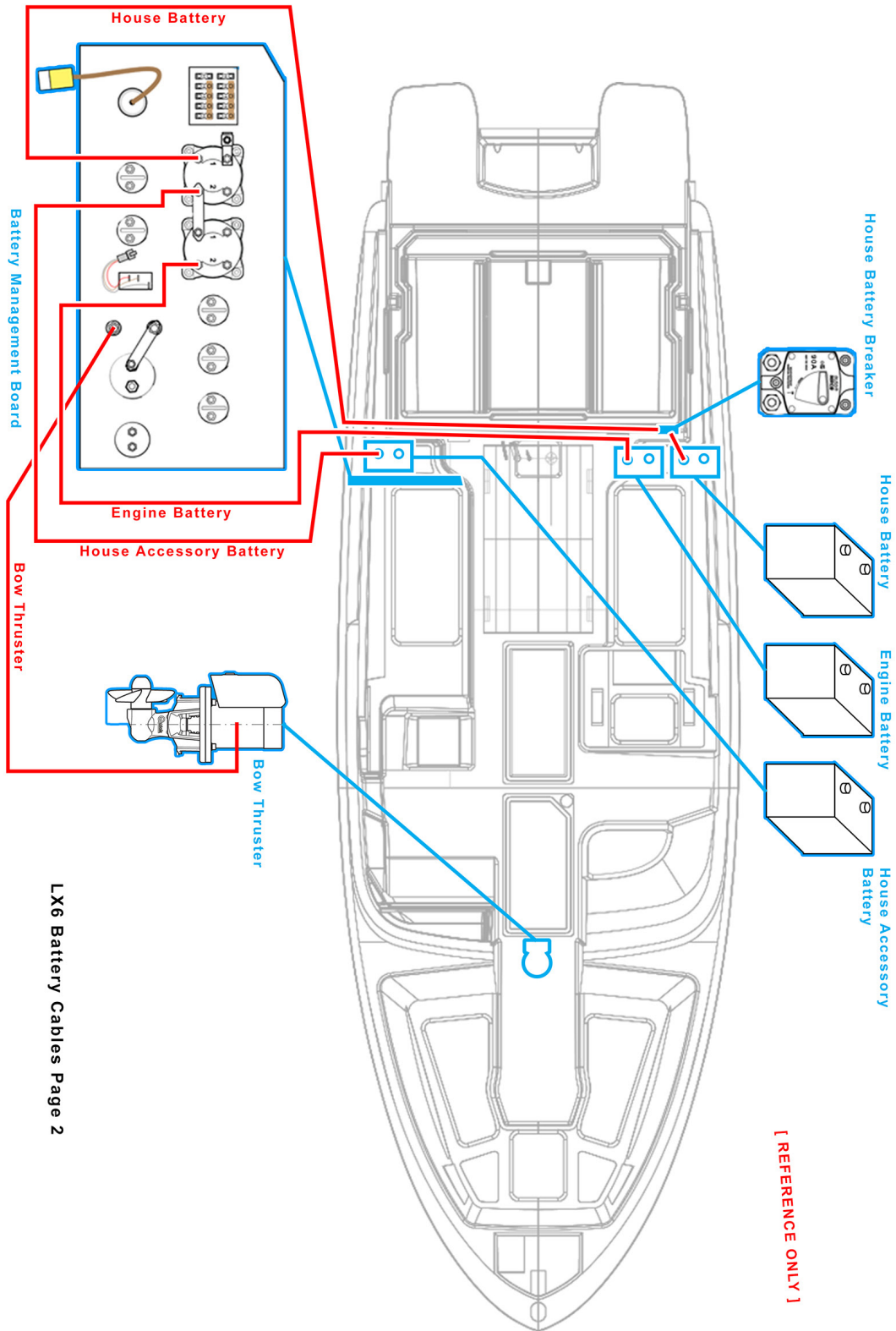

LX6 Battery Cables Page 2

# LX6 DECK HARNESS BREAK OUTS

LX6 Deck Harness

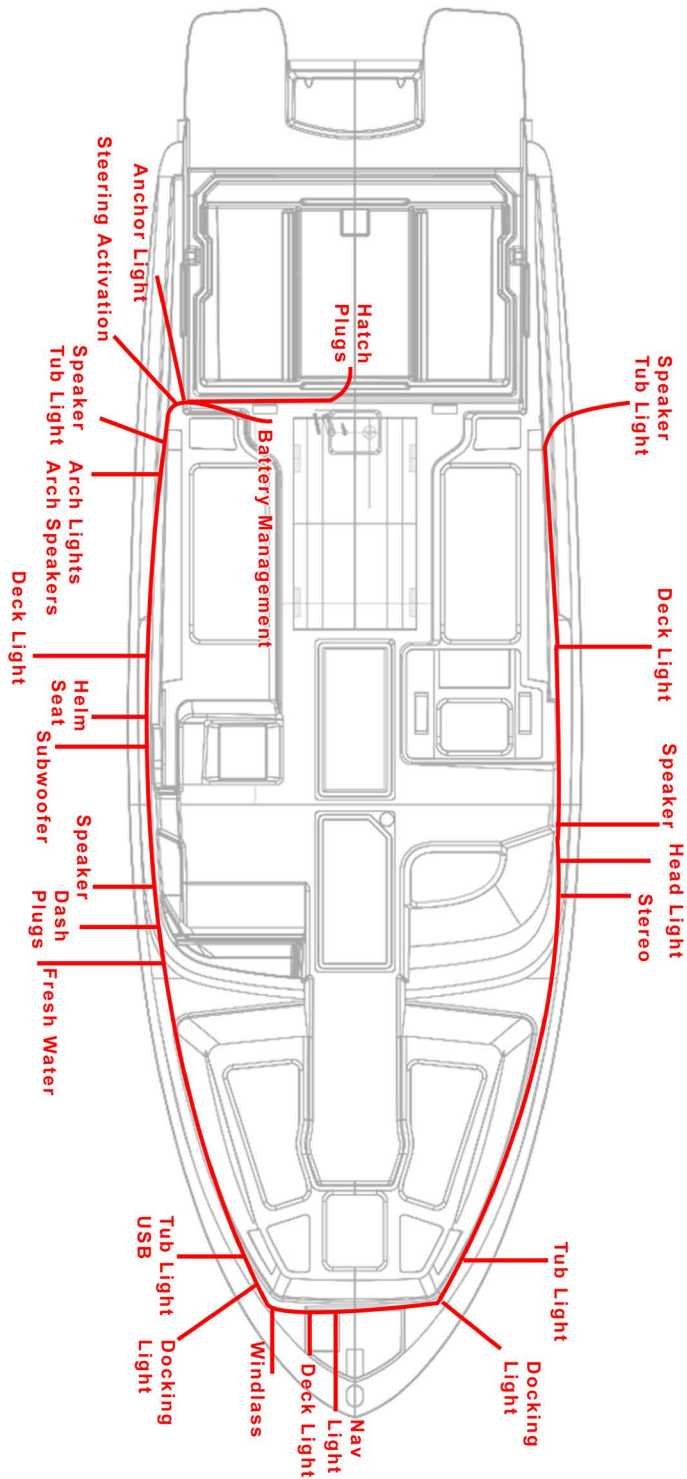

# LX6 DECK HARNESS STEREO PERFORMANCE PKG.

## LX6 SPP Harnesses

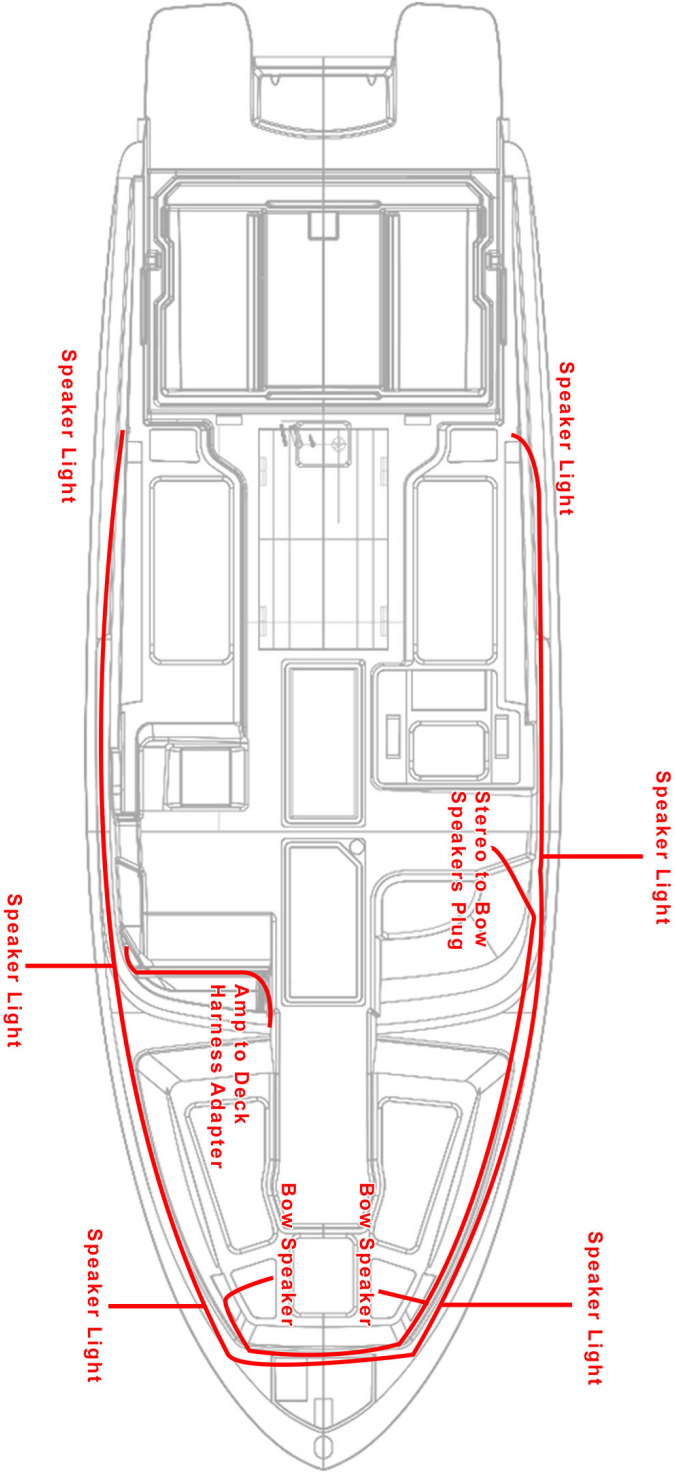

# LX6 DECK HARNESS ACCESSORY EQUIPMENT

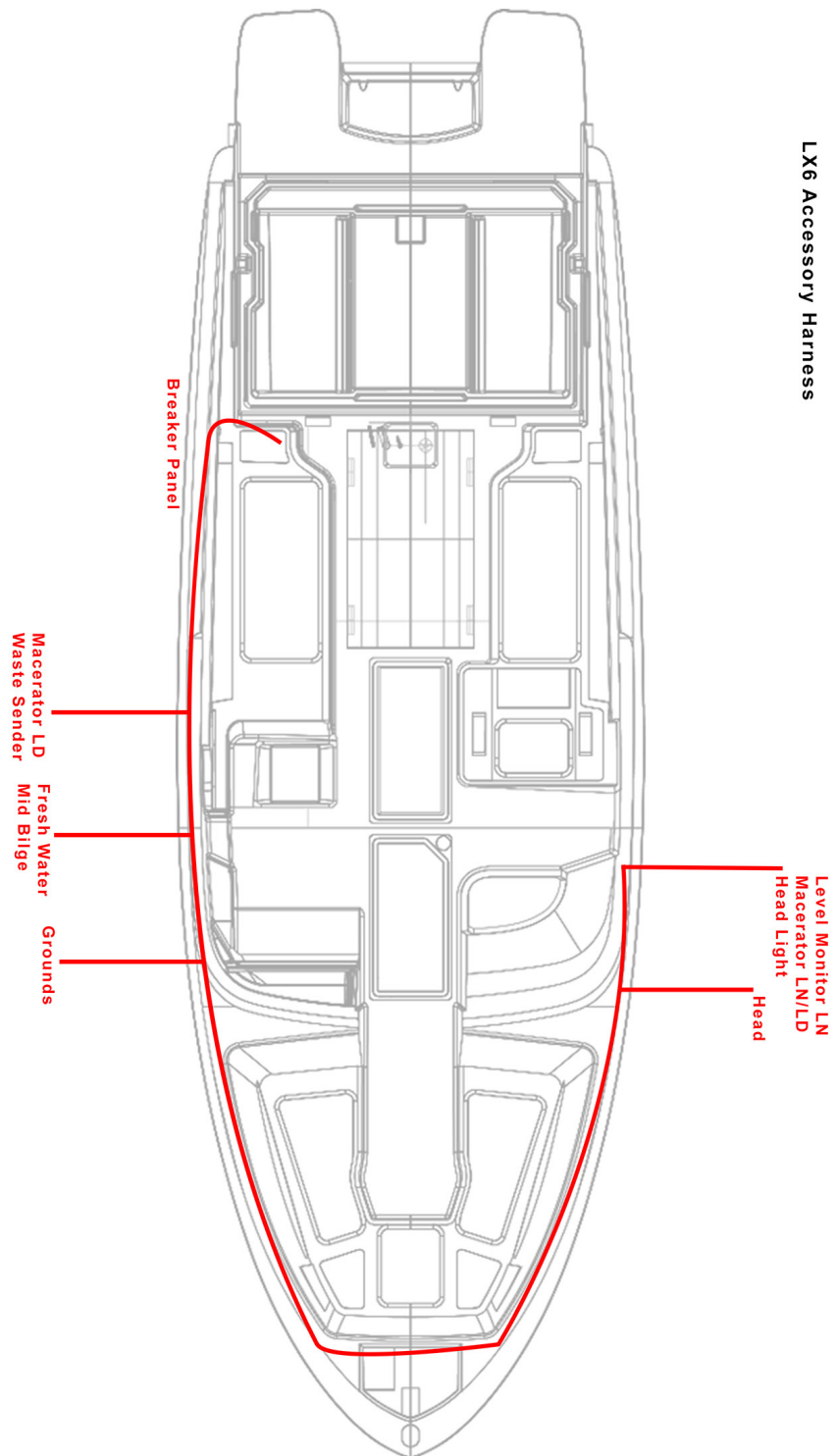

LX6 Accessory Harness

# LX6 DECK HARNESS HATCH ACTUATOR

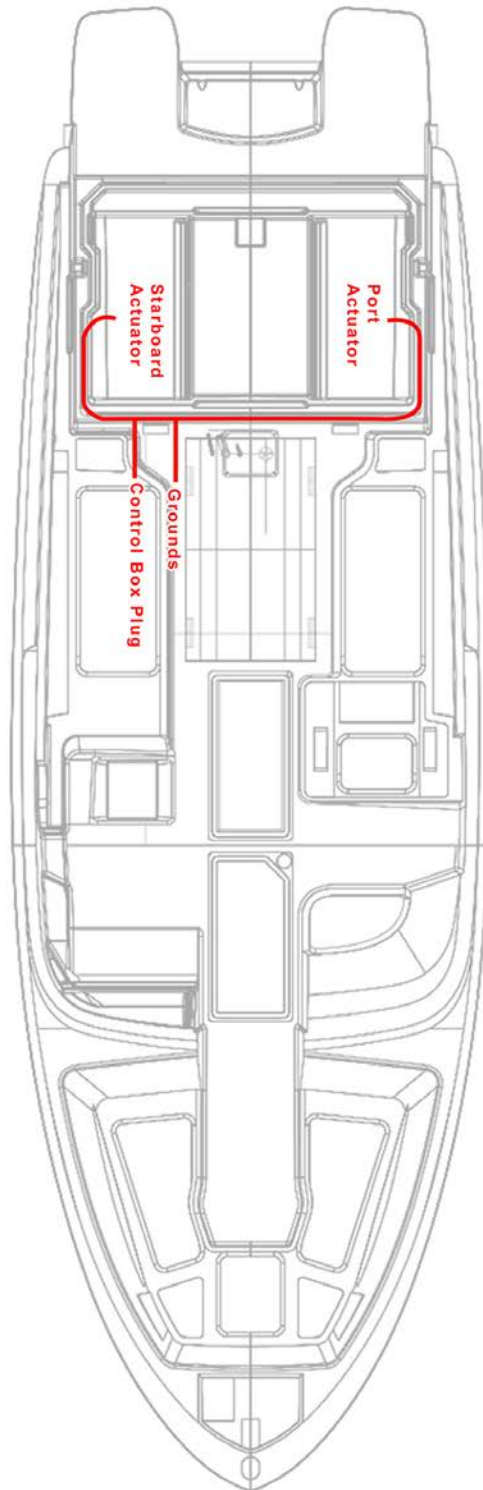

LX6 Hatch Control Box Harness



# LX6 DECK HARNESS POWERTOWER ACTUATOR

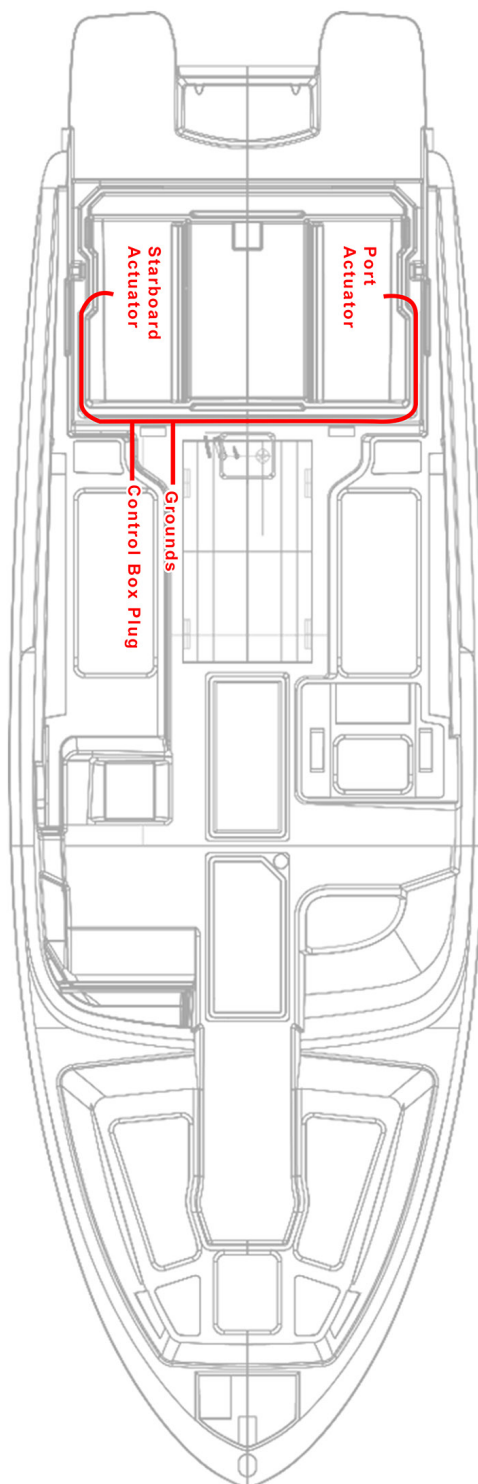

LX6 Arch Control Box Harness



# TYPICAL LX SERIES STEREO SPEAKER WIRING SETTINGS

LS2/LS4/LS6/LS6C/LX2/LX4/LX6 Amplifier Speaker Wiring

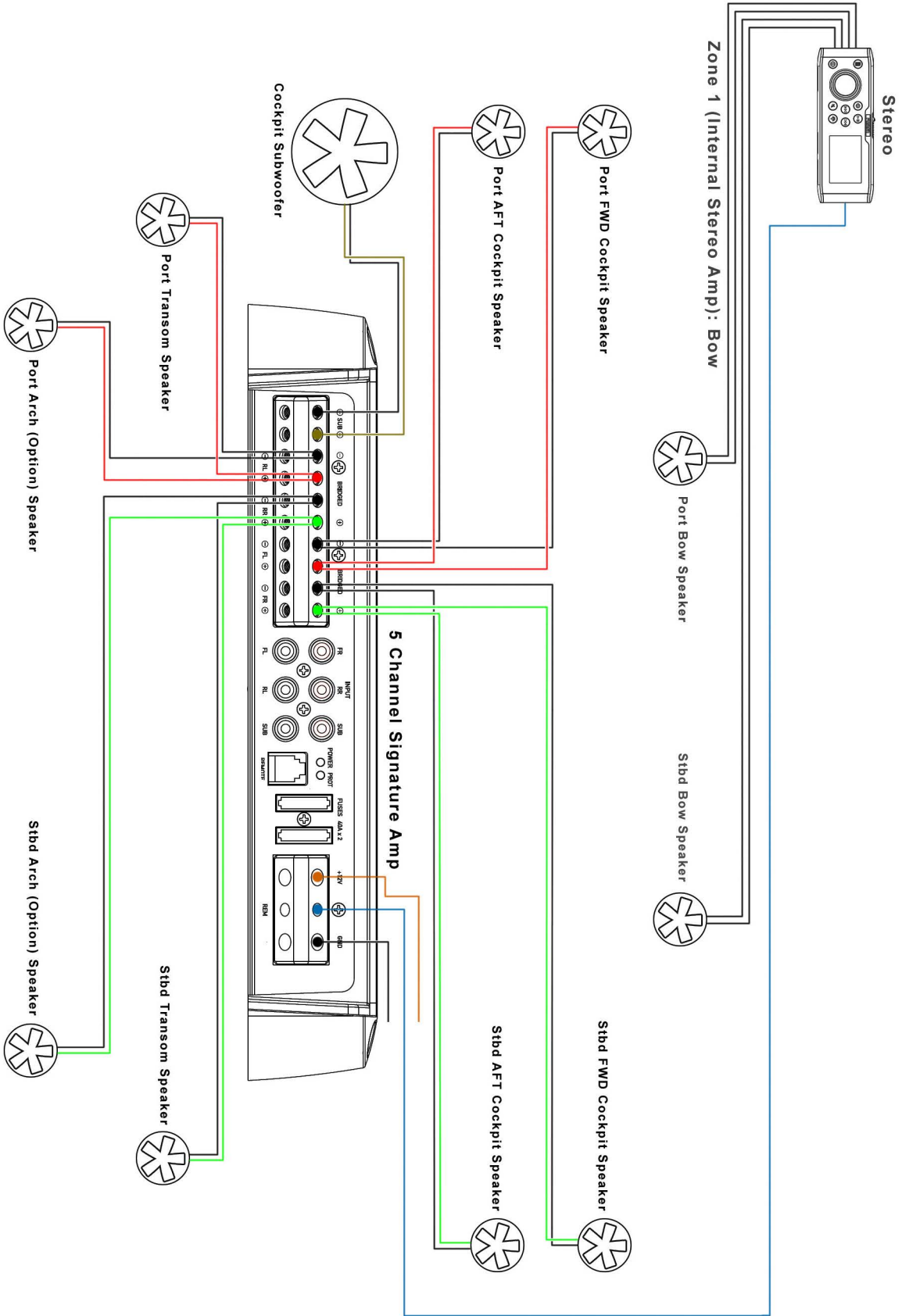

# TYPICAL LX YAMAHA DIGITAL NETWORK CIRCUITRY

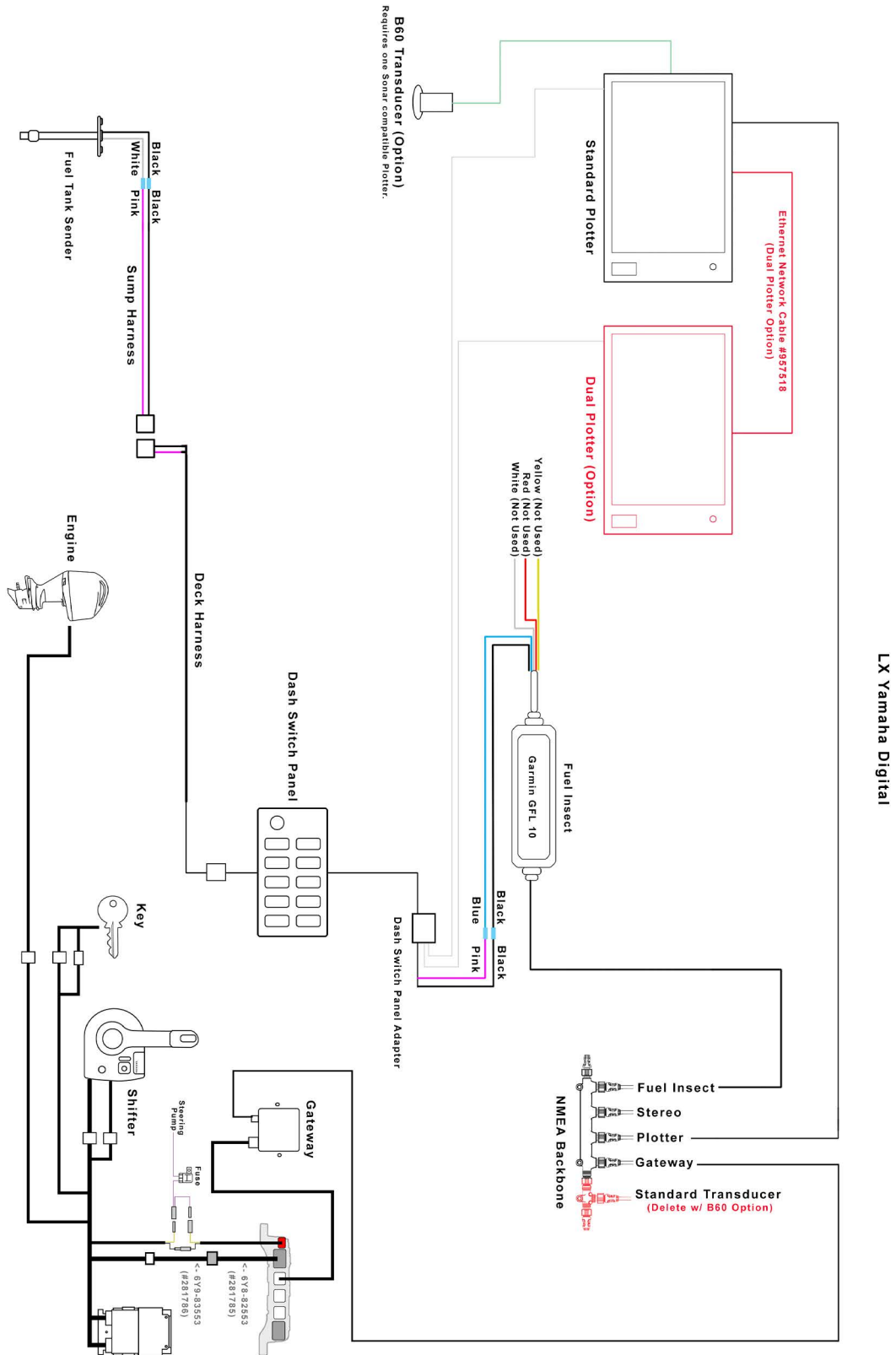

# LX SERIES OPTIONAL TRIM TAB CIRCUITRY

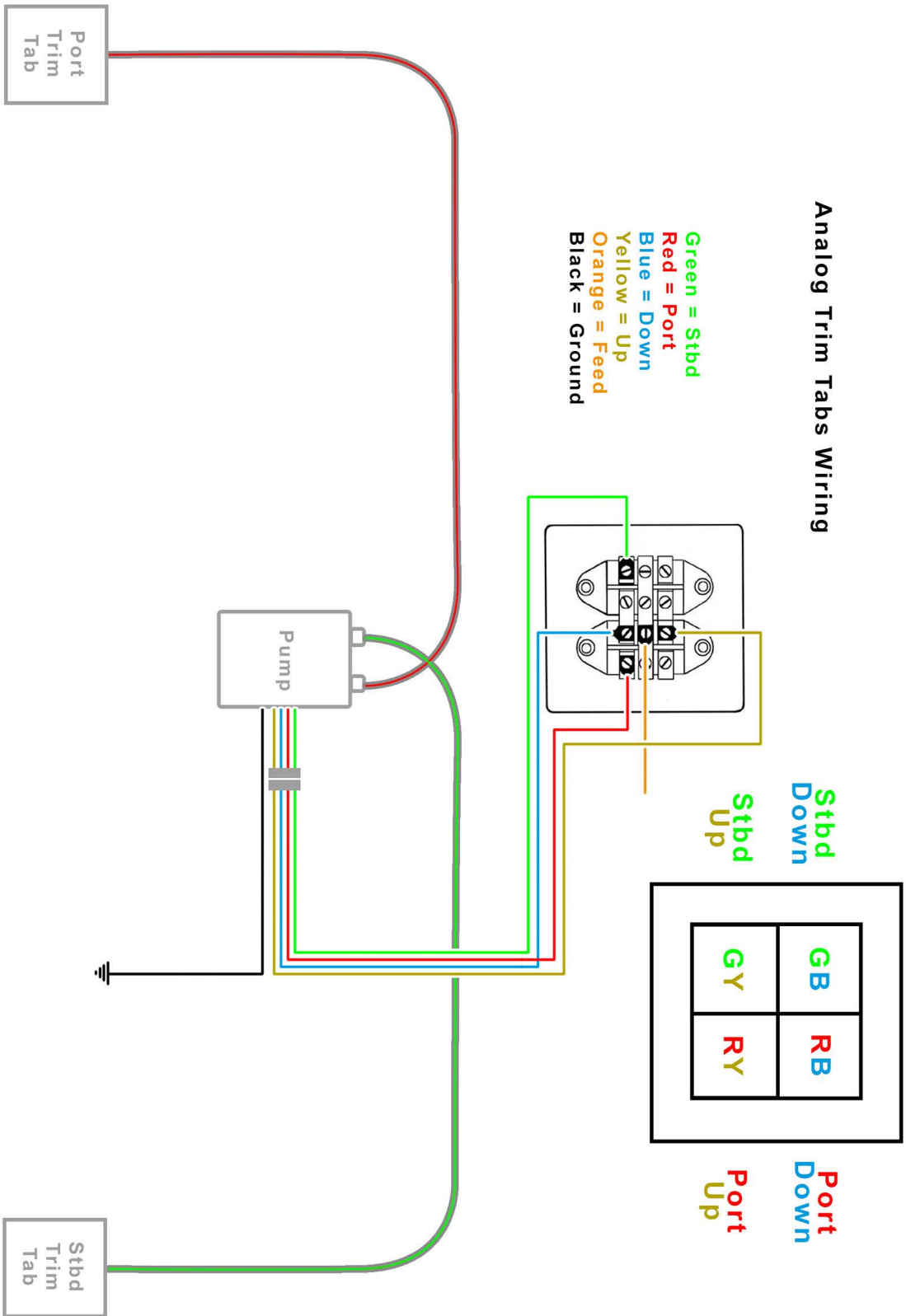



# LX4 HULL HARDWARE 1

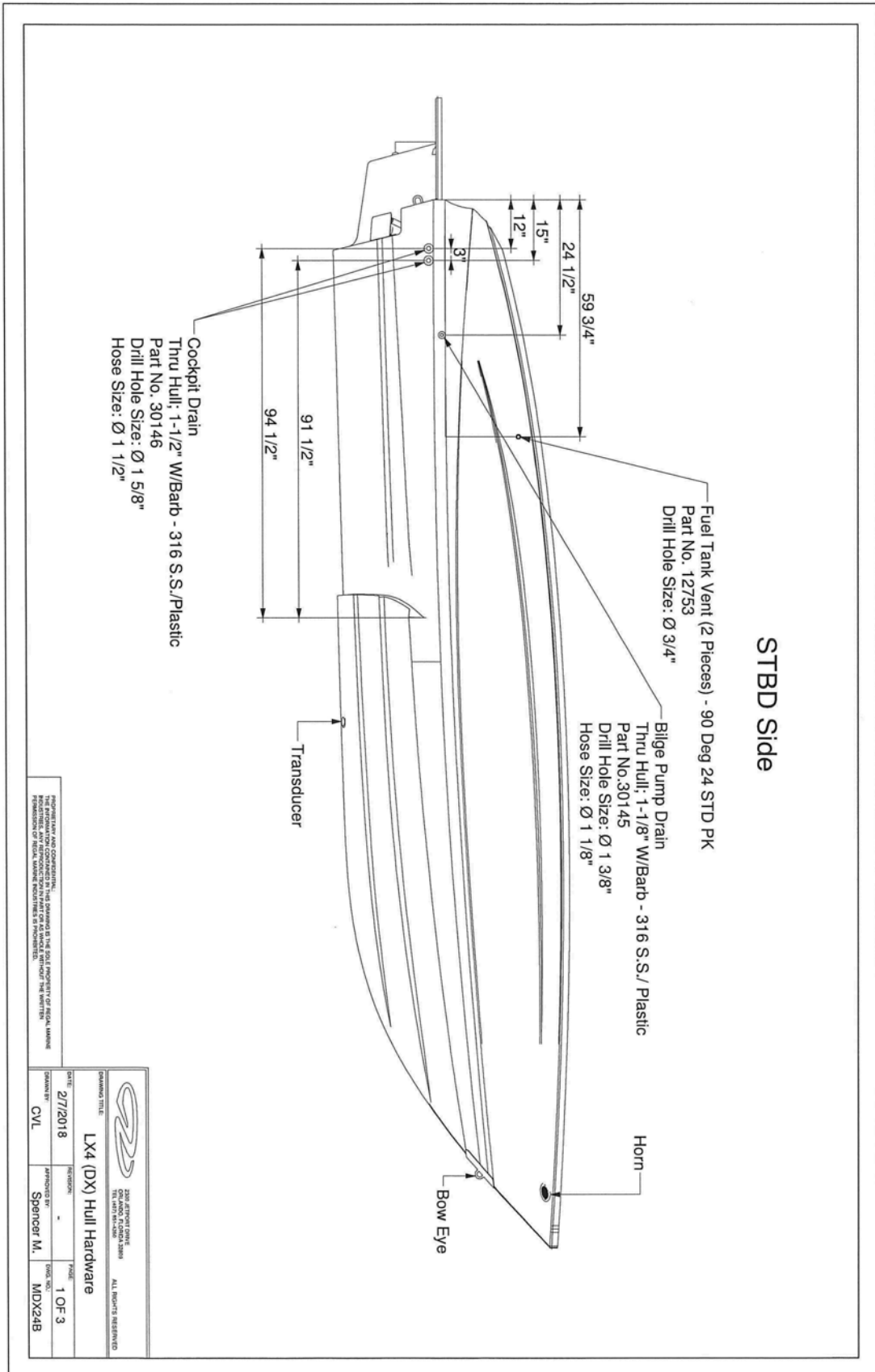

PROFESSIONAL AND COMPETENT.  
 THE PROVISIONS CONTAINED IN THIS DRAWING IS THE SOLE PROPERTY OF HIGAKI, MAKING  
 REVISIONS OF HIGAKI, MAKING REVISIONS IS PROHIBITED.

 HIGAKI ENGINEERING 1741 W. 10th Ave Anchorage, Alaska 99503		ALL RIGHTS RESERVED	
DRAWING TITLE: LX4 (DX) Hull Hardware			
DATE: 2/7/2018	REVISION: -	APPROVED BY: Spencer M.	SCALE: 1 OF 3
DRAWN BY: CVL			DOC. NO.: MDX24B

# LX4 HULL HARDWARE 2

Port Side

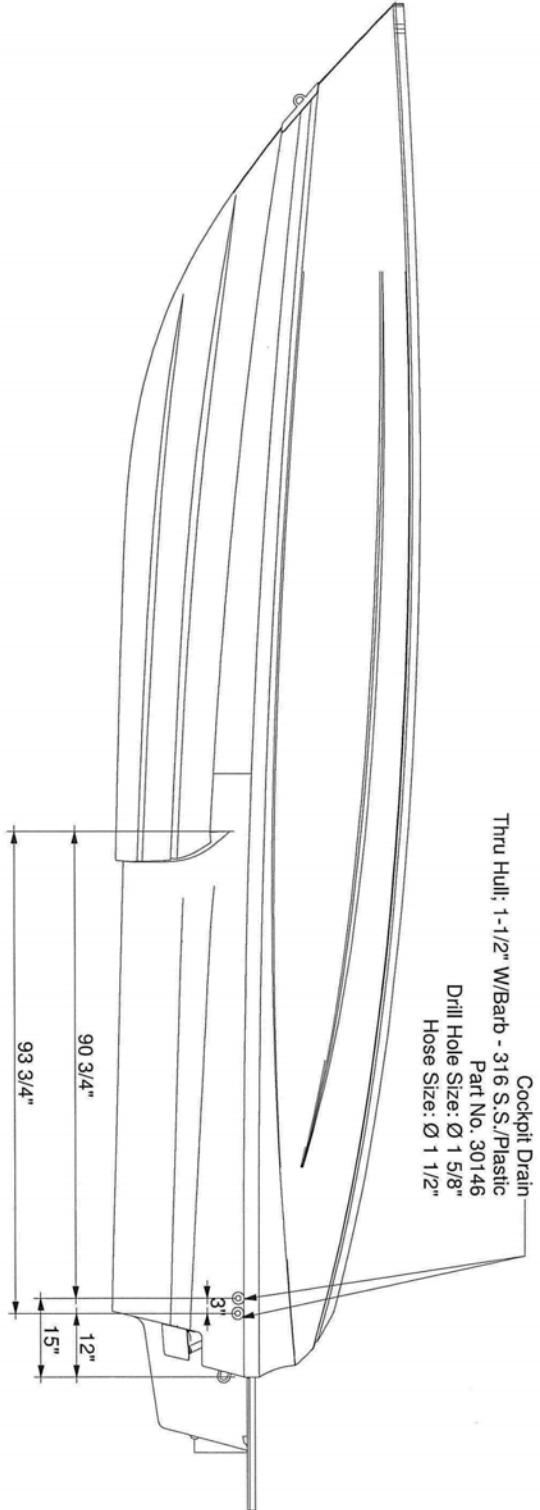

PERMISSION TO REPRODUCE THIS DRAWING IS GRANTED BY THE SOCIETY OF ROBOTICS. THE INFORMATION CONTAINED IN THIS DRAWING IS THE SOLE PROPERTY OF SOCIETY OF ROBOTICS. REPRODUCTION OF THIS DRAWING WITHOUT THE PERMISSION OF SOCIETY OF ROBOTICS IS PROHIBITED.

 SOCIETY OF ROBOTICS 1000 WILSON AVENUE TEL: 407/911-4249		ALL RIGHTS RESERVED	
DRAWING TITLE: LX4 (DX) Hull Hardware			
DATE:	5/22/2019	REVISION:	-
DRAWN BY:	AWR	APPROVED BY:	Spencer M.
		TRIALS:	2 OF 3
		DATE:	MDX24B

# LX4 HULL HARDWARE TRANSOM

Transom View

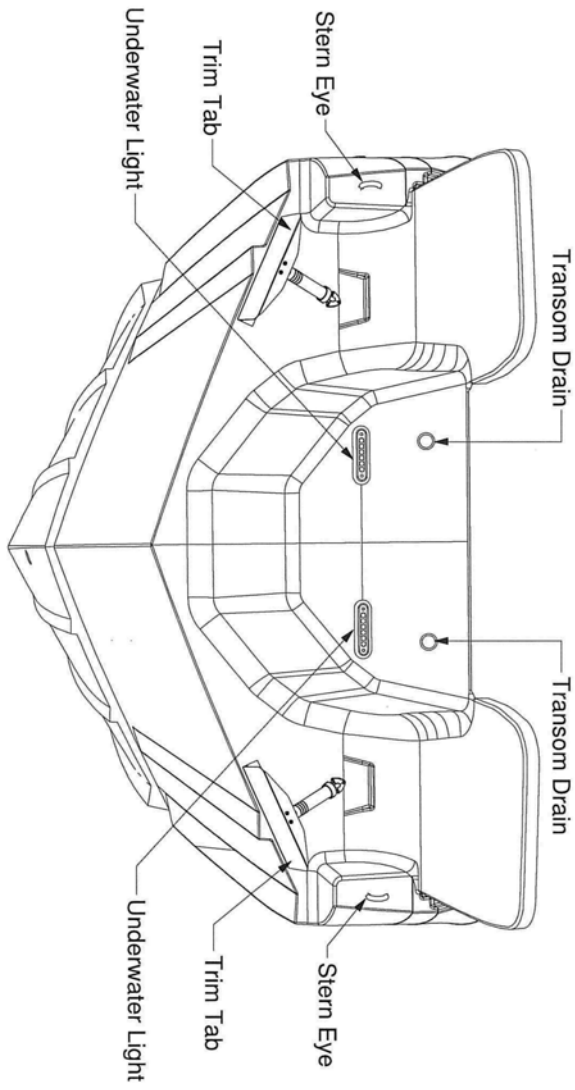

REGAL MARINE INDUSTRIES  
 2000 ALBERTA DRIVE  
 WILSON, BC V9A 1S1  
 TEL: 604-941-4286  
 WWW.REGALMARINE.COM  
 ALL RIGHTS RESERVED

 <p>REGAL MARINE INDUSTRIES                  2000 ALBERTA DRIVE                  WILSON, BC V9A 1S1                  TEL: 604-941-4286                  WWW.REGALMARINE.COM                  ALL RIGHTS RESERVED</p>					
DATE:	5/22/2019	APPROVED BY:	Spencer M.	DATE:	MDX24B
DRAWN BY:	AWR	REVISION:	-	PAGE:	3 OF 3
DRAWING TITLE: LX4 (DX) Hull Hardware					

# LX6 HULL HARDWARE 1

## STBD Side

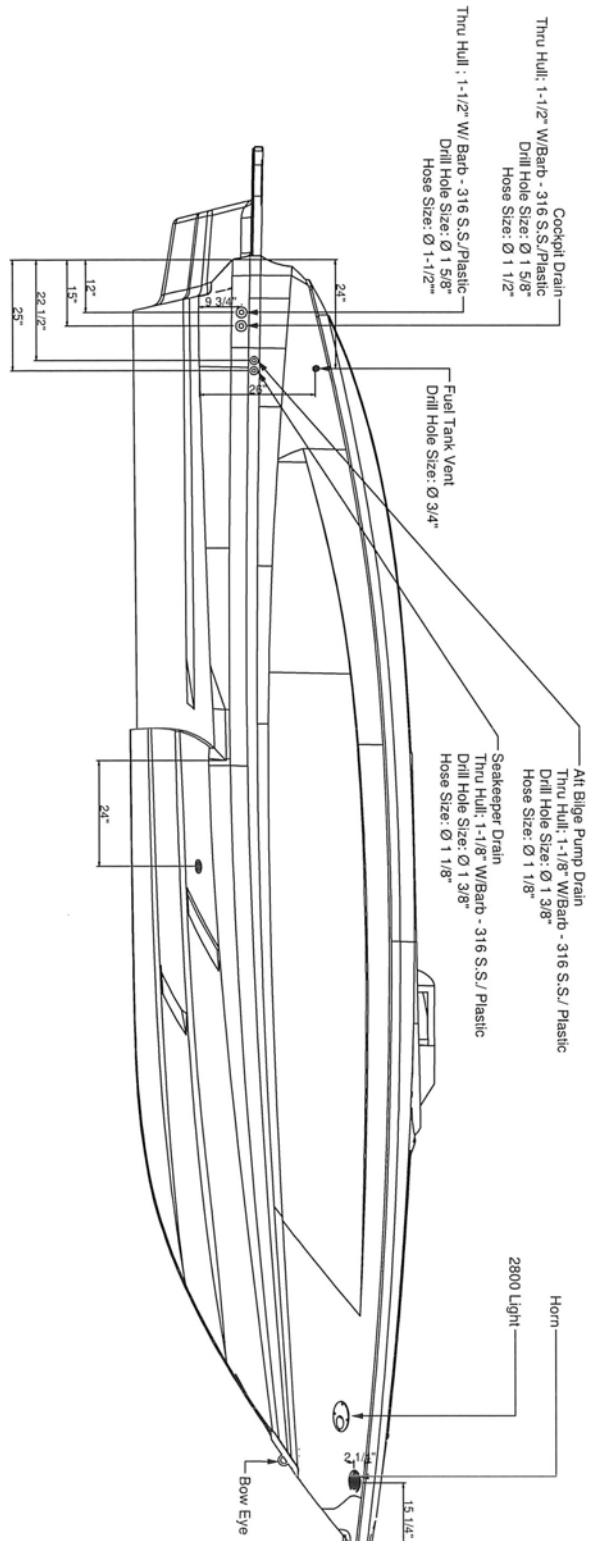

REGAL MARINE INDUSTRIES  
2220 ALCOA BLVD  
MOUNTAIN VIEW, NC 28149  
TEL: 704-835-3333  
WWW.REGALMARINE.COM

 <b>REGAL MARINE INDUSTRIES</b> 2220 ALCOA BLVD MOUNTAIN VIEW, NC 28149 TEL: 704-835-3333 WWW.REGALMARINE.COM		ALL RIGHTS RESERVED	
<b>LX6 (MX) Hull Hardware</b>			
DATE	DESIGNED BY	REVISED BY	PAGE
6/18/2019	TMH	-	1 OF 3
PROJECT NO.		MMX24B	





# LX6 HULL HARDWARE TRANSOM

Transom View

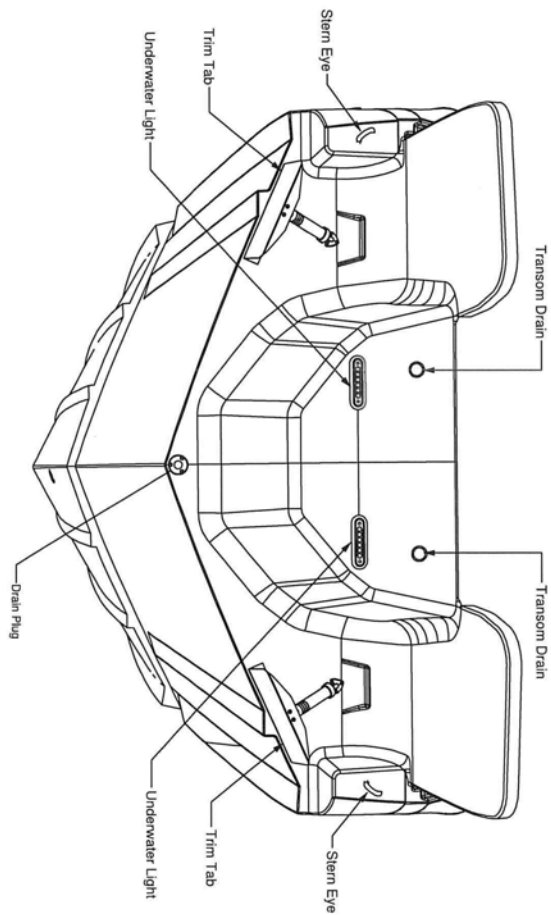

 <b>REGAL MARINE INDUSTRIES</b> 200 ATLANTIC DRIVE FORT LAUDERDALE, FL 33309 TEL: 954.875.4400		ALL RIGHTS RESERVED	
DRAWING TITLE: <b>LX6 (MX) Hull Hardware</b>			
DATE:	6/18/2019	VERSION:	1
DESIGNED BY:	TMH	APPROVED BY:	
PREPARED AND CONSENTED: THIS DRAWING AND SPECIFICATIONS ARE MADE ON OR UNDER THE CLOSEST PERMISSION OF REGAL MARINE INDUSTRIES BY PROVISIONS.		TOTAL: <b>3 OF 3</b>	DRAWING NO.: <b>MMX24B</b>

# LX4 DECK HARDWARE

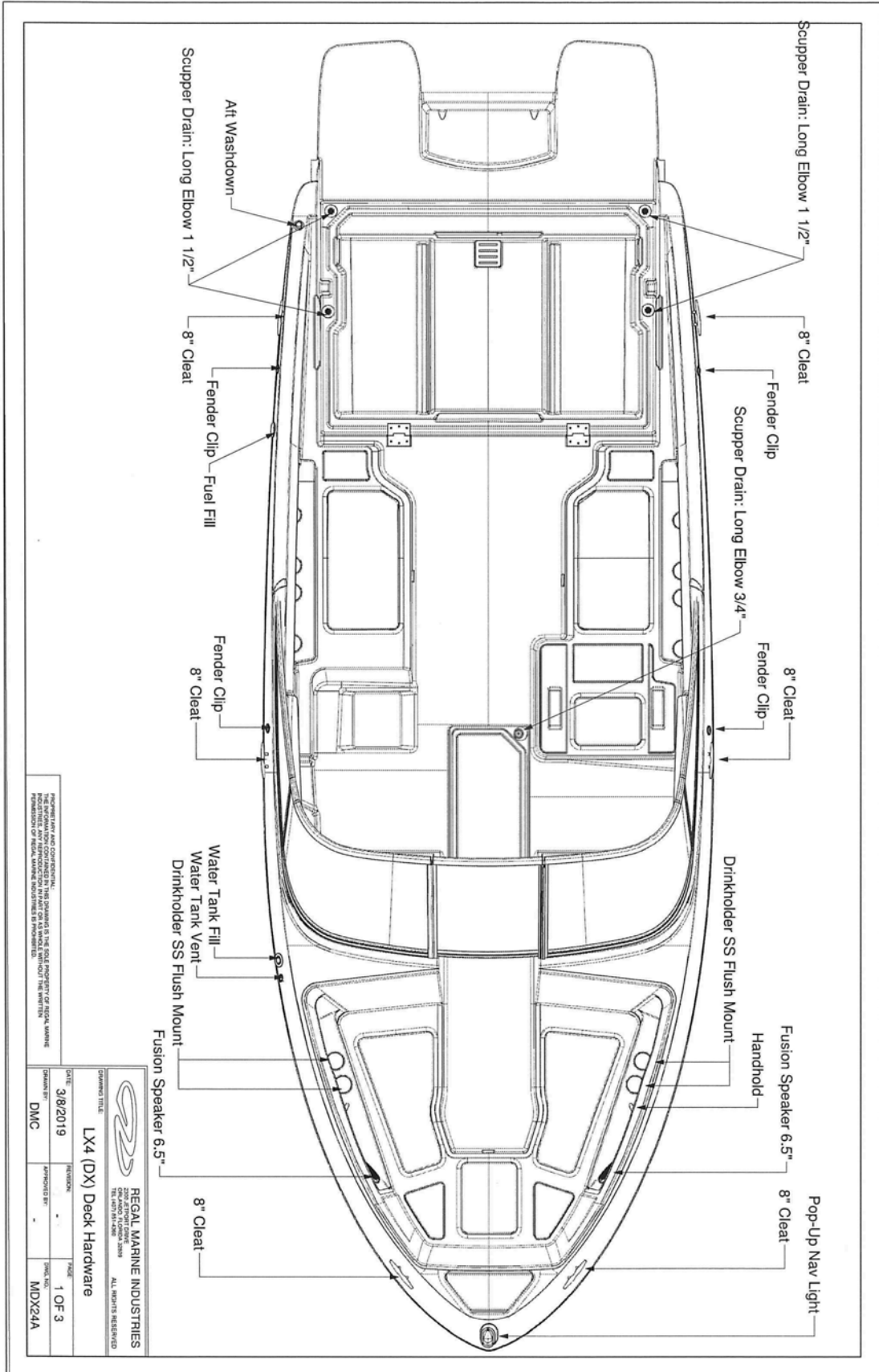

REGAL MARINE INDUSTRIES  
 2200 AIRPORT BLVD  
 FORT WORTH, TX 76117-1496  
 TEL: 817.714.1496  
 FAX: 817.714.1496  
 WWW.REGALMARINE.COM  
 ALL RIGHTS RESERVED

DRAWING TITLE		REGAL MARINE INDUSTRIES	
LX4 (DX) Deck Hardware		2200 AIRPORT BLVD FORT WORTH, TX 76117-1496 TEL: 817.714.1496 FAX: 817.714.1496 WWW.REGALMARINE.COM ALL RIGHTS RESERVED	
DATE	3/8/2019	REVISION	
DRAWN BY	DMC	APPROVED BY	
SHEET NO.		1 OF 3	
SHEET NO.		MDX24A	

# LX4 DECK HARDWARE 2

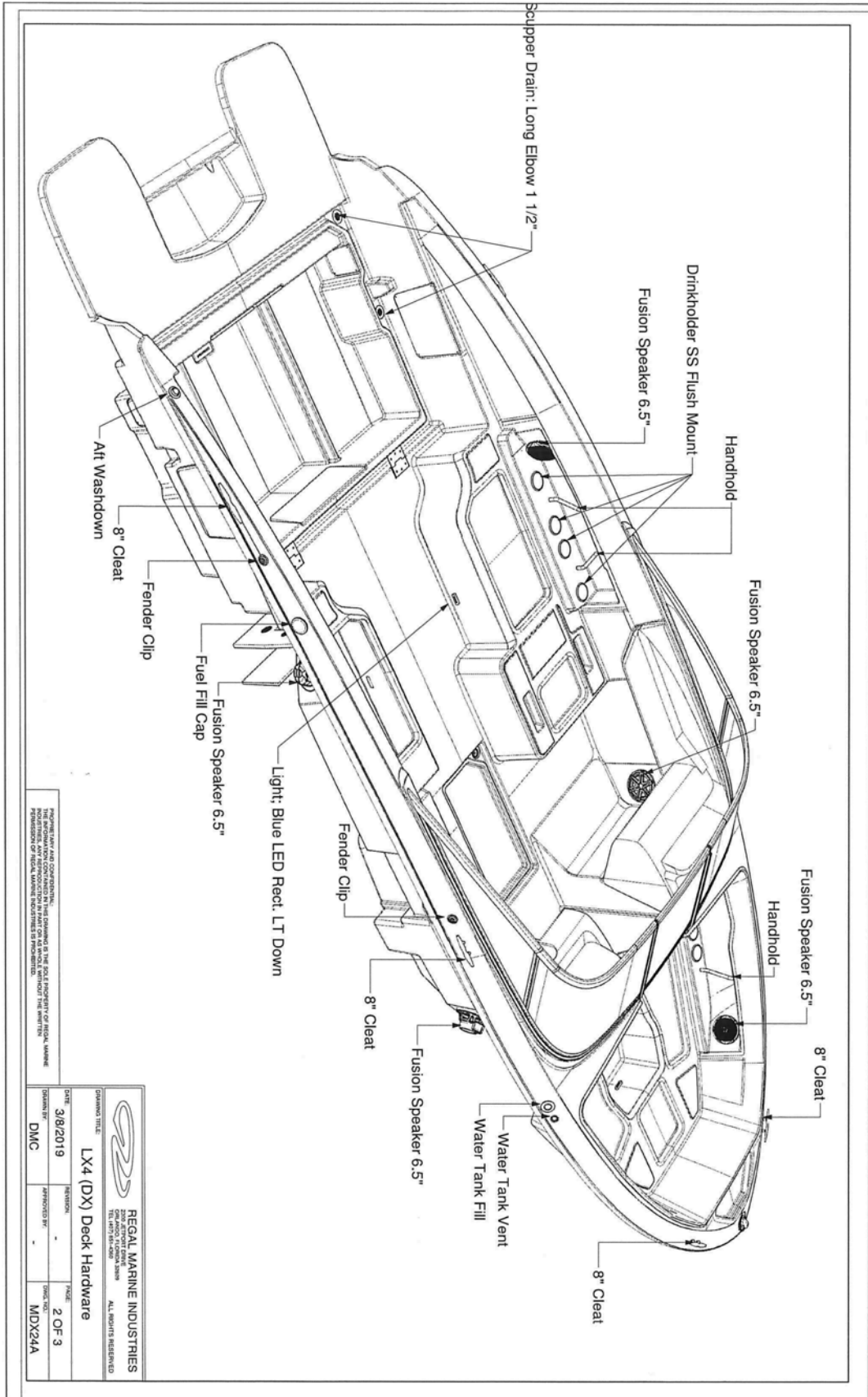

REGAL MARINE INDUSTRIES  
 THE REGAL MARINE GROUP IS THE SOLE PROPRIETOR OF REGAL MARINE  
 PRODUCTS AND SERVICES. ALL RIGHTS RESERVED.

 <p>REGAL MARINE INDUSTRIES                  2000 N. W. 11th Ave.                  Ft. Lauderdale, FL 33304                  ALL RIGHTS RESERVED</p>					
DATE:	3/8/2019	REVISION:		PAGE:	2 OF 3
DRAWN BY:	DMC	APPROVED BY:		TRAC NO.:	MDX244
DRAWING TITLE: LX4 (DX) Deck Hardware					

# LX4 DECK HARDWARE 3

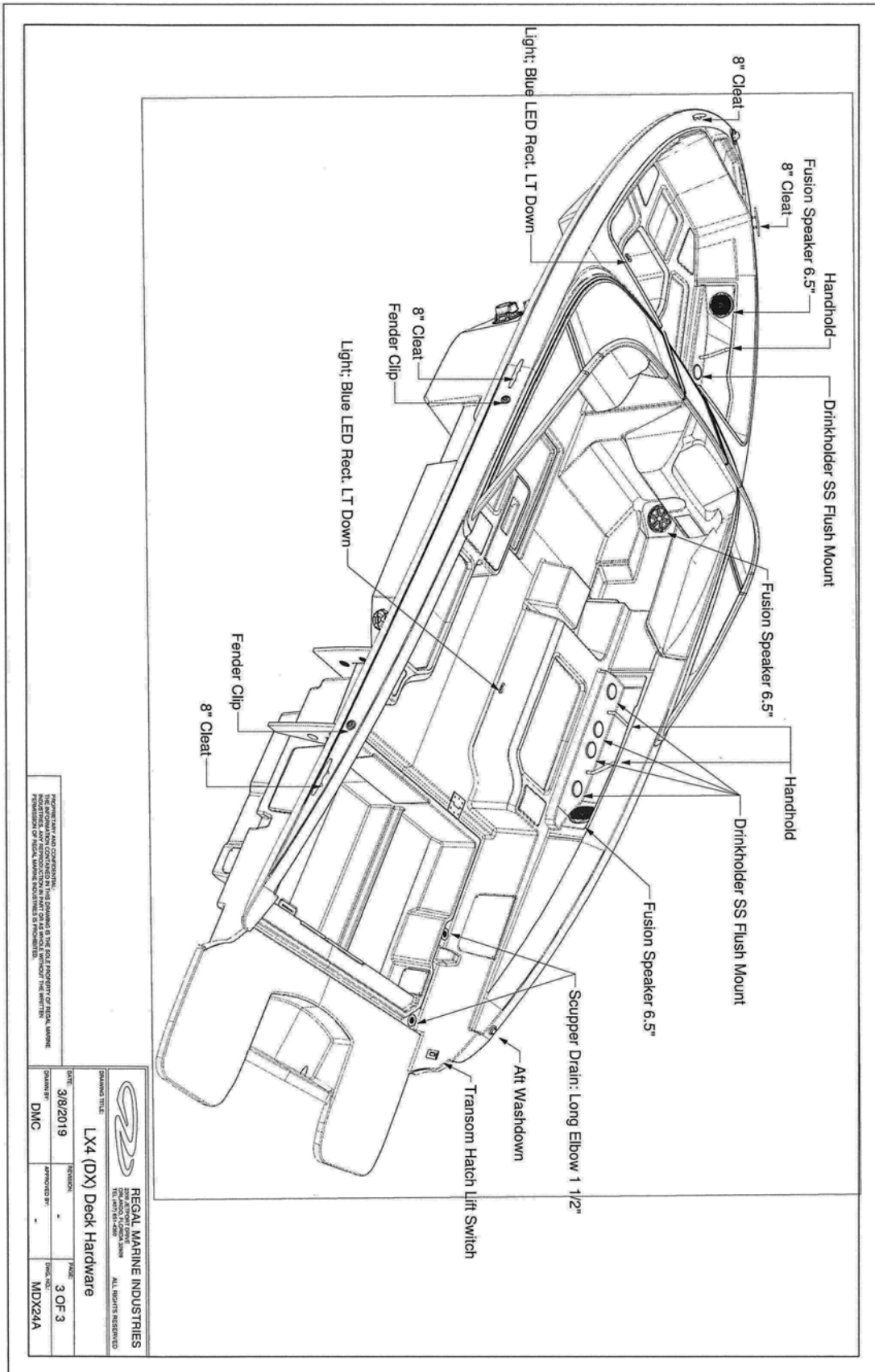









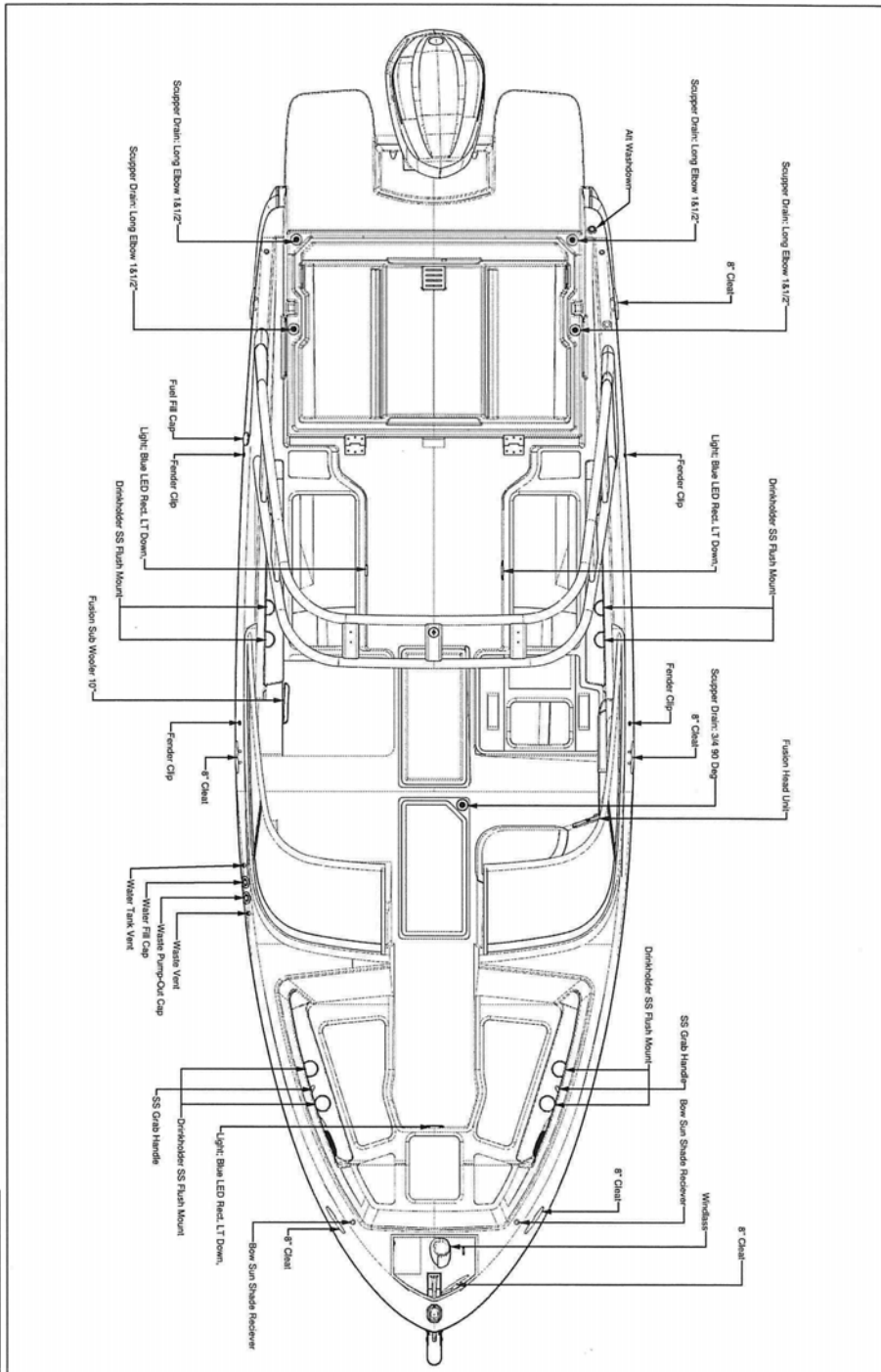

# LX6 DECK HARDWARE 3



REGAL MARINE INDUSTRIES  
 2006 ALBERT DRIVE  
 TEL: 416-731-2428  
 FAX: 416-731-2429  
 WWW.REGALMARINE.COM

 <p><b>REGAL MARINE INDUSTRIES</b>          2006 ALBERT DRIVE          TEL: 416-731-2428          FAX: 416-731-2429          WWW.REGALMARINE.COM</p>	
<p>DATE: 6/17/2019</p>	
<p>DESIGNED BY: TMH</p>	<p>REVISED BY: -</p>
<p>PROJECT: LX6 (MX) Deck Hardware</p>	<p>PAGE: 3 OF 4</p>
<p>DESIGNED BY: Spencer M.</p>	<p>DATE: MMXX24A</p>

# LX6 DECK HARDWARE 4

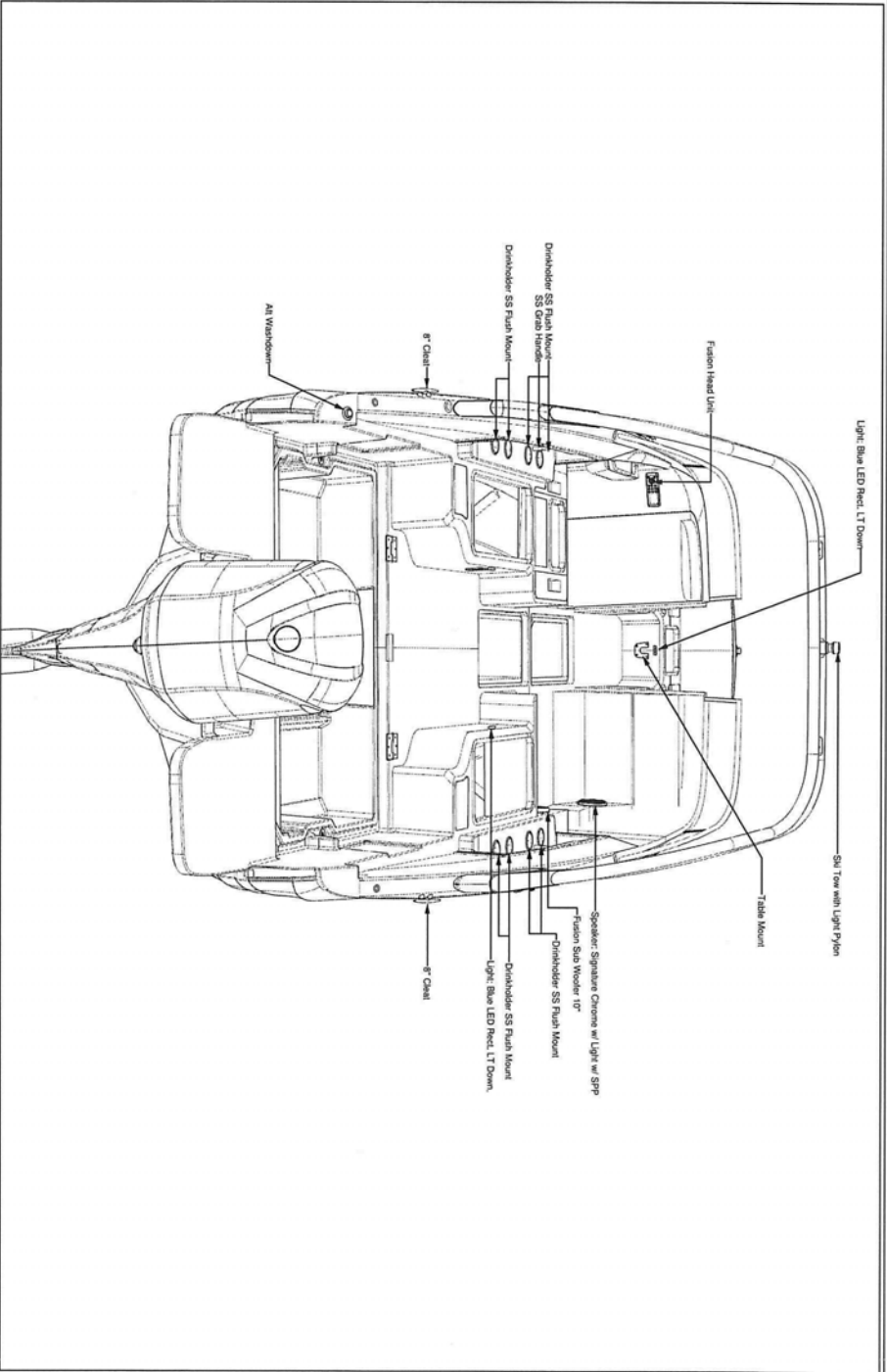

REGAL MARINE AND COMPASS, INC.  
 THE INFORMATION CONTAINED HEREIN IS THE SOLE PROPERTY OF REGAL MARINE AND COMPASS, INC. AND IS TO BE USED ONLY FOR THE PURPOSES SPECIFIED HEREIN. PERMISSION TO REPRODUCE THIS DOCUMENT IS PROHIBITED.

 <b>REGAL MARINE INDUSTRIES</b> 6000 EAST COAST BLVD FORT MYERS, FL 33907 TEL: 888.764.4488		ALL RIGHTS RESERVED	
DRAWING TITLE: <b>LX6 (MX) Deck Hardware</b>			
DATE:	6/17/2019	REVISION:	-
DRAWN BY:	TMH	APPROVED BY:	Spender M.
PAGE: 4 OF 4		SERIAL NO.: MMX24A	

# LX4 SLING LOCATIONS

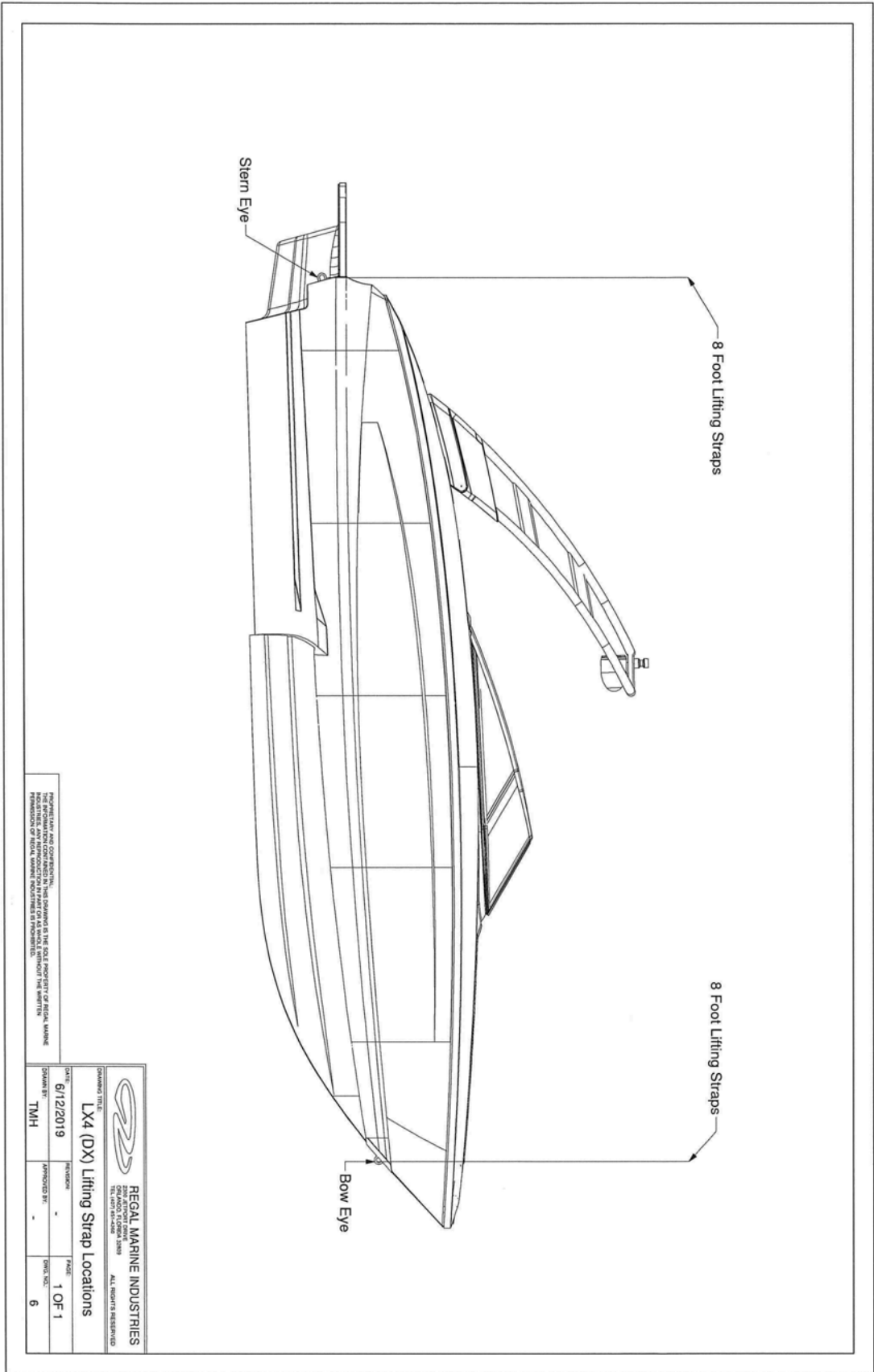

REGAL MARINE INDUSTRIES  
 2000 W. 10th Street  
 St. Louis, MO 63103  
 TEL: 314.771.4200  
 FAX: 314.771.4201  
 WWW.REGALMARINE.COM

 <b>REGAL MARINE INDUSTRIES</b> 2000 W. 10th Street St. Louis, MO 63103 TEL: 314.771.4200 FAX: 314.771.4201 WWW.REGALMARINE.COM	
DRAWING TITLE	
LX4 (DX) Lifting Strap Locations	
DATE	6/12/2019
DRAWN BY	TMH
APPROVED BY	-
PAGE	1 OF 1
DWG. NO.	6

REGAL MARINE INDUSTRIES  
 2000 W. 10th Street  
 St. Louis, MO 63103  
 TEL: 314.771.4200  
 FAX: 314.771.4201  
 WWW.REGALMARINE.COM

# LX6 SLING LOCATIONS

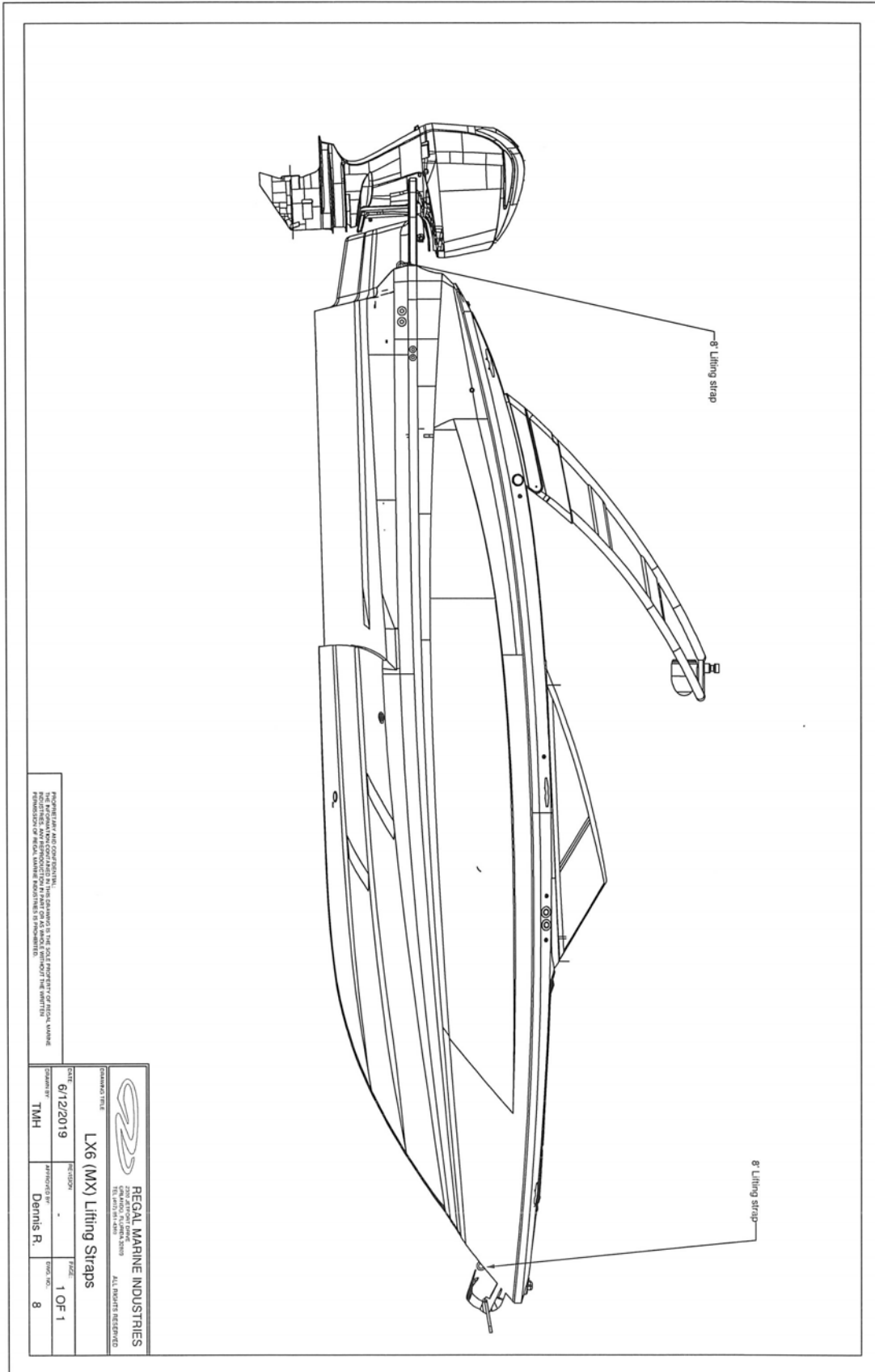

REGAL MARINE INDUSTRIES AND COMPANY, INC. MAKES NO WARRANTY, REPRESENTATION OR STATEMENT OF MERCHANTABILITY OR FITNESS FOR ANY PARTICULAR PURPOSE. THE INFORMATION CONTAINED HEREIN IS THE SOLE PROPERTY OF REGAL MARINE INDUSTRIES AND COMPANY, INC. AND IS TO BE USED ONLY FOR THE PURPOSES SPECIFIED HEREIN.

 <b>REGAL MARINE INDUSTRIES</b> 2000 W. GOLF LINKS ROAD VENICE, FL 33596 TEL: 813-987-1100 FAX: 813-987-1101			
DRAWING TITLE: <b>LX6 (MX) Lifting Straps</b>			
DATE:	REVISED BY:	ISSUE:	1 OF 1
6/12/2019	-	0001	8
DESIGNED BY:	DATE:		
TMH	Demis R.		



# LX6 WASTE SYSTEM ROUTING ELECTRIC TOILET (OPTIONAL)

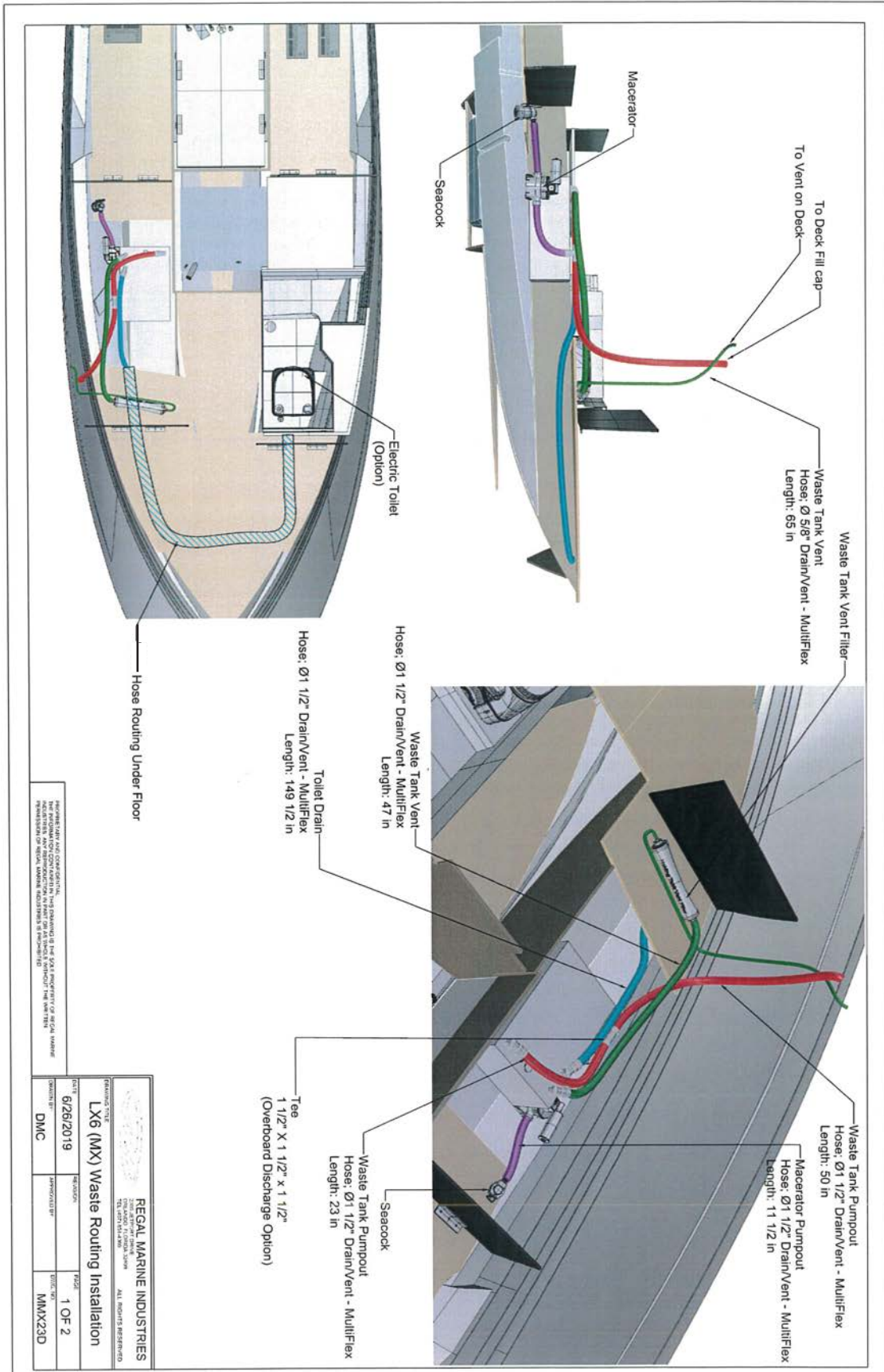

REGAL MARINE INDUSTRIES  
 THE WORLD'S MOST ADVANCED YACHTS  
 THE WORLD'S MOST ADVANCED YACHTS  
 THE WORLD'S MOST ADVANCED YACHTS

<b>REGAL MARINE INDUSTRIES</b> <small>THE WORLD'S MOST ADVANCED YACHTS</small> <small>ALL RIGHTS RESERVED</small>			
<b>LX6 (MX) Waste Routing Installation</b>			
DATE:	REVISION:	PAGE:	
6/26/2019		1 OF 2	
QUANTITY:	APPROVED BY:	DATE:	
DMC		MMX23D	

# LX6 SEAKEEPER LAYOUT (OPTIONAL)

