

Octopus - An Autonomous Wheeled Climbing Robot

Conference Paper

Author(s):

Lauria, Michel; Piguet, Yves; Siegwart, Roland

Publication date:

2002

Permanent link:

<https://doi.org/10.3929/ethz-a-010098355>

Rights / license:

In Copyright - Non-Commercial Use Permitted

OCTOPUS: AN AUTONOMOUS WHEELED CLIMBING ROBOT

M. Lauria, Y. Pigué and R. Siegwart

Autonomous Systems Laboratory
Swiss Federal Institute of Technology (EPFL)
1015 Lausanne, Switzerland
E-mail: michel.lauria@epfl.ch
Tel: +41 21 6937806
Fax: +41 21 6937807

ABSTRACT

This paper presents an innovative off-road wheeled mobile robot, named Octopus, able to deal autonomously with obstacles in rough terrain without getting stuck. To achieve such a performance, the robot is equipped with tilt sensors and tactile wheels. The sophisticated locomotion mechanism of Octopus has 8 motorized wheels and a total of 15 degrees of freedom (14 of them are motorized). A two-dimensional static model and a controller are proposed. The inputs of the controller are the contact points with ground, the geometric angles of the articulations, and the direction of the gravity field. The outputs of the controller are the torques for the wheels, the torques for the forearms, and the position set point for the body.

1 INTRODUCTION

The function of a mobile robot is to move from place to place autonomously, i.e. without human intervention. Building mobile robots able to deal autonomously with obstacles in rough terrain is a very complex task because the nature of the terrain isn't known in advance and may change in time. The role of the path planner is to determine a trajectory in order to reach the destination while avoiding obstacles and without getting stuck. A true autonomous mobile off-road robot has to be able to evaluate its own ability to cross over the obstacles it may encounter. (Fig 1 and fig 2)

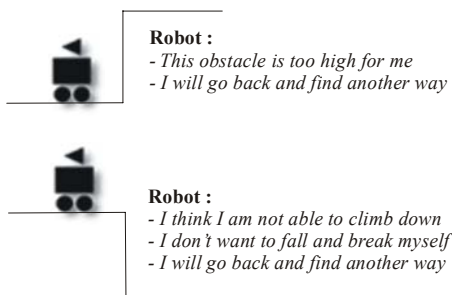

Figure 1: Navigation with robust path planning

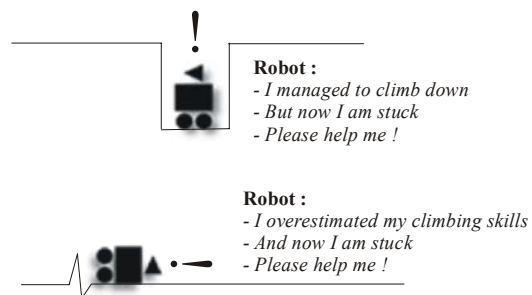

Figure 2: Navigation with hazardous path planning

2 STATICALLY STABLE LOCOMOTION IN ROUGH TERRAIN

There are a large variety of locomotion mechanisms that enable a robot to move throughout its environment. To achieve statically stable locomotion in general, one has to repeatedly do four things in any order [1]:

1. Remove ground contact points from the rear of the robot
2. Place ground contact points in front of the robot
3. Shift weight forward
4. Maintain static equilibrium throughout all motions

2.1 Locomotion using Walking Wheels

Walking robots probably offer the best manoeuvrability in rough terrain. However, they are inefficient on flat ground and need sophisticated mechanics and control. Hybrid solutions, combining the adaptability of legs with the efficiency of wheels, offer an interesting compromise. Especially solutions that passively adapt to the terrain are of high interest for field and space robotics. The Sojourner robot [2] (fig 3) and the Shrimp robot [3] (fig 4) represent such hybrid passive solutions.

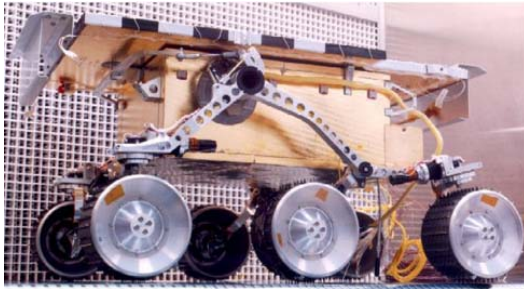

Figure 3: Sojourner Robot (NASA)

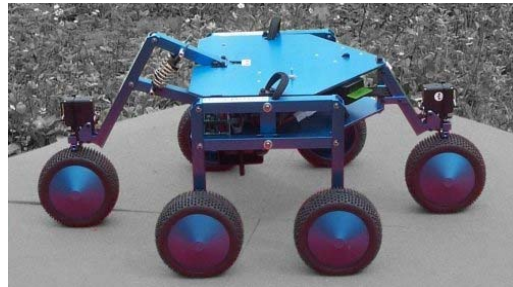

Figure 4: Shrimp Robot (EPFL)

However active locomotion concepts using additional motorized degrees of freedom combined with walking wheels can be more efficient in very rough terrain. Such mechanisms allow the robot to actively control the position of the centre of gravity with respect to the contact points with ground. High mobility is mainly insured by the quality of the control strategy and the pertinent integration of sensors in the structure. The Marsokhod robot [4] (fig 5), the Hybtor robot [5] (fig 6) and the Octopus Robot (fig 7) represent such hybrid active solutions.



Figure 5: Marsokhod Robot (Rover Company Ltd)



Figure 6: Hybtor Robot (IMSRI)

3 THE OCTOPUS ROBOT

3.1 Mechanical design architecture

The sophisticated locomotion mechanism of Octopus has 15 degrees of freedom. The payload support and the two bodies on each side are linked in a passive differential configuration. The two arms and the body on each side of the robot are linked in a motorized parallelogram configuration. The forearms are linked to the arms by a motorized joint. Each forearm has two tactile, motorized wheels attached to it. This mechanism architecture allows the robot to have all the wheels touching the ground at the same time, independently of the terrain profile (fig 7).

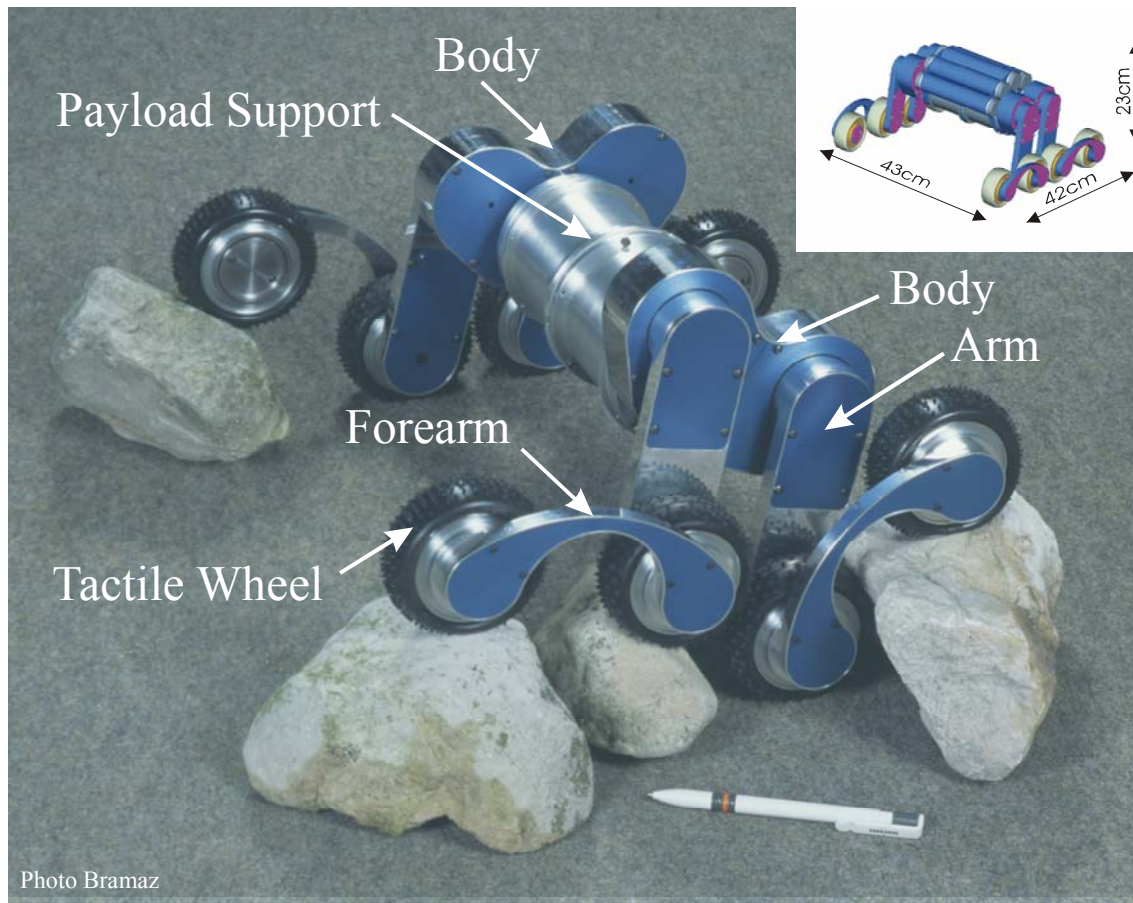

Figure 7: The Octopus Robot. All the wheels touch the ground

The robot measures 43cm in length per 42cm in width per 23cm in height. The mass of the system without payload is about 10 kg. A 5 kg payload can be mounted on the central payload support. A set of batteries (not depicted on the figure) will also be mounted on the central payload support for autonomous operation.

3.2 Integration of tactile wheels

For a mobile robot that explores rough terrain, tactile sensors able to detect obstacles provide more information about obstacles; consequently, the robot can adapt its behaviour to the terrain. The idea is to have a tactile wheel that is able to detect and locate physical contact to the terrain surface on its circumference. A motorized tactile wheel was designed using 16 infrared sensors (fig 8), which measure the tire deformation caused by the ground contact forces (fig 9). This measurement gives the contact points an approximation of the normal contact forces acting on the wheel. The mechanical design allows the sensors to be fixed on the wheel hub. The advantage is that the sensors do not turn with the wheel rims and the tire.

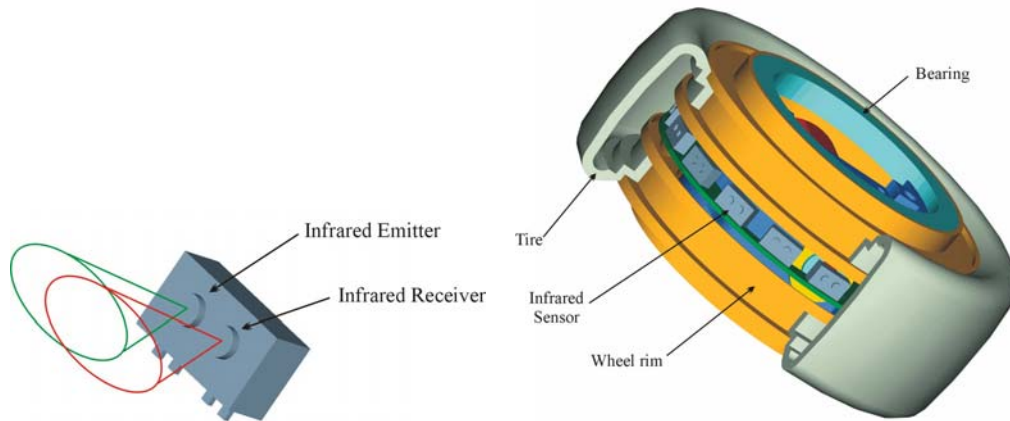

Figure 8: Infrared Sensor TCRT1000 with Tactile Wheel

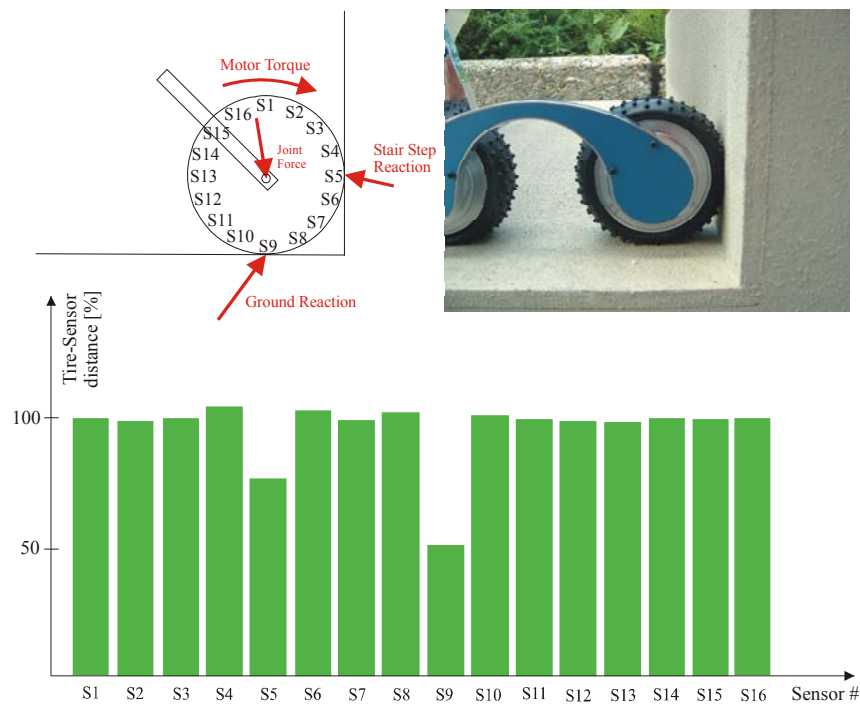

Figure 9: What "sees" the tactile wheel

3.3 Electronic Architecture of Octopus

All the electronic modules components have been integrated in the robot (fig 10). Each motor has a local processor (PIC16F876), which can be used to measure and control the speed, the position or the torque of the wheels and articulations. The tactile wheels have another local processor for the sensor management and for a fast post-processing layer. Each body of the robot contains one 2-axis tilt sensor. All these slave modules are connected to a master module using a standard I2C bus. There are two possibilities for the implementation of the master module:

1. For developing the controller, sensors and actuators are connected to an external computer with a Bluetooth wireless connexion.
2. For totally autonomous operation, a local processor board can be connected with the bus. Slots on the payload support of the robot are provided for this purpose.

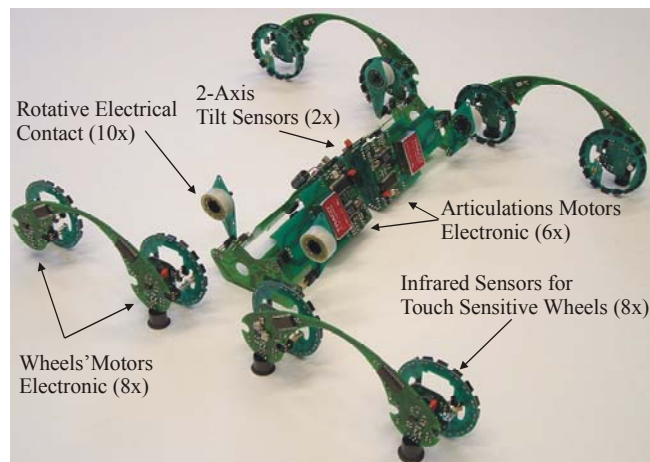
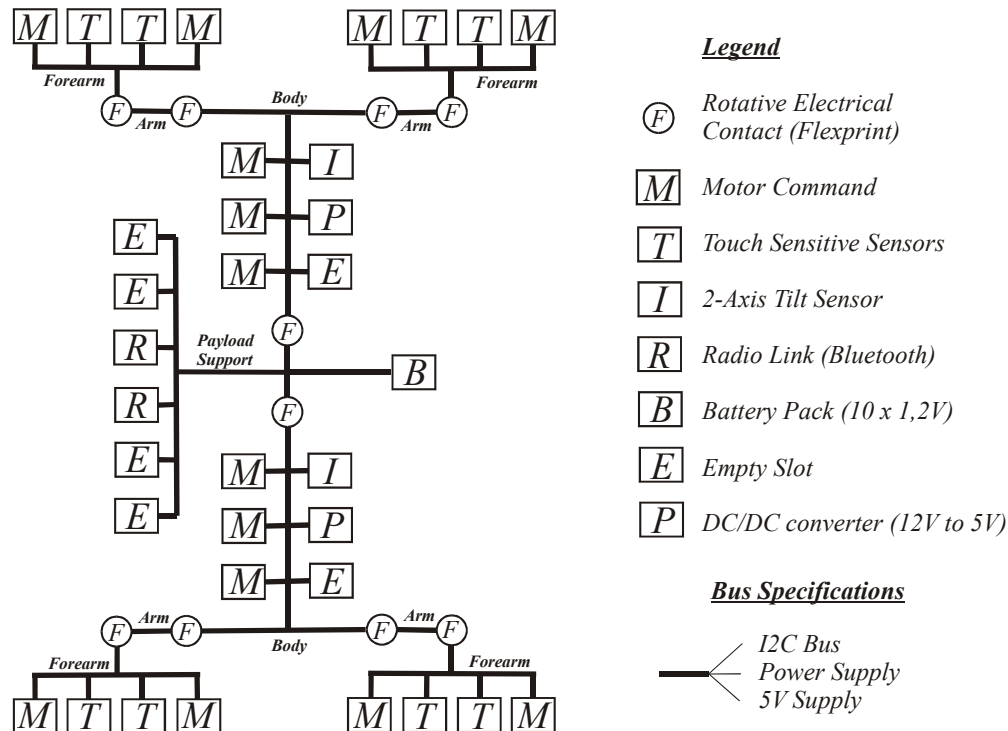

Figure 10: Electronic architecture and implementation

3.4 Step climbing with Octopus

A step-climbing sequence is depicted on the figure below to show the capabilities of the robot. The lines at contact points represent the external forces acting on the robot.

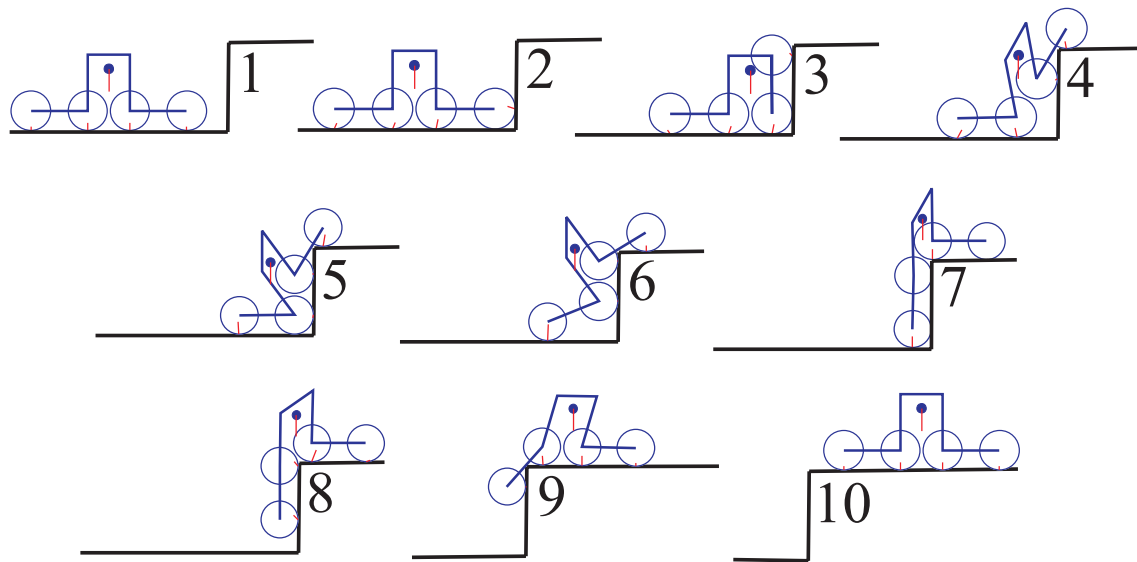

Figure 11: Step Climbing Sequence of Octopus

1. The robot is rolling in his flat terrain configuration with the centre of gravity between the central wheels.
2. The front wheel touches the step.
3. The front forearm raises as the robot continue its advance until the second wheel touches the step.
4. The rear forearm motor and the motorized parallelogram act to raise the body, the front arm, the front forearm and the two front wheels. The front forearm motor acts so that the front wheel follows the terrain profile and reaches the horizontal part of the step.
5. The robot continues its advance until the third wheel touches the step.
6. At this moment the two forearm motors act to raise the body, the two arms and the two central wheels. The weight of the robot is shared between the two external wheels.
7. The second wheel reaches the horizontal part of the step before the last wheel touches the vertical part of the step. The weight of the robot is shared between the two front wheels and the last wheel.
8. The front forearm motor and the motorized parallelogram act to raise the body, the rear arm, the rear forearm and the rear wheels. The weight of the robot is shared between the two front wheels. We remark that the position of the COG is outside the two contact points of the front wheels. In this case some friction on the front wheels is necessary to prevent falling back.
9. The third wheel reaches the horizontal part of the step. The rear forearm rises until the last wheel reaches the summit of the step.
10. The climbing sequence is over.

3 MODEL AND CONTROL OF THE ROBOT

A two-dimensional static model and a controller are proposed. The inputs of the controller are the contact points with ground, the geometric angles of the articulations, and the direction of the gravity field. The outputs of the controller are the torques for the wheels, the torques for the forearms, and the position set point for the body. By considering one side of the robot, there are seven degrees of freedom (torques applied to the wheels and to the forearms and the position of the body). The single equation that must be satisfied in order to achieve the equilibrium on an arbitrary ground is affine with respect to the torques. Optimisation methods are used to minimize the ratio between friction and normal contact forces for each wheel, and therefore the risk of slippage. One possible solution is such that these ratios are equal in absolute value. The resulting equation is a polynomial of order four with respect to the ratio; all coefficients are calculated explicitly from the physical parameters of the robot, its configuration, and the contact points between the wheels and the ground, which is measured. Then all torques are given by affine expressions. This low complexity enables the computation of the optimal solution in real time.

The model and the controller are validated with SysQuake™, software for the design and simulation of dynamic systems (fig 12) [6].

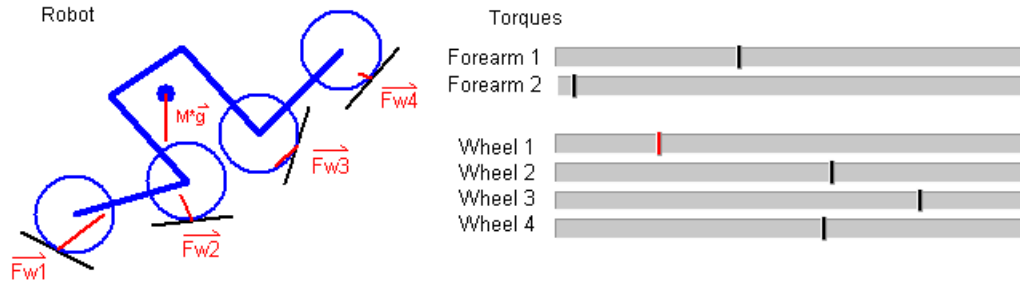

Figure 12: Simulation with SysQuake

4. SUMMARY AND FUTURE WORK

In this paper, a new active locomotion concept using walking wheels is presented. The pertinent combination of the mechanical structure with tactile wheels and tilt sensors insure very high autonomous climbing skills to the robot. In a next step, a controller will be implemented and tested with the real robot. The robot should be able to climb stairs and deal with very rough terrain autonomously. (fig 13)



Figure 13: Future work: Autonomous control of the robot

REFERENCES

- 1 **Yim, M.** (1994) Locomotion with a unit-modular reconfigurable robot. PhD Thesis, Stanford University.
- 2 **Volpe, R., Balaram J., Ohm T., Ivlev T.** (1996) The Rocky 7 Mars Rover Prototype. IEEE/RSJ International Conference on Intelligent Robots and Systems, November 4-8 1996, Osaka Japan.
- 3 **Estier T., Crausaz Y., Merminod B., Lauria M., Piguet R., Siegwart R.** (1994) An innovative Space Rover with Extended Climbing Abilities, Proceedings of Space and Robotics 2000, Albuquerque, USA, February 27-March 2, 2000.
- 4 **Kemurdjian A.L.** (1998) Planet Rover as an object of the engineering design work, Proceedings of the 1998 IEEE/ICRA, Leuven, Belgium, May 1998.
- 5 **Leppänen I., Salmi S., Halme A.** (1998) WorkPartner, HUT Automation's new hybrid walking machine. CLAWAR'98 First international symposium, Brussels, Belgium, 26-28 Nov. 1998
- 6 **Dimmler M., Piguet Y.** (2000) Intuitive Design of Computer Real Time Control Systems. 11th International Workshop on Rapid System Prototyping (RSP 2000), Paris, 2000.