



RetroMagazine

World
future days are back



A lot of
Game

**R
E
V
I
E
W
S**

THE NIGHTLAND

COMMODORE 64

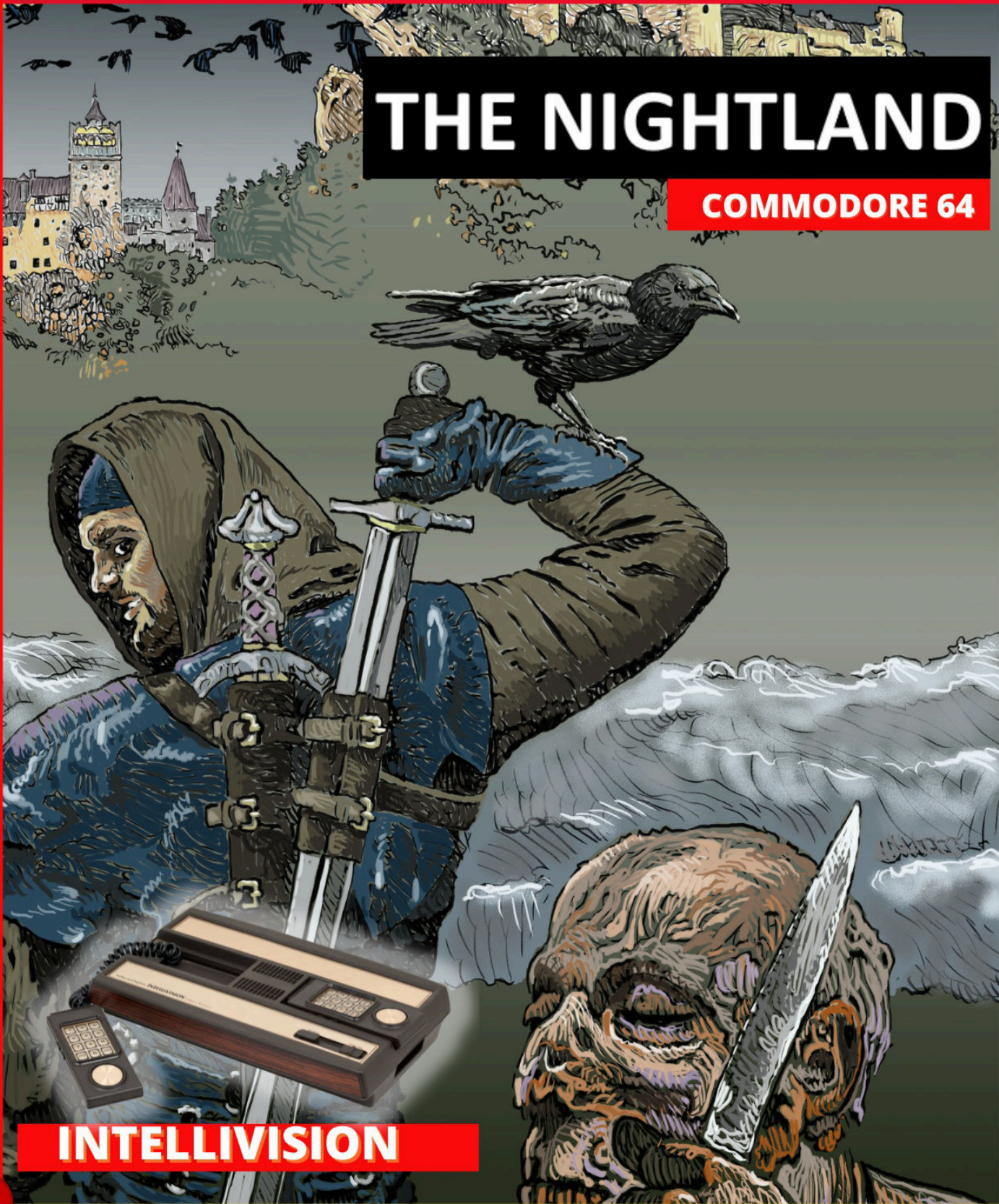

INTELLIVISION

SPECIAL BASIC 10-LINER CONTEST 2022

**Software: A question for the SUSI C64 - Taylor's polynomial
RETRO PROGRAMMING ITALIA: How to create a BASIC game on C64 (part 3)**

**Retrohistory: Battles of The Eras - Happy Birthday Giana Sisters
SUPER NINTENDO: the (un)protections - PANDORA'S BOX Corner**

...and then columns, interviews and much more!



Non Profit Organization RetroMagazine World

"It is not the strongest of the species that survives, nor the most intelligent. It is the one that is most adaptable to change." We at RetroMagazine World have always made this quote from Charles Darwin our mantra. In our nearly 6 years of existence, changes have been occurring systematically to make sure that the magazine and everything around it, could always evolve into something better. Yet another step to continue this evolutionary path was the creation of the **RetroMagazine World - NPO**.

The reasons that have driven us in the past few months to invest time and resources in this activity are many. RetroMagazine World is enjoying quite a success with the public, both in Italy and abroad; the magazine, since the first issue, has been published under the Creative Commons license, because we have always believed in sharing the information and the free circulation of our work. We have found out that our magazines have been published on dozens of sites around the world, and while this can only please us, it has raised some questions. What would happen if in the future someone else wanted to take over the name RetroMagazine World and use it in a way much different and undesirable to us? After all, there was but one FaceBook group behind the magazine like there are millions in the world.... So we decided to protect ourselves, our work and the reputation we have built over all these years. Our work will continue to be published in the same manner, but the fact that the name RetroMagazine World will be linked to a Cultural Association, legally recognized, will effectively guarantee that only those entitled to it will be able to represent it in more or less institutional venues.

The establishment of the association will also allow the editorial staff of RetroMagazine World to manage a small budget, built on yearly membership fees, to finance projects that we have had in the works for quite some time. For example, if we wanted to organize something (even if it was just to rent a venue), in the past it would have to feature some of us in the first person, whereas now, being an association, it would all be done in the name of the association... Some of the foreign readers in the past have asked us if we had a bank account to send us donations. Obviously not having any legal form we could not accept money as an individual, but now instead we could accept contributions in the form of membership fees, be they Ordinary, Volunteers or Supporters...

Of course, the magazine will continue to be published completely free of charge and ad-free. Nothing will be asked to readers, editors and occasional contributors. Those who wish to join our new organization and pay a small amount of money for membership, they are of course welcome, as long as they are well aware that they are helping the RetroMagazine World Cultural Association. In the next issues we will publish more information and a description of the forms of association envisaged, with details on how to register.

Francesco Fiorentini

TABLE OF CONTENTS

◇ Pandora's Box corner	P. 3
◇ Super Nintendo - the (un)protections	P. 8
◇ WONDERSWAN the Bandai console	P. 10
◇ Mattel Intellivision	P. 13
◇ 2022 BASIC 10-LINER CONTEST	P. 19
◇ A question for Susi on the C64 (beginners)	P. 22
◇ Taylor's polynomial and (in)finite precision	P. 24
◇ How to create a game in asic for C64 - part 3	P. 27
◇ The FOCAL language on PDP-8 - part 2	P. 34
◇ Interview with Alessio Scanderebech	P. 36
◇ Battles of the Eras	P. 40
◇ The Great Giana Sisters	P. 43
◇ Track & Field: blood and sweat to go	P. 46
◇ Talent Scout	P. 51
◇ Andro Dunos II (Win/Switch/DC)	P. 52
◇ Brave Battle Saga (MegaDrive)	P. 54
◇ Tony Hawk Pro Skater 4 (PS2)	P. 56
◇ Silverman y la Isla Esmeralda (Amiga)	P. 58
◇ Empire Strikes Back (C64)	P. 59
◇ Crash Time Plumber (Atari ST)	P. 60
◇ Babylon's Ark (C64)	P. 62
◇ Gelatino 2 (MSX)	P. 63
◇ Nightmare II (MSX)	P. 64
◇ The Legend of Zelda - The Minish Cap (GBA)	P. 66
◇ Lupo Alberto (Atari ST)	P. 68
◇ Doraemon (GameBoy)	P. 69
◇ Coryoon (PC Engine)	P. 70
◇ Tusker (C64)	P. 71

People involved in the preparation of this issue of RetroMagazine World (in no particular order):

- Alberto Apostolo
- Dr. Andrea Q.
- Carlo N. Del Mar Pirazzini
- Daniele Brahimi
- Mic the Biker Novarina
- Francesco Fiorentini
- Roberto Lari
- Leonardo Miliani
- Barbara "Morgana" Murgida
- Takahiro Yoshioka
- Roberto Del Mar Pirazzini
- Ingrid Poggiali
- Gianluca Girelli
- Giampaolo Moraschi
- Jacopo "Captain" Orlati
- Brandon Cobb
- Felice Nardella
- Eugenio Rapella
- Cover image: **Giuseppe Mangini**
- Cover layout: **Carlo N. Del Mar Pirazzini**



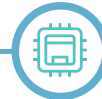

Pandora's Box corner

by Roberto Lari

Today we are going to talk about and compare 3 different models of Pandora's Box, this to allow you to evaluate the pros and cons of every version available and to help you to unravel a little more in this jungle of models and proposals.

For those who are not aware of this type of products or would like to get more technical information about them, I invite you to read the article published at **page 11 of RetroMagazine World English edition #11**. You can find the link at the bottom in the "useful links" section.

Specifically, the 3 models that we are going to analyze in this article are:

- 1) The Pandora's Box EX Jamma (console only).
- 2) The Pandora's Box DX Jamma (only console)
- 3) The Pandora's Box 3D + Wifi (in-dash version with 2 integrated joysticks)

Let's start talking about the last one the 3D+ arcade version, comparing it with the DX / EX (both home and Jamma), some important differences have come out that now I illustrate:

- The emulators (perhaps even some of the roms) used are different, for example on Outrun in the version on the 3D+ you can see at the bottom right the indicator of the gear HIGH / LOW while on the EX / DX this is not present, but unfortunately on the version of 3D+, does not allow us with any button to be able to change gears, making it impossible to play with this game.

Note that although it is possible to connect joystick / gamepad usb to be used in addition or instead of those integrated in the console itself, even with these you can't change gear.

- As for the external USB joysticks/gamepads, you can decide to use these as a substitute for the built-in ones or as an additional supplement, allowing you to play with 3 or 4 players without problems with the titles that allow

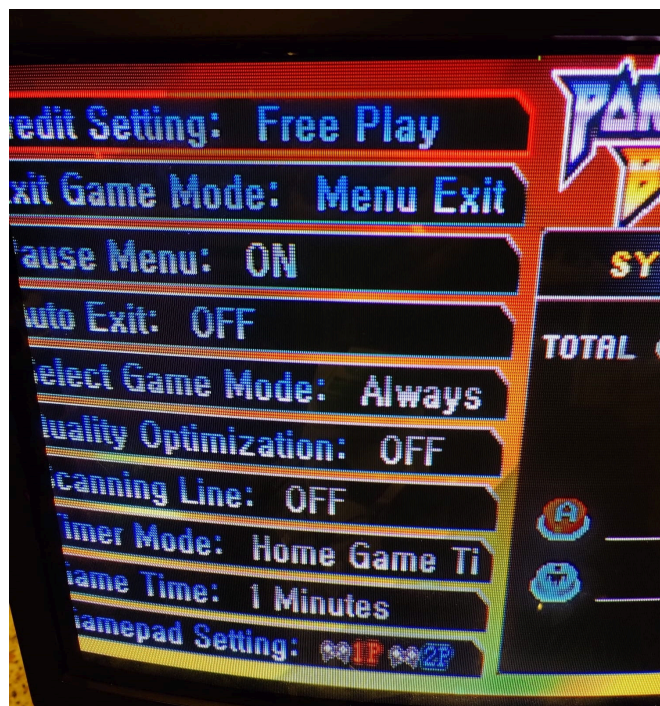

Fig. 1 - 240p RGB in all its glory

it (...and there are many).

- The "Autofire" function on the EX / DX (both home and Jamma) is present but only for some titles (a message appears that you can activate it when you start a preset title such as R-type), while on the 3D+ this function is present only as a global option in the settings menu, but you can only choose between 3 settings, or 5, 10 and 20 shots per second, personally this type of Autofire I do not consider it good enough because they are fired in bursts the precise number of shots that we have selected, followed by a small pause and on titles like R-type, this mode makes the gaming experience less enjoyable. Clearly, if you don't use Autofire as an arcade purist, you can ignore this feature.

As far as I'm concerned, using this feature a lot, I'm inclined to sincerely prefer the one in DX and EX, as the autofire is continuous and not subject to interruptions during use.

- Tate games (from the English word "rotate", those developed vertically): unfortunately, on the 3D+ these



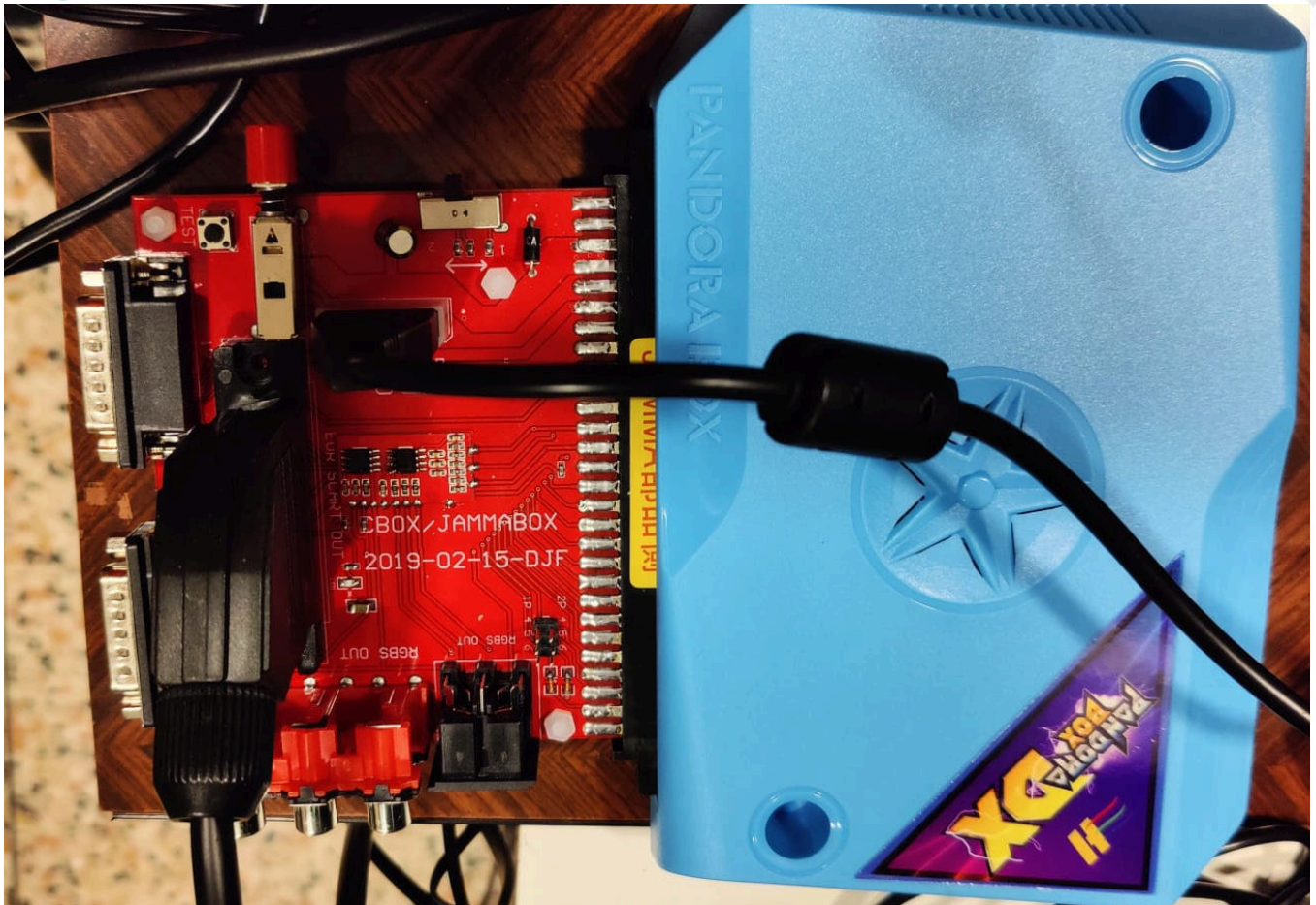

Fig. 2 - The Cbox - JammaBox connected to Pandora's Box DX Jamma

titles (such as Time Pilot or Galaga) are displayed with the image enlarged to the entire screen, leading to a visual result very different from the original arcade version, as deformed, while on DX / EX the image is correctly proportioned with the inevitable black bands on the sides. This display defect leads to ruin, in my opinion strongly the gaming experience.

- The Pandora 3D+ is equipped with a Wifi connection but apart from the fact that it has only one Gigabyte of space available for downloading other games, those downloadable from its store available are already present on board, it is also not manageable via network from the PC.

A positive thing about this model (I think it applies well or badly for all arcade Pandora) is that you can connect it to the PC via a cable that comes with it and use it as a USB arcade joystick, although unfortunately it does not seem possible to use both joysticks with the PC but only the primary one, that is the left one.

Speaking instead of the other two models, the differences

between the EX and DX Jamma are modest but still present and we are going to analyze now. Remember that the Jamma are the versions for cabinets of the Pandora normally used individually or mounted in the console with the two joysticks.

What changes between Home and Jamma is that the Jamma has a hairpin connector with the same name that is used to connect everything that is generally present in a cabinet : a tv or monitor, two or more joysticks, speakers and of course the power supply.

The most obvious difference between the two Jamma under consideration (DX & EX) is the fact that on the EX they have updated the power of the hardware, increasing the maximum resolution supported, coming to Full HD 1080p (in addition to HD 720p already present in the past) but completely losing compatibility with CRT 15 Khz RGB screens, making it impossible to use the EX Jamma with a TV or monitor with such characteristics even in combination with an additional adapter (such as the Cbox / Jammabox, see links in the useful links section)





that serves to provide the Pandora with a Scart socket and other RGB outputs as well as a convenient switch to turn on the same.

Note that the same adapter instead allows the DX Jamma to be able to output in native RGB on a TV or monitor CRT 15Khz quietly and the correct resolution 240p.

Actually you can overcome this inconvenience by using a signal converter from VGA to S-video / composite video, this type of device can be used with any device that comes out in VGA and not only with any model of Pandora (Even a classic PC with VGA output could be used in this way on a CRT 15Khz for emulations), while for the audio part will just use a 3.5 "jack cable - 2 cinch RCA male that will be connected together with the cable S-video or composite on the TV to complete the work.

Honestly, although not native RGB, even going out in Svideo is not bad as a result obtained, clearly with the composite video video quality will be affected more.

Unfortunately, this type of video signal (Svideo) requires that the screen used is able to handle it.

For those who are not interested in going out on a 15Khz CRT TV or monitor, remember that on any model of Pandora's Box, it is always possible to connect a flat screen LCD (it would be better if 4:3 or 5:4, avoiding if possible the 16:9 for the correct video proportions, unless the TV or monitor 16: 9 in use does not have the function to reduce the image to 4:3) through the HDMI output,

alternatively you can opt for a VGA LCD 31 Khz or even better a VGA CRT 31 Khz or one of those classic PC screens of the past that were used before the introduction of LCD screens. (Among other things the tearing, big Achilles' heel typical of Pandora's Box seems completely absent on CRT VGA 31 Khz, leading to consider them really a good option to evaluate)

In the case, you decide to go out only on HDMI screens (perhaps for a modern bartop where you opt for the size, weight and bulk for the use of a small LCD or if you want to use it in the living room with the classic modern LCD TV at home), the EX is present as the best solution because it allows you to have the most updated hardware and software of all models, thus being able to ensure the fluidity and fidelity as high as possible even on the emulation of consoles distinctly 3D as the Playstation Portable, Playstation 1 and Dreamcast.

Beware that the Jamma version will always require a unique connection through its namesake connector or through the aid of an external interface to be able to at least power it (the model I mentioned before is visible in the pictures both alone and connected to a Pandora).

Alternatively, on the DX version (both Jamma and Home), you can use a software called Pandory tools to make improvements such as reducing tearing in games with horizontal scrolling (eg Flicky) or output in 240p directly



Fig. 3 - Pandora's Box EX Jamma



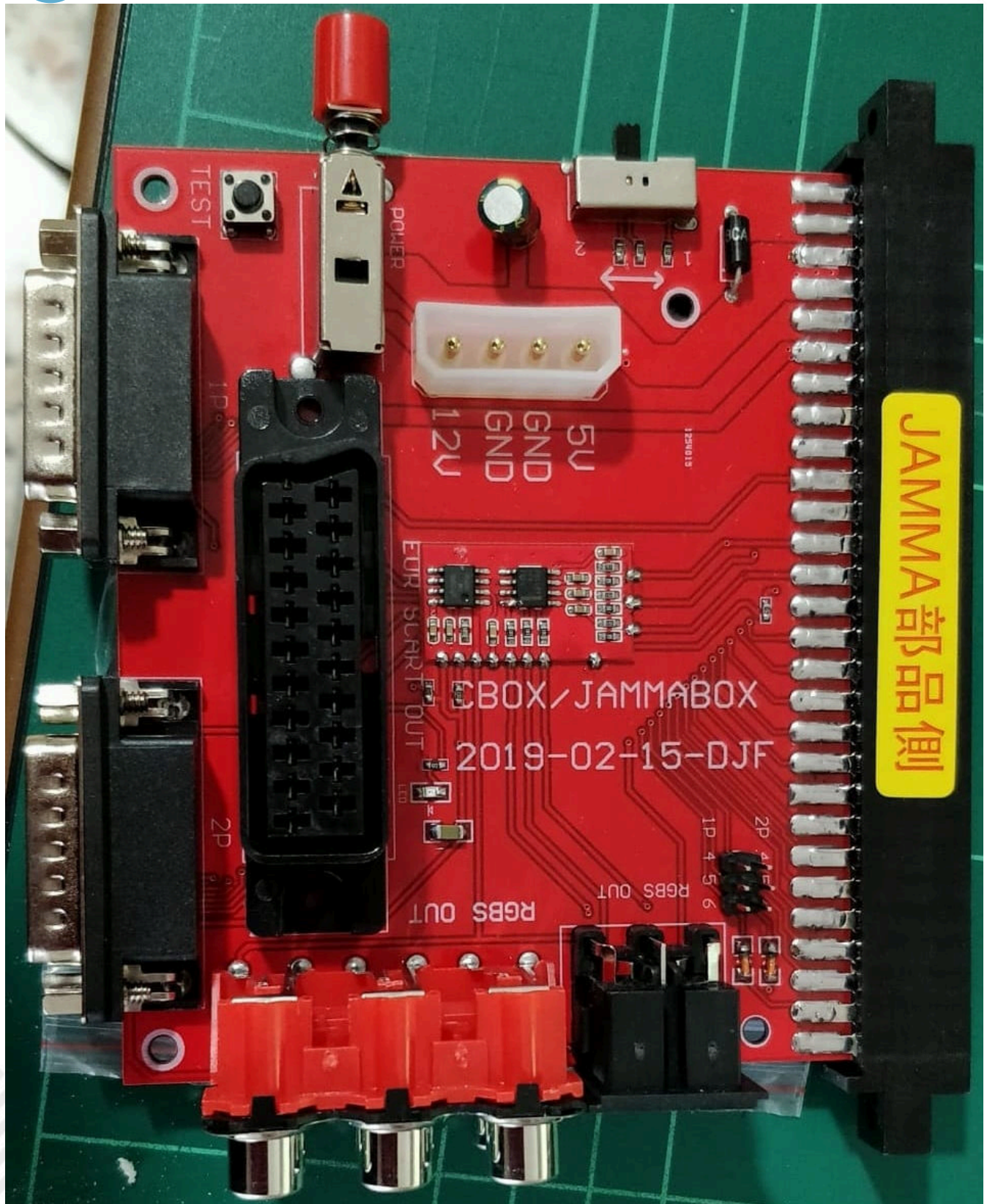

Fig. 4 - A close-up of the Cbox - JammaBox

from the Pandora itself without any signal conversion, this is to get the same video resolution of CRT 15 KHz, and you can force the output in 4:3 even on modern flat screens 16:9, better the black bands on the sides that the image enlarged and deformed!

Conversely, if you want to opt for the use with a CRT 15

Khz screen that accepts the RGB signal, the most suitable solution is the adoption of the Pandora's Box DX in conjunction with the interface mentioned above (on the model I suggested there are also two 15-pin ports for SNK controllers of Neogeo). Clearly this interface is not necessary if you want to use it inside a cabinet that uses the Jamma connector to interface to the console.





Fig. 5 - Pandora's Box 3D+ Wifi onboard

Note: For those who would still like to buy an arcade Pandora, currently you can also find on sale versions with 6 and 8 game buttons for each player (in addition to coin and start) of the EX model (see links in the useful links section at the bottom).

On all these consoles, it is of course possible to add games of the various emulated systems using a common USB stick, the instructions on how to proceed, are easily found online.

All models of Pandora's Box examined both in this article and in the previous one are easily purchased through the company Leon Arcade on Ali Express, which for those who do not know, has created sales channels that ship directly from Spain and in many cases even from Italy itself, allowing you to lower shipping costs, canceling the additional costs related to customs duties and greatly reducing the shipping time.

At this point you just have to choose the model of Pandora's Box that best suits your needs and have fun!

Greetings and remember to join the Facebook groups dedicated to these products.

Useful links:

RetroMagazine World number 11 english Issue

https://www.retromagazine.net/getrm.php?id=11_eng

Pandora's Box Italy Facebook group

https://bit.ly/Facebook_Pandora_Italia

Pandora's Box EX Jamma

<https://bit.ly/3jqdZ16>

Pandora's Box EX Jamma dashboard with 2 deluxe joysticks

<https://bit.ly/3JrJceU>

Pandora's Box EX Jamma dashboard with 2 standard joysticks

<https://bit.ly/3LQmYVJ>

Pandora's Box DX Jamma

<https://bit.ly/3JqKZRI>

Pandora's Box DX Home

<https://bit.ly/3636wI0>

Pandora's Box EX Home

<https://bit.ly/3uoyxNZ>

VGA to S-video / Composite Video Converter

<https://amzn.to/370R0HD>

Cbox / JammaBox (to use Jamma without the cabinet)

<https://bit.ly/302ziEg>





Super Nintendo - the (un)protections

by Dr. Andrea Q. - www.retrofixer.it

Youtube channel: <https://www.youtube.com/channel/UCeW0CQ8LKya9jVvWXkEwp4Q>

Were you expecting an article on the Gamecube? But no, I thought again! Moving chronologically forward, after the Game Boy (and pretending we haven't talked about the GBC and GBA), we do in fact have the SNES.

The Super Nintendo, product code SNS-001 (or Super Famicom in Japan - product code SHVC-001), is Nintendo's second "living room" console; released, depending on the country, between 1990 and 1992, it also has protection systems.



From left to right: **SNES JAP** [SHVC-001] - **SNES USA** [SNS-001] - **SNES EUR** [SNSP-001]

CIC

Like its predecessor, the SNES also implements a lock-key control mechanism with new dedicated chips of which one is in the console and the other inserted in each cartridge with contents very similar to that of the NES CIC.

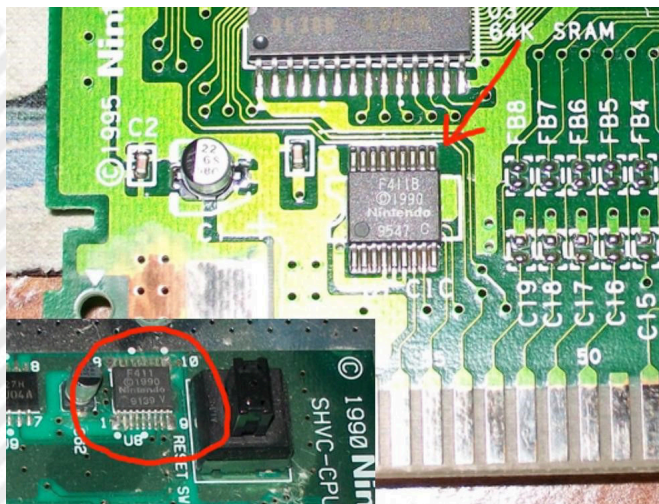

The reasons that made this system necessary are always

the same:

- To give Nintendo overall control over the games released for the platform
- To prevent pirated cartridges from booting on the system
- To make it easier to lockout games from different regions

The chips found are as follows:

- D411 (NTSC cartridges)
- D411A (NTSC cartridges)
- D411B (NTSC cartridges)
- D413 (PAL cartridges)
- D413A (PAL cartridges/consoles)
- D413B (PAL cartridges/consoles)
- F411 (NTSC console)
- F411A (NTSC cartridges/consoles with SuperFX chip, OBC1, maybe others)
- F411B (NTSC cartridges/consoles with SPC7110 chip, maybe others)
- F413 (PAL consoles)
- F413A (PAL cartridges/consoles with SuperFX chip, OBC1, maybe others)
- F413B (PAL cartridges/consoles with SuperFX chip, OBC1, maybe others)

Legend:

- D = Through Hole Mounted type
- F = Type Surface Mounted
- 411 = NTSC
- 413 = PAL
- A/B = chip revision

U.S. and JAP use the exact same chips so the cartridges, with appropriate modification to the console slot (see below), work reciprocally.

Decoded lock/key codes:

- D411
KEY: b14f4b57fd61e98
LCK: _9a185f11e10dec
- D413
KEY: b14f4b57fd61e98





LCK: _6a185f11e10dec

The bypass systems of this pairing are all hardmod and PIC-managed, because there are other forms of control in newer games such as Super Mario RPG or Street Fighter Alpha 2 which refused to start if they found the lock-key system somehow disabled, probably due to a circuit analysis of the SNES not possible in the NES.

One of the best known was the **SuperCIC**:

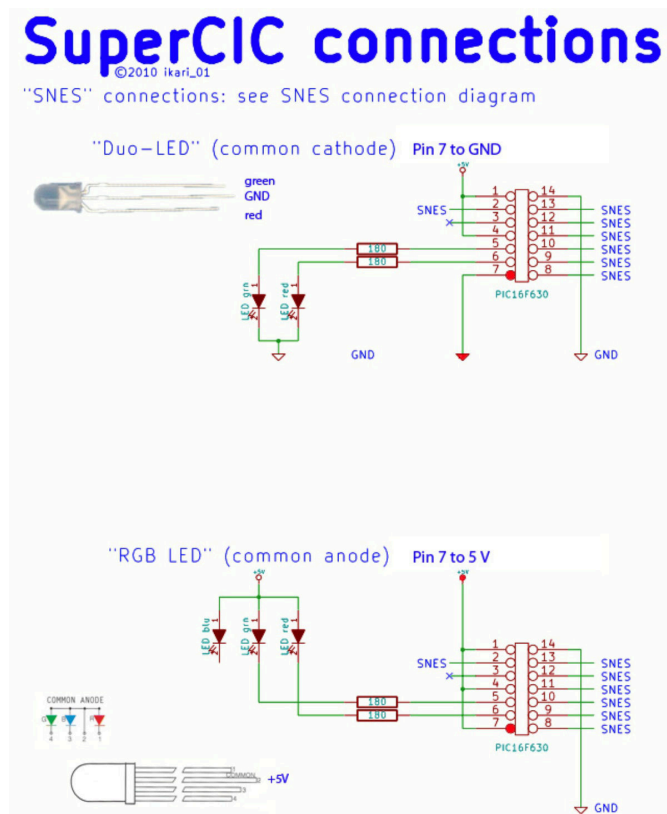

Another bypass system was offered by "adapters" that contained the valid CIC for specific region into which the cartridge of a different region could be inserted:



PHYSICAL PROTECTION

The US and JAP cartridges had a slightly different plastic case:



which required cutting the plastic tabs found in the slot of US consoles to accept JAP cartridges.

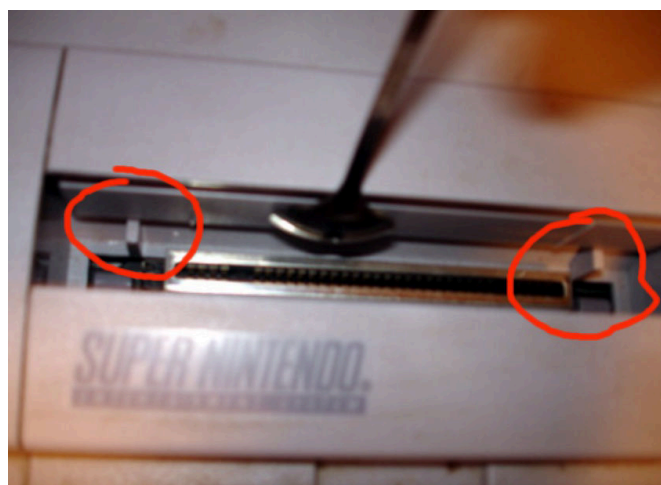

REGION SIGNAL CHECK

NTSC video signal is at 60Hz while PAL video signal is at 50Hz; some games (e.g. Donkey Kong Country, Earthbound, Tetris Attack, Megaman X, Super Metroid...) check the video signal of the console and if it is different from the region for which the game is programmed, the game will not start showing an error message programmed in the game itself:





This control could be bypassed with a hardmod that inserted a switch to change from 50Hz to 60Hz:



or by using a PIC to avoid having to install a switch:

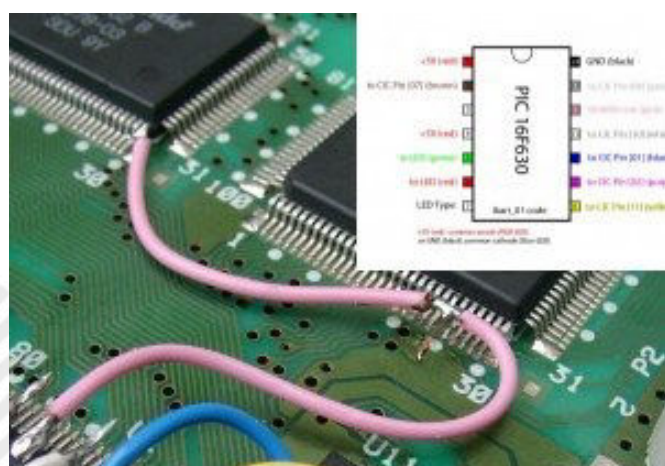

SOFTWARE PROTECTIONS

Eventually, programmers could and may indulge in how to control hardware and program, including, for example, controls on the presence and/or size of save memory (against pirated cartridges).

Or by doing a check on the game data, to prevent tampering with the code to bypass other controls, and adding features that make the game itself unplayable or even interminable. The Earthbound game is a shining example of how these



kinds of protections can be implemented:

In summary, the SNES shows the implementation of systems already in use and at the same time offers some new insights that will be somewhat recycled in future devices as well. Nothing extreme, but still worthy of being known.

Until next time, with Project Reality Ultra.

ATTENTION: LIABILITY DISCLAIMER

The information contained in this article is for informational purposes only.

This documentation is not guaranteed to be error-free. If this information is used to modify your hardware, it is your responsibility to take all necessary emergency, backup, redundancy, and other measures to ensure safe use.

RetroMagazine World assumes no responsibility for any damage caused by the use of the information in this article.



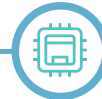

WONDERSWAN the Bandai console

by Takahiro Yoshioka

The Game Boy is the winner of an incredible war, the handheld console war between the 1980s and 1990s, and to this day it remains one of the best-selling game machines ever.

It didn't have the best graphics, but my lords, it had such a strong title pool, merchandising and structure behind it that it destroyed any competitor.

Today we will talk about a competing console, little known in the West, daughter of the same mind that gave birth to the first Game Boy, but not kissed by the same commercial fortune and support.



Fig. 1: The color version

We will talk about the WonderSwan, Bandai's wonder swan! But let's start with the story, after giving us the Game & Watch and making the Game Boy, Gunpei Yokoi, a brilliant software engineer at Nintendo, took the plunge and embarked on a mad attempt to bring virtual reality to everyone's home by making the Virtual Boy.

While the initial idea was not bad at all, the implementation was disappointing and to this day is remembered as one of Nintendo's worst consoles and a misstep in the market. Yokoi was outvoted by the company, and in fact forced to resign about a year after the Virtual Boy was brought to market.

Nintendo is not soft on anyone, even those who made history. Undaunted, he founded Koto Laboratory and began collaborating with Bandai to develop a new handheld gaming device that could "break Nintendo's reigns" in the field.

It was an ill-fated project from birth. In 1997, midway through the work, Yokoi died at the age of only 57 in a car accident, and Bandai's engineers nevertheless completed the small console following the brilliant designer's instructions.

On March 4, 1999, the WonderSwan, an innovatively designed console available in different colors (along the lines of the Game Boy color), arrived on Japanese shelves. Yokoi's death and the project's delay were a blow; in fact, the product was scheduled to go on sale in early 98.

At the time of the launch, Nintendo had recently launched its color version of the handheld console, which made the WonderSwan's monochrome screen look antiquated, despite being significantly larger than the competition. In less than a year, to run for cover, Bandai launched its own color version, called the WonderSwan Color, to try to fight Nintendo on its turf.

But it was an uphill path: despite the sales figures, encouraging when evaluated on their own but discouraging



Fig. 2 - He mourned GUNPEI YOKOI





when compared to Nintendo's sales.

The situation worsened so much that the decision was made to suspend the launch on American soil of the console and relegate sales to Japanese soil only.

The coup de grace came from Nintendo in 2001 when it entered the market with the new Game Boy Advance, closing one era of portable gaming and opening another. For the WonderSwan it was the coup de grace.

Talking about the merits and shortcomings of the console, meanwhile we can say that the design of the machine was revolutionary and allowed great freedom in gaming: the presence of two D-PADs placed one on top of the other on the left side of the machine allowed some games to be enjoyed by turning the console vertically.

Great for some puzzle games or vertical scrolling shooters, the machine could rely on a 2.49-inch diagonal screen. The definition was not exceptional, but the gameplay width was remarkable compared to the competition.

The classic B&W model suffered from low latency, a situation that improved with the color version.

The processor was a 16-bit NEC V30, significantly more powerful than the one inside the Nintendo machine, but even this was not enough.

Bandai also lost the battle in the software field. Few big names tried their hand at the console's high-performance development engine.

Yet there was no shortage of small technical gems.

Game life was about twenty hours on a single AA battery, and weight was about 93 grams without a battery.

Some of the best titles for WonderSwan include:

Klonoa: Moonlight Museum, a beautiful platform game derived from the version for the first Playstation.

One Piece: Grand Battle Swan Colosseum: Beat em up dating game based on the Famous comic book. A gem.

Ganso Jajamura Kun: Fast-paced and highly entertaining platformer.

Final Fantasy Saga: Wonderful conversions of the first three chapters.

Makaimura: A Wonderswan version of the classic Ghost 'n Goblins.

Special mention to the TETRIS version, very playable and well-developed.

Specifications:

CPU: 16 Bit NEC V30 MZ at 3,072 MHz

Screen: FSTN reflective LCD - 224 x 144 pixel resolution

Diagonal: 2.49"

Display: max 512 characters, max 128 sprites (32 on horizontal line)

Bibliography:

Bandai announces release of WonderSwan Color
Bandai August 30, 2000. Archived from the original on November 4, 2004. Retrieved April 28, 2011 – via PromoDuck.

Hardware Classics: Bandai WonderSwan Nintendo Life. Gamer Network." April 8, 2016. Retrieved November 25, 2016.



Fig. 3 - MAKAIMURA on WonderSwan

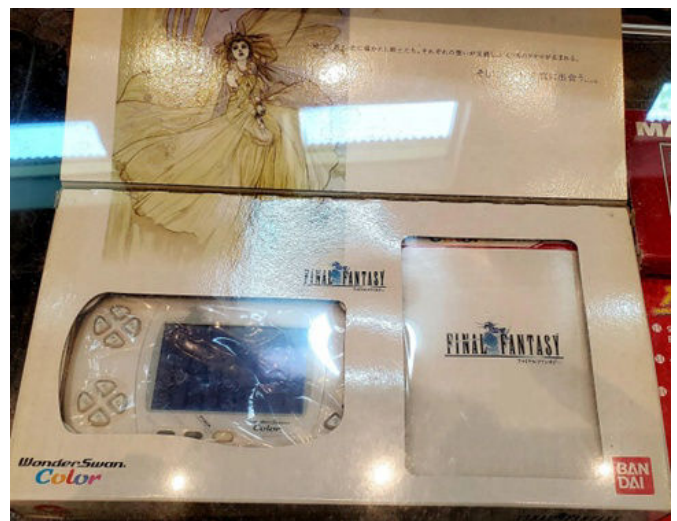

Fig. 3 - WonderSwan Final Fantasy edition





Mattel Intellivision

by *Leonardo Miliani*

After having examined the ColecoVision, an interesting console credited with several "firsts", in this new article we are going to discover the life, death and miracles of another interesting gaming machine born at the end of the 70s of the 20th century and also credited with some firsts. We are talking about the Mattel Intellivision (fig. 1). Turn on your cathode ray tubes and get comfortable, the documentary is about to start.

Origins

The Intellivision has its origins in... dolls. Its manufacturer, Mattel, was founded in 1945 by Harold "Matt" Matson and his wife Ellioth and Ruth Handler in El Segundo (California). Mattel is the combination of Matson's nickname and Ellioth's first two letters. However, Matson soon left for health reasons and the company remained in the hands of the Handlers. Mattel initially sells photo frames but, after a short time, also begins to sell accessories for dolls' houses, made from the scraps of the frames' production. Gradually, this last branch of the business proved to be much more profitable than the first, so much so that it became the company's main line of business. In 1959 the turning point for Mattel occurred: the "Barbie" doll was presented, which became a worldwide success, followed in 1961 by the "Ken" doll. Years of new successful toys and growing turnover followed until, at the beginning of the 1970s, the company showed signs of an economic crisis, also due to less than brilliant acquisitions and disposals. In 1974, at the height of the crisis, the company was accused of falsifying its balance sheets in order to make it appear that it was making profits that were not there. As a result of this investigation, the Handlers had to leave the company they founded, whose reins were

taken by vice-president Arthur S. Spears in 1975, who brought Mattel back to profitability in just under 2 years. At the same time that Mattel returned to profitability, second-generation game consoles appeared on the market: in 1976 it was the turn of the Fairchild Channel F, and in 1977 Atari presented its Video Computer System (VCS), later known as the Atari 2600. Compared to the first generation systems, the performance leap was considerable and the new consoles sold tens of thousands of units. With money to invest again, Richard Chang, head of design and development at Mattel Toys, had the idea of entering this market to create new sources of profit. In the spring of 1977, he hired Glenn Hightower of APH Technological Consulting, a Pasadena-based company that develops hardware and software systems for third parties, to evaluate the feasibility of a home gaming system. A chipset from National Semiconductor was evaluated, but was not very convincing. However, the basis of the system was laid down: it had to have very rich graphics, more than those offered by competing consoles, and the games had to be addictive and have a good longevity, to keep gamers interested for a long time. At the Consumer Electronics Show (CES) in June of that year, National Semiconductors unveiled a new chipset, as did General Instrument. The latter attracted a certain amount of interest: in practice, these are chips capable of managing external gaming peripherals and generating the video signal for a series of games, pre-installed in ROM, flanked by a CPU that creates a complete gaming system, which General Instrument markets under the name of GIMINI. The problem of this system is that it doesn't use RAM, so it can only run the games present in its memory: Dave James, one of the designers of the development group led by Chang, is not convinced by this limitation. Even Mattel's top management is not only not convinced by this solution on a technical level, but they also don't believe that such a system can attract the public, so they decide to freeze the development of the console waiting for new events.

In the meantime, between the end of 1976 and 1977, Mattel released what are considered to all intents and



Fig. 1: Mattel Intellivision (image: Evan-Amos - source: Wikimedia Commons)





Fig. 2 - A handheld electronic game from Mattel Electronics, Battlestar Galactica (image: Joe Haupt - source: Wikimedia Commons)

purposes the first portable electronic games in history, marketed under the brand name "Mattel Electronics" (fig. 2). (fig. 2): they are rudimentary games with luminous LEDs instead of objects or characters with which the user interacts, but they are still a huge success. This prompted Mattel to reconsider the idea of the game console and dust off the project. In the meantime, it was decided to go ahead with the National Semiconductor chipset, even if at the same time negotiations were opened with General Instrument for a customised version of its GIMINI. General Instrument, which is far-sighted and understands the potential of the machine and the possible gains that would derive from a collaboration with Mattel if this went ahead, reviews its chipset and proposes a new solution, which is finally accepted by Mattel in place of that of National Semiconductors. The company that would produce the console was also chosen: Sylvania, a company that produces various types of electronic components.

In 1978, during the development of the console, Texas Instruments contacted Mattel offering its own chipset instead of that of General Instrument. Texas Instruments was developing its own personal computer and already had several components in the pipeline, such as the graphics chip (later known as the TMS9918) and a 16-bit CPU (the TMS9900), for the computer that would be marketed as the TI-99/4. The offer is tempting, because tying up with a partner that is developing a computer

would help Mattel in the development of the console. On the graphics side, there's little difference with the chip being developed by General Instruments, and both solutions are not yet ready, so there wouldn't be much work to do. What doesn't convince, however, are some technical characteristics of the Texas Instruments architecture as well as the reluctance of the latter to meet Mattel's requests for customization, so in the end it was decided to continue with General Instrument, which is instead working with Mattel to meet their requests, to the great satisfaction of Glenn Hightower, who considers the Texas Instruments system inferior.

Marketing and reception

Due to delays in chip supply, the debut missed the Christmas period of 1978 and during 1979 work on the console continued unhurriedly, with handheld electronic games funding its development due to their huge success. A first debut was made at the January CES held in Las Vegas where the console, now renamed Master Component, was unveiled with a price tag of \$165. Along with the console, a module called Keyboard Component was announced, which would turn the console into a real home computer (fig. 3). At the CES in Chicago in June, the console was presented again, but with the price increased to 250 dollars. At the end of 1979, the console was finally ready for its debut. The designers created a machine body characterised by low, square lines, with black and gold as the main colours. The controllers, permanently connected to the console and housed when not in use in special recesses on the top, are different from those of other gaming systems: instead of the classic joystick, they have a disk capable of reading 16 different directions, which is flanked by a numeric keypad with 12 keys on which you can insert pre-printed masks as a reminder of the commands



Fig. 3 - Advanced Dungeons & Dragons: Treasure of Tarmin gives the idea of the depth of the scenes by resorting to a fake 3D (Wikimedia Commons)





Fig. 4 - The game: Baseball (source: Wikimedia Commons)

of the game from time to time performed. On the side are 2 pairs of action buttons: the bottom ones are individual commands while the top pair are the same command. The console is christened "Intellivision", a macedonian word for "Intelligent Television", indicating that it is a system to make the way you use your home television more intelligent.

Due to a scarce production of working chips by General Instrument, the Intellivision was initially put on sale in reduced form at the Gottschalks warehouse in Fresno, California at the price of 275 dollars: with the console, the first four games in cartridge, made by APh Technoligical Consultant, were also put on sale. After this successful debut, in mid-1980 Mattel put the console on sale throughout the USA at the price of \$299. At the same time, the range of games available was enriched by another 15 titles, bringing the total to 19. To boost sales, which initially didn't take off, George Plimpton, a well-known American actor, journalist and writer, was hired. He lent his face to several TV commercials in which the Intellivision graphics were compared to those of the Atari 2600 to better show potential buyers the real capabilities of the console. The move proved successful and by the end of the year, 175,000 consoles had been sold. Things go even better the following year, which closes with 2,000,000 units and a turnover for Mattel of 100 million dollars.

What is striking about Intellivision games is their graphics: rich in colour and detail, as well as elaborate sound effects, they differ from those of the competition, where the technical limitations of the machines often leave it to the player's imagination to see what the programmer has intended to represent. Mattel pushes this difference with the motto 'the closest thing to the real thing' and by

comparing the graphic detail and sound effects of its console to the cube-like graphics and shrill beeps of other gaming systems. Some games simulate a 3D effect to give more realism (fig. 3), or offer elaborate sprite animations in sports games where the realism of movements is impeccable (fig. 4). Mattel also tried to compensate for the lack of conversions of famous arcade games, at that time almost entirely the prerogative of Atari and its 2600, with original and highly playable titles.

Failures and rebirths

In 1983, Mattel presented the 'Intellivision II' (fig. 5), a smaller and cheaper version of the original machine, which was marketed at \$150. At the same time, the development of the 'Intellivision III' began. In the meantime, new competing consoles reached the market, as well as a considerable amount of games for all systems on the market: the number of Intellivision games also reached 100. However, an abundance of titles did not always mean an abundance of quality: in fact, many developers, in order to dive quickly into a market that the previous year had moved 1.5 billion dollars in sales, released games created in a hurry, resulting in poor quality and little success. The console did not sell very well either, as the market was saturated: Mattel had to lower the price to \$69. The bubble explodes and the losses hit everybody: Mattel, although it reaches 3 million consoles sold, loses 300 million dollars and decides to start liquidating Mattel Electronics, which takes place at the beginning of 1984 with the definitive closure of the subsidiary and the sale of the rights of the console and of all the inventories to Intellivision Corp., a company founded by the former vice-president of the marketing department of Mattel Electronics, Terrence Valeski, with the help of various investors. This company later changed its name to INTV Corporation and began selling the consoles and games it acquired, with the proceeds of which it developed and presented the "INTV System III", also known as the "Intellivision Super Pro System", in 1985. This machine is not the Intellivision III originally developed by Mattel (which was a console with third generation hardware features) but simply the Intellivision first series revised and re-boxed in the original container. Production of new games also continued.

The success of the NES slowly overshadowed the INTV System III, which from 1988 was only sold by mail order. Slowly things turned bad for INTV Corporation, which





Fig. 5 - The Intellivision II, put on the market in 1983 (image: Evan-Amos - source: Wikimedia Commons)

was forced to declare bankruptcy in 1990 and close down in 1991, bringing the curtains down on the Intellivision just short of the 3 million unit sales mark in about 10 years. In 1997 former Mattel Electronics programmers acquired the rights to the Intellivision brand and began releasing games and collections for the new systems that came on the market over the years, including consoles in the 2000s and mobile devices in the 2010s. In 2014 the Intellivision materially returns to the shelves with the "Intellivision Flashback", a miniature version of the first console with 2 controllers resembling the original ones and about 60 games preinstalled in the machine's memory. In 2018 Tommy Tallarico, a video game music composer, bought the rights and announced the development of a new, more modern version called "Intellivision Amico" (fig. 6), with wireless controllers and a touch display, but, as of the date of writing this article (May 2022), nothing has yet been put up for sale. Former Intellivision users anxiously await...

Technical specifications

The console is based on General Instrument's CP1610 CPU, a 16-bit CPU that can use 8/10/14/16-bit memories. Since most of the CPU's instructions are only 10 bits long, it was decided to put 10-bit memories next to it. Next to the CPU is the STIC, which stands for Standard Television

Interface Chip, the General Instruments AY-3-8900 graphics chip. The STIC is able to generate an image with a resolution of 160x96 pixels and manage 16 colours: in reality the vertical resolution is 192 video lines but the STIC repeats the lines, halving the resolution. The real resolution drops to 159x96 pixels because the video chip does not show the rightmost column of pixels. The colours are taken from 2 different palettes: the first contains the "primary colours", i.e. black, blue, red, tanno (a light shade of brown), dark green, green, yellow and white. The second contains the "pastel colours": grey, cyan, orange, brown, pink, light blue, light green, purple. The background image is managed by "tiles": each tile covers 8x8 pixels so that the STIC uses 20x12 tiles to cover the entire screen. The use of tiles saves memory because a tile is defined only once but can be repeated several times on the screen. The chip operates in 3 graphic modes. The first is called "foreground/Background" and allows the use of only 2 colours for each of the various cards, one for the primary colour and one for the background colour. The colours can be any of the 16 available with the only limitation being that one of the two must be a primary colour (in simple terms, you cannot use two pastel colours on the same tile). The second is called "Color Stack" and requires that one of the two colours of each tile be either the previous or the next colour in a circular stack of 4





Fig. 6 - The Intellivision Amico (source: Intellivision Entertainment)

colours chosen by the programmer. As all 16 colours can be used in this stack, the limitation of using only one pastel colour per tile in the previous mode does not apply. The last mode is called "Colored Squares" and allows the use of 4 primary colours per tile but at the price of having the tile divided into 4 blocks each 4x4 pixels wide. The STIC can handle 8 sprites of 8x8 pixels or 8 pixels wide and 16 half pixels high (doubling the resolution but not the vertical size). Each sprite can be doubled in size or reflected, in either direction. The STIC also allows hardware scrolling in both horizontal and vertical directions.

Sound is handled by the General Instrument AY-3-8914, capable of handling 3 audio channels of 8 octaves each and a white noise source for sound effects. Both the CPU and STIC share a common memory called System RAM, designated GA-3-9600. This is not a simple memory chip: it contains 240 8-bit locations containing the video information of the 240 tiles, 112 16-bit locations used by the CPU for its stack, and an additional controller to manage access to the graphics ROM (GROM) and graphics RAM (GRAM) by the CPU and STIC (which cannot occupy the bus at the same time). The GROM consists of 2048 8-bit cells containing the predefined 213 8x8 pixel character patterns that the programmer finds already available, so that he does not have to redefine his own set: this preinstalled set contains upper and lower case letters, numbers, graphic symbols and a lot of symbols that can be used in games. The remaining 344 cells, which were to be occupied by 43 other graphic symbols, are occupied by the code that manages the system known as "EXEC", which did not fit in the 4096 10-bit cells, also integrated in GROM, initially dedicated to it. The EXEC not only manages the console's communication with the peripherals, but also provides the programmer with a series of routines for managing the sprites on the screen, loading data into GRAM, creating sound, etc.. In this way, the programmer

can save space on the cartridge by not having to rewrite code that is already available. Available for storing temporary data is an integrated chip called GTE 3539 which offers 256 cells of 8-bit SRAM called Scratchpad RAM, usable not only by the EXEC and the sound chip (149 bytes) but also by the programmer to keep track of lives, levels, points and other variables used by the game (147 bytes). The console interfaces with the outside world via a 44-pin port, used as a cartridge port or expansion port, 2 9-pin ports for controllers, RF/RCA output for audio/video connection.

Peripherals

From the very beginning, Intellivision was conceived as an expandable system. At the time of its launch, the possibility of transforming the console into a real computer through the "Keyboard Component" (fig. 7), a very technologically advanced accessory, was highlighted in the advertisements and on the box itself. In practice, it was a container in which the console was located and to which it supplied a keyboard, a cassette recorder, 16 KB of DRAM and its own MOS 6502 processor for Input/Output management. The cassette recorder managed the tapes in a very sophisticated way, allowing the simultaneous presence of the program, its data and an audio track that could be played synchronously with the image on the screen. In addition to this, the Keyboard Component offers an output for a thermal printer and a port for using Intellivision cartridges. Unfortunately the development was much more complex than expected and since 1981, when it was supposed to debut, it was first cancelled in mid-1982 and after the US Federal Trade Commission (FTC) accused Mattel of fraud and false and misleading commercial announcements, because many users had bought the Intellivision with the promise of being able to turn it into a computer by purchasing the accessory, it was again put back into development and put on the market at \$600 in limited quantities (in the end only 4000 units were produced) and then quickly replaced by another similar accessory, the 'Entertainment Computer System' (ECS). Compared to the Keyboard, it offers less functionality, but it offers enough to close the FTC lawsuit, i.e. a system to transform the console into a computer, basically what Mattel had promised at the beginning of the marketing of the Intellivision. The ECS offers a keyboard and a simple add-on module containing another audio chip identical to the one in the Intellivision, a 12K ROM containing a reduced version of the BASIC language, the





Fig. 7 - The Keyboard Component, which turned the Intellivision into a home computer (image: Daniel McConnell - source: Wikimedia Commons)

interface to connect an external cassette recorder and printer, 2 KB of RAM, and 2 additional ports to add 2 more controllers. A music keyboard can also be connected to the ECS, which, thanks to the possibility of using the two audio chips simultaneously, allows 6 musical notes to be played at once.

The PlayCable is another accessory that has had less luck than expected. Designed for the broadcasting of games via TV signal, it consists of an adapter to be connected to the expansion port that connects to a signal transmitted at a given frequency from which it retrieves the list of available games, about 20 games rotated monthly: these games are the same ones that can be purchased in cartridge but transmitted with the TV signal. Once the game has been selected, the PlayCable tunes in to the frequency where the title is broadcast and retrieves the code, saving it in its RAM memory. The games are downloaded in about 10 to 20 seconds, depending on their size, and remain in the memory until the device is switched off. The problem with this service is that the memory of the PlayCable is only 8 KB, and from 1983 onwards many games are released with larger sizes so that the PlayCable eventually only allows you to play older games. This limitation, coupled with the high cost of the service and the small diffusion it had (the service was only present in a few cities), led to the end of the transmission of the games in 1983.

Another accessory that has not been very popular is Intellivoice, an external module that plugs into the expansion port and has an additional port for connecting cartridges and adds speech synthesis to compatible games via an integrated speech synthesis chip. If the

game does not support Intellivoice, it simply remains inactive and the game's audio is played on the TV without any additions. Intellivoice made Intellivision the first gaming system capable of reproducing the human voice.

Conclusions

The Intellivision was a lady of a console. It was the first console to give the then dominant Atari 2600 a run for its money due to its superior features, and only failed to dethrone it because Atari had more time to build up a loyal user base and a much larger game library. Speaking of firsts, the Intellivision was also the first 16-bit system ever to hit the market, not only in the game console sector but also in the home computer sector, arriving a few months before the Texas Instruments TI-99/4 (the first 16-bit home computer). It was the first console to offer a game download system via the PlayCable. It was the first gaming system to feature a synthesised human voice.

In short, the more than 3 million units sold are no coincidence and the interest in Intellivision games that has remained alive over the years proves that the console has really left its mark on the video game industry.





2022 BASIC 10-LINER CONTEST

by Alberto Apostolo

On April, 9th 2022, as part of the NOMAM (Not Only Marvelous Atari Machinery), an event held annually in Germany, the award ceremony for the "2022 BASIC 10-Liner Contest" (Fig.1) organised by Gunnar Kanold (Fig.2) and his friends from the Homeputerium group took place.

Homeputerium is a laboratory located in the Eider-Treene-Schule in Friedrichstadt (Germany). In the lab, students can practice with home computers from the 1980s that were donated to the school.

As the name implies, the "BASIC 10-Liner Contest" means to try your hand at the (documented) creation of a BASIC program no longer than 10 lines (a link to the rules, written in German and English, can be found in [Kan21b]).

Usually, subscription is scheduled between February and March of the current year. But to be sure of the dates, you have to wait for the announcement on social networks (such as Twitter) or consult the rules on the Homeputerium website.

The programs entered for the 2022 edition have been divided into five categories:

- 1) PUR-80 (games in 10 lines, max 80 chr. per line),
- 2) PUR-120 (games in 10 lines, max 120 chr. per line),
- 3) EXTREME-256 (games in 10 lines, max 256 chr. per line),
- 4) SCHAU (=show i.e. utilities/demos/applications in 10 lines, max 256 chr. per line),
- 5) WILD (programs that do not comply with the previous categories).

Other categories refer to the public's choice through social media (PUBLIC CHOICE).

Competition is always fierce (everyone can submit several programmes for the competition) and a very strict jury has a difficult job to do.

THE WATERBOMB PROGRAM

RetroMagazineWorld also had the opportunity to be represented with a simple game for ZX Spectrum (entered in the PUR-80 category). The game simulates a firefighter helicopter that has to put out a small fire by dropping its load of water (Fig.3,4,5).

In [Apo22] you can find the web page where you can freely download WATERBOMB (saved in an .SNA file and in .TAP format for ZX Spectrum emulators).

THE WINNER OF THE 2022 EDITION

The results are published in [Kan21c] and the programs can be downloaded from the site indicated in [Kan21d].

In the PUR-80 category "The Snake Temple" written by RAX for Oric Atmos won with 8.63 points (Fig.6).

In the PUR-120 category won with 8.25 points "Super



Fig. 1



Fig. 2

```

10 PAPER 1: BORDER 1: BRIGHT 1
:CLS:RANDOMIZE:DATA 137,60,
03,83,136,0,0,255,16,252,254,2
04,124,73,254:FOR U=0 TO 15
:INK 7:READ V:POKE USR,"a"
+U,V:PLOT 30,130:DRAW 15,15,(U
+15)/12:PLOT 50+RND*200,100+RND
*80:NEXT U:FOR G=0 TO 1:LET S
=0
:FOR B=1 TO 9:PRINT AT 0,1;
" WATERBOMB";TAB 15;"round: ";B;TA
B 24;"score: ";S;AT 21,0;PAPER 6
:BRIGHT 0;TAB 31;"
:40 LET R=10+INT (RND*200):PRIN
T AT 20,R;FLASH 1;PAPER 6;INK
2;*:LET A=0:LET Y=0:FOR X=
0 TO 30:PRINT AT 10,X;INK 2;CH
R# 144;CHR# 145
:50 BEEP .01,-1:PAUSE 4:FOR U
=1 TO 30:(Y=0 AND INKEY#<>):LET
Y=10:LET W=X+1:LET A=A+(R=X+1)
:NEXT U:IF Y<>0 THEN GO SUB 10
0
:60 PRINT AT 10,X;" ":NEXT X:
:FOR U=Y+1 TO 30*(Y<>0):GO SUB
100:PAUSE 6:NEXT U:LET A#="ML
KUIHG PFIHOYOI"(1+7*A TO)
:70 FOR U=1 TO 6:BEEP .1,CODE
A#(U):NEXT U:LET S=S+A:PRI
NT AT 10,30;S;AT 20,0;TAB 31;"
:NEXT B
:80 FOR U=0 TO 9:BEEP .02,-20:
POKE 23606,9-U:PRINT AT 12,6;
AND THEN GOSUB 90:(Y/N):NEXT U:
:90 FOR U=0 TO 9:STEP 0:LET Y#
=INKEY#:LET U=(Y#="Y"):LET W#
: NEXT U:LET G=(Y#<>"Y"):PRIN
T AT 12,6;TAB 31;" ":NEXT G:ST
OP
:100 LET Y=Y+1:PRINT AT Y-1,W;
BRIGHT 1;INK 5;" ":BRIGHT 0;AT
Y,W;CHR# 143:LET Y=Y*(Y<20):R
ETURN

```

Fig. 3



**Program description****VARIABLES:**

a = flag (0 for a missed bonfire, 1 for a hit bonfire)
 a\$ = string for musical tones
 b = current round
 g = flag for the game loop
 r = bonfire random horizontal axis
 s = score incremented by variable a
 u = working variable for loops
 v = working variable
 w = horizontal axis of the water released by the helicopter
 x = horizontal axis of the helicopter
 y = vertical axis of the water bomb released by the helicopter

LINES:

10. prepare screen, data for user defined characters. Header loop on working variable u
 20. loop on variable u to create UDGs, draw "moon", plot random stars. Header loop on variable g (game), set score to zero
 30. header loop on variable b (rounds). Display round and score on screen, display yellow ground at the bottom
 40. calculate bonfire random axis in r, display flashing bonfire, set a = 0, set y = 0.
 Header loop on variable x, display helicopter
 50. helicopter sound effect, if a key pressed and y = 0 then set w=x+1, set flag a.
 If y < 0 then call subroutine to line 100
 60. blank helicopter, end loop on x. Loop on variable u to complete the descent of the water bomb.
 Initializing a\$ (depending on hit bonfire or not)
 70. loop for sound effects stored in a\$, update score, clear the bottom of the screen, end loop on b
 80. special effects for the request to play again (a well-known little Speccy trick with a system variable)
 90. waiting for a pressed key. If yes, the loop on g continues otherwise the program stops
 100.subroutine to display the water bomb at (y,w) on screen

Fig.4

"Zombie Apocalypse Simulator" written by Preppie for Atari XL (Fig.7).

In the category EXTREME-256 has won with 9.93 points "Dokoban" realized by Copper France with the Locomotive BASIC (Fig.8).

In the WILD category won (without score) "Alex K Rock Paper Scissors" written by Azimov for the ZX Spectrum. (Fig 9).

In the SCHAU category "8 Bit Sunset" by FeCO for Videoton TV Computer won with 6.80 points (Fig. 10).

In the categories 80, 120, 256, the public's choice was awarded respectively:

"Tuneup" by Michal Radecki Mikulicz (ATARI XL, Fig. 11), "BERT" by Victor Parada (Atari 800 XL, Fig.12),

"Stop The Micro Express" by Ivan BASIC (ZX Spectrum, Fig.13).



Fig. 5

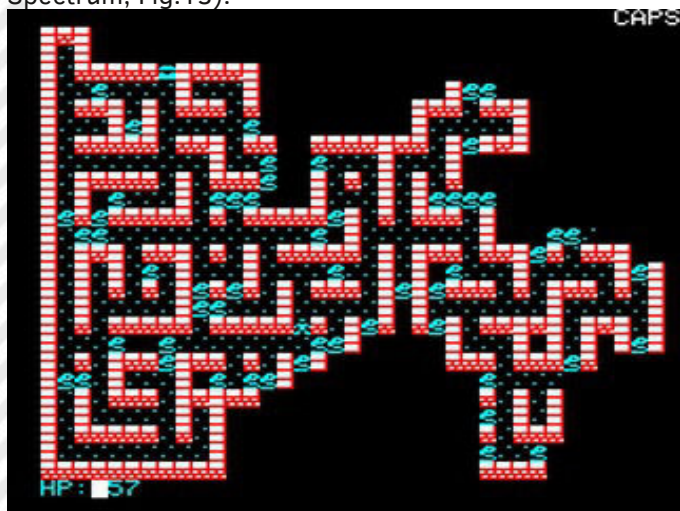

Fig. 6



Fig. 7



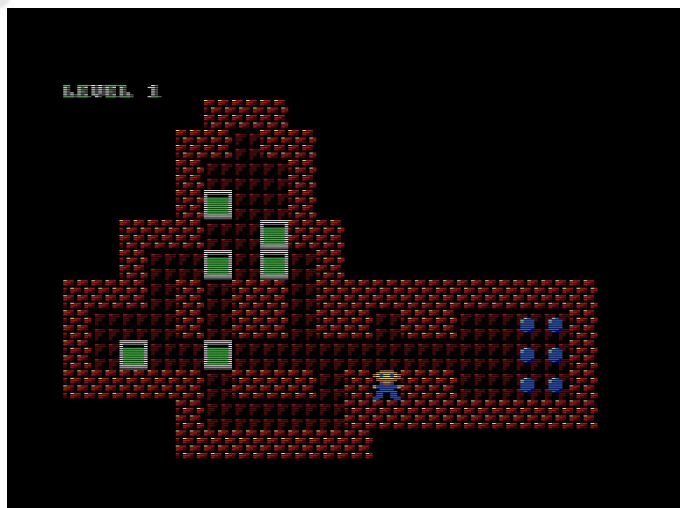

Fig. 8

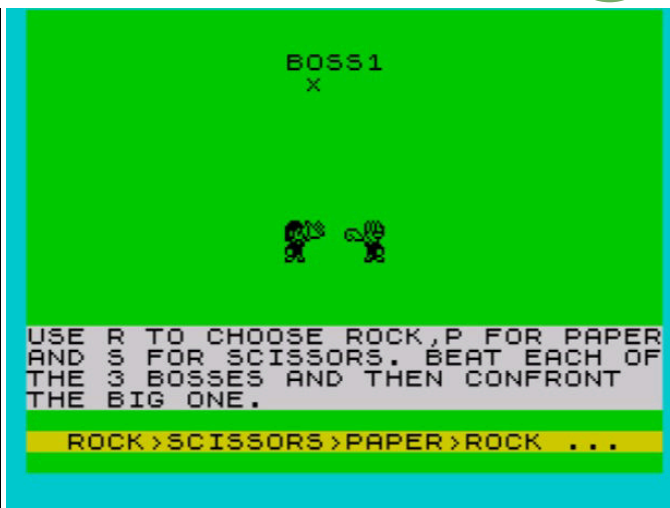

Fig. 9



Fig. 10

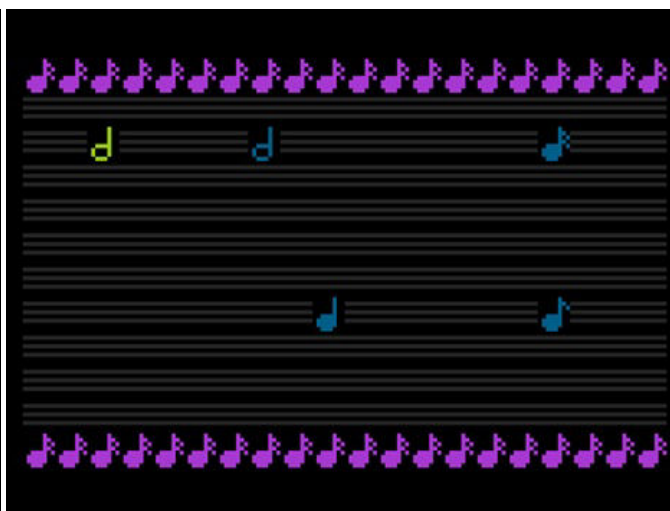

Fig. 11

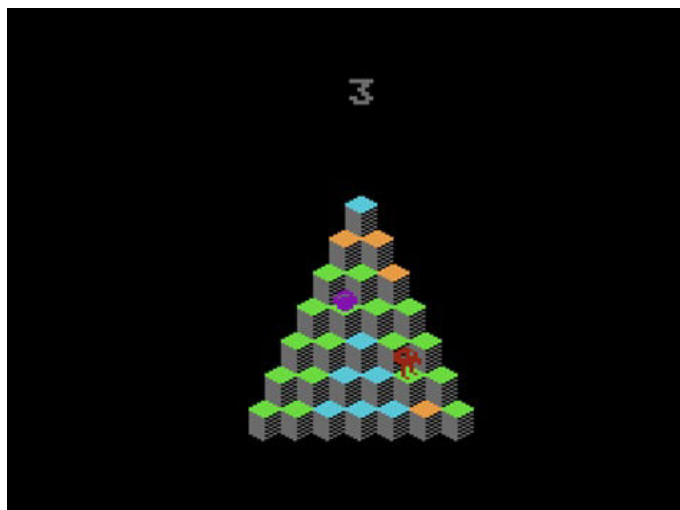

Fig. 12



Fig. 13

CONCLUSIONS

Only enter contests if you already have something ready for the occasion or that can be easily adapted. Make the program while having fun. Your program will be appreciated regardless of the score you receive and the final ranking.

Useful Links

[Apo22] A.Apostolo, "WATERBOMB",
<https://bunsen.it.ch.io/waterbomb-with-the-red-firefighter-helicopter>

[Kan21 a] <https://gkanold.wixsite.com/homeputerium/home>

[Kan21 b] <https://gkanold.wixsite.com/homeputerium/rules2022>

[Kan21 c] <https://gkanold.wixsite.com/homeputerium/results-2022>

[Kan21 d] <https://gkanold.wixsite.com/homeputerium/games-list-2022>





"A query with Susi" for the C64 (for beginners)

by Eugenio Rapella

In "La Settimana Enigmistica" of March, 31 2022 (a famous crosswords Italian weekly magazine, TN) it appears the "984th query with Susi," a classic mind game of the magazine. Here it is:

Let's place side by side all the natural numbers starting with 1:

12345678910111213141516.....

Continuing with this, what is the figure that appears in the 200th position?

Solution: The first nine numbers formed by a single digit are followed by those formed by two digits: 10, 11, 12, ..., 98, 99 which are $99-10+1=90$ numbers.

If we stop here, we have placed side by side all the whole numbers from 1 to 99. The resulting number consists of $9+2*90=189$ digits: the 9 digits of the numbers from 1 to 9 to which the 90 numbers of two digits each have been placed side by side. At this point, the easiest thing to do is to manually add the few missing numbers to reach the digit in the 200 position: the digits already listed are 189 and the number to start with is the number 100:

100 101 102 103.

It looks very much like the 200th digit is "0," the zero that lies between one and three in the number 103.

Will it really be like this? "La Settimana Enigmistica" proposes to send an SMS with the solution; prizes will be drawn among those who send the correct solution (there is even an electric bike). Sending your solution involves a fixed cost of 1.02 euros + the possible cost of an SMS depending on the tariff plan, which is no small investment (here, nowadays, it would seem almost obligatory to put the wink emoticon...). Better then to check. My trusty C64 is there for that (I actually have a C128, but I will use the legendary VICE emulator accompanied by the splendid CBM Prg Studio).

Here then is the little program in C64 Basic:

```
100 for k=1 to 103
110 a$=str$(k)
```

```
120 a$=right$(a$,len(a$)-1)
130 b$=b$+a$
140 print k, a$, len(a$)
150 next k
160 print "*****"
170 print b$
180 print len(b$)
190 print" in position 200 there is > ";
200 print mid$(b$,200,1)
```

The idea is to construct a string (b\$) in which the digits that make up the sequence are pasted, one after the other; we will then go to see who is at position 200.

According to our calculations, the numbers to be put side by side to arrive at the figure of place 200 are from 1 to 103.

At instruction 100, precisely a "for-next" loop is opened with k ranging from 1 to 103 (if you wish, you can replace 103 with a larger value, however, you must not exceed 121 otherwise you get "STRING TOO LONG ERROR IN 130").

At 110, the str\$(k) function transforms the number k into a string of characters that is assigned to the variable a\$ (in C64 Basic, "string" variables are identified by names ending in \$). The str\$ function adds a "space" in front of the number, so if $k=107$, a=str(k) becomes a string consisting of four characters: " 107". The len() function gives the "length" of a string, that is, the number of its characters; in the above example len(a\$) will be 4. The right\$(a\$,n) function returns a string formed by the last n characters of a\$; if, for example, a="commodore"$ and b=right$(a$,4)$, b\$ becomes "dore."

The 120 instruction is in charge of eliminating the "initial space" of the number provided by str\$, in fact, if, for example, $k=102$, we will have a=" 102"$ and, following that, $len(a$)=4$ from which $len(a$)-1=3$ so right\$(a\$,len(a\$)-1) is formed by the last three characters of " 102" that is, "102" without the initial space. This string is reassigned to the variable a\$ which is thus modified.



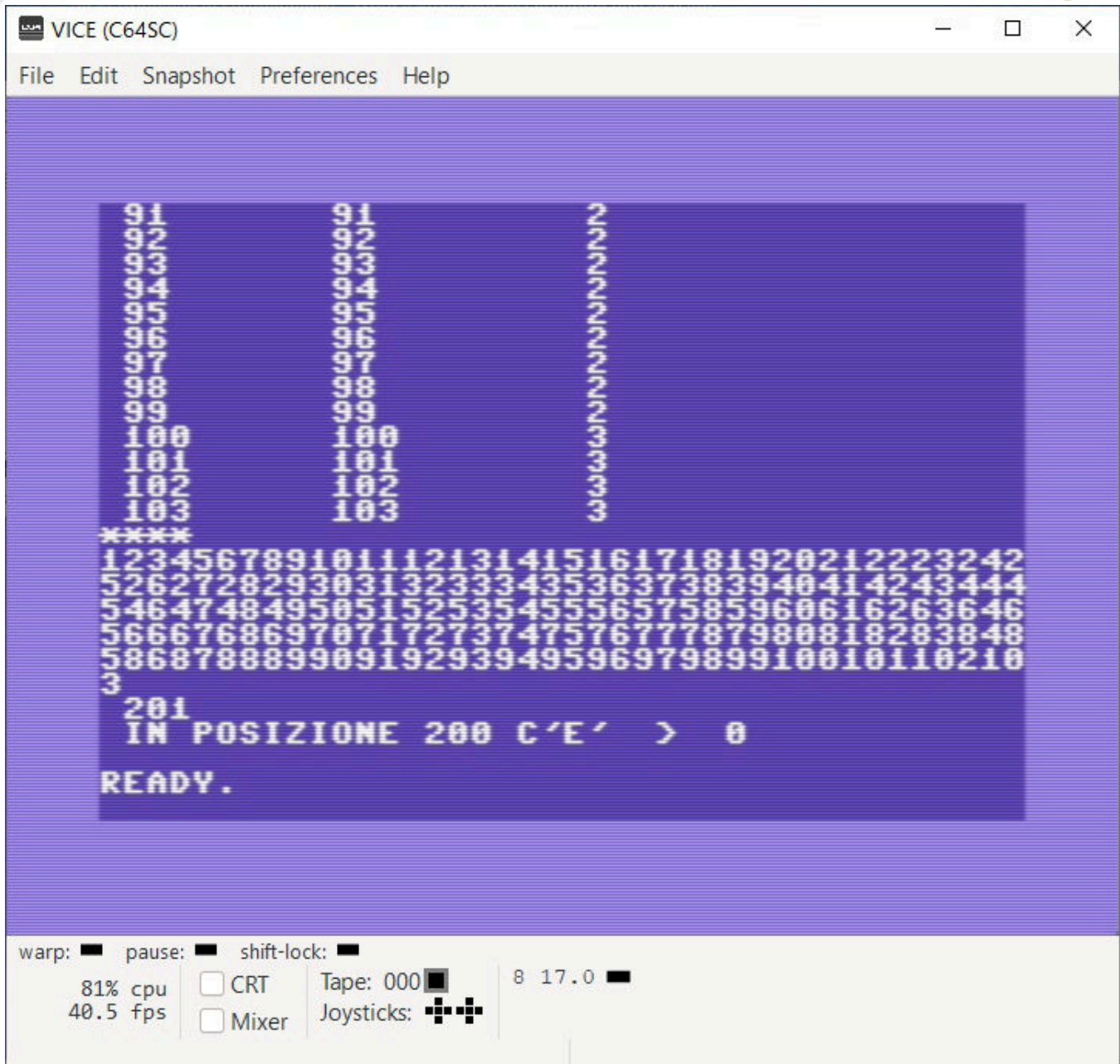

Fig. 1 - The answer provided by the Commodore 64!

At instruction 130, the resulting string is "pasted" (concatenated) at the tail of the string b\$ (initially empty); thus, as k changes, b\$ becomes "1," "12," "123," and so on.

140 is a "control" printout and can also be deleted; it prints k, the string associated with k, stripped of the leading space and its length corresponding to the number of digits that form k.

At the end of the "for-next" loop (instr. 150) b\$ will contain the string that corresponds to our number; b\$ is printed and, at 180, the number of characters corresponding to the number of digits is printed.

Actually, we are only interested in the digit (the character) RETROMAGAZINE WORLD-ENGLISH YEAR 3 - ISSUE 15

that appears at position 200: the function `mid$(r$,n,h)` returns a string formed by h characters of r\$ starting at position n (thus, if `r$="commodore"` and `w$=mid$(r$,3,2)`, we will have `w$="mm"`), so here then `mid$(b$,200,1)` will tell us the digit at position 200.

Our trusty and quick C64 confirms that it is indeed the "zero" digit. We can send the text message and hope for good luck...

La Settimana Enigmistica is a weekly Italian word puzzle and word search magazine, published since 1932 with Europe-wide distribution. It's one of Italy's most popular and top-selling magazines.

Source Wikipedia.





Taylor's polynomial and (un)finite precision

by Carlo Luciano Bianco

In the article "Optimizing the Calculus of PI Greek by Monte Carlo Method," which appeared in RMW No. 34-IT and RMW #12-EN, we had concluded that the use of the Taylor polynomial in that specific case was not recommended. That article ended, however, by saying that in other cases replacing a function with its truncated Taylor polynomial not only does not worsen the final result, but in fact, paradoxically, makes it more accurate, postponing this topic to a later article. Well, this is precisely the topic of this article... ;-)

First of all, however, in order to get a good understanding of how it is possible for an "approximate" calculation to give a more precise result than an "exact" calculation, we need to digress a little and, above all, dispel a couple of myths. In the collective imagination, in fact, computers are always regarded as machines capable of making very precise calculations. A calculation performed by a computer cannot be wrong, barring egregious cases such as the early Pentiums that got some divisions wrong and in fact for this they made the front pages of newspapers. Well, actually this is not true. The truth is that it is very easy for a computer to get a calculation wrong, or, to put it better, it is very easy for a programmer to write a seemingly perfect calculation code that nevertheless "inexplicably" produces a wrong result.

The problem is that the mathematics that computers follow, unfortunately, is not the mathematics that we humans have studied in school since elementary school: computers follow somewhat different rules, and if a programmer does not take them into account, he or she will find himself or herself writing a seemingly perfect code that nonetheless yields totally wrong results. The mathematics we studied in school is characterized by having "infinite precision": we manipulate numbers abstractly, they are all different, and each of them always has infinite decimal places. Since elementary school we are taught that if we simply write "1" we are in fact implying infinite zeros after the decimal point. For a computer, however, this is not the case. The mathematics that follows is characterized by having "finite precision": numbers are

not conceived as abstract entities, but as a binary representation with a finite number of bits. The decimal digits are always finite in number, and two numbers that differ by one decimal digit beyond the maximum number of decimal digits that the computer can process are in fact the same number. To understand this, let us imagine that our computer can only keep in mind 4 decimal places. It means that the number "1.3729356" and the number "1.3729241" are the same number: "1.3729" and no computer will be able to tell the difference between the two. More powerful computers can keep in mind many more decimal digits, but never infinite ones. This "problem" is inherent in the very way computers work: as someone once said, "it's not a bug, it's a feature!" ;-)

To be clearer, and to touch on it, let's immediately give an example with the BASIC V2 of our Commodore 64. Let's try a program like this:

```
10 A=0
20 B=1E-10
30 FOR I=1 TO 1000
40 A=A+B
50 NEXT I
60 PRINT A
```

As you can see, the program itself is quite simple. On line 10 we set the value of A to zero. On line 20 we set the value of B to 0.00000001, which in "scientific" notation is spelled "1," then "E-," and then the number of zeros that fit before the digit "1." Then with the FOR... NEXT loop we add 1000 times the number B to A and finally print the result. We expect the result to equal A to which we add B multiplied by 1000: $0 + 1000 \times B = 0 + 1000 \times 0.00000001 = 0 + 0.0000001 = 0.0000001$. With a RUN we get as a result 1.00000002E-7 which is just what we expected (that 2 in place of a last 0 is due to the way the calculation is done internally by the BASIC interpreter, that last digit is not to be taken into account).

Well, now let's try to modify lines 10 and 20 of the program in this way, leaving the rest unchanged:





```
10 A=1
20 B=1E-7
```

We expect the result to be $1 + 1000 \times 0.0000001 = 1 + 0.0001 = 1.0001$. With a RUN we find that this is indeed the case (except for the usual random digits at the bottom of the number).

Now let's try to modify the program like this:

```
10 A=0
15 C=1
20 B=1E-10
30 FOR I=1 TO 1000
40 A=A+B
50 NEXT I
55 C=C+A
60 PRINT C
```

We expect the result to be the same as in the first case we dealt with, to which we add a 1 at the end: $1 + 0.0000001 = 1.0000001$. With a RUN we verify that this is indeed what happens.

Suppose now that we do not like the way we wrote this program, that we find it unreadable. Certainly having defined the C variable does not help in this regard. Let us try to rewrite it like this:

```
10 A=1
20 B=1E-10
30 FOR I=1 TO 1000
40 A=A+B
50 NEXT I
60 PRINT A
```

Certainly this program is much more readable and clearer. Instead of doing the loop calculation first and then adding 1 at the end, we directly add the loop to 1 by setting A=1 from the beginning. This way we define one less variable and the code is more straightforward. Anyway, we know well that the sum enjoys the associative and commutative property, so it cannot make any difference. We go to execute RUN and get a nice... "1"!!! We get it just like that, without a comma or decimal. That is, we get exactly the value of A. To convince yourself of this, try setting on line

10, for example, A=37.21, and as a result you get just... "37.21"!!!!

How is it possible that the computer so blatantly miscalculates even though the BASIC code is apparently perfect, while that more convoluted and less readable code from before with an extra support variable gave the correct result? Simple, as we said the mathematics in finite precision of the computer follows different rules from the mathematics in infinite precision that we studied in school. In particular, the sum in finite precision does not enjoy the associative property. When our computer first comes to run row 40, it has to calculate $1 + 1E-10$, and it gets 1 since the correct result 1.00000001 would have too many decimal places and is therefore truncated. The value of A then remains 1, and the same is true for all subsequent 999 runs of row 40. The final result is therefore 1. In the previous version of the code, however, on the first execution of line 40 the sum was done with respect to zero, and so there was no truncation. At the end of the loop the value of A had correctly arrived at $1E-7$, and summing it to 1 was the correct result. But by starting directly to run the cycle from 1 we have no hope. Although from our point of view in infinite precision the two approaches should be equivalent, for a computer operating in finite precision they are not at all.

We should note that this "problem," as we said affects any computer, from our Commodore 64 to a very modern 64-bit, 64-core computer, only the number of decimal digits the computer can keep in mind before starting with truncation changes.

OK, but what does all this have to do with the Taylor series? Well, this was just an example to touch on the problem of truncation error, but let us now imagine that we have to calculate the value of this function:

$$[1 - \text{SQR}(1-X)]$$

where SQR is the "square root" function and X is the variable. We could use a simple program like:

```
10 X = ...
20 R = 1-SQR(1-X)
30 PRINT R
```

giving a value to X on line 10 and printing the result on





line 30. But now let's try to ask, what happens if X is too small? Well, at this point it is easy: $1-X$, if X is too small, the computer will calculate it equal to 1, the square root of 1 is 1, and $1-1$ is... zero! Try (a small value of X, like $X=1E-10$) to believe! The result will be $R=0$.

How can the Taylor series help us in all this? Well, from our previous article (as well as from a thousand other sources, not least Wikipedia) we can know that the Taylor series of the square root function is:

$$\text{SQR}(1-X) \sim 1 - X/2$$

Thus we have that:

$$[1-\text{SQR}(1-X)] \sim 1-1+X/2 = X/2$$

In other words, by expanding the square root function into its Taylor polynomial we got out of the way those subtractions from 1 that created all the problems, and the function in its entirety is approximated by a very simple term equal to $X/2$! And if we then modify the program to

```
10 X = ...
20 R = X/2
30 PRINT R
```

For $X=1E-10$ we obtain as a result $R=5E-11$, which may not be most precise as a result (being the result of a first-order approximation of the square root) but which is immeasurably better than the "zero" we obtained with the "exact" formula.

In order to see more quantitatively the trend of the phenomenon, and to understand for what value of X the approximate formula begins to be preferable to the exact one, we can use such a program:

```
10 FOR I=1 TO 15
20 X=1/(10^I)
30 EX=1-SQR(1-X)
40 AP=X/2
50 PRINT:PRINT "X=";X
60 PRINT "RES. 'EXACT'=";EX
70 PRINT "RIS. 'APPROX'=";AP
80 NEXT I
```

At line 10 we start a loop on the variable I that goes from 1 to 15. At line 20 the value of X is set in that way to $1E-I$, that is, to a 1 preceded by a number of zeros after the decimal point equal to I (e.g., $X=0.1$ for $I=1$; $X=0.01$ for $I=2$; $X=0.001$ for $I=3$; $X=0.0001$ for $I=4$; and so on until $X=1E-15$ for $I=15$). At line 30 the EX value is calculated with the exact formula. At line 40 the AP value is calculated with the approximate formula. At lines 50, 60, 70 the values of X, EX, AP are printed. At line 80 the cycle begins again for a new value of I and then for a new value of X.

We can see that as X decreases, the value of AP becomes more and more similar to the corresponding value of EX, as is to be expected since for smaller and smaller X the Taylor approximation is getting better and better. However, contrary to expectations, from when $X = 1E-06$ onward the values of AP and EX begin to be more and more different, until $X = 1E-9$. From this point onward EX always remains zero.

We can therefore conclude that:

-) Until $X \geq 1E-5$ the behavior of EX and AP is as expected: the two values are more and more similar as X decreases, and in this case therefore the "exact" EX result is definitely more accurate.

-) For $X \leq 1E-6$ the behavior of EX and AP is the opposite of that expected: the two values are more and more different as X decreases, this means that the truncation error begins to negatively affect the "exact" EX result, and therefore in this case the "approximate" AP result is more accurate.

-) For $X \leq 1E-9$ the truncation error in the "exact" calculation becomes dominant and thus $EX=0$: in this case obviously the "approximate" result AP is more accurate.

We have thus verified that the Commodore 64, by itself, would not be able to reliably compute the value of $[1-\text{SQR}(1-X)]$ for $X < 1E-5$ but that, by substituting its truncated first-order Taylor polynomial for the SQR function, it is able to compute it even up to $X=1E-15$ and beyond.





How to create a game in BASIC for Commodore 64 - part 3

by Felice Nardella (aka Kimono)



THE SPRITES (part #2)

We continue the topic of sprites, begun in the previous chapter, the theme of which centered on the mythical "Hot Air Balloon"; instead, we will base this chapter on the equally fantastic "Ghostbusters" from the very famous 1980s film, which, as we know, also had a major sequel in the video game sphere.

EXPANDED SPRITE

I reproduce here a simplified register map showing the VIC-II registers numbered with respect to register address 0 whose address is 53248.

Examining the map, we find that, among others, there are two registers that control the so-called expansion of sprites; specifically, we refer to the following locations: 53271 and 53277, named as Sprite Y expansion and Sprite X expansion, respectively. In other words, they allow the size of a sprite to be increased so as to double it, either in height (Y) or width (X) or in both directions. Since one of the rules of optimizing code in Basic, to make it faster at runtime, is to enclose Numbers (especially large ones) in variables, before using them in the program, from now on, as is current practice in such cases, we will make use of the following assignment:

```
V = 53248
```

Consequently, if we wanted to expand, for example, sprite 0 in height we would have to write:

```
POKE V+23, 1
```

However, if we wanted to expand it in both directions, we would write:

```
POKE V+23, 1: POKE V+29, 1
```

LET'S START!

We then open the "Sprite" project in CBM prg Studio, already created earlier, and right-click on "BASIC Files" contained in "Project Explorer"; a small drop-down menu will open as in the figure:

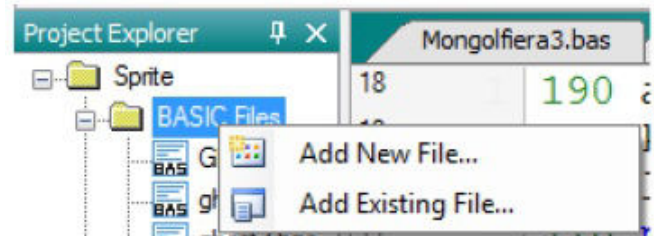

Now click on "Add New File..." and a small window will open where we have to enter the name of the new basic file: in this case "ghost1.bas" and click OK.

This will create a new window with the chosen file name.

Now copy the following program:

```
5 rem cleans the screen
10 print"{clear}"
15 rem store initial register value vic-ii
20 v=53248
25 rem stores sprite pointer values
30 vi=2040:p=11
35 rem stores y-coordinate values
40 a$="{01}{05}{10}{15}{20}{15}{10}{05}{01}"
45 rem initial y coordinate
50 y0=120
55 rem loads sprite data into memory 0
60 for n=704 to 767: read q: poke n,q: next
65 rem activates sprite 0
70 poke v+21.1
75 rem color sprite 0
80 poke v+39.13
85 rem expands sprite 0 in x and in y
90 poke v+29.1: poke v+23.1
95 rem pointer to sprite 0
100 poke vi,p
105 rem cycle coordinate x
110 for x=0 to 345 step 3
115 rem calculates msb activation of sprite 0
120 hx=int(x/256)
125 rem calculates the x position of the
    sprite 0
130 lx=x-256*hx
135 rem x coordinate of sprite 0
```





INDIRIZZO REGISTRO		FUNZIONE
		Posizione
0	53248	Posizione X Sprite 0
1	53249	Posizione Y Sprite 0
2	53250	Posizione X Sprite 1
3	53251	Posizione Y Sprite 1
4	53252	Posizione X Sprite 2
5	53253	Posizione Y Sprite 2
6	53254	Posizione X Sprite 3
7	53255	Posizione Y Sprite 3
8	53256	Posizione X Sprite 4
9	53257	Posizione Y Sprite 4
10	53258	Posizione X Sprite 5
11	53259	Posizione Y Sprite 5
12	53260	Posizione X Sprite 6
13	53261	Posizione Y Sprite 6
14	53262	Posizione X Sprite 7
15	53263	Posizione Y Sprite 7
		Controllo
16	53264	Posizione X MSB
21	53269	Attiva Sprite
23	53271	Espansione Y Sprite
27	53275	Priorità Sprite
28	53276	Sprite multicolor
29	53277	Espansione X Sprite
30	53278	Collisione Sprite-Sprite
31	53279	Collisione Sprite-Sfondo
		Colore
37	53285	Multicolor n. 0
38	53286	Multicolor n. 1
39	53287	Colore Sprite 0
40	53288	Colore Sprite 1
41	53289	Colore Sprite 2
42	53290	Colore Sprite 3
43	53291	Colore Sprite 4
44	53292	Colore Sprite 5
45	53293	Colore Sprite 6
46	53294	Colore Sprite 7

Fig. 1 - Mappa dei registri degli sprite

```

140 poke v,lx
145 rem activates msb for sprite 0
150 poke v+16,hx
155 rem increases the index k
160 k=k+1and7
165 rem computes coordin. y by reading values
in a$
170 y=y0+asc(mid$(a$,k+1,1))

```

```

175 rem y coordinate of the sprite 0
180 poke v+1,y
185 rem repeats the cycle
190 next
195 rem sprite 0
200 date 1,0,0,224,0,0,112,0,0,248,0
205 date 1,212,0,1,252,0,3,222,0,3,198,0
210 date 1,236,0,3,255,0,7,255,224,15,255,248
215 date
12,126,14,24,127,3,96,127,128,0,255,128
220 date 1,255,128,1,255,0,15,254,0,31,248,0
225 date 255,0,0

```

Then save it, compile it, and run it; you will notice a ghost twice the normal size (expanded in both height and width) darting from left to right, swaying rapidly.

All this speed is due, in part, to code optimization.



SOME CODE OPTIMIZATION RULES

A first optimization rule has already been mentioned above, namely that of enclosing numbers in variables, using these, in the program, instead of the numbers themselves. Especially in For...Next loops, whenever we find ourselves frequently using a numeric constant (or string) it is a good idea to assign that constant to a variable, using the latter in subsequent program statements.

Other rules are:

1. Try to keep row numbering low, especially in cases where there are unconditional jump commands such as gosub and/or goto.
2. Try to eliminate comments (rem) to the program as much as possible (in this case it could not be done without them for obvious reasons, but you can try to run the





program by eliminating all comments).

3. Try to minimize the calculations to be performed, perhaps by setting predetermined values, as was done here, by eliminating the `sin()` function and somehow storing predetermined values for the vertical movement of the sprite.

A number of tricks have also been used in the program, representing real "tricks," which will be described below:

- **TRICK 1.** On line 40, values in the form of appropriate ASCII characters were entered into a string variable (`A$`) to store the data of the vertical movement of the sprite, simulating a sinusoidal motion.

In CBM prg Studio it is very simple to make use of these characters; just write their numerical value (which is what we are interested in) inside curly brackets:

```
a$="{01}{05}{10}{15}{20}{15}{10}{05}{01}"
```

As can be seen, these values have been chosen so that the Y coordinates of the phantom oscillate around the initial value chosen. Clearly, it will not be possible to choose values greater than 255.

Then these values are extrapolated to line 170 using the formula:

```
asc (mid$ (a$, k+1, 1) )
```

- **TRICK 2.** On line 160, the index `k` values were determined by a bit-to-bit AND operation:

```
k=k+1and7
```

In this way the variable `k` will take the values 1, 2, 3, 4, 5, 6, 7, 0 from time to time, after which it will start over again.

You need to reason about binary values, for example:

```
1d (00000001b) AND
```

```
7d (00000111b) =
```

```
1d (00000001b)
```

```
2d (00000010b) AND
```

```
7d (00000111b) =
```

```
2d (00000010b)
```

...

```
8d (00001000b) AND
```

```
7d (00000111b) =
```

```
0d (0000000b)
```

etc.

Note that due to the rule of operator precedence, the arithmetic operation `(k+1)` is performed first and then the logical operation `(AND 7)`.

- **TRICK 3.** On line 120, MSB activation for the x-coordinate

of sprite 0, in this case, was automated using the formula:
`hx=int(x/256)`

which will take value 0 for x-coordinates up to 255 and value 1 for those from 256 onward.

Consequently, the value of position `x`, on line 130, was also calculated by the formula:

```
lx=x-256*hx
```

which will take values between 0 and 89 for values of `x` between 256 and 345.

IMPORT SPRITES FROM A PROGRAM

In the program just presented, we own the DATA of our sprite, but we do not have the `spt` file, which is the format used by CBM Prg Studio to store sprites so that we can edit them.

You can derive such a file by importing it directly from the program listing.

Then we right-click on "Sprite Data" in "Project Explorer"; again, a small drop-down menu will open.

Then we click on "Add New File..." and a small window will open where we will have to enter the name of the new `spt` file: in this case we will call it "ghost.spt".

The "Sprite Creation" window will open, after which we click on "Sprites" → "New."

So we go to "File" → "Import" → "From Listing..." and a window like the following will come up:

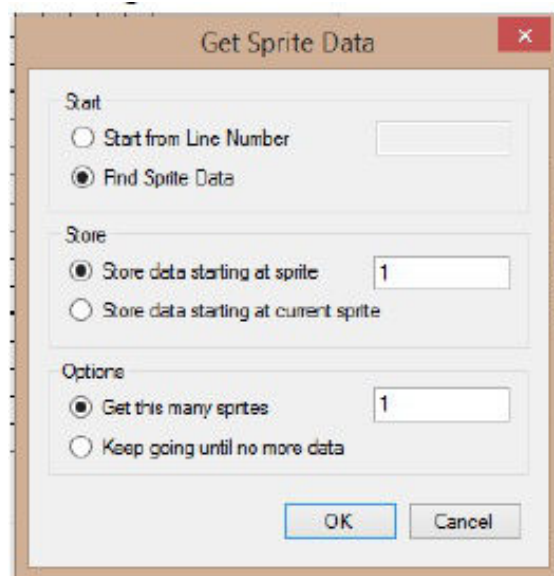

Put a check mark on "Find Sprite Data" and press OK. With that done, we will finally have imported the file containing the sprite data.

We have just learned how to import a sprite from a program containing sprite data.



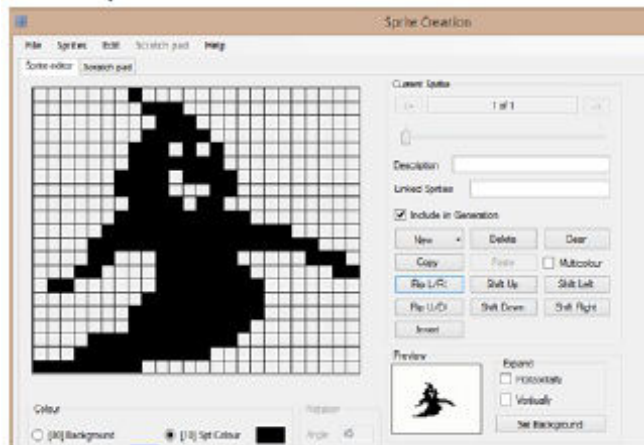

PRIORITY OF SPRITES

Have you ever wondered what would happen if two sprites crossed each other, overlapping?

Which of the two sprites would be visible during the overlay? Or if a sprite passed in front of screen characters, would the sprite or characters be visible?

To answer these questions, let's take an example by exploiting the ghost sprite file we just derived:

Let's go back to the last screen we just saw and click on "Copy." Then we create another spt file as we just learned and call it "ghost2.spt". At this point we click on "Flip L/R": we have now obtained a sprite perfectly mirroring the other one.

Now we derive the data of the second sprite as we have already seen and create a new Basic file called "ghost2.bas".

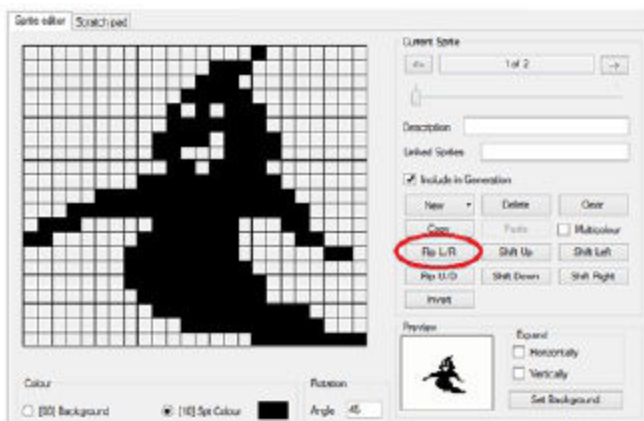

We overlay the following listing:

```

5 rem cleans the screen
10 print "{clear}"
15 rem store initial register value vic-ii
20 v=53248
25 rem stores sprite pointer values
30 vi=2040:p0=11:p1=13
35 rem initial coordinates
40 x1=255:y1=120:y0=y1

```

```

45 rem loads sprite data into memory 0
50 for n=704 to 767: read q: poke
n,q: next
55 rem loads sprite 1 data into memory
60 for n=832 to 895: read q: poke n,q: next
65 rem activates sprites 0 and 1
70 poke v+21.3
75 rem sprite colors 0 and 1
80 poke v+39.13: poke v+40.10
85 rem expands sprites in x and y
90 poke v+29.3: poke v+23.3
95 rem pointer to sprite 0 and 1
100 poke vi,p0: poke vi+1,p1
105 rem cycle x coordinate of sprite 0
110 for x0=0 to 255
115 rem x, y coordinates of the sprite 0
120 poke v,x0: poke v+1,y0
125 rem x, y coordinates of sprite 1
130 poke v+2,x1: poke v+3,y1
135 rem update x coordinate of sprite 1
140 x1=x1-1
145 rem repeats the cycle
150 next
155 rem sprite 0
160 date 1,0,0,224,0,0,112,0,0,248,0
165 date 1,212,0,1,252,0,3,222,0,3,198,0
170 data 1,236,0,3,255,0,7,255,224,15,255,248
175 date
12,126,14,24,127,3,96,127,128,0,255,128
180 date 1,255,128,1,255,0,15,254,0,31,248,0
185 date 255,0,0
190 rem sprite 1
195 date 0,0,128,0,7,0,14,0,0,31,0
200 data 0,43,128,0,63,128,0,123,192,0,99,192
205 data
0,55,128,0,255,192,7,255,224,31,255,240
210 date 112,126,48,192,254,24,1,254,6,1,255,0
215 date
1,255,128,0,255,128,0,127,240,0,31,248
220 data 0,0,255,0

```

As you can observe when overlapping the two sprites, the pink one (sprite 1) will be overlaid by the green one (sprite 0).

This is because by default, sprites with lower numbers have higher priority than those with higher numbers. This means that sprite 0 is the one that takes precedence over all, whether sprites or graphic characters in the Petscii table.



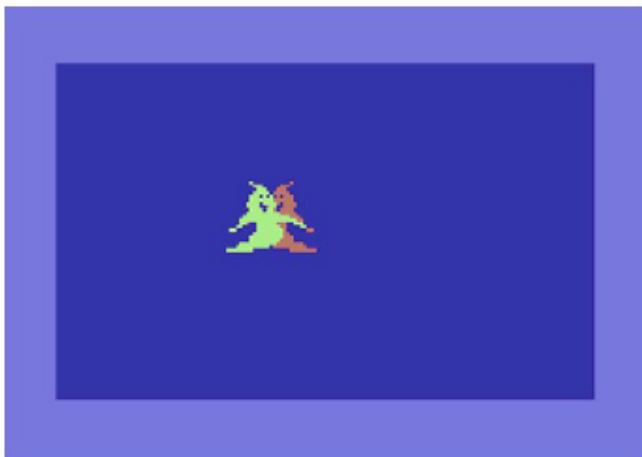

To eliminate this priority between two sprites, you simply need to reverse the number of sprites (sprite 0 becomes sprite 1 and vice versa).

Wanting to make the sprite take second place to the background characters, you need to refer to register 27 (address 53275). As usual, bits 0-7 of this register correspond to sprites 0-7; they are all set to 0, so if you want to invert the priority of any sprite, just turn on its corresponding bit.

SPRITE COLLISIONS

Often in games it is necessary to know when two sprites touch each other: think, for example, of a missile hitting the target or the collision between a ball and a racket. To know this, it is not essential to refer to the position of the two sprites, but there is a very specific register that tells us about the collision: as you can observe, it is register 30 (address 53278).

Again, when there is a collision, the bits corresponding to the sprites involved will go to 1. So if sprite 0 collides with sprite 1, we will activate bit 0 and bit 1: that is, as explained earlier, we will find the value $20 + 21 = 3$ which corresponds to the binary number 00000011.

Let us now use the same previous example, but with different sprites. Let's create a new basic file and call it "ghost3.bas".

Now we copy the following little program:

```
5 rem cleans the screen
10 print"{clear}"
15 rem store initial register value vic-ii
20 v=53248
25 rem stores sprite pointer values
```

```
30 vi=2040:p0=11:p1=13
35 rem initial coordinates
40 x1=255:y1=120:y0=y1
45 rem loads sprite data into memory 0
50 for n=704 to 767: read q: poke n,q: next
55 rem loads sprite 1 data into memory
60 for n=832 to 895: read q: poke n,q: next
65 rem activates sprites 0 and 1
70 poke v+21.3
75 rem sprite colors 0 and 1
80 poke v+39.13: poke v+40.10
85 rem expands sprites in x and y
90 poke v+29.3: poke v+23.3
95 rem pointer to sprite 0 and 1
100 poke vi,p0: poke vi+1,p1
105 rem cycle x coordinate of sprite 0
110 for x0=0 to 255
115 rem reads the value of the collision
register between sprites
120 print"{home}value log 30: "peek(v+30)
125 rem x, y coordinates of the sprite 0
130 poke v,x0: poke v+1,y0
135 rem x, y coordinates of sprite 1
140 poke v+2,x1: poke v+3,y1
145 rem update x coordinate of sprite 1
150 x1=x1-1
155 rem repeats the cycle
160 next
165 rem sprite 0
170 data
0,60,0,0,126,0,0,189,0,0,153,0,1,255,128,1,36
,128,3,0
175 data
92,15,195,224,31,231,240,59,255,184,99,255,14
0,99,255,198,97,255,204,97
180 data
255,24,96,254,240,80,126,160,96,63,0,0,30,0,0
,0,0,0,0,0
185 data 0,0,0
190 rem sprite 1
195 data
0,60,0,0,126,0,0,189,0,0,153,0,1,255,128,1,36
,128,3,0
200 data
192,7,195,240,15,231,248,29,255,220,49,255,19
8,99,255,198,51,255,134,24
205 data
255,134,15,127,6,5,126,10,0,252,6,0,120,0,0,0
```





```
,0,0,0,0
```

```
210 date 0,0,0
```

As you can see, in this case you can read the value of the collision register between sprites:



Without going into too much detail, if we wanted to display all 8 bits and see how they vary during the collision, we would have to add the following lines to the program:

```
120 print"{home}bit: 7 6 5 4 3 2 1 0"
121 print"{home}{down}{down}valore: ";
122 for i=7 to 0 step -1
123 print- ((peek(v+30)and2^i)=2^i) ;
124 next
```

Now run it (maybe in Warp Mode, since it is very slow!) and you will see that bits 0 and 1 will only go to 1 during the collision:



Ultimately if we wanted to know when sprite 0 collides with another sprite we would have to check that bit 0 is equal to 1.

For sprite 1 we will check that bit 1 is equal to 2, and so on...

From a practical point of view, this means that, for sprite 0 we will have to check that:

```
peek(v+30) and 1 = 1
```

For sprite 1 we will need to check that:

```
peek(v+30) and 2 = 2
```

and so on.

There is also the possibility of checking the collision between 2 sprites through their position. In that case we will have to measure their distance and check that it is not less than the width (24) and height (21) of a sprite, like this:

1. if the sprites are not expanded:

```
if abs(x0-x1) < 24 and abs(y0-y1) < 21 then...
```

(where x0 and y0 are the coordinates of sprite 0 and x1 and y1 are the coordinates of sprite 1) 2. whether the sprites are expanded in X and Y:

```
if abs(x0-x1) < 48 and abs(y0-y1) < 42 then...
```

Note that $x_0 - x_1$ represents the distance between sprites on the x axis, while $y_0 - y_1$ represents the distance between sprites on the y axis. Since these differences can be either positive or negative (e.g., in the case where $x_0 < x_1$), the absolute value function `abs()` must be used.

Now delete lines 120 through 124 from the previous program and add the following line:

```
120 if peek(v+30) and 1 = 1 then print"{home}
collision sprite 0!"
```

Or, if you want to use the distance method use this line:

```
120 if abs(x0-x1) < 48 and abs(y0-y1) < 42
then print"{home}collision!"
```

To be fair, in this case it would have sufficed to check only the distance on the x-axis, since the sprites move only horizontally, and so line 120 could be simplified like this:

```
120 if abs(x0-x1) < 48 then print"{home}
collision!"
```

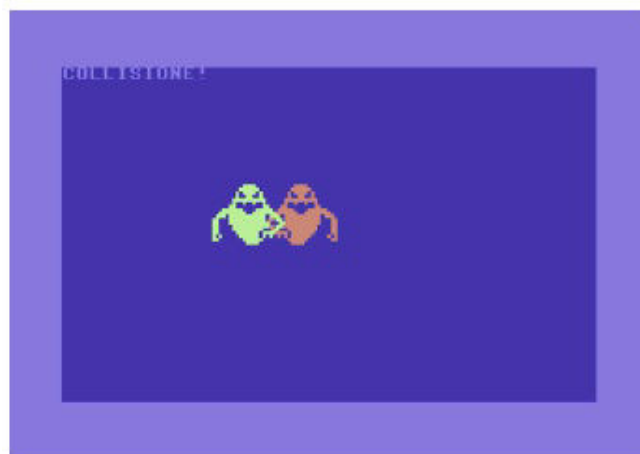

If, on the other hand, you want to check the collision between sprites and background characters, you will have





to operate in the same way, going to read the bits of register 31 (address 53279).

Here is a practical example:

```

5 rem cleans the screen
10 print"{clear}"
15 rem store initial register value vic-ii
20 v=53248
25 rem stores sprite pointer values
30 vi=2040:p0=11
35 rem initial coordinates
40 x1=255:y1=120:y0=y1
45 rem store column values and screen ind.
50 c=20:sc=1024
55 rem draws characters on screen
60 for c=20 to 21
65 for r=2 to 25
70 poke sc+r*40+c,163
75 next:next
80 rem loads sprite data into memory 0
85 for n=704 to 767: read q: poke n,q: next
90 rem activates sprite 0
95 poke v+21.1
100 rem colors sprite 0
105 poke v+39.13
110 rem expands the sprite in x and in y
115 poke v+29.1: poke v+23.1
120 rem pointer to sprite 0
125 poke vi,p0
130 rem cycle x coordinate of sprite 0
135 for x0=0 to 255
140 rem reads the value of the sprite-
character collision register
145 print"{home}value log v+31: "peek(v+31)
150 rem x, y coordinates of the sprite 0
155 poke v,x0: poke v+1,y0
160 rem repeats the cycle
165 next
170 rem sprite 0
175 date 1,0,0,224,0,0,112,0,0,248,0
180 date 1,212,0,1,252,0,3,222,0,3,198,0
185 date 1,236,0,3,255,0,7,255,224,15,255,248
190 date
12,126,14,24,127,3,96,127,128,0,255,128
195 date 1,255,128,1,255,0,15,254,0,31,248,0
200 data 255,0,0

```



As we have already learned, if we wanted the phantom to go "under" the characters we would have to activate bit 0 of register 27, so we would have to add the line:

```
128 poke v+27.1
```



The entire editorial staff of RetroMagazine World thanks and appreciates the work of the Facebook group "RetroProgramming Italia - RP Italia" - A division of "RetroCampus" Associazione Culturale and thanks them for their kind contributions.

We believe that, like other similar groups, they are doing a great job to make known the Italian retrocoding scene in the world.

We invite our readers to collaborate with them in case they have material to share with all the fans of retrocomputing and retrocoding.





FOCAL language on PDP-8 - part 2

by *Francesco Fiorentini*

FOCAL In the **13th issue of RetroMagazine World Eng**, after a brief digression on the **PDP-8** and the **Focal** language, we had talked only about the **TYPE** command without covering the other instructions.

After a short break, here we are at the second part of this series of articles devoted to the FOCAL language.

The ASK command

The ASK command is generally used in the indirect mode to ask the user to provide one or more values to assign to variable(s).

```
*ASK A
:12
*TYPE A
= 12.0000*
```

We mentioned that we can also request more than one variable at a time... Here are couple of examples on how the ASK command can get more than 1 value per time.

```
*ASK A,B
:12
:15
*TYPE A*B
= 180.0000*
```

```
*ASK A, B
:12 :15
*TYPE A*B
= 180.0000*
```

In the first example, after providing the value of variable A, I had pressed RETURN, while in the second example, I pressed SPACE.

As we can see, the FOCAL interpreter is capable of handling both situations.

As with the INPUT command in Basic, text may be specified, before the name of the variable to be populated.

```
*ASK "VARIABLE A" A
```

```
VARIABLE A:20
```

```
*TYPE A
= 20.0000*
```

```
*ASK "VAR A" A, "VAR B" B
```

```
VAR A:20
VAR B:30
*TYPE A*B
= 600.0000*
```

Unfortunately, the values we will be able to get with the ASK command are only numeric. This will greatly limit the possibilities at our disposal and consequently the true potential of the FOCAL language.

At this point, knowing the TYPE and ASK commands, we can try to write our first FOCAL program.

```
*WRITE
C-FOCAL,1969

01.10 TYPE "MULTIPLICATION PROGRAM," !
01.20 ASK "FIRST NUM" A, "SECOND NUM" B
01.30 TYPE "TOTAL," A*B
*G
MULTIPLICATION PROGRAM
FIRST NUM:25
SECOND NUM:20
TOTAL= 500,000*
*
```

To execute the program we simply digit **G**, short for the **GO** command.

I remind you that the exclamation mark at the end of line 1.1 (or 01.10), is to force a 'carriage return', to make the program more aesthetically pleasing.

The WRITE command

As you have probably guessed from the example above, the WRITE command is the 'equivalent of the LIST command in Basic.

As in Basic, by passing no parameters to the WRITE





command, the Focal interpreter will return the complete listing of our program, otherwise we might display an entire routine or one line at a time (see examples below).

```
*WRITE 1
01.10 TYPE "MULTIPLICATION PROGRAM," !
01.20 ASK "FIRST NUM" A, "SECOND NUM" B
01.30 TYPE "TOTAL," A*B

*WRITE 1.3
01.30 TYPE "TOTAL," A*B
*
```

The SET command

As in some Basic, we have to use this command to set the value of a variable within our programs.

Without deleting the previous program, let's add these lines of code:

```
*1.1 TYPE "MULTIPLICATION OF 3 NUMBERS," !
*1.21 SET C=30
*1.3 TYPE "TOTAL," A*B*C
```

After that, our program should look like this:

```
*WRITE
C-FOCAL,1969

01.10 TYPE "MULTIPLICATION OF 3 NUMBERS," !
01.20 ASK "FIRST NUM" A, "SECOND NUM" B
01.21 SET C=30
01.30 TYPE "TOTAL," A*B*C
*G
MULTIPLICATION OF 3 NUMBERS
FIRST NUM:10
SECOND NUM:30
TOTAL= 9000.0000*
```

As you have probably easily guessed, to modify a line you just need to rewrite it, just as it is done in many Basic interpreters. All very simple and intuitive.

The GO command

As we have already seen, this command, abbreviated to G, executes the program in memory of the Focal interpreter. You can also specify a line number and start the execution from that line onward.

```
*G 1.2
FIRST NUM:23
```

```
SECOND NUM:25
TOTAL= 17250,000*
```

The GOTO command

As we mentioned it in the first part, Focal is one of the ancestors of the Basic language, and as such, it could not miss the GOTO command that easily allows to jump unconditionally from one instruction to another. This command, which is strongly discouraged in structured programming, is used in Focal as a basic instruction for making loops and other control structures.

Let's add the following instructions to our program:

```
*1.11 GOTO 2.1
*2.1 TYPE "FIRST THOUGH," !
*2.2 TYPE "LET'S POP IN HERE," !
*2.3 GOTO 1.2
*1.4 QUIT
```

Which at this point should be composed as follows:

```
01.10 TYPE "MULTIPLICATION OF 3 NUMBERS," !
01.11 GOTO 2.1
01.20 ASK "FIRST NUM" A, "SECOND NUM" B
01.21 SET C=30
01.30 TYPE "TOTAL," A*B*C
01.40 QUIT

02.10 TYPE "FIRST THOUGH," !
02.20 TYPE "LET'S POP IN HERE," !
02.30 GOTO 1.2
```

And let's execute it:

```
*GO
MULTIPLICATION OF 3 NUMBERS
THEREFORE.
LET'S POP IN HERE
FIRST NUM:10
SECOND NUM:10
TOTAL= 3000.0000*
*
```

Hope you liked this short article and the FOCAL language so far. See you in the part 3.





Interview with Alessio Scanderebech

by *Francesco Fiorentini*

A few days ago **Nithaiah** presented on our page **The Nightland - Commodore 64**, a game definitely different from the usual.

This is a text-based role-playing game for Commodore 64 (but it also exists in a Plus/4 version) inspired by the works of William Hope Hodgson and Otto Wlazlo's album that recalls fantasy/dungeon atmospheres. To play we will need dice and a set of pawns (not included in the digital version, of course). The pawns start from the outside of the board and advance by rolling the dice. The player controls the character, while the CPU will take care of the opponents and the adventure.

When Alessio Scanderebech, the author of the game, contacted us to ask if we were interested in hosting some information about his game, we thought it would definitely be interesting to find out more about him and his work. So we proposed to interview him and, as you can read below, Alessio willingly agreed to answer our questions.

- Hello Alessio and thank you for accepting our invitation for this interview in the pages of RetroMagazine World. Before we start talking about your game 'THE NIGHTLAND,' let's begin with a few customary questions to get to know the man before the programmer. Would you like to tell us a little bit about yourself? Who is Alessio Scanderebech and what does he do in life?

Thank you for the invitation! Humanities studies, dad, missed Sunday programmer (when it rains), in life I am involved in e-learning and multimedia.

- What was your first computer and what are your memories of it?

After my baptism with the NES, my first computer was a blazing IBM PS/1 with a 386SX processor, 256-color VGA and Disney Sound Source, a technical marvel for the

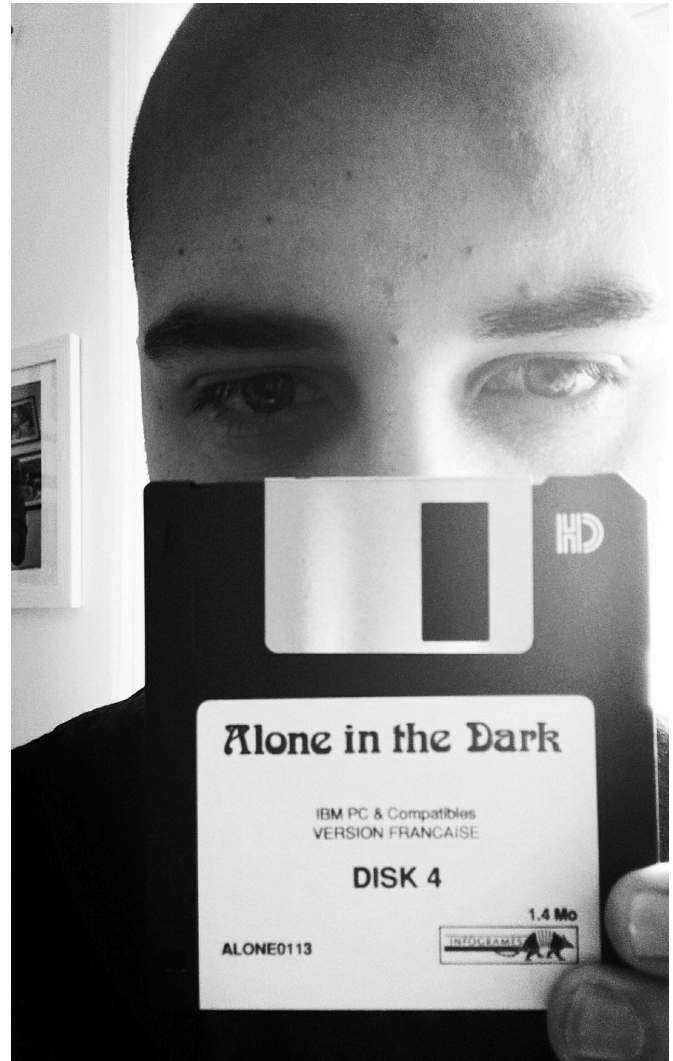

Fig. 1 - Alessio with a pretty unknown game... :-)

period. This transition undoubtedly affected part of my life, although it must not have seemed like such a big change to my parents, seeing me spend whole afternoons in front of the walls of Wolfenstein 3-D concisely pressing the space bar. I approached Commodore machines only later.

- How did you get to know the world of programming?

Because of my humanities studies, I have always looked at programming as something esoteric and inaccessible, despite a constant desire to go beyond mere fruition. About ten years ago, however, I discovered Graham Nelson's Inform, and an endless series of trials, ideas and projects that were never completed (but which I





Fig. 2 - The Nightland

cherish) began.

- What is your favorite retro programming language and why?

Inform 6 of course... That's the only one I know. ;)

However, I do not know if it is right to call it "retro," I find it very current and rather unexplored, at least in Italian (apart from a few well-known exceptions).

- How do you approach retro-computing? Do you own retro-machines or do you prefer emulators and/or FPGAs?

I have long been a "real hardware" and cathode church fundamentalist, in fact, in addition to the C64 I own several vintage PCs, JAMMA cards, CRT monitors, and so on. With time, however (and even after becoming a dad) I think I am realizing that retro-computing and retro-gaming more generally, at least for me, do not correspond so much to the performance or technical accuracy of the experience, but to its lightness (after all, what could be more accurate and sincere than the carefree suspension of disbelief of yesteryear?) so I tend to prefer more "convenient" and compact alternatives such as FPGA (I have a SIDI) or bare-metal emulation today.

- Let's talk a little bit about The Nightland, a game somewhere between digital and analog. How did you come up with the idea for this format?

I am fascinated by "small" but extremely well-curated entertainment products such as Enrico Colombini's text

adventure "The Cave Dragon," as well as by the mixture of board game and computer as in Milton Bradley's "Dark Tower" or Gary Chalk's "Assault of the Ogroids" (published in May 1987 in Sinclair User magazine) and therefore I have always hoped to make something similar. The opportunity came after listening to Otto Wlazlo's dungeonsynth audiocassette "The Nightland" published by Heimat der Katastrophe. I was thunderstruck by the evocative power of the music, and by the idea of including a small fantasy board game to complement the experience: so I thought that writing a "companion app" to play it solo would be a concrete pretext for taking my first steps into the world of programming. It would have been nice, eventually, to be able to host the program on the same cassette as the soundtrack... hence the choice of the Commodore 64 as the target platform.

Regarding the "analog" aspect of gameplay, some time ago I read a very interesting article by Dave Morris ("Does IF need randomness?") in which he stated in no uncertain terms that he could not stand the presence of dice rolling in digital GameBooks: in his opinion, dice rolling was barely acceptable with pen and paper, and became totally nonsensical in digital transposition.

Well, I was struck by the bold comment, decidedly against the grain of general opinion, of an anonymous user who declared himself instead in support of reading digitally by rolling dice--just for the hell of it. However seemingly illogical, this approach seemed right to me: if I just have to press the space bar, or worse watch helplessly as random calculations are made by the computer, indeed randomness loses its *raison d'être*; but if I have to somehow generate a random outcome, I prefer to do it myself by rolling a die, because if I get a particularly lucky (or

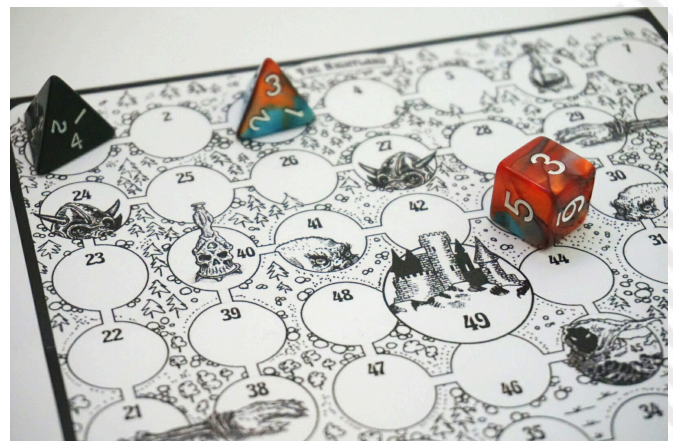

Fig. 3 - The Nightland - the board game



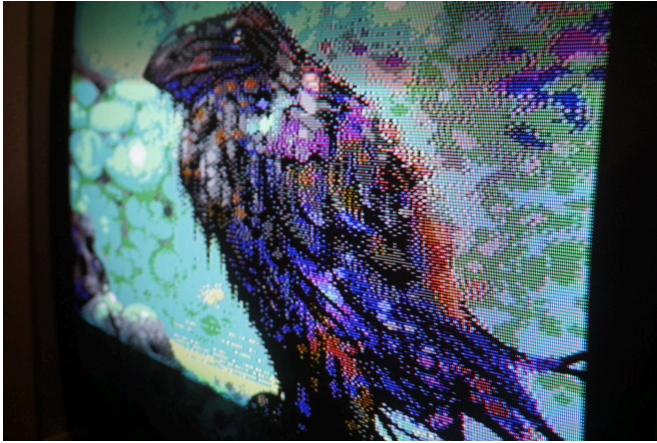

Fig. 4 - A screenshot from the game

unlucky) outcome, the roll makes me feel somehow "responsible" for what happened, or at least deludes me into thinking I was. So I decided to have the (human) player of "The Nightland" roll a real D6.

- How do you develop the action? And how do you keep the player's interest during the game stages?

"The Nightland" is a fast-paced fantasy goose game (a "filler" in board game lingo) in which two characters traverse the darkness of the desolate heath in an attempt to reach the mythical fortified citadel first.

Character classes assign certain advantages and disadvantages: the Paladin, skilled in combat, is frowned upon by certain fairy creatures; the Giant (good) is slow in combat but immune to poisons; the Dwarf knows secret underground passages.

My code not only manages the game's turns but also breathes life into the desolate heath, animating the creatures that inhabit it and adding random "catastrophic" events and easter eggs: magical whirlpools, prankster spellcasters, subterranean labyrinths, mystical mists, fire-breathing dragons and disreputable wayfarers will provide the backdrop for the two desperate adventurers' tormented search for the citadel.

- I read that in making the game you drew inspiration from the works of William Hope Hodgson, a writer who also deeply influenced Howard Phillips Lovecraft for much of the works of the Cthulhu cycle... What fascinates you in his writings?

It is actually Otto Wlazlo's album (and the board game in

it) that was inspired by Hodgson's works, which I discovered at the same time.

- In addition to the texts by William Hope Hodgson, just mentioned, you said you also drew inspiration from other sources, specifically the musical opera 'The Nightland' by Otto Wlazlo. Would you like to tell us about that?

The digital game came into being precisely as a complement to the dungeonsynth album of the same name (available on Heimat der Katastrophe's Bandcamp page), which therefore is its inescapable starting point, to be listened to while playing the game. The evocative soundtrack was a real imaginative spark for my project, not only in the early stages but also in late development.

- How did you get in touch with HDK and what arrangements were made between you for making a game inspired by one of their productions?

As soon as I had what might be called a "beta" ready, I shamelessly e-mailed it to Heimat der Katastrophe in order to elicit some feedback: not only were they kind enough to grant the use of the PDF board for the digital game, but they also gave me the opportunity to publish a physical version, now available on the Bobr Games store. I don't think it could have gone any better! ;)

- If I'm not mistaken, the game was made using Ozmo, a Z-code interpreter for the Commodore 64, 128 and Plus/4 (those who want to learn more can read the article "Text adventures: from Infocom to Inform" by



Fig. 5 - Alessio's Commodore 64





```

This is the land of eternal night!
Is this your first game? (y/n) no
Two players? (y/n) no
Who are you?
the DWARF
the GIANT
the PALADIN
You are THE GIANT.
You are very strong, but too kind.
You are immune to poisons (don't fear
squares 33 and 40) but your kindness
makes you a weak opponent in combat (you
always have -1 in the die roll).
Continue with this character? (y/n)

```

```

the DWARF
the GIANT
the PALADIN
You are THE GIANT.
You are very strong, but too kind.
You are immune to poisons (don't fear
squares 33 and 40) but your kindness
makes you a weak opponent in combat (you
always have -1 in the die roll).
Continue with this character? (y/n) yes
Your opponent is THE DWARF.
The quest for the Fortified Citadel
begins!
YOUR TURN
You are on SQUARE 6.
Roll the dice and type the result: 6
On SQUARE 6, in the top of an old boot,
you uncover a small flask of bluish
liquid: it's a potion of magic speed!
Roll the dice and type the result:

```

Fig. 6 e 7 - The Nightland - screenshots from the game

Giorgio Balestrieri, published in RetroMagazine issue 8, but in Italian language only...). How did the development proceed? Did you encounter any difficulties?

Ozmoo is an extraordinary interpreter, just as extraordinary are the people who developed it: it is super easy to use, either in the on-line version or with a "custom" installation such as the one on the Raspberry Pi used for game development. For the writer in Inform 6, Ozmoo is a magical portal into the world of retrocoding (cheating a bit).

- We have come to the end of our interview. Is there anything you would like to add that was not covered in the questions?

I would like to thank once again those who assisted me in the realization of this project in both digital and physical editions, and all those who supported it even with small donations, feedback and comments. And, of course, my wife and son, to whom this is dedicated.

- Before I leave you, I would like to thank you again for your availability and wish you the best of luck in publishing your game!

Thank you very much to you for the space you have given me!

Useful Links:

Digital version:

<https://scandy.itch.io/the-nightland>

Physical version (BOBR Games):

<https://bobr.games/index.php/nightland/>

Otto Wlazlo's Album (Heimat der Katastrophe):

<https://heimatderkatastrophe.bandcamp.com/album/hdk-32-the-nightland>





Battles of the Eras

by Brandon Cobb - www.diskman.com

In the 1990s, the shareware concept — downloading a limited demonstration version of a game to try for free before buying the full-featured version — was taking the PC game market by storm. Just about every publisher at the time was offering some sort of “teaser” to lure potential customers. Not only were established companies taking advantage of this business model, as many small bands of newcomers also appeared to offer a taste of their wares. But while the shareware concept launched many a success story, countless games were also lost in the shuffle. One such title was Procryon's Battle of the Eras, a fighting game featuring digitized characters a la Midway's Mortal Kombat. Pitched in 1995, the game offered several unique gameplay modes including modem play — a trend that was just starting to catch on — which allowed two players in different locations to battle each other over a data connection sent through their telephone lines.



In spite of its features, Battle of the Eras went completely overlooked without a single copy sold. In the years that followed, even the freely downloadable demo version became difficult to find. Thankfully, its fate wouldn't be sealed so easily.

In June of 2013 I decided to contact Joseph Mocanu, de facto leader of the small team that developed Battle of the Eras. Thanks to him I was finally able to check out the complete game. Not only that, but he was nice enough to take time out of his busy schedule to share the interesting story of the game's development process. I am proud to share that interview with you now.

Interview with Joseph Mocanu of Procryon, by Brandon Cobb

How old were you when development began, and how long did the game take to complete?

14 years old, and it took about 18 months to finish (amidst school and summer vacations).

What sorts of challenges did you face?

Well, I was the only (good) programmer, and the only one who could make music, so it couldn't be as feature rich as I had hoped.

I had to mix and match 3rd party several libraries to make them together (e.g. had a custom library to access XMS memory, which I then had to make work with the sound/music library, which wasn't designed to use that memory) The graphics side were brutal, as we had filmed in front of a green screen hoping to be able to remove the background automatically. However the crappy video digitizer we used created a lot of color noise, that prevented our (limited) paint program from removing the green. In hindsight I probably should have just made my own tool to 'intelligently' remove the background, based on average or smoothed color values, but I hardly had the technical sophistication back then.

The game's documentation highlights the fact that



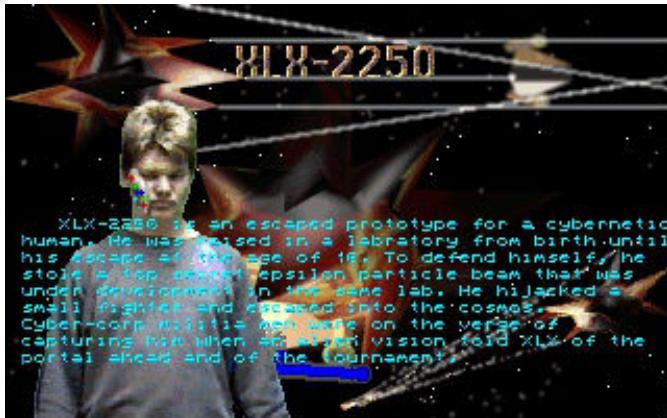

development was undertaken in Belleville, Ontario, and by a small, devoted team. How did you guys come together, and what were your hopes for the final product?

We all went to the same high school, were friends, and were on average less 'cool' than the other kids.

We also liked computers and video games... kind of an eventuality when you take all those factors together.

You must have had fun working on the game together.

Do you have any memorable anecdotes to share?

Ah my memory is fuzzy. I do remember filming in Mark (Gatekeeper's) basement, taping up all the props, and babysitting Tom (XLX)'s little brother Rob (Shadowsnake) as we were doing all of this. I recall a lot of people were wondering what we were up to, and I'm sure Mark's parents thought we were pretty weird kids. Thankfully we never filmed outside or in public else in our small town, it would have drawn quite the odd stares.

Oh there is another one. The minotaur character that has a parasite burst out of it at the start of fighting was total improv. The clay we had used to model that character



(we totally ripped off of Mortal Kombat in the use of claymation for a fighter [they used it for Goro]) was not rigid enough to support complex articulation, so we had to make due with what we had and improvised on the spot with the 'worm' creature.

The storyline is very complicated, to the point of becoming confusing rather quickly. What was the inspiration behind the story, and why did you choose to go in that direction?

Your guess is as good as mine - sands of time and all. I think as a child I was interested in studying genetics (which I ended up doing and making a career out of for a little while), and watched a lot of science fiction. Specific influences, I can't quite recall.

What did you learn from the experience of producing this game? Did it help to better prepare you for your future career?

Well, it taught me that I can successfully complete a complicated project, and gave me the confidence of being able to lead a development team. It also taught me that I should probably seek a market opinion at some point





early in development. I don't really think it directly contributed to preparing for my future career - perhaps in some intangible way.

Were you satisfied with the final product? Looking back, is there anything that you would have done differently?

Not really satisfied with the final product. Graphics could be better, collision detection too. The code was ugly like no tomorrow. Looking back however, I probably couldn't have done much differently with what I knew.

Why do you believe the game was not a commercial success?

Well, it was kind of ugly and buggy :). Also, we may have asked too high of a price to register.

The "Procryon FAQ" mentions that a second game, Omicron 7, was also in development. What became of it?

Nothing - we were planning on using this game's proceeds to fund it. That obviously didn't happen.

Are you still in touch with any of your former Procryon teammates?

Not really - generally fell out of touch with my high school friends, however do occasionally see updates on Facebook or LinkedIn. People grow apart with time, interest change, families happen, you know the drill.





THE GREAT GIANA SISTERS

by *Mic the Biker Novarina*

The great Giana Sisters made its bombastic appearance on the Commodore 64 in 1987, developed by Time Warp Production and distributed by Rainbow Arts, and soon became the most famous clone in the history of video games. Don't ask me why, but my gaming friends and I only discovered it the following year.

It was a day in June 1988. The school had almost come to an end and carried with it its severe burden for me: two subjects to be recovered in September had also arrived that year. Already the previous one I had known the feeling of anxiety linked to the expectation of a judgment, that weight on the stomach, the thought to the future, to those months to come. That is, for a boy accustomed to living the day it was a big change, it was the first real step towards the world of adults.

Even that year the emotion I felt in previous years for the end of school and the beginning of a carefree triptych of months had given way to dark clouds of concern. What would that summer have been like? Surely, I should have spent at least a couple of hours a day studying, recovering. And will it be okay in September? Recriminations about how I could have been more serene if only during the year I had done that little more were the order of the day. Did growing up mean all this?

Luckily, I had at my side that handful of friends and the Commodore 64, my little dream car. That cute plastic piece that allowed me to unplug every now and then, took me to some distant galaxy or surreal worlds. Even the friends were struggling with their problems "when we grew up" and we were all gripped by existential issues.

The life of the band of San Paolo

The summer heat in Turin made our afternoons slow, almost existential movie. In the morning woke up early, after a phone call with an old wheel telephone that was often locked by the parents. We had a kind of lair, a garage overlooking the street in Via Polonghera: sometimes we were there and then we went for a walk by bike or bus, other times we went to someone's house to play. The heat of the early afternoon was used to study for a couple of hours and then go out and go to the park in Via Monfalcone: there were girls there. One morning in July



I went to the usual trusted newsagent in Corso Peschiera to take the Zzap! summery. Bimonthly issue, July and August 1988. I ran home and began, after tampering with the lock on the phone, to make the round of calls to friends: "Raga, a bang of spectacular news. We have to go around the shops." That number was very rich and within a couple of days here we are on 33, direction Via Sacchi. Once we arrived at Americans games, we swooped to the chest of wonders, the one where the copied cassettes were. I read a name, that name, The Great Giana Sisters and I immediately grab the copy.

Friends took two more games, because then we would make copies with each other. Cabbage, Giana on Zzap! took 96%: platformer of the year, fabulous arcade, gold medal! And then I would have had in my hands a Super Mario in C64 sauce, for the good peace of the only VIP friend who had the NES and made us feel inferior with his Mario and cartridges. The next day, not even to say, I meet at my house to melt the cassette. Obviously, I played it already in the evening: who would resist until the next morning?

The Great Giana Sisters, powered by Mario

In game we play as Giana, a girl who suffers from a nightmare in which she travels through 32 locations full of monsters in search of the end of her bad dream. Bizarre name I thought, and then immediately understood that it was a resounding "mistake": it is referred to as Gianna in the sliding introduction!

It turned out years later that a mistake was made on the graphics of the covers, it would probably have cost too much to redo everything, so they left everything like that.





The game was programmed by Armin Gessert, with graphics by Manfred Trenz. The good Manfred was a graphic designer not recent: in his career he boasts "only" the development of the Turrigan video game series and the Commodore 64 version of the R-Type game. A special mention for the genius behind the audio section, Chris Huelsbeck.

The game is a side-scrolling 2D arcade platform. Here we use Giana or her sister Maria, since there is a two-player alternate mode. It only takes a few seconds to be amazed: the game is not simply inspired by Super Mario; it is literally a clone of the same. That is, the first level is practically identical, taken the backdrops, some modifications, different enemies but it is the same game. In the same place where Mario catches the mushroom of growth here, we take a colored ball! Giana does not grow up, however: she becomes Sid Vicious! When he is in punk mode, he can head all the brick boxes that are around the levels. We have exactly one hundred seconds to get to the end of each of them, if we finish first the seconds in surplus will become bonus points.

Each level contains a series of crystals that give points when they are collected. You earn an extra living by collecting a hundred of these gems. Beware that some tiles can give numerous diamonds, but they are well hidden. As in the most famous and original platformer, here too some extra lives are hidden around the levels. And just like in the Nintendo game, enemies can be defeated by jumping on them or shooting them after getting power-ups. The enemies are different since here we are in a beautiful and good nightmare: we will have to deal with owls, rotating eyeballs, carnivorous fish, and insects of various kinds. I still remember the amazement when I first met the giant super ant!

The game, strange to say, alternates locations in the

sunlight with other in dungeons and, by hitting your head on the specific tiles, you can get various bonuses. They range from the single lightning that gives us the single shot to the double lightning that gives us the bouncing bullets. Very useful is the watch that momentarily blocks the bad guys on the screen and a very useful drop of water that makes us immune to fire. Within the levels there are special blocks that are invisible. If they are hit, they teleport us forward in the game making us jump different locations.

We must always pay attention to what is on the screen, even the traps are not all such: many times the seemingly bottomless holes will lead us to secret rooms full of crystals. Of course, you have to fall into it to find out (just like in Super Mario). In this situation we will find ourselves in the 32nd level, when we will arrive at a point that seems to be affected by a bug, being impossible to continue. After time and events have led us to death too many times the only thing to do is throw ourselves into a hole behind us to get to the 33rd level! Here, having killed the flying dragon on duty, you can finally access the room containing the final super diamond!

For us C64 owners, it was an incredible game, a masterpiece of its kind. After all, Nintendo did not grant the conversion of Super Mario to anyone, at the time you could be sure that someone would do something!

Huelsbeck, il genio dietro il SID

A little in-depth analysis of the creator of the audio part is a must: the gentleman in question, in 1986 released the SoundMonitor program for the Commodore 64, inserting it as a list to beat on the Teutonic magazine 64er. This program is considered as the muse of all the music trackers that were born a few years later for 16-bit machines. Huelsbeck has written soundtracks for over 70 titles, including this one by Giana sisters and, dutiful bow, for the Turrigan series. He also created a music





playback routine for Amiga called TFMX. This acronym means "The Final Musicsystem eXtended" and has more music-oriented features than other soundtrackers, such as logarithmic pitch bends, macro-sounds, and individual tempos for each track.

Mario is a punk rocker

The game is really fun and the step from gold medal to legend was short. For this we must thank above all Nintendo and its policy. In fact, its almost twin resemblance to Super Mario aroused in those years a question of image that went down in history. Great Giana Sisters remains the most emblematic case of videogame "displacement" of the eighties and perhaps of history: Mario and Luigi have been replaced with the Punk model Gian(n)a and Maria, the levels are almost identical. They lack bonus sublevels compared to the original Nintendo but they are details: many people still do not know all these levels of the original.

There are several urban legends about the reason why it was taken off the market. The most famous is that Nintendo filed a copyright infringement lawsuit against Time Warp Productions and Rainbow Arts, due to similarities to its new (at the time) game. The key point is that The Great Giana Sisters resumed almost to the letter Super Mario Bros. It copied the graphic style; the structure of some levels was really identical and even the position of the writings above the screen. Nintendo could not turn a blind eye and made sure that the commercial life of this title was very short. It was, and still is, a commercial policy typical of the Japanese company: to directly influence the withdrawal of a title or a series of them from sale. After all, the company had already done it with other games and, as we all know, the vice has not lost it. All this great chaos that had been created, combined with the immediate resemblance to the platformer of the mustachioed

plumber, has ensured the game of the punk sisters' visibility globally. Nintendo urged the creators of The Great Giana Sisters to withdraw the game from the market, arguing that it was an obvious copyright violation. But the die had been cast, the Rubicon passed, and there was no going back, not entirely. Time Warp Productions and Rainbow Arts immediately stopped producing the game, but the game was now firmly present in the underground market of the time. By now the copies had been made, Giana and her sister secured a prominent place on the bulletin board of every gamer of the time. The other side of the coin is that the rarity of the game led its original copies to become a collector's item. Upon its release, The Great Giana Sisters received praise and critical acclaim from gaming magazines across Europe: just think of the beautiful review of Zzap! present in the number 25 of July - August 1988. Here too we can see the internal debate within the editorial staff on the issue, with enthusiastic editors and others who severely pointed the finger at the game. Everything that happened afterwards did nothing but bring the title to an almost legendary level, absolutely to be owned.

Biker's thought

I still remember the emotion that made me try this game, this Super Mario in sixty-four sauce, with the horrible graphics screen but its playability at the top and the beauty in the game. Of course, controlling Mario was perhaps easier because the jump was managed by a button while we used the Knob of the Joystick, but we made the hand. In those years The Great Giana Sisters had practically no competitors and this made it a "must have". Nintendo never wanted to give up the rights to a conversion, but someone made it at home for us, and made it beautiful, fun, captivating and long-lived. In addition, we Commodorians have also had something more from ours than the Japanese counterpart, that is a soundtrack that they could only dream of! In the following years the game has gained a strong following of fans and there have been many reissues that maintain the concept and original graphics. Mario will also have a mustache and as is understood in my area, "If you are one with a mustache you are one who knows", but Giana without an N, even without mustaches, has also written history.





Track & Field: sudore e sangue

di Mic the Biker Novarina

Hello dear readers, today I want to remind you of the blisters and cramps in the hands had in my youth with Track & Field (some were certainly thinking badly, believing we were going to talk about some Lingerie catalog).

The story starts a few years ago, when friends of mine gave me a nice Pandora Box, with its load of thousands of games. This arcade paradise was a dream come true and I started soon to play all the 80s games. I decided to hurt myself with Track & Field, a game that I loved in an incredible way and that I always replay with an emotion worthy of a 13-year-old boy. In fact, as a child I literally loved this coin op and, at the price of having professional calluses and bubbles on my fingers, I was able to make the rounds of the proposed events several times with increased difficulty.

A little bit of History

The game in question was produced in 1983 by Konami. In Japan the name was different, it was called Hyper Olympic, but the substance did not change. Track & Field

was the first arcade title to offer a style of play based on rapid keystrokes. In fact, the original cab was completely devoid of the Joystick lever. I'm honest: I've never seen this fantastic cab, the original vertical one, around. I have always come across this game loaded on "universal" cabinets; many times they were really indecent.

Even rarer is the horizontal version, the legendary Cocktail Table, which had the particularity, beyond the position, of being able to allow the four players game! These possible players, who in the running compete in two at the same time, have four different aspects, all with a mustache. There are a mix of reasons hypothesized in the arcade for this look. The first, the most popular, was that they wanted to give a marked "Mario" imprint to the players, since the Nintendo plumber was already quite famous. The second, perhaps the most likely, was that in those years the mustache was also in fashion in the world of athletics.

How it looks like

The game, as it is easy to imagine, is set in a stadium full of people. The screen is divided into two very characteristic sections. We have the larger one at the bottom, where the action takes place, and the high one where we find scores, names, placements, and times. The graphics of the coin op were very beautiful for 1983: in its simplicity



Track & Field - the arcade



An image that evokes memories...





Long jump

it was huge, with some touch of humor in the expressions of the competitors. The game is divided into six Olympic disciplines where we will almost press the run keys like mad. If this were not enough, an additional button will be pressed, with surgical precision, for jump or to throw an object. For accuracy, it must be said that over the years there have also been versions of Track & Field where the joystick was used to pick up speed. This type of control became, in the years to come, the basis for almost all domestic systems.

Track & Field, the game

Now back to the game itself, let's talk about the various sports disciplines. The first is the queen of the Olympics, the 100 meters dash. You simply must press the run keys as fast as you can, and in the most furious way possible to finish in the expected time and, in the best cases, to make a record. The key to a good performance is the start. There are three possibilities of "false start", just to give the opportunity to get the lightning one right. The three errors will remain in all competitions the maximum allowed before the game over. After that, we will try our skills in the Long Jump. Here in my opinion, we need a violence on the keys even greater than 100 meters, the stuff of blisters and bad words, because speed is more important than the jump point and the inclination of the same. Here we begin to curse the dead of Konami programmers: the keys Layout in the Track & Field cabin is quite absurd. The jump button is placed at the bottom between the two keys for running: if I use the two keys to run, I will almost inevitably jump after the line. But we never gave up! With videogames we turned into infernal



110 meter hurdles

creatures, able of going almost as fast as before but using only a button for running. The techniques were disparate. There was the English lord who had developed the two index and middle fingers' muscles out of the ordinary. On his face not a drop of sweat or expressions of pain. His two fingers tapped at the speed of light alternately, and with an open eye and regular breathing he realized precise jumps. Then there were the Satanic beasts, and I was one of them. After taking positions bordering on contortionism, we started with performance. The button was raped with very fast but very heavy pressures by two fingers. The shoulder-biceps-forearm muscles reached tensions worthy of the young Lou Ferrigno. Often, we did not look at the screen, we raised our heads at the last second to make the jump, pushing the button with unhuman violence. Satanic beasts were sweaty and smelly, often they also lost their burrs. And finally, there were the collaborative. They were curious characters: they placed themselves in the cabin area and watched. They stood there, in silence. They played only when the best friend arrived. One pressed the buttons for running, the other that of jumping. All in a tangle of bodies that seems to have inspired hard movies in the years to follow.

Well, after these historical testimonies as a gamer, I continue with the Track & Field disciplines. The third discipline in which you compete is the javelin throw. The dynamics are identical to the long jump: chasing the limit of madness and at the right time pressing the jump - launch button. This is the first discipline where we find an easter egg: after making a good run we make the





Atari 2600 version

launch by holding the button without releasing it. The shooting angle will reach 80 degrees and our javelin will soar into the sky. When it comes out of the screen it will suddenly fall after piercing an arcane tool with 1000 points value. In the smoky world of arcades there were different theories about what the object was. Probably in the minds of the drug addicted Konami programmers it must have been an alien of some kind. But, there were those who said it was a bird of an unknow race or a chandelier. Yes, you got it right: my blood froze when for the first time, after hitting, the usual bizarre person placed next to the cab like a vulture, exclaimed shouting "Oooh fuck, you hit the chandelier".

After completing the practice of throwing, here we move on to the terrifying 110 meters hurdles, a discipline in which emerges the dark side of the human soul. Of the whole game is the one where I saw the most terrible scenes. A very ignorant 110-meter-long race full of hurdles to jump, to be precise 10. Imagine: you need the most stupid ignorance for hitting the run keys and 10 precise jumps to avoid hurdles. We, the Satanic beasts, had to look at the screen, with painful neck cramps, press that damn running button and, at precise intervals, to punch the jump button. Neither too early, nor too late, because in the first case you end up stumbling into the hurdle slowing down, and in the second you end up long, falling directly to the ground. About halfway through the race the initial grunts were often replaced by unholy blasphemies, all synchronized with the jumps. Even the

English Lords had their problems. Compound, with their two lightning-fast fingers on the running button, if they missed the first jump, they all got them wrong. Of course, because they were synchronized that after several super-fast pressions, corresponded one jump: going crazy was very easy. And they too, imperturbable, blasphemed. Quietly, in the most creeping way possible, so that the Coin op music covered their voices. The collaborative deserves a separate discussion: I saw friendships finish for a series of wrong jumps; you could attend real wrestling matches after a wrong run!

After this critical event we come to the hammer throw. Finally, we can rest the bleeding fingers, because this discipline provides for automatic rotation: the running button is pressed once, and our athlete begins to rotate. When he rotates, the hammer become red when the throw is good. To qualify we need a simple launch with half the rotation speed. But we professionals, we wanted to break through the hundred meters. To do this you had to pull to the last square of the chase, and you must be precise. The perfect launch is obtained between half and three quarters of the last square. The satanic beasts put a hand on the screen, so we don't be distracted by the graphics, and focused only on the bar below. Arrived in the good area, the launch button was pressed for just one second, to obtain an angle of 40-45 degrees: perfect launch assured! And here we are at the grand finale, the high jump. Here the chase is automatic, because the timing required to jump really high must be accurate to the millimeter. The first jumps are very easy even if you miss the detachment.



Commodore 64 version





GameBoy version

From 2.40 meters you must start calculating. The best method is to get almost below the bar and at that moment press the jump button in a lightning-fast way to obtain an angle as vertical as possible. Once the athlete is well up, we press the jump button progressively to decrease the angle and overcome the bar. And here you can find the second easter egg of the game: if we miss the first two jumps to the minimum size, and with the third jump we get to exceed the measure expected for the victory will appear a mole worth 1000 points! After this last test here, we are on the podium, with the blonde on duty that rewards us for the first position. Vangelis' song "Chariots of fire" is the soundtrack to this satisfying moment. Here, depending on how the game board is set, the game will end or will start again, with most difficult qualification goals. Personally, I have always found this second option on cabs: sweating a lot, I was able to make three times the round of the events in question.

Los Angeles 84 spinge Track & Field

The rest is history: the game was a worldwide success and became the precursor of a successful series of Olympic-sports themed games. The fortune of Track & Field was also to be there, at the height of its splendor, during the celebrated 1984 Los Angeles Olympics. I remember well the enthusiasm that surrounded this sporting event, even if for political reasons, related to the previous edition, the URSS and 16 other comunist states boycotted the American

Olympics. As can be seen, the Cold War was still the master in those years. But the people here followed this event with enthusiasm, and all this turned into a great hunger for Track & Field.

Since 1984 there have been a lot of ports of this legendary game. In that year the conversion for Atari 2600 made people cry out for a miracle, with colorful sprites and animated backdrops.

Atari 2600

To succeed in this impossible mission the game cartridge contained more ram memory to make up for the physical limitations of the machine. Atari did things big by releasing a dedicated Track & Field controller that took up the two buttons to run and one to jump: an object that deserves the collection only for its beauty. Yes, because in terms of effectiveness it was much more convenient to control through joystick to fiddle right left as crazy and button for jumping. A control method already presents on bootleg versions of the arcade and resumed on all home systems.

Commodore 64

In the same year came the Commodore 64 version. Edited by Konami and Atari, it turned out to be a colorful and well-made version, very faithful to the original. It was the first "joystick splitting" game, the title that was mandatory to play with microswitches controllers, because the slatted ones gave way resoundingly after two games.

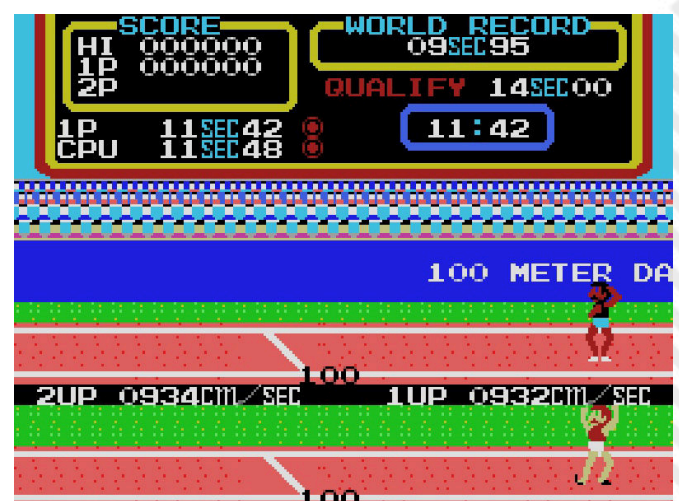

MSX version





MSX

The last system that saw the conversion in that year was the good and never too much understood MSX. The programmers decided, in order not to lose in quality, to divide the game into two separate cartridges. Track & Field I had the 100m, long jump, hammer and the new 400m. Track & Field II the 110m, javelin, high jump, and the new discipline of the 1500m.

NES

In 1985 was released the NES conversion, named after the Japanese version and included only four of the six disciplines of the original. Graphically appealing, it was undoubtedly incomplete and too short. Konami ran for cover years later with the conversion of Hyper Sport, varying its contents and adding other disciplines.

Zx Spectrum

In 1988 the game saw the light on the small Zx of the Spectrum house. The graphic result was not very happy since it was always played on an olive-green backdrop with monochromatic sprites. The fluidity on the other hand was good and the game had its reason to exist.

Game Boy

The years passed and in 1992 Track & Field also landed on the small Nintendo house. The small monochrome display gave us a masterpiece of definition, where flickering was almost absent. The graphics, although not colorful, really resumed the atmosphere and animations of the original bar. The competitions rise to eleven in total: we

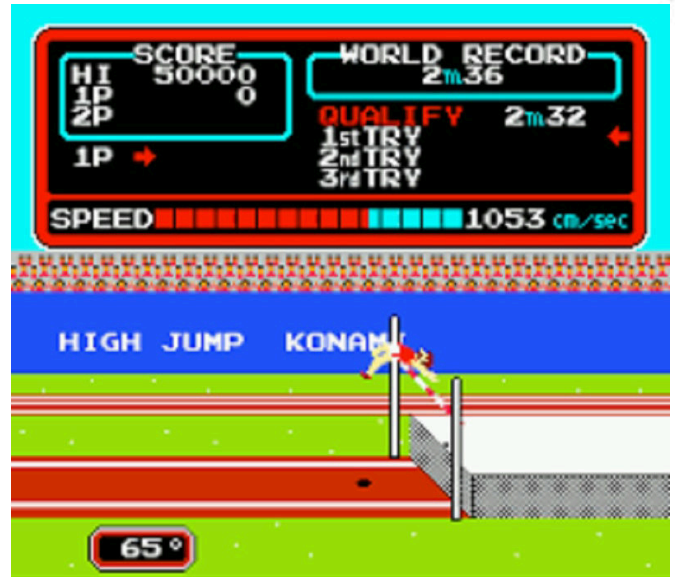

NES version

find weightlifting, archery, and triple jump (legacy of the NES version), swimming and discus throwing. Obviously, the best game mode was the versus mode that exploited the linked game.

I greet you dear readers, I hope you have enjoyed this journey backwards, full of memories arrived directly from the smoky arcades of the past. As a small final cameo, I recommend you to watch a film that is a masterpiece: the Goonies. Well, in this great film appears a nice cabin of Track & Field, have you ever noticed?



Spectrum version





Talent Scout

by Carlo Nithaiah Del Mar Pirazzini

The column was created with the purpose of getting to know programming talents, graphic designers, composers, game designers, all those who keep the passion alive. Today it is Daniele Spadoni's turn.

My name is Daniele Spadoni, I call myself a creative with the goal of reviving the magic of the 80s and 90s. Creativity and spirituality have a strong energy to create and share love by transmitting passion to others. During my teenage years, while my other peers were playing, I spent hours and hours studying and perfecting knowledge and creativity.

I started making my first animations with a Commodore Amiga 500 with the program that was called Deluxe Paint with which I tried my hand at the first rudimentary experiences of 2D graphic creation... I enjoyed reconstructing scenes from movies, frame by frame... then I started dealing with 3D with poor results. In 2006 I managed to post my first short film on YouTube...from there my passion for directing started.

Since then in a determined way I continued to study and self-taught to create new projects that were more like trials, tests for myself.

My first major work was released online in 2012, it has now reached more than 1,000,000 views.

I challenge myself by creating projects to instill in others a feeling of nostalgia and love.

In 2019 I lost the stimulus, a spark, pushed my passion toward a change with the desire to try my hand at something different and new to me.

I transformed my creativity from video maker to retro pixel art video game developer.



**The Secret of Monkey Island RECODED –
The starting Experiment of Daniele**

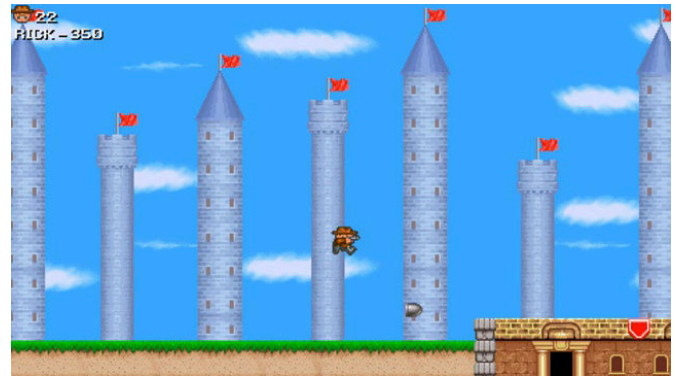

**RICK DANGEROUS in Rainbow Island – One of
Daniele's last creations**

My mind went back in time when I played with the Commodore as a child. I went back to replaying Monkey Island looking for inspiration. I didn't know what I was looking for but at some point I began to notice that certain objects and rooms in the game, located where the protagonist couldn't access or collect, looked interesting for new developments. So here was the spark... I definitely wanted to find out what could happen if collecting or interacting with that particular unconsidered object or entering unknown rooms, never traveled by the protagonist, could change the story opening up to new storylines. The idea was to bring the 80s and 90s of pop culture back to life by creating crossovers that had never been made in order to offer audiences the nostalgia and magic that each of them has been left with in their childhood memories. My goal is to give today's youth through their parents a chance to know what retro represented.

I love putting together certain characters forgotten in time by reviving them thus creating new stories with endless possibilities with wonderful universes where every child can experience events that are only represented in dreams.

There is no game that I prefer because each project has its own charm in the moment of creation.

Links to Daniele's resources

Daniele Spadoni FREE GAMES: <https://danielespadoni82.blogspot.com>

Facebook: <https://www.facebook.com/D.Spadoni.Games>





NEW GAME

ANDRO DUNOS II

Year: 2022

Editor: PixelHeart, VGNYsoft, Just for Games

Platforms: Switch, Xbox One, Playstation 4, Dreamcast, Nintendo 3DS, Windows

Tested on: PC Windows/ Nintendo Switch/Dreamcast

I must admit. I was looking forward to the sequel to Andro Dunos.

If you are a fan of shooters and want to play with the long-awaited sequel to a game released 30 years ago then this AD 2 is for you.

AN UNEXPECTED SEQUEL

Yes, Andro Dunos 2 is an oddity, infact it is a brand new title that follows the game released on the SNK console (and in the arcade) 30 years ago. The original remains to this day a well-made title but identical to a thousand others released at that time. One has to put its release period in context. In those glorious years there were plenty of titles in this genre that tried to stand out and were often superior to the title that the Neo Geo offered. That said, Andro Dunos 2 is something special in that, it captures the spirit of the era while offering a better experience than the original game.

IPER SHOOTING

I must admit that I did not expect too many innovations from this sequel considering its well-done but still "trite" roots, but I am happy to admit that I am quite satisfied with its tight gameplay and superb presentation. To begin with the controls, they are simply perfect. One button fires a series of bullets and missiles, while another button uses the "Hyper" firing system that amplifies the main weapon and requires a loading time.

Interesting mechanics because it



forces us to evaluate the type of combat needed at the most opportune time.

In addition to the elegant hyper shot, we have at our disposal 4 different weapons that we can swipe whenever we wish (via button), each of which offers a different and effective firing system in certain situations. Therefore, switching to the best equipment for each situation is something satisfying, especially when unleashing the hyper shot of a specific piece of equipment that skillfully eliminates an entire opposing swarm. This system reminded me of Thunder Force.





RETRO GOODNESS

As I mentioned, Andro Dunos 2 has an authentic presentation that makes it look like a classic in its genre. In particular, I would say that it looks like it belongs to the mid-90s; only more modern graphic effects are present. For example, seeing enemies flying in the background only to enter the fray is phenomenal and terribly nostalgic. Meanwhile, the levels themselves are cleverly designed with remarkable visual themes and challenging boss fights that will test our skills as gamers. I also liked the sound part, which was very apt.

THE SOUR NOTES

I particularly enjoyed Andro Dunos 2, but there are some aspects that could have been handled better. One of these is the boss fights. Some are really deadly and often make you swear and throw your pad in the air. This often jars with levels where, however well designed, the difficulty curve of opponents is reduced to the very simple continuous blasting. More balance would have been appreciated.

I would also have liked to see some extra modes, multiplayer support and online leaderboards, but instead we only get a boss run mode and a couple

of unlockable bonus rounds... Perhaps too little.

Summing up, it is a game that easily exceeds a full 7. It is worth playing, but it is not perfect.

It's an old-fashioned title perhaps still too much in line with the criteria of arcades where all you had to do was insert the token and nothing more. In domestic platforms we need more substance.

by **Carlo Nithaiah Del Mar Pirazzini**

Steam:

<https://store.steampowered.com/>

PixelHeart:

<https://www.pixelheart.eu/>

OUR FINAL SCORE

» **Gameplay 80%**

Easy to learn, several modes of fire and with good level design.

» **Longevity 75%**

Some bosses are devastating, on the other hand there are levels that are rather easy to deal with.





BRAVE BATTLE SAGA

THE LEGEND OF THE MAGIC WARRIOR

Year: 1996/2022
Editor/Developer: Chuanpu
Platform: Sega Megadrive
Website: <https://www.pixelheart.eu/en/produit/brave-battle-saga-the-legend-of-the-magic-warrior-mega-drive/>

Brave Battle Saga is a role-playing game that alternates between exploratory action phases and turn-based combat phases that you've probably never heard of.

In 1996 it was released only for the Southeast Asian market (Taiwan, China, and little else) and in a uniquely untranslated version.

Only a few years ago (mid-2000s) a few fans translated the rom into English, allowing this title to be enjoyed even by those who, like me, do not speak Chinese.

Brave Battle Saga came out when the fashion for classic Japanese RPGs on consoles was raging. The period of great titles such as Breath of Fire, Secret of Mana or the Final Fantasy saga on Super Nintendo for example. And this title is heavily influenced by these three ludic masterpieces that I mentioned. As we play we will notice that the combat system is similar to that of Breath of Fire, the game world map is set up and explored just as in Secret of Mana and the setting as well as the sprites are reminiscent of the Final Fantasy universe.

However, we are looking at one of the best titles of this genre on Megadrive, and we are amazed how it was not possible to translate it and launch it on the market in 1996.

In spite of all the "copied" content, there is enough original content to make BBS (let's shorten the title that's



better, Ed) a fresh title full of surprises. The game's story holds up well, though





fast-paced, the combats are well-developed, the map is full of places to explore and secrets to discover, there are tons of monsters and numerous non-player characters that in a few minutes we will forget that the game was heavily inspired/pirated by others. It is a very graphically polished title, perhaps reaching peaks that we have seen in other titles for this console, such as Gunstar Hero. Great use of color, so much to think that maybe we have the wrong console, it seems to be on a Super Nintendo machine.

The game world is bright and colorful, full of detail and animated with extreme care. A symptom of excellent knowledge of the machine and how to exploit it properly. Wonderful boss sprites that can also take up a good part of the screen.

The sound aspect, on the other hand, turned out well... but not great! The fight music is decent with a nice rhythm and a with good sound effects, but we find the rest rather generic instead.

Strongly inspired by other titles also the combat system, as we were saying, which makes us learning less difficult and more "friendly." Combat is turn-based, you choose the type of attack/defense/magic and target the enemy who, if not killed immediately, will respond on your character or fellow adventurers (we will be able to expand

the party to a maximum of four elements).

The magic system is interesting because magic can be purchased for any member of the group. Obviously there are characters better suited to casting spells because they have more mana points to cast and others less, but all of them can tend to cast.

The game world is vast and can be revisited over and over again to complete some side-quests or to retrieve some lost items along the way.

In terms of longevity, it is a title that will take about 10 hours to play between basic plots and subplots. It is rewarding and never too difficult, although it requires skill to best combine confrontations.

In short, it is an unknown title for Sega Megadrive that recently went on sale in a "physical" version on cartridge, completed with manual and a well-edited translation by the guys at Pixelheart. If you like the genre it is definitely worth trying.

by **Carlo N. Del Mar Pirazzini**

OUR FINAL SCORE

» Gameplay 90%

Nothing you haven't seen in a game of its kind, but everything works properly and you have fun.

» Longevity 80%

It is not very long but is well structured.





TONY HAWK PRO SKATER 4

Year: 2002
Developer: Neversoft
Publisher: Activision O2
Genre: Alternative Sport
Platforms: PS2, GameCube, PS1, Xbox, Microsoft Windows, Mac OS X, GB Advance, Tapwave Zodiac

Relive the craziest years of adolescence with a joystick, controlling a board, accompanied by a kick-ass soundtrack ranging from AC/DC to N.W.A.

Tony Hawk Pro Skater 4 is not only one of the most awarded alternative sports games of the first decade of the 2000s, but also a key to our memory.

The game features legendary characters in the world of sk8boarding including the legendary Tony Hawk "the king of the vert," Bob Burnquist, Rune Glifberg, Eric Koston, Rodney Mullen and that crazy Bam Margera (Steve-O and Johnny Knoxville's sidekick from the wackiest crew ever "THE Jackass") selectable from the beginning, but also bonus characters "purchasable" during the course of the game.

And so far nothing particularly new compared to previous editions, but then how come THPS4 was considered the turning point within the series? Let's start with the conformation of the game where the user not only unlocks via "Goals" within the game bonus tricks added to the base package, but can customize and "assign" their favorite trick package to their character, making the experience and game play more fluid and comfortable based on their preference and play style.

Another turning point, compared to past editions, is the career mode, whereas in previous editions you had a time limit to find and then perform the quest, in the 4th chapter the developers have thought of making the navigation of the maps more "free" as in a "free skate" mode, giving the player the possibility to choose when to perform one of the 12 quests in each map, which can be activated by interacting with the characters.

Returning to the layout of the game, compared to THPS3 (the previous game, edNith) the maps have been expanded and improved by far, making the game experience more fun and at the same time complex.

This last point brings us to the technical and practical points of game improvement.





OUR FINAL SCORE

» Gameplay 90%

After the first not easy impact with the controls, the game becomes engrossing and as if by magic you find yourself after hours still immersed with the feeling that a handful of minutes have passed.

» Longevity 90%

If we consider only the basic aspect of the quests needed to unlock the maps in the game, the rating would drop significantly. But it would be like giving two brush strokes on a canvas and leaving it 90 percent blank, so to complete the work is definitely a long and winding road.

By expanding and improving the maps, "gaps" (about forty or so per map) have been placed within them on which to perform tricks and combos that confer extra bonuses to the score obtained.

But the most important technical point is the inclusion of "spine transfer" or the ability to make transitions between ramps via a button; something that was not possible in previous versions, making the game much more complex and difficult.

In short, a game that offers much more than just controlling a character on a skateboard. The game as a whole is a complex and intriguing experience to complete 100%, between extra content that can be purchased through bills (collectables within the various maps), additional Pro level quests ended the standard ones, maps to explore and special tricks to acquire. The fun (and frustration XD) is assured.

by Jacopo "Captain" Orlati





NEW GAME

SILVERMAN Y LA ISLA ESMERALDA

Year: 2022
Editor/Developer: Iron Gate
Genre: Explorative Action game
Platform: Amiga
Website: www.xente.mundo-r.com/jojo073/



Where are the cons? There are some level design issues. In some places we will not be allowed to get around the obstacle by going behind houses, some game characters are simply part of the background and it is not possible to interact with them. In-game dialogues are in English and Spanish, and there are definitely very few of them.



It could have been done better. That is the feeling with this title.

If more interaction had been present the grade would be higher and certainly the title more interesting.

This is the prequel to the Silverman saga, this time an action game inspired by classics such as Zelda, set in 1643 where, as Silverman, we will find ourselves searching for a lost treasure.

Too bad because it has a lot of potential and it is also fun to explore the island. The title is available for free in adf format and you can contact the developer by email to have it sent to you.

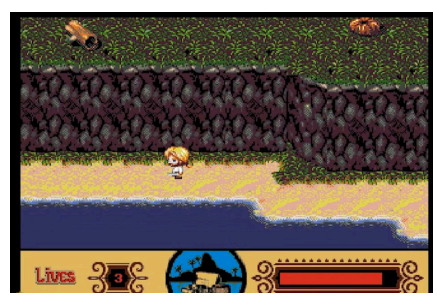

It is an easy title to learn. You use only the fire button on the joystick with which we can fight and interact with the characters on the screen. Graphically I found it neat and it makes excellent use of the Amiga's colors. Atmospheric soundtrack. On the technical side nothing to complain about.

A final note on the developer. The Iron Gate guys have made some other rather interesting titles, and we invite you to view them.

OUR FINAL SCORE

These include the excellent The Lone Ranger or 1987 Escape from Berlin.

» Gameplay 85%
 It is nice and the adventure has strong potential.

by **Giampaolo Moraschi**

» Longevity 60%
 Some basic things of this kind of game are missing: interaction with the environment and interaction with the characters.





NEW GAME

EMPIRE STRIKES BACK



The Empire strikes again! And it really has to be said! Forty years after its release for Atari 2600, Megastyle reissues an updated and revised version of this classic that was so successful on the Atari console and Intellivision (hardware described by Leonardo Miliani in this very issue!).



Games dedicated to Star Wars on the Commodore 64 are certainly not lacking, but no one had yet repurposed one that resembled the Parker brothers' masterpiece. At last, even owners of the breadbin will have the chance to fully enjoy a version almost identical to the original, in fact definitely improved.

The graphics have been completely revised to do justice to the capabilities of the Commodore 8-bit. The opening screen alone is worth the wait for the loading, it is beautiful and evocative. But it is just the icing on the cake. In fact, one only has to take a look at the presentation screens of the game to understand that the enemies are

much more numerous than in the original version. In the Parker brothers' game, in fact, we impersonated Luke Skywalker who, aboard a snowspeeder, had to protect the rebel outposts on the planet Hoth from the attack of the giant AT-ATs. In this case the scenario does not change, but the number of enemies is enriched with Probe Droid, Viper Droid and AT-ST.



We will have to work really hard to defeat the Empire and get through all eight levels unscathed and get to the final sequence. Oh, I forgot, the shots fired by the Imperial forces on the C64 are much more insidious than the original ones... Probably the Empire, over the past 40 years, has sent stormtroopers to adjust their aim...

In conclusion I can only say that the wait is definitely worth it. Download this game, which besides being well made also has the merit of being completely free, and... May the Force be with you!

by **Francesco Fiorentini**

Year: 2022

Editor/Developer: Megastyle

Genre: Shooter

Platform: Commodore 64

Website: [https://](https://megastyle.itch.io/esb-by-megastyle)

megastyle.itch.io/esb-by-megastyle



OUR FINAL SCORE

» Gameplay 85%

It is graphically well done, fast, playable and enjoyable!

» Longevity 80%

Probably in the long run shooting at the same targets could get boring, but you'll definitely want to complete it before putting it aside. However it is suitable for a game every now and then.





CRASH TIME PLUMBER

Year: 2016

Editor/Developer: Templeton,
Gamopat Studios

Genre: Platform

Platform: Atari ST, Ste,
Falcon030 /1MB

Website: [http://
www.atarimania.com/game-
atari-st-crash-time-
plumber_30834.html](http://www.atarimania.com/game-atari-st-crash-time-plumber_30834.html)

As a kid in the 1980s, I grew up with characters like Donkey Kong and Mario. I loved those kinds of games, they entertained me and required skill and memory.

My first contact with Donkey Kong was on one of those wonderful Nintendo Game & Watches. Beautiful. Then my life went through Mario Bros, Popeye and many other titles.

On ST we had wonderful single-screen platformers like Bubble Bobble, Rodland, Bomb Jack...

Crash Time Plunder ironically takes us back to that period.

This is a conversion of Dr.Floyd's PC title of the same name. An extremely well done port for STe.

The game is based on a crazy story. We will play as Dr. Floyd and be forced to go back in time, to 1983 to be precise, and have to prevent the infamous Crash of the Video Games Market. Not an easy task since Mario and Donkey Kong have joined forces and kidnapped all the most famous Atari games characters to make way for the Nintendo Entertainment System.

Crazy story aside, we are looking at a good title. From the beautiful "old



school" graphics reminiscent of all the historical characters of the period.

On the Atari Ste version we also have beautiful 8-way parallel scrolling on 3 levels, lots of colors and graphic effects and perfect animation speed. Everything runs smoothly. Perhaps one of the modern titles for Ste with the best graphics compartment.



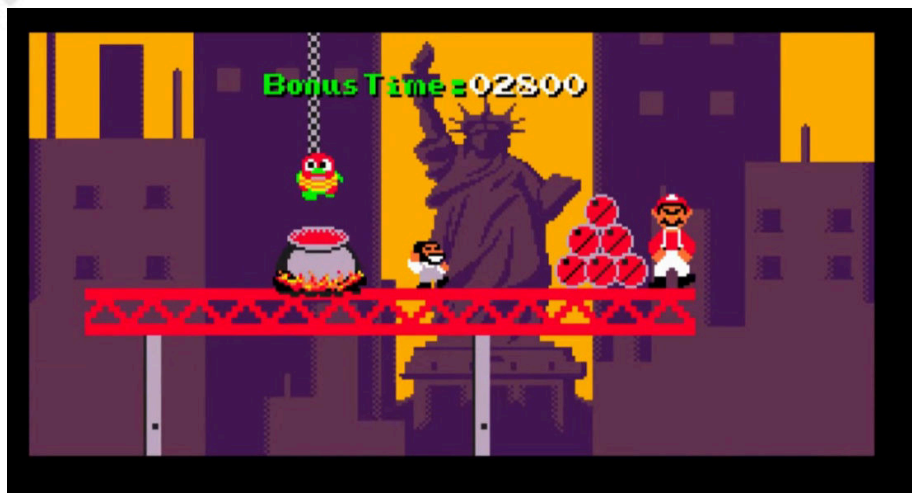

Minimalist and not at all annoying sound that becomes effective in dealing with game levels. It does its dirty work.

As we said this is a Donkey Kong clone. You start in the lower area of the level and will have to climb the platforms until you reach the upper area to save our friends. All of this while avoiding the rolling barrels. But there is more. In the delirium of the level Donkey Kong will occasionally appear and try to hinder our ascent by throwing bananas at us.

Upon reaching the top, however, you will find that the platform is unreachable. In order to get there we will have to load all the hearts on the screen and, via a balloon, reach the top.

So, in the end, we will have to avoid bananas and barrels, grab as many hearts as we can to become able to jump higher, save our friends, and all this in 120 seconds!

There are 10 levels, and I assure you that it is not easy to reach to the end. The first two levels are a breeze, with the difficulty gradually increasing. After the first level, the speed of the barrels already increases, Donkey will throw

more bananas at us, and there will be numerous surprises.

This is a title that requires skill, precision and sharpness of eye. Perfect for old players.

In conclusion.

I really loved this title. On a technical level it's a great product, and on the playability/longevity level we have an almost perfect balance.

An original idea, highly recommended for arcade classic fanatics.

by **Giampaolo Moraschi**

OUR FINAL SCORE

» Gameplay 90%

Easy to learn with excellent levels of gameplay. Crazy but well-developed story.

It requires manual dexterity and a keen eye.

» Longevity 90%

It's not an easy title, but it's damn funny.





NEW GAME

BABYLON'S ARK

Year: 2021
Editor: Protovision
Developers: Frodewin, magicgretel, Roman Werner, Logiker, Matsha
Genre: Adventure
Platform: Commodore 64



The last humans have fled the polluted, semi-deserted earth and they now live in a giant, state-of-the-art spaceship.

It is a huge, gigantic ship, ready to start for a long voyage.

And there is always something going wrong inside that the robot mechanics cannot repair.

It's up to Samuel Fox, the "handyman", to solve problems and talk to everyone on the ship... A crazy and unusual combination of people hiding several surprises.

Babylon's Ark is a nice little project. An old-fashioned adventure where there is a lot to do. Talking to people, interacting with visual elements and trying to solve the adventure that is narrated to us throughout the game.

A title that looks to the genre's past and features a heavy dose of humor



and sarcastic jokes. It often winks at the atmosphere of Star Trek (although in humor it is reminiscent of The Orville) as do some of the characters.

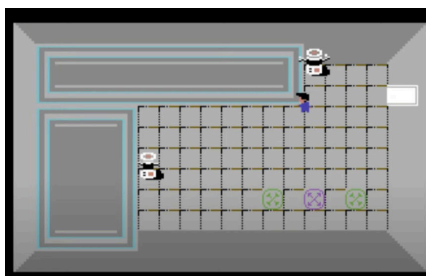

I really appreciated the care of the graphics and the sound (the sound effects are masterpieces), and I must say that it lets you enjoy playing it and is very addictive.

It is finished in about half an hour, and this affects the replayability and longevity of the title a little bit.

You can really interact with any character in the game and with almost any object. And the dialogues are crazy.



A beautiful title that I hope will become a space saga and that we can continue to play the role of Samuel Fox.

by **Carlo Nithaiah Del Mar Pirazzini**

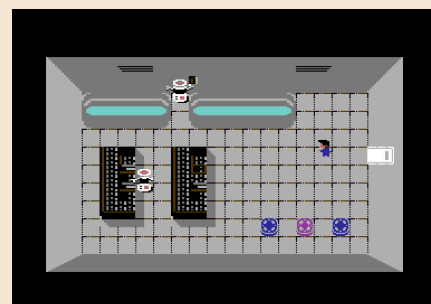
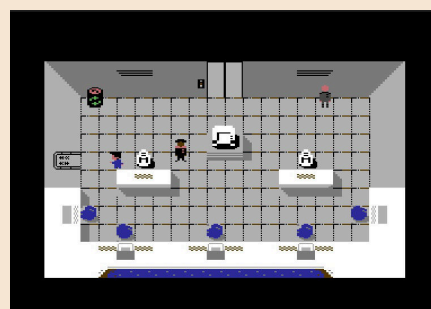

Website: <https://frodewin.itch.io/babylons-ark-c64>

OUR FINAL SCORE

» **Gameplay 80%**
 Simple to learn and with a good narrative that is easy to carry on. Beautiful dialogues.

» **Longevity 60%**
 Just Sufficient. It is a title that can be finished in half an hour in an enjoyable way. Let's hope for future episodes.





NEW GAME

GELATINO 2

Year: 2021
Editor: Physical Dreams
Genre: Platform/Puzzle
Platform: MSX

Email address:
 fisicadreamsgames@gmail.com

The Physical Dreams group in Barcelona led by José Luis Salguero is always super active in producing new titles for MSX systems.

The first Gelatino saw the light in 2020. A very likeable and playable arcade platformer.

This sequel features some new game stages and a more intense system than the first title.

Also present are new characters from other team games (Zorrico, Paco el Bombas) who will provide help during the game.

The product is well packaged and very well maintained on the technical side.

The aim of the game is to free our imprisoned friends and escape the level while avoiding monsters and deadly traps.



Simple game system and a very good difficulty curve.

I find it really very neat.

by Carlo Nithaiah Del Mar Pirazzini



OUR FINAL SCORE

» **Gameplay 85%**
 Simple and straightforward.

» **Longevity 80%**
 Gradual difficulty curve.





KNIGHTMARE II THE MAZE OF GALIOUS

Year: 1987 original version – 2022 MSX2 Enhanced version
Editor/Developer: Konami 1987 / Martinez, Madurga, Galvez, Valburg 2022
Genre: Platform
Platforms: MSX, Nintendo NES – MSX 2 versione 2022

When Konami released Knightmare II: The Maze of Galious for the MSX on April 18, 1987, we were in the midst of a period of action-adventure games. Gamers on the MSX platform and the Nes were craving games with "deeper" gameplay. A year earlier, in 1986, Japan had gotten its hands on The Legend of Zelda, Metroid and Dragon Quest, which mixed action with role-playing. But also 1986 offered gamers amazing things like Sunsoft's Atlantis no Nazo, a game very similar to Galious.

Knightmare II is a middle ground, an awkward blend of the role-playing game aspects of Zelda, the setting of Metroid, and the puzzles of Japanese RPGs of the period.

The story picks up right after Knightmare: Popolon and Aphrodite, having just defeated the "Dark Lord", return to their home and find it invaded by demons. Worse, the evil priest Galious has stormed the gates of heaven and kidnapped our heroes' yet-to-be-conceived son (!). Popolon and Aphrodite will have to reclaim the castle, one level at a time before they face the ultimate villain and retrieve their future offspring.

The player can control both Popolon and Aphrodite, who have similar abilities and powers. The former can break boulders faster and jump a little higher, but cannot swim; Aphrodite, on the other hand, jumps to a constant height and can shoot more projectile

weapons than her beloved. The player can switch between characters at any time.

Although the game is a platformer, it has a structure that is very reminiscent of The Legend of Zelda. The entrances to the ten dungeons are hidden inside the castle, which functions in the same way as the overworld in the Nintendo game.

Heroes gain stamina and skills by defeating bosses, and will be able to upgrade their items during the quests. Enemies release coins that can be spent in stores or items that will help our heroes continue the adventure. Killing opponents will increase the experience indicator, which, when at its maximum, will recharge health. Like Zelda before, Galious turns each of its ten dungeons into a kind of mini-quest that will culminate in a battle against the "Great Demon" of that

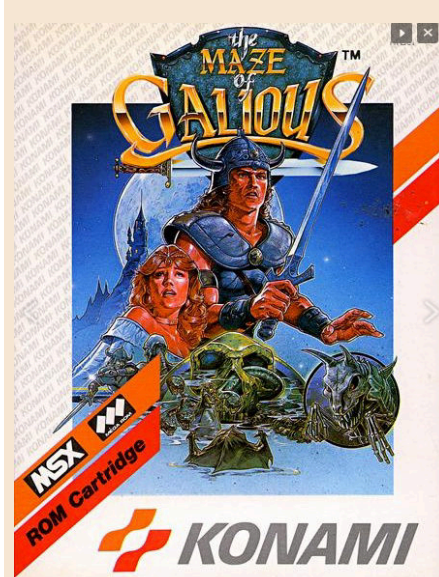



OUR FINAL SCORE

» Gameplay 90%

A nice mix of platformer and gdr in all its incarnations.

» Longevity 87%

A tough title that requires skill but is easy to play. The Enhanced version is beautiful and deserves to be discovered.

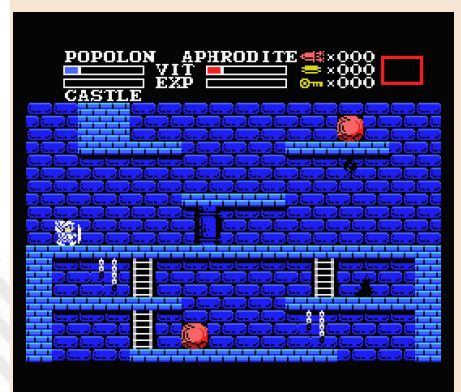
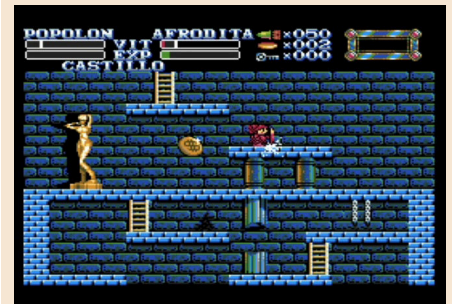
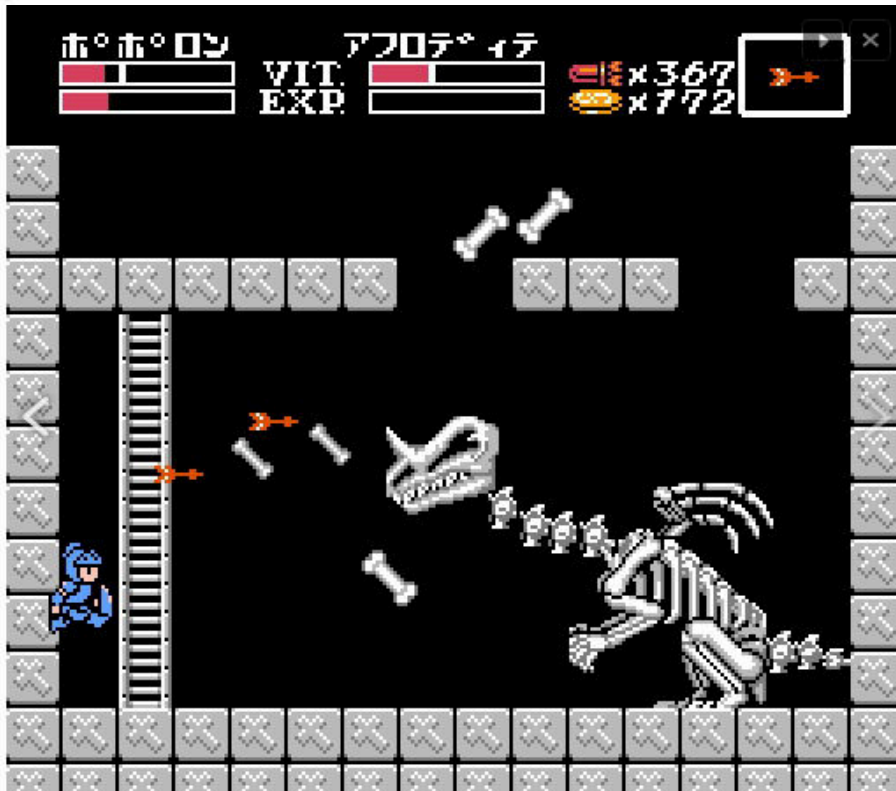

world. Each dungeon contains three hidden items that will serve to help the player: The cloak, which reduces damage; the stirrup, which grants unlimited ammo during boss battles; and the holy water, which halves hit points.

Using a magnifying glass, the player can inspect the various tombstones scattered throughout the dungeon until one of them detects one of ten spells written in Hebrew, e.g., Elohim, Yomar and HaMelech. Typing the correct spell in a room will summon the end-of-level Boss.

That's right, in this game it is spelled out! Although Galious allows the use of the controller on MSX, it makes frequent callbacks to the keyboard, which probably turns out to be a better command system in some situations. The port for the NES, was released 4 months later and is "easier" to play. It is more of a remix than a direct porting. The NES hardware allowed scrolling and larger, more detailed sprites. There is a dedicated jump button and the controls are simplified. Although half

the dungeons of the MSX game are present, these are significantly larger and more labyrinthine.

The game in both versions achieved good success and several fans, so much so that an Enhanced version for MSX2 was released a few days ago.

A work that is not just an improved version of the original title, but a new game.

Technically, a superb job was done on coloring, fixing the animations and setting beautiful backdrops.

The game is free to download at the address you will find here in the review and is in ips format which will need to be patched to the original rom file for MSX.

It may not be the most beautiful Konami title, but it is a good game in all its incarnations.

by **Roberto Del Mar Pirazzini**

Website: <https://github.com/bladeba/MSX/tree/master/Enhanced%20Games/Galious%20-%20enhanced>





THE LEGEND OF ZELDA

THE MINISH CAP

Year: 2005

Editor/Developer: Nintendo-Capcom-Flagship

Genre: Action RPG

Platform: Game Boy Advance

It is common knowledge that Legend of Zelda is one of Nintendo's flagship titles, a staple since the first title was released in 1986.

When I was little, my father played it on the 8-bit Nintendo, the Nes.

In 2001 Nintendo released for the Game Boy advance (my first console) a new "portable" adventure of Link. Inspired by the success of the two Zelda titles for Game Boy color (Oracle of Ages and Oracle of Seasons) this beautiful The Legends of Zelda: The Minish Cap was born.



The story is simple as it is in the series, telling of a period of darkness, the rise of a hero to defeat evil, and the subsequent sealing of this dark evil so that Hyrule can enjoy a period of serenity and peace.

After this brief story, players are welcomed into a wonderful world of colorful pixels that is Link's home, where, once again, he is awakened and sent on an adventure. The enemy this time is the terrible Vaati (who was featured in the Zelda Four Swords games), this time in a deadly form who wants to unleash absolute evil on Hyrule. It quickly becomes apparent

that Link and his new friend/hat Ezlo will aim to disrupt the evil one's plans by tracking down the elusive Picori, better known as Minish.

I was immediately impressed by the art style and character design. The world is incredible and vibrant, full of life. Very rich in detail. The look of the game is reminiscent of Link's adventure on Game Cube (refers to The Wind Waker, EdNith).

Another gem (or rupee!) is the in-game sound and music. Although it is not directed by Zelda theme creator Koji Kondo it is in the very capable hands of Mitsuhiko Takano, who brings wonderful new arrangements to the classic world of Zelda. There is a great atmosphere in the game that mixes the epicness of classical music with the darker tones crafted by Takano. Minish Cap has commendable gameplay, with a snappy and responsive combat system. My only

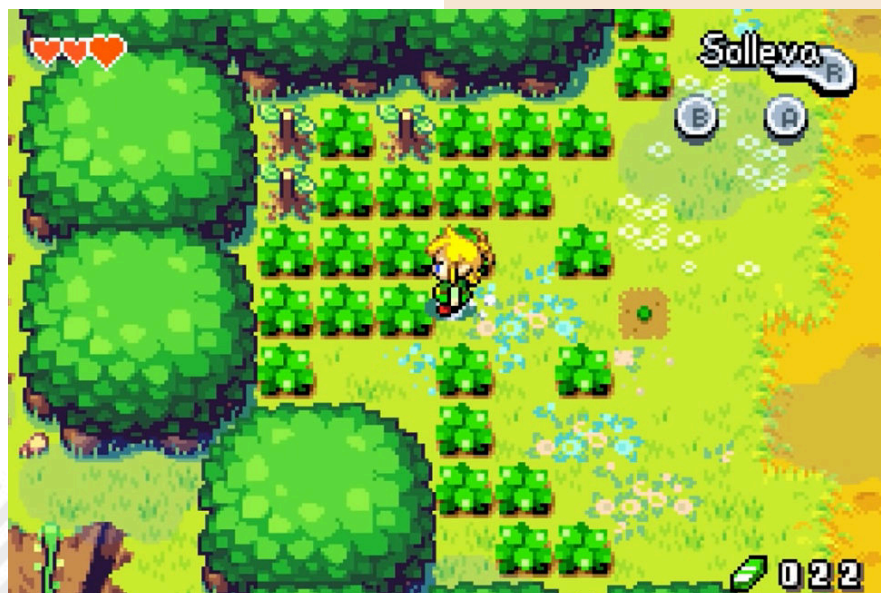



criticism is the return of the inventory system present in previous titles. Players can use A and B as inputs, having only two items assigned at a time.

I understand the limitations of the GBA, but it becomes tedious to pause to shuffle items, especially when we are exploring and when fights become more complex. Fortunately, the dorsal keys allow for the return of rotational control, a method of travel that I preferred for most of the game.

Now, Minish Cap looks delightful, sounds delightful and plays beautifully, and although the story is simple, the puzzles for which the series is known are still present and well-calibrated. As Link explores Hyrule and the world of Minish, he must, of course, overcome the challenges presented in the game's various dungeons.

The title follows the standard progression: find the dungeon, find specific legendary items for puzzles and bosses, earn the heart piece and, in this title, items to reforge the legendary sword. The six dungeons, although lovingly crafted, lack inspiration and tend to be something "already seen." Compared to other titles, I expected something more. It lacks that final effect and that gratifying "AHA!!!" you get when you finish a quest. This

I did not feel. Also, most of the mazes are quite short.

However, although the dungeons seem "simple" the rest of the world to explore is not and is very evocative.

In the end, however, it is still a beautiful adventure in the magical world of Zelda, graphically inspired and with some tedious flaws in the gameplay, but a fine title.

If you have not tried it in the past, I recommend that you retrieve it and play it.

by **Ingrid Poggiali**

OUR FINAL SCORE

» Gameplay 90%

It is a Zelda title. Inspired and well constructed with some limitations due to the menu system and inventory selection.

» Longevity 70%

The dungeons are simple and uninspired.

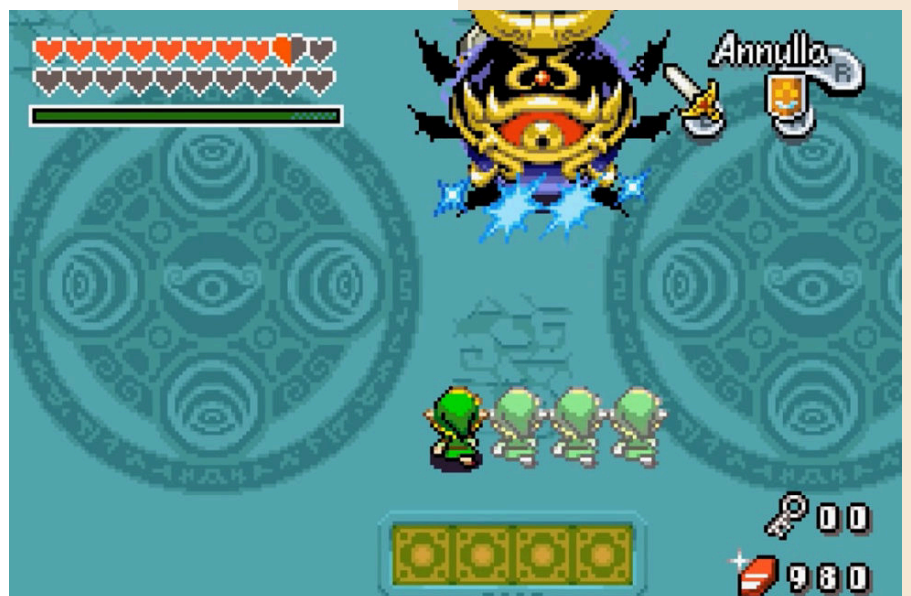



LUPO ALBERTO THE VIDEOGAME – ANNIVERSARY EDITION

Year: 1990/2022
Editor: Idea Software/Lupo Alberto The Videogame
Genre: Platform
Platform: Atari ST
Website: https://www.dropbox.com/s/tvtq5scp1u4eybx/Lupo_ST-Win.zip

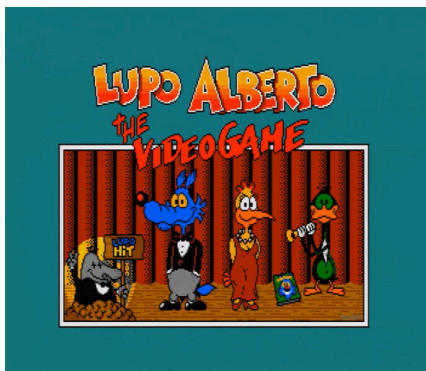

The making of Lupo Alberto The Videogames was a battle against time constraints.

The Idea Software team worked tirelessly throughout the middle of 1990 in order to present this title by the Christmas vacations of that year. Reading the video game's fb page (<https://www.facebook.com/Luca.dSd8/>), the developers tell us how difficult it was to conclude everything and how the game was "closed" the night before the presentation conference.

The Amiga version was unveiled on November 30, 1990, and a few weeks later arrived the Commodore 64 version. It was quite successful in terms of sales and gameplay.

Excellent reviews were written at the time for this fun platform game.

Among the versions under

development, the one for Atari ST, which was ready but remained locked in some drawer, was missing.

The game was finished without the backdrop scroll and without the end-of-level vignettes, but it was definitely ready for launch.

Launch that came 32 years later, thanks to this version also called Fun 4 Fans.

The game is still the same as in 1990, a variable-direction scrolling platformer where Lupo Alberto and Marta must traverse a path to finally succeed in secluding themselves.

This new version features some unreleased hidden characters (one of which makes Yuk Yuk!) and an unreleased one based just on the Atari ST version.

The game is fun and flows smoothly. It belongs to that typical world of the early 90s and is appreciable by fans of Lupo Alberto (which I remember, was very fashionable in Italy) and also by fans of traditional, quiet platform games.

A game to be tried again and play.

by **Giampaolo Moraschi**

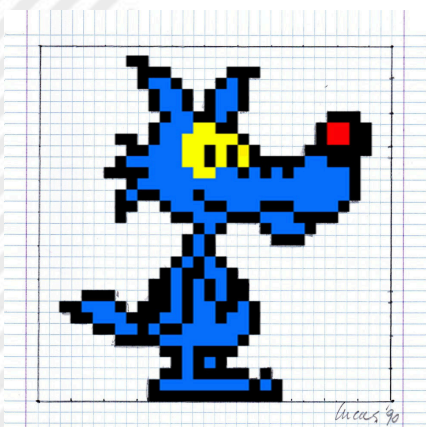

OUR FINAL SCORE

» **Gameplay 85%**
 A nice classic-style platformer with a good game system.

» **Longevity 80%**
 It should not be underestimated in some places and is definitely enjoyable in its hours of play.





SUMO FIGHTER: TOKAIDO BASHO

Year: 1998
Editor: Epoch
Genre: Driving game
Platform: Game Boy

What a piece! Yet another addition to my collection of rarities!

It is an easy-to-play title that will keep you attached to the Game Boy screen or in emulation.



It doesn't require too concentration; it is a crazy and relaxing title. Graphically curated and with funny sound.

Find it, play it, and you will not regret it!

by Barbara "Morgana" Murgida



I still get excited today when I get these cartridges in my hands that never get tired.

And I missed this Sumo Fighter; as soon as it arrived I immediately put it in the GBA!



Released only in Japan and America. Guys, the American artwork is terrible!



But at least they didn't twist the gameplay like they did with other titles!

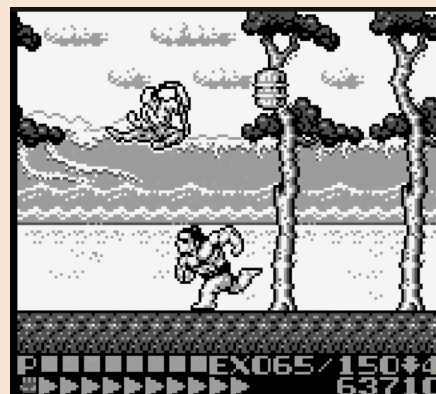
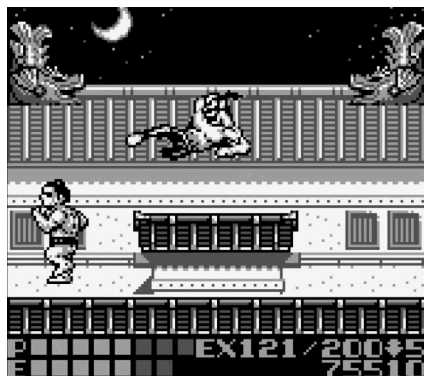

It is a platform, beat 'em up, action-adventure... Our Sumo-boy will have to face the various enemies he encounters on his way in 2D and by breaking rocks he will collect "bowls" "fans" and Japanese treats (I assume it's ste things).



OUR FINAL SCORE 📏

» **Gameplay 75%**
 Very simple, not very varied but well done.

» **Longevity 80%**
 It sounds like a piece of cake, but you have to put in a lot of effort to complete it.





CORYOON

The Pc Engine was the console par excellence for "cartoon" style shooters.



Coryoon (name of the little dragon protagonist) falls into this category and immerses us in a "Kawai"-style gaming experience but with solid old-generation shooter underpinnings. The story tells us about the little dragon Coryoon intent on freeing his friend, the princess, from evil.

Our "chubby" hero hurls himself through eight colorful levels chock-full of more or less friendly but determined pets and creatures. The little dragon starts off by shooting paltry flames, but is capable of charging a large flame the moment no key is pressed, although not very powerful compared to the choreographic effect.

He will be helped by storks carrying in their beaks a sheet containing a number of differently colored spheres (three colors).

Each different type of sphere has different types of firing. The types of firing are standard: motive wave, expansion firing and multiple firing.

In each stage, in addition to the storks, a flying hen appears, which, if hit, will cause a tiny dragonlet to appear at Coryoon's side that will act as a pod

with an additional shot and follow him for the rest of the level.

This is completed by a series of special bonuses that can modify our scaly hero (shield fairies, shrinking effects, etc...).

The first thing you notice when playing this title is the care and neatness of the graphics and in-game action. It is lightning fast and chock full of objects on the screen.

Slowdowns are minimal and this can be attributed to the excellent work of the Naxat group in making the game levels. The graphic designers have created a cheerful and crazy world embellished with a good number of parallax levels. The various bosses and mid-bosses have good designs and range from comical interpretations of various animals to mythological creatures.

The theme music is cute and rather catchy, not intrusive.

If we really want to look for the nit in the (dragon's) egg, we can notice after a while, a certain drop in "inspiration" in the appearance of some levels from the middle of the game onward. Not to mention the final level being the usual "boss rush" already seen in a hundred thousand other games of the genre; but these are venial flaws, compared to the solid game structure, proven gameplay and the good technical compartment.

A linear, simple and fun game that is worth playing.

by **Roberto Del Mar Pirazzini**

Year: 1991

Editor/Developer: Naxat Soft

Genre: Shoot em up

Platform: PC Engine



OUR FINAL SCORE

» **Gameplay 85%**
Solid and proven gameplay.

» **Longevity 80%**
Good level of difficulty but not so much variety after mid-game.



TUSKER

Year: 1989

Developer: System 3

Genre: Action

Platform: Commodore 64

We have once again reached this year's appointment with Milan's infamous thirty degrees. Punctual as usual, although right in the middle of the city center the heat is felt all year round, except of course on rainy days and when there is the famous Milanese fog. This heat had already hit me during one of my retro forays, playing a game whose first level is set right in a desert, where we have to survive by looking for water... Don't ask me how, since I never went to a desert personally, however, with Tusker from System 3, I did! Right from there the game will start, alone against everyone and against thirst in the middle of nowhere!

Tusker was an underrated game and some even called it the bad copy of Indiana Jones; which, in my humble opinion, is soon disproved as the game progresses. Our adventurer decides to embark on this adventure after the mysterious death of his father and, thanks to documents found in his study, discovers possible places to fill the gap left by his parent.

The game is a directional scrolling, consisting of three levels with fixed screens; three levels might seem few, but in fact they are very vast, full of enemies, both human and animal and from different eras. There are also many items to collect both for combat, such as guns and daggers, and for survival such as flasks, compasses and other things that can be combined. Learn how to quench your thirst in the desert by combining the knife and canteen near a cactus with the caution not to drink the water at the first source in the forgotten temple, as it may be poisoned.

The game mechanics, apart from a few minor imperfections, are approachable and assimilable already

after the second game. The accompanying sound is worthy of being set as a phone ringtone or alarm clock.

At the time System 3 gave us two little gifts: the first was to include in the game manual many useful tips to get through the first level; one I have already mentioned, is how to get water, since the scarcity of it is one of the most dangerous enemies. The second little gift is the one I enjoyed the most; the ability to continue indefinitely from the level where you were defeated and with all three lives at your disposal!

What to say more.

Explore and explore! Leave no object behind, visit every screen and avoid the one where there are two air horns that are very difficult to dodge because if they hit you, you will lose all your energy in one shot. Also be very careful when you pick up the gun, because the enemies in the first level will be allowed to decapitate you with a clean slash!

As I said, there are three levels, the first one is set in the desert, the second one in an indigenous village, and finally the third one in a forgotten temple.

The finish line of the adventure is the famous elephant graveyard (all these challenges, matches with death and thirst, for a pile of bones?).

It is definitely a game worth to be played, because although short, it is fun and atmospheric. Once finished you will still want to replay the whole adventure, this time without squeezing your brains, since you will already know it by now. With the hope that this premature heat will spare you and your machines, I look forward to seeing you in the next issue of RMW! by **Daniele Brahimi**

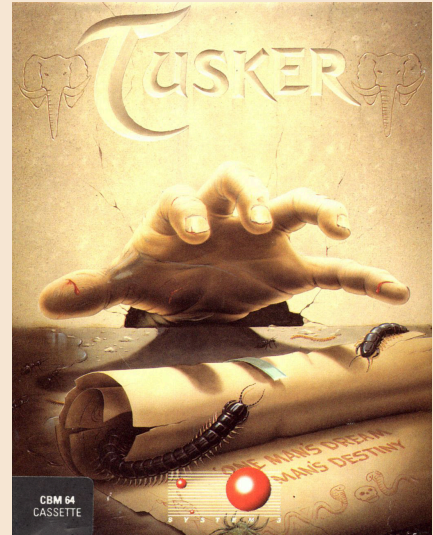

OUR FINAL SCORE

» Gameplay 75%

Apart from a few small imperfections, it works

» Longevity 70%

Three levels don't seem to be too much... But in Tusker they are enough!





Due to layout design constraints, part of the cover image remains hidden.

We felt it was a shame not to share with you Giuseppe's excellent work. So here it's the full version!

Artwork by **Giuseppe Mangini** inspired by the game **The Nightland**.



Ladies and Gentlemen, we need you!

So the fateful day has come, RetroMagazine World is going big!

You already know why; if not, it means you missed or skipped Francesco's editorial completely and that's just not good! Yes, I do understand the urge to immerse yourself in reading this (yet another) great issue of your favorite magazine, but like Mom used to do when bedtime came, I don't want to hear any stories, off to read!

Well, yes, RetroMagazine World becomes a cultural association.

The reasons that prompted us to take this step have already been described by Francesco in the editorial above, so I will not repeat everything, aware that better than he did, it is not possible to explain. This is a historic event, in our small way. Not a point of arrival, indeed, but an event that prompts me to want to share with you just a couple of things, which concern you readers but also us, who have the pleasure and honor of writing in this wonderful magazine.

1. Starting with looking at us, allow me a mighty virtual pat on the back to my esteemed colleagues. Bravo!!! And thanks, too! If you, the reader, every month can count on the release of this great magazine, chock-full of articles, in-depth features, reviews and so much more, it is thanks to the passion, commitment and enormous expertise (the latter mostly of my colleagues, I'm just a videogames nut) that we all put into its production. And yes, also an abundant dose of love for all that world that includes computers, consoles, video games, programming, all preceded by that "Retro" that makes us sigh so much.

Let me also say a personal thank you, from the latest (if not the last, among the last) who, thanks to the great work done over the previous years, has for the past few months had the enormous pleasure of scribbling talking about the video games of the heart, thus realizing one of those little dreams that remained parked there for a long time.

2. Now it is to you dear readers that I am addressing. Consider this a rallying call, it is time to show all your support, perhaps even accompanied by a massive dose of affection. It is time to join! Nothing compulsory guys/gals, let me be clear, your favorite magazine will always be the one you know well, beautiful and totally free.

My appeal has nothing to do with the vile money, by now I think it is clear that it is not what drives us to work on RetroMagazine World every month. Then let's face it, we have so much money that we wouldn't even know where to put it.

No, it's about that pat on the back I was talking about just above, an encouragement from our readers, a virtual gathering of like-minded enthusiasts who, in addition to often being a wee bit grown-up, have a high percentage of pixels running through their veins.

Gathering that then, who knows, might even become real.

Yes because what will be raised through membership will be used solely for the realization of projects that have been rattling around in our heads for some time, including perhaps a physical gathering, why not, where we can finally face each other, discuss amiably and challenge each other to this or that game. In this regard and for the avoidance of doubt, I will say it now: in Sensible Soccer you have no hope.

At the risk of being repetitive, I want to emphasize once again that RetroMagazine World will remain absolutely free. I emphasize this so as not to risk a major misunderstanding, as stated the magazine will be usable by you all/and regardless of membership or not, but also to reiterate that around here profit really doesn't matter.

The only thing we want is to be able to write about our passions, addressing those like you who share them, nothing else. That is how it is and always will be.

Add to this the fact that the cards, strictly physical, are absurdly beautiful. I have seen them, and trust me, just by keeping one in your wallet (or wherever you prefer, the important thing is to always have it!) you will feel a power in you that you have never felt before, a mixture of cross-flows and a DeLorean whizzing by at 88 miles per hour, all accompanied by an amount of style on the levels of the Goblin King, just so we understand each other.

Yes I know, you are all already there wondering how to join, I understand, but fear not: you will have all the information you need to be able to do so in due time, any of you faithful readers deserve it. After all, if we have come this far, it is only because of you, and trust me, this is only the beginning! To next issue, brothers and sisters!

Beppe Rinella

Disclaimer

RetroMagazine World as an aperiodic magazine entirely ad-free is a non-profit project and falls off any commercial circuit. All the published material is produced by the respective authors and published thanks to their authorization.

RetroMagazine World is licensed under the terms of: **Attribution-NonCommercial-ShareAlike 4.0 International** (CC BY-NC-SA 4.0) <https://creativecommons.org/licenses/by-nc-sa/4.0/>

This is a human-readable summary of (and not a substitute for) the license. You are free to:

Share — copy and redistribute the material in any medium or format

Adapt — remix, transform, and build upon the material

The licensor cannot revoke these freedoms as long as you follow the license terms. Under the following terms:

Attribution — You must give appropriate credit, provide a link to the license, and indicate if changes were made. You may do so in any reasonable manner, but not in any way that suggests the licensor endorses you or your use.

NonCommercial — You may not use the material for commercial purposes.

ShareAlike — If you remix, transform, or build upon the material, you must distribute your contributions under the same license as the original.

No additional restrictions — You may not apply legal terms or technological measures that legally restrict others from doing anything the license permits.



RetroMagazine World
Year 3 - Issue 15 - JULY 2022

Chief Editor
Francesco Fiorentini
Managing Editor
David La Monaca
Editing Manager
Marco Pistorio
Web Manager
Giorgio Balestrieri

