

**CDL**



**ROTH SUGAR BUSH**  
MAPLE SUGARING EQUIPMENT

# 2024 CATALOG





# CDL WISCONSIN

## Roth Sugar Bush, Inc

### Maple Equipment and Syrup

656 Tower Drive Cadott, WI 54727  
(715) 289-3820 Fax: (715) 289-3821

Hello Fellow Sugarmakers,

Hopefully this catalog finds all of you happy and healthy and ready to MAKE SOME SYRUP! With the 2024 season almost upon us we here at CDL Wisconsin/Roth Sugarbush Inc. are ready to help you with all of your sugaring supplies.

We have closed our Luck, WI location but would like to thank John and Crystal Morley for all of their time and hard work with the store, we wish them nothing but the best.

We here at our Cadott location along with our sub-dealers throughout the state are here to help you get ready for this upcoming season. We have added a new sub-dealer to our CDL family. We welcome Scott & Erica Walter to our CDL Team! They are located in Viola, WI and are stocked and ready for the 2024 Maple Syrup Season, as are all of our other sub-dealers; Jim Adamski in Antigo, WI., Tony & Roger Bundy of Eau Galle, WI., Emanuel & Owen Hershberger in Caston, WI., Don Hansen in Taylor Falls, MN and Tim & Amber Woodrow in Aitkin, MN.

The maple industry still has a very high potential for growth. With energy costs, labor shortages and production costs on the rise technology is playing a large part in this growth. Our service technicians have made many trips to Canada for advanced training on all CDL equipment and the technology that goes along with it.

Although technology is more and more present in sugarbushes we never forget where it all started, tapping a few trees in the back yard. So, whether you are tapping those few trees, have a small family size operation, or a large-scale operation, you ALL are very important to us!

Our annual Open House will be held again this year the first full week in February. The dates are set for Wednesday February 7<sup>th</sup>, Thursday February 8<sup>th</sup>, Friday February 9<sup>th</sup> and Saturday February 10<sup>th</sup>. Coffee and donuts start at 8:00am and a complimentary lunch will be served daily. As always, we will be offering a 5% cash and carry discount. Please call ahead with any orders to help with your wait time. We will be having seminars and guest speakers during our open house, please watch our website and facebook page for updates on them.

We sincerely thank you for your continued support.

Peter & Dawn Roth

**Annual Open House at our Superstore in  
Cadott, WI. February 7th, 8th, 9th & 10th, 2024  
8:00 AM to 4:00 PM each day**

**Please visit our website and sign up for our Email Newsletter.**

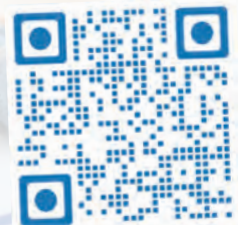

Please Scan for  
Open House  
Seminar Schedule



# Signature SPOUTS

## MINIMUM RESTRICTION

The 45° angle facilitates sap flow and prevents residues or unwanted bacterias from accumulating.

## PERFECT SEAL

Resin conforms to the shape of the tap hole and adheres to the bark.

## SPOUT LENGTH SUITS ALL BARK THICKNESSES.

Thin wall maximizes sap flow while minimizing tree damage.

## THE PERFECT CHOICE FOR YOUR SUGARBUSH

### 5/16" *Signature* SPOUTS



Clear  
66045064



Blue  
66045063



Pink  
66045066



Red  
66045065



Light Blue  
66045068

We recommend the use of the 1/4" drill bit for tapping with 1/4" Signature spouts and the 5/16" drill bit for tapping with 5/16" Signature spouts.

## MAXFLOW MAXFLOW SPOUTS WITH BARBS

5/16"



White  
66090517



Black  
66090516

Note : we recommend the use of a 19/64" drill bit for Maxflow 5/16" tapping



Please scan the QR Code for more information and prices.

rothsugarbush.com



# MAXFLOW

## THE SOLUTION TO PREVENT MICRO-LEAKS

### BETTER GRIP ON TUBING!



The line of 5/16" Maxflow fittings was specifically designed and developed for maple producers wanting to operate **over 25 in-hg (high vacuum)**. These fittings enable a perfect seal with a vacuum level beyond 25 in-hg and offers the following advantages:

- > No parting lines on the first barb.
- > Precision moulding.
- > Eliminates micro-leaks caused by molding lines.
- > Better grip on the tubing.

### MAXFLOW TEES



5/16" health T  
660300099

Compatible with all 5/16" spouts and caps 66030517 and 66030519



5/16" T with pin  
66301099

For use with 66030515 and 660630514



5/16" multi-function T  
660300096



5/16" Maxflow with multi stage pin  
66304099

### MAXFLOW END OF LINE TEES



5/16" end of line health T  
66306357

Compatible with all 5/16" spouts and caps 66030517 and 66030519



5/16" end of line T with pin  
66305099



5/16" multi stage Maxflow end line T  
66305357

### 5/16" MAXFLOW CONNECTORS



5/16" flat hook connector  
66303099



Quick connector  
6601209902



Maxflow multifunctional end of line adaptor  
66267099

### END OF LINE ADAPTORS



5/16" black Y 66014099



5/16" sliding adaptor ETMAT316C



5/16" sliding hook ETMAT316CH



5/16" end of line hook 66279099

### PLUGS



5/16" Rubber plug 6603509905



Health spout pin 66012099



End-line ring ERA1400





**BUCKET SPOUTS**



5/16" bucket spout | Blue 660552



7/16" white bucket spout 66055000A1



7/16" bucket spout Stainless steel 660555



7/16" Spout without hook Aluminum 660557



5/16" Spout without hook Aluminum 660555

**BUCKETS**



2-gallon grey plastic bucket 663054



2-gallon green plastic bucket 663052



3-gallon green plastic bucket 663051



2-gallon blue plastic bucket 663050



3-gallon blue plastic bucket 663053



2-gallon aluminum bucket TMT90010

**COVERS AND ACCESSORIES**



Galvanized cover for 2-gallon bucket 66660



Green plastic cover for 2-gallon bucket 663058



Blue plastic cover for 2-gallon bucket 663059



Green plastic cover for 3-gallon bucket 663057



Blue plastic cover for 3-gallon bucket 663055



Wire for galvanized cover (25/Pkg) LIDWIR



Galvanized bag holder 69BUCKET0102



Blue sap bag 663032



Clear sap bag clearbag

**STARTER KITS**

**TAPPING STARTER KIT - 12 TAPS**



**Includes:**  
 1 tapping bit 7/16"  
 12 hookless spouts 7/16"  
 12 galvanized bag holders  
 12 blue sap bags  
 easy to follow instructions

12 tap bagholderkit

**TAPPING STARTER KIT - 15 TAPS**



**Includes:**  
 1 short tapping bit 5/16"  
 15 bucket spouts 5/16"  
 15 plastic buckets (2 gallon)  
 15 galvanized bucket covers  
 1 CDL aluminum tapping hammer  
 1 aluminum spout remover (15")  
 (color of bucket may vary)

6600800



**Includes:**  
 1 tapping bit 5/16"  
 4 hookless spouts 5/16"  
 4 galvanized bag holders  
 5 blue sap bags  
 2 sq. ft. cheesecloth  
 1 maple sugaring book  
 easy to follow instructions

4 tap bagholderkit



**Includes:**  
 100' 5/16 blue tubing  
 5 clear tubing spouts 5/16"  
 4 health t 5/16"  
 2 end line adaptors 5/16"  
 easy to follow instructions

begintubingkit



Please scan the QR Code for more information and prices.



## 3/16" TUBING



	LENGTH	PRODUCT CODE	WARRANTY
Blue	500'	431610021	8 year
	1 000'	431608221	8 year
Green	500'	431608025	8 year
	1 000'	431608225	8 year

## 3/16" PLIERS



3/16" compact insertion tool with 4WR vise-grip and lateral knife

6623157



Mini 3/16" installation pliers with adjustable automatic pressure and cutter

6623156



Mini 3/16" installation pliers with adjustment screw

66515

## 3/16" SPINSEAL FITTINGS



3/16" BLUE SpinSeal Fitting

66091041

3/16" BLACK SpinSeal Fitting

66091049



9/64" CDL drill bit for 3/16" SpinSeal Fittings

66964

## 3/16" MAXSEAL MULTI-FITTINGS /FIXED HEAD

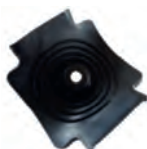

Maxseal single gasket

66091C

Screw kit not included



Screw Kit

66099099



3/4" Maxseal Multi Fitting

66096395

1" Maxseal Multi Fitting

66097395

## 3/16" FITTINGS



3/16" clear spout

*Signature*

66045316

We recommend the use of a 5/16" drill bit for tapping



3/16" white spout with barbs

**MAXFlow**

66090316

We recommend the use of a 19/64" drill bit for tapping



3/16" end of line hook

66279357



3/16" fl at hook connector

66303357



5/16" - 3/16" fl at hook connector

66303356



3/16" - 3/16" - 5/16" health T drop line

66030355



3/16" health T

66030357



3/16" health T end of line

66030358



5-16" - 5/16" - 3/16" health T drop line

66030356





# SpinSeal™

TECHNOLOGY

**CDL EXCLUSIVE**

Save from \$1.80 to \$3.45 (CAD) per lateral line compared to all other systems in the industry.

## THE SPINSEAL TECHNOLOGY

### THE CDL WAY TO SAVE TIME AND MONEY.

Based on an average of 250 fusions per day, your SpinSeal™ System will pay for itself in just two weeks.



**MADE FOR:**

- > Repair hole(s), caused by animals on CDL HD, Spinseal, Fusion or Rapi tube tubing;
- > Plug old 5/16" multi-fitting holes and allow conversion to Spinseal system on CDL HD, Spinseal, Fusion or Rapi tube Pipe;
- > Plug Spinseal holes that are not used anymore.

## DEWALT A SURE VALUE!

SpinSeal welder  
Includes: 1 battery, 1 charger and carrying case. 730100



SpinSeal tool 1" mainline insert. Can be used with a compact fitting tool. Facilitates the installation of the 5/16" tubing on your spinseal fitting. 730115

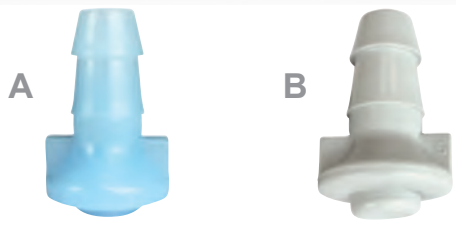

**A** 5/16" BLUE SpinSeal Fitting 66091061

**B** 5/16" GREY SpinSeal Plug 66091059



5/16" SpinSeal drilling template with drill bit 730101



7/32" CDL drill bit for 5/16" SpinSeal Fittings 66732

**Warning:** SpinSeal technology was developed for use on pipe manufactured and distributed by CDL. The use of these technology on pipes manufactured and distributed by other companies can be very risky and won't be covered by the warranty.



**BEST PRICE/QUALITY RATIO IN THE INDUSTRY!**



**FLEX**

- > FLEX
- > Flexible at all temperatures
- > Resists falling trees
- > The best translucency
- > Excellent elastic memory
- > Maximum leakproofness



**VISION**

- > FLEX / SEMI-RIGID
- > Ideal for straight and long laterals
- > Good translucency
- > Good elastic memory
- > Keep its properties over the years



**MAX**

- > SEMI-RIGID / RIGID
- > Less curvature and better hold in low density sugarbushes
- > Ideal for installations where the distance between maple trees is very large
- > The least expensive of the 5/16 CDL tubing line
- > Interesting quality vs price ratio



**BLUE**



**GREEN**



**SHADOW GREY**

	RIGIDITY	CODE	WARRANTY
5/16" CDL Flex	Flex	451610001	10 year
5/16" CDL Vision	Flex / Semi-rigid	451610021	10 year
5/16" CDL MAX	Semi-rigid / Rigid	451605011	

	RIGIDITY	CODE	WARRANTY
5/16" CDL Flex	Flex	451610005	10 year
5/16" CDL Vision	Flex / Semi-rigid	451610025	10 year

	RIGIDITY	CODE	WARRANTY
5/16" CDL Flex	Flex	6600144010	10 year

**SAP LADDER FITTINGS**



5/16" 6-way star 66180

1/2" MIPT



5/16" 3-way star 66183

1/2" MIPT



Double forks 1/2" 66031099

Double forks 3/4" 66032099

Double forks 1" 66033099



INS X INS X INS  
3/4" 66074099

1" 66075099

1" x 1" x 3/4" 66066099

1-1/4" x 1-1/4" x 1" 66034098

**PRECUT DROPS**

- > 10 year warranty
- > Completely clear for an optimal visibility.
- > Unique plastic recipe with UV stabilizers
- > Packaged in bundles of 100 units.



36" 6600100036





Products manufactured by  **CDL**

Choose CDL's quality!

**HD (HIGH DENSITY)**

- > 100 PSI
- > Superior quality high density resin
- > More rigid than the low density | Light tubing

**10-YEAR WARRANTY!**

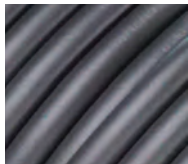

**BLACK  
HD**



**BLUE  
HD**

	500'	403410069	403410061
<b>3/4"</b>	1 000'	403410269*	403410261
	2 500' spool	403410169*	403410161*
	500'	410010069	410010061
<b>1"</b>	1 000'	410010269	410010261
	2 000' spool	410010769	410010761*
	500'	411410069	411410061
<b>1 1/2"</b>	1 000'	411410269*	411410261*
	1 000' spool	-	-
<b>1 1/2"</b>	500'	411210069	411210061



401210049-150

1/2" LD Black Mainline Tubing - 150' Roll



You can use this tubing for side tying your mainline

**MAXSEAL MULTI-FITTINGS / FIXED HEAD**



3/4"	66096096
1"	66097096
1-1/4"	66098096
Maxseal single gasket	66091C

Hole diameter: 31/64".  
Screw kit #66099099 not included.

**MULTI-FITTINGS / FIXED HEAD**



3/4"	66096099
1"	66097099

Hole diameter: 5/16".  
Screw kit not included.

**MULTI-FITTINGS / PLUG**

IDEAL TO REPAIR HOLES IN MAINLINES OR PLUG HOLES WHEN YOU CHANGE THE LOCATION OF A MULTI-FITTING.



3/4"	66094034
1"	66094091

Screw kit not included.

Screw kit	66099099
-----------	----------

**MULTI-FITTINGS / SWIVEL HEAD**



1-1/2"	66064099
--------	----------

Hole diameter: 5/16"



**RAPI-FIX TENSION STRAPPING**

Black	200'	66300099
-------	------	----------



## PRUNO TOOLS FOR SPOUTS AND TUBING



Designed to easily install the 5/16" on SpinSeals or any other straight fittings

6623161



Blade for 5/16" tubing remover pliers

66500



5/16" compact insertion tool with lateral knife and tubing stretcher

66559



5/16" compact insertion tool with lateral knife

66558



Blade for compact insertion tool

665579



5/16" compact insertion tool with 4WR vise-grip and lateral knife

66557



5/16" tubing butt remover without blade

664954



3/16" compact insertion tool with 4WR vise-grip and lateral knife

6623157



5/16" compact insertion tool 30° to 115° with cutter  
Ideal to install Signature spouts and every other CDL spouts

664958



5/16" compact insertion tool 30° to 115°  
Ideal to install signature spouts and every other CDL spouts

664959

## PRUNO TOOLS FOR TUBING



Repair pliers with automatic tension and tubing stretcher

6623160



Mini 3/16" installation pliers with adjustable automatic pressure and cutter

6623156



Mini 3/16" installation pliers with adjustment screw

66515



5/16" installation pliers with adjustment screw

6623158



Repair pliers with adjustment screw with knife and tubing stretcher

66501



Deluxe double automatic tubing tool with cutter and tubing stretcher

662153

## PRUNO WIRE GRIPPER



Spring loaded wire gripper

667068

## PRUNO SUPPORT HOOKS



Kit with 2 aluminum hooks for mainline level

66902

*\*Level not included*



Please scan the QR Code for more information and prices.



## PRUNO PUNCH



5/16" mainline punch	66185
31/64" mainline punch	661851
5/16" drill bit and handle	66185P
31/64" drill bit and handle	661851P
31/64" only drill bit	664979*

\* Product available in limited quantity.

## PRUNO FLOW STOPPER TOOL



Flow stopper tool with adjustment screw	66499
---	-------

## PRUNO TUBING WINDER

- Swivel hook
- Lightweight, adjustable and foldable (for shipping and storage)

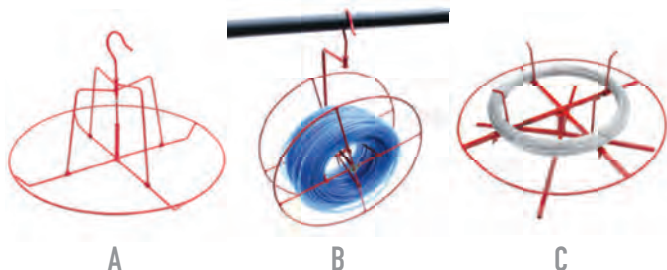

<b>A</b> Horizontal for 3/16" and 5/16" tubing	660411
<b>B</b> Vertical for 3/16" and 5/16" tubing	660410
<b>C</b> Wire winder	66041

## PRUNO MAINLINE DOUBLE FORK PLIERS



1" and 3/4"	662191
1-1/2" and 1"	66219
1-1/4" and 1"	662194
1-1/2" and 1-1/4"	662195
2" and 1-1/2"	662192
3"	662193
3/4" to 2" Kit	662196



Please scan the QR Code for more information and prices.

## WIRE TIES



### REGULAR (18 GA)

5"   1 000/pkg for 3/4" tubing	660851
6"   1 000/pkg for 1" tubing	660861
7"   1 000/pkg for 1 1/2" tubing	660871
8"   1 000/pkg for 1 1/2" tubing	660881
10"   1 000/pkg for 2" tubing	660811

## TENSION GRIP



### REGULAR

3/4"	663098	1"	663099
1-1/4"	663097	1-1/2"	663096
2"	663095	3"	663089

### HAUTE TENSION

#12,5	ETBR012.5HT	50 lb	
-------	-------------	-------	--

### LASHING WIRE

	Stainless steel 1 200'	660660
	Medium gripple 10-14 GA	665503
	Large gripple 7,5-10 GA	665505
	Jumbo gripple 10-12,5 GA	665511
	Repair wire #9 (orange)	662000
	Repair wire #10 (black)	662001
	Repair wire 3/16"	662003
	Repair wire for 1/4" cable	662004
	3/8" hook tensioning screw	667073
	Galvanised steel ratchet	ETMRAT01
	Ratchet handle for wire	ETMRAT02

### WIRE TOOLS



CDL wire bender  
650 kg 667079



Permanent wire gripper  
for path crossing 667066



Crimping tool 665701



High tension wire cutter  
Cuts high carbon wire easily 73069



"Contractor" pliers for gripple  
installation 665504



Light clamp for gripple 665522



Manual wire twister 66090



Automatic wire twister 66091

### THE FIRST CHOICE OF WOODSMEN!



661174 661172 661177 661179

### TOOLS FOR TUBING



30" Drop line cutter 668086



36" Drop line cutter 668089



40" Drop line cutter 668088

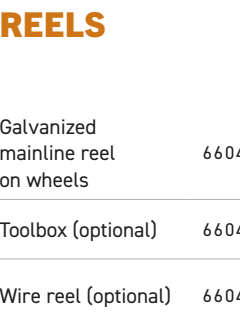

5/16" Drop line pliers 66496

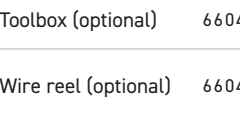

3/16" Drop line pliers 66497

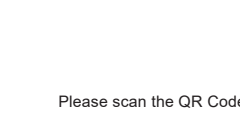

Pliers 5/16" aluminium  
foam sleeves 68049

### REELS

Galvanized mainline reel  
on wheels 660416

Toolbox (optional) 660417

Wire reel (optional) 660418



Please scan the QR Code for more information and prices.





**PREMIUM QUALITY  
4-SEASON TAPE**



- High Quality durable marking tape with great durability
- Designed to withstand the 4 seasons: sun, rain, wind and cold
- Specialized for sugaring and forestry industries
- Fluorescent color increases visibility in the forest:

Orange	661015
Pink	661016
Yellow	661018
Blue	661017



Sighting hand level 666566



The Forestry Pro II laser rangefinder/hypsometer  
Accurate distance measurer with improved capability and accuracy. Faster response time. New function to store up to 250 results. Compact ergonomics and ease of use.  
6606420

**PLIERS FOR SPOUTS AND TUBING**



3/16" Compact insertion pliers  
Icebreaking jaws 73067



Compact insertion pliers  
Icebreaking jaws 73062



Aluminium binder 30" 68044



3/4" to 1-1/2" tubing cutters 63001



5/16" nut driver 660911

**An even larger selection!**  
Many other models in store to answer all your needs and budget, check it out!



3/16" tension hooks 669103



5/16" tension hooks 669104

*Makes forest repairs much easier by keeping the 5/16" (or 3/16") line handy when cutting.*



Repair pliers for 3/16" tubing ETPTR0316C



FISKAR pliers 63FISK



Please scan the QR Code for more information and prices.

## CDL DRILL BITS - HIGH PERFORMANCE



CDL'S DRILL BITS ARE SOLD IN A PROTECTIVE CASE TO ENSURE A PERFECT EDGE!

- > High precision sharpening
- > Developed to maximize cutting accuracy in frozen and semi-frozen wood
- > No cutting burr
- > Developed for maximum performance in sugar maple and red maple trees

17/64" drill bit	66252
19/64" drill bit	66259
1/4" drill bit	662414
5/16" drill bit	662516
7/16" drill bit	66257

## WORK APRONS



- A Cruiser tapping vest Orange Cruiser Vest
- B CDL work apron 66934

## SPOUT REMOVERS



A Steel spout remover	66077
Aluminum spout remover   Small   15"	68015
Aluminum spout remover   Medium   22,5"	68020
B Aluminum spout remover   Long   30"	68030
Aluminum spout remover   X-Long   40"	68040

## BRUSHES FOR BUCKETS AND SPOUTS

	For 1,5-gallon bucket	72940020
	For 2-gallon bucket	72940031
	For 7/16" interior spout	72940041
	For 7/16" interior spout	663562
	For 5/16" - 19/64" spout	663563

## TAPPING ACCESSORIES

	CDL tapping hammer Aluminum handle	73064
	2 face tapping hammer Aluminum handle	68041
	Tapping hammer with blade Aluminum handle	68042
	12" wooden tapping hammer	729254045

## BACKPACK CLEANING KIT

COMPACT, LIGHTER, COMFORTABLE AND SPECIFICALLY DESIGNED FOR MAPLE SUGARING.

Specifically developed by CDL for work under vacuum.

	Backpack cleaning kit with harness and dozer	661616
	Backpack cleaning kit with harness, without dozer	661612
	Dozer gun only, 10 to 20 ml	661698



Please scan the QR Code for more information and prices.





Branon Systems, LLC

# PRECISION TAPPER

## PROFITABILITY STARTS FROM TREES!

### PREVENT

- ✓ Damaged drill bits
- ✓ Inconsistency
- ✓ Oval holes
- ✓ Holes tapped too deep

### GET RID OF

- ✓ Vacuum loss
- ✓ Production loss
- ✓ High labor cost
- ✓ Unhealthy trees

SCAN TO SEE THE VIDEO

[bit.ly/cdlvideos](https://bit.ly/cdlvideos)



**PERFECT TAP,  
PERFECTLY  
AIRTIGHT.**



**PERFECT ANGLE AND  
TAP HOLE DEPTH**



**EXCLUSIVE**



Precision Tapper™ kit  
Includes: 1 drill, 2 batteries, 1 carrying bag and 1 precision template.  
\*Tapping bit adaptor not included.

663970



Precision Tapper™ adaptor  
Installation included on your drill.  
\*Drill bit not included.

663971



Drill bits adaptors

	(1/2"-20 UNF)	(9/16"-18 UNF)
1/4"	6639714	6639714-1
19/64"	6639964	6639964-1
5/16"	6639716	6639716-1

[rothsugarbush.com](https://rothsugarbush.com)



### CONNECTORS



INS x INS

3/4"	662034
1"	662035
1 1/4"	662037
1 1/2"	662038
2"	662039
3"	662033

### REDUCERS



INS x INS

1" x 3/4"	665580
1 1/4" x 3/4"	665586
1 1/4" x 1"	665581
1 1/2" x 3/4"	665587
1 1/2" x 1"	665582
1 1/2" x 1 1/4"	665599
2" x 1"	665596
2" x 1 1/4"	710150
2" x 1 1/2"	665583
3" x 2"	6655302

### ADAPTORS



MIPT x INS

1/2" x 5/16"	664555S
1/2" x 5/8"	710563
3/4"	665589
1"	665592
1 1/4"	665591
1 1/2"	665590
2"	665593
3"	660003

### TEES



INS x INS x INS

1/2"	660503
3/4"	7134341
1"	6607527
1 1/4"	6603106
1 1/2"	6603105
2"	6603108
1" x 1" x 3/4"	660505
1 1/4" x 1 1/4" x 3/4"	660317
1 1/4" x 1 1/4" x 1"	6605061
1 1/2" x 1 1/2" x 3/4"	660507
1 1/2" x 1 1/2" x 1"	660506
1 1/2" x 1 1/2" x 1 1/4"	730312
2" x 2" x 3/4"	660508
2" x 2" x 1"	730311
2" x 2" x 1 1/4"	730314
2" x 2" x 1 1/2"	660511
3" x 3" x 1"	660520



INS x INS x MIPT

1"	66075251
1 1/2" x 1 1/2" x 1"	730308



INS x MIPT x INS

3/4"	7134341S
1"	660515
1 1/4"	66031066
1 1/2"	66031056

### Y



INS x INS x INS

1/2"	6607531
3/4"	6607507
1"	6607501
1 1/4"	6607510
1 1/2"	6607508
2"	6607509
3"	6607522
1" x 1" x 1 1/2"	6607524
1" x 1" x 3/4"	660751
1" x 3/4" x 3/4"	660752
1 1/4" x 1" x 1"	6607511
1 1/4" x 1 1/4" x 3/4"	6607518
1 1/4" x 1 1/4" x 1"	6607512
1 1/2" x 1" x 1"	66075191
1 1/2" x 1 1/4" x 1 1/4"	6607515
1 1/2" x 1 1/2" x 3/4"	6607520
1 1/2" x 1 1/2" x 1"	6607516
1 1/2" x 1 1/2" x 1 1/4"	6607505
2" x 2" x 3/4"	6607514
2" x 2" x 1"	6607513
2" x 2" x 1 1/4"	6607519
2" x 2" x 1 1/2"	6607503
3" x 3" x 1"	66075130
3" x 3" x 1 1/2"	66075128
3" x 3" x 2"	66075129



MIPT x INS x INS

3/4"	66075121
1"	66075122



INS x MIPT x INS

3/4"	66075124
------	----------

**A QUALITY  
THAT MAKES  
ALL THE  
DIFFERENCE!**



### HOOK PLUGS



INS

3/4"	666834
1"	666801
1 1/4"	666114
1 1/2"	666112
2"	666802
3"	666803
4"	666804

### VACUUM ADAPTOR



MANOMETER  
NOT INCLUDED

INS X MIPT X FIPT VACUUM

1 x 1/2"	6655921
----------	---------



**Sharp edges for solid grip, precise machining,  
no restriction, choose CDL quality!**





### COUPLINGS

	1/4"	6010FC025
	3/8"	6010FC0375
	1/2"	6010FC05
	3/4"	6010FC075
	1"	6010FC1
	1 1/4"	6010FC125
	1 1/2"	6010FC15
	2"	6010FC2



### TEES

		FIPT	
	1/4"		712525
	3/8"		6010T0375
	1/2"		711212
	3/4"		713434
	1"		711010
	1 1/4"		6010T125
	1 1/2"		6010T15
	2"		6010T2

### THREADED PLUGS

		FIPT	
	1/4"		SCA025
	1/2"		SCA050
	3/4"		6010BF34
	1"		6010BF1
	1 1/4"		SCA125
	1 1/2"		SCA150
	2"		SCA200
		MIPT	
	1/4"		6010B25
	3/8"		6010B38
	1/2"		6010B12
	3/4"		6010B34
	1"		6010B1
	1 1/4"		6010B114
	1 1/2"		6010B112
	2"		6010B2

### ELBOWS

		90° FIPT x FIPT	
	1/4"		6010914
	3/8"		601090038
	1/2"		601095
	3/4"		6010975
	1"		6010901
	1 1/4"		601090125
	1 1/2"		60109015
	2"		6010902
		90° MIPT x FIPT	
	1/4"		6010913
	3/8"		6010900375
	1/2"		60109S05
	3/4"		601090075
	1"		601090
	1 1/4"		601097
	1 1/2"		601096
	2"		601092
		45° FIPT	
	1/2"		S4E050
	3/4"		S4E075
	1"		S4E100
	1 1/4"		S4E125
	1 1/2"		60109415

### NIPPLES

			
	1/4" close		610151
	1/4" x 3"		601104003
	1/4" x 6"		SNI256
	3/8" close		60150375C
	3/8" x 2"		60382
	3/8" x 2 1/2"		SNI3725
	3/8" x 3"		60150383
	3/8" x 4"		601503754
	3/8" x 5"		SNI375
	3/8" x 6"		SNI376
	1/2" close		60150500C
	1/2" x 1 1/2"		SNI051
	1/2" x 2"		601105002
	1/2" x 2 1/2"		6015150025
	1/2" x 3"		60115003
	1/2" x 4"		601105004
	1/2" x 5"		60111501
	1/2" x 6"		60115006
	3/4" close		60110750C
	3/4" x 2"		601107502
	3/4" x 3"		601107530C
	3/4" x 4"		711005
	3/4" x 5"		711015
	3/4" x 6"		711003
	3/4" x 8"		SNI758
	1" close		60151000C
	1" x 2"		601002
	1" x 3"		60111003
	1" x 4"		711004
	1" x 5"		601110500
	1" x 6"		601110006
	1" x 8"		60118
	1 1/4" close		60111250C
	1 1/4" x 2 1/2"		601112525
	1 1/4" " x 3"		601112503
	1 1/4" " x 4"		711006
	1 1/4" " x 5"		SNI125
	1 1/4" " x 6"		711017
	1 1/2" close		60111500C
	1 1/2" x 2 1/2"		6011150025
	1 1/2" x 3"		60111503
	1 1/2" x 4"		711009
	1 1/2" x 5"		SNI155
	1 1/2" x 6"		601115006
	1 1/2" x 8"		SNI158
	2" close		60152000C
	2" x 3"		SNI203
	2" x 6"		601120006

OTHER LENGTHS AVAILABLE:  
12"-24"-48"-72"-96". CONTACT US.

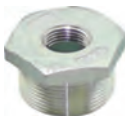

### REDUCERS

			
		FIPT x FIPT	
	1/4" x 3/8"		SC2537
	1/2" x 1/4"		SC5025
	1/2" x 3/8"		SC5037
	3/4" x 1/4"		SC7525
	3/4" x 3/8"		SC7537
	3/4" x 1/2"		SC7550
	1" x 1/4"		SC1025
	1" x 3/8"		SC1037
	1" x 1/2"		SC1050
	1" x 3/4"		SC1075
	1 1/4" x 1/2"		SC1250
	1 1/4" x 3/4"		SC1275
	1 1/4" x 1"		SC1210
	1 1/2" x 1/2"		SC1550
	1 1/2" x 3/4"		SC1575
	1 1/2" x 1"		SC1510
	1 1/2" x 1 1/4"		SC1512
	2" x 1"		SC2010
	2" x 1 1/2"		SC2015
		MIPT x FIPT	
	1/4" x 3/8"		711014
	1/2" x 1/4"		715025
	1/2" x 3/8"		705038
	3/4" x 1/4"		713414
	3/4" x 3/8"		713438
	3/4" x 1/2"		713412
	1" x 1/4"		714014
	1" x 3/8"		SB1037
	1" x 1/2"		711012
	1" x 3/4"		711034
	1 1/4" x 3/8"		SB1237
	1 1/4" x 1/2"		665551
	1 1/4" x 3/4"		714075
	1 1/4" x 1"		714100
	1 1/2" x 1/2"		712050
	1 1/2" x 3/4"		712034
	1 1/2" x 1"		711210
	1 1/2" x 1 1/4"		712114
	2" x 1/2"		SB2050
	2" x 3/4"		711013
	2" x 1"		711020
	2" x 1 1/4"		711225
	2" x 1 1/2"		712015
	3" x 2"		710302

Please scan the QR Code for more information and prices.

### BUTTERFLY VALVES



1½"	60T150
2"	60P88CC2
2½"	60T212
3"	60T300



BUTTERFLY VALVE EPDM GASKET (BLACK BALL)

1½"	60GASKETVALPAP112EPDM
2"	60GASKETVALPAP2EPDM
2½"	60GASKET212EPDM
3"	60GASKETVALPAP3EPDM
4"	60GASKETVALPAP4EPDM

### CLIPS X FIPT FERRULES



1½" x ¾"	6788991D3
1½" x 1"	6788991D4
2" x 1¼"	67THRE2X114ST
2" x 1½"	6598140
2" x 2"	6598142
2½" x 2"	6598141

### ADHESIVES AND TEFLON



A FusionPro tape, 2,5 cm x 3 m (1" x 10')

A 6613001

## BEST QUALITY/PRICE RATIO!

	1"	660848S
	1¼"	660838S
	1½"	660849S
	2"	660843S
	3"	660842S

Heavy duty stainless steel

### QUICK COUPLINGS



COMPLETE SET

¾"	662034SS
1"	662015SS
1¼"	662014SS
1½"	662012SS
2"	662025S

INSERTION PART ONLY

¾"	736650
1"	736651
1¼"	736652
1½"	736655
2"	736656

### CLIPS X MIPT FERRULES



1½" x ½"	66624
1½" x ¾"	736654
1½" x 1"	6788991D1
1½" x 1¼"	770060
1½" x 1½"	770024
2" x 1¼"	60R14SW214
2" x 2"	60R14SW22
2" x 1½"	60R14SW215
2½" x 2"	770049

### CLIPS FERRULES



QUICK

1½"	60R13C112
2"	60R13C2
2½"	60R13C212
3"	60R13C3



HEAVY DUTY

1½"	60R13HC112
2"	60R13HC2
2½"	60R13HC212
3"	60R13HC3
4"	60R13HC

### SILICONE GASKETS FOR FERRULES



1½"	60GASKET112SILI
2"	60GASKET2SILI
2½"	60GASKET212SILI
3"	60GASKET3
4"	60GASKET4

### CLAMPS



Stainless steel

HS-10 (¾")	660822
HS-16 (1")	6608301
HS-20 (1¼")	6608311
HS-24 (1½")	660841
HS-32 (2")	60HAS32



Heavy duty.

For HD mainline

1"	660848HD
1¼"	660838HD
1½"	660849HD



For flexible hose

1½"	660846
2"	660847



QUICK COUPLINGS

POLYETHYLENE

STAINLESS STEEL

PVC

PART A



1/2"	66209005-A	6620102
3/4"	662090075-A	6620107A
1"	662090100-A	6620111
1 1/4"	662090125-A	6620109A
1 1/2"	662090150-A	6620110A
2"	662090200-A	66202A
3"	662090300-A	6620302

PART B



1/2"	66209005-B	6620104
3/4"	662090075-B	6620107B
1"	662090100-B	6620118
1 1/4"	662090125-B	6620129
1 1/2"	662090150-B	6620137
2"	662090200-B	66202B
3"	662090300-B	6620103

PART C



1/2"	66209005-C	6620140
3/4"	662090075-C	6620107C
1"	662090100-C	6620108
1 1/4"	662090125-C	6620109C
1 1/2"	662090150-C	6620110
2"	662090200-C	66202C
3"	662090300-C	6620305

PART D



1/2"	66209005-D	6620106
3/4"	662090075-D	6620107D
1"	662090100-D	6620119
1 1/4"	662090125-D	6620120
1 1/2"	662090150-D	6620133
2"	662090200-D	66202D
3"	662090300-D	6620300

PART E



1/2"	66209005-E	6620141
3/4"	662090075-E	6620112
1"	662090100-E	6620113
1 1/4"	662090125-E	6620114
1 1/2"	662090150-E	6620115
2"	662090200-E	66202E
3"	662090300-E	6620309

PART F



1/2"	66209005-F	6620105
3/4"	662090075-F	6620121
1"	662090100-F	6620122
1 1/4"	662090125-F	6620127
1 1/2"	662090150-F	6620128
2"	662090200-F	6620160
3"	662090300-F	6620306

PART DP



3/4"	662090075-DP	6620130
1"	662090100-DP	6620123
1 1/2"	662090150-DP	6620131
2"	662090200-DP	6620138
3"	662090300-DP	6620311

PART DC



3/4"	662090075-DC	6620134
1"	662090100-DC	6620125
1 1/2"	662090150-DC	6620135
2"	662090200-DC	6620139
3"	662090300-DC	6620144

PART A



PART B



PART C



PART D



PART E



PART F



PART DP



PART DC



REDUCERS | MIPT x FIPT

3" x 2"	63251
---------	-------



BALL VALVES

2"   FIPT	63242
2"   MIPT	63243
2"   3-way FIPT	710156
3"   FIPT	63253



NIPPLES | MIPT x MIPT

2"	63248
3"	63247



GASKETS

3/4"	6607901
1"	6607902
1 1/4" et 1 1/2"	6607903
2"	6607904
3"	6607905

TEES



INS x INS x INS		INS x INS x MIPT	
1/2"	66022	3/4" x 3/4" x 3/4"	678483
3/4"	66023	1" x 1" x 1"	678484
1"	66029	1 1/4" x 1 1/4" x 1 1/4"	678485
1 1/4"	6602801	1 1/2" x 1 1/2" x 1 1/2"	6602804
1 1/2"	66030	2" x 2" x 2"	660331
2"	66033		

INS x INS x FIPT		INS x INS x MIPT	
		3/4" x 3/4" x 1/2"	6602901
		1" x 1" x 1/2"	6602701
		1 1/4" x 1 1/4" x 1/2"	66025010
		1 1/2" x 1 1/2" x 1/2"	6602601

Many other sizes available on our website



Please scan the QR Code for more information and prices.



### A- COUPLINGS WITHOUT RESTRICTION

MIPT x INS	
3/4"	630100
1"	630101
1 1/4"	630102
1 1/2"	630103

### B- ADAPTORS

INS x FIPT	
1/2"	64091
3/4"	64092
1"	64093
1 1/4"	64094
1 1/2"	64096
2"	63230

MIPT x INS	
1/2"	66195
3/4"	64054
1"	64056
1 1/4"	66198
1 1/2"	66199
2"	66200

### C- REDUCING ADAPTORS

MIPT x INS	
1/2" x 3/4"	64053
1/2" x 1"	6605301
3/4" x 1/2"	64058
3/4" x 1"	63200
1" x 3/4"	66089
1" x 1 1/4"	63205
1" x 1 1/2"	63204
1 1/4" x 3/4"	64060
1 1/4" x 1"	64062
1 1/4" x 1 1/2"	63206
1 1/2" x 1"	64064
1 1/2" x 1 1/4"	64066
1 1/2" x 2"	63208
2" x 1 1/2"	63210

### D- NIPPLES

MIPT	
1/4 x 7/8	63021
1/4 x 1-1/2	63023
3/8 x 1-1/2	63068
3/8 x 2	63030
1/2 x close	66082
1/2 x 2	63060
1/2 x 4	63020
3/4 x close	63084
3/4 x 2	63065
3/4 x 3	663232
3/4 x 4	66022
3/4 x 6	6inch
3/4 x 8	630228
1 x close	63086
1 x 2	63070
1 x 3	63018
1 x 4	63024
1 x 6	63025
1 x 10	630251
1-1/4 x close	63088
1-1/4 x 2	63075
1-1/4 x 6	63027
1-1/2 x 1-3/4	63090
1-1/2 x 2	63080
1-1/2 x 4	63028
1-1/2 x 6	63066
2 x 2-1/2	63235
2 x 3	63238
2 x 4	63237
2 x 6	63240
2-1/2 x close	63239
3 x 3	630310
3 x 5	63236
4 x 4	63029
4 x 6	63031

### E- CONNECTORS

INS x INS	
1/2"	66012
3/4"	66013
1"	66014
1 1/4"	66015
1 1/2"	66016
2"	63220

### F- REDUCERS

INS x INS	
3/4" x 1/2"	66069
1" x 1/2"	66066
1" x 3/4"	66065
1 1/4" x 3/4"	66092
1 1/4" x 1"	66073
1 1/2" x 3/4"	66093
1 1/2" x 1"	63175
1 1/2" x 1 1/4"	66078
2" x 1"	63222
2" x 1 1/4"	63225
2 x 1 1/2"	66067

### G- 90° ELBOWS

INS x INS	
1/2"	66045
3/4"	66046
1"	64068
1 1/4"	64070
1" x 3/4"	64073
1 1/2"	64072
2"	66666
3"	66677

INS x FIPT	
3/4" x 1 1/2"	63156
1" x 1 1/2"	64071

### H- CAPS

INS	
1/2"	66076
3/4"	66043
1"	66059
1 1/4"	66060
1 1/2"	66061
2"	66062



### PVC VALVES



BALL VALVES (FIPT)	
1/2"	63100
3/4"	63105
1"	63110
1 1/4"	63115
"	63120
1 1/2"	63125
" 2"	63128
3"	



GATE VALVES (SLIP)	
1"	66175031
1 1/2"	6617504
2"	6617506
3"	6617507
4"	6617509

### STAINLESS STEEL VALVES



BALL VALVES (FIPT)	
1/4"	6617053
3/8"	601438
1/2"	601412
3/4"	601475
1"	6013TBV21
1 1/4"	601414
1 1/2"	601415
2"	6013TBV22



BALL VALVES (INS x INS)	
3/4"	66177075
1"	66177100



BALL VALVES (INS x FIPT)	
3/4"	66178075
1"	66178100



3-WAY VALVES (OSMOSIS)	
3/4"	71017
1"	71014

3-WAY VALVES (STANDARD)	
3/4"	71076W
1"	71077W

### CHECK VALVES



SLIP x SLIP CLEAR PVC	
1 1/2"	6607112
2"	660702
3"	660703

  

FIPT x FIPT CLEAR PVC	
1/2"	660712
3/4"	660734
1"	660701
1 1/4"	660714
"	660715
1 1/2"	660716
" 2"	

### PVC SINGLE UNION VALVES



FIPT x FIPT	
1"	6618100
1 1/2"	6618101
2"	6618102

SLIP	
1"	6618103
1 1/2"	6618104
2"	6618105

### PVC RIGID PIPES \*Price per foot



Sold in 8' length

CLEAR

1 1/2"	6625601040
2"	6625801040

\*Price by foot

### PVC FLEXIBLE HOSES

#### HOSES



1/8" CLEAR THIN WALL

3/4"	6600300
7/8"	660078*
1"	66004001
1-1/8"	660112*
1 1/4"	664507

Not recommended for vacuum (maximum 30 PSI)  
\* Use on CDL reverse osmosis

1/4" CLEAR THICK WALL



3/4"	660030012001
1"	660040012001
1 1/4"	660050992001
1 1/2"	660060992001
2"	66149

Can be used with vacuum (50 to 60 PSI maximum) Maximum 24 inches of mercury.

#### HOSES



CLEAR FLEXIBLE VACUUM

3/4"	66450512
1"	6645051
1 1/4"	664504
1 1/2"	664505
2"	6614922
3"	664503

FLEXIBLE HIGH PRESSURE



3/4"	66243
1"	6600400
1 1/4"	6600500
1 1/2"	66006099200
2"	661491

100 PSI and more (pressure)  
For pressure pumps

## CDL INTELLIGENCE STARTER KIT

Possibility to add-on other CDL Intelligence products over the years based on your growing needs

**The CDL Intelligence starter kit includes:**

ITEM NUMBER : 21090-EN

5 single vacuum sensors



1 gateway



1 controller (mini-pc)



1 HD monitoring screen  
1 wireless mouse + keyboard



## OUTDOORS



**Our technology has been tried and tested for almost a decade. Our sensors are automatically recharged by solar energy, so no battery changing required.**

**Vacuum sensor (single)**

**A** Remotely measure the vacuum in one master line and see the ambient temperature in the woods. SE100-V

**Vacuum sensor (double)**

**B** Remotely measure the vacuum in two master lines and see the ambient temperature in the woods. SE100-V-2

**Communication gateway V2**

**C** Ensures that information is transmitted between the wireless vacuum sensors and the control hub. SG100-V2

**Qi wireless charger and AC/DC adaptor PG200 assy**

**D** Induction charger for the portable gateway. 22201A

**V2 antenna deportation kit (20 ft)**

**E** 21072

## INTERFACE

4.0 MEGAPIXEL PAN & TILT WIRELESS IP CAMERA

**MONITOR EASILY AND REMOTELY KEY OPERATIONS OF YOUR SUGARBUSH.**



20210

**CDL Control base**

Microcomputer required to run your CDL Intelligence system on your devices (computer, tablet, smartphone).

21082A



rothsugarbush.com

Please scan the QR Code for more information and prices.



## MECHANICAL EXTRACTORS



15"			21"			20"					
INLETS			INLETS			INLETS					
12" x 12"	4 x 1-1/2"	750 taps	121208	12" x 18"	4 x 1-1/2" 2 x 1"	3 000 taps	121808	12" x 24"	8 x 1-1/2"	4 000 taps	122408

The specified measurement is the distance between the base of the extractor and the center of water entry.

## MOISTURE TRAPS/High Vacuum



<b>A</b>	CDL 2" moisture Trap	6610508
	CDL 3" moisture Trap	710605
<b>B</b>	Electric option	667282
<b>C</b>	CDL 3" high vacuum moisture trap - mechanical/electric	661710607

## GAUGES



### A Vacuum

2,5" 0-30 HG SS 64011SS

4" 0-30 HG SS 66120SS  
3 % precision



### B Vacuum

2,5" 0-30 HG PA254L-V00

## Submersible Extractors



		INLETS	CAPACITY AT 27" HG	
12" x 24"	1/2 HP (120V)	6 x 1"	2 400 taps	1224ES
18" x 36"	1/2 HP (240V)	8 x 1-1/2"	3500 taps	1836ES
18" x 36"	1-1/2 HP	8 x 1-1/2"	7500 taps	1836ES15
18" x 48"	1 x 2 HP Low pressure	8 x 2"	12 500 taps	2048ES2LP
18" x 48"	2 x 2 HP Low pressure	8 x 2"	25 000 taps	2048ES2DLP

Pressure gauge not included

Many sizes and voltages available



Submersible conversion kits available.

# CDL HIGH VACUUM SAP LIFTER KIT

**THE NEW OPTION TO SOLVE FREEZING, MECHANICAL AND LEAK PROBLEMS IN A REVERSE SLOPE APPLICATION.**

- Different models available depending on the type of power supply and the elevation of the terrain.
- Designed without leaks for high vacuum.
- Electric or propane heating depending on the model.
- 100% insulated gray plastic shelter of superior quality for weather resistant function.
- Small access door for visual inspection and large access door for maintenance or washing.
- Shelter floor with slight slope and bottom drain
- Adjustable ventilation hatches
- Reversible mainline entrance
- Horizontal blue PVC tank with stainless steel legs and transparent covers for better durability and vision of the water level
- Stainless steel hardware and quick connections



## RAISED SUPPORT FOR SAP ELEVATOR

**THINK OF A RAISED SUPPORT TO PREVENT THE SAP ELEVATOR FROM ENDING IN THE SNOW IN SPRING (NOT INCLUDED).**



738120

### AVAILABLE MODELS:



**12 V solar model**  
200 to 700 taps\*.  
Heating with a safe propane pilot  
(propane tank not included).  
73800012V1P



**230 V Electric models**  
Heating with a ceramic heating element  
(75W 220-240V).



From 300 to 1 000 taps*	From 600 to 2 000 taps*	From 275 to 875 taps*	From 1 000 to 2 400 taps*
1 pump	2 pumps	2 pumps	1 pump
7380002301P	7380002302P	7380002302P-HP	7380002301P-HP

\* Depending on your application, height, vacuum level and model chosen.

## SAP LIFTERS



Simple sap filter



300 taps

73015



**DIAPHRAGM VACUUM PUMPS (IDEAL FOR SMALLER PRODUCERS)**

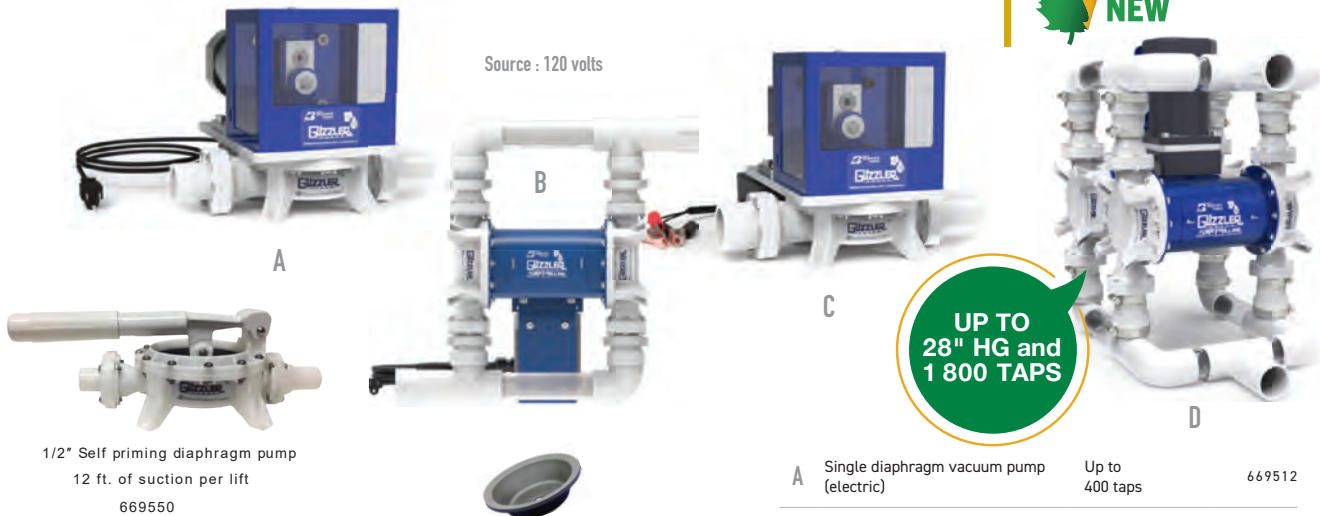

1/2" Self priming diaphragm pump  
12 ft. of suction per lift  
669550

Replacement diaphragm  
G500SK-13

We offer a complete list of parts for the Guzzler Pumps on our Website

**OIL FOR RECLAIMERS**



High vacuum oil,  
18.9 L  
Grade 32 663532



**HIGH VACUUM OIL FOR AIRTECH AND CDL VANE PUMPS**



Vane pump oil ISO 22 3.78 L 6635378

**VACUUM OIL FOR VANE PUMPS**



Vacuum oil, 10 L  
Grade 60 663549  
Ideal for CDL and pump  
without reclaimers



**CDL HIGH PERFORMANCE VANE VACUUM PUMP**



**DESIGNED FOR UP TO 29,9" HG!**

Available from  
0.5HP to 10HP, single or 3 phase motor  
Available in 208-460V, 120v/240V

**ADVANTAGES**

- > Compact and quiet
- > Very low maintenance
- > Very reliable
- > High performance
- > Competitive pricing

**SCAN TO SEE THE VIDEO**  
[bit.ly/cdlvideos](http://bit.ly/cdlvideos)



Contact your CDL sales representative to find out which pump is right for you!

<b>A</b>	Single diaphragm vacuum pump (electric)	Up to 400 taps	669512
	Double diaphragm vacuum pump (electric)	Up to 800 taps	669514
<b>B</b>	24 VDC double diaphragm pump <i>Minimum of 12 hours of operation when used with 2x 12V DC 60 amp batteries. Batteries not included.</i>	Up to 700 taps	669520
<b>C</b>	24 VDC electric diaphragm pump <i>Minimum 20 hours operation on 2 12VDC 60-amp hour batteries. Battery not included.</i>	Up to 400 taps	669510
<b>D</b>	4 diaphragm pump (electric)	Up to 1 800 taps	669660

**AUTOMATIC STARTERS**



	120V	230V	575V CANADA ONLY
1 & 2 HP	-	66573	-
1.5 HP	66574	-	-
3 HP	-	66571	66590
5 HP	-	66562	66595
7.5 HP	-	66561	66588
10 HP	-	66563	66569

**AUTOMATIC STARTERS**



A



B



C

<b>A</b>	Temperature controlled automatic starter	669375
<b>B</b>	Manual adjustment kit for converter	68100
<b>C</b>	Vacuum transmitter probe	GRD1632

**PHASE CONVERTERS**

**Factory preprogrammed**



	1 x 3 PHASE CONVERTER	3 PHASE DRIVE
1.5 HP	66111DA*	-
2 HP	66112DA*	-
3 HP	66113DA*	-
3 HP	66113DA-460**	-
5 HP	66115DA*	-
7.5 HP	66129DA*	-
10 HP	66118DA*	66115DA*
15 HP	66015DA*	66129DA*
20 HP	66120DA*	66118DA*

\* 230V > 208V CONVERTERS  
\*\* 460V CONVERTERS



**ADVANTAGES**

- > Food grade and strong high quality welds allow complete sanitizing;
- > Made of bright 304 stainless steel.



**ROUND BOTTOM TANKS  
SMALL & LARGE CAPACITY**

Threaded Overflows  
for STAINLESS  
STEEL TANKS

**MORE THAN 125 SIZES AVAILABLE  
FROM 50 to 9,200 gallons.**

**Complete listing on our website**

**TRANSPORT TANK FOR ATV**

CDL transport tank  
specially designed for ATVs

75 gallons capacity

66TR075

**STRONG  
STAINLESS STEEL  
DESIGN**

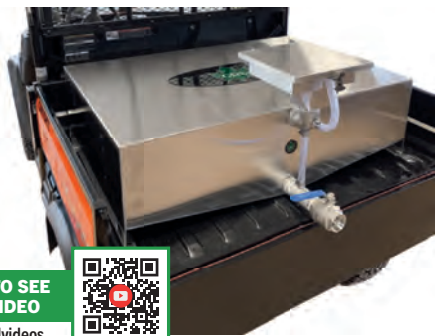

SCAN TO SEE  
THE VIDEO

[bit.ly/cdlvideos](https://bit.ly/cdlvideos)



**Sizes from 2,625 to  
20,730 gallons**

**PRESSURE PUMPS (VACUUM)**

1 st.  
Water inlet 1 1/4"  
Water outlet 1"  
40 GPM



GOULD PUMPS NPE SERIES-220V

3/4 HP	1 st	669003
1 HP	1 st	669000
1-1/2 HP	1 st	669001
2 HP	1 st	669006
3 HP	1 st	669007

**Other Voltages and Sizes available upon request**

Up to 67 PSI. Call one of our experts to determine the speed and power of your pump.

**CDL TRANSPORT  
TANKS**



**NEW**



**New line of transport tanks available in five sizes to  
fit all your needs! 550 to 4,100 gallons.**

**TRANSPORTING YOUR WATER FROM ONE SITE TO  
ANOTHER HAS NEVER BEEN EASIER AND SAFER!**



[rothsugarbush.com](https://rothsugarbush.com)



PRESSURE



GLYCERIN PRESSION

C	Pressure	2.5" 0-100 PSI SS bottom outlet	64010SS
		2.5" 0-100 PSI SS rear outlet	663331SS
D	Glycerin pressure	2.5" 0-200 PSI SS rear outlet	663349SS
		2.5" 0-600 PSI SS rear outlet	663337SS
		2.5" 0-1 000 PSI SS bottom outlet	64014SS

**ADAPTOR FOR STAINLESS TANKS**



1-1/4"	668673
1-1/4"	66867
2"	668672

**TANK LEVEL CONTROL**

6" level control for CDL tanks

73500-6

**ADVANTAGES**

- > The CDL tank level controls are made entirely of stainless steel;
- > In addition, you can very quickly and easily adjust the desired sap level where the pump will start;
- > The solidity of CDL controls prevent breakage caused by ice.





**PLEASE CALL 715-289-3820  
for up to date inventory.**

### HORIZONTAL FOOD GRADE POLY TANKS

US GALLONS	DIAMETER X HEIGHT	LID SIZE	OUTLET	
35	18 x 34	5"	1"	FS0035-18
65	24 x 39	5"	1"	FS0065-24
125	32 x 44	8"	2"	FS0125-32
225	38 x 52	8"	2"	FS0225-38
325	38 x 72	16"	2"	FS0325-38
535	48 x 78	16"	2"	FS0535-48
735	48 x 103	16"	2"	FS0735-48
1,065	56 x 105	16"	2"	FS1065-56W
1,300	62 x 114	16"	2"	FS1300-DW



Bands available for all sizes



Many other sizes available - please call 715-289-3820



### VERTICAL FOOD GRADE POLY TANKS

US GALLONS	DIAMETER X HEIGHT	LID SIZE	OUTLET	
405	52 x 48	8"	2"	VT0405-52
505	46 x 80	16"	2"	VT0505-46
550	52 x 66	8"	2"	VT0550-52
625	64 x 50	8"	2"	VT0625-64
1050	86 x 54	16"	2"	VT1050-86
1500	64 x 115	16"	2"	VT1500-64
1500	86 x 69	16"	2"	VT1500-86
2000	91 x 84	16"	2"	VT2000-90
2500	91 x 103	16"	2"	VT2500-96

Many other sizes available - please call 715-289-3820

### GREEN VERTICAL POLY WATER TANKS

US GALLONS	DIAMETER X HEIGHT	LID SIZE	OUTLET	
2500	96 x 92	16"	2"	WO2500-VT*
3000	96 x 109	16"	2"	WO3000-VT*

\*only for materials 1.0 specific gravity or less

### ADAPTORS

FOR PLASTIC TANKS



1/2"	RA5012
3/4"	RA5032P
1"	RA5034P
1-1/4"	RA5036P
1-1/2"	RA5042P
2" 3"	RA50454P

Elliptical tanks also available - Please call 715-289-3820

### TANK STRAINER BASKETS



For 5" cover	STBA05
For 8" cover	STBA08
For 12" cover	STBA12
For 16" cover	STBA16

### PICK UP TRUCK POLY TANKS



For pickup truck

US GALLONS	DIA. X HEIGHT	LID SIZE	OUTLET	
350	62" x 34"	8"	2"	PUP350-62
450	61" x 41"	8"	2"	PUP450-62

### REPLACEMENT LIDS AND COLLARS

16" solid, non-ventilated cover	LIDP16S
16" ventilated, requires central cover	LIDP16
5" ventilated, for center of 16" cover	LIDPV5
8" solid, non-ventilated cover	LIDP08
5" ventilated 16" cover	LIDP05
8" threaded replacement collar	COL008
12" threaded replacement collar	COL012



Please scan the QR Code for more information and prices.



# HERO

## MODULAR CONCENTRATORS

**100%**  
**MODULAR!**

Available in **STANDARD** (manual) or **INTELLIGENT** (automated) models

Photo: heRO-4T Intelligent Model



Model appearance may vary.

**FROM 720  
TO 7200 GPH**

**CONCENTRATE  
FROM 1.5 BRIX TO  
30 BRIX IN ONE PASS,  
EVEN AT THE END OF  
THE SEASON!**

- > Stainless steel pressure pumps (turbines)
- > Positive recirculation system that allows operation for several hours without loss of performance. This unique system extends the life of the membranes.
- > Posts: Very reliable maintenance-free submersible motors for over 15 years
- > Low pressure protection now controlled by differential pressure, making it easier to manage filtration unit changes.
- > High pressure protection

## CDL NANO RO AND NANO RO MAX REVERSE OSMOSIS SYSTEMS

**PERFECT FOR SMALLER PRODUCERS AND EASY TO USE**



**REDUCE YOUR BOILING TIME**



- > SIMPLE AND EFFICIENT DESIGN
- > THREE STEP PRE-FILTRATION TO ELIMINATE IMPURITIES
- > EFFICIENT MEMBRANE SYSTEM
- > INCLUDES 600 GPD MEMBRANE, CARTRIDGE PRE-FILTERS AND HOOK-UP TUBING
- > LOW ELECTRIC CONSUMPTION 110 VOLTS

	<b>nan RO</b>	<b>nan RO max</b>
<b>Product number</b>	81013R	81015
<b>Number of taps</b>	50 to 150	250 to 750
<b>Capacity</b>	Treats up to 26 GPH of sap Removes up to 13 GPH of filtrate	Treats up to 54 GPH of sap Removes up to 29 GPH of filtrate
<b>Concentration</b>	Possibility up to 6 Brix	Possibility up to 8 Brix

*This Essential Package will be used with the NANO RO & with the NANO RO MAX*

Item Number:  
NANO-essential

- Essential Package Includes:
- 12 - 10" 5 micron pre-cartridge filters
  - 1 - Citric Acid 1 kg powder
  - 1 - Superflow Green Soap 1 kg powder
  - 1 pH 10-13 Papers 50/pack



NANO RO MEMBRANE 600GPD  
660600



NANO RO MAX MEMBRANE 4 x 20  
6606001





## VERTICAL HOBBY REVERSE OSMOSIS SYSTEMS

- > Ideal up to 2000 taps
- > 125 GPH to 250 GPH (1 or 2 posts)
- > Main unit in stainless steel
- > Frame on wheels for easy moving
- > Easy drainage
- > Pump in stainless steel
- > 4" post in stainless steel
- > Membrane: CDL MRO
- > High and low pressure protection
- > Power :  
120 volts (17 Amps),  
240 volts (10 Amps)



81125V	120 V	125 GPH
81125V-240	240 V	125 GPH
81250V	120 V	250 GPH
81250V-240	240 V	250 GPH

# Hobby



**WASHING TANK OPTION**  
available on both models



**NEW**



- > Ideal for up to 3000 taps
- > 350 GPH
- > Stainless steel main unit
- > Casters included for easy movement
- > Easy drainage
- > 1.5 hp all stainless steel pressure pump
- > Recirculation pump included
- > 8" stainless steel membrane housing
- > 8" 8040 membrane
- > Low-pressure and high-temperature protection
- > Electricity: 240 volts (15 A)

81350V-240



Please scan the QR Code for more information and prices.

rothsugarbush.com





### LA FENDEUSE CLASSIC AND DELUXE



### MRO MAX MEMBRANES & STORAGE CANISTERS



	CDL	MRO MAX
4" membrane	66016140	6604040
8" membrane	66016980	6608040
8" membrane (high pressure)	66HP16980	66HP8040
16" membrane	660016	-



A	4" storage canister	724204
B	8" storage canister	724225
	16" storage canister	724226

FENDEUSE CLASSIQUE		FENDEUSE DELUXE
500 À 1500 GPH	GALLON	500 À 3600 GPH
STAINLESS STEEL	MAIN UNIT	STAINLESS STEEL
NO	FINISHING COVERING IN STAINLESS STEEL	YES
PLASTIC	BOOSTER PUMPS	STAINLESS STEEL
1	MAXIMUM NUMBER OF PUMPS PRESSURE (TURBINES)	2
5 HP 7,5 HP	HP FORCES OF PUMPS PRESSURE (TURBINES)	5 HP 7,5 HP
1 X 5 HP 1 X 7,5 HP	POSSIBLE COMBINATIONS FOR PRESSURE PUMPS (TURBINES)	1 X 5 HP 1 X 7,5 HP 2 X 5 HP 1 X 5 HP + 1 X 7,5 HP 2 X 7,5 HP
2	MAXIMUM NUMBER OF 20" PREFILTERS	3
3 VERTICALS	MAXIMUM NUMBER OF MEMBRANES (POSTS)	1 TO 2 VERTICALS 3 TO 8 ON RO POST CART
YES	POSITIVE RECIRCULATION SYSTEM	YES
YES	SUBMERSIBLE MOTOR MAINTENANCE FREE	YES
YES	HIGH PROTECTION TEMPERATURE AND LACK OF WATER	YES
15 BRIX	MAXIMUM CONCENTRATE BRIX IN ONE PASS	30 BRIX

### MISCELLANEOUS

	Food grade o-ring grease   150 g	66535
	Wrench for blue filter	662283
	4" membrane U-cup	66402
	8" membrane U-cup	66401

### PREFILTERS

	5 Micron Pre-Filter 10"	6682101
	5 Micron Pre-Filter 20"	66821
	Plexiglass Cover for Filters	66270
	10" Sap Filter Bag 6-1/2"x16"	EVBAG100
	20" Sap Filter Bag 6-1/2"x32"	EVBAG200

**Bigger sizes & Automated RO Systems available...please call 715-289-3820**



**CLEANING AND STORAGE SOLUTIONS**



**TRUST THE CDL BRAND  
FOR CLEANING AND  
STORAGE SOLUTIONS.  
QUALITY. EFFICIENCY.**



- A Citric acid 1 kg powder 66994
- B Superflow soap 20 kg powder 66239
- C Organic soap Superflow green 4 L liquid 66245
- D Organic soap membrane soap 1 kg powder 662403
- E Oxisan Cleaner 4 L 66298
- F Storage Solution 1 kg 80000
- G 50/50 Glycol 20 L 88020



**FOR ORGANIC  
CERTIFIED PRODUCERS**

**MEASURING INSTRUMENTS**



pH 0-2,5 Papers 50/pkg 668802

pH 10-13 Papers 50/pkg 668813



Calibration solution pH 7.01 20 ml ph701



Calibration solution pH 4.01 20 ml ph401



PH tester 665514

**We offer the very best  
Membrane Washing Service!  
More details call 715-289-3820**

Rather than replacing a poorly flowing RO Membrane, consider getting your membranes professionally cleaned to restore optimal performance. Our proven techniques normally will bring membranes back to 100% flow rates.

Bring or Ship us your 4" or 8" membranes. We will clean them and perform pre and post flow rates as well as sugar passing/quality testing with a printed report.



# THE ONLY 100% ELECTRIC, AUTOMATED AND INTELLIGENT EVAPORATOR ON THE MARKET!

## MASTER-E!

GRANTS MAY  
BE AVAILABLE  
IN YOUR STATE  
OR PROVINCE

### NOW AVAILABLE IN IN 75 OR 100 HP

- ✓ **Produce up to 3 barrels\* of syrup per hour**  
\*with the 100 HP compressor and a 30 Brix concentrate
- ✓ **The energy production cost per barrel can be as low as \$2.75\*\* depending on the configuration!**

\*\*calculated at \$0.10/kW CAD

The Master-E evaporator is fully automated. It can operate with very little labor and supervision. Having the Master-E is the equivalent of having the maple syrup expertise of our entire team at your disposal, in addition to having daily peace of mind!

In fact, as long as there is concentrate in your tank, the master-E will .... alone. It can self-regulate and manage all the parameters in order for you to get syrup continuously.

When it reaches the end of your concentrate tank, it will be able to desugar, rinse and wash completely. It will be ready to start again when you have enough concentrate. The operation may seem complex, but it is simply a perfect synergy between a series of steps

**Note:** The evaporator will only hold 15 gallons of concentrate throughout the process.



Can be connected to



MAPLE SUGARING  
MANAGEMENT SYSTEM

**THE EVAPORATOR IS  
CONNECTED IN REAL TIME  
AND IS ACCESSIBLE  
REMOTELY VIA YOUR SMARTPHONE,  
TABLET AND COMPUTER.**

Front view.  
Evaporator  
appearance  
may vary.





TO GUIDE YOU IN CHOOSING YOUR NEW MASTER EVAPORATOR, HERE ARE SOME THINGS TO CONSIDER DEPENDING ON THE FUEL.

**WOOD EVAPORATORS**

- > Self-sufficiency and fuel availability
- > Independence on energy costs (low and stable)
- > 100% renewable energy
- > Valorization of non-marketable wood from your sugarbush
- > Feeding of the evaporator can be facilitated by mechanical equipment

Ratio Cost / imp. gal	Brix of concentrate			
	15	20	25	30
	0.0065	0.0047	0.0032	0.0025
\$ Cost / imp. gal	\$0.65 (CAD)	\$0.47 (CAD)	\$0.32 (CAD)	\$0.25 (CAD)
\$ Cost / U.S. gal	\$0.81 (USD)	\$0.58 (USD)	\$0.40 (USD)	\$0.31 (USD)
\$ Cost / Barrel (24 imp. gal, 40 U.S. gal)	\$21.99 (CAD)	\$15.82 (CAD)	\$10.99 (CAD)	\$8.48 (CAD)
	\$32.34 (USD)	\$23.26 (USD)	\$16.17 (USD)	\$12.47 (USD)

Based on a price of \$100 CAD (\$150 USD) / wood cord (24" x 4" x 8')



**DELUXE**



CDL's DELUXE oil evaporator was designed for small and medium-sized producers.

This evaporator is very efficient and gives its owner an incomparably comfortable and stable boiling experience. This equipment is very reliable and very simple to operate. To use it is to adopt it!

MAIN FEATURES	
FUEL	OIL, NATURAL GAS OR PROPANE
DIMENSIONS	Available in sizes: 2' x 6' to 6' x 18'
CONSUMPTION	Perfect for small and medium producers. Hassle-free boiling stability and easy operation.
AVAILABLE OPTIONS	Automatic draw-off valve, Syrup drip tray, Hood pre-heater, Permeate pre-filter, Steam pan, Protect-O Level controller protection

Interchangeable and reversible sap inlet and outlet

> **100% REVERSIBLE!**

- > Most proven evaporator in its class
- > Timeless classic look
- > Incomparable value for money
- > Simple and reliable mechanics



**Intens-O-Fire**



The most **PERFORMING** evaporator in the range of wood evaporators with conventional evaporation pan offered by CDL.

MAIN FEATURES	
FUEL	WOOD (soft or hard)
DIMENSIONS	Available sizes: 2½' x 8' to 6' x 18'
CONSUMPTION	Wood consumption 40% less than a conventional evaporator
IDEAL FOR	Balance between performance and boiling stability

Interchangeable and reversible sap inlet and outlet

> **100% REVERSIBLE!**

- > Automated combustion air management system that:
- > Simplifies the operation
- > Allows you to adjust the evaporation rate according to your needs
- > Stabilizes power throughout the wood loading periods
- > Manual air adjustment dampers allow fine-tuning combustion adjustments for optimal performance regardless of the type of wood used



**Venturi**



> **100% REVERSIBLE!**

- > High evaporation capacity at an affordable price
- > Superior lifespan
- > Even boil: softer in front, aggressive in rear
- > No need to preheat the chimney
- > Full throttle in less than 10 minutes
- > Good operation even in low pressure (bad wind)
- > Fully reversible
- > Small amount of bricks needed
- > Perfect for beginners, easy to operate and very limited risk of error
- > No risk of backdraft and very safe
- > Adjustable boiling intensity

The new airtight high performance Venturi evaporators has a unique artificial draft system allowing the intake of primary air at high pressure by suction. It simply and safely increases the evaporation performance of the evaporator. The Venturi Performance system developed by CDL.

MAIN FEATURES	
FUEL	WOOD
DIMENSIONS	12 models from 2'x4' to 4'x15'
CONSUMPTION	Up to 40% more output
AVAILABLE OPTIONS	Wide choice of options available

Interchangeable and reversible sap inlet and outlet





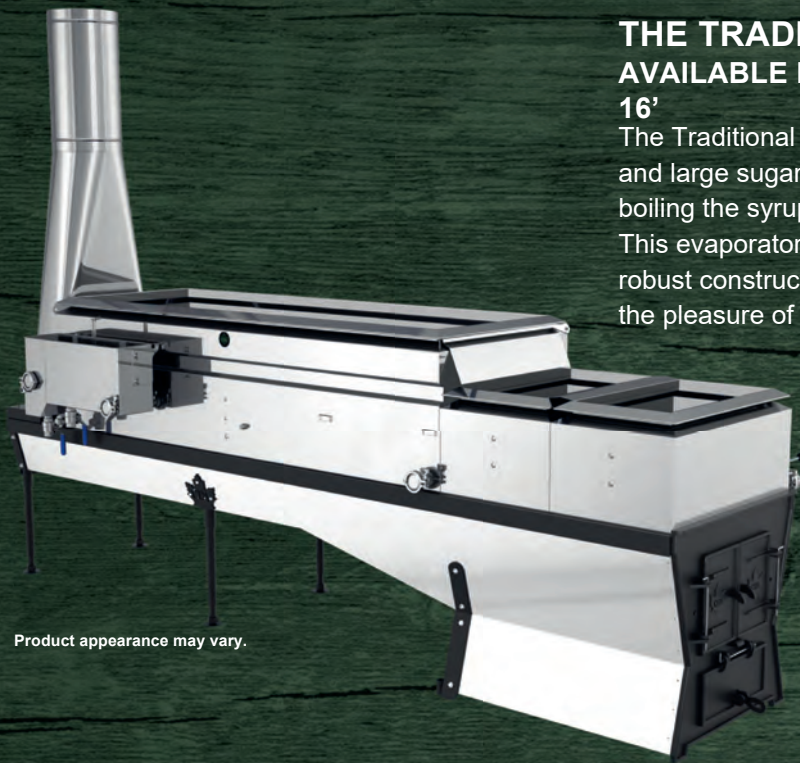

Product appearance may vary.

## THE TRADITIONAL EVAPORATORS AVAILABLE IN SIZES: 2-1/2' X 8' TO 5' X 16'

The Traditional CDL evaporator is designed for owners of medium and large sugarbushes wishing to keep the tradition alive of boiling the syrup with firewood while being effective and efficient. This evaporator will provide an incomparable boiling stability. Its robust construction will allow many generations to experience the pleasure of boiling maple syrup.

### INCLUDES:

- > 32" high furnace with cast iron grates and 2 doors for wood loading.
- > 1 flue pan with 7" argon welded flues.
- > 2 to 3 argon welded syrup pans for finishing (depending on model)
- > Front and rear float boxes.
- > Stainless steel connections, drain valve and draw-off valve.
- > Complete chimney (twice the length of the evaporator) including the stack.
- > 1 rope operated stack cover.
- > Water level on flue pan.

## HOBBY EVAPORATORS

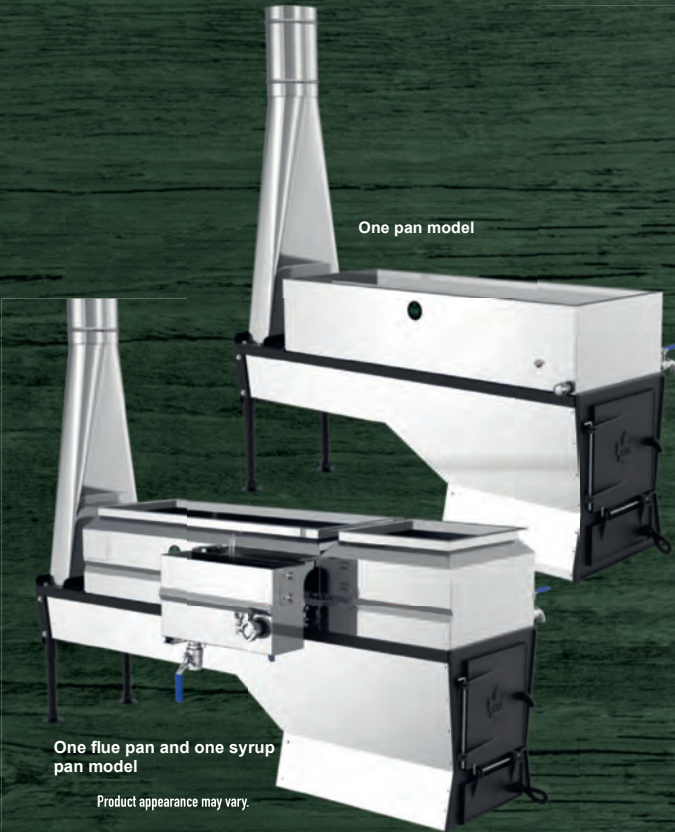

One pan model

One flue pan and one syrup pan model

Product appearance may vary.

The CDL Hobby Evaporator is designed for recreational producers who want to enjoy springtime, while boiling small quantities of maple sap to produce a few gallons of maple syrup per season.

## SYRUP DRAW-OFF NOW FULLY REVERSIBLE! 18" X 48" INCLUDES:

- > Stainless steel furnace with steel grids
- > Stainless steel stack
- > 18" x 48" 304 stainless steel argon welded pan
- > Stainless steel draw-off valve

18" X 48" evaporator with 2-way flue at pan  
1 to 75 taps

6700102WD

18" X 48" Evaporator with 18" x 36" flue pan and 18" x 12" syrup pan  
50 to 125 taps

6700102WP

### AVAILABLE OPTION:

- > Pre-heating pan 67112WPARE

### 18" X 60" INCLUDES:

- > 18" x 42" flue pan
- > 18" x 18" syrup pan
- > Float box with rear control level.
- > Complete smoke stack.

18" x 60" 5" flue pan  
100 to 200 taps

67001



Combine your evaporator with a Nano RO. It will reduce your boiling time! See page 28.



## HOBBY PRO EVAPORATOR

The perfect solution for small producers that want an efficient and affordable wood evaporator to turn sap into maple syrup!

Stainless steel evaporator base (16" x 32")

670090200SS

Flat bottom pan 670090215

3-way pan 670090214

### INCLUDES:

- > Stainless steel base
- > Angle iron grates
- > Ceramic wool
- > 6' of 6" smoke stack and 1 elbow 6" x 90°

### OPTIONAL:

- > Reheat pan 670090218
- > Pan cover 67WPC032
- > 2 wheel kit 670090213
- > Water level 670090216
- > Thermometer EITC0306

Requires bricking kit 1-1/4" x 4-1/2" x 9" (not included).

670090217

**CONFIGURABLE TO YOUR NEEDS  
AND EASY TO ASSEMBLE**



**IDEAL FOR  
UP TO  
25 TAPS**

**IDEAL FOR  
UP TO  
75 TAPS**



**NEW**



## 2'X4' HOBBY PRO EVAPORATOR

Benefit from the same advantages as the smaller Hobby Pro with this new format while increasing your boiling capacity up to 3 times!

Stainless steel evaporator base (24" x 48")

67009020024SS

Flat bottom pan 67009021524

3-way pan 67009021424

Deluxe pan 67009022024

### INCLUDES:

- > Stainless steel base
- > Angle iron grates
- > Ceramic wool
- > 2x 6" smoke stack and 1 elbow 6" x 90°

### OPTIONAL:

- > Reheat pan 670096
- > 2 wheel kit 67009021324
- > Water level 670090219
- > Thermometer EITC0306

Requires bricking kit 1-1/4" x 4-1/2" x 9" (not included).

67009021724



## CDL EVAP-O-GRILL

- > Good up to 50 taps
- > Evaporates up to 7 gallons / hour
- > Easy assembly
- > No bricking necessary

### INCLUDES :

- > 2' x 3' stainless steel pan
- > 3/4" stainless steel draw-off ball valve
- > Cast iron grate set (3X)
- > Cast iron evaporator base
- > Cast iron fire grates (3X)

670090

### OPTIONAL:

- > Reheat pan 670096
- > Smoker with chimney key 67009010



**GREAT  
GIFT IDEA!**

# Evap-O-Grill



**SCAN TO SEE  
THE VIDEO**  
[bit.ly/cdlvideos](https://bit.ly/cdlvideos)



## BEGINNER BOILING KIT



**EASY TO  
ASSEMBLE**

16" x 16" kit PRFW16

### INCLUDES:

- > 1 R-65 propane burner
- > 1 hose and regulator
- > 1 16" x 16" sugar pan
- > 1 propane burner support
- > 1 3/4" stainless steel nipple
- > 1 3/4" FIPT stainless steel ball valve

16" x 32" kit PRFW32

### INCLUDES:

- 2 R-65 propane burners (with fastening kit)
- 2 hoses and regulators
- > 1 16" x 32" sugar pan
- > 1 16" x 32" propane burner support
- > 1 3/4" stainless steel nipple
- > 1 3/4" FIPT stainless steel ball valve

## SUGAR PANS



3/4" valve and cover not included

16" x 16" x 12" 67WP1616

16" x 32" x 12" 67WP1632

16" x 16" Cover 67WPC016

16" x 32" Cover 67WPC032

24" x 24" x 12" 67WP2424

24" x 36" x 12" 67WP2436

24" x 48" x 12" 67WP2448

24" x 72" x 12" 67WP2472

## RECTANGULAR SYRUP FILTER TANKS



Include the stainless steel cover and drain valve.

All syrup filter tanks are 28" high.

## SYRUP FILTER TANKS



US GAL	IMP. GAL	DIAM.
5.85 GAL	5 GAL	9" (mini) 67MINFIL

## NEW RECTANGULAR DRAW-OFF TANKS WITH ALUMINUM STRUCTURE

**CONFIGURABLE ACCORDING TO YOUR NEEDS**

- > PLUMBING
- > COVER
- > SHELF
- > DIAPHRAGM PUMP
- > CORNER BASKET

ALUMINUM STRUCTURE	US GAL	IMP. GAL	
Simple with wheels	35 GAL	29 GAL	6667351FAL
Simple with wheels	55 GAL	46 GAL	6667551FAL
Simple with wheels	75 GAL	62 GAL	6667751FAL

## LEVEL CONTROLLER (PROTECTION)

Protect-0 66876



Silicone gaskets and clip ferrules are available on page 18



### ADVANTAGES

- > Continuous maple syrup draw-off;
- > Eliminates the return effect of the syrup into the pans;
- > Eliminates large volume draw-offs;
- > Improves the constancy of Brix;
- > Easier maple syrup filtration.

Modulating draw-off valve 1-1/2"	66781
Modulating draw-off valve 2"	66775
Modulating draw-off valve 2-1/2"	66782

Clips, silicone gasket and spout not included.

## 1" AUTOMATIC DRAW-OFF VALVE











The CDL 1" automatic draw-off valve allows you to get precise maple syrup flow from your evaporator, every time!

**An innovative solution for syrup lovers and small producers**



66786

## HIGH TEMPERATURE PRODUCTS

	Silicone	60YYYCSL503
	Small brick 2 500 °F 1-1/4" x 4-1/2" x 9"	66869
	Large brick 3 000 °F 2-1/2" x 4-1/2" x 9"	66868
	Briquetting mortar 1 gallon	66866
	Briquetting mortar 4 gallons	668664
	Fiber glass wool rope	60TXP018
	Ceramic wool 1" x 4' x 23.65'   8 lb	60BKT18LB100A
	Ceramic wool 1/2" x 4' x 50'   8 lb	60BKT18LB050A
	Thermofab wool 2" x 1/8"	60GW300100
	Ceramic insulation board 1" x 12" x 36"	EBISOL06

## BRUSHES FOR PANS AND TANKS

	6" x 6" flue brush	 NEW	663565
	2" x 7" without handle		663524
	2" x 7" flue brush		663521
	1/2" x 7" flue brush		66352
	9" handle		EVBRE001
	20" handle		EVBRE003

## STACKS AND ACCESSORIES

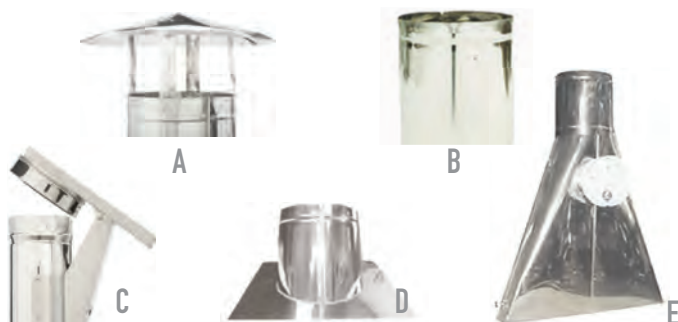

- A** Chinese hats  
Available in diameters from 6" to 32" and optional spark guard
- B** Smoke stacks  
Available in diameters from 6" to 32"
- C** Stack covers  
Available in diameters from 7" to 30" and optional spark guard.
- D** Custom made roof jacks  
From 6" to 32" with collar
- E** Base stacks  
Available for 2' to 6' width evaporators

Please scan the QR Code for more information and prices.





## DEFOAMERS



Kosher | 200 g 66890

Kosher | 2,5 kg 66898



Liquid 8 oz. EVAN108W

Liquid 32 oz. EVAM032W

Liquid 4 L EVAM128W



Organic liquid defoamer 1 gallon

**FOR ORGANIC CERTIFIED PRODUCERS**

EVAM128OG



## PAN CLEANERS



Sani-clean | 3.78 L 6628378

**A** Sani-clean | 20 L 66288

### PAN ACID FOR STAINLESS STEEL

3 lb (powder) EVNSS300

**B** 10 lb (powder) EVNSS010

25 lb (powder) EVNSS250



PAN ACID FOR STAINLESS STEEL  
ROTH PAN CLEANER

1 Gallon ROTHPC

Available in store pick up only

## WATERPROOF THERMAL GLOVES

- Breathable
- Waterproof
- Insulated - PU Coated
- High levels of handling precision and grip
- Provides warmth and protection from liquids in cold conditions, with the comfort of a breathable glove.

Medium 669282M

Large 669282L

X-Large 669282XL

XX-Large 669282XXL



Color may vary...blue or black depending on availability

## BOILING ACCESSORIES STAINLESS STEEL



### DIPPERS AND SKIMMERS

	Round   5" Wooden handle	7205405R
<b>A</b>	Round   6-1/2" Wooden handle	72054065R
	Round   8" Wooden handle	7205408R
	Flat-sided   5" Wooden handle	7205405P
<b>B</b>	Flat-sided   8" Wooden handle	7205408P
	Without holes	6772922007
<b>C</b>	With holes   4"	7205404

### DEFOAMER SUPPORT



	Small	67ANTIMOU P
<b>D</b>	Large	67ANTIMOU G
	9 oz	6700009
<b>E</b>	16 oz	6700016

### FILLING CONTAINERS



<b>I</b>	2 L stainless steel with handle	MEACSL*
<b>J</b>	4 L with handle (measuring)	MEACU4

\* Product available in limited quantity.



### FUNNELS

	Small	66811
	Large	6681102

## HYDROMETERS SAP AND SYRUP

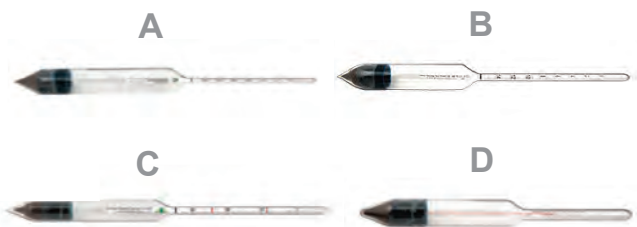

imited warranty and non-returnable items.

<b>A</b>	Sap	0-8 Brix	HYDSAP
<b>B</b>	Sap	0-15 Brix	668433
<b>C</b>	Syrup	45-75 Brix	HYDSYR
	Syrup	45-75 Brix (Vermont state approved)	EIDS4575
<b>C</b>	Syrup	55-70 Brix	66845
<b>D</b>	Syrup	Hydrotherm	66841

8" HYDROMETER CUP



HYDCUP

## DIAL THERMOMETERS

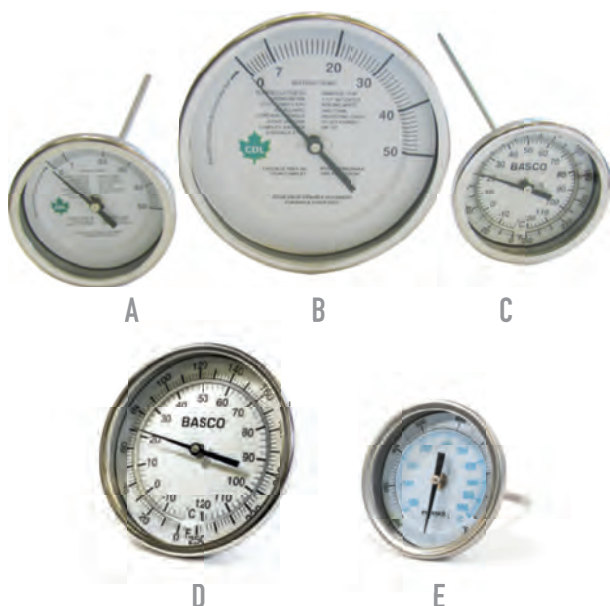

<b>A</b>	3" Dial   9" stem   0-50 °F   1/4" MIPT	72920003
	3" Dial   12" stem   0-50 °F   1/4" MIPT	72920004
	5" Dial   9" stem   0-50 °F   1/4" MIPT	72920001
<b>B</b>	5" Dial   12" stem   0-50 °F   1/4" MIPT	72920002
	3" Dial   12" stem   0-250 °F   1/2" MIPT	668350
<b>C</b>	3" Dial   6" stem   0-50 °F   1/4" MIPT	EITC0306
	3" Dial   9" stem   50-300 °F   1/2" MIPT	EITC0309
	3" Dial   6" stem   0-250 °F   1/4" MIPT	EITC0336
	3" Dial   6" stem   0-250 °F   1/2" MIPT	EITC033612
	3" Dial   9" stem   0-250 °F   1/4" MIPT	EITC0330
<b>D</b>	5" Dial   4" stem   0-250 °F   1/2" MIPT	668356
	3" Dial   4" stem   200-1000 °F   1/4" MIPT	668354
<b>E</b>	3" Dial   6" stem   200-1000 °F   1/2" For evaporator smoke stack	668210

## OTHER THERMOMETERS



<b>A</b>	12" Stem Digital Thermometer -58°F to 572°F	RSB-green
<b>B</b>	8" Stem Digital Candy Thermometer 14°F to 450°F	71750425
<b>C</b>	Candy Thermometer 60°FR to 400°F	71750426

## REFRACTOMETERS



<b>A</b>	Syrup Refractometer 45 to 82 ATC	RSB SYR refrac 45-82
<b>B</b>	Sap Refractometer 0 to 10 ATC	RSB SAP refrac 0-10
<b>C</b>	Sap Refractometer 0 to 32 ATC	RSB SAP refrac 0-32

Measurements are in Brix



### CENTRE ACER PRODUCTS

Calibrating solution for refractometers. Specially designed and developed by the ACER Center to calibrate refractometers for BRIX maple syrup measurement. 66616

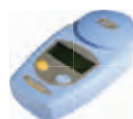

DIGITAL 0-85 Brix 668412

Please scan the QR Code for more information and prices.

# CDL WESFAB

7" presses

10" presses

Short filter press + manual diaphragm pump 3 hollow / 2 waffles	WFCDL7M	-
3 hollow / 2 waffles	WFCDL732	WFCDL1032
4 hollow / 3 waffles	WFCDL743	WFCDL1043
7 hollow / 6 waffles	WFCDL776	WFCDL1076
8 hollow / 7 waffles	WFCDL787	WFCDL1087

**Available options:**

Air dia. pump kit 1/2"	WFCDL7ADP12	WFCDL10ADP12
Dia. pump kit 120v 1/2" 5.3 GPM	WFCDL7EDP1253	WFCDL10EDP1253
Filter press cart	WFCDL7CH	WFCDL10CH

7" CDL WES FAB Waffle Plate	WFP07W
7" CDL WES FAB Hollow Plate	WFP07H
10" CDL WES FAB Waffle Plate	WFP10W
10" CDL WES FAB Hollow Plate	WFP10H

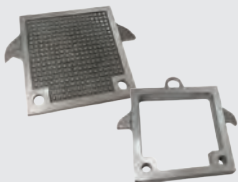

**ADVANTAGES (7" and 10" presses)**

- > Reclinable press (0, 45 and 90 degrees with the cart option) to facilitate the replacement of filter papers;
- > Removable pump kit (to use on another filter press).



**SEPARATING FILTER PRESS PLATE**

Allows you to use only part of your filter press to filter a small quantity. Less cleaning and use less papers.

7" CDLWESFAB press	WFCDL7PLATE
10" CDLWESFAB press	WFCDL10PLATE



**CDL VACUUM FILTER PRESSES**

**Syrup filter tank and filter press. Available in 9", 12", 15" and 18" sizes.**

**Includes : 1 filter and 12 prefilters**

9"	3.6 US GAL.	Up to 400 taps	FAU18PV009K
Thermometer included			
12"	9 US GAL.	Up to 800 taps	FAU18PV012
5-micron vacuum filter press polyester filter		9"	FAU18036
		12"	FAU18038
Vacuum filter press polyester prefilter (12/pkg)		9"	FAU18035
		12"	FAU18037

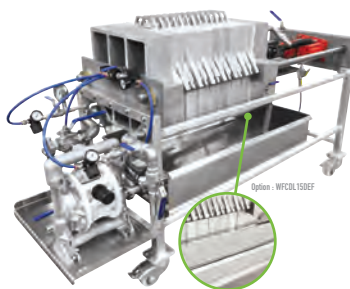

15" and 20" Filter Presses available - please call for more information and pricing

**HOSES FOR FILTER PRESSES**

\*Price per foot



A	Clear 5/8"	6600210
	Clear 1"	6600110

B 5/8" High temperature high pressure  
Use between the pump and the plates.  
66285





## ELECTRIC DIAPHRAGM PUMP KIT



**Quick and easy installation.**  
For filter press pumping or hot syrup transfer.

Motor 115V  
5.3 GPM | 60 PSI



Electric diaphragm pump with support

669653A

## FILTER PRESS PUMPS

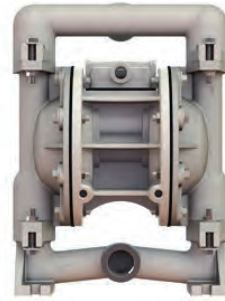

1/2" Diaphragm pump  
(aluminum)

669585

1" Diaphragm pump  
(aluminum)

669601

## ACCESSORIES



A-B



C



D

A	545 Celite filter aid 10 lb		66825
B	545 Celite filter aid 50 lb		66826*
* Product available in limited quantity.			
C	Dicalite filter aid 50 lb		66838
D	CDL filter aid 50 lb		6683CDL



Polyester #8 felt cone filter 5 mic.

66815

Cone pre-filter

pkg 12

66206



Flat Filter woven style  
36" x 36" 1 sheet per pack

ORL3636

Flat Pre-Filter woven style  
36" x 36" 3 sheets per pack

PREW36

	5-1/4" filter papers	pkg 200	66817
	7" filter papers	pkg 400	66828
	10" filter papers	pkg 400	66829
	15" filter papers for CDLWESFAB filter presses	pkg 250	WFCDL668015
	15" filter papers	pkg 250	668015
	20" filter papers 2 holes	pkg 250	668221
	20" filter papers 3 holes with wings	pkg 250	668224



Food grade grease

66530



Please scan the QR Code for more information and prices.

## STAINLESS STEEL BARRELS

The CDL barrel is designed according to the recommendations of the Federation of Maple Syrup Producers of Quebec.



Models may differ from those shown.

Capacity: (15 US GAL.) Empty weight (Tare): 29 lb  
1 plastic cap (2" center)

66819R

Capacity: (40 US GAL.) Empty weight (Tare): 48 lb  
2 plastic caps (2" and 3/4" off-center)

66813

Capacity: (55 US GAL.) Empty weight (Tare): 59 lb  
2 plastic caps (2" and 3/4" off-center)

668161

## PUMP AND BARREL TRANSFER



Pneumatic stainless steel barrel pump DRUPUM

### ADVANTAGES

- > Allows you to empty a barrel of syrup faster;
- > Quicker than a pump;
- > Empty barrels of syrup without making a mess;
- > Very easy to use.

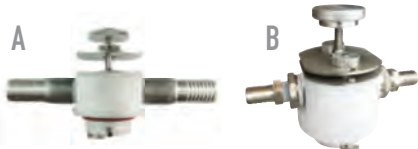

A 1" Teflon barrel transfer

6150P1

B 5/8" Teflon barrel transfer

6150P58

## BARREL CAPS AND ACCESSORIES

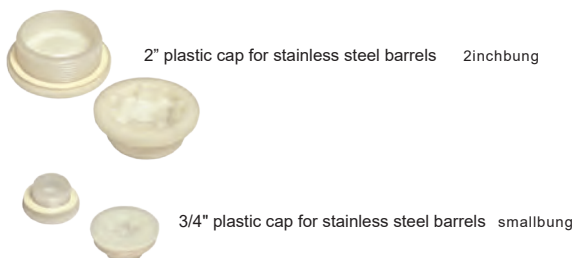

2" plastic cap for stainless steel barrels 2inchbung

3/4" plastic cap for stainless steel barrels smallbung

## HANDLING ACCESSORIES FOR BARRELS



3-wheel stainless steel cart

676055S

## MAPLE CREAM MACHINES



Maple cream machine 8 L   110 V	Brass pump	668828
Maple cream machine 16 L   220 V	Brass pump	668827
Maple cream machine 8 L   110 V	Stainless steel pump	668828S
Maple cream machine 16 L   220 V	Stainless steel pump	668827S

## MAPLE SUGAR MACHINES



Single 8" automatic maple sugar machine - 110 V	668855A
Double 8" automatic maple sugar machine - 220 V	668856A

### ADVANTAGES

- > Fully automated;
- > Uniform granulation;
- > Can function without supervision;
- > Available without automation if requested;
- > Made of stainless steel;
- > 3 in 1: mixer, grinder and dryer;
- > Self-cleaning with hot water;
- > 2 possible modes, "small granules" for brown sugar or "large granules" for larger grains.
- > Produces between 17 and 35 pounds of sugar in approximately one hour of operation.

## CANDY MACHINES



A	Candy machine (motor included)	ECB0100A
B	Auger and pan	ECBMW301
C	Extra pan	ECBMP101
	Motor 1/4 HP	660002

Please scan the QR Code for more information and prices.





## BEGINNER BOTTLING KIT



### INCLUDES:

- > 1 16" x 16" sugar pan cover
- > 1 16" x 16" sugar pan
- > 1 16" x 16" filter holder
- > 1 R-65 propane burner
- > 1 coffee type valve
- > 1 16" x 16" water jacketed tank
- > 1 propane burner support
- > 1 1/2" SS nipple

Assembly required

6600802

With adjustable shelf

## ELECTRIC HOBBY BOTTLER



High quality double walled stainless steel electric hobby bottler.

Capacity: 30 Liter  
Voltage: 120 V  
Power: 1200 W

Temperature control from:  
86° F to 230° F  
30° C to 110° C

This electric bottler will also work great for filtering your syrup into as it will keep your filtered syrup at a constant 180°



HOBBYBOTTLER

Replacement Valve for Electric Bottler Only COFBOT

## WATER JACKETED TANKS



Electric water jacketed tank  
43 US GAL.  
240 V  
67422



Electric water jacketed tank  
15 US GAL.  
240 V  
67422-M

Bottling stand with pedal  
43 US GAL.  
67220-S

Bottling stand with lever  
15 US GAL.  
67220-MS

STAINLESS STEEL

STAINLESS STEEL



Propane burner  
R-65

66803



Electric bottling valve  
Includes 3 stainless steel tips:  
1/4", 3/8", 1/2"

67217



Bottling valve (coffee type) +  
3/4" reducer x M16

67212A



Bottling valve  
3/8", 90°

ECDVP804



Bottling valve  
1/2", 90°

ECDVP805



Bottling nozzle for water  
jacketed tank  
3/8" elbow x 3/4" mipt

67BM12



Bottling nozzle for  
water jacketed tank  
1/2" elbow x 1/2" mipt

6788991B2



Bottling valve

3/8" 67215

5/8" 67216

## WATER JACKETED PANS

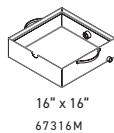

16" x 16"  
67316M

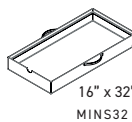

16" x 32"  
MINS32

\* Valve not included

> Water jacketed tank for sugar pan that can be used for the beginner bottling kit on page 115.

> Possibility to install an electric heating element (664934a) 5" high

PURCHASE THE ELECTRIC OPTION TO COMPLETE YOUR KIT!

DESIGNED TO MAINTAIN THE SYRUP AT A PROPER TEMPERATURE TO BOTTLE EFFICIENTLY.

1 500 W electric element with thermostat. Can be installed on a 16x16 water jacketed tank (67316M)  
664934A

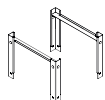

Spacer designed to directly bolt on the propane cooker support.  
67423

## DRAW-OFF ELBOWS

MIPT	TUBE	
1/2"	3/4"	SDE050
3/4"	1"	SDE075
1"	1"	6788991D2
1-1/4"	1-1/2"	SDE125
1-1/2"	2"	SDE150



Please scan the QR Code for more information and prices.



rothsugarbush.com



caps included



# OUR NEW JUG PRODUCTION LINE IS UP AND RUNNING!

WE ARE USING A NEW IML PRINTING PROCESS UNIQUE TO THE MAPLE INDUSTRY FOR A MORE RESISTANT LABEL.

ORDER YOUR STOCK NOW AND GET READY FOR THE NEXT SUGARING SEASON!

SIZE	PRODUCT CODE	QTY/BOX
3.4 oz	EXCD0101U	100
1/2 pint	EXCD0261U	100
1 pint	EXCD0501U	100
1 quart	EXCD1001U	100
1/2 gallon	EXCD2001U	50
1 gallon	EXCD4401U	25

All State & Wisconsin Available

## PLASTIC BOTTLES & CONTAINERS



caps included

OXYGEN BARRIER BOTTLE

A	500 ml	150	661500
B	1 L	90	661000
C	2 L	50	660020-50
D	4 L	40	660400

FREEZER JUG

E	1 gallon	1	EXSH4P
F	5 gallon	1	5GALCONT



Please scan the QR Code for more information and prices.

## CRUCHON PLASTIC JUGS



caps included



SIZE	PRODUCT CODE	QTY/BOX
1.36 oz	EXCR0041	100
3.4 oz	EXCR0101	100
1/2 pint	EXCR0261	100
1 pint	EXCR0501	100
1 quart	EXCR1001	100
1/2 gallon	EXCR2001	50
1 gallon	EXCR4001	24

All State & Wisconsin Available

## BROWN PLASTIC CAPS FOR JUGS



Cap for jugs (40 ml & 100 ml) 661386  
 Cap for jugs (250 ml to 4 L) 6628400

## EXTRA CAPS FOR OXYGEN BARRIER BOTTLES AND FREEZER JUG

A	cap for 375 ml & 500 ml	661375
B	cap for 1L 2L 4L 53mm x 400	661380

rothsugarbush.com



**MODERN AND MAPLE LEAF**

*CAPS NOT INCLUDED*

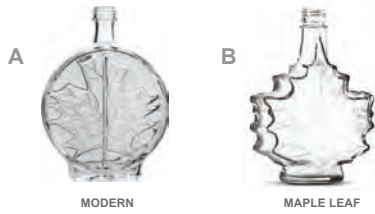

SIZE	PRODUCT CODE	QTY/BOX	CAP CODE
100 ml	EXBV0100M	36	661374 (GOLD)
<b>A</b> 250 ml	EXBV0250M	12	661374 (GOLD)
500 ml	EXBV0500M	12	661388 (GOLD)
50 ml	EXBV0050AU	48	661378 (GOLD)
100 ml	EXBV0100AU	12	661374 (GOLD)
<b>B</b> 250 ml	EXBV0250AU	12	661374 (GOLD)
500 ml	EXBV0500AU	12	661388 (GOLD)

**GALLONE**

*CAPS NOT INCLUDED*



SIZE	PRODUCT CODE	QTY/BOX	CAP CODE
40 ml	EXBVRH50	48	661378 (GOLD)
250 ml	EXBVRH250	12	661377 (BLACK)
500 ml	EXBVRH500	12	661377 (BLACK)
<b>A</b> 1 L	EXBVRH1000	6	661377 (BLACK)
½ gal.	EXBVRH2000	6	661381 (WHITE)
1 gal.	EXBVRH4000	4	661381 (WHITE)
250 ml	EXBV0250GL-12	12	661376 (white)
<b>B</b> 500 ml	EXBVRH500M	12	661376 (white)

**FLASK CAPS NOT INCLUDED**



SIZE	PRODUCT CODE	QTY/BOX	CAP CODE
200 ml	BOTHF2		
12	661384 (BROWN) CAP500 (BROWN)		

**BASQUE-CAPS NOT INCLUDED**



SIZE	PRODUCT CODE	QTY/BOX	CAP CODE
250 ml	EXBV0250B	12	661377 (BLACK) 661390 (BROWN)
500 ml	EXBV0500B	12	661377 (BLACK)

**BASQUE SNOWMAN-CAPS NOT INCLUDED**



SIZE	PRODUCT CODE	QTY/BOX	CAP CODE
250 ml	EXBV0250BSM*	12	661377 (BLACK) 661390 (BROWN)

**BASQUE ANIMALS CAPS NOT INCLUDED**



SIZE	PRODUCT CODE	QTY/BOX	CAP CODE
DEER 250 ml	EXBV0250BPDEER*	12	661377 (BLACK) 661390 (BROWN)

**SAMPLE JARS CAPS NOT INCLUDED**



1 oz. bottles  
EICOL016  
Cap only  
EXBSCAP16



2 oz. bottles  
samplebottle  
Cap only  
661381

**FLAT with HANDLE**

*CAPS INCLUDED*



SIZE	PRODUCT CODE	QTY/BOX	CAP CODE
8 oz	GLAPT.5	12	COV28-white flip 661382-blk-Black Safety 661382-wht-White Safety
12 oz	GLAPT.75	12	COV28-white flip 661382-blk-Black Safety 661382-wht-White Safety
16 oz	GLAPT-16oz	12	COV28-white flip 661382-blk-Black Safety 661382-wht-White Safety

Limited supply - not always in stock

**DECANTER**

*CAPS INCLUDED*



SIZE	PRODUCT CODE	QTY/BOX	CAP CODE
16 oz	GLAPT	12	COV38-white flip COV38-black flip 661381-white plastic
32 oz	GLAQT	12	COV38-white flip COV38-black flip 661381-white plastic

**BASQUE 4 SUGARING SCENES**

*CAPS NOT INCLUDED*



SIZE	PRODUCT CODE	QTY/BOX	CAP CODE
250 ml	EXBV0250B1*	12	661377 (BLACK) 661390 (BROWN)

\* First come, first served.

**BASQUE 4 XMAS SCENES**

*CAPS NOT INCLUDED*



SIZE	PRODUCT CODE	QTY/BOX	CAP CODE
250 ml	EXBV0250BC*	12	661377 (BLACK) 661390 (BROWN)

\* First come, first served.

**CAPS**

**WHITE PLASTIC CAPS**

28 mm x 400	661376
38 mm x 400	661381
38 mm x 400 aluminum liner	661381AL

**GOLD PLASTIC CAPS**

18 mm x 400	661378
24 mm x 400	661374
28 mm x 400	661388

**BROWN PLASTIC CAPS**

24 mm x 400	CAPK25
28 mm x 400	661384
31.5 mm x 400	661390
38 mm x 400	661391
28 mm x 410	CAP500

**BASQUE PLASTIC CAPS**

Black plastic caps Brown plastic caps	661377
	661390

**BLACK PLASTIC CAPS**

18 mm x 400	CAP05B
28 mm x 400	661379
31.5 mm x 400	661377
38 mm x 400	661396

**PLASTIC CAPS / TAMPER EVIDENT**

28 mm x 400	Bag of 12	661382 (WHITE)
28 mm x 400	Bag of 12	661386 (BROWN)
28 mm x 400	Bag of 12	661385 (GOLD)
28 mm x 400	Bag of 12	CAPK85 (BLACK)

**WHITE PLASTIC FLIP TOP CAPS**

38 mm  
COV38-white  
These caps fit Quart & Pint Decanters



WHITE PLASTIC FLIP TOP CAPS  
28 mm  
COV28-white flip  
These caps fit 8oz & 12oz Flat Bottles



**BLACK PLASTIC FLIP TOP CAPS**

38 mm  
COV38-black  
These caps fit Quart & Pint Decanters



WHITE PLASTIC SAFETY CAPS  
28 mm  
COV28-white safety  
These caps fit 8oz & 12oz Flat Bottles



BLACK PLASTIC SAFETY CAPS  
28 mm  
COV28-black safety  
These caps fit 8oz & 12oz Flat Bottles





### CANDY BOXES



12 cavities, 4-1/2" x 6"	60115
25 cavities, 4-1/2" x 9"	60128

### HANG TAGS AND ELASTICS



<b>A</b> Hang Tag	EXEC0050-V	100 per pack
<b>B</b> Gold Foil	EXCAP210 fits 250ml	100 per pack
<b>B</b> Gold Foil	EXCAP310 fits 500ml	100 per pack
<b>C</b> Gold Elastic	EXCEL6G	100 per pack

### GLUCOSE AND POWDER GENUGEL



Glucose 2,25 kg 6680801

For the hardness of sweets and lollipops

Glucose 25 g 66808

For the hardness of sweets and lollipops



Genugel 200 g 72926170

Used for making Jelly

### SELF ADHESIVE NUTRITION LABELS



	Serving Size	PRODUCT CODE	QTY/ROLL
<b>A</b>	White-Varies	nutvarieswhite	100 per pack
	White-1/2 pint-8 serve	nut1/2pintwhite	100 per pack
	White-3/4 pint-12 serve	nut3/4pintwhite	100 per pack
	White-pint- 16 serve	nutpintwhite	100 per pack
	White-quart- 32 serve	nutquartwhite	100 per pack
<b>B</b>	Clear-Varies	nutvariesclear	100 per pack
	Clear-1/2 pint-8 serve	nut1/2pintclear	100 per pack
	Clear-3/4 pint-12 serve	nut3/4pintclear	100 per pack
	Clear-16 serve	nutpintclear	100 per pack
	Clear-32 serve	nutquartclear	100 per pack



<b>A</b> 1/2 lb tub   100/box	EXCUL251U
<b>A</b> 1 lb tub   100/box	EXCUL501U
<b>B</b> 2 oz. granulated sugar container	EXPLSUG2
<b>B</b> 4 oz. granulated sugar container	EXPLSUG4

<b>C</b> Clear Secure Tamper Evident round container 34oz (1L)   250/box (lid not included)	667010
<b>C</b> Clear Secure Tamper Evident round lid 114mm 34oz (1L)   500/box	667904



Black Label  
3" x 3"  
100/roll



Black Label  
2" x 3"  
100/roll



White Horse Label  
3" x 3"  
100/roll



White Horse Label  
2" x 3"  
100/roll



Orange Label  
3" x 3"  
100/roll



Orange Label  
2" x 3"  
100/roll

### SYRUP GRADING SELF-ADHESIVE LABELS



US Golden	EXLAUSG	1000
US Amber	EXLAUSA	1000
US Dark	EXLAUSD	1000
US Very Dark	EXLAUSV	1000



WI Golden	EXLAWIG	1000
WI Amber	EXLAWIA	1000
WI Dark	EXLAWID	1000
WI Very Dark	EXLAWIV	1000



Clear Label  
2" x 3"  
100/roll



Red/Gold  
2" x 3"  
100/roll



Brown Oval  
2" x 3"  
100/roll



Blue/Green  
2" x 3"  
100/roll



## SIGNS AND FLAGS



A



B



C



D



E

DESCRIPTION

PRODUCT CODE

	24" x 36" metal sign	ECMS2436
A	10" x 14" plastic sign	ECMP1014
	24" x 36" plastic sign	ECMP2436
B	20" x 30" plastic sign	SIGNGR
C	18" x 24" coroplast sign	SIGNYE
D	20" x 30" coroplast sign	SIGNAM
E	Flag	663660

*Several other Signs available.  
Visit our website for the complete listing.*

## BOOKS



A



B



C



D



E



F



G

DESCRIPTION

PRODUCT CODE

A	<b>The Maple Syrup Cookbook - 3<sup>rd</sup> edition</b> (Offers recipes for breakfasts, appetizers, beverages, pastries and desserts.)	ECCBOOK3
B	Maple Sugar-The history, lore how to behind this sweet treat.	ECMAPLE
C	"Sugar Snow" by Laura Ingalls Wilder This is a great books to read to your young children.	sugarsnow
D	Welcome to our Sugarhouse Coloring Book	ECSUGCOLOR
E	Making Maple Syrup The Old-Fashioned Way	OLDFASH
F	Curious George Makes Pancakes-Great children's book!	CURGEOCAKE
G	Wisconsin Maple Syrup Association Cookbook This is the 5th edition-many great recipes with maple syrup	WISCOOK



*Several other books available.  
Visit our webstore for the complete listing.*

## RUBBER CANDY MOLDS



8	Maple Leaves	ECMC1137
12	Maple Leaves	ECMC1138
20	Maple Leaves	ECMC1243
72	Maple Leaves	ECMC1204
16	Barrels	ECMC1236
15	Hearts	ECMC1056
20	Hearts	20hearts



- > Made of food grade silicone
- > Unique design for added stability when pouring
- > Entirely self supporting
- > Quick filling without making a mess, giving a uniform quality products without waste.
- > Uniform cavities giving perfect results every time.

## PLASTIC CANDY MOLDS

A  
HARD  
CANDY



B  
SUCKER  
CANDY



	18 Small Hearts	ECMS0204
	12 Maple Leaves	ECMS3185
A	18 assorted shapes	ECMS3057
	7 Barrels	ECMS3205
B	6 Maple Leaves	ECMS3450
	4 Big Smiles	ECMS9824

## SUCKER BAGS AND STICKS

DESCRIPTION	DIMENSIONS	QTY/PKG	PRODUCT CODE
Cellophane bags	4-3/4" x 6-3/4"	100	ECMSC406
Cellophane bags	3" x 4"	100	ECMSC304
Plastic bags	3" x 5"	100	ECMSS305
Plastic bags	4" x 5"	100	ECMSS405
Sticks	3-3/4"	1 000	ECMSB375
Sticks	4-1/2"	1 000	ECMSB450





# ROTH SUGAR BUSH

## Maple Sugaring Equipment & Pure Maple Syrup

Your Land! Your Brand! Run with the Best!

### Roth Sugar Bush Sub Dealers

#### Wisconsin

##### **ADAMSKI SUGAR BUSH**

Jim Adamski  
W10923 Winter Road  
Antigo, WI 54409  
P. 715-623-6853 C. 715-216-7855  
cdladamski@gmail.com

##### **BACKWOODS MAPLE SUPPLY**

Tony & Roger Bundy  
N408 4th Avenue  
Eau Galle, WI 54737  
P. 715-495-6534  
backwoodsmaplesupplies@gmail.com

##### **SUGAR GROVE SUPPLY**

Emmanuel & Owen Hershberger  
S2030 County Road D  
Westby, WI 54667  
P. 608-625-6745 (leave message)

##### **DRIFTLESS FARMS**

Scott & Erica Walter  
16885 County Highway U  
Viola, WI 54664  
P. 608-606-5049  
driftlessfarmsllc@gmail.com

#### Minnesota

##### **DON'S SUGAR SHACK**

Don Hansen  
842 West Street  
Taylors Falls, MN 55084  
P. 612-201-1086  
don@tfmaple.com

##### **TIMBER'S SUGAR SHACK**

Tim & Amber Woodrow  
1037 1st Street NW  
Aitkin, MN 56431  
P. 218-429-5805  
timberssugarshack@gmail.com

### Tubing Instalation & More

The Roth Sugar Bush has added an in house Tubing Installation Crew. We can help with ALL you tubing repair and installation needs.

Some of the Services We Offer Include:

- Mainline Installation
- Lateral & Drop Line Installation
- Releaser and Pump Installation
- New Monitoring System
- Underground Tubing
- Helping to set up your Sugarbush
- Walk your woods with you
- ...and the list goes on and on!

When it comes to maple...you name it...we do it!

Each job is tailored to the customer...we can do as much or as little as you want.

Give us a call today 715-289-3820

### Used Equipment

We Buy & Sell used equipment.  
Check our webiste often if you are looking  
for some good used equipment as it can  
change from week to week.



All prices are F.O.B. Cadott, Wisconsin. We ship daily. We do our very best to fill orders as they are received and generally we will ship within a day or two of when you order, but please allow 3 to 5 days depending on the mail carrier & the time of year.



[www.rothsugarbush.com](http://www.rothsugarbush.com)  
715-289-3820



Subscribe to our YouTube Channel  
rothsugarbush

We buy all grades of bulk pure maple syrup, May 1st to January 1st, paying cash when you deliver to our sugarbush.



# ROTH SUGAR BUSH - Super Store

## Maple Sugaring Equipment

656 Tower Drive

Cadott, Wisconsin 54727

Phone: 715-289-3820 Fax: 715-289-3821

Website: [www.rothsugarbush.com](http://www.rothsugarbush.com)

Email: [info@rothsugarbush.com](mailto:info@rothsugarbush.com)

PRESRT STD  
U.S.POSTAGE  
PAID  
PERMIT NO. 2000  
EAU CLAIRE, WI

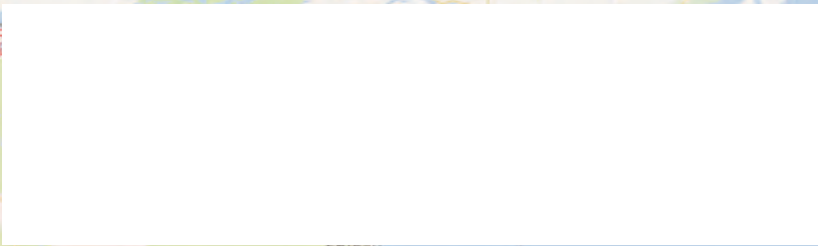
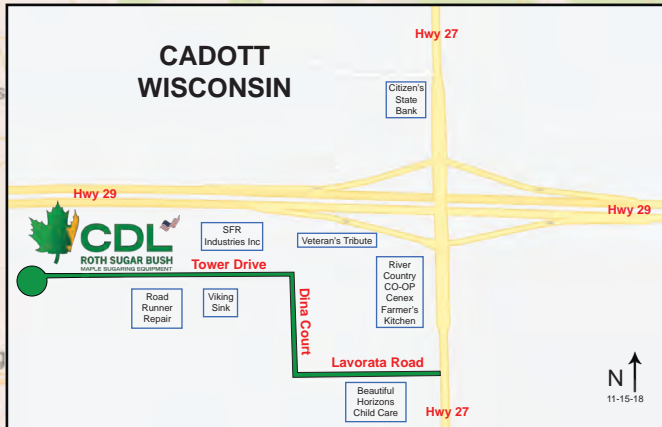

TIM & AMBER WOODROW ★  
AITKIN, MN  
218-429-5805

DON HANSEN ★  
TAYLORS FALLS, MN  
612-201-1086

ROTH SUGAR BUSH  
SUPER STORE  
CADOTT, WI  
715-289-3820

JIM ADAMSKI ★  
ANTIGO, WI  
715-216-7855

TONY & ROGER BUNDY ★  
EAU GALLE, WI  
715-495-6534

EMANUEL & OWEN HERSHBERGER ★  
CASHTON, WI  
S2030 Cty Rd D

SCOTT & ERICA WALTER ★  
VIOLA, WI  
608-606-5049



Scan the QR Code  
for our easy to follow  
"How To Videos"



Subscribe to our YouTube Channel  
[rothsugarbush](https://www.youtube.com/rothsugarbush)

**OPEN HOUSE**  
February 7, 8, 9 & 10, 2024  
Cadott, Wisconsin  
8:00 am - 4:00 pm  
Special Discounts  
Prizes