

# Royal Entomological Society

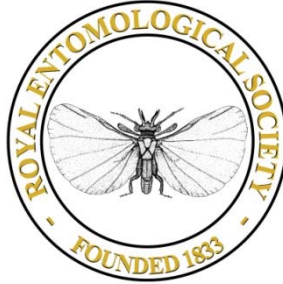

## HANDBOOKS FOR THE IDENTIFICATION OF BRITISH INSECTS

To purchase current handbooks and to download  
out-of-print parts visit:

<http://www.royensoc.co.uk/publications/index.htm>



This work is licensed under a [Creative Commons Attribution-NonCommercial-ShareAlike 2.0 UK: England & Wales License](https://creativecommons.org/licenses/by-nc-sa/2.0/).

Copyright © Royal Entomological Society 2012

Handbooks for the Identification of British Insects  
Vol. II Part 4(a)

# HOMOPTERA APHIDOIDEA (Part)

CHAITOPHORIDAE & CALLAPHIDIDAE

H. L. G. Stroyan



ROYAL ENTOMOLOGICAL SOCIETY OF LONDON

## ERRATA

- On page iii, line 4 from bottom, the words 'Genera and species' to be moved left to lie under 'Keys to genera' 2 lines above.
- 49, line 12, for 'respecitvely' read 'respectively'.
- 53, last line of top paragraph, delete 'of'.
- 81, last line of italicized notes on fagi (L.), delete parenthesis at end.
- 124, reference no. 15 (HILLE RIS LAMBERS & STROYAN, H.L.G.) should read 'HILLE RIS LAMBERS, D., & STROYAN, H.L.G.'

TY OF GREENWICH

**HOMOPTERA  
APHIDOIDEA  
CHAITOPHORIDAE & CALLAPHIDIDAE**

**By  
H. L. G. STROYAN**  
Plant Pathology Laboratory  
Ministry of Agriculture, Fisheries & Food  
Hatching Green, Harpenden  
Herts, AL5 2BD

1977  
ROYAL ENTOMOLOGICAL SOCIETY OF LONDON  
41 Queen's Gate  
London SW7 5HU

# HANDBOOKS FOR THE IDENTIFICATION OF BRITISH INSECTS

World List abbreviation: *Handbk Ident. Br. Insects*

The aim of this series is to provide illustrated keys to the insects of Britain, together with concise morphological, bionomic and distributional information. Each handbook should serve both as an introduction to a particular group of insects and as an identification manual.

Eleven volumes are planned, each of which will be issued in separately paginated parts as manuscripts become available.

The proposed volumes are:

- |                                 |                       |
|---------------------------------|-----------------------|
| I. Part 1. General introduction | Part 9. Ephemeroptera |
| 2. Thysanura                    | 10. Odonata           |
| 3. Protura                      | 11. Thysanoptera      |
| 4. Collembola                   | 12. Neuroptera        |
| 5. Dermaptera and<br>Orthoptera | 13. Mecoptera         |
| 6. Plecoptera                   | 14. Trichoptera       |
| 7. Psocoptera                   | 15. Strepsiptera      |
| 8. Anoplura                     | 16. Siphonaptera      |
- II. Hemiptera  
III. Lepidoptera  
IV. and V. Coleoptera  
VI. Hymenoptera: Symphyta and Aculeata  
VII. Hymenoptera: Ichneumonoidea  
VIII. Hymenoptera: Cynipoidea, Chalcidoidea, Proctotrupeoidea and Ceraphronoidea  
IX. Diptera: Nematocera and Brachycera  
X. Diptera: Cyclorrhapha  
XI. Check List of British Insects

A list of published parts appears at the end of this handbook.

*Published by the*

ROYAL ENTOMOLOGICAL SOCIETY OF LONDON  
41 Queen's Gate,  
London SW7 5HU

## CONTENTS

	<i>Page</i>
INTRODUCTION . . . . .	iv
EXPLANATION OF FIGURES . . . . .	v
ACKNOWLEDGMENTS . . . . .	viii
APHIDOIDEA: General characteristics . . . . .	1
Key to families . . . . .	3
Family Chaitophoridae: General characteristics . . . . .	4
Key to subfamilies . . . . .	6
Subfamily Chaitophorinae: Key to genera . . . . .	6
Genera and species . . . . .	6
Subfamily Atheroidinae: Key to genera . . . . .	33
Genera and species . . . . .	33
Family Callaphididae: General characteristics . . . . .	41
Key to subfamilies . . . . .	44
Keys to genera: <i>alatae</i> . . . . .	45
<i>apterae</i> . . . . .	48
Genera and species . . . . .	50
BIBLIOGRAPHY . . . . .	124
HOST PLANT INDEX . . . . .	125
INDEX TO INSECT NAMES . . . . .	125

## INTRODUCTION

For a number of years there has been no single and comprehensive work available for the identification of the aphid species occurring in the British Isles. The books of Buckton and Theobald, for many years the standard reference works on the British fauna, are now of mainly historical interest, and their use leads only to frustration because of the great advances made in the study of aphid systematics and nomenclature over the last 45 years, mainly as a result of improved techniques for the handling of aphids as subjects for microscopy.

The treatment now offered is intended as the first part of a handbook for the determination of the British aphid fauna by means of dichotomous keys illustrated by black and white figures. No attempt has been made to trace the synonymies of genera or species, which can be derived from a study of the 2nd edition of the Kloet & Hincks *Check List of British Insects*. The bibliography is also minimal, in the knowledge that the few works selected for inclusion themselves contain much more comprehensive references to the literature, so that the enthusiastic student of aphids may be led on to fuller sources of information, while the user who requires only a practical aid to identification is not overburdened with unwanted references or taxonomic refinements. On the other hand, the generic descriptions and a number of the key couplets are of considerably greater length than is often found in handbooks of this kind. This is because aphids are extremely variable in their morphology, in response to environmental changes, and their variability often confounds the taxonomist who is bold enough to devise keys for their identification on the basis of the material known to him. It is therefore essential to support the often very brief diagnostic characters in the generic and specific keys with supplementary information enabling the user to check the determination arrived at by way of the supposedly exclusive species diagnosis. Even with the additional descriptive data given in the keys it is not to be expected that all individual specimens will fall out at the right couplets; but in general it may be hoped that samples of a few (say 5-10) specimens will do so. It must be remembered that aphid species are still being added to the British fauna at a rate of perhaps 5 or 6 per annum, and therefore it is likely that this handbook will be in some few respects out of date even before it is printed. It is, however, possible to hope that it may serve its purpose in bringing the identification of our aphids up to the level of accuracy feasible at the time of writing (1975).

No section has been incorporated dealing with the techniques of handling and mounting aphid material, since these have recently been summarized in Chapter 1 of the handbook *Aphid Technology* edited by van Emden (1972).

## EXPLANATION OF FIGURES

Fig. 1 illustrates by means of diagrammatic drawings from imaginary ideal aphid morphs the various morphological characters referred to in the keys. The component drawings of this figure are as follows:

- A. Dorsal view of alate viviparous female
- B. Ventral view of abdominal apex of viviparous female
- C. Ditto of oviparous female possessing subsiphuncular wax gland fields
- D. Ditto of male
- E. Enlarged view of apical segments of rostrum
- F. Ditto of tarsal joints I and II and apex of tibia
- F'. Ventral view of tarsal joint I, further enlarged
- G. Hind tibia of oviparous female
- H, K, L. Types of wax-producing element (H *Pemphigus*, K *Eriosoma*, L *Aphis*)

The abbreviated captions to Fig. 1 are as follows:

Aed.	Aedeagus	Pr.hrs.	Primary hairs
Ca.	Cauda	Pr.rhin.	Primary rhinaria
C.e.	Compound eye	Pron.	Pronotum
Clr.	Clasper	P.t.	Processus terminalis
Cl.hr.	Claw hair	Ps.	Pterostigma
Cu1	Cubitus 1	Pseudos.	Pseudosensoria
Cu2	Cubitus 2	R.s.	Radial sector
Fr.prom.	Lateral frontal prominence	Sec.rhin.	Secondary rhinaria
Gon.	Rudimentary gonapophyses	Si.	Siphunculus
Ham.	Hamuli	S.p.	Sense peg
Int.m.scl.	Intersegmental muscle sclerites	Sp.hrs.	Spinal hairs
M1-4	Branches of Median	Sp.scler.	Spinal sclerites
Marg. hrs.	Marginal hairs	Spir.pl.	Spiracular plates
Marg.scler.	Marginal sclerites	Sa.pl.	Subanal plate
Marg.tub.	Marginal tubercles	Sg.pl.	Subgenital plate
Meson.lobes	Mesonotal lobes	Subs.hrs.	Subsidiary hairs
Oc.	Ocelli	Subsiph.w.gl.	Subsiphuncular wax gland plate
Pl.hrs.	Pleural hairs	Tars.	Tarsal joints.
Pore pl.	Pore plates		

The remaining figures (2-78) of individual species are taken from micro-projector drawings of cleared specimens on slides, and allowance must therefore be made for slight flattening which makes the illustrated specimens seem a little broader relative to their length than they would appear in life. The drawings are made to three sets of indicated scales, A-C. Some of the enlarged detail figures are from freehand drawings and not to one of the indicated scales. These figures are marked with an asterisk (\*). Melanic pigmentation of sclerotic parts, represented by stipple, is usually confined to one side of the mid-line of the figure wherever overall stippling would interfere with the appreciation of chaetotactic or other detail.

*The figure numbers corresponding to the individual species are placed in parentheses (in bold type) following the specific epithet at the end of the respective key couplets.* Apart from this general group number for the figures representing a given species, the individual detail drawings are indicated by standard code letters signifying the following details:

- a apterous vivipara, whole body (to scale A)
- b alate vivipara, abdomen, dorsal view (scale A)
- c alate vivipara, head, dorsal (scale B)



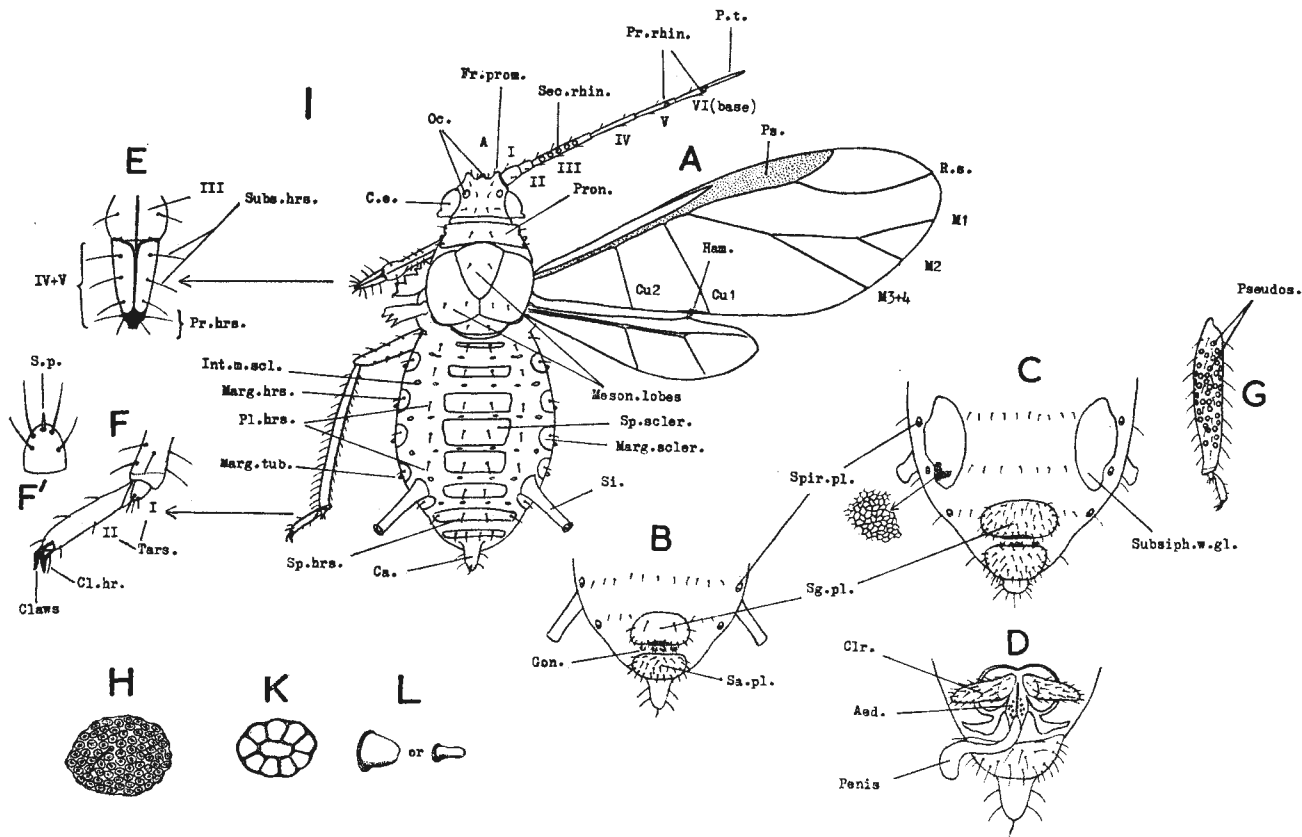

FIG. 1. Morphological features of aphids.

d,d'	apterous, alate viviparae, antenna (scale B) (if whole antenna is not shown, the illustrated joints are given Roman numerals in parentheses)
e	alate vivipara, fore wing (scale C)
f,f'	apterous, alate viviparae, siphunculus (scale B or *)
g,g'	apterous, alate viviparae, cauda (scale B)
h,h'	apterous, alate viviparae, rostral segments (scale B)
i,i'	apterous, alate viviparae, hind tibia and/or tarsus (scale B)
j	first instar, whole body, dorsal (scale B) (where aestivating dimorphs are illustrated this is shown by the abbreviation 'dim.' in parentheses)
k	enlarged cuticular detail (scale B or *) (this includes detail of structure of antennal rhinaria and of wax gland pore groups)
l	enlarged chaetotactic detail (scale B or *)
m	enlarged chaetotactic detail, tarsus of 1st instar (dim.) (*)
n	apterous vivipara, compound eye (scale B)
p	apterous vivipara, 7th abdominal tergite with chaetotaxy (scale B)
q,q'	apterous, alate vivipara, 8th abdominal tergite with chaetotaxy (scale B)
r	alate vivipara, hind femur detail (scale A)
s	alate vivipara, pronotum (scale B)

In addition to these standard code letters there are one or two instances where 'one-off' figures are given of individual species. These are generally self-explanatory. Some figures of legs are marked with the abbreviations Cx for coxa, Tr for trochanter, Fm for femur and Ti for tibia, followed by the number of the pair of legs concerned, 1, 2 or 3. In a few cases the viviparae illustrated are either fundatrices, indicated by (fund.), or mature aestivating dimorphs (dimoult), indicated by (dim.), after the appropriate code letter a or b.

The letter v against a figure indicates that the detail is seen from the ventral side.

In all cases scale lines A and C represent 1mm, while B represents 0.5mm.

#### ACKNOWLEDGMENTS

I am grateful to Dr V. F. Eastop of the British Museum (Natural History) for the opportunity to make drawings from specimens in the Museum's collections of aphids in a number of instances where the collections at the Plant Pathology Laboratory, Harpenden, did not contain suitable slides. I am also indebted to Dr D. Hille Ris Lambers of Bennekom, Netherlands, for leave to use the drawing of the apterous vivipara of *Ctenocallis setosa* (Kltb.) (fig. 49a), which he had made available to me on a previous occasion to illustrate an account of the species published in the Society's *Transactions*.

## HOMOPTERA : STERNORRHYNCHA

### Superfamily APHIDOIDEA

The Aphidoidea are the most numerous and in many ways the most successful members of the division Sternorrhyncha, which comprises those groups of Homoptera in which the rostrum, or modified labium that guides, supports and clamps the feeding stylets (modified mandibles and maxillae), is not articulated to the sclerotic part of the head capsule but appears to arise from the prosternum. Other members of this division are the scale insects or Coccoidea, the jumping plant-lice or Psylloidea and the white-flies or Aleyrodoidea.

All known families of aphids have predominantly parthenogenetic reproduction, accompanied by a strong tendency to neotenic reduction of their primitive winged adult morphs to give wingless adults (*apterae*) devoted primarily to feeding and reproduction. In most genera these apterae retain mobility by walking, but in a few they become modified to sedentary forms looking like coccids. The only British genera with this kind of aptera are *Cerataphis* Lichtenstein and *Hormaphis* Osten-Sacken, the former not being indigenous and only thriving here under glasshouse conditions. In all aphid families except Adelgidae and Phylloxeridae parthenogenesis is accompanied by viviparity, which raises the potential for increase by enabling telescoping of successive generations of embryos. Continuous exploitation of the plant hosts is further promoted in many genera by the transference of part of the annual cycle on to an alternate host with a growth pattern more or less complementary to that of the main overwintering or *primary host*, on which last the males and sexual females (*oviparae*) mate and oviposit, usually in the autumn. This alternation, called *heteroecy*, is common in Aphididae, Thelaxiidae, Anoeciidae, Pemphigidae and Adelgidae, but unknown in Lachnidae, Chaitophoridae, Callaphididae, Mindaridae, Phloeomyzidae and Phylloxeridae, although in some of these there may be a movement between roots and upper parts of the same host.

Fully adult aphids (*alatae*) have two pairs of membranous wings, the anterior pair with a subcostal thickened band terminating in a more or less well-defined *pterostigma*; from the subcostal band arise either 3 or 4 main veins, of which the first or *radial sector (Rs)*, running from the pterostigma to the wing apex, is the vein lost in the 3-veined condition; the second or *median (M)* may be once or twice branched when there are 4 main veins. The posterior wings are smaller (sometimes even reduced to small haltere-like structures), and normally have 1 or 2 main veins, but never more, arising from the subcostal. Wings are absent or vestigial in the neotenic apterous morphs. The antennae are composed of 3 to 6 joints, of which the distal 1 to 4 form the *flagellum*; the last 2 (rarely 3) joints, except when the antenna is 3-jointed, always bear primary sense organs (*rhinaria*); in 3-jointed antennae only joint III has these organs. The flagellar joints also bear varying numbers of *secondary rhinaria* consisting of a thin-walled plaque usually surrounded by a chitinous rim; these are characteristic of *alatae* and males, but may also occur in the apterous viviparae and oviparae. The apical part of the last joint beyond the primary rhinarium is usually more or less produced into an attenuated *unguis* or *processus terminalis*. The head in the alate morphs bears a mediofrontal and 2 lateral *ocelli* or simple eyes,

the latter lying just above the anterior end of the *compound eyes*. These last usually bear a posterior tubercle with 3 facets representing the primary larval eye or triommatidion; in the apterae of some groups this remains even in the adult instar as the only developed representative of the compound eye. The *rostrum* consists of 5 segments, of which the basal one is thin-walled, usually telescopic and rather inconspicuous; segments II-V are stiffened and well-defined; IV-V are more or less combined into what is often termed the apical or ultimate segment, but in some genera, especially in the Lachnidae, they remain distinct. The rostrum is absent from the sexual morphs of Pemphigidae and from males of *Stomaphis* Walker (Lachnidae). The abdomen has a maximum of 9 visible tergites, of which the ninth may be more or less produced into an elongate *cauda*; there are maximally 7 pairs of abdominal spiracles (reduced in Adelgidae and Phylloxeridae to 6, 5 or 1). Abdominal tergite 5 or 6 often bears a pair of *cornicles* or *siphunculi*, varying in structure from simple pores to elongate vasiform or tube-like organs; these serve as repugnatorial weapons through which a rapidly-solidifying waxy secretion, often also embodying an alarm pheromone, is extruded when the aphid is attacked or molested to clog and impede the movements of the attacker.

The last abdominal sternite forms the sclerotic *subanal plate*, which may be entire or with a posterior median cleft or emargination. Anterior to this in adult female morphs lies the *subgenital plate*, a transverse oval, reniform or oblong sclerite behind the posterior margin of which opens the inconspicuous genital orifice. Between the subgenital and subanal plates, and behind the genital orifice, occur 2-4 small hair-bearing lobes which are the rudiments of the primitive *gonapophyses*. In males the external genitalia are much more complex and conspicuous, consisting basically of a subcircular sclerotic apodeme providing leverage for the erection and extrusion of a pair of bristly *claspers* and a tubular sclerotic *aedeagus* terminating in a thin-walled extrusible *penis*.

The legs have the trochanters fused with the bases of the femora; the tibiae in sexual egg-laying oviparous females (and rather rarely also in viviparae or males) may bear varying numbers of so-called *pseudosensoria*, which are in fact small areas of minutely porous cuticle overlying secretory cells that produce a kairomonal sex attractant; the tarsi are typically composed of 2 unequal joints, the second considerably the longer and bearing 2 claws; rarely the tarsal joints in apterae may be fused into one, and even more rarely the tarsi may be reduced to small clawless rudiments or altogether absent. The body may be covered with a waxy coating of a powdery or flocculent consistency, produced by glandular elements usually localized into simple round or flat tubercles or compound groups of pores organized into gland plates. Where present these are distributed segmentally in well-defined marginal, pleural and/or spinal series.

Aphids are entirely phytophagous, living on the sap of angiosperms, gymnosperms, pteridophytes or bryophytes. When living on plants with a well-organized vascular system they insert their stylets into the phloem sieve tubes and utilize the turgor pressure of the plant tissue to help the ingestion of sap. A few specialized aphids living on non-vascular mosses are obliged to obtain their food by sucking out individual cells. Many species of aphids live in some degree of symbiosis with ants, which are strongly addicted to the

sweet excrement or honey-dew produced by the aphids. Some of the more specialized myrmecophiles live within the galleries of ant nests on the exposed roots of plants. In one extreme case, *Paracletus* von Heyden, it has been claimed that the aphids can be fed directly by the ants, but such a trophallactic relationship could only be a partial one, since the primary producer remains the plant host, from which the sugars or other honeydew constituents cementing the bond are derived. The great majority of aphids live on angiosperms; the relationship of some groups, such as Adelgidae, *Mindarus* and many Lachnidae, with gymnosperms is probably primitive, but the very small number of Aphididae that now live on ferns, horsetails and mosses seem certain to have acquired these hosts in very recent times on the evolutionary scale, and the same may be true in a lesser degree of a few small Pemphigidae that now live on mosses.

The taxonomic arrangement in this Handbook follows that of Edition 2 of Kloet & Hincks' *Check List of British Insects* (1964), except that, following Shaposhnikov (1964), the subfamily Anoeciinae and the genera *Mindarus* and *Phloeomyzus* have been elevated to family status. The treatment begins with the family Chaitophoridae rather than the Lachnidae, since a large part of the latter has recently been admirably covered by the very thorough revision of the British species of *Cinara* Curtis published by Eastop (1972). The other families of the British aphids are very much overdue for comprehensive treatment. My ultimate aim is to follow this Handbook with further parts dealing with the families Aphididae to Pemphigidae, but this is a long-term objective. The Adelgidae and Phylloxeridae fall outside the scope of this programme, and are therefore omitted from the 'Key to Families' that follows.

KEY TO FAMILIES OF APHIDOIDEA, EXCEPT ADELGIDAE AND PHYLLOXERIDAE

[Translated and adapted from Shaposhnikov (1964)]

- 1 Processus terminalis (apical process of last antennal joint) shorter than half the basal part of last joint proximal to primary rhinarium. Cauda subtriangular. Forewing in alate viviparous female with radial sector vein (*Rs*) originating from base of pterostigma, about level with the point at which the subcostal vein (*Sc*) reaches costal margin of wing. On conifers of the genera *Abies* or *Picea*

MINDARIDAE

- Processus terminalis more than half as long as basal part of last antennal joint; or if less than half this length, then cauda broadly rounded or with an apical knob delimited by a constriction. Forewing in alate viviparous female with *Rs*, if present, originating from near apex of pterostigma. . . . . 2
- 2 Processus terminalis less than half as long as basal part of last antennal joint. Cauda broadly rounded, without a constriction; or if knobbed, then antennae not more than 5-jointed. . . . . 3
- Processus terminalis more than half as long as basal part of last antennal joint; or if shorter than this, then cauda knobbed and antennae 6-jointed. . . . . 7
- 3 Apterous viviparous females and immature morphs with head and pronotum not fused together, so that compound eyes lie clearly on posterior half of sides of head. Alate viviparous females with wings in repose folded in the form of a roof, and with anterior part of mesonotum clearly divided into 3 lobes of which the middle one is anterior to the lateral ones; or if wings folded flat over the dorsum, then with wax gland plates present marginally and spinally on all abdominal tergites. . . . . 4
- Apterous viviparous females and immature morphs with head capsule fused to pronotum, so that the compound eyes lie about in the middle of the sides of the apparent 'head'. Alate viviparous females with wings in repose folded flat on dorsum, and with anterior part of mesonotum not divided into 3 lobes. If wax

- gland groups present, then only on abdominal tergite 7 or in the form of a border round the body. . . . . 6
- 4 Apical segment of rostrum without a clearly defined terminal 'beak' representing the primitive segment V. Apterous viviparous females with compound eyes composed only of the triommatidion, or if with more than 3 facets then siphunculi absent. Accessory rhinaria around primary rhinarium on last antennal joint 3-4 in number. Tarsi of all legs more or less uniform in size. Marginal tubercles (simple wax gland elements) absent, but gland plates may be present, and the living aphids be covered with flocculent wax. Alate viviparous females with median vein (*M*) in forewing simple or once-branched, only exceptionally twice-branched in individual specimens. Sexual morphs without rostrum **PEMPHIGIDAE**
- Apical segment of rostrum with a more or less well marked terminal 'beak' representing the primitive segment V. Apterous viviparous females with compound eyes many-faceted, or if with only 3 facets then *either* second joint of hind tarsi greatly lengthened (*Tramini*) or sides of body with lateral tubercles (simple wax gland elements) (*Anoeciidae*). Siphunculi conical or pore-like; if absent, then second joint of hind tarsi greatly lengthened (*Trama* v. *Heyden*), more than twice as long as second joints of front and middle tarsi. Wax gland plates absent. Alate viviparous females with *M* in forewing twice- or once-branched, rarely simple . . . . 5
- 5 Marginal tubercles (wax gland elements) absent. Alate viviparous females with pterostigma of forewing 4-20 times as long as its width. On various hosts, but not on Cornaceae, Gramineae or Cyperaceae **LACHNIDAE**
- Marginal tubercles present on pronotum and on abdominal tergites 1-7 or 1-4 and 7, weakly convex. Alate viviparous females with pterostigma of forewing less than 4 times as long as its width. On Cornaceae and on roots of Gramineae or Cyperaceae **ANOECIIDAE**
- 6 Wax glands present only on abdominal tergite 7, in 2 large groups. Antennae of alate morphs 6-jointed, without secondary rhinaria, of apterous viviparae 5- or 6-jointed. Antennae, tibiae and tarsi without spinules, only with weak imbrication, or in apterae with spinules forming reticulations. Cauda broadly rounded. Sexual morphs alate. On *Populus* species **PHLOEOMYZIDAE**
- If wax glands present, then not only on abdominal tergite 7 but distributed round margins of body. Antennae of alatae 5-jointed, with secondary rhinaria, of apterae 5-, 4- or 3-jointed. Rows of small spinules present on antennae or on tarsi and apices of tibiae; sometimes partly fusing one with another; or tarsi absent. Cauda knobbed or rounded. Sexual morphs apterous. On *Fagaceae*, *Betulaceae*, *Orchidaceae* or palms in Europe **THELAXIDAE**
- 7 Cauda knobbed; or if broadly rounded or semicircular, then *either* siphunculi stump-shaped and with reticulate sculpture; or antennae 5-jointed and marginal tubercles absent; or secondary rhinaria narrow and transverse; or if cauda short triangular, then subanal plate with a deep cleft or emargination posteriorly. . . . . 8
- Cauda finger-shaped, ensiform, elongate triangular or short triangular; if semicircular, helmet-shaped or broadly rounded, then siphunculi without reticulate sculpture and not stump-shaped, and antennae 6- or 4-jointed (if 5-jointed, then large marginal tubercles present on pronotum and some other segments of body). Secondary rhinaria, when present, more or less round. Subanal plate not emarginate or cleft posteriorly **APHIDIDAE**
- 8 Siphunculi without reticulate sculpture. Antennae 6-jointed, or if exceptionally 5-jointed (*Callipterinella minutissima* (Stroyan)) then siphunculi ornamented with rows of spinulose denticles and subanal plate emarginate posteriorly. Tarsi with or without spinules. Subanal plate cleft, emarginate or simply rounded **CALLAPHIDIDAE** (p. 41)
- Siphunculi with reticulate sculpture; or if without it, then antennae 5-jointed. Tarsi without spinules, only with smooth imbrications. Subanal plate rounded, or at most very slightly concave in middle of hind margin **CHAITOPHORIDAE** (p. 4)

### Family CHAITOPHORIDAE

A family of mostly rather uniform facies, characterized by the prominent bristly chaetotaxy of the dorsum and often also of the appendages, from which

the family name ('bristle-bearers') is derived. Dorsal hairs in a few species reduced in size and inconspicuous, or antennal and crural hairs similarly reduced; in such cases the body may be very elongate with heavy dorsal sclerotization and pigmentation. Body shape from nearly linear to stoutly ovoid or pyriform, and body length from about 0.8mm in males of *Chaitophorus capreae* (Mosley) to about 4.5mm in some fundatrices such as those of *Periphyllus acericola* (Walker). Colour in life ranging from whitish through various shades of yellow, green and brownish to black; dorsum never clothed with wax flocculence or pulverulence.

Adult viviparae with antennae shorter than body, in Chaitophorinae 6-jointed but in Atheroidinae 5- or even 4-jointed; rarely in small specimens of *Chaitophorus* joints III and IV may more or less fuse to give a 5-jointed condition. Secondary rhinaria typically absent from antennae of apterae; present on joint III or III-IV in alatae, more rarely with 1-2 also on V; subcircular with a distinct double contour, never distinctly fringed or fimbriate, though rims occasionally indistinctly striate, e.g. *Chaitophorus albus* Mordvilko. Primary rhinaria either smooth-rimmed or obscurely fringed; accessory rhinaria on last antennal joint sometimes more distinctly fringed. Compound eyes in adults multifaceted, with a distinct triommatidion. Rostrum normal, not telescopic, usually rather short; apical segment from extremely short and broad to fairly elongate, but not very acute or stiletto-shaped in any British species. Wings normal to rather long and narrow; forewing with *M* either once- or twice-branched; venation sometimes brown-shadowed. Resting posture of wings vertical. Siphunculi usually truncate conical, subcylindrical or stump-shaped, sometimes with irregular swellings or protuberances on posterior face, or with a pronounced apical flare like the mouth of a trumpet; apical part in Chaitophorinae bearing a zone of reticulate sculpture of variable depth; no such sculpture in Atheroidinae, and here the siphunculi often reduced to slightly elevated rim-like structures or mere pores. Cauda from broadly crescent-shaped through semicircular or bluntly subtriangular to distinctly elongate with a more or less marked constriction delimiting an apical knob. Subanal plate sometimes very slightly emarginate in middle of posterior margin, but never deeply cleft or bilobed. Dorsal cuticle often sclerotic with or without dark pigmentation, and sometimes also rugose, nodulose or spinulose. Wax gland elements absent. Dorsal chaetotaxy usually multiplied in adult morphs by interpolation of few to many secondary hairs, normally smaller than the primary series of spinal, pleural and marginal hairs. Individual hairs either long, fine and acute, or stout and hollow with blunt to acute apices, or short and rod-like, or with expanded split, furcate or 'frayed' apices; when strongly reduced in size usually showing more or less modified apices. Legs normal, without modifications for leaping; tibiae often bearing fine spinules between the hairs over part of their length, but tarsi not adorned with rows of fine spinules as in many Callaphididae. Primitive hair number of first tarsal joints 7, all ventral, exceptionally increased to 8 or 9 on individual tarsi; reduction has occurred in many species, giving numbers varying from 2 to 6, and the tarsal chaetotaxy is inconstant within genera. Claw hairs rarely bristle-like; more usually to some extent flattened or blade-like, but seldom much widened towards apex.

Males alate or apterous, with 5- or 6-jointed antennae, and always with



secondary rhinaria on at least joints III-IV. Oviparous females without lateroventral subsiphuncular wax gland fields.

First instars with 4- or rarely 5-jointed antennae and multifaceted compound eyes; siphunculi present; pleural hairs present, or absent except from mesonotum.

British species all monoecious and holocyclic; one or two species to some extent polyphagous. Heteroecy and galling reactions by the host not known. The predominant morph in the cycles of the Chaitophoridae is the apterous viviparous female; alatae are produced in variable numbers, and may sometimes predominate in certain generations, for example the second generation of *Periphyllus acericola* (Walker) and *P. xanthomelas* (Koch), but are rare in Atheroidinae and some species of *Chaitophorus* Koch. The hosts of Chaitophorinae are species of *Salix* and *Populus* (Salicaceae), *Acer* (Aceraceae) and *Aesculus* (Hippocastanaceae); those of Atheroidinae are Gramineae or, more rarely, Cyperaceae or Juncaceae. Species of *Periphyllus* van der Hoeven may aestivate on the host either wholly or partly as specially modified first instar larvae ('dimorphs').

#### KEY TO SUBFAMILIES OF CHAITOPHORIDAE

- 1 Adult viviparae with 6-jointed antennae, or if joints III and IV are fused (in small apterae) then the fusion is not complete and the two articles can still be distinguished. Siphunculi with at least some trace of reticulate sculpture, and more or less stump-shaped. On Aceraceae, Salicaceae and Hippocastanaceae.
 

**CHAITOPHORINAE** (p. 6)
- Adult viviparae with 5-jointed or rarely 4-jointed antennae. Siphunculi rim- or pore-like, truncate conical or vasiform; or if stump-shaped and longer than their thickness in the middle, then without any reticulate sculpture. On Gramineae or Cyperaceae, or rarely Juncaceae.
 

**ATHEROIDINAE** (p. 33)

#### KEY TO GENERA OF CHAITOPHORINAE

- 1 Adult apterae with dorsal cuticle more or less continuously sclerotic over at least abdominal tergites 2-6 in British species, and if with melanic pigmentation then this also is solid or at least not broken into sclerites bearing individual hairs. Adult alatae with cauda rather distinctly knobbed, or if not so then hind tibiae with a few scattered pseudosensoria, and siphunculi not strongly flared at apex. On Salicaceae.
 

**CHAITOPHORUS** Koch (p. 6)
- Adult apterae with dorsal cuticle not continuously sclerotic on abdominal tergites 2-6, and if with melanic pigmentation this is in the form of more or less separate roundish, oval or quadrate sclerites of which at least some bear single hairs. Adult alatae with cauda not distinctly knobbed, or if with some constriction delimiting a slight knob then without any pseudosensoria on hind tibiae, and siphunculi rather strongly flared at apex (figs 12,13f). On Aceraceae and Hippocastanaceae.
 

**PERIPHYLLUS** van der Hoeven (p. 17)

#### Genus CHAITOPHORUS C. L. Koch, 1854

Type-species (designated by Gerstaecker, 1856): *Aphis populi* L.: C. L. Koch, 1854, cited as *Chaitophorus populi* L. (= *Aphis populeti* Panzer, 1805). A later designation by van der Goot (1913) citing *C. leucomelas* Koch is preferable, but although recommended by Hille Ris Lambers and Stroyan (1975) has not yet been endorsed by the International Commission under their plenary powers.

Small to medium-sized aphids (body length not more than 3mm in British species) living solely on Salicaceae.

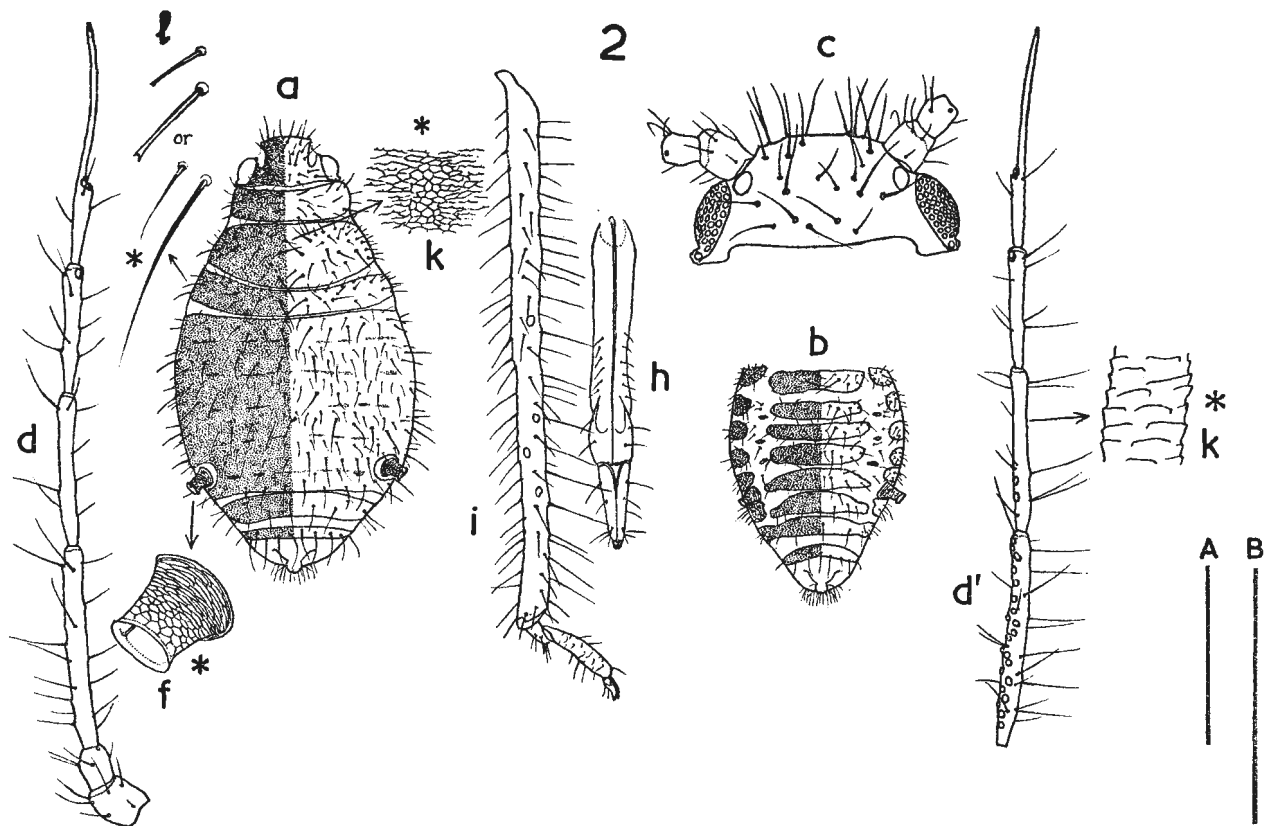

FIG. 2. *Chaitophorus populeti*.

*Apterae*: Body oval, more or less elongate, and variably flattened, more especially so in species living on, under or between leaves. Antennal hairs variable in number and length, from shorter than diameter of antennal joints to several times as long; variable also in structure, from very fine and evanescent at apex to blunt, truncate or furcate. Secondary rhinaria absent except in occasional alatiform specimens. Dorsum extensively sclerotic with variable degrees of melanic pigmentation; abdominal tergites 2-6 in all British species forming a more or less solidly fused carapace, sometimes further enlarged by the addition of the sclerotic band across tergite 1; thoracic tergites and abdominal 7-8 with separate transverse sclerotic bands. Dorsal hairs variable in number, arrangement and structure; often shorter and less numerous in *fundatrices* than in later generations; arranged in a single or confusedly double row across each tergite, the posterior row consisting of longer hairs than the anterior, and containing the primary spinal and pleural hairs in those cases where the row is doubled; apices of hairs varying from fine and acute to strongly furcate. Siphunculi more or less stump-shaped, sometimes with a slight apical rim or flare; with a variable number of rows of polygonal reticulations apically, passing basad into much more transverse cells and striations; situated on abdominal tergite 6. Cauda usually but not always distinctly knobbed, with a rather small number of hairs borne on the apical knob or its equivalent. Subanal plate sometimes slightly emarginate but usually more or less evenly rounded. Subgenital plate typically with a single row of rather long hairs extending right across middle, and a more irregular row of shorter ones along the posterior margin. Legs normal, usually with all fine acute hairs, but sometimes with a few truncate ones on tibial bases and femora in species where such hairs are prevalent on dorsum; tibial apices usually with at least a few fine spinules between hairs; first tarsal joints with 4-9 ventral hairs of which the medio-apical one is a stout sense-peg. Rudimentary gonapophyses 4, the 2 middle ones sometimes hardly separated.

*Alatae*: Head and pterothorax more or less dark sclerotic. Antennae bearing secondary rhinaria on joint III, often also on IV and occasionally on V. Abdominal carapace broken into more or less well developed and pigmented segmental bands and marginal sclerites; dorsal hairs normal and acute. Siphunculi often with an asymmetric rounded bulge on posterior face near base. In other respects similar to apterae. Wings with normal venation, sometimes brown-shadowed.

*Males* apterous or alate, with secondary rhinaria on antennal joints III-V inclusive.

*Oviparae* usually somewhat larger than apterous viviparae; dorsum membranous apart from bands across pronotum and abdominal tergite 8 (rarely also 7); cauda more or less rounded, rarely slightly knobbed; tergite 8 and subgenital plate with more hairs than in corresponding apterous viviparae.

*Immature morphs* similar in chaetotaxy to adult viviparae, but dorsum with at most small discrete hair-bearing scleroites, never solidly sclerotic. First instar never modified into an aestivating dimorph, and showing the normal primary chaetotaxy in longitudinal series of spinal, pleural and marginal hairs; pleurals from mesonotum to abdominal tergite 5, or exceptionally on mesonotum only; later instars have primary chaetotaxy modified

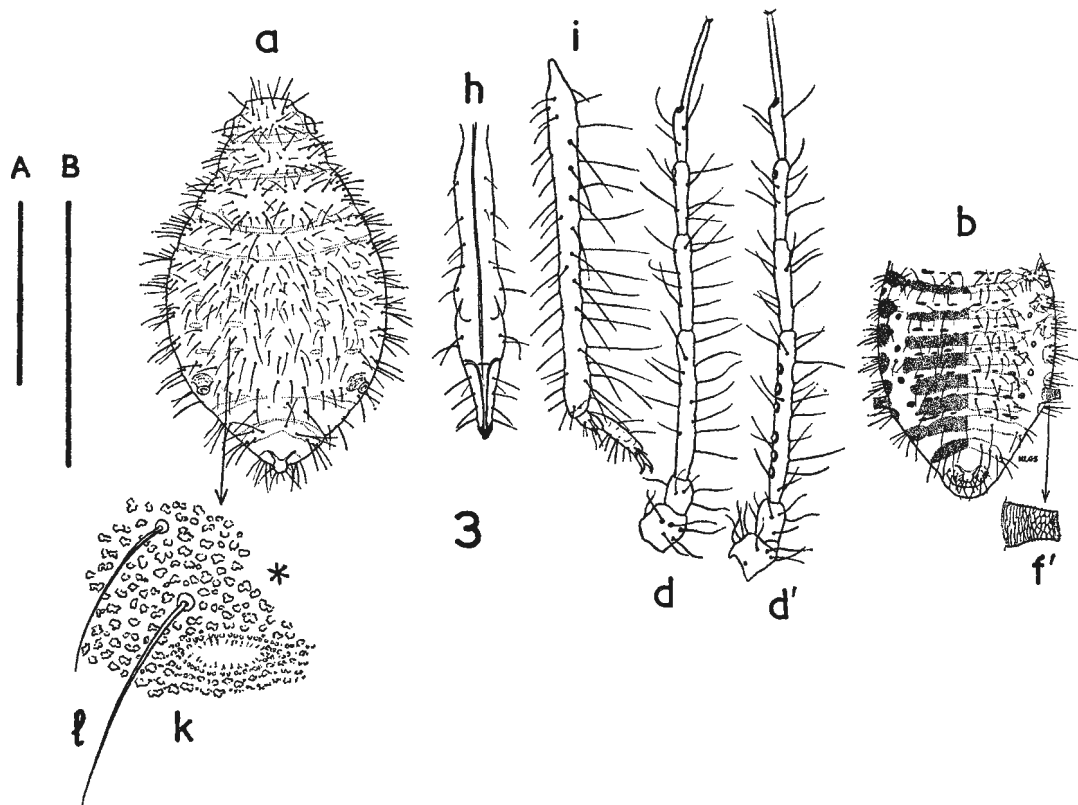

FIG. 3. *Chaitophorus vitellinae*.

by intercalation of varying numbers of secondary hairs. Antenna of first instar 4- or 5-jointed, but if 5-jointed then without antennal hairs on joint III; second and third instars with 5-jointed antennae, joint III with a number of hairs.

There are at present 10 known British species.

### KEY TO SPECIES

- 1 Hind tibiae of *viviparae* bearing a small number of pseudosensoria. (Dorsum of *apterae* dark sclerotic, forming a more or less solid carapace from abdominal tergite 1 to 6 inclusive, or sometimes with a paler median area on tergites 1-2; and with separate bands on pro- and mesonotum and abdominal tergites 7-8. Antennal joint III bearing 10-28 hairs, or a total of 20-52 on both antennae together; longer antennal hairs tending to be arranged in about equal numbers on inner and outer faces of joints, at least in larger specimens. Dorsal cephalic and body hairs variable, their apices acute to truncate, furcate or raggedly chisel-shaped. Apical rostral segment about equal in length to 2nd hind tarsal joint measured without claws, and bearing 5-7 subsidiary hairs in addition to the three constant apical pairs. First tarsal joints with 7 (more rarely, 6, 8 or 9) hairs, one of which is a medioapical sense-peg. *Alatae* with 10-27 secondary rhinaria confusedly arranged along antennal joint III and 0-8 on IV. Wing membrane strongly squamulose, and venation brown-shadowed.) Body length to 2.9mm. **populeti** (Panzer) (2)  
*Living in colonies clustered on young shoots and branches of Populus alba, canescens and tremula, attended by ants. Kent, Hampshire, Suffolk, Inverness; uncommon but distribution probably much wider.*
- Hind tibiae of *viviparae* (unless rarely *fundatrices*) without pseudosensoria. If on *Populus alba, canescens* or *tremula*, then living on leaves and not, or only occasionally, attended by ants.....2
- 2 Longer antennal hairs rather evenly distributed round circumference of joints III-V inclusive, i.e. more or less as in *C. populeti*. (*Apterae* rather broad yellow-green aphids with two darker green pleural longitudinal lines in life, but rarely with any melanic dorsal suffusion. Dorsum normally pale sclerotic, abdominal tergites 1-6 fused into a rather solid carapace with dense, coarse, irregular nodular sculpturing. Hairs all long, erect, very acute and fine apically; antennal joint III bearing 12-23 (or 25-44 in total on both antennae). Processus terminalis not more than twice as long as basal part of antennal joint VI. Apical rostral segment about 1.1-1.2 times as long as 2nd hind tarsal joint without claws, and bearing 4-9 subsidiary hairs. First tarsal joints with 6-7 hairs of which one is a medioapical sense-peg. *Alatae* with rather narrow, evenly spaced transverse dark bands across abdominal tergites; with 3-10 secondary rhinaria on antennal joint III, and rarely up to 2 on IV.) Body length to 2.1 mm.  
**vitellinae** (Schrank) (3)  
*Living in strongly ant-attended colonies clustered on young shoots and twigs of Salix alba, fragilis, amygdalina or viminalis. Suffolk, rare.*
- Longer antennal hairs directed predominantly anterad (on inner face of joints). Species living typically on leaves, only rarely on young shoots; and not, or only casually, visited by ants.....3
- 3 Antennal joint III bearing 0-4 hairs (only rarely more than 6 on both antennae together), the longest of which in *apterae* is not more than 1.7, or in *alatae* not more than 2.2, times as long as basal articular diameter of joint. (*Apterae* small whitish to pale yellow aphids without pigmented dorsal pattern; abdominal tergite 1 more or less fused with tergites 2-6. Dorsal hairs blunt, truncate, chisel-shaped or furcate apically. Abdominal tergite 8 bearing 10-26 hairs. Apical rostral segment about 1-1.3 times as long as 2nd hind tarsal joint without claws, and bearing 1-2 subsidiary hairs. First tarsal joints with 5 (more rarely 4 or 6) hairs. *Alatae* with 3-7 secondary rhinaria in a single line along antennal joint III, and 0-4 on IV; occasionally 1 on V.) Living on underside of leaves of *Salix* spp.....4
- Antennal joint III bearing 3-17 hairs, but not less than 8 on both antennae together, or if less than 8 and *apterae* without pigmented dorsal pattern, then abdominal tergite 8 with only 6-9 hairs, and not living on *Salix*.....5

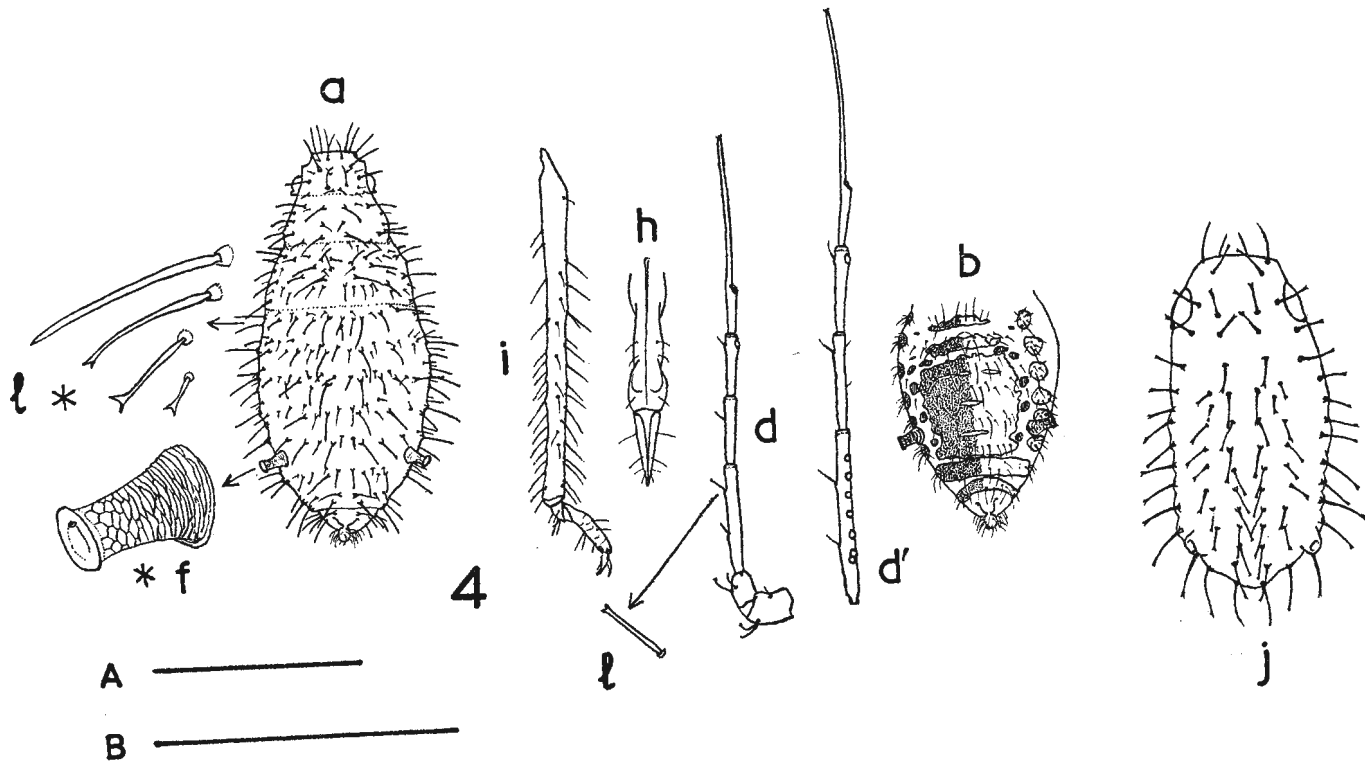
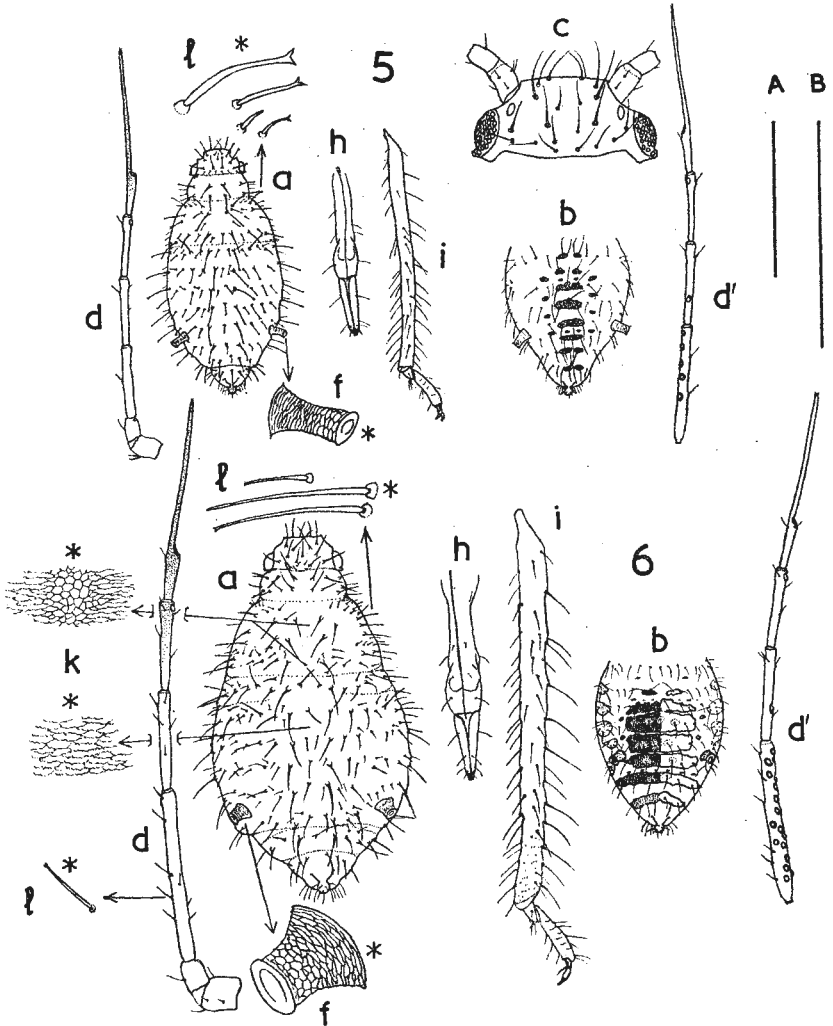

FIG. 4. *Chaitophorus beuthani*.

- 4 *Apterae* more elongate, body length when mounted in slides 2.1–2.5 times its greatest width. Abdominal tergite 3 with 25–45 furcate hairs set in a distinct double transverse row, the anterior row being much smaller hairs than the posterior. Abdominal tergite 8 with 14–26 hairs similarly arranged. Antennal joint III with 1–4 hairs, of which the longest is 1.5–2.1 times as long as basal articular diameter of joint. *Alatae* with 2–4 hairs on antennal III, of which the longest is 1.5–2.1 times as long as b.a.d. of joint. Abdominal tergite 8 with 17–19 hairs. Dark segmental bands on abdominal tergites well developed, those on 3–6 inclusive tending to form a solid rectangular mid-dorsal patch. Body length to 2.3mm. **beuthani** (Börner) (4)



FIGS 5-6. 5, *Chaitophorus capreae*. 6, *C. albus*.

On *Salix viminalis*, *calodendron* and *hybrids* with *viminalis* parentage, i.e. *osier-type willows*. Common.

- *Apterae* less elongate, body length in slides 1.8-2.1 times greatest width. Abdominal tergite 3 with 12-24 furcate hairs set usually in a single transverse row, or rarely with a few small hairs forming a partial anterior row. Abdominal tergite 8 with 10-15 hairs similarly arranged. Antennal joint III with 0-2 hairs, of which the longer is 0.5-1 times as long as basal articular diameter of joint. *Alatae* with 1-3 hairs on antennal III, of which the longest is 0.9-1.3 times as long as b.a.d. of joint. Abdominal tergite 8 with 10-11 hairs. Solid dark segmental bands not developed on abdominal tergites, the much broken pattern on the middle tergites not forming anything like a mid-dorsal rectangular patch. Body length to 1.9mm.

**capreae** (O. Mosley) (5)

On various broad-leaved *sallow-type willows* including *Salix caprea*, *aurita*, *cinerea* and *lapponum*. Very common.

- 5 First tarsal joints typically with 5 hairs (4 + 1 sense-peg), less often with 4, 6 or 7 (evaluate from a sample of several specimens if available) . . . . . 6
- First tarsal joints typically with 7 hairs (6 + 1 sense-peg), less often with 5, 6 or 8 (evaluate from a sample of several specimens if available) . . . . . 8
- 0 Longest hair on antennal joint III in *apterae* 0.9-2.0, in *alatae* 1.3-2.4, times as long as basal articular diameter of joint. (*Apterae* with body entirely pale; abdominal tergite 1 free, not fused with 2-6. Antennal joint III with 3-12 hairs, or 8-23 on both antennae together. Dorsal hairs and longer antennal hairs blunt, truncate or slightly furcate at apex. Abdominal tergite 8 with 6-9 hairs. Apical rostral segment 0.9-1.2 times as long as 2nd hind tarsal joint without claws, and bearing 2 subsidiary hairs. *Alatae* with a rectangular dorsal patch formed by fusion of dark segmental bands on abdominal tergites 3-6, and with marginal sclerites and band across tergite 8 somewhat paler than mid-dorsal patch. Antennal joint III with 7-26 secondary rhinaria, IV with 1-5, V with 0-1. Dorsal and antennal hairs acute. Abdominal tergite 8 with 7-11 hairs.) Body length to 2.5mm.

**albus** Mordvilko (6)

Pale green to whitish aphids, sometimes green-flecked, living under leaves of *Populus alba*, *canescens* and *tremula*. Local.

- Longest hair on antennal joint III in *apterae* more than 3, in *alatae* more than 4, times as long as basal articular diameter of joint. All dorsal and antennal hairs acute. *Alatae* with marginal sclerites and band across abdominal tergite 8 not noticeably paler than segmental bands on tergites 2-7. Antennal joint III with 6-12, IV with 0-4 secondary rhinaria. Living on *Salix* spp . . . . . 7
- 7 Apical rostral segment 0.8-1.07 times as long as 2nd hind tarsal joint without claws, and bearing 2, rarely 3-4, subsidiary hairs. (*Apterae* with dorsum blackish sclerotic, abdominal tergites 1-6 or 2-6 fused into a solid carapace, the dorsal cuticle sculptured with wavy lines of small bead-like or denticular spinules (fig. 7k) that tend to form reticulations in the mid-thoracic and anterior abdominal regions. Siphunculi more or less surrounded by a pale ring of membranous cuticle.) Body length to 2.2mm. **niger** Mordvilko (7)

On leaves of various *willows* including *Salix alba*, *fragilis*, *purpurea*, *laurina*, *amygdalina* and *babylonica*. Local and uncommon.

- Apical rostral segment 1.09-1.5 times as long as 2nd hind tarsal joint without claws, and bearing 4, rarely 3 or 5, subsidiary hairs. (*Apterae* with dorsum varying from blackish sclerotic to wholly pale apart from dusky siphunculi, the latter form in late summer. Blackish specimens with cuticular sculpture of fine wavy lines, less conspicuously spinulose than in *C. niger*, and only rarely forming a few localized reticulations on mesonotum and pleura of some abdominal tergites (fig. 8k). Siphunculi sometimes surrounded by a membranous ring, at other times fused solidly into dorsal carapace.) Body length to 2.3mm **salicti** (Schränk) (8)

On *Salix caprea*, *aurita* and *cinerea* leaves, sometimes ant-attended. Gloucester, rare; may be overlooked or confused with *C. capreae*.

- 4 Dorsum in *apterae* other than *fundatrices* solidly blackish sclerotic, rather densely sculptured with denticular spinules, very often with a paler line or spindle-shaped area along mid-dorsum (fig. 9a). Abdominal tergite 1, except in *fundatrix*, more or less completely fused with the carapace on tergites 2-6. Apical rostral segment typically with 6 subsidiary hairs (2 lateral pairs and 2 dorsals) but sometimes with only 4-5, or exceptionally 3. *Alatae* bearing a total of 19-24 hairs on antennal



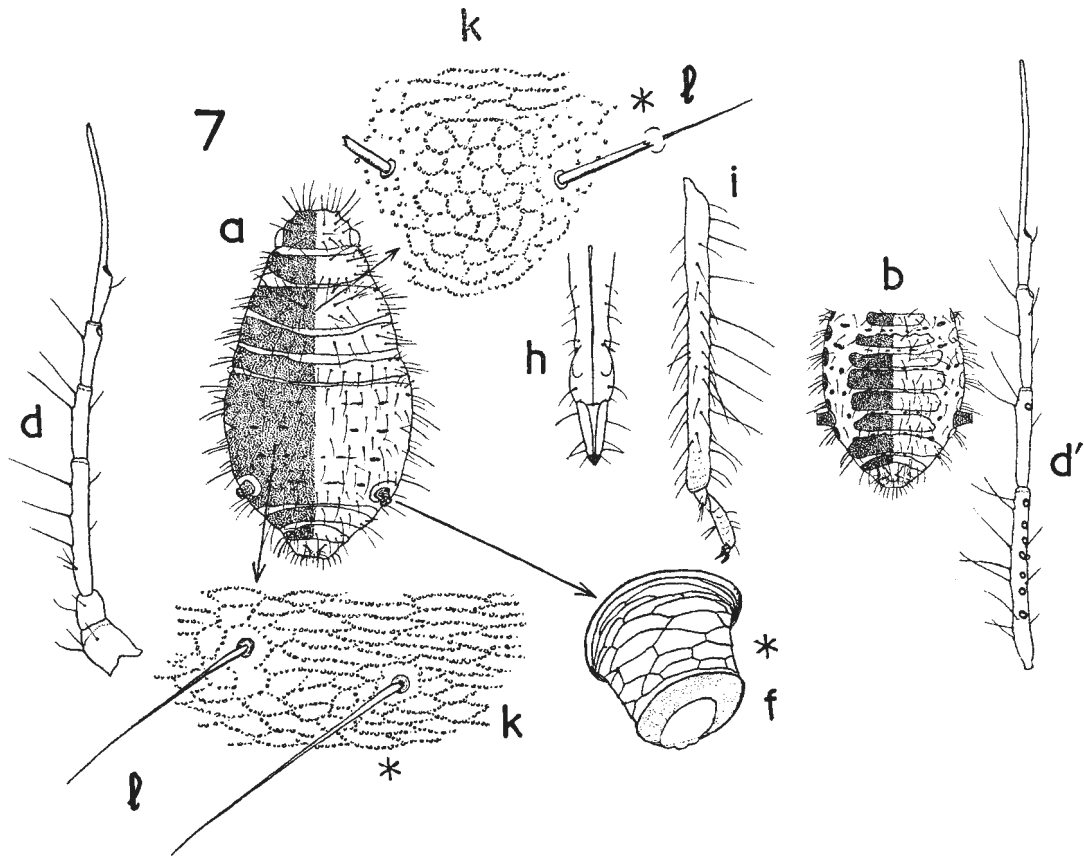

FIG. 7. *Chaitophorus niger*.

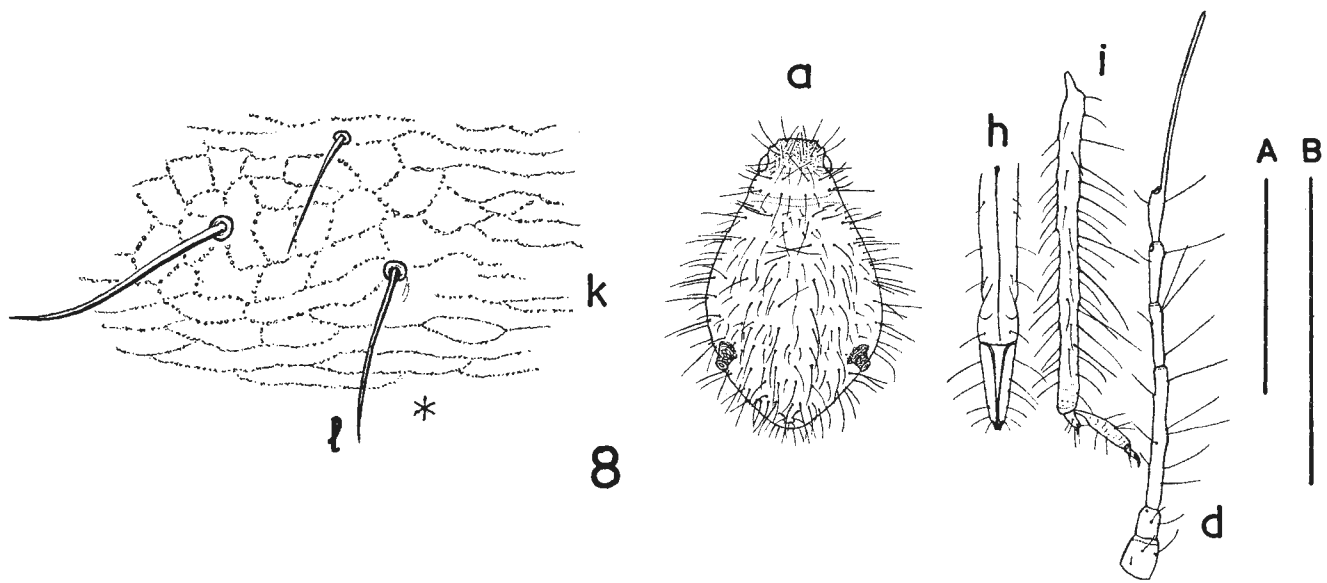

FIG. 8. *Chaitophorus salicti*.

joint III (both antennae), and with 10-23 secondary rhinaria on III on each antenna, these arranged in a confused double to partly triple row along one side of joint; antennal IV with 0-4 secondary rhinaria. Dorsal pigmented bands on abdominal tergites broad, solid and nearly fusing into a solid patch on 3-6 in many specimens. Body length to 2.5mm.

**tremulae Koch (9)**

On leaves of *Populus tremula*, often between those spun together by lepidopterous larvae, or in leaf-nests caused by *Pachypappa tremulae* (L.). Locally common.

- Dorsum in apterae not solidly blackish sclerotic, or if so then the band across abdominal tergite 1 not solidly fused to the carapace on tergites 2-6, the pigmented cuticle only sparsely sculptured with flattish inconspicuous nodules, the apical rostral segment with only 2, or exceptionally 3, subsidiary hairs, and living on *Salix*. Alatae with antennal joint III bearing more than 24 hairs in total on both antennae, or with dorsal pigmented bands on abdominal tergites much broken up, only 2-3 subsidiary hairs on a.r.s., and living on *Salix*.....9

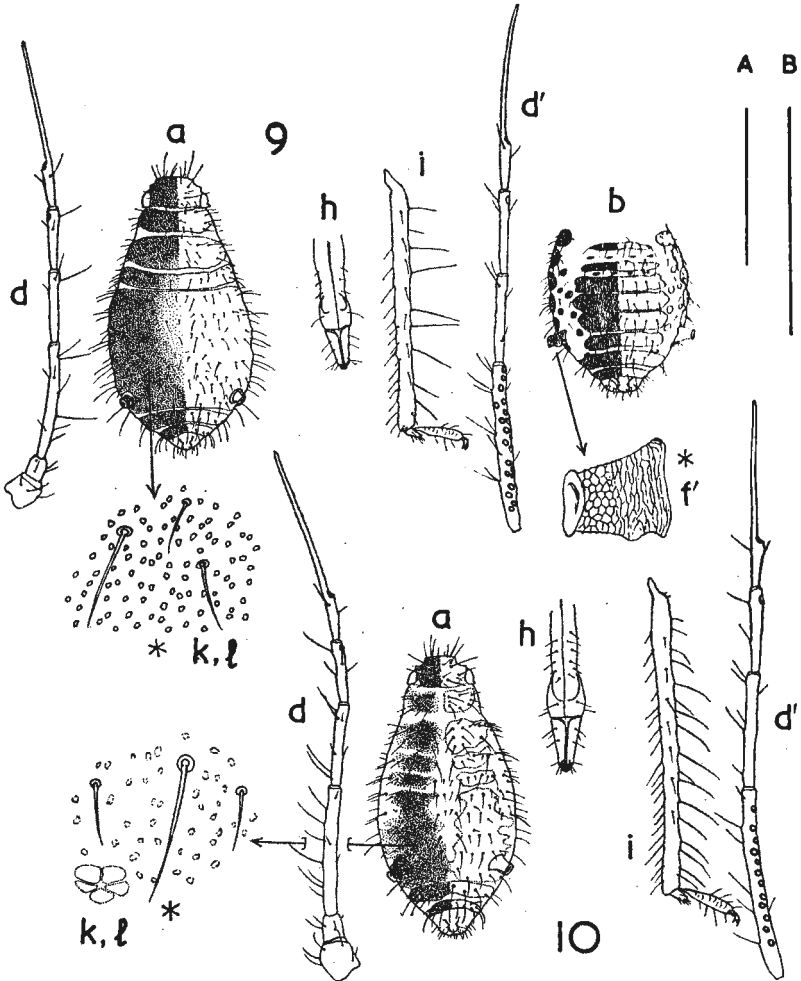

FIGS 9-10. 9, *Chaitophorus tremulae*. 10, *C. leucomelas*.

- ♀ Apical rostral segment with 4-9, but most often 7-8, subsidiary hairs, and 0.9-1 times as long as 2nd hind tarsal joints without claws. (*Apterae* typically with 2 longitudinal dark pleural bands on dorsum, but these sometimes fusing across midline on some posterior segments, or much reduced, even to evanescence, especially in *fundatrices* or at high temperatures. Cuticular sculpture confined to rather sparse nodules, only conspicuous on pigmented areas. *Alatae* bearing a total of 26-34 hairs on antennal III (*both antennae*), and 9-18 secondary rhinaria on III on *each* antenna, these arranged in a more or less single to staggered double row along one side of joint; antennal IV with 0-1 secondary rhinarium. Dorsal pigmented bands on abdominal tergites as in *C. tremulae*.) Body length to 2.7mm.

**leucomelas** Koch (10)

On young shoots and under leaves of *Populus nigra* and *italica*, or occasionally on other species of poplar when adjacent to these in windbreaks, etc.; often in abandoned galls of *Pemphigus* spp. or *Thecabius affinis* (Kltb.). Common.

- ♀ Apical rostral segment bearing 2, or exceptionally 3, subsidiary hairs, and 0.6-0.9 times as long as 2nd hind tarsal joint without claws. (*Apterae* varying from solidly blackish on dorsum to entirely pale, the black specimens mostly occurring in early summer and autumn. Dark areas weakly and sparsely nodulose, pale cuticle hardly visibly sculptured. Dorsal hairs acute to furcate. *Alatae* with a total of 16-19 hairs on antennal III (*both antennae*), and with 6-22 secondary rhinaria on III on *each* antenna, these arranged in a single or confusedly double row along one side of joint; antennal IV with 0-3 secondary rhinaria, V with 0-1. Dorsal pigmented bands on abdominal tergites much broken up and not forming anything like a solid mid-dorsal patch.) Body length to 2.2mm.

**truncatus** (Hausmann) (11)

On leaves of various *Salix* spp. and hybrids including *S. purpurea*, *amygdalina*, *alba*, *triandra*, *babylonica* and *phylicifolia*. Widespread and fairly common. Samples from different host species vary in ways suggesting a need for some revisionary taxonomic work. For example: *oviparae* from *Salix triandra* have *pseudosensoria* on the hind tibiae exhibiting a central pore, while one from *S. phylicifolia* has the *pseudosensoria* grouped in facet-like pairs, triplets or quadruplets. *Apterae* from *S. purpurea* have the dorsum blackish as late as July, while a male from this host shows an unusually high number of secondary rhinaria and of hairs on antennal joint III. Some populations have the dorsal hairs furcate in summer *apterae*, while in others this does not seem to happen. The length of the rostrum as a whole, and of the apical segment, is greater in some early *apterae* than in later ones. This difference does not seem to be size-correlated, but might perhaps be linked to some feature of the life cycle, such as life on catkins rather than foliage in the early generations.

Genus **PERIPHYLLUS** van der Hoeven, 1863

Type-species: *Periphyllus testudo* van der Hoeven, 1863 (= *Phyllophora testudinacea* Fernie, 1852).

Medium-sized to large aphids (*fundatrices* and *alatae* in some species up to 4.5mm long), living on Aceraceae and Hippocastanaceae.

*Apterae*: Body elongate oval or pyriform. Antennal hairs in British species much longer than diameter of antennal joints, except occasionally on basal part of joint VI; usually very acute, sometimes slightly blunted apically; longest hairs directed anterad (inwards when antennae are protracted). Spring viviparae include alatiform intergrading specimens in which antennal joint III bears a few secondary rhinaria. Dorsum mainly membranous, with variable amounts of pigmented sclerotization as localized bands or individual hair-bearing scleroites or sclerites. Dorsal hairs variable in number, arrangement and structure, the chaetotactic variation parallel to that of *Chaitophorus*, the primary spinal, pleural and marginal hairs being longer than any secondarily interpolated hairs that may be present. Hair apices in most species fine and acute, more rarely abruptly acute or blunt to slightly chisel-shaped or furcate. Siphunculi more or less stump-shaped

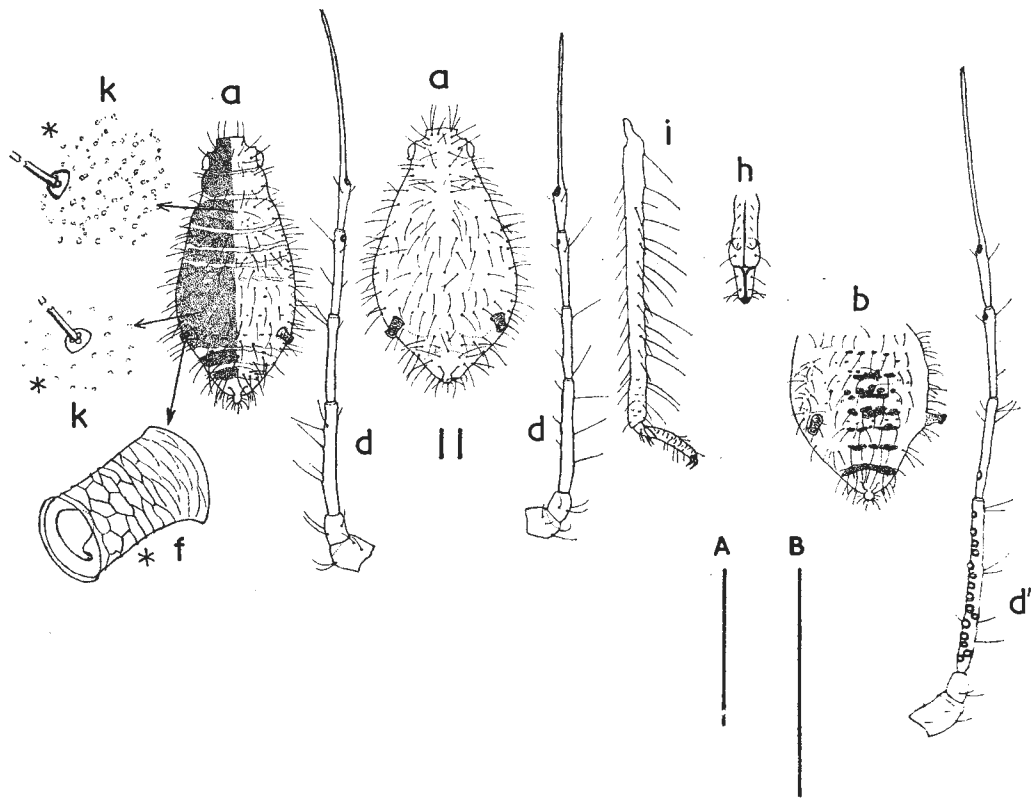

FIG. 11. *Chaitophorus truncatus*.

to cooling-tower-shaped, with a greater or lesser amount of apical flare and a variable number of rows of polygonal reticulations apically (fewest in adults maturing from dimorphs), passing into more transverse cells basad. Cauda varying from broadly rounded to slightly knobbed, but in the latter case with basal part before constriction not widening very markedly towards base. Rostrum in British species with apical segment a little shorter than 2nd hind tarsal joint without claws, and with 0-4 subsidiary hairs. Subanal and subgenital plates as for *Chaitophorus*. Legs normal, outer femoral and tibial hairs usually long and acute, rarely a little blunted; tibiae variably spinulose between hairs towards apex. First tarsal joints typically with 7, or sometimes with 5, ventral hairs, and with individual variations from 2 in some adults maturing from dimorphs ('dimoult's') to 9 in occasional large spring viviparae; the medioapical hairs, when present, are stouter sense-pegs. Rudimentary gonapophyses 4.

*Alatae*: Head and pterothorax more or less dark sclerotic. Secondary rhinaria almost always only on antennal joint III, exceptionally one also on IV. Abdominal tergites normally marked with segmental dark bands or irregularly oval unpaired mid-dorsal sclerites, and with marginal sclerites that may be much paler than the dorsal ones. Siphunculi usually with more extensive reticulation than in apterae, and sometimes with an angular 'step' on posterior face near base (figs 12, 13). Wing venation normal, veins not brown-shadowed.

*Males* usually alate, with stronger abdominal sclerotic pattern than in alatae, and with secondary rhinaria in a dense and irregular arrangement along antennal joints III-V inclusive.

*Oviparae* with dorsal ornamentation like that of apterae, or slightly more pigmented; hind tibiae moderately swollen, with fairly numerous pseudo-sensoria; chaetotaxy of abdominal tergite 8 and subgenital plate denser and more confused than in apterae.

*Immature morphs* generally like apterae. First instars of two types: normal larvae with straight unmodified hairs that develop without diapause, and dimorphic aestivating larvae in which the hairs may be modified into leaf-shaped structures around the margins of the head and body and on the front and middle tibiae (figs 12, 15, 16j), or into very long, thin, sinuate hairs on the dorsum, that project far beyond the body margin (fig. 18j). The latter type of dimorph spends the summer grouped in close aggregations on the underside of the leaves of the host; the former live scattered, assimilating closely in colour to the leaf surface and thus escaping notice unless carefully searched for. A few species are not known to produce dimorphs; others produce a parallel series of normal generations that co-exist with the dimorphs, so that the autumn morphs are partly matured dimorphs or 'dimoult's' and partly the progeny of normal summer viviparae; and yet others spend the summer months only as aestivating dimorphs. All first instars of British species have four-jointed antennae and a basic dorsal chaetotaxy of apical and marginal primary hairs with pleural hairs only on mesonotum.

There are at present 7 known British species, of which 2 (*P. acericola* and *P. ranthomelas*) have been treated as subspecies. The following key may be expected to separate all normal-sized viviparae, but very dwarfed specimens often occur in poor nutritional conditions, and these may not always key to the right species.

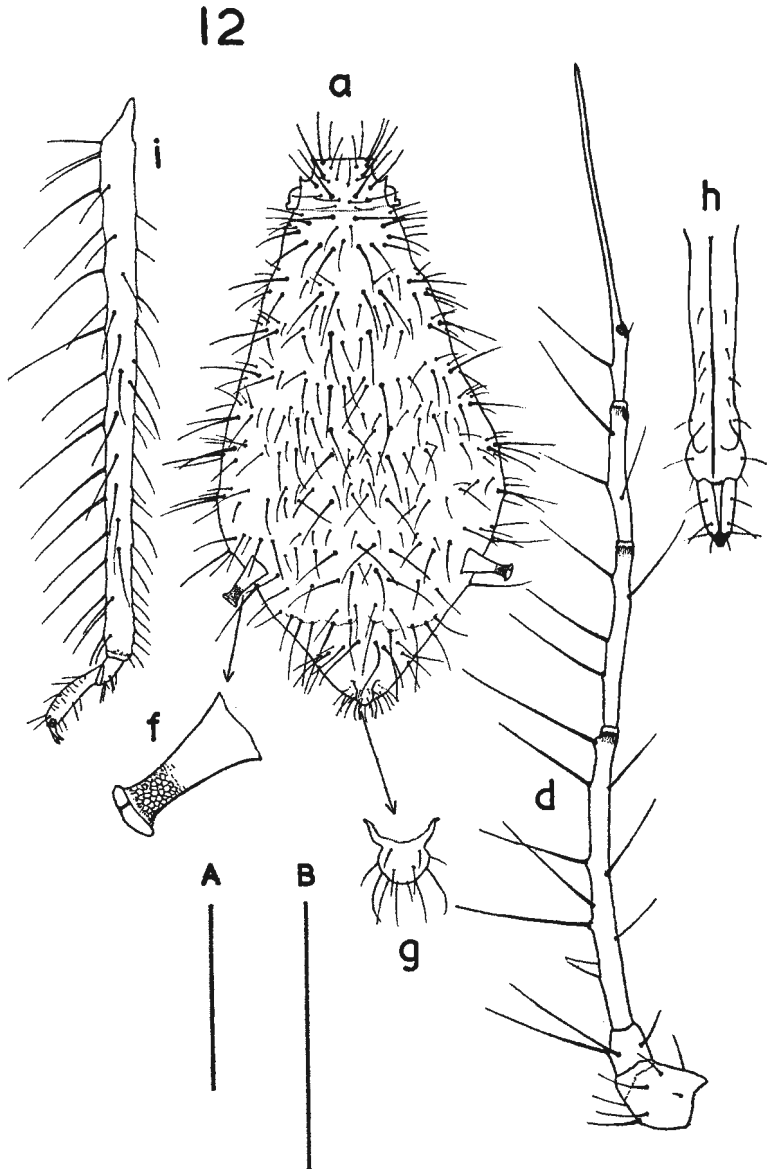

FIG. 12. *Periphyllus hirticornis* (see also opposite page).

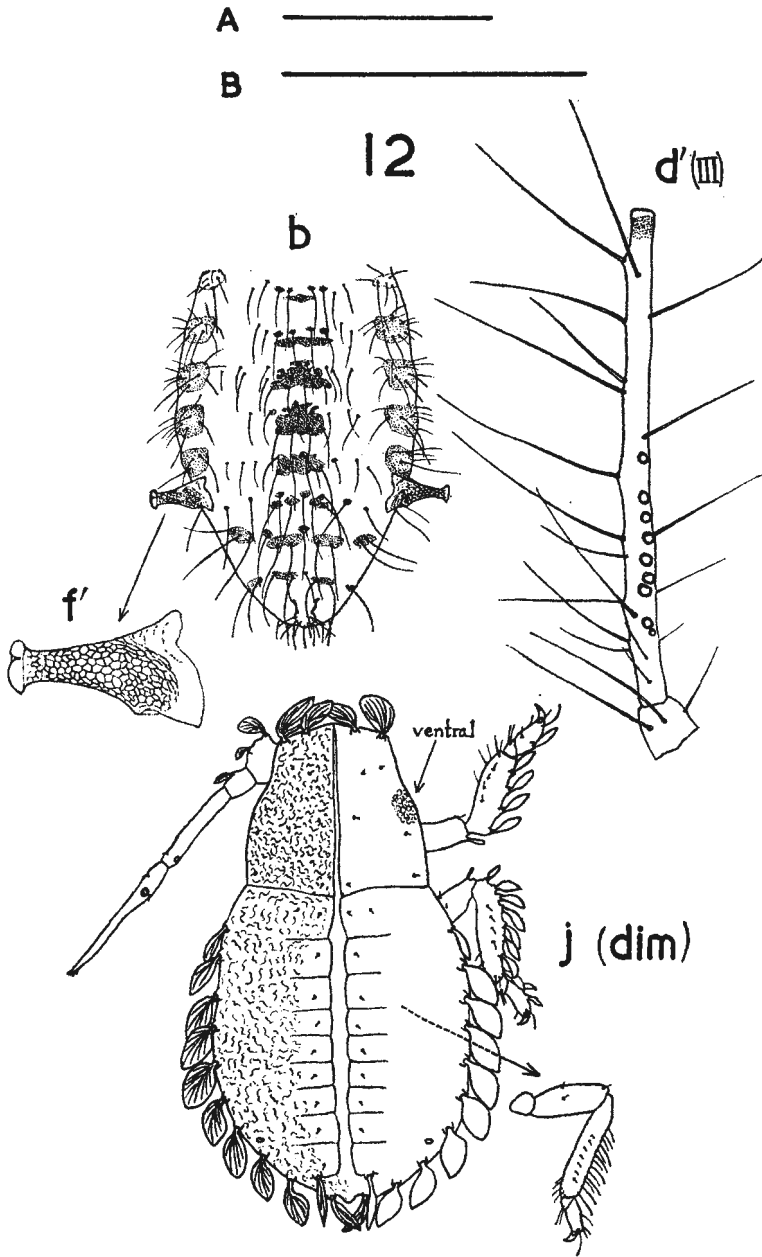

FIG. 12. *Periphyllus hirticornis* (see also opposite page).



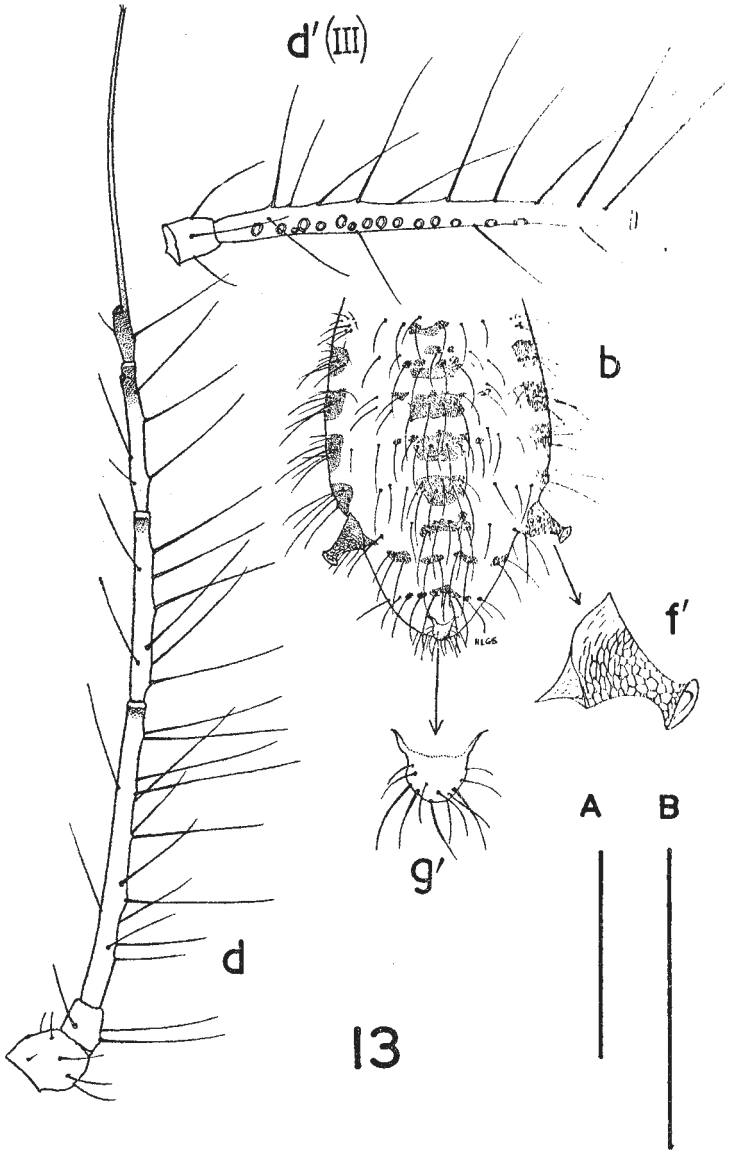

FIG. 13. *Periphyllus lyropictus* (see also opposite page).

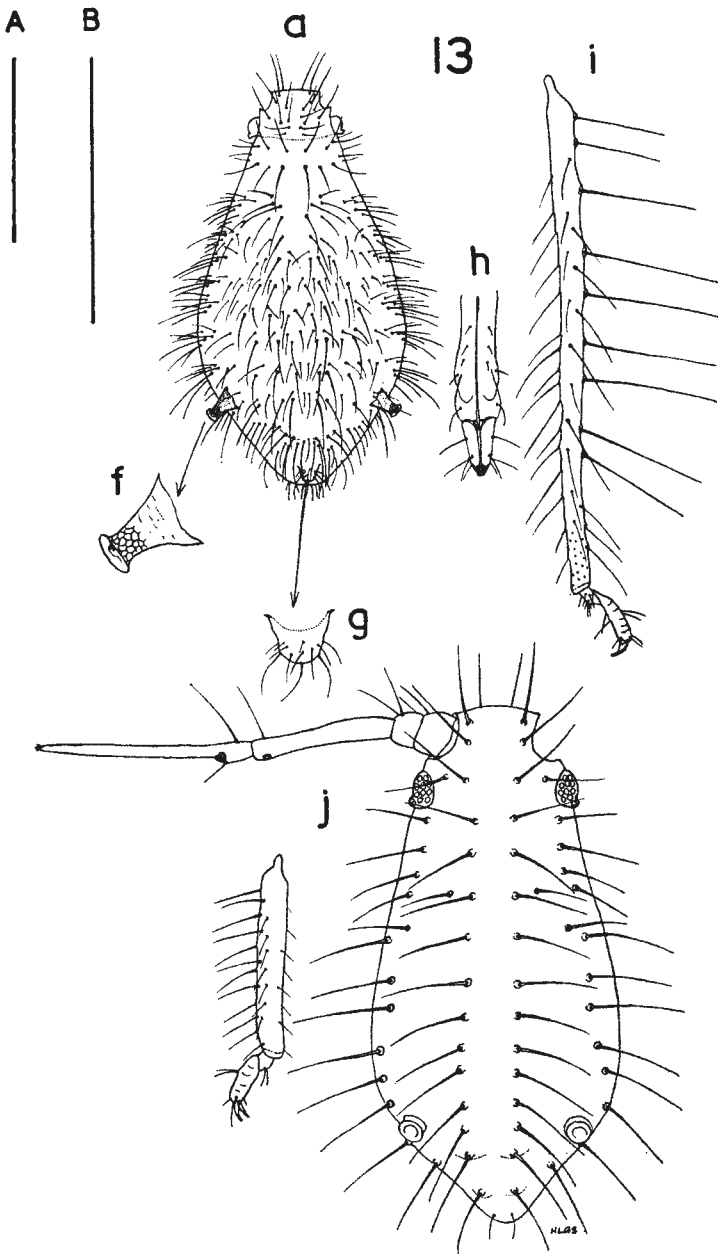
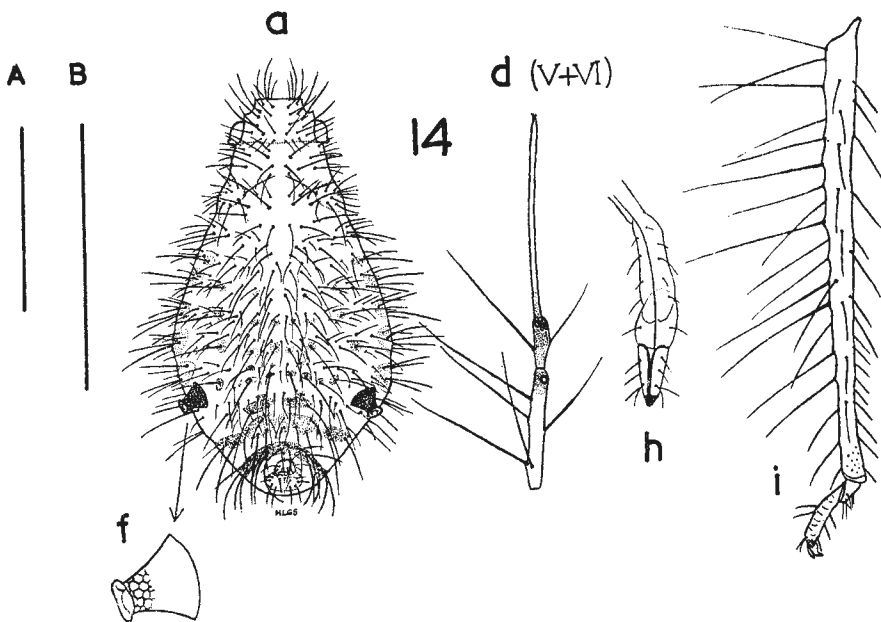

FIG. 13. *Periphyllus lyropictus* (see also opposite page).

## KEY TO SPECIES

- 1 Longer of the 2 hairs on basal part of antennal joint VI more than 4 times as long as shorter. Processus terminalis more than 3 times as long as basal part of antennal joint VI. Siphunculi strongly flared at apex (figs 12 13f, f'). Cauda often with a slight constriction delimiting the apical part as a knob (fig. 12g). Body length 2-3.1mm, *fundatrices* to 3.3mm. ....2
- Longer of the 2 hairs on basal part of antennal joint VI less than 4 times as long as shorter; or if more than 4 times as long, then processus terminalis less than 3 times as long as basal part of antennal joint VI. Siphunculi at most moderately flared at apex (figs 14-18f, f'). Cauda not constricted or knobbed. ....3
- 2 *Apterae* with antennal and dorsal hairs more or less blunt at apex, sometimes even a little expanded, truncate or slightly furcate. *Alatae* with shorter hair on basal part of antennal joint VI 0.019-0.025mm long, and siphunculi 0.21-0.28mm long; antennal joint III with 2-12 secondary rhinaria. Aestivating as foliate-haired dimorphs with bright red eyes and processus terminalis more than 2x basal part of antennal joint IV. Green in life **hirticornis** (Walker) (12)  
*On Acer campestre leaves and fruits. Locally common.*
- *Apterae* with antennal and dorsal hairs acute, fine-pointed. *Alatae* with shorter hair on basal part of antennal joint VI 0.025-0.040mm long, and siphunculi 0.17-0.23 mm long; antennal joint III with 6-20 secondary rhinaria. Aestivating dimorphs not known, and probably not occurring. Yellowish in life, *apterae* with a dark brown lyre-shaped mark on dorsum **lyropectus** (Koslov) (13)  
*Along veins on underside of leaves of Acer platanoides. Locally common, but little recorded.*
- 3 Longer hair on basal part of antennal joint VI more than 0.16mm long, and longer than the short, dark siphunculi; shorter hair on base of VI 0.07-0.14mm long. Processus terminalis 3.2-4.1 times as long as basal part of VI. Aestivating dimorphs not known. Dark blackish green in life. Body length 1.8-2.6mm. **obscurus** Mamontova (14)

FIG. 14. *Periphyllus obscurus*.

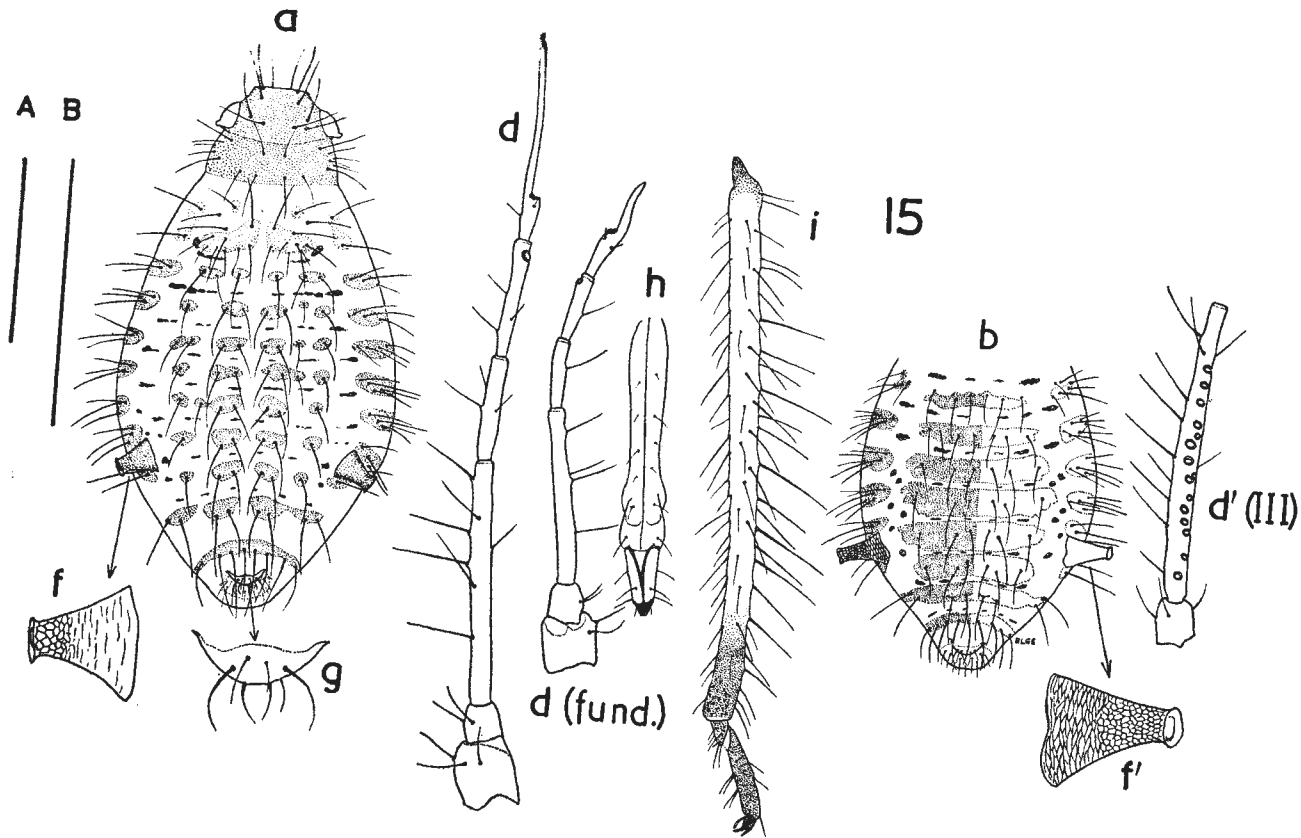
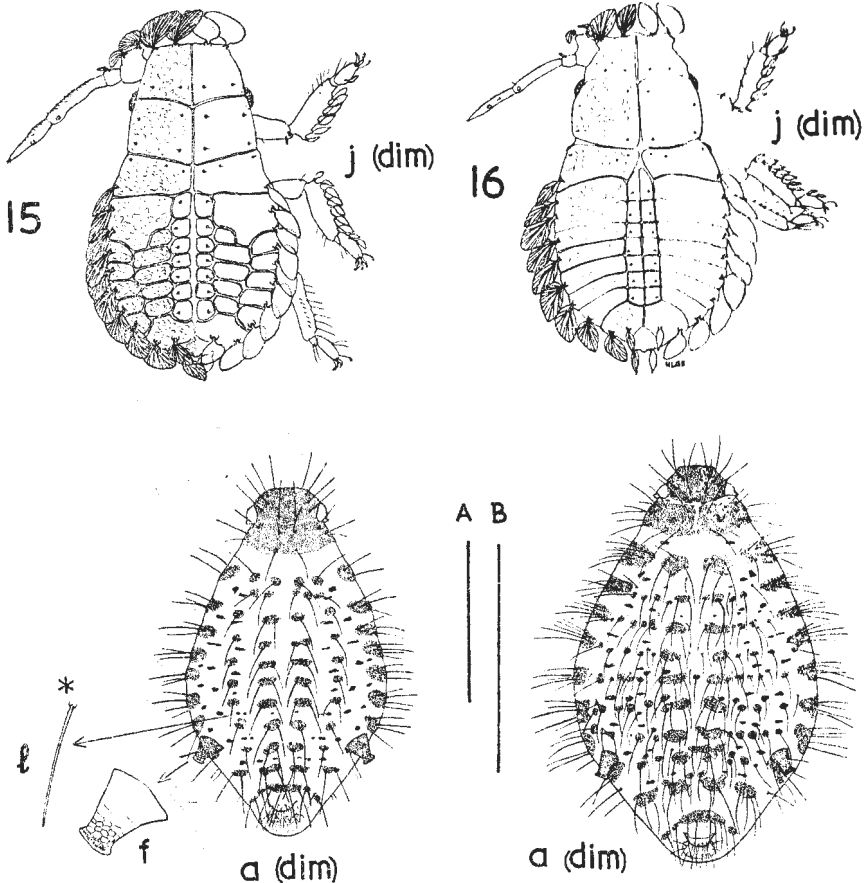

FIG. 15. *Periphyllus testudinaceus* (see also p. 26).

*On leaves of Acer campestre. Hertford, Cambridge, very rare.*

- Longer hair on basal part of antennal joint VI less than 0.10mm long, and shorter than siphunculi. If shorter hair on base of VI more than 0.07mm long, then processus terminalis not more than 3 times as long as basal part of VI. . . . . 4
- 4 Longer hair on basal part of antennal joint VI less than 0.05mm long, and less than 3 times as long as shorter. *Apterae* with head, pronotum, siphunculi and a pattern of spinal, pleural and marginal sclerites on thorax and abdomen dark in macerated specimens; apices of femora, extreme bases and apices of tibiae also darkened. Middle abdominal tergites (3-5) typically with 4 spinal and 2 pleural hairs, and with 3-5 hairs on each marginal sclerite; dorsal hairs abruptly acute or, in autumn dimoult, sometimes blunted. *Alatae* with transverse dark bands across abdominal tergites equally pigmented with marginal sclerites, and darker than pterostigma (characters best seen with a pocket lens). Antennal joint III with 10-20 secondary rhinaria. Foliate-haired *dimorphs* with a completely demarcated series of pleural abdominal plates placed intersegmentally between the spinal and marginal plates



FIGS 15-16. 15, *Periphyllus testudinaceus* (see also p. 25). 16, *P. californiensis* (see also p. 27).

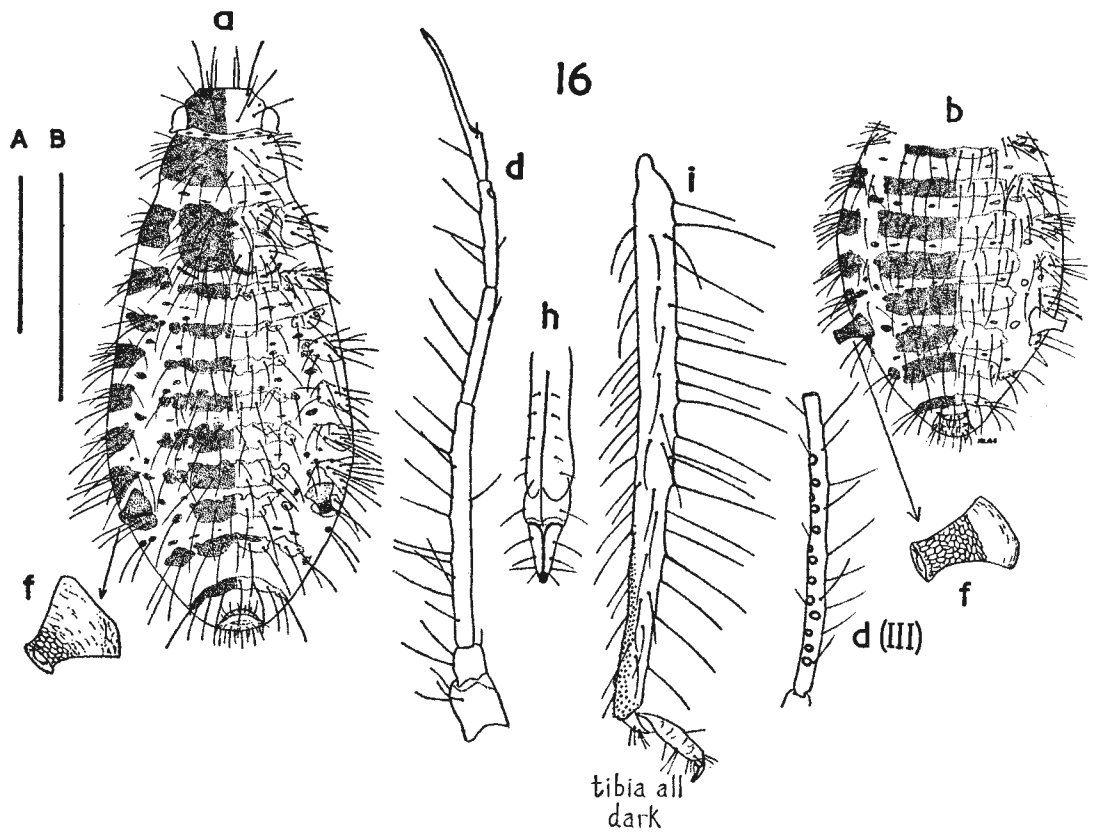

FIG. 16. *Periphyllus californiensis* (see also p. 26).

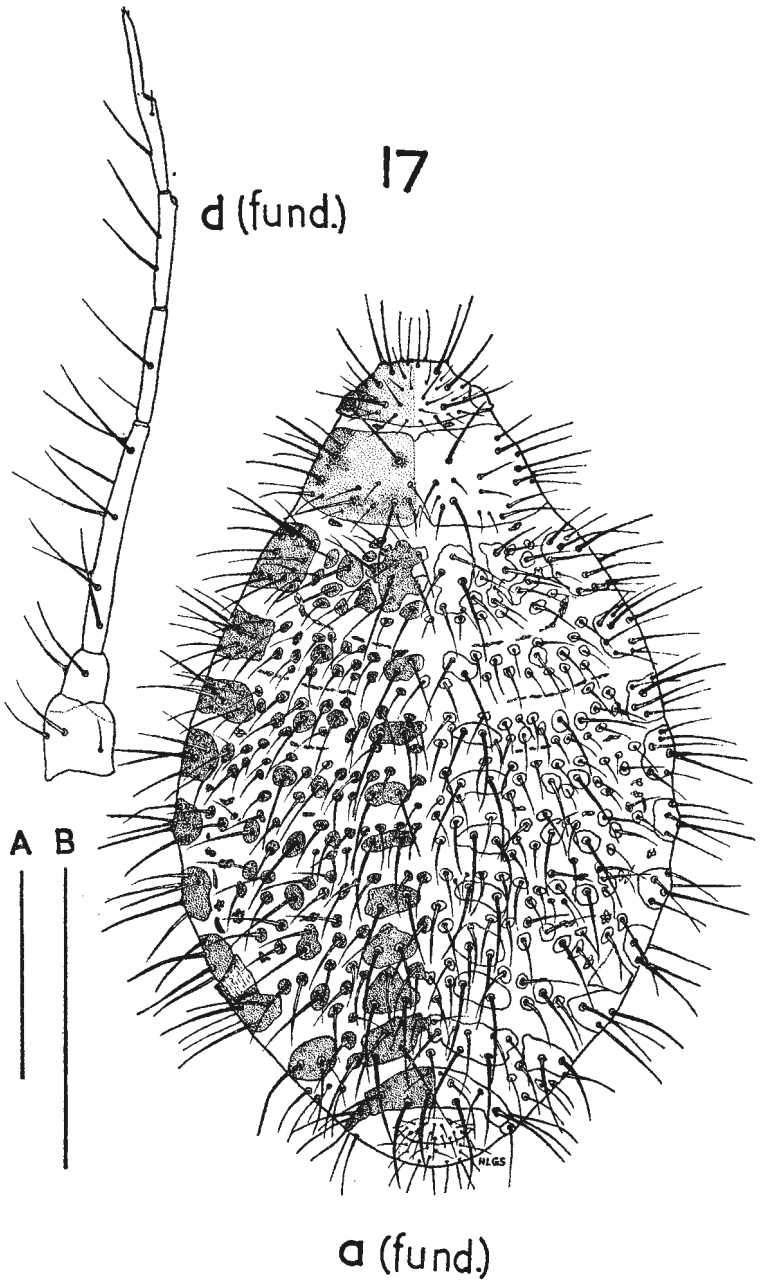

FIG. 17. *Periphyllus acericola* (see also opposite page & p. 31).

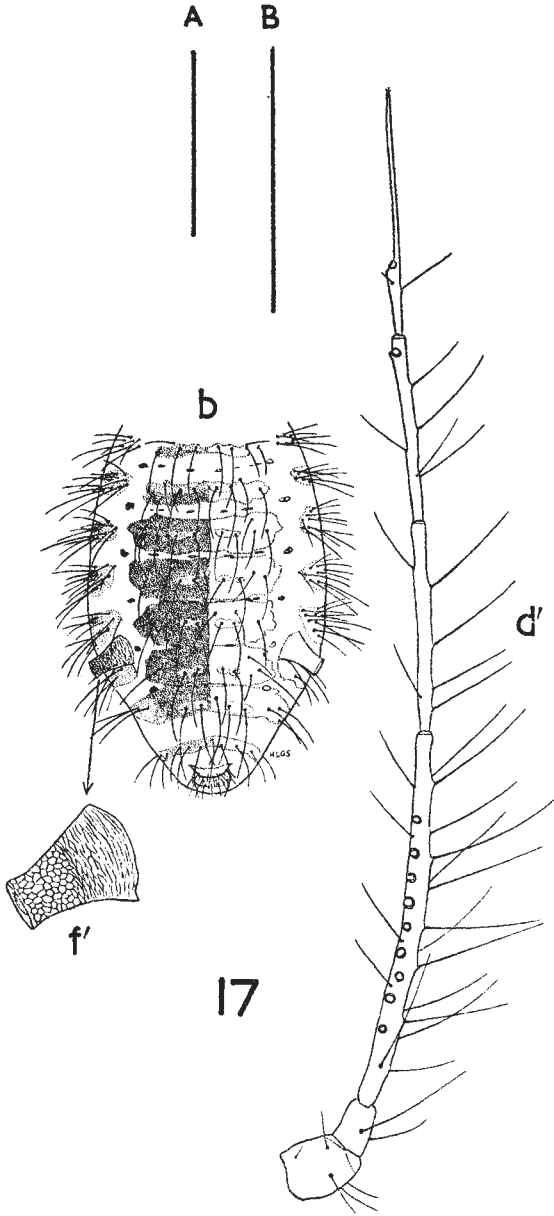

FIG. 17. *Periphyllus acericola* (see also opposite page & p. 31).



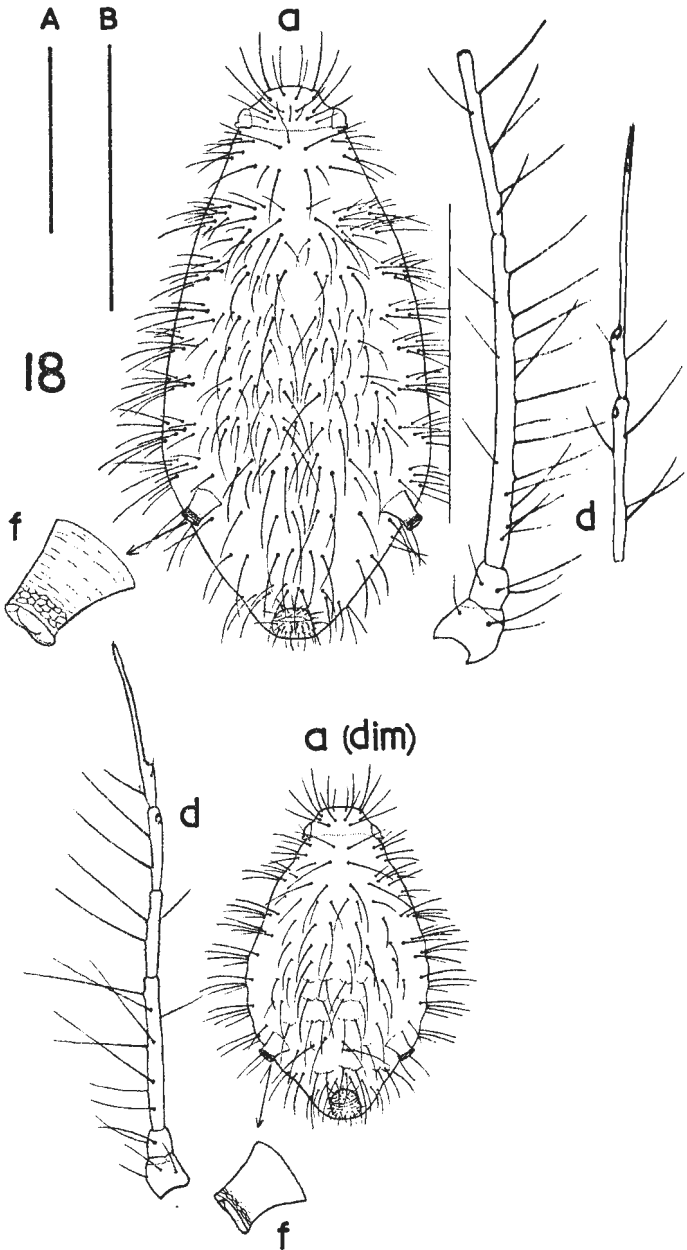
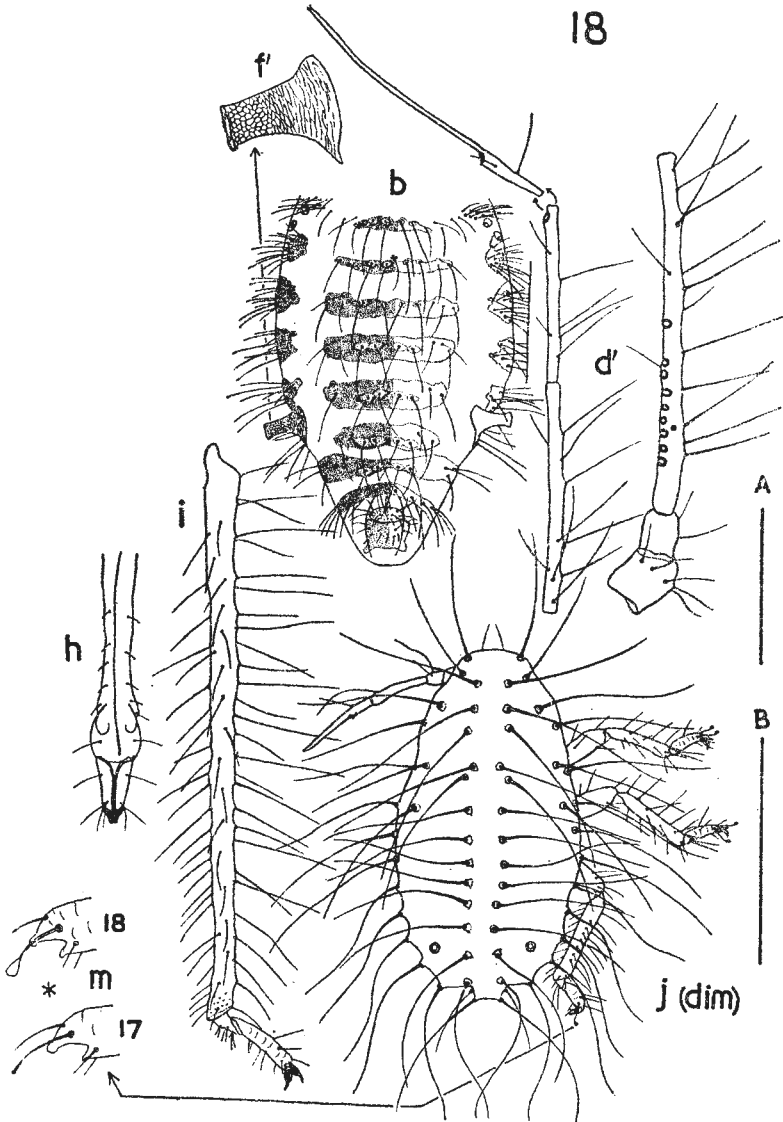

FIG. 18. *Periphyllus xanthomelas* (see also opposite page).



FIGS 17-18. 17, *Periphyllus acericola* (see also pp. 28, 29). 18, *P. xanthomelas* (see also opposite page).

(fig. 15j); with blackish red eyes, and processus terminalis not longer than basal part of antennal joint IV. Adults dirty dark green to dark brown or blackish in life. Body length 2.0–3.7mm. **testudinaceus** (Ferne) (15)

*On many species of Acer, of which the most typical is A. campestre, and also sometimes on Aesculus hippocastanum. The most abundant British species.*

- Longer hair on basal part of antennal joint VI more than 0.05mm long, and either more than 3 times as long as shorter, or if less than 3 times as long, then *apterae* either entirely pale or with at most some indistinct brownish sclerites on dorsum but still with pale head, pronotum, siphunculi and legs, and *alatae* with dark bands on abdominal tergites equally pigmented with pterostigma (pocket lens). If *dimorphs* foliate-haired, then without a separate ploural series of abdominal plates . . . . . 5

- 5 *Apterae* with head, pronotum, siphunculi and most of legs dark (hind tarsi paler than tibiae and femora), and with a dorsal pattern of dark spinal, ploural and marginal sclerites, the spinals sometimes more or less fused across mid-line into irregular bands. Middle abdominal tergites with 10–22 spinal and ploural hairs in total on each segment, and marginal sclerites with 7–12 hairs; dorsal hairs all acute and fine-pointed, and arranged in at least partly double transverse rows across tergites. *Alatae* with dark bands across abdominal tergites darker than pterostigma (pocket lens). Antennal joint III with 7–25 secondary rhinaria. First tarsal joints in *viviparae* typically with 5 hairs (4 + 1 sense-peg), or less often with 4 (no sense-peg) or even 2 in some dimoult; rarely with up to 7 on one or more tarsi. Inner side of tibiae strongly spinulose between hairs on distal third. Foliate-haired *dimorphs* with only 2 series of abdominal plates (spinal and pleuromarginal), but otherwise as in *C. testudinaceus*. Dark olive green to brown in life, *dimorphs* pale green. Body length 2.3–3.5mm. **californiensis** (Shinji) (16)

*Under leaves of Acer palmatum, circinatum, japonicum and various other maples; in the U.S.A. also recorded from Aesculus californica. Surrey (Wisley Gardens and Wimbledon); probably introduced with nursery stock, and likely to prove more widespread.*

- *Apterae* with head, pronotum, siphunculi and legs (except tarsi) pale; dorsum also usually quite pale, at most with a few indistinct brownish bands. *Alatae* with dark bands across abdominal tergites about equally dark with pterostigma (pocket lens); legs pale or at most a little dusky towards apex of hind femora. Antennal joint III with 4–13 secondary rhinaria. Tibiae in *viviparae* with only a few scattered spinules between the distal hairs; first tarsal joints with typically 7 hairs (6 + 1 sense-peg), rarely as few as 4 in dimoult, or as many as 8–9 on individual tarsi in spring morphs. Aestivation by long-haired whitish *dimorphs* living together in close aggregations. Normal *viviparae* not present between midsummer and maturation of *dimorphs* (dimoult) in early autumn . . . . . 6

- 6 Cauda with not more than 20 hairs. Longer hair on base of antennal joint VI in *apterae* 2.25–3.5 times, in *alatae* 2.5–3 times as long as shorter; the latter 0.02–0.04 mm long, its apex not reaching beyond the primary rhinarium. *Alatae* with dark bands across abdominal tergites usually broader, only narrowly separated by a membranous line on intersegments 3/4 to 5/6, and very often distinctly darker than marginal sclerites (pocket lens). *Dimorphs* with lateroapical hairs of 2nd tarsal joints hardly spatulate at apex, and with claw hairs almost linear. Smaller aphids, spring *alatae* maximally 3.5mm long; pale green in life, sometimes with darker markings in spring *apterae*. **acericola** (Walker) (17)

*On Acer pseudoplatanus. Fairly common and widespread, but easily overlooked because of its summer diapause.*

- Cauda with more than 20 hairs. Longer hair on base of antennal joint VI in *apterae* 1.4–3.2 times, in *alatae* 1.4–2.4 times as long as shorter; the latter 0.025–0.1mm long, its apex reaching beyond the primary rhinarium. *Alatae* with dark bands across abdominal tergites relatively narrower, well separated on all intersegments, and marginal sclerites equally dark (pocket lens). *Dimorphs* with latero-apical hairs of 2nd tarsal joints markedly spatulate at apex, and with claw hairs distinctly widened from base to apex. Larger aphids, spring *alatae* up to 4.5mm long; pale yellow in life, *apterae* often with green flecks dorsally. **xanthomelas** (Koch) (18)

*On Acer platanoides. Buckingham, Hertford; probably much more widespread but records lacking.*

## KEY TO GENERA OF ATHEROIDINAE

- 1 Compound eyes very prominent, placed at the apices of lateral peduncle-like outgrowths of the head (fig. 19n). Siphunculi palish, smooth, truncate conical or stump-shaped. Hairs on antennal joint III in *viviparae* maximally about 5 times as long as basal articular diameter of joint. Head and pronotum fused together in *apterae*. Abdominal tergites 1-7 in *apterae* fused into a solid blackish carapace. Cauda slightly knobbed. On *Carex paniculata*. **CARICOSIPHA** Börner (p. 33)
- Compound eyes less prominent, not on peduncles. Longest hairs on antennal joint III less than 3 times as long as basal articular diameter of joint, or if up to 5 times, then siphunculi pore-like . . . . . 2
- 2 Siphunculi consisting of slightly elevated pores on abdominal tergite 6. Elongate mottled grey-green and straw-coloured aphids, with abdominal tergites all mutually free and not fused into a dorsal sclerotic carapace. On *Ammophila* and *Calamagrostis*. **LAINGIA** Theobald (p. 34)
- Siphunculi pore-like, truncate conical or compressed vasiform, located on abdominal tergite 5. *Apterae* with abdominal tergites 2-7 usually fused into a more or less sclerotic dorsal carapace; if with distinct pale membranous intersegments, then not mottled grey-green and straw-coloured in life . . . . . 3
- 3 Siphunculi pore-like. Elongate aphids, body length when mounted in slides 2.5 or more times greatest width. Dorsal cuticle in *apterae* strongly sclerotic, pale brown to black, coarsely rugose or rugulose-punctate; or if dorsum not rugose, then longest hairs on antennal joint III 2.8-5 times as long as basal articular diameter of joint. On Gramineae. **ATHEROIDES** Haliday (p. 36)
- Siphunculi elevated on low rim-like truncate cones, or compressed vasiform. Less elongate, body length in slides less than 2.5 times greatest width. Dorsal cuticle in *apterae* not strongly rugose or rugulose-punctate; usually pale brownish sclerotic in slides, but if solidly black, then longest hairs on antennal joint III 2-2.5 times as long as basal articular diameter of joint. On Gramineae, rarely recorded also on *Juncus* or *Scirpus* spp. **SIPHA** Passerini (p. 39)

Genus **CARICOSIPHA** C. Börner, 1939

Type-species: *C. paniculatae* C. Börner, 1939.

*Apterae*: Body flattened, pyriform, broadest about level of abdominal tergite 4. Dorsum and most of venter of abdomen sclerotic, blackish pigmented, abdominal tergites 1-7 fused into a solid carapace. Head capsule fused with pronotum; meso- and metanotum and abdominal tergite 8 free. Frons simply convex, antennal bases hardly elevated. Antennae pale, barely darkened towards apex of joint V. Antennal hairs nearly all long (maximally about 5 times basal articular diameter of joint III) and usually all directed more or less anterad (inward). Frons and vertex with 2 numerous groups of very long, dark, acute and stiff hairs; occipital hairs consisting of only about 4 long ones and a single line of smaller fine ones at posterior margin. Compound eyes very prominent, on constricted peduncular lateral extensions of the head, the diameter of these much less than that of the eyes; posteroventral triommatidion small but distinct. Marginal and pleural hairs on dorsum of all segments long, spiny and dark like frontals. Spinal hairs on middle body segments smaller and finer, and similar small fine hairs also present among the long ones all over dorsal surface. Abdominal tergite 8 with 7-9 long stiff hairs, maximally about as long as or a little longer than frontals. All pigmented parts of cuticle finely spinulose between the hairs, the spinules much finer than the denticles of *Sipha glyceriae* (p. 41) and tending to form short transverse rows of 2-5 spinules. Central area of metanotum to abdominal tergite 2 tending to be somewhat pale, sometimes with small mediospinal weak spots on intersegment 1/2. Siphunculi palish,

smooth, truncate conical or stump-shaped with a marked flange. Cauda slightly knobbed, with 5-8 hairs. Rostrum not reaching middle coxae, its apical segment blunt, slightly longer than its basal width, with convex sides and 1 pair of subsidiary hairs. Subanal plate slightly emarginate. Legs pale, only tarsi faintly dusky. Tibiae at extreme apex with 2 lateral rows of closely set very fine spinules, and with a few scattered ones also between hairs on apical quarter. First tarsal joints typically with 5 hairs (4 + 1 sense-peg). Claw hairs spatulate. Rudimentary gonapophyses 3.

*Alatae* with dorsal carapace broken into segmental dark bars and marginal sclerites, body hairs shorter and thinner than in apterae, secondary rhinaria only on antennal joint III, and forewings with median vein only once branched.

*Males* apterous, like viviparae but more slender, antennal joint III with up to 35, IV with up to 11 secondary rhinaria.

*Oviparae* similar to apterae but with 10-43 8-shaped pseudosensoria on the slightly swollen hind tibiae.

*Immature morphs* with sclerotic carapace reduced to small sclerites bearing single hairs over most of the dorsum, especially well-marked pleurally; marginal sclerites each bearing several hairs; abdominal tergite 7 with a solid sclerotic band divided in two medially, and 8 with a solid bar. Longer body hairs blackish as in apterae. First instar with 4-jointed antennae (joint III sometimes with a trace of subdivision); pleural hairs from mesonotum to abdominal tergite 5 inclusive; tibiae apically with only very few fine spinules, including a row across extreme apices.

Sole known species appearing blackish in life, non-sclerotic parts reddish. Body length 1.5-2.5mm.

**paniculatae** Börner (19)

On *Carex paniculata* and *vulpina* in marshy places. Kent, Surrey, Berkshire, Bedford, Cambridge, Cumberland, Midlothian. Very local.

### Genus LAINGIA Theobald, 1922

Type-species: *L. psammae* Theobald, 1922.

*Apterae*: Elongate parallel-sided aphids. Antennae very short, flagellar joints (III-V) together less than 0.25 times body length; processus terminalis about 1.2-2.1 times as long as basal part of joint V. Antennal hairs rather sparse and thorn-like, the longer ones (2-3 on III, 1 on IV) up to about 1.5 times as long as basal articular diameter of III, and directed anterad (inward). Frons convex, antennal prominences not developed. Compound eyes fairly large, triommatidion well developed. All body tergites mutually free, largely occupied by variably pale or dusky sclerotic bands and marginal sclerites, these adorned with small blunt spinules in wavy rows that tend to form reticulations laterally. Frontal hairs acute, maximally 0.12-0.17mm long; dorsal cephalic hairs spiny, of variable length; occipitals typically 6 in number (4 along posterior margin and 2 antero-lateral). Primary spinal, pleural and marginal body hairs rather thorn-like, sometimes with split or ragged apices in early generations; smaller secondary hairs arranged in irregular double rows across each tergite, interspersed with primaries. Abdominal tergite 8 with a single row of long acute hairs, 0.17-0.21mm long, on its posterior margin, 8-10 in number, 1 median hair sometimes displaced anterad. Siphunculi rather large round, flanged pores, only very slightly elevated, on pleura

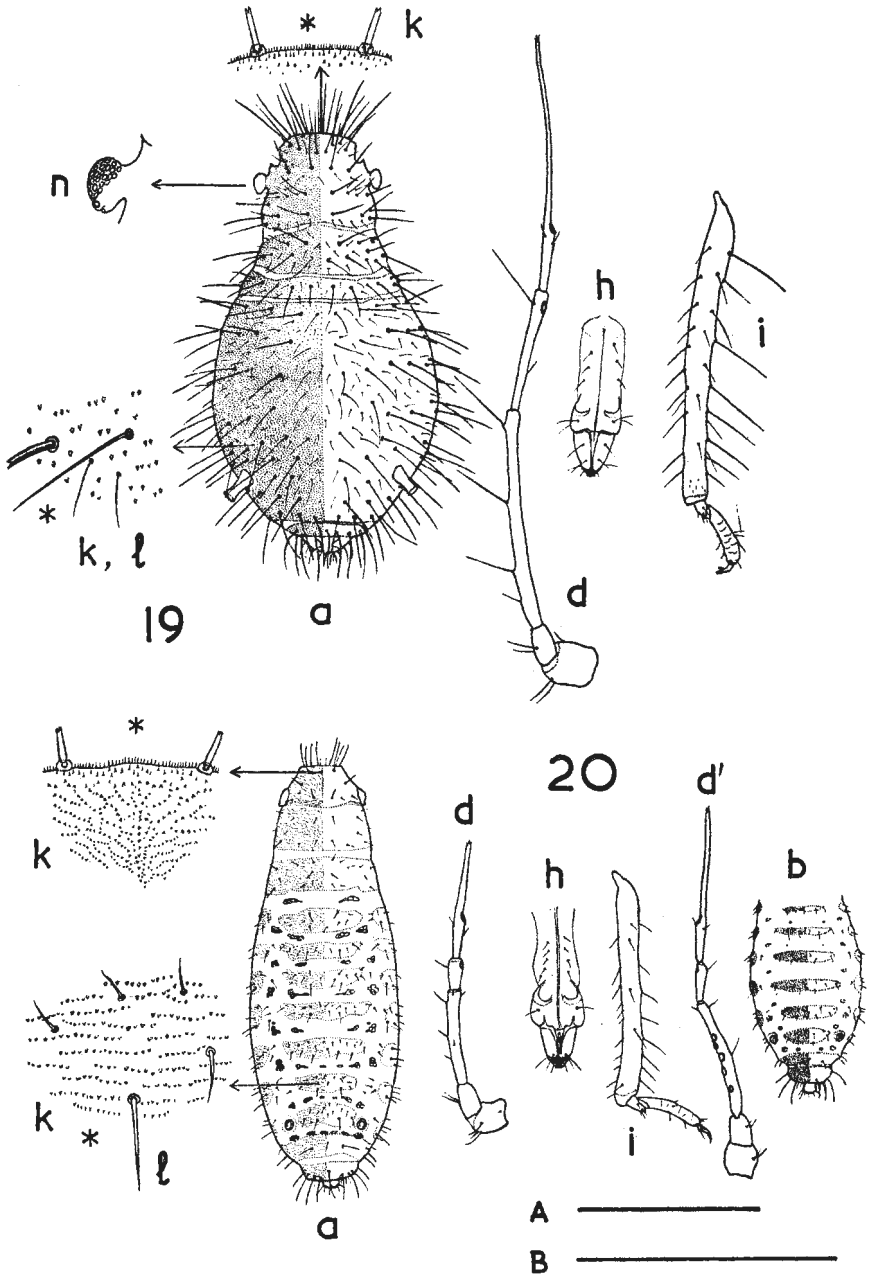

FIGS 19-20. 19, *Curicosipha paniculatae*. 20, *Laingia psammae* (see also p. 122).

of abdominal tergite 6. Cauda rather short, broadly tongue-shaped, often with a trace of constriction at about half its length, and shorter than its basal width. Rostrum not reaching middle coxae, its apical segment blunt, more or less straight-sided, hardly longer than its basal width and without subsidiary hairs. Subanal plate broadly convex to nearly straight or with a very slight median concavity posteriorly. Legs pale dusky; tibiae without spinules; first tarsal joints typically with 5 (4 + 1) hairs, less often with 4 (3 + 1); claw hairs bristle-like. Rudimentary gonapophyses 4, not always easily separable.

*Alatae*: Head and pterothorax dark sclerotic, head and pronotum spinulose, meso- and metanotum smooth. Secondary rhinaria 3-7 in number, in a single row along antennal joint III. Antennal hairs similar to those of apterae, the longer ones up to twice as long as basal articular diameter of III. Frontal hairs 0.09-0.12mm long. Wings long and narrow, forewing with median vein either once or twice branched.

*Males* and *oviparae* not available, and undescribed.

*Immature morphs* with dorsum membranous, only primary dorsal hairs standing on very small dusky 1-haired sclerites; first instar with 4-jointed antennae, and pleural hairs present from pronotum to abdominal tergite 5 or 6 inclusive.

Sole known species mottled greyish green and straw-yellowish in life. Body length 1.8-2.8mm.

**psammae** Theobald (20)

*On leaf blades or inflorescences of Ammophila arenaria and Calamagrostis epigejos. Common on the former round the coast of Britain, less common on the latter in inland localities.*

### Genus ATHEROIDES Haliday, 1839

Type-species: *A. serrulatus* Haliday, 1839, designated by Kirkaldy, 1906.

*Apterae*: Small to medium-sized (body length to 2.5mm) more or less strongly elongate aphids. Dorsum wholly sclerotic, cuticle pale brown to black. Head and pronotum effectively fused by sclerotization of the inter-segmental membrane between them. Abdominal tergites 2-7 usually fused into a solid carapace. Antennae typically 5-, but occasionally 4-jointed; flagellar joints together less than 0.25 times body length. Antennal hairs few, normal and acute. Frons straight to convex in outline. Dorsal body hairs very variable in size, number and structure: acute, thick and hollow, rod-like, furcate or flabellate. Siphunculi pore-like with a small thickened rim surrounding the horseshoe-shaped operculum, sited at anterior margin of abdominal tergite 5. Cauda hardly developed, broadly rounded. Rostrum rather short, its apical segment terminating in a more or less well-developed beak-like structure (fig. 21h). Species with a much elongated acute apical segment have been regarded as a separate genus (*Chaetosiphella* Hille Ris Lambers); but apart from this one highly adaptive character they do not differ significantly in structure or biology from *A. hirtellus* Haliday. Subanal plate broadly convex, hardly different from cauda in shape. Legs normal, with acute hairs; tibiae not spinulose between apical hairs; chaetotaxy of first tarsal joints variable, from 2 (2 + 0) to 5 (4 + 1); claw hairs flattened, broadening markedly to apex. Rudimentary gonapophyses 4, their separation very ill-defined.

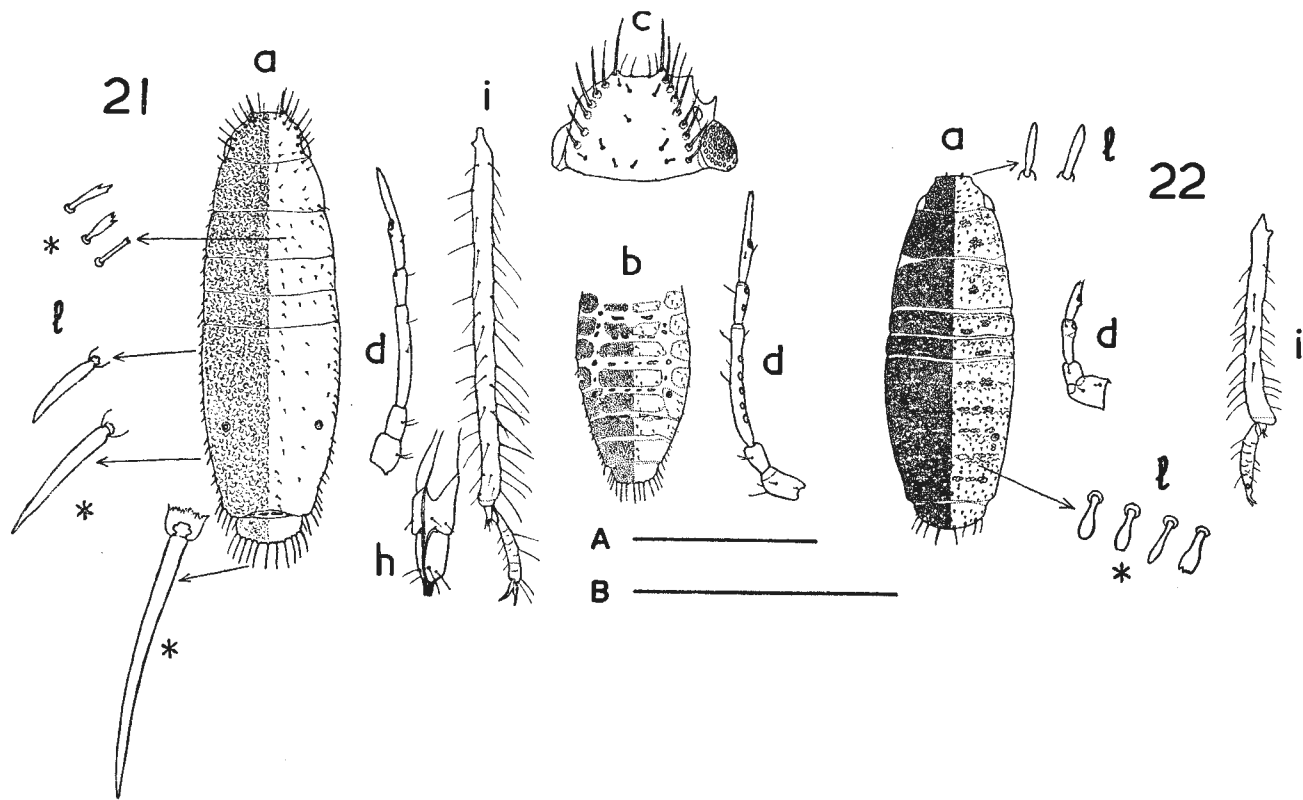

FIGS 21–22. 21, *Atheroides serrulatus*. 22, *A. brevicornis*.



*Alatae*: Head and pterothorax blackish sclerotic; dorsal abdominal carapace of apterae replaced by separate segmental dark bands and marginal sclerites on the tergites. Secondary rhinaria few: up to 7 in a single row on antennal joint III, rarely 1 also on IV. Wings with normal venation, sometimes slightly brown-shaded. Siphuncular pores located on anterior inner angle of marginal sclerites of abdominal tergite 5. Chaetotaxy as for corresponding apterae.

*Males* apterous with rather stout antennae bearing secondary rhinaria on joints III-IV.

*Oviparae* like apterae but usually with more numerous hairs on subgenital plate and with somewhat thickened hind tibiae bearing up to about 100 pseudosensoria often grouped irregularly in pairs, threes or fours.

*Immature morphs* with dorsal sclerotization broken into separate dark hair-bearing sclerites arranged in pairs spinally, pleurally and marginally; each sclerite bearing a number of hairs, and those of the spinal and pleural series often fused into spinopleural pairs. First instar with 4-jointed antennae; pleural hairs present from pronotum to abdominal tergite 6 inclusive; hind tibiae spinulose on outer side between hairs.

#### KEY TO SPECIES

- 1 Dorsal body hairs and those on antennal joint III (when present) less than 0.03mm long, and less than one-third as long as basal part of last antennal joint. Dorsal cuticle in *apterae* pale brown to black, distinctly rugose or rugulose-punctate. Hind margin of abdominal tergite 8 somewhat rounded, overhanging and concealing cauda (figs 21-22a) ..... 2
- Longest dorsal hairs on abdominal tergite 3 0.11-0.18mm long, equal to or longer than basal part of last antennal joint; longest hairs on antennal joint III 0.05-0.07mm long, half or more as long as base of last joint. Dorsal cuticle in *apterae* black, not rugose or rugulose-punctate, but hair bases showing as pale perforations of the tergites when mounted in slides. Hind margin of abdominal tergite 8 more or less straight, not concealing cauda. Antennal joint III bearing 3-5 hairs. Dorsal carapace in *apterae* solid on abdominal tergites 2-7. First tarsal joints typically with 5 (4 + 1) hairs. **hirtellus** Haliday (23)  
*On Deschampsia caespitosa, local but widely distributed.*
- 2 Spinal and pleural hairs on abdominal tergites numbering only 2 + 2 and 1 + 1 per segment respectively; rod-like, with blunt to ragged apices (fig. 211). Frons and posterior margin of abdominal tergite 8 each with a stiff fringe of much longer, acute and spiny hairs. Marginal abdominal hairs becoming progressively shorter and blunter anterad from tergite 8, but remaining longer and more conspicuous than spinals and pleurals. Antennal flagellum in *apterae* more than 0.25mm long, joints III and IV distinct, III bearing 0-3 hairs. Dorsal carapace in *apterae* always solidly sclerotic from abdominal tergite 2 to tergite 7. First tarsal joints typically with 4 (3 + 1) hairs **serrulatus** Haliday (21)  
*On various grasses, very widely distributed and generally common.*
- Dorsal body hairs irregularly scattered in 2-3 transverse rows across tergites, not in spinal and pleural series; all flabellate with round or ragged apices (fig. 221) except for a few variably acute or rod-like ones on frontal apex and posterior margin of abdominal tergite 8. Marginal abdominal hairs not different from spinals and pleurals. Antennal flagellum in *apterae* less than 0.25mm long, joints III and IV often fused to give a 4-jointed antenna, III bearing 0-1 hair. Dorsal carapace in *apterae* either solid from tergite 2 to tergite 7, or more or less divided by membranous lines along intersegments. First tarsal joints typically with 2 (2 + 0) or 3 (2 + 1) hairs **brevicornis** Laing (22)  
*On Festuca rubra and Puccinellia maritima in coastal saltings. Pembroke, Merioneth, Norfolk, Caernarvon, Lancashire, East Lothian. Aberdeen. Inverness: local.*

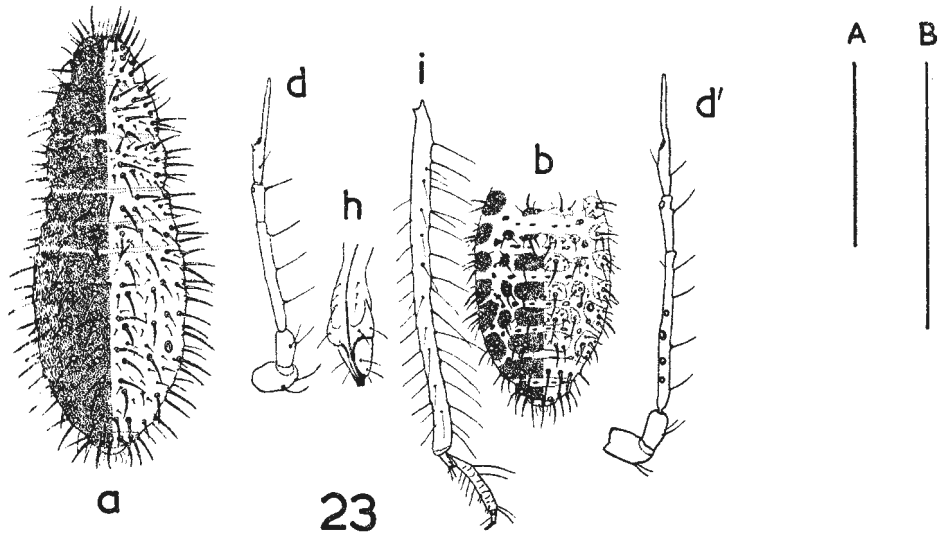

FIG. 23. *Atheroides hirtellus* (see also p. 122).

Genus **SIPHA** Passerini, 1860

Type-species: *Aphis glyceriae* Kaltenbach, 1843.

*Apterae*: Small to medium-sized aphids (body length to 2.5mm) living on Gramineae, or rarely Cyperaceae or Juncaceae. Body oval to elongate oval. Dorsum usually rather solidly sclerotic, with membranous intersegments between the head, thoracic tergites, abdominal tergites 1/2 and 7/8; occasionally with abdominal carapace reduced to discontinuous areas round the dorsal hairs, the condition seen in larval instars. Head with slightly convex frontal outline. Antennae up to about 0.4 times body length, but often much shorter than this; antennal hairs normal, few in number. Sclerotic dorsal cuticle either smooth or rather thickly adorned with fine to strong denticles or nodules; presence or absence of these has been used, in conjunction with caudal shape, to divide *Sipha* from *Rungisia* Mimeur either at the generic or subgeneric level; but this combination of characters is impracticable for such a division, since *Sipha flava* Forbes has the cauda of *Sipha* and the cuticular texture of *Rungisia*. Dorsal body hairs rather stout and blunt to abruptly acute at apex; typically in a more or less staggered double row across abdominal tergites, the large primary hairs lying in the posterior half of each tergite. Siphunculi located on abdominal tergite 5, level with spiracles; truncate conical, sometimes with convex sides, vasiform, or rim-like, with a distinct flange. Cauda broadly rounded or with a small constriction demarcating an apical knob (see remarks above on cuticular sculpture). Rostrum short, reaching about to middle coxae; apical segment subtriangular, with rather acute apex, and with or without subsidiary hairs. Subanal plate broadly rounded. Legs normal, tibiae either smooth between apical hairs,

or with a few fine spinules. First tarsal joints with 3-5 hairs (2-4 + 1 sense-peg). Claw hairs a little flattened in one plane, but appearing bristle-like when viewed with tarsus normally extended in slides. Rudimentary gonapophyses 4, rarely tending to merge into 2 or 3.

*Alatae*: Head and pterothorax dark sclerotic. Antennae up to about 0.5 times body length, with few secondary rhinaria confined to joint III. Sclerotic abdominal carapace broken into separate bands or individual hair-bearing sclerites, or restricted to posterior part of abdomen. Wings with normal venation, but median vein in forewing quite often with second fork reduced or absent unilaterally. Dorsal body hairs thinner and more acute than in apterae.

*Males* apterous, with antennae up to somewhat more than half body length, and with rather numerous secondary rhinaria on joints III-IV.

*Oviparae* very like apterae, but usually with paler and less sclerotic dorsum, more hairs on subgenital plate, and a somewhat calf-like swelling on inner face of basal two-thirds of hind tibia, bearing about 10-70 rather irregularly shaped pseudosensoria.

*Immature morphs* with dorsal carapace broken into separate sclerites or scleroites, the latter on abdominal tergites bearing only 1 hair each, the former on thorax bearing several and representing several amalgamated scleroites. First instar with 4-jointed antennae; pleural hairs present from pronotum to abdominal tergite 6 inclusive. Tibiae externally smooth or spinulose.

There are 4 British species.

#### KEY TO SPECIES

- 1 Cauda with a constriction delimiting a more or less distinct apical knob. Antennal joint III in *viviparae* bearing 2-4 hairs. Dorsal cuticle in *apterae*, at least anteriorly, thickly adorned with small nodules or denticles between the hairs. Sides of head

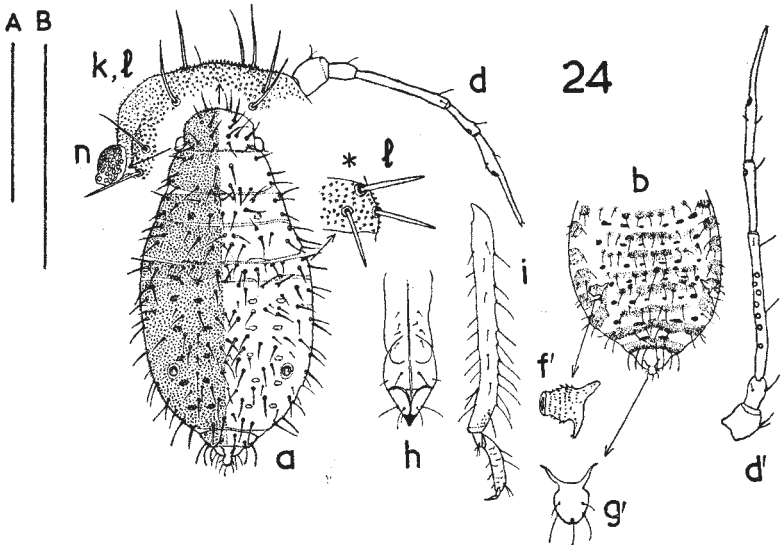

FIG. 24. *Siphia glyceriae*.

between antennal bases and compound eyes in *apterae* about equal in length to antero-posterior diameter of compound eyes, which are very prominent (fig. 24n). First tarsal joints with 3-4 hairs (2-3 + 1 sense-peg).

- Cauda rounded, without a constriction. Antennal joint III in *viviparæ* bearing 5-13 hairs. Dorsal cuticle in *apterae* not adorned with nodules or denticles between hairs. Sides of head between antennal bases and compound eyes in *apterae* shorter than antero-posterior diameter of compound eyes, which are less prominent (fig. 26n). First tarsal joints with typically 5, rarely only 4 hairs. . . . . 3
- 2 Longest hairs on antennal joint III longer than basal articular diameter of joint. Longest hairs on abdominal tergite 3 in *apterae* more than 0.05mm long. Cuticular denticles apically acute when seen in silhouette, and more or less evenly distributed over whole dorsum. Velvety dull green in life, apterous *males* blackish. Body length to 2.5mm. **glyceriæ** (Kaltenbach) (24)

*On various grasses, more especially those growing in moist habitats, such as Glyceria spp., Phalaris arundinacea and Poa spp.; more rarely on some Cyperaceae or Junaceae in the same biotope; and occasionally on grasses or cereals (e.g. barley) under drier conditions. Very common.*

- Longest hairs on antennal joint III from 0.5 to 1 times basal articular diameter of joint. Longest hairs on abdominal tergite 3 in *apterae* 0.01-0.04mm long. Cuticular denticles more nodular, with blunt or rounded apices when seen in silhouette; on posterior tergites often restricted to small roundish areas surrounding dorsal hairs. Dark green to blue-green in life, head and thorax somewhat brownish, colour sometimes obscured by salt or silt following submergence of the host. Body length 1.7-2.2mm. **littoralis** (Walker) (25)

*Living on Spartina maritima, Puccinellia maritima and Festuca rubra in coastal saltings. Probably widely distributed in suitable localities, but very little recorded. Merioneth, Caernarvon, Lancashire, Nairn.*

- 3 Apical rostral segment 0.075-0.09mm long, without subsidiary hairs. Processus terminalis in *apterae* usually more than 1.5 times, in *alatae* 2 or more times as long as basal part of antennal joint V. Dorsum in *apterae* smoky yellowish brown with darker areas round intersegmental sclerites (fig. 26a). *Alatae* with dark bands on abdominal tergites 4-7 not fusing to form a solid carapace engulfing the siphunculi or the marginal sclerites of tergites 6-7. Yellowish brown to brown in life. Body length 1.8-2.1mm. **kurdjumovi** (Mordvilko) (26)

*Living on Agropyron repens, Arrhenatherum elatius, Festuca pratensis and Hordeum murinum; also from time to time on wheat and barley. Holarctic; only moderately common in Britain.*

- Apical rostral segment 0.10-0.11mm long, with 2-3 subsidiary hairs. Processus terminalis in *apterae* less than 1.5 times, in *alatae* less than twice as long as basal part of antennal joint V. Dorsum in *apterae* uniformly dark brown to blackish over sclerotic areas (fig. 27a). *Alatae* with a solid sclerotic carapace extending over abdominal tergites 4-7, and including the siphuncular bases and the marginal sclerites of tergites 6-7 (fig. 27b); abdominal tergites 1-3 with separate dark bands, becoming narrower anterad. Appearing blackish in life. Body length 1.8-2.1mm. **maydis** Passerini (27)

*Recorded from a wide variety of grasses and cereals abroad; in Britain only known as yet from Arrhenatherum elatius and Agropyron repens, not recorded from cereals. Surrey (Kew), rare.*

### Family CALLAPHIDIDAE

A family of mostly slender and delicate species, as suggested by the German name *Zierläuse*, but with a few large and robust genera. Predominantly green, yellow or whitish in colour, more rarely pinkish or brown; often with conspicuous melanic patterns on wings or body. Various shaped projections or prominences occur on the dorsum or sides of the body in many of the genera, and these may bear hairs on or behind their apices. Many genera have only alate *viviparæ*; those with *apterae* as well may produce their *alatae* exclusively or chiefly in a particular generation, or the occurrence of *apterae* may be limited to certain species. Immature and apterous morphs

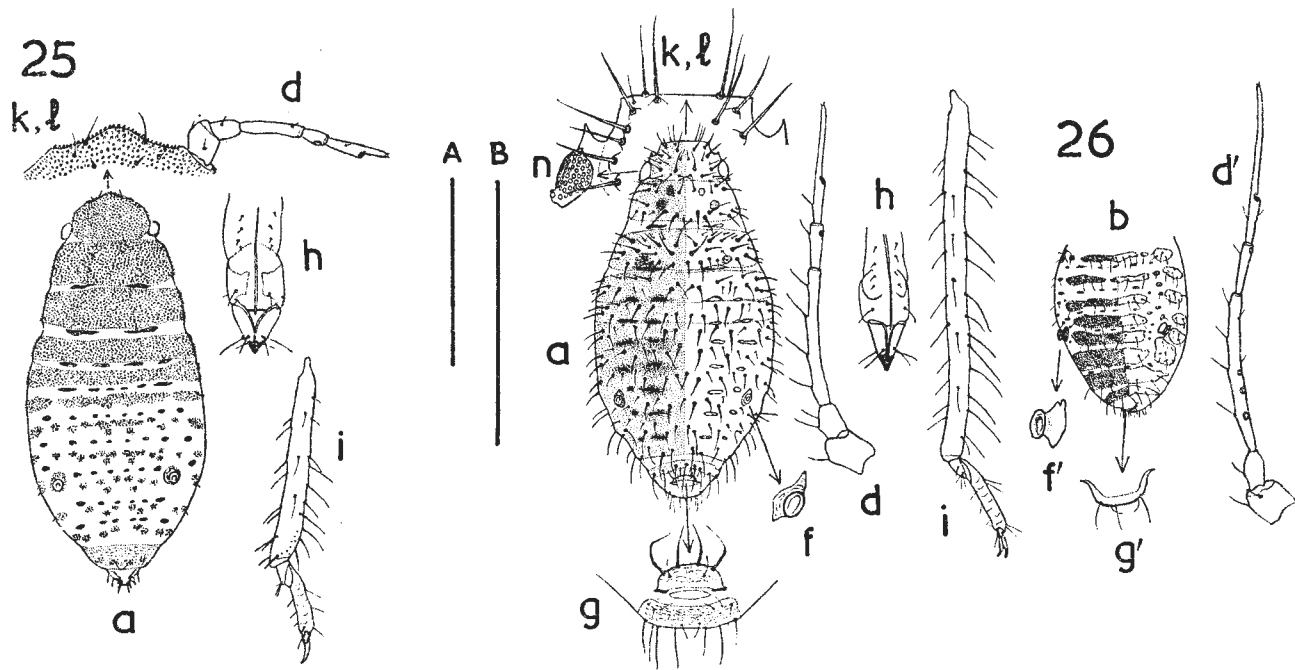

FIGS 25-26. 25, *Siphia littoralis*. 26, *S. kurdjumovi*.

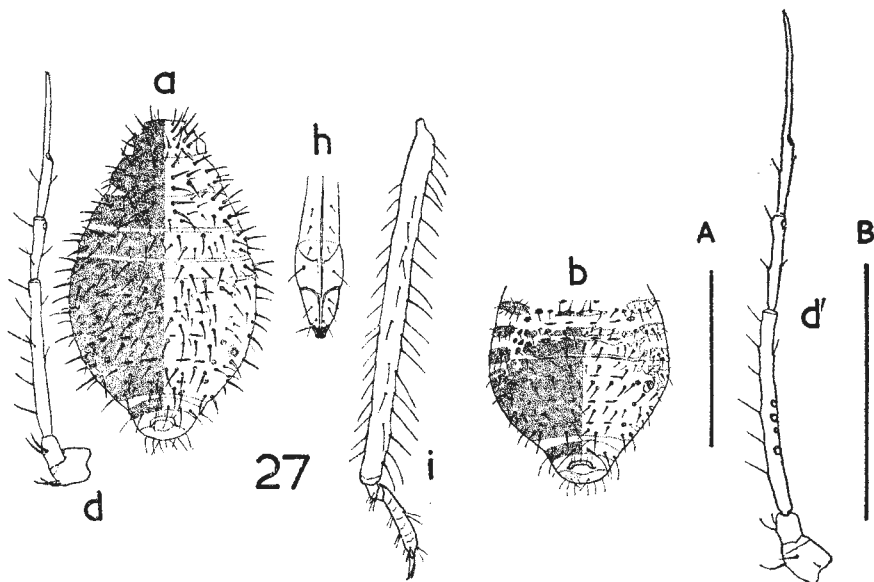
FIG. 27. *Siphia maydis*.

often with conspicuous long body hairs, which may be spiny or capitate, or rarely finely denticulate. Other types of hair modification rare, but including flabellate or funnel-shaped 'microchaetae' in some Saltusaphidinae. Conspicuous wax secretion limited to a few genera, most appearing more or less nude in life.

Adult viviparae normally with 6-jointed antennae, apterae exceptionally with 5-jointed and very short ones. Primary rhinaria in alate morphs always, in apterous morphs nearly always fringed. Secondary rhinaria in viviparae nearly always confined to antennal joint III, very rarely 1-2 present on IV; usually arranged in a more or less single, sometimes staggered row along III; sometimes with a very fine fringe or dotted border, and varying in shape from round to strongly transverse. Processus terminalis usually more or less flagelliform, either shorter or longer than basal part of last joint; rarely very short, unguiform, but then combined with fringed primary rhinaria. Compound eyes in adults multifaceted, usually large and conspicuous especially in alatae; rarely without a clearly marked triommatidion. Rostrum generally rather short, not telescopic, often with a sclerotized wishbone-shaped arch supporting the base of segment II; apical segment varying from very short and blunt to rather elongate, but never conspicuously acute or stiletto-shaped in British species. Wings in British genera either with normal venation, or with vein *Rs* in forewing more or less obsolete; rarely with only one branch vein in hindwing. Resting posture of wings vertical or steeply roof-like, not flat in any British species. Flight musculature, so far as known, functional throughout adult life. Siphunculi usually short, truncate conical or stump-shaped structures, without reticulate

sculpture but sometimes adorned with rows of fine spinules; sometimes bearing one or more hairs representing the marginal hair(s) of abdominal tergite 6; more rarely the siphunculi may be pore-like or elongate vasiform, in the latter case with an apical flange preceded by a well-marked circumcission, but then combined with enlarged front femora and front tibial bases, flattened tarsal claw hairs, fringed secondary rhinaria and remote accessory rhinaria proximal and distal to the primary rhinarium of antennal joint VI. Cauda short, usually to a greater or lesser extent knobbed or constricted, with the caudal hairs all distal to the constriction; rarely rounded or blunt angular without a constriction. Subanal plate with posterior margin often more or less excavated or bilobed. Legs normal, or in some genera with front coxae and/or femora, or front and middle femora and tibiae, enlarged or otherwise modified for leaping; at least apical half of tibiae in most genera with some fine spinules between the hairs; frequently some apical tibial hairs modified into stout spur-like structures, the degree of development of these being correlated with the tendency to leap from the host when disturbed; tarsi spinulose, either in closely set transverse rows or on imbrications (second joint), or scattered among the hairs (first joint); claw hairs in most genera flattened and curved into a scimitar, samara or boomerang shape, only occasionally simple and bristle-like.

Males normally alate, but apterous in a few species that also have apterous as well as alate viviparae. Oviparous females in European species always apterous, sometimes with abdomen protracted behind into an ovipositor-like structure; and in some genera with a large polygonal-faceted wax gland field ventrolaterally below the siphunculi, secreting a powdery wax that is applied to the surface of the winter egg during oviposition.

First instars with 3-, 4- or 5-jointed antennae; in British genera always with multi-faceted compound eyes; with siphunculi present; and with spinules between the tibial hairs.

All known Callaphididae are monoecious, and either mono- or oligophagous. They live either on the aerial parts of broad-leaved trees and shrubs or on herbaceous plants belonging to the families Gramineae, Cyperaceae, Juncaceae or Papilionaceae (non-British species are known also from Asclepiadaceae, Labiatae and Compositae). The tree hosts of British species include oak, beech, chestnut, lime, birch, hornbeam, alder, hazel, elm, maples and walnut. No species is known to cause any galling reaction by the host.

#### KEY TO SUBFAMILIES OF CALLAPHIDIDAE

The following key, based on that of Quednau (1954), uses mainly the characters of first instar larvae, and is interpolated to aid the placing of samples containing these into subfamilies. There is no straightforward way of assigning adults of all the Callaphidid genera to their appropriate subfamilies, and for determination of adults it therefore seems better to follow the example of Shaposhnikov (1964) and key the whole family without subdivision.

- 1 Compound eyes with a clearly distinct 3-faceted posterior lobe, or triommatidion. (*Oviparae* with subanal plate rounded. If on Gramineae, then apterous viviparae not produced.) Claw hairs always flattened to a scimitar-, samara- or boomerang-like form . . . . . 2

- Triommatidion absorbed into the convexity of the compound eyes. Claw hairs flattened or simple. (*Oviparae* with subanal plate bilobed. Apterous viviparae found in all species. On Cyperaceae or Juncaceae, very rarely and casually on Gramineae.) SALTUSAPHIDINAE
- 2 Front coxae not noticeably larger than middle and hind coxae. (On woody plants, including bamboos.) 3
- Front coxae much larger than middle and hind coxae. (*First instar* with or without pleural hairs; thoracic segments with only 1 marginal hair on each side; antennal joint II with only 1 hair. On Papilionaceae.) THERIOAPHIDINAE
- 3 *First instar* with dorsal hairs in 4 longitudinal rows (i.e. without pleural hairs); thoracic segments with only 1 marginal hair on each side; antennal joint II with only 1 hair. CALLAPHIDINAE
- *First instar* with dorsal hairs in at least 6 longitudinal rows (i.e. pleural hairs present) from pro- or mesonotum to abdominal tergite 6; thoracic segments with 2 marginal hairs on each side; antennal joint II with more than 1 hair. PHYLLAPHIDINAE

## KEY TO GENERA: ALATE VIVIPARAE

- 1 Forewings with apical veins ( $M_1 + M_2$ ) broadly and conspicuously dark-bordered (figs 28, 40, 41, 77e). (View with pocket lens.) 2
- Forewings with apical veins not, or only very narrowly and inconspicuously, dark-bordered or shadowed (figs 46-76e). (View with pocket lens.) 6
- 2 Forewings with vein *Rs* obsolete. Vein  $Cu_1$  without dark shadowing (fig. 41e). Abdomen with characteristic blackish pattern (fig. 41b). On *Ulmus* spp. TINOCALLIS Matsumura (part) (p. 66)
- Forewings with *Rs* distinct at least at apex.  $Cu_1$  ending in a dark triangular spot at wing margin. 3
- 3 Antennal hairs conspicuous, much longer than basal articular diameter of antennal joint III. Large aphids (3.5-4.3mm long), with abdominal dorsum regularly transversely banded with blackish. Antennal joint III more than 4 times as long as VI, and processus terminalis much shorter than basal part of VI. On *Juglans regia*. CALLAPHIS Walker (p. 50)
- Antennal hairs inconspicuous, not longer than basal articular diameter of antennal joint III. Smaller aphids (less than 3mm long), with abdomen not regularly transversely banded. 4
- 4 Front and middle femora much enlarged, and these tibiae with sclerotic basal 'knee caps' (fig. 77Ti, kn). Hindwings with only 1 branch vein. Compound eye without a distinct triommatidion. On *Carex* or *Juncus* spp. IZIPHIA Nevsky (p. 118)
- Femora normal, and tibiae without 'knee-caps'. Hindwings with 2 branch veins. Compound eye with a distinct triommatidion. 5
- 5 Sclerotic markings of wings and body densely black in parts, these including the lateral margins of head and thorax, antennae except bases of joints IV-VI, costa of forewing from base to pterostigma, hind femora, and 2 pleural series of sclerites on abdominal tergites 1-7 (figs 40b, c, d', e). Head without a dark ventral band joining inner margins of compound eyes. Dorsal hairs all acute. On *Tilia* spp. EUCALLIPTERUS Schouteden (p. 65)
- Sclerotic markings of wings and body pale to darkish grey or brown; head and thorax not conspicuously dark laterally; antennae only obscurely darker at extreme apices of joints; costa of forewing pale between base and pterostigma; hind femora not darker than front and middle femora; abdominal sclerites at least partly spinal rather than pleural. Head with a ventral dark band running transversely between inner margins of compound eyes (fig. 66c). Dorsal hairs blunt to subcapitate. On Papilionaceae. THERIOAPHIS Walker (part) (p. 107)
- 6 Antennal joint VI with a short, blunt processus terminalis less than half as long as basal part of joint (figs 29d', 50d') 7
- Antennal joint VI with an elongate processus terminalis, at least half as long as basal part of joint (figs 30d', 36d' etc.) 8
- 7 Small (1.6-2.6mm long) pale yellow aphids with only apices of antennal joints,



- sometimes small pairs of spinal spots on abdominal tergites 4-5, a spot near apex of hind (or middle and hind) femora, base and apex of pterostigma, and extreme bases of forewing veins *M*, *Cu*<sub>1</sub> and *Cu*<sub>2</sub>, dark. Siphunculi truncate conical, flanged. Hind tibiae sometimes slightly dusky. Not waxy in life. On *Juglans regia* **CHROMAPHIS** Walker (p. 51)
- Medium-sized (2.2-3.2mm long) yellow-green aphids with at least head, thorax, most of antennae, hind legs and pterostigma uniformly dusky, but bases of *M*, *Cu*<sub>1</sub> and *Cu*<sub>2</sub> in forewing not pigmented. Usually also with abdominal dorsum ornamented with segmental dark bars and marginal sclerites, bearing groups of ring-shaped wax-pores. Living aphid flocculently waxy. Siphunculi pore-like. On *Fagus sylvatica*. **PHYLLOPHIS** Koch (p. 77)
- 8 Clypeus with a sac-like median process (fig. 44c). Pale yellowish or pale green aphids living on bamboos. **TAKECALLIS** Matsumura (p. 71)
- Clypeus without a sac-like process. Not on bamboos. . . . . 9
- 9 Secondary rhinaria on antennal joint III arranged in a single row, or with only occasional rhinaria displaced out of line or 2 abreast. . . . . 10
- Secondary rhinaria on antennal joint III somewhat or quite irregularly arranged (fig. 57d'). On *Betula* spp. . . . . 26
- 10 Abdominal dorsum with paired or partly fused pairs of spinal processes (figs 36-39b, 42-43b, 49b, 67b). . . . . 11
- Abdominal dorsum without spinal processes, or at most with inconspicuous flattish paired or unpaired convexities bearing the dorsal hairs (figs 30-33b, 48b, 51-56b, 59-64b, 66b, 69-71b, 73-76b). . . . . 15
- 11 Front coxae not strongly enlarged. Head without a dark transverse ventral band joining inner margins of compound eyes. . . . . 12
- Front coxae strongly enlarged relative to middle and hind coxae (fig. 65 Cx, Tr). . . . . 14
- 12 Abdomen with a single large, usually basally fused pair of spinal processes forming a V- or Y-shaped structure on tergite 3 (fig. 39b). Antennae very long and slender, much longer than body. Live adult waxy, looking as if killed by fungus. On *Quercus robur*, under lower leaves **TUBERCULATUS** Mordvilko (p. 61)
- Abdomen with paired spinal processes on more than one tergite. Not waxy in life. Antennae not, or not much, longer than body. . . . . 13
- 13 Paired thimble-shaped, finger-shaped or rounded conical processes on all abdominal tergites and on head (2 pairs) and pronotum. Those on abdominal tergites 1-6 placed at inner ends of paired subquadrate spinopleural dark sclerites; those on tergite 7 displaced laterad to lie near outer end of the undivided band across this tergite. Similar processes also on margins of tergites 1-7, that on tergite 6 having the siphuncular pore incorporated in its base anteriorly. Antennal joints not distinctly ringed with blackish apically. On *Sarothamnus scoparius*. **CTENOCALLIS** Klodnitzki (p. 74)
- Low paired conical to finger-shaped processes present on spine of abdominal tergites 1-3 or 1-4 only (occasionally inconspicuous on abd. 1-2). Abdomen without pigmentation apart from the pair of processes on tergite 3, which may or may not be dusky, and the siphunculi, which are usually dusky to black apically, but may be entirely pale. Marginal sclerites of tergites 3-4 with their dorsal margins produced into blunt projections, but remaining tergites without such marginal processes. Antennal joints III-V ringed with blackish apically. On *Quercus* spp. **TUBERCULOIDES** van der Goot (p. 59)
- 14 Head with a dark transverse ventral band joining inner margins of compound eyes. Dorsal processes consisting merely of small conical prominences bearing the rod-like or subcapitate spinal, or spinal and pleural, hairs. Secondary rhinaria transverse oval but not slit-like or semiannular. Pale yellow in life. On *Papilionaceae*. **THERIOAPHIS** Walker (part) (p. 107)
- Head without a dark transverse band ventrally. Dorsal processes varying from subconical to finger-like. Pleural hairs absent. Secondary rhinaria very narrow, slit-like or semiannular, with a protruding, somewhat cicatrice-like plaque (fig. 43k). Pale whitish to yellowish green in life. On *Ulmaceae*. **TINOCALLIS** Matsumura (part) (p. 66)
- 15 Siphunculi elongate with a marked preapical circumcision before the sharply marked flange (fig. 62b). Accessory rhinaria on antennal joint VI lying partly separated from the primary rhinarium (fig. 62k). On *Acer* spp. **DREPANOSIPHUM** Koch (p. 103)

- Siphunculi, if longer than their basal width, then without a preapical circumcission or sharp flange. Accessory rhinaria on antennal joint VI grouped closely round primary rhinarium (figs 30k, 48k, 55-56k, 66k).....16
- 16 Large or rather large (more than 2.5mm long) dark brown aphids living on twigs or small branches of *Betula* or *Alnus* spp. Not waxy or flocculent in life, or dorsum at most with localized bands or spots of wax powder.....17
- Aphids not dark brown, or if so then less than 2.5mm long. If more than 3mm long, then with well-marked gland elements producing a flocculent coating of the body and appendages in life.....18
- 17 Longest hairs on antennal joint III less than twice as long as basal articular diameter of joint (fig. 58d'). Abdominal tergites with a regular series of solid rectangular transverse bands, these and the marginal sclerites being about as dark as the pterothorax. Siphunculi pale in life, sometimes absent. On *Betula pendula* and *pubescens*, attended by ants. **SYMDOBBIUS** Mordvilko (p. 93)
- Longest hairs on antennal joint III more than twice as long as basal articular diameter of joint (fig. 59d'). Abdominal tergites 1-7 only with narrow, much broken up transverse lines of small dusky sclerites bearing individual hairs; these sclerites often reduced almost to vanishing point on some segments, and together with marginal sclerites much less strongly pigmented than pterothorax. Siphunculi always present, darkish but with a coating of whitish wax powder in life. On *Alnus glutinosa*, more rarely on *Betula* spp. **CLETHROBIUS** Mordvilko (p. 96)
- 18 Spinal hairs on abdominal tergites in small paired groups of 2-6, each group situated on a small slightly convex area that may or may not be pigmented (figs 31-33k, l). Wing venation normal; forewing with  $Cu_2$  not noticeably darker than  $M$  and  $Cu_1$ ; viviparae sometimes brachypterous or very rarely apteriform. Processus terminalis longer than basal part of antennal joint VI. Smallish pale yellow or straw-coloured aphids on *Quercus*, *Castanea*, *Corylus*, *Carpinus* or *Myrica*. **MYZOCALLIS** Passerini (p. 53)
- Spinal hairs not in small compact paired groups; if multiplied, then extending across the tergites in scattered rows.....19
- 19 Body very elongate (in slides more than 2.5 times as long as greatest width of abdomen). Compound eyes without a clearly defined triommatidion. Siphunculi pore-like, rim-like or on flat cones. Abdomen either with a more or less solid central dark dorsal patch occupying several tergites, or with broad dark bands occupying the whole width of the individual tergites almost to the marginal sclerites (figs 69-76b). On Cyperaceae.....20
- Body of normal shape, not very elongate (in slides not more than about 2.3 times as long as greatest width of abdomen). Compound eyes with a clearly defined triommatidion. Siphunculi stump-shaped or truncate conical with or without basal and/or apical expansion. Tarsal claw hairs flattened. Not on Cyperaceae.....21
- 20 All dorsal body hairs normal, somewhat thorn-like or very fine. Tarsal claw hairs bristle-like. Hindwing with 2 branch veins. On *Carex* spp. **TRICHOCALLIS** Börner (p. 110)
- At least a proportion of dorsal hairs on head, thorax and abdomen modified into the shape of an everted umbrella ('stellate' or 'mushroom-shaped' microchaetae of various authors) (figs 73-76l). Tarsal claw hairs flattened. Hindwing with only 1 branch vein. On *Carex* or *Scirpus* spp. **SUBSALTUSAPHIS** Quednau (p. 112)
- 21 Abdominal dorsum with large paired spinal sclerites whose centres are largely pale except round the enclosed hair bases. Marginal sclerites of abd. 2, 4 and 5 more strongly pigmented than remaining sclerites. Head with a ventral dark transverse band joining inner margins of compound eyes (fig. 66c). Forewing with  $Rs$  obsolescent on basal half but clearly visible apically, and  $Cu_2$  not more strongly pigmented than  $Cu_1$  (fig. 66e). On *Melilotus* spp. **THERIOAPHIS** Walker (*riehmi* Börner) (p. 107)
- Abdominal dorsum without paired pigmented sclerites, or if with paired sclerites on some tergites then their centres are more or less evenly dark. Head without a ventral dark band. Not on Papilionaceae.....22
- 22 Secondary rhinaria with a distinct ciliate fringe on their proximal side (figs 56k, 60k). On *Betula* spp.....23
- Secondary rhinaria without a ciliate fringe.....24

- 23 Large aphids, more than 3mm long. Body in life clothed with flocculent bluish white wax, produced from gland groups situated on all segments of the body and, in the form of narrow granular striations, on the antennae and tibiae. Cauda a little constricted, delimiting an isodiametric knob. Abdominal tergites varying from totally pale to black-banded on all segments, the last bands to disappear being those of tergites 4-6. **EUCERAPHIS** Walker (p. 100)
- Smallish aphids, less than 2.5mm long. Body without wax gland groups apart from very small simple tubercles sometimes present on marginal sclerites, and without apparent wax secretion in life. Cauda rounded, without constriction or knob. Dorsum with or without a rather large subrectangular dusky patch covering most of tergites 4-6, and with lateral extensions forward on to tergite 3. **BETULAPHIS** Glendenning (p. 88)
- 24 Antennal joint I with inner apical angle blackish, remainder of joints I and II, and head, pale. Processus terminalis shorter than basal part of joint VI, and joint III more than twice as long as joint VI (figs 48c, d'). Secondary rhinaria 2-5 in number, on basal half of joint III. *Rs* in forewing absent or only its extreme apex apparent; *Cu*<sub>2</sub> more strongly pigmented than *M* and *Cu*<sub>1</sub> (view with pocket lens) (fig. 48e). On *Alnus glutinosa*, under leaves. **PTEROCALLIS** Passerini (p. 72)
- Inner apical angle of antennal joint I not noticeably darker than head and remainder of joints I and II. Processus terminalis longer than basal part of joint VI, and joint III less than twice as long as joint VI. Secondary rhinaria on III 4-20 in number, not usually confined to basal half of joint. *Rs* in forewing weak, but often rather indistinctly visible over some or even all of its length; *Cu*<sub>2</sub> not noticeably darker than *M* and *Cu*<sub>1</sub> (pocket lens). On *Betula* spp. . . . . 25
- 25 Frons not concave (fig. 53c). Head and thorax usually blackish pigmented, and abdominal dorsum usually with black bands on at least some tergites, and blackish siphunculi. If head and thorax, and abdomen, wholly pale, then antennal flagellum shorter than body, and antennal joint VI shorter than rostrum. **CALLIPTERINELLA** van der Goot (p. 81)
- Frons concave (i.e. lateral prominences higher than centre of frons) (fig. 55c). Head, thorax and abdomen without black pigmentation, except sometimes on apical half of siphunculi. Antennal flagellum longer than body, and antennal joint VI longer than rostrum. **KALLISTAPHIS** Kirkaldy (p. 85)
- 26 Secondary rhinaria rather transverse, arranged in a somewhat irregular single to partly multiple series along proximal three-quarters of antennal joint III. Antennal joint VI very short, with processus terminalis shorter than basal part of joint. Rather large dark brown aphids living on twigs and young branches. See also couplet 17. **SYMDOBIUS** Mordvilko (p. 93)
- Secondary rhinaria round, arranged quite irregularly along whole of antennal joint III and around one-half of circumference of joint (fig. 57d'). Antennae very long, blackish, joint VI much longer than III, processus terminalis as long as or longer than hind tibiae. Large ventrally flattened cryptic green aphids living singly, usually on upper side of leaves on midrib. **MONAPHIS** Walker (p. 89)

#### KEY TO GENERA: APTEROUS VIVIPARAE

- 1 All tergites with spinal, pleural and marginal wax gland plates consisting of numerous granular pores. Aphids in life with a covering of flocculent wax filaments. . . . 2
- Dorsum without conspicuous wax gland groups, these if present confined to posterior margin of abdominal tergite 8 and some marginal sclerites. Aphids not flocculent in life, at most with an inconspicuous posterior fringe of waxy threads. . . . . 3
- 2 Dorsum wholly dusky sclerotic except for membranous intersegmental boundaries; muscle sclerites, and often also spots round dorsal wax-pore groups, darker than remainder (fig. 69a). Spinal and pleural gland groups much smaller than marginal groups, and individual pores not appearing as granular rings (fig. 69k). Antennal joint III with 0-6 secondary rhinaria. Cauda very pronouncedly knobbed, and subanal plate strongly bilobed. Tarsal claw hairs bristle-like. On *Carex* spp. **TRICHOCALLIS** Börner (part) (p. 110)
- Dorsum not wholly sclerotic, pigmentation if present confined to the wax gland groups. Spinal and pleural gland groups not much if at all smaller than marginal groups, and their individual pores appearing as granular rings (fig. 50k). Antennae without secondary rhinaria. Cauda rounded or only very indistinctly

knobbed, subanal plate only weakly emarginate or bilobed. Tarsal claw hairs flattened. On *Fagus sylvatica*.

**PHYLLAPHIS** Koch (p. 77)

- 3 Dorsum with a complete series of finger-like, backwardly directed spinal and marginal processes on all segments from pronotum to abdominal tergite 7; spinals on abdominal 7 displaced laterad to near marginals; abdominal tergite 8 with only a pair of spinal processes; head with 3 pairs of shorter processes medially and an additional pair lateral to the occipital pair. Siphunculi pore-like, opening at base of anterior face of marginal process of abdominal tergite 6. Spinal processes of pro- and mesonotum duplicated or even triplicated anteroposteriorly. Tergites from mesonotum to abdominal 7 all with a transverse pigmented band, divided into two at mid-line, and bearing the spinal and marginal processes at its inner and outer ends respectively. Pronotum and abdominal tergite 8 each with an entire band (fig. 49a). On *Sarothamnus scoparius*.

**CTENOCALLIS** Klodnitzki (p. 74)

- Dorsum without finger-like processes. . . . . 4
- 4 Dorsal body hairs in British species at least partly modified to small fan-shaped ('flabellate') or everted umbrella-like ('stellate') structures. Compound eyes without a clearly defined triommatidion. On Cyperaceae or Juncaceae. . . . . 5
- Dorsal body hairs not grossly modified, at most somewhat capitate or minutely denticulate. . . . . 6
- 5 Modified dorsal body hairs flabellate. Front and middle femora much thickened for leaping, and all femora more or less dark. Bases of front and middle tibiae with a smooth, very sclerotic dark 'knee-cap' (fig. 77Ti). Arms of mesothoracic furca arising from a short-stalked common invagination. On *Carex* and *Juncus* spp.
- Modified dorsal hairs stellate, sometimes highly irregular in outline or partly intermediate between stellate and normal thorn-like hairs. Front and middle femora not thickened, and all femora more or less pale. Bases of tibiae all normal, without a sclerotic 'knee-cap'. Arms of mesothoracic furca arising from separate invaginations. Body rather elongate and flattened, with or without longitudinal dusky lines (figs 72-76a). On *Carex* or *Scirpus* spp.

**IZIPHYA** Nevsky (p. 118)

- Modified dorsal hairs stellate, sometimes highly irregular in outline or partly intermediate between stellate and normal thorn-like hairs. Front and middle femora not thickened, and all femora more or less pale. Bases of tibiae all normal, without a sclerotic 'knee-cap'. Arms of mesothoracic furca arising from separate invaginations. Body rather elongate and flattened, with or without longitudinal dusky lines (figs 72-76a). On *Carex* or *Scirpus* spp.

**SUBSALTUSAPHIS** Quednau (p. 112)

- 6 Dorsum with a regular series of conspicuously dark transverse bands or a dark quadrate patch. Dorsal hairs with smooth shafts. Tarsal claw hairs flattened. On *Betula* spp. . . . . 7
- Dorsum not regularly blackish-banded nor with a blackish quadrate patch. If bands present, then they are very pale and indistinct. . . . . 8
- 7 Rather large aphids (body length more than 2.5mm). Antennal joint III more than 2.5 times as long as VI. Processus terminalis much shorter than basal part of VI. Antennal hairs numerous, longer than basal articular diameter of III (fig. 58d'). Cauda with 20 or more hairs. Siphunculi present or absent, if present then pale and inconspicuous. Living in colonies on twigs or young branches, attended by ants.

**SYMYDOBIUS** Mordvilko (p. 93)

- Smaller aphids (body length not more than 2.3mm). Antennal joint III less than twice as long as VI. Processus terminalis longer than basal part of VI. Antennal hairs less numerous, usually shorter than basal articular diameter of III (fig. 53d). Cauda with not more than 12 hairs. Siphunculi always present, usually dusky pigmented and quite conspicuous. Living singly or in small groups on leaves, often between those spun together by lepidopterous larvae; sometimes visited by ants but not regularly attended.

**CALLIPTERINELLA** van der Goot (p. 81)

- 8 Body very elongate (figs 69-71a). Compound eyes without a clearly defined triommatidion. Mid-frons very convex (figs 69-71a). Dorsal cuticle with round nodulose sculpture (figs 69-71k). Tarsal claw hairs bristle-like. On *Carex* spp.

**TRICHOCALLIS** Börner (part) (p. 110)

- Body not very elongate. Compound eyes with a distinct triommatidion. Mid-frons not very convex (figs 47-48a, 51-56a, 65a, 67-68a). Dorsal cuticle not nodulose. Tarsal claw hairs flattened. Not on *Carex*. . . . . 9

- 0 Processus terminalis shorter than basal part of antennal joint VI. Antennal joint III with at least 1 rather long acute to subcapitate hair that is much longer than the diameter of the joint (figs 47-48d). Dorsal body hairs with their shafts bearing minute denticulations directed towards the hair apices (figs 47-48l). On *Alnus glutinosa*, under leaves

**PTEROCALLIS** Passerini (p. 72)

- Processus terminalis longer than basal part of antennal joint VI, or if fractionally shorter than antennal joint III without any hairs longer than diameter of joint. Dorsal body hairs with smooth shafts. Not on *Alnus*.....10
- 10 Front coxae very much enlarged relative to middle and hind coxae (fig. 65Cx). Antennae 6-jointed. Dorsal body hairs situated on individual pigmented sclerites. On Papilionaceae. **THERIOAPHIS** Walker (p. 107)
- Front coxae not strongly enlarged relative to middle and hind coxae. Dorsal body hairs not situated on individual pigmented sclerites, or if partly so (fig. 52a) then antennae 5-jointed. On *Betula* spp.....11
- 11 Antennae 6-jointed, joint III without secondary rhinaria. Cauda broadly rounded subtriangular, not constricted, but sometimes with a small apical mucronate point (fig. 56a). Dorsal cuticle pale sclerotic, sometimes irregularly suffused with brownish pigmentation, often slightly wrinkled. Dorsal abdominal hairs in 6 regular series: 2 spinal, 2 pleural and 2 marginal per tergite from 1 to 6 inclusive (fig. 56a); those on mid-dorsum very short and inconspicuous in early summer, becoming longer in autumnal generations **BETULAPHIS** Glendenning (p. 88)
- Antennae with secondary rhinaria on joint III, or if not, then antennae very short and 5-jointed (fig. 52d). Cauda with at least a slight constriction, never with an apical mucronate point. Dorsal cuticle not sclerotic or wrinkled.....12
- 12 Antennae always 6-jointed, joints III—VI together from a little shorter to much longer than body; joint VI longer than rostrum (figs 54—55d, h). Body entirely pale in slides, or with only apices of siphunculi dusky (figs 54—55a). Longest dorsal body hairs always longer than diameter of trochantrofemoral suture, blunt to subcapitate (fig. 54l); middle abdominal tergites with a transverse row of 7 or more, very rarely only 6 on an individual segment. Dorsal cuticle without spinules. Siphunculi smooth or with only traces of imbrication and spinules, but with a strongly flared thick apical rim (fig. 55f)
- KALLISTAPHIS** Kirkaldy (p. 85)
- Antennal joints III—VI or III—V together much shorter than body; if antennae 6-jointed, then joint VI shorter than rostrum (fig. 53d, h). Body in specimens with 5-jointed antennae very small and plump, with a transverse dusky band across abdominal tergite 8 and some small paired dusky spinal, pleural and marginal hair-bearing sclerites on other tergites anterad (fig. 52a). Longest hairs on middle abdominal tergites about as long as diameter of trochantrofemoral suture, and these tergites with a transverse row of 7 or more hairs. Specimens with 6-jointed antennae usually with pale traces of regular transverse segmental bands bearing rows of fine spinules. Siphunculi sculptured with transverse rows of spinules, and not strongly flared at apex (fig. 53f). See also couplet 7
- CALLIPTERINELLA** van der Goot (p. 81)

### Genus **CALLAPHIS** Walker, 1870

Type-species: *Aphis juglandis* Goeze, 1778.

All viviparae *alate*. Large stout aphids (body length 3.5–4.3mm). Antennae short, flagellar joints (III—VI) together about 0.3–0.4 times body length; joint III more than 4 times as long as VI, and processus terminalis less than half as long as basal part of VI. Secondary rhinaria transverse oval, distributed in an irregular staggered row all along joint III, 14–22 in number. Antennal hairs very long and fine, those on III up to 4 or more times as long as basal articular diameter of joint. Frons without lateral prominences. Head with occipital (posterior discal) hairs in a numerous, partly double transverse row. Pronotum dusky with a paler central diamond-shaped area; anteriorly and posteriorly with 2 irregular transverse bands of hairs, the posterior much more numerous (to about 50) than the anterior (to about 20). Rostrum not reaching middle coxae; base of segment II with a sclerotized wishbone-shaped dorsal stiffening formed by the proximal ends of the retractor apodemes; apical segment subtriangular, about 1.5 times as long as its basal width, and with about 8–10 subsidiary hairs. Wings with normal

venation, but with *Rs* in forewing weak over middle part of its course; *Cu*<sub>2</sub> heavily dark-bordered, the other veins somewhat less so and ending in dark triangular spots at wing margin (fig. 28e); costal area mostly broadly dark; membrane between veins hardly squamulose. Hindwing with 7-9 hamuli. Abdomen with dark marginal sclerites and broad dark bands across tergites 3-7, broken ones across tergites 1-2 and a small trapezoid sclerite on tergite 8. Dorsal abdominal hairs fairly numerous, in irregular bands across tergites; tergites 3-7 with about 8-18, tergite 8 with 18-22; marginal sclerites with about 5-16 hairs, the number decreasing from the anterior segments posterad; all hairs long, fine and acute like antennal hairs. Siphunculi truncate conical, flanged, situated on marginal sclerites of tergite 6, whose marginal hairs lie on the siphuncular cones. Cauda with elongate oval knob, bearing numerous (about 30-45) hairs. Subanal plate broadly excavated, the excavation wider than the caudal knob. Abdominal sternites 4-5 with small irregular broken lateroventral pigmented areas, bigger on 5 than on 4. Legs normal. Hind femora with a blackish area encircling them near the apex. Tibiae only apically very finely spinulose between the hairs, and tibial apices without thickened spur-like spines. Hind tibiae in fundatrices sometimes with one or two pseudosensoria (scent plaques). Tarsi fairly densely spinulose, first joints with 5 ventral and 1-3 dorsal hairs, the medioapical ventral one being a sense-peg. Claw hairs roughly boomerang-shaped. Rudimentary gonapophyses 2.

*Males* alate, similar to alate viviparae but more slender; antennal joint III with 36-40 secondary rhinaria, IV with 6-8, V with 6 (Theobald, 1927).

*Oviparae* and *immature morphs* with dark paired marginal and subquadrate spinopleural sclerites in segmental series extending back to abdominal tergite 7; tergite 8 with an undivided band. Chaetotaxy as for viviparae. *Oviparae* with dark, somewhat incrassate hind tibiae bearing numerous pseudosensoria. First instar with 3-jointed antennae; pleural hairs absent; spinal hairs of abdominal tergite 1 slightly displaced laterad.

Sole British species yellow in life, with sclerotic parts dark brown to blackish

**juglandis** (Goeze) (28)

*Living in files along the veins on upperside of leaves of Juglans regia. Locally common but erratic in its appearance. Recent work in the U.S.A. suggests that the presence of Chromaphis juglandicola may adversely affect populations of C. juglandis, and the two aphids are rarely found together.*

### Genus CHROMAPHIS Walker, 1870

Type-species: *Lachnus juglandicola* Kaltenbach, 1843.

All viviparae *alate*. Small pale yellow aphids, body length 1.6-2.6mm. Antennae rather short, flagellar joints (III-VI) together from a little less to a little more than half as long as body; joint III about 2.3-3.1 times as long as VI, and processus terminalis only 0.1-0.25 times as long as basal part of VI. Secondary rhinaria as in *Callaphis* but fewer (6-9). Antennal hairs short, those on III maximally half as long as basal articular diameter of joint. Frons with median protuberance bearing the ocellus, and a pair of flat conical prominences laterodorsal to the median one. Head with occipital (posterior discal) hairs only 4 in number in a transverse row. Pronotum with only 1 anterior and 1 posterior pair of spinal hairs, a single lateral hair at each

28

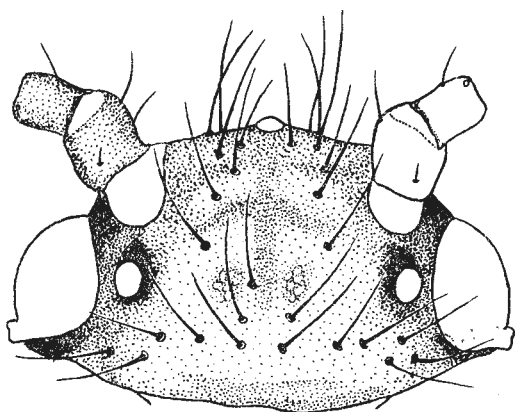

C

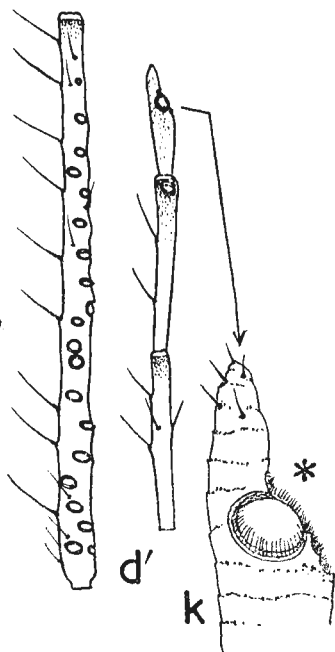

D'

K

B



29

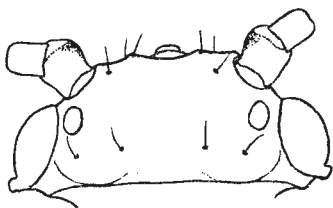

C

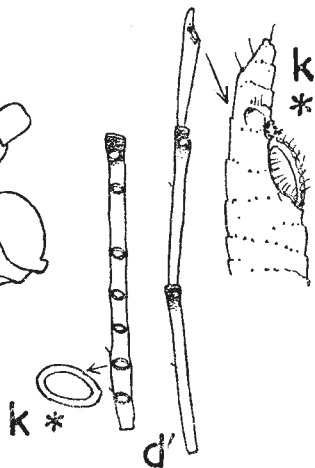

K

K\*

D'

FIGS 28-29. 28, *Callaphis juglandis* (see also pp. 54, 123). 29, *Chromaphis juglandicola* (see also p. 54).

anterior angle and two such hairs on each side posteriorly. Rostrum not reaching middle coxae; apical segment about 1.75 times as long as its basal width, with 5–12 subsidiary hairs. Forewings with *Rs* absent or weakened on basal half of its course; bases of *M* and *Cu* veins dusky for a short distance, and pterostigma outlined in dusky grey. Membrane almost devoid of squamulae between veins. Hindwings with 2 hamuli. Dorsal abdominal hairs few, each tergite with only 2–6 hairs across mid-dorsum except for tergite 8 which bears 8–18. Marginal sclerites with 2–4 hairs. All hairs fine and acute. Siphunculi truncate conical, flanged, situated on marginal sclerites of tergite 6, and with the marginal hairs of this tergite appended to their bases posteriorly. Cauda with a distinctly transverse knob, bearing 15–20 hairs. Subanal plate only slightly emarginate. Legs normal. Tibiae more markedly spinulose between hairs than those of *Callaphis*, and front tibiae with an apical group of 3–4 modified spur-like spines. First tarsal joints typically with 5 ventral and 2 dorsal hairs, the medioapical ventral one being a shorter, stouter sense-peg. Claw hairs as in *Callaphis*. Rudimentary gonapophyses 2. Colour in slides entirely pale except for dark apices to antennal joints III–VI, dusky tarsi and tip of rostrum, and a black spot anteriorly near apex of hind femora. Autumnal specimens may have pigment also on inner apex of antennal joint I and small paired sclerites spinally on abdominal tergites 4–5; even occasionally a small spot on the middle femora in the same position as that on the hind of femora.

*Males* alate, with head, thorax and paired oval spinal sclerites on abdominal tergites 4–5 dark; each of the dorsal sclerites bears 2 hairs. Marginal sclerites of tergite 5 also slightly dusky. Antennae with irregularly arranged secondary rhinaria on joints III–VI (base) inclusive, those on V and VI more or less in a line; III bears 11–24, IV 5–9, V 4–7 and VI (base) 2–3. Otherwise, except for genitalia, morphologically like alate viviparae.

*Oviparae* (Davidson, 1914) with variably developed brownish bands on abdominal tergites 3–5, and some brownish suffusion also on thorax. Hind tibiae somewhat incrassate and bearing pseudosensoria, about 35 in number. Otherwise as for immature morphs, q.v.

*Immature morphs* with a variable number of small paired dark spinal spots, present at least on abdominal tergite 5, and with dark femoral spots as in adult viviparae. Hairs on frons, vertex laterally, margins of body and abdominal tergite 8 conspicuous and capitate; spinal hairs very small and blunt. First instar with 3-jointed antennae, joint III bearing both primary rhinaria; pleural hairs absent, spinals of abdominal tergite 1 slightly displaced laterad.

Sole British species

**juglandicola** (Kaltenbach) (29)

*Living scattered under the leaves of Juglans regia. Not very common, but sometimes occurring in large numbers locally and then capable of causing damage to foliage and immature fruit.*

Genus **MYZOCALLIS** Passerini, 1860

Type-species: *Aphis coryli* Goeze, 1778.

All viviparae normally *alate* in British species, but *brachypterae* prevalent in late summer in one species, and very rarely a few micropterous larviform *apterae* may occur casually in another. Small to medium-sized yellowish



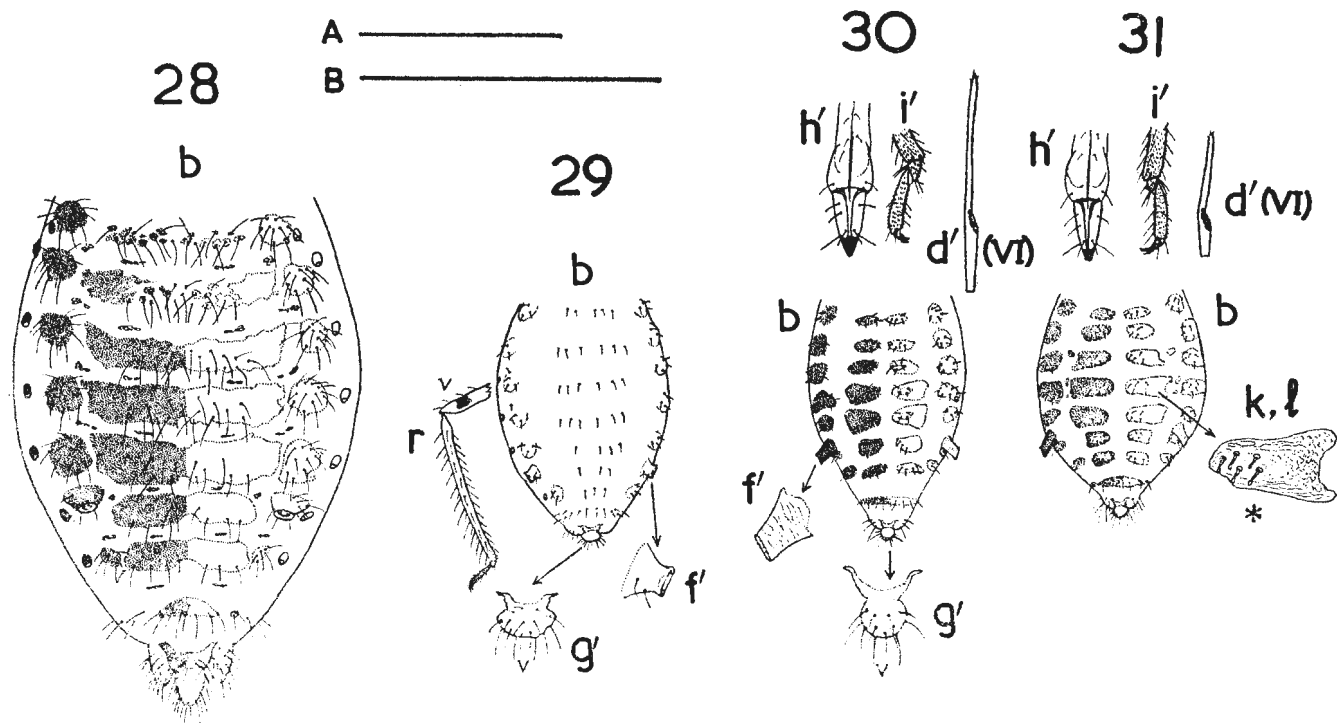

FIGS 28-31. 28, *Callaphis juglandis* (see also pp. 52, 123). 29, *Chromaphis juglandicola* (see also p. 52). 30, *Myzocallis castanicola* (see also p. 56). 31, *M. myricaе*.

aphids (body length 1.3–2.6mm). Head with small lateral frontal prominences and a median frontal prominence dorsal to the median ocellus. First pair of anterior discal hairs on vertex situated on small elevated tubercles; occipital hairs (posterior discals) in a transverse row of 4–6. Antennae 6-jointed, imbricate, the imbrications progressively more spinulose from base towards apex; processus terminalis elongate, longer than basal part of VI. Secondary rhinaria in a single row along joint III, their borders often fimbriate or dotted. Rostrum reaching somewhat beyond front coxae; basally with a sclerotic arch formed by proximal ends of retractor apodemes; apical segment with its basal articular plane rather oblique, the dorsal length being greater than the ventral. Wings with normal venation, the veins sometimes terminating in small dusky spots at the margin; pterostigma of forewing always at least with a small dusky spot just distal to the origin of vein *M*. Hindwing with 2–3 hamuli. Dorsal body hair series multiple, the spinals situated in groups of 2–6 on paired spinal sclerites which may be variably pigmented or quite pale; these sclerites on tergites 1–4 may be distinctly convex but without forming distinct tubercles or processes. Tergite 8 with an irregular single transverse row of hairs. Marginal sclerites of tergites 3–4 with dorsal margin produced into blunt projections, the apices not bearing hairs. Siphunculi stump-shaped, lying between marginal sclerites of tergites 5 and 6, but separated from these and not bearing any appended hairs; not flared at apex, and sculptured to varying degrees with transverse imbricate lines which towards the siphuncular apex may bear a few small spinules. Cauda with a well-defined trapezoid, transverse oval or subquadrate knob, bearing 4 long hairs round the posterior dorsal margin and a number of progressively shorter hairs ventrally. Subanal plate strongly bilobed. Legs normal, spinulose throughout. Front femora a little larger than middle pair. Tibial apices with hairs only slightly broadened, not forming conspicuous spurs, except sometimes on front tibiae. Tarsi typically with 6, 6, 5 ventral and 2 dorsal hairs on first joints, the medioapical one ventrally being a sense-peg. Claw hairs flabellate, slightly sigmoid. Rudimentary gonapophyses 2.

*Males* alate, with secondary rhinaria along antennal joints III–VI (base) inclusive. Abdominal dorsum with transverse dark bands even in those species where the alate vivipara is quite pale.

*Oviparae* and *immature morphs* with the body hairs, and sometimes a few basal antennal hairs, capitate, very much longer than those of males and viviparae. *Oviparae* have no subsiphuncular wax gland field, and no secondary rhinaria on antennal joint III. The very rare micropterous apteriform viviparae have hairs like the oviparae and nymphs, but a developed cauda and subanal and subgenital plates, minute wing rudiments but no pterothorax, and 1–3 secondary rhinaria on antennal joint III.

#### KEY TO SPECIES

- 1 Wing venation under a pocket lens distinctly outlined in brown; forewing with *Rs* more or less distinct, and *M* and *Cu* usually terminating in small triangular brown spots; or if not so terminating, then abdominal dorsum with rather large paired spinal pigmented sclerites, those on tergites 4–5 distinctly larger than those on tergites 1–3 (figs 30–31b); or specimens brachypterous. Apical rostral segment always less than 1.25 times as long as second hind tarsal joint measured without claws. *Oviparae* with dorsal and marginal body hairs grouped on pairs of pig-

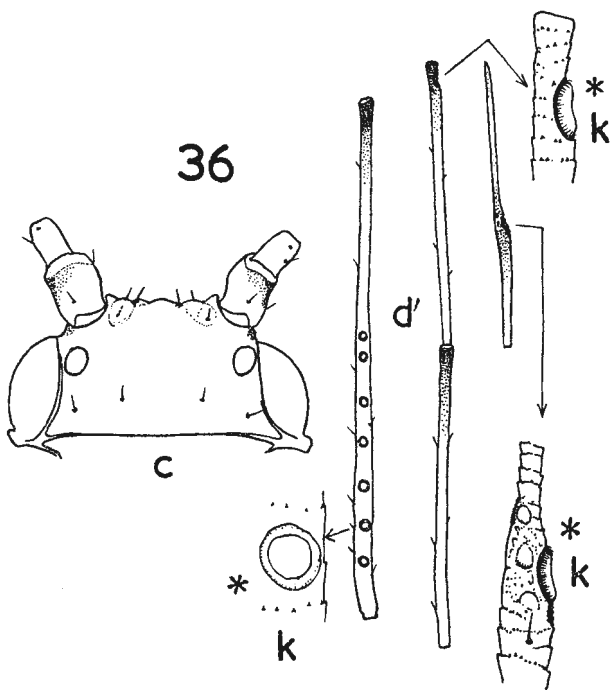
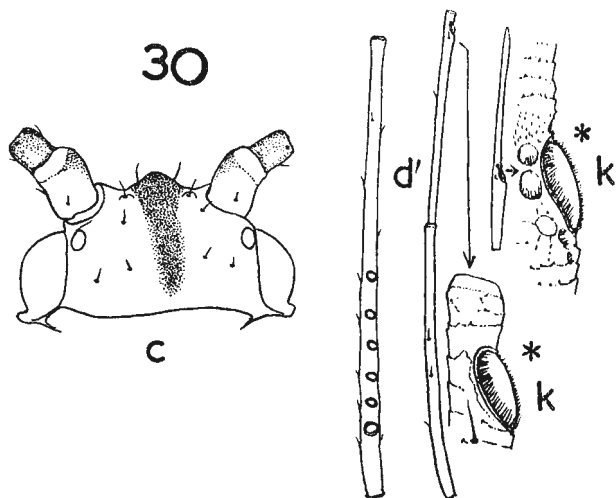

B —————

FIGS 30, 36. 30, *Myzocallis castanicola* (see also p. 54). 36, *Tuberculoides annulatus* (see also p. 60).

- mented spinal and marginal sclerites, the pigmentation being either uniform or paler in the centres of the sclerites than at their margins. . . . . 2
- Wing venation under a pocket lens not very distinctly outlined; *Rs* in forewing indistinct to evanescent. Pigmentation of forewing confined to a small spot at proximal end of pterostigma, and slight darkening of bases of *Cu*<sub>1</sub> and *Cu*<sub>2</sub>. Dorsal abdominal sclerites, when pigmented, rather small and even-sized, those on tergites 4-5 only slightly larger than those on tergites 1-3 (figs 32-35b). Hair-bearing sclerites of *oviparae* either pigmented or quite pale, and spinal hairs of abdominal tergite 8 as for *castanicola*, q.v. *Males* with at least 15 secondary rhinaria on antennal joint III, somewhat irregularly arranged. . . . . 3
- 2 Body length of *alatae* more than 2.1mm, or if not, then 4.8-6.75 times length of antennal joint VI, the latter 0.26-0.36mm long. Antennal joint III with 10-18 hairs. Wing venation always very distinct, and forewing veins ending in brown spots on termen. Very rarely micropterous, and then with larviform sclerites and chaetotaxy. *Oviparae* with spinal hairs of abdominal tergite 8 more slender than those of tergite 7, not very strongly capitate and on less, or not at all, enlarged bases; antennal joint I with inner anterior angle not at all produced and quite pale; VI markedly shorter than III, and III without capitate hairs, or rarely with 1, but with 4-9 normal acute hairs. *Male* with more than 15 secondary rhinaria on antennal joint III, but their density on this joint not more than 60 per mm length  
**castanicola** Baker (30)
- On Quercus spp. and Castanea sativa, widely distributed but local.*
- Body length of *alatae* less than 2.1mm, and 6.9-8.9 times length of antennal joint VI, the latter 0.18-0.26mm long. Antennal joint III with 5-10 hairs. Wing venation distinct, but terminal brown spots at apices of forewing veins less marked than in *castanicola*. Late summer specimens often, or predominantly, brachypterous, but then typically adult in morphology and chaetotaxy. *Oviparae* with spinal hairs of abdominal tergite 8 about as thick as those of tergite 7, strongly capitate and on rather strongly enlarged bases; antennal joint VI a little shorter than III, the latter with 2-3 strongly capitate hairs and about 2 normal acute ones. *Male* with only 7-10 secondary rhinaria in a single row along antennal joint III  
**myrica** (Kaltenbach) (31)
- On Myrica gale; widely distributed in the north and west of Britain.*
- 3 Apical rostral segment in *viviparae* less than 1.19 times, in *males* less than 1.1 times, as long as second hind tarsal joint without claws. . . . . 4
- Apical rostral segment in *viviparae* more than 1.19 times, in *males* more than 1.1 times, as long as second hind tarsal joint without claws. . . . . 5
- 4 Spinal and some marginal sclerites of *viviparae* clearly pigmented when seen under a pocket lens; head and thorax sometimes partly dusky. Ventrally often with paired pigmented lateral sclerites on abdominal sternites 5-6. Smallish *alatae* (body length 1.3-2.2mm); antennal joint VI 3.0-4.3 times as long as apical rostral segment; abdominal tergite 8 with 5-10 but rarely more than 8 hairs. *Oviparae* with inner anterior angle of antennal joint I usually rather produced at the insertion of the capitate hair, and dusky pigmented; joint VI at least a little longer than III, and III with 1-2 capitate hairs (rarely 0 on one side) and 1-4 normal acute ones. *Males* with density of secondary rhinaria on antennal joint III not less than 70 per mm length.  
**boernerii** Stroyan (32)
- On Quercus cerris, suber, variabilis, castanaefolia and x hispanica var. lucombeana; apparently not on native British oaks. Local in parks, arboreta and botanic gardens where the hosts are planted or naturalized. Southern Britain to Northampton and Cardigan; Ireland (Clare and Kerry); probably more widely distributed but overlooked.*
- Spinal and marginal sclerites of *viviparae* not, or at most very faintly, pigmented; head and thorax quite pale, barely darker than abdomen. Never with pigmented sclerites on abdominal sternites 5-6. Antennal joint VI 4.4-5.3 times as long as apical rostral segment, or if less than 4.4 times then larger *alatae* (2.1-2.6mm long), with 9-12 hairs on abdominal tergite 8. Apical rostral segment at most 1.02 times as long as second hind tarsal joint without claws (if more than 1.1 times, check against couplets 6 (fundatrices of *boernerii*) and 7 (*coryli*)). *Oviparae* quite pale; apical rostral segment 0.10-0.11mm long, a little shorter than or subequal to second hind tarsal joint without claws; antennal joint III with only small normal hairs. (*Males* not available.)  
**carpini** (Koch) (33)

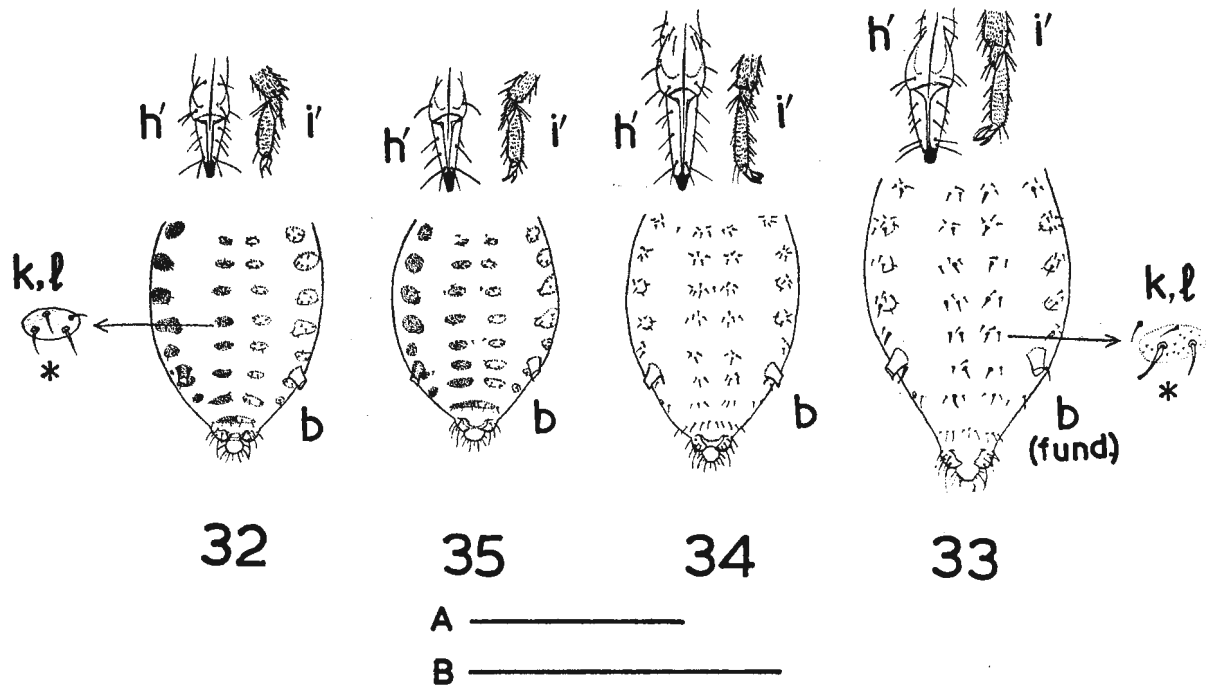

FIGS 32-35. 32, *Myzocallis boernerii*. 33, *M. carpini*. 34 *M. coryli*. 35, *M. schreiberi*.

*On Carpinus betulus, especially when used for hedging. Widespread but not very common.*

- 5 Hairs on spinal abdominal sclerites at least partly blunted, rod-like or capitate. Antennal joint VI 1.7–2.5 times as long as apical rostral segment. (*Fundatrices*).  
..... 6
- Hairs on spinal abdominal sclerites in *viviparae* all acute. Antennal joint VI 2.4–3.7 times as long as apical rostral segment. .... 7
- 6 Apical rostral segment 0.156–0.176mm long. Second hind tarsal joint without claws 0.112–0.124mm long **coryli** (Goeze) (34)  
*On Corylus avellana and C. maxima. Abundant wherever the hosts occur.*
- Apical rostral segment 0.124–0.142mm long. Second hind tarsal joint without claws 0.095–0.112mm long. **boernerii** Stroyan (32)  
*On Quercus spp.; see couplet 4.*
- 7 Apical rostral segment in *viviparae* with 7–14 subsidiary hairs in addition to the 3 constant apical pairs (but only exceptionally less than 9, in very small specimens). Processus terminalis 2.05–2.55 times as long as basal part of antennal joint VI. Spinal abdominal sclerites almost invariably quite pale. *Oviparae* quite pale; apical rostral segment 0.14–0.15mm long, a little longer than second hind tarsal joint without claws; antennal joint III only rarely without a conspicuous capitate hair at about 0.4 of its length from base. Species with a full series of morphs. **coryli** (Goeze) (34)  
*On Corylus spp.; see couplet 6.*
- Apical rostral segment in *viviparae* with 4–7 subsidiary hairs. Processus terminalis 1.28–2.06 times as long as basal part of antennal joint VI. Spinal abdominal sclerites usually a little pigmented, especially so in winter specimens. Sexual morphs not known. **schreiberi** Hille Ris Lambers & Stroyan (35)  
*Found throughout the year under leaves of Quercus ilex. Southern England to Bedford, local.*

### Genus TUBERCULOIDES van der Goot, 1915

Type-species: *Aphis quercus* Kaltenbach, 1843 (= *A. annulatus* T. Hartig, 1841).

All *viviparae alate*. Small to medium-sized yellowish, pale green, bluish green, salmon pink or occasionally leaden grey aphids (body length 1.4–2.9mm). In appearance and habits resembling *Myzocallis* Passerini; differing from this genus in the possession of a pair of not very conspicuous spinal processes on each of the first 3 or 4 abdominal tergites (some of these processes may be poorly developed in small specimens); in the presence of only a single pair of spinal hairs on each of the first 7 abdominal tergites (occasionally one or more of the spinal processes may bear 2 hairs); in the somewhat shorter processus terminalis, which may be shorter than the basal part of antennal joint VI; and in the chaetotaxy of the *oviparae* and *immature morphs*, whose dorsal body hairs (in the British species) are very short, blunt and inconspicuous. Longer and more conspicuous dorsal hairs occur in various non-British species. The genus is regarded by several recent revisers as either synonymous with, or a subgenus of *Tuberculatus* Mordvilko.

There are three British species, adult *alatae* of which are closely similar. All live on native species of *Quercus*.

### KEY TO SPECIES

- 1 *Oviparae* and *immature stadia*, including *embryones* inside *viviparae*, where visible, with marginal body hairs all short and inconspicuous (fig. 36j); e.g. marginal hairs on abdominal tergite 5 in *embryones* and 1st instars 12–15 microns long, distinctly shorter than the diameter of the adjacent siphunculus (this can frequently be measured inside the body of the mother for *embryones*). Adult *viviparae* with at most 3 pairs of spinal processes, on abdominal tergites 1–3, of which that on 3 is

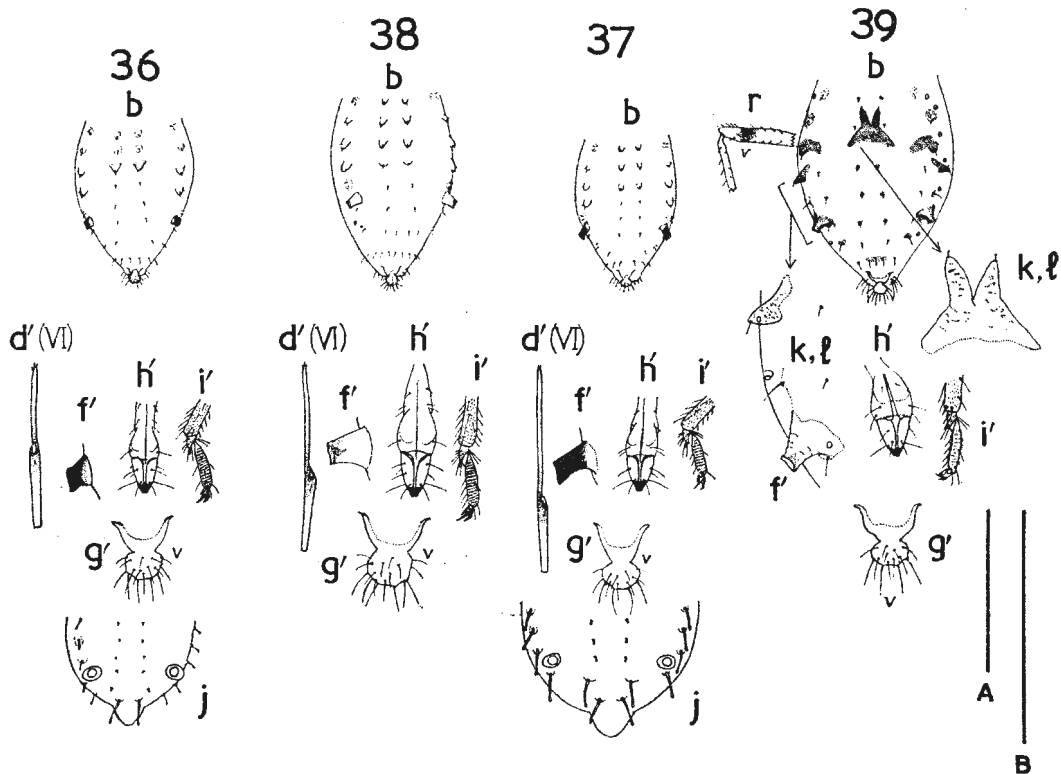

FIGS 36-39. 36, *Tuberculooides annulatus* (see also p. 56). 37, *T. neglectus*. 38, *T. borealis*. 39, *Tuberculatus querceus* (see also p. 62).

the largest (occasionally the only well-developed) pair, and is often dusky pigmented, especially in late summer. Antennal joint III with up to 12 secondary rhinaria. Processus terminalis 0.7–1.1 times as long as basal part of joint VI. Greatest length of siphunculus (in perpendicular line from line joining anterior and posterior basal angles) 0.04–0.07mm, or at most equal to length of caudal knob, but usually shorter than this; anterior margin of siphunculus darkened over its distal two-thirds or more. Apical rostral segment 0.08–0.1mm long, with 5–8 subsidiary hairs. Colour in life very variable: yellow, green, salmon-pink or leaden grey. **annulatus** (Hartig) (36)

*On Quercus robur, less often on Q. petraea or casually on other species of oak when interplanted. Abundant almost wherever the hosts occur.*

- *Oviparae* and *immature stadia*, including *embryones*, with marginal body hairs much longer and more conspicuous than spinal hairs (fig. 37j); e.g. marginal hairs on abdominal tergite 5 in *embryones* and 1st instars 30–46 microns long, distinctly longer than diameter of adjacent siphunculus. Adult *viviparae* with dorsal processes on first 3 or 4 abdominal tergites, all pale, and those on abdominal tergites 1–3 usually of rather even size. Antennal joint III with at most 9 secondary rhinaria. . . . . 2
- 2 *Viviparae* with values above 2 for the function  $a^2/bc$ , when  $a$  = the length of antennal joint VI,  $b$  = the length of the hind tibia and  $c$  = the length of the apical rostral segment, measured as the perpendicular distance between the tip of the apical microsensillae and the line joining the side angles of the base. Spinal processes present almost invariably only on first 3 abdominal tergites (exceptionally small vestiges of processes may occur as slight convexities around the spinal hairs of tergite 4). Processus terminalis 1.0–1.6 times as long as basal part of antennal joint VI. Greatest length of siphunculus 0.07–0.11mm, or 1.3–2.1 times as long as caudal knob; anterior margin of siphunculus blackish or dusky over distal 0.55–0.95 of its length. Apical rostral segment 0.08–0.1mm long, with 4–9 subsidiary hairs. Colour in life pale yellow. **neglectus** Krzywicz (37)

*On Quercus petraea, rarely on Q. robur or hybrid robur x petraea. Bedford, Norfolk, Merioneth, Kirkcudbright, Argyll, Kerry, West Cork; probably widespread over the range of durmast oak.*

- *Viviparae* with values below 2 for the function  $a^2/bc$  (see above). Spinal processes usually present on first 4 abdominal tergites, but the pair on tergite 4 may be very small. Processus terminalis 0.9–1.3 times as long as basal part of antennal joint VI. Greatest length of siphunculus 0.06–0.1mm, or 0.8–1.2 times as long as caudal knob; anterior margin of siphunculus varying from wholly pale to blackish over distal two-thirds of its length, but very rarely over more than half. Apical rostral segment 0.09–0.12mm long, with 7–11 subsidiary hairs. Colour in life mottled green and yellowish. **borealis** Krzywicz (38)

*On Quercus robur, more rarely on Q. petraea or hybrid robur x petraea, or casually on other species of oak when interplanted; occurring at very low density, usually mixed with T. annulatus or even with both the other species. Hertford, Surrey, Suffolk, Cardigan, Kirkcudbright, Argyll, East Inverness, Wester Ross; almost certainly thinly distributed everywhere with Q. robur, but overlooked.*

### Genus TUBERCULATUS Mordvilko, 1894

Type-species: *Aphis quercea* Kalténbach, 1843.

All *viviparae alate*. Rather small straw-coloured aphids, sometimes greyish mottled, with slender, fragile appendages (body length 1.4–2.4mm). Antennae long, flagellar joints (III–VI) together considerably longer (1.2–1.4 times) than body; joint III about 2.0–2.3 times as long as VI, V subequal to VI, processus terminalis longer (about 1.3–1.7 times) than basal part of VI; joint I with inner apical angle a little produced inwards. Secondary rhinaria 6–14 in number, more or less round, with a fimbriate fringe, in a single row along most of antennal joint III, a length of which at base and apex remains bare of rhinaria. Antennal hairs short, fine and inconspicuous, those on III maximally 0.5–0.6 times as long as basal articular diameter of joint. Frons



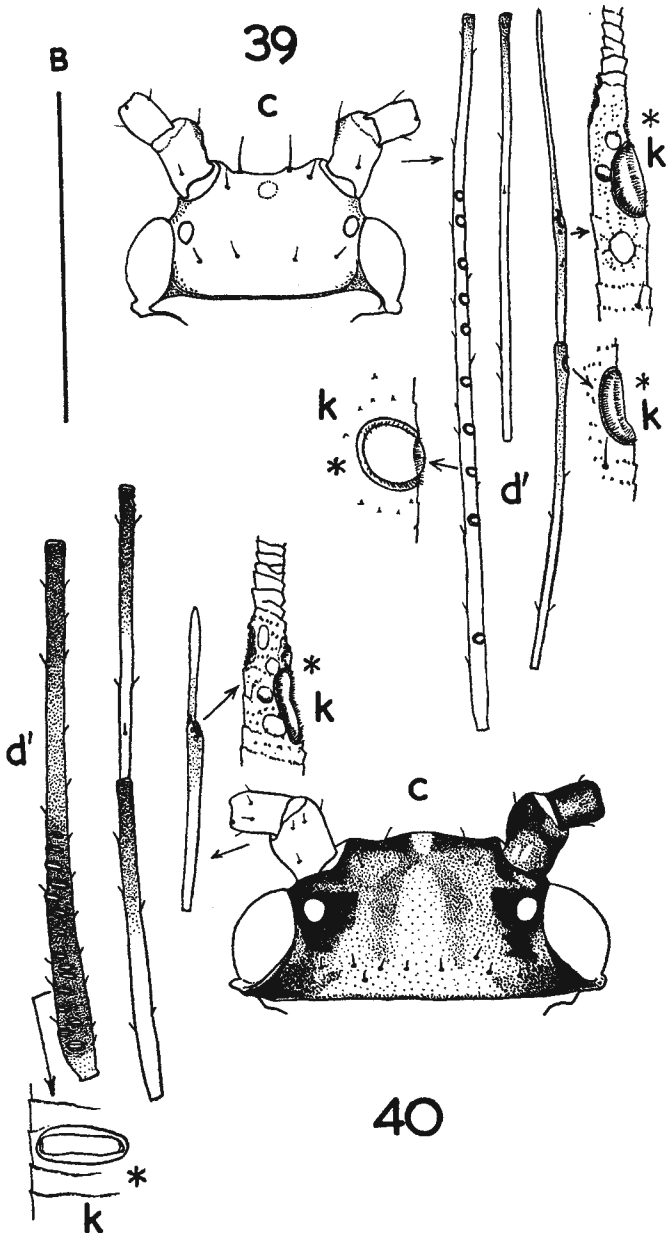

FIGS 39-40. 39, *Tuberculatus querceus* (see also p. 60). 40, *Eucallipterus tiliae* (see also pp. 63, 123).

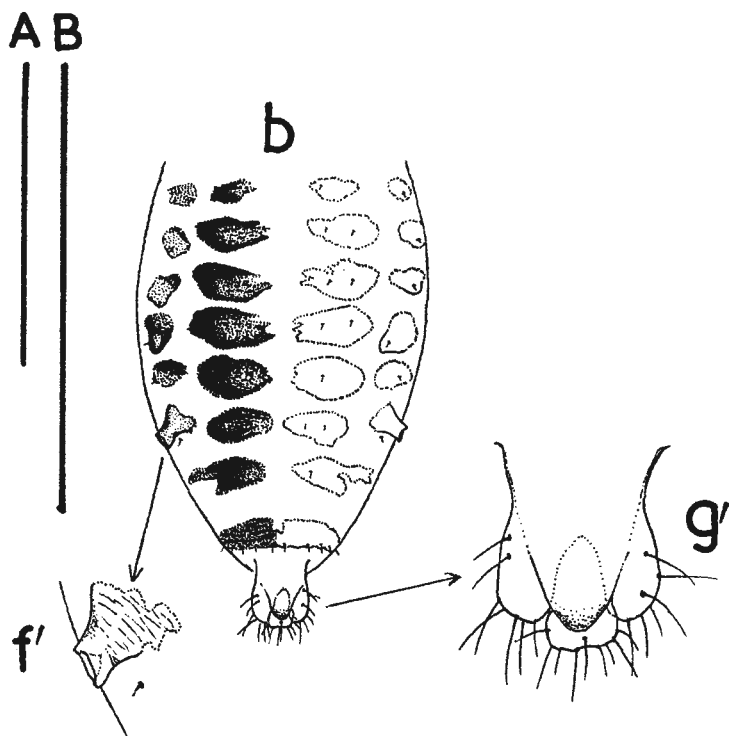

FIG. 40. *Eucallipterus tiliae* (see also pp. 62, 123).

slightly concave, with very small lateral prominences. Frontal pair of hairs on small flat tubercles. Occipital (posterior discal) hairs 4 in number in a single transverse row. Frontal and ventral cephalic hairs much longer than posterior discals. Pronotum with typically 2 pairs of spinal hairs and 2 pairs of marginals, arranged as an anterior and a posterior pair. Rostrum not reaching second coxae, with basal sclerotic arch; apical segment short triangular, shorter than 2nd joint of hind tarsus measured without claws, and with 4-7 subsidiary hairs. Wings ample, venation normal except that *Rs* in forewing is slightly weakened; pterostigma outlined in dusky grey, apices of veins with a dusky triangular spot at wing margin, and bases of *Cu*<sub>1</sub> and *Cu*<sub>2</sub> slightly dusky; *Cu*<sub>1</sub> a little sinuate. Abdominal dorsum with a large dark bifid central process formed by the fusion of a pair of finger-like tubercles (which may occasionally remain separate to their bases) on tergite 3; each arm of this process with an apical spinal hair. Marginal sclerites on tergites 2-4 dark, each with 2 hairs; those on tergite 3 extending inwards towards the dorsal process, and with a smallish lateral projection bearing a hair at its apex; those on tergite 4 not extending inwards on to the dorsum, but bearing a much bigger lateral, almost finger-shaped projection, also with

an apical hair. These projections on the marginal sclerites also each bear a single small round wax gland facet. Marginal sclerites of tergites 5-7 very small, each with only 1 long acute hair and a single wax gland facet. Spinal and pleural hairs fine and acute, 1 pair of each per tergite; becoming longer on posterior segments, but on the middle tergites considerably shorter than marginal hairs. Tergite 8 with 5-6 hairs in a single transverse row, similar in length and structure to marginal hairs of tergites 5-7. Siphunculus dark, truncate subconical or stump-shaped, more or less smooth, not flared apically but with spreading base; lying between marginal sclerites of tergites 5 and 6, and with the marginal (long) and pleural (shorter) hair of tergite 6 lying adjacent to its base posteriorly. Cauda and subanal plate as in *Myzocallis* Passerini, caudal hairs about 14-16. Legs long, front femora slightly thickened, tibiae with apical spurs that are more strongly modified on the front than on the middle and hind legs. Femora each with a dusky pigmented depression near apex anteriorly. Tibiae finely spinulose between the hairs over apical two-thirds. Tarsi spinulose in transverse rows, first joints with typically 7 ventral and 2 dorsal hairs, the medioapical ventral one being a short sense-peg. Claw hairs flattened, narrowly scimitar-shaped, only slightly curved. Rudimentary gonapophyses 2. Body waxy in life, looking as if fungus-infected.

*Males* alate, with no series of transverse spinal dark sclerites like those of *Myzocallis* or *Tuberculoides*, and with a smaller dorsal bifurcate process than that of the viviparae. Secondary rhinaria in a single row along antennal joints III and V, and 1-2 also on basal part of VI, but none on IV in the single specimen available.

*Oviparae* with apex of abdomen very distinctly produced. Antennal joint III with 2-7 secondary rhinaria in a single row. Thorax and abdomen with paired dark spinal spots extending to abdominal tergite 4, and marginal sclerites on these segments also pigmented, those on tergites 1-4 each with 1 long ventral and 1 short dorsal hair. No dorsal furcate tubercle, but spinal hairs of tergite 3 on slight conical protuberances. All dorsal body hairs either acute or very slightly subcapitate. Pleural hairs very small, single, on small sclerites on tergites 3-5 only. Spinals on metanotum and abdomen single, or up to 3 each side on abdominal tergite 3. No subsiphuncular wax gland field. Subanal plate simply rounded as in *Myzocallis* and *Tuberculoides*. Hind tibiae incrassate and bearing about 100 pseudosensoria in the material seen.

*Immature morphs* in general like oviparae, but without paired dark spinal spots except for a small inconspicuous pair bearing the spinal hairs of tergite 3; apices of marginal prominences on tergites 2-4 also more or less dusky, and front aspect of middle and hind femora with a darkish spot near apex. First instar with long hairs on frons and tergite 8; spinals on remaining tergites small and inconspicuous, those on 7 displaced laterad; marginals increasing progressively in size posterad from about abdominal tergite 2.

Sole British species

**quercus** (Kaltenbach) (39)

*Living scattered on underside of leaves of Quercus robur, especially on branches close to the ground of scrubby young growth, saplings or shoots springing from cut stumps. Kent, Sussex, Surrey, Hertford, Bedford, Nottingham, Caernarvon, Argyll; local and rather uncommon.*

Genus **EUCALLIPTERUS** Schouteden, 1906

Type-species: *Aphis tiliae* L., 1758.

All viviparae *alate*. Smallish to medium-sized black and yellow aphids, body length 1.8–3.0mm. Antennae 6-jointed, flagellar joints (III–VI) together a little shorter than or about as long as body. Joint I slightly produced inwards towards apex on inner side. Joint III about 1.4–1.6 times as long as VI, which is a little longer than IV and V individually; processus terminalis elongate, but shorter than basal part of VI. Secondary rhinaria rather transverse, not fimbriate, 7–20 in number in a single row along the somewhat swollen basal part of III; occasionally one or two rhinaria may be divided into 2 small ones lying side by side. Antennal hairs small, acute, those on III maximally about 0.4–0.6 times as long as basal articular diameter of joint. Frons with very small lateral and median prominences, the latter lying dorsal to and partly obscuring the median ocellus. Laterofrontal hairs sometimes lying on very flat tubercles. Occipital (posterior discal) hairs in an irregular transverse row, 12–16 in number; anterior discals single and on flattish conical tubercles. Pronotum with anterior spinal hairs single, posterior spinals multiplied, in 2 groups of about 5–6; marginal hairs single on each side. Mesonotum with nodular sculpture. Rostrum not reaching 2nd coxae; basally with dorsal sclerotic arch, apical segment squat, shorter than 2nd hind tarsal joint measured without claws, and with 2–6 subsidiary hairs. Wings with normal venation, all veins strongly dark-bordered towards apex (fig. 40e), costal region of forewing entirely dark from base of wing to pterostigma, which is broadly outlined in dark pigmentation; hindwing with 2–4 hamuli. Abdomen with a series of paired segmental oval dark sclerites of variable size on tergites 1–7, and a frequently partly divided band across tergite 8; these sclerites bear areas of fine granular cuticle that seem to be wax pores, although the living aphids are not strongly waxy. Marginal sclerites present to tergite 7, those of tergites 3–5 each with a prominence, largest on 4, where it is blunt conical, with the marginal hair subapical. Spinal hairs widely separated, situated on inner ends of paired dorsal sclerites, or mediad from these in lightly marked specimens, normally single. Pleural hairs only irregularly present, and then single. Marginal hairs single. Tergite 8 with about 8–10 hairs in a single transverse row. All dorsal hairs small, acute, about similar to antennal hairs, except those on tergite 8 which are longer. Siphunculi dark, obliquely truncate, smooth apart from faint transverse striae, stump-shaped with a somewhat flared and thickened apical rim; situated on marginal sclerite of tergite 6. Cauda with a roughly isodiametric knob bearing a small dorsal projection, and with about 15–20 hairs. Subanal plate strongly produced and bifid, its central cleft reaching about halfway to its base, and the apices of the lateral lobes about level with caudal apex. Front coxae somewhat enlarged. Tibiae with apical spurs very well developed, those on front tibiae especially being up to one-third as broad as long; apices of tibiae spinulose between hairs. Tarsi with regular transverse rows of spinules on second joints; first joints with typically 7 ventral and 2 dorsal hairs, the medioapical ventral one being a short sense-peg. Claw hairs flattened and rather broad, strongly curved near base in the plane of flattening. Rudimentary gonapophyses 2. The following parts are blackish: most of antennal joint III, apical halves of IV, V and VI, distal three-quarters

of hind femora, sides of head, all or sides only of pronotum, mesonotum and scutellum, and abdominal sclerites as described above. Tibial bases and apices may also be darkened, and tarsi are blackish. In life the black body marking and dark costa and wing venation combine to present the appearance of a pale yellow aphid with broadly black sides.

*Males* alate. Similar to viviparae but with secondary rhinaria on antennal joints III–VI (base) inclusive; those on III in a staggered interdigitating more or less double series on basal half of joint, thereafter in a single row, as also on IV–VI (base). Subanal plate less deeply cleft than in viviparae. Claspers blackish.

*Oviparae* dorsally almost wholly covered by large paired black spinal and marginal sclerites. Antennae without secondary rhinaria. Hairs on frons and abdominal tergite 8 longer than remainder of body hairs, those on frons up to 0.045mm, those on tergite 8 to 0.065mm, the 2 middle ones on a slight prominence. Siphunculi thick-lipped, flared to apex. Subanal plate not cleft. Subsiphuncular wax gland fields present. Spurs present only on front tibiae. Hind tibiae palish, incrassate, with up to about 100 pseudo-sensoria. First tarsal joints very often without dorsal hairs.

*Immature morphs* with dark abdominal sclerites, corresponding to those of the adult vivipara, appearing first in second instar; first instar with spinal and marginal hairs very small and inconspicuous, except for frontals and those of tergite 8 which are longer than diameter of antennal joint III.

Sole British species.

*tiliae* (L.) (40)

*On underside of leaves of Tilia spp.* Abundant almost wherever the hosts occur, and often a nuisance in urban areas where limes are planted on account of the great quantity of honeydew produced.

### Genus *TINOCALLIS* Matsumura, 1919

Type-species: *T. ulmiparvifoliae* Matsumura, 1919.

All viviparae *alate*. Small to medium-sized pale whitish to yellowish green aphids, sometimes with conspicuous black markings. Body length 1.4–2.6mm. Antennae 6-jointed, flagellar joints (III–VI) together shorter than body; joint I not much if at all longer than II; III with transverse oval or slit-like secondary rhinaria in a single row along proximal two-fifths or more of joint; processus terminalis shorter than basal part of VI. Whole antennae sculptured with small individual spinules or denticles passing distally into spinulose imbrications. Antennal hairs small, acute, those on III maximally 0.5–0.7 times as long as basal articular diameter of joint. Head with small convex to subconical median and/or lateral frontal prominences, the former when present lying dorsal to the median ocellus as in *Myzocallis*; sometimes also with paired processes on vertex and occipital region. Dorsal cephalic hairs consisting of one pair of frontals, one pair on vertex and a transverse row of four occipitals; where processes occur on vertex and occiput the pair of vertical hairs and the middle pair of occipitals lie at their apices. Pronotum with one anterior and one posterior pair of spinal hairs, which sometimes lie on subconical processes, and one posterior pair of marginal hairs. Mesonotal lobes with lenticular granulations; sometimes also with two pairs of conical processes one behind the other. Rostrum

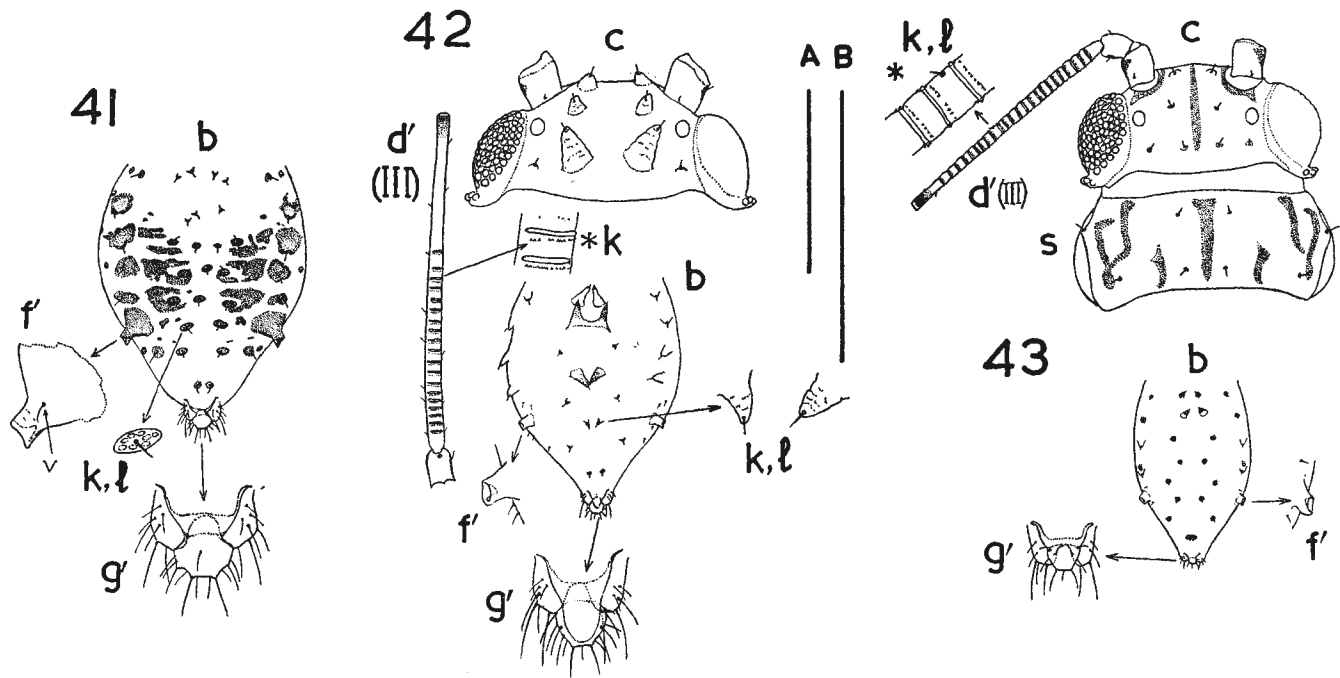

FIGS 41-43. 41, *Tinocallis platani* (see also pp. 69, 123). 42, *T. ulmiparvifoliae*. 43, *T. zelkowae*.

basally with a dorsal sclerotic arch. Forewing with *Rs* obsolescent to obsolete, especially over its middle part; *Mp* and *Cu*<sub>1</sub> somewhat sinuate, *Cu*<sub>2</sub> slightly recurved. Hindwing with 2-4 hamuli. Abdomen typically with only one pair of spinal and one pair of marginal hairs per tergite on segments 1-7 inclusive; tergite 8 with a single median pair of spinals. Spinal hairs of tergites 3, 5 and 7 laterally displaced. Up to three additional intercalated spinal hairs may occur on any of tergites 3-5. Tergal processes bearing the hairs at their apices may occur spinally on tergites 1-2 or 1, 2, 4 and 6; and marginally on tergites 3-4. The other dorsal hairs lie on small convexities that may appear as small discrete roundish dark spots, or may form part of a more extensive pigmented pattern. Spinal and marginal hairs on middle abdominal tergites acute to capitate, those on head and tergites 7-8 acute or subcapitate. Siphunculi variable in size, stump-shaped, situated in the position of the marginal sclerites of tergite 6, and just anteromedial to the marginal hairs, which may appear to arise from the siphuncular base externally if siphunculus and sclerite are pigmented. Cauda with a somewhat transverse to trapezoid knob, with about 8-18 hairs. Subanal plate deeply emarginate to about one-quarter of its length from base, but with apices of lateral lobes not reaching caudal apex. Front coxae much enlarged for leaping, femora and tibiae normal; tibiae with well-developed apical spurs, especially on front legs, and strongly spinulose between the hairs apically. Tarsi regularly spinulose in transverse rows; first joints typically with 6 ventral and 2 dorsal hairs, the mid-ventral one a shorter sense-peg; claw hairs flattened, somewhat boomerang-shaped. Rudimentary gonapophyses 2.

*Immature morphs* with dorsal hairs knobbed, irregularly furcate or flattened at apex; pleural hairs absent, and spinals of abd. 3, 5 and 7 laterally displaced as in adult viviparae.

Of the three species recorded in Britain only one can be considered as established, and none as indigenous. All three live on species of *Ulmaceae*.

#### KEY TO SPECIES: VIVIPARAE

- 1 Veins of forewings, head, thorax and abdominal dorsum extensively marked with black (figs 41b, c, e). Siphunculi black. Abdominal tergites 3-5 frequently with additional intercalary spinal hairs. **platani** (Kaltenbach) (41)

*On underside of leaves of Ulmus laevis and U. thomasi. Rare; recorded from Kew Gardens and the Channel Islands.*

- Veins of forewings not marked or shadowed with black; head, thorax and abdomen pale, the latter with small punctiform dark spots and the former sometimes with narrow dark longitudinal lines or dashes. Siphunculi pale. Abdominal tergites 3-5 without intercalary spinal hairs. Oriental species, so far recorded only from introductions with Japanese 'bonsai' trees. . . . . 2

- 2 Paired spinal processes present on head (3 pairs), pro- and mesonotum (each with 2 pairs) and abd. 1, 2, 4 and 6 (each with 1 pair) (figs 42b, c). Apical rostral segment distinctly shorter than second joint of hind tarsus measured without claws and their associated sclerites. Caudal knob with 15-18 hairs.

**ulmiparvifoliae** Matsumura (42)

*On underside of leaves of Ulmus parvifolia.*

- Head with a small median angled frontal prominence dorsal to median ocellus but without paired processes; these absent also from thoracic tergites, and present only on abd. 1 and 2 (fig. 43b). Head and pronotum each with a narrow median longitudinal dark line, pronotum also with some short dark lateral and pleural dashes (figs 43c, s). Apical rostral segment subequal to second joint of hind tarsus without claws. Caudal knob with 8 hairs. **zelkowae** (Takahashi) (43)

*On underside of leaves of Zelkova serrata.*

41

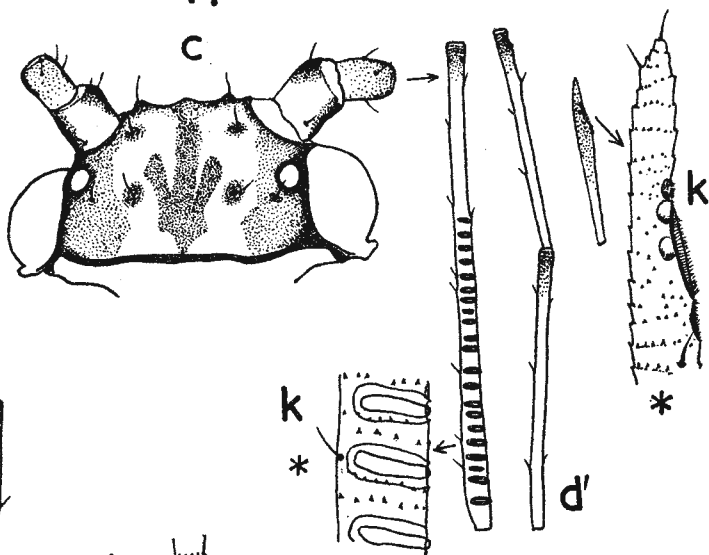

46

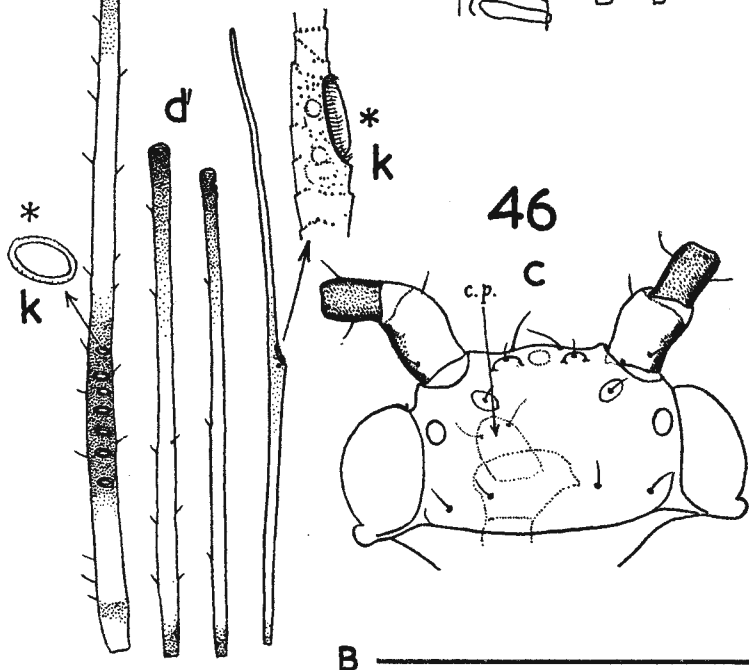

FIGS 41, 46. 41, *Tinocallis platani* (see also pp. 67, 123). 46, *Takecallis arundicolens* (see also pp. 70 and 123).



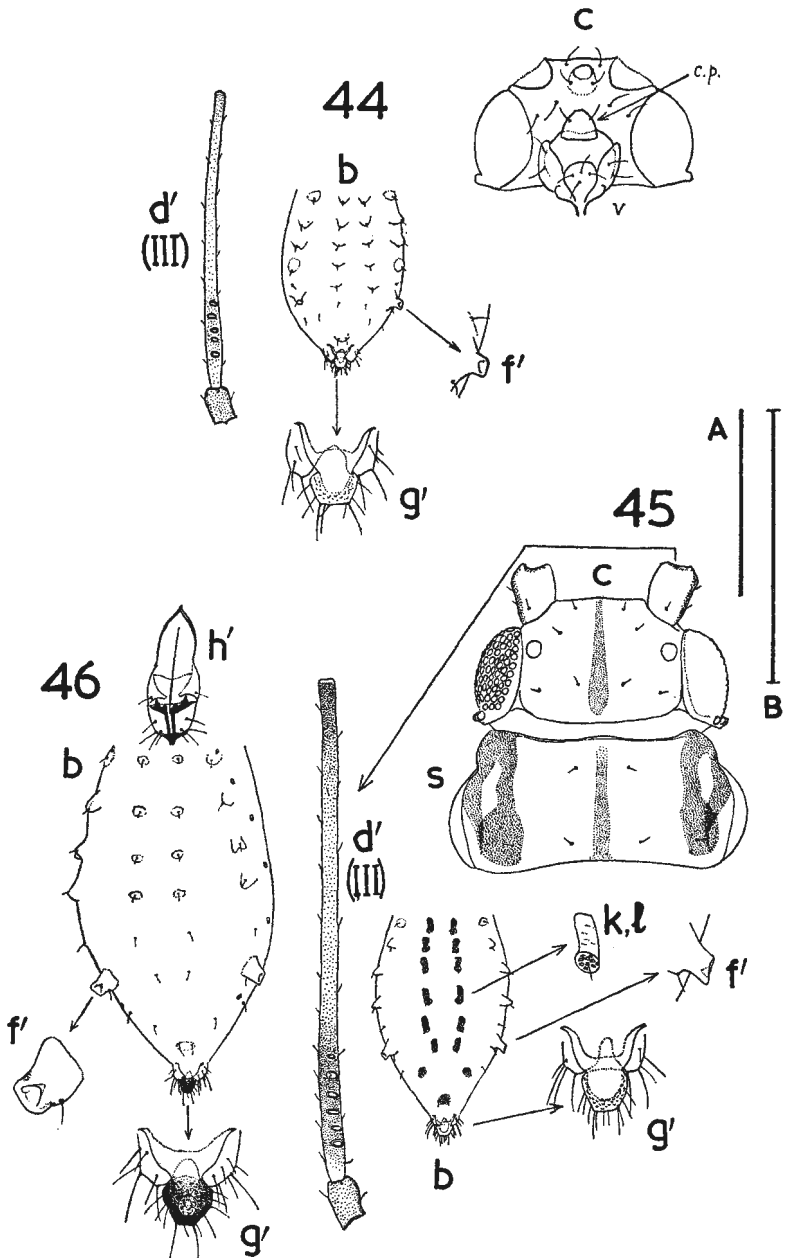

FIGS 44-46. 44, *Takecallis taiwana*. 45, *T. arundinariae*. 46, *T. arundicolens* (see also pp. 69, 123).

## Genus TAKECALLIS Matsumura, 1917

Type-species: *T. bambusae* Matsumura, 1917 (= *Callipterus arundicolens* Clarke, 1903).

All viviparae *alate*. Smallish to medium-sized pale yellow, greyish yellow or pale green aphids living on bamboos. Antennae 6-jointed; processus terminalis subequal to or not much longer than basal part of joint VI; secondary rhinaria more or less transverse oval with a finely dotted border; antennal hairs fine and acute, those on III maximally 0.5–0.6 times basal articular diameter of joint. Frons with only very small lateral prominences; a hardly detectable median swelling dorsal to the median ocellus, and latero-frontal hairs on very low protuberances. Occipital (posterior discal) hairs 4 in number, in a single transverse row. Clypeus with a sac-like anteroventral projection bearing 2 hairs. Rostrum exceedingly short, apical segment not longer than its basal width. Wings with normal venation, *Rs* sometimes weak but usually visible over its whole course, veins usually ending in inconspicuous dusky triangular dots at margin. Spinal and marginal hairs on abdominal tergites all single, the spinals situated on small humps, the marginals of tergites 2–4 subapical on more or less well-developed mammi-form tubercles. Spinal hairs of tergite 6 closer together, those of tergite 7 further apart, than those of tergites 1–5. Tergite 8 with 2–4 hairs. Siphunculi pale, stump-shaped. Cauda with oval, trapezoid or subquadrate knob; subanal plate bilobed, lobes not extending to apex of cauda. Front coxae enlarged and used for leaping, femora and tibiae normal. Tibiae with well-developed apical spurs, spinulose between the hairs on apical half. Tarsi spinulose, in transverse rows on joint 2, joint 1 with typically 5–6 ventral and 2 dorsal hairs. Claw hairs flattened, fairly broad. Rudimentary gonapophyses 2.

*Immature morphs* with body hairs long, capitate; first instar with spinal hairs of tergite abd. 5 slightly further apart than those of tergites 1–4, those of tergite 6 closer together, and those of tergite 7 considerably wider apart, than those of 1–4.

*Sexual morphs* not yet described for the genus.

None of the three British species is truly indigenous.

## KEY TO SPECIES: VIVIPARAE

- 1 Siphunculus bearing the marginal hair of abdominal tergite 6 on its posterior face (figs 45–46f'). Frons with a rather conspicuous V-shaped thickening, the arms of which run from the lateral prominences to a junction posteroventral to the median ocellus. Pale yellow to greyish yellow in life. . . . . 2
- Siphunculus situated in front of the marginal hair of abdominal tergite 6 (fig. 44f'). Frons without conspicuous V-shaped thickening, or if a trace of thickening visible at the lateral prominences then this vanishes before reaching the median ocellus. Cauda pale. Colour in life pale green. **taiwana** (Takahashi) (44)  
*On the still rolled young shoots of bamboos. Surrey, very rare.*
- 2 Spinal hairs of abdominal tergites placed on small humps at the posterior ends of a paired series of anteroposteriorly elongate dark sclerites from tergite 1 to tergite 7 inclusive; those of tergite 8 on a common median sclerite (fig. 45b). Secondary rhinaria on antennal joint III confined to basal third of joint, which is dusky almost to base (fig. 45d') **arundinariae** (Essig) (45)  
*Under expanded leaves of bamboos. Surrey, Berkshire, rare.*

- Spinal abdominal hairs not on pigmented sclerites, whole dorsum pale except for the cauda, which is blackish (figs 46b, g'). Secondary rhinaria on antennal joint III rather remote from base of joint, on a blackish zone, the parts of the joint proximal and distal to the rhinaria being quite pale (fig. 46d')

**arundicolens** (Clarke) (46)

*Under expanded leaves of bamboos. Widely distributed and sometimes locally abundant.*

Genus **PTEROCALLIS** Passerini, 1860

Type-species: *Aphis alni* F., 1775 (= *alni* Degeer, 1773).

Viviparae *apterous* or *alate*. Whitish yellowish or pale green, often with green spots.

*Apterae*: Body length 1.3–2.0mm. Antennae 6-jointed, flagellar joints (III–VI) together about 0.5–0.6 times as long as body; joint I with inner apical angle produced into a rounded prominence; I–III inclusive in British species with 1 or more long capitate hairs in addition to small normal ones; III with 0–3 secondary rhinaria; processus terminalis shorter than basal part of VI; apices of III–V in British species more or less broadly dusky, VI mainly so but especially round primary rhinarium; spinulose imbrication increasing from base to apex of flagellum, base of III nearly smooth. Frons with a very small median prominence, made less conspicuous by the frontal hairs being on somewhat tubercular bases; frontal hairs maximally from about 0.75 times to equal in length to apical rostral segment. Dorsal body hairs with their shafts roughened by minute apically directed denticles, and their apices blunt, raggedly broadened or frayed; meso- and metanotum each with an irregular double transverse row; each abdominal tergite with a single transverse row, consisting of spinal, pleural and marginal hairs, usually with some extra intercalated smaller ones on tergites 1–4, and the marginals of these 4 tergites duplicated. Tergite 8 with 6–12 hairs. Marginal tubercles (wax-producing elements) on pronotum and abdominal tergites divided into several small round separate facets. Siphunculi stump-shaped, more or less thick-rimmed, dusky on apical half in British species. Cauda with a quadrate to slightly transverse knob, bearing a small dorsal protuberance, and with 8–12 hairs. Subanal plate bilobed. Legs with all tibiae spinulose, and with more or less well-developed apical spurs on front tibiae. Hind femora in British species with a dark spot on anterior face near apex. Tarsi dusky, first joints with typically 5 ventral and 0–2 dorsal hairs, the medioapical ventral one being a sense-peg. Claw hairs flattened, more or less scimitar-shaped. Rudimentary gonapophyses 2.

*Alatae*: Mainly similar to apterae, but frontal, antennal and dorsal body hairs all fine, acute and inconspicuous. Antennal joint I with inner apical angle distinctly blackish; III with 2–5 round secondary rhinaria near base, these sometimes with a slightly striate border but not fimbriate. Frons with median prominence bearing the median ocellus. Forewing with *Rs* obsolete except at extreme apex; *M* and *Cu*<sub>1</sub> sometimes a little pigmented towards base; *Cu*<sub>2</sub> more strongly pigmented and originating in a more or less triangular dark spot; pterostigma outlined with dusky pigmentation (fig. 48e). Spinal hairs of abdominal tergites 1–2 situated on very flat, inconspicuous unpaired median prominences. Front coxae slightly enlarged.

*Males*: alate or apterous, in each case with dorsal chaetotaxy agreeing with that of the corresponding viviparous morph. Secondary rhinaria on

♀  
A  
B

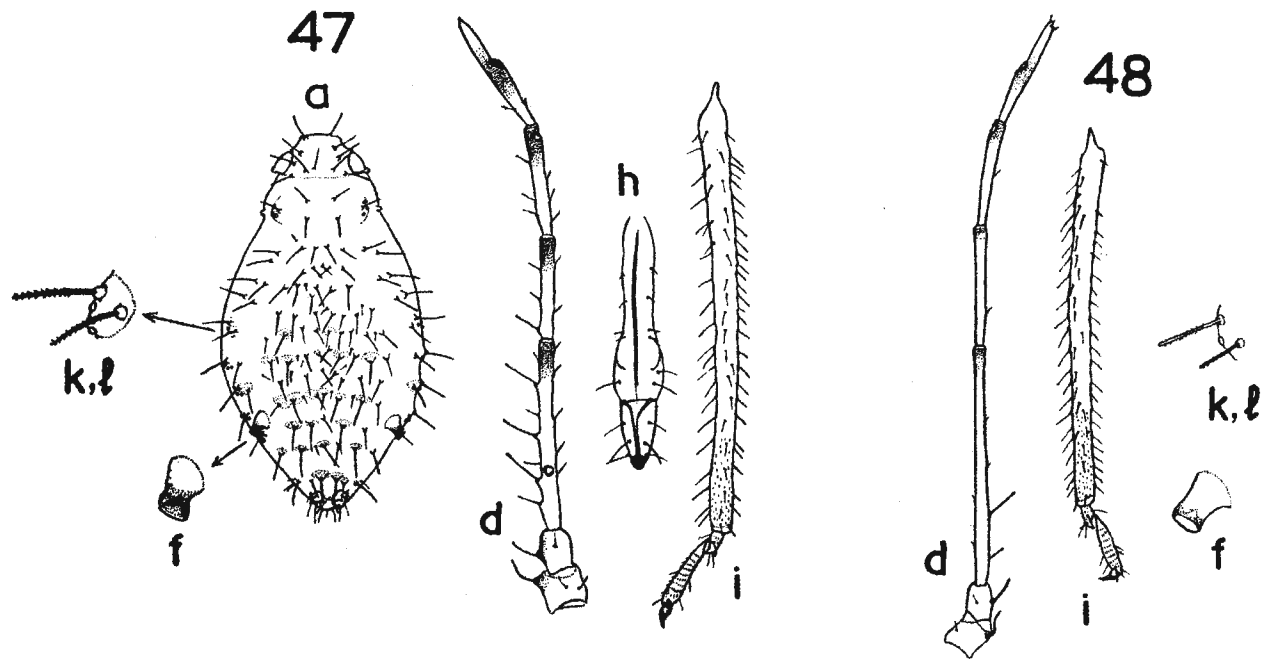

FIGS 47-48. 47, *Pterocallis maculata* (see also p. 79). 48, *P. alni*. (see also pp. 75, 78, 79, 123).

antennal joints III-VI (base) inclusive, in a single row along the joints.

*Oviparae*: Similar to apterous viviparae but with a well-developed subsiphuncular wax gland field and with numerous pseudosensoria on the rather incrassate hind tibiae. Subanal plate rounded, entire. Autumnal apterae may sometimes bear pseudosensoria on the hind tibiae, but these retain a bilobed subanal plate and have no subsiphuncular wax gland field.

*Nymphs* with chaetotaxy like that of *apterae*; first instar with spinal hairs of abdominal tergites 1, 4 and 6 closer together than those of remaining tergites. The 2 British species both live on *Alnus glutinosa*.

#### KEY TO SPECIES

1 *Apterae* and *oviparae* with dorsal body hairs pigmented, situated on very pale and inconspicuous round sclerites, much paler than the dorsal hairs. Antennal joints III-V bearing conspicuous hairs. Outer and inner hairs on basal half of tibiae about equal in length. *Alatae* with antennal flagellum (III-VI) 10-11 times as long as apical rostral segment, and with joint VI 7.5-9 times as long as its maximum width. *Males* apterous, with secondary rhinaria on antennal joint III 6-9, on IV 2-4 in number. **maculata** (von Heyden) (47)

*Under leaves, in colonies along veins, ant-attended. Suffolk, rare.*

- *Apterae* and *oviparae* with dorsal body hairs pale, dorsum entirely pale also. Only antennal joint III with 1-2 conspicuous hairs (sometimes 0 on one side). Inner hairs on basal half of tibiae longer, more conspicuous and more numerous than outer hairs. *Alatae* with antennal flagellum 15-17 times as long as apical rostral segment, and with joint VI 9.5-12.5 times as long as its maximum width. *Males* alate, with secondary rhinaria on antennal joint III 11-14, on IV 5-7 in number. **alni** (Degeer) (48)

*Under leaves, more or less scattered, not ant-attended. Local but very widespread, rarely very abundant.*

#### Genus CTENOCALLIS Klodnitzki, 1924

Type-species: *C. dobrovljanskyi* Klodnitzki, 1924.

Viviparae *apterous* or *alate*. Small pale yellowish aphids with brown markings.

*Apterae*: Body length about 1.4-1.8mm. Antennae 6-jointed, joint I with inner apical angle produced; III with a few transverse oval secondary rhinaria in middle of joint; processus terminalis much shorter than basal part of VI; antennal hairs small and inconspicuous, not more than one-third as long as basal articular diameter of joint. Dorsum with a complete series of dark bands occupying the thoracic and abdominal tergites; those on pronotum and abdominal tergite 8 entire, the remainder interrupted in the mid line; cuticle on these bands irregularly rugose. The marginal, and in the British species also the spinal, extremities of the bands bear a series of long, tapering processes (fig. 49a), each with a minute blunt hair at apex. For details of the arrangement of these processes see Key to Apterae, p. 49. Intersegmental muscle sclerites well developed, darker than the segmental bands. Siphunculi pore-like, situated on anterior face of marginal process of abdominal tergite 6 near its base. Cauda with slightly elongate knob, bearing about 14 hairs. Subanal plate fairly deeply cleft. Legs normal, front coxae slightly produced inward; tibiae with apical spurs hardly developed, spinulose over most of their length; tarsi spinulose, first joints typically with 5 ventral and 2 dorsal hairs, the medioapical ventral one a sense-peg. Claw hairs flattened but very narrow. Rudimentary gonapophyses 2.

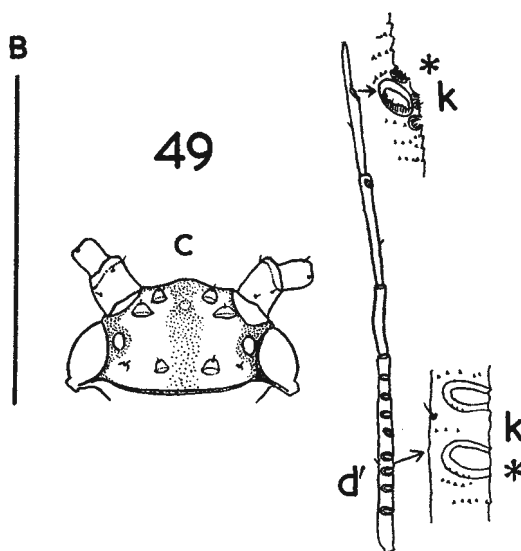
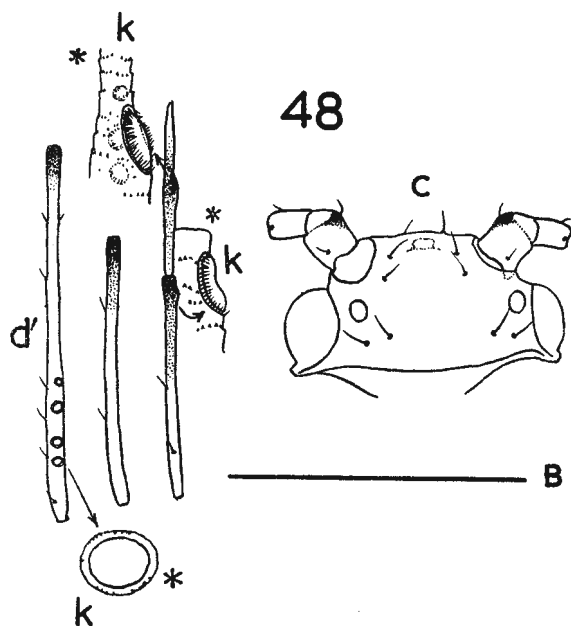

FIGS 48-49. 48, *Pterocallisalni* (see also pp. 73, 78, 79, 123). 49, *Ctenocallis setosa* (see also pp. 76, 123).

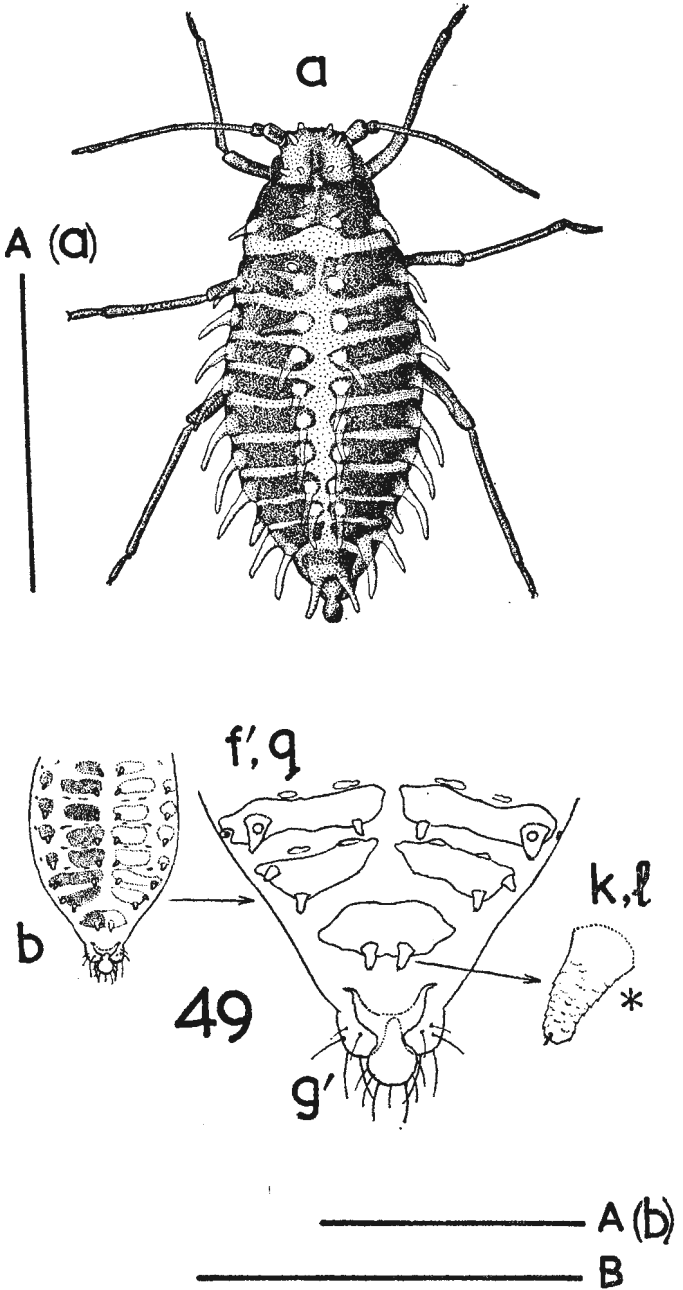

FIG. 49. *Ctenocallis setosa* (see also pp. 75, 123).

*Alatae*: Characters broadly similar, but processes on dorsum reduced to small subconical or teat-like structures. Abdominal tergal bands interrupted pleurally as well as spinally. Forewing with *Rs* more or less obsolete; *Cu*<sub>1</sub> somewhat sinuate; *Cu*<sub>2</sub> ending in a small dusky triangular spot at margin; costal margin with outline of pterostigma forming a slight bulge (fig. 49e). Tibiae with apical spurs more or less undeveloped.

*Males* alate, characters mainly as for alate viviparae. Antennae with secondary rhinaria in a single row along joint III–VI (base) inclusive.

*Oviparae* similar to apterous viviparae, but dorsal processes on posterior segments reduced in size. Abdominal tergite 8 with 2 lateral groups of small acute hairs. Subanal plate not cleft. Subsiphuncular wax gland field absent. Hind tibiae rather incrassate, bearing about 50 pseudosensoria.

*Immature morphs* with complete tergal bands replaced by individual spinal and marginal dusky sclerites bearing the processes, which in the first instar are reduced to subconical projections.

Sole British species.

*setosa* (Kaltenbach) (49)

*Living flattened against the midrib on the upperside of leaflets of Sarothamnus scoparius, including cultivars. Surrey, rare.*

### Genus **PHYLLAPHIS** C. L. Koch, 1856

Type-species: *Aphis fagi* L., 1767.

Viviparae *apterous* or *alate*. Pale green, clothed with wax flocculence in life.

*Apterae* (including *fundatrices*): Medium-sized elongate oval aphids, from midsummer becoming dwarfed. Body length normally 2.0–3.2mm, in dwarfs down to about 1.1mm. Antennae 6-jointed, flagellar joints (III–VI) together less than half length of body; spinulosely imbricate towards apex, and without secondary rhinaria; processus terminalis very short, blunt, unguiform, less than one-quarter as long as basal part of joint VI. Antennal hairs fine, acute, about 0.6–0.8 times as long as basal articular diameter of joint III. Frons simply convex. Compound eyes not strongly convex, triommatidion inconspicuous, the secondary facets more or less clearly divided into a larger dorsal and a smaller ventral group. Occipital (posterior discal) hairs 4 in number; all cephalic hairs simple and acute. Dorsum of head bearing groups of ring-shaped granular wax gland pores surrounding the cephalic hairs, these groups in larger specimens enlarging and fusing to form a more or less complete dorsal shield of wax glands over the whole head. Rostrum rather short, not reaching middle coxae, with a basal sclerotic arch; apical segment normal in shape, with 3–7 subsidiary hairs. Dorsal body chaetotaxy normal, hairs fine and acute; spinal and pleural hairs single, marginals duplicated on meso- and metanotum and on abdominal tergites 5–7 or 6–7. All dorsal hairs surrounded by variably sized and variably pigmented wax gland fields similar to the cephalic ones, with ring-like pores. Abdominal tergite 8 with 4–8 hairs in a transverse row. Siphunculi pore-like, situated on marginal sclerites of abdominal tergite 6. Cauda simply rounded or occasionally with a very slight constriction at about half its length, insufficient to produce an apical knob; in dwarf summer apterae the cauda may be so reduced as to be not apparent. In normal apterae the cauda bears 7–11 hairs. Subanal plate rounded to very slightly excavated medially. Legs



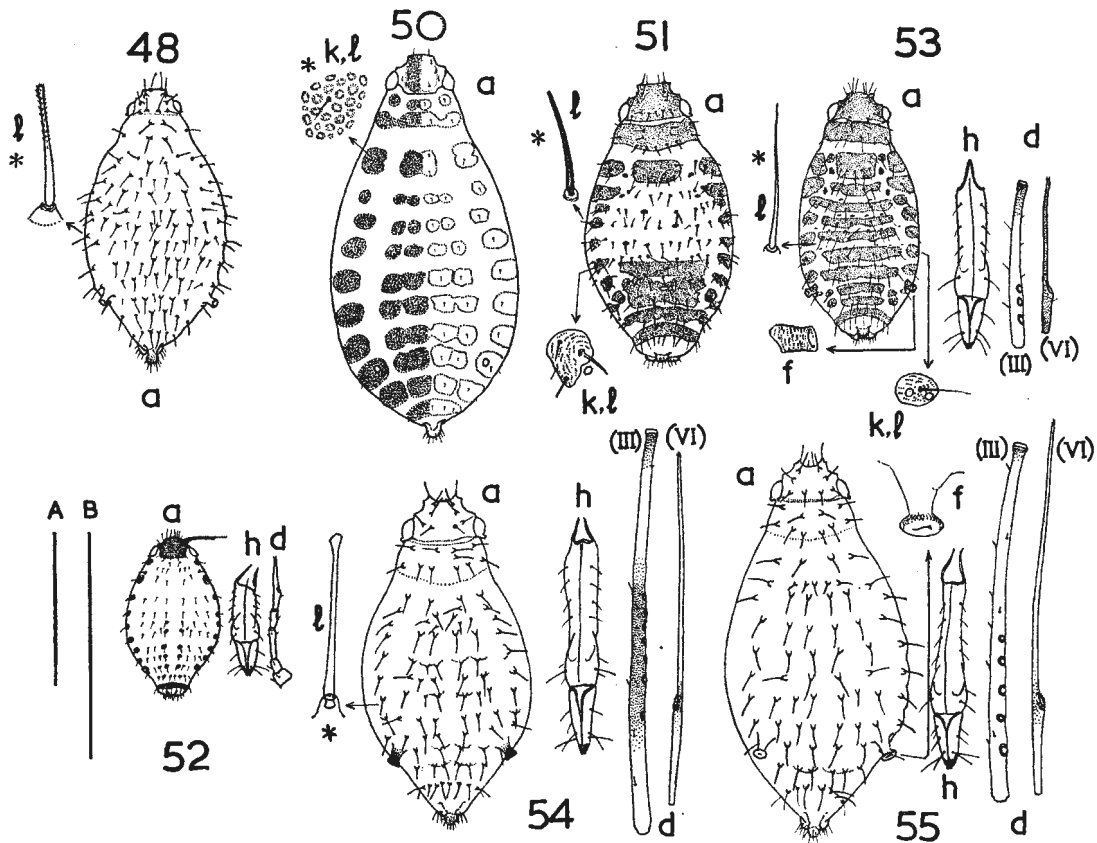

Figs 48, 50–55. 48, *Pterocallis alni* (see also pp. 73, 75, 79, 123). 50, *Phyllaphis fagi* (see also pp. 80, 82). 51, *Callipterinella tuberculata* (see also pp. 80, 123). 52, *C. minutissima* (see also p. 80). 53, *C. calliptera* (see also pp. 80, 82). 54, *Kallistaphis betulicola* (see also pp. 84, 123). 55, *K. flava* (see also pp. 84, 87).

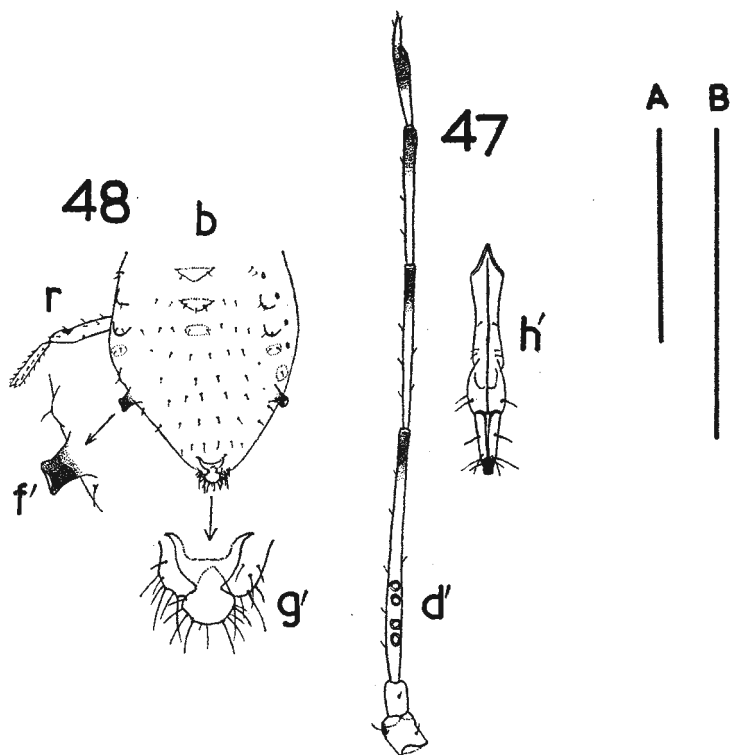

FIGS 47-48. 47, *Pterocallis maculata* (see also p. 73). 48, *P. alni* (see also pp. 73, 75, 78, 123).

normal; tibiae without apical spurs; tarsi only sparsely spinulose, tibial apices even more sparsely so. First tarsal joints with typically 5 ventral hairs (sometimes reduced to 3 on hind tarsus) but no dorsal hairs. Claw hairs flattened. Rudimentary gonapophyses 2.

*Alatae*: Body length about 2.0-3.2mm. In general similar to apterae. Antennae with a single row of 5-10 finely fringed, transverse oval secondary rhinaria. Wing venation normal; hind-wing with 2-3 hamuli. Abdomen with variably developed transverse pigmented tergal bands uniting and more or less enclosing the spinal and pleural wax gland plates; in lightly marked alatae these are broken into individual sclerites around the glands. Cauda distinctly knobbed, with about 9-13 hairs. Subanal plate distinctly bilobed. Some ventral hairs situated on small sclerites enclosing small groups of wax pores. Legs normal; femora and tibiae with a number of wax gland pores; tibiae with apical hairs not spur-like, but occasionally one or two slightly thickened basally; first tarsal joints with typically 5-6 ventral hairs, the medioapical one being a sense-peg.

*Males* alate. Very like alate viviparae, but spinal abdominal wax pore areas much reduced, enclosed in dark transverse oval sclerites. Antennae

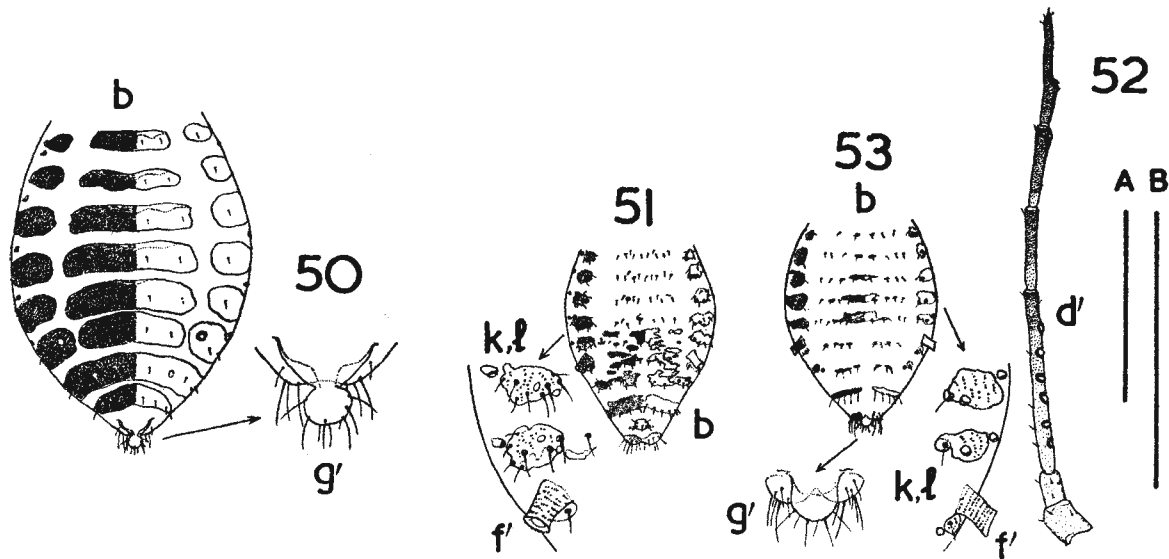

FIGS 50-53. 50, *Phyllaphis fagi* (see also pp. 78, 82). 51, *Callipterinella tuberculata* (see also pp. 78, 123). 52, *C. minutissima* (see also p. 78). 53, *C. calliptera* (see also pp. 78, 82).

with numerous secondary rhinaria along joints III–VI (base) inclusive: about 60–90 on III, 30–50 on IV, 20–40 on V and 5–10 on VI (base). Abdominal sternites with narrow transverse pigmented bands bearing some wax pores. First tarsal joints with 5–8 hairs.

*Oviparae* very like apterous viviparae, but with spinal wax gland plates much smaller and more or less surrounded by transverse oval pigmented sclerotic bars. Abdominal tergite 8 with about 16–17 hairs. Cauda rounded to slightly knobbed, with 9–11 hairs. Subanal plate rounded. Substiphuncular wax gland field present, composed of polygonal facets. Hind tibiae fairly incrassate, with about 50–80 pseudosensoria.

*Immature morphs* like apterous viviparae in chaetotaxy and wax gland arrangement; first instar with inconspicuous hairs, the pleural series present from mesonotum to abdominal tergite 6; wax gland groups present on head and pronotum.

Sole British species.

**fagi** (L.) (50)

*Living in curled leaves of Fagus sylvatica, which wither and die prematurely; especially abundant on beech hedges, which may be severely damaged. Alatae in 2nd generation, aestivation from midsummer by dwarfed apterae that bear sexual morphs in autumn. Common more or less over whole range of the host.*

#### Genus CALLIPTERINELLA van der Goot, 1913

Type-species: *Aphis betularia* Kaltenbach, 1843 (= *tuberculata* von Heyden, 1837).

*Viviparae apterous or alate.* Very variable in colour, from pale to dark green, greyish brown, yellow or reddish, with variable dark markings, the most heavily marked specimens appearing blackish dorsally, with only narrow lines of the ground colour.

*Apterae:* Small to medium-sized, body length 0.9–2.1mm. Antennae 6- or 5-jointed, in the former with a few round secondary rhinaria in a row towards base of III, these without fimbriation. Processus terminalis longer than basal part of last antennal joint. Flagellar joints rather strongly but not spinulose imbricate. Frons slightly convex, lateral prominences not higher than the median convexity; up to 2 pairs of small simple spinal tubercles (single wax elements) variably present on frons, but rather often absent. Occipital (posterior discal) hairs 4–8 in number. Rostrum with well-developed basal sclerotic arch. Dorsum with a very variable pattern of pigmented sclerites; in apterae with 6-jointed antennae at least partly in the form of broad bands across some or all tergites; in those with 5-jointed antennae such a band occurs only on abdominal tergite 8, the remaining tergites having no more than small sclerites carrying the individual dorsal hairs. Early in summer the bands of 6-jointed specimens may be so pale as to be scarcely visible, and much paler than the apices of the antennal joints. At least sclerotic parts of dorsal cuticle finely spinulose. Dorsal body hairs variable, acute, blunt or subcapitate, the latter especially in early summer; their shafts smooth; in a single row across each abdominal tergite; pleural region on each side with up to 5 hairs; occasionally an odd additional hair interpolated between the spinals. Marginal abdominal sclerites with 1, or with 3–7 hairs on each. Abdominal tergite 8 with 8–13 hairs. Spinal and marginal tubercles (wax elements) variable, the former often absent or

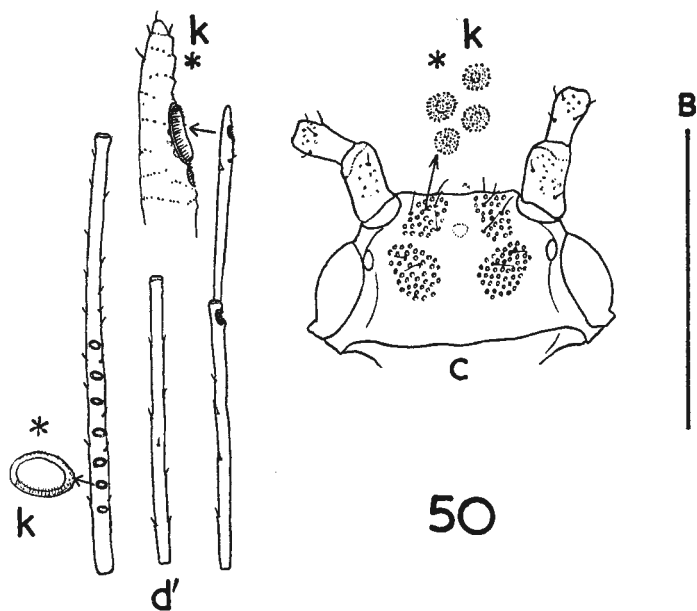

50

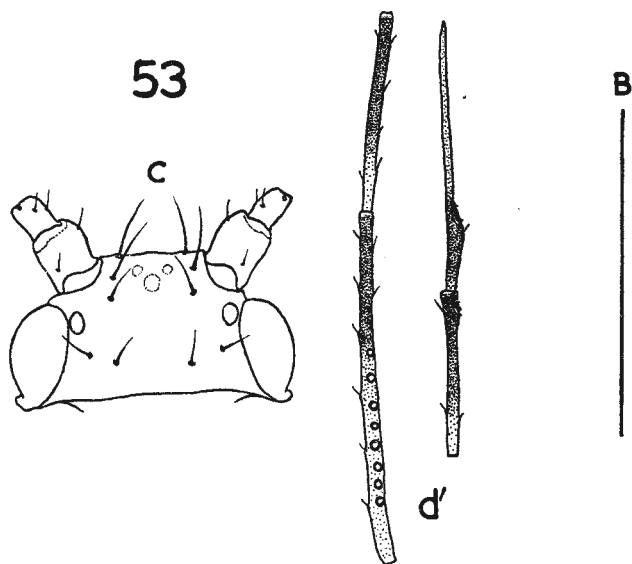

53

d'

FIGS 50, 53. 50, *Phyllaphis fagi* (see also pp. 78, 80). 53, *Callipterinella calliptera* (see also pp. 78, 80).

inconspicuous, the latter occurring down to abdominal tergite 7, and frequently duplicated or triplicated, in specimens with 6-jointed antennae, absent from those with 5-jointed antennae. Siphunculi dusky, with rows of small spinules. Cauda with a slight constriction, very short, with 5-8 hairs. Subanal plate slightly emarginate. Legs normal, very short in apterae with 5-jointed antennae; coxae and femora of all legs more or less equally developed; tibiae with scattered spinules between the hairs, their apical hairs slightly thickened but not forming conspicuous spurs; tarsi with sparse very finely spinulose imbrications; first joints with typically 5-7 ventral hairs (medioapical one a sense-peg) but no dorsal hairs. Rudimentary gonapophyses 2.

*Alatae*: spring specimens, which are probably fundatrices, much paler than late summer ones, and with dorsum more or less pale overall; later specimens apparently rare, and with dark dorsal pattern more or less agreeing with that of the corresponding apterae. Antennae always 6-jointed, the flagellar joints (III-VI) together varying from much shorter to a little longer than body according to species; secondary rhinaria as in apterae, but 4-19 in number on joint III. Wings with venation rather strongly marked or even narrowly brown-bordered; *Rs* in forewing weak or obsolete but usually just visible over most of its length. Dorsal body hairs as a rule somewhat smaller and more slender than those of apterae. Abdominal tergites 1-5 with blunt marginal processes bearing subapical hairs and commonly 1-2 convex marginal tubercles on each; number of marginal hairs as in apterae. Apical tibial hairs somewhat modified to slender spurs; first hind tarsal joint often with a dorsal as well as the ventral hairs.

*Males* apterous or alate, in either case more or less like the corresponding viviparous morph. Secondary rhinaria only on antennal joint III, exceptionally also 1 on IV, arranged as in *alatae*.

*Oviparae* mainly as apterous viviparae. Antennae 6- or rarely 5-jointed, with or without secondary rhinaria on III. Apex of abdomen somewhat elongated behind siphunculi; tergite 8 with up to about 20 hairs. Subsiphuncular wax gland field absent. Hind tibiae a little incrassate, with pseudosensoria usually grouped in pairs or threes, about 20-160 in number.

*Immature morphs* like apterae but with sclerotic pattern reduced to small separate hair-bearing sclerites and a band across tergite 8, or even not apparent at all. Siphunculi and tibiae spinulose. First instar with 4-jointed antennae; pleural hairs present from pronotum to abdominal tergite 6 inclusive.

The 3 British species all live scattered or in small groups on leaves of *Betula* spp., often between leaves spun together by lepidopterous larvae.

#### KEY TO SPECIES

- 1 Marginal sclerites of abdomen in all morphs bearing 3-7 hairs (fig. 511). *Apterae* with dorsal hairs conspicuously dark; abdominal tergites 4-6 bearing a more or less solid quadrate dark patch (fig. 51a); pro- and mesonotum each with an ovoid median sclerite; intervening tergites (metanotum to abd. 3) only with transverse rows of small sclerites bearing individual hairs. *Male* apterous. *Oviparae* with secondary rhinaria on antennal joint III. **tuberculata** (von Heyden) (51)  
*Local and not very common.*
- Marginal sclerites of abdomen in all morphs with only 1 hair (figs 52-53a, 1). *Apterae* with dorsal hairs not conspicuously dark, and dorsum without a solid quadrate dark patch on tergites 4-6. *Males* alate.....2

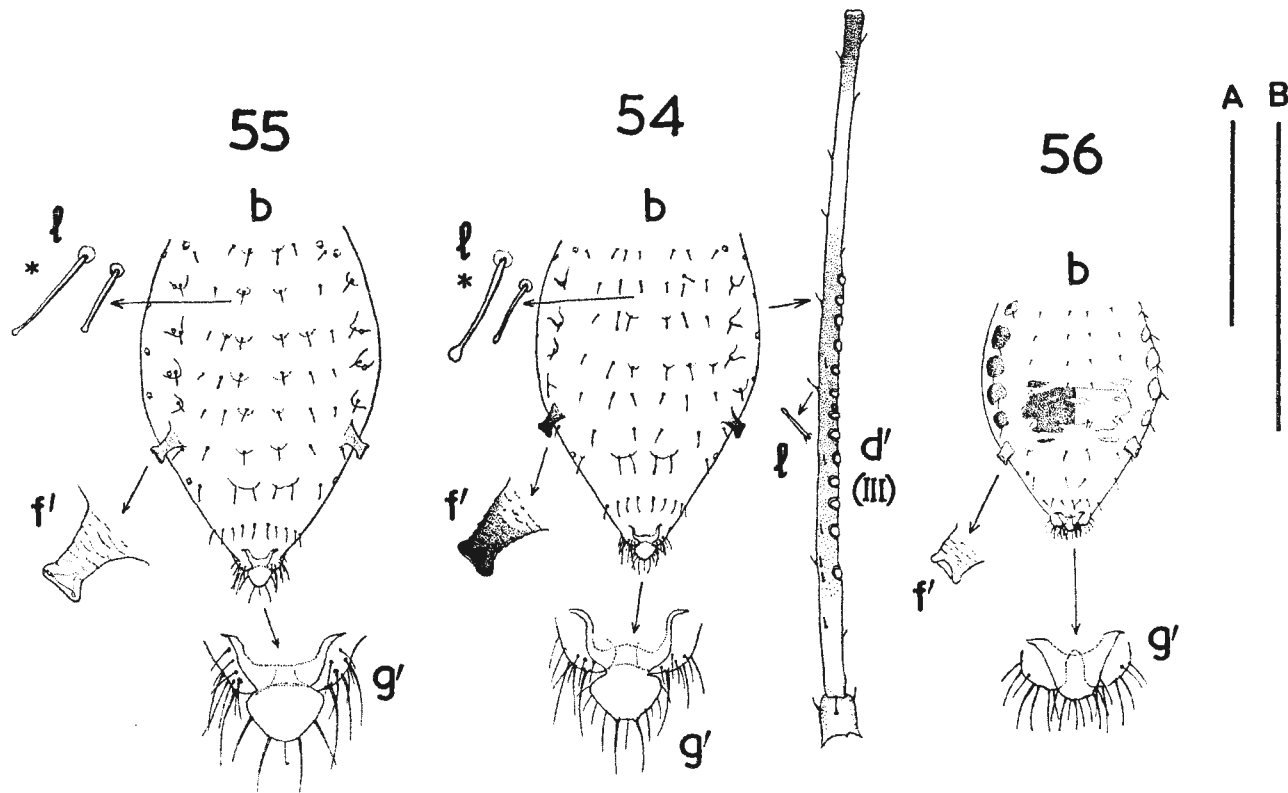

FIGS 54-56. 54, *Kallistaphis betulicola* (see also pp. 78, 123). 55, *K. flava* (see also pp. 78, 87). 56, *Betulaphis quadrituberculata* (see also pp. 87, 90).

- 2 *Apterae* very small (0.9–1.4mm long), plump oval, with very short 5-jointed antennae bearing no secondary rhinaria. Only abdominal tergite 8 with a solid pigmented band (fig. 52a). *Alate morphs* with processus terminalis about 1.25–1.5 times as long as basal part of joint VI. *Ovipara* without secondary rhinaria.

**minutissima** (Stroyan) (52)

*Surrey, Hertford, Cambridge, rare.*

- *Apterae* larger (1.5–2.1mm long), with 6-jointed antennae bearing 2–6 secondary rhinaria on III. Dorsum pale or with dark bands across all tergites (fig. 53a). *Alate morphs* with processus terminalis about 1.75 or more times as long as basal part of joint VI. *Ovipara* with secondary rhinaria on III.

**calliptera** (Hartig) (53)

*Local but widely distributed.*

### Genus **KALLISTAPHIS** Kirkaldy, 1905

Type-species: *Aphis betulicola* Kalténbach, 1843.

*Viviparae* in British species *apterous* or *alate*. Medium-sized pale green to pale yellowish aphids with rather long legs and antennae; body normally quite pale, or in some cold weather forms (e.g. *sexuales*) with more or less well-defined dusky markings on dorsum. Not waxy in life.

*Apterae*: Body length 2.0–2.7mm. Antennae 6-jointed, flagellar joints (III–VI) together from a little shorter to considerably longer than body; at least apices of joints narrowly dusky; joint III with a single row of 2–14 round secondary rhinaria which sometimes have a faint trace of fimbriation; processus terminalis only rarely less than twice as long as basal part of joint VI. Flagellum normally imbricate, not spinulose. Antennal hairs maximally half as long as basal articular diameter of joint III. Frons distinctly concave, the lateral prominences higher than the median convexity; sometimes with a small pair of median tubercles (wax gland elements). Frontal hairs long, pale, capitate or subcapitate; on distinctly rounded conical protuberant bases. Occipital (posterior discal) hairs similar to frontals, 4 in number. Pronotum with a group of 2–3 marginal wax tubercles on each side. Rostrum with sclerotic basal arch, apical segment fairly elongate, normal in shape, with 4–10 subsidiary hairs. Dorsal body hairs similar to frontals; spinals on rounded conical protuberant bases; marginals on abdomen single, also on low conical processes, which may bear a single marginal wax tubercle adjacent to the hair; pleural hairs usually more or less duplicated, so that the middle abdominal segments bear a single transverse row of 7 or more hairs, or rarely 6 on individual tergites. Tergite 8 with a single transverse row of 8–12 hairs. Longest hairs on all tergites longer than diameter of femora across trochantrofemoral suture. Dorsal cuticle without a trace of spinulosity. Siphunculi smooth to faintly imbricate, the imbrications sometimes with minute spinules; truncate conical with a thickened flared apex, and about twice as high from base to apex as their minimum width below the apical flare. Cauda slightly to distinctly constricted, the constriction delimiting a more or less distinct apical knob bearing 7–10 hairs. Subanal plate slightly bilobed or emarginate. Legs normal, coxae not differing appreciably in size between front, middle and hind pairs; femora and tibiae pale except for a small dusky to blackish area at base of each tibia. Tibial hairs partly blunt to subcapitate, particularly towards base of tibiae; apical hairs slightly broadened but not forming conspicuous spurs;



scattered spinules present between hairs on apical half of tibiae. Tarsi spinulose, second joints with spinules in transverse rows on imbrications; first joints with only very few spinules, and usually with 6 ventral and 1-2 dorsal hairs, the medioapical ventral one being a sense-peg. Claw hairs flattened, rather boomerang-shaped. Rudimentary gonapophyses 2, more or less fused.

*Alatae*: in general like apterae. Body length 2-3mm. Antennal flagellum as long as or longer than body; joint III with 8-18 secondary rhinaria. Wings ample, *Rs* in forewing obsolescent, varying from visible over its whole length to a small dusky apostrophe at its extreme apex on the costal margin; the other veins strongly marked, very narrowly to quite heavily (*Cu*<sub>2</sub>) bordered with brown, and usually terminating in small brown triangular spots at termen. Cephalic and dorsal body hairs much smaller and finer than those of apterae, their apices at most subcapitate; arranged as in apterae, but not standing on protuberant bases. Marginal prominences on anterior abdominal tergites more pronounced than those of apterae. Head and pterothorax pale brownish in life; antennae and tibiae tending to be more strongly pigmented than those of apterae, the former sometimes mostly dark, the latter with tibial apices more or less darkened.

*Males*: alate and generally similar to alate viviparae, but head, pterothorax and a series of short mid-dorsal bars on abdominal tergites dark; the latter may partly fuse to form a quadrate patch on tergites 4-6. Antennae with secondary rhinaria in a single row along joint III only, about 13-25 in number.

*Oviparae*: rather similar to apterous viviparae, but sometimes with thoracic and abdominal tergites variably adorned with short dark or dusky spinal bands or (in pleural and marginal areas) with very pale roundish sclerites surrounding individual hair bases. Antennal joint III with 2-5 secondary rhinaria near base. Apex of abdomen somewhat elongate behind siphunculi. Subanal plate simply rounded. Tergite 8 with more hairs than in apterous viviparae (14-20). Subsiphuncular wax gland field absent. Hind tibiae somewhat incrassate, often also more or less dusky, and bearing about 30-250 (van der Goot records 500, but this perhaps refers to the total for both tibiae) pseudosensoria.

*Immature morphs* similar to apterous viviparae; first instar with pleural hairs from pronotum to abdominal tergite 6 inclusive.

The 2 British species live scattered under the leaves of *Betula* spp.

#### KEY TO SPECIES

- 1 *Apterae* with most basal secondary rhinarium on antennal joint III situated at 0.19-0.35 of length of joint measured from base, and with at least apical flange and opercular apodemes of siphunculi dusky. *Alatae* with most basal rhinarium on III at 0.13-0.24 of joint length, and at least apical third of siphunculi blackish or dusky. Pale yellowish to yellow-green in life. **betulicola** (Kaltenbach) (54)  
*Widespread but overlooked, living almost only on small bushes or seedlings of height 10cm to 1m.*
- Both *apterae* and *alatae* with most basal secondary rhinarium on antennal joint III situated at 0.05-0.11 of length of joint measured from base, and with siphunculi entirely pale. Pale green in life. (syn: *basalis* Stroyan) **flava** (Mordvilko) (55)  
*Widespread and locally abundant, liking small bushes but not confined to them.*

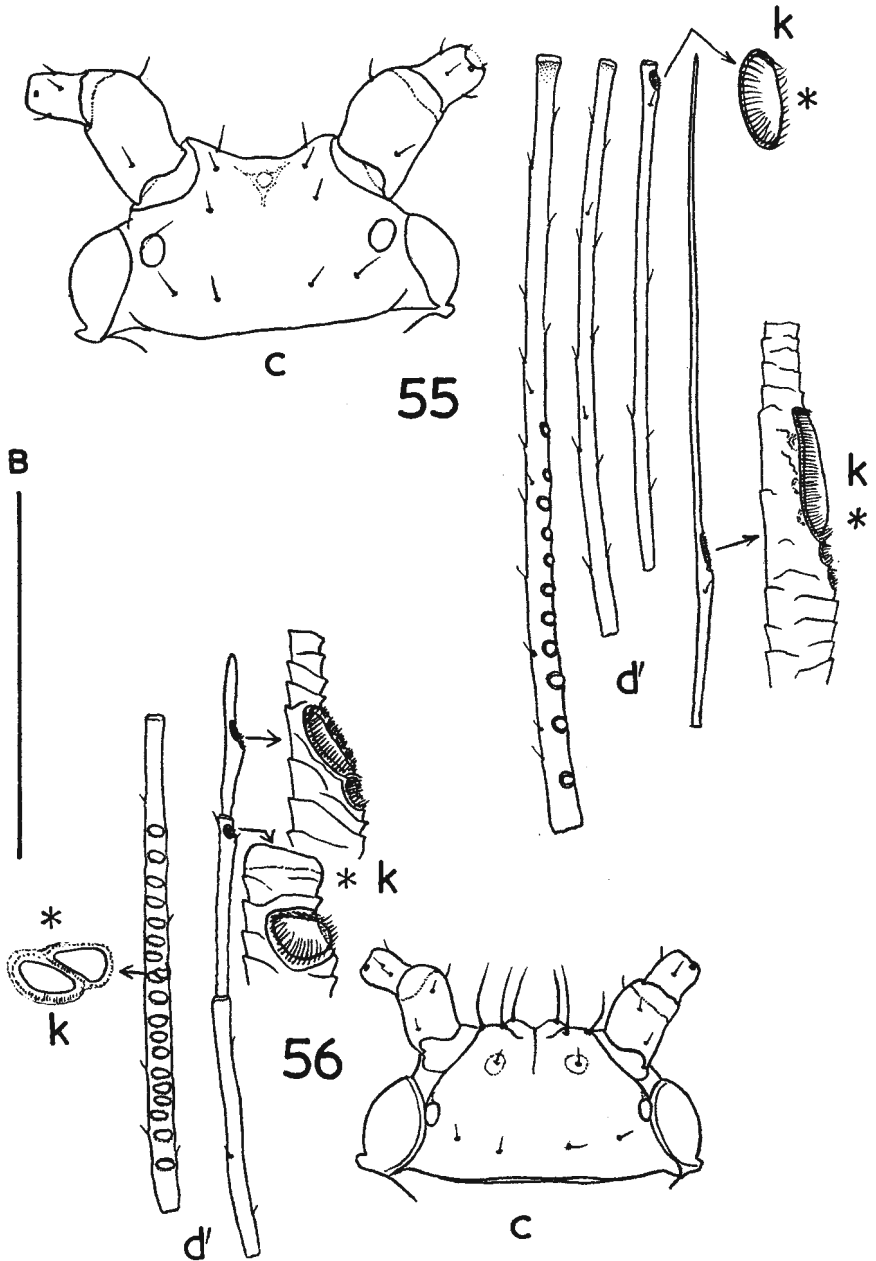

FIGS 55-56. 55, *Kallistaphis flava* (see also pp. 78, 84). 56, *Betulaphis quadrituberculata* (see also pp. 84, 90).

Genus **BETULAPHIS** Glendenning, 1926

Type-species: *B. occidentalis* Glendenning, 1926 (= *Aphis quadrituberculata* Kaltenbach, 1843).

Viviparae *apterous* or *alate*. Small to medium-sized aphids varying in colour from greenish or yellowish white to yellow or yellowish green, sometimes spotted with darker green or yellow.

*Apterae*: Body length 1.3–2.0mm. Antennae 6-jointed, rather stout and much shorter than body; joint III the longest, without any constriction at its base and without secondary rhinaria; joints IV–VI subequal (joint V sometimes shortest and VI sometimes longest), processus terminalis subequal to basal part of VI or a little shorter. Primary rhinaria small, inconspicuously fringed. Imbrications on flagellar joints simple to faintly striate. Antennal hairs rod-like to subcapitate, those on joint III not more than 0.4 times basal articular diameter of joint. Frons hardly convex, but appearing so from the presence of two pairs of low prominences, one pair dorsolateral and each usually bearing 2 long capitate hairs, the other pair ventromedial and each bearing 1 long capitate hair, and with another longer but less capitate hair immediately posterior to each prominence. Occipital (posterior discal) hairs small and blunt, 4 in number. Compound eyes with a well-marked triommatidion. Rostrum short and thick, with well-developed sclerotic basal arch, apical segment with only 0–1 subsidiary hair. Dorsal cuticle pale sclerotic, or occasionally in autumn with indistinct brownish markings on mid-abdominal tergites, or exceptionally also on thoracic tergites as in oviparae; locally slightly wrinkled but not otherwise sculptured; abdominal tergites 1–6 forming a solid carapace, the remaining tergites free. Tergal hairs typically 6 per segment on abdominal, or 8 on thoracic tergites; on the abdomen each tergite bears 1 pair each of spinal, pleural and marginal hairs; on the thorax each bears 2 pairs of marginals, and on the pronotum there are 2 pairs of spinals but no pleurals; abdominal tergite 8 bears 5–6 hairs. Hairs blunt to capitate according to length, the longer ones being more strongly capitate; in fundatrices conspicuous capitate hairs confined to head and abdominal tergites 5–7 (marginals only) and 8 (all), remainder very small and hardly noticeable. In later generations the number of conspicuous hairs (i.e. those as long as or longer than width of tibiae) increases from behind forward and from the margins inward, until in sexuparae the hairs are all more or less conspicuous, but with marginals and those of head and tergite 8 still the longest. Very small marginal tubercles (wax gland elements) sometimes visible behind the marginal hairs of one or more tergites. Siphunculi truncate conical with a strongly flared rim apically, slightly transversely wrinkled, situated just anterior to marginal hairs of abdominal tergite 6. Cauda bluntly obtuse subtriangular, often with a small mucronate apical projection, and with about 8–12 hairs. Subanal plate rather deeply cleft. Legs normal, without saltatorial modifications. Tibiae with scattered spinules between hairs apically, but without modified spur hairs. Tarsi with slightly spinulose imbrications on second joint; first joints typically with 6 ventral hairs, of which the medioapical is a sense-peg, but no dorsal hairs. Claw hairs flattened, boomerang-shaped. The outer tibial hairs may be partly blunt to subcapitate, especially near base of tibia. Rudimentary gonapophyses 2.

*Alatae*: Broadly similar to apterae, but hairs nearly all fine and acute, not capitate unless on abdominal tergite 8. Body length up to 2.2mm, largest in alate fundatrices, summer alatae rather smaller. Antennal joint III with a single row of 8–21 transverse oval, distinctly fringed secondary rhinaria. Head, thoracic lobes, antennae, marginal sclerites from abdominal tergite 2 to 5 inclusive, siphunculi, and a rather large subrectangular patch on abdominal tergites 4–6 with lateral anterior prolongations on to tergite 3, dusky pigmented, at least in the larger alatae; small specimens in late summer may be quite pale. Wings with normal venation, veins brown but not dark-bordered; hindwing with 3–4 hamuli. Marginal hair of abdominal tergite 6 on each side closely appended to base of siphunculus. Cauda rounded but not knobbed, with about 11–14 hairs. Subanal plate deeply cleft. Legs with tibial apices and tarsi darkened; first tarsal joints usually with a pair of dorsal hairs as well as the ventral ones. Apical tibial hairs slightly spur-like.

*Males* apterous. Antennae rather long, flagellar joints (III–VI) together about 0.5–0.8 times body length; small secondary rhinaria present on joints III–VI (base) inclusive. Dorsum with dark sclerotic markings similar to those of oviparae.

*Oviparae* anteriorly like apterous viviparae; behind siphunculi with the posterior abdominal segments produced into an elongate ovipositor-like structure. Tergite 8 with about 18 hairs, of which 1–2 of the longest are blunt or subcapitate. Cauda as in alate viviparae, with just in front of its base a transverse row of about 5 fine acute hairs, suggesting the original chaetotaxy of the primitive tergite 9. Subanal plate not cleft, only with a trace of emargination posteriorly. No subsiphuncular wax gland field. All tergites to abdominal 7 with pigmented sclerotic pattern, the bands darkest and most solid on tergites 4–6, where they form a squarish sclerotic patch; bands on thorax and abdominal tergites 1–3 mutually free, those on metanotum and abdominal 1–2 medially divided. Pigmented areas rugose, showing more or less concentric convolutions pleurally and spinally. Hind tibiae weakly incrassate, with variable-sized pseudosensoria (about 30–60) on inner face of basal half.

*Immature morphs* as for apterae; first instar with pleural hairs from pronotum to abdominal tergite 6 inclusive.

Sole British species.

**quadrituberculata** (Kaltenbach) (56)

*Living scattered or in small groups, or in favourable years sometimes forming dense populations, under leaves of Betula spp. Fundatrices partly alate, remaining generations mainly apterous. Widely distributed but not universally common.*

*B. brevipilosa* Börner, in which all dorsal hairs from the vertex of the head back to abdominal tergite 6 are extremely short and inconspicuous, has at times been placed in synonymy with *quadrituberculata*, but is regarded by Heie (1972) as a good species, living on both upper- and undersides of leaves of *Betula pendula* only. It is not yet known from Britain, but may well be present.

Genus **MONAPHIS** Walker, 1870

Type-species: *Aphis antennata* Kaltenbach, 1843.

All viviparae *alate*. Very large ventrally flattened, highly cryptic green aphids with relatively short legs and very long, conspicuously blackish

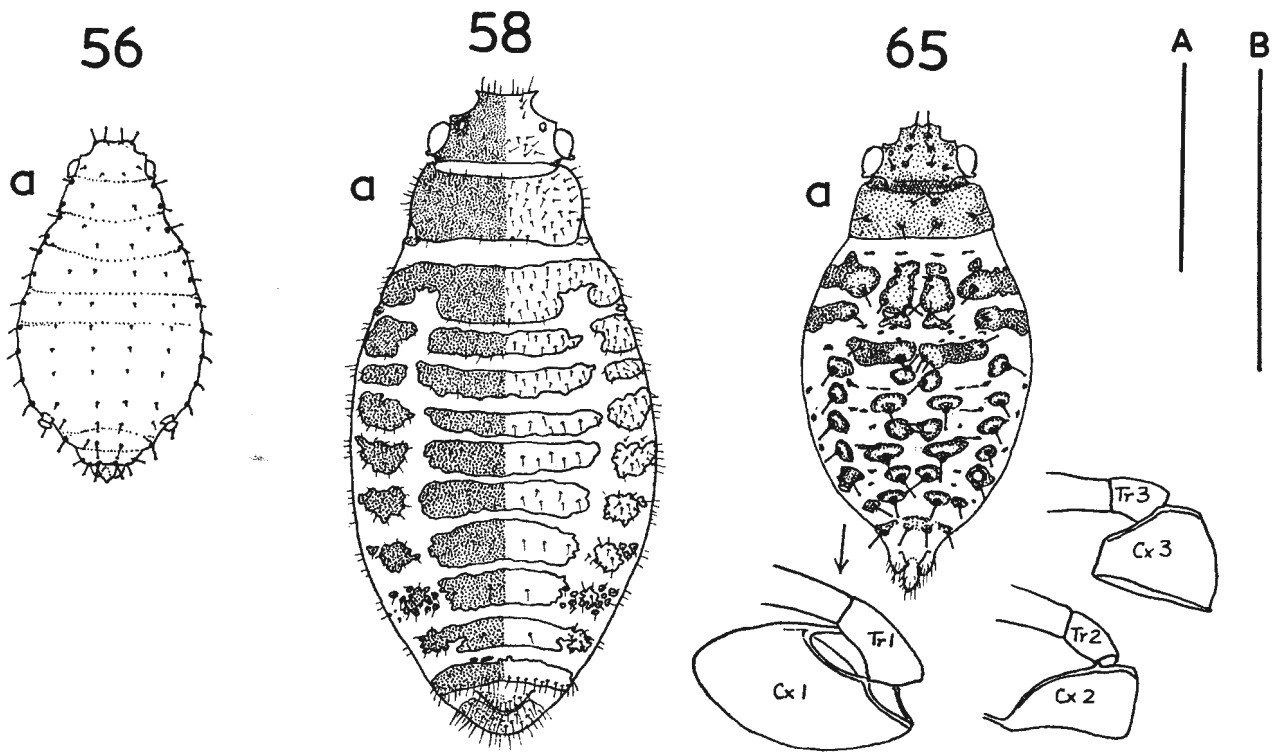

**Figs 56, 58, 65.** 56, *Betulaphis quadrituberculata* (see also pp. 84, 87). 58, *Syndobius oblongus* (see also pp. 94, 123). 65, *Therioaphis ononidis* (see also p. 109).

antennae, and an elongate dark pterostigma. Body length 3.3–4.3mm. Antennae very long, blackish except at extreme base of joint III, which broadens to its basal articulation, and I–II, which are pale. Joint III along most of its length with many irregularly disposed secondary rhinaria, roundish in shape and with borders often very finely dotted or striate but not fringed; III and base of IV smooth or with striate transverse lines passing gradually into imbrications distally; apical half of IV and all of V–VI closely normally imbricate. Processus terminalis very long, nearly twice as long as III, IV or V, which are all nearly equal in length, and up to about 9 times as long as basal part of VI, from which the processus is hardly delimited except by the position of the primary rhinarium and by a very slight tapering around this point. Antennal hairs rather numerous, normal, acute, those on III maximally about 0.25 times as long as basal articular diameter of joint. Frons with marked lateral prominences, higher than median ocellar prominence. Dorsum of head with a supporting framework of thickened sclerotic bands, perhaps correlated with the weight and posture of the long, thick antennae: these bands occupy the sides of the head between the posterior margin of the antennal socket and the anterior margin of the compound eye; here they turn inward and forward, enclosing the lateral ocelli and converging to meet at and surround the median ocellus; a branch leaves the main band a little in front of each lateral ocellus and runs to the dorsal margin of the antennal socket. Behind their inflection at the front margin of the eyes the bands merge posteriorly into the general cuticle of the head. Cephalic hairs small, blunt and inconspicuous; frontals up to about 0.33 times as long as basal articular diameter of antennal joint III; occipitals (posterior discs) similar, rather numerous and irregularly arranged in a multiple transverse row. Thorax pale sclerotic with mesosternum slightly granular centrally. Rostrum short, not reaching middle coxae; its apical segment blunt, with up to 6 subsidiary hairs. Wings with normal venation, unpigmented apart from the long, narrow, dark pterostigma; hindwing with 3–5 hamuli. Abdomen without any sclerotic pigmented pattern; tergites 3–6 with a series of lateral prominences, that on 3 rudimentary, those on 4–5 much more prominent and backwardly directed, that on 6 bearing the siphunculus; each prominence bearing 4–5 blunt hairs of which 1 is subapical except on the siphuncular prominence. Sides of tergite 7 produced into a rounded bulge occupying whole length of tergal margin; ventral surface of this bulge slightly granular, and bearing about 12–14 short (up to 0.03mm) hairs on each side. Spinal abdominal hairs very short, pale, blunt and inconspicuous, almost undetectable. Tergite 8 with about 17–18 hairs, mainly in 2 lateral groups; midtergite with only about 4 ranged on either side of a slight median prominence, and these hairs blunt, maximally 0.03–0.04mm long. Siphunculus very small, pale, truncate conical with a flanged rim. Cauda rounded, broadly tongue-shaped or blunt conical, with about 10–12 hairs. Subanal plate bilobed. Posterior margin of subgenital plate forming a crescentic flap bearing about a dozen long, stout, blunt hairs, up to 0.065mm long. Legs rather short; hind tibiae shorter than processus terminalis. Tibiae apically spinulose between hairs, and their apices with slightly thickened spur hairs. Femora ventrally, and 2nd tarsal joints, with transverse rows of small spinules, those of tarsi on more or less well-marked imbrications. First tarsal joints with normally 2 dorsal and 6–9 (most often 7) ventral hairs, the

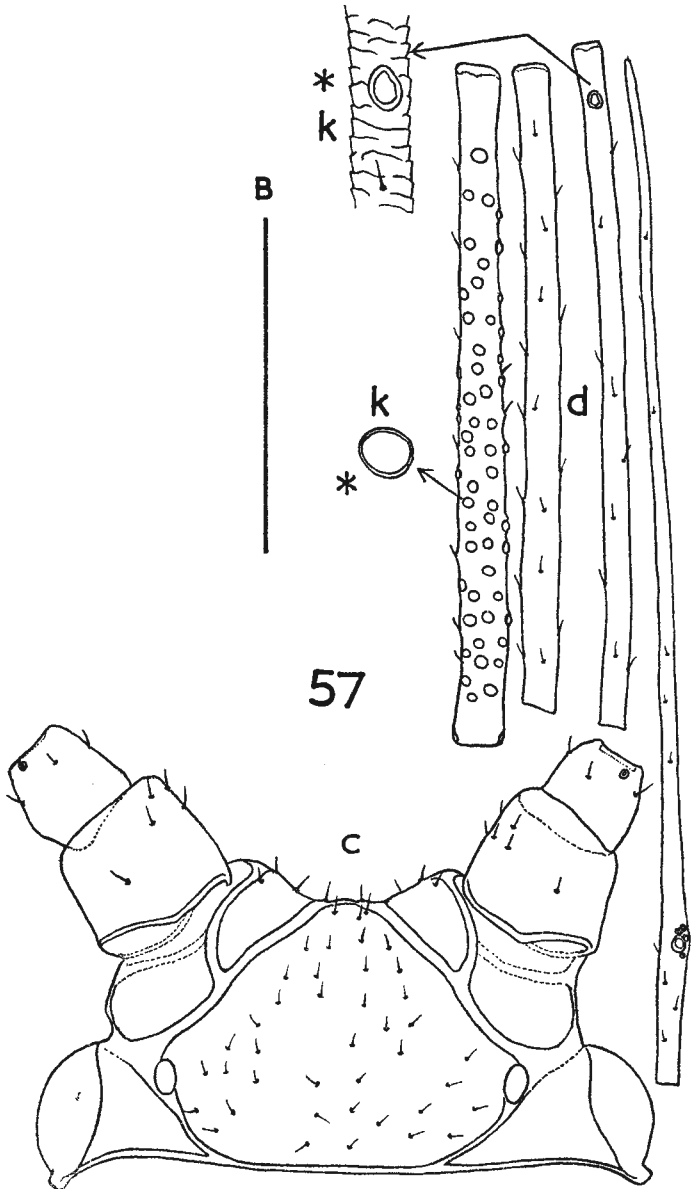

FIG. 57. *Monaphis antennata* (see also p. 97).

medioapical ventral hair being a sense-peg. Claw hairs flattened and curved, broadening apically. Tibiae dusky, darkening at apex, or (hind tibia) dark throughout. Rudimentary gonapophyses 2.

*Males* alate, smaller than viviparae and red in life. Secondary rhinaria very numerous, on antennal joints III–V inclusive. Mesothoracic lobes dark brown (details from van der Goot, 1915).

*Oviparae* green, dorsally very convex, head and prothorax brown. Tergites from mesonotum to abdominal 7 each with a narrow pale brown sclerotic band, those on mesonotum and abdominal 6–7 occupying whole width of tergites, those on remaining segments shorter and not reaching sides of body; tergite 8 with a somewhat heartshaped brown sclerotic shield, its point directed posterad and overhanging the abdominal apex. Abdominal tergites 6 and 7 each with rather protruding lateral angles, the siphunculi occupying those of tergite 6. Subsiphuncular wax gland fields present and producing a silvery oval patch of wax on each side in the living aphid. Antennae long and black, without secondary rhinaria. Hind tibiae dark brown, distinctly swollen, with about 60–80 pseudosensoria.

*Immature morphs* green (except males), highly cryptic. Legs invisible from above. Antennae as in oviparae, carried in a 'longicorn-like' posture, laid back laterally along the body. First instar (Quednau, 1954) with head in front of eyes very long, and a fused dorsal shield extending over whole of head and pronotum; all body hairs very short except on abdominal tergites 7–8; pleural hairs present from posterior half of pronotum to abdominal tergite 6 inclusive.

Sole species.

*antennata* (Kaltenbach) (57)

*Apparently uncommon in Britain and very little known. Living solitarily on the leaves of Betula spp., the immature stadia typically sitting appressed to the midrib on the upperside of the leaf. Occurring in Kew Gardens and on the Bagshot sand areas in Surrey; also recorded from Middlesex (Walker), Hertford, Bedford and Merioneth; very probably more widely distributed, but overlooked because of its cryptic coloration, solitary habits and preference for stunted scrubby birches.*

### Genus SYMYDOBIUS Mordvilko, 1894

Type-species: *Aphis oblonga* von Heyden, 1837.

All viviparae *alate* or *alatiform*, the latter differing from the former virtually only in absence of wings and pterothorax. *Brachypterae* not uncommon in some populations.

*Alatae*: Rather large dark brown aphids, body length 2.7–3.7mm. Antennae 6-jointed, stout, shorter than body; joint III usually about as long as IV, V and VI taken together; processus terminalis shorter than basal part of VI. Whole antenna dark, or with basal half of IV and V paler; closely imbricate throughout. Basal three-quarters of III with a closely set, usually partly double row of 20–30 transverse oval to roundish protuberant unfringed secondary rhinaria. Antennal hairs numerous (up to about 90 on III, 40 on IV, 20 on V, 10 on basal part of VI), fine, acute and erect, those on III maximally a little longer than basal articular diameter of joint. Frons straight to slightly concave. Cephalic hairs long, fine and acute; dorsofrontals in 2 irregular groups of about 6–7; occipitals (posterior discals) also in 2 irregular groups of about 8. Compound eyes and ocelli normal, median ocellus ventral to frontal



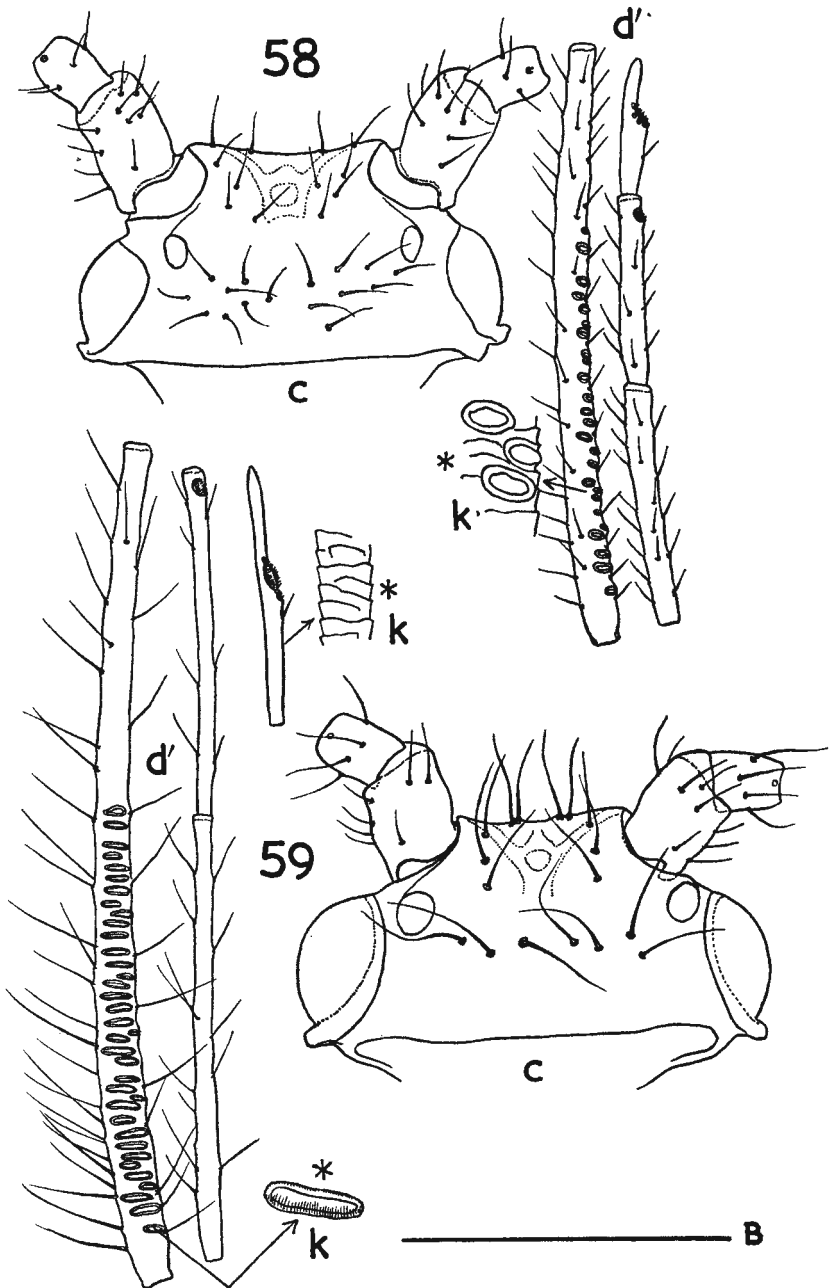

FIGS 58-59. 58, *Symydobius oblongus* (see also pp. 90, 123). 59, *Clethrobrius comes* (see also p. 97).

outline. Rostrum reaching about to middle coxae, with a well-developed basal sclerotic arch; apical segment blunt, with 12-18 subsidiary hairs arranged in 2 dorsal and 2 ventral longitudinal rows. Wings with normal venation, veins brownish-bordered, membrane with strong and dense squamulae. Hindwing with 4-8 hamuli. Dorsal abdominal pattern consisting of a broad dark transverse spinopleural band and a pair of marginal sclerites on each tergite; marginal sclerites of abdominal 2-5 produced into low, blunt and obtuse prominences not with hairs at their apices. Dorsal chaetotaxy consisting of long, fine and acute hairs in irregular groups; spinals decreasing in number progressively posterad, from about 25-30 on pronotum to often only 1 pair on abdominal tergite 7 and 2 pairs on 5-6. Pleural hairs absent from tergites 5-7, and only single on 3-4. Marginal hairs multiple on all tergites to abdominal 7. Tergite 8 with a single row of long, fine hairs, about 10-20 in number along posterior margin. Rudimentary marginal tubercles (wax gland elements) present as small inconspicuous facets about as large as hair bases, in small groups on posterior part of marginal sclerites and posterolaterally on pronotum. Siphunculi, when present, small and truncate, situated on marginal sclerites of abdominal tergite 6. Small spinules present on marginal sclerites and siphunculi, but not on spinopleural bands. Cauda and subanal plate both broadly rounded, or the latter with a very slight posterior emargination. Caudal hairs about 20-35. Ventral hairs arranged in dense irregular multiple (about quadruple) rows across sternites. Spiracles slightly overhung anteriorly by cowl-like opercula. Legs stout, normal, hind tibiae about equal in length to antennal flagellum and somewhat incurved at apex. All coxae and femora uniform, without saltatorial modification. Hind tibiae with a few spinules between hairs towards apex, but front and middle tibiae with hardly any. First tarsal joints with 6-10 ventral and 0-2 dorsal hairs; second joints with finely spinulose imbrication. Claw hairs flattened, outwardly curving like three-dimensional boomerang blades. Rudimentary gonapophyses 3.

*Brachypterae* and *alatiform apterae* virtually the same as *alatae* except that wings, pterothorax, ocelli, secondary rhinaria and sclerotic pattern are reduced proportionally; dorsal sclerotic bands shorter, marginal sclerites tending to be broken up, rhinaria becoming rounder and less transverse as specimens become more apteriform. Pterothorax rudiments spinulose, and the same sometimes applying to a greater or lesser number of the tergal bands. Secondary rhinaria exceptionally absent.

*Males* apterous, very like *alatiform viviparae* but smaller and more slender. Dorsal sclerotic pattern augmented by well-marked dark intersegmental muscle sclerites. Antennal joint III with a partially double row of 35-38 mostly roundish, but a few transversely oval, secondary rhinaria along whole length of joint; IV without secondary rhinaria, V with a few (6-7) in a single line. Subanal plate a little emarginate posteriorly. First tarsal joints with sometimes as few as 5 ventral hairs.

*Oviparae* differing from *viviparae* in having posterior end of abdomen behind siphunculi produced into a rather flexible egg-laying structure (but much less so than in, e.g., *Betulaphis*), this being somewhat telescopic and armed on apical eversible part with pale chitinous teeth. Head and antennae still *alatiform*, i.e. with ocelli and secondary rhinaria. Dorsal sclerotic pattern reduced on segments behind siphunculi; tergite 8 with a narrow, often

divided band across it, and bearing about 40 hairs. Subsiphuncular wax gland field absent. Hind tibiae rather incrassate, with very many (about 250-300) mostly double pseudosensoria on proximal three-quarters.

*Immature morphs* without dorsal pigmented bands except across abdominal tergite 8; anterior tergites with only small paired spinal and marginal hair-bearing sclerites, and these often quite pale and inconspicuous. First instar with pleural hairs back to abdominal tergite 6 or even 7, multiple on thoracic and some anterior abdominal segments; seriation of hairs obscure on these segments.

Absence of siphunculi has been noted as a characteristic of certain populations in Scotland.

Sole British species.

**oblongus** (von Heyden) (58)

*On twigs and young stems or branches of Betula spp., forming aggregations attended assiduously by ants, especially Formica spp. Widely distributed in birchwoods and on heaths with birch scrub.*

### Genus **CLETHROBIUS** Mordvilko, 1928

Type-species: *Callipterus giganteus* Cholodkovsky, 1899.

All viviparae *alate*. Very large, elongate brown aphids, body length 4.1-4.4mm. Antennae 6-jointed, long (flagellar joints together 2.9-3.3mm) and slender, entirely dark; joint III from a little shorter to a little longer than IV and V together; VI shorter than V, processus terminalis shorter than basal part of VI, and thinner at junction with VI (base) than near its apex. Primary rhinarium on VI large, about one-third as long as processus terminalis. Secondary rhinaria on III transverse, rather slit-like, clearly fringed proximally, in a single line occupying basal 0.6 of joint; rarely one or two rhinaria divided transversely. Antennal hairs long, stiff, fine and acute, those on III up to about 3 times as long as basal articular diameter of joint, those on V and VI decreasing markedly in length and number. Frons nearly flat, with only 2 very small flat elevations bearing pairs of frontal hairs. Ventrofrontal aspect of head with a V-shaped thickening the angle of which encloses the median ocellus. Frontal hairs in 4 anteroposterior rows of 3. Occipitals (posterior discals) in 2 groups, about 4 on each side. All cephalic hairs very long, fine and acute. Pro- and mesothoracic region very elongate. Pronotum with rather numerous discal hairs, about 30 in number. Mesonotum with granular sculpture of anterior lobe. Rostrum only reaching about halfway to middle coxae, its apical segment similar to that of *Symydobius*, q.v. Wings normal, venation brown but not bordered. Membrane only finely squamulose. Hindwing with 4-6 hamuli. Abdominal dorsum with pigmentation confined to marginal sclerites, a band across tergite 8, a broken band across tergite 7, and even more broken up sclerites in lines across the anterior tergites and bearing the dorsal hairs. Sclerites as far back as tergite 6 bearing variably developed groups of wax-pore facets showing as small light-coloured granular spots in the sclerites, and producing bands of light wax pulverulence in the live aphid. Marginal sclerites on tergites 1-4 produced into blunt rounded prominences bearing 2-3 marginal hairs each, and also sometimes with faceted groups of marginal tubercles towards their posterior margins. Dorsal hairs arranged in irregular single or

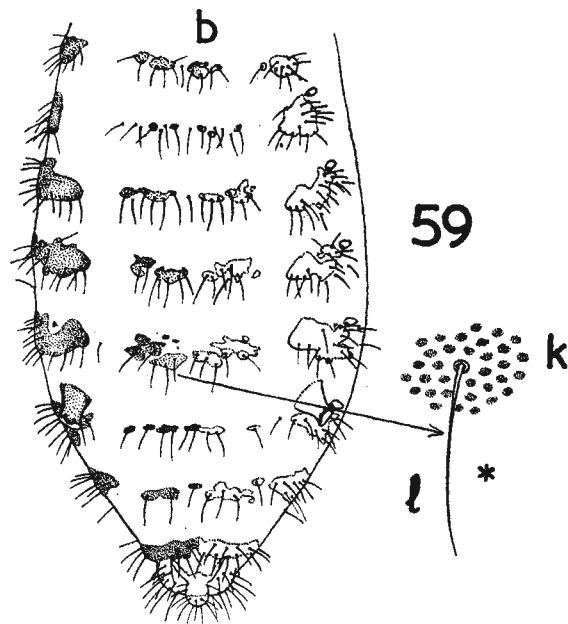
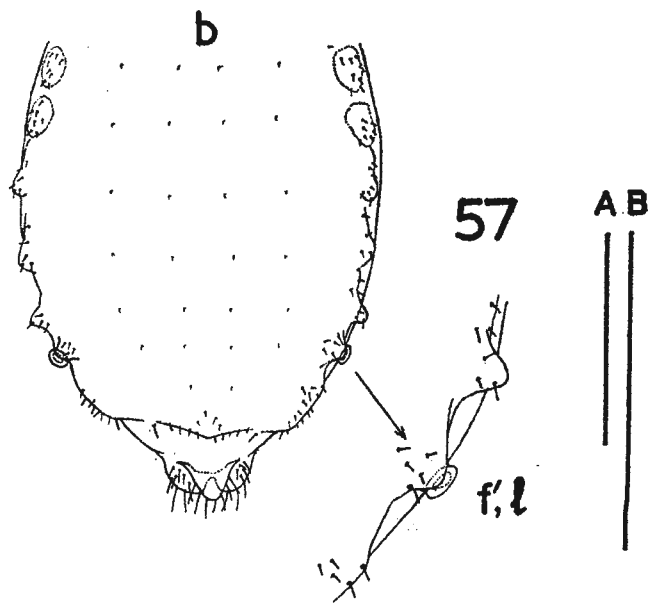

FIGS 57, 59. 57, *Monaphis antennata* (see also p. 92). 59, *Clethrobium comes*. (see also p. 94).

partly double transverse rows across tergites, the number of spinals and pleurals together being about 10–12 per segment. All dorsal hairs long, fine and acute. Tergite 8 with a partly double transverse row of about 15–25 hairs. Siphunculi situated just in front of marginal sclerites of tergite 6, truncate subconical, flared to apex, dusky, slightly rugose but not spinulose; often clothed with whitish wax powder in life. Cauda with a distinct constriction delimiting a slight knob, and with about 18–23 hairs. Subanal plate entire, rounded. All ventral hairs very long and fine, including those of subgenital plate, which bears about 60–75 over its whole area. Legs long; tibiae uniformly dark, as dark as or darker than femora. All femoral hairs long, fine and acute; most tibial hairs similar, but inner hairs towards apex of tibia become shorter and more thorn-like, and well-developed blunt spurs occur at extreme apex on inner side. Fine spinules present between hairs towards tibial apices, and imbrications of second tarsal joints also spinulose. First tarsal joint typically with 7–10 ventral and 2 dorsal hairs, but the latter may be absent from one or more legs. Claw hairs flattened, samariform. Rudimentary gonapophyses 2, their setae rather long and curved or sinuate, to about 0.05mm long.

*Males* alate. Differing from alate viviparae in smaller size, more slender build, greater number of secondary rhinaria (55–65 on III in an irregular, basally partly double or even triple row along whole length; 0 or rarely 1–2 on IV; 14–18 in an irregular single row along distal  $\frac{3}{4}$  of V), and presence of pigmented segmental bars on the abdominal tergites, more or less broken on tergites 1–2 or 1–3. Dorsal bands back to tergite 6 bearing gland groups across their posterior halves. Cauda distinctly and transversely knobbed.

*Oviparae* without secondary rhinaria but with ocelli. Antennal joint III thickening to just before base, the hairs on this joint up to about twice as long as basal articular diameter of joint, those on IV–VI progressively shorter. Dorsal pigmentation consisting of broken lines of sclerites and sclerites across the tergites, the larger ones bearing several hairs each, the smallest none. Dorsal gland groups not apparent. Ventral hairs also standing partly on small single-haired sclerites. Siphunculi with traces of spinulose sculpture. Abdomen somewhat produced behind siphunculi. Cauda rounded, not knobbed. Tergite 8 with about 36 hairs, especially numerous laterally. Subsiphuncular wax gland fields absent. Hind tibiae strongly swollen, with over 400 slightly raised but flat-topped pseudosensoria over nearly whole length of tibia, not grouped in pairs like those of *Symydobius*. First tarsal joints with 6–10 ventral but rarely with any dorsal hairs.

*Immature morphs* generally similar to oviparae in chaetotaxy and sclerotic markings. First instar with joint III of the 4-jointed antennae often showing incipient subdivision; pleural hairs present typically from pronotum to abdominal tergite 6; spinal and marginal hairs multiplied on abdominal tergites; apices of tibiae with modified spur-like setae already well-developed.

Sole British species.

*comes* (Walker) (59)

*Living as a rule on the brown twigs of Alnus glutinosa overhanging streams, or more rarely on Betula which commonly dies back thereafter; whether this die-back is caused by the aphids, or predisposes the tree to their attack, is not clear. Rare, but recorded from widely separated areas: Surrey, Argyll, Angus, Aberdeen, Inverness. Perhaps overlooked owing to its cryptic colour and habit of living on branches that are hard to reach dryshod.*

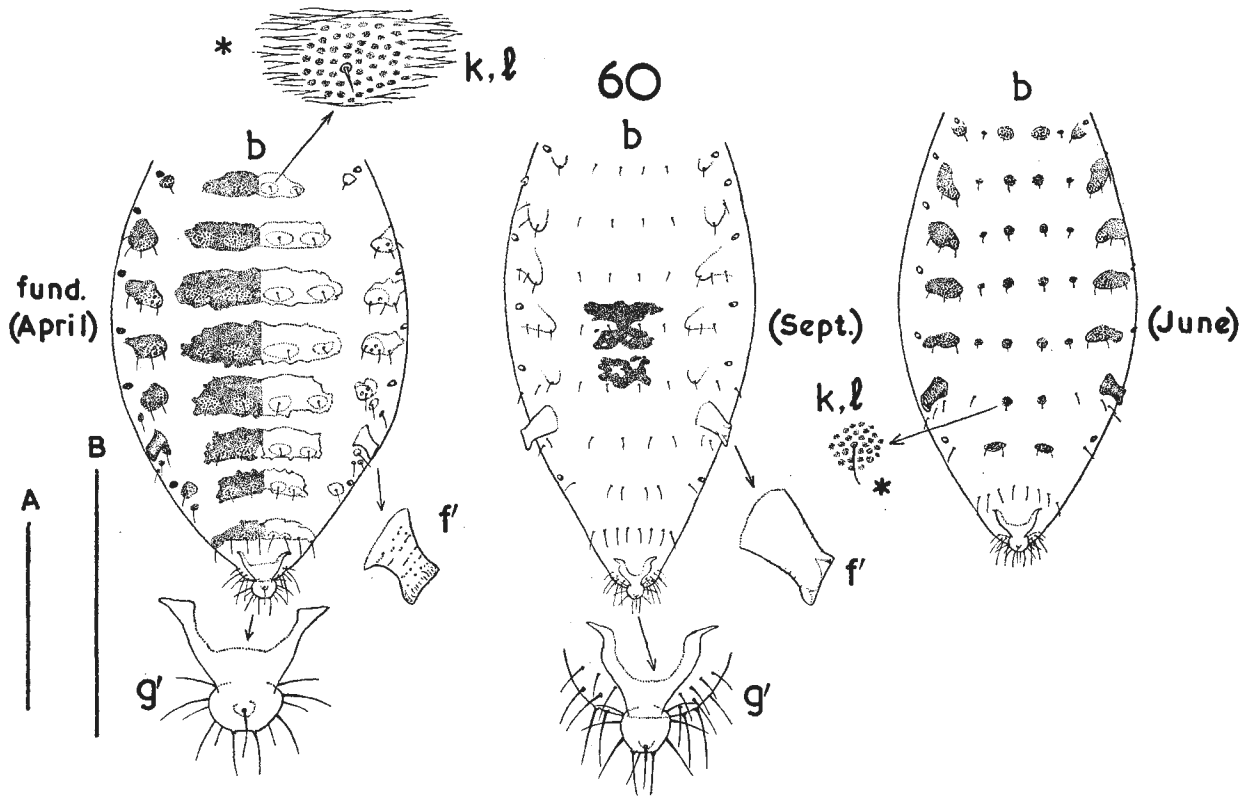

FIG. 60. *Euceraphis punctipennis* (see also p. 101).

Genus *EUCERAPHIS* Walker, 1870

Type-species (by designation of the International Commission on Zoological Nomenclature-Opinion 640): *Aphis punctipennis* Zetterstedt, 1828.

All viviparae *alate*. Large elongate pale green aphids clothed in life with flocculent bluish white wax. Body length 3.5–4.4mm. Antennae 6-jointed, flagellar joints together from not much more than half (in fundatrices) to considerably longer than body; proximally with faint pale granular striations (apparently wax-secreting) passing distally into distinct imbrications; joints I–II with wax-pore areas on inner face. Joint III from not quite 3 to about 3.7 times as long as VI; processus terminalis shorter than basal part of VI, of even thickness or thinner at base than on its distal half. Primary rhinarium on VI large and elongate. Secondary rhinaria confined to basal half of III, which is slightly incrassate; transverse to strongly transverse, with dotted borders and distinctly fringed on proximal side; 11–27 in number in a single to partly double row. Antennal hairs fine, acute, shorter than basal articular diameter of III: about 30–60 on III, 12–40 on IV, 10–20 on V and usually 1 on base of VI. Frons slightly emarginate due to low lateral prominences. Median ocellus more or less ventral, surrounded by a thickened sclerotic ring from which 2 Y-shaped thickened ridges proceed anterodorsad, their inner arms anastomosing on mid-frons, their outer arms diverging towards the lateral prominences. Frontal hairs on each side lying between the arms of the Y-shaped ridge; and 2 pairs of hairs lying within the area bounded by the circumocellar ring and the stems and inner arms of the Y-shaped ridges. Dorsal surface of head with 2 pairs of wax gland plates, a smaller pair just behind frons and a larger pair on vertex. Dorsal cephalic hairs similar to antennals; anterior discals 2–3 on each side, posterior discals (occipitals) 2 on each side. Ventral cephalic hairs up to as long as or longer than basal articular diameter of antennal joint III. Pro- and mesonotum more or less as in *Clethrobius*, but discal hairs on pronotum few, about 1 pair of anterior and 2–3 pairs of posterior spinals only. Pronotum, lateral lobes of mesonotum and scutellum each with more or less apparent pairs of wax gland plates. Rostrum short, not nearly reaching middle coxae, its apical segment similar to those of *Symydobius* and *Clethrobius*. Basal sclerotic arch present, but the thickening evanescent towards middle of dorsal surface. Wings with normal venation, membrane of forewing with only sparse squamulae peripherally. Hindwing with 4–6 hamuli. Entire pterothorax varying from blackish in early spring specimens to pale brown, or with only the mesonotal lobes blackish. Abdominal dorsum with highly variable sclerotic pigmented pattern: fundatrices with a complete series of transverse black bands on all tergites, bearing spinal and pleural wax gland plates in which stand the spinal and pleural hairs; midsummer *alatae* often wholly pale; late summer and autumn *alatae* with bands on middle abdominal tergites only. Wax gland plates in pale specimens very inconspicuous. Lateral prominences present on tergites 1–5, bearing more or less apparent wax gland groups and often also 2–3 small tubercles, but not usually as strongly pigmented as dorsal bands. Dorsal abdominal chaetotaxy normally consisting of a single transverse row of hairs on each tergite, 2 spinal, 2 pleural and 2–6 marginal. Tergite 8 with a transverse row of 5–8 hairs that are much longer than those of the middle tergites, and vary from shorter than

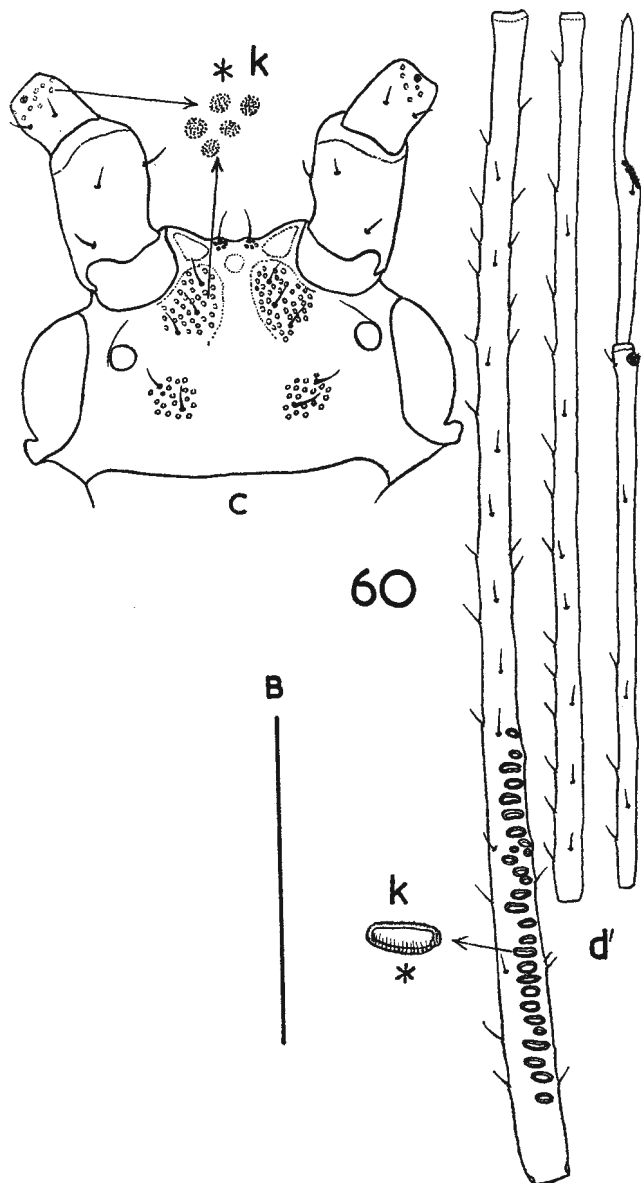

FIG. 60. *Euceraphis punctipennis* (see also p. 99).



to more than twice as long as the basal articular diameter of antennal joint III. Siphunculi situated just in front of the marginal sclerites of tergite 6; obliquely truncate with flared base and apex but no distinct flange, pale to dusky, faintly spinulose-imbricate, this being more apparent in darker specimens. Cauda slightly constricted before the more or less isodiametric knob, which bears a small dorsal excrescence and 11-16 hairs. Subanal plate rounded. Ventral abdominal hairs in more or less double staggered transverse rows, and in dark specimens frequently standing on small dark sclerites. Legs normal, coxae all of more or less even size. Tibiae with apical hairs partly modified into well-marked spurs, and spinulose between hairs near apex; with inconspicuous granular wax-pores on basal half. First tarsal joints with typically 7-9 ventral and 2 dorsal hairs. Second tarsal joints with spinulose imbrication. Claw hairs flattened, samariform. Rudimentary gonapophyses 3, often not recognisable as separate entities. Pigmentation of head and appendages very variable: in dark specimens all more or less blackish; intermediate phases with usually at least a longitudinal median dark vitta on head and some pigment round ocelli, as well as dark tarsi, tibial apices and bases, and anterior faces of femora at apex, and dusky antennae. Legs and antennae retain some dusky pigmentation even in the palest forms.

*Males* alate. Generally similar to viviparae but smaller (body length 3.2-3.5mm) and more slender. Antennae black, secondary rhinaria on III and V, absent from IV; those on III in a partially staggered double or even triple row, 47-68 in number; V with 8-14 in a single row concentrated distally. Abdomen with broad pigmented bands across all tergites, bearing gland groups as in viviparae; ventrally with narrow transverse lines of sclerites or sclerites bearing the ventral hairs.

*Oviparae* 3.7-4.2mm long. Antennal joints III-V with apices (up to half length of joint) blackish, VI mostly so. Secondary rhinaria absent. Hairs on antennal joint III maximally about 0.6 times basal articular diameter of joint, abruptly acute, rather thorn-like. Head sometimes with rudimentary ocelli. Frontal, dorsal and marginal hairs much longer than in alate morphs, their apices blunt to slightly capitate. Wax gland groups absent, replaced by pale brown roundish sclerites bearing the spinal, pleural and marginal hairs. Middle abdominal tergites also with a variable amount of darker sometimes mottled pigmentation round the spinal and pleural sclerites, sometimes forming more or less solid broad sclerotic bands. Siphunculi dark, flared with thickly rounded apical rim, more or less spinulose-imbricate. Abdomen somewhat produced behind siphunculi. Cauda with a trace of basal constriction. Abdominal tergite 8 with about 35-40 hairs, arranged in 2 groups at lateral margins and a single transverse row across middle of tergite. Subsiphuncular wax gland fields absent. Legs brownish sclerotic, tarsi and apices of tibiae blackish. First tarsal joints with or without dorsal hairs. Hind tibiae moderately swollen, with about 120-300 hardly raised pseudosensoria over basal 0.65-0.75 of their length.

*Immature morphs* pale green, waxy and very active; first instar with more or less completely 5-jointed antennae; pleural hairs from pronotum to abdominal tergite 6; spinal and marginal hairs of abdominal tergites not multiplied.

Sole British species.

**punctipennis** (Zetterstedt) (60)

*On young shoots and leaves of Betula spp., not attended by ants. Abundant wherever the hosts occur either naturally or planted.*

Genus **DREPANOSIPHUM** C. L. Koch, 1855

Type-species (Lichtenstein, 1885): *Aphis platanoidis* Schrank, 1801.

All viviparae *alate*. Medium-sized to large elongate aphids. Antennae 6-jointed, flagellar joints together from a little shorter to much longer than body. Joints IV–VI closely imbricate, III becoming smoother basad; processus terminalis much longer than basal part of VI. Primary rhinarium on VI with accessory rhinaria partly detached, 1 lying proximal to and 1 distal to the main group. Secondary rhinaria transverse oval, fimbriate, in a more or less single row along basal half of joint III. Antennal hairs fine and acute, those on III maximally about half as long as basal articular diameter of joint. Frons slightly to strongly emarginate, without or with only a very slight median convexity; structure simple, without thickened cuticular bands. Cephalic hairs simple, acute, slightly swollen at extreme base, and up to about twice or more as long as basal articular diameter of antennal joint III; frons with a medioventral and a laterodorsal pair; a pair behind these on vertex, and 2 pairs of occipitals (posterior discals) arranged more or less in a trapezium with the longer side anterior. Pronotum with an anteroposterior pair of spinal and a similar pair of marginal hairs on each side. Mesonotal and mesosternal lobes very finely shagreened but not nodulose or spinulose, or only very finely spinulose in middle of mesosternum. Rostrum short, not reaching middle coxae; without a basal sclerotic arch; apical segment normal in shape with 6–25 subsidiary hairs. Wings ample, with normal venation, 2nd fork of vein *M* deep; occasionally brachypterous; veins not shadowed, but sometimes with a small apical triangular spot on termen; squamulae mainly concentrated round termen and hind margin of forewings. Hindwing with 4–6 hamuli. Abdomen with a pair of longish spinal and a pair of shorter pleural hairs on each tergite from 1 to 6 inclusive; pleurals absent from tergite 7; marginal sclerites each with 1 long dorsal and 3–7 shorter ventral hairs; tergite 8 with 4–5 hairs. Siphunculi situated level with spinal hairs of tergite 5; long, vasiform (figs 61–64b), with a strong and deep circumcission immediately before the sharp apical flange; almost smooth or faintly cross-wrinkled. Cauda small, with a basal subtriangular part followed by a slight constriction delimiting an apical subcordate knob bearing typically 5 hairs. Subanal plate rounded. Legs with coxae all more or less equal in size; front femora strongly enlarged from near base, with a very large and elongate apical foramen; bases of front tibiae correspondingly enlarged. Tibial apices armed inwardly with 3–5 strong sclerotic dark teeth which are outgrowths of the tibial apices and not modified hairs with basal articulations (fig. 62I'); distal half to three-quarters of all tibiae with spinules between the hairs. First tarsal joints with ventral length more than twice basal width, and with typically 7 ventral and 2 dorsal hairs, the medioapical ventral one being a sense-peg. Second tarsal joints with transverse rows of fine spinules. Claw hairs flattened, scimitar-like. Rudimentary gonapophyses 3, with very small hairs.

*Males alate*. Morphology almost identical with that of viviparae except for genitalia and arrangement of secondary rhinaria, which are smaller, less transverse and arranged in a multiple dense way all along one side of antennal joint III, an irregularly double to triple row along IV and a single row along V.

*Oviparae* variably alatiform; occurrence of ocelli and secondary rhinaria

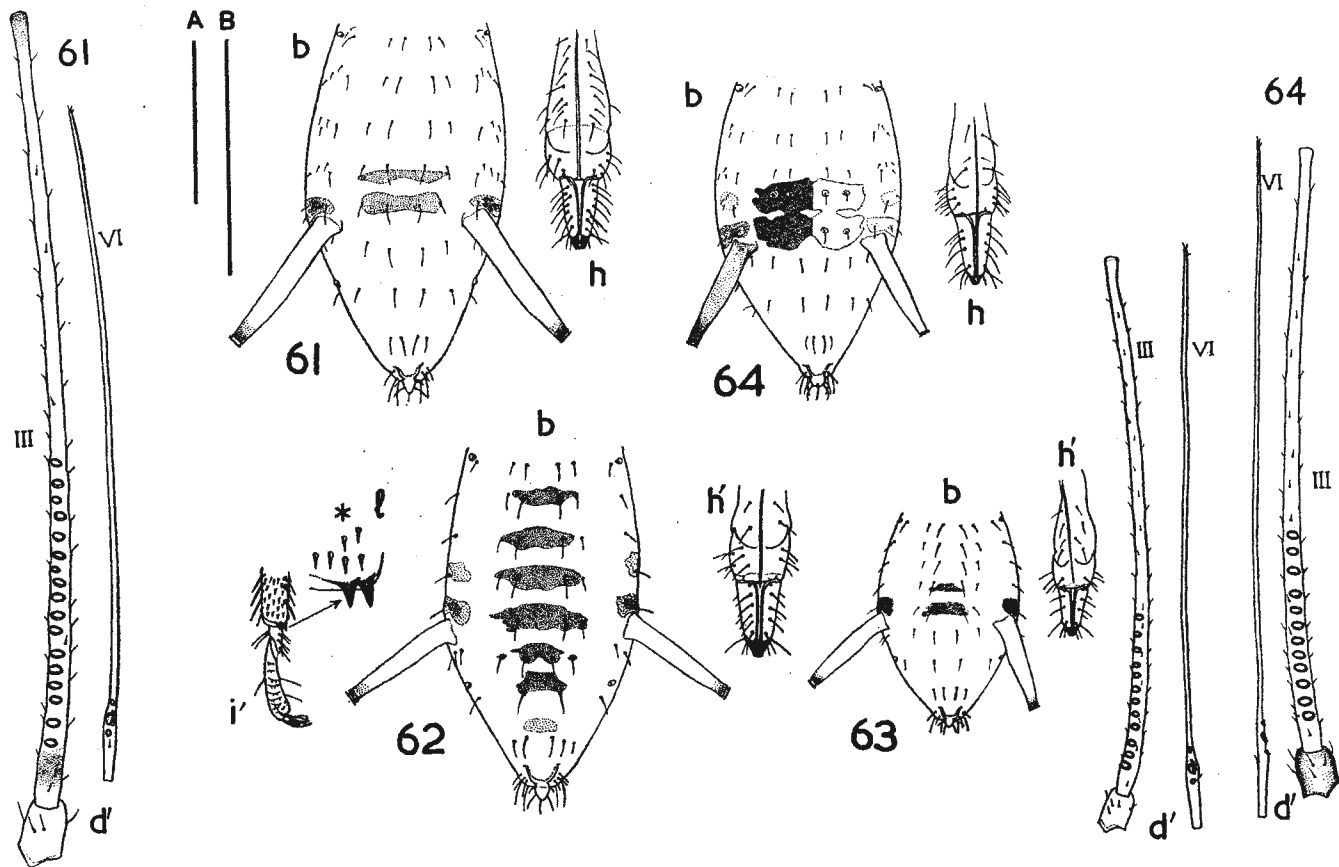

FIGS 61-64. 61, *Drepanosiphum aceris* (see also p. 122). 62, *D. platanoidis* (see also p. 106). 63, *D. acerinum* (see also p. 122). 64, *D. dixonii* (see also p. 122).

varying between species. Dorsal pigmentation variable, dark bands sometimes present on thoracic and first 5 abdominal tergites, at other times reduced or absent. Abdomen behind siphunculi produced into an ovipositor-like extension, the posterior tergites being either wholly membranous or with small individual hair-bearing scleroites. Dorsal body hairs subacute to blunt or subcapitate. Tergite 8 with more hairs than in viviparae, and of two types: very long primary hairs equivalent to those of viviparae, and a more or less variable number of much smaller ones either lateral to primaries or in a row behind them. Cauda without constriction or with only a small step-like one, more or less rounded and with about 14–20 hairs. Subsiphuncular wax gland field absent. Hind tibiae rather weakly swollen, with about 50–200 pseudosensoria.

*Immature morphs* pale and without pigmented hair-bearing scleroites on dorsum; first instar with 4- or 5-jointed antennae; pleural hairs present from mesonotum to abdominal tergite 6 inclusive.

The 4 British species live on the undersides of the leaves of *Acer* spp.

#### KEY TO SPECIES: VIVIPARAE

- 1 Apical rostral segment with 17–25 subsidiary hairs in addition to the constant 3 apical pairs. Forewing with a dusky cloud on membrane at apex in most specimens, between terminations of veins *Rs* and *M*<sub>1</sub>. Always fully winged. Pale whitish green, sometimes with darker green lateral lines. Thoracic lobes, siphunculi especially at apex, and transverse bars across abdominal tergites 4–5, sometimes dusky to blackish. 2.7–4.2mm. **aceris** Koch (61)  
*Under leaves of Acer campestre, usually near the ground. Local.*
- Apical rostral segment with not more than 15 subsidiary hairs. Forewing without dusky apical cloud on membrane; at most with small dusky triangles on margin at ends of main veins ..... 2
- 2 Processus terminalis not more than 0.7 times as long as antennal joint III. Maximal length of hairs on abdominal tergite 3 0.12mm or more. Antennal joint III with 13–24 secondary rhinaria. Apical rostral segment 0.8–1.0 times as long as 2nd hind tarsal joint measured without claws, and with 8–15 subsidiary hairs. Pale green to grey-green, sometimes reddish- or lilac-tinged. Pigmentation of sclerotic parts very variable: in palest specimens only distal parts of antennal joints, tips of siphunculi, extreme bases of tibiae, and tarsi dusky; in darkest specimens most of antennae, posterior half of head, whole of mesonotum, a row of spindle-shaped transverse bars on abdominal tergites, bases and apices of tibiae, and tarsi black, and base of antennae, anterior half of head, pronotum, femora, siphunculi and shafts of tibiae pale to dark brownish. Never with black bands across abdominal tergites 4–5 only while rest of dorsum is pale. 3.2–4.3 mm. **platanoidis** (Schrank) (62)  
*Under leaves of Acer pseudoplatanus, casually also on other Acer spp. Exceedingly abundant nearly everywhere.*
- Processus terminalis more than 0.7 times as long as antennal joint III. Hairs on abdominal tergite 3 maximally 0.05–0.11mm long. Secondary rhinaria on antennal joint III 9–20 in number ..... 3
- 3 Apical rostral segment 0.7–0.8 times as long as second hind tarsal joint without claws, and with 5–6 subsidiary hairs. Always fully winged. Pale whitish green to chrome yellow; mesothoracic lobes sometimes pale brownish sclerotic, siphunculi pale with dusky tips; marginal sclerites of abdominal tergite 5 conspicuously blackish, and often with a blackish sclerotic band across this tergite, or less often across tergites 4 and 5. 2.1–3.3mm. **acerinum** (Walker) (63)  
*Under lower leaves of Acer pseudoplatanus, usually in shade. Local.*
- Apical rostral segment 1.0–1.15 times as long as second hind tarsal joint without claws, and with 8–12 subsidiary hairs. Usually more or less brachypterous, rarely fully winged. Pale yellow with margins of abdomen dull green; head and thorax more or less dusky to dark sclerotic, siphunculi pale brownish with darker

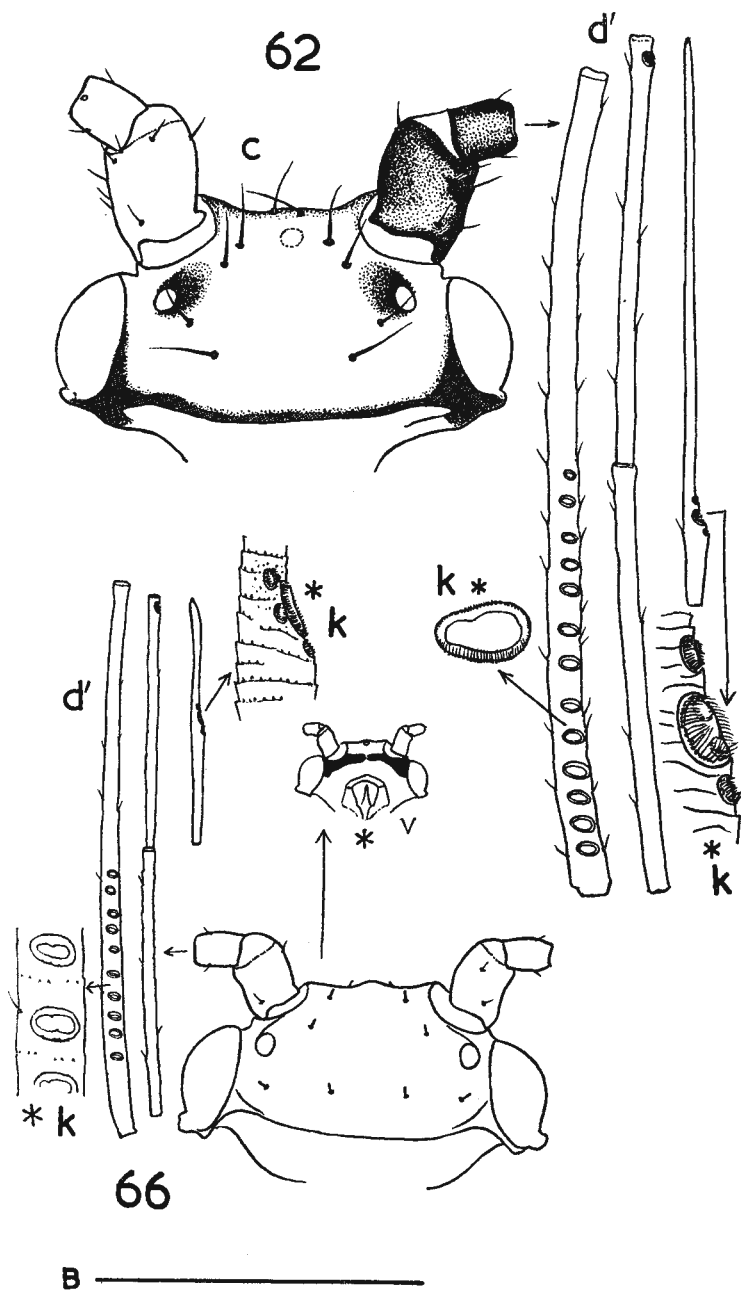

FIGS 62, 66. 62, *Drepanosiphum platanoidis* (see also p. 104). 66, *Therioaphis riehmii* (see also pp. 109, 123)

tips to wholly black; abdominal tergites 4-5 with well-developed brown to black transverse bands, that on 5 often reaching to the black marginal sclerites and thus apparently filling the whole width of the abdomen just in front of the siphunculi. Small paired spinal sclerites sometimes present on tergites anterior and posterior to 4-5. 2.5-3.3mm. **dixoni** Hille Ris Lambers (64)

*Under lower leaves of Acer campestre in shady places, or sometimes on water-shoots springing from lower parts of trunks. Hertford, Cambridge, rare.*

### Genus THERIOAPHIS Walker, 1870

Type-species: *Aphis ononidis* Kaltenbach, 1843.

Viviparae *apterous* or *alate*, or (*T. riehmi*) all *alate*. Rather small to medium-sized yellowish aphids living on various Papilionaceae.

*Alatae*: Body length 1.7-2.7mm. Antennae 6-jointed, slender, shorter than body; minutely spinulose on imbrications; processus terminalis from slightly shorter to slightly longer than basal part of VI; primary rhinaria small; joint III with a single row of mostly transverse secondary rhinaria with fairly wide but not striate or fimbriate rims. Antennal hairs small, fine and acute, shorter than basal articular diameter of joint III. Frons more or less flat or with a slight median convexity dorsal to median ocellus. Compound eyes with prominent triommatidion. Ventral surface of head with a dark transverse band joining anterior angles of compound eyes. Frontal hairs in 2 pairs, 1 ventral and 1 dorsal; 2 further pairs one behind the other on vertex (anterior discals); occipitals (posterior discals) in a transverse row of 4. Dorsal cephalic hairs on slight eminences. Pronotum normally with a single anteroposterior pair of spinal hairs and a single marginal hair on each side; the spinals may be irregularly duplicated. A small flat inconspicuous marginal tubercle (wax gland element) present alongside each marginal hair; this tubercle occasionally duplicated or even triplicated. Pterothorax with smooth featureless cuticle. Rostrum short, not reaching middle coxae; with a well-marked basal sclerotic arch; apical segment normal to rather compressed, its dorsal length greater than ventral length. Wings ample; forewing with *Rs* obsolescent; *M* and *Cu*<sub>1</sub> slightly sinuate, *Cu*<sub>2</sub> somewhat recurved (fig. 66e); veins to a varying degree brownish shadowed, and ending in small brown triangular spots on termen, these again variably developed; apical part of pterostigma also outlined in brown. Hindwing also with veins ending in brown triangular spots, and with 2-4 hamuli. Abdominal dorsum with hairs arranged in single spinal, marginal and often also pleural series, the spinals of tergites 3, 5 and 7 being more or less displaced laterally; occasionally spinal or pleural hairs may be duplicated, thus giving a transverse row of more than 6 hairs across the tergite concerned. Marginal hairs on backwardly directed tubercular projections from tergite 2 to tergite 5 inclusive, those on 2 being the most conspicuous, very black in colour and strongly roughened or nodulose. Spinal and pleural hairs (the latter if present) also often standing on distinct raised tubercular bases. All dorsal hairs bluntly rod-shaped or variably capitate apically. Dorsal pigmentation variable; bases of hairs surrounded by more or less roughened dark sclerites, and these in turn sometimes surrounded by larger, paler areas that shade off from a darkish peripheral ring inwards towards the dark hair base; intersegmental muscle sclerites also well pigmented. Tergite 8 with 2-6 hairs standing on separate pigmented bases. Siphunculi stump-shaped, flangeless, variably rugose,

lying just anterodorsal to marginal sclerites of tergite 6. Cauda rather large, with an elongate, somewhat cordiform knob bearing 2 long hairs at its apical angles and about 10–18 smaller finer ones ventrally. Subanal plate strongly bilobed, depth of emargination about four-sevenths of the length of the plate, and its width at half depth about equal to that of the two lateral lobes at the same level. Marginal tubercles like those on pronotum also occur irregularly on some abdominal marginal sclerites, especially on tergite 7 where they are normally quite clearly present. Front legs with coxae greatly enlarged and used for leaping; remaining coxae normally developed, and all faintly spinulose. Femora normal, ventrally with scattered spinules; tibiae increasingly spinulose between hairs from base to apex, their outer hairs near base of tibiae somewhat blunt, their inner apical hairs modified to thick spur-like spines. First tarsal joints with typically 6 ventral and 2 dorsal hairs, the medioapical ventral one being a sense-peg; second tarsal joints with closely set transverse rows of spinules. Claw hairs flattened, boomerang-shaped. Rudimentary gonapophyses 2.

*Apterae*: characters as for *alatae*, except that dorsal body hairs may be longer and more strongly capitate.

*Males* alate so far as known, with sclerotic pattern like that of *alatae* or sometimes more strongly pigmented, and with secondary rhinaria present on antennal joints III–V inclusive.

*Oviparae* similar to *apterae* in most ways, but with posterior extremity produced into an ovipositor-like extension. Abdominal tergite 8 with more numerous hairs than in *viviparae*, the extra ones being lateral in distribution. Secondary rhinaria present on antennal joint III. Subanal plate entire, rounded. Subsiphuncular wax gland fields absent. Hind tibiae somewhat swollen, with roundish, rather convex pseudosensoria over the basal two-thirds of their length.

*Immature morphs* similar to *apterae*; first instar with spinal hairs of abdominal tergites 3, 5 and 7 displaced laterad, or those of 3 sometimes more or less in line; pleural hairs absent.

#### KEY TO SPECIES

- 1 Abdominal tergites 1–7 each bearing only 1 spinal and 1 marginal hair on each side (only exceptionally an odd pleural hair may occur asymmetrically on one tergite) ..... 2
- First 5 abdominal tergites typically with 6 or more hairs, viz. 1 spinal, 1 pleural and 1 marginal on each side, with or without further interpolated accessory hairs. *Viviparae* both *apterous* and *alate* ..... 3
- 2 Apical rostral segment longer than second hind tarsal joint measured without claws, and with 10–15 subsidiary hairs in addition to the 3 constant apical pairs. *Viviparae* both *apterous* and *alate*. ..... *ononidis* (Kaltenbach) (65)  
*On Ononis spinosa and arvensis. Local.*
- Apical rostral segment shorter than second hind tarsal joint without claws, and with not more than 6 subsidiary hairs. *Viviparae* all *alate*. ..... *riehmi* (Börner) (66)  
*On Melilotus spp. Hertford, Suffolk, rare.*
- 3 First 5 abdominal tergites each with 5–8, but only very rarely more than 6, hairs. Tergite 8 with only exceptionally more than its 2 spinal hairs. ..... *luteola* (Börner) (67)  
*On Trifolium pratense. Hertford, Bedford, very rare.*
- First 5 abdominal tergites each with 7–10 hairs. Tergite 8 with 3–6 hairs, i.e. 1–4 in addition to the 2 spinal hairs. ..... *trifolii* (Monell) (68)  
*On Trifolium, Medicago or Lotus spp. Kent, Berkshire, Essex, Bedford, rare.*

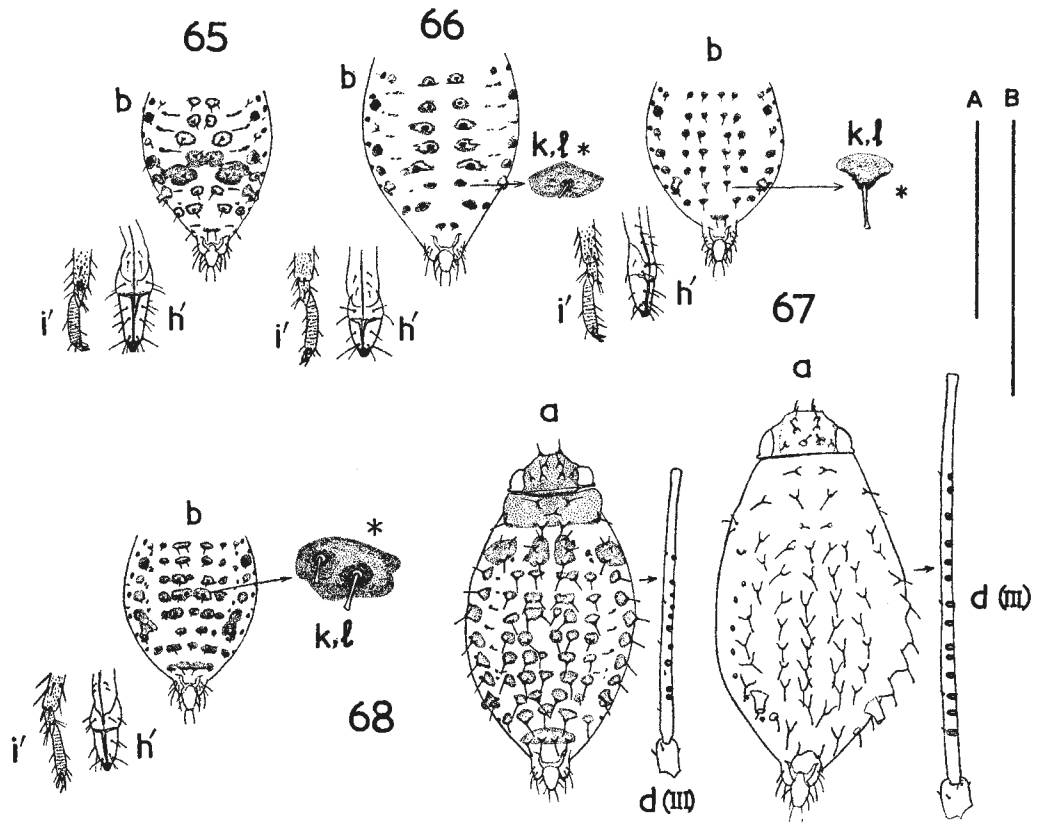

Figs 65-68. 65, *Therioaphis ononidis* (see also p. 90). 66, *T. richmi* (see also pp. 106, 123). 67, *T. luteola*. 68, *T. trifolii*.



Genus *TRICHOCALLIS* C. Börner, 1930

Type-species: *Allaphis caricis* Mordvilko, 1921 (syn.: *Thripsaphis thripsoides* H.R.L., 1939).

Viviparae *apterous* or *alate*. Elongate pale yellow to brownish yellow aphids, sometimes with dusky sclerotic dorsal pigmentation or clothed in life with bluish grey pruinose wax secretion.

*Apterae*: Body length 2.0–3.1mm. Antennae 6-jointed, at most a little more than half as long as body; joint III with up to 6 round secondary rhinaria in a single row; processus terminalis from half as long as to slightly longer than basal part of joint VI. Primary rhinaria rather small, fringed. Antennal hairs fine, acute, shorter than basal articular diameter of joint III. Frons convex to strongly produced medially, lateral prominences not developed. Lateral frontal hairs absent. Compound eyes prominent, without a defined triommatidion. Rostrum short and stout, reaching just past front coxae; apical segment short, bluntly subtriangular with length and basal width about equal, and with 2 subsidiary hairs. Dorsum solidly sclerotic except for intersegmental lines from thorax I/II to abdomen 2/3 inclusive, and abdomen 6/7 and 7/8. Siphunculi slightly raised pores located on margins of abdominal tergite 6. Tergite 8 with hind margin either entire and broadly convex or with the median pair of hairs borne on paired or unpaired projections. Cauda strongly knobbed, the knob bearing 9–26 hairs. Dorsal body hairs short, simple and acute. Subanal plate deeply cleft. Legs normal, front coxae not much larger than middle or hind coxae. Femora, tibiae and tarsi all more or less spinulose, tibial apices without differentiated spur hairs. First tarsal joints typically with 4, rarely 5 long ventral setae and 1 medioapical sense-peg. Claw hairs bristle-like. Rudimentary gonapophyses 2.

*Alatae*: Size range as for apterae. Head, antennae except at base of III, and pterothorax blackish sclerotic. Antennal joint III with about 8–20 roundish to transverse oval secondary rhinaria more or less in a line, these with a dotted or inconspicuously fringed border; joint IV rarely with 1 secondary rhinarium but usually with none. Mesonotum, or pro- and mesonotum, with conspicuous nodulose sculpture. Abdominal dorsum with tergal bands and marginal sclerites which are nodulose or denticulate-spinulose; the tergal bands on abdominal segments 3–6 may fuse into a more or less solid mid-dorsal shield. Wing venation normal, veins brown pigmented or narrowly brown-bordered, sometimes ending in a brown triangular cloud at wing margin.

*Males* apterous, like small viviparae but more slender. Antennae longer than in viviparae, with secondary rhinaria on joints III–VI (base) inclusive; those on III in a staggered double to partly triple row, those on IV–VI more or less in a single row. Abdominal tergites mutually free, not fused into a carapace.

*Oviparae* similar to apterae, but abdominal tergites mutually free as in males. Subsiphuncular wax gland fields present. Hind tibiae slightly to moderately swollen, with about 20–140 pseudosensoria.

*Immature morphs* with dusky head and pronotal shield and marginal sclerites, and small dorsal sclerites bearing individual spinal and pleural hairs. First instar without pleural hairs, and with 4-jointed antennae.

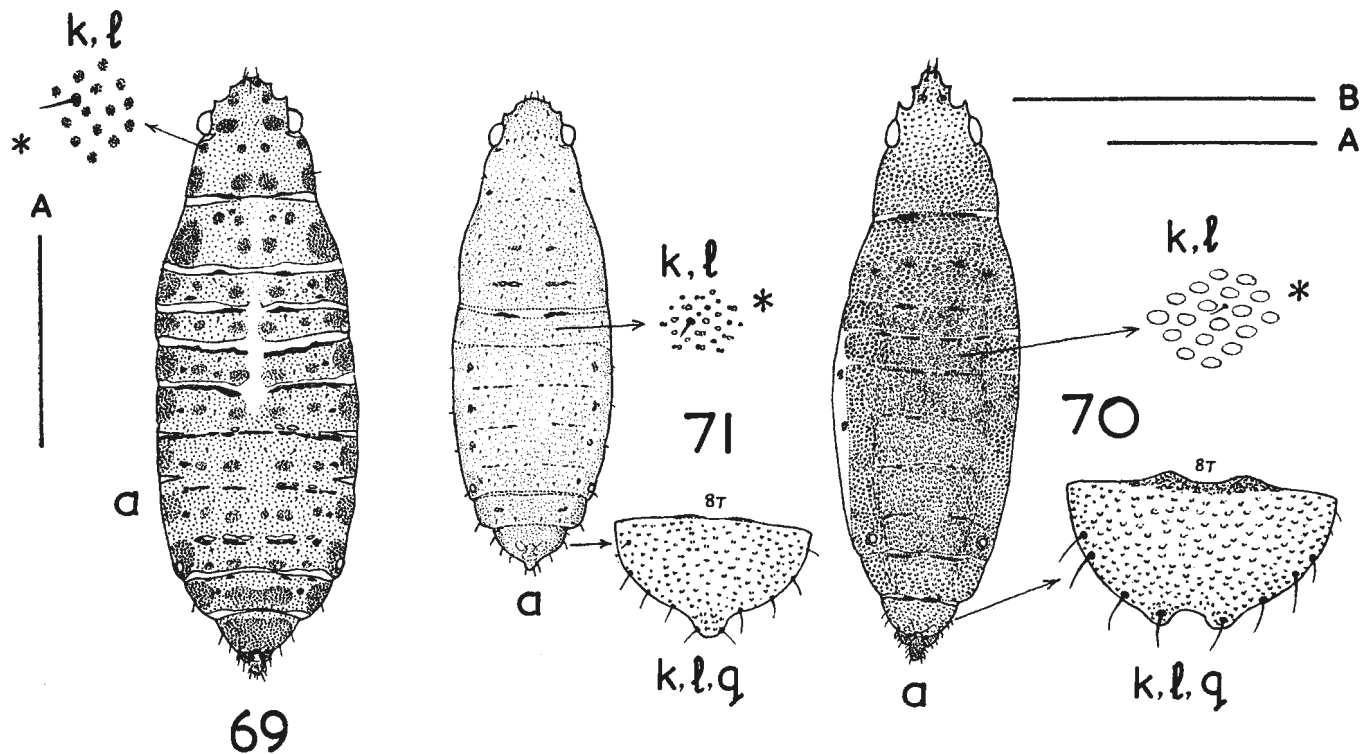

FIGS 69-71. 69, *Trichocallis cyperi*. (see also pp. 113, 115, 123). 70, *T. verrucosa* (see also pp. 113, 115). 71, *T. caricis* (see also pp. 115, 123)

## KEY TO SPECIES: VIVIPARAE

- 1 Dorsum in slides smoky grey-brown with darker spots or patches spinally, pleurally and marginally, these corresponding to groups of roundish wax pores surrounding the primary dorsal hair series (figs 69a, k). Tergites abd. 7-8 each with a continuous transverse band of wax pores, that of tergite 7 lying on posterior half, while anterior half bears a row of more or less discrete hair-centred pore groups. Femora, tibiae and antennae also with pale granular striae or pores that are apparently wax-secreting. Hind margin of abdominal tergite 8 simple, without projections bearing the median hairs. Dorsal abdominal sclerites with at most local areas of sparse denticulate spinulosity. Body in life with a bluish white flocculent wax coating; in alcohol pale straw-coloured with grey-brown suffused dorsal sclerotic pattern or (*alatae*) dark tergal bands. **cyperi** (Walker) (69)  
*On Carex rostrata, vesicaria and spp. Widespread, commoner in the north.*
- Dorsum of *apterae* in slides uniformly palish sclerotic, without darker localized spots or patches. *Alatae* with dark head, thorax and abdominal sclerites. Wax pores absent from most of body, only present locally on posterior margin of abdominal tergite 8. Legs and antennae without wax-secreting striae or pores. Hind margin of abd. tergite 8 with a median prominence or prominences bearing the spinal pair of hairs. Sclerotic dorsal cuticle with rather evenly distributed roundish to oval nodules that may bear small denticles. Body in life not waxy, only with an inconspicuous posterior fringe on abd. 8; colour pale to darkish yellow. . 2
- 2 Frons with a strongly produced rather squarish median process (figs 70a, c). Abdominal tergite 8 not concealing cauda in *apterae*, its spinal hairs on 2 separate slight prominences with a slight emargination between (fig. 70q). Caudal hairs 15-21. Larger aphids (viviparae 2.6-3.1mm), antennal flagellum (III-VI incl.) in *apterae* 0.44-0.55, in *alatae* about 0.60 times body length. Processus terminalis 0.8-1.1 times base of VI. *Alatae* with bands on abd. 3-6 at least partly separated along boundaries of tergites. Dorsal body hairs very fine and inconspicuous, not easily seen under low power (e.g.  $\times 10$ ) objective. **verrucosa** (Gillette) (70)  
*On Carex nigra, ovalis and spp. Widespread and locally common.*
- Frons with a less pronounced, roundish median convexity (fig. 71a). Abdominal tergite 8 overhanging and hiding cauda in *apterae*, its spinal hairs on a small unpaired prominence (fig. 71q). Caudal hairs 9-12. Smaller aphids (viviparae 2.0-2.6mm), antennal flagellum in *apterae* 0.34-0.42, in *alatae* 0.46-0.55 times body length. Processus terminalis 0.5-0.75 times base of VI. *Alatae* with a more or less fused central shield on abdominal tergites 3-6 inclusive. Dorsal body hairs thorn-like, easily seen under a low power objective. **caricis** (Mordvilko) (71)  
*On a wide variety of Carex spp. Widespread but less frequently met with than the other two species.*

## Genus SUBSALTUSAPHIS Quednau, 1953

Type-species: *Saltusaphis intermedia* Hille Ris Lambers, 1939.

Viviparae *apterous* and *alate*. Elongate, rather flattened greyish white to ochreous yellow aphids, with or without dusky dorsal segmental markings in *apterae*; living on Cyperaceae, mostly *Carex* spp. Not pulverulent in life.

*Apterae*: Body length 1.3-3.0mm. General facies like that of *Trichocallis*, but flatter. Antennae without secondary rhinaria, and with all joints more or less strongly spinulose or denticulate on imbrications throughout. Dorsal surface of body pale sclerotic, adorned more or less densely with wavy transverse lines (on pleurae sometimes forming reticulations) of small nodules or denticles, which in surface view appear round, but when seen in silhouette at the abdominal margins are more or less acuminate apically. (In the non-British *S. pallida* (H.R.L.) these are larger, transverse oval and much flatter, and have been interpreted as rings or pori; but following them to the body margin shows them to be slightly convex, and thus not qualitatively different from those of the other species of the genus.) Dorsal and marginal body

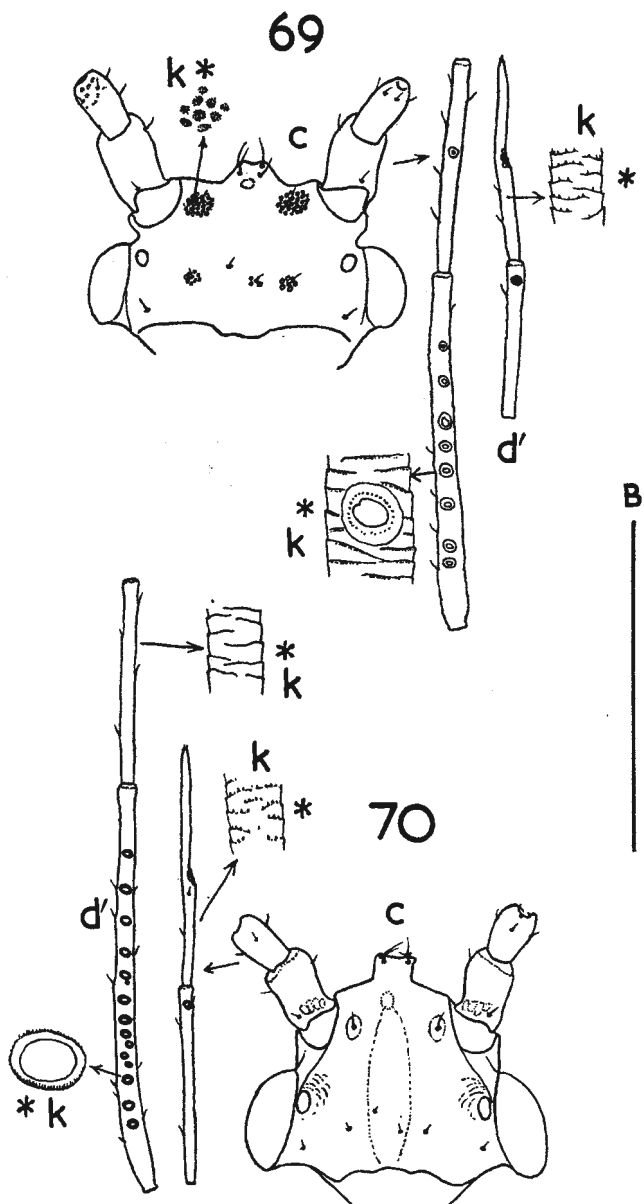

FIGS 69-70. 69, *Trichocallis cyperi* (see also pp. 111, 115, 123). 70, *T. verrucosa* (see also pp. 111, 115).

hairs to a greater or lesser extent modified into structures resembling an everted umbrella, the 'stellate microchaetae'. These and the cuticular nodules are of taxonomic value. The number and density of the stellate microchaetae is variable between and sometimes within species. Hairs of normal structure, with apices varying from acute to blunt, may occur mixed with the stellates, and are always found on the frons and round the margins of abdominal tergite 8, in which places they are long and stout; in addition, other tergites progressing forward from 7 may bear a pair (or rarely more than one pair) of such normal hairs on their margins; this is nearly always so on the hind angles of tergite 7, and rather often also on 6 just behind the siphunculi; but much more rarely on tergites from 5 anterad. Abdominal tergites 3-6 fused together, the rest mutually free. Intersegmental muscle sclerites well developed, showing as dark narrow transverse lines across the body. Abdominal tergite 8 with the 2 middle pairs of hairs on the posterior margin borne on a pair of usually slightly angular projections with a shallow median emargination between them (figs. 72-76a). Dorsal wax gland groups absent. Arms of mesothoracic furca arising from separate invaginations. Legs much as in apterae of *Trichocallis*, but with claw hairs of tarsi flattened.

*Alatae*: In general facies like those of *Trichocallis verrucosa* and *T. caricis*, from which they differ as follows: Frons without any median dorsal projection or prominence overhanging the median ocellus. Head and antennae more strongly denticulate-spinulose. Secondary rhinaria finely fringed, in a more or less single row along III, occasionally also 1-3 on IV. Vertex of head with more numerous hairs, which apart from the frontal pairs are more or less modified into stellate microchaetae. Pronotum evenly adorned with small denticles; mesonotum with a mixture of these and larger, coarser nodules. Abdominal dorsum with a central shield formed by the fused segmental bands of tergites 3-5; tergites 1-2 with a pair of small pleural sclerites on each; tergite 7 with sclerite divided into anterior and posterior components, the latter usually further divided into two parts medially; tergite 6 either with a more or less solid trapezoid sclerite with a paler central area, or with divided sclerites like those of tergite 7. Tergite 8 sclerotised round posterior margin. Marginal sclerites more or less as in *Trichocallis verrucosa* or *T. caricis*. Pigmented sclerites with wavy lines of small nodules like those of apterae, not coarsely and scabrously nodulose as in the two *Trichocallis* species. Distribution of stellate microchaetae as for apterae but usually sparser. Wings more or less as in *Trichocallis* but vein *Cu* (2nd oblique vein) absent from hindwing; veins of forewing sometimes lightly shadowed in pale brownish. Legs rather pale sclerotic with a dusky cloud on each femur towards apex on anterior face.

*Males* apterous. Similar to small slender apterae, but with abdominal tergites mutually free. Secondary rhinaria small, round, fringed, present from antennal joint III to VI (base) inclusive, often lying side by side or even 3 abreast on III.

*Oviparae* similar to apterae but with abdominal tergites 3-6 mutually free. Subsiphuncular wax gland fields present, their polygonal facetting obscure except in oblique view. Hind tibiae somewhat swollen on proximal 0.75 to 0.83 of their length, and with a moderate number (about 70-130) of rather convex pseudosensoria.

*Immature morphs* with dorsal sclerotisation reduced to small individual

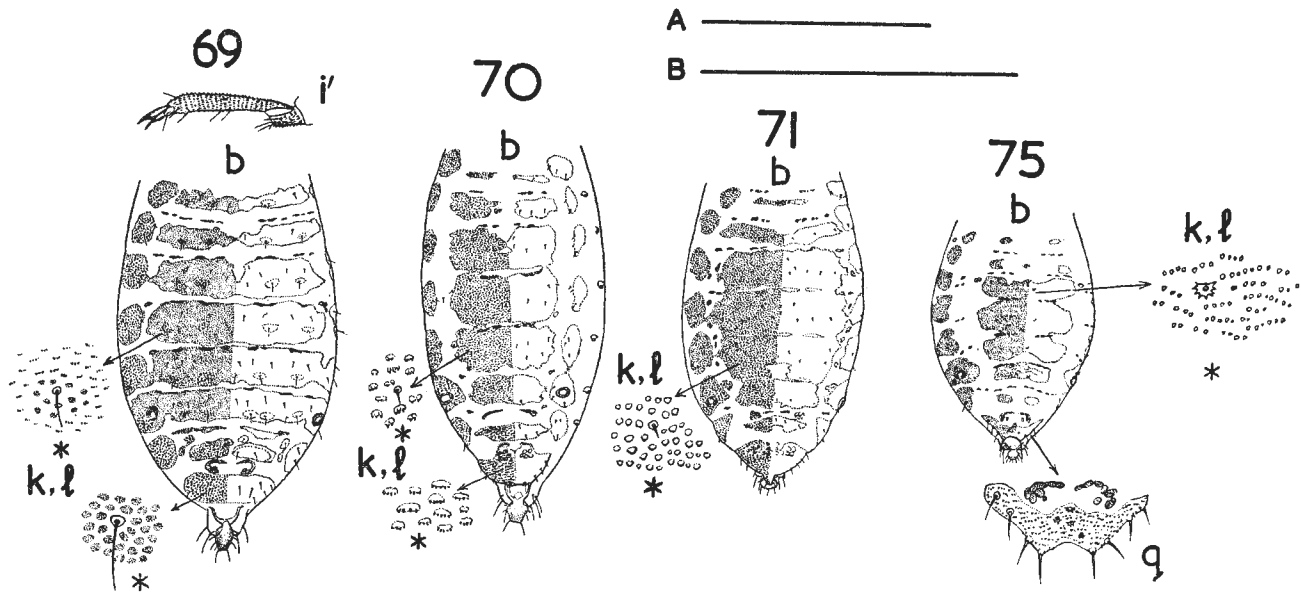

Figs 69–71, 75. 69, *Trichocallis cyperi* (see also pp. 111, 113, 123). 70, *T. verrucosa* (see also pp. 111, 113). 71, *T. caricis* (see also pp. 111, 123). 75, *Subsalsusaphis paniceae* (see also p. 119).

hair-bearing sclerites on a very few posterior tergites (even these absent in younger instars), somewhat larger marginal sclerites, and sclerotic shields occupying the head, pronotum and tergite 8. Chaetotaxy similar to that of adults, or sometimes with stellate microchaetae more or less replaced by normal thorn-like hairs. Legs and antennae strongly spinulose. First instar with pleural hairs usually from pro- or mesonotum to abdominal tergite 6, often irregularly duplicated; antennae 4-jointed.

There are 5 known British species, but as many again are known from neighbouring countries of northern and western Europe, and at least some of these may be confidently expected to occur here. It is hard to find reliable specific discriminants for the species within the group centring on *S. picta* (H.R.L.), since those that have been mainly used hitherto are open to suspicion of liability to modification by environmental factors such as temperature and humidity. The following key to apterous viviparae may serve as a baseline for the further study of the British *Subsaltusaphis*.

#### KEY TO SPECIES: APTEROUS VIVIPARAE

- 1 Dorsum without any trace of dark longitudinal lines (fig. 72a). Microchaetae very numerous, all stellate and of a regular subcircular shape in surface view, with many shallow dentations round their margins (fig. 72l). Margins of abdominal tergite 8 with 16-20 long normal hairs. **flava** (Hille Ris Lambers) (72)  
*On Carex nigra. Anglesey, Inverness, rare.*
- Dorsum with at least faint traces of dusky longitudinal lines (sometimes broken into segmental spots or patches) under low powers of magnification. Abdominal tergite 8 laterally with 6-16 long hairs. . . . . 2
- 2 Dorsal cuticle rather evenly and densely adorned with fairly coarse nodules. Microchaetae in surface view very irregular and usually asymmetrical, with only a few coarse and jagged cusps, or sometimes reduced to forked or blade-shaped structures (fig. 73l), but not simple thorn- or rod-like chaetae. **roszneri** (Börner) (73)  
*On Carex rostrata, elata and vesicaria. Merioneth, Cumberland, Argyll, Inverness, Aberdeen, Caithness, local.*
- Dorsal cuticle adorned with nodules that become finer and less dense towards lateral margins of tergites and towards mid-dorsum. Stellate microchaetae usually with rather few acute and jagged cusps, but not markedly asymmetrical; occasionally partly replaced by simple thorn-like or rod-like chaetae (figs 74-76l). . . . . 3
- 3 Pleural longitudinal dark lines on dorsum well-marked and clearly defined on spinal side; sometimes broken into segmental spots, but normally nearly or quite as dark as the neighbouring intersegmental muscle sclerites (fig. 74a). Mid-dorsum between dark lines strikingly pale, very finely and sparsely nodulose, with at most small traces of dusky sclerites in the middle of one or more of the first 4 abdominal tergites. Sides of abdominal tergites 7-8 bearing long normal hairs. Posterior angle of tergite 7 produced, not much over 100°. **ornata** (Theobald) (74)  
*On Carex riparia and ?acutiformis. Locally common.*
- Pleural longitudinal lines on dorsum very ill-defined, much paler than intersegmental muscle sclerites. Mid-dorsum not conspicuously pale, usually with an ill-defined median line on first 4 abdominal tergites (figs 75-76a). . . . . 4
- 4 Smaller aphids (body length 1.3-2.3mm). Antennal joint III 0.91-1.32 (population means 1.05-1.09) times as long as joint VI. Long normal hairs usually on lateral margins of tergites 7-8, more rarely also on tergite 6. **paniceae** (Quednau) (75)  
*On Carex panicea and flacca. Argyll, Aberdeen, rarely recorded but probably widespread.*
- Larger aphids (body length 2.4-3.0mm). Antennal joint III 1.20-1.51 (population means 1.33-1.42) times as long as joint VI. Long normal hairs usually on lateral margins of tergites 6-8, more rarely only on 7-8. Posterior angle of tergite 7 obtuse, about 120°. **picta** (Hille Ris Lambers) (76)  
*On Carex acuta and ?acutiformis, also sometimes on Scirpus spp. growing in the same biotope (river and pond margins). Locally common.*

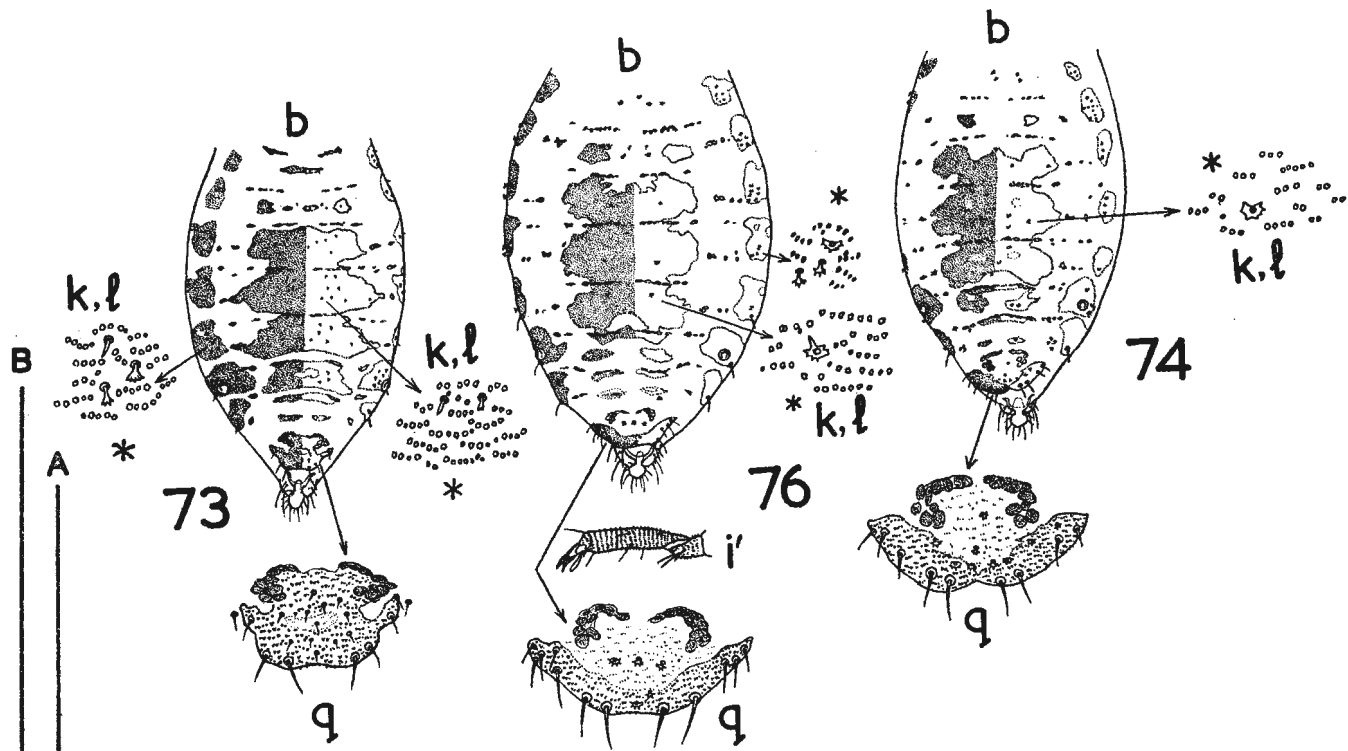

FIGS 73-74, 76. 73, *Subsaltusaphis roszneri* (see also p. 119). 74, *S. ornata* (see also p. 119). 76, *S. picta* (see also pp. 119, 120, 123).



Genus *IZIPHYA* Nevsky, 1929

Type-species: *Iziphya maculata* Nevsky, 1929.

*Viviparae apterous and alate.* Short, broad, squat greyish, yellowish or greenish yellow aphids, usually conspicuously marked with black on dorsum. Living on *Carex* or *Juncus* spp., leaping from the host when disturbed.

*Apterae:* Body length 1.6–2.0mm, not more than about twice maximum width of abdomen when mounted on slides. Antennae 6-jointed, flagellar joints (III–VI) together from a little less to rather more than half as long as body; closely spinulose imbricate throughout; without secondary rhinaria; accessory rhinaria on joint VI mostly lying apart from primary rhinarium and either proximal or distal to it; processus terminalis, measured from distal border of primary rhinarium, about 0.9–1.8 times as long as basal part of VI. Antennal hairs fine and acute, those on joint III maximally about 0.3–0.5 times as long as basal articular diameter of joint. Frons distinctly convex, broad (distance between bases of antennae about one-eighth or more of body length). Compound eyes prominent, without distinct triommatidion. Rostrum very short, not reaching middle coxae; apical segment short and squat, not much longer than its basal width, dorsally with a few fine denticles or spinules, and with 1 pair of subsidiary hairs; from about half to two-thirds as long as second hind tarsal joint without claws. Dorsal hairs on head and body in British species more or less modified to fan-shaped ('flabellate') structures, and total number multiplied so that longitudinal seriation is no longer apparent unless by the primary hair series standing on more elevated and protuberant bases than the supernumerary hairs. Dorsum very variably marked with blackish; head dark with usually a paler central area; large dark areas laterally on metathorax and round each siphunculus, the latter usually more or less joined by an arcuate band across abdominal tergite 5; tergites 7–8 also mainly dark, and remainder of dorsum more or less thickly scattered with dark scleroites bearing many of the dorsal hairs. Dark areas variably adorned with fine spinules. Dorsal wax gland groups absent. Siphunculi short, stump-shaped with a rounded apical rim; ornamented with rows of small denticles; situated towards anterior margin of tergite 6. Cauda with a rather large subquadrate knob bearing about 13–21 hairs. Subanal plate strongly bilobed, the median excision about half as deep as the length of the lateral lobes. Abdominal spiracles small and inconspicuous, overhung by the posterior margins of the dark spiracular plates. Mesothoracic furca with arms arising from a common invagination, and rigidly united. Front and middle legs with strongly enlarged femora, and bases of tibiae modified to a smooth, dark, heavily sclerotic 'kneecap' that articulates with the femoral apex (fig. 77Ti). All femora and bases of tibiae rather dark. Legs strongly spinulose throughout except for 'knee-caps' and basal part of femora. Tibial apices without modified spur hairs, but some basal hairs on outer sides of tibiae usually blunted, subcapitate or flabellate. First tarsal joints typically with 4 long ventral hairs and a shorter medioapical, rather slender sense-peg. Claw hairs flattened, boomerang-shaped. Rudimentary gonapophyses 2.

*Alatae* generally similar to apterae. Antennae relatively a little longer; joint III with about 10–20 small, partly very shortly fringed secondary rhinaria more or less in a single row; IV sometimes with up to 4. Pterothorax

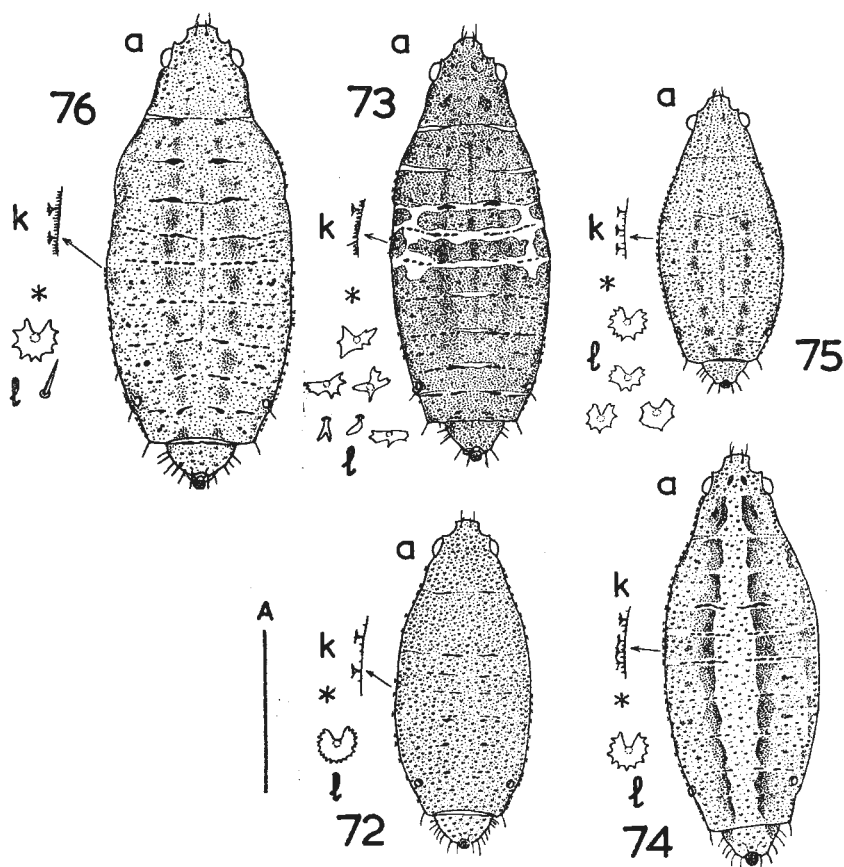

FIGS 72-76. 72, *Subsaltusaphis flava*. 73, *S. rozszneri* (see also p. 117). 74, *S. ornata* (see also p. 117). 75, *S. paniceae* (see also p. 115). 76, *S. picta* (see also p. 117, 120, 123).

dark sclerotic; anterior lobe of mesonotum longitudinally striate, lateral lobes adorned with rather flat oval nodules. Abdominal dorsum with a more or less regular series of dark bands across tergites 3-8; these often enlarged and fusing to form a solid central shield from tergite 3 to tergite 6, which may further be united with the siphuncular sclerites; tergites 1-2 may have more broken sclerotic elements; marginal sclerites separated from the mid-tergal bands by a membranous pleural area, at least in front of the siphunculi. Pigmented sclerites spinulose. Dorsal hairs in a double to triple transverse series across each tergite. Wings strikingly pigmented (fig. 77e). Forewing venation normal, hindwing with only one oblique vein and 2-3 hamuli.

*Males* apterous. Body length 1.2-1.3mm. Antennal flagellum up to nearly 0.75 of body length. Joints III-V with secondary rhinaria (III 10-16, IV 5-8, V 5-7), more irregularly distributed than those of *alatae*. General

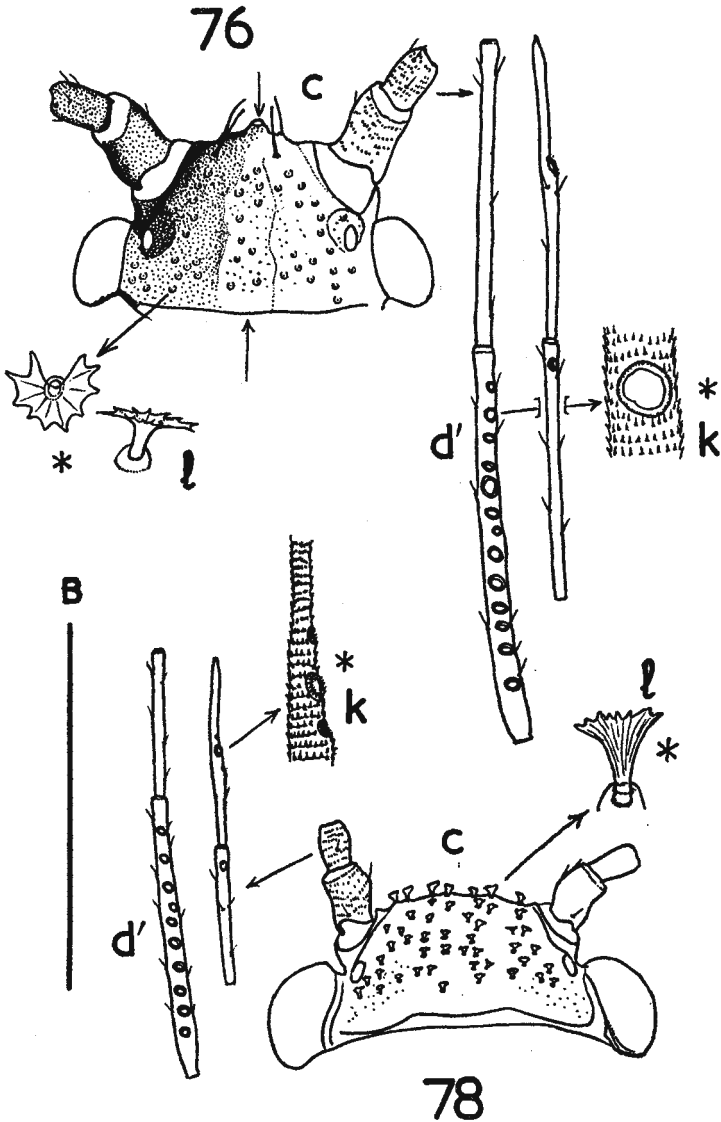

Figs 76, 78. 76, *Subsaltusaphis picta* (see also pp. 117, 119, 123). 78, *Iziphya leege* (see also p. 121).

form and chaetotaxy more or less as for viviparæ. (Described from *I. leegei* only; males of *I. bufo* not available for study.)

*Oviparæ* similar to apteræ but dorsal pigmented pattern more broken. Subsiphuncular wax gland fields present, their polygonal facotting often obscure. Hind tibiae variably swollen, with about 30-120 pseudosensoria in British species.

*Immature morphs* with dorsal hairs on small round individual scleroites; first instar with 4-jointed antennæ, pleural hairs absent.

There are 2 British species known at present.

KEY TO SPECIES

- 1 Pronotum in *viviparæ* with 35-60 flabellate hairs; abdominal tergite 7 including marginal sclerites with 11-30, those on the posterior half mostly of normal type with shaft tapering from base to apex, and apex blunt to subcapitate (fig. 77p).

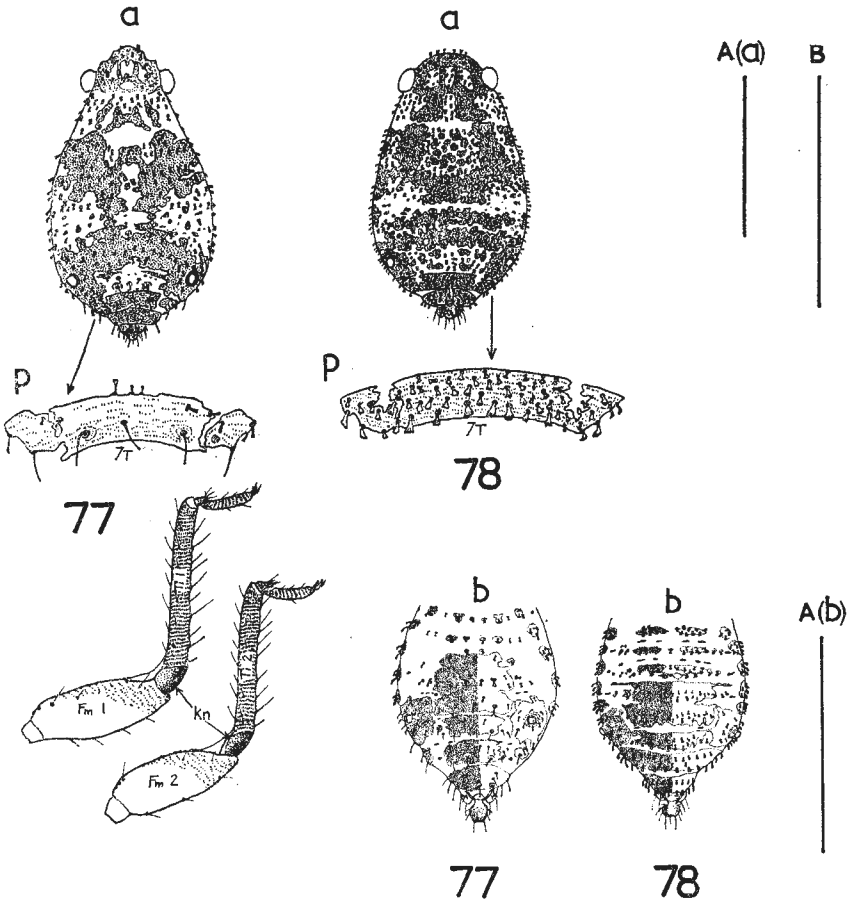

FIGS 77-78. 77, *Iziphya bufo* (see also p. 123). 78, *I. leegei* (see also p. 120).

*Apterae* with primary dorsal hair series placed on conspicuous tubercular bases. *Alatae* with hairs on middle abdominal tergites in a staggered double transverse row. *Immatures* with primary spinal hair-bearing scleroites conspicuously larger than the rest.

**bufo** (Walker) (77)

On *Carex arenaria*, mainly coastal. Glamorgan, Norfolk, Merioneth, Lancashire, Cumberland, Northumberland, 'near Belfast' (Walker).

- Pronotum in *viviparae* with 85-120 flabellate hairs; abdominal tergite 7 including marginal sclerites with 35-80, none of which taper from base to apex and most of which are strongly flabellate (fig. 78p). *Apterae* with primary dorsal hair series not differentiated from the rest unless by slightly larger size. *Alatae* with hairs on middle abdominal tergites at least partly in a triple transverse row. *Immatures* with dorsal hair-bearing scleroites all of rather uniform small size.

**leegei** (Börner) (78)

On *Juncus gerardi*, occasionally on other *Juncus* spp., coastal saltings and muddy shores of reservoirs: Hertford, Norfolk, Cheshire, ?Lancashire (Walker), Aberdeen.

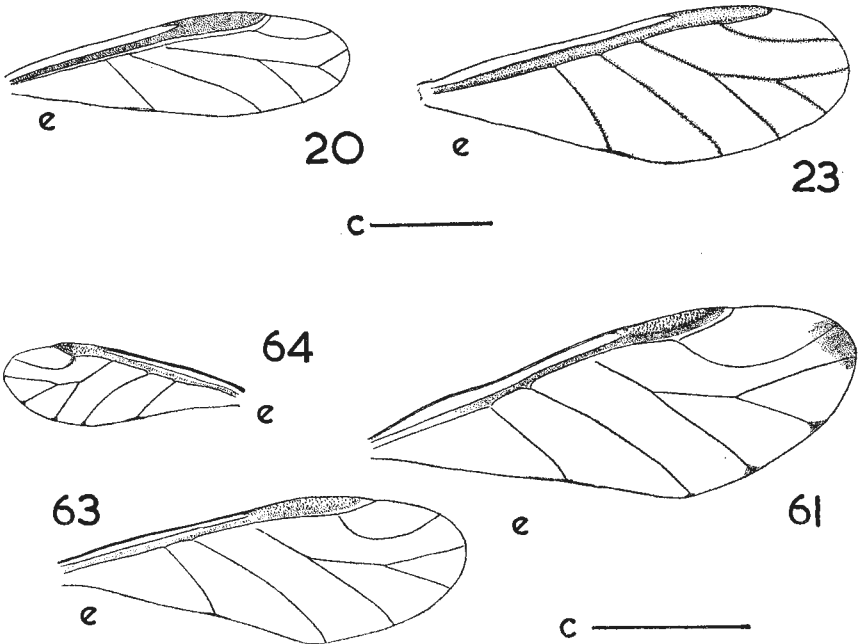

FIGS 20, 23, 61, 63-64. 20, *Laingia psammae* (see also p. 35). 23, *Atheroides hirtellus* (see also p. 39). 61, *Drepanosiphum aceris* (see also p. 104). 63, *D. acerinum* (see also p. 104). 64, *D. dixonii* (see also p. 104).

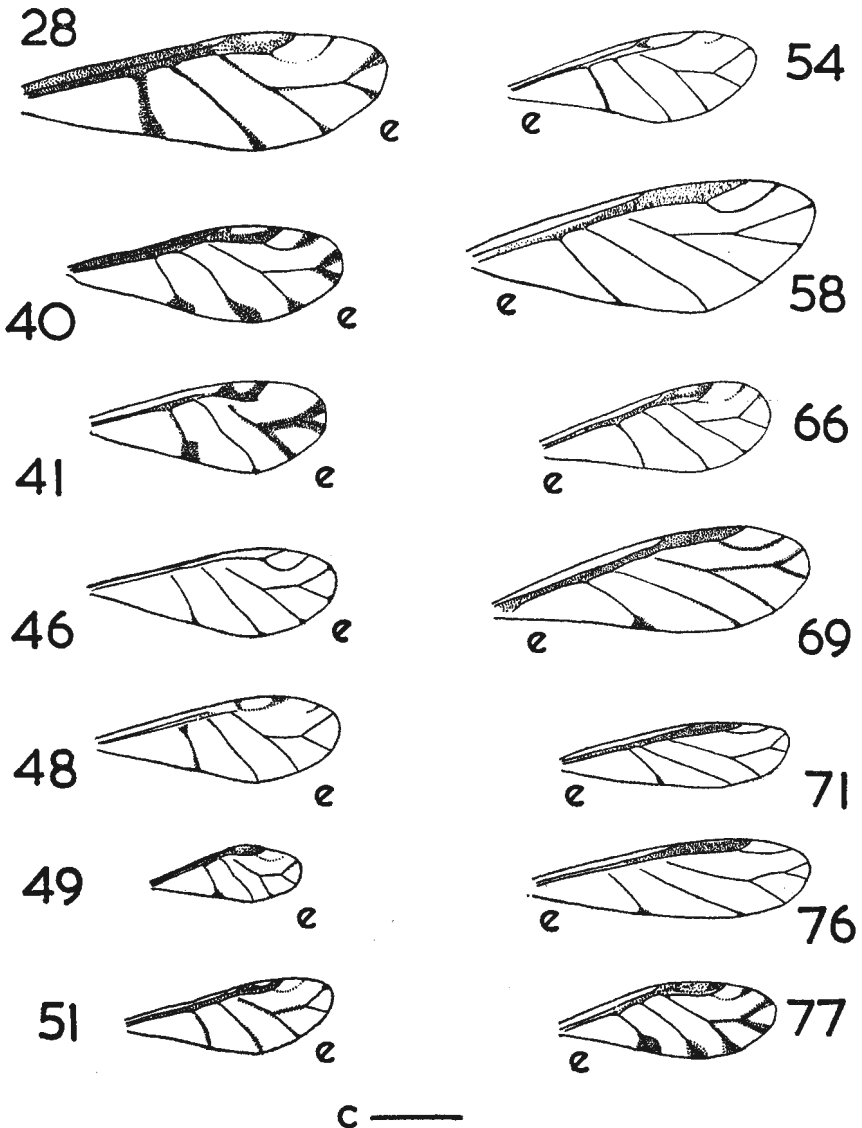

FIG. 28. *Callaphis juglandis* (see also pp. 52, 54). 40, *Eucallipterus tiliae* (see also pp. 62, 63). 41, *Tinocallis platani* (see also pp. 67, 69). 46, *Takecallis arundicolens* (see also pp. 69, 70). 48, *Pterocallis alni* (see also pp. 73, 75, 78, 79). 49, *Ctenocallis setosa* (see also pp. 75, 76). 51, *Callipterinella tuberculata* (see also pp. 77, 80). 54, *Kallistaphis betulicola* (see also pp. 78, 84). 58, *Symydobius oblongus* (see also pp. 90, 94). 66, *Therioaphis riehmii* (see also pp. 106, 109). 69, *Trichocallis cyperi* (see also pp. 111, 113, 115). 71, *T. caricis* (see also pp. 111, 115). 76, *Subsaltusaphis picta* (see also pp. 117, 119, 120). 77, *Iziphyha bufo* (see also p. 121).

## BIBLIOGRAPHY

The following papers, not all referred to in the text, are useful as additional sources of taxonomic information on genera treated in this Handbook.

- DAVIDSON, W. M. 1914. Walnut Aphides in California. *Bull. U.S. Dept. Agric.* **100** : 1-48.
- DONCASTER, J. P. 1961. *Francis Walker's Aphids*. 165 pp. London.
- EASTOP, V. F. 1972. A taxonomic review of the species of *Cinara* Curtis occurring in Britain. *Bull. Brit. Mus. (nat. Hist.) (Ent.)* **27** : 103-186.
- EMDEN, H. F. VAN (ed.) 1972. *Aphid Technology*. xiv + 344 pp. London and New York.
- GERSTAECKER, A. 1856. Bericht über die wissenschaftlichen Leistungen im Gebiete der Entomologie während des Jahres 1855. *Arch. Naturgesch.* **21** : 121-323.
- GOOT, P. VAN DER. 1913. Zur Systematik der Aphiden. *Tijdschr. Ent.* **56** : 69-155.
- 1915. *Beiträge zur Kenntnis der holländischen Blattläuse*. 600 pp. Haarlem.
- HEIE, O. E. 1972. Bladlus på birk i Danmark. *Ent. Meddr.* **40** : 81-105.
- HIGUCHI, H. 1972. A Taxonomic Study of the Subfamily Callipterinae in Japan. *Insecta matsum.* **35** : 19-126.
- HILLE RIS LAMBERS, D. 1947. Notes on the genus *Periphyllus* van der Hoeven. *Zool. Meded. Leiden.* **28** : 225-242.
- 1960. The genus *Chaitophorus* Koch in North America. *Tijdschr. Ent.* **103** : 1-30.
- 1966. New and little known members of the aphid fauna of Italy. *Boll. Zool. agr. Bachic.* (2) **8** : 17-21. [Description of a new *Periphyllus* and key to genus.]
- 1974a. New species of *Tuberculatus* Mordvilko, 1894, with a key to species and some critical notes. *Ibidem* (2) **11** : 21-82.
- 1974b. On American Aphids, with descriptions of a new genus and some new species. *Tijdschr. Ent.* **117** : 138-152. [Description of new taxa in *Trichocallis*, and key to North American species].
- HILLE RIS LAMBERS & STROYAN, H. L. G. 1975. Proposed use of the Plenary Powers to designate a type-species for the nominal genus *Chaitophorus* C. L. Koch, 1854, a genus based upon a misidentified type-species. *Bull. zool. Nom.* **32** : 141-142.
- HILLE RIS LAMBERS, D. & VANDENBOSCH, R. 1964. On the genus *Therioaphis* Walker, 1870, with descriptions of new species. *Zool. Verh. Leiden* **68** : 3-47.
- KLOET, G. S. & HINCKS, W. D. 1964. A Check List of British Insects. Part 1: Small Orders and Hemiptera (2nd edn) *Handbk Ident. Br. Insects* **11** : 1-119.
- QUEDNAU, W. 1954. Monographie der mitteleuropäischen Callaphididae unter besonderer Berücksichtigung des ersten Jugendstadiums. I. Die Junglarven des ersten Stadiums der mitteleuropäischen Callaphididae. *Mitt. biol. Reichsanst. Ld-u. Forstw.* **78** : 1-52, 9 pls.
- RICHARDS, W. R. 1965. The Callaphidini of Canada. *Mem. ent. Soc. Can.* **44** : 1-149.
- 1971. A Synopsis of the World Fauna of the Saltusaphidinae, or Sedge Aphids. *Ibidem* **80** : 1-97.
- 1972. The Chaitophorinae of Canada. *Ibidem* **87** : 1-109.
- SHAPOSHNIKOV, G. KH. 1964. The determination of the insects of the European part of the U.S.S.R. [in Russian]. **1** : 529-545. [Aphidina, Callaphididae and Chaitophoridae.]
- SZELEGIEWICZ, H. 1961. Die polnischen Arten der Gattung *Chaitophorus* Koch s. lat. *Annls zool. Warsz.* **19** : 229-350.
- THEOBALD, F. V. 1927. *The Plant-lice or Aphididae of Great Britain*. **2**: pp. 411. London.
- 1929. *Ibidem* **3** : 1-364. London.

## ALPHABETICAL INDEX TO HOST PLANTS

Plant name	Aphid species
<i>Acer campestre</i> L. ....	<i>Drepanosiphum aceris</i> Koch <i>D. dixonii</i> Hille Ris Lambers <i>Periphyllus hirticornis</i> (Walker) <i>P. obscurus</i> Mamontova <i>P. testudinaceus</i> (Fernie)
<i>A. circinatum</i> Pursh. ....	<i>P. californiensis</i> (Shinji)
<i>A. japonicum</i> Thunb. ....	<i>P. californiensis</i> (Shinji)
<i>A. palmatum</i> Thunb. ....	<i>P. californiensis</i> (Shinji)
<i>A. platanoides</i> L. ....	<i>Drepanosiphum platanoidis</i> (Schrank) <i>Periphyllus lyropictus</i> (Kessler) <i>P. testudinaceus</i> (Fernie) <i>P. xanthomelas</i> (Koch)
<i>A. pseudoplatanus</i> L. ....	<i>Drepanosiphum acerinum</i> (Walker) <i>D. platanoidis</i> (Schrank) <i>Periphyllus acericola</i> (Walker) <i>P. testudinaceus</i> (Fernie) <i>P. testudinaceus</i> (Fernie)
<i>Aesculus hippocastanum</i> L. ....	<i>Sipha glyceriae</i> (Kaltenbach)
<i>Agropyron repens</i> (L.) Beauv. ....	<i>S. kurdjumovi</i> Mordvilko <i>S. maydis</i> Passerini
<i>Agrostis stolonifera</i> L. ....	<i>Atheroides serrulatus</i> Haliday <i>Sipha glyceriae</i> (Kaltenbach)
<i>Alnus glutinosa</i> (L.) Gaertn. ....	<i>Clethrobium comes</i> (Walker) <i>Pterocallis alni</i> (Degeer) <i>P. maculata</i> (von Heyden)
<i>Alopecurus pratensis</i> L. ....	<i>Atheroides serrulatus</i> Haliday
<i>Ammophila arenaria</i> (L.) Link. ....	<i>Laingia psammae</i> Theobald
<i>Arrhenatherum elatius</i> (L.) J. & C. Presl. ....	<i>Sipha kurdjumovi</i> Mordvilko <i>S. maydis</i> Passerini
<i>Arundinaria</i> spp. ....	(see Bamboo)
<i>Avena sativa</i> L. ....	<i>Sipha maydis</i> Passerini
Bamboo ( <i>Arundinaria</i> , <i>Bambusa</i> , <i>Phyllostachys</i> and <i>Sasa</i> spp.) ....	<i>Takecallis arundicolens</i> (Clarke) <i>T. arundinariae</i> (Essig) <i>T. taiwana</i> (Takahashi) (see Bamboo)
<i>Bambusa</i> spp. ....	(see Bamboo)
<i>Betula pendula</i> Roth. ....	<i>Betulaphis quadrituberculata</i> (Kaltenbach) <i>Callipterinella calliptera</i> (Hartig) <i>C. minutissima</i> (Stroyan) <i>C. tuberculata</i> (von Heyden) <i>Clethrobium comes</i> (Walker) <i>Euceraphis punctipennis</i> (Zetterstedt) <i>Kallistaphis betulicola</i> (Kaltenbach) <i>K. flava</i> (Mordvilko) <i>Monaphis antennata</i> (Kaltenbach) <i>Symydobius oblongus</i> (von Heyden)
<i>B. pubescens</i> Ehrh. ....	(as for <i>B. pendula</i> )
<i>Calamagrostis epigjos</i> (L.) Roth. ....	<i>Atheroides serrulatus</i> Haliday <i>Laingia psammae</i> Theobald <i>Sipha glyceriae</i> (Kaltenbach)
<i>Carex acuta</i> L. ....	<i>Subsaltusaphis picta</i> (Hille Ris Lambers)
<i>C. acutiformis</i> Ehrh. ....	<i>S. ?ornata</i> (Theobald) <i>S. ?picta</i> (Hille Ris Lambers)
<i>C. arenaria</i> L. ....	<i>Iziphya bufo</i> (Walker)
<i>C. elata</i> All. ....	<i>Subsaltusaphis rosznerei</i> (Börner)
<i>C. flacca</i> Schreb. ....	<i>S. paniccae</i> (Quednau)
<i>C. hirta</i> L. ....	<i>Atheroides serrulatus</i> Haliday
<i>C. nigra</i> (L.) Reich. ....	<i>Subsaltusaphis flava</i> (Hille Ris Lambers) <i>Trichocallis verrucosa</i> (Gillette)



<i>C. ovalis</i> Goodenough	<i>T. verrucosa</i> (Gillette)
<i>C. panicea</i> L.	<i>Subsaltusaphis paniceae</i> (Quednau)
<i>C. paniculata</i> L.	<i>Caricosipha paniculatae</i> Börner
<i>C. riparia</i> Curt.	<i>Subsaltusaphis ornata</i> (Theobald)
	<i>S. picta</i> (Hille Ris Lambers)
<i>C. rostrata</i> Stokes	<i>S. rosznerei</i> (Börner)
	<i>Trichocallis cyperi</i> (Walker)
<i>C. vesicaria</i> L.	<i>Subsaltusaphis ?rosznerei</i> (Börner)
	<i>Trichocallis cyperi</i> (Walker)
<i>C. vulpina</i> L.	<i>Caricosipha paniculatae</i> Börner
<i>C. spp.</i>	<i>Trichocallis caricis</i> (Mordvilko)
	<i>T. cyperi</i> (Walker)
	<i>T. verrucosa</i> (Gillette)
<i>Carpinus betulus</i> L.	<i>Myzocallis carpini</i> (Koch)
<i>Castanea sativa</i> Mill.	<i>M. castanicola</i> Baker
<i>Corylus avellana</i> L.	<i>M. coryli</i> (Goeze)
<i>C. maxima</i> Mill.	<i>M. coryli</i> (Goeze)
<i>Dactylis glomerata</i> L.	<i>Atheroides serrulatus</i> Haliday
<i>Deschampsia caespitosa</i> (L.) Beauv.	<i>A. hirtellus</i> Haliday
<i>Eleocharis palustris</i> (L.) Roem. & Schult.	<i>Sipha glyceriae</i> (Kaltenbach)
<i>Fagus sylvatica</i> L.	<i>Phyllaphis fagi</i> (L.)
<i>Festuca ovina</i> L.	<i>Sipha maydis</i> Passerini
<i>F. pratensis</i> Huds.	<i>S. kurdjumovi</i> Mordvilko
<i>F. rubra</i> L.	<i>Atheroides brevicornis</i> Laing
	<i>A. serrulatus</i> Haliday
	<i>Sipha glyceriae</i> (Kaltenbach)
	<i>S. littoralis</i> (Walker)
<i>Glyceria declinata</i> Breb.	<i>S. glyceriae</i> (Kaltenbach)
<i>G. fluitans</i> (L.) R.Br.	<i>S. glyceriae</i> (Kaltenbach)
Gramineae, various	<i>Atheroides serrulatus</i> Haliday
	<i>Sipha glyceriae</i> (Kaltenbach)
	<i>S. maydis</i> Passerini
<i>Holcus mollis</i> L.	<i>S. glyceriae</i> (Kaltenbach)
	<i>S. maydis</i> Passerini
<i>Hordeum murinum</i> L.	<i>Sipha kurdjumovi</i> Mordvilko
<i>H. vulgare</i> L.	<i>S. glyceriae</i> (Kaltenbach)
	<i>S. kurdjumovi</i> Mordvilko
<i>Juglans regia</i> L.	<i>Callaphis juglandis</i> (Goeze)
	<i>Chromaphis juglandicola</i> (Kaltenbach)
<i>Juncus articulatus</i> L.	<i>Sipha glyceriae</i> (Kaltenbach)
<i>J. conglomeratus</i> L.	<i>S. glyceriae</i> (Kaltenbach)
<i>J. gerardi</i> Lois.	<i>Iziphya leegei</i> (Börner)
<i>J. sp.</i>	<i>I. leegei</i> (Börner)
<i>Lolium</i> spp.	<i>Sipha maydis</i> Passerini
<i>Lotus corniculatus</i> L.	<i>Therioaphis trifolii</i> (Monell)
<i>Medicago falcata</i> L.	<i>T. trifolii</i> (Monell)
<i>M. lupulina</i> L.	<i>T. trifolii</i> (Monell)
<i>M. sativa</i> L.	<i>T. trifolii</i> (Monell)
<i>Melilotus alba</i> Desr.	<i>T. riehmi</i> (Börner)
<i>M. altissima</i> Thuill.	<i>T. riehmi</i> (Börner)
<i>M. officinalis</i> (L.) Lam.	<i>T. riehmi</i> (Börner)
<i>Myrica gale</i> L.	<i>Myzocallis myricae</i> (Kaltenbach)
<i>Ononis repens</i> L.	<i>Therioaphis ononidis</i> (Kaltenbach)
<i>O. spinosa</i> L.	<i>T. ononidis</i> (Kaltenbach)
<i>Phalaris arundinacea</i> L.	<i>Sipha glyceriae</i> (Kaltenbach)
	<i>S. maydis</i> Passerini
<i>Phyllostachys</i> spp.	(see Bamboo)
<i>Poa annua</i> L.	<i>Sipha maydis</i> Passerini
<i>P. spp.</i>	<i>Atheroides serrulatus</i> Haliday
	<i>Sipha glyceriae</i> (Kaltenbach)
<i>Populus alba</i> L.	<i>Chaitophorus albus</i> Mordvilko
	<i>C. populeti</i> (Panzer)

<i>P. canescens</i> (Ait.) Sm. ....	<i>C. albus</i> Mordvilko
	<i>C. populeti</i> (Panzer)
<i>P. italica</i> (Duroi) Moench .....	<i>C. leucomelas</i> Koch
<i>P. nigra</i> L.....	<i>C. leucomelas</i> Koch
<i>P. tremula</i> L.....	<i>C. albus</i> Mordvilko
	<i>C. populeti</i> (Panzer)
	<i>C. tremulae</i> Koch
<i>Puccinellia maritima</i> (Huds.) Parl. ....	<i>Atheroides brevicornis</i> Laing
	<i>Sipha littoralis</i> (Walker)
<i>Quercus castaneaefolia</i> C. A. Mey. ....	<i>Myzocallis boerneri</i> Stroyan
<i>Q. cerris</i> L. ....	<i>M. boerneri</i> Stroyan
<i>Q. × hispanica</i> var. <i>lucombeana</i> (Sweet) Rehd.	<i>M. boerneri</i> Stroyan
<i>Q. ilex</i> L.....	<i>M. schreiberi</i> Hille Ris Lambers & Stroyan
<i>Q. petraea</i> (Mattuschka) Liebl.....	<i>Tuberculooides annulatus</i> (Hartig)
	<i>T. borealis</i> Krzywicz
	<i>T. neglectus</i> Krzywicz
<i>Q. robur</i> L.....	<i>Myzocallis castanicola</i> Baker
	<i>Tuberculatus querceus</i> (Kaltenbach)
	<i>Tuberculooides annulatus</i> (Hartig)
	<i>T. borealis</i> Krzywicz
<i>Q. suber</i> L. ....	<i>Myzocallis boerneri</i> Stroyan
<i>Q. variabilis</i> Bl. ....	<i>M. boerneri</i> Stroyan
<i>Salix alba</i> L. ....	<i>Chaitophorus niger</i> Mordvilko
	<i>C. truncatus</i> (Hausmann)
	<i>C. vitellinae</i> (Schrank)
	(as for <i>S. alba</i> )
<i>S. amygdalina</i> L. ....	<i>C. capreae</i> (Mosley)
<i>S. atrocinerea</i> Brot. ....	<i>C. capreae</i> (Mosley)
<i>S. aurita</i> L. ....	<i>C. salicti</i> (Schrank)
	<i>C. niger</i> Mordvilko
<i>S. babylonica</i> L. ....	<i>C. truncatus</i> (Hausmann)
<i>S. calodendron</i> Wimmer .....	<i>C. beuthani</i> (Börner)
<i>S. caprea</i> L. ....	<i>C. capreae</i> (Mosley)
	<i>C. salicti</i> (Schrank)
<i>S. cinerea</i> L. ....	(as for <i>S. caprea</i> )
<i>S. fragilis</i> L. ....	<i>C. niger</i> Mordvilko
	<i>C. vitellinae</i> (Schrank)
<i>S. lapponum</i> L. ....	<i>C. capreae</i> (Mosley)
<i>S. laurina</i> Sm.....	<i>C. niger</i> Mordvilko
<i>S. phlycticifolia</i> L. ....	<i>C. truncatus</i> (Hausmann)
<i>S. purpurea</i> L. ....	<i>C. niger</i> Mordvilko
	<i>C. truncatus</i> (Hausmann)
<i>S. triandra</i> L. ....	<i>C. truncatus</i> (Hausmann)
<i>S. viminalis</i> L. and its hybrids .....	<i>C. beuthani</i> (Börner)
	<i>C. vitellinae</i> (Schrank)
<i>Sarothamnus scoparius</i> (L.) Wimmer.....	<i>Ctenocallis setosa</i> (Kaltenbach)
<i>Sasa</i> spp. ....	(see Bamboo)
<i>Scirpus</i> spp.....	<i>Sipha glyceriae</i> (Kaltenbach)
	<i>Subsaltusaphis picta</i> (Hille Ris Lambers)
<i>Spartina maritima</i> (Curt.) Fernald .....	<i>Sipha littoralis</i> (Walker)
<i>Tilia platyphylla</i> Scop. ....	<i>Eucaulipterus tiliae</i> (L.)
<i>T. × vulgaris</i> Hayne .....	<i>E. tiliae</i> (L.)
<i>Trifolium arvense</i> L.....	<i>Therioaphis trifolii</i> (Monell)
<i>T. hybridum</i> L. ....	<i>T. trifolii</i> (Monell)
<i>T. pratense</i> L. ....	<i>T. luteola</i> (Börner)
<i>T. repens</i> L. ....	<i>T. trifolii</i> (Monell)
<i>Triticum aestivum</i> L. ....	<i>Sipha kurdjumovi</i> Mordvilko
	<i>S. maydis</i> Passerini
<i>Ulmus laevis</i> Pall. ....	<i>Tinocallis platani</i> (Kaltenbach)
<i>U. parvifolia</i> Jacq. ....	<i>T. ulmiparvifoliae</i> Matsumura
<i>U. thomasi</i> Sarg. ....	<i>T. platani</i> (Kaltenbach)
<i>Zea mays</i> L. ....	<i>Sipha maydis</i> Passerini
<i>Zelkova serrata</i> (Thunb.) Mak. ....	<i>Tinocallis zelkowsae</i> (Takahashi)



## INDEX TO INSECT NAMES

*Italicized names* are synonyms. Where a trivial name is followed in parentheses by two generic names separated by the sign (=) this means that the species was first described in genus 1 before being either cited as the type-species, or placed in synonymy with another species, of genus 2. *Italicized page numbers* show where the taxon concerned runs out in the keys.

- acericola* (Periphyllus), 5, 19, 28, 29, 31, 32, 125  
*acerinum* (Drepanosiphum), 104, 105, 122, 125  
*aceris* (Drepanosiphum), 104, 105, 122, 125  
 Adelgidae, 1, 2, 3  
*affinis* (Thecabius), 17  
*albus* (Chaitophorus), 5, 12, 13, 126, 127  
 ALEYRODOIDEA, 1  
*alni Degeer* (Pterocallis), 73, 74, 75, 78, 79, 123, 125  
*alni* F. (Aphis = Pterocallis), 72  
*annulatus* (Tuberculoides), 56, 59, 60, 61, 127  
 Anoeciidae, 1, 4  
*Anoeciinae*, 3  
*antennata* (Monaphis), 89, 92, 93, 97, 125  
 Aphididae, 1, 3, 4  
 APHIDOIDEA, 1, 3  
*Aphis*, vii, 6, 39, 50, 53, 59, 61, 65, 72, 77, 81, 85, 88, 89, 93, 100, 103, 107  
*arundicolens* (Takecallis), 69, 70, 71, 72, 123, 125  
*arundinariae* (Takecallis), 70, 71, 125  
 Atheroides, 33, 36  
 Atheroidinae, 5, 6, 33  
  
*bambusae* (Takecallis), 71  
*basalis* (Kallistaphis), 86  
*Betulaphis*, 48, 50, 88  
*betularia* (Aphis = Callipterinella), 81  
*betulicola* (Kallistaphis), 78, 84, 85, 86, 123, 125  
*beuthani* (Chaitophorus), 11, 12, 127  
*boernerii* (Myzocallis), 57, 58, 59, 127  
*borealis* (Tuberculoides), 60, 61, 127  
*brevicornis* (Atheroides), 37, 38, 126, 127  
*brevipilosa* (Betulaphis) 89  
*bufo* (Iziphya), 121, 122, 123, 125  
  
*californiensis* (Periphyllus), 26, 27, 32, 125  
 Callaphididae, 1, 4, 41  
 Callaphidinae, 45  
*Callaphis*, 45, 50  
*calliptera* (Callipterinella), 78, 80, 82, 85, 125  
*Callipterinella*, 48, 49, 81  
*caprae* (Chaitophorus), 5, 12, 13, 127  
*caricis* (Allaphis = Trichocallis), 110, 111, 112, 115, 123, 126  
  
*Caricosipha*, 33  
*carpini* (Myzocallis), 57, 58, 126  
*castanicola* (Myzocallis), 54, 56, 57, 126, 127  
 Cerataphis, 1  
*Chaetosiphella*, 36  
 Chaitophoridae, 1, 3, 4  
 Chaitophorinae, 5, 6  
 Chaitophorus, 5, 6  
 Chromaphis, 46, 51  
 Cinara, 3  
 Clethrobium, 47, 96  
 COCCOIDEA, 1  
*comes* (Clethrobium), 94, 97, 98, 125  
*coryli* (Myzocallis), 53, 58, 59, 126  
*Ctenocallis*, 46, 49, 74  
*cyperi* (Trichocallis), 111, 112, 113, 115, 123, 126  
  
*dixonii* (Drepanosiphum), 104, 107, 122, 125  
*dobrovlskijskii* (Ctenocallis), 74  
*Drepanosiphum*, 46, 103  
  
 Eriosoma, vii  
*Eucallipterus*, 45, 65  
*Euceraphis*, 48, 100  
  
*fagi* (Phyllaphis), 77, 78, 80, 81, 126  
*flava* (Kallistaphis), 78, 84, 86, 87, 125  
*flava* (Sipha), 39  
*flava* (Subsaltusaphis), 116, 119, 125  
  
*giganteus* (Callipterus = Clethrobium) 96  
*glyceriae* (Sipha), 39, 40, 41, 125, 126  
  
*hirtellus* (Atheroides), 36, 38, 39, 122, 126  
*hirticornis* (Periphyllus), 20, 21, 24, 125  
 HOMOPTERA, 1  
 Hormaphis, 1  
  
*intermedia* (Saltusaphis = Subsaltusaphis), 112  
*Iziphya*, 45, 49, 118  
  
*juglandicola* (Chromaphis), 51, 52, 53, 54, 126  
*juglandis* (Callaphis), 51, 52, 54, 123, 126  
*Kallistaphis*, 48, 50, 85  
*kurdjumovi* (Sipha), 41, 42, 125, 126, 127

- Lachnidae, 1, 2, 3, 4  
 Lachnus, 51  
 Laingia, 33, 34  
 leegei (Iziphyta), 120, 121, 122, 126  
 leucomelas (Chaitophorus), 6, 16, 17, 127  
 littoralis (Sipha), 41, 42, 126, 127  
 luteola (Therioaphis), 108, 109, 127  
 lyopictus (Periphyllus), 22, 23, 24, 125
- maculata (Iziphyta), 118  
 maculata (Pterocallis), 73, 74, 79, 125  
 maydis (Sipha), 41, 43, 125, 126, 127  
 Mindaridae, 1, 3  
 Mindarus, 3  
 minutissima (Callipterinella), 4, 78, 80, 85, 125  
 Monaphis, 48, 89  
 myricae (Myzocallis), 54, 57, 126  
 Myzocallis, 47, 53, 64
- neglectus (Tuberculoides), 60, 61, 127  
 niger (Chaitophorus), 13, 14, 127
- oblonga* (Aphis=Symydobius), 93  
 oblongus (Symydobius), 90, 94, 96, 123, 125  
 obscurus (Periphyllus), 24, 125  
*occidentalis* (Betulaphis), 88  
 ononidis (Therioaphis), 90, 108, 109, 126  
 ornata (Subsaltusaphis), 116, 117, 119, 125, 126
- Pachypappa, 16  
 pallida (Subsaltusaphis), 112  
 paniceae (Subsaltusaphis), 115, 116, 119, 125, 126  
 paniculatae (Caricosipha), 33, 34, 35, 126  
 Paracletus, 3  
 Pemphigidae, 1, 2, 3, 4  
 Pemphigus, 17  
 Periphyllus, 6, 17  
 Phloeomyzidae, 1, 4  
 Phloeomyzus, 3  
 Phyllaphidinae, 45  
 Phyllaphis, 46, 49, 77  
 Phylloxeridae, 1, 2, 3  
 pieta (Subsaltusaphis), 116, 117, 119, 120, 123, 125, 126, 127  
 platani (Tinocallis), 67, 68, 69, 123, 127  
 platanoidis (Drepanosiphum), 103, 104, 105, 106, 125  
 populeti (Chaitophorus), 6, 7, 10, 126, 127  
*populi* (Chaitophorus), 6  
 psammae (Laingia), 34, 35, 36, 122, 125  
 PSYLLOIDEA, 1  
 Pterocallis, 48, 49, 72  
 punctipennis (Euceraphis), 99, 101, 102, 125
- quadrituberculata (Betulaphis), 84, 87, 89, 90, 125  
*quercea* (Aphis=Tuberculatus), 61  
 quercus (Tuberculatus), 60, 62, 64, 127  
*quercus* (Aphis=Tuberculoides), 59  
 riehmii (Therioaphis), 47, 106, 108, 109, 123, 126  
 rosneri (Subsaltusaphis), 116, 117, 119, 125, 126  
*Rungsia*, 39
- salicti (Chaitophorus), 13, 15, 127  
 Saltusaphidinae, 45  
 Saltusaphis, 112  
 schreiberi (Myzocallis), 58, 59, 127  
 serrulatus (Atheroides), 36, 37, 38, 125, 126  
 setosa (Ctenocallis), viii, 75, 76, 77, 123, 127
- Sipha, 33, 39  
 STERNORRHYNCHA, 1  
 Stomaphis, 2  
 Subsaltusaphis, 47, 49, 112  
 Symydobius, 47, 49, 93
- taiwana (Takecallis), 70, 71, 125  
 Takecallis, 46, 71  
*testudinacea* (Phyllophora), 17  
 testudinaceus (Periphyllus), 25, 26, 32, 125  
*testudo* (Periphyllus), 17  
 Thecabius, 17  
 Thelaxidae, 1, 4  
 Therioaphidinae, 45  
 Therioaphis, 45, 46, 47, 50, 107  
 Thripsaphis, 110  
*thripsoides* (Thripsaphis=Trichocallis), 110  
 tiliae (Eucallipterus), 62, 63, 66, 123, 127  
 Tinocallis, 45, 66  
 Trama, 4  
 Tramini, 4  
 tremulae (Chaitophorus), 16  
 tremulae (Pachypappa), 16  
 Trichocallis, 47, 48, 49, 110, 112, 114  
 trifolii (Therioaphis), 108, 109, 126, 127  
 truncatus (Chaitophorus), 17, 18, 127  
 tuberculata (Callipterinella), 78, 80, 83, 123, 125  
 Tuberculatus, 46, 61  
 Tuberculoides, 46, 59, 64
- ulmiparvifoliae (Tinocallis), 66, 67, 68, 127  
 verrucosa (Trichocallis), 111, 112, 113, 115, 125, 126  
 vitellinae (Chaitophorus), 9, 10, 127
- xanthomelas (Periphyllus), 19, 30, 31, 32, 125  
 zelkowae (Tinocallis), 67, 68, 127

## POSTSCRIPT

V.F. Eastop & D. Hille Ris Lambers (1976, Survey of the World's Aphids: 428) consider that Takahashi's description of Tinocallis zelkowae applies to vagrants of T. ulmiparvifoliae; and they use the name T. nirecola (Shinji) for the species keyed as zelkowae on p.63, and figured as such on p.67.

R.L. Blackman (1977, Systematic Entomology 2: 1-8) has shown that British Euceraphis comprise 2 species: E. punctipennis whose true host is Betula pubescens and E. betulae (Koch) living on B. pendula. The two species differ in karyotype as well as in average size, antennal and tarsal proportions and degree of melanic pigmentation. The figures of Euceraphis on pp.99 and 101 of this Handbook are drawn from specimens of E. betulae, except for the September specimen on p.99, which is E. punctipennis. In the Host Plant Index on p.125 the name betulae should be substituted for punctipennis opposite Betula pendula Roth, and punctipennis inserted opposite B. pubescens Ehrh., with the sequel '(otherwise as for B. pendula)'.