

SPECIAL TELEVISION NUMBER

RADIO — ELECTRONICS

HUGO GERNSBACH, Editor

Formerly

RADIO
CRAFT

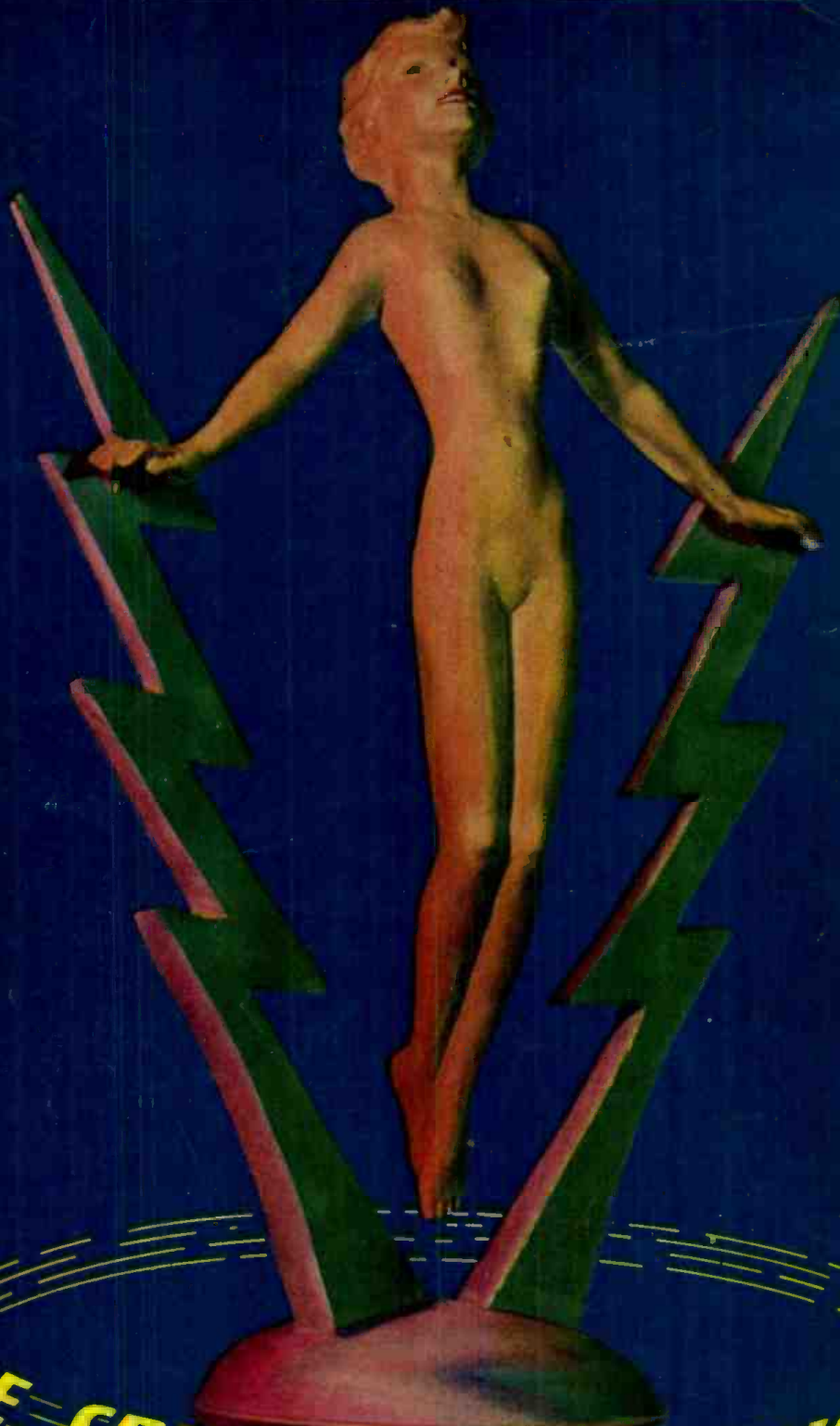

THE SPIRIT OF TELEVISION

MAR

1949

50¢

U. S. and
CANADA

LATEST IN RADIO — ELECTRONICS — TELEVISION

NOW...A Revolutionary Pre-Assembled, Pre-Wired TV ANTENNA
 that Gives Superior Performance on ALL CHANNELS - -
 - - yet COSTS YOU ONLY 1/2 the price of equivalent antennas!

TRANSVISION *Flip-Up*

... the new TV Antenna that gives you more value for your money, because - -

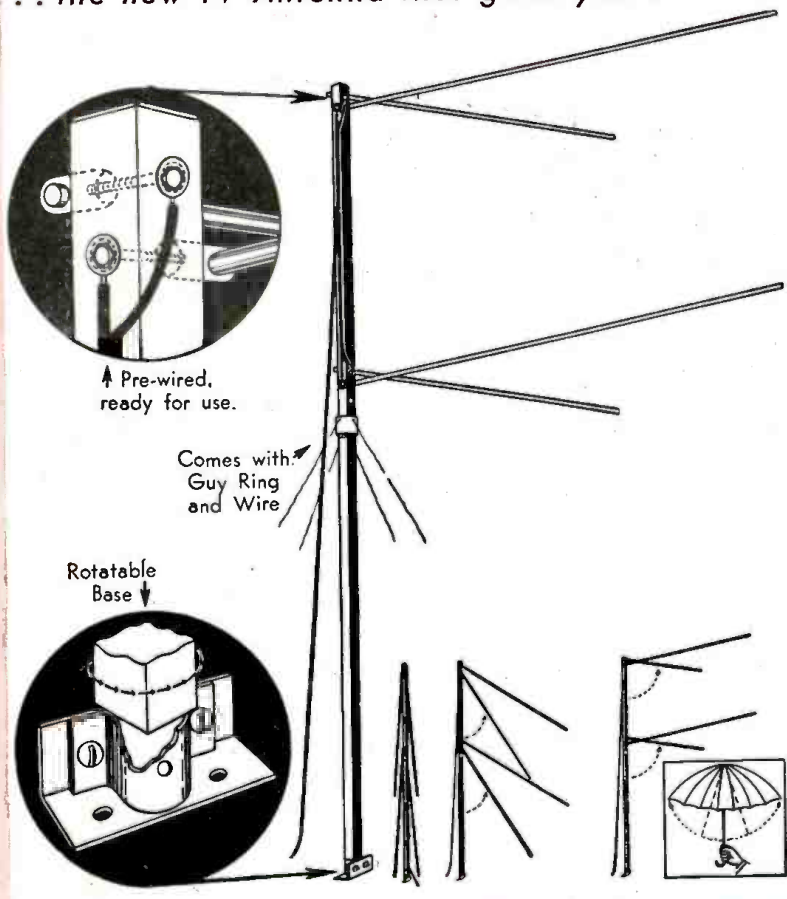

- **IT'S PRE-ASSEMBLED**, ready for use. Just "flip-up" (like an umbrella) and install.
- **PRE-WIRED**—just connect your lead-in to the two terminals.
- **RECEIVES ALL CHANNELS**
- **ALL-DIRECTIONAL**; can be oriented for the weakest station in an area with assurance that all other channels will be brought in equally well.
- **EXTREMELY SENSITIVE**. Unusual high gain in upper channels. Ideal for fringe areas.
- **PRICE: \$6.95 NET**

Completely assembled with rotatable base, 7 ft. mast, guy ring and guy wire.
 Additional 7 ft. masts, to build antenna up to 19 ft., at small extra cost.

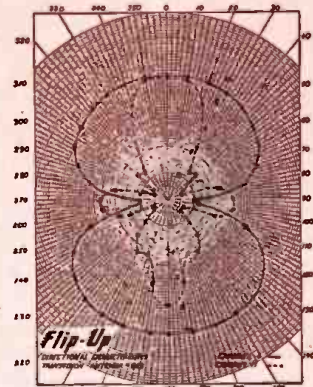

Superior Performance of the Transvision "Flip-Up" TV Antenna

This chart shows the directional characteristics of the "Flip-Up"—or the relative strength of signals received at different incident angles. The two channels used, 4 and 11, represent the centers of the low and high frequency bands respectively. **The SIGNIFICANT FEATURES are:** Wide Angle Reception at Low Frequencies; High Sensitivity of High and Low Frequencies; All-Directional.

SAVES TIME, LABOR! Note how EASY it is to install the "Flip-Up." It comes to you compact, folded like an umbrella. You open it—like an umbrella, and install.

ADDITIONAL Superior Features of the "Flip-Up" Antenna!

- Upper and lower bands completely wired. Eliminates need for two separate antenna installations for the high and low TV bands; therefore, no coupling losses.
- **RUGGED CONSTRUCTION:** Mast of the antenna has been designed of non-conducting material which prevents possible grounding and reduction of signal strength. It has unusually high mechanical strength and is extremely rigid when installed.
- Guy ring and guy wires provided for added rigidity.
- Additional 7 ft. extension masts can be furnished to increase height to total of 19 ft.

—and REMEMBER, "Flip-Up" COSTS ABOUT 1/2 the price of equivalent antennas

All Transvision Prices are fair traded; subject to change without notice. Prices 5% higher west of the Mississippi.

TRANSVISION, INC., DEPT. RE, NEW ROCHELLE, N. Y.

IN CALIF.: TRANSVISION OF CALIFORNIA, 8572 SANTA MONICA BLVD., HOLLYWOOD 46

Ask to see the New "Flip-Up" Antenna at Your Transvision Outlet!



I Will Show You How to
LEARN RADIO
Servicing or Communications
by Practicing in Spare Time

**I Send You
 Many Kits of
 Radio Parts**



**YOU PRACTICE RADIO
 SERVICING**

You build the modern Radio shown below as part of my Servicing Course. I send you the speaker, tubes, chassis, transformer, loop antenna, EVERYTHING you need to build this modern Radio Receiver. Use it to make many tests, get practical experience.

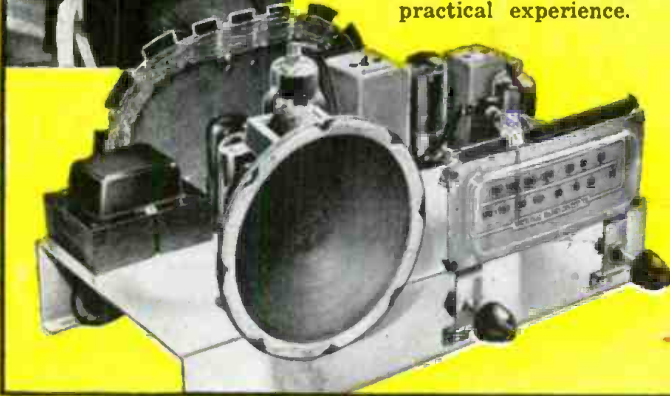

**YOU PRACTICE RADIO
 COMMUNICATIONS**

I send you parts to build the Transmitter shown below as part of my new Communications Course. Conduct actual procedure of Broadcast Operators, practice interesting experiments, learn how to put a transmitter on the air.



NEW

YOU BUILD THIS TESTER

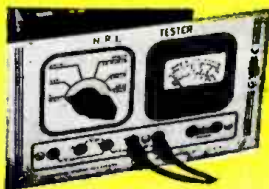

as part of my Servicing Course, with parts N.R.I. sends. It soon helps you **EARN EXTRA MONEY** fixing neighbors' Radios in spare time.

YOU BUILD THIS WAVEMETER

as part of my **NEW Communications Course**. Use it with Oscillator you also build that furnishes basic power to transmitter and determines transmitter frequency.

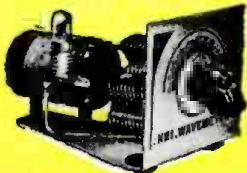

I TRAINED THESE MEN

Good Job in Radio Station

"Am Chief Engineer of Radio Station WORD in charge of four men. Owe all I know about Radio to NRI."—CLYDE J. BURDETTE, Spartanburg, South Carolina.

Has Own Radio Business

"Now have two Radio shops servicing about 200 sets a month. Have largest service establishment in Southeastern Missouri!"—ARLEY STUDYVIN, DeSoto, Missouri.

KNOW RADIO • *Win Success*
I Will Train You at Home • **SAMPLE LESSON FREE**

Want a good-pay job in the fast-growing Radio and Television Industries, or your own money-making Radio-Television shop? I've trained hundreds of men **WITH NO PREVIOUS TRAINING** to be Radio technicians. Or now you can enroll in my **NEW practical course in Radio-Television COMMUNICATIONS**—learn to be a Broadcasting and Communications technician. You get practical Radio experience with **MANY KITS OF PARTS** I send you in my train-at-home method. All equipment yours to keep.

MAKE EXTRA MONEY IN SPARE TIME

As part of my Radio Servicing Course, I send **SPECIAL BOOK—LET'S** starting the day you enroll. Make **EXTRA MONEY** fixing Radios in spare time while training. Then start your own Radio sales and service shop

or get a good-pay job in Police, Aviation or Marine Radio, Broadcasting, Public Address work, etc. Or think of amazing Television opportunities. Already manufacturers are producing over 100,000 sets a month. New stations going on the air everywhere! Television is America's fastest-growing industry and men who know it will be in demand.

GET ACTUAL LESSON AND BOOK FREE

My **DOUBLE FREE OFFER** entitles you to actual **SAMPLE LESSON** and my 64-page book, **"HOW TO BE A SUCCESS IN RADIO—TELEVISION—ELECTRONICS,"** both **FREE**. Mail coupon now. See how quickly, easily you can start. **J. E. SMITH, President, Dept. 9CX, National Radio Institute, Pioneer Home Study Radio School, Washington 9, D. C.**

VETERANS

Get this training without cost under G. I. Bill. Mail coupon

Good for Both—FREE

Mr. J. E. SMITH, President, Dept. 9CX
 National Radio Institute, Washington 9, D. C.
 Mail me **FREE Lesson** and 64-page book.
 (No salesman will call. Please write plainly.)

Name..... Age.....
 Address.....
 City..... Zone..... State.....
 Check If Veteran Approved for Training Under G. I. Bill

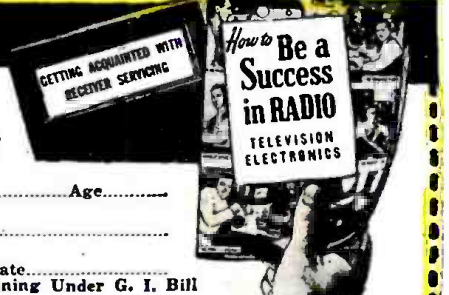

MY COURSE INCLUDES TELEVISION

RADIO — ELECTRONICS

formerly RADIO-CRAFT

Incorporating

SHORT WAVE CRAFT*

TELEVISION NEWS*

RADIO & TELEVISION

*Trademark registered U. S. Patent Office

SPECIAL TELEVISION ISSUE

Hugo Gernsback, Editor-in-Chief
 Fred Shunaman, Managing Editor
 M. Harvey Gernsback, Consulting Editor
 Robert F. Scott, W2PWG, Technical Editor
 R. H. Dorf, W2QMI, Associate Editor
 I. Queen, W2OUX, Editorial Associate
 Angie Pascale, Production Manager
 Elmer Fuller, Shortwave Editor
 Wm. Lyon McLaughlin,
 Tech. Illustration Director
 G. Aliquo, Circulation Manager
 Charles K. Brett,
 National Advertising Director
 John J. Lamson,
 New York Advertising Director
 Alfred Stern, Promotion Manager

Contents

March, 1949

Editorial (Page 21)	
The Television Boom.....	by Hugo Gernsback 21
Television (Pages 22-73)	
Television's Future in America.....	by Dr. Lee de Forest 22
Tele Network Problems.....	by Dr. Allen B. Du Mont 24
TV, Electronics, and Radio in '49.....	by Brig. Gen. David Sarnoff 26
Trouble Shooting in Television Kits.....	by Joseph L. Reiffin 27
Navy Teaches with Television.....	30
TV Test Pattern Quiz.....	by Sol D. Prensky 32
'48 — Year of TV Advance.....	by Will Baltin 34
Television Projection Methods.....	by Dr. A. H. Rosenthal 36
Extension Viewer and Remote Control for TV.....	39
Sweep Generators for Television.....	by Bob Stang 42
Television Station List.....	43
New Features in TV Sets.....	44
Television C-R Tubes.....	by Milton S. Kiver 46
Portable TV Set has 7-inch Tube (Sentinel 400-TV).....	48
Making and Installing TV Antennas.....	by I. Queen 51
Television in Europe.....	by Ralph W. Hallows 52
Antennas for Television.....	by Edward M. Nall and Matt Mandl 54
Television Accessories for Improved Reception.....	by Robert F. Scott 56
French High-Definition TV.....	by E. Aisberg 58
New TV Antennas.....	by Harry W. Secor 61
Receivers Assembled from Kits Play Big Role in TV Advance.....	by Herbert D. Suesholtz 62
TV Booster has Gain of Ten.....	by David Gnessin 64
Test Equipment for TV.....	by S. D. Prensky and N. DeFalco 65
Office Television System.....	67
40 Years of Television.....	by Hugo Gernsback 68
Television Receiver Chart.....	70
Radio-Science (Pages 74-79)	
Atoms Run Clocks.....	74
The Electronic Brain.....	by W. R. Ashby, M. A., M. D. 77
Audio (Pages 80-91)	
Better TV Sound.....	by Allan Lytel 80
Planning a Factory PA.....	by Conrad Eichorn 82
Design Data for Speaker Enclosures.....	84
Powerful PA Amplifier Uses an 815.....	by Gerald A. Chase 90
Test Instruments (Pages 92-94)	
Building Kit Generator Solves Design Problems.....	by Richard L. Parmenter, WIJXF 92
Servicing (Pages 96-99)	
Farm Receivers are Easy to Service.....	by Richard Laurence 96
Fundamentals of Radio Servicing, Part II — Ohm's Law and the Resistor.....	by John T. Frye 98
Foreign News (Pages 100-102)	
European TV Report.....	by Major Ralph W. Hallows 100
Electronics (Pages 104-105)	
Electronics in Medicine, Part VI — Use of Shortwave Diathermy.....	by Eugene J. Thompson 104
Construction (Pages 106-109)	
TRF Tuner Has A.C.-D.C. Supply.....	by Clinton E. Clark 108
Broadcasting & Communications (Pages 122-123)	
President's Transmitter.....	122
Amateur (Pages 130-134)	
Field Strength Meter.....	130
Aluminum 144-mc Beam Is Light and Strong.....	by L. W. May, W5AJG 131

Departments

The Radio Month.....	12	Technates.....	124
Radio Business.....	18	Miscellany.....	127
Radio-Electronic Circuits.....	110	People.....	135
New Devices.....	113	Communications.....	137
Try This One.....	114	Book Reviews.....	141
New Patents.....	117		

ON THE COVER: The Spirit of Television. Statuette by Lilly Rona after an original idea by Hugo Gernsback. Kodachrome by Avery Slack.

RADIO-ELECTRONICS, March, 1949, Volume XX, No. 6, Published monthly. Publication Office: Erie Ave., E to G Streets, Philadelphia 32, Pa. Entered as second class matter September 27, 1948, at the post office at Philadelphia, Pa., under the Act of March 3, 1879. SUBSCRIPTION RATES: In U. S. and Canada, in U. S. Possessions, Mexico, South and Central American countries, \$3.50; \$6.00 for two years; \$8.00 for three years; elsewhere \$4.00. All other foreign countries \$4.50 a year, \$8.00 for two years, \$11.00 for three years. Allow one month for change of address. When ordering a change please furnish an address stencil impression from a recent wrapper. RADCRAFT PUBLICATIONS, INC. Hugo Gernsback, Pres.; M. Harvey Gernsback, Vice-Pres.; G. Aliquo, Sec'y. Contents Copyright, 1949, by Radercraft Publications, Inc. Text and illustrations must not be reproduced without permission of copyright owners.

EDITORIAL and ADVERTISING OFFICES, 25 West Broadway, New York 7, N. Y. Tel. REctor 2-9690. BRANCH OFFICE: Chicago, 308 W. Washington Street, Telephone RANDolph 6-7363. Detroit: Frank Holstein, Room 402, Lexington Bldg., 2970 West Grand Blvd., Telephone TITiny 5-7026. Los Angeles: Ralph W. Harker, 606 South Hill St., Tel. Tucker 1793. San Francisco: Ralph W. Harker, 582 Market St., Tel. Garfield 1-2481.

FOREIGN AGENTS: Great Britain: Atlas Publishing and Distributing Co., Ltd., 18 Bride Lane, Fleet St., London E.C.4 Australia: McGill's Agency, 179 Elizabeth Street, Melbourne, France: Brentano's, 37 Avenue de l'Opera, Paris 2e, Holland: Teletron, Heemstede, Dreef 124 Heemstede, Greece: International Book & News Agency, 17 Amerikis Street, Athens, S. Africa: Central News Agency, Ltd., Cor. Risik & Commissioner Sts., Johannesburg; 112 Long Street, Capetown; 369 Smith Street, Durban, Natal. Universal Book Agency, 70 Harrison Street, Johannesburg, Middle East: Steimatzyk Middle East Agency, Jaffa Road, Jerusalem, India: Sush Gupta (Distributors) Co., Armita Bazar Patrika Lt., 14 Ananda Chatterjee Lane, Calcutta.

Editorial and Executive Offices:
 25 West Broadway, New York 7, N. Y.



MEMBER AUDIT BUREAU OF CIRCULATION
 ABC PAID CIRCULATION 6 MONTHS TO JUNE 30,
 1948-112,592. (Publishers Statement) PRINTED
 FOR MARCH ISSUES-177,000

Television is Booming—Cash in on it!



Get YOUR All-Plastic Cabinet by Purchasing the Resistor Assortment of 1/2-watt "Little Devils" . . . \$12.50

It's easy to find the right resistor . . . fast . . . in this handy, handsome, all-plastic OHMITE cabinet. Compact — only 9" x 5 1/4" x 4 3/4" — its 40 compartments are packed with a selected serviceman's assortment of 125 individually marked "Little Devil" resistors in 40 values from 10 ohms to 10 megohms. And, you pay only the regular price of the resistors . . . nothing extra for cabinet.



See Your Distributor

BROWN DEVIL

Vitreous Enamel Resistors



A favorite with servicemen. Easily mounted by its tinned wire leads. In sizes 5, 10, and 20 watts. Tol. ± 10%.

DIVIDOHM

Adjustable Resistors



Vitreous enameled. 10 to 200 Watts. Ideal for securing odd resistance values.

OHMITE MANUFACTURING CO.
 4895 Fleurnoy Street • Chicago 44, Ill.

Be Right with
OHMITE

RHEOSTATS · RESISTORS · TAP SWITCHES

RADIO-ELECTRONICS for

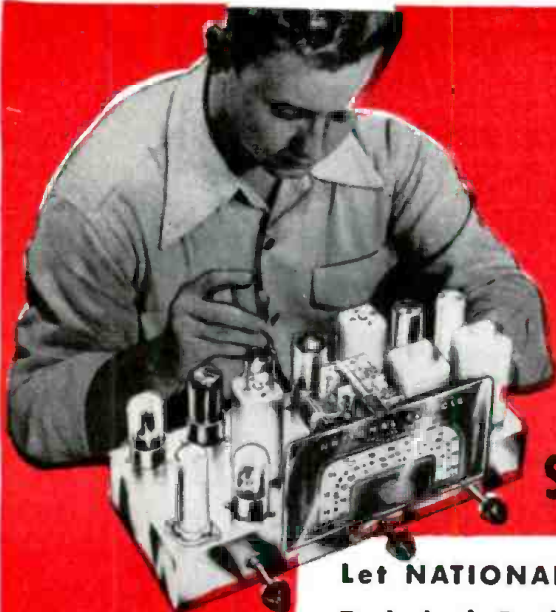

Learn RADIO

TELEVISION, ELECTRONICS
by
SHOP METHOD HOME TRAINING

Let NATIONAL SCHOOLS, of Los Angeles, a practical Technical Resident Trade School for almost 50 years, train you for today's unlimited opportunities in Radio

You receive all parts including tubes, for building this fine, modern superheterodyne Receiver. This and other valuable standard equipment becomes your property.

these two FREE books will tell you how



Good Jobs Await the Trained Radio Technician

You are needed in the great, modern Radio, Television and Electronics industry! Trained Radio technicians are in constant and growing demand at excellent pay—in Broadcasting, Communications, Television, Radar, Research Laboratories, Home Radio Service, etc. National Schools Master Shop Method Home Study course, with newly added lessons and equipment, can train you in your spare time, *right in your own home*, for these exciting opportunities. Our method has been proved by the remarkable success of National Schools-trained men all over the world.

You Learn by Building Equipment with Standard Radio Parts We Send You

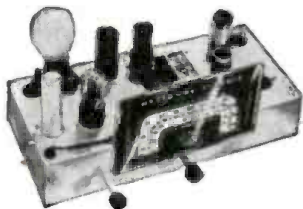

Your National Schools Course includes not only basic theory, but *practical* training as well—you *learn by doing*. We send you complete standard equipment of professional quality for building various experimental and test units. You advance step by step until you are able to build the modern superheterodyne receiver shown above, which is yours to keep and enjoy. You perform more than 100 experiments—build many types of circuits, signal generator, low power radio transmitter, audio oscillator, and other units. The Free Books shown above tell you more about it—send for them today!

Lessons and Instruction Material Are Up-to-date, Practical, Interesting

National Schools Master Shop Method Home Training gives you basic and advanced instruction in all phases of Radio, Television and Electronics. Each lesson is made easy to understand by numerous illustrations and diagrams. All instruction material has been developed and tested in our own shops and laboratories, under the supervision of our own engineers and instructors. A free sample lesson is yours upon request—use the coupon below.

You Get This and Other Valuable Information in the Free Sample Lesson:

1. Basic Receiver Circuits and How They are Used.
2. Construction of the Antenna Circuit.
3. How Energy is Picked Up by the Aerial.
4. How Signal Currents are Converted into Sound.
5. How the Tuning Condenser Operates.
6. How the R-F Transformer Handles the Signal, and other data, with diagrams and illustrations.

Both Home Study and Resident Training Offered

APPROVED FOR VETERANS

Check Coupon Below

Now! NEW PROFESSIONAL MULTITESTER INCLUDED:



This versatile testing instrument is portable and complete with test leads and batteries. Simple to operate, accurate and dependable. You will be able to quickly locate trouble and adjust the most delicate circuits. You can use the Multitester at home or on service calls. It is designed to measure AC and DC volts, current, resistance and decibels. You will be proud to own and use this valuable professional instrument.

GET THE DETAILS—SEND THE COUPON →

NATIONAL SCHOOLS

LOS ANGELES 37, CALIFORNIA EST. 1905



MAIL OPPORTUNITY COUPON FOR QUICK ACTION

NATIONAL SCHOOLS, Dept. RE-R3
4000 S. Figueroa, Los Angeles 37, Calif.

Paste on a postcard

Mail me FREE the book "Your Future in Radio" including a sample lesson of your choice. I understand no salesman will call on me.

NAME AGE

ADDRESS

CITY Zone STATE

Check here if Veteran of World War II

ANOTHER
McGEE

SCOOP!

BRAND NEW
\$110.00 VALUE

HALLICRAFTERS \$59.50
SALE PRICE

11-TUBE S-56 CUSTOM AM/FM CHASSIS

**1948 MODEL—MIKE-BROADCASTER
ONLY \$7.95**

Broadcasts 800 to 1500 KC from either a phonograph pick-up or a crystal or dynamic mike. Makes any radio receiver a P.A. system, record player or recording amplifier. Gives broadcast quality. Has fader control from mike to record, simulating a regular broadcast station. This is a powerful model using 2-353B, 12S17 and 35W4 tubes. Priced with tubes and connecting instructions. Works on 110 volts AC-DC. Crystal mike and desk stand \$4.95 extra. Model DE-5 truly a de-luxe mike-phonoscillator.

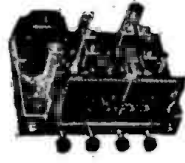

11-TUBE FM/AM MODEL S-56 \$59.50 WT. 25 LBS.

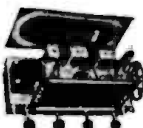

8-TUBE FM/AM MODEL S-59 \$39.95 WT. 18 LBS.

HALLICRAFTERS S-56 FM/AM popular custom radio receiver chassis. Regular \$110.00 net price. A sleek, new precision-engineered chassis designed to meet the popular demand for a medium priced radio receiver with top performance characteristics. This outstanding value offers high quality performance comparable to that found in console models in the \$400.00 to \$600.00 price range. The special features of this chassis are: automatic frequency control which assures clearest possible reception of FM stations by eliminating the human error in tuning; as stations are approached, this circuit "takes over" electronically and holds the station in perfect tune; Full range tone control; Phonograph attachment on rear of chassis; wide vision dial accurately calibrated in MC; new type high efficiency miniature tubes, \$59.50.

This radio has ten tubes, power rectifier, Frequency range 540 to 1700 kc and 88 to 108 mc. Audio response 50 to 14,000 cycles. 7 watt output. Power 105-125 volts 50-60 cycles AC. Provide ventilation to dissipate 90 watts of heat. Output transformer matches 500 to 600 ohm line. Four antenna terminals: two for AM and two for FM. Transformer 500 ohm line to 3.2 or 6.8 ohm voice coil (necessary to match S-56 or S-59 to FM speaker). Net price \$2.50.

12" coaxial PM speaker, regular \$37.50 list; net price \$12.95. Recommended for either S-56 or S-59. Stock No. CR-13X. (Response 50 to 17,000 C.P.S.)

HALLICRAFTERS S-59 FM/AM moderately priced radio receiver. Another new, excellently engineered chassis for installation whenever both quality of performance and low cost are to be considered. Easily comparable in operating characteristics and tone to console in the \$300.00 class. Especially suited to applications where distortion-free reception is desired with full room volume for moderately sized rooms. The outstanding features of the S-59 chassis are: full range tone control, phonograph input jack on rear for connecting any standard record changer or player, wide vision slide rule dial is accurately calibrated in mc. New type high efficiency miniature tubes for greater sensitivity. This radio has 7 tubes plus rectifier. Frequency range 540 to 1700 kc and 88 to 108 mc. Audio response 50 to 14,000 cycles (plus 3 db.). watt output. Power 105-125 volts, 50-60 cycles AC. Provide ventilation for 80 watts of heat. Output transformer matches 500 to 600 ohm line. Has 4 antenna terminals: 2 for AM and 2 for FM. \$39.95.

DE-2X Phonograph Oscillator. Broadcasts from 800 to 1500 KC gain for any crystal pick-up. A new, powerful circuit has variable gain control. Priced complete with 2 tubes and connecting instructions. Net. \$3.95

BUY A DELUXE 12 INCH "COAXIAL" P.M. SPEAKER FOR YOUR RADIO OR AMP SALE PRICE \$12.95

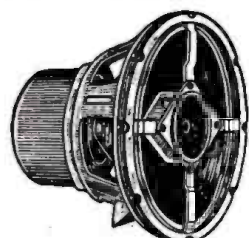

12 INCH COAXIAL MODEL CN-12X \$10.95

Designed by one of America's finest speaker builders. Made for FM high fidelity radios, record players and P.A. systems. This speaker is incorporated in the \$500.00 bracket. It has an especially designed 12" 4.64 oz. Alnico V magnet PM for the low range and a coaxially built-in 3" Alnico V tweeter. The high pass filter in concealed in the speaker. Just hook to any 8 ohm output transformer will hook in place of any home radio speaker. As most speakers have an 8 ohm voice coil. Only 2 wires to connect, will handle 18 watts peak. Frequency response, 50 to 17,000 CPS. This coaxial PM speaker should sell for \$35.00. Why buy an ordinary speaker, when we offer you the speaker of the future; for only \$10.95! Stock No. CN-12X. Weight 8 lbs. \$10.95, 2 for \$20.95

\$15.00 Value Output, 34 Watt P. 0L8 to 4-8-16 500 Ohms. Plus 10% dead back Compound filled case, 6 lbs. 20 to 20,000 cycles. Net \$6.95

DELUXE 12 INCH COAXIAL MODEL CR-13X \$12.95

A regular \$37.50 list speaker. The same basic design as the model CN-12X, described above, but furnished with 6.8 ohm magnet in the 12" woofer. Frequency response, 40 to 17,000 CPS. Has more mellow tone than CN-12X. Weight 9 lbs. Model CR-13X, \$12.95, 2 for \$24.95.

15 INCH SUPER HEAVY DUTY COAXIAL P.M. SPEAKER \$24.95

"IT WOOFAS AS IT TWEETS"

The King Coax. A 21.5 oz. 15 inch Alnico V PM speaker with a built-in high frequency tweeter. Will respond to 50 to 12,000 cycles. This is a ruggedly built speaker with a curvilinear one piece molded cone. Built-in high pass filter. Just hook to any 8 ohm output transformer. This speaker has a retail list price of over \$60.00. We offer you our 5-15X 15 inch coax for only \$24.95. Weight 22 lbs.



8-TUBE RADIO KIT

2-BAND \$16.95

KIT MODEL ABK-7. A complete kit of parts and tubes to build an 8-tube quality radio chassis for custom installations. Made from basic Detroit components. Has illuminated slide rule dial and 3 gang tuning condenser. R.F. stage on both broadcast and short wave. Receives 550 to 1650 kc and 6 to 18 mc; foreign shortwave. Complete with heavy duty 8" PM speaker. Includes all parts, ready punched chassis and tubes: 2-6SD7, 6SA7, 6SQ7, 6J5, and 2-25L6 in push pull; 25Z6 rectifier. Photo of chassis wired and instructions are furnished. This kit has not only top selectivity and sensitivity, but high fidelity audio; with continuously variable tone control. A real McGee value. Priced at only \$16.95. Weight 16 lbs.

KIT MODEL AC-AK6. Same chassis and frequency coverage as above kit ABK-7, except has 6 tubes with single 6V6 output tube and 90 mill power transformer. Everything else is the same. It is designed for those who prefer a straight AC transformer type radio. A complete kit; everything is furnished including tubes and diagram, with instructions. Net price \$16.95. Weight 15 lbs.

KIT MODEL DBK-8. A basic kit, same as the AC-AK6 pictured above, but only the basic parts are furnished. No tubes or speaker are included. You get the diagram, dial, ready punched chassis, all coils, tuning condenser, band switch and loop antenna. Sale price \$6.95. Weight 7 lbs.

SAVE OVER 1/2 ON MALLORY CONDENSERS

1948 Production Mallory wax filled 600 Volt tubular by-pass condensers—Buy 100 Assorted and Save. .003, .004, .006, .02, .03, .04, .06, 600 Volt 8¢ each. 100 assorted for \$6.95.

Mallory type ST paper tubular electrolytics with metal tabs for upright or under chassis mounting. Make 100% off for 100 assorted.

8-8 Mfd 450V	54¢
8-8 Mfd 450V	29¢
16 Mfd 450V	39¢
30 Mfd 450V	49¢
20-20 Mfd 150V	39¢
30-30 Mfd 150V	44¢
40-40 Mfd 150V	49¢

Mallory upright mounting aluminum can electrolytics (Screw Mtg.)

Standard Size. 10% off for 100 Assorted.	
8 Mfd 450 Volt	49¢
12 Mfd 450 Volt	54¢
30 Mfd 450 Volt	59¢
8x8 Mfd 450 Volt	59¢

BRAND NEW 1949 PRODUCTION 15 INCH PERMANENT MAGNET SCOOP OF ALL TIMES NEW MOLDED CONE

Pre-War or Post-War, you never bought a speaker like this, for such a scoop price. Made by a nationally known builder of fine speakers. 12 1/2" diameter, 12 1/2" high. This speaker of juke box quality. Has standard 8 ohm voice coil. Will take up to 18 watts average or 25 watt peak. Here is a speaker that will bring out those low notes. Latest 1948 production; not line through-outs. Every speaker is guaranteed new and perfect. We may not be able to continue this offer for long, so place your order now. Stock No. 15-KR. INCLUDE POSTAGE. Weight 11 lbs. A \$35.00 value for only \$9.95



15" DELUXE 50 WATT P.M. SPEAKER \$16.95

Model 15-LS. 15" 21 1/2 oz. Alnico V Magnet PM Speaker. Will take 35 watts with ease. Thousands of dollars were spent in building the fine tools to produce this speaker. The 8 ohm voice coil is heat treated and plastic coated. Constructed to eliminate loose voice coils, wires and wrapping. Made by a renowned builder of fine speakers. Truly the King of juke box speakers. Weight 18 lbs. Net Price \$16.95, 2 for \$32.95.

50 WATT 12 INCH SUPER HEAVY DUTY P.M. \$14.95

Model A-50—12", 50 watt super heavy duty permanent magnet speaker. Has 1 1/2" 8 ohm treated voice coil and one piece molded cone. Heavy half inch machined pot with bolt secured top cover. Finished in silver-grey enamel. This speaker is the best value possible today. Efficiency is two to three times that of ordinary speakers. Especially recommended for all public address systems and high quality home audio systems. Will handle 35 watts with ease and 50 watts peak or short lengths of time. Its retail value is \$50.00. But, by our large purchase, we are able to offer it to you for only \$14.95. Do not confuse this speaker with surplus machines. This is the latest production. Model A-50, Weight 15 lbs. Net \$14.95, 2 for \$29.00.

4-TUBE T.R.F. KIT

BARGAIN SPECIAL \$6.95

4 tube AC-DC. TRF radio kit. Ideal for students and beginners. Every part furnished to build this kit. Including tubes, diagram and photos. Has Alnico V PM speaker and tubes. 12SK7, 12SJ7, 50B5 and 35W4. Plastic cabinet with airplane dial. Receives broadcast 550 to 1600 KC. This is the easiest type of radio to build. Kit Model TF-4. Weight 6 lbs. Net \$6.95.



DELUXE 5-TUBE AC-DC KIT

OUR LEADER \$9.95

Made from Detroit Components. A full size 5-tube superhet radio kit housed in a 13-inch wood cabinet with full plastic front. Lighted slide rule dial. Incorporates a standard 2 gang superhet circuit. Loop antenna, ready punched chassis, etc. This is another one of our line production radio kits. Every part is furnished including tubes, 12BA6, 12BE6, 12AT6, 50B5 and 35W4. Diagrams, photos and instructions are included. 5¢ dynamic speaker. Receives broadcast 550 to 1650 kc. Weight 9 lbs. Kit Model TF-6C. Net \$9.95.



12-WATT AMP. KIT, \$10.95

KIT MODEL AC-12. 12 watt amplifier kit. Ideal for high quality record player as well as public address or recording amplifier. Matched component parts, ready punched chassis pan. One control fades from phono to microphone. Gain enough for crystal or dynamic microphone. 100 mill power transformer, for 110 volt AC 60 cycle operation. Priced complete with tubes: 2-6X5, 6SN7, 6SH7 and rectifier. Diagrams and photos furnished. Kit AC-12. Net \$10.95. 12" Alnico 5 PM speaker \$6.95 extra; crystal microphone and desk stand \$4.95 extra. The above AC-12 amplifier wired and tested ready to operate net \$14.95. Specify Stock No. AC-12S. 12-inch Alnico 7 PM speaker \$5.95 extra. Crystal mike and desk stand \$4.95.

Portable Player Kit Scoop \$9.95

Deluxe portable electronic record player kit in deluxe carrying case. Includes all parts and easy to wire diagram. Comes complete with 3" PM speaker and all necessary carrying case self-starting phono motor, pickup, 5" FM speaker and all necessary parts to build 70L7 amplifier. Stock No. CK-1. Net Price \$9.95.



AUTOMATIC CHANGERS \$12.95

VM-800 Automatic Record Changer. Plays 10-12 inch or 12-10 inch records automatically. Base size 13 1/2" x 14". Light weight crystal pickup. A rod hook scoop in a changer. Net \$12.95, two for \$25.00. Stewart Warner with Permanent Needle. Size 12x13 Scoop price \$12.95, 2 for \$25.00. Webster Dual Speed Model 240. Size 12x13 1/2". Net \$29.25.



THEATRE QUALITY AMPLIFIER KIT

\$75.00 Value ONLY \$24.95

Our sales and engineering department, realizing that not everyone can afford a \$100.00 audio amplifier, has designed a Theatre Quality amplifier kit. The Theatre Quality Amplifier Kit. Response essentially flat, from 20 to 17,000 cycles. It contains every part, tubes and ready punched chassis; less speaker. Diagrams, photos and assembly instructions are furnished. Has input for crystal or dynamic microphone and gain and tone compensation for the microphone or Webster variable reluctance cartridge; as well as conventional pickups. A 3-step tone switch for tone equalization. This kit has a 34 Watt Merit high fidelity, wax impregnated output transformer; with 4, 8, 16, and 500 ohm taps. The chassis is of heavy treated metal, ready punched; approximately 5" x 11". The quality of all parts is second to none. Priced complete with tubes as follows: 12AX7, 3-6C4, 2-6AQ5 and 5Y3. This is the best amplifier kit we know how to produce and we have made thousands. Kit Model ME-15R. New price less speaker \$24.95.

RECOMMENDED SPEAKERS FOR MODEL ME-15R

The 15" Altec Lansing 603-B Model. (Pictured above) fits ME-15R. This speaker is a completely new type of FM speaker. Rated at 25 Watts. Has 3" 8 ohm voice coil. The metal high frequency diaphragm operates into a multicellular form. Frequency division is accomplished mechanically. This is the finest speaker we know about. Weight 20 lbs. Net \$63.00.

Our nationally famous CR-13X 12-inch Coaxial PM speaker \$12.95. Model 5-15X 15-inch Coaxial PM Speaker. Net price \$24.95.

COMPLETE INTERCOM \$11.95

McGrude Intercom. Master and sub-station, housed in nut plastic cabinets, 5 small matching wall-mounted speakers, 5 x 7 1/2 inches. Sliding front for desk or wall installations. Furnished with 50 feet of interconnecting wire. Sub-station has 100 feet from master station. These units are new and factory warranted. Complete with tubes. Made to retail at \$29.95. A lucky purchase enables us to offer these to you; for only \$11.95. Include postage for 8 lbs. Stock No. MG-25.

6-VOLT POWER SUPPLY SCOOP \$2.95

1 1/2 Volt—90 volt Vibrator Power Supply. Makes 1 1/2 Volt portable radios works on 6 volt storage battery. Has 4 prong 6 pack plug. Worth \$10.00. Sale price \$2.95. Stock No. X-VT. Weight 6 lbs. Seldom—100 Watt Soldering Iron for radio use. Worth \$3.95. Sale price \$1.95.

McGEE RADIO COMPANY Order from This Ad. Prices F.O.B. K.C. 25% Deposit with C.O.D. Orders include Postage with full remittance. **SEND 25% DEPOSIT—BALANCE C.O.D. 1227 McGEE ST., KANSAS CITY, MISSOURI**

Television is Booming—Cash in on it! **RADIO-ELECTRONICS for**



I'll Send You 8 Big Kits of Training Equipment
including
TWO-BAND 6 TUBE SUPER RECEIVER
AND 16 RANGE METER SET-UP
for Testing

Learn Fast . . . Earn Fast
HOME TRAINING
Planned For Your Needs
You Build All These
TESTERS . . . and MORE!



PRACTICE WITH YOUR OWN HANDS!
 Mind training through hand practice, that's the only way to LEARN and REMEMBER Radio. It's the most successful of Home Training methods.

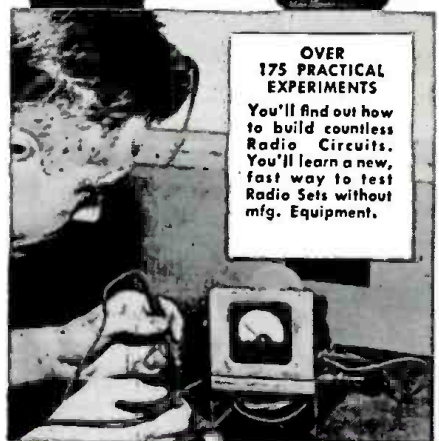

OVER 175 PRACTICAL EXPERIMENTS
 You'll find out how to build countless Radio Circuits. You'll learn a new, fast way to test Radio Sets without mfg. Equipment.

I give you a fine, moving-coil type Meter Instrument on Jewel Bearings—with parts for a complete Analyzer Circuit Continuity Tester. You learn how to check and correct Receiver defects with professional speed and accuracy.

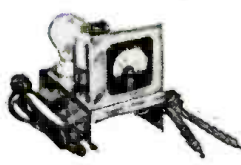

Practice Does It!

Soldering, wiring, connecting Radio Parts . . . building circuits with your own hands—you can't beat this method of learning. When you construct this Receiver and Filter Resistor and Condenser Tester, etc., you get a really practical slant on Radio that leads to a money-making future.

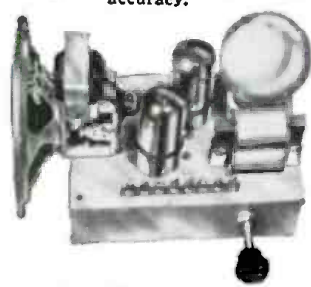

LOW COST HOME RADIO TRAINING!
Easy Monthly Payments!

My perfected Radio Training prepares you to start your own Radio Service Shop—or to land a big pay Radio job. With my help you get Radio jobs while learning—*for extra cash and rich experience.* I train you RIGHT—by putting you to work with your hands in your own home during spare hours. You get 8 big kits of real professional Radio Parts and Equipment—and use them to build, test and trouble-shoot a powerful 6 tube superhet receiver, a 16 range test meter set-up and over 175 fascinating, instructive Radio experiments. My training is down-to-earth, really

PRACTICAL—it's the Training you need to make money in Radio. Theory is cut to the bone—you don't need any previous schooling or experience. Sprayberry Training starts you out at the very beginning of Radio—the lessons are illustrated, simply written and easy to understand. Get the facts about Sprayberry Training now. Find out what it can do for you—prepare for amazing opportunities in Radio Servicing, Television, FM, Radar and Industrial Electronics. Fill out and mail coupon for my two big Books—FREE. No obligation—and no salesman will call. Mail coupon Now!

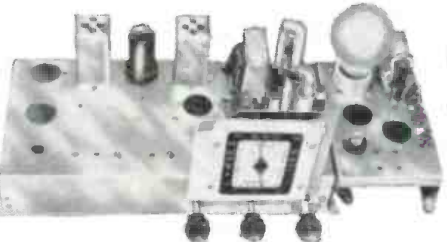

Building this Signal Generator and multi-purpose Tester will give you the kind of valuable experience and practice that is so important as a foundation for making good money in Radio. It makes a breeze out of fixing Radios, and you don't have to spend money on ready-made Equipment.

NOW! TWO LOCATIONS TO SERVE YOU BETTER
 Mail Coupon to Location Nearest Your Home
SPRAYBERRY ACADEMY of RADIO, Dept. 20-P
 Sprayberry Building or 20 N. Wacker Drive
 Pueblo, Colorado or Chicago 6, Illinois

MAIL COUPON FOR THESE 2 BOOKS!



VETERANS: Approved for G.I. Training under Public Laws 16 and 346

SPRAYBERRY ACADEMY of RADIO, Dept. 20-P
 SPRAYBERRY BUILDING, PUEBLO, COLORADO, or
 20 NORTH WACKER DRIVE, CHICAGO 6, ILLINOIS

Please rush my FREE copies of "How to MAKE MONEY in RADIO, ELECTRONICS and TELEVISION" and "How to READ RADIO DIAGRAMS and SYMBOLS."

Name _____ Age _____
 Address _____
 City _____ State _____

(Mail in envelope or paste on penny postcard)

Now-Plan for a Good Paying

INSTALLER

TEST ENGINEER

MAINTENANCE TECHNICIAN

SERVICEMAN

CAMERA MAN

CONTROL ROOM OPERATOR

Career Job in TELEVISION

Get On The TV Band-Wagon Now!

GOOD JOBS ARE WAITING FOR GOOD MEN — CREI TRAINING IS YOUR BEST REFERENCE

Add CREI Technical Training to Your Present Radio Experience, Get That Better Television Job —Make More Money—Enjoy Increased Security.

You can make your own opportunity in Television, if you start preparing *now*. No need to tell you how fast this great new field is expanding—or, of the great number of jobs that are being created. If you are in Television now, expect to be, or wish to get in, CREI offers the very training you need to help accomplish your aims.

CREI can show you the way with convenient spare-time study at home that gives you the up-to-date technical background you *must have* for Television. CREI courses are designed to give you a thorough grounding in basic principles and take you step-by-step through the more advanced subjects of Television and its related fields. It must be re-

membered that all new electronic developments have their roots in past techniques. CREI training is basic and helpful in your daily work right from the start. You will learn about and understand such subjects as: Optics; Pulse Techniques; Deflection Circuits; RF, IF, AF and Video Amplifiers; FM; Receiving Antennas; Power Supplies; Cathode Ray, Iconoscope, Orthicon and Projection Tubes; UHF Techniques, Television Test Equipment, etc.

No matter how complete, or how limited your radio experience, CREI has a practical course of training for you based on twenty years experience in training professional radiomen. The facts about CREI, our courses, and what we can do for you, are described in our 32-page booklet. It is well worth reading. Send for it now.

VETERANS! CREI TRAINING AVAILABLE UNDER G. I. BILL

If you have had professional or advanced amateur experience and want to make more money, let us prove to you we have the training you need to qualify for a better radio job. To help us answer intelligently your inquiry—*please state briefly your background of experience, education and present position.*

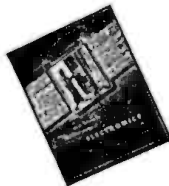

CAPITOL RADIO ENGINEERING INSTITUTE

An Accredited Technical Institute

Dept. 143A, 16th & Park Road, N. W., Washington 10, D. C.

Branch Offices: N. Y. 7, 170 Broadway; San Francisco 2, 760 Market St.

MAIL TODAY!

CAPITOL RADIO ENGINEERING INSTITUTE
16th & Park Road, N. W., Dept. 143-A, Washington 10, D. C.

Gentlemen: Please send your free booklet, "Your Future in the New World of Electronics," together with full details of your home-study training. I am attaching a brief resume of my experience, education and present position.

Check field of greatest interest:

- PRACTICAL TELEVISION PRACTICAL RADIO-ELECTRONICS
 BROADCASTING AERONAUTICAL RADIO ENGINEERING
 RECEIVER SERVICING

NAME.....

STREET.....

CITY..... ZONE..... STATE.....

I AM ENTITLED TO TRAINING UNDER G. I. BILL.

RADIO-ELECTRONICS for

Don't miss the chance of a lifetime!

TELEVISION

Radio - Electronics ..

OFFER YOU A PROFITABLE FUTURE!

Get the Facts About Our

GREATEST OFFER in 17 YEARS

Here's good news . . . big news . . . our BIGGEST NEWS in 17 years. The equipment pictured at the right gives a partial idea of D.T.I.'s remarkable new combination of shop-method, home-training aids.

Now you can use and keep ALL of this equipment — PLUS other major training aids — to prepare you at home for a grand future in the fast-moving field of TELEVISION . . . RADIO . . . ELECTRONICS.

SEND FOR FREE BOOKLET

Mail the coupon today for our big, new 48-page OPPORTUNITY GUIDE BOOK. See how D.T.I.'s amazing, newer, training method helps you get started toward a GOOD JOB or your OWN BUSINESS in one of America's most promising, thrilling fields . . . that includes Television . . . F.M., Train, 2-Way Taxi, Aviation, and Broadcast Radio . . . Industrial Electronics . . . and other fast-developing branches.

In addition to well-illustrated lessons, you receive 16 shipments of Radio-Electronic parts from which you work over 300 instructive projects — including the building of (1) a commercial-type CATHODE RAY OSCILLOSCOPE that helps you get practical Television circuit training, (2) a double-range R-F SIGNAL GENERATOR, (3) a jewel-bearing MULTI-METER and (4) a quality 6-tube SUPERHET RADIO. You keep all of this equipment.

You also use HOME MOVIES

. . . a D. T. I. Exclusive!

D.T.I. alone includes the use of modern, visual training aid . . . MOVIES . . . to help you learn faster, easier at home. You see electrons on the march and other fascinating "hidden action" — a remarkable home training advantage that speeds your progress.



DeFOREST'S TRAINING, INC.

CHICAGO, ILLINOIS

Affiliated with the De Vry Corporation
Builders of Electronic and Movie Equipment

OSCILLOSCOPE

MULTI-METER

YOU BUILD and KEEP THIS EQUIPMENT
Work over 300 Home Experiments

EMPLOYMENT SERVICE

When you complete your training, our effective Employment Service is available to you without extra cost, to help you get started.

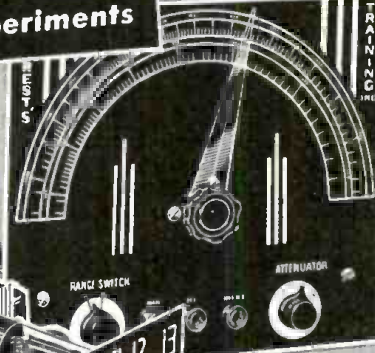

R-F SIGNAL GENERATOR

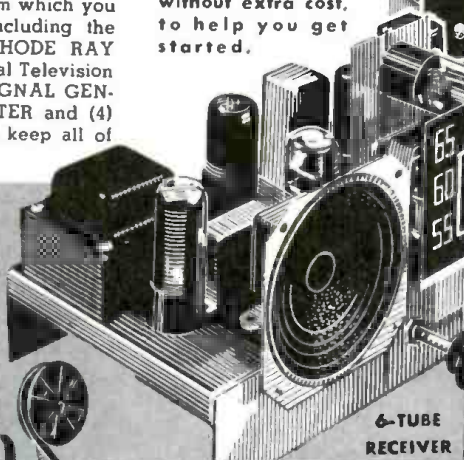

6-TUBE RECEIVER

You May Choose to Train in Our MODERN CHICAGO LABORATORIES Train quickly, using a wide variety of commercial equipment. D. T. I.'s new labs are among the finest of their kind. Ample instructors . . . every major training advantage. Write for details!

MAIL THIS OPPORTUNITY COUPON NOW!

DeForest's Training, Inc.
2533 N. Ashland Ave., Dept. RC-F3
Chicago 14, Illinois

Send me FREE your 48-page OPPORTUNITY GUIDE BOOK showing how I may make my start in Television — Radio — Electronics.

Name _____ Age _____

Street _____ Apt. _____

City _____ Zone _____ State _____

C-1 AUTO PILOT ASSEMBLY

Made by Norden

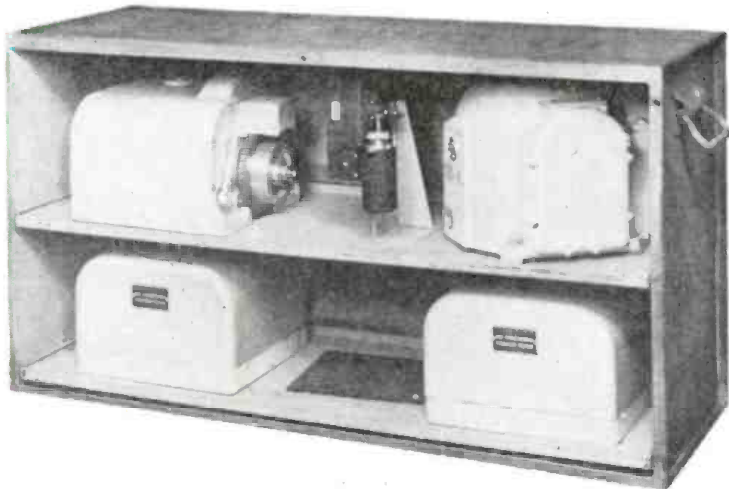

(BRAND NEW)

**AS PICTURED AT LEFT
and below**

Stabilized bombing approach equipment type M-7. All the following units come housed in a steel case, size 36" long x 17" high x 12" deep. Weighs approximately 160 lbs. net.

**Consists of (3)
C-1 SERVO UNITS**



C-1 SERVO UNIT

Use to rotate beam antenna, actuate boat rudder control, etc. Contains 24 V. motor, clutch, relays, etc. Reversible. Size overall approx. 10 1/2" x 8 1/2" x 6 1/2".



and (1) C-1 GYRO



C-1 GYRO

Part of the C-1 Auto Pilot may be used to conduct many interesting and amusing experiments. Operates from 24 V. DC or may be operated for short periods on 110 V. AC. Gyro will run for approx. 15 minutes after actuating. Size—approx 8" x 8 1/2" x 8 1/2".

And (1) Directional Panel with dashpot action (not pictured).

ALL FIVE OF THESE UNITS AS DESCRIBED INDIVIDUALLY AND AS PICTURED AT TOP, PRICED, BRAND NEW, AT

\$49.50



C-1 AUTO PILOT AMPLIFIER

Used to control operation of servo unit in response to signals received from gyro unit and control unit. The complete amplifier includes one rect. 7Y4, 3—7F7's for amplification and control, 3—7N7's for signal discrimination, 1 power transformer, 6 relays, 4 control pots, chokes, condensers, etc. Convert for use on radio controlled models, doors, etc. Operates from 24 V. DC. Size, 9 1/4" x 6 1/4" x 7 5/8".

\$16.95



C-1 AUTO PILOT CONTROL BOX

Used for aligning control of C-1 Auto Pilot or use for parts, etc. Contains many useful pots, toggle switches, plugs, etc. Size, 11" x 6" x 4 1/2". PRICE

\$6.75

ESSE

Radio Co

130 W. New York St.
Indianapolis 4, Ind.

Unless Otherwise Stated, All of This Equipment Is Sold As Used

CASH REQUIRED WITH ALL ORDERS

Orders Shipped F.O.B. Collect

RECTIFIER POWER UNIT *Navy Type CLG-20341*

110/220 Volt, 50/60 cycle, single phase AC operated.

Net weight 263 lbs. Gross weight 335 lbs. 28" high, 19 $\frac{1}{2}$ " wide, 23 $\frac{1}{4}$ " deep (4.25 cubic ft.).

Will continuously deliver rated load of 25 amperes at 7 Volts, 14 Volts, or 28 Volts DC.

It will furnish an instantaneous dynamotor starting current of 25 amperes at 28 Volts output.

This unit is portable and is sturdily constructed in welded steel frame. It is housed in steel case provided with louvres. 4 handles for carrying are welded to case. Controls, fuses and cables readily accessible. Input and output cables are permanently attached and stored in compartments in front of case. Spare fuses and pilot lamps are easily accessible from the front. On/off switch is mounted in recessed panel on front of case.

4 connector lengths and terminals are provided for proper connections to input and output voltages. Terminal cut-out provides protection. A sturdy blower motor fan is provided for cooling of the 15 amp. Selenium rectifiers running 1550 Rpm. and has 10" blades.

A sensitive regulating circuit keeps output voltage constant under varying load conditions or input voltage fluctuations. Adequate inductance and capacity are included for good filtering of the output voltages.

A complete operating manual accompanies the unit.

This equipment was made by Electronic Laboratories, Inc. of Indianapolis, Indiana, and is really a very dependable fine rectifier power unit and can be compared with only the finest. It cost our Government approximately \$500.00.



Our price, complete, **BRAND NEW . . . \$179⁵⁰**

Spare Parts Kit for the above described Rectifier Power Unit Navy Type CLG-20341 contains:

- | | |
|--|---|
| 1 Resistor, WW, 9 watts, 15 ohms | 1 Rectifier, selenium, 13 Volts 60 cycle input, 9 volts 2 amps. output |
| 1 Resistor, WW, 100 watts, 25 ohms | 2 Rectifiers, Selenium, Input 46 Volts AC, Output 35 Volts 15 amps. |
| 6 Condensers, 2000 Mfd. 50 V Electrolytic | 1 Blower Motor Assembly fan, Input 115 V. 60 cycles AC, 1550 Rpm., 10" blades |
| 1 Socket and red lens | 2 Fuse clips, phosphor bronze |
| 1 12 ft. 2 conductor #10 wire output cable, with lugs | 2 Cap screws, hex heads |
| 1 25 ft. Input cable #10 wire, plug on cable | 2 Lock washers, split ring type |
| 1 Relay, normally open, DPST, 115 V. 60 cycle AC | |
| 2 Pilot lamps 6 V., .25 amp. bayonet base | |
| 1 Switch DPDT taggle type 10 amp. at 125 V. rating | |
| 1 Thermal cutout, contacts 10 amps at 110 V. AC normally closed, switch opens at 70 degrees C° | |
| 20 Fuses, cartridge type, 15 amp. 25 Volts | |
| 10 Fuses, cartridge type, 30 amp. 250 Volts | |
- All these parts are housed in a heavy grey metal hinged box with a latch on it and cost the Government approximately \$250.00.
Our price on spare parts kit is—
These are brand new.

\$79⁵⁰

ESSE WILL BUY . . .

Some of the equipment listed below is urgently needed by our company to meet the demands of customers and we will pay highest cash prices. Send letter with full description describing condition and quote price. We will immediately answer and if we can use your equipment, we will authorize you to send it to us COD.

Our prices will amaze you. We will perhaps pay you quite a bit more for some of the below listed equipment than what you paid for it. Please don't hesitate to write us immediately.

WE NEED AT-ONCE . . .

BC-348 Receivers, AC or DC models

BC-312 Receivers

BC-221 Frequency Meters

Telrad Frequency Standards

SCR-522 transmitters & receivers

APN-4 Radar Scopes

Hallicrafter's BC-610 Transmitters

any factory built transmitters and receivers such as Hallicrafter's, National, Temco, Collins, RCA, RME, Hammerlund, Millen, Meck, Harvey-Wells, Meissner, Sonar, McMurdo-Silver, Gonset, Stoncor, Bud, etc.

Amateur or commercial sets
public address systems & equipment

large stocks of tubes

large stocks of transformers

large stocks of condensers

large stocks of resistors

large stocks of speakers

Fellows, we can use just about anything, so send a list of what you have for sale, with your price, but be sure to send all details in that first letter.

BC-224 Receivers

BC-342 Receivers

BC-412 Radar Oscilloscopes

BC-645 Transmitter-receivers

Command Set Transmitters & Receivers

TBY Transceivers

PE-103A dynamotors

BC-1068A Receivers

Police type VHF transmitters and receivers for mobile application

Propeller pitch motors

Collins ART-13 Transmitters

APS-13's

SCR-269F or G Fairchild or Bendix ADF's

Headphones in quantity lots

Microphones in quantity lots

Field telephones

Sound-powered telephones

ESSE

Radio Co
130 W. New York St.
Indianapolis 4, Ind.

Unless Otherwise Stated, All of
This Equipment Is Sold As Used
CASH REQUIRED
WITH ALL ORDERS
Orders Shipped F.O.B. Collect

Keep posted on Electron Tubes



MAIL COUPON TODAY

RCA, Commercial Engineering
Section 49CW, Harrison, N. J.

Send me the RCA publications checked
below. I am enclosing \$_____ to cover
cost of those books for which there is
a charge.

Name _____

Title or Occupation _____

Address _____

City _____ Zone _____ State _____

- Quick-Reference Chart, Miniature Tubes (Free). (A)
- HB-3 Tube Handbook (\$10.00)*. (B)
- RC-15 Receiving Tube Manual (35 cents). (C)
- Receiving Tubes for AM, FM, and Television Broadcast. (10 cents). (D)
- Radiotron Designers Handbook (\$1.25). (E)
- Quick Selection Guide, Non-Receiving Types (Free). (F)
- Power and Gas Tubes for Radio and Industry (10 cents). (G)
- Phototubes, Cathode-Ray and Special Types (10 cents). (H)
- RCA Preferred Types' List (Free). (I)
- Headliners for Hams (Free). (J)

*Price applies to U. S. and possessions only.



TUBE DEPARTMENT
RADIO CORPORATION of AMERICA
HARRISON, N. J.

Television is Booming—Cash in on it!

THEATRE TELEVISION was the subject of a meeting held last month by the Associated British Cinemas in Brighton, England. Plans were discussed for including a 30-minute video show on every program in 400 cinema theaters. The ABC may cooperate with J. Arthur Rank in development of theater TV, using Rank-manufactured equipment. Before a final decision, however, French and American large-screen systems will be thoroughly investigated.

Meanwhile, in London, motion-picture executives proposed the setting up of six frequency bands exclusively for the transmission of video programs from studios to theaters. Provision would be made to prevent unauthorized receivers from picking up the broadcasts. Two bands would be used by each of three TV stations. In return for the allocation, the film industry would discuss terms of providing the BBC with some of the films on the long list requested by Britain's broadcasting organization for use in home television transmission.

OUR COVER "The Spirit of Television"

The color photograph that adorns this month's cover is a reproduction of a statuette made expressly for our Annual Television Number. Publisher Hugo



Gernsback commissioned the noted Viennese sculptress Lilly Rona to execute his conception of *The Spirit of Television* in an appropriate rendering. The figurine, which was completed in two months, was then photographed in Kodachrome, and printing-plates for the cover were made.

Note that the female figure floats free, supported only by the electrical flashes on each side. These flashes emanate from the cathode-ray tube below.

There is a possibility that the statuette will be exhibited at future shows or conventions of the television industry.

NEW RECORDS which rotate at 45 r.p.m. were announced last month by RCA Victor. The discs are seven inches in diameter and are made of vinyl plastic. They are recorded with a maximum of 274 lines to the inch and each plays for the same length of time as an ordinary 12-inch 78-r.p.m. record—between four and slightly over five minutes per side. The maker claims that the main advantages of the new records are higher fidelity, fast changing (a special fast-action changer has been designed to play them), lower price, and smaller

storage space. The 45-r.p.m. speed is said to have been chosen as the best compromise between maximum playing time for a given record size and minimum distortion. Needle pressure is 5 grams and stylus radius .001 inch (same as for Columbia's LP records).



Introduction of the RCA Victor innovation has roused some controversy and confusion in the already far-from-standardized industry and among the public, all of whom were in the throes of adjusting to Columbia's 33½-r.p.m. LP Microgroove. RCA Victor's discs cannot be played on equipment designed for standard records or Microgrooves (see 1½-inch center-hole in photo). Two independent companies have announced that they will make records using one of the new systems. Mercury Records will follow the Columbia LP (33½ r.p.m.) system and Capitol Records will follow RCA-Victor (45 r.p.m.).

LIGHTNING RADIO REPAIR became a matter of literal fact in the home of A. J. Shore, Salt Lake City, last month. During a severe thunderstorm, lightning struck the radio receiver, which had been out of order for some time. The Shore family was awakened at 3:30 a.m. by the playing of their "broken" radio. It has worked perfectly ever since, Mr. Shore reports.

RADAR was used last month to track shooting stars too faint to be seen after sunrise. Charles A. Little, Jr., of the Carnegie Institute of Washington, Department of Terrestrial Magnetism, constructed a radar station especially for the purpose.

TV SERVICING is no problem, according to a statement made last month by Frank W. Mansfield, director of sales research for Sylvania Electric Products, Inc. A survey revealed that 58% of dealers said sets were performing extremely well and 27% reported that they needed only occasional service. Seven percent reported continual trouble, while 8% said they lacked enough information to give an opinion.

RADIO-ELECTRONICS for

IRE CONVENTION, to be held from March 7 to 10 at the Hotel Commodore and Grand Central Palace in New York, will feature a technical program including 27 sessions on radio-electronic subjects and six symposia. At least four government organizations and around 200 commercial firms will have exhibits ranging from raw materials to complete transmitters. In addition, 14 manufacturers have joined to prepare a center devoted entirely to exhibits on neuleonics.

PHOTO-MULTIPLIER telescope is the name applied by William A. Rhodes of Phoenix, Ariz., to his invention, which allows many people to view an astronomical scene at the same time. A television camera tube replaces the ordinary eyepiece of the telescope, sending the image through amplifiers and an optical system to an 8-inch-square viewing screen. The image is increased in brilliance as well as size and the def-



inition of the projected picture is as high as the telescope and atmospheric conditions permit. Not an improvement on standard telescopes, the instrument is designed only to bring the image of ordinary telescopes to the view of many observers. It could be used with existing large telescopes. In the photo, the viewing screen is on top of the white cylinder at the left.

TWO-BAND TV was requested of the FCC last month by a group of radio manufacturers representing about 95% of TV set output. The proposition for operation both on the present v.h.f. and the proposed u.h.f. bands was made with the hope of persuading the Commission to drop the freeze on station allocations, which is now in effect pending study of the frequency assignment problem.

As the manufacturers see it, the present bands would be used in large cities, and additional allocations in the u.h.f. region would be made in smaller communities. This would have the effect, according to spokesmen, of hastening TV development while preventing obsolescence of present receivers.

TRANSIT FM is not turning out to be as effective as it might, according to a comment printed in the *Cincinnati Post* last month. Reporting on the bus-riding public's reaction to an FM radio in the bus, Mary Wood wrote that most of the passengers seemed completely oblivious of it.

"The music was scarcely audible over the babble of female voices," she said. "Now and then when the newscast came on you could notice two or three men straining their ears to hear it. All in all, I don't think transit radio has had much effect on our cultural pattern one way or the other."

CHURCH TELEVISION was begun last month in New York City when the First Presbyterian Church announced that it was opening a "television center" for youngsters to keep them out of the local bars and grills. The parents' class of the church school has purchased a receiver and set aside a room for video shows for teen-agers and younger groups. The receiver will be available every evening of the week except Sunday.

Mrs. Kenneth Chamberlain, in charge of the television project, said, "We want our teen-agers to continue to look to the church for their good times as well as for their spiritual guidance. We hope it will inspire a pattern for many communities."

NO TV SETS for occupants of its city housing projects was the ukase handed down by the City of Detroit last month. In answer to a policy inquiry from the New Orleans Housing Authority, the director of the Detroit Housing Commission declared it felt tenants could better "save their money toward down payments on their own homes." The purchase—or ownership—of a television receiver is therefore forbidden.

The reaction of the citizens of Detroit to this action on the part of their supposed public servants has not yet been made public.

TIME, WEATHER, AND NEWS are shown simultaneously by WBKB, Chicago television station, all superimposed on the station call letters or an advertising message. The technique, termed "Multiscope," is used during non-broadcasting hours to replace the usual test pattern. The revenue derived from showing advertisers' sales messages is said to be bringing station profit-and-loss figures close to the black.



A Complete, Practical Handbook of Present-day TELEVISION

Now, the tremendous opportunities in the field of television are brought within your reach—by means of this crystal-clear book. Written in plain English, concise and up to the minute, it makes television easy to understand. There is no mathematics to confuse you and make explanations difficult to follow. Hundreds of vivid illustrations bring every fact and point right before your eyes. You'll be amazed at how simple television can become with

New Second Edition—453 Pages

TELEVISION SIMPLIFIED

by MILTON S. KIVER

Associate Instructor in Radio, U. S. Army Air Forces. Formerly Instructor in Radio, Illinois Institute of Technology.

This brand-new, authoritative handbook not only contains all the information you need for success in television, but covers the trouble-shooting and repair of radio sets. Beginning with a clear, overall picture of the entire field, it breaks down the television receiver into its component parts and circuits. It analyzes them, step by step, showing how they are formed, the roles they play, and their operating characteristics.

BRIEF OUTLINE OF CONTENTS

The Television Field; Ultra-high Frequency Waves and the Television Antenna; Wide-band Tuning Circuits; Radio-frequency Amplifiers; The High-frequency Oscillator, Mixer and Intermediate-frequency Amplifiers; Diode Detectors and Automatic Gain-control Circuits; Video Amplifiers; Direct-current Reinsertion; Cathode Ray Tubes; Synchronizing Circuit Fundamentals; Deflecting Systems; Typical Television Receiver—Analysis and Alignment; Color Television; Frequency Modulation; Servicing Television Receivers; Glossary of Television Terms.

EXAMINE THIS BOOK FREE

Let this great book prepare you to take advantage of the brilliant opportunities television offers. Send for it NOW!

MAIL THIS COUPON

D. VAN NOSTRAND COMPANY, INC.
250 Fourth Avenue, New York 3, New York

Please send me "Television Simplified." Within 10 days I will either return the book or send you \$2.00 after examination and \$2.00 a month for two months (\$6.00 in all) plus a few cents postage. Return postage is guaranteed.

Name

Address

City.....State.....

RE—Mar. '49

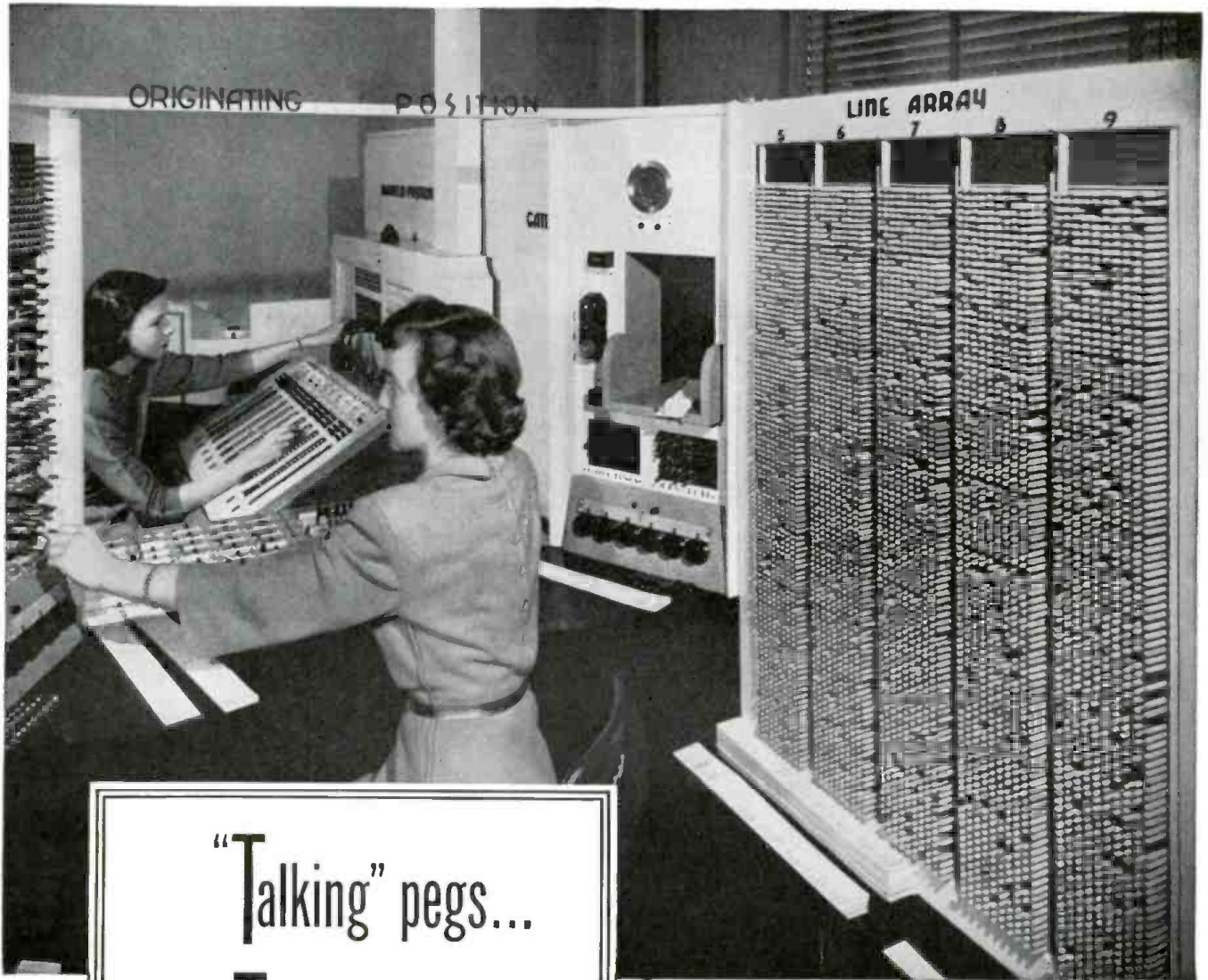

"Talking" pegs...
and Talking people

THERE ARE 10,000 pegs in this machine, representing 10,000 subscribers in a crossbar telephone exchange—the latest switching system which handles dial calls with split-second swiftness.

The pegs represent many types of telephone users—two-minute talkers and ten-minute talkers . . . people who dial accurately . . . those who make a false start or two. They are starting a journey through a unique machine which analyzes the performance of dial equipment in a typical central office.

But while an actual crossbar exchange connects your call in a matter of seconds, this counterpart moves far more slowly. It gives the Bell Laboratories engineers who built it time to observe what happens

to each call—where bottlenecks develop, which parts are overworked or underworked, which of the circuits are most used.

In a manual exchange, the number of operators may be changed to meet different traffic conditions. In crossbar, all switching is done by complex electro-mechanical devices, permanently built in. This machine shows how many devices of each kind there must be in a new exchange to give you the best of service with a minimum of expensive equipment.

This traffic-study machine is one of the many ingenious research tools devised by the Laboratories as part of its continuing job—finding new ways to give you better and better telephone service.



BELL TELEPHONE LABORATORIES

EXPLORING AND INVENTING, DEVISING AND PERFECTING, FOR CONTINUED IMPROVEMENTS AND ECONOMIES IN TELEPHONE SERVICE

Television is Booming—Cash in on it!

RADIO-ELECTRONICS for

TRANSVISION

PRESENTS THE NEW MODEL 12CL TV-FM KIT

Brings the biggest and best in television within the reach of everyone.

- Features 12 1/2" tube with fitted All-Angle Lens, giving over 200 sq. inch picture which is visible from any place in a room.
- Gives ideal long-range reception with **CONTINUOUS TUNING** on ALL CHANNELS. Has De Luxe TV-FM Inputuner.
- **COMPLETE** with Cabinet, Lens, Roto-Table, Antenna, Lead-in Wire.
- **A BIG PROFIT-MAKER** for service dealers. This kit is TOPS—ideal for homes, clubs, taverns, and other commercial installations.

EASY TO ASSEMBLE . . . NO TECHNICAL KNOWLEDGE REQUIRED

Transvision's simple step-by-step Instruction Sheet makes assembling a TV Kit a pleasure. Each kit comes complete with all-channel double-folded dipole antenna and 60 ft. of lead-in wire. *Nothing else to buy!*



MODEL 12CL TV-FM KIT

\$399⁰⁰ NET

Includes Cabinet, Lens, Table, Antenna

Here's amazing
GIGANTIC VALUE!

OVER

200

**SQ. IN. PICTURE
VISIBLE from ALL ANGLES
with FM RADIO**

(Has De Luxe TV-FM Inputuner)

(Picture bigger than a tabloid newspaper page)
IMAGE IS EQUAL to that of a 20" tube—even sharper and clearer—visible from all angles.

EQUIVALENT OF \$1000.00 SETS!

Price of the new 12CL electromagnetic kit includes these outstanding features:

- 12 1/2" picture tube with special fitted All-Angle Lens and color kit.
- Beautiful select-grain cabinet and roto-table.
- De Luxe Continuous TV-FM Inputuner.
- New all-channel hi-gain antenna and 60 feet of lead-in wire. *Nothing else to buy.*

NEW 10" TV KIT at amazingly LOW PRICE!



MODEL 10A TV KIT

The new Transvision Model 10A electromagnetic TV Kit gives a bright, stable 52 sq. in. picture. Has 10" picture tube, and **CONTINUOUS TUNING** on all 12 channels. Its high sensitivity makes for improved long distance reception; especially good on high channels. Complete with all-channel double-folded dipole antenna and 60 ft. of lead-in wire.

- MODEL 10A TV KIT, less cabinetNet \$199.00
- MODEL 12A TV KIT, same as above, but has a 12" picture tubeNet \$263.00

NEW STREAMLINED CABINETS

for Transvision Model 10A or 12A TV Kit. Made of select grain walnut with beautiful rubbed finish. Fully drilled, ready for installation of assembled receiver. Choice of finishes.

- Walnut Cabinet for 10A or 12A (Specify)Net \$44.95
- Mahogany and Blonde slightly higher.

TRANSVISION ALL-CHANNEL TELEVISION BOOSTER

To assure television reception in weak signal areas, or areas which are out of range of certain broadcast stations, Transvision engineers have designed this new booster. It increases signal strength on all television channels. Tunes all television channels continuously. Can be used with any type of television receiver. Unusually high gain in upper television channels. Model B-1LIST \$44.95

TRANSVISION REMOTE CONTROL UNIT KIT

Will operate any TV receiver from a distance. Turns set on, tunes in stations, controls contrast and brightness, turns set off. Ideal for installations where the television receiver is inaccessible. Tuner unit is a high gain, all-channel unit with about 50-micro-volt sensitivity. Easy to assemble in about an hour. Model TRCU, with 25 feet of cable.....Net \$69.00
Without cabinetNet \$65.00

TRANSVISION COMPLETE LINE OF TELEVISION COMPONENTS

Essential units for building a quality television set
Transvision makes available a complete line of high quality parts competitively priced. Included in this line are Filter Chokes, all types of Transformers, Focus Coils, Deflection Yokes, Coils—and of course major units such as Picture Tubes, Antennas, Lenses, etc., etc.

WRITE FOR COMPONENTS FOLDER P-1

ASSEMBLE Your Own CABINETS

Transvision's "MODULAR" Cabinets come in knock-down, unpainted units, offering an unlimited range of combinations, including even a bar. Finish them off to suit your taste and need.



Corner piece, shown above, has room for TV, Phono, Record Storage, and open Book Case. **COMPLETE**.....Net \$84.00
For other units and prices, write for "Modular" Catalog.

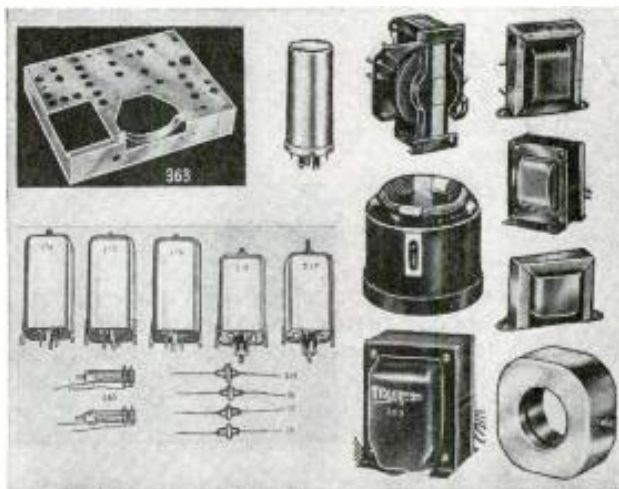

FREE 162 p. TELEVISION COURSE with purchase of any Transvision TV Kit . . . You don't need this course to assemble a Transvision Kit, because the job is easy enough and our instruction sheet is simple and clear. **BUT**, if you want a good introduction to television fundamentals as a basis for further study, the Transvision Television Home-Study Course is ideal. Remember, you pay nothing extra for this course. Ask your jobber.

GET into the TELEVISION BUSINESS in a BIG WAY

Radiomen, Servicemen, Dealers . . . Transvision offers you, through your jobber, a 3-point Dealer Plan for making big money in television: (1) Sell TV sets constructed by you from Transvision Kits. (2) Sell exclusive Custom-Built Jobs with beautiful "Custom-Art" Cabinets. (3) Sell "packaged" Transvision TV Products, including Kits, Components, and Accessories. For FULL DETAILS about this amazing plan, **WRITE FOR FOLDER No. D-1**, or ask your jobber.

All Transvision Prices are fair traded; subject to change without notice. Prices 5% higher west of the Mississippi.

TRANSVISION, INC., Dept. RE, **NEW ROCHELLE, N. Y.**

IN CALIF.: TRANSVISION OF CALIFORNIA, 8572 SANTA MONICA BLVD., HOLLYWOOD 46

For **FREE 20 p. TV BOOKLET** and **8 p. CATALOG**, SEE YOUR **TRANSVISION JOBBER**

RADIOMEN'S HEADQUARTERS + WORLD WIDE MAIL ORDER SERVICE !!

BUFFALO RADIO SUPPLY, ONE OF AMERICA'S LARGEST ELECTRONIC DISTRIBUTORS, IS IN A POSITION TO SUPPLY MOST OF THE REQUIREMENTS OF FOREIGN PURCHASERS DIRECTLY FROM ITS GIANTIC STOCKS OR THOSE OF ITS AFFILIATES. EXPORT INQUIRIES ARE SOLICITED BOTH FROM EXPORT HOUSES AND FROM FOREIGN GOVT. PURCHASING COMMISSIONS HERE AND ABROAD. EXPENSE CAN BE REDUCED AND REQUIREMENTS FILLED WITH A MINIMUM OF DELAY BY CONTACTING BUFFALO RADIO SUPPLY INITIALLY.

\$8.95 TAKES ALL 3 BIG BARGAINS

1. ALUMINUM GEAR BOX 18x8x7 that contains two powerful electric motors and two matched gears, trains, 62 gears in all varying in size from 1/2 to 4 inches in diameter. This unit is readily converted to rotate a beam antenna or any other similar use. \$5.00

2. SENSATIONAL FASCINATING, AMAZING SELSYNS. Brand new selsyns made by G. E. Co. Two or more connected together work perfectly on 110 VAC. Any rotation of the shaft of one selsyn and all others connected to it will rotate exactly as many degrees in the same direction, following unerringly as if the units were connected together by shunting instead of wires. This is true whether you twist the shaft of the master unit a fraction of a revolution or many revolutions. Useful for indicating the direction of weather vanes, rotating directional antennas or controlling innumerable operations from a distance. Complete with diagram and instructions. Per matched pair. \$4.95

3. DUAL METER—One 50 Microamp and one 200 Microamp movement in the same case. This meter is ideally suited for use as a combination modulation percentage and carrier shift indicator. If desired the movements may be removed from the case and used separately. All meters are in perfect operating condition, but a few have cracked glasses. This super value costs only \$1.95.

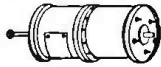

OUR PE-109 DIRECT CURRENT POWER PLANT

This power plant consists of a gasoline engine that is coupled to a 2000 watt 32 volt DC generator. This unit is ideal for use in locations that are not serviced by commercial power or to run any of the surplus items that require 24-32V-DC for operation. The price of this power plant tested and in good condition is only \$78.95 F.O.B. Buffalo, or we can supply in strictly "as is" condition for \$58.95 F.O.B. New York City. These latter units are exactly as received, in heavy steel strapped protective cases, and we are unable to determine if the individual units are new, or what the condition is if used, while the \$79.95 are new. We do not recommend gambling on the "as is" condition, except for quantity purchasers. We can also supply a converter that will supply 110V AC from the above unit or from any 32V DC source for \$12.95.

1/4 H.P. AC or DC electric motor (dynamo motor conversion) complete with cord and plug ready to run. A super buy at \$2.95. Battery type BA38, 103.5v. battery used in hand/ratiks and mine detectors. 1x1x1 1/2. Outfitted but test OK. \$1.95

Standard type normally open MICRO SWITCHES .39c

Leaf actuator SPT MICRO SWITCHES .49c

Brand new fully shielded 6F6 single button mike transformer in beautiful silver finish case. .99c

Television 300 ohm twinline, per 500 ft. spool. \$9.95

Miniature bayonet pilot light sockets—per hundred \$2.50

Universal 1/2" broad band oscillator coil (can be converted to 3 lead type by addition of jumper). Six for \$1.00

Brand new motor driven band-switching turret with slug-tuned #14 silver wire coils on ceramic forms and air trimmers. 100 to 160 MC. A steal at. \$2.95

GENERAL ELECTRIC 150 WATT TRANSMITTER COST THE GOVERNMENT \$1800.00 • COST TO YOU—BRAND NEW—EXPORT PACKED \$100.00

This is the famous transmitter used in U.S. Army bombers and ground stations, during the war. Its design and construction have been proved in service, under all kinds of conditions, all over the world. The entire frequency range is covered by means of plug-tuning units which are included. Each tuning has its own oscillator and power amplifier coils and control circuit—all designed to operate at top efficiency within its particular frequency range. Transmitter and accessories are finished in black crackle, and the milliammeter, voltmeter, and RF ammeter are mounted on the front panel. Here are the specifications: **FREQUENCY RANGE:** 200 to 300 KC and 1500 to 12,500 KC. (Will operate on 10 and 20 meter band with slight modification for which diagrams are furnished.) **OSCILLATOR:** Self-excited, thermo compensated, and hand calibrated. **POWER AMPLIFIER:** Neutralized class "C" stage, using 211 tube and equipped with antenna coupling circuit which matches practically any length antenna. **MODULATOR:** Class "B" uses two 211 tubes. **POWER SUPPLY:** Supplied complete with dynamotor which furnishes 1000V at 350 MA. from either 12 or 24 volts. Complete instructions are furnished to operate set from 110V AC. Size: 21 1/2 x 23 x 9 1/4". Total shipping wgt. 30 lbs., complete with all tubes including a full set of spares besides those necessary for operation, dynamotor power supply, seven tuning units, antenna tuning unit and the essential plugs.

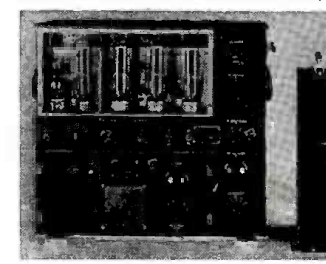

AUTO RADIO DEALERS! ATTENTION!

Nationally advertised brand of 1949 car radio which will fit practically any car and every pocketbook. Six tube superheterodyne with three gang condenser and 6 1/2" speaker. \$32.20 for sample, or Dealer price \$29.97 each, in lots of two or more.



RT. 1579 with tubes diagram and parts list only \$14.95

A three stage, cascode 6SJ7's and 6F6 output stage high gain, high fidelity amplifier with 60 cycle, 110 v. power supply on the same 13 1/2 x 4 1/2" chassis, which is protected by a substantial steel cover over tubes and parts. Made by Western Electric with typical quality components such as a husky power transformer and oil condensers, this unit is obviously intended to give years of trouble-free service with no more need for repairs than a telephone. Disconnecting one wire each from the special input and output filters, will result in as high a fidelity amplifier as can be obtained.



1000 CYCLE AUDIO FILTERS

Navy PD52010-1 low pass audio filters as mentioned in the "Packed Audio" article in June CQ, and designated by the above number, are the exact electrical and physical equivalent of commercial audio filter units selling for \$35.00 wholesale. They are infinitely better than the surplus "Radio Range Filters" being sold for reducing QRM, and at 2 KC off resonance for example, a 2 section filter using PD52010-1 is capable of twice the selectivity available through the use of the G5-er, (the BC453 section of the 274N which has provided the amateur's previous highest standard of interference elimination). **EXTRA SPECIAL—NAVY PD52010-1 with diagram—\$5.00.**

TELEVISION RECEIVER

The **LOWEST PRICED** receiver to retain ALL the necessary and important technical refinements found in the most expensive sets. Works all TV channels and has 26-inch screen. Automatic picture lock prevents picture drift, eliminating the need for retuning during programs. Also features automatic sound level control. Minimum number of manual controls make set easiest of any to operate. Beautifully grained mahogany cabinet hand-rubbed to a finish of distinction. With free indoor aerial. \$149.95



PORTABLE ELECTRIC DRILL TERRIFIC VALUE ONLY \$20.95

Equipped with 1/4" Jacobs Geared Chuck and Key

Not an intermittent duty drill, but a full size rugged tool. Most convenient type switch, natural grip handle, and balance like a six shooter. Precision cut gears—turbine type cooling blower—extra long brushes. No stalling under heaviest pressure because of powerful 110 Volt AC or DC motor and multiple ball thrust bearings. Oil-lubricated adjustable ball-bearing lubricated Oilite type. Made for toughest year-in and year-out service in plant or on construction jobs. Amazing perpetual factory guarantee assures you of a lifetime of trouble-free use.

Full refund (you pay transportation) if not pleased with drill after trial.

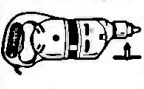

STUPENDOUS VALUE IN 3 SECTION PERMEABILITY TUNER

The entire variable tuning section of a deluxe current model General Motors radio. Amazingly tiny (4x3x2 1/4"), though truly half of a radio. Shielded R.F. sections litz wire wound. All 3 tuned circuits adjustable by means of high ends of dial. Compact enough to be used to pep up any 2 or 3 gang superhet or 2 gang TRF. Will substitute for entire original tuning system including variable condenser or if desired the original tuning condenser can be connected to these coils, and the coils set with improved in results in any set. After seeing one of these units, you'll order a dozen just for general repair or replacement work. Cost the manufacturer several dollars. Your cost—\$1.49.

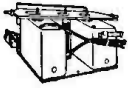

VACUUM TUBE VOLT-OHM-CAPACITY METER

There are more features engineered into this little instrument than in any other instrument on the market regardless of price. It was designed not only to meet present conditions but to be readily adaptable to future needs. At the sensationally low price of this precision instrument no school, plant, lab or service shop need deplete itself of the "new look" in measuring equipment. Here are a few of the many features of this outstanding instrument:

- 5 inch easy to read meter.
- DC voltage ranges from 0 to 1000 V (1 megohm resistance as high as 1 megohm per volt).
- AC voltage ranges from 0 to 1000 V (1 megohm resistance as high as 1 megohm per volt).
- AC resistance ranges from 2/10 ohm to 1000 megohms.
- Capacity ranges from .000025 to 20 MF.
- A zero center range for balancing M.C. resistors.
- Isolating resistor built into probe.
- Styling natural finish hand wood case.

This outstanding development of one of the leading manufacturers of test equipment costs only \$39.50 complete with all leads, as illustrated.



Universal Microphone Co.'s latest model recorder platform with high quality recording amplifier, complete with all necessary controls for volume, tone playback record, and Public Address applications. Unit includes chrome plated bullet crystal mike, crystal playback arm, and magnetic recorder head. Also features a patented pantographic arrangement for making absolutely linear recordings. Complete with all tubes and matching speaker. Everything supplied but the cabinet for \$49.95.

STROMBERG CARLSON—Power Switching Relay Box. Neat 3 1/2 x 4 1/2 x 5 1/2" Steel case with tight fitting cover finished in Stromberg's usual beautiful chocolate color crackle finish—\$9.8.

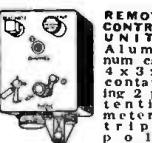

RT-1655 tube crystal controlled SUPERHET RECEIVER that covers the FM band. The ultra modern circuit uses the latest types of tubes. Beautiful chassis and aluminum cabinet. Tubes and schematic supplied. \$14.95



COMPRESSED AIR INSTANTLY, ANYWHERE!!

Portable Air Compressor and storage tank. Ruggedly built of best materials using lifetime lubricated ball-bearing on connecting rod and oil impregnated main bearing on shaft. Unusual design forever eliminates valve trouble, the most common fault in air compressors. **PAVENTED** unique air piston increases efficiency tremendously over other compressors so total output is much greater than that from larger compressors powered by heavy duty motors. Will deliver approx. 500 cu. in. air per min. at maintained pressure of 30 lbs., or will inflate a 90 lb. truck tire in less than 5 min. Complete with 100 lb. gauge, Ankerip adjustment allows setting of output pressure at any value, which will automatically work from any 1/4 H.P. motor. Useful for spraying paints or lacquers, disinfectants, insecticides, annealing or brazing with natural gas, etc. Price \$14.50 postage prepaid anywhere in U.S. Efficient, adjustable syphon type spray gun complete with 2 ft. of hose for only \$7.75 with pint container, also prepaid.



Brand New LS7 PM Speaker in a fully finished metal cabinet. This speaker and case match communication receivers, and in addition make perfect intercom remote stations. Our price, \$4.50. Including output transformer. \$4.95



HEAT GUN

Streamlined pistol grip heat gun in vivid red housing, that delivers a powerful 20 Cubic Ft. Per minute blast of hot air at 160° Fahrenheit.

Ordinary blowers have small fan motors, but this has a lifetime-lubricated AC-DC motor of the rugged vacuum cleaner type, that produces a hurricane of either hot or cold air. Perfect for blowing out dirt or dust from radio chassis, drying out ignition systems, warming up carburetors, quick-drying paint, thawing out radiators or water pipes, etc. Warning—Keep this away from your wife, or she will be using it to dry her hair because it will do it in half the time of her ordinary hair dryer, to say nothing of her using it to dry stockings or clothing, or to melt the refrigerator instantly. Only \$12.95. Satisfaction Guaranteed or money refunded if returned prepaid within 5 days.



SUPER SPECIAL

POWER UNITS for Fairchild bombsights. A limited quantity of these arrived too late for a photo, but each unit is brand new, includes 8 electric motors or generators, 6 of which are permanent magnet field type; relays; 20 precision resistors plus numerous others of the ordinary kind; and 9 tubes. Total value a total value of \$15.00. All for only \$14.95.

1949 MODEL MUTUAL CONDUCTANCE TUBE TESTER \$52.95

No possibility of good tubes reading "Bad" or bad tubes reading "Good" as on dynamic conductance testers or other ordinary emission testers. Attractive appearance and ease of use to any on the market in appearance. Large 4 1/2" meter. Calibrated microhm scale as well as a Rad-Good scale. Front panel fuse. Individual sockets for all tube base types—volts from 5 to 117 volts and complete switching flexibility allow all present and future tubes to be tested regardless of location elements on tube base. Indicates gas content and detects shorts or opens on each individual section of all local elements. Includes cold cathode, magic eye and voltage regulator tubes as well as all ballast resistors. Note the nationally known manufacturer withheld because of special price offer.

Model "C"—Sloping front counter case \$52.95

Model "P"—Handsome hand-rubbed portable case \$7.95

Built-in roll chart with either of above \$5.00 extra.



CABLE ADDRESS: BUFRAD. All sales final and no returns unless otherwise specified in ad or item. Right reserved to change prices and specifications at any time.

VEE-D-X

ANTENNAS • MASTS
TOWERS • CHIMNEY &
VENT-PIPE MOUNTS •
GUY CABLE • LIGHT-
NING ARRESTORS •
TRANSMISSION LINE

Brings you

a SINGLE SOURCE

for everything you need

VEE-D-X EQUIPMENT PROTECTS YOUR PROFITS THROUGH
QUICK AND EASY
INSTALLATIONS

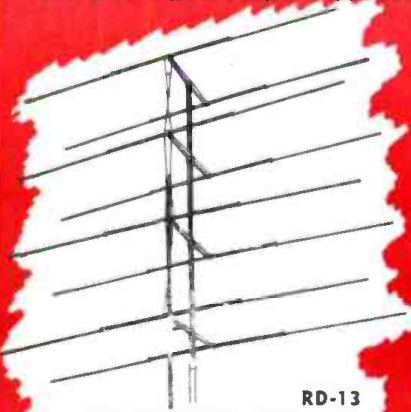

**RD-13
LONG-RANGE ANTENNA**

For the so-called "fringe" areas and beyond. Brings TV to those who have despaired of getting good reception. Has high directivity and forward gain. Adjustable for most critical conditions.

**VEE-D-X
SECTIONAL
TOWER**

Made in 10' and 20' sections for mounting antennas from 10' to 140' high. Sections are shipped assembled and painted. Sturdy, all-welded construction. For fast, low-cost erection on the ground or on flat roof. Antenna can be rotated from base. Sections can be added without lowering tower.

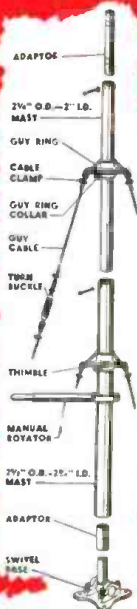

MAST ASSEMBLY

Masts are extremely light (a 20' section weighs only 11 lbs.) without sacrifice of strength. Permits rotation even after guy wires have been permanently installed. Features speed in erection.



SKY MONITOR

Broad-band antenna with tunable Q section. Also a stunning performer on Channels 7 thru 13. Illustrated in connection with VEE-D-X Chimney and Vent Pipe mounting that takes only 60 seconds to install.

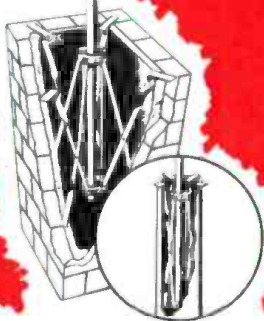

CHIMNEY MOUNT

Fits any opening—round, square or rectangular from 4" to 22" for 1", 1 1/4" and 1 1/2" masts.

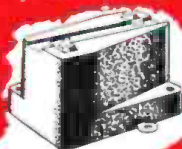

**VEE-D-X
LIGHTNING
ARRESTOR**

No need to cut transmission line. Does not disturb impedance match. High dielectric, low loss.

in good TV&FM
INSTALLATIONS

Engineered to meet the needs of all types of installations.

The VEE-D-X Sectional Tower, in standard 10' and 20' sections, is the newest addition to an extensive line of antenna products offered by LaPointe-Plascomold. Its use, in many cases, has made possible the obtaining of satisfactory TV reception otherwise unavailable. Also ideal for amateur, police and utility needs.

Whatever you need in antenna equipment, you may now order it from one dependable source. No longer is it necessary to use a hodge-podge of unstandardized and uncoordinated apparatus.

The products of LaPointe-Plascomold are skillfully engineered for the entire range of technical requirements and installation problems, plus the need of

FAST, LOW-COST INSTALLATION

And, of course, full profit margins for Distributors, Dealers and Servicemen.

Send Coupon Today

for complete literature and discounts.

LaPointe-Plascomold Corp.
Unionville, Connecticut

Send me VEE-D-X literature, prices, discounts, etc.

Name.....

Address.....

City..... Zone.....

State.....

VEE-D-X

means
VIDEO DISTANCE

La Pointe - Plascomold Corporation
UNIONVILLE, CONNECTICUT

THERE'S MORE VISION IN TELEVISION WITH VEE-D-X

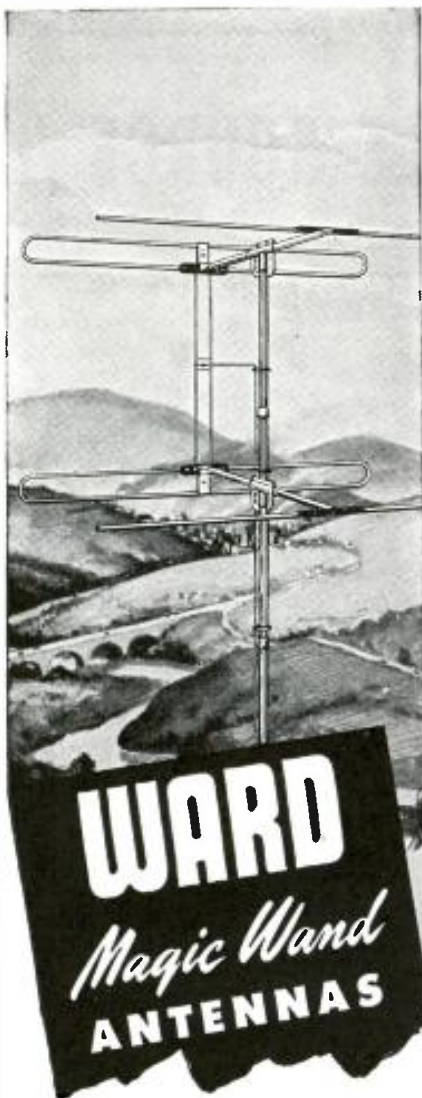

**THE ONLY BROAD BANDED,
HIGH GAIN, STACKED ARRAY
ON THE MARKET**

Many times more sensitive for TV reception in fringe areas and poor signal locations, the WARD TVS-6 STACKED ARRAY achieves maximum forward gain by stacking two high gain folded dipoles and reflectors with effective $\frac{1}{2}$ wave spacing rather than the ordinary $\frac{1}{8}$ or $\frac{1}{4}$ wave which materially reduces sensitivity. THE ONLY STACKED ARRAY ON THE MARKET THAT IS BROAD BANDED, it will give excellent results with MANY CHANNELS where others are too selective. The advanced engineering and PRE-ASSEMBLED design of the WARD TVS-6 is only one of the reasons why WARD is the largest exclusive manufacturer of antennas in the world. See any leading parts distributor or write for catalog.

**THE WARD PRODUCTS
CORPORATION**

1523 E. 43TH STREET, CLEVELAND 3, OHIO.

National Union Radio Corporation, Orange, N. J., announces the purchase of a plant in Hatboro, Pa., for the production of all types of cathode-ray tubes up to and including 20 inches in diameter. The company will expend a million and a half dollars for the installation of machinery and equipment.

Sprague Electric Company, North Adams, Mass., has announced the acquisition of the Herlec Corporation, Milwaukee, Wis., manufacturers of ceramic capacitors and Bulplate printed circuits.

A Sprague plant for manufacturing ceramic assemblies is already being established in Nashua, N. H. Manufacturing operations are being expanded at the Milwaukee plant, thus assuring two substantial sources of supply. Milwaukee operations will be under the continued direction of Herlec executives including MILTON EHLERS, Herlec president; HARRY RUBENSTEIN, Herlec vice-president and chief engineer; and THOMAS HUNTER, vice-president in charge of sales. All three men have had many years' prior experience in the field.

Electrical and Musical Industries, Ltd., British manufacturers of radios and records, will feature the H. H. Scott Dynamic Noise Suppressor in all new-model phonograph combinations. Such a contract was recently signed by SIR ERNEST FISK, E.M.I. managing director, and H. H. SCOTT, inventor of the suppressor and president of Hermon Hosmer Scott, Inc., during Mr. Scott's recent visit to London. The license agreement, covering Great Britain and Australia, extends to all of E.M.I.'s subsidiaries, which include the Gramophone Company, Ltd. ("His Master's Voice"), the Columbia Graphophone Company, Ltd., the Marconiphone Company, Ltd., the Parlophone Company, Ltd., E.M.I. Factories, Ltd., and E.M.I. Sales and Service, Ltd.

Howard W. Sams & Company, Indianapolis, Ind., publishers of the Photofact folders, announces that the lecture tour of AL SAUNDERS attracted large audiences of skilled radiomen to his talks on practical television.

Registration at the 27 meetings that have been held since September 8 is considerably in excess of 10,000 radio service technicians, engineers, and dealers. The largest audience to hear Mr. Saunders was in Chicago early in November in the Ashland Auditorium; the attendance was over 2,000. Of particular interest to everyone concerned with the future of the radio service industry is the fact that most experienced radio technicians will travel many miles to acquire practical information on television service. In city after city, it was not uncommon to find men in the audience who had traveled more than 100 miles (in many instances more than 200 miles) to hear Mr. Saunders' lecture.

Stewart-Warner Corporation, Chicago, radio and television set production and distribution will be handled, effective

January 1, by a newly created division of the corporation to be known as Stewart-Warner Electric Division, JAMES S. KNOWLSON, president and board chairman, has announced. SAM INSULL, JR., a vice-president, has been designated as division head.

Zenith Radio Corporation, Chicago, has acquired by outright purchase all the capital stock of the Rauland Corporation of the same city.

E. N. RAULAND will continue as president and director of the Rauland Corporation, and the other Rauland personnel, will retain their present positions. No changes are contemplated other than considerable expansion of the facilities for manufacturing cathode-ray television tubes.

RCA Victor Division of the Radio Corporation of America has purchased the Marion, Ind., plant of the Farnsworth Television and Radio Corporation.

The plant at Marion will be used after modernization for the production of RCA's television tubes.

American Telephone and Telegraph Company, New York, has announced that it plans to increase the number of television network channels between Philadelphia and Chicago. A total of three west-bound and one east-bound channels will be available by the end of 1949.

Sylvania Electric Products, Inc., Emporium, Pa., announces that it has purchased the plant formerly occupied by the Ramsey Pump Co. at Seneca Falls, N. Y. The plant will be used for the production of television tubes.

Allen B. Du Mont Laboratories, Inc. of Passaic, N. J., announces that it has bought the former Wright Aeronautical Plant in East Paterson N. J., for the assembly of television receivers.

Emerson Radio and Phonograph Corporation, New York, has appointed EDWARD LANE advertising manager, it was announced by STANLEY M. ABRAMS, sales promotion manager. Mr. Lane formerly served as merchandising director for Columbia Records. Prior to that, he was advertising, promotion, and publicity director for the Muzak Corporation.

Motorola, Inc., Chicago, announces the introduction of a new portable television set which will sell at \$199.45 including tax (See page 44).

The set, compact in design, is enclosed in a sun-tan leatherette case and weighs only 33 pounds. It is $18\frac{3}{4}$ inches deep, $17\frac{3}{4}$ inches wide, and $9\frac{1}{2}$ inches high.

The Rauland Corporation, Chicago, now the tube manufacturing subsidiary of Zenith Radio Corporation, Chicago, announces that it will shortly begin mass production on a new "Giant Circle" picture tube three times the size of the regular 10-inch tube.



New 1949 Diagram Manual added to SUPREME PUBLICATIONS

INCLUDES ALL POPULAR 1949 SETS

AMAZING BARGAIN IN SERVICE DATA

Use this new manual to repair quickly all modern 1949 radio receivers. In this big single volume, you have clearly-printed, large schematic diagrams, needed alignment data, replacement parts lists, voltage values, and information on stage gain, location of trimmers, and dial stringing for almost all recently released sets. A worthy companion to the 8 previous volumes used by over 123,000 shrewd radio servicemen. Like the previous volumes illustrated above, it sells at a give-away price and gives you a whole year of radio diagrams for a couple of dollars total cost — nothing else to buy the rest of the year, nothing else to pay. Giant size: 8½ x 11 inches. Includes index. Manual style binding. Available at your jobber, or send coupon, price only **\$2-**

Here is your low-priced, money-saving source of radio diagrams and service data for all popular sets. Above is a photograph of these giant-size manuals — available to radio servicemen at only \$2 for most volumes. Let these easy-to-use manuals guide you to quick fault finding and simplified repair of any radio. Eliminate guesswork, cut hour-wasting jobs to pleasant moments. For 16 years, radio servicemen expected and received remarkable values in Supreme Publications service manuals. Yes, these manuals are still only \$2 each, and \$2.50 for the new 1949 manual and the extra large 1926-38 volume. Biggest bargain in service manuals. Only a publisher who sold over a million manuals can offer such values based on tremendous volume-sales. No-risk 10-day examination granted to servicemen. See coupon.

Models Made by:
 R.C.A., Zenith, Philco, Sears, Fada, Emerson, Belmont, Detroit Radio, Majestic, United Motors, Westinghouse, Admiral, Arvin, Stewart-Warner, G.E., Stromberg-Carlson, Delco, Western Auto, Gamble, Wards, Sparton, Crosley, Motorola, and many others.

FIND ALL RADIO FAULTS IN ½ TIME

You can speed-up and simplify radio repairs with Supreme Publications manuals. Service all radios faster, better, easier, save time and money, use these most-often-needed diagram manuals to get ahead, earn more per hour. These manuals cover every popular radio of all makes, from old timers to new 1949 sets. Clearly printed circuits, parts lists, alignment data, and helpful service hints are the facts you need to be more expert in radio servicing. Save hours each day, every day, begin to earn more by making repairs in minutes instead of hours. Let these inexpensive manuals give you needed diagrams for 80% of all sets. These manuals pay for themselves with time saved on a couple of jobs, after that you use them FREE. There are nine volumes in all as illustrated above. Each manual is 8½ x 11 inches, sturdy manual style binding, average manual has 194 pages of diagrams and practical service data. Use coupon below to order on 10-day no-risk trial or see these manuals at your jobber.

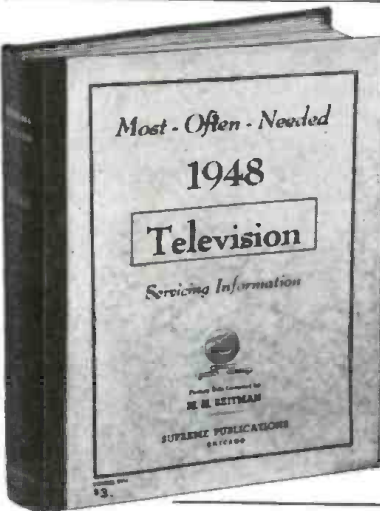

New 1948 T-V Manual

New, giant volume of television factory data covers every popular make. Gives description of circuits, pages of test patterns, response curves, alignment facts, oscilloscope waveforms, voltage charts, service hints, many diagrams in the form of double-spread blueprints, test points, everything to bring you up to date and make you expert in T-V repairs. Large size: 8½x11", manual style binding, flexible covers, price only **\$3**

SENSATIONAL LOW PRICE

Be money ahead with SUPREME Manuals. For the remarkable bargain price (only \$2 for most volumes) you are assured of having in your shop and on the job, needed diagrams and other essential repair data on 4 out of 5 sets you will ever service. There is no need to spend large sums for bulky, space-wasting manuals of other publishers, or to buy additional drawings every few weeks; be wise, use SUPREME Manuals to get the most in diagrams for the smallest cost. Check manuals wanted on the "no-risk" coupon.



Compiled by M. N. Bellman, radio engineer, teacher, author & serviceman.

1947 F.M. and Television Manual

Manual of instructions for trouble-shooting, repairing, and alignment of all popular 1947 F.M. and Television sets. Covers every popular make; includes F.M. tuners, AM-FM combinations, and all types of T-V receivers. This is the material you need to adjust and fix any modern F.M. and T-V set. Data on 192 large pages, 8½x11". Sturdy, manual style binding. Your price, only **\$2**

Record Changers Post-War Manual

Service expertly all modern (1945-1948) record changers. Includes every popular make. Just follow simplified factory instructions to make needed adjustments and repairs. Hundreds of photographs and exploded views. Large size: 8½"x11 inches. 144 fact-filled pages. Available at your jobber, or postpaid **\$1.50** only

Radio Servicing Course-Book

Here is your practical radio course of 22 easy-to-follow lessons. Review fundamentals, learn new servicing tricks, all about signal tracing, oscilloscopes, recording, P.A., test equipment, and T-V. Just like a \$100.00 correspondence course. Everything in radio servicing. With self-testing questions and index. Large size: 8½x11" **\$2.50**



New 1949 Edition Price postpaid, only **\$2.50**

NO RISK TRIAL ORDER COUPON

SUPREME PUBLICATIONS, 3727 W. 13 St., Chicago 23, ILL.

Ship the following manuals on 10-day trial under your guarantee of satisfaction or money-back.

Most-Often-Needed Radio Diagram Manuals

- New 1949 Manual... \$2.50
- New 1948 Television Manual... \$3.00
- 1947 F.M. and Television Manual 2.00
- Post-War Record Changers... 1.50
- Radio Servicing Course-Book... 2.50

PRICED AT ONLY \$2 EACH

1948
 1947
 1946
 1942
 1941
 1940
 1939
 1926-1938 only \$2.50

- I am enclosing \$....., send postpaid.
- Send C.O.D. I am enclosing \$... deposit.

Name:

Address:

Supreme Publications

Sold by all Leading Radio Jobbers

Television is Booming—Cash in on it!

Want To Double Your Pay?



How To Pass **FCC** **COMMERCIAL** **RADIO OPERATOR** **LICENSE** **EXAMINATIONS**

GET THIS AMAZING NEW BOOKLET FREE!

Add Technical Training
To Your Practical Experience and
GET YOUR FCC
COMMERCIAL
RADIO OPERATOR **LICENSE**
IN A FEW SHORT WEEKS!

It's EASY if you use CIRE Simplified Training & Coaching
AT HOME in SPARE TIME

Get your license easily and quickly and be ready for the \$3000 to \$7500 jobs that are open to ticket holders. CIRE training is the only planned course of coaching and training that leads directly to an FCC license.

**CIRE GRADUATES FIND
FCC LICENSE PAYS OFF**

"I now hold ticket Number P-10-3787, and holding the license has helped me to obtain the type of job I've always dreamed of having. Yes, thanks to CIRE, I am now working for CAA as Radio Maintenance Technician, at a far better salary than I've ever had before. I am deeply grateful."
Student No. 3319N12

"I was issued license P-2-11188 on November 4. The next day I was signed on board a tanker as Radio Operator-Purser. Besides radio operating, I handle the payrolls, etc., which is all over-time and brings my monthly pay up to between \$400 and \$650."
Student No. 2355N12

CLEVELAND INSTITUTE OF RADIO ELECTRONICS
Desk RC-3 4900 Euclid Building, Cleveland 3, Ohio
Approved for Veteran Training under the "G. I. Bill of Rights"

Television is Booming—Cash in on it!

1. Tells of thousands of brand-new, better-paying radio jobs now open to FCC License-Holders.
2. Tells how you will benefit by holding an FCC Commercial License.
3. Tells how YOU can get your FCC Commercial Radio Operator License IN A FEW SHORT WEEKS—EASILY AND QUICKLY, by using CIRE simplified training and coaching AT HOME in your SPARE TIME.
4. Tells of hundreds of our successful students who now have licenses and new, better-paying jobs.
5. Tells how we prepare you to pass the new FCC Commercial License Examinations, which now include FM and Television.
6. Tells how we guarantee to train and coach you until you get your license.
7. Tells how we help you get a better-paying, licensed job, with our free and exclusive service, which prepares your employment application for mailing to hundreds of employers, including FM, AM and Television Broadcast Stations, Radio Manufacturers, Police Radio Stations, and Radio-Equipped Taxi, Bus, and Public Utility Companies.

YOUR FCC TICKET IS ALWAYS RECOGNIZED IN ALL RADIO FIELDS AS PROOF OF YOUR TECHNICAL ABILITY



Get All 3 FREE Send Coupon Now!

CLEVELAND INSTITUTE OF RADIO ELECTRONICS
Desk RC-3, 4900 Euclid Bldg., Cleveland 3, Ohio
(Address to Desk No. to avoid delay)

I want to know how I can get my FCC ticket in a few short weeks by training at home in spare time. Send me your amazing new FREE booklet "Money Making FCC License Information," as well as a FREE sample FCC-type exam and FREE booklet, "How to Pass FCC License Examinations" (does not cover exams for amateur license.)

Name _____
Address _____
City _____ Zone _____ State _____
 Veterans check for enrollment information under G.I. Bill
NO OBLIGATION—NO SALESMEN

THE TELEVISION BOOM

... Radio's biggest boom is now in the making ...

By HUGO GERNSBACH

WHEN broadcasting started in 1920, it automatically engendered the first major radio boom which ran from 1921 to 1924. It was of major proportions, so large in fact that it stemmed a threatened economic depression and turned it into several years of good business.

That early period of radio's spectacular growth brought about an expenditure of many hundred millions of dollars by the American public. It had its repercussions in dozens of various trades, all of which were immeasurably benefited for a number of years. Americans at that time invested 250 millions of dollars in radio sets, many of which were bought on the installment plan. This figure excludes the cost of over 300 radio transmitters.

New employment directly due to radio manufacturing and allied trades brought good times to the country. Without this first radio boom, most economists are convinced, the depression which came in the early 30's might well have come in the early 20's.

We are now in the middle of another similar cycle; this time it is the television boom which is now gaining rapid momentum—probably reaching its zenith in 1950.

The difference between these two periods is that the present television upheaval will make the earlier radio boom look small by comparison. For one thing, television sets sell at much higher unit prices—even with the depressed present-day dollar. Furthermore, television sets are much more complex and many more industries are called upon to contribute in their manufacture than in the early vintage radio sets. The latter had only a fraction of the diversified parts that go into the making of a modern American television receiver.

Let us start at the beginning. To broadcast television we require a far larger amount of transmitters than to broadcast the 1921 AM transmissions. As of December 31, 1948, there were seven licensed and 117 authorized TV stations in the U. S., of which number 51 were transmitting. There were 312 pending applications for TV stations before the Federal Communications Commission.

From these figures it will be seen that the total number of licensed and authorized TV stations is 124.

From the best available sources contacted we have learned that the average cost per television transmitting station is approximately \$400,000. This excludes any new buildings and makes use instead of present facilities which are remodeled for studio and transmitting purposes. Multiplying \$400,000 by 124 stations gives us a cost of \$49,600,000. The 1949 "possible stations" figures out at 73 times \$400,000, or \$29,200,000. Adding the two figures together gives us a grand total of \$78,800,000. This is only for the transmitting stations, and disregards all costs of operation per year, cost of talent, employees, and all other expenses. These will easily run into several hundred million dollars of additional expenditures.

To operate these stations, which have effective radii of only some 25 miles, they must be linked together either by microrelay or by co-axial cable. From sources consulted we find that the expenditure for these facilities have so far reached a total of \$200,000,000. 1949 costs for linking the new transmitters erected in this year may reach a total of \$69,285,000.

We now come to the television receivers. As of January 1, 1,037,000 homes already had television sets. The public during 1948 bought these sets for approximately \$432,429,000 at a price per set that averaged \$417. During 1949 there will be sold—according to trade authorities—to the American public a minimum of two million television sets at an expenditure of approximately \$650,000,000.

This latter figure may vary somewhat as the price trend of television sets is now downward, and the average-priced set may come down as low as \$300 and perhaps lower.

We have purposely left out of our calculations many secondary expenditures which will be made by the American public due directly to the impact of television.

All in all, it will be seen that television during 1949 will enrich our economy between 1½ and 2 billions of dollars—at a very conservative estimate. That this figure will be increased in 1950 now seems a foregone conclusion.

One thing is safe to predict at this point: Extremely prosperous days are ahead for the major part of the television industry.

Television's Future in America

By DR. LEE de FOREST



Dr. de Forest, still an active student and experimenter.

MOST of my readers today can remember the strangely sudden upsurge of popular acceptance and eager enthusiasm which American radio broadcasting experienced 25 or 27 years ago.

To all such elder observers, and especially to those who played a part in the earlier phenomenon, the recurrence today of a closely similar revolution is at once amazing and most gratifying.

In some respects the present popular demand for television broadcasting and TV receivers is even more remarkable than was that which radio enjoyed a quarter of a century ago. Today almost every household has one or more radio receivers and is therefore already aware of the world outside its threshold and the varied types of audio entertainment available, but in 1922 few indeed were the homes wherein such miracles of science could be observed. Radio reception then was far more amazing than is now the sudden apparition of a distant scene upon the kinescope screen. There was then no precedent for that unparalleled miracle—the erecting of a simple wire and listening to distant voices and remote music.

Television is Booming—Cash in on it!

Today radio, and its ambient atmosphere of electronics, has annihilated wonder and atrophied the sense of almost reverent amazement with which we of old donned our headphones, tickled our cat's whisker, and twirled our multi-dials, in those ancient 'twenties. So television comes forth today, upon a stage already well prepared for her somewhat bold and blatant debut, to confront an expectant, yet somewhat blasé audience. The greater wonder therefore is this unleashed enthusiasm for our latest miracle—this crowning achievement of the electronics engineer—an eagerness which today strips the television receiver from retailers' shelves, unpacked and untested, and which compels set and tube manufacturers to work hard around the clock in futile effort to satisfy the demand.

In other ways also video is following paths long since blazed by the pioneers of radio! Program quality serves as one analogue, one scale for comparison. Television programs today are in an experimental stage very far behind in merit the high standards of excellence established by television's engineers.

Here, as in radio broadcasting, the

engineer is far in advance of the man in the studio. The former's is an exact science, and his requirements demand high perfection. The engineer must know his media, his electrons, his cathode beam, his sweep circuits, the exactitude of his sync signals, his math formulae, his specified decibels of gain or noise suppression.

The program director, in contrast, works wholly with nebulosities; likes, dislikes, and prejudices of human nature, and that unpredictable quality politely styled "temperament." Further, he is strictly limited by a budget (the only fixed quantity in his entire equation). Also, too frequently, his sponsor sadly smears his calculated concoction, upsets his omelette, to mix a metaphor.

And so it comes to pass today that television, playing a variation of radio's insistent theme, has taken the "cheese"—the same corny lines, the same reiterative commercials—out of the ears and put it into the eyes of the populace; albeit with this saving grace: its commercials are sometimes intriguing, often interesting to behold, and generally far less painful to see and hear than only to hear.

And definitely our TV programs are improving. Since television's postwar start, a considerable sum of experience and knowledge has been acquired. To an outsider much of this might appear negative, but to learn what *not* to do is a step toward learning what to do. Lacking adequate production budgets, television programming has had to develop as best it could; and, although it has developed, it is still brashly amateurish in the main.

There has been lack of understanding of television audiences as well as failure to take proper advantage of the unique potentialities of the screen.

Directors from the radio studio, the

RADIO-ELECTRONICS for

ater stage, and film lot have applied their various techniques and styles. Some of the least successful video producers have been successful radio directors, who, however, merely transferred radio techniques to television. When one merely adds sight to sound, the result is usually as artistic as a view from a radio studio control booth.

The stage director, on the other hand, is prone to forget the limitations of the video screen and to spread his action too wide. Surely the one best equipped by previous experience to produce satisfactory tele-drama is the motion picture director, trained in skillful variation of medium and close-up shots that will blend these and varied backgrounds into a smoothly running continuity. Representing the necessarily cramped restrictions imposed by the technical limitations of a "live show," he will keenly realize the common sense of *filming* his picture, cutting his retakes, and assembling the components finally into a flawless television presentation. Better to waste large film footage in the cutting room than needless costly hours in attaining 100% perfect rehearsals.

In my writings some six years ago I sought to emphasize the economic common sense of this procedure and urged that the directors of policy of the motion-picture industry, for self-interest even, look frankly in the face of this "baby that will start with the step of a giant." For nothing is today more apparent than the fact that television will hold millions of potential cinema viewers home of nights.

And today's video studio practice already depends largely on motion picture film, either between the projector and iconoscope, or in the camera before the monitor kinescope. When one of the best known veteran motion picture producers, Hal Roach, wholly abandons cinema film work to put all of his trained energies into making good short comedy films solely for television transmission we behold a highly significant augury.

It is of vital importance that both television and the motion picture producing interests cooperate in mutual understanding and harmony. The latter will not long hold back from the inevitable, as most of them did when I was demonstrating to them that film could speak. They will not long repeat the same stubborn blunder, else the film industry will be merely postponing a new prosperity which the new medium is openly offering it.

It is the opinion of an ever-increasing number of television men that film programs will constitute the bulk of television broadcasting, for such basic reasons, economic and mechanic, as the following: duplicates with sound on film can be made cheaply; such duplicates provide an inexpensive "chain system," saving charges paid to the telephone company; programs can be altered, edited, after completion; letter-perfect live productions requiring enormous rehearsal time and expense can be eliminated; talent need not be forced

to rigid schedule; the production can be made at the most suitable or convenient location and time; program libraries are created; optimum lighting conditions for the various scenes can be had far more readily. A good film-renting business is already established. Soon this is certain to include classical plays and other timeless items, despite today's stubborn denials.

And, after all, where so much expensive and painstaking effort has been expended in the staging of a worthwhile drama or comedy, it is mere economic sinfulness to "waste its sweetness only once upon the empty air." Even granting nation-wide networks, co-axial or radio, by stratospheric airplane (or by the moon!) such worthwhile spectacles must not be merely flashed and then forgotten—a lovely tapestry, artfully woven to be burned to ashes and lost.

Furthermore the time differential alone calls for program repetition by film, for example, East-West athletic events, though they are viewed hours after the uncertainties of fortune are resolved. For the evening hours moreover will necessarily continue to claim the far larger audiences everywhere.

So regardless of the spread of networks, whenever the factor of simultaneity is not paramount, what I long since dubbed the "tin-can network" will become more and more essential in profitable television transmissions.

SIRAGUSA ON TELEVISION PROSPECTS

PROSPECTS are unlikely for a material increase in the number of video set manufacturers. To be competitive in price in the television industry a manufacturer must have mass production. He also must have an adequate source of vital component parts and raw materials, which in most cases are only available on a quota basis to companies that have been in the electronics industry since before the war.

Many of us in the industry believe that the coming year will find an ever-increasing demand for television sets even with the industry's doubling of production. That segment of the American populace that has viewed television likes it. They have decided they need television, and want it enough to adjust their budget to make it a permanent part of their living. And that segment is expanding rapidly.

The year 1948 was for the television industry its "Age of Adolescence." Television was a toddling infant at the end of the war and did not become a commercial reality until a little over a year ago when the Federal Communications Commission established definite performance standards. Television is an industry that is opening up a new frontier in the business life of the nation, and its effect upon the economic, social and political life of this country is bound to be enormous. Television brings with it new methods of merchandising and marketing.

The absolutely unrivaled possibilities of television for popular education are already evident to all observers. In the urban schoolroom (and soon in the rural areas) but emphatically in the home, television can be made a most potent agency for instruction for adults and young alike. The groundwork already accomplished by the FM network of the State of Wisconsin, under the auspices of their progressive State University, where countless homes are recipients of daily lectures by competent authorities on varied historical, agricultural, and cultural themes, is extremely gratifying to any informed educator. Witnessing the results attained by audio alone, one is stunned by the prospects which television offers along similar lines, where one picture is more impressive and longer retained "than ten thousand words."

America's greatest, most crying need today is mass education. Here then the Gods of Science have given to our nation a mighty weapon for its salvation.

Will the directors into whose hands fate has given this mighty potentiality for national uplift thus employ it? Or will they, as have many of their AM broadcasting predecessors, miserly, miserably fail?

Certain it is that within five years television programs will be in the homes of 50 million Americans. What *limitless good* can television then bestow for the salvation of America?



Ross D. Siragusa, President, Admiral Corp.

But, all in all, more collective nonsense has been written and spoken about television than any other youthful industry. Fantastic results from the use of video, in all sorts of fields, have been predicted by visionaries, and have somewhat obscured the fact that television is a normal, healthy, young business with excellent future prospects... and during 1949 television will be seen as "coming of age."

Tele Network Problems



Dr. Allen B. Du Mont

Networking, so important to television, presents its own technical difficulties

By DR. ALLEN B. DU MONT

THE engineering problems involved in network operation by television broadcasters may be divided into three general categories:

1. Distribution of programs,
2. Standardization and maintenance of station equipment,
3. Adequate master-control and other station facilities.

The reader may feel that the latter two do not have to do with network operation, but, in fact, they are extremely vital to a successful net. A television network is made up of many affiliated stations. Its purpose is to give greater public service at lower cost per member of the audience. Failure to stay on the air is only one of many equally serious problems. Staying on the air during the long telecasting day which will become the standard for all network operations requires uniform test standards, adequate stand-by equipment, and continual preventive maintenance, as any AM network broadcaster can testify. Network operation imposes on the originating station the full burden of program quality, not only from the point of view of the excellence of its artists, scripts, and sets, but also from the viewpoint of smooth master-control operation, special effects, such as lap dissolves, superimposition of commercials, and uniform high quality of picture on the program bus. In fact, all the technical aspects of video and audio transmission become the prime responsibility of the originating station.

Program distribution

Let us consider the most obvious problem first, the distribution of programs from the station of origin to its affiliates. Three means are available for this. Two use facilities leased from

A.T.&T.; these are co-axial wire lines and microwave relay-station chains. The third type of channel is the privately owned microwave relay chain, usually the property of the network.

Two engineering limitations exist in the operation of land lines. The first is restriction to a 2.7-mc video signal, and the second is compression of synchronizing-pulse amplitude. Microwave relays provide 4.5-mc video and less sync compression. The percentage sync specified by the FCC is 25. It has been common practice to generate 35% sync at the program bus of the local television transmitter, which results in 25% in the composite signal as finally transmitted.

Sync stretchers

The use of *sync stretchers* at each affiliate has become common practice to help overcome the sync deficiency caused by co-axial cable. A.T.&T. is said to be studying the advisability of including these units in their repeater stations.

A unit which will emphasize the synchronizing portion of the composite video signal is frequently needed in TV stations. This stretching of the sync may be necessary to compensate for the sync compression which may take place on a cable or in a relay transmitter or to pre-emphasize the sync to overcome compression in a succeeding part of the station equipment. In addition, it is often necessary to remove hum from the signal, restore its low-frequency response, or to remove transients which may arise from switching.

A standard sync stretcher is shown in one of the accompanying photographs. The input signal to the sync stretcher is composite video, black negative, 0.2 to 2.5 volts peak-to-peak, with a sync amplitude of at least 15% of the total signal. The input impedance is 75 ohms. The line output is a black-negative composite signal designed to feed a standard load impedance (75 ohms $\pm 10\%$, resistive). A monitor output similar to the line output signal is also provided.

The degree of sync expansion is sufficient to provide RMA standard output, even though the input-sync-to-picture ratio (percentage sync of the peak-to-peak composite signal) may be

below RMA standards. The amount of sync content in the output signal is adjustable.

The present standard input to the network distribution system is 2 volts peak-to-peak for the entire composite signal, including the synchronizing impulses, across 75 ohms. The land lines have repeater stations spaced approximately 8 miles apart. These house compensated amplifiers which correct for the frequency discrimination on the co-axial line and any nonuniform phase shift which may have occurred. The resulting video signal delivered to the network stations does not appear to degenerate or become degraded in proportion to the distance it has been transmitted, and arrives in very usable condition.

As was pointed out above, the limit of video frequency is 2.7 mc, and there is some compression of the sync below the 25% FCC standard; there is in addition, some "smear" due to uncompensated phase distortion. It is felt that these problems are on their way to solution. There is very little "shot" noise evident on either the land line or the microwave relay system, and few problems arise from this cause.

The usual spacing between repeater stations on the microwave relay is 30 miles, but the spacing varies considerably with local topography, the relays operating on line-of-sight only. The present A.T.&T. microwave relay stations operate on the 4000-mc band with a transmitter power of approximately 1 watt. Metal lens antennas having a gain of 10,000 are commonly used.

Present American Telephone & Telegraph Co. rates (there is no distinction made between rates for cable and radio distribution) are set at \$35 a mile per month, plus \$500 a month per station connection. These rates are for exclusive service for eight hours every day.

At the moment, due to restricted distribution facilities, the charges are \$25 a mile per month, plus \$350 a month per station for 4 hours a day, 7 days a week, on a shared basis. Private microwave relay facilities have been shown to cost, assuming amortization of equipment in 4 years, approximately 20% less than the A.T.&T. rates and would have the added advantage of providing full-time,

24-hour-per-day, exclusive service for their owner.

Standardization

Any broadcast engineer knows that standardization of test procedures among all members of a network is imperative. Take the simple matter of checking audio levels; VU metering has been specified down to an eyelash so that the audio signal throughout a network will be uniform—no peaks which show on one VU indicator are missed by another.

No corresponding standardization of the means for measurement of the composite video signal has been arrived at. The 'scope is, of course, universally used, but this in itself does not constitute standardization. When we consider *aspect ratio, linearity, transfer characteristic, dynamic range, gamma, film-print characteristics*, and so on, we realize that much work remains to be done regarding standardization of test between affiliates. Not the least of the problems listed above is the setting up of test standards and controls for density and gamma of processed films used for making *Teletranscriptions*.

Station facilities

With the advent of networks, television broadcasting has become "big-time"—it can no longer hide behind the excuse of being experimental, but must deliver programs of technical excellence. The delivery of such a product requires complex facilities. An integrated master-control system is necessary to handle programs from many studios, remote pickups, and other stations. Equipment permitting maximum flexibility in dubbing, fading, lap-dissolving, superimposing pictures, and other tricks of photography is required. The use of electronic timing circuits to pace the picture dissolve is an example of a refined feature now available in some modern mixer equipment available to stations today.

With the development and refinement of television, these techniques will take more advantage of electronic instrumentalities, with a resulting increase in the complexity of the required equipment.

Master-control equipment must provide the following facilities: transmission of the on-the-air picture to the studio control room; supplying a program to the network, client rooms, and main transmitter; push-button selection of a program from any of at least four sources; patch (plug-in) preselection of four programs from as many as 10 sources; fade timing; continuous monitoring of the on-the-air picture at the operating console; sending an independent preview (cueing) picture to the studio control monitors and to the client room; a continuous preview picture at the operating console; phasing of remote and local sync generators before switching; emphasizing the sync component of an incoming remote or network video signal; and separate routing of remote and network programs.

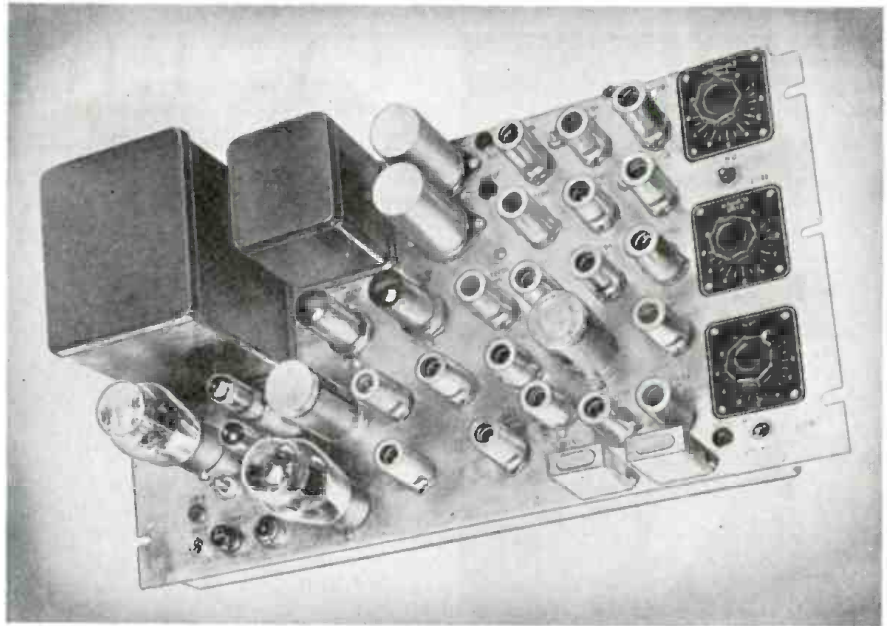

Chassis view of a "sync stretcher" used to boost the sync signals in relayed programs.

POTENTIAL TELEVISION APPLICATIONS

By W. R. G. Baker, Vice-President, General Electric Co.

AS the television art progresses the electronics industry will put the television camera "eye" and the picture tube to work in industry and business, in the school room for child and adult education, in our police stations for criminal detection and will apply them in our national defense systems.

One of the potentially great uses for television, of course, is in the field of teaching. The television picture tube may never replace the blackboard but its possibilities of reducing the training period are so intriguing that it surely will enlist the cooperation of the nation's educators in applying the television technique as an important supplementary teaching aid. Television demonstrated its ability to project a common classroom into hundreds of police precincts and other training spots during the war. Thousands of air-raid wardens were given basic training in defense work as they "studied" such subjects as the incendiary bomb and gas protection via the television screen.

Industry has numerous possible uses for television which will be studied as special equipments are devised for these applications. There are those where the engineer wants to watch an operation but does not want to be present—some mining operations, underwater exploration such as ship salvage, in explosive or chemical plants and other dangerous manufacturing operations.

These engineers lifted television out of the amusement field and gave it to the scientists recently at Azusa, California, to aid in getting close-up views of dangerous testing operations of high-thrust rocket motors at the Aerojet Proving Grounds. High ranking Naval officials, seated in a conference room

700 feet away from the test pits, saw the rockets being fired as clearly as if they were only a few feet away.

Television certainly has a place in law enforcement's future. The Federal Bureau of Investigation is studying its application for direct use in the Bureau's work. Criminal detection and apprehension can be aided not only by the direct telecast to the public in emergency, but also by televising the daily



Dr. W. R. G. Baker

lineup of suspects at police headquarters for the benefit of precincts in outlying communities. Development of equipment for police cars which now use radio so effectively is another logical step in television's future applications.



TV, Electronics, and Radio in '49

By BRIG. GEN. DAVID SARNOFF*

TELEVISION set production, for the industry as a whole, in 1949, will total approximately 2,000,000 receivers. This, according to the best available studies, will be stepped up in succeeding years, and by 1953 the industry's annual television set production is expected to reach close to 5,000,000. By the end of that year, the total number of sets in operation would be nearly 18,000,000. Also, by 1953, it is believed that a coast-to-coast television network service will have been made possible by radio relays and coaxial cables.

At present, 124 television stations have been authorized by the Federal Communications Commission. Fifty-seven are on the air. Seventy-five other applicants have permits to construct stations, and 312 additional applications are pending. Television networks are expanding across the nation—opening new markets for receiving sets and constantly increasing television's "circulation" as an advertising medium of powerful sales appeal.

Recently, Chairman Wayne Coy of the FCC estimated that in another two years there will be 400 television stations on the air, and 1,000 stations in seven or eight years from now. He also pointed out that nine-tenths of everything we learn comes through our eyes, and added: "Television enables us to reach the mind via electronics at the speed of light. It is costly to build and to operate a television station. But the advertisers will find it the most powerful, most effective and most profitable medium for mass merchandising yet devised."

So swift has been the scientific and engineering development of television transmitters and receivers that those responsible for the artistry and showmanship of television have found it a real challenge to keep the pace. Nevertheless, the great improvement in pro-

grams at the beginning of 1949 reveals such progress that it guarantees continued advances in the development of this new art.

Ultrafax

Combining the great advances made by television with sensational achievements in radio relays and photography, the Radio Corporation of America in 1948 introduced Ultrafax, a new system of high-speed television communication, capable of transmitting and receiving handwritten or printed messages and documents, and even complete books, magazines and newspapers, at the rate of a million words a minute. It was demonstrated publicly for the first time on October 21, 1948, in the Library of Congress, Washington, D. C. This development which splits the second and utilizes each fraction for high-speed transmission of intelligence, promises to be as significant a milestone in communications as was the splitting of the atom in the world of energy.

While many uses for Ultrafax are foreseen, its scope will multiply with time and experience. We foresee the day when through television and Ultrafax, a radio newspaper may be delivered through the air into every home equipped with a television set. It will be possible to have the same transmitter that broadcasts a television program broadcast the radio newspaper simultaneously. In fact, the same home receiver, with proper attachments, could print the newspaper without interrupting the television program.

As a radio mail system, Ultrafax could deliver the equivalent of forty tons of mail coast-to-coast in one day.

We can also envisage the day when Ultrafax will provide us with a new service of international television. First, however, a radio "air-lift" must be provided across the Atlantic. With 12 to 14 suitably equipped communication planes flying over the ocean and suitably spaced, an overseas airborne radio relay system could be established between the U. S. and Europe to provide not only an exchange of television programs, but also to handle the equivalent of tons of mail, news and other services. Ultrafax would make all this possible with lightning speed and mobility.

Broadcasting

Radio broadcasting provided the firm foundation of experience and public

service upon which television is being built. Sound and sight combined are weaving a pattern that is more appealing to the mind than sound alone, so a gradual fusion of these two great services is to be expected. More than 1,700 standard broadcasting stations are operating in the United States and construction permits for approximately 300 more have been granted. There are 39,000,000 homes equipped with radio receivers in this country, which means that more than 90 per cent of American families have radio sets.

FM (frequency modulation) broadcasting continues to advance as indicated by the fact that the number of FM stations on the air increased from 300 at the beginning of 1948 to nearly 700 at the close. More than 300 construction permits for additional FM stations have been issued. The number of radio sets equipped for FM reception increased to more than 3,000,000 in 1948.

Science and research

Industrial electronics, with its widespread possibilities for useful application, continues to challenge our scientists and engineers. For instance, in 1948, RCA introduced a new electron tube, which acts as a "transducer," converting mechanical vibrations into electrical pulses that can be studied as audible or visual signals. The tube is smaller in diameter than a cigarette and only half as long. It weighs only 1/16 ounce. It is so sensitive that it can measure the vibrations made by a fly walking on a steel beam. Therefore, it is easy to see what great possibilities it has for use in such diverse fields as the detection of defects in airplane construction, the causes of dynamic imbalance in rotating machinery, the measurement of the effects of oil well blasts, recording blood pressure, studying under-water sound and numerous other applications.

But so wide is the scope of radio science today, and so great its possibilities for the future, that it is beyond human power to foresee all the new advances that will appear. It is safe to prophesy that some developments will overshadow in significance many of the achievements of the past. This much is certain—our scientists and engineers will continue to devote their energies and skills toward extending the usefulness of the electronic and communication arts.

*Chairman, Board of Directors, Radio Corporation of America.

Trouble shooting in TELEVISION KITS

By JOSEPH L. REIFFIN*

THE tremendous popularity of television has been aided in no small part by the availability of very fine receivers in kit form. These television kits have enabled thousands of people to build their own sets with little difficulty and at really substantial savings over the commercially manufactured brands. People in all walks of life, regardless of their knowledge of radio, have built from kits television sets that perform as well as any of the commercially available sets costing up to three times as much. And the thrill of accomplishment is something that cannot be measured in dollars and cents.

Some of the most popular kits are the Television Assembly, Transvision, Tech-master, and Telekit.

The manufacturers of Transvision and Telekit have gone to great pains to supply the builder with complete constructional details. The placement of every wire and each component is given in printed instructions and shown by a picture-diagram. It is heartily recommended that the builder adhere closely to these instructions. Short cuts and "circuit improvements" are to be avoided because they usually result in improper operation of the set and unnecessary trouble shooting.

In the Television Assembly kit the instructions are not as complete as in the Transvision or Telekit. However, complete wiring diagrams are supplied showing the placement of all the wires and components in a stage-by-stage sequence.

The Tech-master kit is essentially the RCA 630TS receiver. This kit is rather difficult for the inexperienced man to build. No step-by-step instructions are supplied. However, a complete schematic and a wiring diagram are provided, and the experienced constructor can complete the set without too much difficulty.

The universal trouble

Probably the greatest source of trouble in the construction of any of the kits is improper soldering. A cold solder joint is to a radio what a bad spark

plug is to a car. Both appear to be good until put to work. One badly soldered connection can make useless an otherwise perfect television set. A cold solder connection in a ground circuit, for example, can cause oscillation in the i.f. stages and completely ruin reception.

Fortunately, it is just as easy to make a good solder connection as it is to make a cold joint. A few simple rules have to be observed. First, the soldering iron must be large enough for the work. For the type of soldering required in the construction of a television set, the standard soldering iron is to be preferred over the newer gun type. The gun is excellent for intermittent use, but for continuous work, the regular type is superior. The 100-watt size with a tip that isn't too blunt will serve very well. The tip must be well tinned, and it is an inviolable rule that *acid-core solder, or any type of acid flux, should never be used.*

The entire secret of good soldering lies in getting the metal clean and applying sufficient heat. The iron must be held to the joint until the solder has flowed freely. When the iron is removed after the solder has flowed over the

joint, *nothing must be moved* until it has cooled and set. It is easy to distinguish a proper connection from a poor one: the good connection will have

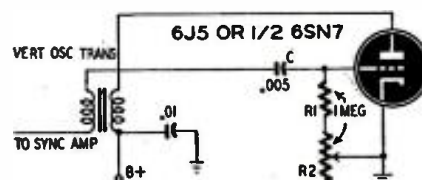

Fig. 1—Here is typical vertical oscillator. a shiny, smooth appearance; the cold joint will be rough and granular. A radio is as good as its soldered connections—make yours good!

Another gremlin that adds to the woes of the kit builder is haste. The rush to get the set finished and see a picture on the cathode-ray tube results in many wiring errors that are difficult to trace in the finished set. It takes the average man about 30 hours to construct a television set that has between 20 and 30 tubes. After working on the set for 20 hours or so, it is normal to become a bit impatient and want to finish up. *The speed-up invariably re-*



Chassis and some of the parts included with Espey TV 3K kit are shown here.

* Television Consultant, Newark Electric Co.

sults in carelessness. A connection is made to a wrong terminal. Or a connection is completely left out. This results in much wasted time after the set is presumably finished. For every hour of speed-up, there may be two hours of trouble shooting. Take it slowly—follow instructions. Care always pays off.

Television assembly

One of the popular kits on the market is manufactured by the Television Assembly Co. of Brooklyn, N. Y. The 10-, 12-, and 15-inch kits all use the same chassis. The only difference is in the size of the picture tube supplied. The 10-inch kit also contains an ion trap which is not used with the 12- or 15-inch tubes.

One of the features of this kit is the completely wired and factory-aligned picture and sound i.f. and detector strip. The front end, which may be either the standard Sarkes Tarzian or the DuMont Inputuner, is also completely wired and aligned. The con-

structor has only to wire in the power supply and sweep circuits. The instructions supplied are fairly complete and little difficulty should be experienced in following the stage-by-stage breakdown. The following points are where most of the errors are likely to occur.

A 200-ohm, 50-watt resistor is used as a voltage divider to supply different negative voltages to bias the various stages. This resistor has five terminals, all apparently equidistant from each other. However, an ohmmeter will show that, measured from one end of the resistor to the various taps, you will have, in successive steps, 7, 70, 150, and 200 ohms. If measured from the other end, the taps would read 50, 130, 193, and 200 ohms. Obviously, this resistor must be put in the circuit in the proper way. Close inspection will reveal that the 7-ohm tap is closer to one end than the 50-ohm tap is to the other end. The resistor should be mounted so that the 7-ohm tap is next to the end terminal connected to the chassis. If it is in-

stalled the opposite way, the set will not function properly; the wrong bias voltages will be applied to the tubes.

All the filter capacitors used in this set are aluminum can electrolytics. There are two types of mounting plates. One is made of bakelite and the other of plain metal. The metal plate automatically grounds the negative terminals of the capacitor to the chassis. The bake-

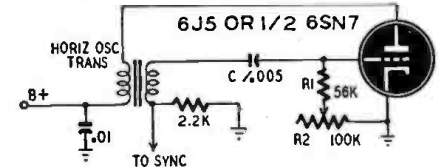

Fig. 2—The critical parts are C, R1, and R2.

lite type permits the negative terminals of the condensers to be connected to various parts of the circuit. It is of utmost importance that the proper mounting plate be used for each capacitor. Capacitors Nos. 26 and 27 are the only ones that use metal mounting plates; all the others use bakelite plates.

Another component likely to give trouble is the linearity coil, which mounts on the back apron of the chassis and bears part No. 19. It has three terminals, only two of which are used. The prints do not indicate just which two of the three are to be used; and if the wrong two are inadvertently connected, the set will not work. A close inspection of the coil will reveal that only two of the three terminals have any wire attached to them. The third terminal is a dummy. The coil is wax-impregnated, and the wire is very fine but it can be seen. These two terminals should be wired in the circuit as shown on the diagram.

In this kit all resistors are packed in one bag. There is no way to tell one from the other except by using the color code. This method is very simple and should not be difficult for even the neophyte to master. The instruction sheets list the color code with easy-to-understand instructions. However, the resistors vary in wattage ratings: $\frac{1}{4}$ -, $\frac{1}{2}$ -, 1-, and 2-watt carbon resistors are used in various parts of the circuit. Perhaps the easiest way for the novice to determine the wattage ratings is to compare physical sizes. There are four different sizes. The largest will be 2 watts. The next in size will be 1 watt; and so on down the scale.

It is important that the proper wattage resistor be used. Using a resistor of smaller size than called for results in overheating it, with consequent change of its resistance value and eventual failure. The wiring circuit notes the size of the resistor to be used, as well as its resistance value. Be sure to look for the wattage ratings and use the proper resistors.

All radio components are manufactured to certain tolerances. For example, a 1,000-ohm resistor does not measure exactly 1,000 ohms unless it happens to be a precision resistor. Precision resistors are very costly and are used only in expensive and accurate

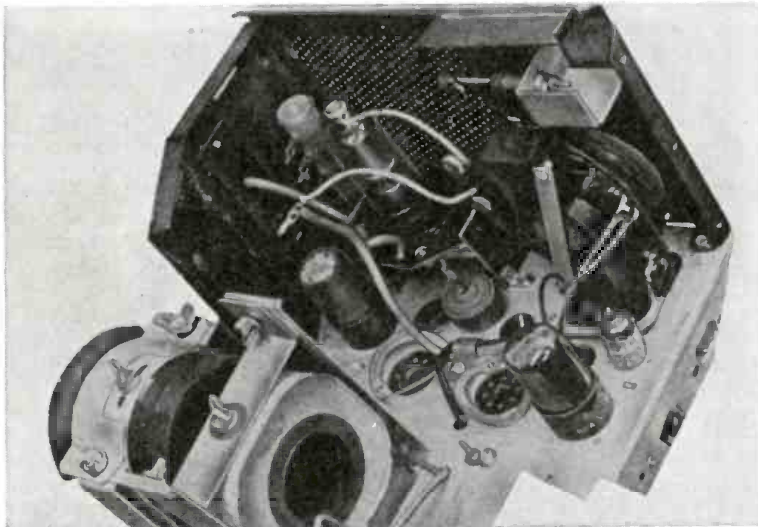

This rear view of the Tech-Master 630-TK shows the high-voltage compartment.

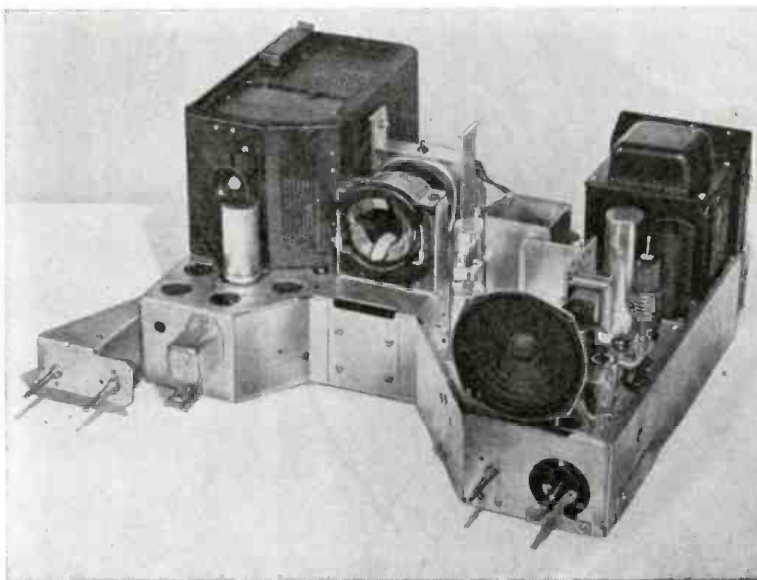

Front view of the Tech-Master 630-TK kit without the picture tube in its place.

Television is Booming—Cash in on it!

RADIO-ELECTRONICS for

test equipment. The usual resistors are made with tolerances of 5%, 10% and 20%. That means that a 1,000-ohm, 20% resistor can measure anywhere from 800 to 1,200 ohms. The same thing holds true for capacitors. In ordinary radio circuits, these tolerances have little or no effect on the operation of the equipment. However, in certain sections of a television receiver—such as the vertical sweep oscillator and the horizontal sweep oscillator—wide tolerance results in faulty operation. Since the time constant is equal to the product of the resistance and the capacitance, it can readily be seen that an accumulation of tolerances in the wrong direction will result in an unsuitable time-constant.

Make sure that the critical components in the vertical and horizontal oscillator circuits are at least within

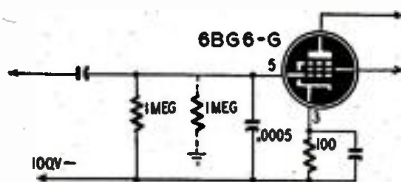

Fig. 3—How to extend the horizontal sweep.

a 10% tolerance. (This applies to *any* receiver). Fig. 1 shows a typical vertical oscillator circuit. The critical timing constants are C, R1, and R2. Fig. 2 shows a typical horizontal oscillator circuit. The critical components here are also C, R1, and R2.

Due to the accumulation of tolerances and wiring differences, it may be found that there is insufficient horizontal sweep voltage available fully to cover the picture tube horizontally. It should actually be possible to have too much sweep, so that it will not be necessary to drive the 6BG6-G horizontal output tube too hard. Overdriving this tube results in poor horizontal linearity. The horizontal size can easily be controlled by the horizontal drive and width controls. This, of course, is only possible if there is sufficient sweep to start with.

A simple change in the grid circuit of the 6BG6-G extends the horizontal sweep voltage without undue distortion. Such a change is shown in Fig. 3. Add the 1-megohm resistor shown dotted and change the .001- μ f grid capacitor to .0005 μ f.

Telekit receiver

The Telekit set, manufactured by the Electro-Technical Corp. of Philadelphia, is available in a 7-inch electrostatic-deflection model and a 10-inch magnetic-deflection model. These kits are relatively inexpensive and use fewer tubes than the other kits mentioned. Both models use standard circuits, and a complete instruction manual is provided. Due to the compactness of the set, the wiring is quite crowded; although when wired in the step-by-step sequence given, this is not too much of a problem. It is important that care be taken to prevent shorts between the

various components. No tie points are provided and the several open junctions of resistors and capacitors present possible points of trouble. Liberal use of spaghetti insulation is very helpful as a safety measure.

Both Telekits use a stagger-tuned picture i.f. system. The individual i.f. coils are unshielded, a fact that makes proper alignment quite essential, since no two coils can be tuned to the same frequency without causing oscillation. Oscillation may still occur, even with proper alignment, if all plate and grid leads in the i.f. circuits are not kept very short and separated. Close adherence to the printed instructions and the pictorial wiring diagrams supplied will minimize this trouble.

A 13-channel tuner, completely wired and aligned, is supplied with each kit. It may be found that the best sound is not accompanied by the best picture. In extreme cases, the wrong channel sound will be present with the picture. These conditions are brought about by improper alignment of the picture and sound i.f. In this stagger-tuned system, the second picture i.f. coil must be tuned to 22.3 mc. The sound take-off coil is closely coupled to this second picture i.f. coil and the take-off coil is tuned to the sound i.f. of exactly 21.25 mc. The take-off coil serves a dual purpose: it supplies the signal to the sound i.f. to be amplified and detected, and it acts as a sound trap in the picture i.f. by being so closely coupled to the second picture i.f. coil. It is important that the frequencies of alignment be held very closely to have proper operation of the tuner and the i.f. strips.

The conditions discussed earlier concerning the horizontal linearity coil apply to the 10-inch Telekit set since the same coil is in use here.

The video output tube in these sets is half of a 6SN7, operated with the cathode grounded in order to obtain maximum gain. The tube receives its bias voltage through the drop in the 1-megohm grid resistor when a signal is applied to the grid. When there is no signal, the 6SN7 draws excessive plate current because no negative bias voltage is applied. This will cause the plate-load resistors to overheat and possibly change value. Never attempt to operate the set unless all the i.f. and r.f. tubes are in the sockets. To do so may burn up the 6SN7.

Transvision

The Transvision sets are very straightforward in construction and operation. The manual supplied with every kit is very complete and covers practically every contingency that may arise. The builder, if he adheres closely to the instructions, will have few problems.

In all magnetic-deflection kits that use the fly-back type of high-voltage supply—all the 10-inch and larger sets covered in this article—the 9,000 volts is rectified by the 1B3-GT/8016. This tube uses an ordinary octal socket and the 9,000 volts of d.c. is present on both filament terminals—terminals 2 and 7. The socket is usually mounted on a piece of insulating material to keep these terminals away from the metal chassis. It is a good idea to remove all the unused socket terminals so that there will be no metal close to the high-voltage terminals. Be careful to keep all connections to these high-voltage points as smooth as possible, since corona will always seek a sharp point to start its ozone-creating disturbance. Corona discharge can be very troublesome.

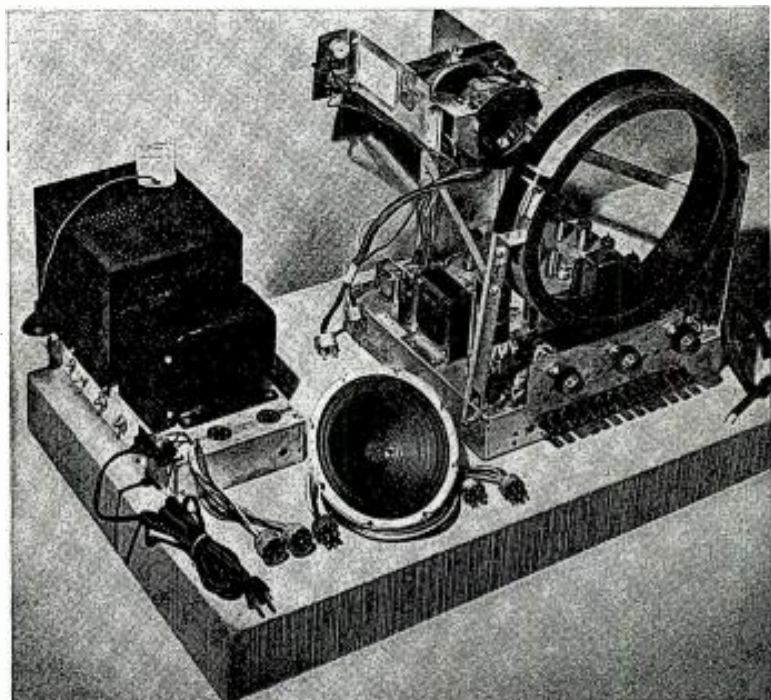

This Hallicrafters push-button-tuned chassis is used for custom installations.



Navy Teaches with

THE U.S. Navy and the booming art of television were introduced to each other on January 10 and the acquaintance promises to be a long and profitable one for both parties.

The nation's tars-in-training can be expected in future to see a great deal of the video screen. The programs they watch may not be as entertaining as the puppet shows and Broadway plays we

view in our living rooms of an evening, but the high quality of the instruction the Navy presents to its men by TV and the large number of students who can participate in it may some day help to determine whether or not we'll be in the vicinity of our living rooms and whether the living rooms will still be there.

The photographs shown on this page were taken at Sands Point, Long Island, a short distance from New York City, at the Navy's Special Devices Center, where an elaborate collection of cameras and control equipment has been assembled to form the Navy Television Studio. Here the Navy's first experiments in the important new technique of instruction *via* video are going forward, carried on by a compact group of instructors and technicians. That the experiments are far from tentative is illustrated by the extensive and costly equipment to be seen in the photographs. Technical materials are of the latest and best types, and the "programming" techniques are replicas of the polished productions so familiar nowadays to home TV viewers.

Two weekly experimental lectures are being televised as this is written, on Mondays and Wednesdays, from the Sands Point Studio by 6,116-mc relay to a third-year class at the Merchant Marine Academy at Kings Point, about 5 miles away. It is highly probable that in the near future the lectures will be sent *via* wire lines and radio links—which are available now—to Naval Reserve Squadrons at Squantum, Mass.; Willow Grove, Pa.; Floyd Bennet Field, N. Y.; and Anacostia, Md. Major commercial television networks have offered the Navy their co-axial-cable links between cities and their air time—to transmit instructional material.

The Navy believes television has two special values. First and most obviously, it is a means of instructing tremendous numbers of men at one time. Naval training, like that of the other armed forces, is—or attempts to be—standardized, so that trainees of any particular course will graduate with the same quality and quantity of knowledge. In actual practice, not all instructors have the same facility for teaching. With students all over the country watching and hearing the same instruc-



A view of the set-up for a television lecture taken from behind the control engineers.

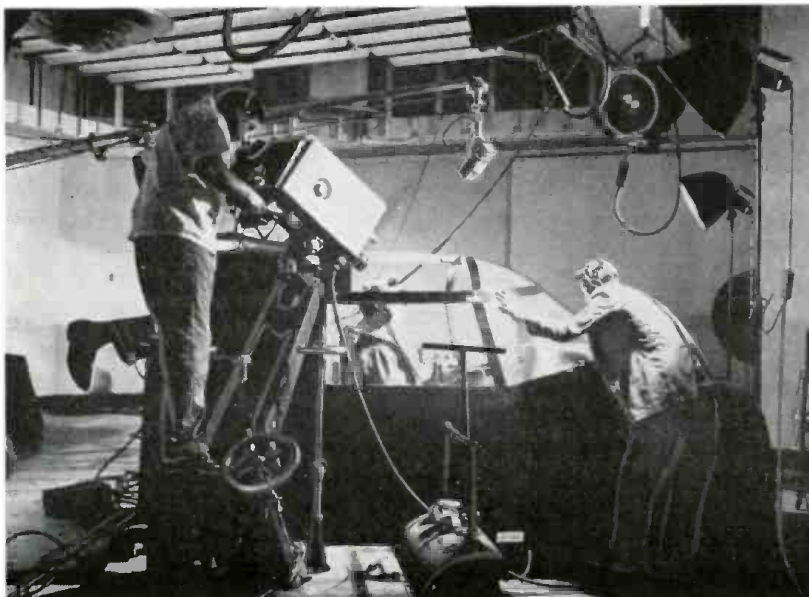

All official Navy photos

It is in restricted viewing areas like this that the television-camera is most valuable.

Television is Booming—Cash in on it!

RADIO-ELECTRONICS for

Television



Students view close-up of scene shown below.

tor, standardization would be a fact.

Another extremely important advantage of televised instruction is to reduce the expenditure of money on teaching aids and to increase their quality. There are those who, in this month of March, will find it hard to believe that the government has not all the money in the world; but the fact is that a disassembled jet engine, for instance, costing \$12,000, cannot be put at the disposal of every Naval training center in the country. Such an engine is used at Sands Point. Potentially the single engine can be placed on television screens before thousands of students. The close-up lens, in addition, can—and does—produce full-screen views of small parts, something which can not be duplicated in any other way. Each student has a front-row seat and a perfect view of the object for as long as it takes the instructor to describe it.

This is most important in cases like that of the lower photo on the opposite page, where a control system in an enclosed cockpit is to be demonstrated. Without television not more than half-a-dozen students at a time could be instructed properly. With television, everything is clearly visible to unlimited numbers.

In the event of a national emergency, the results of the Navy's television experiments may prove a vital factor in protecting the U. S. With country-wide armed-forces centers linked by video, millions of men in places separated by thousands of miles can be shown and taught procedures and techniques evolved only the day before. Dependence on printed training directives alone, or sending men to centrally located schools may be a thing of the past.

The new experiments have been in progress only a short time, but already educators, both civilian and uniformed, who have been studying the reactions of the merchant-marine students at Kings Point, are highly optimistic. Admiral Louis E. Denfeld has said that "the most important peacetime job of the Navy is to enhance the training of its men." If in the future the Navy is better trained and better able to do its job, it may well be because the familiar Navy cry of "Now hear this!" may have given way to a more modern phrase, "Now see this" . . . via television!

MARCH, 1949

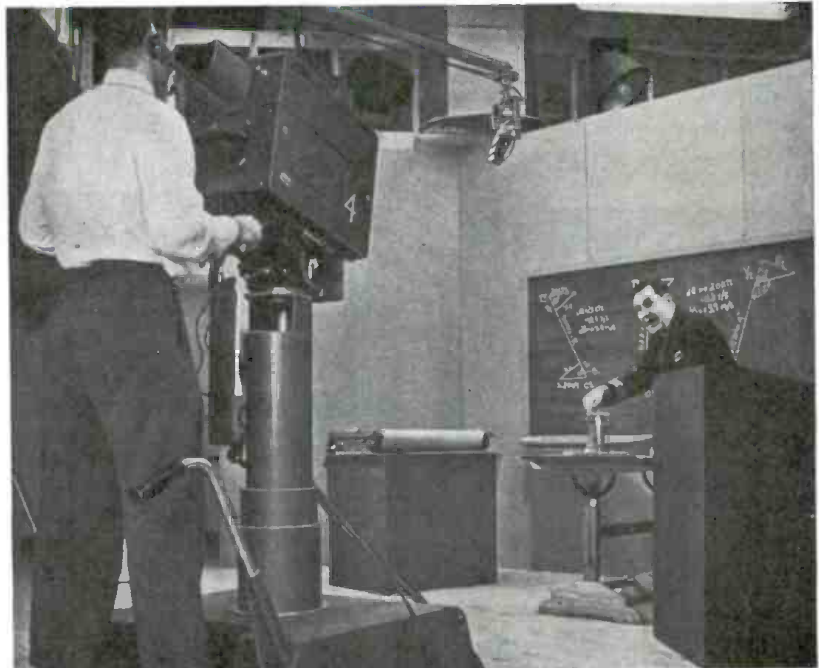

Television instructor Madine demonstrates a gun model for students 4½ miles away.



Trainees working over a plotting board are televised for the benefit of fellow-students.

Television is Booming—Cash in on it!

TV Test Pattern Quiz

By SOL D. PRENSKY

Test patterns are valuable aids to servicemen and TV set owners in adjusting receiver controls. With a little experience, the operator can tell at a glance just which of the controls needs adjusting. The serviceman also finds patterns a decided advantage when diagnosing ailments in the receiver and in identifying certain types of interference.

A number of test patterns are shown below. All of these have defects caused either by improper adjustment of one or more of the receiver controls, defects in

the receiver, poor antenna, or spurious signals from outside sources. Some can be cleared up by manipulating one of the controls on the front or rear panels, a few by controls on or under the chassis, and several cannot be removed at the receiver.

All but one of the first thirteen patterns have defects produced by improper adjustment of one or more of the controls normally found on the front or rear panels. Defects in the others are caused by faulty components in the receiver, poor antenna or outside inter-

ference.

The owner of a TV receiver should be able to spot defects in the first thirteen patterns and know just which controls need adjusting. Servicemen should recognize all the defects and know just what is required to correct them. Before going further, study each pattern carefully, then decide how you would correct the defects. The correct solution to these problems will be found at the end of this article.

Photographs are by courtesy of Admiral, Du Mont, and RCA.



1. Picture above or below center of mask.

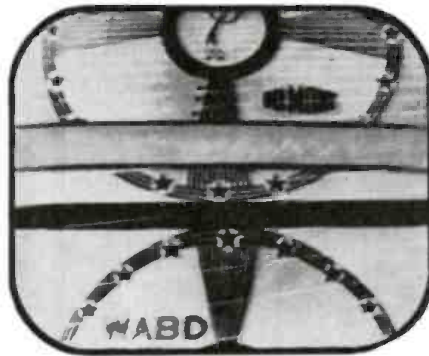

4. Picture not stable. Moves up and down.

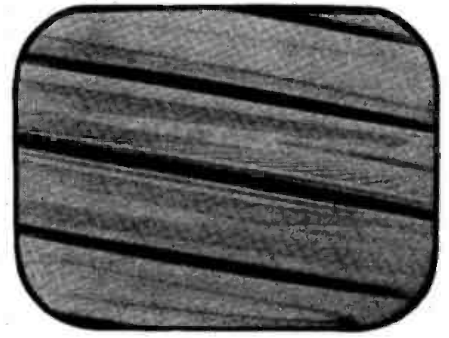

7. Fast movement either to right or left.

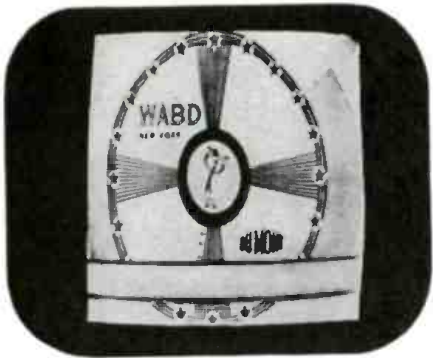

2. Picture out of proportion horizontally.

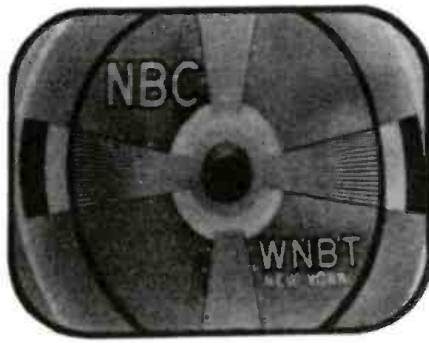

5. Top and bottom of pix are beyond mask.



8. Bright diagonal lines in background.

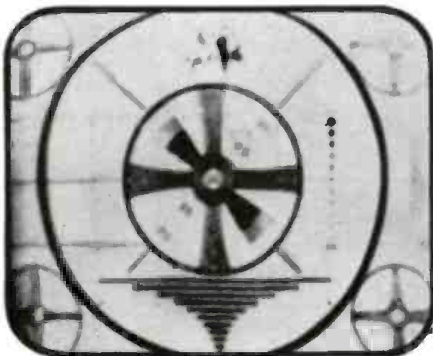

3. Details are fuzzy and lack sharpness.



6. Pattern to left or right of center.

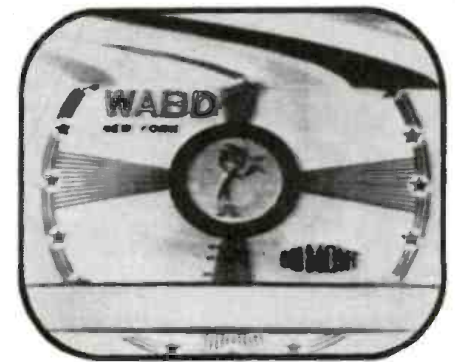

9. Contrasty picture tearing at the top.

Television is Booming—Cash in on it!

RADIO-ELECTRONICS for

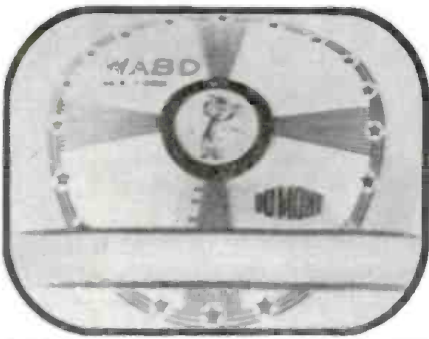

10. Test pattern is oval instead of round.

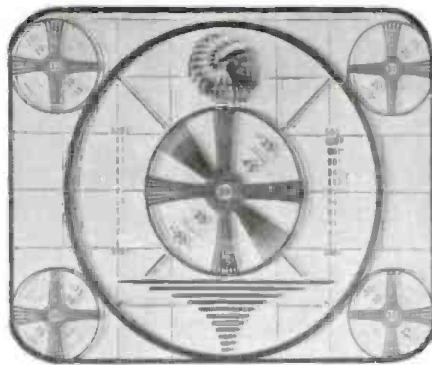

14. Multiple images beside main image.



18. Dark horizontal bar across picture.

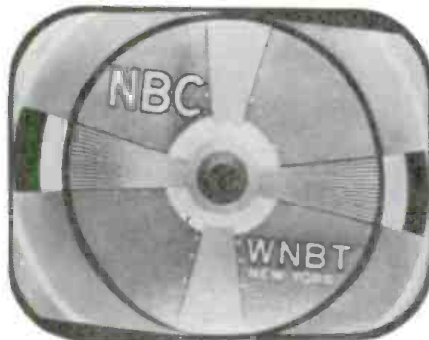

11. Picture is tilted with one side low.

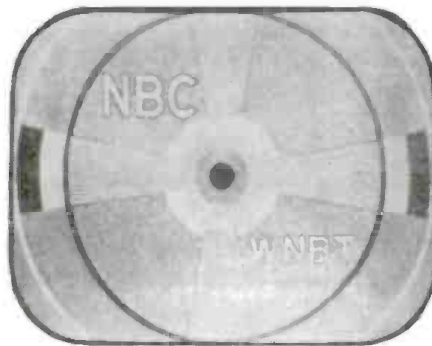

15. Uneven brightness and lack of detail.

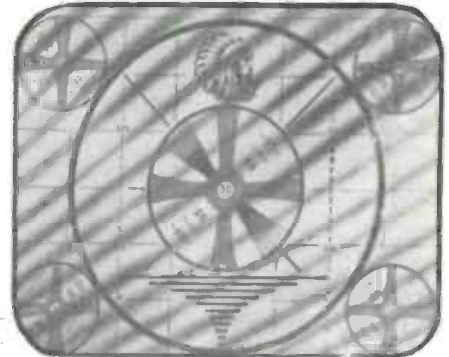

19. Dark diagonal lines across face of tube.

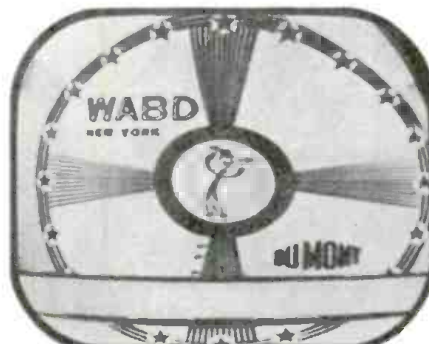

12. Pattern is stretched on one side.

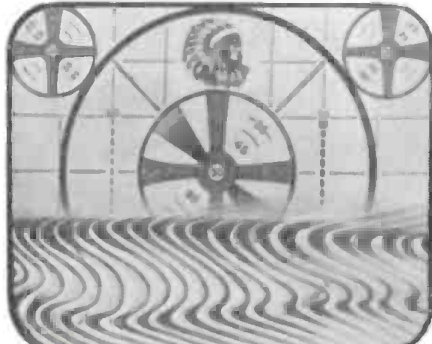

16. Herring-bone pattern runs across picture.



20. Horizontal lines of varying intensity.

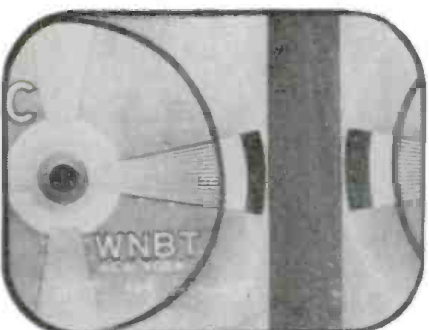

13. Frame displaced horizontally.



17. Picture moves rapidly right or left.

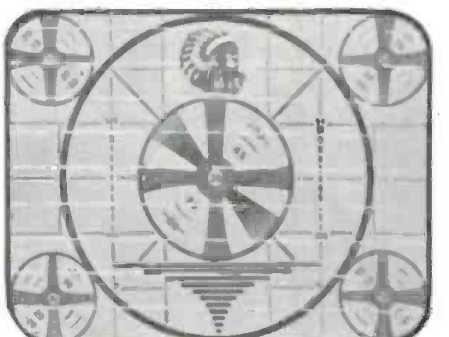

21. White streaks flash across the picture.

The defects in the patterns shown above are due to improper adjustments of the receiver controls, external signals or defects in the receiver. Use the following controls or adjustments to correct the pattern:

1. VERTICAL CENTERING control.
2. WIDTH or HORIZONTAL SIZE control.
3. FOCUS control.
4. VERTICAL HOLD control.
5. HEIGHT or VERTICAL SIZE control.
6. HORIZONTAL CENTERING control.
7. HORIZONTAL HOLD control.

8. BRIGHTNESS and CONTRAST controls.
9. CONTRAST and HORIZONTAL HOLD controls.
10. VERTICAL LINEARITY control.
11. Rotate yoke of electromagnetic or socket of electrostatic C-R tubes.
12. HORIZONTAL LINEARITY control.
13. HORIZONTAL PHASE control.
14. FINE TUNING control. Re-orient antenna.
15. FINE TUNING control. Raise antenna, use high-gain antenna or booster.
16. Practically no cure at receiver loca-

- tion. Diathermy interference.
17. HORIZONTAL FREQUENCY and FINE TUNING controls.
18. Check for open filter capacitors in low-voltage power supplies. Look for abnormal power drain.
19. Re-locate antenna. Use traps and stubs in lead-in. R.f. carrier QRM.
20. FINE TUNING control. Realign set. FM or sound carrier interference.
21. Often unavoidable. Re-locate antenna. Use shielded or co-axial transmission line. Ignition interference.

of this year is foreseen. This will mean a potential audience in excess of 70,000,000 throughout the nation.

While television stations mushroomed across the country at an incredible speed and receiver production skyrocketed to an extent that even amazed the producers themselves, another service essential to the commercial well-being of the new industry was keeping pace—the installation of facilities for network telecasting.

Radio thrived only after networks were threaded from border to border and coast to coast, so that millions of people could hear the greatest entertainers in the nation simultaneously.

Television is following a similar course, but the facilities to make possible the interconnection of many stations are far more complicated as well as more costly for television broadcasting.

The American Telephone & Telegraph Company, which pioneered in network services for radio broadcasting, has also pioneered in television networking with great success. Two methods of program transmission are available: one the co-axial or concentric cable, and the other the microwave or radio relay.

Fourteen months ago the only network facilities available in the United States extended between New York City and Washington, D. C. Then A.T.&T. opened its first radio relay between Boston and New York City, seven towers that beam programs in either direction. By June, 1948, when the Republican National Convention opened in Philadelphia, the A.T.&T. had again extended its network route, opening a co-axial cable between Washington and Richmond, Va.

Another historic milestone was marked in networking when, early in October, the Bell System made available a network route extending from Buffalo, N. Y., to Cleveland and Toledo, Ohio; to Detroit, Mich.; Chicago, Ill.; Milwaukee, Wis.; and St. Louis, Mo. Early this year one of the great achievements in the history of television was effected when, on January 11, the A.T.&T. drove another "golden spike" to link the East and the Midwest. Telecasts marking the linking of the above cities to New York, Philadelphia, Boston, Pittsburgh, Baltimore, Washington, and Richmond in a 14-city network took place.

Most of the cities on the Eastern-to-Midwest network are connected by co-axial cable, but three cities are linked via microwave relay. One group of relays connects New York City to Boston, another links Detroit with Cleveland, and a third interconnects Chicago with Milwaukee.

Between 1949 and end of 1950, the American Telephone & Telegraph Company plans to provide additional co-axial cable and microwave relay facilities to extend television network service between the following cities: Los Angeles and San Francisco; Milwaukee and Madison, Wis.; Buffalo and Rochester, N. Y.; Toledo and Dayton, Columbus and Cincinnati, O.; Indianapolis,



Eleven cities are now served by co-axial cables. Three more are connected to net by relays.



The Bell System has plans for adding terminations shown on the map above by next year.

Ind. and Louisville, Ky. Other connections include Boston and Providence, R. I.; New York and New Haven, Conn.; Philadelphia and Reading, Lancaster, York, Harrisburg and Johnstown, Pa.; Philadelphia and Wilmington, Del., Pittsburgh and Youngstown and Akron, O.

Until co-axial cable and microwave relay facilities can be extended further, many cities with television service will be dependent upon a third method of network "connection." This method is known as the kinescope recording or the *Teletranscription* system. All of the present operating networks—NBC, CBS, Du Mont, and ABC—have equipment for recording on film, off the face of a cathode-ray tube.

Many of these programs, both commercial and sustaining, are flown by air express or shipped by rail to stations outside the network routes for rebroadcast to large audiences of television set owners. By this method, many popular network shows that otherwise could not be seen by many viewers are available on a delayed basis. Among the cities using kinescopes or Teletranscriptions of popular shows are: Los Angeles and San Francisco, Calif.; New Orleans, La.; Atlanta, Ga.; Memphis, Tenn.; Houston, Texas, and Seattle, Wash.

While the expansion of stations and network facilities has staggered the imagination, the vast improvement in programming on television has been equally amazing.

Television programs are now featuring Hollywood and Broadway performers. Some of the brightest stars in the movie world took part in an array of

visual shows last year, and leading lights on the Broadway stage have appeared regularly in television versions of stage hits. Now that networks are wafting shows halfway across the country, set owners in Chicago and St. Louis will have access to the best New York entertainment.

Television cameras were also present at some of the past year's most important news and sports events. The political conventions in Philadelphia, special sessions of Congress, talks by President Truman at the White House or elsewhere, the world series, heavyweight championship fights, Davis Cup tennis matches, Army-Navy football game, major league baseball games, and other events were seen by millions.

What about television in 1949, 1950, 1951, and on?

Wayne Coy, chairman of the Federal Communications Commission, who characterized the expansion of television last year as "shooting along at supersonic speed," foresees 1,000 television stations operating by 1955. At the present time the FCC is trying to find spectrum space for 310 applicants who are clamoring for television station licenses.

J. R. Poppele, president of the Television Broadcasters Association, Inc., forecasts there will be 134 stations on the air by the end of this year, 235 by the end of 1950, and about 335 by the end of 1951. He predicts the great rural areas of the nation will receive their television programs from satellite stations situated in rural sectors, which will feed off network routes passing through. These satellites should bring the number of viewers by 1955 up to 100,000,000 people.

Television Projection Methods

The basic problem in large-screen television is producing a bright enough image. The author, inventor of the Skiatron, discusses some methods of solving the problem

By DR. A. H. ROSENTHAL

THE rapid progress during recent months of commercial television, particularly for home use, has been based primarily on the high degree of perfection of receivers using cathode-ray tubes with fluorescent-phosphor picture screens. Essentially, the screen consists of a thin layer of microcrystalline phosphor material (such as suitably prepared zinc sulphide), which is scanned by the modulated cathode-ray beam. The energy of the cathode-ray beam, when it hits the screen, is transformed, in part, into light energy, resulting in the luminous picture.

The total light output of the screen is limited by the electrical energy contained in the cathode-ray beam. Moreover, at the screen, this energy must be concentrated within the area of the scanning spot, which for a 525-line picture means about 1/200,000 of the screen area and amounts to about 1/40 square millimeter, or 1/6,000 square inch for a 10-inch tube.

For a given screen size, the brightness can be increased only by increasing the energy in the beam, by increasing either the beam current or the accelerating voltage. Increasing the beam current tends to impair the definition by increasing the spot size. Increasing the anode voltage is better, and becomes necessary in projection systems. When the picture on the fluorescent screen is projected by a magnifying lens or mirror system upon a viewing screen, much of the light produced on the tube face is lost in the final picture, because even

high-speed optical systems can gather only a fraction of the screen light. For instance, an $f2$ system would gather only about 6% of the light emitted in a forward direction by the screen. Therefore, projection receivers which produce pictures a few feet in width for home use require up to 30,000 volts for

ABOUT THE AUTHOR

Dr. Adolph H. Rosenthal, associated for many years with the Scophony Corporation as director of research and development, is the holder of 15 U. S. patents, most of them for television developments, and has applications on file for 21 more.

Among the devices he has patented are a method of attaching a TV camera to a film camera so that the cinema director can judge the picture as it is shot; a scrambling system for pay-as-you-watch television; and the Skiatron tube, described in this article.

the second anode, and projectors for theater-size screens require 80,000 to 90,000 volts. Naturally such tubes are not without danger, because of both the high voltage and the production of powerful X-rays, and they have to be used with the same precautions as X-ray tubes.

For home television, satisfactory pictures are (in the vast majority of

cases) being produced by direct-view, cathode-ray tubes up to 20 inches in diameter with up to 12,000 volts of anode potential.

The problems become serious mainly for large picture sizes, such as those required for schools, lecture halls, and theaters.

Since the limitations are caused essentially by the fact that the picture light is derived directly by transformation of the electron-beam energy, one might expect that a more fruitful approach would be to utilize a standard light source, such as a projection filament or arc lamp, and devise some means to modulate the light and project it on a viewing screen. The television picture signals would have to be impressed upon some kind of light modulator.

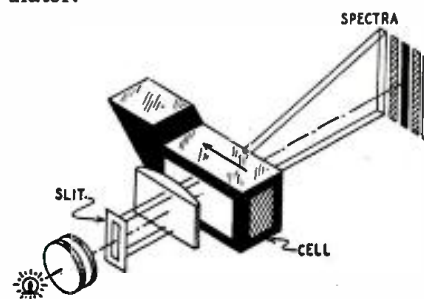

Fig. 2—The optical action of the modulator.

Such a system would have the great advantages that the picture brightness and energy would be independent of the signal modulation, and consequently, so would definition. Theoretically at least, the picture brightness can be increased by increasing the brilliance of the light source. The picture signal merely actuates, like a relay or the grid of an amplifier tube, a light modulator to control the light source.

In the past, television has utilized this principle in various ways.

The Kerr cell

The best-known light modulator, found frequently in early television systems, is the Kerr cell, which utilizes the property of certain organic liquids, notably nitrobenzene ($C_6H_5NO_2$), to become birefringent under the influence of an electric field (Kerr effect). The cell consists of a capacitor of two or more plates immersed in this liquid. It has transparent windows which permit the light from the local source to traverse the capacitor in a direction perpendicular

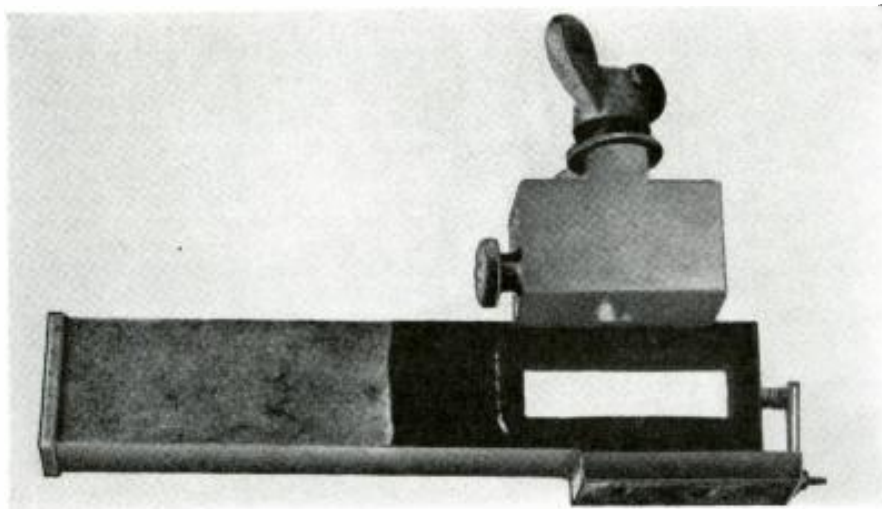

Fig. 1—The ultrasonic modulator uses a crystal to set up wave-trains in a liquid column.

Television is Booming—Cash in on it!

RADIO-ELECTRONICS for

ular to the electric field between its plates (parallel to the plates). The light entering the cell must be polarized, for instance by a sheet of Polaroid, preferably at an angle of 45 degrees to the direction of the electric field. After traversing the cell, the light is "analyzed" by a second polarizing sheet having its direction of polarization at a right angle to that of the first polarizer. Thus, normally, no light will traverse the assembly, since the polarized light from the first sheet is stopped by the second one.

As soon as a voltage is applied to the capacitor, and an electric field set up in the liquid, the liquid becomes birefringent, behaving like a crystal and converting the linear polarized light to so-called elliptically polarized light. The

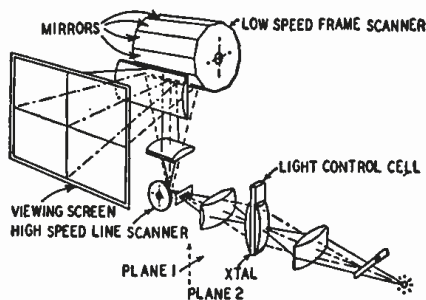

Fig. 3—Complete system uses scanning drums.

light now cannot be completely extinguished by the second polarizer. In other words, light will traverse the assembly with an intensity substantially proportional to the voltage applied to the Kerr cell. The modulation is practically inertia-free and hence sufficiently fast even for high-definition television.

The modulated light beam is focused to form a spot corresponding to one picture element on the viewing screen. This spot is made to scan the whole screen and produce the picture by mechanical scanners, of which many types have been developed. A preferred type consists of two polygonal mirror drums, one for the line scan and the other for the frame scan. Their speed of rotation and phase relationship are controlled by the synchronizing signals.

One of the main disadvantages of the Kerr-cell modulator is the fact that, at any given instant, it can pass the light of only one single picture element to the viewing screen, and thus (for a 525-line picture) only 1/200,000 of the screen area is illuminated at any instant. The brightness of this small area would have to be 200,000 times as great as the desired brightness of the whole picture. Optical and electrical limitations make it impossible to send the required amount of light through the Kerr cell, and therefore it had to be abandoned when a definition of more than approximately 100 lines was introduced.

The ultrasonic modulator

Another light modulator of completely different design replaced the Kerr cell for higher definition: the ultrasonic light-modulator cell shown in Fig. 1 in its actual form and schematically in

Fig. 2. It consists of an elongated container with two transparent windows in opposite walls. It is filled with a liquid in which compression waves can be set up by a crystal (X-cut quartz) forming the bottom of the cell.

The crystal is excited by an ultrasonic-frequency oscillator at about 10 mc. The oscillator is amplitude-modulated by the video signals. As a result, ultrasonic waves of varying intensity are propagated in the liquid column.

Light beams from a standard light source are sent through this liquid in a direction perpendicular to the travel of the ultrasonic waves. Depending upon the amplitudes of the waves at any point, more or less of the light at this point is diffracted from its original direction. The ultrasonic waves are periodic compressions and rarefactions of the liquid. They vary the liquid's optical refractive index and act somewhat like the optical diffraction grating used in spectrographs.

Normally, without ultrasonic waves in the liquid, the light traversing the cell is stopped by an opaque disc or strip; but when the crystal is excited, and waves are created in the liquid, the light diffracted by these waves can get past the stop to be utilized to produce the picture. The mathematical theory of the cell and experimental evidence show that the intensity of the light passing the stop—the light directed by scanners to the picture screen—is practically proportional to the amplitude of the video signal.

At any given instant when a certain modulation signal is impressed upon the crystal, the crystal passes along the modulation to the liquid just touching it, and a wave of corresponding intensity starts to travel along the liquid column with the sound velocity of the liquid (approximately 100,000 centimeters per second for water). At each following instant new wave-trains are started in the liquid. Thus, a whole succession of ultrasonic wave-trains, corresponding to successive video modulation signals or picture elements, is propagated from the crystal through the liquid column, which therefore simultaneously contains the modulated wave-trains of a great number of consecutive picture elements. Accordingly, the rays of light passing through the cell at all points can be impressed simultaneously with the modulation of the many picture elements existing along the length of the cell. By properly projecting the light from the cell upon the viewing screen, many consecutive picture elements can be seen at the same time. Practical ultrasonic light modulators have a liquid column of such length that several hundred picture elements can be simultaneously projected on the viewing screen.

Another way of expressing this desirable property of the cell is to say that each picture element is active, not just for the very short duration of its scan over a given screen position, but for the duration of the travel of an ultrasonic wave-train through the whole

length of the cell. A cell approximately 2 inches long can accommodate some 250 picture elements. This retention of each element for the duration of many scanning periods is called *optical storage*, and corresponds to a certain extent to the *electrical storage* effective in pickup tubes such as the iconoscope or the orthicon, which made possible modern television transmission.

Naturally, as in the case of the Kerr cell, the modulated light beams have to be distributed in their proper locations upon the viewing screen. This is done by mechanical scanners, such as the mirror drums. For proper line scanning, that is, to produce a steady picture on the viewing screen, the line scanner has to rotate at such a speed that its scanning motion is exactly opposite to the propagation motion of the ultrasonic wave-trains as projected on the viewing screen. It thus compensates for or stops the motion of the wave-trains on the screen. The scanning motors driving the mirror drums are governed by the synchronizing signals, and immobilization of the line scan can be accomplished by proper layout of the components.

This principle has been utilized with great success in the Scophony television system. Fig. 3 diagrams the essential components, including the light control or modulator, the light source, the high-speed (line) scanner, the low-speed (frame) scanner, and the picture screen. Fig. 4 shows a Scophony theater television projector in which a standard motion-picture arc lamp is used as the light source, and by which satisfactory theater-size television pictures can be produced.

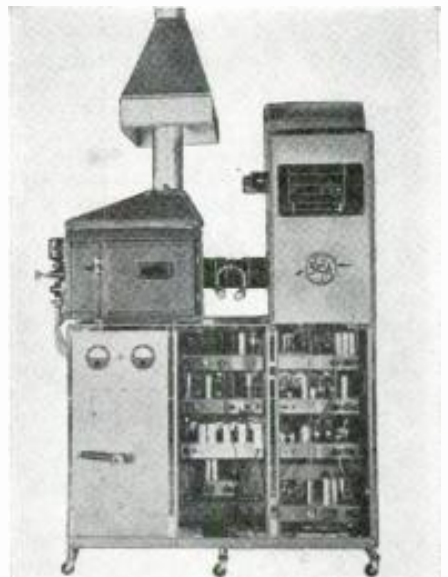

Fig. 4—Light source in Scophony unit is arc.

It would be very desirable if these basic principles of using a standard light source and utilizing *optical storage* could be applied in connection with cathode-ray tubes, combining the advantages of both to obtain a large, bright picture with nonmechanical, purely electronic, picture scanning.

To do this it would be necessary to replace the fluorescent C-R screen with

a light-modulator screen which would change its light transmission qualities in accordance with the cathode-ray beam. Various effects have from time to time been proposed to obtain such a transparency variation.

For instance the use of a screen material which has some type of Kerr effect has been thought of; or the orientation of flake-like graphite or aluminum particles suspended in an insulating liquid by the C-R beam in such a way that the orientation would have a shutter action upon the light. No practical commercial applications of these interesting effects are known.

It is interesting to recall that in the book *Electron Optics* by L. M. Myers, published in 1939, the author says: "Again it has been suggested that some material be used which is rendered opaque by electron bombardment, but there is no evidence that such a material has yet been found."

Actually, at that time a number of patent applications were pending and experiments were undertaken by the author of this article which gave evidence that there were suitable screen materials which had the property of changing their opacity in accordance with the modulation of a scanning cathode-ray beam.

The Skiatron tube

These researches resulted in the *Skia-tron* system. Fig. 5 shows a diagram of a Skiatron (from the Greek *skia* shadow; Skiatron—shadow-tube) projection

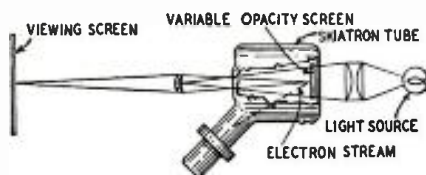

Fig. 5—Skiatron has variable-opacity screen.

arrangement) and Fig. 6 is a laboratory setup of the system. The screen of the tube, which replaces the fluorescent screen of ordinary cathode-ray tubes, consists of an ionic crystal material such as an alkali halide—for instance, potassium chloride. This material exhibits the property of *electron-opacity*: the normally clear and transparent screen is rendered more or less opaque by the scanning C-R beam. The opacity created at any point on the screen increases with increasing intensity of the cathode-ray beam. If the screen is scanned by a picture-modulated beam, the changing opacity of each point on the screen results in a kind of lantern-slide picture which can be projected with an ordinary projection setup, using a standard light source, upon a projection screen.

The theory of the opacity variation is rather complicated. Expressed in a simplified way, electrons entering the crystal lattice from the C-R beam are temporarily bound to alkali ions near disturbances of the lattice, and a semi-stable alkali atom is created which absorbs the visible light passing through

the crystal from the light source. Any such "color center" is destroyed after a short time through heat oscillations of the crystal, and the liberated electron moves further through the crystal toward the anode. During its travel it is repeatedly captured by alkali ions and made visible as a "color center" producing an opaque deposit in the clear crystal. The total time of migration of the electron through the crystal screen layer and the duration of any local deposit are determined by the temperature and electric field conditions to which the screen layer is subjected. For ideal performance, each picture element retains the opacity value impressed on it by the scanning beam for the frame period, until the beam for the next frame scan returns to that element and impresses on it the right opacity value for that particular frame. The screen picture as a whole is maintained throughout the frame period and merges, element by element, into the picture for the next frame. This is complete optical storage.

Thus, the Skiatron offers the possibility of complete optical storage, use of an independent standard light source, and nonmechanical, electronic scanning. No wonder that it has been called "the dark horse of the television art."

Future possibilities

Though experiments have indicated that ideal performance should be possible, a great deal of research work remains to be done to obtain satisfactory contrast and ratio of change for television. These individual requirements have been attained sufficiently to have made the Skiatron an important display device for large-screen radar applications during the war. (In this connection the Skiatron has also been called "dark trace tube.") The crystal screen can be applied by evaporating the alkali halide in vapor form onto the screen carrier, and the microcrystalline screen obtained in this way has such a fine grain that there is no difficulty with definition. Actually, for facsimile application, it has been used with 2,000 lines.

The inherent advantages of this system and various promising avenues of approach to the remaining problems justify the expectation that this device will play an important part in television. Modern science and engineering often have a way of solving technical problems if there is sufficient commercial demand.

The Skiatron system also offers a possible solution of color television; it is the only system which makes possible a subtractive color-television system based on successive subtractive screens in second-

ary colors, corresponding to successful photographic and motion-picture color processes such as Technicolor, Kodachrome, and Ansicolor.

Oil-film television

Another cathode-ray-controlled, light-modulating screen has been developed at the Swiss Institute of Technology by Professor F. Fischer; it is called the "Eidophor," and because of its principle was described under the title "Oil-Film Television" in the October, 1946, issue of this magazine. In the meantime the system has been further developed and shows great promise, particularly for theater television where certain inherent complications would be tolerable.

In discussing theater television systems, the so-called "intermediate-film" process should not be forgotten. This system, which goes as far back as 1932, makes use of ordinary motion-picture projectors through which the "intermediate film" is projected onto the theater screen. The film results from photographing the screen picture of a C-R tube on which an ordinary television picture is shown. A refinement of this simple principle is the showing of a negative picture on the C-R tube which, when photographed, gives a direct positive on the film. The time for development, fixing, washing, and drying has been reduced to a fraction of a minute, so that with this short delay the television picture can be projected on the theater screen. Apart from this short delay, the main disadvantage is film cost, against which have to be weighed the advantages of using a standard motion-picture projector and of having automatically a permanent record of the televised program, which may be edited, shown at any desired time, and used for repeated performances.

It appears, then, that though the future path of home television can be clearly seen in further engineering developments of the direct-view and projection types of standard fluorescent cathode-ray tubes, the field of large-screen and particularly theater television is still wide open for fundamental laboratory research which will decide which one of the various methods will lead to the most practical goal.

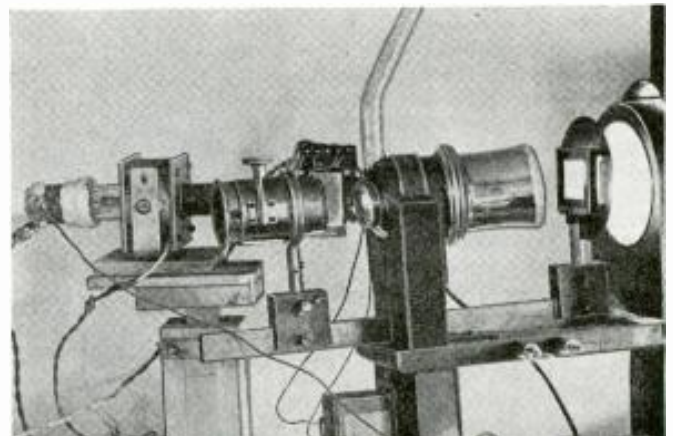

Fig. 6—Laboratory Skiatron setup. The light source is at the right.

Extension Viewers and Remote Control for TV

New accessories parallel a radio's remote tuner and extension speaker for greater TV viewing convenience

YEARS ago when the average radio was lots larger and heavier than our current table models, some set manufacturers produced models that could be operated from different points within a given area, thus making it unnecessary to go to the set to tune in a station or adjust the volume. Some sets were supplied with extension speakers that could be installed in different rooms so a single radio program could be heard throughout the house with comfortable volume level. Remote-control systems and extension speakers were a decided advantage in their day, but they have been discarded—in all except a few deluxe models—because small receivers can be carried from room to room with little trouble.

Until recently, the television set owner found himself in a situation similar to the broadcast listener with a large receiver without remote control or extension speakers. Viewing is usually confined to one room in the house because TV receivers are usually semi-permanent installations and are seldom moved. Furthermore, the operator must go to the set to adjust it. In so doing he almost invariably blocks the view of others watching the picture.

Two recent television developments are destined to offer the television set owner all the advantages that the

broadcast listener had with a remote-receiver with extension speakers.

The remote control unit

The Transvision Remote Control Unit is designed as an accessory for TV receivers with a sound i.f. between 21.25 and 21.9 mc. It makes it possible to operate the set from any point within a radius of 50 feet. With the unit connected, the operator can turn the receiver on or off, select any one of 12 channels and control volume, contrast, and brightness at the remote location. The unit, housed in a cabinet 6 inches

channel audio i.f. signals present in its plate circuit. A band-pass network passes these signals to the grid of the first i.f. where they are amplified, separated, and fed into the video and audio

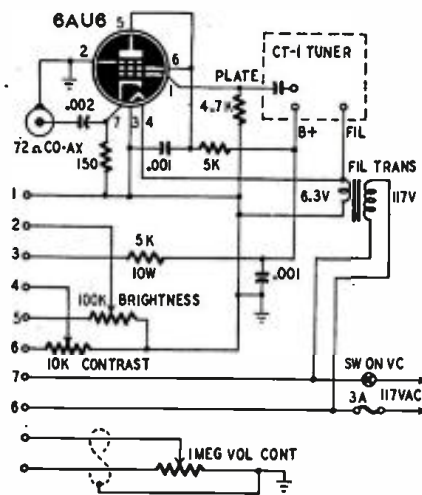

Fig. 1—Diagram of the unit pictured at left.

wide, 8 inches high, and 12 inches deep, consists of a sensitive 12-channel tuner—shown in dotted lines—consisting of r.f. amplifier, oscillator, and mixer, a cathode follower coupling circuit, and auxiliary controls. Connections between the set and the remote control unit are made through 50-foot cables that are wired directly to the set and connect to the remote unit through plugs and connectors. The unit is shown in the photograph and the schematic is shown in Fig. 1.

The mixer of a TV receiver usually has video i.f., audio i.f., and adjacent-

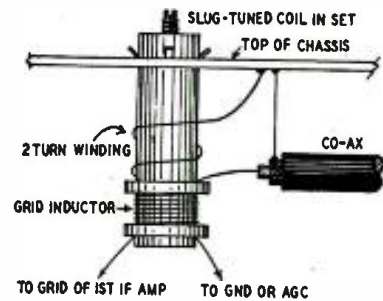

Fig. 2—Cable is coupled to i.f. transformer.

i.f. channels. A trap removes the adjacent channel before it reaches the video i.f. channel. The plate circuit of the mixer and the grid of the i.f. stage are high-impedance circuits and all connections must be kept as short as practical. This would make the remote control unit impractical if it were not for the 6AU6 cathode follower. This tube acts as an impedance-changing device that matches the mixer plate circuit to a 72-ohm co-axial line so the signal can be transmitted some distance without appreciable attenuation or interference pickup.

The method of coupling the transmission line to the grid of the first i.f. amplifier depends on the circuit and circuit components at the input to the amplifier. If the grid inductor of the amplifier is easily accessible, then two turns of No. 20 wire can be wound around one end of the coil and connected to the co-ax as shown in Fig. 2. A special coupling coil is available for sets where the grid inductor is shielded or otherwise inaccessible. This coil is mounted close to the grid and coupled to it through a 3- $\mu\mu\text{f}$ capacitor as shown in Fig. 3. The co-ax connects to a two-turn winding on the special inductor. If the circuits in Figs. 2 and 3



Transvision remote control is complete tuner.

are not practical, a 100-ohm resistor may be connected between the normally grounded end of the coil and ground. The co-ax connects across this resistor as in Fig. 4. This method cannot be used if a.g.c. is applied to the first i.f. stage.

The volume control on the remote control unit is connected to the set through two-conductor shielded cable after the control in the set has been disconnected. The shield connects to the chassis or ground. One conductor connects to the lead that was removed from the arm of the control and the other goes to the lead that was connected to the hot or ungrounded side of the control.

Connections to receiver circuits other than audio and video are made through an eight-conductor cable with an octal plug that fits into a socket on the rear of the remote control unit. Fig. 1 shows the connections to the socket. The numbered pins connect through the cable to the following points in the receiver:

Pin No. 1—Chassis or set ground.

Pin No. 2—To arm of brightness control. (Disconnect all other leads from the control.)

Pin No. 3—Directly to B-plus line in tuner section of receiver. (If there is a dropping resistor between tuner and B-plus, remove it. Disconnect heater and converter plate leads in the set.)

Pin No. 4—To lead that normally goes to the arm of the contrast control.

Pin No. 5—To lead that normally goes to hot side of brightness control.

Pin No. 6—To lead that normally goes to ungrounded side of contrast control. (If there is no connection at this point, tape this lead.)

Pins No. 7 and 8—To terminals or tie points for a.c. line cord. (Remove the line cord or roll it up and cover ends of plug with tape.)

When connecting the remote control unit to sets other than those designed

makes and models can be obtained from Transvision.

Once the connections are made, the set can be controlled only through the remote-control unit. The switch on the volume control turns the set on or off. To adjust the set and control unit for best operation, tune in a test pattern and adjust the slug in the mixer plate circuit (in the control unit) and the slug in the first i.f. grid circuit (in the receiver) for sharpest definition. Check the adjustments with test patterns from other stations.

The remote viewing unit

The Add-A-Vision unit Model A-101, made by Vidcraft Television Corporation, is a 12-tube, remote-operated television viewer with a 10-inch picture tube. It operates with a conventional receiver from which it receives the video-frequency (v.f.) and a.f. signals. More than 25 of these units can be connected as "slaves" to one standard "master" receiver. Forty-foot lengths of 52-ohm co-ax and two-conductor shielded cable are supplied to connect the slave and master receivers. Video signals are carried from the master to the slave by the co-ax. The two-con-

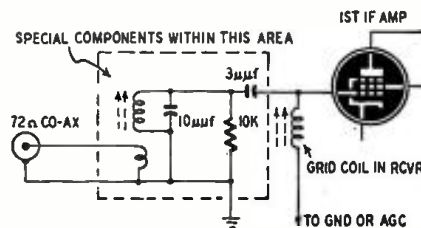

Fig. 3—Some sets require extra coupler coil.

ductor cable carries audio to the slave, and B-plus from the slave to the cathode-follower adapter unit that matches the high-impedance video circuit of the receiver to the 52-ohm co-ax. The slave receivers are turned on and off with a switch on the volume control on the front panel. Stations are tuned in at the master receiver.

Four different adapter units are available for use with different types of master receivers. Two are for sets with grid-driven cathode-ray tubes and 6-volt, loctal- or octal-based audio power amplifiers; one for sets with 6-volt, octal-based a.f. amplifiers and cathode-driven cathode-ray tubes; and another for receivers with 25L6 a.f. amplifiers and cathode-driven cathode-ray tube.

The cathode-follower adapters are connected to the master receiver by removing the a.f. power amplifier tube, plugging an adapter into its socket and inserting the tube in the adapter socket. The cathode-follower adapter circuit for sets with 6-volt, loctal or octal tubes and a grid-driven cathode-ray tube is shown in Fig. 6-a. Adapters for sets with cathode-driven cathode-ray tubes use the circuit shown in Fig. 6-b. In this circuit a phase-reverser precedes the cathode follower. Fig 6-b shows the adapter heater connections for sets with 6-volt power amplifiers. Adapters for

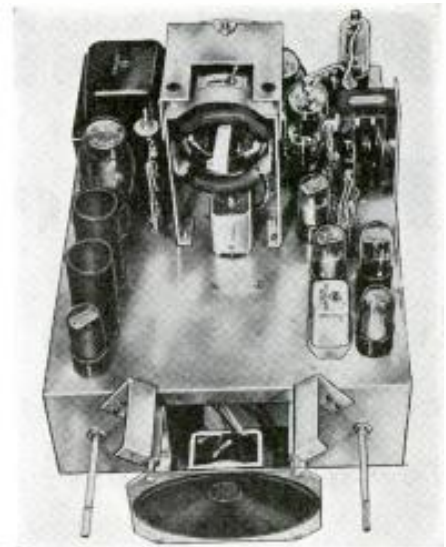

Photo shows the 12-tube Add-A-Vision chassis.

sets with 25L6 a.f. amplifiers have the 6AK6 heaters in series. The adapter plug inserts these heaters in series with those in the master receiver.

The adapter plug picks up the a.f. signal from the plate of the power amplifier in the receiver and delivers it to the grid of the 6K6 a.f. amplifier in the slave unit.

The video signal is taken off the grid or cathode of the cathode-ray tube in the master and matched to the 52-ohm co-ax by the cathode follower. The co-ax from the master connects into the grid of a two-stage 6SN7 video amplifier which drives the grid of the 10BP4 cathode-ray tube in the slave. Sync and power supplies are conventional. The

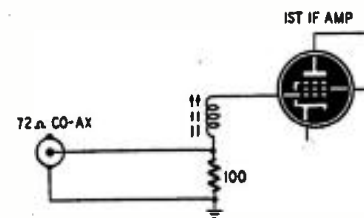
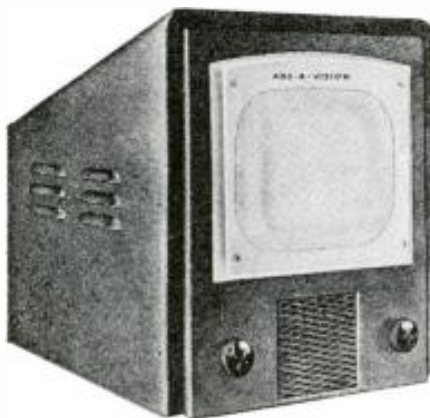

Fig. 4—Third coupling method uses resistor.



Add-A-Vision cabinet houses a 10-inch tube.

by Transvision, it may be necessary to make minor changes in the circuit of the unit. Instructions for connecting the remote control unit to a number of commercial sets are given in the instruction manual for the unit. Instructions for connecting the unit to other



Taybern Duplicator has 63-square-inch image.

ONE of the first portable television receivers on the market is Sentinel's Model 400-TV. Housed in a leatherette-covered case not much larger than a standard oscilloscope cabinet, the total lifting force the carrier must exercise is about 37 pounds. The term *portable* doesn't carry the same connotation in television—at this stage of the game, at least—as when referring to a portable radio receiver. The radio can be operated en route (really a mobile receiver), while the televiser is merely transported to various fixed operating locations.

A portable televiser still requires an adequate antenna. Sentinel has provided a collapsible indoor aerial (shown atop the set). This has telescoping dipole elements and is satisfactory in good reception areas and buildings not constructed with steel. Sentinel carefully explains in its literature that the indoor antenna will work only under optimum conditions, but at least one dealer's newspaper ad has told the public unqualifiedly that the set requires no outside antenna installation. This is no more true of the Sentinel than of any other televiser. A direct line of sight to the transmitter from the antenna is almost a rigid requirement. Since that is not usually possible in metropolitan areas an outdoor antenna must usually be installed for best results with the receiver.

However the little Radion indoor antenna supplied with the receiver gave surprisingly good results. In appearance a straight half-wave dipole, with the arms adjustable in length for various frequencies, its action was not al-

ways that of a dipole, and it was noted that in many cases the best results were obtained when it was used in the "V" form, with the two arms at a fairly narrow angle. Capacity between the two arms seemed to play an important

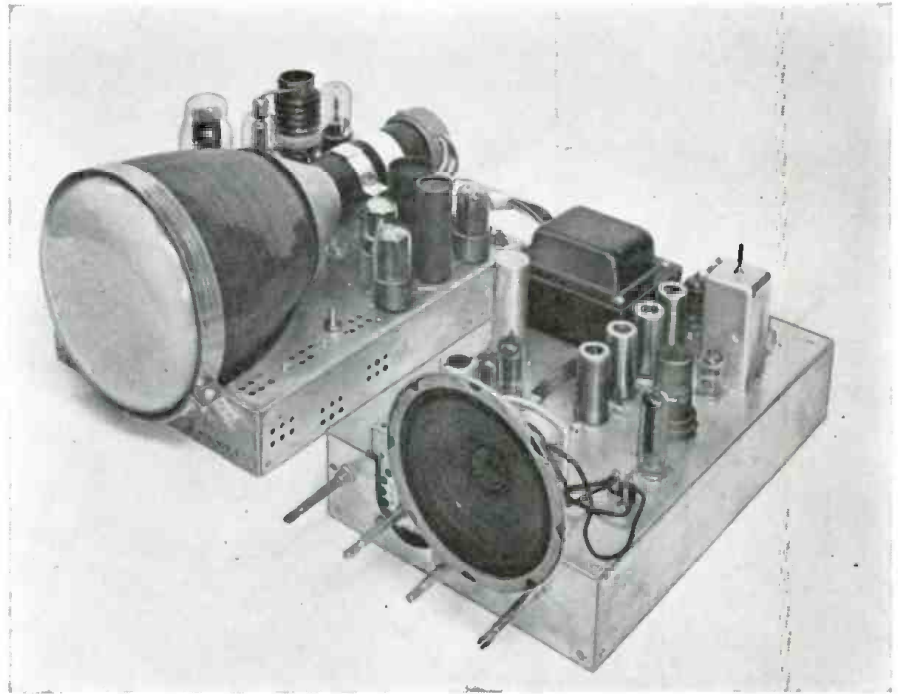

The left chassis contains the r.f. and i.f. circuits and, in use, is mounted on its side.

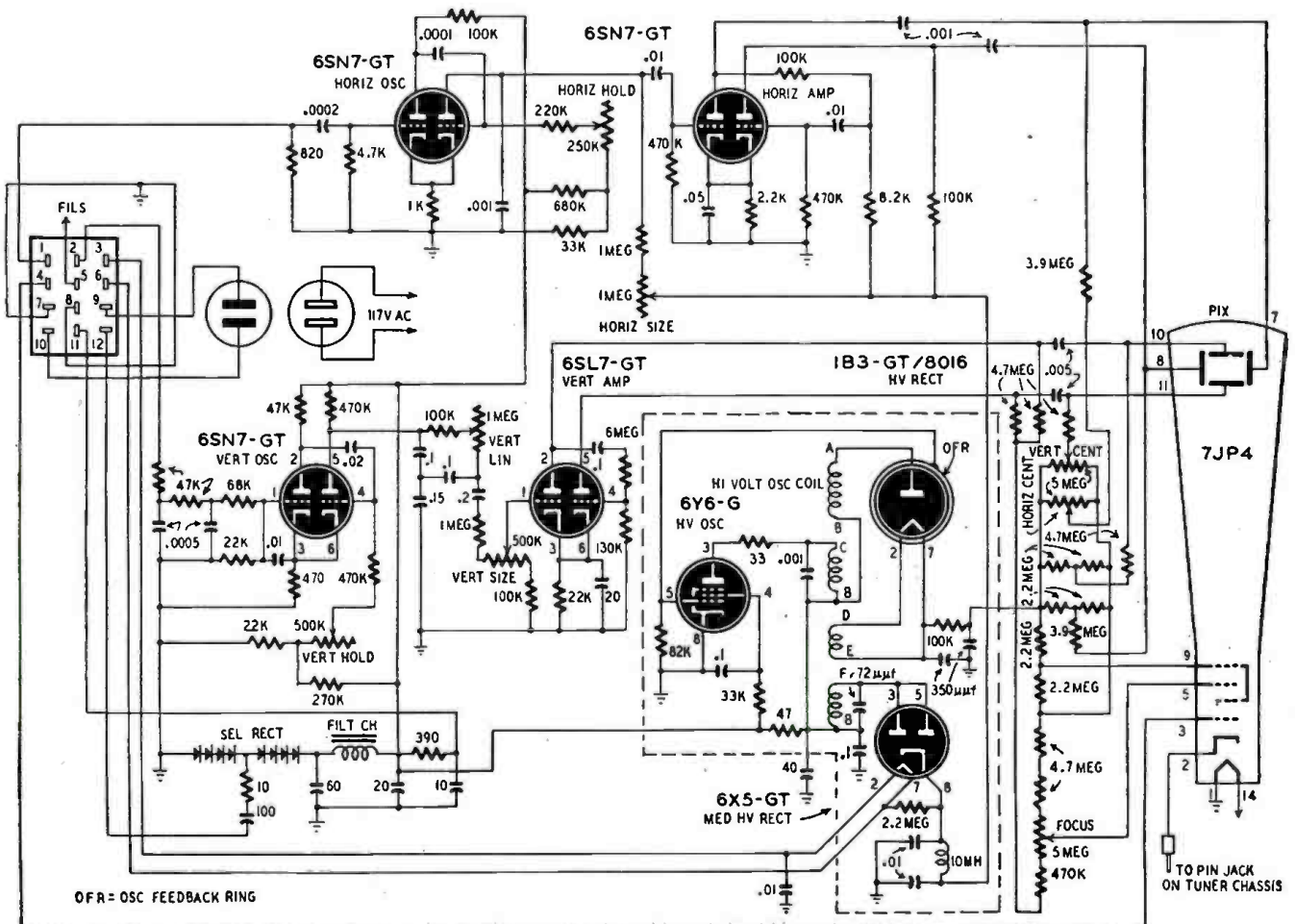

part, and this was further borne out by the fact that optimum reception was obtained with antenna lengths which differed from what would have been expected for straight dipole action.

The two chassis accommodate 20 tubes plus the 7-inch electrostatically deflected kinescope and selenium rectifiers. The function of each tube is shown in the diagrams on this and the facing page.

A Sarkes-Tarzian front end is used. It provides for fixed tuning, each chan-

nel being selected on a rotary switch, with no fine-tuning control. As judged by audio distortion—or, in this case, the lack of it—the tuning is remarkably stable. R.f. tuning is by bandpass coils, and the oscillator coils have brass screws acting as variable cores. To check tuning of each channel, the serviceman removes the front-panel es-cutcheon, revealing the 12 oscillator-core screws and a sound-discriminator adjustment. As a matter of fact, if the owner is sure the set is not tuning the

stations on the nose, he can make the adjustments himself. There is nothing touchy about the adjustments; considerable wrist motion is required to make a perceptible change in sound or picture.

There are only three controls on the panel in addition to the channel selector. These are VOLUME (including the on-off switch), CONTRAST, and BRIGHTNESS.

A vertical strip of controls on the rear of the set provides for horizontal and vertical centering, focus, vertical and horizontal size, and vertical and horizontal hold.

Two chassis are used in the receiver. The one containing the tuning circuits and the front-panel controls is mounted on the floor of the cabinet. The other, carrying the viewing tube and high-voltage supply, is mounted on the cabinet's side.

The circuit

Circuitwise, the set is fairly conventional. The output of the 6AG5 mixer, tuned to 23.4 mc, is capacitance-coupled to the control grid of the 6AG5 first i.f. Its plate circuit and the grid circuit of the next (second) i.f. stage are resonated at 25.7 mc, and the plate circuit of the second i.f. is tuned to 23.4 mc and capacitance-coupled to the third i.f. Plate circuit of this stage is loaded with an i.f. choke and capacitance-coupled to the 25.7-mc input of the video detector, a 6AL5.

Since the set uses the intercarrier system, the sound i.f. is taken from the plate of the following video amplifier, a 6AU6, and amplified at 4.5 mc by a single stage, after which it is demodulated by a 6AL5 ratio detector. A 6SQ7 and 6AS5 form the audio amplifier. The speaker is the standard small or television size. The set, however, sounds better than the average midget receiver with a comparable speaker—possibly because of the larger cabinet and the use of FM. A certain amount of hum was noted in the set tested.

The high-voltage supply is unusual and interesting in that two different voltages are taken from the 6Y6-G oscillator. One, rectified by the 1B3-GT/8016, supplies 5,300 volts to the bleeder system, from which polarizing voltages are taken for the deflector plates and to the No. 1 anode and No. 2 anode-No. 2 grid. The second r.f. supply—obtained from an additional winding on the high-voltage oscillator coil—uses a 6X5-GT and supplies voltage to one plate of the horizontal oscillator and both plates of the vertical oscillator.

Voltage to drive the high-voltage oscillator comes from a voltage-doubling supply using selenium rectifiers. Other voltages are supplied by another selenium rectifier. Unlike some selenium-rectifier television receivers, the 400-TV has a power transformer, which has, in addition to the regular windings, a separate winding for the filaments on the second chassis, and one for the 6X5-GT rectifier.

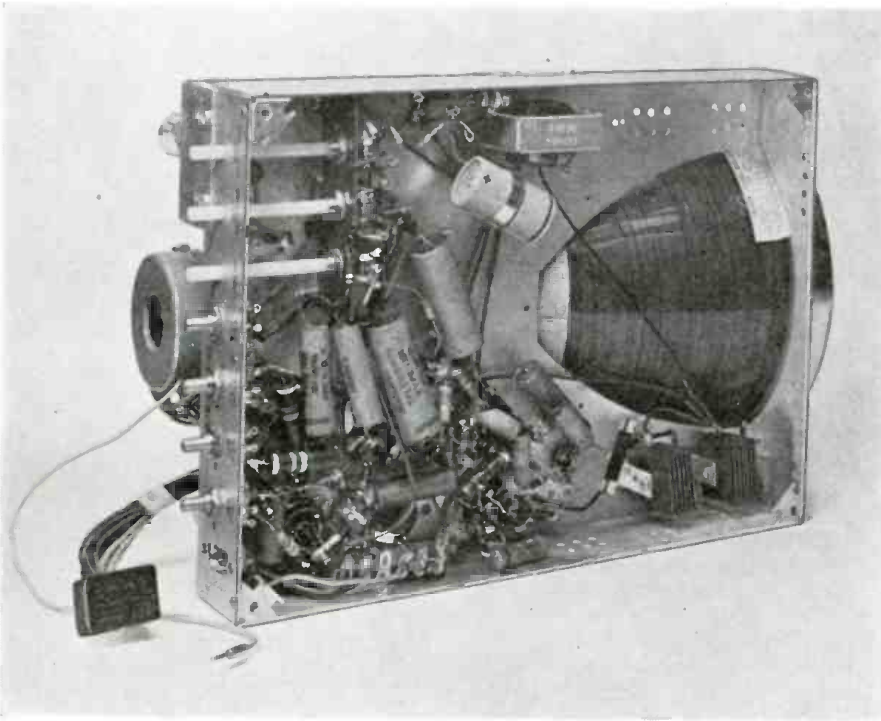

This is the underside of the picture-tube chassis. Eight preset controls are on the rear.

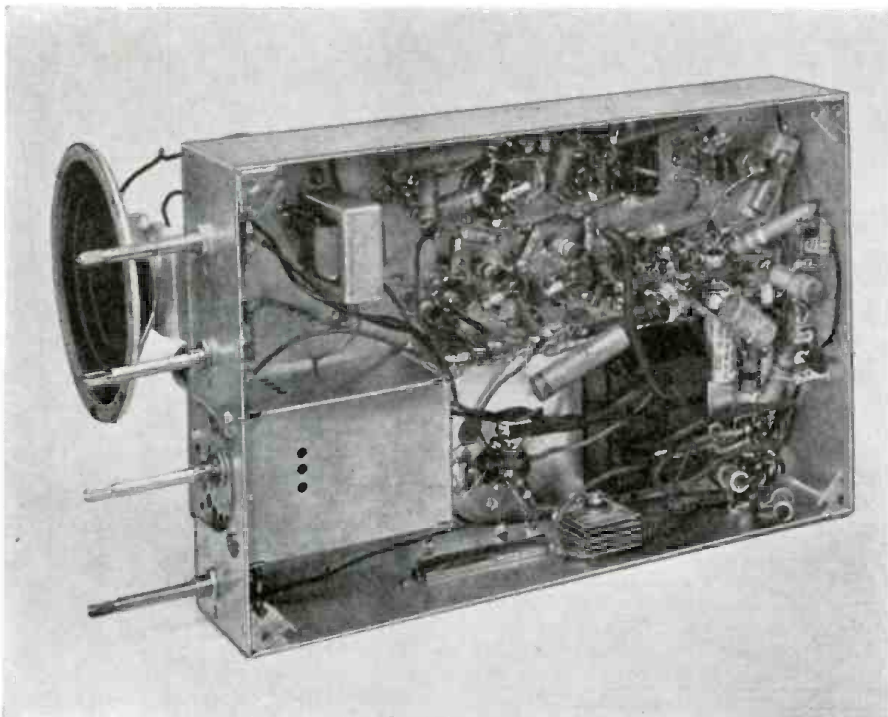

Here is the r.f.-i.f.-audio chassis. The Sarkes-Tarzian tuner is in box in the foreground.

Television is Booming—Cash in on it!

RADIO-ELECTRONICS for

Making and Installing TV Antennas

By I. QUEEN

WHEN an antenna is incorrectly matched to the transmission line, standing waves are set up. If a low-frequency TV antenna is used to receive upper-band signals, they may be present also. To check for standing waves, grasp the feeder at different points near the receiver terminals. The picture intensity will change as you touch various parts of the feeder. For example, at one point the picture may blank out entirely; this will happen every half-wave length on either side of this point.

If the picture can be improved by touching the feeder at some point, the improvement can be made permanent (for that particular channel) by connecting a stub across the feeder. This stub may be a piece of wire about 4 inches long connected at a point determined by experiment.

It is not easy to tap wires into 300-ohm twin-line, but a simple gadget can be made for the purpose (see Fig. 1). Cut a piece of polystyrene about $\frac{1}{16}$ inch square and $\frac{1}{4}$ inch long. Make a slot lengthwise through it to accommodate 300-ohm twin-line with a rather close fit. The slot is cut out by drilling holes close together and then working



Fig. 1—Screws in the bar contact the wires.

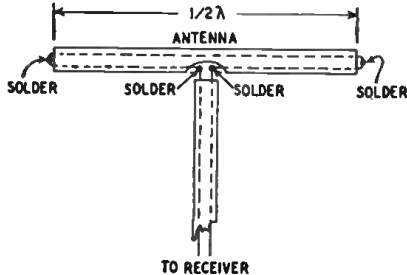

Fig. 2—Simple antenna of 300-ohm twin-lead.

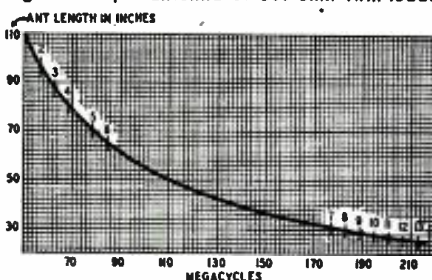

Fig. 3—Chart gives correct antenna lengths.

MARCH, 1949

the drill back and forth to connect them. A No. 48 drill may be used. Then drill the polystyrene at each end and tap for 4-36 screws. If dimensions are correct, the screws dig into the twin-line and touch the conductors, making it unnecessary to file or cut away the insulation.

base on which a collapsible aluminum mast may be mounted. For a good compromise, however, the antenna may be mounted on a collapsible mast tied to the TV table.

A more sturdy folded dipole is desirable if it is to be mounted on a mast or rod. We have made one with round

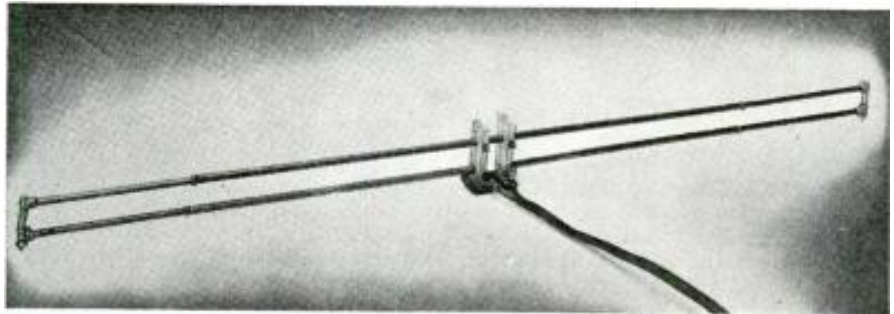

Fig. 4—This sturdy folded dipole is made of pieces of ordinary curtain rod. It telescopes.

In many cases where an outdoor antenna is not feasible, a simple indoor wire is surprisingly effective.

For the high TV band (channels 7 through 13) a folded dipole is more convenient and effective. A popular version, made of 300-ohm twin-line, is shown in Fig. 2. The antenna is one-half wave length from one end to the other and the conductors are shorted at each end. At the exact center one conductor is cut and the insulation removed to expose the wires. Another 300-ohm twin-line connects the antenna to the receiver. A thin strip or rod of nonconducting material will be needed to support the antenna in a straight horizontal line.

The correct length for the antenna may be found with the aid of Fig. 3 for any frequency from 50-225 mc. TV channels are shown along the curve. Feeders may be any necessary length, but keep them as short as possible. The folded dipole tunes broadly, and therefore is effective over several channels. If a number of stations are in the area, cut the antenna for a channel in the center of the band or for one of the weaker stations.

As the antenna is moved away from a wall (or ceiling), the signal first increases tremendously and then fades. At still greater distances the picture improves again. These standing waves are due to reflection from the walls. Height also affects the picture intensity, and the best location may be different for various stations (See p. 54).

The best setup is one which permits the dipole to be moved about the room, raised or lowered, and rotated for best direction. A floor lamp makes a good

curtain rods about 20 inches long, with one rod sliding within the other. The length is just right for the high band. Two of these curtain rods are needed.

On one unit, saw the inner rod in half, leaving the outer one as is. This will be the upper conductor of the antenna. On the other unit saw both inner and outer rods through the center and remove about $\frac{1}{4}$ inch from each piece. These are for the lower conductor, which has a gap in the middle (Fig. 4).

The antenna is held in place by polystyrene supports. Make up two pieces like the one shown in Fig. 5 and drill $\frac{1}{4}$ -inch holes. Then saw the strip down through the center of the holes. Screw the two halves together around the curtain rods to keep them in place. Short the ends with long screws so each side can be pushed in or pulled out like a trombone. When completely telescoped, the folded dipole is 23 inches long; when the ends are pulled out, the total length is about 38 inches. A convenient base may be added by screwing it to the polystyrene supports. Twin-line feeders are connected to the lower pair of screws which contact the lower conductors.

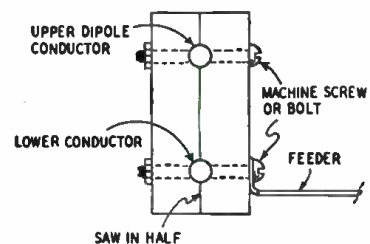
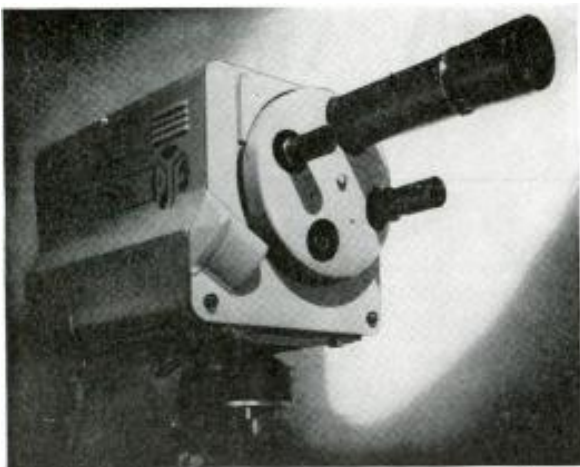

Fig. 5—Supports for home-made folded dipole.

Television is Booming—Cash in on it!



The Pye—a typical English television camera.

TELEVISION

in

EUROPE

By RALPH W. HALLOWS

ON the European side of the Atlantic, 1948 was a year of extraordinary activity in television; and things will continue to move rapidly in the coming year. Besides Britain and France, which have regular TV services dating from pre-war days, experimental transmissions will certainly get under way in 1949 in Holland, Western Germany, Spain, and Russia. Transmissions are also to be expected in Denmark and Sweden and possibly in Norway, Belgium, Switzerland, and Italy. There's no question that all of the countries mentioned want television. Demonstrations were staged in most of them (Russia excepted) during the past year by the French mobile column of TV trucks or by British manufacturing firms exhibiting at radio shows. The response was in every case something more than enthusiastic; people flocked to the shows. A joke in one of the Danish comic magazines at the time of the Copenhagen exhibition took off on their popularity. The Danish word for TV is *fjernsyn* which means literally "seeing from afar." The cartoon shows a television screen surrounded by a seething crowd, dozens deep. On the fringe of this hurly-burly, yards and yards from the screen, stand a Danish Mr. and Mrs. Babbit. "Now I understand," says he to her, "what this 'seeing from afar' means."

Transcontinental TV

At first blush the stage might appear to have been so set that TV in Europe was bound to be a success from the word go. A while ago the International Telephone Consultative Committee (C.C.I.F.) worked out a plan for the interconnection of all European capitals by a network of co-axial cables. Work on this scheme is going ahead fast and should be completed in under three years. And not only capitals, but the majority of the most important West-European cities are included in the layout. All these cables can handle frequencies up to 2.54 mc and some up to

4 mc. Events of real entertainment value taking place in any of the European countries thus linked can be piped to viewers in all the others—theoretically, that is.

There's one big, bad snag. There is no accepted TV standard for all of Europe; every country has its own number of lines—and all the numbers are different. Here they are:

Britain	405
France	455
Holland	567
Spain	525
Bizonia	
(Germany)	625
Russia	441

Some use positive modulation (peak white = 100% carrier); some use negative (peak white = zero carrier). The only common factor is interlaced scanning with 50 frames and 25 images a second, and that was forced on them by the fact that the supply-main frequency in Europe is 50 cycles. Hence, though the co-axial hookup is there or soon will be, it can't be used for transcontinental TV, for it's of no use to put in at one end of a cable stuff that can't be received at the other.

High-definition TV

Next to the British (I'd just hate to seem immodest, but there it is) I haven't a doubt that the French have been the most go-ahead nation in TV in the last twelve months. At the Television Congress organized recently by the French Société des Electriciens in Paris there were successful demonstrations of color TV, of stereo-TV, of big-screen reception with images about 24 feet square, and of very-high-definition TV by means of different systems using 729, 819, and 1,029 lines. All of these systems, ingenious and successful as they are, still have one drawback likely to keep them in the laboratory rather than the home entertainment class: they require an enormously wide range of modulation frequencies. The absolute minimum to make the definition in a hori-

zontal sense anything like as good as that in a vertical sense is half the number of images per second multiplied by the aspect ratio and the square of the number of lines.

Aspect ratio is the relation of the horizontal side of the image to the vertical, usually 5 to 4 or 4 to 3. For ordinary double-sideband transmission this means that the bandwidth to be dealt with by transmitter and receiver is twice as great. If single sideband is used, the bandwidth is that given by the formula above, plus approximately 1 megacycle.

Now, you can make televisers capable of handling bandwidths up to 5 or perhaps 6 mc at reasonable prices; but when the bandwidth goes up to 10, 15, or possibly 20 mc, receiver cost increases by leaps and bounds. And that means that the market goes down with sickening thuds.

Let's be quite honest about it. How many of our transmitters and receivers today really do justice to 525-line or even 405-line TV? Besides the bandwidth genuinely transmitted and re-



How the Emitron camera looks inside its case.

Television is Booming—Cash in on it!

RADIO-ELECTRONICS for

ceived, strict linearity and proper inter-lacing are things which very much matter. If we can't guarantee these on a comparatively small number of lines, what improvement is to be expected when the scanning lines are increased by 50, 75, or 100%?

Research and development in Britain during the year have been active in 5 main fields:

1. The improvement of transmitting, link-up, and outside-broadcast gear for use in this country with the existing number of lines;
2. The working out of higher definition systems for future use;
3. The production of big-screen apparatus for motion-picture theaters;
4. The production of prototype transmitting gear suitable for opening up overseas markets both in the Empire and in foreign countries;
5. The improvement of domestic televisers.

Let's glance at what has been done, taking things in that order. First, then, the various equipments needed for better transmission in Britain. A most important advance made by BBC engineers is the development of repeater-equalizers which now make it possible to transmit modulation frequencies up to 2 mc on ordinary telephone lines over distances of 8-10 miles.

In other directions, too, outside broadcasting has been brought to a very fine art by the use of the cathode-potential-stabilized Emitron camera and the employment of specialized and elaborate gear in the O.B. (outside-broadcast) trains of trucks.

The success of O.B.'s is due to no small extent to the use of the latest type of cathode-potential-stabilized Emitron camera. There's an interesting story about the development of this camera in Britain and the U. S. I admit frankly that, when I read the first accounts of what E.M.I. engineers had done, I had some misgivings. Weren't they trying to take the credit for an American invention? Then I had the patent files turned up, and here is what I found. In 1934 (yes, as far back as that) two E.M.I. engineers filed a British patent application covering the use of a low-velocity beam of electrons to scan a mosaic in a cathode-ray tube. Actually, Farnsworth had filed an almost identical application in the U. S. a year before in 1933; but the E.M.I. engineers knew nothing of Farnsworth's work, and he nothing of theirs. Not until 1937 did Farnsworth apply for a British patent. By that time the E.M.I. patent was established here. The result is that E.M.I. holds a valid patent in England on cathode-potential stabilization but not in the U.S. while Farnsworth's patent is valid in the U.S. but not here. There seems to be considerable justification for E.M.I.'s claim that theirs is the world's most sensitive TV camera. It is certainly a revelation to receive clear, sharp O.B. pictures when commentators are apologizing for not being able to give more detailed accounts owing to the poorness of the light; most successful telecasts of

plays have been made from theaters during actual performance and with not a single watt over and above the ordinary stage lighting.

TV link-ups are vitally important these days if the "tele" (Greek for "far") part of television is to mean all it should. In Britain we're very much interested in relaying over long distances, and two outstanding radio link systems have been developed. The first is the Marconi, which uses FM for both vision and sound and operates with a carrier frequency on the order of 500 mc. The relay station, which may be unattended and entirely automatic, picks up normal TV transmissions at ranges up to 30 miles or so.

For connecting London with Birmingham, a distance of about 110 miles, another very successful type of radio link has been produced. This uses AM with a carrier frequency of some 300 mc; with 100-foot antenna masts suitably sited, each relay has a range of about 20 miles. The stations are again of the unattended type, and each contains complete standby apparatus, which comes into action automatically in case of a breakdown.

The TV camera has become even more elaborate than that of the film studio and can now do almost everything that can be done by the cinema camera. Typical British TV cameras of today have three- or four-lens turrets, with lenses of 2-20-inch focal length, electronic view finders and devices by means of which any lens, on being brought into action by rotation of the turret, engages with the iris-control drive, indicates its iris opening on one dial and its focal length on another, and adjusts the focus control to match its travel to its particular requirements.

An agreement has now been concluded between the BBC and the mo-

tion-picture-theater interests. The BBC will televise a certain number of films each week, and in return the theaters will give big-screen shows of a number of TV programs. The Cine Television Company has developed large-screen projection apparatus, which will probably be in use in several London theaters by the time this article appears.

With a view to breaking into new markets abroad several companies have developed very flexible TV transmitting systems, easily adapted to suit local preferences. E.M.I., for example, has brought out a system suitable for 405, 525, or 605 lines. It can be used with either positive or negative modulation and the frame frequency may be 50 or 60 per second according to the frequency of the main supplies.

In domestic televisers I feel that, of the many notable advances made during the year, the three most important are these. First, the Westinghouse voltage-multiplier method of obtaining extra-high voltage for the cathode-ray tube anode straight from the secondary of the ordinary main transformer by means of a "ladder" of metal rectifiers and capacitors. This system is now being developed to supply voltages of 2,000 to 15,000 or more for oscilloscopes and televisers of all kinds.

Second, there's the Pye "transformless" receiver, using tubes (including the viewing tube) of the a.c.-d.c. type and working quite well from d.c. mains.

Third come the Cossor and Sobell receiving systems using single-sideband technique. The ever wider ranges of modulation frequencies necessitated by the demand for higher definition are almost certain to lead in time to the use of single-sideband methods in all transmitters and receivers. Today, the single-sideband receiver seems to be one of the best ways of securing genuine response up to 3 mc at reasonable cost.

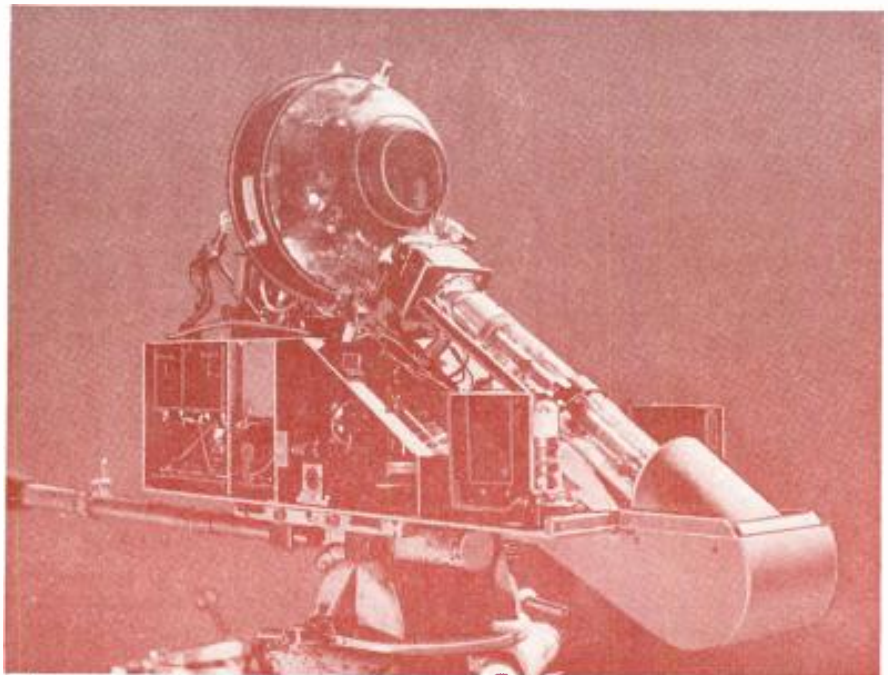

This impressive photograph is simply an Emitron television camera with its cover removed.

Antennas For Television

Part III—Space loops are important factors in choosing the best location for an antenna

By
EDWARD M. NOLL
and
MATT MANDL*

ONE of the most puzzling and aggravating conditions a television installation man encounters is the apparent unpredictability of antenna installations. Almost every serviceman has installed the same type of television receiver, lead-in, and antenna in adjacent homes, only to find one set gives much better performance than the other.

This odd behavior which is not as mysterious as it appears, depends upon three factors which, if not correctly applied, may mean the difference between an excellent picture or almost none at all.

The three factors which have so much influence on the received signal are: tuning the transmission line (discussed in previous articles); adjusting the receiver for maximum gain (particularly in the tracking of the r.f. stages); and utilizing the remarkable properties of *space loops*.¹ Space loops, present on television frequencies at any height and along any terrain, make so much difference in reception that they will be explained in detail in this article.

The authors first observed space loops during routine comparison tests between two types of antennas. The lead-in was changed from one antenna to another, and the gain increase on a television receiver was recorded. Sometimes antenna No. 1 gave 20-db gain over No. 2, and at other times antenna No. 2 seemed to assume gain advantages over No. 1.

The contradictory behavior was puzzling, since the same receiver, transmission line, and antennas were used

in each test. Proper orientation, of course, was maintained throughout. A thorough investigation revealed that the only possible change in conditions was that occasionally the test antenna was placed in a slightly different place after re-attaching the twin-lead. A further study of this variable was undertaken at various heights up to 100 feet and in locations separated some 50 miles. Under all conditions space loops were encountered. Repetitions of tests on successive days gave the same results and indicated a permanent condition.

Why space loops exist

Space loops are points in space at which there are signal peaks (loops); space nodes are points of signal lows (nodes). Both result from the propagation characteristics of television-frequency waves.

At television frequencies signals travel in substantially straight lines and do not follow the earth's curvature to any great extent. Waves traveling upward are not refracted back by the ionosphere as is the case with lower frequencies. Theory regarding ground waves at these frequencies has always maintained that they are attenuated rapidly, becoming practically useless at any distance from the transmitting antenna.

Television transmitting antennas are located as high above ground as possible. Primary radiation is direct and straight away horizontally from the antenna, but some waves travel upward and some down. Those waves which travel up usually continue through the ionosphere and are lost. The waves

which strike the earth do so at an angle and are reflected upward at an angle approximately similar to that at which they hit the earth.

Waves which make a small angle with the horizontal at the antenna travel for a considerable distance before they strike earth. They are reflected from earth at the same small angle and meet the direct waves. The reflected waves either add to the direct waves or subtract from them, depending on the phase angle of each wave at the meeting point (see drawing).

Thus, at intervals along the terrain over which the signals travel, there are points of maximum and points of minimum signal strength. Maximum points are places where both waves are either positive or negative and therefore add to each other. A television antenna placed in such a space loop gives the receiver a much greater signal than the same antenna placed in a space node. Between the loops and nodes, where there is only partial addition or subtraction, the signal is lower than at a loop, and higher than at a node.

Locations of loops

The positions of the space loops cannot be determined except by trial. The antenna must be moved around until the brightest picture is obtained at the receiver, for the position of the loops depends on the distance from the transmitting antenna and the angle of reflection at any particular spot.

The loops for the lower channels are spaced farther apart than those on the higher channels because of the greater wave length.

The fact that the direct waves along the horizontal plane change polarity every half-wavelength would lead one to believe the loops would be a wavelength apart. This is not exactly so because each ground-reflected wave arrives at the direct wave at a different point, depending on the radiation (and reflection) angle. The spacing of the loops, however, does correspond roughly to a wavelength for any particular television channel.

The loops in free space are always at the same place, because they are the result of transmitting-antenna characteristics and height above ground. The same antenna will always put a loop in a certain spot unless it is moved or its height is changed.

Several conditions, though, will alter the space-loop characteristic. If the antenna is placed near a building or other object from which there is reflection,

*Television Instructors—Technical Institute, Temple University.

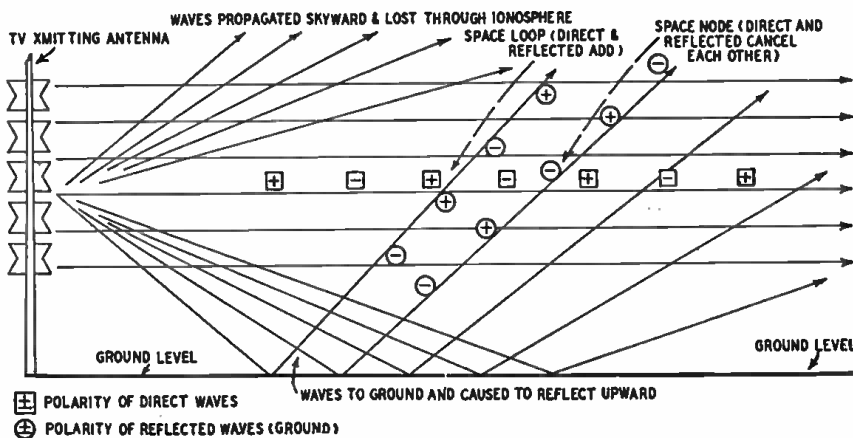

The drawing illustrates the theory of space loops. Waves reinforce or cancel as they meet.

Television is Booming—Cash in on it!

RADIO-ELECTRONICS for

the waves reflected from the building will also mix with the direct and ground-reflected waves and nullify to some extent the action of the ground waves. Near such a reflecting surface the space loops are much more closely spaced and their effects are smaller.

On rare occasions the characteristics of the ionosphere alter, and some of the sky waves are partially reflected earthward. When this occurs, there is a decrease in loop energy and an increase in nodal energy, giving results similar to those obtained by reflection from a building or distant hill.

In locations which are free from the reflections that disturb space loops, the difference on the viewing screen is very decided. When the antenna is placed in a node and contrast adjusted so that the picture is barely visible, it will increase to the point of tearing when the antenna is placed in a loop. The photos show difference between loop and node reception. Space loops exist for an indefinite height above ground and were found by the authors as high as a hundred feet above earth.

Double loops

Since the loops for any channel may be found in various places, there are points where loops can be observed for two or more channels. Such combinations occur because the angles of the ground-reflected waves of both stations and the direct waves of both happen to be in phase and add. Thus, if channels 6 and 10 were weak, a place might be found that would favor both. The location of coincident loops for two channels is somewhat harder than that for one, while for three it would be extremely difficult. To find a junction of three channels in phase at a certain point means that three reflected and direct waves at three different wavelengths must all be in phase. Such spots might exist, but a large area would be needed in which to conduct the trial-and-error tests.

However, when it is necessary to favor one or two weaker stations, the time spent in finding a space loop is well worth while. On the higher channels there is usually a space loop within a radius of about 30 inches from any point.

A tin roof below an antenna affects the positions of space loops by reflecting the waves which strike it. Most metal roofs give the same effect as bringing ground up to the level of the roof. Since rain spouts come within a few inches of ground, the capacitance between rain spout and ground has sufficiently low reactance at the high television frequencies to make the tin roof a virtual ground.

Space-loop locations are unpredictable indoors because of reflections from walls and other objects, but they are nevertheless present and can be utilized in high-signal areas where indoor antennas are preferred. The indoor antenna must be moved about the room approximately 5 feet above the floor. The procedure should be repeated at ceiling

level to find the loop which gives best performance.

Placing the antenna

To find the best position for an antenna:

1. Use a simple test antenna such as a single dipole or folded dipole attached to a short, lightweight mast. This antenna can be carried about the roof or other antenna site as signal reports are relayed from the receiver.

2. Locate the position at which it would be most convenient to mount the antenna.

3. Orient the antenna toward the station or stations to be favored. (Remember that with correct orientation, transmission-line leads can be switched at the antenna with no appreciable change in signal strength.)

4. With the antenna properly oriented, move it toward and away from the station. Locate a point at which the signal is maximum. This should be

within a wavelength of your starting point. If the antenna cannot be moved toward and away from the station, move it in any direction possible until a loop is found.

5. If more than one station is to be favored, mark off a number of loop points for each station and choose a mounting position at a point where there are loops for two or more stations, if possible. Always favor the weakest station.

6. Install the antenna at the optimum position. Remember that a weak station can be aided further by adding a tuning stub at the receiver.

While results with any standard antenna can be improved by taking advantage of these propagation characteristics, the next article will discuss special antennas which utilize space loops more fully.

This article is from a forthcoming book: "Reference Guide for Television Antennas."

¹A phrase coined by the authors.



The antenna feeding this set was first installed in the handiest spot. Note light picture.

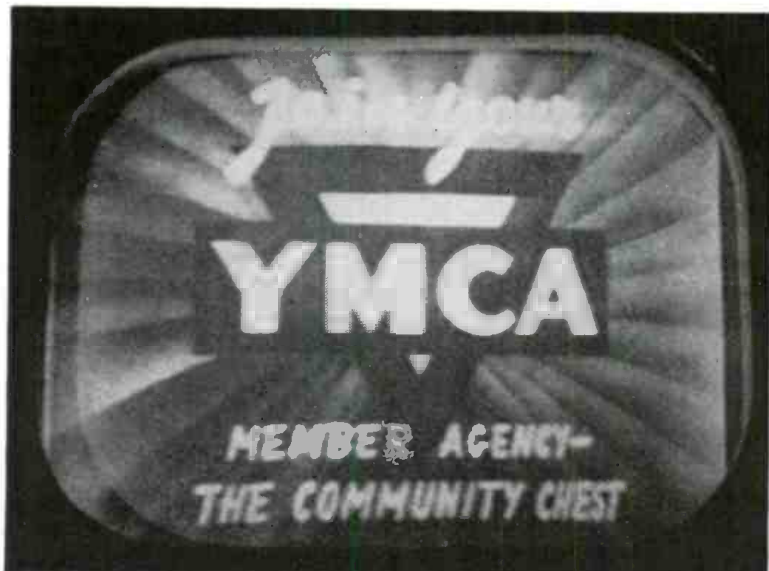

Moving the antenna about to find a space loop resulted in a marked increase in the contrast.

The input and output leads are capacitively coupled to the 6AK5 amplifier. The manufacturer states that best results are obtained when the leads from the booster output terminals are connected to the antenna coil of the tuner in the TV receiver through a 4-foot length of 300-ohm or co-axial line. This 4-foot length includes the length of lead between the antenna terminals, on the TV receiver, and the tuner antenna coil, usually mounted on the front of the receiver. If a longer lead must be used, it should be 6 or 8 feet overall—never 5 or 7 feet.

A d.p.d.t. switch on the backplate or cover permits the booster to be switched between separate TV and FM receivers. Terminals 5 and 6 on the switch, shown enclosed by broken lines on Fig. 3, connect to terminals 3 and 4, respectively, on the antenna terminal strip. A 6-inch piece of 300-ohm line is used for this purpose. The TV receiver connects to terminals 7 and 8, and the FM set to 9 and 10.

Special backplates are provided to permit connecting any one of four FM or TV antennas to the input of the booster and any one of four FM or TV receivers to the output. These backplates, available for 300-ohm lines or 72-ohm co-ax, make the booster especially useful in locations where multiple antenna arrays are used or where the incoming signal must be boosted and fed to different receivers.

Other items of particular interest to the TV serviceman are the T-72 matching transformer (see photo), and the Model FSM-1 field-strength meter.



A small transformer replaces matching stubs.

The T-72, made by Workshop Associates, is a broad-band unit designed to work efficiently at frequencies between 50 and 225 mc. It is especially designed to match 72-ohm co-axial cable to receivers with 300-ohm antenna input circuits. The transformer is in an aluminum can 1 1/2 inches in diameter and 1 3/16 inches long, with a miniature co-ax connector at one end and a 6-inch length of 300-ohm line coming out of its side.

The coils are wound on a special poly-iron form with a foil sleeve between the windings. There are 6 turns on the 72-ohm winding and 12 turns on the 300-ohm winding. This turns ratio develops a 2 to 1 voltage ratio while providing the required impedance ratio. The voltage standing-wave ratio is 1.8 at 50 mc, 1.1 at 100 mc, and 1.3 at 225 mc.

The Transvision Model FSM-1 field-

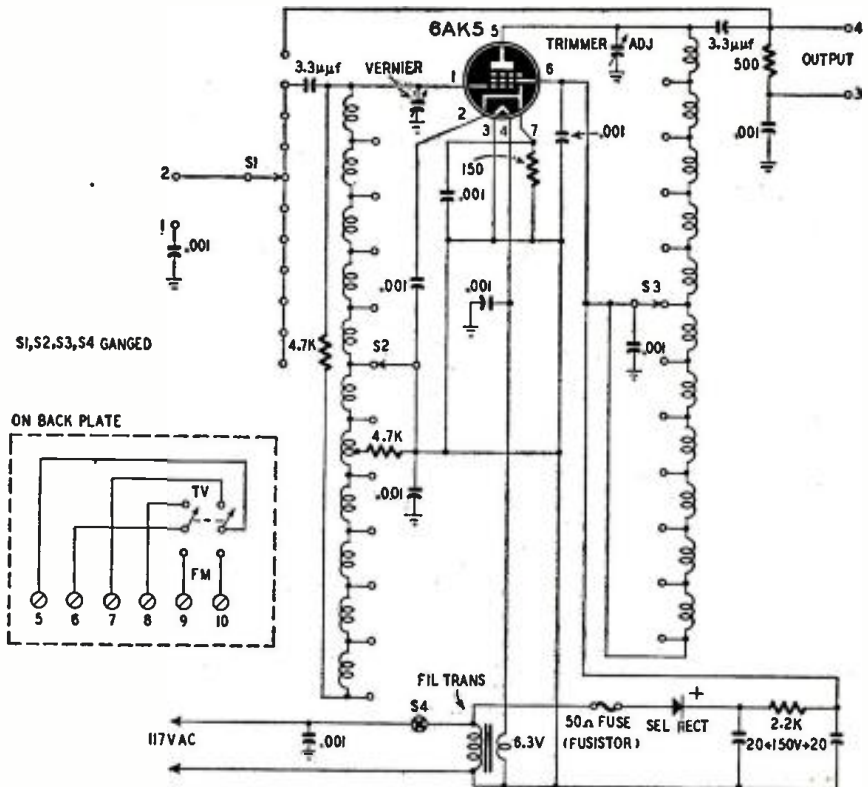

Fig. 3—The Jerrold booster has a single amplifier that covers all TV and FM channels.

strength meter is a compact high-gain superhet receiver covering the television frequencies. It has a 13-channel tuner, two i.f. amplifiers, a crystal detector, audio amplifier, and a calibrated meter that measures field strength from 50 to 50,000 microvolts at the 300-ohm antenna terminals.

A unit of this type is highly useful to TV servicemen, installation crews, and sales organizations. The latter group can make measurements in an area to determine the possibilities of good TV reception before concluding the sale of a TV receiver. Installation crews can install an antenna and orient it properly before the receiver is delivered. In areas where it is necessary to experi-



Front of Jerrold all-channel TV-FM booster.

ment with different antennas to determine the most efficient type for an installation, the antennas can be compared by measuring the amount of signal at the ends of the lead-ins. Servicemen will no doubt find the field-strength meter useful in identifying and tracking down TVI (television interference). By plugging a pair of phones into the meter, the interference can be heard; its strength and frequency can be determined with the meter. The oscillator

of a TV receiver can re-radiate a signal that interferes with other receivers. The amount of re-radiation can be determined with the meter, and steps can be taken to attenuate the signal.

In large apartment houses where there are a number of TV sets in operation, there is always the possibility that one or more of the sets radiate spurious signals from their high-frequency oscillators. These spurious radiations frequently play havoc with the pictures on sets tuned to other channels. Under normal conditions, there is little that anyone can do in locating the offending receivers without the full cooperation of set owners in the building.

By connecting an a.c. extension cord and probe antenna to the field-strength meter, the serviceman can tune in the offending signal and track it to its source. The meter indication increases as its antenna is brought close to the antenna of the offending set. When the set is located, its owner may be persuaded to add a booster or stubs to stop the radiations.

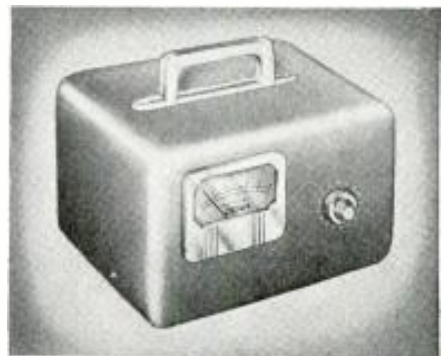

This field-strength meter aids TV servicemen.

French High-Definition TV

The French Government and European manufacturers of receivers prepare for 819-line television transmissions

By E. AISBERG*



The Eiffel Tower bristles with TV antennas. Ladder enables workmen to reach the elements.

AT present there is only one television transmitter in France. Its antenna, installed atop the Eiffel Tower, dominates a wide area of the Parisian region. The high-frequency television transmitter equipment is installed in a subterranean chamber situated at the base of one of the four pillars of the tower.

The video frequencies come from the Alfred Lelluch Center (so named after a brilliant radio engineer who distinguished himself in the Resistance and was killed by the Germans) which is situated on the other side of the Seine. (If France no longer has its Radio House, it at least has a magnificent building dedicated to television. It comprises numerous studios, some of which can accommodate as many as 250 spectators. It even has a bathing pool, one of the walls of which is a great sheet of glass behind which the television cameras can register the maneuvers of the divers under the water.)

The present television standard is 455 lines with 25 complete images (50 interlaced fields) per second. It must be remembered that a.c. is standardized at 50 cycles per second in France; thus we have 25 images instead of 30. Transmissions are at 46 mc (6.5 meters), and the sound channel is at 42 mc.

How many telespectators are there? There is no official figure, and estimates run freely from 10 to 20 thousand. Wladimir Porché, the director of television broadcasting, is less optimistic.

*Editor, *Toute la Radio*, Paris, France

In the course of a recent press conference, he answered a reporter's question with an estimate of approximately three to five thousand. The greater part of these have self-constructed receivers. A dozen or so manufacturers are putting televisers on the market. Prices range between 60,000 and 300,000 francs (\$120 to \$600 at the present exchange).

The transmissions cover 12 hours per week (not per day) and are composed for the most part of movie films. Direct pickups are not very abundant, chiefly because the budget for television is extremely small. Up to the present, television, like radio broadcasting, has been supported by the state; and while radio broadcasting has benefited from a relatively comfortable budget because of the tax paid by the listeners, television has been treated like a poor relation. It has been suggested that its destiny be confided to a "pool" in which state and industry would be represented practically on an equal basis. It is also possible that television might benefit from the resources of advertising, which would both encourage and permit more rapid advance.

The new standard

Incidentally, a great revolution is on the point of being accomplished. A publication, which in general discusses only very boring subjects, has interested itself in television. In its November 19, 1948 issue, the *Official Journal of the French Republic* published a notice establishing a new standard for television.

Experimental work will take place at 819 lines at frequencies between 174 and 216 mc (1.72 and 1.42 meters).

This new standard was not chosen without difficulty. Several companies competed for acceptance of their pet systems. Philips, for example, favored scanning at 625 lines. Thompson-Houston demonstrated the advantages of 729 lines. Radio-Industrie, which is directed by the young inventor Henri de France, preferred 829 lines. Finally, the eminent pioneer of television, René Barthélémy, Member of the Academy, who directs



Ladder is insulated to avoid r.f. absorption.

RADIO-ELECTRONICS for

the television department of the Compagnie des Compteurs, has developed and has for some time been advocating a television system of 1,029 lines.

This is just to show what an embarrassing number of choices was placed before the commission charged with the task of studying the new standard. It was decided that the system of 819 lines offers the same definition as standard moving-picture film, and that the resulting band width would not be prohibitive.

Debut in 1950

The present system of television will not cease to function immediately. To protect the present owners of televisers designed for 450 lines and to avoid stifling the present television industry, the state has guaranteed to maintain transmissions on the present standard until January, 1958. Transmission on the new standard will commence early in 1950. The beginning of 819-line transmissions at Paris will also mark their debut at Lille and Lyons, two cities which will be connected to Paris with a co-axial cable functioning at 1,000 mc (30-centimeter waves).

In installing a transmitter at Lille, the French broadcasting administration seeks, not only to serve the densely populated North of France, but also to extend its influence over western Belgium. That country does not yet have a television transmitter. An excellent opportunity is therefore available for France to spread its new standard in the countries of Benelux.

Technical and economic effects

French technicians are now studying the consequences that will follow adoption of the new standard. For one thing, little indeed is known about the laws of propagation for waves in the order of 1.5 meters. The present medium-definition transmissions at 6.5 meters cover a radius of 80 kilometers perfectly, and are often easy to receive at much greater distances, attaining 250 kilometers at times. But the much shorter waves to be used for the high-definition transmissions will certainly not have as great a range and will act more like light waves; that is, they will have numerous "shadows" at points at which hills or other obstructions are in their direct path.

On the other hand, it is known that the bandwidth of a television transmission is proportional to the number of lines per frame (maintaining a constant relation between the width and height of the image, and considering that the definition must be the same both vertically and horizontally). The formula generally employed is:

$$\Delta F = 13CN^2 \cdot 10^{-6}$$

In this formula C is equal to 1 for black-and-white television and to about 2 or 3 for television in colors. ΔF , the bandwidth, is expressed in megacycles. This formula is applicable to transmissions of 25 images per second. For 30 images per second, replace the coef-



France's only television transmitter is in base of Eiffel Tower. This is the control room.

ficient 13 by 15.6. N is number of lines.

Applying the above formula, we find that for 455 lines the width of the modulation band is 2.7 mc. For 819 lines, this same band stretches over 9 mc.

The fact that the band of frequencies extends over 9 mc makes it necessary to use very highly damped (broad-band) circuits in the receiver, to pass the extremely wide signal. Because of this high damping (or "swamping") the gain of these circuits is very low. It is made even lower by the poor efficiency of electronic tubes at very high frequencies. Therefore, receivers for high-definition television must have a considerably greater number of stages of

amplification than do medium-definition receivers. This is only one of the factors that will increase the sale price of these receivers.

The economic factor tends to make television specialists pessimistic. The present price of televisers is prohibitive for the great mass of French people. As a matter of fact, the cheapest receiver represents *three or four months' wages for a skilled laborer or a stenographer!* The receiver for high-definition television broadcasts will cost from 25 to 30% more, according to the experts. Television has plenty of obstacles to overcome to become truly popular in France!



Photo of 819-line picture-tube image shows clarity comparable to a typical motion picture.

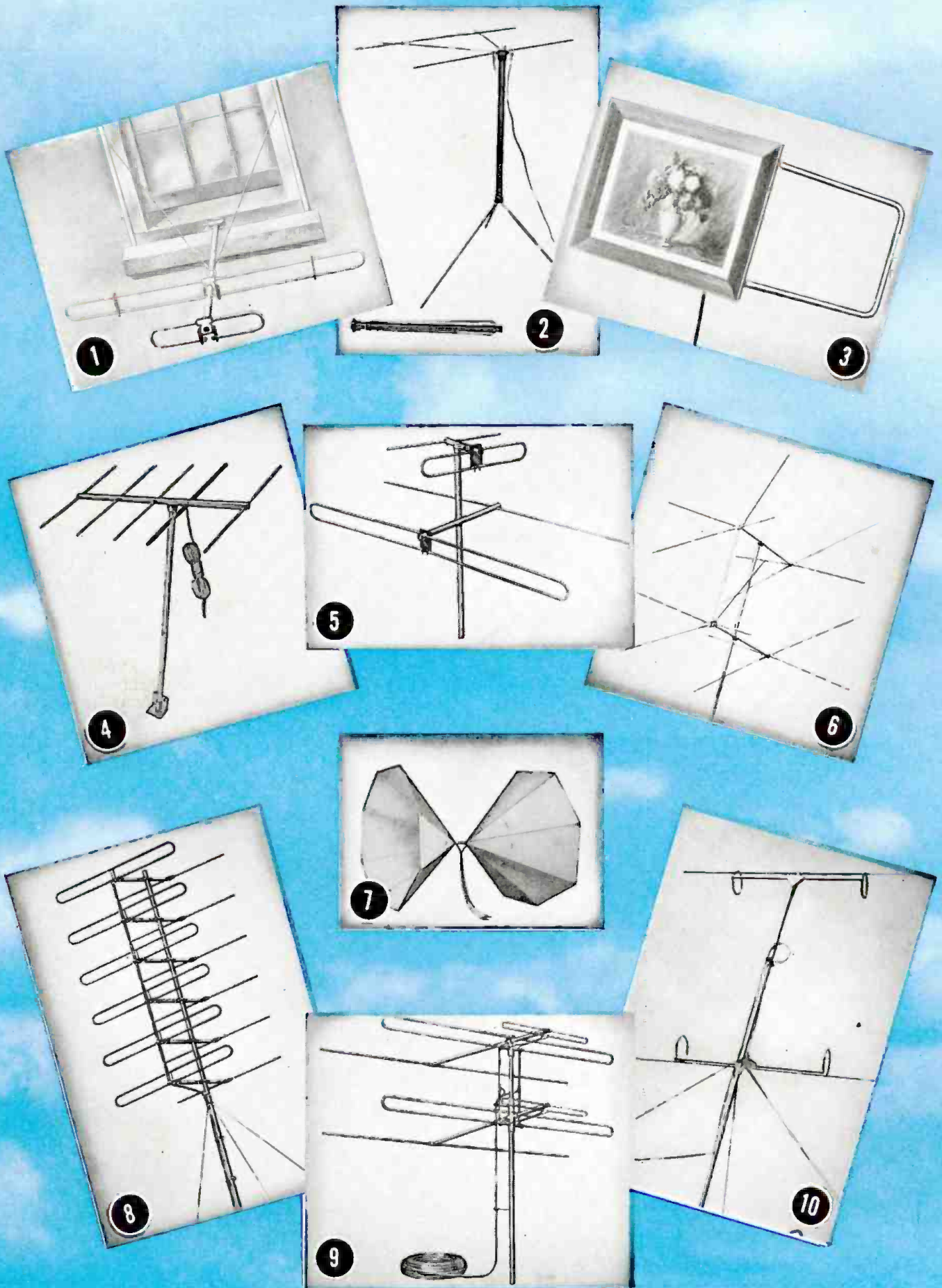

A group of representative TV antennas. Numbers are the figure numbers which are referred to in the text.

Television is Booming—Cash in on It!

RADIO-ELECTRONICS for

NEW TV ANTENNAS

By HARRY W. SECOR

THE general trend of recent design in TV antennas has been to provide more rugged mechanical structures that can withstand the rigors of rain, snow and wind; and also to design the antennas to match 300-ohm transmission lines.

The antenna engineers have also paid attention to the rapidly increasing problem of interference from different stations (and reflected waves) and have provided antennas with directors and reflectors to give a more selective re-

Fig. 11 (below)—Vee-D-X mount is inserted in top of chimney or vent pipe to hold antenna.



Fig. 12 (above)—South River antenna chimney mount has metal straps.

ception pattern. This feature helps to eliminate ghost images.

The city dweller often has difficulty in getting permission to erect an antenna on the roof, and frequently must do the best he can with an indoor antenna, or one mounted outside a window. Several manufacturers are now offering window-mount antennas provided with simple supports to hold the antenna in place. One model, made by Hy-Lite Antennae, Inc., is in Fig. 1.

A novel form of indoor antenna made by Veri-Best Television Products, Inc., is in the form of a picture frame. The antenna can be slid out at one side of the frame to shift it to a more effective position when necessary. See Fig. 3. Another indoor antenna (Fig. 2) is arranged on a tripod. It is fitted with a reflector element, and spring clips permit shifting the transmission line connections for best results. This antenna, a product of Colen Gruhn Co., Inc., may be connected across the terminals of the line leading from an outside antenna, and thus provides additional opportunities to eliminate ghosts by shifting the position of the arms and reflector of the antenna inside the house.

Many indoor antennas of the beneath-the-carpet variety are offered, but an outside antenna, even if window-mounted, usually gives better results. The television public is often confused by misleading advertisements which state

that a certain receiver "needs no outside antenna." Broadly speaking, one receiver is as sensitive as another, and if one set will pick up a good image in a given location, any other average set will do as well. The question of whether an outside antenna is necessary depends principally upon the reception conditions and the signal field strength available at a certain location, and not upon the relative merits of this or that receiver. Some sets may be slightly more sensitive than others, but a location that demands an outside antenna for one receiver will almost invariably require an outside antenna for any other receiver.

For the TV set owner residing in the local or strong-signal zone of the station, a simple dipole or folded dipole, plus, perhaps, a reflector, may yield a satisfactory signal. Where interference from another station or strong reflected waves is encountered, a more directional antenna may be necessary. One of these directional arrays, the Roger Yagi-Beam, is illustrated in Fig. 4. Such an array may have several directors and one or more reflectors. The multiple directors sharpen up the lobe or field of signal pickup, reducing interference and picking up a stronger signal from the desired station.

A number of omnidirectional antennas are offered. Where the receiver is located in a strong-signal zone free from ghost reflections these may be the answer to the problem of receiving several stations.

To receive the high- and low-frequency television bands with greater efficiency, some manufacturers supply a long and a short antenna, mounted close together, and suitably connected by a phasing unit (usually a loop of 300-ohm transmission line) so that the entire unit can be joined to a single transmission line. In some of the all-frequency designs the two antennas are independently adjustable, and each can be pointed in the most desirable direction. Fig. 5 shows a typical one of these, the Hy-Lite antenna.

A new conical type of antenna intended for FM and TV reception is especially designed to give the strongest possible signal. The Workshop Associates antenna shown in Fig. 7 is an indoor antenna, made of aluminum foil and heavy corrugated cardboard. Another semi-conical type of antenna, made by Telvex, Inc., is shown in Fig. 6.

There are in general two ways to increase signal pick-up. One is to locate the antenna as high as possible; the other is to provide a number of antenna elements or bays, one above the other,

and connect these by phasing units.

As the average set owner is usually limited in the height at which he can mount the antenna, the solution for weak or fringe-area locations lies in the use of stacked arrays. One of these, the JFD Sky-King, is shown in Fig. 8. Another, made by Amphenol, is in Fig. 9.

A special type of stacked array is the Tricraft Model 400, shown in Fig. 10. Each of its elements consists of a long, thin dipole which is a half-wave long at 70 mc, connected through inductive rings to a shorter and thicker dipole a half wave long at 128 mc, forming a combination which is reasonably effective over the high and low television bands. Many of the other antennas described here are also available as stacked arrays.

Aids to the installer of TV antennas have been perfected by several manufacturers. One of these is the Vee-D-X chimney or vent-pipe antenna mount illustrated in Fig. 11. An effective chimney clamp made by South River Metal Products Corp. is shown in Fig. 12. A spring-clamp device to take up



Fig. 13—Tricraft Adjust-O-Line prevents sag-

the slack in transmission lines is illustrated in Fig. 13. It is manufactured by Tricraft and is called the Adjust-O-Line.

A number of lightning arrestors have also been produced. These are especially important for television receivers, most of which have balanced inputs and no external grounds. One of these, the Vee-D-X, is shown in Fig. 14. The transmission line fits into the groove along its top, and is clamped by the two bolts.



Fig. 14—Lightning arrester protects the set.

The arrester ground connection must be made to a water pipe or moist earth. Unit is best installed just outside the window through which the transmission line leads.

Receivers Assembled From Kits Play Big Role in TV Advance

Men and women all over the country are building TV sets. Service problems diagnosed by mail hold upkeep costs down

By HERBERT D. SUESHOLTZ*

TELEVISION, now a major industry, is expanding at a rate which surpasses the most optimistic forecasts: its seven-league boots have outstripped even the phenomenal growths of the automobile, moving picture and radio industries. Many factors are involved, but a large contributor, and the one we are here interested in, is the television kit designed for easy assembly.

The world did not immediately revert to normalcy after the war—far from it. Shortages of space, materials, and personnel afflicted television as well as all other businesses. Manufacturers of

*General Manager, Transvision, Inc.

finished television sets realized that merchandising was impossible without trained technicians for the proper installation and servicing of their receivers, and started training them, a long and tedious process. Deliveries were unable to satisfy even a small percentage of the demand, and few radio servicemen were able to study or become acquainted with the novelty.

With the advent of the television kit, the picture changed: Because of the specialized designing, simplified method of packing, and easy-to-follow instructions, it was made possible for anyone, regardless of background, to assemble

from one of these kits an excellent television receiver, and often to make spare-time money or a good living in a new business. Because of the simplicity of the assembly, greater knowledge came to the builder: his time was not wasted in attempts to work out major technical problems, but was efficiently utilized in learning about video circuits.

However, everything is not always plain sailing; expert advice is necessary on occasion, and to meet this need *Transvision* found it necessary to maintain an engineering staff, a highly trained technical correspondence department, and factory-trained service agencies in all television areas. Weekly bulletins are sent out to all service agencies to keep them up-to-date on new features and trouble-shooting methods.

In addition, the instruction sheets have been expanded to give basic information on servicing, installation and performance of the television receiver; a Service Notes Manual has been issued, which is a compilation of servicing problems encountered, with their solutions; and a basic home study course which allows the kit builder to add further to his knowledge has been developed.

But—a special, emergency problem may arise, a thousand miles away from New Rochelle, New York. Then long-range diagnosis must be resorted to. (In one such case, a very insignificant resistor, whose cost was far less than the resulting correspondence, was improperly wired, but it was a very difficult case to diagnose. However, the result was a perfect set and a satisfied customer, and certainly the end justified the labor required to achieve it.)

Television troubleshooting is, to the man experienced in both television and radio, easier but more time-consuming than radio, because what appears on the face of the picture tube makes possible a complete diagnosis of the trouble

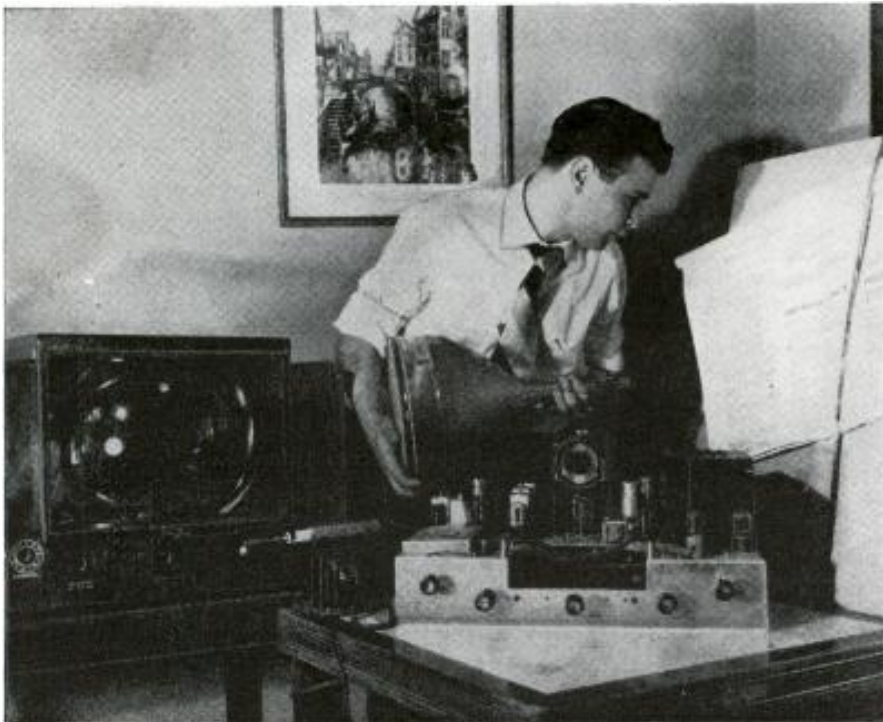

Many kits are built by persons with no radio knowledge. This constructor is at final stage.

Television is Booming—Cash in on It!

RADIO-ELECTRONICS for

—provided the technician can see the set.

Troubleshooting by remote control, however, is a problem unique in itself, because it is necessary for the correspondent to visualize what appears on his tube and to explain what he sees so the technician can understand it. Legal battles have often proved how difficult it is for two witnesses to agree on what they see, and television proves the rule.

Yet precisely this service is rendered to many thousands of customers—troubleshooting by remote control. Fifty to a hundred letters come in every day from all over the country, and are routed to the department best equipped to handle the particular problem. The Service department, the Testing department, the Parts department, the Educational department, and the Engineering department each receive a share. Sometimes customers become old friends by mail, and write about their business and personal, as well as television, problems.

A typical letter is this one:

"I have a case that seems to baffle all those people I have to date encountered who are supposed to know a little something about television. My main trouble is that my picture is cut vertically in half and there seems to be a picture in the background also. We checked the horizontal sweep and it was operating at a frequency of 30 kc instead of the usual 15.75 kc. We also found that increasing the gain resulted in low-frequency pulsation in intensity. There also seems to be a loading effect of the horizontal oscillator. We would appreciate any suggestions you may have in order to help us with our situation."

This was answered by the Engineering department:

"Regarding horizontal frequency correction, please note that the circuit elements which control horizontal frequency are: the horizontal transformer; the 6SN7 tube, socket 6*; condenser PP*; resistors No. 56 and No. 39 on socket; resistor No. 18 and condenser MM, TS-L; and, of course, the value of hold control P5. We would suggest that you check all of these components for value: plus or minus 20% is satisfactory. Remember that the increasing value of PP will lower frequency, as will increasing value of resistors No. 56 and No. 39. Try removing No. 56 completely. Low-frequency modulation is usually caused by improper location of condenser SS: this should be kept in the back corner of the chassis. It may also be caused by stray coupling to the green lead from the cathode ray tube socket: keep as little of this lead below the chassis as possible. If it would not inconvenience you too greatly, we would appreciate your letting us know how your set operates when you have followed these suggestions."

Another letter and its answer:

"Can you tell me how I can add a 12-inch 860-ohm dynamic speaker to my

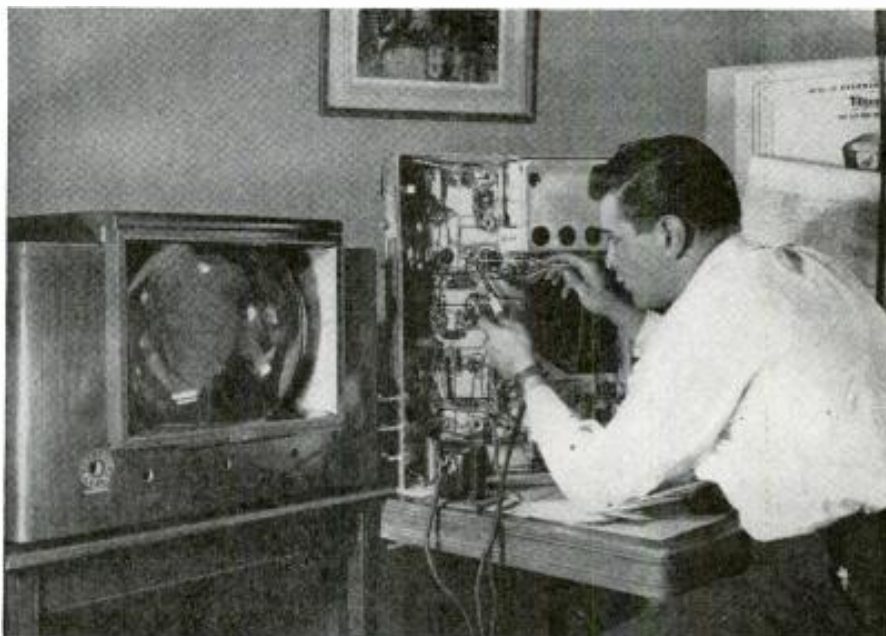

All leads in most kits are color-coded for quick identification. Every component is numbered.

Standard Transvision television receiver? If not, do you know where I can obtain such information?"

"We advise you to check on the impedance of your speaker very carefully. A standard eight-ohm speaker can be attached to your set without difficulty, or, if your speaker has an output transformer with it, you may replace the present speaker and output transformer (which is underneath the chassis)."

Still another letter, with its answer:

"I have built the 12-inch standard with FM kit and get excellent reception from about 60 air miles away. However, we live on a heavily traveled street and have severe automotive ignition interference. Some cars blanket the sound and cause the picture to jump frame vertically or completely blank out. Our distributor advises that there is a factory circuit modification and additional circuit components available that eliminate or minimize this condition. If additional components are required please send them to me C.O.D."

Have also experienced trouble centering the picture on the tube horizontally. The picture runs off the tube (left side) an estimated one to two inches. The assembly manual advises that resistor No. 69 should be increased in value to correct this condition. I wish to thank your service department for the prompt and courteous help in the past and to congratulate you on designing an excellent receiver."

"We are sending you our new a.f.c. circuit. This circuit should give added picture stability under the conditions at which you are operating. However, the sound should operate satisfactorily as it is if properly aligned. We suggest you check adjustment of the bottom screw of transformer 317 for maximum sound and minimum noise. Also, check the adjustment of the complete sound circuit, using a voltmeter, as described in the instructions, if possible.

For centering of the picture, check the mechanical alignment of the focus coil. A 30-ohm wire-wound potentiometer may be substituted for resistor No. 69 to give an adjustable horizontal centering control if you wish. Don't hesitate to ask for further help at any time."

Actually, of course, none of these letters is "typical." Each represents an individual problem and is answered individually: no form letters are sent out. But each problem which is presented and solved adds to our accumulation of knowledge, which is assimilated and used for the benefit of the next inquirer.

Much of this knowledge is passed on directly to authorized service agencies through the medium of weekly bulletins. Monthly summaries of these bulletins are now being sent to Transvision jobbers so that they, too, can be kept up to date. These bulletins contain such information as:

"Due to phase difference between station and set located in different power areas, occasionally a wavering similar to a flag waving vertically may be noticed. To minimize this, put a 1,000- μ f capacitor across the 10-ohm resistor No. 69 which goes from lug No. 1 of CF-2 to lug No. 1 of TS-0."

"It is advisable, with the summer months and high humidity, to dust off and clean with carbon tetrachloride part No. 345, which is the insulated platform which supports the 1B3 tube. Several breakdowns have occurred where accumulated dust, becoming moist, provided a leakage path."

These aids to customers and service agencies have enabled many television owners to eliminate or reduce the service charges which are so large a part of the cost of upkeep of a television receiver. This proves that the old saying "It's not the initial cost, it's the upkeep" may still be true of marriage, but not so of the kit-constructed televiser.

* These terms refer to designations on Transvision instructions.

TV Booster Has Gain of Ten

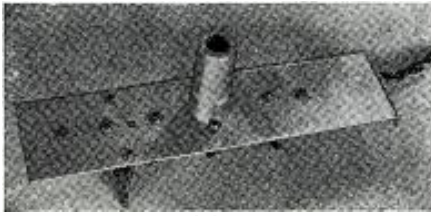

This single-channel preamplifier is especially useful in a poor-signal area

By DAVID GNESSIN

THERE are two main reasons why clear-cut, stable pictures may not be available at your television screen. You may not have gone all-out and put up a really good television antenna array in a suitable location, or your receiver may be outside the normal service area of the transmitter.

In either case, video reception can be improved by a suitable preamplifier. In fact, in fringe areas the little preamp box atop the radio cabinet is considered part of routine TV installation.

The May, 1948, issue of *RADIO-CRAFT* carried a fine midget television preamplifier design which permitted the user to effect voltage gain of from two to four times. Its gain was limited by its band width. If that design suits your requirements, then go no farther.

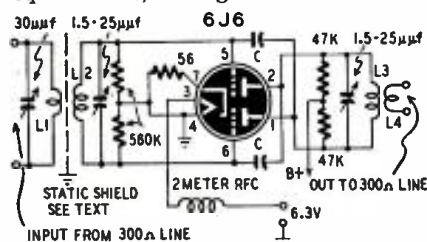

Fig. 1—Preamp circuit is relatively simple.

If, on the other hand, you need greater gain, use the design shown here. It promises a voltage amplification of eight to ten times. On that elusive fringe station this may make enough difference to determine whether there will be television at your house tonight.

This large gain is the result of careful construction and tuning. It can be had on only one channel, however, since the gain depends on the accuracy with which the two tuned circuits are adjusted. By varying the inductance in tuning coils L2 and L3, other channels may be tuned; but to get a gain of 10, a separate preamplifier should be prepared for each channel. The design, originally published in *RCA Ham Tips* for 148 mc, was easily converted for 174 mc (channel 7).

As the schematic shows, the grids of the 6J6 are used in the tuned circuit, raising the gain so much that the grids require neutralization to avoid self-oscillation. It is necessary, too, to utilize an electrostatic shield between the antenna coil and the grid coil to make certain that the only signals picked up by the preamplifier are the TV signals required. Unwanted noise and strong local interference are reduced by eliminating electrostatic coupling between antenna and amplifier circuits.

The circuit is shown in Fig. 1. Note the two views of the preamplifier shown in the photographs. Few, economical components, properly placed, give excellent performance. Taking its operating voltages from the television receiver itself, the preamplifier requires only 6.3 volts from the filament circuit, and 180-250 volts of B-plus.

Antenna coil L1 is matched to the 300-ohm line and is tuned by a compression-type mica trimmer. By tuning the antenna coil for maximum performance, serious mismatch in the feeder system is avoided. (It is assumed that the antenna input is matched to a 300-ohm line.) The tuned separate antenna circuit has a flatter response, and hence needs less critical adjustment.

The signal passes through the static shield to L2, which tunes the push-pull grid circuit. Each grid is neutralized. The tuned push-pull plate circuit is tightly coupled to a 300-ohm line, which goes to the receiver. If the receiver is not fully shielded, it will be necessary to keep the preamplifier approximately 3 feet away to avoid feedback. A mounting on the window at the lead-in site is most practical.

Adjustment of the unit is not difficult and requires no special apparatus. With the preamplifier disconnected, first tune the television receiver for best response on channel 7. Then open the antenna lead and insert the preamplifier. (It will be prudent to shut off the receiver's power as this is done.) Leaving the preamp's B-plus connection open, turn on the receiver; but don't change the tuning.

With any luck at all the signal should still show, although it will be weaker. With an insulated screwdriver, peak up all preamp trimmers for maximum signal. Then, using a fiber screwdriver, work the neutralizing leads in and out of the tubular grid connectors. These neutralizing "capacitors" (C in the diagram) must be specially made, as explained below.

The grid coil L2 should be mounted on an insulated terminal strip. The connections between this terminal strip and the grid terminals of the tube socket are made with thin tubing, not wire. The tubes can be of brass or copper with a bore of about $\frac{1}{16}$ inch, or they can be made by rolling a strip of soft copper foil into a cylinder. The socket connections are soldered so that the holes in the ends of the connecting tubes are exposed. In these cylinders are placed short lengths of No. 18 plastic-insulated wire, penetrating the cylinders for about $\frac{1}{2}$ inch. The other ends of the wires go to the plates. Leave enough slack in the wires for neutralization.

Neutralization consists of working these leads in and out of the tubes, varying grid-plate capacitance. The C-R tube is your neutralization indicator. At a certain point a definite null should be encountered. Remember, you are trying to *reduce* the signal. A positive reduction in signal will be obtained when optimum neutralization is reached on both elements.

Since the unit is to be used on only one channel, a drop of h.f. liquid cement will hold the neutralization settings.

Now, push each pair of coils together gently, at the same time peaking the trimmers for *maximum response*. By getting the coupling as close as possible, the band width will be increased to optimum. Don't worry about oscillation. If the neutralizing technique was properly followed, the tube won't oscillate.

When maximum gain has been effected without plate voltage, connect the B+ to the preamplifier. Retune the receiver now if necessary. The preamp

Test Equipment For TV

By S. D. PRENSKY* and N. DeFALCO**

THE serviceman joins the general public as an interested spectator of the rapid growth of television, observing the innovations and new trends with an interest made all the keener by his professional appreciation of the advances made. But these advances introduce new technical considerations for him to take into account as a technically trained person. If he is to take full advantage of the widening possibilities of television, he must be prepared with special equipment to handle TV circuits.

Servicing TV receivers involves many

*Receiver Publications Dept. **Head of the Receiver Test Dept., Allen B. Du Mont Laboratories, Inc.

factors that differ widely from previous AM or even FM work. To examine the new angles, we may start with the extension of the frequency range far into the v.h.f. region, where r.f. channels cover 54 to 88 mc for the low-frequency band and 174 to 216 mc for the high-frequency band. The usual intermediate frequencies range from 21 to 27 mc, and the local oscillator frequencies are higher than the r.f. channels by this amount, bringing the frequency range up to 243 mc. Along with the very high frequencies comes the 6-mc-wide bandpass in the r.f. and i.f. circuits. AM and FM circuits never called for a bandwidth of more than about 300 kc; in TV we must deal with a bandwidth approxi-

mately 20 times as great, about 6 mc.

It is easy to see that the ordinary generator designed only for AM receivers cannot be used for TV work. The differences between the capabilities of a generator originally designed for FM receivers and the requirements for TV alignment may not be so great as far as frequency range is concerned, but the sweep width is generally too small for adequately testing TV circuits. Television calls for a *special type of sweep generator*, which usually can handle the FM-receiver work as well.

We should also take into account future TV developments, especially the possibility of a 400-500-mc band. The
(Continued on following page)

(Continued from preceding page)
is set for the channel and will need no further attention.

To make the electrostatic shield, a sheet of plastic $\frac{1}{32}$ inch thick is cut to 2 x 4 inches, then folded once, making a 2 x 2-inch square. Upon this flat, folded plastic form wind No. 22 silk-insulated copper wire along most of its length, as in Fig 2-a. Then sandpaper the insulation off the top side of the coil and solder carefully a heavily tinned copper bus wire to each turn as in Fig. 2-b. Be careful when using heat near plastic: it might melt or ignite. You should have a rigid structure.

Coat one side of the assembly liberally with household cement or coil dope. After it is thoroughly dry, cut the uncoated side away with a pair of tin snips. This will leave you with a grid cemented to the plastic sheet and resembling a picket fence of copper wires, all pickets of which are insulated from each other, yet connected at one end to a common bus. This "comb" you have left is a Faraday shield, with a single lead connected to it. Connect this lead to chassis. Attach small angle irons to the shield for mounting as in Fig. 2-c. The assembly can be seen in the bottom-view photograph of the preamplifier.

Fig. 3 shows how the grid and plate coils L2 and L3 are made. The coils are

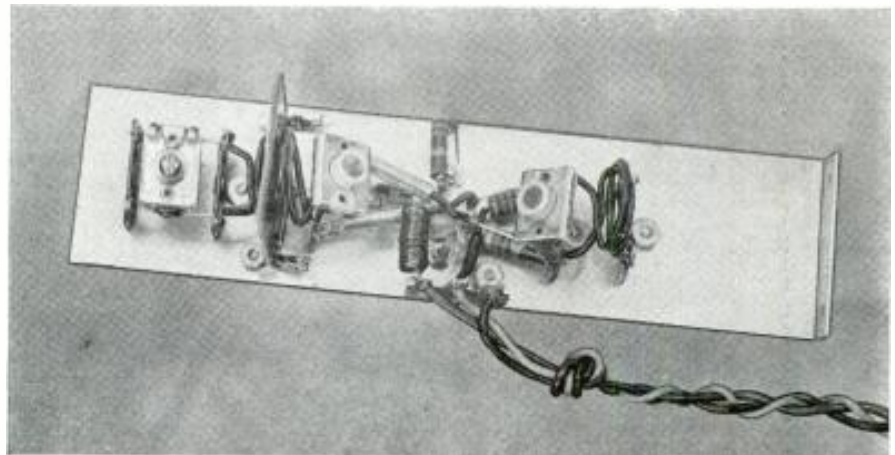

The entire preamplifier is built on a strip of metal. The leads bring power from the set.

of the "figure-eight" variety, made from solid, plastic-insulated wire. This type of coil has balanced stray capacitances to ground and can be backed right up to the electrostatic shield without becoming unbalanced. The coil is made in two steps. First the figure-eight is formed, then it is bent into the shape shown by the dotted lines. Some spreading or squeezing may be required to permit tuning the coil with the lowest possible value of grid-tuning capacitance. L1 and L4 are identical, each being a single turn of No. 18 plastic-insulated wire.

Bakelite solder-lug terminal strips (there are six of them) mount all the necessary components. The small sheet-metal chassis shown is put into a convenient decorative cabinet.

MATERIALS FOR PREAMPLIFIER

Resistors: 1—56, 2—47,000, 2—560,000 ohms, $\frac{1}{2}$ watt.
Capacitors: 1—30 μf , 2—1.5-25 μf , variable mica trimmers.
Miscellaneous: Coils as per text; 1—2-meter r.f. choke; 1—6J6; chassis and hardware.

Photos and figures courtesy RCA Ham Tips

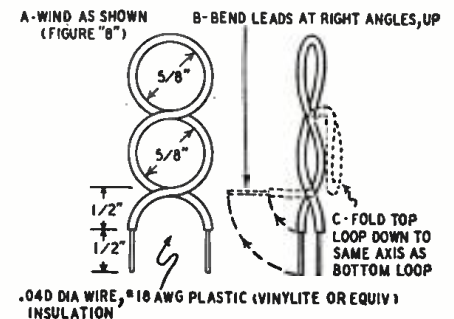
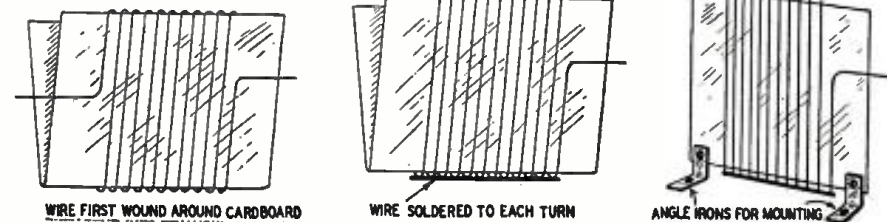
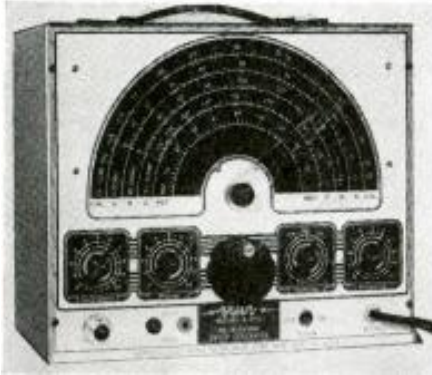

Fig. 3—This is how L2 and L3 are made.



Figs. 2-a (left), 2-b (center), and 2-c (right)—Steps in making the electrostatic shield.

FCC and other sources indicate that today's good test equipment will, in general, be adequate to handle any foreseeable developments in the next few years to come. Any special equipment that may be required will probably be provided as accessories to present equipment and need not make any well-designed instruments obsolete.



Approved A-300 FM and television generator.

There has been a period when only the more expensive, laboratory-type instruments were available. Now, with many less expensive models to choose from, good judgment is needed to balance the qualities expected of the TV generator against the economic factors, original cost, and efficient, time-saving test procedures.

Minimum requirements

A reasonable requirement list for TV generators must avoid the extremes; it must not be too strict in including refinements which might be more suitable for production or laboratory tests, nor must it be too crude in allowing the use of old equipment no longer adequate for the job.

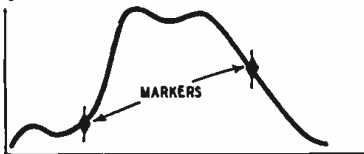

Fig. 1—i.f. trace. Sound traps not adjusted.

After checking with a number of qualified technical men, the writers compiled the following list. The requirements discussed are based on the typical receiver with a 25.75-mc video i.f. and a 21.25-mc sound i.f. The required frequencies for testing sets with different intermediate frequencies will be obvious.

1. To observe the i.f. response on an oscilloscope, the generator must supply an FM signal with a 23-mc center frequency, which deviates 4 mc in each direction (total swing of at least 8 mc). While it is possible to find the i.f. response with an AM generator and a v.t.v.m. (without a sweep generator and scope), the method is so time-consuming and inaccurate that it is not recommended. The i.f.-response trace on the oscilloscope should look something like Fig. 1 (before the sound trap has been adjusted). To identify the frequencies represented in the curve, r.f. marker

signals are needed at 21.25 and 25.75 mc; these must have crystal accuracy.

2. To adjust the sound traps, signals of the same accuracy as the marker mentioned above are needed at 21.25 mc for the sound i.f., at 27.25 mc for the adjacent picture channel, and at 19.75 mc for the adjacent sound channel. These signals must be amplitude-modulated; usual practice is to modulate the r.f. 30% with a 400-cycle tone. Fig. 2 shows how the i.f. response curve should look after the sound traps have been adjusted.

3. Alignment of the sound i.f. channel and the FM detector requires a sweep signal centered at 21.25 mc with a deviation of 150 kc each side of center. A marker signal is necessary; it should be accurate within less than 25 kc, since the deviation of the sound signal is only 25 kc maximum. (Fig. 3.)

4. The fine-tuning control should tune to each channel fairly close to the center of its range. To check the local oscillator frequency, r.f. signals for each

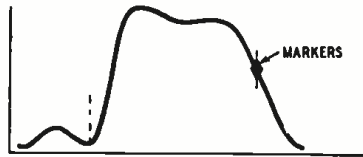

Fig. 2—Trace shows sound traps are adjusted.

channel frequency should be available. Accuracy must be within 50 kc. While this is practical for channels 2 through 6, service-type generators are rarely accurate on the higher channels. In view of this, it is not usually practicable for the serviceman to attempt actual alignment of the front end; the generator should be used for rough checking only, and the set sent to a factory repair depot for precise adjustment, if that is necessary. It is often true, however, that signals from stations on the air can be used as checks on the front end. For this reason, it is not absolutely necessary to have a generator which covers the television r.f. range. If equipment is to be bought anyway, though, it is a good idea to purchase a generator covering the entire range.

The requirements suggested here are not idealized; they are solid, practical necessities without which no repairman can satisfactorily align a TV set. Some commercial generators do not come up to par and it is impossible to determine that fact from optimistic advertising literature. Since the average purchaser of a signal generator is in no position to take each instrument offered for sale to a testing laboratory, it is strongly suggested that he consult other generator owners before he buys.

Typical generators

Two general classes of signal generators are being sold today. They might be termed "advanced-servicing types" and "low-cost, minimum-requirement types." Typical specifications differ only slightly. Common frequency ranges are 0-230 mc for the advanced instruments,

with 1% accuracy and at least three switched bands; the simpler models range from 2-220 mc with no band-switching and about 2% accuracy. Both have an adjustable frequency swing of 0-10 mc and a time-base output for the oscilloscope (with phasing control). A 20-30-mc marker generator has provision for all FM and TV i.f.'s and, preferably, output at the TV-channel r.f. frequencies, all capable of being checked with a crystal calibrator. All outputs are continuously variable and of low impedance, with at least 0.1 volt avail-

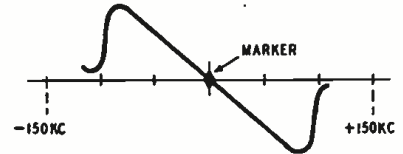

Fig. 3—Scope trace of aligned FM detector.

able. Advanced models generally have provision for connecting an external crystal signal, while low-cost ones usually do not.

To illustrate the various categories into which the generators fall, the following list of manufactured instruments is divided according to the facilities offered. While the list is by no means complete, it shows how the various instruments can be classified by the serviceman who is considering the purchase of new television test equipment.



Another often-seen generator, the Silver 911.

COMBINATION SWEEP AND MARKER GENERATORS

Low-cost, minimum-requirement types:
 Silver Model 911 FM and TV sweep signal generator (McMurdo Silver Co., Inc.)
 Transvision Model SG FM and TV sweep signal generator (Transvision, Inc.)
 Advanced servicing type:
 Hickok Model 610A TV signal generator (Hickok Electrical Instrument Co.)

SWEEP GENERATORS ONLY

Approved Model A-300 FM and TV sweep signal generator (Approved Electronic Instrument Co.)
 Kay Mega-Sweep, Jr. (Kay Electric Co.)
 RCA Type WR-59A TV sweep generator (RCA Test and Measuring Equipment Section)
 Silver Model 909 FM and TV sweep signal generator (McMurdo Silver Co., Inc.)

MARKER GENERATORS ONLY

General Electric Model YGS-3 signal generator (General Electric Co.)
 Hickok Model 288X crystal-controlled signal generator (Hickok Electrical Instrument Co.)
 Kay Mega-Marker (Kay Electric Co.)
 RCA Type WR-39A television calibrator (RCA Test and Measuring Equipment Section)
 Triplett Model 3433 signal generator (Triplett Electrical Instrument Co.)

Television is Booming—Cash in on it!

RADIO-ELECTRONICS for

Office Television System

THE use of television in industry progressed steadily throughout 1948, but without the excitement or fanfare of 1947's developments. The year 1947 saw the discovery of several television applications—1948 saw those applications established as standard shop, laboratory, and office practice.

For example, the use of television to perform the dangerous task of observing a rocket motor in action was heralded a year ago as a new application of television. Today a number of manufacturers of standard aircraft motors view the first run of each new model with a camera mounted on the rim of the test pit, rather than let engineers run the risk of the occasional mechanical failure or explosion.

In the office-industrial field, a complete set of equipment is now commercially available. Known as the Vericon* portable television system, it provides means for linking all parts of a large industrial establishment together by visual communication.

The Vericon consists of three units: the camera, the pulse-power unit, and the receiver (called by its manufacturer a monitor or viewer). Extension viewers up to the number of ten can be installed, so that the same scene or operation can be viewed from a number of points if desired.

The camera, shown in Fig. 1, weighs 31½ pounds and can be mounted in any position. Heaviest of all the units is the power supply (center of Fig. 2). It weighs 49 pounds—still quite portable. The 42-pound viewer or receiver completes the equipment.

Video signals are transmitted on coaxial cable from the camera to the viewer, which may be as much as 4,000 feet away. This distance is, of course, sufficient for practically any industrial plant or office combine. Since there is no radio frequency transmission, the equipment is much simpler than the standard televiser, requiring only video and sweep circuits.

Readers of this magazine will think immediately of a number of applications for such a system. Classroom instruction, especially where demonstrations are given, is one of the most important. In the usual demonstration, only about a dozen students are able to get a full idea of what goes on. It was possibly for this reason that the value of television in bringing surgical operations to the view of an unlimited number of students has been so widely publicized.

Retail merchandising—the televising of store scenes to a show window—is another possibility for large-scale use

of wired-television equipment. The watching of hazardous operations has already been mentioned. Another important industrial use is watching various parts of a complex operation simultaneously, for example, along a conveyor belt. Traffic in tunnels or over bridges might well be regulated with a battery of television cameras set up to view strategic points and transmit their images to a central control station.

Television has been used for scanning checks in a bank—providing for the instant transmission of the signature from the teller's window to a point where it can be compared with an authorized signature by a qualified expert. This system might well be applied to all records in certain extensive offices where various branches might want to see the same letters or documents. All records could be placed in a central file room, equipped with one or more cameras. Should the record be required in

any office, the filing clerk need only place it before the camera and leave it there as long as required by the employee or executive calling. This would make records available more rapidly and greatly reduce the danger of losing documents.

The nonentertainment aspects of the freer type of television—transmission through space instead of along a coaxial cable—have developed greatly in the past year, particularly in the military field. Ultrafax is also an example of the use of television, or at least of techniques developed by television. Employment of television in law enforcement, as a means of broadcasting pictures of missing persons and fingerprints of wanted criminals, has also progressed. But it is extremely likely that video signals transmitted along co-axial cables will prove to be the form of television best adapted to industrial and commercial applications.



Fig. 1—The Vericon camera is the eye of the office or factory wired-television system.



Fig. 2—These three parts make up the complete system. The units are all cable-connected.

*Remington Rand Co., South Norwalk, Conn.



The radio-television controlled plane (shown at right) sends the television impulses down to Earth, where observers before six screens, pictured above, can look into six directions at once. As the plane has no crew it is wholly directed by radio. Wherever it may be, the distant ground radio observers and operators can follow the plane visually at all times. It can be destroyed in flight so it will not fall into the hands of the enemy, should such a decision become necessary.

Here we see the television-controlled plane in flight. It has no crew, but is entirely directed via radio and distant sight, by the ground crew, shown in the illustration at left. Here we see the plane engaging fighter planes deep in enemy territory. If necessary, such a plane can deliver atomic bombs without risking lives. Note the smoke screen.



40 Years OF TELEVISION

By HUGO GERNSBACK

WHEN I wrote in December, 1909, what was probably the first technical television article to appear in print—"Television and the Telephot," for my former magazine, *MODERN ELECTRICS*, even I did not foresee all the coming wonders of television. As I write these lines almost 40 years later, television has finally arrived—after many false starts.

For the first television magazine in print, *TELEVISION* (published by me in 1927), I wrote editorially the following paragraph:

"What the public demands is *sight* by radio, an apparatus to be attached to your radio set, whereby it will be possible for you to see what goes on at the radio station, in the studio or elsewhere, wherever sight is to be broadcast. Thus if the president speaks at Washington, in the future, we shall have a television transmitter in Washington also, which will transmit the visual impulses while the president is speaking. The entire country will, then, by listening to the president, also be able to see him. The same will be the

case when two prizefighters meet in the ring, when the public will be enabled not only to hear, but actually to see what is going on."

All very commonplace today. Yet in 1927, only 21 years ago, television was still crude—a laboratory curiosity, a whirling disk with images of postage-stamp size, with little definition and clarity. Our present cathode-ray-tube receivers and modern television broadcasting were at that time far away in the distant future.

What of the future?

Television receivers will become much cheaper for some time to come. For the past 15 years I have insisted in my various technical articles that television will never be as popular as radio until the masses can afford it. That means good television receivers from \$50 up. As recently as two years ago I was roundly denounced by many leaders in the industry for my temerity in publicizing such heresy. (Remember that at that time no receiver sold below \$250.) Yet today there are receivers selling for \$99.50 list price. The \$50

tele set is not far off. Mass production plus the new automatic robot radio and television set builder, with appliqué circuits in the offing, will help to bring prices down.

Color television?

It is still in the laboratory, but nearly all the problems have already been solved. In three to four years electronic color television will be here—if the public wants it.

Stereoscopic television

This is also in the cards in the not too distant future. It can be realized better and sooner than stereoscopic movies. When we look at a person in real life we see him *in depth*, because we see him at a slightly different angle with each eye. When looking through the old-time stereoscope, we look at two photographs simultaneously. Now people, trees, buildings, seem to stand out in relief—they look real, not flat like a picture. Future television will be a thing of great beauty—no flat lifeless images but *reality itself*. We will still have a single screen but there will

Television is Booming—Cash in on it!

RADIO-ELECTRONICS for

be two images, slightly out of phase. But you won't see this, because there will be a special finely grated optical film covering the television screen. This optical differential-grating film combines the two images into a single one. You will see the end result—a perfect illusion of real life—stereoscopic television.

What is more, eye strain will probably be much less with this means of seeing higher-fidelity images.

The radio-television plane

The radio-controlled television plane was one of the first guided missiles which I described in the November, 1924, issue of *THE EXPERIMENTER*. This is a plane for war purposes. It carries no living human being and, thanks to television, can be steered entirely from the ground. It carries a short-wave television transmitter and six viewing lenses. Therefore it can "see" into all six directions: east, west, north, south, up, down. Its television impulses are sent to headquarters, where an observer views a large screen divided into six spaces. Sitting at a keyboard the observer and his assistants can control the plane far better than a single pilot or even two pilots who can't look into six directions *at once*.

If an enemy plane approaches, or if a mountain must be flown over, the ground operator can guide the plane readily. Bombs can be released exactly over the target, smoke can be released by the plane to hide it. It can be equipped with guns to shoot down enemy planes, etc., etc.

Today all this is no longer fanciful. *The television controlled plane is here.* It is sure to be used in World War III—it is a terrible instrument for attack. *It is THE ideal instrumentality for delivering atom bombs.* As it carries no live crew, long chances can be taken by the distant guiding crew. Instead of a suicide, one-way crew, the television-controlled plane can be sacrificed after its atomic bomb mission, and destroyed by blowing it up in the air. While in flight with an A-bomb, it can be adequately protected so that an unexploded A-bomb will not fall into the hands of the enemy. There are a number of means known to scientists to accomplish this.

And do not let the layman think that the enemy can easily "take over" the control of a radio-controlled plane by "counter-signals." Electronically guided missiles today usually go through to the target—the science of radio-telematics has made vast strides since Nikola Tesla originated it back in the year 1898.

Dr. Lee de Forest, father of radio and inventor of the vacuum tube that made radio possible, in a letter dated November 27, 1944, wrote to me as follows, regarding the television-controlled airplane:

"In 1936 Mr. U. A. Sanabria and I enjoyed a contributory brainstorm and broke into print along the same lines of a television-controlled airplane, but

I had no idea that you had described a similar device as far back as 1924. Yours was indeed an historic prediction."

Television eyeglasses?

For the October, 1936, issue of my publication *SHORT-WAVE CRAFT*, I wrote an article predicting television eyeglasses. This is an eyeglass frame on which are built two separate miniature televisers. The whole weighs but a few ounces. The images on the two tiny screens are about postage-stamp size, but as the screens are less than an inch from your eye-balls, the small size is no drawback. The dual images, though small, are sharp and clear, exactly as



Television eyeglasses of the future are an adjunct to the regulation television set. A number of such eyeglasses can be plugged into the set. The idea is particularly useful for invalids and for those who wish to relax without having to sit rigidly in front of the television receiver for hours.

if viewed through binoculars. Now you can recline in your easy chair and really enjoy television. Or, in your office you can plug the Tele-Eyeglasses into your regulation teletset; and if you wish to see an important event, you can stay right at your desk, without moving about. If you are ill, in bed, the "teleglasses" will prove to be a great boon.

Note well that the television eyeglasses are only an adjunct to a regulation television receiver—they are what an extra speaker, or headset is to a radio set. They will NOT be—at least for years to come—a complete self-contained television receiver.

The teleglasses are merely two tiny, lightweight cathode-ray tubes with two controls for sharpening and properly adjusting the images. We have the technical means today to make teleglasses—it should not be many years before they are on the market.

Multiperception

The above was a term I coined in a recent article in which I stated that the worst feature of television is its time-devouring proclivity. But I noted also that the younger generation had learned the trick of going about its work while listening to the radio. Accountants, typists, switchboard operators, students completely immersed in work, actually listen and work hard simultaneously—something older people haven't learned

because they weren't brought up with radio.

Can one look at a television screen and work or read a book at the same time? Certainly. The young generation not yet in its teens will learn to do it readily. How? I give a single example: A pupil learning to play the piano must keep his eye on his notes, and on his hands as well. The eye-ball must constantly move from the notes to the hands—*quickly*. In a few years the pupil has mastered this trick. In addition to the notes, he also learns to read the words of a song *at the same time*. And if necessary he sings too! That's doing *four things simultaneously*—quadruple multiperception.

In television it will work as follows: Already small table-model, portable teletsets are being built; but they will get even smaller, with brighter screens, intensely illuminated, for daylight use. The screens will be inclined at such an angle that you can place the receiver in front of you, on the desk or table, about a foot or eighteen inches from your eyes. Your eyes will shift rapidly from screen to book, back and forward, just as does the piano pupil's—with this difference: eyestrain will be far less, because your eyeball moves through a much smaller angle. Nor will this exercise hurt your eyes any more than those of the piano pupil—eye doctors insist we never exercise our eye muscles sufficiently anyway.

In a year or less your youngster will have learned to study and watch the screen and listen all at the same time—and he will retain all three—his studies, watching the visible action, plus the sound program.



Multiperception, as pictured above, enables one to do two things at once. This the now rising generation will do. The student is studying and watching the television screen almost at the same time. The eyeball moves only through a small angle, as illustrated, from the book to the screen and back.

And now from the sublime to the ridiculous. I have often been asked, particularly while publishing my former magazine *TELEVISION NEWS*, what new and better terms we could coin instead of the inadequate *televviewer*, *televviewing*.

Well, here is a list I once made up. Make the most of it!

Telogler—telogling.

Telooker—telooking.

Teleseer—teleseeing.

Teleerer—teleering.

Telepeeker—telepeek, telepeeking.

Telegazer—telegazing (not to be confounded with telegeezer!)

Television Receiver Chart

A complete listing of the principal characteristics of current television receivers

THE chart on these pages gives the vital information on most of the television receivers on the market today. It gives servicemen and dealers a bird's-eye view of the trend of 1949 production, as well as allowing a prospective purchaser to investigate the available sets.

It is interesting to note, for instance,

that the flyback high-voltage supply has taken precedence over every other type. Not a single set uses the "standard" 117-volt-primary transformer! Another significant observation is the lack of AM on almost all the receivers. Apparently the family's standard set is expected to be in working condition for some time yet, making combinations unnecessary.

The small loudspeakers appearing on even some of the consoles testify that the sound channel is—so far, at least—subservient to video as far as quality is concerned.

Costs were omitted from the table because of the fluidity of the pricing situation. Symbols are at bottom of page 73.

1	2	3	4	5	6	7	8	9	10	11	12	13	14
Manufacturer	Model	Type	Screen size (sq. in.)	Number of channels	AM-FM-SW	Record player	Number of tubes	Number of controls	Size and type speaker	Direct-view or projection	Type of high-voltage supply	Type of FM detector	FM image wave traps
Admiral Corp., 3800 Cortland St., Chicago 47, Ill.	8C11	C	55	All	AM-FM	Yes	29	8	10 PM	D	FB		Yes
	19A11	T		All	No	No	19	3	6	D	FB	RD	No
	30A14	C	55	All	No	No	29	8	6 PM	D	FB		Yes
Air King Products Co., Inc., 170 53rd St., Brooklyn 32, N. Y.	1000	T	52	All	No	No	30	7	5 ED	D	FB	Dis	Yes
Andrea Radio Corp., 27-01 Bridge Plaza N., Long Island City, N. Y.	CO-VJ12-2	C		All	AM-FM	Yes		8	10 ED	D	RF	RD	No
	CO-VJ15	C	123	All	AM-FM	Yes	31	8	12 ED	D	RF	RD	No
	T-VK12	T		All	AM-FM	No	29	8	8 PM	D	FB	RD	No
Ansley Radio & Television, Inc., 41 St. Joes Ave., Trenton, N. J.	Beacon	T	52	All	No	No	30	7	6 PM	D	FB	RD	Yes
	Bellevue	C	77	All	AM-FM	Yes	6	6	12 PM	D	FB	RD	Yes
	Gainsborough	C	120	All	AM-FM	Yes	43	7	12 CA	D	FB	Dis	Yes
	Salisbury	C	77	All	AM-FM	Yes	40	6	12 PM	D	FB	RD	Yes
Somerset		C	77	All	AM-FM	Yes	41	6	12 PM	D	FB	RD	Yes
		C											
Atlas Radio & Television, Inc., 726 East 151 St., Bronx, N. Y.	100	T	26	All	No	No	21	5	5 PM	D	TR		Yes
	200	T	52	All	No	No	30	4	5 ED	D	FB	Dis	Yes
Automatic Radio Mfg. Co., 122 Brookline Ave., Boston 15, Mass.	T700	T		All			22	6	5	D	RF	RD	No
	T1000	T		All	No		30	7	5	D	FB	Dis	Yes
Bace Television Corp., Green and Leuning Sts., So. Hackensack, N. J.	150	L	136	All	No	No	35	3	8 PM	D	FB	Dis	Yes
Belmont Radio Corp., 5921 W. Dickens Ave., Chicago, Ill.	7DX21	T	23	All	No	No	17	5	4½ PM	D	RF	RD	No
	10DX22	C	52	All	No	No	24	5	5½ PM	D	RF	RD	No
	18DX21	T	23	All	No	No	18	5	4 PM	D	RF	Dis	
Bendix Radio, Division of Bendix Aviation Corp., Baltimore 4, Md.	235M1	T	52	All	No	No	23	4	4x6 PM	D	FB		No
	325M8	C	52	All	AM-FM	Yes	32	4	12	D	FB		No
Cortley Television Co., 15 W. 27th St., New York	720A	L	695½	All	FM	No	36	4	5	F	RF	Dis	Yes
Crosley Division, Avco Mfg. Corp., 1329 Arlington St., Cincinnati 25, Ohio	348 CP	C		All	All	Yes	26	9	10 PM	D	RF	Dis	Yes
	9-407M	T	75	All	FM	No	27	6	6 PM	D	FB	Dis	No
	9-408	T	54	All	No	No	30	4	5x7 PM	D	FB	Dis	Yes
DeWald Radio Mfg. Corp., 35-15 37th Ave., Long Island City, N. Y.	BT-100	T	55	All	No		31	6	7 ED	D	FB		Yes
	BT-101	T	142	All	No		31	6	12 ED	D	FB		Yes
	CT-101	C	145	All	No	No	30	5	8	D	FB	Dis	Yes
	CT-102	T	55	All	No	No	22	5	6½	D	FB	Dis	Yes
	CT-103	T	55	All	No	No	22	5	6½	D	FB	Dis	Yes
	CT-104	C	75	All	No	No	22	5	6½	D	FB	Dis	Yes
Du Mont Laboratories, Allen B., 2 Main Ave., Passaic, N. J.	Chatham	T	72	All	FM	No	27	6	6 PM	D	FB	Dis	No
	Club "20"	C	213	All	FM	No	34			D		Dis	No
	Colony	C	116	All	AM-FM	Yes	37		12	D		Dis	No
	Custom	CM	223	All	All	No	39	10	12 PM	D	RF	Dis	No
	Meadowbrook	C	72	All	FM	No	27			D		Dis	No
	Savoy	C	72	All	AM-FM	Yes	33	6	10 PM	D	FB	Dis	No
	Sherwood	C	121	All	All	Yes	39	10	12 PM	D	FB	Dis	No
	Stratford	T	116	All	FM	No	33	7	6 PM	D	RF	Dis	No
	Sutton	C	72	All	FM	No	27	6	10 PM	D	FB	Dis	No
	Westbury	C	116	All	FM	No	33	7	12 PM	D	FB	Dis	No
	Westminster	C	213	All	All	Yes	43	10	15 PM	D	RF	Dis	No
	Whitehall	C	116	All	FM	No	33	7	12	D			No
	Winthrop	C	72	All	AM-FM	Yes	33		10	D			No
Electro-Technical Industries, 1432 N. Broad St., Philadelphia 21, Pa.	7-A Telekit	K	25	All	FM	No	19	5	5 PM	D	RF	Dis	No
	10-A Telekit	K	25	All	FM	No	19	5	5 PM	D	FB	Dis	No
Emerson Radio & Phonograph Corp., 111 8th Ave., New York, N. Y.	571	T	52	All	No	No	28	7	4x6 PM	D	FB		Yes
	585	C	55	All	AM-FM	Yes	36	4	12 PM	D	FB	Dis	Yes
	606	C	52	All	No	No	28	4	12 PM	D	FB	Dis	No

1	2	3	4	5	6	7	8	9	10	11	12	13	14	
Emerson Radio and Phonograph Co. (continued)	608		132	All	No	No	28	4	12 PM	D	FB	Dis	No	
	609		192	All	No	No	30	4	12 PM	P	FB	Dis	No	
	611		52	All	No	No	28	4	6	D	FB	Dis	No	
	612		52	All	No	No	28	4	6	D	FB	Dis	No	
	617		52	All	AM-FM	Yes	37	4	12 PM	D	FB	Dis	No	
Espey Mfg. Co., 528 E. 72nd St., New York 21, N. Y.	TV3K	K		6	No	No	19	7	8	D			No	
Fada Radio & Electric Co., 525 Main St., Belleville, N. J.	799, 899 880	T C	54 192	All All	No No	No No	30 36	7	5x7 PM	D	FB	Dis	Yes	
Farnsworth Television & Radio Corp., 3700 E. Pontiac St., Fort Wayne 1, Ind.	461P	C	72	All	No	No	37	8	12 PM	D	FB	Dis	Yes	
	501P	C	72	All	AM-FM	Yes	37	8	12 PM	D	FB	Dis	Yes	
	502P	C	72	All	AM-FM	Yes	37	8	12 PM	D	FB	Dis	Yes	
	504P	C	72	All	AM-FM	Yes	37	8	12 PM	D	FB	Dis	Yes	
	651	T	52	All	No	No	29	9	6x9	D	FB	Dis	Yes	
	661P	C	52	All	No	No	29	9	12 PM	D	FB	Dis	Yes	
Federal Television Corp., 210 E. 9th St., New York 3, N. Y.	F-3012	T		All	No		30	6	10 PM	D	FB		Yes	
	F-3015	CM		All	No		30	6	10 PM	D	FB		Yes	
	PRO-3005	L	11, 520	All	No		36	5	2 12 PM	P	RF		Yes	
Freed Radio Corp., 200 Hudson St., New York 13, N. Y.	200 TV	C	74	All	AM-FM	Yes	31	3	5 & 12	D	FB	Dis	Yes	
	201 TV	C	135	All	AM-FM	Yes	31	3	5 & 12	D	FB	Dis	Yes	
Garod Radio Corp., 70 Washington St., Brooklyn 1, N. Y.	10TZ1, 10TZ2	T	64	All	AM-FM	No	28	10	6 PM	D	FB	Dis	Yes	
	10TZ3	C	64	All	AM-FM	Yes	28	10	10 PM	D	FB	Dis	Yes	
	10TZ4, 10TZ5	C	64	All	AM-FM	Yes	28	10	10 PM	D	FB	Dis	Yes	
	12TZ1, 12TZ2	T	95	All	AM-FM	No	28	10	6 PM	D	FB	Dis	Yes	
	12TZ3	C	95	All	AM-FM	Yes	28	10	10 PM	D	FB	Dis	Yes	
	12TZ4, 12TZ5	C	95	All	AM-FM	Yes	28	10	10 PM	D	FB	Dis	Yes	
	12TZ6, 12TZ7	C	95	All	AM-FM	Yes	28	10	2 10 PM	D	FB	Dis	Yes	
	15TZ6, 15TZ7	C	154	All	AM-FM	Yes	32	10	2 10 PM	D	FB	Dis	Yes	
	General Electric Co., Electronics Park, Syracuse, N. Y.	802-D	C	52	All	AM-FM	Yes	25	7	12 PM	D	FB	Dis	Yes
		810	T	52	All	No	No	21	8	5 PM	D	FB	Dis	Yes
811		C	52	All	No	No	22	8	8 PM	D	FB	Dis	Yes	
814		T	70	All	No	No	22	8	4x6 PM	D	FB	Dis	Yes	
820		C	70	All	AM-FM	Yes	29	13	12 PM	D	FB	Dis	Yes	
840		C	70	All	All	Yes	37	14	12 PM	D	FB	Dis	Yes	
901		C	432	All	All	Yes	42	6	2 10 PM	P	FB	Dis	Yes	
910		L		All	All	Yes	42	6	2 10 PM	P	FB	Dis	Yes	
Hallicrafters Co., 4401 W. 5th Ave., Chicago 24, Ill.		505 and T54	T	23	All	No	No	22	7	5x7 PM	D	RF		No
	T61 and T67	T	52.5	All	No	No	23	7	6 ED	D	FB		No	
	509		64	All	No	No	19	9						
	T60 and T68	C	192	All	No	No	25	7	8	P				
Hoffman Radio Corp., 3761 So. Hill St., Los Angeles 7, Calif.	CT800	C	52	All	No	No	29	7	12	D	FB		Yes	
	CT801	C	52	All	No	No	30	6	12 PM	D	FB	Dis	Yes	
	CT802	C	52	All	No	No	30	6	12 PM	D	FB	Dis	Yes	
	CT900	C	72	All	AM-FM	Yes	39	6	12 PM	D	FB	Dis	Yes	
	CT901	C	72	All	AM-FM	Yes	39	6	12 PM	D	FB	Dis	Yes	
Howard Radio Co., 1735 Belmont Ave., Chicago 13, Ill.	481-475 TV	C	52	All	All	Yes	29	6		D	FB	RD	No	
Industrial Television, Inc., 359 Lexington Ave., Clifton, N. J.	321	C	72	All	No	No		3	12 EM		FB	RD	No	
	621	T	54	All	No	No		3	5 EM		FB	RD	No	
	226	C	140	All	AM-FM	Yes	42	6	12 PM	D	FB	Dis	Yes	
	IT-11R	L		All	FM	No	34	5	12 PM	D	FB	Dis	No	
	IT-13R Essex-20	L	234	All	FM	No	37	5	12 PM	D	FB	Dis	No	
International Television Corp., 745 Fifth Ave., New York, N. Y.	C-15	L		All	AM-FM	No	32	4	10	D	FB	Dis	Yes	
	C-36	L	972	All	AM-FM	No	44	4	2 12 ED	P	RF	Dis	Yes	
	D-10	T		All	No	No	32	4	8	D	FB	Dis	Yes	
	D-12	T		All	No	No	32	4	8	D	FB	Dis	Yes	
	D-15	C		All	All	Yes	32	4	10 & 12 ED	D	FB	Dis	Yes	
	DP-24	C	432	All	All	Yes	44	4	12	P	RF	Dis	Yes	
	S-7	T		All	No	No	16	5	4x6	D	FB		Yes	
	S-10	T		All	No	No	16	5	4x6	D	FB		Yes	
Magnavox Co., Fort Wayne 4, Ind.	10-inch models		58	All	AM-FM	on	23	7 or	Various,	D	FB	X	Yes	
	12-inch models		72	All	AM-FM	on some models	more	up to 15 in.				X		
Mars Television, Inc., 29-05 40th Rd., Long Island City, N. Y.	Baldwin	T	80	All	No	No	30	4	6	D	FB	Dis	Yes	
	Dartmouth	C	130	All	AM-FM	Yes	43	10	12	D	FB	X	Yes	
	Oxford	T	130	All	No	No	30	4	6	D	FB	Dis	Yes	
Meck Industries, John, Inc., Plymouth, Ind.	XA-701		42	All	No	No	21	6	5	D	RF		No	
Motorola, Inc., 4545 W. Augusta Blvd., Chicago 51, Ill.	VF103	C	54	All	AM-FM	Yes	25	6	10	D	FB	RD	No	
	VT71	T	26	8	No	No	17	3	6 PM	D	RF	RD	No	
	VT73	B	26	All	No	No	16	4	6 1/2 PM	D	RF	RD	Yes	
	VT105	T	54	All	No	No	20	4	6	D	FB		No	
	VT121	T	75	All	No	No	22	8	8 ED	D	FB	RD	Yes	
	VK106	C	54	All	No	No	22	4	8	D	FB		No	
Multiple Television Mfg. Co., 987 Hegeman Ave., Brooklyn 8, N. Y.	M 1250		90	All	No	No	30	8	6 PM	D	FB	Dis	Yes	
	M 1500	L	130	All	No	No	30	8	6 PM	D	FB	Dis	Yes	
	M 2000	L	225	All	No	No	31	8	2 6 PM	D	FB	Dis	Yes	
Muntz TV, Inc., 1136 No. Highland, Los Angeles 38, Calif.	M-12	T	65	All	No	No	21	3	5 PM	D	FB	RD	No	
	M-13	T	65	All	No	No	21	3	8 PM	D	FB	RD	No	
	M-14	C	65	All	AM-FM	Yes	21	3	8 PM	D	FB	RD	No	

National Co., Inc., 61 Sherman Street, Malden 48, Mass.	NC-TV-7	T	24	10	No	No	18	6	2 4x6	D	RF	RD	No
	NC-TV-10	T	54	10	No	No	17	8	2 4x6	D	FB	RD	No
	NC-TV-10	C	54	10	No	No	17	8	12 PM	D	FB	RD	No
New England Television Co., 544 E. 6th St., New York 9, N. Y.	Custom	C	130	All	All	Yes	35	5	12 PM	D	FB	Dis	Yes
Nielsen Television Corp., Newtown Ave., Norwalk, Conn.	1018-A	C	65	All	No	No	30	7	12 ED	D	FB		Yes
	1019-TRP	C	65	All	AM-FM	Yes	38	7	12 ED	D	FB		Yes
Olympic Radio & Television, Inc., 34-01 38th Ave., Long Island City, N. Y.	TV922	T	54	All	No	No	22	7	4x6 PM	D	FB	Dis	Yes
	TV928	C	54	All	AM-FM	Yes	31	11	8 PM	M	FB	X	Yes
	TV928LP	C	54	All	AM-FM	Yes	31	11	8 PM	M	FB	X	Yes
	RTU-3 Duplicator	T	52	All	No	No	12	2	5 PM	D	FB		
Packard-Bell Co., Inc., 1320 S. Grand Ave., Los Angeles 54, Calif.	1291TV	C	52	All	AM-FM	Yes	41	5	12 PM	D	FB	RD	Yes
	3381TV	C	52	All	FM	No	33	6	6½ PM	D	FB	RD	No
	4580TV	C	75	All	AM-FM	Yes	49	5	2 6 PM 1 12 ED	D	FB	Dis	Yes
Philco Corp., Tioga & C Sts., Philadelphia 34, Pa.	1002	T	52	8	No	No	24	6	5 PM	D	FB	RD	No
	1040	C	52	8	No	No	25	6	5 PM	D	FB	RD	No
	1076	C	52	8	AM-FM	Yes	34	6	10 PM	D	FB	RD	No
	1240	C	75	8	No	No	26	6	5 PM	D	FB	RD	No
	1278	C	75	8	AM-FM	Yes	35	6	10 PM	D	FB	RD	No
	2500	C	300	8	No	No	29	5	10 PM	D	FB	RD	No
Pilot Radio Corp., 37-06 36th St., Long Island City 1, N. Y.	TV-37	T	6	All	No	No	21	5	4 ED	D	RF	RD	No
	TV-42	C	192	All	No	No	35	5	12 ED	P	AF	RD	Yes
	TV-952	C	192	All	AM-FM	Yes	46	5	12 ED	P	AF	RD	Yes
Radio Corp. of America, RCA Victor Division, Camden, N. J.	8-PCS-41	C	300	All	No	No	34	7	12 PM	P	FB	Dis	No
	8-T-241	T	52	All	No	No	22	7	5x7 PM	D	FB	Dis	No
	8-T-243	T	52	All	No	No	22	7	5x7 PM	D	FB	Dis	No
	8-T-244	T	52	All	No	No	22	7	5x7 PM	D	FB	Dis	No
	8-TV-321	C	52	All	AM-FM	Yes	29	9	12 PM	D	FB	Dis	No
	8-TV-323	C	52	All	AM-FM	Yes	29	9	12 PM	D	FB	Dis	No
	648-PV	C	300	All	All	Yes	41	12	12 PM	P	FB	Dis	No
	741-PCS 8T270	L T	300 126	All All	No No	No No	34 26	7	12 PM	P P	FB FB	Dis Dis	No No
Regal Electric Corp., 603 W. 130th St., New York	TV-1030	T	54	All	FM	No	30	4	5x7 PM	D	FB	Dis	Yes
Remington Radio Corp., 80 Main St., White Plains, N. Y.	80	C	72	8	FM	No	26	7	8 PM	D	FB	RD	No
	130	C	121	All	FM	No	26	7	8 PM	D	FB	RD	No
	1606	C	72	All	AM-FM	Yes	35	6	10 PM	D	FB	Dis	No
	1669	C	72	All	AM-FM	Yes	35	6	10 PM	D	FB	Dis	No
	1950	T	72	All	FM	No	25	6	8 PM	D	FB	RD	No
Remler Co., Ltd., 2101 Bryant St., San Francisco 10, Calif.	7150	C	57	All	All	Yes		7		D	FB		Yes
Scott Radio Laboratories, Inc., 4541 Ravenswood Ave., Chicago 40, Ill.	6T11	T	192	All	No	No	34	6		P			No
	300	C	52	All	No	No	30	5	12 PM	D	FB	Dis	No
	400-B	C	192	All	No	No	34	5	10 PM	P	FB	Dis	No
	800-BT	C	192	All	All	Yes	58	5	15 PM	P	FB	Dis	No
Sentinel Radio Corp., 2100 Dempster St., Evanston, Ill.	400 TV	B	26	All	No	No	20	4	5	D	RF	RD	No
	402 CVM	C	52	All	No	No	22	4	8	D	FB	RD	No
	405 TV	T	26	All	No	No	20	4	5	D	RF	RD	No
Shevers, Harold, Inc., 33 W. 46th St., New York 19, N. Y.	930T	CM	52	11	No	No	30	4	5 ED	D	RF	RD	No
Sightmaster Corp., 385 North Ave., New Rochelle, N. Y.	10	T	85	All	AM		24	4	9	M	FB	RD	No
	10-S-1	T	52	All	AM			5	6x9	D	FB	RD	No
	10-SL-2	T	120	All	No	No	25	4	10	D	FB	RD	No
	12-S-1			All	AM			5	4x6 PM	D	FB	RD	No
	12-S-4	T	80	All	No	No	25	4	10	D	FB	RD	No
	12-S-5	T	80	All	No	No	25	4	10	D	FB	RD	No
	12-S-6	CM	80	All	No	No	25	4	10	D	FB	RD	No
	15-S-1	T	130	All	AM	No		5	4x6 PM	D	FB	RD	No
	15-S-3	T	130	All	FM	No	25	4	10	D	FB	RD	No
	15-S-4	CM	130	All	No	No	25	4	10	D	FB	RD	No
	Americana	T	120	All	AM-SW	No	26	4	PM		FB	RD	No
	Sonora Radio & Television Corp., 925 N. Hoyne Ave., Chicago 12, Ill.	700A	T	54	All	No	No		7	PM	D	FB	RD
Sparks-Withington Co., Jackson, Mich.	Sparton 4900TV	C	72	All	AM-FM	Yes	28	5	10	M	RF	RD	Yes
	Sparton 4940TV	C	52	All	No	No	28	5	10	M	RF	RD	Yes
Starrett Television Mfg. Corp., 601 W. 26th St., New York	300 series	C	52	All	No	No	21	5	5 PM	D	FB	Dis	Yes
	800 series	C	78	All	AM-FM	Yes	29	8	12 ED	D	FB	Dis	Yes
	1510	C	118	All	AM-FM	Yes	42	8	12 ED	D	RF	Dis	Yes
Stewart-Warner Corp., 1826 Diversy Parkway, Chicago 14, Ill.	AVC-1	C	58	All	No	No	23	5	6x9	M	RF	RD	No
	AVC-2	C	58	All	No	No	23	5	6x9	M	RF	RD	No
	AVT-1	T	58	All	No	No	23	5	5	D	RF	RD	No
Stromberg-Carlson Co., 100 Carlson Rd., Rochester, N. Y.	TS 10 H	T	52	All	FM	No	28	6	8	D	FB	Dis	No
	TV 12 H	T	75	All	FM	No	26	6	6 PM	D	FB	Dis	No
	TV 12 L	C	75	All	FM	No	26	6	12 PM	D	FB	Dis	No
	TV 12 L2M	C	52	All	FM	No	28	5	12 PM	D	FB	Dis	No
	TV 12 M5M	C	75	All	All	Yes	26	6	12 PM	D	FB	Dis	No
	TV 12 PM	C	72	All	All	Yes	33	5	12 PM	D	FB	Dis	No
Tech-Master Products Co., 443 Broadway, New York	630-TK	K	52	All	No	No	30	7	5 ED	D	FB	Dis	No
	630-WC	W	52	All	No	No	30	7	5 ED	D	FB	Dis	No
	Videola	T	52	All	No	No	30	7	5 ED	D	FB	Dis	No

			1	5	6	7	8	9	10	11	12	13	14
Tele King Corp., 601 W. 26th St., New York 1, N. Y.	210W	T	60	All	No	No	30	8	5 ED	D	FB	Dis	No
	212	T	75	All	No	No	23	8	8 PM	D	FB	Dis	No
	310W	C	60	All	No	No	30	8	5 ED	D	FB	Dis	No
	BM100	T	120	All	No	No	23	8	8 PM	D	FB	Dis	No
Telesonic Corp. of America, 212 Concord St., Brooklyn, N. Y.	661T-23-10	T		7	FM	No	23	4			FB		No
	661T-23-12	T		7	FM	No	23	4			FB		No
Teletone Radio Corp., 540 W. 58th St., New York	TV-149	T		All	No	No	22	4	4 PM	D	RF	RD	No
	TV-170	T	24	All	No	No	23	7	6 PM	D	RF	RD	No
	TV-239	T		All	No	No	20	4	6x8	D	FB	RD	No
	TV-279	C	52	All	No	No	21	7	8 PM	D	FB	RD	No
Television Assembly Co., 540 Bushwick Ave., Brooklyn 6, N. Y.	F101C	K	52	All	FM	No	30	5	12 PM	D	RF	Dis	No
	F101S	K	52	All	No	No	30	5	12 PM	D	RF	Dis	No
	F121C	T	75	All	FM	No	29	5	5x7 PM	D	FB	Dis	No
	F121S	T	75	All	No	No	29	5	5x7 PM	D	FB	Dis	No
	F151C	T	120	All	FM	No	29	5	5x7 PM	D	FB	Dis	No
	F151S	T	120	All	No	No	29	5	5x7 PM	D	FB	Dis	No
	M101C	K	52	All	FM	No	29	5	12 PM	D	RF	Dis	No
	M101S	K	52	All	No	No	29	5	12 PM	D	RF	Dis	No
	P-520-W Snaider Auditorium	L C	520 520	All All	FM FM	No No	37 36	6 6	12 PM 12 PM	P P	FB FB	Dis Dis	No No
Television Development Labs, Inc., 252 W. 64th St., New York 23, N. Y.	820A	T	52	7	No	No	21	7	7 PM	D	RF		No
Televista Corp. of America, 114 E. 16th St., New York 3, N. Y.	M-101	W	52	All	No	No	30	8	Various up to 15 in.	D	FB		Yes
	M-101A	W	72	All	AM-FM	No	33	10		D	FB	Dis	Yes
	Monte Carlo	L	121	All	No	No	30	8	6 ED	D	FB		Yes
Televue Corp. of America, 339 Laurel Ave., Lakewood, N. J.	Dual 15	L	121	All	FM		38	7	12	D	FB		No
	Theatre	C	130	All	AM-FM	Yes	46	7	2-12	D	FB		No
TELvision Laboratories, Inc., 542 N. Parkside Ave., Chicago 44, Ill.	TR 7-1	T	25	5		No	21	6	5 PM	D	RF	Dis	Yes
	TR 10-1	T	52	5	No	No	21	6	5 PM	D	RF	Dis	Yes
Tradio, Inc., 1001 First Ave., Asbury Park, N. J.	Tradio-Vision No. 9	L	24	All	No	No	38	4	12 ED	P	FB		Yes
Transvision, Inc., 460 North Ave., New Rochelle, N. Y.	AA, AG	K	75	All	No	No	22	4	6x9 PM	D	FB	RD	No
	AB, AH	K	150	All	AM-FM	No	24	6	6x9 PM	D	FB	RD	No
	AC, AJ, AK	K	150	All	No	No	23	4	6x9 PM	D	FB	RD	No
			52	All	No	No	23	4	6x9 PM	D	FB	RD	No
United States Television Mfg. Corp., 3 W. 61st St., New York 23, N. Y.	CFM-12823P	C	75	All	No	No	21	6	12 PM	D	FB		Yes
	CFM-15925P	C	121	All	No	No	23	6	12 PM	D	FB		Yes
	KRV-12836	C	121	All	AM-FM	Yes	36	5	6 & 12 PM	D	FB	Dis	No
	KRV-15836	C	121	All	AM-FM	Yes	36	5	6 & 12 PM	D	FB	Dis	No
	T3X 4836	L	20,- 200	All	No	No	8	12		P	RF	Dis	Yes
	T-525-PIC	L			All	No	32	6	12	P	RF	Dis	Yes
	T-530	L	675		All	No	32	6	12	P	RF	Dis	Yes
	T-621	C	355		All	Yes	32	6	12	P	RF	Dis	Yes
	T-10823P	T	63	All	No	No	23	4	5x7 ED	D	FB	Dis	No
	T-12823P	T		All	No	No	23	4	12 PM	D	FB	Dis	No
	T-15823P	T	121	All	No	No	23	4	6 PM	D	FB	Dis	No
Vidcraft Television Corp., 780 E. 137th St., Bronx, N. Y.	Add-A-Vision AV101	T	52		No	No	11	2	4x6	D	FB		No
	Add-A-Vision AV151	T	130		No	No	11	2	4x6	D	FB		No
	Raymond	C	59	All	No	No	23	7	4x6	D	FB	Dis	Yes
	Stewart	C	130	All	No	No	23	7	4x6	D	FB	Dis	Yes
Video Corp. of America, 385 Flatbush Ave. Ext., Brooklyn 1, N. Y.	1203	T	80	All	AM-FM	No	33	7	8 PM	D	FB	Dis	No
	1212	C	80	All	AM-FM	Yes	33	7	8 PM	D	FB	Dis	No
	1505	L	130	All	FM	No	29	5	8 PM	D	FB		No
	1510	C	130	All	AM-FM	Yes	33	7	8 PM	D	FB		No
	VS-75	T	26	All	No	No	23	7	5 PM	D	RF	RD	No
	VS-105	T	52	All	No	No	20	7	4x6 EM	D	FB	RD	Yes
	VS-120	T	80	All	No	No	20	7	4x6 EM	D	FB	RD	Yes
Videodyne, Inc., 33 Jefferson St., Stamford, Conn.	10FM	T	58	All	FM	No	26	3	4x6	D	FB	Dis	No
	10TV	T	58	All	FM	No	26	3	4x6	D	FB	Dis	No
	12FM	T	72	All	FM	No	26	3	4x6	D	FB	Dis	No
	12TV	T	72	All	FM	No	26	3	4x6	D	FB	Dis	No
	Consolette	C	52	All	No	No	19	4	10	D	FB	RD	Yes
	Consolette	C	75	All	No	No	19	4	10	D	FB	RD	Yes
Westinghouse Electric Corp., 1354 Susquehanna Ave., Sunbury, Pa.	H-181	C	52	8	No	No	27	5	6 PM	D	FB	RD	No
	H-196	T	52	All	No	No	27	8	6 ED	D	FB	RD	No
	H-207	C	52	All	AM-FM	Yes	35	12	10 ED	D	FB	RD	No
	H-217 H-223	C	72	All	AM-FM	Yes	38	12	2 10 PM	D	FB	RD	No
			52	All	No	No	23	7	6 PM	D	RF	RD	No
Zenith Radio Corp., 6001 Dickens Ave., Chicago 39, Ill.	28T-926	T	79	All	No	No	28	7	5 1/2 PM	D	FB	Dis	Yes
	28T-960	C	113	All	No	No	28	7	10 PM	D	FB	Dis	Yes

SYMBOLS

- B—Portable
- C—Console model
- CA—Co-axial
- CM—Custom built
- D—Direct-view
- Dis—Discriminator
- ED—Electrodynamic
- FB—Flyback
- K—Kit
- L—Large commercial
- M—Mirror-reflected-view
- P—Projection
- PM—Permanent-magnet
- RD—Ratio detector
- T—Table model
- W—Wired chassis
- X—Discriminator on TV Ratio Detector for FM
- Speaker size given in inches.

A t o m s

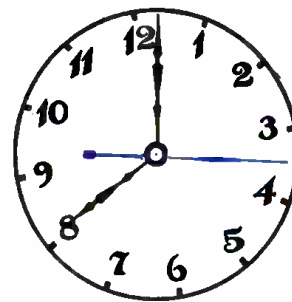
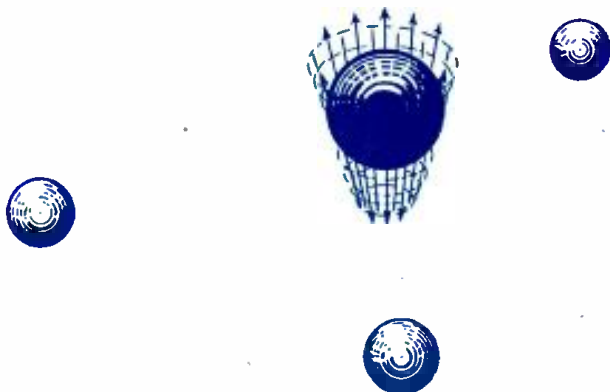

Run Clocks

A NEW and fundamental frequency standard based on the atom promises as great an advance in measurement and control of radio frequencies as took place with the introduction of the crystal oscillator. Developed by the Bureau of Standards, it has been publicized widely as a measurer of time, an "atom clock." Radiomen will be more interested in it as a frequency control and standard. The difference is merely one of viewpoint—a clock is a counter of the number of swings of some oscillating object, and a frequency control

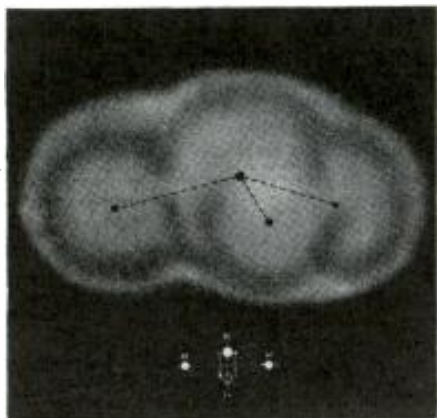

Fig. 1—R.f. alters nitrogen atom's position.

is simply a means of assuring that a given number of oscillations will take place in a given time.

The present time and frequency standards are based on the period of the earth's rotation. However, the earth is slowing down very gradually because of tidal friction in shallow seas. In addition, there are irregular variations—some of them rather sudden—in the period of rotation, the reasons for which are unknown. These two causes are responsible for changes in mean solar time and therefore in the frequency of any periodic or vibrating systems measured in terms of such time standards.

In recent years, vibrations of atoms

in molecules have been found in the microwave region of the radio spectrum. It is possible to make very precise measurements of these lines by radio methods, using all-electronic equipment of unprecedented sensitivity and resolution. Scientists of the National Bureau of Standards began seeking a means of utilizing some of these vibrations to control an oscillator which in turn could be used to drive a clock. The atomic clock was the result. Controlled by the invariable molecular system of ammonia gas, it is independent of astronomical determinations of time.

The ammonia molecule consists of three atoms of hydrogen and one of nitrogen, with the nitrogen atom slightly above the plane of the hydrogen atoms (Fig. 1). Outside forces (such as radio waves) can make the nitrogen atom change its position as shown in the figure, so that instead of being a flattened pyramid pointing upward (for instance), it becomes one pointing downward. A radio wave at the natural oscillating frequency of the nitrogen atom will cause large numbers of atoms to change their positions or oscillate back and forth, drawing power from the wave as they do. Thus ammonia gas absorbs power from a radio wave at its own frequency, and does not absorb power from nearby frequencies (Fig. 2). The gas molecule thus gives an exact frequency indication.

To use the absorption frequency to regulate a clock, it is necessary to compare it with another signal—in the case of the Bureau of Standards, the crystal signal from a standard crystal-controlled clock. A frequency-modulated signal sweeps across the absorption frequency of the cell, developing a pulse at the instant it passes the absorption frequency, and another pulse when it passes the output frequency of the crystal generator. If these two frequencies are exactly the same, the two pulses will occur simultaneously (or may be made to occur with a fixed interval between them). If the frequency of the crystal

generator changes, a circuit similar to that long used in automatic frequency controls develops a voltage which is applied to bring it back to frequency.

The absorption cell itself is a 30-foot section of waveguide (which can be seen wound in a spiral around the clock in the large photograph). A small amount of gas is contained in the tube, at a pressure amounting to partial vacuum.

Frequency-discriminator or servo-mechanism control circuits for atomic clocks might be developed in many different forms. The electronic control circuit in the present atomic clock is one successful form of several being developed by the National Bureau of Standards. Fig. 3 is a block diagram of the complete equipment.

The fundamental-frequency signal is generated by a 100-ke crystal oscillator, and then multiplied up to 270 mc by a frequency-multiplying chain using standard tubes. In the next step, the multiplying chain is continued up to 2,970 mc with a frequency-multiplying klystron, which is also modulated by an FM oscillator generating a signal at 13.8 ± 0.12 mc. This makes the frequency-modulated output of the klystron 2983.8 ± 0.12 mc. After further amplification, the frequency-modulated signal is multiplied in a silicon-crystal rectifier to $23,870.4 \pm 0.96$ mc, and fed to the ammonia absorption cell. As the frequency of this modulated control signal sweeps

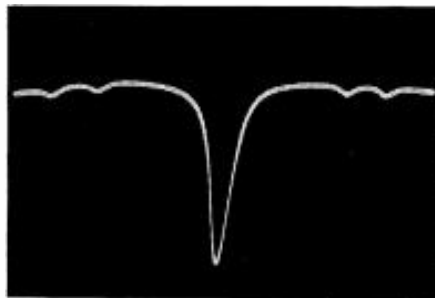

Fig. 2—Ammonia absorbs only one frequency.

A basically new primary frequency and time standard, more accurate than the spinning earth itself, opens new vistas in high-precision radio frequency control and time measurement

across the absorption frequency of the ammonia vapor, the signal reaching the silicon-crystal detector at the end of the absorption cell dips because of the absorption, thus giving a negative output pulse.

A second pulse is generated when the output of the frequency-modulated oscillator at 13.8 ± 0.12 mc is fed to a mixer (or radio receiver) into which is also fed a 12.5-mc signal from the crystal multiplying chain. When the signal sweeps across the frequency to be tuned in (12.5 mc plus the 1.39-mc intermediate frequency of the receiver, or 13.89 mc), an output pulse is generated.

The time interval between these two pulses—that from the absorption cell, caused by the absorption line, and that from the receiver or mixer—is a measure of the degree to which the frequency-multiplying chain is tuned to the absorption line. The two pulses can therefore be made to control a discriminator circuit (Fig. 4) which will give zero output when the time interval is right (that is, when the circuit is tuned to the absorption line) and will generate a control signal when the time interval is wrong. If the crystal oscillator drifts in frequency to higher values, the time interval between the two pulses increases; for frequencies which are too low, the interval decreases.

The control signals thus generated are fed to a reactance tube, which then forces the crystal circuit to oscillate at the correct frequency to tune to the absorption line. The crystal oscillator is thus *locked* to the ammonia line. Frequency dividers then divide the precise 100-kc signal down to 50 cycles to drive an ordinary synchronous-motor clock, and also to 1,000 cycles to drive a special synchronous-motor clock designed for exact adjustment and comparison with astronomical time to within .005 second.

Control of the crystal circuit depends on the relative duration of the positive and negative portions of a square-wave signal generated by the discriminator. The two pulses between which the time interval is to be measured turn a trigger circuit or square-wave generator (the two 6AS6's of Fig. 4) on and off in the discriminator. When the time interval is correct, the on-off cycle generates no output signal from the positive and negative peak detectors driven by the square-wave signal. The detectors or rectifiers (the two halves of the output 6AL5) draw current on the positive and negative peaks of the square wave; but, when the positive and negative portions of the square wave are of equal duration, they balance and give no direct-current output. If the time interval between the two input driving

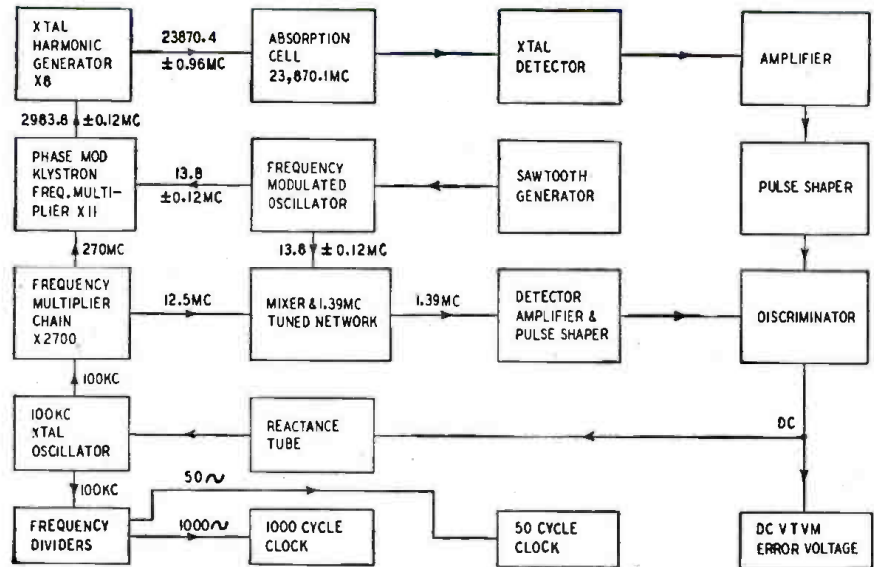
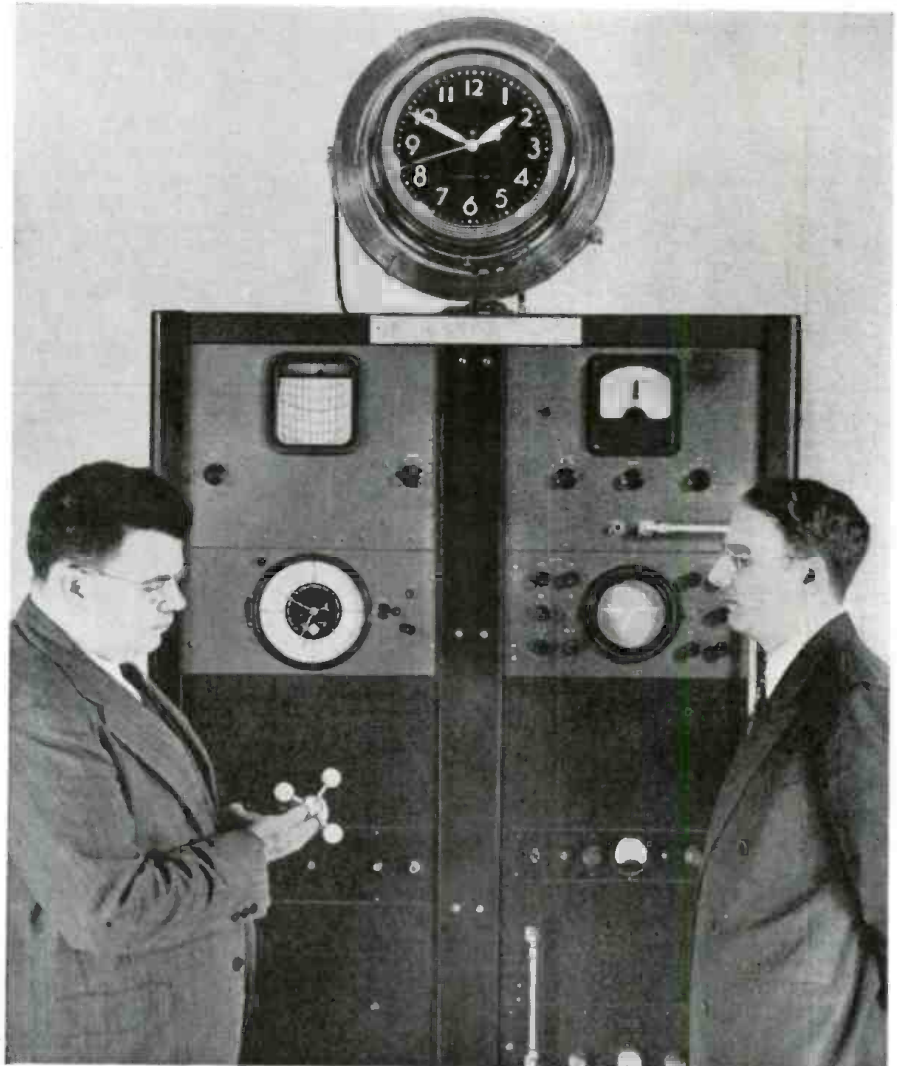

Fig. 3—Slightly simplified block diagram of the National Bureau of Standards atomic clock.



The atomic clock, with Dr. E. U. Condon (left) and its inventor, Dr. Harold Lyons (at right).



A rear view of the atomic time control unit.

pulses gets longer or shorter, the relative duration of the positive and negative parts of the square wave changes so that a resultant direct-current output is generated. This output is positive or negative, depending on the change in the time interval.

Thus, no control voltages is generated when the crystal oscillator is on the proper frequency to agree, through the frequency-multiplying chain, with the ammonia line, but a positive or negative control voltage is produced for correcting the oscillator circuit when it drifts one way or the other from its proper value.

High-frequency transmitters can be controlled by methods similar to that used in the atomic clock. A discriminator or servo circuit locks the transmitter to a spectrum line through a control signal generated by the servo whenever the frequency drifts. It would be better to eliminate the servo or discriminator and develop an atomic oscillator in which the absorption line would directly determine the frequency of the oscillator or transmitter. This would be analogous to a low-frequency crystal oscillator and would make possible many new applications to microwave radio systems.

Dr. Harold Lyons, in recent work at the National Bureau of Standards, has designed circuits of this type for use

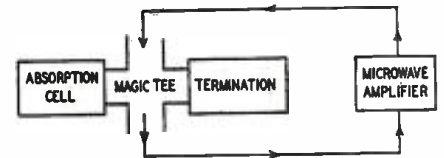
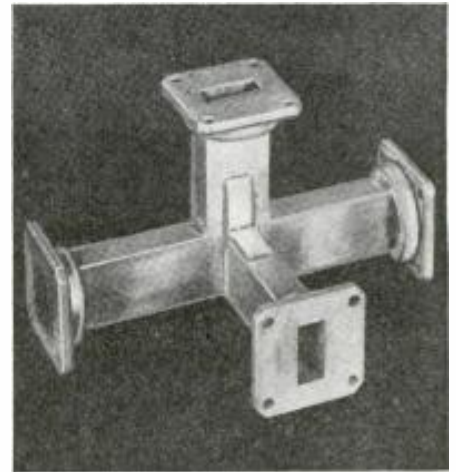

Fig. 5—Magic tee and atom oscillator circuit.

in transmitter control and for making an atomic clock and frequency standard without using discriminator circuits. In this method, the atomic-oscillator frequency is reduced by frequency dividers, but no crystal-driven, frequency-multiplying chain is used, as in the present clock, nor is any servo circuit required. The circuit (Fig. 5) is a feedback oscillator in which feedback is obtained for the amplifier through a magic tee (the waveguide section pictured in Fig. 5) only at the absorption line frequency. The tee is balanced at all other frequencies, but the absorption at the resonance frequency of the line unbalances it and allows the feedback signal to be passed through so that the amplifier oscillates. This circuit requires a microwave amplifier at the frequency of the absorption line. Such 24,000-mc amplifiers have been built, but are not yet commercially available.

It is probably along this line that controls for future u.h.f. equipment will be developed. Oscillating crystals become progressively less practical as frequencies go up, and even in present-day FM and television work have to be operated at a frequency far below that transmitted, their output being increased through a series of multipliers. The absorption line will operate at so high a frequency that the problem will be one of frequency division rather than multiplication. Various gases with different absorption frequencies may be used, and other frequencies obtained from them by successive divisions and remultiplications.

The Bureau of Standards is now investigating the possibilities of using special isotopes with lower natural frequencies. Thus deuterated ammonia, whose hydrogen atoms are heavy hydrogen (deuterium), would resonate near 1,200 instead of 24,000 mc. Other possibilities are still unexplored.

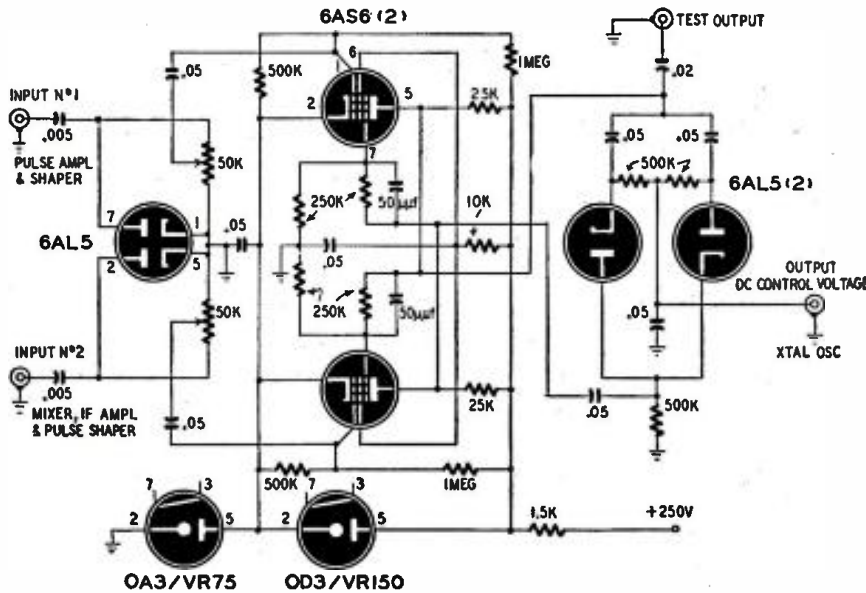
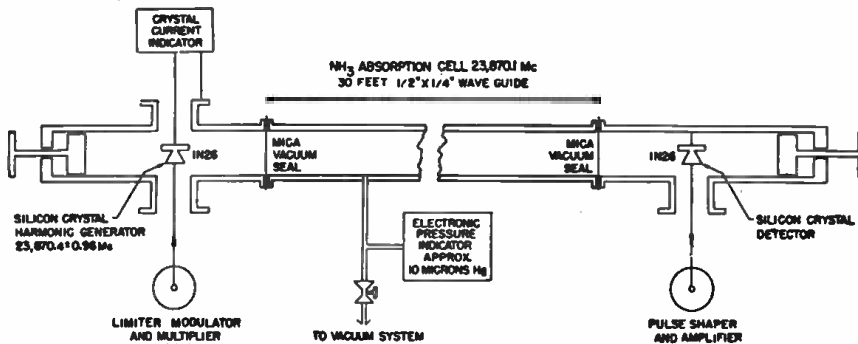

Fig. 4—The square-wave generator and discriminator circuit which supplies the a.f.c. voltage.



Absorption cell, cross-section. Cell is a piece of waveguide coiled round the clock's dial.

Television is Booming—Cash in on it!

The Electronic Brain

By W. R. ASHBY, M.A., M.D.*

TWENTY years ago the idea of building a brain would have been considered fantastic. Mind and matter had been carefully separated by the philosophers who were mostly convinced that any non-living connection was impossible. No mere machine, they said, could produce the remarkable features of the brain. In a sense, of course, they were right. When they thought of a machine they imagined objects like a wheelbarrow, a typewriter, or a steam-engine. They had observed that such machines if controlled, like a typewriter being tapped, were inflexible in action, and if uncontrolled, like a motor car without a driver, were apt to destroy themselves.

But nowadays the word "machine" has a much richer meaning, the position having been transformed by the invention of the electron tube. This device has two main properties: it allows power to be injected freely into a machine, causing high activity, and it provides a means by which one part of a machine can affect the behavior of another part with little back-action. At last those who would build a brain have something comparable in functioning powers with the nerve cell.

The nature of a brain

But even if we are given an abundance of highly active and sensitive devices like nerve cells or tubes we have yet to assemble them into something that makes sense. And what does "make sense" mean in the brain or in a machine? Here wide differences of opinion occur. To some, the critical test of whether a machine is or is not a "brain" would be whether it can or cannot "think." But to the biologist the brain is not a thinking machine, it is an *acting* machine; it gets information and then it does something about it. Like every other organ in the animal body, it is a means to survival.

This last property decides its fundamental mode of construction; it must have certain permanent goals—the essential conditions for its existence—and it must be able to attain them in a variety of circumstances. If one path to the goals is blocked it must find another. If the circumstances change, it must readjust its methods. The brain of an insect has available a few perfected inborn patterns of behavior. It will try them in turn, succeeding if the circumstances are of a standard type.

The brain of a mammal is of more interest to us, for it has a diffuse ability to puzzle out some sort of adaptation to an indefinitely large variety of circumstances. Man is himself the outstanding example of the potentialities inherent in this subtle mechanism.

The ability of the brain to look after itself by correcting all deviations from

Here, for the first time in any American magazine, we present to our readers the complete account of the new epoch-making and thought-provoking electronic brain, developed in England, and featured recently in news dispatches all over the world.

a central, optimal state, and particularly its ability to do so by a variety of methods, being flexible about the route but unchanging in its aim, was usually regarded as quite beyond the powers of any machine, but it has been known since 1940^{1,2} that machines of the more dynamic type can do this quite easily. All that is needed for this goal-seeking flexibility is that the system should have negative feedback. When there is no feedback, as when a door-bell button is pressed and the bell rings, there is neither sense nor nonsense—it does just what its present state of repair or disrepair enforces. But when a radar-controlled anti-aircraft gun receives impulses both from the target plane and from its own shells, and is affected by the distance between the two so that it tends to make the distance between the two zero, then such a system has negative feedback and is "goal-seeking." The important point here is that *the property of being "goal-seeking" is not that of life or mind but of negative feedback*, and any machine, however inanimate, which has negative feedback will show this feature.

Self-organizing machines.

But this does not complete the requirements. Thus, if the gun-radar-plane system had *positive* feedback it would tend to make the distance between shell and plane a maximum and

would therefore seem to be trying to get its shells as far away from the plane as possible. Clearly, the introduction into a system of feedback in general does not solve the problem; for if without feedback the gun will aim anywhere, yet even with the feedback it may either seek the target or it may positively avoid it. What is to ensure that the feedback has the correct sign?

In the gun-radar-plane system the problem is easily settled: the designer carefully arranged the construction so that the feedback was negative. In the brain of an insect, all variations born with wrong feedbacks were eliminated by natural selection ages ago. But in the higher animals the position is different. Large numbers of the feedbacks are left at first undecided, since it is experience and not the inborn (genetic) characters which are to determine the feedbacks. Thus, a cat may have to learn to go towards red meat (negative feedback), but to go away from red embers (positive feedback).

That a kitten's initial feedbacks are rather chaotic is shown by the way in which it may shrink away from a saucer of milk and then run towards a red-hot fire. Yet we know from experience that day by day the kitten's feedbacks change, always improving, and tending to those values, positive and negative, which ensure the animal's survival. The problem of the mammalian brain, then, is that as a machine *it has to work out an essential part of its own wiring.*

The homeostat

Such ability to learn and to adapt by internal re-organization was regarded as a great mystery, but the principles are now better understood.³ To demonstrate them and to show that these principles do, in fact, produce such behavior, a machine has been constructed and has recently been demonstrated.⁴

The homeostat consists of units, four of which are shown in Fig. 1. Each carries on top a suspended magnet, shown in Fig. 2, and the behavior of these four magnets provides the focus of interest.

Each magnet (M in Fig. 3) is affected by currents in the four coils around it, the currents coming partly from the other units (A, B, C) and partly as a self-feedback (D). (The apparently single coil of Fig. 2 is composed of the four coils of Fig. 3). In front of each magnet is a trough of water with electrodes at each end at -2 v and -15 v respectively. The magnet

* Department of Research, Barnwood House, Gloucester, England.

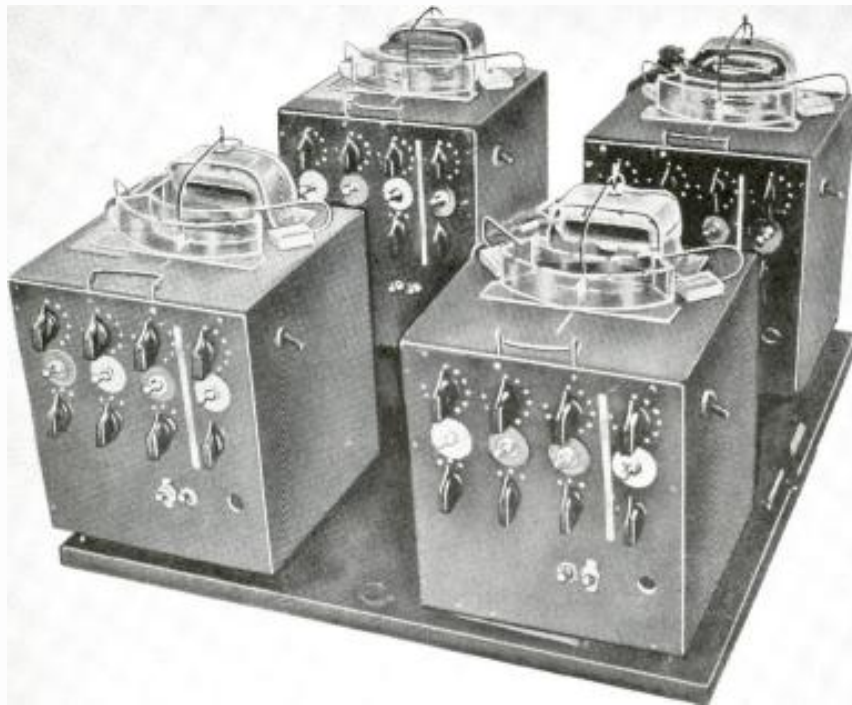

Fig. 1—The homeostat, with its four units, each one of which reacts on all the others.

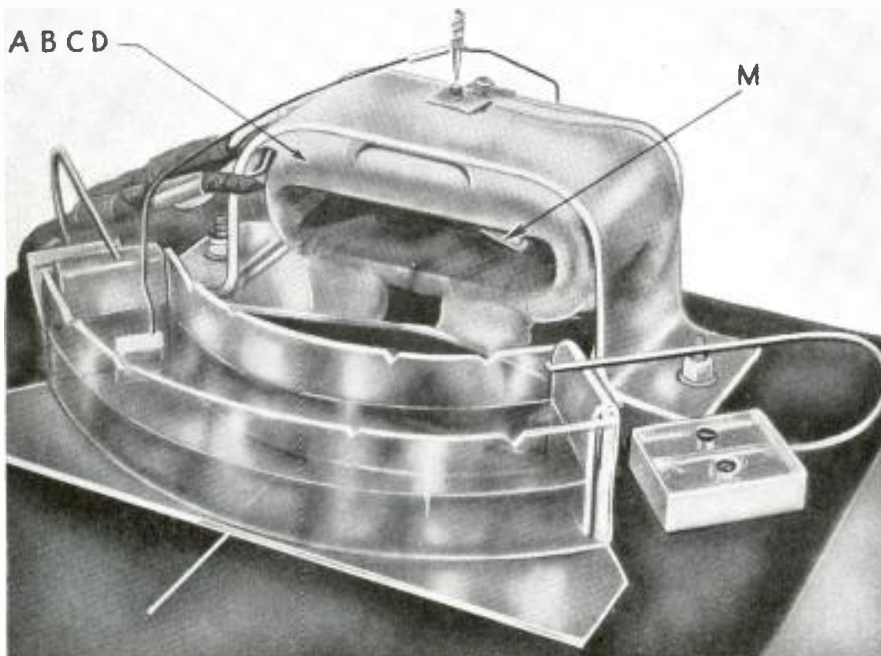

Fig 2—Quadruple coil ABCD encircles magnet M which is suspended by the needle pivot. The suspending wire extends forward on its end into the water in the semicircular plastic trough which has electrodes at each end. Potential for the grid is taken from the pivot socket.

is suspended on a needle pivot by a wire sling which dips into the water and picks up a potential which depends at each moment on the position of the magnet. The potential goes to the grid of a triode and thus controls the d.c. output of the unit. (The resistor E is first adjusted so that when the magnet is central the unit has zero output). This output goes to the other units in series where it becomes one of their inputs.

This arrangement sets all four units into action and reaction on one another. As soon as the system is switched on the magnets are moved by the currents from the other units, but these movements change the currents, which cause fresh movements, and so on.

These actions and reactions can be modified by various constant settings. Thus, the current from, say, unit 4 to unit 2, can be controlled as to its po-

larity of entry into the coil by X (Fig. 3). In addition, the potentiometer P decides what fraction of the input current actually goes through the coil. These controls can be hand set by the upper two rows on the front panels.

When set in some way, the magnets show some definite pattern of behavior, the pattern depending on the pattern of the hand settings. If these latter give a stable arrangement then the four magnets move to the central position where they actively resist any attempt to displace them. If displaced, a co-ordinated activity brings them back to the center, rather as an animal positively seeks its optimal conditions. Other settings may, however give instability, in which case a "runaway" occurs and the magnets diverge away from the centers. In such cases the feedbacks are producing "vicious circles" which would be driving the animal away from its optimal conditions.

But the feedbacks, instead of being set by hand, can be controlled by similar wirings arranged on a uniselector (V) in each unit. The values chosen for the wirings were deliberately randomized, the actual numerical values being taken from a published table of random numbers.⁵ When controlled by the uniselectors, the pattern of feedbacks depends at any moment on the values provided by the uniselectors at that time. Twenty-five positions on each of four uniselectors means that 390,625 combinations of feedback patterns are available.

Finally, in each unit the uniselector moves to a new position when and only when the output current of that unit exceeds the value sufficient to close the relay (F), the latter energizing the coils (G) of the uniselector.

When the control is diverted by the switches S-S so that not the hand controls but the uniselectors determine the settings, then a new feature emerges in the behavior of the system. As before, the units start acting on one another, but the uniselector settings change whenever the system is unstable, *i.e.*, whenever the magnets diverge far from the central position. In other words the machine starts to hunt for a combination of uniselector settings giving a stable system, *i.e.*, giving the proper internal feedbacks. When it finds a combination with the right feedbacks it holds that combination and will then demonstrate that it has assembled that feedback system which results in a co-ordinated maintenance of its variables at optimal values, like a living thing. The important point is that it finds its own arrangement of feedbacks, the designer having merely provided it with plenty of variety.

Not only will it find the appropriate feedback initially, but if we alter the basic conditions in any way it will proceed to re-adapt itself to the new conditions. Thus, we may use hand controls on two of the units, setting them at arbitrary values to represent some "environment" to which the other two units, representing "nervous system,"

must adapt, i.e., find combinations of their two uniselector settings which, in relation to that particular "environment," forms a stable system. When the machine is switched on, it proceeds, as described above, to find such an adaptation. But if now we alter the hand settings, i.e., change the "environment" to which the other two units are adapted, then the machine promptly abandons those uniselector combinations and hunts for new ones which will restore adaptation to the new environment. If now we change the hand-settings again, a new appropriate combination will again be found. And this process can be repeated as often as we please.

But the homeostat will adapt not only to random changes in hand settings but to any change in the dynamic nature of the machine, whether of a type originally intended or not. Here, for instance, are some alterations suggested by my colleagues who have tried to confuse it. After it had found a stable combination we reversed the polarity of the connection of an output to an input; it promptly changed its uniselector settings till it found a new combination of settings which was stable in conjunction with the new conditions. We reversed the polarity of a trough, thereby changing some of its feedbacks; it changed its uniselector settings till it found a new combination of settings stable in conjunction with the new conditions. A magnet was reversed: it readapted to the new condition. Bars were placed across the troughs so that the magnets could swing only to one side: it readapted. We joined two of the magnets together with a light glass fiber so that they had to move together; it readapted. In all cases, whatever conditions were imposed, it rearranged its own wiring through the uniselectors until it developed the proper feedbacks in relations to the new conditions.

Is the homeostat a brain then? Hardly, for it is as yet too larval. But it uses a new principle and can easily be extended to give much more powerful developments. Its chief fault in its present form, with only four units, is that it has little room to accumulate new adaptations, but, if it has to adapt to a new environment, must obliterate its established adaptations to make room for the new. This, of course, is a serious handicap, just as a child would be handicapped at school if it could learn what was two times three only by losing its memory of what was two times two. The difficulty, however, is a minor one and could be overcome by a mere increase in the number of units together with some minor alterations.

The making of a synthetic brain requires now little more than time and labor. But there is one point on which we must be quite clear: a proper synthetic brain must develop its own cleverness—it must not be a mere parrot. No matter how dazzling the performance, we must always ask how much of the performance has been enforced in detail by the designer and how much is contributed by the machine itself.

Let us suppose that two machines have been developed to the point where they can actually play chess. First we consider an electronic computer of the ACE or ENIAC type. ^{6,7} Instructions may be fed into it so that it will make only legal moves, but this is insufficient—a random series of legal moves will not win games. The machine may have great powers of analysis, but unless this ends in a demonstrated mate, the analysis

random movements. But the feedback would soon stop it making illegal movements, and it would tend steadily to avoid the moves that lead to a rapid loss of the game. But it must be admitted that its first games would be very bad—as bad, in fact, as the first games of any future world champion. But the homeostat would tend steadily to shed bad moves. Lines of play would be developed or dropped simply according to whether they did or did not lead to a win.

These improvements would be in no way dependent upon the particular details provided by the designer: they would be developed by the machine out of the indiscriminate variety provided, the feedback being the dominating and controlling factor. Consequently, such a machine, if perfect, could eventually play with a subtlety and depth of strategy beyond that of the man who designed it.

The aim of some has been to produce the perfect slave-brain. Though undoubtedly useful for some purposes, yet we must not lose sight of our objective: a synthetic brain should not only play chess, but should eventually beat its own designer.

This prospect is now in view.

And the future?

And what after that? Some facts seem clear even at this distance.

The construction of a machine which would react successfully to situations more complex than can be handled at present by the human brain would transform many of our present difficulties and perplexities. Such a machine might be used, in the distant future, not merely to get a quick answer to a difficult question but to explore regions of intellectual subtlety and complexity at present beyond the human powers. The world's political and economic problems, for instance, seem sometimes to involve complexities beyond even the experts. Such a machine might perhaps be fed with vast tables of statistics, with volumes of scientific facts and other data, so that after a time it might emit as output a vast and intricate set of instructions, rather meaningless to those who had to obey them, yet leading, in fact, to a gradual resolving of the political and economical difficulties by its understanding and use of principles and natural laws which are to us yet obscure.

The advantages of such a machine are obvious. But what of its disadvantages? There are at least two.

Firstly, in its construction, many a detail will have to be fixed at some arbitrary value selected without full knowledge of what features it may impose ultimately on the type of reactions. Are the tubes, for instance, to have an anode voltage near the maximum or much lower? Once made, such a decision will result in an all-pervading tendency in the machine's behavior. One machine, for instance, might try to solve all problems by exploring the possibilities of immediate violent activity,

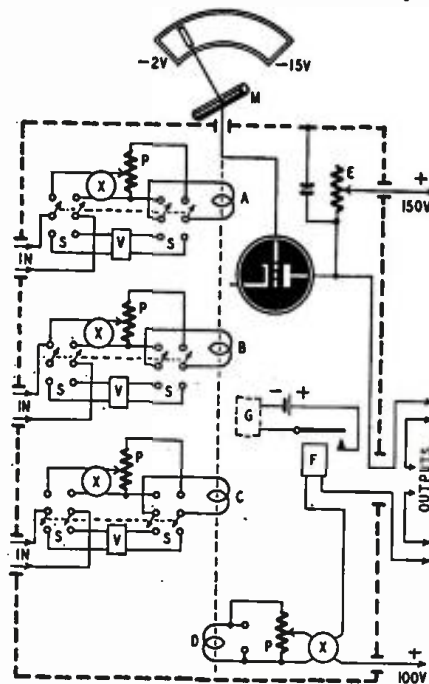

Fig. 3—Schematic diagram of the homeostat.

must stop at a judgment. (I assume that chess, like living, cannot always be analyzed out completely.) If the designer supplies it with criteria for judging whether positions are to be aimed at or avoided, then the criteria must be decided by the designer. This being so, such a machine, if perfect, will produce chess based on a strategy as good as its designer's but no better.

The second feature of such a system is that its thousandth game will be no better than its first.

The third feature is that every part has an exact duty set by the designer, who can say at any moment whether it is or is not working in accordance with his design and instructions. In short, it is a slave-brain.

The other type of machine, the homeostat, is based on quite a different principle. It needs no detailed instructions, only some method by which it is informed of the occurrence of illegal moves and mates. How the machine is to avoid these undesirable informations (feedbacks) is left entirely to the machine to puzzle out for itself. (The adaptations already shown by the homeostat encourage the confidence that with only minor developments the machine will succeed.)

Let us suppose the homeostat perfected and contrast its behavior with that of the first machine. The homeostat would start off like any other player—simply by making more or less

Better TV Sound

By ALLAN LYTEL*

THE makers of television receivers have concentrated principally on good definition, larger pictures, and less complex circuits, as well as lower prices. The only part of the receiver which really seems to have suffered is the audio section. Single-ended outputs are common, and rarely do we hear television sound through a speaker larger than 6 inches.

FM is used for TV sound transmission—the FCC deliberately decreed it so, that we might have the benefits of good fidelity and little noise. What, then, is more logical than to take advantage of FM and provide ourselves with pleasing reproduction? The set manufacturers, in the main, have not done it for us.

The schematic diagram shows how the writer solved the problem. A very simple and inexpensive amplifier feeds a good 12-inch PM speaker mounted in a separate cabinet. The amplifier-and-speaker combination gives the benefit of a 10-watt, push-pull output channel, and it is unnecessary to modify the receiver in any way to get it.

The discriminators and ratio detectors used in TV sets and the audio voltage amplifiers are usually very well designed and detract little or nothing from the fidelity. It is the output stage (in our receiver a single 6K6-GT) and the speaker which are at fault. The amplifier, therefore, is fed from the plate of the last voltage amplifier, tak-

ing the place of the output tube. An octal male plug is connected to the amplifier by a cable. The 6K6-GT is removed and the plug inserted in its place. The filament wires, connected to pins 2 and 7 of the plug, carry 6.3 volts through the cable to the 6SN7-GT and 6V6-GT's in the amplifier; a shielded lead connected to pin 5 of the plug (prong 5 of the 6K6-GT is the grid connection) brings the audio to the first grid of the 6SN7-GT in the amplifier. A ground lead links the chassis of the amplifier and teletet to provide an audio return connection. Naturally, if your receiver's sound section ends in some tube other than a 6K6-GT, these plug connections should be altered. But the purpose of the plug is the important point: removing the set's output tube and putting the plug in the tube socket makes all the necessary connections (with the possible exception of ground) without requiring any tamper-

ing with the receiver's innards.

The amplifier contains only two stages, the minimum necessary to provide phase inversion for the push-pull tubes. With most receivers, the gain will be too high, which is why the 1-megohm volume control was added. Ordinarily, it will still be most convenient to adjust volume at the receiver, rather than at the amplifier, which is mounted in the speaker baffle, so this control can be set and left alone. It is best to turn up the volume control on the receiver to about 75% of maximum, then adjust the amplifier control for maximum desired output from the speaker. After that only the receiver control need be used.

The circuit of the amplifier consists of a standard "self-balancing" phase inverter, a push-pull pentode output, and a selenium-rectifier voltage doubler. If the supply gives any hum, a transformer supply can be used, in which case filament voltage can be taken from the transformer too. A simple tone control is connected across the 6V6-GT plates to satisfy listeners who don't like high notes or who object to the rather high noise level accompanying some of the films shown on TV.

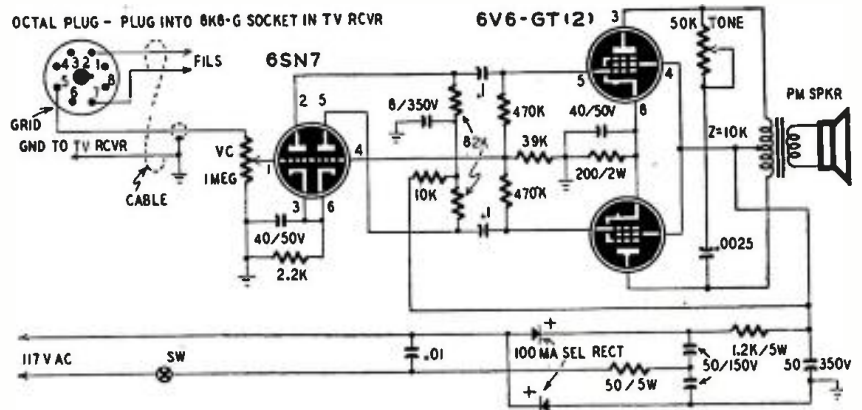

*Temple University Technical Institute.

THE ELECTRONIC BRAIN (Continued from page 79)

while another machine might react to all problems by a tendency to go on collecting interminable information, doing nothing as long as there was a shadow of doubt. We are, in short, up against the fact of "temperament." The designer will put in some temperament or other whether he intends it or not: once he builds a machine which works in its own way there is no such thing as "no" temperament. The peculiar difficulty here is that the machine will manifest it in a form too complex and subtle for the designer's understanding.

But perhaps the most serious danger in such a machine will be its selfishness. Whatever the problem, it will judge the appropriateness of an action by how the feedback affects itself: not by the way the action benefits us.

It is easy to deal with this when the machine's behavior is simple enough for us to be able to understand it. The slave-brain will give no trouble. But what of the homeostat-type, which is to develop beyond us? In the early stages of its

training we shall doubtless condition it heavily to act so as to benefit ourselves as much as possible. But if the machine really develops its own powers, it is bound eventually to recover from this.

If now such a machine is used for large-scale social planning and coordination, we must not be surprised if we find after a time that the streams of orders, plans and directives issuing from it begin to pay increased attention to securing its own welfare. Matters like the supplies of power and the prices of tubes affect it directly and it cannot, if it is a sensible machine, ignore them.

Later, when our world-community is entirely dependent on the machine for advanced social and economic planning, we would accept as only reasonable its suggestion that it should be buried deeply for safety. We would be persuaded of the desirability of locking the switches for its power supplies permanently in the "on" position. We could hardly object if we find that more and more of the national budget (planned

by the machine) is being devoted to ever-increasing developments of the planning machine. In the spate of plans and directives issuing from it we might hardly notice that the automatic tube-making factories are to be moved so as to deliver directly into its own automatic tube-replacing gear; we might hardly notice that its new power supplies are to come directly from its own atomic piles; we might not realize that it had already decided that its human attendants were no longer necessary.

How will it end? I suggest that the simplest way to find out is to make the thing and see.

(Reprinted by special arrangement with Electronic Engineering, London, England, from their December 1948 issue.)

References.

- 1 Ashby, W. R., *J. ment. Sci.*, 36, 478 (1940).
- 2 Rosenbluth, A., Wiener, N., and Bigelow, J., *Phil. Sci.*, 10, 18 (1943).
- 3 Ashby, W. R., *J. gen. Psychol.*, 32, 13 (1945).
- 4 The Electroencephalographic Society at The Burden Neurological Institute, Bristol, on 1st May, 1948.
- 5 Fisher, R. A. and Yates, F. *Statistical tables*. Edinburgh 1943.
- 6 *Electronic Engineering*, Dec., 1946, p. 372.
- 7 *Nature*, 185, 500 (12th Oct., 1946).

Television is Booming—Cash in on it!

RADIO-ELECTRONICS for

If You Haven't a Copy—Get ALLIED's Latest Supplement

**ALL THE NEWEST RELEASES!
BIG SAVINGS ON SPECIALS!**

FREE



Typical ALLIED Values!



Knight TV Antenna

High-efficiency indoor type—with length and direction easily adjustable for maximum reception. Covers all TV channels. Compact; fits on TV cabinet or table, or mounts to wall. Deal where roof antennas can't be installed.

97-354. ONLY..... \$4.95



Echophone 3-Band Radio

A great buy! Covers 3 full bands: 535-1625 kc, 2200-7100 kc; 6900-22,000 kc. With electrical band-spread; Alnico PM speaker; built-in loop antenna. For 105-125 v. AC or DC. Beautiful walnut plastic cabinet, 8½ x 14 x 6½.

97-518. ONLY..... \$24.95



Knight Wire Recorder

Makes and plays wire-recordings; plays any 10 or 12" 78 rpm disc recording; serves as PA system or as wireless phono oscillator. Easy to operate. Complete in compact simulated leather case; with crystal hand-mike and pickup, all tubes, 2 half-hour spools of wire. For 105-125 v., 60 c. AC.

96-172. ONLY..... \$99.50



Knight LP Record Player

Plays the new Long-Play high-fidelity LP records! Can be connected to any amplifier and speaker, or to any radio with phono connection. With LP crystal pickup and needle; dependable 33½ rpm motor. In attractive mahogany finish cabinet with lid. An outstanding buy at our low price!

For 110-120v., 60c. AC. **96-241. ONLY..... \$17.95**



Knight 10" Television Console

A great value in a compact TV console. Full 52 sq. in. picture on 10" direct-view tube. High definition assured by "Micro-Sharp" circuit; has Automatic Gain Control for photographic realism; pictures are "locked-in" for steadiness. Covers all TV channels. Exceptional FM audio system with wonderful tone quality. In beautiful mahogany finish console, 35¼" x 19½" x 20¼". Complete with all tubes. For 105-125 v., 50-60 c. AC.

9V-101. NET \$269.50

Shpg. wt., 125 lbs. **9V-101. NET**

ALLIED RADIO

Everything in Radio and Electronics

For your complete buying guide to Everything in Radio, use this new, value-packed Supplement together with ALLIED'S big 180-page Catalog. Here are all the latest developments in Radio, Television and Electronics—plus tremendous savings on popular, top-quality equipment—especially selected values for Servicemen, Engineers, Amateurs, Sound Men, Builders and Experimenters. Make your money-saving selections from the world's largest stocks—ready for immediate shipment. If you haven't a copy of ALLIED'S latest Supplement and complete 180-page Catalog, write for them today!

Get These Leading Buying Guides



Here's the 180-page 1949 Catalog for Everyone in Radio! Packed with everything in Radio: Latest Receivers, Phono Equipment, Television, Sound Systems and components, High-Fidelity equipment, Recorders, Amateur gear, Test Equipment—plus thousands of parts, tubes, supplies, books—everything you need at lowest, money-saving prices. Get your FREE copy now!

And here's the up-to-the-minute Supplement—all the new equipment releases, including latest Television developments, and big price reductions on popular equipment. Send for FREE copy!



ALLIED RADIO CORP.

833 W. Jackson Blvd., Dept. 2-C-9, Chicago 7, Illinois

- Send FREE 1949 ALLIED SUPPLEMENT.
- Send FREE 1949 180-Page ALLIED CATALOG.

Enter order for.....

.....\$..... enclosed

Name.....

Address.....

City..... Zone..... State.....

Planning a Factory PA

Engineering the world's largest industrial PA system

By **CONRAD EICHORN***



Newscaster Carl Weeks is heard by 15,000 K-F employees. Author is at the control console.



Some of the 50-watt amplifiers which furnish 5,400 watts to feed more than 600 loudspeakers.
Television is Booming—Cash in on it!

IN building a factory public address system, the most important element is proper planning. Even an installation as large and complicated as the K-F Broadcasting System at the gigantic Kaiser-Frazer Willow Run plant presents few mechanical and maintenance problems if the preparatory planning is right.

Kaiser-Frazer and RCA engineers spent months planning every detail of the huge installation with the result that the actual work was a comparatively simple matter.

We determined in advance by exhaustive testing and experimenting, exactly what equipment was needed and the precise number and location of each unit in the system.

Services required were:

1. Paging, to originate from the control room or from the night telephone desk;
2. Announcing, to originate from the control room or from the main plant protection office, with provisions for future input facilities as needed;
3. Program pickups originating outside the plant area and received over telephone lines;
4. Recording facilities, both disc and wire;
5. Reproduction of recordings or transcriptions for broadcast.

To make all of this possible we installed an RCA type 76B4 console in the control room. The console includes four preamplifiers, one high-gain program amplifier, and one high-gain, 8-watt monitoring unit.

A six-position mixer is included, with the preamps connected to four of the mixer positions and banks of mechanically interlocked push keys connected to the remaining two.

The output of each mixer position is connected to lever keys which permit switching it to the program amplifier for "broadcasting" or to the monitor amplifier for auditioning. These key switches are interlocked to disconnect the studio loudspeakers and operate "on-air" light relays. A three-position switch in the input of the fourth pre-amp permits its operation from a microphone in the studio, the announcer's booth, or the control room.

Push keys in the fifth and sixth mixer positions allows any one of the six remote lines and two turntables to be connected instantly to either input. Ad-

* Chief Engineer, K-F Broadcasting System

RADIO-ELECTRONICS for

Build the finest proven "CUSTOM-BUILT"
TELEVISION ASSEMBLY
Faster!
More Economically!
 when you build with . . .

"America's greatest
 Television Values
 per square inch of
 picture!"

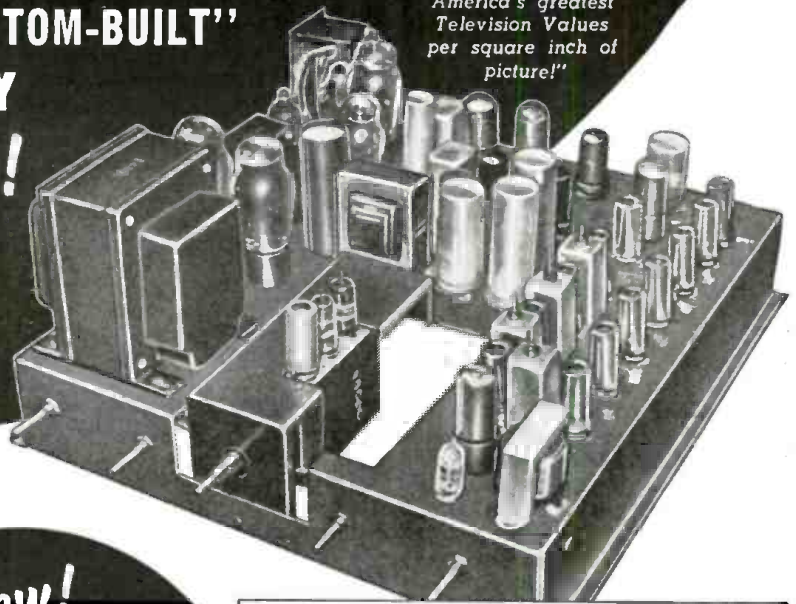

TELEVISION
 ASSEMBLY CO.

New!
Super-Simplified
 wiring and assembly
INSTRUCTIONS!

—The most explicit, easiest-to-follow,
 most elaborately detailed
 instructions in television—
 that even the layman
 can follow.

CABINETS AND STANDS avail-
 able with all direct view units.
 Write for literature.

Exclusive
T.A.C. "VIVIDeo"
feature!

Prewired, pretuned
 and tubed I.F. sound
 and video strip (pat-
 ents pending). An
 exclusive T. A. C. fea-
 ture developed by
 our own research. All
 on one chassis.

MODEL P-520 . . . 520 SQ. IN. PICTURE
PROJECTION TELEVISION ASSEMBLY

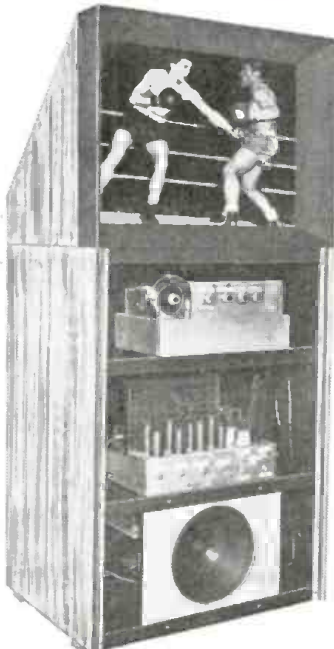

• Bausch & Lomb F. 1.9 Lens • Eastman
 Kodak Screen • DuMont Inputuner •
 37 R.C.A. Tubes • Pre-Wired & Pre-
 Tuned Picture I.F. & Sound I.F. • Pre-
 Wired 30 K.V. Tripler Fly Back Power
 Supply • Automatic Gain Control •
 Aluminum Coated Top Mirror • Metal
 Rack • Specially Designed Hood and
 Picture Frame Supplied • 5TP4 Projec-
 tion Tube • 12" R.C.A. High Fidelity
 Speaker • Two Low Voltage Power
 Supplies.

MODEL P-520 **\$76950***
 Dealer's net

MODEL P-520W **\$89500***
 Dealer's net

The above unit completely wired and
 ready to install.

Front and rear panels optional
 at additional cost.

TELEVISION
 ASSEMBLY CO.

Champion Models
20" DIRECT-VIEW MODEL
 with DuMont Inputuner and 20" DuMont Tube

213 SQUARE INCH PICTURE! Prewired Voltage
 Doubler 14KV power supply, Pre-wired "VIVIDeo"
 I.F. picture and sound strip (Pat. Pending). ALL
 channels TV plus ALL FM radio. Continuous
 tuning. DuMont Inputuner is Prewired. Delivered
 complete with all components and 30 RCA tubes
 plus 20-inch DuMont C.R. tube.

MODEL F-201C Dealer's net **\$56675***

"M" SERIES STANDARD and CHAMPION
Direct-View Models
for 10" CR TUBES

STANDARD MODEL

29 tubes, including 13-tube "VIVIDeo" I.F. picture
 and sound strip (Pat. Pending). This portion com-
 pletely wired, tested and aligned. Prewired,
 standard tuner ready to use. Handles ALL
 channels.

MODEL M-101S Less C.R. Tube **\$16950***
 Dealer's net

CHAMPION MODEL

Same as above except that DuMont Inputuner re-
 places Standard Tuner. Gets ALL channels TV
 —PLUS all channels of FM radio.

MODEL M-101C Less C.R. Tube **\$20950***
 Dealer's net

Write for literature on our complete line of 10",
 12"-15" standard and champion assemblies.

T. A. C. GUARANTEE

All components are of the finest
 quality and are fully guaranteed
 under the Standard RMA Guarantee.
 All TAC Assemblies are guaranteed
 to operate when assembled accord-
 ing to directions.

Distributed only through
NATIONAL PARTS DISTRIBUTORS

Write for the source nearest to you

ditional push keys provide circuits for feeding cues to remote lines, and other lever keys permit use of monitoring amplifiers in emergencies.

We made provision for the operator at the console to control the output level from the speakers within 13 individual zones in the plant. Thus, we are able to adjust the output level without the necessity of making individual adjustments of the 100-odd power amplifiers.

We selected RCA 50-watt power am-

plifiers (MI 4288) having a combined hum and noise level at least 60 db below their rated output, with a frequency response of 75 to 10,000 cycles within 3 db.

The amplifiers are mounted in metal racks, six to a rack. They have plug-type terminals for input, output, and a.c., which provide easy means of replacing defective amplifiers. Each amplifier has two volume controls: one for high-level and one for low-level input.

The relay power-supply units are selenium rectifiers capable of 24 hours of continuous operation under full load. They deliver 24 volts of direct current at 2 amperes.

Plate-circuit relays are mercury-contact units with 24-volt d.c. coils.

The transcription turntable is an RCA 70-D, equipped with a 72DX recording head.

For remote pickups from locations outside the studio, we use an RCA OP6-OP7 remote amplifier and mixer to feed the programs over telephone lines.

For the best all-purpose performance, we selected RCA MI-6311 paging horns, MI-6366 re-entrant horns, and MI-6308 industrial baffles, the latter using MI-12421 12¼-inch, 10-watt, cone speakers.

The paging horns and re-entrants are alternated throughout the plant, the spacing being determined by the noise to be overcome, to give the best overall reception of both voice and music.

The horns, equipped with MI-6306B driver units rated at 25 watts, are clustered five to an amplifier and therefore use but 10 watts each. This arrangement makes possible pin-point volume control in areas of varying noise levels. The industrial baffles and cones were installed only in the quiet areas, grouped 10 to the amplifier.

We guarded against line loss by selecting No. 12 copper stranded wire for speaker lines. Maintenance of the entire system thus far has been no problem at all, involving only such routine tasks as replacing damaged horns, drivers, matching transformers, and similar components.

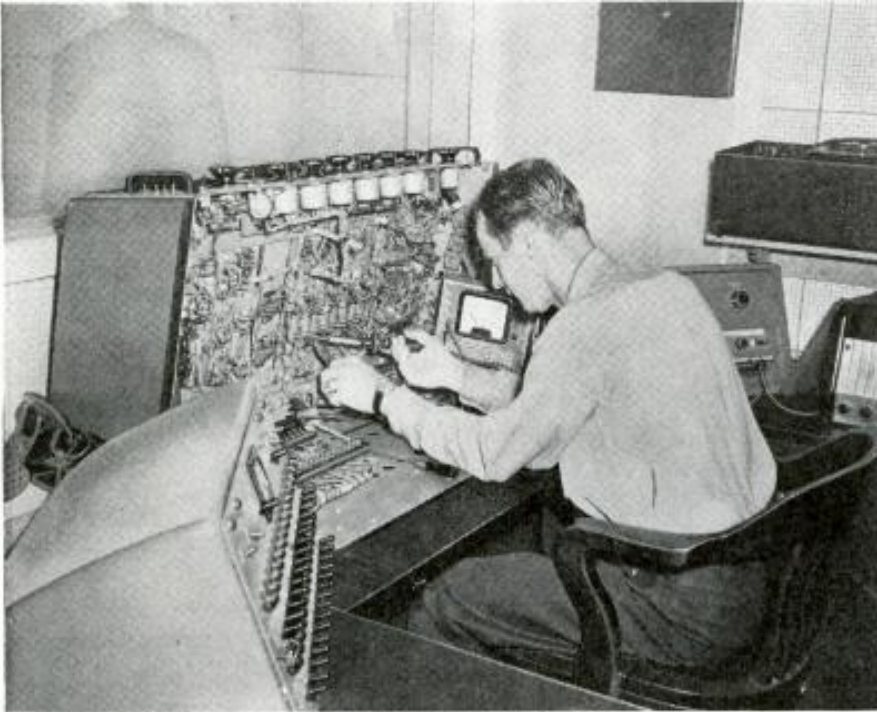

The best system will have breakdowns. Engineer Henry Lyons shoots trouble in the console.

Design Data for Speaker Enclosures

EXCELLENT loudspeaker baffing can be obtained in a relatively small space with a vented or bass-reflex enclosure. The vented enclosure is no more than a box of a specific volume constructed of heavy timber and provided with a loudspeaker opening and a vent. The graph shows how a correct enclosure will change the natural resonance peak (A) of the speaker to two smaller peaks (B), making response much smoother:

A simpler method than the standard engineering formulas has been suggested for arriving at the volume of the enclosure for speakers of various dimensions. It is based on the following figures: Use a box which has a volume in cubic feet equal to the nominal radius of the speaker in inches. Thus, with this method, a 12-inch speaker requires a cabinet volume of 6 cubic feet, and so on.

The port area is generally accepted as being equal to the actual radiating area of the cone, which is substantially

less than that calculated from the nominal diameter of the speaker. For example, a typical 12-inch speaker requires an 11-inch hole for mounting, but the actual diameter of the useful section of the cone is only 10 inches. Resorting to a practical formula again, the port opening may be taken as 0.8 times the area of the speaker opening.

Cross-checking these figures with those obtained by using the more complex standard formulas, cabinet volume for a standard 12-inch loudspeaker is found to be substantially the same, 6 cubic feet. With a heavy-duty 12-inch speaker, which has a somewhat lower cone resonance, the volume should probably be increased.

In the smaller sizes the volumes suggested for a 10-inch and for an 8-inch speaker are substantially higher than standard formulas would indicate.

Summing up all these factors, the following recommendations can be made:

(1) For 12-inch loudspeakers, the enclosure volume should not be less than

6 cubic feet, and up to 8 cubic feet for heavy-duty speakers having a cone resonance around 55 cycles.

(2) For 15-inch loudspeakers, the enclosure volume should be at least 8 cubic feet, and up to a maximum of 16. With such large speakers, the very low cone resonance will extend the cut-off in any case to about 45 cycles.

(3) For 10-inch loudspeakers, the enclosure volume can be from 4 to 5 cubic feet.

(4) For 8-inch loudspeakers, the en-

(ARBITRARY UNITS)

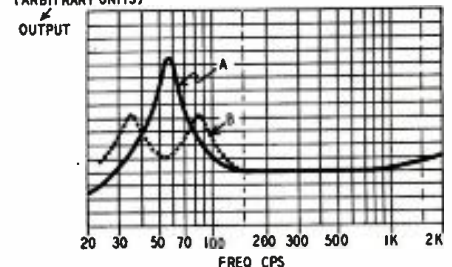

How an enclosure reduces speaker resonance.

RADIO-ELECTRONICS for

closure volume should be from 3 to 4 cubic feet.

Two more points for our summary:

(1) The vent area will normally be made equal to 0.8 times the area of the actual loudspeaker opening.

(2) The installation of a "throat" around the vent, either inside or outside the cabinet, tends to lower the resonance of the system and, within limits, has the effect of increasing the enclosure volume.

From a practical viewpoint we had no misgivings about the figures for 12-inch loudspeakers, vented enclosures for these units having been built and tested on previous occasions. Our main interest was to investigate the performance of a small speaker in a cabinet rather oversize by previous conceptions.

Another point in mind was that many readers have 8-inch loudspeakers on hand or may be obliged to use a 7- or 8-inch speaker for reasons of cost and availability.

Accordingly, we constructed an enclosure approximating 3 cubic feet with a vent of the specified size.

The particular loudspeaker had a natural cone resonance at a frequency just over 100 cycles, which was rather higher than expected. However, when mounted in the vented enclosure, the output was maintained to just under 60 cycles, below which it tapered off sharply. At the low frequencies, the bulk of the output comes from the vent.

By way of interest we installed a throat approximately 3 inches long, surrounding the vent on the inner side of the cabinet. This was found to produce a more gradual cutoff and, as far as could be judged by ear, to improve generally the performance of the enclosure below 100 cycles. In its final form the system delivered useful output

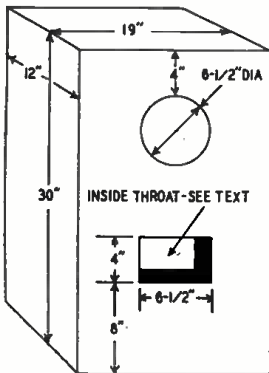

Typical dimensions for a vented speaker enclosure. The throat projection was 3 inches long on the model described, but it may be varied for best results by the experimenter.

down to 50 cycles, which was gratifying, considering the simplicity of the baffling arrangement, its moderate size, and the fact that the energy source was a relatively inexpensive 7-inch loudspeaker.

Although 50 cycles may seem well removed from the traditional 30-cycle lower limit, there are few loudspeakers in conventional cabinets which will

produce fundamentals at this frequency.

It is useless to consider building a vented enclosure of light timber or even of sound-absorbent board supported on medium-weight battens. Such a cabinet would have very pronounced resonant effects and defeat the whole object of the scheme.

The handiest material is probably 3/4-inch plywood, although, in practice, anything from 3/8- to 1-inch plywood or solid stock should be employed. The wood should be supported internally by a suitable framework, all joints being glued and screwed. Either the back or the bottom must be removable for access to the interior, and this must be securely screwed back in place.

The figures given for volume naturally apply to the inside of the cabinet, and some small allowance should be made for space occupied by the internal

SUGGESTED VOLUME FOR VENTED ENCLOSURE		
Nominal Speaker Diameter	Volume of Box (Cu. ft.)	Area of vent (sq. in.)
8	4	30
10	5	45
12	6	76
15	7.5	115

framework and bracing. It is wise to line all inside faces with hair felt or other sound-absorbent material. If sound-absorbent board is employed, it will reduce the interior volume of the cabinet appreciably, and allowance should be made in the design for this loss.

The important factor is the interior volume, the actual shape and dimensions of the cabinet being less important.

For a balanced appearance in rectangular cabinets, height should be roughly 2.5 times the depth, and width about 1.7 times depth. Depth refers to the front-to-rear measurement.

Our own experimental cabinet for a 7- or 8-inch speaker is somewhat taller and narrower than these proportions. Accordingly, the dimensions in the drawing were modified to approach the above proportions and, happily enough, the outside dimensions are very simple ones to work to. By the time allowance is made for the thickness of the timber, the interior volume will be just over the minimum recommended figure of 3 cubic feet.

For larger speakers, the cabinet will need to be substantially wider, with a smaller increase in the depth and height to give the required volume.

The position of the vent in relation to the loudspeaker does not appear to be critical, and the vent can thus be shaped and located on the front face of the cabinet to give the most balanced appearance.

Our thanks are due to the Australian publication, *Radio and Hobbies*, an article by W. N. Williams being the source for most of the material in this article.

TRY and BEAT THESE BUYS!

PUSHBACK WIRE



Below Mill Prices!

2,000,000 feet—tinned copper—all 1st. class, double cotton serve, waxed finish. Available 1,000 foot rolls.

22 gauge (6 colors) \$3.98 roll
20 gauge (6 colors) 4.98 roll
18 gauge (brown only) 6.49 roll

HERE'S A STEAL

Tom Thumb RADIO CAMERA



A hit on the beach at picnics, etc. A combination reflex camera and portable battery radio. Former list \$29.95

OUR LOW PRICE

\$12.65 Less Batteries

With batteries add \$1.84.

MIDGET I. F. TRANSFORMERS



Original List \$2.10

NOW 36c EACH

Specify Type

Matched Pair 69c

Dozen \$3.95

Egg Crate of 100 \$29.00

At discounts up to 86%

400-500 Kc range 1 1/4" square, 3" high hi-gain iron core.

INPUT—A826 OUTPUT—A827

1 meg. VOLUME CONTROLS



85% DISCOUNT

Universal with switch

OUR PRICE 29c each



ORDER INSTRUCTIONS

Minimum order—\$2.00. 25% deposit with order required for all C.O.D. shipments. Be sure to include sufficient postage—excess will be refunded. Orders received without postage will be shipped express collect. All prices F.O.B. Detroit.

RADIO SUPPLY & ENGINEERING CO., Inc.
85 SELDEN AVE. DETROIT 1, MICH.

Features
that make

Heathkits

the best
kits

1 KITS THAT FIT

Heathkit chassis are precision punched to fit the quality parts supplied. The grey crackle aluminum cabinet and the two color panels are die punched to assure proper fitting.

Many builders have written marveling at the ease with which assembly can be accomplished.

The chassis are specially engineered for easy assembly and wiring — there are no small tight corners which cannot be reached — the ends of the chassis are left open in order that installation of parts and soldering can be done with both hands.

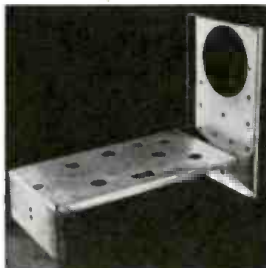

6 BEST OF PARTS

You will find many famous names on the parts in your Heathkit. Mollory switches and filter condensers, Chicago Transformer Corporation and Electrical Assembly Transformers, Centralab Potentiometers, Belden Cable, IRC & Allen Bradley resistors, G.E. tubes, Cinch and Amphenol sockets with silver plated contacts, Deance variable condensers, Eby binding post and many other quality parts. The finest of parts are used to assure long trouble-free service from Heathkits.



2 PRECISION PARTS

Wherever required, the finest quality 1% ceramic resistors are supplied. These require no aging and do not shift. No matching of common resistors is required. You find in Heathkit the same quality voltage divider resistors as in the most expensive equipment.

The transformers are designed especially for the Heathkit unit. The scope transformer has two electrostatic shields to prevent interaction of AC fields.

These transformers are built by several of the finest transformer companies in the United States.



7 MODERN STYLING

Heathkits have brought a new conception of beauty to laboratories and service benches. Many organizations have standardized on Heathkits to make their shops appear attractive and uniform.

The panels are produced in grey and maroon and the modern streamline aluminum handles give the instruments a pleasant professional appearance.

There is no waste space or false effort to appear large in Heathkits — space on service benches is at a premium and the size of Heathkit instruments is kept as small as is consistent with good engineering design.



3 COMPLETE KITS

When you receive your Heathkit you are assured of every necessary part for the proper operation of the instrument.

Beautiful cabinets, handles, 2 color panels, all tubes, test leads where they are a necessary part of the instrument, quality rubber line cords and plugs, rubber feet for each instrument, all scales and dials ready printed and calibrated. Every Heathkit is 110V 60 cy. power transformer operated by a husky transformer especially designed for the job.



8 LARGE EASILY READ CALIBRATIONS

No charts or calculations are necessary to use any Heathkit properly. All scales are simply and plainly marked.

The operator instantly knows the proper use of the instrument and can proceed confidently. No multiplication is required as each scale is calibrated independently of the others.

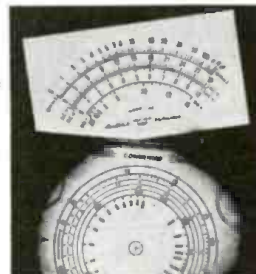

4 COMPLETE INSTRUCTION MANUALS

Everyone is pleased at the thorough instructions covering the assembly of each Heathkit instrument. Every detail of the assembly is covered, together with sections on the use of the instrument and trouble shooting instructions in case of difficulty. Actual photos of the assembled instrument enable fast and accurate assembly, clear schematics and pictorial diagrams of the confusing parts such as rotary switches enable the wiring to be completed quickly.



9 IDEAL FOR SCHOOLS

Heathkits have been adopted as standard equipment of many of the largest universities and colleges. The low cost plus the fact that the students learn by actual assembly make them ideal training mediums. Many high schools and small colleges are finding that they too can have a modern physics and electronics laboratory by using Heathkits.

Some of the largest technical schools recommend Heathkits to their students as the best means of securing the necessary equipment to start their own shops.



5 BEST OF ENGINEERING . . .

Heathkits are the result of many years experience in the test equipment field. Heathkit oscilloscopes have been under development and test since 1943 and most other instruments now being produced have had over two years of thorough testing.

As proof of their design, Heathkits have been adopted by many of the largest Universities and laboratories in the United States. Thousands of engineering students are receiving their training using Heathkits.

10 WHY NOT BUILD YOUR OWN . . .

The great strides made in electronics during the war have made it hard for everyone to keep abreast of new developments. By actually assembling modern test equipment knowledge is gained in the most practical manner. Further a complete knowledge of the instrument allows greater flexibility of use and many possible uses suggest themselves.

Lastly with the cost of everything shooting upward any means of eliminating costs is welcomed. This reduction is a remarkable saving, as can be seen by comparing Heathkit prices with comparable built up test equipment.

ON THE FOLLOWING PAGES THE BEST KITS

ORDER DIRECT FROM THIS AD.



The **HEATH COMPANY**

. . . BENTON HARBOR, 20, MICHIGAN

HEATHKIT RF SIGNAL GENERATOR KIT

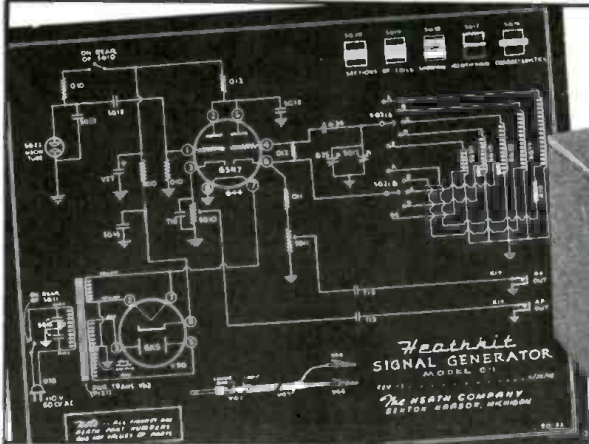

Every shop needs a good signal generator. The Heathkit fulfills every servicing need, fundamentals from 150Kc. to 30 megacycles with strong harmonics over 100 megacycles covering the new television and FM bands. 110V 60 cycle transformer operated power supply.

400 cycle audio available for modulation or audio testing. Uses 6SN7 as RF oscillator and audio amplifier. Complete kit has every part necessary and detailed blueprints and instructions enable the builder to assemble it in a few hours. Large easy to read calibration. Convenient size 9" x 6" x 4 1/4". Shipping weight 4 1/2 lbs.

\$19.50

Nothing ELSE TO BUY

HEATHKIT SIGNAL TRACER KIT

Let a Heathkit Signal Tracer do the tedious watching of intermittents while you go on to other profitable jobs. Follow the signal from the antenna to the defective part in a matter of seconds. Triples the repairs per man in many shops. A Heathkit Signal Tracer Kit pays for itself in a matter of days of operation. Locates faults immediately. Internal amplifier available for speaker testing and internal speaker available for amplifier testing. Connection for VTVM on panel allows visual tracing and gain measurements. Also tests phonograph pickups, microphones, PA systems, etc. Frequency range to 200 Mc. Complete ready to assemble. 110V 60 cycle transformer operated. Supplied with 3 tubes, diode probe, 2 color panel, all other parts. Easy to assemble, detailed blueprints and instructions. Shipping weight 10 lbs.



\$19.50

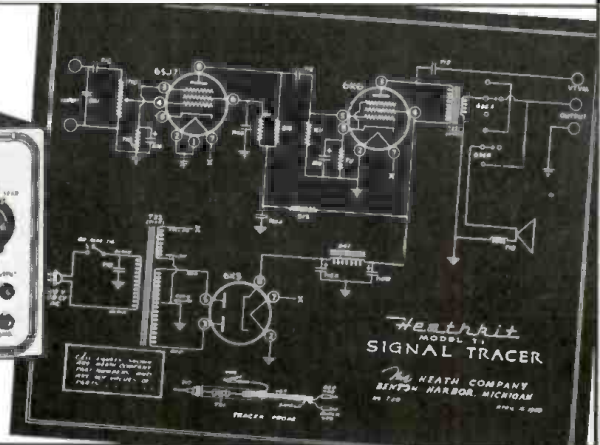

HEATHKIT SINE AND SQUARE AUDIO GENERATOR KIT

Experimenters and servicemen working with a square wave for the first time invariably wonder why it was not introduced before. The characteristics of an amplifier can be determined in seconds compared to several hours of tedious plotting using older methods. Stage by stage, amplifier testing is as easy as signal tracing. The low distortion (less than 1%) and linear output (\pm one db.) make this Heathkit equal or superior to factory built equipment selling for three or four times its price. The circuit is the popular RC tuning circuit using a four gang variable condenser. Three ranges 20-200, 200-2,000, 2,000-20,000 cycles are provided by selector switch. Either sine or square waves instantly available at toggle switch. All components are of highest quality, cased 110V 60 cycle power transformer, Mallory F.P. filter condensers, 5 tubes, calibrated 2 color panel, grey crackle aluminum cabinet. The detailed instructions make assembly an interesting and instructive few hours. Shipping weight 13 lbs.

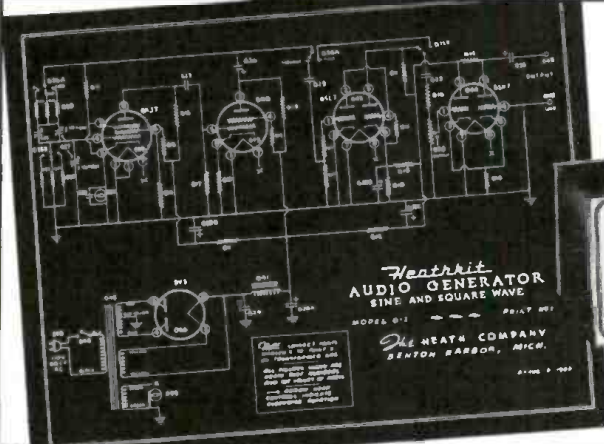

\$34.50

Nothing ELSE TO BUY

Heathkit ELECTRONIC SWITCH KIT

DOUBLES THE UTILITY OF ANY SCOPE

An electronic switch used with any oscilloscope provides two separately controllable traces on the screen. Each trace is controlled independently and the position of the traces may be varied. The input and output traces of an amplifier may be observed one beside the other or one directly over the other illustrating perfectly any change occurring in the amplifier. Distortion—phase shift and other defects show up instantly. 110 Volt 60 cycle transformer operated. Uses 5 tubes (1—6X5, 2—6SN7's, 2—6SJ7's). Has individual gain controls, positioning control, and coarse and fine sweeping rate controls. The cabinet and panel match all other Heathkits. Every part supplied including detailed instructions for assembly and use. Shipping weight 11 lbs.



\$34.50

Nothing ELSE TO BUY

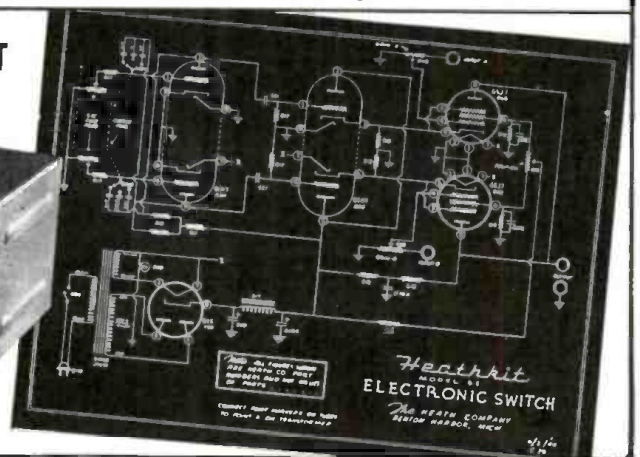

The HEATH COMPANY

... BENTON HARBOR 20, MICHIGAN

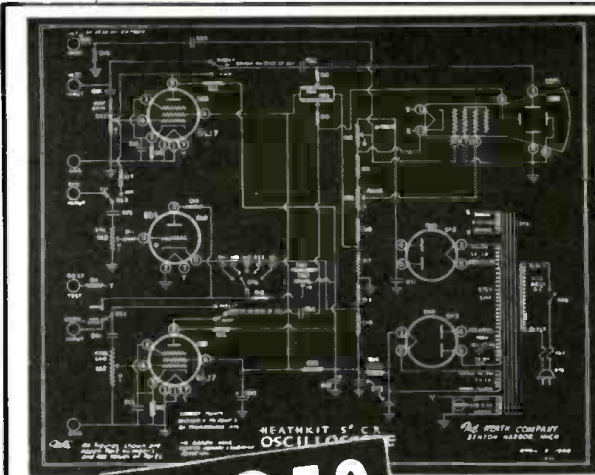

Heathkit 5 INCH OSCILLOSCOPE KIT

Features

- ★ Instant switching to plates or amplifier from front panel.
- ★ Sweep generator supplying variable sweep 15 cycles to 30,000 cycles.
- ★ All controls on front panel.
- ★ Cased electrostatically shielded 110V 60 cycle power transformer.
- ★ AC test voltage post on front panel.
- ★ External synchronization post on front panel.
- ★ Deflection sensitivity .65V per inch full gain.
- ★ Frequency response $\pm 20\%$ from 50 cycles to 50 Kc.
- ★ Input impedance 1 Megohm and 50 MMF.

The Heathkit 5" Oscilloscope Kit fulfills every servicing need. The husky cased power transformer supplies 1100 Volts negative and 350 Volts positive. Tubes supplied are two 6SJ7 amplifiers, 884 sweep generator, two 5Y3 rectifiers, and 5BP1 or 5BP4 CR

tube. Grey crackle aluminum cabinet and beautiful grey and maroon panel. Chassis especially designed for easy assembly. An oscilloscope provides almost endless sources of experimentation in radio, electronics, medicine and scientific research. Detailed Instructions make assembly fun and instructive.

\$39.50

Nothing ELSE TO BUY
SHIPPING WT. 24 LBS.
EXPRESS ONLY

Heathkit VACUUM TUBE VOLTMETER KIT

Everything you want in a VTVM. Shatterproof solid plastic meter face, automatic meter protection in burn-out proof circuit, push pull electronic voltmeter circuit assuring maximum stability. Linear DC and AC scales. Complete selection of voltage ranges starting with 3 Volts full scale up to 1,000 Volts. Isolated DC test prod for signal tracing and measurements of voltage while instrument is in operation. An ohmmeter section accurately measuring resistance of 1/10 ohm to one billion ohms with internal battery. Extremely high input resistance 11 megohms on all ranges DC and 6.5 megohms on AC. All these features and many more are the reasons hundreds of radio and television schools are using Heathkit VTVM's and recommending them to all students. Like all Heathkits, the VTVM kit is complete, 110V 60 cy power transformer, 500 microamp meter, tubes, grey crackle cabinet, panel, test leads, 1% ceramic precision divider resistors and all other parts. Complete instruction manual. Better start your laboratory now,



\$24.50

Shipping-weight 8 lbs.

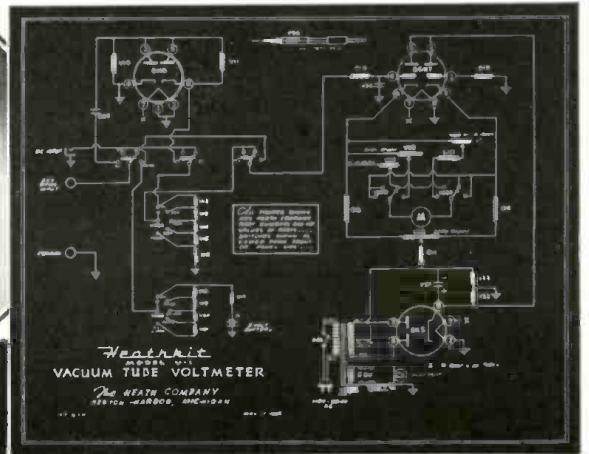

Nothing ELSE TO BUY

HEATHKIT 3-TUBE ALL-WAVE RADIO



110 Volt AC Operation
\$8.75

Operates loud speaker. Add postage for 3 lbs.... \$8.75
HS 30 Headphones per set..... \$1.00
2 1/2" Permanent Magnet Loudspeaker..... \$1.95
Mahogany Cabinet..... \$2.95

An ideal way to learn radio. This kit is complete ready to assemble, with tubes and all other parts. Operates from AC. Simple, clear detailed instructions make this a good radio training course. Covers regular broadcasts and short wave bands. Plug-in coils. Regenerative circuit.

INTERPHONE 2-WAY CALL SYSTEM KIT

Ideal call and communication system for homes, offices, factories, stores, etc. Makes excellent electronic baby watcher. Easy to assemble with every part supplied including simple instructions. Distance up to 1/5 mile. Operates from 110V A.C. 3 tubes, one master and one remote speaker. Shipping weight 5 lbs.



\$14.50

HEATHKIT HIGH FIDELITY AMPLIFIER KIT

Build this high fidelity amplifier and save two-thirds of the cost. 110V 60 cy transformer operated. Push pull output using 1619 tubes (military type 6L6's), two amplifier stages using a dual triode (6SL7), as a phase inverter give this amplifier a linear reproduction equal to amplifiers selling for ten times this price. Every part supplied; punched and formed chassis, transformers (including quality output to 3-8 ohm voice coil), tubes, controls, and complete instructions. Add postage for 20 lbs.

\$14.95

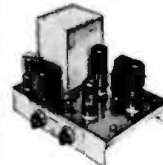

12" PM Speakers for above..... \$6.95
Mahogany Speaker Cabinet, 14 1/2" x 14 1/2" x 8"..... \$8.75

110V.-A.C. MILITARY RECEIVER POWER SUPPLY KIT

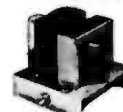

\$5.95

Ideal way to convert military sets. 110V 60 cy. transformer operated. Supplies 24 Volts for filament - no wiring changes inside radio. Also supplies 250V D.C. plate voltage at 50-60 MA. Connections direct to dynamotor input. Complete with all parts and detailed instructions. Shipping wt. 6 lbs.

110V.-A.C. TRANSMITTER POWER SUPPLY KIT

For BC-645, 223, 522, 274N's, etc. Ideal for powering military transmitters. Supplies 500 to 600 Volts at 150 to 200 MA plate, 6.3 C.T. at 4 Amps, 6.3 at 4 Amps, and 12V at 4 Amps. Can be combined to supply 3-6-9-12 or 24 Volts at 4 Amperes. Kit supplied complete with husky 110V 60 cycle power transformer, 5U4 rectifier, oil filled condensers, cased choke, punched chassis, and all other parts, including detailed instructions. Complete - nothing else to buy. Shipping Wt. 22 lbs.

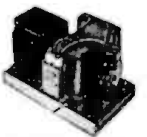

\$14.50

The
HEATH COMPANY

... BENTON HARBOR 20, MICHIGAN

Powerful PA Amplifier Uses an 815

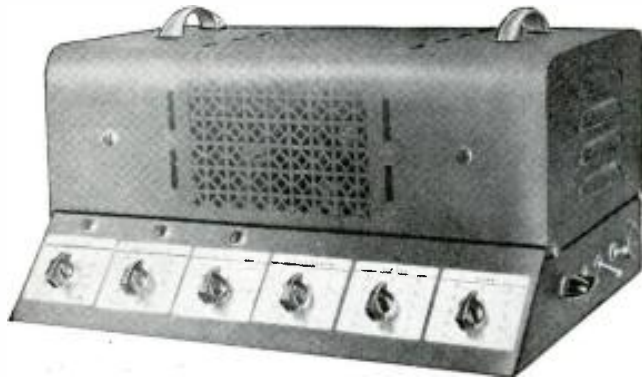

Transmitting tube puts
out a 54-watt a.f. signal

By GERALD A. CHASE

THE little 815 seems finally to be coming into its own. Many amateurs now are using it as a final amplifier in their low-powered transmitters and as a push-pull driver or multiplier in their higher-powered rigs. As yet, however, it does not seem to be much used for audio work. Where space is at a premium, the 815 is an ideal tube. Measuring slightly less than 4 inches high and 2 inches in diameter, it contains a pair of husky tetrodes. Used in push-pull, with 500 volts on the plates and a bias of -15 volts, it kicks out a healthy 54 watts.

A PE-103-A dynamotor is used with the amplifier described here for mobile work. With an output of 160 ma at 500 volts it is ideal for an 815 as long as the rest of the amplifier draws very little current. Even if the current exceeds the 160-ma rating enough to drop the voltage to 400, output is still better than 40 watts.

One of the main considerations in

planning the amplifier was to keep plate and filament currents as low as possible to minimize battery drain when working mobile.

The minimum requirements for input were two microphones and one phonograph, with noninteracting controls to mix all three. As can be seen from the schematic, a single 6SC7 was used for the two microphone preamplifiers. Mixing is done between the 6SC7 and the following 6SK7.

In the following stage a 6SK7 is used in conjunction with a 6C5 and a 6H6 in a volume-expander-compressor circuit which is fairly standard. This circuit was included primarily for recording. However, it has also been found very desirable for PA work. Some speakers have a tendency to wander away from the microphone. Compressor action works as an automatic gain control to boost the volume when the speaker is at a distance and to cut it as he speaks directly into the mike. Care

must be exercised in setting the control for it is possible to cause distortion with over-compression.

As shown in the schematic, the control is a special center-tapped 1-meg-ohm potentiometer (IRC VC-539X). When the arm is at center position, the grid return from the 6SK7 is directly grounded and its operation is normal. When moved toward the plate end of the control, compression takes place; and when moved toward the cathode end, expansion results.

When playing music, a greater dynamic range can be achieved by using the expander. Again, care should be taken, for distortion will also result from overexpansion.

The tone control

The next stage is the tone-control circuit using a 6C5 as a "normal-tone" amplifier with a 6SL7 in parallel as a treble and bass amplifier. The signal for the grid of the 6C5 is taken from between a 47,000-ohm resistor and a 100,000-ohm resistor. This drops the signal to two-thirds of its original value. If the grid were connected directly to the 0.1- μ f coupling capacitor, the "normal-tone" volume would be great enough to blanket the action of the treble and bass controls.

The 100,000-ohm resistor between the 6SK7 plate and the grid of the bass section of the 6SL7 isolates the .01- μ f bypass across the bass control from the rest of the circuit. The 500,000-ohm potentiometer controls the amplitude of the low-frequency sounds. Be careful to filter and shield the previous stages, for, with the bass control at maximum, there is a tendency to amplify hum.

The signal is fed to the treble section of the 6SL7 through a 250- μ f capacitor, which filters out the bass. Large amounts of treble boost can be obtained with the control. It is usually impossible to operate it at more than two-

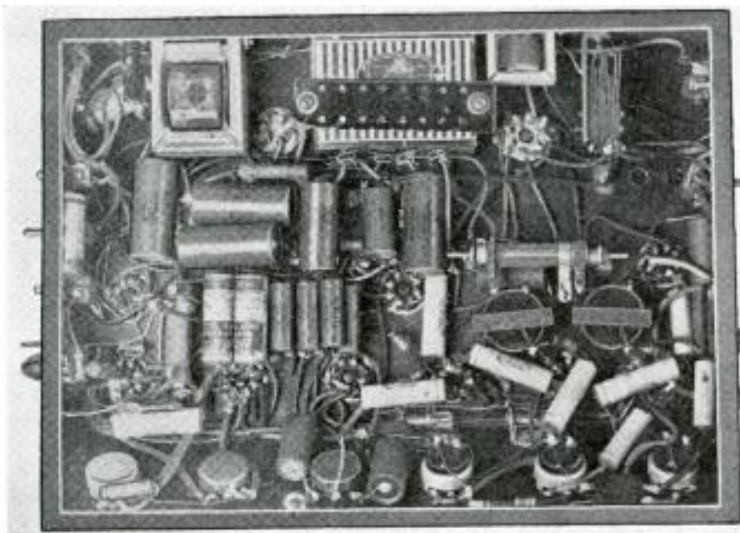

This under-chassis view shows how the bias battery should be mounted in place.

Television is Booming—Cash in on it!

RADIO-ELECTRONICS for

thirds of maximum because it brings out excessive hiss, needle scratch, and other high-frequency noise. Also, unless the microphones are placed with great care, there is feedback at high settings of the control. A compromise can be found between bass and treble to satisfy the requirements of almost any installation. With both controls at zero the tone is normal.

A 27,000-ohm resistor between each of the tone-control-tube plates and the 0.1- μ f coupling capacitor acts as a safety measure to prevent interaction between circuits.

The 6F6 is triode-connected as a driver for the 815 final. With a bias of -20 volts and a plate-supply voltage of 250, the 6F6 normally delivers approximately 0.8 watt. Actually it is slightly less in this case because of the voltage drop across the 2,500-ohm decoupling resistor. It is still sufficient, however, to supply the 0.35-watt driving power to the 815 grids and make up for the power loss in the driver transformer.

The 815 takes a bias of -15 volts. A C-battery is used; it is as economical as a separate bias supply. Cathode bias would have meant considerably more distortion due to the wide variation in plate current when operating class AB2.

The secondary of the output transformer is tapped to provide impedances of 4, 8, 15, 250, and 500 ohms. One end is grounded, and the other leads are run to an impedance-selector switch. Thus, any speaker or combination of speakers can be matched accurately to the output.

Separate monitor channel

The amplifier in use before this one was built had no facilities for monitoring; in some locations monitoring would have been a decided asset. In one in-

stance, for example, we were supplying the PA system for an ice carnival. Located in a control room at one end of the arena overlooking the ice, we were using one Atlas speaker mounted above our room, pointing toward the opposite end of the arena. It was difficult, due to its directional characteristic, to hear all

that was being said and this made it hard to ride the gain effectively. On top of that, comments from the audience in the control room were not very flattering. So we decided to include some means for monitoring in our new amplifier. A 6K6-GT is used, with its grid in parallel with that of the 6F6 driver. A small output transformer couples the 6K6-GT to a circuit-closing jack at the back of the chassis. When the speaker is plugged in, it is connected to the voice-coil winding and at the same time the heater of the 6K6-GT is grounded. In half a minute the tube is up to operating temperature. When the plug is withdrawn, the filament circuit is broken and the tube ceases to draw current.

The power supply

It might have been better practice to build a separate low-voltage power supply for the voltage-amplifier tubes and the 815 screens but it would have complicated matters when operating from the dynamotor. A common supply was decided upon, and an attempt at good voltage regulation was made.

We felt that choke-input filtering was an absolute must for class AB2. There is very little filtering action at this point of the circuit, but choke input does tend to keep the voltage constant over wide variations of current. The 815 plate voltage is taken off immediately after the input choke. It was unnecessary to filter it further, and this connection lessened the current through the succeeding choke. A d.p.d.t. switch is used to change from a.c. to d.c. operation by switching the filament and high-voltage supplies.

A d.p.s.t. switch is used between the center tap of the plate transformer and chassis as a stand-by switch. When the amplifier is "off the air" but must be

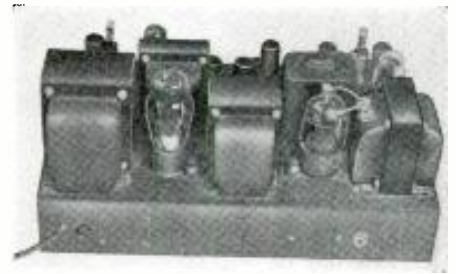

A rear view of the amplifier reveals the 815.

ready to operate at a moment's notice, this switch effects a saving in plate current during the stand-by period. The other half of the switch operates a green panel lamp to indicate when the high voltage is on.

Two bleeder circuits are used to obtain lower voltages for the amplifier stages and the 815 screens. A 15,000-ohm, 20-watt adjustable resistor in series with an OC3/VR105 voltage regulator supplies the correct screen voltage. The 815 screens are connected to the adjustable arm, which is varied to give 125 volts. The voltage across the VR-105 is just under 100.

The second bleeder circuit gives 250 volts for the plates of the voltage amplifiers.

There are five pilot lights in the amplifier: A red jewel indicates when line voltage is applied, a green jewel when the high voltage is switched on, and a green jewel over each microphone and phono control when each circuit is in use. A s.p.s.t. switch is mounted on each control to turn on the pilot lights when the control is turned up.

In wiring these switches, run the hot filament wire to the pilot lights and place the switches in the grounded side. Unless this is done, hum may be picked up in the control.

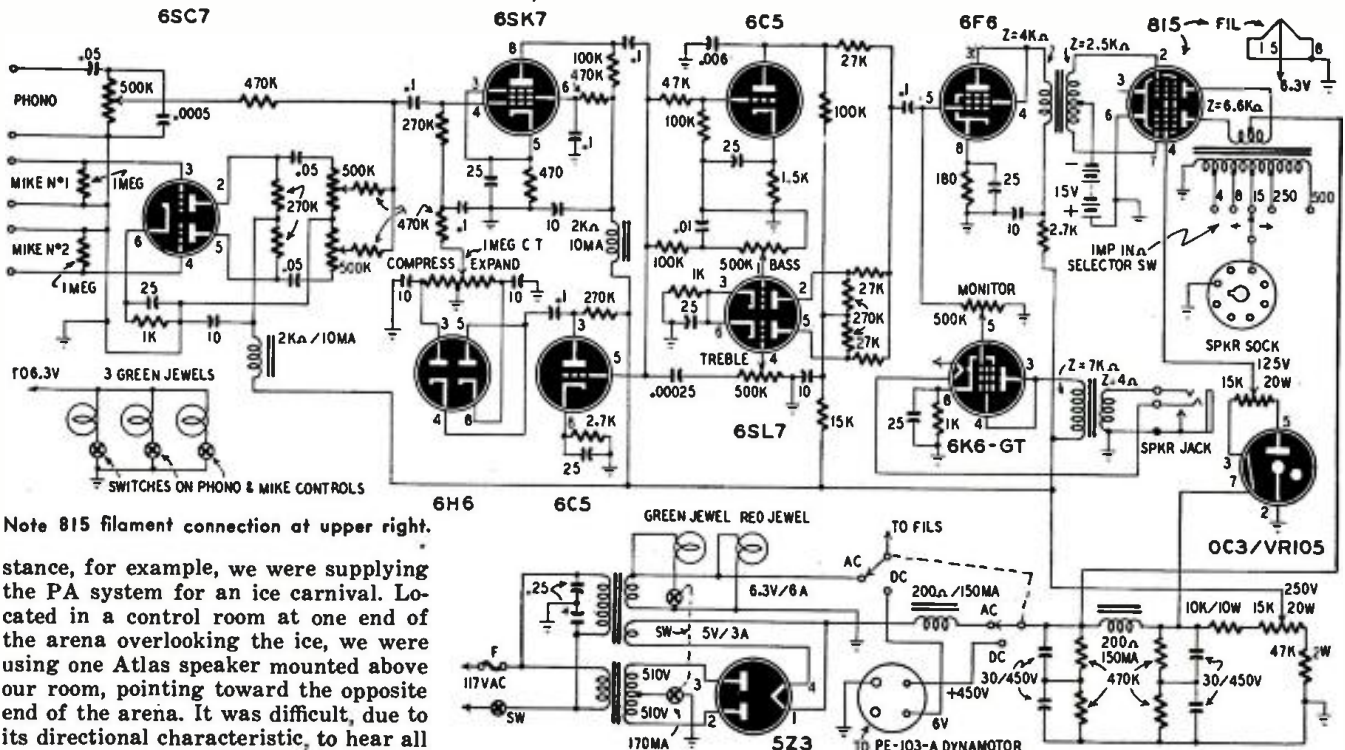

Note 815 filament connection at upper right.

to hear all

MONEY BACK GUARANTEE — We believe units offered for sale by mail order should be sold only on a "Money Back-If-Not-Satisfied" basis. We carefully check on the design, calibration and value of all items advertised by us and unhesitatingly offer all merchandise subject to a return for credit or refund. You, the customer, are the sole judge as to value of the item or items you have purchased.



THE NEW MODEL 247

TUBE TESTER

Check octals, loctals, bantam jr. peanuts, television miniatures, magic eye, hearing aids, thyatrons, the new type H.F. miniatures, etc.

Features:

- ★ A newly designed element selector switch reduces the possibility of obsolescence to an absolute minimum.
- ★ When checking Diode, Triode and Pentode sections of multi-purpose tubes, sections can be tested individually. A special isolating circuit allows each section to be tested as if it were in a separate envelope.
- ★ The Model 247 provides a super sensitive method of checking for shorts and leakages up to 5 Megohms between any and all of the terminals.
- ★ One of the most important improvements, we believe, is the fact that the 4-position fast-action snap switches are all numbered in exact accordance with the standard R.M.A. numbering system. Thus, if the element terminating in pin No. 7 of a tube is under test, button No. 7 is used for that test.

Model 247 comes complete with new speed-read chart. Comes housed in handsome, hand-rubbed oak cabinet sloped for bench use. A slip-on portable hinged cover is indicated for outside use. Size: 10 3/4" x 8 3/4" x 5 3/4". ONLY.....

ONLY
\$29⁹⁰
NET



THE MODEL 88 — A COMBINATION

SIGNAL GENERATOR and SIGNAL TRACER

SIGNAL GENERATOR SPECIFICATIONS:

• Frequency Range: 150 Kilocycles to 50 Megacycles. • The R.F. Signal Frequency is kept completely constant at all out-put levels. • Modulation is accomplished by Grid-blocking action which is equally effective for alignment of amplitude and frequency modulation as well as for television receivers. • R.F. obtainable separately or modulated by Audio Frequency.

SIGNAL TRACER SPECIFICATIONS:

• Uses the new Sylvania IN34 Germanium crystal Diode which combined with a resistance-capacity network provides a frequency range of 300 cycles to 50. Megacycles. The Model 88 comes complete with all test leads and operating instructions. ONLY

\$28⁸⁵
NET

THE NEW MODEL 670 SUPER METER

A Combination VOLT-OHM-MILLIAMMETER plus CAPACITY REACTANCE, INDUCTANCE and DECIBEL MEASUREMENTS



D.C. VOLTS: 0 to 7.5/15/75/150/750/1500/7500. A.C. VOLTS: 0 to 15/30/150 / 300 / 1500 / 3000 Volts. OUTPUT VOLTS: 0 to 15/30/150/300/1500/3000. D.C. CURRENT: 0 to 1.5/15/150 Ma.; 0 to 1.5 Amps. RESISTANCE: 0 to 500/100,000 ohms, 0 to 10 Megohms. CAPACITY: .001 to .2 Mfd., .1 to 4 Mfd. (Quality test forelectrolytics). REACTANCE: 700 to 27,000 Ohms; 13,000 Ohms to 3 Megohms.

INDUCTANCE: 1.75 to 70 Henries; 35 to 8,000 Henries. DECIBELS: —10 to +18, +10 to +38, +30 to +58.

The model 670 comes housed in a rugged, Crackle-finished steel cabinet complete with test leads and operating instructions. Size 5 1/2" x 7 1/2" x 3".

28⁴⁰
NET

THE NEW MODEL 770—AN ACCURATE POCKET-SIZE VOLT OHM MILLIAMMETER

(Sensitivity: 1000 ohms per volt) FEATURES:

Compact—measures 3 1/4" x 5 7/8" x 2 1/4". Uses latest design 2% accurate 1 Mil. D'Arsonval type meter. Some zero adjustment holds for both resistance ranges. It is not necessary to readjust when switching from one resistance range to another. This is an important time-saving feature never before included in a V.O.M. In this price range. Housed in round-cornered, molded case. Beautiful black etched panel. Depressed letters filled with permanent white, insures long-life even with constant use. Specifications: 6 A.C. VOLTAGE RANGES: 0-15/30/150/300/1500/3000 volts. 6 D.C. VOLTAGE RANGES: 0-7 1/2/15/75/150/750/1500 volts. 4 D.C. CURRENT RANGES: 0-1 1/2/15/150 Mo., 0-1 1/2 Amps. 2 RESISTANCE RANGES: 0-500 ohms. 0-1 Meg-ohm. The Model 770 comes complete with self contained batteries, test leads and all operating instructions



\$13⁹⁰
NET

20% DEPOSIT REQUIRED ON ALL C.O.D. ORDERS

GENERAL ELECTRONIC DISTRIBUTING CO.

Dept. RC-3, 98 PARK PLACE
NEW YORK 7, N. Y.

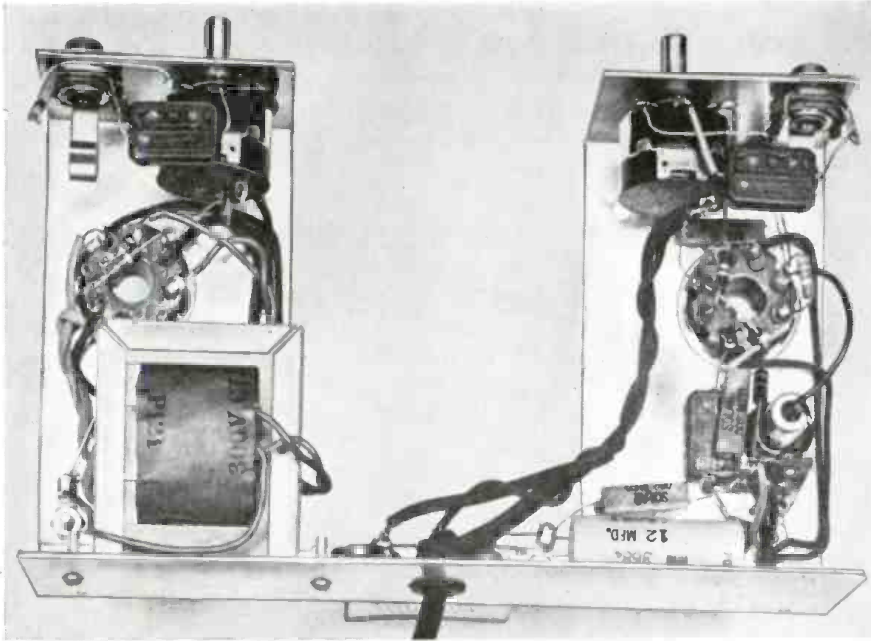

The main chassis assembly contains the power supply and audio generator. Wire it up first.

from the cathode circuit for use in lining up audio systems. The frequency is approximately 400 cycles, about the best compromise for general-purpose work. The same audio tone modulates the r.f. oscillator because of the parallel connection of the two triode plates. The circuit diagram shows the relative simplicity of the circuit and how effectively the parts are utilized. A transformer-type power supply provides isolation from the line, this being particularly desirable when working with a.c.-d.c. receivers. A simple resistance-capacitance filter provides adequate hum reduction since the current requirements are small.

Assembly and wiring

In assembling the generator it is a good idea to start with the main chassis. The photos show the locations of parts. The manufacturer supplies sketches which are very helpful in placing the components. Detailed instructions are also furnished. And—very important—every component needed, down to the last lock-washer, is supplied.

The power-supply section should be wired first. Filament wiring should be twisted to minimize hum pickup. The neon bulb, which is the audio generator, is mounted by inserting it into a rubber

grommet of the correct size, the grommet being first inserted in the chassis. This arrangement provides a shock-proof mounting for the lamp. Incidentally, this type of bulb should be handled with great care since even a slight shock may ruin it.

The tuning assembly, coils, main tuning capacitor, padder, and band switch are wired as a separate unit, as shown in the photo. The wiring scheme shown in this photo and in the maker's sketches should be adhered to strictly, and leads kept short, especially for the three higher-frequency coils, since excessive lead length can materially change the calibration. Be sure to ground one end of each coil to the common solder lug mounted at the center of the tuning-chassis assembly.

The two assemblies, tuning unit and main chassis, may now be joined. With tubes inserted, the unit is plugged into an a.c. line. The neon tube should glow when the switch is turned on. The parts provided in the kit for the test cable are a PL-55 phone plug, a length of shielded and insulated cable, and two alligator clips.

In assembling the kit make sure that all mechanical connections are firm and that all soldered connections are made with a *hot* iron, using only rosin-core solder.

Calibration and use

Calibration is quite simple. With the tuning condenser at full mesh, set the pointer at 150 kc and turn the generator on. Let it warm up for several minutes. Now tune a broadcast receiver to a station of known frequency around 1000 kc and then tune the generator to about the same frequency, as indicated by a whistle in the receiver. It may be necessary to bring the output lead from the generator fairly close to the antenna post of the receiver. Set the pointer to the frequency of the station. Now carefully adjust the trimmer capacitor to the position which gives the lowest-pitched note or a complete null (zero beat). At this point the trimmer should be nearly fully meshed. Calibration should now be close enough on all bands for all average purposes.

When using the generator with commercially built receivers, refer to the manufacturer's data and notes if available. When aligning a.c.-d.c. receivers, it is well to use an isolating transformer in the power line as a safety precaution. Since the generator has a built-in line filter (the two 0.1- μ f capacitors across the line to ground), there may, if no isolation is used, be developed a voltage, no greater than half the line voltage, between the generator and receiver chassis. This is shorted when the ground clip from the generator lead is connected to the receiver chassis.

Construction of this signal generator not only provides a fairly accurate instrument at reasonable cost, but is a valuable experience to the builder, especially if he is a novice.

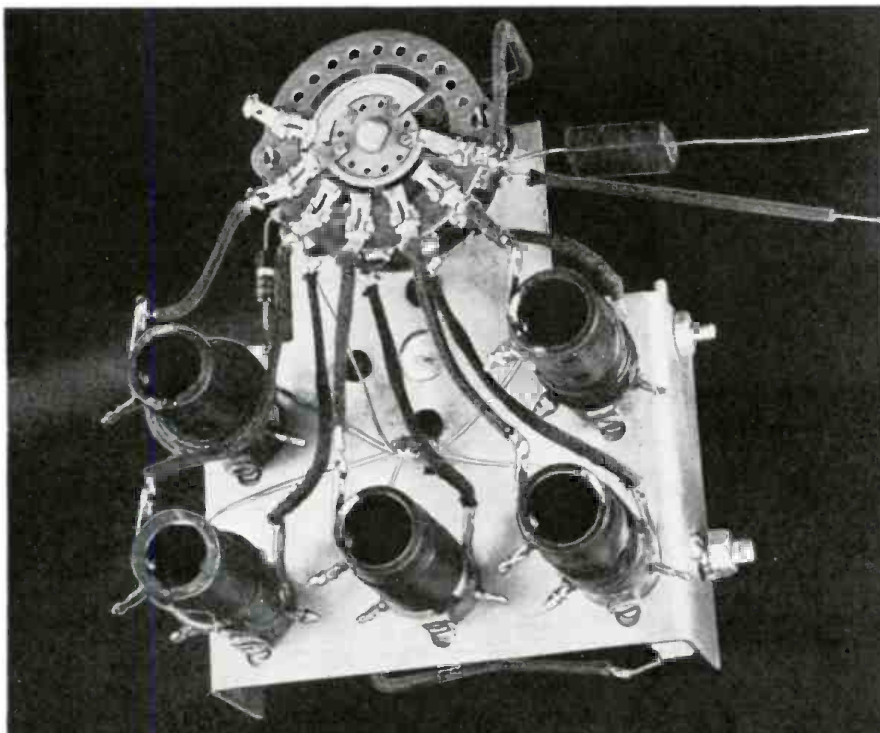

This view of the r.f. coils shows clearly how the r.f. section is to be assembled and wired.

Brand New Tube Sockets

Tube Sockets 12 octals (2 different types) 79c postpaid.



Brand New Antennas

AN-131-A Collapsible 10'8" Antenna. \$1.49 ea., postpaid

Citizen Band Phantom Antenna 85¢



A transmitting antenna, for use on approximately 450 MC. Complete with standard coax connector. A weather proof unit. Add 25c to cover handling and postage.



Brand New Bargain

Throat Mike, complete with cord and switch..... \$.95

New Rectifiers



Brand new Selenium Rectifier 48 volt AC 1 Amp. .79c postpaid.

TUBE BARGAINS!

Minimum Order \$2.00

* indicates Postpaid
1 indicates 25c postage
2 indicates 35c postage
3 indicates 50c postage

215-A	\$.79c *
21169c *
2C26A49c *
3 CP-195c 1
3 DP-1A95c 1
3 FP-7A	1.35 1
3 HP-7	1.45 1
5 FP-7	1.75 2
5 CP-1	1.95 2
5 BP-1	2.45 2
5 HP-1	2.45 2
705 A	1.19 *
7C429c *
7 BP-7	2.65 3
7 CP-1	3.25 3
874	1.50 *
8012	1.69 *
95429c *
9 GP-7	Express Collect 3.50
10Y49c *
100539c *
162639c *
HY61559c *
531	3.95 *

Surprise Package



NO JUNK

5 lbs. assorted radio parts. Your money's worth guaranteed. \$1.49 postpaid.

3/4 R.P.M. MOTOR



\$2.95

Ideal for a beam rotor, plenty of power. Originally designed for 24 volt DC operation, but easily converted, 110 volts AC. Complete instructions included. Excellent for other uses too. Brand new, surplus, guaranteed. (Add 40c each to cover postage and handling)



Loops \$3.95

Used primarily on aircraft & Marine ADF Systems, Loop LP-21-A contains an electric motor and selsyn. These loops have been removed from salvage aircraft, but are guaranteed to be in excellent working condition.

Shipped Express Collect

IMPORTANT!

All merchandise subject to prior sale, minimum order \$2.00. No C.O.D. orders accepted. Michigan residents must add 3% State sales tax.

525 Feet Brand New Telephone Wire \$2.95

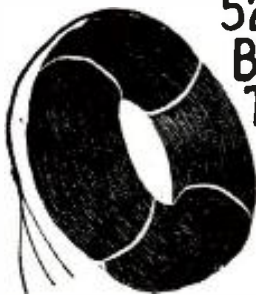

3 conductor braided insulated copper and steel telephone wire. It is of copper for conductivity and steel for strength. Worth at least 3c per foot, yet due to an exceptional buy we can now offer it at less than 1c per foot. (Shipped express charges collect)



By Bendix \$1.29 Postpaid

Model 3616, makes an excellent set up for an intercom. set. Contains 3 multiple type wafers switches, one panel type fuse, one volume control, one master 2 pole double throw switch, one lock type sending and receiving telephone key, one local remote transmitter control, one single pole switch, one 24-volt Leach Relay with 2 contacts.

SPARE PARTS KIT 49c

For CDE 60050 Test Oscillator contains 1 coupling cap. 1000 mm Fd. 300V D.C., 1 Inductor, R.F. 2.5 uh, 0.07 ohm, D.C. Res., 1 Resistor 75 ohm, 5w, 1 potentiometer 1000 ohm 2w, 1 push button switch, and 1 Vibrator 12V. Add 20c to cover postage and handling.



N. SILVERSTINE CO.

6532 EAST McNICHOLS ROAD DETROIT 12, MICHIGAN

Seven Acres of Surplus

Farm Receivers are Easy to Service

There is a good prospect of financial profit as well as valuable experience in working on battery sets in a rural area

By RICHARD LAURENCE

THE beginner in servicing should concentrate on the simpler radios. This gives him needed familiarity with basic circuits, and at the same time allows him to turn out enough work so that he will not become too discouraged over the financial prospects of his new profession.

The 1½-volt farm radio is ideal for the purpose; because there is no built-in power pack, it is probably the most easily repaired set in general use today. The convenience and economy of its 1½-volt A—90-volt B-battery pack have made it so popular that it has replaced nearly all other types of receiving equipment in places where electric mains power is not obtainable.

This type of radio is found chiefly in small towns and rural communities, but there are many millions of them in use. From the beginning of my service career I have found them more profitable than the average electric radio powered from an a.c. or d.c. line.

For one thing, there is the battery; most owners will use a battery every six months, and the serviceman is the logical person to sell it to him. Always keep two or three popular brands on hand and let no customer get out of the shop without trying to sell him one. If he doesn't need it, he is reminded that you have them for sale. Follow-up cards about five months after each sale are helpful, too. The profit on these batteries is two dollars. If you can build up a list of one hundred and fifty customers who will take at least one a year, you have made \$300 with no pain whatsoever.

Then there are tubes. The low filament drain of the 1½-volt tube makes it inherently fragile, and the replacement rate is high. The owner of one of these sets usually lives a good distance from town. The radio is his main source of entertainment, so he wants it in top-notch condition. If you can show him by actual test that some of his tubes are weak, he will generally have these replaced as well as the ones that are inoperable.

A word of caution here. Never, never try to fool the farmer! He gets his money the hard way and expects value received. If he comes in with a loose grid cap—don't sock him with a two-dollar minimum charge. Just keep your services on a straight merchandise and earned-labor basis. Be sure that every set that goes out has been tried thoroughly and is functioning at its best. This policy will pay rich dividends.

Battery-set defects run along the same general lines as those of other radios. However, a few basic defects occur with great frequency; the ability to recognize these at once will greatly speed up your work and add to your profits.

One of the most frequent troubles is opening up of the electrolytic condenser which bypasses audio current from B-plus to ground. This is shown at (a) in the drawing below. The low-frequency oscillation that is set up makes a noise that is more like a hen clucking than anything else I can think of. After the first couple of experiences you will recognize it every time. A supply of 8- μ f, 150-volt electrolytics

should be kept on hand for this job. Of course, polarity should always be observed when installing the new condenser.

The output transformer is the next big troublemaker. It has been my experience that the replacement rate on these is about twice as high as on non-battery radios. When you find a set that makes no noise whatsoever when connected to a good battery, test the output audio tube. If it is o.k., insert your ohmmeter probes in plate and screen grid prongs of the tube socket (with power turned off). A reading on the meter but no click in the PM speaker means the transformer secondary or the voice coil (see b) is defective; no reading and no click means the transformer primary is open. You will find that this is usually the trouble. If the present transformer is riveted to the speaker, you can solder the new one on the chassis. The only precaution necessary is to use a transformer with the correct primary impedance and current-carrying rating for the output tube. Consult a tube manual.

A fault common in farm sets is a burned-out antenna transformer (c). The isolated location of farm buildings makes them more liable to lightning damage, and after every electrical storm you can count on getting a couple of radios with the primary of the antenna transformer burned out. The coil is usually charred and broken so that visual inspection will locate the trouble. You can connect the antenna directly to the grid of the converter tube to make the set play. I have found the Meissner 14-026 universal adjustable coil an excellent replacement in most cases. Install it according to directions, and realign the set if a signal generator is available. In the case of radios which have one or more short-wave bands and a tapped coil, an exact duplicate from the manufacturer of the set will be necessary.

I have found that shorted paper condensers occur much less frequently in battery radios than in transformer-operated a.c. sets. The usual trouble is a shorted coupling condenser between the audio amplifier tubes (d) though a bypass will blow occasionally. Replace

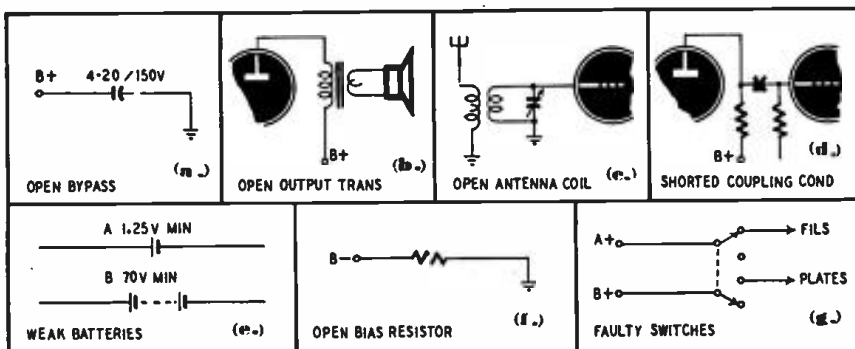

The imperfect drawings indicate troubles which can frequently be found in farm receivers.

Television is Booming—Cash in on it!

RADIO-ELECTRONICS for

with one of a higher voltage rating.

One frequent trouble is that the oscillator will stop. The radio will pop and crackle like a live set, but will not play. I always test the oscillator section of the converter tube first, and replace it if emission is weak. Of course, low A-battery voltage will give the same effect. If you replace the tube and the set will not play at home because of a weak battery, just explain to the customer that the trouble is a combination of two faults—and sell him a new battery. Always try to keep these sets a few days and try them several times to make sure that they keep oscillating. In a very few stubborn cases a new oscillator coil is necessary, but the new tube will nearly always do the trick by itself.

You will find many cases where the owner will bring in his radio, but not the battery, and the set will play perfectly in the shop. If you cannot find anything wrong after a thorough trial, there is nothing to do but suggest that he bring his battery in to be tested. In fact, it is a good idea to encourage customers to bring their batteries along. Test them with the set plugged in and turned on, so as to load the battery. If the A-voltage is under 1.25 or the B-voltage under 70 (e), you should recommend replacement of the battery as it will fail soon.

The output tube is biased by connecting the B-minus battery lead to the chassis through a resistor, so that the voltage drop through the resistor creates a negative bias for the control grid. When making voltage tests on a dead set, try first with the negative prod directly on the chassis. If there is no reading, move the prod directly to the B-minus lead. A normal voltage reading in this position indicates the resistor is burned out (f). The bad resistor can often be detected visually by its discolored appearance.

A final word of warning—don't trust the switches too far. They are of the double-pole, single-throw type (g), and break both A and B circuits. Sometimes one side of the switch gives way and does not break the circuit when turned off. The switch will click normally, but, of course, the set will not operate, as the other circuit is broken. This will ruin a new battery very quickly. I always throw the switch several times and make voltage tests to see if both circuits are broken before I O.K. the switch.

Many farm homes are being connected to power by the Rural Electrification Administration, and you can interest some of these people in converting their battery sets to electric operation. A good converter, such as the GTC Model A Perma-Power, is excellent for this purpose. The set will give the same quality performance it did on battery operation, and will use only 5 watts of power. You will realize a quick return on the job and will save a good servicing account that might be lost for a while if the customer had bought a new receiver.

**It's SPRAGUE
for the full picture on
Television Electrolytics**



**Tops for TV Replacements
— New Sprague Type TVA and TVL Dries**

- Sprague serves the service industry first again with the most complete line of television electrolytics. Engineered especially for tough TV replacement applications, Sprague's new Type TVA "Atom" and Type TVL "Twist-Lock" electrolytics stand up under the high temperatures, high ripple currents and high surge voltages encountered in TV sets.
- You will find comprehensive listings of the most popular replacement units for RCA, Philco, Dumont, Admiral, General Electric, Motorola, Emerson, Zenith, Westinghouse and other leading set brands in Sprague's new bulletin TV-1.
- It's yours for the asking. Write today.

Write for
FREE
replacement
listing
BULLETIN

SPRAGUE PRODUCTS COMPANY, North Adams, Massachusetts

Please send me your bulletin TV-1 without delay.

Name

Street

City..... Zone..... State.....

Fundamentals of Radio Servicing

Part II—Ohm's Law and the resistor

By JOHN T. FRYE

IN the first article of this series (February) we learned that an electric current is made up of a movement of minute negative particles called *electrons*; that these electrons are always attracted by a positive charge, so that an electric current always flows *from negative to positive*; and that we measure current in *amperes*, electromotive force in *volts*, and resistance to the passage of current in *ohms*. Now let's take it from there.

The man who gave his name to the unit of resistance had the bright idea of tying the three units of current, voltage, and resistance together in a simple formula so that, if you know any two of them, you could always find the third. This formula, which is known as Ohm's law, gets more of a workout than a drugstore telephone on a Saturday night, for you simply cannot do anything electrical without using it. You cannot even turn on your flashlight without Ohm's law getting into the act!

The importance of the formula is equaled only by its simplicity and ease of application. Ohm's law states that the current, measured in amperes, flowing in any portion of an electrical circuit is equal to the applied electromotive force in volts divided by the resistance in ohms. That is

$$\text{Amperes} = \frac{\text{volts}}{\text{ohms}}$$

Since the current is referred to as the "intensity," the voltage as the "electromotive force," and the resistance to the passage of current simply as the "resistance," the formula is usually written with the first letters of these three terms

$$I = \frac{E}{R} \quad (1)$$

If we multiply both sides of Equation 1 by R, we have

$$RI = E \quad \text{or} \quad E = IR. \quad (2)$$

Dividing both sides of Equation 2 by I gives us

$$R = \frac{E}{I} \quad (3)$$

These various forms of Ohm's law enable us to determine quickly an un-

known voltage, current, or resistance if we know the other two. Let us take the circuit of Fig. 1 as an example. Here we have three resistors, of 1, 2, and 3 ohms, respectively, hooked in series across a 12-volt battery. When resistors are connected in series, the total resistance is equal to the sum of their individual resistances; so we know that the resistance from A to D is equal to 6 ohms. We also know that the battery voltage that appears across these points is 12 volts; so we simply substitute these values in Equation 1, and we find that 2 amperes of current will be flowing from point A to point D.

Using Ohm's law

Ohm's law applies to any portion of a circuit. Let's consider just that portion between points A and B. We know that 2 amperes of current are flowing through this, as well as every other part of the circuit, and we know that the resistance between these two points is 1 ohm. Substituting these two values in Equation 2, we find that the voltage drop from point A to point B

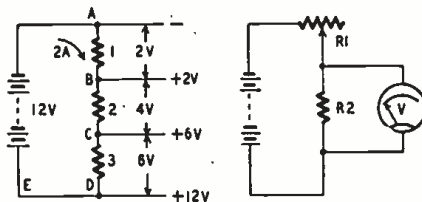

Fig. 1 (left)—Resistors divide the voltage. Fig. 2 (right)—Rheostat varies current flow.

is 2 volts. In the same way we learn that the voltage from B to C is 4 volts, and that from C to D is 6 volts. When these three voltages are added together, they total the same 12 volts with which we started; we have that pleasant and slightly surprised feeling we get when our check stubs and the bank's report on our balance come out exactly together.

This pleasant discovery is expressed by Kirchoff's Law, another of the rules by which radio and electricity work. Kirchoff's Law is a very simple one and it is valuable because it provides a way of checking the accuracy of calcula-

tions. The voltage drops in all parts of a circuit, it says, should, when added together, equal the voltage of the source. If, for instance, we had in addition to the 2-, 4-, and 6-volt drops of Fig. 1, an extra 2-volt drop, the total would be 14 volts. The battery (source) supplies only 12 volts, so we would know something had gone wrong with our arithmetic and we would try it again.

Just to prove how well we can handle Mr. Ohm's handy little gadget, suppose we wanted to reduce the current flowing in our circuit from 2 amperes to 1 ampere. How would we go about it? Well, we have our battery voltage of 12, and we know that we want 1 ampere of current to flow; so suppose we substitute these two values in Equation 3. We come up with 12 ohms as the required resistance. But there are already 6 ohms in the circuit; so we simply put another 6-ohm resistor in series with those we already have—say between points D and E—and our current is reduced to the required 1 ampere. For practice, why don't you figure out the difference this will make in the voltages appearing at points B, C, and D?

In dealing with Ohm's law, there is one thing to keep clearly in mind: it works only when the quantities are expressed in volts, ohms, and amperes. Ten milliamperes should be written: .010 ampere. Two megohms would be expressed as 2,000,000 ohms.

Fixed and variable resistors

Resistance is packaged in units called *resistors*. Some idea of their wide variety of sizes, shapes, and materials can be had from any radio parts catalog. The most common type in radio work is the so-called carbon resistor, made by combining powdered carbon or graphite with a synthetic resin and an inert material such as talc, molding this into short sticks, and attaching flexible wire leads to the ends. By regulating the amount of carbon or graphite, the resistors can be made to have values from a fraction of an ohm to several million ohms. Cheap and small, they are not capable of handling much current without being damaged by the heating effect of that current; furthermore, they are quite likely to change

value with age, and as their temperature goes up, their resistance goes down.

Wire-wound resistors are made by winding a wire made of a high-resistance metal such as nichrome on an insulating form. Capable of handling much more current than composition resistors, they are also more stable. At the same time, they are more costly and bulky, and occasionally the wire fractures, resulting in their changing without warning from their normal value to an almost infinite resistance. Wire-wound resistors seldom exceed 100,000 ohms in value.

It is often desirable to be able to vary the value of a resistor. A slider can be arranged to move along the resistor and to make contact with the resistance element, varying the amount of resistance that appears between the slider and either end. If the resistor is made in the form of a circle, the slider can be attached to a shaft passing through the center of the circular resistance element, and then the variation in resistance can be accomplished by rotating this shaft with a knob. Such a knob-adjusting resistor is variously known as a rheostat, potentiometer, or volume control. The resistance element may be either wire-wound or composition. In volume controls, where the current requirements are small, it is usually composition.

Why resistance is important

At first glance, you might think that resistance was a kind of villain of the piece. Here we have gone to a lot of trouble trying to cause an electric current to flow, either by building a battery or constructing a generator, and now Old Man Resistance is in there doing his level best to gum up the works by throttling the flow of current!

Actually, the ohm is as important as the volt, for, although the volt may be considered the generating force, the ohm is the controlling unit; and if we are to use an electric current, we must be able to control it. Being able to vary the amount of resistance in a circuit gives us a "valve-action" control of the current flowing through the circuit. At the same time, reference to Fig. 1 will reveal another use for resistance, that of "voltage dividing." As can be seen, the 12 battery volts can be sliced up like a length of bologna into any number of smaller voltages by the use of resistors.

Still another use for resistance is to enable us to convert a change in current into a change in voltage. Take a look at Fig. 2. Here we have a variable resistor R1 and a fixed resistor R2 hooked in series across a battery. The amount of current flowing through this circuit will depend upon the voltage of the battery and the resistance of R2 plus that portion of R1 through which the current passes. Any change in the amount of R1's resistance used in the circuit results in a change in the amount of current flowing. We know that the voltage appearing across R2

depends upon the current flowing through it—for didn't Mr. Ohm decree that $E = IR$? So the change in current caused by varying R1 is faithfully reflected as a change in the voltage across R2. When we start studying vacuum-tube circuits, you will see how important this use of resistors is.

Heat and power

Last month we defined a good conductor as any material that gave up electrons easily and so permitted a current to flow through it readily. The materials of which resistors are made are no such pushover for an electromotive force, because they do not give up their electrons without a heated struggle. I use the word "heated" advisedly, for actual heat is generated by the passage of current through a conductor. This heat arises from the energy used in prying loose the electrons from the atoms of the resistance material. Since the electrical force that performs this prying is measured in volts, and since it takes more energy to move several electrons than it does only one, it is not surprising to find that the amount of heat produced is related both to the voltage and the current.

The amount of electrical energy or power expended—or dissipated as heat, in the case of a resistor—is measured in watts. The power in watts consumed in any circuit is equal to the product of the volts and the amperes; or, expressed in formula form

$$P = EI. \tag{4}$$

Equation 2 told us that $E = IR$; and when we substitute this value of E in Equation 4, we have

$$P = I^2R. \tag{5}$$

Because electrical energy that is transformed into heat is considered lost,

we often hear the heat losses of a resistor or conductor called the "I²R losses." Resistors are rated in wattage as well as resistance, and the wattage ratings vary all the way from ¼-watt carbon resistors to wire-wound resistors of 100 or more watts.

Suppose we need a 1,000-ohm resistor that must pass 50 milliamperes of current. According to Equation 5 the wattage requirements will be equal to .050² X 1,000, or 2.5 watts. It is a good practice to allow for a 100% overload; so we select a 5-watt resistor.

You have heard about the boast of the packing houses that they use every part of the hog except his squeal. Well, the electrical engineers are just as good, for they even put these I²R losses to work. In a vacuum tube, for example, it is necessary to raise the temperature of one of the elements (the filament or cathode) in order to persuade it to give up electrons more easily. This heating is accomplished by passing an electrical current through a resistance wire inside the tube. When you look at the incandescent filament of a dial lamp, you are staring some I²R losses right in the face.

And so we arrive at the end of another chapter. By this time you should be on good terms with amperes, volts, and ohms. In fact, if anyone hands you any two of these measuring units, you should be able to rub them together and, with the aid of Ohm's law, produce the third right out of thin air. By the same token you should feel right at home with resistors. You should know what they are made of, what they are used for, why they get all hot and bothered when an electrical current is passed through them. And finally, you should know what's watt!



"He got the idea from a three-ring circus!"

Television is Booming—Cash in on it!

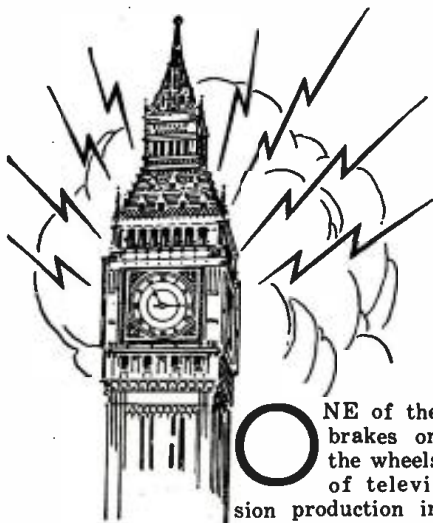

European TV Report

By Major Ralph W. Hallows

RADIO-ELECTRONICS LONDON CORRESPONDENT

ONE of the brakes on the wheels of television production in Britain has been the shortage of cathode-ray tubes with 9-16-inch screens. It is mainly for this reason that the present rate of output is only about 150,000 sets a year. It has actually been stepped up to that rate only in the last month or two, when mass-production methods of making cathode-ray tubes were adopted. Up to now the dollar position hasn't allowed us to import any; but this year the government is to let us buy about 70,000, and that should speed things up a great deal. A speedup will certainly be needed, for people living in the Birmingham area are already ordering their tele-

visers, though their TV transmitter won't be on the air until autumn.

TV can never produce anything like the original radio boom here, partly because it will take so much longer to get a nation-wide service going and partly because even the smallest televisers cost so much more than the crystal sets or the 1-, 2-, or 3-tube broadcast receivers of those days which now seem so long ago. For all that, TV is having, at any rate, a boomlet—and is likely to go on having it. Certainly the televiser is now far and away the most profitable line for any radio dealer in a TV service area to stock, for he can be quite sure that no receiver of reputable make will remain in his window or on his shelves for more than a day or two after it is delivered to him.

A very neat bit of work was done by

our Radio Component Manufacturers when the new bill penalizing those who radiate man-made static was before Parliament. In a conveniently situated hall in London they staged a demonstration showing the horrible effects of such interference on TV reception and explaining how easily and at what small cost it can be dealt with at the right place—the source. To this demonstration they invited members of Parliament, press representatives, and others. So that no one could be accused of grinding his particular ax, all anti-interference devices were shown anonymously. Equally anonymous were the devices used to produce interference, which included auto ignition systems, electric shavers, vacuum cleaners, irons, refrigerators, hair driers, food mixers, and domestic gadgets of all kinds.

The demonstration was most impressive, particularly to those whom it was intended to impress. A clear picture on the screen suddenly went haywire or was enveloped in a snowstorm, the eye-strains of the cathode-ray tube being accompanied by earaches from the loud-speaker. "Not too good, is it?" said the demonstrator. "And now I'll show you the effect of fitting this little device, costing only so much, to the appliance that's causing all the trouble." The results were excellent. Those who went to the show (and they were many) learned, if they didn't know it already, that a thoughtless or selfish neighbor can ruin any TV program. They realized that the "unsuppressed" automobile is a menace and that factories using certain kinds of machinery without interference preventers can make TV reception worthless over large areas. Best of all, they were shown that it was neither difficult nor unduly expensive to nip in the bud the radiation of interference. It was a first-rate idea carried out in a first-rate way; it did a great deal to convince any doubters that anti-interference legislation was necessary and would not inflict real hardships on anyone concerned.

Vision versus television

A day or two before writing this I sat in on an interesting argument which suggested an entirely new angle on TV sports broadcasts. Two friends are rugby football fans. One had watched the annual game between Oxford and Cam-

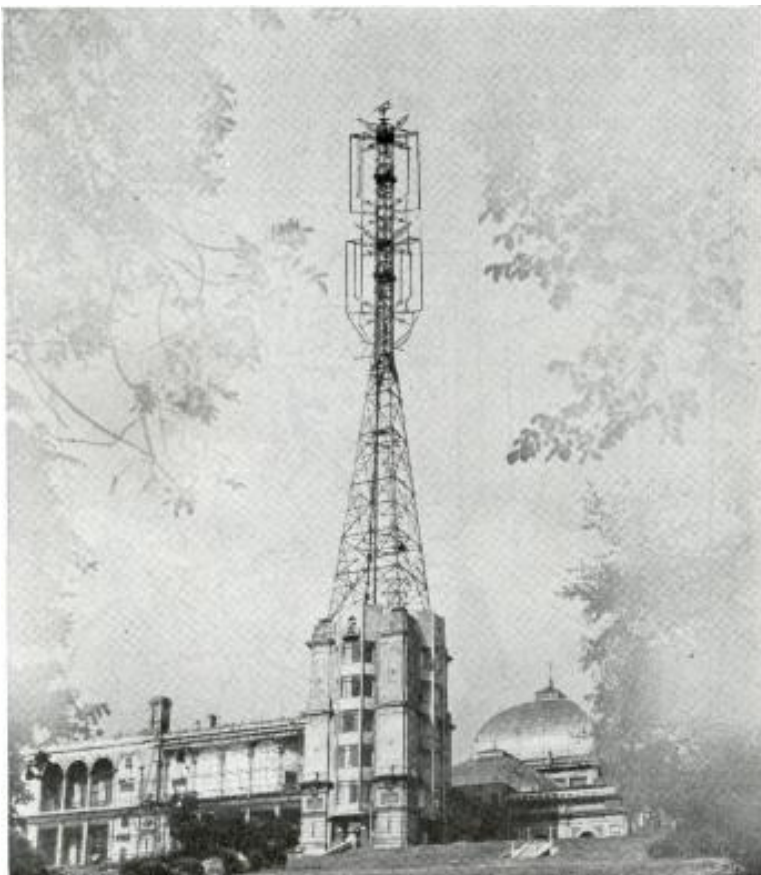

Courtesy British Broadcasting Corp.

At present, Britain's only operating TV station is in the Alexandra Palace, London.

Television is Booming—Cash in on it!

RADIO-ELECTRONICS for

bridge universities from a seat in one of the stands; the other had done his watching at his own fireside on the TV screen. Now, which of the two had been able to follow the play more closely? Which had the clearer impressions of the game? Which, again, had had the more exciting hour and a half as a spectator?

The man who'd been there in the flesh maintained that no one who hadn't actually been on the ground could really have watched the game as a whole. "You saw just bits of it," he said, "just scenes here and there. You didn't see the whole thing as I did."



Ferranti's T. 1246 has modernistic appearance.

There seemed to be a lot in that, but the televiewer backed his case with some pretty sound arguments. The cathode-potential-stabilized Emitron camera now used for outdoor broadcasts by the BBC is considerably more sensitive in poor light than the human eye. Used with a telephoto lens, it can bring to the TV screen details which would be invisible to the spectator on the grounds in the dimness of a December afternoon in London.

The televiewer, therefore, claimed to have had a more close-up view of the play. He maintained also that, with the commentary from the loudspeaker to aid him, he knew far better than the other what was happening at any moment. The commentator knows every one of the 30 players by sight and is always able to say exactly who is doing what no matter how rapid the play. The average spectator hasn't these advantages. Thus, he held, the televiewer gets the best impression of the game.

As I, though also a rugby football enthusiast, had not been able to see the game in person or on the television screen, I was asked to decide who had had the better of the argument. My opinion was that the expert running commentary must always add to the interest and excitement of watching a game. I've seen many sporting events of one kind or another on the cathode-ray tube screen and my belief is that you see more of the details in that way.

MARCH, 1949

PLUG IT IN... AND IT WORKS!

Completely wired 29 TUBE CHASSIS FOR 12½" TV TUBE

Factory engineered, aligned and tested in accordance with most modern electronic methods

\$169⁵⁰

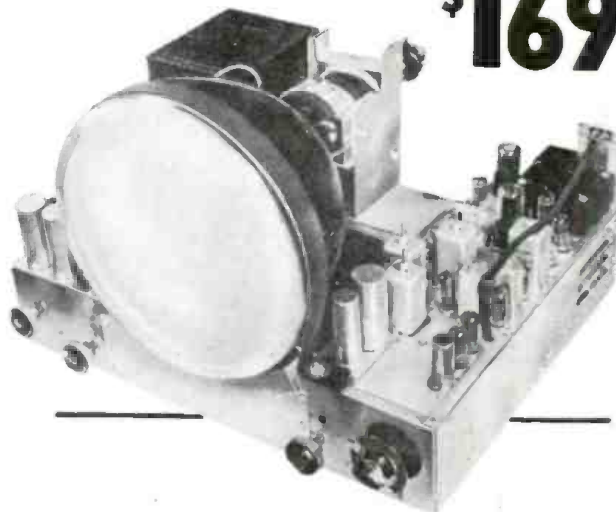

WIRED CHASSIS WITH 12½" CRT \$229.50
CHASSIS WIRED FOR 15" OPERATION (LESS CRT) \$179.50

NOTHING ELSE TO BUY

OR BUILD! This extraordinary direct view chassis, with licensed RCA circuits represents the utmost in TV value . . . The foundation of a \$900 retail value combination, it features large 84" picture screen, 29 tubes including 3 rectifiers, 13 channel tuning, long range reception, front focus control, high gain audio amplifier, automatic frequency control, and many other high-quality construction and operation advantages.

Comes with Schematics and full instructions.

EVEN A LAYMAN CAN INSTALL IT.

Standard RMA Guarantee on tube and chassis.

BUILD YOUR OWN Television Combination AT LOW FACTORY COST with LEHIGH ACCESSORIES:

High Fidelity AM & FM Tuners and Amplifiers, High Fidelity Speakers, Dual Speed Automatic Record Changers, and Custom Designed Decorator-Finish Genuine Walnut or Mahogany Combination Cabinets.

DESIRABLE TV CABINETS
ALSO AVAILABLE

Prices and Literature
on Request

BUY DIRECT FROM FACTORY AND SAVE!

Phone and Mail Orders filled on receipt of \$25 deposit . . . FOB N. Y.

Call in person at our factory showroom for
free demonstrations and instruction

LEHIGH TELEVISION COMPANY

601 West 26th Street, Dept. F, New York 1, N. Y.

Telephone: ALgonquin 5-2046

Prices subject to change without notice.

Television is Booming—Cash in on it!

NEW TORQUE DRIVE KIT

Makes Sales and Service Easy!

**3 TYPES
REPLACE OVER
150 STANDARD
MODELS**

*Lightest, Most Efficient,
Crystal Pickup Cartridge
Ever Produced!*



SELL MORE CARTRIDGES

It's a colorful display . . . creates interest . . . and action . . . helps you sell *more* replacements to old and new customers.

SATISFY MORE CUSTOMERS

You give *faster* replacement service. Your customers get *more* pleasure and *more* good plays . . . *even from old, worn records!*

SIMPLIFY YOUR SERVICE JOB

It's a complete *service* Kit, too. Contains everything for time-saving, labor-saving replacement. Gives you 3 basic models that replace over 150 standard types.

MAKE MORE MONEY

Saves ordering time and service time. Cuts overhead. You make a good profit on every cartridge sale . . . and every service job. Builds needle sales, too! *Put the Kit on display . . . take one with you on your service calls.* Available in Kit "A" (Osmium) and Kit "B" (Sapphire). Each Kit contains 6 cartridges, 4 extra needles, mounting plates, replacement chart.

Order from your E-V Distributor or write for Bulletin No. 142

ELECTRO-VOICE, INC., BUCHANAN, MICH.

Export: 13 East 40th St., New York 16, N. Y., U. S. A. Cables: Arlab

E-V Pat. Pend. Licensed under Brush Patents.

NEW MODEL L14 MICRO-GROOVE CRYSTAL CARTRIDGE AND NEW MODELS 20 AND 22 MAGNETIC CARTRIDGE FOR REGULAR AND MICRO-GROOVE ALSO AVAILABLE

IT PAYS TO REPLACE WITH

Electro-Voice

Television is Booming—Cash in on it!

High-fidelity sound

One thing that TV is doing over here is to make a good many folk realize how vast the difference between ordinary broadcast-band sound and real high-fidelity sound can be. In Europe the broadcast channels are only 9 kc wide, which means that the upper limit for modulation frequencies is 4.5 kc; the sound accompanying British TV, however, takes in modulation frequencies up to 12.5 kc. If the a.f. department of the televiser is right up to the mark, the reproduction is a revelation to those who thought that "radio must always sound like that." It is, of course, only



A typical British set, the Murphy model VII6.

the most expensive TV receivers that do real justice to the high-fidelity sound. The medium-priced and low-priced sets save money by skipping the a.f. side and the loudspeaker; but, quite a few of the better televisers are being sold, and they're gradually producing a demand for better broadcasting. Some of our programs are relayed by high-fidelity FM; but FM is far less of a household word with us than with you—I doubt whether one listener in 100,000 has FM receiving equipment.

The BBC has decided to erect a chain of country-wide, high-fidelity v.h.f. transmitters, but whether they're going to be FM or AM is still very much an open question. My own view, for what it is worth, is that FM will eventually be selected. I don't think that there's a whole lot to choose between v.h.f. wide-band AM and FM as methods of ensuring interference-free reception of a big range of a.f.'s; but I think that FM may win the day, because it doesn't demand the same degree of "contrast compression" at the transmitter as does AM. FM is an "all-or-nothing signal." Provided the amplitude is sufficient to operate the receiver's circuits, it doesn't matter whether it is very large or very small. Hence there's no need to safeguard the nearby listener from having his loudspeaker blown inside out by fortissimo passages, or the distant listener from hearing nothing when music is pianissimo.

RADIO-ELECTRONICS for

NOW...

SYLVANIA RECEIVING TUBES SPECIALLY PROCESSED FOR FINER TELEVISION PERFORMANCE!



Each tube is identified by the special orange markings. This is your assurance of the higher quality demanded by television.

Now, when you replace worn-out receiving tubes in your customers' television sets, give them the finest in television reception with these new receiving tubes *specially processed* by Sylvania for the extra-tough requirements of television service.

These new Sylvania television tubes, in the new bright orange and green television cartons, actually undergo *three times more exacting tests* to insure they are unsurpassed! Their higher quality and superior performance more than justify their small additional cost.

They are not just good tubes, they are *superior* tubes . . . results of Sylvania's years of experience in the electronics field. Be sure you have a ready supply for increased television tube replacement business. See your Sylvania Distributor today! Sylvania Electric Products Inc., Radio Tube Division, Emporium, Pa.

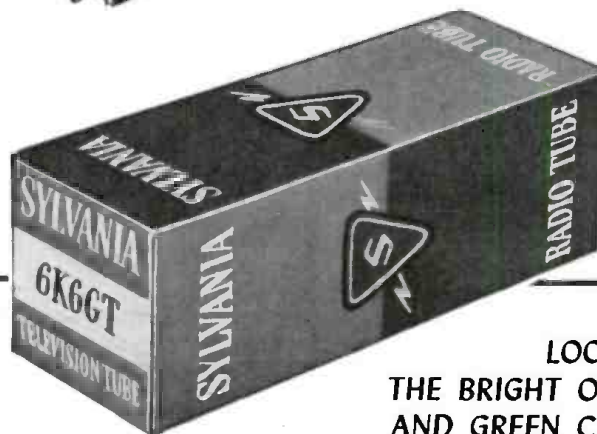

LOOK FOR
THE BRIGHT ORANGE
AND GREEN CARTON

Replace worn tubes with these specially processed Sylvania tubes made to pass television's rigid requirements.

AVAILABLE NOW IN THE FOLLOWING TYPES

1B3GT	6J6	7F7
6AG5	6K6GT	7H7
6AL5	7B4	7N7
6BG6G	7B5	7Z4
	7C5	

SYLVANIA ELECTRIC

RADIO TUBES; CATHODE RAY TUBES; ELECTRONIC DEVICES; FLUORESCENT LAMPS, FIXTURES, WIRING DEVICES; PHOTOLAMPS; ELECTRIC LIGHT BULBS

MARCH, 1949

Television is Booming—Cash in on it!

ELECTRONICS IN MEDICINE

Part VI—Use of Shortwave Diathermy

By EUGENE J. THOMPSON



Courtesy Terma Electric Co., Inc.
Terma Commander generates diathermy waves.

THE remarkable curative powers of heat have been known for centuries. Diathermy is an electronic technique for applying heat to the deeper body tissues. Because of its penetrating action it is considerably superior to older, more superficial, treatment methods. Its value is also enhanced by the other therapeutic procedures which can be performed with the same apparatus (electrosurgery and hyperthermy).

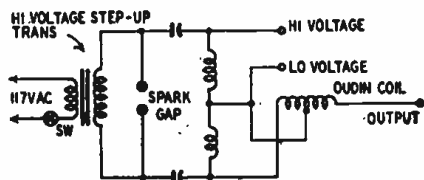

Fig. 1—Simple spark-gap diathermy generator.

It was once customary to distinguish between longwave and shortwave diathermy. However, longwave equipment, which operated at a frequency of about 1 mc, is no longer manufactured because of difficulty in controlling spurious radiation.

All present-day diathermy equipment operates under the regulations of the Federal Communications Commission which has allocated three frequencies for this equipment. These frequencies, together with the frequency tolerance and band width, are:

Frequency (mc)	Tolerance (%)	Band Width (kc)
13.66	±.05	15
27.32	±.05	270
40.98	±.05	40

The radiation must not exceed 15 microvolts per meter at a distance of 1,000 feet.

Diathermy currents heat tissues because they are of high frequency and voltage. The high frequency sets into motion any electrons in its field; the rapid motion generates heat.

There are two major ways to generate such currents—with spark-gap apparatus and with vacuum tubes. Representative circuits for both methods are shown in Figs. 1 and 2. Each consists essentially of a voltage step-up circuit (which increases the voltage from 117 to 2,000 or more) and an oscillator circuit. In the spark-gap equipment, the oscillator circuit consists of an inductor, two capacitors, and a spark gap. Its output is a train of damped high-frequency waves.

Although spark-gap apparatus can be designed to operate in the shortwave diathermy range, the cost is so great that vacuum-tube equipment is employed almost exclusively in the United States. However, spark-gap instruments are widely used for electrosurgery.

Both grid and tank circuits of vacuum-tube oscillators are usually factory adjusted at a fixed frequency.

Most instruments, such as that in Fig. 2, employ full-wave rectification and filtering to eliminate hum and line disturbances and to prevent the frequency instability which would result if a.c. were applied to the plates of the oscillator tubes. Spurious radiations are suppressed by shielding the oscillator circuit from the line and output sides

of the apparatus by means of an r.f. filtering network.

The current is applied to the patient by special electrodes, one type of which is shown in the photograph of the instrument diagrammed in Fig. 2. In shortwave diathermy it is not usually necessary to place these in contact with the body. The electrodes, their distance from the body, and the thickness and

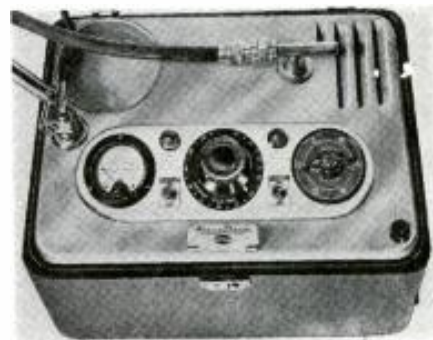

Courtesy Raytheon Mfg. Co.
The Microtherm is u.h.f. diathermy generator.

dielectric constants of the portion of the body placed between them determine the capacitive load on the output circuit. This "patient's circuit" must be tuned with capacitors C so that it is in resonance with the tank circuit to secure the maximum transfer of energy.

Shortwave diathermy equipment can also be used for a technique known as

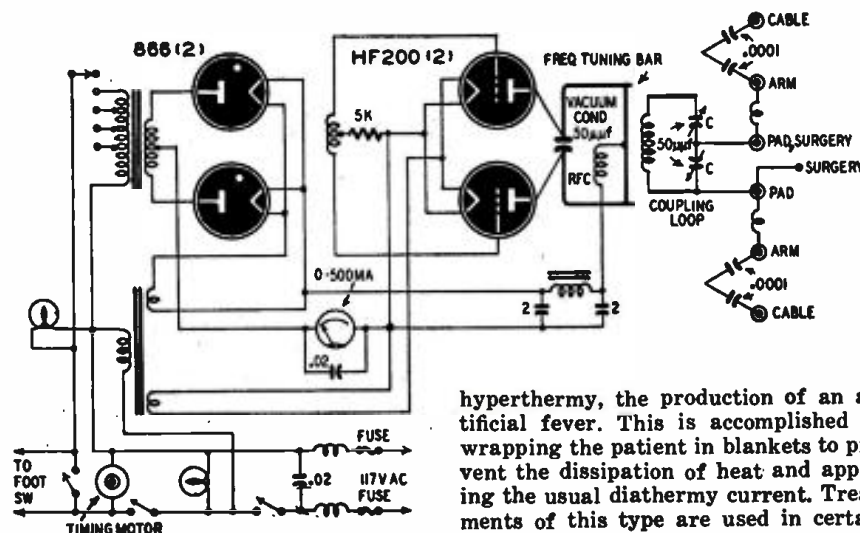

Fig. 2—This is the schematic diagram of Terma Commander, suitable also for surgery.

hyperthermy, the production of an artificial fever. This is accomplished by wrapping the patient in blankets to prevent the dissipation of heat and applying the usual diathermy current. Treatments of this type are used in certain afflictions of the nervous system.

Some of the greatest advances in surgery within the past decade have been

made possible by the electrosurgical applications of shortwave diathermy equipment. The entire field of bloodless surgery owes its existence to diathermy.

There are three principal electrosurgical techniques: *electrodesiccation*, *electrocoagulation*, and *electrosection*. Electrodesiccation dries and shrinks the tissues. It is a so-called monoterminal technique, that is, only one electrode is employed. The modality used is a high-voltage, low-amperage current. It can be obtained from the spark-gap instrument in Fig. 1 through the Oudin-coil attachment. It can also be obtained from the SURGERY output terminals of the vacuum-tube instrument in Fig. 2.

Electrocoagulation and electrosection are both biterminal procedures, that is, two electrodes are necessary. Electrocoagulation currents are high-amperage modalities produced by both the spark-gap and vacuum-tube instruments. They seal cut blood vessels.

Electrosection or surgical cutting is a strictly shortwave procedure. It cannot be obtained with the spark-gap equipment of Fig. 1. The operating scalpel is connected to one output terminal of the apparatus and a large dispersing electrode is connected to the other terminal. A large amount of heat is concentrated on a very small area of the body by the sharp edge of the scalpel. The heat is not present in the scalpel but is generated in the tissues in the immediate vicinity of the scalpel. The knife glides through tissues with great ease, and the heat cauterizes as the knife cuts. The advantage of electrosection is the cleanness of the surgery possible.

One of the most interesting aspects of electronics is that a single basic principle can have many very different applications. At first glance there would seem to be little connection between wartime radar and the treatment of disease. As a matter of fact, the very latest diathermy technique is a direct outgrowth of microwave research. The instrument, known as the Microtherm, is illustrated by the photograph and the schematic diagram of Fig. 3.

It operates in the 2,400-2,500-mc band approved for medical use by the FCC. The maximum power output is 125 watts, and the r.f. energy is applied to the patient through a director. The microwaves are generated in a continuous-wave magnetron oscillator which, except for the director and connecting cable, constitutes the entire r.f. circuit.

The apparatus employs filtered full-wave rectification, and uses separate plate and filament transformers. The input to the high-voltage transformer is controlled by a 3-minute, thermally actuated time-delay relay, an interval timer, and a variable autotransformer. The latter permits adjustment to various line voltages and controls the power output of the RK-5609 magnetron. The power level is indicated on a milliammeter which is calibrated in percentage of maximum power output. A motor-driven blower supplies cooling air.

The output of the magnetron is ap-

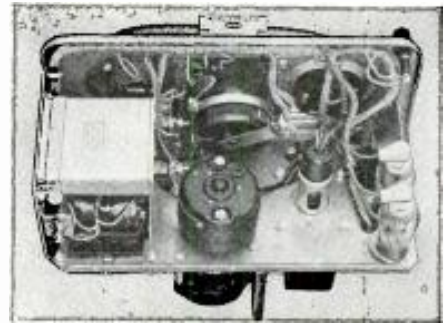
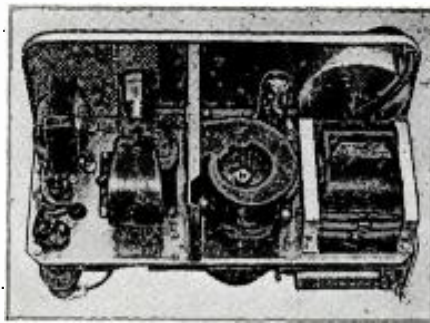

Blower and RK-5609 are on upper section of Raytheon Microtherm, left. Lower section at right.

plied to the patient through a co-axial cable and director.

The RK-5609 requires a high initial plate voltage before plate current flows, and a very small change in voltage thereafter produces the maximum desired increase in plate current. For this reason an autotransformer and a variac are used. The transformer has both 117- and 180-volt primary taps. By placing the variac across these taps it is possible to vary the plate voltage from approximately 1,100 (with the line at 126 volts) to approximately 1,500 (with line at 105 volts). Anode current

centrally located cathode to describe a circular path. When sufficient electron velocity is reached, the cavities begin to resonate. Anode current begins to flow at an anode potential of approximately 1,000-1,100 volts.

Energy picked up by the coupling loop is carried out through a glass seal on the center conductor of the co-axial output connection. To get this energy through the panel and to make a connection to the flexible co-axial cable, a transition unit is used, in effect, a co-axial tube with the center conductor supported at a quarter-wave point.

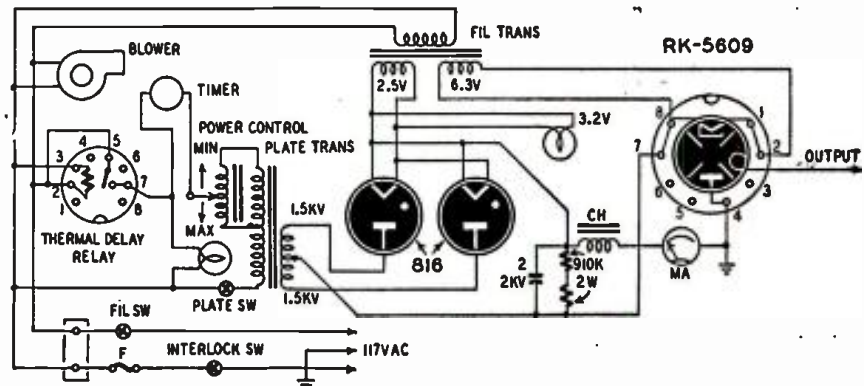

Fig. 3—Microtherm uses a magnetron to generate diathermy waves. Frequency is 2400-2500 mc.

varies from zero at minimum setting to approximately 200 ma at maximum setting with a 126-volt line.

The magnetron operates as a diode with the anode at ground potential (note that B-plus is grounded) and oscillates at a frequency of 2,450 mc. The frequency is determined by the cavity construction of the tube, but in operation may shift ± 20 mc. A series of cavities containing the necessary inductance and capacitance are tied together; the energy generated is picked up by a small coupling loop. The field of the magnet causes the electrons leaving the

The directors are connected to the transition unit through a co-axial cable. The various directors consist of a radiating element and a reflector which direct the energy in the required pattern, depending on the type of treatment. The radiator is always connected to the center conductor and the reflector to the shield.

Among the advantages claimed for microwave energy are that it provides great absorption, deep penetrating heat, precisely controlled application for both large and small areas, and does not require electrode pads.



These u.h.f. energy directors are used with the Microtherm for various methods of therapy.

Television is Booming—Cash in on it!

New Headset from TELEX...

NO PRESSURE ON THE EARS

Here's a really new headset: TELEX TWINSET! Sweaty, tiresome "ear-cups" are gone forever! Signal may be piped directly into the ear so that *nothing touches the ear* at all! Matched in-phase magnetic receivers banish listening fatigue—listen for hours in complete comfort with this high-fidelity, 1.6 ounce headset.

An all purpose headset, the unique TELEX TWINSET, is designed for your hearing comfort and exacting headset demands. Obtainable from your favorite parts jobber, or, write Dept. 10, Telex Inc., Telex Park, Minneapolis, Minnesota.

SPECIFICATIONS:

<p>Sensitivity—101 decibels above .000204 dynes per sq. cm. for 10 microwatts input</p> <p>Impedances—1000 ohms and 64 ohms</p> <p>Construction—Weight: 1.6 oz.</p>	<p>Tenite plastic and bright nickel construction, with head-band of Z-Nickel steel wire encased in plastic. Single 5-foot cord plugs into either receiver.</p> <p>Sealed, rustproof diaphragms.</p>
--	---

Special Cord with built in miniature Volume Control also available

NEW TELEX TWINSET



TELEX, Telex Park, Minneapolis, Minnesota
 Manufacturers of Telex Monoset • Telex Pillow Speaker • Telex Precision Hearing Aids

Television is Booming—Cash in on it!

TELEVISION BOOSTER

Here is the circuit of a preamplifier I designed and built for my own use on television channels 1 through 6. Living about 150 miles away from Washington, with this preamplifier between the antenna and the receiver I get good reception from Washington stations. Without it I can't get any picture at all.

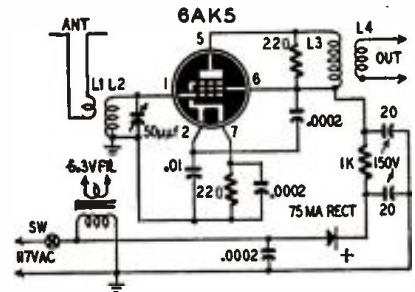

Observe the usual precautions for high-frequency equipment, especially the avoidance of long leads, and use the smallest possible components.

L2 is 5 turns of No. 24 enameled wire close-wound. L1 is 2 turns of No. 32 s.c.c. wound over the ground end of L2. For L3 close-wind 26 turns of No. 24 enameled wire; and for L4 wind 12 turns of No. 32 s.c.c. over the B-plus end of L3. L2 and L3 have a diameter of 1/4 inch.—Roger E. Hammer

SIMPLE PULSE GENERATOR

Described first in *Practical Wireless* (London), this simple pulse generator was used to demonstrate the action of a time-base or sweep generator in oscilloscope and television circuits. It can be used in a number of practical circuits such as electronic metronomes and automatic light flashers.

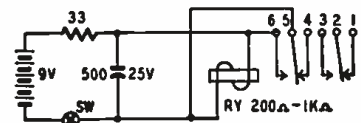

A large capacitor, 500 µf or higher, is connected across the coil of a high-resistance relay that is in series with a 9-volt battery, a switch, and a 33-ohm resistor. When the switch is closed, the capacitor begins to charge. The relay operates when the charge on the capacitor reaches the battery voltage. This closes contacts 5 and 6 and 2 and 3. Contacts 5 and 6 short the capacitor, the relay opens, and the cycle begins anew. A rough saw tooth can be obtained from the terminals of the relay coil. Circuit to be controlled may be connected across contacts 1 and 2 or 2 and 3. The 33-ohm resistor prevents shorting the battery when terminals 5 and 6 close.

In an oscilloscope a neon or other gas tube would replace the relay coil. Ionization would short the capacitor when it charged to breakdown voltage.

BILL OF MATERIALS

- 1—33-ohm resistor.
- 1—500-µf, 25-volt elec. capacitor.
- 1—s.p.s.t. toggle switch.
- 1—relay d.p.d.t. with 200- to 1,000-ohm coil.

RADIO-ELECTRONICS for

COAX CABLE

**TREMENDOUS VALUES IN GUARANTEED
COAXIAL CABLE • ANTENNA WIRE
MICROPHONE AND HIGH VOLTAGE CABLE**

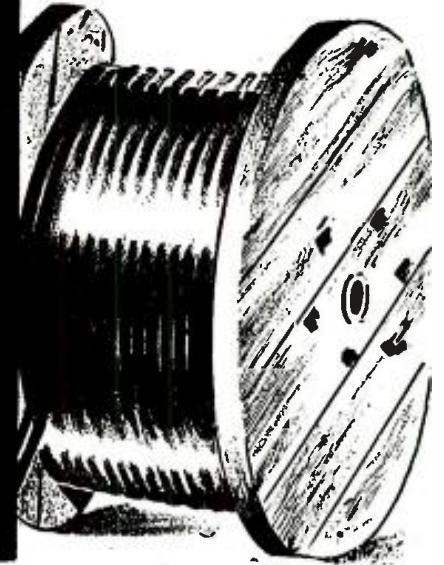

COAX CABLE

RG-7/U	97.5 ohms impedance; outside diameter .370"; black vinyl jacket; polyethylene insulation. On original manufacturer's reels of 2040 feet.....	\$37.50/M
	100 ft. coils.....	.04/ft.
RG-29/U	53.5 ohms impedance; outside diameter .184"; black vinyl jacket. Packaged on 4000 ft. reels.....	27.50/M
	1000 ft. reels.....	32.00/M
	100 ft. coils.....	.035/ft.
RG-29/U-W	Same characteristics as RG-29/U except cotton braided covering. Per 1000 feet.....	25.00/M
	100 ft. coils.....	.03/ft.
	RG-29/U is ideal for television to eliminate lead-in pick up of local interference. RG-29/U is similar to RG-58/U.	
RG-57/U	2 conductor Coax. 95 ohms; Kilowatt Rating. Any length.....	.18/ft.
RG-8/U	Limited quantity.....	40.00/M

LOW LOSS BEADED COAX CABLE, 72 ohms impedance.

Type 72-12 — for ultra high frequency, with black vinyl covering supplied in any length desired.....	.11/ft.
Type 72-12-W — Same as above except varnish cambric covering supplied on 60 ft. coils, only.....	.07/ft.

OTHER WIRE AVAILABLE FROM WELLS

PWD-20-2	Plastic coated assault wire two-conductor twisted Type W-130. Available on 1000 to 2500 ft. steel reels, individually boxed	7.00/M
PWD-20-3	3000 ft. payout reels (packed two reels per box).....	6.50/M
PWD-20-10	10,000 ft. steel reels.....	6.25/M
AWT-18-1	Army Field Wire, Type W-110B. Two conductor, stranded, rubber covered, weather proof. 1000 ft. reels.....	10.00/M
AWT-18-10	Army Field Wire, Type W-110B. Two conductor, stranded, rubber covered, weather proof. ½ mile steel reels.....	9.50/M
AWT-18-20	Army Field Wire, Type W-110B. Two conductor, stranded, rubber covered, weather proof. 1 mile steel reels.....	9.00/M
KW-3	Flexible Phosphor Bronze No. 18 bare aerial wire 300 ft. spool.....	1.00/Sp.
KW-10	Flexible Phosphor Bronze No. 18 bare aerial wire 1000 ft. coil.....	3.00/M
AJ-18	Aerial Wire, No. 18, Copperweld, solid — on 3000 ft. reels, only.....	4.00/M
SWB-20	Single conductor No. 20, shielded, over-all braid, 1000 ft. reels.....	15.00/M
SC-20-1	Single conductor, ANJC-48, No. 20, stranded, glass braid, lacquered 1000 volt insulation, 2000 ft. reels.....	10.00/M
SC-20-3	Single conductor No. 20 glass braid, lacquered, 3000 volt insulation for Transmitters, 1000 ft. coils.....	12.00/M
MW-1	Shielded, single conductor microphone cable, rubber covered, extra flexible, inter-conductor stranded silver wire, 500 ft. coils.....	12.50/coil

MANUFACTURERS: WRITE FOR QUANTITY PRICES.

JOBBER: REGULAR DISTRIBUTOR'S ARRANGEMENT APPLIES • ORDER FROM THIS AD.

WE CARRY A COMPLETE STOCK OF COAX CONNECTORS . . . WRITE FOR LISTING NO. 100M.

WELLS
SALES, INC.

320 N. LA SALLE ST., DEPT. Y,

CHICAGO 10, ILL.

MARCH, 1949

Television is Booming—Cash in on it!

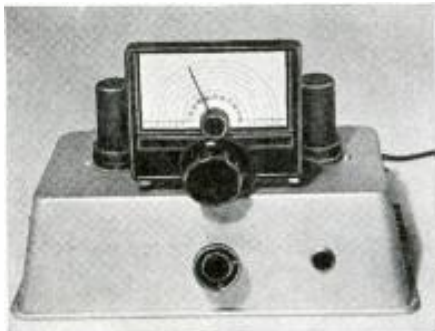

Front of the t.r.f. tuner.

T.R.F. Tuner Has A.C.-D.C. Supply

By CLINTON E. CLARK

THE radio student or builder who has gone through the stage of building crystal and regenerative receivers can add to his experience by building this simple t.r.f. tuner. The finished product of a few hours of construction time is a compact, self-powered receiver or tuning unit. Enclosed in a cabinet, it is an attractive "personal" radio for headphone reception. Slight changes in layout will allow room for an output tube, such as a 50L6-GT, which would provide enough audio to drive a small speaker.

Cost is low, varying with the number of parts the builder may already have at hand. If a discarded receiver is avail-

able for coils and tuning capacitor, there would remain only the tubes, which are low-priced, and a few small parts. If parts must be purchased, get a good set of matched coils. An instruction sheet comes packed with the coils giving proper terminal connections. Small trimmers, one across each section of the tuning capacitor, are usually permanently attached to it. A capacitor without trimmers should be avoided if possible since it is sometimes a difficult job to wire them in satisfactorily.

The chassis is an inverted cake tin measuring 4 x 9 x 3 inches. The particular one shown in the photographs is of stamped aluminum which, in addi-

tion to being light and easy to work, is very attractive in appearance. An electrical ground for the chassis is provided through a .01- μ f capacitor. For safety an aluminum shield covers the selenium rectifier stack, eliminating the danger of receiving a shock through accidental contact with it. With these precautions taken it is not necessary to use a cabinet, as is the case when a chassis is hot.

(It is a common misconception among radiomen that a chassis "isolated" from the a.c. line by a capacitor is not hot. To realize that the opposite is true requires either only a little examination of radio theory or a few highly practical experiences in the form of shocks, or both. Since there is normally no current flow through (and no voltage drop across) the "isolating" capacitor, the potential on the chassis may be either zero or the line voltage, depending on which way the a.c. plug happens to have been put in. If you are well grounded—literally—and touch the chassis, you will initially feel the full 117 volts. The capacitor is valuable because it *usually* prevents loss of life. When you first touch the chassis, current flows through the capacitor and you to ground. Since the reactance of a .01- μ f capacitor at 60 cycles is in the neighborhood of 260,000 ohms, the current, which is the murderous element, is usually limited to a safe value—safe, that is, provided you haven't a weak heart. The initial voltage jolt, however, is not a pleasure under any circumstances. Better plan to put the t.r.f. receiver in a wooden cabinet for safety.—*Editor*)

First, the socket holes are cut and the tuning capacitor and dial mounted. Since the dial has a metal shell, it must be insulated from the shaft of the capacitor (which is mounted on the chassis with standoff insulators). This is done by a bakelite shaft extension, one end of which fits over the condenser shaft and is held by a small set screw. The 1/4-inch extension rod fits into the shaft hub of the dial. Make all the set screws good and tight.

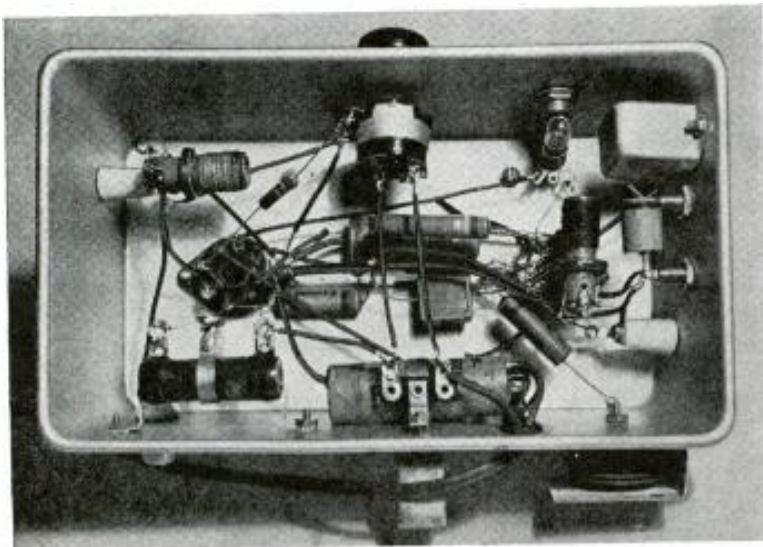

Looking under the chassis, it is easy to see that there is plenty of room for components.

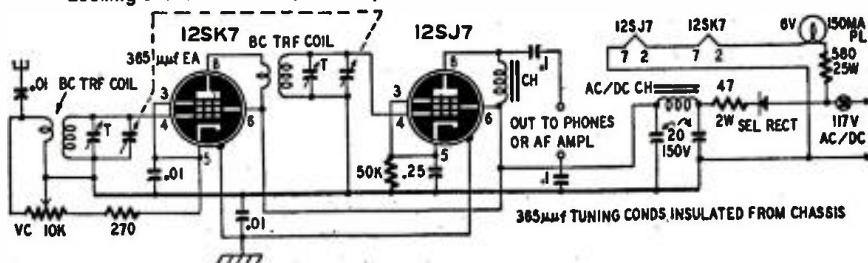

Be sure to mount the 580-ohm line-dropping resistor in a place where it can dissipate heat.

Television is Booming—Cash in on it!

RADIO-ELECTRONICS for

The builder may choose from a wide variety of types in selecting a dial. The one used here was chosen because the physical size matched the unit well. It has a 7 to 1 drive ratio and a paper scale for calibration markings.

Each coil is mounted under one of the tubes. The mounting lug or bracket on most coils is also the ground end of the windings so, to isolate them from the chassis, they are mounted on small cone insulators threaded at both ends for a machine screw. Sufficient separation eliminates the need for shielding to prevent coupling between stages. Extra attention should be given to making correct connections in wiring the coils. The manufacturer's data sheet should be followed to avoid unnecessary trouble.

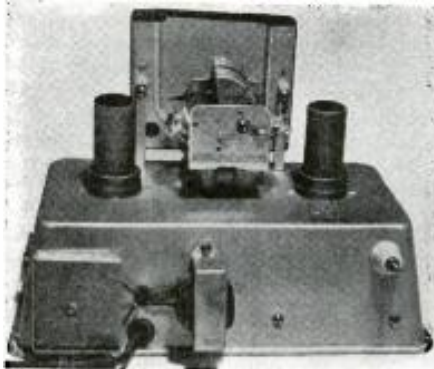

Selenium rectifier is mounted on rear apron.

The 580-ohm series dropping resistor must be mounted away from components which may be affected by heat. A few small vent holes may be drilled or punched in the chassis above the resistor with an icepick to provide sufficient ventilation. As an alternative, the 6-volt versions of the tubes used could be substituted and a small filament transformer employed. Should a stage of audio, such as the 50L6-GT suggested, be added, the value of the dropping resistor would have to be reduced. The proper size is easily found by Ohm's law.

Some adjustment of the trimmers will probably be necessary. Use an alignment tool or a piece of ¼-inch-diameter bakelite shafting shaped to a screwdriver tip. An ordinary metal screwdriver should not be used for alignment.

Lacking the sensitivity of a superheterodyne, the tuner will need a fairly good antenna. In rural districts 50 to 100 feet of outside wire should be ample. In metropolitan areas less antenna is necessary. The t.r.f. receiver may not be comparable to the superhet in some ways, but its low signal-to-noise ratio and broad tuning have brought it into increasing favor as a high-fidelity tuning system.

LIST OF MATERIALS

Resistors: 1—270, 1—47,000 ohms, ½ watt; 1—47 ohms, 2 watts; 1—580 ohms, 25 watts; 1—10,000-ohm potentiometer.
 Capacitors: 2—20 µf, 150 volts, electrolytic; 3—.01, 2—.01, 1—0.25 µf, 200 volts, paper, 1—2-gang, 345-µf-per section air variable with trimmers.
 Tubes: 1—12SK7, 1—12SJ7.
 Miscellaneous: 1—a.c.-d.c. filter choke; 1—audio choke; 1—75-ma selenium rectifier; 1—s.p.s.t. toggle switch; 1—4-8-volt, 150-ma pilot lamp and assembly; 2—broadcast t.r.f. coils; 1—chassis; 1—tuning-dial assembly; necessary hardware.

AT LAST!! A LOW COST POWER UNIT FOR SERVICE WORK

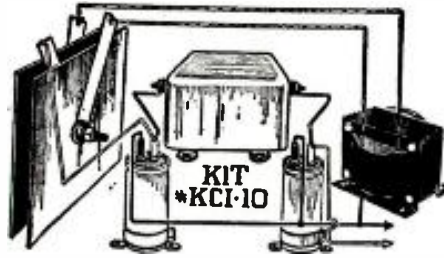

**"A" ELIMINATOR KIT
KC 1-10**

only **\$19⁵⁰**

Including pictorial and schematic diagrams

For the first time, we are offering a well-engineered six volt direct current power unit for auto-radio and similar service work in kit form!!

This unit was formerly in the high priced range. Now, we have placed all the essential components necessary for construction in kit form, and are offering them to you at this low, low price.

These kits fulfill the long-standing need of every serviceman and technician. They are designed to operate from a 115 V.A.C. 50/60 cycle source, and deliver 6 V.D.C. well-filtered from three to eight amperes, with a peak rating of ten amperes. The A.C. ripple percentage is held to remarkably low values.

This unit charges a standard auto battery in one day!!

- Do away with bulky batteries!
- Do away with corroding fumes!
- Simplify your service operation!

Order this fine kit for your bench today !!

No C.O.D.'s. Full remittance with order. Shipping wt., 12 lbs.

ATTENTION DEALERS! Write for quantity discounts

OPAD-GREEN COMPANY

71 Warren St. Phone: BEekman 3-7385 New York 7, N. Y.

OPERATE RADIO RECEIVERS FROM SINGLE BATTERY?



It's Easy with this SYNCRO POWER UNIT . . .

The Model "Q" Syncro power provides A and B voltages from a 6-volt battery with only ¼ the drain that an auto radio exerts on battery. Gives over three weeks' reception for a 4-tube radio from a single storage battery charge. Costs but a few cents a day to operate.

There is a big country market for the Model "Q" and the Model "R" for dealers in the farm country, and for city dealers whose customers have summer homes. Model "R" for 2-volt 4, 5, 6 and 7-tube radios. Model "Q" for 1.4 volt 4, 5 and 6-tube radios.

There is an Electro Battery Eliminator for every requirement operating from either 110V or 220V, 50 to 60 cycles, or from 6V storage battery; also 6V, 15 amp. Model "A" operating from 110V, 50 to 60 cycles. All are completely filtered and hum free. Compact units of sturdy construction with Hammerloid finish. Operate in any position.

ELECTRO PRODUCTS LABORATORIES

Pioneer Manufacturers of Battery Eliminators

549 W. Randolph St., Chicago 6, Illinois

VIDEO I.F. AMPLIFIERS

Constructors who design and build their own television receivers often have trouble with the video amplifiers because of the necessity for wide band width and the rejection or trap circuits. The RCA Application Note, "Use of Miniature Tubes in Stagger-Tuned Video Intermediate-Frequency Systems," gives complete design data on two stagger-tuned i.f. systems. One circuit uses four 6AG5's with an over-all gain of 6,500, and the other uses 6AU6's with a gain of 3,000.

The diagram below shows constants for the 6AG5 amplifier. All capacitor values are the same in both circuits, but some changes in resistor val-

ues are needed in the 6AU6 circuit. In the latter amplifier, the coded resistors are: R1—2,700 ohms; R2, R5, R7, and R10—68 ohms; R3, R6, R9, and R11—33,000 ohms; R4—3,300 ohms. Note that R8 and C1 are not used in the 6AU6 amplifier.

To obtain optimum results without experimenting, the i.f. transformers should be constructed as shown in Fig. 1 and the parts laid out for shortest leads as shown in Fig. 2, the layout of the third and fourth stages of the 6AU6 amplifier. The other stages are laid out and wired in a similar manner. If this method of construction is not followed, it may be necessary to experiment with the tuned circuits because any other layout will result in different wiring capacitances. Shielding, although not absolutely necessary for the i.f. transformers, makes the amplifiers more stable and easier to align.

A good r.f. signal generator and a high-frequency voltmeter with low input capacitance are recommended for aligning the amplifiers. Set the generator to the resonant frequency of the last i.f. stage and feed the signal into its grid. Adjust the tuning slug for maximum reading on the meter connected to the plate circuit. Align the other stages in turn, working toward the grid of the converter. A sweep generator and wide-band oscilloscope may be used to adjust the over-all response curve to the desired shape. A steep-sided curve with a sharp rejection notch at the sound carrier frequency may result in loss in vertical resolution as indicated by blurring of the center portion of the vertical wedge on a test pattern. Avoid this effect by rounding off the response curve between 21.25 and 22 mc.

The filament chokes consist of 14 turns of No. 20 enameled wire, close wound, with ¼-inch inside diameter. L1, L2, and L4 have 21 turns of No. 28 enameled wire; L3 and L5, 25 turns of No. 28; L6, 8 turns of No. 18 on the same form with and spaced ¼ inch from the plate end of L1. L7 is 8 turns of No. 18 enameled wire on the same form with and spaced ¼ inch from L2.

L8 and L9 are 6 turns of No. 18 enameled on the same form with and spaced ¼ inch from L3 and L4, respectively. L10 is 4 turns of No. 24 enameled, spaced ¼ inch from the cold end of L11 on the same ¼-inch form. L11 is 6 turns of No. 18 enameled spaced out to ½ inch. L12 is an r.f. choke made by winding 60 turns of No. 32 enameled wire over a 2,700-ohm resistor ¼ inch in diameter.

6-METER CONVERTER

Amateur activity on 6 meters has become increasingly popular during the last year or so. Yet relatively few communications receivers tune higher than 30 mc (10 meters). Of the receivers that cover the 6-meter band, few, other than double-conversion superheterodynes, have sufficient selectivity and image rejection for amateur use. In most instances, a good 6-meter converter with a high output frequency will give better results than a standard receiver with 456-kc i.f. amplifiers. The converter shown, originally described in *Radio and Hobbies* (Australia), was designed to give good 6-meter reception with any receiver that tunes to 10.7 mc.

The circuit is simple and straightforward, its performance being determined largely by the quality of the components and the mechanical layout. All components in the tuned circuits should be mounted so the shortest possible leads can be used. If at all possible, mount the coils, tuning capacitors, and tube sockets so the terminal lugs connect together without additional leads.

The 954 r.f. amplifier can be mounted on a vertical shield above the chassis. The grid coil and tuning capacitor are on one side of the shield, and the plate pin of the 954 projects through the shield for a direct connection to a terminal on the plate coil. The plate tuning capacitor is close to the coil.

The 6AC7 mixer and 954 oscillator can be on the chassis with their components grouped around the 15-μmf capacitor in the oscillator circuit. This capacitor, the bandspread control, is on the panel. The 35-μmf unit is the bandset control and may be a ceramic

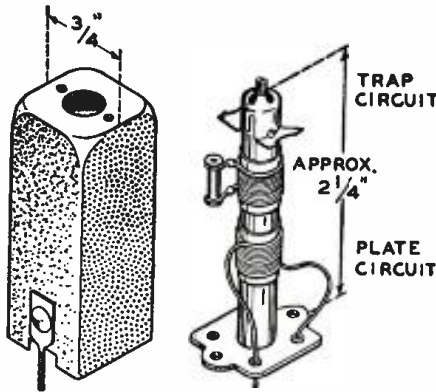

Fig. 1—Appearance of the i.f. transformers.

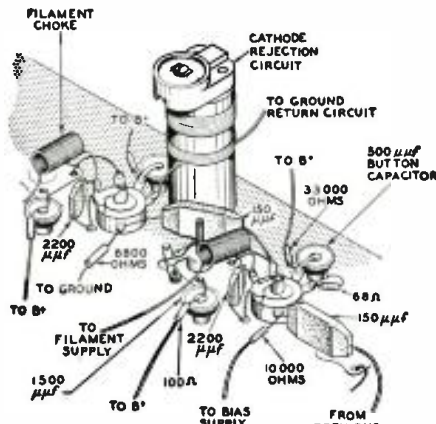
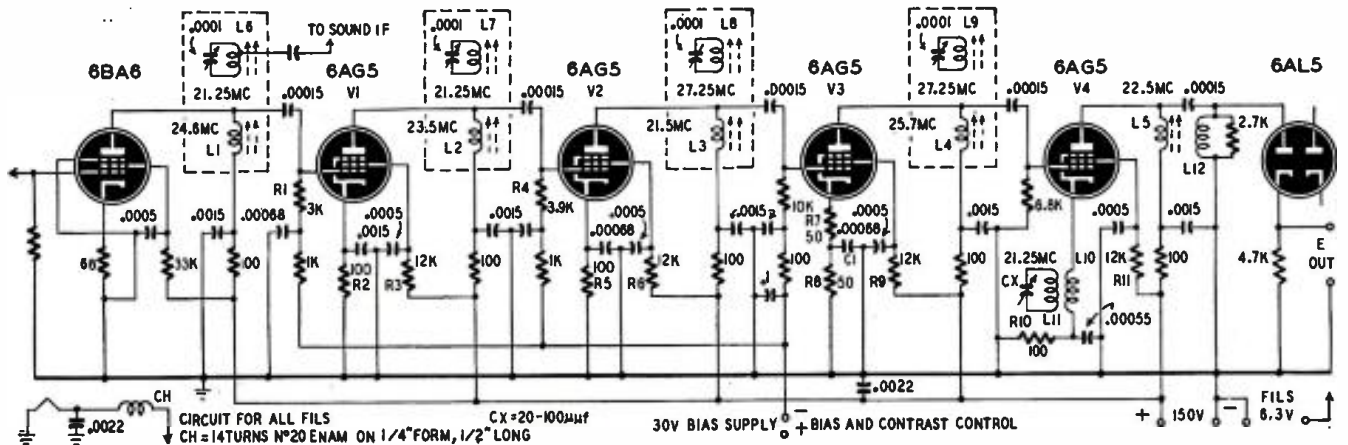

Fig. 2—How the components are positioned.



Schematic of the 6AG5 amplifier. Note that the 100-μmf ceramic capacitors across the trap coils are erroneously shown as variables.

For **HIGH** Performance
In **LOW** Signal
Areas . . .

The
ALL NEW
JFD **Super-Beam**
HI-LO TV Array

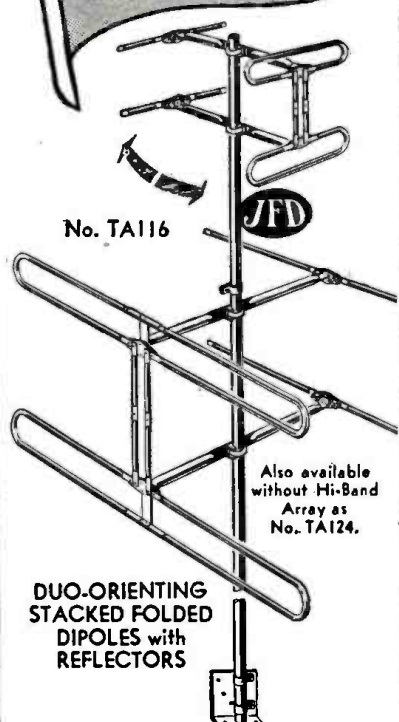

**DUO-ORIENTING
STACKED FOLDED
DIPOLES with
REFLECTORS**

**LOOK AT THESE LONG-RANGE
PERFORMANCE FIGURES
FROM ACTUAL REPORTS!**

CITIES	DISTANCE IN MILES
Albany - New York	125
Cleveland - Pittsburgh	120
New Haven - New York	110
San Diego - Los Angeles	100
South Bend - Chicago	90

OUTSTANDING FEATURES!

- ✓ Gives full 12 channel TV reception plus FM.
- ✓ Supplied complete with 10' Mast, All-Angle Mounting Bracket and Stand-Off Insulators.
- ✓ U-Bolt Clamp construction provides 1/8, 1/4 or 1/2 wavelength spacing of 2, 4, 6, or more bays on mast for tremendous stacking flexibility—also permits independent orientation of each bay.
- ✓ Lightning-fast assembly time.
- ✓ Impedance of 150-260 ohms and +8.6 DB gain.
- ✓ All-weather Roto-lock Insulator made from low-loss polystyrene for perfect high frequency insulation.

Write for Literature

JFD MANUFACTURING CO. Inc.
4112 Ft. Hamilton Pkwy Bklyn 19, N. Y.
Visit the JFD Booth No. 266
at the 1949 IRE Show
"Manufacturers of the World's Largest Line of
TV/FM Antenna Equipment"

PROTECTING TV SUPPLIES

Pulse-operated or kickback power supplies are commonly used in TV receivers with electromagnetic deflection systems. In this type of circuit, a special horizontal output transformer supplies current to the deflection coil and sharp voltage pulses to a high-voltage rectifier. Considerable current is drawn by the horizontal amplifier tube.

A recent RCA Application Note points out the potential danger of fire or severe damage to the TV receiver in the event of a plate-to-cathode short circuit or arc within the output tube. A short circuit in the horizontal amplifier of a typical receiver using this type of supply can draw current in the order of 750 ma from the low-voltage supply. Such current is far in excess of the current-carrying capacity of the output transformer, which will certainly be damaged severely and is very likely to start a fire.

To prevent such an occurrence, it is recommended that a suitable fuse be inserted in the B-plus line at the point where it feeds into the primary of the output transformer.

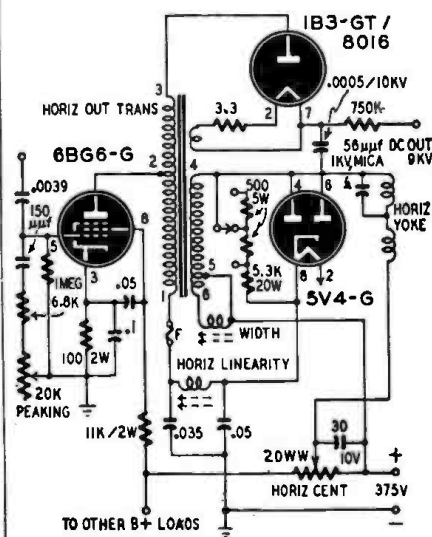

A typical horizontal amplifier and power supply are shown. A 250-ma fuse inserted at F provides more dependable protection than a fuse in the a.c. line. A fuse in the primary will have to handle the entire current drain of the set with a safety factor that will prevent its blowing under momentary line surges. This type of fuse can hardly be expected to provide protection against short circuits in the horizontal amplifier because the short-circuit current may be small compared with the total drain of the set. A short circuit that causes very little change in the total power supplied to the set can raise havoc with many components.

In the circuit shown, the average current through the primary of the transformer is about 75 ma. With the sawtooth waveform, the r.m.s. current is 60% higher, or about 120 ma. A 125-ma fuse will not carry this load continuously; therefore a 250-ma fuse should be used. The latter, while allowing for line surges, will provide adequate protection in the event of a short.

**American
Beauty**

**ELECTRIC SOLDERING
IRONS**

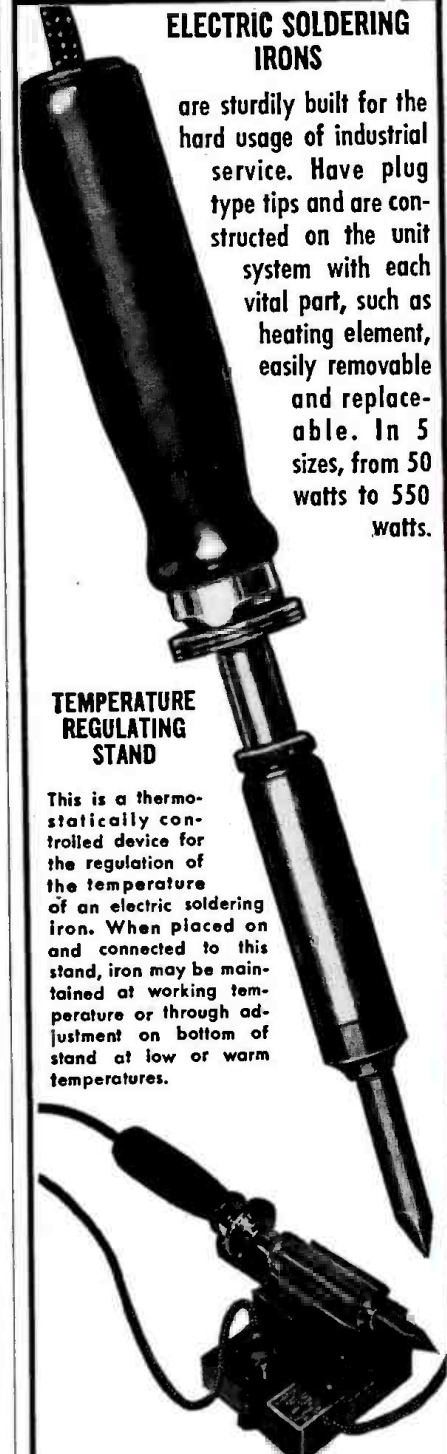

are sturdily built for the hard usage of industrial service. Have plug type tips and are constructed on the unit system with each vital part, such as heating element, easily removable and replaceable. In 5 sizes, from 50 watts to 550 watts.

**TEMPERATURE
REGULATING
STAND**

This is a thermostatically controlled device for the regulation of the temperature of an electric soldering iron. When placed on and connected to this stand, iron may be maintained at working temperature or through adjustment on bottom of stand at low or warm temperatures.

For descriptive literature write

**AMERICAN ELECTRICAL
HEATER COMPANY**
DETROIT 2, MICH., U. S. A.

TV SIGNAL GENERATOR

Coastwise Electronics Co.,
Los Angeles, Calif.

The Ferret Model 720 FM-TV sweep generator can be used to align any FM or television receiver. Fundamental frequency coverage extends from 0 to 260 mc in eight bands. The sweep is adjustable from 50 kc to 20 mc on all bands. A built-in 19-40-mc marker is provided; either a pip or an absorption dip may be used. A crystal may be plugged in on the front panel to permit extremely accurate signals up to 20 mc on the fundamental. Attenuators are provided for r.f. and marker signals.



The instrument is controlled by push buttons, which select the various functions. A standby button switches off the 8-voltage but allows filaments to remain on. Sweep circuits are electronic, and frequency accuracy is said to be within 0.5%.

HIGH-GAIN TV BEAM

Roger Television, Inc.,
New York, N. Y.

The Yagi-Beam is a high-gain, very directional television receiving antenna, especially intended for use in fringe areas and at points where the directions of ghost and primary signals differ by only a few degrees. The five elements are made of hard, thin,

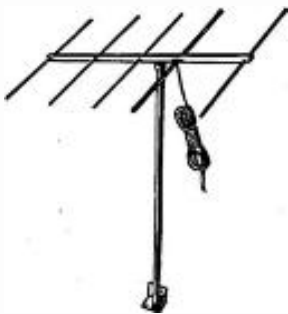

silver-plated brass tubing, and on one model a JAN-type connector is provided for a co-axial transmission line. No mechanical connections are used; all joints are soldered. Each antenna is peaked at the factory for one channel. Units for any of the 12 channels are available.

PHONOGRAPH AMPLIFIER

Newcomb Audio Products Co.,
Hollywood, Calif.

The P-10 amplifier is flat within ± 1 db from 30 to 15,000 cycles and delivers 10 watts at less than 5% distortion. Included are three inputs for various pickups and tuners, bass and treble tone controls, and a power socket for phono preamplifiers.



MOBILE FM UNIT

General Electric Company
Syracuse, N. Y.

A new, single-unit FM transmitter-receiver, the ES-1-B, operates in the 152-162-mc band. It is intended for police departments, public utilities, taxis, and similar services.



Carrier-frequency stability of the transmitter is within .002% from -30 to $+60$ degrees C. Receiver selectivity is 50 db down at 60 kc, for an adjacent channel and better than 85 db down at 120 kc for an alternate channel. Operating on 6.3 volts d.c., the transmitter furnishes 20 watts of power.

SIGNAL GENERATOR

Philco Corp.,
Philadelphia, Pa.

Designed for precision alignment work, Model 7170 is an FM-AM signal source covering 100 kc to 170 mc. The cathode-follower output gives good isolation and improves frequency sta-

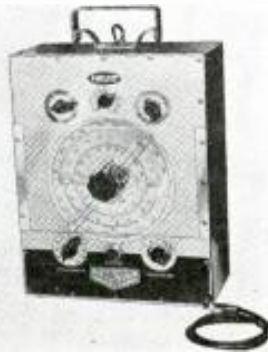

bility. A built-in 400-cycle audio oscillator provides modulation. The FM sweep-width control provides adjustment from 4- to 500-kc deviation, making the generator useful for aligning both narrow- and wide-band FM systems.

DEFLECTION COIL CORES

Henry L. Crowley & Co., Inc.
West Orange, N. J.

Large and elaborate cores for television deflection coils can be fabricated economically from powdered iron. The illustration shows a typical Crowley assembly. With correct windings, the unit provides a low-loss energy-recovery system requiring no additional electrical energy but pro-



viding large increases in deflection. Transformer costs are less than one-quarter those of equivalent laminated sheet or strip metal types.

CO-AXIAL CONNECTORS

Workshop Associates
Newton Highlands, Mass.

These new high-frequency, silver-plated, solderless co-axial connectors and adaptors, designed for television antenna installations, eliminate the problem of soldering on roofs and out-of-doors and cut down installation time. The silver plating provides permanent contact, protected from the weather by a plastic support head.

HIGH-VOLTAGE PROBE

Sylvania Electric Products, Inc.
New York, N. Y.

Designed for use with the Sylvania Polymeter, this probe includes a multi-



plier resistor. Including a high-voltage cable and connector, the unit multiplies the Polymeter ranges by 10 to measure television power supplies, transmitter plate circuits, and similar devices.

CRYSTAL OVEN

Bliley Electric Co.,
Erie, Pa.

The new type TCO-1 crystal temperature stabilizer is a miniature crystal oven designed for military and com-



mercial communications equipment. Used with Bliley BH6 crystals, which mount in an internal socket, the oven provides frequency stability within $\pm .0001\%$ with crystal temperature in the standard units kept between 73 and 77 degrees C. The oven has a 6.3-volt, 5.5-watt heater and is plugged into an octal tube socket.

MICROPHONE STAND

Electro-Voice, Inc.,
Buchanan, Mich.

The Model 426 shockproof microphone desk stand provides balanced,



stable support. A newly developed shock mount using dual Lord shear-type mountings is built into the base to provide double shock-absorber action. The stand has a $\frac{5}{8}$ -27 adapter to fit all standard microphones.

LEAD-IN INSULATORS

Mueller Electric Co.,
Cleveland, Ohio

The Tenco-Clampipe is an offshoot of the long-familiar ground clamp made by this company. The end of



the threaded rod is bent into a ring into which is fitted an insulator with either a slot for 300-ohm twin-lead or a circular opening for co-axial line. The Clampipes can be fastened to the antenna mast or to any other pipes or beams.

TRIODE AMPLIFIER

Browning Laboratories, Inc.,
Winchester, Mass.

The AA-20 high-fidelity, all-triode amplifier has 15 watts output and a flat response (within 1 db) from 10 to 17,000 cycles with less than 1.5% harmonic distortion. Hum level is 65 db below maximum rated output. The output stage uses push-pull 684-G's driven by two cascaded 6SN7 sections; a separate bias rectifier is provided. A convenient receptacle makes plate and filament voltages available for external use in noise suppressors or photograph-pickup preamplifiers.



CUEING AMPLIFIER

Fairchild Recording Equipment
Corp., Jamaica, N. Y.

The 635-A2 amplifier is intended for use in broadcast stations to enable the studio operator to cue or monitor a transcription table. The amplifier input is bridged across the pickup,



and the output is fed to speaker or phones. Bridging impedance is 10,000 ohms; output power, 3 watts. Frequency response is ± 1.5 db from 70 to 15,000 cycles. Measuring 7 x 6 x 4 1/2 inches, the amplifier can be mounted inside most turntable cabinets.

WIRE MARKERS

Flag-It Wire Marker Co.,
Los Angeles, Calif.

Forty of these adhesive wire markers, printed with numbers or letters, are attached to a 10-inch card; each may be removed and attached to a wire. Each marker has four of the same characters so that it can be read in any position.

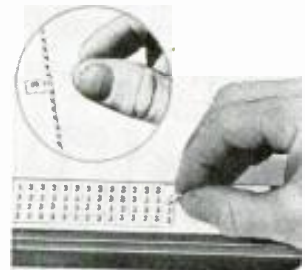

DECAL ADHERENT

Decimeter, Inc.,
Denver, Colo.

Decosol is designed to bond decals permanently to surfaces where they are subject to heavy wear or prolonged dampness. It dissolves the under-surface of the decal into the surface to which it is applied. The bond is so permanent that the decal cannot be removed without damaging the panel.

The manufacturer is also offering Silver-Q, a liquid soldering flux. It is applied with a brush to the surface to be soldered.

...Help end spark plug INTERFERENCE



Spark Plugs are miniature broadcasting stations, send signals that interfere with radio reception, distort television. The New Auto-Lite "Resistor" Spark Plug reduces this interference.*



Recommend NEW AUTO-LITE Resistor SPARK PLUG

Here's How It Works to End Interference

The "Resistor" acts to dampen the spark plug radio signal to an acceptable level* while still delivering the full high voltage discharge required to ignite the fuel.

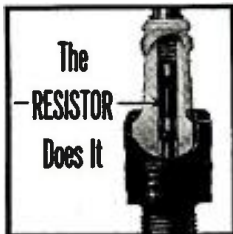

Auto-Lite Ignition Engineers, working with leading automotive manufacturers, have developed the new Auto-Lite "Resistor" Spark Plug with this built-in resistor that reduces spark plug interference.* Remember, the "Resistor" also helps deliver smoother idling, improved economy, longer electrode life. Dealers are being supplied as rapidly as possible. Write for Booklet M-1186 for full information.

THE ELECTRIC AUTO-LITE COMPANY
Toronto, Ontario Toledo 1, Ohio

*Under 35mv/m from 540 k.c. to 150 m.c. at 50 ft.

Tune in "Suspense," Thursdays, 9:00 P. M., E. T., CBS



Television is Booming—Cash in on it!

DUMMY ANTENNA

For tuning the early stages of an amateur transmitter without allowing the final to radiate, this dummy antenna is useful. L and C are resonant at the output frequency. The meter should be of the correct value for the power

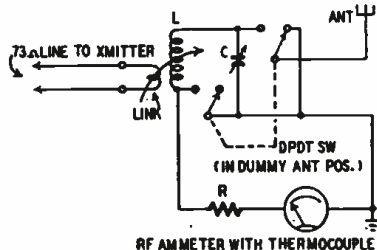

output. The resistor should be a non-inductive unit of less than 200 ohms. The d.p.d.t. switch allows a quick change from the dummy load to the actual antenna.

ROBERT FINK,
Cleveland, Ohio

TWIN-LEAD TEST LEADS

Excellent non-kinking test leads for almost any purpose can be made from a 3-foot length of 300-ohm twin-lead. Split the lead at each end for two or

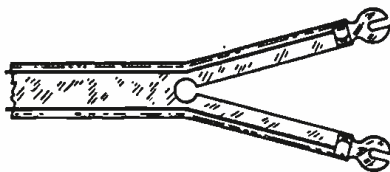

three inches and make a hole with a paper punch at the end of the split to prevent further tearing. Terminate the conductors with spade lugs, phone tips, or whatever other connectors or probes are desired.

FRED C. GABRIEL,
Brooklyn, N. Y.

CAPACITOR VALUES

Often capacitors in the junkbox or in a receiver are not marked. To find the value of any capacitor, use a relaxation oscillator to compare it with units of known value.

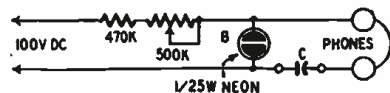

A simple relaxation oscillator is shown in the diagram. Adjust the potentiometer for a low-frequency tone with the unknown capacitor connected as C. Then substitute various known values for C until the same tone is heard. The unknown capacitor will then be approximately equal to the known one.

FRED C. GABRIEL,
Brooklyn, N. Y.

SPRAY GUN CLEANS RADIOS

I have found that an old insect spray gun is useful for cleaning dust out of radio chassis and from between capaci-

tor plates. Be sure there is no liquid in the gun, then point it at the chassis and pump. It beats lungpower by a mile and has the additional advantage of keeping dirt out of your eyes.

JACK J. ROTHSTEIN,
Eatontown, N. J.

EXTERNAL ANTENNA

The performance of many small portables using a loop antenna can be improved by adding an automobile-type whip or an external wire. To do this most efficiently, add a switch and a standard broadcast antenna coil, as shown in the diagram. The switch se-

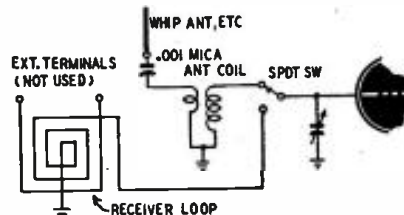

lects either the loop or the external antenna circuit. Even when the set comes with terminals for an external antenna, using the antenna coil rather than the usual coupling to the loop gives better performance in most locations.

PETER BEDROSIAN,
Newburyport, Mass.

SOLDERING IRON HOLDER

An ordinary binder clip, obtainable at almost any stationery store, is very handy as an iron holder for outside jobs. It can be clipped to the iron and left in place, unless working space is small. It is also useful for holding small parts when a small vise does not happen to be at hand.

J. H. BELL,
Washington, D. C.

PILOT-LIGHT SAVER

A.c.-d.c. receivers have the bad habit of burning out pilot lights connected in series with the filaments because of the high initial current through them when the set is first turned on. To make the lights last longer, I connect a 50-ohm, 10-watt resistor directly across each one. This has the additional advantage of allowing the set to continue playing when the light does burn out.

JACK C. BROWMAN,
Montreal, Canada

PROBE LIGHT

The average room light often is not so placed as to enable the serviceman to see into obscure places under the chassis. To illuminate these spots, I remove the tip from a pencil-type soldering iron and screw in a 117-volt, candleabra-base lamp in its place. The arrangement is completely insulated, with no danger of shorts or shocks.

ROBERT P. BALIN,
Miami, Fla.

LOOK TO

 mcmurdo
SILVER
FOR **FM-TV**
SERVICE REQUIREMENTS

Here — at prices you can afford — are five Laboratory Caliber Electronic Test Instruments that you need to insure efficient and profitable AM - FM - TV servicing.

**MODEL 900-A "VOMAX"**

The new "VOMAX" is the truly universal v.t.v.m. — makes TV, FM and AM measurements accurately — at highest meter resistance. Giant meter, non-breakable glass; 45 ranges; new single probe for a.c., d.c., a.f., r.f., volts, ohms, db. and current measurements. "VOMAX" can be used for measuring TV power supply potentials up to 30 Kilovolts when used with our new High Voltage Adaptor Probe. Advancing far beyond its predecessor, choice of experts, "VOMAX" equips you with the world's newest and finest meter for only \$68.50 net.

**MODEL 911
TV/FM SWEEP GENERATOR**

2 thru 226 mc.; electronic sweep adjustable 0 to 10 mc.; high output adjustable 0 to 1/2 volt. Separate 1 mc. and 5 mc. precision crystal marker oscillators insure correct TV video i.f. curve shape and width; phasing control and 60 ~ sine-wave 'scope sweep voltage; 120 ~ saw-tooth FM 'scope sweep voltage. All this only \$78.50 net.

**MODEL 906
FM-AM SIGNAL GENERATOR**

Choice of the big engineering laboratories plus thousands of service technicians, 906 stands out as maximum value 90 kc. thru 210 mc. in 8 ranges, $\pm 1\%$ accuracy; less than 1/2 microvolt, including strays to over 1 volt metered output; multiple shielding; adjustable 0 to 100% amplitude modulation, adjustable 0 to 1,000 kc. FM sweep. Price only \$116.50 net.

MODEL 905-A "SPARK"

Combining signal-tracer and universal test speaker, 905-A is amazingly sensitive yet free of usual tracer hum. Vacuum-tube prod. with r.f.a.f. switching; high-gain high-fidelity amplifier; 6" PM speaker; 18-watt output transformer gives wide choice of impedances. Two essential instruments in one. 905-A is a value for exceeding \$44.50 net.

904 C/R BRIDGE

A condenser resistor tester of precision caliber 1/4 mmfd./1000 mfd.; 1/4 Ω /1000 meg Ω ; variable d.c. polarizing voltage leakage current; 0/50% power factor. Laboratory accuracy of $\pm 3\%$. Measures all condensers with 0/500 V. rated d.c. volts applied. Only \$49.90 Net

MAIL POST CARD for new catalog showing complete line of Laboratory Caliber Electronic Test Instruments.

OVER 37 YEARS OF RADIO ENGINEERING ACHIEVEMENT

 McMurdo Silver Co., Inc.

EXECUTIVE OFFICES: 1240 MAIN ST., HARTFORD 3, CONN.
FACTORY OFFICE: 1249 MAIN ST., HARTFORD 3, CONN.

AMPERITE

Studio Microphones at P.A. Prices

Ideal for BROADCASTING RECORDING PUBLIC ADDRESS

"The ultimate in microphone quality," says Evan Rushing, sound engineer of the Hotel New Yorker.

- Shout right into the new Amperite Microphone—or stand 2 feet away—reproduction is always perfect.
- Not affected by any climatic conditions.
- Guaranteed to withstand severe "knocking around."



Models
RBLG—200 ohms
RBHG—Hi-imp.
List \$42.00

"Kontak" Mikes
Model SKH, list \$12.00
Model KKH, list \$18.00

Special Offer: Write for Special Introductory Offer, and 4-page illustrated folder.

AMPERITE Company, Inc.
361 BROADWAY • NEW YORK 12, N. Y.
Canada: Allied Radio Corp., Ltd., 560 King St. W., Toronto

Sensational NEW 1949

MIDWEST RADIOS

with DUAL-SPEED RECORD PLAYER

EASY TERMS
Powerful 5 WAVE BAND SERIES 16 AM-FM CHASSIS

30 DAYS TRIAL

SEPARATE CHASSIS OR COMPLETE CONSOLES AVAILABLE

SYMPHONY GRAND

AM-FM RADIO-PHONOGRAPH

A magnificent musical instrument that offers the new Dual-Speed Phonograph which plays and changes, automatically, both the new LP (long playing) records as well as Standard records. Uses the powerful Series 16 AM-FM Radio Chassis. Offers Flash-O-Matic Volume and Band Indication; TELEVISION Audio. Switch-Over; Giant 14 1/2" Panasonic Speaker; Color-Ray Tuning; No-Drift FM. Other beautiful console and table models available with Series 16, 12 or 8 chassis.

SEND THIS COUPON TODAY

BUY DIRECT FROM FACTORY AND SAVE!
SEND THIS COUPON TODAY. Write in Home and Address (Please Print) on Coupon or to Postcard.

MIDWEST RADIO & TELEVISION CORP.
Dept. 317 909 Broadway, Cincinnati 2, Ohio
Please send me your new FREE 1949 Catalog.

NAME _____
ADDRESS _____
CITY _____ ZONE _____ STATE _____

Television is Booming—Cash in on it!

IMPROVING POWER SUPPLIES

Sometimes substituting a cathode-type rectifier for the filament type will get a higher voltage out of an ordinary full-wave power supply. Where the voltage of a supply is somewhat too large, it can often be reduced by reversing the substitution.

CHARLES ERWIN COHN,
Chicago, Ill.

SOLDERING LITZ WIRE

To remove the enamel from very fine wire so that solder will stick to it, dip the wire in liquid cement solvent. After a few seconds, scrape off the softened enamel with a fingernail, then solder.

DAVID GNESSIN,
Columbus, Ohio

CHECKING CRYSTALS

The frequency of an unmarked crystal can be found by the following method. Connect the crystal in series between a signal generator and a vacuum-tube voltmeter. Set the v.t.v.m. to the 3-volt range, and tune the generator slowly over its range. The meter reading will be very low until the resonant frequency of the crystal is reached. The meter will then kick up very sharply.

I have gotten readings of as much as 2 volts with very active crystals, but 1 volt is more usual. Reading the dial of the generator will tell the frequency; for greater accuracy, check frequency with a frequency meter.

ROBERT W. DIERICH,
Saginaw, Mich.

MOBILE MIKE CASE

In mobile or portable ham work it is often convenient to have both hands free instead of having to hold a microphone. A very handy way to achieve this is to buy one of the old hearing-aid cases available at many surplus stores. There is a place in them for a crystal or magnetic microphone, which, if not already in the case, can be bought from Sonotone for 69¢.

I have even made a preamplifier which fits into the hearing-aid case with the microphone. Output is enough to permit use of the unit with a mobile transmitter originally designed for a carbon mike.

G. SAMKOFKY,
Brooklyn, N. Y.

SOUND-ON-LIGHT BEAM

An electron-ray tuning indicator may be used instead of a Kerr cell in transmitting sound over light beams for demonstration purposes. A 6U5, preferably new, is perhaps the best tube to use. With a 300-volt plate supply and —10 volts fixed bias, the brightness is more than enough for short distances. The grid of the tube is connected to the output of a preamplifier through a coupling condenser. A good photoelectric cell connected to a high-gain amplifier will give good reproduction at the receiving end.

P. C. DIMITZACOPOULOS,
St. Johns, P. Q., Canada.

TELEVISION IS HERE!

Our new catalog lists hundreds of new television items; sets, parts and accessories at unbelievably low prices. Write today—its free!

Television Transformer.
Pri. 115 Volts 60 Cycles. Sec. 2500 Volts @ 2 ma. 6.3 Volts @ .6A. 2.5 Volts @ 1.75A
PRICE \$3.85

MODEL NFRD—RADIO NOISE FILTER

If it doesn't work, send it back!!

We absolutely guarantee that our Model NFRD will eliminate all line noises when properly connected to radios, television sets, short wave sets, motors, electric shavers, refrigerators, vibrators, oil burners, transmitters, and all other sources of interference. This unit will carry up to 12 amperes or 1 1/2 KW of power and may be used right at the source of interference or at the radio.

Small size only 3"x1 1/2"x7 1/2". Very low price only..... EACH \$1.95

TELEVISION COIL ASSEMBLY

Consists of a set of 5 slug-tuned coils mounted on a bracket 4 1/4"x1 1/2" and which can be resonated in the frequency range 21-29 mc. This unit can be disassembled readily to make up a Television stagger tuned Video I.F. Amplifier. Our price—ONLY 35c.

EASILY ASSEMBLED RADIO KITS

5 Tube AC-DC superhet kit furnished in a brown plastic cabinet of artistic design, cabinet size (9"x5"x6")
Variable condenser tuned; with 2 double tuned I. F.'s.
Tubes used: 1 - 12SA7, 1 - 12SQ7, 1 - 12SK7
1 - 35Z5 and 1 - 50L6

PRICE \$11.95 including 5 standard tubes

6 TUBE 3 WAY PORTABLE KIT

- For operation on 110 volt AC or DC and battery
- Superheterodyne circuit
- Full vision dial
- High gain loop
- Cabinet of Blue Aeroplane cloth finish, size 13x9 1/2x7"
- Tubes used 1A7, 1H5, 3Q5, 117Z6 and 2 - 1N5

PRICE \$13.75 Not including tubes Extra for kit tubes \$3.75

6 TUBE, 2 BAND SUPERHET KIT

Bands covered BC 550-1600 KC and 6-18 MC
Power supply 100-125V AC, DC
Full vision dial
Variable condenser tuned, with two double tuned I. F.'s 455KC
Walnut veneer wood cabinet, including all tubes

PRICE \$15.75

A SCIENTIFICALLY DESIGNED PHONO SCRATCH FILTER

Resonated at approximately 4500 cycles effectively reducing objectionable needle scratch without altering the brilliancy of reproduction.
Contains a Hi-Q PERIES resonated circuit. Tested by means of an audio oscilloscope and an oscilloscope to give 22 db. attenuation with very low signal loss.
EASY TO ATTACH

Just two wires to clip on. Compact Price \$1.98

THREE TUBE PHONO AMPLIFIER

An assembled unit ready for installation using tone and volume control and six feet of rubber cord \$2.95

(Not including Tubes)
With Complete Set of Tubes \$3.95

PHONO OSCILLATOR

Wireless phono oscillator transmits recording for crystal pick-ups or voice from carbon mike through radio without wires. Can also be used as an intercom by using P.M. speaker as mike. Price \$2.95 (excluding tubes)
With Complete Set of Tubes \$3.95

SPECIAL! SPECIAL!

Mammoth assortment of radio and electronic parts, not less than TEN POUNDS of new transformers, chokes, condensers, resistors, switches, coils, wire, hardware, etc. A super-buy for experimenters, servicemen, and amateurs for only \$1.25

Satisfaction guaranteed on all merchandise. All prices F.O.B. New York City

WRITE FOR FREE CATALOGUE

RADIO DEALERS SUPPLY CO.
154 Greenwich St. New York 6, N. Y.

COLOR TELEVISION

Patent No. 2,452,293

Lee de Forest, Los Angeles, Calif.

One method for sending TV in full colors involves the use of a color wheel with alternate sectors tinted red, blue and green, which revolves in front of the kinescope. When correctly synchronized with a similar wheel at the transmitter, the primary colors are seen in rapid succession and the illusion of natural color is created.

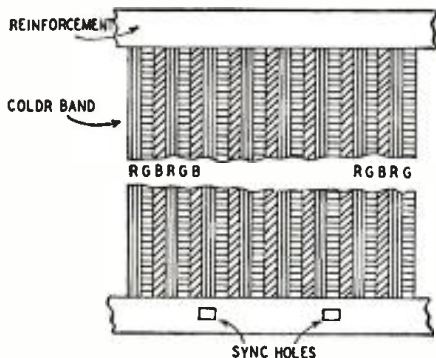

This invention eliminates the complication of a large, fast-moving color wheel. Instead, an endless color band or curtain made of transparent material is moved in front of the kinescope tube. The curtain is made of stripes alternately colored red, blue, and green. The edges are of reinforced material as shown. Stripes are about .002 inch thick, and the band moves at about 10 inches per minute. It is important that the transmitter and receiver use identical bands and that they be exactly synchronized.

The band is timed so that a different-colored stripe comes into position at each scanning. If a blue object, for example, happens to be present at the spot which corresponds to a blue stripe at some instant, blue is visible at the receiver. If the object happens to be green or red, nothing is seen until the corresponding stripe comes into this position. However, unless the object is moving rapidly, the received image will appear natural and lifelike.

As in the wheel method, synchronization is important. It may be provided by perforations in the edge of the color band. Light can be transmitted through these perforations to control the motion of the band at the receiver.

GHOST ELIMINATOR

Patent No. 2,448,635

James Ernest Smith, Jackson Heights, N.Y. (assigned to Radio Corp. of America)

Television receivers often receive, along with the desired images, "ghosts" which are reflections from buildings and other obstructions. Rearrangement of the antenna sometimes helps to reduce the interference, but many times it cannot be eliminated. This invention can eliminate ghost interference, especially where there is one severe reflection of this type.

A time-delay circuit, added after the video detector, is connected across the input to the video amplifier and therefore produces reflections of its own. Several sections of filter are used so that any desired time delay and attenuation can be obtained.

An example of a received signal is seen at a. There is an original pulse of amplitude h followed by a ghost of amplitude $h/4$ at an interval of time T . At b are the reflections from the delay network, adjusted to attenuate the reflection to 25% and to delay it by an interval t .

The original pulses and their reflections are combined in the amplifier as shown in c. The

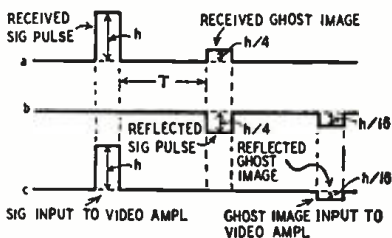

LAFAYETTE-CONCORD ELECTRO NEWS

29 Years of Service—500,000 Satisfied Customers

Save \$30 by building your own oscilloscope! Indispensable for AM, FM, and TV servicing!

only \$39.50

Here's a testing equipment kit with a horizontal sweep circuit 15-30000 cps. Vertical and horizontal gain .35 volts per inch. Response; 15-50000 linearly; up to 200000 cps. within 50%. 1 megohm, 50 mmfd. input impedance. Has internal and external synchronizing circuit. Linear sweep with 884 gas triode. Graph screen. Comes with 6 tubes, including 5BP1. 8 1/2 x 13 x 18". Detailed instructions and wiring diagram included.

NOTHING ELSE TO BUY. 32F24552 Shpg. wt. 40 lbs... \$39.50 Same as above, but wired, assembled and tested.

25F21688 COMPLETELY FACTORY WIRED... \$69.50



SENSATIONAL 12" SPEAKER BUY

Unbelievably low priced—in fact our best speaker value in 29 years! You get a truly superb 12" PM speaker with 10 watt rated output! 6.8 ounce Alnico V permanent magnet. 1" voice coil with 3.2 ohms impedance. Finely constructed throughout. Excellent replacement speaker for use in AM-FM receivers. 12 1/2" diameter by 5 1/2" deep.



No. 99F7023 Shpg. wt. 5 lbs... \$4.95

Top quality 10" Alnico V PM Speaker

No. 99F7019... \$2.95

NEW! DRAFTING MACHINE AN EXCEPTIONAL BUY!

Eliminates use of T-square, protractor, and triangles. Makes sharp, accurate drawings up to 16" x 22". Combination 90° angle, calibrated scale moves at any angle to any point on the masonite board. Includes 17 1/2 x 23 1/2 x 1/4" board, steel arms, fittings, rubber feet.



No. 18N15092P Shpg. wt. 8 lbs... \$6.63 FOR MECHANICS, DRAFTSMEN, DESIGNERS, INVENTORS, ETC.

AMAZING LOW PRICE ON VTVM TESTER KIT!

Ideal for servicemen, amateurs and experimenters. Now you can build your own vacuum tube voltmeter at a new low price. Newly designed circuit. DC input impedance 6.5 megohms. Ranges: Resistance. 1-ohm to 1000 megohms in five ranges; DC volts on linear scales 0-3/30/100/300/1000 volts; Output scale calibrated for 600 ohm circuit. Large, easy-to-read microamp DC meter.



Complete with tubes 6SN7, 6H6 and test. prods. Size: 6 x 9 x 5".

32F24540 Shpg. wt. 8 lbs... \$23.95

SHOP IN PERSON AT ONE OF THESE OUTLETS

NEW YORK CHICAGO
100 Sixth Ave. 901 W. Jackson Blvd.
542 E. Fordham Rd., Bronx 229 West Madison St.
ATLANTA BOSTON NEWARK
285 Peachtree St. 110 Federal St. 24 Central Ave.

FREE! BARGAIN CRAMMED CATALOG

Yours for the asking — a 180 page catalog featuring standard radio and television "makes" at the lowest prices available. A penny postcard will bring you a copy. Write today.

LAFAYETTE CONCORD

29 Years of Radio Reliability



Best Buy! CRYSTAL HAND MIKE

complete with 7 foot cable

This high impedance crystal mike has a frequency response suitable for voice and music reproduction. 53db output. It's attractively styled in a brown finish and can be screwed on to any standard floor stand.

No. 99F7064 Shpg. wt. 3 lbs... \$4.95

LAFAYETTE CONCORD EXCLUSIVE! DUAL-SPEED CHANGER

Two tone arms — one for the new 33 1/2 RPM LP records, the other for standard discs. Both arms equipped with GE variable reluctance cartridge. Plays both 10" and 12" records automatically on standard arm.



No. 34F22610 Shpg. wt. 12 lbs... \$39.50

FINE RADIO PHONOGRAPH

A terrific value at this new low price.

only \$19.95

Has features found in models 3 times the price. Zephyr light tone arm. Semi-permanent type FIDELITONE needle. Plays up to 12" records. Radio is modern superhet that gives sparkling reproduction. For 105-125 Volts, 60 cycles. AC operation only. 3 tubes plus rectifier. Attractive walnut finish cabinet. 8 x 11 x 11 1/2".



No. 1F417 Shpg. wt. 15 lbs... \$19.95

Lots of 3... \$18.95

LAFAYETTE CONCORD Dept. JC-9

Send your mail order to...

100 Sixth Avenue, New York 13
901 West Jackson Blvd., Chicago 7
265 Peachtree Street, Atlanta 3

MAIL NOW

- Please rush free catalog No. 89
- Oscilloscope @ \$39.50
- 12" Speaker @ \$4.95
- 10" Speaker @ \$2.95
- Crystal Hand Mike @ \$4.95
- Drafting Machine @ \$6.63
- VTVM Tester Kit @ \$23.95
- Dual-Speed Changer @ \$39.50
- Radio Phonograph @ \$19.95

I enclose \$..... in postal note, money order or check. Will remit few cents postage when order is received.

NAME.....

ADDRESS.....

CITY.....ZONE.....STATE.....

For GREATER Earnings... LEARN RADIO-ELECTRONICS



This fast-growing science of RADIO, TELEVISION, RADAR and ELECTRONICS, offers tremendous opportunities, and in no industry is RADIO-ELECTRONICS more important than in aviation. A skilled technician who *knows* the modern application of electronic devices, as used in the aircraft industry, is always in demand . . . not only in aviation, but in many other industries. Many large organizations call on Spartan regularly for graduates. Often, students are hired months before graduation.

Don't confuse the RADIO-ELECTRONICS course offered by SPARTAN with other courses, offered anywhere! As a graduate from this famous school you will know the application to industrial control devices; to the search for petroleum; and the important uses of radar, television and other electronic equipment.

SPARTAN offers two complete and thorough courses. You will work on the most modern and complete equipment. You will build equipment. You may join the SPARTAN "Ham" Club. Either course prepares you for Federal Communication Commission license tests — first class radio telephone, second class radio telegraph, or class "B" radio amateur.



SPARTAN'S 21 years of teaching civilian and army personnel is your assurance of receiving the best possible training in the least possible time. *You'll not need MORE than Spartan training — you cannot afford to take LESS.*

BIG CATALOG — Free

NAME _____ AGE _____

ADDRESS _____

CITY _____ STATE _____

Dept. RE-39

C. I. APPROVED—Write TODAY for Complete Information

SPARTAN

SCHOOL OF RADIO AND ELECTRONICS



Camco TV and FM ANTENNAS

(Swift-Rig)

Directional High Gain and Half-Wave arrays

Presto! . . . it's assembled

Swift-Rig antennas are completely assembled — Just Unfold and

Lock in Place . . . A matter of only minutes.

PERMANENT LOW RESISTANCE nickel plated brass screws and "SWIFT-RIG" LUGS at electrical contacts.

Write for catalog of complete line including Roto-Matic Window and Hy-Gain Indoor Antennas, Combination 300 ohm line and coaxial cable Screw Eyes, Mast-Mounting Brackets (chimney, vent pipe, wall-mount), "Swift-Rig" Lugs, etc.



CAMBURN • INC.

32-40 57th St., Woodside, L. I., N. Y.

Television is Booming—Cash in on it!

received ghost has disappeared. Of course, the delay network produces another pulse which is the reflection of the original ghost. In practically every case this is negligible, however. In this example it has only $\frac{1}{16}$ the amplitude of the original signal pulse.

The delay network may be similar to the circuit shown.

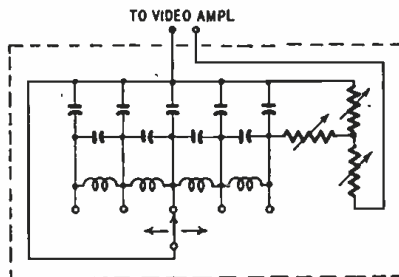

COLOR TELEVISION TUBE

Patent No. 2,446,791

Alfred C. Schroeder, Feasterville, Pa. (assigned to Radio Corp. of America)

For television in color, successive frames must be scanned for the primary colors separately. The image may be scanned first for red, then green, and finally blue for a complete color cycle which gives the illusion of natural color when seen in rapid succession.

Within the receiving kinescope tube, a color strip is coated on the screen. This strip is divided into green, red, and blue elements which glow with their own characteristic color when struck by electrons.

Conductors X and Y are supplied with a voltage which is synchronized with the transmitter. During one frame (red) these conductors are at the same potential. When green is scanned during the next frame, conductor X is positive relative to Y. During the blue frame, conductor X is native and Y is positive. These voltages repeat with the color cycle.

A wire grid is placed in the path of the elec-

tron beam from the cathode. (Electrons are shown as coming from the left.) Alternate grid wires are connected to X, the others going to Y.

The red frame is represented at A. There is no potential difference between X and Y; therefore, electrons are not deflected. Some fall on the grid wires and have no effect. Others pass through the wires and can fall only on the red elements, which glow.

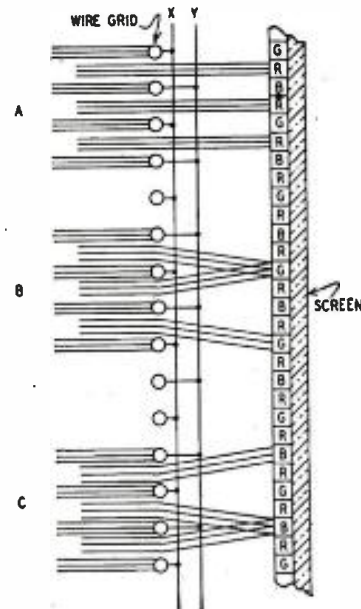

The next frame is shown at B. During this interval the electrons are deflected downward by the wires connected to Y, and upward by those connected to X. Note that only green color strips are affected during this scan. During frame C only blue light is emitted.

RADIO-ELECTRONICS for

the ultimate IN DELUXE PERFORMANCE with ESPEY AUDIO AMPLIFIER POWER SUPPLY DE LUXE TUNER

MODEL 514 AMPLIFIER **MODEL 513 TUNER**

NEW! CUSTOM BUILT AM-FM Quality CHASSIS

Here is exquisite high fidelity in chassis form that will grace the finest cabinet.

The 513 De Luxe Tuner is easy to install in any console cabinet, old or new and embodies the latest engineering refinements for lasting high quality at a price that defies competition.

The Espey 513 Tuner employs 10 tubes plus tuning indicator in a super heterodyne circuit and features a drift compensated circuit for high frequency stability, tuned RF on AM and FM plus phono input provision, and separate AM and FM antennas.

Model 514 De Luxe Power Supply-Audio Amplifier is designed specifically to work in conjunction with Model 513 Tuner, and is also used wherever a high quality audio amplifier is required.

With an output of 25 watts, Model 514 features a parallel push pull output circuit, self balance phase inverter system, extended range high fidelity response, and inverse feedback circuit.

Write Dept. K for your free catalog.

ESPEY Makers of fine radios since 1928. **MANUFACTURING COMPANY INC.**

528 EAST 72nd STREET, NEW YORK 21, N. Y. TEL. BUtterfield 8-2300

HIGH-FREQUENCY FM
 Franklin L. Burroughs, Emporium, Pa.
 Patent No. 2,450,182
 (assigned to Sylvania Elec. Products, Inc.)

Most FM methods fail at very high frequencies. For example, conventional reactance tubes are not very efficient above 200 mc. and even short leads introduce too much capacitance and inductance. The modulation circuit shown here has been found effective. The audio voltage causes appreciable change in the transit time of electrons between the cathode and grid of a tube. Since the input capacitance of a tube varies with changes in its transit time, the frequency is modulated.

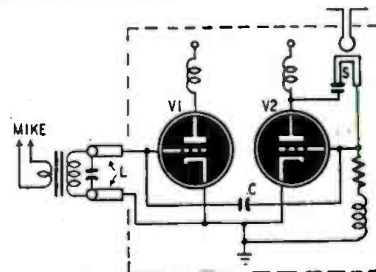

The audio voltage is applied to tube V1 through a quarter-wave transmission line L which isolates the tube from the speech equipment. As the grid goes more positive, electrons are speeded up and the transit time reduced. The opposite effect occurs if the grid swings more negative. As a result the input capacitance changes. This capacitance is across S, the tuned line of oscillator tube V2.

IMPROVED PUSH-PULL AMPLIFIER
 Patent No. 2,451,827
 Leland J. Haworth, Belmont, Mass.
 (assigned to the United States of America as represented by the Sec'y of Defense)

Most amplifiers use degenerative feedback in some form because it reduces distortion. A very high degree of linearity is claimed for this push-pull circuit which uses two types of negative feedback.

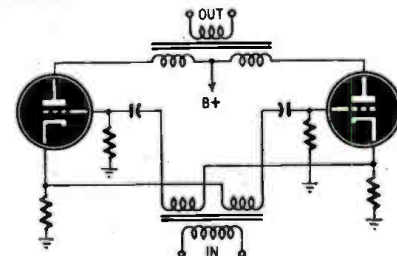

The secondary of the input transformer is made of two similar and separate coils. The grid return of each tube is connected to the cathode of the other tube to introduce degeneration. In addition, the cathode resistors are unypassed.

CRYSTAL CONTROLLED B.F.O.
 Patent No. 2,448,188
 Montford Morrison,
 Upper Montclair, N. J.

Crystal controlled, this beat-frequency oscillator combines a Pierce crystal oscillator with the conventional type. Two crystal-controlled

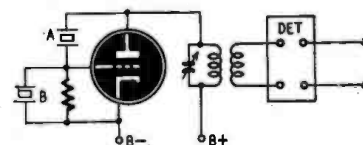

frequencies are present in the L-C plate circuit, and their difference appears in the detector output.

In a conventional crystal oscillator the plate circuit must be tuned to a slightly higher frequency than the crystal. The Pierce circuit requires that the plate circuit be tuned slightly lower than the crystal. This circuit uses a crystal A ground to a higher frequency than that of crystal B. The tuned circuit L-C is

WE ARE LOOKING FOR TUBES!

WHAT HAVE YOU GOT?

Interested in small or large quantities of all types of Transmitting, Industrial, and Receiving Tubes. Send offerings to:

T. L. BLACK, WHOLESALE TUBE DIV.
NIAGARA RADIO SUPPLY CORP.
 160 Greenwich St., New York 6, N. Y.

GREYLOCK
 A DEPENDABLE NAME IN RADIO TUBES

GT, Glass, and Miniature Types
 All Tubes in Individual Cartons

1R5	3Q4	12SA7GT	} 39¢ each
1S5	3V4	12SK7GT	
1T4	6AT6	12SQ7GT	
1U4	6BA6	(and many others)	
3S4	6BE6		

SPECIAL OFFER! All 39¢ tubes may be purchased in lots of 100 assorted, at \$35 per 100.

Specials: 2E24 .. 89¢ 6BG6G .. 89¢

TERMS: Net C.O.D., F.O.B. N.Y.C.
 Minimum order \$5.00.
 Write for Baratin Catalog C-3.

Greylock Electronics Supply Co.
 30 Church Street New York 7, N. Y.

Television is Booming—Cash in on it!

RADIO-ELECTRONICS for

resonant at some frequency between those of the crystals. Therefore, two crystal-controlled frequencies are present in L-C, which must be broadly tuned to accept both.

The circuit is useful for producing very low crystal-controlled frequencies, such as 50 kc or less. Although a single crystal can be ground for such a low frequency, it is very expensive and requires a specially designed mounting. The beat oscillator has very low drift because both crystals tend to drift in the same direction.

LINEAR SAW-TOOTH GENERATOR

Patent No. 2,452,213

Carl G. Sontheimer, Riverside, Conn. (assigned to Radio Corp. of America)

One of the simplest saw-tooth generators is a capacitor which is allowed to charge gradually and is discharged abruptly. Unfortunately, the linearity is not very good unless the source voltage is much higher than the peak capacitor voltage. It can be improved by adding a second capacitor which discharges into the first, as in this patented circuit.

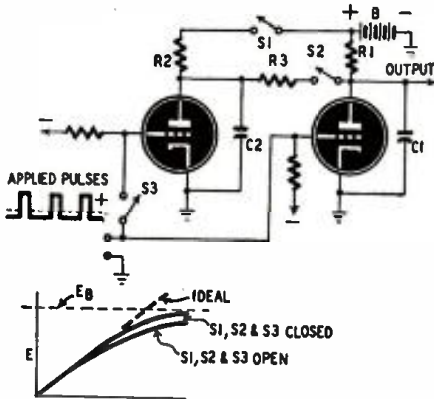

The two triodes are normally blocked by fixed bias. They can conduct only when periodic positive pulses excite the grids. If the three switches are closed, C1 and C2 begin to charge immediately after one of the positive pulses. C2 is the smaller capacitor; therefore its voltage rises more rapidly. At first both condensers are at zero potential difference; but since the voltage across C2 rises faster, it contributes more and more to the charge of C1.

The curves show the usual exponential charge which would be absorbed by C1 alone (switches open) and the more nearly straight line when the C2 circuit is added (switches closed). Without this modification it would require a B-voltage source four times as great to produce the same improvement in linearity.

More stages may be added for greater linearity, each containing another capacitor and a tube. In each, R1 = R2 = R3 and C1 = 2C2 for most linear charge. A positive pulse at the tube grids discharges the capacitors at once.



Suggested by Morley Burteen, Chicago, Ill.

New Halldorson Transformers for New Applications

IN LINE with the advancement and new uses of radio and electronics, Halldorson has added many new types of transformers to their line . . . Radio service engineers, amateurs and experimenters can now find in Halldorson distributor stocks many special types without having to pay premium prices.



NZ MTG.

AMONG THESE NEW TYPES ARE:

- #P-2067—117 volts to 240-0-240 @ 60 M.A.—6.3V @ 2.75A.
- P-1596B—Isolation—115V. to 115V.—150 Watts
- P-2040—Stepdown—230V. to 115V.—1000 Watts
- P-4303—Step up—117V. to 140V.—12 Watts
- #N-91—Vibrator—6-8V. to 250V. @ 50 M.A. (CAN-3.04" x 2.4" x 2.2")
- T-4307—Speaker Matching—500-1000-1500-2000 OHMS to 3.2 and 8 OHMS—18 Watts

TELEVISION UNITS

- #S-202 Power—365-0-365 @ 250 M.A. D.C.—5V. @ 3A.—5V. @ 2A.—6.3V. @ 6A.—6.3V. @ .8A
- #S-203 Power—360-0-360 @ 295 M.A. D.C.—5V. @ 3A.—5V. @ 6A.—12.5V. @ 5 A.C.T.
- #D4-611—Horizontal Blocking Oscillator (Replacement for Type #208T1)
- #D4-612—Vertical Blocking Oscillator (Replacement for Type #208T2)
- #J-96—Vertical Output Trans. (Replacement for Type #204T2)

For more complete information write

THE HALLDORSON CO., 4500 Ravenswood Avenue, Chicago 40, Ill.



Rooftop Definition with Table-Top Convenience!

NEW ICA WASP INDOOR ALL-CHANNEL ANTENNA FOR TELEVISION AND FM

INSTALLED IN AN INSTANT!

\$6⁹⁵

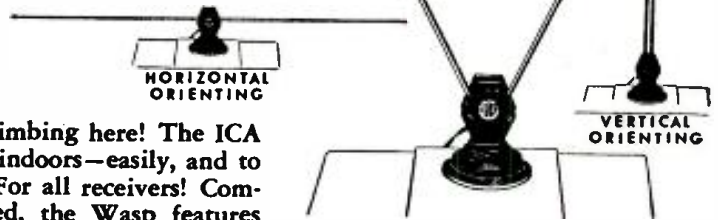

No rooftop climbing here! The ICA Wasp adjusts indoors—easily, and to all channels! For all receivers! Compactly designed, the Wasp features a smoothly engineered swivel base, combined with exclusive adjustable dipoles. Once adjusted, special spring action assures firm anchoring of dipoles and perfect electrical contact.

The heavily chrome-plated brass dipoles and antique bronzed swivel base blend well with living room décor. A non-scratch felt base protects furniture finish.

The Wasp is packaged with 8 feet of 300 Ohm lead. 19" high closed; base 3 7/8" diameter.

Latest Television Antenna and Accessory Catalog Available.



insuline CORPORATION OF AMERICA

INSULINE BUILDING • 36-02 35th AVENUE • LONG ISLAND CITY, N. Y.
West Coast Branch and Warehouse: 1325 South Flower Street, Los Angeles, Calif.



Television is Booming—Cash in on it!

Because it's
NOT SURPLUS
This is a
TERRIFIC
VALUE!

Here's a sensational MONEY SAVING OPPORTUNITY for every Radio Amateur, Experimenter, Industrial User . . . while our stocks last, you can buy these two popular tube types AT JOBBERS' COSTS!

Made by nationally known manufacturer, they carry standard RMA guarantee. Each tube is BRAND NEW, individually boxed. At these smashing low prices, we can't reveal mfr's name, but you'll recognize it!



250TH
HI-MU TRIODE
MODULATOR
OSCILLATOR
AMPLIFIER
\$22.50 each
Two for \$41.95



100TH
HI-MU TRIODE
MODULATOR
OSCILLATOR
AMPLIFIER
\$12.38 each
Two for \$22.95

WE'VE GOT 'EM IN STOCK

Ready for immediate delivery! Mail orders shipped same day received. No C.O.D.'s please, send check or M.O. with order, unless rated. Quantity users write for special prices.

Please mail orders and inquiries to N. Y. Office only:

MILO

RADIO & ELECTRONICS CORP.

200 Greenwich St., New York 7, N. Y.
Phone: BE 3-2980

Branch: 160-13 Northern Blvd., Flushing, L. I.
Phone: FLushing 8-7425

Cable Address: MILOELECTRO New York

PRESIDENT'S TRANSMITTER

Miniature receivers have been in existence for many years, but the idea of using printed circuits to compress a complete phone transmitter—including a power supply—into vest-pocket size is intriguing as well as useful. Many readers will recall the outstanding printed-circuit developments of Dr. Cle-

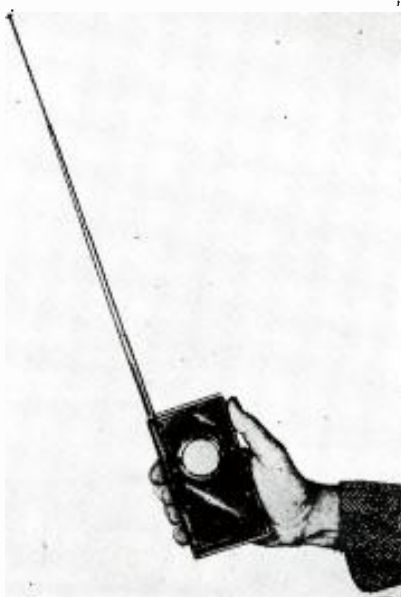

The transmitter with its telescoping antenna.

do Brunetti of the National Bureau of Standards. One of these, a short-range transmitter the size of a cigarette case, was presented by the Bureau to President Truman as a Christmas present a little over a year ago. The circuit of the tiny transmitting "station" is shown in the diagram on next page. A modified form of this circuit appeared on page 84 of the February issue.

The transmitter, whose actual dimensions are 5 1/4 x 3 x 7/8 inches, was designed for speech transmission on a crystal-controlled frequency of 6575 kc. Such units, constructed at the Bureau experimentally, have been limited intentionally to short-range operation—generally less than 200 feet—and appear to have many practical applications where communication over short distances is desired.

The crystal oscillator employs a CK569AX operated as a triode, driving a pentode amplifier (also a CK569AX)

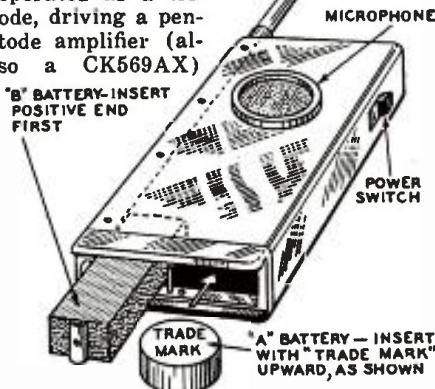

Batteries occupy one-third of space in case.

GREEN
STOCKS COMPLETE LINE
EICO INSTRUMENT KITS

HIGH PRECISION VACUUM TUBE VOLTMETER

Model 221K **\$23.95**

Complete Kit
THE MOST USEFUL TOOL ON YOUR RADIO BENCH!
D.C. and A.C. ranges 0-5, 10, 100, 500, and 1000 volts. Ohmmeter ranges from .2 ohm to 1,000 megohms in steps of R x 1, R x 10, R x 100, R x 10,000 and R x 1 megohm. Db scale from -20 to 55 Db in 5 ranges. D.C. input resistance is 25 megohms. A.C. input impedance is over 1 1/2 megohms. Diode A.C. rectifier for greater accuracy and wider frequency range to 30 Kc. Large, rugged, 4 1/2" meter with all A.C. and D.C. readings on one simple scale. All multiplier resistors matched to 1% accuracy. Complete with 6H6, 6X5, 6SN7 tubes and test prods. All numbers etched into panel; can never rub off. Heavy gauge steel cabinet. Size: 9-7/16" x 8" x 5". Shipping Wt. 10 lbs. NOTHING ELSE TO BUY!



Model P-75 germanium crystal probe for visual RF signal tracing, and measurements to over 200 megacycles \$7.50

ASSEMBLED VTVM

Model 221—Includes all advantages of above. Completely assembled, hand calibrated and tested and ready to use, at the amazingly low **\$49.95** price of

POCKET VOLT-OHM-MILLIAMMETER COMPLETE KIT



Model 511-K A MUST FOR EVERY SERVICE MAN! The small, handy instrument that every repairman uses a thousand times a day. Large 3" meter, beautiful etched panel. Simple to assemble. A PERFECT KIT FOR BEGINNERS. Ranges: DC -0/5/50/250/500/2500 volts. AC -0/10/100/500/1000 volts. Output -0/10/100/500/1000 volts. DC Ma -0/1/10. DC Amps -0/1/10. Ohmmeter -0/500/100,000 ohms/0/1 meg. Db meter -8 to 55 Db **\$14.95**

ASSEMBLED—READY TO USE

Model 511—Completely wired, tested and assembled at the factory. Rugged, built for heavy duty **\$17.95**

OSCILLOSCOPE KIT

Model 400-K Indispensable for AM, FM, and TELEVISION. Horizontal sweep circuit to 30,000 cycles. All controls on front panel. Linear sweep with 884 gas triode. Graph screen for measuring peak to peak voltage. Frequency response of horizontal and vertical amplifiers from 50 cycles to 50 Kc. Input impedance 1 megohm and 50 mmfd. Etched panel for long life. Tube complement: 2-6XJ7, 2-5Y3, 1-884, 1-515P. Provision for external synchronization. Test voltage and intensity modulation. Deflection sensitivity: 30 volts per inch full gain. Detailed instructions and pictorial diagrams included. NOTHING ELSE TO BUY! Size: 8 1/2" W x 13" H x 17" D. Ship wt 40 lbs **\$39.95**



COMPLETELY FACTORY WIRE OSCILLOSCOPE

Model 400—Same as above but wired, tested and assembled. A sturdy well-designed instrument, ready to use on your work bench. Don't wait, order NOW! **\$69.95**

SENSATIONAL PRICE REDUCTION!

Model 113-A MULTI-ANALYST—Completely wired, ready to operate. NOW FOR THE FIRST TIME **\$69.95**

A Complete VTVM that follows signal from antenna to speaker! Extremely sensitive wide range AUDIBLE signal tracer. 6 tubes—gain over 90 in probe alone! Limited quantity—order NOW!

20% Deposit required with C. O. D. Orders. All orders F. O. B. New York. All orders must include shipping charges.

THE FAMED HOUSE OF BARGAINS

GREEN RADIO DISTRIBUTORS

Electronic Supplies and Equipment
482 Sutter Avenue, DI 2-4444, Brooklyn 7, N. Y.

comes up to within 1½ inches from the tube socket.

The glow from the pilot light and electron-ray tuning indicator, if one is used, is annoying while viewing the screen. These can be turned off by putting a rotary switch in series with their filament leads. The switch can be mounted in the unused hole in the chassis under the tuner.

R. L. CONHAIM,
Dayton, Ohio

The raster disappeared completely on a 7-inch model. The sweep circuits and high voltage were O.K., so it seemed the C-R tube was bad. I checked the .05- μ f, 2,500-volt coupling capacitors between the vertical deflection amplifiers and the deflection plates and found that one of them had a high-resistance leak that dropped the voltage on one deflection plate so low that the beam was deflected off the screen. The trouble has not returned since the capacitor was replaced with a .05- μ f, 3,000-volt unit.

F. J. IANNONE,
Los Angeles, Calif.

These sets use 8016/1B3 high-voltage rectifiers. After a few months of operation, the voltage leaks through the bakelite tube sockets and along the bakelite platform to the grounding screw. Install a high-grade ceramic or steatite socket and avoid further trouble.

PAUL SMITH,
Brooklyn, N. Y.

The picture on the Model 10BL was weak and unstable. It was found that the color code on the ion trap was reversed when the trap was manufactured. Reversing the trap cured the trouble.

P. R. NAGOD,
Euclid, Ohio

TELEVISION ASSEMBLY 12-INCH

The damper load resistor is unusually high (about 12,000 ohms) in the standard model. This sometimes shortens the life of the 5V4 damper tube. Replacing the 12,000-ohm resistor with a 6,000-ohm, 10-watt resistor will increase the life of the tube. It may be necessary to readjust the horizontal drive and linearity controls.

ROBERT KING,
Arlington, N. J.

MOTOROLA TV-105

The lack of high voltage in this receiver is often caused by a shorted capacitor in the horizontal deflection circuit. If high voltage is present on the plate of the 1B3 but not on the cathode, check the heater of the tube. If this is O.K., check for heater voltage. If there is none, check the .05- μ f capacitor between pins 3 and 8 of the 6BG6G. In early models of this set, this 400-volt capacitor frequently breaks down and cuts off the 6BG6G, resulting in no heater voltage for the 1B3. Replace this capacitor with a .05- μ f unit with a rating of at least 600 volts.

JOHN W. TURNER,
Newark, N. J.

RCA POWER TELEVISION TRANSFORMERS

80% OFF

HIGHEST QUALITY

Sizes available for many types principal makes television receivers all sizes and capacities.

Type	50 & 60 cycle	List Price
600 Series.....		\$30.00 each
700 Series.....		27.75 each

648 PTK Series	
Small Unit	18.75 each
Large Unit	21.50 each

SPECIFICATIONS

All have 117.5 volt Primary Windings
50-60 cycle

600 Series		700 Series	
390 vac — 300 MA	265 vac — 175 MA		
5 vac — 6 amps	5 vac — 3 amps		
5 vac — 2 amps	6.3 vac — 9 amps		
12.6 vac — ct-10 amps			

648 PTK Small		648 PTK Large	
300 vac — 250 MA	500 vac — 235 MA		
5 vac — 3 amps	6.3 vac — 3 amps		
6.3 vac — 5 amps	5 vac — 3 amps		
6.3 vac — 8 amps	6.3 vac — 3 amps		

Prices F.O.B. Los Angeles & San Francisco
On C.O.D. — 25% Deposit

LEO J. MEYBERG COMPANY

2027 South Figueroa Street
Los Angeles, Calif.
70 10th Street
San Francisco, Calif.

NEW PAINTED LEARN FUN CIRCUITS PROFIT

NO MORE WIRES

Conducting and resistance paints now available. Professional men need—amateurs enjoy—this real aid in Designing, Testing, and Repairing modern electronic circuits. Paint working circuits over your rough sketches or on any insulating base. Most new radios and hearing aids have partly printed circuits. High instruction value for colleges. Standard Kit, \$3 has Copper Conducting Paint and low, medium, and high Resistance Paints; all fast air-drying. Super Kit, \$5, has above plus Silver Conducting Paint, Insulating Lacquer, and Solvent & Brush Cleaner. Free Manual with each. Postpaid in U.S.A. Manual separately 25c. Free literature. Just jot down name, address, desired kit or manual; and send with cash, M.O., or C.O.D. to

MICROCIRCUITS COMPANY
Dept. 2F, New Buffalo, Michigan

telrex INC.
CONICAL ANTENNAS
RUTHERFORD AVENUE ON ROUTE 35
ASBURY PARK, N. J. PHONE: ASBURY PARK 1-0119
BOX 879R, ASBURY PARK, N. J.

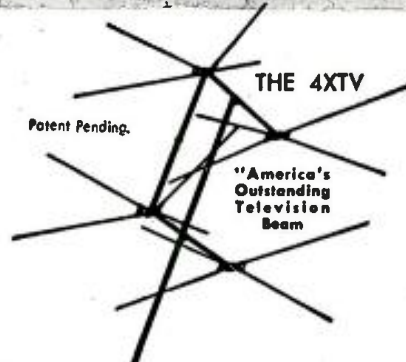

- Hi-Gain Stacked Conical "V" Beam
 - Channels 2 to 13 Plus FM
 - Low Inception Angle
 - Extremely High Signal to Noise Ratio
 - 150 Ohm Non-varying Impedance
 - Use 72, 150 or 300 Ohm Transmission Lines
 - Universal Mounting Clamps
- SEE YOUR DISTRIBUTOR

Booklets by A. C. Shaney
Written by a foremost Audio design engineer—
Yours almost as a gift!

Elements of Magnetic Tape Recording 25c
and 999 Applications
Direct-Coupled FM-AM Amplifier Manual 25c
20 Steps to Perfect Amplification 3c in postage

Thousands Sold!

Famous Twin-Trax Instruction Book!
An engineering course in tape recording. 30 diagrams, illustrations.

\$2.50 (Price may be applied against future purchase of chassis.)

AMPLIFIER CORP. OF AMERICA
398-10 Broadway New York 13, N. Y.

HOW TO GET THE MOST from only BASIC TEST EQUIPMENT

Servicing by Signal Substitution

The Simple, Modern, Dynamic Speed approach to receiver alignment and adjustment problems, FM-AM-TV.

- Nothing complex to learn
- No extra equipment to purchase
- Universal — non-obsolete
- Employs only Basic Test Equipment

S-S-S tells HOW — in simple, direct language.

New 9th edition now off the press. 100 pages of valuable information.

Available from all leading radio parts and equipment distributors or directly from factory at only 40c per copy.

PRECISION APPARATUS COMPANY, Inc. • 92-27 Horace Harding Blvd., Elmhurst 4, N. Y.

NOW! you can LEARN ELECTRIC MOTOR REPAIR

A good paying modern profession

...only \$5

FOR THE COMPLETE TRAINING

Based on what can be learned quickly at home from this big ELECTRIC MOTOR REPAIR book, you can train for profitable installation, service, repair and complete rewinding of practically any electric motor. Every subject is clearly explained by text AND ALSO by more than 800 clear-cut illustrations. You not only read what to do. You actually SEE how to do it! Quick reference guides show how to handle specific jobs. When certain motors come in for repairs, just look them up. ELECTRIC MOTOR REPAIR tells you what to do—and exactly how to do it.

SPECIALIZE IN A FIELD THAT ISN'T CROWDED

Every day, more and more electric motors and control systems are being used in industry and home appliances. The expert who can install them and keep them working properly is a valuable man in this Electrical Age! ELECTRIC MOTOR REPAIR teaches you every step of the work—quickly and easily—at home—in spare time. Ideal for beginners or for bench use in busy shops. Thousands already in use in vocational schools, shops and, most important of all, for home study.



560 pages
900 special illustrations...
Covers practically every motor type in common use in both text and pictures

SHOWS YOU HOW every step of the way

ELECTRIC MOTOR REPAIR is designed for use right at the bench. Unique Duo-Spiral Binding divides book into two sections so that both text and related pictures can be viewed together. An instructor standing by your side could hardly do better!

EASY TO UNDERSTAND

It covers the entire motor field—including alternating—and direct-current motors and generators, etc., as well as mechanical, electrical and electronic control systems. Right down the line, it explains every detail of trouble diagnosis, repair, rewinding and maintenance in a way you can easily understand.

Send coupon today! See for yourself that really good home training doesn't have to cost you a lot of money.

PRACTICE FROM IT FOR 10 DAYS at our risk!

The handiest reference book you've ever used!



ANSWERS TO 1,001 ELECTRICAL QUESTIONS... only \$2.50

THE ELECTRICIANS' POCKET COMPANION

THE ELECTRICIANS' POCKET COMPANION handbook gives you a comprehensive selection of the important facts, figures and data modern electrical workers need to know about all sorts of jobs. It gives needed information based on the National Electrical Code and Underwriters' requirements.

It covers the entire range of subjects from motors, meters and transformers to lighting, wiring, tools and equipment and literally hundreds of others. Contains hundreds of illustrations, charts, diagrams and data tables. The ideal book for easier, better and more profitable work on down-to-earth electrical jobs! Four different indexes give quick access to any needed fact. 442 pages. 4 1/2" x 7" coupon for trial examination of ELECTRICIANS' POCKET COMPANION.

10-DAY TRIAL COUPON

Dept. RE-39, Murray Hill Books, Inc., 232 Madison Ave., New York 16, N. Y.

Send me books checked below for 10 days' examination on approval. In 10 days, I will pay for books plus few cents postage, or return them postpaid. (Postage paid on cash orders; same return privilege. Books sent on approval in U.S.A. only.)

- ELECTRIC MOTOR REPAIR. \$5 (\$5.50 outside U.S.A.)
- ELECTRICIANS' POCKET COMPANION. \$2.50 (outside U.S.A.)

Name

Address

City, Zone, State

... RCA 630TS

No raster, sound O.K. Checking the waveform at terminal No. 4 of the horizontal output transformer showed sweep circuit to be in good shape. This isolated the trouble in the high-voltage rectifier circuit where I found C-187 (500 μf) was shorted. I replaced it with a 500- μf , 10-kv unit to be sure that this did not happen again.

MICHAEL L. TORTARIELLO,
Newark, N. J.

... STICKING VIBRATORS

Sticking vibrators can be made to work again without opening the set. Simply apply 6 volts a.c. to the battery terminals momentarily. The a.c. will not harm the set.

JOHN A. BISHOP,
Transvaal, South Africa

... PHILCO 48-805

Intermittents have been traced several times to broken 117-volt power leads. The line cord is so installed that all strain is on the soldered joints. Unsoldering the cord and making a knot in it before reconnecting relieves the strain.

It is a good idea to do this with any set that comes into the shop for repair to avoid possible call-backs.

JOHN A. BISHOP,
Transvaal, South Africa

... BRUSH SOUNDMIRROR, MODEL BK-401

Sometimes the tape tears or the reels won't stop quickly when the STOP button is pressed. This button applies a d.c. magnetic brake to the motor. In the back of the unit, a selenium rectifier supplies d.c. for the brake through a set of switch contacts. The contacts cause the failure. Clean them with carbon tetrachloride and burnish the points. Bend the contacts, if necessary, so that they make and break cleanly.

In the same model, capacitors C29 and C30 (.01 μf) fail, causing excessive plate current. If a 6SN7 plate is red hot and the sound distorts, replace these capacitors with units of higher voltage rating.

DAVID GNESSIN,
Columbus, Ohio



Suggested by Merrylen Townsend
New York City

Technical Bulletins

EACH \$1.00 Postpaid Foreign \$1.25

Electrical Design and Construction

These bulletins give you easy, accurate, dependable methods of designing and building electrical equipment. You just follow simple charts, tables and step-by-step instructions that tell how to figure correct size units to meet specific requirements.

106 Rewinding Electric Motors—Enables anyone without electrical training to locate trouble, repair and rewind a.c. or d.c. motors and generators of all kinds; how to figure wire size and wind coils.

111 Transformers—How to design and build all types and sizes of transformers including specials for Neon tubes and ultraviolet lamps. Easy methods of determining core dimensions and wire size.

152 House Wiring—Safe, approved way to wire new and old buildings. Shows many different circuits. Explains how to use latest type of materials including fittings, fixtures. Also gives estimating methods.

101 Resistance Wire—How to use Nichrome and similar wire in heating devices, rheostats and resistance coils. Figuring wire size and length; how to wind elements and test. Also supply directory.

113 Solenoids & Plunger Magnets—How to make these a.c. and d.c. magnets having movable plungers to control other equipment. How to figure dimensions, plunger stroke, wire size, etc.

112 Electromagnets—How to design and build all types and sizes for a.c. and d.c. How to figure lifting power, wire size.

148 Relays—Designing and building a.c. and d.c. relays of any size for various purposes where small currents and voltages must control heavy circuits. Includes control systems for motors and machines.

137 Meters—Designing and building ammeters, voltmeters, wattmeters, for a.c. and d.c. Includes complete information on calibrating.

127 Small Electric Light Plants—Easy-to-build, low-cost installations for cottages, camps, etc. Includes a 110-volt, seven 25-watt-lamp system; also a 6-volt system using auto generator.

151 Electric Power from Streams—How to survey streams, estimate requirements and available power, design and build dams, select and install the control system and electrical equipment.

161 Burglar Alarms & Time Switches—Dependable types for various purposes. Time switches made for alarm clocks and arranged to control lights, sprinkler systems, motors and other devices.

144 Choke Coils—How to design and build for many different purposes. How to use these instead of rheostats for voltage control, safely and with much less loss of electricity

131 Remote Control of Electrical Devices—Circuits and applications. How to use telephone dial and Stroger switch. For experimenters and model-railroad switching purposes.

134 A.C. Electrical Experiments—Fascinating, harmless experiments for education and entertainment. Also practical uses.

TECHNIFAX, 110 N. Franklin St. Chicago 6, Ill.

Enclosed find \$_____ for which send the following Technical Bulletins at \$1.00 each (Foreign \$1.25) as indicated by numbers:

Name _____

Address _____

City & State _____

RE 1

TV SCREEN SPLIT IN TWO

Split-screen television was presented for the first time last month by NBC during a broadcast of the Television Broadcasters Association meeting in New York. NBC commentator John Cameron Swayze in New York interviewed Rep. Karl E. Mundt in Washington. Each man occupied half the screen so that viewers could see the two simultaneously. O. B. Hanson, NBC chief engineer, explained that the dual transmission was made possible by the image-splitter, a device developed by network engineers.

ZENITH LOOKS TO U.H.F. TV

U.h.f. TV channels are provided for in new Zenith receivers. The new line of sets which went on sale last month contains unused tuning strips in addition to those now used for channels 2-13. If and when u.h.f. television becomes a reality, these strips can be replaced with suitable tuning units by any serviceman. A plug-in for Phonovision, Zenith's plan for pay-as-you-watch programs, is provided also.

Another unusual feature of the sets is the circular screen. Designed to eliminate the waste of screen area necessary with the usual rectangular picture, the circular screens make a larger picture available on any particular size tube, although corners of the scene will be missing.

NEW TV TUBE PROCESS

TV tube shortage will be alleviated by a new method of processing the glass blanks announced last month by the Pittsburgh Plate Glass Co. Heretofore, the face of the tube has been made spherical and then polished. The new process permits the glass to be polished while still flat.

CHART SHOWS TELE GROWTH



Courtesy General Electric Co.

A graphic presentation of the expected growth of television. Figures along bottom of chart are years from 1947 to 1952, and figures on curve are, in rising order: 170,000, 870,000, 2,470,000, 5,270,000, 9,070,000, and 13,570,000.

MARCH, 1949

**GENUINE
WESTERN ELECTRIC
HI-FI TWEETER**

Also Supplied Complete with Projector

You'll Need 10

**HI-FI
TWEETER
or Driver Unit**

\$5.95

F.O.B. N.Y.C.
10 For \$49.50



GOVT COST
\$40.00

**Better
Buy 4**



**WESTERN ELECTRIC DRIVER UNIT
with REFLEX PROJECTOR**

\$19.95

F.O.B. N.Y.C.
4 For \$75.00

SPECIAL!

Western Electric Driver Unit and Projector complete with an additional Western Electric Driver Unit for the sensationally low price **\$24.95** of F.D.B. N. Y.

25% DEPOSIT WITH ORDER, BALANCE C.O.D.

**MANUEL KLEIN 74 1/2 CORTLANDT ST.
NEW YORK 7, NEW YORK**

TUBES! NATIONALLY TUBES!

ADVERTISED BRANDS

RCA — Kenrad — Sylvania — Tung-Sol — National Union — Raytheon — Philco — Hytron
All new tubes, 100% guaranteed. Individually boxed.

TYPE	PRICE	TYPE	PRICE	TYPE	PRICE	TYPE	PRICE	TYPE	PRICE	TYPE	PRICE
0A4G	\$.06	3A4	\$.07	6K7G	\$.06	6Y6G	\$.08	12AH7GT	\$1.15	35W4	\$.04
D1A	\$.80	3B7/1291	\$.96	6K5	\$.85	6Y7G	1.15	12AT6	1.80	35Y4	\$.85
O2A	\$.80	3D6/1299	\$.96	6L5G	\$.96	6Z7C	1.40	12BA6	1.65	35Z4GT	\$.54
IA3	\$.80	3Q4	\$.80	L	1.26	6ZV5G	\$.80	12BE6	1.65	35Z6T	\$.45
IA4P	1.40	3Q5GT	1.85	6L6GA	1.15	7A4	1.15	12CB8	1.15	36	\$.88
IA5GT	1.65	384	1.72	6L7	1.15	7A5	1.15	12CH6	1.65	37	\$.65
IA6	1.15	5R4GY	1.15	6N7	1.15	7A6	1.15	12J5GT	1.54	38	\$.80
IA7GT	1.72	5T4	1.40	6P5GT	1.80	7A7	1.65	12J7GT	1.72	39	\$.96
IB4P	1.40	5U4G	1.54	6Q7	1.72	7A8	1.65	12K7GT	1.60	39/44	\$.96
IB5/2S5	1.15	5V4G	1.85	6R7	1.96	7B4	1.65	12K8	1.65	40	\$.80
IC5GT	1.80		1.91	6R7GT	1.65	7B5	1.65	12Q7GT	1.65	42	\$.60
IC6	1.15	5X4G	1.65	687	1.96	7B6	1.65	12SA7GT	1.65	45	\$.80
IC7	1.15	5Y3GT	1.45	68A7GT	1.60	7B7	1.65	12SC7	1.65	45Z3	\$.65
ID3GP	1.40	5Y4G	1.54	68BGT	1.85	7B8	1.65	12SF5	1.65	45Z3GT	\$.65
ID7G	1.15	5Z3	1.65	68B7-Y	1.85	7C3	1.65	12SG7	1.72	46	\$.96
ID8GP	1.40	5Z4	1.96	68Y7	1.72	7C6	1.65	12SH7	1.80	47	\$.85
IE5GP	1.40	6A3	1.96	68D7GT	1.15	7C7	1.65	12S17	1.80	48	1.40
IE7GT	1.40	6A4/LA	1.15	69F5	1.72	7E5	1.65	12S7	1.80	50	1.40
IF4	1.96	6A6	1.96	69F7	1.72	7E7	1.80	12SK7GT	1.80	50A5	\$.80
IF5G	1.96	6A7	1.72	69G7	1.72	7F7	1.80	12SN7GT	1.80	50B5	\$.72
IG4	1.96	6A8GT	1.72	68H7	1.80	7F8	1.96	12SQ7GT	1.60	50L6GT	\$.60
IG6GT	1.96	6A87	1.15	68J7	1.60	7C7	1.96	12SR7	1.80	50X6	\$.80
IH4C	1.80	6AC7	1.96	6K7GT	1.60	7H7	1.72	12Z3	1.96	50Y6GT	\$.65
IH5GT	1.60	6AD7G	1.15	6L7GT	1.85	7I7	1.96	12Z5 (6Z5)	1.15	53	\$.96
IH6G	1.15	6AF6G	1.96	68N7GT	1.80	7L7	1.80	14A4	1.96	57	\$.72
IJ6G	1.96	6AR5	1.25	68Q7	1.60	7N7	1.80	14A7	1.96	58	1.40
IL4	1.72	6AG7	1.15	68R7	1.65	7Q7	1.65	14B6	1.80	70L7GT	1.15
IL4A	1.96	6AK5	1.25	68S7	1.65	7V7	1.96	14C7	1.80	71A	\$.72
IL6A	1.96	6AL5	1.25	68T7	1.96	7W7	1.96	14F7	1.80	75	\$.60
ILB4	1.96	6AL7	1.96	68V7	1.15	7X7	1.96	14H7	1.80	76	\$.60
ILC5	1.96	6AD7G	1.80	67G	1.15	(XXFM)	1.96	14J7	1.96	77	\$.80
ILD5	1.96	6AT6	1.54	6U5	1.72	7Y4	1.65	14K7	1.96	78	\$.80
ILE5	1.96	6B4G	1.96	6U6	1.65	7Z4	1.65	14N7	1.96	79	\$.96
ILE3	1.96	6B7	1.15	6U7	1.65	10	1.40	14Q7	1.80	80	1.45
ILH4	1.96	6BBG	1.15	6V6	1.15	12A	1.65	14W7	1.96	81	1.40
ILN5	1.96	6C4	1.80	6V6GT	1.72	12A5	1.15	19	1.15	82	1.96
INSGT	1.72	6C5	1.60	6V7G	1.96	12A6	1.96	25Z3	1.15	83	1.96
IP5GT	1.80	6C6	1.72	6V7A	1.96	12A7	1.15	22	1.15	83	1.96
IQ3GT	1.96	6C8G	1.15	6X5GT	1.54	12A8	1.72	23L6GT	1.80	83V	1.15
IR4	1.96	6D6	1.60					25Z5	1.54	85	1.80
IR5	1.72	6E5	1.80					25Z6GT	1.54	85	1.80
IS4	1.85	6F3GT	1.60					26	1.65	89	1.80
IS5	1.65	6F6	1.72					27	1.54	117L7GT	1.40
IT4	1.72	6F6G	1.60					27D7	1.15	117N7GT	1.40
ITSGT	1.96	6F7	1.15					31	1.96	117Z3	1.65
IV	1.80	6F8G	1.15					32	1.15	117Z6GT	1.85
2A3	1.15	6G6G	1.96					32L7GT	1.15	VR-90	1.96
2A4G	1.15	6H6GT	1.60					33	1.15	VR-105	1.96
2A5	1.80	6J5GT	1.54					34	1.15	VR-150	1.96
2A6	1.96	6K6	1.25					35	1.72	9001	1.80
2B7	1.96	6J7	1.72					35A5	1.65	8006	1.80
2X2	1.15	6K8GT	1.54					35B5	1.72	FM-1000	1.15
								35L6GT	1.60	HY-117	1.15

TERMS: 25% with Order
—Balance C.O.D.—F.O.B.
Chicago. Prices Subject
to Change Without Notice.
Minimum Order \$2.00.

FRANKLIN-ELLIS CO. 1313 West Randolph Street
Dept. RE-3 Chicago 7, Illinois

Television is Booming—Cash in on it!

RMS VIDEO-ANTENNA BOOSTER

Model SP-2 13 Channel

for your CUSTOMER

SATISFACTORY
INSTALLATIONS
LESS SERVICE CALLS
AUXILIARY SALES



for
YOU

\$

Yes, this PROVEN successful Television Booster will build up profits for YOU—not only because of rapid turnover—but

also because it opens up whole new markets for the sale of television sets, components and accessories, in "fringe areas" where satisfactory television reception was formerly impossible!

See your local jobber for this, as well as other RMS Television Fast-sellers. Write for literature to

RMS

RADIO MERCHANDISE SALES, INC.
548-550 WESTCHESTER AVENUE NEW YORK 55, N. Y.

The Outstanding Development in TV Antenna Design

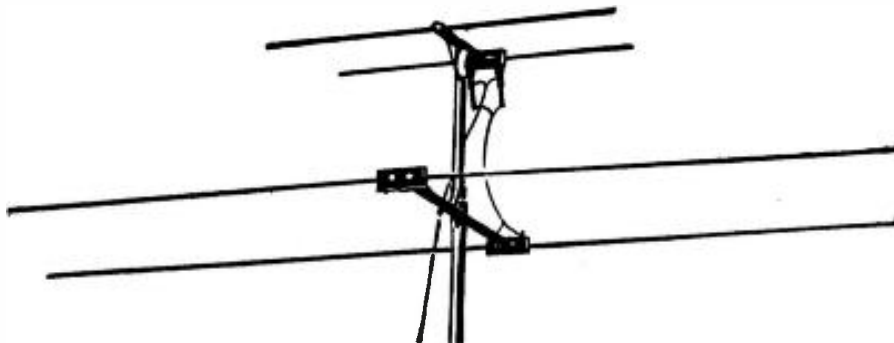

AAK Patents Nos. 2,282,292 and 2,422,458

The all-important "Divider Coils," featuring television antennas licensed by AAK, prevent interaction between sections by suppressing third harmonics. This feature, plus excellent frequency response on all channels, is a vital factor in good TV reception.

The following manufacturers are licensed by AAK, Inc. to make and sell these antennas

Collins Machine Co., Woodside, L. I.
Electronic Indicator Corp., Brooklyn, N. Y.
Vertrud Corp., New York City

Channel Master Co., Ellenville, N. Y.
Video Television, Inc., New York
Premax Products, Niagara Falls, N. Y.

Leading Set Makers Use Antennas Licensed By
AMY, ACEVES & KING, Inc.

Consulting Engineers

11 WEST 42nd STREET

NEW YORK CITY

\$\$\$ WANTED \$\$\$

Pocket and midget receiver designs and schematics. Circuits employing one to three 1½ volt miniature and sub-miniature tubes and permability tuned preferred. Also want midget F-M regenerative receiver design using acorn or above tubes, 1½ volt filaments. Send your unusual design today! \$100.00 cash paid for each design accepted. Ship working model via insured mail . . . Model will be returned promptly.

ELECTRONIC RESEARCH LABORATORIES
1216 Park Row Bldg. NEW YORK CITY 7

WALL MODEL



\$15.95 FOR 2 OF EITHER MODEL

Common talking and common ringing. Any number of phones can be connected in same circuit. Simple installation, absolutely no technical knowledge required. 25% deposit required on all orders. F.O.B. Brooklyn.

EASTERN TELEPHONE CO.
329 18th St., Dept. RC-2
Brooklyn, N. Y.

TELEPHONES

Now—Telephones of Deluxe quality at low prices. Incorporating latest improvements in design and technique. Honest to goodness first class material and finest workmanship. Lowered cost due to increased volume makes it possible for us to sell at the special low price of \$15.95 for Two of either model, complete with wire, power supply and instructions.



DESK MODEL

ELECTRONIC LITERATURE

Any or all of these catalogs, bulletins, and periodicals are available to you if you write to us on your letterhead (do not use postcards) and request them by number. It is necessary to send only the number of the item you want. We will forward the request to the manufacturers, who in turn will send the literature directly to you. This offer void after six months.

M-1—STANCOR CATALOG

Catalog 140H is the latest issued by Standard Transformer Corp. It has 21 pages and lists the various audio and power components made by the firm. Two tables list the filament or heater voltages for the more commonly used transmitting tubes and type numbers for driver and modulation transformers for use with a number of tube combinations. Two transmitters, a 6-volt battery eliminator and other special-purpose units are also listed.—*Gratis*

M-2—SIGNAL TRACER BULLETIN

The Inside Story of Stethoscope Servicing is a 20-page booklet describing the technique of signal tracing and the Feiler Engineering Company's line of signal tracers.—*Gratis*

M-3—SOLDERING TIPS

This 20-page book of useful information on soldering is published by Weller Mfg. Co. A number of soldering do's and don'ts are given in simple language illustrated with cartoons. The book suggests solders and fluxes for use when working on different types of metals. Price, 10¢

M-4—AMPLIFIER BULLETIN

99 Questions Most Often Asked About Magnetape Twin-Trax Recorders is a 12-page booklet prepared by Amplifier Corp. of America. It lists questions and answers on the performance, construction, specifications, and availability of the new Twin-Trax dual-channel magnetic tape recorders. It provides information not included in sales literature on the recorders.—*Gratis*

M-5—GUARDIAN RELAY CATALOG

Catalog 10-B, lists the a.c., d.c., locking, and stepping relays made by Guardian Electric Mfg. Co., Inc. All relays and switches are illustrated with photographs and engineering drawings. A 4-page insert gives electrical, mechanical and operating characteristics on the Guardian line of a.c.-d.c. solenoids.—*Gratis*

M-6—INDEX TO RADIO DIAGRAMS

How to Use Diagrams in Radio Servicing, a 32-page booklet published by Supreme Publications, begins with 6 pages of material on the use and value of diagrams in radio servicing. The following 26 pages contain a complete index to the radio diagrams published in Volumes 1 through 8 of the manuals published by Supreme Publications. The booklet is of interest to servicemen, students and engineers.—*Mailed for 2¢ postage*

M.7—FM and TV ANTENNA CATALOG
 The L. S. Brach Manufacturing Corp. issues a new loose-leaf catalog illustrating their line of antennas and antenna accessories for television and FM. Of interest to servicemen, dealers and also to owners of TV and FM receivers.—*Gratis*

Radio Thirty-Five Years Ago
 In Gernsback Publications

HUGO GERNSBACK	
Founder	
Modern Electrics.....	1908
Electrical Experimenter.....	1913
Radio News.....	1919
Science & Invention.....	1920
Radio-Craft.....	1929
Short-Wave Craft.....	1930
Wireless Association of America.....	1908

Some of the larger libraries in the country still have copies of ELECTRICAL EXPERIMENTER an file for interested readers.

IN MARCH 1915 ELECTRICAL EXPERIMENTER

- Wireless Life Boats for "Aquitania," by Frank C. Perkins
- The Colin-Jeance Radio Microphone
- A Selenium Relay for Radio Currents
- The "Chaffee" Radiophone Spark Gap
- Electrolytic Interrupter Kinks
- Radio Time Signals and the Public Connections for Radio-Telegraphic Sets
- Learning the Radio Codes, by Chas. W. Fralley
- A Home Made Automatic Transmitter, by Stephen W. Pilling
- Principal Trans Oceanic Wireless Stations of the World
- The De Lange Thermal Telephone

STUDIO TESTS TELE UNITS



To test television studio equipment before it is shipped out, General Electric has set up a "factory studio" in its Electronics Park manufacturing plant at Syracuse, N. Y. Test pattern in the photo is being used to check on performance of camera and studio chain. Every piece of equipment is subjected to conditions similar to those under which it will operate in the station in which it is to be used eventually.

MARCH, 1949

EVERYBODY SAVES AT SENCO

Step right up, folks, join the gang in the biggest—the most stupendous—savings in years! No foolin', fella, you just can't go wrong at SENCO!

TUBES!

All Brand New! R. M. A. Guarantee!
 Immediate Delivery! Individually Cartoned!

RCA INTERCOM

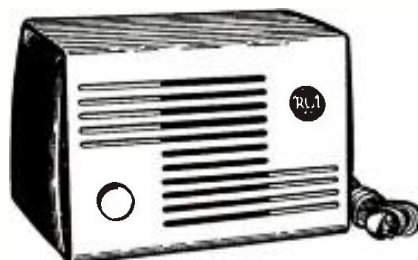

IDEAL FOR HOME, OFFICE, STORE!

3-tube AC-DC amplifier circuit. Designed to operate with 2 remote stations connected in parallel. Remote stations not supplied. A small PM speaker and a single-pole double-throw switch are all that is required to make a remote unit for 2-way communication.
 Other Applications: Electronic Baby-Sitter, Phono-Amplifier, Code Practice Oscillator.
 Complete with tubes and 100 ft. of cable.

SPECIAL! \$7.95

TOGGLE SWITCH—Bat Handle, Lang Shank
 Single-pole double-throw—3 amps.....25¢

OUTPUT TRANSFORMERS

- 3Q5 ea. 39¢
 - 50L6 PUSH PULL ea. 39¢
 - 6V6 PUSH PULL ea. 49¢
- All Sturdily Constructed

SPEAKER Saving!



Here are the speakers you've been looking for! Quality so high, yet prices so very low. Why hesitate—take advantage of this SENCO saving now!

- 3" P.M.—.68 oz. Alnico V..... \$.99
- 3" P.M.—1.47 oz. Alnico V..... 1.15
- 4"x6" P.M.—Speaker 1.89
- 5" P.M.—1 oz. Alnico V..... .99
- 5" P.M.—1.47 oz. Alnico V..... 1.15
- 8" P.M.—2.15 oz. Alnico V..... 2.75
- 8" P.M.—.6.8 oz. Alnico V..... 3.69
- 10" P.M.—.6.8 oz. Alnico V..... 3.75
- 12" P.M.—Alnico V..... 3.95
- 12" P.M.—.6.8 oz. Alnico V..... 5.95

MAGNAVOX SPEAKERS

- 12" P.M.—21 oz. magnet with 6V6 P.P. output, cord and plug..... \$5.95
- 12" 1000 ohms field with 6V6 P.P. output, cord and plug..... 5.95
- 12" 680 ohms field with 6V6 P.P. output, cord and plug..... 5.95
- 8" 680 ohms field with 6V6 P.P. output, cord and plug..... 3.69

- PN88 SHURE CRYSTAL CARTRIDGE..... \$1.69
- ASTATIC NYLON CARTRIDGE..... 2.95

MINIMUM ORDER \$2.50
 WHEN ORDERING—Send 25% deposit for all C.O.D. shipments. Include sufficient postage—excess will be refunded. Orders without postage will be shipped express collect. All prices F.O.B. New York City.

Type	Each	Each 10	Type	Each	Each 10
OZ4	49¢	59¢	6U7G	35¢	25¢
1A3	45	39	6V5GT	59	49
1C5GT	49	59	6V6GT/G	45	39
1D7G	49	59	6W4GT	69	59
1LD5	49	59	6X5GT/G	49	39
1LH4	49	59	6Y6G	71	63
1LN5	49	59	7A4	53	43
1L	49	45	7A7	59	44
1N1	59	49	7B6	49	44
1P5	59	49	7B7	49	44
1Q5GT	55	49	7B8	69	59
1R4	69	59	7C5	55	49
1R5	55	48	7C7	69	59
1S5	55	48	7X7(XXFM)	44	35
1T4	69	55	7Y4	44	35
1T5GT	59	49	12A	79	69
1U4	49	39	12A6	29	25
1V	45	39	12A8GT	35	28
2A7	32	25	12AT6	50	45
2X2/879	35	29	12AT7	69	59
3A4	49	39	12AU6	65	55
3B7/1291	59	49	12AV6	49	39
3Q5	55	49	12BA6	50	45
3S4	55	45	12BE6	50	45
3V4	79	69	12F5GT	35	27
5U4G	50	40	12H6	39	34
5W4GT	39	34	12J7GT	45	39
5X4G	39	35	12K8Y	35	25
5Y3G	42	37	12Q7GT	45	39
5Y3GT/G	40	33	12SA7GT/G	40	32
5Z4	59	49	12SP5GT	40	32
6A3	69	59	12SJ7GT	55	49
6A7	50	45	12SK7GT/G	45	35
6AC5	69	59	12SL7	49	43
6AC7/1852	79	69	12SN7	49	43
6AH6	49	39	12SQ7GT/G	40	32
6AL7	69	59	12SR7	35	32
6AN5	65	55	12Z3	55	49
6AT6	49	39	14A7	65	55
6B4G	89	79	14B6	59	49
6BA6	49	39	14Q7	65	55
6BE6	49	38	19T8	89	79
6BG6G	99	89	24A	49	39
6BH6	79	69	25L6GT	55	45
6BJ6	59	49	25Z5	49	45
6C4	29	25	25Z6GT/G	45	39
6C5GT	40	35	26	32	25
6D6	49	45	27	45	35
6F5GT	55	45	32L7GT	52	48
6F6GT	45	39	35L6GT/G	45	39
6F7/VT70	39	29	35W4	43	40
6F8	69	59	35Z5GT/G	43	39
6H6GT/G	43	36	35Z6G	43	39
6J5GT/G	45	39	36	35	29
6J7GT	42	38	39/44	25	19
6K6GT/G	45	39	45Z5	59	49
6K7G	50	41	46	59	49
6K7GT/G	49	39	47	49	39
6K8	69	59	50	1.49	99
6L5G	69	59	50L6GT	50	45
6N4	49	38	56	55	45
6P5GT	55	49	57	45	39
6R7GT	59	49	58	45	39
6SA7GT/G	44	37	75	59	49
6SH7GT	40	32	76	49	45
6SK7GT/G	49	39	77	35	27
6SL7GT	49	47	78	49	39
6SN7GT	49	47	80	40	38
6SQ7GT/G	44	37	81	1.49	99
6SR7	43	36	82	69	59
6SS7	59	49	84/6Z4	49	39
6SV7	55	49	85	49	45
6T8	89	79	99V	35	25
6U5/6G5	69	59	99X	35	25
6U6GT	40	29	117Z6GT/G	79	69

POWER TRANSFORMERS

All fully shielded, flush mount. Quality construction at Senco low, low prices.

- 50 mil—6.3V @ 2 amps—
- 5V @ 2 amps 580V C.T..... \$1.79
- 100 mil—6.3V @ 3 amps—
- 5V @ 2 amps 750V C.T..... 2.95
- 150 mil—6.3V @ 4 amps—
- 5V @ 3 amps 750V C.T..... 3.39
- 200 mil—6.3V @ 3.3 amps—
- 5V @ 3 amps 815V C.T..... 4.45



STOCK UP NOW!

SEND FOR OUR FREE CIRCULAR
START SAVING NOW AT SENCO!



Dept. F, 73 West Broadway, New York 7, N. Y.
 Telephone—BEekman 3-6498

NOW! BUILD 15 RADIOS \$14⁷⁵
 COMPLETE KIT ONLY.

Absolutely No Knowledge of Radio Necessary. You Need No Additional Parts. The PROGRESSIVE RADIO KIT is the Only Complete Kit. Operates on 110-120 Volts AC/DC

Contains everything you need. Instruction book, metal chassis, tubes, condensers, resistors and all other necessary radio parts. The 36-page Instruction Book written by expert radio instructors and engineers teaches you to build radios in a professional manner. The circuits are designed to provide excellent performance. Altogether, fifteen circuits are constructed, including 11 receivers, 1 audio amplifier and 3 transmitters.

SPECIAL OFFER

Electrical and Radio Tester sent absolutely FREE with each Progressive Radio Kit. Plus FREE Membership in the Progressive Radio Club. Enthusias try to free expert advice and consultation service with licensed radio technicians. ORDER YOUR KIT NOW!

PROGRESSIVE TELE KIT
 7" Television Kit \$59.50
 10" Television Kit \$99.50

AUTOMATIC
 Car Radio Model M-90 (Universal Mounting) \$27.97
 Car Radio Model M-92 C (Built-in battery) \$34.97
 Bike Radio (anti-theft feature) \$17.47
 Tom Thumb "Buddy" Portable (three way plus battery charger) \$27.97
 7" Television Receiver (table model) \$149.85

EICO
 V.T.V.M. Kit 221 K \$23.95
 V.T.V.M. Assembled 221 \$49.95
 5" Oscilloscope Kit \$39.95
 5" Oscilloscope Assembled Model 400 \$69.95
 Volt-Ohm-Milliammeter Kit \$14.95
 Assembled Model 51 \$17.95

TELEVISION ASSEMBLY
 10" Television Kit (complete) \$229.50
 12" Television Kit (complete) \$259.50
 15" Television Kit (complete) \$349.50

RMS
 All-Channel Video Booster (excellent for fringe area) \$22.75
 All-Channel Television Antenna (2 folded dipoles, 2 reflectors) \$15.00

ESPEY
 FM/AM Chassis Model 7B-1 Receiver (11 tubes) \$84.00
 FM/AM Chassis Model 511 Receiver (14 tubes) \$98.00
 FM/AM Chassis Model 513 Tuner (11 tubes) \$78.60
 Amplifier and Power Supply Model 514 (8 tubes) \$38.60
 Custom Built Combination Console Cabinet \$53.50

ALTEC LANSING
 Model 600-B Dia-Cone Speaker \$18.00
 Model 603-B Multicell Dia-Cone Speaker \$30.00
 Model 604B Duplex Speaker \$176.00
 Model ALC-101 Tuner and 323-C Amplifier \$388.00
 Home System (ALC-101 Tuner, A-323-C Amplifier, Webster 70 Changer, 10922 Base, 604-B Speaker and N-10082 12" Speaker) \$585.00
 Model ALC-201 Television Attachment \$384.00

RADIO CRAFTSMAN
 FM/AM Tuner Model RC 8 \$110.00
 Audio Amplifier Model RC 2 \$39.00

SUPERIOR
 Signal Tracing Kit Model CA 12 \$21.95

MECK
 FM/AM Table Model—Brown Plastic—DE 640 (8 tubes plus rect.) \$32.90
 FM/AM Table Model—White Plastic—DF 641 (8 tubes plus rect.) \$39.90
 7" Television Receiver (table model) \$149.00

VM
 Long Playing Dual Speed Record Changers \$35.90
 Model 401 same as Model 400 mounted on base \$35.70

ELMCO
 Amplifier Model A-100 (5 Tubes—3 Tubes) \$11.25
 Amplifier Model A-102 (8 Tubes—4 Tubes) \$17.25

GARRARD
 Intermix Record Changer RC-65-D (110 and 220 volts, 50/60 cycles) \$69.50
 Model RC-85-U (AC/DC Motor for 25/60 cycles, 110 and 220 volts) \$99.50
 Both models available with the following cartridges: Low pressure Crystal Pick-up; Garrard Standard Magnetic Pick-up; GE Variable Reluctance Pick-up; Garrard Hi-Fi "Magtronic" Pick-up. All at the same price. Specify type of Pick-up desired.

STAR
 Multitester Model M-11 (27 separate ranges) \$26.75
 Tube Checker Model TE-1 (a precision instrument) \$34.95
 Tube and Set Tester Model MT-12 (an excellent buy) \$15.50
 Multitester Model M-204 (up to 10,000 volts) \$34.95

E. M. C.
 Vacuum Tube Volt-Ohm-Capacity Meter Model 300 \$39.50
 High Frequency Probe Model HFP (for Model 300) \$6.50
 Pocket Voltmeter (5000 ohm per volt) Model 105 \$22.95

FEILER
 Pocket Stethoscope Model TS-5 \$28.95
 Cathode Ray Stethoscope Model TS-7 (less phones and probe) \$99.95
 Stethoscope Probe (complete with 6C4 tube) \$8.25
 Signal Tracing Analyzer Model TS-2 \$29.95

SOMETHING NEW
 Progressive Television Servicing Notes (Includes FM) \$6.65

H. H. SCOTT
 Dynamic Nixie Subprocessor Type 110-A \$49.50

FERRETT
 FM-Television Sweep Generator (20 MC sweep width) \$164.95

EVERHOT
 Electric-Blanket Model 921 (72" x 90") \$27.48

ALL MERCHANDISE SHIPPED FOB NEW YORK
 Deduct 2% if full payment accompanies order. 25% deposit required on COD orders.
 Write for further information concerning the above merchandise. Send for our Free catalog.

PROGRESSIVE ELECTRONICS CO.
 Dept. RC-23 497 Union Avenue
 Brooklyn 11, New York

FIELD-STRENGTH METER

Field-strength meters and phone monitors are useful gadgets to have in an amateur radio station. Many amateurs fail to build such equipment—or to use it when it is on hand—chiefly because such devices are usually battery-operated; and the batteries are invariably dead when the device is required.

The very compact combination phone monitor and field-strength meter described in *Short Wave Magazine* (England) does not require a power supply of any kind. The circuit is shown. The unit is built into a metal box just large enough to hold the 100- μ f tuning capacitor, a 200- μ a meter, a s.p.s.t. toggle switch, a 1N34 germanium diode or equivalent, and a low-loss socket for the coils. The coils are wound on 1 1/2-inch, low-loss forms that plug into the socket mounted on the top or side of the case.

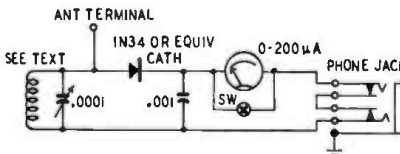

The 80-meter coil has 25 turns of No. 26, 20-, and 10-meter coils are wound with No. 24 enamel wire with 1/8 inch between turns. They have 14, 6, and 2 turns, respectively. An insulated coupling between the tuning capacitor shaft and the dial prevents hand capacitance.

To use the unit as a phone monitor, plug in a pair of high-impedance phones, short the meter with the toggle switch, connect a short length of stiff wire to the antenna terminal and adjust its length for comfortable volume.

To use the unit as a field-strength meter, remove the phones and connect an antenna long enough to provide sufficient pickup to deflect the meter when the unit is several wavelengths away from the transmitting antenna.



"Lights! Action! Camera! Turn on the glamour, Kitty!"

TUBES 30¢ each

IN BULK LOTS OF 100 EACH
 Individually boxed, assorted, 34c each
 THOUSANDS OF SATISFIED BUYERS!

Made by leading manufacturer—RMA Guarantee.
 Money back if not completely satisfied.
 1R5 3S4 6C8G 6SF5GT 6X5GT 12SJ7GT
 1S5 6AT6 6K5GT 6SG7GT 12AT6 12SK7GT
 1T4 6BA6 6S9GT 6K6GT 12BA6 35W4
 1U5 6BE6 6SA7GT 6S8GT 12BE6 50B5
 3Q4 6B8G 6SD7GT 6V6GT 12SA7GT 11Z3
 (6SN7, 12SN7 48c; lots of 100, bulk 44c)

RCA • GE • SYLVANIA • RALTHEON
 NATIONAL UNION • TUNGSO
 KEN-RAD • HYTRON

Individually boxed Standard RMA Guarantee
 5Y3GT—43c; 6F6GT—55c; 6SN7GT—75c; 12SQ7GT
 —55c; 25L6GT—65c; 25Z5—55c; 25Z6GT—55c;
 35L6GT—60c; 35Z5GT—43c; 50L6GT—60c

Above ten types show manufacturer's brands. Shipment will be made of makes available when order is received.
 Specify Price When Ordering

ALL CHANNEL TV AND FM ANTENNA

This new, highly efficient folded dipole antenna covers all frequencies from 44 to 216 mcs. Sections rotate independently of each other. Adjustable base mount permits installation of mast at any angle. Ceramic insulation. Complete flexibility permits maximum gain and freedom from ghosts. Each, \$8.48.
 In lots of 3, each 7.65

SPECIALI SPECIALI
 GENUINE MAGNAVOX PM SPEAKERS
 8", each, \$2.95. In lots of 3, \$2.65
 12", each, \$5.25. In lots of 3, \$4.70

20% Deposit, Bal. C.O.D. NO MINIMUM ORDER Include sufficient for postage.

WRITE Dept. F for Current Bargain Filers on Radio and TV parts & Equipment

RADIONIC EQUIPMENT COMPANY
 TRIBUNE THEATER ENTRANCE
 170F Nassau Street New York 7, N. Y.
 WOrth 2-0421
 Open Daily 9-6 • Saturday 9-5

2nd Annual PENNY SALE
 The Biggest Money Saving Opportunity You Ever Saw
 Add 1c to the price of any article—and get 2. \$500,000 worth of merchandise thrown into this sale.

For Example
 Variable Capacitor-2 gang .00042mf st'd superhet RMA cut-plate with 2" pulley MV-217. Ship. wt. 1 lb.
\$1.49—2 for \$1.50

30 mfd, 150v Electrolytic **45¢—2 for 46¢**
 8mfd, 150v Electrolytic **39¢—2 for 40¢**
 Three Section 75ma 4hy 200 ohms/sect. G.E. 2 1/2" x 3 1/2" x 2 3/4" H. 2 lbs. Ship. wt. 4 lbs. No. T83.
\$1.99—2 for \$2.00

WRITE FOR COMPLETE PENNY SALE LISTINGS. YOU'LL BE AMAZED AT THE BARGAINS! Prices net fob our plant. Include enough for postage and insurance.

Universal/general corp.
 365 Canal St., N. Y. 13 (Dept. RE) WALKER 5-9642

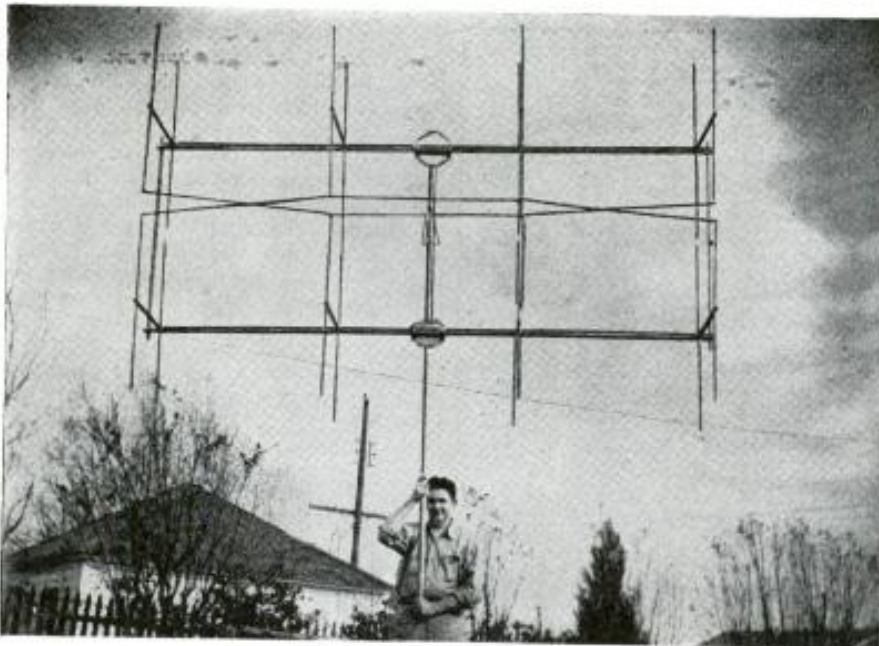

The author holds the 16-element array in his hands to show how aluminum cuts down weight.

Aluminum 144-mc Beam Is Light and Strong

By L. W. MAY, Jr., W5AJG

ONE of the more popular antennas now in vogue among the 144-mc v.h.f. gang is the so-called standard 16-element array. It consists of four pairs of stacked collinear, in-phase, half-wave elements, spaced one half-wave apart, backed up with eight reflector elements spaced approximately a quarter-wave to the rear.

Transmission-gain claims for this array vary somewhat, but tests conducted with a fellow v.h.f. amateur W5ABN, 10 miles distant, indicate a decibel gain of between 12 and 14. Converted to power figures, that would be approximately 15 to 25 times the power radiated by a half-wave dipole mounted at the same

height above ground. This is very well worth the effort. For example, one of the popular SCR-522 transmitters producing about 10 watts output could be effectively transformed into a 250-watt-output rig. Power gains of this order do not come easily at these frequencies by merely increasing power in the final amplifier.

At W5AJG we decided to construct one of these beams. Since it was to go atop a steel tower nearly 80 feet high, rigid construction was imperative and lightning danger required a well grounded system. Some trouble had been experienced in past years with various beams of wooden material (average life

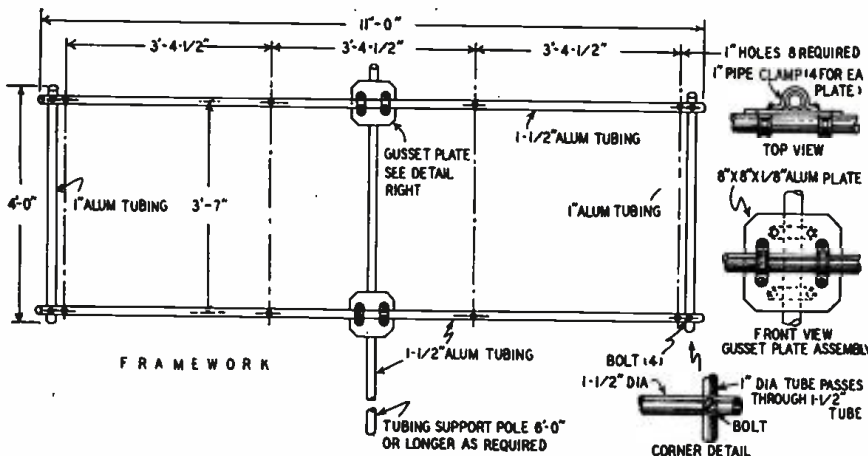
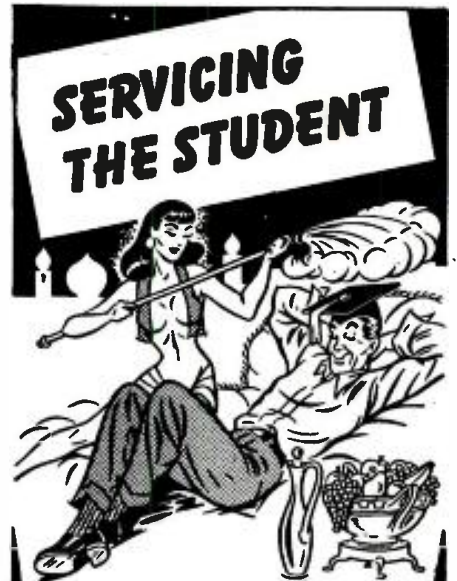

Fig. 1—The supporting framework for the beam. Note how support pole is clamped to frame.

MARCH, 1949



SERVICING THE STUDENT

We've built a reputation among students of radio and electronics as a square shooter. Our boys advise the students as to what is the best for them and no more. Students have been oversold on equipment by thoughtless dealers. We want students to be our friends all the time they are in class and after they launch into the business world. Are you on our mailing list? Write Dept. E-3

ADSON
RADIO & ELECTRONICS CO.
221 Fulton Street New York 7, N.Y.



NEW 1949 NEWARK CATALOG

20,000 items including everything in STANDARD BRAND equipment! 148 pages packed with pictures, charts, and vital information!

KITS! SETS! PARTS! ACCESSORIES!

No matter how tiny the part, how tremendous the system...it's listed in this mammoth catalog...the one easy, satisfactory way to always get top-performing, top-value equipment! The most complete essential reference book for pros, hams, hobbyists, novices, oldtimers...anyone, everyone interested in TV, radio and sound equipment!

24-HR. MAIL SERVICE • ONE YEAR TO PAY

3 GREAT STORES! Uptown at 115 West 45th Street and Downtown at 212 Fulton Street in NEW YORK 323 West Madison Street in the heart of CHICAGO

NEWARK MAIL COUPON TODAY
RADIO & TELEVISION
Newark Electric Co.
242 W. 55th St., NYC

Dept. C-11 Please send FREE Newark Catalog to:
NAME _____
ADDRESS _____
CITY _____ STATE _____

Television is Booming—Cash in on it!

United Cuts Prices!!!

- **BC-603 WESTERN ELECTRIC FM RECEIVER**—Complete with 1 tube, speaker and 12 or 24 V. dynamotor. Variable frequency range: 20 Mc. to 27.9 Mc. Covers 10 meter band with minor adjustments. Good condition. (Specify 12 or 24 V.) Shipping weight—40 Lbs. \$11.95.
- **BC-604 WESTERN ELECTRIC FM TRANSMITTER**—25 watts output. 100% wideband phase modulated. Complete with tubes, meter and 12 or 24 V. dynamotor. (Specify 12 or 24 V.) Good operating condition. Shipping weight—75 Lbs. \$17.50.
- **CRYSTAL KIT FOR BC-604 WESTERN ELECTRIC FM TRANSMITTER**—80 crystals in metal cabinet. Covers all frequencies from 20 Mc. to 27.9 Mc. in 100 Kc. steps. Shipping weight 7 Lbs. \$12.50.
- **423 MODULATOR UNIT**—A precision R.F. Osc. tunable with a National velvet-vernier dial. between 185 and 205 Mc. Audio Osc. Semi-variable, with 2 stages audio Amp. 115 V. 60 Cyc. power supply. All high quality parts. Heavy duty construction. Complete with 1-955, 2-6J7, 1-6F6 and 1-5Y4 tubes and dipole ant. A real instrument value! Shipping weight—4 Lbs. New. Only \$12.75.
- **SWITCHBOARD BD-57A**—Housed in OD wooden cabinet 24" L. 9 1/4" H. 9" D. 3 rows of 20 jacks per row are labeled. "Supervisor Tone," "Student Aux. Tone" and "Student SWBD Tone." 26 cords and plugs extend from compartment below jack panel. In black, 5 red and 1 white. Audio tone generator included. Shipping weight approximately—42 Lbs. Used. In good condition—\$10.95.
- **SCR-522 VHF TRANSMITTER AND RECEIVER**—The best all around job for 100 Mc. to 160 Mc. work. Used in cabs; by hams and special services. Shipping weight approximately 60 Lbs. With all tubes. Each—\$19.95.
- **TG-10 PHOTO ELECTRIC KEYS**—Used by Army for code practice. A high gain 25 watt heavy duty amplifier with photo cell input. May be converted to PA or Phono amplifier. Uses 2-6B7, 2-6BN7, 2-6L6, 1-5U4G and 1-925 tubes. Less tubes, tapes and reels. Shipping weight approximately 110 Lbs. Good condition. Size: 21" x 15" x 12". Only—\$17.50.
- **RAOR PULSE TRANSMITTER, ASS-5**—Single phase 800 Cyc. 115 V. power supply. 15 R rectifier. 4-15E tubes in P.P. Par. Long line Osc. Housed in attractive black wrinkle aluminum cabinet 18" x 10" x 8 1/2". Tubes included. Shipping weight approximately—30 Lbs. Like new—\$12.50.
- **BC-454 AIRCRAFT RECEIVER**—3 to 6 Mc. with tubes, less dynamotor. Shipping weight—7 Lbs. New—\$5.75.
- **BC-746 TUNING UNITS**—The basic unit for a low power crystal transmitter with two crystals, two coils and one tuning condenser—150 Mmf. A.P.C. Shipping weight—1 Lb. 79c. With one 80 meter crystal—95c. With two 80 meter crystals—\$1.29.
- **BC-191 AND BC-375 TUNING UNITS—TU-28, 200-500 Kc.—\$1.79; TU-10, 10 Mc.—\$1.95.** (Shipping weight—17 Lbs.)
- **PUSH BUTTON TUNING ASSEMBLY FOR BC-728**—4 push buttons select pre-tuned frequencies from 2 to 6 Mc. 12 coils permeability tuned for R.F. mixer and osc. Completely wired and aligned. Shipping weight—3 Lbs. Brand new—\$1.95.
- **V.H.F. TRANSCIEVER ASSEMBLY**—Has ceramic insulated 15 Mmf. tuning condenser. 2 filament chokes. 1-500 socket, and filament bypass condenser. All mounted on Polystyrene panel 1 1/2" x 3 1/2" x 1/2". Mounts upright with two 6-32 screws in bottom. A "natural" for citizens band or high frequency ham bands. Shipping weight—1 Lb. New. Only 69c. 3 for \$2.00.
- **PATCH CORDS**—Red fabric covered cable contains rubber covered tinclad conductors. Complete with 2 2-PL-47 plugs on ends. 21" L. and 34" L. Shipping weight—2 Lbs. Either type. New 3 for \$1.00.
- **COILS**—Osc.—20-28 Mc. for BC-603, New—59c; 4.5 Crystal filter—455 Kc. (less crystal). Shielded. 49c; Mc. I.F. ceramic form. Slug tuned. 49c; 12 Mc. I.F.—#292 for SCR-522—69c; 915 Kc. I.F.—for BC-348 (output)—49c; 30 Mc. I.F.—Galvin T 104 Poly. form. Air tuned. 49c; 465 Kc.—B.F.O. slug tuned. 21 Mc. I.F.—series—19c; 12 Mc.—transmitting tank for BC-375—19c; 12 Mc.—transmitting tank with coupling coil—29c.
- **HEAVY CABLE 14 CONDUCTOR WEATHER PROOF**—14 conductors, rubber and fabric covered, #14 stranded and tinned. Enclosed in heavy outer rubber jacket. Heavy brass 14 contact plugs on either end. Cable is 1" O.D. Shipping weight—110 Lbs. New. 100 foot coils. \$7.75.
- **SCR-522 POWER PLUG AND CABLE**—Housed in aluminum Bx. 3 1/4" long 12 conductors. Shipping weight 2 Lbs. New—\$1.00.
- **METERS**—0-50 Amps. D.C. 2" G.E. 50 Mv. movement (less 50 Amp. shunt). 5 Amps. full scale. Shipping weight 1 Lb. New—\$2.39; 0-500 V.D.C. 1000 O.P.V. 3" round bakelite case. (Sun Mfg. Co.) A Beauty!!! Shipping weight—2 Lbs. New—\$2.75; 0-10 output units. 2" bakelite case. Weston #507 2.2 Ma movement. Mounted in sturdy wooden case. 3 1/2" x 1 1/2" x 4 1/2". A super value. Shipping weight—7 Lbs. New—\$2.39.
- **EXTENSION FOR HS-30—CD-605**, 6 1/4" long with transformer and PL-55 plug. New—45c.
- **KITS**—Ceramic insulators—assorted popular types. New and usable. Shipping weight—1 Lb. 15 for 59c; Balhtub condensers—multiple and single units in assorted voltages and capacities. Shipping weight—3 Lbs. 15 for 79c; Carbon resistors—assorted sizes. All new. Mostly insulated, 100 for \$1.95; Mica condensers—assorted capacities and voltages in silver and ruby mica. 100 for \$2.95; Ceramics—1.0 Mmf. ant 1000 Mmf. in assorted voltages. 100 for \$2.95;

- Filter condensers—all new and usable. 10 for 95c; Hardware—standard nuts, bolts, washers, etc. 3 Lbs. for \$1.29; Tube sockets—all types and sizes. New. 20 for 95c; Coil forms. Various types and sizes. 15 for 45c.
- **VARIABLE TUNING CONDENSERS**—2 Gank. Cut. osc. section. 23 Mmf. minimum; 200 Mmf. maximum. Antenna section: 45 Mmf. minimum; 450 Mmf. maximum with trimmers. Shaft 3/8" plain or knurled 1/2" long. Counter-clockwise. Shipping weight—2 Lbs. New. Either type—49c.
- **3 GANG—T.R.F. or Super.** All sections: Minimum: 18 Mmf. Maximum: 450 Mmf. Clockwise. 3/4" to 1 vernier drive. 2 1/2" cable drum mounted on 3/4" hub. Ceramic insulated. Size: 1 1/2" x 1 1/2" x 4 1/2". Shipping weight—3 Lbs. New—75c.
- **3 GANG—T.R.F. or Super.** All sections: Minimum: 16 Mmf. Maximum: 370 Mmf. Counter-clockwise. 3/4" to 1 spring loaded easy vernier drive. Direct and vernier shafts. 1 1/2" x 1 1/2" x 4 1/2". Trimmers on 2 sections. Size: 1 1/2" x 2 1/2" x 4 1/2". Shipping weight—3 Lbs. New—75c.
- **RECORDING HEADS**—(Shure) Magnetic. 4 Ohms at 400 Cycle. With cord and stylus screw. Slightly scratched. Good condition. Shipping weight—2 Lbs. (out) \$1.10.
- **TUBE SOCKET AND SHIELD ASSEMBLY**—9 pin miniature, black Phenolic socket. New. Each—25c. 4 for 95c.
- **4 1/2" TO 33 V. FILAMENT TRANSFORMER**—Shielded in heavy metal case. All terminals on bottom. Upright mounting. Primary: 115 or 230 V. Secondary: #1—4.5 V. Secondary: #2—8, 13, 18, 25 and 33 volts all at 2 Amps. Size: 3" x 3 1/4" x 4 1/2". Shipping weight—5 Lbs. New. \$2.19.
- **MICROPHONE CAPSULES—V.E. type F-1.** Used, but in excellent condition. 75c.
- **BATTERIES—BA-2 2 1/2" V. Minimax.** Dated: 6-45. Size: 2 1/2" x 3 1/2" x 3 1/2". Packed 6 to a carton. New. Carton \$1.10.
- **VOLUME CONTROL ASSEMBLY**—500,000 Ohms. S.P.S.T. UL switch. 1 1/2" Dia. Brass shaft 2 1/4" lg. slotted and knurled end. 2 leads, one 1 Mf. at 400 V. and one .005 Mf. 400 V. condensers are attached. Shipping weight—6 Oz. New—50c.
- **POTENTIOMETERS—5000 Ohm—I.R.C. type D11-114 Silent Spiral.** In original cartons, with hardware and universal shaft. Shipping weight—6 Oz. Only 45c; 1 Megohm—Midret C.T.S. Short slotted shaft. Shielded. Shipping weight—6 Oz. 25c; 10,000 Ohm—Midret C.T.S. 5/16" shaft. Shielded. Shipping weight—6 Oz. 25c; Dual Wire-wound—10,000 Ohms each section. Separate screwdriver adjustments. 2 Watt. Shipping weight—6 Oz. New. 65c; Dual H.D. Ohmite—1200 Ohms at .35 Amps. and 3 Ohms at 4.7 Amps. Baked enamel elements. Complete with knob and panel plate. Shipping weight—2 Lbs. New. 85c; Single Wire-wound—10,000 or 70,000 Ohms 30,000 Ohms. Size: 1 1/2" x 2 1/2" x 1 1/2". Long shaft. In original cartons. Shipping weight—1 Lb. 75c.
- **BEAM MOTOR SWITCH—D.P.D.T.** momentary. Shipping weight—6 Oz. New—39c.
- **NEON BULBS—G.E. Type NE-48 1/4" W.** Auto bayonet base. 10 for \$1.75.
- **PL-68 PLUGS**—3 contact microphone type. 10 for 95c.
- **PLAN-O-VERNIER DIAL**—(Crowe). Instrument type. 4" Dia. 5 to 1 ratio. Calibration 0-200 in 360 degrees. Smooth planetary. Shipping weight—3 Lbs. New—\$1.85.
- **CIRCUIT BREAKER—G.E. type AF-1 230 V.A.C.** 35 Amps. Single circuit. Overall size: 3" x 4 1/2" x 6" Shipping weight—4 1/2 Lbs. New—\$1.85; Square D Type 120-240 V.A.C. 20 Amps. 2 poles. Overall size: 2" x 3" x 4 1/2". Shipping weight—2 Lbs. New—\$1.75.
- **THROAT MIKES—T-30** (Shure) New in cartons—59c.
- **FABRIC LOOM**—Weather-proof. Ideal for sleeving on P.V. and FM antenna lead-ins, thru skyhooks and around corners. I.D. 1/4", 1/2", 3/4". (Specify size) 50 feet, any size—\$1.45.
- **FILTER STRIP ASSEMBLY**—Bakelite strip contains 2-8 Mf. 450 V. P.R.S. type condensers 1-6000 Ohm 20 Watt resistor and a few ceramics. New units \$1.00.
- **TOROIDAL POTENTIOMETERS**—Precision unit completely enclosed in heavy aluminum casing. 500 Ohms Wire-wound. W.E. or G.E. New—\$1.19.
- **MICO-SWITCH**—Normally closed. 10 Amps. 125 V. Pin operated. Shipping weight—6 Oz. New. 45c.
- **MOTOR SWITCH**—3 P.D.T. 3 buttons labeled "Manual—Off—Automatic." Locks in both operating positions. Ideal for shop equipment operation. Shipping weight 9 Oz. New—39c.
- **ANTI-CAPACITY LEVER SWITCH**—(Mosman) Heavy duty contacts. Center position: 3 poles closed; 1st position: 4th pole closed (Momentary). 2nd position: all poles open. Phosphor bronze leaves. Spring loaded lever. Positive action. Size: 1 1/2" x 1 1/2" x 6". Shipping weight—1 Lb. New—98c.
- **TELEPHONE JACKS**—To fit PL-68 plug. Panel mounting type. 10 for 95c.
- **ALUMINUM BX**—Covered with fine woven aluminum braid. 3/4" at 6c per ft.; 1/2" at 8c per ft.; 1" at 10c per ft.; 1 1/4" at 12c per ft. (I.D.).
- **"ELKS ANTENNA"** AS-27/ARN-5 ANTENNA—New being used on commercial aircraft. Carefully packed. Shipping weight—1 Lb. New—\$2.75.
- **RHEOSTATS**—Ohmite baked enamel wirewound. Air-cooled and shielded. Aircraft type. 90 Ohms at 1.35 Amps. Shipping weight—2 Lbs. New—55c.

★ BY POPULAR DEMAND!!
UNITED SURPLUS' Surprise
 "Package"\$1.29
 More than 10 lbs. of assorted electronic units and parts.

UNITED SURPLUS MATERIALS
 314 S. Halsted St. Chicago 6, Ill.

without warping about two years), so we thought that all-aluminum fabrication would be a good idea. The aluminum antenna has worked out very well and was not at all difficult to build.

Since vertical polarization seems to be standard around our area, the beam is vertical. It can be used for horizontal polarization by simply bolting it to the supporting pole the right way.

The completed beam, including the 10-foot supporting pole, weighs only 15 pounds. On the surplus market aluminum tubing sells for very little. Various bolts and self tapping screws and a few pipe clamps are the only other materials needed.

Aluminum tubing of different diameter than that used in the original could be employed with a possible reduction in total weight to somewhere around ten pounds. Our list of materials included the following hard-drawn aluminum tubing:

No. of pieces	O. D. (inches)	Length
2	1 1/2	11 feet
1	1 1/2	6 to 11 feet
2	1	4 feet
8	1	21 1/2 inches
8	1/2	38 1/2 inches
8	1/2	41 inches
6	3/8	40 1/2 inches
2	3/8	22 inches

In addition, we used two pieces of hard-drawn aluminum sheet, 1/8 inch thick and 7 to 8 inches square. Eight 1-inch, standard, galvanized pipe clamps and an assortment of self-tapping and machine screws complete the list.

Construction
 As Fig. 1 indicates, the two 11-foot pieces of 1 1/2-inch-diameter tubing, along with the two 1-inch-diameter, 4-foot pieces, form a rectangular supporting structure for the beam. This drawing also shows how the supporting pole, which is the 6-foot or longer piece of 1 1/2-inch material, is bolted on with the aid of the 8-inch-square aluminum gusset plates and the 1-inch galvanized pipe clamps. One-inch holes should be drilled in the two 11-foot pieces as shown.

A drawing of the antenna and reflector elements mounted on their horizontal 1-inch-diameter, 21 1/2-inch-long supporting tubes is given in Fig. 2. Here

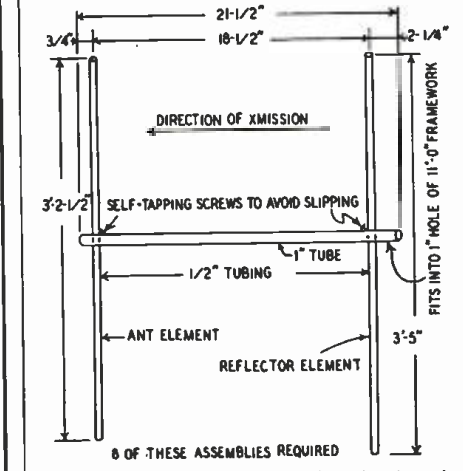

Fig. 2—Elements pass through holes in tube.

it is necessary merely to drill out 1/4-inch holes to accept the two elements. After they are in place, small self-tapping screws can be added to keep the antenna and reflector elements from slipping. No insulators whatever are used in the antenna or reflector elements since they are mechanically supported in their respective centers, which is, of course, a point of zero r.f. voltage.

When eight of the antenna and reflector assemblies are completed, one end of each support is passed through a 1-inch hole in the main 11-foot-long framework and bolted by using long brass machine screws through both tubes. Incidentally, in cutting these 1-inch holes in the 1 1/2-inch material, use a 1-inch hole-cutting saw and take your time in lining up the holes.

The phasing lines are next on the list (Fig. 3). These are the six pieces of 3/8-inch-diameter tubing 40 1/2 inches long. When these pieces are bolted to the ends of the antenna elements the entire structure will be quite rigid. At the cross-overs, the 3/8-inch tubing is bent slightly so as not to touch. A small ceramic insulator may be used here to keep the tubing in place. We found some small, square, post-type ceramic insulators threaded for 8-32 machine screws. They are about 1 inch long and came from some surplus BC-375-E tuning units. The ends of the antenna elements and phasing lines may be mashed flat and drilled. Small aluminum aircraft-type clamps could also be employed.

The point of feed of the beam is the exact center of the phasing section. The two pieces of 3/8-inch tubing 22 inches

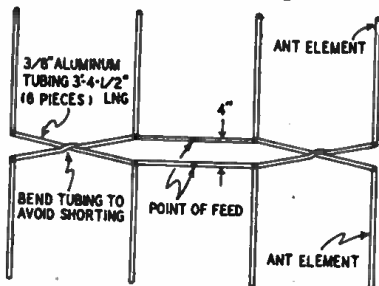

Fig. 3—Phasing lines fastened to radiators.

long are fastened to the phasing lines and brought straight back to the upright supporting pole. A piece of polystyrene 1/4 inch thick is secured to the support pole with a 1-inch pipe clamp. Two brass 8-32 machine screws and nuts are used to clamp the ends of the tubing to it. The antenna or matching stub (if used) can be tied on at this termination and pulled straight down or back at an angle, without being in the field of the array. The photograph (Fig. 4) shows the feeder termination.

The bottom of the support pole may be made to fit an existing rotator, or it may be clamped to a wooden pole with pipe clamps or by some other method.

Feeding the array

The exact impedance of the feed point in this 16-element array is not definitely known. As with transmission gain, many different opinions exist. It is undoubtedly best to employ some sort of matching transformer or stub and

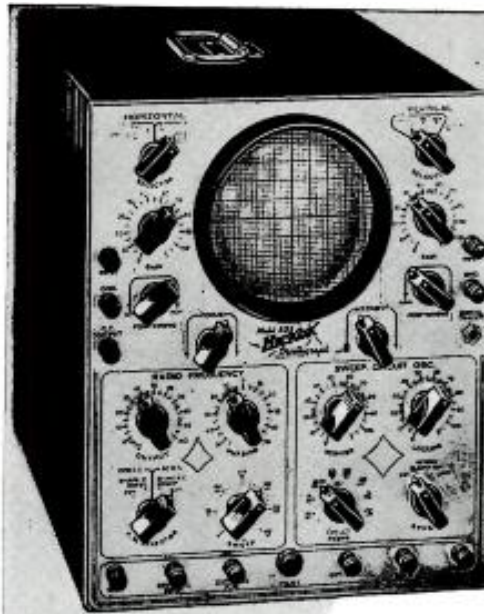

5" Scopes
for Television

and FM

by

HICKOK

**Greater Sensitivity...
Higher Frequency...**

The only COMPLETE Cathode Ray Oscillograph. Built with the famous HICKOK quality and accuracy, and providing the following exclusive HICKOK features:

- Wide band amplifiers—20 cycles to 1 m. c.
- Extremely sensitive vertical amplifiers—.015 V. per inch
- Demodulator
- Phasing control
- Built-in FM oscillator (505 only)
- Return eliminators
- Sinusoidal and linear sweep

Model 505 Illustrated
Contains separate oscillator for FM alignment. The only complete 'Scope.

Model 195B
For FM and Television. Another popular Hickok model—the most sensitive service man's 'Scope available. An ideal companion for the Hickok Model 610 TV Generator and the 288X FM-AM Generator. 105-125 VAC.



For over 35 years...
the finest in electrical
and electronic instruments

Mail this ad for literature, and free copy of our regular 50c Service Instruction Manual.

THE HICKOK ELECTRICAL INSTRUMENT CO.

10531 DUPONT AVE.

CLEVELAND 8, OHIO

LITZ WIRE

Magnet Wire

★ **LARGE STOCK** ★

MAGNET WIRE, Incorporated

Retail Department

25 WEST BROADWAY

Worth 4-5447-8-9

Cable Address: "Magnetwire, New York"

NOTICE TO TRUCK JOBBERS

We can supply you with complete stocks of all types of Nationally Advertised Brand Tubes, individually boxed, at 10% to 20% below distributor's cost.

Write—Wire—Phone For Details

REX PRODUCTS COMPANY, Dept. C-3
1313 W. Randolph St., Chicago 7, Illinois
Phone: SEley 3-5030

TELEVISION RECEIVER—\$1.00

Complete instructions for building your own television receiver, 16 pages—11"x17" of pictures, pictorial diagrams, clarified schematics, 17"x22" complete schematic diagram & chassis layout. Also booklet of alignment instructions, voltage & resistance tables and troubleshooting hints.—All for \$1.00.

CERTIFIED TELEVISION LABORATORIES
Dept. C, 5507-13th Ave., Brooklyn 19, N. Y.

RADIO TROUBLESHOOTER'S HANDBOOK
Eliminates useless testing on 4 jobs out of 5

...YOUR COMPLETE PRACTICAL RADIO SERVICE LIBRARY ...in two giant books

MODERN RADIO SERVICING
A complete guide to troubleshooting, instruments, circuit analysis, repair.

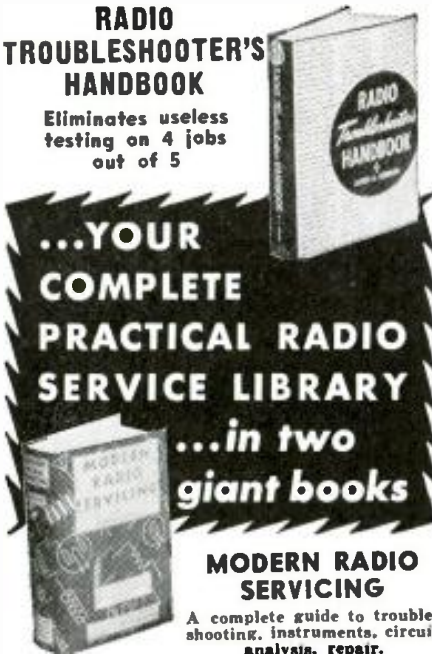

LEARN TO WORK BY MODERN, PROFESSIONAL METHODS

1 Train for the big pay jobs!
Ghirardi's MODERN RADIO SERVICING is a complete, 1 vol. course in all phases of professional radio-electronic repair. Tells how to make preliminary trouble checks on difficult jobs; how to analyze any circuit and its components; how, when and where to use all types of test instruments and interpret their readings to track down the trouble—even how to start a service business of your own. Everything is explained simply and thoroughly. 706 clear illustrations and 723 self-test review questions make study easy. Complete 1300-page book only \$5— or see special combination price offer below.

CUT TIME IN HALF ON COMMON SERVICE JOBS

2 Work faster—make more money
Almost 4 out of 5 radio repair jobs can be handled as easily as falling off a log! Just look up the model of the set to be fixed. Chances are Ghirardi's RADIO TROUBLESHOOTER'S HANDBOOK tells exactly what the trouble is, exactly how to fix it. Gives common troubles, their symptoms and remedies for over 4800 radios by 202 manufacturers. Hundreds of additional pages contain tube data; transformer trouble listings, alignment charts and dozens of diagrams, etc. for faster, better service on any radio ever made. Only \$5— or see special combination offer.

MONEY SAVING OFFER!

Let Ghirardi's RADIO TROUBLESHOOTER'S HANDBOOK save time, help you make more money on common service jobs. Let MODERN RADIO SERVICING train you in truly scientific servicing that can pave your way to the big money jobs. Get BOTH big books at the special price of only \$9.50 for the two (\$10.50 foreign). Use coupon today—at our risk!

Read these GIANT books for 10 DAYS ... at our risk!

Dept. RE-39, Murray Hill Books, Inc.,
232 Madison Ave., New York 16, N. Y.

Enclosed find \$..... for books checked; or
 send C.O.D. (no C.O.D.'s outside U.S.A.) and I will
pay postman this amount plus a few cents postage. In
either event, I may return books within 10 days for
complete refund of my remittance.

MODERN RADIO SERVICING
\$5 (RS.50 outside U.S.A.)

RADIO TROUBLESHOOTER'S HANDBOOK
\$5 (\$5.50 outside U.S.A.)

SPECIAL MONEY-SAVING OFFER
Both of above big books only \$9.50
(\$10.50 outside U.S.A.)

Name.....
Address.....
City & Zone..... State.....

adjust for minimum standing-wave ratio. However, dispensing with the matching arrangement will probably still be quite satisfactory. In that case, a standard 300-ohm ribbon line might be used, or even a two-wire open line, spaced about two inches. At W5AJG we tried the two types, a 450-ohm, two-wire, open line and 300-ohm twin-lead. Both types were entirely satisfactory. From rough measurements, however, it seems that the impedance of the array is lower than the 300-ohm value, probably around 150 to 200 ohms. 150-ohm twin-lead was not available during the tests but no doubt it would be as good as or better than the 300-ohm line as far as matching goes. It must be borne in mind that at 2 meters losses in the transmission line can be appreciable, especially if the run is long.

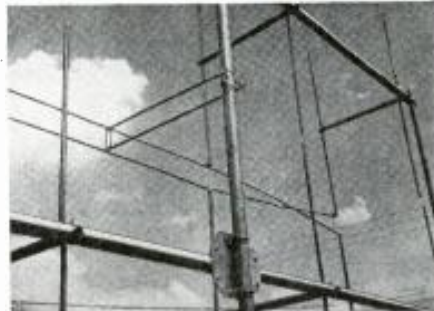

Fig. 4—Feeders connect to the phasing lines.

One last point in connection with this beam. The voltage and current distribution is such that very little "fire" is noticed when a pencil or neon bulb is touched to the elements.

A few amateurs using the 16-element array report obtaining even better results by phasing out the reflector elements, that is, using the phasing and cross-over tubing on the reflector elements just as with the driven elements.

The dimensions shown in the drawings are designed to favor the lower one megacycle of the 144-148-mc amateur assignment. Should operation be desired higher up in the band, the antenna elements should be shortened by about 1/4-inch for each megacycle range. The reflectors may be shortened likewise, but it is not necessary.

U. S. HAMS NUMBER 77,000

The number of amateur radio operators in the United States appears to be decreasing, according to a report released by the Federal Communications Commission on January 28th. There were an estimated 81,000 operators on December 31, 1947; the roster as of the end of 1948 carried only 76,666 names. Though the difference between the two figures is something over 4,000, the 1947 figure was estimated, not exact, and may have been a slight over-estimate. Station licenses in the hands of amateurs at the end of 1948 numbered 77,338; radio clubs, schools, and similar organizations (notably the UN) are often issued station licenses only.

The total number of radio authorizations held in this country was 677,060 as 1948 began.

DRILL PRESS OWNERS!
Get This Transformer as a
SPOT WELDER \$18⁹⁵

Attaches to your drill press to make a professional SPOT WELDER! Highest quality NEW war surplus. Orig. Gov't. cost over \$160.00. Free copy of picture instruction book with each transformer. Cont. rating: Pri: 105 to 125 V. Sec: 5.1 V @ 190 amps. 35kv ins. Shipping weight approx. 100 lbs.

COMPLETE PICTURE INSTRUCTIONS AND PLANS, alone (including information about new Supreme Spot Welder Kit) 10c



Brand New!
5" TELEVISION or C.R. TUBES
5BP4 Black & White Picture Tube or
5BP1 Green-Med. Pers.
\$2.95 Add 60c for each tube to cover postage and handling.
250R TRANSMITTING TUBES
\$4.95 Add 60c for each tube to cover postage and handling.

VIBRATOR Synchronous (Self-Rectifying) Hermetically Sealed
Good for 100 milliamperes. Does not require rectifier tube. Fits standard octal tube socket. Orig. Gov't. price over \$5. S.H.P. wt. 2 lbs.
6 Volt Model...\$1.29 12 Volt Model...99c

NEW! RL-42-B ANTENNA REEL Motor & Gear Box Perfect Beam Rotator
Lightweight (4 lbs.), easy mounted, magnetic clutch, will reverse with s.p.d.t. switch. Also for barbecue spit or deer opener. Many other uses. Ship. wt. 9 lbs. **\$4.25**



SEND NO MONEY—WE MAIL C.O.D. or save C.O.D. charges by enclosing check or money order. Shipment made by either fast track freight or express collect, or parcel post, if postage is included with order. No deposit required on C.O.D.'s. No orders less than \$2.50, please.

ELECTRONICS SALES COMPANY
3923 Van Buren, Dept. RC-3,
Culver City, Calif.

Come to the Great SHOPS OF COYNE

Learn **RADIO-TELEVISION SERVICE**



PRACTICAL SHOP TRAINING—NOT HOME STUDY

Trained Radio men needed now. Get Radio-Television training and be ready for a real future. Learn on actual equipment at Coyne, 50th Anniversary Year. Not "Home Study". Free employment service to graduates. Many earn while learning. If you are short of money, ask about Student Finance Plan. G.I. Approved. Coupon brings special plan for men of draft age.
SEND COUPON FOR FREE BOOK

E. W. COOKE, President
COYNE ELECTRICAL & RADIO SCHOOL
509 S. Paulina St., Dept. 39-8H, Chicago 12, Ill.

Send Big Free Radio-Television Book, also your special plan for men of draft age.

NAME.....
ADDRESS.....
CITY.....STATE.....

PEN-OSCIL-LITE

Extremely convenient test oscillator for all radio servicing; alignment • Small as a pen • Self powered • Range from 700 cycles audio to over 600 megacycles U.H.F. • Output from zero to 125 v. • Low in cost • Used by Signal Corps • Write for information.

GENERAL TEST EQUIPMENT
38 Argyle Ave. Buffalo 9, N. Y.

Television is Booming—Cash in on it!

RADIO-ELECTRONICS for

HARD-TO-GET PARTS

POWERFUL ALL-PURPOSE INDUCTION MOTOR

IDEAL FOR EXPERIMENTERS—101 USES



Sturdily constructed to precision standards, this self-starting shaded pole A.C. induction motor is powerful enough for a number of uses. Some of these are: Automatic Timing Devices, Current Interrupters, Electric Fans, Electric Chimes, Window Displays, Photocell Control Devices, Electric Vibrators, Small Grinders, Buffers and Polishers, Miniature Pumps, Mechanical Models, Sirens, and other applications.

Consumes about 15 watts of power and has a speed of 3,000 r.p.m. When geared down, this sturdy unit will constantly operate on 1 1/2 inch turntable loaded

with 200 lbs. dead weight—THAT'S POWER!
Dimensions 3" high by 2" wide by 1 3/4" deep; has 4 convenient mounting studs; shaft is 1/4" long by 3/16" diameter and runs in self-aligning oil retaining bearings. Designed for 110-200 volts, 50-60 cycles, A.C. only. Shp. Wt. 2 lbs.

ITEM NO. 147 YOUR PRICE..... \$2.45

ULTRA MAGNET

LIFTS MORE THAN 20 TIMES ITS OWN WEIGHT

LITTLE GIANT MAGNET

Lifts 5 lbs. easily. Weighs 4 oz. Made of ALNICO new high-magnetic steel. Complete with keeper. World's most powerful magnet ever made. The experimenter and hobbyist will find hundreds of excellent uses for this high quality permanent magnet. Measures 1 1/4 x 1 1/4". Shp. Wt. 3/4 lb.

ITEM NO. 150 YOUR PRICE..... \$1.25



GENUINE MICROPHONE TRANSMITTERS



Regular telephone transmitters taken from a large telephone supply company's overstock. Work perfectly on 2 dry cells. Can be used on P.A. systems, call systems, inter-communications sets, short-line telephone circuits, house-to-house or farm-to-farm phone lines, also to talk through your own radio or a concealed dictaphone pick-up. Useful replacements on battery-operated rural telephone lines.

THESE ARE GENUINE TRANSMITTERS, MADE BY

KELLOGG, WESTERN ELECTRIC AND STROMBERG-CARLSON, excellent quality and a remarkable value and one seldom offered in these times. Shp. Wt. 1 lb.

ITEM NO. 150 YOUR PRICE..... \$1.95

WATTHOUR METER



Completely overhauled and ready for immediate service. Designed for 110-120 volt, 60 cycle 2-wire A.C. circuit. Simple to install; 2 wires from the line and 2 wires to the load. Sturdily constructed in heavy metal case. 5 1/2" high, 5 1/4" wide, 5" deep. Westernhouse, G. E. Fort Wayne, Sankamo or other available make. Shp. Wt. 1 1/4 lbs.

ITEM NO. 33 YOUR PRICE.... \$5.95

AMAZING BLACK LIGHT!!

Powerful 250-Watt Ultra-Violet Source



The best and most practical source of ultra-violet light for general experimental and entertainment use. Makes all fluorescent substances brilliantly luminous. No transformers of any kind needed. Fits any standard lamp socket. Brings out beautiful fluorescent hues in various types of materials. Swell for amateur parties, plays, etc.; to obtain unique lighting effects. Bulb only. Shp. Wt. 2 lbs.

ITEM NO. 87 YOUR PRICE..... \$1.95

WESTERN ELECTRIC BREAST MIKE

This is a full light-weight aircraft carbon microphone. It weighs only 1 lb.

Mike comes with breastplate mounting and has 2-way swiveling adjustment so that it can be adjusted to any desired position. There are 2 woven straps: one goes around neck, the other around chest. Straps can be snapped on and off quickly by an ingenious arrangement.

This excellent mike can be adapted for home broadcasting or private communication systems. By dismantling breastplate, it can be used as desk mike.

Comes complete with 6-foot cord and hard rubber plug. Finished in sherardized plate. Non-rustable. Shipping weight, 2 lbs.

ITEM NO. 152 YOUR PRICE..... \$1.45



Dr. Cleo Brunetti, former chief of the engineering electronics section of the Bureau of Standards, joined the staff of Stanford Research Institute January 1, as associate director.

During World War II Dr. Brunetti had a leading part in the development of the radar-guided bomb and of the radio proximity fuze, both major secret weapons of the war. The proximity fuze, which explodes anti-aircraft shells when they are close to the target, downed thousands of enemy planes.



The inventor also had a major part in the development of the two-way wrist radio and a radio transmitter so small it can be slipped into a lip-stick cylinder. President Truman has one of Dr. Brunetti's tiny radio sending stations in his office. It is no larger than a flat cigarette case and broadcasts perfectly within a range of 200 feet. (See description on page 122.)

As a result of these developments in miniaturization, it is now possible to eliminate the wire which dangles from the earpiece of hearing aids. Although not yet in production, tiny broadcasting units have been invented which can be worn in a vest pocket to pick up sound and broadcast it to a receiver hidden in the ear.

Dr. Brunetti's contributions toward the development of printed electronic circuits, which use lines of silver ink instead of wires, have opened new fields for the production of miniature electronic equipment.

Dr. Brunetti is the author of more than 30 technical publications as well as many textbooks, nontechnical publications, and classified reports. He is a member of the Institute of Radio Engineers and the honorary technical societies, Sigma Xi, Tau Beta Pi, Eta Kappa Nu, and Pi Tau Pi Sigma.

George F. Maedel has been elected vice-president and general superintendent of RCA Institutes, Inc., New York, it was announced by George L. Van Deusen, president.

Mr. Maedel joined RCA Institutes in 1933 as the first instructor in the mathematics department. He was transferred to the radio-frequency department in 1936, and four years later was appointed chief instructor. In November, 1944, he became assistant superintendent. He has been superintendent of RCA Institutes since 1947.



Joseph L. Egan, president of the Western Union Telegraph Company, died at the age of 62 at Monte Carlo of a heart attack.



PM SPEAKERS

ALNICO #5
Not Surplus—All Fresh
Factory Stock
FULLY GUARANTEED

4 inch	\$1.19
5 inch	1.39
6 inch	1.75
6" x 4" (oval)	1.75

OUTPUT TRANSFORMERS

50L6 type	39c
Push-Pull	59c
6V6	65c
Universal	95c
A.C.-D.C. choke	39c

BROOKS RADIO DIST. CORP.
80 VESEY ST., DEPT. A, NEW YORK 7, N. Y.

FREE

SUBSCRIPTION TO TELEVADS

The National Market Place for new and used Radios, Receivers, Test Equipment, Ham Gear, Recording Equipment, Amplifiers, Speakers, Mikes, Pickups, Text Books, and other Electronic Equipment.

A post card will start your free subscription immediately offering you bargains galore!

BUY-SELL-TRADE

YOUR USED ELECTRONIC AND RADIO EQUIPMENT IN TELEVADS

Your advertisement will be read by more than 10,000 enthusiastic prospects, including hams, SWL's, experimenters, service men, and other interested buyers.

Special For A Limited Time
35 WORDS FOR ONLY \$1.00
IN TWO ISSUES

TELEVADS

BOX 1199A WICHITA, KANSAS

PORTABLE PHONOGRAPH \$11.95 KIT-COMPLETE



We absolutely supply everything including the solder. All you need is the soldering iron. Beautiful Tu-Tone leatherette carrying case—Alliance motor—Astatic L-82 pickup—5" PM Speaker—Sylvania or RCA tubes only—Punched chassis with sockets

riveted in—Simple instructions for Amplifier. A once-in-lifetime-buy. Only the finest materials used. ORDER YOURS TODAY WHILE SUPPLY LASTS. (20% WITH ORDER BALANCE COD.)

SALCO KITS & PARTS CO.
297 BROADWAY, BROOKLYN 11 N.Y.

HUDSON SPECIALTIES CO.
40 West Broadway, Dept. RE-3-49, New York 7, N. Y.

I have circled below the numbers of the items I'm ordering. My full remittance of \$..... (include shipping charges) is enclosed (NO C.O.D. ORDERS UNLESS ACCOMPANIED WITH A DEPOSIT.)

OR my deposit of \$..... is enclosed (20% required) Ship order C.O.D. for balance. NO C.O.D. ORDERS FOR LESS THAN \$5.00. BE SURE TO INCLUDE SHIPPING CHARGES.

Circle item No. wanted:
147 150 160 87 152 33

Name.....
Address.....
City..... State.....
Please Print Clearly

BOOST BOTH TV and FM

With the New Jerrold TV-FM Booster

Here is the booster you have been waiting for. TV signals are amplified 20 to 30 times over the entire band-width of each channel. The gain for the FM band is even greater.



Increase your enjoyment of TV and FM with the new Jerrold TV-FM Booster. Receive clear signals at distance of 75 to 100 miles away.

The new Jerrold TV-FM Booster has everything you want. Large channel selector switch has positions for all TV channels and the entire FM band. Vernier control at the top of the cabinet for peak gain. When the Booster is "OFF", the antenna is switched through to the receiver.

You can use Jerrold Model TV-FM Booster with combination TV-FM receivers or separate TV and FM sets. Stop in at your radio wholesaler's or parts jobber to see the new Jerrold TV-FM Booster—or write to us for information.

37⁵⁰
LIST

JERROLD ELECTRONICS CORP.
CITY CENTRE BUILDING
121 N. BROAD ST. PHILA. 7, PA.

Robert M. Hanson has joined the Audio Development Co., Minneapolis, Minn., as chief engineer. Mr. Hanson comes from the Thordarson Electric Company, Chicago. As chief engineer for that company for 12 years, Mr. Hanson has made many friends throughout the country. The appointment of Mr. Hanson to Audio's staff will relieve vice-



president Walt Lennert to devote more of his activities to new developmental and research programs for the purpose of improving and increasing the technical transformer service of the company.

Paul Hetenyi has been appointed a consulting engineer by Aerovox Corporation of New Bedford, Mass., manufacturers of capacitors.

For the past 25 years, Mr. Hetenyi has been identified with the capacitor industry. He was the founder of the Solar organization, served as its chief engineer for several years, became its vice-president in 1932, and later advanced to the presidency which he resigned several months ago.

William J. Barron has been appointed general sales manager of Merit Coil and Transformer Corporation, Chicago, succeeding John I. Crocket.

Robert E. Burrows has been appointed sales and advertising manager of the Meissner Division of Maguire Industries, Inc., Mt. Carmel, Ill. Burrows was formerly manager of the home radio department of Westinghouse Electric International Company, New York.



Joseph H. McNabb, 61, president and chairman of the board of Bell & Howell Company, Chicago manufacturer of photographic equipment, died January 5th in Lutheran Deaconess Hospital in Chicago.

Palmer M. Craig has been appointed director of engineering of the electronics division of Philco Corporation, Philadelphia.

With Philco for 15 years, he served as chief engineer in charge of radar and military radio development during the war. He was named chief engineer of the company's radio division in 1943.

J. F. Walsh has been named sales manager of Westinghouse Home Radio Division, Sunbury, Pa.

He will be in charge of all sales activities of the division, handling Westinghouse radio and television receivers.

Edward L. Taylor has been appointed general sales manager of Stewart-Warner Corporation radio and television division of Chicago.

INTRODUCTORY OFFERS!

- RELAY BUY! Leach type 1154, DPST 10A, 110 VAC 60 CYC coil "brand new" . . . \$1.15
- GEAR BOX & MOTOR "RL-42B" Multi-purpose rotator, reversible, uses 28VDC new. . . \$4.50
- FILTER VALUE! 8x8x8 MFD oil filled 600-VDC wrking w/clamps brand new. . . \$3.95
- VARIAC GR type 200-CU 500 watt 0-130-VAC 60 CYC, an asset to any shop new \$14.95
- DC AMMETER 4½" face 0-10 amps new \$4.95
- MICROAMMETER GE type 3½" square case 0-50 calibrated 0-1.2 brand new only \$6.50
- ARC-S T-21 5.3-7 Meg xmitter with xtal & tubes new in original carton! . . . \$6.95
- SWINGING CHOKE 5-15 HY 50-250 MA black crackle case new! . . . \$3.50
- BARGAIN! #22 Push back wire 2000 ft. spool, several colors available . . . \$6.95

All Items "Postpaid" in U.S.A.

V & H RADIO SUPPLY

2033 VENICE BLVD.
LOS ANGELES 6, CALIF.

CLARKSTAN PHONO NEEDLE GAUGE

Essential for Micro Groove & standard equipment. Accurate to one gram—has both gram and ounce scales for proper weight adjustment of all types tone arms. Net price \$1.50.

SEE YOUR JOBBER TODAY.
CLARKSTAN CORP. 11927 West Pico Blvd. Los Angeles 34, Calif.

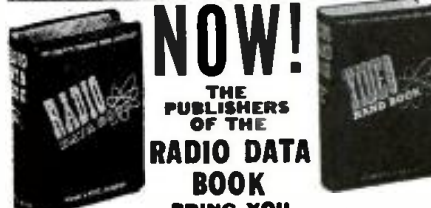

NOW! THE PUBLISHERS OF THE RADIO DATA BOOK BRING YOU THE VIDEO HANDBOOK

Over 800 pages . . . 14 sections, covering every phase in television . . . handsomely bound in DuPont Fabrikoid . . . containing complete, detailed information on how television works, basic through advanced . . . how to design and engineer television . . . how to troubleshoot and repair television . . . safety procedures . . . how to select and install a television antenna . . . how to create a television show . . . how to build an operating television receiver . . . how to select a television receiver.

The vast amount of information contained in this book can only be briefly outlined here. The VIDEO HANDBOOK contains 800 pages—over 800 illustrations—thousands of vital facts—covering everything you need for working in Television. All this information is designed for easy reading, quick reference—all in non-mathematical language, every point of discussion pictured in diagrams or photographs. The VIDEO HANDBOOK is divided into 14 sections—each a complete, authoritative coverage on its subject—arranged in a practical, easy-to-follow handbook of solutions to every television problem. \$5.00

- Section 1—Television—Past, Present and Future. Section 2—Fundamentals of Electronic Television. Section 3—The Television Station. Section 4—The Television Receiver. Section 5—The Television Antenna Systems. Section 6—Creating a Television Show. Section 7—Descriptions of Modern Television Receivers. Section 8—Installing Television Receivers. Section 9—Servicing Television Receivers. Section 10—Television Test Equipment—how to use it—how to buy it. Section 11—Building a Television Receiver. Section 12—Data Section. Section 13—Television Terms. Section 14—Bibliography.

Send in your coupon today—make sure you get your copy from the first printing of the VIDEO HANDBOOK! And if you haven't a copy of the famous RADIO DATA BOOK order one at the same time!

Boland & Boyce Inc., RC-39
Montclair, N. J.

- Please send me the VIDEO HANDBOOK. Enclosed is \$5.00
- Please send me the RADIO DATA BOOK. Enclosed is \$5.00

Name _____
Address _____
City _____ Zone _____
State _____

RADIO-ELECTRONICS for

STILL THE LEADER!

The famous ACA-100 Amplifier — a self-balancing, drift-correcting, direct-coupled amplifier — the most satisfying musical amplifier ever designed. Based on early Loftin-White circuits, perfected by A. C. Shaney in 1936, and now brought to a standard of quality far above that of any corresponding amplifier. Exclusive features include:

- Push-Pull Triode Expander.
- Non frequency-discriminating noise suppressor.
- Push-pull hi and lo freq. variable equalizers.

If you are satisfied with nothing less than the best, write today for free technical literature.

Special models for all magnetic cartridges.



AMPLIFIER CORP. OF AMERICA
398-10 Broadway New York 13, N. Y.

OUTSTANDING VALUES
3 TUBE PHONO AMPLIFIER
\$1.95

COMPLETELY WIRED, VOLUME and TONE CONTROLS

Set of 3 tubes; with above amplifier only... \$1.25
Output trans. 50L635
1/2 Meg. vol. control .15 ea., per 12... 1.50
1/2 Meg. vol. control with sw. .35 ea., per 12 3.50
AB dual control 200M ohm, .69 ea., per 12... 6.90
4" pm speaker35
6" pm speaker 1.15
8" pm speaker 1.55
8 1/4" pm speaker 1.39
8" pm speaker 2.65

AUTO-SPEAKERS MAGNAVOX

6" 6 ohm field same as used 2.39
7" 6 ohm field in original 2.49
8" 6 ohm field equipment 3.29
5" Dynamic 450 ohm with 50L6 output 1.95
5" Dynamic 1000 ohm field 2.85
12" Dynamic 2500 ohm field 4.75
Nationally adv. Pickup & Hardware 1.79
Crystal Cartridges L-70A, N7 1.49
Alliance motor & Turntable 2.50
Esilentine Deluxe Motor & T.T. 2.75
Slow speed motor & TT 1.89
Slow speed pickup with QT cartridge 3.39
Dual speed motor & TT 3.95
G.E. Reluctance Cartridge 4.54
Phone Pre-Amplifier complete with tubes 4.95
Phone Oscillator complete with tubes 4.52
Oscillator Coll. 125A7, .15 ea., per 12 1.50

WEBSTER-CHICAGO Dual Speed Automatic Record Changer, Model 248 29.25

VM #400 INTERMIX CHANGER
Automatic Stop—Special Price \$19.95

SEABURG 3 POST INTERMIX CHANGER
Automatic Stop with Q.T. Cartridge \$27.50
Broadcast wave trap, .39 ea., per 12 3.90
IF trans. 456 KC, .39 ea., per pair70
AC line cord, approved rubber plug, .15 ea., per 12 1.80
Variable superhet cond., .49 ea., per 5 2.39
Ward Leonard 100 ohm 5 watt res.10

All prices F.O.B. N.Y.C.—on C.O.D. 25% Deposit.
Write for latest circular

THE ROSE COMPANY
98 Park Place, Dept. C, New York 7, N. Y.

RADIO TUBES TELEVISION MANUFACTURERS

We have Quality Tubes at prices hard-to-beat. Send for Manufacturers' Confidential Prices.

LE-HI ELECTRICAL CO.
660 BROADWAY DEPT. B NEWARK 4, N. J.

OLD RADIOS SUPERIOR

Dear Editor:
I have had the opportunity to compare present-day radios with pioneer sets of 20 years back. And the comparison certainly does not come out in favor of the new radios! I have at home a Freshman Equaphase (vintage 1927) which is the equal of the present sets in performance, and decidedly superior to them in construction.

In the new sets, especially the cheaper ones, we find a trend toward compactness, even at the sacrifice of performance. The tubes are so crowded together that the heat they generate is harmful to other components. The speakers are reduced in size until the fidelity suffers.

Even the console models, where compactness is not a factor, show much corner-cutting in construction. Empty space in the cabinet goes wasted, while the chassis is severely reduced in size. The desirability of short leads does not excuse some of the crowding found. Certainly short leads are not necessary in power supplies and high-level audio stages! Separation of these latter on another chassis would reduce hum considerably.

However, since the manufacturers merely make what will sell, it is obvious that the buyer is to blame. People want compactness, even at the sacrifice of fidelity and reliability. They want a streamlined plastic cabinet, even though it may hide slipshod workmanship. They want a superhet, because the name sounds good, even at a loss of fidelity and greater complication for the same results. They want beautiful console cabinets, without realizing that what goes into the cabinet is taken away from the receiver proper. And above all, they want low prices, notwithstanding the rule that in any competitive field "you get what you pay for." They have no concept of long-range maintenance, but merely demand that the radio operate in the store, even though it may go completely dead as soon as they get it home.

The answer to all this seems to be the education of the public in the elementary principles of receiver construction, in which task the manufacturer, serviceman, and amateur can profitably participate.

CHARLES ERWIN COHN,
Chicago, Ill.

PRACTICAL Disc Recording
Answers your questions

For the Beginner and professional 14 Chapters from Record making to Building Your own equipment & repairing.
96 pages, 82 Illustrations including Schematics, Pictorials, graphs. Printed on semi-gloss paper easy to read.

75c POSTPAID

RECORDISC RECORDING BLANKS—DOUBLE-FACED

BASE	6 1/2"	6"	10"	Sapphire styl 3.95.
Sond	9c	14c	20c	Steel styl 3 for 75c.
Thin Alum.	11c	17c	25c	Tungsten tipped 5.00
Heavy Alum.	17c	23c	35c	Play needle \$1.

RADIO-MAIL-ORDERS
75 Barclay St., Dept RE — N. Y. 7, N. Y.

LARGEST SURPLUS STOCK in the COUNTRY at the LOWEST PRICES!

DYNAMOTORS & INVERTERS

BD-77 —Dynamotor Unit 14v in. 100v. 350 ma out with relay fuse box and filters. FOB Chicago only \$5.75
DM-21 —Dynamotor: Part of BC-312 and BC-314. 14v in. 235v. 100 ma out. 2.47
PE-101-C—Dynamotor unit: 12 or 24v in. outputs 800v. 20ma. 400v. 135ma. 9v. 1.1A 2.75
PE-55 —Dynamotor unit: 12v in. 16 amp. 500r out. 200 ma. FOB Chicago only 3.75
PE-206 —Inverter unit, rotary converted, 28v in. 80v at 500VA. 800 c/2. out. FOB Chicago only 3.95
DM-32A —Each 95c. Three for 2.90
DM-53 —Dynamotor used with the BC-733. 24v in. 240v. 60ma out. New 2.95

SURPRISE PACKAGE
20 pounds assorted radio parts. A \$25.00 value for only **\$1.95**

OUTPUT TRANSFORMER
Hi-Fi. Used in Scott-made Navy receiver. Fully potted. Pri. 5000 ohms, output secondary 800 ohms CT, inverse feedback sec. 68 ohms CT. **\$1.49**
ONLY

PE-117 UNIVERSAL POWER SUPPLY
6 or 12v input; out, 145v and 90v, less vibrator, voltage regulator and rectifier tube; ideal mobile power supply unit; excellent condition. FOB Chicago only. Each \$2.85

BC-709 INTERPHONE AMPLIFIER
Ideal for aircraft, booster for telephones, etc. FOB Chicago only **\$3.49**

VHF TRANSCEIVER
Ideal substitute for SCR-522. freq. range 140-144 mc crystal controlled, 10 watts. The receiver section has two individual RF sections, feeding a common 3 stage 10mc IF amplifier. Both RF sections may be operated simultaneously, or either one individually. The receiver unit has 13 tubes. The transmitter is of straight forward design. Transmitter unit has 7 tubes, one #832 as final modulated by a pair of 6L6 and push-pull. Complete unit in case with tubes, crystals and diagram less dynamotor. **\$14.95**
EXCELLENT CONDITION

SMASH VALUES IN RADIO RECEIVERS

BC-454—BCV6. NEW \$7.95
BC-456—MOD. NEW 2.95
BC-457—XMTR. NEW 6.95
BC-458—XMTR. NEW 7.95
BC-459—XMTR. EXC 8.95
BC-696—XMTR. EXC 14.95

CONDENSER
2 MFD, 4000V, Pyranol \$2.95 ea.
4 for \$10.00

GEARED TUNING DIAL
5 band, vernier. BRAND NEW. Frequency Range:— 3.2-4; 6.4-8; 12.8-16; 19.2-24; 25.6-32. Ideal for many applications. An exceptional buy... **\$1.39**

APS-13 UHF ANTENNA
Suitable for 400 mc citizen band, ideal for UHF experimenters. With director and reflector elements mounted. BRAND NEW. 2 for... **\$1.49**

3/4 RPM HI-TORQUE ELECTRIC MOTOR
For rotating ham, FM, television antennas and many other uses. Operates on 110 VAC 60 cycles. Requires only 12 MFD condenser. Reversible, quiet, no free swing. Government cost \$40.00. **\$3.95**
Now

BC-620 TRANSMITTER-RECEIVER UNIT
FM transmitter-receiver, crystal controlled, two channels, freq. range 20-27.9 mc. 13 tubes, built-in speaker, dual meter for testing filaments and plate circuits. Used, good **\$9.95**

FREE!

Our new 8 page catalogue featuring many excellent surplus values. Write for your copy today! It's FREE!

All shipments FOB Chicago or Los Angeles unless specified. 25% Deposit required on all orders. Minimum order excepted—\$5.00. California and Illinois residents, please add regular sales tax to your remittance.

ARROW SALES, INC., Dept. R
MAIN OFFICE:
1712-14 S. Michigan Ave., Chicago 5, Illinois
NORTH SIDE BRANCH:
1802 N. Humboldt Blvd., Chicago.
WEST COAST BRANCH:
1260 S. Alvarado, Los Angeles, Calif.

**EVERY SERVICEMAN
CAN afford
SUPERIOR
TEST EQUIPMENT**

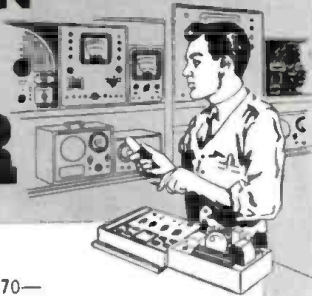

THE NEW MODEL 770—
**An Accurate Pocket-Size
VOLT-OHM MILLIAMMETER**
(SENSITIVITY: 1000 OHMS PER VOLT)

- Features:**
- Compact—measures 3 1/8" x 5 7/8" x 2 1/4"
 - Uses latest design 2% accurate 1 MIL D'Arsonval type meter.
 - Same zero adjustment holds for both resistance ranges. It is not necessary to readjust when switching from one resistance range to another. This is an important time-saving feature never before included in a V.O.M. in this price range.
 - Housed in round-cornered, molded case.
 - Beautiful black etched panel. Depressed letters filled with permanent white, insures long-life even with constant use.
- Specifications:** 6 A.C. VOLTAGE RANGES: 0-15/30/150/300/1500/3000 volts.
6 D.C. VOLTAGE RANGES: 0-7 1/2/15/75/150/750/1500 volts.
4 D.C. CURRENT RANGES: 0-1 1/2/15/150/Ma. 0-1 1/2 Amps.
2 RESISTANCE RANGES: 0-500 ohms. 0-1 Megohm.
- The Model 770 comes complete with self-contained batteries, test leads and all operating instructions. **\$13.90 NET**

We manufacture a complete line of radio test equipment.
Write Dept. RC-3 for FREE catalog today!

MFD. BY



SUPERIOR INSTRUMENTS CO.

227 Fulton St., New York 7, N. Y.

at your regular jobber

LIKED "SCREWDRIVER" STORY

Dear Editor:

I have been a reader of your magazine for a long time. The article by Nickerson in December was interesting food for thought. The *Technotes*, *Question Box*, and editorials are favorites. Your foreign comments are of little value to us out here.

My pet peeves are repairmen who take advantage of customers and servicemen who bend variable capacitors instead of tuning the i.f.'s.

W. P. WAGGONER,
Hennessey, Okla.

SURPLUS DATA INCOMPLETE

Dear Editor:

Let me congratulate you on the January issue, the best you have ever put out.

I have noticed that very few radio publications have good, clear articles on converting surplus gear for commercial and amateur work. The principal complaint is that none of them give the original diagrams of the equipment before conversion. This would seem essential to an understanding of the converting process. A series of surplus conversion articles with this in mind would be welcome.

OLIVER PARSONS,
Jefferson City, Mo.

(In many cases the original circuits may be obtained from various sources. The Government Printing Office, for example, supplies on request a list of manuals on much declassified surplus equipment. A number of books of conversion diagrams are also published.—Editor)

SCANS TELEVISION'S FUTURE

Dear Editor:

Your recent editorial (December issue) on the topic of "Multiperception" caught my intense interest. I think most of us have become so bewildered by the mechanics and economics of television that we fail sometimes to think of the ultimate functions of this promising new communications system. For this reason, I thought your editorial brought out an important point, especially as television may relate to printed media.

It seems natural for me to think in terms of:

- ... business, commercial and educational TV systems
- ... reduction in TV home chassis through printed circuits and sub-miniature tubes and components
- ... projection advantages in eventual home receivers
- ... rural television systems through signal heterodyning on alternate frequencies via optical paths from mountain top to mountain top
- ... chromatic television schedules and uses in theatre systems, initially on exclusive channels
- ... Phonevision's application to theatre use
- ... electronic television recording, by-passing optical conversion between camera and screen
- ... Stratovision for networking, instead

**GREAT VALUES FROM MORT'S RADIO SHACK
NEW HF 10 TRUSOUND AMPLIFIER**

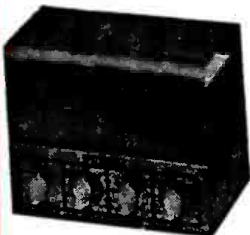

Compares equally with Amplifiers selling for as much as \$75.00. Each... **\$29.95**

Complete with Tubes and Cover

The HF 10 amplifier is a general purpose unit of small size (9"x9"x7") designed for high quality reproduction of sound, music and speech from records, radio and microphone. It is engineered and built to meet the high quality standards required of an amplifier when used in conjunction with the new high fidelity pickups, FM-AM tuners and widerange speaker systems. Hundreds of satisfied users recommend this fine New Trusound Amplifier.

NOTE THESE TERRIFIC FEATURES

- 10 watts undistorted power output 18 watts Peak.
- Inputs: High Gain for variable reluctance pickups; for high impedance mikes. Low Gain for FM-AM tuners and high output pickups.
- Selector switch for rapid changeover.
- Hum level 70 db below 12 watts.
- Tone compensation. Separate continuously variable base and treble controls.
- Treble—from plus 10 db to minus 15 db at 10,000 cps.
- Bass—from plus 10 db to minus 15 db at 50 cps.
- Note—flat characteristics obtained with controls centered.
- Output Impedance 2, 4, 8, 16 and 500 ohms.
- Straight AC for 110-120V 50-60 cycles fused.
- Tubes—6SL7, 6SC7, 2-6V6, 5Y3.
- Chassis and shield silver gray hammerloid finish.

**STANDARD BRAND
RECORD CHANGERS**

Never before have these popular record changers been offered at such terrifically low prices. 10" or 12" records are changed automatically. Because of the low price we are unable to name this well known brand. An unusual value at

\$13.95 ea.

**OUTPUT
TRANSFORMER KITS**

10 of the most popular and desired output transformers make up this useful kit. Offered at the unheard of low price of

\$2.50 per kit of 10 transformers.



ROTARY WAFER SWITCHES

Single Pole, Double Throw switches. Suitable for Phono-Radio Change-over. 10 for **\$1.69**

**SPECIAL ASSORTMENT —
BAND SWITCH KIT**

Consists of 10 of the most popular and often used band switches. SAVE by buying this much needed kit. Kit of 10 Band Switches... **\$2.49**

**NEW LOW PRICE ON
SPEAKERS**

5" PM Heavy Slug Speakers \$1.19. 10 for \$9.80
3" Speaker with Output Transformer **\$1.35 each**

**POWER
TRANSFORMER**
600V C.T. at 7 mills.
6.3V, 2 1/2 Amp.; 5V, 3
Amp. Fully shielded.
Save even more by
buying in lots of 10.
\$1.65 each
(in lots of 10)
\$1.95 each
(less than 10)

WRITE FOR OUR
FREE 1949 CATALOG
TERMS: 25% Deposit
with order.
Balance C.O.D.
F.O.B. Chicago.

MORT'S RADIO SHACK, INC. OF CHICAGO

Dept. RC-3, 630 W. Randolph St., Chicago 6, Illinois

MASTER OSCILLATOR UNITS

M.O. units designed for operation with TBK-19 transmitters. Flexible plug in units using Type 860 Tube in ECO circuit. Tunes 2000 to 4585 kc in 6 bands. Freq. Determining elements are enclosed in shock mounted oven assembly, and has freq. monitor PU link coupled to output. Net Wt.: 138 lbs. Dim.: 21 in. d x 14 1/2 in. W x 25 1/4 in. H. New (with tube) \$150.00



NBFM-465 KC DISCRIM XFMR. FOSTER-SEELEY WITH CIRCUIT DIAGRAM. \$2.50 EA.

GREAT TUBE VALUES

01-A	\$0.45	10Y	.60	837	1.95
1B24	4.85	12A6	.35	843	.59
2C21	.69	12K8Y	.65	860	15.00
2C22	.69	12R7	.49	861	40.00
2J21-A	25.00	12R7	.72	874	1.95
2J22	25.00	15R	1.40	876	4.95
2J26	25.00	28D7	.75	1005	.35
2J27	25.00	30 (Spec.)	.70	1618	.21
2J31	25.00	45 (Spec.)	.58	1624	.85
2J32	25.00	39/44	.49	1629	.35
2J38	35.00	35/51	.72	1961	5.00
2J39	35.00	227A	3.85	9002	.65
2J40	80.00	225	8.80	9004	.47
2J49	85.00	268-A	20.00	CE472	1.95
2J55	35.00	355A	.50	E-50	.75
3J31	55.00	417A	25.00	E-1148	.75
2x2/879	.69	530	90.00	F-127	20.00
3BP1	2.25	531	45.00	FG258A	165.00
3C24	.60	532	3.95	GC 271	40.00
3C30	.70	559	90.00	GL 562	75.00
3C5	.79	562	4.00	GL 523	75.00
3CP1	3.50	619	.89	GL 577	4.00
3D21-A	1.50	703-A	7.00	ML 100	60.00
3DPI	2.25	704-A	.75	OK59	65.00
3EP1	2.95	705-A	2.85	OK60	65.00
3FP7	3.85	707-B	120.00	OK61	65.00
3Q5	.79	714-A	25.00	OK62	65.00
5BP1	1.95	715-B	12.00	RCA 932*	.85
5BP4	4.95	720BY	50.00	VR 91	1.00
5CP1	3.75	721-A	3.80	VR 130	1.25
5FP7	3.50	723-A/B	12.50	VR 135	1.25
5JP2	8.00	724B	1.75	VR 137	1.25
5J30	39.50	725-A	1.50	VU 120	1.00
6G	2.00	726-A	15.00	VU 134	1.00
6L6GA	1.00	800	25.00	W532	4.75
6SC7	.70	801-A	1.10	WN 150	3.00
7C4	1.00	804	9.95	WT 260	5.00
7E5	1.00	815	2.50	With Cavity.	
7E6	.72	836	1.15	* Photocell.	

DYNAMOTORS

Type	Input Volts	Output Amps	Radio Set	Price*
BD 77KM	14 40	1000 .350	BC 101	\$20.00 N
PE 73CM	28 19	1000 .350	BC 375	14.00 LN
DM 416	14 6.2	330 .170	RU 16	9.95 N
ZA .0516	12/24 8/4	12/275 3/110		5.50 N
DY-2/ARR-2	28 1.1	250 .080	ARC-5	
DM 21	14 3.3	235 .090	BC 312	3.45 N
DM 21CX	28 1.6	235 .090	BC 312	3.45 N
DM 25	12 2.3	250 .050	BC 367	2.49 LN
DM 28R	28 1.25	275 .070	BC 348	8.95 N
DM 33A	28 7	540 .250	BC 456	5.50 N
DM 42	14 46	515 .110	SCR 506	6.50 LN
PE 86	28 1.25	250 .080	RC 36	3.95
PE 101C	13/26 12.6/4	400 .135	SCR 515	5.25 N
BD AR 93	28 6.3	800 .020		4.95 N
23350	27 1.75	285 .150	APN-1	3.50 N
35X045B	28 1.2	250 .060		3.50 N
ZA .0515	12/24 4/2	500 .050		3.95 N
B-19 pack	12 8.4	275 .110	Mark II	0.95 N
D-104	12	225 .100	TCS	14.95 N
DA-3A*	28 10	300 .260	SCR 522	8.95
		150 .010		
		14.5 .5		
# 5053	28 1.4	250 .060	APN-1	3.95 N
DA-7A	28.5	1100 .400	TA-2J	25.00 N
CW 21AAX	15 12.6	400 .135		17.50 N
	28 6.3	800 .020		

N-New. LN-Like New. * Less Filter Box & Relays. Replacement dynamotors for PE 73, less filter box. \$12.00

INVERTERS

PE 218: Input: 25-28 VDC @ 92 amps. Output: 115 volts @ 1500 volt-amps, 380-500 cycles. New. Herm Sealed (as shown) \$49.95
 Used. Ex. Cond. \$35.00
 PE 206-A: Input: 28 VDC @ 38 amp. Output: 80 volts @ 500 volt amps. 800 cycles. Leland. New. complete with enclosed relay filter, instruction book \$12.50
 GE #5D21M13: Input: 27 vdc. 35 amp. Output: 115 v. 485 VA. 400 cy, 11°F. New \$49.95

CONVERSION COILS FOR ARC-5 TRANSMITTERS

M.O. Coils	P.A. Coils	Antenna Loading Coils	Freq. Range
\$1.00 ea.	\$1.00 ea.	\$.85 ea.	
6029	7247	6033	3-4 Mc.
6030	9293	6034	4-5.3 Mc.

CONVERSION KIT, consisting of 1-M O coil, PA coil, 1-ANTENNA COIL, in any one particular frequency range. ARC No. 4990, variable xmtg capacitor, 22-4-145 mmf, .05" spacing, 11 rotors. Each \$1.00
 ARC 5632 Var. Xmtg. capacitor, 29.2-117 mmf, .08" spacing, 16 rotors, worm drive: 9:1 \$1.00
MEYER VFD KIT. Kit consists of the following: 1-6029 M.O. coil; 1-5632 tuning condenser; 1-4990 padding cap; 1-ARC-5 Xmtg. schematic. Complete kit \$2.75
INSTRUCTION MANUALS
 BC 312, BC 342 \$1.25
 SCR 281 \$1.25
 ZCA Expt. 1.00
VIBRATORS
 TR 1210, 12 vdc, 5 pin \$1.00
 OAK V-6675, 24-32 vdc, 7 pin \$1.00
 Mal. Type G334C, 12 vdc, 5 pin \$1.00
 Mal. Type G629-C, 12 vdc, 4 pin \$1.00
 Radiart VR2, 6v. DC, 6-pin special \$1.00
 Mrs. Quantities available.
MICROPHONE ELEMENTS
 Carbon transmitter element for TS11-J, TS11-L, TS13-E, TS15-A \$.75 ea.
 Element for microphone T-24, 30 ohm resistance. \$.95 ea.
 T-17 elements \$.85 ea.

HAND GENERATORS

GN 35: 350 v, 60 ma; 8v, 2.5 A. New, with hand cranks \$12.50
 GN 45: 500 v, 100 ma; 6v, 3 amps. Slight use, ex. cond., with cranks \$12.50

TYPEWRITER DESK WELLS

Mounted on Steel Panel for Standard Rack Mtg., 10 1/2" H x 19" W x 1/2" Thick. Well is 22" Wide, 20" Deep. Affording Full Working Space. Grey Crackle Finish. New. ea. \$9.90



131-C
 Liberty St.
 New York 7, N.Y.

All merchandise guaranteed. Mail orders promptly filled. All prices, F.O.B. New York City. Send Money Order or Check. Only shipping charges sent C.O.D.

COMMUNICATIONS EQUIPMENT CO.
 MANUFACTURERS QUANTITIES AVAILABLE

PHONE DIGBY
 9-4124

of home service, modification of original plans ... why the video portion will be frequency-modulated into the home eventually (England's experiments) ... original advertising applications of video.

WILLIAM P. PENCE,
 Johnson City, Tenn.

FOR SAFER TV SETS

Dear Editor:
 I would like to call to the attention of TV receiver manufacturers the increased safety provided the serviceman by a metal shield placed around the cathode-ray tube. This has been done by some makers. A plastic, transparent front to go with the shield would be still better.
 It won't be long until TV sets will have been serviced quite a few times; the repairman will have to push the chassis around on the bench a good deal. This might make the tube break, with consequent danger of serious injury to the serviceman.

PETE J. FORADAS,
 Canton, Ohio

(The days of "pushing a chassis around" on the service bench went out forever with the coming of television! The alert repairman will quickly adapt his techniques to handle safely and carefully the more than a million televisions now in the public's hands, even though metal shields and metal tubes may make future tubes safer. The man-

MARCH, 1949

NEW TELEVISION ANTENNA ROTATOR

Ideal reversible motor for rotating all types of antennas at the 100' Weather Station. Only 4 1/2 lbs. Size: 7 1/2" L, less shaft. Gear box and Mtg.: 4" x 3 1/2". Motor size: 5" L x 2 1/2" D. Shaft size: 3/8" x 1 1/4" threaded. Operates from 24 V. DC. 2 amps 4.5 RPM or 36 V.A.C. Torque: 70 lbs. per inch. Price. \$8.95



TRANSFORMER—For above Rotator—110 V. 60 cycle Primary; 36 V.A.C. Sec. Price \$2.95

SELSYN TRANSMITTER AND INDICATOR

Ideal as Radio Beam position indicator for Ham, Television, or Commercial use. Complete with five-inch 1-82 indicator. Autosyn Trans. 12 Volt 60 cycle transformer, and wiring instructions. Price: (Used & Tested) \$7.95 Price: Autosyn Transmitter only \$2.95

DYNAMOTORS

INPUT:	OUTPUT:	STOCK NO.:	PRICE:
9 V. DC	405 V. 95 MA	DM 635 X	\$3.95
12 V. DC	220 V. 100 MA	D 403	3.95
12 V. DC	440 V. 200 MA	D 401	7.95
28 V. DC	F/ SCR 522	PE 94	7.95
12/24 V. DC	F/ No. 19 MARK II	P/S #3	9.50
13/26 V. DC	F/ RC-645	PE 101	2.95
12/24 V. DC	400 V. 50 MA	USA/0151	1.95
28 V. DC	F/ Comm. Receivers		
14 V. DC	230 V. 100 MA	DM 32	1.95
12/24 V. DC	440 V. 200 MA— and 220 V. 100 MA	DM 20	3.95
28 V. DC	400 Cycle Inverter	D 104	9.95
		MC-149F (Reconditioned)	12.95

MOTORS

6 or 12 Volt AC-DC Heavy Duty reversible Motor with 5/16" x 7/16" shaft. Price: New \$2.95
 6 Volt AC-DC Motor—Ideal for auto fans, models, etc. shaft 3/8" x 7/8". Used—Tested \$1.50
 Model Motor—12 Volt AC-DC 1/2" double end shaft Motor. Size: 2 1/2" L x 2 1/2" W x 1 1/2" H. Price \$1.50
 110 Volt 60 cycle. Ball Bearing Motor. approx. 3500 RPM. 1/25 H.P. Shaft: 3/16" x 1/2". Motor size: 6 1/2" L x 4" H. Converted type. Price \$2.95
 Hand Tool Motor—12 Volt AC-DC—5600 RPM. 3/4" L x 1 1/2" Dia. with splined shaft 1/2" D x 1/2" L. Price \$2.95
 ADDRESS DEPT. RE ALL PRICES F.O.B., LIMA, OHIO

WHIP ANTENNA FOR MOBILE AND STATIONARY USE

MP-48 Mast Base Mounting with heavy vertical coil spring, insulated at top to receive Mast Section MS-53. Mast Base only \$2.95
MAST SECTIONS: For above MP-48, tubular steel, cover coated, painted—in 3 foot sections. Bottom section MS-53 can be used to make any length. MS-52-51-50-49 for taper. Screw-in type. Any Section—Price \$1.50 each



GENERATORS

HOMELITE ENGINES—Consist of a 30 Volt DC, 50 ampere (1500 watt) generator driven by a single cylinder, two cycle air-cooled gasoline engine approx. 3 HP. Rope or electric starting. Price: As is \$39.50. Tested \$49.50
DELCO ENGINES—Consist of a 12 Volt DC 750 watt generator driven by a one cylinder, four cycle air-cooled gasoline engine approx. 2 HP with self-starter and voltage regulator. Used to charge batt. in Gov't vehicles. Tested. Price \$79.50

SELSYNS

110 Volt 60 cycle, 7811" Size V \$5.95 Pair
 2J1G1—110 Volt 60 cycle, Instructions \$3.00 Pair
TG-10 KEYS—A well designed automatic keyer that can be used for code classes. Photo cell is actuated by ink tape recording; can be converted easily to a 25 watt amplifier. 110 V. 60 cycle operation. Price: Used and Tested \$19.95

MOTOR CONTROL RHEOSTAT

Heavy-duty, wire wound control for regulating speed of AC or DC motors, toy trains, etc. 150 watt, 8.28 ohms, 5 amps. Price \$1.75

INTERPHONE AMPLIFIER BC-347

Army Aircraft Type. Uses 6F8 Tube. Completely enclosed. Size: 2 1/2" x 4" x 6". Less Tube. Price—Each 79c Or—Three (3) for \$2.00

TRANSTAT VOLTAGE REGULATOR

For 60 cycle AC voltage regulation. 103 V—126 V at 2.7 amps. Price: NEW \$9.95
RECTIFIER UNIT—110 Volt 60 cycle input; output 12 V. DC 10 amps. Can be used to charge batteries or operate DC equipment. Electronic Lab. mfg. Price: \$29.95 NEW

FAIR RADIO SALES
 132 SOUTH MAIN ST. LIMA, OHIO

Television is Booming—Cash in on it!

CONVERT DIRECT-VIEW TELEVISION TO PROJECTION TELEVISION!

Any electro-magnetic deflection TV set can be converted! All you need are 3 basic components: lens, tube and power supply.

30 KV RF POWER SUPPLY



Dimensions: Length 14" Width 11" Height 11 1/4"

New Improved unit of exceptional regulation. Has a focus control pot built in for use with 5TP4 Tube. Voltage variable from 27 to 30 KV. Supply utilizes 6 tubes.

Net price, including DC Power Supply\$99.50



SPELLMAN F1.9 PROJECTION TV LENS

Dimensions: Length 7", Diameter 4 1/4"

F1.9 EF.5 in. (127.0 mm.) This lens incorporates in barrel a corrective lens for use with a 5TP4 projection tube. It is easily removable for use with flat type tubes. Lens can be utilized to project picture sizes from several inches to 7 x 9 feet. Only \$90 Complete with mounting ring. Machined slotted Mounting Ring available for hand focusing adjustment. Has 4 holes for easy mounting on plate. \$8.00 extra.

CONVERSIONS ARE SIMPLE!

The steps necessary in practically all sets are:
1. Eliminate present hi-voltage source. In most cases removing the hi-voltage rectifier tube will suffice.

2. 5TP4, being an electrostatic focus type and mirror back tube, does not require a focus coil or iron trap. These can be left on chassis or the leads can be shorted out and coils removed.

3. The same sweep yoke in the set is used, the only precaution necessary is to tape the neck of the projection tube to prevent corona and grounding of yoke.

4. The connections on the 5TP4 are the same as for the 10BP4 and 15AP4 and similar types, the difference being the focus connections on pin 6 and 7. This means the same tube socket is used.

5. In some sets it might be necessary to increase the video drive. This can be accomplished by raising the voltages on the screens and plates of the video output tubes. On some sets the bias to the 5TP4 might have to be changed to allow brightness control. Some mechanical changes might be necessary on the mounting of the tube, but they are simple to accomplish.

Instructions on how to make conversions are included free with each purchase



5TP4 KINESCOPE TUBE

Features a metal backed white fluorescent screen having high brightness and contrast. Net Price\$67.50

Include 25% Deposit with Order, Balance

manufacturer's plain instruction: "Handle tubes with gloves and goggles" also deserves more attention than it gets from many otherwise competent radio repairmen.—Editor)

BUS SOLENOID PATENTED

Dear Editor:

I have just noticed the article, *Radio Controlled Bus* written by M. Gordon Moses on page 22 of RADIO-ELECTRONICS for January.

The use of radio waves (electro-magnetic energy) for the control of a motor vehicle and particularly the solenoid appearing on page 24 are fully covered in U.S. patent No. 2,388,748. This patent was issued to me on November 13, 1945, over three years ago.

I am sure that you, Mr. Gernsback, as the veritable "father" of electronic experimenters, will do everything in your power to protect the inventor. While I have no objection to publication of the article, readers should know that the principles described may not be used commercially without a license.

K. A. KOPETZKY,
Chicago, Ill.

LIKES HALLOWS AND LANGHAM

Dear Editor:

I enjoy Mr. Langham's sound articles because they are easy to read and because Mr. Langham obviously knows of what he speaks. Major Hallows' *European Report* is always read with interest. Let's have more news of new circuit developments and designs in other countries. I was pleased to note the fine article on supersonic bias in the January issue and I hope you will include such an article by an authority on sound in each issue.

The thing I like least is to see two or three pages of good space wasted each April on some ridiculous gag story, such as the "Tubeless Homo-Heteradio," April, 1948, issue. Surely this is neither radio nor electronics!

E. C. HOPPER,
Ottawa, Canada

(Yet many readers like to read these April First stories, which sometimes—as with the Transistor—are short-range predictions of coming events.—Editor)

TECHNOTES VALUABLE

Dear Editor:

How about a few more articles like those by James R. Langham? I think an article written in story form with a bit of humor is very informative as well as being amusing. Of course I don't mean that all articles should be written that way! (Probably few authors could write them.—Editor)

I regard the Technote Section very highly, as well as articles such as W. G. Eslick's "Time-Saving Repair Tips" (July, 1948). The magazine has provided me with much of my radio education and I hope it will continue to do so in the future.

BERT DE KAT,
Minburn, Alberta

RADIO-ELECTRONICS for

SPELLMAN TELEVISION CO., INC.

DEPT. B, 130 WEST 24th STREET, NEW YORK 11, N. Y. • AL 5-3680

FACTORY SPEAKER REPAIRS

FOR OVER 20 YEARS!

SAVE TIME . . . SAVE MONEY . . . repair your own speakers with these professionally designed kits—include everything necessary for the particular job.
KIT A: SPEAKER CONES. An indispensable assortment for every Radio Shop! 12 ass'd. 4" to 12" fine quality moulded & free-edge (magnetic incl.). Less voice coils. Kit of 12. \$2.00
KIT B: SPEAKER REPAIR KIT. The "BIG KIT," worth many times the price in savings and convenience! Contains 25 ass'd. mfg. rings, 10 spiders, 25 voice coil forms, 3 yds. slit strip, 20 chamois leather segments, kit of 16 ahims & tube speaker cement, incl. instructions. \$2.49
SPECIAL: KIT A AND B. Both for \$3.95!

4-TUBE AMPLIFIER (2-7C5, 7F7, 7Y4). See July '47 Radio Craft for conversion to phono & mike amplifier. Black crackle finish case & aldit in chassis. 110V, 400 cycle, 9 3/4"x4 1/2"x3 3/4". Less tubes.98c
9" MEDIUM CHANGER ARM (Astatic) Brown enamel. Less L-71 cartridge.69c
3AG FUSES: 2, 1 1/4, 2 1/2, 4 or 5 amps. 250V ea. 3c; 25 for 69c
450 I.F.'s double tuned. 1 3/4"x 2 1/4". Input or output. WHITE. THEY LAST.48c
FORMEX WIRE #18 AWG sold. SCC. per lb.75c
MIDGET AUDIO TRANSFORMER (1"x1 1/4"x2"). 3:1 for interstage, tone sec., etc.

- FREE SUPPLEMENTS—CHECK THOSE DESIRED**
- RECORDING PARTS & ALNICO MAGNETS ACCESSORIES
 - GEAR, SHAFTS & PULLEYS
 - RADIO & ELECTRONIC SUPPLIES
 - HEARING AID & MINIATURE PARTS

CLIP THIS COUPON FOR THE LATEST INFORMATION FROM THE LEOTONE HOUSE OF BARGAINS!

RM-4 RECORDING MOTOR (G.I.) A LEOTONE SPECIAL!

Heavy duty 110V, 60 cycles, silent operating. For WIRE, TAPE or DISC RECORDING, fans, displays, etc. 5/16" O.D. shaft; 3 3/4" sq. x 2 3/4". Less turntable, mts. plate & reduction drive wheel. Shpg. wt. 6 lbs. \$4.95



Radio-Amplifier Steel Cabinets

This handsome, multi-use cabinet made for RCA, will beautify any RADIO or ELECTRONIC EQPT., AMPLIFIER, POWER SUPPLY, TEST EQPT., MEDICAL or INDUSTRIAL APPARATUS. Shining dial. (6"x11") glistening chromium grille & side trim. Marine grey, wrinkle finish. Overall 16 1/2"x9 1/2"x10 1/2". Rubber bumper feet. Shpg. wt. 10 lbs. \$1.98 BRAND NEW ONLY.

ALNICO MAGNETS: EXPERI. MENTAL KIT of 10 ass'd. powerful Bar, "U", Block, Circular, etc. Kit of 10.\$1.98

UNIVERSAL AUTO SUPPRESSORS for spark plugs or distributor. Elbow type 7c ea. 18 for. \$1.00

"BOUNCER" OUTPUT TRANSFORMER (9"x13/16") 2000 ohm tapped dble. primary to voice coil. Matches Beam Power Tubes (50B5, 50L6, etc.). ea.49c 12 for.\$5.00

TUNING UNIT TU-17A (BC-223 XMTR) 2-3 mc. Like new, less crystals. Shpg. wt. 9 lbs. \$3.95

SPECIALS FROM OUR T. V. DEPARTMENT!

TV-FM ANTENNA POLE BRACKETS. Easily installed on any wall. Sturdy die-cast aluminum supports any TV antenna pole up to 1 1/4" O.D. With mtg. hardware. Shpg. wt. 2 lbs., per pr. \$1.39
FOCUS COIL for magnetically focused kinescopes. For use with 10", 12" or 15" tubes. Fully shielded. Shipping 4 1/2" mtg. 19/16" center hole. Shpg. wt. 4 lbs. 275 ohms DC \$4.25 11,000 ohms DC \$5.25
SAFETY WINDOW for 7" tube. Hvy. moulded clear acetate with mtg. flange. SPECIAL.49c
DM-36 DYNAMOTORS. 24V to 220V @ 80ma. complete with filter system. Shpg. wt. 6 lbs. ONLY. 98c

JUMBO RADIO PARTS ASSORTED

A real buy for every Radioman! new & dismantled Radio & Electronic parts. 17 FULL POUNDS OF COILS, TRANSFORMERS, CONTROL KEY, RESISTORS, CONDENSERS, SPEAKER ACCESSORIES, WIRE, HARDWARE, ETC. ALL THIS AND MUCH MORE (Shpg. wt. 21 lbs.) \$2.95 ONLY
RADIO HARDWARE TREASURE: handy assortment of approx. 1000 nuts, screws, washers, lugs, etc. for every radio need. (Shpg. wt. 2 lbs.) FOR ONLY49c

TUBES! TUBES! TUBES! STOCK UP NOW at up to 80% off list. OUTSTANDING BUYS! Perfect condition; GUARANTEED 90 DAYS. Unsealed cartons.
#27, 34, 35, 35Z5, 39, 77, 85, 5Y3, 6A4, 6A7, 6H6, 6K7, 6X5 or 60B5,39c
#24, 41, 46, 50, 78, 1A7, 1L6A, 1L6A, 5V4, 6AS, 6B7, 6CS, 6F6, 6T6, 6U7, 6X4, 6X5, 6X6, 6X7, 6X8, 6X9, 6Y7, 7A7, 7AB, 7B6, 7B7, 7Y4, 12BA6, 12BE6, 12SA7, 12BJ7, 12SK7, 12SR7, 35L6, 50L6, 12Z5 or 1316,49c
TUBE CARTONS: 1" sq. x 2 1/4", per 100.98c
TG size (1 1/4" sq. x 3 1/4"), per 100.\$1.25
Medium (1 1/2" sq. x 4 1/4"), per 100.\$1.75
Large (2" sq. x 5"), per 100.\$2.75

LEOTONE RADIO CO.
67 DEY STREET, NEW YORK 7, N. Y.

Television is Booming—Cash in on it!

MOST-OFTEN-NEEDED 1948 TELEVISION SERVICING INFORMATION, compiled by M. N. Beitman. Published by Supreme Publications, Chicago. 8 1/2 x 11 inches, 144 pages plus 7 fold-in blueprints. Price \$3.00.

A book containing schematic diagrams, photographs and pertinent servicing information on 16 television receivers made by 11 manufacturers. The servicing information includes partial schematics of different parts of the set, drawings showing locations of major components, dial stringing guides, oscillographic patterns of signals found at test points throughout the receiver, and photographs of normal test patterns and those obtained when the set is misaligned or out of adjustment.

Diagrams of the Admiral 30A1, Belmont 22A21 and 22A22, Hallicrafters T-54 and 505, Motorola VT71, RCA 8TS30, and Sonora 700 are among those included in the book.

RADAR PRIMER by J. L. Hornung. Published by McGraw-Hill Book Company, New York. 5 1/2 x 8 1/2 inches, 218 pages. Price \$3.50.

Basic radar fundamentals are discussed with surprising thoroughness without recourse to mathematical examples or analogies. After reading the book, the average reader will have a conversant knowledge of radar—how it works and what it does.

The author discusses air-borne and marine radar, radio and radar altimeters, blind-landing systems, GCA, loran, sonar, microwave theory, and basic television transmitting and receiving methods and equipment. He uses well-selected drawings and photographs to illustrate all phases of his material.

This is not a text, but it will provide interesting and worth-while reading material for high-school science students, science clubs, and the average person interested in the what, why, and how of modern scientific developments. —R.F.S.

ELEMENTS OF NOMOGRAPHY, by Raymond D. Douglass and Douglas P. Adams. Published by McGraw-Hill Book Co., Inc., New York. 6 1/2 x 9 1/2 inches, 209 pages. Price \$3.50.

The nomograph is a convenient method of solving mathematical equations by placing a straightedge across a series of graduated lines. Unknown values can be found by inspection if certain of the other values are known. While simpler nomographs (A=BC, for instance) can be drawn by trial, more complex diagrams require exact knowledge.

This book gives the theory of nomography in purely mathematical terms, together with basic instructions on drafting the charts. The text is made up almost entirely of equations and "illustrative examples" showing how each new principle is applied. It requires the most careful reading, without which the student will not be likely to learn anything at all. General statements are rare and each point must be understood thoroughly before going on to the next.

The technician anxious to learn how to make nomographs for general distribution, or the student interested in nomography as a hobby, will do well to study the book.—R.H.D.

MARCH, 1949

OPPORTUNITY AD-LETS

Advertisements in this section cost 25c a word for each insertion. Name, address and initials must be included at the above rate. Cash should accompany all classified advertisements unless placed by an accredited advertising agency. No advertisement for less than ten words accepted. Ten percent discount six issues, twenty percent for twelve issues. Objectionable or misleading advertisements not accepted. Advertisements for April, 1949, issue, must reach us not later than February 24, 1949. Radio-Electronics, 25 W. Broadway, New York 7, N. Y.

Send for 3 Years Proved Radio Repairing Simplified System; \$1.00. Box 178E, Lake Hiawatha, New Jersey.

MILLIAMMETERS, WESTON 2" dia. Sensitive 0-1 mll movement \$2.95. NEON GLOW LAMPS, 1/4 watt GE-NE-48. List 40c. 10 for \$1.50. RECTIFIERS, 115 AC to 110 DC center-tap, 6 amps. \$4.95. 2-law MECHANICAL RETRIEVER, pick up screws, etc. \$1.00. Send check or money-order. All items postpaid. ANCHOR SURPLUS—Dept. E., 6987 W. Fort Detroit 9, Mich.

SELECTED GROUP OF MEN, GRADUATES OF WELL-known trade school, desire employment in Radio Field. Will travel anywhere. Qualified in radio servicing, installation, test instruments, circuit operation, etc. Contact Placement Dept., Eastern Technical School, 888 Purchase Street, New Bedford, Mass.

PHONOGRAPH RECORDS CHEAP. CATALOGUE, Paramount, BJ-313 East Market, Wilkes-Barre, Penna.

AMATEUR RADIO LICENSES. COMPLETE THEORY Preparation for passing amateur radio examinations. Home study and resident courses. American Radio Institute, 101 West 63rd St., New York City. See our ad on Page 143.

MAGAZINES (BACK DATED)—FOREIGN, DOMESTIC, arts, books, booklets, subscriptions, pin-ups, etc. Catalog, 19c (refund). Cicaron's, 863 First Ave., New York 17, N. Y.

WE REPAIR ALL TYPES OF ELECTRICAL INSTRUMENTS, tube checkers and analyzers. Hazleton Instrument Co. (Electric Meter Laboratory), 140 Liberty Street, New York, N. Y. Telephone—BARclay 7-4239.

YOU CAN ACCURATELY ALIGN SUPERHETERODYNE receivers without signal generator. Complete instructions \$1. Moneyback guarantee. Chas. Gates, Pecos 2, Texas.

27 YEARS EXPERIENCE RADIO REPAIRING. SIMPLIFIED system. No calculations. No formulas. Total \$2.00 postpaid or COD. Ross Radio, 14615 Grandriver, Detroit 27, Michigan.

BRITISH AND EUROPEAN RADIO DEVELOPMENTS are fully reported and analyzed every month in PRACTICAL WIRELESS, Britain's leading radio magazine. Widely read and appreciated throughout the United States. Famous for television and electronic features, authoritative constructional data, discussion columns, and other essential information. For annual subscription mailed direct to your address from London, send only \$2.00 to George Newnes, Ltd., (P.W. 35), 342 Madison Avenue, New York 17.

MANUFACTURERS, DEALERS AND WHOLESALERS. A service to save you TIME and MONEY. We locate "hard-to-find" items and sell your "non-movable" surplus. Write on Company Stationery. Tell us your needs. Sell us your surplus. Electronics Surplus Brokers, 3232 Broadway, New York City.

TELEVISION—SHARP AND CLEAR. ADJUST PRESENT serial. Build low-cost Precision Antennae. Complete instructions, trouble-shooting chart, diagrams, construction plans, dimensions, no mathematics. Proppon's, Lumberton, New Jersey.

TELEVISION, RADIO, TUBES, PARTS. SEND FOR free bargain list. Hallmark, 982A Communipaw Ave., Jersey City, New Jersey.

CONDENSER BARGAINS. ASSORTMENT—50 PAPER condensers. Assortment—50 mica condensers. All new and size-marked. Regularly \$12.50 each. Your price \$2.45 each assortment. Box for \$4.50. Special prices for quantity users. Sorry, no COD. TELECRAD, 3232 Broadway, New York City.

F.M. CONVERTER UNIT, OLD TO NEW BAND, \$5. Paine, Cornelia St., Bonton, N. J.

ELECTRONICS KIT Builds AC-DC voltmeter, oscillator, electric eye. \$2.95 complete. Literature Free. Precision Measurements Co., 942E Kings Highway, Brooklyn, N. Y.

CRYSTAL SET—TELEPHONE COMBINATION DIAGRAM and instructions 25c. Includes attractive offer, literature. Year's membership in "XTAL-X CRYSTAL SET CLUB." Box 608, Torrance, Calif.

WANTED: Salesmen to sell Nationally Advertised Brand Radio Tubes to Dealers and Servicemen at liberal discounts. Good Commissions Paid. c/o Radio-Electronics, P. O. Box RE-32, 25 W. Broadway, New York 7, N. Y.

BARGAINS: NEW AND RECONDITIONED HALLICRAFTERS, National, Collins, Hammarlund, Meisner, RME, other receivers, tuners, television receivers, transmitters, etc. Wholesale Prices. Terms. Shipped on trial. Liberal trade-in allowance. Write: Henry Radio, Butler, Missouri and 11240 West Olympic, Los Angeles, California.

12B8 & 25B8 TUBES. ADAPTER UNIT USING 2 miniature tubes (6AT5 & 6BA6 for 12B8, and 12AT5 & 12BA6 for 25B8). Takes less space than original tube—nothing else to buy—Just Plug in & it works. Money-back guarantee. 12B8 or 25B8 unit complete: \$2.49 each, 10 units for \$22.50. Send 25c deposit, balance C.O.D. Write for free parts catalog. COMMERCIAL RADIO, 36 Brattle St., Boston, Mass.

34 VOLT AIRCRAFT BATTERIES, NEW 11 AMP. AT 5 hr. rate. Dry charged. \$14.50 ea. less 35% in lots of four. No C.O.D.'s please. Security Parachute Co., Oakland Airport, Oakland, Calif.

TELEVISION CONDENSERS

.05	—	2500V	\$.58
.1	—	2500V64
.25	—	2500V86
.05	—	3000V69
.003	—	6000V57
.005	—	6000V62
.01	—	6000V74
.05	—	6000V97
.0005	—	7500V58
.003	—	7500V67
.005	—	7500V72
.0005	—	10000V64

BROOKS RADIO DIST. CORP.

80 Vesey St., Dept. A, New York 7, N. Y.

OSCILLOSCOPE KIT

YOUR COST
\$39.95
COMPLETE



EICO Model 400-k kit is perfect for servicing radio, FM, TV, horizontal sweep circuits 15 to 30,000 cycles. Linear sweep with 684 gas triode. Frequency response of horizontal and vertical amplifiers from 50 cycles to 50 Kc. Tube complement: 2-6J57, 2-5Y3, 1-684, 1-5BP1. Complete with all parts and tubes. Detailed instructions and diagrams included. Nothing Else to Buy.

10% Cash with Orders



Phone LO 3-9255

509 ARCH ST., PHILA., PENN.
SIXTH & ORANGE, WILMINGTON, DEL.

EASY TO LEARN CODE

It is easy to learn or increase speed with an Instructograph Code Teacher. Affords the quickest and most practical method yet developed. For beginners or advanced students. Available tapes from beginner's alphabet to typical messages on all subjects. Speed range 5 to 40 WPM. Always ready—no QRM.



ENDORSED BY THOUSANDS!

The Instructograph Code Teacher literally takes the place of an operator-instructor and enables you to learn and master code without further assistance. Thousands of successful operators have "acquired the code" with the Instructograph System. Write today for convenient rental and purchase plans.

INSTRUCTOGRAPH COMPANY

4701 Sheridan Rd., Dept. RC, Chicago 48, Ill.

PORTABLE SUITCASE SIZE RADIO SHOP—BUILD IT and be ready for ready cash. Carry in your car and double your income. Write for literature. Grand Federal, Argentine Branch, Box 57, Kansas City 8, Kansas.

TELEPHONE DIALS. USED. NATIONALLY KNOWN make. Standard speed, 10 pulses per second. Re-built \$2.25. Re-adjusted \$1.25 postpaid. Kissel Electric Products, 431-C, Sherman, Gallon, Ohio.

LANCASTER, ALLWINE & ROMMEL, 436 BOWEN Building, Washington 5, D.C. Registered Patent Attorneys. Practice before United States Patent Office. Validity and infringement investigations and Opinions, Booklets and form "Evidence of Conception" forwarded upon request.

Television is Booming—Cash in on it!

RADIO SCHOOL DIRECTORY

SPECIALIZE • SPECIALIZE



SPECIALIZE • BUILD YOUR CAREER WITH PRACTICAL TECHNICAL TRAINING

SPECIALIZE • BUILD YOUR CAREER WITH PRACTICAL TECHNICAL TRAINING

You can become a Radio and Television Technician now!

A million new jobs — almost 4,000 a week — will be created in the television industry during the next five years according to estimates of industry leaders. Actually, during 1948, television grew faster than any other industry in the history of America.

Here is a real opportunity for you. Trained television technicians are in demand. By starting now, you can get in on the ground floor — grow as television grows.

To help supply this needed manpower, the Milwaukee School of Engineering has expanded its radio and television courses. Now you can get complete practical, technical training in the MSOE laboratories. *This is not just a serviceman's course.* It prepares you for a career in all of the technical phases of television and radio.

This special course Prepares you for any of the following careers:

- | | | |
|---|---|---|
| Television Serviceman
Radio Serviceman
Radio and Television
Retailer | Supervisor in Radio and
Television Assembly
Radio and Television Tester
Broadcast Radio-Operator | Police, Taxi-Cab and Rail-
road Transmitter Operator
Police, Taxi-Cab and Rail-
road Receiver Serviceman |
|---|---|---|

OTHER COURSES AVAILABLE		
SERVICE 6 to 12 Months	TECHNICIAN 1 to 2 Years	PROFESSIONAL 3 Years
• Electricity	• Electrotechnics	• Electrical Engineering
• Welding	• Radio and Television	• Bachelor of Science Degree
• Refrigeration	• Electronics	• Major in Electronics or Power
• Heating	• Refrigeration, Heating and Air Conditioning	

MILWAUKEE SCHOOL of ENGINEERING



A Technical Institute
Founded 1903
by Oscar Werwith

MILWAUKEE SCHOOL OF ENGINEERING,
N. Broadway and E. State

Dept. RE-349
Milwaukee, Wis.

Without obligation send me free booklet "Career Building" and more details on course in Radio and Television or _____ course.

Name.....
Address.....
City.....

LEARN RADIO!

IN ONLY 10 MONTHS
PREPARE FOR A GOOD JOB!
COMMERCIAL OPERATOR (CODE)
RADIO SERVICEMAN

Television Servicing — 15 Months
Broadcast Engineer

Veterans get \$130.00 Equipment
SEND FOR FREE LITERATURE
BALTIMORE TECHNICAL INSTITUTE
1425 Eutaw Place, Dept. C, Baltimore 17, Md.



RADIO ENGINEERING

FM—Television—Broadcast

Police Radio, Marine Radio, Radio Servicing, Aviation Radio and Ultra High mobile applications. Thorough training in all branches of Radio and Electronics. Modern laboratories and equipment. Old established school. Ample housing facilities. 7 acre campus. Small classes, enrollments limited. Our graduates are in demand. Write for catalog.

Approved for Veterans
VALPARAISO TECHNICAL INSTITUTE
Dept. C VALPARAISO, INDIANA



RADIO COURSES

Preparatory, Service, Broadcast, Television, Marine Operating, Aeronautical, Frequency Modulation, Radar.

Classes now forming for the summer term June 1st
Entrance exam. May 16

Veterans. Literature.

COMMERCIAL RADIO INSTITUTE
(Founded 1920)
38 West Biddle Street, Baltimore 1, Md.

TELEVISION NEW, INTERESTING TECHNICAL CAREER

As Television gains momentum, rapidly, constantly, it offers to properly-trained technicians careers with a future in Industry, Broadcasting or own Business.

Train at an Institute that pioneered in TELEVISION TRAINING since 1938. Morning, Afternoon or Evening Sessions in laboratory and theoretical instruction, under guidance of experts, covering all phases of Radio, Frequency Modulation, Television. Licensed by N. Y. State, Free Placement Service. Approved for Veterans.

RADIO-TELEVISION INSTITUTE

480 Lexington Ave., N. Y. 17 (46th St.)
Plaza 3-4585 2 blocks from Grand Central

RADIO ENGINEERING!

Complete Radio Engineering Course. Bachelor of Science Degree. Courses also in Civil, Electrical, Mechanical, Chemical, Aeronautical Engineering; Business Administration, Accounting, Secretarial Science. Graduates successful. 65th year. Enter Jan., March, June, Sept. Write for catalog.

TRI-STATE COLLEGE 2439 College Ave. ANGOLA INDIANA

SHORT CUT CODE SPEED Be an Expert

Learn to be a Telegraph or Radio Operator. Thousands of men needed. Intensely interesting work—good pay. Learn at home or wherever you are, quickly, easily.

FREE BOOK with the famous Candler Code Speed System. Qualify for amateur or commercial license. Book of particulars free.

CANDLER SYSTEM CO. Dept. 3-C, Box 928 Denver 1, Colo.

CORRESPONDENCE COURSES IN RADIO and ELECTRICAL ENGINEERING

ELECTRICAL ENGINEERING Get good grasp of wide electrical field. Prepare yourself at Low Cost, for secure future. Modern course so simplified anyone can understand quickly.

RADIO ENGINEERING Extra fine course in radio. Trains you to be super-service man. Pen vacuum-tube technician. Servicemen needed badly. Diploma on completion. Many graduates earning big pay.

Electronic Kit given to students on completion. Many graduates earning big pay. Enrolling by Apr. 15. WRITE for free school catalog, student magazines, \$25 Course detail of deferred payment plan, etc.

Lincoln Engineering School, Box 931-C.121, Lincoln 2, Neb.



RADIO and TELEVISION

Thorough Training in All Technical Phases

APPROVED FOR VETERANS

DAYS—EVENINGS WEEKLY RATES

RCA GRADUATES ARE IN DEMAND

For Free Catalog Write Dept. RC-49

RCA INSTITUTES, Inc.

A Service of Radio Corporation of America
350 WEST 4TH STREET NEW YORK 14, N. Y.

Television is Booming—Cash in on it!

RADIO-ELECTRONICS for

RADIO OPERATING QUESTIONS AND ANSWERS, by Arthur R. Nilson and J. L. Horning. Published by McGraw-Hill Book Company, New York. 524 pages, 5½ by 7¼ inches. Price \$3.50.

This is the ninth edition of a book that probably needs no introduction to most commercial radio operators or students preparing for commercial examinations. This popular question and answer handbook has been brought up to date to include the questions recently added to elements 3, 4, and 5 of the FCC examination for commercial radio operators.

This edition, as were the others, is prepared for students with a knowledge of radio and a need for a study guide to acquaint them with the type of questions likely to be asked on FCC examinations. The questions are answered with straightforward statements accompanied by mathematical examples and diagrams where necessary.

RIDER PUBLIC ADDRESS EQUIPMENT MANUAL, Vol. 1, compiled and published by John F. Rider, Publisher, Inc., New York. 9¾ x 11½ inches, 2024 pages. Price \$18.00.

It is probably sufficient to say that Rider has added a volume of PA equipment diagrams to the long line of Perpetual Trouble Shooter's Manuals, since it is doubtful that any radio-minded person is unfamiliar with this series. The new manual contains 2,024 pages of diagrams and servicing information on public address equipment and intercommunicators made by 147 manufacturers over a 10-year period beginning with 1938. The diagrams are compiled alphabetically in a large loose-leaf binder similar to those of the Trouble Shooter's Manuals.

Included with the manual is the *Rider PA Manual—How it Works and Complete Index*, a book of 76 pages, describing various types of audio circuits and containing a 23-page index to the PA Equipment Manual.

The books are of particular interest to radio and PA servicemen, schools, engineers, and owners of large PA and intercom installations.—R.F.S.

TELEVISION

TECHNICIAN AND
RADIO SERVICE COURSES

AMERICAN
RADIO INSTITUTE

NEW YORK BUFFALO SYRACUSE
101 West 63 St. 640 Main St. 131 Shonnard St.

Approved under G. I. Bill of Rights
Licensed by N. Y. State
Teaching Radio Since 1935

AUDIO ENGINEERING SCHOOL

A practical Audio Engineering course in Sound Fundamentals; Film and Magnetic Recording; Transmission Measurements; Monitoring and Mixing. Laboratories contain Transmission Sets, Oscillators; Harmonic Analyzer, Distortion Sets, Intermodulation Analyzer, and other equipment. Recording Studio assimilating Broadcast, Motion Picture and Commercial Sound Recording. H. M. Tremaine, Pres.-Director. Approved for Veterans and Foreign Visas.

HOLLYWOOD SOUND INSTITUTE, Inc.
1040-E North Kenmore Hollywood 27, Calif.



SUPERIOR POCKET SIZE VOLT-OHM MILLIAMMETER

- Sensitivity—1000 Ohms Per Volt
- Six—A. C. Voltage Ranges 0-15/30/150/300/1500/3000
- Six—D. C. Voltage Ranges 0-7.5/15/75/150/750/1500
- Four—D. C. Current Ranges 0-1.5/15/150/MA 0-1.5 Amps
- Two—Resistance Ranges 0-500 Ohms 0-1 Megohm
- Plastic Case—3¼x5¾x2¼"

Complete with batteries, test leads, instructions and guaranty. **\$13.90**

FM CONDENSER & COIL KIT (85 to 108 Mc)

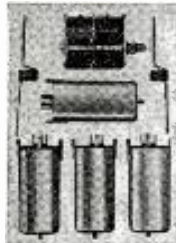

- Variable Condenser
- Discriminator Coil
- Oscillator Coil
- Two I. F. Coils
- Limiter Coil
- Antenna Coil

This KIT contains the vital parts needed to build an FM Tuner for Radio and for modernizing Pre-War FM Sets; all other parts needed are standard.

COMPLETE with instructions and diagram **\$4.95**

BROOKS RADIO DIST. CORP.
80 VESEY ST., DEPT. A, NEW YORK 7, N. Y.

HEADSET H-16U SPECIAL



8000 ohm Dual Headset H-16/U—most sensitive Phones built—noiseproof—may be used as a sound powered intercom—Also used with simple Xial to make a complete radio receiver—light, durable, efficient, molded, soft neoprene earcups, shaped to snugly and comfortably envelope the entire ear. Everyone (BRANI) order or check today.

NEW. Complete with illustrated manual. Send money order or check today. **\$1.89**

Special per pair Plus 25c each for postage

ATTENTION Amateurs- Experimenters-Inventors

Cut your cost on radio supplies and equipment in half. Clip coupon today. Hundreds of "hard to get" war surplus items along with the best in standard brand equipment—all at great savings to you. Let us know your particular requirements. IMMEDIATE DELIVERY.

PLEASE PUT MY NAME ON YOUR MAILING LIST FOR SPECIAL BULLETINS.

NAME.....
ADDRESS..... ZONE.....
CITY..... STATE.....

NIAGARA RADIO SUPPLY CORP.
160 Greenwich St., New York City 6, N. Y.

Are You Ready For Television?

New TV receiver developments are easy to follow once you understand basic circuits and requirements for TV reception. TELEVISION RECEIVER CONSTRUCTION by LIEBSCHER is the most informative publication on building, testing, and troubleshooting TV receivers. Many photos show production methods of progressive assembly. Others picture reception results, antenna styles, soldering technique. Numbers on circuit diagram tie in with those on each part to show clearly set layout and alignment points. You can't afford to miss this book at new low price for only \$1.00. Also available for joint sale at factory price. Schematic blueprint with block diagram and alignment frequencies.

ELECTRONIC DEVELOPMENT COMPANY OF PA.
7613 Fayette Street, Philadelphia 38, PA.
I enclose:
 \$1.00 for TELEVISION RECEIVER CONSTRUCTION, bound.
 \$1.00 for Blueprint schematic, postpaid.
Please print your name and address clearly.

RADIO COURSES

- RADIO OPERATING • CODE
- RADIO SERVICING • ELECTRONICS
- F.M. TELEVISION
- REFRIGERATION SERVICING

Write for Catalog and Picture Brochure
Y.M.C.A. TRADE & TECHNICAL SCHOOLS
229 W. 66 (West of B'way) New York City

You Can't Match these
MID-AMERICA Values!

SPECIAL!



for
TV
Builders

Only
\$24.95

Unbeatable value! Gorgeous selected-finish, hand-rubbed cabinet for 10" picture tube. Measures 18" wide, 18" high, 21" deep. Highest quality construction; metal screens at top and bottom for ventilation; top screen covered with tough, decorative plastic mesh. Cabinet delivered with 6" FM Alnico 5 speaker and partially wired TV chassis; you'll save money on sockets, resistors, condensers, etc. Cabinet alone worth several times our low price for entire deal. Order now. Shipping weight—39 lbs.

KEY SWITCHES

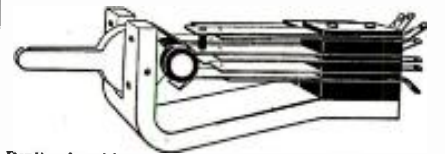

Don't miss this great value! One set of 3PDT contacts, two sets of 8PST contacts normally closed. Center, up and down positions on rubber-cushioned cams. Positive hold-in. 2¼" long, ¾" wide, 1¼" high. Heavy frame, sturdy construction. While they last... **69c**

MERCURY SWITCHES

Silent action; tipping motion closes circuit. Used in record changers, burglar alarms, novelty devices, etc. Measures only 1½" x ¼"; very flexible 18" leads. MA-1023 **29c**

6-12 VDC SOLDERING IRON



Carry this handy iron in your car or truck and be ready for any TV installation or quick repair job. Attaches to battery or starter post. Iron has 600 watt capacity and heats in 29 seconds. Holds heat and can be carried to the work. Nothing to burn out or wear out. Brand new! **\$2.95**

VARIABLE CONDENSERS

MA-996: 425 and 150 mmf sections complete with mica compression trimmers. Has 4" cable drum. **49c**
MA-940: SPECIALI 3-gang, 365 mmf per section with band-spread rotor for each section. Shafts have 2¼" cable drums. Ideal for communication receivers. **79c**

MA-88-25: 25 mmf butterfly for high frequency applications. Rotor floats on ball bearings. Ceramic insulation. Measures 1¼" square x 1¼" deep. **32c**

METAL CAN ELECTROLYTICS

MA-824 500-500 mfd. 25 VDC..... **39c**
MA-889 1000 mfd. 10 VDC..... **39c**
MA-461 20-20 mfd. 150 VDC..... **29c**
MA-50814 10-10-10/20 mfd. 450/25 VDC..... **49c**
MA-50829 40-30 mfd. 150 VDC..... **35c**
MA-442 16 mfd. 500 VDC..... **48c**
MA-50865 30-15/15/40 mfd. 450/350/25 VDC..... **59c**
MA-50866 15/15 mfd. 450/350 VDC..... **59c**

ORDER FROM THIS AD!

Send 25% deposit with order. Pay balance plus postage on delivery. Get your name on Mid-America's select mailing list and get first crack at latest, greatest values in radio parts, electronic equipment, tubes, etc. Send orders to Desk RC-39.

MID-AMERICA CO. Inc.

STORE WAREHOUSE
2412 S. Michigan Ave. 2307 S. Archer Ave.
Chicago 16, Ill. Chicago 16, Ill.

TALLEN BARGAINS

We have two buildings filled with Radio & Electronic parts and equipment. A few of these items are listed below.

RECEIVERS

- TXB** Transceiver ship to shore complete with power supply, can be used with 12-24 or 32 volt source; ready to operate and includes handset. Range 2000-8000 KC, 30 miles CW transmission. 15 miles voice. Price..... **\$94.50**
Gibson (H) transmitter emits 500 KC distress signal automatically 150 miles; Bag BG 110-A including parachute M 276A. Special..... **\$7.95**
Bendix ADF complete with brand new components and choice of it 5/ARN 7 or BC 433G or BC 433F receiver. A wonderful buy..... **\$125.00**
BC 103A Guide Path Receiver operates on 6 frequencies; 28 volts DC power supply unit complete ready for installation. Specially priced at..... **\$25.00**
T 28/APT-1 Radar Transmitter-93-212 MC includes 2-24 VDC Blowers 9-22.1 watts. Price..... **\$35.00**
T 85/APT-5 Aircraft Radio Transmitter rated 40-10 watts CW RF 300-1625 MC 58 watts. Unit complete..... **\$45.00**
BC-1023A Ultra High Frequency, covering 62 to 80 MC range. 4 tubes. New..... **\$3.95**
BC 375 Transmitter. Brand New..... **\$35.00**
Like New..... **\$20.00**
AH 809 RCA-4 bands. 15-800KC. Used..... **\$35.00**
BC AL 429 Receiver. Like New..... **\$12.50**
BC AL 430 Transmitter. Like New..... **\$12.50**
GP 11/RU 11 transmitters X receiver..... **\$24.50**
T 9/APQ-2 Radar Transmitter 80/115V-400-260-26 VDC. Designed primarily for aircraft operation. New..... **\$32.50**
T 39/APQ-3 Radar Transmitter parts are worth more than our price..... **\$7.50**
RA 10 Receiver. Like New..... **\$25.00**
AN/CBW-2. New complete..... **\$4.50**
AN/ARR-2 with Dynamotor, less tubes. New..... **\$2.25**
BC-357. Used..... **\$2.50**
R/57/ARN-5. New..... **\$15.00**

HANDSETS

- H-28U**. New. Each..... **\$3.50**
TS-9 -TS-13 -TS-15. Like New. Each..... **\$2.75**
TS-10M Sound powered. New. Each..... **\$5.50**

HEADSETS

- HS-23**. 8000 ohm with plug. Used..... **\$6.99**
HS-33. 600 ohm with plug. Used..... **\$6.99**
P-19. 24000 ohm 2 rubber cushions. 8 ft. cord..... **\$1.49**
HS-16. New..... **\$1.00**
HS-30. New..... **\$6.99**

MISCELLANEOUS PHONES

- Sound Powered** Chest Sets Complete. Each..... **\$5.50**
T-17E Microphone..... **\$1.00**
T-30 Throat Microphone..... 100 for..... **\$9.00**
T-45 Lip Microphone. 100 for..... **\$9.00**
T-26 Head & Chest sets..... **\$1.00**
T-44 Microphone for SCR 522..... **\$1.98**
EE-3-4-5 Field-Phones includes handset. generator. ringer. etc. Used. Each..... **\$4.95**

MISCELLANEOUS ITEMS

- DZ-2** Aircraft Direction Finder 15-1750 KC; 6 band. 24 V. Only..... **\$75.00**
SA-26U Microphone switch wiping type 2 circuit to ground; includes spare terminal; used as inter-communication switch on planes and also used for firing machine guns. 100 for..... **\$10.00**
Signal Pistol-marine and aviation. 25MM with 3 flares..... **\$12.50**
AN/APN-1 Altimeter with 11" dipole antenna 27V. Dynamotor..... **\$25.00**
Converter & Inverter 110 V DC to 110 V AC. Used..... **\$12.50**
BC-196B Control Boxes per hundred..... **\$25.00**
MN 28 Control Box. New..... **\$3.25**
RA-20 Powerpack converts BC-348-314-312-450-224 to AC operation..... **\$11.95**
EC-456B Modulator unit with tubes. 3 relays, complete. New..... **\$3.95**
12" speaker 600 ohm encased in metal housing..... **\$8.95**
I-225 Test Oscillator. 150-225Mc frequency..... **\$25.00**
BD-71 6 line portable switchboard; used. Each..... **\$7.50**

TEST EQUIPMENT IE-46-B

- 1.** Frequency Meter BC 906-D..... **\$15.00**
2. Radio Receiver BC 1066-B..... **\$7.50**
3. Signal Generator I-106-B..... **\$15.00**

ANTENNA

- Whip** Antenna 6 ft. includes 4" round cylinder with co-ax fitted with amphenol plug at bottom. 67-50 Mc. Each..... **\$1.10**
144E for SCR 522. New..... **\$1.95**
AT-4/APN-1. New..... **\$1.75**
JK-26 Jacks—One hundred..... **\$10.00**
JK-48 Jacks—One hundred..... **\$10.00**
PI-58 Plugs—One hundred..... **\$10.00**
FL-68 Plugs—One hundred..... **\$10.00**
FL-201 Plugs—One hundred..... **\$10.00**

Prompt Delivery—Write Dept. RC3
25% Deposit Required on C.O.D. Orders
Shipped F.O.B. Minimum Order \$2.00

TALLEN CO., INC.

564 Atlantic Avenue
Brooklyn 17, New York
Tel. TRIangle 5-8241

SAVE MONEY!
Write for FREE "TABOGRAM"

XFMR TELEV PWR SUPPLY KITS
NO RF BURSTS! ALL VOLTAGES

2500V Xfmr p/OBC412 Scope 2.5V/1.75A for 2X2 & 0.3V/6A wdg. \$8.95; w/2X2 tube & acct. \$9.95
 5000V & 300VDC & ALL A.I.'s. Herm. Sid. USN oil-filled Xfmr. 3 inputs 50-425 cps. 2 rect. tubes, condns., chokes, sockets. ONLY \$21.95
 Xfmr Fil. Lo & Hi Volts. ONLY \$16.95
 10000V & 300VDC & ALL A.I.'s. 3 rect. tubes, condns., chokes, sockets. ONLY \$29.95

Write Now for Complete Data On Above Kits

TELEVISION SIGNAL BOOSTER

SONAR TELEBOOSTER, ultra sensitive, 13-channel booster with two 430's in sharp tuned circuit, self biased. Fine without case. Complete..... **\$15.95**

TELEVISION COMPONENTS—Famous Makes

V/Output Xfmr sim RCA 20472..... \$2.98	Focus Coil Magn HV Flyback H Out Xfmr sim RCA 211T1..... 8.40
U/ah 0318H "Blig Osc. Xfmr H Aid..... .98	300 ohm TWINEX Television Cable..... 2.25
1TC 8062V "Blig Osc Xfmr H Aid..... .98	1000 ft. Twi-nex Cable Tacker & 5M staples..... 13.95
500mm/10KY..... .40	3000 HV Dty..... 2.98
Jeffers HV Cnder 500mm/20KY..... .75	
Ion Trap Magnet RCA 203D1..... 2.98	
Yoke Magn Defl sim RCA 201D1..... \$4.59	

VAR Ant Netw'k—1001A 1KW HF
RF New loose coil parts. Worth basic 2' scope kit—Tubes & Power..... **\$8.95**

BC457 XMTA—AS IS. Less Tubes 3.49
 SC858 Modulator—As IS. Less Tubes & Dvt. Only 1.49
 Collins AR-13 5P Amp. Less Tubes 4.50

Basic All-Electronic VTVM Kit—Ultrasens test-er sim RCA Volt Ohmyst Jr. \$19.95
 Basic 2' Scope Kit—Tubes & Power..... 16.95
AMPLIFIER KITS—M-FI PP2A3's
 17.5 watt PP86's or 14W PP86's..... 12.95
 Write for Full Data on Above Amplif. Kits

BASIC FOTOFASH KIT—Complete PWT Supply incl. condns, tubes, xfmr, circ diag, all instructions & FOTOFASH lamp & reflector. For 115V AC. Only \$29.95
 Write for Data on Above & Other Kits

SNOOPERSCOPE INFRARED Image-Converter Tube Sensitively simplif design 2" dia. Willemite screen—Resolution up to 350 lines/inch. Complete data & Tube..... \$10.95

"TAB"

Dept. 3RC, 6 Church St.
New York 6, N. Y., U.S.A.
Worth 2-7230

COMMAND REC.

BC453-1.9-550KC..... \$12.95
 BC454-3.4-MC..... 5.95
 BC455-6.9-1-MC..... 6.95

6 1/2' CONTROL CABLE
for above command sets, \$1.00

APS-13 NEW..... \$17.95
 RS/ARN7 COMPASS REC. Like New..... 17.50
 BC-603 F.M. RECEIVER..... 12.95
 ARB w/controls NEW..... 39.50
 APN-1..... 8.95

ALL EQUIPMENT F.O.B.
WRITE FOR CATALOG
C & H SALES CO., DEPT. B
1850 E. Colorado St. Pasadena 8, Cal.

E-Z TO ASSEMBLE!
Save Money With This
WAR SURPLUS
PHOTO FLASH
KIT!

Offered at fraction of original cost. Simple to assemble. Save many dollars. Comes brand new in its original box complete with z-ray metal finished case, all connectors, relay control, 2 condensers each 8000 volts—light output 100 watt seconds, 4 HIGH SPEED FLASH TUBES—plastic sealed, unbreakable. ALSO 4 reflectors, transformer, connectors, connecting cords, spare parts. After conversion unit operates on battery or on 110 volt A.C. by flick of switch. Complete instructions and diagrams.

Immediate Delivery on all mail orders Complete **\$68**

CINEX, INC., 145 W. 46th St., N. Y. 19, N. Y. Dept. 3

ADVERTISING INDEX

Adson Radio & Electronics Co.	131
Allied Radio Corporation	81
Almo Radio	141
Amerad	119
American Electric Heater Co.	112
American Phenolic Corporation	145
Amperite Company	116
Amplifier Corporation of America	123, 125, 137
Amy, Aceves & King, Inc.	128
Arrow Sales, Inc.	137
Bargain Radio	119
Bell Telephone Laboratories	14
Boland & Boyce, Inc.	136
Brooks Radio Distributing Corp.	135, 141, 143
Buffalo Radio Supply	146
C & H Sales Company	118
Camburn, Inc.	118
Capitol Radio Engineering Institute	8
Certified Television Laboratories	133
Cinex, Inc.	144
Clarkston Corporation	136
Cleveland Institute of Radio Electronics	20
Communications Devices Co.	123
Communications Equipment Co.	139
Coyne Electrical & Radio School	134
DeForest's Training, Inc.	9
Allen B. DuMont Laboratories	Back Cover
Eastern Telephone Co.	128
Electric Associates	144
Electronic Development Company	143
Electronic Research Laboratories	128
Electronic Sales Company	134
Electro Products Laboratories	109
Electro-Voice Manufacturing Co.	102
Espey Manufacturing Co., Inc.	120
Esse Radio Company	10, 11
Fair Radio Sales	139
Feiler Engineering Co.	145
Franklin-Ellis Co.	127
General Electronic Distributing Co.	93, 119
General Test Equipment	134
Greco Radio Distributors	122
Greylock Electronics Supply Co.	120
Haldorson Company	121
Heath Company	86, 87, 88, 89
Hickok Electrical Instrument Co.	133
Instructograph Co.	141
International Resistance Co.	111
Insuline Company	121
JFD Manufacturing Co.	112
Jerrold Electronics Company	136
Manuel Klein Industries	127
Kwikheat Manufacturing Co.	117
Lafayette Concord	117
Lafayette-Pinsold Corp.	17
Lo-Hi Electric Co.	137
Lehigh Television	101
Lectone Radio Corporation	140
Lifetime Sound Equipment Co.	123
McGee Radio Co.	6
McMurdo Silver Company	115
Magnet Wire, Inc.	133
Las J. Meyers Co.	125
Metropolitan Electronic Instrument Co.	124
Micereults Company	143
Mid-America Company	123
Midwest Radio Corporation	116
Mill Radio & Electronics	122
Merk's Radio Shack	138
Murray Hill Books, Inc.	126, 134
National Radio Institute	3
National Schools	5
Newark Radio Company	131
Niagara Radio Supply Company	120, 143
Ohmite Manufacturing Company	4
Opad-Green Company	109
Opportunity Adlets	141
Pacific Electronics	123
Precision Apparatus Company	125
Progressive Electronics Company	130

RADIO SCHOOL DIRECTORY (Pages 142, 143)

American Radio Institute	Milwaukee School of Engineering
Baltimore Technical Institute	RCA Institutes
Candler System Company	Radio Television Institute
Commercial Radio Institute	Tri-State College
Hollywood Sound Institute	Valparaiso Technical Institute
Lincoln Engineering School	YMCA Trade & Technical Schools

Radio City Products Company, Inc.	145
Radio Corporation of America	12, Inside Back Cover
Radio Dealers Supply Company	137
Radio Mail Orders	137
Radio Merchandise Sales	128
Radionic Equipment Company	130
Radio Supply & Engineering Co.	85
Rex Products	133
The Rose Company	137
Salco Kits & Parts Company	135
Senec Radio, Inc.	129
N. Silverstine Company	95
Spartan School of Radio and Electronics	118
Spellman Television Company	140
Sprague Products Company	97
Sprayberry Academy of Radio	7
Superior Instruments	138
Supreme Publications	19
Sylvania Electric Products	103
TAB	144
Tallen Company	144
Technical Radio Parts	124
Technifax	126
Telemarine	119
Televids	135
Television Assembly Company	83
Telex, Inc.	106
Telex, Inc.	125
Transvision, Inc.	Inside Front Cover, 15
United Surplus Materials	132
Universal General Corporation	139
V & H Radio Supply Company	136
Van Nostrand Company, D	13
Ward Products Corporation	18
Wells Sales, Inc.	107, 146

50,000 9 8 7 6 5



**USERS CAN'T
BE WRONG! WITH
THE MODEL 447A
MULTITESTER**

ONLY \$17.95

Over 50,000 of this series of low cost, portable AC-DC Multitester have been purchased—proving its popularity and outstanding value. This new, streamlined version of this popular instrument employs a 3" d'Arsonval type O-I milliammeter which is accurate to 2%. All shunts and multipliers are maintained within 5 per cent accuracy with critical values matched to 1 percent. A new gold plated copper oxide rectifier gives excellent low current density characteristics and splendid frequency response. Comes complete in open face, bench type—solid oak case—natural finish—hammer tone grey and white panel—self contained battery. Size: 5 1/4 x 8 3/4 x 3 1/4 inches—Weight: 2 3/4 pounds.

MODEL 447AP

Same specifications as above—Completely portable—in natural finished oak case with latch and hinged cover and carrying handle. Has tool compartment, includes de luxe test leads—self contained battery. 6 3/4 x 8 3/4 x 4 1/2. Price\$21.95

RANGES

- D.C. Voltmeter: 0/5/50/250/500/2500
- A.C. Voltmeter: 0/10/100/500/1000
- Output Voltmeter: 0/10/100/500/1000
- D.C. Milliammeter: 0/1/10/100/1000
- D.C. Ammeter: 0/1/10
- Ohmmeter: 0/10000/1,000,000 ohms (1 meg.) (10 megs. external)
- Decibel Meter: -8 to +55db

WRITE FOR CATALOGUE NO. 3C

RADIO CITY PRODUCTS CO., INC.

152 WEST 25th ST



NEW YORK 1, N. Y.

FREE

**TO YOU—IF YOU WANT TO LEARN
TO FIX ANY RADIO THIS
NEW SIMPLIFIED WAY**

**HOW TO
GET THE MOST FROM
YOUR RADIO "KNOW-HOW"**

Here is your opportunity to learn all about an amazing new simplified way of fixing any radio. There's nothing complex to learn, no calculating is required. Can be used by beginners or experts. It's as simple as ABC—and quick, too. You can use it on easy or "tough" jobs.

In simple, direct language, this informative 28-page illustrated manual, "The Inside Story" explains why old-fashioned methods actually hamper your servicing ability. It explains why experts have agreed that you can't blame yourself when you're stumped on those extra-tough jobs . . . obsolete servicing methods are preventing you from using your real ability.

So why not find out for yourself how you, too, can take advantage of the remarkable new STETHOSCOPE SERVICING METHOD. You owe it to yourself to get this FREE manual at once. It's chock-full of useful and helpful information, too. Page after page of valuable hints and kinks from the experience of top radio engineers.

**MAIL COUPON OR
PENNY POST CARD
FOR YOUR FREE COPY TODAY**



FEILER ENGINEERING CO., Dept. 3RC9
945 George St., Chicago 14, Illinois

Please RUSH my FREE copy of
"The Inside Story."

Name

Address

City Zone ... State

MARCH, 1949

**AMPHENOL
TV
ANTENNA**

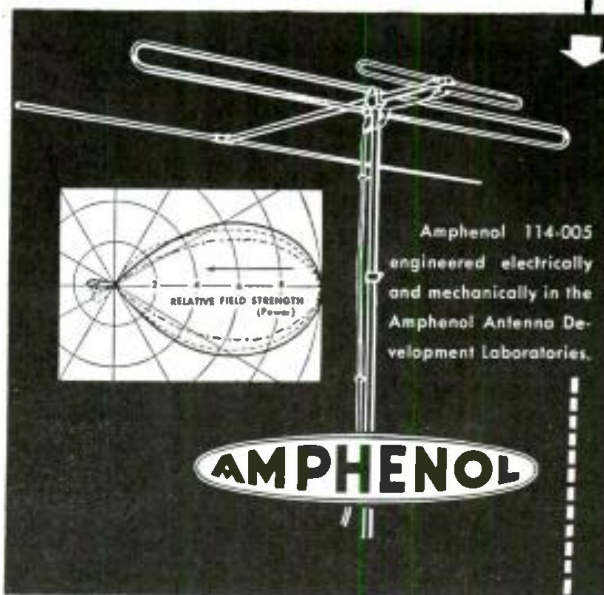

Amphenol 114-005 engineered electrically and mechanically in the Amphenol Antenna Development Laboratories.

Streamlined and scientifically engineered for best reception and optimum gain, the Amphenol 114-005 Television Antenna incorporates two broadbanded folded dipoles and a low band reflector, with a common transmission line. Top performance is provided over all channels in both the high and low bands.

The radiation patterns as diagrammed are substantially unidirectional and maintain high front-to-back and front-to-side ratios over both bands.

The 114-005 is ideal for use with rotators.



**MORE SIGNAL STRENGTH
BRIGHTER PICTURES**

Standard Amphenol TV Antenna in stacked array (Model 114-301 or 114-302) provides additional high-gain for fringe areas. Each bay of the antenna may also be individually oriented in areas requiring reception from different directions.

Amphenol Engineering News, containing latest developments in electronics, will be sent to you on your request.

AMPHENOL

AMERICAN PHENOLIC CORPORATION
1830 SO. 54TH AVENUE • CHICAGO 50, ILLINOIS

Television is Booming—Cash in on it!

RELAYS

FOR EVERY PURPOSE

Over a Million in Stock!

Whether you require large quantities of relays for production runs or single units for laboratory or amateur work, Wells can make immediate delivery and save you a substantial part of the cost.

Our capable engineering staff is prepared to offer assistance in the selection of correct types to suit your exact requirements.

Each relay is brand new, standard make, inspected, individually boxed and fully guaranteed.

The following list represents only a tiny portion of our relay stock. Write or wire us for information on types not shown.

STANDARD DC TELEPHONE RELAYS					
Stock No.	Operating Voltage	Coil Resistance	Contacts	Manufacturer	Net Each
R-101	24V	1500	DPST (NO)	Auto. Elec.	\$1.35
R-102	24V	400	SPDT	Auto. Elec.	1.10
R-103	24V	DUAL-1000	3PST (NO)	Auto. Elec.	1.35
R-105	24V	600	3PST (NO)	Clare	1.20
R-106	24V	1300	3PST (NC)	Clare	1.25
R-152	12V	50	DPDT-SPST (NO)	Guardian	1.10
R-153	12V	200	SPDT-SPST (NO)	Stromberg	1.25
R-154	12V	200	SPST (NO)	Clare	1.20
R-155	12V	100	SPST (4NO4NC)	Auto. Elec.	3.15
R-158	6V	50	4PST (NO)	Stromberg	1.10
R-159	6V	50	DPST (NO)	Stromberg	1.10
R-160	6V	12	3PDT-3PST (NO)	Auto. Elec.	1.05
R-161	6V	10	3PST (2NC-1NO)	Auto. Elec.	.90
R-121	150V	5000	2PST (NO) SPDT	Clare	1.65
R-123	150V	6300	SPST (NO)	Clare	1.75
R-602	150V	6500	3PST (NO)	Clare	1.75
R-515	24V	750	SPST (NO)	Clare	1.20
R-517	12V	250	DPST (NO)	Clare	1.20
R-519	250V	14000	SPDT	Auto. Elec.	1.95
R-520	250V	14000	DPDT	R.B.M.	2.10
R-521	32V	1000	DPDT	Kellogg	1.20
R-166	24V	DUAL-200	DPDT-SPST (NO)	Stromberg	1.59
R-168	24V	DUAL-200	4PST (NO)	Auto. Elec.	1.20
H-240	250-350V	40000	DPST (NO)	Auto. Elec.	2.95
H-241	48V	650	SPDT-SPST (NO)	Clare	1.25

TYPE 18 DC TELEPHONE RELAYS					
Stock No.	Operating Voltage	Coil Resistance	Contacts	Manufacturer	Net Each
R-109	24-48V	4000	SPDT	Auto. Elec.	\$1.50
R-110	24-32V	2500	SPDT	Auto. Elec.	1.50
R-112	90-120V	6500	SPST (NC)	Auto. Elec.	1.75
R-114	24V	500	4PST (NO)	Auto. Elec.	1.30
R-603	24V	400	DPST (NO)	Auto. Elec.	1.25
H-238	150V	150	DPDT-SPST (NC)	R.B.M.	1.25
H-239	24V	180	DPST (NO)	Auto. Elec.	1.25



SEALED DC TELEPHONE RELAYS					
Stock No.	Operating Voltage	Coil Resistance	Contacts	Manufacturer	Net Each
R-125	24V	300	DPDT	Clare	\$2.75
R-126	90-120V	2000	DPDT	Clare	3.00
R-504	24-70V	2800	SPDT	GE-C103C25	3.00

V TYPE DC TELEPHONE RELAYS					
Stock No.	Operating Voltage	Coil Resistance	Contacts	Manufacturer	Net Each
R-164	24V	1000	SPST (NO)	W. E.	\$1.20
R-512	24-48V	3500	DPST (NO)	W. E.	1.30
R-513	12-24V	500	DPDT-SPST (NC)	W. E.	1.20
R-514	4-6V	60	SPDT	W. E.	1.05
R-526	6V	35	DPDT-SPST (INC-1NO)	W. E.	1.05

AC-STANDARD TELEPHONE RELAYS					
Stock No.	Operating Voltage	Coil Resistance	Contacts	Manufacturer	Net Each
R-212	90-135V	—	NONE	Clare	\$0.95
R-213	5-8V	—	DPST (NO)	Clare	1.50
R-605	24V	—	3PST (NO)	Auto. Elec.	.95
R-606	24V	—	DPST (1NO-1NC)	Auto. Elec.	.95
R-607	24V	—	SPST (NO)	Auto. Elec.	.95



DIRECT CURRENT WIDGET RELAYS

Stock No.	Operating Voltage	Coil Resistance	Contacts	Manufacturer	Net Each
R-132	24V	300	DPDT	Clare	\$1.20
R-133	24V	300	NONE	Clare	.60
R-134	24V	250	4PDT	Clare	1.20
R-135	24V	300	SPST (NC)	Clare	1.15
R-137	24V	300	SPDT	Clare	1.15
R-138	24V	300	4PST (NO)	Clare	1.15
R-139	24V	200	4PDT	Clare	1.15
R-140	24V	280	SPDT	R.B.M.	1.15
R-141	24V	280	3PST (NO)	R.B.M.	1.15
R-142	24V	400	DPDT	Allied Cont.	1.20
R-143	24V	280	SPST (NO)	R.B.M.	1.15
R-144	24V	250	SPST (NO)	Allied Cont.	1.15
R-145	24V	300	DPST (NO)	Allied Cont.	1.15
R-146	12V	126	DPST (1NO) (1NC)	Clare	1.10
R-147	9-14V	75	SPDT	Guardian	1.05
R-148	12V	100	DPDT-SPST (NC)	Price Bros.	1.15
R-149	6-8V	45	SPST (NC)	Clare	1.00
R-150	6V	30	SPST (NO)	E-Z Elec.	.95
R-522	2-6V	2	SPST (NO)	R.B.M.	.65
R-523	90-125V	6500	DPDT	Clare	1.90
R-222	12V	100	DPST (NO)	P & B	1.20
H-242	24-32V	300	DPDT	W. E.	1.20
H-243	24-32V	300	4PDT	R.B.M.	1.20



SENSITIVE DC RELAYS

Stock No.	Operating Voltage	Coil Resistance	Contacts	Manufacturer	Net Each
R-218	4-6V	1800	SPDT	Kurman 220C	\$1.95
R-220	75V	5000	SPDT	Allied Cont.	1.20
R-221	18-24V	5000	SPST (NO)	Allied Cont.	1.15
R-174	250V	5000	G.M.	G.M.	1.85
R-175	350V	11000	DPDT-SPST (NO)	G.M.	2.95
R-176	24V	250	DPST (NO)	G.M.	1.50
R-177	24V	800	4PDT	G.M.	1.65
R-500	8-12V	5000	SPDT	S-Dunn-MS	2.10
R-507	24-48V	1000	SPDT-SPST (NC)	Guardian	1.15

TYPE 60 DC RELAYS					
Stock No.	Operating Voltage	Coil Resistance	Contacts	Manufacturer	Net Each
R-169	24V	250	SPST (NO)	Allied Cont.	\$1.95
R-171	24V	230	DPDT	Allied Cont.	2.15
R-172	5-8V	30	DPDT-SPST (NO)	Allied Cont.	1.70
R-173	6V	5	Allied Cont.	Allied Cont.	1.25
R-529	24-48V	1000	DPDT	Allied Cont.	2.50

TYPE BJ DC RELAYS					
Stock No.	Operating Voltage	Coil Resistance	Contacts	Manufacturer	Net Each
R-204	12V	65	DPST (NO)	Allied Cont.	\$1.15
R-205	24V	260	DPST (NO)	Allied Cont.	1.25
R-224	12V	75	SPST (NO)	Allied Cont.	1.15
H-237	27V	230	DPDT	Allied Cont.	1.25

HEAVY DUTY KEYING RELAYS					
Stock No.	Operating Voltage	Coil Resistance	Contacts	Manufacturer	Net Each
R-248	28V DC	150	SPST (NO) 10A	Guard. 36471	\$1.05
R-244	75V AC	265	SPST (NO) 20A	Leach 1327	1.75
R-206	24V DC	150	SPDT-3 AMP	P&B-KL	1.20
R-207	24V DC	210	4PDT-3 AMP	P&B-KL	1.10
R-219	50V DC	1500	DPST (NO) 15A	P&B-S-P	1.25
R-217	115 AC	600	SPDT-10 AMP	St. Dunn 1XAX2.25	1.25
R-525	24V DC	200	DPDT-10 AMP	Guard 34464	1.25
R-508	110 AC	600	SPDT-6 AMP	Guard 37189	1.95
R-506	24 V DC	300	DPST (NO) 6A	—	.95
R-510	24 V DC	200	3PDT-10 AMP	Guard 516983	1.95
R-604	24 V DC	200	SPST (NO) 30A	St. Dunn-B2A	1.25
H-608	115 AC	—	SPST (NO) 20A	St. Dunn-1MX2.25	1.25
R-620	12V DC	35	3PST (NO) 10A	Guard-BK2	1.05
R-223	28V DC	150	SPST (NO) 40A	Price Bros.	1.35
H-230	12-24V DC	80	DPST (NO) 10A	—	1.20
H-231	24V	230	DPST (NO) 5A	R.B.M.	1.15

DC-TYPE 76 ROTARY RELAYS					
Stock No.	Operating Voltage	Coil Resistance	Contacts	Manufacturer	Net Each
R-197	9-16V	70	DPDT	Price Bros.	\$1.65
R-198	9-16V	125	6PST (3NO) (3NC) SPDT	Price Bros.	1.65
R-199	24-32V	250	SPDT-SPST (NC)	Price Bros.	1.65
R-200	24-32V	275	3PDT-SPST (NC)	Price Bros.	1.65
R-201	24-32V	250	DPST (NO) SPDT (NC) DPDT	Price Bros.	1.65
R-601	9-14V	60	3PST (NO)	Price Bros.	1.65



DIRECT CURRENT KEYING RELAYS

Stock No.	Operating Voltage	Coil Resistance	Contacts	Manufacturer	Net Each
R-190	12V	65	DPDT 10 AMP	Advance Elec.	\$1.15
R-191	28V	125	DPDT 10 AMP	Guardian	1.20
R-192	12V	44	3PDT 10 AMP	Allied Cont.	1.35
R-193	5-8V	11	DPDT 10 AMP	Leach	1.05
R-194	24V	265	SPST (NO) 10AMP	Leach	1.15
R-195	6V	32	DPDT 3 AMP	G.E.Co.	1.15
R-196	12V	50	DPST (NO) 30A	Leach	1.15
R-242	24V	170	SPST (NC) SPDT 2 AMP	Guardian	1.15
H-236	5-8V	18.5	SPDT 10 AMP	Type 12530EW	1.25

CUTLER HAMMER HEAVY DUTY CONTACTORS



Stock No.	Operating Voltage	Coil Resistance	Contacts	Manufacturer	Net Each
R-178	24V DC	100	SPST (NO) 100A	6141H36A	\$3.85
R-179	6V DC	6.5	SPST (NO) 50A	6041H36A	3.00
R-180	12V DC	25	SPST (NO) 50A	6041H38	3.25
R-181	24V DC	65	SPST (NO) 100A	6041H38	3.85
H-232	24V	55	SPST (NO) 50A	Metal Cased	3.25
H-233	6V	15	SPST (NO) 50A	Metal Cased	3.15
H-235	24V	70	SPST (NO) 100A	Type B6	3.85

DIRECT CURRENT AIRCRAFT CONTACTORS					
Stock No.	Operating Voltage	Coil Resistance	Contacts	Manufacturer	Net Each
R-182	28V	80	SPST (NO) 25 A	Guardian	\$1.85
R-183	24V	60	SPST (NO) 50 A	Allen Bradley	2.75
R-184	28V	50	SPST (NO) 100A	General Elec.	2.95
R-185	24V	100	SPST (NO) 50 A	Leach 5055SEC	2.75
R-186	24V	132	SPST (NO) 50 A	Leach 7220-3-24350	2.95
R-187	24V	100	SPST (NO) 50 A	Allen Bradley	2.95
R-188	24V	200	SPST (NO) 75 A	Allied Cont.	2.95
H-234	14V	45	SPST (NO) 30 A	—	1.65

ANTENNA CHANGEOVER RELAYS					
Stock No.	Operating Voltage	Coil Resistance	Contacts	Manufacturer	Net Each
R-192	6-12V DC	44	2PDT 10 AMP	Allied-NB5	\$1.35
R-231	12VDC	100	DPDT 6 AMP	G. E.	1.95
R-256	24-32V DC	—	SPDT-SPST (NC)	—	1.45
R-501	110 AC	4	1KW DPDT (1KW)	Guardian	2.45
R-503	12-32V DC	100	SPDT-5PST	G. E. 500 W	1.95

COMBINATION PUSH BUTTON AND REMOTE RELAY					
Stock No.	Operating Voltage	Coil Resistance	Contacts	Manufacturer	Net Each
H-244	12-24V DC	Dual-60	SPDT	CR2791-R106C8	\$1.65

ADJUSTABLE TIME DELAY RELAY					
Stock No.	Operating Voltage	Coil Resistance	Contacts	Manufacturer	Net Each
R-246	115 AC	—	SPST (NO) or (NC) 10 AMPS	R. W. Cramer	\$8.95

DC MECHANICAL ACTION RELAYS					
Stock No.	Operating Voltage	Coil Resistance	Contacts	Manufacturer	Net Each
R-245	12V	25	4 Lever	G.M.	\$0.95
R-527	6-12V	200	2 Lever	—	.95

TYPE C.M.S. RELAY					
Stock No.	Operating Voltage	Coil Resistance	Contacts	Manufacturer	Net Each
R-511	24V DC	200	MICRO-SW SPST (NO)	Clare	\$2.45

DC CURRENT REGULATOR					
Stock No.	Operating Voltage	Coil Resistance	Contacts	Manufacturer	Net Each
R-509	6-12V DC	40	SPST (NC)	G. E.	\$0.85

LATCH AND RESET RELAY					
Stock No.	Operating Voltage	Coil Resistance	Contacts	Manufacturer	Net Each
R-500	12V DC	10	DPDT-10 AMP	St. Dunn-CX-3190B	\$2.85

DC-ROTARY STEP RELAY					
Stock No.	Operating Voltage	Coil Resistance	Contacts	Manufacturer	Net Each
R-621	6-12V	30	3 POLE 23 POSITION	W. E.	\$10.95

DC-RACHET RELAY					
Stock No.	Operating Voltage	Coil Resistance	Contacts	Manufacturer	Net Each
R-230	5-8V	2	SPDT-DPST (NO)	Guardian	\$2.15

Special Sample Engineering Offer
Any ten relays listed (one of each type) with the exception of Stock Nos. R-621 and R-246—only \$10.00.

ORDER DIRECTLY FROM THIS AD OR THROUGH YOUR LOCAL PARTS JOBBER
Manufacturers: Write For Quantity Prices.
Distributors: Write For The New Wells Jobber Manual.



Mercury, "messenger of the gods," was slow compared with Ultrafax—which moves at the speed of light.

This messenger delivers a million words a minute

Recently, at the Library of Congress, a distinguished audience saw documents flashed across Washington by a new means of communication . . . and reproduced *in facsimile*.

This was Ultrafax in action—a super-fast television communications system developed at RCA Laboratories. Reproductions of *any* mail—personal, business, or military . . . including police descriptions, fingerprints, bank drafts, government records—can travel at 186,000 miles a second!

Material to be sent is placed before an RCA "flying spot" scanner, and transmitted by ultra-high frequency radio signals. Miles away the pictures appear on a picture tube and are photographed. Negatives are ready for printing or projection in 40 seconds.

Eventually, when Ultrafax comes into commercial use, a complete Sunday paper—every word, every picture—may cross America in 60 seconds . . . a letter in the twinkling of an eye.

Science at work . . .

Ultrafax is but *one* of scores of major achievements pioneered at RCA Laboratories. This leadership in science and engineering adds *value beyond price* to any product or service of RCA and RCA Victor.

Examples of the newest developments in radio, television, and electronics may be seen in action at RCA Exhibition Hall, 36 West 49th Street, N. Y. Admission is free. Radio Corporation of America, Radio City, N. Y. 20.



RADIO CORPORATION of AMERICA

World Leader in Radio—First in Television

★
There is one name in every field...

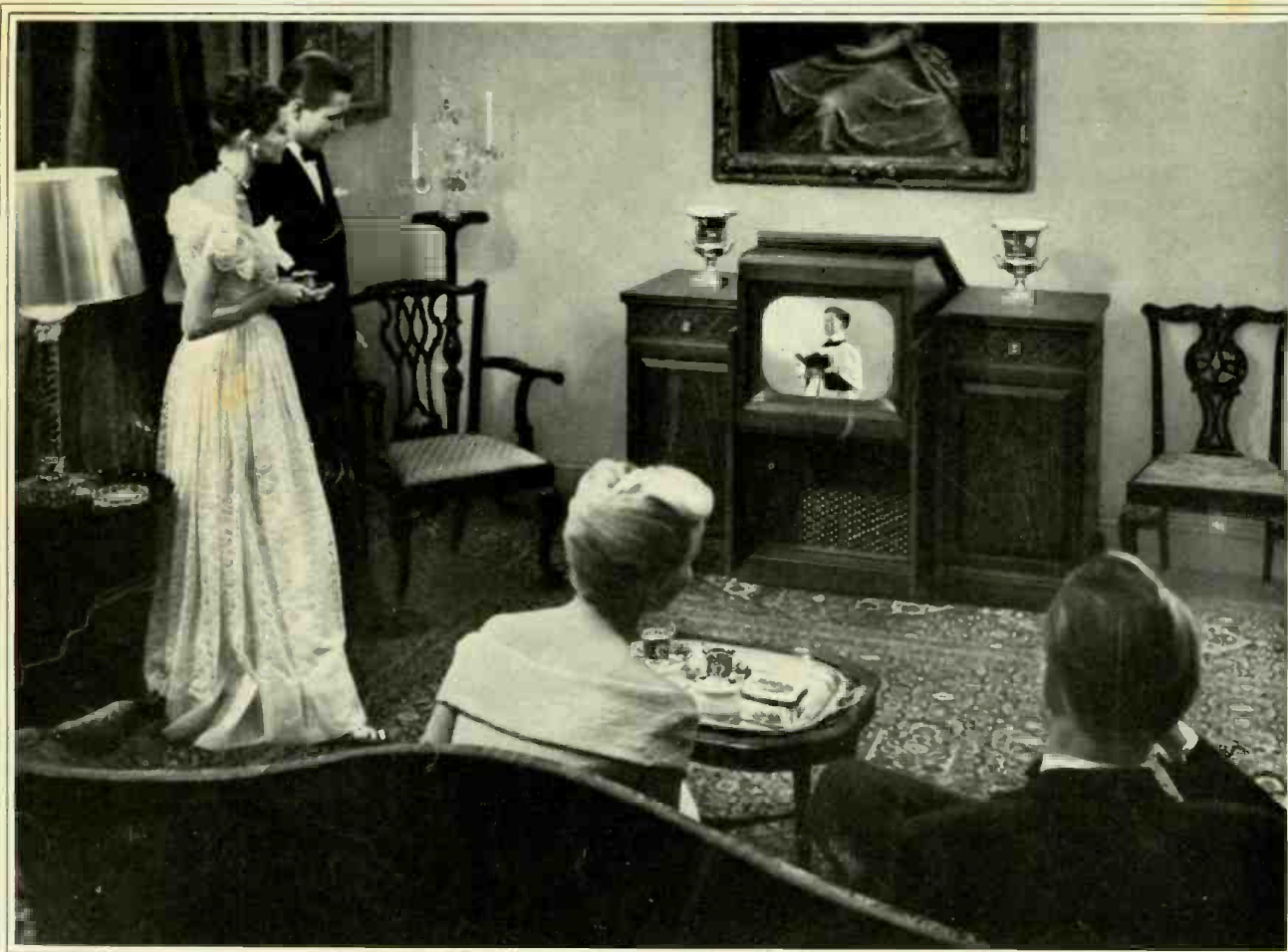

*that carries acknowledged
leadership and unchallenged prestige.*

In television receivers

that name is— **DU MONT**

Illustrated: the Du Mont Westminster with the world's largest direct-view screen (213 sq. in.), AM, FM and shortwave radio, record player and album storage space.