

Wireless Technologies



V7.0

Cellular, GNSS, RFID,
Short- & Long Range Wireless Solutions

Content

Introduction/Linecard	3
GSM	4 – 13
Cellular Modules	6 – 7
Cellular Data Cards	8
5G Solutions	9 – 10
IoT Terminals	11
Selection Guide	12 – 13
LPWAN	14 – 23
Dual Radio Devices	15
Unlicensed Modules	16
Licensed Modules	17 – 18
LPWAN Modules with DECT NR+ Protocols	19 – 21
Selection Guide	22 – 23
GNSS	24 – 31
GNSS Wireless Modules	25 – 28
Gateway Solutions	29
Selection Guide	30 – 31
UWB	32 – 35
Selection Guide	32 – 33
UWB Modules	33 – 35
WLAN	36 – 51
Dual Band Wi-Fi ICs	38
WiFi 6E Modules	39
Multi Band Wi-Fi Modules	40 – 44
Dual and Tri band Wi-Fi Modules & Cards	45
Selection Guide	46 – 51

Bluetooth®	52 – 69
Bluetooth® Low Energy SoCs	54 – 56
Bluetooth® Low Energy Modules	57 – 60
AIROC™ Bluetooth® and Bluetooth® Low Energy	61 – 62
Bluetooth® SDK with ModusToolbox™ Software	63
Selection Guide	64 – 69
ISM	70 – 73
Wireless Control Receiver ICs	71
Selection Guide	72 – 73
RFID/NFC	74 – 81
RFID Modules, Readers & Passive Transponders	76 – 77
Selection Guide	78 – 81
Protocols	82 – 83
Wireless Protocols / Proprietary Protocols	82 – 83
Antennas	84 – 93
Active Antenna Band Switching	84
Next-Gen IoT Connectivity with DECT NR+	85
Embedded Antennas	86 – 89
Internal Antennas	90 – 91
External Antennas	92 – 93
Security	94 – 107
Energy Harvesting	108 – 109
Power Management IC	110
Range Extender	111

Our Product Portfolio

- Semiconductors
- Boards & Systems
- Passive Components
- Storage Technologies
- Electromechanical Components
- Wireless Technologies
- Displays & Monitors

Our Initiatives

- RUTRONIK IT ELECTRONICS
- RUTRONIK SOLUTIONS
- RUTRONIK AUTOMOTIVE
- RUTRONIK EMBEDDED
- RUTRONIK POWER
- RUTRONIK SMART

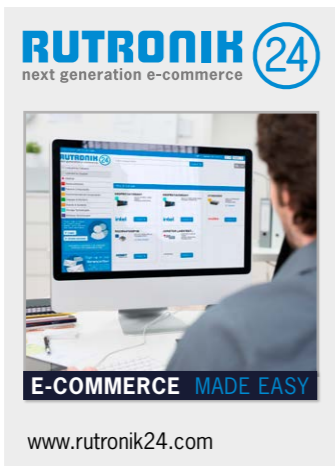

Committed to excellence

Consult – Know-how. Built-in.

The Technical Competence from RUTRONIK
Worldwide and individual consulting on the spot by competent sales staff, application engineers & product specialists.

Components – Variety. Built-in.

The Product Portfolio from RUTRONIK
Wide product range of semiconductors, passive and electromechanical components, displays & monitors, boards & systems, storage and wireless technologies for optimum coverage of your needs.

Logistics – Reliability. Built-in.

The Delivery Service from RUTRONIK
Innovative and flexible solutions: from supply chain management to individual logistics systems.

Quality – Security. Built-in.

Quality without Compromise from RUTRONIK
The integrated management system (IMS) encompasses quality control, information security, environmental protection, occupational health and safety.



Wireless Technologies Portfolio

Offering a product range that is unrivalled in breadth and depth, Rutronik is established as one of the largest independent global distributors with a very strong focus and technical support on wireless products. Our unique product portfolio is complemented by well-trained engineers based around the globe as well as in the wireless competence center tailored to almost all customer requirements.



Wireless Technologies	2J Antennas	Advantech	ASUS	CHINMORE	EnOcean (Dolphin)	FUJITSU	GARMIN	GIANTEC SEMI-CONDUCTOR	GNS	GradConn	iDTRONIC	Infineon Technologies	Insight SIP	Intel	iVativ	Ethertronics AVX	Mineew	Molex	Murata	NORDIC Semiconductor	Panasonic	Pulse	a YAGEO company	ROHM SEMICONDUCTOR	SILEX	TDK	TELIC	TELT	Unicore	YAGEO
Bluetooth																														
Bluetooth Classic Modules						X																								
Bluetooth LE (Low Energy) Modules					X	X	X						X	X	X	X				X	X	X		X	X	X	X			
Bluetooth Dual Mode Modules					X	X							X							X										
Bluetooth Dual Mode System on Chips					X								X							X										
Bluetooth LE (Low Energy) System on Chips					X								X							X										
Bluetooth devices (Beacons, Key Finder, Dongles etc.)			X		X								X	X	X	X														
GSM/GPRS/UMTS/LTE/NB-IoT/5G																														
Modules																														
Cards		X																		X	X							X	X	
Terminals		X																								X	X			
With integrated GPS		X																								X	X			
SIM-Card Connectivity		X																								X	X			
GNSS																														
GPS/GNSS Modules									X								X	X									X	X		
GPS/GNSS Cards		X																												
GPS/GNSS Chips												X																X	X	
Ultra High Precision																											X	X		
Modules with integrated Antenna		X							X																		X	X		
Proprietary Wireless																														
Receiver Chips												X																		
Transceiver Modules				X		X							X				X				X									
Transceiver Chips												X									X									
Transmitter Chips												X									X									
Gateway Solution		X										X									X									
USB Sticks				X		X												X			X									
Long Range Wide Area Network																														
LoRa		X											X	X	X	X	X			X										
Sigfox																														
RFID/NFC																														
Passive Reader Modules						X		X		X															X					
Passive Transponder Chips								X												X										
Passive Transponder Devices								X		X										X										
Passive Reader Chips								X												X										
NFC Pairing Chip						X							X				X	X	X											
Hardware Security Solutions																														
Authentication												X																		
Trusted Computing												X																		
ZigBee™																														
System on Chips												X								X										
Modules						X	X	X					X	X	X	X	X			X				X	X		X			
WIFI																														
Modules WiFi a/b/g/n/ac						X							X	X	X				X	X	X		X	X		X	X			
Modules WiFi 6 (ax)													X	X				X	X	X		X	X		X	X				
Modules SubGHz-WiFi (ah)																														
Cards WiFi a/b/g/n/ac		X											X	X																
Cards WiFi 6 (ax)													X																	
Chips WiFi a/b/g/n/ac/ax												X							X	X										
Access Points / Gateways / Routers		X	X													X	X								X					
Accessories																														
Adapter Cables	X	X								X																				
Antennas (internal)	X			X												X			X				X						X	
Antennas (external)	X			X												X			X				X						X	
Antennas (surface mounted)	X			X												X			X				X						X	
SIM-card Holders										X						X			X											
Energy Harvester						X																								
Special Wireless Technologies																														
ADS-B										X																				
TMC										X																				
UWB																														
Modules														X			X	X												





Cellular Wireless Technologies

Cellular technologies play a crucial role in today's connected world and enable wireless communication over long distances. LTE (4G) and 5G are two advanced cellular standards that offer high data transfer speeds and reliable connectivity. LTE is currently widely used and enables fast internet on mobile devices such as smartphones and tablets. 5G, on the other hand, promises even faster speeds, lower latency and higher capacity, which forms the basis for future technologies such as the Internet of Things (IoT) and autonomous vehicles. These technologies have applications in various sectors such as telecommunications, healthcare, transportation and industry. With the continuous development and implementation of LTE and 5G, we will see even more innovative applications and services in the future.

How does cellular wireless technology work?

Cellular wireless technology enables wireless communication between mobile devices and networks. Signals are transmitted via radio waves to establish a connection. With the imminent shutdown of 2G and 3G networks, the importance of 4G and 5G technologies is increasingly coming into focus. While 4G is already widespread and used by a large user base, 5G is still being developed, but offers significantly faster transmission rates and lower latency times. Current figures show that over 60% of mobile users worldwide already use 4G technology, while the use of 5G is continuously increasing. According to forecasts, the majority of mobile connections will be based on 5G by 2025. It is important to note that both 4G and 5G technologies will exist in parallel to cover different requirements and usage scenarios. The future of cellular wireless technology therefore promises even faster and more reliable mobile communication for users worldwide.

LTE

LTE (Long Term Evolution) is a widely used mobile technology that offers high data rates and low latency. It is mainly used for broadband access and the transmission of multimedia content.

LTE Cat M1 (eMTC) is a variant of LTE that was specially developed for the Internet of Things (IoT). This technology is particularly suitable for applications such as smart metering, asset tracking and wearables that require reliable and energy-efficient wireless communication.

LTE NB1 (NB-IoT) is another variant of LTE that is optimized for Low-Power Wide Area Networks (LPWAN). It is ideal for IoT applications with low data volume and low bandwidth, such as smart parking lot systems, environmental sensors and remote monitoring systems. Each of these technologies offers specific benefits and use cases that enable companies to develop customized solutions for their IoT projects, increasing efficiency and opening up new business opportunities.

5G

5G is the current cellular communication system generation. With IoT-enabled devices in mind, 5G connects a higher density of devices at higher speeds and makes things lag nearly non-existent. As a result, 5G creates an excellent user experience irrespective of what application, device or service you touch. As adoption grows, they will evolve and use public and private networks to stream virtual and augmented reality and 3D video (which requires high bandwidth).

Moreover, 5G applications will be used for critical communications like factory automation, uncrewed aerial vehicles (UAVs) and more. 5G IoT will improve everyday life from personal applications to changing how we work and live. With 5G IoT, facilities will continue improving to send critical upgrades to networks without freezing functionality or overloading servers.

Previously, the focus on 5G has been primarily on its remarkable speed and minimal latency. However, the truth is that 5G represents a novel and costly technology that remains inaccessible for numerous IoT applications, even in areas with coverage.

5G RedCap

5G RedCap (Reduced Capacity) emerges as a potential solution to this challenge, offering a compromise by providing some of the speed and low latency benefits of full-fledged 5G at a significantly lower cost.

The technology is tailored for use cases where ultra-low latency isn't critical, but a decent level of data transfer speed is necessary to support the requirements of advanced applications in the future with throughput rates of 150Mbps for downloads and 50Mbps for uploads. It finds utility in applications such as wireless industrial sensors, video surveillance systems, and smart wearable devices.

LTE

Technology	Description	Performance Data
LTE & LTE-Advanced Long Term Evolution & Long Term Evolution-Advanced	<ul style="list-style-type: none"> Long Term Evolution (LTE) is a 4G wireless broadband technology Technology was named "Long Term Evolution" because it represents the next step (4G) in a progression from GSM, a 2G standard, to UMTS, the 3G technologies based upon GSM LTE-Advanced (Long Term Evolution-Advanced) is a cellular networking standard that offers higher throughput than its predecessors 	<ul style="list-style-type: none"> LTE provides significantly increased peak data rates: 100 Mbps downstream and 30 Mbps upstream, reduced latency, scalable bandwidth capacity, and backwards compatibility with existing GSM and UMTS technology. LTE Advanced can deliver up to 1 GB per second of data, which has to be compared to a maximum of 300 MB per second over LTE networks. LTE-Advanced networks use multiple-input, multiple-output (MIMO) technology
LTE Cat 1 LTE Cat M1 LTE NB1 / NB-IoT LTE Cat 1 bis	<ul style="list-style-type: none"> IoT Focused, Lower Cost, Smaller Size, Reduced Power, Lower Data Speeds LTE Lower Categories are Low Power Wide Area Networks (LPWANs) radio technology standards developed to enable a wide range of devices and services to be connected using cellular telecommunication band LTE Cat1 bis is evolved version of the LTE Cat 1 standard & represents a significant advancement in mobile communication for IoT and M2M applications The distinctive feature of LTE Cat 1 bis is its support for a single antenna design for IoT devices and enables IoT device manufacturers to streamline their designs and reduce costs while still benefiting from the capabilities of LTE Cat 1 	<ul style="list-style-type: none"> LTE Cat 1 provides a downlink peak rate of 10 Mbps and 5 Mbps upstream LTE Cat M1 provides a downlink and upstream peak rate of 1 Mbps LTE NB1 provides 250 Kbps as downlink peak rate up to 20-250 Kbps as uplink peak rate LTE Cat 1 bis technology is recognized for its higher data rates compared to conventional LPWAN technologies. It provides downlink speeds of up to 10 Mbit/s and uplink speeds of up to 5 Mbit/s, thereby offering similar data rates to LTE Cat 1
5G 5G RedCap	<ul style="list-style-type: none"> 5G is the fifth generation of wireless technology Promises to offer faster speeds, lower latency and more reliable connections than its predecessors Huge variety of advanced technologies like millimeter wave-frequencies, massive MIMO and beamforming 5G RedCap is suitable for applications which involve simpler and lower-cost IoT devices such as sensors and actuators that send small packets of information continuously and require a long battery life 	<ul style="list-style-type: none"> Faster speed with a peak download speed of up to 20Gbps Lower latency Improved reliability: 5G uses advanced technologies like beamforming and massive MIMO to improve the reliability 5G RedCap delivers throughput of 150Mbps downlink and 50 Mbps uplink





Cellular Modules

Cellular Modules



xE910 Family – Unified Form Factor (UFF) and Family Concept

Telit Cinterion xE910 Unified Form Factor Family is comprised of 4G, 5G, 3GPP and 3GPP2 high category as well as LTE Cat. M1 / NB-IoT products. All products share a common LGA form factor of 28.2 x 28.2 x 2.2 mm and have same electrical and programming interfaces which allows developers to implement a "design once, use anywhere" strategy.

Product Group	Description	Cellular Technology	Bands	Typical Applications	GNSS
ME910G1	<ul style="list-style-type: none"> The ME910G1 is the Category M1/NB2 evolution of the Telit Cinterion xE910 family, specified in the approved Release 14 of the 3GPP standard Cat M1/NB2 devices are specifically tailored for low-data throughput IoT applications for optimized power consumption and enhances quality of coverage Supports the Power Saving Mode (PSM) and the extended Discontinuous Reception (eDRX), for longer battery operation 	4G (LTE Cat M1 / NB2) 2G (for EU & WW Version)	Worldwide	<ul style="list-style-type: none"> Cat M1/NB2 devices are specifically tailored for IoT applications, offering optimized power consumption and enhanced coverage The ME910G1 helps increase the addressable market for LTE technology to include a broad range of new applications and use cases best served with lower maximum data rate, ultra-low power, reduced complexity and costs Smart meters, industrial sensors, healthcare monitors, home automation, asset tracker and many more low data rate IoT devices 	Embedded GNSS non concurrent with cellular
LE910 (C1)/(C4)	<ul style="list-style-type: none"> The LE910x series, available as Linux and ThreadX variant is optimized for LTE low category networks Modules are available in single mode and 3G/2G fallback options In addition to VoLTE support, the LE910 Cat 1 series are swappable with other modules in the xE910 family 	4G LTE Cat 1 4G LTE Cat 4	EMEA, North America, APAC, LATAM	<ul style="list-style-type: none"> Ideal platform for IoT applications, mobile data and computing devices Applications requiring lower data rates 	Embedded GNSS non concurrent with cellular
LE910R1	The LE910R1 module is a cost-optimized LTE Cat1 bis module, supporting 2G fallback as well as VoLTE. It allows a smooth migration from 2G and 3G networks and offers a higher performance compared to Cat M1 and NB-IoT with respect to data rate, latency, mobility and voice support	LTE Cat 1 bis	EU, EMEA, APAC	<ul style="list-style-type: none"> Ideal for IoT applications, using a single antenna. Besides it's suitable for areas where cellular LPWA aren't yet activated. 	Optional GNSS
LE910Q1	The LE910Q1 module is designed for industrial use and offers a cost-effective solution for connecting IoT devices. Compliant with 3GPP release (Rel) 13 LTE Cat 1 bis standards	LTE Cat 1 bis	Global and North America variants	Ideal for various applications requiring data transmission, such as asset tracking, vehicle telematics and remote monitoring and security panels	Optional GNSS
FE910C04	The FE910C04 module facilitates mid-speed 5G connectivity through the latest 4GPP release 17 Redcap technology. Its robust design	5G Rel 17 + LTE Cat 4	Global, North America and EMEA	Ideal for applications such as video surveillance and monitoring, industrial routers and gateways, EV charging infrastructure and machine telematics	Embedded GNSS non concurrent with cellular



xE310 Family – Ultra Small Formfactor for Telit LTE-M & NB-IoT Solutions

The Telit Cinterion xE310 Unified Form Factor Family for miniature IoT modules includes pin-to-pin compatible options such as Cat M1/NB2 modules. The compact xE310 family presents significant business and technical advantages for OEMs, integrators, and IoT device developers seeking low-power, cost-effective, and space-efficient solutions to propel their digital transformation endeavors throughout their operations.

Product Group	Description	Cellular Technology	Coverage	Typical Applications	GNSS
ME310M1-W1	The ME310M1 LGA module with ultra-low, best-in-class power consumption represents the latest advancement within xE310 product line, tailored for modern IoT deployments. It facilitates secure and efficient connectivity for IoT applications with minimal data requirements and includes Power Saving Mode (PSM) and extended Discontinuous Reception (eDRX), prolonging battery life of connected devices. It complies with 3GPP release 14 standards and is poised for future upgrades to Release 15, 16, and 17.	LTE Cat M1/NB2	Global	The module boasts an arrange of features that makes it ideal for device OEMs, systems integrators and enterprises, including utilities that need to extend the service life of their IoT devices. Ideal for applications such as smart metering, asset tracking, e-Health and smart agriculture as well as for medical devices and wearables	Embedded GNSS and Wi-Fi scan for outdoor and indoor positioning, non concurrent with cellular, In future: ME310M1-W3 concurrent with cellular
ME310G1-WW	ME310G1 is specifically designed for Cat M1/NB2 applications, tailored for low-data throughput IoT applications, delivering optimized power efficiency and enhanced coverage quality. Power Saving Mode (PSM) and extended Discontinuous Reception (eDRX), enables devices to intermittently wake up, transmit small data packets, and promptly return to a low-power sleep mode, conserving energy effectively.	LTE Cat M1/NB2 Optional 2G fallback	Global ME310G1-W2 supporting 410 and 450 MHz bands for metering applications	The ME310G1 empowers businesses to implement compact designs across various domains such as asset tracking, healthcare monitoring, smart metering, portable devices, industrial sensors, home automation, and numerous others. These applications leverage the module's low-power and low-data rate features to their advantage.	Embedded GNSS non concurrent with cellular
NE310L2-WW	Featuring a compact form factor and exceptionally low power usage, the NE310L2 is tailored for low-data throughput IoT applications and delivers optimized power efficiency and superior coverage quality. It creates new IoT-enabled business models by tackling connectivity and battery longevity concerns, catering to the needs of OEMs, integrators, and device developers aiming to expand data collection capabilities from their operations and clientele via IoT devices	LTE Cat NB2 Optional 2G fallback	Global	NE310L2 empowers businesses to roll out innovative, compact designs across a multitude of application domains, encompassing smart metering, healthcare monitoring, home automation, industrial sensors, smart agriculture, asset tracking, portable devices	No

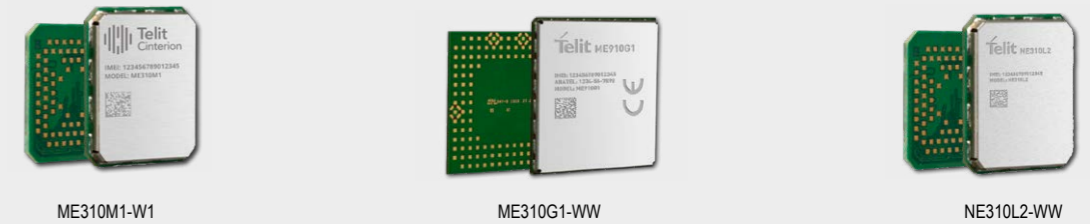

Product Group	Description	Cellular Technology	Coverage	Typical Applications	GNSS
TN23	The TN23 IoT module designed with a compact form factor ("Things" footprint of 15 x 15mm), simplifies the creation of small, battery-powered LPWA cellular devices. Its unique architecture allows the flexibility to run applications with a host processor or inside the module itself using the integrated processor dedicated to customer application for on-board processing, optimizing size and costs. TN23 supports optimized 3GPP power modes PSM and eDRX revolutionizing design possibilities for battery-operated cellular devices.	LTE Cat. NB1/NB2	Global	Ideal for small payment terminals, connected sensors, track and trace solutions, metering application, monitoring for smart homes, cities and agriculture	No
TX62/82	Cinterion TX62/82 IoT modules with "things" footprint have been engineered to deliver global LPWAN LTE connectivity from a single SKU. They support optimized 3GPP power modes PSM and eDRX designed for battery-operated cellular devices. The devices feature an integrated processor with Real-Time Operating System (RTOS) enabling hostels architecture with an SDK to build and run the entire application on the small feature-packed module.	LTE Cat. M1/NB1/NB2 TX82 with 2G fallback	Global	Ideal for applications such as small payment terminals, connected sensors, monitoring for smart homes, cities and agriculture	Optional GNSS
EXS62/EXS82	The EXS62/62 IoT wireless module platform spearheads the transition from LTE to 5G, facilitating LPWA connectivity for countless new industrial applications, offering worldwide LTE-M and NB-IoT connectivity, with the option for 2G fallback and support for emerging 5G advancements. Providing a variety of efficient IoT-optimized data speeds, the platform is well-suited for compact, battery-operated devices situated in remote areas.	LTE Cat. M/NB/2G	Global	Ideal for smart meters, asset trackers to healthcare applications, wearables, and solutions for smart cities	Optional GNSS
PLS83	Provides a high-speed global IoT connectivity delivering 18 Band LTE Cat.4 with 2G/3G fallback. It's suitable for applications that require high bandwidth plus longevity and stability of LTE networks	LTE Cat 1 / Cat 4	Global	Ideal for IoT applications such as transportation, industrial automation, gateways, security panels, telematics and asset tracking	Optional GNSS

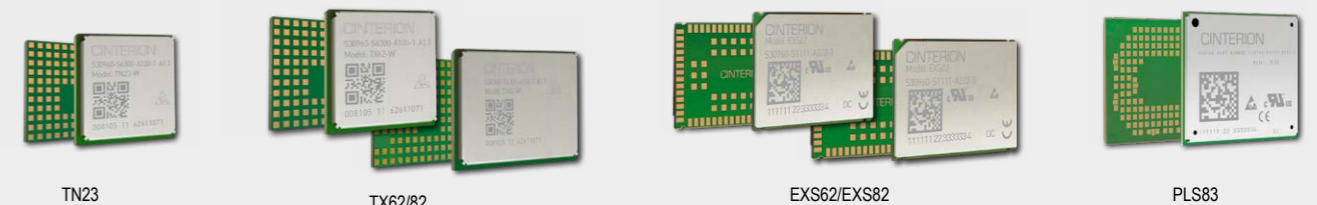



Cellular Data Cards



LN 920 Cat 6 / Cat 12 / Cat 13

The LN920 M.2 data card is part of the family of Telit Cinterion highspeed data cards. Designed in M.2 (NGFF) form factor, it is the natural evolution toward 5G technology.

The LN920 is available as LTE Category (Cat) 12 (600 Mbps peak data rate DL, 150 Mbps UL), Cat 13 (400 Mbps peak data rate DL, 150 Mbps UL) and Cat 6 (300 Mbps peak data rate DL, 50 Mbps UL). This data card supports a broad set of LTE frequency bands and carrier combinations and includes 3G/HSPA+ legacy technology and a GNSS receiver, making it ideal for worldwide deployments. Compatible with 3GPP Release (Rel) 12, it is certified for global deployments across EMEA, the Americas and APAC, including specific MNO certifications in regions requiring them like APAC and NA.

Key Benefits

- Standard M.2 (NGFF) form factor
- Same form factor and pinout available as 4G Cat 12, Cat 13 and Cat 6
- 3G/HSPA+ Rel 8 for fallback to legacy networks
- Broad frequency band support, ideal for worldwide deployments and private LTE networks
- Certified with leading MNOs
- Single-side printed circuit board for optimal heat dissipation
- High-speed USB 3.0 port
- Support of up to 3xCA DL (Cat 12)
- Up to three independent firmware images onboard selectable at boot to support various network operator requirements
- State-of-the-art GNSS receiver with separate RF connector
- Internal GNSS L1 LNA, allowing the use of less expensive passive antennas and lowering the total cost of ownership
- Advanced security features: SELinux, secure boot
- Full industrial operating temperature range
- Drivers support: Windows 10, Linux
- 2 x 2 MIMO



5G Solutions



FN990 Data Card and FE990 5G Module

The Telit Cinterion FN990 data card and FE990 5G module are designed for use in high-speed data applications such as enterprise routers, gateways, and fixed wireless access. This product offers high-speed, low-latency 5G connectivity with advanced security features, making it a suitable solution for a wide range of IoT applications that require fast and reliable connectivity. Both are capable of delivering high-speed data transfer rates with its support for 5G NR Sub-6GHz and mmWave frequencies, as well as 4G LTE-Advanced Pro. The advanced technology allows for low-latency connectivity, making it an ideal solution for applications that require real-time data transfer, such as industrial automation or virtual reality. It is designed to support future 5G features and capabilities, ensuring that devices using this module will remain relevant and functional for years to come.

Key Benefits

- High-speed data transfer
- Low latency: The Telit Cinterion FN990's advanced 5G technology allows for low-latency connectivity, making it an ideal solution for applications that require real-time data transfer, such as industrial automation or virtual reality.
- Compact form factor
- Advanced security features
- The FE990 LGA module is ideal for applications that require ruggedized modems that are feature- and interface-rich with a compact footprint, suitable for high-performance enterprise and industrial applications, such as indoor and outdoor fixed wireless access, video streaming and surveillance devices, mobile and industrial routers and gateways



Telit 5G Solutions



MV32

The Telit Cinterion MV32-W is the latest generation of 3GPP release 16 compliant 5G modem cards, a new addition to the MV series after the success of the first generation MV31. The MV32 further improves on class-leading thermal efficiency and enables unrivalled throughput performance in an extremely compact card form factor with integrated eSIM inside. With 3GPP Release 16 support, the MV32 modem card, stays at the forefront of the 5G technological evolution, combining both enhanced mobile broadband (eMBB) and ultra-reliable low latency communication (URLLC) to serve high bandwidth and mission critical applications such as industrial router/gateways, 8K video stream security and camera applications, smart manufacturing, robotics and private network implementations.

Key Benefits

- Ultra compact design- smallest 5G M.2 Adapter card in the market
- Innovative thermal design for industrial grade performance
- Single global variant delivering connectivity for 5G, LTE Cat. 20, 3G fallback
- The advanced positioning technology with dual-frequency GNSS supports GPS, Glonass, Beidou and Galileo for precise positioning anywhere in the world
- Ideal for applications such as industrial gateways and enterprise routers, fixed wireless access (FWA) indoor/outdoor and high power mmWave CPEs, professional 4K/8k video broadcasting and private 5G networks



FN920C04 / FE910C04 / PVR81 – 5G Redcap

The 5G RedCap LGA modules PVR81 and FE910C04 level up performance and efficiency and are pin-to-pin and software compatible with Telit Cinterion LTE modules, as well as the FN920C04 M.2 standard adapter card. The modules are designed to maintain compatibility with R15/16 and LTE Cat 4 fallback, ensuring smooth communication and comprehensive coverage. The modules offer a forward-thinking solution that prolongs the usability of LTE Cat1 and Cat4 modules ensuring sustained effectiveness and functionality.

Key Features

- Global design for full flexibility and longevity with 5G technology
- Improved operational efficiency and precise GNSS positioning with support for L1 and L5 frequencies and a dedicated antenna port
- Ideal for applications such as cellular routers and gateways, fixed wireless access (FWA), connected healthcare, video surveillance and monitoring, EV charging infrastructure and machine telematics



Smart Module SE250B04 – Android IoT System-on-Module LTE Cat4 150/50

The SE250B04 series offers all-in-one package cellular LTE, Wi-Fi, Wi-Fi, Bluetooth® Low Energy, GNSS for highly flexible and integrated design. It provides a reliable and secure cellular connectivity solution for a wide range of IoT applications, with global coverage, low power consumption and secure firmware capabilities. It supports integrated peripherals like high-resolution touch displays, advanced cameras and audio and digital sensor faces.

Key Features

- Enables reliable and secure connectivity for IoT devices in one package for fast time to market
- Simplifies development and integration of IoT solutions
- Provides global coverage for IoT applications with cellular connectivity, multi-mode 4G/3G/2G cellular radio for wide-area network coverage
- Low power consumption for optimized battery life and reduced maintenance
- Extended temperature range for use in a variety of environments

Key Applications

- Mobile point-of-sale (mPOS), smart cash registers and vending machines
- Smart alarms panels
- Security surveillance cameras and home automation security systems
- Smart home gateways
- Smart robots
- Handled PCs and tablets
- Telematics cameras
- Police and law enforcement equipment



IoT Terminals



LT910-EUBis – LTE Cat.1 bis Terminal for cost-optimized application

The LT910-EUBis is a compact and robust IoT terminal designed for the use in the LTE network with fallback to the GSM network. The device is based on the Telit LE910R1-EU module is an industrial-grade, cost-optimized LTE Cat 1 bis Terminal for the use in the European region. The terminal provides industrial standard interfaces and the ability for a safe, fast and reliable data transfer. The integrated power-saving mode supports the use in applications where low power consumption is required. The LT910-EUBis terminal is ideal for use cases that require higher performance compared to Cat M1 and NB-IoT in terms of data rate, latency and mobility.

Key Features

- Based on Telit LTE Cat 1 bis module LE910R1-EU with GSM fallback
- Interfaces: Power supply; SIM card holder lockable; FME antenna connector; RS232 (V.24/V.28) on Sub-D; USB
- Supply Voltage: 7-32V DC
- Operation temperature: -30°C - +75°C
- Support of low-power mode
- Robust & compact housing for industrial use
- Housing is mechanically compatible with GT910-G, HT910-E (G), LT910-WW (E), NT910-G
- Firmware Over-The-Air (FOTA) Update
- Optional variants on request: e.g. USB powered
- Extensive range of accessories

Key Applications

- Monitoring of vending machines
- Monitoring of data from industrial plants
- Intelligent control and monitoring of power grids
- Transmission of meter readings from electricity, gas and water meters
- Live transmission of video images
- Monitoring of heating, ventilation and air conditioning



Functionality	Interfaces	Software	Approvals
Built in UDP/TCP/PPP/HTTP/HTTPS/NTP/FTP stack	Power connector 6P6C modular jack	Telit application development environment: AppZoneC	CE
IPv4/IPv6 stack	RS-232 interface DSUB 9-pin female		WEEE, RoHS and REACH compliant
Control via AT commands according to 3GPP TS 27.005, 27.007 and Telit custom AT commands	USB 2.0, connector mini USB		
SIM application Tool Kit 3GPP TS 51.01	Antenna connector FME (male)		
	SIM chip option, 3 Status LEDs		





What is LPWAN?

Low Power Network (LPN) or Low Power Wide Area Network (LPWAN) is a new technology where a high network coverage and low power consumption are the key criteria in the operation of such a wireless network.

There are currently numerous technologies from which IoT decision makers can choose. From a technology point-of-view, they differentiate broadly into 2 major categories:

1. LPWAN technologies operate in unlicensed bands, typically in the Sub 1 GHz area. All technology contenders belonging to this category can be considered proprietary, i.e. all Intellectual Property Rights (IPRs) are either owned by one or by a limited number of companies.
2. The second category covers those technologies which operate in licensed bands, which are accessible only to mobile network operators which have purchased appropriate licenses from local regulatory authorities.

SigFox and LoRa, among others, belong to this category. As the name suggests, networks operating in unlicensed band can be deployed by virtually anyone.

This category of LPWAN technologies is standardized by the 3GPP (3rd Generation Partnership Project), an international standards organization which has also produced the standards for the GSM, UMTS and LTE mobile network technologies.

The technologies known as NB-IoT and LTE Cat-M1 are the key LPWAN options which have been standardized by the 3GPP.

Feature	Cat M1	Cat NB1 / Cat NB2 / NB-IoT	LoRa	SigFox
Radio Spectrum	Licensed	Licensed	Unlicensed	Unlicensed
Guaranteed QoS	Yes	Yes	No	No
Latency	Milliseconds – Seconds	Seconds	Seconds – Minutes	Seconds – Minutes
Roaming	Global	Global	Local	Single network
Peak Data Rate	375 kbps (DL/UL)	27.2 / 62.5 kbps (DL/UL) Cat NB2: 159kbps/127 kbps	5.5 – 50 kbps	100 / 500 bps (UL/DL)
Range	Basement	Underground	Underground	Underground
Mobility	Vehicular (full handover)	Nomadic (no handover)	No	No
Voice support	Yes	No	No	No
Battery life	5-10 years	10 years +	10 years +	10 years +
Module cost	Low	Low	Low	Low
SIM Card	Yes	Yes	No	No

Dual Radio Devices with Integrated Antennas Bluetooth LE / ANT+ / NFC / LoRa Mixed Solutions

The InsightSIP "Ready-to-go" RF modules offer you the fast, low risk way to deploy your IoT infrastructure, with fully CE, FCC, IC, Telec and Bluetooth SiG certified solutions. All modules are based on Nordic Semiconductor's SoCs.

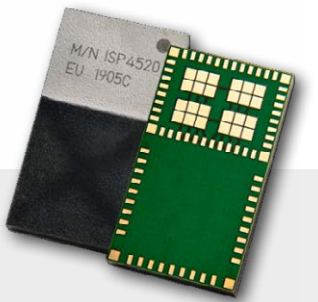

Part Number	ISP4520-EU	ISP4520-US	ISP4520-AS
Main protocol	LoRa		
BT Features	Bluetooth LE 5.0		
Other protocol	BT Mesh - ANT		
LoRa Tx Power	+14 dBm	+22 dBm	+14 dBm
BT Tx Power	+4 dBm		
LoRa Chip	SX1261	SX1262	SX1261
BT Chip	nRF52832		
Processor	Cortex M4F		
Flash	512 kB		
RAM	64 kB		
GPIOs (ADCs)	23 (8)		
Interfaces	(High Speed) SPI, TWI, UART, PWM, PDM		
NFC tag	Yes		
Temperature	85°C		
Dimensions	9.8 mm x 17.2 mm x 1.7 mm		



ISP4520 – LPWAN LoRa / BLE Module
Worldwide LoRa band coverage through EU (EMEA), US (Americas) and AS (Asia) versions.

For large spectrum of IoT applications:

- Smart cities / Smart retail
- Industrial Internet
- Big data / Data science
- Energy engagement / Smart grids

LoRa Module



Model No.	Antenna	ChipSet	Dimensions (mm)	Transmission Range	Transmission Power	Reception Sensitivity	GPIO
MS21SF1	IPEX	SX1262/LLCC68	16.4*15*3	5KM	+22dBm	-146dBm	5
MS23F1	/	STM32WLE5CCU6	20.72*19.13*3.2	5KM	+20dBm	-146dBm	24
MS24SF1	PCB+IPEX	nRF52840+SX1262	27*23.5*2.8	5KM	+22dBm	-146dBm	35
ME25LS01	/	nRF52840+LR1110	25.5*19*2.6	5KM	BLE: +6dBm LoRa: +22dBm	BLE: -96dBm LoRa: -136dBm	44



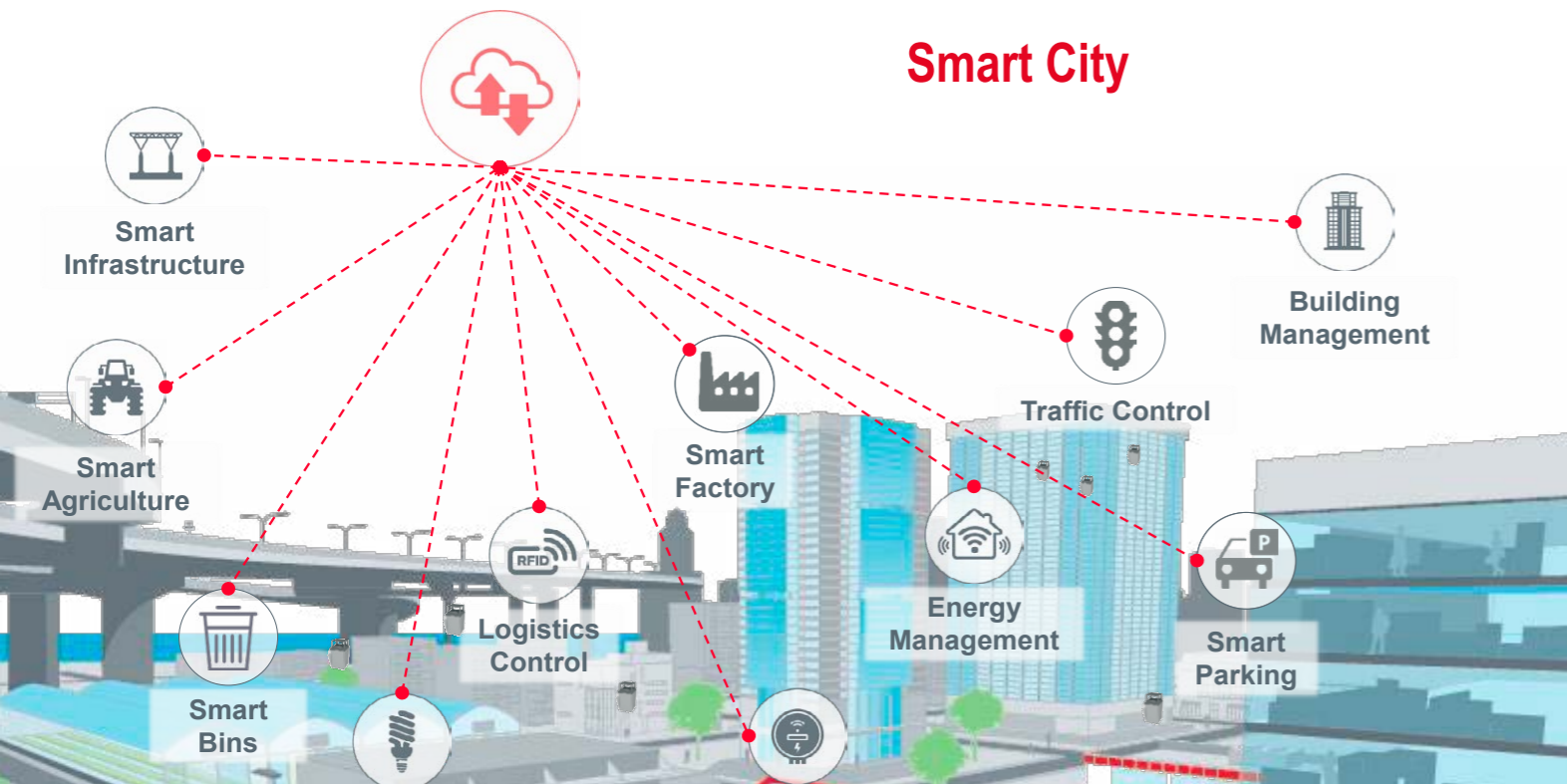

Unlicensed Modules – LoRa



LBAA0XV2GT Module

The Type 2GT is Murata's newest release to the LoRaWAN module Family with a size of 9.98 x 8.7 x 1.74 max mm. Based on Semtech LR1121 Chipset.

Key Features

- Radio Chip: Semtech LR1121
- Multi-band LoRa & LR-FHSS Communication Over:
 - Sub-GHz
 - 2.4 GHz & Satellite S-Band
- External Antenna
- Host Interface: SPI, GPIOs
- LGA package with 48 pads
- RF Tx Power:?
- Operation Temperature: -40°C to +85°C
- Metal Shield Can Package
- Low current consumption Rx mode?
- VDDdd: 1.8V to 3.6V
- Radio Certification (FCC / IC / TELEC)

Key Applications:

- Asset Management
- Smart Building
- Smart Agriculture
- Crowd Control
- Sensor End Node



LBAA0QB1SJ Module

The Type 1SJ is Murata's LoRaWAN module and with a size of only 10 x 8.0 x 1.6 mm it is one of the smallest on the market. It is based on the Semtech SX1262 and the STM32L with a Cortex M0+ processor for stack and application is integrated. The module has a lower power consumption and higher output than previous products.

Key Features

- Radio Chip: Semtech SX1262
- MCU STM32L Cortex M0+ (192 kBytes Flash)
- Open MCU for Application
- External Antenna
- Host interfaces: UART, SPI, I²C
- Other interfaces: GPIO/ADC
- LGA (56 pads)
- RF Tx Power: +14 dBm (+21.5 dBm with PA boost)
- Operating Temperature Range: -40°C to +85°C
- Resin Mould package
- Low current consumption Rx mode
- Vcc: 2.0 V to 3.6 V

Key Applications

- Asset/Animal Tracking
- Smart Parking
- Smart Agriculture
- Fuel/Water Management
- Smart Waste
- Smart Home



Industry's Smallest Size and Lightweight Design

In the development of IoT devices, there are many situations where compact, lightweight, and well-designed modules such as wearables are required. Murata's LPWA module is the smallest module available in the industry, making it ideal for use in hardware designs.

Licensed Modules – LTE Cat.M1 & NB-IoT



ME310M1 Series – LTE Cat M1/NB2 LGA Module

Enabling a new generation of massive power efficient IoT device deployments and catering low-data throughput IoT applications, the ME310M1 series, with 3 worldwide variants is a next-generation member of Telit Cinterion's xE310 product family. Exceeding market demands for optimized power consumption and enhanced quality of coverage, Cat M1/NB2 devices are specifically tailored for low data throughput IoT applications. The ME310M1 enhances coverage and provides superior in-building penetration, making them ideal for the growing number of OEM devices, system integrators and enterprises such as utilities that need to extend the lifecycle service of their IoT devices.

Key Features

- LTE UE Category M1 (1.4 MHz), NB2 (200 kHz)
- Single Rx, single antenna
- PSM, eDRX, Extended Coverage
- 3GPP Rel 14 compliant
- Control via AT commands according to 3GPP TS 27.005, 27.007 and customized Telit Cinterion AT commands
- Extended temperature range: -40° C to +85° C
- Supply voltage: Nominal: 3.8 V dc
- Over-the-air firmware update
- Embedded GNSS and Wi-Fi scan for outdoor and indoor positioning

Key Benefits

- Compact form factor, optimized for high yield and low cost manufacturing
- Global SKU with future support for non-terrestrial networks (NTN)
- Ultra-low, best-in-class power consumption profile
- Embedded GNSS and Wi-Fi scan for outdoor and indoor positioning

Key Applications

- Smart metering/agriculture
- Asset tracking
- Industrial sensors
- Medical devices and wearables



Software Development Kits

nRF91 DK

The nRF9160 DK is an affordable, pre-certified single-board development kit for evaluation and development on the nRF9160 SiP for LTE-M, NB-IoT and GNSS. It also includes an nRF52840 board controller that for example can be used to build a Bluetooth Low Energy gateway.

Nordic Thingy:91

The Thingy:91 is an easy-to-use battery-operated prototyping platform for cellular IoT using LTE-M, NB-IoT and GNSS. It is ideal for creating Proof-of-Concept (PoC), demos and initial prototypes in your cIoT development phase.

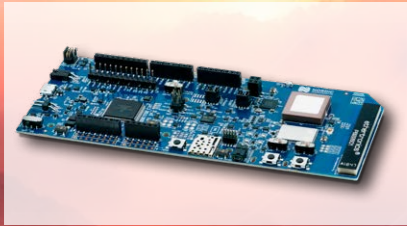

Low Power SiP with Integrated LTE-M, NB-IoT and GNSS Wireless Modem



nRF9160 – Cellular IoT System-in-Package

The nRF9160 SiP is making the latest LTE technology accessible for a wide range of applications and developers. With the fully integrated SiP and pre-certification for global operation, it solves the complex wireless design challenges as well as the comprehensive set of qualifications needed to utilize cellular technology. By integrating an application processor, multimode LTE-M/NB-IoT/GNSS modem, RF front-end (RFFE) and power management in a 10x16x1.04 mm package, it offers the most compact solution for cellular IoT (cIoT) on the market. Targeting asset tracking applications, the nRF9160 SiP has built-in support for nRF Cloud Location Services. These services provide built in GNSS and LTE location support with assisted GPS, predicted GPS, single-cell and multi-cell location services.

Key Features

- Fully integrated SiP for cellular IoT
- Multimode LTE-M/NB-IoT modem with integrated RF front-end
- 700-2200 MHz LTE band support
- Certified for global operation
- Dedicated application processor and memory
- 10x16x1.04 mm LGA package
- Arm TrustZone + Arm CryptoCell

Applications

- Logistics and asset tracking
- Smart city & smart agriculture
- Predictive maintenance & industrial
- Wearables & medical



Feature	nRF9160-S1AA	nRF9160-S1CA
Wireless Protocol	LTE-M only product	LTE-M/NB-IoT/GNSS product
Type	System in Package	
CPU	64 MHz Arm Cortex-M33	
FPU	x	
DSP Instruction Set	x	
Cache	x	
Memory	1 MB Flash/256 kB RAM	
Clocks	64 MHz / 32 kHz	
Arm Trustzone	x	
Arm CryptoCell	310	
Root-of-trust	x	
Secure key storage	x	
AES encryption	x	
LTE-M/NB-IoT/GPS Modem	x	
LTE band support in hardware	B1-B5, B8, B12-B14, B17-B20, B25-B26, B28 and B66	
Frequencies	700-2200 MHz	
Maximum TX Power	23 dBm	
RX Sensitivity	-108 dBm (LTE-M), -114 dBm (NB-IoT), -155 dBm (GPS)	
Antenna interface	50 Ω single-ended	
TWI, SPI, UART	4xTWI/SPI/UART	
PWM	4	
PDM	x	
I2S	x	
ADC, Comparator	ADC	
Timer, RTC	3, 2	
Temperature Sensor	x	
Applications	Sensor networks, Smart energy, Smart agriculture, Logistic and asset tracking, Industrial Systems, Smart Buildings, Retail and monitor devices, Medical devices, Wearables	
Certifications	nordicsemi.com/9160cert	
Operating Temp.	-40 to 85 °C	
Supply Voltage Range	3.0 V to 5.5 V	
Development Kits	nRF9160 DK, Nordic Thingy:91	
Packages	10x16x1.04 mm LGA	



LPWAN Modules with DECT NR+ Protocols

Introducing DECT NR+, the world's first non-cellular 5G standard

DECT NR+ (DECT New Radio plus or previously referred to as DECT-2020) is one of the latest radio protocols for IoT applications. This non-cellular radio standard is recently included as part of the 5G standards by the ITU. NR+ employs a self-healing, decentralized, and autonomous mesh network, making it easy to add new devices and eliminating any single points of failure. It has a flexible and highly scalable network structure that has use-cases and applications across many industries. NR+ utilizes known cellular techniques and provides a robust standardized solution that is unmatched by any other non-cellular technologies.

Applications

NR+ fills a genuine gap in the IoT ecosystem in terms of large-scale machine-to-machine operations that will allow enterprise IoT customers to build their own low-cost private networks. Moreover, it is also the first non-cellular radio standard to be recognized as a radio technology fulfilling the formal IMT-2020 5G requirements, for both Ultra-Reliable Low Latency Communication (URLLC) and massive Machine Type Communication (mMTC) use cases. NR+ can be valuable both as a low-cost alternative to existing solutions and unrealized applications. Many next-generation applications are being held back due to needing the reliability and low latency of a wired connection, but without the physical constraints of wires, and NR+ can offer exactly that.



Markets

- Asset Tracking
- Smart City
- Metering
- Industrial IoT





LPWAN Modules with DECT NR+ Protocols



nRF91X1 Series - NEW Low power SiP's with integrated DECT NR+ modem, LTE-M/NB-IoT and GNSS

The nRF91X1 series sets a new standard for highly integrated System-in-Package (SiP) solutions, specifically designed for cellular IoT and DECT NR+ applications. Leveraging low-power LTE technology, advanced processing capabilities, and robust security features, the nRF91X1 offers unparalleled performance and versatility. It offers enhanced capabilities compared to its predecessor (nRF9160), including DECT NR+ support and 3GPP release 14 LTE-M/NB-IoT support.

Main Benefits

- Enhanced Capabilities: The nRF91X1 series surpasses its predecessor, with improved features including support for DECT NR+ and 3GPP Release 14 LTE-M/NB-IoT LTE stack.
- Global Connectivity and Power Efficiency: The integrated modem of the nRF91X1 enables global connectivity without regional limitations, and include new unique modem features for further power saving and ease of use.
- Unleashing the Potential of DECT NR+: Harness the capabilities of the DECT NR+ stack with the nRF91X1, enabling massive mesh applications that prioritize reliability, secure connections, long range, and scalability.
- Compared to its predecessor (nRF9161), the nRF9151 boasts a significant footprint reduction of 20% and brings additional support for Power Class 5 20 dBm

Key Features

- Fully integrated SiP with 64 MHz Arm Cortex-M33 and multimode LTE-M/NB-IoT modem with DECT NR+ support and GNSS
- 700-2200 MHz LTE band support
- 1.9GHz NR+ band support
- Certified for global operation
- Dedicated programmable application processor and memory
- 1 MB flash + 256 KB RAM
- Arm TrustZone + Arm CryptoCell 310

Applications

- Asset Tracking
- Smart Metering
- Smart City
- Smart Agriculture
- Predictive maintenance
- Portable Medical Devices
- Industry 4.0

nRF9161 SiP



10 x 16 mm

nRF9151 SiP



12 x 11 mm

nRF9131 mini SiP



11 x 7 mm

LPWAN Modules with DECT NR+ Protocols



nRF9161 DK - Cellular IoT development kit for LTE-M, NB-IoT, GNSS and DECT NR+

The nRF9161 DK is an affordable, pre-certified single board development kit for evaluation and development on the nRF9161 System-in-Package (SiP) for LTE-M, NB-IoT, GNSS and DECT NR+. It has a dedicated LTE-M, NB-IoT and DECT NR+ antenna that supports a wide range of bands to operate globally. The nRF9161 DK has the same coverage as the nRF9161 SiP. LTE bands B1-B5, B8, B12, B13, B17-B20, B25, B26, B28, B65, B66 and B85 are supported.

Key Features

- Global LTE-M/NB-IoT antenna
- GNSS antenna
- Supports DECT NR+

- Arduino Uno form factor
- 4 LEDs user-programmable
- 4 buttons user-programmable
- SEGGER J-Link OB Debugger with

- debug out support
- UART interface through VCOM port
- USB connection for debug/programming and power
- Bundled with a SIM card, preloaded with data

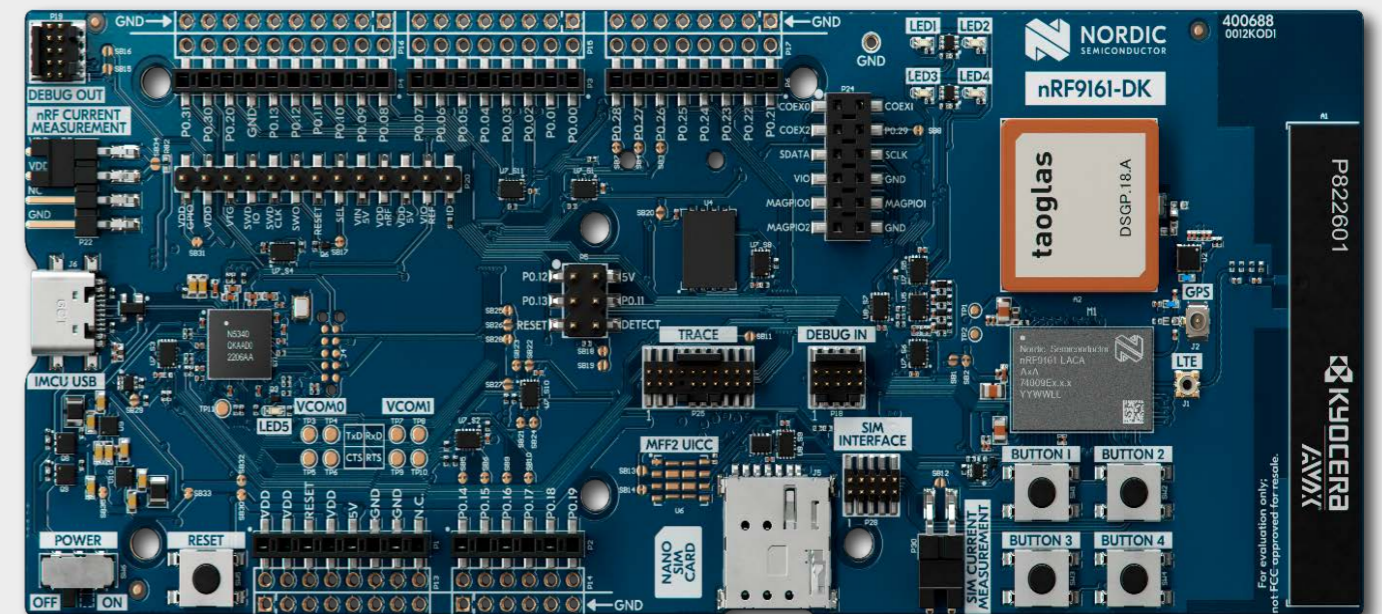

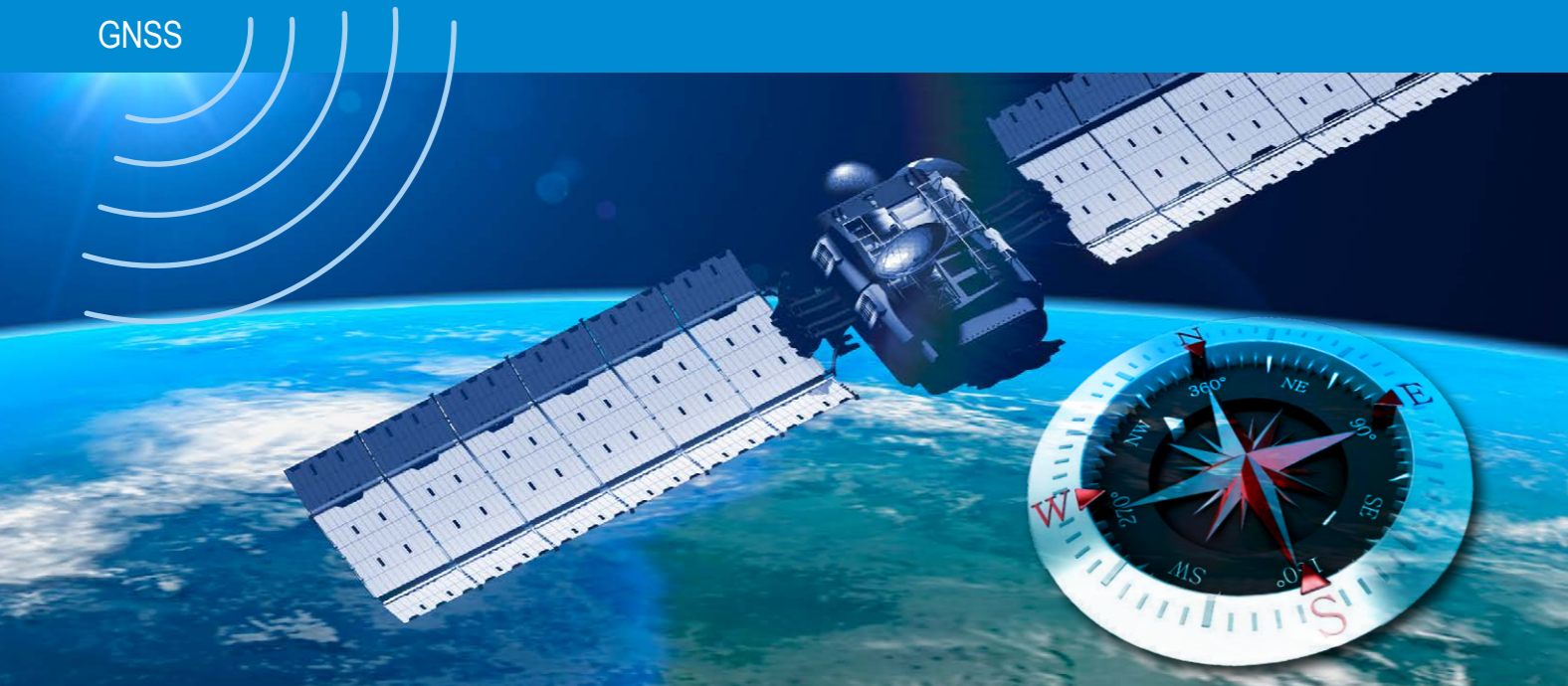

Global Navigation Satellite Systems (GNSS)

A Global Navigation Satellite System (GNSS) is a system of satellites providing autonomous geospatial positioning with global coverage. It allows small electronic receivers to determine their locations to a high precision by using time signals transmitted along a line of sight by radio from satellites.

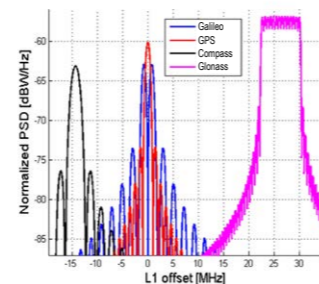

GNSS Wireless Modules – GPS/BDS/GLONASS/Galileo/QZSS



Operational Navigation Constellations

- GPS (24-satellite constellation + 6 backup SVs)
- Glonass (24-satellite constellation + 6 backup SVs)

Navigation Constellations in Development

- Galileo (currently 18 SVs launched)
- Beidou (currently 19 SVs launched)

USA	RUSSIA	EUROPE	CHINA
<ul style="list-style-type: none"> CDMA 24+6 orbiting SV 6 orbital planes with 4 SV each Frequencies (MHz): 1575.42 (L1), 1227.6 (L2), 1176.45 (L5) Each SV is identified by its own ID 	<ul style="list-style-type: none"> FDMA 24+6 orbiting SV 3 orbital planes with 8 SV each Frequencies (MHz): 1602 (L1) + k1, 1246 (L2) + k2, where: k1=(-7 to +13) * 562.5 KHz, k2=(-7 to +13) * 437.5 KHz Each SV is identified by its own frequency 	<ul style="list-style-type: none"> CDMA 24+6 orbiting SV Frequencies (MHz): 1575.42 (E1), 1227.6 (L2), 1176.45 (E5A), 1207.14 (E5B), 1278.75 (E6) Each SV is identified by its own ID 	<ul style="list-style-type: none"> CDMA 5 Geostationary SV + 27+5 orbiting SV Frequencies (MHz): 1561.098 (B1), 1207.14 (B2), 1268.52 (L5) Interface control document (ICD) "test version" published in October 2011 Each SV is identified by its own ID

GNSS Technologies

System	USA	Russia	EU	China	Japan
Type	Global	Global	Global	Global	Regional
Date Deployed	1995	1995/2011	2016 / 2018	2015/2020	Future (ex. 2020?)
Frequency	L1=1575.42 MHz	L1=1602 MHz	E1=1575.42 MHz	B1=1561.098 MHz	L1-SAIF =1575.42 MHz
Num. of Satellites	24-32	~ 30	27-30	30-35	4

UM980 – All-constellation Multi-frequency High Precision RTK Positioning Module

UM980 is Unicore's new-generation proprietary high-precision RTK positioning module. By combining advanced hardware design and exclusive algorithms, UM980 supports BDS B1I/B2I/B3I/B1C/B2a/B2b*, GPS L1/L2/L5, GLONASS L1/L2, Galileo E1/E5a/E5b, QZSS L1/L2/L5, and SBAS. The built-in multi-frequency anti-jamming technology realizes enhanced RTK engine calculation working on multiple modes and frequencies, which significantly improves RTK initialization speed, measurement accuracy and reliability in complex environments such as city blocks and tree shades. Relying on the excellent performance, UM980 is well suited for high precision navigation and positioning applications such as UAV, lawn mower, precision agriculture, surveying and mapping and intelligent driving.

Key Features

- Based on the new generation GNSS SoC - NebulasIV, which integrates RF, baseband, and high precision algorithm 17.0 x 22.0 x 2.6 mm SMD
- Supports on-chip RTK positioning calculation on all systems and multiple frequencies
- Supports BDS B1I/B2I/B3I/B1C/B2a/B2b + GPS L1/L2/L5 + GLONASS L1/L2 + Galileo
- E1/E5a/E5b + QZSS L1/L2/L5 + SBAS
- All-system multi-frequency RTK engine and advanced RTK technology
- Independent tracking of each frequency and 60dB narrowband anti-jamming technology

About Unicore

Technical Side

- More than 10 years of experiences in positioning
- Customized functions available for key accounts

Product Side

- Varies accuracy options from centimeter to meter level
- Solid success stories with world famous brands and partners
- High reliability with large shipments each and every month
- Whole solution available from hardware to software

Support

- Efficient technical support
- Designated Sales and FAE





GNSS Wireless Modules



SE873K5 – Multi-Constellation Smart Antenna GNSS

The SE873K5 is the latest addition to Telit SE873 family and is the natural migration path from SE873 and SE873Q5. The SE873K5 is a multi-constellation receiver in 7x7x2.25 mm QFN-like package including embedded SQI flash, RTC, TCXO. The SE873K5, thanks to its small package, the latest generation chipset, and the advanced power modes is the ideal solution for wearable, light portable devices and battery powered solutions.

Key Benefits

- Latest generation chipset
- Complete GNSS module, including TCXO, RTC, and flash memory
- Full GNSS compliance: GPS, Glonass, Galileo and BeiDou
- Flexible power management modes allow improvement to the battery life
- Supports both local and server-based A-GNSS for improved TTFFs
- Satellite Based Augmentation System (SBAS) corrections increase positioning accuracy
- Battery-friendly 1.8 V GPIO

Application Fields

- Fleet management systems
- European GPS-assisted road tolling systems
- Cellular base stations
- In-car navigation systems
- Automotive telematics
- GPS-based personal sports training monitors



GNSS Wireless Modules



SE868K5 – Multifrequency and Multiconstellation Positioning Receiver Module

SE868K5 as single-frequency (SF) using only the L1 band and multifrequency (D) using L1/E1 and L5/E5 band are multiconstellation positioning receiver modules of the xE868 Telit Cinterion form factor family. Both are pin-out compatible with SE868SY family and legacy products JF2 and SE868 V3.

Key Benefits

- SE868K5-SF ultralow power consumption and multiple low power modes
- Pre-selection SAW filter for best immunity and coexistence with other radios
- SE868K5-SF/D Embedded LNA allows optimal performance even with passive antennas
- Full GNSS compliance: GPS, GLONASS, Galileo, BeiDou and QZSS
- PVT logging

Application Fields

- Fleet management systems
- E-mobility applications
- Road tolling systems
- Automotive telematics systems
- Wearable sports training monitors
- Drones

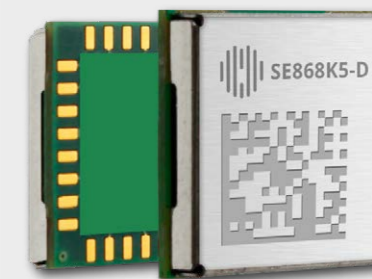

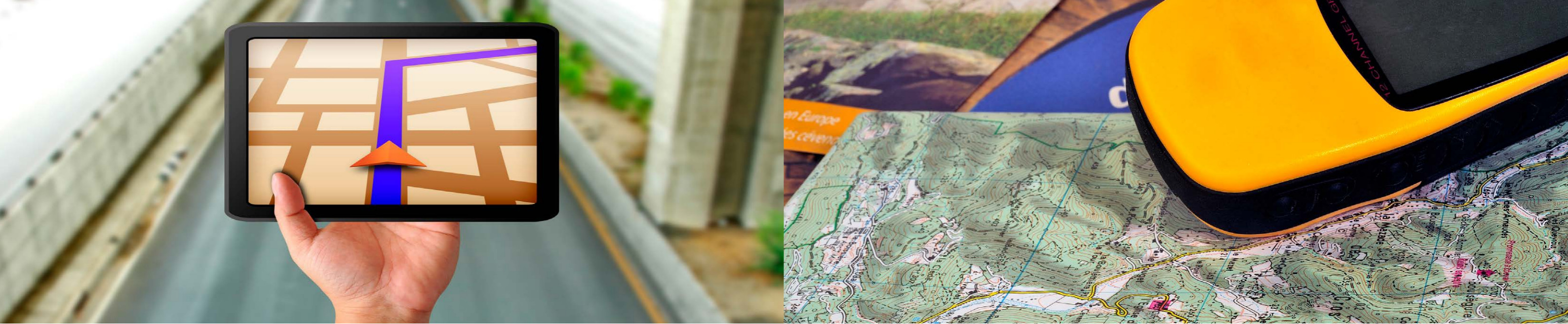

GNSS Wireless Modules



SE868K5-RTK – Multifrequency and Multiconstellation Positioning Receiver Module with Real Time Kinematics (RTK)

The SE868K5-RTK is a multifrequency and multiconstellation positioning receiver module with Real Time Kinematics (RTK) capabilities, using two frequencies (L1/E1 and L5/E5) for enhanced location accuracy and reduction of multipath effect in urban areas. In addition to its standard capabilities, with the injection of differential corrections, the SE868K5-RTK can achieve centimeter level accuracy.

Key Benefits

- Real Time Kinematics support up to 10 Hz (RTCM 3.x input)
- Footprint compatible with SE868K5 family, with SE868SY family, and with legacy JF2 and SE868V3 variants
- Full GNSS compliance: GPS, GLONASS, Galileo, BeiDou and QZSS
- SAW filter for optimal coexistence with other radios
- Embedded LNA allows optimal performance even with passive antennas
- Support ephemeris file injection (A-GNSS) as well as on-board ephemeris prediction (A-GPS)
- PVT Logging

Application Fields

- Fleet management systems
- E-mobility applications
- Lawn mowers/robots
- Precision Agriculture
- Automotive telematics systems
- Drones

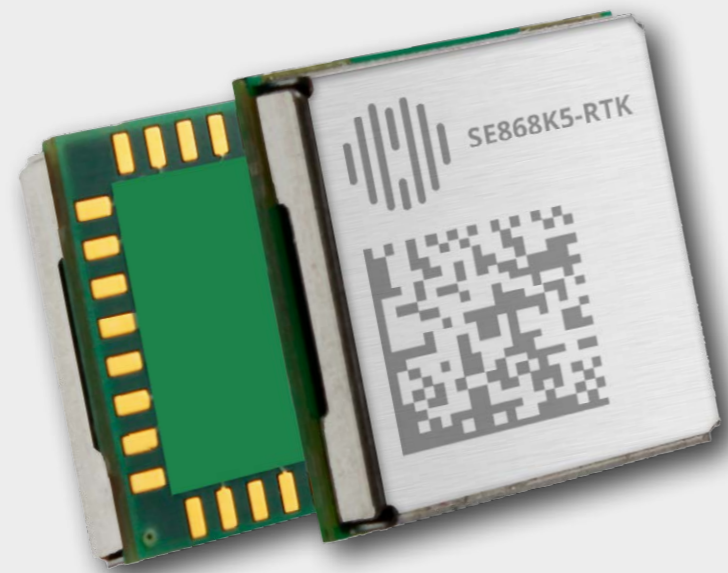

Gateway Solutions



Smart IoT Gateway Solutions

The smart IoT gateways solution SGX31 and SGL81 offer an out-of-the-box connectivity for faster time to market with simplified plug-and-play integration. The EGX81/82 supporting LTE Cat-M, NB-IoT and 2G fallback represents an efficient gateway solution with flexible interfacing options.

Key applications:

- Industrial monitoring/sensors
- Asset tracking
- Security and agricultural applications
- Video surveillance
- Robotics & Industry 4.0
- Remote maintenance & control
- Smart cities/meters/agriculture & vending machines
- Healthcare applications

SGX31

Key Benefits

- Flexible, cost-effective platform for connecting industrial assets
- Cat-M, NB-IoT connectivity with 2G fallback
- Connectivity with data speeds of up to 300kbps



SGL81

Key Benefits

- Easy-to-use migration option for gateway applications
- LTE Cat-4 connectivity with seamless 3G/2G fallback
- Connectivity with data speeds 150Mbps



EGX81/82

Key Benefits

- Simple and reliable plug-and-play cellular connectivity
- LTE Cat-M/NB-IoT with 2G fallback
- High efficiency for a long life by leveraging power class 5 (20dBm) and efficient eDRX and PSM



GNSS Modules – Selection Guide



Manufacturer	Part Name	Chipset	Sensitivity (in dBm)			Power (in mW)		Power (in µW)	Interface				Features										Time to First Fix (90%@ -130 dBm)		Antenna Typ		Dimensions (mm)	Package	Evaluation Kit / Development Kit
			Acquisition	Navigation	Tracking	Acquisition	Tracking		NMEA Output	DGPS/RTCM Input	MEMS Port	Others	1 PPS (ns RMS)	PPS output	GPS	Glo-nass	Galileo	Beidou	NAVIC	SBAS	QZSS	LNA	Hot start	Cold start	GPS Patch antenna	GPS Chip antenna			
Telit	SL869L-V2	MT3333	-148 dBm	-160 dBm	-162 dBm	86	76	23	x			UART, I2C	x	x	x	x	x	x		x	x	x	1s	< 28s			16 x 12.2 x 2.4	LCC	EVK-SL869L-V2S
	SL869-V3	ST Teseo 3	-147 dBm	-158 dBm	-162 dBm	171	147	251	x	x		UART, I2C	x	x	x	x	x	x		x	x	x	1s	< 35s			16 x 12.2 x 2.4	LCC	EVK-SL869-V3
	SL871L	MT3333	-147 dBm	-160 dBm	-163 dBm	86	76	21	x			UART			x	x	x	x		x	x	x	1s	< 31s			10.1 x 9.7 x 2.4	LCC	EVK-SL871L
	SL871L-S	MT3337	-147 dBm	-161 dBm	-164 dBm	64	54	21	x			UART			x					x	x	x	1s	< 31s			10.1 x 9.7 x 2.4	LCC	EVK-SL871L-S
	SE868K3-A	MT3333	-148 dBm	-161 dBm	-164 dBm	111	99	59	x			UART, I2C, SPI, GPIO	x	x	x	x	x			x	x	x	1s	< 35s	x		11 x 11 x 6.1	QFN	EVK-SE868K3-A
	SE868K3-AL	MT3333	-146 dBm	-157 dBm	-165 dBm	111	99	59	x			UART, I2C, SPI, GPIO	x	x	x	x	x			x	x	x	1s	< 35s	x		11 x 11 x 4.1	QFN	EVK-SE868K3-AL
	SE868K5-D/I	MT AG3335MN	-146 dBm	-165 dBm	-165 dBm	54	59	36	x	x		UART, I2C, SPI	x	x	x	x	x	x		x	x	x	1s	< 28s			11 x 11 x 2.8	QFN	SE868K5D/I EVK
	SE868K5-RTK	MTAG3335MN	-146 dBm	-165 dBm	-165 dBm	70	70	36	x	x		UART, I2C, SPI	x	x	x	x	x	x		x	x	x	1s	< 28s			11 x 11 x 2.8	QFN	DVT3990252433
	SE878K3-A		-148 dBm	-163 dBm	-165 dBm	93	34		x			UART, I2C, SPI	x	x	x	x	x	x		x	x	x	1s	< 35s	x		18 x 18 x 6.1	QFN	EVK-SE878K3-A
	SE868K7-A	MT3337	-148 dBm	-163 dBm	-164 dBm	85	71	21	x			UART, GPIO	x	x	x					x	x	x	1s	< 35s	x		11 x 11 x 6.1	QFN	EVK-SE868K7-A
GNS	TC6000GN	TI CC4000	-147 dBm	-162 dBm	-162 dBm				x			UART	x	x	x					x	x		1s	< 34s			10 x 9.3 x 2.3	LGA	TC6000GN Starter Kit
	TC6000GTIM	TI CC4000	-146 dBm	-162 dBm	-162 dBm				x			UART	x	x	x					x	x	x	1s	< 34s			10 x 9.3 x 2.3	LGA	TC6000GTIM Starter Kit
	GNS2301	SirFStarV	-146 dBm	-160 dBm	-165 dBm				x	x		UART, I2C, SPI	x	x	x	x	x	x		x	x	x	1s	< 35s			10 x 9.3 x 2.1	SMD	GNS2301 GPS/GLONASS Starter Kit
	GNS802	SirFStarV	-146 dBm	-160 dBm	-165 dBm				x	x		UART, I2C, SPI	x	x	x	x	x			x	x	x	1s	< 35s		x	16 x 10 x 2.1	SMD	GNS802 GPS/GLONASS Starter Kit
	GNS3301	MT3333	-148 dBm	-165 dBm	-165 dBm				x	x		UART	x	x	x	x	x			x	x		1s	< 34s			10 x 9.3 x 2	SMD	GNS3301 GPS/GLONASS Starter Kit
	GNS3301B	MT3333	-148 dBm	-165 dBm	-165 dBm				x	x		UART	x	x	x					x	x		1s	< 34s			10 x 9.3 x 2	SMD	GNS3301B GPS Starter Kit
	GNS902	MT3333	-148 dBm	-165 dBm	-165 dBm				x	x		UART	x	x	x	x				x	x	x	1s	< 35s		x	16 x 10 x 2.1	SMD	GNS902 GPS/GLONASS Starter Kit
	GNS902B	MT3333	-148 dBm	-165 dBm	-165 dBm				x	x		UART	x	x	x	x				x	x	x	1s	< 35s		x	16 x 10 x 2.1	SMD	GNS902B GPS Starter Kit
	GNS2201	MT3337	-148 dBm	-165 dBm	-165 dBm				x	x		UART	x	x	x	x				x	x	x	1s	< 34s			10 x 9.3 x 2	SMD	GNS2201 GPS Starter Kit
	GNS202	MT3337	-148 dBm	-165 dBm	-165 dBm				x	x		UART	x	x	x					x	x	x	1s	< 34s		x	16 x 10 x 2.1	SMD	GNS202 GPS Starter Kit
Minew	MS31SN1		-148 dBm	-160 dBm	-162 dBm					x		UART			x	x			x	x		1s	< 35s			10.1 x 9.7 x 2.4	SMD		
	MS32SN1		-148 dBm	-160 dBm	-165 dBm							UART			x					x			1s	≤29s			10.1 x 9.7 x 2.4	SMD	
	MS32SN4		-148 dBm	-160 dBm	-165 dBm							UART			x					x			1s	≤29s			18.2 x 18.2 x 6.8	SMD	
	MS33SN1		-148 dBm	-160 dBm	-165 dBm					x		UART			x	x	x	x		x	x		1s	≤24s			10.1 x 9.7 x 2.4	SMD	
	MS34SN2		-148 dBm	-160 dBm	-165 dBm					x		UART			x	x	x	x		x	x		1s	≤28s			16 x 12.2 x 2.4	SMD	
	MS34SN3		-148 dBm	-160 dBm	-165 dBm					x		UART			x	x	x	x		x	x		1s	≤28s			22 x 17 x 2.4	SMD	
	MS34SNA		-148 dBm	-160 dBm	-165 dBm					x		UART			x	x	x	x		x	x		1s	≤24s			17 x 22	SMD	
	MS35SN1		-148 dBm	-160 dBm	-165 dBm					x		UART			x	x	x	x		x	x		1s	≤28s			10.1 x 9.7 x 2.4	SMD	
	MS35SN2		-148 dBm	-160 dBm	-165 dBm					x		UART			x	x	x	x		x	x		1s	≤28s			16 x 12.2 x 2.4	SMD	
	MS36SN4		-148 dBm	-160 dBm	-165 dBm					x	x	UART			x	x	x	x			x		≤2s	≤27s			16 x 21 x 2.6	SMD	
MS37SN2		-148 dBm	-160 dBm	-167 dBm					x	x	UART			x	x	x	x			x		1s	≤24s			16 x 12.2 x 2.4	SMD		

GNSS Cards – Selection Guide



Manufacturer	Part Name	Chipset	Sensitivity (in dBm)		Power (in mA)		Interface			Features										Time to First Fix (90%@ -130 dBm)		Antenna Typ		Dimensions (mm)	Package													
			Acquisition	Tracking	Acquisition	Tracking	NMEA Output	DGPS/RTCM Input	Others	Acquisition channels	1 PPS (ns RMS)	PPS output	GPS	Glo-nass	Galileo	Beidou	SBAS	QZSS	Deep sleep	Hot start	Cold start	GPS Patch Antenna	GPS Chip Antenna															
Advantech	EWM-G110H01E Half-size Mini-PCIe card	u-blox NEO-M8U	-160 dBm	-167dBm																			72	30 ns		x	x	x	x	x	x		1.5s	26s	UFL Connector			
Advantech	AIW-210 XU-001 M.2 2242 card	u-blox NEO-M9N	-160 dBm	-167dBm																				92	30 ns		x	x	x	x	x	x		2s	24s	UFL Connector		





UWB/ BLE Modules

MS01SF1 –BLE & UWB Combo Module

This highly miniaturized LGA module, 12 x 12 x 1.5 mm, is based on the QM33110 UWB transceiver and nRF52833 BLE chip. Using a simple user interface via the SPI connection and integrating a Cortex™ M4 CPU, flash and RAM memory combined with optimized antennas, ISP3080 offers the perfect stand-alone ranging module solution for RTLS, access control and indoor positioning applications. The module also includes a 3D accelerometer to allow for low power modes with wake up dictated by movement.

Key Features

- Bluetooth Low Energy 5.2
- UWB IEEE 802.15.4z
- Thread, Zigbee, NFC
- PCB+Ceramics Antennas
- UWB section based on Devawave DW3120
- BLE section based on Nordic Semi nRF52833
- Configurable 23 GPIOs (BLE) and 4 GPIOs (UWB)
- Dimension of 26.12x19.13x3.2mm
- 10-30 cm Ranging Accuracy
- Temperature -40 to +85 °C

Applications

- Security warning devices
- Smart meters
- Building automation
- Agricultural sensors
- Smart cities
- Retail store sensors
- Street lighting
- Environmental sensors
- Smart parking
- Smart medical



What is Ultra-Wide-Band (UWB)?

Ultra-Wide-Band (UWB) is based on the use of an extremely wide frequency spectrum for wireless communication. Unlike traditional wireless technologies such as WLAN or Bluetooth, which use narrow frequency bands, UWB utilizes a very wide frequency range, typically spanning several GHz (3,1 – 10,6 GHz). This wide frequency band usage is key to the performance of UWB and enables a variety of applications, including precise positioning, high-resolution positioning and fast data transmission.

The IEEE 802.15.4z standard defines the specific parameters for the operation of UWB systems. This standard defines how UWB devices modulate, encode and transmit their signals to ensure interoperability and regulatory compliance.

In general, UWB technology is based on the transmission of very short, fast pulses over a wide frequency spectrum. These pulses can have a duration of only a few nanoseconds and are often so short that they require only a tiny amount of energy per pulse. By using spread spectrum and modulation techniques, UWB devices can transmit high-bandwidth data while ensuring compliance with regulatory requirements and minimizing interference with other radio technologies.

UWB devices also often utilize advanced signal processing techniques, such as multipath propagation processing.

Selection Guide UWB



Manufacturer	Name	Used Ics	CPU Core	Flash / RAM	UWB Channel	UWB Frequency (MHz)	Bluetooth specification	Max. Transmit Power TX (dBm)	Supply Voltage Range (V)	Input Sensitivity RX (dBm)	Interfaces									Antenna		Operating Temperature	Size (mm)	Package	Evaluation Kit / Development Kit		
											GPIO	PCM	SPI	UART	JTAG	ADC	I ² C	USB	RS-232	other	Intergrated Antenna					Without Antenna	
Murata	LBUA5QJ2AB	Qorvo QM33120W Nordic nRF52840	Arm Cortex-M4	1MB / 256kB	5 & 9	6250 - 8250	BLE 5.2	8	2.5 - 5.5	-92			x	x			x	x					x	40°C + 80°C	10.5 x 8.3 x 1.44	LGA	LBUA5QJ2AB-828EVB
	LBUA2ZZ2DK	NXP Trimention SR040 NXP QN9090	Arm Cortex-M4	640kB / 152kB	5 & 9	6250 - 8250	BLE 5.0		1.9 - 3.6					x								x	30°C + 80°C	19.6 x 18.2 x 2.3	LGA	LBUA2ZZ2DK-EVK	
	LBUA0VG2BP	NXP Trimention SR150	Arm Cortex-M33	- / 128kB	5 & 9	6250 - 8250	-		1.71 - 1.98				x	x								x	30°C + 80°C	6.6 x 5.8 x 1.2	LGA	LBUA0VG2BP-EVK-P	
Insight SiP	ISP3080-UX	Qorvo QM33110 Nordic nRF52833	Arm Cortex-M4	512kB / 128kB	5 & 9	6490 - 7987	BLE 5.1	8	2.4 - 3.6	-93			x	x								x	40°C + 85°C	12 x 12 x 1.5	LGA	ISP3080-UX-DK	
Minew	MS01SF17	Qorvo DW3120 Nordic nRF52833	Arm Cortex-M4	512kB / 128kB	5 & 9	6240 - 7987	BLE 5.2	8	2.8 - 3.6	-94			x	x								PWM	40°C + 85°C	26.12 x 19.13 x 3.2			



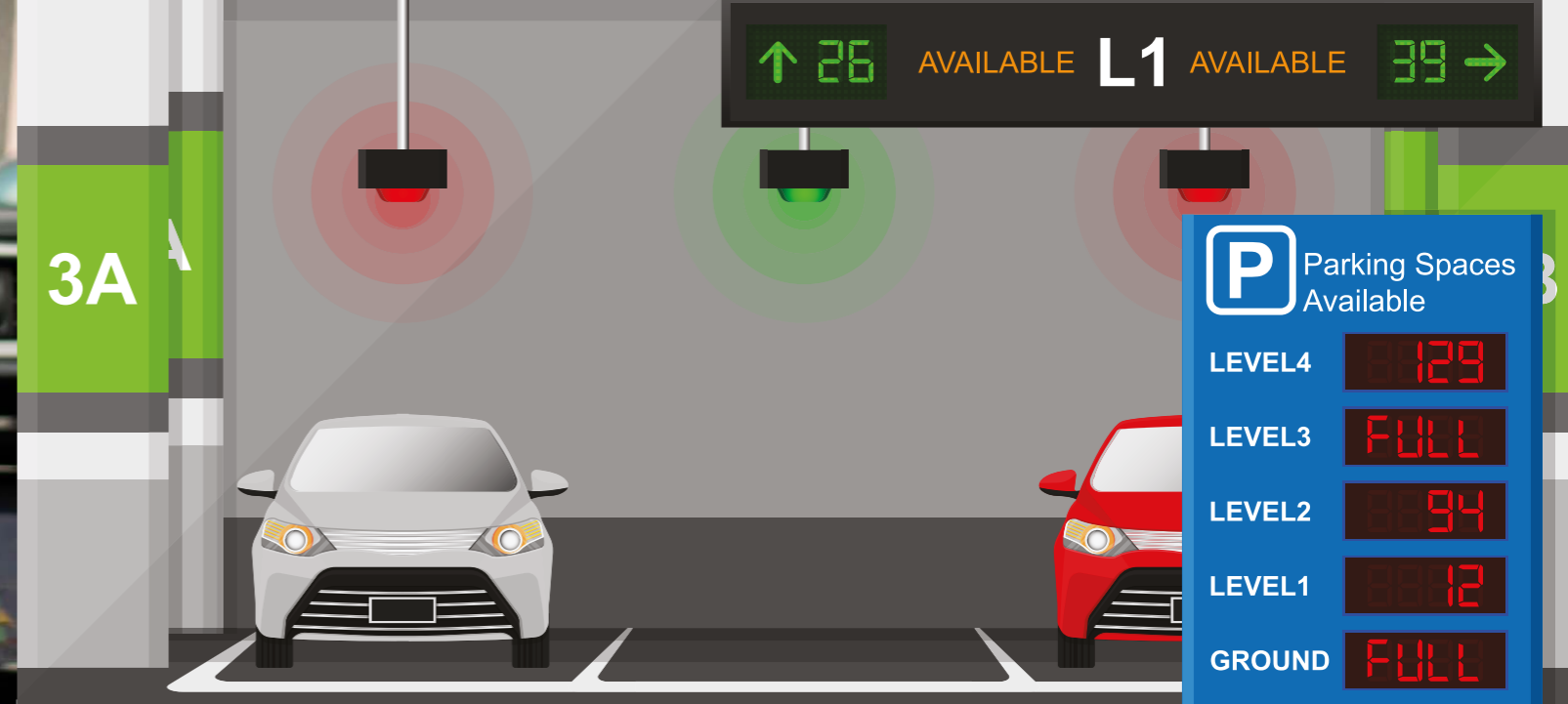

BLE/UWB Combo Module



ISP3080 – Ultra-Wide Band and Bluetooth Low Energy

This highly miniaturized LGA module, 12 x 12 x 1.5 mm, is based on the QM33110 UWB transceiver and nRF52833 BLE chip. Using a simple user interface via the SPI connection and integrating a Cortex™ M4 CPU, flash and RAM memory combined with optimized antennas, ISP3080 offers the perfect stand-alone ranging module solution for RTLS, access control and indoor positioning applications. The module also includes a 3D accelerometer to allow for low power modes with wake up dictated by movement.

Key Features

- UWB IEEE 802.15.4z
- Bluetooth Low Energy 5.1 Direction Finding and Long Range
- BT Mesh, Thread, Zigbee, ANT+ NFC
- Fira Compatible – Near Field Interaction
- Fully integrated RF Matching and Antenna UWB 6.5 GHz band 5 and 8.0 GHz band 9 BLE 2.4 GHz
- Integrated 32 MHz & 32 kHz Clocks
- Integrated ultra-low-power high-performance accelerometer MEMS LIS2DE12
- DC/DC converter with loading circuit
- Based on Nordic Semiconductor nRF52
- UWB section based on Qorvo QM33110
- BLE section based on Nordic Semi nRF52833
- Configurable 23 GPIOs including 5 ADCs
- 8 QM33110 GPIOs for UWB functions
- Digital interfaces USB, QSPI, SPI, UART, I²S, PDM, PWM
- Power supply 2.4 to 3.6V
- Very small size 12 x 12 x 1.5 mm
- Temperature -40 to +85 °C

Applications

- Find Me applications with accurate distance
- Precision Real Time Location Systems (RTLS) for Healthcare, Sport and Wellness
- Consumer, Industrial...
- Security bubble
- Access control
- Indoor positioning

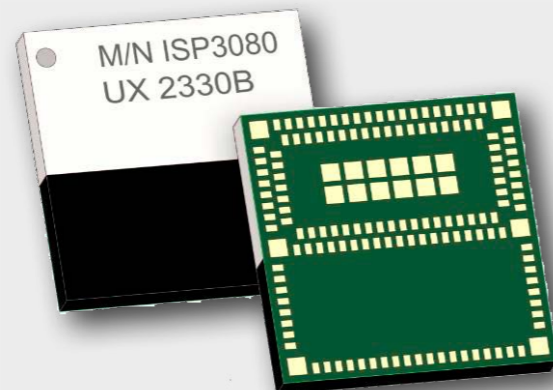

UWB-Modules



Ultra Wide Band (UWB) technology is good for secure and precise distance measurement which is based on Time of Flight (ToF) of radio waves.

The Type 2AB from Murata is designed as Ultra-small, high quality and lower power consumption UWB module. Ideally suited for small, battery operated IoT devices and applications. It supports UWB Ch 5 & 9 and supports Bluetooth 5.2 with the integrated BLE Wireless MCU.

The Murata Type 2DK is also all-in-one UWB + Bluetooth® LE combo module which integrates NXP Trimension™ SR040 UWB Chipset, NXP QN9090 Bluetooth® LE Wireless MCU, integrated antennas and peripheral components. Ideally suited for UWB Tag/Tracker which operates by coin-cell battery, and general IoT devices. It supports also UWB Ch 5 & 9 and Bluetooth 5.0 similar to the Type 2AB.

The Murata Type 2BP is the ultra-small UWB module which includes NXP's SR150 UWB chipset, clock, filters and peripheral components. It supports UWB Ch 5 & 9 without the Bluetooth feature and is very compact with a size of 6.6 × 5.8 × 1.2(max)mm.

Name	Used Ics	UWB Channel	Size (mm)	Package	UWB Frequency (MHz)
LBUA5QJ2AB-828	Qorvo QM33120W Nordic nRF52840	5 & 9	10.5 x 8.3 x 1.44	LGA	6250 - 8250
LBUA2ZZ2DK-882	NXP Trimensi-on SR040 NXP QN9090	5 & 9	19.6 x 18.2 x 2.3	LGA	6250 - 8250
LBUA0VG2BP-741	NXP Trimensi-on SR150	5 & 9	6.6 x 5.8 x 1.2	LGA	6250 - 8250

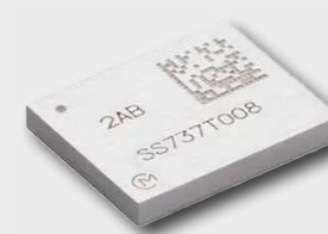

LBUA5QJ2AB-828

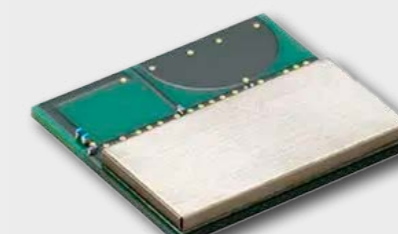

LBUA2ZZ2DK-882

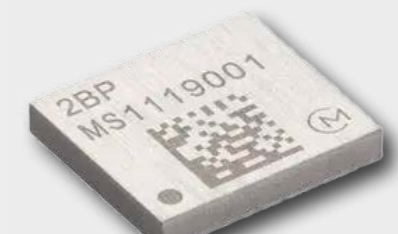

LBUA0VG2BP-741





What is the difference between Wireless LAN and WiFi?

WLAN is a type of Local Area Network (LAN) that uses high frequency radio waves rather than wires to communicate and transmit data. As wired networks connect devices to the internet by using cables, WLAN is a flexible data communication system implemented as an extension or an alternative to wired LANs. WLAN usually provides a connection through an access point to the wider internet. This gives users the ability to move around within a local coverage area and still be connected to the network.

The term "WiFi" refers on one hand to a company consortium of 300 companies, which certifies devices with wireless interface. On the other hand, WiFi is also the associated brand name, as products which are certified according to the guidelines of the WiFi-alliance are labeled with its logo.

The 802.11 standard defines different operating modes:

Access Point Mode
The module should manage a network itself (coordinator and router in one network)

Access Point mode

Infrastructure Mode
The module has to connect to an existing access point to join a network

A Wireless Network in Infrastructure Mode

Ad hoc Mode
Module can be connected to one or more other devices without having a coordinator (an access point is not involved here). The ad hoc network is a decentralized type of network as it does not rely on a pre-existing infrastructure such as routers or access points. Here each wireless node forwards data to other nodes until the receiver is reached

WiFi-Direct
This standard enables devices to connect quickly with each other without requiring a wireless access point or a router (e.g. camera and printer)

Wi-Fi ALLIANCE
Wi-Fi CERTIFIED Wi-Fi Direct™
Personal Wi-Fi networking that goes with you anywhere

Which WLAN Network Standards exist?

802.11 refers to a family of specifications developed by the IEEE (Institute of Electrical and Electronics Engineers) for WLAN technology. 802.11 specifies an over-the-air interface between a wireless client and a base station or between two wireless clients.

There are several specifications in the 802.11 family

Standard	Released	Modulation	Frequency	Bandwidth	Highest Data-rate
802.11 (Legacy)	1997	DSSS, FHSS	2.4 GHz	20 MHz	2 Mbps
802.11 b	1999	DSSS	2.4 GHz	20 MHz	11 Mbps
802.11 a	1999	OFDM	5 GHz	20 MHz	54 Mbps
802.11 g	2003	DSSS, OFDM	2.4 GHz	20 MHz	54 Mbps
802.11 h	2006	OFDM	5 GHz	20 MHz	54 Mbps
802.11 n (WiFi 4)	2009	OFDM	2.4 / 5 GHz	20 MHz / 40 MHz	72 - 600 Mbps
802.11 p	2010	OFDM	5 GHz	10 MHz	27 Mbps
802.11 ad	2012	64-QAM SC-OFDM	60 GHz	2 GHz	6930 Mbps
802.11 ac (WiFi 5)	2013	256-QAM OFDM	5 GHz	80 MHz / 160 MHz	433 - 6933 Mbps
802.11 ah (WiFi Halow)	2016	OFDM	900 MHz	2 MHz	150 Kbps
802.11 ax (WiFi 6)	2019	1024-QAM OFDMA	2.4 / 5 GHz	80MHz / 160 MHz	600 - 9600 Mbps
802.11 ax (WiFi 6E)	2020	1024-QAM sOFDMA	2.4 / 5 / 6 GHz	80MHz / 160 MHz	600 - 9600 Mbps
802.11 be (WiFi 7)	2024	4096-QAM OFDMA	2.4 / 5 / 6 GHz	320 MHz	1440 - 23050 Mbps

Which Wireless Safety Standards are applicable?

Wi-Fi Protected Access (WPA) and Wi-Fi Protected Access II (WPA2) are two security protocols and security certification programs developed by the Wi-Fi Alliance to secure wireless computer networks. WPA (sometimes referred to as the draft IEEE 802.11i standard) became available in 2003. The Wi-Fi Alliance intended it as an intermediate measure in anticipation of the more secure and complex WPA2.

WPA superseded the previous security specification Wired Equivalent Privacy (WEP), which had shown to have security vulnerabilities. WPA implemented a subset of a draft of 802.11i. WPA2 has replaced it in 2004 and is therefore called IEEE 802.11i-2004 or 802.11i. WPA2, which requires testing and certification by the Wi-Fi Alliance, implements the mandatory elements of IEEE 802.11i. In particular, it introduces CCMP, a new AES-based encryption mode with strong security. Certification began in September, 2004; from March 13, 2006, WPA2 certification is mandatory for all new devices to bear the Wi-Fi trademark.

What are Wireless Operation Modes?

There are several kinds of hardware that may be used to implement a WiFi wireless network:

- Wireless adapters or network interface controllers (NICs) are network cards with the 802.11 standard which let a machine connect to a wireless network.
- Access points (AP, sometimes called hotspots) can let nearby WiFi-equipped stations access a wired network to which the access wpoint is directly connected.

(Please see graphics on the top)





DIGITAL HEALTH



Dual Band Wi-Fi IC: Nordic's first Wi-Fi Product



nRF7002 an Ultra-Low Power, Dual-Band Wi-Fi 6 Companion IC

The nRF70 Series comprises three WiFi companion ICs. The nRF7001 offers low-power 2.4 GHz connectivity, while the nRF7002 operates in both the 2.4 and 5 GHz bands. The nRF7000 is designed purely for active and passive scanning of Wi-Fi networks. These ICs ensure excellent coexistence with Bluetooth LE devices, advanced power saving with TWT and OFDMA for efficient uplink and downlink communication.

The nRF70 Series devices are designed for Internet of Things (IoT) applications and are ideal for adding modern Wi-Fi 6 capabilities to existing Bluetooth® Low Energy, Thread, or Zigbee systems, as well as adding Wi-Fi Access Point scanning capabilities to LTE/GPS systems.

Application Fields

- White goods
- Home automation
- Fitness equipment
- Lighting control
- Printer
- Smart meters
- Media player
- POS terminal
- Patient monitors

nRF7002 Wi-Fi Companion IC

Low-power, advanced security, seamless coexistence

- 2.4GHz and 5GHz Dual-band
- Low-power and Secure Wi-Fi for the IoT
- Ideal coexistence with Bluetooth LE
- Supported in nRF Connect SDK
- Wi-Fi 6 Station (STA)
- Complies with 802.11a/b/g/n/ac/ax
- 1 Spatial Stream (SS)
- 20 MHz channel bandwidth
- 64 QAM (MCS7), 86 Mbps PHY throughput
- OFDMA (Downlink and Uplink)
- BSS Coloring
- TWT
- SPI / QSPI
- Co-existence interfaces



nRF7001 Wi-Fi Companion IC

Low-power, advanced security, seamless coexistence

- 2.4 GHz single-band
- Low-power and Secure Wi-Fi for the IoT
- Ideal coexistence with Bluetooth LE
- Supported in nRF Connect SDK
- Wi-Fi 6 Station (STA)
- Complies with 802.11b/g/n/ax
- 1 Spatial Stream (SS)
- 20 MHz channel bandwidth
- 64 QAM (MCS7), 86 Mbps PHY throughput
- OFDMA (Downlink and Uplink)
- BSS Coloring
- TWT
- SPI / QSPI
- Co-existence interfaces



nRF7000 Wi-Fi Companion IC

SSID-based Wi-Fi locationing

- Ideal for SSID-based Wi-Fi locationing
- 2.4 GHz and 5 GHz Dual-band
- Coexistence with Bluetooth LE
- Supported in nRF Connect SDK
- BSS Coloring
- SPI / QSPI
- Co-existence interfaces



WiFi 6E Modules



SX-PCEAX – Industry's First Tri-band Wi-Fi 6E 2x2 PCIe Module

The SX-PCEAX, based on Qualcomm's QCA2066, is one of the first Wi-Fi 6E modules. To increase the overall capacity and performance, the SX-PCEAX has been equipped with the 6 GHz band (Wi-Fi 6E) in addition to the 2.4 and 5 GHz bands plus Bluetooth 5.2 BR/EDR/HS/LE.

WiFi6e works with the same standard as WiFi6 but with an extended spectrum of additional up to 1.2GHz. Access to the 6GHz frequency brings more bandwidth, faster speeds and lower latency, as well as is ideal for future-proof devices.

Silex's Wi-Fi 6e module family is certified for Europe, North America, Japan and Canada and is available in several sizes and form factors to meet a wide range of requirements. The SX-PCEAX is used in medical applications, especially in the field of imaging diagnostics, storage/logistics applications such as self-propelled trucks or intelligent production lines, as well as in industrial environments.

SX-PCEAX-AP/6E Access Point Module

Silex's SX-PCEAX-AP Series modules are embedded wireless LAN modules utilizing Qualcomm's QCN9072 chipset, designed specifically for access points, gateways, and routers in medical and industrial settings. The SX-PCEAX-AP Wi-Fi 6 module ensures stable communication in both 2.4GHz and 5GHz frequency bands, even in congested wireless environments. On the other hand, the SX-PCEAX-AP6E Wi-Fi 6E module offers connectivity in the less crowded 6GHz spectrum. By combining both Wi-Fi 6 and 6E modules, a seamless Wi-Fi access point compatible with 2.4GHz, 5GHz, and 6GHz frequencies can be achieved.

SX-SDMAX - Dual-band Wi-Fi 6 plus Bluetooth® Combo SDIO Module Powered by NXP

The SX-SDMAX is a dual-band Wi-Fi 6 (2.4 GHz/5 GHz) module with Bluetooth v5.3 BR/EDR/LE capabilities, utilizing the NXP IW611 chipset. It supports the latest 802.11ax standard, ensuring reliable and secure wireless connectivity. Designed for plug-and-play integration, it offers enhanced performance with low latency, high throughput, and low power consumption, making it ideal for use with NXP i.MX series and other platforms. It excels in dense environments, facilitating improved communication capabilities.

Model	Frequency	Bluetooth	Temperature	Size (mm)	Package
SX-PCEAX	2,4 / 5 / 6 GHz	LE v. 5.2	-20 to 65°C	14.0 x 18.0 x 1,9 29.85 x 26.65 x 2,9 22.0 x 30.0 x 2,7	M.2 LGA Type 1418 Half-size mini PCIe Card M.2 1630 Card
SX-PCEAX-AP	2,4 / 5 GHz	-	-40 to 85°C	29.85 x 50.80 x 4,55	Mini PCIe Express Card
SX-PCEAX-AP6E	6GHz	-	-40 to 85°C	29.85 x 50.80 x 4,55	Mini PCIe Express Card
SX-SDMAX	2,4 / 5 GHz	LE v. 5.3	-40 to 85°C	17.0 x 18.0 x 2,65 60.0 x 26.0 x 2,65	Surface Mount Micro SD Card





Single and Dual Band Wi-Fi Modules



WE310F5 and WE310K6

The WE310 Wi-Fi family includes fully integrated, single as well as dual band Wi-Fi and BLE5 IoT modules with low-cost, high-speed and serial-to-wireless connection to MCU, providing faster development times and market availability. They are compliant with industry standards and global regulatory and industry certification requirements. The fully integrated WE310K6 dual band combo of Wi-Fi6 with BT and BLE5.2 provides an easy, cost-effective way for manufacturers to add wireless connectivity to their products.

Key Features

WE310F5 – Single band Wi-Fi Modules

- Fully integrated, single-band Wi-Fi and BLE 5.0 combination IoT module
- Low power consumption
- Advanced Security features (including WPA3)
- Variants with (WE310F5-I) and without (WE310F5-P) antennas

WE310K6 – Dual band Wi-Fi Modules

- Dual band 2.4 GHz and 5 GHz
- Fully integrated dual band Wi-Fi, BT and BLE 5.2 combo IoT module
- Advanced security features (including WPA3) with integrated crypto hardware

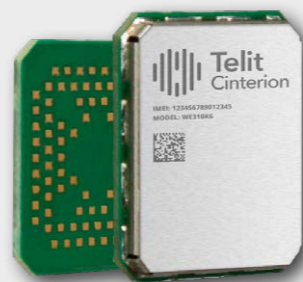

Applications

- Industrial automation
- Sensor gateways
- Condition-based monitoring
- Security panel
- Energy management
- Inspection camera
- Data logger
- Building automation
- Smart Home
- Thermostat
- Air purifier
- Air conditioner
- Security/monitoring camera
- Pet food dispenser

Single, Dual and Tri Band Wi-Fi Modules



Type 1YN

The Murata Type 1YN single band WiFi IEEE 802.11 b/g/n and Bluetooth BR/EDR/ LE 5.2 combo module comes with a very small form factor of only 6.95 x 5.15 x 1.1 mm. It is based on Infineons CYW43439 chipset.

Key Benefits

- 2.4 GHz WiFi + Bluetooth module
- Based on Infineon CYW43439
- IEEE 802.11 b/g/n
- Bluetooth BR/EDR/LE 5.2
- FCC/IC certified, EN compliant by Reference Antenna design
- Package: LGA (46 pads)
- Support for CubeMX, i.MX

Key Features

- Host interfaces: SDIO / UART, PCM
- External Antenna
- 6.95 x 5.15 x 1.1 mm
- Operating Temperature: -30°C to +70°C
- WiFi Transmit Power: +19 dBm max
- Bluetooth Transmit Power: +14dBm max (Class 1)

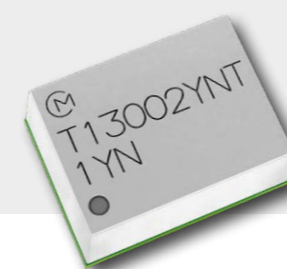

Type 2AE

The Type 2AE is based on Infineon's CYW4373E and supports WiFi 802.11 a/b/g/n/ac and Bluetooth 5.2 BR/EDR/LE. Data rates on WiFi are up to 433 Mbps and 3Mbps PHY data rate on Bluetooth. The small form factor of only 8.0 x 7.8 x 1.15 mm makes the module a perfect solution for size-sensitive applications, but also for IoT, smart home and gateways.

Key Benefits

- 2.4 + 5 GHz WiFi + Bluetooth module
- Based on Infineon CYW4373E
- IEEE 802.11 a/b/g/n/ac
- Bluetooth BR/EDR/LE 5.2
- FCC/IC certified
- Support for Linux, Modus, i.MX Yocto

Key Features

- Host interfaces: SDIO / UART, USB
- External Antenna
- Operating Temperature: -40°C to +85°C
- WiFi Transmit Power: +19.5 dBm
- Bluetooth Transmit Power: +14 dBm

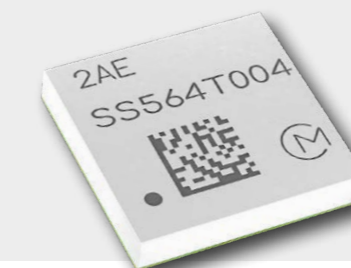

Type 2EA

The Murata Type 2EA is a Wi-Fi 6E plus Bluetooth BR/EDR/LE 5.3 module based on the new Infineon CYW55573 Chip with tri-band capability (2.4GHz, 5GHz and 6GHz) and 2x2 MIMO. It has a small form-factor of only 12.5 x 9.4 x 1.2 mm and connectors for external antennas. It can be used in applications in the Smart Home area like e.g. camera systems, as well as in AV/VR applications.

Key Features

- IEEE 802.11 a/b/g/n/ac/ax + BR/EDR/LE 5.3
- 2.4 GHz + 5 GHz + 6 GHz
- Based on Infineon CYW55573
- 2x2 MIMO
- Host interface: PCIe, SIO for Wi-Fi / UART, PCM for Bluetooth
- Support for i.MX+Linux
- Dimension: 12.5 x 9.4 x 1.2 mm
- External antennas (Optional dedicated Bluetooth Antenna)

Target Applications

- Smart Home (e.g. camera systems)
- AV/VR applications





WiFi 5 & Wi-Fi 6 Dual Band Modules

Panasonic

Dual Band Wi-Fi Modules

ISP5261-WX • Wi-Fi 6 and Bluetooth Low Energy Module

This module act as a fully functioning Bluetooth LE and Wi-Fi radio node, with only a battery required. It forms the core of an autonomous IOT device requiring Bluetooth LE and Wi-Fi connectivity.

Key Features

- Based on NXP RW612
- Wi-Fi 6 IEEE 802.11ax/ac/n/a/g/b/e/i/k/v/w
- Wi-Fi dual-band 2.4GHz / 5GHz support, 20 MHz channel
- Bluetooth Low Energy 5.3 Long Range, and Wi-Fi Coexistence
- 802.15.4
- Matter, Thread
- Fully integrated RF Matching and Antennas
- Wi-Fi & Bluetooth at 2.4 GHz, Wi-Fi at 5 GHz
- Integrated 40 MHz & 32.768 kHz Crystals
- DC/DC converters with loading circuit
- 4MB of QSPI flash memory, 1.2MB SRAM
- Configurable 64 GPIOs including ADC & DAC
- Digital interfaces USB, QSPI, UART, I²S, PDM, PWM
- Power supply 3.3V
- Temperature -40 to +85 °C



Key Applications

- Smart home devices
- Enterprise and industrial automation
- Smart accessories
- Smart energy



Combo WiFi 4 & WiFi 6 Modules

The WiFi modules support Wi-Fi 4/6 and Bluetooth 5, making it highly versatile in applications such as smart homes, consumer electronics, wearable devices and more.



Model No.	Picture	Antenna	SoCset	Dimension (mm)	Wi-Fi Version	Bluetooth Version	SPI Flash	RAM	GPIO
MS11SF1		PCB	ESP32-C3FN4	16.6*13.2*2.2	Wi-Fi 4 (802.11 b/g/n)	BLE 5.0	4MB	400KB	22
MS12SF1		PCB+IPEX	nRF7002+nRF5340	27*23.5*2.8	Wi-Fi 6 (802.11 ax)	BLE 5.3	1MB+256KB	512KB+64KB	29
MS13SF1		PCB	ESP32-D0WD-V3	25.5*18*2.2	Wi-Fi 4 (802.11 b/g/n)	BLE 4.2	8M+448KB	520KB+16KB	21
MS15SF1		PCB	ESP32-C6FH4	16.6*13.2*2.2	Wi-Fi 6 (802.11 ax)	BLE 5.3	4MB+320KB	512KB+16KB	22

WiFi 5 & Bluetooth 5.2 (BR, EDR, LE)



WiFi 6 Bluetooth 5.2 (BR, EDR, LE) (& 802.15.4)



PAN9028



Key Features

- 2.4 + 5 GHz Wi-Fi 5 + Bluetooth Classic & LE
- Based on NXP 88W8987
- Interface: SDIO (Wi-Fi) & UART (BT)
- OS Support: Linux, Android, FreeRTOS for i.MX RT
- Size: 24 x 12 x 2.8 [mm]
- Operating Temp: -30 to +85 °C

Key Benefits

- Included PMIC for simple HW design & reduction of BOM costs
- Possibility to switch between Chip Antenna & Bottom Pad
- Power Tables stored on OTP to fulfill regional regulatory requirements

Antenna Variants

- Integrated chip antenna
- Terminal antenna via bottom pad

Further antenna variants on request

Regulatory certification



PAN9019 (A)



Key Features

- 2.4 + 5 GHz Wi-Fi 6 + Bluetooth Classic & LE + 802.15.4 (PAN9019A)
- Based on NXP IW611 / IW612
- Interface: SDIO (Wi-Fi) & UART (BT)
- OS Support: Linux, Android, FreeRTOS/Zephyr for i.MX RT
- Size: 15.3 x 12 x 2.5 [mm]
- Operating Temp: -40 to +85 °C

Key Benefits

- Size optimized
- Multiple antenna options
- Flexible handling of Power Tables via binary files for regional regulatory requirements

Antenna Variants

- External chip antenna
- External PCB antenna
- External terminal antenna

Further antenna variants on request

Regulatory certification



Infrastructure

- EV Charging
- Professional Equipment

Medical

- Equipment
- Diagnostic
- Patient Monitoring

Smart Home / Building

- Home Appliance
- HVAC
- Gateways



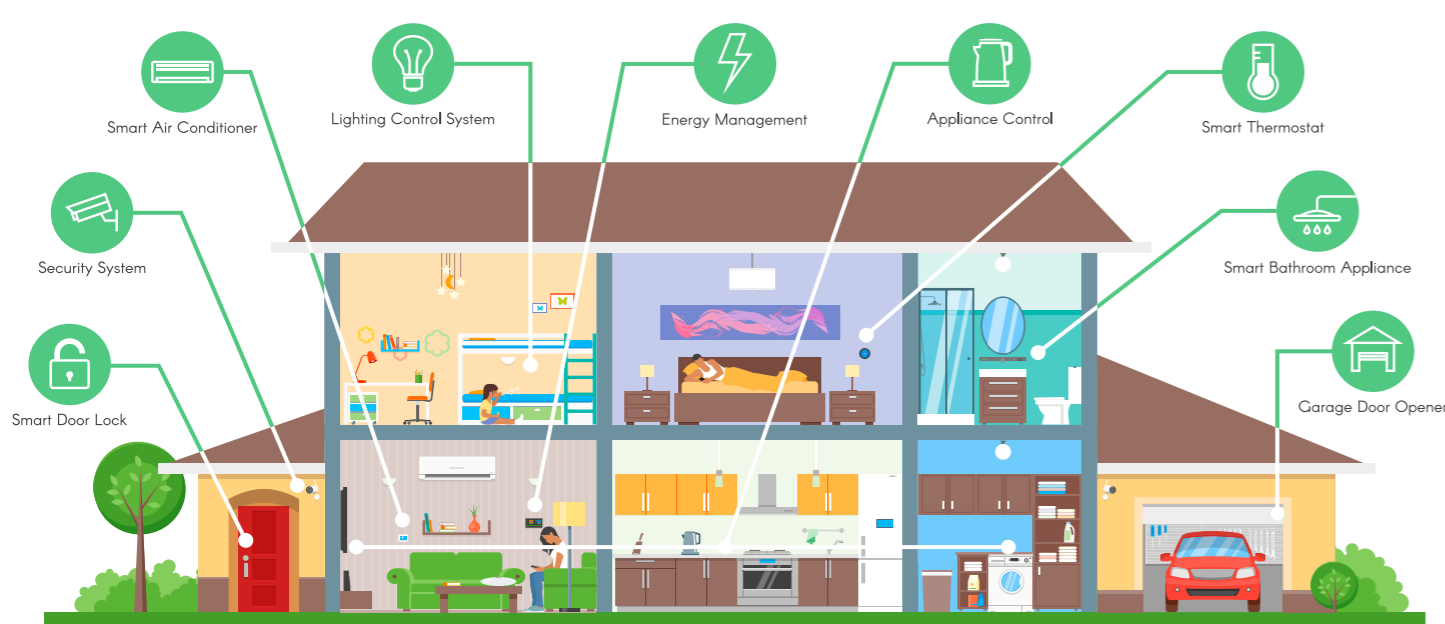

Dual Band Wi-Fi Modules



WE866 Wi-Fi Family

Integrating Wi-Fi™ to your IoT solution is simplified with the use of Telit's pre-certified Wi-Fi modules. This new & upcoming WE866 variants offer a rich feature set while packed in a small footprint. See what low energy Wi-Fi and Wi-Fi + Bluetooth combo solutions can do by integrating Telit's line of fully certified modules.

Key Features

- Dual band (2.4GHz/5GHz) Wi-Fi modules for high bandwidth IoT applications
- International regulatory certifications
- Industrial grade temperature range
- Proprietary technology delivers power consumption savings of up to 97% when compared to the IEEE standard and competitors

Applications

- Connected home
- Wearables
- Healthcare
- Automobiles
- Audio/video
- Smart Home / Smart Energy
- Industrial controls, monitoring

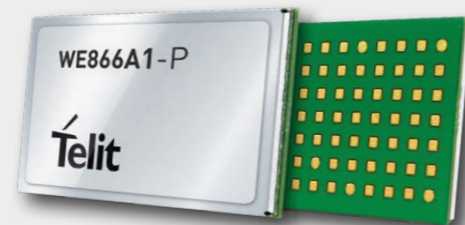

Specifications	WE866C6-P	WE866C3 (LE910 Companion Solution)
Frequency	2.4 & 5 GHz	2.4 & 5 GHz
IEEE 802.11	802.11 a/b/g/n/ac	802.11 ac
Bluetooth	BT/BLE5	Bluetooth v4.2 + HS
IEEE 802.15.4	-	-
ANT	-	ANT+
TCP/IP	Yes	-
Drivers	Linux	Linux, Android OS
MCU	Cortex M4-F	-
Internal Flash	4MB	-
Operating Temp.	-40°C to +85°C	-40°C to +85°C
Operating Voltage	3.3 V	3.3 V
Peripherals	SDIO 3.0, UART, PCM	SDIO 3.0, UART, PCM
Antenna options	External (RF Pad)	External (RF Pad)
Certifications	FCC, IC, CE, TELEC, ANATEL, WPC-ETA, KC, SRRC, RCM	FCC, IC, CE
Dimensions	13 x 15 x 2.2 mm	13 x 13 mm

WE866C6-P – Application Fields

Transportation / Mobility

- Aftermarket/OEM telematics
- Fleet management
- Asset tracking
- Intelligent transportation
- Car phone
- OBD (onboard diagnostics)

Industrial / Infrastructure

- Condition-based monitoring
- Agriculture
- Video surveillance
- Healthcare equipment monitoring

Commercial / Enterprise

- Commercial building automation
- Patient monitoring
- Home security and automation
- Kiosks, vending, POS

Dual and Tri Band Wi-Fi Modules & Cards



Intel WiFi 5, WiFi 6, WiFi 6E and WiFi 7 M.2 Cards

Since more than 20 years WiFi is connecting the world and the technology is developing fast. Intel is participating in this development and offers various solutions, to fulfill users different requirements. From WiFi 5 (IEEE 802.11 ac), over WiFi 6/6E (IEEE 802.11 ax) to the newest evolution WiFi 7 (IEEE 802.11 be), Intel offers M.2 cards in different versions.

Type	WiFi 5 9560*	WiFi 5 9462*	WiFi 5 9461*
Code Name	Jefferson Peak 2	Jefferson Peak 1	Jefferson Peak 1
Estimated SW support until		Q4 2026	
TX/RX Streams	2x2		1x1
Bands		2.4 GHz, 5 GHz	
Max Speed	1.73 Gbps	433 Mbps	433 Mbps
Integrated Bluetooth		V5.1	
From Factor		M.2 2230 M.2 1216 (SMD)	
Supported Operating Systems		Microsoft Windows 10, Linux, Chrome	
System Interface Type		CNVio, GPIO	
Use Conditions		PC Client	
vPRO support possible	Yes	No	No

Type	WiFi 6E AX210	WiFi 6E AX211*	WiFi 6E AX411*	WiFi 7 BE200**	WiFi 7 BE201*	WiFi 7 BE202
Code Name	Typhoon Peak 2	Garfield Peak 2	Garfield Peak 4	Gale Peak 2	Fillmore Peak 2	Misty Peak 2
Estimated SW support until	Q4 2028	Q4 2028	Q4 2028	Q3 2030	N/A	Q3 2030
TX/RX Streams				2x2		
Bands				2.4 GHz, 5 GHz, 6 GHz		
Max Speed	2.4 Gbps	2.4 Gbps	3 Gbps	5.8 Gbps	5 Gbps	2.4 Gbps
Integrated Bluetooth		V5.2		V5.4		
From Factor				M.2 2230 M.2 1216 (SMD)		
Supported Operating Systems	Windows 10, 64-bit, Google Chrome OS, Linux	Windows 10, Linux	Windows 10, Linux	Windows 11, Windows 10, Linux	Windows, Linux, ChromeOS	Windows 11, Windows 10, Linux
System Interface Type	PCIe (WiFi), USB (BT)	CnVio2	CNVio2	PCIe (WiFi), USB (BT)	CNVio3	PCIe (WiFi), USB (BT)
Use Conditions	PC Client, Industrial, Embedded	PC Client	PC Client	PC Client, Industrial, Embedded	PC Client	PC Client
vPRO support possible	Yes	Yes	Yes	Yes	Yes	No

* CRF (Companion RF) modules
** Still in development phase of embedded and industrial versions



WLAN Modules – Selection Guide

Manufacturer	Name	Frequency		WLAN Protocol								Other Protocols		WLAN Software on Module			WLAN Security					Antenna		Chipset	Certifications	Interfaces					Operating Temp. (°C)	Size (mm)	Package	Evaluation Kit / Development Kit	Drivers	Comments
		2.4GHz	5GHz / 6 GHz	802.11a	802.11b	802.11g	802.11n	802.11ac	802.11ad	802.11ah	802.11ax	802.11be	Bluetooth	Other	TCP/IP	Access Point	WiFi-Direct	Web Server	WPA2-Enterprise	WPA3	WPS	WPA1	SSL/TLS			Integrated Antenna	Antenna Connector	SDIO	SPI	UART						
Intel	Wireless-AC 9560	x		x	x	x	2T/2R	2T/2R									x	x			x					x	CNVi	0 to +80	22x30x2.4 12x16x1.57	M.2 2230 M.2 1216 card		Microsoft Windows 10, Linux (limited feature support), Chrome	CRF (Companion RF) module; 1.73 Gbps 433 Mbps			
	Wireless-AC 9461	x		x	x	x	1T/1R	1T/1R									x	x			x					x	CNVi	0 to +80	22x30x2.4 12x16x1.57	M.2 2230 card M.2 1216 card						
	Wireless-AC 9462	x		x	x	x	1T/1R	1T/1R									x	x			x					x	CNVi	0 to +80	22x30x2.4 12x16x1.57	M.2 2230 card M.2 1216 card			CRF (Companion RF) module; 433 Mbps			
	Wireless AX210	x	x	x	x	x	x	x							2T/2R			x	x	x							WiFi: PCIe BT: USB	0 to +80 -40 to +85	22x30x2.4 12x16x1.65	M.2 2230 M.2 1216	Embedded Kit: AX210, NGWGE.NVK Industrial Kit: AX210, NGWGI.NVK	Windows 11, 64-bit*, Windows 10, 64-bit*, Linux*				
	Wireless AX211	x	x	x	x	x	x	x							2T/2R			x	x	x							CNVio2	0 to 80	22x30x2.4 12x16x1.65	M.2 2230 M.2 1216		Windows 11, 64-bit*, Windows 10, 64-bit*, Linux*, Chrome OS*	CRF (Companion RF) module			
	Wireless AX411	x	x	x	x	x	x	x							2T/2R			x	x	x							CNVio2	0 to 80	22x30x2.4 16x25x1.65	M.2 2230 M.2 1625		Windows 11, 64-bit*, Windows 10, 64-bit*, Linux*	CRF (Companion RF) module			
	Wireless BE200	x	x	x	x	x	x	x							2T/2R	x		x	x								WiFi: PCIe BT: USB	0 to 80	22x30x2.4 12x16x1.65	M.2 2230 M.2 1216		Windows 11, Windows 10, Linux				
	Wireless BE201	x	x	x	x	x	x	x							2T/2R	x		x	x								CNVio3	0 to 80	22x30x2.4 12x16x1.65	M.2 2230 M.2 1216		Windows, Linux, ChromeOS	CRF (Companion RF) module			
Wireless BE202	x	x	x	x	x	x	x							2T/2R	x		x	x								WiFi: PCIe BT: USB	0 to 80	22x30x2.4 12x16x1.65	M.2 2230 M.2 1216		Windows 11, Windows 10, Linux					
Panasonic	PAN9520	x			x	x	x										x	x	x								"QSPI, I²C, I²S, GPIO"	-40 to 85	24 x 13 x 3.1	Surface Mount	PAN9520 Eval Board / ENW49D01AZKF	Fully embedded				
	PAN9026		x		x	x	x	1T/1R										x											-30 to 85	17.5 x 10.0 x 2.6	Surface Mount	PAN9026 EVALKIT / ENWF9201AYEF	Linux / Android Driver			
	PAN9028		x		x	x	x	x										x											-30 to 85	17.5 x 10.0 x 2.6	Surface Mount		Linux / Android Driver	Scheduled for autumn 2019		
Telit	WE310F5 single band with integrated/external antenna	x			x	x	x										x	x															Integrated antenna WE310F5-1: 18 x 15 External antenna (WE310F5-P): 14.3 x 13.1	WE310F5-I EVK		
	WE310K6 dual band	x		x	x	x	x										x	x											-40 to 85	18 x 15 x 2.6	LGA package	WE310K6-P EVK	Linux			
	WE866C6-P	x						x									x	x											-40 to 85	15 x 13 x 2.2	LGA package	WE866C6-P EVK	Linux			
	WE310G4-I/P	x		x	x	x	x										x	x										-40 to 85	WE310G4-I: 18 x 15 WE310G4-P: 14.3 x 13.1	LGA package	WE310G4-I EVK					
Avantech	EWM-W194M201E	x		x	x	x	2T/2R	x									x	x										-30 to 85	22x30x2.85	M.2 2230 card		Linux (Kernel v4.0 and above)				
	EWM-W306S01E	x		x	x	x	2T/2R	x									x	x											-30 to 85	12x16x1.85	M.2 1216 LGA		Linux OS			
	AIW-163BR	x		x	x	x	2T/2R	x									x	x											0 to 70	30x22x2.2	M.2 2230 A-E Key card		Windows 10			
	AIW-164SN	x		x	x	x	x										x	x											-40 to 85	20x18x2.8	LGA		Linux			
	AIW-165BN	x		x	x	x	x										x	x											-40 to 85	28x30x3.95	M.2 2830 E Key card		Linux			
	AIW-168BM	x	x														x	x											-10 to 70	22 x 30 x 2.3	M.2 2230 E key		Windows 11			
	AIW-170BQ-001		x	x		x	x	x									x	x											-40 to 85	22 x 30 x 2.2	M.2 2230, E-key card		Windows/Linux			
	AIW-171HQ-001		x		x	x	x	x									x	x											-40 to 85	29.85 x 26.65 x 4.2	Mini PCIe		Windows/Linux			
Insight SiP	ISP5261		x		x	x	x										x	x											-40 to +85	12 x 12 x 1.8	LGA		x			
iVativ	MIST	x			x	x	x										x																			
	AVIC	x			x	x	x										x																			
	RILA	x			x	x	x										x																			
	BALI		x														x													-40 to 85	11.8 x 12 x 1.6 LGA	M.2 1630 M.2 2230 Half-size Mini PCIe				
	EVIA		x														x													-40 to +85	11.8 x 12 x 1.6 12 x 16 x 1.9	Surface Mount M.2 1630, M.2 2230 Half-Size Mini PCIe / Mini PCIe		Supported Ecosystem: WICED, i.MX		
Minew	MS11SF1	x			x	x	x																							-40 to +85	16.60 x 13.20 x 2.20					
	MS12SF1		x																											-40 to +85	27 x 23.5 x 2.4					
	MS13SF1	x			x	x	x																							-40 to +85	25.5 x 18 x 2.2					
	MS15SF1	x			x	x	x																							-40 to +105	16.60 x 13.20 x 2.20					
	MS93MFZ	x			x	x	x																							-40 to +85	38.5 x 26					





What is Bluetooth®?



Bluetooth is a wireless technology standard implemented for exchanging data over usually short distances from fixed and mobile devices, building Personal Area Networks (PANs). Here, short-wavelength microwaves in the ISM band from 2.4 to 2.485 GHz are used.

Bluetooth is managed by the Bluetooth Special Interest Group (SIG), which today has more than 38,000 member companies in the area of telecommunication, computing, networking, and consumer electronics. The term "Bluetooth" covers a number of different versions which evolved over the last years. Today, classic Bluetooth is differentiated from the latest Bluetooth standards 4.0-5.4, which are known as Bluetooth Low Energy / Bluetooth Dual Mode. Actually, Bluetooth Low Energy and Classic Bluetooth have to be seen independently from each other (an exception are Dual Mode modules or chips, where both standards, Classic Bluetooth

and Bluetooth Low Energy can be used). While the overall difference between the diverse versions of Classic Bluetooth consists of an improved enhancement of the transferred data rate, the most recent Bluetooth Low Energy standard is rather classified as an individual standard which was designed to create low data rate networks using a minimum amount of power.

Furthermore, it does not only enable point-to-point connection but also mesh topology for establishing many-to-many device communications.

Common Bluetooth Versions and Their Characteristics

Bluetooth-Version	Description	Release Date	Max. Date Rate	Comment
1.0 + 1.0B	Basic-Rate Mode	Jul 99	732.2 kbit/s	Obsolete
1.1	Basic-Rate Mode	Feb 01	732.2 kbit/s	Obsolete
1.2	Basic-Rate Mode	Nov 03	1 Mbit/s	Obsolete
2.0 + EDR	Enhanced Data Rate	Nov 04	2.1 Mbit/s	Obsolete
2.1 + EDR	Enhanced Data Rate	Aug 07	2.1 Mbit/s	Easy pairing of devices compared to older Bluetooth-versions
3.0 + HS	Bluetooth High Speed	Apr 09	3 - 24 Mbit/s	Add. HS-channel available; can reach a data rate of 24 Mbit/s
3.0 + EDR	Enhanced Data Rate	Apr 09	3 Mbit/s	With additional Wi-Fi Hardware
4.0 LE	Bluetooth Low Energy	Dec 09	220 kbit/s	Bluetooth Low Energy is not compatible to Classic Bluetooth
4.0 DM	Bluetooth Dual Mode or Low Energy	Dec 09	LE: up to 220 kbit/s Classic: up to 24 Mbit/s	Bluetooth Dual Mode is compatible to Classic Bluetooth & Bluetooth Low Energy
4.1	Bluetooth Dual Mode or Low Energy	Dec 13	LE: up to 220 kbit/s Classic: up to 24 Mbit/s	Seamlessly with other wireless technologies, an essential link for the IoT
4.2	Bluetooth Dual Mode or Low Energy	Dec 14	LE: up to 1 Mbit/s Classic: up to 24 Mbit/s	Improved privacy + increase speed, soon-to-be ratified profile will enable IP connectivity
5.0	Bluetooth Dual Mode or Low Energy	Dec 16	LE: up to 2 Mbit/s Classic: up to 24 Mbit/s	4x range, 2x speed and 8x broadcasting message capacity compared to previous version
5.1	Bluetooth Dual Mode or Low Energy	Jan 19	LE: up to 2 Mbit/s Classic: up to 24 Mbit/s	Direction finding using Angle of Arrival or Angle of Departure
5.2	Bluetooth Dual Mode or Low Energy	Jan 20	LE: up to 2 Mbit/s Classic: up to 24 Mbit/s	
5.3	Bluetooth Dual Mode or Low Energy	Jul 21	LE: up to 2 Mbit/s Classic: up to 24 Mbit/s	LE Audio and Auracast™
5.4	Bluetooth Dual Mode or Low Energy	Feb 23	LE: up to 2 Mbit/s Classic: up to 24 Mbit/s	new features such as PAwR and Encrypted Advertisement Data + bi-directional communication

What are Bluetooth® Profiles?

The Bluetooth profile is an individual application layer on top of the Bluetooth HCI (Host Controller Interface) layer. In order to use Bluetooth technology, a device must be compatible with the subset of Bluetooth profiles necessary to use the desired services. The way a device uses Bluetooth technology depends on its profile capabilities. The profiles provide standards, which manufacturers follow to allow devices to use Bluetooth in the intended manner. Bluetooth Low Energy is using other profiles than Classic Bluetooth – based on top of GAP and GATT, which can be user-defined.

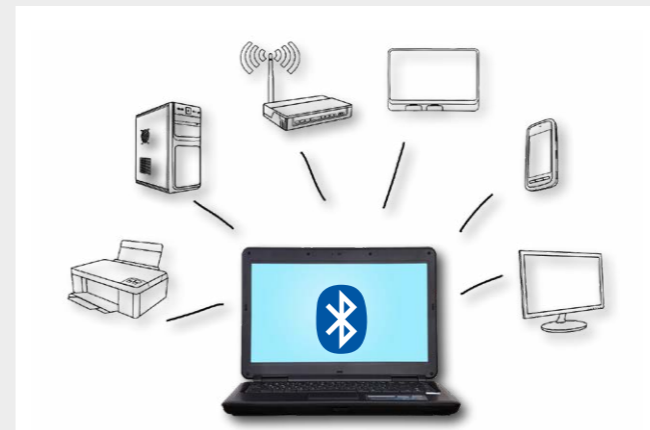

New Security Regulations

Security standards are a major topic at Bluetooth SIG. To keep this standard high, safe and always available, several standards for producing Bluetooth applications have to be maintained: Lately the new EN ETSI and RED (Radio Equipment Directive – 2014/53/EU) decree were released which implicate duties for manufacturers.

Especially for body-close applications you need to do SAR measurements and a special Bluetooth declaration process is required.

Bluetooth Profiles

Profile	Description	Application	Bluetooth Type
SPP	Serial Port Profile	Serial data transfer	Classic
A2DP	Advance Audio Distribution Profile	Streaming of audio multimedia	
HDP	Health Device Profile	Facilitates transmission of Medical Device Data	LE
HID	Human Interface Device Profile	For devices with which the end-user interacts directly	
HCI	Host Controller Interface	Interface between BT Hardware and application profiles	
iAP	iPhone Accessory Profile	support the development of accessories for Apple devices such as the iPhone or iPad.	
GAP	Generic Access Profile	Provides basis for all other profiles + defines how two Bluetooth® units establish a connection with each other	
GATT	Generic Attribute Profile	Provides profile discovery and description services for Bluetooth® SMART protocol	





Bluetooth® Low Energy nRF5340 - Dual-core SoC

nRF5340 – Dual-Core Bluetooth 5.4 SoC supporting Bluetooth LE, Bluetooth mesh, NFC, Matter, Thread and Zigbee

The nRF5340 is the world's first wireless SoC with two Arm® Cortex®-M33 processors. The combination of two flexible processors, the advanced feature set, and an operating temperature up to 105 °C, makes it the ideal choice for LE Audio, professional lighting, advanced wearables, and other complex IoT applications.

Key Features

- **High-performance application processor**
 - 128/64 MHz Arm Cortex-M33 with FPU & DSP instructions
 - 1 MB Flash + 512 kB low leakage RAM
 - 8 kB 2-way set associative cache
- **Fully-programmable network processor**
 - 64 MHz Arm Cortex-M33 with 2 kB instruction cache
 - 256 kB Flash + 64 kB RAM
 - Ultra-low power
- **Next level security**
 - Trusted execution with Arm TrustZone
 - Hardware accelerated cryptography with Arm CryptoCell-312
 - Secure Key Storage
 - Secure bootloader with root-of-trust and DFU
- **Bluetooth Low Energy**
 - Bluetooth 5.3
 - LE Audio
 - Direction Finding
 - 2 Mbps, Advertising Extensions and Long Range
- **Bluetooth mesh**
 - Thread, Zigbee and 802.15.4
 - NFC
 - **Full range of digital interfaces with EasyDMA**
 - Full-speed USB
 - 96 MHz encrypted QSPI
 - 32 MHz high-speed SPI
 - **105 °C extended operating temperature**
 - **1.7-5.5 V supply voltage range**

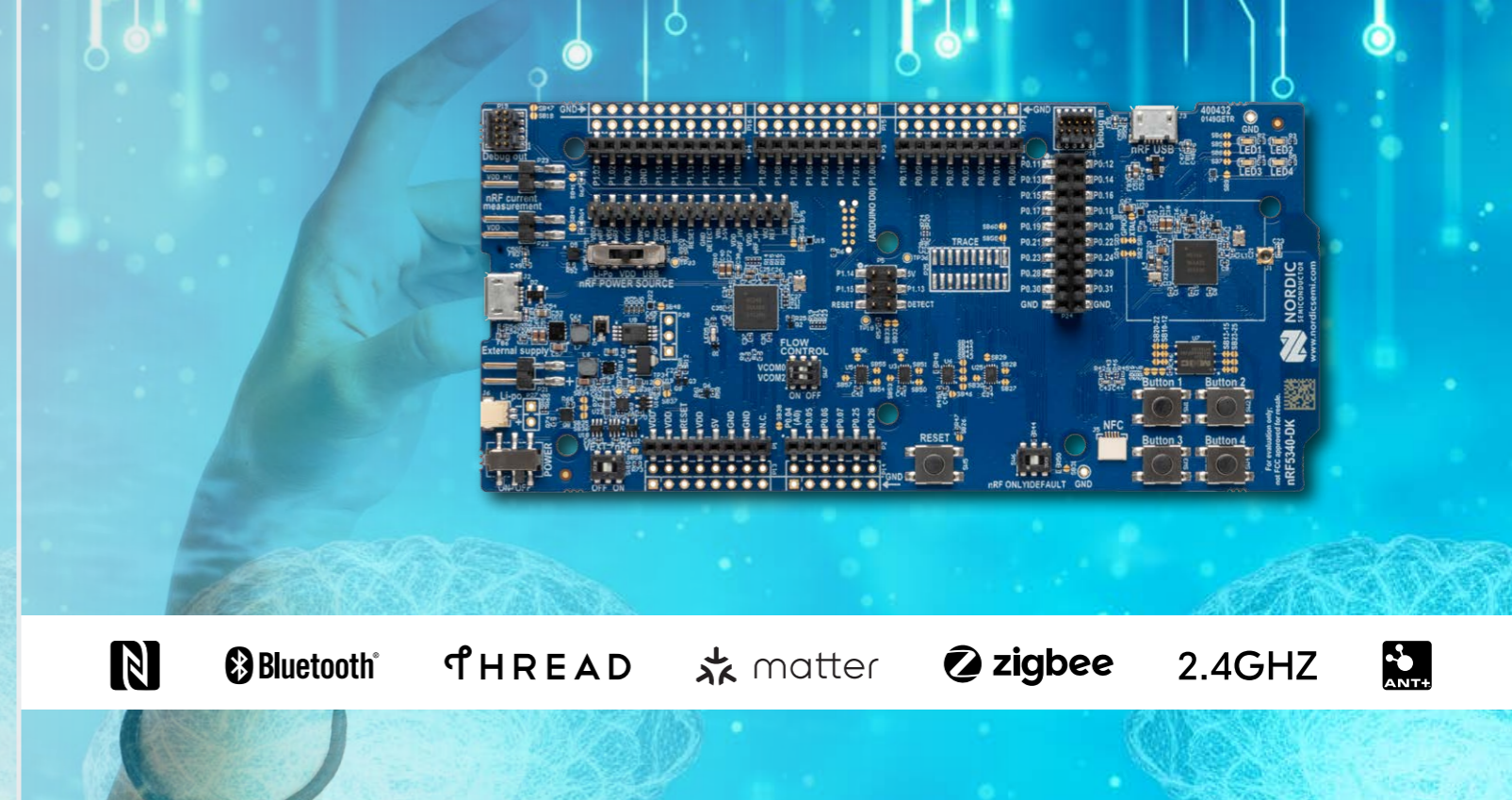

Start your Development today!

nRF5340 DK

Development kit for the nRF5340, a dual-core Bluetooth 5.4 SoC supporting Bluetooth Low Energy, Bluetooth mesh, NFC, Matter, Thread and Zigbee.

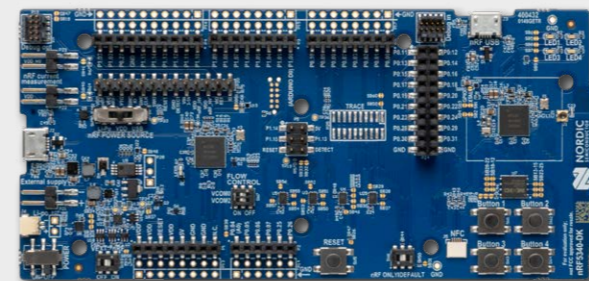

nRF5340 Audio DK

The nRF5340 Audio DK is a development kit for Bluetooth LE Audio applications. It contains everything needed to get started with development. Better audio quality, longer playtime, and Auracast™ features.



Nordic Thingy:53

The Thingy:53 is Nordic's rapid prototyping platform, based on the nRF5340 System-on-Chip (SoC), the current flagship dualcore wireless SoC. With integrated sensors for motion, sound, light and environmental factors, it is the perfect platform for building proof-of-concepts and developing new prototypes in a very short time.



Power Profiler Kit II

The Power Profiler Kit II (PPK2) is an affordable, flexible tool that measures the real-time power consumption of your designs. The PPK2 can measure current on any external board (e.g. nRF5 Series or nRF91 Series DKs).





Coming soon!

Bluetooth® Low Energy SoC



nRF54H20

nRF54H20 is a compact all-in-one solution that can replace multiple components on the PCB, reducing design size. For example, an application MCU, an external flash, and a wireless SoC can be replaced with a single compact nRF54H20. In addition, its excellent energy efficiency enables smaller batteries to be used, further reducing both the design size and cost.

Main Benefits

- Reduced design size/ highly integrated SoC
- Prolonged battery life/ reduced battery size
- Providing long range: Best-in-class multiprotocol radio
- State-of-the-art protection against security threats

Key Features

- Multiple Arm Cortex-M33 processors, clocked up to 320 MHz
- Multiple RISC-V coprocessors
- 2 MB non-volatile memory
- 1 MB RAM
- Bluetooth Low Energy, LE Audio, Bluetooth mesh, Thread, and Matter
- New peripherals: High-speed USB (480 Mbps), CAN FD controller, 2 x I3C and 14-bit ADC
- Designed for PSA Certified Level 3 IoT security standard
- Physical security

Applications

- Advanced wearables
- Smart home and Matter
- Medical and healthcare
- LE Audio
- Industrial
- Gaming
- Virtual reality and augmented reality
- E-mobility



nRF54L15

nRF54L15 is the first System-on-Chip (SoC) in the nRF54L Series. It is an ultra-low power Bluetooth 5.4 SoC with a new best-in-class multiprotocol radio and advanced security features. nRF54L Series takes the popular nRF52 Series to the next level with excellent processing power and efficiency, expanded memory, and new peripherals, all in a more compact package.

Main Benefits

- Takes nRF52 Series to the next level
- State-of-the-art protection against security threats
- Providing long range: Best-in-class multiprotocol radio
- Prolonged battery life/ reduced battery size

Key Features

- 128 MHz Arm Cortex-M33 processor
- 1.5 MB non-volatile memory
- 256 KB RAM
- Bluetooth Low Energy, Bluetooth mesh, Thread, and Matter
- New peripherals: Global RTC, 14-bit ADC, and a software-defined peripheral enabled by a RISC-V coprocessor
- Designed for PSA Certified Level 3 IoT security standard
- TrustZone isolation, side-channel protection, and tamper detection
- Ultra-compact packages

Applications

- PC accessories, gaming controllers, and remotes
- Virtual reality and augmented reality
- Smart home and Matter
- Medical devices
- Industrial IoT



Bluetooth® Low Energy Module

Panasonic

PAN178x – Bluetooth® Low Energy 5.1

The PAN178x Series RF Module is a high technology device featuring the Nordic nRF52 Series Single-Chip Controller and is ideal for IoT Wireless Connectivity applications.

Block Diagram

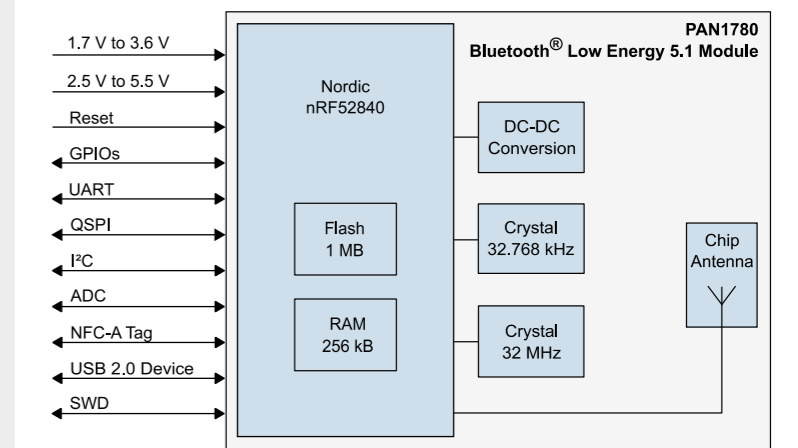

PAN1780 – the Flagship based on nRF52840

- Bluetooth 5 & 802.15.4
- Support of Matter, BLE Mesh, ZigBee, Thread and Wireless
- All 48 GPIOs available
- Extended certifications
- U.FL connector and AT Command Set variants
- Separate 32 kHz Crystal Oscillator
- Small size of 15.6 x 8.7 x 2 [mm]

Broad portfolio based on

- From low- to high-end feature chipsets
- Integrated antenna and u.FL connector versions
- With or without AT Command stack variants

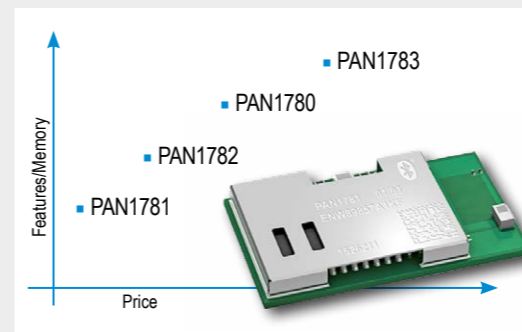

Infrastructure

- EV Charging
- Professional Equipment
- Smart Lighting

Medical

- Equipment
- Diagnostic
- Patient Monitoring

Smart Home / Building

- Home Appliance
- HVAC
- Gateways

Production Line Panasonic

100% end-of-line tested	European development & production
0 ppm failure rate	Produced according to IATF 16949
Certified for CE RED, FCC, ISED, MIC, KCC, RCM, SRRC	

PAN1780	PAN1780AT	PAN1770	PAN1781	PAN1782	PAN1783
Bluetooth Low Energy 5.3		Bluetooth Low Energy 5.1		Bluetooth Low Energy 5.1	
nRF52840		nRF52820		nRF52833	
ARM® Cortex® -M4F		ARM® Cortex® -M4		ARM® Cortex® -M4	
1MB Flash, 256kB RAM	AT Command Set	1MB Flash, 256kB RAM	256kB Flash, 32kB RAM	512kB Flash, 128kB RAM	1 MB Flash & 512 KB RAM 256 KB Flash & 64 KB RAM
Chip Antenna		u.FL connector	Chip Antenna	Chip Antenna	Chip Antenna
15.6 x 8.7 x 2 [mm]					



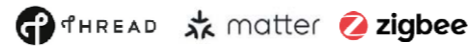

Bluetooth® Low Energy Fast-Track Your IoT Deployment with Insight SiP Solutions

The InsightSiP "Ready-to-go" RF modules offer you the fast, low risk way to deploy your IoT infrastructure, with fully CE, FCC, IC, Telec and Bluetooth SiG certified solutions. All modules are based on Nordic Semiconductor's SoCs.



ISP1507-AX

- All purpose device
- Core Bluetooth feature set
- Large application capacity
- Balanced price/performance trade off

ISP1807-LR

- High-capacity Flash/RAM
- Advanced Bluetooth features
- Long range
- Angle of arrival
- Mesh
- Rich I/O set

ISP1907-LL / ISP1907-HT

- Connectivity node
- Simple applications
- Cost effective solution
- Simple angle of arrival tag

ISP2053-AX

- High end dual core architecture
- Power optimized
- Advanced security features
- BLE audio support
- Advanced real time capability
- Trust Zone

Part Number	ISP1507-AX	ISP1807-LR	ISP1907-LL	ISP1907-HT	ISP2053-AX
Bluetooth	5.0	5.0	5.1	5.1	5.2
BT Features	Bluetooth LE	Bluetooth LE Long Range	Bluetooth LE Long Range Dir. Finding	Bluetooth LE Long Range Dir. Finding	Bluetooth LE Long Range Dir. Finding - Audio
Other protocol	BT Mesh - ANT	BT Mesh - ANT Thread - Zigbee	BT Mesh - ANT	BT Mesh Thread - Zigbee	BT Mesh - ANT Thread - Zigbee
Tx Power	+ 4 dBm	+ 8 dBm	+ 4 dBm	+ 8 dBm	+ 3 dBm
Chip	nRF52832	nRF52840	nRF52811	nRF52833	nRF5340
Processor	Cortex M4F	Cortex M4F	Cortex M4	Cortex M4F	2 x Cortex M33
Flash	512 kB	1 MB	192 kB	512 kB	1 MB + 512 kB
RAM	64 kB	256 kB	24 kB	128 kB	256 kB + 64 kB
Security	-	Cryptocell	-	-	TrustZone - Cryptocell
GPIOs (ADCs)	30 (8)	46 (8)	13 (3)	30 (8)	46 (8)
Interfaces	(High Speed) SPI, TWI, UART, PWM, PDM (Applicable for all)				
NFC tag	Yes	Yes	-	Yes	Yes
USB	-	Yes	-	Yes	Yes
Temperature	85°C	85°C	85°C	105°C	105°C
Dimensions	8 mm x 8 mm x 1 mm (Applicable for all)				

MinewSemi Focuses on Connectivity Module



Bluetooth low power communication module, extremely low power consumption, strong anti-interference ability, can connect a variety of devices at the same time.



Application:



Bluetooth® Low Energy Modules



Bluetooth® LE Module – Overview

Cutting edge Nordic Semiconductor nRF52 series SoCs enables MinewSemi Bluetooth Low Energy module collections with multiple protocol capabilities, high flexibility and ultra low power. Global certifications and preloaded MinewSemi Uart firmware reduce customers' BOM cost and time-to-market for multi IoT applications. With multi Nordic nRF52805/nRF52810/nRF52832/nRF52833/nRF52840 SoCs, higher performance PCB/Ceramic and u.FL antenna type, integrated DC/DC and 32.768Khz crystal oscillator, MinewSemi module will meet your requirements in different IoT industries.



Model Series	MS52SF1 Series	MS52SF2 Series	MS51SF1 Series	MS50SF7 Series	MS53SF1 Series	MS53SF2 Series	MS88SFA Series	MS88SFB Series
Model No.	MS52SF11	MS52SF21	MS51SF11	MS50SF71	MS53SF11	MS53SF21	MS88SFA8	MS88SFB8
Antenna	PCB	PCB	PCB	PCB	PCB	PCB	PCB/IPEX	PCB/IPEX
SoCset	Telink TLSR8208	Telink TLSR8208	Nordic nRF52833	Nordic nRF52832	BlueNRG-355M	BlueNRG-332AC	Nordic nRF52833/840	Nordic nRF52833
Max Range	80M	80M	80M	80M	300M	500M	600M	600M
Dimension(mm)	15.8*12*2	20*12*2	9.8*8.4*2	9.8*8.4*2	20*12*2	20*12*2	23.2*17.4*2	23.2*17.4*2
Flash	128KB	128KB	512KB	512KB	256KB	192KB	1M/512KB	512KB
RAM	16KB	16KB	128KB	64KB	64KB	24KB	256KB/128KB	128KB
Sensitivity(RX)	-97dBm	-97dBm	-96dBm	-96dBm	-97dBm	-97dBm	-96dBm	-96dBm
Transmission Power	-45~+10dBm	-45~+10dBm	-40~+8dBm	-40~+4dBm	-20~+8dBm	-20~+8dBm	~+20dBm	~+20dBm
Current(TX)	0dBm-9.5mA	0dBm-9.5mA	0dBm-4.9mA	0dBm-5.3mA	0dBm-4.3mA	0dBm-4.3mA	Peak:150mA	Peak:200mA
Current(RX)	9.1mA	9.1mA	4.6mA	5.4mA	3.4mA	3.4mA	/	/
GPIO	14	15	20	24	25	19	29	29
Certification	SRRC,BQB,FCC,CE REACH,ROHS	/	/	/	/	/	CE,FCC,REACH, ROHS	REACH,ROHS

Firmware
1. For module based on nRF52811/833/840, it is null module without any firmware preloaded in default.
2. For module based on nRF52805/810/832, it has the UART-Slave/Master firmware preloaded in default. We can provide UART command list if needed.





MEDICAL HEALTH CARE AND PHARMACY



Bluetooth® Low Energy Module



BLE v5.2 Module - LBCA1HN2EG (Type 2EG)

The latest Type 2EG module consists of OnSemi's RSL15, a 48MHz crystal for timing and an on-board antenna. The module provides a Serial Port Interface (SPI) and UART Interface to Arm Cortex's M33 processor.

Features

- Bluetooth® v5.2
 - Higher throughput
 - Increased broadcast capacity
 - Improved channel co-existence algorithm (SCA)
 - Long range
 - Proximity
- onsemi RSL15 SoC
- Built-in ARM Cortex M33 core with 80kB RAM (including 64kB user RAM) and 512kB Flash
- Dimension 7.4 mm x 7.0 mm x 1.0 (max.) mm
- Packaging: LGA
- Antenna Configuration:
 - Built-in PCB antenna
 - Optional external antenna from pin pad
- Max. transmit power: 6 dBm
- Receive sensitivity: -96 dBm @ 1Mbps
- Ultra-low power
 - TX 4.3 mA @ 0dBm
 - RX 2.7 mA @ 1Mbps
 - Sleep mode 36nA @3V VBAT
- Host interface: UART, SPI Peripheral interfaces: 15 GPIO, ADC, DAC, PWM, I2C, UART, SPI (QSPI), PCM and Debug SWD
- Operating temperature range: -40°C to 85°C
- RoHS compliant
- MSL Level 3 in accordance with JEDEC J-STD-020
- Regulatory certificates: FCC, ISED, ETSI, TELEC

Target Markets

- Building automation
- Industrial IoT
- Healthcare
- Consumer applications

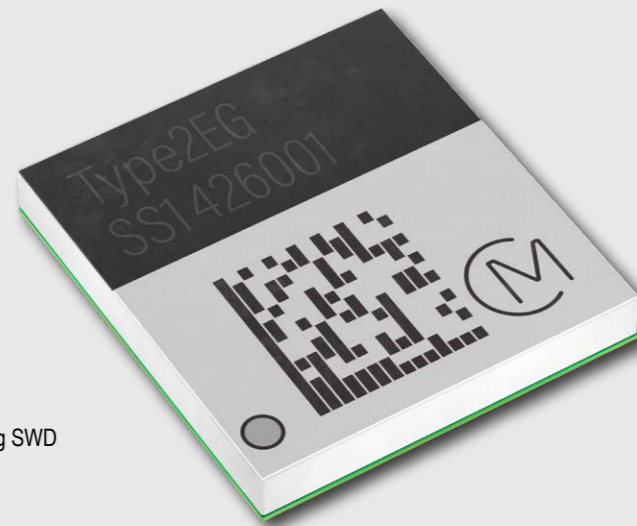

AIROC™ Bluetooth® and Bluetooth® Low Energy Solutions



Infineon's AIROC™ Bluetooth® Low Energy-only and dual-mode Bluetooth® solutions deliver the most reliable and highest performing connectivity for your applications. These SoC's are supported in ModusToolbox™ Software and Tools with copious Bluetooth® code examples as well as in-house AIROC™ globally certified modules for rapid time to market.

AIROC™ Bluetooth® Low Energy portfolio consists of the CYW20736, CYW20835 and their respective modules, as well as the PSoC™ 4 Bluetooth® LE and PSoC™ 6 Bluetooth® LE System-on-Chip (SoC) devices and fully certified modules.

Product	SDK	CPU	Flash (KB)	RAM (KB)	GPIOs	Bluetooth LE Max Tx Power	RX Sensitivity
AIROC™ CYW20736	ModusToolbox™	24 MHz Arm® Cortex®-M3	External	60	14	4 dBm	-93 dBm
AIROC™ CYW20835	ModusToolbox™	96 MHz Arm® Cortex®-M4	External	384	24	12 dBm	-94.5 dBm
PSoC™ 4 MCU w/ Bluetooth® LE	PSoC™ Creator	48 MHz Arm® Cortex®-M0	Up to 256KB	Up to 32	36	3 dBm	-91 dBm
PSoC™ 63 MCU w/ Bluetooth® LE	ModusToolbox™	150 MHz Arm® Cortex®-M4 & 100 MHz Arm® Cortex®-M0	Up to 1MB	Up to 288	Up to 84	4 dBm	-95 dBm

AIROC™ CYW20835 Bluetooth® LE SoC

is designed to support the entire spectrum of Bluetooth® Low Energy IoT device use cases like home automation, sensors, lighting, Bluetooth® Mesh, and wireless input devices.



PSoC™ 63 MCU with AIROC™ Bluetooth® LE

is a dual core, highly optimized, flexible and ultra low power, machine learning ready microcontroller with Bluetooth® Low Energy for IoT applications.



The dual-mode Bluetooth® portfolio includes Bluetooth® SIG-compliant, devices and modules that integrate Bluetooth® standard profiles and protocols for embedded applications.

Product	CPU	Flash (KB)	RAM (KB)	GPIOs	Basic rate Max Tx Power	E2M Max Tx Power	E2M Rx Sensitivity	LE Max Tx Power	LE RX Sensitivity
AIROC™ CYW20706	48 MHz Arm® Cortex®-M3	External	352	24	12 dBm	9 dBm	-95.5 dBm	9 dBm	-96.5 dBm
AIROC™ CYW20719	96 MHz Arm® Cortex®-M4	1 MB	512	Up to 40	5 dBm	0 dBm	-94 dBm	5.5 dBm	-95.5 dBm
AIROC™ CYW20721	96 MHz Arm® Cortex®-M4	1 MB	512	Up to 40	5 dBm	0 dBm	-94 dBm	5.5 dBm	-95.5 dBm
AIROC™ CYW20819	96 MHz Arm® Cortex®-M4	256	176	22	5 dBm	0 dBm	-94.5 dBm	4.5 dBm	-95 dBm
AIROC™ CYW20820	96 MHz Arm® Cortex®-M4	256	176	22	11.5 dBm	2.5 dBm	-94 dBm	11.5 dBm	-94.5 dBm

AIROC™ CYW20820 Bluetooth® & Bluetooth® LE SoC

Bluetooth® and Bluetooth® LE connectivity that is 5.2 core spec compliant. An integrated Arm® Cortex®-M4 processor with a floating point, enables high performance compute capabilities.



AIROC™ CYW20819 Bluetooth® & Bluetooth® LE SoC

The CYW20819 is a Bluetooth® 5.2 core spec compliant device for IoT applications. The CYW20819 employs high levels of integration to minimize external components, reducing the device footprint and the costs associated with implementing Bluetooth® solutions.





AIROC™ Bluetooth® Modules

Bluetooth® SDK along with the ModusToolbox™ Software

All of the AIROC™ Bluetooth® modules are fully integrated, globally certified, programmable modules designed to help you build your products faster and easier.

Building your product has never been easier or faster

The Bluetooth® SDK, embedded within ModusToolbox™, contains everything you need to build applications following dual-mode (BR + EDR + Bluetooth® LE).

Product	Size (mm)	Base Chip	FLASH	RAM	GPIO	LE Range (meters, LoS)	Bluetooth core spec.	Bluetooth LE	Bluetooth Classic	Operating Temp.	Evaluation Kit
CYBT-343026-01	12 x 15.5 x 1.95	AIROC™ CYW20706	512KB SFLASH	352KB	11	250	5	Yes	Yes	-30~85°C	CYBT-343026-EVAL
CYBT-413055-02	12.0 x 16.3 x 1.70	AIROC™ CYW20719	1MB	512KB	17	75	5	Yes	Yes	-30~85°C	CYBT-413055-EVAL
CYBT-483056-02	12.75 x 18.59 x 1.80	AIROC™ CYW20719	1MB	512KB	15	1 km	5	Yes	Yes	-30~85°C	CYBT-483056-EVAL
CYBT-483062-02	12.75 x 18.59 x 1.80	AIROC™ CYW20721	1MB	512KB	15	1 km	5	Yes	Yes	-30~85°C	N/A
CYBLE-343072-02	13.3 x 21.89 x 1.95	AIROC™ CYW20835	512KB SFLASH	352KB	24	225	5.2	Yes	No	-30~85°C	CYBLE-343072-EVAL-M2B
CYBT-243053-02	12x16.61x1.7	AIROC™ CYW20820	256KB	176KB	22	200	5	Yes	Yes	-30~85°C	CYBT-243053-EVAL
CYBT-213043-02	12.0 x 16.6 x 1.70	AIROC™ CYW20819	256KB	176KB	22	75	5	Yes	Yes	-30~85°C	CYBT-213043-EVAL

The Bluetooth® SDK integrated within the ModusToolbox™ software and tools and Bluetooth® configurator tools form a powerful but easy-to-use toolset that helps you create amazing Bluetooth®-enabled IoT solutions such as beacons, trackers, smart watches, audio devices, HID device (remotes, mice, and keyboards) medical devices, and home automation platforms.

ModusToolbox™ was built to make the developers life easy. It is a collection of easy-to-use software and tools enabling rapid development of Infineon MCUs, covering applications from embedded sense and control to wireless and cloud-connected systems using AIROC™ Wi-Fi, AIROC™ Bluetooth® and AIROC™ Wi-Fi and combo devices.

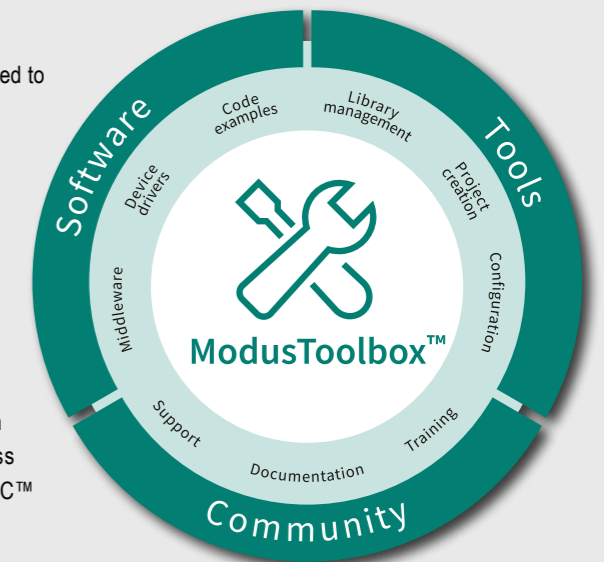

AIROC™ CYW20820 Bluetooth® LE Modules

These modules like the CYBT-243053-02 are highly integrated modules.

AIROC™ CYW20820 Bluetooth® LE Module Evaluation Kit

The Infineon AIROC™ CYW20820 Bluetooth® LE Module Evaluation Kit (CYBT-243053-EVAL) enables you to evaluate and develop single-chip AIROC™ Bluetooth® applications using the CYBT-243053-02 module.

Globally certified to support fast time-to-market and supported by the AIROC™ Bluetooth® SDK in ModusToolbox™ software.

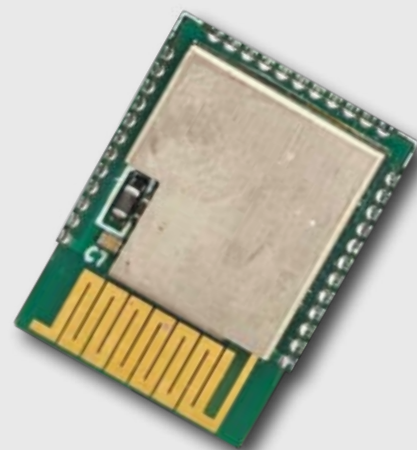

AIROC™ CYBT-243053-02 Module

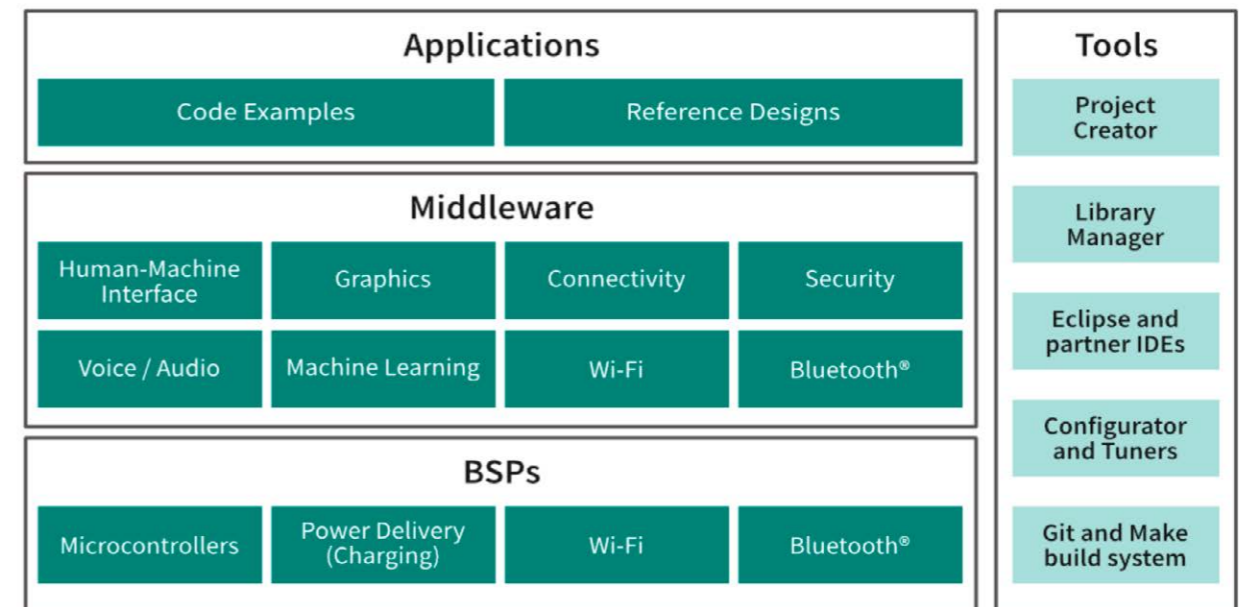
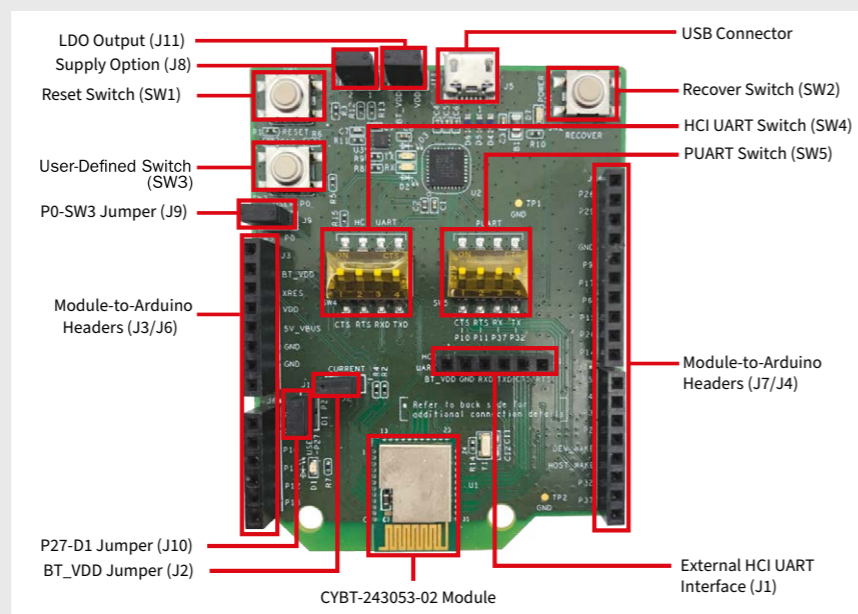



What is ISM?

The industrial, scientific and medical (ISM) radio bands are radio bands that are internationally reserved for the use of radio frequency (RF) energy for industrial, scientific and medical purposes. ISM covers frequency bands from 125 kHz to 50 GHz.

That means that not only the worldwide operating 2.4 GHz band is supported by ISM, but also the European (169 MHz, 433 MHz, 868 MHz) as well as the US-American (315 MHz, 915 MHz) SubGHz bands. Consequently, ISM covers those frequency bands which cover short range radio technology applications.

SubGHz ISM radio frequency solutions as well as 2.4 GHz ISM radio frequency solutions are presented in this chapter. Still, ISM has to be differentiated from other wireless technologies which use the same frequency bands.

At Rutronik, the classification group ISM covers all solutions which do not belong to WiFi, Bluetooth, ZigBee, RFID, GSM or GPS.

These technologies are presented in the previous or the now following chapters.

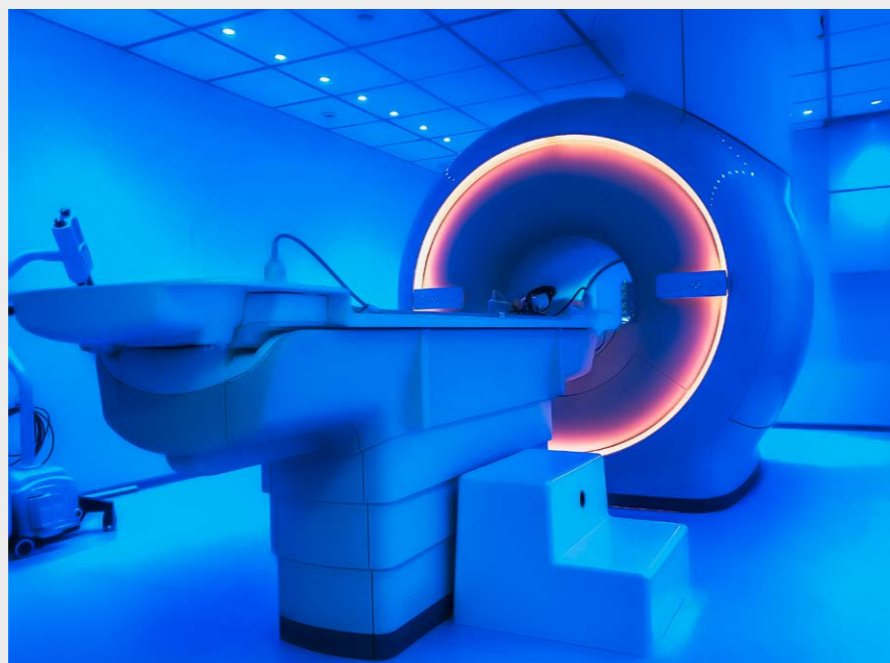

Wireless Control Receiver ICs



The Wireless Control Receiver series from Infineon is made up by a group of very low power consumption single chip ASK and ASK/FSK Superheterodyne Receivers (SHR) for the sub 1 GHz frequency bands. The ICs offer a high level of integration and need only a few external components.

TDA5240, TDA5235 & TDA5225 – High sensitivity, low-power receiver family SmartLEWIS RX+

Features:

- Multi-band (300-320, 425-450, 863-870, 902-928 MHz) for worldwide operation coverage
- 10.5 Hz high resolution Sigma-Delta Fractional-N PLL
- One crystal frequency for all supported frequency bands
- Integrated IF-filter but also optional external CER filter possible
- Low supply current: 0,8 μ A in Power down, 12 mA for Run mode
- Datarate up to 112 kchip/s
- ESD protection +/-2kV on all pins
- Digital RSSI peak detectors
- On-chip temperature sensor
- Voltage supply range 3.3 / 5.0 V
- Temperature range -40 to +105 °C
- Automotive Qualified
- Higher sensitivity due to improved noise figure and reducible noise bandwidth
- Programmable on-chip channel bandpass filter
- Improved channel selectivity due to dual conversion architecture
- Improved blocking performance against co-channel interference
- Full finest resolution sigma-delta PLL
- Both 3.3V and 5V-compatible I/O interface to microcontroller
- Configurable AGC and AFC for improved dynamic range and handling of freq.offsets

Additional Features for TDA5240 & TDA5235

- Highest sensitivity receiver: Typ. -118 dBm for FSK, Typ. -116 dBm for ASK
- Autonomous receive mode leads to reduced noise of host processor, improved sensitivity and reduced power consumption of the system
- Up to 4 (TDA5240) / 2 (TDA5235) parallel parameter sets and up to 12 different frequency channels (TDA5240 only)
- Several embedded encodings and modulation schemes
- Support for additional encodings biphas and NRZ
- Ultrafast Fallback Wake-up criterion reduces receiver's active time (and average current consumption), when no data available
- More configuration options for autonomous polling schemes

Applications

- Remote keyless entry systems
- Remote start applications
- Tire pressure monitoring
- Remote control units
- Cordless alarm systems
- Remote metering

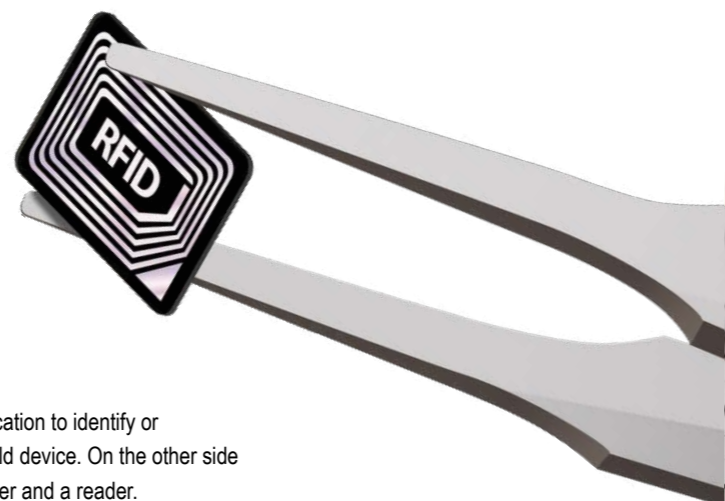

What Does RFID Mean?

RFID stands for Radio Frequency Identification and is a special kind of wireless communication to identify or count an object contactless. On one side there is a RFID-reader, like a terminal or handheld device. On the other side there is a transponder, like a tag or a label. Within a smartphone there is both a transponder and a reader.

In a passive RFID system, the reader sends out a field of energy and data. The transponder uses the energy and data to read out his memory and sends back the content to the reader. In an active RFID system the transponder has its own battery, which allows much bigger memory sizes, a wider range and a faster communication.

Technologies

Parameter	Low Frequency	High Frequency	Ultra High Frequency
Frequency	125 kHz	13.56 MHz	868 – 915 MHz
Reading Distance (typical)	1 m	5 cm	10 m
Reading Rate	slow	depending on ISO-standards	fast
Humidity	No influence	No influence	Negative influence
Metal	Negative influence	Negative influence	No influence
ISO Standards	11784/85, 14223 and 18000-2	14443, 15693 and 18000-3	14443, 15693 and 18000-6
Applications	Admission control, going away barrier, gas reading	Asset management, ticketing, tracking & tracing, group collection	Pallet collection, container tracking

It is also possible to make own active RFID systems by using components of 868 MHz or 2.4 GHz, which can be found in other chapters of this catalogue.

What is the difference between RFID and NFC?

NFC means Near-Field-Communication and is based on the RFID-technology. However, NFC can be seen as an “extension” or “specialisation” of the RFID-technology. NFC transfers low data rates on a short distance (max. 10cm) and stands out for a safe way of data transfer. It also provides standardized application data packets.

While data transfer based on RFID-technology has to take place between an active and a passive party, with NFC it is also possible peer-to-peer (between two active parties, e.g. a checkout counter in a supermarket and a NFC-mobile). The frequency band reserved for NFC-technology is standardized on an individual wave-band (135kHz; 13,56MHz, ISO 18000-2, -3; 22536).



Transponder Applications Examples

ISO and Hybrid Cards

Available 125 kHz, 13.56 MHz and UHF IC technologies. Cards can be customized with different personalization and encoding options.

Smartlabels and Tickets

Adhesive labels, Windshield Labels, Multi-Purpose Labels, Logistic Single Labels



Special Tags

On-Metal Tags, High Temperature Tags, Laundry Tags, Heavy Duty Tags, etc.

Keyfobs and Wristbands

All keyfobs and wristbands are waterproof and can be printed and personalized.

Disctags

These tags are all available with different diameters, with printing and with/without centre hole.



RFID Modules, Readers & Passive Transponders



NFC Panel Reader – NEO

The RFID HF | NFC Panel Reader - NEO is a compact RFID reading and writing device with an integrated 80 cm long cable (other cable lengths available on request). It is ideal for integration into existing control panels or cabinets within access controls on machines for employee identification, Industry 4.0 environments, or data exchange via NFC.



Product Features

- Dimensions: Panel cut-out: 22,3 mm
- Cable Length: 80 cm
- Housing Material: ABS
- Power Supply: 5 Vdc via USB or RS232
- IP Protection Class: IP65
- Operating Systems:
 - Windows 7 and higher
 - Linux (3.x.x., 2.6.x)
- Antenna: integrated
- Operating Temperature: -20 °C to +80 °C

Frequency Range	Supported Standards
UHF	ISO 18000-63
HF / NFC	ISO 14443A/B
	ISO 15693
LEGIC	ISO 18000-3M3
LF	Prime + Advant
	EM4200
	Hitag-1 Hitag-S

NFC Desktop Reader – NEO 2

The HF | NFC | Desktop Reader - NEO 2 is a modern RFID desktop reader with USB 2.0 interface. The USB RFID reader is the perfect device for the latest IoT applications in companies and is ideal for a wide range of applications in retail, telecommunications, banking or healthcare. It supports the RFID standards LF, HF / NFC, LEGIC or UHF.



Product Features

- Dimensions: 115 × 70 × 17 mm
- Housing Material: ABS
- Power Supply: USB VCP + HID or PC/SC
- Operating Systems:
 - Windows 7 and higher
 - Linux (3.x.x., 2.6.x)
- Antenna: Integrated
- Operating Temperature: -20 °C to +70 °C
- Interface: USB 2.0 VCP/HID (Plug-and-play), CH340E Chip, PC/SC

BLUEBOX Professional RFID

BLUEBOX professional RFID is a family of highly sophisticated RFID controllers, readers, antennas and solutions allowing easy system integration.

BLUEBOX Unique Advantages

- Ruggedized product design and enclosures (All components minimum IP67 or IP54)
- Available for
 - UHF 860–960 MHz (ISO18000-6C, EPC Class1 Gen2),
 - HF 13.56 MHz (ISO15693, ISO14443A/B, ISO 18000-3)
 - LF 125 kHz (ISO18000-2, ISO11784/11785)
- Solutions for Near Field, Short-, Mid- and Long-Range appl.
- Contr. with integr. antenna or for running 1, 2 and 4 antennas
- Extended range of application specific antennas
- Outstanding read / write performance and reading distances
- Possibility of using diff. RFID standards in parallel in one application
- Multiple Interface Options (USB, CANbus, RS232/485, Ethernet, Profibus, Profinet, etc.)
- Integrated Webserver for remote access to Controller
- Suitable for Stand-Alone operation
- Integrated I/O ports
- Micro SD slot for memory extension
- Diagnostic interface
- Several Standard Read Modes like Buffered Read Mode, Scan Mode, Notification Mode, RSSI Mode
- Unique SDK for all BLUEBOX products
- BLUEBOX SHOW applications software
- M12 connections for trouble-free and secure connection and installation (optional RJ45 for UHF CX Controller)

Passive RFID Transponders – Overview

With its large portfolio of chips idTRONIC covers the total frequency bandwidth of LF, HF and UHF RFID transponders.

Freq.	IC Version	ISO-Standard	Memory Cap.
UHF	NXP NTAG203	ISO/IEC 14443A	168 Byte
	Alien UHF Higgs 3 Gen2	ISO/IEC 18000-6C	64 Byte
	UHF U-Code Gen2	ISO 18000-6C	16 Byte
HF	NXP Mifare Ultralight (UL)	ISO 14443 A	64 Byte
	NXP Mifare Ultralight (UL) C	ISO 14443 A	192 Byte
	NXP Mifare Classic Mini	ISO 14443 A (1-3)	320 Byte
	NXP Mifare Classic 1K	ISO 14443 A	1024 Byte
	NXP Mifare Classic 4K	ISO 14443 A	4096 Byte
	NXP Mifare MF1S20 (mini)	ISO 14443	A 320 Byte
	NXP Mifare MF1S50 (1K)	ISO 14443 A	1024 Byte
	NXP Mifare MF1S70 (4K)	ISO 14443 A	4096 Byte
	NXP Mifare DESFire EV1 (2K)	ISO 14443 A (1-3)	2048 Bytes
	NXP Mifare DESFire EV1 (4K)	ISO 14443 A (1-3)	4096 Byte
	NXP Mifare DESFire EV1 (8K)	ISO 14443 A (1-3)	8192 Byte
	NXP Mifare Plus S 2K	ISO 14443 A	1 kB
	NXP Mifare Plus S 4K	ISO 14443 A	4 kB
	NXP Mifare Plus X 2K	ISO 14443 A	1 kB
	NXP Mifare Plus X 4K	ISO 14443 A	4 kB
	NXP I-Code SLI	ISO 15693	128 Byte
	NXP I-Code SLI-S (2K)	ISO 15693	256 Byte
LEGIC MIM256	ISO 14443 A	256 Byte	
LEGIC MIM1024	ISO 14443 A	1024 Byte	
TI Tag-it HF-I	ISO 15693	256 Byte	
LEGIC Advant 1024	ISO 14443 / 15693	128 Byte	
LEGIC Advant 2048	ISO 14443 / 15693	256 Byte	
STM SRI512	ISO 14443 B	64 Byte	
STM LRI2K	ISO 15693	256 Byte	
STM SRI4K	ISO 14443 B	512 Byte	
Contactl. EM4100/4200	Read Only	8 Byte	
Contactl. Card EM4450/4550	ISO 11784/85	125 Byte	
Atmel Temic 5567	ISO 11784/88	363 Byte	
LF	NXP Hitag 1	ISO 11784/88	256 Byte
	NXP Hitag 2	ISO 11784/88	32 Byte
	NXP Hitag S256	ISO 11784/88	256 Byte
	NXP Hitag S2048	ISO 11784/88	2 kB

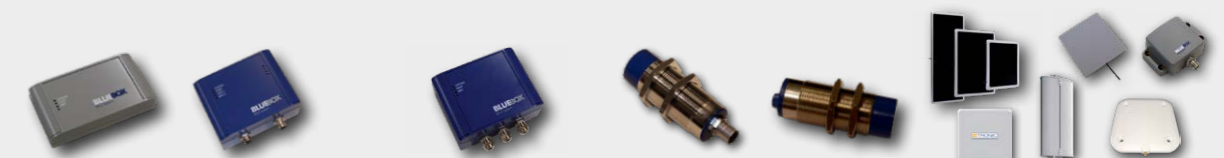

Freq.-Range	Desktop Reader	Various Controller with integrated Antenna	Various Controller with up to 4 ports for external Antenna	M30 Cylindrical Reader (metal)	Various M18/M30 Cylindrical Antennas	Various other Short Range, Mid Range and Long Range Antennas
UHF Reading Distance	Up to 30 cm	Up to 3 m	Up to 10 m	up to 50 cm*	Up to 20 cm	
HF Reading Distance	Up to 15 cm	Up to 15 cm	Up to 15 cm	Up to 8 cm	Up to 6 cm	Up to 80 cm
LF Reading Distance	Up to 10 cm	Up to 15 cm	Up to 30 cm	Up to 6 cm	Up to 8 cm	Up to 13 cm

*IP67



Reader Devices – Selection Guide

Parameters	Manufacturer	Description	Order Code	Frequency (Hz)			ISO 15693	ISO 14443 A	ISO 14443 B	ISO 18000-6C	ISO 18000-3	Supported Tags	Power Supply	Interface USB	Antenna	Dimensions (mm)	Weight (g)	
				LF	HF (NFC)	UHF												
USB Readers	iDTRONIC	NFC Stick Reader EVO - USB VCP HID	R-Stick-EVO-NFC										5V	x	internal	75 x 20 x 10		
		HF NFC Desktop Reader - NEO 2 - USB	R-DT-NEO2-HF/NFC-USB											5V	x	internal	115 x 70 x 17	
		HF NFC Desktop Reader - NEO 2 - HID	R-DT-NEO2-HF/NFC-HID												x	internal	115 x 70 x 17	
		HF NFC Desktop Reader - NEO 2 - PC/SC	R-DT-NEO2-HF/NFC-PC/SC												x	internal	115 x 70 x 17	
		HF LF Desktop Reader - NEO 2 - USB	R-DT-NEO2-HF/LF-USB												x	internal	115 x 70 x 17	
		HF LF Desktop Reader - NEO 2 - HID	R-DT-NEO2-HF/LF-HID												x	internal	115 x 70 x 17	
		LEGIC Desktop Reader NEO2 - USB	R-DT-NEO2-LEG												x	internal	115 x 70 x 17	
LEGIC Desktop Reader NEO2 - HID	R-DT-NEO2-LEG-HID												x	internal	115 x 70 x 17			
LEGIC 4500M Desktop Reader NEO2 - USB	R-DT-NEO2-LEG-45M												x	internal	115 x 70 x 17			
LF Desktop Reader NEO2 - USB	R-DT-NEO2-LF-USB												x	internal	115 x 70 x 17			
LF Desktop Reader NEO2 - USB VCP HID	R-DT-NEO2-LF-HID												x	internal	115 x 70 x 17			
NDEF Desktop Reader - NEO 2	R-DT-NEO2-NDEF-USB												x	internal	115 x 70 x 17			
UHF Desktop Reader NEO2 - USB	R-DT-NEO2-UHF-USB												x	internal	115 x 70 x 17			
UHF Desktop Reader NEO2 - USB HID	R-DT-NEO2-UHF-USB-HID												x	internal	115 x 70 x 17			
Cylindrical Readers	iDTRONIC	UHF Cylindrical Reader BLUEBOX - RS232	R-IN-UHF-5224U												internal	M30 x 1.5 x 90.65	115	
		UHF Cylindrical Reader BLUEBOX - RS485	R-IN-UHF-5225U			865-868M						incl. Class 1 Gen2	Alien Higgs 2/3/4m Impinj Monza, NXP UCODE, etc.	10-36VDC		internal	M30 x 1.5 x 90.65	115
Short Range Readers	iDTRONIC	UHF Cylindrical Reader BLUEBOX - SAE J1939	R-IN-UHF-5226U												internal	M30 x 1.5 x 90.65	115	
		UHF Cylindrical Reader BLUEBOX - CANopen	R-IN-UHF-5227U												x	internal	M30 x 1.5 x 90.65	115
Mid Range Readers	iDTRONIC	HF NFC Cylindrical Reader BLUEBOX - M12 without cable - RS232	R-IN-HF-5224H		13.56M		x	x	x			MIFARE Family	10-36VDC	x	internal	M30 x 1.5 x 78	220	
		HF NFC Cylindrical Reader BLUEBOX - M12 without cable - RS485	R-IN-HF-5225H		13.56M		x	x	x			MIFARE Family	10-36VDC	x	internal	M30 x 1.5 x 78	220	
Long Range Readers	iDTRONIC	HF NFC Cylindrical Reader BLUEBOX - Cable 1.5 m with open ends - RS232	R-IN-HF-5227H		13.56M		x	x	x			MIFARE Family	10-36VDC	x	internal	M30 x 1.5 x 78	220	
		HF NFC Cylindrical Reader BLUEBOX - Cable 1.5 m with open ends - RS485	R-IN-HF-5228H		13.56M		x	x	x			MIFARE Family	10-36VDC	x	internal	M30 x 1.5 x 78	220	
Panel Readers	iDTRONIC	UHF Short Range Reader BLUEBOX - RS232/RS485	R-IN-UHF-5721U										10-36VDC		internal	120 x 122 x 37	400	
Wall Readers	iDTRONIC	UHF Mid Range Reader BLUEBOX - Basic Version ETSI	R-IN-UHF-5426U-G												internal	190 x 190 x 80		
		UHF Mid Range Reader BLUEBOX - Real Time Clock ETSI	R-IN-UHF-5426U-RTC-G													internal	190 x 190 x 80	
Wall Readers	iDTRONIC	UHF Mid Range Reader BLUEBOX - Wiegand Interface ETSI	R-IN-UHF-5427U-G												internal	190 x 190 x 80		
		UHF Mid Range Reader BLUEBOX - CANbus (J1939)	R-IN-UHF-5428U-G													internal	190 x 190 x 80	
Long Range Readers	iDTRONIC	UHF Long Range Reader BLUEBOX - RJ45 Ethernet + RS232/485	R-IN-UHF-5345U			840-960M									Two external (50 Ω) TNC-female	110 x 140 x 62	700	
		UHF Long Range Reader BLUEBOX - RJ45 Ethernet + RS232/485 + Real Time Clock	R-IN-UHF-5345U-RTC			840-960M						incl. Class 1 Gen 2	Alien Higgs 2/3/4, Impinj Monza, NXP UCODE, etc.	10-36VDC		Two external (50 Ω) TNC-female	110 x 140 x 62	700
Panel Readers	iDTRONIC	UHF Long Range Reader BLUEBOX - M12 Ethernet + RS232/485	R-IN-UHF-5346U			840-960M									Two external (50 Ω) TNC-female	110 x 140 x 62	700	
		UHF Long Range Reader BLUEBOX - M12 Ethernet + RS232/485 + Real Time Clock	R-IN-UHF-5346U-RTC			840-960M										Two external (50 Ω) TNC-female	110 x 140 x 62	700
Panel Readers	iDTRONIC	UHF Long Range Reader BLUEBOX - M12 Wiegand	R-IN-UHF-5347U			840-960M									Two external (50 Ω) TNC-female	110 x 140 x 62	700	
		UHF Long Range Reader BLUEBOX - M12 CANbus (SAE J1939 or CANopen) + Ethernet	R-IN-UHF-5348U			840-960M										Two external (50 Ω) TNC-female	110 x 140 x 62	700
Panel Readers	iDTRONIC	HF NFC Panel Reader NEO - USB	R-IN-HF-5224H		13.56M		x	x	x				5VDC	x	internal	Panel cut-out: ø 22.3 mm Cable Length: 80 cm (other lengths on request)	35	
		HF NFC Panel Reader NEO - RS232	R-IN-HF-5225H		13.56M		x	x	x				5VDC	x	internal	Panel cut-out: ø 22.3 mm Cable Length: 80 cm (other lengths on request)	35	
Wall Readers	iDTRONIC	HF NFC Panel Reader NEO - RS232	R-IN-HF-5227H		13.56M		x	x	x				5VDC	x	internal	Panel cut-out: ø 22.3 mm Cable Length: 80 cm (other lengths on request)	35	
		HF NFC Panel Reader NEO - RS232	R-IN-HF-5228H		13.56M		x	x	x				5VDC	x	internal	Panel cut-out: ø 22.3 mm Cable Length: 80 cm (other lengths on request)	35	
Wall Readers	iDTRONIC	EM4135, EM4043, EM4x33, EM4x35, ICode SLI / SLIX, M24LR16/64, TI Tag-it HF-I, SRF55Vxx (my-d vicinity)	Read/write: MIFARE® Classic/1K/4K, MIFARE Ultralight®/C, MIFARE® DESFire®EV1/2, MIFARE® Smart MX, MIFARE® Plus S / X, MIFARE® Pro X, NTAG 21x, Read UID only of all other ISO14443A RFID tags		13.56M										internal	110 x 56 x 18	50	
		Read/write: MIFARE® Classic/1K/4K, MIFARE Ultralight®/C, MIFARE® DESFire®EV1/2, MIFARE® Smart MX, MIFARE® Plus S / X, MIFARE® Pro X, NTAG 21x, Read UID only of all other ISO14443A RFID tags			13.56M											internal	110 x 56 x 18	50
Wall Readers	iDTRONIC	SRI4K, SR1X4K, AT88RF020, 66CL160S, SR176			13.56M										internal	110 x 56 x 18	50	
					13.56M										internal	110 x 56 x 18	50	
Wall Readers	iDTRONIC	I-Code ILT-M			13.56M										internal	110 x 56 x 18	50	
					13.56M										internal	110 x 56 x 18	50	
Wall Readers	iDTRONIC	MIFARE® Classic Mini / 1K / 4K			13.56M								12 Vdc (±5 % regulated)		internal	100 x 46 x 20	50	
					13.56M								5Vdc or 12 Vdc (±5 % regulated)	x	internal	100 x 46 x 20	50	
Wall Readers	iDTRONIC	R-PROF-DES-LOCK-CAN-125			13.56M								5VDC		internal	81 x 68 x 24		
		R-PROF-DES-LOCK-CAN-250			13.56M								5VDC		internal	81 x 68 x 24		
Wall Readers	iDTRONIC	R-PROF-DES-LOCK-CAN-500			13.56M								5VDC		internal	81 x 68 x 24		
					13.56M								5VDC		internal	81 x 68 x 24		





Wireless Protocols / Proprietary Protocols

Further technologies are available to build up wireless mesh networks. Some protocols are based on top of the IEEE802.15.4 specification (PHY and MAC layer specification) which is the standard for low data rate, low power networks. The advantage is the possibility to change the transceiver from one supplier to another, so you are more independent than using a single source. The disadvantage is the specification itself. The DSSS modulation, having 5 MHz per channel and only 16 channels available is very often not the perfect choice for an application because it needs more energy and frequency resources than other modulation schemes. Also IEEE802.15.4 solutions are often based on SoCs instead of separated transceiver and microcontroller. In case of using a SoC the advantage of being independent from a single source is not given.

Thread

Thread is based on IEEE 802.15.4. At the network and transport layers. Thread uses a combination of IPv6, 6LoWPAN (IPv6 over Low power Wireless Personal Area Networks), UDP (user Datagram Protocol) and DTLS (Datagram Transport Layer Security).

The application layer can be defined individually.

As it is using IPv6, Thread can be used to integrate home automation devices directly to the IoT, without the need of making any protocol and address conversion. IPv6 has a strong encryption and authentication mechanism integrated – the IPsec.

Part of this security protocol is:

- Interoperability
- Cryptographic protection of the transmitted data
- Access control
- Integrity of data
- Authentication of transmitter (user authentication)
- Encryption
- Authentication of keys
- Administration of keys (key management)
- The Thread Group has some strong market drivers in its board, so we would not wonder if it will be the de facto standard for home applications soon.

ZigBee

Zigbee is based on IEEE 802.15.4. The technology supports large mesh networks and operates globally in 2.4 GHz unlicensed bands. Transport and application layers are defined by the CSA which aims to create IoT standards.

Zigbee is already widely adopted and includes a mature application layer called the Zigbee Cluster Library. Zigbee uses the counter mode (CTR) encryption, which has a 128 bit AES length and the cipher block chaining (CBC) with a 128 bit AES for the generation of the message integrity code (MIC). Within Zigbee a Trust Center (TC) device is determining and approving who wants to join the network. The Trust Center either instructs the router to authenticate the joined device or force it to leave.

There are three types of Zigbee security keys to protect the data: link, network and master/ application keys. All of them are symmetric.

EnOcean delivers under their Dolphin brand energy harvesting solutions also for 2.4 GHz ZigBee systems. The PTM 216Z for examples enables the realization of battery-less wall switches for smart home applications using the ZigBee Green Power standard. The use of ECO 200 plus the transmitter module PTM 535Z allows the design of e.g. remote controls, key card switches or industrial switches.

Matter

Matter aims to make it easy for developers to create a secure and reliable solution. If you want your products to be interoperable with the major smart home ecosystems, Matter is the way to go. Matter, which began as Project CHIP (Connected Home over IP) started in December 2019.

The starting companies were Amazon, Apple, Google, and others including Nordic Semiconductor. The goal is to agree on a unified application layer standard for connected things at home.

Matter is using Thread, Wi-Fi + Ethernet for transport and Bluetooth® LE for commissioning. All Matter devices based on Thread are required to feature Bluetooth® LE concurrently to enable adding new devices to a network. Wi-Fi can be used for low and high bandwidth applications.

It can be used for devices in range of the local Wi-Fi. Thread is an IPv6-based mesh protocol that targets low bandwidth applications. It is the go-to option for battery-powered devices that require the best energy efficiency and for simple actuators like smart plugs or light bulbs. Most mains-connected Thread devices work as a Thread router and will expand the network's range. Thread is a self-healing low-power mesh that can adapt to new devices or to devices being removed from the network.

6LowPan

6LoWPan is an acronym for IPv6 over low power Wireless Personal Area Networks and is another protocol using IEEE 802.15.4. The working group IETF (Internet Engineering Task Force) created the basis for connecting wireless sensor networks with the internet. The specialty of this protocol is that it is not proprietary and is an open IoT networking protocol. It is able to connect to the internet and thus offers the possibility to allocate an unique IP address to every single device. Furthermore in contrast to other proprietary protocols it is able to communicate with other IEEE 802.15.4 devices and can operate with devices on other IP networks link (e.g. Wi-Fi).

Well suitable applications for 6LoWPan can be found in e.g. building management, transport business and healthcare management.

EnOcean Wireless Standard

The EnOcean radio standard (ISO/IEC 14543-3-1X) operates in license-free 868 MHz (Europe, RED regulations), 902 MHz (North America, FCC/IC specifications) and 928 MHz (Japan, ARIB specification) frequency bands with 1% duty cycle and a reliable radio range of approx. 30m indoors and 300 meters in free field. For sending a signal in the EnOcean standard there is only an extremely small amount of energy necessary: Already 50 µWs are enough for a standard EnOcean energy harvesting wireless module to transmit a signal. Radio telegrams are of extremely short signal duration of maximum one millisecond enabling maintenance free sensor designs. Communication of the EnOcean solutions is possible via Gateways to bus systems like KNX, LON, DALI, BACnet or TCP/IP.

Wirepas

Wirepas connectivity technology is an automated multi-hop, self-configuring, self-healing low power wide-area mesh network. It's an ideal solution for large-scale industrial and infrastructure IoT applications such as smart meters and smart cities.

All the Wirepas Connectivity intelligence is in the network. The devices decide the best actions by themselves locally. No central network management is needed. The local decision-making ensures that the devices always operate the similar way, independent of the network size or the devices' locations within the network. Through Wirepas, devices can automatically choose their role according to the situation. This means that every device is a possible routing point for forwarding data. The user does not need to define the roles of the devices, this is done automatically depending on what the optimal topology is at a given time.

Wirepas devices can act synchronously, and co-operatively select the times and channels used for communication. All the available channels in a given band can be used. Whenever two devices want to communicate with each other they know the channel and the exact times to send and receive. This way all unnecessary overhead, such as overhearing, idle listening, and intra-network collisions, are removed. Furthermore Wirepas devices can communicate data over multiple hops. The topology is optimized continuously and adapts to changes in the environment and the network. For each device there are multiple routing options (next hops), and multiple Gateways (backhaul connection) can be used in the same network.



Active Antenna Band Switching for Small IoT Devices



1004795-EC646-01 Evaluation Board

KYOCERA AVX evaluation board 1004795-EC646-01 is engineered to reduce the number of device design iterations, improve accuracy, and hasten product time-to-market for low- and high-band frequencies (700–960MHz and 1.71–2.17GHz) for 4G, LTE Cat-M, NB-IoT, and LPWA.

Engineers can test the band switching and antenna performance on a typical board size of IoT devices, reducing the number of prototype iterations. The EVB uses the standard FR4 embedded LTE antenna 1004795 together with the chipset EC646 for band switching or aperture tuning.

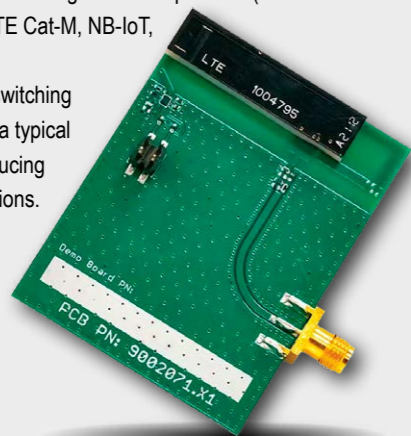

Nordic nRF9160 Reference Design on a 53 x 53 mm PCB

The LTE Antenna Band Switching Solution and GPS for nRF9160 is an easy-to-use battery-operated prototyping platform for cellular IoT using LTE-M, NB-IoT and GPS. It is ideal for creating Proof-of-Concept (PoC), demos and initial prototypes in the IoT development phase. The small form factor nRF9160 antenna solution that KYOCERA AVX offers for easy implementation and premium performance consists of the standard FR4 embedded LTE antenna 1004795 together with the chipset EC646 for band switching or aperture tuning. For the GPS frequency the small patch antenna 1004322 is used.

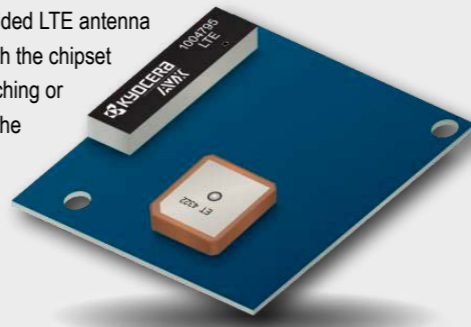

Key Features

- Evaluation board size: 45.5 x 60mm
- Frequency: 700 – 960MHz / 1700 – 2170 MHz
- 4 active stages
- Efficiency: 18 – 30%
- Connector: SMA

Application Fields

- Asset trackers
- Industrial sensors
- Small IoT devices

1004795-EC646-01 Evaluation Board Diagrams

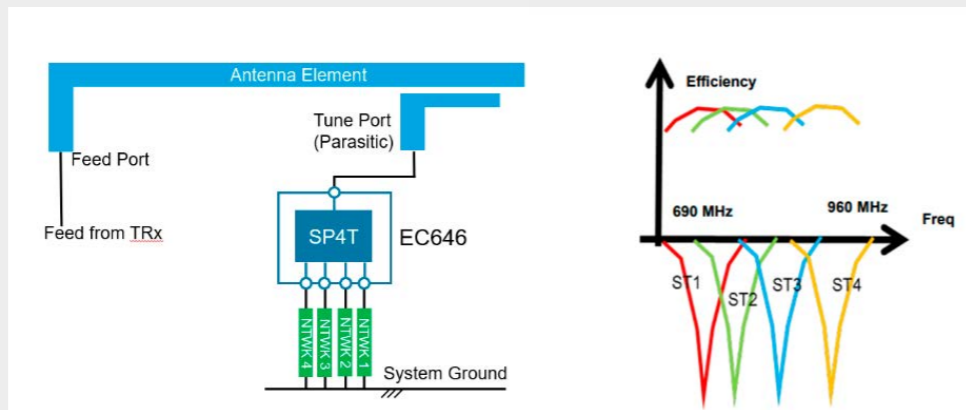

Next-Gen IoT Connectivity with DECT NR+



1001013 – DECT NR+ SMD Antenna

Experience the full potential of the next generation in wireless communication with KYOCERA AVX's antenna part number 1001013, now optimized for DECT NR+, a new cutting-edge technology employed in the newest Nordic DECT NR+ capable SiPs, such as nRF9161, nRF9131 and nRF9151. This antenna is a gateway to excellent efficiency, compactness, and reliability in IoT applications spanning from industrial sensors to smart grids. Engineered specifically for the 1880-1930 MHz band, the 1001013 antenna provides exceptional performance without the need for additional LTE bands. This allows for a smaller form factor (based on the antenna footprint), perfectly suited for DECT NR+ exclusive applications. This antenna has also the capability to work over metal surfaces, thanks to the versatile design to work off or on ground.

Key Features

- FR4 antenna
- Off and On ground capabilities (works over metal surfaces!)
- Size: 15.0 x 3.2 x 3.3 mm
- Frequency: 1.9 GHz
- Efficiency: 80%
- SMT

Application Fields

- Smart Metering
- Smart Lighting
- Asset trackers
- Industrial sensors
- Smart Cities



VSWR and Efficiency Plots (Off-Ground) – Typical performance on 50 x 70 mm PCB

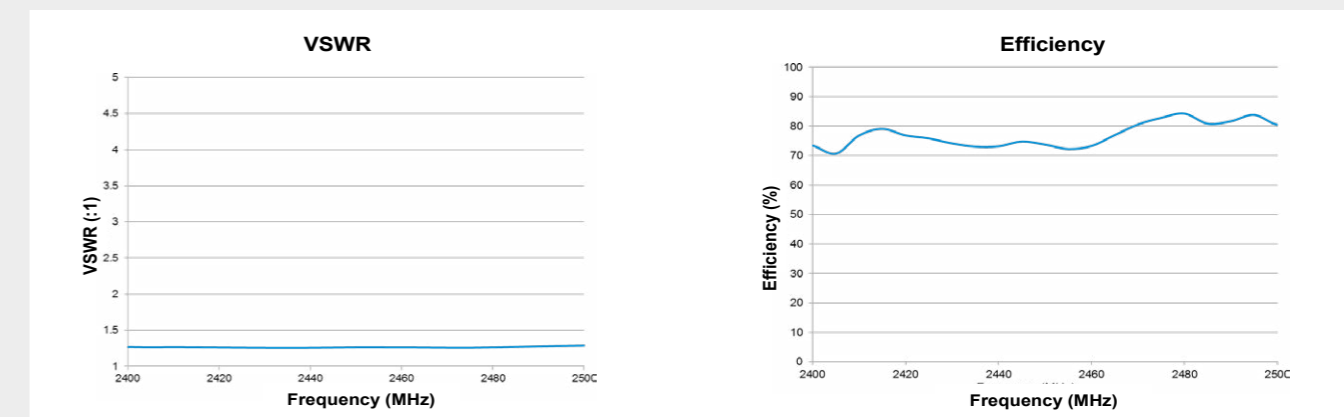



Embedded Antennas

Manufacturer	Part	Picture	Standard							Antenna Type	Frequencies	Peak Gain (dBi)	Efficiency (%)	VSWR	Size (mm)	Polarization	Return loss (dB)	Temperature (C)	Impedance (Ohm)
			RFID	GSM / 2G	UMTS / 3G	LTE / 4G	ISM Standard	Bluetooth	WLAN										
KYOCERA AVX	P822601		X	X	X	X					698-960 MHz 1710-2700 MHz 3300-3800 MHz	2.6 4.0 2.8	68 60 59	2.5:1	49.6 x 8.0 x 3.2	Linear	-7.5	-40 to +85	50
	1004795		X	X	X	X					617-960 MHz 1710-2200 MHz 2500-2700 MHz	1.6 3.1 1.7	64 55 53	2.5:1 2.5:1 3.0:1	36.0 x 9.0 x 3.2	Linear	-7.5 -7.5 -6.0	-40 to +85	50
	1001013					X	X				2400-2485 MHz or 1.9 GHz	2.6 1.6	76 80	1.5:1	15.0 x 3.2 x 3.3	Linear	-14	-40 to +85	50
	1000146						X	X			2400-2485 MHz 5150-5850 MHz 5925-7125 MHz	1.7 4.1 3.8	81 68 64	2.0:1 2.0:1 2.2:1	17.85 x 6.9 x 4.3	Linear	-9.5 -9.5 -8.5	-50 to +125	50
	1002427					X		X	X		868-915 MHz 2400-2485 MHz or 1560-1606 MHz	3.0 3.4 1.8	67 61 65	2.0:1	31.2 x 2.28 x 3.9	Linear	-9.5	-50 to +125	50
	1001312					X	X			X	2400-2485 MHz or 6000 - 8500 MHz	1.88 4.8	62 84	1.8:1 2.0:1	2.0 x 1.2 x 0.55	Linear	-11 -9.5	-50 to +125	50
	M830120								X		1559-1610 MHz or 1575.2 MHz 1227.6 MHz 1176.45 MHz	1.8 2.7 2.8 2.7	70 80 76 77	2.0:1 2.0:1 2.5:1	8.00 x 3.00 x 1.33	Linear	-9.5 -9.5 -7.5	-40 to +85	50
	M620720					X					863 - 870 MHz or 902 - 928 MHz	0.30 0.75	58 60	1.6:1 2.5:1	6.00 x 2.00 x 1.08	Linear	-12.7 -7.5	-40 to +85	50
	9001978						X	X		X	2400-2485MHz or 2400-2485MHz 5150-5850MHz or 6000-8500MHz	3.5 3.0 3.0 5.7	68 65 50 80	2.5:1 2.1:1 7.0:1 2.6:1	1.00 x 0.55 x 0.40	Linear	-7.5 -9 -2.5 -7	-55 to +125	50
	9002137								X		1559-1610 MHz or 1575.2 MHz 1227.6 MHz 1176.45 MHz	2	75 86 72	1.5:1 1.7:1 2.0:1	1.00 x 0.55 x 0.40	Linear	-14 -12 -7.5	-55 to +125	50
	9001157								X		1563-1587 MHz 1593-1610MHz	3.8 4.3	65 71	3.2:1	18.0 x 18.0 x 4.0	RHCP	-5.6	-40 to +85	50
	1002649								X		1559-1563 MHz 1575 MHz 1559-1591 MHz 1593-1610 MHz	5.0 5.5 5.5 5.5	-	1.4:1	25.0 x 25.0 x 6.7	RHCP	-15	-40 to +85	50

Manufacturer	Part	Picture	Standard							Antenna Type	Frequencies	Peak Gain (dBi)	Efficiency (%)	VSWR	Size (mm)	Polarization	Return loss (dB)	Temperature (C)	Impedance (Ohm)
			RFID	GSM / 2G	UMTS / 3G	LTE / 4G	ISM Standard	Bluetooth	WLAN										
Yague / Pulse	W3008C						X	X	X		2400-2483.5 MHz	-1.3	68	*	3.2 x 1.6 x 1.1	Linear	-8	-40 to +85	50
	W3008						X	X	X		2400-2483.5 MHz	-1.1	66	*	3.2 x 1.6 x 1.1	Linear	-4	-40 to +85	50
	W3325		X								791-960 MHz	-1.3	>55	*	14 x 7 x 1.5	Vertical	5dB	-40 to +85	50
	W3326		X	X							791 - 960 MHz 1710 - 2170 MHz	-0.6 -2.3	>50 >55	*	20 x 7 x 1.5	Vertical	5dB	-40 to +85	50
	W3043						X	X	X	X	1575.42 MHz 2400-2483.5 MHz	-0.35 ~4	43 70	*	3.2 x 1.6 x 1.1	Linear	-15 -12	-40 to +85	50
	W3340									X	6-8.5 GHz	>1.5	>65	*	3.2 x 1.6 x 1.1	Linear	9	-40 to +85	50
	W3540									X	2700-8200 MHz	-5.89	81	~2:1	12.5 x 10.6 x 0.8	Vertical	10	-40 to +85	50
	W3015L						X				433 MHz	-2.5	35	*	10 x 3.2 x 4	Linear	*	-40 to +85	50
	W3078						X	X	X		2400 - 2483.5 MHz 4950 - 5850 MHz	-1.7 -4.3	65 80	*	3.2 x 1.6 x 1.1	Linear	-10 -6	-40 to +85	50
	W3079						X	X	X		2400-2483.5 MHz 5150-5850 MHz	-2.4 -5.7	70 77	< 1.9 < 2.5	3.2 x 1.56 x 1.1	Linear	*	-40 to +85	50
	W7001		X								13.56 MHz	*	*	*	25 x 25 x 0.12	*	*	-40 to +85	50 / 80



Embedded Antennas

Manufacturer	Part	Picture	Standard							Antenna Type	Frequencies	Peak Gain (dBi)	Efficiency (%)	VSWR	Size (mm)	Polarization	Return loss (dB)	Temperature (C)	Impedance (Ohm)
			RFID	GSM / 2G	UMTS / 3G	LTE / 4G	ISM Standard	Bluetooth	WLAN										
Yageo / Pulse	W7002		x								13.56 MHz	*	*	*	94.6 x 56.8 x 3.65	*	*	-40 to +85	50 / 80
	W3211					x					902-928 MHz	-1.35	43	*	10 x 3.2 x 5	Linear	-10	-40 to +85	50
	W3214					x					863-873 MHz	-1	38	*	10 x 3.2 x 5	Linear	-20	-40 to +85	50
	W3012					x					902 - 928 MHz	-2	70	*	10 x 3.2 x 4	Linear	-6	-40 to +85	50
	W3796			x	x	x					698-960 MHz	-1.5	65	~3:1	40 x 7 x 3	Linear	6dB	-40 to +85	50
											1427.9-1660.5 MHz	-2	55						
											1695-2200 MHz	-5.5	75						
	W3544A			x	x						824 - 960 MHz	-1.9	65	*	7.65 x 26 x 3	Linear	-4.1	-40 to +85	50
											1710 - 1880 MHz	-1.3	74						
											1850 - 1990 MHz	-1.3	74						
	W3070			x	x	x					1920 - 2170 MHz	-1.66	68	*	10 x 3.2 x 2	Linear	-5.1	-40 to +85	50
											880-960 MHz	-1.2	65						
W3056						x	x	x			1558-1616 MHz	-0.5	45	*	10 x 3.2 x 1.5	Linear	-5	-40 to +85	50
										2.4-2.5 GHz	-2	65							
W3320					x			x			868/915 MHz	-1	64	*	3.2 x 10 x 2	Vertical	<-7dB	-40 to +85	50
										2.4 GHz	-3	68							

Manufacturer	Part	Picture	Standard							Antenna Type	Frequencies	Peak Gain (dBi)	Efficiency (%)	VSWR	Size (mm)	Polarization	Return loss (dB)	Temperature (C)	Impedance (Ohm)	
			RFID	GSM / 2G	UMTS / 3G	LTE / 4G	ISM Standard	Bluetooth	WLAN											GNSS
Yageo / Pulse	ANT3216LL-00R2400A						x	x			2.4 GHz	5	*	*	3.2x1.6x1.2	Linear	-10	-40 to +105	50	
	ANT1608LL-14R2400A						x	x	x		2.4 GHz	2.0	*	6.0 max	1.6x0.8x0.4	Linear	-8	-40 to +105	50	
	ANT-1818B00AT1575S									x	1575 MHz	2	*	1.5 max	18x18x2	RHCP	-10	-40 to +105	50	
	ANT8010LL-05R1516A									x	1575-1602 MHz	1.69	*	*	8.0x1.0x1.0	Linear	-10	-40 to +105	50	
	ANT 1818B00BT1516									x	1575-1606 MHz	2.59	*	2:1	18x18x4	RHCP	-10	-40 to +105	50	
	ANT-2525B00DT1516S									x	1575-1606 MHz	5	*	2	25x25x4	RHCP	-10	-40 to +105	50	
	ANT1204LL-00R0918A			x								900 MHz	1.6	*	3.0 max	12.0x4.4x1.2	Linear	-10	-40 to +105	50
											1800 MHz	1.08								
	ANT3505B002T-WPENS			x	x							824-960 MHz	2.9	*	2.8 max	35x5x6	Linear	-7	-40 to +105	50
										1710 - 2170 MHz	3.5 max									

*Not specified by supplier

Internal Antennas

Manufacturer	Part	Picture	Standard							Antenna Type	Frequencies	Peak Gain (dBi)	Efficiency (%)	Size (mm)	Polarization	Cable Length (mm)	Connector	Impedance
			GSM / 2G	UMTS / 3G	LTE / 4G	ISM Standard	Bluetooth	WLAN	GNSS									
2J	2JF0415P					x				FPC / Adhesive	868 MHz	2.7	58	25 x 70 x 0.2	Linear	100	U.FL compatible	50
											915 MHz	3.6	77					
KYOCERA AVX	1000423						x	x		Screw Mount	2400-2485 MHz 5150-5850 MHz	0.6 4.5	57 75	40.0 x 15.0 x 6.4	Linear	-	MHF / U.FL compatible	50
	1002289		x	x	x	x				FPC / Adhesive	698-960 MHz 1710-2700 MHz	2.9 4.3	74 58	53.6 x 25.1 x 0.2	Linear	25 - 300	MHF or SMA	50
	W3-Family						x	x		PCB or FPC / Adhesive	2400-2485 MHz 5150-5850 MHz 5925-7127 MHz	2.3 5 2.5	70 60 65	35.20 x 8.50 x 0.40	Linear	50 - 300	MHF or MHF4L	50
	9001815F0		x	x	x	x				FPC / Adhesive	600-960 MHz 1415-2690 MHz 3400-3800 MHz 5150-5850 MHz	1.5 4.6 3.8 4.8	35 60 47 56	102 x 14.5 x 0.2	Linear	50-300	MHF or MHF4L	50
	9001169								x	FPC / Adhesive	1575 MHz	~15	55	41 x 15.5	Linear	50-300	MHF / U.FL compatible	50
Yageo / Pulse	W3915		x	x					x	PCB	880-960 MHz 1710-2170 MHz 1565-1605 MHz	1 2 0.5	50 75 55	74 x 19	Linear	100	U.FL compatible	50
						x	x	x		Adhesive	2400-2500 MHz 4900-6000 MHz	4 5.5	50 70	4.3 x 15.3 x 0.1	Linear	150	U.FL compatible	50
											FPC / Adhesive	698-960 MHz 1400-1600 MHz 1710-2690 MHz 3300-3800 MHz 4900-6000 MHz	1.9 2.5 3.2 3.3 3.5	45 53 66 57 37	30 x 120 x 0.2	Linear	143	U.FL compatible
	W3312XXXXXX					x				FPC / Adhesive	863-928 MHz	0.8	45	75 x 15	Linear	100	U.FL compatible	50

Manufacturer	Part	Picture	Standard							Antenna Type	Frequencies	Peak Gain (dBi)	Efficiency (%)	Size (mm)	Polarization	Cable Length (mm)	Connector	Impedance
			GSM / 2G	UMTS / 3G	LTE / 4G	ISM Standard	Bluetooth	WLAN	GNSS									
Yageo	ANTX100P001B24553									PCB	2400 - 2500 MHz	4.6	81	50 x 10 x 0.95	Linear	100	U.FL / I-PEX	50
											5150 - 5875 MHz	3.9	62					
Yageo	ANTX100P001BWPEN3		x	x						PCB	850-960 MHz	5.1	68	50 x 10 x 0.95	Linear	100	U.FL / I-PEX	50
											1800-2100 MHz	5.0	76					
IDTRONIC	A910: 20 x 30 mm - M8 U.FL A911: 20 x 30 mm - M8 U.FL									PCB	13.56 MHz			20x30 20x40	U.FL or Molex PicoBlade 53261	50		
	A912: 35 x 50 mm - M8 U.FL									35x50								
	A913: 80 x 80 mm - M8 U.FL									80x80								
	A914: 60 x 80 mm - M8 U.FL									60x80								
	A915: 45 x 86 mm - M8 U.FL									45x86								
	A916: 49 x 55 mm - M8 U.FL									49x55								

*Not specified by supplier



External Antennas

Manufacturer	Part	Picture	Standard					Antenna Type	Frequencies	Peak Gain (dBi)	Eff. (%)	VSWR	Size (mm)	Polarization	Cable Length (mm)	Connector	Impedance (Ohm)
			GSM / 2G	UMTS / 3G	LTE / 4G	ISM Standard	Bluetooth										
2J	2J301M		x	x				Magnetic Mount	824-960 MHz	~1.7	~49	~1.6:1	30.9 x 71.5	Linear	3000	SMA-Male	50
										1710-2170 MHz	~0.3	~28	~1.8:1	30.9 x 71.5	Linear	3000	SMA-Male
	2J664B		x	x	x	x	x	Body Mount	824-2400 MHz	~2.2	*	<2.6:1	77.4 x 15.9	Linear	2500	FME-Female	50
	2J620PF		x	x				Adhesive Mount	824-960 MHz	~1.5	~43	~1.6:1	Ø77 x 12	Linear	3000	SMA-Male	50
							x			1710-2170 MHz	~0.5	~32					
	2J6602B					x	x	Screw Mount	2410-2490 GHz	~4.9	~48.7	~1.5:1	Ø77.3 x 15	Linear	3000	RP-SMA-Male	50
						x	x			4920-5925 GHz	~4.5	~29.2					
	2J5115-XXX					x		Adhesive Mount, Flexible	433/ 868/ 915 MHz	3.4	62.4	1.2	122 x 14 x 6	Linear	3000	multiple connectors available	50
	2J0202					x	x	Connector Mount	2410-2490 GHz	~4.0	~60	~1.4:1	56 x 9.5	Linear	-	RP-SMA-Male	50
										4920-5925 GHz	~5.2	~83					
	2J050		x	x				Connector Mount	824-2400 MHz	~2.2	*	<2.5:1	54 x 6.7-9.65	Vertical	-	SMA-Male	50
	2J6A24BA		x	x	x			Screw Mount	698-960 MHz	~0.8	~35	~2.8:1	Ø77.3 x 65.5	Linear	3000	SMA-Male	50
									1710-2170 MHz	~2.5	~51	~1.7:1	Ø77.3 x 65.6				
									2500-2700 MHz	~3.4	~49	~1.3:1	Ø77.3 x 65.7				
	2J300M		x	x	x			Magnetic Mount	698-960 MHz	~1.0	~47	~1.9:1	Ø31 x 72	Linear	3000	SMA-Male	50
									1710-2170 MHz	~2.4	~39	~1.5:1					
									2500-2700 MHz	~2.1	~36	~1.3:1					
	2J670B		x	x				Body Mount	824-2170 MHz	2.2 max	*	<2:1	77.3 x 36.5	Horizontal	2500	C1(Mobile): FME-Female; C2 (Navigation): SMA-Male	50
									1575.42 MHz	*	*	<1.2:1		RHCP			
2J0B15					x		Connector Mount	433/ 868/ 915 MHz	1.2	69.3	1.8	44-48 x 19,1 x 9	Linear	-	SMA-Male-R/A	50	
2J6050PGF		x	x	x	x	x	Adhesive Mount	698-960 MHz	~2.9	~55.6	~2.2:1	80 x 76 x 16	Linear	3000	SMA-Male	50	
								1710-2170 MHz	~3.2	~56.0	~1.2:1						
								2500-2700 MHz	~2.1	~38.7	~2.2:1						
								2410-2490 MHz	~3.2	~50	~1.3:1						
								4920-5925 MHz	~4.2	~30	~1.3:1						
2J7624B		x	x	x	x	x	Screw Mount	1575-1606 MHz	*	*	<=1.4:1 dB	Ø50 x 50.08	Linear	3000	SMA-Male	50	
								698-960 MHz	2.6	56	2.1:1						
								1710-2170 MHz	3.2	56	1.8:1						
						2500-2700 MHz	1.4	38	2.5:1								

Manufacturer	Part	Picture	Standard					Antenna Type	Frequencies	Peak Gain (dBi)	Eff. (%)	VSWR	Size (mm)	Polarization	Cable Length (mm)	Connector	Impedance (Ohm)
			GSM / 2G	UMTS / 3G	LTE / 4G	ISM Standard	Bluetooth										
KYOCERA AVX	X9000984		x	x	x	x		Connector Mount	790 – 960 MHz 1710 – 2170 MHz	3.4 4.7	40 40	3.5:1 3.0:1	196.00 x Ø6.00	Linear	-	SMA or RP-SMA Male	50
	X9001091							Connector Mount	2400-2485 MHz 5150-5850 MHz	1.8 4.0	75 80	1.5:1 1.8:1	84.0 x Ø9.35	Linear	-	SMA or RP-SMA Male	50
	X9001376		x	x	x	x		Connector Mount	790-960 MHz 1710-2170 MHz	1.16 2.50	63 62	2.0:1 2.5:1	180.0 x Ø12.98	Linear	-	SMA or RP-SMA Male	50
	X1005245		x	x	x	x		Adhesive Mount	698 – 960 MHz 1710 – 2700 MHz 1561 MHz, 1575 MHz, 1602 MHz	4.2 3.5 28	48 60	2.0:1	136.2 x 72.4 x 12.7	Linear RHCP	1000-3000	SMA-Male (others available)	50
	X9001248		x	x	x	x		Magnet Mount	698-960 MHz, 1710-2690 MHz	1.8 1.9	54 36	3.5:1 3.0:1	112.0 x Ø29.0	Linear	1000-3000	SMA Male or RP-SMA Male (others available)	50
	1002857							Connector Mount	1575 MHz	-3.0	27	2.0:1	34.93 x Ø15.0	RHCP	-	SMA-Male	50
	AA-C02MT07FME-397		x					Magnetic Mount	900 MHz 1800 MHz	-0.45 -1.05	75 48	1.26:1 1.69:1	Ø26.7 x 79	Linear	3000	FME-Female	50
AA-C13M05SMA-1107		x					Magnetic Mount	900 MHz 1800 MHz	-1.71 -3.68	60 63	1.85:1 1.69:1	Ø52.2 x 343.7	Linear	3000	SMA-Male	50	
EM-B10.0X106-069						x	Connector Mount	2.4 GHz	~3.5	45	1.7:1	Ø67.5 x 108.0	Linear	-	SMA-Male	50	
EM-W117G-2ANT-240						x	Connector Mount	868 MHz	0-3	*	2.0:1	Ø37 x 112.6	Vertical	-	SMA-Male	50	
GS-10D174MCX-198							Adhesive Mount	1575.42 MHz	~3.8	*	2.0:1	38.2 x 34.2	RHCP	300	MCX-Male	50	
CA-C09-1SMAM-094		x					Adhesive Mount	840-960 MHz 1760-1860 MHz	-3.06 -5.23	59 88	1.72:1 1.30:1	129.5 x 22.8	Linear	3000	SMA-Male (90°)	50	
EM-B9.3X33.0-168						x	Connector Mount	2.4 GHz	1.3	*	2.0:1	Ø9.4 x 33	Vertical	-	SMA-Male	50	
EM-9.10X55.8-058		x	x				Connector Mount	824-960 MHz 1710-2170 MHz	~2.3 ~2.5	*	2.5:1	Ø6.5 x 56.6	Vertical	-	SMA-Male	50	
EM-W79B-7ANT-108		x	x				Connector Mount	824-2170 MHz	~2.8	*	5.6:1	Ø9.3 x 114	Vertical	-	FME-Female	50	
CA-C09-1FMEF-019		x	x				Adhesive Mount	900-1800 MHz	-1.78 -4.77	42 81	1.36:1 1.45:1	129.5 x 22.8	Linear	3000	FME-Female	50	
Vago / Pulse	W5028x					x	x	Connector Mount	2.4-2.5 GHz 5.15-5.85 GHz	1.9 3.8	>80 >50	*	Ø10 x 128	Vertical	-	RP-SMA-Male	50
	W5084x		x	x	x			Connector Mount	698-960 MHz 1400-2690 MHz 3400-3700 MHz	2 4 5	58 78 60	3 max 3.6 max 3 max	228.84	Vertical	-	TNC-Male/ SMA-Male	50
	W5017						x	Connector Mount	868-928 MHz	0.9	70	2.5 max	179	Vertical	-	SMA-Male	50



Why is Security important?....

Threats resulting from new technologies regularly make the headlines – whether thefts of vehicles with Keyless Go, illicit surveillance scandals, data theft, disclosure of passwords on the Internet, or phishing attacks. However, the greatest damage is in most cases not suffered by the users: Once negative publicity has stuck to a product, or a manufacturer, it becomes a serious threat to the business.

Encryption technologies offer comparatively cost-effective protection. When handling personal data, encryption is required by data protection laws in any case.

Security is Always a System

The issue of security is often neglected in relation to embedded systems especially. The result: Industrial spies can use hacked devices to penetrate the entire corporate network, gain access to the company's intellectual property (IP) and business secrets, and manipulate data.

Users of smart home devices might unintentionally disclose information to potential thieves through their security cameras, or even open doors and windows for them by way of automated control systems.

Automobiles are also subject to virtually infinite vulnerabilities thanks to autonomous driving and over-the-air firmware updates. When such cases become known, customers trust in the device – or even the entire business – is lost.

In view of this, encryption should be top of the priority list for all manufacturers of connected products. In order to understand encryption, it is helpful to consider what its aims are. These are focused on three key areas: authenticity, confidentiality, integrity.

When a user wirelessly connects multiple products in his home, for example, it is important that only authorized products can join the network, and that both the data in the network and the complete system are protected.

That is to say, protection must be in place against unauthorized access to the network (authenticity), data tapping (confidentiality) and manipulation (integrity).

State-of-the-art cryptography covers all three aspects. It is available in two fundamentally different modes: symmetric and asymmetric encryption.

Hardware or Software?

Each encryption method can be implemented by software or hardware. Software-based encryption entails the major disadvantage that the program is not an autonomous self-contained unit, but is always dependent on its environment, such as the operating system. It is susceptible to errors and attacks as a result. And there is another negative: As the micro-controller or processor of an embedded system additionally has to handle the complex encryption and decryption, loss of performance is inevitable.

The opposite case is represented by encryption using specially developed ICs. Their sole function is encryption, so there is no performance loss. Many encryption ICs are additionally protected against physical attacks. The security of those components – and also of the keys – is thus independent of the security of the overall system.

Encryption ICs in different designs meet the requirements of a range of applications: Simple authentication chips, such as the Infineon OPTIGA™ Authenticate S, use asymmetric encryption (ECC163), and are good choice for the authentication of original accessories in consumer electronics for example. The OPTIGA™ Trust M with ECC521 and SH512 assures authentication of medical equipment, in smart homes, in industry, or in cloud computing authentication for license management for example.

Encrypted Smart Home

A simple practical example illustrates the use of encryption ICs: In a smart home, simple authentication chips such as the OPTIGA™ Authenticate S ensure that only authorized devices – such as shutter controls or surveillance cameras installed by the user – are able to log in to the central smart home gateway.

A OPTIGA™ TPM in the central gateway assures key storage, firmware updates, and the transfer of all data to the Cloud. As a result, the e.g. Smart Home owner can be certain that authenticity, confidentiality and integrity are assured.



Selection Guide

Manufacturer	Part Name	Security Level	Functionality	NVM (Data)	Cryptography	Type of Host System	Interface	Package
Infineon	OPTIGA™ TPM SLM 9670	CC EAL 4+	Security Cryptocontroller for Trusted Platform Modules	6.9 kByte	ECC, ECC BN-256, ECC NIST P-256, ECC NIST P-384, RSA1024, RSA2048, HMAC, SHA-1, SHA-256	Embedded Linux / Windows / MCU without OS / proprietary OS	SPI	PG-VQFN-32
	OPTIGA™ TPM SLB 9672	CC EAL 4+	Security Cryptocontroller for Trusted Platform Modules	51 kByte	Up to RSA4096 and ECC NIST P384 HMAC and up to SHA2-384 and AES-256	Windows / Linux	SPI	PG-UQFN-32
	OPTIGA™ TPM SLB 9673 FW26.xx	CC EAL 4+	Security Cryptocontroller for Trusted Platform Modules	51 kByte	Up to RSA4096 and ECC NIST P384 HMAC and up to SHA2-384 and AES-256	Windows / Linux	I2C	UQFN-32
	OPTIGA™ Trust M	CC EAL 6+	Connected device security	Up to 10 kB user memory	ECC: NIST curves up to P-521, Brainpool r1 curve up to 512	MCU without OS / proprietary OS / RTOS, Embedded Linux	I2C with shielded connection	USON-10
	OPTIGA™ Trust M Express	CC EAL 6+	Secure IoT device deployment to the cloud	Up to 10 kB user memory	ECC: NIST curves up to P-521, Brainpool r1 curve up to 512, RSA with keys up to 2048 bits	MCU without OS / proprietary OS / RTOS, Embedded Linux	I2C with shielded connection	USON-10
	OPTIGA™ Trust M MTR	CC EAL 6+	Secured matter compatibility	10 kByte	AES key up to 256 ; HMAC up to SHA512 ; TLS v1.2 PRF and HKDF up to SHA512	MCU without OS / proprietary OS / RTOS, Embedded Linux	I2C with shielded connection	USON-10
	OPTIGA™ Authenticate S	CC EAL 6+	Enhanced device authentication	3 types of lockable NVM sizes (1 K, 2 K, 5 Kbit)	ECC 163-bit	Host code software – with new OS library	GPO, SWI, I2C	PG-TSNP-6-12
	OPTIGA™ Authenticate NBT*	CC EAL 6+	Secured device authentication, configuration & activation	8KB	ECDSA-based asymmetric cryptography (NIST P-256), AES-128-based symmetric cryptography	MCU without OS / proprietary OS / RTOS, Embedded Linux	NFC, I2C	PG-USON-8-8
	OPTIGA™ Trust Charge	CC EAL 6+	Qi Authentication for inductive wireless charging	10 kByte	ECC: NIST P256/P384, SHA-256, TRNG, DRNG	Wireless Charging MCU, host SW for typical MCUs provided	I2C	PG-USON-10-2,-4
	OPTIGA™ Connect Consumer	CC EAL 6+	eSIM for cellular-connected consumer devices	800 kByte	RSA up to 2048 bit, ECC up to 521 bit, NIST P-256, Brainpool256r1, FRP256v1	Cellular Modem + LPA (Android or Windows)	UART	XFWL-25-3, VQFN-8-4
OPTIGA™ Connect IoT	CC EAL 5+	eSIM for cellular-connected IoT devices	350 kByte	SHA, DES, AES, ECC, RSA, COMP128, MILENAGE, TUAK, CAVE	Cellular Modem	UART	PG-VQFN-8-4	

*) From June onwards





OPTIGA™ TPM – Trusted Platform Module



Certified Security high-end controllers for computing, IoT networking and embedded applications

OPTIGA™ TPM (Trusted Platform Module) is a standardized security controller which protects the integrity and authenticity of devices and systems in embedded networks. Built on proven technologies and supporting the latest TPM 2.0 standard, OPTIGA™ TPM highlights include secured storage for keys, certificates and passwords as well as dedicated key management. As the established, trusted market and innovation leader in the Trusted Computing space, we offer a broad portfolio of certified OPTIGA™ TPM security controllers based on the Trusted Computing Group (TCG) standard to suit all needs.

Key Features

- High-end security controller with advanced cryptographic algorithms implemented in hardware (e.g. RSA & ECC256, SHA-256, AES)
- Common Criteria (EAL4+) and FIPS security certification
- Flexible integration with SPI and I2C interface support
- Extended temperature range (-40 to +85 °C) for a variety of applications

Benefits

- Reduced risk based on proven technology
- Fast time to market through concept reuse and standardized approach
- Flexibility thanks to wide range of security functions as well as dedicated key management
- Easy integration into all platform architectures and operating systems

Target Applications

- PC and embedded computing
- Printers
- Network equipment
- Industrial control systems
- Smart Home / Smart City security and automation
- Energy generation and distribution systems
- Automotive electronics



Overview of OPTIGA™ TPM Family

SLB 9645	SLB 9670	SLM 9670	SLI 9670	SLB 9672 FW15.xx	SLB 9672 FW 16.xx	SLB 9673
<ul style="list-style-type: none"> TPM 1.2 I2C Interface Based on EAL 4+ certified hardware and firmware TSSOP-28 or VQFN-32 packages 	<ul style="list-style-type: none"> SPI Interface Either TPM 1.2 or TPM 2.0 compliant TCG and Common Criteria EAL 4+ FIPS 140-2 certified VQFN-32 package 	<ul style="list-style-type: none"> SPI Interface TPM 2.0 certified TCG and Common Criteria EAL 4+ FIPS 140-2 certified Industrial quality grade VQFN-32 package 	<ul style="list-style-type: none"> SPI interface TPM 2.0 certified TCG and Common Criteria EAL 4+ FIPS 140-2 certified Automotive qualific. (AEC-Q100) VQFN-32 package 	<ul style="list-style-type: none"> SPI interface Optimized for Computing (laptops/desktops/servers) TPM 2.0 Certified TCG and Common Criteria EAL 4+ UQFN-32 package FIPS 140-2 certified 	<ul style="list-style-type: none"> SPI interface Enhanced security features for IoT networking and connected devices TPM 2.0 certified TCG and Common Criteria EAL 4+ UQFN-32 package FIPS 140-2 certified 	<ul style="list-style-type: none"> I2C Interface Enhanced security features for IoT networking and connected devices TPM 2.0 certified TCG, Common Criteria and FIPS Certifications UQFN-32 package

OPTIGA™ TPM – TPM SLM 9670



Standardized and certified TPM 2.0 security solution for industrial & demanding applications

The OPTIGA™ TPM SLM 9670 addresses the requirements of industrial and other demanding applications where an extended temperature range, an extended lifetime and industrial-grade quality are key. Pushing beyond the qualifications processes performed for standard TPMs, the OPTIGA™ TPM SLM 9670 is qualified according to the industrial JEDEC JESD47 standard to enable the requisite performance under demanding environmental conditions.

OPTIGA™ TPM SLM 9670 offers high levels of flexibility to address innovative use cases of Smart Factories and Industry 4.0 that call for robust security:

- Strong digital device ID and device authentication
- Secured communication for data confidentiality and IP protection
- Integrity protection of devices and software incl. software updates

A ready-to-use security building block, SLM 9670 is equipped with a variety of functions to secure industrial devices and systems.

These include:

- Key storage and management
- Identification and authentication
- Signature generation and verification
- Software and firmware integrity attestation
- Secured logging and secured time



Key Features

- SPI Interface
- TPM 2.0 certified
- Common Criteria EAL 4+, FIPS 140-2 level 2 certified
- Industrial quality grade
- VQFN-32 package
- Asymmetric Cryptography: ECC, ECC BN-256, ECC NIST P-256, ECC NIST P-256, RSA1024, RSA2048
- Symmetric Cryptography: HMAC, SHA-1, SHA-256

Benefits

- Standardized security chip compliant with TCG TPM 2.0 standard
- Secured storage for critical data and secrets
- Advanced protection mechanisms against physical and logical attacks
- Support for cryptographic algorithms RSA-1028, RSA-2048, ECC NIST P256, ECC BN256, SHA-1, SHA-256
- Ext. temp. range: -40 to 105 °C
- Ext. lifetime: 20 years
- JEDEC JESD47 industrial qualification
- Security evaluated and certified independently

Target Applications

- Industrial PCs, servers, Programmable Logic Controllers (PLC)
- Network infrastructure devices & equipment like gateways, routers, wireless access points, and switches





OPTIGA™ TPM SLB 9672



Ready-to-use TPM with SPI interface and PQC-protected firmware update mechanism, optimized for PCs and servers

OPTIGA™ TPM SLB 9672 is Infineon's standardized, ready-to-use Trusted Platform Module with an SPI interface that serves as a robust foundation to identify and authenticate PCs, servers, and connected devices, and to protect data integrity and confidentiality. Feature-rich, ready for current and future security challenges OPTIGA™ TPM SLB 9672 is future-proof – it comes with extended memory and stronger cryptographic algorithms, and is the first TPM in the market that offers a PQC-protected firmware update mechanism. Integrated resiliency features allow the TPM firmware to be recovered in compliance with the NIST SP 800-193 Platform Firmware Resiliency Guidelines. This, combined with improved computational performance, takes system security to the next level.

OPTIGA™ TPM SLB 9672 is available in two versions:

OPTIGA™ TPM SLB 9672 FW15.xx

this standardized and certified security solution is the primary choice for Microsoft Windows environment/ecosystem and connected devices with PC architecture.

Target Applications

- Home & Office devices: Laptops / Desktops / Tablets, Servers, Enterprise Printers

OPTIGA™ TPM SLB 9672 FW16.xx

Compared with the FW15.xx version, the FW16.xx version offers flexible configuration options, enhanced security features including AES bulk encryption, configuration of the TPM's unique ID, and configuration of the endorsement primary seed.

Target Applications

- Home & Office devices: Enterprise printers
- Smart Building: Surveillance camera
- Industrial Automation: Factory robots, Programmable Logic Controllers (PLC)
- Network infrastructure: Routers, Switches, Access Point, Gateway, 5G Equipment

Key Features

- High-end standardized security controller
- PQC-protected firmware update mechanism
- Support for latest specifications of TCG TPM 2.0 standard (rev. 1.59)
- TCG, CC and FIPS certifications
- Windows HLK certification
- Support for various cryptographic algorithms: up to RSA-4096, AES-128, AES-256, ECC NIST P256, ECC BN256, ECC NIST P384, SHA-1, SHA2-256, SHA2-384
- Extended non-volatile memory (51 kB)
- SPI interface
- Thin PG-UQFN-32 package

Benefits

- Proven, standardized turnkey security solution
- High confidence level based on common criteria and FIPS certification
- faster cryptographic operations (2-4 times faster, depending on the functions)
- Easy integration with Windows and Linux OS Platforms



OPTIGA™ TPM SLB 9673 FW26.xx



Ready-to-use TPM with a PQC-protected firmware update mechanism, optimized for embedded systems with an I2C interface

OPTIGA™ TPM SLB 9673 FW26.xx is the latest addition to the OPTIGA™ TPM family targeted at connected devices that require enhanced security features. This standardized, ready-to-use security solution comes with an I2C interface. It serves as a robust foundation to identify and authenticate network infrastructure and light industrial machines such as factory robots and Programmable Logic Controllers (PLC). In addition, it protects data integrity and confidentiality.

OPTIGA™ TPM SLB 9673 FW26.xx

is future-proof thanks to a PQC-protected firmware update mechanism, extended memory, and strong algorithms. Integrated resiliency features allow the TPM firmware to be recovered in compliance with the NIST SP 800-193 Platform Firmware Resiliency Guidelines.

OPTIGA™ TPM SLB 9673 FW26.xx gives "things" a unique identification number so they can connect to the IoT or the network. This number can be used to track IoT devices and equipment on the networks, and to validate their access rights. To avoid the risk of counterfeit, this number is protected from being modified. A set of configurable commands is available to set the TPM up according to application-specific needs during platform manufacturing.

Its enhanced security features include AES bulk encryption, configuration of the TPM-unique ID, and a configurable endorsement primary seed.

Key Features

- I2C interface up to 1 MHz
- Extended non-volatile memory (51 kB)
- Support for latest cryptographic algorithms: up to RSA-4096, ECC NIST P384, SHA2-384
- TCG TPM2.0 (revision 1.59), CC and FIPS certifications
- PQC-protected firmware upgrade mechanism using XMSS signatures
- Thin UQFN-32 package
- Extended temperature range: (-40°C to 105°C)

Benefits

- Proven, standardized turnkey security solution
- High confidence level based on Common Criteria and FIPS certifications
- Easy integration with Linux OS platforms
- Faster cryptographic operations than previous generation



Target Applications

- Home & Office devices: Enterprise printers
- Industrial Automation: Factory robots, Programmable Logic Controllers (PLC)
- Smart Building: Surveillance Camera
- Health & Lifestyle: Monitoring System
- Renewable Energy: Solar energy farms, Electrical windmills
- Smart Mobility: EV charging
- Network infrastructure: Routers, Switches, Access point, Gateway, 5G Equipment





OPTIGA™

OPTIGA™ Trust M

Secured cloud service provisioning – the easy way!



Cloud services and AI are driving a wave of innovative applications. The number of devices connected to these applications is growing, presenting great opportunities – but also increased security risks. Responding to a growing focus on embedded systems amongst attackers, Infineon offers the OPTIGA™ Trust M solution, a high-end security controller optimized for connected devices.

It provides extremely flexible, high-performance, secured access to any major cloud provider for industrial and building automation, smart home and consumer applications.

<p>Key Features</p> <ul style="list-style-type: none"> CC EAL6+ (high) certified high-end security controller I²C interface with shielded connection Hibernate mode for zero power consumption USON-10 package (3 x 3 mm) Standard and extended temperature ranges: -40 to +105 °C Up to 10 kB user memory Configurable device security monitor Lifetime of 20 years for industrial and infrastructure applications Cryptographic ToolBox MIT licensed software framework on GitHub 	<p>Benefits</p> <ul style="list-style-type: none"> Secured zero-touch provisioning Easy integration Future-proof security Performance MIT licensed software 	<p>Target Applications</p> <ul style="list-style-type: none"> Industrial and building automation Smart home Consumer devices Drones
---	---	--

OPTIGA™ Trust M Express

The easiest way to securely deploy IoT devices to the cloud at scale



OPTIGA™ Trust M Express is a pre-provisioned Secure Element that simplifies the integration of security in IoT devices. It makes it easier to claim the devices and transfer the certificates to the product cloud at scale. The Infineon cloud service automates the IoT device certificate registration and device provisioning in the product cloud. This solution simplifies the production flow, accelerates time-to-market, and increases cost efficiency.

<p>Key Features</p> <ul style="list-style-type: none"> Pre-provisioned with Ready-to-use certificates / keys AWS multi-account registration Azure IoT Hub pre-registration Infineon cloud service support CC EAL6+ (high) certified ECC: NIST curves up to P-521, Brainpool r1 curve up to 512 bits RSA with keys up to 2048 bits AES key up to 256 bits HMAC up to SHA-512 TLS v1.2 PRF + HKDF up to SHA-512 TRNG/DRNG random number generator Cryptographic toolbox commands SHA-256, ECC and RSA® features, AES, HMAC and key derivation 	<p>Benefits</p> <ul style="list-style-type: none"> Off-the-shelf secure elements Ready to connect to Azure and AWS Automated device provisioning Product-to-cloud provisioning Simple device claiming process No manual intervention required Faster design-in process Easy-to-use developer kit NDA-free product documentation Robust Security 	<p>Target Applications</p> <ul style="list-style-type: none"> Smart Home Smart Buildings Smart Mobility Smart Cities Industrial IoT Healthcare / Lifestyle
--	--	---





OPTIGA™ Trust M MTR

The easiest way to add Matter and security to your smart home devices



OPTIGA™ Trust M MTR is our OPTIGA™ Trust M discrete security solution combined with a Matter provisioning service. It is Matter-certified and works with any MCU/SoC, making it easy to add secured Matter compatibility to existing IoT designs. Working closely with our partner Kudelski IoT, we offer late-stage personalized Device Attestation Certificate injection to give OEMs the flexibility to update DACs right up until the start of production.

Key Features

- CSA Certified Matter certificates
- Pre-provisioned TLS certificates
- CC EAL 6+ certified
- ECDH, ECDSA
- ECC NIST Curves up to P521
- Cryptographic toolbox
- ECC 512 and RSA up to 2K key size
- AES, HMAC and Key derivation
- TRNG AIS-31 certified
- Built-in crypto accelerator

Benefits

- Easy to add Matter compatibility
- Works with any MCU/MPU
- Allows retention of existing designs
- Personalized DAC for download
- High flexibility
- Allows creation of multiple variants
- Robust Security
- NDA-free product documentation

Target Applications (e.G. Smart Home)

- Smart Home
- Lighting
- Blinds/Shades
- Climate Control
- Television
- Access Control
- Surveillance Camera, Alarm
- Gateway Access Point
- Speaker



OPTIGA™ Authenticate S

Enhanced device authentication to protect against counterfeits



Infineon's anti-counterfeit turnkey solution, combining enhanced device authentication with unprecedented levels of configuration flexibility. OPTIGA™ Authenticate S gives each product a secret key so it can be authenticated at the point of use, and so products can be tracked and traced throughout the supply chain. With its rich set of 16 customization options, it supports even the most complex authentication requirements – all on a single, tiny footprint. OPTIGA™ Authenticate S is suited to an ever-expanding range of applications, from single-use disposables and rechargeable batteries for smartphones, portable devices and e-mobility solutions, to computing and robotic systems in highly complex IoT environments. The turnkey solution comes with full system integration support including embedded software, host software and advanced ecosystem support tools based on the latest PSoc™ 6 MCUs. An NDA is required.

Key Features

- 4 ECC authentication modes (one-way, mutual, host binding and host support)
- 4 lifecycle counters with independent kill structures
- 3 types of lockable NVM Sizes (1K, 2K, 5Kbit)
- 3 temperature options (-40 to 85°C / -40 to 105°C / -40 to 120°C)
- 2 ECC 163-bit key pairs and 193-bit ODC
- 2 Serial communication options (SWI & I2C + GPO)
- Host code software – with new OS library
- 1.5 x 1.5 x 0.38 mm PG-TSNP-6-12 package
- Infineon proprietary protection against reverse engineering (PRE)
- High-end security controller certified to Common Criteria EAL6+ (high)

Benefits

- Rich customization options
- Effortless implementation – full turnkey solution – full system integration support
- Additional customer services, such as alerts when spare parts need replacing
- Security to rely on – e.g. enhanced HW security with extended key length
- Freedom to design even very small products – tiny package of 1.5 mm²

Target Applications

- Batteries and accessories and battery powered tools, such as portable devices, e-scooters
- Replacement parts (water filters, printer cartridge, purifiers)
- Electronics (power tools, wearable devices, multicopters and drones)

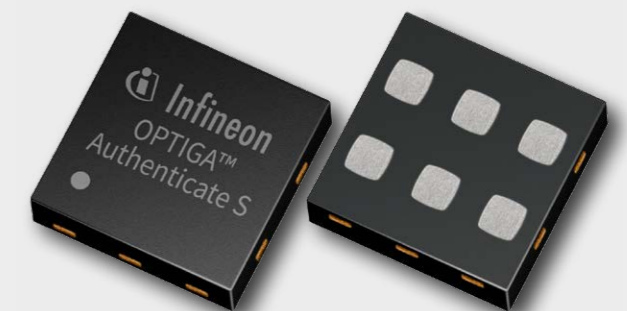



OPTIGA™

OPTIGA™ Authenticate NBT

for contactless authentication and secured configuration of IoT devices



The OPTIGA™ Authenticate NBT is a high-performance NFC-I2C bridge tag which enables IoT device authentication and secured configuration with just a tap. The bridge tag is embedded in the IoT device and is connected to internal components like the microcontroller (MCU) via the I2C interface. It facilitates communication between NFC-enabled devices such as smart phone and I2C-connected components. The product harnesses Infineon's much-acclaimed Integrity Guard™ security architecture and, provides symmetric and asymmetric cryptographic operations as well as password-based data protection schemes. These makes the product ideal for secured configuration of an electronic device without display such as industrial control panel, data logging in patient monitors, activation of shared mobility vehicles, and commissioning of non-powered smart bulbs prior to installation.

Key Features

- NFC Forum Type 4 Tag certification, Common Criteria EAL 6+ certification (for hardware and the crypto library), Personal Health Device Communication (PHDC) compliant
- 106 to 848 kbit/s data transfer rate for contactless interface
- I2C standard mode, fast mode, fast mode 'plus' clock frequencies
- Device verification through ECDSA-based asymmetric cryptography, AES-128-based symmetric cryptography
- 32-bit password-based verification
- 78 pF on-chip tuning capacitance
- Storage capacity of 8 KB user NVM
- Chip-individual pre-provisioned certificate

Benefits

- Easy configuration of electronic devices using an NFC-enabled smart phone/reader
- Reduces system costs by eliminating the need for displays, keys and knobs
- Ultra-fast data rates provide enhanced user experience with just a tap
- Safeguards against unauthorized access by ensuring that only authorized personnel can modify device parameters
- High on-chip tuning capacitance for supporting smaller antenna designs
- Large on-chip memory

Target Applications

- Industrial applications (for device configuration and sensor data logging)
- Healthcare applications (for data logging, NFC PHDC-compliant device communication and disposable authentication)
- Shared e-bikes (for device activation/deactivation)
- Smart home devices (for easy customer onboarding, passive commissioning and remote diagnostics)

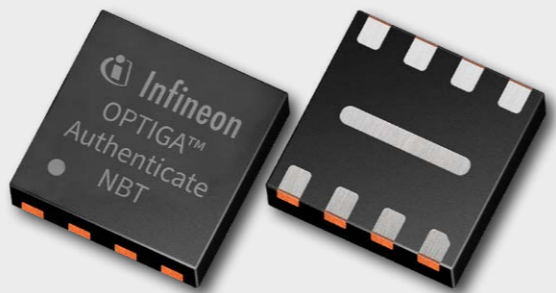

OPTIGA™ Trust Charge

The trusted authentication solution for wireless charging



Infineon's OPTIGA™ Trust Charge is a turnkey solution providing secured device authentication for inductive wireless charging according to the Qi 1.3 wireless charging standard. Secured authentication with OPTIGA™ Trust Charge contributes to device and user safety by protecting against fake chargers. The turnkey setup – with full system integration support and all key and certificate material preprogrammed – minimizes customer effort for design, integration and deployment.

OPTIGA™ Trust Charge comes with preprogrammed locked OS, locked application code, and host-side modules to integrate with host microcontroller software. Integration support includes a reference board and documentation for rapid design-in.

Key Features

- WPC Qi 1.3 authentication
- Common Criteria EAL6+ (high) certified hardware
- ECDSA P-256 authentication
- NIST P-256, SHA-2 cryptography
- Up to 10 kB user memory
- Qi certificate format
- PKI
- I²C serial communication
- USON10-2 package (3 x 3 mm)
- Extended temperature range version available
- Full turnkey solution incl. drivers, SW library, preimplemented certificate(s) and key pair(s)

Benefits

- Protection of consumers against fake charging devices
- Turnkey solution with full system integration support including embedded software, host software, a development board, a reference board and documentation
- WPC-specific personalized keys and certificates preloaded at secured Infineon fabs
- Tiny package (3 x 3 mm) optimized for small devices
- Versions for standard and extended temperature ranges

Target Applications

- Mobile phones
- Tablets
- Cameras
- Accessories and other small personal electronic devices with charging according to the Qi standard
- Health tech devices

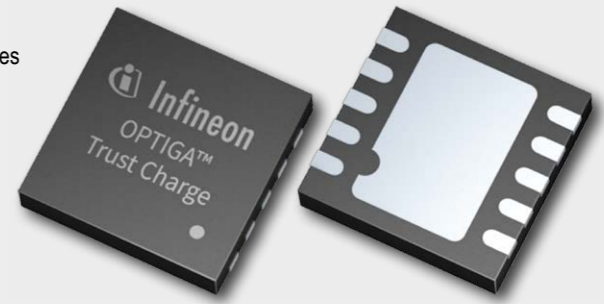



OPTIGA™ Connect Consumer

eSIM turnkey solution for cellular-connected consumer devices



OPTIGA™ Connect Consumer is a ready-to-connect embedded SIM (eSIM) solution for consumer devices. It is especially suited to extending cellular connectivity to smaller devices like smart watches, fitness trackers and other wearables. OPTIGA™ Connect Consumer represents the next generation of eSIMs implementing GSMA's technical specification for mobile consumer devices. This turnkey solution securely authenticates the device to the subscribed carrier networks of choice. Remote SIM provisioning (RSP) allows the user to change or add carriers over the air provided the device is equipped with a local profile assistant (LPA). Generally speaking, SIM-based cellular connectivity is more resistant to security breaches than typical wireless network connections as it provides end-to-end encryption and secured key exchange.

Key Features

- Compliant with network technologies 2G, 3G, 4G (LTE), 5G
- Network Access Applications SIM, USIM, CSIM, RUIM and ISIM
- Remote SIM Provisioning (RSP) compliant with GSMA SGP.22 v2.2.2
- Compliant with Trusted Connectivity Alliance (TCA) eUICC Profile Package V2.3.
- Interoperable with MNOs offering commercial eSIM services
- Chip-scale (2.9 x 2.5 x 0.4 mm) and ETSI MFF2 (5.0 x 6.0 mm) packages
- Up to 800 kB free memory for MNO profiles, applications, and data (supporting integration of additional applets)
- Certified and tested solution according to GSMA

Benefits

- Increased customer convenience
- More design flexibility by providing an ultra-small package size
- Future-ready device
- Based on a solid security platform
- Interoperable
- Turnkey solution with lower design-in and qualification effort

Target Applications

- Smartphones
- Tablets
- Wearables
- Laptops
- Access Points
- Consumer IoT Devices



OPTIGA™ Connect IoT

Turnkey eSIM solution for cellular-connected IoT devices



OPTIGA™ Connect IoT is a ready-to-connect embedded SIM (eSIM) solution for cellular IoT devices. This turnkey solution allows easy, secured and cost-optimized deployment and management of cellular-enabled IoT devices at scale. It comes with a pre-installed GSMA-compliant operating system and pre-integrated connectivity capabilities. Supported by the partner Tata Communications, this eSIM offers global cellular network coverage with a choice of 640+ networks across 200 countries. End-to-end connectivity management extending from design through manufacture to deployment reduces complexity, offers full visibility into IoT devices and simplifies control. It addresses today's key pain points in connectivity management, namely interoperability across different vendors' GSMA subscription management platforms, local service deployment options, technical support, cost and coverage.

Key Features

- Reprogrammable eSIM
- Compliant with GSMA remote SIM provisioning specification SGP.02 v3.2 Support 2G, 3G, 4G, 5G LTE-M, NB IoT1)
- ETSI TS102 221 and ETSI TS102 671 compliance
- MFF2 (QFN8) package (other packages on request)
- Supported interface: ISO7816- UART
- Voltage classes: A, B, C › Industrial grade (-40 to +105°C)
- Data retention: 10 years
- Common criteria EAL5+ certified hardware
- Free memory available for storage of up to 10 operator profiles
- Bootstrap connectivity with global cellular coverage (640+ networks, 200 countries/ territories)
- Adjustable data plan
- Single secured access point to remote data and connectivity management via partner portal

Benefits

- Ready to connect with onboarded bootstrap
- Global cellular coverage
- Flexible connectivity services for IoT devices
- Free choice of Mobile Network Operator (MNO)
- Cost-effective, pervasive (worldwide) and secured connectivity
- Easy deployment and management of cellular IoT at scale
- Reduced complexity through interoperability and connectivity management Simplified path to market
- Single SKU for all applications and regions
- Open for integration of additional applets
- Low power consumption

Target Applications

- Smart Home (Security Cameras, alarms, air conditioning, access control)
- Smart city (security cameras, lighting, park sensors)
- Smart energy (metering, storage, distribution)
- Industry automation (factory automation, asset tracking)
- Wearables (Health monitoring)





Energy Converters

Energy can be found everywhere – in the movement of doors and windows or machine components, the vibration of motors, changes in temperature or variances in luminance level. These energy sources, which usually remain unused, can be tapped into by means of energy harvesting to power electronic devices and transmit wireless signals. This principle is the basis of energy harvesting wireless technology from EnOcean.

EnOcean
Self-powered IoT

The World of Energy Harvesting Wireless Technology

Sending a wireless signal over the EnOcean standard requires only a small amount of energy. This energy can be generated by so called energy converters, which convert energy from the environment into electric energy. Due to the fact that no further power supply is required, the product can be designed to be maintenance-free. Electric energy can be harvested from temperature differences, light and motion.

The EnOcean Energy Harvesters are intended for powering the international standard ISO/IEC 14543-3-1X (EnOcean standard). This standard is optimized for ultra-low power wireless application and energy harvesting. The EnOcean ISO/IEC standard uses different license-free frequency bands in the SubGHz range to meet the specifics and legal regulations of countries all around the world, for example:

- 868 MHz for Europe and China
- 902 MHz for North America and Canada
- 928 MHz for Japan

EnOcean's energy harvesting solutions can also connect to the Zigbee/IEEE 802.15.4 standard as well as to Bluetooth® networks which both use the worldwide available 2.4 GHz frequency band.

Application Fields

- Building and Home automation: HVAC, lighting, shutter control...
- Ultra-low power devices
- Consumer LED lighting control
- Window contact sensors
- Temperature sensors
- Humidity sensors



ECO 260

Kinetic Energy Harvesting



The kinetic converter in combination with a wireless module enables numerous battery-free switch applications. Energy from a switching operation (button pressure):

- Electrodynamical energy converter
- Energy generation from kinetic motion
- Typically more than 1,000,000 switching cycles at 25 °C
- For small and flat switch designs

ECS 300

Solar Cell for Self-Powered Wireless Sensors



Solar cell for energy harvesting wireless sensors ECS 300.

Form Factor: 35.0 × 12.8 × 1.1 mm

- Indoor solar cell
- Designed for use with EnOcean STMicroelectronics sensors
- The small ECS 300 is ideal for unidirectional sensor applications

ECT 310 Perpetuum

Thermo Energy Harvesting



Ultra-low power DC/DC converter for thermal energy harvesters.

Heat dissipation as energy source

- Standard peltier element
- Usage of minimum temperature difference
- Maintenance free, full integration
- Allows energy harvesting actuators

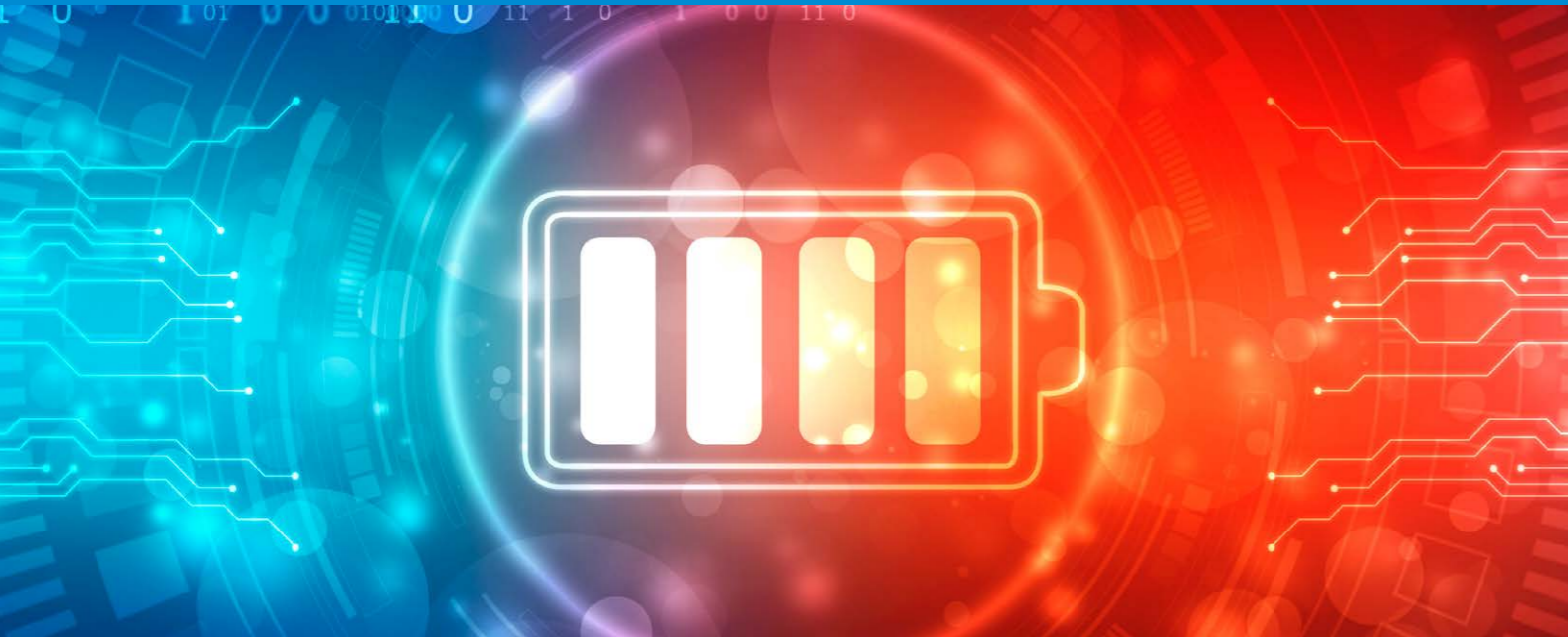
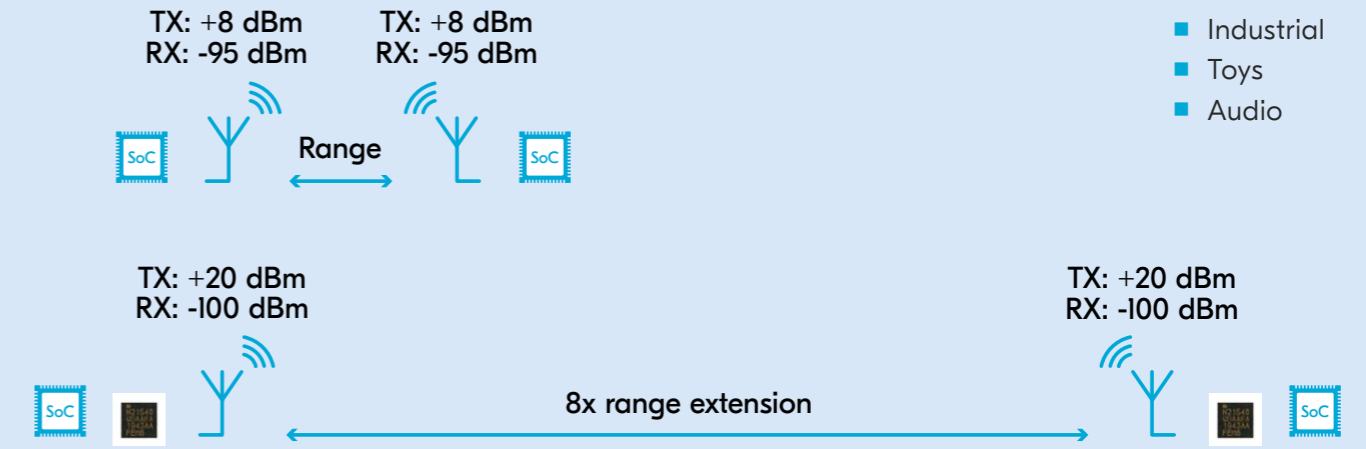

Figure of link budget improvement Overview



Link budget improvement for the nRF21540-DK compared to the nRF52840-DK.

- Professional lighting
- Smart Home
- Industrial
- Toys
- Audio

Introduction to Power Management



nPM Series – Extremely Compact Power Management IC (PMIC) with Power Path and Charging

Nordic Semiconductor leverages its extensive experience in ultra-low power wireless technology to develop power management ICs, enabling industry-leading low power wireless solutions.

Type	nPM1300	nPM1100	nPM6001
Buck regulator	2	1	4
Battery charger	✓	✓	
LDO	2		2
Load switch	2		
Termination voltage	3.5 to 4.45 V	4.1 to 4.2 V, or 4.25 to 4.35 V	
Max charging current	800mA	400mA	
Dynamic power-path management	✓	✓	
Thermal protection	✓	✓	
Battery compatibility	LiFePO4, Li-ion, LiPo	Li-ion, LiPo	
Input voltage	4 to 5.5 V	4.1 to 6.7 V	3 to 5.5 V
USB compliance	Type-C	✓	
Regulated output voltage	1 to 3.3 V	1.8 to 3 V	0.5 to 3.3 V
Max current per buck	200 mA, 200 mA	150mA	550 mA, 200 mA, 150 mA, 150 mA
System monitoring	System, input bus and battery voltages. Battery current and temperature. Die temperature.		
Fuel gauge	✓		
Hard system reset	✓		
Timed wake-up	✓		
Watchdog timer	✓		✓
Ship / hibernate mode	✓		✓
Brown-out detector	✓	✓	✓
LED drivers, GPIOs	3, 5	2, 0	0, 3
Control interface	TWI	Pin-configurable	TWI
Regulatory compliance	CE, JEITA, RoHS	CE, JEITA, RoHS	CE, RoHS
Operating temperature	-40 to 85°C	-40 to 85°C	-40 to 85°C
Package Dimensions	5x5 mm QFN32, 3.1x2.4 mm WLCSP	4x4 mm QFN24, 2.1x2.1 mm WLCSP	2.2x3.6 mm WLCSP
Evaluation kits	nPM1300 EK	nPM1100 EK	nPM6001 EK

Introduction to Range Extender



nRF21 Series – RF front end module (FEM)

The range and link robustness of Nordic nRF52 and nRF53 Series SoCs fulfill the requirements of most applications and use-cases, but sometimes adding an RF front-end module (FEM) is the correct choice. An RF FEM increases the range at which two wireless devices can communicate, while also enhancing link robustness. Combining the nRF21540 RF FEM with an nRF52 or nRF53 Series SoC can boost range between 6.3-10x.

Key Features

- Supports
 - Bluetooth® Low Energy (incl. Bluetooth mesh)
 - Thread and Zigbee (802.15.4)
 - Proprietary 2.4 GHz
- Adjustable output power in small increments up to +21 dBm
- +13 dB receive gain with 2.5 dB noise figure
- Two antenna ports for antenna diversity
- Control interface via GPIOs, SPI, or a combination
- -40°C to +105°C operating temperature range
- 1.7 V to 3.6 V input supply range
- 4 x 4 mm QFN16 package
- When combined with an nRF52 or nRF53 Series SoC:
 - Up to 6.3-10x range increase /
 - 100 dBm RX sensitivity (Bluetooth LE, 1 Mbps)
- Current consumption:
 - TX tuned to +20 dBm: 110 mA / RX: 2.9 mA
- Power down mode: 30 nA

nRF21540 Development Bundle

The nRF21540 DB consists of the nRF21540 development kit (DK) and the nRF21540 evaluation kit (EK).

The nRF21540 DK is the perfect tool to develop products that require the range extension capabilities or link budget improvements provided by the nRF21540 RF front-end module (FEM). The nRF21540 EK can connect to lab equipment via SMA connectors to monitor the RF FEM's performance.

Applications

- Asset tracking and RTLS
- Professional lighting
- Smart Home
- Industrial
- Toys

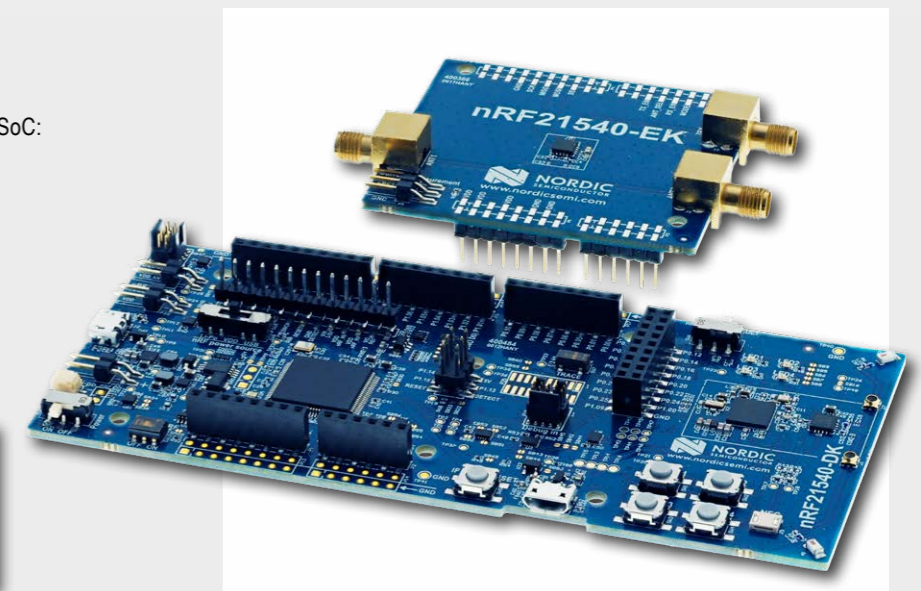
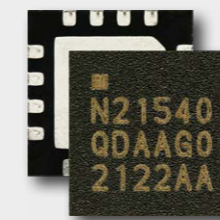

Committed to excellence

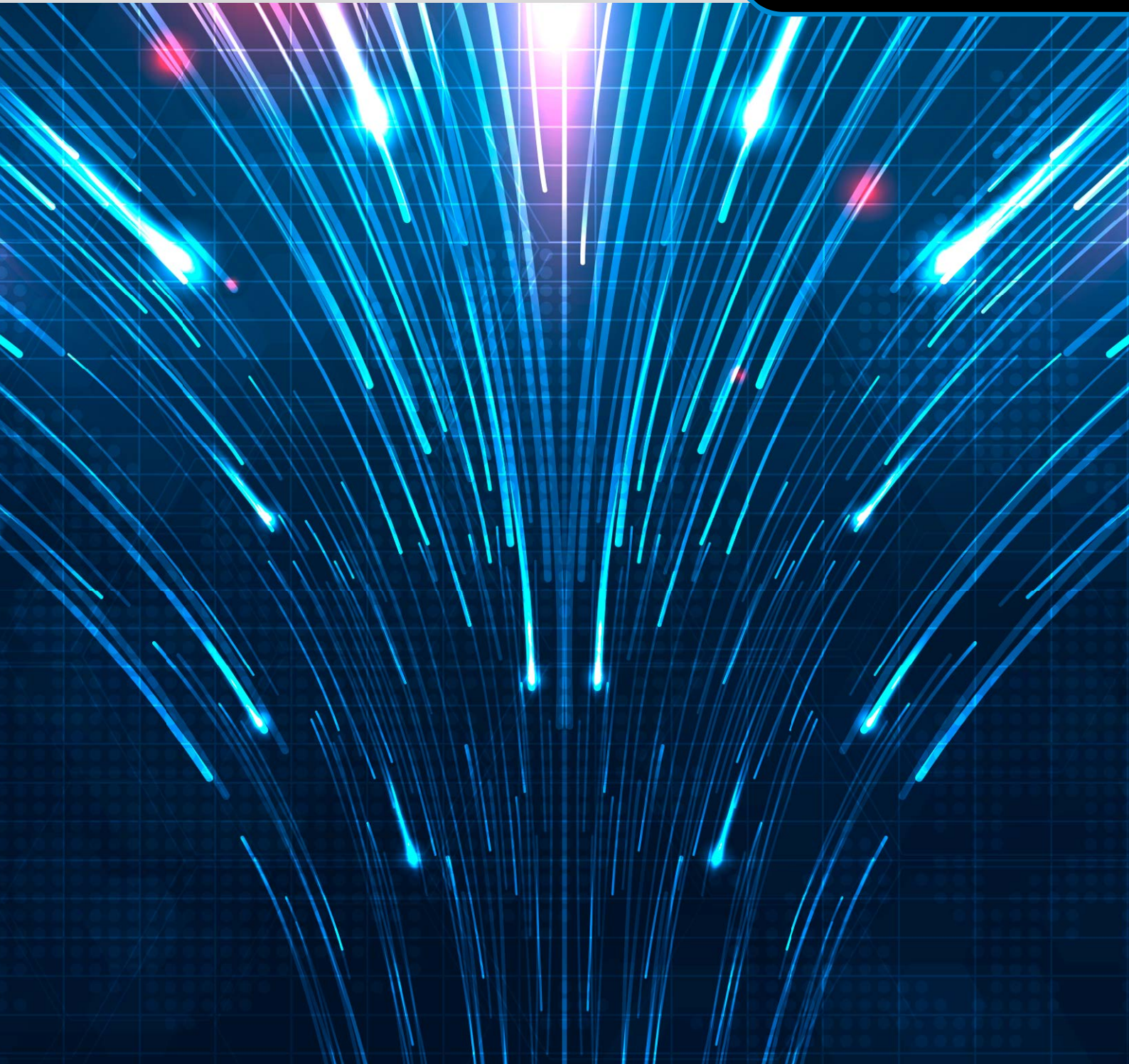

Find your regional Rutronik contact!



info@rutronik.com | www.rutronik.com