



Animal Surgery and Modeling Solutions



Animal Administration and Blood Sampling Solutions



Behavioral Experiment Solutions



In Vivo Imaging Solutions



Pathological Section Solutions



Neural Signal Research Solutions



Cellular and Molecular Biology Research Solutions



## RWD Life Science Co.,Ltd

Add: Building 7A (9th, 19th-20th Floors), Building 7D (9th Floor), Shenzhen International Innovation Valley, Dashi 1st Road, Nanshan District, Shenzhen, Guangdong, China

Web: [www.rwdstco.com](http://www.rwdstco.com) E-mail: [rwd@rwdstco.com](mailto:rwd@rwdstco.com)

## RWD Life Science Inc.

Add: 10410 Corporate Drive, Sugar Land, TX 77478, USA

Tel: 1-858-900-5879 Tech support: [service@rwdstco.com](mailto:service@rwdstco.com)

## PRODUCT CATALOGUE

[www.rwdstco.com](http://www.rwdstco.com)  
[rwd@rwdstco.com](mailto:rwd@rwdstco.com)

Speed up Life Science Research  
Achieve Better Healthcare for Human & Animals



Learn more about us at:  
[www.rwdstco.com](http://www.rwdstco.com)

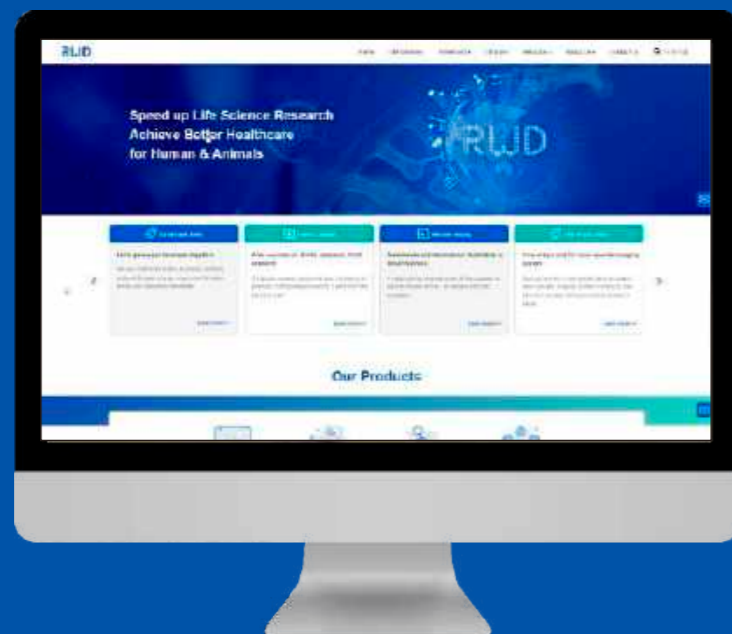

# CONTENTS

<b>Animal Surgery and Modeling Solutions</b> .....	<b>01</b>	<b>Cellular and Molecular Biology Research Solutions</b> .....	<b>65</b>
Stereotaxic Instruments .....	1	Single Cell Suspension Dissociator .....	65
Precise Impactor .....	16	Magnetic Microbeads Cell Separation Products .....	67
Animal Anesthesia Machine .....	18	CO <sub>2</sub> Incubator .....	68
Animal Ventilator .....	27	Automated Cell Counter .....	70
Surgical Auxiliary Equipment .....	29	Centrifuge .....	75
Veterinary Laser Therapy .....	34	Gradient Thermal Cycler .....	80
Smart Animal ICU .....	35		
Surgical Instruments & Matrix .....	36	<b>Surgical Instruments &amp; Matrix</b> .....	<b>82</b>
<b>Neural Signal Research Solutions</b> .....	<b>37</b>		
Optogenetics System .....	37		
Fiber Photometry System .....	40		
Micropipette Puller .....	42		
Motorized Micromanipulator .....	44		
<b>Behavioral Experiment Solutions</b> .....	<b>45</b>		
Olfactometer .....	45		
<b>In Vivo Imaging Solutions</b> .....	<b>47</b>		
Laser Speckle Imaging System .....	47		
<b>Animal Administration and Blood Sampling Solutions</b> .....	<b>49</b>		
Drug Delivery Cannula .....	49		
Osmotic Pumps .....	54		
Blood Sampling and Administration System .....	55		
Syringe Pumps .....	57		
<b>Pathological Section Solutions</b> .....	<b>59</b>		
Rotary Microtome .....	59		
Cryostat .....	63		

## Introduction

Established in 2002, RWD Life Science has been dedicated to being a leading manufacturer in research and veterinary equipments worldwide. We specialize in anesthesia, physiological and surgical equipments, which are used by pre-clinical researchers and veterinarians. Our mission is to provide high quality products and integrated solutions to our customers with prompt and professional support.

For more information about our products, such as Laser Speckle Perfusion Imager, Anesthesia Machine, Ventilator, Stereotaxic Instrument, Syringe Pump, Cannula System and Surgical tools etc., please check our website:  
[www.rwdstco.com](http://www.rwdstco.com)

### RWD Life Science Co., Ltd

Add: 9/F, 19/F, 20/F, Building 7A, 9/F Building D, Shenzhen International Innovation Valley, XiLi Street, Dashi 1st Road, Nanshan District, Shenzhen, Guangdong, China.

Web: [www.rwdstco.com](http://www.rwdstco.com)  
E-mail: [rwd@rwdstco.com](mailto:rwd@rwdstco.com)

### RWD Life Science Inc.

Add: 10410 Corporate Drive, Sugar Land, TX 77478, USA  
Tel: 1-858-900-5879  
Tech Support: [service@rwdstco.com](mailto:service@rwdstco.com)

# Animal Surgery and Modeling Solutions

Stereotaxic instrument is an important research equipment widely used in many fields such as neuroanatomy, neurophysiology, neuropharmacology and neurosurgery. Up to now, RWD's stereotaxic instrument has helped global neuroscience researchers to publish more than 3000 articles in Cell, Nature, Science and other academic journals, and has been widely recognized in the industry.

- Meet the needs of rats, mice, guinea pigs, tree shrews, cats, rabbits, dogs, monkeys and other different animal experiments.
- Three kinds of accuracy 100μm, 10μm, 1μm are available.
- Except for the automated model 71000, other models can be upgraded to digital or dual manipulator models.

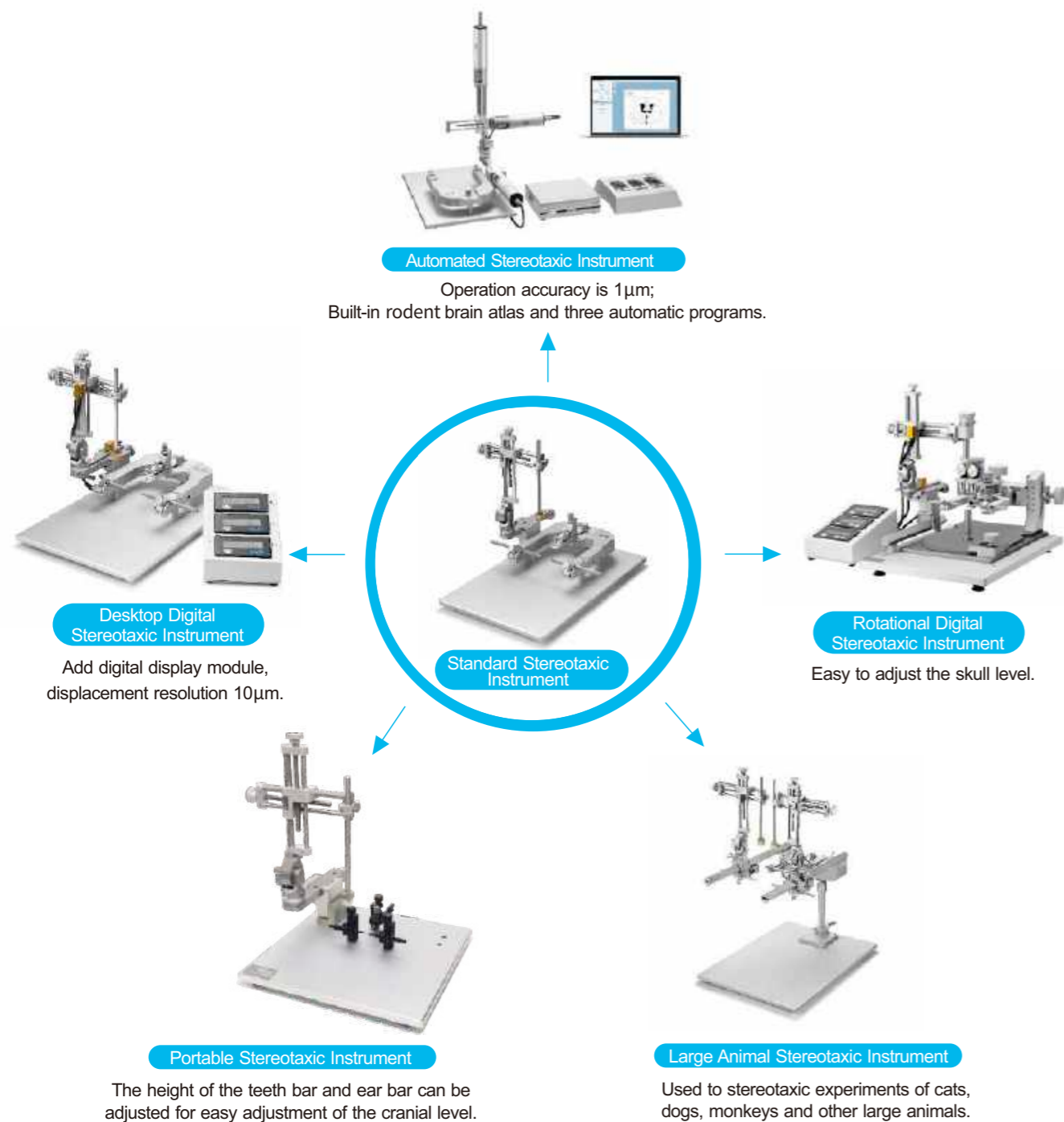

## Small Animal Stereotaxic Instruments

### 71000 Series Automated Stereotaxic Instrument

71000 is an automated and intelligent stereotaxic instrument with high precision (1 μm). The software has built-in rat and mouse brain atlas and automatic procedures (skull window, tissue removal and automated injection procedure), which can be observing the position of the probe relative to the brain area is convenient and efficient, and the operation is easy to use, greatly reducing the errors and damage caused by manual operation. In addition, it has an anti-collision function to prevent animal damage caused by wrong movement, which is safer.

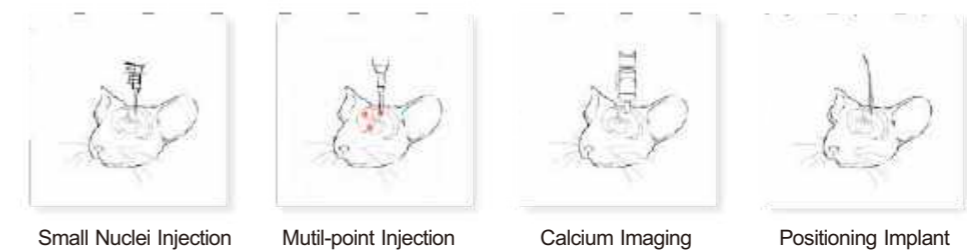

#### Features:

- Precision**
  - 1 Micron resolution.
  - Motor instead of manual, precise control of displacement.
- Rich Functions**
  - Convenient and efficient.
  - Automated procedures such as Skull Window, Tissue Removal, and Automated Injection Programs.
- Precise Positioning Without Leveling**
  - Atlas Calibration Function.
- Efficient**
  - Two-arm operation, Time-Saving.
  - Small experimental error, high repeatability, avoid repeated.
- Tiltable Injection**
  - Manipulators Tilt Function, no need to manually calculate the positioning path.experiments.
- Brain Atlas Integration**
  - Visualization of probe displacement.



## Tissue Removal Optional Kit

Tissue removal Optional kit is used for tissue aspiration before implanting Lens in calcium imaging experiments. The kit includes a vacuum pump, reservoir, holder, needle connector, needle and tubing. Used together with the automated stereotaxic instrument, it can ensure that the end surface of the wound is smooth and reduce the damage caused by manual operation.

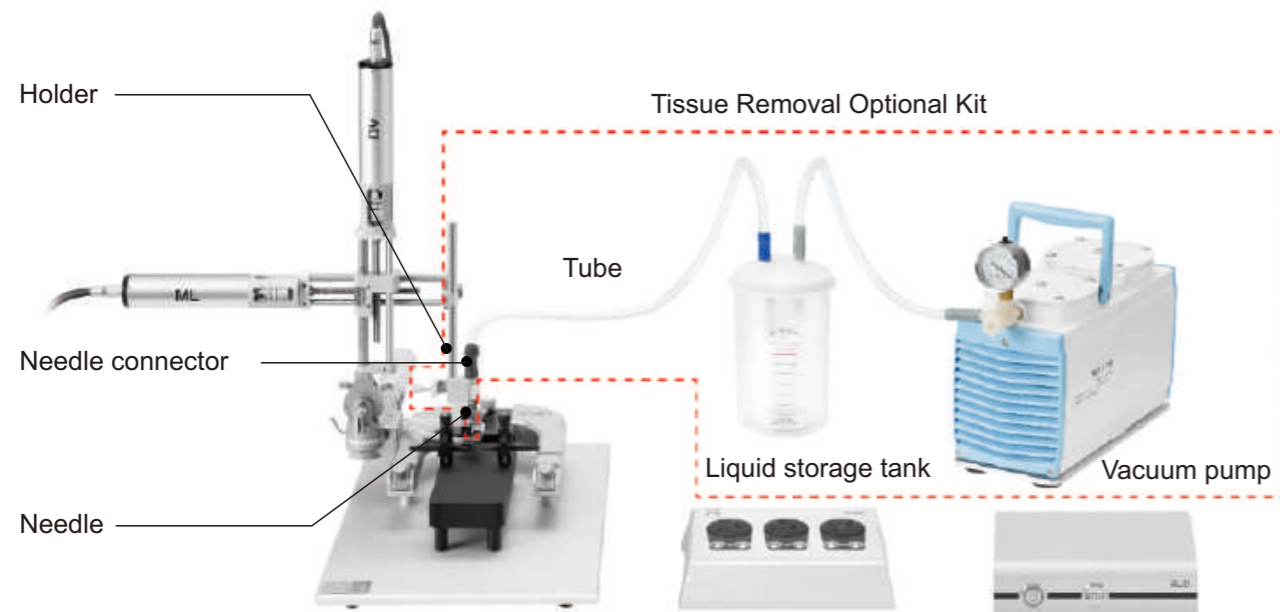

### Features:

- Set the suction window size, shape, layer number and depth of each layer through the automatic software, and automatically and accurately remove brain tissue;
- The software can set the depth and speed of lens implantation, one-click implantation;
- Ensure the flatness of the wound end surface and reduce damage;
- Improve the survival of neurons per unit area and enhance the imaging effect;
- Reduce errors caused by traditional manual operations and improve experimental repeatability.

Auto ▶

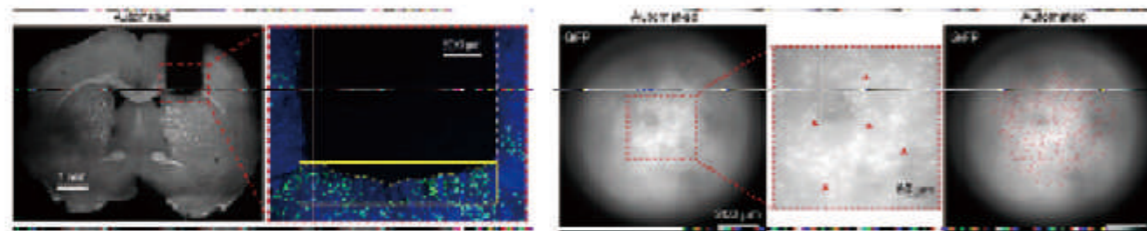

More smoothness, less damage

Manual ▶

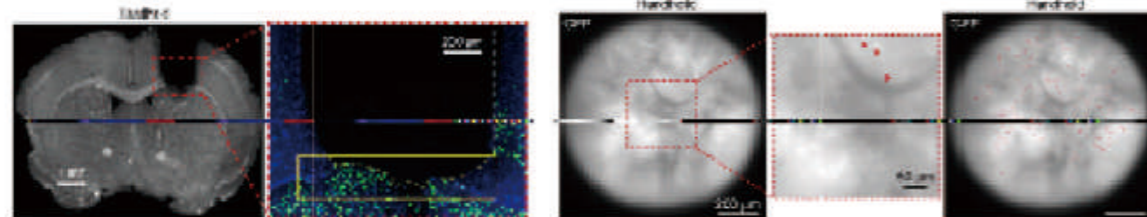

Improve neuron survival, better imaging

### Order Information:

Model	Product Description	Remarks	Category
71001-S	Automated Stereotaxic Instrument, SGL.M, Automatic Injection	Left manipulator and nanoliter injection pump included, without adaptor, ear bars, holder and mask	Stereotaxic host (without accessories)
71000-S	Automated Stereotaxic Instrument, SGL.M	Left manipulator, without adaptor, ear bars, holder and mask	
71001-D	Automated Stereotaxic Instrument, Dual.M, Automatic Injection	Two manipulators and nanoliter injection pump included, without adaptor, ear bars, holder and mask	
71000-D	Automated Stereotaxic Instrument, Dual.M	Two manipulators, without adaptor, ear bars, holder and mask	
68055	Mouse Adaptor	More details on accessories can be found on page 13.	Required accessories (optional)*
68030	Mouse/Neonatal Rat Adaptor		
68057	Mouse Anesthesia Adaptor		
68021	Rat Adaptor		
68053	Rat Anesthesia Adaptor		
68301	Rat 18° Ear Bars		
68306	Mouse 60° Ear Bars		
68201	Standard Probe Holder-Corner		
TRA-220	Tissue Removal Optional Kit (220V )	Optional when using tissue removal procedure, including needle connector, holder (68202), vacuum pump-GM-0.5 II -220V-50HZ, liquid storage tank, connecting tube, needle.	
TRA-110	Tissue Removal Optional Kit (110V )	Optional when using tissue removal procedure, including needle connector, holder (68202), vacuum pump-GM-0.5 II -110V-50HZ, liquid storage tank, connecting tube, needle.	
71000-LT	Laptop for Automated Stereotaxic Instrument (software included)	i3-1215U/8G/256G/WIN10/Set display/14"	

\*Indicates that other specifications can be selected, which can be viewed from the product catalog of RWD.

## Rotational Digital Stereotaxic Instrument

The 69100 series Rotational Digital Stereotaxic can adjust skull level and align sagittal suture quickly and accurately, and the time of skull adjustment is greatly shortened without repeated fixation.

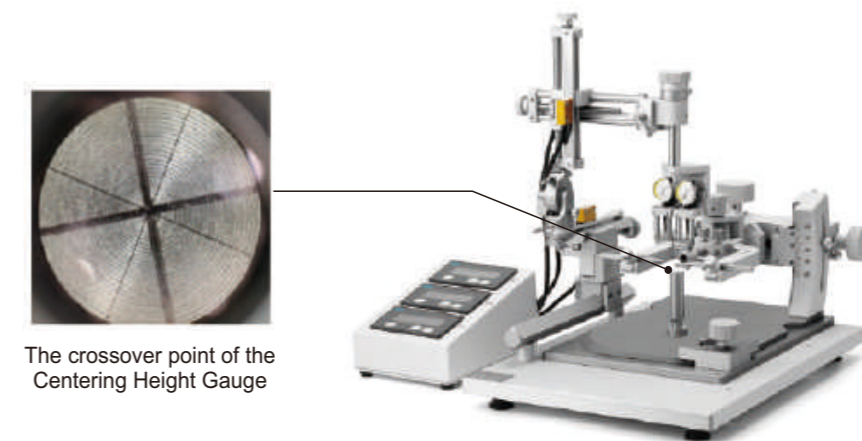

The crossover point of the Centering Height Gauge

### Features:

- Precise rotation adaptor can adjust skull position in 3 dimensional space, to maximize the adjustment of horizontal degree and the midline alignment.
- The axis of the rotation adaptor is focused on the crossover point of the Centering Height Gauge, the 40X Center Magnifier assists in adjusting the Bregma to coincide with this point and there is no need to set Bregma repeatedly.
- Improve the efficiency of skull horizontal adjustment, and the adjustment process needs no repeated fixation.
- The 40X Centering Magnifier and the Alignment Indicator assist the skull adjustment, achieving high horizontal degree and good repeatability.
- Contain an anesthetic mask that can be used with inhaled anesthetics to reduce animal mortality.
- Easy realization of 3D multi-angle fixation, easy to tilt injection or other special experiment treatments.

**Recommended Accessories:**



**40X Central Magnifier (69133)**

Assist in finding Bregma and Lambda, to ensure that the midline is parallel to the Y axis. Assist in adjusting the Bregma to coincide with the rotation axis, no need to set the Bregma repeatedly.



**Alignment Indicator (69137)**

The deflection angle difference of the Alignment Indicator can feedback horizontal level with a 0.01mm



**15° Angle Adaptor (69113)**

Easy to adjust the skull level (front to back), to meet the needs of greater adjustment.



**Operating Platform for Stereotaxic (69136)**

50mm height adjustable.

**Technical parameters:**

Item	Parameter
Sagittal triaxial displacement distance	30mm
Angle adjustment range (left to right)	±30°
Angle adjustment range (forth to back)	±10°
Angle adjustment range (central base plate)	±10°
X-, Y-, Z-axis operating range	80mm
Base plate	400mmX325mm
Central Magnifier	40X
Alignment Indicator resolution	0.01mm

**Order Information:**

Model	Product Description	Remarks
69108	Rotational Digital Stereotaxic for Mouse, SGL.M, 69110, 69113, 69114, 69133, 69137	Standard configuration, contains 69110 Mouse Anesthesia Adaptor with Tubing, 69113 15° Angle Adaptor, 69114 60° Ear Bars for Mouse, 69133 40X Central Magnifier and 69137 Alignment Indicator.
69118	Rotational Digital Stereotaxic for Mouse, Dual M, 69110, 69113, 69114, 69133, 69137	Standard configuration, contains 69112 Rat Anesthesia Adaptor with Tubing, 69113 15° Angle Adaptor, 69116 18° EarBars for Rat, 69133 40X Central Magnifier and 69137 Alignment Indicator.
69109	Rotational Digital Stereotaxic for Rat, SGL.M, 69112, 69113, 69116, 69133, 69137	Standard configuration, contains 69112 Rat Anesthesia Adaptor with Tubing, 69113 15° Angle Adaptor, 69116 18° EarBars for Rat, 69133 40X Central Magnifier and 69137 Alignment Indicator.
69119	Rotational Digital Stereotaxic for Rat, Dual M, 69112, 69113, 69116, 69133, 69137	Standard configuration, contains 69112 Rat Anesthesia Adaptor with Tubing, 69113 15° Angle Adaptor, 69116 18° EarBars for Rat, 69133 40X Central Magnifier and 69137 Alignment Indicator.
69136	Operating Platform for Stereotaxic	
69110	Mouse Anesthesia Adaptor with Tubing(<30g)	69108, 69118 contains.
69111	Mouse Anesthesia Adaptor with Tubing(30~70g)	Not included in standard configuration, optional according to experimental needs.
69112	Rat Anesthesia Adaptor with Tubing(<300g)	69109, 69119 contains.
69114	60° Ear bars for Mouse	69108, 69118 contains.
69116	18° Ear bars for Rat	69109, 69119 contains.
69120	3-axis Digital Manipulator, Left Hand	69108, 69118, 69109, 69119 contains.
69121	3-axis Digital Manipulator, Right Hand	69118, 69119 contains.
69207	Attachment for Rotational Digital Stereotaxic Holder	

**Standard Stereotaxic Instrument**

Classical U-type base design, professional services in the laboratory for 20 years!  
The displacement accuracy of the standard stereotaxic instrument is 100 μm, and the classic U-shaped frame can perform stereotaxic surgery on different types of small animals by replacing the adaptor and ear bars.

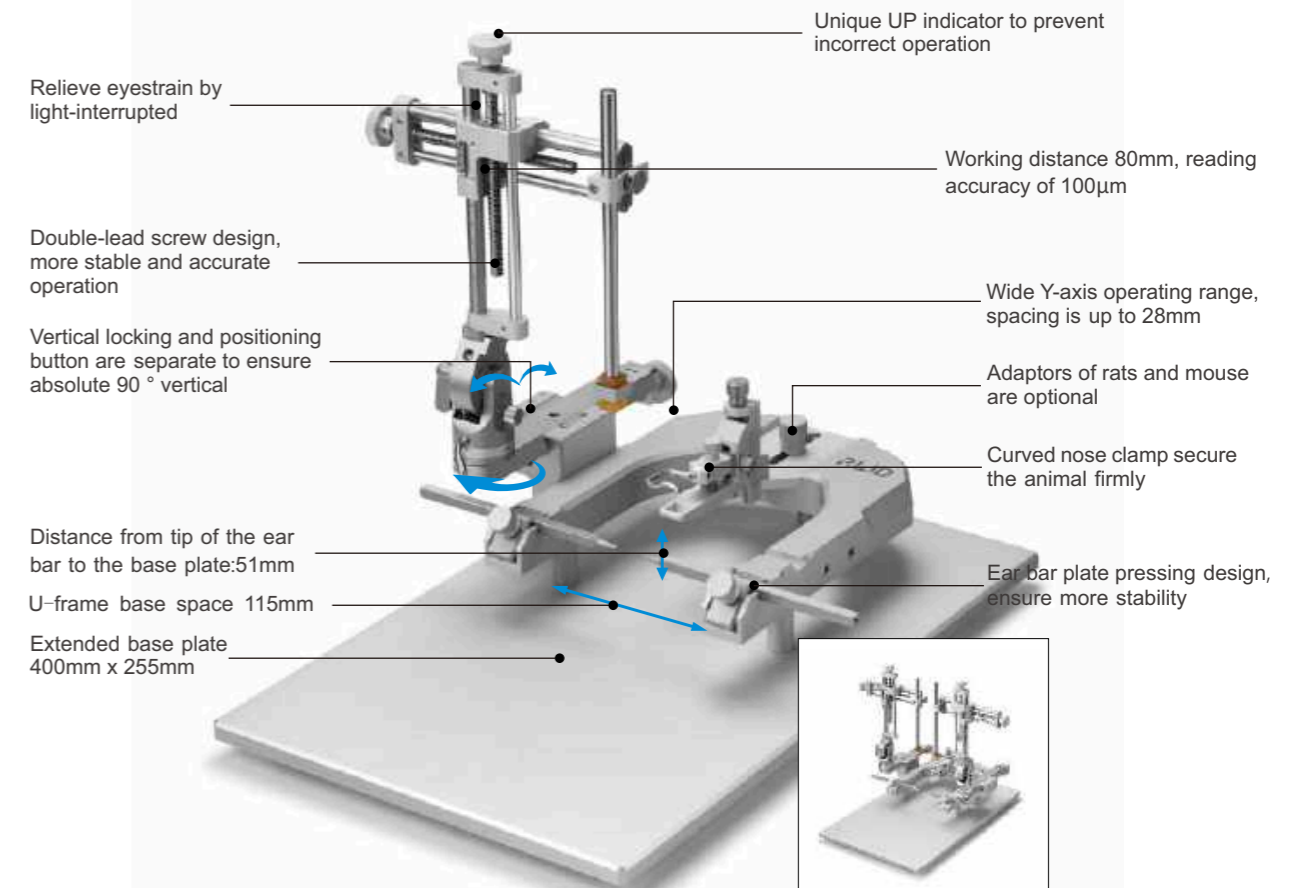

**Product configuration**

A complete set of configurations consists of a standard stereotaxic instrument, adaptor (page 13), ear bars (page 14), holder (page 13), and nosecone mask (optional for gas anesthesia, page 15). The single manipulator type can be changed into a dual manipulator type by adding the right manipulator (68402), and you can also contact us to upgrade to a digital display type (accuracy is 10μm).

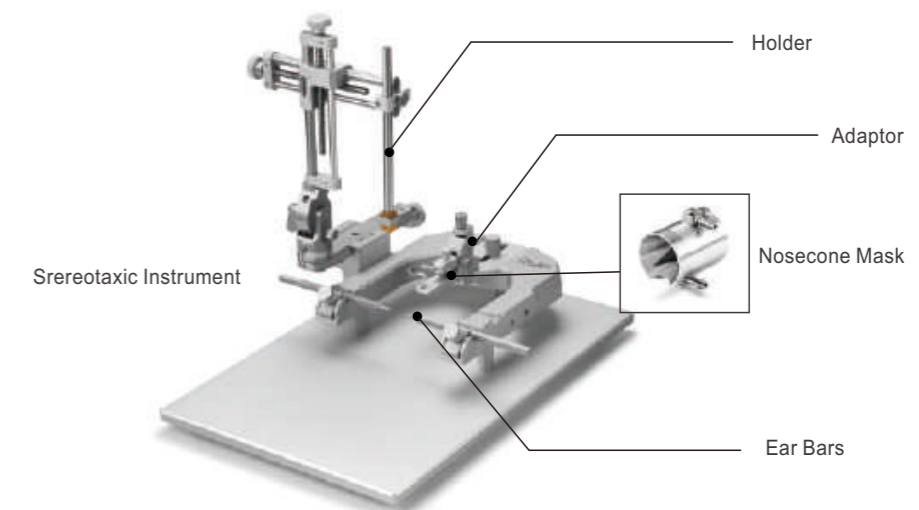

Complete Configuration =Stereotaxic Instrument + Adaptor + Ear Bars + Holder + Nosecone Mask(optional for gas anesthesia)

**Order Information:**

Model	Product Description	Remarks
68801	Standard Stereotaxic Instrument, SGL M	Standard configuration, contains 68861N base, 68401 3-axis manipulator-left, without adaptor, ear bars, holder and mask
68802	Standard Stereotaxic Instrument, Dual M	Standard configuration, contains 68861N base, 68401 3-axis manipulator-left and 68402 3-axis manipulator-right, without adaptor, ear bars, holder and mask
68861N	Stereotaxic Base Plate, Standard	68801, 68802 include
68401	3-Axis Manipulator-Left	68801, 68802 include
68402	3-Axis Manipulator-Right	68802 include

**Desktop Digital Stereotaxic Instrument**

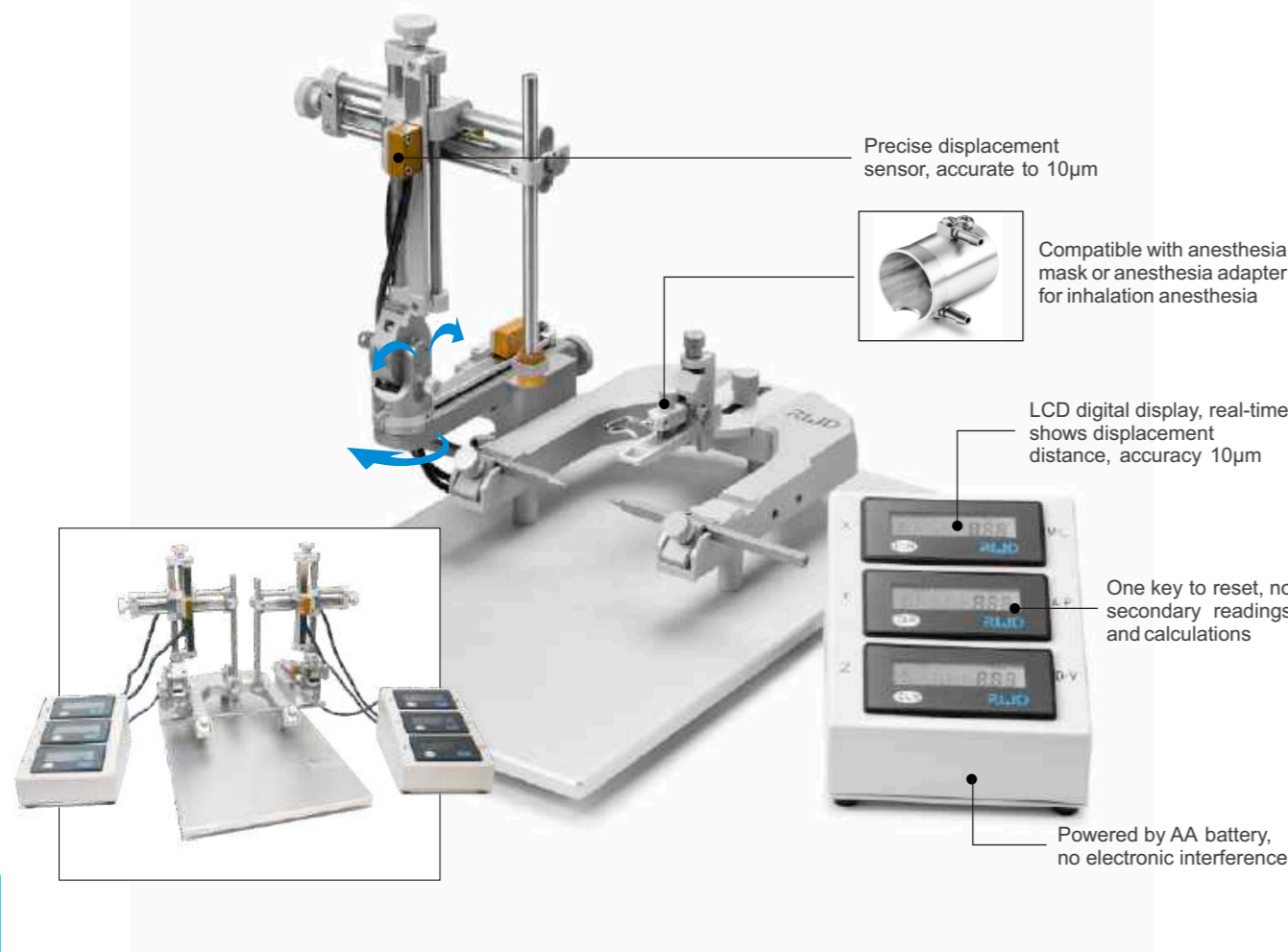

**Product configuration**

A complete set of configurations consists of a desktop digital stereotaxic instrument, adaptor (page 13), ear bars (page 14), holder (page 13) and anesthesia nosecone mask (optional for gas anesthesia, page 15). Single manipulator models can add the manipulator-right (68410) to become dual manipulator models.

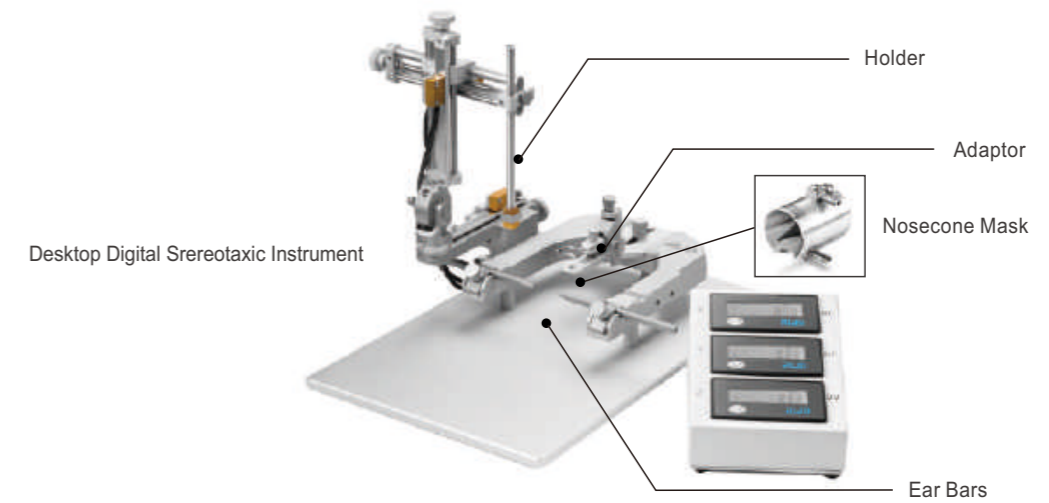

Complete Configuration=Stereotaxic Instrument+ Adaptor + Ear Bars + Holder + Nosecone Mask(optional for gas anesthesia)

**Order Information:**

Model	Product Description	Remarks
68803	Desktop digital stereotaxic instrument, SGL M	Standard configuration, contains 68861N base, 68409 3-axis digital manipulator-left, without adaptor, ear bars, holder and mask.
68804	Desktop digital stereotaxic instrument, Dual M	Standard configuration, contains 68861N base, 68409 3-axis digital manipulator-left and 68410 3-axis digital manipulator-right, without adaptor, ear bars, holder and mask.
68861N	Stereotaxic Base Plate, Standard	68803B, 68804B include
68409	3-Axis Digital Manipulator-Left	68803B, 68804B include
68410	3-Axis Digital Manipulator-Right	68804B include

**Portable Mouse Stereotaxic Instrument**

- The portable stereotaxic instrument cancels the traditional U-shaped frame, and the operation space is larger;
- This type is specially designed for mouse. The height of the nose bar and ear bars can be adjusted from 0-20mm, which is convenient for adjusting the level of the skull;
- The accuracy of non-digital models is 100 µm, and the accuracy of digital models is 10 µm.

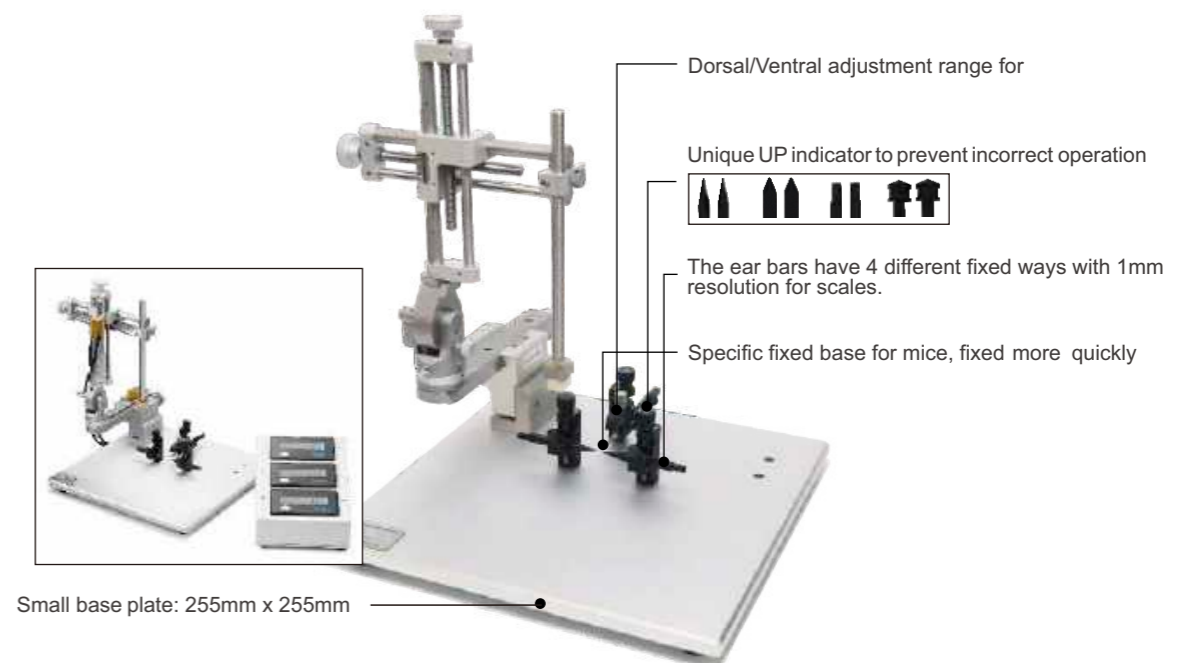

**Product configuration**

A complete set of configurations consists of a portable mouse stereotaxic instrument, nose bar, ear bars, holder (page 13) and anesthesia nosecone mask (optional for gas anesthesia, page 15). The single manipulator model cannot simply increase the right manipulator to become a dual manipulator model. If you already have a single manipulator model and need another manipulator, please contact us for an upgrade.

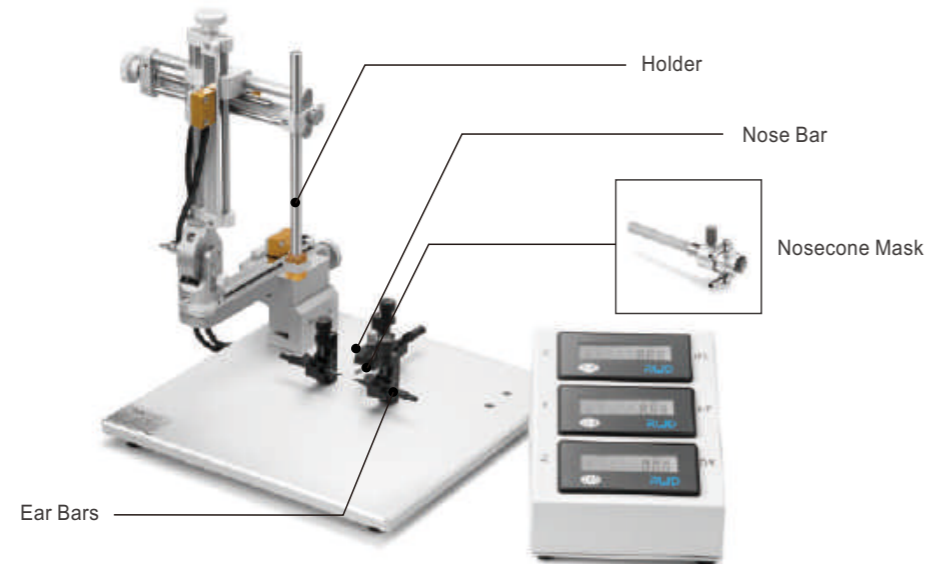

Portable Mouse Stereotaxic Instrument

Complete Configuration=Stereotaxic Instrument+ Nose Bar + Ear Bars + Holder + Nosecone Mask(optional for gas anesthesia)

**Order Information:**

Model	Product Description	Remarks
68805	Portable Mouse Stereotaxic Instrument, SGL M	Standard configuration, non-digital model (accuracy is 100µm), including 68863S base, 68401 3-axis manipulator-left, without nose bar, ear bars, holder and mask.
68806	Portable Mouse Stereotaxic Instrument, Dual M	Standard configuration, non-digital model (accuracy is 100µm), including 68863D base, 68401 3-axis manipulator-left, 68402 3-axis manipulator-right, without nose bar, ear bars, holder and mask.
68807	Portable Mouse Stereotaxic Instrument, SGL M, Digital	Standard configuration, digital model (accuracy is 10µm), including 68863S base, 68409 3-axis digital manipulator-left, without nose bar, ear bars, holder and mask.
68808	Portable Mouse Stereotaxic Instrument, Dual M, Digital	Standard configuration, digital model (accuracy is 10µm), including 68863D base, 68409 3-axis digital manipulator-left, 68410 3-axis digital manipulator-right, without nose bar, ear bars, holder and mask.
68033	Nose Bar For 68030 Mouse Adaptor	Optional, the cross-sectional size of the nose bar is 5* 5mm.
68313	45°Ear Bars For 68030 Mouse Adaptor	Optional, including two tips of 45° and rubber, the cross-sectional size of the ear bars is 5*5mm.
68034	18°Ear Bars For 68030 Mouse Adaptor	Optional, including two tips of 18° and serrated, the cross-sectional size of the ear bars is 5*5mm.

**Portable Rat and Mouse Stereotaxic Instrument**

- The portable stereotaxic instrument cancels the traditional U-shaped frame, and the operation space is larger;
- The adaptor and ear bars are removable for rodents of different weights;
- The height of the adaptor is adjustable from 0-55mm, and the height of the ear bars is adjustable from 0-45mm, which is convenient for adjusting the level of the skull;
- The accuracy of non-digital models is 100 µm, and the accuracy of digital display models is 10 µm.

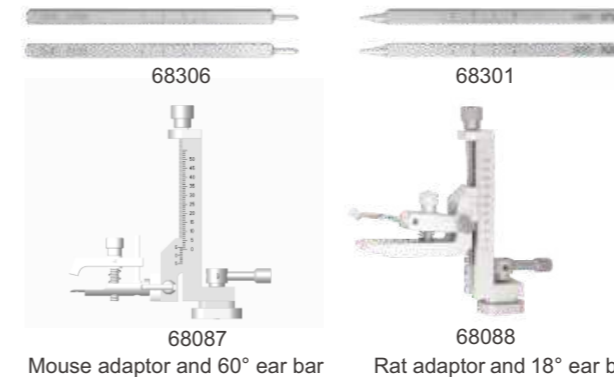
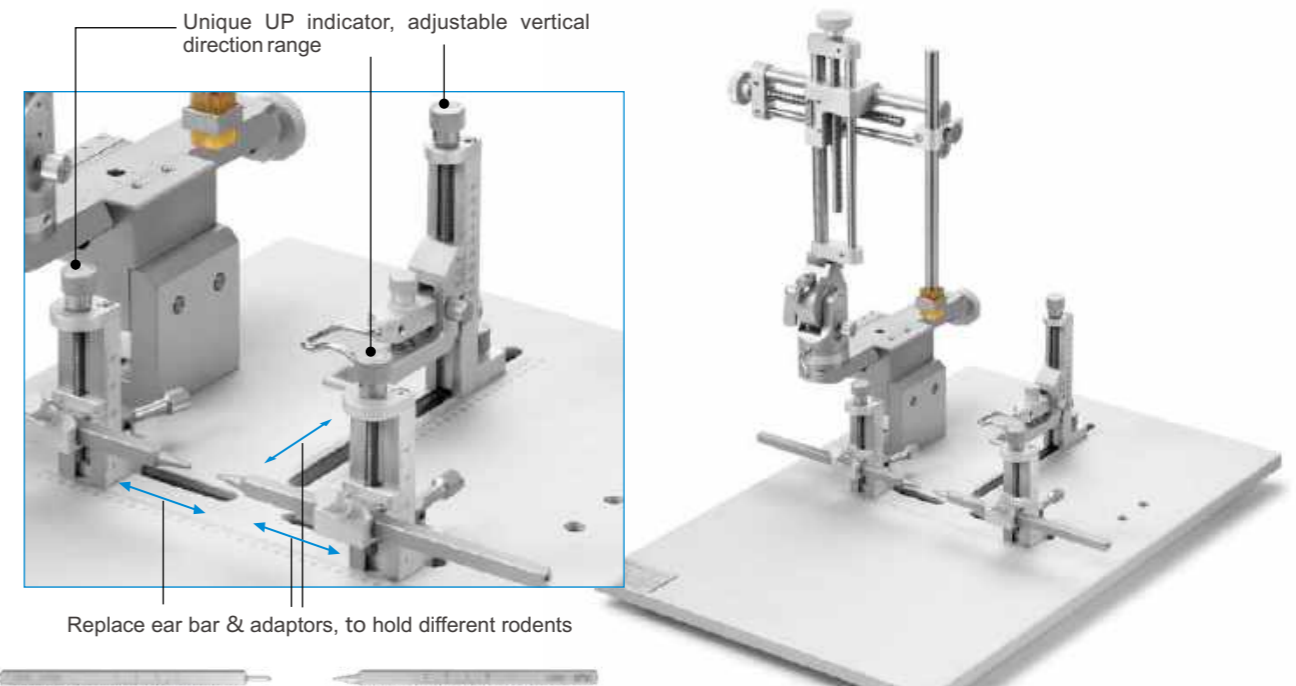

**Product configuration**

A complete set of configurations consists of a portable rat and mouse stereotaxic instrument, adaptor, ear bars (page 14), holder (page 13) and anesthesia nosecone mask (optional for gas anesthesia, page 15) composition. The single manipulator model cannot simply increase the right manipulator to become a dual manipulator model. If you already have a single manipulator model and need another manipulator, please contact us for an upgrade.

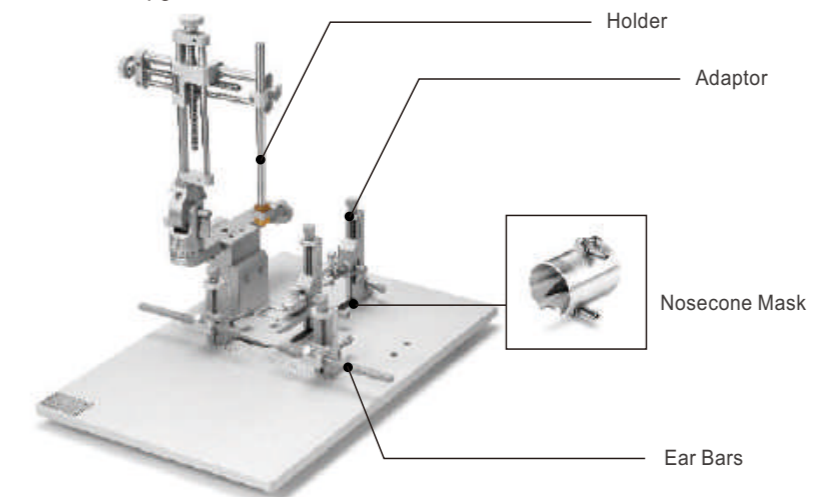

Portable Rat and Mouse Stereotaxic Instrument

Complete Configuration=Stereotaxic Instrument+ Adaptor + Ear Bars + Holder + Nosecone Mask(optional for gas anesthesia)

**Order Information:**

Model	Product Description	Remarks
68809	Portable Rat and Mouse Stereotaxic Instrument, SGL M	Standard configuration, non-digital model (accuracy is 100µm), including 68867S base, 68401 3-axis manipulator-left, without adaptor, ear bars, holder and mask.
68810	Portable Rat and Mouse Stereotaxic Instrument, Dual M	Standard configuration, non-digital model (accuracy is 100µm), including 68867D base, 684013-axis manipulator-left, 68402 3-axis manipulator-right, without adaptor, ear bars, holder and mask.
68811	Portable Rat and Mouse Stereotaxic Instrument, SGL M, Digital	Standard configuration, digital model (accuracy is 10µm), including 68867S base, 68409 3-axis digital manipulator-left, without adaptor, ear bars, holder and mask.
68812	Portable Rat and Mouse Stereotaxic Instrument, Dual M, Digital	Standard configuration, digital model (accuracy is 10µm), including 68867D base, 68409 3-axis digital manipulator-left, 684103-axis digital manipulator-right, without adaptor, ear bars, holder and mask.
68087	Mouse Adaptor	Only used for portable rat and mouse stereotaxic instrument
68088	Rat Adaptor	Only used for portable rat and mouse stereotaxic instrument

**▶ Large Animal Stereotaxic Instrument**

- Large animal stereotaxic instrument is suitable for cats, dogs, monkeys, pigs, etc.;
- It contains a two-dimensional manipulator (X, Z axis). The accuracy of the non-digital model is 100 µm, and the accuracy of the digital model is 10 µm;
- Two kinds of adaptors are optional, the 68081 monkey adaptor is generally suitable for large animals of 10-30kg, and the 68041 is generally suitable for large animals below 10kg.

Adaptors are available for dogs, monkeys, pigs, and other large animals.

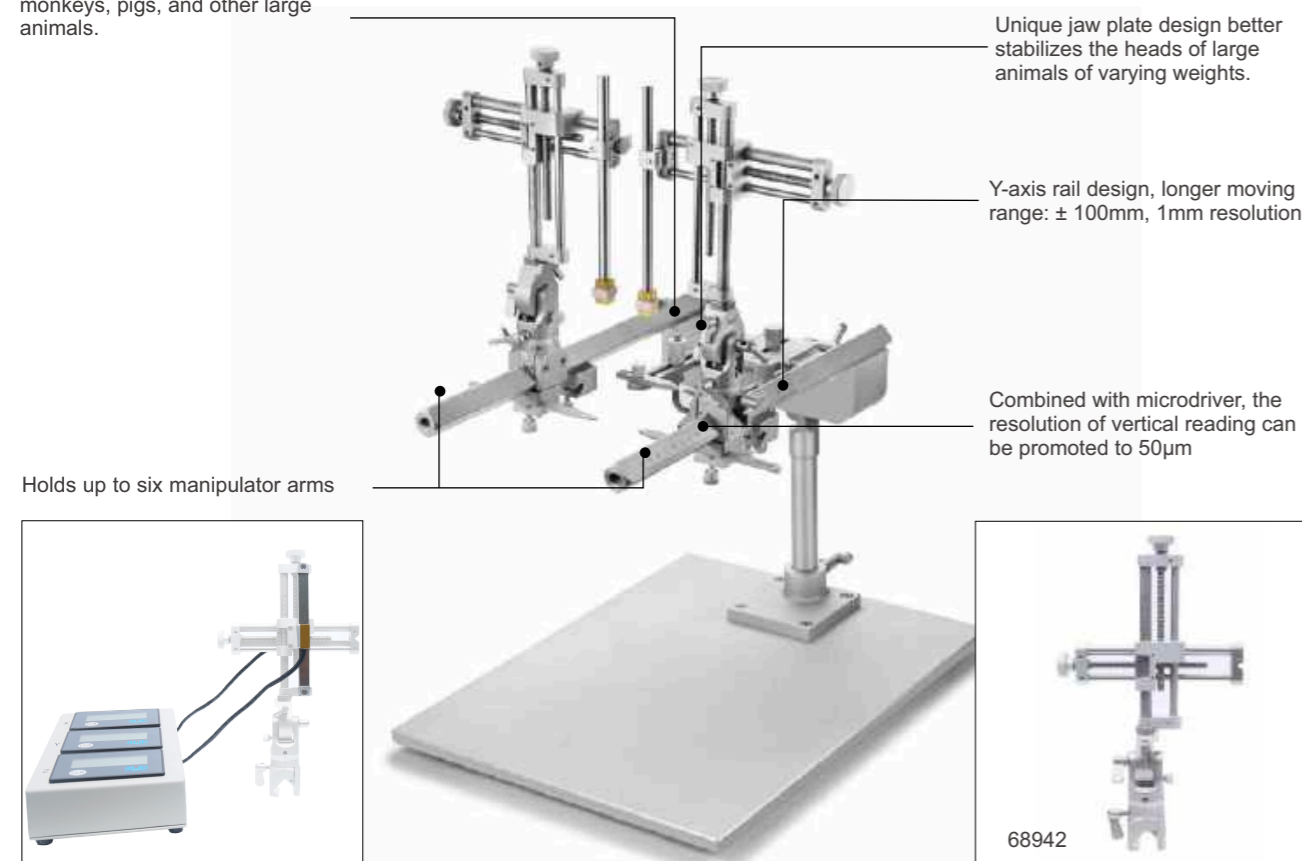

**Product configuration**

A complete set of configurations consists of a large animal stereotaxic instrument, an adaptor (page 13), ear bars (page 14), holder (page 13). A single manipulator model can add the right manipulator to become a dual manipulator model.

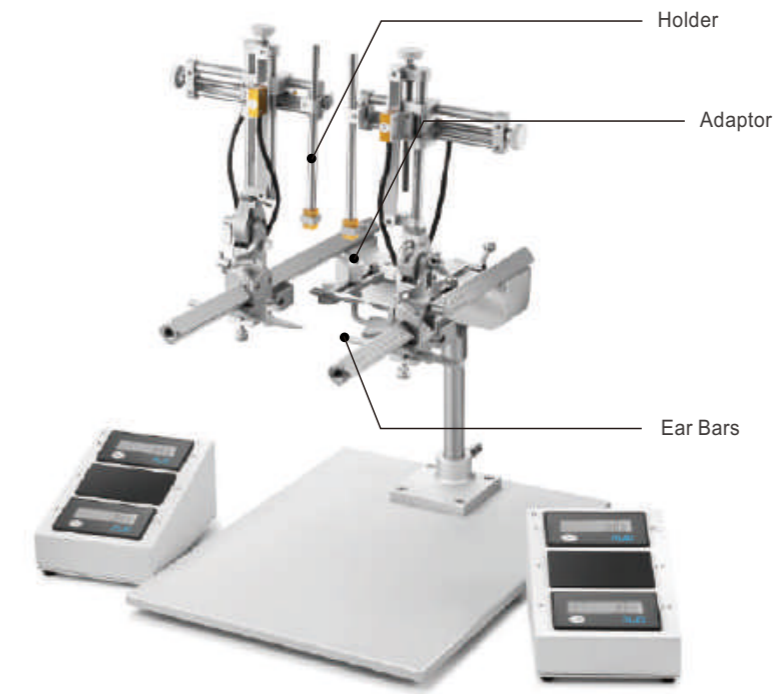

Large Animal Stereotaxic Instrument

Complete Configuration=Stereotaxic Instrument+ Adaptor + Ear Bars + Holder

**Order Information:**

Model	Product Description	Remarks
68813	Stereotaxic for Large Animals, SGL M.	Standard configuration, non-digital display model (accuracy 100µm), including 68868N base, 689412-axis manipulator-left, without adaptor, ear bars, holder.
68814	Stereotaxic for Large Animals, SGL M.	Standard configuration, non-digital display model (accuracy 100µm), including 68868N base, 689412-axis manipulator-left, 68942 2-axis manipulator-right, without adaptor, ear bars and holder.
68815	Stereotaxic for Large Animals, SGL M, Digital	Standard configuration, digital display model (accuracy 10µm), including 68868N base, 68944 2-axis digital manipulator-left, without adaptor, ear bars, holder.
68816	Stereotaxic for Large Animals, Dual M, Digital	Standard configuration, digital display model (accuracy 10µm), including 68868N base, 68944 2-axis digital manipulator-left, 68945 2-axis digital manipulator-right, without adaptor, ear bars and holder.
68941	2-axis Manip for Dog/Monkey Stereotaxic, Left	68813, 68814 include
68942	2-axis Manip for Dog/Monkey Stereotaxic, Right	68814 includes
68944	2-axis Digital Manip for Dog/Monkey Stereotaxic, Left	68815, 68816 include
68945	2-axis Digital Manip for Dog/Monkey Stereotaxic, Right	68816 includes



## Stereotaxic Instruments Accessories

### Electrode Holders

68201 Standard Probe Holder-Corner



V-groove design, widely used for syringe needles or electrodes with diameter 0.3mm-1.5mm.

68211 Cannula Holder



Compatible with stereotaxic instruments with dual manipulators. Holds electrodes or cannulas of 2.1mm to 5.0mm in diameter.

68210 Electrode Holder



Holder is specifically designed for electrophysiological experiments. Two electrodes, controlled individually, can be located very close to each other. Holds thin electrodes with diameter from 0.7mm to 2.5mm.

### Cannula Holders

68205 Cannula Holder



It's made of metal. Suitable for holding the single cannula or double cannula with the outer diameter of 3.5mm plastic.

68217 Cannula Holder



Suitable for holding the single cannula or double cannula with the outer diameter of 3.5mm plastic base.

68214/68215 Ceramic Ferrule Holder



Hold cannula or Ceramic Ferrule during implantation.

- Versions for Ø1.25 mm — 68214 Cannula or Ceramic Ferrule.
- Versions for Ø2.5 mm — 68215 Cannula or Ceramic Ferrule.

### Multi-function Holders

68202 Large Probe Holder



Lateral fixation, holds micro syringe needles, large diameter electrodes and flexible drill handles etc. V-groove design with 6mm-12mm diameters.

68218 Syringe Holder



Holder is applicable for micro-injection, which holds syringe and needle simultaneously, and the clamping of the syringe is more stable, the syringe holding range is 6mm to 12mm and needle's is 0.3mm to 1.5mm.

68605 Microdrill Holder



Holder secures the microdrill to stereotaxic instruments. Controls the depth of drilling by the manipulator. Easy and accurate operation protects brain tissue from damage caused by excessive drilling. Holds the microdrill with diameter about 14.5mm.

### Adaptors

#### Mouse Adaptors

68030 Mouse/Neonatal Rat Adaptor  
(with 18° ear bars 68034 and 45° ear bars 68313)

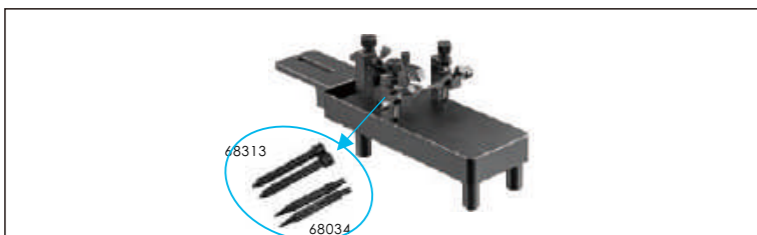

This adaptor can not only fix the mouse and neonatal rat head, but also avoid damage to the skull. Four kinds of earstick tips are available, the height of the earstick and earstick are adjustable, and the adjustment range is 20mm.

68055 Mouse Adaptor

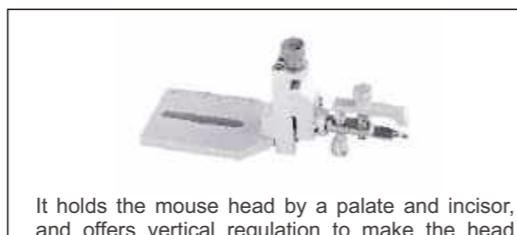

It holds the mouse head by a palate and incisor, and offers vertical regulation to make the head level or at certain angle. The Vertical adjustable range from +10mm to -20mm, with 100µm resolution; Horizontal adjustable range of 43.5mm; Horizontal rotatable range of 35°.

68057 Mouse Gas Anesthesia Head Holder

This model offers maximal adjustment for positioning the head. The adaptor can rotate the head to multi angle without blocking the anesthetic gas delivery.

- Vertical adjustable range: 30mm (+10mm~-20mm), with 100µm accuracy.
- Vertical rotatable range: 70° (-35°~+35°), with 5° accuracy.
- Horizontal rotatable range: 70° (-35°~+35°), with 5° accuracy.
- Horizontal adjustable range: 43.5mm
- Diameter of inlet/outlet of the mask: 2mm

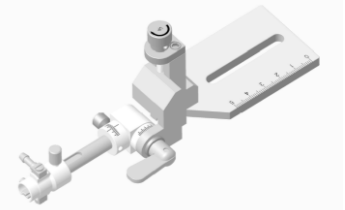

#### Rat Adaptors

68021 Rat Adaptor

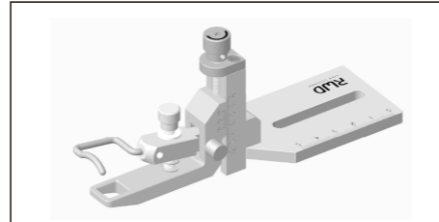

It holds rat head firmly through incisor, nose clip and ear bars. This adaptor can be adjusted 30 mm vertically along dovetail slide with 100µm resolution and 50mm horizontally, which makes it applicable for rats of different weight.

68053 Rat Anesthesia Adaptor



This adaptor integrates the gas anesthesia mask function while hold the rat head firmly. The adaptor can rotate the head to multi angle without blocking the anesthetic gas delivery.

- Vertical adjustment range is 30mm (-20mm ~ + 10mm), with 100µm accuracy.
- Vertically rotatable range is 70°(-35° ~ + 35°), with 5° accuracy.
- Horizontal rotatable range is 70° (-35°~ + 35°), with 5° accuracy.
- Horizontal adjustment range is 43.5mm.

#### Multi-function Adaptor

68091 Spinal Cord Adaptor for Rat & Mouse

The adaptor is ideal for spinal securing of rat and mouse. The base plate is 210mm(L) x 165mm(W) x 15mm(H), which can be attached to RWD 68000 series small animal stereotaxic instruments. There are 3 vertical bars and locking blocks. which can be easily disassembled through the T slots without wrench. The adjustment range of vertical bar is 56mm. The height of locking block can be easily adjusted by screw. This adaptor can be adjusted in Vertical/Lateral, Anterior/Posterior and Ventral/Dorsal directions. Standard accessories contain: Base plate, 3 vertical bars and locking blocks and spinal cord clamp (3 pairs).

#### Specifications:

- Accurate and reliable positioning.
- Wide various components and accessories can be used in module.
- Simple, fast and effective clamping and locking.
- Compatible with small animal stereotaxic instruments.



#### Ear Bars

RWD ear bar with the scale of 35mm, 1mm resolution, square 6.15mm

68301



Ear Bars, Rat, 18 Deg. (0.8mm radius tip)

68302



Ear Bars, Rat, 45 Deg (for guinea pigs, prairie rats, birds, squirrel monkeys 0.8mm tip).

68306

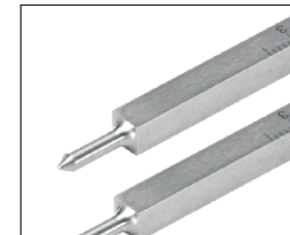

Ear Bars, Mouse, 60 Deg.

68314



Mouse Ear Bars - height adjustable (tooth tip range: -5mm ~ +5mm).

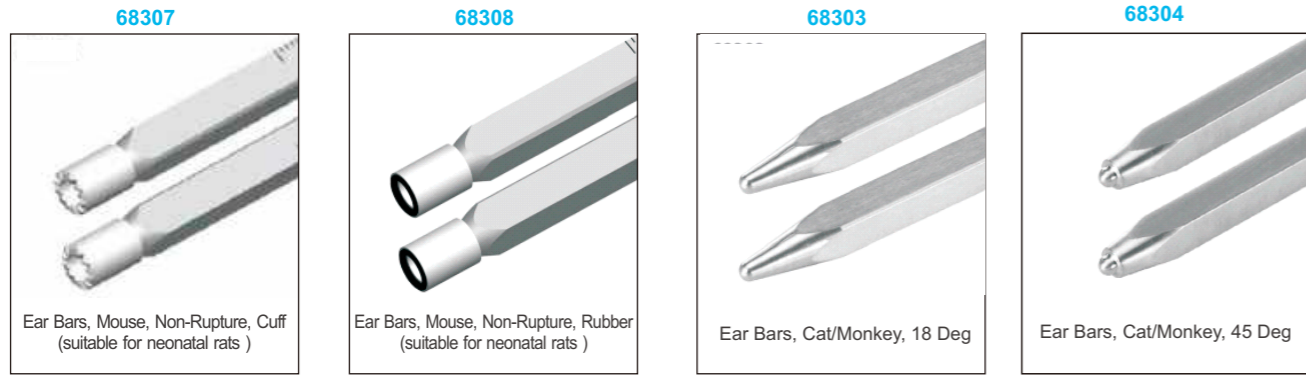

### Stereotaxic Frame Nosecone Masks

- This type of anesthetic masks are specifically designed to fit most stereotaxic frame and deliver anesthetic gases with minimal exposure during surgery. They are locked onto the adaptor with the cone opening toward the open "U". The animal's teeth is placed over the incisor bar.
- Two kinds of Stereotaxic Frame Nosecone Masks are available: one is "passive" mask with collinear inlet and outlet, and the other one is "active" mask with separate (non-collinear) inlet and outlet on both sides. the "passive" mask is used with charcoal canister only, and the "active" mask can be used with evacuation apparatus.

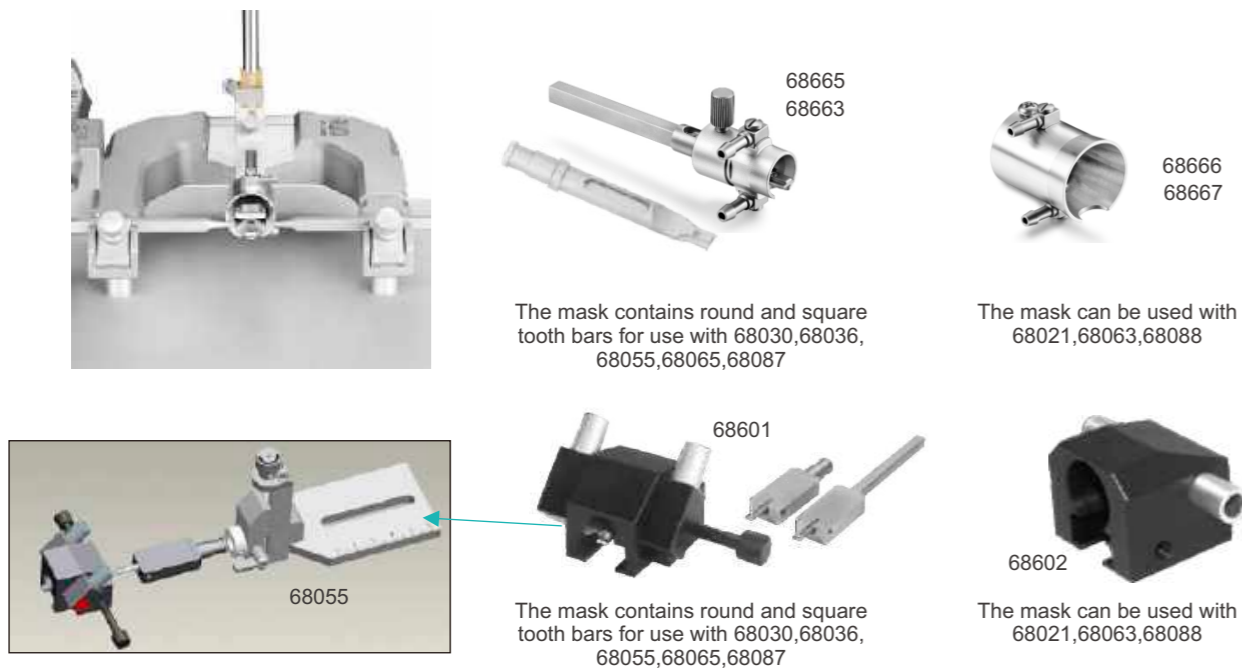

#### Order Information:

Model	Product Description	Remarks
68601	Stereotaxic Anesthesia Mask Kit -mice or neonatal rats (<70g, Canister & Tubing included)	For Passive Scavenging
68602	Stereotaxic Anesthesia Mask Kit - rats (<300g, Canister & Tubing included)	
68663	Stereotaxic Anesthesia/Evacuation mask- mice or neonatal rats (<30g)	For Active Scavenging
68665	Stereotaxic Anesthesia/Evacuation mask- mice or neonatal rats (30~70g)	
68666	Stereotaxic Anesthesia/Evacuation mask- rats (<300g)	
68667	Stereotaxic Anesthesia/Evacuation mask- rats (>300g)	

## Precise Impactor

### 68099 II Precise Impactor

The 68099 II Precise Impactor is an instrument used for traumatic brain injury and spinal cord injury model. The system adopts pneumatic-electric control, which can precisely adjust the speed, depth and dwell time to achieve precise impact. Touch screen design, convenient and friendly operation. The zero method uses a sensor contact mechanism to automatically detect the zero interface, which is sensitive and efficient.



#### Features:

- Pneumatic-electric design, stable blow without shaking, to ensure the repeatability of the experiment;
- It is suitable for small animal brain and spinal cord injury models such as mice, rats, and guinea pigs;
- LCD touch screen, wide-angle visibility, convenient and friendly operation;
- Sound alarms and text message prompts improve the human-computer interaction between the equipment and the user, and reduce human errors in the operation process;
- The zero-contact method can automatically determine the zero interface to reduce human error;
- A variety of cylindrical flat-head head hammers with outer diameters of 1.3, 2, 3, 4 and 5mm, which can meet the needs of traumatic brain injury and spinal cord injury model;
- Speed calibration function to ensure the stability and repeatability of the experiment;
- Speed range is 0.5-5.6m/s, resolution 0.1m/s; depth range is 0.00-5.00mm, resolution 0.01mm; dwell time range is 0.00-5.00s, resolution 0.01s;
- The rotatable design ensures that the brain and spinal cord are hit vertically and improves the repeatability of the experiment.

#### Traumatic Brain Injury(TBI)

- Two kinds of brain adaptors for rats and mice are optional. The rotational adaptor can rotate left and right  $\pm 30^\circ$ , the height adjustment range of  $+10 \sim -20\text{mm}$ , and the precise rotational adaptor can rotate left and right  $\pm 30^\circ$ , swing up and down  $\pm 10^\circ$ , three-axis displacement 30mm;
- The base is movable, 0~116mm in X direction and 0~98mm in Y direction.

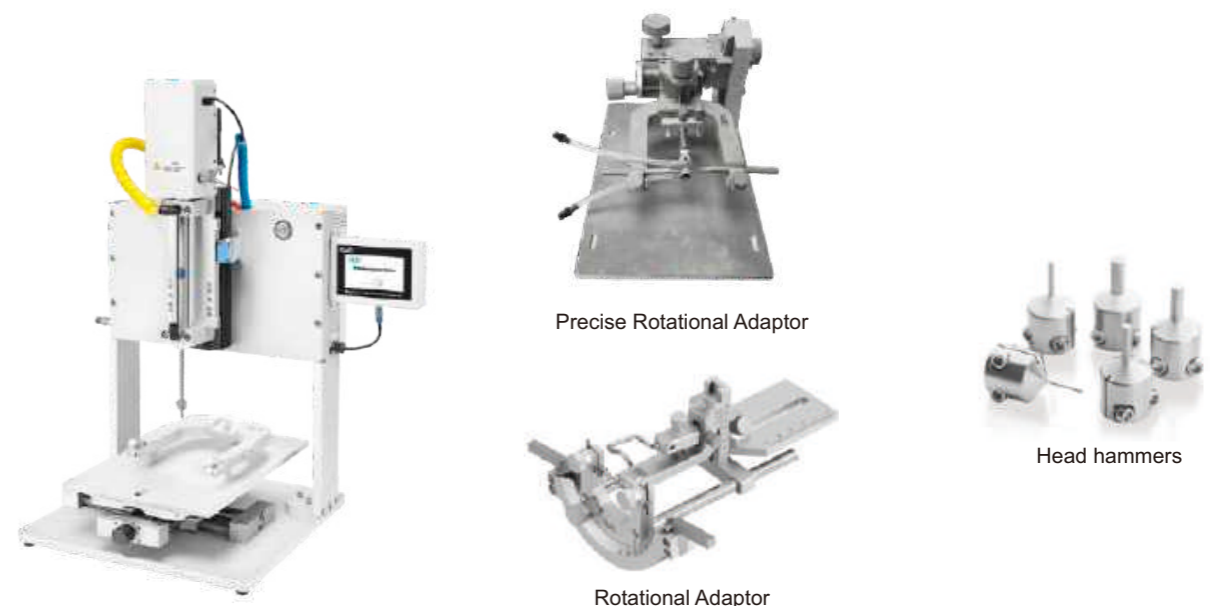

### Spinal Cord Injury(SCI)

- The rat and mouse spinal cord adaptor adopts the method of supporting the spinal cord from the lower sides of the spine to avoid the depth error caused by the collapse of the animal when breathing or impacting;
- The three-axis micro-manipulated rotatable platform includes a universal adjustment device, which can adjust the level of the spinal cord to ensure vertical strikes and improve experiment repeatability.



#### Order Information:

Model	Product Description	Remarks
68099 II	Precise Impactor-Brain	Standard configuration (without adaptor)
68099 II -S-M	Precise Spinal Impactor for Mice	Standard configuration (including adaptor)
68099 II -S-R	Precise Spinal Impactor for Rat	Standard configuration (including adaptor)
68063	Rotational Rat Adaptor, 60°Ear Bars Incl.	Optional
68065	Rotational Mouse Adaptor, 60°Ear Bars Incl.	Optional
69100-03	Precise Rotational adaptor for Rat	Optional, includes mouse anesthesia adaptor(69112) and ear bars(69116).
69100-04	Precise Rotational adaptor for Mouse	Optional, includes rat anesthesia adaptor (69110) and ear bars(69114).
69110	Mouse Anesthesia Adaptor with Tubing(<30g)	Optional (69100-04 including)
69111	Mouse Anesthesia Adaptor with Tubing(30~70g)	Optional
69112	Rat Anesthesia Adaptor with Tubing	Optional (69100-03 including)
69114	60°Ear Bars for Mouse, One pair	Optional (69100-04 including)
69116	18°Ear Bars for Rat, One pair	Optional (69100-03 including)

## Animal Anesthesia Machine

### Small Animal Anesthesia Machines ▶

Suitable for rats, mice, hamsters, guinea pigs, rabbits, cats and other animals within 7kg

#### R500 Compact Anesthesia Machine

Regular assembly (R500-A),vaporizer(R580),Inlet/Outlet End Caps(R580-IO)and tube accessory kit are included in the R500 anesthesia machine.Different air supply, induction chambers,small animal masks, filter canisters and gas evacuation apparatuses can be selected for anesthesia recovery of different animals.



Note: Oxygen flush is commonly used to flush out anesthetic gas to the filter canister before opening the induction chamber to prevent the operators from anesthetic gas.

#### Order Information:

Model	Product Description	Remarks
R500IP	Compact Small Animal Anesthesia Device-Isoflurane, Pour Fill, 0-4L	Contains connection tubing for mask&induction chamber
R500SP	Compact Small Animal Anesthesia Device-Sevoflurane, Pour Fill, 0-4L	

## TAJI Small Anesthesia Machine

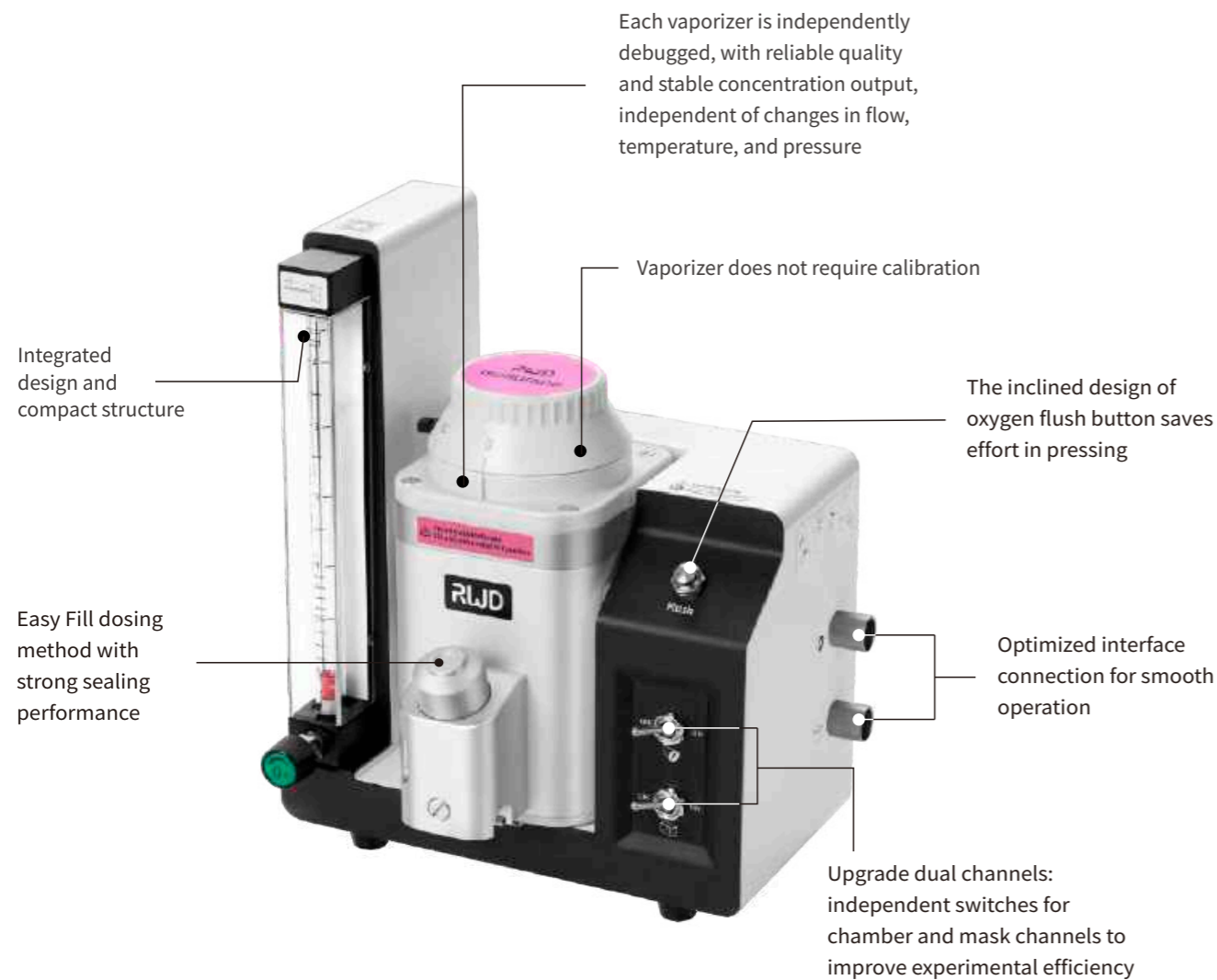

### Order Information:

Model	Product Description
TAJI-IE	Compact Small Animal Anesthesia Machine, Isoflurane, Easy Fill, 0-4L

## R550 Multi-output Anesthesia Machine

Regular assembly (R550-A), vaporizer (R580), Inlet/Outlet End Caps (R580-IO) and tube accessory kit are included in the R550 anesthesia machine. Different air supply, induction chambers, small animal masks, filter canisters and gas evacuation apparatuses can be selected to form the experimental platform for anesthesia recovery of different animals.

With the latest design, it can be applies to simultaneous anesthesia of multiple mice, rats, cats, rabbits and other animals (1-5 small animals), and every channel can be controlled independently.

0-4L/min oxygen flowmeter, reserved additional flowmeter mounting hole, can be expanded into dual flowmeter

Stable concentration output, unaffected by flow, temperature and pressure

Can be upgraded into portable anesthesia machine to save space and facilitate movement



Aluminum alloy material, the whole weight less than 7.5kg

Gas flow of induction chamber can be adjusted independently, ranging from 0 to 2.5 L/min

Toggle switch, quick switching of gas circuit, 100 thousand times of life

### Order Information:

Model	Product Description	Remarks
R550IE	Enhanced Small Animal Anesthesia Device-Isoflurane, Easy Fill, 0-4L	Contains connection tubing for mask & induction chamber.
R550SE	Enhanced Small Animal Anesthesia Device-Sevoflurane, Easy Fill, 0-4L	

## Mobile Trolley



- Integrating gas supply, anesthesia induction, and waste gas recovery, convenient loading and unloading, saving space
- Universal belt lock casters for convenient mobile operation

### Order Information:

Model	Product Description
R510-T	Compact Small Animal Anesthesia MachineTrolley

## Veterinary Anesthesia Machines ▶

### R620-S1 Universal Veterinary Anesthesia Machine

R620-S1 universal veterinary anesthesia machine is applicable to clinical anesthesia of dogs, cats, pigs, monkeys, rodent, reptiles, birds etc. With "one-click" operation mode, it would be easy, safe and reliable to perform surgery on pets.

**User-friendly design**

Blocking bar design for breathing circuit, wheel brake for Universal wheel, and tray shelf for placing monitor

**Rail-mounted CO<sub>2</sub> absorber**

One step to assemble and disassemble, save time and effort to a great extent

**Full inspection policy**

Inspection would be made before shipment to make sure high accuracy

**Minimal operation design**

Just press to close APL valve; turn the switch to shift between rebreathing and non-rebreathing circuit; with only one action to install and uninstall the vaporizer; With one switch to turn, the smart weighing canister start to work

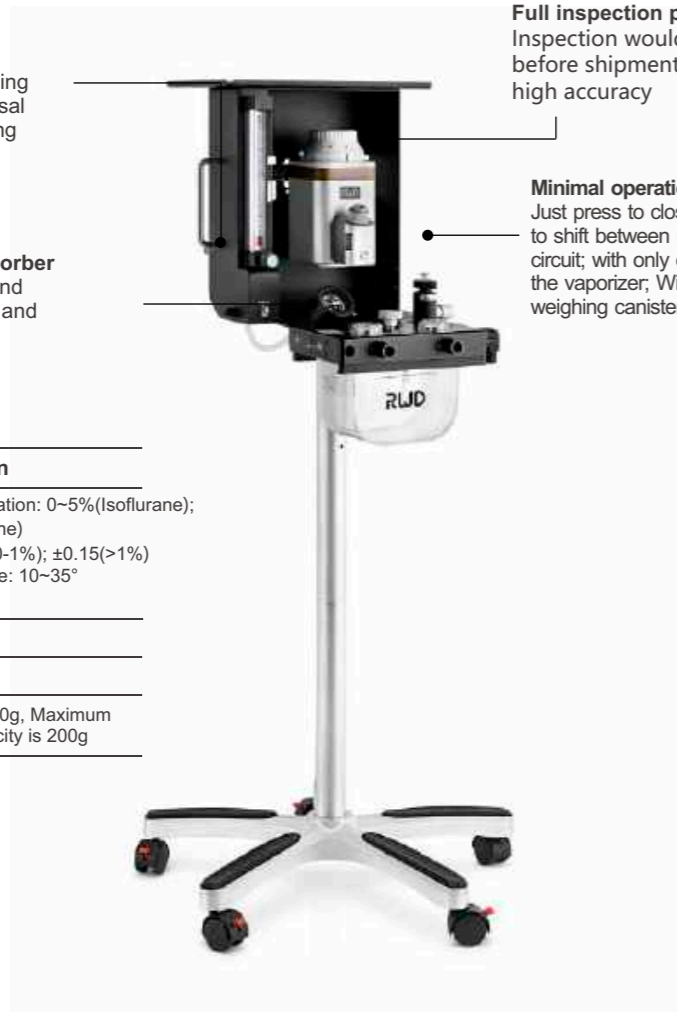

Item	Specification
Vaporizer	Output concentration: 0~5%(Isoflurane); 0~8%(Sevoflurane) Accuracy: ±0.1(0-1%); ±0.15(>1%) work temperature: 10~35° Volume>120ml
Flowmeter	0-4L/min
CO <sub>2</sub> Absorber	1.8L
Filter canister	Self-weight is 800g, Maximum absorption capacity is 200g

Optinal: MRI Conditional Animal Anesthesia Machine are available for purchase.

**Order Information:**

Model	Product Discription	Remarks
R620-S1-IEC	Veterinary Anesthesia Machine-Pole Mount,Isoflurane,Easy Fill,Cagemount	Respiratory Circuit,Endotracheal Intubation,Gas Filter Canister,Breathing Bag are included.
R620-S1-SEC	Veterinary Anesthesia Machine-Pole Mount,Sevoflurane,Easy Fill,Cagemount	
R620-S1-IPC	Veterinary Anesthesia Machine-Pole Mount,Isoflurane,Pour Fill,Cagemount	
R620-S1-SPC	Veterinary Anesthesia Machine-Pole Mount,Sevoflurane,Pour Fill,Cagemount	
R620-MRI	MRI Conditional Animal Anesthesia Machine	Additional non-magnetic oxygen tube

## Complete Anesthesia and Respiration Solutions ▶

### Multi-function Anesthesia Solutions



The experimental system is equipped with a gas recovery system to provide a safe experimental environment to maximize the protection of the operator; by replacing different types of anesthesia machines and masks to meet the needs of animal experiments, such as cerebral ischemia and myocardial ischemia model, osteoporosis model, tail vein injection, abdominal aorta blood sampling, heart blood sampling, ventricular injection, tissue / organ removal and other animal surgery experiments.

### Stereotaxic Anesthesia Solutions



By changing the different types of stereotaxic instruments and adaptors to meet the needs of different animal experiments, such as the neurological disease models (such as Parkinson, Alzheimer's disease, craniocerebral injury, spinal cord injury, etc.), brain drug injection, Cannula Implantation (long term repeated administration), physiology experiment (such as nerve stimulation, signal recording, wireless telemetry, etc.), microdialysis experiments (probe implantation and short-term dialysis) and other experiments.

## Combination Solutions of Ventilator to Anesthesia System

### Small animals



Small animal ventilator

This program is the combination of anesthesia machine and ventilator. While keeping the animal under anesthesia, it provides a certain volume (tidal volume) of oxygen and respiratory rate to support the normal breathing of animals.

It can meet the requirements of long surgeries or surgeries on animals suffering from certain diseases (such as cardiovascular and cerebrovascular diseases, hypertension, cerebral infarction, thrombosis), it's suitable for mice, rats, rabbits, cats and other animals within 1kg.

### Large animals



Oxygen Concentrator

Circular anaesthetic mask

Laryngoscopes

Endotracheal Tubes

Calcium lime

This program is suitable for the anesthesia and auxiliary respiration of animals within 100kg, such as pigs, monkeys, dogs and cats.

## Anesthesia Machine Accessories ▶

### (Anesthesia Machine) Vaporizer

Adopted advanced design, R580 series vaporizer can be perfectly collaborated with small animal anesthesia machine and large animal anesthesia machine to make sure accurate transmission of anesthetic gas. RWD offers Pour Fill, Easy Fill and Key Fill Cagemont and Selectatec.



Isoflurane vaporizer

Sevoflurane vaporizer

- Two kinds of vaporizers
- Three dosing methods
- Two installation

#### Features:

- The built-in temperature compensator ensures the stable concentration of anesthetic gas at different temperatures and flow rates, the flow range is 0.2-10L/min.
- Mixed anesthetic gas output pressure range  $\Delta P \leq 2.5kPa$ .
- Applicable temperature range: 10-35 °C.
- Good tightness, internal 50kPa pressure can be maintained, zero leakage, safe and reliable.
- Internal capacity is not less than 120ml, and the range of isoflurane vaporizer concentration is 0-5% (Sevoflurane: 0-8%).
- Anti-accident open lock structure and closed state security protection structure to ensure safety.
- The average filling rate is greater than 2ml/s, and the dosing adapter can withstand the pressure of 0.1mpa without leakage (Key Fill).

## Gas Evacuation Apparatus

The gas evacuation apparatus (GEA) was designed to safely and actively remove waste gas associated with everyday inhalation anesthesia. The waste gas from cone mask, concentric tubing mask and stereotaxic frame nosecone masks can be pulled through activated charcoal canister so that the air can be re-circulated into the room. The GEA will accommodate waste gas supply from at least 5 masks. The new one has been upgraded with a wider range of exhaust flow, Low noise, and Exquisite exterior design.

#### Features:

- New design make it more exquisite and easy to carry.
- A wide range of flow rate-8~60LPM, real-time display through LED screen.
- Small size 232mm (W)\*200mm (D)\*184mm (H).
- Noise reduction system within 50dB. One click set mute to prevent noise.
- Two level overweight alarm: 990g and 1010g.
- Power: 100-240V, 50/60Hz.
- Automatic temperature compensation system can help stably run even in 5°C-40°C.
- Integrated negative pressure recovery system and weighing alarm functions, can weigh and display the weight of the gas filter tank at anytime to confirm whether the adsorption is saturated.



R546Pro

#### Order Information:

Model	Product Description
R546Pro	Gas Evacuation Apparatus with Weight Monitoring, 110-240V

## Gas Filter Canister



Used to absorb isoflurane, sevoflurane and enflurane and other gases, disposable, large and small size are available, large canister (net weight: 800g) absorb 200-240g gas; small canister (net weight: 250g) absorb 50g gas.

### Order Information:

Model	Product Description
R510-31-6	Gas Filter Canister, Large, pkg of 6pcs
R510-31S-6	Gas Filter Canister, Small, pkg of 6pcs
R510-31S-16	Gas Filter Canister, Small, pkg of 16pcs

## Induction Chambers

The anesthetic gas is inducted into the chamber, and exhausted to the connected charcoal canister. With following features:

- Transparent plexiglass material, durable, easy to clean, convenient to observe the anesthetic state of animals.
- Positive pressure gaskets at lids.
- Both ports on one side to reduce tubing in procedure area.



### Order Information:

Model	Product Description	Remarks
V100	Induction Chamber-mouse (15cm*10cm*10cm)	Contains 1 plexiglass box, 1.2m bellows and 1 gas filter canister (R510-31S)
V101	Induction Chamber-rat (24cm*12cm*18cm)	
V102	Induction Chamber-rabbit/cat (40cm*18.5cm*25cm)	

## Low Stress Anesthesia Induction Chamber

Low stress: Rodents lack cone cells that sense red light and are insensitive to red light. The red transparent appearance is convenient for the experimenter to observe the state of the animal while reducing the stress response of the animal and reducing the impact on the biological rhythm of the animal. Comply with animal welfare.

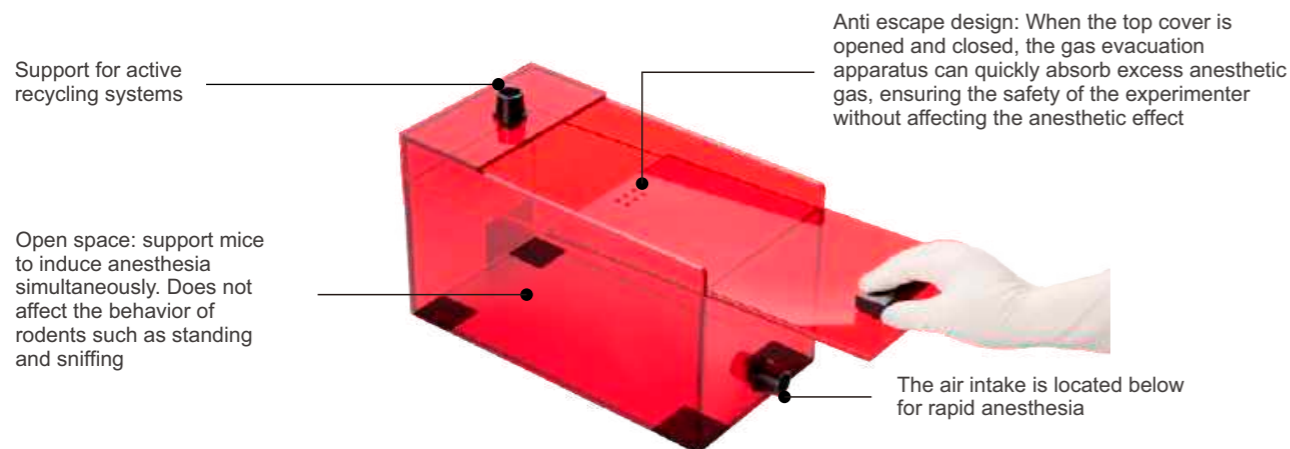

### Order Information:

Model	Product Description	Remarks
V105	Low Stress Anesthesia Induction Chamber, for Mice and Rats (31cm*15cm*19cm)	The pipeline connecting the Gas Evacuation Apparatus is already included

## Small Animal Anesthesia Mask

### Concentric Tubing Masks

- Using Concentric Tubing design, sturdy and durable; Compatibility between rat and mouse can be achieved by changing the mask core.
- The entire mask (including tubing) is made of non-metallic material suitable for MRI environments.
- It can be used with the Gas Filter Canister (R510-31-6) and the Gas Evacuation Apparatus (R546Pro) for waste gas recovery to protect the experimental operators and the experimental environment.
- Optional fixing Mounting Bracket (68625) can be used to fix the mask, and the height can be adjusted up and down, or it can be fixed on the Anesthesia Operation Platform-Concentric Tubing type (R510-PGL).

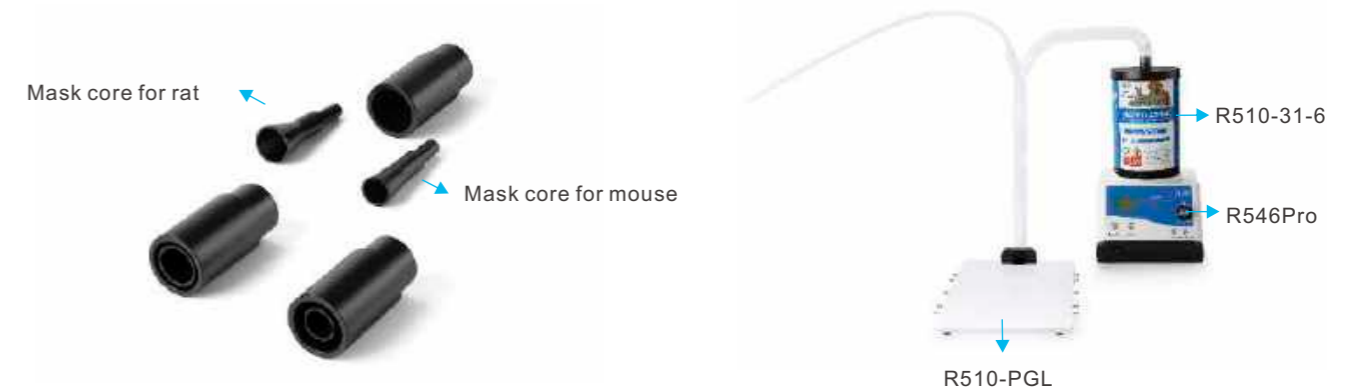

### Order Information:

Model	Product Description	Size
R510-M	Concentric Tubing Mask for rat and mouse - including pipe	/
R510-PGL	Anesthesia Operation Platform- Concentric Tubing type	300*210*10mm

### Cone Masks

- Small size, without interfering with head, ophthalmology and other related experimental operations.
- The exhaust gas will hardly leak from the mask to protect the experimental operators and the experimental environment. The exhaust gas can be recovered with the Gas Filter Canister (R510-31-6).
- The Anesthesia Operation Platform-Cone type (R510-PYZ) is optional for animal limb fixation.

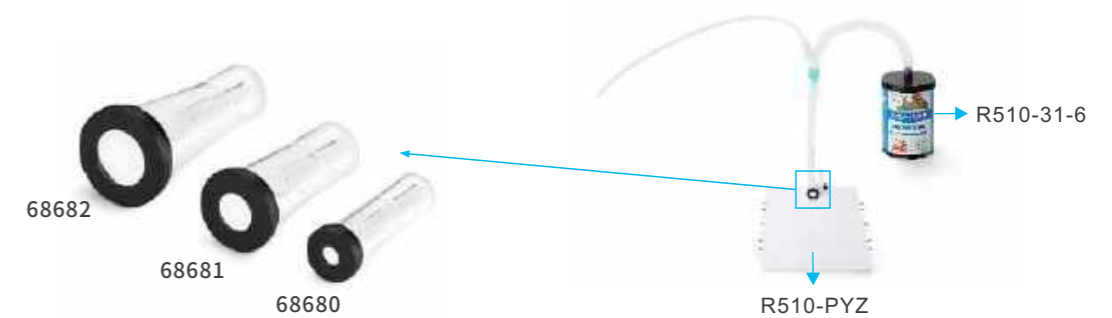

### Order Information:

Model	Product Description	O.D. (size)	I.D.(size)	D(size)
68680	Cone Mask with Tubing for Neonatal Mouse(<15g)	13mm	5mm	24mm
68681	Cone Mask with Tubing for Mouse or Neonatal Rat(15-40g)	20mm	10mm	28.5mm
68682	Cone Mask with Tubing for Rat(200-350g)	25mm	15mm	38mm

Model	Product Description	Size
R510-PYZ	Anesthesia Operation Platform-Cone type	300*210*10mm

## Animal Ventilator

### VentStar Small Animal Ventilator

Animal ventilator is the most commonly used equipment to assist animal respiration. It is widely used in basic medicine, clinical medicine, animal medicine and other scientific research experiments (such as myocardial ischemia model making, lung function evaluation), respiratory management, animal first aid and respiratory treatment in clinical surgery. Small animal ventilator suitable for 10g-1kg mice, rats and guinea pigs and other small animal.

Suitable for mice, rats and guinea pigs and other animals weighing 10g-1kg

Input power range: 100 ~ 240V, 50/60Hz, 24V, 40W, 1.67A adapter DC power supply, safe and effective

Small size, compact layout, flexible operation

7 inches LCD touch screen, wide-angle visual

The pressure-time graph can be displayed in real time in volume and pressure modes

10 groups of different respiratory parameters can be stored and called, which is convenient and efficient

R415-AP

Set the respiratory parameters such as PIP/PEEP/Sigh/INSP.Hold/EXP.Hold

After submitting the animal weight, and the device automatically sets the reference breathing parameters

The adjustable range of I:E ratio is from 20% to 80%; the sigh increases the tidal volume from 0 to 20%, and can set auto-sigh once after every 10 to 999 breaths or manual control

Provide safe and effective intermittent positive pressure ventilation (IPPV), volume and pressure modes are available.

Sound, intelligent text, error code and other fault alarm alerts

The breathing frequency can be switched between 10 ~ 300bpm

Tidal volume range: 0.05ml ~ 5ml

Airway pressure range: 1~50cmH<sub>2</sub>O, the accuracy range: ±0.7 cmH<sub>2</sub>O; positive end expiratory pressure (PEEP) range is 0~10cmH<sub>2</sub>O

Model	Product Description
R415	Small Animal Ventilator
R415-AP	Accessory package for Anesthesia and Ventilator

### RE20 Animal Endotracheal Intubation Kit

Noninvasive endotracheal intubation kit for animals guided by cordless optic fiber to support mouse, rat and other similar small rodents in a stable and comfortable position for experimenters to perform endotracheal intubation, drug infusion and other operations, effectively reducing animal damage, and enhancing the experimental efficiency and precision of the experiment results.

#### Features:

- PU material, moderate soft and hard, comfortable and not harmful to animals;
- The cordless portable optic fiber lighting system, which has been patented for an invention, improves the visibility of the airway and facilitates users to quickly and accurately finish endotracheal intubation;
- The stand angle can be adjusted, including: 45°, 60°, 90°, to meet the requirements of users with different operation habits;
- An endotracheal magnifier with auxiliary positioning function and a tracheoscope mirror that helps to confirm intubation result are more user-friendly.



#### Order Information:

Model	Product Description
RE20-R	Endotracheal intubation tube for rat (length 50mm)
RE20-M	Endotracheal intubation tube for mouse (length 25mm)

### R419 Intelligent Animal Ventilator

R419 intelligent animal ventilator as mechanical ventilation device, which is completely according with veterinary clinical practice. There are 3 modes of operation, including VCV, PIPCV and APNEA, to meet multiple clinical applications.

Equipped with two different sizes of bellows, the output tidal volume 20 ~ 300mL and 300 ~

Bellow-1500ml

Three working modes:  
Capacity control mode (VCV)  
Pressure control mode (PIPCV)  
APNEA mode

5-inch LCD color display, realtime display device power, air pressure column, tidal volume, respiratory rate, suction ratio, pressure peak, average and other parameters

Respiratory rate (2 ~ 60 BPM) linear adjustable, respiratory ratio (1: 1.0 ~ 1: 4.0) real-time adjustable and airway pressure rate (5 ~ 35cmH<sub>2</sub>O) real-time adjustable to meet the respiratory demand of different kinds of animals

#### Order Information:

Model	Product Description
R419	R419 Intelligent animal ventilator
R409-MB	Mounting Bracket for R409 Ventilator

- Adjustable power supply (110 / 220V)
- Light weight, portable, user-friendly design, multi-parameter fixed platform, easy to operate
- Provides safe and effective intermittent positive pressure ventilation (IPPV)
- Provide internal battery power, which can work more than 4 hours



## Surgical Auxiliary Equipment

### DOM-1001 Digital Microscope

DOM-1001 is a digital microscope without eyepiece, with dual light sources and a cross arm bracket. High-end optical components and 16 million pixel CMOS camera can be used to capture real-time images and video, realizing multi-person sharing. Mainly used in life science, university teaching, industrial manufacturing, material science and other fields.



**Features:**

- Novel and unique integrated design**  
 High-end optical components and a 16 million pixels digital camera, combined with LED ring lights and gooseneck light control components, and optional brackets for various scenarios, together create a powerful DOM-1001 digital surgical microscope system.
- Excellent ergonomic design**  
 The comfortable electric adjustment knob on the side is combined with the foot focus adjustment, and with the 11.6-inch display, the operator can maintain a correct and comfortable working posture, reducing fatigue and damage caused by long-term use.
- Real-time ultra high-definition projection screen**  
 Built-in digital camera with zoom optical components, high depth of field (maximum depth of field 6.7mm), adjustable magnification 8-44X(11.6-inch display), 18-100X(27-inch display), support real-time display with high-definition monitor or notebook computer connection.
- Convenient and practical remote control**  
 With the infrared remote control, you can directly perform remote control, including many functions such as taking pictures, recording videos, flipping and zooming, adjusting brightness and contrast of images, and white balance.
- Homogeneous and coaxial optical design**  
 Always displayed in the center of the field of view in a clear and optimal state-no need to refocus even when changing the magnification.
- Greater operating space**  
 The working distance of 180 mm, the lens body can be adjusted at multiple angles, which greatly improves the operating space and ensures that observation and operation are performed simultaneously.

### Microscope

77001S Desktop Binocular Stereo Microscope equips with universal support; researchers can observe in high resolution and three-dimension.



77001S

**Features:**

NO.	Products Name	Products Detail
1	Eyepiece	10X Eyepieces, View field diameterφ22mm
2	Objective Lens	0.67X-4.5X Objective lens ratio 1:6.7
3	Binocular Drawtube	Pupil Distance 55-77mm Diopter adjustment±5 ,Diopter 45°Incline 360°Spin
4	View field Range	31.2 mm -5.1mm
5	Total Magnification	6.7X-45X(10X Eyepiece),3.35X-22.5X(10X Eyepiece +0.5X Assist lens)
6	Working Distance	Working distance 105mm(10X Eyepiece),Working distance 177mm (10X Eyepiece +0.5X Assist lens)
7	Focusing Mechanism	Focusing hand wheel is adjustable
8	Universal Support	360°Spin, Retractable
9	Lighting	TY-B-2 Ring LED Illumination

On the basis of the binocular microscope, 77008S Trinocular Zoom Stereo microscope increase the interface, so that the camera, video camera can be installed in the microscope to achieve real time observing of the objects.



77008S

## 77002 Vertical Animal Operating Microscope

The vertical animal operating microscope is a simple operating microscope with single person and binocular coaxial illumination. The body is small and light with high flexibility, which can meet the requirements of general animal microsurgery.

### Features:

- Eyepiece magnification: 12.5x, objective lens focal length: 200 mm.
- Working distance: 190mm, main mirror magnification: 5.3x, 8x, 12x.
- Field of view diameter: 38mm, 25mm, 17mm.
- The adjustment range of diopter: ± 5D, the adjustment range of pupil distance: 50mm-70mm.
- Lighting source: 12V / 100W, cold reflection medical halogen bulb.
- Lighting type: 6 ° + 0 ° cold source coaxial lighting.
- Illumination of coaxial lighting surface: ≥ 20000 LX, transverse arm extension radius: 870 mm.
- Vertical adjustment range (ground to large objective): 700mm-1100mm, fine focus stroke: 30mm.
- Voltage: AC220 V ± 10%, 50 Hz ± 1 Hz, power: 120 VA.
- Fuse: AC250V T1.25A weight: 41kg.



77002

## Manual Syringe Pumps(68606)

Compatible with RWD stereotaxic instruments, simple installation, with 10µm displacement accuracy and up to 25mm distance, it is an economical and practical microinjection pump!

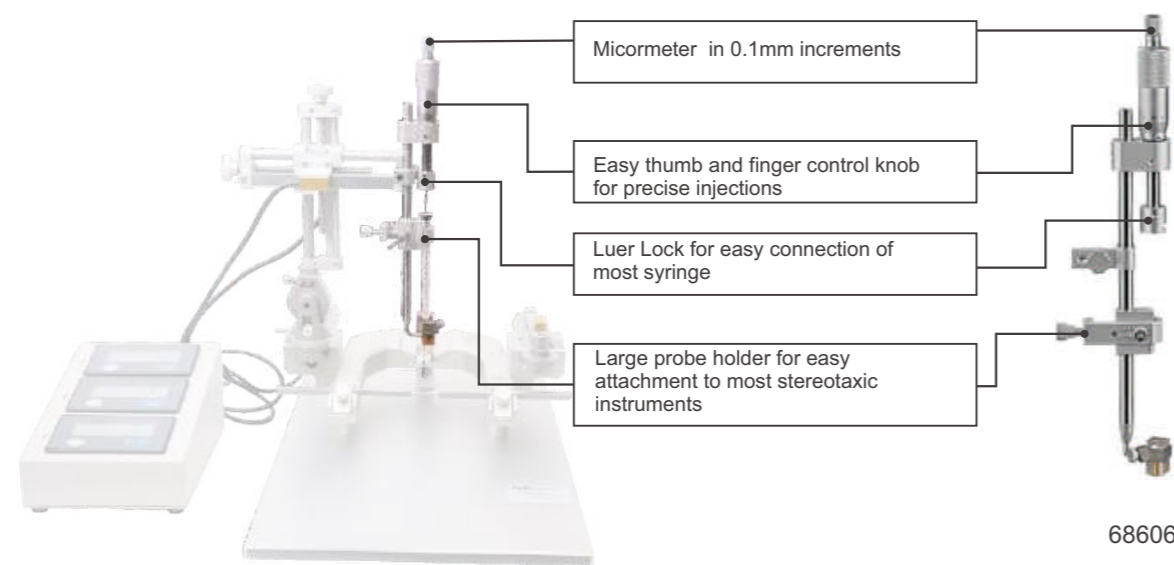

68606

### Features:

- Precisely-controlled infusion/withdrawal of picoliter volume.
- Provides an economical means of injecting or withdrawing a calibrated volume with simple, precise manual control.
- The injector has a universal adaptor for all RWD and Hamilton 700,7000 or Gas-Tight Series syringers, ranging from 1 to 100µl sizes and enables a wide range of volumes to be delivered-both infusion and withdrawal operation.
- The Manual Stereotaxic injector is graduated in 0.01mm increments. One complete revolution advances the plunger of the syringe 0.5mm.

## Microdrill

It takes only one second to drill the skull, easy to operate and control. It can also be used for grinding the skull.



### Features:

- Speed up to 35,000rpm.
- Forward or reverse available.
- Controlled manually or by foot pedal.
- Can be installed onto the stereotaxic instrument by the microdrill holder (Model: 68605) and controlled by the manipulator.
- Various drill bits available, diameter from 0.5-2.3mm.

### Order Information:

Cat No.	Product Description
78001	Microdrill (bits not included)
78040	Drill Bits HM1005 0.5mm, Round Tip, pkg of 5
78041	Drill Bits HM1006 0.6mm, Round Tip, pkg of 5
78042	Drill Bits HM1008 0.8mm, Round Tip, pkg of 5
78043	Drill Bits HM1010 1.0mm, Round Tip, pkg of 5
78060	Drill Bits HM31008 0.8mm, Flat Tip, pkg of 5
68605	Microdrill Holder

## Fiber-lite Illuminator

The halogen fiber-lite illuminator adopts dual-pipe pipe optic coaxial lighting, provide better field of view, with good brightness; stable output voltage, safe and reliable light bulb; size is about 280 x, 100 x 165mm, and the light intensity can be adjusted continuously, with color temperature 3200K.



Halogen fiber-lite illuminator

### Order Information:

Model	Product Description	Remarks
76301	Fiber-Lite Illuminator(150W)	Dual-Pipe Fiber Optic, Bulb and Main Engine
76304	Main Engine	
76310	Dual-Pipe Fiber Optic(Included in illuminator)	
76307	Replacement Bulb for 76301 Illuminator (21V 150W) -OSRAM	

## ThermoStar Homeothermic Monitoring System

During the process of animal surgery or acute anesthetized animal experiment, maintaining animals' body temperature is very important for the accuracy and reliability of results, furthermore, it is an important way to reduce the mortality of the animals. In order to fulfill this need, RWD launched a new generation of homeothermic monitoring system "Thermostar", the control unit acquired a 4.3 inch color LCD touch screen, allows users to clearly view the subject's real-time body temperature, set the target temperature, view the heating state and set audible alarms when subject's body temperature turns abnormal. A specific control separate circuit for heating pad and rectal probe, respectively to ensure the stability and safety of the system.



heating pad (69023 / 69024 / 69025)

temperature probe (69022)

### Features:

- Real-time display of the working status of the heating pad, and monitor the working state of every channel, show: IDLE, WARNING, STANDBY, and WORKING.
- Heating range: 20-45°C, 0.1°C resolution, Degrees Celsius and Fahrenheit can be switched.
- Power supply: 100-240V, 50/60Hz.
- Control unit size: L205 x W148 x H80 mm.
- Control unit weight: 1.3kg.

### Order Information:

Type	Model	Product Description	Remarks
Complete system	69020	ThermoStar Temperature Controller, 69023 pad incl.	A heating pad (69023) and a temperature probe (69022) incl.
	69026	ThermoStar Temperature Controller, 69024 pad incl.	A heating pad (69024) and a temperature probe (69022) incl.
	69027	ThermoStar Temperature Controller, 69025 pad incl.	A heating pad (69025) and a temperature probe (69022) incl.
Temperature probe	69022	Temperature Probe	1.5mm diameter, 30mm rod length, the length of the probe is 200cm.
Heating pad	69023	Heating Pad-12.0*20.5cm	the length of heating pad is 150cm.
	69024	Heating Pad-9.0*17.0cm	
	69025	Heating Pad-7.0*10.0cm	

## RLT-24 Veterinary Laser Therapy

RLT-24 Veterinary Laser Therapy is non-invasive, deep penetrating, painless and without side effects. It can be used in the treatment or study of diverse diseases such as recalcitrant wounds, chronic diabetic ulcers, neurological injuries etc. Furthermore, the machine supports to expansion of the laser surgery function by being equipped with a surgical accessory kit.



### Features:

- **Intelligence Solutions:** With more than 1,300 recommended treatments built-in, it can be adjusted according to the specific experiment.
- **Multiple modes:** support three laser emission modes: CW mode, Pulse mode and ISP mode. The combination of multiple modes can improve the treatment efficiency, reduce thermal burns, and intensify laser treatment.
- **Laser surgery:** The surgery fiber diameter is tiny to 400 μm, which can effectively focus energy to realize precise cutting and less bleeding.
- **High power:** The laser power is up to 24W, with remarkable treatment effect, stable light, safe and fast.
- **Four wavelengths:** The arbitrary combination of four wavelength lasers of 650nm, 810nm, 915nm and 980nm, different wavelengths of laser can be selected for various experiments.
- **User-friendly design:** LCD touch screen; the rear-mounted large optical fiber winding disk, which is convenient for storage and protects the optical fiber and prolongs its service life.
- **Easy to start:** built-in video tutorial module, "hands-on" teaching, and no difficulty to start operation; automatic storage of treatment records for easy information traceability.

### Order Information:

Cat No.	Description
RLT-24	Veterinary Laser Therapy
RLT-24SK	Laser surgical accessory kit

### Included:

Description	Amount	Function	Remarks
Veterinary Laser Therapy	1	Laser therapy	Included
Optical fiber handpiece	1	Laser transmission and control	
Lens	5	Change the beam size to realize optimal treatment and diversity	
Protective goggles	6	3 for staff and 3 for animals for eyes protection	
Interlock	1	The interlock should be connected to the device to prevent any personnel entering the room and being exposed to the laser irradiation	
Power adaptor	1	Device power input	
Toolkit	1	Store lens and optical fiber handpiece	
Laser surgical accessory kit	1	For laser surgery, containing a surgical fiber, a surgical handle, a fiber stripper, a fiber cutter, fiber needles, and a foot switch.	Optional

## R-CU600pro Smart Animal ICU

R-CU600 pro The Smart Animal ICU, provides animal patients with the most comfortable medical care environment to help animals recover faster. It is suitable for postoperative recovery, emergency care of critical animals, delivery, infant care, respiratory diseases, aging diseases, animal atomization therapy and other animal diseases treatment.



### Features:

- **Digital operation:** 7-inch touchscreen for best simplicity, all parameters are clear at a glance
- **Smart pre-set:** Parameters setting automatically matching animal species-age-disease
- **Heat preservation:** Three-sides heating and floor cooling by the semiconductor temperature control element
- **Maintain proper humidity:** Dehumidification by semiconductor technology and ultrasonic humidification
- **Support oxygen therapy:** Maintain a certain oxygen concentration, convenient to provide oxygen-enriched environment for small animals
- **Environmental purification:** UVC lamp & Anion function for effective sanitation management, to avoid patients cross infection
- **Carbon dioxide automatic removal:** Effectively prevent CO<sub>2</sub> accumulation through CO<sub>2</sub> absorbent and ventilation, to avoid causing animal breathing disorders Built-in failure alarms: Abnormal high/low temperature, humidity, sensor failure and CO<sub>2</sub> levels

### Order Information:

Model	Product Description
R-CU600pro	Smart Animal ICU

### Standard Configuration:

Description	Amount
Host	1
IV stand pole	1

## Surgical Instruments & Matrix

RWD surgical instruments and Matrices products cover more than 10 types of instruments and consumables such as surgical scissors, clamps, forceps, auxiliary instruments, sterilizers, molds, sutures. There are thousands of specifications as well offer well-equipped surgical kits which could satisfied with all kind of animal modeling experiment. More details please refer to the catalog from page 66 to 81, or visit our web: www.rwdstco.com.

### The surgical kits included:

Surgical instrument kit for MCAO, spinal cord injury, universal dissecting, cardio-cerebral perfusion surgery, brain micro injection surgery and micro dialysis surgery etc. which could satisfied with the whole experiment operation for rodents from skin dissection to sutured.



### Surgical scissors included:

Micro spring scissors, delicate scissors, surgical scissors, dissecting scissors, boon cutters and ophthalmic scissors etc. which could satisfied with different experiment requirement of tissues dissecting, cutting, and separate.

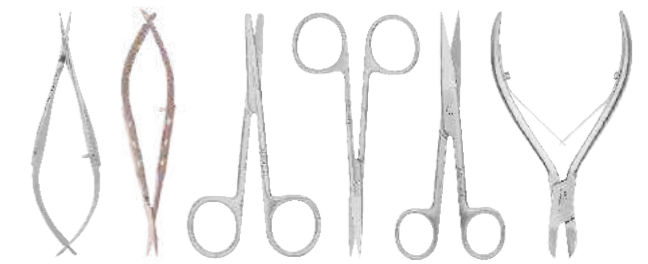

### Surgical forceps included:

Tissue forceps, hemostatic forceps, needle holder and bone rongeurs etc. which could satisfied with the requirement of tissues clamping, fixation, hemostasis, stitich and bone trimming and cutting.

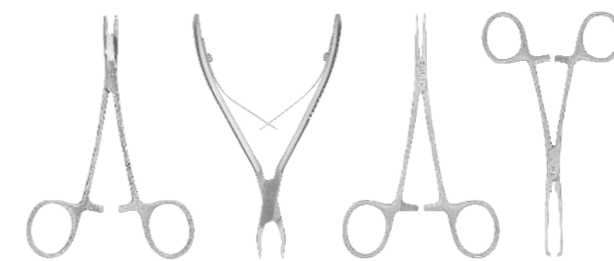

### Surgical forceps included:

Micro forceps, tissue forceps and dressing forceps and ophthalmic forceps etc. it is mainly used for the clamping and separation of soft tissues such as blood vessels, nerves, organs, skin etc.

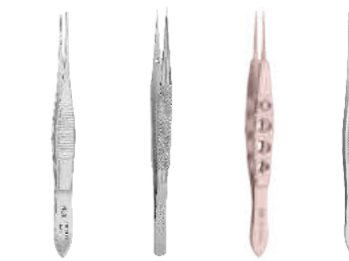

### Auxiliary instruments such as:

Scalpel, retractors, hooks, blood vessel clamps, sutures <with needle>, sterilization box and marking instrument etc. to meet the requirement of skin dissection.



### The matrices included:

Brain and hear matrix, stainless material offered solid and durable quality which could be heated, cooled, autoclaved and scrubbed for long time using. Sterilizer mainly used for Instruments' high temperature sterilization with high efficiency. MCAO sutures made of Silica gel wrapped nylon thread material which could easily enter the common carotid artery and embolize the middle cerebral artery without puncturing the inner wall of the vessel, which greatly improves the success rate and repeatability of the modeling.



# Neural Signal Research Solutions

## Optogenetics System

Optogenetics uses light-responsive proteins to control biological processes. The unmatched spatiotemporal precision, high tunability, reversibility, and few side effects of light makes optogenetics a powerful strategy to study neuroscience and complex biological systems. RWD new intelligent optogenetics system, on the basis of the last generation machines (laser and waveform generator integrated into one), has made another leap in the performance.

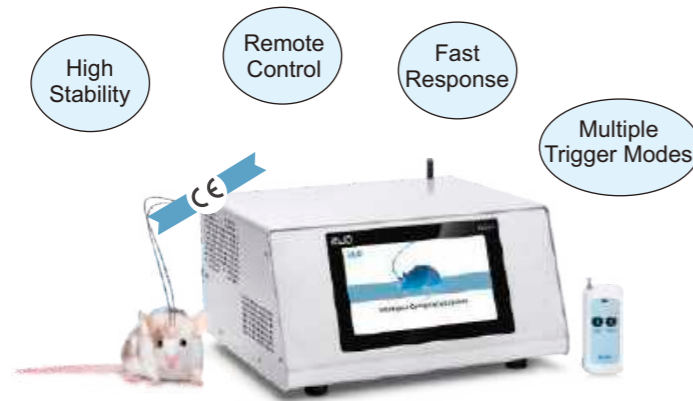

### Features:

- Built-in CW(continuous wave)mode, one-button power test.
- The test/experiment mode can be switched with one key, and the test power value can be directly written into the experiment program.
- Equipped with a remote control, which can control multiple optogenetics devices simultaneously within a range of ten meters.
- Three external trigger modes: Edge/Real-time/Gate, to meet more experimental requirements.
- Edge mode1:** If the trigger voltage is higher than or equal to the set value of trigger voltage, the program will run; the trigger is only featured by the "on" function and the program's duration depends on its set duration.
- Real-time mode2:** If the trigger voltage is higher than or equal to the set value of the trigger voltage, the program will run; if it is lower than that value, the program will stop; the trigger is characterized by the "on/off" function. The duration of the program depends on the duration of the trigger.
- Gate mode3:** The running power relies on the first subprogram selected and other parameters are defined by the external device, and only response to the square wave with frequencies  $\leq 500\text{Hz}$ .
- High resolution signal processing, external signal delay  $< 1\text{ms}$ .
- High stability, long-term operation power fluctuation is less than 1%.
- Support program group custom editing, import and export, experimental programs and records can be exported externally to review.
- With signal input/output interface, it can be compatible with electrophysiology, fiber photometry system, behavioral instruments and other equipment.
- Can be connected to multi-channel fiber photometry system. Enables stimulation and signal acquisition at the same site.

### Software Interface:



### Technical Parameters:

Parameter item	Specification
Power	1-100mW, 1mW resolution
Operation mode	Remote control/touch screen/external trigger
Input	2V-10V
Output	10mV-5V
Safety	Password; High temperature alarm; Program run prompt
Storage	Internal memory/USB flash disk

### Order Information:

Model	Product Description
IOS-465	Intelligent Optogenetics System(465nm)
IOS-589	Intelligent Optogenetics System(589nm)
IOS-635	Intelligent Optogenetics System(635nm)

### Patchcord and Optical Fiber

- Low insertion loss
- Good repeatability
- High return loss
- Stable temperature
- Low auto-fluorescence
- Good mutual insertion performance
- Optional fiber
- Applicable wavelength: 400nm-1100nm
- Numerical aperture: 0.22, 0.39, 0.50
- Default length is 1m, other length: 1.5-5m, step 0.5m (customized)
- Core diameter: 100 $\mu\text{m}$ , 200 $\mu\text{m}$ , 300 $\mu\text{m}$ , 400 $\mu\text{m}$



### Order Information:

Model	Product Description
R-FC-PC-N2-100-L1	FC/PC Optical Fiber Patch Cables(m) - 100 $\mu\text{m}$ ,0.22NA,1m
R-FC-PC-N2-200-L1	FC/PC Optical Fiber Patch Cables(m) - 200 $\mu\text{m}$ ,0.22NA,1m
R-FC-PC-N2-300-L1	FC/PC Optical Fiber Patch Cables(m) - 300 $\mu\text{m}$ ,0.22NA,1m
R-FC-PC-N2-400-L1	FC/PC Optical Fiber Patch Cables(m) - 400 $\mu\text{m}$ ,0.22NA,1m
R-FC-PC-N3-200-L1	FC/PC Optical Fiber Patch Cables(m) - 200 $\mu\text{m}$ ,0.39NA,1m
R-FC-PC-N3-300-L1	FC/PC Optical Fiber Patch Cables(m) - 300 $\mu\text{m}$ ,0.39NA,1m
R-FC-PC-N3-400-L1	FC/PC Optical Fiber Patch Cables(m) - 400 $\mu\text{m}$ ,0.39NA,1m
R-FC-PC-N5-200-L1	FC/PC Optical Fiber Patch Cables(m) - 200 $\mu\text{m}$ ,0.50NA,1m
R-FC-PC-N5-400-L1	FC/PC Optical Fiber Patch Cables(m) - 400 $\mu\text{m}$ ,0.50NA,1m
R-FC-L-N2-100-L1	Optic Fiber(m), FC/PC Adapter with $\Phi 1.25$ mm Ceramic Ferrule, 100 $\mu\text{m}$ Core,0.22NA,1m
R-FC-L-N2-200-L1	Optic Fiber(m), FC/PC Adapter with $\Phi 1.25$ mm Ceramic Ferrule, 200 $\mu\text{m}$ Core,0.22NA,1m
R-FC-L-N2-300-L1	Optic Fiber(m), FC/PC Adapter with $\Phi 1.25$ mm Ceramic Ferrule, 300 $\mu\text{m}$ Core,0.22NA,1m
R-FC-L-N2-400-L1	Optic Fiber(m), FC/PC Adapter with $\Phi 1.25$ mm Ceramic Ferrule, 400 $\mu\text{m}$ Core,0.22NA,1m
R-FC-P-N2-100-L1	Optic Fiber(m), FC/PC Adapter with $\Phi 2.5$ mm Ceramic Ferrule, 100 $\mu\text{m}$ Core,0.22NA,1m
R-FC-P-N2-200-L1	Optic Fiber(m), FC/PC Adapter with $\Phi 2.5$ mm Ceramic Ferrule, 200 $\mu\text{m}$ Core,0.22NA,1m
R-FC-P-N2-300-L1	Optic Fiber(m), FC/PC Adapter with $\Phi 2.5$ mm Ceramic Ferrule, 300 $\mu\text{m}$ Core,0.22NA,1m
R-FC-P-N2-400-L1	Optic Fiber(m), FC/PC Adapter with $\Phi 2.5$ mm Ceramic Ferrule, 400 $\mu\text{m}$ Core,0.22NA,1m
R-FC-L-N3-200-L1	Optic Fiber(m), FC/PC Adapter with $\Phi 1.25$ mm Ceramic Ferrule, 200 $\mu\text{m}$ Core,0.39NA,1m
R-FC-L-N3-300-L1	Optic Fiber(m), FC/PC Adapter with $\Phi 1.25$ mm Ceramic Ferrule, 300 $\mu\text{m}$ Core,0.39NA,1m
R-FC-L-N3-400-L1	Optic Fiber(m), FC/PC Adapter with $\Phi 1.25$ mm Ceramic Ferrule, 400 $\mu\text{m}$ Core,0.39NA,1m
R-FC-P-N3-200-L1	Optic Fiber(m), FC/PC Adapter with $\Phi 2.5$ mm Ceramic Ferrule, 200 $\mu\text{m}$ Core,0.39NA,1m
R-FC-P-N3-300-L1	Optic Fiber(m), FC/PC Adapter with $\Phi 2.5$ mm Ceramic Ferrule, 300 $\mu\text{m}$ Core,0.39NA,1m
R-FC-P-N3-400-L1	Optic Fiber(m), FC/PC Adapter with $\Phi 2.5$ mm Ceramic Ferrule, 400 $\mu\text{m}$ Core,0.39NA,1m
R-FC-L-N5-200-L1	Optic Fiber(m), FC/PC Adapter with $\Phi 1.25$ mm Ceramic Ferrule, 200 $\mu\text{m}$ Core,0.50NA,1m
R-FC-L-N5-400-L1	Optic Fiber(m), FC/PC Adapter with $\Phi 1.25$ mm Ceramic Ferrule, 400 $\mu\text{m}$ Core,0.50NA,1m
R-FC-P-N5-200-L1	Optic Fiber(m), FC/PC Adapter with $\Phi 2.5$ mm Ceramic Ferrule, 200 $\mu\text{m}$ Core,0.50NA,1m
R-FC-P-N5-400-L1	Optic Fiber(m), FC/PC Adapter with $\Phi 2.5$ mm Ceramic Ferrule, 400 $\mu\text{m}$ Core,0.50NA,1m
YX0S-1*2-473-200/220-2.0- $\Phi 1.25$ (FC) (150/50cm)	Fusion fiber-200 $\mu\text{m}$ , NA0.22, FC/PC Adapter with $\Phi 1.25$ mm Ceramic Ferrule, bundle end-1.5m, beam splitting end-0.5m
YX0S-1*2-473-200/220-3.0- $\Phi 1.25$ (FC) (200/100cm)	Fusion fiber-200 $\mu\text{m}$ , NA0.22, FC/PC Adapter with $\Phi 1.25$ mm Ceramic Ferrule, bundle end-2m, beam splitting end-1m
YX0S-1*2-473-200/220-2.0- $\Phi 2.5$ (FC) (150/50cm)	Fusion fiber-200 $\mu\text{m}$ , NA0.22, FC/PC Adapter with $\Phi 2.5$ mm Ceramic Ferrule, bundle end -1.5m, beam splitting end-0.5m
YX0S-1*2-473-200/220-3.0- $\Phi 2.5$ (FC) (200/100cm)	Fusion fiber-200 $\mu\text{m}$ , NA0.22, FC/PC Adapter with $\Phi 2.5$ mm Ceramic Ferrule, bundle end-2m, beam splitting end-1m
YX0S-1*2-473-2.0- $\Phi 1.25$ (FC) (150/50cm)	Fusion fiber-200 $\mu\text{m}$ , NA0.37, FC/PC Adapter with $\Phi 1.25$ mm Ceramic Ferrule, bundle end-1.5m, beam splitting end-0.5m
YX0S-1*2-473-3.0- $\Phi 1.25$ (FC) (200/100cm)	Fusion fiber-200 $\mu\text{m}$ , NA0.37, FC/PC Adapter with $\Phi 1.25$ mm Ceramic Ferrule, bundle end-2m, beam splitting end-1m
YX0S-1*2-473-2.0- $\Phi 2.5$ (FC) (150/50cm)	Fusion fiber-200 $\mu\text{m}$ , NA0.37, FC/PC Adapter with $\Phi 2.5$ mm Ceramic Ferrule, bundle end-1.5m, beam splitting end-0.5m
YX0S-1*2-473-3.0- $\Phi 2.5$ (FC) (200/100cm)	Fusion fiber-200 $\mu\text{m}$ , NA0.37, FC/PC Adapter with $\Phi 2.5$ mm Ceramic Ferrule, bundle end-2m, beam splitting end-1m

### Fiber Optic Rotary Joint



Applicable to long time stimulation and observation experiments on awake and free moving animals, avoids twining of the fiber optic.

### Order Information:

Model	Product Description
R-FC-1x1	FC-FC Optic Fiber Commutator

## Fiber-optic Cannulas

### Features:

- Material: Ceramic, Optical fiber
- Type: White Series/Black Series
- Applicable wavelength: 400-2200nm
- Core diameter: 100µm, 200µm, 300µm, 400µm
- Numerical aperture: 0.22, 0.39, 0.50
- Outer diameter: 1.25mm (6.4mm long), 2.5mm (10.5mm long)
- Optical fiber length: 2mm-25mm (Ø1.25mm), 2mm-20mm (Ø2.5mm), step 0.5mm (Other lengths can be customized)
- Low auto-fluorescence



### Order Information:

No.	Model	Product Description
1	R-FOC-L200C-39NA	Fiber Optic Cannulae with Ø1.25 mm Ceramic Ferrule, 200um Core, 0.39NA, 20/pkg
2	R-FOC-L300C-39NA	Fiber Optic Cannulae with Ø1.25 mm Ceramic Ferrule, 300um Core, 0.39NA, 20/pkg
3	R-FOC-L400C-39NA	Fiber Optic Cannulae with Ø1.25 mm Ceramic Ferrule, 400um Core, 0.39NA, 20/pkg
4	R-FOC-F200C-39NA	Fiber Optic Cannulae with Ø2.5 mm Ceramic Ferrule, 200um Core, 0.39NA, 20/pkg
5	R-FOC-F300C-39NA	Fiber Optic Cannulae with Ø2.5 mm Ceramic Ferrule, 300um Core, 0.39NA, 20/pkg
6	R-FOC-F400C-39NA	Fiber Optic Cannulae with Ø2.5 mm Ceramic Ferrule, 400um Core, 0.39NA, 20/pkg
7	R-FOC-L200C-22NA	Fiber Optic Cannulae with Ø1.25 mm Ceramic Ferrule, 200um Core, 0.22NA, 20/pkg
8	R-FOC-L300C-22NA	Fiber Optic Cannulae with Ø1.25 mm Ceramic Ferrule, 300um Core, 0.22NA, 20/pkg
9	R-FOC-L400C-22NA	Fiber Optic Cannulae with Ø1.25 mm Ceramic Ferrule, 400um Core, 0.22NA, 20/pkg
10	R-FOC-F200C-22NA	Fiber Optic Cannulae with Ø2.5 mm Ceramic Ferrule, 200um Core, 0.22NA, 20/pkg
11	R-FOC-F300C-22NA	Fiber Optic Cannulae with Ø2.5 mm Ceramic Ferrule, 300um Core, 0.22NA, 20/pkg
12	R-FOC-F400C-22NA	Fiber Optic Cannulae with Ø2.5 mm Ceramic Ferrule, 400um Core, 0.22NA, 20/pkg
13	R-FOC-L200C-50NA	Fiber Optic Cannulae with Ø1.25 mm Ceramic Ferrule, 200um Core, 0.50NA, 20/pkg
14	R-FOC-F200C-50NA	Fiber Optic Cannulae with Ø2.5 mm Ceramic Ferrule, 200um Core, 0.50NA, 20/pkg
15	R-FOC-L400C-50NA	Fiber Optic Cannulae with Ø1.25 mm Ceramic Ferrule, 400um Core, 0.50NA, 20/pkg
16	R-FOC-F400C-50NA	Fiber Optic Cannulae with Ø2.5 mm Ceramic Ferrule, 400um Core, 0.50NA, 20/pkg
17	R-FOC-BL200C-39NA	Fiber Optic Cannulae(Black) with Ø1.25 mm Ceramic Ferrule, 200um Core, 0.39NA, 20/pkg
18	R-FOC-BL300C-39NA	Fiber Optic Cannulae(Black) with Ø1.25 mm Ceramic Ferrule, 300um Core, 0.39NA, 20/pkg
19	R-FOC-BL400C-39NA	Fiber Optic Cannulae (Black)with Ø1.25 mm Ceramic Ferrule, 400um Core, 0.39NA, 20/pkg
20	R-FOC-BF200C-39NA	Fiber Optic Cannulae (Black)with Ø2.5 mm Ceramic Ferrule, 200um Core, 0.39NA, 20/pkg
21	R-FOC-BF300C-39NA	Fiber Optic Cannulae (Black)with Ø2.5 mm Ceramic Ferrule, 300um Core, 0.39NA, 20/pkg
22	R-FOC-BF400C-39NA	Fiber Optic Cannulae (Black)with Ø2.5 mm Ceramic Ferrule, 400um Core, 0.39NA, 20/pkg
23	R-FOC-BL100C-22NA	Fiber Optic Cannulae (Black, yellow nylon coating)with Ø1.25 mm Ceramic Ferrule, 100um Core, 0.22NA, 20/pkg
24	R-FOC-BL200C-22NA	Fiber Optic Cannulae (Black, yellow nylon coating)with Ø1.25 mm Ceramic Ferrule, 200um Core, 0.22NA, 20/pkg
25	R-FOC-BL300C-22NA	Fiber Optic Cannulae (Black, yellow nylon coating)with Ø1.25 mm Ceramic Ferrule, 300um Core, 0.22NA, 20/pkg
26	R-FOC-BL400C-22NA	Fiber Optic Cannulae (Black, yellow nylon coating)with Ø1.25 mm Ceramic Ferrule, 400um Core, 0.22NA, 20/pkg
27	R-FOC-BF100C-22NA	Fiber Optic Cannulae (Black, yellow nylon coating)with Ø2.5 mm Ceramic Ferrule, 100um Core, 0.22NA, 20/pkg
28	R-FOC-BF200C-22NA	Fiber Optic Cannulae (Black, yellow nylon coating)with Ø2.5 mm Ceramic Ferrule, 200um Core, 0.22NA, 20/pkg
29	R-FOC-BF300C-22NA	Fiber Optic Cannulae (Black, yellow nylon coating)with Ø2.5 mm Ceramic Ferrule, 300um Core, 0.22NA, 20/pkg
30	R-FOC-BF400C-22NA	Fiber Optic Cannulae (Black, yellow nylon coating)with Ø2.5 mm Ceramic Ferrule, 400um Core, 0.22NA, 20/pkg
31	R-FOC-BL200C-50NA	Fiber Optic Cannulae (Black)with Ø1.25 mm Ceramic Ferrule, 200um Core, 0.50NA, 20/pkg
32	R-FOC-BF200C-50NA	Fiber Optic Cannulae (Black)with Ø2.5 mm Ceramic Ferrule, 200um Core, 0.50NA, 20/pkg
33	R-FOC-BL400C-50NA	Fiber Optic Cannulae (Black)with Ø1.25 mm Ceramic Ferrule, 400um Core, 0.50NA, 20/pkg
34	R-FOC-BF400C-50NA	Fiber Optic Cannulae (Black)with Ø2.5 mm Ceramic Ferrule, 400um Core, 0.50NA, 20/pkg

Notes: The above white series specifications can be customized to black.

## Ceramic Cannulas & Ceramic Ferrules Protective Caps



Ceramic Cannula



Ceramic Ferrules Protective Cap

### Order Information:

Model	Product Description
R-MS-1.25	Ceramic Sleeves, Ø1.25mm (20pcs/ pkg)
R-MS-2.5	Ceramic Sleeves, Ø2.5mm (20pcs/ pkg)
R-BMS-1.25	Black Ceramic Sleeves, Ø1.25mm (20pcs/ pkg)
R-BMS-2.5	Black Ceramic Sleeves, Ø2.5mm (20pcs/ pkg)
R-DC-2.5	FC/PC Ceramic Ferrules Protective Cap- Ø2.50mm (200pcs/pkg)
R-DC-1.25	LC/PC Ceramic Ferrules Protective Cap- Ø1.25mm (200pcs/pkg)

## Fiber Photometry System

The fiber photometry system records changes in the intensity of fluorescence of neurons in specific brain regions to characterize changes in the activity of neuronal populations. The fiber photometry system can detect population neurons in free-moving animals for long periods of time, which is helpful to explore the correlation between neuron activity and animal behavior.

RWD Multichannel Fiber Photometry System has three wave lengths, 410nm, 470nm and 560nm, of which 410 is used to acquire reference signal and eliminate noise. The system can record signal of green fluorescence indicator like GCaMP and dLight or neurotransmitter probe and red fluorescence indicator like RCaMP, jrGECO1a or neurotransmitter probe. The system also support 635nm light input for optogenetics stimulation and signal recording at the same site.



### Features:

- Three kinds of excitation light sources, that is 410nm,470nm and 560nm, are respectively used for excitation of reference, green fluorescence and red fluorescence;
- Support up to 9 channels, suitable for simultaneous experiment of multiple animals or multiple brain locations;
- Dual highly sensitive detectors enabling independent and sequential detection to avoid interference of fluorescence excitation and detection, acquiring more accurate signal;
- Professional acquisition and analysis softwares are flexible and easy to operate with data processing functions available. No matlab programming is required;
- Supports multiple acquisition modes including continuous acquisition, interval acquisition, acquisition upon trigger, delayed acquisition and timing acquisition;
- Live display of DeltaF/F acquisition to check scale of signal changes during acquisition;Supports simultaneous video acquisition of behaviors with multiple cameras;
- Customized adjustment of output signal parameter, easily trigger and control external excitation equipment to achieve closed-cycle control of excitation and recording;
- Compatible with optogenetics for recording and stimulation at the same site.

### Software functions

#### Professional acquisition and analysis softwares



Professional acquisition and analysis software enable stable data acquisition and easy processing. Data analysis includes data clipping, bleaching correction, smoothing, movement correction, event heat map, peak statistics, area under curve and heat map of behavior trajectory.

#### Rapid generation of heat map

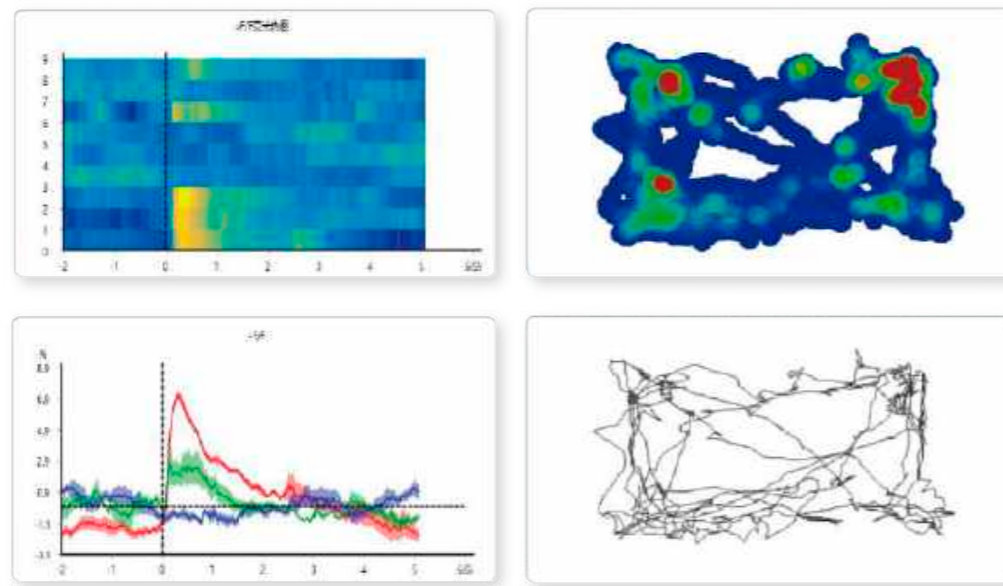

Generation of Peri-event heat map with one click. Supports comparison of data groups. Freely choose and handle events of interest, and flexibly add or remove events. The results can be easily saved and exported to DetaF/F, Z-score, Peri-event, peak statistics and AUC. Information in the image can be freely edited by saving the image as editable SVG format.

### Hardware functions

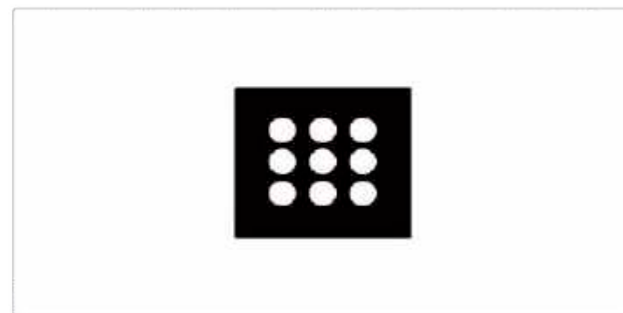

Supports up to 9 channels enabling high throughput acquisition and simultaneous detection of multiple downstream and upstream brain locations; optical fiber of low fluorescence can effectively reduce interference by background fluorescence



Dual highly sensitive detectors with green fluorescence and red fluorescence entering corresponding detector; independent and sequential detection to avoid interference of fluorescence excitation, acquiring more accurate signal



Stable LED light source and 3 types of excitation light sources to enable free combination of modes and support excitation of reference signal, green fluorescence and red fluorescence



4 Input ports, support a variety of external TTL signal trigger and marking; 4 Output ports, support outputting TTL signals to trigger external equipment; customize output parameters to meet the need of closed-cycle control.

#### Technical parameters:

Parameter item	Specification
Wavelength of excitation light	R811: 410nm 470nm; R821: 410nm 470nm 560nm
Power	Min 0μW, Max≥100μW, adjustable with an accuracy of 0.1μW
Number of channels	9 (200μm)
Frame rate of fluorescent sampling	Max 250fps
Exposure time setting range	1-100ms
Digital signal interface	4Input 4Output
Signal output	Output frequency 0-500Hz, adjustable output pulse width and duration
Marker	Manual marker (10), automatic marker (4), ROI marker (9)
Behavior camera	1920*1080(30fps) 1280*720(60fps) Switchable among multiple frame rates of resolution
Optogenetics compatibility	optional (for 635nm)
Electrophysiological grounding interface	Yes
Pre-installed software	Yes

#### Order Information:

Model of Fiber Photometry System	Product Description
R811	410nm, 470nm, Optogenetics compatibility
R821	410nm, 470nm, 560nm, Optogenetics compatibility

## Micropipette Puller

### MP-600 Micropipette Puller

RWD MP-600 micropipette puller is developed to solve the microelectrode problems in patch clamp and microinjection experiments. It has avant-garde intelligent operation interface, unique fixed position design of the heating filament and other user-friendly design. MP-600 integrates stability, intelligence and humanization, which can meet the requirements of microelectrode-related experiments and enhance user experience at the same time. In summary, MP-600 is an excellent choice for microelectrode related experiments.



#### Four Highlights:

- Unique fixed position design of the heating filament
- The integrated plug-in humidity control chamber
- Full-color capacitor operation interface
- The pulling of micropipettes is stable and efficient

**Features:**

- The unique fixed position design of the heating filament makes it easier to replace various models of filaments.
- The user interface adopts capacitive color touch screen (1024\*600px) with high sensitivity.
- The integrated plug-in humidity control chamber is easy to disassemble, which can keep the air around the filament and the capillary glass dry during the pulling process to avoid the adverse effect of humid air on the pulling result.
- Two microelectrodes with symmetrical tips are stably produced every time. The tip diameter can be less than 0.06 μm, the taper length 3~15 mm, and the impedance range from 1 to above 100MΩ with high repeatability.
- According to the type of the capillary glass tube and the heating filament and the kinds of glass microelectrodes to be pulled (patch clamp microelectrodes, intracellular recording microelectrodes, etc.), the corresponding pull protocols are provided as a reference and can be modified according to special requirements.
- The device can store up to 150 pulling programs.
- The system diagnostic function can be used to manually check whether all the components of the puller are in normal working condition.
- The preheat mode can reduce the influence of the accumulation of jaw heat on the consistency of the pulling results during continuous pulling.
- The safe heat mode can avoid the damage of the filament from high temperature.
- The front panel cover adopts a roller design, which is convenient for users to open easily.

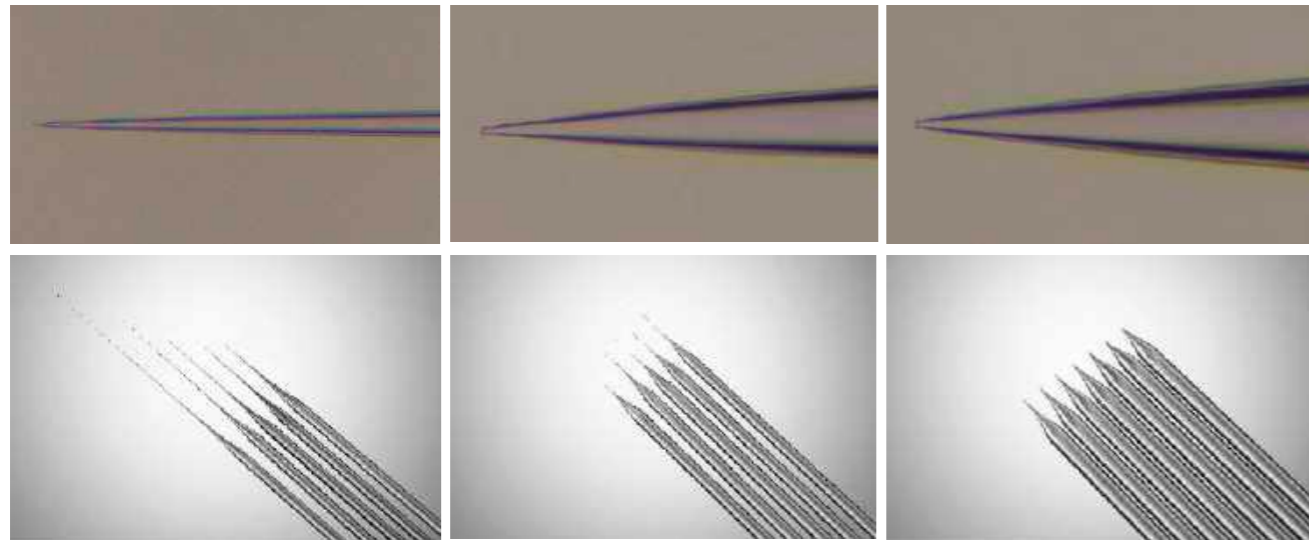

**Order Information:**

Model of micropipette puller	Product Description
MP-600 (HF-3025B)	Users can choose one of the three kinds of commonly used heating filament according to actual needs. One has already been installed on the puller before leaving the factory, and the other one is for replacement. In addition, we will add an additional filament that can be used for different types of experiments.
MP-600 (HF-3030B)	
MP-600 (HF-2545B)	
Model of heating filament	Platinum-iridium alloy(platinum90%, iridium10%)W× L of square box; HF=Heating Filament, B=Box
HF-3025B	2.5×3.0mm
HF-3030B	3.0×3.0mm
HF-2545B	4.5×2.5mm
Model of borosilicate glass with filament	Borosilicate glass with filament (O.D. × I.D. × L)B = Borosilicate, F = Filament, Qty: 200
B-10050-10F	1.0×0.5×100mm
B-10078-10F	1.0×0.78×100mm
B-12069-10F	1.2×0.69×100mm
B-12094-10F	1.2×0.94×100mm
B-15086-10F	1.5×0.86×100mm
B-150110-10F	1.5×1.1×100mm
B-15086-8.5F	1.5×0.86×85mm
B-150110-8.5F	1.5×1.1×85mm

**Motorized Micromanipulator**

**MM-500 Motorized Micromanipulator**

Motorized micromanipulators are mostly used to manipulate recording electrodes and stimulate the movement of electrodes in electrophysiological experiments. The MM-500 was designed to meet a wide variety needs for the scientific community, and is suitable for patch clamp experiments, microinjection, extracellular recording, intra-cellular recording and precision robotic positioning applications.



**Features:**

- Small and light size, humanized bilingual operation interface, flexible program debugging.
- The TFT screen shows the position and moving speed of the activated manipulator as well as X, Y and Z.
- High-resolution stepper motor meets four-axis drive, the maximum distance of X, Y, Z and diagonal movement is 25mm, with good stability and small drift.
- A rotary photoelectric encoder can control two manipulators and switch freely. Origin/working position function can meet the requirement of rapid return of electrode to original working position.
- Compatible with mainstream micromanipulation platform, can be used with any microscope, can hold a variety of probes and microsyringes.

**Technical parameters:**

Parameter item	Specification
Travel	25 mm on all four axes
Maximum Speed	2.9mm/s
Resolution	0.132μm/0.033μm
Long Term Stability	10nm/h at 24°C.
Repeated positioning accuracy	Single axis ≤1μm, three axis ≤2μm

**Order Information:**

Model of micropipette puller	Product Description
MM-500-2	Motorized micromanipulators(Double-handed setup)
MM-500-L	Motorized micromanipulators(Left-handed setup)
MM-500-R	Motorized micromanipulators(Right-handed setup)
MM-500L	Left-handed mechanical manipulator
MM-500R	Right-handed mechanical manipulator
MT-75/MT-150	Supporting column/Chamber column
MT-500	XY control moving platform Contains 3 supporting columns, 1 XY mobile platform, 1 microscope mounting bracket, 1 XY mobile platform mounting bracket
MT-800	Microscope moving platform Contain 1 XY mobile platform, 1microscope mounting bracket, 1XY mobile platform mounting bracket



# Olfactometer

## Olfactometer

RWD Olfactometer is based on odor stimuli associated with water reward feedback, and builds a learning task to quickly help users carry out mice cognitive assessment experiments. The Olfactometer supports 8 mice training at the same time, including sound cubicle, mouse head-fixing, licking rewards, odor control, signal transmission, IR camera and desktop software. The Olfactometer can deliver precise odors and study olfaction sensory physiology and study cognitive behavior response. The Olfactometer helps to carry out research on neurological diseases, cognitive learning mechanisms, and olfactory neural circuit.



### Features:

- High-throughput training for 8 mice, can be configured with 8 or 16 odor vials for maximum flexibility.
- System software includes Go/No-Go, DNMS, DPA working memory paradigm, and userdefined paradigm.
- Quickly odor pulse switchover, accurate lick counting module.
- Digital input/output module, TTL signals transmission.
- Odor control module associated with licking water reward module, integrated behavioral training system.
- Configure with IR camera recording real-time images of mouse licking behavior.



Support multi-channel independent and synchronous operation, and the interface displays the trial parameters in real time.



Channel details interface displays key result parameters such as Hit, Miss, False Choice, Correct Rejection, Lick Number, Performance, Correct Rate, and displays the gas cylinder status in real time.

### Technical parameters:

Parameter item	Specification
Channels	1/4/8
Odor vials	8/16
Odor rise time	<100 ms
Odor elimination time	<100 ms
Odor flow range	0-0.5 L/min
Air flow range	0-2 L/min
Liquid reward flow range	0-20 $\mu$ L
IR camera	600*480 pixels, 60 fps

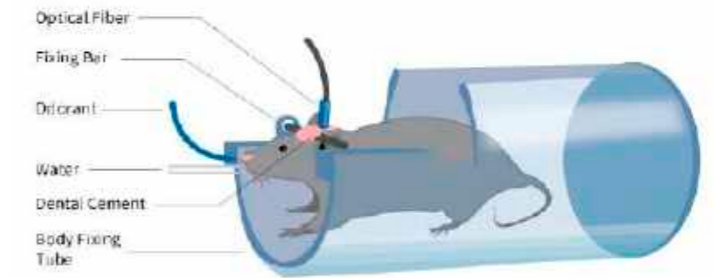

### Software internal Learning Task:

#### Go/No-Go task

The task trains mice to discriminate between two odors (A&B). Choosing the correct odor stimuli (S+) will be rewarded with liquid. Choosing the incorrect odor stimuli (S-) will not be rewarded.

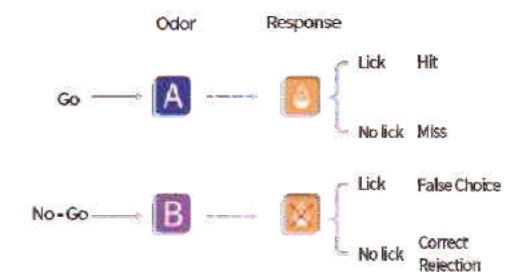

#### DNMS (Delayed Non-Matching to sample task)

The task trains mice to respond correctly based on the non-matching odor to obtain drinking rewards. Give the mice two odors one after another. If the two odors are different, choose licking the water tube will be rewarded with liquid. If the two odors are the same, choose licking the water tube will not be rewarded.

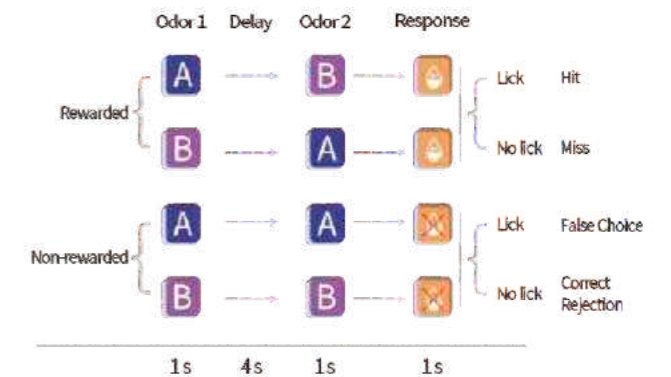

#### DPA (Delayed Paired Association task)

The task trains mice to respond correctly based on the pair-coupling relationship of odors to obtain drinking rewards. Give the mice two odors one after another. If the two odors are fixed combination (such as odor A&D, B&C), choose licking the water tube will be rewarded with liquid. In addition, odor combination (such as odor A&C, B&D), choose licking the water tube will not be rewarded.

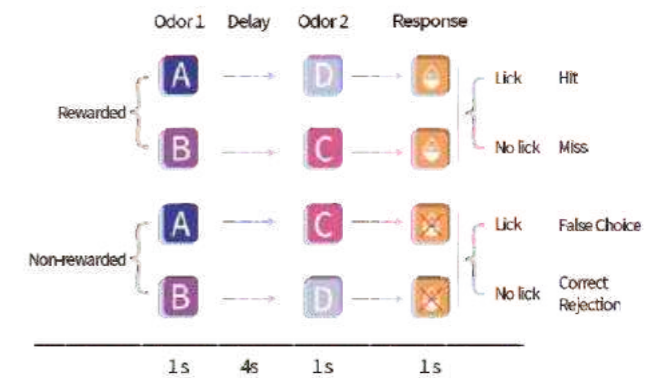

# In Vivo Imaging Solutions

## Laser Speckle Imaging System

Based on the Laser Speckle Contrast Imaging(LSCI) technology, RWD laser speckle imaging system provides real-time and full-field blood perfusion calculation. In non-contact way, reliable quantified data and high definition images can be obtained for various pre-clinical researches. It can be used to record the microcirculation of any exposed organ.



RFLSI ZW

Stable and reliable data, laser power change <1%

The optimal spatial resolution is 3.9 μm/pixel

### Product Features

Non-contact, No contrast agent

Multi-output: Data, Video, Image

### Order Information:

Model	RFLSI ZW
Monitoring range	0-5000 PU
Resolution	2064*1544
Maximum sample rate (regular)	100 FPS
Maximum sample rate (high resolution)	50 FPS
Maximum number of image composites - Spatial Algorithm	375
Maximum number of image composites - Temporal Algorithm	1500
Optical zoom	10X
Focus method	AF
Focus speed	4s
Camera Type	CMOS Global Shutter Camera
lens coating	Filter coating, beam splitting coating, polarizing coating
Monitoring laser	785nm
Indicating laser	650nm*2
Laser safety level	Class 1
Working distance	10-40cm
Maximum imaging area	22.5*30 cm <sup>2</sup>
Extensibility	2*BNC
Calibration block	√
Video magnification	0.25, 0.5, 1, 2, 4, 8, 16, 32, 64
Cooling method	Semiconductor refrigeration
Real-time working distance display	√
Auto Gain	√
Background removal function	√
Automatic threshold	√
Measurement and Analysis Methods	Online measurement, online analysis, offline analysis

### Related research topics

- Cerebral Cortex Blood Perfusion Monitoring
- MCA-Occlusion Assessment
- Cortical Spreading Depression Observation
- Hindlimb Ischaemia Research
- Skin Burn/Skin Flap Transplantation Research
- Organ Microcirculation Observation

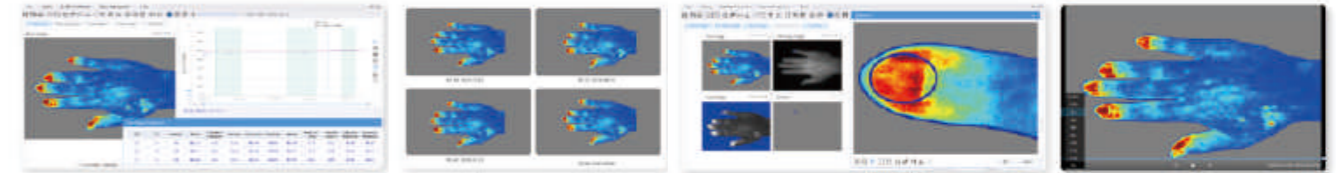

Simultaneous display of perfusion image/graph, and statistic analysis of ROI/TOI

Image comparison from different time points

Image magnification by free selection

Video preview/export with selected play rate (0.25X-64X, all 9 kinds)

### Partial references: (More than 100 articles have been published and more are in the works.)

- Tedeschi A, Larson M J E, Zouridakis A, et al. Harnessing cortical plasticity via gabapentinoid administration promotes recovery after stroke[J]. *Brain*, 2022, 145(7): 2378-2393.
- Song Z, Fang J, Wang Z, et al. Rod-Shaped Polymeric Nanoparticles Intervene Neutrophils for Efficient Ischemic Stroke Therapy[J]. *Advanced Functional Materials*, 2023: 2212326.
- Zhao Y, Zhu W, Wan T, et al. Vascular endothelium deploys caveolin-1 to regulate oligodendrogenesis after chronic cerebral ischemia in mice[J]. *Nature Communications*, 2022, 13(1): 6813.
- Shen C, Liu M, Xu R, et al. The 14-3-3 ζ - c-Src-integrin- β 3 complex is vital for platelet activation[J]. *Blood*, 2020, 136(8): 974-988.
- Xu K , Gao X , Xia G , et al. Rapid gut dysbiosis induced by stroke exacerbates brain infarction in turn[J]. *Gut*, 2021, 70(8): gutjnl-2020-323263. DOI:10.1136/gutjnl-2020-323263.
- Wu Y, Wu H, Zeng J, et al. Mild traumatic brain injury induces microvascular injury and accelerates Alzheimer-like pathogenesis in mice[J]. *Acta neuropathologica communications*, 2021, 9(1): 1-14.
- Wu Y, Tang X, Lee S, et al. Endothelial PPAR δ facilitates the post-ischemic vascular repair through interaction with HIF1 α [J]. *Theranostics*, 2022, 12(4): 1855.
- Lei H, Fan D. A Combination Therapy Using Electrical Stimulation and Adaptive, Conductive Hydrogels Loaded with Self-Assembled Nanogels Incorporating Short Interfering RNA Promotes the Repair of Diabetic Chronic Wounds[J]. *Advanced Science*, 2022, 9(30): 2201425.
- Martín-Aragón Baudel M, Flores-Tamez V A, Hong J, et al. Spatiotemporal control of vascular Cav1. 2 by α 1c S1928 phosphorylation[J]. *Circulation Research*, 2022, 131(12): 1018-1033.
- Xu X, Wang W, Wang Z, et al. DW14006 as a direct AMPK α activator ameliorates diabetic peripheral neuropathy in mice[J]. *Diabetes*, 2020, 69(9): 1974-1988.
- Wang S, Zhang J, Liu H, et al. The effect of blood velocity in solid tumor on intratumorally accumulation and penetration of nanocarriers and drugs[J]. *Nano Today*, 2023, 50: 101870.

### Case show

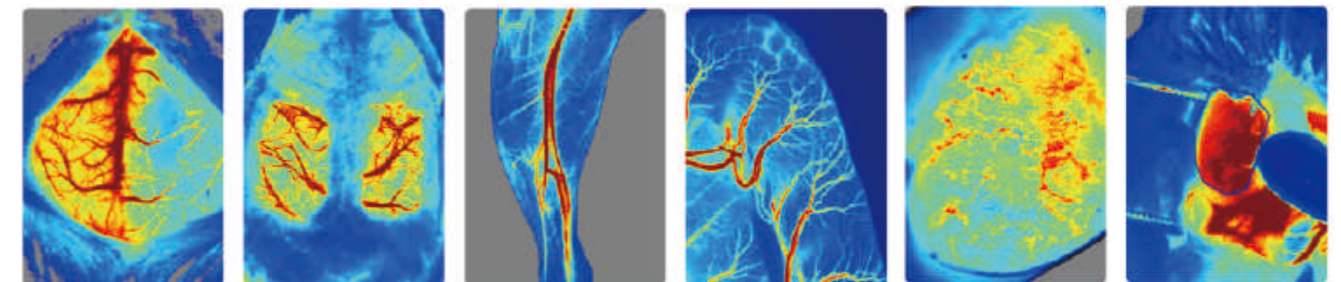

MCAO Model    CBF Monitoring    Hindlimb Ischemia    Septic Shock    Tumor Angiogenesis    Kidney blood Flow Monitoring

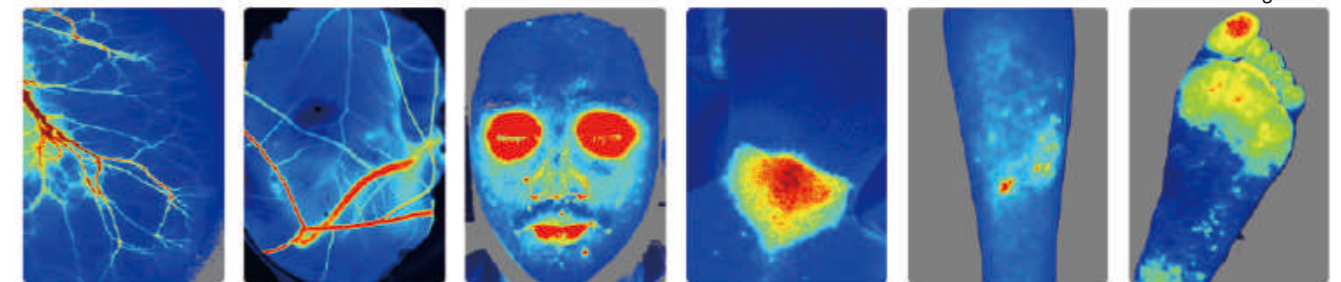

Thrombus    Chicken Chorioallantoic Membrane Assay    Skin allergies    Laser Therapy    Eczema    Diabetic Foot

# Animal Administration and Blood Sampling Solutions

## Drug Delivery Cannula

Cannula implantation is the international general method for acute and chronic intracranial drug administration in animal experiments. RWD offers customized services for users, the users can customize according to specific experimental requirements.



### Single Cannula

#### Components:

##### Guide cannula

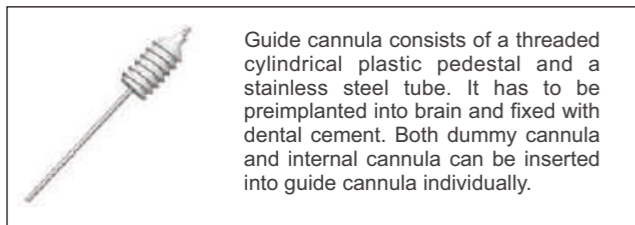

##### Dummy cannula

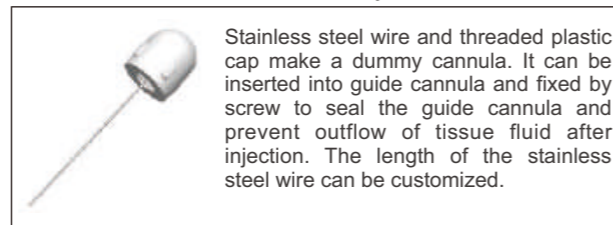

##### Metal Cannula



##### Internal cannula

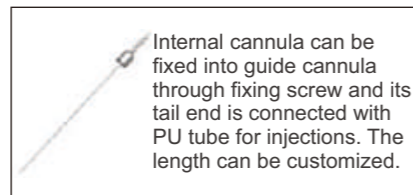

##### Fixing screw

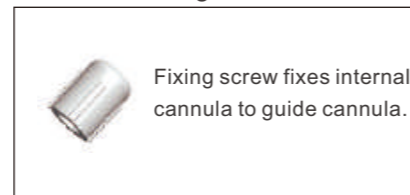

##### PU Tube

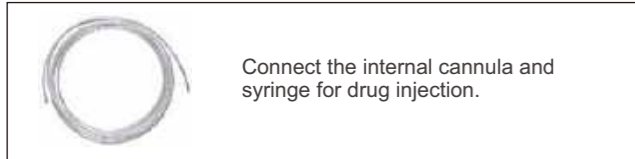

##### Pharmport

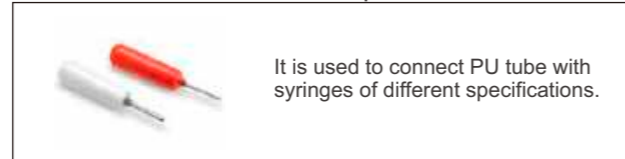

#### Cording Diagram:

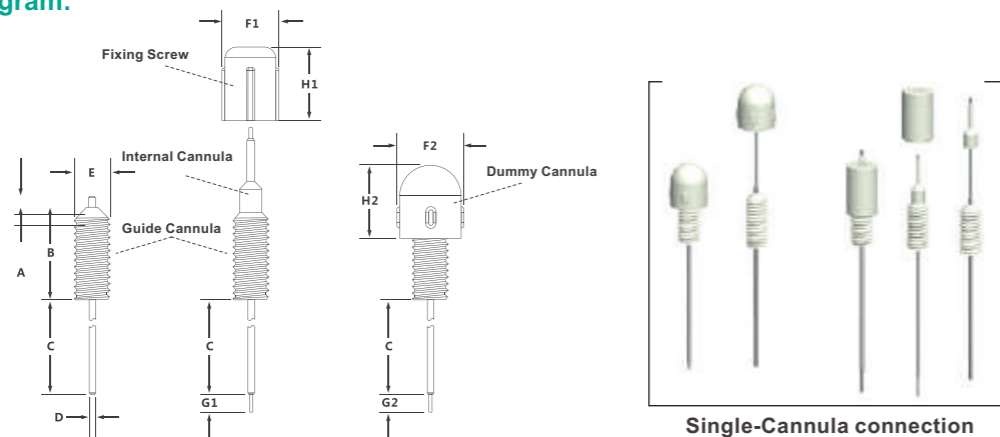

#### Diagrams:

- A - The length of the stainless steel tubing below the plastic pedestal.
- B - The height of the cylindrical plastic base.
- C - The length of the stainless steel tubing below the plastic pedestal, can be customized.
- D - External diameter of stainless steel guide cannulas.
- E - External diameter of cylindrical plastic base.
- F1 - External diameter of Fixing screw.
- F2 - External diameter of Dummy Cannulas.
- H1 - Height of Fixing screw.
- H2 - Height of Dummy Cannulas.
- G1- The internal cannulas projection length beyond the guide cannulas tip, can be customized.
- G2- The dummy cannulas projection length beyond the guide cannulas tip, can be customized.

#### Ordering Instructions:

- D-outer diameter of the Guide Cannula (Unit:g) , five sizes 22, 23, 24, 26 and 27g are available.
- C-length (Unit: mm) of the metal tube below the plastic pedestal (B).
- G1-length (Unit: mm) of the protrudent Injector through the Guide Cannula, 0.5 or 1.0mm is recommended.
- G2-length (Unit: mm) of the protrudent Dummy Guide, 0.5 or 1.0mm is recommended.

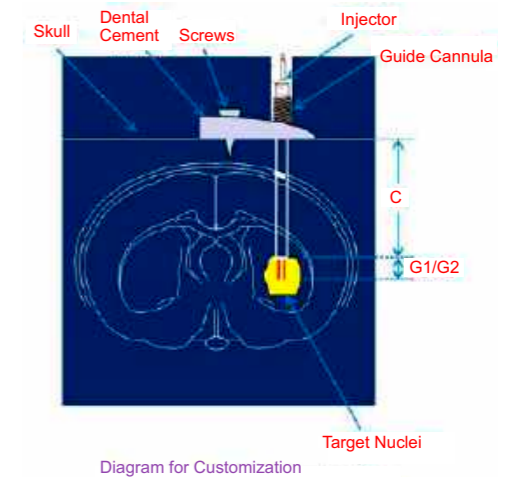

#### Order information (Unit: mm):

Matching	Guide Cannula (OD x ID)	Internal Cannula (OD x ID)	Dummy Cannula (plastic OD)	Dummy Cannula (metal OD)	Fixing Screw	PU Tube	Pharmport	Range of customized length		
								C	G1	G2
Cannula	62001(23g) 0.64x0.45	62201 0.41x0.25	62101 0.4	62106 0.4	62502	BC-22	P22-R P22-W	1~15	0.5~1	0.5~15
	62002(24g) 0.56x0.38	62202 0.36x0.2	62102 0.3	62107 0.3						
	62003(26g) 0.48x0.34	62203 0.3x0.14	62102 0.3	62107 0.3						
	62004(27g) 0.41x0.25	62204 0.21x0.11	62104 0.2	62108 0.2						
	62005(22g) 0.71x0.45	62201 0.41x0.25	62101 0.4	62106 0.4						

**Notes:** The height and external diameter of the cylindrical plastic base are 6mm and 3.5mm respectively. Plastic or metal dummy cannula is optional.

### Double Cannula

#### Introduction:

RWD has launched I, II, III and IV series double cannula systems for acute and chronic intracranial drug administration in animal experiments.

Series I: Recommended for rat or mouse use, 0.48mm (outer diameter) x 0.34mm (internal diameter).

Series II: Recommended for rat use, 0.64mm (outer diameter) x 0.45mm (internal diameter).

Series III: Specifically for mouse use, 0.48mm (outer diameter) x 0.34mm (internal diameter). The height of cylindrical plastic pedestal of Guide cannula is different from Series I.

Series IV: 0.41mm (outer diameter) x 0.25mm (internal diameter).

#### Application:

Double cannula system is used for bilateral implantation, suitable for injecting one or two drugs into two different brain regions.

**Cording Diagram:**

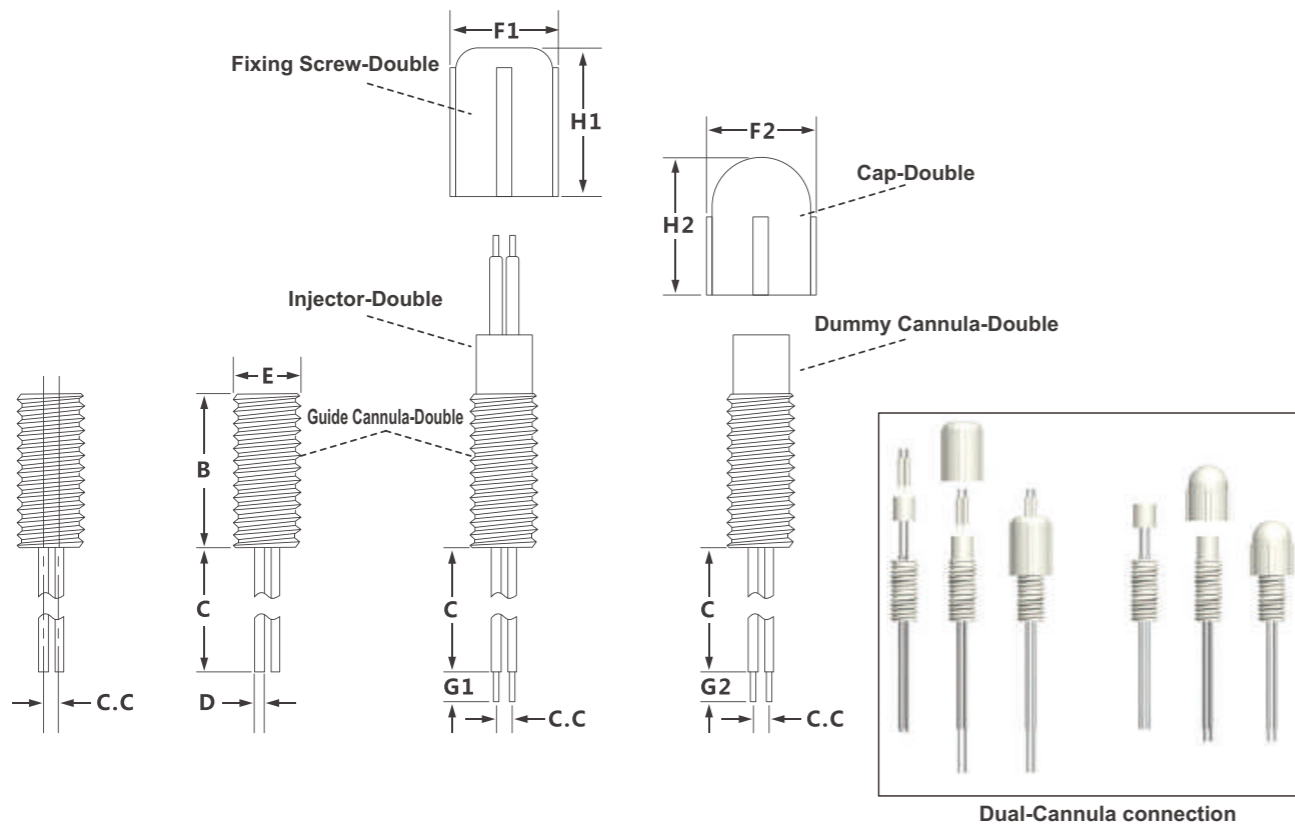

**Comments:**

- B - Height of cylindrical plastic pedestal which is 7.8mm for Series I, II & IV and 5.5mm for Series III
  - ★C - Length of stainless steel tube below the cylindrical plastic pedestal. The default value is 13.7mm for Series I & III, 20.0mm for Series II and 10.0mm for Series IV. The length can be customized with default value as maximum
  - ★C.C - Center distance between double guide cannulas, double dummy cannulas and double injectors. These 3 values should be the same in one system. It can be customized (range: 0.5mm-3.0mm)
- D - Outer diameter of stainless steel tube and it has 3 sizes: 0.48mm for Series I & III, 0.64mm for Series II and 0.41mm for Series IV
- E - Outer diameter of the cylindrical plastic pedestal and it comes with 3.5mm or 5.0mm. It is related to the outer diameter and centre distance between double guide cannulas
- F1 - Outer diameter of fixing screw and it comes with 5.0mm (when E=3.5mm) or 7.0mm (when E=5.00mm)
- F2 - Outer diameter of guide cannula cap and it comes with 5.5mm (when E=3.5mm) or 7.0mm (when E=5.0mm)
- H1 - Height of the fixing screw and it comes with 7.5mm (when E=3.5mm) and 8.0mm (when E=5.0mm)
- H2 - Height of guide cannula cap and it comes with 7.00mm (when E=3.5mm) and 7.5mm (when E=5.0mm)
  - ★G1 - Length of protruding part after internal cannula is inserted into guide cannula. This length can be customized
  - ★G2 - Length of protruding part after dummy cannula is inserted into guide cannula. This length can be customized

**Ordering Instructions:**

Determine the target brain region for drug administration and then determine target values of C, C.C, G1 and G2. These values can not exceed the default ones. Please refer to :

- ★ part of comments of cording diagram for more detail.
- ★ C: Maximal customized length is 13.7mm for Series I & III, 20.0mm for Series II and 10.0mm for Series IV.
- ★ C.C: Customized range is 0.5mm-3.0mm.
- ★ G1: Maximal customized length is 6.0mm for Series I, 4.0mm for Series II, 8.0mm for Series III and 4.0mm for Series IV.
- ★ G2: Maximal customized length is 2.0mm for Series I, 5.0mm for Series II, 4.0mm for Series III and 5.0mm for Series IV.

**Order Information: (Unit: mm)**

**Series I: Recommended for rat or mice**

Matching	C.C	Guide Cannula	Internal Cannula	Dummy Cannula	Cap	Fixing Screw	PU Tube	Pharmport	Range of customized length		
									C	G1	G2
Cannula (26G) O.D.0.48mmxI.D.0.34 mm Dummy Cannula: O.D.0.30mm Internal Cannula: O.D.0.30mm x I.D.0.14mm Plastic Pedestal of Guide Cannula: Height B = 7.8mm Diameter E = 3.5mm	0.6	62022	62250	62122	62523	62521	BC-22	P22-R P22-W	1~13.7	0,0.5~6	0,0.5~2
	0.8	62023	62223	62123							
	1.0	62024	62224	62124							
	1.2	62025	62225	62125							
	1.4	62027	62227	62127							
	1.5	62028	62228	62128							
	1.6	62029	62229	62129							
	1.8	62030	62230	62130							
Plastic Pedestal of Guide Cannula: Diameter E = 5 mm	2.0	62031	62231	62131	62524	62522	BC-22				
	2.2	62032	62232	62132							
	2.4	62033	62233	62133							
	2.6	62034	62234	62134							
	3.0	62036	62236	62136							

**Series II: Recommended for rat**

Matching	C.C	Guide Cannula	Internal Cannula	Dummy Cannula	Cap	Fixing Screw	PU Tube	Pharmport	Range of customized length		
									C	G1	G2
Cannula(23G) O.D.0.64mmx I.D.0.45 mm Dummy Cannula: O.D.0.40mm Internal Cannula: O.D.0.41mm x I.D.0.25mm Plastic Pedestal of Guide Cannula: Height B = 7.8mm Diameter E = 3.5 mm	0.8	62037	62237	62137	62523	62521	BC-22	P22-R P22-W	1~20	0,0.5~4	0,0.5~5
	1.0	62038	62238	62138							
	1.2	62039	62239	62139							
	1.4	62041	62241	62141							
	1.5	62042	62242	62142							
	1.8	62043	62243	62143							
Plastic Pedestal of Guide Cannula : Diameter E = 5 mm	2.0	62044	62244	62144	62524	62522	BC-22				
	2.2	62045	62245	62145							
	2.4	62046	62246	62146							
	2.8	62048	62248	62148							
	3.0	62049	62249	62149							

**Series III: Recommended for mice**

Matching	C.C	Guide Cannula	Internal Cannula	Dummy Cannula	Cap	Fixing Screw	PU Tube	Pharmport	Range of customized length		
									C	G1	G2
Cannula (26G) O.D.0.48mmxI.D.0.34 mm Dummy Cannula: O.D.0.30mm Internal Cannula : O.D.0.30mm x I.D.0.14mm Plastic Pedestal of Guide Cannula: Height B = 5.5mm Diameter E = 3.5mm	0.8	62052	62223	62123	62523	62521	BC-22	P22-R P22-W	1~13.7	0,0.5~8	0,0.5~4
	1.0	62053	62224	62124							
	1.2	62054	62225	62125							
	1.4	62056	62227	62127							
	1.5	62057	62228	62128							
	1.6	62058	62229	62129							
	1.8	62059	62230	62130							
	2.0	62060	62231	62131							

Series IV: Recommended for mice

Matching	C.C	Guide Cannula	Internal Cannula	Dummy Cannula	Cap	Fixing Screw	PU Tube	Pharmport	Range of customized length		
									C	G1	G2
Cannula (27G) O.D.0.41mm x I.D.0.25 mm Dummy Cannula: O.D.0.20mm Internal Cannula: O.D.0.21mm x I.D.0.11mm Plastic Pedestal of Guide Cannula: Height B = 7.8mm Diameter E = 3.5mm	0.6	62062	62251	62162	62523	62521	BC-22	P22-R P22-W	1~10	0,0.5~4	0,0.5~5
	0.8	62063	62263	62163							
	1.0	62064	62264	62164							
	1.2	62065	62265	62165							
	1.4	62067	62267	62167							
	1.5	62068	62268	62168							
	1.6	62069	62269	62169							
	1.8	62070	62270	62170							
2.0	62071	62271	62171								

Notes : (1)For cap, plastic or metal is optional. Metal cap 62525 (corresponding plastic cap 62523), Metal cap 62526 (corresponding plastic cap 62524).

(2)The difference between Series I and Series III is the height of the pedestal, the former is 7.8mm and the later is 5.5mm, and Series III is specially designed for mice

Screws



Model	Product Description
62513	Screw-M1.0xL2.0mm
62514	Screw-M1.2xL2.0mm
62515	Screw-M1.4xL2.5mm

Osmotic Pumps

The osmotic pump has become the best tool for continuous dose of unrestrained laboratory animals. It can be implanted subcutaneously or intraperitoneally in animals. Minimizes side effects and experimental variables, and reduces the risk of stress due to frequent animal handling. And it is used for continuous delivery of a wide range of drugs, including antibodies, growth factors, cytokines, chemotherapeutics, addictive drugs, hormones, steroids and more.



Features:

- Ensure continuous and uninterrupted administration, maintaining the preset speed for the administration of the animal.
- Storage capsules have good drug compatibility, and protection for short half-life drugs.
- Capsules have good biocompatibility and do not affect the physiology of animals.
- Easy to use, It allows one-time operation in an experiment instead of frequent operation.
- Avoid the stress caused by repeated administration, reducing the impact of non-experimental factors on the experimental results.
- Small size, can be applied to experiments on mice, neonatal rats and other small animal.
- Ensure that the drug is delivered to the target site accurately.

The osmotic pump can be directly implanted in the abdominal cavity or the back of the neck for drug administration, or it can be applied to specific tissue and organ, such as blood vessels, brain, spinal cord, subcutaneous part, abdominal cavity, etc., by connecting the catheter or other accessories.

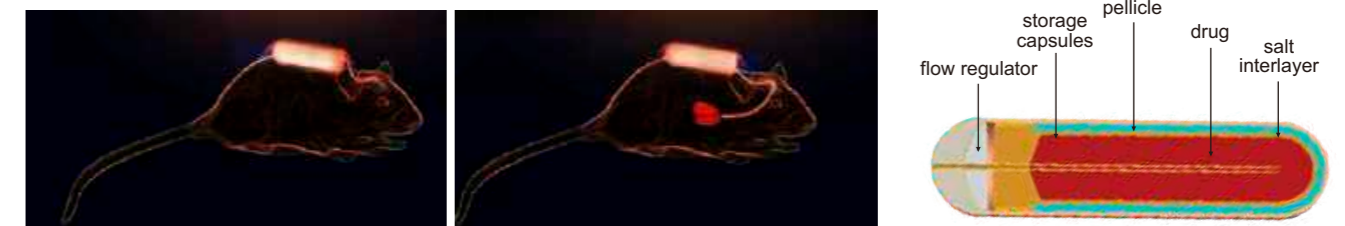

- Flow regulator: The sole outlet for drug solution, which is used to connect the catheter to target administration area.
- Storage capsules: Fill with solution. It has good corrosion resistance to acid and alkali.
- Shell: Firmness, designed to protect the internal structure of osmotic pump, with fluid passability characteristics.
- Salt interlayer: absorption of tissue fluid by osmosis. After the salt interlayer absorbs the tissue fluid, it can only be extruded inwards to slowly pump the solution out of the capsule.
- Pellicle: prevents the salt layer from diffusing into the tissue, and ensures that the tissue fluid can enter the salt layer to squeeze the storage capsule and pump out the drug solution

Technical Parameters:

Capsule (10 pieces/box)	Capacity	100µL					200µL				2mL		
	Type	1003D	1001W	1002W	1004W	1006W	2003D	2001W	2002W	2004W	2ML1W	2ML2W	2ML4W
	Duration	3D	1W	2W	4W	6W	3D	1W	2W	4W	1W	2W	4W
	Pumping Rate(µL/hr)	1	0.5	0.25	0.13	0.083	2.0	1.0	0.5	0.25	10.0	5.0	2.5
Flow regulator (10 pieces/box)	Cap	Without					PE material						
	Tube	304 stainless steel material											
Infusion (1 pieces/box)	Syringe	Flat head for the injection of liquid											

Osmotic pump kit information(optional):

	Model	Description
Brain Infusion Kit	Bic-3	For 1-3mm deep brain area administration (10 Bags/ Package)
	Bic-5	For 3-5mm deep brain area administration (10 Bags/ Package)
Catheter Delivery Kit	Mic	For long-distance muscle administration (10 Bags/ Package)



# Blood Sampling and Administration System

The catheter is surgically inserted into the target location (jugular vein, carotid artery, bile duct, portal vein, etc.), and the Implant Button is then fixed subcutaneously, allowing simultaneous drug administration and blood sampling. It is suitable for manual continuous and repeated blood sampling and drug administration, long-term automatic drug administration and blood sampling by machine.

### Features:

- Suitable for up to 10 sampling sites such as jugular vein, carotid artery, femoral vein and bile duct.
- The design is compact and firm, not easy to be damaged by animals, and the biocompatibility has been verified by experiments.
- It can be matched with syringes, catheters and other sampling methods.
- Effectively reduce the stress reaction caused by repeated injection.



### Components:

#### Implant Button



The Implant Button consists of transparent shell, magnet, felt and capillary tube. Catheter is connected to capillary tube and inserted into a blood vessel. The Button is implanted subcutaneously and fixed by suturing the epidermis.

#### Pharmport



The Pharmport consists of shell (red and white) and capillary tube, sizes: 25g and 22g. The Pharmport is connected with the Implant Button as a simple infusion and blood sampling device.

#### Catheter connector



The Catheter connector is composed of shell and capillary tube, size: 25G, 22G. For connecting Pharmport and PE tubes in vitro.

#### Syringe connector



Syringe connector is composed of transparent shell and capillary tube, with a size of 25G. The front end of the injection needle can be directly inserted into the Pharmport for infusion and blood sampling, the rear end can be connected with the standard syringe.

#### Implant Button Cap



The Implant Button cap is made of high quality duralumin alloy and magnet. When the Implant Button is not in use, The cap can be used to ensure that the injection end is not contaminated. The magnet allows the operator to quickly attach the cap to Implant Button.

#### Handling



The Handling is made of high quality duralumin alloy and magnet. Fix the animal with one end of the Handling to pull out the Implant Button Cap, and then use the other end (including magnet) to continue to fix the animal for infusion or blood sampling operation.

#### Catheter



The size of the catheter matches the capillary of the Implant Button, and the catheter can be inserted into the blood vessels of experimental animals. The node ensures that the catheter is not easy to fall off after implantation.

#### Swivel



The swivel can rotate as the animal moves. It can protect the catheter at the tether side from kinking or tangling. It also supports blood sampling and infusion when animals are awake and active.

#### Tether



The tether of the catheter may be used in combination with the swivel and the implantable vascular access button, to protect the catheter connected to the button from being kinked or dislodged, supporting sampling or infusion when animals are awake and active. It is ideal for self-administration tests.

#### Multi-axis counter-balanced lever arm



The multi-axis counter-balanced lever arm comes in two styles, and the swivel mount can vertically move with the animal. Mating the swivel, it can make blood sampling and infusion possible when animals are awake and active.

#### Bile circulator



The bile circulator is attached to the implantable vascular access button for rats, in conjunction with the catheter for rat bile duct, to suit the need for long-term collection of bile or duodenal injection of target test fluids.

### Order Information:

Product Description	Model
Implant Button (single channel 25G for mice-white)	
Implant Button (mouse dual channel 25G/25G)	BMD25/25
Implant Button (single channel 22G for rat-white)	BRSW22
Implant Button (single channel 22G for rat-Rad)	BRSR22
Implant Button (Rat dual channel 22G/22G)	BRD22/22
Catheter connector (22G)	C22
Catheter connector (25G)	C25
Syringe connector	SC-1
Pharmport (22G Red)	P22-R
Pharmport (22G White)	P22-W
Pharmport (25G Red)	P25-R
Pharmport (25G White)	P25-W
Implant Button Cap (mouse single channel-silver)	CMSC-S
Implant Button Cap (mouse single channel-gold)	CMSC-G
Implant Button Cap (mouse dual channel-gold)	CMDC-G
Implant Button Cap (rat-silver)	CRSC-S
Implant Button Cap (rat-gold)	CRSC-G
Handling	BH
Carotid Artery Catheters for Rats	PURCA
Jugular Vein Catheters for Rats	PURJV

Product Description	Model
Bile Duct Catheters for Rats	PURBD
Portal Vein Catheters for Rats	PURPV
Femoral Artery Catheters for Rats	PURFA
Femoral Vein Catheters for Rats	PURFV
Jugular Vein Catheters for Guinea pigs	PUCJV
Carotid Artery Catheters for Guinea pigs	PUCCA
Carotid Artery Catheters for Mice	PUMCA
Jugular Vein Catheters for Mice	PUMJV
Swivels (Single Channel 22G)	SS1-22
Swivels (Single Channel 25G)	SS1-25
Swivels Mount for Mice	MLA-M
Swivels Mount for Rats	MLA-R
Tether (mouse single channel)	TM-1
Tether (mouse dual channel)	TM-2
Tether (drug administration for Rat)	TR-1dr
Tether (blood sampling for Rat)	TR-1bl
Tether (rat dual channel)	TR-2
Bile Loop	DZXHQ
PE Tubing 22	BC-22
PE Tubing 25	BC-25

## Syringe Pumps

### R462 Syringe Pump

RWD series syringe micro-injection pumps are widely used in scientific research. The upgrade from the first generation to the current second-generation products includes single-channel and dual-channel options.



#### Features:

- Control the stepper motor for stable and high-precision operation at low speed.
- The communication with the touch screen of the host computer can control the output torque and rotation speed of the stepper motor according to the input, and then control the injection thrust and injection speed.
- Reserved communication interface (BNC, USB-B, and PC communication, RS485 multi-injection pump communication).
- Can input and output, 15-pin D-sub Connector.
- With encoder, feedback speed, alarming when speed is abnormal, equipment operation suspend.
- Safety certification: EMC, ESD, and CE.
- Running indicator: convenient for users to intuitively discover the current status of the pump.

#### Order Information:

Model	Name	Note
R462	RWD 462 Syringe Pump	Dual-channel

#### Technical Parameters:

Operating mode	Injection/withdrawal
Injection accuracy	± < 0.35%
Repeatability	± < 0.05%
Syringe range	0.5µL-60 mL
Minimum flow rate	0.0001 µL / min (0.5 µL syringe)
Maximum flow rate	102 mL/min (60 mL syringe)
Linear thrust	50lbs (23 kg)
Operating temperature	4 °C to 40 °C
Storage temperature	-10 °C ~ 70 °C
Humidity	20% to 80%, non-condensing
Communication interface	USB-B, BNC, RS485 and TTL ports
Advance stroke per step	0.046µm / step
Display	5.0-inch LCD touch screen

### R-480 Nanoliter Injection Pump

The newly launched R-480 Nanoliter Injection Pump is highly precise & airtight, stable & easy to operate, which can be used to accurate microinjection or suction for oocytes, larva, protozoa, animal brain, eyeball, etc.



#### Features:

- Stable operation and high injection precision
- High airtightness, ensures no leakage during injection or withdrawal
- The brightness of the screen can be adjusted to meet different experimental situations
- Added the function to set needle retention time. A timer is no longer required if the needle is retained after the injection

#### Technical Parameters:

Operating mode	Injection/withdrawal
Injection Volume	0.6 nL-5000 nL
Minimum flow rate	0.02 nL/s
Maximum flow rate	200 nL/s
Emptying rate	0.02 nL-200nL/s
Withdrawing rate	0.02 nL-200 nL/s
Glass Capillary size	OD1.14mm, ID0.53mm
Minimum injection volume resolution	0.1 nL
Circle	1-8000
Display	5.0-inch LCD touch screen

#### Order Information:

Accessory Name	Model	Description	Quantity	
R-480 Nanoliter Injection Pump	—	Host(including Injector Head )	1	Standard configurations
Power adapter	—	Plug-in power wire for device power input	1	
3.5-inch (8.89cm) glass capillary	GC-3.5	Attached to the Injector head for injection;OD1.14mm,ID0.53mm	100	
7-inch (17.78cm) glass capillary	GC-7	Attached to the Injector head for injection;OD1.14mm,ID0.53mm	100	
Fixed fittings	R480-SF	For conjunction with brain stereotaxer and micromanipulator	1	
Filling needle	R480-FN	For filling mineral oil: 30 Gauge, 2" length	1	
Sealing material	R480-SM	For replacing the sealing material inside the Injector Head	1	
Foot switch	R480-FS	For foot controlled injection	1	Optional Accessories
Adapter for Micromanipulator	R480-AFM	With special accessories for RWD Motorized Micromanipulator	1	
Vattachment	68207	Accessory equipped with stereotaxic instrument	1	

# Pathological Section Solutions

## Minux® Rotary Microtomes(S700/S700A)

Rotary microtome is a device for paraffin section,widely used in medical and biological research. It is used for pathological diagnosis in clinical,and used for research at the tissue and cell level.



### ► Features:

#### Visual pointer

- » Designed with the visual pointer on precise positioning system, easy to adjust the sample to the target angle, reducing trimming and sample waste.
- » Adjust multiple devices to the same angle easily and quickly.

#### The side knobs

- » Integrated with the machine, ergonomic design, make operation more comfortable and coordinated.
- » The sample feeding speed can be adjusted freely between 0-1800µm/s, more choice and more efficient.
- » Durable military-grade devices, service life is more than 20 million times.

#### Automatic section

- » It is stable and maintains slice consistency.
- » No extra skills required, easy to complete the operation.
- » Some specimens such as embryos and brains need to be cut for hundreds of pieces. It is hard for you, but easy for automatic section.

#### Easily removable waste tray

- » With magnetic function, easy to disassemble and install.
- » Special coating materials tray, easy to clean up, shorten the cleaning time to a few seconds.

### ► Technical Parameters

Parameters	Model	S700 Semi-Automated	S700A Fully-Automated
Section thickness setting range: 0.5 - 100 µm		✓	✓
Trimming section thickness setting range: 1 - 800 µm		✓	✓
Electric coarse feed speed: 0-1800µm/s		✓	✓
Specimen retraction: 0-250µm		✓	✓
Specimen feed: 28mm, vertical stroke: 70mm		✓	✓
Specimen orientation: X/Y axis 8°, Z axis 360°		✓	✓
Maximum specimen size:55*50*30mm		✓	✓
Automated mode and manual mode switch			✓
Emergency stop button			✓
Cut window function			✓
Slice speed selection			✓
Four slice modes: Int.,Single,Cont., Multi.			✓
Pedals(optional)			✓

### ► Order Information

Cat No.	Product Description
S700A	Fully-Auto rotary microtome
S700	Semi-Auto rotary microtome
S700-F3	Universal clamp
S700-F4	Standard clamp
S700-F7	Blade holder assembly
S700-F9	Blade holder upper bracket
S700-F10	Easy-clean waste tray
S700A-F3	Foot Switch for Rotary & Cryostat Microtome (optional)

### ► Disposable Microtome Blades-low profile



#### ► Features:

- Sharp and durable, cost-effective
- For rotary microtomes and cryostats use
- Packed in a push-out distribution box for easy access

### Order Information

Cat No.	Product Description
PB-2	Disposable Microtome Blades, 80mm*8mm*0.25mm, 50 pcs, for paraffin and frozen section



## Minux® Rotary Microtomes (S710/S712)



### ► Precise

#### Precise sampling system

- Precise cross roller bearings and screw rod, combined with a five-phase high-resolution stepper motor and a Link block made of aviation aluminum, form a high-precision sampling system to ensure section quality.
- Stable gantry structure design, high hardness alloy transfer, improve the rigidity of the host, and the hard tissue section is still accurate.

#### Precise knife holder

- The position change is extremely small after changing the knife edge by moving sideways.
- Scales on the knife holder to determine the best position of the blade holder.

### ► Safe

#### Dual hand wheel locking system

- Handwheel lock on top of the handwheel, safe to replace the sample. Any position lock to brake the handwheel in any position.
- Sample advance and retreat, trim/section conversion, thickness adjustment, position memory and half-knife function can be realized by using separate control panel.

#### Hand wheel balance at any position

- The handwheel can be stopped at any position, making it more secure to use

#### Knife guard device

- The knife guard covers the full length of the blade to avoid potential injury during operation.

### ► Convenient



#### Rapid positioning

- Unique visual pointer, visible angle adjustment. Sample positioning is faster and more precise.
- Adjust multiple devices to the same angle easily and quickly.



#### Convenient operation

- The small handwheel injection method is used with the side knob to adjust the slice thickness, which is ergonomically designed and the operation is more comfortable.
- The single-turn sampling distance of the small handwheel can be adjusted to meet individual needs.
- The torque at any position is lower than 2.5 kgf·cm, the operation is easy, and it is easy to use all day.



#### Easy to clean

- With magnetic function, easy to disassemble and install.
- Large capacity, special coating waste tray, easy to clean up, shorten the cleaning time to a few seconds.

#### Information backtracking

- With historical record system, operation and alarm logs are show on 5-inch touch screen, to query the microtome usage and facilitate information tracking.

### ► Available accessories



Universal clamp  
S700-F3



Standard clamp  
S700-F4



Blade holder assembly  
S700-F7



Blade holder upper bracket  
S700-F9



Separate Control Panel  
S710-F1

### ► Quick Compare Chart

Parameter	Model	S710	S712
Section thickness range: 0.5 - 100 μm		✓	✓
Trimming section thickness range: 1 - 800 μm		✓	✓
Electric coarse feed: 0 - 1800μm/s adjustable		✓	✓
Specimen retraction: 0 - 250μm adjustable		✓	✓
Horizontal feed: 28mm		✓	✓
Vertical stroke: 70mm		✓	✓
Specimen orientation: X/Y axis 8°		✓	✓
Maximum specimen size: 55*50*30mm		✓	✓
W x Dx H: 490*430*315mm		✓	✓
Machine Weight:30kg		✓	✓
Rock mode		✓	✓
Position memory function		✓	✓
Separate Control Panel		Option	Standard

## Minux® Cryostats (FS800/FS800A)

Cryostat is a device for rapidly cooling tissue to a certain hardness under low temperature conditions and then slicing. It is a quick and easy method.

Hospitals mainly use it for rapid pathological diagnosis during surgery. Researchers use it for preparation of biological tissue samples for in situ hybridization, immunohistochemistry, etc.



### ► Features

#### Stable

- **Stable temperature:** advanced temperature control system, small temperature fluctuations. Even if the window is opened for more than 1 hour, the temperature is still stable.
- **Stable slice quality:** high-precision cross rail and screw, five-phase high-resolution sampling motor and horizontal sampling slider made of aviation aluminum, form a precise sampling system to ensure stable slice quality.

#### Safe

- **UVC disinfection:** the latest low-temperature UVC disinfection technology. The irradiation intensity can effectively kill bacteria and viruses, disinfect the inner surface and the air of the cabinet, and reduce the risk of contamination by infectious materials.
- **Waste liquid management system:** a waste liquid volume display on the touch screen. There are reminders of full bottle and not in place to prevent waste liquid from flowing out and contaminating the ground.

#### Efficient

- **Efficient operation:** the color touch screen, with a joystick that integrates coarse sample feeding, trimming and section switching, and slice parameter adjustment, constitutes an efficient operating system.

- **Quick positioning:** precise positioning system with  $\pm 8^\circ$  visual pointer, easy to adjust the specimen clamp to the target angle, reducing trimming and sample waste.
- **Automatic sleep and wake-up:** saving energy, simplify manual operation and reduce waiting time.
- **Sample installation and marking:** Buckle design, convenient installation and firm fixation. The unique label design of specimen discs makes it easy to record and identify each sample to prevent confusion.
- **Efficient and thorough defrosting:** automatic defrosting for cryochamber, specimen head, quick-freeze shelf, more thorough. For manual defrosting, there are different parts to choose to improve efficiency.

### ► Technical Parameters

Parameters	Model	FS800 Semi-Automated	FS800A Automated
Section thickness setting range: 0.5 - 100 $\mu\text{m}$		✓	✓
Trimming section thickness setting range: 1 - 800 $\mu\text{m}$		✓	✓
Electric coarse feed speed: 0-1800 $\mu\text{m/s}$ adjustable		✓	✓
Specimen retraction: 0-250 $\mu\text{m}$		✓	✓
Specimen feed: 28mm		✓	✓
Vertical stroke: 70mm		✓	✓
Specimen orientation with visual pointer: X/Y axis $8^\circ$ , Z axis $360^\circ$		✓	✓
Number of refrigerated sites: 15		✓	✓
Number of fast cooling sites: 2		✓	✓
Cryochamber temperature range: $0^\circ\text{C}\sim-35^\circ\text{C}$		✓	✓
Automatic and manual defrosting		✓	✓
Automatic and manual UVC disinfection		✓	✓
Automated mode and manual mode switch			✓
Emergency stop button			✓
Cut window function			✓
Slice speed selection			✓
Four slice modes: Int., Single, Cont., Multi.			✓
Pedals(optional)			✓

### ► Order Information

Cat No.	Type	Product Description
FS800	Specimen	Semi-Auto,with UVC disinfection,specimen cooling system
FS800A	Auto	Fully-Auto,with UVC disinfection,specimen cooling system,auto section function

# Cellular and Molecular Biology Research Solutions

## Single Cell Suspension Dissociator

RWD Single cell suspension dissociator uses tissue processing tubes, tissue dissociation kits, and built-in optimization programs for preparing high-activity single-cell suspension and tissue homogenate. The preparation of single-cell suspension with high cell viability can be completed within 15-30 minutes, which makes the experiments more reproducible. 4 or 8 independent operating channels and heating jackets can automate the processes and improve the efficiency of tissue processing. It is widely used in single-cell sequencing, primary cell culture, fluorescence activated cell sorting, cell therapy, and other research fields.



Tube position detecting



Visualized and editable programs

### Product Characteristics

#### Intelligent

- Pre-defined standard processes and 500 customized processes supported.
- Processes can be imported and synchronized via USB ports.

#### Safe

- Multiple alarms guarantee the safety of both operators and samples.
- Fully sealed tube prevents contamination of cells.

#### Gentle

- Stable motor speed ranges from 0 to 4000 rpm.
- Customized tissue dissociation kits and tissue processing tubes can ensure cell viability and reduce experimental losses.

#### Efficient

- 4 or 8 independent channels work simultaneously for different tissue processing.
- Heating jackets are available for fully automated sample preparation.
- Capable of single-cell suspension and tissue homogenate.

### Technical Parameters:

Model	DSC-400	DSC-800
Sample volume	20-4000 mg	
Buffer volume	0.3-10 mL	
Speed	0-4000 rpm	
Temperature	37°C	
Operation method	Touch screen	
Channels	4	8
Dimensions (W*D*H)	215*380*190 mm	415*381*256 mm
Weight	10.3 kg	18 kg

### Order Information

Cat No.	Product Description
DSC-400	Single cell suspension dissociator
DSC-800	Single cell suspension dissociator
SCT-25	Tissue processing tube(25pcs/box)
SCT-100	Tissue processing tube(100pcs/box)
HJ-400	Heating Jacket(4 pcs)

### Consumables:

#### Tissue Processing Tube

- Ethylene oxide(EO) sterilized
- Independent packaging make it convenient for storage and use



\*The tissue processing tubes of RWD are not available in the USA market

### Order Information:

Model	SCT-25	SCT-100
Sample volume	20-4000 mg	
Buffer volume	0.3-10 mL	
Dimensions	35*89 mm	
Package	25pcs/box	100pcs/box

### Enzymatic Digestion Kit

- Targeted optimization of enzymatic hydrolysis formula can ensure high cell viability
- Preserving cell surface epitopes leads to no effect for downstream experiments



### Order Information:

Product Description	Model	Number of reactions
High Activity Tumor Tissue Enzymatic Digestion Kit (Mouse)	DHTE-5001	50T
High Activity Neonatal Brain Enzymatic Digestion Kit (Mouse and Rat)	DHNBE-5002	50T
High Activity Adult Brain Enzymatic Digestion Kit (Mouse and Rat)	DHABE-5003	50T
High Activity General Tissue Enzymatic Digestion Kit	DHGT-5004	50T
High Activity Tumor Tissue Enzymatic Digestion Kit (Human)	DHTEH-2505	25T
High Efficiency Debris Removal Kit	DHDR-5006	50T
High Activity Intestine Tissue Enzymatic Digestion Kit (Mouse)	DHIE-5007	50T
High Activity Brain Tumor Enzymatic Digestion Kit	DHBTE-2508	25T
High Activity Whole Skin Enzymatic Digestion Kit (Mouse)	DHWSE-2509	25T
High Activity Adipose Tissue Enzymatic Digestion Kit (Mouse and Rat)	DHAE-5010	50T

## Magnetic Microbeads Cell Separation Products

RWD cell separation products include self-developed magnetic microbeads cell separation kits and cell separation columns, which can obtain target cells with high purity and high viability through simple operation. Nano-sized magnetic beads do not need elution, and the separated cells can be directly used in downstream experiments such as flow cytometry, cell culture, single-cell sequencing, etc.



### Application field:

- Immunology research
- Oncology research
- Neuroscience
- Stem cell research
- Cell therapy

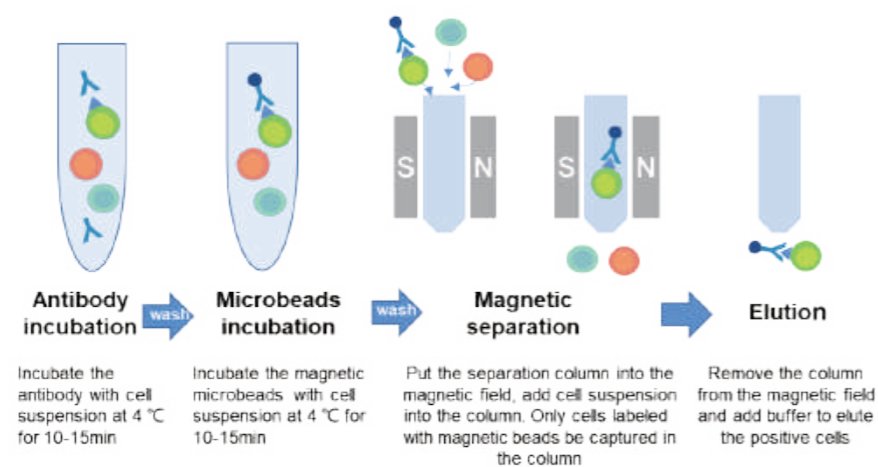

### Ordering Information

Cat NO.	Product name	Size	Capacity
K1301-10	Mouse CD3+ Cell Separation Kit	1ml*2	for 1*10 <sup>9</sup> total cells
K1302-10	Mouse CD4+ Cell Separation Kit	1ml*2	for 1*10 <sup>9</sup> total cells
K1303-10	Mouse CD8+ Cell Separation Kit	1ml*2	for 1*10 <sup>9</sup> total cells
K1304-10	Mouse CD45+ Cell Separation Kit	1ml*2	for 2*10 <sup>9</sup> total cells
K1305-20	Mouse CD19+ Cell Separation Kit	1ml*2	for 2*10 <sup>9</sup> total cells
K1306-10	CD11b+ (Microglia) cell separation Kit	1ml*2	for 1*10 <sup>9</sup> total cells
K1201-10	Human CD3+ Cell Separation Kit (RUO)	1ml*2	for 1*10 <sup>9</sup> total cells
K1202-10	Human CD4+ Cell Separation Kit (RUO)	1ml*2	for 1*10 <sup>9</sup> total cells
K1203-10	Human CD8+ Cell Separation Kit (RUO)	1ml*2	for 1*10 <sup>9</sup> total cells
K1204-10	Human CD14+ Cell Separation Kit (RUO)	1ml*2	for 1*10 <sup>9</sup> total cells
K1205-10	Human CD45+ Cell Separation Kit (RUO)	1ml*2	for 1*10 <sup>9</sup> total cells
K1206-10	Human CD19+ Cell Separation Kit (RUO)	1ml*2	for 1*10 <sup>9</sup> total cells
K1207-10	Human NK Cell Isolation Kit (RUO)	2ml*2	for 1*10 <sup>9</sup> total cells
HCSC-25	LarSep Columns (25pcs/box)	25pcs/box	/
HCSC-10	LarSep Columns (10pcs/box)	10pcs/box	/
LSC-S1	LSC Separator (single channel)	1pcs	/
SS01	Separation stand	1pcs	/
CSAK-01	Cell Separation assembly kit (single channel)	1set	Including LarSep Columns (25pcs), LSC Separator (single channel) 1pcs, Separation stand 1pcs

## CO<sub>2</sub> Incubator

### Provide A More Suitable Environment for Cell Culture

D180 CO<sub>2</sub> incubator provides a more suitable culture environment for cells by controlling temperature, CO<sub>2</sub> concentration precisely and by maintaining a high relative humidity (RH). It is an indispensable cell culture tool in the fields of stem cell research, immunology research, neurobiology research and cancer research.



### Product characteristics

#### Stable environment for cell culture

- Accurate IR sensor monitors the CO<sub>2</sub> concentration change.
- Six-sided air jacket heating system ensures fast heating.
- Optional humidity probe to monitor real-time humidity changes.

#### Contamination control of inner chamber

- High efficient sterilization by 140°C dry heat.
- In-chamber HEPA to filter the microorganism.
- Easy cleaning with coved corners and removable shelves design.

#### Intelligent operation

- 7-inch touchscreen controller for real-time display.
- Automatic data record of 7 days curve display.
- External USB port for fast and convenient data export.

#### Multiple alarm system

- Internal and external door open overtime alarm.
- Abnormal inner cavity core parameters alarm.
- High temperature sterilization over temperature alarm.

#### Convenient and flexible design

- Handle design enables a comfortable door opening.
- Optional bracket with casters for convenient moving of the chamber.
- Less consumables in cavity for easy cleaning.



Stainless steel liner & water pond



High efficiency filtration system

► Technical Parameters

Temperature	Control & Range	±0.1°C@ 37°C, 5°C above ambient to 50°C
	Heating Method	Air jacket
	Uniformity	±0.3°C @ 37°C
	Alarm Setting	Customized, Upper limit: (T+0.1) ~ (T+5.0); Lower limit: (T-0.1) ~ (T-5.0)
	Sensor	Pt1000 Platinum thermistor
	Controller	PID
	Readability & Setability	0.1°C
	Sterilization Method	140°C dry heat sterilization
CO <sub>2</sub> Concentration	Control & Range	±0.1%@5%, 0-20%
	Sensor	Heat-resistant infrared (IR) sensor
	Inlet Pressure	1.0 bar (recommended)
	Uniformity	±0.3%
	Readability & Setability	0.10%
Humidity	Water Pond Volume	~3.8 L
	Display	1% RH
Shelves	Dimensions	48.7×46.1 cm
	Surface Area	224.5 cm <sup>2</sup>
	Number (Standard & Max)	4; 17
Size & Weight	Interior Volume	188 L
	Interior Dimensions	51.0(W)×54.7(D)×67.5(H) cm
	Exterior Dimensions	69.5(W)×67.0(D)×97.0(H) cm
	Net Weight	110 kg

► Accessories

Device Options	Order no.	Description
CO <sub>2</sub> gas inlet pipe package	D180-F01	Connect cylinders to equipment
Horizontal shelves with bracket	D180-F02	Carrier for culture dishes
Water Pond	D180-F03	Holding water to increase humidity
HEPA filter	D180-F04	5.5 inch HEPA filter for inner air filtration
High efficiency filter	D180-F05	For air filtration at sampling port
Stacking racks	D180-F06	For stacking and fixing of equipment
Stacking Stand with castors	D180-F07	For supporting equipment and movement

► Order Information

Device Options	Order no.	Description
CO <sub>2</sub> Incubator with Humidity monitoring	D180	volume 188L; 140°C setrilization; humidity sensor; voltage 200~240VAC, 50Hz, 5A
CO <sub>2</sub> Incubator with Humidity monitoring	D181	volume 188L; 140°C setrilization; humidity sensor;voltage 100~120VAC, 60Hz, 10A
CO <sub>2</sub> Incubator without Humidity monitoring	D180	volume 188L; 140°C setrilization; without humidity sensor; voltage 200~240VAC, 50Hz, 5A
CO <sub>2</sub> Incubator without Humidity monitoring	D181	volume 188L; 140°C setrilization; without humiditysensor; voltage 100~120VAC, 60Hz, 10A

Automated Cell Counter

RWD Automated Cell Counter adopts Trypan Blue staining method, intelligent image recognition and advanced optical imaging technology to achieve accurate and automatic cell analysis. The algorithm can identify both live and dead cells within 9 seconds. Information such as cell counts, viability, diameter can be obtained by just one-click. With fluorescence cube, C100&C100-Pro can display images in BF and FL channels simultaneously and clearly present cell counts and cell morphology. In order to meet the needs of cell therapy and biopharma, the data management and software system of C100-Pro fully conforms to FDA 21 CFR Part 11. It is an optimal device for cell analysis in cell therapy, biopharmaceutical, immunology and vaccine development, tumor research, stem cell and metabolism research.



► Product Characteristics

High accuracy

- The self-developed algorithm can identify clustered cells.
- Intelligently cell marks contribute to precise cell recognition.
- RBC counting.
- Low autofluorescence and high-transmit filter enable clear imaging.

Time-saving

- User-friendly UI and built-in user guide interfaces ensure easy operation.
- Up to 1000 counting results can be stored. No need another device for extra storage.

User-friendly

- Autofocus and auto exposure.
- Powerful computing capability ensures high efficiency.

Compact design

- Compact size fits into different placements.
- Removable modular FL cubes allow easy switches among various scenes.

► Accessories and consumables



Disposable Cell Counting Slide



FL Cube

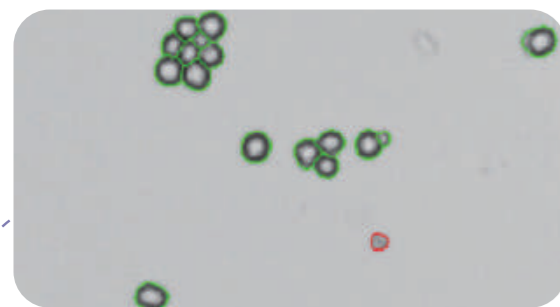

• Clustered cell recognition algorithm

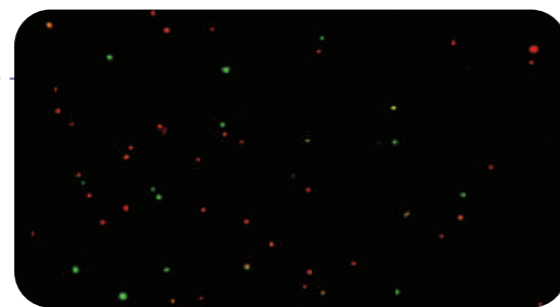

• Clear fluorescence imaging



• Pre-dilution calculator

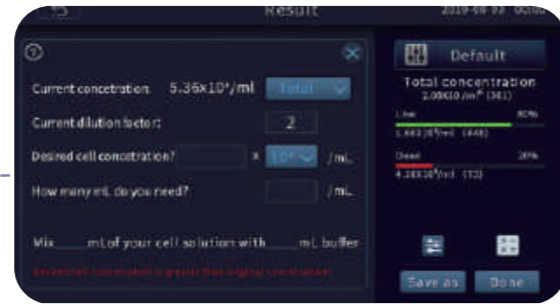

• Cell splitting calculator

## C100-Pro Automated Cell Counter



### Product Characteristics

- FDA 21 CFR Part11 compliance.
- Ensuring data security with account login and account permissions setting.
- Ensuring data integrity with electronic signature and electronic recording.
- Data transmission via LAN and server.

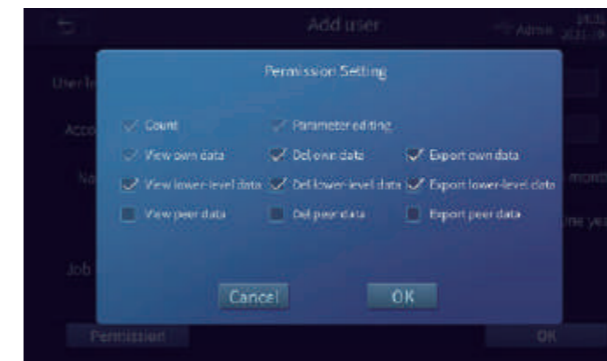

User manage

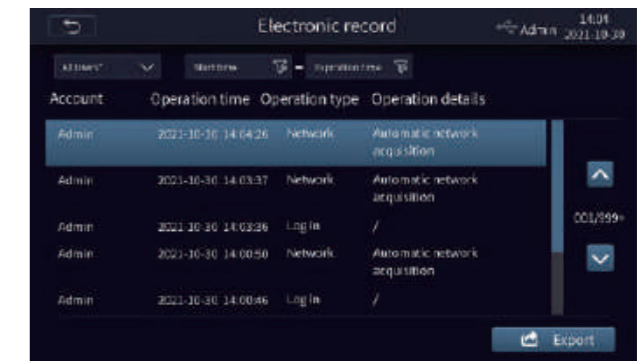

Electronic records

### Technical Parameters

Parameters	Description		
Model	C100-SE	C100	C100-Pro
Optional fluorescence application	N/A	● (Ex :375/28nm ;Em:460/50nm) ● (Ex :480/30nm ;Em:535/40nm) ● (Ex :540/25nm ;Em:620/60nm)	
Amplification Factor	2.5X, 5.0 Megapixel		
Focus Method	Manual focusing & Autofocusing		
Counting Area	2.15 mm×1.62 mm		
Cell Type	Cell lines, stem cells, primary cells, pollens, beer yeast		
Cell Size Range	4-60 μm (Optimal: 7-60 μm)		
Cell Concentration Range	10 <sup>4</sup> -10 <sup>7</sup> cells/mL		
Cell counting Time	Less than 9s		
Historical Data Storage	1000 counting reports and images at most		
Languages	Chinese and English		
Dimensions	212 mm(W)* 264 mm(H)* 165 mm (D)		
Weight	~3.0kg	~3.2kg	~3.5kg

FL Cube	Excitation	Emission	General Dyes
FL Cube-01	375/28nm	460/50nm	DAPI, Hoechst, BFP
FL Cube-02	480/30nm	535/40nm	Acridine Orange (AO), Calcein-AM, Alexa fluor 488, SYBR Green, FITC, GFP
FL Cube-03	540/25nm	620/60nm	Propidium Iodide (PI), DsRed, dTomato, RFP

### Order Information

Cat No.	Product Description
C100-SE	Automated Cell Counter (BF)
C100	Automated Cell Counter (BF + FL)
C100-Pro	Automated Cell Counter (BF + FL, FDA 21 CFR Part 11 Compliance)
FL Cube-01	● (Ex :375/28nm ;Em:460/50nm)
FL Cube-02	● (Ex :480/30nm ;Em:535/40nm)
FL Cube-03	● (Ex :540/25nm ;Em:620/60nm)
DS-50	Disposable Slide (50 pcs/box)

# Fluorescent cell counter C200FL



## Product Characteristics

### More precise, more stable

- No need to focusing and the imaging is clearer
- Preset parameters can be used directly without manual operation
- Intelligently cell marks for precise cell recognition
- Low autofluorescence and high-transmit filter enable clear imaging

### Smarter and more efficient

- APP style program, one click counting
- 6-channel counting slide, automatic sampling
- Optional 1-3 counting area, 5s/sample
- 500G storage, one click export multiple formats of data

### Safer and easier to use

- FDA 21 CFR Part 11 compliance
- Multiple built-in help interfaces, easy to use
- Compact size fits into different placements

## Product Interface

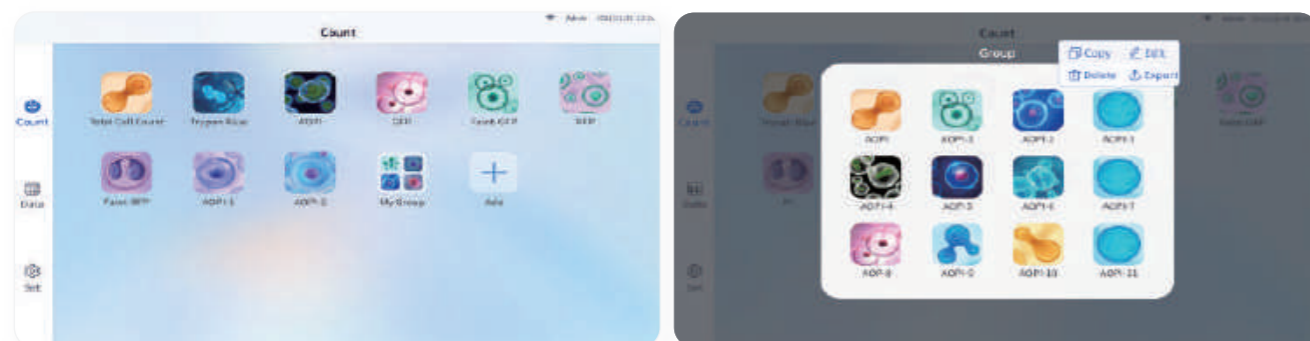

• APP style program, one click counting

• APPs can be managed in group

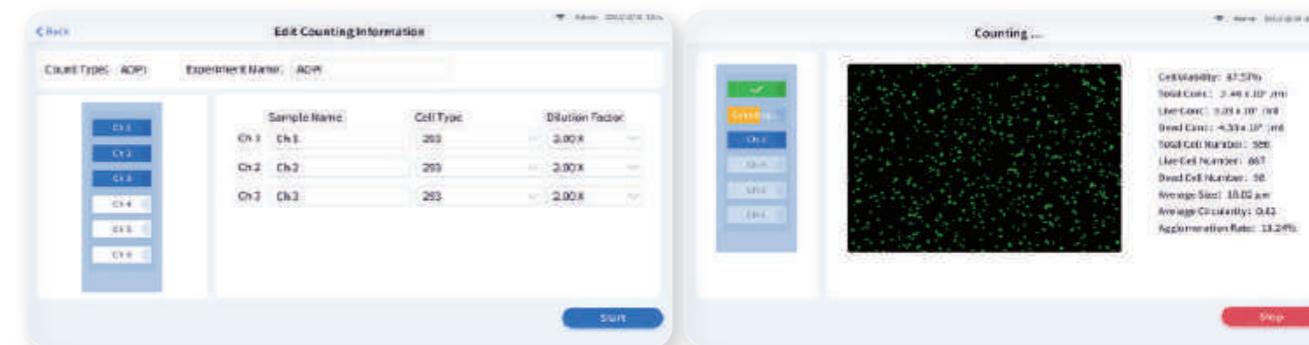

• 6-channel automatic sampling

• Real time display of counting results

## Consumables

6-channel disposable counting slide for C200FL counter

- One-piece cover plate, no cover glass required
- Disposable consumables, no manual cleaning
- Disposable design to avoid biological safety hazards
- Separate and easy-to use packaging

Parameters	Description
Model	DS-66
Chamber volume	20uL
Number of chambers	6
Dimensions of slide	75mm*25mm*2.1mm
Dimensions of chamber	16.2mm*6.2mm*0.2mm
Package	50PCS/box



## Technical Parameters

Model	C200FL
Optical parameters	5×, 5.0 Megapixel
Fluorescence parameters	AO/GFP: Ex: 480/30nm, Em: 535/40nm PI/RFP: Ex: 525/30nm, Em: 590LP
Cell size range	3-180μm (Optimal: 5-30μm)
Cell concentration range	1×10 <sup>4</sup> - 3×10 <sup>7</sup> /mL
Counting area	1.72mm×1.3mm (Optional 1-3 zones)
Cell counting time	5s/sample (bright field)
Storage	500G
Dimensions	310mm(W)*420mm(H)*270mm(D)
Weight	~11KG
Languages	Chinese and English
Display	10.1-inch LCD touch screen
Consumables	6-channel counting slide, 20μL/sample

## Centrifuge

### M1324R Refrigerated Microcentrifuge

RWD microcentrifuges M1324R and M1324 simplify centrifugation, which can work stably and quietly at the maximum speed of 15800rpm. Optional rotors for different needs (PCR tubes, 1.5/2 mL EP tubes, etc.). Small footprint and low noise, touch screen interaction, all your user-defined preset programs can be called by one click. The refrigerated microcentrifuge M1324R will still make sure the stable temperature centrifugation of samples at -10°C~40°C even at the highest speed.

All the functions are designed according to your needs, which is the best choice for laboratory separation.



M1324R Microcentrifuge

#### Product Characteristics

##### Efficient

- Quick precooling. From RT to 4 °C in only 8 minutes.
- The seamlessly fit for inner cavity winding technology enables high-efficient energy transfer.
- Adjustable 10 ACC/DEC ramps to satisfy different customers' needs.

##### Stable and Safe

- High-density foaming technology benefits energy-saving and heat-preservation.
- Standard aerosol-tight rotor with aerospace-grade aluminum alloy withstands high temperature sterilization and avoids biohazards.
- Qualified ultrasonic non-destructive test, Schenck balancing test and extreme blasting test to protect personnel safety.
- Multiple Real-time rotor dynamic balancing monitoring system and alarm functions guarantee safe operation.

##### Simple

- Combination of touch screen and function keys provides quick and convenient setting and parameter use.
- 12 custom programs enable immediate centrifuge operation in multiple scenarios.
- Magnetic condensed water collection pan to eliminate inner water accumulation.
- Mechanical lock design for the centrifuge lid enables easy opening and closing.
- Quick-Lock rotor, closes with only a 1/8 turn.

##### Compact

- One-pipette-width compact design.
- Lid hinge design with suspending hovering optionally.

Self-locking lid

Standard aerosol-tight rotor

Combination of buttons and touch interaction

Small, quiet and durable

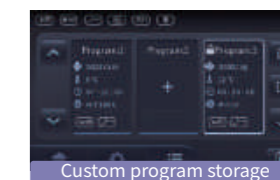
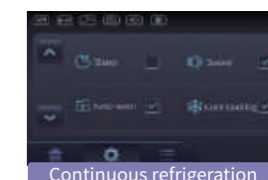

### M1324 Ventilated Microcentrifuge



M1324 Microcentrifuge

#### Product Characteristics

##### Excellent and Efficient

- Unique heat dissipation material and duct design to enhance heat dissipation performance.
- Double cooling system to ensure stable centrifugation of samples at the highest speed.
- Running vibration amplitude ≤ 1um to maintain stable operation.

##### Stable and Safe

- Standard aerosol-tight rotor with aerospace-grade aluminum alloy withstands high temperature sterilization and avoids biohazards.
- Qualified ultrasonic non-destructive test, Schenck balancing test and extreme blasting test to protect personnel safety.
- Real-time rotor dynamic balancing monitoring system and multiple-imbalance alarm functions guarantee safe operation.



**Intelligent and Quiet**

- Dual noise control system with intelligent three-gear fan control, full load at maximum speed noise <50dB(A).
- Combination of touch screen and function keys provides quick and convenient setting and parameter use.
- Use EPP foam material to reduce noise pollution.

**Simple and Practical**

- Quick-lock rotor closes with only 1/6 turn for easy and secure sample handling.
- 10 acceleration and deceleration ramps meet the centrifugation needs of different samples.
- 48 custom programs enable immediate centrifuge operation in multiple scenarios.
- Automatic lid opening design, easy and quick to take samples.



**Technical Parameters**

Parameters	M1324R	M1324
Max. Speed	15800 rpm	
Max. RCF	23444 × g	
Max. Capacity	5mL × 10	
ACC/DEC Ramps	10/10	
Display	Touch screen	
Program	12	48
Temperature Control	-10°C to 40°C	/
Noise Level	<54dB (A)	<50dB(A)
Dimension (W*H*D)	304mm*304mm*517mm	262mm*286mm*385mm
Weight (with rotor)	33kg	~22kg

**Order Information**

Model	Product Description
M1324R	Refrigerated Microcentrifuge (With M-F24QG rotor)
M1324	Ventilated Microcentrifuge (With M-F24QG rotor)
M-F10QG	Aerosol-tight Lid , 10×5 mL tube quick- lock rotor
M-F24QG	Aerosol-tight Lid , 24×1.5/2.0 mL tube quick- lock rotor
M-F24Q	24×1.5/2 mL tube quick- lock rotor
M-F24G	Aerosol-tight Lid , 24×1.5/2 mL tube rotor
M-F24	24×1.5/2 mL tube rotor
M-F4PCR	4 × PCR tube rotor
M-F18Kit	18 × Spin column rotor

**M1416R High-Speed Benchtop Refrigerated Centrifuge**

RWD High-Speed Benchtop Refrigerated Centrifuge provides intelligent centrifugation, adapting various applications from micro to medium throughput with a speed up to 18,000 rpm (30,000 × g). Offer a broad selection of rotors and adaptors (swing-bucket rotors and fixed-angle rotors) to meet different customers' needs. The capacity of M1416R ranges from 24 × 2mL to 4 × 400mL, and the plate rotor also accommodates PCR and deep-well plates. In addition, equipped with a 7-inch touch screen, M1416R provides visual operation and a personalized account management system ensuring efficient and quality control.



**Product Characteristics**

- Abundant accessories**
  - Multi-purpose device equips with various rotors and adaptors.
  - Self-locking rotors enable non-tools required installation and removal and exchange in 3 seconds.
  - Fixed-angle rotor equipped with the quick-lock lid, closes with only a 1/6 turn.
- Various guarantees**
  - Multi-level alarm reminders for fast dealing.
  - Static rotor identification function for maximum operational safety.
  - Precision assembly motor with special bearings ensures the precision of speed ≤ ±1rpm, amplitude ≤ 0.01mm.
- Ergonomic operation**
  - Scheduling reservations provide the pre-cooling function for organized experiments.
  - Acceleration and braking ramps setting achieves stable centrifugation.
  - Built-in simple introduction for quick operation.
- Multipurpose function**
  - An intuitive touch screen shows key parameters clearly.
  - View the centrifuge health with one click.
  - Front USB port for easy and quick data transfer.
  - More than 100 pre-program setting storage with customized steps achieves continuous centrifugation.



- Integrated frame of swing-out rotor for long-time use
- Equip with biocontainment lids for one-handed operation
- Various optional adaptors for different experiments

► Technical Parameters

Parameters	Description
Swing-out Rotor	
Maximum Capacity	M-S4-400-P, 4*400mL
Maximum Speed	M-S4-200-P, 5500rpm
Maximum RCF	M-S4-200-P, 5580 x g
Fixed-angle Rotor	
Maximum Capacity	M-F6-100CF, 6*100mL
Maximum Speed	M-F24-2QG, 18,000rpm
Maximum RCF	M-F24-2QG, 30,000 x g
Details	
Temperature range	-10°C to +40°C
Noise	56dB(A)
Acceleration/Deceleration ramps	9 /10
Program Storage	100 programs with the ability to do step programming
Dimension (W*H*D)	627*409*688mm
Weight without rotor	98kg

Order Information

Model	Product Description
M1416R	High-Speed Benchtop Refrigerated Centrifuge (Without Rotor)

► Rotor Information

Model	Product Description	Maximum Speed (rpm)	Maximum RCF(xg)
M-S4-400-P	4*400mL Swing-out rotor	5000	4696
M-S4-400-CP	4*400mL Swing-out rotor(incl. 4*M-A4-50 and 4*M-A9-15 adaptors)	5000	4696
M-S4-200-P	4*180mL Swing-out rotor (incl. 4*M-A1-50 and 4*M-A5-15 adaptors)	5500	5580
M-S2-DWP-P	2*3 Standard 96-well plate (2*1 DWP)	4000	2272
M-F24-2QG	Aerosol-tight Lid , 24×2 mL tube quick- lock rotor	18,000	30,000
M-F30-2QG	Aerosol-tight Lid , 30×2 mL tube quick- lock rotor	15,200	25,830
M-F48-2QG	Aerosol-tight Lid , 48×2 mL tube quick- lock rotor	15,200	25,314
M-F18-5QG	Aerosol-tight Lid , 18×5 mL tube quick- lock rotor	15,000	24,652
M-F6-50QG	Aerosol-tight Lid , 6×50 mL tube quick- lock rotor	12,100	20,133
M-F8-50CF	8×50 mL tube carbon fiber rotor	14,500	24,446
M-F14-50CF	14×50 mL tube carbon fiber rotor	10,000	17,105
M-F6-100CF	6×100 mL tube carbon fiber rotor	15,000	24652
M-F30-15C	30×15 mL tube clinic rotor	5650	4997
M-A4-50	Suitable for M-S4-400 rotors, 4*50mL adapters, each adapter can put 4*50mL tubes		
M-A9-15	Suitable for M-S4-400 rotors, 4*15mL adapters, each adapter can put 9*15mL tubes		
M-A-15	Suitable for M-F6-50QG rotor, 6*15mL adapters		

M2-96G Gradient Thermal Cycler

The M2-96G provides precise temperature control and an intelligent user operating system to achieve rapid and specific amplification of target DNA fragments. With temperature gradient function, 12 groups of gradient can be realized at one time to optimize PCR protocol.

It is widely used in molecular biology, microbiology, genetics, cell biology, food science and agronomy to carry out experimental research such as molecular cloning, gene expression analysis, genotype identification, sequencing, and pathogenic microorganism analysis.



► Product characteristics

Intelligent and efficient linear gradient function

- 12 linear gradients in the same run allow to optimize the ideal annealing temperature.
- Temperature and time cycle can be incremented or decremented to realize different experiments like Touchdown PCR and Long PCR experiments.

Fast ramping and precise temperature control

- Fast ramp rate of up to 6 °C/s to realize efficient PCR runs.
- Long-life Peltier elements for temperature accuracy and uniformity.

Data visualization for easy operation

- 7 inch touch screen enables intuitive and quick programming.
- Personalized account management system provides organized programs and unwanted changes.

Thoughtful multifunctional design

- Processes can be imported and synchronized via USB ports and achieve multi-machine collaborative work.
- Capable for PCR experiments and constant temperature incubation function.



Easy access to create a new protocol

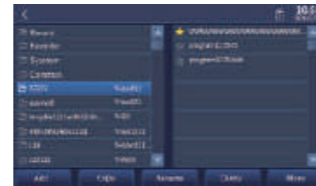
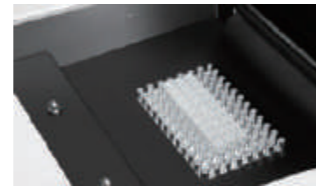

Personalized account management system

► Technical Parameters

Description	M2-96G
Sample Capacity	96x0.2 ml/0.1ml tubes or 1x96-well plate
Reaction volume	10~100 µL
Heating block	96-well
Temperature control range of the block	0~100°C
Gradient capability	Yes
Gradient range	30~100°C
Lid temperature range	40~110°C
Temperature accuracy	±0.25°C (35~100°C)
Temperature Uniformity	≤±0.35°C (After reaching a constant temperature of 95°C for 20s)
Max. heating and cooling rate	6.0°C/s; 4.5°C/s
Average heating and cooling rate	4.5°C/s; 3.5°C/s
Display	7 inch LCD touch screen
Max. amount of storage	2000
Max. number of program cycles	99
Max. number of program steps	64
Inc/Dec temp input range	±0.1~5°C
Inc/Dec time input range	±1~240s
Power-off protection	Yes
Interface	RS232, USB, Network ports
Dimensions (W×D×H)	264mm×470mm×259mm
Weight	16.5kg
Power supply	220V/50HZ; 110V/60HZ
Max. power consumption	925W

Ordering information

Order no.	Description
M2-96G	96-well Gradient thermal cycler

# Animal Surgical Instrument & Matrices

RWD surgical instruments cover surgical scissors, surgical forceps, orthopedic instruments, scalpels and blades, vascular forceps, needle forceps, with more than 1,000 kinds of models.

## Surgery Instrument Kit

**SP0001-G**  
General Surgery Instrument Kit for Rodents



Cat.No.	Product Description	Qty
S11001-08	VANNAS Spring Scissors (Triangular)-S/S Str/8*1.5mm/8cm	1
S11002-08	VANNAS Spring Scissors (Triangular)-S/S Cvd/8*1.5mm/8cm	1
S12009-11	IRIS-Fine Scissors (Round Type)-S/S Str/25*5.6mm/11.5cm	1
S12010-11	IRIS-Fine Scissors (Round Type)-S/S Cvd/23.5*6mm/11.5cm	1
S12005-10	IRIS-Fine Scissors (Round Type)-S/S Str/23*5mm/10.5cm	1
S12004-09	IRIS-Fine Scissors (Round Type)-S/S Cvd/24*4.6mm/9.5cm	1
F11001-11	Micro Forceps-Str, head length 30mm, Tip 0.2*0.12mm, 11cm	1
F11004-11	Micro Forceps-Cvd, head length 26.8mm, Tip 0.2*0.12mm, 11cm	1
F12010-10	Dressing Forceps-Str, Tip width 1.8mm, teeth length 15mm, 10.5cm	1
F12011-10	Dressing Forceps-Cvd, Tip width 1.9mm, teeth length 15mm, 10.5cm	1
F21001-12	HALSTED Artery Forceps-Str/23.5*1mm/12.5cm	2
F21002-12	HALSTED Artery Forceps-Cvd/24*1mm/12.5cm	2
F22002-10	HARTMAN Mosquito Forceps-Str/20*0.8mm/10.5cm	2
F22003-10	HARTMAN Mosquito Forceps-Cvd/20.8*1mm/10cm	2
F31047-12	OLSEN-HEGAR Needle Holders with Scissors-Str, 10*2.15mm/12cm	1
S13029-14	MAYO-STILLE Dissecting & Operating Scissors-B/B Str/37*9mm/14cm	1
S15001-11	SPENCER Ligature Scissors (Slender Type)-27*6mm/11cm	1
S21010-15	BOHLER Rongeurs (Double)-Light Cvd/2*19mm/15cm	1
S22004-11	Bone Cutters with Flat Blades (SGL)-15*6.8mm/11cm	1
S14014-12	Operating Scissors (Round Type)-S/S Str/37.6*8.5mm/12.5cm	1
S31011-01	11# Scalpel Blades (Box of 100pcs)	1
S32003-12	Scalpel Handles with Ruler 3# Solid-12.5cm	1
S33009-06	Scalpel Blade Remover-6.5cm	1
F13019-12	ADSON 1x2 Teeth Tissue Forceps, Tip width 1.8mm, 12cm	1
R21027-12	STEVENS Hooks, 1 Angled Tooth, 5mm depth, 12.5cm	1
R22009-01	ALM 4x4 Teeth Retractors-Blunt, 65mm Spread, 7.5cm	1
R22005-45	3x3 Teeth Retractors-Blunt, 30mm Spread, 5cm	1
R51003-11	Dual-end Micro Spatula w/tip W. 2mm x Thk. 0.3mm - Cvd/11cm	1
F35204-70	NA Nylon Sutures w/Needle-△3/8/2.5×5/30cm/7-0 (50/Box)	0.2
F35401-50	NA Terylene Sutures w/Needle-○3/8/3×10/90cm/5-0 (50/Box)	0.2
R31006-06	SS Micro Clamps-Cvd/L*W 6.6*1mm/17mm	5
R31005-06	SS Micro Clamps-Str/L*W 6*1mm/19mm	5
R34001-14	Clip Applicator for R31005- and R31006-Clamps-8.4*5mm/14cm	1
SP0001-P	Instrument Storage Portfolio	1

**SP0003-R**  
Microsurgery Instrument Kit for Rat, Cat, Rabbit etc.



Cat.No.	Product Description	Qty
S12005-10	IRIS-Fine Scissors (Round Type)-S/S Str/23*5mm/10.5cm	1
S12010-11	IRIS-Fine Scissors (Round Type)-S/S Cvd/23.5*6mm/11.5cm	1
F31047-12	OLSEN-HEGAR Needle Holders with Scissors-Str, 10*2.15mm/12cm	1
F11001-11	Micro Forceps-Str, head length 30mm, Tip 0.2*0.12mm, 11cm	1
R31005-06	SS Micro Clamps-Str/L*W 6*1mm/19mm	5
R34001-14	Clip Applicator for R31005- and R31006-Clamps-8.4*5mm/14cm	1
S11001-08	VANNAS Spring Scissors (Triangular)-S/S Str/8*1.5mm/8cm	1
S11002-08	VANNAS Spring Scissors (Triangular)-S/S Cvd/8*1.5mm/8cm	1
F21001-12	HALSTED Artery Forceps-Str/23.5*1mm/12.5cm	1
F21002-12	HALSTED Artery Forceps-Cvd/24*1mm/12.5cm	1
F35401-50	NA Terylene Sutures w/Needle-○3/8/3×10/90cm/5-0 (50/Box)	0.2
S32003-12	11# Scalpel Blades (Box of 100pcs)	1
S31011-01	Scalpel Handles with Ruler 3# Solid-12.5cm	1
SP0001-P	Instrument Storage Portfolio	1

**SP0003-M**  
Microsurgery Instrument Kit for Mice



Cat.No.	Product Description	Qty
S12005-10	IRIS-Fine Scissors (Round Type)-S/S Str/23*5mm/10.5cm	1
S12004-09	IRIS-Fine Scissors (Round Type)-S/S Cvd/24*4.6mm/9.5cm	1
F31047-12	OLSEN-HEGAR Needle Holders with Scissors-Str, 10*2.15mm/12cm	1
F11001-11	Micro Forceps-Str, head length 30mm, Tip 0.2*0.12mm, 11cm	1
R31005-04	SS Micro Clamps-Str/L*W 4*0.75mm/16mm	5
R34001-14	Clip Applicator for R31005- and R31006-Clamps-8.4*5mm/14cm	1
S11001-08	VANNAS Spring Scissors (Triangular)-S/S Str/8*1.5mm/8cm	1
S11002-08	VANNAS Spring Scissors (Triangular)-S/S Cvd/8*1.5mm/8cm	1
F22002-10	HARTMAN Mosquito Forceps-Str/20*0.8mm/10.5cm	1
F22003-10	HARTMAN Mosquito Forceps-Cvd/20.8*1mm/10cm	1
F35401-50	NA Terylene Sutures w/Needle-○3/8/3×10/90cm/5-0 (50/Box)	0.2
S32003-12	11# Scalpel Blades (Box of 100pcs)	1
S31011-01	Scalpel Handles with Ruler 3# Solid-12.5cm	1
SP0001-P	Instrument Storage Portfolio	1

**SP0005-R**  
Brain Microinjection Surgery Instrument Kit for Rat



Cat.No.	Product Description	Qty
S31011-01	Scalpel Handles with Ruler 3# Solid-12.5cm	1
S32003-12	11# Scalpel Blades (Box of 100pcs)	1
S12005-10	IRIS-Fine Scissors (Round Type)-S/S Str/23*5mm/10.5cm	1
S12006-10	IRIS-Fine Scissors (Round Type)-S/S Cvd/22*4.5mm/10.5cm	1
F12010-10	Dressing Forceps-Str, Tip width 1.8mm, teeth length 15mm, 10.5cm	2
F12011-10	Dressing Forceps-Cvd, Tip width 1.9mm, teeth length 15mm, 10.5cm	2
F21001-12	HALSTED Artery Forceps-Str/23.5*1mm/12.5cm	2
F21002-12	HALSTED Artery Forceps-Cvd/24*1mm/12.5cm	2
F31047-12	OLSEN-HEGAR Needle Holders with Scissors-Str, 10*2.15mm/12cm	1
S14014-12	Operating Scissors (Round Type)-S/S Str/37.6*8.5mm/12.5cm	1
F35204-70	HARTMAN Mosquito Forceps-Str/20*0.8mm/10.5cm	0.2
R22009-01	ALM 4x4 Teeth Retractors-Blunt, 65mm Spread, 7.5cm	1
R51003-11	Dual-end Micro Spatula w/tip W. 2mm x Thk. 0.3mm - Cvd/11cm	1
SP0001-P	Instrument Storage Portfolio	1

**SP0007-M**  
Universal Dissecting Surgery Instrument Kit for Mice



Cat.No.	Product Description	Qty
S12005-10	IRIS-Fine Scissors (Round Type)-S/S Str/23*5mm/10.5cm	1
S12004-09	IRIS-Fine Scissors (Round Type)-S/S Cvd/24*4.6mm/9.5cm	1
S13003-11	STEVEN'S Fine Dissecting Scissors (Flat Type)-B/B Str/25*4mm/11.5cm	1
S13004-11	STEVEN'S Fine Dissecting Scissors (Flat Type)-B/B Cvd/28*5mm/11.5cm	1
S15001-09	SPENCER Ligature Scissors (Slender Type)-20.3*4mm/9cm	1
S32003-12	11# Scalpel Blades (Box of 100pcs)	1
S31015-01	15# Scalpel Blades (Box of 100pcs)	1
F12005-10	IRIS Dissecting Forceps-Str, Tip width 1mm, teeth length 14mm, 10cm	2
F12006-10	IRIS Dissecting Forceps-Light Cvd, Tip width 1mm, teeth length 13.5mm, 10cm	2
F22002-10	HARTMAN Mosquito Forceps-Str/20*0.8mm/10.5cm	2
F22003-10	HARTMAN Mosquito Forceps-Cvd/20.8*1mm/10cm	2
F13029-10	IRIS 1x2 Teeth Tissue Forceps-Str, Tip width 1.3mm, 10.5cm	1
F31047-12	OLSEN-HEGAR Needle Holders with Scissors-Str, 10*2.15mm/12cm	1
F35401-50	NA Terylene Sutures w/Needle-○3/8/3×10/90cm/5-0 (50/Box)	0.2
R22005-45	3x3 Teeth Retractors-Blunt, 30mm Spread, 5cm	1
R31005-04	SS Micro Clamps-Str/L*W 4*0.75mm/16mm	5
R42002-12	Spinal Cord Hook - Tip Dia. 3mm/12cm	1
R34001-14	Clip Applicator for R31005- and R31006-Clamps-8.4*5mm/14cm	1
SP0001-P	Instrument Storage Portfolio	1

**SP0008-M** Cardio-cerebral Perfusion Surgery Instrument Kit for Mice



Cat.No.	Product Description	Qty	Cat.No.	Product Description	Qty
S14014-10	Operating Scissors (Round Type)-S/S Str/32.7*8.45mm/10.5cm	1	F35204-70	HARTMAN Mosquito Forceps-Str/20*0.8mm/10.5cm	0.2
S12005-10	IRIS-Fine Scissors (Round Type)-S/S Str/23*5mm/10.5cm	1	R21027-12	STEVEN'S Hooks, 1 Angled Tooth , 5mm depth, 12.5cm	1
S11001-08	VANNAS Spring Scissors (Triangular)-S/S Str/8*1.5mm/8cm	1	R22005-45	3x3 Teeth Retractors-Blunt, 30mm Spread, 5cm	1
F12007-10	IRIS Dissecting Forceps-Large Cvd, Tip width 0.9mm, teeth length 10mm, 10cm	1	F31047-12	OLSEN-HEGAR Needle Holders with Scissors-Str, 10*2.15mm/12cm	1
F12010-09	Dressing Forceps-Str, Tip width 1.8mm, teeth length 13.5mm, 9.5cm	2	R31005-04	SS Micro Clamps-Str/L*W 4*0.75mm/16mm	5
F22002-10	HARTMAN Mosquito Forceps-Str/20*0.8mm/10.5cm	2	R34001-14	Clip Applicator for R31005- and R31006-Clamps-8.4*5mm/14cm	1
F22003-10	HARTMAN Mosquito Forceps-Cvd/20.8*1mm/10cm	2	R42002-12	Spinal Cord Hook - Tip Dia. 3mm/12cm	1
F35401-50	NA Terylene Sutures w/Needle-○3/8/3×10/90cm/5-0 (50/Box)	0.2	SP0001-P	Instrument Storage Portfolio	1

**SP0005-M**  
Brain Microinjection Surgery Instrument Kit for Mice



Cat.No.	Product Description	Qty
S31011-01	Scalpel Handles with Ruler 3# Solid-12.5cm	1
S32003-12	11# Scalpel Blades (Box of 100pcs)	1
S12005-10	IRIS-Fine Scissors (Round Type)-S/S Str/23*5mm/10.5cm	1
S12004-09	IRIS-Fine Scissors (Round Type)-S/S Cvd/24*4.6mm/9.5cm	1
S14014-10	Operating Scissors (Round Type)-S/S Str/32.7*8.45mm/10.5cm	1
F12005-10	IRIS Dissecting Forceps-Str, Tip width 1mm, teeth length 14mm, 10cm	2
F12006-10	IRIS Dissecting Forceps-Light Cvd, Tip width 1mm, teeth length 13.5mm, 10cm	2
F22002-10	HARTMAN Mosquito Forceps-Str/20*0.8mm/10.5cm	2
F31047-12	OLSEN-HEGAR Needle Holders with Scissors-Str, 10*2.15mm/12cm	1
F35204-70	HARTMAN Mosquito Forceps-Str/20*0.8mm/10.5cm	0.2
F22003-10	HARTMAN Mosquito Forceps-Cvd/20.8*1mm/10cm	2
R51003-11	Dual-end Micro Spatula w/tip W. 2mm x Thk. 0.3mm - Cvd/11cm	1
SP0001-P	Instrument Storage Portfolio	1

**SP0007-R**  
Universal Dissecting Surgery Instrument Kit for Rat



Cat.No.	Product Description	Qty
S12005-10	IRIS-Fine Scissors (Round Type)-S/S Str/23*5mm/10.5cm	1
S12006-10	IRIS-Fine Scissors (Round Type)-S/S Cvd/22*4.5mm/10.5cm	1
S12010-11	IRIS-Fine Scissors (Round Type)-S/S Cvd/23.5*6mm/11.5cm	1
S13005-14	METZENBAUM Dissecting Scissors (Round Type)-B/B Str/40*6.3mm/14.5cm	1
S13006-14	METZENBAUM Dissecting Scissors (Round Type)-B/B Cvd/44*7.5mm/14.5cm	1
F21001-12	HALSTED Artery Forceps-Str/23.5*1mm/12.5cm	2
F21002-12	HALSTED Artery Forceps-Cvd/24*1mm/12.5cm	2
F12010-10	Dressing Forceps-Str, Tip width 1.8mm, teeth length 15mm, 10.5cm	2
F12011-10	Dressing Forceps-Cvd, Tip width 1.9mm, teeth length 15mm, 10.5cm	2
F13029-10	IRIS 1x2 Teeth Tissue Forceps-Str, Tip width 1.3mm, 10.5cm	1
F31047-12	OLSEN-HEGAR Needle Holders with Scissors-Str, 10*2.15mm/12cm	0.2
S15001-11	SPENCER Ligature Scissors (Slender Type)-27*6mm/11cm	1
S32003-12	11# Scalpel Blades (Box of 100pcs)	1
S31015-01	15# Scalpel Blades (Box of 100pcs)	1
F35401-50	NA Terylene Sutures w/Needle-○3/8/3×10/90cm/5-0 (50/Box)	1
R22009-01	ALM 4x4 Teeth Retractors-Blunt, 65mm Spread, 7.5cm	1
R31005-06	SS Micro Clamps-Str/L*W 6*1mm/19mm	5
R42002-12	Spinal Cord Hook - Tip Dia. 3mm/12cm	1
R34001-14	Clip Applicator for R31005- and R31006-Clamps-8.4*5mm/14cm	1
SP0001-P	Instrument Storage Portfolio	1

**SP0008-R**  
Cardio-cerebral Perfusion Surgery Instrument Kit for Rat



Cat.No.	Product Description	Qty
S14014-12	Operating Scissors (Round Type)-S/S Str/37.6*8.5mm/12.5cm	1
S12005-10	IRIS-Fine Scissors (Round Type)-S/S Str/23*5mm/10.5cm	1
S11002-08	VANNAS Spring Scissors (Triangular)-S/S Cvd/8*1.5mm/8cm	1
F12007-10	IRIS Dissecting Forceps-Large Cvd, Tip width 0.9mm, teeth length 10mm, 10cm	1
F12005-10	IRIS Dissecting Forceps-Str, Tip width 1mm, teeth length 14mm, 10cm	2
F21001-12	HALSTED Artery Forceps-Str/23.5*1mm/12.5cm	2
F21002-12	HALSTED Artery Forceps-Cvd/24*1mm/12.5cm	2
F35401-50	NA Terylene Sutures w/Needle-○3/8/3×10/90cm/5-0 (50/Box)	0.2
F35204-70	HARTMAN Mosquito Forceps-Str/20*0.8mm/10.5cm	0.2
R21027-12	STEVEN'S Hooks, 1 Angled Tooth , 5mm depth, 12.5cm	1
R22005-45	3x3 Teeth Retractors-Blunt, 30mm Spread, 5cm	1
F31047-12	OLSEN-HEGAR Needle Holders with Scissors-Str, 10*2.15mm/12cm	1
R31005-06	SS Micro Clamps-Str/L*W 6*1mm/19mm	5
R42002-12	Spinal Cord Hook - Tip Dia. 3mm/12cm	1
R34001-14	Clip Applicator for R31005- and R31006-Clamps-8.4*5mm/14cm	1
SP0001-P	Instrument Storage Portfolio	1

**SP0011-B MCAO**  
Surgical Instrument Kit for Rat & Mice



Cat.No.	Product Description	Qty
S32003-12	Scalpel Handles with Ruler 3# Solid-12.5cm	1
S31015-01	15# Scalpel Blades (Box of 100pcs)	1
S14014-15	Operating Scissors (Round Type)-S/S Str/48*10mm/15.5cm	1
S12005-10	IRIS-Fine Scissors (Round Type)-S/S Str/23*5mm/10.5cm	1
S12006-10	IRIS-Fine Scissors (Round Type)-S/S Cvd/22*4.5mm/10.5cm	1
F12005-10	IRIS Dissecting Forceps-Str, Tip width 1mm, teeth length 14mm, 10cm	1
F12006-10	IRIS Dissecting Forceps-Light Cvd, Tip width 1mm, teeth length 13.5mm, 10cm	1
F13029-10	IRIS 1x2 Teeth Tissue Forceps-Str, Tip width 1.3mm, 10.5cm	1
F13030-10	IRIS 1x2 Teeth Tissue Forceps-Light Cvd, Tip width 1.3mm, 10.5cm	1
R21013-01	MANNERFELT Hooks, 2 Teeth (7mm), Blunt, 15.5cm*	4
R31005-06	SS Micro Clamps-Str/L*W 6*1mm/19mm	5
F11028-13	Micro Forceps-Cvd, head length 38mm, Tip 0.1*0.06mm, 13cm	1
F11027-13	Micro Forceps-Str, head length 37.5mm, Tip 0.1*0.06mm, 13cm	1
F11003-13	Micro Forceps-45°Angled, head length 30mm, Tip 0.15*0.1mm, 13cm	1
F11002-11	Micro Forceps-Str, head length 36.5mm, Tip 0.15*0.1mm, 11cm	1
F22002-10	HARTMAN Mosquito Forceps-Str/20*0.8mm/10.5cm	1
F22003-10	HARTMAN Mosquito Forceps-Cvd/20.8*1mm/10cm	1
S11001-08	VANNAS Spring Scissors (Triangular)-S/S Str/8*1.5mm/8cm	1
F31047-14	OLSEN-HEGAR Needle Holders with Scissors-Str, 17.3*1.7mm/14cm	1
F35204-70	NA Nylon Sutures w/Needle-△3/8/2.5×5/30cm/7-0 (50/Box)	0.2
SP0001-P	Instrument Storage Portfolio	1

**SP0010-B** Basic Surgical Instrument Kit for Rat & Mice



Cat.No.	Product Description	Qty	Cat.No.	Product Description	Qty
S11001-08	VANNAS Spring Scissors (Triangular)-S/S Str/8*1.5mm/8cm	1	F22003-10	HARTMAN Mosquito Forceps-Cvd/20.8*1mm/10cm	1
S12005-10	IRIS-Fine Scissors (Round Type)-S/S Str/23*5mm/10.5cm	1	F31047-12	OLSEN-HEGAR Needle Holders with Scissors-Str, 10*2.15mm/12cm	1
F12005-10	IRIS Dissecting Forceps-Str, Tip width 1mm, teeth length 14mm, 10cm	1	S33007-12	ZIEGLER Knives-8mm Cutting Edge/1.5mm Width/12cm	1
F12006-10	IRIS Dissecting Forceps-Light Cvd, Tip width 1mm, teeth length 13.5mm, 10cm	1	R31005-06	SS Micro Clamps-Str/L*W 6*1mm/19mm	1
F11020-11	Micro Forceps-Str, head length 36mm, Tip 0.05*0.01mm, 11cm	1	R31006-06	SS Micro Clamps-Cvd/L*W 6.6*1mm/17mm	1
F22002-10	HARTMAN Mosquito Forceps-Str/20*0.8mm/10.5cm	1	SP0001-P	Instrument Storage Portfolio	1

**SP0009-R** General Surgery Instrument Kit for Rat



Cat.No.	Product Description	Qty
F11020-11	Micro Forceps-Str, head length 36mm, Tip 0.05*0.01mm, 11cm	1
F11021-11	Micro Forceps-45°Angled, head length 30mm, Tip 0.1*0.06mm, 11cm	1
S32003-12	Scalpel Handles with Ruler 3# Solid-12.5cm	1
S31011-01	11# Scalpel Blades (Box of 100pcs)	1
F35401-50	NA Terylene Sutures w/Needle-○3/8/3×10/90cm/5-0 (50/Box)	0.2
F35204-70	NA Nylon Sutures w/Needle-△3/8/2.5×5/30cm/7-0 (50/Box)	0.2
F31047-12	OLSEN-HEGAR Needle Holders with Scissors-Str, 10*2.15mm/12cm	1
S11001-08	VANNAS Spring Scissors (Triangular)-S/S Str/8*1.5mm/8cm	1
S11002-08	VANNAS Spring Scissors (Triangular)-S/S Cvd/8*1.5mm/8cm	1
R22009-01	ALM 4x4 Teeth Retractors-Blunt, 65mm Spread, 7.5cm	1
F12005-10	IRIS Dissecting Forceps-Str, Tip width 1mm, teeth length 14mm, 10cm	1
F12006-10	IRIS Dissecting Forceps-Light Cvd, Tip width 1mm, teeth length 13.5mm, 10cm	1
F12007-10	IRIS Dissecting Forceps-Large Cvd, Tip width 0.9mm, teeth length 10mm, 10cm	1
F13029-10	IRIS 1x2 Teeth Tissue Forceps-Str, Tip width 1.3mm, 10.5cm	1
S12009-11	IRIS-Fine Scissors (Round Type)-S/S Str/25*5.6mm/11.5cm	1
S12010-11	IRIS-Fine Scissors (Round Type)-S/S Cvd/23.5*6mm/11.5cm	1
F21001-12	HALSTED Artery Forceps-Str/23.5*1mm/12.5cm	1
F21002-12	HALSTED Artery Forceps-Cvd/24*1mm/12.5cm	1
SP0001-P	Instrument Storage Portfolio	1

**SP0009-M**  
General Surgery Instrument Kit for Mouse



Cat.No.	Product Description	Qty
F11020-11	Micro Forceps-Str, head length 36mm, Tip 0.05*0.01mm, 11cm	1
F11021-11	Micro Forceps-45°Angled, head length 30mm, Tip 0.1*0.06mm, 11cm	1
S32003-12	Scalpel Handles with Ruler 3# Solid-12.5cm	1
S31011-01	11# Scalpel Blades (Box of 100pcs)	1
F35401-50	NA Terylene Sutures w/Needle-○3/8/3×10/90cm/5-0 (50/Box)	0.2
F31047-12	OLSEN-HEGAR Needle Holders with Scissors-Str, 10*2.15mm/12cm	1
S11001-08	VANNAS Spring Scissors (Triangular)-S/S Str/8*1.5mm/8cm	1
S11002-08	VANNAS Spring Scissors (Triangular)-S/S Cvd/8*1.5mm/8cm	1
R22029-04	Colibri Eye Specula-15mm spread, 4cm	1
F12005-10	IRIS Dissecting Forceps-Str, Tip width 1mm, teeth length 14mm, 10cm	1
F12006-10	IRIS Dissecting Forceps-Light Cvd, Tip width 1mm, teeth length 13.5mm, 10cm	1
F12007-10	IRIS Dissecting Forceps-Large Cvd, Tip width 0.9mm, teeth length 10mm, 10cm	1
F13029-10	IRIS 1x2 Teeth Tissue Forceps-Str, Tip width 1.3mm, 10.5cm	1
S12005-10	IRIS-Fine Scissors (Round Type)-S/S Str/23*5mm/10.5cm	1
S12004-09	IRIS-Fine Scissors (Round Type)-S/S Cvd/24*4.6mm/9.5cm	1
F22002-10	HARTMAN Mosquito Forceps-Str/20*0.8mm/10.5cm	1
F22003-10	HARTMAN Mosquito Forceps-Cvd/20.8*1mm/10cm	1
SP0001-P	Instrument Storage Portfolio	1



**VANNAS Spring Scissors**

- Cat.No:S11001-08**
- Triangular/Straight/8cm
  - Sharp&Sharp
  - Cutting Edge(Length):8mm
  - Width:1.55mm



- Cat.No:S11002-08**
- Triangular/Curved/8cm
  - Sharp&Sharp
  - Cutting Edge(Length):8mm
  - Width:1.5mm



- Cat.No:S11003-08**
- Triangular/Angled/8.5cm
  - Sharp&Sharp
  - Cutting Edge(Length):6.3mm
  - Width:1.35mm



**VANNAS Spring Scissors**

- Cat.No:S11035-08**
- Triangular/Straight/8cm
  - Sharp&Sharp
  - Cutting Edge(Length):3.5mm
  - Width:1.3mm



- Cat.No:S11036-08**
- Flat/Straight/8cm
  - Sharp&Sharp
  - Cutting Edge(Length):8.2mm
  - Width:1.5mm



- Cat.No:S11037-08**
- Flat/Curved/8cm
  - Sharp&Sharp
  - Cutting Edge(Length):8mm
  - Width:1.5mm



**IRIS-Fine Scissors**

- Cat.No:S12003-09**
- Straight/9cm
  - Sharp&Sharp
  - Cutting Edge(Length):24.5mm
  - Width:5mm



- Cat.No:S12004-09**
- Curved/9.5cm
  - Sharp&Sharp
  - Cutting Edge(Length):24mm
  - Width:4.6mm



- Cat.No:S12005-10**
- Straight/10.5cm
  - Sharp&Sharp
  - Cutting Edge(Length):23mm
  - Width:5mm



- Cat.No:S12006-10**
- Curved/10.5cm
  - Sharp&Sharp
  - Cutting Edge(Length):22mm
  - Width:4.5mm



- Cat.No:S12011-12**
- Straight/12.5cm
  - Sharp&Sharp
  - Cutting Edge(Length):31mm
  - Width:5.8mm



- Cat.No:S12010-11**
- Curved/11.5cm
  - Sharp&Sharp
  - Cutting Edge(Length):23.5mm
  - Width:6mm



- Cat.No:S12031-11**
- Curved/11.5cm
  - Sharp&Sharp
  - Cutting Edge(Length):29mm
  - Width:6mm



- Cat.No:S12034-12**
- Straight/12.5cm
  - Sharp&Sharp
  - Cutting Edge(Length):17mm
  - Width:6mm



**VANNAS Spring Scissors**

- Cat.No:S11007-12**
- Straight/12.5cm
  - Sharp&Sharp
  - Cutting Edge(Length):19mm
  - Width:4.25mm



- Cat.No:S11019-14**
- Straight/14cm
  - Sharp&Sharp
  - Cutting Edge(Length):14.5mm
  - Width:3.2mm

**Cat.No:S11022-14**

- Curved/14cm
- Sharp&Sharp
- Cutting Edge(Length):14.5mm
- Width:3.2mm



**VANNAS Spring Scissors**

- Cat.No:S11014-12**
- Straight/12.5cm
  - Sharp&Sharp
  - Cutting Edge(Length):5.5mm
  - Width:1.9mm



- Cat.No:S11008-12**
- Curved/12cm
  - Sharp&Sharp
  - Cutting Edge(Length):14mm
  - Width:0.2mm



**Delicate Scissors**

- Cat.No:S13001-10**
- Straight/11.5cm
  - Sharp&Sharp
  - Cutting Edge(Length):25.5mm
  - Width:6mm



- Cat.No:S13020-11**
- Straight/12cm
  - Sharp&Sharp
  - Cutting Edge(Length):20mm
  - Width:5mm



- Cat.No:S13002-10**
- Curved/10cm
  - Sharp&Sharp
  - Cutting Edge(Length):26mm
  - Width:5.5mm



- Cat.No:S13005-14**
- Straight/14.5cm
  - Blunt&Blunt
  - Cutting Edge(Length):40mm
  - Width:6.3mm



- Cat.No:S13050-16**
- Curved/16cm
  - Blunt&Blunt



**Operating Scissors**

- Cat.No:S14001-10**
- Straight/10.5cm
  - Sharp&Blunt
  - Cutting Edge(Length):33mm
  - Width:7.5mm



- Cat.No:S14001-13**
- Straight/13cm
  - Sharp&Blunt
  - Cutting Edge(Length):40.5mm
  - Width:9.4mm



- Cat.No:S14001-15**
- Straight/15.5cm
  - Sharp&Blunt
  - Cutting Edge(Length):50mm
  - Width:10mm



- Cat.No:S14016-11**
- Curved/11.5cm
  - Sharp&Blunt
  - Cutting Edge(Length):35.4mm
  - Width:7.5mm



- Cat.No:S13030-14**
- Curved/14cm
  - Blunt&Blunt
  - Cutting Edge(Length):41mm
  - Width:9.5mm



**Cat.No:S14014-12**

- Straight/12.5cm
- Sharp&Sharp
- Cutting Edge(Length):37.6mm
- Width:8.6mm



**Cat.No:S14014-13**

- Straight/13cm
- Sharp&Sharp
- Cutting Edge(Length):45mm
- Width:9.8mm



**Cat.No:S14014-15**

- Straight/15.5cm
- Sharp&Sharp
- Cutting Edge(Length):48mm
- Width:10mm



**Operating Scissors**

**Cat.No:S14014-10**

- Straight/10.5cm
- Sharp&Sharp
- Cutting Edge(Length):32.7mm
- Width:8.45mm



**Cat.No:S13004-11**

- Curved/11.5cm
- Blunt&Blunt
- Cutting Edge(Length):28mm
- Width:5mm



**Cat.No:S13006-14**

- Curved/14.5cm
- Blunt&Blunt
- Cutting Edge(Length):44mm
- Width:7.5mm



**Cat.No:S13029-14**

- Straight/14cm
- Blunt&Blunt
- Cutting Edge(Length):37mm
- Width:9mm



**Cat.No:S13038-14**

- Straight/14.5cm
- Blunt&Blunt
- Cutting Edge(Length):41mm
- Width:10mm



**Operating Scissors**

**Cat.No:S13050-15**

- Curved/15cm
- Blunt&Blunt



**Stitch Scissors**

**Cat.No:S15006-09**

- Curved/9.5cm
- Sharp&Sharp
- Cutting Edge(Length):13.5mm
- Width:4mm



**SPENCER Ligature Scissors**

**Cat.No:S15001-11**

- Slender Type/11cm
- Cutting Edge(Length):27mm
- Width:6mm



**Cat.No:S15001-09**

- Slender Type/9cm
- Cutting Edge(Length):20.3mm
- Width:4mm



**BEEBE Bone Cutters**

**Cat.No:S16001-10**

- Straight/10.5cm
- Cutting Edge(Length):21mm
- Width:10mm



**BEEBE Bone Cutters**

**Cat.No:S22005-12**

- Flat Blades/12.5cm
- Cutting Edge(Length):15.2mm
- Width:7.4mm



**Rongeurs**

**Cat.No:S21022-14**

- Curved/14cm
- Cutting Edge(Length):0.5mm



**Cat.No:S22004-11**

- Flat Blades/11cm
- Cutting Edge(Length):15mm
- Width:6.8mm



**Cat.No:S21002-15**

- Curved/15cm
- Cutting Edge(Length):12.5mm
- Width:3.5mm



**Cat.No:S21010-15**

- Curved/15cm
- Cutting Edge(Length):19mm
- Width:2mm



**Cat.No:S21023-14**

- Curved/14cm
- Cutting Edge(Length):0.7mm
- Width:7mm



**Cat.No:S21024-14**

- Curved/14cm
- Cutting Edge(Length):1mm
- Width:6.5mm



**Rongeurs**

**Cat.No:S21019-14**

- Straight/14.5cm
- Cutting Edge(Length):0.5mm
- Width:7.5mm



**Scalpel Blades(4#)**

**Cat.No:S31010-01**

- Box of 100 pcs



**Scalpel Blades(11#)**

**Cat.No:S31011-01**

- Box of 100 pcs



**Scalpel Blades(12#)**

**Cat.No:S31012-01**

- Box of 100 pcs



**Scalpel Blades(15#)**

**Cat.No:S31015-01**

- Box of 100 pcs



**Scalpel**

**Cat.No:S33006-13**

- Straight/13cm
- Cutting Edge(Length):25mm
- Width:3mm



**Scalpel Handles(3#)**

**Cat.No:S32003-12**

- 12.5cm



**Scalpel Handles(4#)**

**Cat.No:S32004-13**

- 14cm



**Micro Forceps**

- Cat.No: F11029-11**
- Straight/11cm
  - Tips: 0.14X0.09mm



**Micro Forceps**

- Cat.No: F11030-11**
- 45° Angled/11cm
  - Tips: 0.1X0.06mm



**Micro Forceps**

- Cat.No: F11031-11**
- Curved/11cm
  - Tips: 0.07X0.03mm



- Cat.No: F11002-11**
- Straight/11cm
  - Tips: 0.15X0.1mm



- Cat.No: F11020-11**
- Straight/11cm
  - Tips: 0.05X0.01mm



**ADSON Dressing Forceps**

- Cat.No: F12002-12**
- Straight/12cm
  - Tips width: 0.6mm



- Cat.No: F12003-12**
- Straight/12cm
  - Tips width: 1.5mm



- Cat.No: F13029-10**
- Straight/10.5cm
  - 1X2 teeth
  - Tips width: 1.3mm



- Cat.No: F13030-10**
- Curved/10.5cm
  - 1X2 teeth
  - Tips width: 1.3mm



- Cat.No: F12012-10**
- Straight/10cm
  - Tips: 0.4X0.2mm



- Cat.No: S12011-13**
- Curved/13cm
  - Width: 1.2mm



- Cat.No: F12019-10**
- Straight/10.5cm
  - Tips width: 2mm



- Cat.No: F18017-09**
- Ring/9cm
  - ID: 2.2mm
  - OD: 3.2mm



- Cat.No: F12005-10**
- Straight/10cm
  - Tips width: 1mm



- Cat.No: F12006-10**
- Curved/10cm
  - Tips width: 1mm



- Cat.No: F12007-10**
- Curved/10cm
  - Tips width: 0.9mm



- Cat.No: F14012-10**
- Curved/10cm
  - Tips width: 0.5mm



- Cat.No: F12013-10**
- 45° Curved/10cm
  - Tips : 0.5x0.2mm



**MCPHERSON Forceps**

- Cat.No: F18011-09**
- Straight/9cm
  - Tips : 0.4X0.9mm
  - 5mm Platform



- Cat.No: F11003-13**
- 45° Angled/13cm
  - Tips: 0.15X0.1mm



- Cat.No: F11021-11**
- 45° Angled/11cm
  - Tips: 0.1X0.06mm

**Micro Forceps**

- Cat.No: F11003-11**
- 45° Angled/11cm
  - Tips: 0.3X0.15mm



- Cat.No: F13004-11**
- Curved/11.5cm
  - Tips: 0.3X0.15mm



- Cat.No: F11004-11**
- Curved/11cm
  - Tips: 0.2X0.12mm

**Micro Forceps**

- Cat.No: F11022-11**
- Curved/11.5cm
  - Tips: 0.1X0.06mm



- Cat.No: F11027-13**
- Straight/13cm
  - Tips: 0.1X0.06mm

**Micro Forceps**

- Cat.No: F11027-13**
- Straight/13cm
  - Tips: 0.1X0.06mm



**Dissecting Forceps (Standard)**

- Cat.No: F12019-10**
- Straight/10cm
  - Width: 2mm



- Cat.No: F12010-13**
- Straight/13cm
  - Width: 1.3mm



- Cat.No: F12029-09**
- Straight/9.5cm
  - Width: 0.8mm



- Cat.No: F12011-10**
- Curved/10.5cm
  - Width: 1.9mm



- Dressing Forceps**
- Cat.No: F15007-15**
- Curved/15cm
  - Width: 1.2mm



- 1X2 Teeth Tissue Forceps (Standard)**
- Cat.No: F13023-14**
- Straight/14cm
  - Width: 1.8mm



- Cat.No: F12010-10**
- Straight/10.5cm
  - Width: 1.8mm



**SEMKEN 1X2 Teeth Tissue Forceps**

- Cat.No: F13014-12**
- Straight/13cm
  - Width: 1mm



**Cat.No:F21002-12**  
 ● Curved/12.5cm  
 ● Width:1mm

**Artery Forceps**

**Cat.No:F21001-12**  
 ● Straight/12.5cm  
 ● Width:1mm



**Cat.No:F18001-10**  
 ● Curved/10.5cm  
 ● Width:5.4mm

**Cover Glass Forceps**

**Cat.No:F18015-10**  
 ● Straight/10.5cm  
 ● Width:4mm



**Cat.No:F22003-10**  
 ● Curved/10cm  
 ● Width:1mm

**Artery Forceps**

**Cat.No:F21019-16**  
 ● Straight/16cm  
 ● Width:1mm



**Cat.No:F21020-16**  
 ● Curved/16cm  
 ● Width:1.5mm



**Cat.No:F21011-14**  
 ● Straight/14.5cm  
 ● Width:2mm



**Cat.No:F22002-10**  
 ● Straight/10.5cm  
 ● Width:0.8mm



**Cat.No:C22002-10**  
 ● Straight/10.5cm  
 ● Punch Dia:2mm

**Ear Punch**

**Cat.No:C22001-10**  
 ● Straight/10.5cm  
 ● Punch Dia:1mm



**Cat.No:R31005-04**  
 ● Straight/16mm  
 ● Cutting Edge (Length):4mm  
 ● Wtdth:0.75mm



**Cat.No:R31005-06**  
 ● Straight/19mm  
 ● Cutting Edge (Length):6mm  
 ● Wtdth:1mm



**Cat.No:R31005-08**  
 ● Straight/18mm  
 ● Cutting Edge (Length):8mm  
 ● Wtdth:2mm



**Cat.No:R31005-10**  
 ● Straight/20mm  
 ● Cutting Edge (Length):10mm  
 ● Wtdth:2mm



**Cat.No:R31006-04**  
 ● Curved/17mm  
 ● Cutting Edge (Length):6.3mm  
 ● Wtdth:1mm



**Cat.No:R33001-48**  
 ● Straight/48cm  
 ● Cutting Edge(Length):14mm  
 ● Width:4mm



**Cat.No:R31010-26**  
 ● 45° Angled/26.5mm  
 ● Cutting Edge(Length):15mm  
 ● Wtdth:2.5mm



**Cat.No:R33003-01**  
 ● Straight/58mm  
 ● Cutting Edge (Length):17mm  
 ● Wtdth:3.7mm



**Cat.No:R33003-02**  
 ● Curved/58mm  
 ● Cutting Edge (Length):18.5mm  
 ● Wtdth:4mm



**Cat.No:R31006-06**  
 ● Curved/17mm  
 ● Cutting Edge (Length):6.6mm  
 ● Wtdth:1mm

**Micro Clamps**

**Cat.No:R34001-14**

● Straight/14cm  
 ● Cutting Edge (Length):8.4mm  
 ● Wtdth:5mm



**Cat.No:F31047-14**  
 ● Straight/14cm  
 ● Cutting Edge(Length):17.3mm  
 ● Width:1.7mm

**Needle Holders**

**Cat.No:F31047-12**  
 ● Straight/12cm  
 ● Cutting Edge(Length):10mm  
 ● Width:2.15mm



**BARRAQUER Needle Holders**

**Cat.No:F31031-15**  
 ● Straight/15.5 cm  
 ● Width:2.5mm



**Cat.No:F31026-12**  
 ● Straight/12 cm  
 ● Width:3mm



**Cat.No:F31034-14**  
 ● Straight/14cm  
 ● Cutting Edge(Length):17.5mm  
 ● Width:1.75mm



**Needle Holders**

**Cat.No:F31025-13**  
 ● Straight/13cm  
 ● Cutting Edge(Length):17.5mm  
 ● Width:1.75mm



**Hooks**

**Cat.No:R21027-12**  
 ● 1 Angled Tooth/12.5cm  
 ● 5mm depth



**Spatula**

**Cat.No:R51003-11**  
 ● Curved/11cm  
 ● Tips :2X0.3mm



**Retractors**

**Cat.No:R22029-03**  
 ● 15mm Spread/3cm



**Retractors**

**Cat.No:R22005-45**  
 ● 30mm Spread/5cm



**Retractors**

**Cat.No:R22011-50**  
 ● 30mm Spread/5.5cm



**Retractors**

**Cat.No:R22009-01**  
 ● 65mm Spread/7.5cm



**Retractors**

**Cat.No:R22029-04**  
 ● 15mm Spread/4cm



**Retractors**

**Cat.No:R22013-10**  
 ● 10mm Spread





**Tying Forceps**

- Cat.No:FC11001R-11
- Straight(SS)/11cm
- Tips:0.3X0.5mm



**Tying Forceps**

- Cat.No:FC11002R-08
- Straight(SS)/8.5cm
- Tips:0.3X0.5mm



**Tying Forceps**

- Cat.No:FC11001T-11
- Straight(TA)/11cm
- Tips:0.3X0.5mm



**Tying Forceps**

- Cat.No:FC11002T-08
- Straight(TA)/8.5cm
- Tips:0.3X0.5mm



**Tissue Forceps**

- Cat.No:FC13002R-08
- Straight(SS)/8.5cm
- Tips:0.3X0.5mm



**Tissue Forceps**

- Cat.No:FC13001T-11
- Straight(TA)/10.7cm
- Tips:0.3X0.5mm



**Tissue Forceps**

- Cat.No:FC13001R-11
- Straight(SS)/10.7cm
- Tips:0.3X0.5mm



**Tissue Forceps**

- Cat.No:FC13002T-08
- Straight(TA)/8.5cm
- Tips:0.3X0.5mm



**Corneal Forceps**

- Cat.No:FC12001T-11
- Straight(TA)/10.7cm
- Tips width: 0.3mm



**Corneal Forceps**

- Cat.No:FC12002R-08
- Curved(SS)/8.5cm
- Tips width: 0.3mm



**Corneal Forceps**

- Cat.No:FC12001R-11
- Straight(SS)/10.7cm
- Tips width: 0.3mm



**Corneal Forceps**

- Cat.No:FC12002T-08
- Curved(TA)/8.5cm
- Tips width: 0.3mm



**Capsulorhexis Forceps**

- Cat.No:FC14001R-11
- Curved(SS)/11cm
- Tips:0.6X0.6mm



**Capsulorhexis Forceps**

- Cat.No:FC14001T-11
- Curved(TA)/11cm
- Tips:0.6X0.6mm



**Cataract Scissors**

- Cat.No:SC12001R-13
- Straight(SS)/13cm
- Tips:19X1mm



**Cataract Scissors**

- Cat.No:SC12002R-13
- Curved(SS)/13cm
- Tips:19X1mm



Cat.No: SC11001R-12

- Curved(SS)/12cm
- Sharp&Sharp
- Cutting Edge(Length):15mm
- Width:3mm

**Corneal/Conjunctival Scissors**

Cat.No: SC11002R-11

- Curved(SS)/11cm
- Sharp&Sharp
- Cutting Edge(Length):11mm
- Width:3mm



Cat.No: SC11001T-12

- Curved(TA)/12cm
- Sharp&Sharp
- Cutting Edge(Length):15mm
- Width:3mm



Cat.No: SC11002T-11

- Curved(TA)/11cm
- Sharp&Sharp
- Cutting Edge(Length):11mm
- Width:3mm



**Ear Tag applicator**

Cat.No: C23001-14

- Straight/14.5cm
- Punch Dia:2.55mm
- Width:3mm



**Ear Tag**

Cat.No: 23001-5

- Black number A1-A500

**Glass Bead Sterilizer**

The sterilizer provides a safe, convenient and affective method for sterilizing your surgical instruments before and during surgery, ensuring the tools free of pathogens and microbial contaminants. The highest temperature can reach 300 °C. The surgical instrument could be sterilized completed within 5 seconds.

**Ordering Information:**

Model	Products Description	Price
RS1501	150g Glass Bead Sterilizer-4x8cm(110V)	\$429.00
RS1502	150g Glass Bead Sterilizer-4x8cm(220V)	\$429.00
RS3001	300g Glass Bead Sterilizer-4x14cm(110V)	\$514.00
RS3002	300g Glass Bead Sterilizer-4x14cm(220V)	\$514.00
RS1500	Glass Beads for Sterilizer, 1500g	\$40.00



**Sterilization Trays**

**Sterilization Trays**

Cat.No.: C12006-01

- Plastic
- Width: 270x160x22mm

**Sterilization Trays**

Cat.No.: C12006-02

- Plastic
- Width: 215x135x22mm



**Brain & Heart Matrices**

RWD Brain and Heart matrices are made of stainless steel, electroless plating, through precision machining and highly polished, strong durability, which can be heated, chilled, autoclaved scrubbed and used in a variety of harsh conditions. The surface will not be damaged by thermal pressure, and will not be damaged by mechanical impact, keeping the product in use for a long time.

Brain matrices have coronal sections and sagittal sections, each section can be as 0.5 mm or 1 mm. Widely used in preparing pathological tissue sections and cutting out TTC dyeing organization.



**Order Information:**

Model	Product Description	A (mm)	B (mm)	C (mm)	D (mm)	E (mm)	Depth (mm)	Diagram
68707	Brain Matrix, Mouse 40-75g, Coronal, 1mm, Stainless steel	3.18	11.1	8.73	19.1	12.5	7.40	[Diagram 1]
68708	Brain Matrix, Mouse 40-75g, Sagittal, 1mm, Stainless steel	3.18	11.1	8.73	19.1	12.5	7.40	
68709	Brain Matrix, Rat, 175-300g, Coronal, 1mm, Stainless steel	4.76	17.9	14.7	36.6	27.35	8.94	
68710	Brain Matrix, Rat, 175-300g, Sagittal, 1mm, Stainless steel	4.76	17.9	14.7	36.6	27.35	8.94	
68711	Brain Matrix, Rat, 300-600g, Coronal, 1mm, Stainless steel	4.76	19.8	14.7	36.6	25.7	10.91	[Diagram 2]
68712	Brain Matrix, Rat, 300-600g, Sagittal, 1mm, Stainless steel	4.76	19.8	14.7	36.6	25.7	10.91	
68713	Brain Matrix, Mouse, 40-75g, Coronal, 0.5mm, Stainless steel	3.18	11.1	8.73	19.1	12.5	7.40	
68714	Brain Matrix, Mouse, 40-75g, Sagittal, 0.5mm, Stainless steel	3.18	11.1	8.73	19.1	12.5	7.40	
68715	Brain Matrix, Rat, 175-300g, Coronal, 0.5mm, Stainless steel	4.76	17.9	14.7	36.6	27.35	8.94	[Diagram 3]
68716	Brain Matrix, Rat, 175-300g, Sagittal, 0.5mm, Stainless steel	4.76	17.9	14.7	36.6	27.35	8.94	
68717	Brain Matrix, Rat, 300-600g, Coronal, 0.5mm, Stainless steel	4.76	19.8	14.7	36.6	25.7	10.91	
68718	Brain Matrix, Rat, 300-600g, Sagittal, 0.5mm, Stainless steel	4.76	19.8	14.7	36.6	25.7	10.91	
68719	Heart Matrix, Mouse 20-75g, Coronal, 1mm, Stainless steel	8.3	12.7	-	-	-	4.8	[Diagram 4]
68720	Heart Matrix, Rat 175-400g, Coronal, 1mm, Stainless steel	12.7	19.9	-	-	-	9.6	
68721	Heart Matrix, Mouse 20-75g, Coronal, 0.5mm, Stainless steel	8.3	12.7	-	-	-	4.8	
68722	Heart Matrix, Rat 175-400g, Coronal, 0.5mm, Stainless steel	12.7	19.9	-	-	-	9.6	

## MCAO Sutures

RWD MCAO suture utilizes high-quality nylon thread to induce ischemic stroke model. The within-group variation of stroke models can be reduced by the super smooth surface and evenness of RWD suture. Without rupturing the vesicle, RWD suture makes its insertion into the animal brain much easier. The stability is also increased for the cerebral ischemia modeling. Diameters of silicone-rubber coated part range from 0.19mm to 0.44mm; Length of suture from 2-3cm.



### ► Features

- It adopts high-quality nylon thread with very good flexibility, not easy to puncture blood vessels, which increase the success of stroke model development.
- Ensure high uniformity and stability of the MCAO model.
- Silicone-rubber coated in tip, greatly reduces the risk of puncturing blood vessels.
- The line is marked with black dots, increased the observability during plugging into the blood vessel.
- The new manufacturing process makes sutures lighter and easier to use. The success rate of model making is higher and it is more suitable for long-term experiment.
- L1 in mouse suture: 3~4mm
- L1 in rat suture: 5~6mm
- L1 could be customized: 2~8mm

### Order Information:

Model	Diameter of Head end (mm)	Silicone head length (mm)	Diameter of suture body (mm)	Total Length (mm)	Animal's weight (g)	Packing (pcs)
MSMC19B007PK50	0.17~0.19	3~4	0.07	30	15~20g	50
MSMC19B008PK50	0.17~0.19	3~4	0.08	30	15~20g	50
MSMC19B100PK50	0.17~0.19	3~4	0.1	30	15~20g	50
MSMC21B007PK50	0.20~0.21	3~4	0.07	30	21~25g	50
MSMC21B008PK50	0.20~0.21	3~4	0.08	30	21~25g	50
MSMC21B100PK50	0.20~0.21	3~4	0.1	30	21~25g	50
MSMC21B120PK50	0.20~0.21	3~4	0.12	30	21~25g	50
MSMC23B007PK50	0.22~0.23	3~4	0.07	30	26~30g	50
MSMC23B008PK50	0.22~0.23	3~4	0.08	30	26~30g	50
MSMC23B100PK50	0.22~0.23	3~4	0.1	30	26~30g	50
MSMC23B120PK50	0.22~0.23	3~4	0.12	30	26~30g	50
MSMC25B120PK50	0.24~0.25	3~4	0.12	30	31~35g	50
MSMC25B150PK50	0.24~0.25	3~4	0.15	30	31~35g	50
MSMC26B150PK50	0.25~0.26	3~4	0.15	30	>35g	50
MSRC32B200PK50	0.31~0.32	5~6	0.2	50	<200g	50
MSRC35B200PK50	0.33~0.35	5~6	0.2	50	200~250g	50
MSRC37B200PK50	0.36~0.37	5~6	0.2	50	251~280g	50
MSRC40B200PK50	0.38~0.40	5~6	0.2	50	281~330g	50
MSRC42B200PK50	0.41~0.42	5~6	0.2	50	331~400g	50
MSRC45B200PK50	0.43~0.45	5~6	0.2	50	>400g	50

Copyright ©RWD Life Science Co., LTD. 2024. All rights reserved.

No part of this document may be reproduced or transmitted in any form or by any means without prior written consent of RWD Life Science Co., LTD.

### Trademark Notice

RWD, RWD瑞沃德, and RWD are trademarks or registered trademarks of RWD Life Science Co., LTD.

Other trademarks, product, service and company names mentioned are the property of their respective owners.

### General Disclaimer

The information in this document may contain predictive statements including, without limitation, statements regarding the future financial and operating results, future product portfolio, new technology, etc. There are a number of factors that could cause actual results and developments to differ materially from those expressed or implied in the predictive statements. Therefore, such information is provided for reference purpose only and constitutes neither an offer nor an acceptance.

RWD may change the information at any time without notice.

www.rwdstco.com