

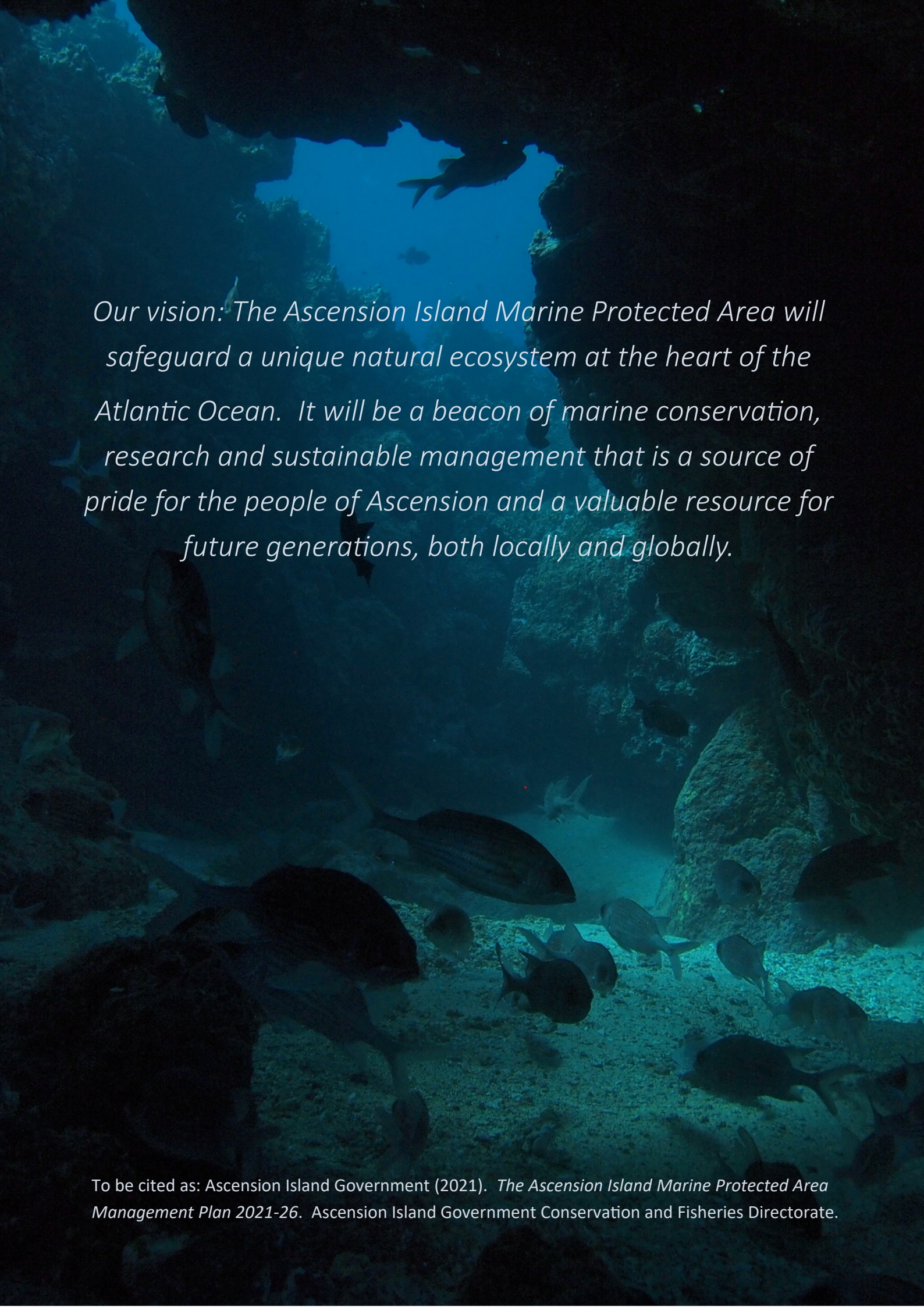

The Ascension Island Marine Protected Area
Management Plan 2021-2026



An underwater photograph showing a variety of fish swimming in a clear, blue-green environment. The scene is framed by dark, rocky structures, possibly a cave or a reef overhang. The lighting is soft and diffused, highlighting the textures of the rocks and the silhouettes of the fish. The overall atmosphere is serene and natural.

Our vision: The Ascension Island Marine Protected Area will safeguard a unique natural ecosystem at the heart of the Atlantic Ocean. It will be a beacon of marine conservation, research and sustainable management that is a source of pride for the people of Ascension and a valuable resource for future generations, both locally and globally.

To be cited as: Ascension Island Government (2021). *The Ascension Island Marine Protected Area Management Plan 2021-26*. Ascension Island Government Conservation and Fisheries Directorate.

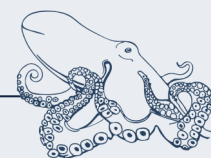

Foreword	4
Executive summary	5
Acknowledgements	6
Introduction	
Purpose of the MPA Management Plan	8
An introduction to the MPA and its values	9
The MPA map	10
The MPA objectives	
The MPA objectives	12
Strategic and operational objectives	13
What is the MPA protecting?	
Ascension’s marine biodiversity and cultural heritage	16
Coastal habitats	17
Shallow water habitats	18
Seamounts	19
Pelagic habitats	20
Deep benthic habitats	21
Cultural heritage	22
What activities are permitted in the MPA?	
Activities that take place in the MPA	24
Prohibited activities	25
Restricted activities	26
Permitted activities	27
Threats to the MPA	
Overview of threats	32
Legislation	
MPA legislation	36
Other relevant Ascension legislation	37
International agreements and obligations	38
Enforcement	39
Governance	
Principles of governance	41
Management structure	42
Management plan implementation	44
Financial governance	44
Assessment of new proposals	45
Relationship to other plans and strategies	46
Management actions	
Actions to achieve the MPA’s objectives	48
Monitoring and evaluation	
Measuring the success of the MPA	54
The future of the MPA	57
References	62

Foreword by Lord Goldsmith of Richmond Park

Biodiversity loss is the defining challenge of our time. Our response to that crisis will determine the health and prosperity not only of the world the next generation will inherit, but the world we live in now.

The harm we are doing to the marine environment is well documented. Over-fishing, numerous forms of pollution, ocean acidification, and unsustainable levels of development are just some of the factors causing entire marine ecosystems around the world to rapidly degrade. The time to act to reverse these changes is now.

Ascension Island's vast Marine Protected Area (MPA), designated in 2019, will provide long-term protection for the island's extraordinary marine biodiversity against the environmental pressures, which are increasingly threatening even the remotest places. The MPA Management Plan that underpins the designation demonstrates the commitment shared by Ascension islanders and the UK Government to the highest standards of ongoing management, scientific monitoring and enforcement for the MPA. The Plan will ensure the ongoing protection for the wealth of biodiversity around the island, including the top predators whose size, sadly, is now rare in other parts of the world. It will also act as a framework for further study of the island's habitats.

I congratulate Ascension Island Government for the designation of the MPA, the publication of the Management Plan, and the commitment to long term protection for the island's marine environment; and I would like to thank the Blue Belt programme team for their ongoing support. I particularly commend the collaboration with a wide range of stakeholders and experts, and the use of innovative technologies, and I look forward to following future developments in scientific research and management of the MPA. The UK leads efforts to protect 30% of the world's oceans by 2030, and so I am proud that Ascension Island has taken this step, expanding the Blue Belt of marine protection, and making a major contribution to regional and global marine protection.



The Rt Hon Lord Zac Goldsmith

Minister of State (Minister for the Pacific and the Environment)

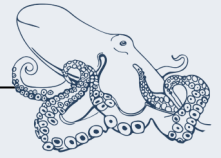

- The Ascension Island MPA will safeguard 445,000km² of ocean at the centre of the Atlantic Ocean, making it one of the largest protected areas in the world
- The MPA is home to threatened and endemic species, but what makes the waters around Ascension exceptional is how little they have been disturbed by human activity relative to other parts of the world. The MPA will seek to protect entire marine ecosystems and the natural processes that support them as well as respecting the cultural significance of the ocean to people living on Ascension.
- The MPA has four objectives:
 - 1) To conserve Ascension Island's marine biodiversity, habitats and ecological functions for long-term ecosystem health
 - 2) To support the sustainable development of social and economic activities in the MPA that are compatible with protection of the marine environment
 - 3) To promote scientific research and share knowledge about Ascension Island's marine biodiversity in order to encourage support for marine conservation locally and internationally
 - 4) To achieve effective governance and management of the MPA that is transparent and underpinned by sustainable financial and human resources
- In order to achieve these objectives, large scale commercial fishing will be banned throughout the MPA and no fishing of any kind other than licensed research fishing will be permitted beyond 12 nautical miles of the island. Recreational and sports fishing will continue close to the island and a community-led management system will be put in place to regulate these
- No mining will be allowed in the MPA, and development and pollution will be regulated to ensure they do not cause significant damage to the MPA
- Climate change, new non-native species and illegal and poorly-managed fisheries are the greatest threats to the MPA
- 22 management actions have been identified and will be delivered over the coming five years to achieve the objectives of the MPA
- The MPA will be managed by the Ascension Island Government, but the island community will be central to decision making through their involvement in oversight committees that ensure transparency and accountability
- Monitoring and research will be crucial to achieving the MPA's objectives. Independent scientists will advise on management of the MPA and each year the results of the monitoring will be published so that everyone can see how well the MPA is performing.
- Future management will be guided by the results of the monitoring in an adaptive approach that ensures new and growing threats trigger a rapid response

Acknowledgements

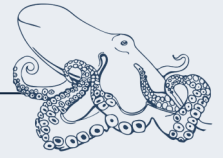

We would like to thank the Blue Belt Programme for funding the Ascension Island Government Conservation Marine Team on Ascension, who produced this plan, and for the comments the delivery partners MMO and CEFAS provided on previous drafts. Particular thanks go to Hannah Thomas, Emily Hardman, Ness Smith and Paul Whomersley for their insightful advice and support.

The Blue Marine Foundation and RSPB have provided continued support for the Ascension MPA designation process and we would like to give special thanks to Clare Brook, Adrian Gahan and Jonathan Hall.

This plan has built on the work of many scientists who have studied Ascension's marine life. They are too numerous to list but we would like to make particular mention of previous members of the AIG Conservation Team: Jude Brown, Andy Richardson, Sam Weber, Nicola Weber, Kate Downes, Emma Nolan, Rob Mrowicki and Kate Chadwick or laying the foundation of this plan.

We would also like to thank the individuals and organisations who responded to the public consultation on an earlier draft of this document and provided comments that have strengthened the plan.

Alan Nicholls and Xander Halliwell kindly proof read earlier drafts of this document and greatly improved its accuracy.

The exceptionally talented Lucie Machin created the beautiful paintings and illustrations used throughout this plan.



Many thanks to the generous people who contributed stunning photographs to this document.

Photo credits: front cover: Alamy, Matt Wall, Steve Brown, Simon Browning, Gemoar; page 2 Cath Bailey; page 4: Ness Smith; 7 & 8: Jude Brown; page 9: National Geographic; page 11: Geomar; page 15 & 17 (top) Jude Brown; page 17 (bottom): Sam Weber; page 18, 19 & 20 Jude Brown; page 20: AIGCFD; page 21: Geomar; page 22: AIGCFD; page 23: Jude Brown; page 24: Alamy; page 31: Ricky Carlisle; page 36: Ness Smith; page 40: AIGCFD; page 41: Jude Brown; page 45: Ness Smith; page 48 Cath Bailey; page 49: Matt Wall; page 54: Matt Stritch; page 56: Ness Smith; page 57: Sam Weber; page 62: Ness Smith.

Most of all, we would like to thank past and present members of the Ascension Island Council - Kitty George, Alan Nicholls, Sue Lawrence, Terry Young, Nicky John and Andrew Ellick - who have shown such vision and leadership to bring about the designation of the MPA.



Introduction



This Plan sets out how we, the Ascension Island Government (AIG) and our partners, will manage the Ascension Island Marine Protected Area (MPA). It describes what we want to achieve, how we plan to do it and who we need to help us. The plan is a legal document and decisions about the management and development of the MPA must pay regard to its objectives and principles. It is also a working document that we will use on a daily basis to guide our management of the MPA and inform the global community about what is being done to protect this internationally-important site.



The Management Plan has been developed through consultation with people living on Ascension and our partners around the world. It will be reviewed every five years to ensure it is achieving the MPA's aims.

In addition to the main Management Plan, there are a number of associated strategies that are referred to through this document. These provide greater detail on specific areas of management.

Once completed, all of the following associated strategies will be available on the MPA website:

- Monitoring, Evaluation and Research Strategy
- Financial Strategy
- Offshore Fisheries Compliance and Enforcement Strategy
- Inshore Fisheries Management Strategy
- Biosecurity Strategy
- Pollution Control Strategy
- Public Engagement Strategy
- Climate Change Resilience Strategy
- Tourism Strategy



The Ascension Island Marine Protected Area was designated in August 2019. It covers the entirety of Ascension's 445,000km² Exclusive Economic Zone at the centre of the Atlantic Ocean. The MPA is surrounded by international waters that receive little regulation, making it a haven of protection for the abundant and unique marine biodiversity found around the island.



The ocean around Ascension is a special place. It has been relatively little affected by human activity, and the large fish and other top predators lost in so many parts of the world's oceans are still seen in abundance around the island. We have many marine species that are found nowhere else on earth, as well as globally-important populations of breeding turtles and seabirds. The overall abundance of life is what makes Ascension exceptional, and it is these whole ecosystems and the natural processes that sustain them, rather than individual features or species, that the MPA will seek to protect. The Ascension Island MPA is an example to the rest of the world of what all of our oceans should and could look like in the future.

As well as safeguarding the marine environment, the MPA will also seek to preserve and strengthen the deep connection between the island community and the ocean. The history, prosperity and identity of Ascension and its people are bound to the surrounding ocean and the MPA will seek to generate social and economic benefits for those living on the island.

Ascension's MPA is one of a network of MPAs established around the UK Overseas Territories and their dependencies as part of the UK Government's Blue Belt Programme. This programme has resulted in the long-term protection of over 4 million km² of ocean and contributed to the UK Government's wider aspiration of including 30% of the world's oceans within MPAs by 2030.

The MPA map



The MPA covers the whole of Ascension's Exclusive Economic Zone and extends from the tidal limit at mean high water spring tide out to 200 nautical miles in all directions from the island. This results in an impressive protected area, but a very boring map.

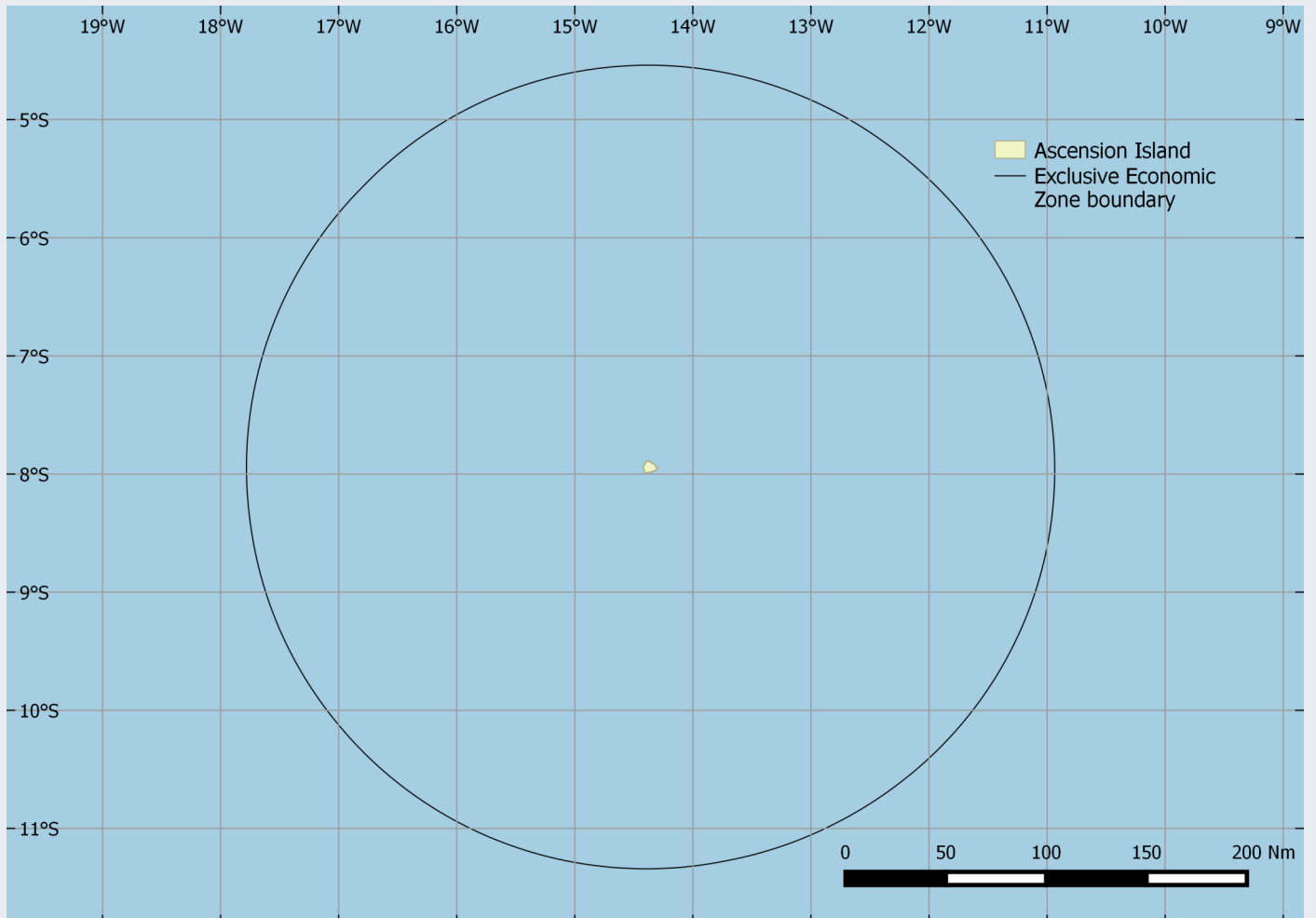

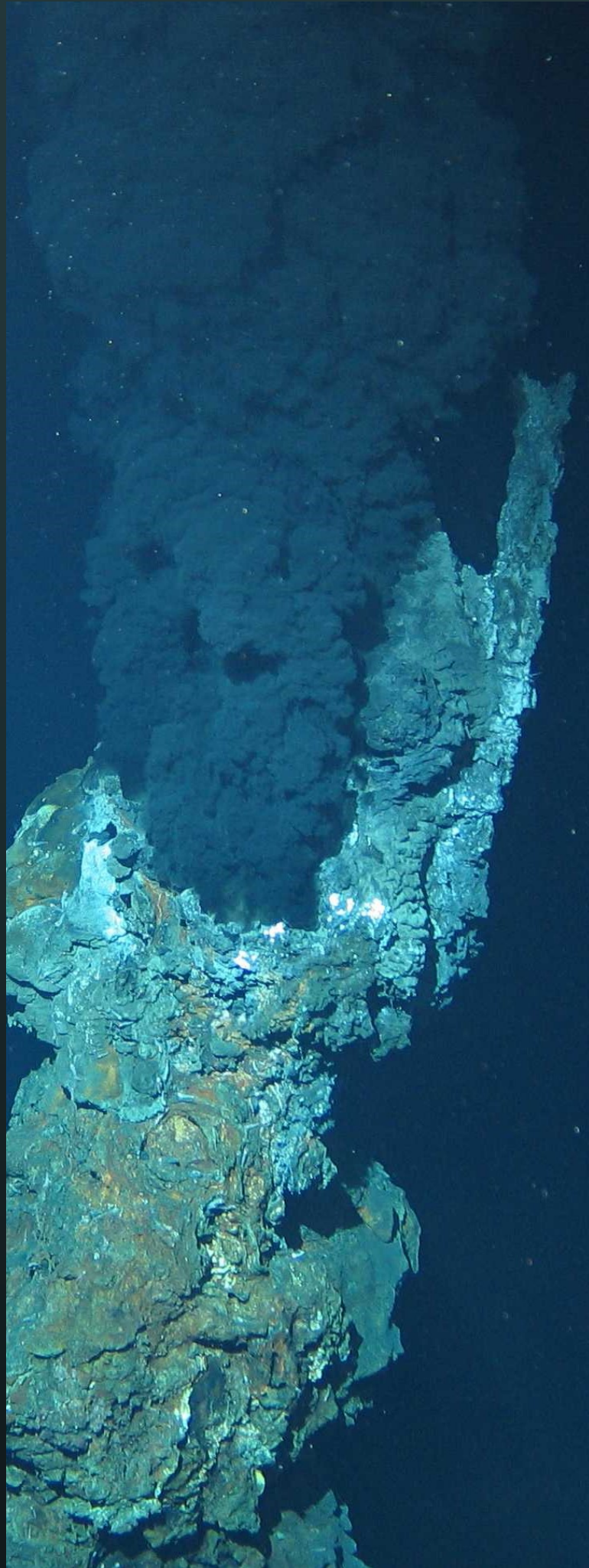

The MPA Objectives



Translating the vision for the MPA into practical action requires a couple of steps in between where we define in increasing detail what we want the MPA to achieve. These steps are the strategic and operational objectives.

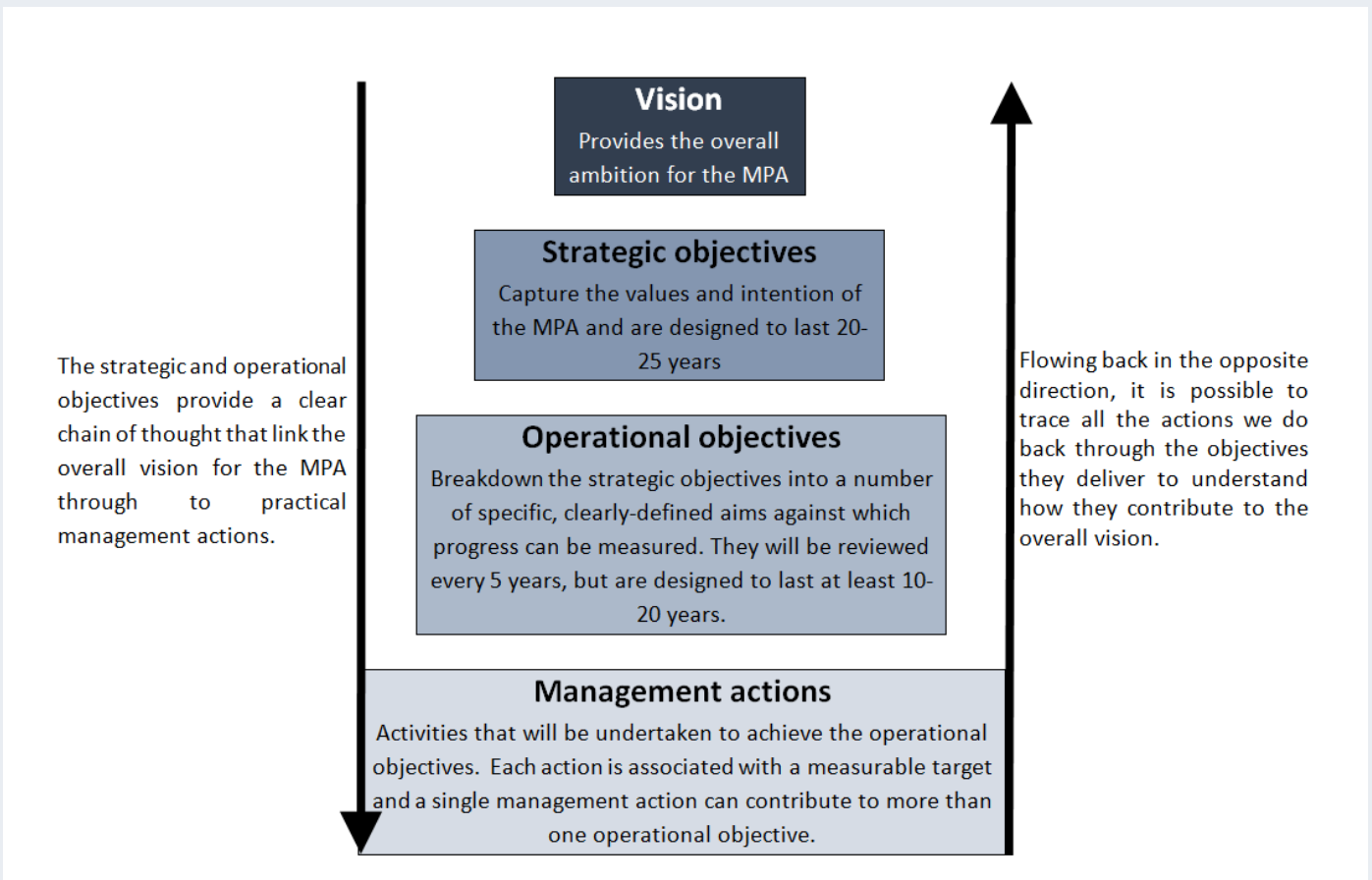

Some of our operational objectives are going to be difficult to achieve and measure with current technology and resources. We want to keep these objectives in place so we don't lose sight of our goal, but in these cases we have also identified a proxy objective that is a little easier to achieve in the short term.

Setting the biological objectives has been difficult. We have chosen to aim for no overall reduction in measures of ecosystem condition, and the Monitoring, Evaluation and Research Strategy provides more detail of how this will be assessed given the natural variability found in biological systems. The oceans around Ascension are not completely pristine and so an objective of 'no reduction' implicitly accepts any losses that have gone before. In the absence of historical baselines this is the only pragmatic option for management and, in the face of major threats such as climate change, maintaining the current position is still an ambitious aim. For a small number of species such as turtles and seabirds we know that specific pressures have been removed and targets for these species reflect our expectation that they will continue to rebound. However, for the MPA overall, maintaining the current diversity and abundance will be our objective.

The objectives described here focus on management outcomes. Monitoring and research will also be essential to the success of the MPA, but is not an objective in itself and so is covered separately in more detail in the Monitoring, Evaluation and Research Strategy.



Strategic objective 1. To conserve Ascension Island's marine biodiversity, habitats and ecological functions for long-term ecosystem health

This goes to the fundamental purpose of the MPA. Ascension has a wealth of marine life and we aim to ensure it is protected and thrives for generations to come.

Operational Objectives

- 1a. No loss of species and no reduction in species abundance or ecosystem complexity in offshore areas
- 1b. Proxy objective: Surveillance, compliance and enforcement regime effectively detects all known threats to offshore ecosystems
- 1c. No loss of species and no reduction of species abundance or ecosystem complexity in inshore areas
- 1d Proxy objective: Monitoring, regulation and management regime effectively tackles all known threats to inshore ecosystems
- 1e. Maintain the size distribution and age at maturity of species in inshore areas
- 1f. No loss of genetically distinct sub-populations from inshore or offshore areas
- 1g. No reduction in the extent or condition of key habitats

Strategic objective 2. To support the sustainable development of social and economic activities in the MPA that are compatible with protection of the marine environment

The marine environment is fundamental to the identity of the island and one of Ascension's greatest assets. We want the island community to realise its health, welfare and economic benefits in ways that don't compromise the prosperity and enjoyment of future generations.

Operational objectives

- 2a. People living on Ascension have access to recreational and fishing opportunities in the MPA that are equitably shared and enjoyed by the community
- 2b. Fishing pressure in inshore areas is adaptively managed by local stakeholders to prevent it contributing to the decline of any stock
- 2c. Ecological relationships between harvested, dependent and related species are maintained in inshore areas
- 2d. Ascension is recognised as a world leader in the responsible management of sports fishing and ecotourism; these activities have no negative impact on the behaviour or population size of protected species
- 2e. A significant proportion of revenue from sports fishing, ecotourism and other economic activities in the MPA is retained on the island
- 2f. Future developments are assessed and designed to be compatible with the conservation objectives of the MPA

Strategic objective 3. To promote scientific research and share knowledge about Ascension Island's marine biodiversity in order to encourage support for marine conservation locally and internationally

Ascension's marine environment is globally important and we want to share this resource with researchers and the public to increase understanding and appreciation of the world's oceans.

Operational objectives

- 3a. The Ascension Island MPA becomes a world-renowned site for the scientific study of marine species and ecosystems
- 3b. Ascension becomes an active and influential member of international networks of MPA managers, and initiates and participates in collaborative projects
- 3c. Every person on Ascension is aware of the MPA and its purpose
- 3d. The Ascension MPA and the conservation and scientific work being undertaken reaches a global audience leading to increased political and financial support

Supporting Objective 4. To achieve effective governance and management of the MPA that is transparent and underpinned by sustainable financial and human resources

The potential benefits of the MPA to biodiversity, the people of Ascension and the wider global community will only be achieved if it is well-managed with the resources and oversight required.

Operational objectives

- 4a. The Legal and operational framework for the MPA (primary and secondary legislation, regulations, management plan) is fit-for-purpose and enforcement action is effective
- 4b. Management actions are designed to deliver the MPA objectives, based on the best available information and subject to regular monitoring and review
- 4c. The Ascension Island community is effectively engaged in MPA governance structures and the benefits and impacts of management decisions are equitably shared
- 4d. Human and financial resources are secured to deliver effective management

We do not feel there is any contradiction between the objective to protect biodiversity and the objectives to encourage sustainable development and scientific research. With good management these will not just coexist, but will actually support and enhance each other. However, should any points of conflict arise, the primary objective of the MPA will be Strategic Objective 1: *to conserve Ascension Island's marine biodiversity, habitats and ecological functions for long-term ecosystem health.*

A large manta ray is shown swimming in clear, blue water. The ray is seen from above, with its wide, flat body and long, thin tail. The water is bright blue, and the ray's dark, patterned skin is visible. The background shows the surface of the water with ripples and light reflections.

What is the MPA
Protecting?



The vast scale of the Ascension Island MPA means it encompasses a great range of habitats from sandy beaches to the seafloor 4,000m below the ocean surface. The MPA seeks to protect all of these because they are connected and we must safeguard whole marine ecosystems, the natural processes that support them and their cultural importance in order to secure their long-term future. The waters around Ascension are a special place because, unlike many parts of the world's oceans, those connections and processes are still intact.

There are rare species, unique species and globally-threatened habitats in the MPA, but the others are important too. This section provides an introduction to the marine biodiversity and cultural importance of the MPA by giving just a glimpse of the extraordinary diversity it contains.

Ascension Island is the tip of a 3.8km high volcano that has risen from the sea floor over successive eruptions. This speck of dry land in the vast ocean has a variety of **coastal habitats** that offer safe breeding areas for seabirds and turtles. There is only a narrow band of **shallow water habitat** around the island due to the steep sides of the volcano, but it contains abundant marine life and species found nowhere else on earth. Three shallow water **seamounts** in the waters around Ascension give a glimpse of what Ascension was like before it breached the ocean surface and provide a rich marine habitat in their own right. Away from the island and seamounts, more than 99.9% of the MPA is comprised of **pelagic habitats** - open oceanic waters deeper than 500m and descending at their maximum to over 4,000m. The **deep benthic habitats** in these areas consist largely of loose sediment offering challenging conditions for life to thrive, but hydrothermal vents found along the Mid Atlantic Ridge provide habitats for communities of specialised creatures. The constant presence of the ocean in people's lives has given it a crucial role in Ascension's **cultural heritage** and shaped the history and identity of the island.





The limit of the MPA stops at the high tide mark, but some species do not notice this boundary and move onto Ascension's sandy beaches, coastal plateaus and sea cliffs to breed. With dry land at a premium in the central Atlantic, species that require it to complete their life cycles have congregated on Ascension making it one of the most important sites for nesting turtles and seabirds in the Atlantic. Though not part of the MPA, many of these coastal breeding sites are designated as terrestrial nature reserves, creating a seamless landscape of protection for these charismatic species.

Ascension has 47.5km of coastline that varies greatly in character from expanses of sandy beach to steep basaltic cliffs. In some places the coastal landscape is dramatic with lava flows frozen in time as they reached the water. There has been little in the way of coastal development on Ascension, and most of the coastline is in its natural state with only localised modification and protection works in the north-west of the island.

Some of the species found in Ascension's coastal habitats:

Green turtle

Chelonia mydas

Endangered



Ascension is home to the second-largest green turtle breeding colony in the Atlantic with an estimated 50,000 nests recorded in the most recent whole-island census in 2017. The Ascension green turtle population is currently rebounding from intense human exploitation in the 19th and early 20th century that significantly reduced their numbers (Broderick et al. 2006).

Ascension frigatebird

Fregata aquila

Vulnerable



The Ascension frigatebird is endemic to the island. They would once have nested around the coast of the island, but the introduction of cats led to such high levels of predation that breeding was confined to Boatswain Bird Island for many centuries. It wasn't until 2012, eight years after cats were eradicated from Ascension, that frigatebirds bred once again on the main island. In recent years over a thousand chicks have fledged from the mainland.



Shallow water habitats support the highest diversity of species found in Ascension's MPA. This includes a total of 133 coastal fish species, 11 of which are found nowhere else on earth and a further 20 fish species are shared only with St Helena and St Peter and Paul's rocks (Wirtz *et al.* 2014). Taken together, this means the mixture of fish species found in the shallow waters around Ascension is completely unique.

Anyone visiting Ascension is struck by the abundance of marine life. The number of black triggerfish is particularly astounding, and their combined grazing and scavenging activity shape inshore habitats by preventing the growth of soft corals or algae and favouring the hard coralline algae and rhodoliths around Ascension's coast.

The other striking feature of Ascension's shallow-water habitats is the presence of high numbers of large, predatory fish, a phenomenon that is also seen in the small number of other sites around the world where fishing pressure has never been high.

Some of the species found in Ascension's shallow water habitats:

Rock hind grouper

Epinephelus adscensionis



Rock hind grouper are large fish that predate crabs and smaller fish in rocky habitats around Ascension. Though solitary, they are found in exceptional densities and appear to have very small home ranges. All rock hind begin life as females and transition to male at between 5 and 8 years of age. Spawning occurs in synchronised events between June and November usually with a peak in August.

Ascension wrasse

Thalassoma ascensionis

Endemic



Ascension wrasse are found nowhere else on earth. Their ancestors arrived on Ascension from other shallow water areas in the Atlantic. On reaching Ascension, they evolved in isolation to become so different from their ancestors that they are classed as separate species. Wrasse are abundant in the tidal pools and shallow waters around Ascension where they provide a cleaning function for larger fish removing parasites from the skin surface.

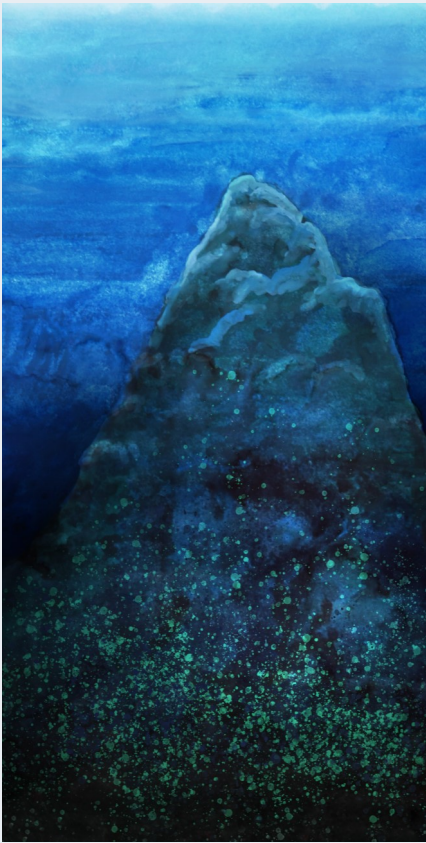

There are three prominent shallow water seamounts within Ascension's MPA. Like Ascension Island itself, the seamounts have formed from repeated eruptions of lava from the seafloor that over time have built up into steep-sided volcanic cones under the water.

The ocean around the Grattan and Young seamounts in the southeast quadrant of the MPA have a much higher density of zooplankton and large pelagic fish compared to the surrounding open ocean (Weber *et al.* 2018). This 'zone of enrichment' is seen up to 10km from the summit of the seamounts and makes them oases of life in the vast expanse of ocean.

The habitats and feeding opportunities provided by seamounts may play an important role in the migration and dispersal routes of marine species. They form 'stepping stones' between Ascension and neighbouring St Helena and could be crucial to maintain the biological connection between the two islands.

Some of the species found around Ascension's seamounts:

Yellowfin tuna

Thunnus albacares

Near-threatened



Tracking studies suggest that some yellowfin tuna spend long periods around Ascension Island and the southern seamounts. However, there is no evidence of them breeding in the MPA. The yellowfin tuna found in the Ascension MPA are thought to spawn in the Gulf of Guinea, suggesting they may be part of a larger regional population.

Galapagos shark

Carcharhinus galapagensis



The most commonly encountered shark around Ascension's coast and the shallow water seamounts is the Galapagos shark. They are found at much higher densities within 5km of the seamounts than in the surrounding open ocean. Tracking studies on the southern seamounts showed that many tagged individuals stayed close to the summits for the entire 235 days of the study period, suggesting they may be part of resident populations.



We measure the size of the MPA in terms of its area, but it is actually a three-dimensional space, and this is most evident in open ocean (pelagic) habitats. The average depth of water within Ascension Island's EEZ is 3300m, providing a vast volume of marine habitat.

This water is not still. The ocean around Ascension is strongly influenced by the Atlantic South Equatorial Current, which is a complex system of alternating bands of westward and eastward flows that extends from approximately 4°N to 20°S of the equator and brings nutrient-rich waters to the northern part of the MPA.

The depth to which light can penetrate has a profound influence on ocean life, with the surface waters the most diverse and productive: This is the realm of flying fish, giant marlin, sharks and immense shoals of tuna. Some pelagic species migrate from deeper water into the upper layers of the ocean at night to take advantage of the better feeding whilst avoiding predators.

Some of the species found in Ascension's pelagic habitats:

Flying fish

Exocoetidae



Flying fish are common in tropical and subtropical oceans, and there are five species found in Ascension's waters. All have elongated pectoral fins that they use to glide above the water at speeds of up to 70km per hour. Flying fish feed mainly on plankton and are an important part of the diet of larger pelagic fish, dolphins and seabirds.

Blue shark

Prionace glauca

Near - threatened

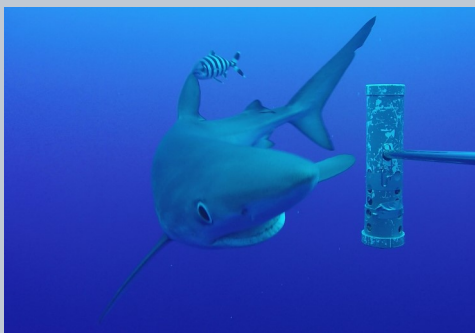

Blue sharks are the epitome of a pelagic fish with a slim and graceful profile, large eyes and long, narrow pectoral fins. They are found throughout the world in tropical and temperate oceans and at depths ranging from 0-350m. Blue sharks are the most heavily fished shark species with millions caught annually, including in the tuna longline fishery that operates in the Atlantic outside of the Ascension MPA.

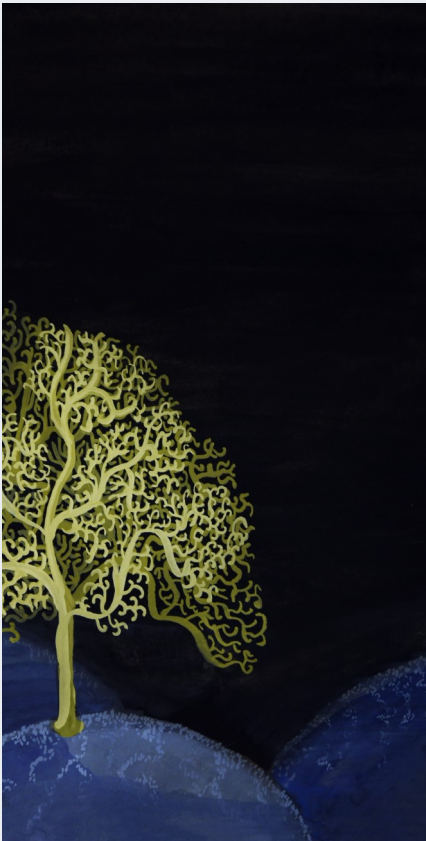

The average water depth in the Ascension MPA is 3300m. Most of the seafloor in the MPA is abyssal plain with relatively flat topography and substrate consisting of mud and soft sediment. Interrupting these vast plains are features associated with past or current volcanic activity. Around the slopes of the Island and seamounts, the coarse sand and rock habitat seen in shallow water extends to a considerable depth (at least 1000m). Along the Mid-Atlantic Ridge, volcanic activity and the spreading seafloor create hydrothermal vents of superheated water (300- 450°C) under immense pressure and rich in chemicals. These features create a more diverse range of niches for specialised organisms and can be rich in biodiversity relative to the surrounding plains.

The lack of light penetration limits primary productivity in most deep benthic habitats. Instead, they depend on energy falling through the water column to the seafloor in the form of dead animals or waste products. The exceptions are hydrothermal vents and cold seeps where energy comes from chemicals in the superheated water.

Some of the species found in Ascension's deep benthic habitats:

Vestimentiferan tubeworms



Vestimentiferan tubeworms are some of the most abundant species found on hydrothermal vents and can be seen in groups of many thousands of individuals. They anchor themselves to the substrate and, over many decades, can grow up to 2m long. Like most organisms found around hydrothermal vents, they rely on chemicals in the water as their main source of energy.

Bathymodiolus mussels

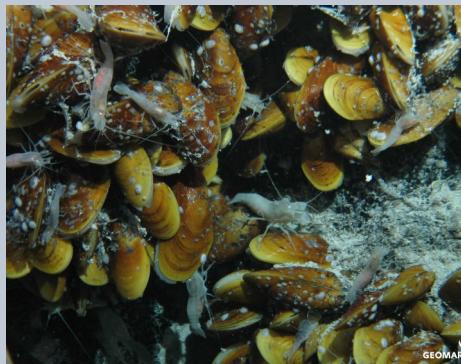

Bathymodiolus mussels are found at hydrothermal vents and cold seeps. There are often large distances between the vent fields, and this has led to the evolution of many different species, some of which are unique to just a single vent field. They typically live at depths of 3,600m where the cold temperatures favour slow-growth and a sluggish metabolism, but over many years they can grow up to 20cm long.



The sea is a constant presence in the lives of everyone living on Ascension, and so it is not surprising that it plays a crucial role in the identity and culture of the island. In interviews and questionnaires conducted in 2019, the majority of people surveyed named the sea and coast when asked to describe the ‘essence’ of Ascension (Canelas et al. 2019). The sea, and in particular fishing, is closely bound to the identity of many people living on Ascension and the beaches and pier are important locations for social gatherings and community cohesion on the island.

Two participants in the 2019 survey described the importance of the pier to them:

“we always go there for fishing and if you go on a Saturday or Friday night you always find people you can have a chat with”

“it’s great there, you have the sea right there, the fish swimming around and the people gather at the Pier”



Many of the people living on Ascension come from St Helena and until 2018 the main route home was the *RMS St Helena* that would travel between the islands every six weeks. The three-day journey across 700km of ocean that now includes both the Ascension and St Helena MPAs was a lively affair with plenty of eating, drinking and skittles. Though this has now been replaced by an airlink, for many people the idea of home still lies across the ocean.

The history of Ascension is also closely bound to the ocean. Ascension was discovered by a Portuguese sailor in 1501 and for the following centuries, most visitors were mariners looking for safety and fresh meat. Notable explorers such as William Dampier, James Cook and Charles Darwin all called at Ascension, and early maps show an ocean teeming with life. That sense of a remote outpost providing comfort to weary travellers continues to this day, and there is a culture of helping those in need that has come to the aid of many merchant sailors and transatlantic yachtspeople in recent years.



What activities
are permitted in
the MPA?

Activities that take place in the MPA



Ascension is a remote island with a population of just over 800 people. There are strong cultural connections with the sea, and it plays an important part in the recreation and diet of the island community. However, the ocean around Ascension still sees little human activity. What does occur is concentrated within a few miles of the island.



For that reason, protection of the MPA required only a small number of activities to be prohibited or restricted through legislation and these are described over the following pages. The activities that continue to take place within the MPA are also described along with a summary of the regulations or policies in place to ensure they do not damage the MPA. If new activities are proposed in the future, then existing powers within the National Protected Areas Ordinance allow for the introduction of new regulations restricting or prohibiting activities to ensure the MPA is protected. Any new regulations would be discussed with the Ascension Island Council and require approval from the Governor of St Helena, Ascension and Tristan da. Cunha.

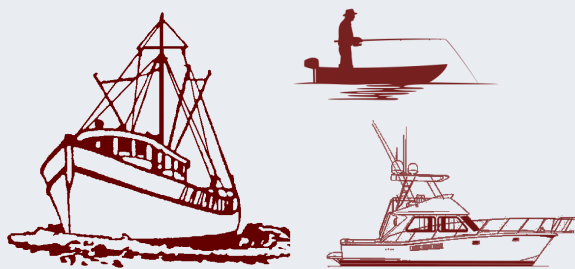

- **Fishing beyond 12 nautical miles of the island**

No fishing other than licensed research fishing is allowed within the MPA beyond 12NM of the island. This includes all types of fishing (commercial, sports and recreational), for all species using any type of gear. The no-fishing zone includes Ascension's three shallow-water seamounts and a total area of 443,000km².

Regulation:

The Fisheries (Conservation and Management) Ordinance, 2015, prohibits all fishing (except licensed research fishing) within the MPA beyond 12NM of the island. Satellite surveillance is used to detect illegal fishing activity and enforcement action will be taken through the flag state of offending vessels (see the MPA Offshore Fisheries Compliance and Enforcement Strategy). This will be coordinated by the Blue Belt Surveillance and Intelligence Hub (BBSIH) based in the UK.

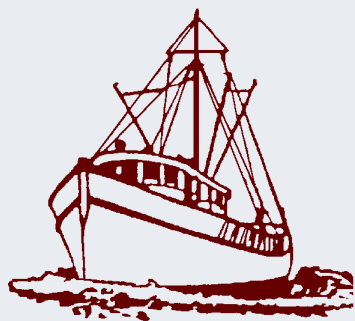

- **Large-scale commercial fishing in any part of the MPA**

The steep drop off around Ascension means that large pelagic fish are found close to the shore, and large-scale commercial fishing could be viable within 12NM of the island. To ensure that this does not take place, large-scale commercial fishing is prohibited in all parts of the MPA. This does not affect boats based on Ascension that sell their catch on the island or licensed sports fishing companies, all of which can operate within 12NM of the coast.

Regulation:

The Fisheries (Conservation and Management) Ordinance, 2015, prohibits large scale commercial fishing (defined as; *extractive fishing or fishing-related operations by any person, the primary purpose of which is the taking of fish to export from Ascension for sale elsewhere, whether any such sale is by or on behalf of that person or by another*) in any part of the MPA. Satellite surveillance is used to detect illegal fishing activity by the BBSIH based in the UK.



- **Mineral extraction**

No mineral extraction will be permitted within the MPA: This includes deep-sea mining activity, extraction of rocks and minerals from inshore waters, and the removal of sand from beaches. The only exception will be the periodic dredging required to maintain access to Ascension's one pier. This activity is critical to the functioning of the island and will be granted a specific exemption by the Administrator of Ascension.

Regulation:

The National Protected Areas Ordinance, 2003, has been amended to prohibit all mining activities throughout the MPA.

• Development within the MPA

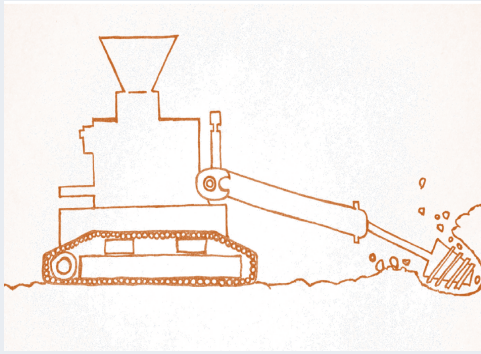

There has been little historical development around Ascension's coast. Any new developments, such as the building of structures or the laying of pipes within the MPA, will require permission from the Administrator. This would only be granted if an Environmental Impact Assessment demonstrates that it is compatible with the objectives of the MPA, or in the very small number of cases where a development is critical for the island and mitigation measures have been put in place. Where there is doubt about the impact of a new development, the precautionary principle will be applied and the onus will be on the developer to demonstrate a minimal impact.

Regulation:

The National Protected Areas Ordinance, 2003, has been amended so that no building or other development can take place anywhere in the MPA unless it is authorised by the Administrator. An assessment of the impact on the environment must be undertaken for each proposed development, and the Administrator must take this assessment and the advice of the Director of Conservation into account when making such decisions.

• Discharge of waste and effluents.



Two pipelines are discharging hypersaline water from the island's desalination plants at English Bay and the US Air Force (USAF) Base into the MPA. There is also a pipeline discharging treated wastewater from the USAF Base. These provide vital functions for the island and their impact on the marine environment will be monitored to ensure current treatment results in only insignificant, localised effects. The Administrator has powers to restrict any proposed new discharges that could have a negative impact on the MPA.

Regulation:

The National Protected Areas Ordinance, 2003, provides powers for the Administrator to place restrictions on new discharges if they are deemed harmful or to have a disturbing effect on the natural ecology or organisms of the MPA.

The Environmental Protection (Overseas Territories) Order, 1988, States that a licence from the Governor is required for: the deposit of substances from all vessels within 12NM of the island; the deposit of substances from British vessels or those that have loaded on Ascension within 200NM of the island; and all discharges of solid waste from specially-constructed structures on land.

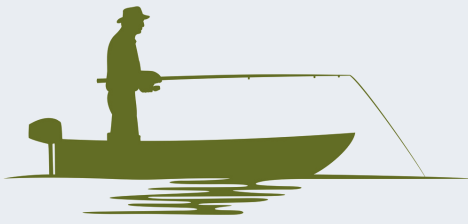

• Recreational fishing

Fishing is an important part of the local culture on Ascension and provides a valuable source of food for the island community. Most fish are taken for personal consumption or given to friends and family on Ascension or St Helena, though a small amount is sold on an informal basis. Fish are typically taken by rod and line, handline or spearfishing. The main species targeted are yellowfin tuna, rock hind grouper, glasseye snapper, moray eel, wahoo, spiny lobster and octopus. Fishing is undertaken from the shore or from small boats that venture out to a maximum 5km from the island. Most fishing effort is concentrated in the north-west part of the island.

Regulation:

The Fisheries (Conservation and Management) Ordinance, 2015, prohibits recreational fishing beyond 12NM of the island.

The Wildlife Protection Ordinance, 2013, prevents the taking of a list of protected species (including all endemic fish, sharks and cetaceans) and female spiny lobster in berry (with eggs).

An Inshore Fisheries Advisory Committee made up of local fishermen and AIG Conservation staff has been established to develop the Inshore Fisheries Management Strategy and associated legislation.

• Sports fishing

This fishery differs from the recreational one in that it is run on a commercial basis and, though the fish caught may be consumed, the primary product is the experience of catching fish. Three commercial sports fishing companies operated on Ascension prior to the suspension of the South Atlantic Airbridge in 2017. They primarily targeted blue marlin, tuna and wahoo caught either by rod and line or by spear. An estimated £300,000 was generated from sports fishing annually between 2015 and 2017, and it is likely to be the basis of any growth in tourism on Ascension.

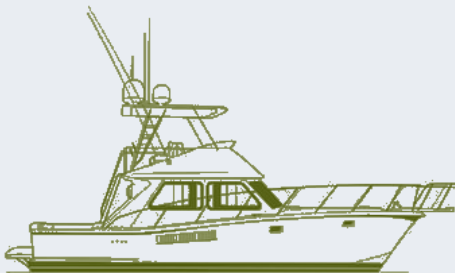

Regulation:

The Fisheries (Conservation and Management) Ordinance, 2015, prohibits sports fishing beyond 12NM of the island.

The Wildlife Protection Ordinance, 2013, prevents the taking of a list of protected species (including all endemic fish, sharks and cetaceans) and female spiny lobster with eggs.

An Inshore Fisheries Advisory Committee made up of local fishermen and AIG Conservation staff is developing the Inshore Fisheries Management Strategy that will set out the detail of how this sector will be regulated through legislation and licensing.



• Recreation and Tourism

Swimming, snorkelling, SCUBA diving and wildlife watching are popular activities for people living on Ascension as well as for visitors. There is the potential to grow this sector if the air service improves (Millington 2019) but it will always be constrained by the primary military purpose of the island and competition with more developed tourist destinations.

Yachts and cruise ships also bring visitors to Ascension. Typically around 20 yachts visit Ascension each year usually en route from St Helena to the Caribbean. In 2018 two cruise ships moored at Georgetown and over 400 passengers came ashore and participated in tours from the Conservation Directorate and Heritage Society.

Regulation:

The Wildlife Protection Ordinance, 2013, prevents the willful taking, killing, trading and molestation of protected species.

Business permits required by all ecotourism businesses operating on Ascension would include conditions to minimise impacts on species and habitats within the MPA.

• Supply of goods to the Island

Sea freight is the principal means by which imports reach Ascension from South Africa, the UK and the USA. Ascension has no port facilities. Cargo is delivered by unloading from vessels moored approximately 400m offshore onto shallow-draft barges, which then move alongside the pier allowing cargo to be craned ashore.

Fuel supplies reach the island from specialised fuel transport vessels via the MOD's ship-to-shore pipeline at Georgetown Pier or Encompass's pipeline at English Bay.

Regulation:

The Environmental Protection (Overseas Territories) Order (1988) prevents the dumping of waste from any vessel that unloads at Ascension within 200NM of the island.

Under the **UN Convention on the Laws of the Sea (UNCLOS)**, foreign vessels have the right to free navigation and to lay undersea cables.

The International Convention for the Prevention of Pollution from Ships (MARPOL) requires all vessels flagged to the 156 state signatories to follow pollution prevention standards.

The Harbours (Ascension) Ordinance, 2005, requires vessels arriving at Ascension to follow the direction of the Harbour Master including where to berth.

The Biosecurity (Ascension) Ordinance, 2020, requires that all vessels wishing to disembark cargo and crew must meet a vessel specification that requires pest control, a ballast management plan and proof of hull anti-fouling treatments. No ballast water should be discharged within 12NM of the island.



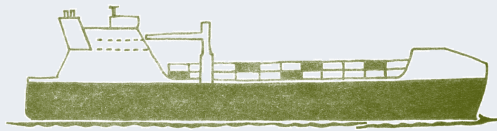

- **Vessels transiting through the EEZ**

The majority of ships in Ascension's waters are vessels transiting through the EEZ that have nothing beyond radio contact with the island. Under the United Nations Convention on the Laws of the Sea (UNCLOS), Ascension must allow vessels to pass through the MPA. The right of free passage does not apply to territorial waters within 12NM of the coast, and most ships remain beyond this distance.

Regulation:

The Environmental Protection (Overseas Territories) Order (1988) prevents the dumping of waste from any vessel within 12NM of Ascension and any British flagged vessel or vessel that has loaded on Ascension within 200NM of the island.

The Ballast Water Management Convention requires that vessels flagged to a signatory state cannot discharge ballast water within 200NM of a port and by 2024 must implement a ballast water management plan. Neither the UK nor the USA have currently ratified the convention.

The International Convention for the Prevention of Pollution from Ships (MARPOL) requires all vessels flagged to the 156 state signatories to follow pollution prevention standards.

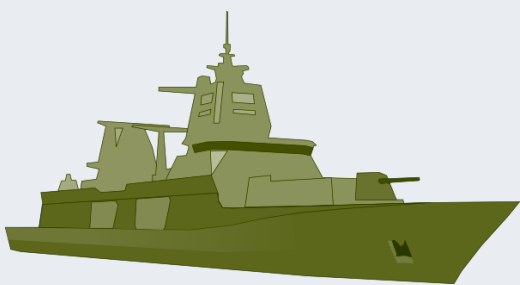

- **Military Activities**

Both the United States Air Force (USAF) and UK Ministry of Defence (MOD) have an established presence on Ascension. The activities undertaken are not made public, and no external environmental impact assessment is carried out. However, there is no indication that any military activities are having any negative impact on the marine environment. The USAF Final Governing Standards and the UK MOD Sustainable Development and Environmental Manual (JSP 418) set out their commitments to avoiding environmental damage.

Regulations:

MOD and USAF governing standards cover military operations

The US military presence on Ascension is governed by a number of bilateral agreements between the UK and US governments, principally a 1956 agreement known as '**The Bahamas Agreement.**'

- **Scientific research**

Scientific research has been carried out in the seas around Ascension, and this will be further encouraged as an objective of the MPA. Much of the past research has been initiated by the Ascension Island Government Conservation and Fisheries Directorate (AIGCFD) and its academic partners. This includes long-standing partnerships with the University of Exeter and the Royal Society for the Protection of Birds to collect population and productivity data for the green turtle and seabird populations respectively.

There are other research activities carried out in the Ascension MPA not directly linked to AIGCFD, but that will contribute to the growing body of knowledge on the marine environment. One example is the multinational PIRATA (Prediction and Research Model Array in the Tropical Atlantic) project that is collecting climate and oceanographic data to underpin climate change predictions.

Regulation:

All researchers visiting Ascension require a research permit to gain entry to the island.

The Fisheries (Conservation and Management) Ordinance, 2015, requires that all fishing for research within the MPA must be conducted under a licence.

Under the **Wildlife Protection Ordinance, 2013**, any research on a protected species requires a licence approved by the Administrator.

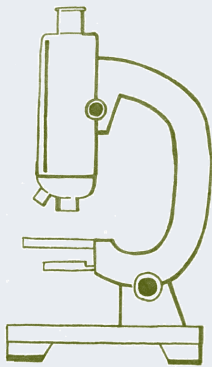
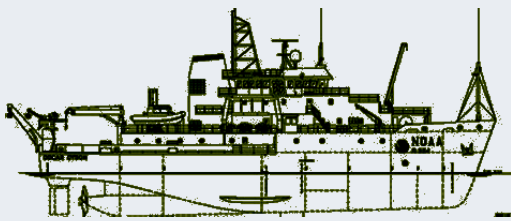

A large, detailed photograph of a fish, possibly a snapper or similar species, swimming in deep blue water. The fish is the central focus, shown in profile from the side, facing left. Its scales are visible, and its eye is prominent. In the background, several smaller fish are scattered across the frame, and some dark, rocky structures are visible at the bottom. The overall lighting is dim, creating a serene underwater atmosphere.

Threats to the MPA



The creation of the MPA and introduction of new regulations have provided a high degree of protection for Ascension's waters, but some threats still remain. This section considers those threats and how they could prevent the MPA meeting its objectives. The focus here is on threats to the habitats and species found in the MPA, but there are other pressures that may threaten the social and economic objectives of the MPA.

More work still needs to be done to gain a better understanding of the threats and refine the best methods to address them. The Monitoring, Evaluation and Research Strategy describes how we will do this. The threat assessment will be revised each year with the assistance of the MPA Scientific Advisory Committee.

The summary figures on the following pages provide an overview of which threats to the natural features of the MPA are thought to be the most significant. The method used to determine this is described below.

Threat assessment method

- Expert judgment was used to produce a semi-quantitative assessment of threats facing the MPA.
- This initial threat assessment exercise was undertaken by six scientists with direct knowledge of Ascension. In future years the MPA Scientific Advisory Committee will undertake the assessment to contribute a wider range of expertise and international perspective.
- In order to make the exercise manageable, AIGCFD undertook an initial screening to produce a list of threats relevant to Ascension and a suite of natural features that encompasses the broad scope of the MPA.
- Individuals were asked to consider in turn how each threat would affect each of the natural features. For every combination of threat/natural feature they were asked to provide a score (0-5) for the likelihood of an impact occurring and a second score (1-5) for the severity of the impact if it did occur. A qualitative description of each score (e.g. severity score 1 = negligible) was provided to encourage consistency of approach.
- An extract of the spread sheet used to capture the scores is shown below:

Description	IUU fishing in the MPA		Commerical fishing outside MPA		Recreational fishing		Sportsfishing		Increased water temperatur	
	Likelihood	Severity	Likelihood	Severity	Likelihood	Severity	Likelihood	Severity	Likelihood	Severity
Habitats										
Sandy beaches										
Coastal plateaus										
Sea cliffs										

- The Delphi method was used to a create more robust assessment. This involves bringing the experts together to compare and discuss their initial scores and allowing them to revise the scores in light of this.
- The final scores were then combined to produce the threat assessment. The mean likelihood score was multiplied by the mean severity score to give a value for each threat/objective or threat/natural feature combination. It was then possible to sum the values for all of the natural features for each threat (p.33) or to look at the cumulative threat to each natural feature (p.34).

What are the most significant threats to the natural features of the MPA? A comparison of the importance of each threat based on expert judgment of how many species and habitats they will affect and how severely they will affect them. The font size of each threat reflects its significance.

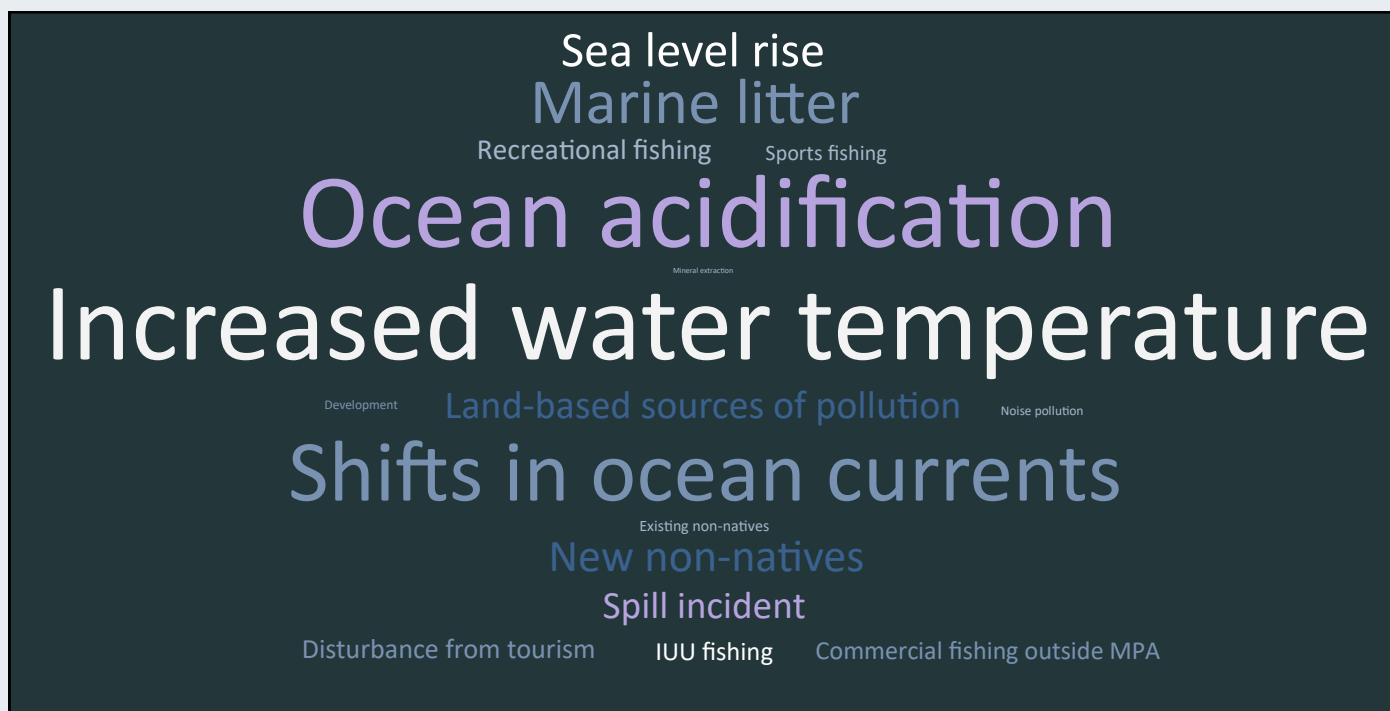

The effects of climate change (rising sea temperatures, shifts in ocean currents, ocean acidification and sea level rise) are the biggest threats to both inshore and offshore areas of the MPA. The next greatest threat is from marine litter, particularly plastic. The introduction of new non-native species is a serious threat, though it is mainly confined to inshore habitats. Illegal fishing within the MPA, and the Atlantic tuna fishery in international waters outside of it, pose a threat to offshore ecosystems, while poorly-managed recreational and sports fishing could affect inshore ecosystems. Pressures that are significant in other parts of the world such as development, pollution discharges and noise pollution are assessed as being relatively low risk on Ascension.

Many of the most serious threats identified are outside of our control as MPA managers. We feel it is important to undertake a full and honest assessment of the threats so we confront the limitations of our management levers. MPAs are a vital tool in marine conservation, but additional action to address global threats will also be necessary to protect our oceans.

Whilst the threat assessment considers all threats, our management actions are firmly focused on addressing those we do have control over. Even though their predicted impact on the MPA is dwarfed by climate change, threats such as sport fishing could still damage the MPA. The 'Management actions' section of this plan sets out how we will manage the threats we can influence.

By the end of 2021 we will have produced a Climate Change Resilience Strategy for the MPA. This will consider what local management actions are available to combat climate change impacts and what further monitoring, research and engagement work Ascension can undertake to contribute to global efforts to address this threat.

Which natural features of the MPA are most threatened? - The cumulative threat to some of the natural features of the MPA based on expert judgment of which threats are likely to affect a feature and how severe their effect would be.

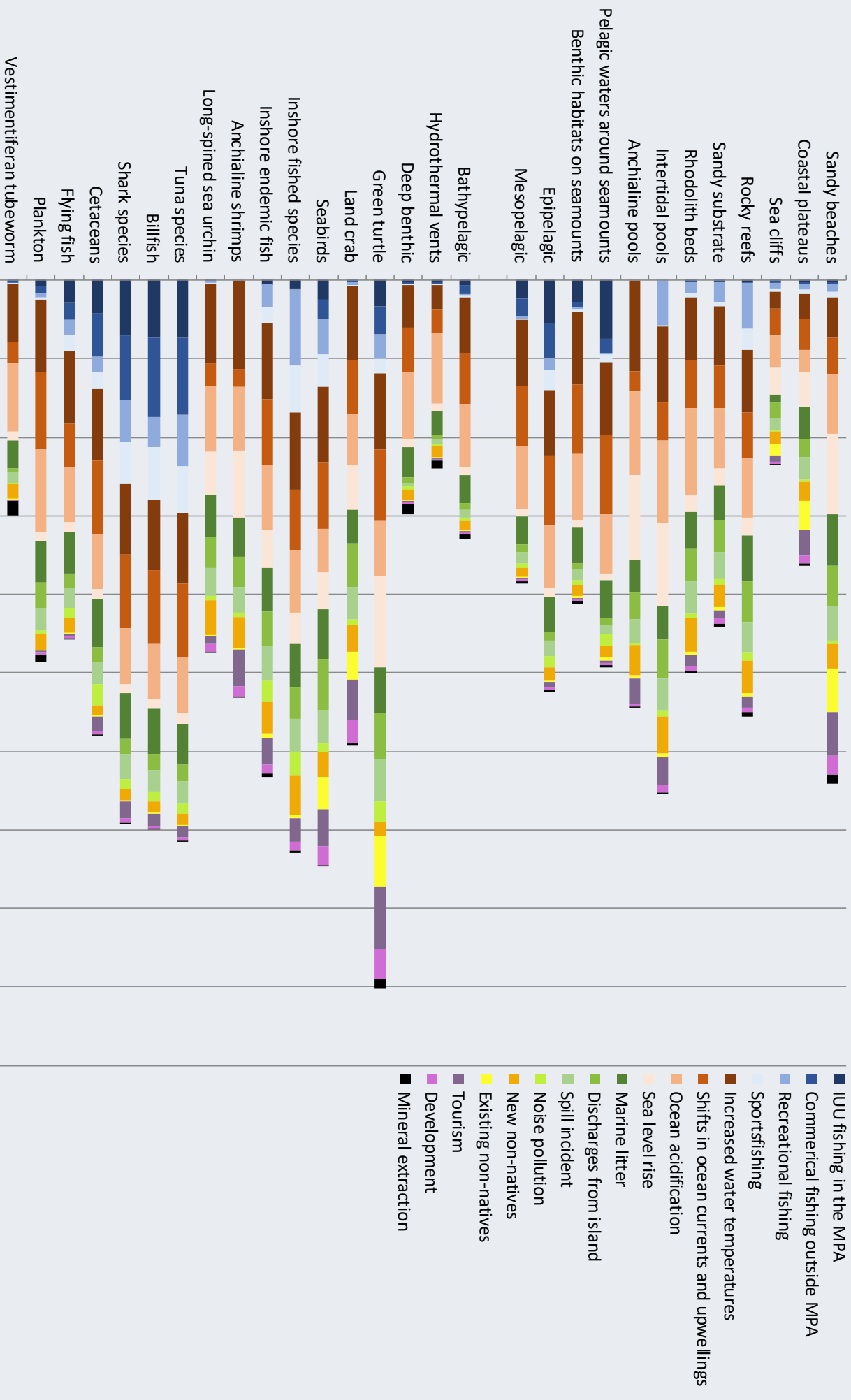



Legislation

A successful MPA needs a strong legal foundation. This includes powers to create the MPA in the first place and laws to tackle some of the most important threats. This section describes the legal framework for the Ascension MPA including legislation specifically drafted to support the MPA, existing local legislation that affects the MPA and relevant international agreements that Ascension is party to.

MPA Legislation



In 1978, the **Fisheries Limits Ordinance** asserted Ascension Island's claim to the exclusive use of the marine environment out to 200NM around the island. This provides the legal basis for the Ascension Island Government to control activities in these waters and underpins management of the MPA.

The MPA was designated by an Order under the **National Protected Areas Ordinance, 2003**, and specific amendments to the NPAO and **Fisheries (Conservation and Management) Ordinance, 2015**.

- **The National Protected Areas Ordinance, 2003**, has been amended so that no building or other development can take place anywhere in the MPA unless it is authorised by the Administrator. An assessment of the impact on the environment must be undertaken for each proposed development and the Administrator must take this assessment and the advice of the Director of Conservation into account when making such decisions. Further amendments to the Ordinance grant powers to introduce regulations restricting activities in the MPA and appoint wardens to enforce those regulations.
- **The Fisheries (Conservation and Management) Ordinance, 2015**, has been amended so that large-scale commercial fishing (defined as: *extractive fishing or fishing-related operations by any person, the primary purpose of which is the taking of fish to export from Ascension for sale elsewhere, whether any such sale is by or on behalf of that person or by another*) is prohibited throughout the MPA.
- **The Fishery Limits (Licensing of Fishing) (Offshore Zone) Order, 2015**, has been amended so that licences to fish in the offshore zone, between 12 and 200NM from the island, can only be issued for research activities. The Order already states that all fishing in the offshore zone requires a licence, so restricting the granting of licences only to research fishing means all other forms of fishing are prohibited in this part of the MPA.

This Management Plan has legal status under the National Protected Areas Ordinance (2003) and decisions about the management of the MPA must follow the principles laid out here.



There are also other pieces of domestic legislation that affect how the MPA is managed.

- **Environmental Charter** – Ascension signed an Environment Charter in 2001. This contains guiding principles and commitments for developing environmental policies, legislation and standards in order to meet international obligations for biodiversity conservation.
- **Fisheries Conservation and Management Ordinance, 2015** - Provides the powers necessary to take action to prevent illegal, unreported and unregulated fishing including the power to appoint Fisheries Protection Officers, board and inspect vessels and to take enforcement action. To date these powers have only been applied to the area of the EEZ beyond 12NM of the island through the Fishery Limits (Licensing of Fishing) (Offshore Zone) Order, 2015.
- **Wildlife Protection Ordinance, 2013** - Lists 70 species including 49 marine species and 11 seabirds that it is an offence to willfully kill, take, trade or molest.
- **Environmental Protection (Overseas Territories) Order (1988)** - Prohibits the depositing of substances or scuttling of vessels within Ascension's territorial waters and for many vessels within 200NM of the island unless carried out under a licence issued by the Governor. No dumping of solid waste into the MPA from a specially-constructed structure unless it is licenced by the Governor.
- **Harbours (Ascension) Ordinance, 2005** - Provides for the regulation, management and control of harbour areas on Ascension (the Northwest coast between Catherine Point and Northwest Point) including the removal of sand from beaches, laying of moorings and registering of boats.
- **Biosecurity (Ascension) Ordinance, 2020** - Places responsibilities on importers and vessel captains to reduce the risk of introducing non-native species and provides powers to inspect goods coming onto the island and treat or destroy those contaminated with non-native species. All vessels intending to land cargo or passengers on Ascension must meet a specification that includes proof of regular hull anti-fouling and good ballast water management. Vessel captains must take all reasonable steps to ensure no ballast water is discharged within 12NM of the island.
- **Inshore Fisheries Legislation** - It is anticipated that in 2020/21 an Inshore Fisheries Order will be introduced under the Fisheries (Conservation and Management) Ordinance 2015. This is still being developed following recommendations from the Inshore Fisheries Advisory Committee, but is likely to include a register for local fishermen, licence system for visiting fishermen and sports fishing businesses and the power to introduce management measures where monitoring indicates a fish stock is in poor health.



Ascension is party to a number of international agreements that have a bearing on marine management. Responsibility for compliance with these obligations rests with the UK Government.

- **The Convention on Biological Diversity (CBD)** has three aims:

1. The conservation of biodiversity
2. The sustainable use of the components of biodiversity
3. The fair and equitable sharing of the benefits arising out of the utilisation of genetic resources

The CBD has set out a 2050 vision of 'Living in Harmony with Nature' and is developing a Global Biodiversity Framework to achieve that vision.

- **The Convention on the Conservation of Migratory Species (CMS)** aims to conserve terrestrial, marine and avian species throughout their range. The UK ratified the CMS in 1985. Green turtle and hawksbill turtle are listed on Appendix 1 of the convention placing obligations to protect those species and their habitats.

- **The United Nations Convention on the Law of the Sea (UNCLOS)** is a comprehensive regime of law and order on the world's oceans and seas, establishing rules governing all uses of the oceans and their resources. It gives coastal states sovereign rights over their 12NM territorial waters and certain rights with respect to natural resources and certain economic activities in their 200NM Exclusive Economic Zone, but requires that other states are given freedom of passage through these waters. It binds states to prevent and control marine pollution and to allow scientific research that is conducted for peaceful means. Agreements under the Convention require states to cooperate on the management of straddling fish stocks and to take action to prevent IUU fishing in their waters.

- **The Convention on International Trade in Endangered Species of Wild Flora and Fauna (CITES)** restricts the import, export and trade of listed species including turtles and whales that are known to occur in Ascension's MPA.

- **International Commission for the Conservation of Atlantic Tuna (ICCAT)** is the regional fisheries management organisation responsible for regulating the Atlantic tuna fishery. Ascension has no registered vessels and no longer licenses foreign-flagged commercial fishing vessels. However, it does still have obligations as a coastal state to regulate and report on recreational and sports fisheries. ICCAT regulations govern the tuna fishery in the high seas beyond Ascension's MPA.



Enforcement of legislation relating to the MPA will always be carried out with proportionality, consistency and accountability to ensure it is fair and seen to be fair. An information campaign and continued public engagement will be carried out to ensure a high level of understanding of legislation relevant to the MPA amongst the island population, visitors and those passing through the MPA.

In carrying out any enforcement, the aims are:

- To change behaviour
- To deter non-compliance
- To limit any financial or other benefit from non-compliance
- To reassure those who are complying
- To impose sanctions either domestically or through a vessel's flag state that are proportionate to the offence
- To pursue prosecutions for very serious and deliberate non-compliance or repeated non-compliance

Those carrying out enforcement action will be authorised to do so as Fishery Protection Officers or Biosecurity Officers under the relevant Ascension legislation.

In most cases enforcement will be carried out on Ascension using local legislation. However, for breaches of the regulations regarding offshore fishing, the most effective means of enforcement will be through ICCAT and the flag state of the offending vessel. This will be coordinated by the Blue Belt Surveillance and Intelligence Hub and more details of how such enforcement would be undertaken are provided in the Offshore Fisheries Compliance and Enforcement Strategy.





Governance

This section describes how the MPA will be governed including how decisions will be made and who will be involved in making them. It also includes the means by which those decisions will be checked and scrutinised to ensure the MPA is being managed properly.

Principles of governance



The Ascension Island MPA will be governed according to the following principles:

Evidence-based - We will make all decisions based on the best available information. We will endeavour through the Monitoring, Evaluation and Research Strategy to address knowledge gaps and evaluate management effectiveness to improve the quality of our actions.

This will be achieved by monitoring the outcomes of our actions and applying an adaptive management approach that assesses both the success of implementation and progress against the MPA objectives.

Transparent - We will share the information we have, the decisions we make and the processes by which we make them in a form that is accessible to the people of Ascension and the global community.

This will be achieved through the publication of the MPA Management Plan, annual workplans, monitoring data and effectiveness reviews, as well as an active Public Engagement Strategy. Research outcomes will be shared with the scientific community through peer-reviewed publications and more widely with the general public through a variety of engaging means. There will be a presumption in favour of sharing data collected in the MPA to encourage trust, collaboration and advance global knowledge.

Accountable - We welcome scrutiny and oversight of our decisions to ensure they are consistent with the objectives of the MPA.

This will be achieved through public consultation on the drafting and review of the MPA Management Plan and the requirement for the Management Plan and Annual Workplan to be approved by elected members of the Ascension Island Council. The MPA Steering Group, Inshore Fisheries Advisory Committee, Youth Committee and Scientific Advisory Committee will provide oversight and ensure the MPA is achieving its objectives and following international best practice.

Management structure



The role of the MPA Management Authority will be undertaken by the Ascension Island Government, principally through a dedicated team within its Conservation and Fisheries Directorate (AIGCFD). External oversight and support will be provided by the elected members of the Ascension Island Council, the MPA Steering Group, Inshore Fisheries Advisory Committee, MPA Youth Committee an independent Scientific Advisory Committee and the UK Government's Blue Belt Programme.

Adoption of the MPA Management Plan after every five year review as well as any changes to the MPA legislation will require approval from the Governor of St Helena, Ascension and Tristan da Cunha following a recommendation from the Ascension Island Council.

Most core management activities will be delivered by staff based on Ascension. The exception is compliance and enforcement of offshore fisheries regulations, which will be undertaken by the Blue Belt Surveillance and Intelligence Management Hub housed within the UK's Marine Management Organisation.

The diagram on the next page explains how the MPA will be managed by highlighting the key documents that will guide all management activity and identifying who will be involved in approving and reviewing those documents. The groups and organisations shown in the diagram are introduced below.

The Governor - is the Queen's representative who approves legislation and the adoption of the MPA Management Plan. The Administrator is the Governor's representative on Ascension and specific pieces of legislation give the Administrator powers to grant permissions and licences.

Ascension Island Council (AIC) - includes five or seven elected members who make formal recommendations to the Governor on matters including the adoption of the MPA Management Plan.

MPA Steering Group - made up of eight volunteers from the Ascension Island community who will review the Management Plan and provide advice on all aspects of MPA management.

MPA Youth Committee - made up of eight young people under 18 years of age who live on Ascension and will provide advice on all aspects of MPA management.

Inshore Fisheries Advisory Committee (IFAC) - made up of volunteers from the Ascension fishing community who will advise on management of the inshore fisheries.

Scientific Advisory Committee - made up of academics and experts with experience relevant to managing the MPA who will advise on monitoring and management.

Blue Belt Partners - the UK's Marine Management Organisation and the Centre for Ecology, Fisheries and Aquaculture Science who will advise on all aspects of MPA management.

The MPA Management Plan plays a central role and will be reviewed every five years following external oversight, a public consultation and recommendation from the Ascension Island Council.

The Management Plan will guide the production of annual workplans to be delivered by the AIG Conservation and Fisheries Directorate and our partners. These workplans will also be subject to review and external oversight.

Monitoring the outcomes of management activities will be crucial to the success of the MPA. The Monitoring, Evaluation and Research Strategy will be produced and implemented with advice from the Scientific Advisory Committee to ensure lessons are learned and future management is improved through an 'adaptive management' approach.

Associated strategies listed on p. 8 will provide additional detail on specific topics and feed into the main MPA Management Plan.

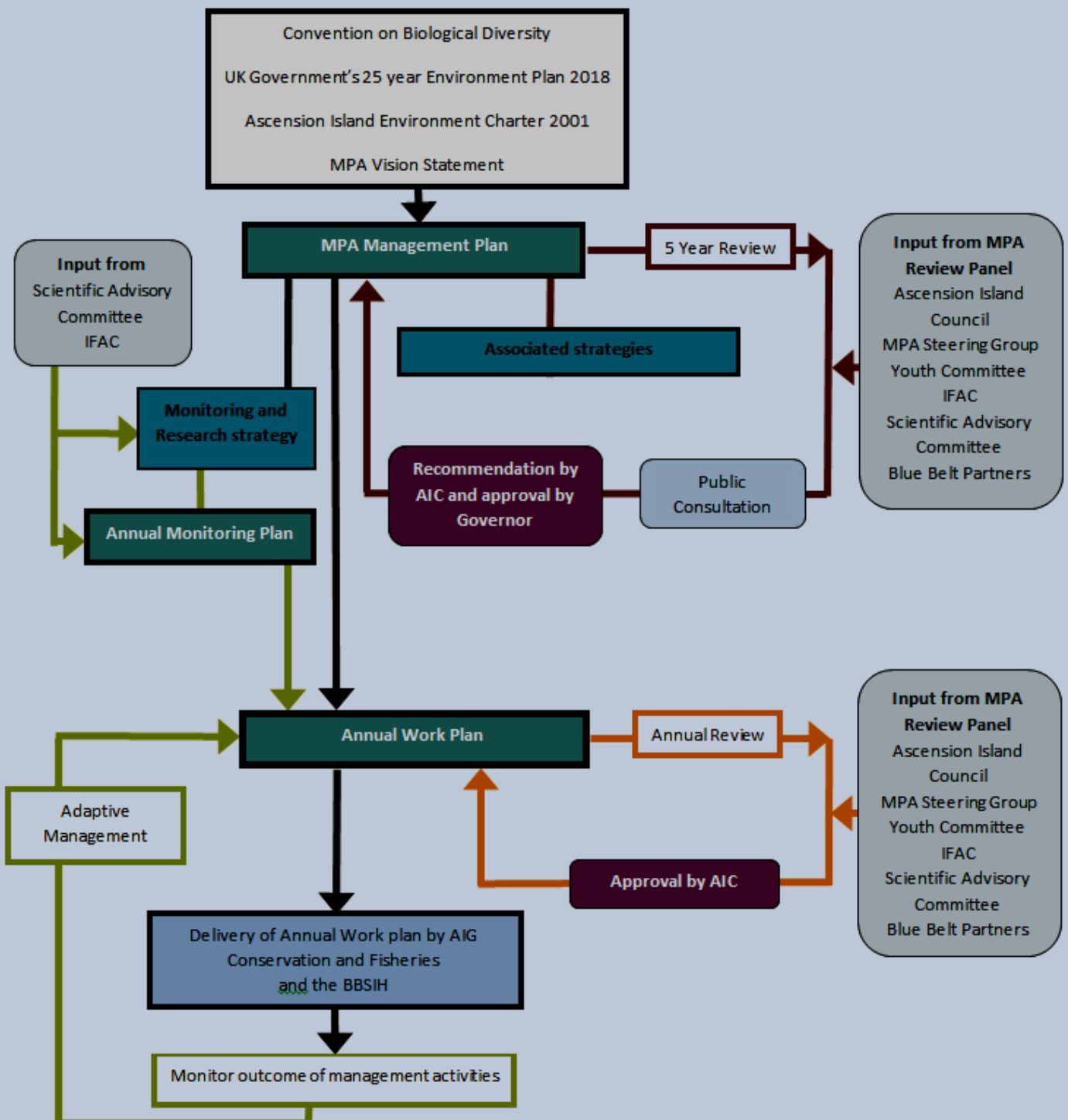

Management plan implementation



This MPA Management Plan describes what we hope to achieve over its five year lifespan, but we will need to prioritise and stage the actions it contains in order to produce an Annual Workplan that will define our activities each year. Alongside this, we will create an Annual Monitoring Plan derived from the Monitoring, Evaluation and Research Strategy that will ensure we collect the data necessary to measure management effectiveness. These annual plans will be created by AIGCFD with input from the Blue Belt Programme, Scientific Advisory Committee and IFAC. The annual plans will require approval from the AIC before being adopted.

Implementation of the Annual Workplan and Monitoring Plan will be undertaken by AIGCFD or external collaborators and contractors as appropriate. Responsibility for delivering the Annual Workplan will rest with AIGCFD.



Financial governance

The AIG Director of Conservation and Fisheries will act as the accounting officer for all funding and expenditure linked to the MPA. Individual budgets will be established for the different funding streams and project grants to allow them to be tracked and reported independently. All payments will be administered through AIG's bank account by the AIG Finance Department and subject to annual external audit. As a minimum, all Ascension financial regulations and AIG financial policies (on issues such as procurement and tendering) will be followed. Additional requirement will be agreed as necessary between AIG and funding providers.



The MPA designation is permanent. Regulations and management measures have been designed to address the current pressures, but new proposals with the potential to damage the MPA will arise over its lifetime. These will have to be assessed on a case by case basis, but the principles set out below will ensure those assessments are carried out consistently and in line with the values agreed by consultees on this management plan.

Development

Development is defined as *any change in use of land, the erection of any structure, the laying of underground cables or pipework and the carrying out of any drainage, dredging or sewerage scheme*. The National Protected Areas Ordinance, 2003, requires that development can only take place in the MPA with authorisation from the Administrator. Such determinations will be based on the following principles:

- There is a presumption against development within the MPA and the onus will be on the developer to demonstrate that the development will not conflict with the MPA objectives through an Environmental Impact Assessment.
- The Administrator will determine whether the development is likely to have a significant effect on the MPA after taking advice from the Director of Conservation and Fisheries.
- Where there is doubt or lack of evidence, the precautionary principle will be applied and the development will not be permitted.
- Developments with the potential to damage the MPA can be permitted in the small number of cases where the Administrator determines it is necessary for the island's military mission or critical functions, and, after taking advice from the Director of Conservation and Fisheries, that all alternative options have been considered and all reasonable mitigations put in place.

Research

Research is defined as *a detailed study of a subject using scientific methods in order to discover or revise facts*. Research is needed to improve and inform management, and to realise the potential global benefits of the MPA, but we recognise that some research could also damage the MPA if not carried out carefully. All research in the MPA must be carried out under a permit approved by the Director of Conservation and Fisheries or by the Administrator where a species listed in the Wildlife Protection Ordinance would be affected. The decision to grant a permit will be based on the following principles:

- The impact of proposed research on features of the MPA will be assessed and permission will only be granted where the benefits to the Ascension MPA outweigh any negative effects. These benefits may not be immediate, but they must be specific and locally applicable. Where there is doubt about the negative impacts of a research proposal, the precautionary principle will be applied and the onus will be on the researcher to demonstrate their work will not result in significant damage to the MPA.
- Research priorities identified in the MPA Monitoring, Evaluation and Research Strategy will be assumed to provide greater benefit to the MPA.
- All researchers must agree to share their data with AIGCFD and provide copies of all published work that arises from it.



The Ascension Island MPA Management Plan sits within the context of wider conservation planning and management strategies on Ascension and in the UK Overseas Territories. The MPA Management Plan is consistent with these strategies to ensure there is no conflict for those implementing them and to strengthen support for achieving the shared objectives.

- **Ascension Island National Biodiversity Action Plan (NBAP)** - The work of AIGCFD is underpinned by the NBAP that was created in 2015 and covers marine and terrestrial ecosystems. Specific action plans have been developed for 18 species and three habitats based on a threat analysis; of these, eight Species Action Plans and two Habitat Action Plans relate to the marine environment. The threat analysis and proposed actions for the marine species and habitats included in the NBAP have been used as part of the MPA Management Plan to avoid duplication or inconsistencies. The intention is for the MPA Management Plan to be incorporated into the NBAP when it is reviewed in 2021.
- **The UK Government's 25 Year Environment Plan (2018)** sets out a plan of government action to help the natural world regain and retain good health. It has a wide scope, but makes particular mention of marine protection in the Overseas Territories (OTs):

Working with our OTs we will continue the implementation of the Blue Belt Programme, including supporting efficient monitoring and enforcement of large scale protected areas. With their vast marine areas, the OTs offer an opportunity to lead the world in marine protection. The Blue Belt of marine protection around our OTs, conserves habitats and the species they support, increases resilience to long-term pressures such as climate change and damaging human activities in surrounding areas, and supports sustainable economic development for the long term.

The creation of the Ascension Island MPA and its effective management through this plan will help deliver this objective. The long-term support from the UK Government promised in the strategy will be vital to the success of the MPA.

- **The Global Ocean Alliance** was founded by the UK Government in 2019 and is calling for at least 30% of the world's oceans to be included in Marine Protected Areas by 2030. By designating 100% of its waters as an MPA, Ascension is providing an example to other countries and making a significant contribution to the overall global target.
- **The UK Overseas Territories Biodiversity Strategy (2009)** - The UK Overseas Territories Biodiversity Strategy was developed 'to enable the UK and Territory Governments to meet their international obligations for the conservation and sustainable use of biodiversity in the Overseas Territories.' One of five strategic priorities is developing ecosystem-based initiatives for the conservation and sustainable use of the marine environment. This Management Plan delivers this priority by laying the foundation for sustainable management of Ascension's waters at an ecosystem level.



Management
actions

Actions to achieve the MPA's objectives



This section describes the actions we will take to achieve the MPA's objectives. The Ascension MPA is about doing things rather than just stopping things. Although there are some actions to prevent or restrict damaging activities, there are many more aimed at restoring, improving, researching and publicising Ascension's amazing marine environment.

The MPA is going to be around forever and it will be a long journey to achieve everything we want. In the first five years covered by this plan we have focused on the actions that will achieve the greatest positive change to the MPA within our resources. This means there are no actions linked to substantial threats such as ocean acidification and rising sea temperatures because we simply don't have the management tools to address them. It also means ambitious aspirations to develop Ascension as a global science hub will have to be achieved in stages and the futuristic submarine laboratory complex will have to wait until phase two.

The designation of the MPA was underpinned by sound science and this evidence-based approach is carried forward into management of the site. Where possible we have designed management actions based on existing data and experience of what will be effective. However, we know we don't have all the answers from the start so targets, monitoring and refinement of our management will be essential. How we will do this is described in the Monitoring, Evaluation and Research Strategy.

The tables on the following pages describe the actions we are planning to undertake over the next five years. Each action is accompanied by the outcomes we hope to achieve and targets against which we will measure our success.



Management actions that will be undertaken in the MPA 2021-26

Action	Description	Outcomes	Targets
1. Prevent illegal offshore fishing	Establish effective surveillance, compliance and enforcement regime to prevent illegal commercial fishing within the MPA. This will use a risk-based approach and be based on remote satellite surveillance technology and enforcement via the flag state of offending vessels. More detail is provided in the Offshore Fisheries Compliance and Enforcement Strategy	Effective detection of suspect vessels and enforcement via ICCAT and Flag States deters illegal fishing in the MPA and prevents the unsustainable harvest of target and bycatch species.	Year 1: Surveillance system in operation based on risk assessment. Staff trained. System for assessing effectiveness of surveillance designed Year 5: All cases of suspect vessels in the MPA are investigated and appropriate enforcement action taken. Evidence collection is always of the standard required for prosecution. Failures in investigations and enforcement are analysed and used to refine procedures and capture lessons learnt.
2. Monitor new threats to the MPA habitats	Conduct annual horizon scanning exercise to identify threats to the MPA not currently being managed. This will be achieved by reviewing activities underway or proposed in the Ascension MPA and the experience of other MPAs in the Blue Belt and Big Ocean networks. Newly-identified threats will be incorporated into management and monitoring workplans as appropriate.	New potential threats are identified and managed before they cause significant damage to the MPA.	Year 1: Threat assessment published Year 5: Annual threat assessments published. Management and monitoring of all significant new threats incorporated into the next Annual Workplan and Monitoring Plan
3. Regulate and manage inshore fisheries	Introduce Inshore Fisheries Management Strategy underpinned by legislation. This will establish a stakeholder-led adaptive management system to regulate inshore fisheries based on data collected by fishermen and AIGCFD. A public information campaign will be introduced as part of the strategy.	Adaptive management system overseen by the Inshore Fisheries Advisory Committee that intervenes with effective and proportionate management measures to prevent stocks falling below sustainable levels. The fishing community understands the need for regulations and feels involved in the management process ensuring good compliance with the regulations.	Year 1: Inshore Fisheries management system and legislation introduced following public consultation. Designs for information leaflets and signs completed Year 5: Monitoring system in place for all exploited stocks. Catch data being supplied by at least 70% of fishermen. Annual assessments made on exploited stocks by the IFAC. Evidence-based management measures agreed and introduced if required. Information campaign in place.
4. Implement Marine Pollution Control Plan	Review and improve on-island pollution control measures and spill response capability through implementation of recommendations in the Marine Pollution Control Plan	Adequate control and mitigation measures in place for all known potential sources of pollution in the MPA	Year 1: Marine pollution control plan published and pollution response capability assessed by Maritime and Coastguard Agency. Year 5: Adequate bunding and spill control measures in place around all fuel storage sites. Effective treatment and disposal of all waste effluents. Emergency spill containment plans and equipment in place.
5. Review Protected Areas legislation	Review the National Protected Areas (NPA) Ordinance, Wildlife Protection Ordinance and Harbours Ordinance to ensure they are compatible with the MPA Regulations and effective at preventing damaging activities in the MPA	Up-to-date legislation and schedule with operational and legal capacity to enforce penalties	Year 1: NPA and Harbour Ordinances reviewed and deficiencies identified Year 5: Updated Ordinances drafted as required

Action	Description	Outcomes	Targets
6. Recognise genetically distinct subspecies in legislation	Identify the presence of any genetic sub-populations of charismatic or exploited species within the MPA. Update the Wildlife Protection Ordinance and feed into development of Inshore Fisheries legislation to include genetically-distinct populations	Management and protection at the population level through inclusion of genetically-distinct populations in the WPO and Inshore Fisheries Ordinance	Year 1: Identify potential research partners. Year 5: Evidence for inclusion of separate sub-populations of one species considered.
7. Control developments in or near the MPA	Establish effective development control and/or licensing system incorporating robust Environmental Impact Assessment (EIA)	All development proposals in or adjacent to the MPA are assessed and activities potentially damaging to the MPA are modified or mitigated	Year 1: Pilot EIA process with developments undertaken by Ascension Island Government Operations Directorate Year 5: EIA and development control process and/or legislation in place covering all developments in or adjacent to the MPA
8. Non-native species control	Control invasive non-native species in coastal Nature Reserves to protect sea turtle and seabird nesting habitat and maintain the natural character of these sites. This will be achieved through the mechanical removal and chemical control of invasive plant species and the targeted poisoning of rodents around sensitive sites.	Spread of invasive non-native vegetation, in particular vigorous woody species, is halted or reversed. Rodent populations are reduced to below the level where they pose a significant threat to overall breeding success of seabirds and turtles.	Year 1: Complete eradication of non-native shrubs in buffer areas around all coastal nature reserves. Establish rodent monitoring protocol Year 5: Extend buffer zones clear of non-native plant buffers further from coastal nature reserves. Targeted rodent control programme initiated around all coastal nature reserves
9. Biosecurity controls	Implement Biosecurity Strategy and associated legislation that establish inspections of vessel hulls and ballast water records, surveillance monitoring and measures to reduce the risk of non-native species introductions to Ascension.	Risk of introductions of new non-native species to marine and coastal habitats on Ascension is minimised through pre-border prevention measures and the interception or early detection of species that do arrive.	Year 1: Introduce biosecurity legislation including standards that all incoming vessels and imports must meet to gain entry clearance. Begin a system of risk-based inspection and regular surveillance monitoring. Year 5: Biosecurity inspections are a routine part of entry procedures to Ascension. Entry and import standards have been refined based on experience. Regular surveillance monitoring undertaken including eDNA sampling and visual transects.
10. Conduct regular litter clearance	Conduct regular volunteer litter clearance events to prevent the accumulation of marine plastics and other debris. This will be done around beaches and on SCUBA in shallow water habitats.	Beaches and coastal areas are kept free of litter. The Ascension community becomes involved in positive action to protect the MPA.	Year 1: Four beach cleans involving a minimum 80 people undertaken Year 5: The four most popular beaches are cleaned every six months. Other sites cleaned annually. Two dive cleans undertaken at popular fishing sites each year. In total, a minimum of 120 people involved.
11. Restoration of turtle nesting beaches	Remove the legacy concrete structures and invasive tree roots from Long Beach. Where feasible, remove barriers to the landward migration of beaches.	Long Beach is returned to a natural state of erosion and deposition with fewer obstacles for nesting turtles. Beaches are able to migrate landward where this is possible.	Year 1: Identify barriers to the landward migration of beaches. Year 5 all concrete structures and invasive tree roots removed from Long Beach. Barriers to landward migration of beaches removed where this is feasible.

Action	Description	Outcomes	Targets
12. Tourism development strategy	Depending on outcome of 'Future of Ascension' discussions, develop tourism growth strategy. Employ a tourism development officer to lead an online marketing campaign and provide on-island business development support	Coordinated approach to creating and marketing a tourist offer that maximises the potential of Ascension's marine environment to attract tourists. People living on Ascension are supported to develop businesses that retain revenue from marine resources on-island	Year 1: Establish scope of Tourism Development Strategy in consultation with Ascension Island Council. Year 5: If appropriate, Tourism Growth strategy produced and implemented. Tourist development officer employed by AIG. Marketing strategy results in at least 300 tourists per year visiting Ascension. Support at least three island-based businesses to develop sports fishing and ecotourism products
13. Guidance and regulations for sports fishing and ecotourism	Regulations and best practice guidance put in place governing the conduct of sports fishing and ecotourism businesses. Business licence renewal linked to compliance. Regulations and guidelines on avoidance of disturbance to wildlife provided with employment contracts and entry permits and publicised through videos, briefings, leaflets and signs at key locations	Sports fishing and tourist activities are conducted sustainably without damaging stocks or disturbing non-target species. Only businesses that adhere to regulations are licensed to operate. Widespread awareness of and compliance with regulations and guidance.	Year 1: Inshore Fisheries legislation covering sports fishing operations drafted and enacted. Review of Business Permit process. Videos, briefing presentations and designs for leaflets and signs produced Year 5: Best practice guidance documents for sports fishing and ecotourism produced via stakeholder consultation. Signs present at all main tourist areas. Leaflets available at key sites for visitors Video shown at arrivals hall and cinema. Leaflet included with all contract packs.
14. Develop Ascension as a scientific research hub	Develop a 'promotional package' for visiting scientists to promote Ascension as a research hotspot. Develop facilities for visiting researchers including field equipment, lab upgrade and accommodation. Provide a data collection service for institutions that have research projects that are consistent with the MPA objectives.	Increased number and diversity of collaborations with research institutions that generate income for the island, improve knowledge of Ascension's marine environment and raise the island's international profile. Ascension becomes directly involved in innovative research projects and acquires a reputation for being a research 'hot-spot.'	Year 1: Promotional package completed and distributed to all UK and relevant international academic institutions. Identify gaps in provision for visiting researchers Year 5: Facilities developed to meet the main needs of researchers. Legal and insurance procedures to lease facilities and equipment to visiting organisations established. Data collection service in place and being used by external partners.
15. Ascension Island public engagement campaign	Undertake a public engagement campaign that aims to increase levels of knowledge and interest in the MPA amongst the Ascension population. More detail is provided in the Public Engagement Strategy	Greater level of awareness of the MPA and marine conservation amongst the island community leads to higher levels of compliance and generates new ideas for better management. Local stakeholders feel involved in the MPA process and young people on Ascension feel empowered to contribute to global marine conservation efforts.	Year 1: All priority actions in the Public Engagement Strategy initiated including a marine festival, visitor centre, school trips, press articles and social media posts. Year 5: Public Engagement Strategy fully implemented. At least 200 members of the Ascension community participate in events linked to the MPA.
16. Global public engagement campaign	Undertake an engagement campaign aimed at the global community to raise awareness and support for the Ascension MPA and by extension the island. More detail is provided in the Public Engagement Strategy	The unique biodiversity of Ascension and the work being done to protect it reaches a global audience generating public support. Potential funders and collaborators can see the work being done in the Ascension MPA and the potential for further innovative management and research.	Year 1: Public Engagement Strategy initiated including at least 50 social media posts produced and two videos created. Year 5: Public Engagement Strategy fully implemented including at least 150 social media posts and six videos created.

Action	Description	Outcomes	Targets
17. Sustainable financing strategy	Assess and preferentially target sources of long-term secured income.	Generate income for managing the MPA and move towards financial independence and self-sufficiency. Long-term security of funding for core management priorities.	Year 1: Produce sustainable financing strategy Year 5: Reduce reliance on UK Government funding to less than 33% of total MPA management costs
18. Strengthen governance structures	Build on governance structures established at MPA designation to ensure there is strong leadership, accountability and involvement of the island community and other key stakeholders in decision making.	MPA governance structure and decision-making processes are clear and involve the island community, scientific experts and other stakeholders.	Year 1: MPA governance arrangements have been agreed by the Ascension Island Council. Scientific Advisory Committee established. Year 5: Governance structures are established and demonstrated input into annual setting of workplans and 5 year review of Management Plan.
19. Effectively enforce regulations	MPA-related regulations and those in other pieces of domestic legislation that are relevant to the MPA are effectively enforced to ensure there is a high level of compliance and support amongst those using the MPA.	Major threats to the objectives of the MPA are successfully controlled through legislation. The Ascension community and people visiting the island are aware of and support the legislation.	Year 1: Regulations are drafted following consultation and introduced along with a public information campaign. MPA Officers are warranted and trained to carry out enforcement action. Remote surveillance of offshore zone effectively undertaken by Blue Belt Surveillance and Intelligence Hub (BBSIH). Year 5: Detected infringement of the regulations is at a low level. Appropriate enforcement action is taken in all cases of infringement by either AIGCFD in the inshore zone and BBSIH in the offshore zone. There is a high level of support for enforcement activities amongst the island population.
20. Meet International obligations	Implement ICCAT obligations for offshore waters, supply data on recreational catches and introduce minimum landing size for billfish into inshore fisheries legislation	Ascension achieves full compliance with ICCAT obligations across its entire EEZ.	Year 1: Establish catch reporting system including logbooks and associated information campaign for recreational fishermen. Year 5: Ascension achieving and reporting compliance with all ICCAT obligations. Catch data being supplied by at least 70% of recreational fishermen
21. Data management system	Establish robust data management system to collate information from biological, socio-economic and enforcement monitoring	Databases required to collate and curate essential information are fit-for-purpose, adequately secure and have appropriate backup protocols in place. Procedures in place for dealing with sensitive information such as illegal fisheries compliance intelligence.	Year 1: Deficiencies in data management capacity and procedures identified. Year 5: Robust data management processes in place and being followed by all MPA staff and collaborators. Data storage is secure
22. Monitoring and evaluation regime	Establish a monitoring and evaluation regime such that all actions are monitored and outcome evaluation is built into annual workplans	Adaptive management refines and improves management over time and ensures it is evidence-based and responsive to changing conditions	Year 1: Implementation of the Monitoring, Evaluation and Research Strategy, with monitoring linked to all objectives and management actions initiated. Year 5: Completed cycles of monitoring, evaluation and management refinement demonstrate effective adaptive approach in place.



Monitoring and Evaluation



Monitoring, evaluation and research are so fundamental to the success of the MPA that we have dedicated an entire strategy to them. We need to be able to demonstrate to our funders, partners and supporters that we are making a difference and achieving our objectives, and we need to learn from experience and keep improving what we do through adaptive management.



We are very clear about what we want the MPA to achieve, but have the humility to acknowledge that we will need to adapt our management as and when further information becomes available. We will be continually checking that there are no new or growing threats to our marine ecosystems and that the management actions we are taking to tackle the existing threats are working.

That doesn't mean we will monitor everything; we simply don't have the resources and it isn't necessary. We will encourage external researchers to come to Ascension and advance our overall knowledge of the marine environment, but our work will be firmly focused on the information we need to make better management decisions. That requires not just a robust monitoring system embedded from the start, but also a strong evaluation process that encourages honest assessment and is prepared to alter the direction of management if necessary.

Our monitoring approach is split into two strands:

Management Plan implementation - have planned management actions been completed and outcomes achieved?

There are performance targets connected to all the management actions. Attainment of the target will be recorded to demonstrate the actions have been accomplished as planned.

Performance monitoring - are we achieving the MPA objectives?

All of the operational objectives have metrics and targets associated with them by which progress towards achieving the objective can be measured. It is not currently possible to measure all the suggested metrics (particularly for pelagic and deep sea ecosystems) and initially there will be an emphasis on the metrics that can be measured, reliance on key indicator species/habitats and, where necessary, proxy objectives. A major focus of the Monitoring, Evaluation and Research Strategy will be to develop resource-efficient means of addressing the major gaps in recording the metrics.

This dual approach to monitoring is essential to distinguish success in delivering the management actions from success in meeting the objectives. If objectives are not being achieved then it is important to know whether greater effort is needed to complete the management actions, or whether the actions themselves need to be reviewed.

To balance the need for frequent evaluation against the need for management stability, we have adopted a model of an annual progress review combined with a much more detailed and comprehensive revision of the MPA Management Plan every five years. The evaluation process will be transparent and involve external oversight to ensure it is rigorous and objective. The Monitoring, Evaluation and Research Strategy outlines the review process in more detail.

The evaluation of the MPA's performance will be of interest to a range of audiences and we will publish the results in formal reports, infographics and brief snap shots of progress for dissemination via social media. We want all the outputs from the evaluation to be accessible and compelling, such that anyone will quickly be able to see the areas that are working and those that need improvement.





The future of
the MPA

Forever is a long time. The MPA designation is a commitment to provide permanent protection for the marine biodiversity around Ascension whatever the future holds. It is impossible to predict accurately all the changes that will come, but this section is an attempt to scan the horizon for the major issues likely to affect the MPA. Some may be opportunities, others challenges. Since many of the challenges will be faced by other large MPAs and remote islands, the need to address them will create opportunities for Ascension to become a testing ground for innovative solutions and encourage global partnerships. It is hoped that by anticipating future changes and applying the principles laid down in this Management Plan, the Ascension MPA will be able to seize the opportunities and surmount the challenges.

Expansion of protection

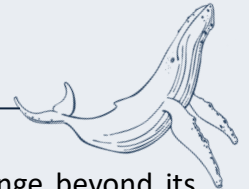

The MPA covers the entire Ascension EEZ, but many fish, turtle and seabird species range beyond its boundaries. This means that some species can only be protected for part of their lifecycles and fishing effort for target species will largely be displaced to outside of the MPA. Ascension is providing the maximum protection it can, but without tighter regulation or the establishment of connected protected areas in the wider Atlantic Ocean, some species will continue to face threats.

The MPAs and Marine Management Zones created around Ascension, St Helena and Tristan da Cunha through the Blue Belt Programme provide an excellent opportunity for the UK Government to cement its position as a world leader in marine protection by pioneering ocean-scale protection through a combination of connected MPAs and enhanced management measures in Areas Beyond National Jurisdictions (ABNJs). The need to look beyond national borders has been recognised and a new international treaty is being developed under the UN Convention on the Laws of the Sea to safeguard marine biodiversity in ABNJs. The UK is already playing a leading role in these negotiations and its major influence in the South Atlantic could make it the perfect stage on which to demonstrate this new phase of ocean protection.

Using remote techniques for surveillance, enforcement and monitoring

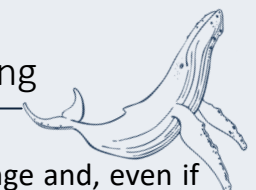

Carrying out surveillance and enforcement of 445,000km² of ocean is a significant challenge and, even if hard assets such as vessels and aircraft were available, they would struggle to provide an effective response to all incidents of illegal fishing or other infringements of the MPA regulations. These problems are common to all large MPAs and high seas fisheries, creating a pressure that is driving researchers, NGOs, Government Agencies and private companies to collaborate and push against the boundaries of current technology.

We don't yet have the solution and in the short-term it is possible that some illegal activity will go unchallenged. However new capabilities allowing rapid, high resolution satellite images to be taken, or for unidentified vessels behaving suspiciously to be tracked to their next port are being developed. This coupled with the legal framework to act on the intelligence will provide the tools necessary for effective enforcement. Ascension needs to be an early-adopter of these new technologies and preferably play a part in developing them through collaborations with pioneers in the field.

Creation of a scientific hub



Ascension's greatest asset is its location. Its position at the centre of the Atlantic has made it strategically important for the military and communications industry and science could be the next phase of the island's evolution. Interest in ocean and climate science has never been higher and, whilst resources are always stretched, opportunities to carry out research can actually be the limiting factor. There is no reason why in this context Ascension couldn't become the 'Mauna Loa' of the Atlantic.

Ascension could provide a convenient jumping off point for research into deep ocean ecosystems, global processes in the absence of land-based pressures and the effectiveness of oceanic MPAs. These are very active areas of scientific research and the experience of the British Indian Ocean Territory has successfully demonstrated the demand for such study sites and the benefits this can bring. Ascension's remote location, relatively pristine seas and stable political system make it an attractive option for researchers, and a number of international institutions already have established links with the island. This could be further enhanced by a restored South Atlantic Airbridge providing frequent direct flights to the UK, a well-designed permit system and improved on-island accommodation and laboratory facilities. Ascension would benefit from a raised international profile, an improved knowledge base to guide management and the channeling of scientific grant funding into the island through income from visitors, facilities hire and research permit charges.

Science is a collaborative process and Ascension will need to forge links with academic institutions and other MPA management authorities. The members of the Scientific Advisory Committee will be crucial to achieving this. Ascension is one of five overseas territories that are developing their marine protection as part of the Blue Belt Programme and will hopefully become a member of the international Big Ocean network of large MPAs. There is huge variation in the ocean environments and the challenges faced across these networks, but also common themes that lend themselves to knowledge sharing and the development of joint projects that pool resources and increase the benefits and impacts.

Climate change



Climate change is a current threat to the MPA, but one that is also predicted to increase in the future and may exacerbate the impact of other threats. It is so profound that it may call into question the entire premise of protected areas, even ones the size of the Ascension MPA, and make many of the MPA's objectives completely unachievable. As a management authority there are limited options for us to prevent or mitigate the impacts of climate change locally beyond trying to build resilience in ecosystems through the reduction of other pressures. This is a global, existential threat and Ascension's contribution to fighting it could be to act as a valuable outdoor laboratory for research in the absence of other confounding pressures.

Blue carbon



The need to mitigate the impacts of climate change has led to the development of global carbon markets and payments for the creation and management of habitats that sequester and store carbon. Currently such payment mechanisms are confined to terrestrial or coastal habitats such as forests, mangroves and seagrass beds. Extending this to management of the open ocean still requires considerable research. We know phytoplankton in our oceans absorb significant quantities of carbon from the atmosphere, but quantifying this, understanding how the carbon is then stored and assessing whether this is enhanced within well-managed MPAs compared to the rest of the ocean will take many years of further study. As this research develops, it could demonstrate that the Ascension Island MPA is making a globally-significant contribution to climate change mitigation and in time provide a sustainable source of funding in recognition of this.

Uncertain outcome of the 'Future of Ascension' discussions



The UK Government is in the process of deciding the future governance model for Ascension Island. The Foreign, Commonwealth and Development Office state that the aim of this assessment is *'to ensure the island is funded and managed in a way that enables it to meet the strategic needs of the UK.'*

The outcome of the 'Future of Ascension' discussions will not affect the existence of the MPA since it is a UK Government commitment and will be a priority in all potential scenarios. However, the focus of management, key stakeholders and potential funding sources could all be significantly affected depending on the option chosen. A military island is unlikely to encourage sports fishing and ecotourism, meaning these would not require the same management input, but would also not provide any income for the MPA. Under such a scenario, the RAF and USAF Commanders on the island would become the most important local stakeholders for management decisions and emphasis may shift away from community involvement if the workforce becomes more transient.

Growth of the tourism sector



Ascension is a remote island whose primary function is as a military base, meaning mass tourism is neither likely nor desirable. However, depending on the 'Future of Ascension' that is chosen, tourism could offer one of the few areas for income growth on Ascension and much of that would be linked to the marine environment. Prior to the suspension of the South Atlantic Airbridge, sports fishermen accounted for an estimated 72% of the average 190 visitors per year and it is the world class fishing that is likely to be the primary draw for visitors to Ascension (Millington 2019). Wildlife tourism, diving and geology may attract additional visitors or provide secondary activities for fishermen. Improved air access will be the key factor determining the resurrection of Ascension's tourist industry, but a well-regulated and managed MPA will enhance the offering and raise the global profile of Ascension.

MPA permit fees could offer a means of channeling some money from visitors back into MPA management but, since the number of tourists is likely to be small in relative terms, this will never be a significant source of funding. A more important benefit will be the money tourists bring to the island that could help sustain leisure businesses. This also provides amenities for the local community and stimulates new business start-ups that generate income and tax revenue. Demonstrating that sustainable use of the marine environment can be more profitable than uncontrolled exploitation is an important aim of the MPA.

Securing funding and political support



Marine conservation is a high profile issue and charitable donations to this cause totaled \$1.9billion globally between 2010 and 2015, though most of this was given and spent in the USA (Packard Foundation, 2017). The challenge lies in converting this goodwill into sustained financial support for Ascension. The Trust Fund established by the Blue Marine Foundation with initial capitalisation of £2 million provides a model for how philanthropic donations could provide a long-term income to fund conservation and community projects on Ascension.

There has never been such a high level of public interest in marine conservation. This has translated into cross-party, sustained political support for the UK Government's Blue Belt Programme and the UK is positioning itself as a global leader in ocean protection. Ascension can help the UK achieve its targets and in return benefit from the resources and expertise available. It will also provide the political will to mainstream marine protection across all areas of legislation.



References

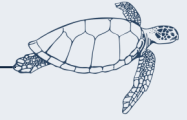

Broderick, A.C., Frauenstein, R., Glen, F., Hays, G.C., Jackson, A.L., Pelembe, T., Ruxton, G.D. & Godley B.J. (2006) Are green turtles globally endangered?. *Global Ecology and Biogeography* 15:21-26
http://www.seaturtle.org/PDF/BroderickAC_2006_GlobalEcologyandBiogeography.pdf

Canelas, J., Fish, R., Bormpoudakis, D. & Smith, N. (2019) *Cultural Ecosystem Services in the Ascension Island* Final Report. Natural Capital Assessment. South Atlantic Overseas Territories (SAERI/University of Kent)

Millington, K. & Smith, N. (2019) *South Atlantic Natural Capital Project; Ascension Island Tourism Report*. Natural Capital Assessment. South Atlantic Overseas Territories (SAERI/Acorn Tourism)

Weber, S.B., Richardson, A.R., Broderick, A.C., Brown, J., Campanella, F., Godley, B.J., Howard, F., Hussey, N., Meeuwig, J., Rose, P., Shepherd, M., Thompson, C., van der Kooij, J. & Witt, M.J. (2018) *A baseline ecological of Ascension Island's shallow water seamounts as candidate marine protected areas*. Ascension Island Government Conservation & Fisheries Department. 56 pp.

Wirtz, P., Bingeman, J., Bingeman, J., Fricke, R., Hook, T.J. & Young, J (2014) The fishes of Ascension Island, central Atlantic Ocean—new records and an annotated checklist. *Journal of the Marine Biological Association of the United Kingdom*, 1-16.



#smallislandBIGVISION



@AscensionMPA



@Ascension_MPA



@AscensionMPA
