

RWD

PRODUCT CATALOGUE

*Diversified solutions for
scientific researchers*

12th Edition

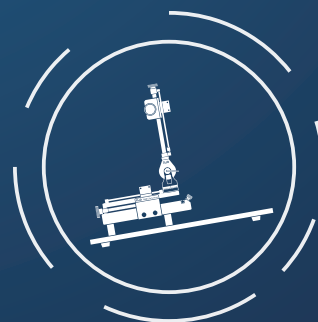

Dedicated to providing remarkable quality

RWD Life Science

RWD not only focus on individual instrument, but also whole solution

we are all with you



Learn more about us at:
www.rwdstco.com





Introduction

Established in 2002, RWD Life Science has been dedicated to being a leading manufacturer in research and veterinary equipments worldwide. We specialize in anesthesia, physiological and surgical equipments, used by pre-clinical researchers and veterinarians. Our mission is to provide high quality products and integrated solutions for our customers with prompt and professional support.

For more information about our supplies, such as Laser Speckle Perfusion Imager, Anesthesia Machine, Ventilator, Stereotaxic Instrument, Syringe Pump, Cannula System and Surgical tools, please check our website:

www.rwdstco.com

RWD Life Science

Add: 6540 Lusk Blvd, San Diego, CA 92121, USA

Add: No.13 Hi Tech North Rd, Nan Shan Dist.,
Shenzhen, P.R.China

Web: www.rwdstco.com

Email: sales@rwdstco.com

Tel: +1-858-900-6602 (USA)

+86-755-86111286 (China)

CONTENT

New Products in 2019	01
Intelligent Optogenetic System	01
Digital Microscope	02
Cordless Microdrill	02
Paraffin Slicing Machine	03
Inhalation Anesthesia Solutions	04
Small Animal Anesthesia Machines	07
Veterinary Anesthesia Machines	11
Anesthesia Machine Vaporizer	13
Gas Evacuation Apparatus	15
Anesthesia Mask	16
Ventilator	20
Stereotaxic Instrument Solutions	26
Stereotaxic Instruments	27
Holders	34
Adaptors	36
Ear Bars	40
Microdrill	43
Temperature Controller	44
Microscope	45
Precise Impactor	48
Microinjection	50
Single Cannula	50
Double Cannula	52
Syringe Pump	55
Implantable Osmotic Pump	56
Physiological & Pharmacological	57
MCAO Sutures	57
Brain & Heart Matrices	58
RFLSI Pro ⁺ Laser Speckle Perfusion Imager	59
Fiber Optogenetic System	61
Intelligent Optogenetic System	62
Traditional Optogenetic System	63
Ceramic Ferrule	64
Surgical Instruments	65

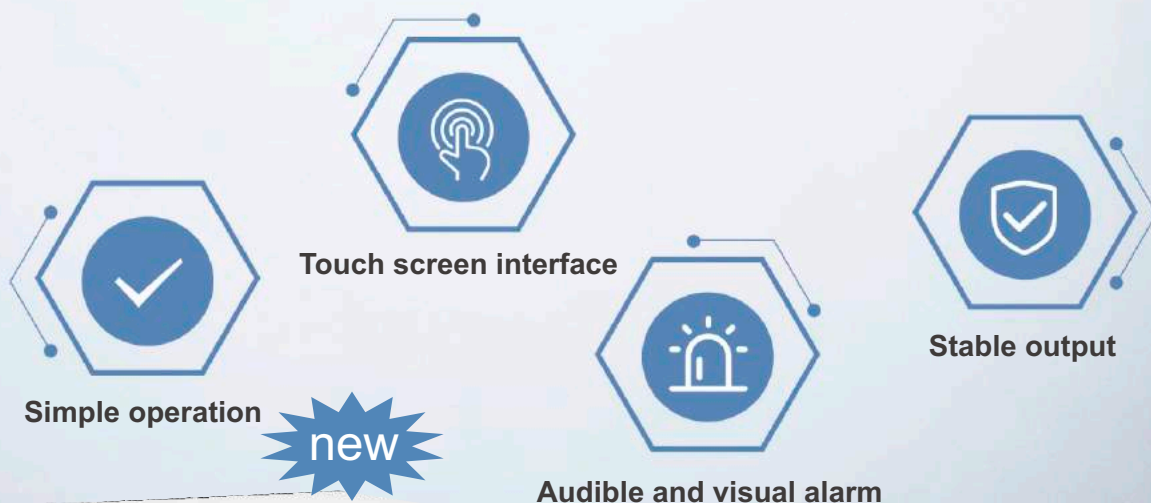

Intelligent Optogenetic System

The Intelligent Optogenetic System integrates light source output and control together. Convenient operation with stable performance, it greatly simplifies the experimental process and the setting of parameters.

Technical Parameters

Category	Description
PowerTouch	0-80mw (Blue light), 0-100mw (Yellow light), 1mw resolution, adjustable power
screen pixels	7-inch capacitive touch screen, 1024PX * 600PX resolution
Stability	1%
Wavelength	473, 450, 488, 532, 589 and 650nm (optional)
TTL signal output	10mV-5Ve
Light source interfac	FC/PC
Dimensions	258*220.5*147mm (L*W*H)

77001D Digital Microscope new

RWD Digital Microscope 77001D Focus on Bregma or The Blood Vessels Precisely

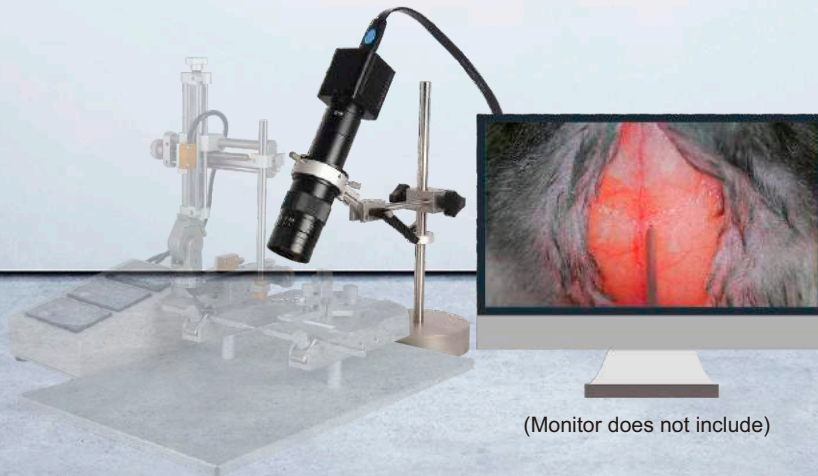

(Monitor does not include)

The digital microscope 77001D provides an opportunity to improve stereotaxic or surgical operation. The digital microscope is a digital camera fitted with a parfocal zoom magnifying lens with fine focus and a working distance of 7.0 inches.

Camera parameters

- 3.5MP, 1/2.3" CMOS sensor
- 20x - 120x magnification
- Shutter can be controlled manually or remotely
- Focusing range from 15 to 576mm²
- LED ring illuminator

Photo/Video Capture, Memory, & Ports

- Streams 1080p videos via a mini-HDMI port at 60 fps
- Captures 60 fps AVI videos: HD 1080p, 1920 x 1080
- Saves visual data to a built-in microSD card
- Captures interpolated JPEG photos with resolution of up to 16.0 MP
- Mini-HDMI video out port for direct streaming to HDTV displays

Cordless Microdrill new

No need to connect the power supply, convenient, easy to operation, space saving Precisely

Features:

- Cordless design, simple & controllable operation
- The double-bearing design is used at the joint of the drill bit, make drilling and grinding more stable
- 750mA lithium battery, can be used continuously for 45 mins after fully charged
- Wide range of applications, can be used with a 2.3mm diameter drill bit for drilling and polishing
- It can be equipped with a cranial drill holder (68228) fixed to Stereotaxic, free hands operation
- Speed: 12000rpm
- Stall torque: 1.25 oz./in
- Power: 100-240V
- Dimension: length 20cm, body diameter 19.5mm

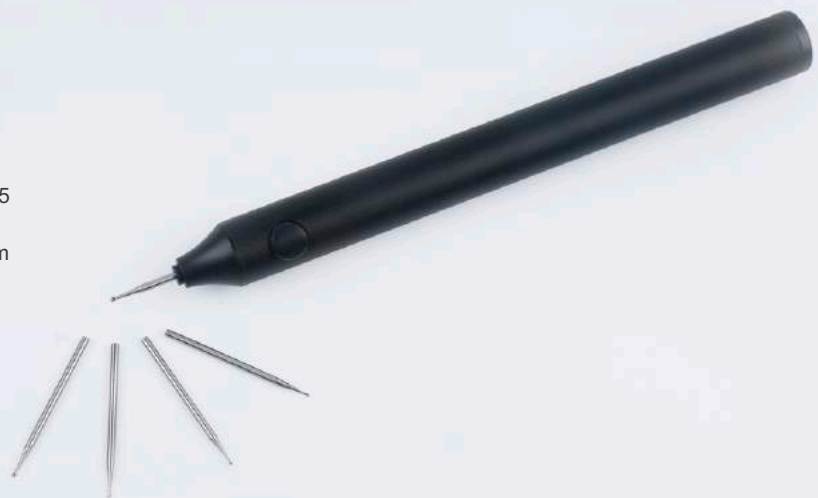

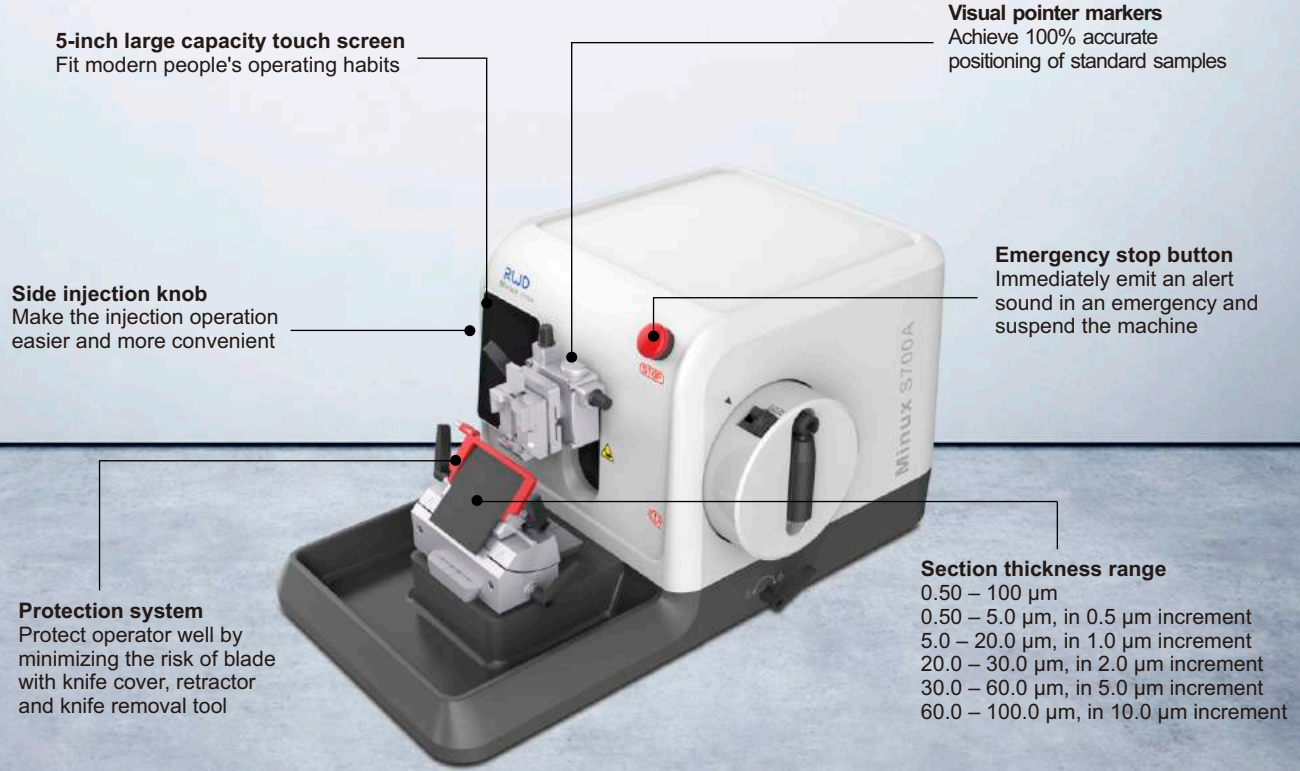

Paraffin Microtome coming soon...

The paraffin microtome is an auxiliary machine, which is widely used in medicine and biological research, that combines tissue and wax for slicing. Slices prepared with a paraffin microtome can be used to detect a variety of clinical lesions to ensure that doctors can make more accurate judgments or assist researchers in tissue-level exploration.

Technical Parameters

Paraffin Microtome	Semi-automated microtome: S700
	Automated microtome: S700A
Section Thickness Setting Range	0 – 100 μm
Maximum Specimen Size	55×50×30 mm (W×D×H)
Total Horizontal Specimen Stroke	28 ± 1 mm
Vertical Specimen Stroke	72 ± 1 mm
Specimen Retraction	40 ± 5 μm
Trimming Thickness	1 – 600 μm

Inhalation Anesthesia Solutions

Advantages of Inhalation Anesthesia:

- Can offer an improved level of control over depth and duration of anesthesia, especially for prolonged procedures.
- Relatively insolubility and faster elimination in blood enables rapid recovery.
- Be of rapid onset and offset with minimal side effects.
- Have little or no toxic effect thanks to non-metabolism characteristic of sevoflurane and isoflurane.
- Be safer and more efficient performance to reduce morbidity rates and increase the chance for successful outcomes.

Small Animal Anesthesia Machines



Compact (see P07)



Tabletop (see P08)



Multi-output (see P09)



Portable (see P10)



Smart Wall-hung



VentStar Ventilator
(see P20)

Veterinary Anesthesia Machine



Portable
(see P11)



Dual-Drug
(see P12)



Intelligent
animal ventilator
(see P22)

Complete Anesthesia and Respiration Solutions

Multi-function Anesthesia Solutions



The experimental system is equipped with a gas recovery system to provide a safe experimental environment to maximize the protection of the operator; by replacing different types of anesthesia machines and masks to meet the needs of animal experiments, such as cerebral ischemia and myocardial ischemia model, osteoporosis model, tail vein injection, abdominal aorta blood sampling, heart blood sampling, ventricular injection, tissue / organ removal and other animal surgery experiments.

Stereotaxic Anesthesia Solutions



By changing the different types of stereotaxic instruments and adaptors to meet the needs of different animal experiments, such as the neurological disease models (such as Parkinson, Alzheimer's disease, craniocerebral injury, spinal cord injury, etc.), brain drug injection, Cannula Implantation (long term repeated administration), physiology experiment (such as nerve stimulation, signal recording, wireless telemetry, etc.), microdialysis experiments (probe implantation and short-term dialysis) and other experiments.

Combination Solutions of Ventilator to Anesthesia System

Small animals



Small animal ventilator
see P20

This program is the combination of anesthesia machine and ventilator. While keeping the animal under anesthesia, it provides a certain volume (tidal volume) of oxygen and respiratory rate to support the normal breathing of animals.

It can meet the requirements of long surgeries or surgeries on animals suffering from certain diseases (such as cardiovascular and cerebrovascular diseases, hypertension, cerebral infarction, thrombosis), and suitable for mice, rats, rabbits, cats and other animals within 5KG.

Large animals



Gas supply(see P23)

Circular anaesthetic mask(see P23)

Oxygen Concentrator
(See P23)

Endotracheal Tubes

Calcium lime

Laryngoscopes

This program is suitable for the anesthesia and auxiliary respiration of animals within 50kg, such as pigs, monkeys, dogs and cats.

Small Animal Anesthesia Machines ▶

R500 Compact Anesthesia Machine

Regular assembly (R500-A), vaporizer (R580), Inlet/Outlet End Caps (R580-IO) and tube accessory kit are included in the R500 anesthesia machine. Different air supply, induction chambers, small animal masks, filter canisters and gas evacuation apparatuses can be selected for anesthesia recovery of different animals.

Suitable for rats, mice, hamsters, guinea pigs, rabbits, cats and other animals within 7kg

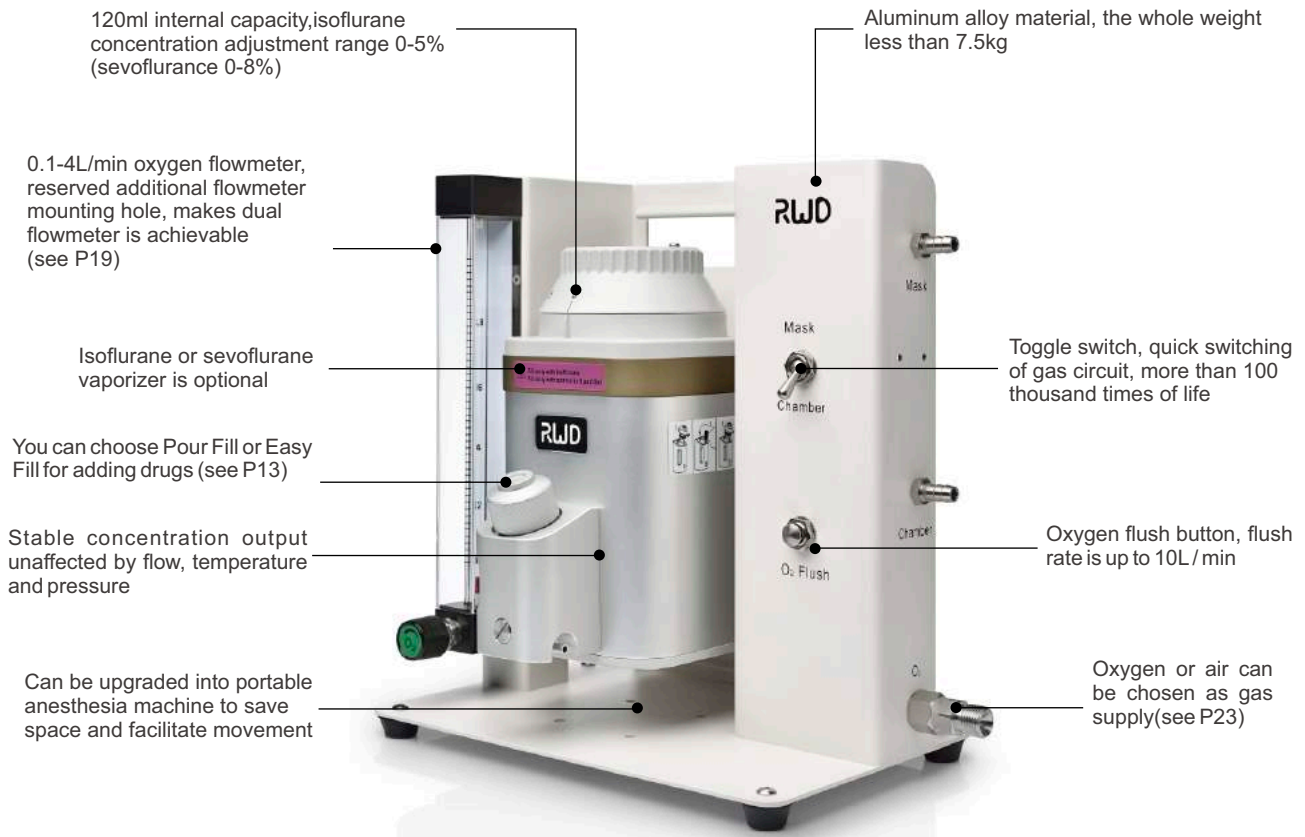

Note: Oxygen flush is commonly used to flush out anesthetic gas to the filter canister before opening the induction chamber to avoid the escape of anesthetic gas into the personnel.

Order Information:

Cat No.	Product Description	Configuration	Remarks
R500IE	Compact Small Animal Anesthesia Device-Isoflurane, Easy Fill, 0-4L	●	Contains connection tubing for mask&induction chamber
R500IP	Compact Small Animal Anesthesia Device-Isoflurane, Pour Fill, 0-4L	●	
R500IK	Compact Small Animal Anesthesia Device-Isoflurane, Key Fill, 0-4L	●	
R500SE	Compact Small Animal Anesthesia Device-Sevoflurane, Easy Fill, 0-4L	●	
R500SP	Compact Small Animal Anesthesia Device-Sevoflurane, Pour Fill, 0-4L	●	
R500SK	Compact Small Animal Anesthesia Device-Sevoflurane, Key Fill, 0-4L	●	
R510-S	Portable Stand for R510 Series Anesthesia Machine	○	Upgrade to portable type

Note: ● Recommended configuration ○ Optional

R540 Enhanced Anesthesia Machine

Regular assembly (R540-A), vaporizer(R580), Inlet/Outlet End Caps(R580-IO) and tube accessory kit are included in the R540 anesthesia machine. Different air supply, induction chambers, small animal masks, filter canisters and gas evacuation apparatuses can be selected for anesthesia recovery of different animals.

Suitable for rats, mice, hamsters, guinea pigs, rabbits, cats and other animals within 7kg



Note: Oxygen flush is commonly used to flush out anesthetic gas to the filter canister before opening the induction chamber to avoid the escape of anesthetic gas into the personnel.

Order Information:

Cat No.	Product Description	Configuration	Remarks
R540IE	Enhanced Small Animal Anesthesia Device-Isoflurane, Easy Fill, 0-4L	●	Contains connection tubing for mask&induction chamber
R540IP	Enhanced Small Animal Anesthesia Device-Isoflurane, Pour Fill, 0-4L	●	
R500IK	Enhanced Small Animal Anesthesia Device-Isoflurane, Key Fill, 0-4L	●	
R540SE	Enhanced Small Animal Anesthesia Device-Sevoflurane, Easy Fill, 0-4L	●	
R540SP	Enhanced Small Animal Anesthesia Device-Sevoflurane, Pour Fill, 0-4L	●	
R500SK	Compact Small Animal Anesthesia Device-Sevoflurane, Key Fill, 0-4L	●	
R510-S	Portable Stand for R510 Series Anesthesia Machine	○	Upgrade to portable type

Note: ●Recommended configuration ○ Optional

R550 Multi-output Anesthesia Machine

Regular assembly (R550-A), vaporizer (R580), Inlet/Outlet End Caps (R580-IO) and tube accessory kit are included in the R550 anesthesia machine. Different air supply, induction chambers, small animal masks, filter canisters and gas evacuation apparatuses can be selected to form the experimental platform for anesthesia recovery of different animals.

With the latest design, it can be applies to simultaneous anesthesia of multiple mice, rats, cats, rabbits and other animals (1-5 small animals), and every channel can be controlled independently.

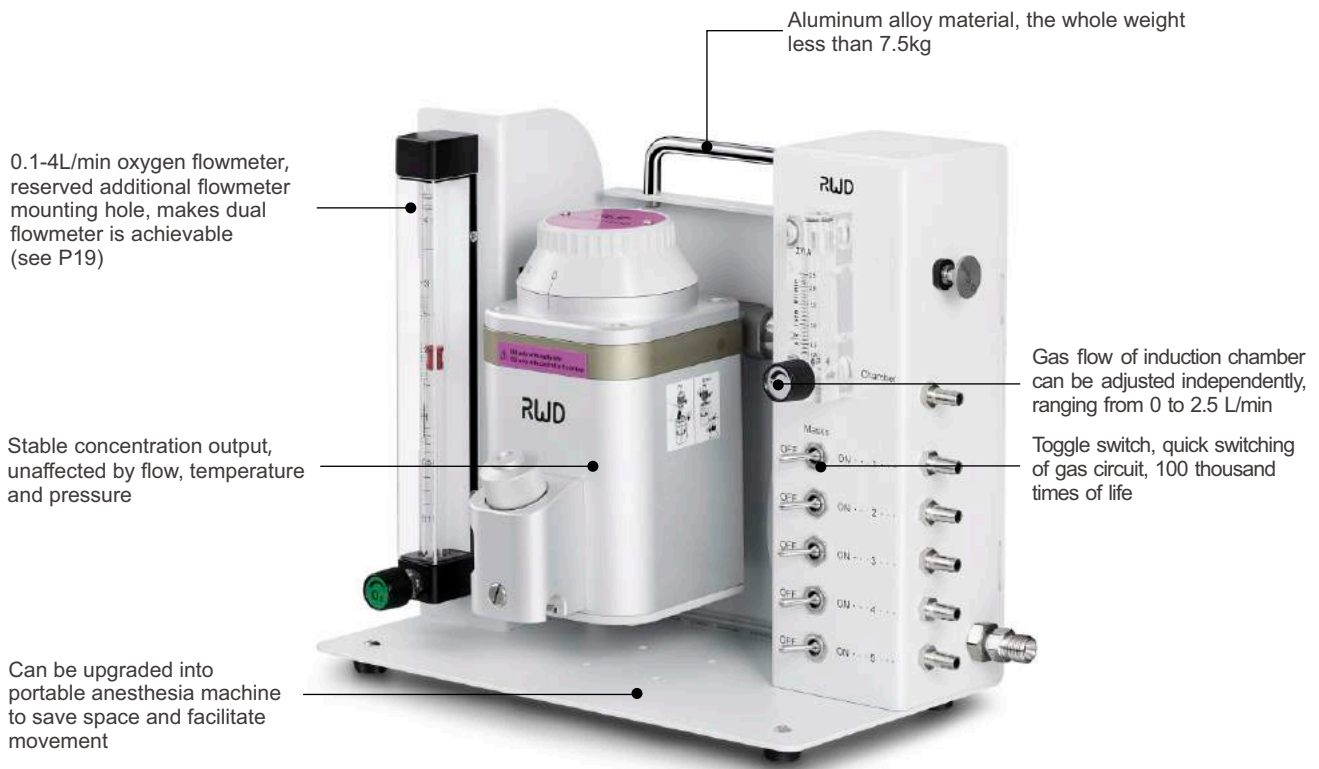

Order Information:

Cat No.	Product Description	Configuration	Remarks
R550IE	Enhanced Small Animal Anesthesia Device-Isoflurane, Easy Fill, 0-4L	●	Contains connection tubing for mask & induction chamber
R550IP	Enhanced Small Animal Anesthesia Device-Isoflurane, Pour Fill, 0-4L	●	
R550IK	Enhanced Small Animal Anesthesia Device-Isoflurane, Key Fill, 0-4L	●	
R550SE	Enhanced Small Animal Anesthesia Device-Sevoflurane, Easy Fill, 0-4L	●	
R550SP	Enhanced Small Animal Anesthesia Device-Sevoflurane, Pour Fill, 0-4L	●	
R550SK	Compact Small Animal Anesthesia Device-Sevoflurane, Key Fill, 0-4L	●	
R510-S	Portable Stand for R510 Series Anesthesia Machine	○	Upgrade to portable type

Note: ● Recommended configuration ○ Optional

R520/R530 Portable Anesthesia Machine

Regular assembly (R540-A), vaporizer (R580), Inlet/Outlet End Caps (R580-IO), induction chamber, fixed bracket for gas evacuation apparatus, air pump, and portable assembly (R510-S), tubing are included in the R520 anesthesia machine. Different air supply, induction chambers, small animal masks, filter canisters and gas evacuation apparatus should be purchased separately. The difference between R520 & R530 is only the anesthesia assembly.

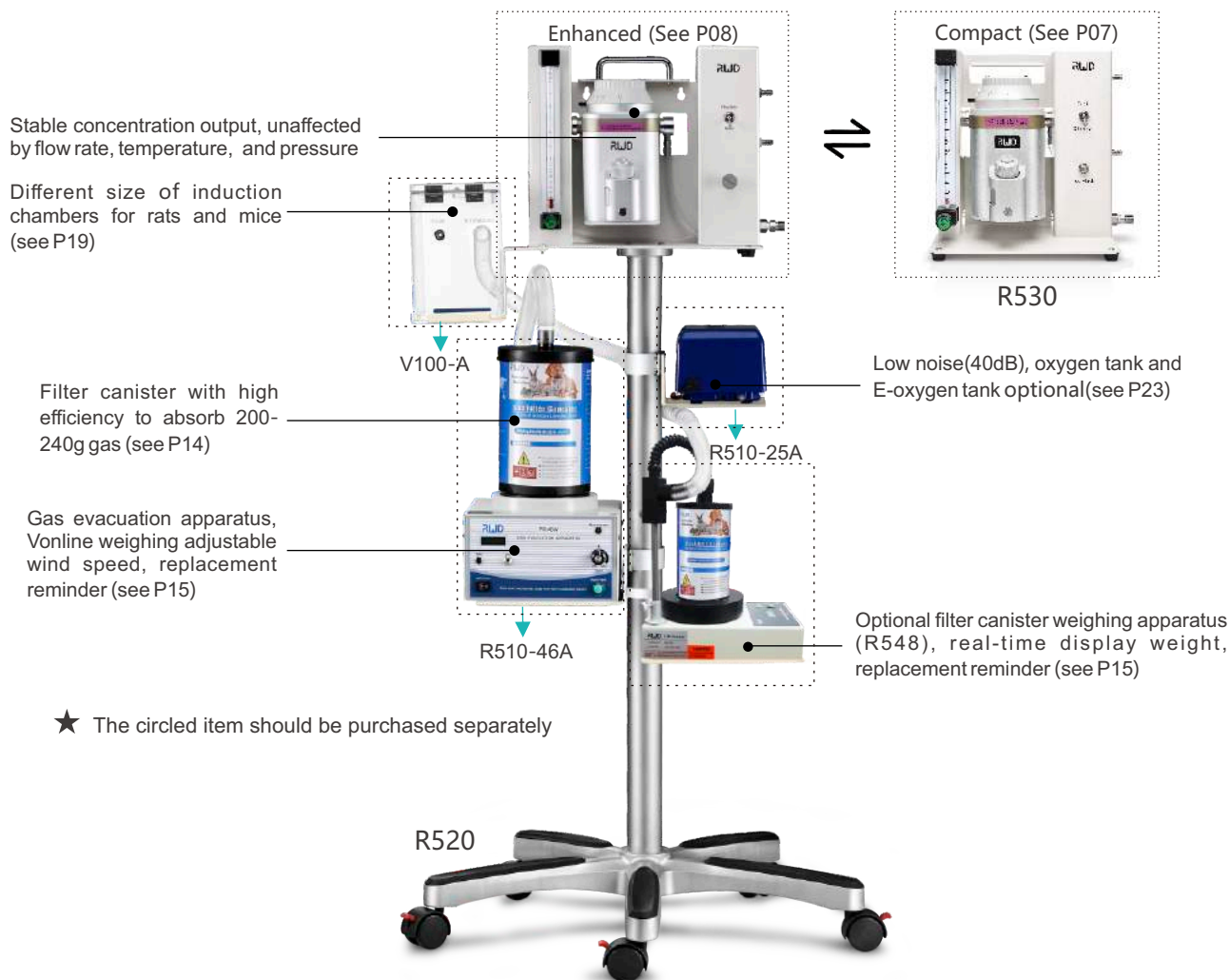

Order Information:

Cat No.	Product Description	Configuration	Remarks
R520IE	Movable Small Animal Anesthesia Machine-Isoflurane, Easy Fill, 0-4L	●	Including fixed bracket for induction chamber, evacuation apparatus, filter canister.
R520IP	Movable Small Animal Anesthesia Machine-Isoflurane, Pour Fill, 0-4L	●	
R520SE	Movable Small Animal Anesthesia Machine-Sevoflurane, Easy Fill, 0-4L	●	
R520SP	Movable Small Animal Anesthesia Machine-Sevoflurane, Pour Fill, 0-4L	●	
R530IE	Portable Anesthesia Machine, Isoflurane, Easy Fill, 0-4L	●	Including fixed bracket for induction chamber, evacuation apparatus, filter canister.
R530SE	Portable Anesthesia Machine, Sevoflurane, Easy Fill, 0-4L	●	

Note: ● Recommended configuration ○ Optional

Veterinary Anesthesia Machines ▶

R620-S1 Universal Veterinary Anesthesia Machine

R620-S1 universal veterinary anesthesia machine is applicable to clinical anesthesia of dogs, cats, pigs, monkeys, rodent, reptiles, birds etc. With minimal operation design, vets shall feel easy, safe and reliable to perform surgery on pets.

User-friendly design

Blocking bar design for breathing circuit, wheel brake for Universal wheel, and tray shelf for placing monitor

Rail-mounted CO₂ absorber

With simply 2 steps and one hand, one can install and disassemble the canister easily. Set your hand free, and save time and effort

Full inspection policy

Every single vaporizer is inspected to ensure they will arrive at customers' hands with high accuracy quality

Minimal operation design

Just press to close APL valve; turn the switch to shift between rebreathing and non-rebreathing circuit; with only one action to install and uninstall the vaporizer; With one switch to turn, the smart weighing canister start to work

Intelligent waste gas scavenging

The intelligent alarm design of weighing meter can prevent waste gas leakage due to overload of the filter canister, in turn avoid anesthesia gas pollution in operation room.

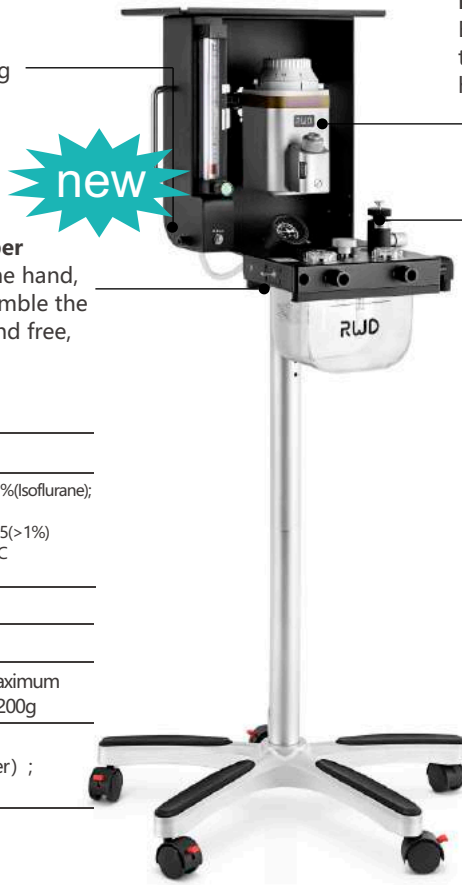

Item	Specification
Vaporizer	Output concentration: 0~5%(Isoflurane); 0~8%(Sevoflurane) Accuracy: ±0.1(0-1%); ±0.15(>1%) work temperature: 10~35°C Volume>120ML
Flowmeter	0.1-4L/min
CO ₂ Absorber	2.1L
Filter canister	Self-weight is 800g, Maximum absorption capacity is 200g
Weighing device	Alarm range>1000g (R510-31 filter canister) ; Resolution:1g

Order Information:

Cat No.	Product Description	Configuration	Remarks
R620-S1-IEC	Veterinary Anesthesia Machine-Pole Mount, Isoflurane, Easy Fill, Cagemount	●	Basic package. One filter canister is included. And the isoflurane, gas supply, calcium lime, laryngoscope, masks should be purchased separately.
R620-S1-IPC	Veterinary Anesthesia Machine-Pole Mount, Isoflurane, Pour Fill, Cagemount	●	
R620-S1-SEC	Veterinary Anesthesia Machine-Pole Mount, Sevoflurane, Easy Fill, Cagemount	●	
R620-S1-SPC	Veterinary Anesthesia Machine-Pole Mount, Sevoflurane, Pour Fill, Cagemount	●	
R620-S1-IECS	Veterinary Anesthesia Machine-Pole Mount, Isoflurane, Easy Fill, Cagemount	●	Super package. Compared with the basic package, an additional oxygen valve, calcium lime, a bottle of trial isoflurane and an automatic Weighing Apparatus are included.
R620-S1-IPCS	Veterinary Anesthesia Machine-Pole Mount, Isoflurane, Pour Fill, Cagemount	●	
R620-S1-SECS	Veterinary Anesthesia Machine-Pole Mount, Sevoflurane, Easy Fill, Cagemount	●	
R620-S1-SPCS	Veterinary Anesthesia Machine-Pole Mount, Sevoflurane, Pour Fill, Cagemount	●	
R620-S1-IECP	Veterinary Anesthesia Machine-Pole Mount, Isoflurane, Easy Fill, Cagemount	●	Luxury package. Compared with the super package, an extra mask kit 68643, lamp laryngoscope C45001-00, an automatic Weighing Apparatus are included. (see P24)
R620-S1-IPCP	Veterinary Anesthesia Machine-Pole Mount, Isoflurane, Pour Fill, Cagemount	●	
R620-S1-SECP	Veterinary Anesthesia Machine-Pole Mount, Sevoflurane, Easy Fill, Cagemount	●	
R620-S1-SPCP	Veterinary Anesthesia Machine-Pole Mount, Sevoflurane, Pour Fill, Cagemount	●	

Note: ● Recommended configuration ○ Optional

R630 Dual-Drug Veterinary Anesthesia Machine

RWD develop a new Dual-Drug Veterinary Anesthesia Machine based on the veterinary clinic, which is suitable for clinical anesthesia of dogs, cats, pigs, monkeys, rodents, reptiles and birds.

One Machine, Two Choices

Different cases use different anesthetic to improve the quality of anesthesia

No anesthetic mixing

There is "Non-return" parallel structure to avoid anesthetic mixing



No leakage and no wrong filling

The way to fill the vaporizer is Easy Fill to ensure there is no anesthetic leakage and wrong anesthetic filling

Minimal operation

Quick occlusion of APL valve, circuit switch, rail-mounted CO₂ absorber

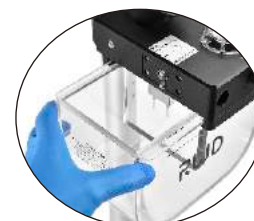

Rail-mounted CO₂ absorber

With simply 2 steps and one hand, one can install and disassemble the canister easily. Set your hand free, and save time and effort

Item	Specification
Vaporizer	Output concentration: 0~5% (Iso) ; 0~8% (Sevo) Accuracy: ±0.1(0-1%); ±0.15(>1%) work temperature: 10~35°C Volume>120ML
Flowmeter	0.1-4L/min
CO ₂ Absorber	2.1L
Filter canister	Self-weight is 800g, Maximum absorption capacity is 200g
Weighing device	Alarm range>1000g (R510-31 filter canister) ; Resolution:1g

Order Information:

Cat No.	Product Description	Configuration	Remarks
R630-EC	Dual-Drug Veterinary Anesthesia Machine-Pole Mount, Sevoflurane, Easy Fill, Cagemount	●	Basic package. One filter canister is included. And the isoflurane, gas, calcium lime, laryngoscope, masks should be purchased separately.
R630-ECP	Dual-Drug Veterinary Anesthesia Machine-Pole Mount, Sevoflurane, Easy Fill, Cagemount	●	Luxury package. Compared with the basic package, an extra mask kit 68643, an additional oxygen valve, calcium lime, a bottle of trial isoflurane/sevoflurane are included. (see P24)

Note: ● Recommended configuration ○ Optional

Anesthesia Machine Accessories ▶

(Anesthesia Machine) Vaporizer

R580 series vaporizer adopts the most advanced design, which can accurately control the output concentration of anesthetics. RWD offers Pour Fill, Easy Fill and Key Fill Cagemont and Selectatec.

Two kinds of vaporizers
Three dosing methods
Two installation



Isoflurane vaporizer



Sevoflurane vaporizer



Pour-Fill

Easy-Fill

Key-Fill



Cagemont

selectatec

R580-SA

R580-IO

Feature:

- The built-in temperature compensator ensures the stable concentration of anesthetic gas at different temperatures and flow rates, the flow range is 0.2-10L/min
- Mixed anesthetic gas output pressure range $\Delta P \leq 2.5\text{kPa}$
- Applicable temperature range: 10-35°C
- Good tightness, internal 50kPa pressure can be maintained, zero leakage, safe and reliable
- Internal capacity is not less than 120ml, and the range of isoflurane vaporizer concentration is 0-5% (Sevoflurane: 0-8%)
- Anti-accident open lock structure and closed state security protection structure to ensure safety
- The average filling rate is greater than 2ml/s, and the dosing adapter can withstand the pressure of 0.1mpa without leakage (Key Fill)

Order Information:

Cat No.	Product Description
R580S	Vaporizer - Isoflurane/Pour Fill/Cagemont
R581S	Vaporizer - Sevoflurane/Pour Fill/Cagemont
R582S	Vaporizer - Sevoflurane/Easy Fill/Cagemont
R583S	Vaporizer - Isoflurane/Easy Fill/Cagemont
R584S	Vaporizer-Isoflurane/Key Fill/Cagemount
R585S	Vaporizer-Sevoflurane/Key Fill/Cagemount
R580-IO	Vaporizer Endcaps (1 pair)

Cat No.	Product Description
R580SS	Vaporizer - Isoflurane/Pour Fill/Selectatec
R581SS	Vaporizer - Sevoflurane/Pour Fill/Selectatec
R582SS	Vaporizer - Sevoflurane/Easy Fill/Selectatec
R583SS	Vaporizer - Isoflurane/Easy Fill/Selectatec
R584SS	Vaporizer-Isoflurane/Key Fill/Selectatec
R545SS	Vaporizer-Sevoflurane/Key Fill/Selectatec
R580-SA	Vaporizer Suspension Assembly - R640

Note: When purchasing a Cagemont vaporizer, vaporizer endcaps (model: R580-IO) should be purchased separately.

When purchasing a Selectatec vaporizer, the vaporizer mount assembly(model:R580-SA) should be purchased separately.

Vaporizer of Easy Fill includes adapter R582-01 or R583-01.

Vaporizer of Key Fill includes adapter R584-01 or R585-01.

Isoflurane & Sevoflurane



Isoflurane



Sevoflurane

Order Information:

Cat No.	Product Description
R510-22-16	Isoflurane-100ml (16 bottles/box)
R511-22	Sevoflurane-100ml
R511-22-04	Sevoflurane-100ml (4 bottles/box)

Gas Filter Canister



Used to absorb isoflurane, sevoflurane and enflurane and other gases, disposable, large and small size are available, large canister (net weight: 800g) absorb 200-240g gas; small canister (net weight: 250g) absorb 50g gas.

Order Information:

Cat No.	Product Description
R510-31-6	Gas Filter Canister, Large, pkg of 6pcs
R510-31S-6	Gas Filter Canister, Small, pkg of 6pcs
R510-31S-16	Gas Filter Canister, Small, pkg of 16pcs

Breathing Bags

Order Information:

Cat No.	Product Description
R600-NL-0.5L	Reusable Non Latex Breathing Bag, 0.5L
R600-NL-1L	Reusable Non Latex Breathing Bag, 1L

Cat No.	Product Description
R600-NL-2L	Reusable Non Latex Breathing Bag, 2L
R600-NL-3L	Reusable Non Latex Breathing Bag, 3L



Breathing Circuits



R-NBC-F(JR)



R-BC-DL

Order Information:

Cat No.	Product Description
R-NBC-F(JR)	Mapleson F Non-rebreathing Circuit (Jackson-Rees)
R-BC-DL	Breathing Circuit Duo-Limb, 22mm(M)/15mm(F), 1.5m

Gas Evacuation Apparatus

The gas evacuation apparatus (GEA) was designed to safely and actively remove waste gas associated with everyday inhalation anesthesia. The waste gas from cone mask, concentric tubing mask and stereotaxic frame nosecone masks can be pulled through activated charcoal canister so that the air can be re-circulated into the room. The GEA will accommodate waste gas supply from at least 5 masks.

- No venting hood is required while using.
- Powerful capture allows to accommodate waste gas supply from 1 to 5 masks.
- The velocity of "pull" or "draw" can be adjusted depending on the stations (masks).
- Great remove effectiveness to replace the traditional exhaust fan with remove ability less than 5g.
- Small size 215mm (W)*215mm (D)*170mm (H).
- Easy to connect to your vaporizer system and insert a activated charcoal canister.
- Online weighing, get the weight of canister directly from the display.
- Two level overweight alarm: 990g and 1010g.
- The outer diameter of the filter tank mounting position :124mm
- Wind regulation:35-60LPM
- Power: 100-240V, 50/60HZ

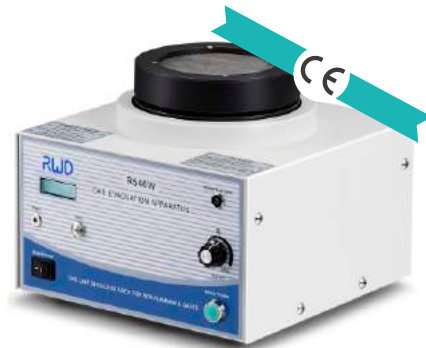

R546W

R546W, with the latest design of weighing, will be additionally used to weigh the activated charcoal canister at any time to check its saturation. Two levels alarm (990g and 1010g), indicator light and buzzer remind to change the canister and maintain its effectiveness.

Order Information:

Cat No.	Product Description
R546W	Gas Evacuation Apparatus with Weight Monitoring, 110-240V

Automatic Weighing Apparatus



Exhaust gas inlet
(from mask or induction chamber)

- One key to reset, real-time display the weight of filter canister, accurate to 1g
- Two level saturation alarm to remind, replace filter canister .
 - ◆ Level I : large canister reaches 1000-1020g, small canister reaches 300-310g
 - ◇ Audible and visual alarm, 0.5hz (0.5 time/s)
 - ◆ Level II: large canister reaches 1020-1500g, small canister reached 310-500g
 - ◇ Audible and visual alarm, 2hz (2 time/s)
- ◆ Overweight alarm: more than 1500g, stable 1 second
 - ◇ Audible and visual alarm, lasting lighting and buzzing
- Automatically identify RWD's large & small canister
- Long press the mute button to suspend alarm
 - ◆ Short press the mute button, restore alarm after 5min of mute
 - ◆ Long press the mute button 3s, restore alarm after 30min of mute
- Compact size, save space
- Mounting bracket (R548-MB) is optional, to mount on the mobile stand

Cat No.	Product Description
R548	Automatic Weighing Mechanism for Gas Filter Canister
R548-MB	Weighing Bracket

Small Animal Anesthesia Mask

• Concentric Tubing Masks

Using Concentric Tubing design, sturdy and durable, can be placed arbitrarily on the desktop. The entire mask (including tubing) is made of non-metallic material suitable for MRI environments.

- The mask can be secured by fixed bracket (68625) or the fixed platform (68626), height of the mask is adjustable, and it can also be fixed and placed in MRI, PET and SPECT imaging systems



- Simultaneous experiments can be performed on 2-5 rats or mice with five channels of anesthesia mask



Order Information:

Cat No.	Product Description
R510-86	SGL MRI Compatible Mask for Mouse
R510-88	Dual MRI Compatible Masks for Mouse
R510-54	Five-channel Tubing Anesthesia Mask Kits-rat/mouse
68625	MRI Compatible Mounting Bracket for Tubing or Cone Mask, optional

Cat No.	Product Description
R510-87	SGL MRI Compatible Mask for Rat
R510-89	Dual MRI Compatible Masks for Rat
R510-90	SGL MRI Compatible Mask for Rabbit
68626	MRI Compatible Mounting Platform for Tubing or Cone Mask-rat/mouse

● Cone Masks(Bowl Masks)

- Clear cone for full visualization of muzzle.
- The Cone Masks can be installed onto 68620 anesthesia operation platform(300*210*75mm) to secure the animal in it.
- Height of the mask can be adjusted to meet different experimental needs.
- Special semi-enclosed mask design, coordinating with the evacuation apparatus to absorb and remove the waste gas outside the mask completely.



Order Information:

Cat No.	Product Description
68620	Small Animal Anesthesia Operation Platform (bellows(R-CT-18))
68634	Juvenile Rat mask -44mm OD*5mm ID*24mm depth
68635	Mouse mask -44mm OD*10mm ID*24mm depth
68636	Rat mask -44mm OD*15mm ID*24mm depth

● Cone Masks

- Special designed with inlet tubing inside make the animal anesthesia exhaust gas can be absorbed by gas filter canister.
- Allows access to eyes, ears and top of head.
- The cone masks can be installed onto 68630 operation bed for single cone mask (300*210*75mm) or 68657 manifold for five cone masks.

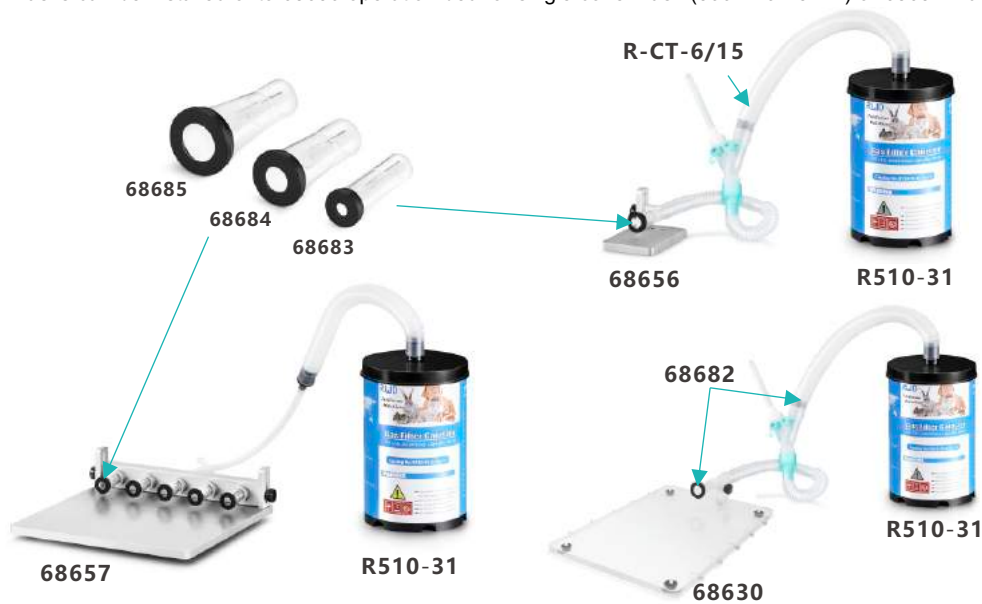

Order Information:

Cat No.	Product Description	OD (size)	ID(size)	D(size)
68680	Cone Mask with Tubing for Neonatal Mouse(<15g)	13mm	5mm	24mm
68681	Cone Mask with Tubing for Mouse or Neonatal Rat(15-40g)	20mm	10mm	28.5mm
68682	Cone Mask with Tubing for Rat(200-350g)	25mm	15mm	38mm
R-CT-6/15	Concentric Tubing, 6mm Inlet/15mm Outlet, 45cm			
68656	Manifold for Single Cone Mask			
68657	Manifold for Five Cone Masks			
68630	Anesthesia Operation Platform			
68683	Cone Mask for Neonatal Mouse(<15g)	13mm	5mm	24mm
68684	Cone Mask for Mouse or Neonatal Rat(15-40g)	20mm	10mm	28.5mm
68685	Cone Mask for Rat(200-350g)	25mm	15mm	38mm

• Stereotaxic Frame Nosecone Masks

This type of anesthetic masks is specifically designed to fit most stereotaxic frame and deliver anesthetic gases with minimal exposure during surgery. They are locked onto the adaptor with the cone opening toward the open "U". The animal's teeth is placed over the incisor bar.

Two kinds of Stereotaxic Frame Nosecone Masks are available: one is "passive" mask with collinear inlet and outlet, and the other one is "active" mask with separate (non-collinear) inlet and outlet on both sides. The "passive" mask is used with charcoal canister only, and the "active" mask can be used with evacuation apparatus.

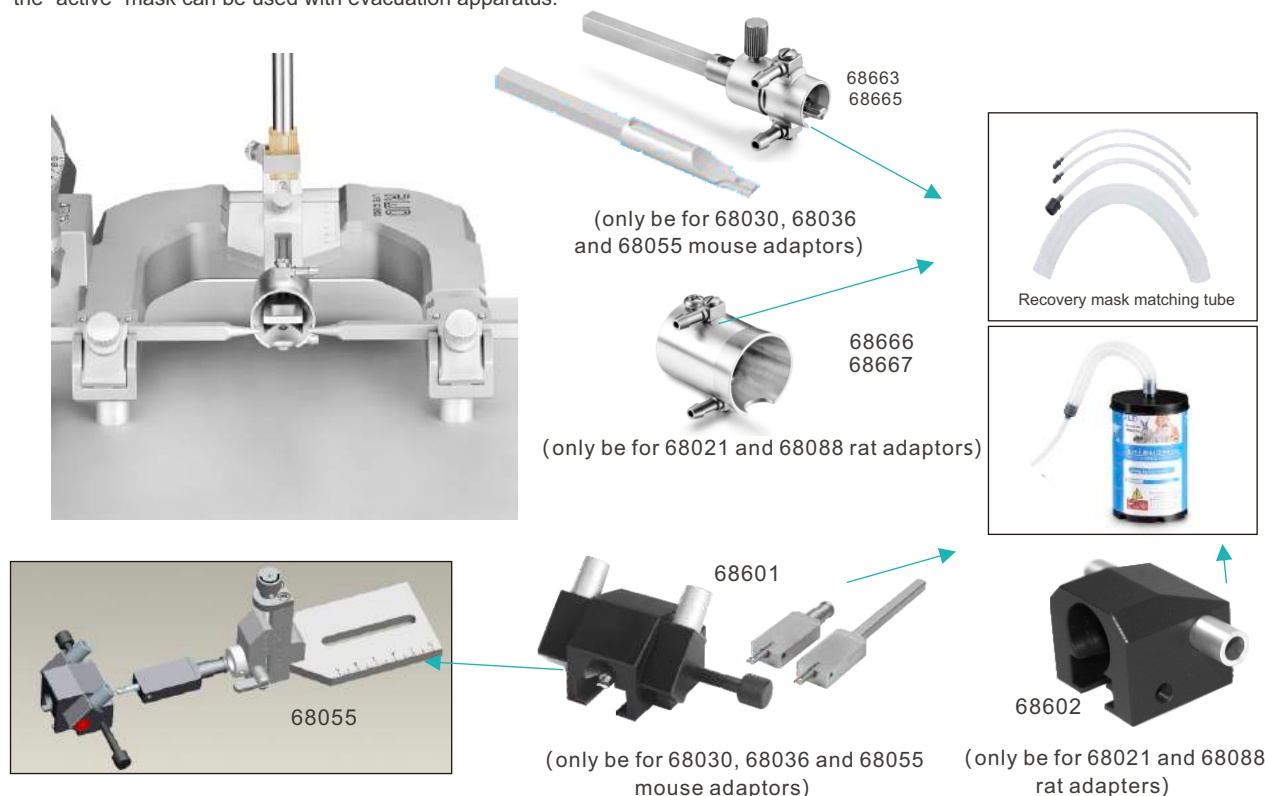

Order Information:

Cat No.	Product Description	Remarks
68601	Stereotaxic Anesthesia Mask Kit -mice or neonatal rat (<70g, Canister & Tubing included)	For Passive Scavenging
68602	Stereotaxic Anesthesia Mask Kit - rats (<300g, Canister & Tubing included)	
68663	Stereotaxic Anesthesia/Evacuation mask- mice or neonatal rats (<30g)	For Active Scavenging
68665	Stereotaxic Anesthesia/Evacuation mask- mice or neonatal rats (30 ~ 70g)	
68666	Stereotaxic Anesthesia/Evacuation mask- rats (<300g)	
68667	Stereotaxic Anesthesia/Evacuation mask- rats (>300g)	

• Imaging Mask

This mask mainly works with ultrasound animal imaging heating platform and the anesthetic mask for the actual operation of ultrasound imaging to ensure that animals are quiet, fixed, to meet the needs of special environmental imaging.

Order Information:

Cat No.	Product Description
68669	Anesthesia mask - mouse and neonatal rat (<70g)
68670	Anesthesia Mask - rat (<300g)



Induction Chambers

For rapid induction of anesthesia before animal surgery, takes only 2-5 minutes; Animal status can be observed in real time during anesthesia.

The anesthetic gas is inducted into the chamber, and exhausted to the connected charcoal canister. With following features:

- Transparent plexiglass material, durable, easy to clean, convenient to observe the anesthetic state of animals.
- Positive pressure gaskets at lids.
- Both ports on one side to reduce tubing in procedure area.



Order Information:

Cat No.	Product Description	Remarks
V100	Induction Chamber-mouse (15cm*10cm*10cm)	Contains 1 plexiglass box, 1.2m bellows and 1 gas filter canister (R510-31S)
V101	Induction Chamber-rat (24cm*12cm*18cm)	
V102	Induction Chamber-rabbit/cat (40cm*18.5cm*25cm)	
V103	Induction Chamber-large animal (50cm*30cm*30cm)	

Flowmeters

Multi-output flowmeter



R510-07



R510-09

R510-07 five-output flowmeter and R510-09 can be used in conjunction with R520 and R540 series small animal anesthesia machines to meet the simultaneous anesthesia of 5 or 2 animals, and each port can adjust the flow rate independently.

Extended flowmeter



RWD anesthesia is equipped with an extended flow meter mounting position, which expands a variety of gas flowmeters to meet the need of a variety of gas supply.

Order Information:

Cat No.	Product Description	Remarks
R510-09	Dual Channel Flowmeter - Range 0.1-1L / min	Standard contains 2.2 meter silicon tube (ID:6.0mm)
R500-N2O-1E	Expansion Assembly with 0.1-1LPM N ₂ O Flowmeter	Silicone tube and Y-three way and other accessories
R600-O2-4E	Expansion Assembly with 0.1-4LPM O ₂ Flowmeter	Silicone tube and Y-three way and other accessories

Ventilator

VentStar Small Animal Ventilator

Animal ventilator is the commonest instrument for assisting animal respiration, which is widely used in scientific researches of preclinical medicine, clinical medicine and veterinary medicine (such as myocardial ischemia model), as well as respiratory management in animal surgery, emergency treatment and respiratory therapy.

Suitable for mice, rats and guinea pigs and other animals weighing 10g-1kg

Input power range: 100 ~ 240V, 50/60Hz, 24V, 40W, 1.67A adapter DC power supply, safe and effective

Small size, compact layout, flexible operation

Provide safe and effective intermittent positive pressure ventilation (IPPV), volume and pressure modes are available.

7 inches LCD touch screen, wide-angle visual

The pressure-time graph can be displayed in real time in volume and pressure modes

Sound, intelligent text, error code and other fault alarm alerts

10 groups of different respiratory parameters can be stored and called, which is convenient and efficient

R415-AP

Set the respiratory parameters such as PIP/PEEP/Sigh/INSP.Hold/EXP. Hold

After submitting the animal weight, and the device automatically sets the reference breathing parameters

The breathing frequency can be switched between 10 ~ 300bpm

Tidal volume range: 0.05ml ~ 5ml

Airway pressure range: 1~50cmH₂O, the accuracy range: ±0.7 cmH₂O; positive end expiratory pressure (PEEP) range is 0~10cmH₂O

The adjustable range of I:E ratio is from 20% to 80%; the sigh increases the tidal volume from 0 to 20%, and can set auto-sigh once after every 10 to 999 breaths or manual control

Cat No.	Product Description
R415	Small Animal Ventilator
R415-AP	Accessory package for Anesthesia and Ventilator

Small Animal Ventilator

Equipped with high quality motor, speed reducer and controller, RWD's ventilator with low noise, precisely control and durable. They could be run separately with air or oxygen as the gas source, or together with anesthesia machine for improving the anesthetic effect.



- Application: R405 is for mouse, neonatal rat, while R407 is for rat, hamster, rabbit, cat, puppy and other animal within 5kg
- The digital LED panel shows the respiratory rate in real time
- Tidal volume and respiratory rate are linear controlled, can be adjusted while the ventilator is running
- R405: tidal volume 0.1-1.0cc, adjustment accuracy 0.1cc
- R407: equipped with two sizes of pistons (large piston: tidal volume of 3-30cc, adjustment accuracy of 3cc; small piston: tidal volume of 0.5-5cc, adjustment accuracy of 0.5cc)
- Respiratory rate range: 18-150 breaths / min
- Control positive end expiratory pressure (PEEP)

Order Information:

Cat No.	Product Description	Remarks
R405	Mouse Ventilator, 220V	Including Ventilator, connecting silicon tube and trachea cannula (20G)
R405V	Mouse Ventilator, 110V	
R407	Small Animal Ventilator, 220V	Including Ventilator, connecting silicon tube and trachea cannula (14G)- 1.85mm OD
R407V	Small Animal Ventilator, 110V	
R510-27	Accessory Package for Anesthesia and Ventilator	

R419 Intelligent animal ventilator

R419 intelligent animal ventilator as mechanical ventilation device, which is completely according with veterinary clinical practice. There are 3 modes of operation, including VCV, PIPCV and APNEA, to meet multiple clinical applications.

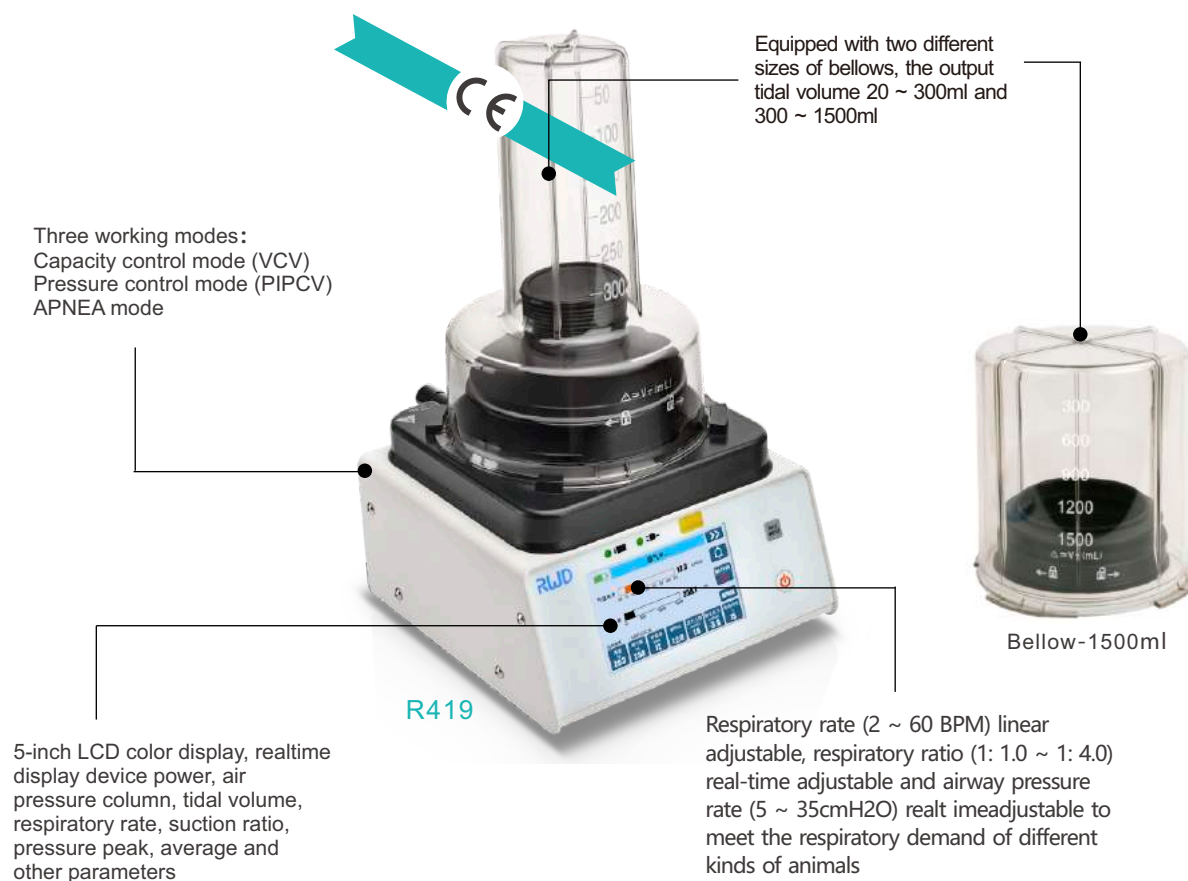

- Adjustable power supply (110 / 220V)
- Light weight, portable, user-friendly design, multi-parameter fixed platform, easy to operate
- Provides safe and effective intermittent positive pressure ventilation (IPPV)
- Provide internal battery power, which can work more than 4 hours

Order Information:

Cat No.	Product Description
R419	R419 Intelligent animal ventilator
R409-MB	Mounting Bracket for R409 Ventilator

Anesthesia and Respiration Accessories ▶

Gas Supply



Air Pump
(R510-29/R510-30)



R-PG-O2-1M(CN)Pro Medical Oxygen Tank



R-GM-ET(S)



R-GM-ET(D)



E-Oxygen Tank

Oxygen or air can be chosen as gas supply of small animal anesthesia machines. Air pump (R510-29/R510-30) can provide air as gas supply; medical oxygen and E-oxygen tanks can provide oxygen as gas supply (you need to buy oxygen relief valve (R-GM-ET(S)) for Oxygen tanks, E-oxygen tanks are only suitable for portable anesthesia machines and need to purchase E-oxygen tank (R-GM-ET(S)) or double tanks (R-GM-ET(D)) mounting bracket, (as shown above), oxygen is provided by the user.

Oxygen Concentrator

Generate medical oxygen from the air, oxygen is more convenient, is suitable for supplying oxygen for anesthesia, anesthesia recovery etc.

Features:

- Flow rate: 5L/min
- Generate medical oxygen(USP93%) from the air. Cost effective and never run out of oxygen supply
- Tri-filtration system, 99.999% of bacteria, viruses and odor can be removed effectively
- LOW O₂ PURITY ALARM and ABNORMAL ALARM available
- Quiet design, stable performance, safe operation, light weight and easy to move
- Outlet pressure 40-60KPa
- Power: 220V, 50Hz, 380VA
- Dimension L 248 x W 330 x H 535mm



ROC-5A

Feline/Canine Masks

Apply to the anesthesia induction, breathing rescue of felines, canines and the same size of animals.



Order Information:

Cat No.	Product Description
68637	Feline Mask, 44mm(OD)*22mm(ID)*24mm(Depth)
68638	Feline Mask, 57mm(OD)*30mm(ID)*29mm(Depth)
68639	Feline Mask, 60mm(OD)*33mm(ID)*35mm(Depth)
68640	Canine Mask, 87mm(OD)*30mm(ID)*73mm(Depth)
68641	Canine Mask, 110mm(OD)*42mm(ID)*97mm(Depth)
68642	Canine Mask, 130mm(OD)*54mm(ID)*121mm(Depth)
68643	Feline/Canine Mask Set of 6 pcs

Laryngoscopes

Apply to medium or large animals' laryngeal examination and tracheal intubation.

Type	Specification	Technical Parameter
Handle		Length L: 150mm, diameter D: 23mm
Curved lens (Bulb and fiber)	1#	Length L1: 80mm, width W1: 8mm
	2#	Length L1: 95mm, width W1: 10mm
	3#	Length L1: 105mm, width W1: 13mm
	4#	Length L1: 135mm, width W1: 15mm
	5#	Length L1: 155mm, width W1: 15mm
Straight lens (Bulb and fiber)	1#	Length L2: 80mm, width W2: 11mm
	2#	Length L2: 105mm, width W2: 11mm
	3#	Length L2: 155 mm, width W2: 14 mm
	4#	Length L2: 195 mm, width W2: 14 mm
	5#	Length L2: 205 mm, width W2: 17 mm



Macintosh Laryngoscope



Miller Laryngoscope

Order Information:

Cat No.	Product Description
C45001-00	Miller Lamp Laryngoscope, 5 Blades+Handle+Case
C45002-00	Miller F.O. Laryngoscope, 5 Blades+Handle+Case
C45003-00	Macintosh Lamp Laryngoscope, 5 Blades+Handle+Case
C45004-00	Macintosh F.O. Laryngoscope, 5 Blades+Handle+Case

Endotracheal Tubes

Medical non-toxic PVC design, suitable for the obstruction of animal throat, respiratory dysfunction and respiratory obstruction. After tracheotomy, the trachea is inserted to keep breathing, with features of smooth/firm tube design, comfortable feeling after intubation etc., ISO standard interface (OD: 15MM), and can be connected with breathing circuit.

Order Information:

Cat No.	Product Description	Remarks
R600-ET	Cuffed Endotracheal Tubes 2.0-10.0mm (1 set)	
R600-ET-20	Uncuffed Endotracheal Tubes-I.D.2.0mm*O.D.3.3mm(Without airbag)	10psc/box
R600-ET-25	Cuffed Endotracheal Tubes-I.D.2.5mm*O.D.3.7mm	10psc/box
R600-ET-30	Cuffed Endotracheal Tubes-I.D.3.0mm*O.D.4.0mm	10psc/box
R600-ET-35	Cuffed Endotracheal Tubes-I.D.3.5mm*O.D.4.7mm	10psc/box
R600-ET-40	Cuffed Endotracheal Tubes-I.D.4.0mm*O.D.5.3mm	10psc/box
R600-ET-45	Cuffed Endotracheal Tubes-I.D.4.5mm*O.D.6.0mm	10psc/box
R600-ET-50	Cuffed Endotracheal Tubes-I.D.5.0mm*O.D.6.7mm	10psc/box
R600-ET-55	Cuffed Endotracheal Tubes-I.D.5.5mm*O.D.7.3mm	10psc/box
R600-ET-60	Cuffed Endotracheal Tubes-I.D.6.0mm*O.D.8.0mm	10psc/box
R600-ET-65	Cuffed Endotracheal Tubes-I.D.6.5mm*O.D.8.7mm	10psc/box
R600-ET-70	Cuffed Endotracheal Tubes-I.D.7.0mm*O.D.9.3mm	10psc/box
R600-ET-75	Cuffed Endotracheal Tubes-I.D.7.5mm*O.D.10.0mm	10psc/box
R600-ET-80	Cuffed Endotracheal Tubes-I.D.8.0mm*O.D.10.7mm	10psc/box
R600-ET-85	Cuffed Endotracheal Tubes-I.D.8.5mm*O.D.11.3mm	10psc/box
R600-ET-90	Cuffed Endotracheal Tubes-I.D.9.0mm*O.D.12.0mm	10psc/box
R600-ET-95	Cuffed Endotracheal Tubes-I.D.9.5mm*O.D.12.7mm	10psc/box
R600-ET-100	Cuffed Endotracheal Tubes-I.D.10.0mm*O.D.13.3mm	10psc/box
R-ET-WHF	Wall Hanging Frame for Endotracheal Tubes(ID 2.0-13.0mm)	



Wall Hanging Frame for Endotracheal Tubes



Tubing Connector



Order Information:

Cat No.	Product Description	Cat No.	Product Description
R-LCM-1/8	Luer Connector-Male, 1/8"	R-RC-3/8-1/4	Reduced Connector - T-type, 3/8" x 3/8" x1/4"
R-Y-1/4	Y-three Way Valve-PP-1/4"	R-RC-1/4-3/8	Reduced Connector -1/4"-3/8"
R-Y-1/8	Y-three Way Valve-PP-1/8"	R-T-1/4	Three way Valve- combined with R-LCF-1/4(1 PCS) and R-LCM-1/4(2 PCS)
R-Y-1/16	Y-three Way Valve-PP-1/16"	R-Y-7/8	Y-connector-OD: 22mm
R-LCF-1/4	Luer Connector-Female, 1/4"	R-TC-22-22/15	Reduced Connector-15mm(M)-22mm(M)/15mm(F)
R-LCM-1/4	Luer Connector-Male, 1/4"	R-RC-15-15/22	Reduced Connector-15mm(M)-15mm(F)/22mm(M)
R510-25-86	9/16 TO Φ8 Cone Connector	R409-TC	T-connector – 9/16
R-AH-C	Oxygen Tube Connector-9/16(F)-M16*1.5(F)		

Tubes



Order Information:

Cat No.	Product Description	Cat No.	Product Description
R-PT-80	PVC Tubing - ID: 8.0mm	R-CT-18	Corrugated Tube - ID 22.0mm, L1.2m
R-ST-15	Silicone Tubing - ID:1.5, OD:4.5mm	R-CT-22-03	Corrugated Tube - ID 22.0mm, L0.3m
R-ST-30	Silicone Tubing - ID:3.0, OD:6.0mm	R-AH-80	O ₂ Hose - ID8.0- M16*1.5-9/16 Connector, 2m
R-ST-60	Silicone Tubing - ID:6.0, OD:9.0mm	R409-AH-80	O ₂ Hose - ID8.0-2*9/16 Connector, 1m
R-ST-60A	Silicone Tubing - ID:6.0,OD:10.0mm		

Stereotaxic Instrument Solutions

Stereotaxic instruments are widely used in many fields such as neuroanatomy, neurophysiology, neuropharmacology and neurosurgery etc.

RWD offer a series of stereotaxic instruments to meet the experimental needs of rat, mouse, guinea pig, tree shrew, cat, rabbit, dog, monkey and other different animals . Moreover, RWD stereotaxic instrument is fully equipped (see P35-42), which greatly improves the applicability and application of each stereotaxic instrument.

So, how to choose a most suitable stereotaxic instrument?

First of all, according to the experimental object and the type of experiment, you can choose the following type, like: standard type, compact type, rail-mounted type, large animal type etc. (the following figure shows the basic version, see P27-33).



Standard type



Compact type



Rail-mounted type

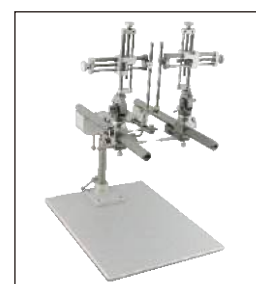

Large animal type

Secondly, according to the preferred experimental accuracy to choose the stereotaxic instruments with different accuracy 100um, 10um, two different precision readings are available.



Standard (100um)



Digital (10um)

In addition, all of the manual stereotaxic instruments can be upgraded into digital stereotaxic instruments, while the single manipulator can be upgraded into double-manipulator and can be converted freely.



SGL M



Dual M

Standard Stereotaxic Instruments

Classical U-type base design, professional services in the laboratory for 15 years!

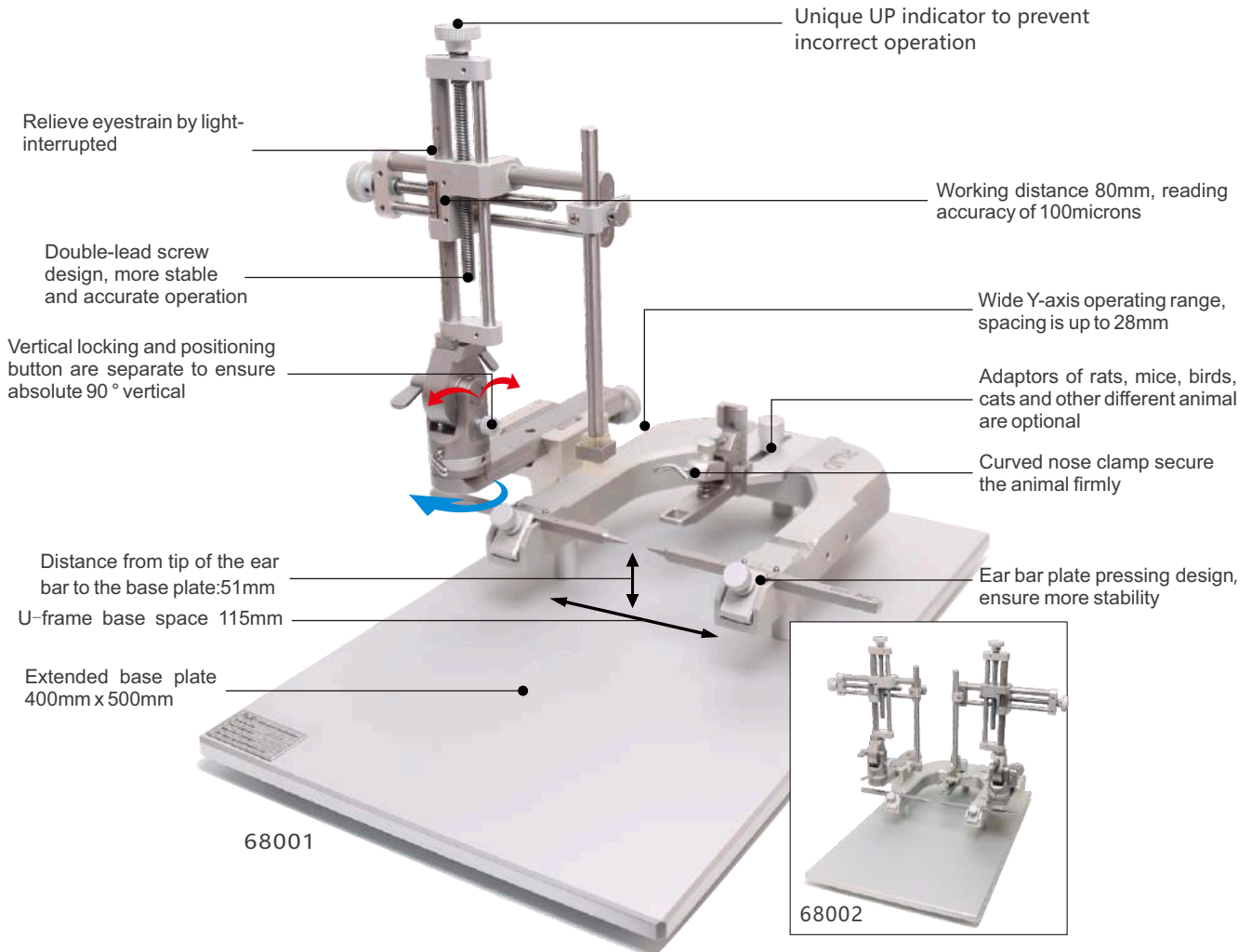

Composition:

68001 and 68002 are complete sets of stereotaxic (see figure), both containing 68861N base plate, 68401 three-dimensional manipulator - left, 68021 rat adaptor, 68301 rat 18° ear bar, 68201 standard holder, and 68002 includes an extra 68402 three-dimensional manipulator - right.

Order Information:

Cat No.	Product Description	Remarks
68001	Stereotaxic for Rat, SGL M, 18 Deg.	
68002	Stereotaxic for Rat, Dual M, 18 Deg.	
68005	Stereotaxic for Rat, SGL M, 45 Deg.	
68006	Stereotaxic for Rat, Dual M, 45 Deg.	
68037	Stereotaxic for Mouse, SGL M, 68030 Adaptor Incl.	
68038	Stereotaxic for Mouse, Dual M, 68030 Adaptor Incl.	
68043	Stereotaxic for Mouse, SGL M, 68055 Adaptor, 60 Deg.	
68044	Stereotaxic for Rat, Dual M, 68055 Adaptor, 60 Deg.	
68535	Stereotaxic for Mouse, SGL M, 68077 Adaptor, 60 Deg.	
68536	Stereotaxic for Rat, SGL M, 68078 Adaptor, 18 Deg.	
68861N	Stereotaxic Base Plate, Standard	

Desktop Digital Stereotaxic Instruments

Digital displacement display, higher accuracy, higher efficiency!



Composition:

68025 and 68026 are complete sets of stereotaxic (see figure), both containing 68861N base plate, 68401 three-dimensional manipulator - left, 68021 rat adaptor, 68301 rat 18 ° ear bar, 68201 standard holder, 68026 includes an extra 68402 three-dimensional manipulator-right and 68023 digital display module.

Order Information:

Cat No.	Product Description	Remarks
68025	Stereotaxic for Rat, SGL M, Digital, 18 Deg.	
68026	Stereotaxic for Rat, Dual M, Digital, 18 Deg.	
68027	Stereotaxic for Rat, SGL M, Digital, 45 Deg.	
68028	Stereotaxic for Rat, Dual M, Digital, 45 Deg.	
68018	Stereotaxic for Mouse, SGL M, Digital, 68030 Adaptor Incl.	
68019	Stereotaxic for Mouse, Dual M, Digital, 68030 Adaptor Incl.	
68045	Stereotaxic for Mouse, SGL M, Digital, 68055 Adaptor, 60 Deg.	
68046	Stereotaxic for Mouse, Dual M, Digital, 68055 Adaptor, 60 Deg.	
68537	Stereotaxic for Mouse, SGL M, Digital, 68077 Adaptor, 60 Deg.	
68538	Stereotaxic for Rat, SGL M, Digital, 68078 Adaptor, 18 Deg.	
68861N	Stereotaxic Base Plate, Standard	
68023	3-axis Digital Readout for Upgrade-68000	With digital base and displacement sensor

Portable/Rail Rat Stereotaxic Instruments

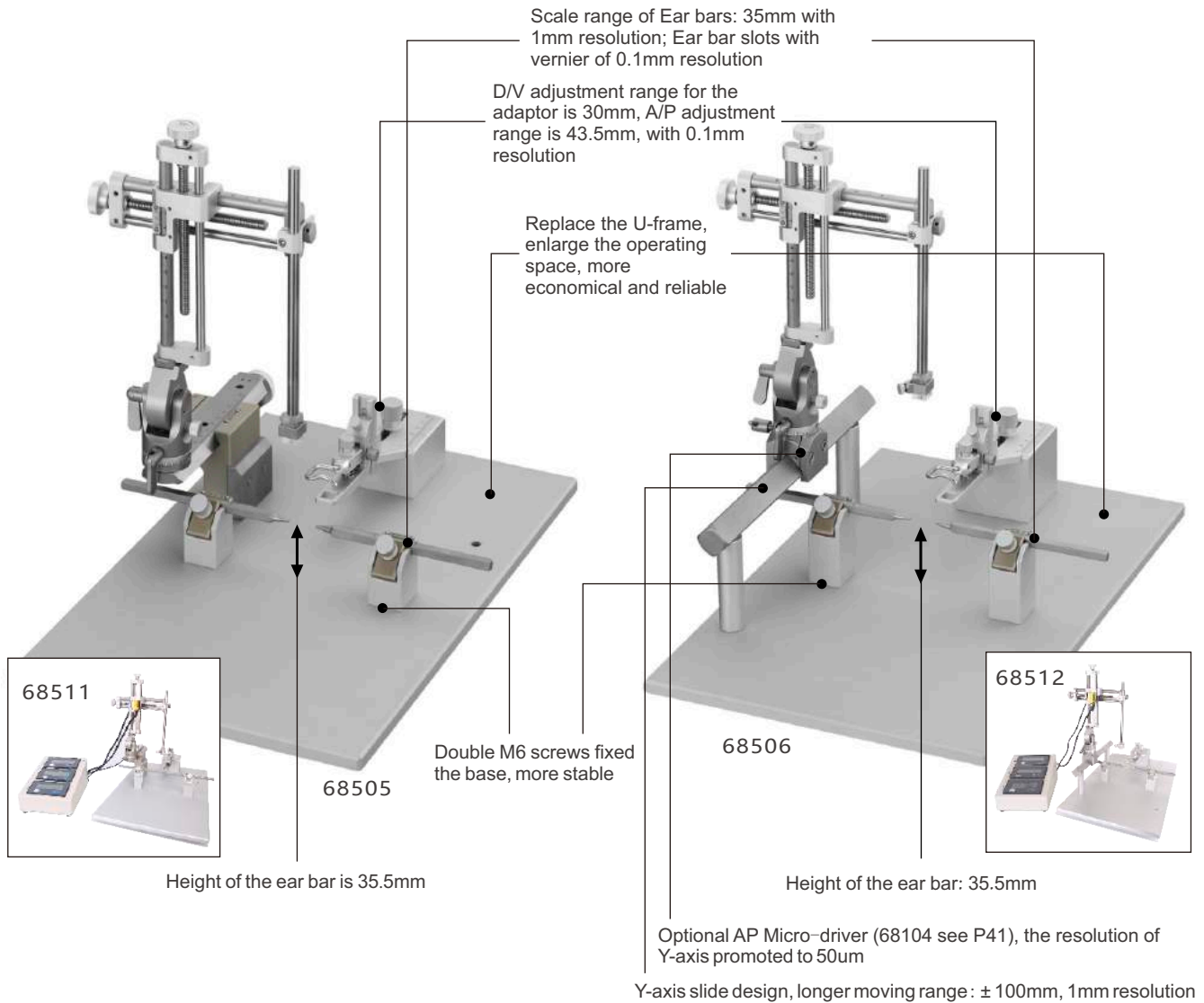

Composition:

68505 and 68506 are a complete sets of stereotaxic (see figure), both containing 68021 rat adaptor, 68301 rat 18 ° ear bar, 68201 standard holder, 68505 with the 68864S base plate and a 68401 three-dimensional manipulator - left, 68506 with the 68865S base plate and 68851 two-dimensional manipulator - left.

Order Information:

Cat No.	Product Description
68505	Stereotaxic for Rat, SGL M, Portable
68508	Stereotaxic for Rat, Dual M, Portable
68511	Stereotaxic for Rat, Digital and Portable, SGL M
68514	Stereotaxic for Rat, Digital and Portable, Dual M
68864S	Stereotaxic Base Plate for Rat, Portable, SGL M
68864D	Stereotaxic Base Plate for Rat, Portable, SGL M

Order Information:

Cat No.	Product Description
68506	Stereotaxic for Rat, SGL M, Rail-type
68509	Stereotaxic for Rat, Dual M, Rail-type
68512	Stereotaxic Frame for Rat, Portable, SGL M
68515	Stereotaxic for Rat, Digital and Rail-type, Dual M
68865S	Stereotaxic Base Plate for Rat or Mouse, Rail-type, SGL M
68865D	Stereotaxic Base Plate for Rat or Mouse, Rail-type, Dual M
68941	2-axis Manip for Rat Stereotaxic, Left Hand

Compact Mouse Stereotaxic Instruments

(One Mouse)

(Two Mouse)

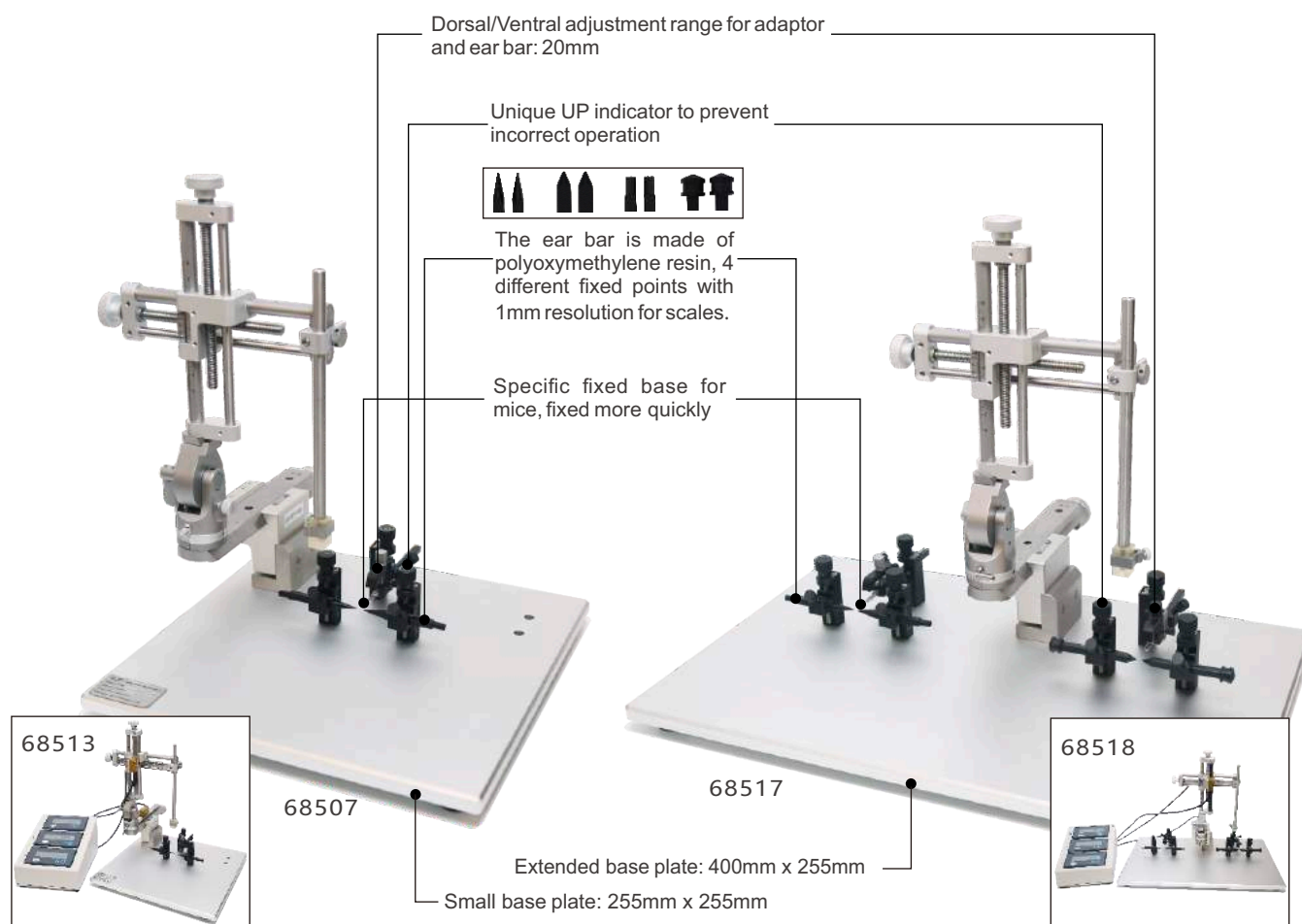

Suitable for mice or neonatal rats particularly for gene knockout and transgenic mice related neuroscience studies.

Composition:

68507 and 68517 are complete sets of stereotaxic (see figure), both containing 68033 mouse nose clip, 68034 and 68313 mouse 18° and 45° ear bars, 68201 standard holder, 68401 three-dimensional manipulator - left, 68507 with 68863S base plate, while 68517 with 68866N base plate, Digital version 68513 and 68518 adds 68023 three-dimensional digital display module.

Order Information:

Cat No.	Product Description
68507	Stereotaxic for Mouse, SGL M, Portable
68510	Stereotaxic for Mouse, Dual M, Portable
68513	Stereotaxic for Mouse, Digital and Portable, SGL M
68516	Stereotaxic for Mouse, Digital and Portable, Dual M
68863S	Stereotaxic Base Plate for Mouse, Portable, SGL M
68863D	Stereotaxic Base Plate for Mouse, Portable, Dual M

Order Information:

Cat No.	Product Description
68517	Stereotaxic for 2 Mice, Portable, SGL M
68518	Stereotaxic for 2 Mice, Digital & Portable, SGL M
68866N	Stereotaxic Base Plate for Two Mice, Portable

Portable Rat & Mouse Stereotaxic Instruments

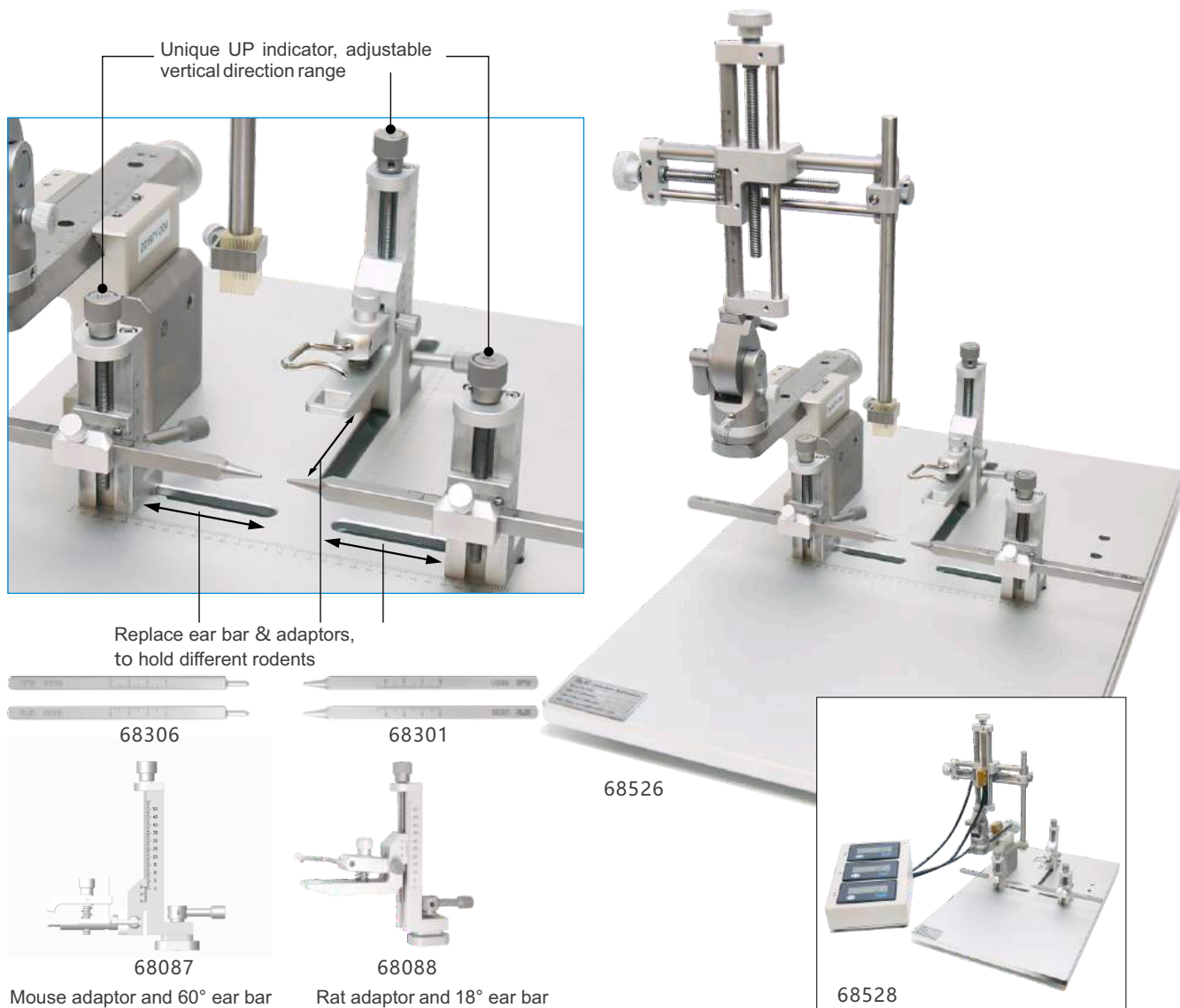

Composition:

68526 is a complete set stereotaxic configurations, containing 68867S base plate, 68401 three-dimensional manipulator - left, 68087 mouse adaptor and 68088 rat adaptor, 68301 rat 18° ear bars and 68306 mouse 60° ear bars, 68201 standard holder; Digital version 68528 adds 68023 three-dimensional digital display module.

Order Information:

Cat No.	Product Description	Remarks
68526	Stereotaxic for Rat and Mouse, SGL M, Portable	
68527	Stereotaxic for Rat and Mouse, Dual M, Portable	
68528	Stereotaxic for Rat and Mouse, SGL M, Digital and Portable	
68529	Stereotaxic for Rat and Mouse, Dual M, Digital and Portable	
68867S	Stereotaxic Base Plate for Rat and Mouse, Portable, SGL M	
68867D	Stereotaxic Base Plate for Rat and Mouse, Portable, Dual M	
68087	Mouse adaptor (Stereotaxic for Rat and Mouse)	
68088	Rat adaptor (Stereotaxic for Rat and Mouse)	

Large Animal Stereotaxic Instruments

Unique jaw plate design better stabilizes the heads of large animals of varying weights.

Y-axis rail design, longer moving range: $\pm 100\text{mm}$, 1mm resolution

Combined with microdriver (68104, see P41), the resolution of vertical reading can be promoted to $50\mu\text{m}$

Adaptors are available for dogs, monkeys, pigs, and other large animals.

Holds up to six manipulator arms

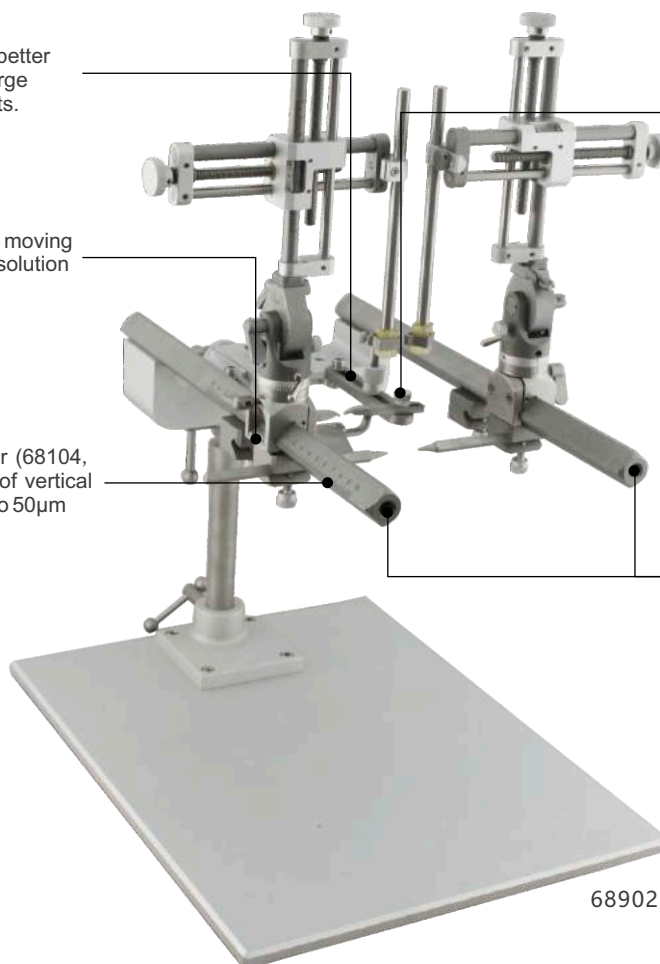

68902

Composition:

68902 is a complete set of stereotaxic, containing 68868N base plate, 68941 two-dimensional manipulator - left, 68942 two-dimensional manipulator - right, 68081 dog/monkey adaptor, 68303 cat/ monkey 18 ° ear bar, 68201 standard holder; Digital version 68916 adds 68024 two-dimensional digital display module.

Order Information:

Cat No.	Product Description	Remarks
68901	Stereotaxic for Dog/Monkey, SGL M, 68081 Adaptor Incl.	
68902	Stereotaxic for Dog/Monkey, Dual M, 68081 Adaptor Incl.	
68911	Stereotaxic for Cat/Monkey, SGL M, 68041 Adaptor Incl.	
68912	Stereotaxic for Cat/Monkey, Dual M, 68041 Adaptor Incl.	
68916	Stereotaxic for Dog/Monkey, Digital, SGL M, 68081 Adaptor Incl.	
68917	Stereotaxic for Dog/Monkey, Digital, Dual M, 68081 Adaptor Incl.	
68920	Stereotaxic for Cat/Monkey, Digital, SGL M, 68041 Adaptor Incl.	
68921	Stereotaxic for Cat/Monkey, Digital, Dual M, 68041 Adaptor Incl.	
68868N	Stereotaxic Base Plate for Dog, Pig, Monkey etc.	Adaptor/ear bar see P36-41
68941	2-axis Manip for Dog/Monkey Stereotaxic, Left Hand	
68942	2-axis Manip for Dog/Monkey Stereotaxic, Right Hand	
68944	2-axis Digital Manip for Dog/Monkey Stereotaxic, Left Hand	
68945	2-axis Digital Manip for Dog/Monkey Stereotaxic, Right Hand	

Dog/Monkey MRI Stereotaxic Instruments (Customized)

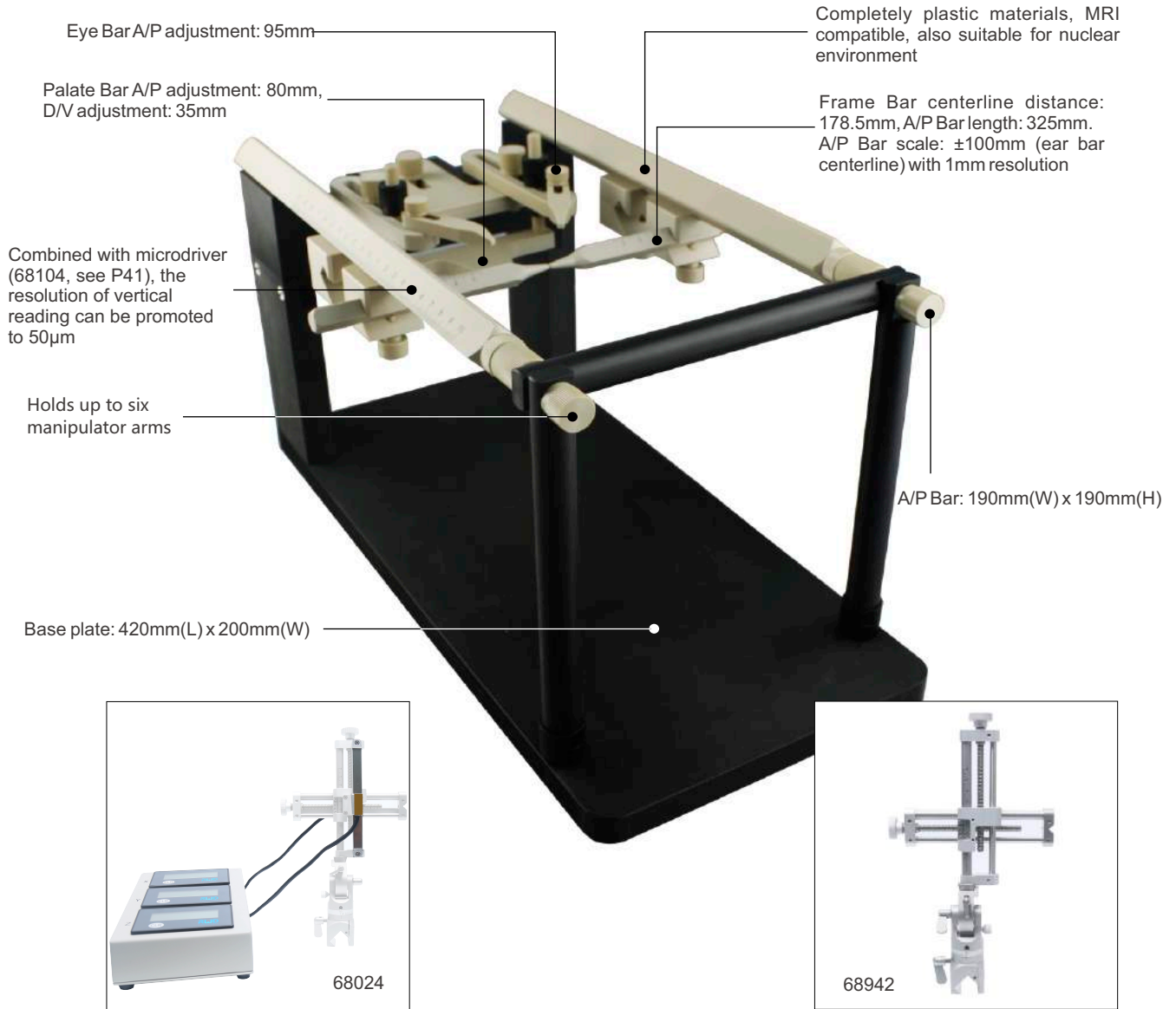

Order Information:

Cat No.	Product Description	Remarks
68915	MRI Compatible Stereotaxic for dog/monkey/68081/Base Plate (Customized)	manipulator is not included
68941	2-axis Manip for Dog/Monkey Stereotaxic, Left Hand	Adaptor/ear bar see P36-41
68942	2-axis Manip for Dog/Monkey Stereotaxic, Right Hand	
68024	2-axis Digital Readout for Upgrade-68000	
68944	2-axis Digital Manip for Dog/Monkey Stereotaxic, Left Hand	
68945	2-axis Digital Manip for Dog/Monkey Stereotaxic, Right Hand	
68104	AP-Microdriver (50 μ m)	

Stereotaxic Instruments Accessories

Holders

RWD offers various holders to fix different shapes and ranges of electrodes, needles, cannulas, headstages, probes, drills, injectors etc.



Standard Probe Holder

68201 Standard Probe Holder-Corner
V-groove design, widely used for syringe needles or electrodes with diameter 0.3mm-1.5mm.

68213 Standard Probe Holder-Side Clamp
With a similar structure to the standard Probe Holder 68201; holds syringe needle or electrode with diameter 0.4mm- 4.0mm



Cannula Holders

68217 Cannula Holder



Suitable for holding the single cannula or double cannula with the outer diameter of 3.5mm plastic base.

68214/68215 Ceramic Ferrule Holder



Hold cannula or Ceramic Ferrule during implantation.

- Versions for Ø1.25 mm—68214 Cannula or Ceramic Ferrule.
- Versions for Ø2.5 mm—68215 Cannula or Ceramic Ferrule.

68211 Cannula Holder



Compatible with stereotaxic instruments with dual manipulators. Holds electrodes or cannulas of 2.1mm to 5.0mm in diameter. It can place them within a distance of 0.3mm.

68221 Cannula Holder



Threaded locking mode is used to specifically hold RWD 3.5mm cannula system.

Electrode Holder

68210 Electrode Holder



Holder is specifically designed for electrophysiological experiments. Two electrodes, controlled individually, can be located very close to each other. Holds thin electrodes with diameter from 0.7mm to 2.5mm.

68220 Electrode Holder



Head of the holder is wedge-shaped and holds electrodes with 0.9mm to 3mm diameters.

68216 Electrode Holder



Holder is designed for the dual operating electrophysiology experiments. Distance between two electrodes can be as close as 200µm. Holds electrodes with 0.4mm to 1.5mm diameters.

Multi-function Holders

68202 Large Probe Holder

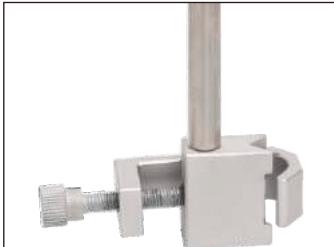

Lateral fixation, holds micro syringe needles, large diameter electrodes and flexible drill handles etc, V-groove design with 6mm-12mm diameters.

68106 Headstage Holder



Holder is designed for holding micro amplifier or headstage (Such as TBSI headstage and Plexon microelectrode amplifier). C-shaped head and suitable for diameter from 0.1-7.0mm.

68218 Syringe Holder



Holder is applicable for micro-injection, which holds syringe and needle simultaneously, and the clamping of the syringe is more stable, the syringe holding range is 3mm to 12mm and needle's is 0.3mm to 1.5mm.

68605 Microdrill Holder



Holder secures the microdrill to stereotaxic instruments. Controls the depth of drilling by the manipulator. Easy and accurate operation protects brain tissue from damage caused by excessive drilling. Holds the microdrill with diameter about 14.5mm.

68228 Cordless Microdrill Holder



Holder secures the cordless microdrill to stereotaxic instruments. Controls the depth of drilling by the manipulator. Easy and accurate operation protects brain tissue from damage caused by excessive drilling. Holds the microdrill with diameter about 19.5mm.

68397 Level Calibrator - Rat



68397 calibrator refers to the International Brain Atlas of rats and take craniofacial Bregma and Lambda as the reference points, The distance between B(0) and L(0) is about 7.67mm.

Adaptors ▶

Rat Adaptors

68021 Rat Adaptor

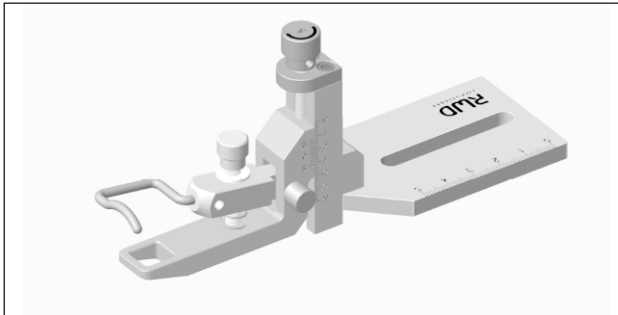

Note: Matched with the ear bar, see P41

It holds rat head firmly through incisor, nose clip and ear bars. This adaptor can be adjusted 30 mm vertically along dovetail slide with 100 μ m resolution and 50mm horizontally, which makes it applicable for rats of different weight.

68053 Rat Anesthesia Adaptor



This adaptor integrates the gas anesthesia mask function while hold the rat head firmly. The adaptor can rotate the head to multiangle without blocking the anesthetic gas delivery.

- Vertical adjustment range is 30mm (-20mm ~ + 10mm), with 100 μ m accuracy.
- Vertically rotatable range is 70°(-35° ~ + 35°), with 5°accuracy.
- Horizontal rotatable range is 70° (-35° ~ + 35°), with 5°accuracy.
- Horizontal adjustment range is 43.5mm.

68011 MRI Rat Adaptor (customized)



This adaptor is designed for MRI equipments, with special materials to avoid magnetic interference. The fixation of animal is convenient and stable.

size: 360mm(L)x125mm(W)x96mm(H)

68022 Rat Adaptor-Aural (customized)

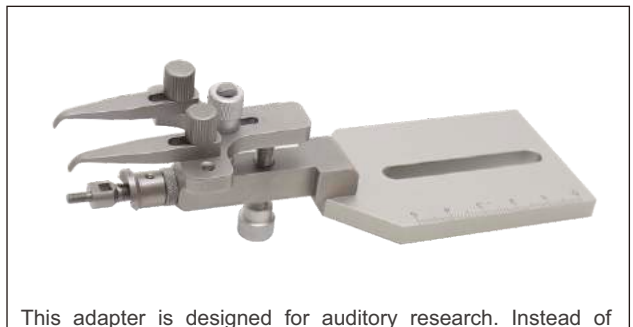

This adapter is designed for auditory research. Instead of holding the rat head by ear bars and incisors, it holds the head firmly by orbital approach to ensure no obstacle while auditory stimulation. Currently, RWD is the only company in the world offering this kind of product.

68063 Rat Rotation Adaptor (with 18 ° ear bar 68310)(customized)

This adaptor is specifically designed for some special applications. The head of the rat will be fixed by a pair of ear bars, nose and incisors, and can be rotated according to the experimental requirements to facilitate the operation of different parts of the rat head in different directions. The vertical adjustable range of the adaptor is 30mm (-20mm ~ +10mm), the adjustment accuracy is 100 μ m; Horizontal adjustable range of the adaptor is 43.5mm; the rotation angle of the head is 60° (-30° ~ +30°)

68065 Mouse Rotation Adaptor (with 60° ear bar 68312).

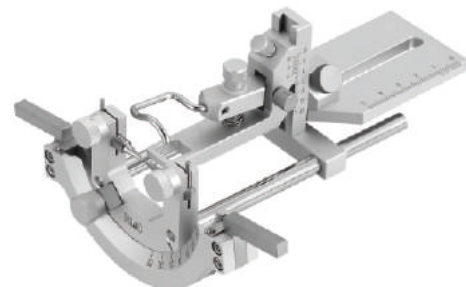

Mouse Adaptors

68030 Mouse/Neonatal Rat Adaptor
(with 18° ear bars 68034 and 45° ear bars 68313)

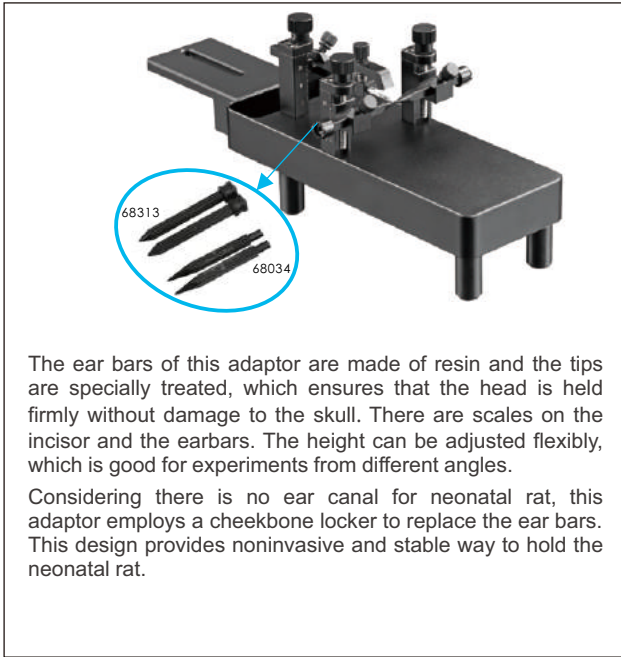

68036 Mouse Warm Water Adaptor
(with 18° and 45° ear bars)



68014 Neonatal Mouse Adaptor
(with 20° ear bars 68315 and 45° ear bars 68316)

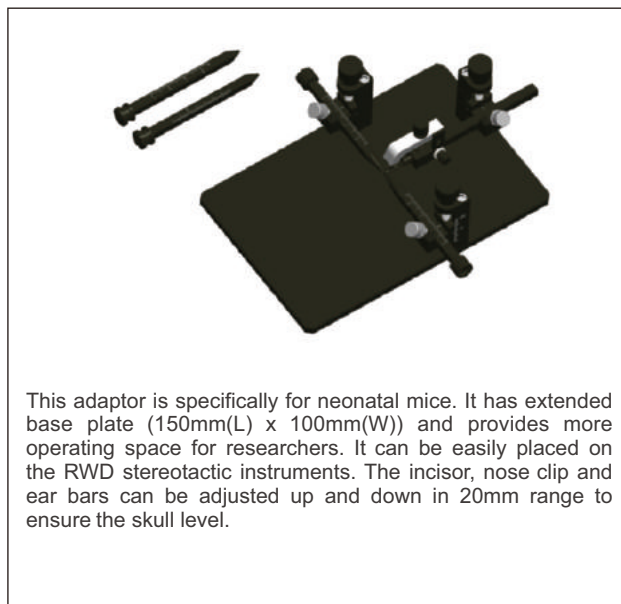

68072 Neonatal Mouse Anesthesia Adaptor

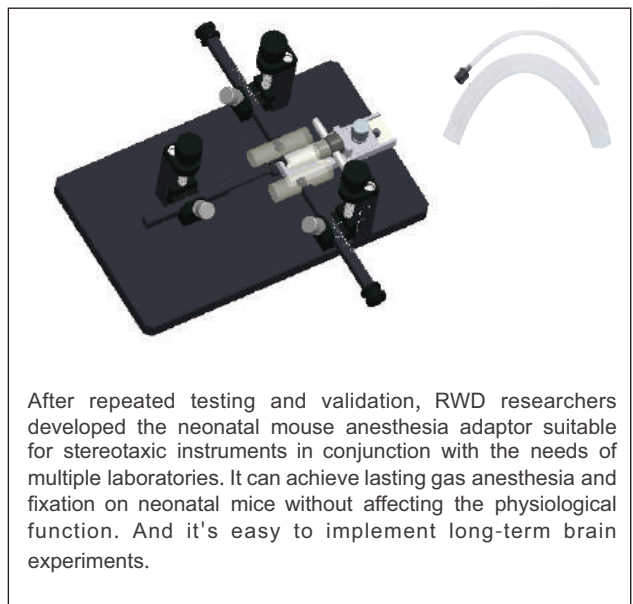

68055 Mouse Adaptor

Note: Matched with the ear bar, see P41

It holds the mouse head by a palate and incisor, and offers vertical regulation to make the head level or at certain angle. The Vertical adjustable range from +10mm to -20mm, with 100 μ m resolution; Horizontal adjustable range of 43.5mm; Horizontal rotatable range of 35°.

68077 Mouse Anesthesia Adaptor (Tubing included)

Note: Matched with the ear bar, see P41

It holds the mouse head by mask and incisor bar, with stable and good effect, and the mask outlet can be connected with the gas evacuation apparatus to evacuate the waste gas and ensure the safety and cleanliness of the operators and the environment.

The screw connection between the head and the fixed plate ensures convenient vertical adjustment.

68033 Nose Bar For Mouse/Neonatal Rat

This nose bar is available for 68030 and 68036 adaptors, and portable mouse stereotaxic instruments (like 68507, 68510, 68513, 68516, 68517 and 68518 portable stereotaxic instruments). The arch design fits for the mouse nose to make head-holding more stable.

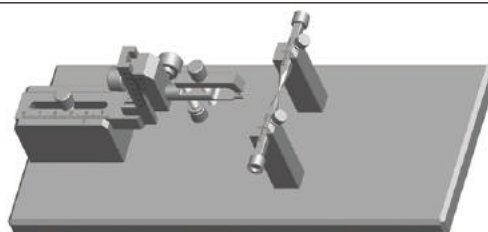
68069 MRI Mouse Adaptor (customized)

Vertical adjustable range: 30mm (+10mm~-20mm), with 100 μ m accuracy.

Horizontal adjustable range: 45mm.

Ear bars laser engraved scale, good for operation.

Two ear bar fixing modes for preventing damage to skull.

Plate dimension: 280mm(L) x 120mm(W) x 93mm(H)

68057 Mouse Gas Anesthesia Head Holder

This model offers maximal adjustment for positioning the head. The adaptor can rotate the head to multiangle without blocking the anesthetic gas delivery.

- Vertical adjustable range: 30mm (+10mm~-20mm), with 100 μ m accuracy.
- Vertical rotatable range: 70° (-35°~+35°), with 5° accuracy.
- Horizontal rotatable range: 70° (-35°~+35°), with 5° accuracy.
- Horizontal adjustable range: 43.5mm
- Diameter of inlet/outlet of the mask: 2mm

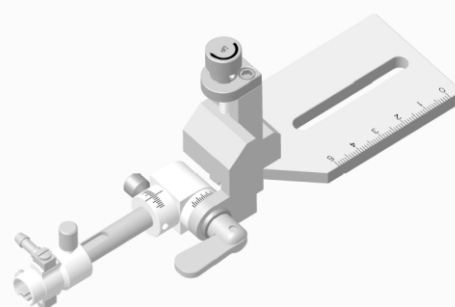

Other Adaptors

68041 Cat/Monkey Adaptor



68081 Dog/Monkey/Pig Adaptor

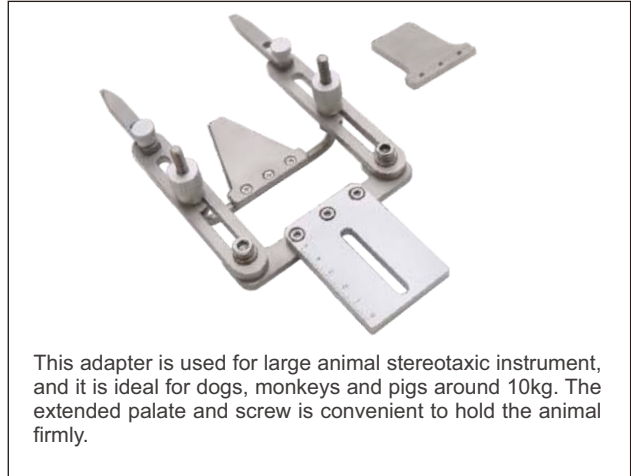

68084 Rabbit Adaptor (customized)

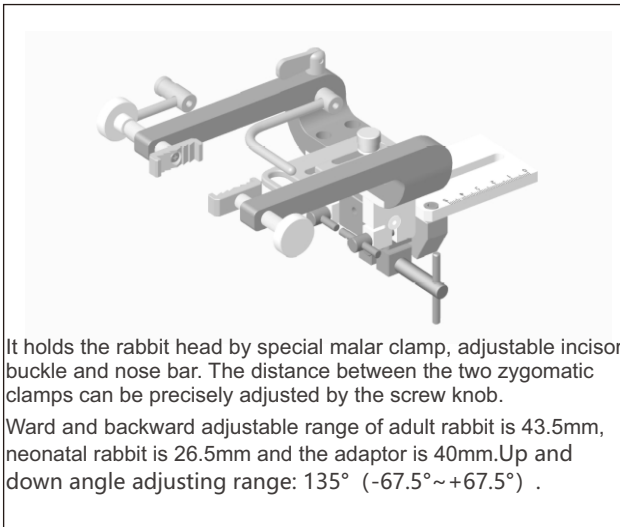

68076 Tree Shrew Anesthesia Adaptor Kit (with tubing/ customized)

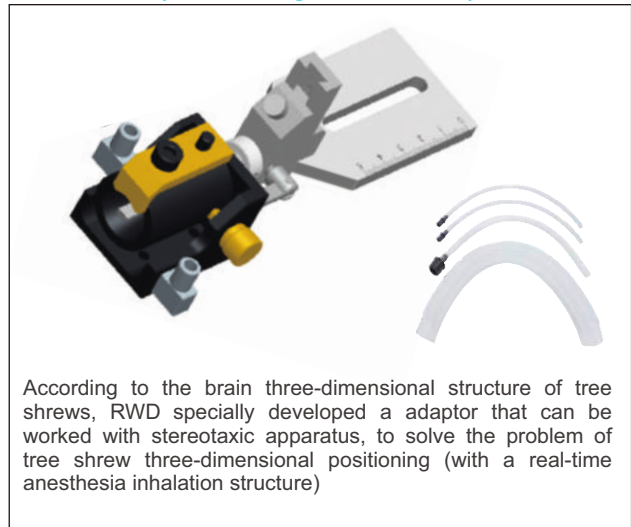

68075 MRI Adaptor for Tree Shrews (customized)

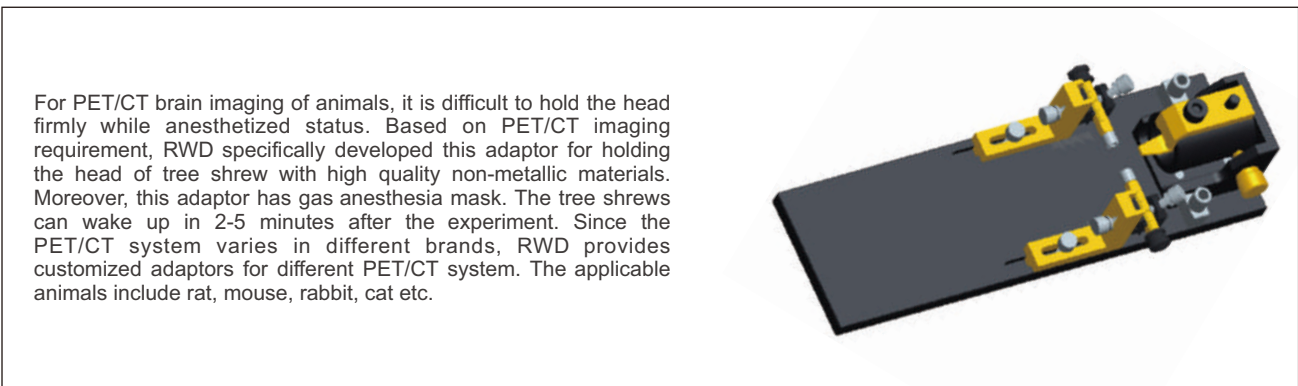

Multi-function Adaptor

68091 Spinal Cord Adaptor for Rat & Mouse

The adaptor is ideal for spinal securing of rat and mouse. The base plate is 210mm(L) x 165mm(W) x 15mm(H), which can be attached to RWD 68000 series small animal stereotaxic instruments. There are 3 vertical bars and locking blocks, which can be easily disassembled through the T slots without wrench. The adjustment range of vertical bar is 56mm. The height of locking block can be easily adjusted by screw. This adaptor can be adjusted in Vertical/Lateral, Anterior/Posterior and Ventral/Dorsal directions. Standard accessories contain: Base plate, 3 vertical bars and locking blocks and spinal cord clamp (3 pairs).

Specifications:

- Accurate and reliable positioning.
- Wide various components and accessories can be used in module.
- Simple, fast and effective clamping and locking.
- Compatible with small animal stereotaxic instruments.

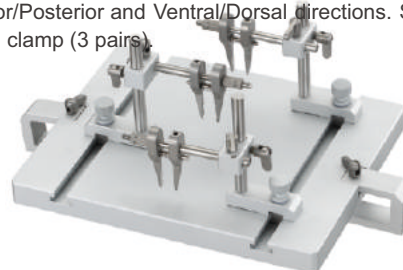

68073 Head Rotation Platform for Rats and Mice

The height of the platform can be adjusted according to the specific experimental requirements; the head holder can be adjusted in the vertical direction and 360° rotation in the horizontal direction, the platform below the head is suspended, especially for rats and mice that require 180° rotation in the head and body during surgery, such as, the experimental study on cerebral ischemia by thread embolism, real-time monitoring the changes of the blood flow in animals' head (fixed fiber on the skull surface) to determine whether the model is successful or not.

- 68071 Animal rotation platform - Mouse (with mouse rotation adaptor and 60° ear bar)
- 68074 Animal rotation platform - Rat (with rat rotation adaptor and 18° ear bar)
- 68073 Animal rotation platform - Rat/Mouse (with rat and mouse rotating adaptor and ear bar)

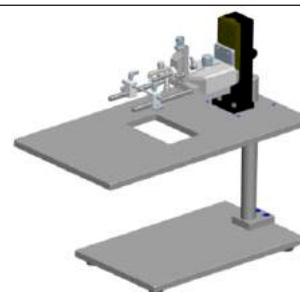

Ear Bars

RWD ear bar with the scale of 35mm, 1mm resolution, square 6.15mm

68301



68302



68305

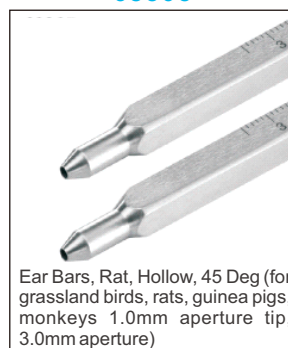

68306



68307



68308

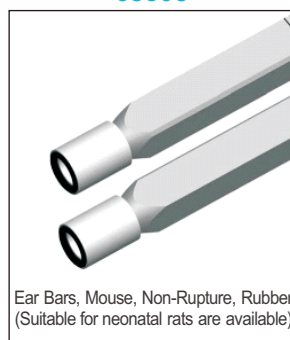

68314

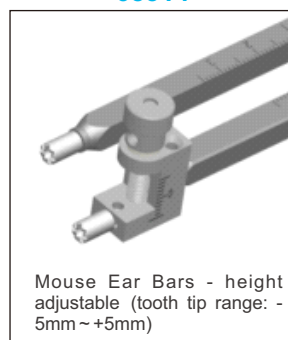

68303



68304



Ear Bars, Cat/Monkey, 45 Deg

68060



Ear Bar Adaptor - Rat (with 18° ear bar)

68413

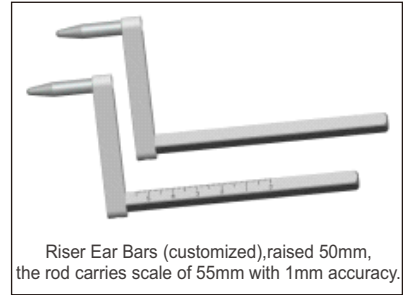

Riser Ear Bars (customized), raised 50mm, the rod carries scale of 55mm with 1mm accuracy.

Other Accessories ▶

68104 AP-Microdriver (50µm)

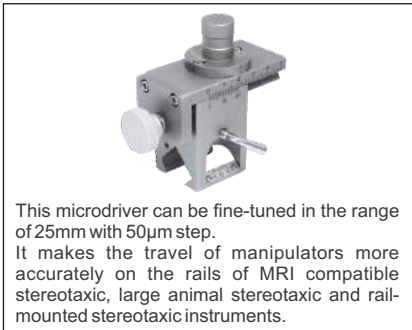

This microdriver can be fine-tuned in the range of 25mm with 50µm step. It makes the travel of manipulators more accurately on the rails of MRI compatible stereotaxic, large animal stereotaxic and rail-mounted stereotaxic instruments.

68207 V attachment

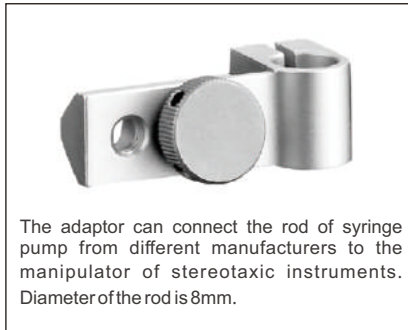

The adaptor can connect the rod of syringe pump from different manufacturers to the manipulator of stereotaxic instruments. Diameter of the rod is 8mm.

R-VTA-08 V-clamp

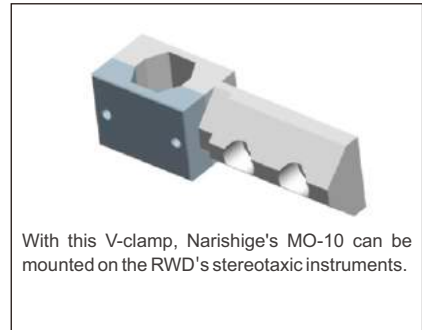

With this V-clamp, Narishige's MO-10 can be mounted on the RWD's stereotaxic instruments.

68399 Electrode Zero Adjuster (customized)

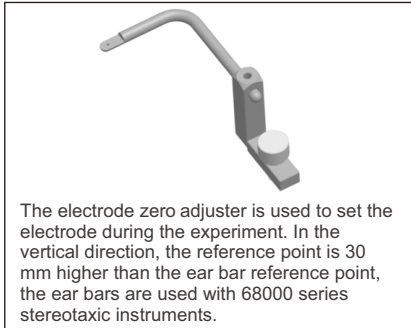

The electrode zero adjuster is used to set the electrode during the experiment. In the vertical direction, the reference point is 30 mm higher than the ear bar reference point, the ear bars are used with 68000 series stereotaxic instruments.

68400 Electrode Calibrator (customized)

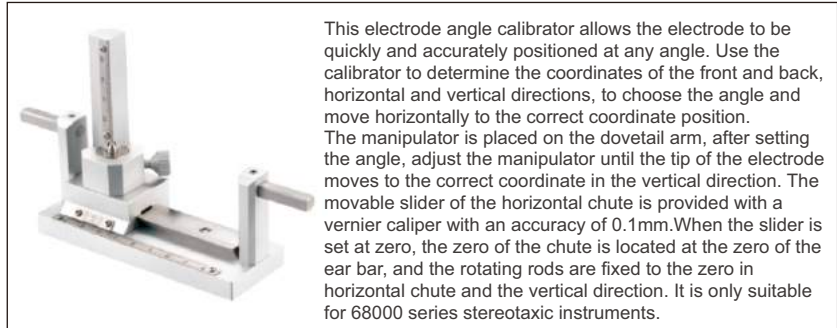

This electrode angle calibrator allows the electrode to be quickly and accurately positioned at any angle. Use the calibrator to determine the coordinates of the front and back, horizontal and vertical directions, to choose the angle and move horizontally to the correct coordinate position. The manipulator is placed on the dovetail arm, after setting the angle, adjust the manipulator until the tip of the electrode moves to the correct coordinate in the vertical direction. The movable slider of the horizontal chute is provided with a vernier caliper with an accuracy of 0.1mm. When the slider is set at zero, the zero of the chute is located at the zero of the ear bar, and the rotating rods are fixed to the zero in horizontal chute and the vertical direction. It is only suitable for 68000 series stereotaxic instruments.

68412 D/V Rotation Adaptor (2-axis Manipulator not included customized)

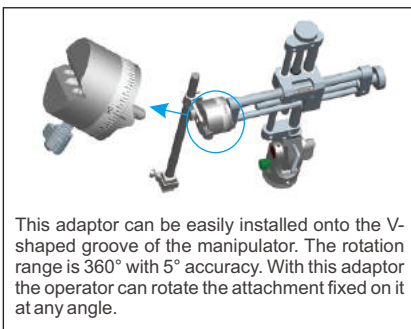

This adaptor can be easily installed onto the V-shaped groove of the manipulator. The rotation range is 360° with 5° accuracy. With this adaptor the operator can rotate the attachment fixed on it at any angle.

68398 A / P Zero Calibrator (customized)

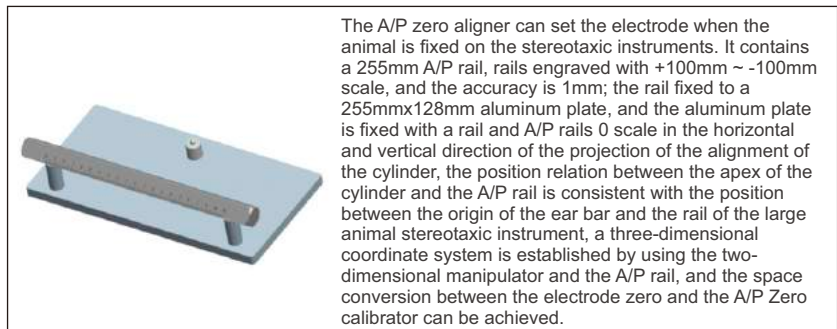

The A/P zero aligner can set the electrode when the animal is fixed on the stereotaxic instruments. It contains a 255mm A/P rail, rails engraved with +100mm ~ -100mm scale, and the accuracy is 1mm; the rail fixed to a 255mmx128mm aluminum plate, and the aluminum plate is fixed with a rail and A/P rails 0 scale in the horizontal and vertical direction of the projection of the alignment of the cylinder, the position relation between the apex of the cylinder and the A/P rail is consistent with the position between the origin of the ear bar and the rail of the large animal stereotaxic instrument, a three-dimensional coordinate system is established by using the two-dimensional manipulator and the A/P rail, and the space conversion between the electrode zero and the A/P Zero calibrator can be achieved.

Manual Syringe Pumps(68606)

Compatible with RWD stereotaxic instruments, simple installation, with 10µm displacement accuracy and up to 25mm distance, it is an economical and practical microinjection pump!

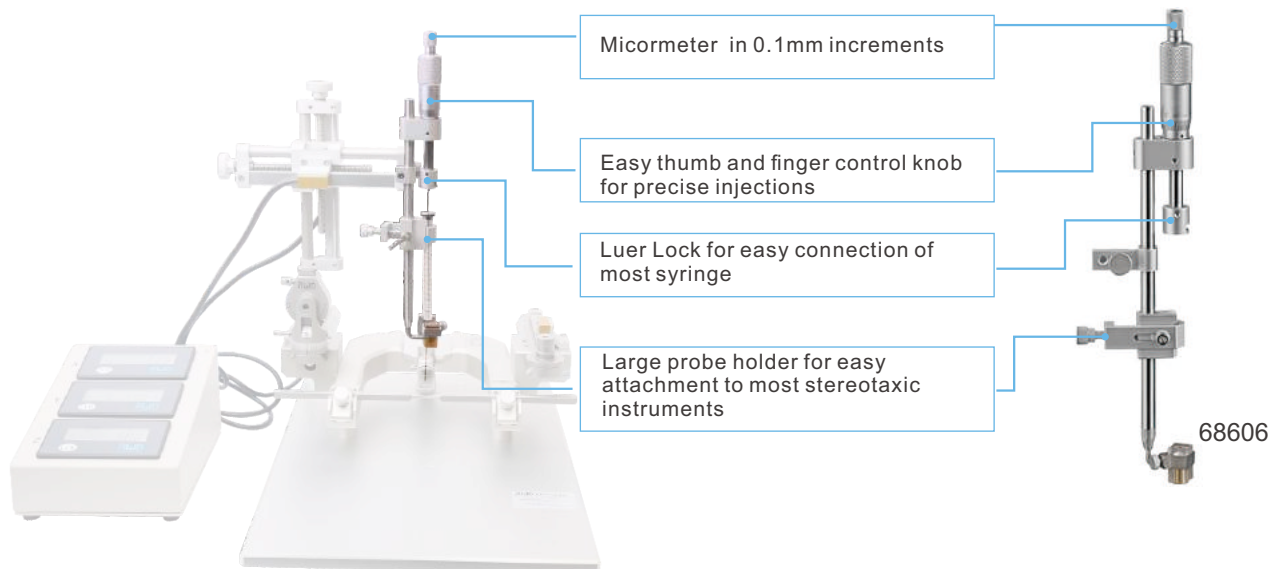

- Precisely-controlled infusion/withdrawal of picoliter volume.
- Provides an economical means of injecting or withdrawing a calibrated volume with simple, precise manual control.
- Allows precise injection directly through the needle into the tissue. Avoids the compliance issues that arise when injections are forced through plastic tubing. Volumes as small as 200 picoliters may be infused.
- It is simple to pick up even one small sample. This results in minimal waste, preventing degradation of precious samples.
- The injector has a universal adaptor for all RWD and Hamilton 700, 7000 or Gas-Tight Series syringers, ranging from 1 to 100ul sizes and enables a wide range of volumes to be delivered-both infusion and withdrawal operation.
- The Manual Stereotaxic injector is graduated in 0.01mm increments. One complete revolution advances the plunger of the syringe 0.5mm.

Stage Platform

Balance the animal's body and head to ensure that the animals breathe freely during the operation.

Non-metallic platform, grinding treatment, anti-skidding, polished non-metallic platform anti-skidding, easy to clean

Metal plate, firm

Specifications:
Platform: 195mm(L) x 90mm(W) x 11mm(H)
Base plate: 195mm(L) x 110mm(W) x 12mm(H)
Lift height: 50mm

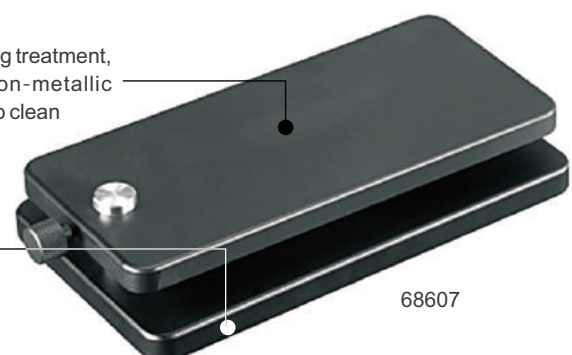

Cordless Microdrill



No need to connect the power supply, convenient, easy to operation, space saving.

Features:

- Cordless design, simple & controllable operation
- The double-bearing design is used at the joint of the drill bit, make drilling and grinding more stable
- 750mA lithium battery, can be used continuously for 45 mins after fully charged
- Wide range of applications, can be used with a 2.3mm diameter drill bit for drilling and polishing
- It can be equipped with a cranial drill holder (68228) fixed to Stereotaxic, free hands operation
- Speed: 12000rpm
- Stall torque: 1.25 oz./in
- Power: 100-240V
- Dimension: length 20cm, body diameter 19.5mm



Order Information:

Cat No.	Product Description
87001	Cordless Microdrill (Bits Not Included, some details see below)
68228	Cordless Microdrill Holder(See P35)

Microdrill

It takes only one second to drill the skull, easy to operate and control. It can also be used for grinding the skull.



Specifications:

- Speed up to 38,000rpm
- Forward or reverse available
- Controlled manually or by foot pedal
- Can be installed onto the stereotaxic instrument by the microdrill holder (Model: 68605) and controlled by the manipulator
- Various drill bits available, diameter from 0.5-2.3mm

Order Information:

Cat No.	Product Description	Cat No.	Product Description
78001	Microdrill (bits not included)	78050	Drill Bits HM1027 2.7mm, Round Tip, pkg of 2
78040	Drill Bits HM1005 0.5mm, Round Tip, pkg of 5	78060	Drill Bits HM31008 0.8mm, Flat Tip, pkg of 5
78041	Drill Bits HM1006 0.6mm, Round Tip, pkg of 5	78061	Drill Bits HM31010 1.0mm, Flat Tip, pkg of 5
78042	Drill Bits HM1008 0.8mm, Round Tip, pkg of 5	78062	Drill Bits HM31012 1.2mm, Flat Tip, pkg of 5
78043	Drill Bits HM1010 1.0mm, Round Tip, pkg of 5	78063	Drill Bits HM31014 1.4mm, Flat Tip, pkg of 5
78044	Drill Bits HM1012 1.2mm, Round Tip, pkg of 5	78064	Drill Bits HM31016 1.6mm, Flat Tip, pkg of 5
78045	Drill Bits HM1014 1.4mm, Round Tip, pkg of 5	78065	Drill Bits HM31018 1.8mm, Flat Tip, pkg of 5
78046	Drill Bits HM1016 1.6mm, Round Tip, pkg of 5	78066	Drill Bits HM31021 2.1mm, Flat Tip, pkg of 5
78047	Drill Bits HM1018 1.8mm, Round Tip, pkg of 5	78067	Drill Bits HM31023 2.3mm, Flat Tip, pkg of 5
78048	Drill Bits HM1021 2.1mm, Round Tip, pkg of 5	68605	Microdrill Holder
78049	Drill Bits HM1023 2.3mm, Round Tip, pkg of 5		

ThermoStar Homeothermic Monitoring System

During the process of animal surgery or acute anesthetized animal experiment, maintaining animals' body temperature is very important for the accuracy and reliability of results, furthermore, it is an important way to reduce the mortality of the animals. In order to fulfill this need, RWD launched a new generation of homeothermic monitoring system "Thermostar", the control unit acquired a 4.3 inch color LCD touch screen, allows users to clearly view the subject's real-time body temperature, set the target temperature, view the heating state and set audible alarms when subject's body temperature turns abnormal. A specific control separate circuit for heating pad and rectal probe, respectively to ensure the stability and safety of the system.

Specifications:

- Real-time display of the working status of the heating pad, and monitor the working state of every channel, show: IDLE, WARNING, STANDBY, and WORKING
- Heating range: 20-45°C, 0.1°C resolution, Degrees Celsius and Fahrenheit can be switched
- Power supply: 100-240V, 50/60Hz
- Control unit size: L205 x W148 x H80 mm
- Control unit weight: 1.3kg

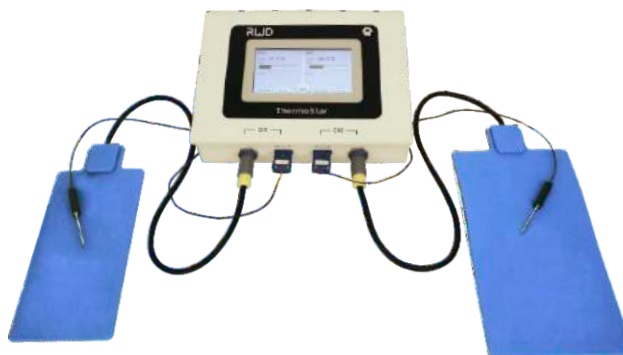

Order Information:

Type	Cat No.	Product Description	Remarks
Complete system	69020	ThermoStar Temperature Controller, 69023 pad incl.	A heating pad (69023) and a temperature probe (69022) are included
	69026	ThermoStar Temperature Controller, 69024 pad incl.	A heating pad (69024) and a temperature probe (69022) are included
	69027	ThermoStar Temperature Controller, 69025 pad incl.	A heating pad (69025) and a temperature probe (69022) are included
Temperature probe	69022	Temperature Probe	1.5mm diameter, 30mm rod length, 150cm line length (suitable for rat/mouse)
Heating pad	69023	Heating Pad -12.0*20.5cm	
	69024	Heating Pad -9.0*17.0cm	
	69025	Heating Pad -7.0*10.0cm	

Water Circulation System

During anesthesia, the animal surgical operation platform can choose the water circulation system to keep the animals warm.

Water circulation pump:

- High-resolution LED displays real-time water temperature
- Water temperature setting from room temperature to 20-60°C
- Microcomputer intelligent temperature control system, with timing shutdown, preheating sleep, alarm and off-power due to water depletion, overload protection, low protection function
- Water and electricity separation technology, no fire hazard
- Hose anti-stripping interface to prevent the risk of hose shedding during product operation
- Power: 110/220v, 50Hz, 290w.5mm

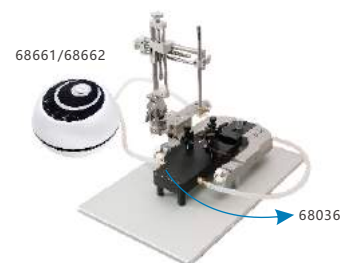

Order Information:

Cat No.	Product Description
68661	Warm Water Recirculator, 110V
68662	Warm Water Recirculator, 220V
68664	Water Heated Surgical Bed, Flat Type, 360*300*25mm
68036	Mouse Warm Water Adaptor with 18° and 45° Ear Bars



LED Fiber-lite Illuminator

(Halogen Fiber-lite Illuminator and LED Fiber-lite Illuminator are available in RWD)

The halogen fiber-lite illuminator adopts dual-piple pipe optic coaxial lighting, provide better field of view, with good brightness; stable output voltage, safe and reliable light bulb; size is about 280 x, 100 x 165mm, and the light intensity can be adjusted continuously , with color temperature 3200K.

LED Fiber-lite Illuminator using high-power single-chip LED as the light source, with the advantages over the halogen illuminator like high light efficiency, energy saving, true "cool light" source, long life, low noise(<42db) and small size: 210mm*100mm*150mm.



Halogen fiber-lite illuminator LED Fiber-lite Illuminator

Order Information:

Cat No.	Product Description	Remarks
76301	Fiber-Lite Illuminator(150W)	Dual-Pipe Fiber Optic, Bulb and Main Engine
76304	Main Engine	
76310	Dual-Pipe Fiber Optic(Included in illuminator)	
76306	Bulb(21V 150W)-Philips	
76312	LED Fiber Optic Illuminator, 20W, 90-260V	Include Main unit, Dual Pipe and Focus End for Fiber Optic Pipe(1 pair)
76313	LED Fiber Optic Illuminator Controller, 20W, 90-260V	
76314	Double Fiber	
76315	Kohler Condenser (1)	

77001D Digital Microscope new

RWD Digital Microscope 77001D Focus on Bregma or The Blood Vessels Precisely.

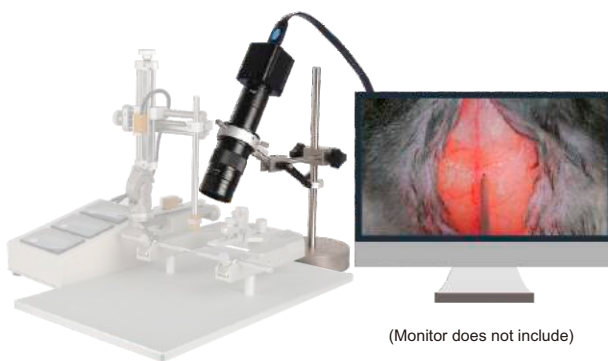

Digital Microscope Mounted on a Stereotaxic Instrument

The digital microscope 77001D provides an opportunity to improve stereotaxic or surgical operation and free your eyes.

The digital microscope is a digital camera fitted with a parfocal zoom magnifying lens with fine focus and a working distance of 7.0 inches. It connects to a monitor, which it may share with the digital camera, by a HDMI cable. No PCI cards are necessary. And you can take photos or video for storage in one-click. At the same time, you can conduct vertical or oblique observation to find a better perspective.

Camera parameters

- 3.5MP, 1/2.3" CMOS sensor
- 20x - 120x magnification
- Shutter can be controlled manually or remotely
- Focusing range from 15 to 576mm²
- LED ring illuminator

Photo/Video Capture, Memory, & Ports

- Streams 1080p videos via a mini-HDMI port at 60 fps
- Captures 60 fps AVI videos: HD 1080p, 1920 x 1080
- Saves visual data to a built-in microSD card
- Captures interpolated JPEG photos with resolution of up to 16.0 MP
- Mini-HDMI video out port for direct streaming to HDTV displays

Microscope

77001 Desktop Binocular Stereo Microscope equips with universal support; researchers can observe in high resolution and three-dimension.

Order Information:

NO.	Products Name	Products Detail
1	Eyepiece	10X Eyepieces, View field diameter ϕ 20mm
2	Objective Lens	0.7X-4.5X Objective lens ratio 1:6.4
3	Binocular Drawtube	Pupil Distance 55-77mm Diopter adjustment \pm 5 ,Diopter 45°Incline 360°Spin
4	View field Range	31.2 mm -5.1mm
5	Total Magnification	7X-45X(10X Eyepiece),3.5X-22.5X(10X Eyepiece +0.5X Assist lens
6	Working Distance	Working distance 100mm(10X Eyepiece),Working distance 170mm (10X Eyepiece +0.5X Assist lens)
7	Focusing Mechanism	Focusing hand wheel is adjustable
8	Universal Support	360°Spin, Retractable

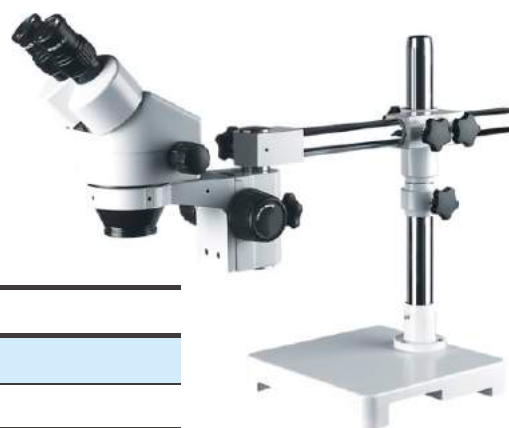

77001

Standard Configuration: Universal support(1 unit), Binocular drawtube (1 unit), 10X Eyepiece(1pair), 0.5X Objective Lens (1 unit), Blinder (1 unit), Dust cover (1 unit), Instruction Manual (1 unit).

Configuration:

NO.	Specification	Product name
1	77025	Ring Fluorescence Illumination, one piece
2	77026	Ring LED Illumination, one piece

On the basis of the binocular microscope, 77008 Trinocular Zoom Stereo microscope increase the interface, so that the camera, video camera can be installed in the microscope to achieve real time observing of the objects.

77002 Binocular Surgical Microscope

77002 Binocular Surgical Microscope is a simple binocular coaxial illumination surgery microscope, with compact design and high flexibility to meet the requirements of general animal microsurgery.

Features:

- Eyepieces: 12.5X Focus length of objective: 200mm
- Working distance: 190mm Total magnification: 5.3X, 8X, 12X
- Visual field(mm): 38mm, 25mm, 17mm
- Diopter adjustment range: +5D
- Pupil distance range: 50mm~70mm
- Bulb: 12V/100W (Medical halogen lamp Bulb with coldreflection)
- Type of Illumination: 6°+ 0° cold light source coaxial illumination
- Intensity of Illumination: 20000Lx or up
- Maximum stretching radius of arm: 870mm
- Vertical movement range (from floor to front surface of big objective): 700mm~1100mm
- Range of fine focusing adjustment: 30mm
- Input voltage: AC220V \pm 10%, 50Hz \pm 1Hz Input power: 120VA
- Fuse: AC250V T1.25A Net weight: 41kg



77002

Animal restrainer

Tubular type Restrainer

Tubular type restrainer is used to restrict the animal from turning or moving, by fixation on rear-end and flexibly regulated. To reduce injury caused by animal movements. Unique design of tapered nose restrainer provide easy-access for animals, meanwhile makes animals feel safety. In addition, a vent located on nose restrainer makes the animal to breath easier. Tail is able to stretch, helped the animal to stay still for over 1 hour.

Taper restrainer is a new fixed tool design for animal injection, suitable for fast and efficient batch injection, it has the characteristics of transparent, durable, easy to clean and stable.

★Typical Application

Conscious animal non-invasive blood pressure measurements, tail blood sampling, intravenous infusion, tail root subcutaneous or intracutaneous injection, tail tenderness, animal behavior observation, etc.

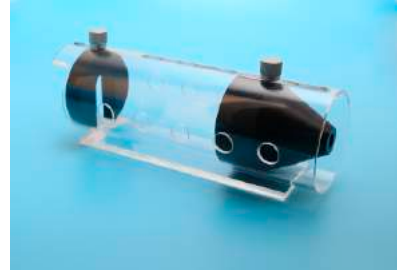

Restrainer



Taper restrainer

Ordering Information:

Specification	Products description
9131	Small restrainer for up to 25g Mouse/L110xI.D.20mm
9132	Medium restrainer for 25-50g Mouse/L135xI.D.30mm
9133	Large restrainer for 50-75g Mouse/L160xI.D.40mm
9134	Small restrainer for 75-200g Rat/L200xI.D.50mm
9135	Medium restrainer for 200-300g Rat/L210xI.D.60mm
9136	Large restrainer for 300-500g Rat/L220xI.D.70mm
9137	Extra Large restrainer for above 500g Rat/L230xI.D.80mm
9138	Taper restrainer for Rat and Mice/L150xH130xO.D.100mm

Rats & Mice Shaver

Features:

- Applicable to shave off hair on animals' cephalosome, face, legs and ear
- AA batteries use
- Low vibration and noise as well as ergonomic design
- Suitable for small animals



CP-5200

Precise Impactor

68099 Precise Impactor for Rat/Mouse

68099, the precise impactor is a very friendly tool for assessing spinal cord injury mechanisms in basic medical research. This impactor, combined with our adapters- 68094 (Mice) and 68095 (Rats), can perfectly locked and impacted the spinal cord.

This system uses pneumatic standard pure electric control, touch screen operation, user-friendly interface, easy to master. Using standard cylindrical metal flat heads to impact small rodents' spinal cords, the sunken depth of the cortex can be precisely controlled. Show the speed of the impact moment, the dwell time and the sunken depth of the cortex.

In addition, a unique sensor contact mechanism is used to accurately and reliably auto-detect the cortical surface datum point before the impact process. Reducing the cumbersome process of manual zeroing helps to produce accurate and reproducible spinal cord injury models. It is an accurate tool with high efficiency, high repeatability and good stability, effectively guarantees the reproducibility of injury model.

Features:

- Pneumatic pure electric control.
- Color LCD touch screen interface, with friendly and easy operated software.
- Strike speed is up to 3m/s, speed range: 0.5-3m/s, accuracy: 0.1 m/s.

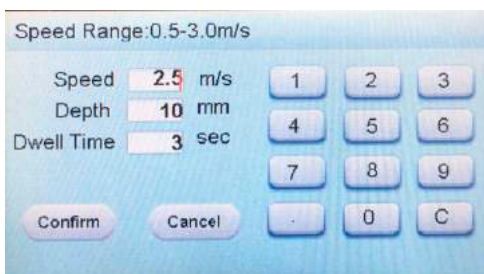

- Control the dwell time and strike depth, the time range: 0-5.00s, accuracy: 0.01s, the depth range: 0-5.00mm, accuracy: 0.01mm
- A variety of cylindrical flat head hammers, the outer diameters are 1mm, 2mm, 3mm, 4mm and 5mm

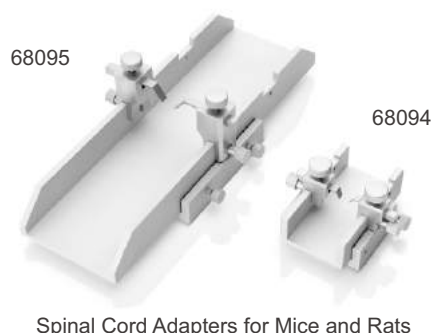
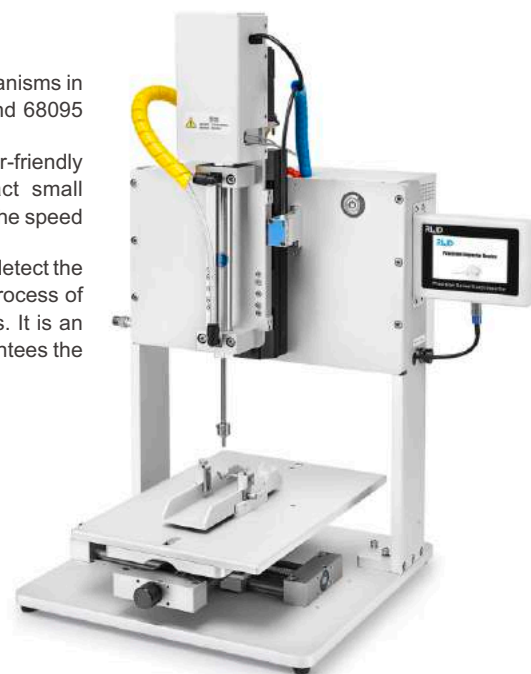

- High efficiency, automatic detection of zero interface, avoid the cumbersome manual process before the strike
- Use ball screw to control displacement, stable and reliable rotation, large screw handle, easy operation
- Support a variety of gas supply, containing 9/16 "and φ8 quick connection, easy to connect oxygen tanks or aerostatic press
- Solid and heavy frame, stable, effective against air recoil
- The spinal cord adapters provide stable spinal fixation and improve the success rate of modeling

Application

- Neurology
- Surgery
- Chinese Medicine
- Emergency Medicine
- Pediatrics
- Psychiatry
- Pharmacy
- Endocrinology
- Clinical Medicine
- Biology
- Oncology
- Psychology
- Related Researches

68098 Monkey Spinal Cord Impactor

RWD's monkey spinal impactor is a unique tool to evaluate the mechanisms of injury spinal cord model. It adopts the precise laser to achieve the precise location and measurement. Used together with the large animal stereotaxic instrument and the monkey spinal cord adaptor, the spinal impactor solve the problem of modeling error caused by spinal collapse, thus to ensure the effectiveness and uniformity during the experiment.

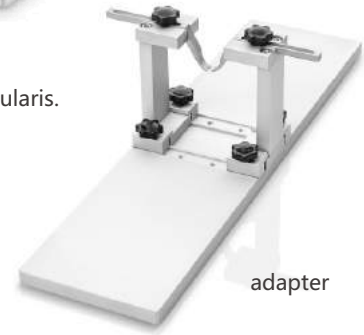

Specification:

- New design & easy operation, suitable for monkey within 5 kg, such as Macaca Fascicularis.
- Pneumatic control on speed, depth, dwell time.
- Professional laser sensor to ensure accurate measurement, with 0.01mm accuracy.
- Speed, dwell time and displacement graph can be displayed in PC through software and recorded.
- Data can be recalled at any time to review an experiment. High reliability as better simulation trauma biomechanics characteristic.



- The cylindrical flat hammer, OD 3 mm, can be dismantlable
- Be of high temperature and high pressure sterilization Convenient to trigger by depressing the button or clicking on the software.
- Speed 0.00~1.00m/s, depth 0.00~9.00mm, dwell time 0.05~1.00s.
- The spinal cord adapter hold the spinal cord from bilateral processus transversus, avoiding the depth measurement error due to animals breathe; it also avoid the subsidence of the spinal cord on impacting. Windows XP, 7,8,10 compatible. Computer not included
- 3 axis manual position control
 - X — Range: 8" (200mm)
 - Y — Range: 3" (80mm)
 - Z — Range: 3" (80mm)

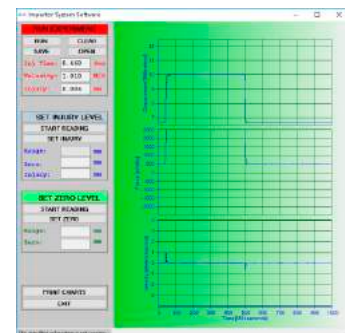

Microinjection

Single Cannula

Cannula implantation is the international general method for acute and chronic intracranial drug administration in animal experiments. RWD offers customized services for users, the users can customize according to specific experimental requirements.



Single Cannula

Components:

Guide cannula

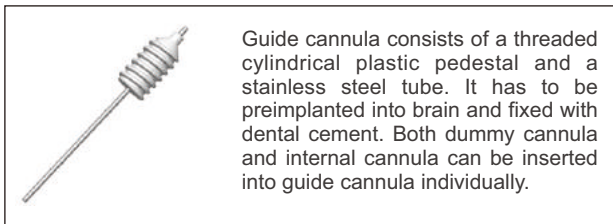

Guide cannula consists of a threaded cylindrical plastic pedestal and a stainless steel tube. It has to be preimplanted into brain and fixed with dental cement. Both dummy cannula and internal cannula can be inserted into guide cannula individually.

Dummy cannula

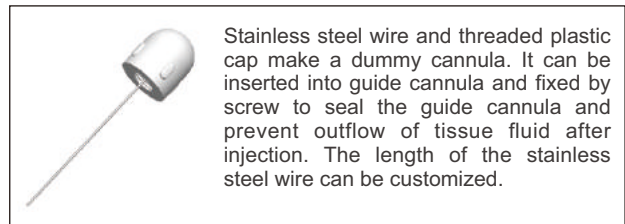

Stainless steel wire and threaded plastic cap make a dummy cannula. It can be inserted into guide cannula and fixed by screw to seal the guide cannula and prevent outflow of tissue fluid after injection. The length of the stainless steel wire can be customized.

Metal Cannula

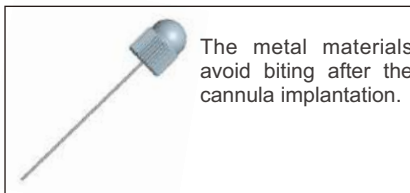

The metal materials avoid biting after the cannula implantation.

Internal cannula

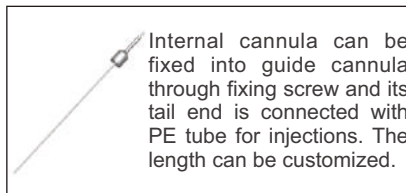

Internal cannula can be fixed into guide cannula through fixing screw and its tail end is connected with PE tube for injections. The length can be customized.

Fixing screw

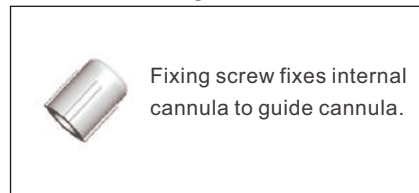

Fixing screw fixes internal cannula to guide cannula.

Cording Diagram:

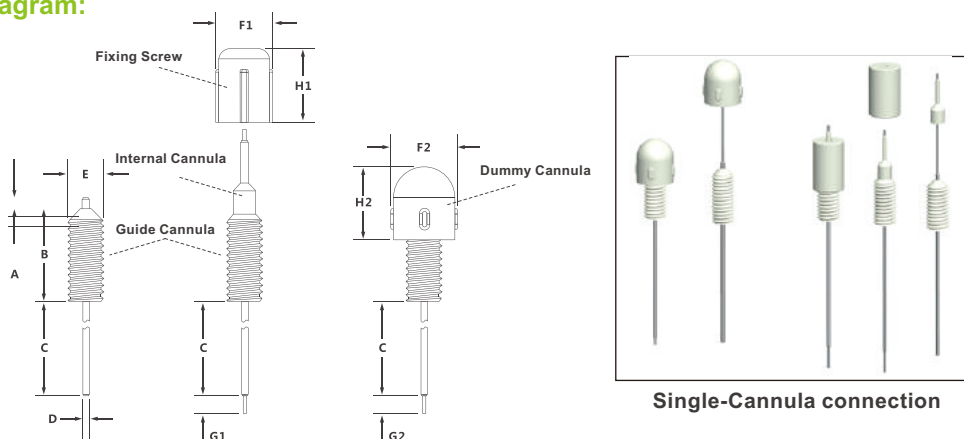

Diagrams:

- A - The length of the stainless steel tubing below the plastic pedestal.
- B - The height of the cylindrical plastic base.
- C - The length of the stainless steel tubing below the plastic pedestal, can be customized.
- D - External diameter of stainless steel guide cannulas.
- E - External diameter of cylindrical plastic base.
- F1 - External diameter of Lock nut.
- H1 - Height of Lock nut.
- F2 - External diameter of Dummy Cannulas.
- H2 - Height of Dummy Cannulas.
- G1 - The internal cannulas projection length beyond the guide cannulas tip, can be customized.
- G2 - The dummy cannulas projection length beyond the guide cannulas tip, can be customized.

Guide cannula	Dummy cannula	Internal cannula	Fixing screw	A	B	C	D	E	F1	H1	F2	H2
62001	62101	62201	62501	1	9	20	0.64	3.5	5.5	7.5	5	7
62002	62102	62202	62502	1	7	22	0.56	3.5	5.5	7	5	6.5
62003	62102	62203	62502	1	6	15	0.48	3.5	5.5	7	5	6.5
62004	62104	62204	62502	1	6	13	0.41	3.5	5.5	7	5	6.5
62005	62101	62205	62501	0	9	32	0.71	3.5	5.5	7.5	5	7

Ordering Instructions:

- D-outer diameter of the Guide Cannula, five sizes 0.64, 0.56, 0.48, 0.41 and 0.71mm are available
- C-length (Unit: mm) of the metal tube below the plastic pedestal (B), that is, also the vertical distance from the skull to Target Nuclei
- G1-length (Unit: mm) of the protrudent Injector through the Guide Cannula, 0.5 or 1.0mm is recommended
- G2-length (Unit: mm) of the protrudent Dummy Guide, 0.5 or 1.0mm is recommended

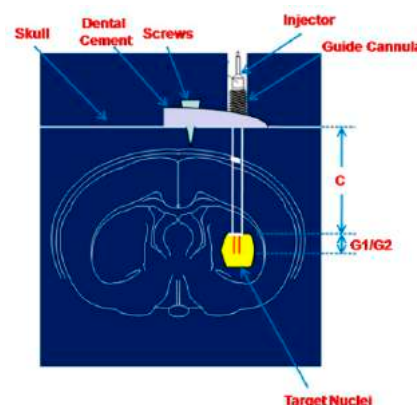

Diagram for Customization

Order information (Unit: mm):

Cannula

Matching	Guide Cannula	Dummy Cannula (plastic)	Dummy Cannula (metal)	Internal Cannula	Fixing Screw	PE Tube
1	62001	62101	62106	62201	62501	62329
	OD 0.64 x ID 0.45	OD 0.40	OD 0.40	OD 0.41 x ID 0.25	OD 5.5 x L7.5	OD 1.50 x ID 0.50
2	62002	62102	62107	62202	62502	62329
	OD 0.56 x ID 0.38	OD 0.30	OD 0.30	OD 0.36 x ID 0.20	OD 5.5 x L7.0	OD 1.50 x ID 0.50
3	62003	62102	62107	62203	62502	62329
	OD 0.48 x ID 0.34	OD 0.30	OD 0.30	OD 0.30 x ID 0.14	OD 5.5 x L7.0	OD 1.50 x ID 0.50
4	62004	62104	62108	62204	62502	62329
	OD 0.41 x ID 0.25	OD 0.20	OD 0.20	OD 0.21 x ID 0.11	OD 5.5 x L7.0	OD 1.50 x ID 0.50
5	62005	62101	62106	62205	62501	62329
	OD 0.71 x ID 0.45	OD 0.40	OD 0.40	OD 0.41 x ID 0.25	OD 5.5 x L7.5	OD 1.50 x ID 0.50

Notes:

Plastic or metal dummy cannula is optional

Screws



Cat No.	Product Description
62513	Screw-M1.0xL2.0mm
62514	Screw-M1.2xL2.0mm
62515	Screw-M1.4xL2.5mm

Double Cannula

Introduction:

RWD has launched I, II, III and IV series double cannula systems for acute and chronic intracranial drug administration in animal experiments.

Series I: Recommended for rat or mouse use, 0.48mm (outer diameter) x 0.34mm (internal diameter).

Series II: Recommended for rat use, 0.64mm (outer diameter) x 0.45mm (internal diameter).

Series III: Specifically for mouse use, 0.48mm (outer diameter) x 0.34mm (internal diameter).

The height of cylindrical plastic pedestal of Guide cannula is different from Series I.

Series IV: 0.41mm (outer diameter) x 0.25mm (internal diameter).

Application:

Double cannula system is used for bilateral implantation, suitable for injecting one or two drugs into two different brain regions.

Cording Diagram:

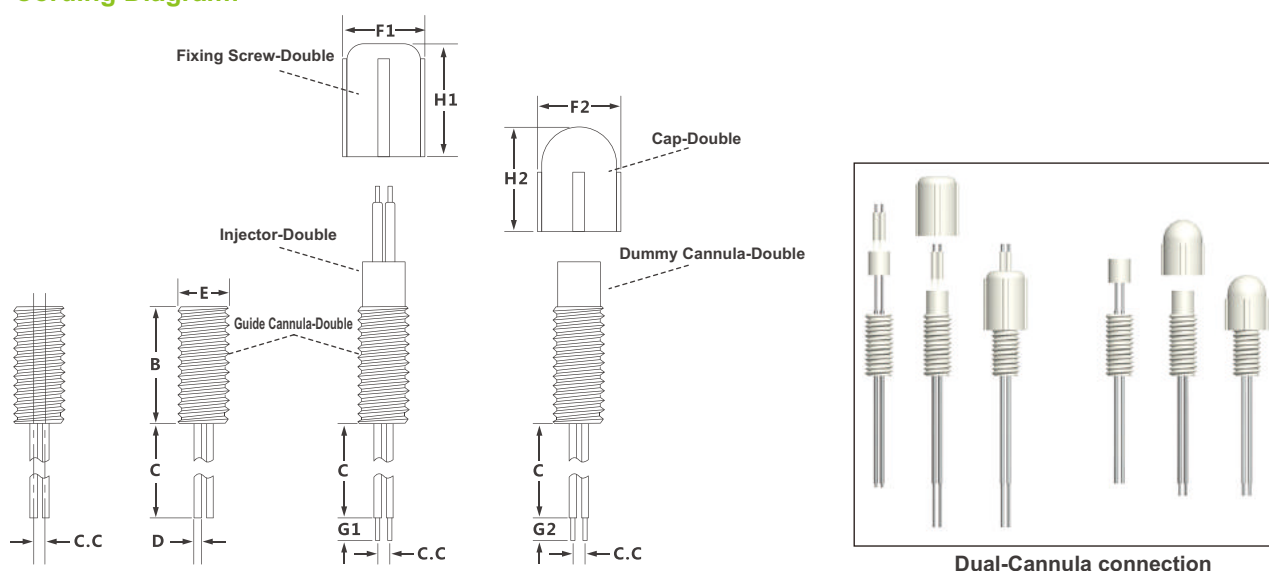

Comments:

- B - Height of cylindrical plastic pedestal, which is 7.8mm for Series I, II & IV and 5.5mm for Series III
- ★C - Length of stainless steel tube below the cylindrical plastic pedestal. The default value is 13.7mm for Series I & III, 20.0mm for Series II and 10.0mm for Series IV. The length can be customized with default value as maximum
- ★C.C - Center distance between double guide cannulas, double dummy cannulas and double injectors. These 3 values should be the same in one system. It can be customized (range: 0.5mm-3.0mm, the minimal increment 0.1mm)
- D - Outer diameter of stainless steel tube and it has 3 sizes: 0.48mm for Series I & III, 0.64mm for Series II and 0.41mm for Series IV
- E - Outer diameter of the cylindrical plastic pedestal and it comes with 3.5mm or 5.0mm. It is related to the outer diameter and centre distance between double guide cannulas
- F1 - Outer diameter of fixing screw and it comes with 5.5mm (when E=3.5mm) or 7.0mm (when E=5.00mm)
- H1 - Height of the fixing screw which is 7.5mm
- F2 - Outer diameter of guide cannula cap and it comes with 5.5mm (when E=3.5mm) or 7.0mm (when E=5.0mm)
- H2 - Height of guide cannula cap and it comes with 7.00mm (when E=3.5mm) and 7.5mm (when E=5.0mm)
- ★G1 - Length of protruding part after internal cannula is inserted into guide cannula. The default value is 5.5mm for Series I, 3.5mm for Series II, 7.5mm for Series III and 4.0 mm for Series IV. This length can be customized
- ★G2 - Length of protruding part after dummy cannula is inserted into guide cannula. The default value is 3.0mm for Series I, 4.0mm for Series II, 5.5mm for Series III and 4.0 mm for Series IV. This length can be customized

Ordering Instructions:

Determine the target brain region for drug administration and then determine target values of C, C.C, G1 and G2. These values can not exceed the default ones. Please refer to :

- ★ part of comments of cording diagram for more detail.
- ★ C: Maximal customized length is 13.7mm for Series I & III, 20.0mm for Series II and 10.0mm for Series IV.
- ★ C.C: Customized range is 0.5mm-3.0mm with minimal increment 0.1mm.
- ★ G1: Maximal customized length is 5.5mm for Series I, 3.5mm for Series II, 7.5mm for Series III and 4.0mm for Series IV.
- ★ G2: Maximal customized length is 3.0mm for Series I, 4.0mm for Series II, 5.5mm for Series III and 4.0mm for Series IV.

Order Information:

Series I:

	C.C	Guide Cannula	Dummy Cannula	Injector	Cap	Fixing Screw	PE Tube
Guide Cannula: O.D.0.48mm x I.D.0.34mm Dummy Cannula: O.D.0.30mm Injector: O.D.0.30mm x I.D.0.14mm Cap: F2 5.5mm x H2 7.0mm (62523) F2 7.0mm x H2 7.5mm (62524) Fixing Screw: F1 5.5mm x H1 7.5mm (62521) F1 7.0mm x H1 7.5mm (62522) Plastic Pedestal of Guide Cannula: Height B = 7.8mm Diameter E = M3.5mm	C.C 0.5mm	62021	62121	62250	62523	62521	62320
	C.C 0.6mm	62022	62122	62250			
	C.C 0.8mm	62023	62123	62223			
	C.C 1.0mm	62024	62124	62224			
	C.C 1.2mm	62025	62125	62225			
	C.C 1.3mm	62026	62126	62226			
	C.C 1.4mm	62027	62127	62227			
	C.C 1.5mm	62028	62128	62228			
	C.C 1.6mm	62029	62129	62229			
	C.C 1.8mm	62030	62130	62230			
Plastic Pedestal of Guide Cannula: Diameter E = 5.0mm	C.C 2.0mm	62031	62131	62231	62524	62522	62329
	C.C 2.2mm	62032	62132	62232			
	C.C 2.4mm	62033	62133	62233			
	C.C 2.6mm	62034	62134	62234			
	C.C 2.7mm	62035	62135	62235			
	C.C 3.0mm	62036	62136	62236			

Series II:

	C.C	Guide Cannula	Dummy Cannula	Injector	Cap	Fixing Screw	PE Tube
Double Cannula: O.D.0.64mm x I.D.0.45mm Dummy Cannula: O.D.0.40mm Injector: O.D.0.41mm x I.D.0.25mm Cap: F2 5.5mm x H2 7.0mm (62523) F2 7.0mm x H2 7.5mm (62524) Fixing Screw: F1 5.5mm x H1 7.5mm (62521) F1 7.0mm x H1 7.5mm (62522) Plastic Pedestal of Guide Cannula: Height B = 7.8mm Diameter E = M3.5mm	C.C 0.8mm	62037	62137	62237	62523	62521	62323
	C.C 1.0mm	62038	62138	62238			
	C.C 1.2mm	62039	62139	62239			
	C.C 1.3mm	62040	62140	62240			
	C.C 1.4mm	62041	62141	62241			
	C.C 1.5mm	62042	62142	62242			
	C.C 1.8mm	62043	62143	62243			
	Plastic Pedestal of Guide Cannula: Diameter E = M5.0mm	C.C 2.0mm	62044	62144			
C.C 2.2mm		62045	62145	62245			
C.C 2.4mm		62046	62146	62246			
C.C 2.5mm		62047	62147	62247			
C.C 2.8mm		62048	62148	62248			
C.C 3.0mm		62049	62149	62249			

Series III:

	C.C	Guide Cannula	Dummy Cannula	Injector	Cap	Fixing Screw	PE Tube
Guide Cannula: O.D.0.48mm x I.D.0.34mm Dummy Cannula: O.D.0.30mm Injector: O.D.0.30mm x I.D.0.14mm Cap: F2 5.5mm x H2 7.0mm (62523) F2 7.0mm x H2 7.5mm (62524)	C.C 0.5mm	62050	62121	62250	62523	62521	62320
	C.C 0.6mm	62051	62122	62250			
	C.C 0.8mm	62052	62123	62223			
	C.C 1.0mm	62053	62124	62224			
	C.C 1.2mm	62054	62125	62225			
	C.C 1.3mm	62055	62126	62226			
Fixing Screw: F1 5.5mm x H1 7.5mm (62521) F1 7.0mm x H1 7.5mm (62522) Plastic Pedestal of Guide Cannula: Height B = 5.5mm Diameter E = M3.5mm	C.C 1.4mm	62056	62127	62227	62523	62521	62320
	C.C 1.5mm	62057	62128	62228			
	C.C 1.6mm	62058	62129	62229			
	C.C 1.8mm	62059	62130	62230			
	C.C 2.0mm	62060	62131	62231			

Series IV:

	C.C	Guide Cannula	Dummy Cannula	Injector	Cap	Fixing Screw	PE Tube
Guide Cannula: O.D.0.41mm x I.D.0.25mm Dummy Cannula: O.D.0.20mm Injector: O.D.0.21mm x I.D.0.11mm Cap: F2 5.5mm x H2 7.0mm (62523) Fixing Screw: F1 5.5mm x H1 7.5mm (62521) Plastic Pedestal of Guide Cannula: Height B = 5.5mm Diameter E = M3.5mm	C.C 0.5mm	62061	62161	62251	62523	62521	62320
	C.C 0.6mm	62062	62162	62251			
	C.C 0.8mm	62063	62163	62263			
	C.C 1.0mm	62064	62164	62264			
	C.C 1.2mm	62065	62165	62265			
	C.C 1.3mm	62066	62166	62266			
	C.C 1.4mm	62067	62167	62267			
	C.C 1.5mm	62068	62168	62268			
	C.C 1.6mm	62069	62169	62269			
	C.C 1.8mm	62070	62170	62270			
	C.C 2.0mm	62071	62171	62271			

Notes: For Dummy Cannula, plastic or metal is optional, 68525 is for mental Dummy while 68523 is plastic Dummy. The difference between Class I and Class III is the height of the pedestal, the former is 7.8mm and the later is 5.5mm, and Class III is specially designed for mice.

PE & Silicone Tubings

PE (polyethylene) tube, with good fluidity, high thermal stability and good flexibility, is widely used in the field of life science. Currently, RWD has 9 types of PE tube and 1 type of silicone tube, including the international standard tubes PE10, PE20 and PE50, which can be used in microdialysis, animal artery intubation, venous cannula, bile duct intubation, subcutaneous implantation of buried pipe, lateral ventricle buried pipe, portal vein intubation and so on. These tubes can be used together with syringe, guide cannula, microdialys connector and luer stubs.

Order Information:

No.	Cat No.	Product Description
1	62320	PEDAX Tubing-0.85*0.42mm, pkg of 10m
2	62321	PE Tubing (HDPE)-0.85*0.42mm, pkg of 10m
3	62322	PE Tubing-0.50*0.25mm, pkg of 10m
4	62323	PE Tubing-1.00*0.50mm, pkg of 10m
5	62324	PE10 Tubing-0.61*0.28mm, pkg of 10m
6	62325	PE20 Tubing-1.09*0.38mm, pkg of 10m
7	62326	PE25 Tubing-0.91*0.46mm, pkg of 10m
8	62327	PE50 Tubing-0.97*0.58mm, pkg of 10m
9	62328	PE60 Tubing-1.20*0.80mm, pkg of 10m
10	62329	PE Tubing-1.50*0.50mm, pkg of 10m

Note: Except 62322, other PE tube can be High-pressure steam sterilization(121°C, 30min).



Syringe Pumps ▶

Multi-channel Syringe Pumps

This multi-channel syringe pump is specifically designed for those applications that require constant flow rates and precise injection delivery. It can be used for single or chronic, repeated microinjections through a cannula system.

Features:

- Easy to install syringes
- Straightforward operation: simply enter syringe diameter, injection rate and Volume to start injection
- Storage of customized parameters
- Display of real time injection status on LCD screen
- Built-in standard syringe parameters, for convenient use

Specifications:

- Accuracy: <1%
- Repeatability: $\pm 0.1\%$
- Syringe range: 10 μ l-140ml
- Flow rate: 0.001 μ l/min-138.7ml/min
- Stroke distance: 0.039 μ m/step
- Stroke rate: 0.0094mm/min-87.211mm/min
- Dimension: 27cm \times 25cm \times 12cm
- Linear force: 18Kg
- LCD screen: 128 \times 64px
- Five customized parameters can be stored
- RS232 interface is used to communicate with the computer
- RS485 interface is used for the communication between machines
- Interface: RS232, Rs485
- Running temperature: 20-40 $^{\circ}$ C



R404
(Syringe does not include)



R452
(Syringe does not include)

Order Information:

Cat No.	Product Name	Remarks
R404	4ch Syringe Infusion Pump	Single motor, simultaneous injection of four syringes(10 μ l-140ml)
R452	2ch Syringe Infusion/Withdrawal Pump	Single motor, simultaneous injection or withdrawal of two syringes(10 μ l-140ml)

Implantable Osmotic Pump ▶

The implantable osmotic pump is a micro device that uses osmotic pressure as a power to pump liquid stored in the capsule at a constant rate and release it into a specific site or blood.

The implanted osmotic pump has been the best tool for the delivery of drugs in the life sciences study. It can be implanted into the subcutaneous or abdominal cavity of experimental animals, and the test agent is delivered continuously and accurately through the catheter at a rate of $\mu\text{l/h}$, up to four weeks. Multi-disease animal models can be established by continuous administration of osmotic pump, such as hypertension and Parkinson's diseases animal models. It is widely used in drug and molecular screening, pharmacodynamics and other fields of research.

- Simple, convenient, reliable, low cost
- No battery, no power supply, no mobile module
- High repeatability and continuity
- Minimal side effects on animals and stress interference

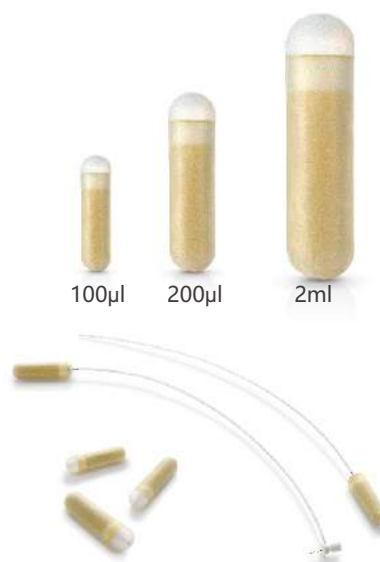

Different Accessories kit

The catheter can be introduced into different sites, such as: the cranial cavity and spinal cord, intravascular, liver, spleen and other organs and trauma.



Features:

- Ensure continuous and uninterrupted administration, maintaining the preset speed for the administration of the animal
- Storage capsules have good drug compatibility, and protection for short half-life drugs
- Capsules have good biocompatibility and do not affect the physiology of animals
- Easy to use, an experiment requires only one administration, no longer need night or weekend experiment
- Avoid the stress caused by repeated administration, reducing the impact of non-experimental factors on the experimental results
- Small size, can be applied to experiments on mice, neonatal rats and other small animal
- Ensure that the drug is delivered to the target site accurately

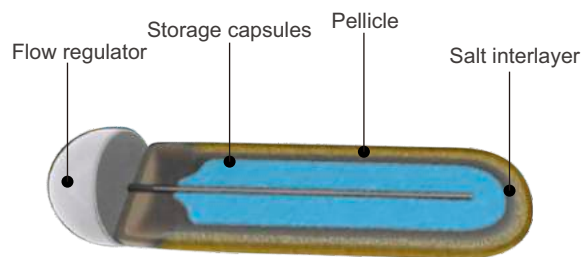

Specifications:

	Drug capacity	100 μl				200 μl						2ml		
		Cat No.	1003D	1001W	1002W	1004W	2001D	2003D	2001W	2002W	2004W	2006W	2ml1W	2ml2W
Capsule	Cycle	3d	1w	2w	4w	1d	3d	1w	2w	4w	6w	1w	2w	4w
	Injection rate ($\mu\text{l/hr}$)	1.0	0.5	0.25	0.11	7.0	2.0	1.0	0.5	0.25	0.15	10.0	5.0	2.5
	Flow regulator	Cap	PE material, a variety of colors optional, remove the air and prevent leakage											
	Draft tube	304 stainless steel material												
Infusion tube	Syringe	Flat head for the injection of liquid												

coming soon

Physiological And Pharmacological

MCAO Sutures

RWD MCAO suture utilizes high-quality silicon rubber-coated monofilaments to induce ischemic stroke model. The within-group variation of stroke models can be maximally reduced by the super smooth surface and evenness of RWD suture. And without rupturing the vesicle, RWD suture makes its insertion into the animal brain much easier. The stability is also greatly increased for the cerebral ischemia modeling and more consistent data. RWD sutures are available in nylon monofilament material, diameters of silicone-rubber coated part range from 0.19mm to 0.44mm; Length of suture from 2-3cm.



Specifications:

- It adopts high-quality medical suture with very good flexibility, not easy to puncture blood vessels, which increase the success of stroke model development
- Unique mold manufacturing technology, ensure high uniformity and stability of the MCAO model
- Silicone-rubber coated in tip, greatly reduce the risk of puncturing blood vessels
- The use of black suture material, increased the observability during plugging into the blood vessel

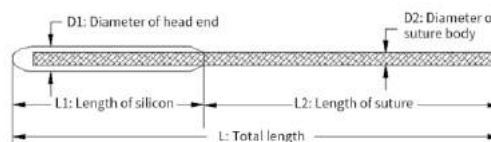

- ★ L1 in mouse suture: 3~4mm
- ★ L1 in rat suture: 5~6mm
- ★ L1 could be customized: 2~8mm

Order Information:

No.	Cat No.	Diameter of Head end D1 (mm)	Diameter of suture body D2 (mm)	Total Length L (mm)	Animal's weight (g)	Packing (pcs)	
1	MSMC19B009PK50	0.21±0.02	0.102	20	15~20g	50	Mouse
2	MSMC21B009PK50	0.22±0.02	0.104	20	21~25g	50	
3	MSMC23B011PK50	0.23±0.02	0.104	20	26~30g	50	
4	MSMC24B011PK50	0.24±0.02	0.104	20	31~35g	50	
5	MSMC25B011PK50	0.25±0.02	0.104	20	35g	50	
6	MSRC28B019PK50	0.27±0.02	0.104	30	200g	50	Rat
7	MSRC32B019PK50	0.35±0.03	0.235	30	200~250g	50	
8	MSRC36B019PK50	0.40±0.03	0.26	30	251~280g	50	
9	MSRC38B019PK50	0.43±0.03	0.26	30	281~330g	50	
10	MSRC42B019PK50	0.47±0.03	0.26	30	331~400g	50	
11	MSRC44B019PK50	0.50±0.03	0.26	30	400g	50	

Note: Customized service is available.

Brain & Heart Matrices

RWD Brain and Heart matrices is made of stainless steel, electroless plating, through precision machining and highly polished, strong durability, which can be heated, chilled, autoclaved scrubbed and use in variety of harsh conditions. The surface will not be damaged by thermal pressure, and will not be damaged by mechanical impact, keeping the product in use for a long time.

Brain matrices have coronal sections and sagittal sections, each section can be as 0.5 mm or 1 mm. Widely use in preparing pathological tissue section and cut out TTC dyeing organization.

Heart matrices have coronal sections. The section can be as 0.5 mm or 1 mm. The mouse heart matrices are also suitable for neonatal rats. It can be used for the experiment on myocardial ischemia, ischemia reperfusion and other cardiac related experiments. It can also be chilled and used in experiments of freezing tissue.

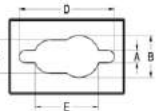
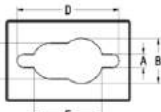
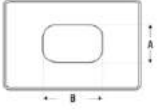
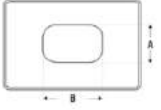

Order Information:

Cat No.	Product Description	A (mm)	B (mm)	C (mm)	D (mm)	E (mm)	Depth (mm)	Diagram
68707	Brain Matrix, Mouse 40-75g, Coronal, 1mm, Stainless steel	3.18	11.1	8.73	19.1	12.5	7.40	
68708	Brain Matrix, Mouse 40-75g, Sagittal, 1mm, Stainless steel	3.18	11.1	8.73	19.1	12.5	7.40	
68709	Brain Matrix, Rat, 175-300g, Coronal, 1mm, Stainless steel	4.76	17.9	14.7	36.6	27.35	8.94	
68710	Brain Matrix, Rat, 175-300g, Sagittal, 1mm, Stainless steel	4.76	17.9	14.7	36.6	27.35	8.94	
68711	Brain Matrix, Rat, 300-600g, Coronal, 1mm, Stainless steel	4.76	19.8	14.7	36.6	25.7	10.91	
68712	Brain Matrix, Rat, 300-600g, Sagittal, 1mm, Stainless steel	4.76	19.8	14.7	36.6	25.7	10.91	
68713	Brain Matrix, Mouse, 40-75g, Coronal, 0.5mm, Stainless steel	3.18	11.1	8.73	19.1	12.5	7.40	
68714	Brain Matrix, Mouse, 40-75g, Sagittal, 0.5mm, Stainless steel	3.18	11.1	8.73	19.1	12.5	7.40	
68715	Brain Matrix, Rat, 175-300g, Coronal, 0.5mm, Stainless steel	4.76	17.9	14.7	36.6	27.35	8.94	
68716	Brain Matrix, Rat, 175-300g, Sagittal, 0.5mm, Stainless steel	4.76	17.9	14.7	36.6	27.35	8.94	
68717	Brain Matrix, Rat, 300-600g, Coronal, 0.5mm, Stainless steel	4.76	19.8	14.7	36.6	25.7	10.91	
68718	Brain Matrix, Rat, 300-600g, Sagittal, 0.5mm, Stainless steel	4.76	19.8	14.7	36.6	25.7	10.91	
68719	Heart Matrix, Mouse 20-75g, Coronal, 1mm, Stainless steel	8.3	12.7	—	—	—	4.8	
68720	Heart Matrix, Rat 175-400g, Sagittal, 1mm, Stainless steel	12.7	19.9	—	—	—	9.6	
68721	Heart Matrix, Mouse 20-75g, Coronal, 0.5mm, Stainless steel	8.3	12.7	—	—	—	4.8	
68722	Heart Matrix, Rat 175-400g, Sagittal, 0.5mm, Stainless steel	12.7	19.9	—	—	—	9.6	

RFLSI Pro⁺ Laser Speckle Perfusion Imager ▶

- Rapid ●High-resolution ●Large area ●Non-contact ●No damage ●All in one design

A new RFLSI Pro⁺Laser Speckle Perfusion Imager is based on the latest LSCI technology (Laser Speckle Contrast Imaging/LSCI, Laser Speckle Ratio Analysis). With the advantages of the unique non-contact, high time and spatial resolution, rapid imaging, it provides a new recording way for the life sciences basic research and clinical medical, which can achieve real-time dynamic blood flow monitoring and video imaging, it is the vital basis for understanding the organization, organ pathology and physiological indicators.. Contrast agent is not needed, time resolution can be in milliseconds, spatial resolution can be in microns. It also achieves the requirements of real-time observation of microvascular blood flow distribution and relative changes in values.RWD adopts a new all in one design to improve the operability for the user.



High time & spatial resolution, High contrast●

●Continuous imaging, No need to scan



Non-contact, No contrast agent●

●Multi-output: Video, Image, Blood flow data, Diameter analysis

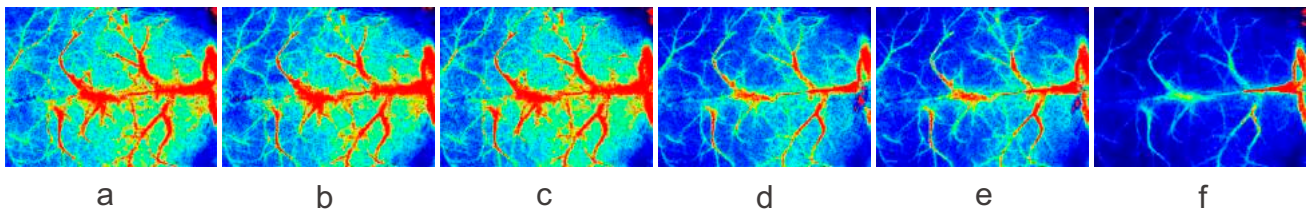

▶ Performance Advantages

- Real-time monitoring of two-dimensional blood flow images in microns. Use corrected static tissue structure interference and multiple scattering effects algorithm to quantitatively analyze blood flow changes and improve the accuracy of blood flow monitoring in vessels of different diameter
- With the function of real-time online and off-line analysis of mean flow-rate and the vascular diameter in ROI (Region of Interest), and off-line analysis of mean and standard deviation of ROI (Region of Interest), supporting the selection, copy, and deletion of ROI for any shape and quantity, and the ROI position and size can be adjusted with the mouse by free dragging and dropping
- Maintain a high imaging speed of not less than 60fps under Full-Frame state (the camera's area array is all used)
- The positioning grid can be adjusted arbitrarily to meet the image positioning of different groups of experiments
- The distance scale and real-time ROI area are added to facilitate the acquisition of relevant information

- Real-time focal length adjustment, read the magnification directly, no calculations required
- Select multiple vessels, online/off-line analysis of vascular diameter and its changes to meet the requirements of hemodynamics research
- Multiple data storage format: Original blood flow-rate data /Standard images in various formats (jpg, bmp, png) / .avi format video / etc.
- Multiple blood flow image acquisition methods: flexible continuous acquisition, designated time interval acquisition, designated frame number acquisition, etc.
- Highly coherently stable laser light source and low noise 12bit fast camera ensure the stability of excellent flow-rate measurement.
- All-inclusive supporting solutions and after-sales service
- The function of saving and load of ROI files has been added to meet the requirement of synchronous ROI analysis between different groups of experiments

▶ Application Areas

- CBF
- MCAO model
- Gastrointestinal blood flow
- Lower limb ischemia / Angiogenesis
- Burns assessment
- Skin patch test
- Cerebral cortex diffusion inhibition

► **Technical Parameters**

- The range of the blood flow monitoring is from zero to infinity. The spatial resolution of the blood flow imaging is $3.3\mu\text{m}/\text{pixel}$, and the maximum is $2\mu\text{m}/\text{pixel}$
- Laser type: laser diode, wavelengths 785nm, monitoring camera power 90mW
- Highly coherently stable laser light source and low noise 12bit fast camera ensure the stability of excellent flow-rate measurement
- Monitoring distance: 110mm, directly read the magnification, no autofocus measurement distance calibration
- In the recording process, choose any number of blood vessels, real-time display diameter changes and angle
- The effective pixels in the unit area are no less than 1800000 pixels / cm^2 ; the monitoring pixel is $656*494$ pixels
- With two modes of continuous recording and interval recording
- The image monitoring area is $14.4*10.9\text{-}2.15*1.62\text{mm}$, and the imaging speed is not less than 60 fps in full amplitude state
- ROI area and vessel diameter measurements are be added arbitrarily during the recording process or off-line analysis to support any shape and number of ROI choices
- Optical magnification: conventional 0.67-4.5 times, 0.071NA, optional 0.5 times, 2 times auxiliary objective lens; increase the auxiliary objective lens, the monitoring area and blood flow imaging spatial resolution will be adjusted accordingly
- The monitoring records can be exported to AVI format video files, including curves, blood flow, experimental process records, the output video can be adjusted as required

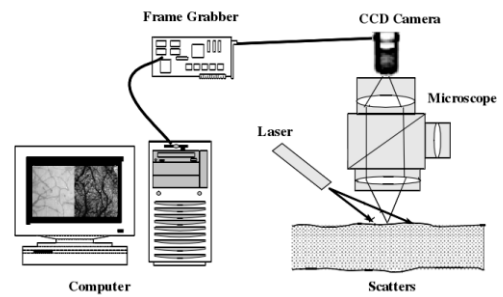

Tree shrew (nonhuman primate) cerebral cortical blood flow imaging ►

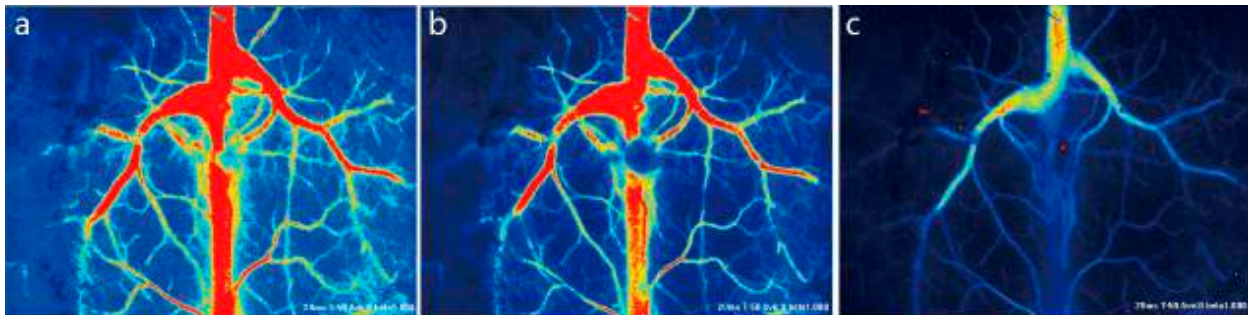

(a) Normal cerebral cortical blood flow distribution of tree shrew; (b) The distribution of cerebral cortical blood flow when start to over anesthesia; (c) The distribution of dying cerebral cortical blood flow when severe overdose of anesthesia.

Cerebral cortical blood flow distribution of the rat mini-stroke model ►

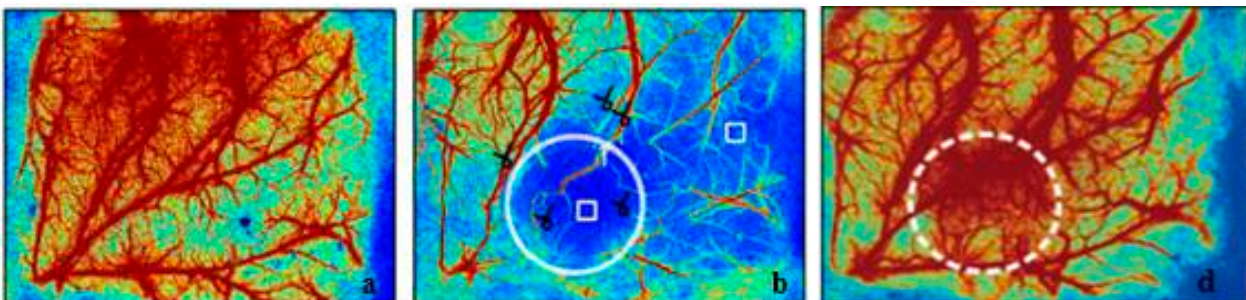

(a) Normal cerebral cortical blood flow distribution; (b) Cortical blood flow distribution after established the mini-stroke model; (c) Cortical blood flow distribution after removal of the mini-stroke model for 24h

Photochemical induction of mouse cerebral cortex ischemia model ►

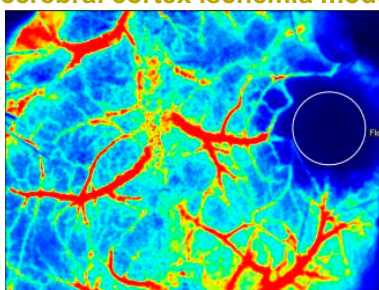

The blood flow imaging of the rat dorsal skin window model ►

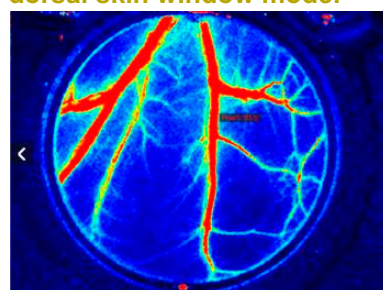

Fiber Optogenetic system

Intelligent Optogenetic System

The application of optogenetics has been rapidly developing since 2010, its research field covers several classical experimental animal species, such as flies, mice, rats, zebrafish, primates (Monkey, cynomolgus monkey, rhesus monkey, etc.). These animals generally have the advantages of short developmental and reproductive cycle and easy integration of foreign genes, thus facilitating the introduction of Photosensitive Protein Gene and the screen of the state of expression. The Intelligent Optogenetic System integrates light source output and control together. Compared with the Traditional Optogenetics System, it really achieves compact and easy to use, stable and efficient, intelligent and humane.

- Simple operation
- Touch screen interface
- Stable output
- Audible and visual alarm



Features:

- Integrating the output and control of the light source, simplifying the operation of the experiment
- Touch screen operation interface with convenient parameter setting and control and visible waveform state
- Group custom editing and data import or export are available
- High power laser output from 0 to 100mw with good stability (<1%), Power adjustable
- Acousto-optic alarm at the end of the experimental process or when the temperature of the laser is abnormal
- Compatible with electrophysiological, behavioral devices and other devices

Technical Parameters

Category	Description
PowerTouch	0-80mW (Blue light), 0-100mW (Yellow light), 1mw resolution, adjustable power
screen pixels	7-inch capacitive touch screen, 1024PX * 600PX resolution
Stability	1%
Wavelength	473, 450, 488, 532, 589 and 650nm (optional)
TTL signal output	10mV-5V
Light source interfac	FC/PC
Dimensions	258*220.5*147mm (L*W*H)



Traditional Optogenetic System ▶



Common configuration options:

No.	Product Name	Cat No.	Quantity	Remarks
1	Arbitrary Waveform/Function Generator-20MHz	AFG2021-SC	1	
2	473nm Blu-ray Laser-50mW/power adjustable/stability<5%	R-LG473-50-A5	1	Optional
3	532nm Green Laser-50mW/power adjustable/stability<5%	R-LG532-50-A5	1	
4	593nm Yellow Laser-50mW/power adjustable/stability<5%	R-LG593-50-A5	1	
5	FC/PC Optical Fiber Patch Cables(m) - 200um,0.22NA,1m	R-FC-PC-N2-200-L1	1	
6	FC-FC Optic Fiber Commutator	R-FC-1x1	1	
7	Optic Fiber(m), FC/PC Adapter with Φ 1.25 mm Ceramic Ferrule, 200um Core,0.22NA,1m	R-FC-L-N2-200-L1	1	
8	Ceramic Sleeves, Φ 1.25mm, pkg of 20pcs	R-MS-1.25	1	
9	Ceramic Ferrule- Φ 1.25mm/200um/0.22NA (20/pkg)	R-FOC-L200C-22NA	10	
10	Ceramic Ferrules Protective Cap, Φ 1.25mm, pkg of 200pcs	R-DC-1.25	1	
11	Fiber Stripper- suitable for 100um - 600um fiber	R-OFT-600	1	
12	Laser Goggles against Green and Yellow Light	R-LS-Y	1	Optional
13	Laser Goggles against Blue and Green Light	R-LS-G	1	
14	Laser Power Meter -40mW	LP-1	1	

Waveform Generator

Adjusting and controlling the output of Laser, like frequency of output, duty ratio, etc.



Laser

Features:

- Wavelength: Blue Light 473nm, Green Light 532nm, Yellow Light 593nm
- Stability: <10%, <5% and <1%
- Output power:0-50mW, 0-100mW and 0-200mW
- Connect a variety of fibers, FC-PC connectors
- Connect the waveform generator or stimulator to control the light output
- Reliable performance, long lifetime, average life expectancy is more than 10 thousand hours
- Exquisite appearance, compact size, portable



Components

Laser Power Meter

Features:

- Using a silicon photodiode probe, applicable to multiband measurement with broad spectrum range
- Short response time, good thermal stability, small volume, convenient installation and fixation
- Convenient to operate with digital display, applicable to the measurement on a variety of laser power
- Automatic shut down (about 30 minutes) to save battery power

Specifications:

Spectral range	400-1100nm
Models	LP-1
Measure range	0-40μW,0-400μW,0-4mW,0-40mW multiple ranges can be selected.
Measurement accuracy	0.01μW
Optical probe	silicon photodiode probe(φ9mm)
Measurement error	±5%



Application: Accurately measure the power of continuous laser stable temperature.

Patchcord and Optical Fiber

- Low insertion loss
- Good Repeatability
- High return loss
- Stable temperature
- Good mutual insertion performance
- Optional fiber
- Applicable wavelength: 400nm-1100nm
- Numerical aperture: 0.22, 0.37, 0.50
- Default length is 1m ,Optical fiber length: 0.5m-5m,step 0.5m (customized)
- Core diameter: 100um,200um,300um,400um

Order Information:

Model No.	Product Description
R-FC-PC-N2-100-L1	FC/PC Optical Fiber Patch Cables(m) - 100um,0.22NA,1m
R-FC-PC-N2-200-L1	FC/PC Optical Fiber Patch Cables(m) - 200um,0.22NA,1m
R-FC-PC-N2-300-L1	FC/PC Optical Fiber Patch Cables(m) - 300um,0.22NA,1m
R-FC-PC-N2-400-L1	FC/PC Optical Fiber Patch Cables(m) - 400um,0.22NA,1m
R-FC-PC-N3-200-L1	FC/PC Optical Fiber Patch Cables(m) - 200um,0.37NA,1m
R-FC-PC-N3-300-L1	FC/PC Optical Fiber Patch Cables(m) - 300um,0.37NA,1m
R-FC-PC-N3-400-L1	FC/PC Optical Fiber Patch Cables(m) - 400um,0.37NA,1m
R-FC-PC-N5-200-L1	FC/PC Optical Fiber Patch Cables(m) - 200um,0.50NA,1m
R-FC-PC-N5-400-L1	FC/PC Optical Fiber Patch Cables(m) - 400um,0.50NA,1m
R-FC-L-N2-100-L1	Optic Fiber(m), FC/PC Adapter with Ø1.25 mm Ceramic Ferrule, 100um Core,0.22NA,1m
R-FC-L-N2-200-L1	Optic Fiber(m), FC/PC Adapter with Ø1.25 mm Ceramic Ferrule, 200um Core,0.22NA,1m
R-FC-L-N2-300-L1	Optic Fiber(m), FC/PC Adapter with Ø1.25 mm Ceramic Ferrule, 300um Core,0.22NA,1m
R-FC-L-N2-400-L1	Optic Fiber(m), FC/PC Adapter with Ø1.25 mm Ceramic Ferrule, 400um Core,0.22NA,1m
R-FC-P-N2-100-L1	Optic Fiber(m), FC/PC Adapter with Ø2.5 mm Ceramic Ferrule, 100um Core,0.22NA,1m
R-FC-P-N2-200-L1	Optic Fiber(m), FC/PC Adapter with Ø2.5 mm Ceramic Ferrule, 200um Core,0.22NA,1m
R-FC-P-N2-300-L1	Optic Fiber(m), FC/PC Adapter with Ø2.5 mm Ceramic Ferrule, 300um Core,0.22NA,1m
R-FC-P-N2-400-L1	Optic Fiber(m), FC/PC Adapter with Ø2.5 mm Ceramic Ferrule, 400um Core,0.22NA,1m
R-FC-L-N3-200-L1	Optic Fiber(m), FC/PC Adapter with Ø1.25 mm Ceramic Ferrule, 200um Core,0.37NA,1m
R-FC-L-N3-300-L1	Optic Fiber(m), FC/PC Adapter with Ø1.25 mm Ceramic Ferrule, 300um Core,0.37NA,1m
R-FC-L-N3-400-L1	Optic Fiber(m), FC/PC Adapter with Ø1.25 mm Ceramic Ferrule, 400um Core,0.37NA,1m
R-FC-P-N3-200-L1	Optic Fiber(m), FC/PC Adapter with Ø2.5 mm Ceramic Ferrule, 200um Core,0.37NA,1m
R-FC-P-N3-300-L1	Optic Fiber(m), FC/PC Adapter with Ø2.5 mm Ceramic Ferrule, 300um Core,0.37NA,1m
R-FC-P-N3-400-L1	Optic Fiber(m), FC/PC Adapter with Ø2.5 mm Ceramic Ferrule, 400um Core,0.37NA,1m
R-FC-L-N5-200-L1	Optic Fiber(m), FC/PC Adapter with Ø1.25 mm Ceramic Ferrule, 200um Core,0.50NA,1m
R-FC-L-N5-400-L1	Optic Fiber(m), FC/PC Adapter with Ø1.25 mm Ceramic Ferrule, 400um Core,0.50NA,1m
R-FC-P-N5-200-L1	Optic Fiber(m), FC/PC Adapter with Ø2.5 mm Ceramic Ferrule, 200um Core,0.50NA,1m
R-FC-P-N5-400-L1	Optic Fiber(m), FC/PC Adapter with Ø2.5 mm Ceramic Ferrule, 400um Core,0.50NA,1m



Patchcord



Optical Fiber

Ceramic Ferrule

Features:

- Material: Ceramic
- Applicable wavelength: 400-2200nm
- Core diameter: 100um, 200um, 300um, 400um
- Numerical aperture: 0.22, 0.37, 0.50
- Outer diameter: 1.25mm (6.4mm long) , 2.5mm (10.5mm long)
- Core-inserting length: 10.5mm (customized)
- Optical fiber length: 2mm-25mm, step 0.5mm (customized)



Order Information:

No.	Model No.	Product Description	No.	Model No.	Product Description
1	R-FOC-L200C-37NA	Ceramic Ferrule-Ø1.25mm/200um/0.37NA (20/pkg)	10	R-FOC-L400C-22NA	Ceramic Ferrule-Ø1.25mm/400um/0.22NA (20/pkg)
2	R-FOC-L300C-37NA	Ceramic Ferrule-Ø1.25mm/300um/0.37NA (20/pkg)	11	R-FOC-F100C-22NA	Ceramic Ferrule-Ø2.5mm/100um/0.22NA (20/pkg)
3	R-FOC-L400C-37NA	Ceramic Ferrule-Ø1.25mm/400um/0.37NA (20/pkg)	12	R-FOC-F200C-22NA	Ceramic Ferrule-Ø2.5mm/200um/0.22NA (20/pkg)
4	R-FOC-F200C-37NA	Ceramic Ferrule-Ø2.5mm/200um/0.37NA (20/pkg)	13	R-FOC-F300C-22NA	Ceramic Ferrule-Ø2.5mm/300um/0.22NA (20/pkg)
5	R-FOC-F300C-37NA	Ceramic Ferrule-Ø2.5mm/300um/0.37NA (20/pkg)	14	R-FOC-F400C-22NA	Ceramic Ferrule-Ø2.5mm/400um/0.22NA (20/pkg)
6	R-FOC-F400C-37NA	Ceramic Ferrule-Ø2.5mm/400um/0.37NA (20/pkg)	15	R-FOC-L200C-50NA	Ceramic Ferrule-Ø1.25mm/200um/0.50NA (20/pkg)
7	R-FOC-L100C-22NA	Ceramic Ferrule-Ø1.25mm/100um/0.22NA (20/pkg)	16	R-FOC-L400C-50NA	Ceramic Ferrule-Ø1.25mm/400um/0.50NA (20/pkg)
8	R-FOC-L200C-22NA	Ceramic Ferrule-Ø1.25mm/200um/0.22NA (20/pkg)	17	R-FOC-F200C-50NA	Ceramic Ferrule-Ø2.5mm/200um/0.50NA (20/pkg)
9	R-FOC-L300C-22NA	Ceramic Ferrule-Ø1.25mm/300um/0.22NA (20/pkg)	18	R-FOC-F400C-50NA	Ceramic Ferrule-Ø2.5mm/400um/0.50NA (20/pkg)

Fiber Optic Rotary Joint

Applicable to long time stimulation and observation experiments on awake and free moving animals, avoids twining of the fiber optic.

Order Information:

Model No.	Product Description
R-FC-1x1	FC-FC Optic Fiber Commutator



Ceramic Cannula & Ceramic Ferrules Protective Cap

Order Information:

Model No.	Product Description
R-MS-1.25	LC Mating Sleeves, Ø1.25mm (20pcs/pkg)
R-MS-2.5	FC Mating Sleeves, Ø2.50mm (20pcs/pkg)
R-DC-2.5	FC/PC Ceramic Ferrules Protective Cap-Ø2.50mm (200pcs/pkg)
R-DC-1.25	LC/PC Ceramic Ferrules Protective Cap-Ø1.25mm (200pcs/pkg)



Ceramic Cannula



Ceramic Ferrules Protective Cap

Laser Goggles

R-LS-Y Laser Goggles against Green and Yellow Light
 R-LS-G Laser Goggles against Blue and Green Light



To prevent or reduce the damage to human eye from laser.

Fiber Tongs

- Suitable for 100um-800um fiber for stripping fiber coating



R-OFT-600

Animal Surgical Instruments

RWD surgical instruments cover surgical scissors, surgical forceps, orthopedic instruments, scalpels and blades, vascular forceps, needle forceps, with more than 1,000 kinds of models.

Surgery Instrument Kit ▶

SP0001-G General Surgery Instrument Kit for Rodents

Cat.No.	Product Description	Qty
S11001-08	Spring Scissors (Triangular)-S/S Str/5*0.1mm/8.5cm	1
S11002-08	Spring Scissors (Triangular)-S/S Cvd/5*0.1mm/8.5cm	1
S12005-10	IRIS-Fine Scissors (Round Type)-S/S Str/10.5cm	1
S12009-11	IRIS-Fine Scissors (Round Type)-S/S Str/11.5cm	1
S12010-11	IRIS-Fine Scissors (Round Type)-S/S Cvd/11.5cm	1
S12004-09	IRIS-Fine Scissors (Round Type)-S/S Cvd/9.5cm	1
F11001-11	Micro Forceps-Str, 0.2mm Tips, 11cm	1
F11004-11	Micro Forceps-Cvd, 0.2mm Tips, 11cm	1
F12010-10	Dressing Forceps-Str, 1.9mm Tips, 10.5cm	1
F12011-10	Dressing Forceps-Cvd, 1.9mm Tips, 10.5cm	1
F21001-12	HALSTED Artery Forceps-Str, 1.0mm Tips, 12.5cm	2
F21002-12	HALSTED Artery Forceps-Cvd, 1.0mm Tips, 12.5cm	2
F22002-10	HARTMAN Mosquito Forceps-Str, 0.8mm Tips, 10.5cm	2
F22003-10	HARTMAN Mosquito Forceps-Cvd, 1.0mm Tips, 10cm	2
F31047-12	OLSEN-HEGAR Needle Holders with Scissors-Str, 12cm	1
S13029-14	MAYO-STILLE Dissecting & Operating Scissors-B/B Str/14cm	1
S15001-11	SPENCER Ligature Scissors (Slender Type)-11cm	1
S21010-15	BOHLER Rongeurs (Double)-Light Cvd/2mm Cup/15.5cm	1
S22004-11	Bone Cutters with Flat Blades (SGL)-11cm	1
S14014-12	Operating Scissors (Round Type)-S/S Str/12.5cm	1
S31011-01	11# Scalpel Blades (Box of 100pcs)	1
S32001-12	Scalpel Handles 3# Solid-12.5cm	1
S33009-06	Scalpel Blade Remover-6.5cm	1
F13019-12	ADSON 1x2 Teeth Tissue Forceps, 1.8mm, 12cm	1
R21027-12	STEVENS Hooks, 1 Angled Tooth (6mm long), 12.5cm	1
R22009-01	ALM 4x4 Teeth Retractors-Blunt, 7.5cm	1
R22005-45	3x3 Teeth Retractors-Blunt, 5cm	1
R51003-11	Micro Spatula w/tip W. 2mm x Thk. 0.3mm - Cvd/11cm	1
F35205-60	Sutures w/Needle-3/8/2.5x7/30cm/7-0	10
F35305-50	PGA Sutures w/Needle-1/2/4x10/90cm/5-0	10
R31006-06	SS Micro Clamps-Cvd/L*W 6.6*1mm/17mm	5
R31005-06	SS Micro Clamps-Str/L*W 6*1mm/19mm	5
R34001-14	Clip Applicator for R31005- and R31006-Clamps-14cm	1
SP0000-P	Instrument Storage Portfolio, 32*22cm	1



SP0003-R Microsurgery Instrument Kit for Rat, Cat, Rabbit etc.

Cat.No.	Product Description	Qty
S12005-10	IRIS-Fine Scissors (Round Type)-S/S Str/10.5cm	1
S12010-11	IRIS-Fine Scissors (Round Type)-S/S Cvd/11.5cm	1
F31047-12	OLSEN-HEGAR Needle Holders with Scissors-Str, 12cm	1
F11001-11	Micro Forceps-Str, 0.2mm Tips, 11cm	1
R31005-06	SS Micro Clamps-Str/L*W 6*1mm/19mm	5
R34001-14	Clip Applicator for R31005- and R31006-Clamps-14cm	1
S11001-08	Spring Scissors (Triangular)-S/S Str/5*0.1mm/8.5cm	1
S11002-08	Spring Scissors (Triangular)-S/S Cvd/5*0.1mm/8.5cm	1
F22006-12	HALSTED Mosquito Forceps-Str, 1.2mm Tips, 12.5cm	1
F22007-12	HALSTED Mosquito Forceps-Cvd, 1.0mm Tips, 12.5cm	1
F35401-50	Needle-3/8/3x10/90cm/5-0	10
S32001-12	Scalpel Handles 3# Solid-12.5cm	1
S31011-01	11# Scalpel Blades (Box of 100pcs)	1
SP0000-P	Instrument Storage Portfolio, 32*22cm	1



SP0003-M Microsurgery Instrument Kit for Mice

Cat.No.	Product Description	Qty
S12004-09	IRIS-Fine Scissors (Round Type)-S/S Cvd/9.5cm	1
S12005-10	IRIS-Fine Scissors (Round Type)-S/S Str/10.5cm	1
F31047-12	OLSEN-HEGAR Needle Holders with Scissors-Str, 12cm	1
F11001-11	Micro Forceps-Str, 0.2mm Tips, 11cm	1
R31005-04	SS Micro Clamps-Str/L*W 4*0.75mm/16mm	5
R34001-14	Clip Applicator for R31005- and R31006-Clamps-14cm	1
S11001-08	Spring Scissors (Triangular)-S/S Str/5*0.1mm/8.5cm	1
S11002-08	Spring Scissors (Triangular)-S/S Cvd/5*0.1mm/8.5cm	1
F22002-10	HARTMAN Mosquito Forceps-Str, 0.8mm Tips, 10.5cm	1
F22003-10	HARTMAN Mosquito Forceps-Cvd, 1.0mm Tips, 10cm	1
F35401-50	Needle-3/8/3x10/90cm/5-0	10
S32001-12	Scalpel Handles 3# Solid-12.5cm	1
S31011-01	11# Scalpel Blades (Box of 100pcs)	1
SP0000-P	Instrument Storage Portfolio, 32*22cm	1



SP0004-M
Brain Microdialysis Surgery Instrument Kit for Mice

Cat.No.	Product Description	Qty
S31011-01	11# Scalpel Blades (Box of 100pcs)	1
S32001-12	Scalpel Handles 3# Solid-12.5cm	1
S33007-12	ZIEGLER Knives-4mm Cutting	1
S12004-09	IRIS-Fine Scissors (Round Type)-S/S Cvd/9.5cm	1
S12005-10	IRIS-Fine Scissors (Round Type)-S/S Str/10.5cm	1
S14014-11	Operating Scissors (Round Type)-S/S Str/11.5cm	1
F12005-10	IRIS Dissecting Forceps-Str, 1.0mm Tips, 10cm	2
F12006-10	Forceps-Light Cvd, 0.8mm Tips, 10cm	1
F22002-10	HARTMAN Mosquito Forceps-Str, 0.8mm Tips, 10.5cm	2
F31047-12	Needle Holders with Scissors-Str, 12cm	1
F35205-60	Sutures w/Needle-3/8/2.5x7/30cm/7-0	10
F22003-10	HARTMAN Mosquito Forceps-Cvd, 1.0mm Tips, 10cm	2
SP0000-P	Instrument Storage Portfolio, 32*22cm	1



SP0004-R
Brain Microdialysis Surgery Instrument Kit for Rat

Cat.No.	Product Description	Qty
S31011-01	11# Scalpel Blades (Box of 100pcs)	1
S32001-12	Scalpel Handles 3# Solid-12.5cm	1
S33007-12	ZIEGLER Knives-4mm Cutting	1
S12005-10	IRIS-Fine Scissors (Round Type)-S/S Str/10.5cm	1
S12006-10	IRIS-Fine Scissors (Round Type)-S/S Cvd/10.5cm	1
S14014-12	Operating Scissors (Round Type)-S/S Str/12.5cm	1
F12010-10	Dressing Forceps-Str, 1.8mm Tips, 10.5cm	2
F12011-10	Dressing Forceps-Cvd, 1.9mm Tips, 10.5cm	1
F22006-12	HALSTED Mosquito Forceps-Str, 1.2mm Tips, 12.5cm	2
F31047-12	OLSEN-HEGAR Needle Holders with Scissors-Str, 12cm	1
F35205-60	w/Needle-3/8/2.5x7/30cm/7-0	10
R22009-01	ALM 4x4 Teeth Retractors-Blunt, 7.5cm	1
F22007-12	HALSTED Mosquito Forceps-Cvd, 1.0mm Tips, 12.5cm	2
SP0000-P	Instrument Storage Portfolio, 32*22cm	1



SP0002-G
General Ophthalmic Surgery Instrument Kit for Rodents

Cat.No.	Product Description	Qty
S11001-08	Spring Scissors (Triangular)-S/S Str/5*0.1mm/8.5cm	1
S11002-08	Spring Scissors (Triangular)-S/S Cvd/5*0.1mm/8.5cm	1
S11003-08	Spring Scissors (Triangular)-S/S Angled/5*0.1mm/8.5cm	1
S12005-10	IRIS-Fine Scissors (Round Type)-S/S Str/10.5cm	1
S12006-10	IRIS-Fine Scissors (Round Type)-S/S Cvd/10.5cm	1
S15006-09	O'BRIEN Stitch Scissors-S/S Angled/10cm	1
F12013-10	Dressing Forceps w/o Serrations-45°Cvd, S/S, 10cm	1
F13019-12	ADSON 1x2 Teeth Tissue Forceps, 1.8mm, 12cm	1
F12005-10	IRIS Dissecting Forceps-Str, 1.0mm Tips, 10cm	1
F12006-10	IRIS Dissecting Forceps-Light Cvd, 1.0mm Tips, 10cm	1
F18011-09	Forceps w/5mm Platform-Str, 0.2mm Tips, 9cm	1
F31047-12	HEGAR Needle Holders with Scissors-Str, 12cm	1
F35401-50	Needle-3/8/3x10/90cm/5-0	10
R21027-12	STEVENS Hooks, 1 Angled Tooth (6mm long), 12.5cm	1
R22029-04	Colibri Eye Specula-30mm spread, 4cm	1
SP0000-P	Instrument Storage Portfolio, 32*22cm	1



SP0007-M
Univeral dissecting Surgery Instrument Kit for Mice

Cat.No.	Product Description	Qty
S12004-09	IRIS-Fine Scissors (Round Type)-S/S Cvd/9.5cm	1
S12005-10	IRIS-Fine Scissors (Round Type)-S/S Str/10.5cm	1
S13003-11	Fine Dissecting Scissors (Flat Type)-B/B Str/11.5cm	1
S13004-11	Fine Dissecting Scissors (Flat Type)-B/B Cvd/11.5cm	1
S15001-09	SPENCER Ligature Scissors (Slender Type)-9cm	1
S32001-12	Scalpel Handles 3# Solid-12.5cm	1
S31015-01	15# Scalpel Blades (Box of 100pcs)	1
F12005-10	IRIS Dissecting Forceps-Str, 1.0mm Tips, 10cm	2
F12006-10	IRIS Dissecting Forceps-Light Cvd, 1.0mm Tips, 10cm	2
F22002-10	HARTMAN Mosquito Forceps-Str, 0.8mm Tips, 10.5cm	2
F22003-10	HARTMAN Mosquito Forceps-Cvd, 1.0mm Tips, 10cm	2
F13029-10	IRIS 1x2 Teeth Tissue Forceps-Str, 1.3mm Tips, 10.5cm	1
F31047-12	OLSEN-HEGAR Needle Holders with Scissors-Str, 12cm	1
F35305-50	PGA Sutures w/Needle-1/2/4x10/90cm/5-0	10
R22005-45	3x3 Teeth Retractors-Blunt, 5cm	1
R31005-04	SS Micro Clamps-Str/L*W 4*0.75mm/16mm	5
R42002-12	Spinal Cord Hook - Tip Dia. 3mm/12cm	1
R34001-14	Clip Applicator for R31005- and R31006-Clamps-14cm	1
SP0000-P	Instrument Storage Portfolio, 32*22cm	1



SP0005-R
Brain Microinjection Surgery Instrument Kit for Rat

Cat.No.	Product Description	Qty
S31011-01	11# Scalpel Blades (Box of 100pcs)	1
S32001-12	Scalpel Handles 3# Solid-12.5cm	1
S12005-10	IRIS-Fine Scissors (Round Type)-S/S Str/10.5cm	1
S12006-10	IRIS-Fine Scissors (Round Type)-S/S Cvd/10.5cm	1
F12010-10	Dressing Forceps-Str, 1.8mm Tips, 10.5cm	2
F12011-10	Dressing Forceps-Cvd, 1.9mm Tips, 10.5cm	2
F22006-12	HALSTED Mosquito Forceps-Str, 1.2mm Tips, 12.5cm	2
F22007-12	HALSTED Mosquito Forceps-Cvd, 1.0mm Tips, 12.5cm	2
F31047-12	OLSEN-HEGAR Needle Holders with Scissors-Str, 12cm	1
S14014-12	Operating Scissors (Round Type)-S/S Str/12.5cm	1
F35205-60	Sutures w/Needle-3/8/2.5x7/30cm/7-0	10
R22009-01	ALM 4x4 Teeth Retractors-Blunt, 7.5cm	1
R51003-11	Micro Spatula w/tip W. 2mm x Thk. 0.3mm - Cvd/11cm	1
SP0000-P	Instrument Storage Portfolio, 32*22cm	1



SP0005-M
Brain Microinjection Surgery Instrument Kit for Mice

Cat.No.	Product Description	Qty
S31011-01	11# Scalpel Blades (Box of 100pcs)	1
S32001-12	Scalpel Handles 3# Solid-12.5cm	1
S12004-09	IRIS-Fine Scissors (Round Type)-S/S Cvd/9.5cm	1
S12005-10	IRIS-Fine Scissors (Round Type)-S/S Str/10.5cm	1
S14014-11	Operating Scissors (Round Type)-S/S Str/11.5cm	1
F12005-10	IRIS Dissecting Forceps-Str, 1.0mm Tips, 10cm	2
F12006-10	IRIS Dissecting Forceps-Light Cvd, 1.0mm Tips, 10cm	2
F22002-10	HARTMAN Mosquito Forceps-Str, 0.8mm Tips, 10.5cm	2
F31047-12	OLSEN-HEGAR Needle Holders with Scissors-Str, 12cm	1
F35205-60	Sutures w/Needle-3/8/2.5x7/30cm/7-0	10
F22003-10	HARTMAN Mosquito Forceps-Cvd, 1.0mm Tips, 10cm	2
R51003-11	Spatula w/tip W. 2mm x Thk. 0.3mm - Cvd/11cm	1
SP0000-P	Instrument Storage Portfolio, 32*22cm	1



SP0006-M
Bone Surgery Instrument Kit for Mice

Cat.No.	Product Description	Qty
S14014-11	Operating Scissors (Round Type)-S/S Str/11.5cm	1
S16014-09	NAIL Scissors (Broad Type)-S/S Str/9cm	1
S21020-14	Friedman-Pearson Rongeurs (SGL)-Str/0.7mm Cup/14cm	1
S22004-11	Bone Cutters with Flat Blades (SGL)-11cm	1
S21023-14	Friedman-Pearson Rongeurs (SGL)-Cvd/0.7mm Cup/14cm	1
S23007-12	LAMBOTTE Osteotomes - 4mm Cutting Edge/12.5cm	1
S33006-13	GRAEFEE Scalpels-4mm Cutting Edge/13cm	1
SP0000-P	Instrument Storage Portfolio, 32*22cm	1



SP0006-R
Bone Surgery Instrument Kit for Rat, Cat, Rabbit etc.

Cat.No.	Product Description	Qty
S14014-14	Operating Scissors (Round Type)-S/S Str/15.5cm	1
S16014-09	NAIL Scissors (Broad Type)-S/S Str/9cm	1
S21021-14	Pearson Rongeurs (SGL)-Str/1.0mm Cup/14cm	1
S22005-12	Bone Cutters with Flat Blades (SGL)-12.5cm	1
S23007-12	LAMBOTTE Osteotomes - 4mm Cutting Edge/12.5cm	1
S23002-16	FREER Chisels - Cvd/4mm Cutting Edge/16cm	1
S33006-13	GRAEFEE Scalpels-4mm Cutting Edge/13cm	1
S21024-14	Pearson Rongeurs (SGL)-Cvd/1.0mm Cup/14cm	1
SP0000-P	Instrument Storage Portfolio, 32*22cm	1



SP0007-C
Universal Dissecting Surgery Instrument Kit for Cat, Rabbit

Cat.No.	Product Description	Qty
S12005-10	IRIS-Fine Scissors (Round Type)-S/S Str/10.5cm	1
S12010-11	IRIS-Fine Scissors (Round Type)-S/S Cvd/11.5cm	1
S12031-11	Standard Scissors (Round Type)-S/S Full Cvd/11.5cm	1
S13005-14	Dissecting Scissors (Round Type)-B/B Str/14.5cm	1
S13006-14	Dissecting Scissors (Round Type)-B/B Cvd/14.5cm	1
F12010-13	Dressing Forceps-Str, 1.3mm Tips, 13cm	2
F12011-13	Dressing Forceps-Cvd, 1.2mm Tips, 13cm	2
F21001-12	HALSTED Artery Forceps-Str, 1.0mm Tips, 12.5cm	2
F21002-12	HALSTED Artery Forceps-Cvd, 1.0mm Tips, 12.5cm	2
S15001-11	SPENCER Ligature Scissors (Slender Type)-11cm	1
S32001-12	Scalpel Handles 3# Solid-12.5cm	1
S31015-01	15# Scalpel Blades (Box of 100pcs)	1
F13014-12	1x2 Teeth Tissue Forceps-Str, 1.2mm Tips, 13cm	1
F31047-14	OLSEN-HEGAR Needle Holders with Scissors-Str, 14cm	1
F35305-50	PGA Sutures w/Needle-1/2/4x10/90cm/5-0	10
R22015-02	WULLSTEIN 3x3 Teeth Retractors-Blunt, 13cm	1
R31008-26	Schwartz Micro Clamps-Str/11*2mm/28mm	5
R42002-12	Spinal Cord Hook - Tip Dia. 3mm/12cm	1
SP0000-P	Instrument Storage Portfolio, 32*22cm	1



SP0007-R
Universal Dissecting Surgery Instrument Kit for Rat

Cat.No.	Product Description	Qty
S12005-10	IRIS-Fine Scissors (Round Type)-S/S Str/10.5cm	1
S12006-10	IRIS-Fine Scissors (Round Type)-S/S Cvd/10.5cm	1
S12010-11	IRIS-Fine Scissors (Round Type)-S/S Cvd/11.5cm	1
S13005-14	Dissecting Scissors (Round Type)-B/B Str/14.5cm	1
S13006-14	Dissecting Scissors (Round Type)-B/B Cvd/14.5cm	1
F21001-12	HALSTED Artery Forceps-Str, 1.0mm Tips, 12.5cm	2
F21002-12	HALSTED Artery Forceps-Cvd, 1.0mm Tips, 12.5cm	2
F12010-10	Dressing Forceps-Str, 1.8mm Tips, 10.5cm	2
F12011-10	Dressing Forceps-Cvd, 1.9mm Tips, 10.5cm	2
F13029-10	IRIS 1x2 Teeth Tissue Forceps-Str, 1.3mm Tips, 10.5cm	1
F31047-12	OLSEN-HEGAR Needle Holders with Scissors-Str, 12cm	1
S15001-11	SPENCER Ligature Scissors (Slender Type)-11cm	1
S32001-12	Scalpel Handles 3# Solid-12.5cm	1
S31015-01	15# Scalpel Blades (Box of 100pcs)	1
F35305-50	PGA Sutures w/Needle-1/2/4x10/90cm/5-0	10
R22009-01	ALM 4x4 Teeth Retractors-Blunt, 7.5cm	1
R31005-06	SS Micro Clamps-Str/L*W 6*1mm/19mm	5
R42002-12	Spinal Cord Hook - Tip Dia. 3mm/12cm	1
R34001-14	Applicator for R31005- and R31006-Clamps-14cm	1
SP0000-P	Instrument Storage Portfolio, 32*22cm	1



SP0008-M
Cardio-cerebral Perfusion Surgery Instrument Kit for Mice

Cat.No.	Product Description	Qty
S14014-11	Operating Scissors (Round Type)-S/S Str/11.5cm	1
S12005-10	IRIS-Fine Scissors (Round Type)-S/S Str/10.5cm	1
S11001-08	Spring Scissors (Triangular)-S/S Str/5*0.1mm/8.5cm	1
F12007-10	IRIS Dissecting Forceps-Large Cvd, 0.9mm Tips, 10cm	1
F12010-09	Dressing Forceps-Str, 1.8mm Tips, 9.5cm	2
F22002-10	HARTMAN Mosquito Forceps-Str, 0.8mm Tips, 10.5cm	2
F22003-10	HARTMAN Mosquito Forceps-Cvd, 1.0mm Tips, 10cm	2
F35305-50	PGA Sutures w/Needle-1/2/4x10/90cm/5-0	10
F35205-60	Sutures w/Needle-3/8/2.5x7/30cm/7-0	10
R21027-12	STEVENS Hooks, 1 Angled Tooth (6mm long), 12.5cm	1
R22005-45	3x3 Teeth Retractors-Blunt, 5cm	1
F31047-12	OLSEN-HEGAR Needle Holders with Scissors-Str, 12cm	1
R31005-04	SS Micro Clamps-Str/L*W 4*0.75mm/16mm	5
R34001-14	Clip Applicator for R31005- and R31006-Clamps-14cm	1
R42002-12	Spinal Cord Hook - Tip Dia. 3mm/12cm	1
SP0000-P	Instrument Storage Portfolio, 32*22cm	1



SP0008-R
Cardio-cerebral Perfusion Surgery Instrument Kit for Rat

Cat.No.	Product Description	Qty
S14014-12	Operating Scissors (Round Type)-S/S Str/12.5cm	1
S12005-10	IRIS-Fine Scissors (Round Type)-S/S Str/10.5cm	1
S11002-08	Spring Scissors (Triangular)-S/S Str/5*0.1mm/8.5cm	1
F12007-10	IRIS Dissecting Forceps-Large Cvd, 0.9mm Tips, 10cm	1
F12005-10	IRIS Dissecting Forceps-Str, 1.0mm Tips, 10cm	2
F22006-12	HALSTED Mosquito Forceps-Str, 1.2mm Tips, 12.5cm	2
F22007-12	HALSTED Mosquito Forceps-Cvd, 1.0mm Tips, 12.5cm	2
F35305-50	PGA Sutures w/Needle-1/2/4x10/90cm/5-0	10
F35205-60	Sutures w/Needle-3/8/2.5x7/30cm/7-0	10
R21027-12	STEVENS Hooks, 1 Angled Tooth 6mm long), 12.5cm	1
R22005-45	3x3 Teeth Retractors-Blunt, 4.5cm	1
F31047-12	OLSEN-HEGAR Needle Holders with Scissors-Str, 12cm	1
R31005-06	SS Micro Clamps-Str/L*W 4*0.75mm/13mm	5
R42002-12	Spinal Cord Hook - Tip Dia. 3mm/12cm	1
R34001-14	Clip Applicator for R31005- and R31006-Clamps-14cm	1
SP0000-P	Instrument Storage Portfolio, 32*22cm	1



SP0009-R
General Surgery Instrument Kit for Rat

Cat.No.	Product Description	Qty
F11020-11	Micro Forceps-Str, 0.05mmx0.01mm Tips, 11cm	1
F11021-11	Micro Forceps-45°Angled, 0.10x0.06mm Tips, 11cm	1
S32001-12	Scalpel Handles 3# Solid-12.5cm	1
S31011-01	11# Scalpel Blades (Box of 100pcs)	1
F35401-50	Needle-ø3/8/3x10/90cm/5-0	10
F35205-60	Needle-ø3/8/2.5x7/30cm/7-0	10
F31047-12	OLSEN-HEGAR Needle Holders with Scissors-Str, 12cm	1
S11001-08	Spring Scissors (Triangular)-S/S Str/5*0.1mm/8.5cm	1
S11002-08	Spring Scissors (Triangular)-S/S Cvd/5*0.1mm/8.5cm	1
R22009-01	ALM 4x4 Teeth Retractors-Blunt, 7.5cm	1
F12005-10	IRIS Dissecting Forceps-Str, 1.0mm Tips, 10cm	1
F12006-10	IRIS Dissecting Forceps-Light Cvd, 1.0mm Tips, 10cm	1
F12007-10	IRIS Dissecting Forceps-Large Cvd, 0.9mm Tips, 10cm	1
F13029-10	IRIS 1x2 Teeth Tissue Forceps-Str, 1.3mm Tips, 10.5cm	1
S12009-11	IRIS-Fine Scissors (Round Type)-S/S Str/11.5cm	1
S12010-11	IRIS-Fine Scissors (Round Type)-S/S Cvd/11.5cm	1
F21001-12	HALSTED Artery Forceps-Str, 1.0mm Tips, 12.5cm	1
F21002-12	HALSTED Artery Forceps-Cvd, 1.0mm Tips, 12.5cm	1
SP0000-P	Instrument Storage Portfolio, 32*22cm	1



SP0009-M
General Surgery Instrument Kit for Mouse

Cat.No.	Product Description	Qty
F11020-11	Micro Forceps-Str, 0.05mmx0.01mm Tips, 11cm	1
F11021-11	Micro Forceps-45°Angled, 0.10x0.06mm Tips, 11cm	1
S32001-12	Scalpel Handles 3# Solid-12.5cm	1
S31011-01	11# Scalpel Blades (Box of 100pcs)	1
F35401-50	NA Terylene Sutures w/Needle-ø3/8/3x10/90cm/5-0	10
F31047-12	OLSEN-HEGAR Needle Holders with Scissors-Str, 12cm	1
S11001-08	VANNAS Spring Scissors (Triangular)-S/S Str/5*0.1mm/8.5cm	1
S11002-08	VANNAS Spring Scissors (Triangular)-S/S Cvd/5*0.1mm/8.5cm	1
R22029-04	Colibri Eye Specula-30mm spread, 4cm	1
F12005-10	IRIS Dissecting Forceps-Str, 1.0mm Tips, 10cm	1
F12006-10	IRIS Dissecting Forceps-Light Cvd, 1.0mm Tips, 10cm	1
F12007-10	IRIS Dissecting Forceps-Large Cvd, 0.9mm Tips, 10cm	1
F13029-10	IRIS 1x2 Teeth Tissue Forceps-Str, 1.3mm Tips, 10.5cm	1
S12004-09	IRIS-Fine Scissors (Round Type)-S/S Cvd/9.5cm	1
S12005-10	IRIS-Fine Scissors (Round Type)-S/S Str/10.5cm	1
F22002-10	HARTMAN Mosquito Forceps-Str, 0.8mm Tips, 10.5cm	1
F22003-10	HARTMAN Mosquito Forceps-Cvd, 1.0mm Tips, 10cm	1
SP0000-P	Instrument Storage Portfolio, 32*22cm	1



SP0010-B
Basic Surgical Instrument Kit for Rat & Mice

Cat.No.	Product Description	Qty
S11001-08	VANNAS Spring Scissors (Triangular)-S/S Str/5*0.1mm/8.5cm	1
S12005-10	IRIS-Fine Scissors (Round Type)-S/S Str/10.5cm	1
F12005-10	IRIS Dissecting Forceps-Str, 1.0mm Tips, 10cm	1
F12006-10	IRIS Dissecting Forceps-Light Cvd, 1.0mm Tips, 10cm	1
F11020-11	Micro Forceps-Str, 0.05mmx0.01mm Tips, 11cm	1
F22002-10	HARTMAN Mosquito Forceps-Str, 0.8mm Tips, 10cm	1
F22003-10	HARTMAN Mosquito Forceps-Cvd, 1.0mm Tips, 10cm	1
F31047-12	OLSEN-HEGAR Needle Holders with Scissors-Str, 12cm	1
S33007-12	ZIEGLER Knives-8mm Cutting Edge/1.5mm Width/12cm	1
R31005-06	SS Micro Clamps-Str/L*W 6*1mm/19mm	1
R31006-06	SS Micro Clamps-Cvd/L*W 6.6*1mm/17mm	1
SP0000-P	Instrument Storage Portfolio, 32*22cm	1



Sterilizer

The sterilizer provides a safe, convenient and affective method for sterilizing your surgical instruments before and during surgery, ensuring the tools free of pathogens and microbial contaminants.

The highest temperature can reach 300 °C. The surgical instrument could sterilized completed Within 5 seconds.

Order Information:

Cat No.	Product Name
RS1501	150g Glass Bead Sterilizer-4x8cm(110V)
RS1502	150g Glass Bead Sterilizer-4x8cm(220V)
RS3001	300g Glass Bead Sterilizer-4x14cm(110V)
RS3002	300g Glass Bead Sterilizer-4x14cm(220V)
RS1500	Glass Beads for Sterilizer, 1500g



Surgical Instruments

Note: the price of the surgical instruments as noted in this product manual will fluctuate with the market price, and the final price will be subject to the quotation of the company.

★The size of the picture is 1:1 to the actual size.

Micro Spring Scissors



Cat No.	Description of Blade	Cutting Edge (Length)	Cutting Edge (Width)	Total Length
S11001-08	Straight Sharp&Sharp	7.5mm	1.5mm	8.5cm
S11002-08	Curved Sharp&Sharp	6mm	1.5mm	8.5cm
S11003-08	Curved Sharp&Sharp	8mm	1.5mm	8.5cm



Cat No.	Description of Blade	Cutting Edge (Length)	Cutting Edge (Width)	Total Length
S11035-08	Straight Sharp&Sharp	3.5mm	1.0mm	8.0cm
S11036-08	Straight Sharp&Sharp	8mm	2.0mm	8.0cm
S11037-08	Curved Sharp&Sharp	8mm	2.0mm	8.0cm

Micro Spring Scissors



Cat No.	Description of Blade	Cutting Edge (Length)	Cutting Edge (Width)	Total Length
S11005-09	Curved Blunt&Blunt	9mm	3.5mm	9.5cm



Cat No.	Description of Blade	Cutting Edge (Length)	Cutting Edge (Width)	Total Length
S11029-12	Curved Blunt&Blunt	11mm	2mm	11.5cm



S11024-11

Cat No.	Description of Blade	Cutting Edge (Length)	Cutting Edge (Width)	Total Length
S11024-11	Curved Sharp&Sharp	17mm	3.5mm	11.5cm



S11014-12

Cat No.	Description of Blade	Cutting Edge (Length)	Cutting Edge (Width)	Total Length
S11014-12	Straight Sharp&Sharp	5mm	1.7mm	12.5cm

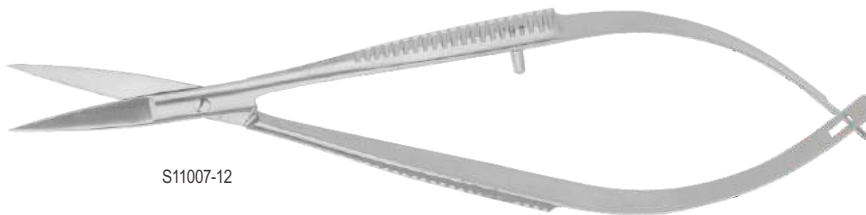

S11007-12

Cat No.	Description of Blade	Cutting Edge (Length)	Cutting Edge (Width)	Total Length
S11007-12	Straight Sharp&Sharp	18mm	4mm	11.5cm

Delicate Scissors

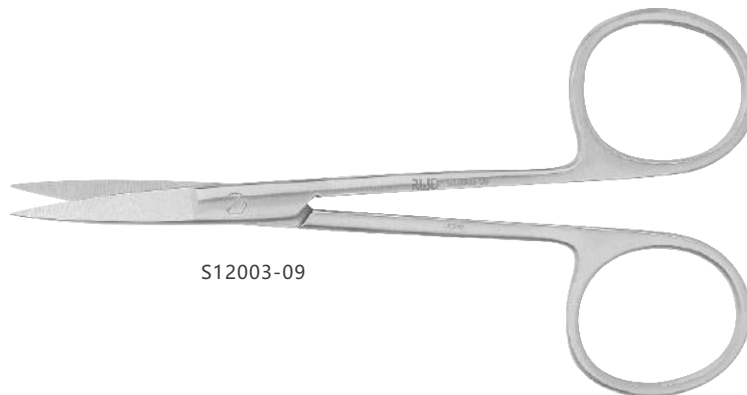

S12003-09

Cat No.	Description of Blade	Cutting Edge (Length)	Cutting Edge (Width)	Total Length
S12003-09	Straight Sharp&Sharp	25mm	4mm	9cm
S12005-10	Straight Sharp&Sharp	22mm	5mm	10.5cm
S12009-11	Straight Sharp&Sharp	25mm	6mm	11.5cm
S12014-13	Straight Sharp&Sharp	31mm	8mm	13cm



S12004-09

Cat No.	Description of Blade	Cutting Edge (Length)	Cutting Edge (Width)	Total Length
S12004-09	Curved Sharp&Sharp	24mm	4.5mm	9.5cm
S12006-10	Curved Sharp&Sharp	23mm	4.5mm	10.5cm
S12010-11	Curved Sharp&Sharp	26mm	5.5mm	11.5cm
S12015-13	Curved Sharp&Sharp	26mm	7mm	13cm

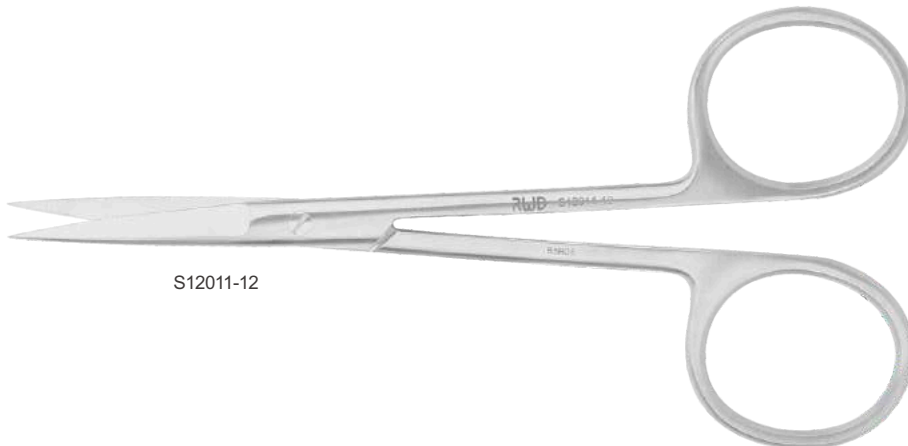

S12011-12



S12012-12

Cat No.	Description of Blade	Cutting Edge (Length)	Cutting Edge (Width)	Total Length
S12011-12	Straight Sharp&Sharp	31mm	5.5mm	12cm
S12012-12	Curved Sharp&Sharp	26mm	5mm	11.5cm

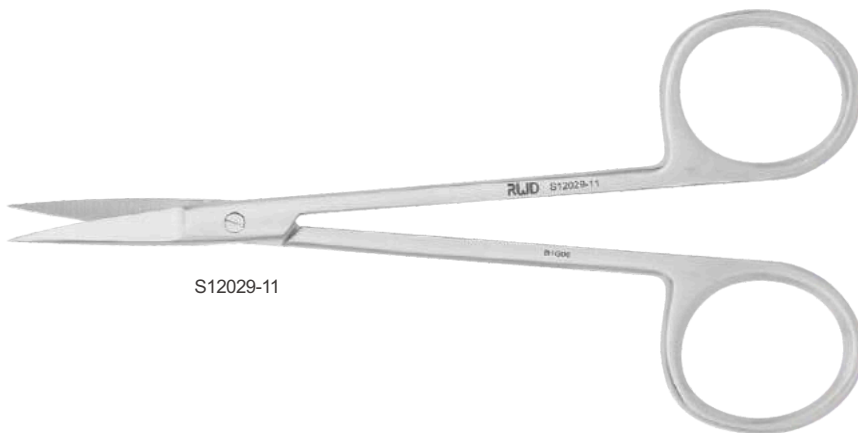

S12029-11



S12030-11

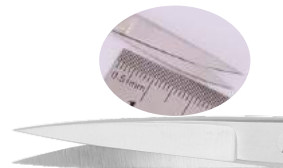

S12031-11

Cat No.	Description of Blade	Cutting Edge (Length)	Cutting Edge (Width)	Total Length
S12029-11	Straight Sharp&Sharp	23mm	6mm	11.5cm
S12030-11	Curved Sharp&Sharp	23mm	5.5mm	11.5cm
S12031-11	Curved Sharp&Sharp	29mm	6mm	11.5cm
S12034-12	Straight Sharp&Sharp	17mm	6mm	12.5cm

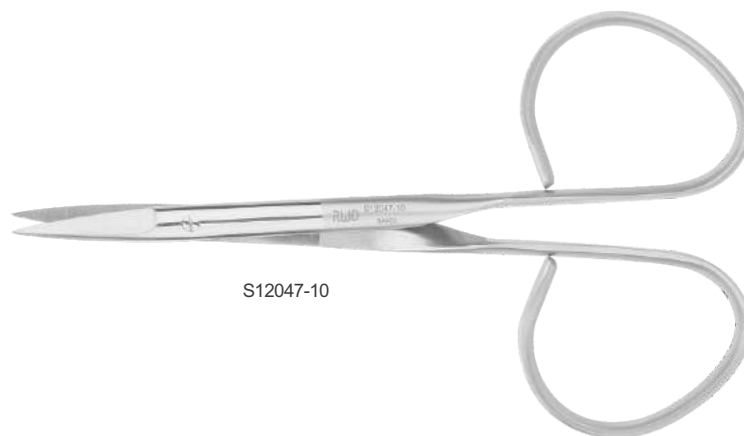

S12047-10

Cat No.	Description of Blade	Cutting Edge (Length)	Cutting Edge (Width)	Total Length
S12047-10	Straight Sharp&Sharp	18mm	4.5mm	10cm



S18001-09



S18002-09

Cat No.	Description of Blade	Cutting Edge (Length)	Cutting Edge (Width)	Total Length
S18001-09	Straight Sharp&Sharp (Teeth)	22mm	5mm	9cm
S18001-10	Straight Sharp&Sharp (Teeth)	24mm	5mm	10cm
S18001-11	Straight Sharp&Sharp (Teeth)	25mm	5mm	11.5cm
S18002-09	Curved Sharp&Sharp (Teeth)	20mm	5mm	9cm
S18002-10	Curved Sharp&Sharp (Teeth)	23mm	5mm	10cm
S18002-11	Curved Sharp&Sharp (Teeth)	25mm	6mm	11.5cm



S18004-09



S18005-09

Cat No.	Description of Blade	Cutting Edge (Length)	Cutting Edge (Width)	Total Length
S18004-09	Curved Sharp&Sharp	21mm	5mm	9cm
S18004-10	Curved Sharp&Sharp	22mm	5mm	10.5cm
S18004-11	Curved Sharp&Sharp	22mm	5mm	11.5cm
S18005-09	Straight Sharp&Sharp	20mm	4.5mm	9cm
S18005-10	Straight Sharp&Sharp	22mm	5mm	10.5cm
S18005-11	Straight Sharp&Sharp	24mm	5mm	11.5cm

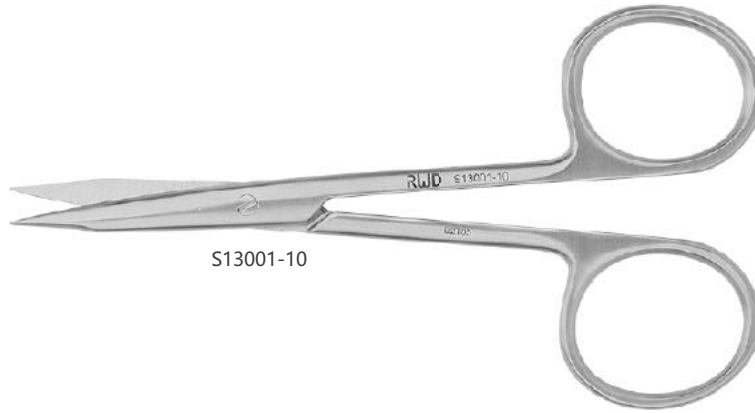

S13001-10

Cat No.	Description of Blade	Cutting Edge (Length)	Cutting Edge (Width)	Total Length
S13001-10	Straight Sharp&Sharp	26mm	6mm	6cm



S13003-11



S13004-11

Cat No.	Description of Blade	Cutting Edge (Length)	Cutting Edge (Width)	Total Length
S13003-11	Straight Blunt&Blunt	25mm	5mm	11.5cm
S13004-11	Curved Blunt&Blunt	28mm	5mm	11.5cm

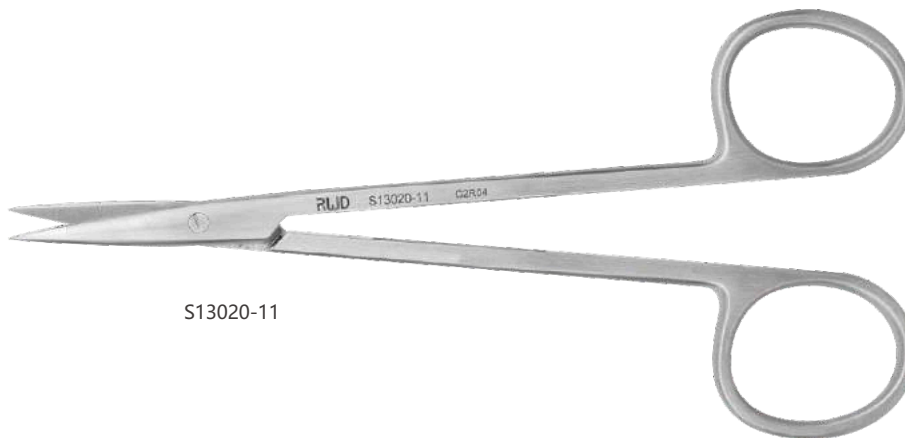

S13020-11

Cat No.	Description of Blade	Cutting Edge (Length)	Cutting Edge (Width)	Total Length
S13020-11	Straight Sharp&Sharp	20mm	5mm	12cm

Dissecting Scissors

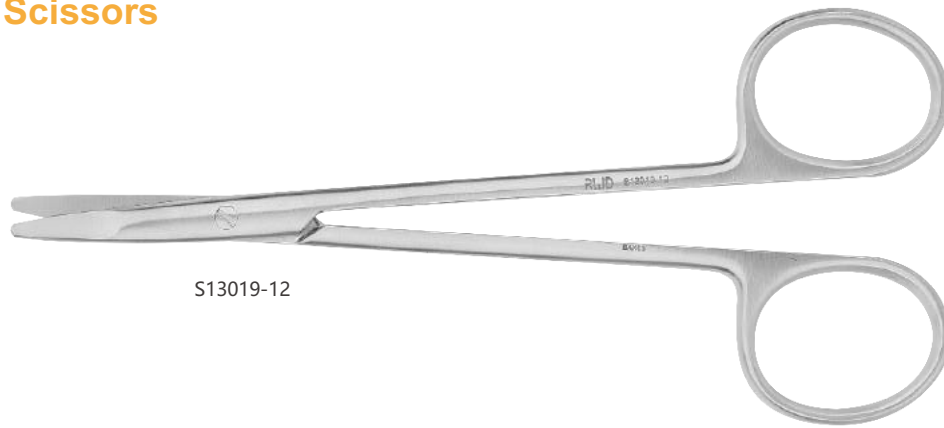

S13019-12

Cat No.	Description of Blade	Cutting Edge (Length)	Cutting Edge (Width)	Total Length
S13019-12	Curved Blunt&Blunt	25mm	4.5mm	12.5cm



Cat No.	Description of Blade	Cutting Edge (Length)	Cutting Edge (Width)	Total Length
S13027-18	Straight Blunt&Blunt	35mm	7mm	18cm

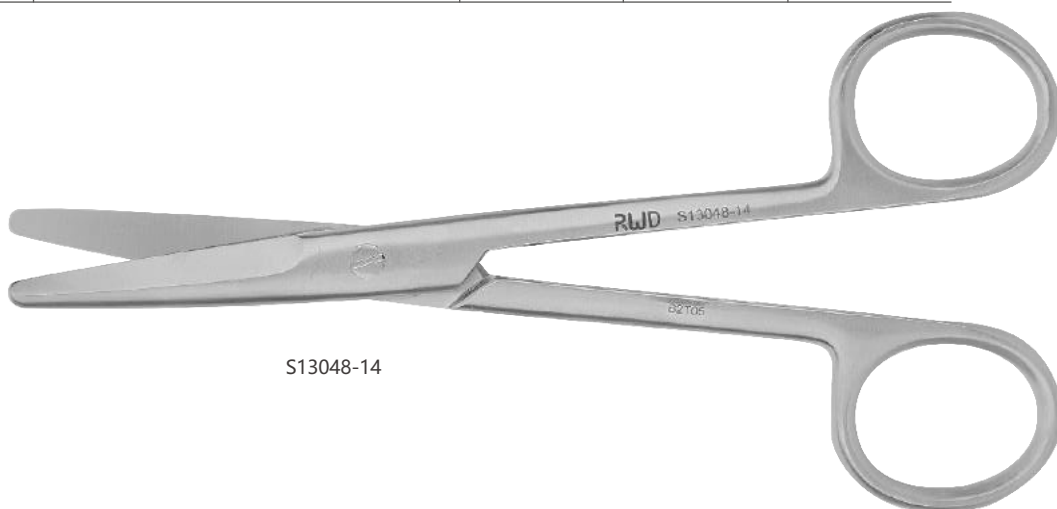

S13048-14

Cat No.	Description of Blade	Cutting Edge (Length)	Cutting Edge (Width)	Total Length
S13048-14	Curved Blunt&Blunt	32mm	9mm	14cm



S13035-16

Cat No.	Description of Blade	Cutting Edge (Length)	Cutting Edge (Width)	Total Length
S13035-16	Straight Blunt&Blunt	45mm	9.5mm	16.5cm



S13047-14

Cat No.	Description of Blade	Cutting Edge (Length)	Cutting Edge (Width)	Total Length
S13047-14	Straight Blunt&Blunt	43mm	10mm	14.5cm



S13029-14

Cat No.	Description of Blade	Cutting Edge (Length)	Cutting Edge (Width)	Total Length
S13029-14	Straight Blunt&Blunt	37mm	9mm	14cm
S13030-14	Curved Blunt&Blunt	41mm	9.5mm	14cm

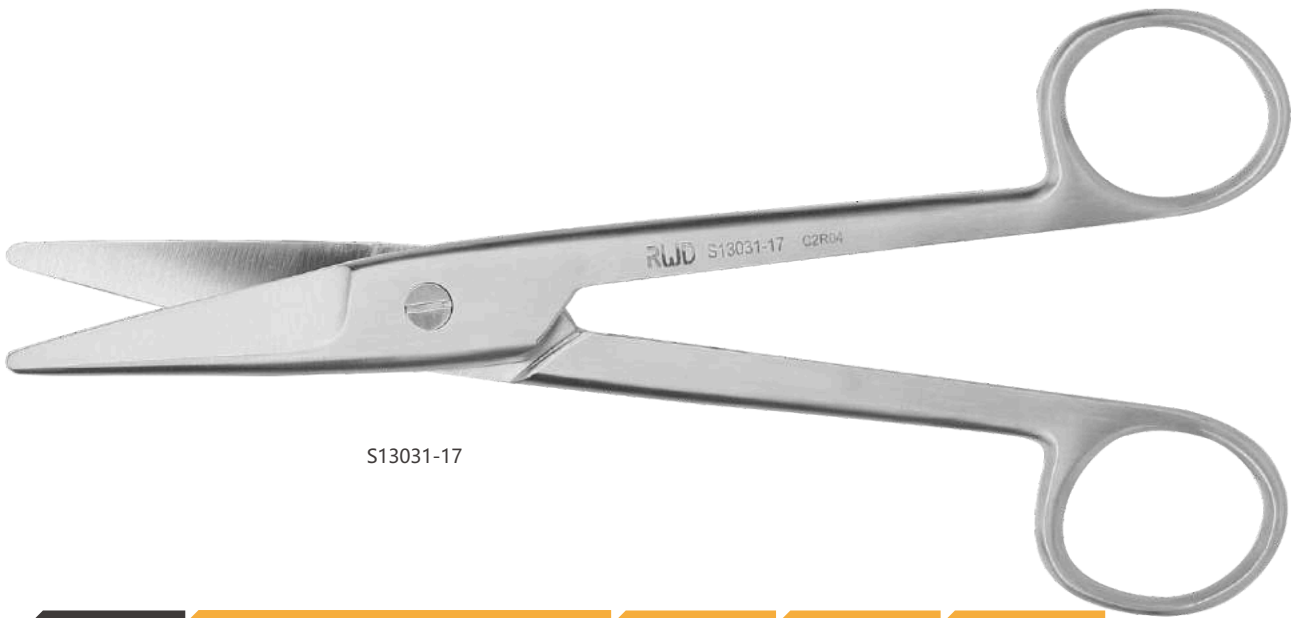

S13031-17

Cat No.	Description of Blade	Cutting Edge (Length)	Cutting Edge (Width)	Total Length
S13031-17	Straight Blunt&Blunt	50mm	13mm	17cm



S13038-14

Cat No.	Description of Blade	Cutting Edge (Length)	Cutting Edge (Width)	Total Length
S13038-14	Straight Blunt&Blunt	41mm	10mm	14.5cm

Surgical Scissors

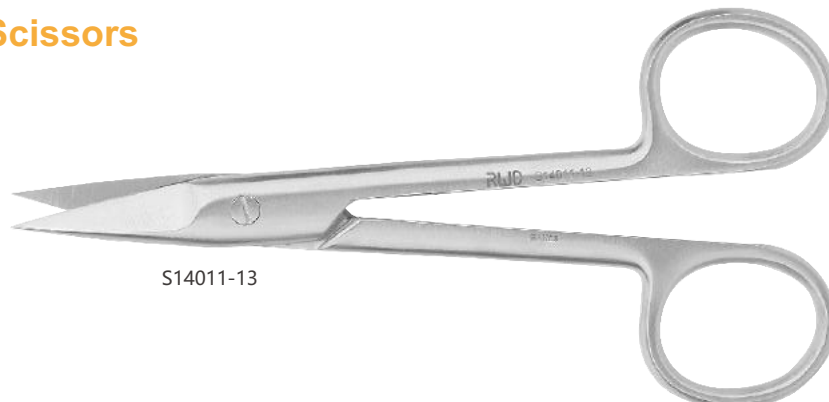

S14011-13

Cat No.	Description of Blade	Cutting Edge (Length)	Cutting Edge (Width)	Total Length
S14011-13	Straight Sharp&Sharp	28mm	10mm	13cm



S14016-11

Cat No.	Description of Blade	Cutting Edge (Length)	Cutting Edge (Width)	Total Length
S14016-11	Curved Sharp&Sharp	34mm	7.5mm	11.5cm



S14002-10

Cat No.	Description of Blade	Cutting Edge (Length)	Cutting Edge (Width)	Total Length
S14002-10	Curved Sharp&Blunt	30mm	7mm	10cm
S14002-13	Curved Sharp&Blunt	42mm	8.5mm	13cm
S14002-14	Curved Sharp&Blunt	47mm	10mm	14.5cm

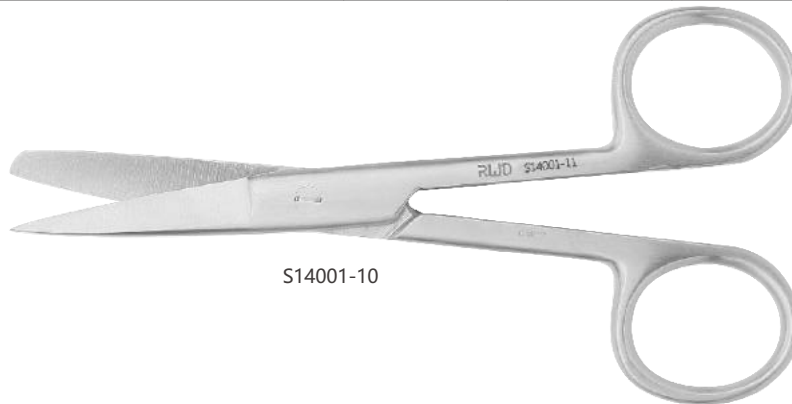

S14001-10

Cat No.	Description of Blade	Cutting Edge (Length)	Cutting Edge (Width)	Total Length
S14001-10	Straight Sharp & Blunt	33mm	7.5mm	10.5cm
S14001-11	Straight Sharp & Blunt	35mm	8.5mm	11.5cm
S14001-13	Straight Sharp & Blunt	40.5mm	9.4mm	13cm
S14001-14	Straight Sharp & Blunt	48mm	10mm	14.5cm
S14001-15	Straight Sharp & Blunt	48mm	10mm	15.5cm
S14001-16	Straight Sharp & Blunt	53mm	10mm	16.5cm



S14014-10

Cat No.	Description of Blade	Cutting Edge (Length)	Cutting Edge (Width)	Total Length
S14014-10	Straight Sharp&Sharp	33mm	8.5mm	10.5cm
S14014-11	Straight Sharp&Sharp	35mm	8.5mm	11.5cm
S14014-12	Straight Sharp&Sharp	38mm	8.5mm	12.5cm
S14014-13	Straight Sharp&Sharp	45mm	9.8mm	13cm
S14014-14	Straight Sharp&Sharp	47mm	9mm	14.5cm
S14014-15	Straight Sharp&Sharp	48mm	10mm	15.5cm
S14014-16	Straight Sharp&Sharp	52mm	10mm	16cm
S14014-17	Straight Sharp&Sharp	57mm	12.5mm	17.5cm



S14015-10

Cat No.	Description of Blade	Cutting Edge (Length)	Cutting Edge (Width)	Total Length
S14015-10	Straight Blunt&Blunt	35mm	7.5mm	10.5cm
S14015-11	Straight Blunt&Blunt	36mm	8mm	11.5cm
S14015-12	Straight Blunt&Blunt	37mm	8.5mm	12.5cm
S14015-14	Straight Blunt&Blunt	46mm	9.5mm	14.5cm
S14015-16	Straight Blunt&Blunt	54mm	11.5mm	16.5cm
S14015-17	Straight Blunt&Blunt	54mm	11.5mm	17.5cm



S14017-10

Cat No.	Description of Blade	Cutting Edge (Length)	Cutting Edge (Width)	Total Length
S14017-10	Curved Blunt&Blunt	33mm	7.5mm	10.5cm
S14017-16	Curved Blunt&Blunt	51mm	10.5mm	16cm



S14003-14

Cat No.	Description of Blade	Cutting Edge (Length)	Cutting Edge (Width)	Total Length
S14003-14	Straight sharp & blunt	47mm	9.5mm	14.5cm



S15006-09

Cat No.	Description of Blade	Cutting Edge (Length)	Cutting Edge (Width)	Total Length
S15006-09	Curved sharp & sharp	14mm	4cm	10cm

Ligature Scissors

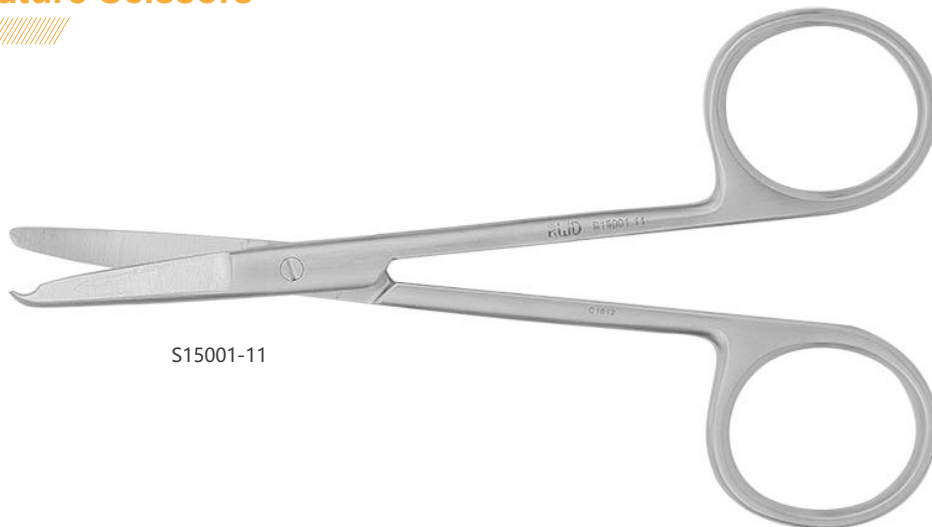

S15001-11

Cat No.	Description of Blade	Cutting Edge (Length)	Cutting Edge (Width)	Total Length
S15001-11		25mm	5.5mm	11cm
S15001-09		22mm	4mm	9cm

Bone Cutters



S16001-10

Cat No.	Description of Blade	Cutting Edge (Length)	Cutting Edge (Width)	Total Length
S16001-10	Straight	18mm	10mm	10.5cm

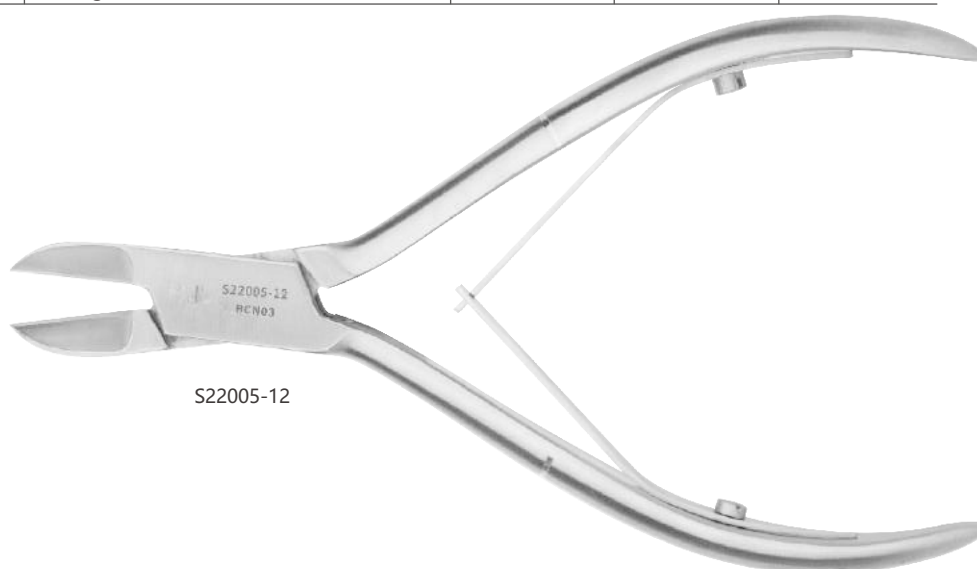

S22005-12

Cat No.	Description of Blade	Cutting Edge (Length)	Cutting Edge (Width)	Total Length
S22005-12	plane	16mm	5mm	12.5cm
S22004-11	plane	12mm	4mm	11cm

Bone Chisel



S23002-16



S23007-12

Cat No.	Description of Blade	Cutting Edge (Length)	Cutting Edge (Width)	Total Length
S23002-16	Curved	12mm	4mm	16cm
S23007-12			4mm	12.5cm

scalpel



S33007-12



S33006-13

Cat No.	Description of Blade	Cutting Edge (Length)	Cutting Edge (Width)	Total Length
S33007-12		8mm	1.5mm	12cm
S33006-13		25mm	3mm	13cm

Surgical Handles



S32001-12 (matches 10#, 11#, 12#, 15# blades)



S32003-12 (matches 10#, 11#, 12#, 15# blades)



S32004-13 (matches 20#, 21#, 22#, 23# blades)



S32005-12

(matches 10#, 11#, 12#, 15# blades)

Cat No.		Total Length
S32001-12	3#(Standard)	12cm
S32003-12	3#(Ruler)	12.5cm

Cat No.		Total Length
S32004-13	4#(Standard)	14cm
S32005-12	7#	12.5cm

Surgical Blades



Cat No.		
S31010-01	10#	Box of 100pcs



Cat No.		
S31011-01	11#	Box of 100pcs



Cat No.		
S31012-01	12#	Box of 100pcs



Cat No.		Total Length
S31015-01	15#	Box of 100pcs



Cat No.		
S31023-02	23#	Box of 100pcs



Cat No.		Total Length
S33009-06	Blade Remover	6.5cm

Delicate Forceps



F11001-11

Cat No.	Tip Shape	Tip Length	Tip Width	Tip Thickness	Total Length
F11001-11	Straight	30mm	0.20mm	0.12mm	11cm
F11002-11	Straight	36mm	0.15mm	0.1mm	11cm
F11001-13	Straight	33mm	0.15mm	0.1mm	13cm
F11020-11	Straight	36mm	0.05mm	0.01mm	11cm



F11003-11

Cat No.	Tip Shape	Tip Length	Tip Width	Tip Thickness	Total Length
F11003-11	45°Curved	8mm	0.3mm	0.15mm	11cm
F11021-11	45°Curved	8mm	0.10mm	0.06mm	11cm
F11003-13	45°Curved	8mm	0.15mm	0.1mm	13cm



F13002-11

Cat No.	Tip Shape	Tip Length	Tip Width	Tip Thickness	Total Length
F13002-11	Straight	30mm	0.30mm	0.1mm	11cm



F13004-11

Cat No.	Tip Shape	Tip Length	Tip Width	Tip Thickness	Total Length
F13004-11	Curved	32mm	0.3mm	0.15mm	11.5cm
F11004-11	Curved	30mm	0.15mm	0.1mm	11cm
F11022-11	Curved	32mm	0.1mm	0.06mm	11cm



F11008-09

Cat No.	Tip Shape	Tip Width	Tip Thickness	Total Length
F11008-09	1x2Teeth 5mm Platform	0.2mm	0.2mm	9.5cm



F11014-11

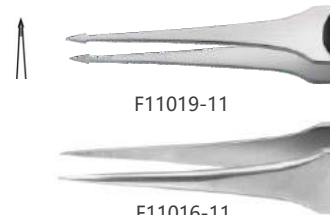

F11019-11

F11016-11

Cat No.	Tip Shape	Tip Length	Tip Width	Tip Thickness	Total Length
F11014-11	Straight	33.5mm	0.15mm	0.05mm	11cm
F11019-11	Straight	33.5mm	0.3mm	0.1mm	11cm
F11016-11	Straight	33.5mm	0.3mm	0.15mm	11cm



F11027-13

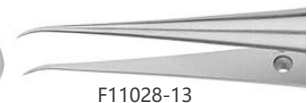

F11028-13

Cat No.	Tip Shape	Tip Length	Tip Loidth	Tip Thickness	Total Length
F11027-13	Straight	38mm	0.1mm	0.06mm	13cm
F11028-13	Curved	38mm	0.1mm	0.06mm	13cm



F11029-11



F11030-11

F11031-11

Cat No.	Tip Shape	Tip Length	Tip Width	Tip Thickness	Total Length
F11029-11	Straight Titanium Alloy	30mm	0.05mm	0.03mm	11cm
F11030-11	45°Curved Titanium Alloy	32mm	0.1mm	0.06mm	11cm
F11031-11	Curved Titanium Alloy	35.5mm	0.07mm	0.03mm	11cm

Dissecting Forceps



Cat No.	Tip Shape	Tip Length	Tip Width	Total Length
F12002-12	Dissecting Forceps	11.5mm	0.6mm	12cm
F12003-12	Dissecting Forceps	18mm	1.5mm	12cm

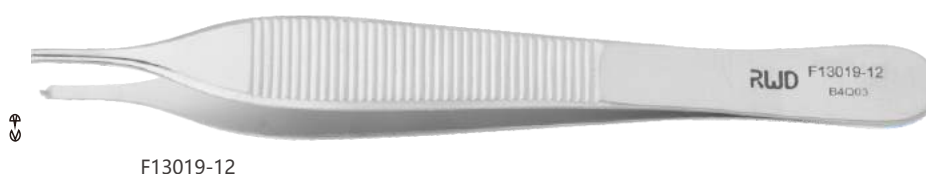

Cat No.	Tip Shape	Tip Length	Tip Width	Total Length
F13019-12	Straight 1x2Teeth		1.8mm	12cm

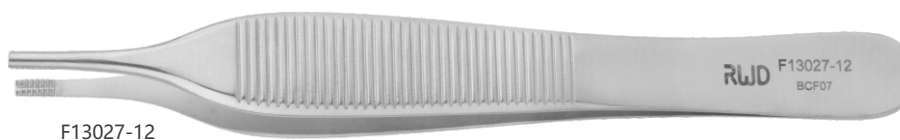

Cat No.	Tip Shape	Tip Length	Tip Width	Total Length
F13027-12	7x7Teeth Straight	4mm	2.3mm	12cm

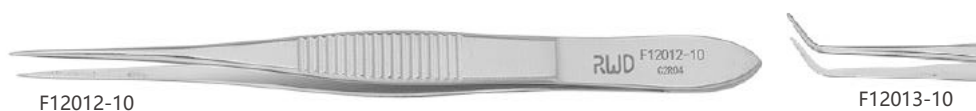

Cat No.	Tip Shape	Tip Length	Tip Width	Total Length
F12012-10	Straight Not Teeth		0.4mm	10cm
F12013-10	45°Curved Not Teeth	7.5mm	0.5mm	10cm



Cat No.	Tip Shape	Tip Length	Tip Width	Total Length
F15007-15	50°Curved	13mm	1.2mm	15cm



F14009-10



F15017-14

Cat No.	Tip Shape	Tip Length	Tip Width	Total Length
F14009-10	Curved	7mm	1mm	10.5cm
F15017-14	Straight	17mm	1.5mm	15.5cm



F12010-09

Cat No.	Tip Shape	Tip Length	Tip Width	Total Length
F12010-09	Straight	13mm	1.8mm	9.5cm
F12010-10	Straight	15mm	1.8mm	10.5cm
F12010-11	Straight	16mm	2.5mm	11.5cm
F12010-13	Straight	17mm	1.3mm	13cm



F12011-09

Cat No.	Tip Shape	Tip Length	Tip Width	Total Length
F12011-09	Curved	11mm	1.8mm	9.5cm
F12011-10	Curved	17mm	1.9mm	10.5cm
F12011-13	Curved	15mm	1.2mm	13cm



F12019-10

Cat No.	Tip Shape	Tip Length	Tip Width	Total Length
F12019-10	Straight	15mm	2.0mm	10.5cm
F12019-11	Straight	16.5mm	1.9mm	11.5cm
F12019-13	Straight	18mm	2.0mm	13cm
F12019-16	Straight	20mm	1.8mm	16cm



F13029-10



F13030-10

Cat No.	Tip Shape	Tip Length	Tip Width	Total Length
F13029-10	Straight		1.3mm	10.5cm
F13030-10	Curved		1.3mm	10.5cm
F13009-11	Straight		1.6mm	11cm



F12018-10

Cat No.	Tip Shape	Tip Length	Tip Width	Total Length
F12018-14	Straight	19mm	2.2mm	10.5cm



F12016-15



F12029-09

Cat No.	Tip Shape	Tip Length	Tip Width	Total Length
F12016-15	Straight	18mm	1.4mm	15.5cm
F12029-09	Straight	13mm	0.8mm	9.5cm



F13014-12

Cat No.	Tip Shape	Tip Length	Tip Width	Total Length
F13014-12	Straight 1x2Teeth		1.2mm	13cm

Ophthalmic forceps



F12005-10



F12006-10



F12007-10



F14012-10

Cat No.	Tip Shape	Tip Length	Tip Width	Total Length
F12005-10	Straight	14mm	1.0mm	10cm
F12006-10	Curved	13.5mm	1.0mm	10cm
F12007-10	Curved	10mm	0.9mm	10cm
F14012-10	Curved		0.5mm	10cm

Tissue Forceps



F13023-14

Cat No.	Tip Shape	Tip Length	Tip Width	Total Length
F13023-14	Straight 1x2Teeth		1.8mm	14cm



F13028-15

Cat No.	Tip Shape	Tip Length	Tip Width	Total Length
F13028-15	Straight circinal	9.5mm	7.0mm	15cm



F18003-12

Cat No.	Tip Shape	Tip Length	Tip Width	Total Length
F18003-12	Straight		0.5mm	12cm



F18011-09

Cat No.	Tip Shape	Tip Length	Tip Width	Total Length
F18011-09	Straight	16mm	0.2mm	9cm

Glass Cover Forceps



F18015-10



F18001-10

Cat No.	Tip Shape	Tip Length	Tip Width	Total Length
F18015-10	Straight	11mm	4.0mm	10.5cm
F18001-10	Curved	12mm	4.7mm	10.5cm

Tissue Forceps

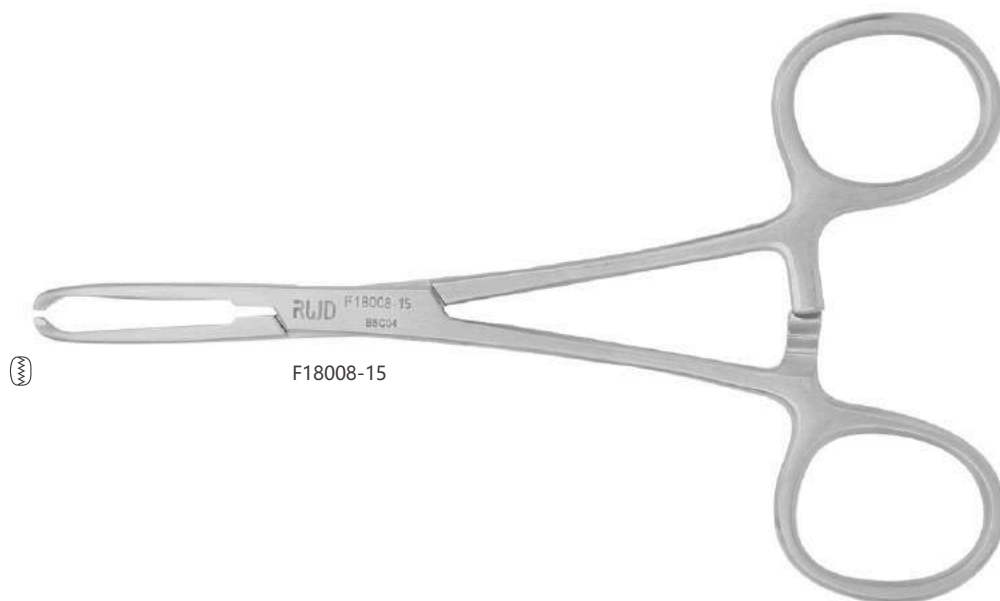

F18008-15

Cat No.	Tip Shape	Tip Length	Tip Width	Total Length
F18008-15	Straight 4x5Teeth	39mm	5mm	15.0cm
F18009-15	Straight 5x6Teeth	44mm	5mm	15.5mm



F21002-12

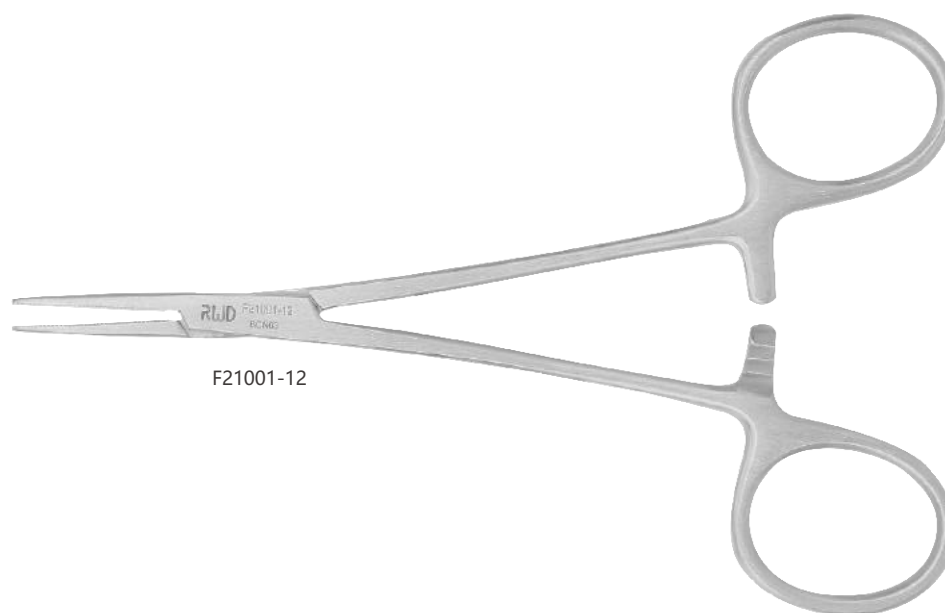

F21001-12

Cat No.	Tip Shape	Tip Length	Tip Width	Total Length
F21001-12	Straight	21mm	1.0mm	12.5cm
F21002-12	Curved	21mm	1.0mm	12.5cm

Haemostatic Forceps

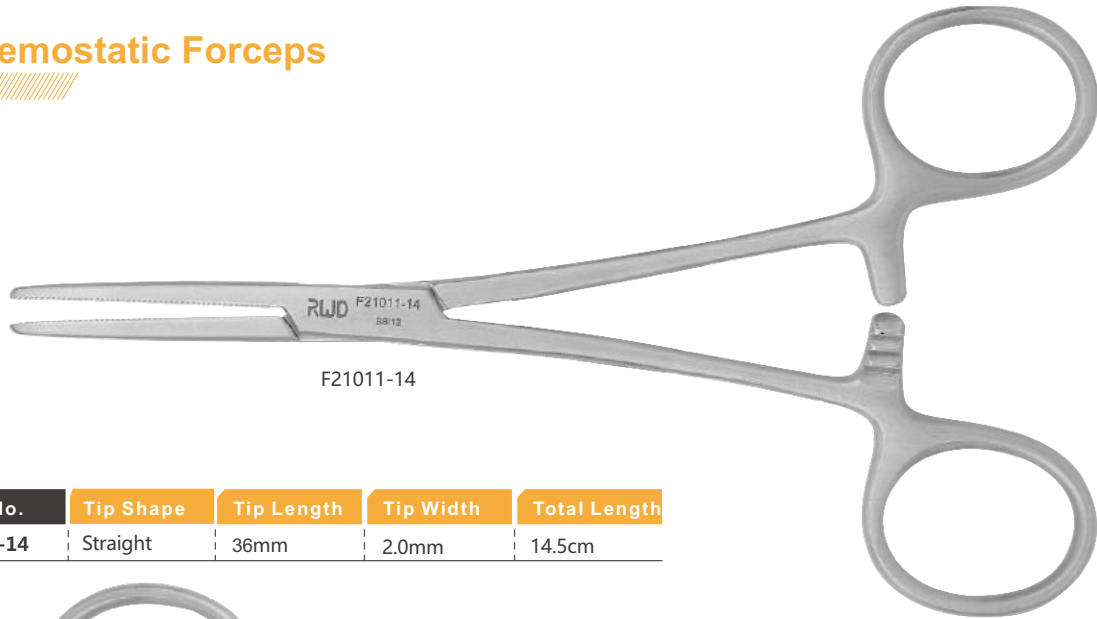

F21011-14

Cat No.	Tip Shape	Tip Length	Tip Width	Total Length
F21011-14	Straight	36mm	2.0mm	14.5cm

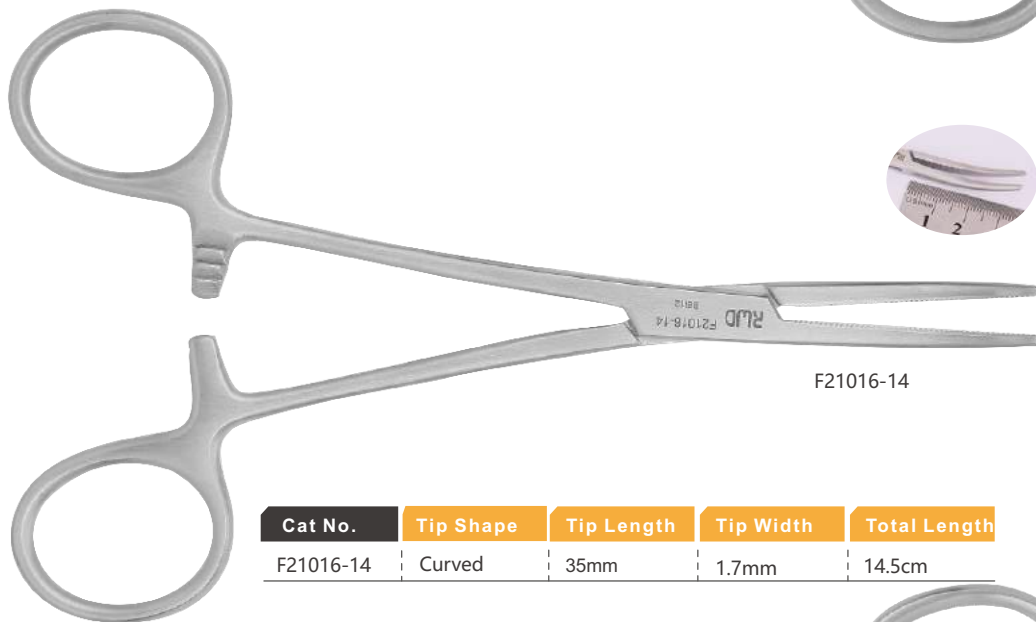

F21016-14

Cat No.	Tip Shape	Tip Length	Tip Width	Total Length
F21016-14	Curved	35mm	1.7mm	14.5cm



F21020-16



F21019-16

Cat No.	Tip Shape	Tip Length	Tip Width	Total Length
F21019-16	Straight	37mm	1mm	16cm
F21020-16	Curved	37mm	1.5mm	16cm



Cat No.	Tip Shape	Tip Length	Tip Width	Total Length
F22006-12	Straight	20mm	1.2mm	12.5cm

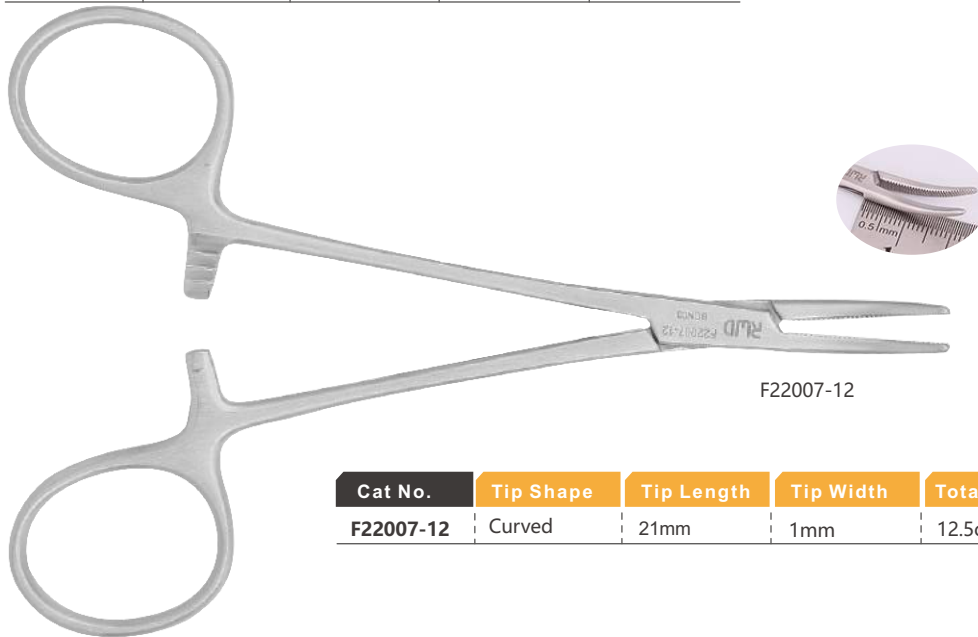

Cat No.	Tip Shape	Tip Length	Tip Width	Total Length
F22007-12	Curved	21mm	1mm	12.5cm

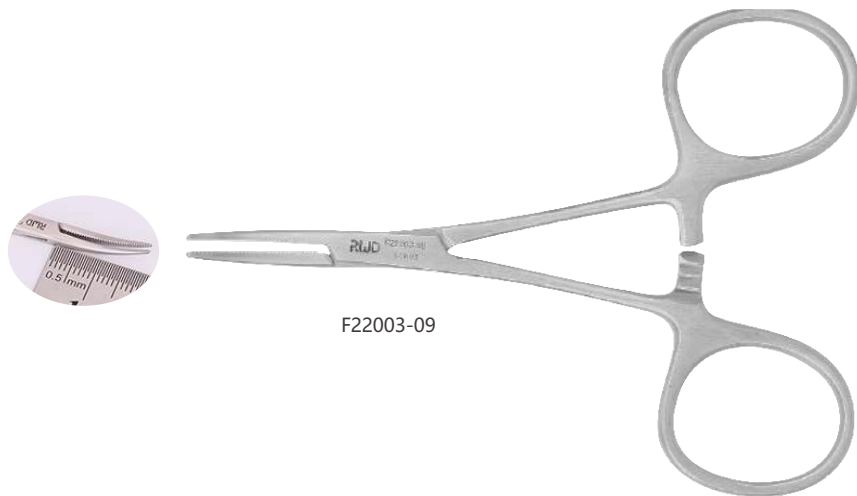

Cat No.	Tip Shape	Tip Length	Tip Width	Total Length
F22003-09	Curved	19mm	1.0mm	9cm
F22003-10	Curved	18mm	1.0mm	10cm



F21004-12



F21003-12



Cat No.	Tip Shape	Tip Length	Tip Width	Total Length
F21003-12	Straight 1x2Teeth	22mm	1.5mm	12.5cm
F21004-12	Curved 1x2Teeth	20mm	1.6mm	12.5cm



F21006-14

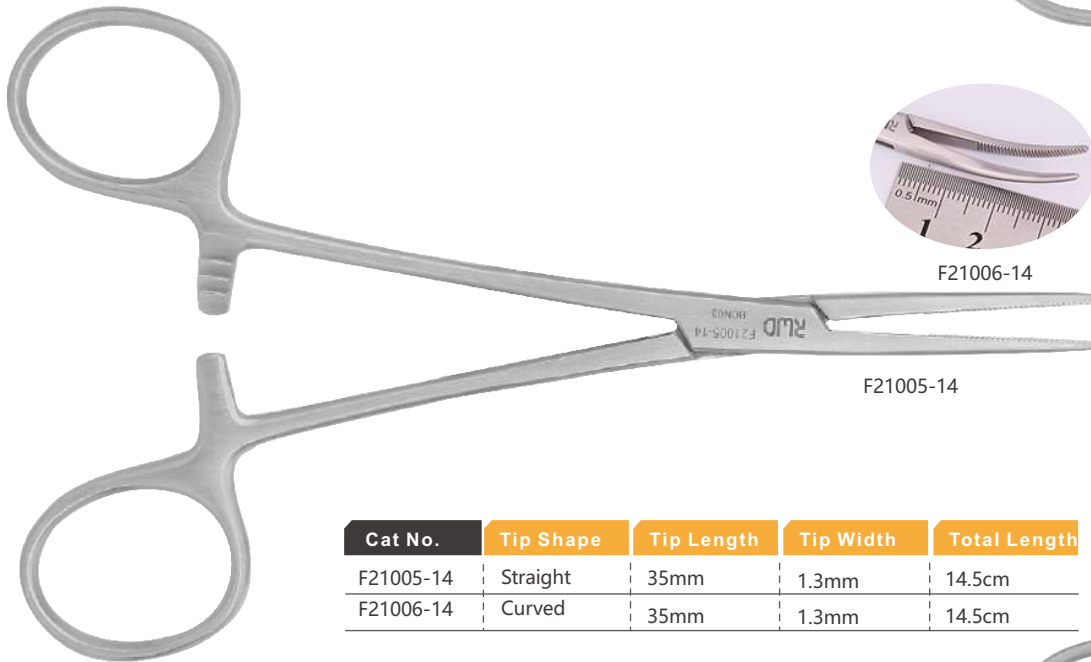

F21005-14

Cat No.	Tip Shape	Tip Length	Tip Width	Total Length
F21005-14	Straight	35mm	1.3mm	14.5cm
F21006-14	Curved	35mm	1.3mm	14.5cm



F22002-09

Cat No.	Tip Shape	Tip Length	Tip Width	Total Length
F22002-09	Straight	19mm	1.0mm	9cm
F22002-10	Straight	20mm	0.8mm	10.5cm

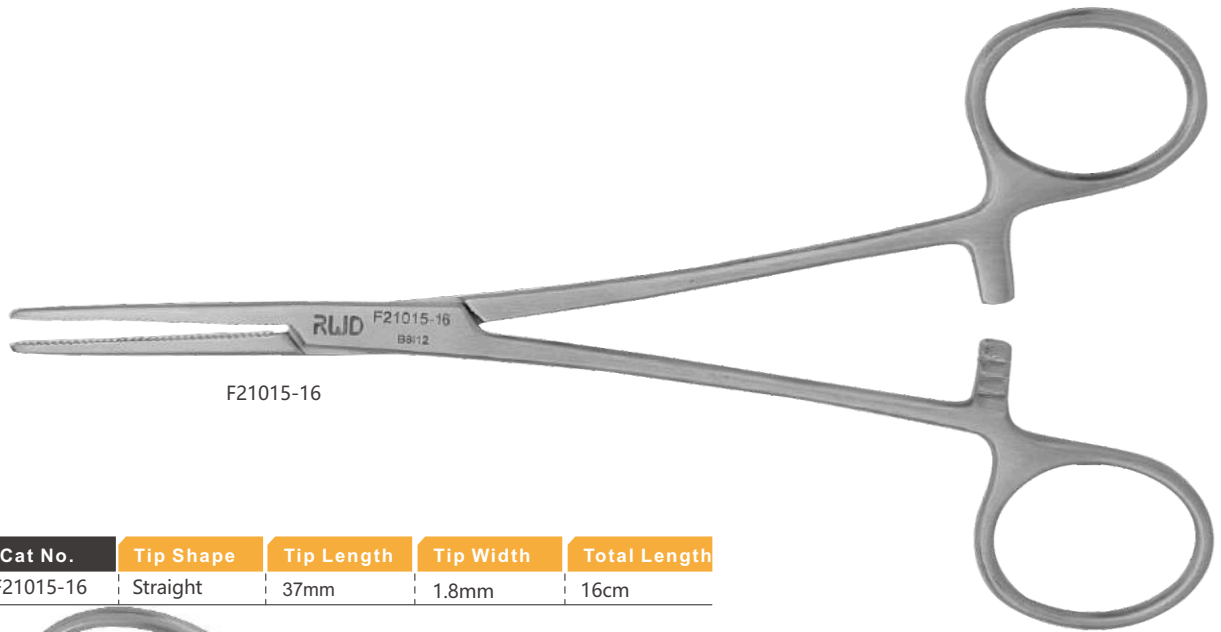

Cat No.	Tip Shape	Tip Length	Tip Width	Total Length
F21015-16	Straight	37mm	1.8mm	16cm

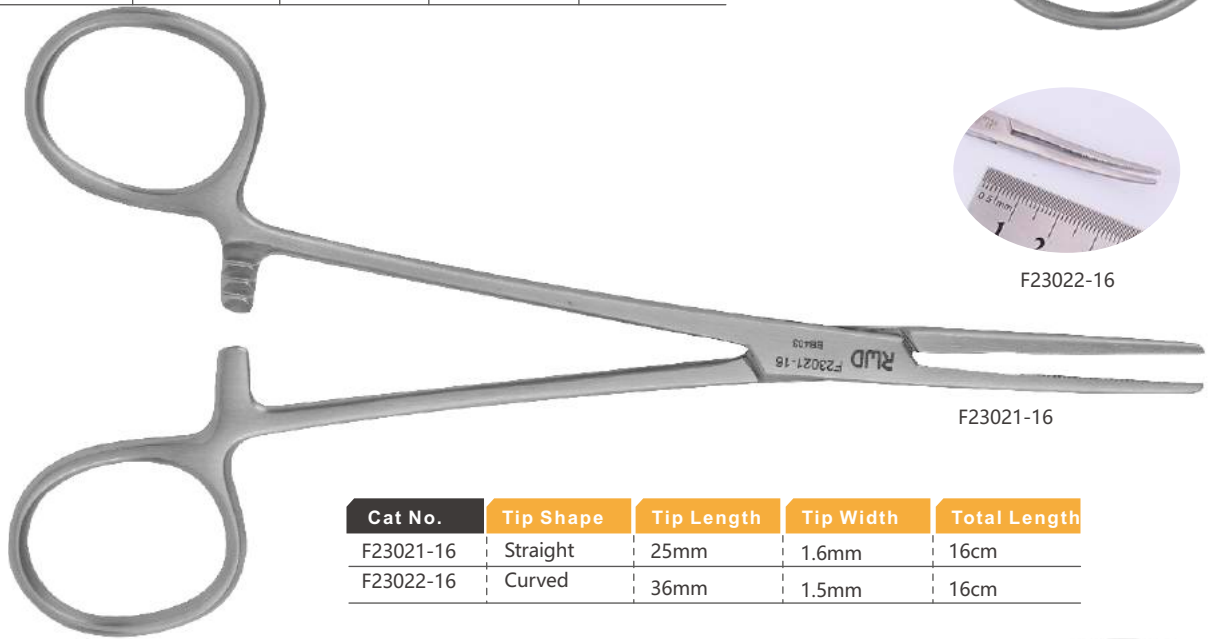

Cat No.	Tip Shape	Tip Length	Tip Width	Total Length
F23021-16	Straight	25mm	1.6mm	16cm
F23022-16	Curved	36mm	1.5mm	16cm



Cat No.	Tip Shape	Tip Length	Tip Width	Total Length
F31047-12	Straight	8mm	2.0mm	12cm
F31047-14	Straight	13mm	2.0mm	14cm

Needle Holders

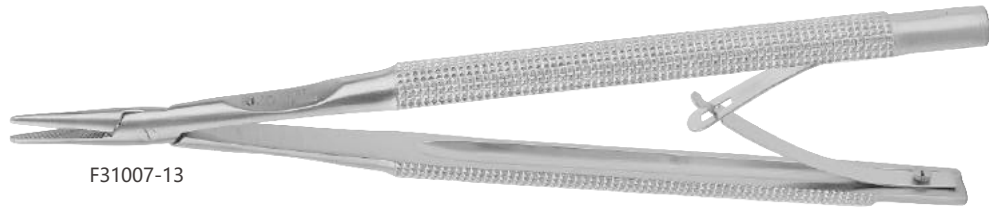

Cat No.	Tip Shape	Tip Length	Tip Width	Total Length
F31002-13	Straight	14mm	1.0mm	13.5cm
F31007-13	Straight	13mm	1.2mm	13.0cm



Cat No.	Tip Shape	Tip Length	Tip Width	Total Length
F31031-15	Straight	19mm	2.6mm	15.5cm



Cat No.	Tip Shape	Tip Length	Tip Width	Total Length
F31025-13	Straight	16mm	2.0mm	13cm



Cat No.	Tip Shape	Tip Length	Tip Width	Total Length
F31034-12	Straight	16mm	2.0mm	13cm
F31034-14	Straight	18mm	1.8mm	14cm

Suture



Sutures w/Needle- Δ 3/8/2.5 \times 7/30cm/
6-0 (50/Box)
No. F35205-60 \$233



PGA Sutures w/Needle- \circ 1/2/4 \times 10/90cm/
5-0 (50/Box)
No. F35305-50 \$370



Needle- \circ 3/8/3 \times 10/90cm/5-0 (50/Box)
No. F35401-50 \$233

Bone Rongeurs



S21002-15

Cat No.	Jaw Shape	Jaw Size (Cup)	Jaw Length	Total Length
S21002-15	Curved	3.5mm	11mm	15cm



S21010-15

Cat No.	Jaw Shape	Jaw Size (Cup)	Jaw Length	Total Length
S21010-15	Curved	2mm	18mm	15.5cm



S21027-17

Cat No.	Jaw Shape	Jaw Size (Cup)	Jaw Length	Total Length
S21027-17	Straight	1.0mm	12mm	17cm

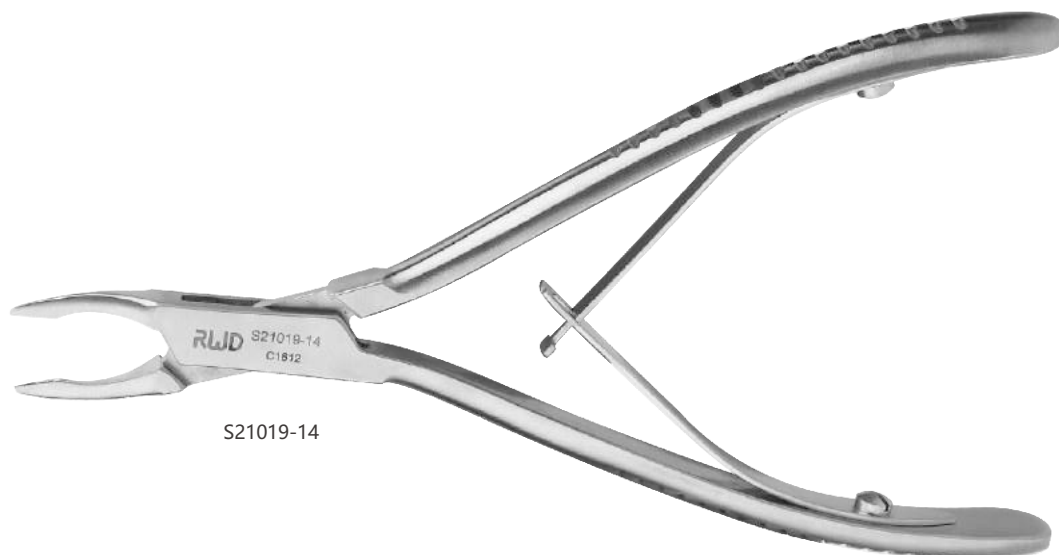

S21019-14

Cat No.	Jaw Shape	Jaw Size (Cup)	Jaw Length	Total Length
S21019-14	Straight	0.5mm	7mm	14cm
S21020-14	Straight	0.7mm	6mm	14cm
S21021-14	Straight	1.0mm	9.5mm	14cm



S21023-14

Cat No.	Jaw Shape	Jaw Size (Cup)	Jaw Length	Total Length
S21023-14	Curved	0.7mm	7mm	14cm
S21024-14	Curved	1.0mm	9mm	14cm

Blood Vessel Clamps



Cat No.	Tip Shape	Tip Length	Tip Width	Total Length
R31005-04	Straight	4mm	0.75mm	16mm
R31005-06	Straight	6mm	1.0mm	19mm
R31005-08	Straight	8mm	2.0mm	18mm
R31005-10	Straight	10mm	2.0mm	20mm
R31006-04	Curved	6.3mm	1.0mm	17mm
R31006-06	Curved	6.6mm	1.0mm	17mm
R33001-38	Straight	11mm	3.8mm	38mm
R33001-48	Straight	14mm	4mm	48mm
R33002-38	Curved	11mm	3.8mm	38mm
R33002-48	Curved	15mm	4mm	50mm
R33003-01	Straight	17mm	3.7mm	58mm
R33003-02	Curved	18.5mm	4.0mm	58mm
R31008-26	Straight	11mm	2.0mm	28mm
R31009-26	30°Curved	14mm	2.5mm	28mm
R31010-26	45°Curved	15mm	2.5mm	26.5mm



R34001-14
Used only to clamp R31005, R31006 series vascular clamps.

Cat No.	Tip Shape	Tip Length	Tip Width	Total Length
R34001-14		8.4mm	5mm	14mm

Retractors

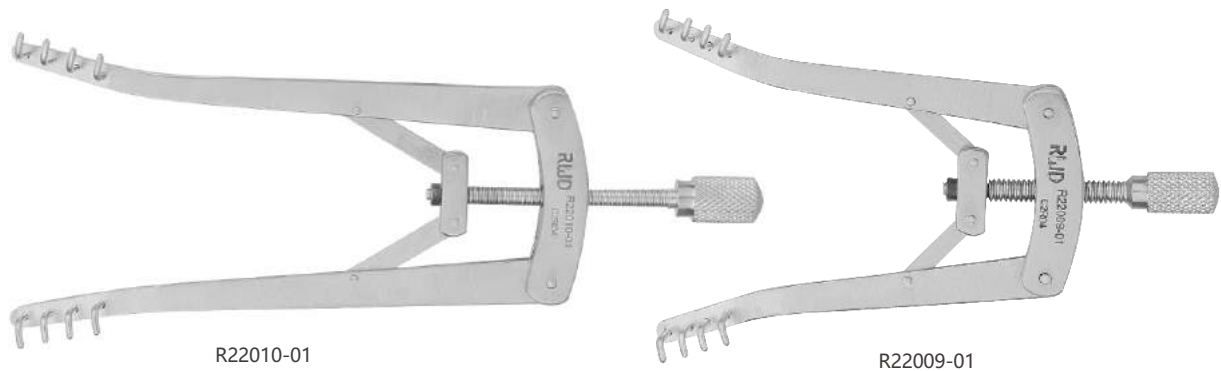

Cat No.	Teeth Shape	Teeth Length	Teeth Width	Teeth Depth	Maximum Spread	Total Length
R22009-01	Blunt 4x4Teeth	9.5mm	1mm	3.5mm	60mm	7.5cm
R22010-01	Blunt 4x4Teeth	10mm	1mm	3mm	65mm	10cm



Cat No.	Teeth Shape	Teeth Length	Teeth Width	Teeth Depth	Maximum Spread	Total Length
R21027-12		6mm	1.2mm	5mm		12.5cm



Cat No.	Teeth Shape	Teeth Length	Teeth Width	Teeth Depth	Maximum Spread	Total Length
R22029-03		10mm	0.9mm	6mm	1.5cm	3cm
R22029-04		13.5mm	0.9mm	7mm	30mm	4cm
R22012-45		13mm	0.9mm	6mm	32mm	4.5cm

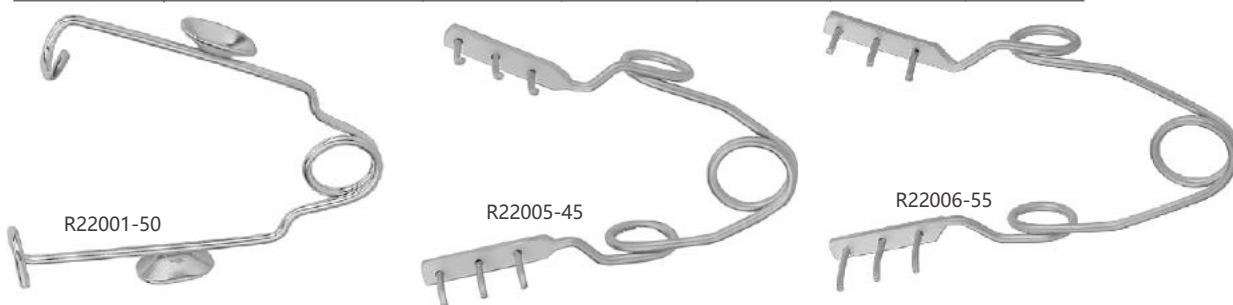

Cat No.	Teeth Shape	Teeth Length	Teeth Width	Teeth Depth	Maximum Spread	Total Length
R22001-50	Blunt 1x1Teeth	7.5mm	1.5mm	8.9mm	40mm	5cm
R22005-45	Blunt 3x3Teeth	11mm	1mm	7mm	36mm	5cm
R22006-55	Blunt 3x3Teeth	11mm	1mm	3mm	36mm	5.5cm

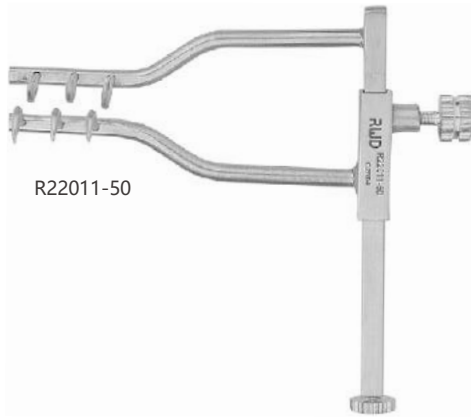

R22011-50



Cat No.	Teeth Shape	Teeth Length	Teeth Width	Teeth Depth	Maximum Spread	Total Length
R22011-50	Sharp 3x3Teeth	11mm	0.8mm	6mm	32mm	5.5cm
R22030-03	Sharp 3x3Teeth	7mm	1mm	2.2mm	1.8cm	3cm

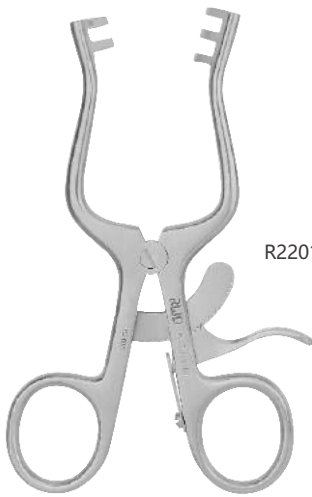

R22013-10



Cat No.	Teeth Shape	Teeth Length	Teeth Width	Teeth Depth	Maximum Spread	Total Length
R22013-10	Blunt 2x3Teeth		2.2mm	6.5mm	61mm	11.5cm
R22015-02	Blunt 3x3Teeth	13.5mm	2.2mm	6.5mm	62mm	13cm



C12005-01 With Holes



C12005-02 With Holes and Handle

Cat No.	Shape	Dimensions
C12005-01		210*120*50mm
C12005-02		240*160*50mm

Find More Surgical Tools On Website!



www.rwdstco.com

RWD

RWD Life Science



RWD Life Science

Add: 6540 Lusk Blvd, San Diego, CA 92121, USA

Add: No.13 Hi Tech North RD, Nan Shan Dist., Shenhen, P.R.China

Web: www.rwdstco.com Email: sales@rwdstco.com Tel: +1-858-900-6602 (USA) +86-755-86111286 (China)