

2023 ELECTRIC DISTRIBUTION DESIGN MANUAL

Historical Record: 8/25/2023
External Version



GENERAL INFORMATION	5000
OVERHEAD LAYOUT SYSTEMS	5100
UNDERGROUND LAYOUT SYSTEMS	5200
DEMAND ESTIMATING	5300
VOLTAGE DROP	5400
CONDUCTOR AMPACITIES	5500
TRANSFORMERS	5600
PADS & SUBSTRUCTURES	5700
CAPACITORS	5800
WIRE & SUPPORTS	5900
SUBSTATION LOAD FORECASTING	6000
SECTIONALIZING & PROTECTION	6100
SYSTEM ENGINEERING	6200
SUBSTATION ENGINEERING	6300
INTRODUCTION	
DISCLAIMER & CONTACTS	
SUMMARY OF CHANGES	



DISTRIBUTION SYSTEM DESIGN MANUAL

INTRODUCTION

The Design Manual is a technical reference intended for use by customer project planners and engineers. The design and planning standards described within the manual have been developed through the joint efforts of line and staff personnel. The objective has always been to identify and document consistent and cost effective criteria and procedures for designing and planning the electric distribution system. The general contents of the manual are, therefore, to be considered standards, not guidelines. And all system designs and expansion plans should be developed in accordance with them, when technically and economically feasible. Application of the Design Manual in this spirit will help to assure uniform design practices and consistent levels of service reliability among the different districts.

Michael J. Coburn
Manager
Electric Distribution Engineering

© 1998 - 2012 San Diego Gas & Electric Company. All rights reserved. Removal of this copyright notice without permission is not permitted under law.

	 Indicates Latest Revision	Completely Revised	New Page	Information Removed
REVISION	SDG&E DISTRIBUTION DESIGN MANUAL			
DATE 2-8-2012 APPD JCE / MJC	DESIGN MANUAL INTRODUCTION			

ATTENTION:

THESE STANDARDS WERE DEVELOPED FOR MAINTAINING SAFETY AND RELIABILITY OF THE ELECTRIC DISTRIBUTION AND SERVICE SYSTEMS.

THE INTENT OF THIS STANDARD IS TO GUIDE ENGINEERS, DESIGNERS/PLANNERS AND CONSTRUCTION PERSONNEL AND PROVIDE TYPICAL CONSTRUCTION METHODS FOR ELECTRIC DISTRIBUTION. NOT ALL ARRANGEMENTS ARE DEPICTED AND IT IS THE USER'S RESPONSIBILITY TO APPLY THESE STANDARDS APPROPRIATELY. ALL USERS MUST USE GOOD JUDGMENT. STANDARDS ARE UPDATED AS NEEDED. CONSULT EDE FOR LATEST VERSION. SDG&E STANDARDS MUST BE APPLIED. PRE-CONSTRUCTION APPROVAL OF A "DEVIATION REQUEST" IS REQUIRED FOR ANY EXCEPTION TO THESE STANDARDS. ANY ALTERATIONS, MODIFICATIONS OR IMPROVEMENTS TO THIS AND ALL STANDARDS MUST BE REVIEWED, APPROVED AND DOCUMENTED BY EDE-CONSTRUCTION STANDARDS AND DISTRICT C&O'S.

THE CPUC'S GENERAL ORDER 95 RULES/REQUIREMENTS ARE NOT INTENDED FOR USE AS COMPLETE CONSTRUCTION SPECIFICATIONS BUT EMPLOY ONLY THE MINIMUM REQUIREMENTS WHICH ARE MOST IMPORTANT FROM THE STANDPOINT OF **SAFETY AND RELIABILITY**. SDG&E MAY IMPOSE STRICTER RULES AND REQUIREMENT IN THE INTEREST MAINTANANING SAFETY AND RELIABILTY OF OUR ELECTRICAL SYSTEM.

CONSTRUCTION SHALL BE ACCORDING TO ACCEPTED GOOD PRACTICE FOR GIVEN LOCAL CONDITIONS IN ALL SITUATIONS NOT SPECIFIED IN THE STANDARD.

SDG&E WILL NOT ACCEPT ANY SYSTEM DESIGN OR INSTALLATION WHICH DOES NOT CONFORM TO THESE STANDARDS DEVIATIONS CANNOT BE GRANTED WHICH CONFLICT WITH THE CPUC GENERAL ORDERS OR OTHER GOVERNING AGENCIES. THESE MAY INCLUDE SEPARATION FROM ENERGIZED FACILITIES AND WORKING CLEARANCES.

BASED ON UNUSUAL OR UNSAFE SITE CONDITIONS SDG&E MAY IN THE INTEREST OF SAFETY OR RELIABILITY REQUIRE CONSTRUCTION MEASURES BEYOND THOSE SPECIFICALLY STATED IN THIS MANUAL.

EXCEPT FOR A REQUIREMENT TO IMMEDIATELY ADOPT NEWLY PUBLISHED STANDARDS, THE APPLICATION OF NEWLY PUBLISHED STANDARDS IS REQUIRED FOR ALL WORK UP TO THE 30% PROJECT DESIGN APPROVAL LEVEL. ALL DESIGN AND CONSTRUCTION WORK AFTER 30% PROJECT DESIGN APPROVAL MAY USE CONSTRUCTION STANDARDS THAT IMMEDIATELY PRECEDE THE NEWLY UPDATED STANDARD, UNLESS THE IMMEDIATE ADOPTION OF NEWLY PUBLISHED STANDARDS IS MANDATED.

USE OF "BLOCK STOCK" MUST BE COORDINATED WITH INVENTORY & LOGISTICS AND IS GENERALLY ONLY APPLIED AS A "LAST RESORT" AFTER CONSULTATION AND AGREEMENT WITH STAKEHOLDERS AND AN ALTERNATE SOLUTION, SUPPLIER, MATERIAL OR METHOD IS DEEMED ACCEPTABLE AND AVAILABLE.

IF YOU HAVE ANY QUESTIONS REGARDING THE CONTENT OF THESE MANUALS PLEASE EMAIL

CONSTRUCTIONSTANDARDSADMINISTRATORS@SEMPRAUTILITIES.COM OR CONTACT:

MANUAL	CONTACT	EMAIL ADDRESS	PHONE
Electric Distribution Design Manual	Martha Lachmayr	mlachmayr@sdge.com	(858) 654-8245
Overhead Construction Standards	Mike Forchette	mforchette@sdge.com	(619) 244-7495
Service Standards & Guide	Israel Juarez	ijuarez@sdge.com	(858) 636-3941
Electric Vehicle Supply Equipment Standards	Israel Juarez	ijuarez@sdge.com	(858) 636-3941
Underground Construction Standards	Eddie Alcobia	ealcobia@sdge.com	(619) 574-4988
Electric Standard Practices	Joey Kucharyski	jkucharyski@sdge.com	(760) 566-5919
Tool Catalog	Roy Guilao	rguilao@sdge.com	(760) 672-6211

PRINTED COPIES:

FOR PRINTED VERSIONS, WITH BINDER AND TAPS, OF THE **OVERHEAD CONSTRUCTION STANDARDS** PLEASE CONTACT CONSTRUCTIONSTANDARDSADMINISTRATORS@SEMPRAUTILITIES.COM. THESE WILL BE PROVIDED AT THE COST OF YOUR DEPARTMENT. PLEASE INCLUDE IN THE EMAIL:

- NAME, COST CENTER #, I/O #, MAIL STOP #

**5000
GENERAL
INFORMATION**

**5000
GENERAL
INFORMATION**

PAGE

SUBJECT

5042

G.O. 95 CLIMBING AND WORKING SPACE REQUIREMENTS

© 1998 - 2023 San Diego Gas & Electric Company. All rights reserved. Removal of this copyright notice without permission is not permitted under law.

REV	CHANGE	DR	BY	DSN	APV	DATE	REV	CHANGE	DR	BY	DSN	APV	DATE
C							F						
B	DM Major Revision	QTC	KNM	FRC	KRG	08/07/2023	E						
A	Original Issue	-	-	PRM	CAK	01/01/1990	D						

SHEET 1 of 1	<input type="checkbox"/> Indicates Latest Revision <input checked="" type="checkbox"/> Completely Revised <input type="checkbox"/> New Page <input type="checkbox"/> Information Removed	DM5001.1
	SDG&E ELECTRIC DISTRIBUTION DESIGN MANUAL	
	TABLE OF CONTENTS SYSTEM ENGINEERING	

A. CLIMBING SPACE

Climbing space is the space reserved along the surface of a climbable pole or structure (i.e., wood poles or smooth non-wood poles with steps) that permits ready access for linemen to equipment and conductors.

The location of the climbing space is measured from the centerline of the pole and shall be provided on one side or may be rotated in one quadrant in the area of an acknowledged obstruction of poles or structures. See O.H. Standards 251 for Company Standards. G.O. 95 states the minimum climbing space dimensions.

1. Armless Construction

Armless construction is construction without the use of crossarms. Other mechanical devices are used to support conductors and other components.

a. 12kV and Above

1) Tangent construction (G.O. 95, Rule 54.11 F. 1)

For a single circuit at the top of a pole, the climbing space shall be maintained to the lowest conductor on the climbing side of the pole. The climbing space shall be maintained through the conductor level (4 ft. above and below).

The climbing space shall be a square of the following horizontal dimensions:

0.75-46 kV	36 inches
46-75 kV	48 inches
More than 75 kV	48 inches plus 1/2 inch per kV over 75 kV

Fiberglass supports are considered to be crossarms when determining climbing space.

EXCEPTION: For a circuit at the top of the pole, the climbing space shall be maintained to the lowest conductor of the circuit on the climbing side of the pole. For a pole top circuit that includes buck position conductors located within a vertical distance of 4 feet or less from the lowest associated line conductor, climbing space need only be maintained to the lowest conductor in the buck position on the climbing side of the pole.

2) Deadend Construction (G.O. 95, Rule 54.11 F2, Fig. 54-11)

Climbing space through the levels of conductors dead-ended on poles in vertical configuration shall be a square, and one side shall be parallel and bounded by the vertical plane of the dead-ended conductors.

Dimensions:	0.75-7.5 kV	30 inches
	7.5-46 kV	36 inches
	More than 46 kV	36 inches plus 1/2 inch per kV over 46 kV

b. 4kV

The only difference in climbing space requirement between 4kV and 12kV is the size of the climbing space.

2. Line Arm Construction (G.O. 95, Rule 54.7A)

The climbing space shall be maintained in the same position for a distance of not less than 4 feet vertically above and below each conductor level through which it passes. Climbing space shall not be changed through conductor levels that are less than 4 feet apart. If the vertical distance between conductor levels is greater than 4 feet and less than 8 feet, the climbing space may be shifted not more than one-quarter of the distance around the pole.

Where a single level of circuitry is installed at the top of a pole, the climbing space shall extend up to the level of such pole-top circuitry and need not be provided through and above such level.

a. Line Arm Construction Dimensions (G.O. 95, Rule 54.7A1)

The climbing space where line arms are involved, without related buck arms, shall be on one side or on the face of the pole, with the center line of the pole approximately midway on one side of the climbing space.

© 1998 - 2023 San Diego Gas & Electric Company. All rights reserved. Removal of this copyright notice without permission is not permitted under law.

REV	CHANGE	DR	BY	DSN	APV	DATE	REV	CHANGE	DR	BY	DSN	APV	DATE
C	DM Major Revision	QTC	KNM	FRC	KRG	08/07/2023	F						
B	Editorial Change	EPC	FRC	JAS	CZH	11/17/2021	E						
A	Original Issue	-	-	JCE	VCR	03/01/2002	D						

<p>SHEET 1 of 3</p>	<p>X Indicates Latest Revision</p>	<p>Completely Revised</p>	<p>New Page</p>	<p>Information Removed</p>	<p>DM5042.1</p>
	<p>SDG&E ELECTRIC DISTRIBUTION DESIGN MANUAL</p>				
	<p>G.O. 95 CLIMBING AND WORKING SPACE REQUIREMENTS</p>				

Dimensions:	0-7.5 kV	30 inches
	7.5-46 kV	36 inches
	More than 46kV	36 inches plus 1 /2 inch per kV over 46kV

3. Buck Arm Construction (G.O. 95, Rule 54.7A2)

Buck arms are used when it is desired to change the direction of a circuit or extend a circuit in another direction. The addition of buck arms changes the climbing space requirements. See O.H. Standards 251. The climbing space where line arms and related buck arms are involved on poles or structures shall be on one side or face of the pole or in a quadrant as defined below:

- a. Where the vertical clearance between conductors on line and buck arms is 4 feet or more, the climbing space dimensions shown below shall be provided on one side or face of the pole for each arm.

Dimensions:	0-7.5 kV	30 inches
	7.5-46 kV	36 inches
	More than 46 kV	36 inches plus 1 /2 inch per kV over 46 kV

- b. Where the vertical clearance between conductors on line and buck arms is less than 4 feet, the climbing space shall be provided through such levels and located in a quadrant and shall have at least the following dimensions.

Dimensions:	0-7.5 kV	30 inches
	7.5-35 kV	42 inches

3. For combination arm construction with line and buck arms:

- 1) Where vertical separation between conductor levels on line and buck arms is 4 feet or more, the climbing space dimensions shown below shall be provided on one side or side or face of the pole for each level.

Dimensions:	0-7.5 kV	30 inches
	7.5-46 kV	36 inches
	More than 46 kV	36 inches plus 1 /2 inch per kV over 46 kV

- 2) Where vertical separation between conductor levels on line and buck arms is less than 4 feet, such separation shall not be less than 2 feet, and the climbing space shall not be less than the dimensions shown below. The dimensions shall also be in accordance with the highest voltage adjacent to the climbing quadrant.

Dimensions:	0-7.5 kV	30 inches
	7.5-35 kV	42 inches

4. Allowable Climbing Space Obstructions (G.O. 95, Rule 54.7A3)

See Rule 54.7A3 of G.O. 95 for these limitations.

5. Joint Poles (G.O. 95, Rule 93)

Telco is to allow climbing space to gain access to facilities above them.

6. Clearance Poles (G.O. 95, Rule 54.8C2)

A clearance pole is a pole that supports conductors for the purpose of obtaining/maintaining prescribed clearances. If supply service drop conductors are positioned at least 25 inches (horizontally) from the center line of the pole, service drops may be supported at a vertical distance of fewer than four feet but not less than 24 inches above a communication circuit.

7. Rack Construction (G.O. 95, Rule 54.9F)

- a. Standard Position - A climbing space shall be maintained 4 feet above the top conductor and four feet below the bottom conductor.
b. Under Transformer - When the rack is mounted under a transformer, the climbing space is on the back side of the pole (See G.O. 95 Rule 54.7A).
c. Reduced Clearances - When a clearance involving a secondary rack is reduced to four feet, there may be only one attachment.

© 1998 - 2023 San Diego Gas & Electric Company. All rights reserved. Removal of this copyright notice without permission is not permitted under law.

REV	CHANGE	DR	BY	DSN	APV	DATE	REV	CHANGE	DR	BY	DSN	APV	DATE
C	DM Major Revision	QTC	KNM	FRC	KRG	08/07/2023	F						
B	Editorial Change	EPC	FRC	JAS	CZH	11/17/2021	E						
A	Original Issue	-	-	JCE	VCR	03/01/2002	D						

SHEET 2 of 3	X Indicates Latest Revision	Completely Revised	New Page	Information Removed	DM5042.2
	SDG&E ELECTRIC DISTRIBUTION DESIGN MANUAL				
	G.O. 95 CLIMBING AND WORKING SPACE REQUIREMENTS				

8. Transformer Through Bolts (G.O. 95, Rule 58.1 B3)

Transformer through bolts that extend into the climbing space shall be covered with a suitable protective covering.

B. Working Space

1. Working space is defined as the space reserved for working below, above, and between conductor levels.
2. Working space dimensions shall be as defined in G.O. 95, Rule 54.7.

REFERENCES

- a. OH Construction Standard 251, Working and Climbing Space
- b. Original General Order 95, Rules For Overhead Electric Line Construction

© 1998 - 2023 San Diego Gas & Electric Company. All rights reserved. Removal of this copyright notice without permission is not permitted under law.

REV	CHANGE	DR	BY	DSN	APV	DATE	REV	CHANGE	DR	BY	DSN	APV	DATE
C	DM Major Revision	QTC	KNM	FRC	KRG	08/07/2023	F						
B	Editorial Change	EPC	FRC	JAS	CZH	11/17/2021	E						
A	Original Issue	-	-	JCE	VCR	03/01/2002	D						

<p>SHEET 3 of 3</p>	<p>X Indicates Latest Revision</p>	<p>Completely Revised</p>	<p>New Page</p>	<p>Information Removed</p>	<p>DM5042.3</p>
	<p>SDG&E ELECTRIC DISTRIBUTION DESIGN MANUAL</p>				
	<p>G.O. 95 CLIMBING AND WORKING SPACE REQUIREMENTS</p>				

**5100
OVERHEAD LAYOUT
SYSTEMS**

**5100
OVERHEAD LAYOUT
SYSTEMS**

<u>PAGE(S)</u>	<u>SUBJECT</u>
5111 5111.1	Overhead Line Visual Appearance Guidelines: Line Simplification Vertical Construction Maintaining Uniformity
5111.1 – 5111.2	Important Incidental Details
5112 5112.1 5112.2	Conversion Design Considerations: Conversion Considerations Cable Poles
5113	Common General Order 95 Infractions
5121 5121.1 – 5121.2 5121.2	Pole Placement Guidelines: General Line Poles Cable Poles Pole Location in Conversion Area
5121.2 – 5121.3 5121.3	State Highways, Freeways, Street Improvements Pole Locations Near Gas Lines
5122.1 – 5122.2	Pole Selection Criteria
5123	Crossarm Construction Considerations: Double Crossarms Alley Arms Crossarm Checklist
5124 5124.1 – 5124.2	Primary Conductor Requirements: Span Lengths Reduced Tension Spans Mixing Copper & Aluminum Conductor Conductor Protection Primary Neutral Conductor
5125	Secondary & Service Conductor Requirements: Guard Arms on Secondary Cable Deadends Overhead Services Low Services
5126	Warning of Overhead Conductors / Boat Operating – Launching Areas
5127	Electric Load Study Requirements
5128	Avian Protection
5129	Distribution Phase Spacing

© 1998-2017 San Diego Gas & Electric Company. All rights reserved. Removal of this copyright notice without permission is not permitted under law.

REV	CHANGE	BY	DSGN	APPV	DATE	REV	CHANGE	BY	DSGN	APPV	DATE
A	EDITORIAL CHANGES	JCE	MBL	MDJ	08/22/2017	D					
B						E					
C						F					

SHEET 1 OF 1	Indicates Latest Revision	<input checked="" type="checkbox"/> Completely Revised	<input type="checkbox"/> New Page	<input type="checkbox"/> Information Removed	DM 5101
	SDG&E ELECTRIC DISTRIBUTION DESIGN MANUAL				
	OVERHEAD SYSTEM LAYOUT TABLE OF CONTENTS				

SCOPE

This standard provides criteria to be considered when designing overhead pole lines to minimize the visual impact of the line to the public.

1. Line Simplification

The need for overhead lines to be inconspicuous and to blend into the surroundings can best be accomplished by:

- a. Avoiding unnecessary duplication of lines such as placing poles on both sides of a street.
- b. Using joint construction with the CIP (Communication Infrastructure Provider). The design shall consider the structural loading requirements of all supply and communication facilities planned to occupy the pole. The "planned" facilities are those that are actually known to SDG&E at the time of design. This requirement applies to new poles and poles being replaced.
- c. Consolidating circuits wherever possible.
- d. Keeping pole heights as low as legal clearances will allow.
- e. Reducing the number and size of components in the makeup of a line.
- f. Using cable secondaries and services.
- g. Omitting unnecessary guys.

2. Vertical Construction

Vertical construction is no longer allowed for new construction unless this construction is the only one that will fit in existing narrow easements that will not permit crossarm construction.

3. Maintaining Uniformity

Compatibility with other components of the line is an important principle to observe. This can be achieved in the following ways:

- a. Design a line having straight alignment wherever possible.
- b. Maintain the conductors at a grade even with the contour of the ground.
- c. Use current construction standard. However, when reworking a line, use the present construction standards and not those retained for "field maintenance only".
- d. When replacing insulators, ensure all insulators are the same type.

4. Important Incidental Details

Attention to small details is also important to pole line aesthetics. The following details should be considered:

- a. Straightening poles, crossarms and other equipment when required.

© 1998-2017 San Diego Gas & Electric Company. All rights reserved. Removal of this copyright notice without permission is not permitted under law.

REV	CHANGE	BY	DSGN	APPV	DATE	REV	CHANGE	BY	DSGN	APPV	DATE
A	EDITORIAL CHANGES	JCE	MBL	MDJ	08/22/2017	D					
B						E					
C						F					

SHEET 1 OF 2	<input type="checkbox"/> Indicates Latest Revision	<input checked="" type="checkbox"/> Completely Revised	<input type="checkbox"/> New Page	<input type="checkbox"/> Information Removed	DM 5111.1
	SDG&E ELECTRIC DISTRIBUTION DESIGN MANUAL				
	OVERHEAD LINE VISUAL APPEARANCE GUIDELINES				

- b. Pulling excessive slack from conductors and guys (sags of all components in a span should be made in accordance with Design Standard 5911).
- c. Removing damaged weatherproof wire covering or replacing conductor when requested.
- d. Controlling excessive lengths of jumpers, drip loops and other incidental wiring.

© 1998-2017 San Diego Gas & Electric Company. All rights reserved. Removal of this copyright notice without permission is not permitted under law.

REV	CHANGE	BY	DSGN	APPV	DATE	REV	CHANGE	BY	DSGN	APPV	DATE
A	EDITORIAL CHANGES	JCE	MBL	MDJ	08/22/2017	D					
B						E					
C						F					

SHEET 2 OF 2	Indicates Latest Revision	<input checked="" type="checkbox"/>	Completely Revised	New Page	Information Removed	DM 5111.2
	SDG&E ELECTRIC DISTRIBUTION DESIGN MANUAL					
	OVERHEAD LINE VISUAL APPEARANCE GUIDELINES					

SCOPE

This standard provides criteria for the design process associated with overhead to underground conversion projects.

1. Conversion Considerations

The following questions are to be considered when designing an overhead conversion project:

- a. Is the proposed conversion boundary practical? Can improvements be made to better fit the overhead and/or underground requirements? Check for possible circuit backfeed, cutover, and rearrangements to avoid converting more **or less – more practical boundary** than necessary. This must be done at the time of the preliminary boundary check on 20A projects.
- b. Are there existing circuits in the conversion area, and primary voltages available?
- c. Are there existing customers in the conversion area? What voltage and number of phases are required to serve the existing customers? What is the availability of the neutral? What power is required to serve the load and the size and type of loads to be served?
- d. Can the underground facilities be extended from existing underground facilities in or adjacent to the conversion area?
- e. What are the locations of the required cable poles? Can the number of cable poles be reduced by rerouting or cutovers? What is the visual impact of the proposed cable poles?
- f. What are District Engineering requirements, proposed cutovers, and existing or proposed main feeders through proposed conversion area? Do not reroute circuit to adjacent streets to avoid conversion.
- g. What switching is required to make the conversion?
- h. What fusing is required?
- i. What capacitors are required in the conversion area or are required to be relocated outside of the area?
- j. Are there street improvements involved in the conversion?
- k. What are the rights-of-way required to complete the conversion?
- l. What are **Communication Infrastructure Provider (CIP)** requirements?
- m. What permits are required from city, county, state, scenic highway, coastal zone, environmental or tree trim?
- n. What is the visual impact of the entire job?
- o. Are there any construction constraints such as accessibility of heavy items (transformers, manholes, handholes) and other items requiring special equipment to install?

© 1998-2017 San Diego Gas & Electric Company. All rights reserved. Removal of this copyright notice without permission is not permitted under law.

REV	CHANGE	BY	DSGN	APPV	DATE	REV	CHANGE	BY	DSGN	APPV	DATE
A	EDITORIAL CHANGES	JCE	MBL	MDJ	08/22/2017	D					
B						E					
C						F					

SHEET 1 OF 2	X Indicates Latest Revision	Completely Revised	New Page	Information Removed	DM 5112.1
	SDG&E ELECTRIC DISTRIBUTION DESIGN MANUAL				
	CONVERSION DESIGN CONSIDERATIONS				

2. Cable Poles

- a. The number of runs up any single cable pole should be limited to two runs and two spares for electric. The backside of the ladder arm(s) is reserved for secondary and CIP attachment. Poles with switching equipment (i.e. MVR) should be evaluated on a case by case basis.
- b. Risers should not be placed at the edge of the quadrant climbing space. Where practical, half pole climbing space must be maintained.
- c. New cable poles shall have a standard setting depth of 9' to prevent unearthing the pole during conduit bringup. It is not necessary to reset an existing pole which is converted to a cable pole.
- d. For joint cable poles and cable pole replacements, all riser quadrants shall be field coordinated with the CIP(s) engineer/designer whose name is shown on the work order. CIPs shall be given quadrant locations in writing and on job sketches.

References:

- 1. Overhead Construction Standard 1402 and Underground Construction Standard 4202, Standard Joint Cable Pole Riser Positions
- 2. Service Planning Manual 705, Conversion Procedure – Rule 20.A
- 3. Service Planning Manual 228, Cable Pole Riser Coordination
- 4. Overhead Construction Standard 1400 Section, 12.47kV and below deadend cable poles

© 1998-2017 San Diego Gas & Electric Company. All rights reserved. Removal of this copyright notice without permission is not permitted under law.

REV	CHANGE	BY	DSGN	APPV	DATE	REV	CHANGE	BY	DSGN	APPV	DATE
A	EDITORIAL CHANGES	JCE	MBL	MDJ	08/22/2017	D					
B						E					
C						F					

SHEET 2 OF 2	X	Indicates Latest Revision	Completely Revised	New Page	Information Removed	DM 5112.2
	SDG&E ELECTRIC DISTRIBUTION DESIGN MANUAL					
	CONVERSION DESIGN CONSIDERATIONS					

SCOPE

This guideline provides the common state General Order 95 (GO 95) infractions discovered while fielding overhead jobs along with suggestions to correct these infractions.

COMMON INFRACTIONS WITH SDG&E EQUIPMENT

The following is a list of the most common overhead infractions found when fielding a job:

1. PVC riser in climbing space.
2. Exposed secondary in climbing space (i.e. rack, aerial cable).
3. PVC feed to Dusk-to-Dawn light in climbing space.
4. Cutout or pothead in climbing space.
5. Service drop in climbing space.
6. No climbing space at (a) 12kV (b) 4kV (c) secondary level.
7. 12kV jumper or cable in climbing space.
8. More than one guy in climbing space.
9. Insufficient clearance between conductor levels.
10. No guy sectionalizing insulator above Communication Infrastructure Provider (CIP) level.
11. Lack of coordination between overhead and underground jobs as to what quadrant to use for UG risers.

Correction of infractions should be included as part of the job being prepared. Other considerations in fielding and designing overhead jobs are:

1. When designing overhead construction that is not shown in the Overhead Standards, prepare a detailed drawing and obtain approval from Construction Standards.
2. Draw out complicated corner poles to show climbing and working space.
3. Arrange arms, conductors and equipment on poles so that climbing space is not rotated more than once. If possible, arrange for climbing space consistent with CIPs.
4. Infractions caused by CIPs – Follow Compliance Management Notification of GO 95 Rule 18 Infraction process.

COMMON INFRACTIONS WITH CIP EQUIPMENT

It is a violation of GO 95 to install CIP attachments as follows:

1. Less than six feet below SDG&E primary conductors.
2. Less than one foot below or two feet above a street light bracket.
3. With bolts that protrude more than one and a half inches beyond surface of pole.
4. Not properly dead-ended when changing from tensioned construction to slack construction (three bolt clamps on side of pole not acceptable).
5. Blocking the climbing space on a pole.
6. With less than six-foot clearance without a guard arm on a clearance pole across a street when more than one power service is on the pole.
7. Without proper clearances in mid-span as well as at pole.
8. With guys that are ungrounded.
9. With guard arms that are not properly oriented.
10. Loose lashing wire.

© 1998-2017 San Diego Gas & Electric Company. All rights reserved. Removal of this copyright notice without permission is not permitted under law.

REV	CHANGE	BY	DSGN	APPV	DATE	REV	CHANGE	BY	DSGN	APPV	DATE
A	EDITORIAL CHANGES	JCE	MBL	MDJ	08/22/2017	D					
B						E					
C						F					

<p>SHEET 1 OF 1</p>	Indicates Latest Revision	<input checked="" type="checkbox"/> Completely Revised	<input type="checkbox"/> New Page	<input type="checkbox"/> Information Removed	<p>DM 5113</p>
	<p>SDG&E ELECTRIC DISTRIBUTION DESIGN MANUAL</p>				
	<p>COMMON GENERAL ORDER 95 INFRACTIONS</p>				

SCOPE

This standard provides criteria for the proper placement of new or existing poles.

PURPOSE

Generally, poles should be located to provide the maximum support at the least cost. However, there are times when public relations or mechanical requirements make this impractical.

CRITERIA

The following should be considered each time a pole location is selected:

1. General Line Poles
 - a. The pole should be located to minimize the visual impact to the public.
 - b. The pole should be located away from existing intersections, corners and driveways to reduce the risk of vehicle contact. A pole that has been hit by a vehicle should have its location reviewed and analyzed by the appropriate C&O center to determine if relocating it would be feasible and would lessen the possibility of it being hit in the future.
 - c. Present or future improvements should not be impacted by pole location.
 - d. Make sure poles are properly placed to prevent poles being located on both sides of the street.
 - e. Avoid placing poles in locations without access such as back lot lines, fenced-in back yards, etc. Do not place sectionalizing or protection equipment (switches, fuses and reclosers) on inaccessible poles. This also applies to capacitors and regulators.
 - f. Try to avoid locating the pole where an angle with incoming conductors will cause excessive side pull.
 - g. Try to locate the pole so that normal crossarm construction can be used. Alley arm construction should be avoided.
 - h. Avoid locating a pole near trees, fire hydrants, signs and buildings that would block climbing access on the pole.
 - i. Are there any subsurface facilities such as water, sewer, Communication Infrastructure Provider (CIP), etc.?
 - j. Will the pole have joint use attachments (CIPs)?
 - k. In 15-foot or 20-foot alleys, pole positions should be four feet or less from the property line to the face of the pole as far off the edge of the roadway as possible within the public right-of-way.
 - l. In streets, a minimum clearance of 18 inches is required between the curb face or shoulder edge and face of pole. If street improvements do not allow 18-inch clearance, then a deviation may be considered in lieu of a pole relocation.
 - m. Substation Design should be consulted for exact pole placement if a pole needs to be installed within 20 feet of a substation fence.

© 1998-2017 San Diego Gas & Electric Company. All rights reserved. Removal of this copyright notice without permission is not permitted under law.

REV	CHANGE	BY	DSGN	APPV	DATE	REV	CHANGE	BY	DSGN	APPV	DATE
A	EDITORIAL CHANGES	JCE	MBL	MDJ	08/22/2017	D					
B						E					
C						F					

SHEET 1 OF 3	Indicates Latest Revision	<input checked="" type="checkbox"/> Completely Revised	<input type="checkbox"/> New Page	<input type="checkbox"/> Information Removed	DM 5121.1
	SDG&E ELECTRIC DISTRIBUTION DESIGN MANUAL				
	POLE PLACEMENT GUIDELINES				

- n. Set new pole on property line if possible.
- o. Poles should be located behind the sidewalk. The preferred location for a new pole is on the property line. If this is not possible due to aerial encroachments, lack of sufficient right-of-way, or some other physical barrier, the poles may be located in the normal sidewalk area provided the sidewalk is either constructed to meander around the poles or the sidewalk is widened in the area of poles to provide a minimum of four feet of useable walkway.

2. Cable Poles

- a. Cable poles that are installed to feed the conversion/subdivision should be located on the boundary of the subdivision with the pole located outside of the subdivision. Anchors, stubs, stubs with anchors, etc., are allowed within the subdivision.
- b. If there is an existing line down a perimeter street that is included within the boundary of the subdivision and conversion of these poles is not required, any suitable pole may be used as a cable pole to feed the subdivision.
- c. More than one cable pole may be established to provide service to a subdivision or development provided the additional service point(s) will:
 - 1) Result in an overall saving of construction costs to SDG&E on the project.
 - 2) Not adversely affect system integrity and reliability.
 - 3) Not adversely affect the aesthetics of the project's future inhabitants and the neighbors surrounding the project.
 - 4) Not require the introduction of new poles into our system. Project Management Supervisor may waive this condition if warranted by unusual conditions.

If the developer can meet all of the above requirements except 2.c.1, he will be permitted to pay the additional costs of establishing more than one cable pole for his project.

- d. Avoid designating a corner pole as a cable pole.

3. Pole Location in Conversion Areas

- a. The nearest pole suitable for becoming a cable pole should be designated to serve the underground area. If the nearest existing pole is not suitable, the cost of a new pole or relocating equipment on the existing pole should be weighed against installing additional cable to bypass the closest pole in lieu of another existing pole.
- b. Some municipalities require conversion of overhead facilities within one-half block of a new underground subdivision that may alter the location of the cable pole.

4. State Highways, Freeways, Street Improvements

Replacing an existing pole adjacent to a designated scenic highway is allowed if the pole is replaced less than four feet from the existing pole location. A move of four feet or more is not considered by the CPUC to be in the same location and therefore requires either an exception from the CPUC, or undergrounding of the line affected.

© 1998-2017 San Diego Gas & Electric Company. All rights reserved. Removal of this copyright notice without permission is not permitted under law.

REV	CHANGE	BY	DSGN	APPV	DATE	REV	CHANGE	BY	DSGN	APPV	DATE
A	EDITORIAL CHANGES	JCE	MBL	MDJ	08/22/2017	D					
B						E					
C						F					

SHEET 2 OF 3	Indicates Latest Revision	<input checked="" type="checkbox"/> Completely Revised	<input type="checkbox"/> New Page	<input type="checkbox"/> Information Removed	DM 5121.2
	SDG&E ELECTRIC DISTRIBUTION DESIGN MANUAL				
	POLE PLACEMENT GUIDELINES				

- a. Avoid pole installation along the outside of a curve, especially on narrow secondary highways.
- b. Future overhead facilities on secondary highways must be 20 feet from the edge of the driven way. On highways with curb and sidewalk improvements, the normal curb position can be used. The edge of the driven way is defined as the white line on the side of the road.
- c. Poles must be placed a minimum at 30 feet from edge of the driven way on major highways and freeways. Overhead freeway crossings should be made in a single span, avoiding the placement of poles within the right-of-way limits.
- d. No longitudinal encroachments should be planned for major highways or freeways. No encroachments should be planned within designated freeways and highways, with more than one lane each way. If in doubt, contact Land Management.
- e. If pole or structure is in a sidewalk, determine if moving the pole can be avoided by the pouring of additional sidewalk. Contact Land Management for assistance.

5. Pole Locations Near Gas Lines

Power poles and/or anchors shall not be located closer than five feet to any gas pipeline that is operated at pressures in excess of 60 psi. Whenever it becomes necessary to locate a pole or an anchor in an existing pipeline right-of-way, every reasonable effort should be made to place the facility on the narrow side of the right-of-way in order to minimize the difficulty of installing a future pipeline in that same right-of-way.

Should it become necessary to locate the facility closer than five feet from the gas pipeline, special precautions should be taken to:

- a. Positively determine the location of the pipeline with respect to the desired location for the pole or anchor by means of excavation in the field prior to any pole hole digging.
- b. Consult the Gas Engineering Department to determine if special construction is required. Should it be necessary to locate the pole or anchor nearer than five feet from the pipeline, insulating or casing material may be installed to prevent accelerated fatigue at a welded joint or branch connection.
- c. Provide a permanent pipeline marker at the site to guide line crews in the event of future repairs or replacements of either the pole or the anchor.

References:

- 1. Service Standards & Guide SG 202, Customer-Owned Service & Meter Poles Permanent/ Climbable 0 – 600 Volts.
- 2. Service Standards & Guide SG 204, Customer-Owned Service & Meter Poles Temporary/Non-climbable 0 – 600 Volts.

© 1998-2017 San Diego Gas & Electric Company. All rights reserved. Removal of this copyright notice without permission is not permitted under law.

REV	CHANGE	BY	DSGN	APPV	DATE	REV	CHANGE	BY	DSGN	APPV	DATE
A	EDITORIAL CHANGES	JCE	MBL	MDJ	08/22/2017	D					
B						E					
C						F					

SHEET 3 OF 3	Indicates Latest Revision	<input checked="" type="checkbox"/>	Completely Revised	New Page	Information Removed	DM 5121.3
	SDG&E ELECTRIC DISTRIBUTION DESIGN MANUAL					
	POLE PLACEMENT GUIDELINES					

SCOPE: This standard provides considerations for the selection of poles based on mechanical requirements, overhead construction techniques, geographical location, and known local conditions.

1. The following considerations must be included in the proper selection of a pole:

- a. Poles shall be of adequate length to provide at least the minimum conductor clearances above ground and from other utility's conductors, including Communication Infrastructure Providers (CIPs) and other structures per GO 95 (See Overhead Construction Standards 220-224).
- b. For a new pole being set, or a pole replacement, where the pole is bucket truck accessible, design into and maintain sufficient clearance to accommodate the use of a bucket truck and rubber gloving work method. Sufficient clearance will be a minimum of six feet between two primary levels, primary and secondary level, primary line and buck, or primary and communication level.
- c. It is recommended that a five-foot taller pole be installed for pole replacements.
- d. A pole loading calculation analysis is required to determine if pole classes are adequate for all vertical and horizontal loadings by using approved software. The design shall consider the structural loading requirements of all supply and communication facilities planned to occupy the pole, and must be calculated using approved software. The "planned" facilities are those that are actually known to SDG&E at the time of design. This requirement applies to new poles and poles being replaced. A post-construction pole load calculation must be performed for all poles upon completion of construction. This post-construction "true-up" report shall include all pole loads, applicable load cases and shall state "percent remaining strength" used for the calculation and the date such intrusive data was obtained. This post-construction report shall be placed in PIDS (Pole Information Data System) within 10 months after completion of construction.

Note: For steel pole construction, the design shall take into consideration the factory drilled hole locations to reduce the amount of field drilling required during construction. The factory drilled hole locations ("knockouts") shall be used for calculation purposes in the design when determining attachment heights on the pole for crossarms, equipment and guying. Refer to Overhead Construction Standard 310 for steel pole factory drilled hole pattern.

- e. Poles must be designed to meet the loading conditions as set forth in Electric Transmission & Distribution Engineering Standard 12100 "Direct Buried Pole Selection and Loading Criteria" in accordance with Non-Operational Electric Standard Practice (ESP) 015 "Structural Pole Loading Calculation Requirements." Additionally, poles in High Fire Threat Districts Tier-2 and Tier-3 must be designed in accordance with Overhead Construction Standard page 340.2, section 2. In all cases, facilities will meet or exceed GO 95. Refer to Table 1.
- f. Determine if any special hauling and/or digging instructions are required.
- g. Determine adequate guying for the design.
- h. Determine pole stepping requirements. See Overhead Construction Standard 363.
- i. Determine future pole height requirements. Consider future distribution, possible joint utility attachment(s).
- j. Minimum pole class shall be class 1. See Overhead Construction Standard 354 for pole classes.
- k. Provide room for pole-bolted transformers when they are needed. This can be done using either (a) taller poles for rearrangement of conductor levels, or (b) pole top extensions (see Overhead Construction Standard 473). Wood pole top extensions are not to be used on steel poles.
- l. The preferred construction in the Cleveland National Forest (CNF) shall be weathering steel poles. Composite poles are available for use in wetland areas of the CNF.

© 1998 - 2022 San Diego Gas & Electric Company. All rights reserved. Removal of this copyright notice without permission is not permitted under law.

REV	CHANGE	DR	BY	DSN	APV	DATE	REV	CHANGE	DR	BY	DSN	APV	DATE
C	EDITORIAL CHANGES	EPC	FRC	JAS	FRC	01/07/2022	F						
B	EDITORIAL CHANGES	-	JCE	MBL	MDJ	09/01/2018	E						
A	EDITORIAL CHANGES	-	JC	TR	MDJ	5/5/2015	D						

SHEET 1 OF 2	X Indicates Latest Revision	Completely Revised	New Page	Information Removed
	SDG&E ELECTRIC DISTRIBUTION DESIGN MANUAL			
	POLE SELECTION CRITERIA			

DM5122.1

- m. Weathering steel poles are not to be installed in Contamination District 1. Refer to Table 1.
- n. Steel poles shall not be used in wetland/high water table areas. In these cases, composite poles shall be used. Refer to Table 1.
- o. Weathering steel poles are not to be installed in sidewalks (improved streets), as they will stain the sidewalk when the patina is washed off the pole due to rain or irrigation. Refer to Table 1.
- p. All steel poles shall be grounded as described in OH Standard 1000.

2. Pole Selection Matrix

- a. TABLE 1 will help to identify what type of pole to use in certain locations. As always, field conditions should be considered when choosing the correct pole. Aesthetics should be considered in some cases.

Application Location	Wood	Galvanized Steel	Weathering Steel	Composite
Back Lot	✓	✓	✓	✓
Cleveland National Forest	-	-	✓	**
Contamination District 1	✓	✓	-	✓
Contamination District 2 & 3	✓	✓	✓	✓
High Fire Threat Districts Tier-2 and Tier-3	-	✓	✓	**
Improved Street	✓	✓	-	-
Unimproved Street	✓	✓	✓	*
Wetland	*	-	-	✓
High Wind (Circuit-170, 171, 172, 221)	-	-	✓	-

✓ = Approved

- = Not Approved

* = Approved by Deviation request only

** = Approved for use in wetland area of CNF and the High Fire Threat Districts Tier-2 and Tier 3.

NOTES:

- (A) Steel poles come pre-drilled from the factory with knock-out holes. If field drilling holes consistently in the same location, contact Electric Distribution Engineering for possible additional knock-outs. See Overhead Construction Standard 310 for factory drilled hole locations ("knockouts").
- (B) Pole Loading Calculation Compliance Training is MANDATORY before performing pole loading calculations.

© 1998 - 2022 San Diego Gas & Electric Company. All rights reserved. Removal of this copyright notice without permission is not permitted under law.

REV	CHANGE	DR	BY	DSN	APV	DATE	REV	CHANGE	DR	BY	DSN	APV	DATE
C	EDITORIAL CHANGE	EPC	FRC	JAS	FRC	01/07/2022	F						
B	EDITORIAL CHANGES	-	JCE	MBL	MDJ	09/01/2018	E						
A	EDITORIAL CHANGES	-	JC	TR	MDJ	5/5/2015	D						

SHEET 2 OF 2	X Indicates Latest Revision	Completely Revised	New Page	Information Removed
	SDG&E ELECTRIC DISTRIBUTION DESIGN MANUAL			
	POLE SELECTION CRITERIA			

DM5122.2

SCOPE

This standard provides criteria for the proper use of crossarm overhead construction.

1. Double Crossarms

Specify double crossarm installation only when this type of construction is required. This will result in improved aesthetics and savings in construction costs.

2. Alley Arms

Alley arms are installed:

- a. To avoid conductor contact with trees.
- b. To comply with easement and private property requirements.
- c. For street improvements which require the relocation of one or more poles to maintain existing conductor alignment.
- d. To maintain radial clearance from buildings through alleyways.
- e. To maintain a straight line in two directions on a corner with a wide radius.

3. Crossarm Checklist

- a. Evaluate and confirm required conductor and hardware spacing.
- b. For Grade A crossings, ensure correct safety factors are applied when performing crossarm loading calculations.
- c. Double arms if required to support conductor load.
- d. Utilize most recent approved crossarm calculation software to confirm crossarm loading criteria.
- e. Check conditions of crossarms: split, rotten, evidence of tracking.
- f. When converting a 4 kV system to 12 kV, all crossarms and hardware must be modeled for the correct voltage level.
- g. When utilizing existing primary line and buck arms on cutovers with top level dead-ended and the lower level on pins and insulators, separate line and buck by 30 inches (standard spacing for primary is 24 inches).

© 1998-2017 San Diego Gas & Electric Company. All rights reserved. Removal of this copyright notice without permission is not permitted under law.

REV	CHANGE	BY	DSGN	APPV	DATE	REV	CHANGE	BY	DSGN	APPV	DATE
A	EDITORIAL CHANGES	JCE	MBL	MDJ	08/22/2017	D					
B						E					
C						F					

<p>SHEET 1 OF 1</p>	<input type="checkbox"/> Indicates Latest Revision	<input checked="" type="checkbox"/> Completely Revised	<input type="checkbox"/> New Page	<input type="checkbox"/> Information Removed	<p>DM 5123</p>
	<p>SDG&E ELECTRIC DISTRIBUTION DESIGN MANUAL</p>				
	<p>CROSSARM CONSTRUCTION CONSIDERATIONS</p>				

SCOPE: This standard provides criteria for the proper use of primary conductors in overhead construction.

1. Span Lengths

Care should be taken when changing from vertical configuration to triangular or horizontal configuration so that pin spacing is not reduced. Long spans should be avoided in this situation. See Overhead Construction Field Maintenance Only Standards Section 499 for span lengths required when using vertical construction.

2. Reduced Tension Spans

Reduced tension construction is used only when adequate guying cannot be installed. The installation of conductor at reduced tension should be avoided. Keep reduced tension span conductors in the same relative position at both ends of the span (i.e. do not change from horizontal to vertical construction in a reduced tension span).

3. Mixing Copper and Aluminum Conductor

Do not use aluminum and copper conductors in the same span. The dissimilarity in sag can cause conductors to slap together and result in service interruptions.

4. Conductor Protection

Weatherproof copper wire is no longer installed on primary, series, or secondary circuits. All cutovers from 4 kV to 12 kV on the main feeder should not use existing weatherproof wire for 12 kV. Specify bare copper or ACSR/AW conductor on all future work orders and replace services where insulation is missing.

Line guards are to be installed over 5005, ACSR, or AWAC conductors on distribution circuits at all pin, clamp top or suspension supports. See Overhead Construction Standard 759.

5. Primary Neutral Conductor

In addition to jobs issued specifically to install a primary neutral conductor on the primary overhead system, primary neutral conductors shall be included or poles shall be framed for primary neutral conductors in the following jobs:

- a. The fourth conductor (primary neutral) shall be installed on all new or reconducted distribution feeders. If the primary neutral conductor cannot be connected to the substation ground without major expense, an existing grounding bank neutral shall be considered (see **Filed Maintenance Only (FMO) OH1194** for grounding bank information). It is preferable that a fourth wire/primary neutral is connected to the substation.
- b. The primary neutral shall have a ground every 1000 feet or less if only steel poles are within that distance. If steel, wood, or composite poles exist within the 1000-foot distance only steel poles shall be grounded. If there are only wood or composite poles within the 1000-foot distance none of the poles shall be grounded. All equipment shall be grounded. Grounded equipment and cable poles do not count toward the ground every 1000 feet requirement.
- c. Circuits that operate at 12,470 volts wye (Mountain Empire District), where the primary neutral extends from the substation, shall have a ground every 1000 feet or less if only steel poles are within that distance. If steel, wood, or composite poles exist within the 1000-foot distance only steel poles shall be grounded. If there are only wood or composite poles within the 1000-foot distance none of the poles shall be grounded. All equipment shall be grounded. Grounded equipment and cable poles do not count toward the ground every 1000 feet requirement.
- d. All new or reconducted **distribution feeders, starting at the substation,** shall be designed and framed for the primary neutral.
- e. The primary neutral conductor is not required on a two-wire distribution tap/lateral.
- f. **The Neutral conductor shall be appropriately labeled as primary neutral "PN" or Common Neutral "CN".**

Depending on the current circuit /conductor configuration the primary neutral can be installed in the outside or inside pin position.

Installation problems may exist when installing a primary neutral conductor on an existing vertical pole due to primary conductor position as

© 1998 - 2021 San Diego Gas & Electric Company. All rights reserved. Removal of this copyright notice without permission is not permitted under law.

REV	CHANGE	DR	BY	DSN	APV	DATE	REV	CHANGE	DR	BY	DSN	APV	DATE
C							F						
B	EDITORIAL CHANGES	EPC	MBL	FRC	CZH	12/12/2021	E						
A	EDITORIAL CHANGES		JCE	MBL	MDJ	08/22/2017	D						

SHEET 1 OF 2	X Indicates Latest Revision	Completely Revised	New Page	Information Removed
	SDG&E ELECTRIC DISTRIBUTION DESIGN MANUAL			
	PRIMARY CONDUCTOR REQUIREMENTS			
DM5124.1				

The primary neutral conductor should be installed on the inside position closest to the pole. However, field conditions and construction needs should be considered as there may be pole top arrangements where placement of the primary neutral conductor in an outside position would be safer.

If existing construction has the primary neutral on the inside position, then the primary neutral should continue to be located on the inside position for a job that extends the circuit from the point the primary neutral stopped on the existing circuit.

© 1998 - 2021 San Diego Gas & Electric Company. All rights reserved. Removal of this copyright notice without permission is not permitted under law.

REV	CHANGE	DR	BY	DSN	APV	DATE	REV	CHANGE	DR	BY	DSN	APV	DATE
C							F						
B	EDITORIAL CHANGES	EPC	MBL	FRC	CZH	12/12/2021	E						
A	EDITORIAL CHANGES		JCE	MBL	MDJ	08/22/2017	D						

SHEET 1 OF 2	X Indicates Latest Revision	Completely Revised	New Page	Information Removed	DM5124.1
	SDG&E ELECTRIC DISTRIBUTION DESIGN MANUAL				
	PRIMARY CONDUCTOR REQUIREMENTS				

SCOPE

This standard provides criteria for the proper use of secondary and service conductors in overhead construction.

1. Guard Arms on Secondary Cable Deadends

When guard arms are required above a dead-ended secondary aerial cable (0-750V), double guard arms are required. They are to be located parallel to dead-ended cable and not more than four inches above the top of the cable. These arms must be a minimum of four feet long and braced.

2. Overhead Services

- a. Check for legal clearance.
- b. Check size of customer's panel and customer load requirement to determine appropriate conductor size.
- c. Determine service point for street light services.
- d. If existing service is bare wire or gray wire, it shall be replaced with triplex/quadruplex conductor.
- e. A triplex/quadruplex conductor shall be installed for a new service.
- f. If existing service is open wire and needs to be replaced, it shall be replaced with triplex/quadruplex conductor.

3. Low Services

The following recommended procedures may be used to obtain legal clearances for services:

- a. Pull slack from conductors and services.
- b. Raise conductors and services on poles where possible by installing a guard arm above rack construction in compliance with GO 95, Rule 54.9E.
- c. Remove buck arms and install triplex/quadruplex services on ends of line arms.

Intersect service poles to obtain required clearance. Set clearance poles on customer's property when no other options exist.

© 1998 - 2021 San Diego Gas & Electric Company. All rights reserved. Removal of this copyright notice without permission is not permitted under law.

REV	CHANGE	DR	BY	DSN	APV	DATE	REV	CHANGE	DR	BY	DSN	APV	DATE
C							F						
B	EDITORIAL CHANGE	EPC	FRC	JAS	CZH	11/17/2021	E						
A	EDITORIAL CHANGES		JCE	MBL	MDJ	08/22/2017	D						

SHEET 1 OF 1	X Indicates Latest Revision	Completely Revised	New Page	Information Removed	DM5125
	SDG&E ELECTRIC DISTRIBUTION DESIGN MANUAL				
	SECONDARY & SERVICE CONDUCTOR REQUIREMENTS				

SCOPE

This standard provides a guideline for the selection of locations for the installation of warning spheres on overhead lines. Warning spheres are used to call the public's attention to the presence of energized overhead conductors, with voltages between zero and 22,500 volts, in authorized boat operating and launching areas.

PURPOSE

To determine appropriate locations where warning spheres should be installed on overhead lines.

DEFINITION

Nautical Craft – a boat/raft/dredge/barge/etc. with a mast, antenna or superstructure that when erected would extend vertically above 14'-3" from the ground or body of water.

GUIDELINES

Warning spheres shall be installed on overhead lines, at the discretion of **SDG&E**, when (1) physical evidence (2) together with personal observation or (3) notification from the general public suggests that nautical craft may come within 20 feet of energized conductors (0-22,500 volts) while being operated or preparing for operation with the mast, boom, antenna or superstructure erected.

This applies but is not limited to the following locations:

1. A designated nautical craft launching area or driveway to such area.
2. A body of water that is frequented by nautical craft as evidenced by posted signs, personal observation or notification from the general public.
3. A nautical craft storage facility.

APPLICATION

Customer Project Planner shall notify the C&O Center's Operations and Engineering Manager with a written request for investigation whenever an overhead conductor requires warning spheres, as specified in the guideline above. The District Operations and Engineering Manager shall determine whether the conductor should be protected with warning spheres according to Overhead Construction Standard 325, or the line should be either relocated or converted to underground based on cost and physical limitations.

References:

1. California Vehicle Code, Section #35250.
2. **Overhead** Construction Standard 325, **Boat Launching Area Warning Sphere**.

© 1998-2017 San Diego Gas & Electric Company. All rights reserved. Removal of this copyright notice without permission is not permitted under law.

REV	CHANGE	BY	DSGN	APPV	DATE	REV	CHANGE	BY	DSGN	APPV	DATE
A	EDITORIAL CHANGES	JCE	MBL	MDJ	08/22/2017	D					
B						E					
C						F					

SHEET 1 OF 1	X Indicates Latest Revision	Completely Revised	New Page	Information Removed	DM 5126
	SDG&E ELECTRIC DISTRIBUTION DESIGN MANUAL				
	WARNING OF OVERHEAD CONDUCTORS BOAT OPERATING – LAUNCHING AREAS				

SCOPE

This standard provides the requirements for submitting electric load studies for load additions to the overhead and underground electrical distribution system.

FIGURES

None

INSTALLATION

None

BILL OF MATERIALS

None

NOTES

Electric Load Studies are required for any load addition to a 2.4 KV, 4 KV, or 12 KV circuit. This applies to any transformer kVA addition either through an increase caused by a transformer replacement, an increase by addition of a new transformer load, or an addition of load through a primary metered system. A load study is not required if a load increase to an existing transformer does not require the size to be increased.

Some additional items are now required to assist in processing Electric Load Studies.

- I. Load studies for 1 MW or greater load additions must be reviewed and approved by the Senior/Principal Engineer.
- II. The Planning Engineer must review and approve the specified circuit or circuits required to serve the load additions on the load study.
- III. To control new load added to 4 KV circuits, any station greater than 500 kVA will require a Construction Standard Deviation and approval from Distribution Planning.
- IV. For primary metered load additions, the Planning Engineer will review and approve the load addition and selected circuit.
- V. The Customer Project Planner will submit a Fusing Request that is in conjunction with the load study.
- VI. The Customer Project Planner shall include the items listed below on the load study:
 - a. All added transformer kVA load to either overhead or underground transformers.
 - b. Identified circuit, substation, and existing station number if identified for the additional load.
 - c. Description detailing the cause for the new load addition.
 - d. Motors of 25 horsepower or larger, and all elevator motors, include intended use of motor and number of starts per hour per day.
 - e. Additional items within the load study, please reference Service Planning Manual 392.

REFERENCE

- a. Service Planning Manual 392, Load Studies, Gas and Electric.

© 1998-2020 San Diego Gas & Electric Company. All rights reserved. Removal of this copyright notice without permission is not permitted under law.

REV	CHANGE	DR	BY	DSN	APV	DATE	REV	CHANGE	DR	BY	DSN	APV	DATE
C							F						
B	REVISED	CSE	MVM	FRC	CZH	11/09/2020	E						
A	EDITORIAL CHANGES		JCE	MBL	MDJ	08/22/2017	D						
SHEET 1 OF 1		X	Indicates Latest Revision			Completely Revised		New Page		Information Removed			
			SDG&E ELECTRIC DISTRIBUTION DESIGN MANUAL										
			ELECTRIC LOAD STUDY REQUIREMENTS										
													DM5127.1

SCOPE

This standard references the designated avian protection critical areas and those standards and publications which provide guidance for the application of avian safe construction.

The San Diego Gas & Electric (SDG&E) Avian Protection Plan (APP) was approved and implemented in January 2005. The APP was developed in a partnership between the Departments of Land Planning and Natural Resources and Electric Distribution Engineering. Following this plan assures that SDG&E is in compliance with its 50-year environmental permit and Federal laws that protect both raptors and all migratory birds.

The SDG&E Overhead Construction Standards Section 1600 was developed to provide these guidelines and should be followed to maintain compliance.

Reference:

1. Overhead Construction Standards Section 1600, Wildlife Protection.

© 1998-2017 San Diego Gas & Electric Company. All rights reserved. Removal of this copyright notice without permission is not permitted under law.

REV	CHANGE	BY	DSGN	APPV	DATE	REV	CHANGE	BY	DSGN	APPV	DATE
A	REAFFIRMED	JCE	MBL	MDJ	08/22/2017	D					
B						E					
C						F					

<p>SHEET 1 OF 1</p>	Indicates Latest Revision	Completely Revised	New Page	Information Removed	<p>DM 5128</p>
	<p>SDG&E ELECTRIC DISTRIBUTION DESIGN MANUAL</p>				
	<p>AVIAN PROTECTION</p>				

SCOPE

This standard provides guidelines for the evaluation of spans for phase spacing.

GUIDELINES

When a span of the overhead electric distribution system has been identified as having the potential to have phases slap together, the following steps should be followed to correct the problem. These guidelines apply to spans with three or four conductors.

1. Correctly sag the conductors.
2. Increase phase separation on the existing crossarms or apply longer crossarms (if feasible). Apply Overhead Construction Standard 819. "Two-over-two" or delta configuration should be considered.
3. For existing construction only apply spacers until step 2 can be completed. Spacers should be installed as close to the middle of the span as possible. It is possible that spacers could still be applied on existing spans even if phase separation is correct depending on environmental conditions (i.e. high wind area, long span). Spacers may also be used for freeway crossings if phase separation is an issue.

The following factors regarding spacers should also be considered when determining if they can be used:

- Spacers are helpful in maintaining mid-span phase conductor separation in cases where dissimilar conductors exist (size or type differ). Regardless, spacers applied in this manner are an interim measure until a permanent solution is completed (re-build, reconductor, re-route, undergrounding, etc.)
- Spacers will add wind loading and weight to the line. Spacers will also expedite the accumulation of ice in areas subject to extreme winter weather.
- Spacers shall not be used on new construction without a deviation request approved by Electric Distribution Engineering.

Listed below are guidelines for reviewing phase spacing based on span length and conductor size.

Span Length (FT)	Smallest Conductor Size in Span		
Less than 600	#2 ACSR or smaller	or	#4 Copper or smaller
600 to 799	3/0 ACSR or smaller	or	#2 Copper or smaller
800 to 999	336 ACSR or smaller	or	#1/0 Copper or smaller
1000 or longer	Consult Electric Distribution Engineering regardless of conductor size		

NOTE:

Refer to Overhead Construction Standard 755 for spacer installation instructions. Bucket truck access to the spacer location is required. More than one spacer may be installed within a span if bucket truck access to the middle of the span is not possible.

Helicopter application of distribution phase spacers is not feasible.

References:

1. Overhead Construction Standard 755, Fiberglass Conductor Spacer.
2. Overhead Construction Standard 819, Horizontal Conductor Spacing General Information.
3. Overhead Construction Standard 1650, Delta Poletop Configuration.
4. Overhead Construction Standard 1655, "Two-Over-Two" Poletop Configuration.

© 1998-2017 San Diego Gas & Electric Company. All rights reserved. Removal of this copyright notice without permission is not permitted under law.

REV	CHANGE	BY	DSGN	APPV	DATE	REV	CHANGE	BY	DSGN	APPV	DATE
A	REAFFIRMED	JCE	MBL	MDJ	08/22/2017	D					
B						E					
C						F					

SHEET 1 OF 1	Indicates Latest Revision	Completely Revised	New Page	Information Removed	DM 5129
	SDG&E ELECTRIC DISTRIBUTION DESIGN MANUAL				
	DISTRIBUTION PHASE SPACING				

**5200
UNDERGROUND
LAYOUT SYSTEMS**

**5200
UNDERGROUND
LAYOUT SYSTEMS**

PAGE(S)

SUBJECT

5211

5211.1 – 5211.3

Underground Design Process Guideline

Customer Load Information, Job Location,
Distribution Planning, Secondary Systems,
Primary Systems, Protection

5221

Loop Criteria for Commercial and Industrial Loads

5222

Single-Family Residential Secondary and Service Design Criteria

5222.1

General Design Procedure

5222.2 – 5222.4

Preferred Design Configuration

5223

Single-Family Residential Secondary Systems

5227

Common G.O. 128 Infractions

5231

Trench Position Requirements

5231.1 – 5231.4

Positive Relative to Fire Hydrants

Trench Depth

Sharing

Trench in Proximity to Wet Utilities

5236

Sight Distance Requirements

5240

Underground System Equipment

5240.1 – 5240.4

Selection and Location

5250

Underground Sectionalizing Equipment

5250.1 – 5250.6

Application Guide

© 1998-2020 San Diego Gas & Electric Company. All rights reserved. Removal of this copyright notice without permission is not permitted under law.

REV	CHANGE	BY	DSGN	APPV	DATE	REV	CHANGE	BY	DSGN	APPV	DATE
C						F					
B	FORMATTING	JIK	-	-	02/21/2020	E					
A	ORIGINAL ISSUE	-	JCE	VCR	03/01/2002	D					

 Indicates Latest Revision	Completely Revised	New Page	Information Removed
---	--------------------	----------	---------------------

SHEET
1 OF 1

SDG&E ELECTRIC DISTRIBUTION DESIGN MANUAL

**TABLE OF CONTENTS
UNDERGROUND SYSTEM LAYOUT**

DM5201.1

SCOPE

This standard provides criteria for the design process associated with underground construction.

A. Customer Load Information

SDG&E will provide the customer with appropriate service voltages depending on the customer's load based on the appropriate demand estimating criteria (DS5311 – Commercial, DS5322 – Residential). The customer's serving voltage will be one of the voltage levels specified in the "Rules for the Sale of Electric Energy". The Customer Project Planner must know the customer's service voltage as soon as possible to allow proper choice of material and equipment for design.

B. Job Location

The location of the project should be the Customer Project Planner's second consideration. All projects should be checked in the field. On-site inspection will give the Customer Project Planner information on the following:

1. Existing Facilities
2. Possible Conflicts
3. Future Area to be Developed
4. Elevations, if Grading has Started

C. Distribution Planning Work Sheet (Should be Submitted for Most Jobs)

1. Number and size of primary feeder circuits (Cable and Feeder conduits)
2. Any sectionalizing requirements (Switches and Fuse sizes)
3. Special requirements for extra ducts, such as allowances for SCADA cables

NOTE: The Customer Project Planner shall design the project in accordance with the feeder requirements specified on the Long Term Feeder Arrangement Plan.

D. Location of Load (Service Points)

In single-family subdivisions, apply Design Standard 5223. Otherwise:

1. Locate transformer near load
2. Size service or secondary cables
3. Size secondary conduit
4. Provide secondary substructure, if required
5. Route primary cable and conduit as required

NOTE: Three phase loads may not be served from three separate one phase cables brought together from separate one phase sources (As opposed to 3 – one phase cables from a common three phase source) at the location where three phase service is required.

© 1998-2020 San Diego Gas & Electric Company. All rights reserved. Removal of this copyright notice without permission is not permitted under law.

REV	CHANGE	BY	DSGN	APPV	DATE	REV	CHANGE	BY	DSGN	APPV	DATE
C						F					
B	FORMATTING	JIK	-	-	02/21/2020	E					
A	ORIGINAL ISSUE		CVN	RDG	01/01/1987	D					

SHEET 1 OF 4	X Indicates Latest Revision	Completely Revised	New Page	Information Removed	DM5211.1
	SDG&E ELECTRIC DISTRIBUTION DESIGN MANUAL				
	UNDERGROUND DESIGN PROCESS GUIDELINE				

E. Energy Source

The energy source needed to energize the primary system will be one of the following:

NOTE: Supervisory Control and Data Acquisition: Remote Switching Cable which also gather information (Temperature, Voltage, Current, etc.) for Distribution Planning.

1. Overhead source from a cable pole
2. Underground source
 - a. New Underground Structure
 - b. Old Underground Extension
3. Substation System
4. Trenching to Cable Poles or Existing Facilities

NOTE: As a general rule, the applicant/contractor will be allowed to complete the trench and installation of conduits and/or substructures.

F. Secondary Systems

A secondary system is an electric system between the transformer and last connection point of service before connection to customer's service panel. The customer project planner should take into consideration the following when designing a secondary system:

1. Distance between service point (Metering facilities) and transformer
2. Locating secondary substructures
3. Sizing conductors
4. Pulling tension
5. Voltage drop
6. Conduit sizing
7. Load growth
8. Voltage flicker
9. Service trenches

The following are acceptable service trench positions:

- a. Figure 5 shows the preferred service trench layout when the grade differential between lots is less than 3'. The service trench may be installed on either side of a common lot line according to field conditions with the customer project planner's or inspector's approval.
- b. Figure 6 shall be used when the grade differential between lots is 3' or more. Gas service trench location will be determined by the customer project planner or inspector for joint installation.

© 1998-2020 San Diego Gas & Electric Company. All rights reserved. Removal of this copyright notice without permission is not permitted under law.

REV	CHANGE	BY	DSGN	APPV	DATE	REV	CHANGE	BY	DSGN	APPV	DATE
C						F					
B	FORMATTING	JIK	-	-	02/21/2020	E					
A	ORIGINAL ISSUE	-	CVN	RDG	01/01/1987	D					

SHEET 2 OF 4	X Indicates Latest Revision	Completely Revised	New Page	Information Removed
	SDG&E ELECTRIC DISTRIBUTION DESIGN MANUAL			
	UNDERGROUND DESIGN PROCESS GUIDELINE			
DM5211.2				

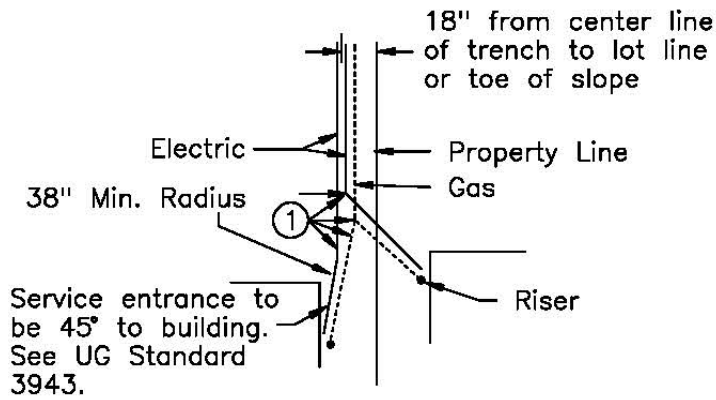

FIGURE 5

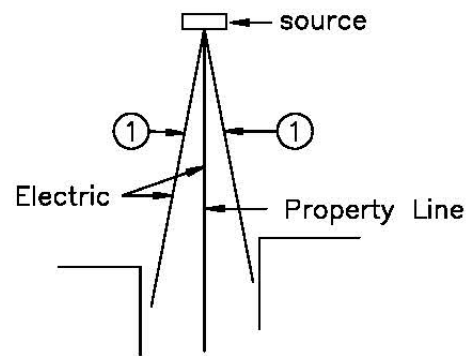

FIGURE 6

G. Primary System

An underground primary system is an electrical system from a primary voltage source (12 KV, 7.2 KV, 6.9 KV, 4 KV, or 2.4 KV) to one or more primary transformers depending on the type of development to be served. In designing an underground primary system, the customer project planner should take into consideration the following:

1. Transformer location (Or point of service for primary-metered customers)
 - a. Single-family Residential
 - b. Multi-family Residential or Commercial
2. Primary Cable
 - a. Single-family or Multi-family Residential
 - b. Commercial
 - c. Cable Pulling
3. Primary Structure Locations
 - a. Single-family Residential
 - 1) Substructure
 - 2) Conduit and Trench
 - b. Multi-family Residential or Commercial
 - 1) Substructure
 - 2) Conduit and Trench

© 1998-2020 San Diego Gas & Electric Company. All rights reserved. Removal of this copyright notice without permission is not permitted under law.

REV	CHANGE	BY	DSGN	APPV	DATE	REV	CHANGE	BY	DSGN	APPV	DATE
C						F					
B	FORMATTING	JIK	-	-	02/21/2020	E					
A	ORIGINAL ISSUE	-	CVN	RDG	01/01/1987	D					

SHEET 3 OF 4	Indicates Latest Revision	Completely Revised	New Page	Information Removed
	SDG&E ELECTRIC DISTRIBUTION DESIGN MANUAL			
	UNDERGROUND DESIGN PROCESS GUIDELINE			
DM5211.3				

- 4. Connections
 - a. Loadbreak
 - b. Non-Loadbreak

H. Protection

When designing a primary system, the following protective devices for the primary electric system should be provided:

- 1. Fuse cutouts on poles
- 2. Fused switching cabinets
- 3. Transformer fusing
- 4. Fused elbow connectors

See Sectionalizing and Protection (Section 6100) for further details.

REFERENCES

- 1. Service Planning Practice 204, Closest Source Policy
- 2. Service Planning Practice 240, Gas and Electric Service Line Extensions and Service / Meter Requirements for Subdivisions / Developments
- 3. Service Planning Practice, 349, Field Check Request
- 4. Service Planning Practice 341, Design Procedure
- 5. Service Planning Practice 280, Underground Three-Phase Bring-Up
- 6. Service Planning Practice 740, Guidelines for Installing / Intersetting / Relocating Overhead Facilities on Rule 20 B & C Conversions
- 7. Service Planning Practice 228, Facilities Coordination with CATV and Private use Companies
- 8. Service Planning Practice 229, Facilities Coordination with Telephone Companies
- 9. Design Manual 5231, Trench Position Requirements

© 1998-2020 San Diego Gas & Electric Company. All rights reserved. Removal of this copyright notice without permission is not permitted under law.

REV	CHANGE	BY	DSGN	APPV	DATE	REV	CHANGE	BY	DSGN	APPV	DATE
C						F					
B	FORMATTING	JIK	-	-	02/21/2020	E					
A	ORIGINAL ISSUE	-	CVN	RDG	01/01/1987	D					

SHEET 4 OF 4	 Indicates Latest Revision	Completely Revised	New Page	Information Removed
	SDG&E ELECTRIC DISTRIBUTION DESIGN MANUAL			
	UNDERGROUND DESIGN PROCESS GUIDELINE			

DM5211.4

SCOPE

This design criteria establishes a looped distribution system which is fused when required by the transformer size.

PURPOSE

The looped local distribution system allows a troubleshooter to restore service to all but two transformers by operating 200 amp loadbreak elbows. Transformers which are too large to be fused are served from the feeder system.

DEFINITIONS

Loop Design – Incorporates a fused local distribution cable. Therefore, this design is limited for fusible transformers whose total connected KVA does not exceed the fuses' capability.

Lot Development Design – Combines the loop design for fusible transformers with radially fed transformers which are too large to fuse.

Commercial Load Forecast – Provides an ultimate demand estimate for a commercial or industrial building constructed in a lot development project when no developer load information is provided.

Residential Looping Criteria – Provides minimum looping criteria for single-family and multi-family residential developments.

CRITERIA

A. General Design Criteria for Commercial and Industrial Systems

The commercial/industrial primary system design was based on an ACO (Annual Cost of Ownership) economic analysis that determined the minimum system requirements and particular equipment layout. All fusible transformers shall be attached to the looped local distribution system; however, large transformers are served radially from the feeder system.

1. The primary system shall be designed in accordance with this standard whenever three or more transformers totaling at least 450 KVA will ultimately be required.
2. The transformer size may be estimated from the Commercial and Industrial Demand Estimating Criteria (Design Standard 5311) or the Commercial Load Forecast Criteria provided in Section D of this standard.

B. Loop Design

The loop design is limited to fused local distribution cable. Transformers which are too large to be fused are served radially from the feeder. This method used to serve large transformers is detailed in Section C "Lot Development Design."

1. The loop design may be constructed through loop-feed transformers (Figure 5) or the transformers may be served radially from a looped local distribution cable installed in the street (Figure 6).
2. No more than two transformers may be served from a radial cable and no more than two radial cables may be connected to a cable tap (Figure 6). In the event of an outage, a troubleshooter shall be able to restore service to all but two transformers by isolating the damaged equipment.
3. The Molded Vacuum Interrupter (MVI) shall not be installed on underground circuits that connect to an open point on the same circuit or an open point that creates a tie with another circuit.
4. Transformers 1500 KVA and larger may not be attached to the fused loop design (Figure 8).
5. A single fuse cabinet loop design (Figure 1) can serve up to 2080 KVA. A two fuse cabinet loop design (Figure 3) can serve up to 3120 KVA.

© 1998-2020 San Diego Gas & Electric Company. All rights reserved. Removal of this copyright notice without permission is not permitted under law.

REV	CHANGE	BY	DSGN	APPV	DATE	REV	CHANGE	BY	DSGN	APPV	DATE
C	EDITORIAL	JAE	FRC	CZH	09/25/2020	F					
B	FORMATTING	JIK	-	-	02/21/2020	E					
A	ORIGINAL ISSUE	-	JCE	VCR	03/01/2002	D					

SHEET 1 OF 7	X Indicates Latest Revision	Completely Revised	New Page	Information Removed
	SDG&E ELECTRIC DISTRIBUTION DESIGN MANUAL			
	RESIDENTIAL/COMMERCIAL/INDUSTRIAL PRIMARY SYSTEM DESIGN (LOOP SYSTEMS)			

DM5221.1

NOTE: Use #2 AL cable for a single fuse cabinet loop (Figures 1 & 2) and use 2/0 AL cable for a two fuse cabinet loop (Figure 3).

6. The loop design does not have to be completed on the initial work order if future job(s) will ultimately complete the looped local distribution cable.
7. The preferred fused device, because of its lower install cost, is a cable pole which is not subject to future removal. However, a fuse cabinet is acceptable in all situations.
8. The local distribution cable's circuit length shall be at least twice as long as the feeder line segment it surrounds (Figure 4). This prevents the loop design from sharing too much load when the loop is in parallel with the feeder.
9. Surface operable loadbreak equipment shall be used within the loop design. Therefore, manholes may only be used to aid cable pulling within the loop and supply a fuse cabinet that serves the loop.
10. Each loop design shall have:
 - a. A single normally open point located at the load center.
 - b. A single normally open point located at the point furthest from the single fused device (Figures 1, 2 & 3). The normally open point shall be tagged "normally open loop" and preferably not located within a transformer compartment.

C. Lot Development Design

A lot development design is completed before the developer has provided connected load information. The estimated demand per lot is determined from the Commercial Load Forecast of Section D.

1. All lots shall be supplied with a 4" conduit stub.
2. A 4" loop conduit system shall be installed in the street for the fused local distribution system.
3. A 5" loop conduit system shall be installed in the street when at least 2000 KVA will be served on an unfused cable (Design Standard 6232). A 4" radial conduit system is sufficient when a single 1500 KVA transformer will be served.
4. Lots which may be served with unfused cable (Greater than 1000 KVA) shall be provided with two 4" conduit stubs in case the lot is subdivided prior to the installation of electric facilities. Each stub shall originate from a substructure that will permit the transformer(s) to be served from fused cable while only one stub must allow connection to unfused cable.
5. A combination of lots which, if constructed as a single lot, may require unfused cable (Greater than 1000 KVA) shall be provided with a 4" conduit stub originating from a substructure that will permit the transformer(s) to be served from either fused or unfused cable.
6. Substructure/conduit configurations shall be able to serve lots on both sides of the street if the land is vacant on both sides of the street.
7. A fuse cabinet pad shall be placed as close to the feeder as possible (Design Standard 6121) to serve the local distribution system. More than one pad is required when the estimated fusible load exceeds 2080 KVA.
8. In most cases, a 3315 primary substructure is adequate. However, a 3316 substructure may be used when required or cost justified.

D. Commercial Load Forecast

The commercial load forecast provides an ultimate demand estimate for a commercial or industrial building constructed in a lot development project. It is based on land use information which the developer submits to the

© 1998-2020 San Diego Gas & Electric Company. All rights reserved. Removal of this copyright notice without permission is not permitted under law.

REV	CHANGE	BY	DSGN	APPV	DATE	REV	CHANGE	BY	DSGN	APPV	DATE
C	EDITORIAL	JAE	FRC	CZH	09/25/2020	F					
B	FORMATTING	JIK	-	-	02/21/2020	E					
A	ORIGINAL ISSUE	-	JCE	VCR	03/01/2002	D					

SHEET 2 OF 7	X Indicates Latest Revision	Completely Revised	New Page	Information Removed
	SDG&E ELECTRIC DISTRIBUTION DESIGN MANUAL			
	RESIDENTIAL/COMMERCIAL/INDUSTRIAL PRIMARY SYSTEM DESIGN (LOOP SYSTEMS)			
DM5221.2				

municipality in the form of a City Approved Design Guideline or other document.

- Equation 1 shall be used to determine the estimated transformer size for each lot within a lot development project. The choice of system design, loop, or lot development is dependent on the estimated transformer size.

$$KW = SQFT \times BLDCVG \times MAXSTR \times KWSQFT \quad \text{Equation 1}$$

Where:

- KW – estimated connected kW
- SQFT – gross square footage of the lot
- BLDCVG – maximum building coverage on the lot
- MAXSTR – maximum number of building stories permitted
- KWSQFT – KW per square foot given in DM 5311.6 for the type of building to be constructed

NOTE: Estimated transformer size is based on estimated KW calculation above and Transformer Selection Tables in Design Manual 5621.

a. Example 1 (Loop Design)

The developer provided information pertaining to the project shown in Figure 9 resulted in a 150 KVA transformer being selected for lots 1, 2, 6, & 7. A 300 KVA transformer was selected for lots 3, 4, & 5. Referring to the electrical layout shown in Figure 9:

- A single fused cabinet, installed as close to the feeder as possible, is sufficient to serve the 1500 KVA project (Rule B.4).
- A 3314 handhole, installed as close to the fuse cabinet as possible, is required to house the three way cable tops needed to start the fused local distribution system.
- No more than two transformers, served from the fused local distribution system, are supplied from a radial cable run. The use of deadbreak tees (Lots 1, 2, 3, 4, 6, & 7) adheres to this rule while permitting the use of a radial conduit system layout (Rule B.2).
- The local distribution system loop is created by having parallel cables running in the street between the 3315 handholes. A splice is required at lot one for cable pulling purposes.

b. Example 2 (Lot Development Project)

The following information pertaining to Figure 7 was provided by the developer on the City Approved Design Guideline:

NOTE: The gross square footage is 25,000 square feet for lots 1, 2, 3, & 5, 115,000 square feet for lot 4, and 35,000 square feet for lots 6, 7, & 8.

- As a business park with shell building construction, a KW / Sq. Ft. of .012 was selected from Design Manual 5311.
- An estimated load was determined for each lot using the area load forecast criteria:
 - 300 KW – Lots 1, 2, 3, & 5
 - 1380 KW – Lot 4
 - 420 KW – Lots, 6, 7, & 8

© 1998-2020 San Diego Gas & Electric Company. All rights reserved. Removal of this copyright notice without permission is not permitted under law.

REV	CHANGE	BY	DSGN	APPV	DATE	REV	CHANGE	BY	DSGN	APPV	DATE
C	EDITORIAL	JAE	FRC	CZH	09/25/2020	F					
B	FORMATTING	JIK	-	-	02/21/2020	E					
A	ORIGINAL ISSUE	-	JCE	VCR	03/01/2002	D					

SHEET 3 OF 7	X Indicates Latest Revision	Completely Revised	New Page	Information Removed
	SDG&E ELECTRIC DISTRIBUTION DESIGN MANUAL			
	RESIDENTIAL/COMMERCIAL/INDUSTRIAL PRIMARY SYSTEM DESIGN (LOOP SYSTEMS)			
				DM5221.3

3) Estimated transformer requirements based on Design Standard 5621:

300 KVA – Lots 1, 2, 3, & 5

1500 KVA – Lot 4

500 KVA – Lots 6, 7, & 8

4) Referring to the conduit layout shown in Figure 7:

- All lots (1 – 8) are supplied with 4” conduit stubs (Rule C.1)
- Lot 4 also has an additional 4” conduit stub in case the lot is subdivided prior to installation of the electric facilities (Rule C.4)
- A 5” conduit loop is installed in the street because there is a possibility that 3000 KVA (Lots 4, 6, 7, & 8) may be served by feeder cable (Rule C.3)
- A fuse cabinet pad is provided at each end of the project (As close to the feeder as possible) because the fusible load may exceed 2080 KVA (Rule C.7)
- All primary substructures are 3316 handholes to allow connection of the loop feeder cable. 3315 handholes are adequate if a radial unfused cable is required.

5) Referring to the electrical layout shown in Figure 8:

- Lots 1, 2, 3, 5, 6, 7, & 8 are served from fused local distribution cable because the installed transformers are 1000 KVA or less.
- No more than two transformers, served from the fused local distribution system, are supplied from a radial cable run. The use of deadbreak tees (Lots 1, 2, 3, 6, 7, & 8) adheres to this rule while permitting the use of a radial conduit system layout (Rule B.2)
- The total amount of fusible load (2700 KVA) exceeds the capacity of a single fuse cabinet. Therefore, two fuse cabinets are required. The normally open point is placed at the approximate center of the load (Rules B.4 & B.10)
- Spare positions are provided from the fused local distribution at lot 4 in case the lot is split. This requires the use of a deadbreak tee serving lots 3 and 8. However, if it is known that lot 4 will not be split, the deadbreak tee may be eliminated and each transformer (Lots 3 & 8) may be served directly from the cable top (Rule C.4)
- An unfused radial cable is installed in the street to serve lot 4 because the total load connected to unfused cable is less than 2000 KVA (Rule C.3)

E. Residential Looping Criteria

New single-family homes and multi-family residential developments shall consider a primary looping system when the minimum criteria below are met.

1. Looping shall be considered when a branch will have 3 or more transformers that serve more than 350 customers, or when the branch will have 3 or more transformers that have a connected load greater than 450kVA.
2. Looping in residential systems shall be limited to 3 phase systems.

© 1998-2020 San Diego Gas & Electric Company. All rights reserved. Removal of this copyright notice without permission is not permitted under law.

REV	CHANGE	BY	DSGN	APPV	DATE	REV	CHANGE	BY	DSGN	APPV	DATE
C	EDITORIAL	JAE	FRC	CZH	09/25/2020	F					
B	FORMATTING	JIK	-	-	02/21/2020	E					
A	ORIGINAL ISSUE	-	JCE	VCR	03/01/2002	D					

SHEET 4 OF 7	X Indicates Latest Revision	Completely Revised	New Page	Information Removed
	SDG&E ELECTRIC DISTRIBUTION DESIGN MANUAL			
	RESIDENTIAL/COMMERCIAL/INDUSTRIAL PRIMARY SYSTEM DESIGN (LOOP SYSTEMS)			
				DM5221.4

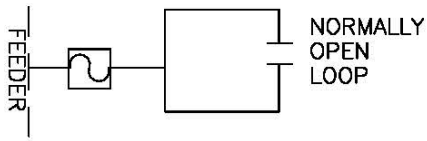

FIGURE 1

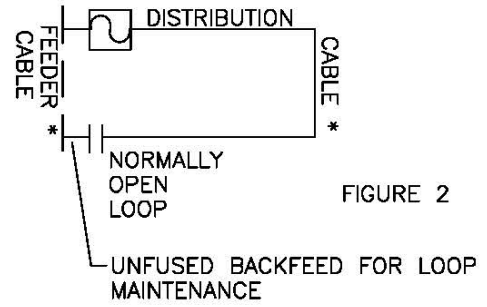

FIGURE 2

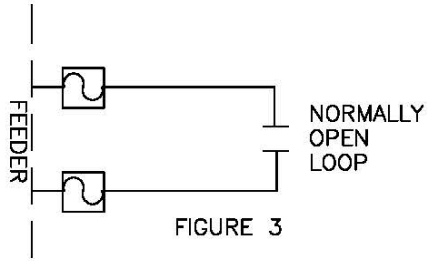
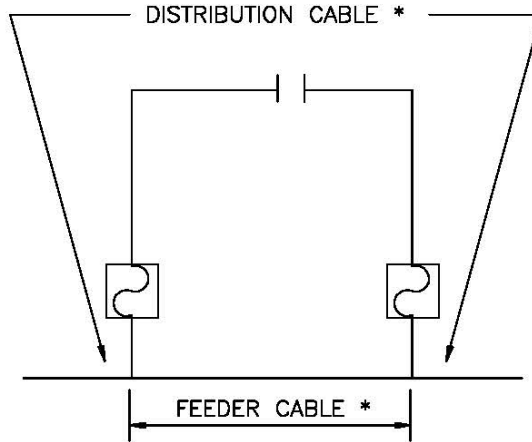

FIGURE 3



* SEE CRITERIA B.7: DISTRIBUTION CABLE LENGTH TO BE AT LEAST TWICE AS LONG AS FEEDER CABLE LENGTH.

FIGURE 4

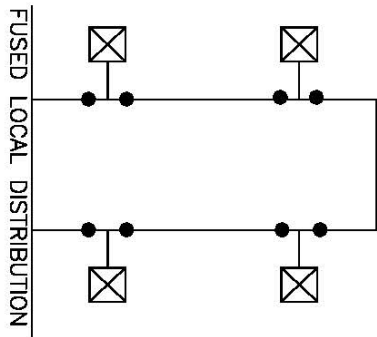

FIGURE 5

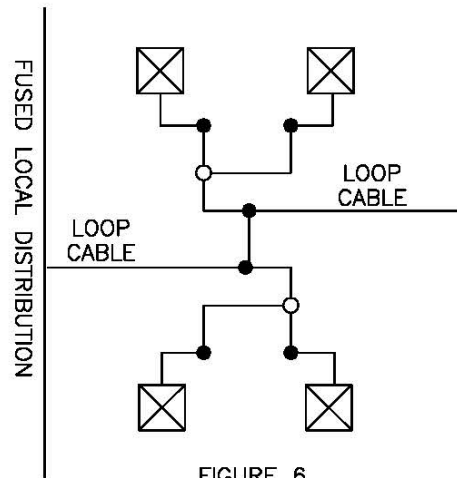

FIGURE 6
SEE CRITERIA B.2

© 1998-2020 San Diego Gas & Electric Company. All rights reserved. Removal of this copyright notice without permission is not permitted under law.

REV	CHANGE	BY	DSGN	APPV	DATE	REV	CHANGE	BY	DSGN	APPV	DATE
C	EDITORIAL	JAE	FRC	CZH	09/25/2020	F					
B	FORMATTING	JIK	-	-	02/21/2020	E					
A	ORIGINAL ISSUE	-	JCE	VCR	03/01/2002	D					

X Indicates Latest Revision Completely Revised New Page Information Removed

SHEET
5 OF 7

SDG&E ELECTRIC DISTRIBUTION DESIGN MANUAL

**RESIDENTIAL/COMMERCIAL/INDUSTRIAL PRIMARY
SYSTEM DESIGN (LOOP SYSTEMS)**

DM5221.5

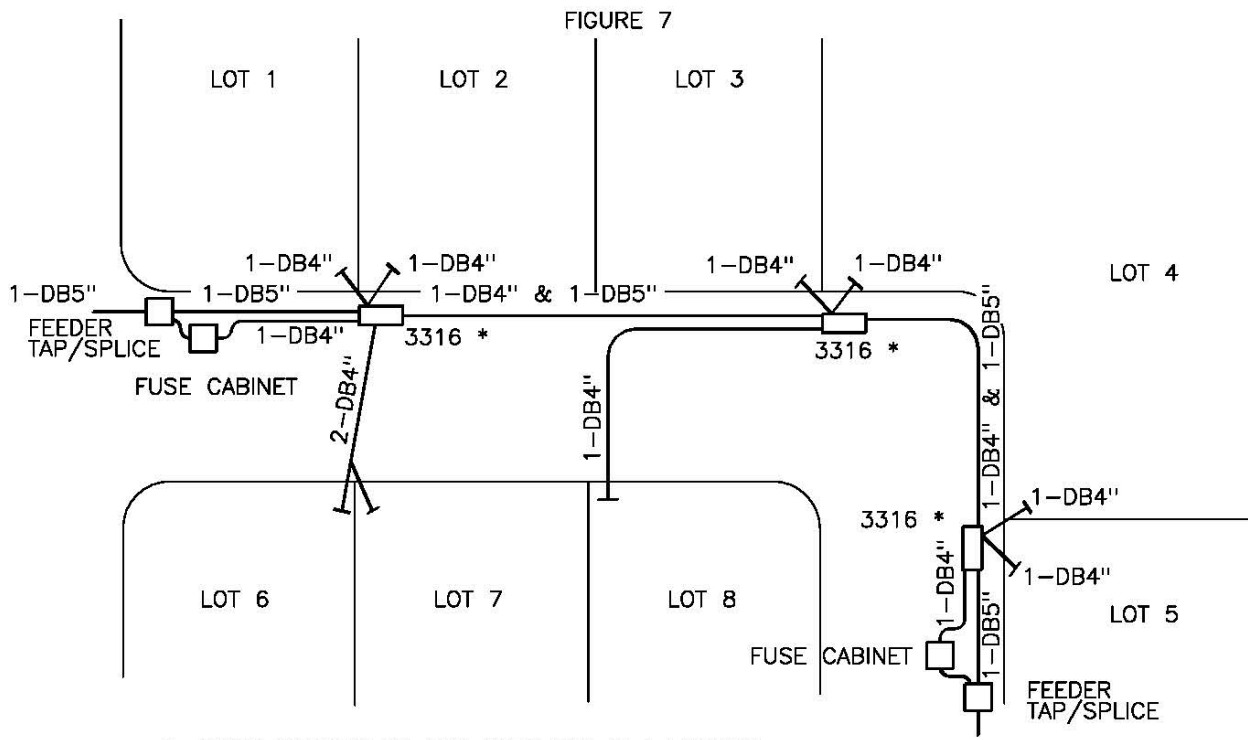

* 3315 HANDHOLES ARE ADEQUATE IF A LOOPED FEEDER SYSTEM IS NOT REQUIRED

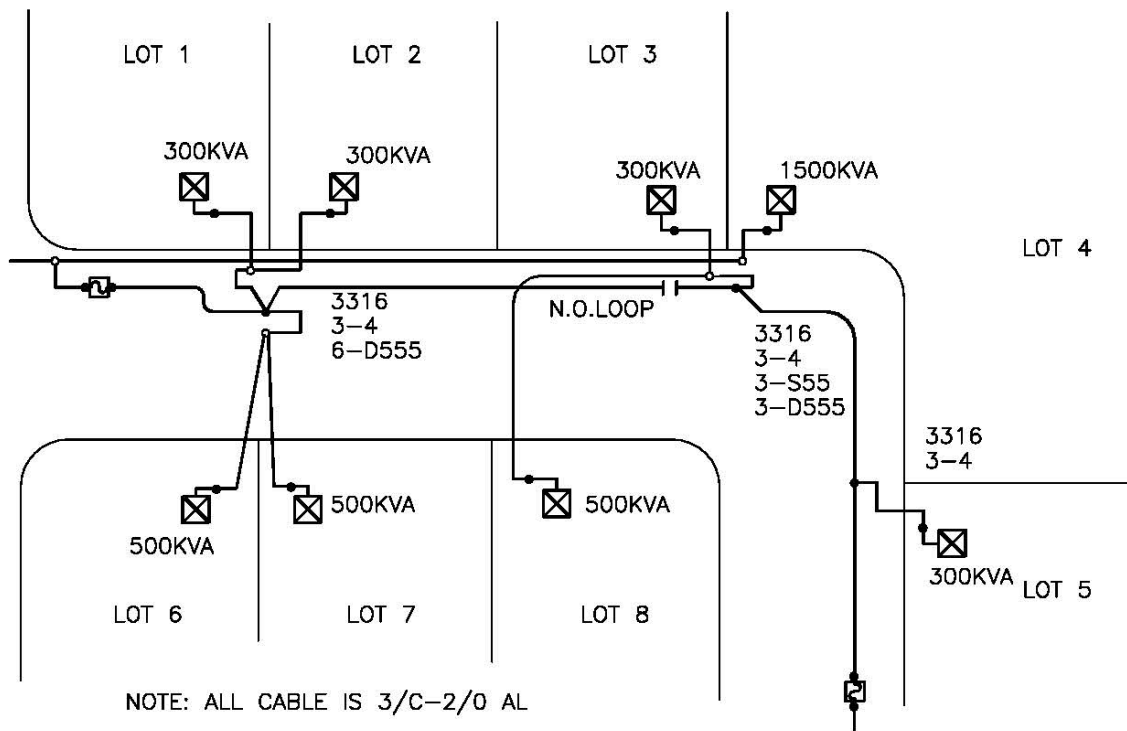

© 1998-2020 San Diego Gas & Electric Company. All rights reserved. Removal of this copyright notice without permission is not permitted under law.

REV	CHANGE	BY	DSGN	APPV	DATE	REV	CHANGE	BY	DSGN	APPV	DATE
C	EDITORIAL	JAE	FRC	CZH	09/25/2020	F					
B	FORMATTING	JIK	-	-	02/21/2020	E					
A	ORIGINAL ISSUE	-	JCE	VCR	03/01/2002	D					

X Indicates Latest Revision Completely Revised New Page Information Removed

SDG&E ELECTRIC DISTRIBUTION DESIGN MANUAL

RESIDENTIAL/COMMERCIAL/INDUSTRIAL PRIMARY SYSTEM DESIGN (LOOP SYSTEMS)

SHEET 6 OF 7

DM5221.6

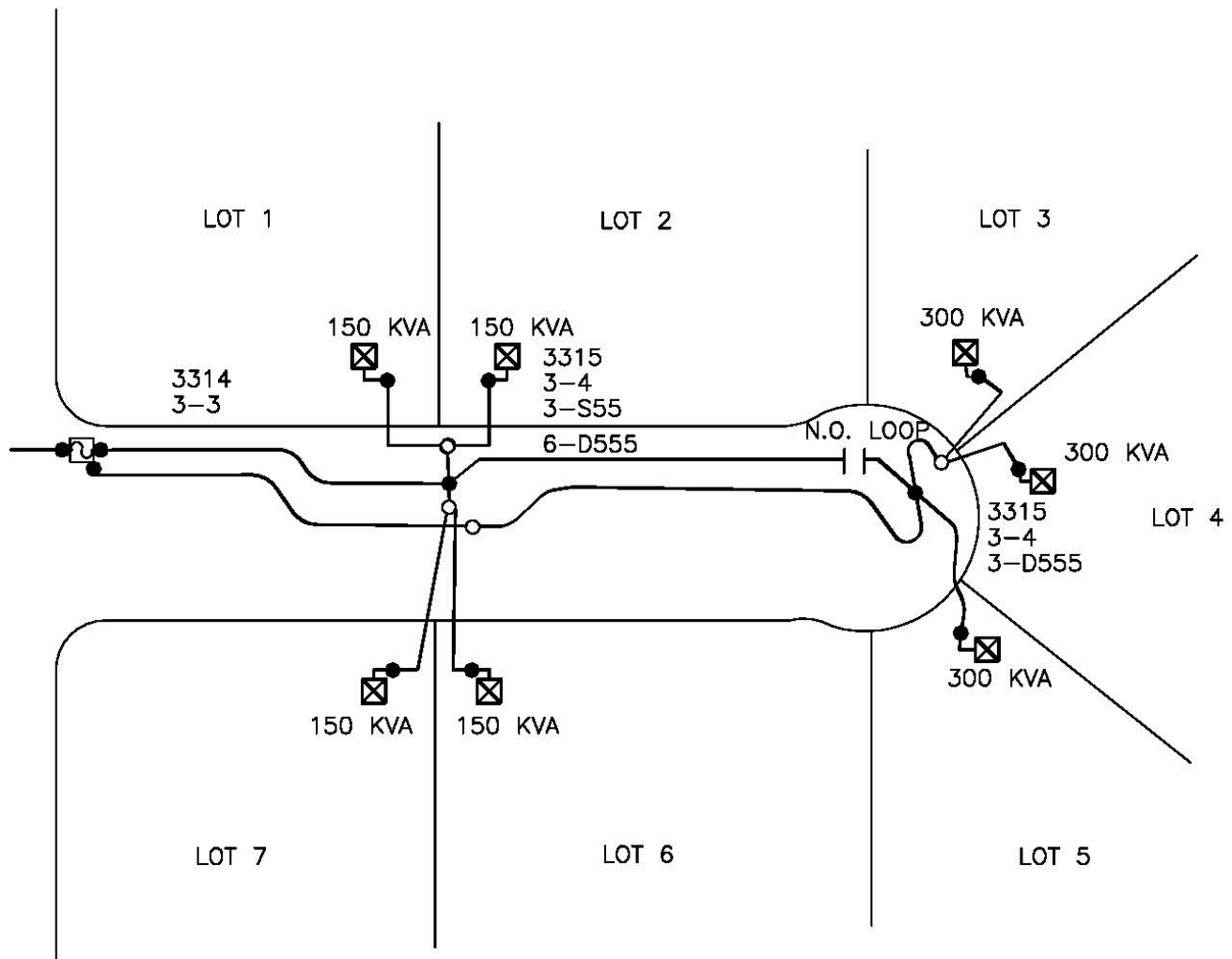

FIGURE 9

© 1998-2020 San Diego Gas & Electric Company. All rights reserved. Removal of this copyright notice without permission is not permitted under law.

REV	CHANGE	BY	DSGN	APPV	DATE	REV	CHANGE	BY	DSGN	APPV	DATE
C	EDITORIAL	JAE	FRC	CZH	09/25/2020	F					
B	FORMATTING	JIK	-	-	02/21/2020	E					
A	ORIGINAL ISSUE	-	JCE	VCR	03/01/2002	D					

X Indicates Latest Revision Completely Revised New Page Information Removed

SHEET
7 OF 7

SDG&E ELECTRIC DISTRIBUTION DESIGN MANUAL

**RESIDENTIAL/COMMERCIAL/INDUSTRIAL PRIMARY
SYSTEM DESIGN (LOOP SYSTEMS)**

DM5221.7

SCOPE

This standard describes SDG&E's methodology for designing underground residential secondary and service systems.

PURPOSE

The design considerations and procedures described in this standard have been established to insure the lowest cost system design is installed.

DEFINITIONS

NONE

CRITERIA

The following design considerations and procedures shall be used for residential system design.

A. Design Parameters

1. The maximum allowable voltage drop in the secondary/service is determined by subtracting the voltage drop across the transformer from 4.2%. For example, if a 150 KVA Padmount transformer is loaded to 60% of nameplate, the voltage drop across it is 1.1% (See Design Manual 5425.2). The allowable voltage drop across the secondary/service would then be 3.1% (4.2 – 1.1 + 3.1).
2. Standard secondary cable sizes shall be #2, 1/0 and 3/0 USA. The use of 350 KCML secondary cable is for exceptional cases only.
3. The use of 2 - #2 and 1 - #4 as a secondary cable is acceptable providing at least 10 percent of the total cable runs are 2 - #2 and 1 - #4.
4. Service cables are restricted to #2, 1/0 and 3/0 USA.
5. Locate the transformer and secondary handholes as close as practical to the load centers of the lots they are to serve.
6. The maximum allowable flicker is normally 6 percent. For an existing residential customer served from an existing transformer, the secondary flicker may be raised to 7% if a larger transformer would be required to meet the 6% secondary flicker limit while serving normal load.
7. The load power factor is assumed to be .9.
8. Secondary handholes shall be eliminated whenever possible as described in Design Manual 5712.

B. General Design Procedures

1. Establish the KW demand category based on the Residential Demand Estimating Criteria (Design Manual 5322).
2. The secondary distance and structure (Transformer pad or handhole) placement is dictated by the lot front footage, street width, and meter location. Typically, the structures will be placed at load centers to serve as many meters as possible from one location. This requires the secondary distance to span from one to four lots or the street width. Therefore, the secondary footage is determined by:

© 1998-2020 San Diego Gas & Electric Company. All rights reserved. Removal of this copyright notice without permission is not permitted under law.

REV	CHANGE	BY	DSGN	APPV	DATE	REV	CHANGE	BY	DSGN	APPV	DATE
C						F					
B	FORMATTING	JIK	-	-	02/21/2020	E					
A	ORIGINAL ISSUE	-	JCE	VLR	03/01/2002	D					

SHEET 1 OF 4	 Indicates Latest Revision	Completely Revised	New Page	Information Removed
	SDG&E ELECTRIC DISTRIBUTION DESIGN MANUAL			
	SINGLE FAMILY RESIDENTIAL SECONDARY AND SERVICE DESIGN CRITERIA			

DM5222.1

- a. Measuring the distance across the number of lots being spanned or the distance across the street.
 - b. Adding footage to the overall distance for cable tails (See Design Manual 5922). The typical secondary distance for a subdivision should be determined by measuring several lot combinations.
3. The service distance for a single-sided array service or double-sided array short service is equal to the service panel setback. The double-sided array long service is equal to the service panel setback plus the distance from the originating structure, across the street, to the property line. The service panel setback is either an estimated or measured distance from behind the sidewalk at the property line to the service panel location. Additional footage shall be added to this distance for service cable tails (See Design Manual 5922).
 4. Select the subdivision single-sided and double-sided optimum array configurations from the optimum array tables (See Design Manual 5223) using the appropriate KW demand, secondary, and service lengths. The optimum array selection for the subdivision may be used for each individual array whose secondary and service footage does not differ from the typical by more than 10 feet. Otherwise, an individual array selection must be made.
 5. The subdivision should now be blocked off in groups of lots corresponding to the number of customers that can be served by the selected optimum array(s).
 - a. A single-sided and double-sided array combination can be used effectively to serve lots of irregular width or layout (Such as a cul-de-sac). The combination array must be constructed as shown below where the variation can only be used directly off the transformer, not as an extension from any of the handholes.

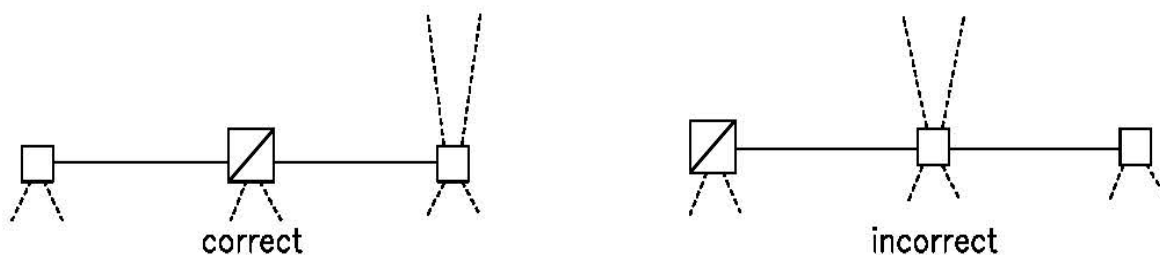

- b. Additional lots may be served from any handhole in an optimum array provided the number of runs connected in the handhole do not exceed the handholes' capacity (Presently 6). However, the voltage drop, flicker, and transformer loading limits must be satisfied based on Design Standards 5431 and 5621.
6. When the required system configuration does not permit selection of an optimum array, the Design Parameters of this standard should be applied to develop the residential design. Verification that the limits have been satisfied require application of the 120/240V nomograph (Design Manual 5431) to determine cable sizing and to determine the transformer size in accordance with Design Standard 5621.
 - a. When sizing cable for lots with air conditioning systems, always check secondary flicker (Design Standard 5413). Some systems are now flicker limited due to the higher voltage drop allowance.
 - b. Eliminate all possible secondary handholes as described in Design Manual 5712.

© 1998-2020 San Diego Gas & Electric Company. All rights reserved. Removal of this copyright notice without permission is not permitted under law.

REV	CHANGE	BY	DSGN	APPV	DATE	REV	CHANGE	BY	DSGN	APPV	DATE
C						F					
B	FORMATTING	JIK	-	-	02/21/2020	E					
A	ORIGINAL ISSUE	-	JCE	VLR	03/01/2002	D					

X	Indicates Latest Revision	Completely Revised	New Page	Information Removed
---	---------------------------	--------------------	----------	---------------------

SHEET
2 OF 4

SDG&E ELECTRIC DISTRIBUTION DESIGN MANUAL

**SINGLE FAMILY RESIDENTIAL SECONDARY
AND SERVICE DESIGN CRITERIA**

DM5222.2

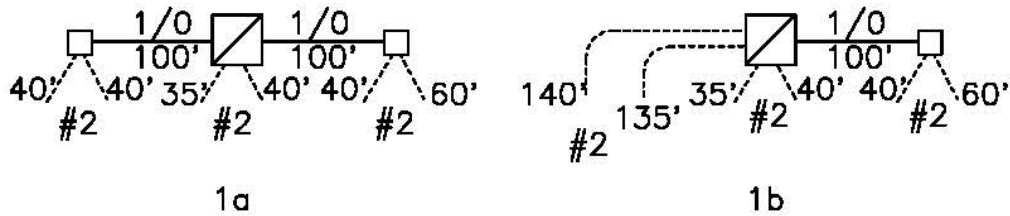
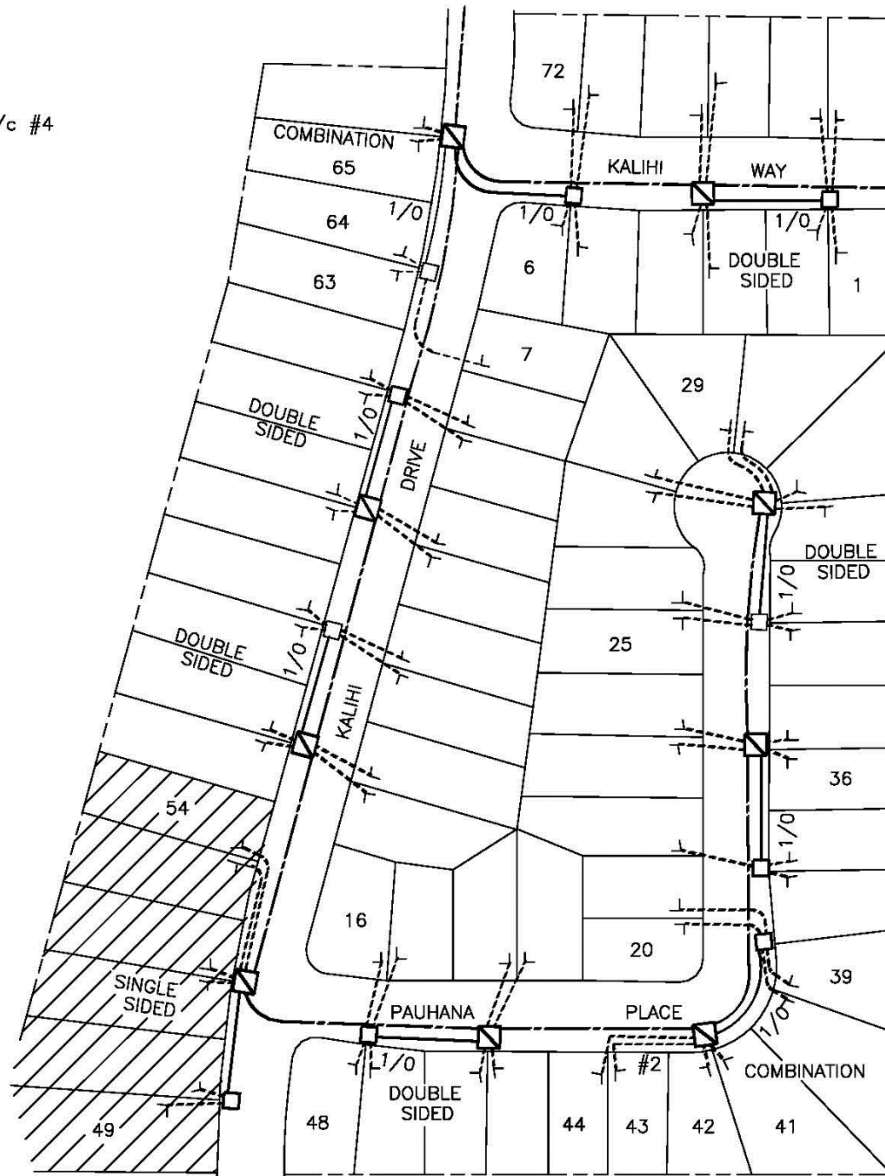

Figure 2: Subdivision used as a study vehicle in the example.

0 - 1299 SQ. FT.
 200 amp board
 5kW demand (per table 1, 5322.3)
 Electric Water Heating

--- Primary
 — Secondary
 - - - - - Service*

*All services are
 2-1/c #2 & 1-1/c #4



© 1998-2020 San Diego Gas & Electric Company. All rights reserved. Removal of this copyright notice without permission is not permitted under law.

REV	CHANGE	BY	DSGN	APPV	DATE	REV	CHANGE	BY	DSGN	APPV	DATE
C						F					
B	FORMATTING	JIK	-	-	02/21/2020	E					
A	ORIGINAL ISSUE	-	JCE	VLR	03/01/2002	D					

X Indicates Latest Revision Completely Revised New Page Information Removed

SHEET
4 OF 4

SDG&E ELECTRIC DISTRIBUTION DESIGN MANUAL

**SINGLE FAMILY RESIDENTIAL SECONDARY
AND SERVICE DESIGN CRITERIA**

DM5222.4

SCOPE

This design standard provides the residential secondary and service system optimum array tables used in conjunction with the General Design Criteria provided in Design Manual 5222. These tables represent an economic analysis of secondary and service system design alternatives, on a cost per lot basis, for approximately 9600 different array possibilities.

PURPOSE

The optimum array tables shall be used for residential single-family subdivision design to insure the lowest cost system is installed.

DEFINITIONS

NONE

OPTIMUM ARRAY TABLE APPLICATION

A. The optimum array tables provide the optimum array configuration, transformer size and secondary/service cable selections based on KW demand, secondary distance, and service distance. The instructions for properly applying the optimum array tables are as follows:

1. Determine KW Demand

Determine the KW demand per lot for the subdivision from the Residential Demand Estimating Criteria, Design Manual 5322.

2. Determining Secondary Distance

The secondary footage and structure (Transformer Pad or Handhole) placement is dictated by the lot front footage, street width, and meter location. Typically, the structures will be placed at the load center to serve as many meters as possible from one location. This requires the secondary footage to span from one to four lots or the street width. Therefore, the secondary footage is determined by:

- a. Measuring the distance across the number of lots being spanned or the distance across the street
- b. Adding footage to the overall distance for cable tools (Design Manual 5922). The typical secondary footage for a subdivision should be determined by measuring several lot combinations and using the most common footage(s) as a benchmark for optimum array selections.

3. Determining Service Distance

The service distance for a single-sided array service or double-sided array short service is equal to the service panel setback. The double-sided array long service is equal to the service panel setback plus the distance from the originating structure across the street to the property line. The service panel setback is either an estimated or measured distance from behind the sidewalk at the property line to the service panel location. Additional footage shall be added to this distance from the service cable tails (Design Manual 5922).

4. Selecting Optimum Arrays

Select the subdivision single-sided and/or double-sided optimum array configuration from the table with the appropriate KW demand, secondary and service lengths. The optimum array selection for the subdivision may be used for each individual array whose secondary and service footage does not differ from the typical by more than ten feet. Otherwise, an individual array selection must be made.

© 1998-2020 San Diego Gas & Electric Company. All rights reserved. Removal of this copyright notice without permission is not permitted under law.

REV	CHANGE	BY	DSGN	APPV	DATE	REV	CHANGE	BY	DSGN	APPV	DATE
C						F					
B	FORMATTING	JIK	-	-	02/21/2020	E					
A	ORIGINAL ISSUE	-	CVN	RDG	01/01/1987	D					

SHEET 1 OF 7	X Indicates Latest Revision	Completely Revised	New Page	Information Removed
	SDG&E ELECTRIC DISTRIBUTION DESIGN MANUAL			
	SINGLE FAMILY RESIDENTIAL SECONDARY SYSTEMS			
DM5223.1				

- a. There are a sufficient number of optimum array tables to address most of the system configurations that will be encountered in residential subdivisions. However, when the required system configuration does not permit selection of an optimum array, consult Design Manual 5222, General Design Procedures Paragraph 7.
- b. The short service on single and double-sided arrays (Service to the homes on the same side of the street as the transformer) is 2 - #2 and 1 - #4 Al unless a note to the contrary appears below the table.
- c. Listed below are the double-sided array, long service, and corresponding short service distances.
- d. The arrays are symmetrical about the transformer unless a note to the contrary is shown.

Double-sided array

Long Service	Short Service
150'	50'
140'	50'
130'	50'
120'	40'
110'	40'
100'	30'
90'	30'
80'	20'

- 5. The subdivision should now be blocked off in groups of lots corresponding to the number of customers that can be served by the selected optimum array(s):
 - a. A single-sided and double-sided array combination can be used effectively to serve lots of irregular width or layout (Such as in a cul-de-sac). The combination array must be constructed as shown in Example 3 where the variation can only be used directly off the transformer; not as an extension from any of the handholes.
 - b. Additional lots may be served from any handhole in an optimum array provided the number of runs connected in the handhole do not exceed the handhole capacity (Presently 6). However, the voltage drop, flicker, and transformer loading limits must be satisfied based on Design Manuals 5431 and 5621.

EXAMPLES

Select the single-sided optimum array for a subdivision having USA cable an average secondary distance of 120' (55' lot fronts, 6' additional for USA cable tails), average service length of 40' (30' service panel setback, 6' additional for USA cable tails), serving 1200 square foot homes with electric water heating.

- 1. From the optimum array table on Design Manual 5223.4, the single-sided optimum array for 120' secondary and 40' service serves six customers with a 25 KVA as shown below.

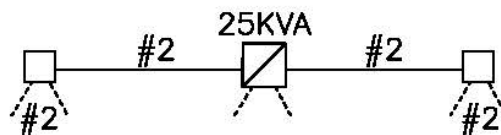

© 1998-2020 San Diego Gas & Electric Company. All rights reserved. Removal of this copyright notice without permission is not permitted under law.

REV	CHANGE	BY	DSGN	APPV	DATE	REV	CHANGE	BY	DSGN	APPV	DATE
C						F					
B	FORMATTING	JIK	-	-	02/21/2020	E					
A	ORIGINAL ISSUE	-	CVN	RDG	01/01/1987	D					

SHEET 2 OF 7	X Indicates Latest Revision	Completely Revised	New Page	Information Removed	
SDG&E ELECTRIC DISTRIBUTION DESIGN MANUAL					
SINGLE FAMILY RESIDENTIAL SECONDARY SYSTEMS					
DM5223.2					

Select the double-sided optimum array for the subdivision described in Example 1 having a 90' long service (50' wide streets).

- From the optimum array table on Design Manual 5223.4, the double-sided optimum array for this combination serves eight customers with a 25 KVA as shown below.

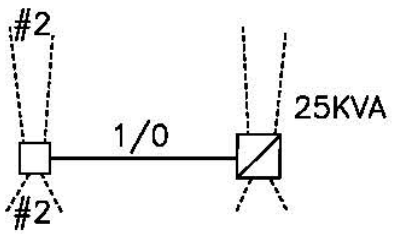

Select the combination optimum array having 1200 square foot homes with electric water heating (Single-sided and Double-sided) to serve the cul-de-sac shown below. The lot front footages are provided; short-service length is 40', long-service length is 90'.

- The resulting combination optimum array serves ten customers, 4 double-sided (140' secondary) and six single-sided (60' secondaries). The transformer loading for ten customers is 36 KW. Therefore, a 50 KVA transformer is selected.

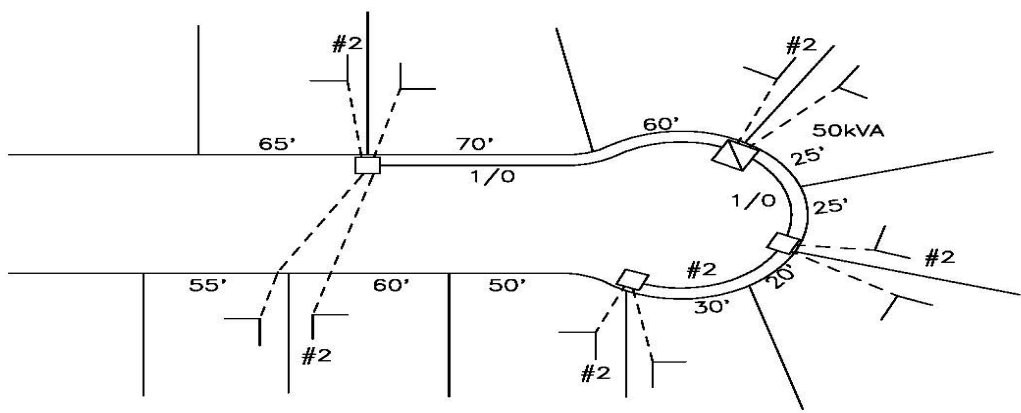

REFERENCES

- Design Manual 5223 – Residential Distribution System Design
- Design Manual 5712 – Secondary Handhole Elimination
- Design Manual 5411 – Voltage Drop & Flicker Application Guidelines
- Study – “Reduced Secondary and Service System Cost Through Optimum Single-Family Residential Design”, May 1985
- Design Manual 5922 – Cable Tail Length Requirements
- Design Manual 5322 – Residential Demand Estimating

© 1998-2020 San Diego Gas & Electric Company. All rights reserved. Removal of this copyright notice without permission is not permitted under law.

REV	CHANGE	BY	DSGN	APPV	DATE	REV	CHANGE	BY	DSGN	APPV	DATE
C						F					
B	FORMATTING	JIK	-	-	02/21/2020	E					
A	ORIGINAL ISSUE	-	CVN	RDG	01/01/1987	D					

SHEET 3 OF 7	X Indicates Latest Revision	Completely Revised	New Page	Information Removed
	SDG&E ELECTRIC DISTRIBUTION DESIGN MANUAL			
	SINGLE FAMILY RESIDENTIAL SECONDARY SYSTEMS			

DM5223.3

Sq. Ft.: 1300-1999 SINGLE-SIDED

4kW Base Load (BL)				6kW Air Conditioning (A/C)				6kW Electric Water Heater (EWH)				5kW Electric Heater(EH)				4kW A/C Option			
Sec Ft	Serv Ft	S1-S2	# Cust	Sec Ft	Serv Ft	S1-S2	# Cust	Sec Ft	Serv Ft	S1-S2-S3	# Cust	Sec Ft	Serv Ft	S1-S2	# Cust	Sec Ft	Serv Ft	S1-S2	# Cust
60-80	20-80	#2-#2	10	60-70	20-50	1/0-1/0	10	80	20	3/0-1/0-1/0	14	60-80	20-80	1/0-#2	8(e)	80	40-50	1/0-1/0	8(a)(a)
90	20-30	1/0-#2	10	80	20-50	1/0-1/0	10(e)	80	30	3/0-1/0-1/0	12(u)	90-100	20-40	1/0-1/0	8(a)	70	40	1/0-1/0	10
100-110	20-30	1/0-1/0	10	90	20	3/0-1/0	10	80	40-50	3/0-1/0-1/0	12(u)(b)	90-100	50	1/0-1/0	8(a)	25KVA			
120	50	1/0-1/0	10	90	30-50	3/0-1/0	10(e)	70	20-90	3/0-3/0-3/0	12(v)	110	20	#2	6	80	20-30	1/0-1/0	8(a)(a)
120	20-40	#2	6	100	20	3/0-3/0	10	25KVA				110	30-80	3/0-1/0	8(a)	70	20-30	3/0-1/0	8(a)
130-150	20-80	#2	6	100	30-50	3/0-3/0	10(e)	80-120	20-50	#2	6	120	20-40	#2	6	70	40-50	3/0-1/0	8(a)(a)
				110	20-50	3/0-3/0	10(e)	130	20-40	#2	6	120	50	3/0-1/0	8(a)	80	20	3/0-1/0	8(a)
				120	20-40	3/0-3/0	8(f)	130	50	1/0	6	130-150	20-50	#2	6	80	30-40	3/0-1/0	8(t)(f)
				120	50	3/0-3/0	8(a)	140-150	20-50	1/0	6	80	50	1/0	6	80	50	1/0	8
				130	20-40	1/0	6	130	50	1/0	6	100	20-50	1/0	6	90	20-50	1/0	6
				130	50	1/0	6	140-150	20-40	1/0	6	100	50	1/0	6(f)	100	50	1/0	6
				140-150	20-40	1/0	6	140-150	20-40	1/0	6	110	20-30	1/0	6	110	20-30	1/0	6
				140-150	50	1/0	6(f)	140-150	50	1/0	6(f)	110	40-50	1/0	6(f)	120	20-30	1/0	6
												120	40	1/0	6(f)	120	40	1/0	6
												120	50	3/0	6	120	50	3/0	6
												130	20	1/0	6	130	20	1/0	6
												130	30	1/0	6(f)	130	30	1/0	6
												130	40-50	3/0	6	130	40-50	3/0	6
												140	20	1/0	6(f)	140	20	1/0	6
												140	30-50	3/0	6	140	30-50	3/0	6
												150	20	1/0	6(f)	150	20	1/0	6
												150	30-40	3/0	6	150	30-40	3/0	6
												150	50	3/0	6(f)	150	50	3/0	6(f)

a)H2=1/0, b)H3=1/0, c)H1=1/0, d)H4=1/0, e)H2-H5=1/0-1/0, f)H1-H4=1/0-1/0, g)H2-H4=1/0-1/0
 h)H3-H6=1/0-1/0, i)H3-H5=1/0-1/0, j)H2=3/0, k)H3-H5=3/0-1/0, m)H2-H4=1/0-3/0, n)H1-H4=3/0-3/0
 o)H2-H5=3/0-3/0, p)H2-H4=3/0-3/0, q)H1-H2-H4=1/0-1/0-1/0, r)H1=3/0
 s)S4=#2, t)S4=1/0, u)S4-S5=1/0-#2, v)S4-S5=1/0-1/0, w)S2-S4=3/0-1/0, x)S4=3/0

DOUBLE-SIDED

4kW Base Load (BL)				6kW Air Conditioning (A/C)				6kW Electric Water Heater (EWH)				5kW Electric Heater(EH)				4kW A/C Option			
Sec Ft	Serv Ft	S1-S2	# Cust	Sec Ft	Serv Ft	S1-S2	# Cust	Sec Ft	Serv Ft	S1-S2	# Cust	Sec Ft	Serv Ft	S1-S2	# Cust	Sec Ft	Serv Ft	S1-S2	# Cust
60	80-150	1/0-1/0	20	60	80-100	3/0-3/0	18(a)(f)	60	80110	3/0-3/0	20	80	80-150	3/0-1/0	20	80	80	3/0-1/0	20
70-80	80-150	3/0-1/0	20	60	110-150	3/0-3/0	18(g)(f)	60	120-150	3/0-3/0	20(e)	70	80-150	3/0-1/0	20(e)	80	90-120	3/0-1/0	20(e)
90	80-140	3/0-1/0	20	70	80-100	1/0	12	70	80	3/0-3/0	20	80	80-110	3/0-3/0	20	80	130-140	3/0-3/0	20(e)
				70	110-150	3/0-3/0	18(g)(f)	70	90-100	3/0-3/0	20(e)	80	120	3/0-3/0	18(f)	80	150	3/0-3/0	20(e)
90	150	#2	6	80	80-90	1/0	12	70	110	1/0	12	90	80	3/0-3/0	20(e)	70	80-120	3/0-1/0	20(e)
100	80-150	#2	6	80	100-130	3/0-3/0	18(g)(f)	80	80-100	3/0-3/0	20(e)					70	130	3/0-3/0	20(e)
110	80-130	#2	6	80	140-150	3/0	12(f)	80	110	1/0	12	80	130-150	1/0	6	70	140-150	3/0-3/0	20(e)
110	140-150	1/0	6	90	80-90	1/0	12					80	90-150	1/0	6	80	80-100	3/0-1/0	20(e)
120	80-90	#2	6	90	100-150	1/0	12(f)	70	120-150	1/0	12	100-110	80-150	1/0	6	80	110-130	3/0-3/0	20(e)
120	100-150	1/0	6	100	80	1/0	12	80	120-140	1/0	12	120	80-130	1/0	6	80	140-150	3/0-3/0	20(e)
130-150	80-150	1/0	6	100	90-130	1/0	12(f)	80	150	1/0	12(e)	130	140-150	1/0	8(c)	90	80-120	3/0-1/0	20(e)
120	100-150	1/0	6	100	140-150	3/0	12(f)	90	80-120	1/0	12	130	80-100	1/0	6	90	140-150	3/0-3/0	20(e)
130-150	80-150	1/0	6	110	80-130	1/0	12(f)	90	130-150	1/0	12(f)	130	110-150	1/0	8(c)	100	80	3/0-1/0	20(e)
				110	140-180	3/0	12(f)	100	80-110	1/0	12	140	80-80	1/0	6	100	90-110	3/0-3/0	20(e)
				120	80-110	1/0	12(f)	100	120-150	1/0	12(f)	140	100-150	1/0	8(c)	100	140-150	3/0-3/0	20(e)
				120	120-140	3/0	12(f)	110	80	1/0	12	150	80-120	1/0	8(c)				
				120	150	3/0	12(f)	110	90-150	1/0	12(f)	150	130-150	3/0	8	90	130	3/0-3/0	18(t)(w)
				130	80-90	3/0	12	120	80-120	1/0	12(f)					100	120	3/0-3/0	18(t)(w)
				130	100-130	3/0	12(f)	120	130-150	3/0	12					100	130	3/0-3/0	16(w)
				130	140-150	3/0	12(n)	130	80	1/0	12(f)					110	80-90	1/0	12(f)
				140	80-90	3/0	12	130	90-140	3/0	12					110	100-150	3/0	12(f)
				140	100-130	3/0	12(f)	130	150	3/0	12(f)					120	80-90	1/0	12(f)
				140	140-150	3/0	12(n)	140	80-120	3/0	12					120	100-130	3/0	12(f)
				150	80-90	3/0	12	140	130-150	3/0	12(f)					120	140-150	3/0	12(n)
				150	100-120	3/0	12(f)	150	80-110	3/0	12					130	80-90	1/0	12(f)
				150	130-150	3/0	12(n)	150	120-150	3/0	12(f)					130	100-130	3/0	12(f)
																130	140-150	3/0	12(f)
																140	80-120	3/0	12(f)
																140	130-150	3/0	12(n)
																150	80-120	3/0	12(f)
																150	150	3/0	12(f)

© 1998-2020 San Diego Gas & Electric Company. All rights reserved. Removal of this copyright notice without permission is not permitted under law.

REV	CHANGE	BY	DSGN	APPV	DATE	REV	CHANGE	BY	DSGN	APPV	DATE
C						F					
B	FORMATTING	JIK	-	-	02/21/2020	E					
A	ORIGINAL ISSUE	-	CVN	RDG	01/01/1987	D					

Indicates Latest Revision

Completely Revised

New Page

Information Removed

SHEET 5 OF 7

SDG&E ELECTRIC DISTRIBUTION DESIGN MANUAL

SINGLE FAMILY RESIDENTIAL

SECONDARY SYSTEMS

DM5223.5

Sq. Ft.: 2000-2999 SINGLE-SIDED

4.5kW Base Load (BL)				7kW Air Conditioning (A/C)				7kW Electric Water Heater (EWH)				8kW Electric Heater(EH)				4.5kW A/C Option			
Sec Ft	Serv Ft	S1-S2	# Cust	Sec Ft	Serv Ft	S1-S2	# Cust	Sec Ft	Serv Ft	S1-S2	# Cust	Sec Ft	Serv Ft	S1-S2-S3	# Cust	Sec Ft	Serv Ft	S1-S2-S3	# Cust
70-80	20-60	#2	10	80	20-40	3/0-1/0	10	80	20-50	1/0-1/0	10	80	20	3/0-1/0-1/0	14	80	20	3/0-3/0-1/0	14
90-100	20-50	1/0-#2	10	80	50	3/0-1/0	10(e)	70	20-40	1/0-1/0	10	80	30	3/0-1/0-1/0	12(u)	60	30	3/0-3/0-1/0	14(h)
120-150	20-50	1/0-1/0	10	70	20-50	3/0-3/0	10	70	50	1/0-1/0	10(e)	80	40-50	3/0-1/0-1/0	12(u)(b)	60	40-50	3/0-3/0-3/0	14(h)
	20-50	1/0-1/0	8	80	20-40	3/0-3/0	10	80	20-50	3/0-1/0	10	70	20-50	3/0-1/0-3/0	12(v)	70	20-30	3/0-3/0-3/0	14(h)
	20-50	#2	8	80	50	3/0-3/0	10	90	20-30	3/0-1/0	10			25kVA		70	40	1/0	8(f)
				80	20-30	3/0-3/0	10(e)	100	40-50	3/0-1/0	10(e)	80-120	20-50	#2	6	70	50	3/0-1/0	10(e)
				80	40	3/0-3/0	10(e)	110	20-40	3/0-3/0	10	130	20-40	#2	6	80-90	50	3/0-3/0	10(e)
				80	50	3/0-3/0	10(e)	110	50	3/0-3/0	10(e)	130	50	1/0	6	100-110	50	3/0-3/0	10(e)
				100	20	3/0-3/0	10	110	20-30	3/0-3/0	10	140-150	20-50	1/0	6			25kVA	
				100	30-40	3/0-3/0	10(e)	120	40	3/0-3/0	8(t)					80	20	1/0	8
				100	50	3/0-3/0	10(e)	120	50	3/0-3/0	8(t)					80	30-40	1/0	8(f)
				110	20-40	1/0	8	130-150	20-50	1/0	8					90-100	20-40	1/0	8(f)
				110	50	3/0	8									110	40	3/0	8
				120	20-30	1/0	8									110	20	3/0	8(f)
				120	40	1/0	8(f)									120	20	3/0	8
				120	50	3/0	8									120	30-40	3/0	8(f)
				130	20-30	1/0	8									120	50	3/0	8(n)
				130	40	1/0	8(f)									130	20	3/0	8
				130	50	3/0	8									130	30	3/0	8(f)
				140	20-30	1/0	8									130	40-50	3/0	8(n)
				140	40-50	3/0	8									140	20	3/0	8(f)
				150	20-40	3/0	8									140	30-40	3/0	8(n)
				150	50	3/0	8(f)									140	50	350	8
																150	20	3/0	8(f)
																150	30	3/0	8(n)
																150	40	350	8
																150	50	350	8
																150	50	350	8(f)

DOUBLE-SIDED

4.5kW Base Load (BL)				7kW Air Conditioning (A/C)				7kW Electric Water Heater (EWH)				8kW Electric Heater(EH)				4.5kW A/C Option			
Sec Ft	Serv Ft	S1-S2	# Cust	Sec Ft	Serv Ft	S1-S2	# Cust	Sec Ft	Serv Ft	S1-S2	# Cust	Sec Ft	Serv Ft	S1-S2	# Cust	Sec Ft	Serv Ft	S1-S2-S3	# Cust
80-100	1/0-1/0	20	80	150	350-3/0	18(x)(a)	80	80	3/0-3/0	20(e)	80	80-110	3/0-3/0	20	60	80-110	3/0-1/0	20(e)	
110-150	3/0-1/0	20(e)	70	150	350-3/0	18(x)(a)	80	90-120	3/0-3/0	18(t)(f)	80	120-150	3/0-3/0	20(e)	60	110-150	3/0-3/0	20(a)	
80-100	1/0-1/0	20(e)	80	150	350-350	18(x)(a)	80	130	3/0-3/0	18(t)(f)	70	80	3/0-3/0	20	70	80-90	3/0-3/0	20(e)	
110-140	3/0-1/0	20	80	80-120	1/0	12(f)	70	140-150	3/0-3/0	18(t)(f)	70	90-100	3/0-3/0	20(e)	70	100-150	3/0-3/0	20(a)	
150	3/0-1/0	20(e)	80	80-120	1/0	12(f)	70	80-120	3/0-3/0	18(t)(f)	70	110	1/0	12	80	80	3/0-3/0	20(e)	
80-110	3/0-1/0	20	80	130-140	3/0	12(f)	70	130	3/0-3/0	18(t)(k)	80	80-100	3/0-3/0	20(e)	80	90-130	3/0-1/0	20(a)	
120-150	3/0-1/0	20(e)	70	80	3/0	12	70	120-150	350-3/0	18(t)(g)	80	110	1/0	12	80	140-150	350-3/0	20(a)	
80-90	3/0-1/0	20(e)	70	90-140	3/0	12(f)	80	90-90	350-3/0	18(t)(g)	80		50kVA		90	80	3/0-3/0	20(a)	
100-110	3/0-3/0	20	80	80	3/0	12	80	100-150	350-3/0	18(t)(g)	70		50kVA		90	90-120	3/0-3/0	20(a)#	
80-110	3/0-3/0	20	80	90-130	3/0	12(f)	80		50kVA		80	120-150	1/0	12	90	130-150	350-3/0	20(a)	
80	25kVA		80	80	3/0	12(n)	80	80-100	1/0	12(f)	80	120-140	1/0	12	90	100-110	3/0-3/0	20(a)#	
90			80	140	3/0	12	80	110-120	3/0	12	90	80-120	1/0	12	100	120-130	350-3/0	20(a)	
90-100	120-150	1/0	8	90	90-120	3/0	12(f)	90	130-150	3/0	12	90	130-150	1/0	12	110	100-110	350-3/0	20(a)(n)
100-110	80-150	1/0	8	90	130-150	3/0	12(n)	100	80-100	3/0	12	100	80-110	1/0	12			50kVA	
80-140	1/0	8	100	80-120	3/0	12(f)	100	110-150	3/0	12(f)	100	120-150	1/0	12	100	80-100	3/0	12(e)	
150	1/0	8(c)	100	130-150	3/0	12(n)	110	80-90	3/0	12	110	80	1/0	12	100	140-150	3/0	12(e)	
80-120	1/0	8	110	80-110	3/0	12(f)	110	100-150	3/0	12(f)	110	90-150	1/0	12	110	80-90	3/0	12(e)	
130	130-150	1/0	8(c)	110	120-150	3/0	12(n)	120	80	3/0	12	120	80-120	1/0	12	110	120-150	3/0	12(n)
130	80-110	1/0	8	120	80-100	3/0	12(f)	120	90-120	3/0	12(f)	120	130-150	3/0	12(f)	120	80-90	3/0	12(e)
140	120-150	1/0	8(c)	120	110-150	3/0	12(n)	130	130-150	3/0	12(n)	130	80	1/0	12	120	100-150	3/0	12(n)
140				130	80-100	3/0	12(f)	130	80-110	3/0	12(f)	130	90-140	3/0	12	130	80-90	3/0	12(e)
150				130	110-150	3/0	12(n)	130	120-150	3/0	12(n)	130	150	3/0	12(f)	130	100-140	3/0	12(n)
150				140	80-90	3/0	12(f)	140	80-100	3/0	12(f)	140	80-120	3/0	12	130	150	350	8(f)
				140	100-140	3/0	12(n)	140	110-150	3/0	12(n)	140	130-150	3/0	12(f)	140	80-120	3/0	12(n)
				140	150	350	12(n)	150	80	3/0	12(f)	150	80-110	3/0	12	140	130-150	350	8(f)
				150	80-90	3/0	12(f)	150	90-150	3/0	12(n)	150	120-150	3/0	12(f)	150	80-110	3/0	12(n)#
				150	100-140	3/0	12(n)	150								150	120	350	8(f)
																150	130-150	350	8(f)

H2-H5 SHORT=1/0-1/0
H1-H4 SHORT=1/0-1/0

a)H2=1/0, b)H3=1/0, c)H1=1/0, d)H4=1/0, e)H2-H5=1/0-1/0, f)H1-H4=1/0-1/0, g)H2-H4=1/0-1/0
h)H3-H5=1/0-1/0, i)H3-H5=1/0-1/0, j)H2=3/0, k)H3-H5=3/0-1/0, m)H2-H4=1/0-3/0, n)H1-H4=3/0-3/0
o)H2-H5=3/0-3/0, p)H2-H4=3/0-3/0, q)H1-H2-H4=1/0-1/0-1/0, r)H1=3/0
s)S4=#2, t)S4=1/0, u)S4-S5=1/0-#2, v)S4-S5=1/0-1/0, w)S2-S4=3/0-1/0, x)S4=3/0

© 1998-2020 San Diego Gas & Electric Company. All rights reserved. Removal of this copyright notice without permission is not permitted under law.

REV	CHANGE	BY	DSGN	APPV	DATE	REV	CHANGE	BY	DSGN	APPV	DATE
C						F					
B	FORMATTING	JIK	-	-	02/21/2020	E					
A	ORIGINAL ISSUE	-	CVN	RDG	01/01/1987	D					
Indicates Latest Revision		Completely Revised		New Page		Information Removed					
SDG&E ELECTRIC DISTRIBUTION DESIGN MANUAL SINGLE FAMILY RESIDENTIAL SECONDARY SYSTEMS											
SHEET 6 OF 7										DM5223.6	



Sq. Ft. 0-1299

Sq. Ft. 1300-1999

H1-H4 SHORT=1/0-1/0

Sq. Ft. 2000-2999

SINGLE-SIDED

SINGLE-SIDED

SINGLE-SIDED

6.5kW EH & EWH				6kW A/C & EWH				7.5kW EH & EWH				7kW A/C & EWH				8kW EH & EWH				8kW A/C & EWH			
Sec Ft	Serv Ft	S1-S2-S3	# Cust	Sec Ft	Serv Ft	S1-S2	# Cust	Sec Ft	Serv Ft	S1-S2	# Cust	Sec Ft	Serv Ft	S1-S2	# Cust	Sec Ft	Serv Ft	S1-S2	# Cust	Sec Ft	Serv Ft	S1-S2	# Cust
80	30	50kVA		60-70	20-50	1/0-1/0	10	80	20-30	1/0-1/0	10	80	20-40	3/0-1/0	10	80	20	1/0-1/0	10	80	20-40	3/0-1/0	10
80	30-50	3/0-3/0-1/0	14	80	20-50	1/0-1/0	10(e)	80	40-80	1/0-1/0	10(e)	80	50	3/0-1/0	10(e)	80	30-50	3/0-1/0	10(e)	80	30-50	3/0-1/0	10(e)
80	20-50	1/0-1/0	10	90	20-50	3/0-1/0	10	70	20-50	3/0-1/0	10	70	20-50	3/0-3/0	10	70	20-50	3/0-1/0	10	70	20-50	3/0-1/0	10
80	20	3/0-1/0	10	90	30-50	3/0-1/0	10(e)	80-90	20-50	3/0-3/0	10	80	20-40	3/0-3/0	10	80	20-50	3/0-3/0	10	80	20-50	3/0-3/0	10
80	30-50	3/0-3/0	10	100	20	3/0-3/0	10	100	20	3/0-3/0	10	80	20-30	3/0-3/0	10	80	30-50	3/0-3/0	10	80	30-50	3/0-3/0	10
90-110	20-50	#2	6	100	30-50	3/0-3/0	10(e)	100	30-50	3/0-3/0	10(e)	90	40	3/0-3/0	10(e)	100	20	3/0-3/0	10	100	20	3/0-3/0	10
120-150	20-50	1/0	6	110	20-50	3/0-3/0	10(e)	110	50	3/0-3/0	10(e)	90	50	3/0-3/0	10(e)	100	30	3/0-3/0	8(e)(f)	80	40-50	3/0-3/0	10(e)
				120	50	3/0-3/0	8(e)	120-150	20-50	1/0	8	100	20	3/0-3/0	10(e)	100	40-50	3/0-3/0	8(e)(f)	80	50	3/0-3/0	10(e)
						25kVA						100	30-40	3/0-3/0	10(e)	100	20	3/0-3/0	10	100	20	3/0-3/0	10
				130	20-40	1/0	6					100	50	3/0-3/0	10(e)	100	30	3/0-3/0	10	100	30	3/0-3/0	10
				130	50	1/0	6					110	20-40	1/0	6	100	40	1/0	6	100	40	1/0	6
				140-150	20-40	1/0	6					120	40	1/0	8(f)	110	20-30	1/0	6	110	20-30	1/0	6
				140-150	50	1/0	8(f)					120	20-30	1/0	6	120	20-30	1/0	6	120	20-30	1/0	6
												130	40	1/0	8(f)	130	20	1/0	6	130	20	1/0	6
												130	50	3/0	6	130	30-40	1/0	6	130	30-40	1/0	6
												140	20-30	1/0	6	140	20	3/0	6	140	20	3/0	6
												140	40-50	3/0	6	140	20	1/0	6	140	20	1/0	6
												150	20-40	3/0	6	140	40-50	3/0	6	140	40-50	3/0	6
												150	50	3/0	8(f)	150	20	3/0	6	150	20	3/0	6
												150	50	3/0	8(f)	150	30-40	3/0	6	150	30-40	3/0	6
																150	50	3/0	8(f)	150	50	3/0	8(f)

o)H2=1/0, b)H3=1/0, c)H1=1/0, d)H4=1/0, e)H2=H5=1/0-1/0, f)H1=H4=1/0-1/0, g)H2=H4=1/0-1/0
 h)H3=H6=1/0-1/0, i)H3=H5=1/0-1/0, j)H2=3/0, k)H3=H5=3/0-1/0, m)H2=H4=1/0-3/0, n)H1=H4=3/0-3/0
 o)H2=H5=3/0-3/0, p)H2=H4=3/0-3/0, q)H1=H2=H4=1/0-1/0-1/0, r)H1=3/0
 s)S4=#2, t)S4=1/0, u)S4=SS=1/0-#2, v)S4=SS=1/0-1/0, w)S2=SS=3/0-1/0, x)S4=3/0

DOUBLE-SIDED

DOUBLE-SIDED

DOUBLE-SIDED

6.5kW EH & EWH				6kW A/C & EWH				7.5kW EH & EWH				7kW A/C & EWH				8kW EH & EWH				8kW A/C & EWH			
Sec Ft	Serv Ft	S1-S2	# Cust	Sec Ft	Serv Ft	S1-S2	# Cust	Sec Ft	Serv Ft	S1-S2	# Cust	Sec Ft	Serv Ft	S1-S2	# Cust	Sec Ft	Serv Ft	S1-S2	# Cust	Sec Ft	Serv Ft	S1-S2	# Cust
60	80-90	3/0-3/0	20	80	80-100	3/0-3/0	16(e)(f)	60	80-100	3/0-3/0	16(f)(g)	60	150	350-3/0	16(x)(y)	80	80-100	3/0-3/0	16(f)(j)	80	80-80	3/0	12
80	100-150	3/0-3/0	20(e)	80	110-150	3/0-3/0	16(g)(h)	80	100-120	3/0-3/0	16(h)(i)	70	150	350-3/0	16(y)(z)	80	110	3/0-3/0	16(f)(k)	80	100-140	3/0	12(f)
70	80-100	3/0-3/0	20(e)	70	80-100	1/0	12	80	130-150	3/0-3/0	16(i)(l)	80	150	350-350	16(z)(aa)	80	120-140	350-3/0	16(f)(m)	80	150	350-3/0	20(a)
		50kVA		70	110-150	350-3/0	16(g)(n)	70	80	3/0-3/0	16(f)(o)	80	150	350-3/0	16(aa)(ab)	80	150	350-3/0	16(f)(p)	80	80	3/0	12
70	110-150	1/0	12	80	80-90	1/0	12	80	90	350-3/0	16(f)(q)	80	80-120	1/0	12(f)	70	80	350-3/0	16(f)(r)	70	90-140	3/0	12(f)
80	80-110	1/0	12	80	100-130	350-3/0	16(g)(s)	70	100-150	350-3/0	16(h)(t)	80	130-140	3/0	12(f)	70	90-120	350-3/0	16(f)(u)	70	150	3/0	12(f)
80	120-150	1/0	12(f)	80	140-150	3/0	12(f)	80	80-110	350-3/0	16(i)(v)	70	80	3/0	12	70	130-140	350-3/0	16(f)(w)	80	80	3/0	12
90	80-100	1/0	12	90	80-90	1/0	12	80	120-140	350-3/0	16(j)(x)	70	90-140	3/0	12(f)	80	150	350-3/0	16(f)(y)	80	90-130	3/0	12(f)
90	110-150	1/0	12(f)	90	100-150	1/0	12(f)			50kVA		80	80	3/0	12	70	150	3/0	12(f)	80	140-150	3/0	12(f)
100	80-150	1/0	12	100	80-130	1/0	12	80	150	3/0	12(f)	80	90-130	3/0	12(f)	80	80-100	3/0	12(f)	80	80	3/0	12
110	80-110	1/0	12(f)	100	140-150	3/0	12(f)	80	80-90	3/0	12	80	140	3/0	12(f)	80	110-150	3/0	12(f)	90	90-120	3/0	12(f)
110	120-140	3/0	12	100	140-150	3/0	12(f)	90	100	3/0	12	90	80-80	3/0	12	90	130-150	3/0	12(f)	90	130-150	3/0	12(f)
120	80-110	3/0	12	110	80-130	1/0	12(f)	90	110-150	3/0	12(f)	90	100-140	3/0	12(f)	100	80-120	3/0	12(f)	100	80-120	3/0	12(f)
120	120-150	3/0	12	110	140-150	3/0	12(f)	100	80-110	3/0	12	100	130-150	3/0	12(f)	100	100-140	3/0	12(f)	100	130-150	3/0	12(f)
130	80-110	3/0	12	120	80-110	1/0	12(f)	110	80-130	3/0	12(f)	100	150	3/0	8(e)	100	80-110	3/0	12(f)	110	110-150	3/0	12(f)
130	120-150	3/0	12(f)	120	120-140	3/0	12(f)	110	140-150	3/0	8(e)	110	80-110	3/0	12(f)	100	90-140	3/0	12(f)	110	120-150	3/0	12(f)
140	80-100	3/0	12	130	100-130	3/0	12	120	80-110	3/0	12(f)	110	120-150	3/0	12(f)	110	120	3/0	12(f)	120	80-100	3/0	12(f)
140	100-150	3/0	12(f)	130	140-150	3/0	12(f)	120	120-150	3/0	8(e)	120	80-100	3/0	12(f)	110	130-150	3/0	12(f)	120	110-150	3/0	12(f)
150	80-90	3/0	12	140	100-130	3/0	12	130	80	3/0	12(f)	130	110-150	3/0	12(f)	120	100	3/0	8(e)	120	120	3/0	12(f)
				140	140-150	3/0	12(f)	130	100-130	3/0	12(f)	130	110-150	3/0	12(f)	120	110-140	3/0	12(f)	120	130	350	12
				150	80-90	3/0	12	140	140-150	3/0	12(f)	140	80-80	3/0	12(f)	130	150	3/0	8(f)	130	80	350	12
				150	100-120	3/0	12(f)	140	80	3/0	12(f)	140	100-140	3/0	12(f)	130	80-120	3/0	8(f)	130	90-130	350	12(f)
				150	130-150	3/0	12(f)	140	120	3/0	12(f)	150	80-80	3/0	12(f)	140	110-150	3/0	12(f)	140	80	350	12
								140	130-150	3/0	9(f)	150	100-140	3/0	12(f)	150	110-150	350	12(f)	150	140-150	350	8(f)

© 1998-2020 San Diego Gas & Electric Company. All rights reserved. Removal of this copyright notice without permission is not permitted under law.

REV	CHANGE	BY	DSGN	APPV	DATE	REV	CHANGE	BY	DSGN	APPV	DATE
C						F					
B	FORMATTING	JIK	-	-	02/21/2020	E					
A	ORIGINAL ISSUE	-	CVN	RDG	01/01/1987	D					

SHEET
7 OF 7

Indicates Latest Revision

Completely Revised

New Page

Information Removed

SDG&E ELECTRIC DISTRIBUTION DESIGN MANUAL

SINGLE FAMILY RESIDENTIAL

SECONDARY SYSTEMS

DM5223.7

SCOPE

This guideline provides common infractions of state General Order (G.O.) 128 and the associated rules.

COMMON MARKING INFRACTIONS

A. Subsurface equipment not marked

Manholes, handholes, and subsurface equipment enclosures shall be marked as to ownership (Rule 17.8).

B. Missing signs

(Rule 35.3) – Warning signs indicating high voltage shall be installed:

1. On an exterior surface, or barrier if present, inside the entrance of vaults, manholes, handholes, pad-mounted transformer compartments and other above ground enclosures containing exposed live parts above 750 volts.
2. On an exterior surface of all such pad-mounted transformer compartments and other above ground enclosures.
3. So as to be clearly visible to a person in position to open any such access door, other opening, or barrier.

C. Cables Not Clearly Identified

Where there is more than one cable circuit in excess of 750 volts, the cables shall be permanently and clearly identified by tags or other suitable means to indicate their operating voltage and the circuit with which they are normally associated. This marking shall appear at each manhole or other commonly accessible location of the underground system (Rule 35.1).

COMMON EQUIPMENT SECURITY & PROTECTION INFRACTIONS

A. Enclosures Not Secure

Compartments and enclosures shall be made secure against entry by unauthorized persons by the use of locks or other suitable means (Rule 34.3C).

B. Covers Not Bolted Down

Manholes, handholes, and subsurface equipment enclosures while not being worked in, shall be securely closed by covers and shall require a tool or appliance for opening (Bolt down covers – Rule 32.7).

C. Possible Wire Entry

Compartments and enclosures which will, during normal operation, contain exposed live parts shall be designed and installed to prevent a person from passing a wire or other conducting material into such compartments from the outside when it is closed (Rule 34.3B).

D. Equipment Not Secured in Place

Pad-mounted equipment cases or enclosures shall be secured in place (Rule 34.3A).

E. Equipment Not Grounded

Grounding is required on: (Rule 36.5A)

© 1998-2020 San Diego Gas & Electric Company. All rights reserved. Removal of this copyright notice without permission is not permitted under law.

REV	CHANGE	BY	DSGN	APPV	DATE	REV	CHANGE	BY	DSGN	APPV	DATE
C						F					
B	FORMATTING	JIK	-	-	02/21/2020	E					
A	ORIGINAL ISSUE	-	JCE	VLR	03/01/2002	D					

<p>SHEET 1 OF 2</p>	 Indicates Latest Revision	Completely Revised	New Page	Information Removed	<p>DM5227.1</p>
	<p>SDG&E ELECTRIC DISTRIBUTION DESIGN MANUAL</p>				
	<p>COMMON G.O. 128 INFRACTIONS</p>				

1. Transformer windings not exceeding 250 volts.
2. Neutral conductors of 0-750 volt circuits.
3. Neutral conductors of supply circuits above 750 volts (Shall be grounded in manholes and at other locations where the conductors are accessible).
4. Metal cases of transformers, switches, and other supply equipment.
5. Above-ground metal enclosures in which supply conductors are terminated.

GENERAL INFRACTIONS

A. Ducts not Sealed

Lateral ducts for service to buildings, through which water may enter buildings, shall be plugged or sealed (Rule 31.6).

B. Equipment Too Close to Buildings

Equipment containing oil shall be so that the nearest metal parts of such equipment clear the surface of buildings by not less than three feet. This clearance may be reduced to two feet if the building surface is non-combustible (Rule 34.3D).

© 1998-2020 San Diego Gas & Electric Company. All rights reserved. Removal of this copyright notice without permission is not permitted under law.

REV	CHANGE	BY	DSGN	APPV	DATE	REV	CHANGE	BY	DSGN	APPV	DATE
C						F					
B	FORMATTING	JIK	-	-	02/21/2020	E					
A	ORIGINAL ISSUE	-	JCE	VLR	03/01/2002	D					

SHEET 2 OF 2	X Indicates Latest Revision	Completely Revised	New Page	Information Removed	DM5227.2
	SDG&E ELECTRIC DISTRIBUTION DESIGN MANUAL				
	COMMON G.O. 128 INFRACTIONS				

SCOPE

This standard provides criteria for determining the proper electric distribution trench positioning and depth.

PURPOSE

The criteria was developed to insure trench stability during and after construction by maintaining adequate separation from foreign objects.

DEFINITIONS

NONE

CRITERIA

- A. Distribution Trench Positioning
 - 1. Fire Hydrants

Fire hydrants are installed with a thrust block which is a large body of concrete that poses a difficult construction obstacle. When design permits, locate the underground system on the opposite side of the street from water lines and fire hydrants. When this cannot be accomplished, locate underground systems as shown in Figures 1 and 2 below.

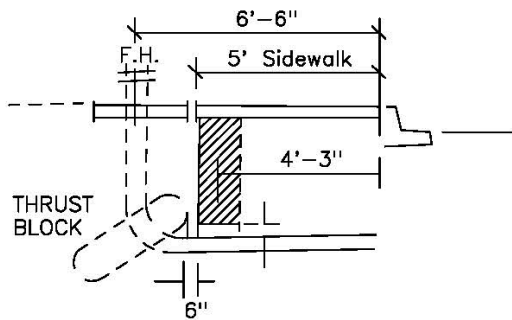

FIGURE 1

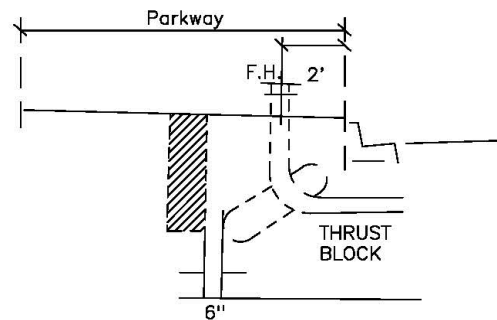

FIGURE 2

- a. Dimension the center line of the trench so that electric and gas positions fall under the back edge of sidewalk. Electric conduit should not extend beyond the edge of sidewalk and a 6" minimum clearance from fire hydrant thrust block shall be maintained.
- b. If possible, the trench position should be located 3' from the rear of the fire hydrant thrust block. If this cannot be done and a 6" minimum separation is used, it should be noted on the work order that the fire hydrant must be shut off by the water company prior to digging.

NOTE: The County of San Diego requires a 3' separation between the fire hydrant and any above ground obstacle such as a piece of pad-mounted equipment.

© 1998-2020 San Diego Gas & Electric Company. All rights reserved. Removal of this copyright notice without permission is not permitted under law.

REV	CHANGE	BY	DSGN	APPV	DATE	REV	CHANGE	BY	DSGN	APPV	DATE
C						F					
B	FORMATTING	JIK	-	-	02/21/2020	E					
A	ORIGINAL ISSUE	-	CVN	RDG	09/04/1984	D					

SHEET 1 OF 4	X Indicates Latest Revision	Completely Revised	New Page	Information Removed
	SDG&E ELECTRIC DISTRIBUTION DESIGN MANUAL			
	TRENCH POSITION REQUIREMENTS			
DM5231.1				

2. Tile Lines (Sewer Leach Lines)

The San Diego County Health Services Department requires a homeowner to locate tile lines or a seepage pit at least 5' laterally from the utility trench for each 1' of trench depth (See Measurement "D" in Figure 3). It is SDG&E's policy to maintain this separation (Figure 3) in San Diego and Orange Counties when placing a trench in the vicinity of existing tile lines or seepage pits.

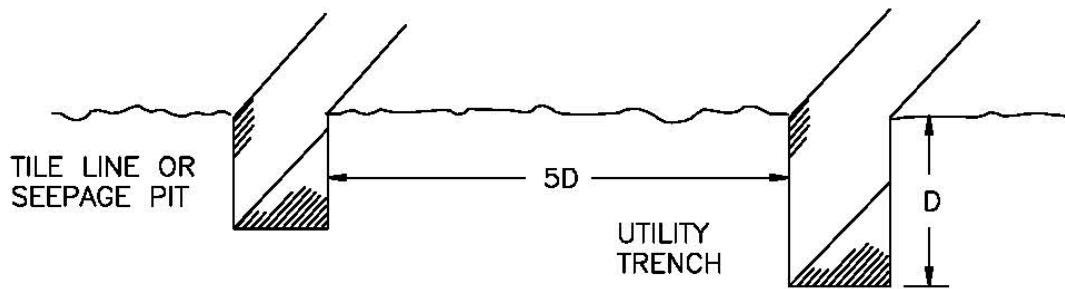

D = Trench Depth in Feet

FIGURE 3

3. Trenches in Proximity to Buildings

- a. Service conduit will only be allowed underneath the building being served by the cable. No conduit is allowed under one building to serve another building.
- b. 45 Degree Rule: Any trench paralleling a building footing, or any other foundation shall maintain a 1' lateral separation for every 1' of trench depth as shown in Figure 4.

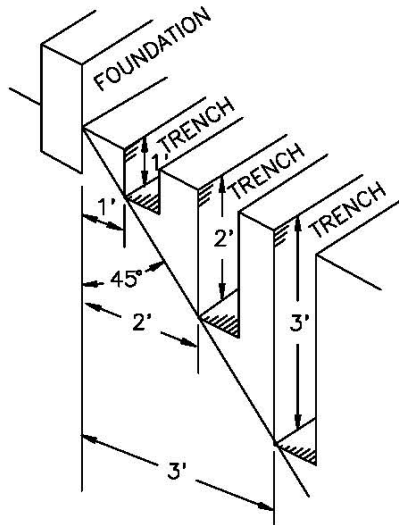

FIGURE 4

NOTE: The depth for a trench paralleling any foundation is limited by the distance from the foundation. For example, trench depth for a trench with the nearest side two feet from a foundation is limited to a maximum depth of two feet.

© 1998-2020 San Diego Gas & Electric Company. All rights reserved. Removal of this copyright notice without permission is not permitted under law.

REV	CHANGE	BY	DSGN	APPV	DATE	REV	CHANGE	BY	DSGN	APPV	DATE
C						F					
B	FORMATTING	JIK	-	-	02/21/2020	E					
A	ORIGINAL ISSUE	-	CVN	RDG	09/04/1984	D					

X Indicates Latest Revision Completely Revised New Page Information Removed

SHEET
2 OF 4

SDG&E ELECTRIC DISTRIBUTION DESIGN MANUAL

TRENCH POSITION REQUIREMENTS

DM5231.2

- c. This standard shows a typical service trench exception paralleling a residential building. (Exception to the 45 degree rule in UG Standard 3367.1 & Gas Standard 7415.1)

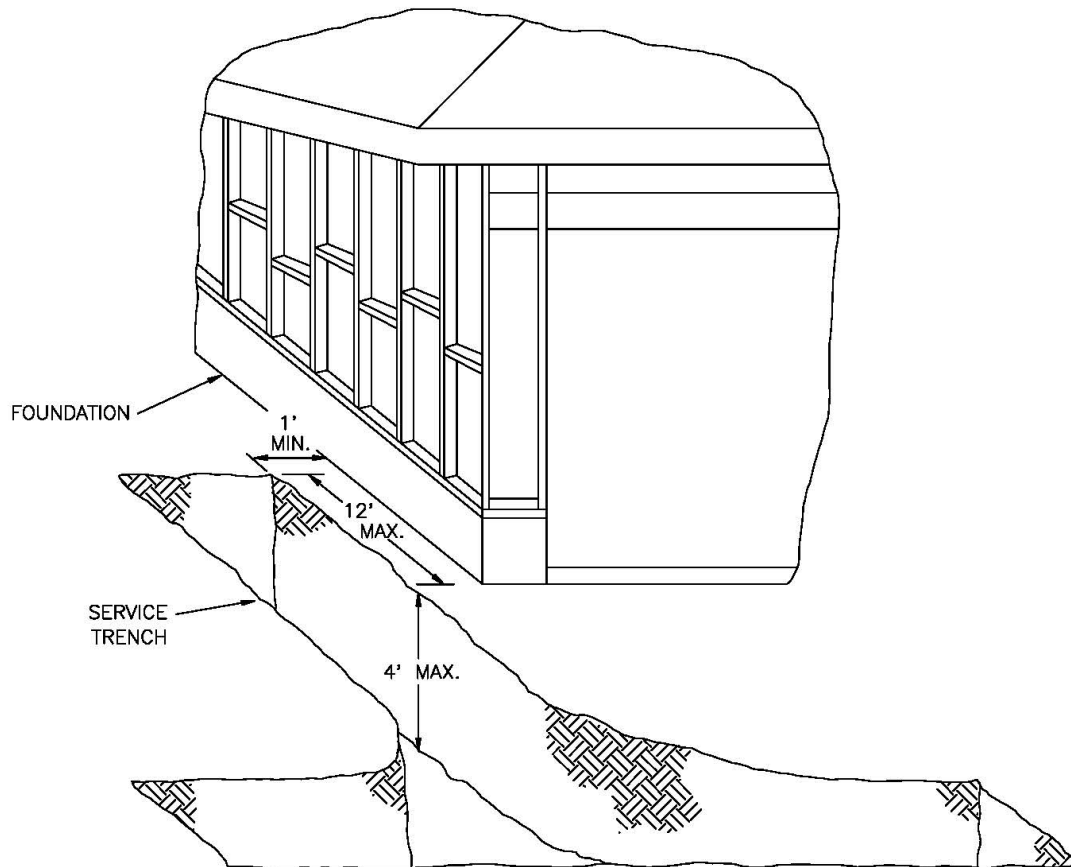

FIGURE 5

INSTALLATION

A. The following conditions must be met:

1. Building has a continuous concrete slab
2. Building height is limited to two stories
3. Trench must be a minimum of one foot from the foundation, must not exceed a 12 foot length along the foundation, and must not exceed a 4 foot depth as shown in Figure 5.
4. Soil conditions must be stable and must not cause undermining of the foundation.
5. Trench walls must be stable before and after the excavation.

B. If the condition(s) in note cannot be met, then the 45 degree rule must be followed.

© 1998-2020 San Diego Gas & Electric Company. All rights reserved. Removal of this copyright notice without permission is not permitted under law.

REV	CHANGE	BY	DSGN	APPV	DATE	REV	CHANGE	BY	DSGN	APPV	DATE
C						F					
B	FORMATTING	JIK	-	-	02/21/2020	E					
A	ORIGINAL ISSUE	-	CVN	RDG	09/04/1984	D					

Indicates Latest Revision Completely Revised New Page Information Removed

SHEET
3 OF 4

SDG&E ELECTRIC DISTRIBUTION DESIGN MANUAL

TRENCH POSITION REQUIREMENTS

DM5231.3

CRITERIA - CONTINUED

B. Distribution Trench Depths

1. Depth Determination

See Underground Service Standard 3370.1 to determine trench depth required for individual application.

2. Sharing

All trenches 60' or deeper require sharing. If a project requires sharing, it must be reflected in the cost estimate as a cost for the party providing the trench. Any trench less than 60" where ground movement is suspected must be shared upon request of SDG&E's inspector.

C. Trench in Proximity to Wet Utilities

A minimum of 5' centerline to centerline, with 3" of undisturbed soil, is the required separation between SDG&E trench and wet utilities. See Underground Standard 3370.4, Note J, and 3371.4, Note H.

REFERENCES

- A. Service Planning Manual 282 – Trenching in the Proximity of Existing Gas and/or Electric Facilities
- B. Service Planning Manual 360 – Gas Meter Locations, Service Extensions, and Barricades
- C. Service Planning Manual 487 – Trench Inspection Procedures
- D. Underground Construction Standard 3370.1 – Underground Distribution (UD) Trenches and Utility Placement
- E. Underground Construction Standard 3367 – Trench Paralleling Foundations
- F. Trenching and Sharing Manual

© 1998-2020 San Diego Gas & Electric Company. All rights reserved. Removal of this copyright notice without permission is not permitted under law.

REV	CHANGE	BY	DSGN	APPV	DATE	REV	CHANGE	BY	DSGN	APPV	DATE
C						F					
B	FORMATTING	JIK	-	-	02/21/2020	E					
A	ORIGINAL ISSUE	-	CVN	RDG	09/04/1984	D					

<p>SHEET 4 OF 4</p>	 Indicates Latest Revision	Completely Revised	New Page	Information Removed	<p>DM5231.4</p>
	<p>SDG&E ELECTRIC DISTRIBUTION DESIGN MANUAL</p>				
	<p>TRENCH POSITION REQUIREMENTS</p>				

SCOPE

This standard provides criteria for locating pad-mounted electrical equipment near all street intersections in order to provide crossing and merging vehicles with an unobstructed view of oncoming traffic. It also applies to driveways in shopping centers, commercial/industrial areas, and residential areas.

DEFINITIONS

Sight Distance – The distance along a roadway that an object of 4.5 feet in height is continuously visible to a driver on a cross street. This distance is determined by the height of the driver’s eye above the road surface, assumed to be 3.5 feet, and the speed of oncoming traffic.

CRITERIA

- A. At all street intersections, pad-mounted equipment shall not be located within the area between the sight distance line and the street (See Exceptions below). This area is indicated by the hatched area shown in Figures 1 and 2 on Design Manual Page 5236.2. This sight distance line is measured between Points A and B as shown in the figures:
 - 1. The distance between Points A and B is equal to eleven (11) times the design speed limit of the through street. Example: For a speed limit of 35 MPH, the distance between Points A and B is 385 feet.
 - 2. Point A is 3.5 feet (42 inches) above the road and is located three (3) feet to the right of center on the cross street and fifteen (15) feet back from the curb face line or edge of pavement of the through street. (See Detail A, Page 5236.2)
 - 3. Point B is 4.25 feet (51 inches) above the road and is located six (6) feet to the right of the left edge of the near lane. (See Detail B, Page 5236.2)
- B. If possible, padmount equipment should not be located within 100 feet of any intersection as measured from the nearest point of curb return (PCR). (See Figure 3, Page 5236.3)
- C. An effort should first be made to place the padmount equipment to the right side of the intersection because this will eliminate most conflicts. If the padmount equipment is placed at the right of the intersection, a line of sight review is still required.
- D. These criteria also applies to street intersections that do not meet at 90 degrees as shown in Figure 2.

EXCEPTIONS

- A. Poles and streetlights may be located within the sight distance.
- B. Facilities may be located between the sight distance line and the street, provided they are completely under the sight distance line. In most cases, where the topography is level, a single-phase transformer and pad and a three-phase transformer and pad are less than 42 inches high and will meet these criteria, so a line of sight calculation is not required. However, care must be used to determine this for each case. If the through road is lower than elevation, then a calculation is required.
- C. If the through road is higher in elevation to the left of the cross street, then pad-mounted equipment may be located in the hatched area, provided the sight distance line is higher than the installed height of the equipment. This must be determined by calculation.
- D. If the through road is a one-way street, the line of sight distance only applies to the direction where the traffic is approaching the cross street. If the intersection is an all way stop, the line of sight distance does not apply. (See Figure 4, Page 5236.3)

© 1998-2021 San Diego Gas & Electric Company. All rights reserved. Removal of this copyright notice without permission is not permitted under law.

REV	CHANGE	DR	BY	DSN	APV	DATE	REV	CHANGE	DR	BY	DSN	APV	DATE
C	UPDATED DRAWINGS & ADDITIONAL TEXT	GLC	CSE	JCE	CZH	11/16/2020	F						
B	FORMATTING		JIK		CZH	02/21/2020	E						
A	ORIGINAL ISSUE			PRM	CAK	01/01/1998	D						

SHEET 1 OF 3	<input checked="" type="checkbox"/> Indicates Latest Revision	<input type="checkbox"/> Completely Revised	<input type="checkbox"/> New Page	<input type="checkbox"/> Information Removed
	SDG&E ELECTRIC DISTRIBUTION DESIGN MANUAL			
	SIGHT DISTANCE REQUIREMENTS			

DM5236.1

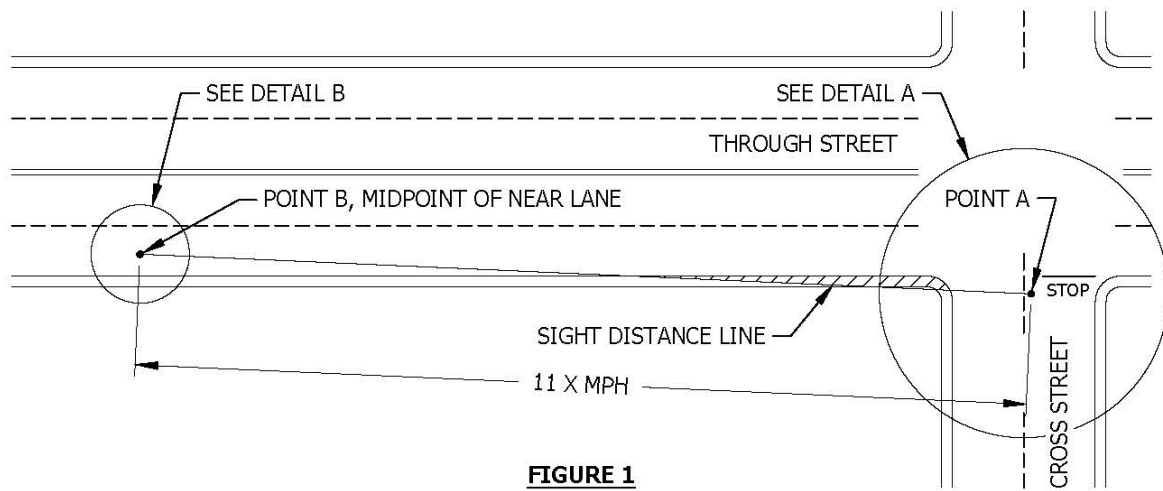
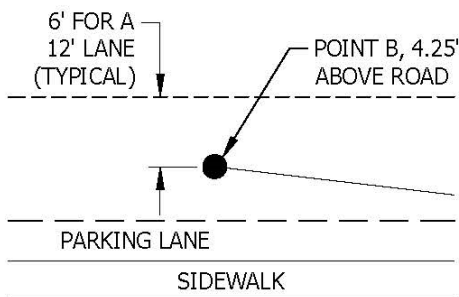
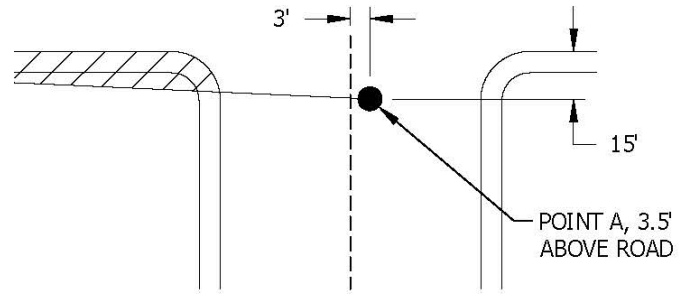

FIGURE 1



DETAIL B



DETAIL A

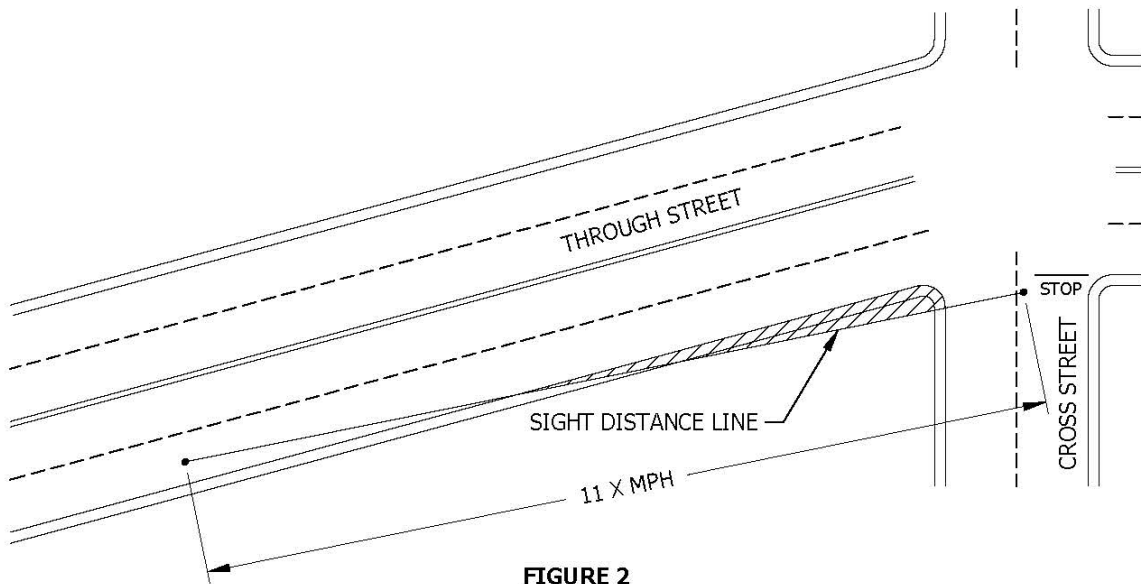

FIGURE 2

© 1998-2021 San Diego Gas & Electric Company. All rights reserved. Removal of this copyright notice without permission is not permitted under law.

REV	CHANGE	DR	BY	DSN	APV	DATE	REV	CHANGE	DR	BY	DSN	APV	DATE
C	UPDATED DRAWINGS & ADDITIONAL TEXT	GLC	CSE	JCE	CZH	11/16/2020	F						
B	FORMATTING		JIK		CZH	02/21/2020	E						
A	ORIGINAL ISSUE			PRM	CAK	01/01/1998	D						

Indicates Latest Revision	Completely Revised	New Page	Information Removed
---------------------------	--------------------	----------	---------------------

SHEET
2 OF 3

SDG&E ELECTRIC DISTRIBUTION DESIGN MANUAL

SIGHT DISTANCE REQUIREMENTS

DM5236.2

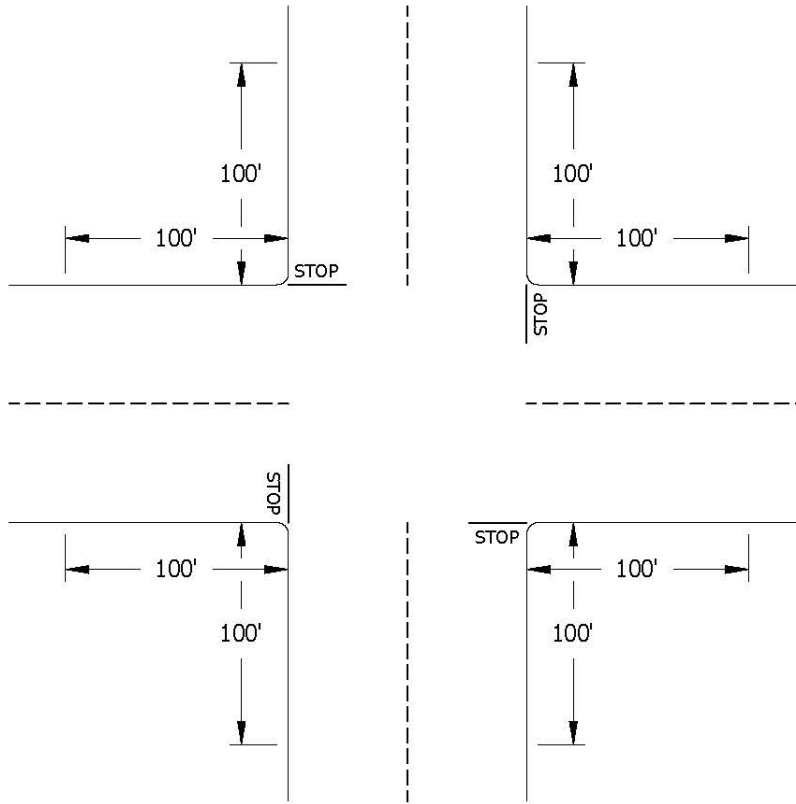

FIGURE 3

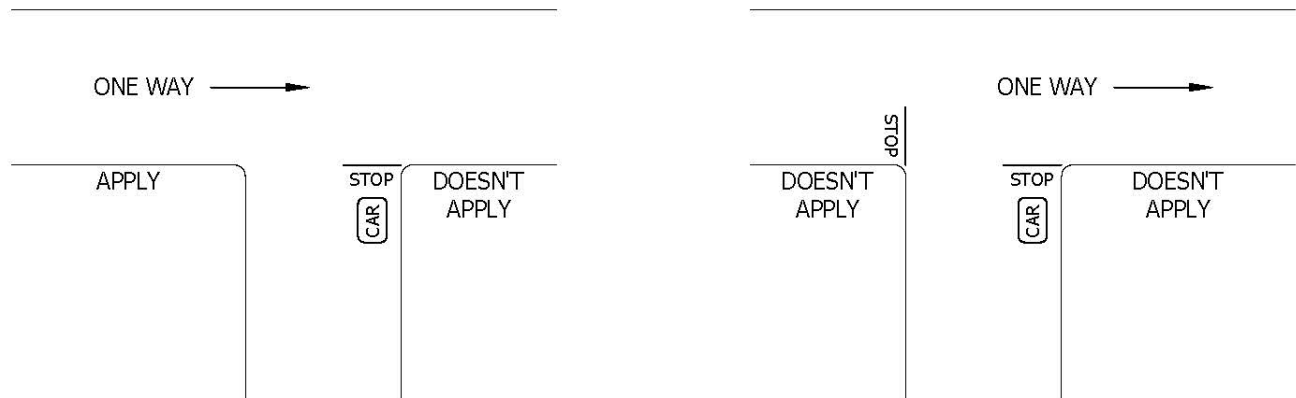

FIGURE 4

© 1998-2021 San Diego Gas & Electric Company. All rights reserved. Removal of this copyright notice without permission is not permitted under law.

REV	CHANGE	DR	BY	DSN	APV	DATE	REV	CHANGE	DR	BY	DSN	APV	DATE
C	UPDATED DRAWINGS & ADDITIONAL TEXT	GLC	CSE	JCE	CZH	11/16/2020	F						
B	FORMATTING		JIK		CZH	02/21/2020	E						
A	ORIGINAL ISSUE			PRM	CAK	01/01/1998	D						

Indicates Latest Revision Completely Revised New Page Information Removed

SHEET
3 OF 3

SDG&E ELECTRIC DISTRIBUTION DESIGN MANUAL

SIGHT DISTANCE REQUIREMENTS

DM5236.3

Purpose

To provide criteria for selecting between pad-mounted and subsurface equipment for the underground distribution system. This standard also provides criteria for locating pad-mounted equipment in public right-of-way.

Considerations According to Project Type

Conversions/Retrofits

Normally, specific customers do not exist for conversions/retrofit projects. Easements are not easily obtained from customers already in service and uncontrollable delays in job construction are normal. These delays escalate the job costs and sometimes costly re-designs are required. On these types of jobs, when practical, every effort should be made to locate facilities within the public right-of-way and avoid the necessity for easements and their costly construction delays.

New Business (Specified Customer)

The customer is required to sign easement documents prior to energizing any new facilities. Location of any new facilities, whether on private property or in the public right-of-way, will not normally cause delays in job construction on this type of job. Follow standard SDG&E practices to locate facilities.

General Considerations

Pad-mounted equipment, as opposed to subsurface equipment, is standard for all applications on the electric distribution system. New loads connected to the underground system are to be served with pad-mounted transformers. Except for single family residential applications, transformers are to be located on the customer's property or inside the customer's building in a dry vault.

Some of the reasons for the pad-mounted standard are listed below:

Transformers, switches and other equipment installed in subsurface environments are exposed to ground water seepage, high humidity, and corrosive run off (fertilizers). These factors lead to accelerated equipment deterioration and increased maintenance. Subsurface equipment will experience higher failure rates than is expected for pad-mounted equipment due to the hostile subsurface environment.



Customer service interruptions are longer when failures occur in subsurface systems. In general, a crew is required to operate subsurface switches because of difficult access and the frequent need to pump water from substructures before restoration procedures can begin. Pad-mounted equipment, on the other hand, can generally be operated by a single troubleshooter.

Subsurface systems are more expensive than pad-mounted systems. Initial installation costs and continuing maintenance costs for the subsurface system combine to produce a higher overall cost.

Criteria for Selecting Between Pad-Mounted and Subsurface Equipment

Pad-mounted equipment is to be used for all underground 4kV and 12kV applications, except as noted below. Even though subsurface equipment is allowed for some applications, its use is to be strictly limited to the situations described below.

1. Subsurface equipment may be installed in urban and/or redevelopment areas where the general criteria for locating pad-mounted equipment cannot be met (see following section).

	 Indicates Latest Revision	Completely Revised	New Page
REVISION	SDG&E DISTRIBUTION DESIGN MANUAL		5240.1
DATE 1-1-90	UNDERGROUND SYSTEM EQUIPMENT		
APPD CVN 	SELECTION AND LOCATION		

This situation is most commonly found in Downtown San Diego and on overhead to underground conversion projects. In these cases, there may be insufficient right-of-way to accommodate pad-mounted equipment and maintain all of the required operating clearances of Underground Standard 3483.

2. Subsurface equipment may be installed when the only available pad-mounted location would put the equipment at unusual risk due to vehicle contact.
3. A subsurface switch should be installed if all of the following conditions apply:
 - a. Existing Substructure – There is an existing substructure that will accommodate the switch, and the substructure does not have a significant water problem.
 - b. Traffic Control – The operation or maintenance of the switch will not create excessive traffic congestion, or excessive traffic control requirements.
 - c. Cost Differential – The installed cost of the pad-mounted switch exceeds the installed cost of the subsurface switch by 30% or more.

Note:

Subsurface switches that are being changed out due to corrosion, leaks or other reasons, should be replaced in kind, if at all possible.

4. The following list of equipment may be installed subsurface if the criteria of this standard are met.
 - a. 120/240 Volt single-phase transformer stations
 - b. 240/120 Volt and 208Y/120 Volt three-phase transformer stations
 - c. Three-Phase fuse cabinets
 - d. Four-Way 600A switches
 - e. ON-OFF switch

Criteria for Locating Pad-mounted Equipment in Public Right-Of-Way

1. The overall width of the area between the face of curb, berm, or edge of roadway and the property line must be large enough to accommodate the equipment and provide required SDG&E clearances. When sidewalks are present a minimum of 48", for wheelchair clearance, must be provided. Wheelchair clearance can be defined as pedestrian traffic area where wheelchairs can travel within a 48" wide path, excluding curb, unobstructed by above ground facilities/equipment. See figure 1 & 2.
2. The position of pad-mounted equipment must meet the operating clearances clearances and the barrier & protection clearances shown in the underground construction standards 3481 & 3483. Clearances may be reduced but only after approval of a deviation request, which should be processed during the design phase and prior to job issue.
3. Pad-mounted equipment must not interfere with the sight distance requirements of Design Standard 5236.

	Indicates Latest Revision	Completely Revised	New Page
5240.2	SDG&E DISTRIBUTION DESIGN MANUAL		REVISION
	UNDERGROUND SYSTEM EQUIPMENT SELECTION AND LOCATION		DATE 1-1-96 APPD JW / <i>BJ</i>

4. The preferred location for pad-mounted equipment is behind sidewalk, 5' from driven roadways, as shown in figure 2. However, if this is not practical, equipment may be set using traffic barriers, as shown in figure 1.
5. Transformers installed should also comply with noise criteria in DM 5621.
6. Aesthetics of the installation must be considered. The following lists some considerations which should be taken into account:
 - a. Facilities should be placed to present as neat an appearance as possible. It is generally better to group equipment together rather than randomly string green boxes along a sidewalk. However, avoid grouping so many pad-mounted cabinets that a cluttered appearance is created.
 - b. Avoid setting pad-mounted equipment in sidewalks that have a very heavy flow of pedestrian traffic, such as the more congested areas downtown.
 - c. Avoid setting any equipment that would have the appearance of blocking the entrance to any building, or the appearance of being an obstruction to pedestrian traffic.
 - d. When pad-mounted equipment is set in sidewalks, it should be set back from the intersection far enough to avoid "surprising" pedestrians or bicycle riders when they turn the corner.
7. If these requirements cannot be met, then subsurface equipment should be considered. The design should address safety, integrity of the distribution system, and aesthetics.

	Indicates Latest Revision	Completely Revised	New Page
REVISION	SDG&E DISTRIBUTION DESIGN MANUAL		5240.3
DATE 1-1-90	UNDERGROUND SYSTEM EQUIPMENT		
APPD CVN / <i>ROJ</i>	SELECTION AND LOCATION		

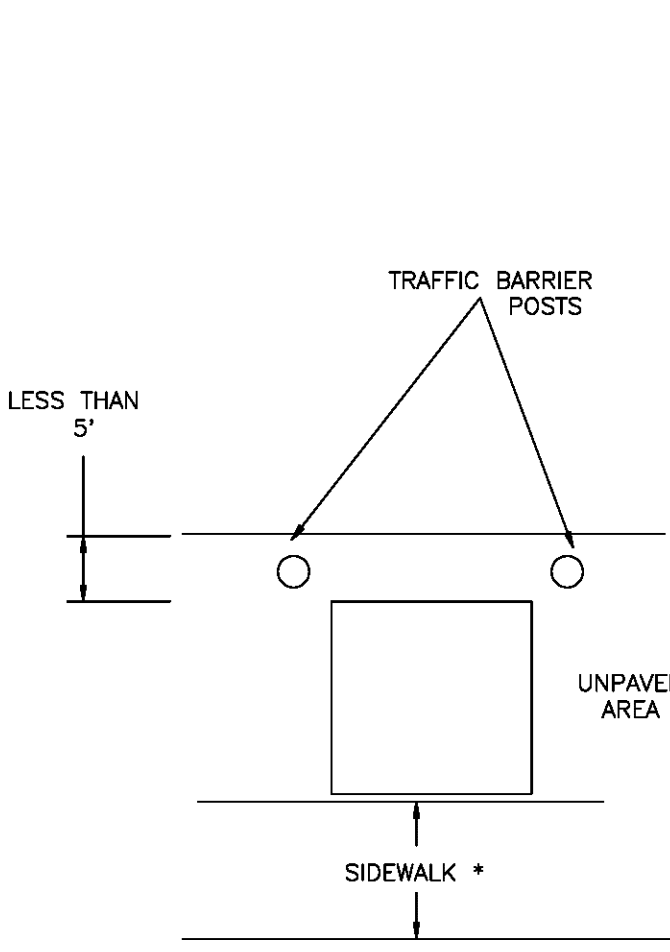

FIGURE 1

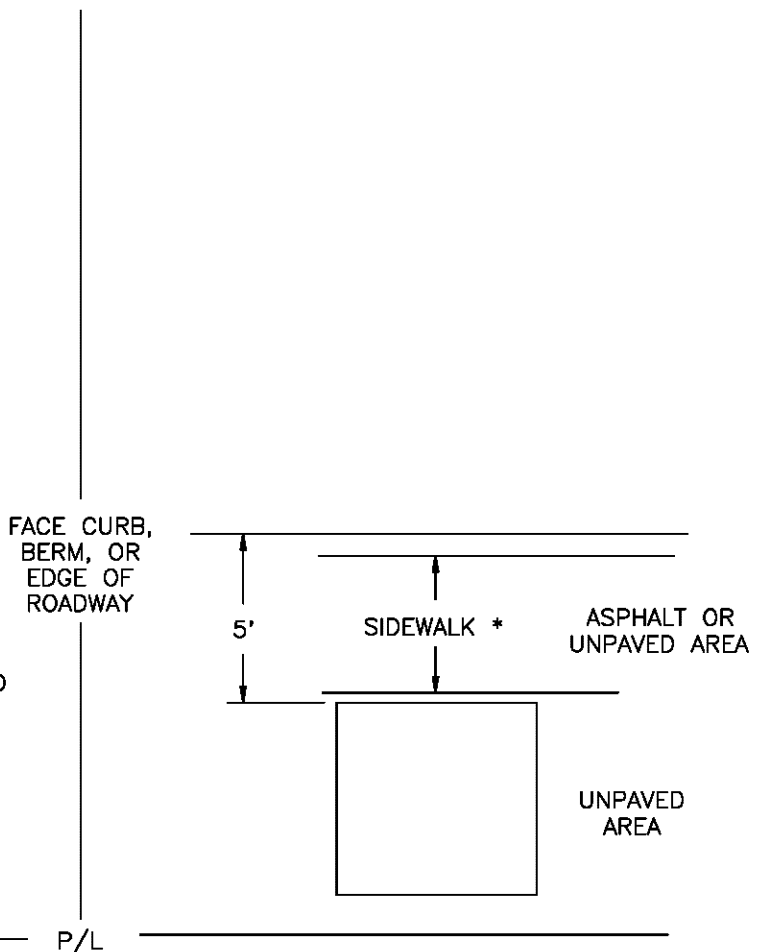

FIGURE 2

* MINIMUM 48" CLEAR SIDEWALK AREA, EXCLUDING CURB, REQUIRED FOR WHEELCHAIR CLEARANCE.

	Indicates Latest Revision	Completely Revised	New Page
5240.4	SDG&E DISTRIBUTION DESIGN MANUAL		REVISION
	PAD-MOUNTED EQUIPMENT LOCATION		DATE 1-1-90
			APPD CVN/BJ

SCOPE

This design standard provides descriptions, primary uses and application guidelines for underground sectionalizing equipment.

PURPOSE

These guidelines are established to promote consistency and uniformity when designing feeder extensions, and to standardize on the types of equipment used to sectionalize the UG distribution system.

EQUIPMENT DESCRIPTIONS

PME-9 Switch/Fuse Cabinet

Description:

This is an air-insulated, padmounted cabinet providing two-600 Amp three phase group operated switches, in compartments 1 and 2. Additionally, three phase fusing is provided from a common 600 Amp bus in compartments 3 and 4. Cabinets in normal (M&S) inventory arrive from the factory set up for the 140 Amp "X-Limiter" Current Limiting Fuse. Cabinets can be special ordered to accommodate the SM-4 "expulsion" fuse (up to and including 200 Amps), if needed for coordination with downstream devices, or due to load overhead exposure or primary service point. Also, parts can be special ordered to convert one or more compartments on a regular inventory PME-9 from CLF to SM-4.

Available with factory-installed SCADA, use DPSS unit "PME-9S"

Primary Uses:

Loop feeder through the switch positions. Use remaining fuse compartments to serve local distribution, or major industrial customer(s). Recommend SM-4 fuses for primary meter services, isolated on their own compartment.

PME-10 Switch Cabinet

Description:

This is an air-insulated, padmounted cabinet providing four-600 Amp three phase group-operated switches, in compartments 1 through 4. No fusing is provided in any of the compartments, however fused elbows may be installed on the back of any 600 Amp Tee.

Available with factory-installed SCADA, use DPSS unit "PME10S"

Primary Uses:

Bifurcate or trifurcate feeder. Establish feeder tie. Can serve primary meter service where demand does not allow SM-4 or CL fusing.

PME-11 Switch/Fuse Cabinet

Description:

This is an air-insulated, padmounted cabinet providing three-600 Amp three phase group operated switches, in compartments 1, 2, and 4. Fusing is provided in compartment 3 only, as described for compartments 3 and 4 on the PME-9.

	 Indicates Latest Revision	Completely Revised	New Page
REVISION	SDG&E DISTRIBUTION DESIGN MANUAL		5250.1
DATE 1-1-2000 APPD MJC/ <i>Wd</i>	UNDERGROUND SECTIONALIZING EQUIPMENT APPLICATION		

EQUIPMENT DESCRIPTIONS (continued)

Available with factory-installed SCADA, use DPSS unit "PME11S"

Primary Uses:

Bifurcate Feeder while serving local distribution load. Loop feeder through two switch positions and establish tie on the third, serving local distribution or major customer from compartment 3 (fused).

PME-3 Switch Cabinet

Description:

This is an air insulated, padmounted cabinet providing a single 600 Amp three phase group operated switch.

Available with factory-installed SCADA, use DPSS unit "PME-3S"

Primary Uses:

Mid-point sectionalizing for circuits
 Establish tie between two UG feeders
 Terminate new feeder extensions to avoid later outage when extensions are continued.

PME-5 Fuse Cabinet

Description:

This is an air insulated, padmounted fuse cabinet. Connections are made with 200 amp load break elbows.

Primary Uses:

Feeder taps for certain local distribution loads and field maintenance jobs replacing older PMH-5 (live front) cabinets.

Source - Transfer Switch

Description:

Also called an auto-transfer switch. Available in a PME configuration. The air-insulated cabinet provides two 12kv 600 Amp group operated switches coupled to a special high-speed operating mechanism. This mechanism is controlled by a microprocessor device that senses loss of device that senses loss of potential from either source. Upon a sensed loss of potential, the device will initiate an "open" command on one switch, followed by a "close" command on the other. Timing parameters are variable, and are a function of settings at the feeder breaker(s), service restorer(s), or other devices/factors. Settings for the microprocessor control are determined by Protection Engineering.

Provided with factory-installed SCADA equipment

Primary Uses:

Used in special situations when alternate service is to be provided automatically. Typically used when a "special facilities" agreement is established, with a major customer, for alternate service. The alternate circuit should originate from a substation different from the preferred, or at least from a different bus at the same substation.

Note: Long lead time, special order item. Contact Standards at least six months in advance of the scheduled in-service-date, to ensure timely arrival and to confirm exact PME configuration.

<input checked="" type="checkbox"/>	Indicates Latest Revision	<input type="checkbox"/>	Completely Revised	<input type="checkbox"/>	New Page
5250.2	SDG&E DISTRIBUTION DESIGN MANUAL				REVISION
	UNDERGROUND SECTIONALIZING EQUIPMENT APPLICATION				DATE 3-1-02 APPD JCE / <i>JKL</i>

EQUIPMENT DESCRIPTIONS (continued)

Padmounted Service Restorer (PMSR)

Description:

The PMSR is a padmounted recloser with fault sensing and automatic fault interruption ability. The device includes a controller which can be set for the automatic fault clearing characteristics of each installation. Cable terminations are dead front, using 600 Amp tee's and cam links.

Provided with factory installed SCADA equipment.

Primary Use:

The PMSR is typically set at or near the midpoint of a circuit, to provide immediate sectionalizing in the event of a fault on the load side of the device.

Fuse Cabinet with Provisions for Feed-Through

Description:

This is a three-phase pad-mounted fuse cabinet with provisions for feed-through on the line and load side. Connections are made with 200A load break elbows.

Primary Uses:

Provides an alternative to installing a second fuse cabinet or 200A dead front terminators. Precaution should be taken not to overload the 200A load break elbows or feed-through bushings.

Fused Elbow

Description:

This is a load break elbow with a current-limiting fuse (30 amp). (See UG Standard 4191)

Primary Uses:

Fusing small loads – Fused elbows are a low-cost method of tapping small loads off of the underground system.

Handhole and 600A Dead Front Terminator

Description:

TEEs are used to splice feeder cable, and may be used as tapping points for the local distribution system. When installed in handholes, TEEs are mounted at an angle so one end is accessible for attaching 200A load break elbows. (See UG Standards 3646 & 3649)

Primary Uses:

Splice feeder cable and tap to local distribution – TEEs are a low-cost method of tapping underground feeders when there is no need for feeder sectionalizing.

<input checked="" type="checkbox"/>	Indicates Latest Revision	<input type="checkbox"/>	Completely Revised	<input type="checkbox"/>	New Page
REVISION	SDG&E DISTRIBUTION DESIGN MANUAL				5250.3
DATE 3-1-02	UNDERGROUND SECTIONALIZING EQUIPMENT APPLICATION				
APPD JCE / <i>VGL</i>					

Cam Link

Cam Link: UG device providing the ability to quickly isolate UG feeder segments. Operable by a single Electric Troubleshooter, the cam-link is a molded connector assembly including a removable, current carrying part that can be replaced with a non-current carrying counter-part. Shall be operated only after both sides are tested denergized. Can be installed within a 600 amp deadfront terminator to provide some basic feeder sectionalizing ability. Very economical and able to carry full line full line current. Installed on padmounted service restorers to provide a visible open that can be tagged as part of a line authorization.

VISTA Switch

Description:

VISTA switches are stainless steel, gas insulated, load interrupting multi-position switches. Each position can be grounded individually, and a viewing window is included to verify the status (open, closed, grounded). A test panel is included for each position, providing an easy, quick method to verify status (energized or de-energized) prior to grounding.

The VISTA switch is available in four configurations, two of which include fault interrupter modules, and two of which provide strictly feeder switch positions.

Fault interrupters are applied only in a radial manner; no ties with other circuits are allowed, although the interrupters and associated bushings are rated for 600 Amp load. Fault interrupters are available on the "633" and "422" configurations. See UG Standard 3585, 3670, 3671 and Vault specifications manual for more detail.

The available configurations include:

- 330—three feeder switches only, with or without SCADA
- 440—four feeder switches only, with or without SCADA
- 422—two feeder switches, and two fault interrupters, with SCADA
- 633—three feeder switches, and three fault interrupters, with SCADA

SCADA Autosectionalizing is not available on the six-way (633) VISTA.

Primary Uses:

1. Downtown or other dry vault installations (with or w/o SCADA)
2. Padmount installations that fit within normal franchise (330 model only, with or w/o SCADA)
3. Subsurface/surface operable installations that fit within franchise (440 model only, with or w/o SCADA)

Due to the higher cost, applications 2 and 3 are normally restricted to cases where PME easements cannot be obtained at a cost equal or less than the installed cost differential. PME cabinets are always less expensive, and provide all the functionality of VISTA's, for most applications. The application protocol for projects not using dry vaults requires a good faith effort to obtain an easement sufficient for PME application, including an offer of compensation.

	<input checked="" type="checkbox"/> Indicates Latest Revision	Completely Revised	New Page
5250.4	SDG&E DISTRIBUTION DESIGN MANUAL		REVISION
	UNDERGROUND SECTIONALIZING EQUIPMENT APPLICATION		DATE 3-1-02 APPD JCE / <i>val</i>

EQUIPMENT SELECTION DIAGRAM

The following logic diagram is designed to assist in determining the appropriate equipment to use for the different types of loads and requirements.

The equipment recommendations are intended to maximize the work-ability, safety, and cost-effectiveness of the system. However, certain conditions may exist which may preclude the installation of the recommended device: right-of-way problems, working space limitations, equipment unavailability, etc.

Note:

If field conditions make it prohibitive to install the equipment recommended by the logic diagram, the Distribution Planning engineer will determine what equipment should be used in its place.

DIRECTIONS

Start at the left end of the diagram (where it says "Extend Feeder") and follow the arrow. The answer to the question inside the first diamond will direct you to other diamonds, where other questions will be asked. Ultimately, you will arrive at a recommended piece of equipment.

	 Indicates Latest Revision	Completely Revised	New Page
REVISION	SDG&E DISTRIBUTION DESIGN MANUAL		5250.5
DATE 1-1-98	UNDERGROUND SECTIONALIZING EQUIPMENT APPLICATION		
APPD <i>SRM / CAC</i>			

5300
DEMAND
ESTIMATING

5300
DEMAND
ESTIMATING

PAGE(S)

SUBJECT

5311

5311.1-5311.4

5311.4

5311.5

5311.6

5311.7

5311.8

Commercial and Industrial Demand Estimating

Application

Commercial Class Selection Table

Converting Customer Load to KW

Demand Estimating Worksheet

Review Guide for New Business Products

Break Even Year Matrix

5321

Single-Phase Air Conditioning

5322

5322.1-5322.6

Residential Demand Estimating

Criteria

5323

5323.1-5323.3

Multiple Residential Service Load

Diversity

© 1998-2020 San Diego Gas & Electric Company. All rights reserved. Removal of this copyright notice without permission is not permitted under law.

REV	CHANGE	BY	DSGN	APPV	DATE	REV	CHANGE	BY	DSGN	APPV	DATE
C						F					
B	FORMATTING	JIK	-	-	02/21/2020	E					
A	ORIGINAL ISSUE	-	CVN	RDG	01/01/1990	D					

 Indicates Latest Revision	Completely Revised	New Page	Information Removed
---	--------------------	----------	---------------------

**SHEET
1 OF 1**

SDG&E ELECTRIC DISTRIBUTION DESIGN MANUAL

**TABLE OF CONTENTS
DEMAND ESTIMATING**

DM5301.1

SCOPE

This standard establishes the criteria for estimating commercial & industrial customer loads based upon Square Foot Demand and Load Schedule Demand.

PURPOSE

This criteria provides a standard method for estimating new commercial customer demands for sizing distribution transformers and secondary/service cables.

DEFINITIONS

Square Foot Demand – the estimated demand in kilowatts/square foot based upon building area and customer type.

Load Schedule Demand – the estimated demand based on the sum of the diversified loads, identified individually.

Future Load – connected load that is not installed by the building/project in-service date.

Estimated Demand Selection – the chosen demand estimate based upon Square Foot Demand or Load Schedule Demand.

Commercial Diversity Factor – the factor that is applied to the sum of the individual (customer) service point demands connected to any three-phase equipment or system.

Minimum Transformer Size – The smallest size transformer that will serve the initial peak load.

Ultimate Transformer Size – The size transformer that is needed to serve the ultimate (future) load of a building/project.

DEMAND ESTIMATING WORKSHEET APPLICATION

The following example demonstrates the proper use of the Demand Estimating Worksheet shown on page 5311.6.

EXAMPLE

The following equipment data has been provided from the Energy Load Information Agreement Form:

Given: A 22,400 square foot bank having a 120/208V service with a 1,000A service panel.

The transformer pad is 100 feet from the service panel. Total Air Conditioning load is 110.6 kW; the sum of two units.

	Indicates Latest Revision	Completely Revised	New Page
REVISION	SDG&E DISTRIBUTION DESIGN MANUAL		
DATE 1-1-90 APPD CVN/ <i>BJ</i>	COMMERCIAL AND INDUSTRIAL DEMAND ESTIMATING		5311.1

STEP 1

Indicate the following on Demand Estimating Worksheet:

- Work Order Number
- DPSS Number
- Job Location
- Job Name

STEP 2

Building/Service Information:

- Transfer building/service information from the Energy Load Information Agreement Form to the Demand Estimating Worksheet:

- Building/service point number 1
- Building area 22,400 sq.ft.
- Serving voltage 120/208 Volts
- Service panel size 1,000 Amps
- Transformer to service panel distance 100 Ft.
- Largest motor size 25 HP (A/C Compressor)

Note:

It is necessary to identify the service point for each building by a number designation because larger buildings may be granted multiple service points.

STEP 3

Square Foot Demand Calculation: (Method one)

- Check box on Demand Estimating Worksheet by appropriate customer class to be calculated. (Refer to Table 1 on Page 5311.4).
- Multiply building area from Building/Service Information by the customer class (kW/sq.ft.) factor.

- Customer Class Bank
- Building Unit Demand $22,400 \times 0.006 \text{ kW/sq.ft.} = 134.4 \text{ kW}$

STEP 4

Load Schedule Demand Calculation: (Method two)

The following load schedule: (Work in kW using conversion factors from page 5311.7).

Lighting	28 kW	
Air Conditioning	110.6 kW	(Total of two units)
Receptacles	28 kW	
Spare	17 kW	

- Load Schedule Demand (kW = Sum of Load x D.Factor)
for each type of load

Lighting	28 kW	x 0.9	= 25.2 kW
Air Conditioning	55.3 kW	x 1.0	= 55.3 kW (1st unit)
	55.3 kW	x 0.8	= 44.2 kW (2nd unit)
Receptacle	28 kW	x 0.1	= 2.8 kW
			<hr/>
	Total Demand = 127.5 kW		

	 Indicates Latest Revision	Completely Revised	Information Removed
5311.2	SDG&E DISTRIBUTION DESIGN MANUAL		REVISION
	COMMERCIAL AND INDUSTRIAL DEMAND ESTIMATING CRITERIA		DATE 1-1-2000 APPD JW <i>[signature]</i>

STEP 5

– Estimated Demand Selection:

If the Square Foot Demand (SFD) divided by the Load Schedule Demand (LSD) is between .8 and 1.2, inclusive, choose the Square Foot Demand as the Estimated Demand Selection. If SFD/LSD is outside the .8 to 1.2 range, choose the lesser of the two as the Estimated Demand. However, if the LSD exceeds the change-out value of the selected transformer, the LSD should be checked for accuracy of information. Once a more accurate value is determined, the choice of transformer size should be made. If the load is for a chain store, an effort should be made to find out if there is an existing store in our service territory that is the same square footage and load profile. The Commercial Customer Demand Listing (Superdata Book) can be used to make a comparison between the SFD and LSD.

Peak KVA of similar accounts in Superdata Book (Customer #1 & Customer #2)

Customer #1 = 129 kW
Customer #2 = 133 kW

$$\text{Estimated Peak demand} = \text{Average Demand} = \frac{129 + 133}{2} = 131 \text{ kW}$$

STEP 6

Equipment Selection:

- Permanent Facilities
- Conduit, substructures and transformer pads to be sized in accordance with UG Construction Standard 3942.

Transformer:

- For Transformer Loading refer to Design Standard 5621.
- Select transformer size based on the estimated demand selection value obtained in Step 4.

For this example:

Estimate result in 150 kVA per 5621.1

Secondary & Service:

- Use PMWORKS to determine size.

BREAK EVEN ANALYSIS

When there is a clear understanding of the end use of the customer's building, use the results obtained with the Demand Estimating Worksheet. If, however, it is not clear what the building's initial use is or the load is not well defined, then a "Break Even Analysis" can be used. This will compare installing less capacity initially vs. full capacity.

A Break Even Year Matrix is shown on page 5311.8. Inputs to the matrix are the initial and ultimate transformer sizes. The output of the matrix is the number of years the installation of the ultimate transformer must be delayed to justify installing the smaller unit initially. At the end of the break even year, the total present value cost of installing and replacing the the smaller transformer will equal the total cost of initially installing the ultimate transformer.

Good judgment must be used forecasting the ultimate building use and demand. Consider similar buildings in the area with comparable floor space and similar customers in the service territory.

	 Indicates Latest Revision	Completely Revised	New Page
REVISION	SDG&E DISTRIBUTION DESIGN MANUAL		5311.3
DATE 1-1-2000	COMMERCIAL AND INDUSTRIAL		
APPD HB <i>Wcl</i>	DEMAND ESTIMATING CRITERIA		

REFERENCES:

1. Design Standard 5621, Initial Transformer Design Loading for Balanced Loads
2. Design Standard 5411, Voltage Drop and Flicker Nomographs Application Guide
3. Design Standard 5431, Underground Cable Voltage Drop and Flicker Nomograph
4. Design Standard 5432, Overhead Conductor Voltage Drop and Flicker Nomograph.
5. Service Planning Practices 392, Load Studies, Gas and Electric
6. Service Planning Practice 930, Energy Load Information Agreement

TABLE 1 – CUSTOMER CLASS SELECTION
BUSINESS TYPE

OFFICES	Lending institutions, insurance brokers, real estate legal services, etc. (4 stories or less)
DEPARTMENT STORES	Sears, Mervyns, Woolworths or large shops
RETAIL STORES	Variety stores, general merchandise, or small shops
BANKS	Local, state and federal banking
MEDICAL OFFICES	Dentists, physicians and laboratories
MEDICAL HOSPITALS	Hospital complexes, 3 stories or less
RESTAURANTS (fast fd.)	McDonalds, Burger King, Wendy's
RESTAURANTS (dining)	Denny's, Black Angus, El Toritos
CONVENIENCE STORES	Stop and Go, 7-11, U-Totem, corner delis
GROCERY STORES, CLUB STORES	Major chains, i.e. Vons, Safeway, Lucky, Costco
HOTEL/MOTEL	Hotels or motels, i.e. Hilton, Holiday Inn, Motel 8
LIGHT COMMERCIAL/ INDUSTRIAL	Fabrication, light manufacturing, non-assembly line, product distributing, machine shops, auto repair shops, bakeries
MANUFACTURING	Heavy manufacturing, assembly line
WAREHOUSING	Storage, distribution

Contact Distribution Standards for customers not identified in Table 1.

 Indicates Latest Revision	Completely Revised	New Page
---	--------------------	----------

5311.4

SDG&E DISTRIBUTION DESIGN MANUAL

COMMERCIAL AND INDUSTRIAL DEMAND ESTIMATING

REVISION
DATE 1-1-2000
APPD HB *1/16*

TABLE 2 – MISC LOADING/CONVERSION

WELDERS:

Convert input amps of welder to kW using the following equation;

$$\text{single-phase input kW} = \frac{\text{serving voltage} \times \text{input amps} \times .9(\text{PF})}{1000}$$

$$\text{three-phase input kW} = \frac{\text{serving voltage} \times \text{input amps}(\ast) \times .85(\text{PF}) \times 1.73}{1000}$$

(*) input amps per phase

1 or 2 welders apply demand factor of .80 to the sum

3 to 5 welders apply demand factor of .60 to the sum

6 or more welders apply demand factor of .40 to the sum

Note: Use the same criteria for both transformer arc and motor generator welders.

X-RAY MACHINES:

Convert the rated kVA of x-ray equipment to kW by multiplying by a .9 p.f.

1 x-ray machine, apply demand factor of .80

2 x-ray machines, apply a demand factor of .60

3 or more x-ray machines, apply a demand factor of .32

MOTORS:

Convert the rated horsepower (hp) into kW using the following equation assuming 85% efficiency

$$1\text{hp} = .9\text{kW}$$

Convert the rated horse power (hp) into kVA using the following equation assuming .9pf.

$$- 1\text{hp} = 1\text{kVA}$$

TABLE 3 – COMMERCIAL DIVERSITY FACTORS

The following commercial diversity factors apply:

1 customer	1.00
2 customers	.90
3 customers	.80
4 customers	.70

THREE-PHASE KW CONVERSION FACTORS

$$\text{KW } 3\phi = \text{AMPS.} \times \begin{matrix} 0.306 \text{ for } 120/208 \\ 0.353 \text{ for } 120/240 \\ 0.707 \text{ for } 277/480 \end{matrix}$$

THREE-PHASE KW CONVERSION CALCULATION

$$\text{KW} = \frac{\text{Amps (Voltage line to line)}(0.85\text{pf})(1.732)}{1000}$$

 Indicates Latest Revision

Completely Revised

New Page

REVISION

SDG&E DISTRIBUTION DESIGN MANUAL

DATE 1-1-98

COMMERCIAL AND INDUSTRIAL DEMAND ESTIMATING

APPD *SRM / CMC*

5311.5

DEMAND ESTIMATING WORKSHEET

WORK ORDER NO.				DPSS NO.				
JOB LOCATION				JOB NAME				
This worksheet provides values of kW demand for new customers that may be used for sizing distribution transformers and services.								
TRANSFORMER NO:		PANEL SIZE: Amps		SERVICE VOLTAGE: / Volts		PHASE:	WIRE:	SELECTED TRANSFORMER SIZE: kVA
Building or Serv. Pt.	SQUARE FOOT DEMAND				Type of Load	LOAD SCHEDULE DEMAND		
	Bldg.sq.ft.	x	kW/sq.ft.	= Demand in kW		Total Load x D.Factor	= Demand in kW	
	x	=	kW		x	=	kW	
	x	=	kW		x	=	kW	
	x	=	kW		x	=	kW	
	x	=	kW		x	=	kW	
Total				kW	Total		kW	
TRANSFORMER NO:		PANEL SIZE: Amps		SERVICE VOLTAGE: / Volts		PHASE:	WIRE:	SELECTED TRANSFORMER SIZE: kVA
Building or Serv. Pt.	SQUARE FOOT DEMAND				Type of Load	LOAD SCHEDULE DEMAND		
	Bldg.sq.ft.	x	kW/sq.ft.	= Demand in kW		Total Load x D.Factor	= Demand in kW	
	x	=	kW		x	=	kW	
	x	=	kW		x	=	kW	
	x	=	kW		x	=	kW	
	x	=	kW		x	=	kW	
Total				kW	Total		kW	
LOAD DENSITY				DEMAND FACTORS BY TYPE OF LOAD				
Type of Building:		kW/sq.ft.		Type of Load		D.FACTOR		
		*Climate Zone 1	*Climate Zone 2					
<input type="checkbox"/> Office small (<40k sq. ft.)		0.006	0.007	<input type="checkbox"/> Lighting		0.9		
<input type="checkbox"/> Office large (>40k sq. ft.)		0.004	0.005	<input type="checkbox"/> Air Conditioning				
<input type="checkbox"/> Retail Store		0.005	0.006	1st unit		1.0		
<input type="checkbox"/> Department Store		0.004	0.005	2nd through 5th unit		0.8		
<input type="checkbox"/> Bank		0.006	0.007	6th and up unit		0.7		
<input type="checkbox"/> Medical Office		0.008	0.009	<input type="checkbox"/> Motors				
<input type="checkbox"/> Hospital		0.007	0.008	Continuous Use		0.9		
<input type="checkbox"/> Restaurant (fast food)		0.022	0.024	Elevator/Process		0.8		
<input type="checkbox"/> Restaurant (dining)		0.014	0.016	Equipment Machine Shop		0.5		
<input type="checkbox"/> Bio-Medical		0.016	0.018	Machine Tools		0.3		
<input type="checkbox"/> Grocery/Conv. Store (<40k sq. ft.)		0.011	0.012	<input type="checkbox"/> Heating (Induction/ Resistance) Largest unit		1.0		
<input type="checkbox"/> Grocery/Conv. Store (>40k sq. ft.)		0.009	0.010	Balance		0.5		
<input type="checkbox"/> Hotel/Motel		0.004	0.005	<input type="checkbox"/> Computers		0.8		
<input type="checkbox"/> Light Commercial		0.007	0.008	<input type="checkbox"/> Receptacles		0.1		
<input type="checkbox"/> Manufacturing		0.009	0.010	<input type="checkbox"/> Commercial Cooking		0.4		
<input type="checkbox"/> Warehousing		0.005	0.006	<input type="checkbox"/> Resistance Welders		0.6 to 1.2		
<input type="checkbox"/> School		0.005	0.006	<input type="checkbox"/> Arc Welders				
<input type="checkbox"/> Church		0.007	0.008	Largest unit		1.0		
				Balance		0.5		
SQUARE FOOT DEMAND (SFD) = LOAD SCHEDULE DEMAND (LSD) COMPARISON RATIO (CR) If $0.8 \leq CR \leq 1.2$, choose SFD as Estimated Demand. If $CR < 0.8$ or $CR > 1.2$, choose the lesser (SFD or LSD) as the Estimated Demand.				NOTE: CONTACT DISTRIBUTION STANDARDS TO MODIFY DEMAND FACTOR FOR SPECIAL SITUATIONS. FURTHER ANALYSIS SHOULD BE DONE IF THE COMPARISON RATIO IS GREATER THAN 1.2.				
Submitted by: _____				Approved by: _____ Project Management Supervisor				

* Climate zones are same as contamination zones. See Overhead Standards page 287. Page _____ of _____

© 1998 - 2011 San Diego Gas & Electric Company. All rights reserved. Removal of this copyright notice without permission is not permitted under law.

	<input checked="" type="checkbox"/> Indicates Latest Revision	<input type="checkbox"/> Completely Revised	<input type="checkbox"/> New Page	<input type="checkbox"/> Information Removed
5311.6	SDG&E DISTRIBUTION DESIGN MANUAL			REVISION
	COMMERCIAL AND INDUSTRIAL DEMAND ESTIMATING			DATE 6-30-2011 APPD JCE/MJC

CONVERSION FACTORS

277/480 VOLT
THREE PHASE, FOUR WIRE *
(PF = .85, MOTOR EFFICIENCY = 85%)
LOADS ARE ASSUMED BALANCED

To Get ==>	Amps	kW	kVA	Tons A/C	Motor HP
Multiply Amps by	1.00	.71	.83	.55	.83
" kW by	1.42	1.00	1.18	.78	1.18
" kVA by	1.20	.85	1.00	.67	1.00
" Tons A/C by	1.80	1.28	1.50	1.00	1.50
" Motor HP by	1.20	.85	1.00	.67	1.00

120/208 VOLT
THREE PHASE, FOUR WIRE *
(PF = .85, MOTOR EFFICIENCY = 85%)
LOADS ARE ASSUMED BALANCED

To Get ==>	Amps	kW	kVA	Tons A/C	Motor HP
Multiply Amps by	1.00	.31	.36	.24	.36
" kW by	3.27	1.00	1.18	.78	1.18
" kVA by	2.78	.85	1.00	.67	1.00
" Tons A/C by	4.16	1.28	1.50	1.00	1.50
" Motor HP by	2.78	.85	1.00	.67	1.00

120/240 VOLT
SINGLE PHASE, THREE WIRE *
(PF = .90, MOTOR EFFICIENCY = 85%)
LOADS ARE ASSUMED BALANCED

To Get ==>	Amps	kW	kVA	Tons A/C	Motor HP
Multiply Amps by	1.00	.22	.24	.16	.24
" kW by	4.63	1.00	1.11	.74	1.11
" kVA by	4.17	.90	1.00	.67	1.00
" Tons A/C by	6.25	1.35	1.50	1.00	1.50
" Motor HP by	4.17	.90	1.00	.67	1.00

* Factors for 208 volt, 240 volt, or 480 volt three phase, three wire systems can be converted by using the corresponding table for 120/208 volt, 120/240 volt, 277/480 volt three phase, four wire systems.

	<input type="checkbox"/> Indicates Latest Revision	<input type="checkbox"/> Completely Revised	<input type="checkbox"/> New Page
REVISION	SDG&E DISTRIBUTION DESIGN MANUAL		
DATE 1-1-98	COMMERCIAL AND INDUSTRIAL DEMAND ESTIMATING		
APPD <i>KRM / CAK</i>	5311.7		

120/240 VOLT
 THREE PHASE, FOUR WIRE *
 (PF = .85, MOTOR EFFICIENCY = 85%)
 LOADS ARE ASSUMED BALANCED

To Get ==>	Amps	kW	kVA	Tons A/C	Motor HP
Multiply Amps by	1.00	.35	.42	.28	.42
" kW by	2.83	1.00	1.18	.78	1.18
" kVA by	2.41	.85	1.00	.67	1.00
" Tons A/C by	3.61	1.28	1.50	1.00	1.50
" Motor HP by	2.41	.85	1.00	.67	1.00

* Factors for 208 volt, 240 volt or 480 volt three phase, three wire systems can be converted by using the corresponding table for 120/208 volt, 120/240 volt or 277/480 volt three phase, four wire systems.

NOTE: CONTACT DISTRIBUTION STANDARDS FOR CONVERSION FACTORS NOT IDENTIFIED.

BREAK EVEN YEAR MATRIX
 INITIAL VS. ULTIMATE TRANSFORMER REQUIREMENT

277/480 Secondary Voltage (Minimum Change-Out Delay Required to Justify Initial Installation Of Smaller Unit (In Years)

Ultimate Transformer (KVA)	2000	2	1	4	2	4
	1500	2	2	6	5	X
	1000	3	3	>10	X	X
	750	3	6	X	X	X
	500	9	X	X	X	X
			300	500	750	1000
		Initial Transformer Size (KVA)				

120/208 Secondary Voltage (Minimum Change-Out Delay Required To Justify Initial Installation Of Smaller Unit (In Years)

Ultimate Transformer (KVA)	1500	2	3	2	2	4
	1000	3	4	2	4	X
	750	5	7	6	X	X
	500	7	>10	X	X	X
	300	7	X	X	X	X
			225	300	500	750
		Initial Transformer Size (KVA)				

NOTES:

1. Install the smaller size transformer unless the ultimate size transformers will be required prior to the breakeven year shown in the table above. For example, in the case of installing a 120/208 volt, 500 KVA unit initially where a 750 KVA unit initially where a 750 KVA unit will be required ultimately, the 500 KVA should be used if it will meet customer load requirements for at least 6 years.
2. Table values assume service cable will be sized to match transformer.

	Indicates Latest Revision	Completely Revised	New Page
5311.8	SDG&E DISTRIBUTION DESIGN MANUAL		REVISION
	COMMERCIAL AND INDUSTRIAL DEMAND ESTIMATING		DATE 1-1-98 APPD <i>DKM / CMK</i>

CRITERIA

A. Tons of Air Conditioning and BTU's of Cooling

Tons of air conditioning refers to the amount of heat an air conditioner can remove in a one hour period. One full ton of air conditioning is equivalent to the removal of 12,000 BTU/HR of heat and will normally cool an area from 200 to 600 square feet of floor space.

1. A one ton air conditioner would be rated at 12,000 BTU/HR; a three ton at 36,000 BTU/HR; and a five ton at 60,000 BTU/HR.

B. Air Conditioning - Horsepower

When used in reference to an air conditioner, HORSEPOWER (HP) generally refers to the rating of the compressor of the equipment only. The relationship of compressor HORSEPOWER to TONS OF COOLING varies.

1. The HORSEPOWER to TONS ratio is generally 1.5 HP to 1 ton. This does not include the HP rating of auxiliary fans, pumps, motors, etc.
2. The HORSEPOWER to kVA ratio is generally 1 HP to 1 kVA. This assumes an 85% efficiency and 90% power factor.

C. KW Rating of Air Conditioners

1. The ratio of KW to TONS OF COOLING will be found to be 1.35 to 1.
 - a. Discretion should be exercised when using the average relationships and ratios above to positively rate individual equipment without seeing it. Within the two general types described above, there is much individual variation from one make and model to another. The most reliable means of rating individual equipment is to take its total nameplate amperage and work out the KW or HP rating using the above relationships as a general guide.
 - b. When 240 volt, single-phase service is provided to loads which include air conditioners, the following starting currents should be used as a guide for voltage flicker calculations: (The actual amperage may be found on the equipment nameplate as locked rotor amps or L-R)

TABLE 3

STARTING CURRENT FOR 240V 1Ø AIR CONDITIONERS	
AIR CONDITIONER SIZE	STARTING CURRENT*
Up to 30,000 BTU/HR (2-1/2 ton)	85A
31,000 – 42,000 BTU/HR (2-1/2 to 3-1/2 ton)	85 – 120A or 110A Average
43,000 – 60,000 BTU/HR (3-1/2 to 5 ton)	120 – 170A or 150A Average

* Assumes 5.5 times motor running current

© 1998-2020 San Diego Gas & Electric Company. All rights reserved. Removal of this copyright notice without permission is not permitted under law.

REV	CHANGE	BY	DSGN	APPV	DATE	REV	CHANGE	BY	DSGN	APPV	DATE
C						F					
B	FORMATTING	JIK	-	-	02/21/2020	E					
A	ORIGINAL ISSUE	-	MF	RDG	09/04/1984	D					

SHEET 1 OF 1	 Indicates Latest Revision	Completely Revised	New Page	Information Removed	DM5321.1
	SDG&E ELECTRIC DISTRIBUTION DESIGN MANUAL				
	SINGLE-PHASE AIR CONDITIONING REQUIREMENTS				

SCOPE

This design standard provides criteria for the proper selection of residential kW demand and multiple dwelling diversified demand based on dwelling type, dwelling size and major appliance usage.

PURPOSE

The Residential Demand Estimating Criteria was established to provide a uniform demand estimate for various residential dwelling types.

DEFINITIONS

Base load – refers to those dwellings whose electrical load consists of lights, refrigerator, electric range, dishwasher and receptacle load such as television, stereo, microwave, etc.

Major appliances – refers to central or through-the-wall air conditioning, electric heating, and electric water heating.

Dwelling type – refers to the classification of a residential dwelling as either single-family detached (no common walls with another dwelling, i.e., subdivision), single-family attached (one common wall or condominium/townhouse), multi-family (two or more common walls such as apartments) and mobilehome (regardless of length and width).

Residential Diversity Factor – refers to a multiplier applied to the sum of the individual service point (customer) demands connected to any single-phase or three-phase electric distribution system.

CRITERIA

A. Residential Demand Selection

The residential kW demand per unit selection is dependent on the dwelling type, dwelling square footage and major appliance usage or connected appliances.

1. Table 1 provides the kW demand per unit selection for dwellings in a project that are less than 3000 square feet. Select a square footage category based on the majority of dwellings. If a square footage is not obtainable, select a square footage category that is typical for that dwelling type, i.e., single-family detached (1300–1999), single-family attached and multi-family (0–1299).
2. Table 2 provides the kW demand selection for a dwelling that is 3000 square feet or greater, i.e., custom dwelling. To determine the kW demand from Table 2, add the connected appliance loads for each demand category and multiply this sum by the appropriate demand factor. The sum of these factors will provide the kW demand requirement.

	Indicates Latest Revision	Completely Revised	Information Removed
REVISION	SDG&E DISTRIBUTION DESIGN MANUAL		5322.1
DATE 1-1-2000	RESIDENTIAL DEMAND ESTIMATING		
APPD HB <i>1/16/00</i>			

3. When both air conditioning and electric heating are installed in a dwelling, the higher of the two demand estimates shall be used.
4. Section B provides diversity factor(s) for serving three or more dwellings.

B. Residential Diversity Selection

The residential diversity factors are applied based on the number of customers being served, diversity factor category and dwelling type. The following guidelines shall apply when determining the diversified demand from Table 3:

1. Determine diversified demand based on the sum of the individual service point (customer) demands multiplied by the appropriate diversity factor.
2. When applying an air conditioning diversity factor, pay particular attention to the two subcategories (single-family detached and single-family attached or multi-family).

	Indicates Latest Revision	Completely Revised	Information Removed
5322.2	SDG&E DISTRIBUTION DESIGN MANUAL		REVISION
	RESIDENTIAL DEMAND ESTIMATING		DATE 1-1-2000 APPD HB <i>1/1/00</i>

TABLE 1 Residential Dwelling kW Demand Per Unit (Less Than 3000 sq. ft.)

Dwelling Type	Square Footage	KW DEMAND CATEGORIES ^(a)					
		Base Load	Air Cond.	Elec. Water Heating	Elec. Heating	Elec. Heating & Water Heating	A/C & Elec. Water Heating
single-family detached	0-1299	3.0	5.0	5.0	4.0	6.5	6.0
	1300-1999	4.0	6.0	6.0	5.0	7.5	7.0
	2000-2999	4.5	7.0	7.0	6.0	8.0	8.0
single-family attached (condo/townhouse)	0-1299	3.0	4.0	5.0	4.0	6.5	5.0
	1300-1999	4.0	5.0	6.0	5.0	7.5	6.0
	2000-2999	4.5	5.5	6.5	5.5	8.0	6.5
multi-family (apartments)	0-1299	1.5	3.5	3.5	4.0	6.5	4.5
	1300-1999	2.0	4.0	4.0	4.5	7.0	5.0
mobile-homes	0-1299	2.5	5.0	(b)	5.0	(b)	(b)
	1300-1999	3.0	6.0		6.0		

TABLE 2 Custom Residential Dwelling kW Demand (3000 sq. ft. or greater)

Demand Categories	Demand Factor	Connected Appliances	Connected kW Demand per Unit Estimate ^(c)
LIGHTS	.50	internal lighting	4-6
HVAC (heat pump)	.50	3 to 7-1/2 ton single or multiple units	1.35kW/ton
MAJOR APPLIANCES	.50	range water heater water heater (quick recovery) clothes dryer dishwasher heat strip	8-12 ea. 4.5 ea. 9 ea. 5.5 ea. 1.2 ea. 5-15 ea.
EXTERIOR LOADS	.50	tennis court lighting swimming pool equipment exterior lighting	varies varies varies
OTHER LOADS	.40	convenience outlets wine cellar sauna small motor load	varies

Indicates Latest Revision

Completely Revised

New Page

REVISION

SDG&E DISTRIBUTION DESIGN MANUAL

DATE 9-4-84

RESIDENTIAL DEMAND ESTIMATING

APPD CVN *[Signature]*

5322.3

TABLE 3 Residential Diversity Factors

Number Of Customers	Diversity factor categories		
	Base load electric heating electric water heating	Air conditioning	
		SF detached	MF, SF attached
1-2	1.00	1.00	1.00
3-4	.75	0.85	0.70
5-7	.65	0.80	0.65
8-14	.55	0.75	0.65
15 and above	.50	0.70	0.60

SF = single-family

MF = multi-family

Notes:

- Ⓐ The kW demand provided in Table 1 represents the total demand requirement in each category.

i.e., base load category = strictly base load
air conditioning category = base load plus air conditioning load
- Ⓑ If kW demand is required for these categories, consult Design Planning.
- Ⓒ Use the kW demand per unit estimate in Table 2 as a check for submitted connected loads. These estimates can also be used if connected loads are not known.

Example 1:

Determine the diversified demand estimates for a 12 lot subdivision with single-family detached dwellings ranging from 1800-2400 square feet with 4 ton air conditioning. Assume the following distribution configuration:

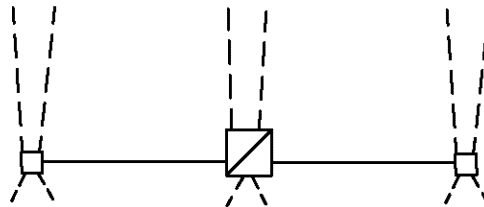

	Indicates Latest Revision	Completely Revised	New Page
5322.4	SDG&E DISTRIBUTION DESIGN MANUAL		REVISION
	RESIDENTIAL DEMAND ESTIMATING		DATE 1-1-2000 APPD HB <i>1/16/00</i>

Use Table 1 and 3 to determine diversified demand for this transformer and secondary/service system.

- dwelling type = single-family detached
- square footage range = 2000-2999 ①
- demand per unit from Table 1 = 7kW
- total demand (transformer) = 12x 7kW = 84kW
- total demand (either secondary) = 4 x 7kW = 28kW
- diversified demand from Table 3 (transformer) = .75 x 84kW = 63kW
- diversified demand from Table 3 (secondary) = .80 x 28kW = 22kW

The diversified demand of 63kW and 22kW would be used to size the transformer and secondaries respectively.

Example 2:

Determine the kW demand estimate for a custom home that is 4500 square feet with the following appliances being served:

Connected Appliance Load Breakdown ②

- air conditioning (2 units) - 1-3 ton, 1-5 ton
- electric range - demand not known (use estimate at 8kW)
- water heating - 4.5kW
- clothes dryer - 5.5kW
- heat strips - 2 at 5kW each
- tennis courts - 4kW
- swimming pool - 1-7 1/2 hp, 1-1 1/2 hp
- sauna - 8kW
- internal lighting - 5kW

The diversified kW demand for a custom home is obtained from Table 2 as follows:

- add the connected appliance loads in each demand category ②
- multiply by the appropriate demand factor
- the sum of these will produce total diversified kW demand

Demand Category ②	Sum of Connected Load	x	Demand Factor	=	Diversified Demand
Lights	5kW	x	.50	=	2.5kW
HVAC	11kW	x	.50	=	5.5kW
Major Appliances	28kW	x	.50	=	14kW
Exterior Loads	12kW	x	.50	=	6kW
Other Loads	8kW	x	.40	=	3.2kW
total diversified kW demand					31.2kW

The total diversified kW demand of 31kW would be used to size transformer and secondary/service system.

	Indicates Latest Revision	Completely Revised	New Page
REVISION	SDG&E DISTRIBUTION DESIGN MANUAL		
DATE 1-1-87 APPD CVN/BJ	RESIDENTIAL DEMAND ESTIMATING		5322.5

Notes:

- ① The square footage range of 2000–2999 was selected because 7 of the 12 dwellings occupied this range.
- ② Consult Table 2 for the connected appliance load to demand category relationship.

References:

- 1. Design Standard 5222, Secondary and Service Guidelines, Secondary Conductors
- 2. Design Standard 5411, Voltage Drop, Secondary Conductors
- 3. Design Standard 5413, Voltage Fluctuation (flicker), Secondary Conductors
- 4. Design Standard 5431, Underground Voltage Drop and Flicker Nomograph
- 5. Design Standard 5432, Overhead Voltage Drop and Flicker Nomograph
- 6. Design Standard 5621, Initial Transformer Design Loading For Balanced Loads

	 Indicates Latest Revision	Completely Revised	New Page
5322.6	SDG&E DISTRIBUTION DESIGN MANUAL		REVISION
	RESIDENTIAL DEMAND ESTIMATING		DATE 9-4-84 APPD CVN/ <i>ROJ</i>

SCOPE

This standard provides tables to determine the diversified demand in KW for multiple residential customers with uniform loads.

PURPOSE

These tables were established to provide easy application of the residential demand estimating diversity factors.

DEFINITIONS

NONE

CRITERIA

TABLE 1 – BASE LOAD, ELECTRIC WATER HEATING, ELECTRIC HEATING – ALL DWELLING TYPES

DIVERSIFIED KW DEMAND (1)

KW Demand/Unit		1.5	2	2.5	3	3.5	4	4.5	5	5.5	6	6.5	7	7.5	8
No. of Customers	Diversity Factor (Reference)														
3	0.75	3.4	4.5	5.6	6.8	7.9	9	10.1	11.3	12.4	13.5	14.6	15.8	16.9	18
4	0.75	4.5	6	7.5	9	10.5	12	13.5	15	16.5	18	19.5	21	22.5	24
5	0.65	4.9	6.5	8.1	9.8	11.4	13	14.6	16.3	17.9	19.5	21.1	22.8	24.4	26
6	0.65	5.9	7.8	9.8	11.7	13.7	15.6	17.6	19.5	21.5	23.4	25.4	27.3	29.3	31.2
7	0.65	6.8	9.1	11.4	13.7	15.9	18.2	20.5	22.8	25	27.3	29.6	31.9	34.1	36.4
8	0.55	6.6	8.8	11	13.2	15.4	17.6	19.8	22	24.2	26.4	28.6	30.8	33	35.2
9	0.55	7.4	9.9	12.4	14.9	17.3	19.8	22.3	24.8	27.2	29.7	32.2	34.7	37.1	39.6
10	0.55	8.3	11	13.8	16.5	19.3	22	24.8	27.5	30.3	33	35.8	38.5	41.3	44
11	0.55	9.1	12.1	15.1	18.2	21.2	24.2	27.2	30.3	33.3	36.3	39.3	42.4	45.4	48.4
12	0.55	9.9	13.2	16.5	19.8	23.1	26.4	29.7	33	36.3	39.6	42.9	46.2	49.5	52.8
13	0.55	10.7	14.3	17.9	21.5	25	28.6	32.2	35.8	39.3	42.9	46.5	50.1	53.6	57.2
14	0.55	11.6	15.4	19.3	23.1	27	30.8	34.7	38.5	42.4	46.2	50.1	53.9	57.8	61.6
15	0.5	11.3	15	18.8	22.5	26.3	30	33.8	37.5	41.3	45	48.8	52.5	56.3	60
16	0.5	12	16	20	24	28	32	36	40	44	48	52	56	60	64
17	0.5	12.8	17	21.3	25.5	29.8	34	38.3	42.5	46.8	51	55.3	59.5	63.8	68
18	0.5	13.5	18	22.5	27	31.5	36	40.5	45	49.5	54	58.5	63	67.5	72
19	0.5	14.3	19	23.8	28.5	33.3	38	42.8	47.5	52.3	57	61.8	66.5	71.3	76
20	0.5	15	20	25	30	35	40	45	50	55	60	65	70	75	80
21	0.5	15.8	21	26.3	31.5	36.8	42	47.3	52.5	57.8	63	68.3	73.5	78.8	84
22	0.5	16.5	22	27.5	33	38.5	44	49.5	55	60.5	66	71.5	77	82.5	88
23	0.5	17.3	23	28.8	34.5	40.3	46	51.8	57.5	63.3	69	74.8	80.5	86.3	92
24	0.5	18	24	30	36	42	48	54	60	66	72	78	84	90	96
25	0.5	18.8	25	31.3	37.5	43.8	50	56.3	62.5	68.8	75	81.3	87.5	93.8	100
26	0.5	19.5	26	32.5	39	45.5	52	58.5	65	71.5	78	84.5	91	97.5	104
27	0.5	20.3	27	33.8	40.5	47.3	54	60.8	67.5	74.3	81	87.8	94.5	101.3	108
28	0.5	21	28	35	42	49	56	63	70	77	84	91	98	105	112
29	0.5	21.8	29	36.3	43.5	50.8	58	65.3	72.5	79.8	87	94.3	101.5	108.8	116
30	0.5	22.5	30	37.5	45	52.5	60	67.5	75	82.5	90	97.5	105	112.5	120

© 1998-2020 San Diego Gas & Electric Company. All rights reserved. Removal of this copyright notice without permission is not permitted under law.

REV	CHANGE	DR	BY	DSN	APV	DATE	REV	CHANGE	DR	BY	DSN	APV	DATE
C							F						
B							E						
A	Table Revisions	CSE	JCE	FC	CZH	06/08/2020	D						

SHEET 1 OF 3	 Indicates Latest Revision	Completely Revised	New Page	Information Removed
	SDG&E ELECTRIC DISTRIBUTION DESIGN MANUAL			
	MULTIPLE RESIDENTIAL SERVICE LOAD DIVERSITY			

DM5323.1

TABLE 2 – AIR CONDITIONING: SINGLE FAMILY DETACHED

DIVERSIFIED KW DEMAND (1)

KW Demand/Unit		2.5	3	4	4.5	5	6	7	8
No. of Customers	Diversity Factor (Reference)								
3	0.85	6.4	7.6	10.2	11.5	12.8	15.3	17.9	20.4
4	0.85	8.5	10.2	13.6	15.3	17	20.4	23.8	27.2
5	0.80	10	12	16	18	20	24	28	32
6	0.80	12	15.8	19.2	21.6	24	28.8	33.6	38.4
7	0.80	14	16	22.4	25.2	28	33.6	39.2	44.6
8	0.75	15	18	24	27	30	36	42	48
9	0.75	16.9	20.3	27	30.4	33.8	40.5	47.3	54
10	0.75	18.8	22.5	30	33.8	37.5	45	52.5	60
11	0.75	20.6	24.8	33	37.1	41.3	49.5	57.8	66
12	0.75	22.5	27	36	40.5	45	54	63	72
13	0.75	24.4	29.3	39	43.9	48.8	58.5	68.3	78
14	0.75	26.3	31.5	42	47.3	52.5	63	73.5	84
15	0.7	26.3	31.5	42	47.3	52.5	63	73.5	84
16	0.7	28	33.6	44.8	50.4	56	67.2	78.4	89.6
17	0.7	29.8	35.7	47.6	53.6	59.5	71.4	83.3	95.2
18	0.7	31.5	37.8	50.4	56.7	63	75.6	88.2	100.8
19	0.7	33.3	39.9	53.2	59.9	66.5	79.8	93.1	106.4
20	0.7	35	42	56	63	70	84	98	112
21	0.7	36.8	44.1	58.8	66.2	73.5	88.2	102.9	117.6
22	0.7	38.5	46.2	61.6	69.3	77	92.4	107.8	123.2
23	0.7	40.3	48.3	64.4	72.5	80.5	96.6	112.7	128.8
24	0.7	42	50.4	67.2	75.6	84	100.8	117.6	134.4
25	0.7	43.8	52.5	70	78.8	87.5	105	122.5	140
26	0.7	45.5	54.6	72.8	81.9	91	109.2	127.4	145.6
27	0.7	47.3	56.7	75.6	85.1	94.5	113.4	132.3	151.2
28	0.7	49	58.8	78.4	88.2	98	117.6	137.2	156.8
29	0.7	50.8	60.9	81.2	91.4	101.5	121.8	142.1	162.4
30	0.7	52.5	63	84	94.5	105	126	147	168

© 1998-2020 San Diego Gas & Electric Company. All rights reserved. Removal of this copyright notice without permission is not permitted under law.

REV	CHANGE	DR	BY	DSN	APV	DATE	REV	CHANGE	DR	BY	DSN	APV	DATE
C							F						
B							E						
A	Table Revisions	CSE	JCE	FC	CZH	06/08/2020	D						

SHEET 2 OF 3	 Indicates Latest Revision	Completely Revised	New Page	Information Removed
	SDG&E ELECTRIC DISTRIBUTION DESIGN MANUAL			
	MULTIPLE RESIDENTIAL SERVICE LOAD DIVERSITY			

DM5323.2

TABLE 3 – AIR CONDITIONING: MULTI FAMILY AND SINGLE FAMILY ATTACHED

KW DEMAND (1)

KW Demand/Unit		1.5	2	3	3.5	4	4.5	5	5.5	6	6.5
No. of Customers	Diversity Factor (Reference)										
3	0.70	3.2	4.2	6.3	7.4	8.4	9.5	10.5	11.6	12.6	13.7
4	0.70	4.2	5.6	8.4	9.8	11.2	12.6	14	15.4	16.8	18.2
5	0.65	4.9	6.5	9.8	11.4	13	14.6	16.3	17.9	19.5	21.1
6	0.65	5.9	7.8	11.7	13.7	15.6	17.6	19.5	21.5	23.4	25.4
7	0.65	6.8	9.1	13.7	15.9	18.2	20.5	22.8	25	27.3	29.6
8	0.65	7.8	10.4	15.6	18.2	20.8	23.4	26	28.6	31.2	33.8
9	0.65	8.8	11.7	17.6	20.5	23.4	26.3	29.3	32.2	35.1	38
10	0.65	9.8	13	19.5	22.8	26	29.3	32.5	35.8	39	42.3
11	0.65	10.7	14.3	21.5	25	28.6	32.2	35.8	39.3	42.9	46.5
12	0.65	11.7	15.6	23.4	27.3	31.2	35.1	39	42.9	46.8	50.7
13	0.65	12.7	16.9	25.4	29.6	33.8	38	42.3	46.5	50.7	54.9
14	0.65	13.7	18.2	27.3	31.9	36.4	41	45.5	50.1	54.6	59.2
15	0.60	13.5	18	27	31.5	36	40.5	45	49.5	54	58.5
16	0.60	14.4	19.2	28.8	33.6	38.4	43.2	48	52.8	57.6	62.4
17	0.60	15.3	20.4	30.6	35.7	40.8	45.9	51	56.1	61.2	66.3
18	0.60	16.2	21.6	32.4	37.8	43.2	48.6	54	59.4	64.8	70.2
19	0.60	17.1	22.8	34.2	39.9	45.6	51.3	57	62.7	68.4	74.1
20	0.60	18	24	36	42	48	54	60	66	72	78
21	0.60	18.9	25.2	37.8	44.1	50.4	56.7	63	69.3	75.6	81.9
22	0.60	19.8	26.4	39.6	46.2	52.8	59.4	66	72.6	79.2	85.8
23	0.60	20.7	27.6	41.4	48.3	55.2	62.1	69	75.9	82.8	89.7
24	0.60	21.6	28.8	43.2	50.4	57.6	64.8	72	79.2	86.4	93.6
25	0.60	22.5	30	45	52.5	60	67.5	75	82.5	90	97.5
26	0.60	23.4	31.2	46.8	54.6	62.4	70.2	78	85.8	93.6	101.4
27	0.60	24.3	32.4	48.6	56.7	64.8	72.9	81	89.1	97.2	105.3
28	0.60	25.2	33.6	50.4	58.8	67.2	75.6	84	92.4	100.8	109.2
29	0.60	26.1	34.8	52.2	60.9	69.6	78.3	87	95.7	104.4	113.1
30	0.60	27	36	54	63	72	81	90	99	108	117

NOTES: (1) The Diversity Factor Column Is Provided for Reference Only.

© 1998-2020 San Diego Gas & Electric Company. All rights reserved. Removal of this copyright notice without permission is not permitted under law.

REV	CHANGE	DR	BY	DSN	APV	DATE	REV	CHANGE	DR	BY	DSN	APV	DATE
C							F						
B							E						
A	Table Revisions	CSE	JCE	FC	CZH	06/08/2020	D						

SHEET 3 OF 3	 Indicates Latest Revision	Completely Revised	New Page	Information Removed
	SDG&E ELECTRIC DISTRIBUTION DESIGN MANUAL			
	MULTIPLE RESIDENTIAL SERVICE LOAD DIVERSITY			

DM5323.3

5400
VOLTAGE DROP

5400
VOLTAGE DROP

PAGE(S)

SUBJECT

5411

5411.1
5411.2 - 5411.3
5411.4
5411.5 – 5411.6

Voltage Drop and Flicker Application Guideline

Simple System Voltage Drop Calculation
Simple System Flicker Calculation
Compound System Voltage Drop Calculation
Complex System Voltage Drop Calculation

5412

5412.1 – 5412.2

Street Light Voltage Drop Calculation

Street Light Cable Sizing Criteria

5413

5413.1
5413.2 – 5413.3
5413.4 – 5413.7

Secondary Flicker

Flicker Due to Customer Equipment
Transformer Flicker Due to Motor Starting
Transformer Impedance Values

5421

5421.1
5421.2 – 5421.3

Primary System Voltage Flicker Limit Calculation

Procedure
Examples

5425

Transformer Percentage Voltage Drop

5431

Underground Cable Voltage Drop and Flicker Nomograph

5432

Overhead Conductor Voltage Drop and Flicker Nomograph

© 1998-2020 San Diego Gas & Electric Company. All rights reserved. Removal of this copyright notice without permission is not permitted under law.

REV	CHANGE	BY	DSGN	APPV	DATE	REV	CHANGE	BY	DSGN	APPV	DATE
C						F					
B	FORMATTING	JIK	-	-	02/21/2020	E					
A	ORIGINAL ISSUE	-	PRM	CAK	01/01/1998	D					

SHEET 1 OF 1	 Indicates Latest Revision	Completely Revised	New Page	Information Removed	DM5401.1
	SDG&E ELECTRIC DISTRIBUTION DESIGN MANUAL				
	TABLE OF CONTENTS VOLTAGE DROP				

SCOPE

This standard describes the calculation method used to determine secondary and service voltage drops for Simple, Compound, and Complex systems.

DEFINITIONS

Simple Secondary System – A single service run from a transformer.

Compound Secondary System – A single service secondary run from a transformer with multiple services.

Complex Secondary System – A system using multiple secondary runs with service(s) attached to the end of each secondary.

APPLICATION

- A. The total volt drop in the transformer and secondary/service system is to be limited to 4.2% (5V on 120V base per Design Manual 6211). The sizing of the secondary/service will depend on how much of the 4.2% is left after the transformer volt drop has been determined. The procedure is as follows:
 - 1. Determine transformer volt drop percentage from Design Manual 5425.
 - 2. Subtract transformer volt drop from total allowable volt drop of 4.2% to determine the available secondary/service volt drop.
 - 3. If the volt drop limits cannot be met, tapped transformers can be used to reduce volt drop. Contact Distribution Workflow and Planning for further assistance.
 - 4. See Design Manual 5222.1 Section A-1 for sample calculation of transformer loading in excess of 100%.
- B. The estimated diversified demands used to determine load requirements shall be in accordance with the following:
 - 1. Residential (Design Manual 5322)
 - 2. Commercial (Design Manual 5311)
- C. Equipment selection shall be made in accordance with the following:
 - 1. Conduit, substructures, and pads are to be sized in accordance with Underground Construction Standard 3942.
 - 2. Transformer (Design Manual 5621)
 - 3. Secondaries and Service (Design Manuals 5431 & 5432)

CALCULATIONS

Use of the voltage drop and flicker nomograph is described in the following examples:

- A. Simple System Voltage Drop Calculation (Refer to Nomograph in Design Manual 5431)

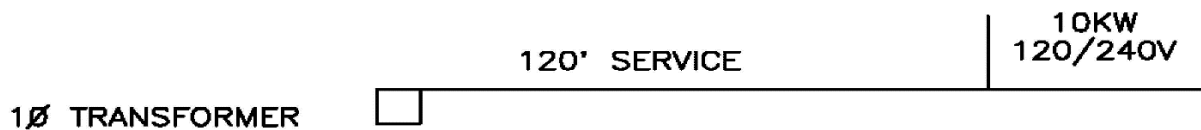

© 1998-2020 San Diego Gas & Electric Company. All rights reserved. Removal of this copyright notice without permission is not permitted under law.

REV	CHANGE	BY	DSGN	APPV	DATE	REV	CHANGE	BY	DSGN	APPV	DATE
C						F					
B	FORMATTING	JIK	-	-	02/21/2020	E					
A	ORIGINAL ISSUE	-	JW	RDG	01/01/1996	D					

SHEET 1 OF 5	X Indicates Latest Revision	Completely Revised	New Page	Information Removed	DM5411.1
	SDG&E ELECTRIC DISTRIBUTION DESIGN MANUAL				
	VOLTAGE DROP AND FLICKER APPLICATION GUIDELINE				

1. Demand refers to line "A" and given in KW or amps. The KW demand column includes a 90% power factor.
 - a. Enter line "A" @ 10 KW
 - b. Requires 1 - #2AL cable run for ampacity (First cables size on line "A" above 10 KW)
2. Length of Run refers to line "B" and given in feet.
 - a. Enter line "B" @ 120 feet
3. Transition Line refers to line "E" and determines the cable or conductor requirements for a 2% voltage drop allowance when a line is drawn from the Demand to the Length of Run.
 - a. Requires 1 - #2 AL cable run for voltage considerations (First cable size on line "E" above line drawn between demand and cable length). If a large cable is required due to cable ampacities (Line "A"), the larger cable is selected.
4. Cable or Conductor Size refers to line "D" and is used to determine the actual voltage drop for the cable selection required on the Transition Line.
 - a. Enter line "D" @ 1 - #2AL cable run
5. Percentage Voltage Drop refers to line "C" and provides the actual voltage drop when a line is drawn from the Transition Line through the Cable or Conductor Size.
 - a. 1.6% voltage drop, actual

B. Simple System Flicker Calculation

1. Determine the maximum percent flicker allowed for a three ton central air conditioner. The maximum permitted flicker is found by using the secondary flicker frequency chart on Design Manual 5431.1 (For multiple motors, add the frequency of the motor starts before using the chart).
 - a. Air conditioning equipment is listed in group 1 and flicker is limited to 6%.
2. Determine the percent flicker through the transformer using the transformer flicker tables on Design Manual 5413.6 (For multiple motors, use the largest motor unless simultaneous starting is indicated on the engineering questionnaire).
 - a. The air conditioner rating in tons must be converted to horsepower prior to determining the percent flicker through the transformer. 3 tons = 3 X 1.5 hp = 4.5 hp (Design Manual 5321).
 - b. The percent flicker through the 25 KVA transformer is obtained from Table 5 on Design Manual 5413.6 as: 1.8% flicker, transformer
3. Using the voltage drop and flicker nomograph:
 - a. Starting Current refers to line "A" and is given in air conditioning tons or locked rotor amps. Locked rotor (L – R_ amps refers to the amperage load demanded by the motor upon starting and may be obtained from the motor nameplate.
 - 1) Enter line "A" at 3 tons

© 1998-2020 San Diego Gas & Electric Company. All rights reserved. Removal of this copyright notice without permission is not permitted under law.

REV	CHANGE	BY	DSGN	APPV	DATE	REV	CHANGE	BY	DSGN	APPV	DATE
C						F					
B	FORMATTING	JIK	-	-	02/21/2020	E					
A	ORIGINAL ISSUE	-	JW	RDG	01/01/1996	D					

SHEET 2 OF 5	 Indicates Latest Revision	Completely Revised	New Page	Information Removed	DM5411.2
	SDG&E ELECTRIC DISTRIBUTION DESIGN MANUAL				
	VOLTAGE DROP AND FLICKER APPLICATION GUIDELINE				

- b. Transition Line refers to line "E" and determines the cable or conductor requirements based on the length of run used previously in voltage drop calculation 2.
- c. Percent Secondary and/or Service Flicker refers to line "C" and is based upon the cable or conductor size selected previously in voltage drop calculation 4.
 - 1) 3.3% flicker, secondary and/or service
- d. Total Percent Flicker is equal to the sum of the percent flicker through the transformer and the percent flicker on the secondary and/or service.
 - 1) $1.8\% + 3.3\% = 5.1\%$ flicker, total
 - 2) The maximum allowable flicker is normally six percent. However, this may be raised to seven percent for an existing customer served from an existing transformer, when an increase in transformer size would be required to meet the six percent limit.

C. Compound System Voltage Drop Calculation (Refer to Nomograph in Design Manual 5431.1)

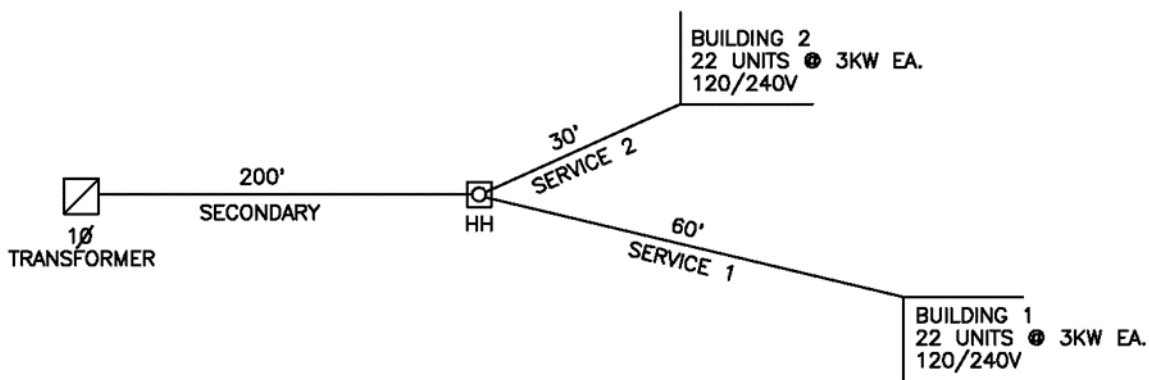

1. Demand – Using the Residential Demand Estimating Standard: Design Manual 5322
 - a. Services 1 & 2 = 33 KW each residential building (22 units @ 3 kw each)
 - b. Requires 1 – 3/0 cable run for ampacity
 - c. Secondary = 66 KW (44 units @ 3 kw each)
 - d. Requires 3 – 3/0 cable runs for ampacity
2. Length of Run – Size of the secondary run using the total distance to the last customer.
 - a. 260 feet
3. Transition Line – Using 66 kw demand on line "A" and 260 feet on line "B" and draw a straight line connecting these points.
 - a. Requires 3 – 350 KCMIL AL cable runs for the secondary

© 1998-2020 San Diego Gas & Electric Company. All rights reserved. Removal of this copyright notice without permission is not permitted under law.

REV	CHANGE	BY	DSGN	APPV	DATE	REV	CHANGE	BY	DSGN	APPV	DATE
C						F					
B	FORMATTING	JIK	-	-	02/21/2020	E					
A	ORIGINAL ISSUE	-	JW	RDG	01/01/1996	D					

SHEET 3 OF 5	X Indicates Latest Revision	Completely Revised	New Page	Information Removed
	SDG&E ELECTRIC DISTRIBUTION DESIGN MANUAL			
	VOLTAGE DROP AND FLICKER APPLICATION GUIDELINE			
DM5411.3				

4. Percent Voltage Drop, Secondary – Using the actual Length of Run and Demand for the secondary (200 feet & 66 kw). Redraw the intersection point on the Transition Line and find the percentage voltage drop for 3 – 350 KCMIL AL cables at line "D".
 - a. 1.2% voltage drop, actual
5. Percent Voltage Drop, Service – Using the remaining voltage drop allowance ($2 - 1.2 = .8\%$) size for services
 - a. Service #1 – Using the actual Length of Run and Demand for the service (60 feet & 33 kw). Redraw the intersection point on the Transition Line and find the service cable requirement from line "D" with a .8% voltage drop allowance.
 - 1) Requires 1 – 350 AL cable runs
 - b. Service #2 – Using the actual Length of Run and Demand for the service (30 feet & 33 kw) and .8% voltage drop allowance determines the cable requirement from line "D".
 - 1) Requires 1 – 1/0 KCMIL cable run

D. Complex System

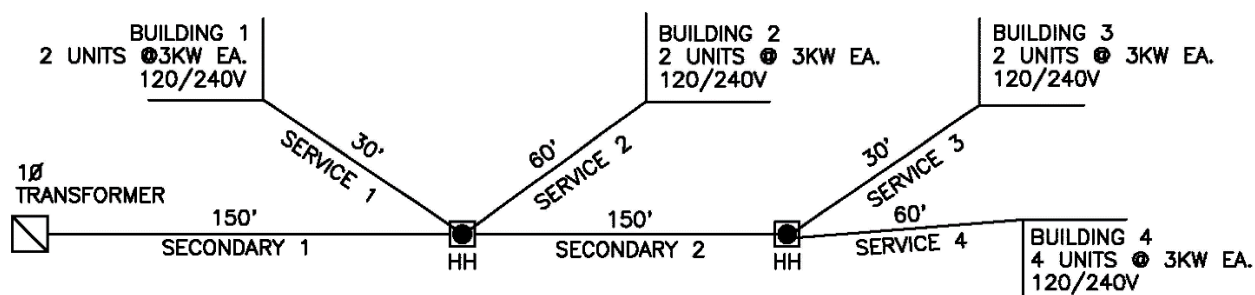

1. Demand using the Residential Demand Estimating Standard: Design Manual 5322
 - a. Services 1, 2, & 3 – 6 kw (No diversity for less than four customers)
 - b. Service 4 – 9 kw (4 units @ 3 kw each)
 - c. Secondary #2 – 11.7 kw (6 units @ 3 kw each)
 - d. Secondary #1 – 16.5 kw (10 units @ 3 kw each)
2. Length of Run – Size the secondary runs using the total distance to the last customer.
 - a. 360 feet
3. Transition Line
 - a. Secondary #1 – 16.5 kw demand at 360 feet requires 1 – 350 KCMIL AL cable run
 - b. Secondary #2 – 11.7 kw demand at 360 feet requires 1 – 350 KCMIL AL cable run

© 1998-2020 San Diego Gas & Electric Company. All rights reserved. Removal of this copyright notice without permission is not permitted under law.

REV	CHANGE	BY	DSGN	APPV	DATE	REV	CHANGE	BY	DSGN	APPV	DATE
C						F					
B	FORMATTING	JIK	-	-	02/21/2020	E					
A	ORIGINAL ISSUE	-	JW	RDG	01/01/1996	D					

SHEET 4 OF 5	X Indicates Latest Revision	Completely Revised	New Page	Information Removed
	SDG&E ELECTRIC DISTRIBUTION DESIGN MANUAL			
	VOLTAGE DROP AND FLICKER APPLICATION GUIDELINE			
				DM5411.4

4. Percent Voltage Drop, Secondary – Using the actual Length of Run and Secondary Demand. Determine percentage voltage drop for the cables selected in Step 3.
 - a. Secondary #1 – 16.5 kw demand, 150 feet, 1 – 350 KCMIL AL cable run has .65% voltage drop.
 - b. Secondary #2 – 11.7 kw demand, 150 feet, 1 – 350 KCMIL cable run has .45% voltage drop.
5. Percent Voltage Drop, Service
 - a. Services #1 & 2 are served from secondary #1 with a .65% voltage drop. The remaining voltage drop allowance for the service is 1.35%.
 - 1) Service #1 – 6 kw demand, 30 feet Length of Run, 1.35% voltage drop requires 1 - #2 AL cable run.
 - 2) Service #2 – 6 kw demand, 60 feet Length of Run, 1.35% voltage drop requires 1 - #2 AL cable run.
 - b. Services #3 & 4 are served from secondaries #1 & 2 with a combined voltage drop of 1.1%. The remaining voltage drop allowance for the service is .9%.
 - 1) Service #3 – 6 kw demand, 30 feet Length of Run, .9% voltage drop requires 1 -#2 AL cable run.
 - 2) Service #4 – 6 kw demand, 60 feet Length of Run, .9% voltage drop requires 1 - #2 AL cable run.

REFERENCES

- A. Design Manual 5311 – Three-Phase Demand Estimating Criteria
- B. Design Manual 5321 – Single-Phase Air Conditioning Requirements
- C. Design Manual 5322 – Residential Demand Estimating
- D. Design Manual 5413 – Voltage Fluctuations (Flicker)
- E. Design Manual 5431 – Underground Cable Voltage Drop and Flicker Nomograph
- F. Design Manual 5432 – Overhead Conductor Voltage Drop and Flicker Nomograph
- G. Design Manual 5621 – Initial Transformer Design Loading for Balanced Loads
- H. Service Planning Manual 491 – Voltage Complaints

© 1998-2020 San Diego Gas & Electric Company. All rights reserved. Removal of this copyright notice without permission is not permitted under law.

REV	CHANGE	BY	DSGN	APPV	DATE	REV	CHANGE	BY	DSGN	APPV	DATE
C						F					
B	FORMATTING	JIK	-	-	02/21/2020	E					
A	ORIGINAL ISSUE	-	JW	RDG	01/01/1996	D					

SHEET 5 OF 5	X Indicates Latest Revision	Completely Revised	New Page	Information Removed	DM5411.5
	SDG&E ELECTRIC DISTRIBUTION DESIGN MANUAL				
	VOLTAGE DROP AND FLICKER APPLICATION GUIDELINE				

SCOPE

This standard provides the criteria to properly size cable serving sodium vapor street lights.

PURPOSE

The standard was established to maintain adequate voltage to SDG&E owned sodium street lights.

CRITERIA

Table 1 – Sodium Vapor Street Light Requirements

Light Size (Watts)	Load Current (amps)		Allowable Voltage Drop (percent)
	Low Pressure	High Pressure	
35	0.6	–	8
50	–	1.2	4
55	0.7	–	8
70	–	1.6	4
90	1.2	–	8
100	–	2.2	4
135	1.7	–	8
150	–	3.3	4
180	2.0	–	8
200	–	2.1	8
250	–	2.7	8
400	–	4.1	8
1000	–	9.9	8

NOTE: The load current is based on a 120 volt installation including the light and ballast.

EXAMPLE

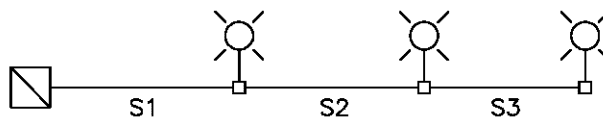

Figure 1

Select the proper cable to serve the 150 watt High Pressure Sodium Vapor street lights shown in Figure 1.

1. Determine the load in each secondary run:

S3 = 3.3 amps

S2 = 6.6 amps

S1 = 9.9 amps

	Indicates Latest Revision	Completely Revised	New Page
REVISION	SDG&E DISTRIBUTION DESIGN MANUAL		
DATE 1-1-87	STREET LIGHT VOLTAGE DROP CALCULATION		
APPD CVN / <i>[Signature]</i>	5412.1		

2. Using the Street Light Nomograph on page 5431.5, size the secondary runs using the total distance to the last street light while limiting the voltage drop to 4 percent (Table 1).

S3 = #8 based on 3.3 amps for 900'

S2 = #2 based on 6.6 amps for 900'

S1 = #2 based on 9.9 amps for 900'

3. Determine the secondary cable voltage drop from the Street Light Nomograph.

S3 = 1.1 percent

S2 = 0.55 percent

S1 = 0.75 percent

Total = 2.4 percent

NOTE: This is the worst case because all lights were assumed to be connected to the same two conductors. The voltage drop would be lower if lights 1 or 2 were connected to different conductors than light 3.

	 Indicates Latest Revision	Completely Revised	New Page
5412.2	SDG&E DISTRIBUTION DESIGN MANUAL		REVISION
	STREET LIGHT VOLTAGE DROP CALCULATION		DATE 1-1-96 APPD JW / <i>ROJ</i>

SCOPE

This standard defines permissible levels of voltage flicker on the secondary distribution system. It shall be used by Planners when sizing transformers and secondary/service cables. The subject of primary flicker is discussed in Design Standard 5421.

PURPOSE

This standard provides a basis for selecting the transformer and secondary/service wires to prevent customer complaints from flickering lights and damage to sensitive electronic equipment.

DEFINITIONS

Secondary System Voltage Flicker, also known as secondary flicker, is defined as the percentage voltage fluctuation that occurs within the distribution transformer and secondary/service system. For calculation purposes, this standard assumes negligible primary system impedance.

CRITERIA

Sudden reductions in secondary system voltage or rapid voltage fluctuations affect the lumen output of lamps and may damage sensitive electronic equipment in a number of ways. Flicker refers to the variation in light output of lamps as well as sudden reductions/rapid fluctuations of voltage. The acceptable amount of secondary system voltage fluctuation as a function of frequency is illustrated in Figure 1. Secondary flicker that occurs in excess of these values is likely to result in customer complaints.

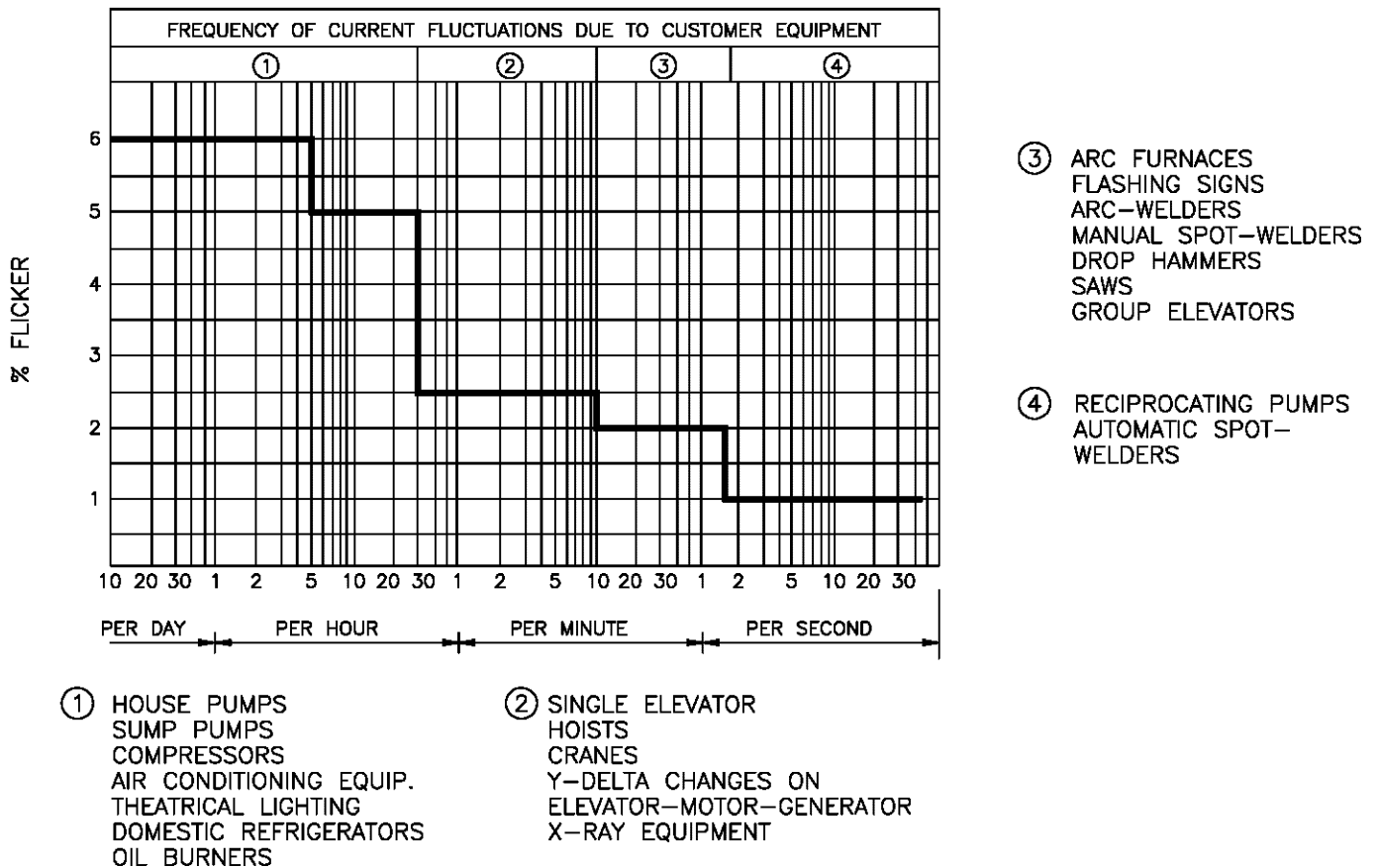

FIGURE 1

	Indicates Latest Revision	Completely Revised	New Page
REVISION	SDG&E DISTRIBUTION DESIGN MANUAL		
DATE 1-1-91 APPD CVN <i>[Signature]</i>	SECONDARY FLICKER		5413.1

APPLICATION

Planners are responsible for determining secondary flicker requirements according to the criteria established in this standard and the Voltage Drop and Flicker Nomographs in Design Standards 5431 and 5432. When the resulting secondary flicker is greater than the allowable limit shown on the secondary flicker chart, remedial action must be taken. Rule 2.E.1 of the Rules For The Sale Of Electric Energy requires the customer to "provide whatever corrective measures are necessary" to comply with the secondary flicker criteria. SDG&E excludes residential subdivisions from this requirement. But in all other cases, the Planner is responsible for advising the customer of his options according to SPM 272, 925 and the following:

- A. Limit inrush current. The customer is to be advised of the maximum permitted inrush current which is acceptable to SDG&E. The following procedure can be used to determine the amount of inrush current reduction required to comply with this standard.
1. Calculate the flicker percentage for the customer equipment specified using nomograph on 5431/2, and transformer flicker tables on 5413.5/.6/.7.
 - a. Determine the "normal" wire size needed to meet customer ampacity and volt drop requirements based on customer's demand. Using this "normal" wire size calculate the flicker % on the wire.
 - b. Determine "normal" transformer size needed based on customer's demand.
 2. Calculate maximum flicker percentage permitted by the secondary flicker chart on 5413.1.
 3. Calculate the acceptable inrush current by dividing step 2's answer by step 1's and multiplying the result by the motor starting current found in the transformer flicker tables.

Ex: A customer wishes to install a 30 HP single elevator motor to be served underground by 3 phase, 120/208V service with 100' of cable. Assume that ampacity and voltage drop analysis has been completed and, you have selected a 75 kVA transformer and 1 run of # 1000 kcmil cable.

Step 1: Calculate % flicker.

Referring to 5431.2, using 100' of # 1000 cable to feed a 30 HP motor, the nomograph yields a flicker of 1.5%.

From 5413.7, Table 8, the 75 kVA transformer has 4.5% flicker for a 30 HP motor.

The total flicker is 1.5% + 4.5%=6.0%

Step 2: Determine maximum permitted secondary flicker.

Consult 5413.1, the maximum permitted secondary flicker is 2.5%.

Step 3: Calculate maximum permitted inrush current:

The maximum permitted inrush current is equal to:

$$\left(\frac{\text{maximum permitted secondary flicker}}{\text{total flicker}} \right) \times \text{LRC}$$

From 5413.7, Table 8, the LRC is 481 amps. Calculating maximum permitted inrush current yields:

$$\frac{2.5\%}{6.0\%} \times 481 = 200 \text{ amps.}$$

	<input type="checkbox"/> Indicates Latest Revision	<input checked="" type="checkbox"/> Completely Revised	<input type="checkbox"/> New Page
5413.2	SDG&E DISTRIBUTION DESIGN MANUAL		REVISION
	SECONDARY FLICKER		DATE 1-1-2000 APPD <i>SRM / CAK</i>

Conclusion:

The "normal" facilities required to serve the customer's load, based on demand, and needed to meet cable ampacity & volt drop requirements are 1 run of #1000 and a 75 KVA transformer. But the customer is installing equipment such that the "normal" facilities are not able to prevent flicker problems. Several solutions are available.

B. Solutions

- Option 1. Reduce system impedance by increasing the size or shortening the length of the secondary/service wires. The customer is to pay the cost for any additional facilities beyond "normal". See Rule Interpretation E.3.6.
- Option 2. Reduce system impedance by increasing the size of the transformer. The customer is to pay the cost for any additional facilities beyond "normal". See Rule Interpretation E.3.6.
- Option 3. (3 phase equipment) Have the customer install an inrush limitation device, Rule 2.e.1. Some examples are:
 - a. Wye-Delta starter.
This device typically limits inrush current to about 33% of it's normal locked rotor current. (locked rotor current is generally about 6 times the value of the full load current).
 - b. Electronic Motor Controller.
This device is adjustable and can limit inrush current as low as 25% of full load current.
 - c. Electronic Motor Controller. (2nd type)
This device is adjustable and can limit inrush current as low as 50% of full load current. It also offers pump control to provide smooth acceleration and deceleration for centrifugal pumps.

Considerations:

- How much fusing capacity, in KVA, is remaining on the branch/system. And will additional transformer KVA surpass this remaining capacity?
- What's the potential for future growth. Will this future growth have a feeder to rely on, or is the current branch/system, with it's remaining capacity, all there is?
- Does the circuit have sufficient capacity for load growth?
- It is reasonable to provide the additional transformer KVA to be used only for motor inrush/starting?
- Larger transformers have higher no-load losses.

Recommendations

- Choice #1: Provide additional secondary/service wire.
- Choice #2: Provide additional 75 or 150 KVA transformer capacity.
- Choice #3: Have the customer install a current inrush limiting device, or install additional transformer capacity in excess of 150 KVA. This choice is at the customer project planner's discretion and should be based on economic and or the above considerations.
- Choice #4: Any combination of the above 3 choices.

General Notes

1. Transformers and secondary/service conductors may be sized for 10% secondary flicker when no incandescent lamps or sensitive electronic equipment will be powered from the serving transformer. Dedicated services to submersible pumps, wind machines, etc. may satisfy this requirement.
2. A 6% secondary flicker is specified for single-phase residential subdivisions on the secondary flicker chart. For an existing residential customer served from an existing transformer, the secondary flicker may be raised to 7% if a larger transformer would be required to meet the 6% secondary flicker limit while serving normal load.

<input checked="" type="checkbox"/> Indicates Latest Revision		<input type="checkbox"/> Completely Revised		<input type="checkbox"/> New Page	
REVISION		SDG&E DISTRIBUTION DESIGN MANUAL			
DATE 3-1-02		SECONDARY FLICKER			
APPD JCE/vcl					
		5413.3			

3. The permitted secondary frequency chart, 5413.1, is dependent on the frequency of fluctuations (per day/hour/etc), as indicated at the base of the chart. It is therefore necessary to know the number of times a motor or other equipment causing inrush will start. For multiple motors add the frequency of motor starts before using the chart.
4. The transformer flicker percentage (obtained from Tables 1 thru 8) should be based on the largest motor attached to the system, not the sum of the motors connected, unless simultaneous starting is indicated. When in doubt, regarding simultaneous starts, ask the customer or check the submitted electrical plans.
5. With multiple customers being served from the same transformer, all the customers will see the transformer flicker for the largest motor/equipment from any of the individual customers. The transformer flicker for this largest motor/equipment should be used to calculate the total flicker (transformer + secondary/service) for each of the other customers.
6. An example using the secondary flicker chart and transformer flicker tables is shown on DM 5411.3.

The following transformer flicker tables were constructed using the equation and assumptions below:

$$V\%, 1Ph = \left(\frac{\text{Starting Current}}{\text{Transformer KVA}} \right) \times (\%R \cos\theta + \%X \sin\theta)$$

$$V\%, 3Ph = \left(\frac{\text{Starting Current}}{\sqrt{3} \times \text{Transformer KV}} \right) \times (\%R \cos\theta + \%X \sin\theta)$$

- a. The motor starting current, or locked rotor current, was obtained from tables 1 and 2 of Rule 2 within SDG&E's Rules For the Sale of Electric Energy.
- b. Motor starting Power factor:
 single phase motor = 0.75 --> $\cos\theta = 0.75$, $\sin\theta = 0.66$
 three phase motor = 0.3 --> $\cos\theta = 0.3$, $\sin\theta = 0.95$
- c. Transformer resistance (R) and reactance (X) represent typical values for transformers purchased by SDG&E.
- d. Table 1 concerning the open-delta station has 58 percent of the three-phase current going to each transformer, while all the single-phase current goes to the larger transformer. The maximum 10 HP requirement on newly constructed and converted (going from overhead to underground) open-delta station applies to single-phase and three-phase motors. This is because larger single-phase motors produce an unacceptable voltage unbalance while larger three-phase motors will not operate properly due to the missing phantom phase voltage. All submersible pumps shall be served from a closed delta station.
- e. Each transformer in a closed-delta station supplies 1/3 of the three-phase current.
- f. Tables assume the transformer is fully loaded at whatever operating voltage is permitted for the transformer. Because the tables are voltage independent the locked rotor current for all permitted voltage levels is not duplicated on each table.
- g. Table 1 applies to the single-phase load attached to an open-delta station as well as the single-phase load attached to a single-phase station.
- h. The effect of air conditioning equipment on flicker can be determined from the tables by dividing the HP by 1.5 to convert to tons (Design Standard 5321).

Indicates Latest Revision Completely Revised New Page

5413.4

SDG&E DISTRIBUTION DESIGN MANUAL

SECONDARY FLICKER

REVISION

DATE 3-1-02

APPD JCE/VCL

Table 1 – Percent Flicker on Single-Phase Transformer or Larger Transformer in Open-Delta Overhead Station

1-Phase Trans (kVA)	Single-Phase Motor (Sized in HP)											Transformer Data						
	1	1.5	2	1	1.5	2	3	4.5	5	6	7.5	10	R	X	X/R Ratio	Z%		
	120V			240V														
10	2.2	3.3	4.5	1.3	1.6	2.2	3.3	5.0	5.6	6.8	8.5	10.6	1.9%	0.9%	0.5	2.1%		
15	1.6	2.3	3.1	0.9	1.2	1.6	2.3	3.5	3.9	4.7	5.9	7.4	1.5%	1.5%	1.0	2.1%		
25	0.9	1.4	1.8	0.5	0.7	0.9	1.4	2.0	2.3	2.8	3.4	4.3	1.5%	1.4%	0.9	2.1%		
50	0.5	0.7	1.0	0.3	0.4	0.5	0.7	1.1	1.2	1.5	1.9	2.3	1.3%	1.9%	1.5	2.3%		
75	0.3	0.5	0.6	0.2	0.2	0.3	0.5	0.7	0.8	0.9	1.2	1.5	1.1%	1.9%	1.7	2.2%		
100	0.3	0.4	0.5	0.1	0.2	0.3	0.4	0.6	0.6	0.8	1.0	1.2	1.3%	2.0%	1.5	2.4%		

Locked Rotor Current

46 69 92 27 34 46 69 103 115 140 175 218

Table 2 – Percent Flicker on Either Transformer in Open-Delta Overhead Station

1-Phase Trans (kVA)	Three-Phase Motor (Sized in HP)						Transformer Data			
	3	4.5	5	6	7.5	10	R	X	X/R Ratio	Z%
10	2.2	2.9	3.1	3.6	4.3	5.5	1.9%	0.9%	0.5	2.1%
15	1.9	2.6	2.8	3.2	3.8	4.9	1.5%	1.5%	1.0	2.1%
25	1.1	1.5	1.6	1.8	2.2	2.8	1.5%	1.4%	0.9	2.1%
50	0.7	0.9	1.0	1.1	1.3	1.7	1.3%	1.9%	1.5	2.3%
75	0.4	0.6	0.6	0.7	0.9	1.1	1.1%	1.9%	1.7	2.2%
100	0.4	0.5	0.5	0.6	0.7	0.9	1.3%	2.0%	1.5	2.4%

Locked Rotor Current

●240V 64 85 92 106 127 162

Table 3 – Percent Flicker on Closed-Delta or Wye Overhead Station

1-Phase Trans (kVA)	Three-Phase Motor (Sized in HP)															Transformer Data			
	3	4.5	5	6	7.5	10	15	20	25	30	40	50	75	100	150	R	X	X/R Ratio	Z%
10	1.3	1.7	1.8	2.1	2.5	3.2	4.6	5.7	7.2	8.6						1.9%	0.9%	0.5	2.1%
15	1.1	1.5	1.6	1.8	2.2	2.8	4.0	5.0	6.3	7.5	10.0					1.5%	1.5%	1.0	2.1%
25	0.6	0.8	0.9	1.0	1.3	1.6	2.3	2.9	3.6	4.3	5.7	7.2	10.7			1.5%	1.4%	0.9	2.1%
50	0.4	0.5	0.6	0.6	0.8	1.0	1.4	1.8	2.2	2.6	3.5	4.4	6.6	8.8		1.3%	1.9%	1.5	2.3%
75	0.3	0.3	0.4	0.4	0.5	0.6	0.9	1.1	1.4	1.7	2.3	2.9	4.3	5.7	8.6	1.1%	1.9%	1.7	2.2%
100	0.2	0.3	0.3	0.3	0.4	0.5	0.7	0.9	1.2	1.4	1.8	2.3	3.4	4.6	6.9	1.3%	2.0%	1.5	2.4%

Locked Rotor Current

●240V 64 85 92 106 127 162 232 290 365 435 580 725 1085 1450 2170
 ●208V 71 94 102 117 140 179 257 321 404 481 641 802 1200 1603 2400

Indicates Latest Revision Completely Revised New Page

REVISION

SDG&E DISTRIBUTION DESIGN MANUAL

DATE 1-1-2000
 APPD JRM / CMK

SECONDARY FLICKER

5413.5

Table 4 – Percent Flicker on Closed Delta Overhead Station

1-Phase Trans (kVA)	Three-Phase Motor (Sized in HP)															Transformer Data			
	3	4.5	5	6	7.5	10	15	20	25	30	40	50	75	100	150	R	X	X/R Ratio	Z%
25	0.6	0.8	0.9	1.0	1.3	1.6	2.3	2.9	3.6	4.3	5.7	7.2	10.7	1.5%	1.4%	0.9	2.1%		
50	0.4	0.5	0.6	0.6	0.8	1.0	1.4	1.8	2.2	2.7	3.5	4.4	6.6	8.8	1.3%	1.9%	0.5	2.3%	
75	0.3	0.3	0.4	0.4	0.5	0.6	0.9	1.1	1.4	1.7	2.3	2.9	4.3	5.7	8.6	1.1%	1.9%	1.7	2.2%

Locked Rotor Current

@480V 32 43 46 53 63.5 81 116 145 183 218 290 363 543 725 1085

Table 5 – Percent Flicker on Single-Phase Padmount or Larger Transformer in Open-Delta Padmounted Station

1-Phase Trans (kVA)	Single-Phase Motor (Sized in HP)												Transformer Data			
	1	1.5	2	1	1.5	2	3	4.5	5	6	7.5	10	R	X	X/R Ratio	Z%
	120V			240V												
15	1.5	2.3	3.0	0.9	1.1	1.5	2.3	3.4	3.8	4.6	5.8	7.2	1.7%	1.2%	0.7	2.1%
25	0.9	1.3	1.7	0.5	0.6	0.9	1.3	2.0	2.2	2.7	3.3	4.1	1.6%	1.2%	0.8	2.0%
50	0.5	0.7	0.9	0.3	0.3	0.5	0.7	1.0	1.2	1.4	1.8	2.2	1.3%	1.7%	1.3	2.1%
75	0.3	0.4	0.6	0.2	0.2	0.3	0.4	0.6	0.7	0.9	1.1	1.4	1.1%	1.8%	1.7	2.0%
100	0.2	0.3	0.5	0.1	0.2	0.2	0.3	0.5	0.6	0.7	0.9	1.1	1.1%	1.9%	1.7	2.2%

Locked Rotor Current

46 69 92 27 34 46 69 103 115 140 175 218

Table 6 – Percent Flicker on Either Transformer in Open-Delta Padmounted Station

1-Phase Trans (kVA)	Three-Phase Motor (Sized in HP)						Transformer Data			
	3	4.5	5	6	7.5	10	R	X	X/R Ratio	Z%
	240V									
15	1.7	2.2	2.4	2.8	3.4	4.3	1.7%	1.2%	0.7	2.1%
25	1.0	1.3	1.4	1.6	2.0	2.5	1.6%	1.2%	0.8	2.0%
50	0.6	0.8	0.9	1.0	1.2	1.6	1.3%	1.7%	1.3	2.1%
75	0.4	0.5	0.6	0.7	0.8	1.0	1.1%	1.8%	1.7	2.0%
100	0.3	0.4	0.5	0.5	0.6	0.8	1.1%	1.9%	1.7	2.2%

Locked Rotor Current

@240V 64 85 92 106 127 162

Table 7 - Percent Flicker on Closed-Delta Padmounted Transformer Station

1-Phase Trans (kVA)	Three-Phase Motor (Sized in HP)																		Transformer Data X/R Ratio Z%			
	3	4.5	5	6	7.5	10	15	20	25	30	40	50	60	75	100	125	150	200	R	X	Z%	
15	.9	1.2	1.3	1.5	1.8	2.2	3.2	4.0	5.1	6.0	8.0	1.2%	1.2%	1.0	1.7%							
25	0.5	0.7	0.8	0.9	1.1	1.4	2.0	2.5	3.1	3.7	4.9	6.1	1.3%	1.2%	0.9	1.8%						
50	0.4	0.5	0.5	0.6	0.7	0.9	1.3	1.6	2.0	2.4	3.2	4.0	4.8	5.9	7.9	1.2%	1.7%	1.4	2.1%			
75	0.2	0.3	0.4	0.4	0.5	0.6	0.9	1.1	1.4	1.7	2.2	2.8	3.3	4.1	5.6	6.9	8.3	1.2%	1.8%	1.5	2.2%	
100	0.2	0.2	0.2	0.3	0.3	0.4	0.6	0.7	0.9	1.1	1.5	1.9	2.2	2.8	3.7	4.7	5.6	7.4	1.1%	1.6%	1.5	1.9%

Locked Rotor Current
 @240V 32 85 92 106 127 162 232 290 365 435 580 725 870 1085 1450 1815 2170 2900

Table 8 - Percent Flicker on Three-Phase Padmounted Transformer - 208 V

3-Phase Trans (kVA)	Three-Phase Motor (Sized in HP)																		Transformer Data X/R Ratio Z%			
	3	4.5	5	6	7.5	10	15	20	25	30	40	50	60	75	100	125	150	200	R	X	Z%	
45	1.4	1.8	1.9	2.2	2.7	3.4	4.9	6.1	7.7	9.1	1.9%	1.9%	1.0	2.7%								
75	0.5	0.7	0.7	0.8	1.0	1.3	1.8	2.3	2.9	3.4	4.5	5.7	6.9	8.6	1.0%	1.3%	1.2	1.6%				
150	0.2	0.3	0.3	0.4	0.5	0.6	0.9	1.1	1.4	1.6	2.1	2.7	3.2	4.0	5.4	6.7	8.0	1.0%	1.2%	1.2	1.5%	
225	0.2	0.3	0.3	0.4	0.5	0.7	0.9	1.2	1.4	1.9	2.3	2.8	3.5	4.7	5.8	7.0	9.3	0.9%	1.6%	1.8	1.9%	
300	0.4	0.5	0.5	0.6	0.7	0.9	1.3	1.7	2.1	2.5	3.3	4.2	5.0	6.2	8.3	10.4	12.5	16.7	1.0%	4.2%	4.2	4.4%
500	0.2	0.3	0.3	0.4	0.5	0.6	0.9	1.1	1.3	1.6	2.1	2.7	3.2	4.0	5.3	6.7	8.0	10.7	1.0%	4.5%	4.5	4.6%
750	0.2	0.3	0.3	0.3	0.4	0.5	0.7	0.9	1.1	1.3	1.7	2.1	2.6	3.2	4.3	5.4	6.4	8.6	0.9%	5.6%	6.3	5.6%
1000	0.1	0.2	0.2	0.2	0.3	0.4	0.5	0.6	0.8	1.0	1.3	1.6	1.9	2.4	3.2	4.0	4.8	6.4	0.8%	5.6%	7.3	5.7%
1500	0.1	0.1	0.1	0.2	0.2	0.2	0.4	0.4	0.6	0.7	0.9	1.1	1.3	1.6	2.2	2.8	3.3	4.4	1.0%	5.7%	5.9	5.8%

Locked Rotor Current
 @208V 71 94 102 117 140 179 257 321 404 481 641 802 962 1200 1603 2007 2400 3207

Table 9 - Percent Flicker on Three-Phase Padmounted Transformer - 480 V

3-Phase Trans (kVA)	Three-Phase Motor (Sized in HP)																		Transformer Data X/R Ratio Z%									
	3	4.5	5	6	7.5	10	15	20	25	30	40	50	60	75	100	125	150	200	250	300	350	400	450	500	R	X	Z%	
75	0.7	0.9	1.0	1.1	1.3	1.7	2.4	3.0	3.8	4.5	6.0	7.5	9.0	11.0	1.4%	1.5%	1.1	2.1%										
150	0.6	0.8	0.8	1.0	1.2	1.5	2.1	2.6	3.3	4.0	5.3	6.6	7.9	9.9	13.0	17.0	19.8	1.0%	3.2%	3.2	3.3%							
225	0.2	0.2	0.3	0.3	0.4	0.4	0.6	0.8	1.0	1.2	1.6	2.0	2.4	3.0	4.0	5.0	6.0	8.0	0.8%	1.3%	1.6	1.6%						
300	0.1	0.2	0.2	0.2	0.3	0.3	0.5	0.6	0.7	0.9	1.1	1.4	1.7	2.1	2.9	3.6	4.3	5.7	7.2	8.7	0.9%	1.2%	1.4	1.5%				
500	0.2	0.2	0.2	0.3	0.3	0.4	0.6	0.7	0.9	1.0	1.4	1.7	2.1	2.6	3.5	4.4	5.2	7.0	8.8	10.6	12.3	14.0	15.6	17.5	0.8%	2.8%	3.7	2.9%
750	0.2	0.3	0.3	0.3	0.4	0.5	0.7	0.9	1.1	1.3	1.8	2.2	2.7	3.3	4.5	5.6	6.7	8.9	11.3	13.6	15.7	17.9	20.0	22.4	0.8%	5.6%	7.2	5.7%
1000	0.2	0.2	0.2	0.2	0.3	0.4	0.5	0.7	0.9	1.0	1.3	1.7	2.0	2.5	3.4	4.2	5.0	6.7	8.5	10.2	11.8	13.5	15.1	16.9	0.8%	5.6%	7.3	5.7%
1500	0.1	0.1	0.1	0.2	0.2	0.3	0.4	0.5	0.6	0.7	0.9	1.1	1.4	1.7	2.3	2.8	3.4	4.5	5.7	6.9	7.9	9.0	10.1	11.3	0.6%	5.7%	9.5	5.8%
2000	0.1	0.1	0.1	0.1	0.2	0.2	0.3	0.3	0.4	0.5	0.7	0.8	1.0	1.3	1.7	2.1	2.5	3.4	4.2	5.1	5.9	6.7	7.5	8.4	0.7%	5.7%	8.4	5.7%
2500	0.1	0.1	0.1	0.1	0.1	0.2	0.2	0.3	0.3	0.4	0.5	0.7	0.8	1.0	1.3	1.7	2.0	2.7	3.4	4.1	4.7	5.4	6.0	6.8	0.6%	5.7%	10.0	5.7%
3000	0.1	0.1	0.1	0.1	0.1	0.1	0.2	0.2	0.3	0.3	0.4	0.5	0.6	0.8	1.1	1.3	1.6	2.1	2.7	3.3	3.8	4.3	4.8	5.4	0.6%	5.4%	8.5	5.4%

Locked Rotor Current
 @480V 32 43 46 53 63.5 81 116 145 183 218 290 363 435 543 725 908 1085 1450 1825 2200 2550 2900 3250 3635

© 1998 - 2011 San Diego Gas & Electric Company. All rights reserved. Removal of this copyright notice without permission is not permitted under law.

REVISION	Indicates Latest Revision	<input checked="" type="checkbox"/> Completely Revised	<input type="checkbox"/> New Page	<input type="checkbox"/> Information Removed
DATE 6-30-2011	SDG&E DISTRIBUTION DESIGN MANUAL			5413.7
APPD JCE/MJC	SECONDARY FLICKER			

SCOPE

This standard defines permissible levels of voltage flicker on the primary distribution system. It also provides the analytical tools necessary to calculate motor starting inrush kVA. The subject of secondary flicker is discussed in Design Standard 5413.

PURPOSE

District Engineering personnel should use this standard as a reference when dealing with customer inquiries. It also provides a basis for specifying equipment operating limitations necessary to avoid customer complaints due to primary voltage flicker.

DEFINITIONS

Primary System Voltage Flicker, also known as primary flicker, is defined at SDG&E as the percentage voltage fluctuation from the distribution substation to the customer's primary metering station or primary terminals of the distribution transformer due to the operation of cyclic loads or motor starting.

CRITERIA

Sudden reductions in system voltage or rapid fluctuations in voltage effect the lumen output of lamps. This variation in light output is referred to as flicker. The acceptable amount of primary system voltage fluctuation as a function of frequency is illustrated in Figure 1. Primary system flicker limitations are more restrictive than secondary system limitations due to the larger number of affected customers, and the relatively high cost of eliminating a primary flicker problem.

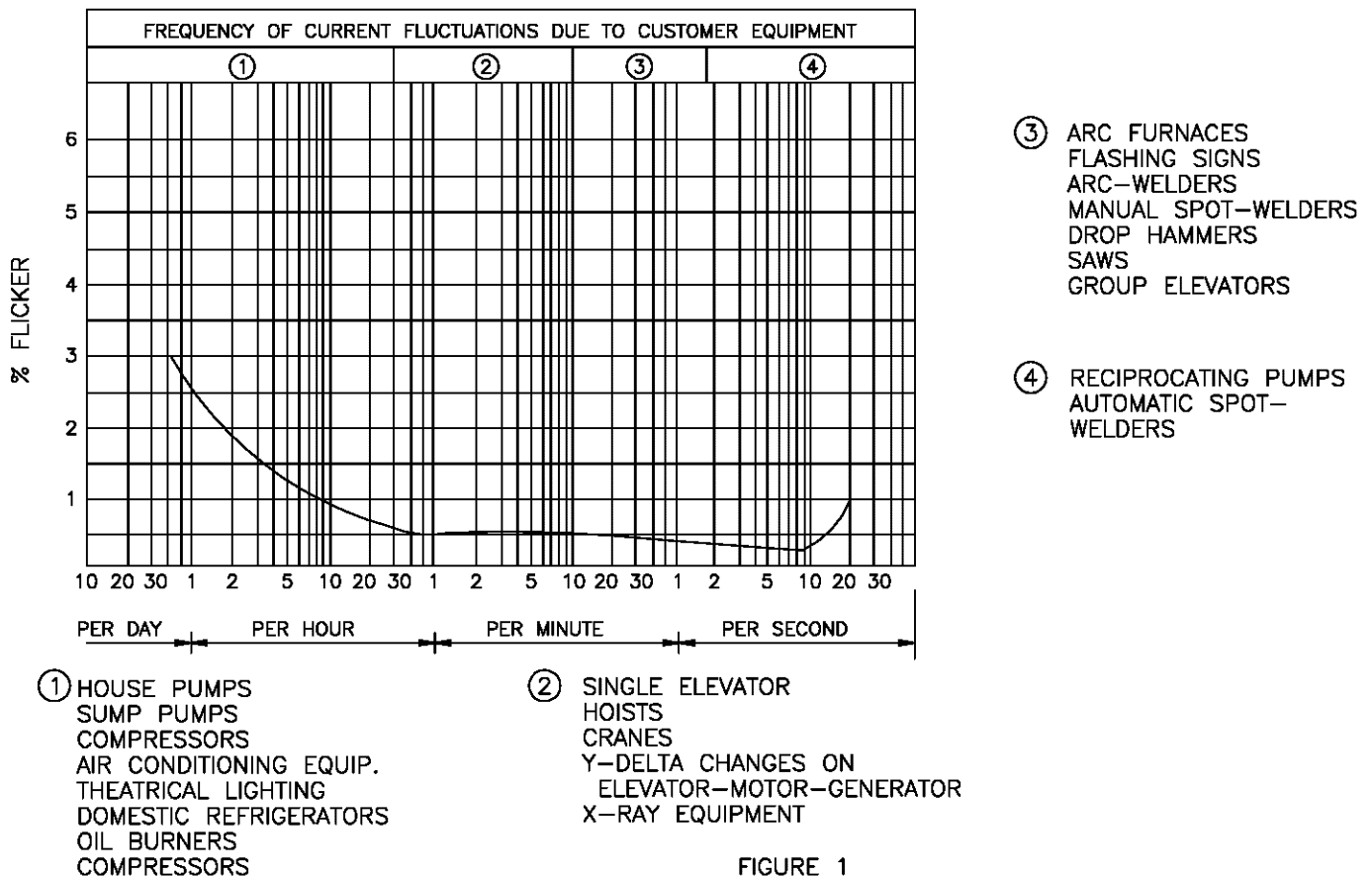

FIGURE 1

	Indicates Latest Revision	Completely Revised	New Page
REVISION	SDG&E DISTRIBUTION DESIGN MANUAL		
DATE 1-1-91	PRIMARY SYSTEM VOLTAGE FLICKER LIMIT CALCULATION		5421.1
APPD CVN / <i>[Signature]</i>			

The 3 percent maximum permitted primary flicker applies to all equipment connected to the distribution system, including switched capacitors. Generally, motor start analysis is performed to determine the extent to which starting inrush current must be restricted to prevent exceeding the primary flicker limitations established in Figure 1. Across-the-line starting of a motor may result in initial currents of 6 times the motor's rated full load current. However, motors and/or motor control centers may be designed to limit the starting current significantly. Other equipment such as impulse loads, arc furnaces, and customer owned generators can also produce an unacceptable level of primary flicker.

The district engineer must determine the inrush limitations according to Equation 1. The customer applying for service is to be supplied with the inrush limitation along with the following:

1. Motor kVA and voltage
2. Assumed starting intervals (once per hour, etc.)
3. Assumed starting power factor

$$\text{Inrush kVA} = \frac{(\% \text{ flicker}) (\text{base kVA})}{100 (R \cos \phi + X \sin \phi)} \quad \text{Equation 1}$$

Where:

1. % flicker - Maximum permissible primary flicker for a specified starting interval (Figure 1).
2. R,X = total system Resistance and Reactance (substation bus impedance plus distribution line impedance on a common base).
3. ϕ = angle of motor starting power factor from the table below or as supplied by the customer.

The following motor starting power factor table should be used when exact motor starting characteristics cannot be supplied by the customer:

MOTOR - HP	COS ϕ	SIN ϕ
30	.419	.908
40	.390	.921
50	.382	.924
60	.349	.937
75	.330	.944
100	.309	.951
150	.280	.960
200	.251	.968
250	.231	.973
300	.219	.976
400	.199	.980
500	.178	.984
600	.167	.986
700	.167	.986
800	.167	.986
900	.161	.987
1000	.148	.989
1200	.148	.989
1500	.148	.989

	Indicates Latest Revision	Completely Revised	New Page
5421.2	SDG&E DISTRIBUTION DESIGN MANUAL		REVISION
	PRIMARY SYSTEM VOLTAGE FLICKER LIMIT CALCULATION		DATE 1-1-89 APPD CVN / <i>CVN</i>

EXAMPLE

An Electric Service Load Study indicates that a small manufacturing plant intends to attach a 200 hp motor to the 12kV system supplied by a 20 Mva substation transformer. The motor starts once every two minutes. The address and serving circuit are also specified. Using this information, the following steps should be taken:

1. From the Primary Voltage Flicker Chart (Page 5421.1) the flicker limitation is found to be 0.6 percent for a load starting 30 times per hour.

2. The total impedance (distribution line and 12kV bus) to the point of service is determined from the PSSU program to be:

$$Z_{line} = 2.015 + j1.156 \text{ p.u. on 100 Mva base}$$

3. The starting power factor was not provided by the customer so it is necessary to use the information for a 200 HP motor from the above table:

$$\cos\theta = 0.251, \sin\theta = 0.968$$

4. The inrush kVA is calculated using Equation 1 as follows:

$$KVA_{inrush} = \frac{(0.6)(100,000)}{100 [(2.015)(0.251) + (1.156)(0.968)]} = 369 \text{ kVA}$$

5. The customer is provided the following:

Maximum Inrush = 369 kVA at 208 volts

Starts Per Hour = 30

Starting PF = 0.251

<input checked="" type="checkbox"/> Indicates Latest Revision		Completely Revised	New Page
REVISION	SDG&E DISTRIBUTION DESIGN MANUAL		5421.3
DATE 3-1-02	PRIMARY SYSTEM VOLTAGE FLICKER LIMIT CALCULATION		
APPD JCE/Vcl			

SCOPE

This standard establishes the percentage voltage drop at various transformer load percentages.

SINGLE PHASE POLEMOUNT

Transformer Loading	Transformer Size						
	10 kVA	15 kVA	25 kVA	50 kVA	75 kVA	100 kVA	167kVA
50%	1.1	1.0	0.8	0.9	0.8	0.8	0.9
60%	1.3	1.2	1.0	1.1	1.0	1.0	1.0
70%	1.5	1.4	1.2	1.2	1.2	1.2	1.2
80%	1.7	1.6	1.4	1.4	1.4	1.3	1.4
90%	1.9	1.8	1.6	1.6	1.5	1.5	1.5
100%	2.1	2.0	1.7	1.8	1.7	1.7	1.7
110%	2.3	2.2	1.9	1.9	1.9	1.8	1.9
120%	2.5	2.4	2.0	2.1	2.0	2.0	2.1
130%	2.7	2.6	2.2	2.3	2.2	2.2	2.2
140%	2.9	2.8	2.4	2.5	2.4	2.3	2.4
150%	3.2	3.0	2.6	2.6	2.5	2.5	2.6
160%	3.4	3.2	2.7	2.8	2.7	2.7	2.7
170%	3.6	3.4	2.9	3.0	2.9	2.8	2.9

SINGLE PHASE PADMOUNT

Transformer Loading	Transformer Size					
	15 kVA	25 kVA	50 kVA	75 kVA	100 kVA	167 kVA
50%	1.1	0.8	0.9	0.9	0.8	0.8
60%	1.3	1.0	1.1	1.0	1.0	1.0
70%	1.5	1.1	1.2	1.2	1.2	1.2
80%	1.7	1.3	1.4	1.4	1.3	1.3
90%	1.9	1.4	1.6	1.6	1.5	1.5
100%	2.1	1.6	1.8	1.7	1.7	1.7
110%	2.3	1.8	1.9	1.9	1.8	1.8
120%	2.5	1.9	2.1	2.1	2.0	2.0
130%	2.7	2.1	2.3	2.2	2.2	2.2
140%	2.9	2.2	2.5	2.4	2.4	2.3
150%	3.2	2.4	2.6	2.6	2.5	2.5
160%	3.4	2.6	2.8	2.8	2.7	2.7
170%	3.6	2.7	3.0	2.9	2.9	2.8

© 1998 - 2021 San Diego Gas & Electric Company. All rights reserved. Removal of this copyright notice without permission is not permitted under law.

REV	CHANGE	DR	BY	DSN	APV	DATE	REV	CHANGE	DR	BY	DSN	APV	DATE
C							F						
B	EDITORIAL CHANGES		EPC	VMV	FRC	CZH	08/26/2021	E					
A	ORIGINAL ISSUE					01/01/1998	D						

X	Indicates Latest Revision	Completely Revised	New Page	Information Removed
SDG&E ELECTRIC DISTRIBUTION DESIGN MANUAL				

SHEET
1 OF 2

TRANSFORMER PERCENTAGE VOLTAGE DROP

DM5425.1

THREE PHASE PADMOUNT – 120/208V

Transformer Loading	Transformer Size								
	45 kVA	75 kVA	150 kVA	225 kVA	300 kVA	500 kVA	750 kVA	1000 kVA	1500kVA
50%	1.3	1.2	1.3	0.8	1.3	1.6	1.8	1.8	1.8
60%	1.6	1.5	1.5	1.0	1.6	1.9	2.2	2.1	2.2
70%	1.8	1.7	1.8	1.1	1.8	2.2	2.5	2.5	2.6
80%	2.1	2.0	2.1	1.3	2.1	2.5	2.9	2.9	2.9
90%	2.3	2.2	2.3	1.4	2.3	2.8	3.3	3.2	3.3
100%	2.6	2.4	2.6	1.6	2.6	3.1	3.6	3.6	3.7
110%	2.9	2.7	2.8	1.8	2.8	3.4	4.0	3.9	4.0
120%	3.1	2.9	3.1	1.9	3.1	3.7	4.3	4.3	4.4
130%	3.4	3.2	3.4	2.1	3.4	4.0	4.7	4.6	4.8
140%	3.6	3.4	3.6	2.3	3.6	4.4	5.1	5.0	5.1
150%	3.9	3.7	3.9	2.4	3.9	5.0	5.4	5.4	5.5

THREE PHASE PADMOUNT – 277/480Y

Transformer Loading	Transformer Size										
	75 kVA	150 kVA	225 kVA	300 kVA	500 kVA	750 kVA	1000 kVA	1500 kVA	2000 kVA	2500 kVA	3000 kVA
50%	1.0	1.2	0.7	1.3	1.3	1.8	1.8	1.8	1.8	1.7	1.8
60%	1.2	1.5	0.8	1.6	1.5	2.2	2.1	2.1	2.1	2.1	2.1
70%	1.4	1.7	1.0	1.8	1.8	2.5	2.5	2.5	2.5	2.4	2.5
80%	1.6	2.0	1.1	2.1	2.0	2.9	2.8	2.8	2.8	2.8	2.8
90%	1.8	2.2	1.2	2.4	2.3	3.2	3.2	3.2	3.2	3.1	3.2
100%	2.0	2.5	1.4	2.6	2.5	3.6	3.5	3.5	3.5	3.5	3.5
110%	2.2	2.7	1.5	2.9	2.8	4.0	3.9	3.9	3.9	3.8	3.9
120%	2.4	2.9	1.6	3.1	3.0	4.3	4.2	4.2	4.2	4.2	4.2
130%	2.6	3.2	1.8	3.4	3.3	4.7	4.6	4.6	4.6	4.5	4.6
140%	2.8	3.4	1.9	3.7	3.5	5.0	4.9	5.0	4.9	4.9	4.9
150%	3.0	3.7	2.0	3.9	3.8	5.4	5.3	5.3	5.3	5.2	5.3

Note: Single phase values assume power factor of 0.9, and three phase values assume power factor of 0.85.

© 1998 - 2021 San Diego Gas & Electric Company. All rights reserved. Removal of this copyright notice without permission is not permitted under law.

REV	CHANGE	DR	BY	DSN	APV	DATE	REV	CHANGE	DR	BY	DSN	APV	DATE
C							F						
B	EDITORIAL CHANGES	EPC	VMV	FRC	CZH	08/26/2021	E						
A	ORIGINAL ISSUE					01/01/1998	D						

SHEET 2 OF 2	X Indicates Latest Revision	Completely Revised	New Page	Information Removed	DM5425.2
	SDG&E ELECTRIC DISTRIBUTION DESIGN MANUAL				
	TRANSFORMER PERCENTAGE VOLTAGE DROP				

SEE GENERAL NOTES ON PAGE 5413.3 IF THE % FLICKER IS GREATER THAN ALLOWABLE LIMITS.

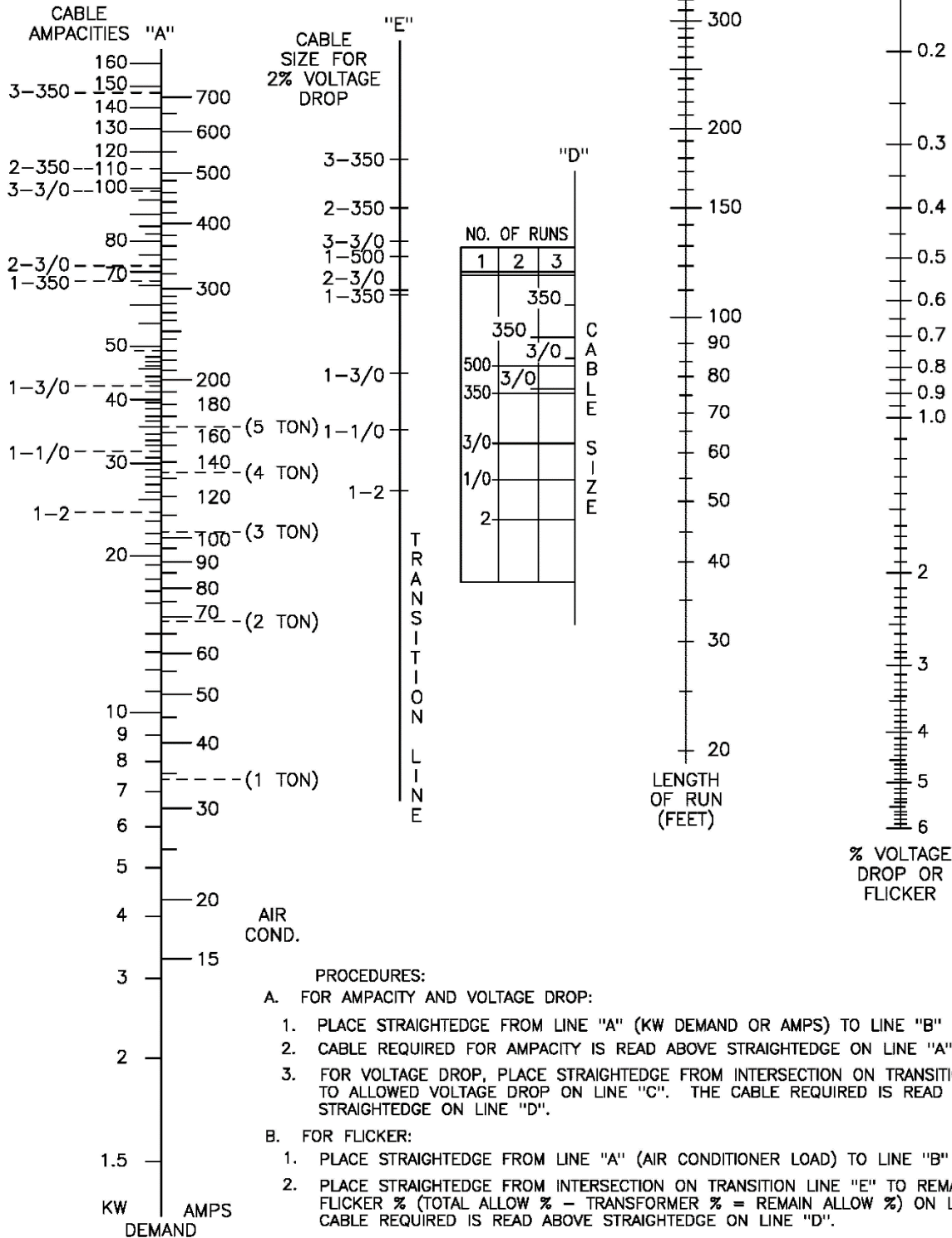

© 1998-2020 San Diego Gas & Electric Company. All rights reserved. Removal of this copyright notice without permission is not permitted under law.

REV	CHANGE	BY	DSGN	APPV	DATE	REV	CHANGE	BY	DSGN	APPV	DATE
C						F					
B	FORMATTING	JIK	-	-	02/21/2020	E					
A	ORIGINAL ISSUE	-	CVN	RDG	01/01/1994	D					

X Indicates Latest Revision Completely Revised New Page Information Removed

SHEET
1 OF 5

SDG&E ELECTRIC DISTRIBUTION DESIGN MANUAL

**SINGLE-PHASE 120/240V UNDERGROUND VOLTAGE DROP
AND FLICKER NOMOGRAPH**

DM5431.1

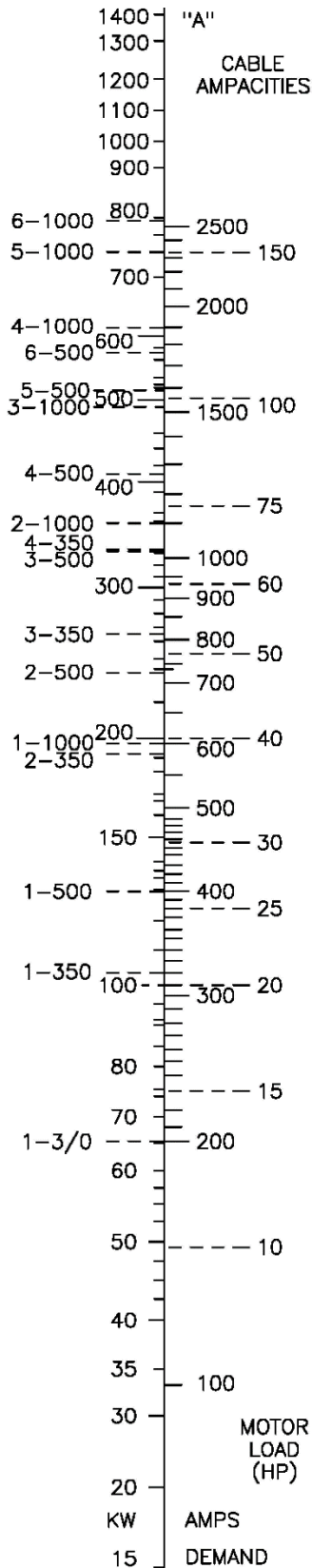

SEE GENERAL NOTES ON PAGE 5413.3 IF THE % FLICKER IS GREATER THAN ALLOWABLE LIMITS.

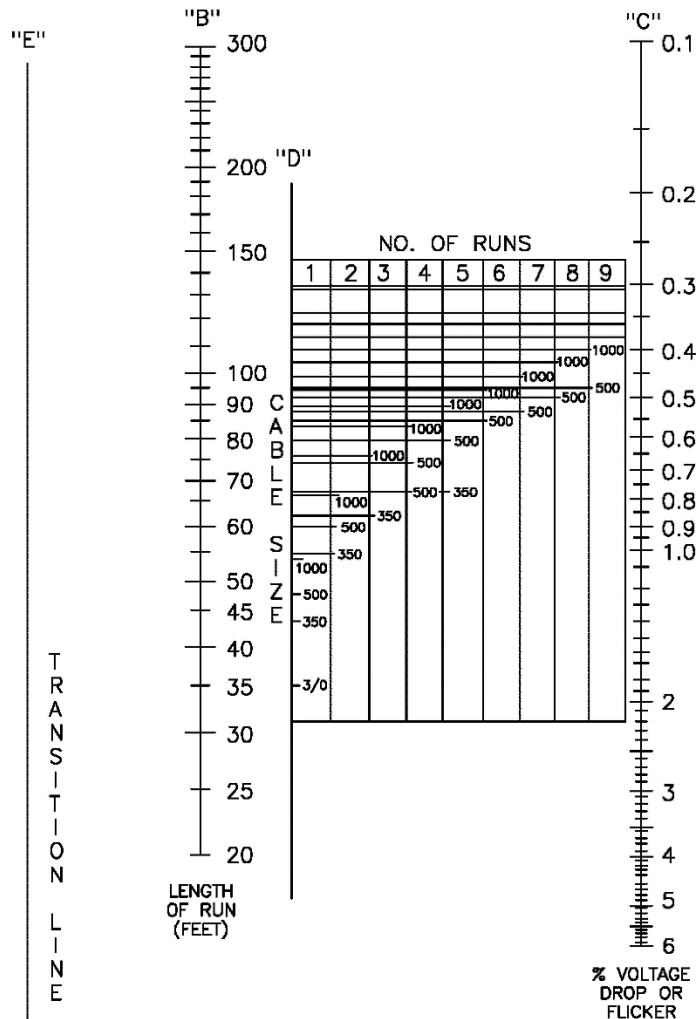

- PROCEDURES:**
- A. FOR AMPACITY AND VOLTAGE DROP:**
1. PLACE STRAIGHTEDGE FROM LINE "A" (KW DEMAND OR AMPS) TO LINE "B" (LENGTH OF RUN).
 2. CABLE REQUIRED FOR AMPACITY IS READ ABOVE STRAIGHTEDGE ON LINE "A"
 3. FOR VOLTAGE DROP, PLACE STRAIGHTEDGE FROM INTERSECTION ON TRANSITION LINE "E" TO ALLOWED VOLTAGE DROP ON LINE "C". THE CABLE REQUIRED IS READ ABOVE STRAIGHTEDGE ON LINE "D".
- B. FOR FLICKER:**
1. PLACE STRAIGHTEDGE FROM LINE "A" (MOTOR LOAD) TO LINE "B" (LENGTH OF RUN).
 2. PLACE STRAIGHTEDGE FROM INTERSECTION ON TRANSITION LINE "E" TO REMAINING ALLOWABLE FLICKER % (TOTAL ALLOW % - TRANSFORMER % = REMAIN ALLOW %) ON LINE "C". THE CABLE REQUIRED IS READ ABOVE STRAIGHTEDGE ON LINE "D".

© 1998-2020 San Diego Gas & Electric Company. All rights reserved. Removal of this copyright notice without permission is not permitted under law.

REV	CHANGE	BY	DSGN	APPV	DATE	REV	CHANGE	BY	DSGN	APPV	DATE
C						F					
B	FORMATTING	JIK	-	-	02/21/2020	E					
A	ORIGINAL ISSUE	-	CVN	RDG	01/01/1994	D					

Indicates Latest Revision Completely Revised New Page Information Removed

SHEET
2 OF 5

SDG&E ELECTRIC DISTRIBUTION DESIGN MANUAL

**3Ø 120/208Y UNDERGROUND VOLTAGE DROP
AND FLICKER NOMOGRAPH**

DM5431.2

PROCEDURES:

PLACE STRAIGHTEDGE FROM KW DEMAND OR AMPS (LINE "A") TO LENGTH OF RUN (LINE "B"). THEN FROM THE TRANSITION POINT (LINE "E") TO THE SIZE OF CABLE (LINE "D"). READ THE % VOLTAGE DROP (LINE "C") FOR THAT SEGMENT OF CABLE.

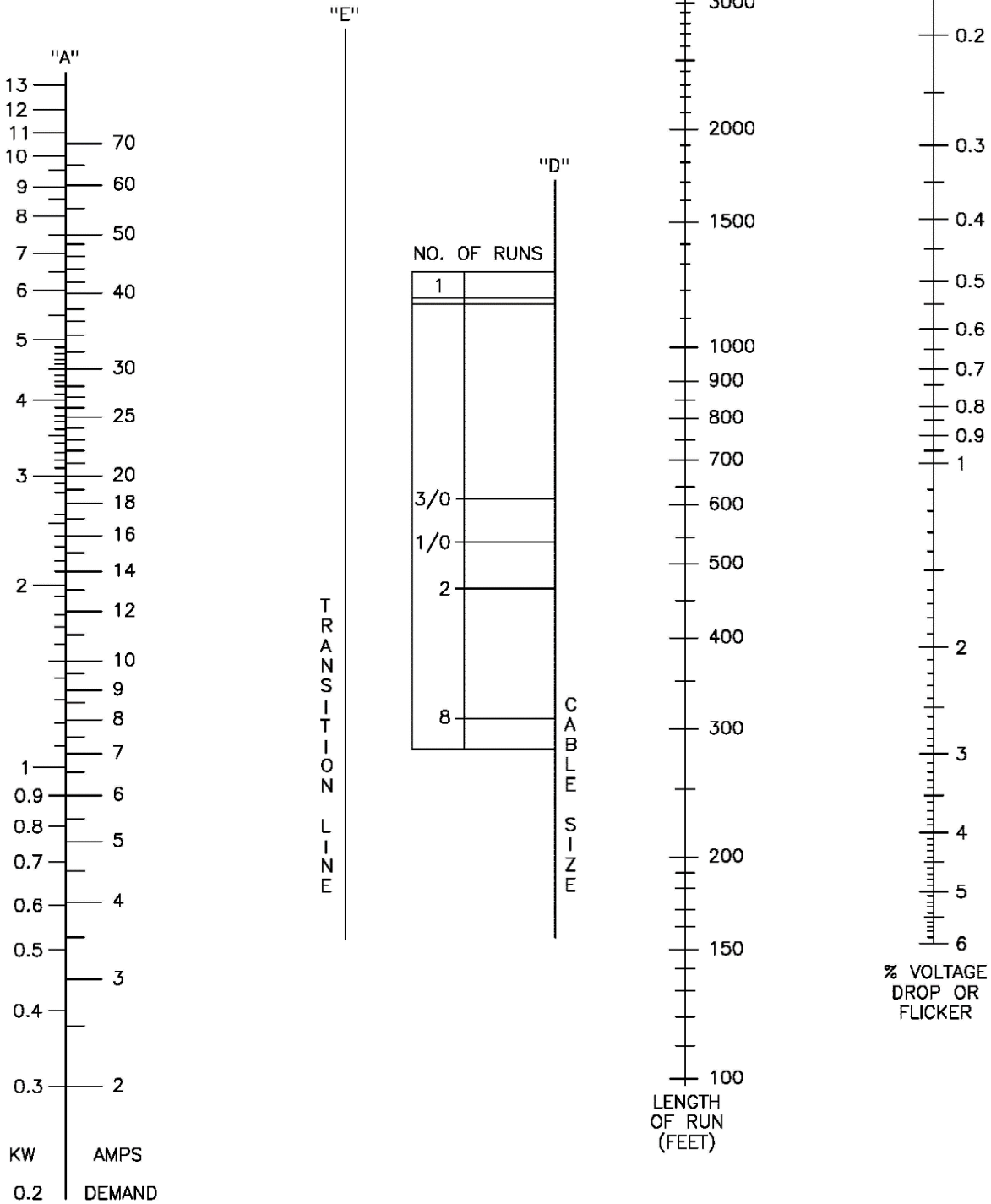

© 1998-2020 San Diego Gas & Electric Company. All rights reserved. Removal of this copyright notice without permission is not permitted under law.

REV	CHANGE	BY	DSGN	APPV	DATE	REV	CHANGE	BY	DSGN	APPV	DATE
C						F					
B	FORMATTING	JIK	-	-	02/21/2020	E					
A	ORIGINAL ISSUE	-	CVN	RDG	01/01/1994	D					

Indicates Latest Revision Completely Revised New Page Information Removed

SHEET
5 OF 5

SDG&E ELECTRIC DISTRIBUTION DESIGN MANUAL

**SINGLE-PHASE 120/240 V UNDERGROUND
STREET LIGHT NOMOGRAPH**

DM5431.5

PROCEDURES:

A. FOR AMPACITY AND VOLTAGE DROP:

1. PLACE STRAIGHTEDGE FROM LINE "A" (KW DEMAND OR AMPS) TO LINE "B" (LENGTH OF RUN).
2. WIRE REQUIRED FOR AMPACITY IS READ OFF TABLE BELOW.
3. FOR VOLTAGE DROP, PLACE STRAIGHTEDGE FROM INTERSECTION ON TRANSITION LINE "E" TO ALLOWED VOLTAGE DROP ON LINE "C". THE CABLE REQUIRED IS READ ABOVE STRAIGHTEDGE ON LINE "D".

B. FOR FLICKER:

1. PLACE STRAIGHTEDGE FROM LINE "A" (AIR CONDITIONER LOAD) TO LINE "B" (LENGTH OF RUN).
2. PLACE STRAIGHTEDGE FROM INTERSECTION ON TRANSITION LINE "E" TO REMAINING ALLOWABLE FLICKER % (TOTAL ALLOW % - TRANSFORMER % = REMAIN ALLOW %) ON LINE "C". THE CABLE REQUIRED IS READ ABOVE STRAIGHTEDGE ON LINE "D".

NOTE: RACK CONSTRUCTION PRODUCES LOWER VOLTAGE DROP THAN CROSS-ARM CONSTRUCTION DUE TO THE SHORTER DISTANCE BETWEEN CONDUCTORS.

SEE PAGES 5411.1-5411.6 FOR INSTRUCTIONS ON HOW TO SIZE CABLE FOR COMPOUND OR COMPLEX SYSTEMS.

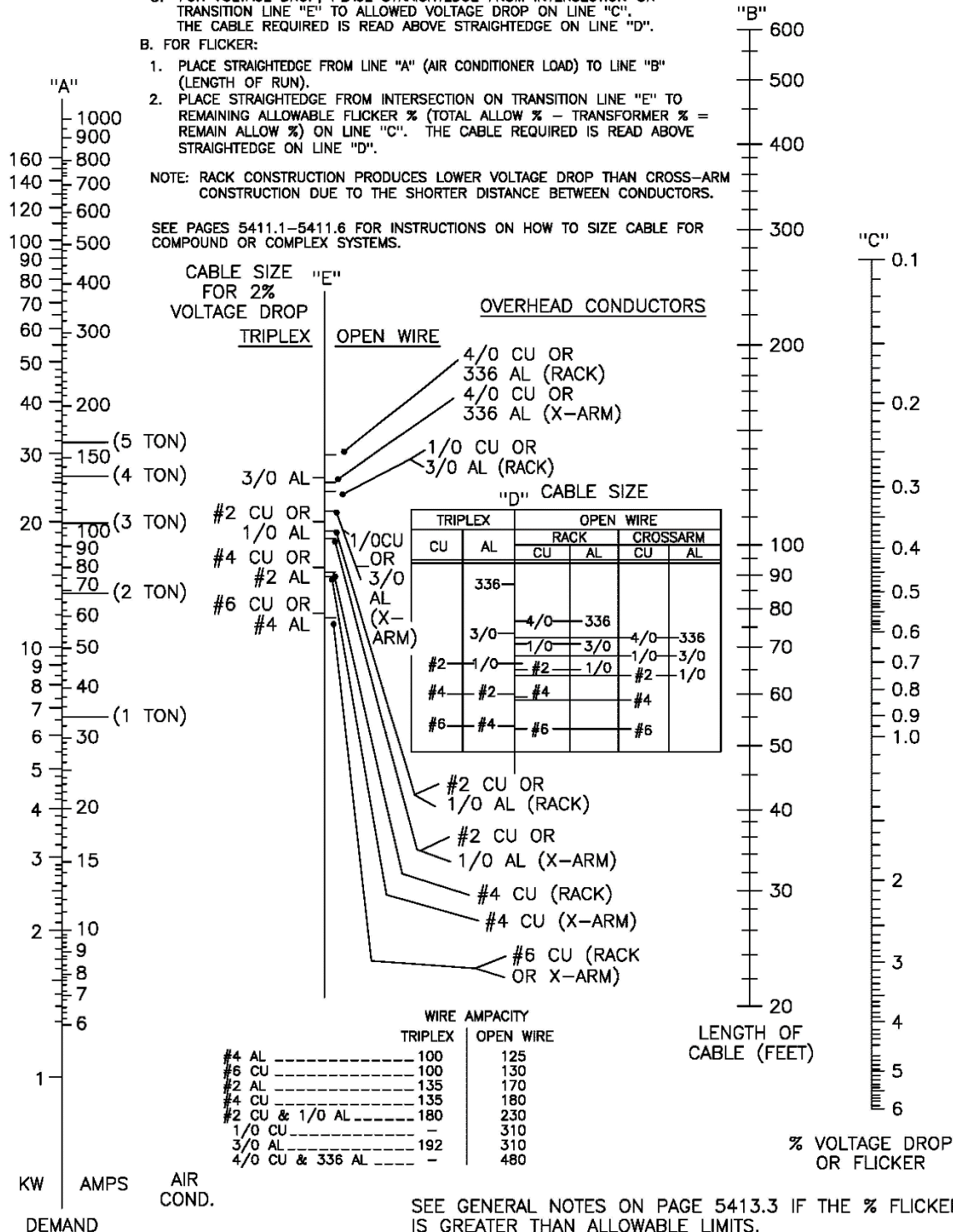

SEE GENERAL NOTES ON PAGE 5413.3 IF THE % FLICKER IS GREATER THAN ALLOWABLE LIMITS.

© 1998-2020 San Diego Gas & Electric Company. All rights reserved. Removal of this copyright notice without permission is not permitted under law.

REV	CHANGE	BY	DSGN	APPV	DATE	REV	CHANGE	BY	DSGN	APPV	DATE
C						F					
B	FORMATTING	JIK	-	-	02/21/2020	E					
A	ORIGINAL ISSUE	-	CVN	RDG	01/01/1990	D					

SHEET 1 OF 4

Indicates Latest Revision | Completely Revised | New Page | Information Removed

SDG&E ELECTRIC DISTRIBUTION DESIGN MANUAL

SINGLE-PHASE 120/240V OVERHEAD VOLTAGE DROP AND FLICKER NOMOGRAPH

DM5432.1

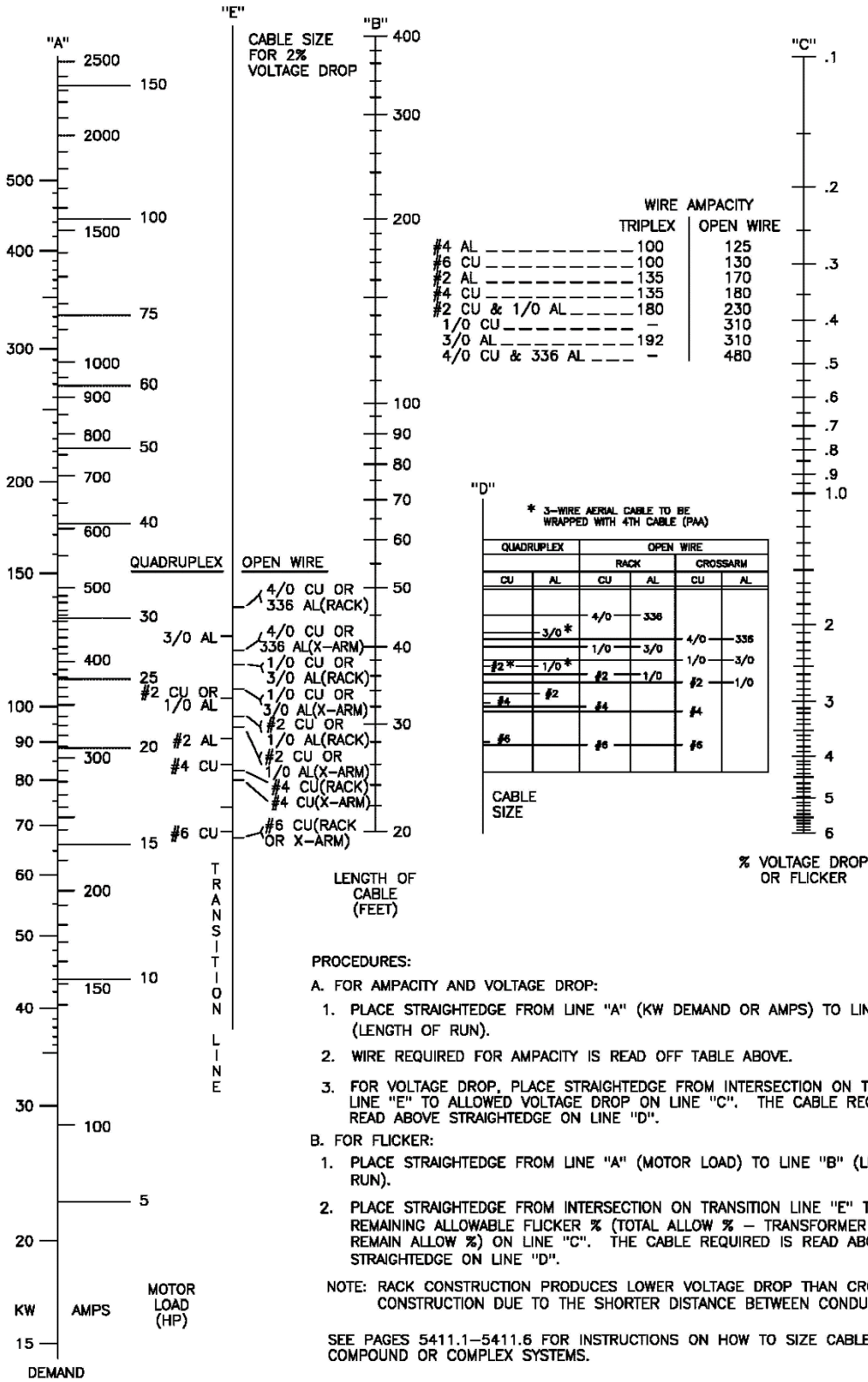

PROCEDURES:

- A. FOR AMPACITY AND VOLTAGE DROP:**
1. PLACE STRAIGHTEDGE FROM LINE "A" (KW DEMAND OR AMPS) TO LINE "B" (LENGTH OF RUN).
 2. WIRE REQUIRED FOR AMPACITY IS READ OFF TABLE ABOVE.
 3. FOR VOLTAGE DROP, PLACE STRAIGHTEDGE FROM INTERSECTION ON TRANSITION LINE "E" TO ALLOWED VOLTAGE DROP ON LINE "C". THE CABLE REQUIRED IS READ ABOVE STRAIGHTEDGE ON LINE "D".
- B. FOR FLICKER:**
1. PLACE STRAIGHTEDGE FROM LINE "A" (MOTOR LOAD) TO LINE "B" (LENGTH OF RUN).
 2. PLACE STRAIGHTEDGE FROM INTERSECTION ON TRANSITION LINE "E" TO REMAINING ALLOWABLE FLICKER % (TOTAL ALLOW % - TRANSFORMER % = REMAIN ALLOW %) ON LINE "C". THE CABLE REQUIRED IS READ ABOVE STRAIGHTEDGE ON LINE "D".

NOTE: RACK CONSTRUCTION PRODUCES LOWER VOLTAGE DROP THAN CROSS-ARM CONSTRUCTION DUE TO THE SHORTER DISTANCE BETWEEN CONDUCTORS.

SEE PAGES 5411.1-5411.6 FOR INSTRUCTIONS ON HOW TO SIZE CABLE FOR COMPOUND OR COMPLEX SYSTEMS.

SEE GENERAL NOTES ON PAGE 5413.3 IF THE % FLICKER IS GREATER THAN ALLOWABLE LIMITS.

© 1998-2020 San Diego Gas & Electric Company. All rights reserved. Removal of this copyright notice without permission is not permitted under law.

REV	CHANGE	BY	DSGN	APPV	DATE	REV	CHANGE	BY	DSGN	APPV	DATE
C						F					
B	FORMATTING	JIK	-	-	02/21/2020	E					
A	ORIGINAL ISSUE	-	CVN	RDG	01/01/1990	D					

X Indicates Latest Revision Completely Revised New Page Information Removed

SDG&E ELECTRIC DISTRIBUTION DESIGN MANUAL

SHEET
2 OF 4

**THREE PHASE 120/208Y OVERHEAD VOLTAGE DROP
AND FLICKER NOMOGRAPH**

DM5432.2

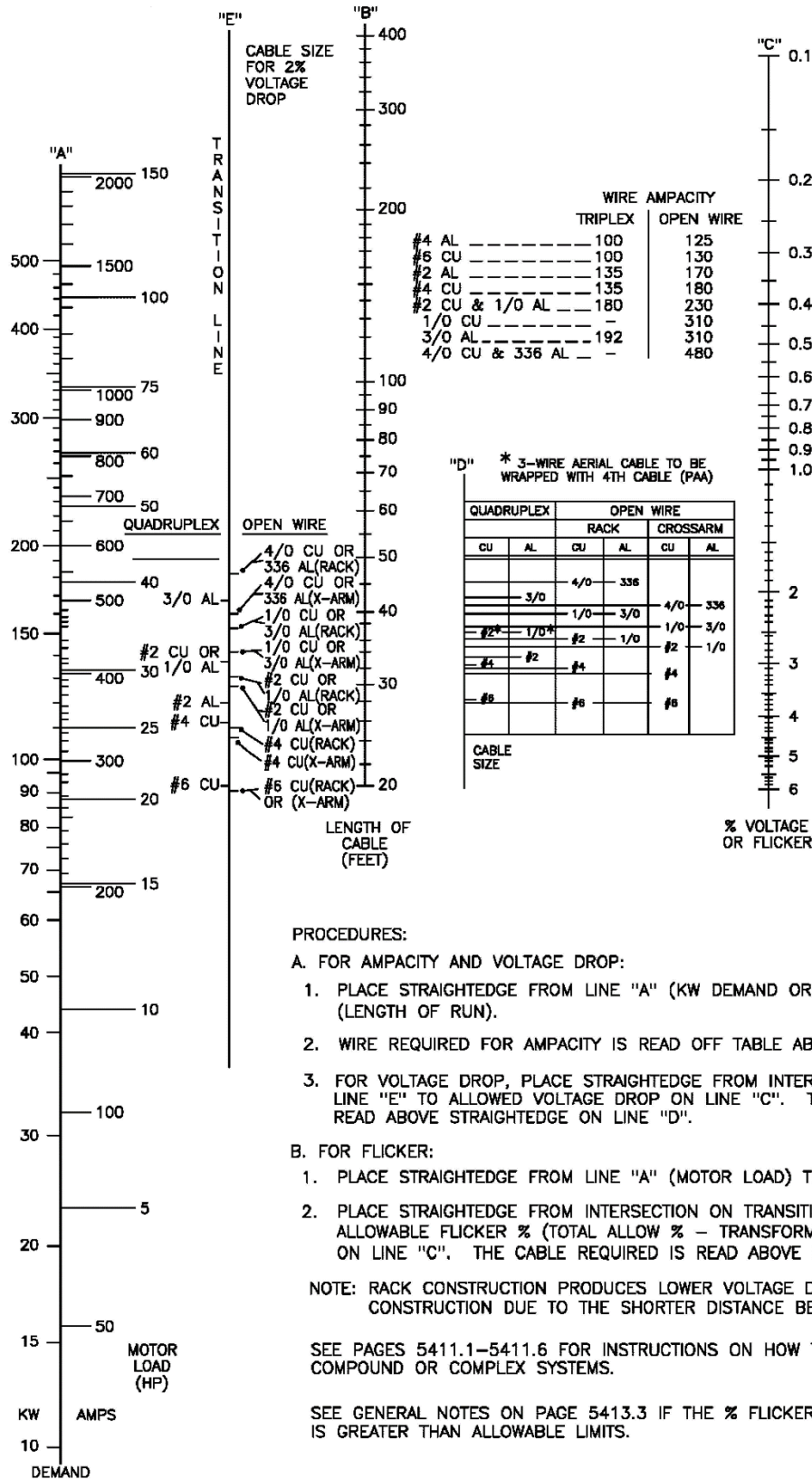

© 1998-2020 San Diego Gas & Electric Company. All rights reserved. Removal of this copyright notice without permission is not permitted under law.

REV	CHANGE	BY	DSGN	APPV	DATE	REV	CHANGE	BY	DSGN	APPV	DATE
C						F					
B	FORMATTING	JIK	-	-	02/21/2020	E					
A	ORIGINAL ISSUE	-	CVN	RDG	01/01/1990	D					

X Indicates Latest Revision Completely Revised New Page Information Removed

SHEET
3 OF 4

SDG&E ELECTRIC DISTRIBUTION DESIGN MANUAL

**THREE PHASE 120/240V OVERHEAD VOLTAGE DROP
AND FLICKER NOMOGRAPH**

DM5432.3

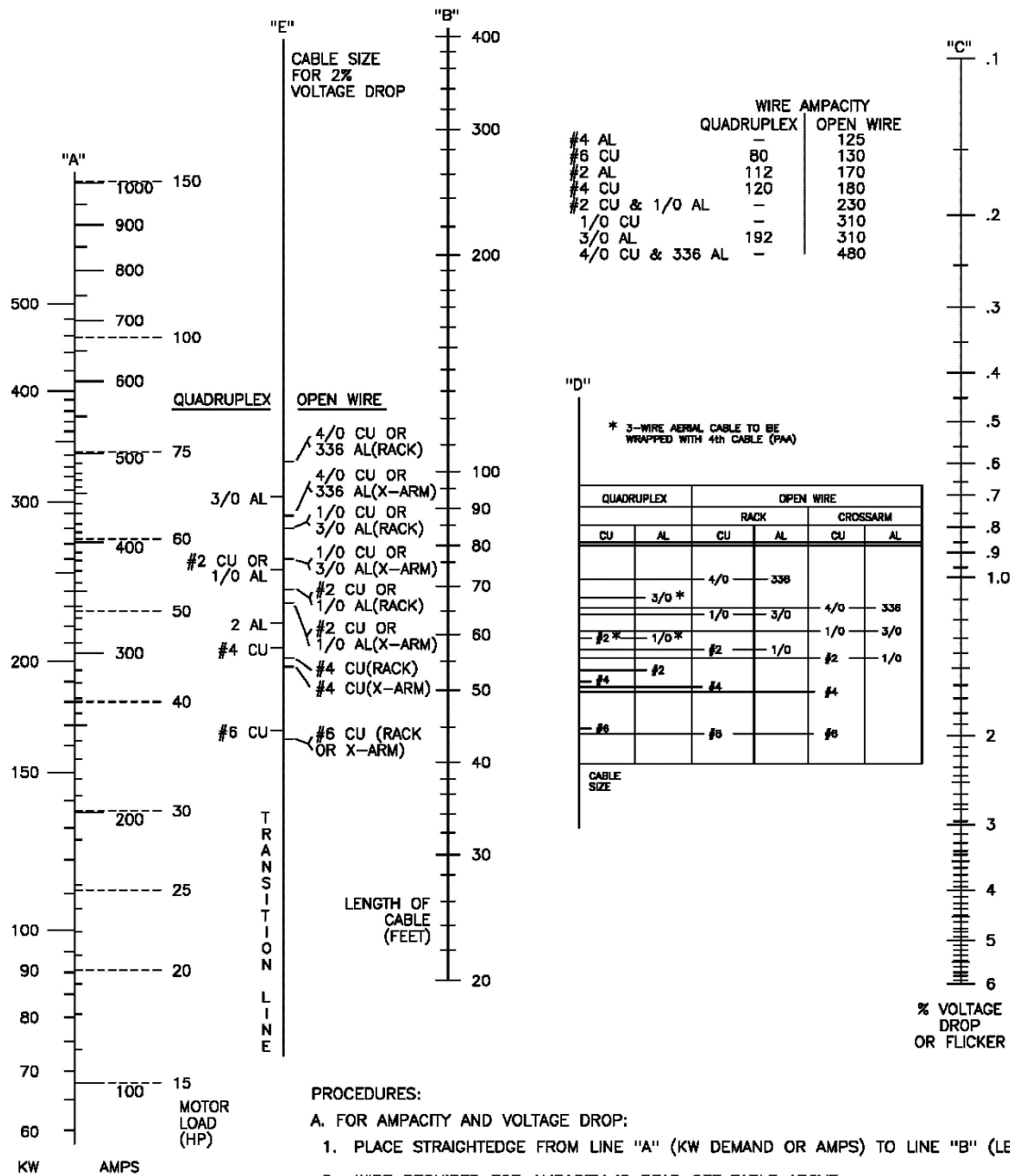

PROCEDURES:

A. FOR AMPACITY AND VOLTAGE DROP:

1. PLACE STRAIGHTEDGE FROM LINE "A" (KW DEMAND OR AMPS) TO LINE "B" (LENGTH OF RUN).
2. WIRE REQUIRED FOR AMPACITY IS READ OFF TABLE ABOVE.
3. FOR VOLTAGE DROP, PLACE STRAIGHTEDGE FROM INTERSECTION ON TRANSITION LINE "E" TO ALLOWED VOLTAGE DROP ON LINE "C". THE CABLE REQUIRED IS READ ABOVE STRAIGHTEDGE ON LINE "D".

B. FOR FLICKER:

1. PLACE STRAIGHTEDGE FROM LINE "A" (MOTOR LOAD) TO LINE "B" (LENGTH OF RUN).
2. PLACE STRAIGHTEDGE FROM INTERSECTION ON TRANSITION LINE "E" TO REMAINING ALLOWABLE FLICKER % (TOTAL ALLOW % - TRANSFORMER % = REMAIN ALLOW %) ON LINE "C". THE CABLE REQUIRED IS READ ABOVE STRAIGHTEDGE ON LINE "D".

NOTE: RACK CONSTRUCTION PRODUCES LOWER VOLTAGE DROP THAN CROSS-ARM CONSTRUCTION DUE TO THE SHORTER DISTANCE BETWEEN CONDUCTORS.

SEE GENERAL NOTES ON PAGE 5413.3 IF THE % FLICKER IS GREATER THAN ALLOWABLE LIMITS.

© 1998-2020 San Diego Gas & Electric Company. All rights reserved. Removal of this copyright notice without permission is not permitted under law.

REV	CHANGE	BY	DSGN	APPV	DATE	REV	CHANGE	BY	DSGN	APPV	DATE
C						F					
B	FORMATTING	JIK	-	-	02/21/2020	E					
A	ORIGINAL ISSUE	-	CVN	RDG	01/01/1991	D					

X Indicates Latest Revision Completely Revised New Page Information Removed

SHEET
4 OF 4

SDG&E ELECTRIC DISTRIBUTION DESIGN MANUAL

**THREE PHASE 480 OVERHEAD VOLTAGE DROP
AND FLICKER NOMOGRAPH**

DM5432.4

**5500
CONDUCTOR
AMPACITIES**

**5500
CONDUCTOR
AMPACITIES**

PAGE(S)

SUBJECT

5521

Feeder Cable Ampacities Based on Thermal Loading Limits

5521.1

Definitions, Table of Ampacity Limits Required to Use Standard

5521.2

Conversion Table Between Different Conductor Size and Type

5521.2 – 5521.4

Examples

5521.5 – 5521.7

Cable Ampacity Graphs

5522

Cable Ampacity Program

5522.1

Definitions, Daily Load Factor

5522.2 – 5522.3

S/C Ratio, Soil Resistivity, Soil Temperature, Program Operation

© 1998-2021 San Diego Gas & Electric Company. All rights reserved. Removal of this copyright notice without permission is not permitted under law.

REV	CHANGE	BY	DSGN	APPV	DATE	REV	CHANGE	BY	DSGN	APPV	DATE
C						F					
B	FORMATTING	MBL	FRC	CZH	02/19/2021	E					
A	ORIGINAL	-	JCE	VCR	03/01/2002	D					

SHEET 1 OF 1	Indicates Latest Revision	X Completely Revised	New Page	Information Removed	DM5501.1
	SDG&E ELECTRIC DISTRIBUTION DESIGN MANUAL				
	TABLE OF CONTENTS CONDUCTOR AMPACITIES				

SCOPE:

This standard provides a graphical methodology for determining normal and emergency underground cable ampacity ratings dependent on system characteristics. The graphs provide the cable rating of the underground feeder in question when the loads in the neighboring feeders are given. A computer program is available that will provide more precise cable ampacity calculations. A guide to using this program is described in Design Standard 5522.

Note: Refer to Design Standard 6241 for primary conductor economic loading limits.

DEFINITIONS

Circuit in Question – the circuit with the desired ampacity rating.

Neighboring Circuit(s) – all circuits in the duct bank other than the one in question.

Emergency Cable Ampacity Rating – elevated cable rating assuming load will be returned to normal within 12 hours.

ASSUMPTIONS

–Position with respect to earth

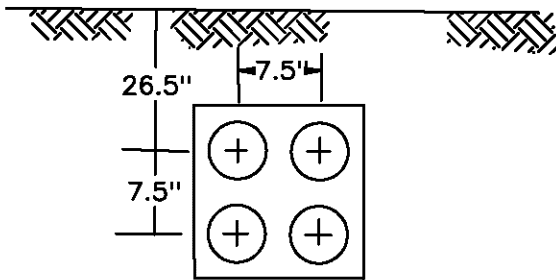

- Conduit size = 5 inches
- S/C = 0.100 (SEE 5522.2)
- Soil Resistivity = 120° C–cm/W
- Soil Temperature = 25° C
- Concrete Encased Conduit
- Concrete Resistivity = 85° C cm/W
- Load Factor = 0.6
- Cable Temp = 90° C

Results were obtained by running the Underground Cable Ampacity Program (EE321) and using the above assumptions. For a more detailed description of this program see Design Standard 5522.

- (1) If any of the neighboring circuits have a higher loading than listed below, use the computer program to determine allowable cable ampacity. Do not use the Cable Ampacity Graphs.

TABLE 1 *

# Circuits in Bank	Aluminum Cable			Copper Cable	
	1000 kcmil	750 kcmil	350 kcmil	500 kcmil	#4/0 Cable
2	580 amps	500 amps	320 amps	450 amps	275 amps
3	530 amps	455 amps	300 amps	410 amps	255 amps
4	490 amps	425 amps	280 amps	390 amps	240 amps

* Ampacity values provided are per circuit

	<input checked="" type="checkbox"/> Indicates Latest Revision	<input type="checkbox"/> Completely Revised	<input type="checkbox"/> New Page
REVISION	SDG&E DISTRIBUTION DESIGN MANUAL		
DATE 3-1-02	FEEDER CABLE AMPACITIES BASED ON THERMAL LOADING LIMITS		
APPD JCE/vcl	5521.1		

(2) Are all the conductors in the bank the same size and type?

The graphs were made assuming that each circuit had the same size and type conductor as the circuit in question. If one or more circuits are not the same size or type, multiply the load in those circuits by their respective correction factors as listed in table 2, and use these values in the weighted average calculation.

TABLE 2

Convert to	From	Multiply by
#4/0 CU	500 kcmil CU	0.654
350 kcmil AL	750 kcmil AL	0.685
350 kcmil AL	1000 kcmil AL	0.621
500 kcmil CU	#4/0 CU	1.54
750 kcmil AL	1000 kcmil AL	0.862
750 kcmil AL	350 kcmil AL	1.54
1000 kcmil AL	350 kcmil AL	1.78
1000 kcmil AL	750 kcmil AL	1.16

Note: The development of factors to convert from AL to CU and vice-versa was found to be impractical. Use the computer program whenever CU and AL are used together.

(3) Are the currents in the neighboring circuits equal to each other?
(Not applicable if there is only one neighboring circuit).

If the load in the neighboring circuits is similar (within approximately 10 percent of each other), use the highest neighboring circuit load.

For more accurate results of any combination of loads it is better to use a weighted average of neighboring circuit loads.

For 2 neighboring circuits: Weighted Average =
$$\left[\frac{I_1^4 + I_2^4}{2} \right]^{1/4}$$

For 3 neighboring circuits: Weighted Average =
$$\left[\frac{I_1^4 + I_2^4 + I_3^4}{3} \right]^{1/4}$$

EXAMPLE 1

I₁ = 400 A
1000 kcmil AL

I₂ = 400 A
1000 kcmil AL

I₃ = ?
1000 kcmil AL

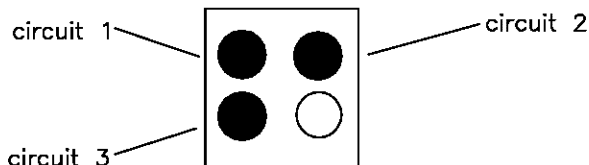

FIND - Ampacity and emergency rating of circuit 3.

	Indicates Latest Revision	Completely Revised	New Page
5521.2	SDG&E DISTRIBUTION DESIGN MANUAL		REVISION
	FEEDER CABLE AMPACITIES BASED ON THERMAL LOADING LIMITS		DATE 9-4-84 APPD CVN <i>[Signature]</i>

SOLUTION - From Table 1 on page 5521.1 we see that for a 1000 kcmil AL cable in a system with 3 circuits, the maximum allowable load is 530 amps. Therefore, for a neighboring circuit load of 400 amps, the graphs may be used to find a rating for the circuit in question (5521.6 - 3 circuits).

Load in neighboring circuits = 400 A
 Ampacity of circuit in question = 570 A
 Emergency rating = 650 A

EXAMPLE 2

$I_1 = 850 \text{ A}$ Twinned Circuit 1000 kcmil AL	$I_2 = 200 \text{ A}$ 750 kcmil	$I_3 = ?$ 750 kcmil
---	------------------------------------	------------------------

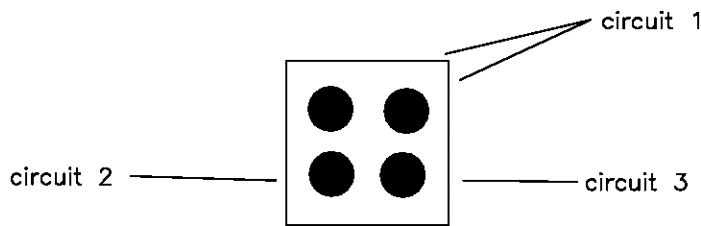

FIND - Ampacity and emergency rating of circuit 4

SOLUTION

- Assume twinned circuit is two separate circuits of 425 A each.
- Table 1 on page 5521.1 indicates that 425 A in 1000 kcmil AL and 200 A in 750 kcmil AL is less or equal to program assumptions given by table 1 and, therefore, the graphs may be used.

Converting neighboring conductors:

Using Table 2:

To convert to 750 kcmil cable from 1000 kcmil cable, multiply the load in the 750 kcmil cable by 0.862

$$I_{1000} = 425 \text{ A}$$

$$I_{1000} \text{ (simulated 750)} = (425 \times 0.862) = 366 \text{ A}$$

This means that 425 A in 1000 kcmil AL supplies as much heat as 366 A in 750 kcmil AL.

The neighboring circuits now have same size conductors as the circuit in question.

	Indicates Latest Revision	Completely Revised	New Page
REVISION	SDG&E DISTRIBUTION DESIGN MANUAL		
DATE 1-1-89	FEEDER CABLE AMPACITIES BASED ON THERMAL LOADING LIMITS		5521.3
APPD CVN / <i>[Signature]</i>			

- Find weighted average of loads in neighboring circuits:



$$\begin{aligned} \text{Weighted Average} &= \left[\frac{I_1^4 + I_2^4 + I_3^4}{3} \right]^{1/4} \\ &= \left[\frac{366^4 + 366^4 + 200^4}{3} \right]^{1/4} \\ &= 334 \text{ Amps} \end{aligned}$$

Using the 4 Circuits - Aluminum Conductors Graph:

<p>Ampacity of circuit 3 = 465 A Emergency rating = 545 A</p>

References:

Computer Program EE321, Underground Cable Ampacities and Temperatures Program
Design Standard 6241, Primary Conductor Cost Comparison

	 Indicates Latest Revision	Completely Revised	New Page
5521.4	SDG&E DISTRIBUTION DESIGN MANUAL		REVISION
	FEEDER CABLE AMPACITIES BASED ON THERMAL LOADING LIMITS		DATE 1-1-89 APPD CVN / 

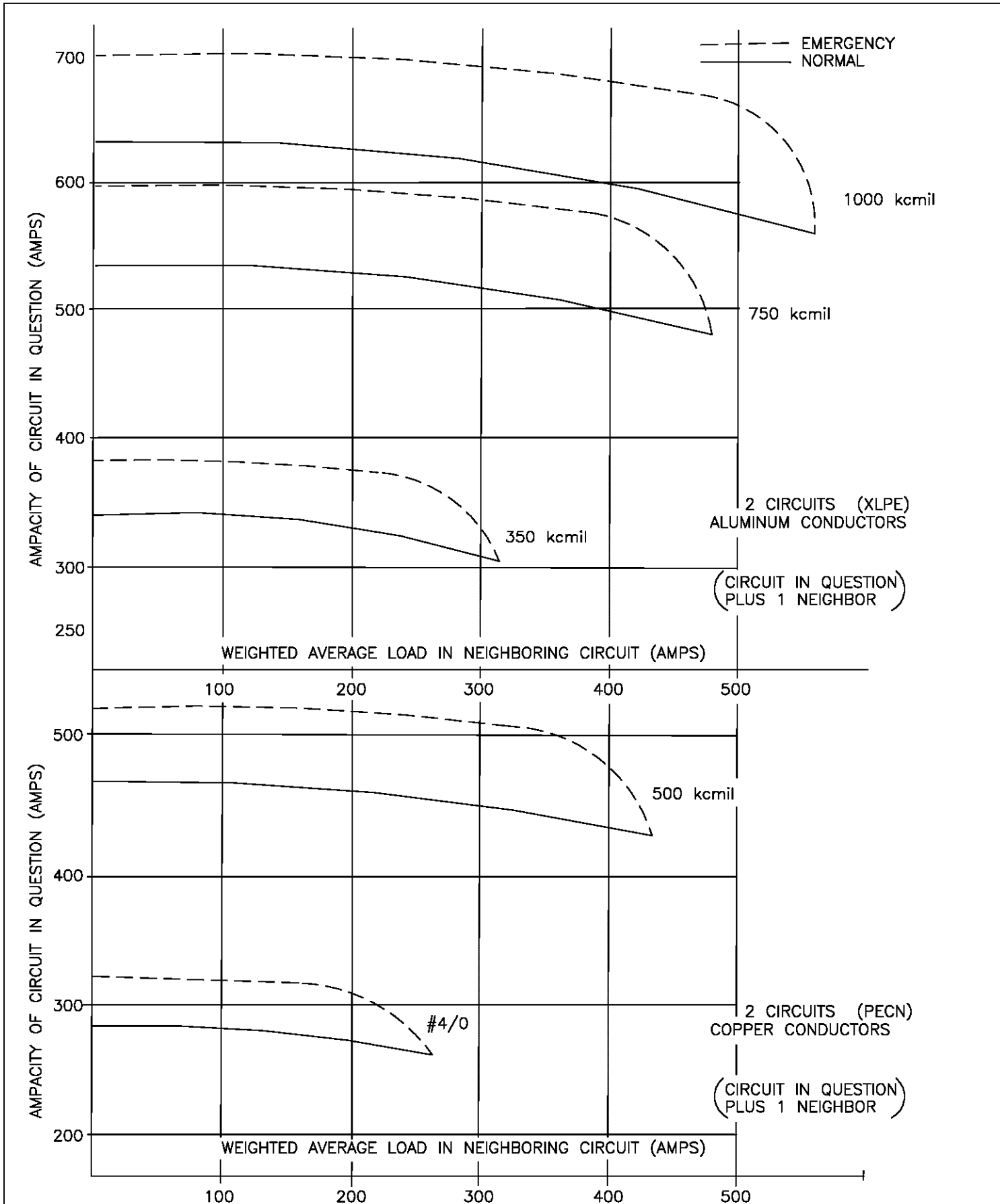

 Indicates Latest Revision	Completely Revised	New Page
---	--------------------	----------

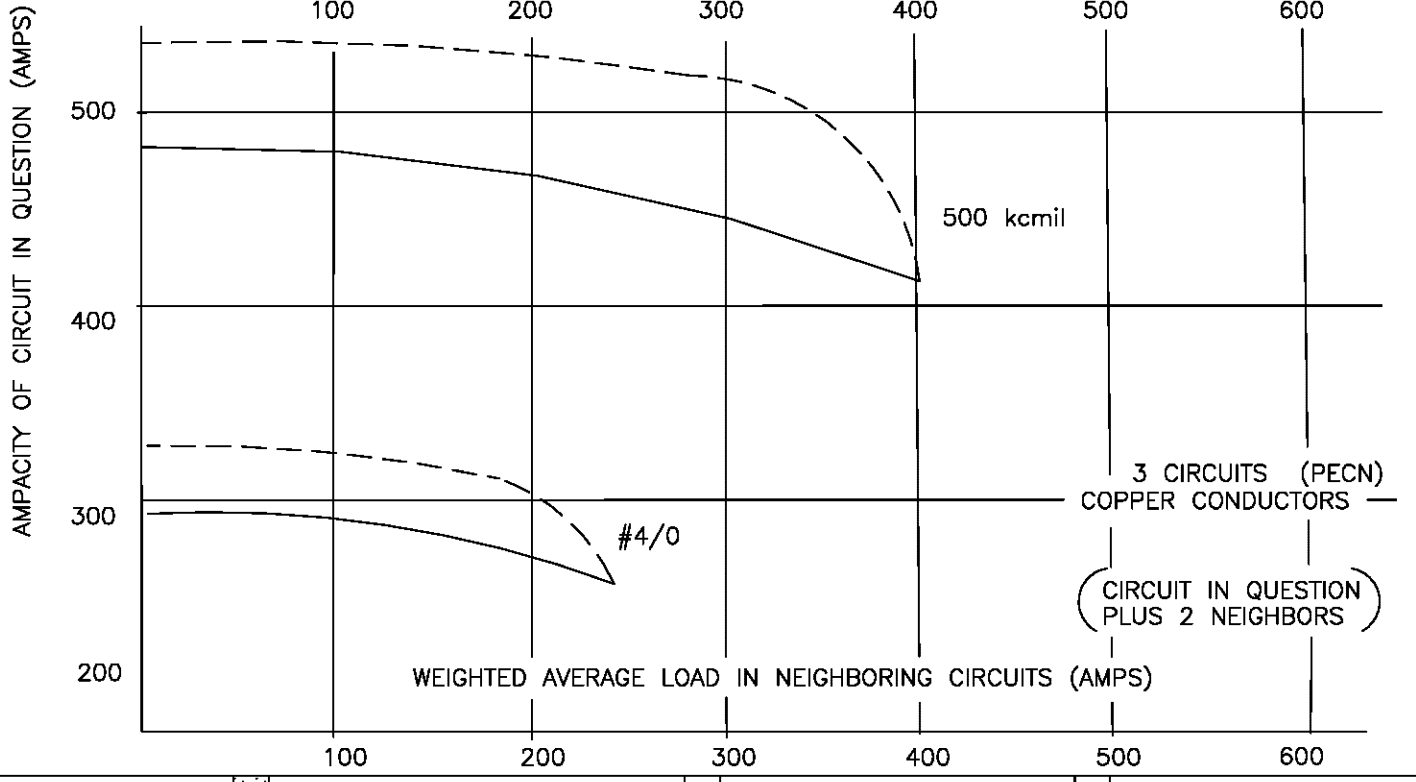
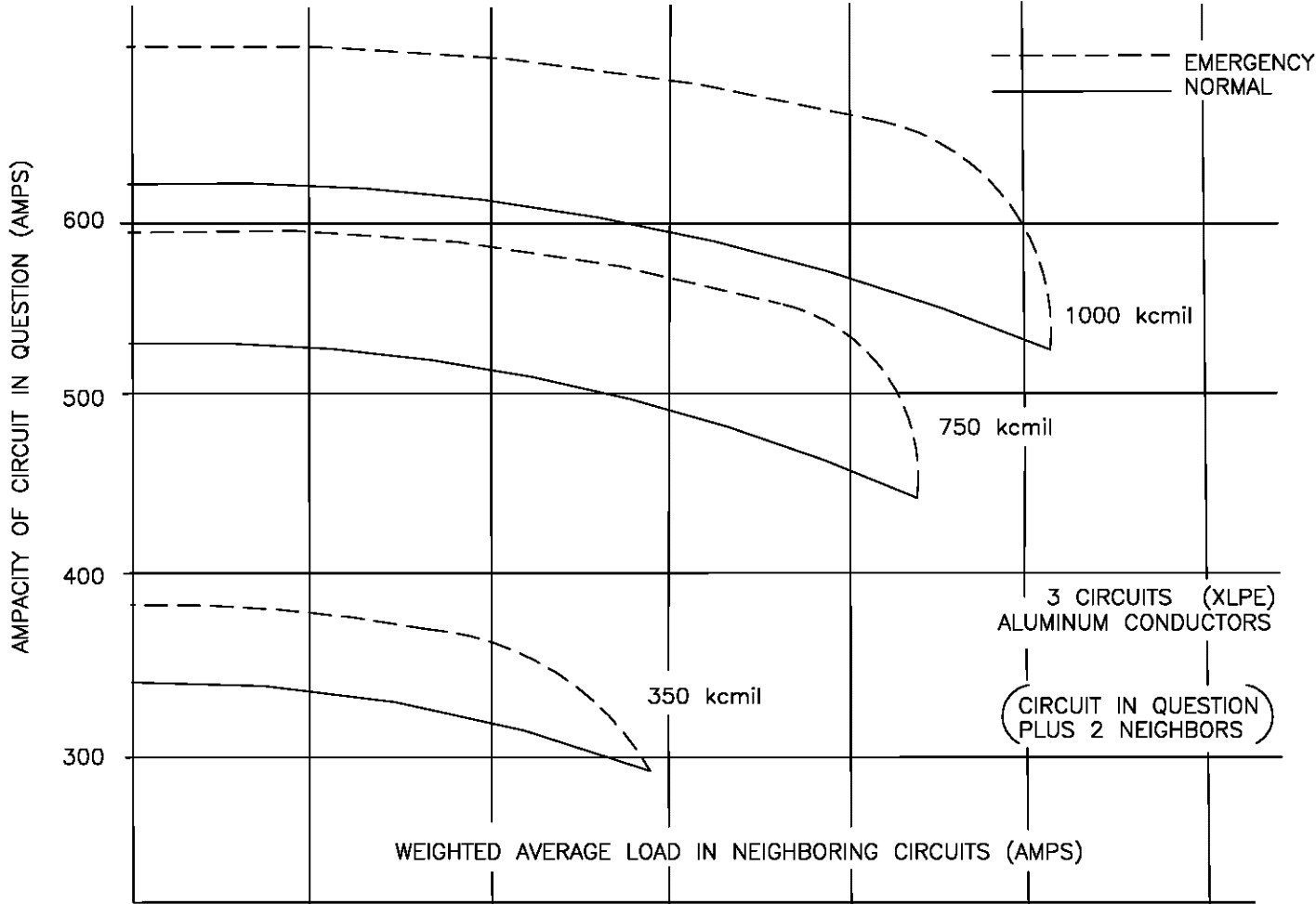

Indicates Latest Revision
 Completely Revised
 New Page

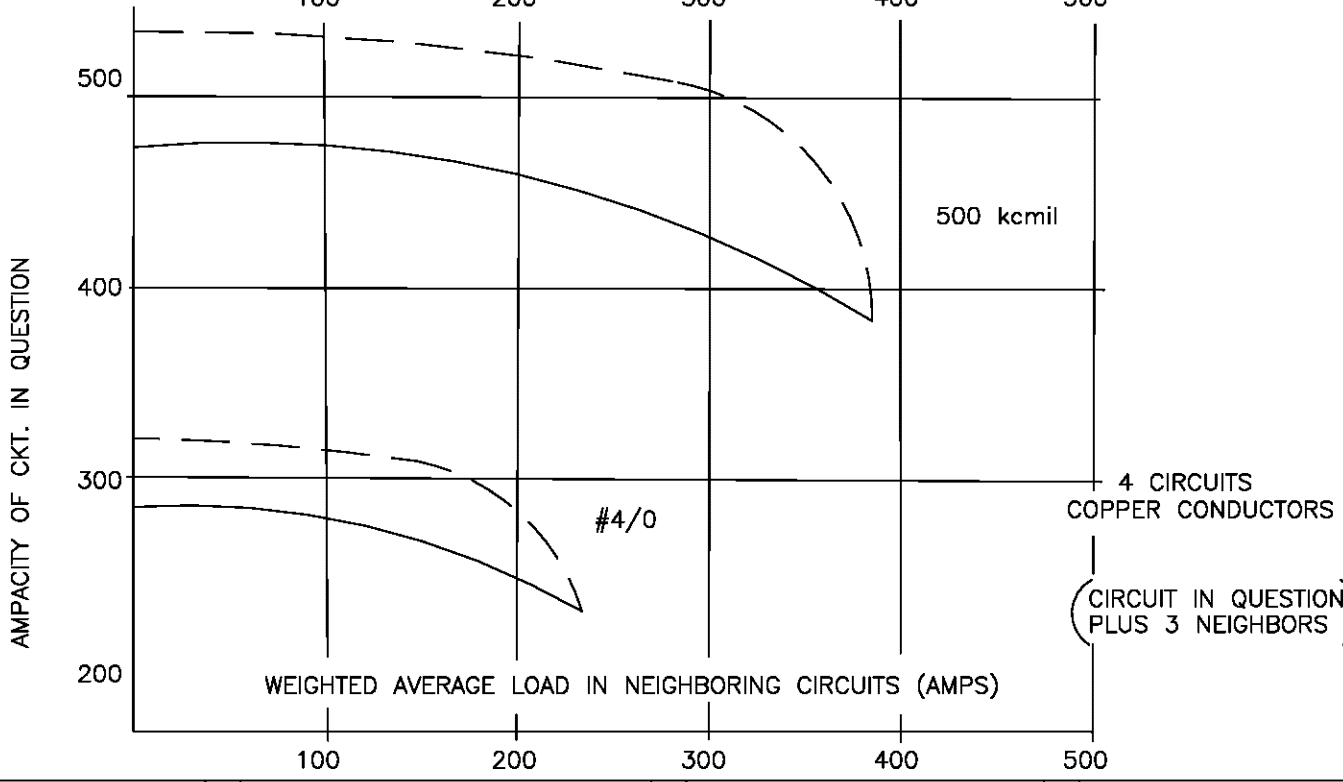
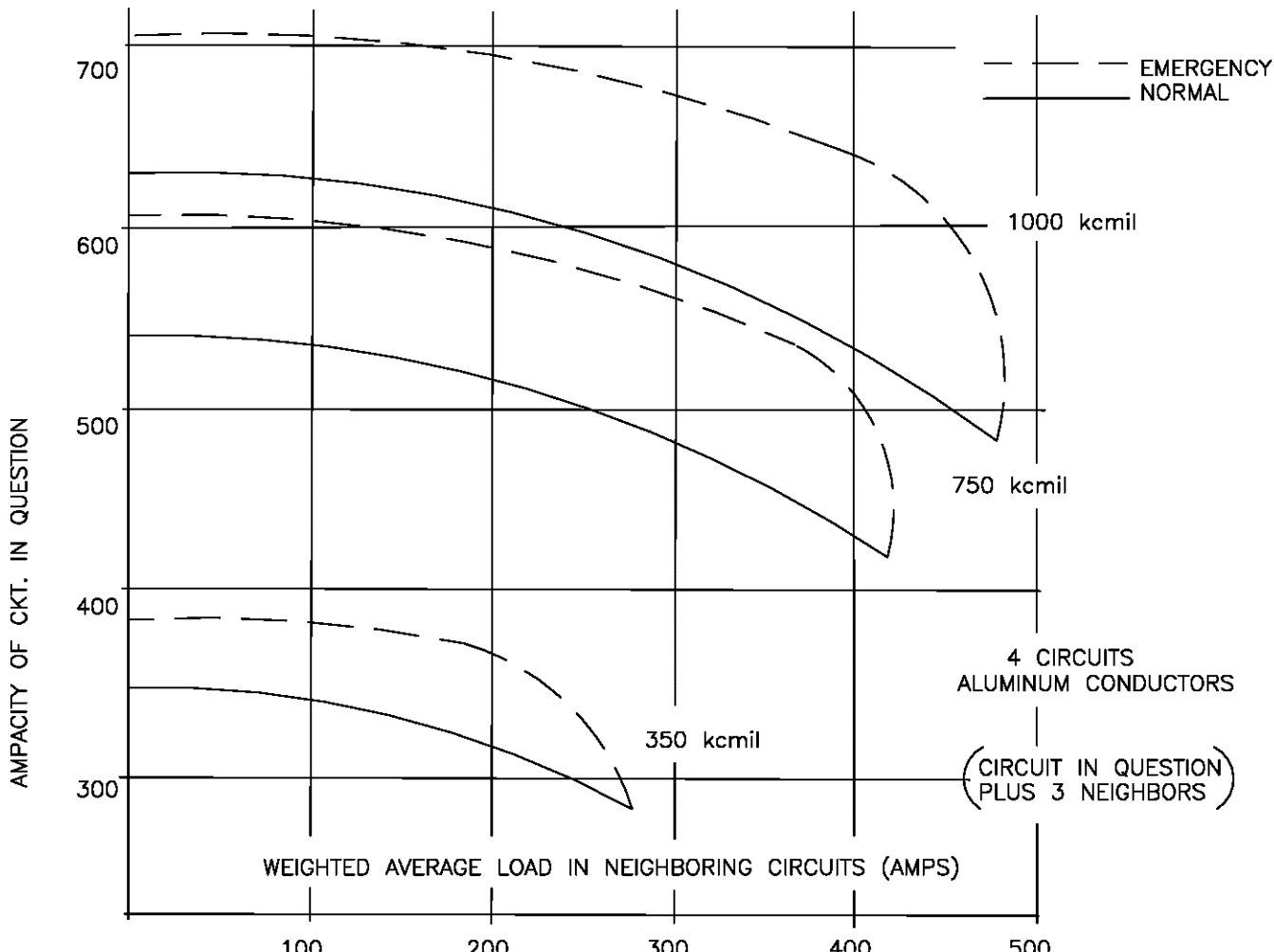

Indicates Latest Revision Completely Revised New Page

SCOPE

This standard provides a guide to using SDG&E’s Cable Ampacity computer program. An explanation of the factors that limit cable ampacity and the sensitivity of changing different inputs is discussed

PURPOSE

This standard is provided so the user can understand how to properly use the Cable Ampacity Program.

DEFINITIONS

Cable Ampacity Program – Provides steady state and emergency current values. These are discussed below:

NOTE: The PC version of the cable ampacity program provides cable operating temperatures corresponding to the user specified currents. The cable operating temperature can then be compared to the thermal limits of the cables. The PC version also provides the maximum allowable current for a particular cable in a duct package corresponding to the user specified operating temperature and currents for all other cables. The PC version of the cable ampacity program can be run as a DOS-based or “Excel in Visual Basic” application.

<u>Cable Type</u>	<u>Standard Thermal Unit</u>	<u>Thermal Unit</u>
XLPE, XLPE-PEJ, EPR-PEJ	90°C	109°C
HMWPE	75°C	89°C
PILC (Lead)	90°C	

Daily Load Factor – Average load for a 24 hour period divided by the peak load in the period. The program default value of .6 should be used when the actual daily load factor can not be determined. A load factor change can have a significant impact on the allowable conductor loading. On SCADA circuits, the actual load factor projected for adverse-peak operation should be calculated and used in the ampacity program.

S/C Ratio – Ratio of Shield wire current to conductor current. Typical value are:

<u>Cable Type</u>	<u>S/C Ratio</u>
1 – 1/C Local Distribution	.75
2 – 1/C Local Distribution	.25
3 – 1/C Local Distribution	.25
3 – 1/C Feeder	.10

- A. In special cases where short term budget levels or timing does not allow correction overloads at the 90°C and 75°C level, these higher temperature ratings can be used until funding can be obtained. From a long range planning perspective, it is undesirable to use these higher temperature limits.

Conduit Depth – Distance to center of conduit that is closest to ground level. The program default value is 42 inches. The actual conduit depth should be used if known.

Soil Resistivity – Thermal ability of the soil to conduct heat. The program default value at 90°C cm/watt should be used in all areas except the desert where the dry sandy soil has a value of 160°C

Soil Temperature – Ambient soil temperature. The program default value of 25°C should be used in all areas except the desert where it is 30°C.

© 1998-2020 San Diego Gas & Electric Company. All rights reserved. Removal of this copyright notice without permission is not permitted under law.

REV	CHANGE	BY	DSGN	APPV	DATE	REV	CHANGE	BY	DSGN	APPV	DATE
C						F					
B						E					
A						D					
SHEET 1 OF 3		X Indicates Latest Revision		Completely Revised		New Page		Information Removed		DM5522.1	
		SDG&E ELECTRIC DISTRIBUTION DESIGN MANUAL									
		CABLE AMPACITY PROGRAM									

PVC Conduit Resistivity – Thermal ability of the PVC conduit to conduct heat. The program default value of 700°C cm/watt should be used in all areas.

Concrete Resistivity - 75°C cm/watt

PROGRAM OPERATION

A. DOS Based Program

1. Execute program "Ampac.exe"
2. Go to Ampac Main Menu
3. Enter General Input Data
4. Enter Duct Bank Input Data
5. Enter Circuit Input Data
6. Return to Main Menu
7. Run Program
 - a. Calculate steady state temperature for give currents (Option G)
 - b. Calculate maximum current for given temperature (Option H)
8. Repeat for all cables as necessary.

B. Excel in Visual Basic Program

1. Open "Current Ampacity Program.xls"
2. Enter General Data
3. Enter Duct Bank Data
4. Enter Circuit Data
5. Run Program (Calculates steady state temperatures and all individual cable maximum currents).

REFERENCES

SDG&E Publications:

- A. EE321INS.DATA – Cable ampacity program – Basic User’s Guide
- B. EE321DOC.DATA – Contains user’s guide and other information such as: example calculations, program equations, deviations and symbols, and instructions on how to add a cable.
- C. EE321CLI.CLIST – Listing of the CLIST that generates the menu panels.
- D. EE321V3.FORT – Complete listing of the FORTRAN program together with the CLIST, make up the EE321 cable ampacity program package.

NOTE: These may be obtained by the procedure described previously in this standard. EE321DOC.DATA is the one that is recommended for usage. The last two documents are for a programmer’s use only and are of little value to the normal user.

© 1998-2020 San Diego Gas & Electric Company. All rights reserved. Removal of this copyright notice without permission is not permitted under law.

REV	CHANGE	BY	DSGN	APPV	DATE	REV	CHANGE	BY	DSGN	APPV	DATE
C						F					
B	FORMATTING	JIK	-	-	02/21/2020	E					
A	ORIGINAL ISSUE	-	JCE	VCR	03/01/2002	D					

SHEET 2 OF 3	X Indicates Latest Revision	Completely Revised	New Page	Information Removed	DM5522.2
	SDG&E ELECTRIC DISTRIBUTION DESIGN MANUAL				
	CABLE AMPACITY PROGRAM				

REFERENCES CONT'D

IPCEA – NEMA Standards Publications:

- A. Ampacities including Effect of Shield Losses for Single Conductor Solid Dielectric Power Cable 15 KV Through 69 KV (Copper and Aluminum Conductors), IPCEA Publication P-53-426, NEMA Publication No. WC 50-1976.

AMPACITY EXCEL OWNER'S MANUAL

- A. Procedure for Adding Ampacity Program into Forecast Workbooks.

© 1998-2020 San Diego Gas & Electric Company. All rights reserved. Removal of this copyright notice without permission is not permitted under law.

REV	CHANGE	BY	DSGN	APPV	DATE	REV	CHANGE	BY	DSGN	APPV	DATE
C						F					
B	FORMATTING	JIK	-	-	02/21/2020	E					
A	ORIGINAL ISSUE	-	JCE	VCR	03/01/2002	D					

<p>SHEET 3 OF 3</p>	 Indicates Latest Revision	Completely Revised	New Page	Information Removed	<p>DM5522.3</p>
	<p>SDG&E ELECTRIC DISTRIBUTION DESIGN MANUAL</p>				
	<p>CABLE AMPACITY PROGRAM</p>				

5600
TRANSFORMERS

5600
TRANSFORMERS

<u>PAGE(S)</u>	<u>SUBJECT</u>
5611 5611.1 – 5611.3	Single-Phase Transformer Application: Balancing Transformers NDL & NDS Transformers Stainless Steel Transformer
5612.1 – 5612.2	Transformer Noise Criteria
5613	Three-Phase HKB Transformer Application
5614	Dedicated Transformers
5621 5621.1 5621.2 5621.3 – 5621.4	Initial Transformer Design Loading for Balanced Loads: Three-Phase Padmount, Single-Phase Padmount Single-Phase Polemount Open-Delta, Closed-Delta Examples
5625.1 – 5625.2	Transformer Replacement Guideline
5626.1 – 5626.2	Transformer Design Guideline for Fire Pumps
5641.1 – 5641.3	Voltage Regulator Application Guidelines

© 1998-2017 San Diego Gas & Electric Company. All rights reserved. Removal of this copyright notice without permission is not permitted under law.

REV	CHANGE	BY	DSGN	APPV	DATE	REV	CHANGE	BY	DSGN	APPV	DATE
A	EDITORIAL CHANGES	JCE	MBL	MDJ	10/16/2017	D					
B						E					
C						F					

SHEET 1 OF 1	X Indicates Latest Revision	Completely Revised	New Page	Information Removed	DM 5601
	SDG&E ELECTRIC DISTRIBUTION DESIGN MANUAL				
	TRANSFORMERS TABLE OF CONTENTS				

SCOPE

This standard establishes application criteria for single-phase transformer stations. It shall be used by District Engineers & Planners designing the distribution system.

CRITERIA

A. Balancing Policy

1. When connecting single-phase 12kV or 6.9kV transformers on a three phase system, they shall be connected such that:
 - a. The fuse sizing policies in section 6100 have been met.
 - b. The loads are balanced (a) within 150kVA per phase for all installations except fused elbows and (b) 25kVA for fused elbow installations.
 - c. 6.9kV (phase-neutral) UG laterals should be limited to 350kVA maximum. For more than 350kVA and less than 700kVA a 2nd. phase wire should be installed and the load split/balanced between the two phases. Greater than 700kVA requires a 3rd. phase with the load again being balanced.

These procedures have been established to reduce current imbalances that can cause improper operation of circuit fuses, substation relays and grounding banks. (See Design Standard 6212, "Effects of Voltage Unbalance on Customer Equipment".)

2. Balancing of 6.9kV Transformers

- a. When connecting 6.9kV transformers on a three-phase circuit they shall be balanced independently of any 12kV single-phase transformer connected on the circuit. This is due to the current and phase differences between the same kVA rated 12kV and 6.9kV transformers.
- b. Total single-phase loads connected on the 6.9kV transformer shall be equally divided on each of the three phases or within the criteria stated above, (i.e., total single-phase kVA/3 = load on each phase).
- c. Example
 - a. Total single-phase load = 150kVA
 - b. Equally divide load on each phase.
 $150/3 = 50\text{kVA}$ per phase
 - c. Six 25kVA transformers can be used if they are equally divided on the three phases.

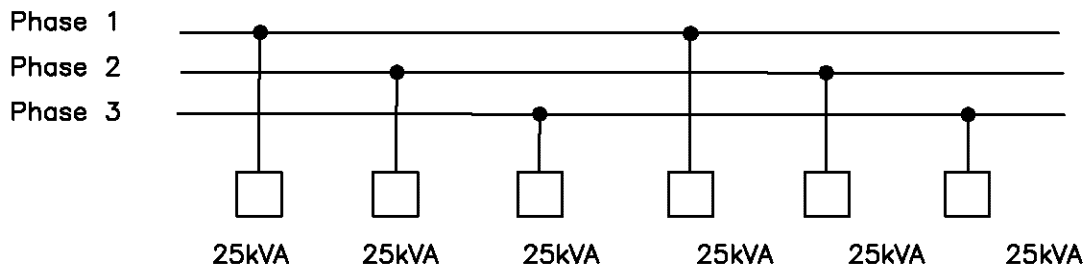

Indicates Latest Revision

Completely Revised

New Page

REVISION

SDG&E DISTRIBUTION DESIGN MANUAL

DATE 1-1-91

SINGLE-PHASE TRANSFORMER APPLICATION

APPD CVN/ROJ

5611.1

3. Balancing of 12kV Transformers

- a. When connecting 12kV transformers on a three-phase circuit they shall be balanced independent of any 6.9kV transformers connected on the circuit.
- b. Total single-phase loads connected on the 12kV transformers shall be equally divided between each of the three-phases or within the criteria stated in "A" of page 5611-1. (i.e. total single-phase kVA/3 = load between phases 1 and 2, 2 and 3, and 3 and 1).

C. Example:

- a. Total single-phase load = 75kVA
- b. Equally divide load between each phase.
 $75/3 = 25\text{kVA}$ between phases.
- c. Three 25kVA transformers should be used if equally divided between the three phases.

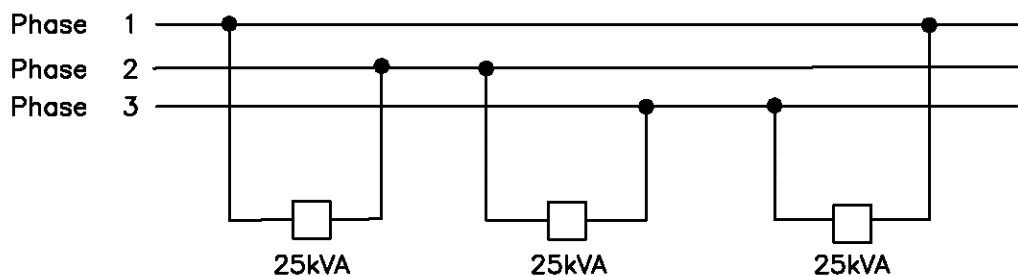

B. Application Of Three-Way Loop, 6.9kV Transformers

1. A single-phase transformer with three primary bushings, prefix NDL & NDS, should be used to serve load in two directions from one transformer. This transformer has provisions for an incoming line, an outgoing line, and a tap line. Refer to Underground Construction Standard 3711. The basic purpose of this transformer is to avoid the cost of installing underground facilities necessary to branch a single phase circuit in two directions.
2. The tap position of the transformer must not serve more than three (3) additional transformers. This is to avoid long outages to a large number of customers, when changing out an NDL & NDS transformer.
3. The balancing policy of this standard must also be met when applying NDL & NDS transformers.

Indicates Latest Revision

Completely Revised

New Page

5611.2

SDG&E DISTRIBUTION DESIGN MANUAL

SINGLE-PHASE TRANSFORMER APPLICATION

REVISION

DATE 3-1-02

APPD JCE / *[Signature]*

C. Application of Stainless Steel Transformers

Effective January 1, 2002 all single-phase padmount transformers purchased will be 100% stainless steel. These transformers will be used for all new installations and when replacing corroded single-phase padmount transformers.

	<input checked="" type="checkbox"/> Indicates Latest Revision	<input type="checkbox"/> Completely Revised	<input checked="" type="checkbox"/> Information Removed
REVISION	SDG&E DISTRIBUTION DESIGN MANUAL		5611.3
DATE 3-1-02 APPD JCE/vcl	SINGLE-PHASE TRANSFORMER APPLICATION		

SCOPE: This standard provides minimum separation distances between various transformers and window openings within an adjacent building.

PURPOSE:

This criteria was established to insure that the sound level at the window opening is within the sound level guidelines established by the City and County of San Diego.

DEFINITIONS:

WINDOW OPENING – An opening in the building exterior wall (such as a window that will open or a sliding glass door) which permits transformer noise to radiate inward to an occupied space such as living room, bedroom, etc.

CRITERIA:

Table 1 provides the minimum separation required between a transformer and a window opening. The distance is dependent on the allowable noise (expressed in decibels(db)) established in Table 2.

TABLE 1:

TRANSFORMER SEPARATION					
ULTIMATE TRANSFORMER			ALLOWABLE NOISE PERMITTED (DB)		
			40	50	55
			DISTANCE (FT.)		
15kVA	1 phase	6.9kV	11	5	4
25kVA	1 phase	6.9kV	11	5	3
50kVA	1 phase	6.9kV	11	5	3
75kVA	1 phase	6.9kV	15	7	5
100kVA	1 phase	6.9kV	16	7	5
25-50kVA	1 phase	12kV	13	6	4
75-100kVA	1 phase	12kV	17	8	5
167kVA	1 phase	12kV	26	11	7
45kVA	3 phase	12kV	20	9	6
75kVA	3 phase	12kV	33	14	10
150-300kVA	3 phase	12kV	52	21	14
500kVA	3 phase	12kV	61	25	16
750kVA	3 phase	12kV	68	28	18
1000kVA	3 phase	12kV	77	31	20
1500kVA	3 phase	12kV	115	46	30
2000kVA	3 phase	12kV	129	52	33
2500kVA	3 phase	12kV	145	58	37
3000kVA	3 phase	12kV	142	57	36

© 1998 - 2021 San Diego Gas & Electric Company. All rights reserved. Removal of this copyright notice without permission is not permitted under law.

REV	CHANGE	DR	BY	DSN	APV	DATE	REV	CHANGE	DR	BY	DSN	APV	DATE
C	EDITORIAL CHANGES	EPC	JAS	FRC	CZH	12/06/2021	F						
B	EDITORIAL CHANGES		SL	JE	MDJ	08/25/2017	E						
A	TABLE UPDATES		SL	JE	MDJ	02/25/2017	D						

SHEET 1 OF 2	<input checked="" type="checkbox"/> Indicates Latest Revision <input checked="" type="checkbox"/> Completely Revised <input checked="" type="checkbox"/> New Page <input checked="" type="checkbox"/> Information Removed	DM5612.1
	SDG&E ELECTRIC DISTRIBUTION DESIGN MANUAL	
	TITLE	

TABLE 2:

ALLOWABLE NOISE PERMITTED	
ZONING CLASSIFICATION	NOISE
Single-Family Residential	40db
Multi-Family (2-29 units per acre, Church, Public School, Mobile Home Park)	40db
Multi-Family (30 units per acre and above), Professional's Office, Hospital, Convalescent Center	50db
Commercial & Light Industrial	55db

NOTES:

- The following General considerations for noise control shall be observed:
 - Locate transformers away from walls which can reflect noise back toward the window opening under consideration.
 - When a transformer is located within a paved area, leave 6 inches of earth beneath the pad or install a felt expansion joint beneath and around the sides of the pad.
 - When a transformer is located over an underground parking area of a building, it must be placed between bearing walls and not over a bearing wall.
- It is possible to have different noise requirements on adjacent properties, such as commercial and multi-family. Although the minimum distance to the commercial building may be maintained, it is possible that the transformer would be too close to the multiple-family project. The minimum transformer distance specified in table 1 must be maintained from all adjacent structures.
- Transformers located in mobile home parks require additional care to insure that the transformer will not be too close to a coach or any window openings when it is placed on the site at a future date.
- If the minimum noise clearances specified in Table 1 cannot be met, a transformer sound enclosure is required in accordance with Underground standard 3478 (Service Guide 500.7).
- Sound studies done within the last 5 years showing ambient noise levels higher than the maximum thresholds provided in table 2 may be used to justify transformer noise levels up to that of the ambient noise level.

© 1998 - 2021 San Diego Gas & Electric Company. All rights reserved. Removal of this copyright notice without permission is not permitted under law.

REV	CHANGE	DR	BY	DSN	APV	DATE	REV	CHANGE	DR	BY	DSN	APV	DATE
C	EDITORIAL CHANGES	EPC	JAS	FRC	CZH	12/06/2021	F						
B	EDITORIAL CHANGES		SL	JE	MDJ	08/25/2017	E						
A	TABLE UPDATES		SL	JE	MDJ	02/25/2017	D						

<input checked="" type="checkbox"/>	Indicates Latest Revision	<input checked="" type="checkbox"/>	Completely Revised	<input checked="" type="checkbox"/>	New Page	<input checked="" type="checkbox"/>	Information Removed
SDG&E ELECTRIC DISTRIBUTION DESIGN MANUAL							

SHEET
2 OF 2

TRANSFORMER NOISE CRITERIA

DM5612.2

SCOPE

This standard establishes selection criteria associated with the three-phase (HKB) transformer.

PURPOSE

This criteria was established to provide the project management specialist a guide to determine the appropriate three-phase transformer installation.

CRITERIA

1. Transformers shall be sized in accordance with the Initial Transformer Design Loading for Balanced Loads, Standard 5621.
2. Design personnel shall determine how to most economically serve three-phase 120/240 loads from a padmount station.
 - a. The HKB padmount provides three-phase 120/240V service. It should be considered in conversions whenever the single-phase load is less than 20% of the 3-phase transformer rating. However, a properly sized open or closed-delta station may be less costly when the power transformer(s) may be kept small. The designer should size the HKB and open and closed-delta station in accordance with design standard 5621 and determine which is least costly.

EXAMPLE:

It is necessary to serve 70kW (60 kW non-motor load & 10kW motor load) of three-phase and 10 kW of balanced (between the two PS legs) single-phase load at 120/240V. Should a HKB, open-delta or closed-delta transformer station be used ?

(Using the transformer selection process described in Example 1 on 5621.3 , a comparative evaluation can be made)

- a. An open-delta transformer station would require 2-50kVA transformers at an installed cost of \$4,032 including cables and connectors.
(open-delta configuration not normally recommended for serving large three-phase and small single-phase loads)
- b. A closed-delta transformer station would require 3-25kVA transformers at an installed cost of \$6,122 including cables and connectors.
- c. A 75kVA type HKB would be required at an installed cost of \$4,367.

The open-delta station should be chosen as it is the least costly alternative.

Note: Open-delta transformer stations shall not be selected to serve motor load larger than 10 HP, see 5413.4, d.

	Indicates Latest Revision	Completely Revised	New Page
REVISION	SDG&E DISTRIBUTION DESIGN MANUAL		
DATE 1-1-94 APPD MF/BJ	SINGLE CABINET THREE-PHASE (HKB) TRANSFORMER APPLICATION		5613

SCOPE

This guideline provides requirements for dedicated transformers for 400 amp and 600 amp single family and multi-family residential panels served from the 2.4kV, 4kV, 6.9 kV, and 12kV voltage systems.

PURPOSE

These guidelines are established so that the potential load served from these panel sizes would not exceed the capacity of the largest single phase transformers stocked by SDG&E at the 2.4kV, 4kV, 6.9kV, and 12kV voltage levels. Allowable loading for a residential transformer is 168 percent, assuming peak load to last 4 hours.

A. A dedicated transformer is required for the following single phase panel sizes:

1. 600 Amp panel served from the 6.9kV
2. 600 Amp panel served from the 2.4kV or 4kv system

Note: A 12kV Single-phase (1-Ø) transformer can serve a maximum of two 600 Amp residential panels.

B. 6.9kV Transformer max load residential

1. 25kVA = 104 Amps x 168% = 175 Amps
2. 50kVA = 208 Amps x 168% = 349 Amps
3. 75kVA = 312 Amps x 168% = 524 Amps
4. 100kVA = 416 Amps x 168% = 699 Amps

C. 12kV Transformer max load residential

1. 25kVA = 104 Amps x 168% = 175 Amps
2. 50kVA = 208 Amps x 168% = 349 Amps
3. 75kVA = 312 Amps x 168% = 524 Amps
4. 100kVA = 416 Amps x 168% = 699 Amps
5. 167kVA = 696 Amps x 168% =1169 Amps

© 1998 - 2022 San Diego Gas & Electric Company. All rights reserved. Removal of this copyright notice without permission is not permitted under law.

REV	CHANGE	DR	BY	DSN	APV	DATE	REV	CHANGE	DR	BY	DSN	APV	DATE
C							F						
B	EDITORIAL CHANGE	EPC	FRC	JAS	FRC	02/14/2022	E						
A	NEW PAGE		JCE	MBL	MDJ	08/29/2017	D						

SHEET 1 OF 2	X Indicates Latest Revision	Completely Revised	New Page	Information Removed	DM5614.1
	SDG&E ELECTRIC DISTRIBUTION DESIGN MANUAL				
	DEDICATED TRANSFORMERS				

Table 1:

Number of Costumers	DIVERSITY FACTOR CATEGORIES DM5322-5323		
	Base Load Electric Heating Electric water heating	Air conditioning	
		SF detached	MF, SF attached
1-2	1	1	1
3-4	.75	.85	.70
5-7	.65	.80	.65
8-14	.55	.75	.65
15+	.50	.70	.60

Multi Family Criteria:

Multifamily Scenarios for dedicated transformers

A. 6.9kV & 2.4kV System

1. 4-400 Amp Panels: $(4 \times 400) = 1600 \times 80\%$ panel demand $\times .55$ diversity = 704 Amps **(One transformer cannot serve this scenario)**. At .65 diversity load is 832 Amps **(One transformer cannot serve this scenario)**
2. 3-400 Amp Panels: $(3 \times 400) = 1200 \times 80\%$ panel demand $\times .55$ diversity = 528 Amps **(One transformer can serve this scenario)**. At .65 diversity load is 624 Amps **(One transformer can serve this scenario)**
3. 1-600 Amp & 1-400 Amp Panels: $(600+400) = 1000 \times 80\%$ panel demand $\times .55$ diversity = 440 Amps **(One transformer can serve this scenario)**. At .65 diversity load is 520 Amps **(One transformer can serve this scenario)**
4. 1-600 Amp & 2-400 Amp Panels: $(600+800) = 1400 \times 80\%$ panel demand $\times .55$ diversity = 616 Amps **(One transformer can serve this scenario)**. At .65 diversity load is 728 Amps **(One transformer cannot serve this scenario)**
5. 2-600 Amp Panels: $(2 \times 600) = 1200 \times 80\%$ panel demand $\times .55$ diversity = 528 Amps **(One transformer can serve this scenario)**. At .65 diversity load is 624 Amps **(one transformer can serve this scenario)**

B. 12kV & 4kV System

1. 6-400 Amp Panels: $(6 \times 400) = 2400 \times 80\%$ panel demand $\times .55$ diversity = 1056 Amps **(One transformer can serve this scenario)**. At .65 diversity load is 1248 Amps **(One transformer cannot serve this scenario)**
2. 5-400 Amp Panels: $(5 \times 400) = 2000 \times 80\%$ panel demand $\times .55$ diversity = 880 Amps **(One transformer can serve this scenario)**. At .65 diversity load is 1040 Amps **(One transformer can serve this scenario)**
3. 1-600 Amp & 2-400 Amp: $(600+800) = 1200 \times 80\%$ panel demand $\times .55$ diversity = 616 Amps **(One transformer can serve this scenario)**. At .65 diversity load is 728 Amps **(One transformer can serve this scenario)**

© 1998 - 2022 San Diego Gas & Electric Company. All rights reserved. Removal of this copyright notice without permission is not permitted under law.

REV	CHANGE	DR	BY	DSN	APV	DATE	REV	CHANGE	DR	BY	DSN	APV	DATE
C							F						
B	EDITORIAL CHANGE	EPC	FRC	JAS	FRC	02/14/2022	E						
A	NEW PAGE		JCE	MBL	MDJ	08/29/2017	D						

SHEET 2 OF 2	X Indicates Latest Revision	X Completely Revised	X New Page	Information Removed	DM5614.2
	SDG&E ELECTRIC DISTRIBUTION DESIGN MANUAL				
	DEDICATED TRANSFORMERS				

SCOPE

This design standard provides the allowable initial transformer design loading for balanced three-phase and single-phase estimated demands served by open-delta, closed-delta and three-phase padmounted transformer stations. This practice only applies to those transformer stations in which the single-phase load is equally divided among the three incoming phases.

PURPOSE

This standard was developed to provide improved initial transformer utilization considering allowable voltage drop and economic loading levels. Higher transformer loading may be achieved with Design Standards approval when the secondary/service voltage drop is less than 2.0 percent for single-phase and 1.0 percent for three-phase transformers.

DEFINITIONS

Initial Transformer Design Loading Range – The transformer loading criteria for the initial installation that allows for future load growth.

Estimated Demand - the chosen demand estimate based on the Demand Estimating Guidelines provided in Design Manual Section 5300.

Equivalent Demand - the calculated demand required to allow the proper transformer selection based on individual transformer winding load.

CRITERIA

TABLE 1:

THREE-PHASE PADMOUNTED TRANSFORMERS				
TRANSFORMER SIZE (kVA)	120/208V		277/480V	
	kVA	kW	kVA	kW
75	0-88	0-74	0-88	0-74
150	89-176	75-135	89-176	75-135
225	177-264	136-224	177-264	136-224
300	265-352	225-299	265-352	225-299
500	353-588	300-499	353-588	300-499
750	589-825	500-701	589-825	500-701
1000	826-1100	702-935	826-1100	702-935
1500	1101-1650	936-1402	1101-1650	936-1402
2000			1651-2200	1735-1870
2500			2201-2750	1871-2337
3000			2751-3300	2338-2805

© 1998 - 2021 San Diego Gas & Electric Company. All rights reserved. Removal of this copyright notice without permission is not permitted under law.

REV	CHANGE	DR	BY	DSN	APV	DATE	REV	CHANGE	DR	BY	DSN	APV	DATE
C							F						
B	EDITORIAL CHANGES	EPC	FRC	VMV	CZH	08/20/2021	E						
A	ORIGINAL				SRM	01/01/1998	D						

SHEET 1 OF 4	X Indicates Latest Revision	Completely Revised	New Page	Information Removed
	SDG&E ELECTRIC DISTRIBUTION DESIGN MANUAL			
	INITIAL TRANSFORMER DESIGN LOADING FOR BALANCED LOADS			
DM5621.1				

TABLE 2:

SINGLE PHASE PADMOUNTED TRANSFORMERS		
TRANSFORMER SIZE (kVA)	kVA	kW
25	0-33	0-29
50	34-67	30-60
75	68-100	61-90
100	101-134	91-120
167	135-224	121-201

TABLE 3:

SINGLE-PHASE POLEMOUNTED TRANSFORMERS				
TRANSFORMER SIZE (kVA)	RESIDENTIAL		COMMERCIAL	
	kVA	kW	kVA	kW
15	0-20	0-18	0-17	0-14
25	21-33	19-29	18-29	15-24
50	34-67	30-60	30-58	25-49
75	68-100	61-90	59-88	50-74
100	101-134	91-120	89-117	75-99
167	135-224	121-201	118-196	100-166

Note: Initial transformer loading assumes Power Factor = 0.90 for single phase residential, 0.85 for commercial.

1. Single-Phase Transformer Stations

Use the diversified demand estimate determined from Design Standard 5322, "Residential Demand Estimating" to select the proper size transformer from table 2 or 3.

2. Three-Phase Transformer Stations

An attempt should be made to balance the single-phase load equally within the three-phase transformer station windings. This may be done by placing 1 /3 of the total single-phase load between each pair of the three incoming phases (see Design Standard 5611, "Single-Phase Transformer Application").

- a. 1. 120/208V three-phase power is obtained from a three-phase padmounted transformer station. Use the total diversified three-phase and single-phase demand estimate determined from Design Standard 5311, "Three-Phase Demand Estimating Criteria" to select the proper size transformer from table 1.
- b. 120/240V three-phase power is obtained from an open-delta or closed delta overhead transformer station
 - i. Closed Delta (large three phase loads with small single phase loads are served most efficiently by the closed delta configuration)

If the single-phase load is equally divided among the three transformers, use 1 /3 of the total three-phase and 1 /3 of the total single-phase demand estimate to select three equally sized single-phase transformers from table 2 or 3. Otherwise, select unequal transformers in accordance with Table 1 on OH Construction Standards page 1105.1.

© 1998 - 2021 San Diego Gas & Electric Company. All rights reserved. Removal of this copyright notice without permission is not permitted under law.

REV	CHANGE	DR	BY	DSN	APV	DATE	REV	CHANGE	DR	BY	DSN	APV	DATE
C							F						
B	EDITORIAL CHANGES	EPC	FRC	VMV	CZH	08/20/2021	E						
A	ORIGINAL				SRM	01/01/1998	D						

X	Indicates Latest Revision	Completely Revised	New Page	Information Removed
SDG&E ELECTRIC DISTRIBUTION DESIGN MANUAL				
INITIAL TRANSFORMER DESIGN LOADING FOR BALANCED LOADS				

SHEET
2 OF 4

DM5621.2

- ii. Open Delta (small three phase loads with large single phase loads are served most efficiently by the open delta configuration)

If the single-phase load is balanced across the three-phase lines, use 58 percent of the total three-phase and single-phase demand estimate from Design Standard 5311 to select two equally sized single-phase transformers from table 2 or 3.

If all of the single-phase load is connected across only two I lines, the two single-phase transformers may not be equally sized. To determine the proper size single-phase transformer:

- 1) Smaller Single-Phase Transformer - use 58 percent of the three-phase demand estimate from Design Standard 5311 to select the proper size transformer from table 2 or 3.
- 2) Larger Single-Phase Transformer - use 58 percent of the three-phase and all of the single-phase demand estimate from Design Standard 5311 to select the proper size transformer from table 2 or 3.

c. 120/240V three-phase power obtained from the type **HKS** padmounted transformer is similar to the overhead closed delta station of subparagraph B.2.a. For unbalanced single-phase load simply add twice the single-phase load to the three-phase load to determine the three-phase kVA requirements.

d. 120/208 4W, 3Ø, an overhead station delta-wye bank, the procedure is to take 1/3 of the three phase load plus 1/3 of the total single phase load to equally size each transformer.

EXAMPLES

1. 1. Select the proper transformers to serve an estimated demand of 70 kW (60 kW non-motor load and 10 kW motor load) three-phase load and 10 kW of balanced (between the two PS legs) single phase load.
The load may be served from either an open-delta or closed-delta polemounted three-phase transformer station or a three-phase padmounted transformer station.

a. Open-delta polemount:

- i. Determine the equivalent demand
70kW, 3Ø x 0.58 = 40.6, 3Ø
10kW, 1Ø x 1 = 10kW, 1Ø
- ii. Determine total equivalent demand
40.6 + 10 = 50.6kW
- iii. Select the proper transformers
2-50kVA transformers required

b. Closed-delta polemount:

- i. Determine the equivalent demand
70kW, 3Ø x 1/3 = 23.3 kW, 3Ø
10kW, 1Ø x 1/3 = 3.3 kW, 1Ø
- ii. Determine total equivalent demand
23.3 + 3.3 = 26.6kW
- iii. Select the proper transformers
3-25kVA transformers required

c. Three-phase padmount:

- i. Determine the equivalent demand
70kW, 3Ø x 1 = 70kW, 3Ø
10kW, 1Ø x 1 = 10kW, 1Ø
- ii. Determine total equivalent demand
70 + 10 = 80kW

© 1998 - 2021 San Diego Gas & Electric Company. All rights reserved. Removal of this copyright notice without permission is not permitted under law.

REV	CHANGE	DR	BY	DSN	APV	DATE	REV	CHANGE	DR	BY	DSN	APV	DATE
C							F						
B	EDITORIAL CHANGES	EPC	FRC	VMV	CZH	08/20/2021	E						
A	ORIGINAL				SRM	01/01/1998	D						

SHEET 3 OF 4	X Indicates Latest Revision	Completely Revised	New Page	Information Removed
	SDG&E ELECTRIC DISTRIBUTION DESIGN MANUAL			
	INITIAL TRANSFORMER DESIGN LOADING FOR BALANCED LOADS			

DM5621.3

- i. Select the proper transformer
1-75kVA transformer required
2. Select the proper transformers to serve a three-phase estimated demand of 10kW with an additional single-phase demand of 70kW connect across one transformer.
- The load should be served from either a polemounted or padmounted open-delta transformer station to prevent oversizing the transformers.
- a. Open-delta polemount:
 - i. Determine the equivalent demand
10kW, $3\phi \times 0.58 = 5.8\text{kW}$, 3ϕ
70kW, $1\phi \times 1 = 70\text{kW}$, 1ϕ
 - ii. Determine the total equivalent demand
 $5.8 + 70 = 75.8\text{kW}$ on the larger transformer
 $5.8 + 0 = 5.8\text{kW}$ on the smaller transformer
 - iii. Select the proper transformers
1-75kVA & 1-10kVA transformer required
 - b. 120/240 padmount:
 - i. $10 + 2(70) = 150$
 - ii. Selected 150kVA
3. Select the proper transformer to serve three single-phase estimated demands of 10kW, 15kW, and 20kW, respectively
- a. Single-phase polemount:
 - i. Determine the total equivalent demand
 $10 + 15 + 20 = 45\text{kW}$
 - ii. Determine the proper diversity factor from Table 3, Design Manual Standard 5322, "Residential Demand Estimating"
 $45\text{kW} \times 0.75 = 33.8\text{kW}$
 - iii. Select the proper transformer
1-50kVA transformer required
 - b. Single-phase polemount
 - i. Using the equivalent diversified demand from above
1-50kVA transformer required

References:

- 1. Design manual Standard 5311, Three Phase Commercial Demand Estimating Criteria
- 2. Design manual Standard 5322, Residential Demand Estimating
- 3. Overhead Construction Standards 1105-1107, Transformer Loading Guide for 3ϕ Stations with 1ϕ Transformers

© 1998 - 2021 San Diego Gas & Electric Company. All rights reserved. Removal of this copyright notice without permission is not permitted under law.

REV	CHANGE	DR	BY	DSN	APV	DATE	REV	CHANGE	DR	BY	DSN	APV	DATE
C							F						
B	EDITORIAL CHANGES	EPC	FRC	VMV	CZH	08/20/2021	E						
A	ORIGINAL				SRM	01/01/1998	D						

SHEET 4 OF 4	X Indicates Latest Revision	Completely Revised	New Page	Information Removed
	SDG&E ELECTRIC DISTRIBUTION DESIGN MANUAL			
	INITIAL TRANSFORMER DESIGN LOADING FOR BALANCED LOADS			
DM5621.4				

SCOPE:

This design standard establishes the allowable transformer load limits before the replacement of three-phase and single-phase transformer station (padmounted and pole mounted). The change out loading limits were developed based on the thermal limits of transformers.

PURPOSE

This standard is intended to prevent unnecessary expenditure and promote efficiency when transformer replacement is being considered. Load limits in the table below are only a guide and do not take into consideration voltage problems associated with these loads.

Separate load limits were developed for residential and commercial customers because the duration of peak loads is usually different. Residential peak loads are assumed to last 4 hours. Commercial peak loads are assumed to last 8 hours.

DEFINITIONS

Transformer change out or replacement loading limit – the load at which the decision to replace a transformer is made.

CRITERIA

TABLE-1 THREE-PHASE PADMOUNTED TRANSFORMERS

Transformer Size (kVA)	Residential 168%		Commercial 147%	
	kVA	kW	kVA	kW
45	76	68	66	56
75	126	113	110	94
150	252	227	221	187
225	378	340	331	281
300	504	454	441	375
500	–	–	735	625
750	–	–	1103	937
1000	–	–	1470	1250

TABLE-2 SINGLE-PHASE PADMOUNTED TRANSFORMERS

Transformer Size (kVA)	Residential 168%		Commercial 147%	
	kVA	kW	kVA	kW
15	25	23	22	19
25	42	38	37	31
50	84	76	74	62
75	126	113	110	94
100	168	151	147	125
167	281	253	245	209





	 Indicates Latest Revision	 Completely Revised	 New Page
REVISION	SDG&E DISTRIBUTION DESIGN MANUAL		
DATE 1-1-98 APPD <i>DRM / CAC</i>	TRANSFORMER REPLACEMENT GUIDELINE		5625.1

TABLE-3 SINGLE-PHASE POLEMOUNTED TRANSFORMERS

Transformer Size (kVA)	Residential 168%		Commercial 147%	
	kVA	kW	kVA	kW
10	17	15	15	12
15	25	23	22	19
25	42	38	37	31
50	84	76	74	62
75	126	113	110	94
100	168	151	147	125

NOTES:

If the duration of peak loads exceed the hours stated above, consult Distribution Planning.

	 Indicates Latest Revision	Completely Revised	New Page
5625.2	SDG&E DISTRIBUTION DESIGN MANUAL		REVISION
	TRANSFORMER REPLACEMENT GUIDELINE		DATE 1-1-98 APPD <i>SRM / CMK</i>

SCOPE

This standard establishes guidelines for sizing transformers and service lateral conductors that serve fire pumps.

PURPOSE

This standard was developed to provide the Customer Project Planner with a guide to determine the appropriate transformer and service lateral conductors to serve a fire pump.

DEFINITION

Fire pump – Pump that provides water to a building that would be used in the event of a fire.

CRITERIA

Section 430–31 of the National Electric Code (NEC) indicates that provisions for motor and branch circuit running overload protection are not to be interpreted as requiring overload protection where it might introduce additional or increased hazards as in the case of fire pumps. Fire pump motors are required to have much larger overcurrent protection than other motors. The overcurrent protection is actually short circuit and ground fault protection since the motor is to operate to failure. The NEC recognizes that fire pumps must be allowed to operate to failure rather than removing them from the line in fire conditions.

SDG&E needs to size the transformer and service lateral conductors to hold the locked rotor current of the motor(s) for a reasonable time.

EXAMPLE

It is necessary to serve a fire pump with a 480 volt 125 horsepower (HP) motor. The motor nameplate has the code letter "G". The code letter stands for the KVA per horsepower with locked rotor. Various code letters are shown in the table below.

Code Letter	KVA per HP with Locked Rotor
A	0 – 3.14
B	3.15 – 3.54
C	3.55 – 3.99
D	4.0 – 4.49
E	4.5 – 4.99
F	5.0 – 5.59
G	5.6 – 6.29
H	6.3 – 7.09
J	7.1 – 7.99
K	8.0 – 8.99

Code Letter	KVA per HP with Locked Rotor
L	9.0 – 9.99
M	10.0 – 11.19
N	11.2 – 12.49
P	12.5 – 13.99
R	14.0 – 15.99
S	16.0 – 17.99
T	18.0 – 19.99
U	20.0 – 22.39
V	22.4 and up

	<input type="checkbox"/> Indicates Latest Revision	<input type="checkbox"/> Completely Revised	<input checked="" type="checkbox"/> New Page
REVISION	SDG&E DISTRIBUTION DESIGN MANUAL		5626.1
DATE 3-1-02 APPD JCE / <i>JKL</i>	TRANSFORMER DESIGN GUIDELINE FOR FIRE PUMPS		

To size the transformer, find the code letter in the table and multiply the motor HP by the upper limit of the kVA per horsepower range. Divide the result by 2 and size the transformer bank to the next standard SDG&E size.

$$(125 \text{ HP}) (6.29 \text{ kVA}) / 2 = 393.1 \text{ kVA}$$

The next higher rating is a 500 kVA transformer. This will load the transformer to a maximum of 200% at locked rotor. The service lateral conductor size and number of runs should then be selected to handle the capacity of the 500 kVA transformer.

The reason for the selection of 200% is to allow the transformer to hold the load for as long as necessary to allow the motor to run to failure and to maintain the voltage drop through the transformer to an acceptable level. SDG&E should not have the liability of having a transformer failure or providing low voltage in a fire situation.

Most of the fire pump installations are in high rise buildings fed from a large service and transformer. The transformer and service is normally already sized adequately based on SDG&E's estimated demand load, voltage drop and flicker calculation to serve a fire pump. However there may be situations where this is not the case and it is important to make sure the transformer and service lateral conductors are sized to serve the fire pump.

	 Indicates Latest Revision	<input type="checkbox"/> Completely Revised	<input checked="" type="checkbox"/> New Page
5626.2	SDG&E DISTRIBUTION DESIGN MANUAL		REVISION
	TRANSFORMER DESIGN GUIDELINE FOR FIRE PUMPS		DATE 3-1-02 APPD JCE / <i>Vcl</i>

SCOPE

This standard provides application guidelines for installing regulators.

DEFINITIONS

Single Phase Regulator – A transformer which provides a voltage output from minus to plus ten percent of its input voltage in thirty-two, 5/8 percent steps.

Reversible Feed Regulator – A regulator which will, under reverse power flow conditions, short out the compensation and regulate the non-substation output voltage. This regulator is to be used only for locations where reverse power flow can be experienced due to co-generators.

Auto Booster Voltage Regulator – A regulator with limited voltage regulation above or below the input voltage, but not both. Due to a number of limitations, these units are no longer purchased.

APPLICATION GUIDELINES

1. On three-phase, three-wire circuits, regulators should be connected either open-delta using two regulators or closed delta using three regulators. The addition of the third regulator and closing the delta does not permit the regulator bank to carry more load, but it does increase the regulation range of the bank by approximately 50 percent. That is, when installing three, ± 10 percent single-phase regulators in closed delta, the regulation range of the three-phase bank is approximately ± 15 percent.
2. On three-phase, three-wire circuits, the use of three single-phase regulators connected in wye is not recommended. The neutral or common point of the wye connection would be floating, and unbalanced load conditions or different regulator control response characteristics could cause this point to shift. With individual regulator controls, unstable operation could result.
3. On three-phase, four-wire circuits, regulators should be connected wye with the neutral tied to the system neutral. Do not install regulators open-delta since no regulation is provided for load connected on the third phase.
4. When either two or three single-phase regulators are connected delta, the line current through the series winding will be shifted 30 degrees with respect to the voltage across the exciting winding. As a result, the voltage from the line drop compensator will not subtract in proper phase from the control winding voltage being applied to the contact-making voltmeter, unless provision is made to correct for this phase shift. On later model regulators having a Phase-Shift Selector built into them, or on regulators provided with a Phase Shift Transformer, care must be taken to make connections or settings in accordance with the manufacturers instruction book. On regulators without phase shift correction, an increase in line-drop compensator setting will partly offset the effect of phase difference under usual load conditions.

	Indicates Latest Revision	Completely Revised	New Page
REVISION	SDG&E DISTRIBUTION DESIGN MANUAL		
DATE 1-1-90	VOLTAGE REGULATOR APPLICATION GUIDELINES		5641.1
APPD CVN/ <i>CVN</i>			

5. When two single-phase regulators are connected open delta, the voltage on the phase with no regulator may be higher or lower than the voltage on either of the other phases. The amount of voltage unbalance will depend upon the unbalance in the load, the power factor of the load, the phase rotation and the connection used. If the connection initially used does not result in satisfactory voltage balance at the load center, a different connection should be tried as shown below for regulator installations which do not feed tie points with other circuits. This may be accomplished by means of a transposition in the line on the load side of the installation.

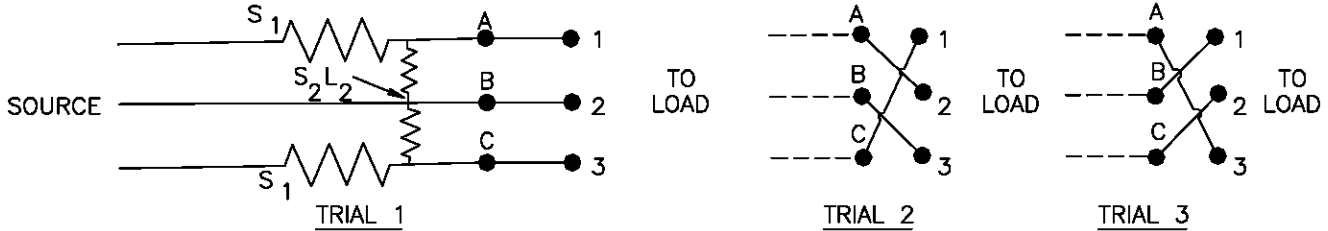

6. The reversible feed regulator is to be used only on circuits where a reverse power flow can be expected at the regulator due to a co-generator on the circuit. These regulators, under reverse power conditions, will eliminate all compensation and will continue to regulate voltage on the non-substation side of the regulator. Experience thus far has shown that these co-generators will have less control over the voltage at the regulator installation than our system will. Such installations should initially be monitored to make sure that proper voltage regulation is being obtained. These regulators are not to be used for situations in which reverse power flow can be expected from a different substation due to circuit reconfiguration.
7. Make sure regulator is in the neutral position and on "Manual" control before operating bypass-disconnect switches.
8. All Distribution Feeder Voltage Regulators purchased in 1958 or later, and regulators of some manufacturers purchased earlier, have provision for obtaining added load capacity. This feature is designated by various manufacturers as "Vari-Amp", "Load Bonus", or "Add-Amp". To accomplish this, it is necessary to restrict the voltage regulating range. The table below shows the current rating in amperes that may be obtained with each of the five regulating ranges. Consult manufacturers' instruction books for procedure to adjust regulating range.

If full $\pm 10\%$ regulating range is not required for a given application, cost savings can be achieved by specifying a regulator of reduced Kva capacity.

REGULATOR BASE AMPERES	BOOST OR BUCK RANGE				
	10%	$\pm 8-3/4\%$	$\pm 7-1/2\%$	$\pm 6-1/4\%$	$\pm 5\%$
25	25	27.5	30	34	40
50	50	55	60	67.50	80
100	100	110	120	135	160
200	200	220	240	270	320

9. APPLICATION OF AUTO-BOOSTER VOLTAGE REGULATORS

Auto-Booster Voltage Regulators (also called Auto-Boosters, or 4-Step Regulators) are lower in cost than the 32-step Distribution Feeder Voltage Regulators. However, they have certain characteristics which limit their use. These characteristics are:

- a) They change voltage in large steps (4 steps of 1-1/2% each for the 6% range Auto-Boosters).
- b) They have a wide band width (2.8 volts for 6% Auto-Boosters).
- c) They do not have line drop compensation.
- d) They do not have adjustable time delay nor position indicators.
- e) They may be connected either boost or buck, but not both. When installed to boost voltage, they cannot lower it unless it exceeds the top of the control band width.

Because of their limitations, auto-boosters are no longer purchased for new installations.

	Indicates Latest Revision	Completely Revised	New Page
REVISION	SDG&E DISTRIBUTION DESIGN MANUAL		5641.3
DATE 1-1-90	VOLTAGE REGULATOR APPLICATION GUIDELINES		
APPD CVN/ <i>ROJ</i>			

5700
PADS &
SUBSTRUCTURES

5700
PADS &
SUBSTRUCTURES

PAGE

SUBJECT

5711

5711.1-5711.2
5711.3

CONDUIT AND SUBSTRUCTURE SELECTION CRITERIA

SUBSTRUCTURE AND CONDUIT SELECTION TABLE
EXAMPLE, REFERENCES

5712

HANDHOLE APPLICATION REQUIREMENTS

5721

5721.1-5721.2
5721.3
5721.4
5721.5
5721.6

CONDUIT POSITIONING WITHIN SUBSTRUCTURES

CRITERIA
3315 HANDHOLE
3316, 3317 HANDHOLE
MANHOLE
REFERENCES

5722

5722.1
5722.2
5722.3

CONDUIT APPLICATION

MATERIALS, RIGID CONDUIT GUIDELINES
CONCRETE ENCASEMENT, SPARE CONDUITS, FUTURE CONDUITS, SERVICE STUBS
CONDUIT APPLICATION

5723

5723.1
5723.2
5723.2-5723.5

SUBSTRUCTURE DETAIL CRITERIA

DEFINITIONS, CRITERIA
EQUIPMENT DESIGNATIONS
EXAMPLES, REFERENCES

5725

TRENCHLESS ELECTRIC INSTALLATION

5745

5745.1-5745.2
5745.3-5745.4
5745.5-5745.6
5745.7-5748.8
5745.9
5745.10
5745.11-5745.13
5745.14-5745.15

ELECTRIC VAULT DESIGN TABLES FOR SDG&E INTERNAL USE

BELOW GRADE SINGLE TRANSFORMER VAULT REQUIREMENTS FOR 120/208V AND 277/480V
BELOW GRADE MULTIPLE TRANSFORMER VAULT REQUIREMENTS FOR 120/208V AND 277/480V
ON GRADE SINGLE TRANSFORMER VAULT REQUIREMENTS FOR 120/208V AND 277/480V
ON GRADE MULTIPLE TRANSFORMER VAULT REQUIREMENTS FOR 120/208V AND 277/480V
CAPACITOR REQUIREMENT FOR VAULTS
SUPERVISORY CONTROL AND DATA ACQUISITION (SCADA) REQUIREMENTS
THREE-PHASE WALL-MOUNTED FUSE CABINET 12KV, 200A
EQUIPMENT COMBINATION GUIDELINES

© 1998 - 2022 San Diego Gas & Electric Company. All rights reserved. Removal of this copyright notice without permission is not permitted under law.

REV	CHANGE	DR	BY	DSN	APV	DATE	REV	CHANGE	DR	BY	DSN	APV	DATE
C							F						
B	EDITORIAL CHANGES	EDM	ADW	JES	KRG	04/22/2022	E						
A	REVISION	-	-	-	JCE/VCR	03/01/2002	D						

SHEET 1 OF 1	X Indicates Latest Revision	Completely Revised	New Page	Information Removed	DM5701.1
	SDG&E ELECTRIC DISTRIBUTION DESIGN MANUAL				
	TABLE OF CONTENTS PADS AND SUBSTRUCTURES				

SCOPE

This design standard is for conduit and substructure selection, based on the underground feeder circuit and underground local distribution cable run requirements.

PURPOSE

This standard was developed to maintain substructure unobstructed space in accordance with Underground Construction Standard section 3600.

DEFINITIONS

Underground Feeder Circuit – the term applied to unfused three-phase 600 amp primary underground cable runs where 350, 750 or 1000 kcmil cable enters and leaves a substructure.

Underground Local Distribution Cable Run – the term applied to fused or unfused three-phase 200 amp primary underground cable runs where #2 or 2/0 cable enters or leaves a substructure.

GUIDELINE

Table 1 – Substructure and conduit selection based on ultimate 3-phase underground feeder circuit and underground local distribution cable run requirements.

FEEDER CIRCUIT REQUIREMENTS	10	10EB5"	3326-20'	3326-20'	3326-20' 3523	3326-20' 3523	3326-20' 3523	3326-20' 3316	3326-20' 3316	NOT APPLICABLE	NOT APPLICABLE	NOT APPLICABLE			
	9	9EB5"	3326-20'	3326-20'	3326-20' 3523	3326-20' 3523	3326-20' 3523	3326-20' 3316	3326-20' 3316						
	8	8EB5"	3326-20'	3326-20'	3326-20' 3523	3326-20' 3523	3326-20' 3523	3326-20' 3316	3326-20' 3316						
	7	7EB5"	3326-20'	3326-20'	3326-20' 3523	3326-20' 3523	3326-20' 3523	3326-20' 3316	3326-20' 3316						
	6	6EB5"	3325-14'	3325-14'	3325-14' 3523	3325-14' 3523	3325-14' 3523	3325-14' 3316	3325-14' 3316						
	5	5EB5"	3325-14'	3325-14'	3325-14' 3523	3325-14' 3523	3325-14' 3523	3325-14' 3316	3325-14' 3316						
	4	4EB5"	3316 ⁵	3316	3316 3523	3316 3523	3316 3523	3316 3316	3316 3316						
	3	3EB5"	3316	3316	3316 3523	3316 3523	3316 3523	3316 3316	3316 3316						
	2	2EB5"	3315 ⁵	3316	3316	3316	3316	3316 3315	3315 3316				3316 3316	3316 3316	3316 3316
	1	1EB5"	3315	3315	3315	3315	3315	3316	3315 3316				3315 3316	3315 3316	3315 3316
	0	---	SUBSTR.	3523	3523	3523	3523	3316	3316				3316 3523	3316 3523	3316 3523
CIRCUIT OR CABLE RUN QUANTITY (3Ø)		CONDUIT	---	1DB4"	2DB4"	3DB4"	4DB4"	5DB4"	6DB4"	7DB4"	8DB4"	9DB4"			
		0	1 ^A	2	3	4	5	6	7	8	9				
LOCAL DISTRIBUTION CABLE RUN REQUIREMENTS															

Indicates Latest Revision Completely Revised New Page



REVISION	SDG&E DISTRIBUTION DESIGN MANUAL	5711.1
DATE 3-1-02	CONDUIT & SUBSTRUCTURE SELECTION CRITERIA	
APPD JCE <i>1/vel</i>		

NOTES:

- A. Table 1 assumes that all cable is terminated with connectors within the substructure. If a substructure contains terminated and straight-through cables, the substructure selection should be made based on terminated cables only and then verified with applicable Construction Standards to determine if the additional straight-through can be accommodated.
- B. A single local distribution cable run requirement does not allow for future local distribution cable runs because it must originate from 200A deadbreak elbows connected to 600A deadbreak tees.
- C. Substructure selection is made at the intersection of Feeder Circuit and Local Distribution Cable Run Requirements. When two substructures are shown, both are required.
- D. To properly apply the guideline, all fuse cabinets require only one cable run to supply the load (Note: the source is obtained from 200A load-break elbows connected to 600A deadbreak tees).
- E. The substructure requirements for 2 through 8 local distribution cable runs permit 3-phase loadbreak termination of each cable run. When single-phase equipment or combinations of loadbreak and deadbreak equipment are desired, consult Underground Construction Standards section 3600.

The following assumptions apply to this guideline:

- 1. Local distribution cables shall not occupy a 5" conduit unless approved by Distribution Planning.
- 2. Ultimate feeder circuit requirements are specified by District Engineering and are generally supported by the long term feeder arrangement plan for the area.
- 3. The 3315 and 3316 substructures intended to house 1 local distribution cable run and an ultimate of 2 and 4 feeder circuits respectively shall have a note indicating "FEEDER ONLY" on job print in accordance with the Mapping & Records Section - DFIS Manual page SI-4.
- 4. When two substructures are required at the same trench location to serve the primary circuit configuration, a minimum separation of 25 feet between exterior walls shall be maintained to allow for feeder conduit sweeps occurring between substructures.
- 5. When local distribution is not required and an odd number of feeder conduits exist, an additional EB5" is NOT to be installed in vacant conduit spacer position provided substructure selection is not affected.

	 Indicates Latest Revision	 Completely Revised	<input checked="" type="checkbox"/> Information Removed
5711.2	SDG&E DISTRIBUTION DESIGN MANUAL		REVISION
	CONDUIT & SUBSTRUCTURE SELECTION CRITERIA		DATE 3-1-02 APPD JCE <i>/vcl</i>

Example:

Determine the conduit and substructure requirement assuming that the feeder and local distribution circuits occupy the same trench.

Given:

- Distribution Planning has indicated that 2-1000 Kcmil AL feeder circuits are initially required.
- Long-term feeder arrangements require 4-1000 Kcmil AL feeder circuits.
- A fused local distribution circuit (1-3/C #2/0 AL) is required to serve 2-150 HZB transformers from 3-1/C #2 AL.

1. Sketch the electrical single line for the ultimate configuration from the information given.

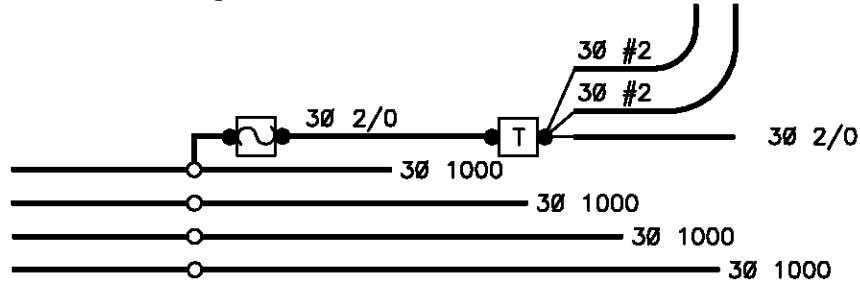

2. Determine the ultimate number of feeder circuits required in the substructure(s):
 - 4
3. Determine the number of local distribution cable runs required in the substructure(s):
 - 4 (1-fuse cabinet, 2-transformers, 1-outgoing circuit)
 - Note: fuse cabinets require one cable run (page 5711.2, note D)
4. Select the substructure(s) required from the guideline:
 - 3316 - for feeder circuit requirements
 - 3523 - for local distribution cable run requirements
5. Assign the conduit requirements to the substructure(s) from the guideline. The following conduit and substructure sketch results:

Figure 1 - Example as shown on Preliminary plan and Final Work Order Sketch

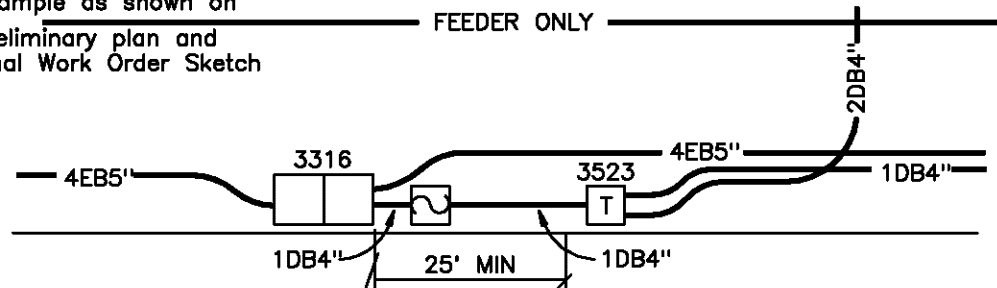

References:

1. Construction Standards Section 3300, Substructures and Conduits
2. Construction Standards Section 3600, Subsurface Sectionalizing Equipment

	<input checked="" type="checkbox"/> Indicates Latest Revision	<input type="checkbox"/> Completely Revised	<input type="checkbox"/> New Page
REVISION	SDG&E DISTRIBUTION DESIGN MANUAL		
DATE 3-1-02 APPD JCE <i>1/vel</i>	CONDUIT & SUBSTRUCTURE SELECTION CRITERIA		5711.3

SCOPE

This design standard provides the criteria for the location and elimination of secondary handholes in residential designs.

PURPOSE

This criteria has been developed to insure the lowest cost secondary system design is produced.

CRITERIA

A. POSITIONING SECONDARY HANDHOLES (3312 & 3313)

Secondary handholes are used to provide access to secondary and service cables, and to provide a place for cable pulling and connections made with secondary cable connectors and compression lugs. The location of secondary handholes is determined from the following:

1. Changes in grade will influence the location of the secondary handhole. Normally, substructures are to be located on the low side of the property line (where cars will not be driven or parked).
2. Most secondary handholes are to serve a minimum of two lots.
3. Secondary handholes are to be placed to avoid excessive service runs, so as not to exceed pulling tension limitations (See Design Standard 5921).
4. The normal location for handholes in residential subdivisions is behind the sidewalk adjacent to the common lot line. In non-subdivision areas the handhole must be installed in an area where motor vehicles cannot drive or park on it.
5. Install 3313 handhole with traffic cover when circumstances require placement of secondary handhole in a driven area.

B. ELIMINATION OF SECONDARY HANDHOLES

Secondary handholes should be eliminated when:

1. Conduit services do not exceed pulling tension requirement.
2. The amount of trench required for secondary cable with handholes versus individual service laterals is the same.
3. The cost of additional service cable does not exceed the cost of the handhole (this applies only when more than two services are involved).

Secondary handholes cannot be eliminated when:

1. The number of secondary and service runs into a transformer would exceed 7.
2. The number of secondary and service runs into a remaining handhole would exceed 6.

REFERENCES

1. Underground Construction Standard 3942, Underground Electric Service Lateral
2. Underground Construction Standard 4173, 0-600 volt connectors
3. Design Standard 5921, Cable Pulling Tension Calculation
4. Underground Construction Standard, 4003, Cable Pulling Tension

	 Indicates Latest Revision	Completely Revised	New Page
REVISION	SDG&E DISTRIBUTION DESIGN MANUAL		
DATE 1-1-87 APPD <i>MFR</i>	SECONDARY HANDHOLE APPLICATION REQUIREMENTS		5712

SCOPE

This design standard provides supplementary criteria for selection of the occupied conduit position within substructures. Primary considerations are provided in Underground Standards sections 3646 and 3649. Apply the criteria presented in this standard when the UGS does not cover your specific application.

PURPOSE

This standard was developed to provide a safe working environment for construction personnel in accordance with Underground Standards 3646 & 3649.

DEFINITIONS

Circuit Position – the cable racking position (either horizontal or vertical) for individual conductors of a three-phase circuit.

Occupied Knockout – the conduit position within a particular conduit array that is occupied by a particular feeder circuit or local distribution cable run.

Conduit Array – the grouping of conduit positions at the entrance to a substructure such as columns A–B or C–D (as shown in the examples).

Transition Area – the radial area adjacent to substructures where conduits transition from stacked configuration (main trench) to a pattern compatible with substructure knockouts.

CRITERIA

The occupied knockout depends on the equipment installed in the substructure.

- A. Switches : see UG standard 3649 for technical illustrations.
 - 1. Cables must enter the manhole in the conduit array nearest the wall that is opposite of the switch.
 - 2. Connectors and splices must be placed on the wall opposite the switch.
 - 3. Switches must be placed nearest the wall that is opposite of the manhole opening.

- B. Connectors, splices : see UG standard 3646 & 3649 for technical illustrations.
 - 1. Cables may enter manholes in the conduit array nearest either wall; the wall with connectors or splices is preferred.
 - 2. Feeder cables must be racked or terminated on the same wall with the connectors or splices and therefore must enter and leave the handhole that is nearest the wall with terminating equipment.
 - 3. Connectors or splices may be placed within a manhole without regard to the manhole opening when a switch or future switch is not a consideration..
 - 4. Cable pulled straight through manholes or handholes must enter and leave the substructure on opposite end walls in the knockout position directly across from each other.

- C. The following limitations apply to all equipment:
 - 1. Local distribution cable may be racked either horizontally or vertically, provided that horizontal racking does not cause the cable to interfere with the unobstructed space or future cable pulling & training.
 - 2. Feeder cable may only be racked horizontally in manholes, vertically in handholes.
 - 3. The preferred entrance for feeder and local distribution cables is on the same wall, but they may enter a manhole in the conduit array nearest the wall that is opposite of connectors or splices.
 - 4. Local distribution cable may enter a handhole in the conduit array nearest the wall that is opposite of connectors or splices, but feeder cables must enter and exit a handhole on the same wall as the connectors or splices.

	Indicates Latest Revision	Completely Revised	New Page
REVISION	SDG&E DISTRIBUTION DESIGN MANUAL		
DATE 1-1-94 APPD MF/ROJ	CONDUIT POSITIONING WITHIN SUBSTRUCTURES		5721.1

5. When two cable runs will occupy adjacent conduits they may be positioned either horizontally or vertically according to the following rules (refer to examples for label reference):
 - the bottom row of conduits (number 1) must be filled by cable prior to using the next row (number 2).
 - the lowest available horizontal row must be occupied prior to going up to the next row.
 - the first cable installed must occupy the outside conduit position (such as A or D).
6. Local distribution cables are to occupy conduits closer to the surface. Feeder cables shall be installed in the lower conduits.
7. Conduit branching from the main trench should occupy a position in the duct bank on the same side as branching is intended.
8. Conduit routed to facilities in close proximity to substructures should be designed to avoid crossing conflicts with other conduits in the transition area.

Conduits cannot cross through the transition area if they are impeded by other conduits occupying the same elevation. Use discretion to select a preferred conduit position that will avoid crossing conflicts.

If unable to avoid crossing conflicts select an alternate conduit position on adjacent corner of substructure. See figure 1 below.

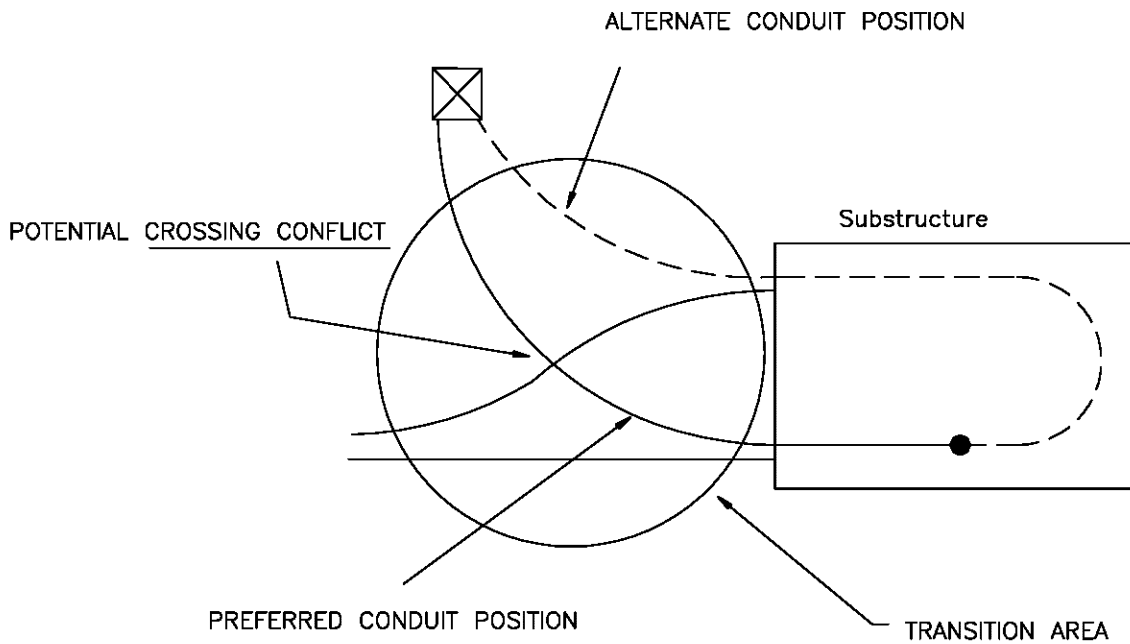

FIGURE 1

	Indicates Latest Revision	Completely Revised	New Page
5721.2	SDG&E DISTRIBUTION DESIGN MANUAL		REVISION
	CONDUIT POSITIONING WITHIN SUBSTRUCTURES		DATE 1-1-94 APPD MF/ROJ

EXAMPLES:

The following examples show various possible cable knockout positions for manholes and handholes.

- Most of the examples have a vertical line with an arrow (\longleftrightarrow) to show the knockout positioning on either side of the substructure. This does not mean that cable can occupy both sides of the substructure at the same time, but merely demonstrates the proper location to install cable, relative to the substructure wall.

LEGEND

- F1 - Feeder (first installed)
- F2 - Feeder (second installed etc.)
- Ff - Feeder (future, as specified by Electric Distribution Planning)
- Fs - Feeder (spare, installed on conversions for ease of future construction)
- L - Local Distribution
- X - May be occupied by future local distribution

1. 3315 HANDHOLE

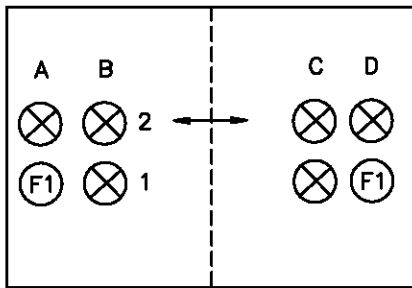

1-FEEDER

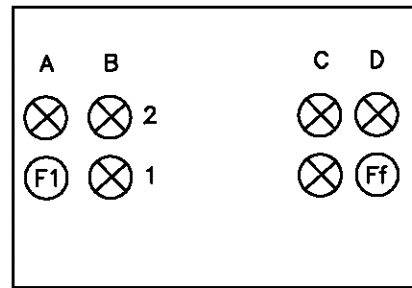

1-FEEDER & 1-FEEDER (FUTURE) *

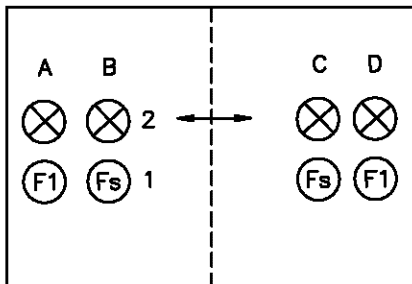

1-FEEDER & 1-FEEDER F. SPARE

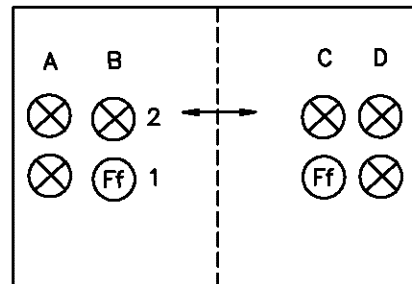

1-FEEDER (FUTURE)

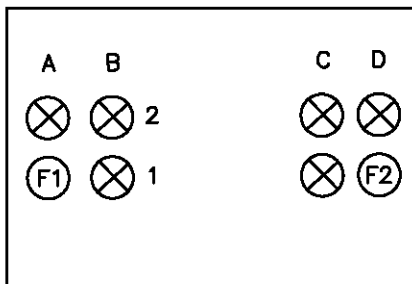

2-FEEDERS *

* Use a 3316 handhole when installing two feeders or one feeder + future feeder with distribution cable.

Special Note: One set of 600 amp tees, in most cases, is all that is allowed on one wall of a 3315 handhole. Careful attention should be paid not to exceed the allowable 3315 connection/cable combinations as indicated on Underground Standard 3649.9 thru 3649.14.

	Indicates Latest Revision	Completely Revised	New Page
REVISION	SDG&E DISTRIBUTION DESIGN MANUAL		
DATE 1-1-86 APPD CVN/BJ	CONDUIT POSITIONING WITHIN SUBSTRUCTURES		5721.3

2. 3316 HANDHOLE

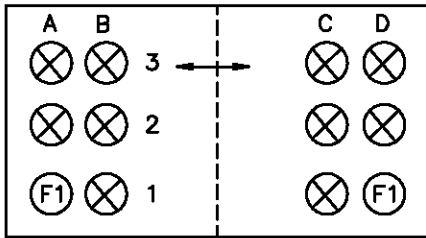

1-FEEDER

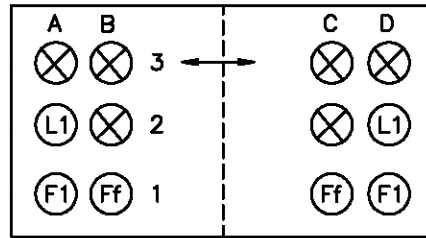

1-FEEDER, 1-FEEDER (FUTURE)
& 1-LOCAL

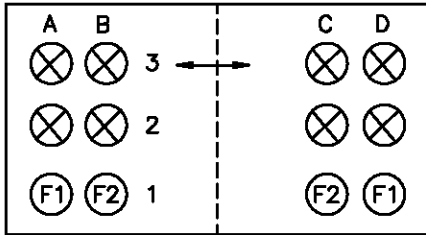

2-FEEDERS

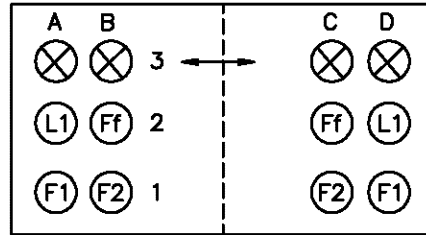

2-FEEDERS, 1-FEEDER (FUTURE)
& 1-LOCAL

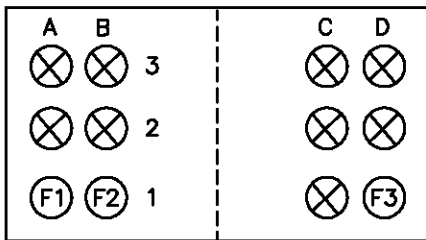

3-FEEDERS

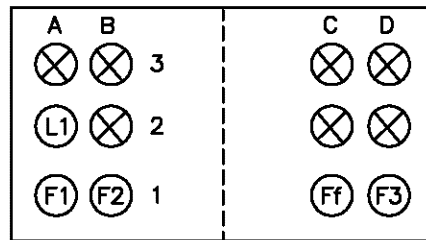

3-FEEDERS, 1-FEEDER (FUTURE)
& 1-LOCAL

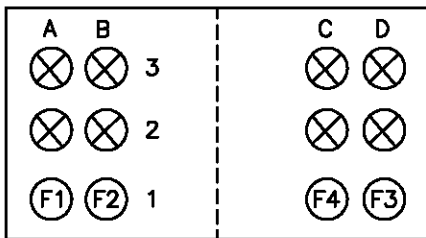

4-FEEDERS

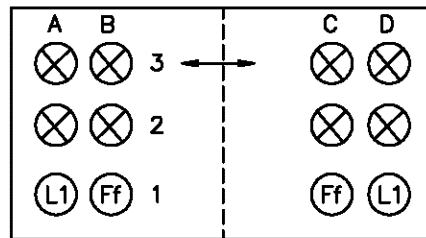

1-FEEDER (FUTURE)
& 1-LOCAL

3. 3317 HANDHOLE

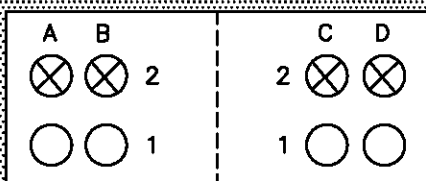

Indicates Latest Revision Completely Revised New Page Information Removed

SDG&E DISTRIBUTION DESIGN MANUAL

5721.4

CONDUIT POSITIONING WITHIN SUBSTRUCTURES

REVISION
DATE 3-1-02
APPD JCE / *lck*

4. 3324, 3325, 3326 MANHOLE:

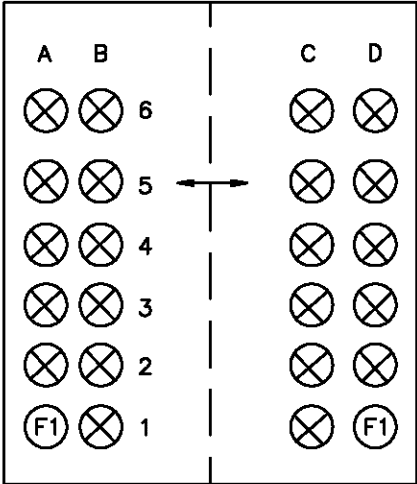

1-FEEDER

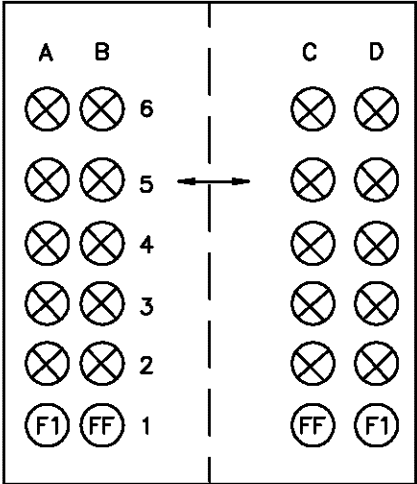

1-FEEDER & 1-FEEDER (FUTURE)

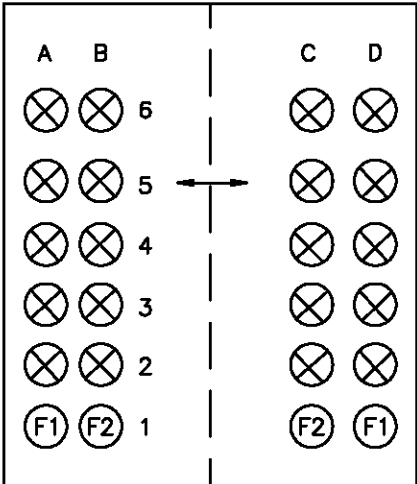

2-FEEDERS

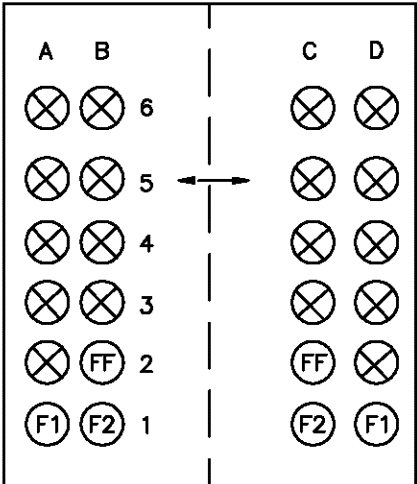

2-FEEDERS & 1-FEEDER (FUTURE)

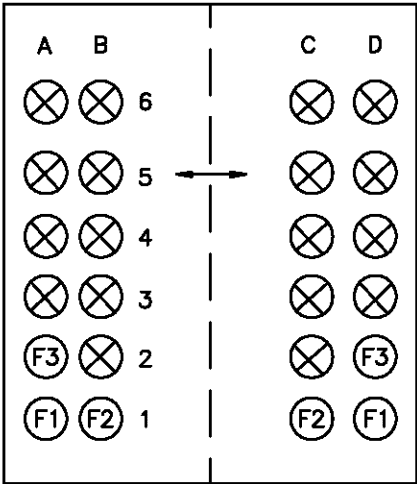

3-FEEDERS

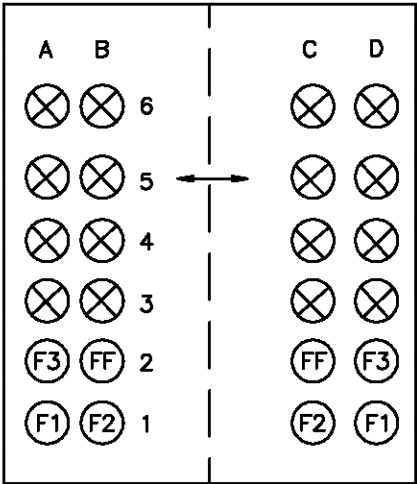

3-FEEDERS & 1-FEEDER (FUTURE)

<input checked="" type="checkbox"/> Indicates Latest Revision		<input type="checkbox"/> Completely Revised	<input type="checkbox"/> New Page	<input type="checkbox"/> Information Removed
REVISION DATE 3-1-02 APPD JCE <i>1/16/02</i>	SDG&E DISTRIBUTION DESIGN MANUAL CONDUIT POSITIONING WITHIN SUBSTRUCTURES			5721.5

References:

1. Design Standard 5711, Conduit and Substructure Selection Criteria
2. Construction Standards Section 3600, Subsurface Sectionalizing Equipment
3. Construction Standards 4004, Minimum Bending Radius For UG Aluminum.

	 Indicates Latest Revision	Completely Revised	New Page
5721.6	SDG&E DISTRIBUTION DESIGN MANUAL		REVISION
	CONDUIT POSITIONING WITHIN SUBSTRUCTURES		DATE 1-1-91 APPD CVN / <i>CVN</i>

I. Materials

Rigid conduit is classified in the following major categories:

1. Schedule 40 and Schedule 80 Conduit – This conduit can be used either above or below ground and must be made of PVC (polyvinyl chloride) only. It can be characterized as having a relatively heavy wall thickness that is suitable for those applications requiring added strength.

The schedule 80 conduit (heavier wall thickness) is installed for the first eight feet up cable poles and schedule 40 conduit (lighter wall thickness) is installed the remaining distance. 2" conduit is not allowed per G.O. 128 for the first 8', use 3" schedule 80 the first eight feet up the cable pole; see UGS 4204.2 for an illustration. 2" conduit is the smallest size permitted for use as a cable pole riser above the 8' level.

2. Concrete Encasement (EB) and Direct Burial (DB) Conduit – These conduits are suitable for below grade applications only and may be made of either ABS (acrylonitrile-butadiene-styrene) or PVC. Material for EB and DB application has a thinner wall thickness than schedule 80 and 40 conduit.

II. Rigid Conduit Guidelines

A. Rigid Plastic Conduit

Rigid plastic DB conduit shall be used in cases which do not require EB conduit (Section B) or steel conduit (Section C).

B. Concrete Encasement

Concrete Encasement of conduit is required for the following:

1. All 5" conduit.
2. Conduit on Port District land.

- NOTES:
1. It is not economical to have an even number of EB conduits (either feeder or feeder plus local distribution) in one-sack concrete encasement simply to displace concrete.
 2. Concrete encasement may be required for conduits installed at reduced depth (see Construction Standard 3370).
 3. Concrete encasement (1-sack mix) is required for stacked conduits.

C. Steel Conduit / Bridge Conduit

Exposed conduit attached to a bridge shall be galvanized steel. The conduit must be grounded at one end of the bridge using 2 separate 8' driven ground rods spaced 6' apart.

The conduits and the hanging hardware (for conduits) are special order items, via RMS. Contact SDGE's Civil Structural Engineering Dept. for design and specification of hanging hardware and conduits. Approval to hang conduits on bridge required from appropriate Governmental authority, Cal-Trans, City, etc.

	Indicates Latest Revision	Completely Revised	New Page
REVISION	SDG&E DISTRIBUTION DESIGN MANUAL		
DATE 1-1-96	CONDUIT APPLICATION		
APPD JW / <i>[Signature]</i>	5722.1		

II. Rigid Conduit Guidelines (continued)

D. Spare Conduits

The terms "spare conduit" refers to empty conduit/s specified by the Planner mainly for operating and maintenance requirements. Spare conduits should be considered or installed:

1. When requested by a customer at his own expense.
2. When it is economical to install conduit in lieu of concrete.
3. Based on future (system) construction limitations such as beneath bridges, roadways and railroad tracks.
4. In conversion or new business projects to allow easy bypass of the pole during removal. Conduits installed for this purpose shall not go up the pole but rather, shall extend past the pole a minimum of 6 feet.
5. When installing spare conduits on cable poles do not exceed the limitations as expressed and illustrated on UGS 4204.

E. Future Conduits

The term "future conduit" refers to an empty conduit specified by either the Planner or Distribution Workflow & Planning for areas with growth potential. Future feeder conduit specified by Distribution Workflow & Planning must be supported by the Long Term Feeder Arrangement Plan.

III. Conduit Application

A. Feeder Conduits

1. Distribution Workflow & Planning is responsible for providing the present, ten year and ultimate primary feeder requirements for underground distribution installations.

No future conduits shall be specified by Distribution Workflow & Planning that are not supported by the long term feeder arrangement plan.

2. Planners will specify the number of feeder conduits on the construction work order according to the ultimate feeder requirements indicated by Distribution Workflow & Planning.
 - a. All feeder conduits are to be 5-inch.
 - b. When concrete encasement is required, the concrete encased portion of the duct bank should contain an even number of conduits only when two-sack concrete is applied. This will reduce the cost associated with pouring concrete where the conduit would normally be placed. Leave an odd number of conduits in the ducts, if 1-sack concrete is used for encasement.

B. Local Distribution Conduits

1. Paralleling Feeder Conduit

Distribution Workflow & Planning or the Planner will provide at least one local distribution conduit when design specifications for a project require installation of one or more feeder conduit. These distribution conduit(s) are required to support:

- a. Present and future fusing. Paralleling the feeder with distribution conduit will minimize the number of fuse cabinets required throughout the project
- b. Looping

	Indicates Latest Revision	Completely Revised	New Page
5722.2	SDG&E DISTRIBUTION DESIGN MANUAL		REVISION
	CONDUIT APPLICATION		DATE 1-1-96 APPD JW / <i>[Signature]</i>

B. Local Distribution Conduits (continued)

c. Design considerations such as future loads.

NOTE: If distribution conduit is not required to support a, b or c above, and the need for future local distribution seems unlikely such as in a completely developed area or in areas where ordinances will likely prevent future development (i.e. parks), an exception may be warranted.

2. Local Distribution Work Only

Planners will include local distribution conduits on new distribution installations. If there is growth potential which may require 2/0 or 3/C-#2 aluminum cable, then a 4" conduit shall be specified.

C. Service Stubs

If services are not installed at the time the distribution system is installed, rigid conduit stubs will be installed to the property line.

It shall be the responsibility of the developer to provide and install the extension of rigid conduit to the building.

IV. Conduit Sizing

A. Horizontal bends (primary, secondary & services) in the conduit shall be made only with long sweeps of 25' radius or larger whenever possible. Smaller radius sweeps may be installed only if space limitations prohibit the use of the 25' radius sweeps and pulling tensions permit (e.g. short-side services in a subdivision). Should field conditions warrant a smaller radius, approval must come from both the Customer Project Planner and the SDG&E inspector.

B. Secondary and service conduits should be chosen as the larger of the following based upon cable requirements:

1. Sized according to applicable Underground Standards.
2. Sized according to the cable selection based on voltage drop and flicker requirements.

V. Abandonment or Removal of Conduit

Abandonment or removal of facilities should be documented on work orders when they are no longer in service. Federal Energy Regulatory Commission accounting rules require that they be removed from plant in service.

The conduits found on the DFIS facilities maps are kept current in the DFIS database via work order documentation. Underground conduit abandoned or removed can be documented by using the generic AU's found in DPSS Family 20805. The size and number of these conduits can and should be specified by using the AU notes feature available with the DBL locations.

Special Note: Abandonment or removal of conduit is not a standard practice, especially conduits in the franchise area. In general, conduits should not be abandoned or removed unless future use can be completely ruled out or when customers need to vacate private property for development. Empty conduits should not be considered for abandonment or removal simply because they're empty.

References:

1. Underground Standards 3372 and 3942.
2. Service Planning Practice 240, Gas/Electric Line Extensions and Service/Meter Requirements for Subdivisions/Developments

	Indicates Latest Revision	Completely Revised	New Page
REVISION	SDG&E DISTRIBUTION DESIGN MANUAL		
DATE 1-1-98 APPD <i>PRM / CAK</i>	CONDUIT APPLICATION		5722.3

SCOPE

This design standard provides the criteria for diagramming substructure details on work order sketches.

PURPOSE

This standard was developed to provide a standardized method for diagramming substructure details on work order sketches.

DEFINITIONS

DESTINATION SUBSTRUCTURE – is the substructure (pad or handhole) where conduit or conduit package will be terminated.

CONDUIT TERMINATION DESIGNATION – is a specific conduit knockout position on destination substructure where conduit will terminate, to be used only when it is not clear where conduit(s) will terminate or when rolling/swapping multiple conduits.

CONDUIT PACKAGE – is considered to be two or more conduits originating and terminating together.

CONDUIT CALLOUT – is the identification of conduit size, cable size, circuit, destination substructure, equipment designation and conduit termination designation for a particular conduit knockout or conduit package.

EQUIPMENT DESIGNATION – specific type of padmounted equipment where conduit will terminate.

CRITERIA

1. Substructure detail diagrams should be provided on work order sketches for all 3315, 3316, 3324, 3325, 3326 and 3399 substructures. Substructure details should also be provided for 3315, 3316 and 3320 substructures located under padmounted switches. The substructure detail provides vital conduit/cable installation information for construction and reference information for future extensions.
2. When placing substructure details on work order sketch, the orientation should be the same as the substructure it is illustrating.

	<input checked="" type="checkbox"/> Indicates Latest Revision	<input type="checkbox"/> Completely Revised	<input type="checkbox"/> New Page
REVISION	SDG&E DISTRIBUTION DESIGN MANUAL		5723.1
DATE 3-1-02 APPD JCE / <i>Vcl</i>	SUBSTRUCTURE DETAIL CRITERIA		

3. Each conduit callout should include:
- conduit size (whether occupied by cable or spare)
 - cable size and number of conductors, i.e., 3-1000, 2-#2
 - circuit number, i.e., Cir 273, Sec
 - destination substructure identification, i.e., D123567, H109145
 - equipment designation (applicable to padmounted equipment) – See Item 4.
 - (optional) conduit termination designation; i.e., A1, A2, A3, B1, etc. This should be used only when it is not clear where conduits are to terminate or when rolling/swapping multiple conduits.

4. EQUIPMENT DESIGNATIONS:

<u>PADMOUNT DEVICE</u>	<u>DESIGNATION</u>
Transformer	STA
Fuse Cabinet	FC
Terminator	TERM
Switch	SWI
Capacitor	CAP
Service Restorer	SR
SCADA Pad	SCP

5. Refer to Design Standard 5721 for conduit positioning within substructures.
6. Refer to Design Standard 5722 for conduit application guidelines.
7. When providing substructure details on work orders, indicate whether substructure is existing (dashes) or new (solid). Both existing and new conduit callouts should be provided on substructure detail.
8. Conduit packages which originate and terminate as a package should be indicated on substructure detail by boxing.

EXAMPLES:

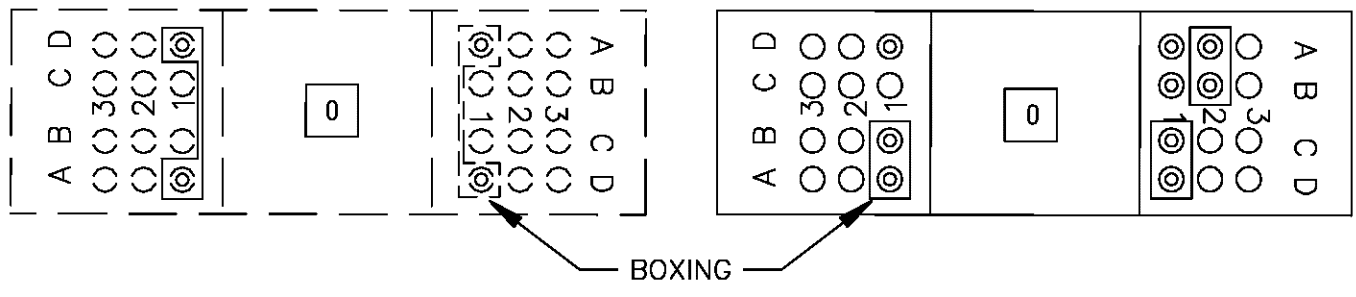

9. The following are examples of the proper method for diagramming substructure details:

NEW SUBSTRUCTURE

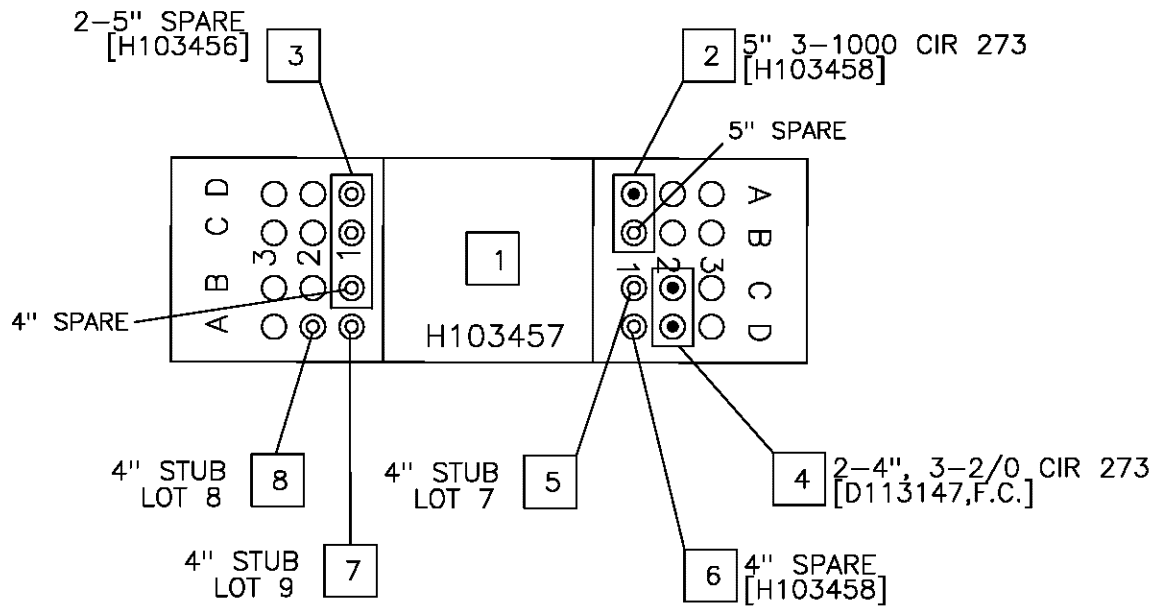

EXISTING SUBSTRUCTURE

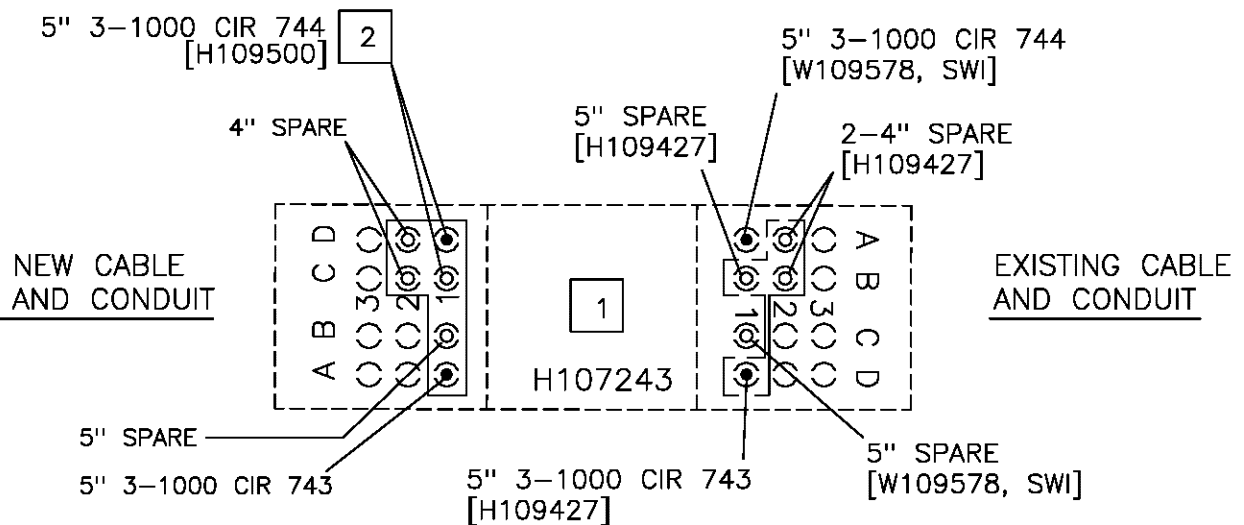

	Indicates Latest Revision	Completely Revised	New Page
REVISION	SDG&E DISTRIBUTION DESIGN MANUAL		
DATE 1-1-96	SUBSTRUCTURE DETAIL CRITERIA		
APPD JW <i>[Signature]</i>	5723.3		

10. The following substructure details on 5723.4 and 5723.5 show the method for detailing conduit placement from one substructure to another.
 EXISTING SUBSTRUCTURE – (originating substructure):

NEW SUBSTRUCTURE – (DESTINATION SUBSTRUCTURE)

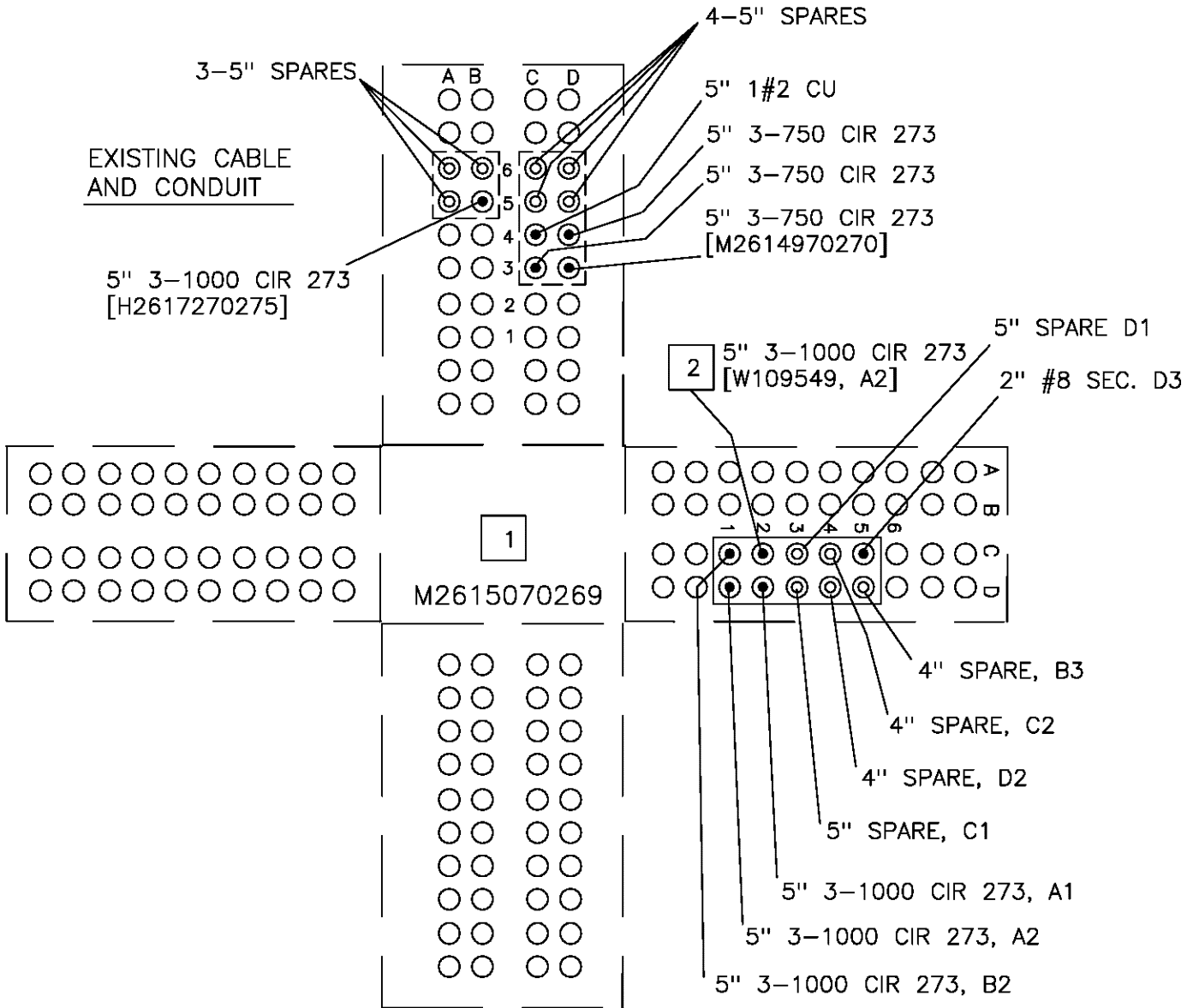

NEW CABLE AND CONDUIT

SEE 5723.5 FOR DESTINATION SUBSTRUCTURE

	Indicates Latest Revision	Completely Revised	New Page
5723.4	SDG&E DISTRIBUTION DESIGN MANUAL		REVISION
	SUBSTRUCTURE DETAIL CRITERIA		DATE 1-1-96 APPD JW <i>[Signature]</i>

NEW SUBSTRUCTURE - (DESTINATION SUBSTRUCTURE)

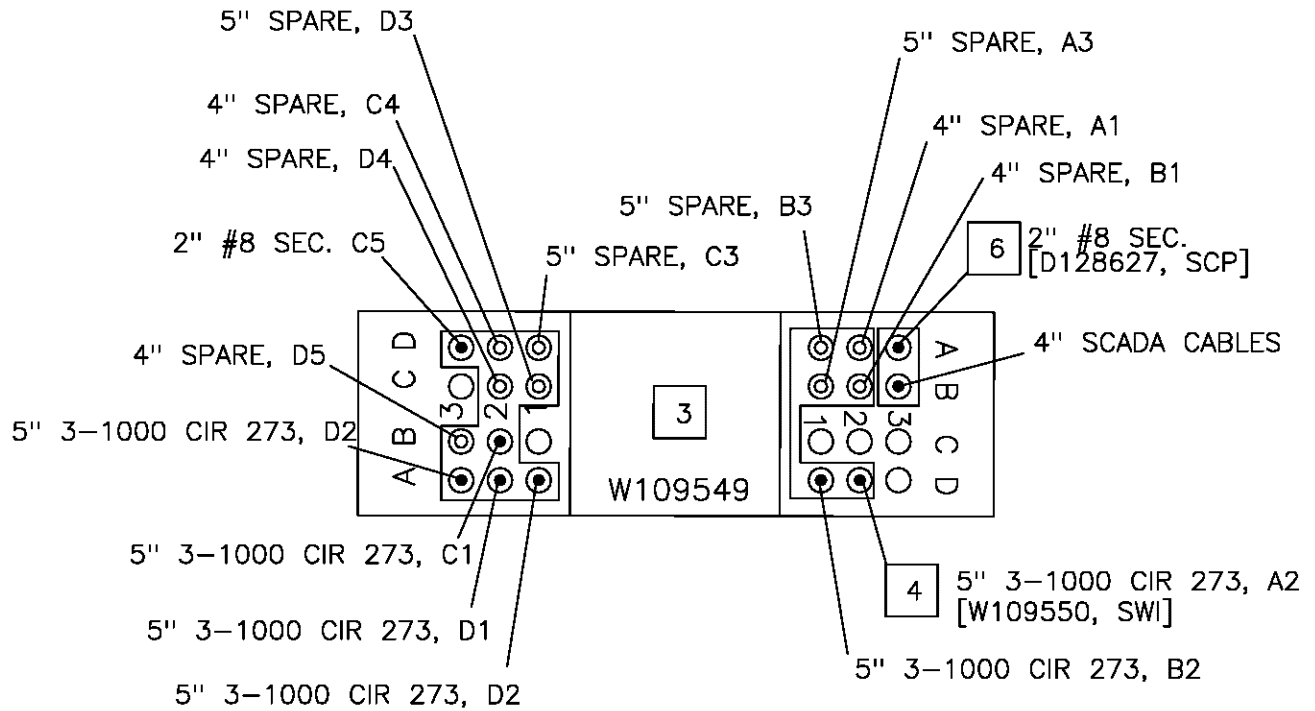

REFERENCES:

1. Design Standard 5721, Conduit Positioning Within Substructures.
2. Design Standard 5722, Conduit Application.
3. Construction Standards Section 3500, Padmount Switch Installations.
4. Construction Standards Section 3600, Subsurface/Surface Operable Switch Installations.
5. Service Planning Manual 1085, Work Order Sketch.

	Indicates Latest Revision	Completely Revised	New Page
REVISION	SDG&E DISTRIBUTION DESIGN MANUAL		
DATE 1-1-96	SUBSTRUCTURE DETAIL CRITERIA		
APPD JW / <i>[Signature]</i>	5723.5		

Scope

The following criteria has been developed to assist planners and field review personnel in determining whether an electric underground construction job is a good candidate for directional bore.

Description

Trenchless installation of electric conduits can be accomplished using non-directional and directional boring techniques. Non-directional tools, such as pneumatic piercing tools (moles), are used to install single conduits, usually for short runs. Installations of multiple ducts are generally done using directional boring machines, which are electronically trackable and steerable to avoid any underground obstacles and existing utilities in their path. During the directional bore, a mixture of bentonite clay and water is emitted through small diameter jets in the rod, allowing it to work its way through the soil, stabilize the trench wall, and lubricate the conduit during pullback.

Applications

- A. Street crossings are ideal candidates. Lateral installations will be considered on a job by job basis.
- B. Primary or secondary installations.
- C. Single duct installation – 2" through 5" conduit.
- D. Multiple ducts:
 - 1. Up to 2 – 5" conduits (4–5" conduits)*
 - 2. Up to 3 – 4" conduits
 - 3. Up to 4 – 3" conduits
 - 4. Up to 5 – 2" conduits
 For 2"–4" conduit installations other combinations are possible. Contact Underground Standards.

Other Considerations

- A. Coiled or Straight Length Conduit–
 - 1. Polyethylene coiled conduit is available in the 2" to 4" sizes.
 - 2. Straight lengths are recommended for 5" conduit because of handling constraints.
- B. Coming In or Out of Substructures–
 - 1. At present there are no special fittings for PE installations to substructures.
 - 2. It is recommended that a PVC stub should be left sticking out of the substructure and the PE will then be transitioned from the PVC stub using mechanical couplings.
- C. Conduit Transitions–
 - 1. Mechanical couplings should be used for any transitions from PVC to PE and vice versa.
- D. Soil Conditions–
 - 1. It should be realized that difficult soil conditions may not allow for a directional bore application.
 - 2. Difficult soil conditions may slow down a job or force the job to be done using open trench methods.

* Trenchless technology installations of 4–5" conduits is to be limited to street crossings. There shall be no trenchless installation of 4–5" conduits or more near substations.

	Indicates Latest Revision	Completely Revised	New Page
REVISION	SDG&E DISTRIBUTION DESIGN MANUAL		
DATE 1-1-96	TRENCHLESS ELECTRIC INSTALLATION		
APPD JW / <i>[Signature]</i>	5725		

SCOPE: THIS STANDARD DESCRIBES THE BELOW GRADE SINGLE TRANSFORMER VAULT REQUIREMENTS FOR 120/208V AND 277/480V.

ATTENTION:

* THIS DOCUMENT IS FOR INTERNAL SDG&E USE ONLY. IT SHALL NOT BE ISSUED TO THE CUSTOMER.

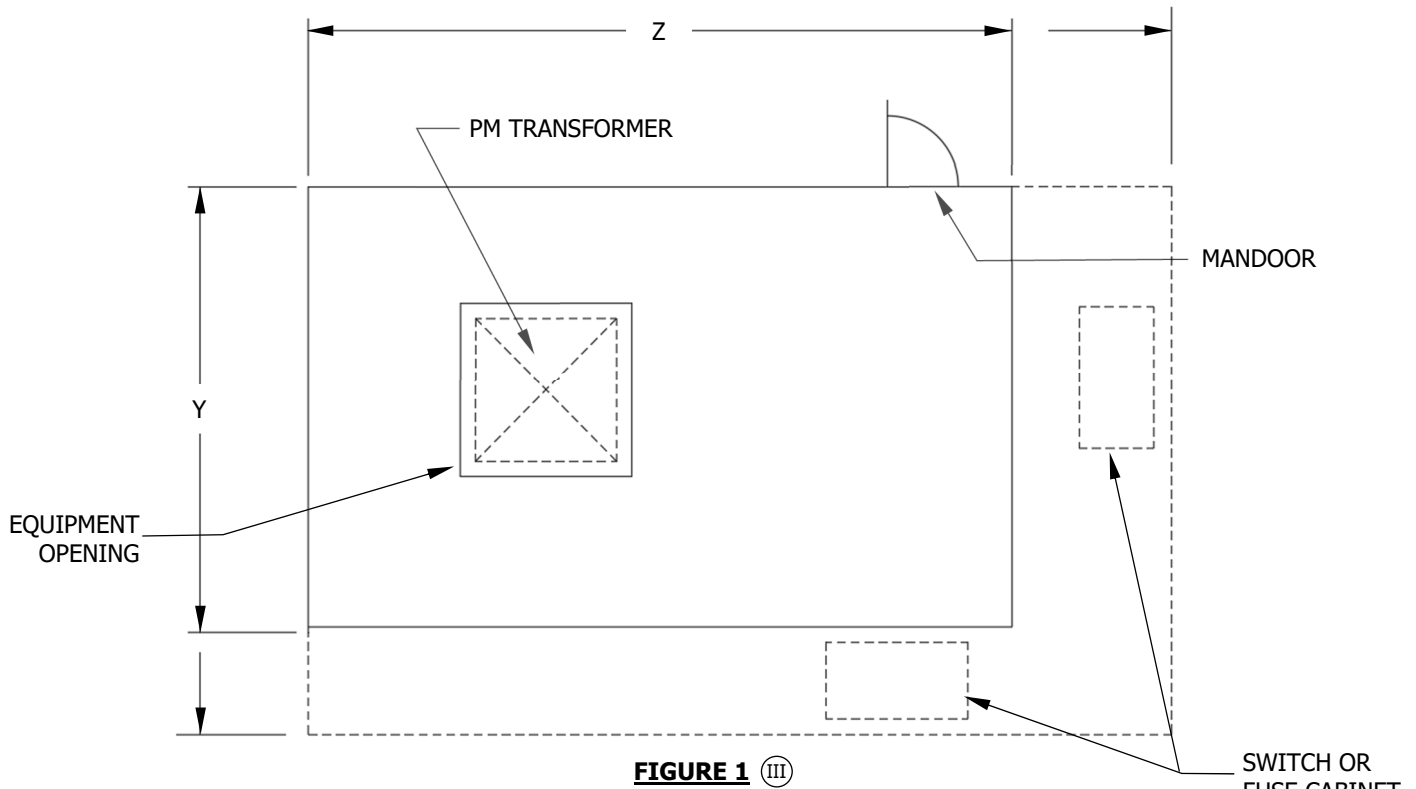

FIGURE 1 (III)

TABLE 1

BELOW GRADE MINIMUM ELECTRIC VAULT REQUIREMENTS FOR SINGLE TRANSFORMER INSTALLATION – 3-PHASE TRANSFORMER												
CUST. BOARD SIZE	208V TRANSF. SIZE (KVA)	480V TRANSF. SIZE (KVA)	FRONT TO BACK LENGTH Z (IV)	WALL TO WALL WIDTH Y	ALONG W/TRANSF. SWITCH INST. ON SIDE WALL		ALONG W/TRANSF. SWITCH INST. ON END WALL		FLOOR TO CEILING HEIGHT	CEILING EQUIPMENT OPENING	TRANSF. WEIGHT LBS	SUMP CAP. GALLONS
					LENGTH Z	WIDTH Y	LENGTH Z	WIDTH Y				
120/208V												
200	75	--	13'-6"	9'-6"	NA				8'-0"	4'-6" X 6'-6"	3,500	240
400	150	--	13'-6"	9'-6"					8'-0"	4'-6" X 6'-6"	3,900	240
600	225	--	14'-0"	9'-6"					8'-0"	5'-0" X 6'-6"	4,200	240
800	300	--	15'-0"	10'-6"					8'-6"	6'-0" X 7'-6"	5,000	255
1000	300	--	15'-0"	10'-6"					8'-6"	6'-0" X 7'-6"	5,000	255
1200	500	--	16'-6"	12'-6"	21'-6"	15'-0"	19'-6"	20'-9" (IV)	9'-0"	6'-6" X 7'-6"	6,600	290
1600	500	--	16'-6"	12'-6"	21'-6"	15'-0"	19'-6"	20'-0" (IV)	9'-0"	6'-6" X 7'-6"	6,600	290

© 1998 - 2022 San Diego Gas & Electric Company. All rights reserved. Removal of this copyright notice without permission is not permitted under law.

REV	CHANGE	DR	BY	DSN	APV	DATE	REV	CHANGE	DR	BY	DSN	APV	DATE
C							F						
B	EDITORIAL CHANGES	EDM	ADW	JES	KRG	04/22/2022	E						
A	ORIGINAL ISSUE	-	-	-	-	06/22/2004	D						

SHEET 1 OF 15	X Indicates Latest Revision	Completely Revised	New Page	Information Removed
	SDG&E ELECTRIC DISTRIBUTION DESIGN MANUAL			
	BELOW GRADE SINGLE TRANSFORMER VAULT REQUIREMENTS FOR 120/208V AND 277/480V			
DM5745.1				

TABLE 1 (CONT'D):

**BELOW GRADE
MINIMUM ELECTRIC VAULT REQUIREMENTS FOR
SINGLE TRANSFORMER INSTALLATION – 3-PHASE TRANSFORMER**

CUST. BOARD SIZE	208V TRANSF. SIZE (KVA)	480V TRANSF. SIZE (KVA)	FRONT TO BACK LENGTH Z (IV)	WALL TO WALL WIDTH Y	ALONG W/TRANSF. SWITCH INST. ON SIDE WALL		ALONG W/TRANSF. SWITCH INST. ON END WALL		FLOOR TO CEILING HEIGHT	CEILING EQUIPMENT OPENING	TRANSF. WEIGHT LBS	SUMP CAP. GALLONS
					LENGTH Z	WIDTH Y	LENGTH Z	WIDTH Y				
120/208V												
2000	750	--	17'-0"	12'-6"	22'-6"	15'-0"	20'-0"	20'-0" (IV)	9'-0"	7'-0" X 7'-6"	7,550	425
2500	1000	--	18'-0"	13'-6"	23'-6"	16'-6"	21'-6"	20'-0" (IV)	10'-0"	8'-0" X 7'-6"	8,200	435
3000	1000	--	18'-0"	13'-6"	23'-0"	16'-6"	21'-6"	20'-0" (IV)	10'-0"	8'-0" X 7'-6"	8,200	435
4000	1000 1500 (V)	--	20'-0"	16'-0"	25'-6"	19'-0"	23'-0"	20'-0" (IV)	11'-0"	10'-0" X 9'-0"	10,150	515
277/480V												
200	--	150	13'-6"	9'-6"	NA				8'-0"	4'-6" X 6'-6"	3,900	240
400	--	300	15'-0"	10'-6"	NA				8'-6"	6'-0" X 7'-6"	5,000	255
600	--	500	16'-6"	12'-6"	21'-6"	15'-0"	19'-6" (IV)	20'-0"	9'-0"	6'-6" X 7'-6"	6,600	290
800	--	500	16'-6"	12'-6"	21'-6"	15'-0"	19'-6" (IV)	20'-0"	9'-0"	6'-6" X 7'-6"	6,600	290
1000	--	750	17'-0"	12'-6"	22'-6"	15'-0"	20'-0" (IV)	20'-0"	9'-0"	7'-0" X 7'-6"	7,550	425
1200	--	1000	18'-0"	13'-6"	23'-6"	16'-6"	21'-6" (IV)	20'-0"	10'-0"	8'-0" X 7'-6"	8,200	435
1600	--	1000	18'-0"	13'-6"	23'-6"	16'-6"	21'-6" (IV)	20'-0"	10'-0"	8'-0" X 7'-6"	8,200	435
2000	--	1500	20'-0"	16'-0"	25'-6"	19'-0"	23'-0" (IV)	20'-0"	11'-0"	10'-0" X 9'-0"	10,150	515
2500	--	2000	20'-0"	16'-6"	25'-6"	19'-6"	23'-0" (IV)	20'-0"	12'-0"	10'-0" X 10'-0"	17,300	570
3000	--	2000	20'-0"	16'-6"	25'-6"	19'-6"	23'-0" (IV)	20'-0"	12'-0"	10'-0" X 10'-0"	17,300	570
4000	--	2500 3000 (VI)	20'-0"	16'-6"	25'-6"	19'-6"	23'-0" (IV)	20'-0"	12'-0"	10'-0" X 10'-0"	17,300	580

INSTALLATION: NONE

BILL OF MATERIALS: NONE

NOTES:

I. THE DIMENSIONS IN TABLE 1 COVER NECESSARY WORK AREAS INCLUDING FUSING EQUIPMENT MOUNTED ON WALL WITHIN THE 8-FOOT WORK AREA IN FRONT OF TRANSFORMER.

II. VAULTS ALL REQUIRE STANDARD 3'-0" X 6'-8" MANDOR ADJACENT TO WORK AREA IN FRONT OF TRANSFORMER.

(III) VAULTS WHERE MANDOR ACCESS IS NOT READILY ACCESSIBLE 24 HOURS REQUIRE A MANHOLE ENTRANCE IN CEILING LOCATION (MANHOLE WILL ACCESS TO WORK AREA, NOT OVER EQUIPMENT).

(IV) THIS DIMENSION MAY BE REDUCED BY 2 FEET WHERE MANDOR ENTRANCE IS LOCATED JUST TO THE FRONT AND SIDE OF SWITCH.

(V) 1500KVA IS SUBJECT TO DISTRICT ENGINEERING APPROVAL. 1000KVA IS MAXIMUM INDICATED. (a)

(VI) MAXIMUM ALLOWED. (a)

REFERENCE:

(a) SEE RULE II, 5.a,b,c.

© 1998 - 2022 San Diego Gas & Electric Company. All rights reserved. Removal of this copyright notice without permission is not permitted under law.

REV	CHANGE	DR	BY	DSN	APV	DATE	REV	CHANGE	DR	BY	DSN	APV	DATE
C							F						
B	EDITORIAL CHANGES	EDM	ADW	JES	KRG	04/22/2022	E						
A	ORIGINAL ISSUE	-	-	-	-	06/22/2004	D						

SHEET 2 OF 15	X Indicates Latest Revision	Completely Revised	New Page	Information Removed
	SDG&E ELECTRIC DISTRIBUTION DESIGN MANUAL			
	BELOW GRADE SINGLE TRANSFORMER VAULT REQUIREMENTS FOR 120/208V AND 277/480V			

DM5745.2

SCOPE: THIS STANDARD DESCRIBES THE BELOW GRADE MULTIPLE TRANSFORMER VAULT REQUIREMENTS FOR 120/208V AND 277/480V.

ATTENTION:

* THIS DOCUMENT IS FOR INTERNAL SDG&E USE ONLY. IT SHALL NOT BE ISSUED TO THE CUSTOMER.

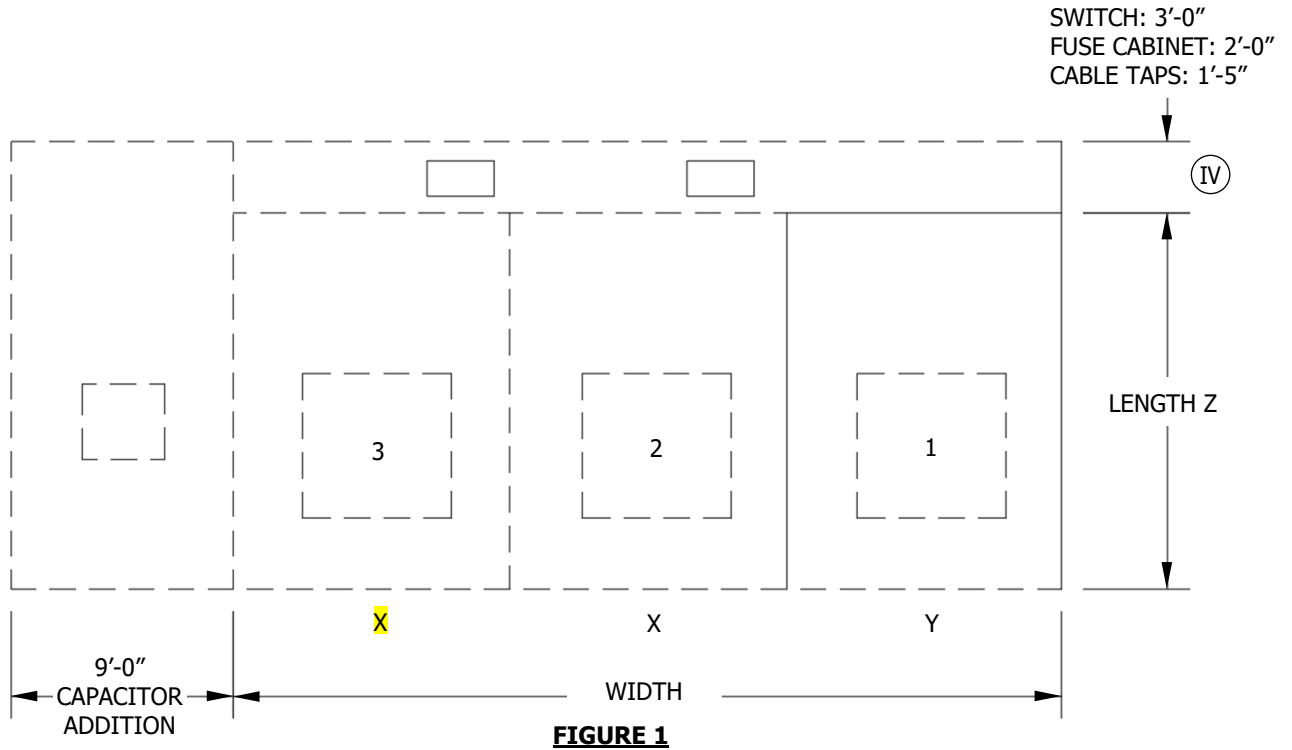

FIGURE 1

TABLE 1

BELOW GRADE MULTIPLE TRANSFORMER INSTALLATION MINIMUM VAULT DIMENSIONS FOR MULTI-SERVICES (III)												
120/208V SIDE BY SIDE	MINIMUM VAULT DIMENSIONS FOR ONE SERVICE PANEL											
	MAIN SIZE	200i	400i	600i	800i	1000i	1200i	1600i	2000i	2500i	3000i	4000i
	LENGTH Z	13'-6"	13'-6"	14'-0"	15'-0"	15'-0"	16'-6"	16'-6"	17'-0"	18'-0"	18'-0"	20'-0"
	WIDTH Y	9'-6"	9'-6"	9'-6"	10'-6"	10'-6"	12'-6"	12'-6"	12'-6"	13'-6"	13'-6"	16'-0"
	ADDITIONAL VAULT WIDTH FOR EACH ADDED SERVICE MAIN											
WIDTH X	7'-6"	7'-6"	7'-6"	8'-6"	8'-6"	9'-6"	9'-6"	9'-6"	10'-6"	10'-6"	12'-0"	
277/480V SIDE BY SIDE	MINIMUM VAULT DIMENSIONS FOR ONE SERVICE PANEL											
	MAIN SIZE	200i	400i	600i	800i	1000i	1200i	1600i	2000i	2500i	3000i	4000i
	LENGTH Z	13'-6"	15'-0"	16'-6"	16'-6"	17'-0"	18'-0"	18'-0"	20'-0"	20'-0"	20'-0"	20'-0"
	WIDTH Y	9'-6"	10'-6"	12'-6"	12'-6"	12'-6"	13'-6"	16'-0"	16'-6"	16'-6"	16'-6"	16'-6"
	ADDITIONAL VAULT WIDTH FOR EACH ADDED SERVICE MAIN											
WIDTH X	7'-6"	8'-6"	9'-6"	9'-6"	9'-6"	10'-6"	10'-6"	12'-0"	12'-6"	12'-6"	12'-6"	

© 1998 - 2022 San Diego Gas & Electric Company. All rights reserved. Removal of this copyright notice without permission is not permitted under law.

REV	CHANGE	DR	BY	DSN	APV	DATE	REV	CHANGE	DR	BY	DSN	APV	DATE
C							F						
B	EDITORIAL CHANGES	EDM	ADW	JES	KRG	04/22/2022	E						
A	ORIGINAL ISSUE	-	-	-	-	06/22/2004	D						

<p>SHEET 3 OF 15</p>	<p>X Indicates Latest Revision</p>	<p>Completely Revised</p>	<p>New Page</p>	<p>Information Removed</p>	<p>DM5745.3</p>
	<p>SDG&E ELECTRIC DISTRIBUTION DESIGN MANUAL</p>				
	<p>BELOW GRADE MULTIPLE TRANSFORMER VAULT REQUIREMENTS FOR 120/208V AND 277/480V</p>				

INSTALLATION: NONE

BILL OF MATERIALS: NONE

NOTES:

I. TO CALCULATE MULTIPLE SERVICE VAULT DIMENSION, START WITH LARGEST APPLICABLE MAIN SIZE, THEN ADD APPROPRIATE FOOTAGES FOR EACH ADDITIONAL SERVICE MAIN.

II. **EXAMPLE:**

120/208V

CUSTOMER'S 1-3000i AND 1-2000i

	Z	Y
3000i =	18'-0"	13'-6"
2000i =	--	9'-6"
SWITCH, FUSE CABINET AND CABLE TAPS =	3'-0"	--
CAP. =	--	9'-0"
VAULT DIM'S. =	21'-0"	32'-0"

III DIMENSIONS ARE TYPICAL AND MAY VARY DEPENDING ON CUSTOMER'S ACTUAL ALLOCATED SPACE FOR VAULT. REARRANGING FACILITIES WITH NECESSARY REQUIREMENTS TO BE WORKED OUT WITH PROJECT ENGINEER.

IV MAXIMUM DISTANCE REQUIRED IS 3 FEET SINCE ALL EQUIPMENT WILL FIT WITHIN THAT ALLOCATED SPACE.

REFERENCE: NONE

© 1998 - 2022 San Diego Gas & Electric Company. All rights reserved. Removal of this copyright notice without permission is not permitted under law.

REV	CHANGE	DR	BY	DSN	APV	DATE	REV	CHANGE	DR	BY	DSN	APV	DATE
C							F						
B	EDITORIAL CHANGES	EDM	ADW	JES	KRG	04/22/2022	E						
A	ORIGINAL ISSUE	-	-	-	-	06/22/2004	D						

X	Indicates Latest Revision	Completely Revised	New Page	Information Removed
----------	---------------------------	--------------------	----------	---------------------

SDG&E ELECTRIC DISTRIBUTION DESIGN MANUAL

SHEET
4 OF 15

BELOW GRADE MULTIPLE TRANSFORMER VAULT
REQUIREMENTS FOR 120/208V AND 277/480V

DM5745.4

SCOPE: THIS STANDARD DESCRIBES ON GRADE SINGLE TRANSFORMER VAULT REQUIREMENTS FOR 120/208V AND 277/480V.

ATTENTION:

* THIS DOCUMENT IS FOR INTERNAL SDG&E USE ONLY. IT SHALL NOT BE ISSUED TO THE CUSTOMER.

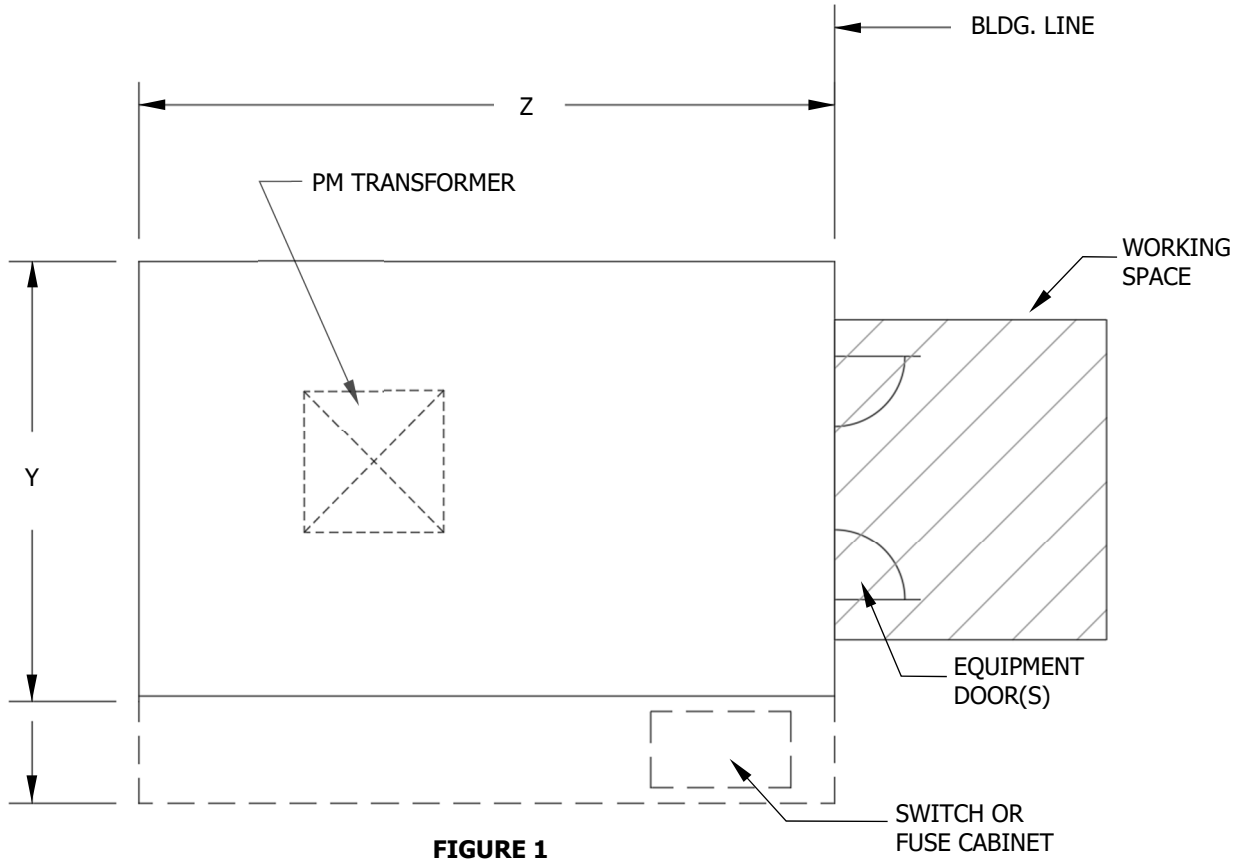

FIGURE 1

TABLE 1

**ON GRADE
MINIMUM ELECTRIC VAULT REQUIREMENTS FOR
SINGLE TRANSFORMER INSTALLATION – 3-PHASE TRANSFORMER**

CUST. BOARD SIZE	208V TRANSF. SIZE (KVA)	480V TRANSF. SIZE (KVA)	FRONT TO BACK LENGTH Z (II)	WALL TO WALL WIDTH Y	ALONG W/TRANSF. SWITCH INSTALLED ON SIDE WALL		FLOOR TO CEILING HEIGHT	ON GRADE EQUIPMENT OPENING		TRANSF. WEIGHT LBS	SUMP CAP. GALLONS	CLEAR & LEVEL WORKING SPACE IN FRONT OF EQUIP. OPENING	
					LENGTH Z	WIDTH Y		WIDE	WIDE			WIDE	WIDE
120/208V													
200	75	--	14'-6"	9'-6"	14'-6"	12'-6"	8'-0"	7'-6"	6'-6"	3,500	240	6'-0"	7'-6"
400	150	--	14'-6"	9'-6"	14'-6"	12'-6"	8'-0"	7'-6"	7'-6"	3,900	240	6'-0"	7'-6"
600	225	--	16'-0"	9'-6"	16'-0"	12'-6"	8'-0"	7'-6"	7'-6"	4,200	240	6'-0"	7'-6"
800	300	--	17'-0"	10'-6"	17'-0"	13'-6"	8'-0"	8'-6"	8'-6"	5,000	255	7'-0"	8'-6"
1000	300	--	17'-0"	10'-6"	17'-0"	13'-6"	8'-0"	8'-6"	8'-6"	5,000	255	7'-0"	8'-6"
1200	500	--	19'-6"	12'-6"	19'-6"	12'-6"	9'-0"	8'-6"	8'-6"	6,600	290	7'-0"	8'-6"

© 1998 - 2022 San Diego Gas & Electric Company. All rights reserved. Removal of this copyright notice without permission is not permitted under law.

REV	CHANGE	DR	BY	DSN	APV	DATE	REV	CHANGE	DR	BY	DSN	APV	DATE
C							F						
B	EDITORIAL CHANGES	EDM	ADW	JES	KRG	04/22/2022	E						
A	ORIGINAL ISSUE	-	-	-	-	06/22/2004	D						

SHEET 5 OF 15	X Indicates Latest Revision	Completely Revised	New Page	Information Removed
	SDG&E ELECTRIC DISTRIBUTION DESIGN MANUAL			
	ON GRADE SINGLE TRANSFORMER VAULT REQUIREMENTS FOR 120/208V AND 277/480V			

DM5745.5

TABLE 1 (CONT'D):

**ON GRADE
MINIMUM ELECTRIC VAULT REQUIREMENTS FOR
SINGLE TRANSFORMER INSTALLATION – 3-PHASE TRANSFORMER**

CUST. BOARD SIZE	208V TRANSF. SIZE (KVA)	480V TRANSF. SIZE (KVA)	FRONT TO BACK LENGTH Z (II)	WALL TO WALL WIDTH Y	ALONG W/TRANSF. SWITCH INSTALLED ON SIDE WALL		FLOOR TO CEILING HEIGHT	ON GRADE EQUIPMENT OPENING		TRANSF. WEIGHT LBS	SUMP CAP. GALLONS	CLEAR & LEVEL WORKING SPACE IN FRONT OF EQUIP. OPENING	
					LENGTH Z	WIDTH Y		WIDE	WIDE			WIDE	WIDE
120/208V													
1600	500	--	19'-6"	12'-6"	19'-6"	12'-6"	9'-0"	8'-6"	8'-6"	6,600	290	7'-0"	8'-6"
2000	750	--	20'-0"	12'-6"	20'-0"	15'-6"	9'-0"	8'-6"	8'-6"	7,550	425	8'-0"	8'-6"
2500	1000	--	21'-0"	13'-6"	21'-0"	16'-6"	10'-0"	8'-6"	8'-6"	8,200	435	8'-0"	8'-6"
3000	1000	--	21'-0"	13'-6"	21'-0"	16'-6"	10'-0"	8'-6"	8'-6"	8,200	435	8'-0"	8'-6"
4000	1000 1500 (III)	--	23'-0"	16'-0"	23'-0"	19'-0"	11'-0"	10'-0"	10'-0"	10,150	515	10'-0"	10'-0"
277/480V													
200	--	150	14'-6"	9'-6"	14'-6"	12'-6"	8'-0"	7'-6"	7'-6"	3,900	240	6'-0"	7'-7"
400	--	300	17'-0"	10'-6"	17'-0"	13'-6"	8'-6"	8'-0"	8'-6"	5,000	255	7'-0"	8'-6"
600	--	500	19'-6"	12'-6"	19'-6"	15'-6"	9'-0"	8'-6"	8'-6"	6,600	290	7'-0"	8'-6"
800	--	500	19'-6"	12'-6"	19'-6"	15'-6"	9'-0"	8'-6"	8'-6"	6,600	290	7'-0"	8'-6"
1000	--	750	12'-0"	12'-6"	20'-0"	15'-6"	9'-0"	8'-6"	8'-6"	7,500	425	8'-0"	8'-6"
1200	--	1000	21'-0"	13'-6"	21'-0"	16'-6"	10'-0"	8'-6"	8'-6"	8,200	435	8'-0"	8'-6"
1600	--	1000	21'-0"	13'-6"	21'-0"	16'-6"	10'-0"	8'-6"	8'-6"	8,200	435	8'-0"	8'-6"
2000	--	1500	23'-0"	16'-0"	23'-0"	19'-0"	11'-0"	10'-0"	10'-0"	10,150	515	10'-0"	10'-0"
2500	--	2000	23'-0"	16'-6"	23'-0"	19'-6"	12'-0"	10'-0"	10'-0"	17,300	570	10'-0"	10'-0"
3000	--	2000	23'-0"	16'-6"	23'-0"	19'-6"	12'-0"	10'-6"	10'-0"	17,300	570	10'-0"	10'-0"
4000	--	2500 3000 (IV)	23'-0"	16'-6"	23'-0"	19'-6"	12'-0"	10'-6"	10'-0"	17,300	580	10'-0"	10'-0"

INSTALLATION: NONE

BILL OF MATERIALS: NONE

NOTES:

I. DIMENSIONS IN TABLE 1 COVER NECESSARY WORK AREA INCLUDING FUSING EQUIPMENT MOUNTED ON WALL WITHIN 8-FOOT WORK AREA IN FRONT OF TRANSFORMER.

(II) THIS DIMENSION MAY BE REDUCED BY 6 FEET WHEN THE PAD MOUNTED TRANSFORMER IS THE ONLY SDG&E EQUIPMENT INSTALLED IN VAULT AND THE CLEAR AND LEVEL WORKING SPACE REQUIREMENT OUTSIDE VAULT IS MAINTAINED AND AT THE SAME GRADE AS VAULT FLOOR.

(III) 1500KVA IS SUBJECT TO DISTRICT ENGINEERING APPROVAL. 1000KVA IS MAXIMUM INDICATED. (a)

(IV) MAXIMUM ALLOWED. (a)

REFERENCE:

(a) SEE RULE II, 5.a,b,c.

© 1998 - 2022 San Diego Gas & Electric Company. All rights reserved. Removal of this copyright notice without permission is not permitted under law.

REV	CHANGE	DR	BY	DSN	APV	DATE	REV	CHANGE	DR	BY	DSN	APV	DATE
C							F						
B	EDITORIAL CHANGES	EDM	ADW	JES	KRG	04/22/2022	E						
A	ORIGINAL ISSUE	-	-	-	-	06/22/2004	D						

SHEET 6 OF 15	X Indicates Latest Revision	Completely Revised	New Page	Information Removed
	SDG&E ELECTRIC DISTRIBUTION DESIGN MANUAL			
	ON GRADE SINGLE TRANSFORMER VAULT REQUIREMENTS FOR 120/208V AND 277/480V			

DM5745.6

SCOPE: THIS STANDARD DESCRIBES ON GRADE MULTIPLE TRANSFORMER VAULT REQUIREMENTS FOR 120/208V AND 277/480V.

ATTENTION:

* THIS DOCUMENT IS FOR INTERNAL SDG&E USE ONLY. IT SHALL NOT BE ISSUED TO THE CUSTOMER.

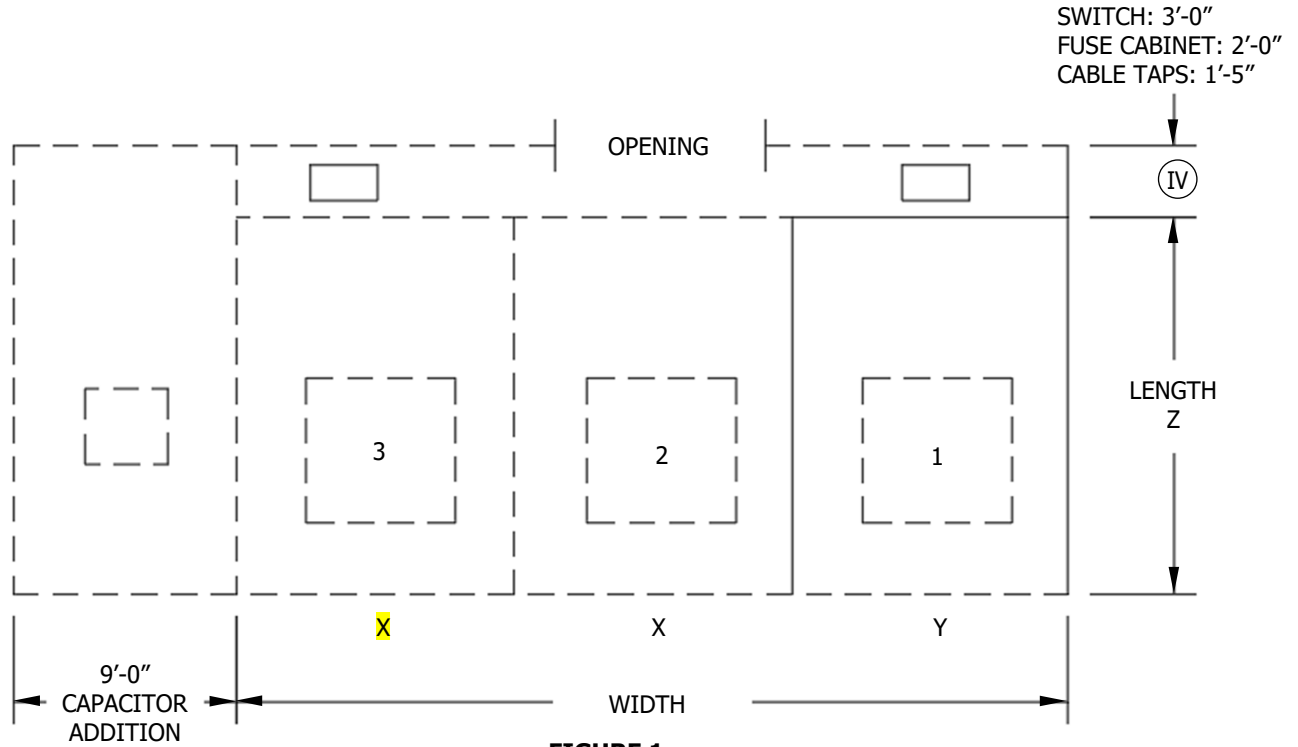

FIGURE 1

TABLE 1

ON GRADE MULTIPLE TRANSFORMER INSTALLATION MINIMUM VAULT DIMENSIONS FOR MULTI-SERVICES (III)												
120/208V SIDE BY SIDE	MINIMUM VAULT DIMENSIONS FOR ONE SERVICE PANEL											
	MAIN SIZE	200i	400i	600i	800i	1000i	1200i	1600i	2000i	2500i	3000i	4000i
	LENGTH Z	14'-6"	14'-6"	16'-0"	17'-0"	17'-0"	19'-6"	19'-6"	20'-0"	21'-0"	21'-0"	23'-0"
	WIDTH Y	9'-6"	9'-6"	9'-6"	10'-6"	10'-6"	12'-6"	12'-6"	12'-6"	13'-6"	13'-6"	16'-6"
	ADDITIONAL VAULT WIDTH FOR EACH ADDED SERVICE MAIN											
WIDTH X	7'-6"	7'-6"	7'-6"	8'-6"	8'-6"	9'-6"	9'-6"	9'-6"	10'-6"	10'-6"	12'-0"	
277/480V SIDE BY SIDE	MINIMUM VAULT DIMENSIONS FOR ONE SERVICE PANEL											
	MAIN SIZE	200i	400i	600i	800i	1000i	1200i	1600i	2000i	2500i	3000i	4000i
	LENGTH Z	14'-6"	17'-0"	19'-6"	19'-6"	20'-0"	21'-0"	21'-0"	23'-0"	23'-0"	23'-0"	23'-0"
	WIDTH Y	9'-6"	10'-6"	12'-6"	12'-6"	12'-6"	13'-6"	16'-0"	16'-6"	16'-6"	16'-6"	16'-6"
	ADDITIONAL VAULT WIDTH FOR EACH ADDED SERVICE MAIN											
WIDTH X	7'-6"	8'-6"	9'-6"	9'-6"	9'-6"	10'-6"	10'-6"	12'-0"	12'-6"	12'-6"	12'-6"	

© 1998 - 2022 San Diego Gas & Electric Company. All rights reserved. Removal of this copyright notice without permission is not permitted under law.

REV	CHANGE	DR	BY	DSN	APV	DATE	REV	CHANGE	DR	BY	DSN	APV	DATE
C							F						
B	EDITORIAL CHANGES	EDM	ADW	JES	KRG	04/22/2022	E						
A	ORIGINAL ISSUE	-	-	-	-	06/22/2004	D						

<p>SHEET 7 OF 15</p>	<p>X Indicates Latest Revision</p>	<p>Completely Revised</p>	<p>New Page</p>	<p>Information Removed</p>	<p>DM5745.7</p>
	<p>SDG&E ELECTRIC DISTRIBUTION DESIGN MANUAL</p>				
	<p>ON GRADE MULTIPLE TRANSFORMER VAULT REQUIREMENTS FOR 120/208V AND 277/480V</p>				

INSTALLATION: NONE

BILL OF MATERIALS: NONE

NOTES:

- I. TO CALCULATE MULTIPLE SERVICE VAULT DIMENSION, START WITH LARGEST APPLICABLE MAIN SIZE, THEN ADD APPROPRIATE FOOTAGES FOR EACH ADDITIONAL SERVICE MAIN.
- II. IN DETERMINING THE NUMBER OF EQUIPMENT ENTRY OPENINGS FOR SLIDE-IN OR ROLL-IN FACILITIES, PRIME CONSIDERATION SHALL BE GIVEN TO LOCATION AND SPACE REQUIRED FOR SWITCH, TAPS, AND FUSES MOUNTED ON OR ADJACENT TO WALLS. ONE EQUIPMENT OPENING IS SUFFICIENT IF ANY ONE PIECE OF EQUIPMENT CAN BE INSTALLED OR REMOVED VIA THAT OPENING WITHOUT DISTURBING OTHER EQUIPMENT PLACED IN VAULT.
- III DIMENSIONS ARE TYPICAL AND MAY VARY DEPENDING ON CUSTOMER'S ACTUAL ALLOCATED SPACE FOR VAULT. REARRANGING FACILITIES WITH NECESSARY REQUIREMENTS TO BE WORKED OUT WITH PROJECT ENGINEER.
- IV MAXIMUM DISTANCE REQUIRED IS 3 FEET SINCE ALL EQUIPMENT WILL FIT WITHIN THAT ALLOCATED SPACE.

REFERENCE: NONE

© 1998 - 2022 San Diego Gas & Electric Company. All rights reserved. Removal of this copyright notice without permission is not permitted under law.

REV	CHANGE	DR	BY	DSN	APV	DATE	REV	CHANGE	DR	BY	DSN	APV	DATE
C							F						
B	EDITORIAL CHANGES	EDM	ADW	JES	KRG	04/22/2022	E						
A	ORIGINAL ISSUE	-	-	-	-	06/22/2004	D						

SHEET 8 OF 15	X Indicates Latest Revision	Completely Revised	New Page	Information Removed	DM5745.8
	SDG&E ELECTRIC DISTRIBUTION DESIGN MANUAL				
	ON GRADE MULTIPLE TRANSFORMER VAULT REQUIREMENTS FOR 120/208V AND 277/480V				

SCOPE: THIS STANDARD DESCRIBES THE CAPACITOR REQUIREMENTS FOR VAULTS.

ATTENTION:

* THIS DOCUMENT IS FOR INTERNAL SDG&E USE ONLY. IT SHALL NOT BE ISSUED TO THE CUSTOMER.

INSTALLATION: NONE

BILL OF MATERIALS: NONE

TABLE 1

CAPACITOR REQUIREMENTS FOR VAULTS											
PANEL	200	400	600	800	1000	1200	1600	2000	2500	3000	4000
120/208 3Ø 4W	0	0	0	0	0	0	0	0	0	1	1
277/480 3Ø 4W	0	0	0	0	0	0	1	1	1	1	1

NOTES:

- I. ADD PANEL SIZES BY VOLTAGE CLASS. TAKE THE TOTAL AND APPLY TO THE TABLE. ROUND UP TO NEXT SIZE. WHEN THE TOTAL EXCEEDS 4000, ALLOW FOR ONE PAD MOUNTED CAPACITOR AND START OVER, ADDING THE REMAINING PANEL RATINGS.
- II. A "1" INDICATES VAULT SPACE REQUIRED FOR ONE PAD MOUNTED CAPACITOR.
- III. A "0" INDICATES NO CAPACITOR REQUIRED.
- IV. CAPACITOR WEIGHT IS 1,925 LBS.

REFERENCE: NONE

© 1998 - 2022 San Diego Gas & Electric Company. All rights reserved. Removal of this copyright notice without permission is not permitted under law.

REV	CHANGE	DR	BY	DSN	APV	DATE	REV	CHANGE	DR	BY	DSN	APV	DATE
C							F						
B	EDITORIAL CHANGES	EDM	ADW	JES	KRG	04/22/2022	E						
A	ORIGINAL ISSUE	-	-	-	-	06/22/2004	D						

<p>SHEET 9 OF 15</p>	<p>X Indicates Latest Revision</p>	<p>Completely Revised</p>	<p>New Page</p>	<p>Information Removed</p>	<p>DM5745.9</p>
	<p>SDG&E ELECTRIC DISTRIBUTION DESIGN MANUAL</p>				
	<p>CAPACITOR REQUIREMENTS FOR VAULTS</p>				

SCOPE: THIS STANDARD DESCRIBES SUPERVISORY CONTROL AND DATA ACQUISITION (SCADA) REQUIREMENTS.

ATTENTION:

* THIS DOCUMENT IS FOR INTERNAL SDG&E USE ONLY. IT SHALL NOT BE ISSUED TO THE CUSTOMER.

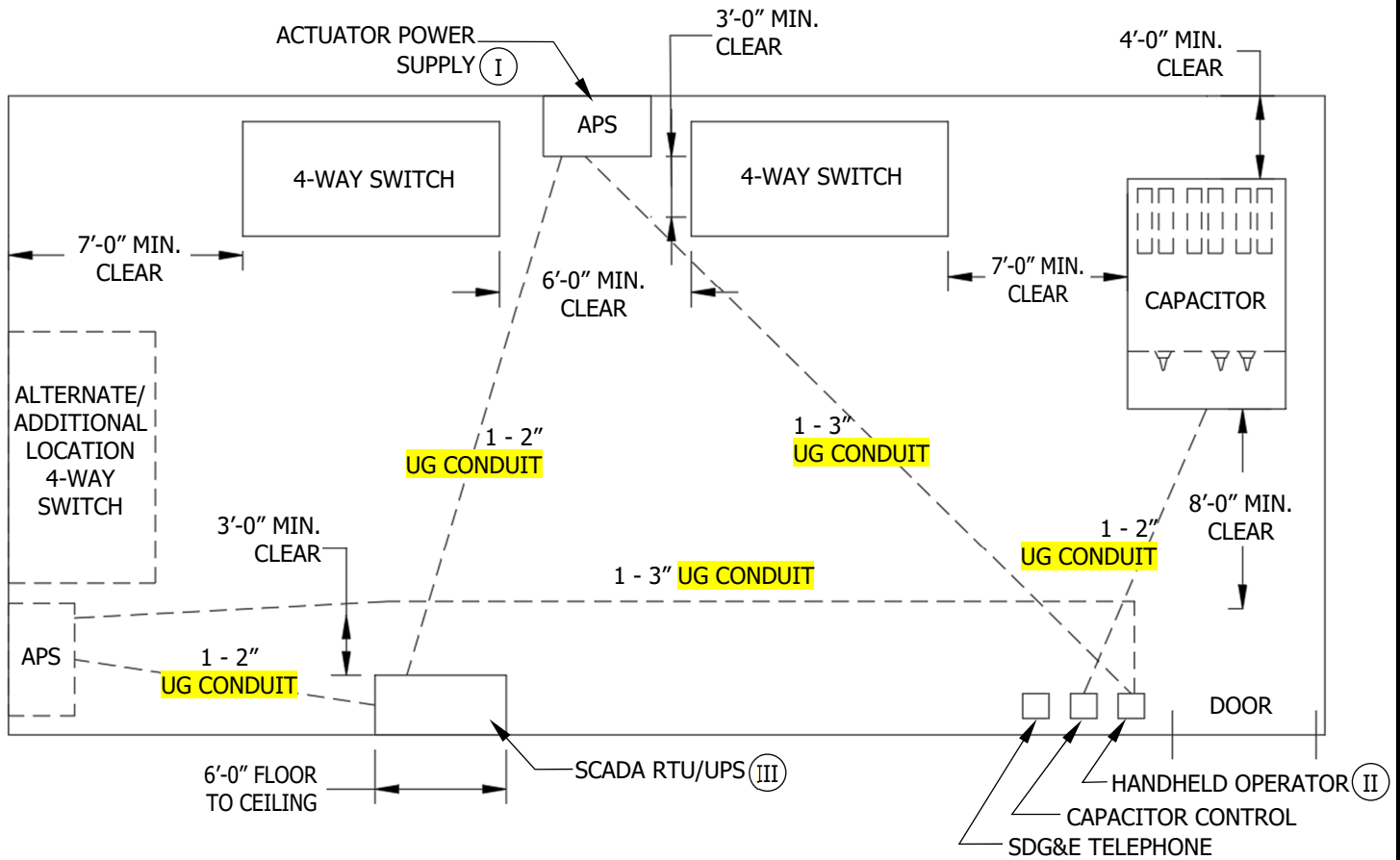

FIGURE 1
TYPICAL SCADA INSTALLATION

INSTALLATION:

- A. INSTALL 50 PAIR CABLE "TO SPLIT-66" TERMINAL IN ALL VAULTS FOR SDG&E TELEPHONE AND SCADA, PRESENT OR FUTURE.
- B. IN CONDUIT PACKAGE COMING INTO THE VAULT, INSTALL TWO 4-INCH CONDUITS ABOVE 5-INCH CONDUITS.
- C. INSTALL 120V SERVICE TO FEED SCADA RTU BOX. THIS MAY OR MAY NOT REQUIRE A 2-INCH CONDUIT, DEPENDING ON THE VAULT ARRANGEMENT.

BILL OF MATERIALS: NONE

NOTES:

- (I) ONE ACTUATOR POWER SUPPLY (APS) CAN CONTROL UP TO TWO 4-WAY SWITCHES. A THIRD SWITCH REQUIRES A SECOND APS.
- (II) ONE PER SWITCH. CONNECTS TO APS.
- (III) 120V SOURCE REQUIRED.

REFERENCE: NONE

© 1998 - 2022 San Diego Gas & Electric Company. All rights reserved. Removal of this copyright notice without permission is not permitted under law.

REV	CHANGE	DR	BY	DSN	APV	DATE	REV	CHANGE	DR	BY	DSN	APV	DATE
C							F						
B	EDITORIAL CHANGES	EDM	ADW	JES	KRG	04/22/2022	E						
A	ORIGINAL ISSUE	-	-	-	-	06/22/2004	D						

SHEET 10 OF 15	X Indicates Latest Revision	Completely Revised	New Page	Information Removed
	SDG&E ELECTRIC DISTRIBUTION DESIGN MANUAL			
	SUPERVISORY CONTROL AND DATA ACQUISITION (SCADA) REQUIREMENTS			
DM5745.10				

SCOPE: THIS STANDARD SHOWS A 12KV, 200A WALL MOUNTED FUSE CABINET USED FOR FUSING IN TRANSFORMER VAULTS.

ATTENTION:

* THIS DOCUMENT IS FOR INTERNAL SDG&E USE ONLY. IT SHALL NOT BE ISSUED TO THE CUSTOMER.

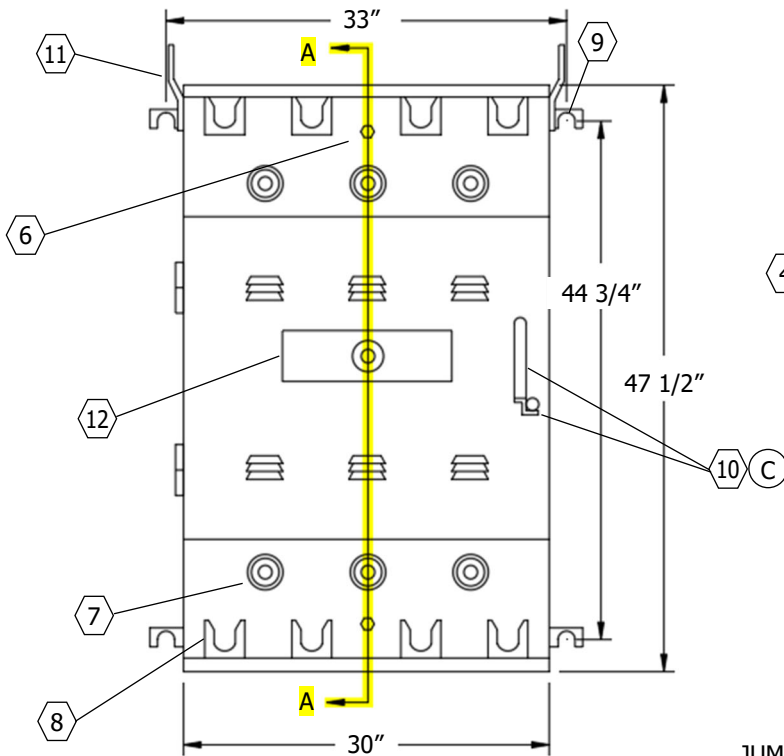

FIGURE 1 (1)
FRONT
SEE TABLE 2

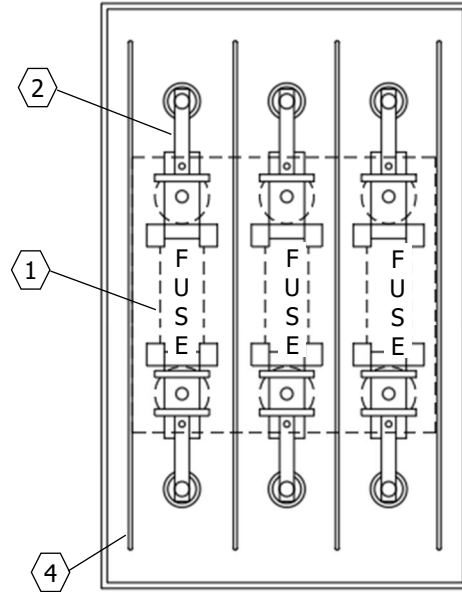

FIGURE 1
FRONT SECTION
SEE TABLE 2

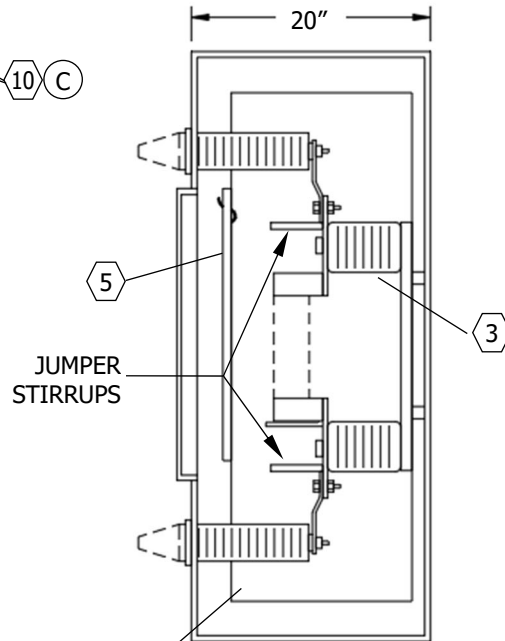

FIGURE 1
SECTION A-A
SEE TABLE 2

© 1998 - 2022 San Diego Gas & Electric Company. All rights reserved. Removal of this copyright notice without permission is not permitted under law.

REV	CHANGE	DR	BY	DSN	APV	DATE	REV	CHANGE	DR	BY	DSN	APV	DATE
C							F						
B	EDITORIAL CHANGES	EDM	ADW	JES	KRG	04/22/2022	E						
A	ORIGINAL ISSUE	-	-	-	-	06/22/2004	D						

X Indicates Latest Revision Completely Revised New Page Information Removed
SDG&E ELECTRIC DISTRIBUTION DESIGN MANUAL

SHEET
11 OF 15

THREE-PHASE WALL MOUNTED FUSE CABINET
12KV, 200A

DM5745.11

TABLE 1

ELECTRIC RATINGS	
VOLTAGE	15KV
B.I.L.	110KV
MAX FUSE SIZE	200A

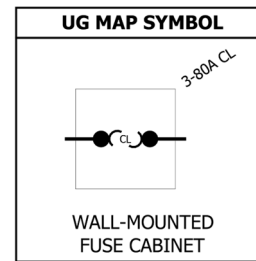
**INSTALLATION:**

- (A) BUSHING WELLS WILL ACCEPT BUSHING PLUGS OR FEED-THRU INSERTS FOR LOADBREAK CAPABILITY. (2)(3)
- (B) INSTALL FEED-THRU INSERTS ON LOAD SIDE OF ALL CABINETS.
- (C) CABINET DOOR HANDLE DOES NOT REQUIRE A PADLOCK.

BILL OF MATERIALS:

ITEM	DESCRIPTION	WEIGHT (LB)	QUANTITY	STANDARD PAGE	STOCK NUMBER	DESIGN UNITS
1	THREE-PHASE WALL MOUNTED FUSE CABINET	380	1	--	S190444	FC-VLT
2	PLUG, BUSHING	--	AS REQ'D	--	S544676	--
3	INSERT, FEED-THRU	--	AS REQ'D	--	S544678	--

TABLE 2

PARTS LIST	
ITEM	DESCRIPTION
(1)	200A CURRENT LIMITING FUSE (a)
(2)	COPPER BUS
(3)	BUSHING
(4)	BARRIER
(5)	REMOVABLE BARRIER
(6)	GROUNDING POSITION
(7)	BUSHING WELL (A)(B)
(8)	PARKING STAND
(9)	MOUNTING BRACKET
(10)	CABINET DOOR HANDLE AND PENTAHEAD BOLT PROVISION (B)
(11)	LIFTING TABS
(12)	MR OUCH DECAL
(13)	NAME PLATE (ON INSIDE OF DOOR) (II)

© 1998 - 2022 San Diego Gas & Electric Company. All rights reserved. Removal of this copyright notice without permission is not permitted under law.

REV	CHANGE	DR	BY	DSN	APV	DATE	REV	CHANGE	DR	BY	DSN	APV	DATE
C							F						
B	EDITORIAL CHANGES	EDM	ADW	JES	KRG	04/22/2022	E						
A	ORIGINAL ISSUE	-	-	-	-	06/22/2004	D						

X	Indicates Latest Revision	Completely Revised	New Page	Information Removed
SDG&E ELECTRIC DISTRIBUTION DESIGN MANUAL				

**SHEET
12 OF 15**

**THREE-PHASE WALL MOUNTED FUSE CABINET
12KV, 200A**

DM5745.12

NOTES:

I. WALL MOUNTED FUSE CABINET IS DELIVERED FROM THE SUPPLIER WITH ALL THE PARTS LISTED IN TABLE 2 EXCEPT FUSES.

II NOT SHOWN ON FIGURES.

REFERENCE:

- a) SEE UG4302 FOR FUSE APPLICATION GUIDE.
- b. SEE TRANSFORMER VAULTS SPECIFICATIONS BOOK FOR INSTALLATION LOCATION.
- c. SEE UG3480, UG3481, UG3482 AND UG3483 FOR CLEARANCE IN FRONT OF CABINET.
- d. SEE UG3516 (PREVIOUS #UG3580).

© 1998 - 2022 San Diego Gas & Electric Company. All rights reserved. Removal of this copyright notice without permission is not permitted under law.

REV	CHANGE	DR	BY	DSN	APV	DATE	REV	CHANGE	DR	BY	DSN	APV	DATE
C							F						
B	EDITORIAL CHANGES	EDM	ADW	JES	KRG	04/22/2022	E						
A	ORIGINAL ISSUE	-	-	-	-	06/22/2004	D						

SHEET 13 OF 15	 Indicates Latest Revision	Completely Revised	New Page	Information Removed	DM5745.13
	SDG&E ELECTRIC DISTRIBUTION DESIGN MANUAL				
	THREE-PHASE WALL MOUNTED FUSE CABINET 12KV, 200A				

SCOPE: THIS STANDARD PROVIDES EQUIPMENT COMBINATION GUIDELINES.

ATTENTION:

* THIS DOCUMENT IS FOR INTERNAL SDG&E USE ONLY. IT SHALL NOT BE ISSUED TO THE CUSTOMER.

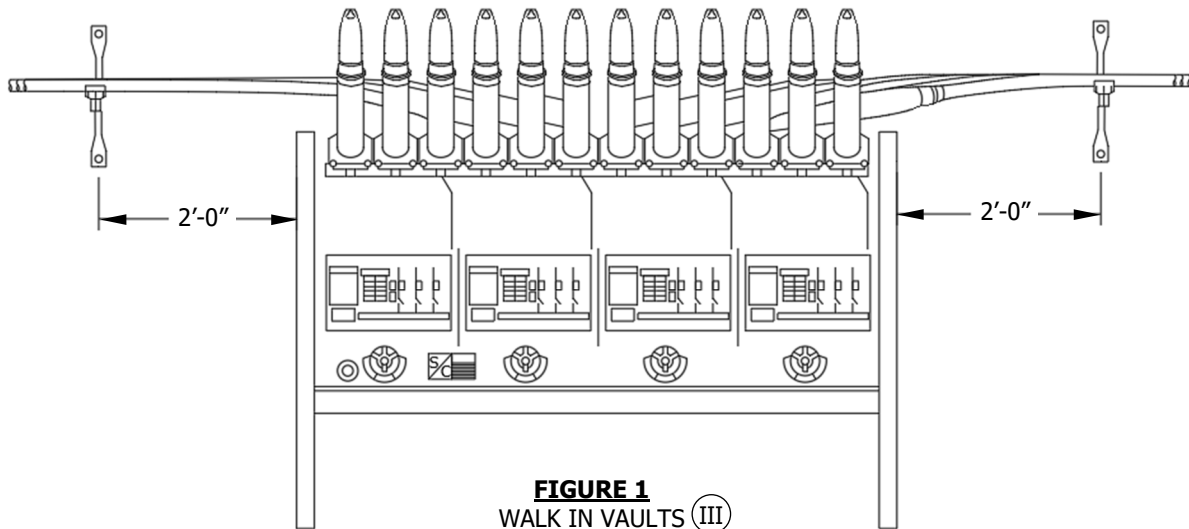

FIGURE 1
WALK IN VAULTS (III)
TYPICAL 4-WAY MANUAL OR SCADA SWITCH
FRONT VIEW

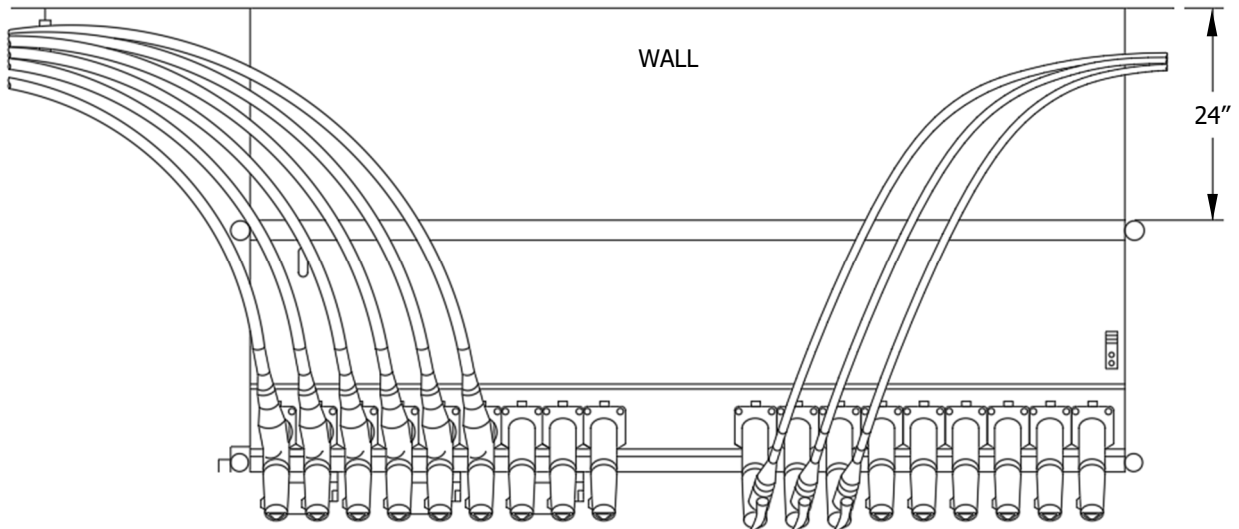

FIGURE 2
WALK IN VAULTS (III)
TYPICAL 6-WAY SCADA SWITCH
TOP VIEW

© 1998 - 2022 San Diego Gas & Electric Company. All rights reserved. Removal of this copyright notice without permission is not permitted under law.

REV	CHANGE	DR	BY	DSN	APV	DATE	REV	CHANGE	DR	BY	DSN	APV	DATE
C							F						
B	EDITORIAL CHANGES	EDM	ADW	JES	KRG	04/22/2022	E						
A	ORIGINAL ISSUE	-	-	-	-	06/22/2004	D						

X	Indicates Latest Revision	Completely Revised	New Page	Information Removed
----------	---------------------------	--------------------	----------	---------------------

SDG&E ELECTRIC DISTRIBUTION DESIGN MANUAL

SHEET
14 OF 15

EQUIPMENT COMBINATION GUIDELINES

DM5745.14

INSTALLATION: NONE

BILL OF MATERIALS: NONE

NOTES:

- I. THE 6-WAY SCADA SWITCH AND FAULT INTERRUPTERS IS THE PREFERRED SWITCH FOR VAULTS.
- II. 4-WAY AND 6-WAY VISTA SWITCHES MAY BE INSTALLED IN DRY VAULTS WITHOUT A DEVIATION REQUEST.
- III FOR ALL SIZES OF PRIMARY AND SECONDARY CABLES.

REFERENCE:

- a. SEE UG3649.

© 1998 - 2022 San Diego Gas & Electric Company. All rights reserved. Removal of this copyright notice without permission is not permitted under law.

REV	CHANGE	DR	BY	DSN	APV	DATE	REV	CHANGE	DR	BY	DSN	APV	DATE
C							F						
B	EDITORIAL CHANGES	EDM	ADW	JES	KRG	04/22/2022	E						
A	ORIGINAL ISSUE	-	-	-	-	06/22/2004	D						

SHEET 15 OF 15	X Indicates Latest Revision	Completely Revised	New Page	Information Removed
	SDG&E ELECTRIC DISTRIBUTION DESIGN MANUAL			
	EQUIPMENT COMBINATION GUIDELINES			

DM5745.15

5800
CAPACITORS

5800
CAPACITORS

PAGE(S)

SUBJECT

5811

Capacitor Application Criteria

5811.1-5811.5

© 1998-2020 San Diego Gas & Electric Company. All rights reserved. Removal of this copyright notice without permission is not permitted under law.

REV	CHANGE	DR	BY	DSN	APV	DATE	REV	CHANGE	DR	BY	DSN	APV	DATE
C							F						
B	TEMPLATE UPDATE	CE	MBL	FRC	CZH	11/09/2020	E						
A	EDITORIAL CHANGES		GB			10/10/2017	D						

SHEET 1 OF 1	X Indicates Latest Revision	Completely Revised	New Page	Information Removed	DM5801.1
	SDG&E ELECTRIC DISTRIBUTION DESIGN MANUAL				
	CAPACITORS TABLE OF CONTENTS				

SCOPE

Electric Distribution Planning and/or the C&O Engineering Centers shall use the following criteria when designing and locating capacitor stations. Connection requirements of overhead capacitors are not included in this standard.

PURPOSE

The capacitor application criteria is provided to ensure proper placement and sizing of field capacitors to economically achieve the following benefits in this order of priority:

1. Maintain proper voltage levels and voltage rise limits
2. Target circuit power factor as 0.995 lagging to reduce circuit load
3. Minimize distribution line losses

DEFINITIONS

- A. Load Power Factor - the load power factor prior to the addition of any capacitor(s).
- B. Lagging Power Factor - the Power Factor when the current follows or lags the voltage. A lagging load consumes vars, as in the case of inductive loads.
- C. Leading Load Power Factor - the Power Factor when the current precedes or leads the voltage. A leading load generates vars, as in the case of capacitors or a synchronous motor operating in a leading mode.
- D. Switched Capacitors - for DM 5811, includes capacitors with legacy controllers and SCADA capacitors.
- E. Fixed Capacitor - for DM 5811, includes capacitors without controller, or switched and SCADA capacitors with controller set with a constant ON setting

CAPACITOR TYPES AND SIZES AVAILABLE

UG: The padmounted SCADA-switched capacitor station is available for 12kV (600 kvar or 1200 kvar size) and 4kV (150 kvar or 300 kvar sizes) applications.

OH: Overhead 12kV SCADA-switched capacitor stations are available in 600 or 1200 kvar sizes. Overhead 4kV SCADA switched capacitors are available in 150 kvar or 300 kvar sizes. (See OH Construction Standard 1314 for capacitor connections.)

SUB: The common 7200 kvar substation capacitor bank is primarily used to compensate for substation transformer reactance. The capacitor is designed to operate in 4 stages of 1800 kvar each.

APPLICATION

- A. Capacitors Installed for Voltage Improvement
 1. The voltage rise that results from adding shunt capacitors can be calculated from Equation 1.

© 1998-2020 San Diego Gas & Electric Company. All rights reserved. Removal of this copyright notice without permission is not permitted under law.

REV	CHANGE	DR	BY	DSN	APV	DATE	REV	CHANGE	DR	BY	DSN	APV	DATE
C							F						
B	REVISION	CSE	JCE	FC	CZH	08/10/2020	E						
A	EDITORIAL CHANGES		GB			05/16/2017	D						
SHEET 1 of 8	 Indicates Latest Revision	Completely Revised				New Page		Information Removed					
	SDG&E ELECTRIC DISTRIBUTION DESIGN MANUAL												
	CAPACITOR APPLICATION CRITERIA												
DM5811.1													

Equation 1

$$\%V = (C)(X)(1/1000)$$

Where:

%V = Percent voltage rise at the capacitor bank.

C = Three phase kvar rating of the capacitor bank.

X = Per unit system line to neutral reactance at the capacitor location; this may be obtained from the Synergi software.

Figure 1 shows the expected voltage rise from a 1200 kvar capacitor installed on the 12kV overhead system. This utilizes an equivalent spacing of 66.7 inches which is standard for 10 foot crossarm construction. This illustrates that for a 1200 kvar capacitor, 3% voltage rise is achieved at distances of about 4.5 to 6 miles from the substation regardless of the overhead conductor size. These 4.5 to 6 miles results for 1200 kvar capacitors must be considered when placing or replacing capacitor banks.

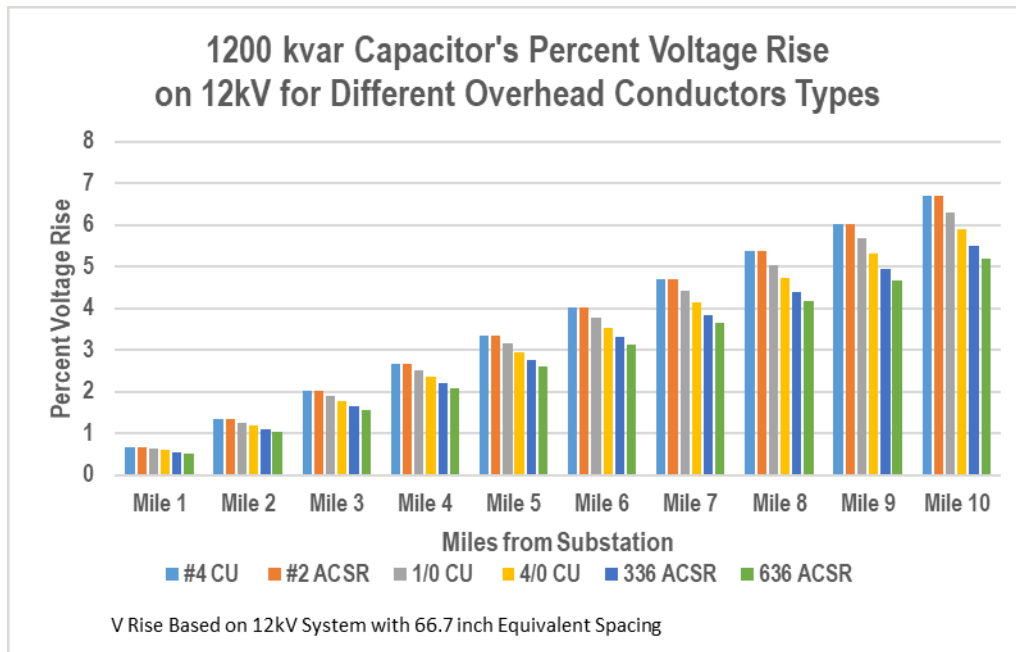

Figure 1

© 1998-2020 San Diego Gas & Electric Company. All rights reserved. Removal of this copyright notice without permission is not permitted under law.

REV	CHANGE	DR	BY	DSN	APV	DATE	REV	CHANGE	DR	BY	DSN	APV	DATE
C							F						
B	REVISION	CSE	JCE	FC	CZH	08/10/2020	E						
A	EDITORIAL CHANGES		GB			05/16/2017	D						
SHEET 2 of 8		Indicates Latest Revision		Completely Revised		New Page		Information Removed		DM5811.2			
		SDG&E ELECTRIC DISTRIBUTION DESIGN MANUAL											
		CAPACITOR APPLICATION CRITERIA											

Figure 2 shows the voltage rise for typical underground cables. As shown, the voltage rise per mile is much less than the overhead system, due to the lower reactance for underground cables.

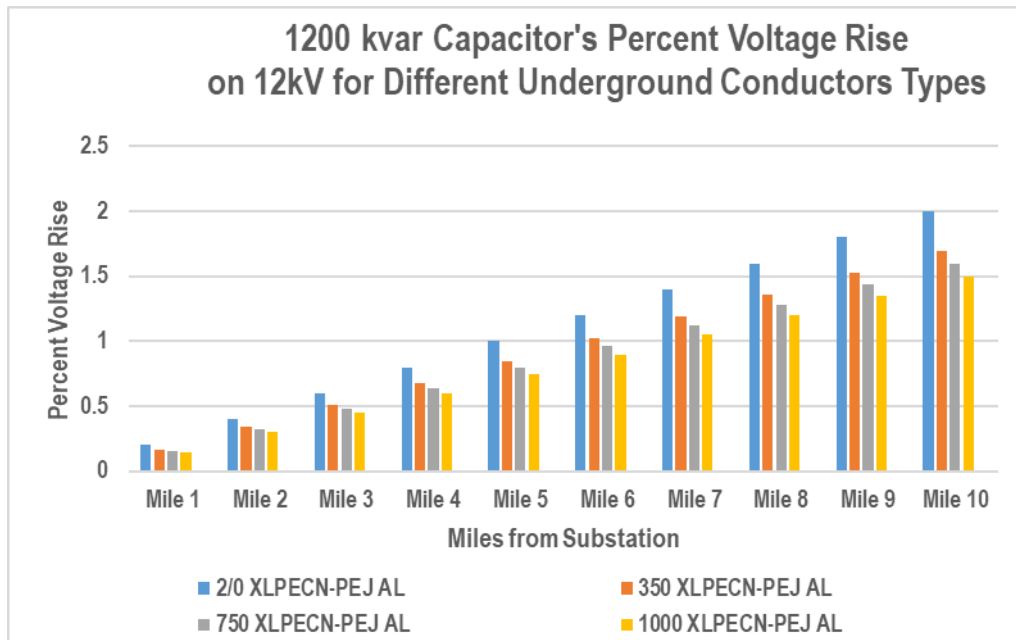

Figure 2

2. The voltage rise that results from adding shunt capacitors can be calculated from Equation 1: The maximum primary voltage for CVR circuits is 123 volts, on a 120 volt basis. For non-CVR circuits, the maximum is 126 volts.
3. For switched capacitors, the voltage rise at any single location shall be limited to 3 percent to avoid flicker problems.
4. For fixed capacitors the cumulative voltage rise of all capacitors on any circuit shall not exceed 3 percent with the following exception for non-CVR circuits only
 - a. The voltage rise may reach 5% if the circuit is modeled under multiple loading scenarios to confirm the voltage will not exceed 125 volts and also the capacitor has a controller set with a voltage override to turn the capacitor off if it exceeds 125 volts.
5. If the criteria for #1, #2, #3 and #4 above cannot be achieved, then other options must be evaluated.

© 1998-2020 San Diego Gas & Electric Company. All rights reserved. Removal of this copyright notice without permission is not permitted under law.

REV	CHANGE	DR	BY	DSN	APV	DATE	REV	CHANGE	DR	BY	DSN	APV	DATE
C							F						
B	REVISION	CSE	JCE	FC	CZH	08/10/2020	E						
A	EDITORIAL CHANGES		GB			05/16/2017	D						
SHEET 3 of 8		X	Indicates Latest Revision		Completely Revised		New Page		Information Removed				
		SDG&E ELECTRIC DISTRIBUTION DESIGN MANUAL											
		CAPACITOR APPLICATION CRITERIA											
													DM5811.3

B. Capacitors Installed for Reactive Power Support

1. A 12kV distribution circuit should have sufficient fixed capacitors and switched capacitors to correct the off-peak and on-peak power factor to the targeted 0.995 lag at the substation 12kV bus. The actual uncorrected power factor for specific circuits should be used if available. If the actual uncorrected PF is not available, use .90 lag for summer peaking and .90 lag for winter peaking load. The kvar needed to improve power factor can be calculated as follows:

$$\text{kvar needed to correct to } pf_2 = KVAR_1 - KVAR_2$$

where:

$$KVAR_1 = KVA_1 (\sin(\cos^{-1} pf_1))$$

$$KVAR_2 = KVA_2 (\sin(\cos^{-1} pf_2))$$

Pf₁ = existing power factor

Pf₂ = desired power factor

KVA₁ = kVA of load at initial pf

KVA₂ = kVA of load at improved pf

$$= KVA_1 * (pf_1 / pf_2)$$

For example, a summer peaking circuit with no capacitors has a peak load of 400 amps. The power factor of this load is assumed to be .90 lag. The amount of kvar needed to raise the power factor of this circuit to .995 lag can be calculated as follows:

$$KVAR_1 = (400A)(12kV)(1.732)(\sin(\cos^{-1} 0.90)) = 3620 \text{ kvar}$$

$$KVAR_2 = (400A)(12kV)(1.732)(.9/.995)(\sin(\cos^{-1} 0.995)) = 750 \text{ kvar}$$

$$\text{kvar needed to correct to } pf_2 = (3620 \text{ kvar}) - (750 \text{ kvar}) = 2870 \text{ kvar}$$

© 1998-2020 San Diego Gas & Electric Company. All rights reserved. Removal of this copyright notice without permission is not permitted under law.

REV	CHANGE	DR	BY	DSN	APV	DATE	REV	CHANGE	DR	BY	DSN	APV	DATE
C							F						
B	REVISION	CSE	JCE	FC	CZH	08/10/2020	E						
A	EDITORIAL CHANGES		GB			05/16/2017	D						
SHEET 4 of 8		 Indicates Latest Revision	Completely Revised			New Page			Information Removed				
		SDG&E ELECTRIC DISTRIBUTION DESIGN MANUAL											
		CAPACITOR APPLICATION CRITERIA											
													DM5811.4

Figure 3 provides the required kvar to correct power to 0.995 using multiple kW values and different initial power factors.

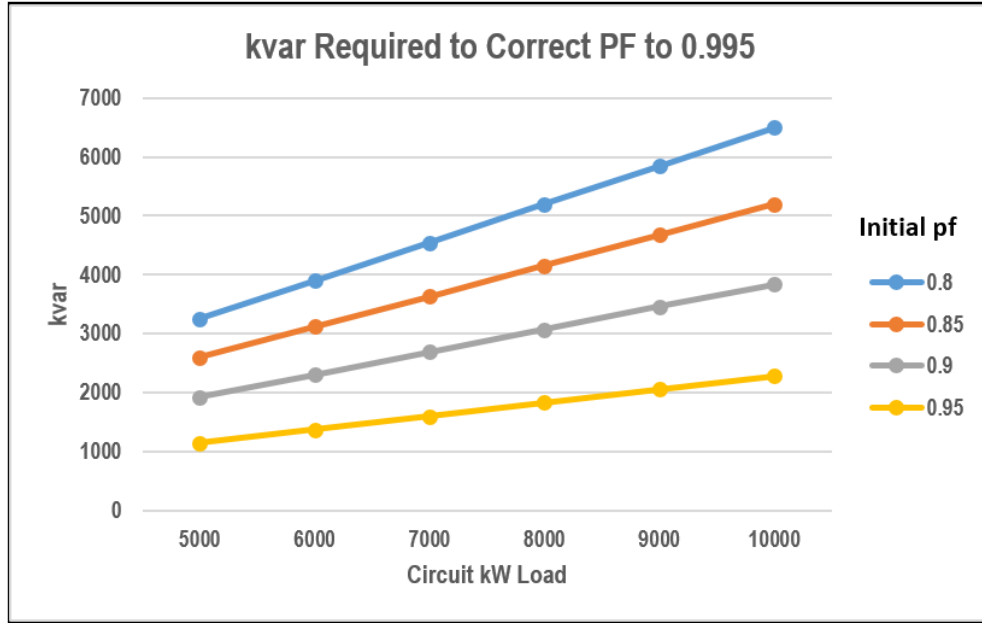

Figure 3

- An individual substation 12kV bus may be corrected to a leading power factor at peak, measured at the 12kV bus, if it is necessary to accommodate a request from Transmission Planning or Grid Operations.
- Switched Capacitors should be set to operate only in a continuous mode, to correct off peak power factor. A general rule is that the fixed kvar should not exceed about 30% of the total kvar on a circuit. For example, if a circuit has 10 MW of load @ 0.9 pf, it would require 3840 kvar to correct to .995 pf. Then the amount of manually on (or fixed) kvar should be about $.3 \times 3840 = 1152$ kvar which results in using a 1200 kvar capacitor. Therefore, the amount of switched kvar would be approximately: $3840 - 1200 = 2640$ kvar. Most of this 2640 kvar requirement can be achieved by 2-1200 kvar SCADA capacitor banks. Depending on the circuit, this could be sufficient kvar.

If the circuit has sufficient capacitor kvar installed but actual kvar information (i.e. substation SCADA) indicates a deficiency, contact the appropriate C&O District Engineer to ensure all existing capacitors are in service and operating properly before adding new capacitors. SCADA data can also be utilized to confirm their operation. This will prevent excessive vars from being added to the circuit that are not needed.

- Switched capacitors are required, as capacitors operating in a fixed mode are no longer available. New capacitor installations are all SCADA controlled which allows multiple options for switching requirements.

© 1998-2020 San Diego Gas & Electric Company. All rights reserved. Removal of this copyright notice without permission is not permitted under law.

REV	CHANGE	DR	BY	DSN	APV	DATE	REV	CHANGE	DR	BY	DSN	APV	DATE
C							F						
B	REVISION	CSE	JCE	FC	CZH	08/10/2020	E						
A	EDITORIAL CHANGES		GB			05/16/2017	D						

SHEET 5 of 8	X Indicates Latest Revision	Completely Revised	New Page	Information Removed
	SDG&E ELECTRIC DISTRIBUTION DESIGN MANUAL			
	CAPACITOR APPLICATION CRITERIA			
DM5811.5				

5. The reactive power loss in a fully loaded 28 MVA substation transformer bank is 3.9 Mvar, calculated as follows:

$$\text{Reactive Loss} = I^2X$$

$$\text{where: } I = 28 \text{ MVA}/15 \text{ MVA} = 1.87 \text{ p.u.}$$

$$X = 7.5\% \text{ on a 15 MVA base.}$$

$$\text{Reactive Loss} = (1.87)^2(.075) (15\text{MVA}) = 3.9 \text{ Mvar}$$

Therefore, for every 28 MVA substation transformer bank that approaches its full load rating, there should be 4 Mvar of substation capacitance. The ultimate design rating of substation capacitors is 7.2 Mvar to offset the inability to place sufficient caps on the circuit.

6. An Electric Distribution Planner will assess whether the current standard of .995 lag during peak is being met or if additional kvar are needed before a new location is approved.

C. **Capacitor Location**

1. Do not install polemount and padmount switched capacitors on the load side of sectionalizing fuses or electronic sectionalizers. Do not install sectionalizing fuses or electronic sectionalizers on the line side of existing polemounted fixed or switched capacitors and padmount switched capacitors. If particular operating needs require a capacitor to be installed past sectionalizing fuses or electronic sectionalizers, contact Electric Distribution Engineering.
2. The capacitor placement method is based on the minimum voltage being achieved. If capacitors are not sufficient to raise the voltage, other measures such as voltage regulators may be required.
3. New capacitors should be placed utilizing the Voltage Imposed 1/2 Rule. This method is to be utilized with Synergi to properly model the kvar flow and impact on voltage rise. The generic 1/2 Rule is intended to place the capacitor where the kvar flow would be split half upstream and half downstream. The Voltage Imposed 1/2 Rule adjusts the location to provide the proper voltage support as stated in A2 and A3 above. A flowchart to illustrate this process is shown in Figure 4.
4. For circuits with voltage regulators, Synergi simulation studies must account for their interaction with capacitors. Also, to accurately determine the percent voltage rise when the capacitor switches on, the simulation model must place the regulator in a manual mode temporarily otherwise excessive voltage rise may be masked.
5. The minimum distance between capacitor banks should be no less than 1200 ft.
6. When customers with large loads are added to a circuit, it may be required to place a capacitor adjacent to their location to compensate for the added large kvar requirements.

© 1998-2020 San Diego Gas & Electric Company. All rights reserved. Removal of this copyright notice without permission is not permitted under law.

REV	CHANGE	DR	BY	DSN	APV	DATE	REV	CHANGE	DR	BY	DSN	APV	DATE
C							F						
B	REVISION	CSE	JCE	FC	CZH	08/10/2020	E						
A	EDITORIAL CHANGES		GB			05/16/2017	D						
SHEET 6 of 8		X	Indicates Latest Revision		Completely Revised		New Page		Information Removed				
		SDG&E ELECTRIC DISTRIBUTION DESIGN MANUAL											
		CAPACITOR APPLICATION CRITERIA											
													DM5811.6

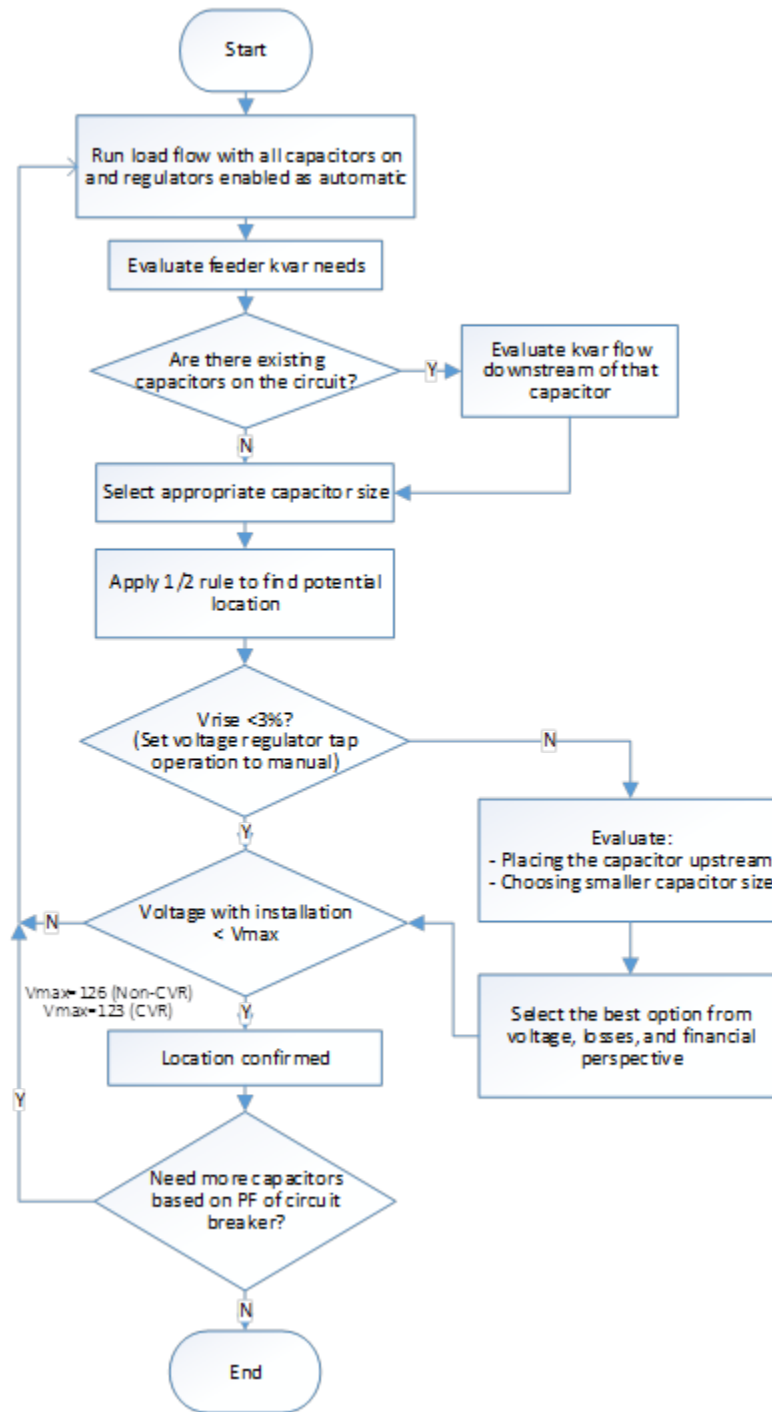

Figure 4

7. Capacitor banks operating in a fixed mode should be located to minimize peak load losses. Physical constraints or the need for voltage correction may require an exception to the minimum loss location.
8. Capacitors should not be located on a pole at a highway or freeway crossing. The selected pole must be accessible by a bucket truck.

© 1998-2020 San Diego Gas & Electric Company. All rights reserved. Removal of this copyright notice without permission is not permitted under law.

REV	CHANGE	DR	BY	DSN	APV	DATE	REV	CHANGE	DR	BY	DSN	APV	DATE		
C							F								
B	REVISION	CSE	JCE	FC	CZH	08/10/2020	E								
A	EDITORIAL CHANGES		GB			05/16/2017	D								
SHEET 7 of 8		Indicates Latest Revision		Completely Revised		New Page		Information Removed		SDG&E ELECTRIC DISTRIBUTION DESIGN MANUAL CAPACITOR APPLICATION CRITERIA DM5811.7					

- The padmounted capacitor station should be installed, or right of way easement provisions made for future installations in conjunction with new customer projects when possible. The easement should be acquired in accordance with UG page 3483.1 to provide proper clearances. This is to minimize retrofit installations that may cause adverse customer reaction.

D. Connection

- Every padmounted capacitor station must be connected to a 4kV or 12kV primary system where the capacitor neutral is floating. Feed for a padmounted capacitor station can be tapped directly from a 600 amp feeder, branch feeder, or a 200 amp local distribution branch. A padmount capacitor cannot be the only load connected to a switch position of a PMH/PME, Trayer, Vista or ISG Switches. The PMH/PME, Trayer, Vista or ISG switches are not designed to switch only capacitive loads.
- The distance from the connection point to the padmounted capacitor should be as short as practical when connecting directly to 600 amp feeder. This is to minimize exposure to dig-in failure of the unfused line as well as reducing losses. However, it is recognized that in some cases it may be impossible to install the capacitor close to the feeder and still comply with traffic considerations, aesthetics, or other physical constraints.
- The originator of the request for the installation of a capacitor, whether it is the C&O Engineer or Distribution Planning Engineer, should provide a Distribution System Engineering Capacitor Information Form with the request. The Capacitor Information Form will contain the initial settings needed to put the capacitor on-line. If the C&O Engineer is requesting a capacitor, they should talk to their Distribution Planning Engineer to determine the appropriate settings for the capacitor control or if a new capacitor is needed. A copy of this form should be issued with the work order to install the capacitor. Construction cannot install/energize the capacitor without one. File the original Capacitor Information Form in the design/planning folder. A sample form is shown in Figure 5.

CAPACITOR CONTROLLER SETTINGS FORM			
GENERAL SETUP & CONTROL SCHEMES			Available Schemes
Low Voltage Override	Summer Control Scheme	Winter Control Scheme	TimeClock 1/2
117			Voltage Only On
High Voltage Override	Summer Start Date	Winter Start Date	Voltage Only Off
125	15-Apr	15-Oct	Kvar (SELS Only)
TIMECLOCK CONTROL 1			
	Days of the Week	Time of Day On	Time of Day Off
Schedule 1			
Schedule 2			
TIMECLOCK CONTROL 2 SELs Only			
	Days of the Week	Time of Day On	Time of Day Off
Schedule 1			
Schedule 2			
KVAR CONTROL STRATEGY			
	Default	Custom	Must be values of 440 kVAR apart (110% of single phase cell kVAR) in order to prevent hunting
Lagging KVAR Threshold (1Φ)	200 kVAR		
Leading KVAR Threshold (1Φ)	-220 kVAR		
VOLTAGE ONLY CONTROL STRATEGY			
Preferred Capacitor Bank Position		ON / OFF	
FIXED POSITION CONTROL			
ON / OFF			

Figure 5

E. Capacitor Survey

- Each district should perform an annual survey of capacitor banks to verify proper operation. The GIS (Geographic Information System) Facilities File shall be updated by C&O Engineering after the survey to serve as a planning tool for system kvar maintenance. Details of the capacitor survey procedures are contained in the Electric Standard Practice 155, "Capacitor Survey."

NOTES: NONE

REFERENCE: NONE

© 1998-2020 San Diego Gas & Electric Company. All rights reserved. Removal of this copyright notice without permission is not permitted under law.

REV	CHANGE	DR	BY	DSN	APV	DATE	REV	CHANGE	DR	BY	DSN	APV	DATE
C							F						
B	REVISION	CSE	JCE	FC	CZH	08/10/2020	E						
A	EDITORIAL CHANGES		GB			05/16/2017	D						
SHEET 8 of 8	 Indicates Latest Revision	Completely Revised		New Page		Information Removed		SDG&E ELECTRIC DISTRIBUTION DESIGN MANUAL CAPACITOR APPLICATION CRITERIA					
	DM5811.8												

5900
WIRE & SUPPORTS

5900
WIRE & SUPPORTS

SCOPE

This design standard provides Overhead Conductor SAG Criteria.

PURPOSE

Initial and final sag calculations are necessary to ensure sufficient clearance (based on G095 requirements) will exist between conductors at different levels. In addition, the final sag calculation is necessary to ensure there is adequate ground clearance from the lowest conductor.

DEFINITIONS

Initial Sag – amount of conductor sag in feet and inches at the time conductor is installed.

Catenary Curve – refers to a template constructed to a scale of 1"=200' horizontally and 1"=50' vertically.

Catenary Number – refers to the number assigned to a particular Catenary Curve which depicts the overhead conductor sag to a known scale.

* Final Sag – refers to the amount of conductor sag (at a given temperature) that will occur 10 years after the conductor has been installed.

* Final Tension – refers to the final conductor tension (at a given temperature) used to calculate a Catenary Curve identification number.

Loading District – refers to Light, Medium, Heavy or Extra Heavy as defined by General Order 95. The Light Loading District applies to parts of San Diego and Orange Counties with an elevation between 0–3000 feet, medium 3000–4500 feet, heavy applies above 4500 feet. The Extra Heavy Loading District applies only to unprotected areas on Palomar and Volcan Mountains.

Actual Ruling Span – refers to the theoretical span length in which the changes in conductor tension, due to changes in temperature and loading, will most nearly agree with the average tension in a series of spans of varying length, AND with flexible supports (poles) between dead ends. See equation 1 on 5911.3 .

Approximate Ruling Span – Ruling Span, closest in value to the actual Ruling Span, found in the Design Tables section of the Overhead Sag and Tensions Standards.

Standard Pin Spacing – pin spacing specified in Overhead Standard 382 & 383 for crossarms. Modification of Standard Pin Spacing on crossarms will require re-calculation of published vertical and horizontal loading factors.

CRITERIA

A. Sag Table Application

1. Sag and tension data and tables can be found in the Overhead Sag and Tensions Standards. The standards are published by the Electric Distribution Standards Dept.
2. Use the sag tables found in the Overhead Sag and Tensions Standards for ruling spans of 150', 200', 300' & 400' (500' for AWAC). Electric Distribution Standards will prepare special sag tables for those ruling spans not found in the manual. The following information will be needed to prepare a special sag table:
 - a. Wire size and type
 - b. Ruling span
 - c. Initial tension
 - d. Loading district
 - e. Maximum and minimum span length

One copy of the specially prepared sag table shall be attached to the work order package sent to the Construction Department. Another copy should be placed in the Design file folder.

* Find these values in the Design Tables section of the Overhead Sag and Tensions Standard.

	 Indicates Latest Revision	Completely Revised	New Page
REVISION	SDG&E DISTRIBUTION DESIGN MANUAL		
DATE 1-1-94	OVERHEAD CONDUCTOR SAG		
APPD <i>MFI/ROJ</i>	5911.1		

CRITERIA (continued)

A. Sag Table Application

3. The Ruling Span must be calculated prior to using the sag tables or whenever a special sag table is prepared. Equation 1 in Table 1, on 5911.3, should be used to calculate the ruling span.

B. Catenary Curve Usage

Catenary curves are stored, for common use, as follows:

Electric Systems Design Resource Center
 Metro Resource Center
 Northern Resource Center
 Orange County District Office – with Geoff Lehy

Equation 2 in Table 1, on 5911.3, should be used to calculate the Catenary numbers. See 'Selecting Catenary Curves', step 2a in the sample problem on 5911.4 .

C. Reduced Tension Spans

1. A lower anchor guy tension may be achieved by using multiple guys in combination with a reduced tension span. A typical example is shown in Figure 1.

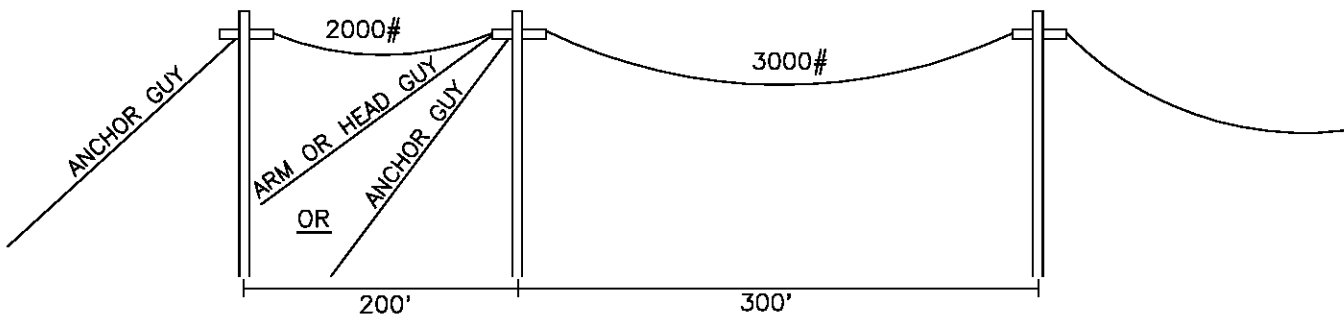

FIGURE 1

2. Ruling Spans of 200 feet or less have less sag at rated tension due to the span length and, therefore, may be installed as reduced tension without creating G095 clearance problems.
3. Reduced tension ruling spans require a sag table for the particular tension being used. Electric Distribution Standards will prepare this sag table and the Designer shall attach the stringing table to the work order for Construction Department use.

D. Sag

Sag is determined from the sag tables in the Overhead Sag and Tensions Standards Manual. USE the DESIGN TABLES section FOR SYSTEM DESIGN. The Initial and Final Sag Tables, the second section, is for construction use only

E. Conductor Separation / Pin Spacing

Multiple conductors on the same crossarm must maintain a certain horizontal separation to prevent the wires from slapping together. This amount of separation is known as minimum Pin Spacing and is calculated using Equation 3 in Table 1, on 5911.3.

	Indicates Latest Revision	Completely Revised	New Page
5911.2	SDG&E DISTRIBUTION DESIGN MANUAL		REVISION
	OVERHEAD CONDUCTOR SAG		DATE 1-1-94 APPD MF/ROJ

TABLE 1
(Sag Related Equations)

$$\text{Actual Ruling Span} = \sqrt{\frac{S_1^3 + S_2^3 + S_3^3 \dots + S_n^3}{S_1 + S_2 + S_3 \dots + S_n}} \quad \text{Equation 1}$$

Where:

$\sqrt{\quad}$ = Mathematical symbol for 'take the square root of'. Applies to any number or equation contained within the symbol.

S = number of feet in a span.

S_1 = number of feet in span number 1

n = number of spans involved in the Ruling Span equation.

S_1^3 = number of feet in span number 1 raised to the 3rd power (cubed).

$$\text{* Catenary number} = \frac{\text{Final Tension}}{[\text{Conductor}] \text{ Weight}} - \text{Final Sag} \quad \text{Equation 2}$$

Where:

Final Tension = Final conductor tension at a given temperature for the Approximate Ruling Span. Found in the Design Tables section (DTs) of the Overhead Sag and Tension Standards (OSTS).

[Conductor] Weight = Weight of conductor at a given temperature for the Approximate Ruling Span. Found in the DTs of the OSTs.

Final Sag = Final sag at a given temperature for the Approximate Ruling Span. Found in the DTs of the OSTs.

* GO 95 rule 43 states that "maximum temperature shall be assumed to be 130° F in computing sag". Select the proper table in the DTs of the OSTs. USE the FINAL TENSION, [Conductor] WEIGHT, and FINAL SAG factors (from the table selected) ASSOCIATED WITH 130° F to calculate a catenary number FOR a HOT CURVE.

When uplift is a concern, make an additional calculation using the "Design Conditions" temperature (either 0° or 25° F, depending on the Loading District; see OHS 340). Select the proper table in the DTs of the OSTs. USE the FINAL TENSION, [Conductor] WEIGHT, and FINAL SAG factors (from the table selected) ASSOCIATED WITH THE DESIGN CONDITIONS TEMPERATURE to calculate a catenary number FOR a COLD CURVE.

$$\text{Pin Spacing} = 8\sqrt{\text{Final Sag}} + 3.5 \quad \text{Equation 3}$$

Where:

Pin Spacing = Minimum pin spacing required, in inches.

Final Sag = In feet, at 130° (GO 95 rule 43), for the Approximate Ruling Span. Found in the DTs section of the OSTs.

SAMPLE PROBLEM: Find the Catenary number, and the Pin Spacing required, for a new line constructed with 4/c # 636 ACSR/AW conductor, at 3000# tension, in heavy loading district, having five spans whose lengths are: 250', 280', 270', 300', and 350'.

Step 1. Determine the Actual Ruling Span for the line.

	Indicates Latest Revision	Completely Revised	New Page
REVISION	SDG&E DISTRIBUTION DESIGN MANUAL		
DATE 1-1-95 APPD MF/ROJ	OVERHEAD CONDUCTOR SAG		5911.3

SAMPLE PROBLEM (continued)

Step 1.

$$\begin{aligned}
 * \text{ Actual Ruling Span} &= \sqrt{\frac{250^3 + 280^3 + 270^3 + 300^3 + 350^3}{250 + 280 + 270 + 300 + 350}} = \sqrt{\frac{127,135,000}{1450}} \\
 &= \sqrt{87,697.3} = 296.1 = 296 = \text{Actual Ruling Span}
 \end{aligned}$$

* Raising numbers to the 3rd power, addition of the resulting values, division and taking of square roots can easily be accomplished using any simple hand held calculator.

Step 2. Using the value calculated for the Actual Ruling Span in step 1, select an Approximate Ruling Span, closest in value, from the DTs in the OSTs. Using the data from the table for the Approximate Ruling Span, calculate the Catenary number and Pin Spacing.

2a.

With a value of 296 for the Actual Ruling Span select an Approximate Ruling Span of 300'. In the DTs of the OSTs can be found a 300' Ruling Span [Heavy Loading] table for 636 ACSR/AW Tension 3000 lbs. Use the data found in the table (at the GO 95 required temperature of 130°) to solve the Catenary number equation for a HOT CURVE. If needed, calculate a second Catenary number using the Design Conditions temperature (in this case: 0° F for Heavy Loading) to solve the Catenary number equation for a COLD CURVE.

$$\text{Catenary number} = \frac{\text{Final Tension}}{[\text{Conductor}] \text{ Weight}} - \text{Final Sag}$$

HOT CURVE: Final Tension = 942 [Conductor] Weight = .786 Final Sag = 9.43

$$\text{HOT CURVE Catenary number} = \frac{942}{.786} - 9.43 = 1189.04 = 1189$$

COLD CURVE: Final Tension = 2968 [Conductor] Weight = 1.970 Final Sag = 7.49

$$\text{COLD CURVE Catenary number} = \frac{2968}{1.970} - 7.49 = 1499.01 = 1499$$

Selecting Catenary Curves:

Select a Catenary Curve with an identifying number within 50 units ± of the calculated Catenary number. If the Catenary number is not within 50 units ± of a exiting Catenary Curve identifying number, select a Catenary Curve with an identifying number closest and below the Catenary number calculated.

2b. Calculate minimum Pin Spacing required using the value for Final Sag already selected (9.43).

$$\begin{aligned}
 \text{Pin Spacing} &= 8 \sqrt{\text{Final Sag}} + 3.5 = 8 \sqrt{9.43} + 3.5 = \\
 &= 8 (3.07) + 3.5 = 28.06 = 28 \text{ (inches)}
 \end{aligned}$$

Use the minimum Pin Spacing calculated to confirm or select crossarms for the intended construction. See Overhead Standards 381 & 382 to select crossarms with the required pin spacing, based on vertical loading criteria. See Overhead Standard 383 & 384 to select crossarms with the required pin spacing, based on horizontal loading criteria. Modification of the Standard Pin Spacing specified in the OH Standards will require re-calculation of the published vertical and horizontal loading factors.

	Indicates Latest Revision	Completely Revised	New Page
5911.4	SDG&E DISTRIBUTION DESIGN MANUAL		REVISION
	OVERHEAD CONDUCTOR SAG		DATE 1-1-95 APPD MF/ROJ

12.47KV WIRE IMPEDANCES ②

% IMPEDANCE/1000', 20 MVA BASE

POSITIVE SEQUENCE (Z⁺)
ZERO SEQUENCE (Z^o)

Equivalent Spacing, D_E ①

Conductor Size	31"	36.0"	46.8"	66.7"	82.5"	103.3"
1033.5 MCM ACSR	$\frac{.221 + j1.22}{.919 + j7.41}$	$\frac{.221 + j1.26}{.919 + j7.32}$	$\frac{.221 + j1.34}{.919 + j7.17}$	$\frac{.221 + j1.44}{.919 + j6.96}$	$\frac{.221 + j1.51}{.919 + j6.83}$	$\frac{.221 + j1.57}{.919 + j6.70}$
636 MCM ACSR	$\frac{.358 + j1.29}{1.06 + j7.48}$	$\frac{.358 + j1.34}{1.06 + j7.40}$	$\frac{.358 + j1.41}{1.06 + j7.24}$	$\frac{.358 + j1.52}{1.06 + j7.03}$	$\frac{.358 + j1.58}{1.06 + j6.91}$	$\frac{.358 + j1.65}{1.06 + j6.77}$
500 MCM CU	$\frac{.291 + j1.36}{.989 + j7.56}$	$\frac{.291 + j1.41}{.989 + j7.47}$	$\frac{.291 + j1.49}{.989 + j7.31}$	$\frac{.291 + j1.59}{.989 + j7.10}$	$\frac{.291 + j1.65}{.989 + j6.98}$	$\frac{.291 + j1.72}{.989 + j6.85}$
394.5 MCM AL	$\frac{.660 + j1.40}{1.36 + j7.59}$	$\frac{.660 + j1.44}{1.36 + j7.50}$	$\frac{.660 + j1.52}{1.36 + j7.35}$	$\frac{.660 + j1.63}{1.36 + j7.14}$	$\frac{.660 + j1.69}{1.36 + j7.01}$	$\frac{.660 + j1.75}{1.36 + j6.88}$
336.4 MCM ACSR	$\frac{.677 + j1.38}{1.37 + j7.57}$	$\frac{.677 + j1.42}{1.37 + j7.48}$	$\frac{.677 + j1.50}{1.37 + j7.33}$	$\frac{.677 + j1.61}{1.37 + j7.12}$	$\frac{.677 + j1.67}{1.37 + j6.99}$	$\frac{.677 + j1.73}{1.37 + j6.86}$
4/0 CU	$\frac{.677 + j1.51}{1.37 + j7.70}$	$\frac{.677 + j1.55}{1.37 + j7.61}$	$\frac{.677 + j1.63}{1.37 + j7.46}$	$\frac{.677 + j1.73}{1.37 + j7.25}$	$\frac{.677 + j1.80}{1.37 + j7.12}$	$\frac{.677 + j1.86}{1.37 + j6.99}$
3/0 ACSR	$\frac{1.36 + j1.60}{2.06 + j7.79}$	$\frac{1.36 + j1.64}{2.06 + j7.70}$	$\frac{1.36 + j1.72}{2.06 + j7.55}$	$\frac{1.36 + j1.82}{2.06 + j7.34}$	$\frac{1.36 + j1.89}{2.06 + j7.21}$	$\frac{1.36 + j1.95}{2.06 + j7.08}$
2/0 CU	$\frac{1.07 + j1.58}{1.77 + j7.77}$	$\frac{1.07 + j1.62}{1.77 + j7.68}$	$\frac{1.07 + j1.70}{1.77 + j7.53}$	$\frac{1.07 + j1.80}{1.77 + j7.32}$	$\frac{1.07 + j1.87}{1.77 + j7.19}$	$\frac{1.07 + j1.93}{1.77 + j7.06}$
1/0 CU	$\frac{1.35 + j1.61}{2.05 + j7.80}$	$\frac{1.35 + j1.65}{2.05 + j7.72}$	$\frac{1.35 + j1.73}{2.05 + j7.56}$	$\frac{1.35 + j1.84}{2.05 + j7.35}$	$\frac{1.35 + j1.90}{2.05 + j7.23}$	$\frac{1.35 + j1.97}{2.05 + j7.09}$

Indicates Latest Revision

Completely Revised

New Page

REVISION

SDG&E DISTRIBUTION DESIGN MANUAL

DATE 3-30-84

OVERHEAD CONDUCTOR IMPEDANCES

APPD CVN 

5912.1

12.4KV WIRE IMPEDANCES②

POSITIVE SEQUENCE (Z⁺)
 ZERO SEQUENCE (Z^o)
 Equivalent Spacing, D_E①

Conductor Size	31"	36.0"	46.8"	66.7"	82.5"	103.3"
#6 CU	$\frac{5.38 + j1.81}{6.08 + j8.00}$	$\frac{5.38 + j1.85}{6.08 + j7.92}$	$\frac{5.38 + j1.93}{6.08 + j7.76}$	$\frac{5.38 + j2.04}{6.08 + j7.55}$	$\frac{5.38 + j2.10}{6.08 + j7.42}$	$\frac{5.38 + j2.17}{6.08 + j7.29}$
#4 CU	$\frac{3.38 + j1.74}{4.08 + j7.93}$	$\frac{3.38 + j1.78}{4.08 + j7.84}$	$\frac{3.38 + j1.86}{4.08 + j7.69}$	$\frac{3.38 + j1.97}{4.08 + j7.48}$	$\frac{3.38 + j2.03}{4.08 + j7.35}$	$\frac{3.38 + j2.10}{4.08 + j7.22}$
#2 ACSR	$\frac{3.43 + j1.72}{4.13 + j7.92}$	$\frac{3.43 + j1.77}{4.13 + j7.83}$	$\frac{3.43 + j1.84}{4.13 + j7.67}$	$\frac{3.43 + j1.95}{4.13 + j7.46}$	$\frac{3.43 + j2.01}{4.13 + j7.34}$	$\frac{3.43 + j2.08}{4.13 + j7.20}$
#2 CU	$\frac{2.15 + j1.68}{2.85 + j7.87}$	$\frac{2.15 + j1.72}{2.85 + j7.78}$	$\frac{2.15 + j1.80}{2.85 + j7.63}$	$\frac{2.15 + j1.91}{2.85 + j7.42}$	$\frac{2.15 + j1.97}{2.85 + j7.29}$	$\frac{2.15 + j2.03}{2.85 + j7.16}$
#1 CU	$\frac{1.70 + j1.64}{2.40 + j7.84}$	$\frac{1.70 + j1.69}{2.40 + j7.75}$	$\frac{1.70 + j1.77}{2.40 + j7.59}$	$\frac{1.70 + j1.87}{2.40 + j7.38}$	$\frac{1.70 + j1.93}{2.40 + j7.26}$	$\frac{1.70 + j2.00}{2.40 + j7.13}$
TWIN CIRCUIT 394.5 MCM AL	$\frac{.0329 + j.697}{1.023 + j6.454}$					

4.16KV WIRE IMPEDANCES
% IMPEDANCE/1000', 20 MVA BASE

POSITIVE SEQUENCE (Z^+)

ZERO SEQUENCE (Z^0)

Equivalent Spacing, D_E (1)

Conductor Size	17.2"	18.3"	37.1"	53.3"
4/0 CU	$\frac{5.62 + j11.0}{11.4 + j66.7}$	$\frac{5.62 + j11.2}{11.4 + j66.4}$	$\frac{5.62 + j12.9}{11.4 + j63.0}$	$\frac{5.62 + j13.8}{11.4 + j61.2}$
2/0 CU	$\frac{8.89 + j11.6}{14.7 + j67.3}$	$\frac{8.89 + j11.8}{14.7 + j67.0}$	$\frac{8.89 + j13.5}{14.7 + j63.6}$	$\frac{8.89 + j14.4}{14.7 + j61.8}$
1/0 CU	$\frac{11.2 + j11.9}{17.0 + j67.6}$	$\frac{11.2 + j12.1}{17.0 + j67.3}$	$\frac{11.2 + j13.8}{17.0 + j63.8}$	$\frac{11.2 + j14.7}{17.0 + j62.1}$
#6 CU	$\frac{44.6 + j13.6}{50.4 + j69.3}$	$\frac{44.6 + j13.7}{50.4 + j69.0}$	$\frac{44.6 + j15.5}{50.4 + j65.5}$	$\frac{44.6 + j16.3}{50.4 + j63.7}$
#4 CU	$\frac{28.0 + j13.0}{33.8 + j68.7}$	$\frac{28.0 + j13.1}{33.8 + j68.4}$	$\frac{28.0 + j14.9}{33.8 + j64.9}$	$\frac{28.0 + j15.8}{33.8 + j63.1}$
#2 CU	$\frac{17.8 + j12.5}{23.6 + j68.2}$	$\frac{17.8 + j12.6}{23.6 + j67.9}$	$\frac{17.8 + j14.4}{23.6 + j64.4}$	$\frac{17.8 + j15.3}{23.6 + j62.6}$
#1 CU	$\frac{14.1 + j12.2}{19.9 + j67.9}$	$\frac{14.1 + j12.3}{19.9 + j67.6}$	$\frac{14.1 + j14.1}{19.9 + j64.1}$	$\frac{14.1 + j15.0}{19.9 + j62.3}$

NOTES:

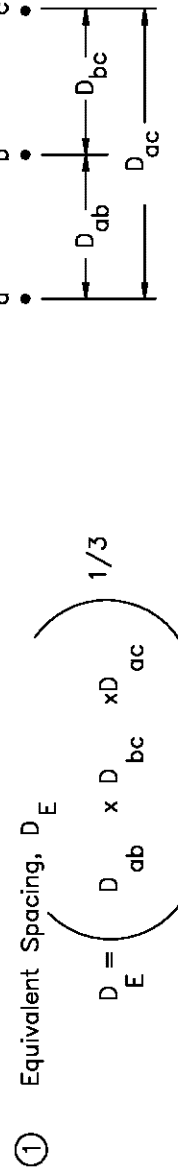

(2) 4kV impedances can be obtained by multiplying the 12.47kV impedances by 8.32.

4kV impedances with old 4kV spacing is available on page 5643.3.

Indicates Latest Revision

Completely Revised

New Page

REVISION

SDG&E DISTRIBUTION DESIGN MANUAL

DATE 3-30-84

OVERHEAD CONDUCTOR IMPEDANCES

APPD CVN/1008

5912.3

12.47kV UNDERGROUND CABLE IMPEDANCES
PERCENT IMPEDANCE/1000 FEET, 20 MVA BASE

Triplex Cable Configuration

Positive Sequence (Z^+)
Zero Sequence (Z^0)

<u>Aluminum</u>	<u>2 Circuits</u>	
	<u>1 Circuit</u>	<u>Paralleled</u>
3-1/c 1000 KCMIL AL XLPECN-PEJ	$0.367 + j0.415$ $1.064 + j0.303$	$0.183 + j0.208$ $0.535 + j0.136$
3-1/c 750 KCMIL AL XLPECN-PEJ	$0.443 + j0.436$ $1.337 + j0.360$	$0.222 + j0.218$ $0.674 + j0.157$
3-1/c 750 KCMIL AL COMP. EPR-PEJ	$0.388 + j0.282$ $2.328 + j0.675$	
3-1/c 350 KCMIL AL XLPECN	$0.834 + j0.492$ $2.895 + j0.820$	$0.417 + j0.246$ $1.497 + j0.304$
3-1/c #2/0 AL XLPECN	$2.137 + j0.561$ $6.162 + j2.718$	$1.069 + j0.281$ $3.535 + j1.00$
3-1/c #2 (solid) AL XLPECN	$4.292 + j0.610$ $7.561 + j1.75$	$2.146 + j0.305$ $3.971 + j0.632$
 <u>COPPER</u>		
3-1/c 500 KCMIL CU PECN	$0.394 + j0.476$ $1.189 + j0.387$	$0.197 + j0.238$ $0.598 + j0.175$
3-1/c #4/0 CU PECN	$0.808 + j0.542$ $2.777 + j0.829$	$0.404 + j0.271$ $1.431 + j0.318$
3-1/c #2 CU PECN	$2.494 + j0.649$ $4.639 + j1.051$	$1.247 + j0.324$ $2.372 + j0.415$
3-1/c #4 CU PECN	$3.972 + j0.682$ $7.123 + j1.722$	$1.986 + j0.341$ $3.731 + j0.634$

<input checked="" type="checkbox"/> Indicates Latest Revision	<input type="checkbox"/> Completely Revised	<input type="checkbox"/> New Page
REVISION DATE 1-1-2000 APPD <i>[Signature]</i>	SDG&E DISTRIBUTION DESIGN MANUAL UNDERGROUND CABLE IMPEDANCES	5913.1

ASSUMPTIONS:

- a) Conductor and concentric neutral wire temperatures are 90° C and 70° C, respectively, for aluminum cables.
- b) Conductor and concentric neutral wire temperatures are 75° C and 55° C, respectively, for copper cables.
- c) Insulation thicknesses of 175 and 220 mils are used, respectively, for aluminum and copper cables.
- d) These impedance values are correct for both jacketed and non-jacketed cables.
- e) Positive and negative sequence impedances are equal.
- f) For two circuits in parallel, 7.5 inch spacing (between the duct centers) is used.

	 Indicates Latest Revision	Completely Revised	New Page
5913.2	SDG&E DISTRIBUTION DESIGN MANUAL UNDERGROUND CABLE IMPEDANCES		REVISION DATE 1-1-86 APPD CVN / <i>ROJ</i>

600V ALUMINUM CABLE L-N IMPEDANCE TABLE

CABLE TYPE	1 RUN		2 RUNS		3 RUNS	
	R	X	R	X	R	X
#2	0.3390	0.0450	0.1695	0.0225	0.1130	0.0150
1/0	0.2120	0.0440	0.1060	0.0220	0.0707	0.0147
3/0	0.1380	0.0420	0.0690	0.0210	0.0460	0.0140
350kcmil	0.0650	0.0400	0.0325	0.0200	0.0217	0.0133
500kcmil	0.0460	0.0390	0.0230	0.0195	0.0153	0.0130
1000kcmil	0.0240	0.0370	0.0120	0.0185	0.0080	0.0123

CABLE TYPE	4 RUNS		5 RUNS		6 RUNS	
	R	X	R	X	R	X
#2	0.0848	0.0113	0.0678	0.0090	0.0565	0.0075
1/0	0.0530	0.0110	0.0424	0.0088	0.0353	0.0073
3/0	0.0345	0.0105	0.0276	0.0084	0.0230	0.0070
350kcmil	0.0163	0.0100	0.0130	0.0080	0.0108	0.0067
500kcmil	0.0115	0.0098	0.0092	0.0078	0.0077	0.0065
1000kcmil	0.0060	0.0093	0.0048	0.0074	0.0040	0.0062

CABLE TYPE	7 RUNS		8 RUNS		9 RUNS	
	R	X	R	X	R	X
#2	0.0484	0.0064	0.0424	0.0056	0.0377	0.0050
1/0	0.0303	0.0063	0.0265	0.0055	0.0236	0.0049
3/0	0.0197	0.0060	0.0173	0.0053	0.0153	0.0047
350kcmil	0.0093	0.0057	0.0081	0.0050	0.0072	0.0044
500kcmil	0.0066	0.0056	0.0058	0.0049	0.0051	0.0043
1000kcmil	0.0034	0.0053	0.0030	0.0046	0.0027	0.0041

CABLE TYPE	10 RUNS		11 RUNS		12 RUNS	
	R	X	R	X	R	X
#2	0.0339	0.0045	0.0308	0.0041	0.0283	0.0038
1/0	0.0212	0.0044	0.0193	0.0040	0.0177	0.0037
3/0	0.0138	0.0042	0.0125	0.0038	0.0115	0.0035
350kcmil	0.0065	0.0040	0.0059	0.0036	0.0054	0.0033
500kcmil	0.0046	0.0039	0.0042	0.0035	0.0038	0.0032
1000kcmil	0.0024	0.0037	0.0022	0.0034	0.0020	0.0031

CABLE TYPE	CONDUCTOR RADIUS (IN)	INSULATION THICKNESS (IN)	EXPLANATION OF HEADINGS
#2	0.1460	0.0600	R - RESISTANCE VALUE
1/0	0.1865	0.0800	
3/0	0.2350	0.0800	X - REACTANCE VALUE
350kcmil	0.3405	0.0950	
500kcmil	0.4065	0.0950	
1000kcmil	0.5760	0.1100	

Notes:

- A. All values are in OHMS per 1000 ft. at 90° C
- B. Source of the values: National Electrical Code (NEC) 1996.

	Indicates Latest Revision	Completely Revised	New Page
REVISION	SDG&E DISTRIBUTION DESIGN MANUAL		
DATE 1-1-2000 APPD <i>JMC / CLK</i>	UNDERGROUND 600V CABLE IMPEDANCES		5913.3

PULLING TENSION CALCULATIONS

THE INTENT OF THE FOLLOWING EQUATIONS IS TO HELP YOU TO DETERMINE TENSIONS FOR A TYPICAL CABLE INSTALLATION. IN ORDER TO USE THESE FORMULAS, THE CABLE PULL SHOULD BE DIVIDED INTO SPECIFIC SECTIONS. PLEASE TAKE NOTE THAT THE TENSION OBTAINED WHEN PULLING IN ONE DIRECTION OFTEN DIFFERS FROM THE TENSION OBTAINED WHEN PULLING IN THE OPPOSITE DIRECTION, THIS IS DUE TO THE SLOPE OF THE PULL AND THE LOCATION OF THE BENDS.

STRAIGHT SECTIONS

CASE 1: HORIZONTAL

$$T_2 = T_1 + L W C$$



CASE 2: INCLINE UPWARD

$$T_2 = T_1 + L W [\sin \theta + C \cos \theta]$$

NOTE: ANGLE θ (IN DEGREES) MEASURED FROM THE HORIZONTAL AXIS.

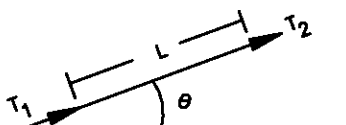

CASE 3: INCLINE DOWNWARD

$$T_2 = T_1 - L W [\sin \theta - C \cos \theta]$$

NOTE: ANGLE θ (IN DEGREES) MEASURED FROM THE HORIZONTAL AXIS.

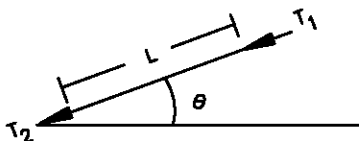

CURVE SECTIONS

$T_{OUT} = T_{IN} K$, WHERE THE VALUE OF K (THE CURVE CONSTANT) IS DETERMINED BY

THE ANGLE, IN DEGREES, OF THE CURVE SECTION.

E.G. $T_2 = T_1 K$

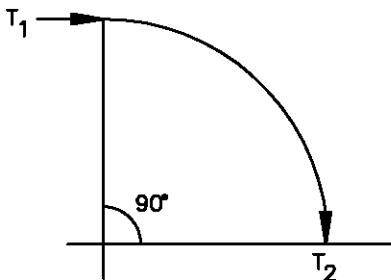

LEGEND

T_x	PULLING TENSION AT A POINT 'X'. (T_1 = TENSION AT POINT NUMBER 1)
L_x	LENGTH OF STRAIGHT SECTION 'X'. (L_1 = LENGTH OF STRAIGHT SECTION NUMBER 1)
W	WEIGHT OF CABLE IN LBS PER FOOT (LBS/FT). UGS 4003.1 LISTS CABLE WEIGHT IN LBS/1000 FT TO FIND LBS/FT DIVIDE BY 1000, E.G. $W (1/C \#2 \text{ SOL XLPECN-PEJ AL }) = \frac{440}{1000} = .44 \text{ (LBS/FT)}$
C	.70 (COEFFICIENT OF FRICTION)
θ	GREEK ALPHABET LETTER USED TO IDENTIFY OR NAME AN ANGLE. PRONOUNCED 'THETA'.
K	CURVE CONSTANT.
SIN	ABBREVIATION FOR SINE, A TRIGONOMETRY RATIO RELATED TO ANGLES. ($\sin \theta$ = SINE OF THE ANGLE THETA)
COS	ABBREVIATION FOR COSINE, A TRIGONOMETRY RATIO RELATED TO ANGLES. ($\cos \theta$ = COSINE OF THE ANGLE THETA)

CURVE CONSTANTS TABLE

ANGLE IN DEGREES	K VALUE
11.25°	1.05
22.5°	1.10
33.75°	1.16
45°	1.22
56.25°	1.28
67.5°	1.34
78.75°	1.41
90°	1.48

TRIGONOMETRY TABLE

ANGLE θ	SIN θ	COS θ
2°	.035	.999
3°	.052	.999
4°	.070	.998
5°	.087	.996
6°	.105	.995
7°	.129	.993
8°	.139	.990
9°	.156	.988
10°	.174	.985
11°	.191	.982
12°	.208	.978
13°	.225	.974
14°	.242	.970
15°	.259	.966



Indicates Latest Revision

Completely Revised

New Page

Information Removed

REVISION

DATE 1-1-2000

APPD AS *1/val*

SDG&E DISTRIBUTION DESIGN MANUAL

CABLE PULLING TENSIONS, PRIMARY AND SECONDARY

5921.1

THE ABOVE FORMULAS MAKE FOR FAST AND CONVENIENT MANUAL PULLING TENSION CALCULATIONS. THE COMPLETE PULLING TENSION EQUATIONS ARE MORE COMPLEX THAN THOSE PRESENTED ABOVE AND ARE INCORPORATED INTO THE INTELICAD PROGRAM. IF MORE PRECISE CALCULATIONS ARE REQUIRED USE THE INTELICAD INTELICAD PROGRAM. OTHERWISE, THE MANUAL CALCULATIONS PROVIDE AN EQUIVALENT APPROXIMATION.

ASSUME INITIAL TENSION TO BE 50 LBS (REEL TENSION) AT THE BEGINNING OF ALL PULLS

-BOTTOM OF FIRST ELBOW OF PADMOUNT EQUIPMENT
-FEED-IN POINT OF SUBSTRUCTURES

ALL CALCULATIONS USE VALUE OF .70 FOR COEFFICIENT OF FRICTION, REGARDLESS OF TYPE OF CONDUIT.

CABLE PULLING TENSION:

THE FORCE REQUIRED (IN POUNDS) TO PULL A CABLE THROUGH A CONDUIT. MAXIMUM CABLE TENSIONS HAVE BEEN SET TO PROTECT THE CABLE AND CONDUIT FROM DAMAGE DUE TO EXCESSIVE PULLING FORCE. UNDERGROUND STANDARD 4003.1 LISTS MAXIMUM PULLING TENSIONS ALLOWABLE FOR BOTH PRIMARY AND SECONDARY CABLE.

SIDEWALL BEARING PRESSURE (SWBP):

SWBP IS THE PRESSURE EXERTED BY THE CABLE ON THE SIDEWALL OF THE CONDUIT WHEN GOING THROUGH A BEND. SWBP IS CALCULATED USING THE CABLE TENSION AT THE BEND EXIT, DIVIDED BY THE RADIUS OF CURVATURE OF THE BEND (MEASURED IN FEET). UNDERGROUND STANDARD 3373.2 LISTS RADIUS OF CURVATURE, EITHER IN FEET OR INCHES, FOR INDIVIDUAL CONDUITS.

MAXIMUM ALLOWABLE SWBP:

CONCRETE ENCASED CONDUITS, JACKETED CABLE	1250 LBS/FT
CONCRETE ENCASED CONDUITS, UN-JACKETED CABLE	750 LBS/FT
DIRECT BURIED CONDUITS	300 LBS/FT

INSTALLATION:

1. DO NOT EXCEED MAXIMUM PULLING TENSIONS ALLOWABLE, FOR PULLING GRIP OR EYE.
2. TO OBTAIN LOWEST TENSION, USE AS FEW CURVED SECTIONS AS POSSIBLE AND MAXIMUM POSSIBLE RADIUS OF CURVATURE.
3. DO NOT EXCEED MAXIMUM ALLOWABLE SWBP FOR APPROPRIATE CONDUIT AND CABLE TYPE.
4. PULLING TENSIONS SHALL BE CALCULATED FOR PULLING FROM EACH DIRECTION. WHEN ALLOWABLE PULLING LIMITS ARE MET PULLING IN ONE DIRECTION ONLY, THE CUSTOMER PROJECT PLANNER SHALL SPECIFY THE PREFERRED DIRECTION OF PULL ON THE JOB SKETCH AND IN THE DBL LOCATION NOTES .
5. CABLE IS ALWAYS PULLED AT THE CABLE POLE. CALCULATE CABLE POLE PULLS FOR ONE DIRECTION ONLY – FEEDING TOWARD THE CABLE POLE.

	Indicates Latest Revision	Completely Revised	New Page	Information Removed
5921.2	SDG&E DISTRIBUTION DESIGN MANUAL			REVISION
	CABLE PULLING TENSIONS, PRIMARY AND SECONDARY			DATE 1-1-2000 APPD AS <i>Wd</i>

SAMPLE CALCULATION TO DETERMINE PULLING TENSION AND DIRECTION OF FEED

GIVEN: 1/C #2 SOL AL (XPLECN-PEJ) CABLE
 1DB2" CONDUIT
 90° = ANGULAR CHANGE IN DIRECTION BETWEEN T3 & T4
 L1 = 200'
 L2 = 120'
 Ø = 5°

UNDERSTOOD: C = .70
 NEEDED: VALUE FOR K (AT 90°)
 VALUE FOR SIN 5°
 VALUE FOR COS 5°
 VALUE FOR W, IN LBS/FT, FOR CABLE INDICATED

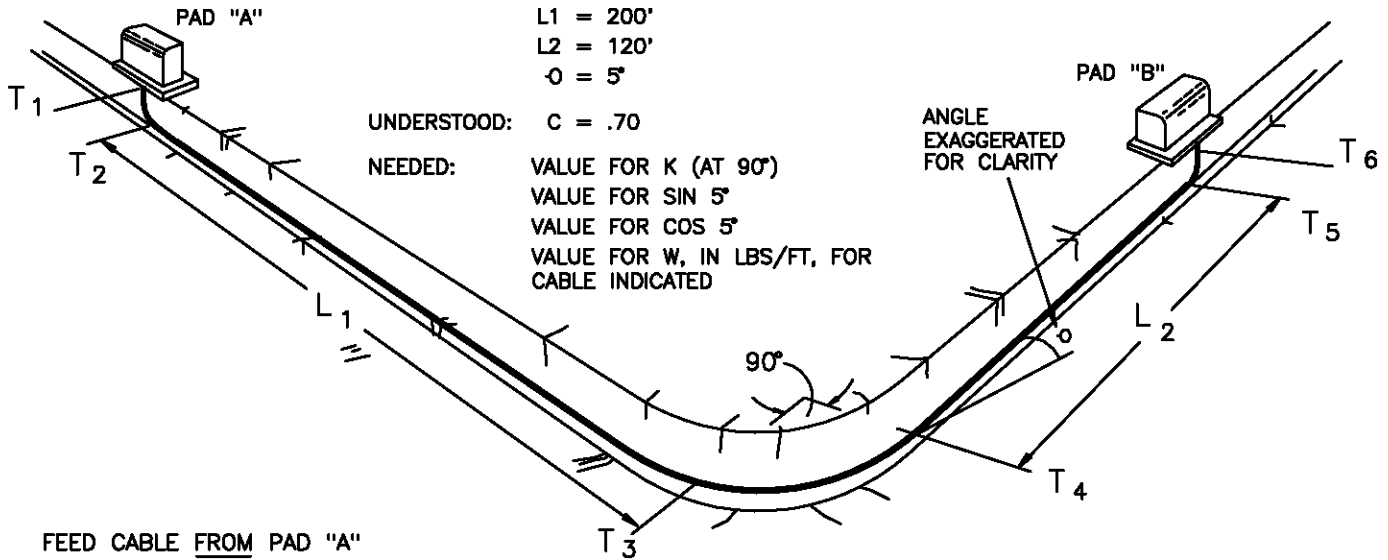

FEED CABLE FROM PAD "A"

$T_2 = 50$, ASSUMES 50 LBS REEL TENSION
 $T_3 = T_2 + L_1 W C = 50 + (200 \times .44 \times .70)$
 $= 50 + 61.6$
 $T_3 = 111.6$
 $T_4 = T_3 K$ (FOR 90°) $= 111.6 \times 1.48 = 165.17$
 $T_5 = T_4 + L_2 W [\sin \theta + C \cos \theta] = 165.17 + (120 \times .44 [.087 + (.70 \times .996)])$
 $= 165.17 + (52.8 [.087 + .697])$
 $= 165.17 + (52.8 [.784])$
 $= 165.17 + (52.8 \times .784)$
 $= 165.17 + 41.39$
 $T_5 = 206.6$
 $T_6 = T_5 K$ (FOR 90°) $= 206.6 \times 1.48 = 305.7$
 $T_{TOTAL} = T_6 = 306$ LBS

FEED CABLE FROM PAD "B"

$T_5 = 50$, ASSUMES 50 LBS REEL TENSION
 $T_4 = T_5 - L_2 W [\sin \theta - C \cos \theta] = 50 - (120 \times .44 [.087 - (.70 \times .996)])$
 $= 50 - (52.8 [.087 - (.697)])$
 $= 50 - (52.8 [-.610])$
 $= 50 - (52.8 \times -.610)$
 $= 50 - (- 32.208)$
 $= 50 + 32.208$
 $T_4 = 82.208 = 82.21$
 $T_3 = T_4 K = 82.21 \times 1.48 = 121.67$
 $T_2 = T_3 + L_1 W C = 121.67 + (200 \times .44 \times .70)$
 $= 121.67 + 61.6$
 $T_2 = 183.27$
 $T_1 = T_2 K = 183.27 \times 1.48 = 271.2$
 $T_{TOTAL} = T_1 = 271$ LBS

RESULTS: TENSION IS WITHIN ACCEPTABLE LIMITS USING PULLING GRIP (OR EYE) AND PULLING FROM EITHER DIRECTION. SWBP AT ELBOWS IS ALSO WITHIN ACCEPTABLE LIMITS FOR DB2" CONDUIT.

CONCLUSION: OKAY TO MAKE THE PULL. SINCE TENSION PULLING FROM PAD "B" IS LOWER, THAT IS THE PREFERRED DIRECTION OF PULL.

UG 4003.4	Indicates Latest Revision	Completely Revised	New Page	Information Removed
REVISION	SDG&E DISTRIBUTION DESIGN MANUAL			5921.3
DATE 1-1-2000	CABLE PULLING TENSIONS, PRIMARY AND SECONDARY			
APPD AS / <i>val</i>				

SCOPE:

This standard establishes the cable tail length required to locate and terminate underground cable in equipment or on cable poles.

PURPOSE

The purpose of this standard is to provide the necessary additional cable footage (Cable Tail Length) to the total cable requirements.

DEFINITIONS

Lateral Distance – the horizontal separation (L) between points of cable entry into underground equipment. This is normally represented as the trench length between adjacent pieces of equipment.

Cable Tail Length – the additional cable footage required beyond the lateral distance to allow for the trench depth (D) and cable termination (T).

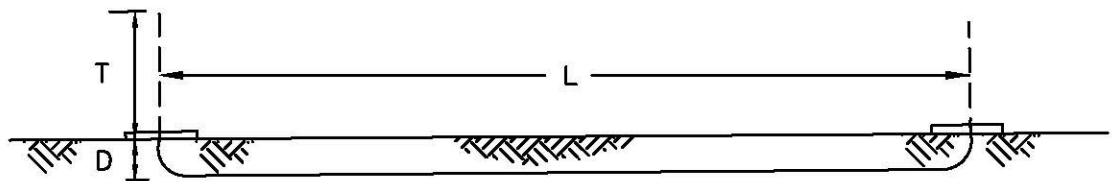

APPLICATION:

The following illustrations show standard cable tail lengths for a variety of design configurations.

A. Cables Poles

For primary cable
For secondary cable

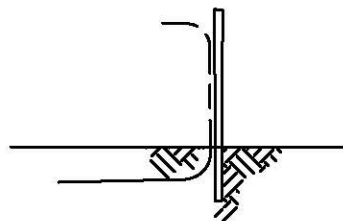

Cable Tail Lengths
Calculation of cable tail lengths for cable poles is based on the measurement from the ground line to the top of the conduit plus 8 feet of cable.

B. Pad Mounts

Single-phase terminator (3522)

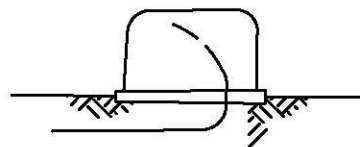

6 feet

Service Restorer (3575)

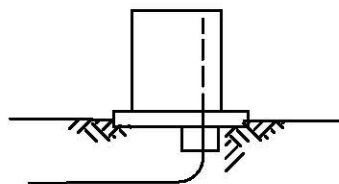

10 feet

© 1998 - 2008 San Diego Gas & Electric Company. All rights reserved. Removal of this copyright notice without permission is not permitted under law.

Indicates Latest Revision | Completely Revised | New Page | Information Removed

REVISION	SDG&E DISTRIBUTION DESIGN MANUAL		5922.1
DATE 8-26-08	CABLE TAIL LENGTH REQUIREMENTS		
APPD JE /MC			

Illustrations

Cable Tail Lengths

With three-phase terminator, existing (3520 or 3521)

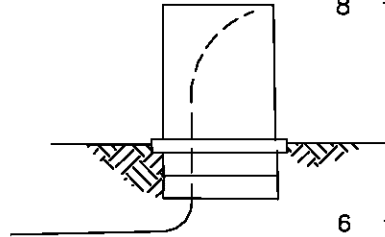

8 feet

With single-phase fuse cabinet (3512)

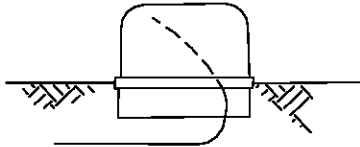

6 feet

With three-phase fuse cabinet (3513)

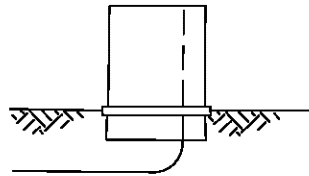

8 feet

With single-phase livefront or deadfront transformer (3711 or 3712)

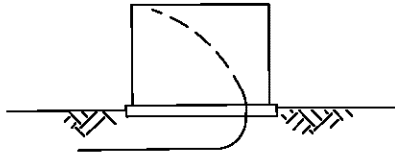

6 feet

With single-phase livefront or deadfront transformer with handhole

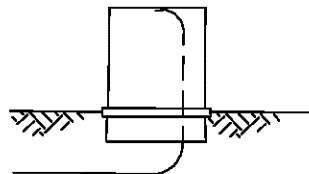

7 feet

With single-phase deadfront, open delta transformer with handhole

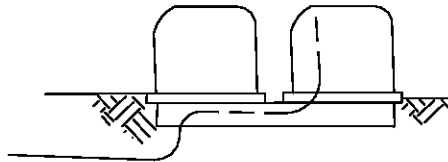

11 feet

With three-phase deadfront transformer

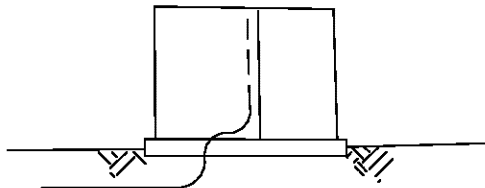

7 feet

	Indicates Latest Revision	Completely Revised	New Page
5922.2	SDG&E DISTRIBUTION DESIGN MANUAL		REVISION
	CABLE TAIL LENGTH REQUIREMENTS		DATE 3-30-84 APPD CVN <i>ROJ</i>

Illustrations

Cable Tail Lengths

With three-phase livefront transformer (225 to 1000 kVA)

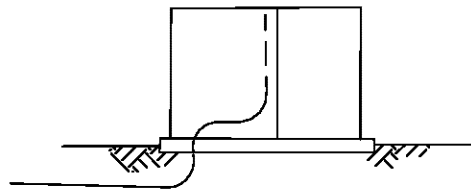

10 feet

With three-phase livefront transformer (1500 to 2500 kVA)

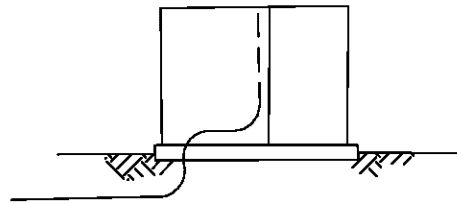

13 feet

C. Handholes

3312

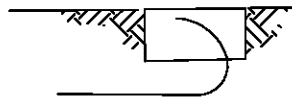

6 feet

3313

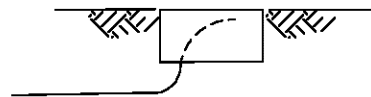

7 feet

3314

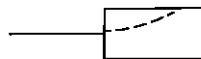

8 feet

3314
With cable taps

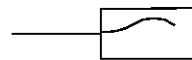

9 feet

3315

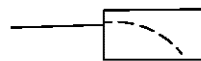

8 feet

3315
With cable taps

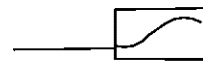

10 feet

3315 or 3316
With pad-mounted switch

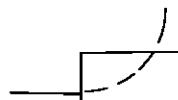

13 feet

3316

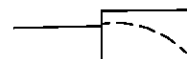

13 feet

	Indicates Latest Revision	Completely Revised	New Page
REVISION	SDG&E DISTRIBUTION DESIGN MANUAL		
DATE 1-1-94 APPD MF/RD	CABLE TAIL LENGTH REQUIREMENTS		5922.3

Illustrations

Cable Tail Lengths

3316
With cable taps

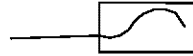

16 feet

D. Manholes

3320 w/PMH 9
or PMH 11 Switch

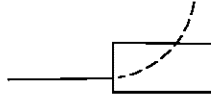

16 feet

3322

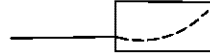

11 feet

3322
For #2/0 & below

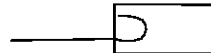

8 feet

3322
For 350 kcmil & above



30 feet

3322
With switch (existing)



12 feet

3322
With switch (existing)

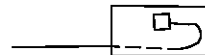

19 feet

3324 - 14'



16 feet

3324 - 14'
For 2/0 & below

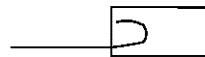

10 feet

3324 - 20'



22 feet

3324 - 20'
for 350 kcmil & above

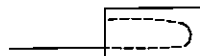

50 feet

 Indicates Latest Revision	Completely Revised	New Page
---	--------------------	----------

5922.4	SDG&E DISTRIBUTION DESIGN MANUAL	REVISION
	CABLE TAIL LENGTH REQUIREMENTS	DATE 3-30-84 APPD MF/ROJ

Illustrations

Cable Tail Lengths

3324 - 14'
With one switch



16 feet

3324 - 14'
With one switch



19 feet

3324 - 20'
With one switch
(existing)



22 feet

3324 - 20'
With one switch
(existing)

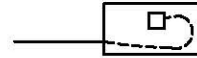

40 feet

3324 - 26'
With two switches

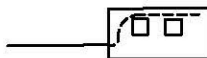

40 feet

3324 - 26'
With two switches



65 feet

E. METER PANELS

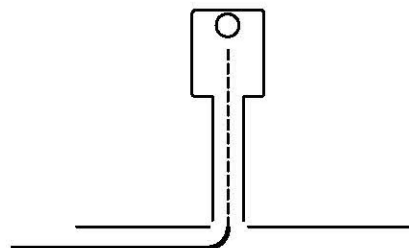

10 feet

© 1998 - 2008 San Diego Gas & Electric Company. All rights reserved. Removal of this copyright notice without permission is not permitted under law.

<input checked="" type="checkbox"/> Indicates Latest Revision	<input type="checkbox"/> Completely Revised	<input type="checkbox"/> New Page	<input type="checkbox"/> Information Removed
---	---	-----------------------------------	--

REVISION	SDG&E DISTRIBUTION DESIGN MANUAL		5922.5
DATE 8-26-08	CABLE TAIL LENGTH REQUIREMENTS		
APPD JE / MC			

SCOPE:

This standard establishes preferred cable installation practices, and shall be used by all designers/planners when designing underground jobs.

A. General Primary Conductor Application

Cable size is to be determined based on expected loading and Design Standard 6241.

1. Single-phase branches extending from a three-phase system should use 1/C #2 aluminum cable.
2. Three-phase loads should use 3-1/C-#2 or 3-1/C-#2/0 aluminum cable as required for ampacity. Refer to Design Standard 6241 for optimum design loading.
3. 350 kcmil, TRXLPECN-PEJ, 3-1/C aluminum cable can be used as a feeder cable where the largest available conduit is 4" and projected load will not require the use of 750 compact cable.
4. 1000 kcmil, TRXLPECN-PEJ, 3-1/C aluminum cable should be used as feeder cable when 5" conduit is available except in the substation getaway.
5. 1000 kcmil, TRXLPECN-PEJ, 3-1/C copper cable should be used in the substation getaway to the first substructure or cable pole outside the substation fence when 5" conduit is available.
6. 750 kcmil, EPR-PEJ, compact aluminum and copper cable is available for use as replacement for PILC cable and for a substation getaway or feeder extension where the largest conduit available is 4".
7. For areas where existing PILC circuits are to be extended, splicing kits are available to transition from PILC to PECN. These transition kits must be ordered for each job. See Underground Construction Standard 4147. If space is available in the substructure the Patton and Cooke junction grounding bar should be installed. See Underground Construction standard 4183.

B. Special Use of 3-1/C - #2/0 Aluminum Cable

There are some cases when the load to be served is too large for a single fusing device, but not large enough to need cable larger than 2/0 aluminum. In those cases 2/0 cable may be used subject to the following criteria:

1. All looping criteria must be met. This includes both feeder and local distribution (See Design Standard 5221.)
2. The 2/0 cable is the most economical cable to use as determined according to Design Standard 6241.
3. The area to be served by 2/0 cable is "enclosed", i.e., no future development is possible, except as allowed in (4) below.
4. In some cases 2/0 cable may be used to delay the installation of more expensive larger cable. This may be done if the larger cable is not needed for at least ten (10) years.

© 1998 - 2014 San Diego Gas & Electric Company. All rights reserved. Removal of this copyright notice without permission is not permitted under law.

	<input checked="" type="checkbox"/> Indicates Latest Revision	<input type="checkbox"/> Completely Revised	<input type="checkbox"/> New Page	<input type="checkbox"/> Information Removed
REVISION	SDG&E DISTRIBUTION DESIGN MANUAL			
DATE 8-21-2014	UNDERGROUND CABLE INSTALLATION CRITERIA			5923
APPD JCE / DW				

HOW TO USE THE GUY COMPUTER

NOTE: In using rotating arm scale, all readings are perpendicular to the upper scale edge.

Example No. 1

To Determine

1. Angle which guy makes with pole
2. Point where anchor rod enters ground
3. Depth of anchor hole
4. Tension on guy wire
5. Size of guy wire, using a factor safety of 2.

Given

Pole Attachment (HT)..... 40 ft.
 Horizontal distance, anchor hole to pole (D) 35 ft.
 Length of anchor rod..... 8 ft.
 Number and size of conductors
 at top circuit position..... 3 - #4 and
 1-#6 B. Str. H.D.

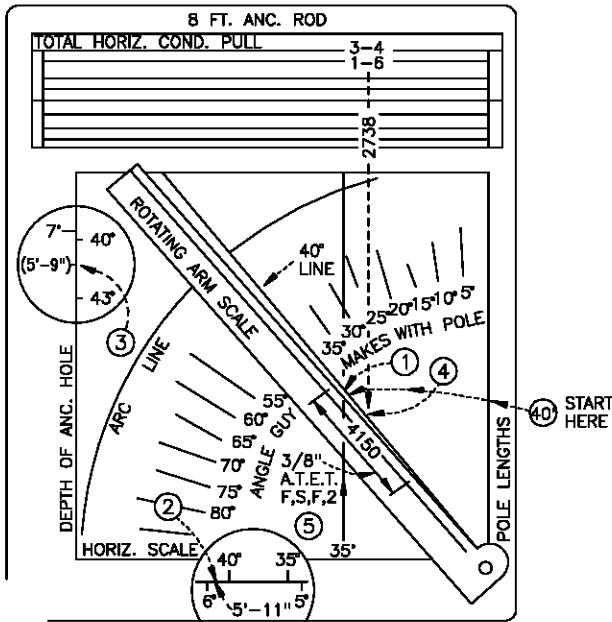

EXAMPLE NO. 1

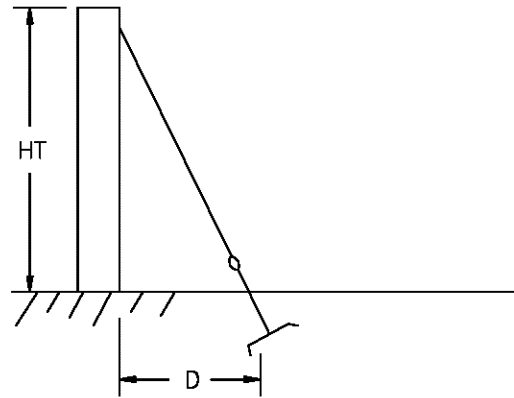

Solution

1. Use 8 ft. anchor rod chart. Find 35' mark on the Horizontal Distance scale at bottom of chart; project a line vertically from this mark to where it intersects with curve line marked 40'. Rotate scale arm so that upper edge coincides with intersection. Read 41° - on angle scale, which is the angle that the Guy makes with Pole.
2. On the horizontal scale at bottom of page titled "Anchor Hole to Beginning of Anchor Rod Slot" find 41°-mark. By interpolation it will be found that this distance is approximately 5'11".
3. The depth of anchor hole can be found in a similar manner on the vertical scale at the left side of the chart, answer - 6'9".
4. On the conductor tensions at the top of the chart in the section titled "Hard Drawn Bare Stranded" and on the line containing 4 wire combinations, find 3 - #4 and 1-#6. Follow this dashed line to where it intersects scale arm resting on 41° -diagonal. Read 4150# at intersection point on top scale of arm.
5. Inspection will show this tension falls within the 3/8" A.T. & T. band on the third line of the arm scale.

	Indicates Latest Revision	Completely Revised	New Page
REVISION	SDG&E DISTRIBUTION DESIGN MANUAL		
DATE 1-1-87	DETERMINING GUY REQUIREMENTS		5931.1
APPD CVN / <i>[Signature]</i>	WITH THE GUY COMPUTER		

VECTERING

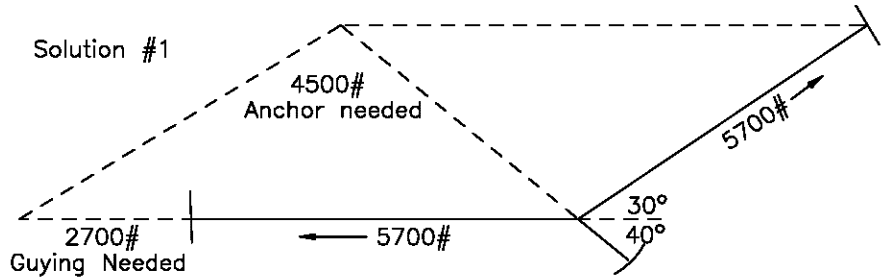
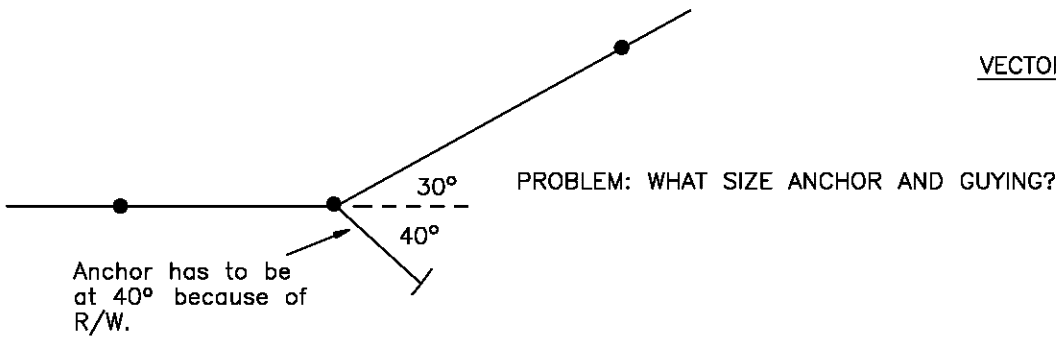

When using rotating arm scale, all readings are perpendicular to the upper scale edge.

Example No. 2

To Determine

1. Resultant Tension or Pull when anchor is to be installed on the bisection of angle in the line.
2. Angle which guy makes with pole.
3. Tension on guy wire.
4. Size of guy wire, using a factor safety of 2.

Given

Length of pole..... 45 ft.
 Horizontal Distance anchor hole to pole..... 37 ft.
 Length of anchor rod..... 10 ft.
 Number of conductors at top circuit position . 3-#1/0 and 1 - #2 B. Str. H.D.
 Angle of departure of line..... 24°

Solution

1. Use 10 ft anchor chart. Under the title "Total Horizontal Conductor Pull" at top of chart in Hard Drawn Bare Stranded section on the line containing 4 wire combinations, find 3 - #1/0 and 1 - #2. Follow this dashed line to where it intersects the arc line. Rotate scale arm to where upper edge coincides with this intersection. Find 24° on 2nd line of rotating scale. Mark this point at upper scale edge. Swing scale to horizontal positions. Project a line from point vertically downward to scale, read 2900#, which is the total horizontal pull.

	Indicates Latest Revision	Completely Revised	New Page
5931.2	SDG&E DISTRIBUTION DESIGN MANUAL		REVISION
	DETERMINING GUY REQUIREMENTS WITH THE GUY COMPUTER		DATE 3-30-84 APPD CVN/RJG

2. Find guy angle by method described in previous problem, answer – 39° .
3. Set scale arm on 39° . Read tension on scale where previously projected 2900# line intersects 39° line, answer – 4600#
4. The 4600# guy tension falls within the band marked for 3/8" A.T. & T.

If the guy angle has not previously been determined and it is desired to make the most of shortened "lead" distance and maximum use of any indicated size of guy wire, this can be accomplished by the following operation. Rotate the scale arm to where 5750# (maximum safe tension for 3/8" A.T.&T.) on scale arm coincides with previously projected 2900# line. The scale arm will reset on the 31° angle. Find intersection of pole height curve line for 45' pole and follow vertically downward to Horizontal Distance scale, read 27'. Similarly follow through for 7/16" A.T. & T (9000# max.) Answers—19° and 16'. Inspection will show that 5/16" A. T. & T. is applicable in this case only to an angle such as those produced by head guys.

Solution #2

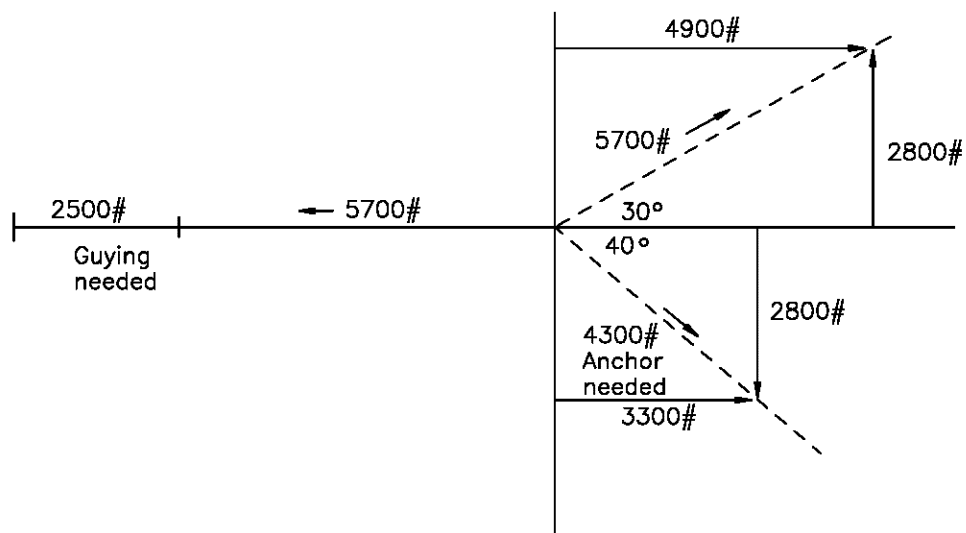

	Indicates Latest Revision	Completely Revised	New Page
REVISION	SDG&E DISTRIBUTION DESIGN MANUAL		
DATE 3-30-84	DETERMINING GUY REQUIREMENTS WITH THE GUY COMPUTER		
APPD CVN / <i>BJ</i>	5931.3		

**6000
SUBSTATION
LOAD FORECASTING**

**6000
SUBSTATION
LOAD FORECASTING**

The design standards pertaining to Load Forecasting are being revised, and have temporarily been removed from the Design Manual. Please contact Distribution Planning for the latest procedures describing substation or circuit load forecasting. The design standards being revised are: 6021, 6022, 6023, and 6024.

	<input checked="" type="checkbox"/> Indicates Latest Revision	<input type="checkbox"/> Completely Revised	<input type="checkbox"/> New Page
REVISION DATE 3-1-02 APPD JCE <i>1/vel</i>	SDG&E DISTRIBUTION DESIGN MANUAL TABLE OF CONTENTS SUBSTATION LOAD FORECASTING		6001

6100
SECTIONALIZING
& PROTECTION

6100
SECTIONALIZING
& PROTECTION

PAGE**SUBJECT**

6111 6111.1–6111.7	Feeder Circuit Sectionalizing And Protection Switch Application Criteria
6112 6112.1–6112.2	Recloser Application Criteria
6113 6113.1–6113.4	Automatic Self-Resetting Fault Indicator Definition, Criteria, Application, Examples
6114 6114.1–6114.2	Underground Service Restorer Application Criteria
6115 6115.1–6115.4	Design Checklist For SCADA Jobs
6121 6121.1–6121.12	Fuse Application Criteria
6131 6131.1–6131.7	Underground Transformer/Fuse Coordination Tables
6132 6132.1–6132.5	Current-Limiting Protecting Fuse Coordination Tables
6133 6133.1–6133.14 6133.15–6133.31 6133.40–6133.44 6133.45–61.33.49	Fuse Coordination Tables Expulsion Protecting Fuse Coordination Tables MVI Fuse Coordination Tables Fault Tamer Fuse Coordination Tables SMU-20 Fuse Coordination Tables
6134 6134.1–6134.4	Relay and Fuse Coordination Tables
6136 6136.1–6136.2	Service Restorer/Fuse Coordination Table
6142 6142.1–6142.3	Secondary Fault Current Calculations Utility Contribution to Secondary Fault Current Minimum Service Distance
6144 6144.1–6144.7 Attachments A-D	Distribution Circuit Protection Analysis Analytical Steps
6145 6145.1–6145.8	Distribution Circuit Reliability Analysis

© 1998 - 2021 San Diego Gas & Electric Company. All rights reserved. Removal of this copyright notice without permission is not permitted under law.

REV	CHANGE	DR	BY	DSN	APV	DATE	REV	CHANGE	DR	BY	DSN	APV	DATE
C	EDITORIAL CHANGES	JAS	JAS	FRC	CZH	01/22/2021	F						
B	FORMATTING				JAS	12/02/2020	E						
A	ORIGINAL ISSUE				DW	08/21/2014	D	EDITORIAL CHANGES	EPC	JA	FRC	CZH	08/26/2021

Indicates Latest Revision Completely Revised New Page **X** Information Removed

SDG&E ELECTRIC DISTRIBUTION DESIGN MANUAL

**SHEET
1 OF 1**

**TABLE OF CONTENTS
SECTIONALIZING AND PROTECTION**

DM6101

SCOPE:

This design standard provides criteria for the placement of overhead and underground switches on 12kV feeder circuits.

PURPOSE:

The switch application criteria was established to maintain distribution system reliability and to facilitate construction operations during maintenance, new business activities, and restoration of service activities. There is no such thing as a typical circuit so this criteria represents the ultimate concept of what the switch configuration should look like when the system is mature. For SCADA switch installations the overall plan is to separate a circuit into 4-5 switching segments (approximately every 100 amps of actual load) plus have tie switches available to support the faulted circuits.

DEFINITIONS:

Overhead Feeder – the term used for the 600 A primary overhead system incorporating J/0 ACSR and larger conductors.

Underground Feeder – the term used for the 600 A primary underground cable system where 350, 750 and 1000 KCMIL AL or 4/0 and 500 KCMIL CU primary cable is used.

Major Critical Customer – the term used for those customers exceeding 1000 kVA connected load who are engaged in life support activities, protection of the public, or where large groups of people may be present. Facilities such as hospitals, military installations, major law enforcement and fire protection installations, major shopping centers, high rise buildings, and customers with critical manufacturing processes shall be included.

Feeder Cable Pole – a pole used to convert overhead to underground where 350, 750 and 1000 KCMIL AL or 4/0 and 500 KCMIL CU underground cable is attached.

Feeder Line Segment – the feeder conductor that exists between adjacent sectionalizing switches.

Demand Factor – the ratio of actual load to transformer connected kVA. It is estimated to be 50 percent system wide for loads on the feeder system.

CRITERIA

Switch placement is determined by circuit configuration as defined below.

A. Feeder Circuit Criteria

1. Based on the division of the average 12 kV feeder circuit into line segments, the following placement of switches results.
 - a. No more than one mile of overhead or underground feeder should exist between switches.
 - b. An overhead or underground switch should be placed every 100 A of actual 12 kV peak load or 4000 kVA of connected **line transformer nameplate load**, whichever comes first. This means that 4000 kVA is maximum amount of load that can be connected directly to a feeder line segment.
 - c. **No more than 1000 metered customers shall be connected between switches.**
 - d. Load connected to the feeder line segment past a switch position should be used to meet the criteria in 1.b.
2. PME style switchgear shall be used for new underground switch installations, unless the PME style is determined not to be feasible due to lack of space or easement turndown. Easements shall be acquired when necessary to accommodate the PME switchgear.

© 1998 - 2021 San Diego Gas & Electric Company. All rights reserved. Removal of this copyright notice without permission is not permitted under law.

REV	CHANGE	DR	BY	DSN	APV	DATE	REV	CHANGE	DR	BY	DSN	APV	DATE
C	EDITORIAL CHANGES	JAS	JAS	FRC	CZH	01/22/2021	F						
B	CRITERIA A.1				JAS	12/02/2020	E						
A	ORIGINAL ISSUE				JCE	03/01/2002	D						

SHEET 1 OF 7	X Indicates Latest Revision	Completely Revised	New Page	Information Removed	DM 6111.1
	SDG&E ELECTRIC DISTRIBUTION DESIGN MANUAL				
	FEEDER CIRCUIT SECTIONALIZING AND PROTECTION				

3. All branch circuit connections to the underground feeder systems shall be made through fuses or 600 A switch positions.
 - a. All transformers 2500 kVA or less shall be connected to the feeder system through appropriate fusing, except as noted in 3d.
 - b. PME style switchgear shall be used to fuse 1500, 2000, and 2500 kVA transformers, except as noted in 3c and 3d
 - c. An existing 600 A vacant switch position may be used with a fuse cabinet to connect a single 1500 or 2000 kVA transformer, subject to sectionalizing and load criteria described in 1. Contact the appropriate Distribution Planning engineer for approval to use any vacant switch position.
 - d. An existing 600 A vacant switch position may be used without fusing to connect a single 2500 kVA transformer, subject to sectionalizing and load criteria described in 1. Contact the appropriate Distribution Planning engineer for approval to use any vacant switch position.
 - e. A dedicated switch position shall be used for all 3000 kVA transformer connections. Contact the appropriate Distribution Planning engineer for approval to use an existing 600 A vacant switch position if it is being considered to serve this transformer.
 - f. All primary metered service connections to the feeder system shall be made through fuses, switches, or switch positions capable of fault interruption. They are exempt from the requirements in A1b of this section. **Current Limiting Fuses should not be used, as they will generally not coordinate well with the customer's equipment, and may result in more extended outages for the primary customer.**
4. In cases where a maximum transformer capacity of 1500 kVA is being connected, and no feeder sectionalizing is required, now or in the future, a fuse cabinet may be used if reviewed and approved by Distribution Planning. In cases where transformer capacity greater than 1500 kVA and/or feeder sectionalizing is anticipated in the future, easements shall be acquired for future PME switchgear at or near the fuse cabinet position. For 4000 A main panels obtain easements for the 3423 box pad regardless of initial calculated demand.

The connections discussed in items 3a-3e and 4 are summarized in Table 1 below.

TABLE 1

Transformer Size	PME with Fuse Compartment	PME Switch	Fuse Cabinet Connected to Vacant Switch Position (Requires Distribution Planning Approval) See Item 3c	Fuse Cabinet Connected to Feeder Line Segment (Requires Distribution Planning Approval) See Item 4	Vacant Switch Position (Requires Distribution Planning Approval) See Item 3d & 3e
1500 kVA	X		X	X	
2000 kVA	X		X		
2500 kVA	X				X
3000 kVA		X			X

5. Exceptions to the above may be warranted based on existing system conditions. This could include not fusing a single transformer if it is being served by not more than 30 feet of local distribution cable and a suitable fused elbow location is not within 120 feet of the transformer. These exceptions shall be reviewed and approved by the Design Standards engineer in Distribution Standards.

© 1998 - 2021 San Diego Gas & Electric Company. All rights reserved. Removal of this copyright notice without permission is not permitted under law.

REV	CHANGE	DR	BY	DSN	APV	DATE	REV	CHANGE	DR	BY	DSN	APV	DATE
C	EDITORIAL CHANGES	JAS	JAS	FRC	CZH	01/22/2021	F						
B	CRITERIA A.3				JAS	12/02/2020	E						
A	ORIGINAL ISSUE				JCE	03/01/2002	D						

SHEET 2 OF 7	X Indicates Latest Revision	Completely Revised	New Page	Information Removed
	SDG&E ELECTRIC DISTRIBUTION DESIGN MANUAL			
	FEEDER CIRCUIT SECTIONALIZING AND PROTECTION			
DM 6111.2				

EXAMPLES

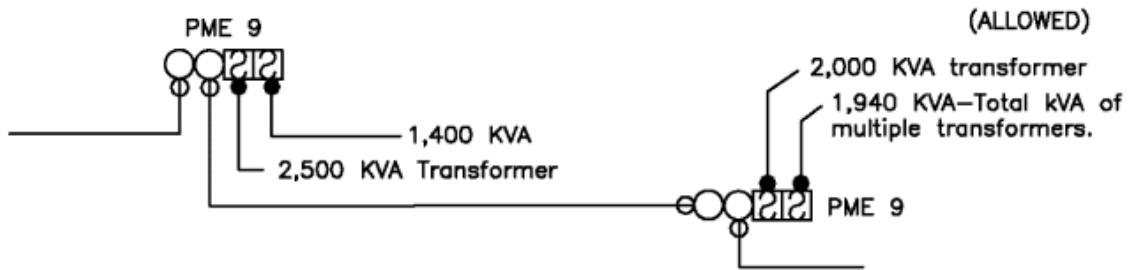
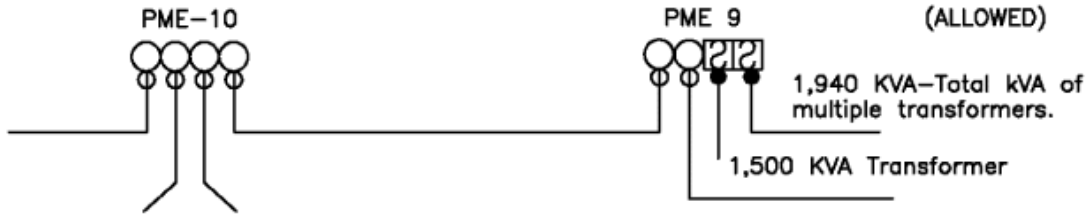
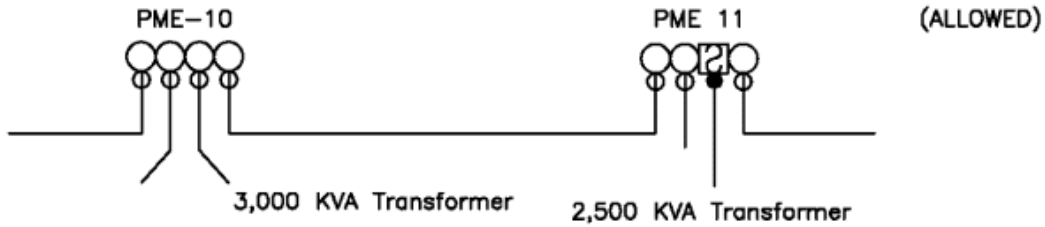

EXISTING SWITCH WITH VACANT SWITCH POSITION(S)

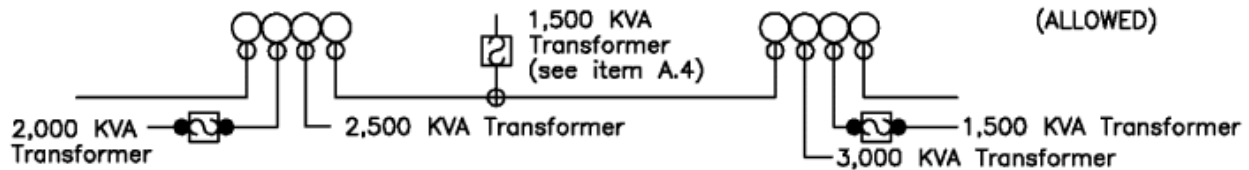

6. To provide for future extension of the distribution feeder without the necessity of a long prearranged outage and to allow service restoration of the feeder as promptly as possible, a switch should be placed on each load side feeder line segment as shown below provided at least 100 A of actual load or 4000 kVA of connected load exists on the line segment. If the minimum requirements are not met, switch placement is dependent on condition A.1. above.

a. Overhead Feeder Split Line

The switch placement for a source side feeder line segment serving two loads is illustrated below

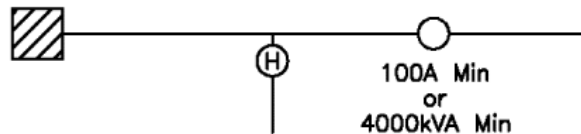

© 1998 - 2021 San Diego Gas & Electric Company. All rights reserved. Removal of this copyright notice without permission is not permitted under law.

REV	CHANGE	DR	BY	DSN	APV	DATE	REV	CHANGE	DR	BY	DSN	APV	DATE
C	EDITORIAL CHANGES	JAS	JAS	FRC	CZH	01/22/2021	F						
B	FORMATTING				JAS	12/02/2020	E						
A	ORIGINAL ISSUE				JCE	03/01/2002	D						

X Indicates Latest Revision Completely Revised New Page Information Removed
 SDG&E ELECTRIC DISTRIBUTION DESIGN MANUAL

**SHEET
3 OF 7**

FEEDER CIRCUIT SECTIONALIZING AND PROTECTION

DM 6111.3

If one of the switches is used as a circuit tie, it should be gang-operated, and the other switch should be located on the source side feeder line segment as shown in the following diagram. This will allow greater flexibility during load restoration.

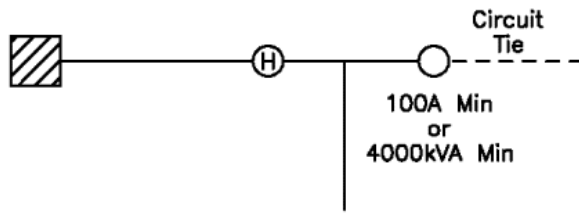

b. Underground Feeder Line Split

The underground switch provides a switch position on each feeder line segment as shown below, therefore, differentiation is not needed when one line segment is a circuit tie.

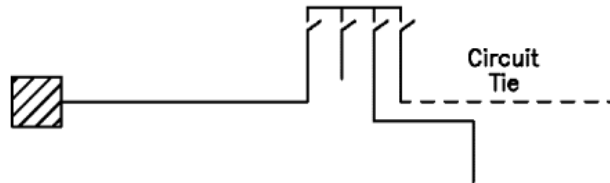

B. Major Critical Customer Criteria

- To provide maximum operating flexibility, the feeder line segments surrounding a major critical customer shall be sectionalized as shown in the following diagram. This permits service restoration of the major critical customer through a tie switch to an adjacent circuit.

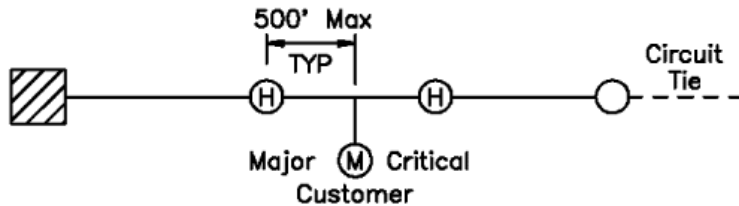

C. Future Feeder Switch Criteria

- Overhead

A switch should be installed as needed to satisfy the Feeder Circuit Criteria (A.1 and A.6).

- Underground

A switch should be installed as needed to satisfy the Feeder Circuit Criteria (A.1 and A.6) provided that delayed installation of the switch to a future date will not result in excessive customer outage due to feeder system interruption. If future installation of the switch would result in excessive customer outage, it should be provided for while the rest of the underground system is being installed in the area. Reasonable judgment should be used when deciding how far in advance a switch should be installed. Generally, switch installation is warranted if need is anticipated within two years. Otherwise, no substructure should initially be installed to provide for cable training to a future padmounted switch.

© 1998 - 2021 San Diego Gas & Electric Company. All rights reserved. Removal of this copyright notice without permission is not permitted under law.

REV	CHANGE	DR	BY	DSN	APV	DATE	REV	CHANGE	DR	BY	DSN	APV	DATE
C	EDITORIAL CHANGES	JAS	JAS	FRC	CZH	01/22/2021	F						
B	FORMATTING				JAS	12/02/2020	E						
A	ORIGINAL ISSUE				MF	01/01/1989	D						

SHEET 4 OF 7	X Indicates Latest Revision	Completely Revised	New Page	Information Removed
	SDG&E ELECTRIC DISTRIBUTION DESIGN MANUAL			
	FEEDER CIRCUIT SECTIONALIZING AND PROTECTION			
DM 6111.4				

D. Future Feeder Switch Criteria

A switch should be installed on each feeder cable pole to provide isolation of the underground system from the overhead system unless:

1. A padmounted switch is in close proximity to the pole with no load tapped and no possibility of load being tapped between the cable pole and the switch.
2. On overhead switch, with truck access, is in close proximity with no load tapped and no possibility of load being tapped between the switch and the underground tie-in/connection point.

E. Geographic Criteria

A line switch should be installed:

1. At on accessible location (one near a roadway), and
2. At each end of a feeder line segment that traverses an inaccessible area which is susceptible to damage and difficult to patrol. This will allow isolation of on area that requires a longer than average patrol.

F. Switch Selection Criteria

1. Overhead
 - a. Use 3-Ø gang-operated switches at the following locations:
 - 1) Tie switches
 - 2) Where line switches are required under the Feeder Circuit Criteria (page 6111.1, A.1) such that there is a gang-operated switch at least every one mile or 100 A of load, but not more often than every ½ mile or 50 A of load.
 - 3) Where pole climbing limitations would extend the time required for switching, (e.g., 4kV underbuild).
 - b. Hookstick switches are to be installed at all other 4kV and 12kV switch application locations.
 - c. FO-11 Oil Switches in the 4 kV System:

When they are removed for maintenance, one of the following steps shall be taken:

- 1) If sectionalizing is still required, replace the FO-11, 4kV oil switch with a 600 ampere, air insulated 14.4kV disconnect (M&S 707008) without regard for proximity to the coast.
- 2) If sectionalizing is no longer required, remove the FO-11 switch and jumper out deadends.

© 1998 - 2021 San Diego Gas & Electric Company. All rights reserved. Removal of this copyright notice without permission is not permitted under law.

REV	CHANGE	DR	BY	DSN	APV	DATE	REV	CHANGE	DR	BY	DSN	APV	DATE
C	EDITORIAL CHANGES	JAS	JAS	FRC	CZH	01/22/2021	F						
B	FORMATTING				JAS	12/02/2020	E						
A	ORIGINAL ISSUE				DRM	01/01/1998	D						

SHEET 5 OF 7	X Indicates Latest Revision	Completely Revised	New Page	Information Removed
	SDG&E ELECTRIC DISTRIBUTION DESIGN MANUAL			
	FEEDER CIRCUIT SECTIONALIZING AND PROTECTION			

DM 6111.5

2. Underground

Padmounted switches should be installed in accordance with Design Manual Standard 5240 (Underground System Equipment Selection and Location) and 5236 (Sight Distance Requirement) and 5250 (UG Sectionalizing Equipment Application).

- a. The following arrangement shall be used for making circuit ties involving underground circuits:

Overhead to Underground: The underground connection shall be:

- 1) From a padmounted switch to a cable pole with 600 A hook stick switches, or
- 2) From 3-way 600 A Tees, a 3-Ø terminator, or a subsurface switch to a cable pole with a gang-operated switch.

Underground to Underground:

- 1) The preferred connection shall be from 3-way 600 Amp Tees to a subsurface or padmounted switch. The intent here is to avoid using two 600 A, 4-way switches for the sole purpose of making a circuit tie.
- 2) The tie may be made between two 600 A switches if both switches are needed for other reasons.

3. Examples

A new 12 kV circuit is to be built. It will have 240 A of uniformly distributed actual load along its 3.75 mile feeder. Determine the switch locations.

- a. Determine the load at one mile increments along the feeder:
 $240\text{ A} \div 3.75\text{ mi} = 64\text{ A per mile}$
- b. Based on the Feeder Circuit Criteria (A.1), switches should be installed every mile along the feeder because each mile feeder line segment serves more than 50 A, but less than 100 A of load.

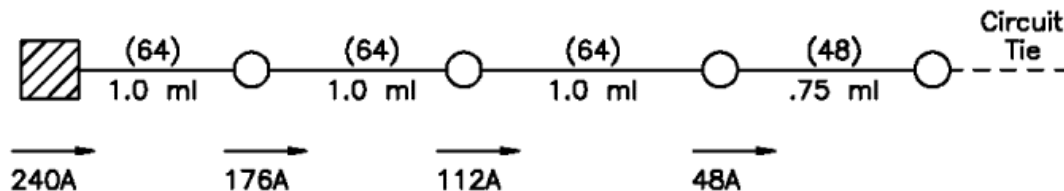

Notes:

- 1) All switches shall be gang-operated because they are required under the Feeder Circuit Criteria (page 6111. 1, A 1)
- 2) (64) denotes 64 A of actual load on feeder line segment.

© 1998 - 2021 San Diego Gas & Electric Company. All rights reserved. Removal of this copyright notice without permission is not permitted under law.

REV	CHANGE	DR	BY	DSN	APV	DATE	REV	CHANGE	DR	BY	DSN	APV	DATE
C	EDITORIAL CHANGES	JAS	JAS	FRC	CZH	01/22/2021	F						
B	FORMATTING				JAS	12/02/2020	E						
A	ORIGINAL ISSUE				MF	01/01/1988	D						

SHEET 6 OF 7	X Indicates Latest Revision	Completely Revised	New Page	Information Removed
	SDG&E ELECTRIC DISTRIBUTION DESIGN MANUAL			
	FEEDER CIRCUIT SECTIONALIZING AND PROTECTION			
DM 6111.6				

G. SCADA Switches Criteria

1. This criteria represents the ultimate concept of what the switch configuration should look like when the system is built out. Switches installed at strategic points on the circuit using the criteria shown in A.1 through C.2 (breaking the circuit into 4 to 5 switching segments or at key tie points) should normally be SCADA switches if the following applies:
 - a. At strategic points on a circuit such as major intersections or circuit branching points, where the circuit bifurcates, or trifurcates, or
 - b. Is at a strategic location and is required to help provide an adequate number of SCADA tie switches to fully support faulted circuits. SCADA tie switches should be located such that at least 40% of customers on the feeder should be connected between the point of tie connection and the substation circuit breaker. The Distribution Planning engineer should consider future circuit configuration changes when deciding whether to put in a SCADA tie switch.
 - c. At least 40% of the customers on a feeder shall be located between the substation circuit breaker and the first SCADA switch.
 - d. If it is a circuit with a high SAIDI index, recent reliability records should be consulted for this information. Use the last five years' history.
 - e. Other factors equal, SCADA ties between circuits originating from different substations are preferred.
 - f. Switches not at key sectionalizing or tie points as specified above, will not be SCADA switches unless other requirements make it necessary (i.e. Major Customer as defined on DM 6111.1, and Special Commercial Customers as defined on DM 6145.1, etc.)
2. All new, as well as replacement switches being installed, should be evaluated against this criteria whether:
 - a. Installing switches on new business projects, regardless of the type of customers (commercial, industrial, residential), or
 - b. Installing switches on new feeder and circuit extension projects, or
 - c. Overhead to underground conversions, or
 - d. When replacing existing switches on maintenance, switches in strategic locations should be SCADA, or
 - e. For reliability projects
Projects are always prioritized using contemporary methods to provide a ranking. The aggregate value of reliability projects almost always exceeds what the approved capital budget allocations can support in a given calendar.
3. A request to install a SCADA switches should be submitted on a Distribution Planning Worksheet for the planning engineer's approval. The planning engineer needs to take into account the long-range configuration for the circuit when specifying SCADA switch locations. Some smaller circuits from a SCADA substation may be too small (in customer count, length and/or MW) to require SCADA switches. The planning engineer is responsible to determine if a SCADA switch is required.
4. Design manual pages 6115.1 & .2 provides a check list for installing SCADA switches.

© 1998 - 2021 San Diego Gas & Electric Company. All rights reserved. Removal of this copyright notice without permission is not permitted under law.

REV	CHANGE	DR	BY	DSN	APV	DATE	REV	CHANGE	DR	BY	DSN	APV	DATE
C	EDITORIAL CHANGES	JAS	JAS	FRC	CZH	01/22/2021	F						
B	CRITERIA G.1 AND G.2				JAS	12/02/2020	E						
A	ORIGINAL ISSUE				DRM	01/01/2000	D						

SHEET 7 OF 7	X Indicates Latest Revision	Completely Revised	New Page	Information Removed
	SDG&E ELECTRIC DISTRIBUTION DESIGN MANUAL			
	FEEDER CIRCUIT SECTIONALIZING AND PROTECTION			
DM 6111.7				

SCOPE

This design standard provides application criteria for service restorers used to protect overhead feeders.

PURPOSE

Service restorers are placed on 12kV overhead circuits to reduce the number of customers effected by service interruptions. Service restorers act as on-line OCB's, clearing transient faults and locking open permanent faults. They reduce substation OCB operations. Only customers downstream of the device are affected by it.

DEFINITIONS

Service Restorer – the term used to identify an electronically controlled distribution line recloser.

Electronically Controlled Distribution Line Recloser – provides automatic sectionalizing of feeder circuits. It has the ability to re-energize the feeder up to three times, prior to remaining permanently open, in an attempt to restore service.

Major Critical Customer – the term used for those customers exceeding 1000KVA connected load who are engaged in life support activities, protection of the public, or where large groups of people may be present. Facilities such as hospitals, military installations, major law enforcement and fire protection installations, major shopping centers, high rise buildings, and customers with critical manufacturing processes shall be considered major critical customers.

CRITERIA

- A. A Service Restorer should be installed on any 12kV circuit which serves at least 1000 customers, provided it meets one of the following conditions:
 - 1. The total unfused feeder circuit length is at least 14 miles.
 - 2. The circuit has experienced at least 2 environmentally caused feeder interruptions over the last 3 years (such as trees, weather, foreign objects) and the total unfused feeder circuit length is at least 6 miles.
- B. A Service Restorer may be installed on the source side of a feeder line segment which has experienced at least 2 environmental interruptions over the last three years, provided it protects a Major Critical Customer. This may be done on circuits which do not meet the 1000 customer requirement.

APPLICATION

- A. Service Restorers Installed according to criteria A shall be placed at the following locations:
 - 1. The Service Restorer should be located so that at least half the circuit load is protected. This means that less than half the load shall be on the load side of the Service Restorer.
 - 2. The Service Restorer should be located on the load side of the feeder line segments which are subject to environmental interruptions.

	Indicates Latest Revision	Completely Revised	New Page
REVISION	SDG&E DISTRIBUTION DESIGN MANUAL		
DATE 1-1-87 APPD <i>DRM / CMC</i>	OVERHEAD SERVICE RESTORER APPLICATION CRITERIA		6112.1

- B. Service Restorers shall be accessible to a troubleshooter in all weather. Vehicle access shall be provided within 100 feet of the Service Restorer.
- C. A Service Restorer is controlled by electronic relays which sense phase and ground fault currents. Distribution Planning is responsible for establishing the control settings based upon load and fault current provided by Protection Engineering. Therefore, Distribution Planning must be contacted prior to preparing a workorder to install a Service Restorer.

OPERATION

- A. If the fault current is such that the recloser operates in the range of the time time curve settings.
 - 1. The Service Restorer will open once a fault exceeding the phase or ground trip setting is detected.
 - 2. The Service Restorer will close 5 seconds later in an attempt to restore service.
 - 3. The Service Restorer will open again if the fault is still present. Otherwise, it will remain closed and service will have been restored.
 - 4. The Service Restorer will close 10 seconds later in a second attempt to restore service.
 - 5. The Service Restorer will open again, and remain permanently open, if the fault is still present. A troubleman will be required to manually reset the Service Restorer before it can be closed again.
- B. If the fault current is high enough to activate the instantaneous curve the following typical control settings in use at SDG&E curve the following Service Restorer operations:
 - 1. The Service Restorer will open on the instantaneous trip.
 - 2. The Service Restorer will close 5 seconds later in an attempt to restorer service.
 - 3. The Service Restorer will open again, and remain open, if the fault is still present.

	 Indicates Latest Revision	Completely Revised	New Page
6112.2	SDG&E DISTRIBUTION DESIGN MANUAL		REVISION
	OVERHEAD SERVICE RESTORER APPLICATION CRITERIA		DATE 3-1-02 APPD JCE / <i>Vcl</i>

SCOPE

This design standard provides criteria for the placement of permanently installed automatic self-resetting fault indicators (FI) on the overhead and underground **distribution systems**.

PURPOSE

Establish criteria to provide Operations a visual indication of a faulted feeder or **branch segment** by using FI. **Table 1** summarizes the different FI available with the recommended application when designing a job or used in the field.

DEFINITIONS

Automatic Self-Resetting Fault Indicator - a per-phase device that will visually indicate when fault current exceeds the minimum trip setting, **resulting from a downstream fault**.

- Current FI will automatically return to normal (reset) when three-phase (3-Ø) load current has been restored for a minimum of 60 seconds. **See the reset column in Table 1 for additional information.**
- Voltage FI will automatically return to normal (reset) when 5kV or more has been restored for a minimum of 60 seconds. **See the reset column in Table 1 for additional information.**

Minimum Trip Value - the minimum amount of fault current required to cause the FI to **operate**.

HFTD – High Fire Threat District consisting of both Tier 2 and Tier 3

- **Tier 2** - Consists of areas on the California Public Utilities Commission’s Fire-Threat Map (“CPUC Fire-Threat Map”) where there is an elevated risk for destructive utility-associated wildfires. The CPUC Fire-Threat Map is currently in an advanced stage of development
- **Tier 3** - Consists of areas on the CPUC Fire-Threat Map where there is an extreme risk for destructive utility-associated wildfires.

Cable Sizes

- **Feeder Cable** - 350 KCMIL, 500 KCMIL, 750 KCMIL and 1000 KCMIL
- **Branch Cable** - 2 SOL, 2 STR, 2/0 STR, 4/0 CU and 350 KCMIL

Conductor Sizes

- **Feeder Conductor** – 636 ACSR, 336ACSR, 394.5 5005 and 4/0 ACSR
- **Branch Conductor** – 3/0 ACSR, 1/0 ACSR, #2, #4 and #6 B.STRD

Fusing Request – Electric Distribution Planning document required when installing FI within the HFTD. A Fusing Specialist will size the FI and approve the Fusing Request.

End-Zone-Of-Operation - all locations on the feeder that the fault indicator must sense fault current. This is limited by an automatic isolating device, such as a **Fault Interruption switch**, Service Restorer or Fuse.

CRITERIA

A. Applications on all future installations

The following application criteria will ensure sequence tripping of FI; a **RED** target **or Flashing LED** for a downstream fault and no indication for an upstream fault.

Note: Location of the FI must be identified and pre-digitized during the design process to correctly map them in the GIS and OMS systems. Phasing identification must be performed prior to installation.

© 1998 - 2021 San Diego Gas & Electric Company. All rights reserved. Removal of this copyright notice without permission is not permitted under law.

REV	CHANGE	DR	BY	DSN	APV	DATE	REV	CHANGE	DR	BY	DSN	APV	DATE
C							F						
B	Standard re-write	FRC	JAS	FRC	CZH	08/20/2021	E						
A	ORIGINAL ISSUE				MF	01/01/1994	D						

SHEET 1 OF 4	X	Indicates Latest Revision	Completely Revised	New Page	Information Removed	DM6113.1
	SDG&E ELECTRIC DISTRIBUTION DESIGN MANUAL					
	AUTOMATIC SELF-RESETTING FAULT INDICATORS					

1. Installing Fault Indicators:

- a. A Fusing Request is required if the circuit is within the HFTD
 - i. A Fusing Specialist from Electric Distribution Planning shall select the FI type based on the calculated fault current within the FI's End-Zone-Of-Operation
- b. A Fusing Request is **NOT** needed if the circuit is non- HFTD

2. In applying FI, only one trip rating will be used within each End-Zone-Of-Operation.

3. See [Table 1](#) to select which FI is suitable for the location.

4. FI require three-phase (3-Ø) load current or voltage to operate. Note: some FI are Auto-reset, see [UG Fault Indicator Reference Sheet](#) or [Table 1](#) for additional information.

B. Underground Feeder Circuit Application

Automatic Self-Resetting Fault Indicators are installed in polyphase (3-Ø) configurations. These units should be installed on the following distribution equipment. Applies to 4kv and 12kV circuits.

- 1. FI shall be installed on ALL manual switches which meet criteria "A" above. FI are to be installed on each switch position, including line side and tie position(s).
 - a. Existing FI installed on any switch positions shall not be removed if the line switch position becomes a tie switch position.
 - b. SCADA switches do NOT need FI. The SCADA switches are equipped with internal FI and use the controller relay to communicate status to the control center.

NOTE: If a SCADA switch has FI, REMOVE the FI and contact EGIS

2. One 3-phase FI should be installed on one single position three-phase (3-Ø) subsurface switch (on/off).

3. FI shall be installed on all new CLEER connectors which meet criteria "A" above.

4. FI shall be installed on all new 600A MVI switches which meet criteria "A" above.

5. FI shall be installed on all dead front/load break terminators which meet criteria "A" above

- a. Due to space limitation, FI shall not be installed inside live front terminators

6. Underground FI are calibrated to feeder cable conductor sizes only; use correctly sized units at all times.

- 7. Polyphase (3-Ø) FI shall not be installed:
 - a. on any unused switch positions
 - b. on any fused elbow on a switch position
 - c. on service restorers
 - d. on fuses

© 1998 - 2021 San Diego Gas & Electric Company. All rights reserved. Removal of this copyright notice without permission is not permitted under law.

REV	CHANGE	DR	BY	DSN	APV	DATE	REV	CHANGE	DR	BY	DSN	APV	DATE
C							F						
B	Standard re-write	FRC	JAS	FRC	CZH	08/20/2021	E						
A	ORIGINAL ISSUE				MF	01/01/1994	D						

SHEET 2 OF 4	X	Indicates Latest Revision	Completely Revised	New Page	Information Removed	DM6113.2
	SDG&E ELECTRIC DISTRIBUTION DESIGN MANUAL					
	AUTOMATIC SELF-RESETTING FAULT INDICATORS					

C. Overhead Feeder Circuit Application

Automatic voltage-reset fault indicators are installed on at the following location. Applies to 4kv and 12kv circuits.

1. On cable poles
2. On load side of manual line switches (Hook or Gang operated)
3. On feeder bifurcation points (both load sides)
4. Voltage-reset FI shall "NOT" be installed:
 - a. on 2.4 kV circuits
 - b. at service restorers
 - c. on any fused local distribution branches

D. References

5. See [Table 1](#) - Summary of UG and OH Fault Indicators
6. See Newsletter dated [February 2021](#)
7. Electric Standard Practice
 - a. ESP 110 – 'Distribution System Service Restoration'
8. Design Standard
 - a. DM 6111 'Feeder Circuit Sectionalizing & Protection'
9. Overhead (OH) Construction Standard
 - a. OH 1275 'Overhead Fault Indicator Installation & Operation'
10. Underground (UG) Construction Standard
 - a. UG 4352 'Automatic Fault Indicator - Self-Resetting, Hot Stick Operable'
 - b. UG 4359 'Overhead Fault Indicator - Self-Resetting, Hot Stick Operable'
 - c. UG 4360 'Load Tracker Faut Indicator'

© 1998 - 2021 San Diego Gas & Electric Company. All rights reserved. Removal of this copyright notice without permission is not permitted under law.

REV	CHANGE	DR	BY	DSN	APV	DATE	REV	CHANGE	DR	BY	DSN	APV	DATE
C							F						
B	Standard re-write	FRC	JAS	FRC	CZH	08/20/2021	E						
A	ORIGINAL ISSUE				MF	01/01/1994	D						

SHEET 3 OF 4	X Indicates Latest Revision	Completely Revised	New Page	Information Removed	DM6113.3
	SDG&E ELECTRIC DISTRIBUTION DESIGN MANUAL				
	AUTOMATIC SELF-RESETTING FAULT INDICATORS				

Table 1 – UG and OH Fault Indicators Reference Sheet

UG Fault Indicators Options

Fault Indicator	Application	Reset	Conductor	Min Trip Values	Stock #	Reference
Test Point Reset	Fixed Install (Permanent)	Voltage (≥6kV) for 15kv and 25kV rated elbows Voltage (≥7kV) for 35kV rated elbows	200A Elbow with test point	450A	S423770	ESP 225 SEL-TPR
Crab Series 222	Fixed Install (Permanent)	Automatic after 2 hours	Branch cable	400A	Pending	ESP – Pending FCI 222 Type M
			Feeder Cable	800A	S423716	
UG Current Reset	Fixed Install (Permanent)	Current (>3A)	Feeder Cable	800A	S423762	UG 4352
				1000A	S423760	SEL-CR
Manual Reset	Temporary Install (Trouble--shooting only)	Manual	Branch Cable	200A	S423744	ESP 224 SEL-MR
				450A	S423772	
				800A	S423742	
			Feeder Cable	450A	S423768	
				800A	S423758	
Reset Wireless	Under Review	Automatic	-	50A – 1200A	S423708	ESP 246 UG 4344 SEL-8301
UG Load Tracker	Fixed Install POWER delivery	Current (5A) Small	Branch Cable	200A	S423718	ESP - Pending UG4360 FCI Load Tracker
		Current (10A) Large	Feeder Cable		S423714	

OH Fault Indicators Options

Fault Indicator	Application	Reset	Conductor	Min Trip Values	Stock #	Reference
WSO 11 – 3rd Gen	Discontinued end of 2021, 4 th Gen replacement	Current (>5A)	Branch or Feeder Conductor	50A-1200A	S423710	ESP 322 OH1276 SEL-WSO
Autoranger	Fixed 4KV & 12kV	Self-adjusting	Branch or Feeder Conductor	50A-1200A	S423702	ESP 322 OH1276 SEL-AR

© 1998 - 2021 San Diego Gas & Electric Company. All rights reserved. Removal of this copyright notice without permission is not permitted under law.

REV	CHANGE	DR	BY	DSN	APV	DATE	REV	CHANGE	DR	BY	DSN	APV	DATE
C							F						
B	Standard re-write	FRC	JAS	FRC	CZH	08/20/2021	E						
A	ORIGINAL ISSUE				MF	01/01/1994	D						

SHEET 4 OF 4	X Indicates Latest Revision	Completely Revised	New Page	Information Removed
	SDG&E ELECTRIC DISTRIBUTION DESIGN MANUAL			
	AUTOMATIC SELF-RESETTING FAULT INDICATORS			
DM6113.4				

SCOPE

This document provides criteria for the selection and application of 12KV feeder sectionalizing devices on selected high-risk circuits.

PURPOSE

Application of automatic sectionalizing devices for underground circuits (pad-mounted service restorer and PME3 with SCADA) can be beneficial in reducing the number of customers affected by service interruptions. These devices are also helpful in reducing the projected SAIDI by minimizing the impact of a failure of the unfused high molecular polyethylene (HMWPE or PECH in GFMS or unjacketed cross-linked polyethylene (XLPE) cable.

CRITERIA

- A. Circuits chosen for study should meet one or more of the following:
1. A high amount of unfused type HMWPE or XLPE cable as defined by
 - a. Total cable length exceeding one mile or
 - b. Exceeding 20 percent of the total underground cable length
 2. Underground outage history exceeding three feeder outages over the last three years regardless of cause.
- B. In addition to the above, the application must be prioritized based on the cost-to-benefit (C/B) ratio analysis in Design Manual section 6145. The projected value (the inverse of the C/B ratio) must be greater than one to justify the additional sectionalizing devices. Alternate methods of project methods of project justification may be allowed by Electric Distribution Planning.

APPLICATION

The circuit under consideration must be examined to ensure that it will meet the switching provisions of Design Manual section 6111 after modification. Service restorers are the preferred device because of the automatic operation and the fact that they can immediately reduce the number of customers affected by an outage. If a service restorer is already in use on a circuit, the PME3 with SCADA should be used where substation SCADA is available or will be available within two years. In cases where the frequency is not as critical, the PME3 with SCADA may be the most economical choice.

1. 600A Padmounted Service Restorer
 - a. Consideration must be made regarding the location and length of the unfused cable segments when locating the service restorer. As a general guide, locate the service to maximize the amount of load on the line side of the device and to maximize the circuit length on load side. The service restorer should be located to protect at least one half of the circuit load. If this is not practical, locate to maximize the isolation of the unfused cable sections.
 - b. A line switch is required immediately ahead of the service restorer for maintenance. This may be an overhead gang operated or hookstick switch, a padmount switch, a handhole switch (On-Off), or a manhole switch (group/On-Off). Manhole switches are acceptable for this application but they are not preferred.

	 Indicates Latest Revision	Completely Revised	New Page	Information Removed
REVISION	SDG&E DISTRIBUTION DESIGN MANUAL			6114.1
DATE 3-1-02 APPD JCE / <i>VCL</i>	UNDERGROUND SERVICE RESTORER APPLICATION CRITERIA			

APPLICATION (continued)

- c. No load should be connected between the service restorer and the line switch immediately ahead. An exception to this rule would be the placement of a single phase transformer that would only provide secondary service for the actuator device within the service restorer. This single phase transformer may tap the feeder at either the switch, the service restorer or in between. Following is an illustrative one-line diagram for the three optional hookups.

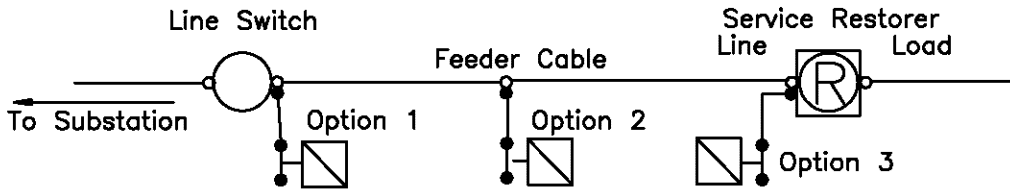

Special Note: DM 6121.3.d.1 requires that a fuse request be submitted and approved prior to installation of un-fused transformer stations.

- d. If the service restorer is located so as to protect a purely underground section it shall be set for one test reclosing 5 seconds after the fault, then lockout. Distribution Planning will determine the number of test reclosings for circuits with overhead spans on the load side of the service restorer.
- e. Distribution Planning must be contacted to obtain settings for all protective devices on the circuit.

2. PME3 with SCADA or SCADA Overhead Switch

The PME3 with SCADA should be applied in cases where: 1) A feeder has an existing service restorer and protection (fuse) coordination is not possible. 2) The less expensive SCADA switch will provide adequate protection for the circuit being studied.

- a. If existing subsurface or padmount switchgear is strategically placed for service restoration contact Electric Distribution Standards about SCADA actuator retro-fit. This option can be more economical than other options.
- b. Install SCADA type switches at the midpoint, one-quarter and three-quarter points on the feeder in that order of preference. These may be the new PME3 SCADA switch, SCADA overhead switch, or an existing underground switch retro-fitted with SCADA.
- c. SCADA operated devices may be installed on feeders from current non-SCADA substations where SCADA is not planned within two years. Substations where SCADA is not planned within two years will limit options to automatic protection devices.
- d. Consideration should be given to converting strong tie switches to SCADA.

	Indicates Latest Revision	Completely Revised	New Page	Information Removed
6114.2	SDG&E DISTRIBUTION DESIGN MANUAL			REVISION
	UNDERGROUND SERVICE RESTORER APPLICATION CRITERIA			DATE 1-1-94 APPD MF/ROJ

SCOPE

This design manual section provides guidance for planners, in the form of a checklist, to help ensure that all aspects of SCADA installation are addressed in the appropriate phase of each SCADA job. SCADA jobs differ from traditional distribution work in that much more coordination is required, involving different departments, and in some cases outside organizations. Often, SCADA work targets major customers, making successful, smooth completion more critical.

PURPOSE

The objective of Supervisory Control and Data Acquisition (SCADA) is to improve service reliability with remote switching capability. Being able to remotely switch will help ensure that service is restored to customers as quickly as possible. SDG&E's Distribution Operations Department can isolate faults more quickly and transfer customers to other circuits. SCADA is also a valuable tool for gathering information such as voltage, current, power factor, etc. for Distribution Planning activities.

Definitions

Communications - ability of equipment in the field to exchange data with the SCADA master computer located at Distribution Operations.

Power Source - Most new distribution line SCADA equipment derives control power directly from the 12kV line; there is no need for a separate secondary source. Exceptions to this are 1) Line (load) monitors, and 2) Switches with SCADA control. Contact Distribution Standards for details.

Points List –

- document sent to Distribution Operations describing the format of the data that will flow between the field device and the SCADA master computer. SPACE will provide DNP (Distributed Network Protocol) map settings to EDOT for new equipment.
- Kearny SCADA Crew will submit a points list to SPACE to be completed and confirmed by SPACE then returned to Kearny.

SCADA Number & RTU Address - integers that index the field Remote Terminal Unit (RTU) for entry into the SCADA master computer database.

"Signal Check Request" - Form that planners use to confirm communication arrangements for a site, sent early in the design process to Sempra - Infrastructure Technology (IT). Sempra - IT takes information from the top of the form and completes the bottom half with recommendations on how to best communicate to the site of interest. This step must be completed prior to completion and submittal of the points list. Form available in email format from Distribution Standards. This form is shown on Design Manual page 6115.3.

Procedure/Checklist

A. **Preliminary Design Phase** - for use in the initial stages of an approved SCADA Job, or for obtaining budgetary estimates of proposed SCADA installations

- Verify communications requirements with Sempra-IT. Use "Signal Check Request" form.
- Confirm other job requirements (location of RTU cabinet, available pole space, mounting height).
- Generate cost estimate for the job.

B. **Design Phase**

- Complete and submit points list to Distribution Operations Principal Engineer. Obtain SCADA number and RTU address.
- Finalize facility placement consistent with safety, traffic contact avoidance, and aesthetics.

© 1998 - 2022 San Diego Gas & Electric Company. All rights reserved. Removal of this copyright notice without permission is not permitted under law.

REV	CHANGE	DR	BY	DSN	APV	DATE	REV	CHANGE	DR	BY	DSN	APV	DATE
C							F						
B	EDITORIAL CHANGES	EPC	FRC	NTB	FRC	03/01/2022	E						
A	ORIGINAL ISSUE	-	-	MJC	VCR	01/01/2000	D						

Indicates Latest Revision

Completely Revised

New Page

X

Information Removed

SHEET
1 OF 4

SDG&E ELECTRIC DISTRIBUTION DESIGN MANUAL

REQUEST FOR SCADA 900 MHZ RADIO FREQUENCY COORDINATION

DM6115.1

3. Verify status of any other construction that must be finished before SCADA work can commence, such as switch change-out, telecommunications cable, radio, or leased line, etc.
4. Verify status of required special permits, i.e., port district, railroad, Caltrans, etc. For SCADA jobs for major customers, confirm target customers are aware of the work to be done, what the completed installation will look like, and the need for pre-arranged outage, if required. Marketing has primary responsibility for customer interface.

Submit "fuse request" form for all SCADA projects other than line (load) monitors. Cover the following:

- a. Fusing on any PME-9S or PME-11S cabinet.
- b. Fault interrupter programming for any installation using fault interrupting switchgear (downtown San Diego area).
- c. Distribution Workflow & Planning (DW&P) will confirm minimum end-of- line fault current to ensure correct fault indicator operation. SCADA equipment normally uses fault indicators with a trip setting of 1000 Amps. Other values are available on special order. Contact Distribution Standards.
- d. Confirm desired switch positions for autosectionalizing/fault interruption. This includes all load-side or single position switches where at least 5 Amps of three phase load is expected continuously. This is necessary to ensure fault indicators are always armed. Line and tie switch positions are not included. As a general rule, at least 500 kVA of connected stations are required to ensure 5 Amps continuous load on any given switch position. Individual cases may vary from this and can be confirmed once the site has been on-line through SCADA for a month or two. When necessary, this will be examined cooperatively through Distribution Standards and Distribution Operations.
- e. DW&P and SPACE will confirm the need for upstream (line-side) recloser interval changes, if any. A request will be sent to Protection Engineering to implement changes when required.
- f. Make a note on the job of the switch position(s) where the auto- sectionalizing feature is expected to be activated (enabled). Kearny SCADA crews will use this information to help complete final tests and release to operations. Note: the default status for autosectionalizing is not-activated (disabled).
- g. Remember that load transfer jobs or other reconfiguration work may work require changes to autosectionalizing status of individual SCADA switches or SCADA switch positions.

C. Construction Phase

1. Manage project for completion on schedule and within budget. Pay special attention to the need for joint meet between different departments, such as C&O crew, Electric Construction and Maintenance (EC&M), and Telecommunications. Overhead Service Restorer installations normally require a joint meet between the district C&O crew and EC&M crew.

© 1998 - 2021 San Diego Gas & Electric Company. All rights reserved. Removal of this copyright notice without permission is not permitted under law.

REV	CHANGE	DR	BY	DSN	APV	DATE	REV	CHANGE	DR	BY	DSN	APV	DATE
C							F						
B	EDITORIAL CHANGES	EPC	FRC	NTB	FRC	03/01/2022	E						
A	ORIGINAL ISSUE	-	-	MJC	VCR	01/01/2000	D						

SHEET 2 OF 4	X Indicates Latest Revision	Completely Revised	New Page	Information Removed
	SDG&E ELECTRIC DISTRIBUTION DESIGN MANUAL			
	REQUEST FOR SCADA 900 MHZ RADIO FREQUENCY COORDINATION			

DM6115.2

Items to be completed as follows: Items 1, 2, 4, 6 & 7 by Planner/Designer; Item 3 by IT Network Engineering & Operations; Item 8 Planning Engineer; Item 9 System Protection; Items 5 and 10 by Electric Distribution Operations System Services.

1. REQUESTED BY:

(To be completed by Designer/Planner)

Name of Designer/Requester:		Date:	
Telephone No:	E-mail address:		
Project Office:	Mail Location/Contractor:		
Proj Name, DPSS or SAP:			
Switch WO#		Kearny/SAP SCADA WO#	

2. PROPOSED SCADA SITE DATA:

(To be completed by Designer/Planner)

City:	Lat:
Structure Number	Long:
Nearest Intersection/Address:	
District:	
Expected Construction Start Date:	
Equipment Type	
Substation:	Circuit

Planner Notes:

Installing a new SCADA Capacitor-

(To be completed by IT - Network Engineering & Operations)

3. SCADA MASTER RADIO BASE STATION/SUPERVISORY CABLE RECOMMENDATION:

(To be completed by IT - Network Engineering & Operations)

The following information is to be included on the construction work order:

Recommended Master Station or Repeater:	
Recommended Antenna:	
Type:	
Orientation:	
Pole or antenna support height:	

Telecom Notes:

--

Reviewed by: _____ Ticket # _____

© 1998 - 2021 San Diego Gas & Electric Company. All rights reserved. Removal of this copyright notice without permission is not permitted under law.

REV	CHANGE	DR	BY	DSN	APV	DATE	REV	CHANGE	DR	BY	DSN	APV	DATE
C							F						
B	EDITORIAL CHANGES	EPC	FRC	NTB	FRC	03/01/2022	E						
A	ORIGINAL ISSUE	-	-	MJC	VCR	01/01/2000	D						

Indicates Latest Revision Completely Revised New Page Information Removed

SDG&E ELECTRIC DISTRIBUTION DESIGN MANUAL

**SHEET
3 OF 4**

REQUEST FOR SCADA 900 MHZ RADIO FREQUENCY COORDINATION

DM6115.3

4. Check the "switch type" in the left hand column below.

- Include the type of switch in Equipment type field (i.e., PME, Vista 422, ISG, Trayer, Recloser, etc.)
- Check Yes or No if Autosectionalizing is be ENABLED or DISABLED for in each compartment of a PME or Vista type switch.
- On Vista, Trayer and ISG switches: check Yes or No for Ways that will have Fault Interrupting (F) ENABLED or DISABLED
- Place the switch numbers in the bottom row according to the construction design.

NOTE: System Protection must review all SCADA switches via Fuse Request (refer to SPM 450 or AD/CD Manual 450)

DEVICE MODEL: Capacitor

<input type="checkbox"/>	ANEMOMETER						
<input type="checkbox"/>	LINE (LOAD) MONITOR						
<input type="checkbox"/>	CAPACITOR						
<input type="checkbox"/>	RETROFIT SERVICE RESTORER (RECLOSER)	SERVICE RESTORER	BYPASS SWITCH				
<input type="checkbox"/>	SVC RESTORER (F6, IR, MVR SDR) SWITCH (F6, IR, MVR, SDR)	<input type="checkbox"/> SERVICE RESTORER <input type="checkbox"/> SWITCH	BYPASS SWITCH				
<input type="checkbox"/>	REGULATOR	REG 1	REG 2	REG 3			
<input type="checkbox"/>	PME	CMPT - 1	CMPT - 2	CMPT - 3	CMPT - 4		
<input type="checkbox"/>	Autosectionalizing Enabled	<input type="checkbox"/> Y <input type="checkbox"/> N	<input type="checkbox"/> Y <input type="checkbox"/> N	<input type="checkbox"/> Y <input type="checkbox"/> N	<input type="checkbox"/> Y <input type="checkbox"/> N		
<input type="checkbox"/>	TRAYER SWITCH	WAY 1	WAY 2	WAY 3	WAY 4	WAY 5	
	Fault Interrupting Enabled	<input type="checkbox"/> Y <input type="checkbox"/> N	<input type="checkbox"/> Y <input type="checkbox"/> N	<input type="checkbox"/> Y <input type="checkbox"/> N	<input type="checkbox"/> Y <input type="checkbox"/> N	<input type="checkbox"/> Y <input type="checkbox"/> N	
<input type="checkbox"/>	ISG	WAY 1	WAY 2	WAY 3	WAY 4	WAY 5	WAY 6
	Fault Interrupting Enabled	<input type="checkbox"/> Y <input type="checkbox"/> N	<input type="checkbox"/> Y <input type="checkbox"/> N	<input type="checkbox"/> Y <input type="checkbox"/> N	<input type="checkbox"/> Y <input type="checkbox"/> N	<input type="checkbox"/> Y <input type="checkbox"/> N	<input type="checkbox"/> Y <input type="checkbox"/> N
<input type="checkbox"/>	VISTA	WAY 1	WAY 2	WAY 3	WAY 4	WAY 5	WAY 6
	Autosectionalizing Enabled	<input type="checkbox"/> Y <input type="checkbox"/> N	<input type="checkbox"/> Y <input type="checkbox"/> N	<input type="checkbox"/> Y <input type="checkbox"/> N	<input type="checkbox"/> Y <input type="checkbox"/> N	N/A	N/A
	Fault Interrupting Enabled	N/A	N/A	<input type="checkbox"/> Y <input type="checkbox"/> N	<input type="checkbox"/> Y <input type="checkbox"/> N	<input type="checkbox"/> Y <input type="checkbox"/> N	<input type="checkbox"/> Y <input type="checkbox"/> N
	SWITCH No's →						

NOTE: EACH SWITCH NO. MUST BE PLACED IN THE CORRECT FIELD BY CMPT, WAY, ETC.

7	PLANNING ENGINEER CONTACT:		
----------	-----------------------------------	--	--

Name Telephone #

8.	REVIEWED:	<input type="checkbox"/> YES	<input type="checkbox"/> NO		BY:	
-----------	------------------	------------------------------	-----------------------------	--	------------	--

9. SYSTEM PROTECTION FEASIBILITY REVIEW (Required for all SCADA switches).

<input type="checkbox"/>	N/A	<input type="checkbox"/>	Approved	<input type="checkbox"/>	Disapproved	<input type="checkbox"/>	Pre-approved	Reviewer:	
--------------------------	-----	--------------------------	----------	--------------------------	-------------	--------------------------	--------------	------------------	--

10. RTU TYPE: SEL-734

Submit Request, with all supporting documentation to RBrownfield@semprautilities.com, Place "SCADA Telecommunications Coordination & SCADA Site Request in the subject line of the email. Roberta will open the Sempra Help Ticket and forward to Telecommunications

© 1998 - 2021 San Diego Gas & Electric Company. All rights reserved. Removal of this copyright notice without permission is not permitted under law.

REV	CHANGE	DR	BY	DSN	APV	DATE	REV	CHANGE	DR	BY	DSN	APV	DATE
C							F						
B	EDITORIAL CHANGES	EPC	FRC	NTB	FRC	03/01/2022	E						
A	ORIGINAL ISSUE	-	-	MJC	VCR	03/01/2002	D						

Indicates Latest Revision
 Completely Revised
 New Page
 Information Removed

SDG&E ELECTRIC DISTRIBUTION DESIGN MANUAL

**SHEET
4 OF 4**

REQUEST FOR SCADA 900 MHZ RADIO FREQUENCY COORDINATION

DM6115.4

SCOPE:

This design standard provides criteria for the application of current-limiting and expulsion fuses on 12kV local distribution branches. It Includes guidelines for new and existing locations.

PURPOSE

The underground fuse application criteria was established to provide isolation of the underground system from the overhead and limit the amount of energy let-through to the underground system under faulted conditions. Overhead fuse application was established to provide the most cost effective fuse placement needed to maintain distribution system reliability.

DEFINITIONS

Cascaded Sub-Branch Fuse - The term applied to a protecting sub-branch fuse installed in series with a protected branch fuse.

Current-Limiting Fuse (CLF) - These fuses introduce a relatively high impedance into the circuit when the element melts, thus forcing the current to a relatively low value prior to opening which limits the total fault current.

Electric Troubleshooter (ETS) - First responder to outages on the overhead and underground electric system.

Expulsion Fuse - These fuses do not limit available fault energy nor do they substantially reduce peak let-through currents.

Fault Tamer - New type of overhead current-limiting fuse for overhead sub-branches that does not cause sparks and other material to reach the ground during operation. They are available in 5, 10, 15, and 20 Amp sizes. They can only be used on the 12kV system.

Feeder Tap Location - Refers to the point where the local distribution branch attaches to the feeder.

Fused Circuit Tie - The term for a normally open fused cutout installed between two adjacent circuits.

Fuse Request - A form submitted to Electric Distribution Planning to size and/or locate/relocate new and existing fuses and non adaptive trip fault indicators.

Local Distribution Branch - Refers to a local distribution conductor that is directly connected to the feeder. The local distribution branch includes all sub-branches it serves.

Local Distribution Sub-Branch - Refers to a local distribution conductor that does not connect directly to the feeder, but originates from a local distribution branch. The local distribution sub-branch includes all the sub-branch taps it serves.

Local Distribution Sub-Branch Tap - Refers to a local distribution conductor that does not connect directly to a local distribution branch but originates from a local distribution sub-branch.

Overhead Local Distribution - The term used for the primary overhead system incorporating conductors smaller than 3/0 ACSR or #1 CU.

SMU-20 - New type of overhead expulsion fuse for overhead main line and sub-branches that does not cause sparks and other material to reach the ground. They are available in 25, 30, 40, 50, 65, 80, 100, 125, 150, and 200 amp sizes. They can be used on the 12kV, 4kV, and 2.4 kV systems.

Underground Local Distribution - The term used for the primary underground system incorporating conductors smaller than 350 KCMIL AL or 4/0 CU.

Wireless Fault Indicator (WFI) - An overhead fault indicating device that senses and reports faults (along with load) with the ability to adjust the fault detection trigger point based on steady state load.

© 1998 - 2018 San Diego Gas & Electric Company. All rights reserved. Removal of this copyright notice without permission is not permitted under law.

REV	CHANGE	BY	DSGN	APPV	DATE	REV	CHANGE	BY	DSGN	APPV	DATE
C						F					
B	EDITORIAL CHANGES	ML	ML	CZH	9/1/2018	E					
A	REVISION			JCE/DW	1/11/2013	D					

SHEET 1 OF 12	X	Indicates Latest Revision	Completely Revised	New Page	Information Removed	DM 6121.1
	SDG&E DISTRIBUTION DESIGN MANUAL					
	FUZE APPLICATION CRITERIA					

CRITERIA

A. New Fuse Application

1. Fuses shall be installed on circuit branches as close to the feeder as practical. If this cannot be done because of connected kVA or fuse coordination constraints, contact Distribution Planning or Protection Engineering about the use of an electronic sectionalizer.
2. Fuses shall be installed to insure that all "end-of-line" faults that are not sensed by substation relays will be cleared by the fuse according to the margins contained in section B.1.a.
3. Fused devices, (i.e., fused poles, fuse cabinets or fused elbows) shall be accessible to an ETS in all weather. Vehicle access shall be provided to within 100' of the fused device.
4. When fusing the feeder is desirable, in very remote areas, a disconnect switch shall be placed parallel to the fuse (figure 1) to insure that circuit ties are not disabled.

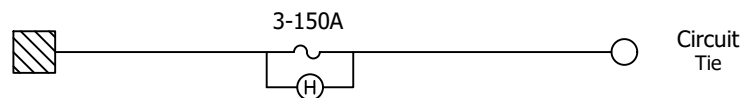

Figure 1 - Fused Feeder

5. Fuses shall be placed around any large inaccessible area such as forests or canyons at the point where the local distribution branch enters and leaves the area.
6. Each local distribution cable pole shall be fused with a CLF provided that:
 - a. The load on the fused cable pole is not more than 2080 kVA connected and
 1. The available line-to-ground short circuit current exceeds 1,050 amps.
 2. The fused cable pole does not serve any 12kV overhead line that is unprotected by a QA or Fault Tamer fuse on the up cable pole.
 3. The fused cable pole does not serve a 12kV transformer that is not provided with expulsion fuse protection which coordinates with the CLF such as HDP, HUP, HSV, HGP, WGP, HOP and HHP.
 - b. If the above criteria are not met, then the use of a QA or Fault Tamer fuse is required.
 - c. If the load served exceeds the capabilities of a single fused cable pole, use a disconnect switch with WFI or FI in its place.
7. Cutouts shall not be installed on a pole:
 - a. Where an ETS cannot operate the fuse without climbing through an under-built circuit.
 - b. Where climbing space is restricted.

© 1998 - 2018 San Diego Gas & Electric Company. All rights reserved. Removal of this copyright notice without permission is not permitted under law.

REV	CHANGE	BY	DSGN	APPV	DATE	REV	CHANGE	BY	DSGN	APPV	DATE
C						F					
B	EDITORIAL CHANGES	ML	ML	CZH	9/1/2018	E					
A	REVISION			JCE/DW	1/11/2013	D					

X Indicates Latest Revision Completely Revised New Page Information Removed

SHEET
2 OF 12

SDG&E DISTRIBUTION DESIGN MANUAL

FUSE APPLICATION CRITERIA

DM 6121.2

7. Cutouts shall not be installed on a pole:
- Where an ETS cannot operate the fuse without climbing through an under-built circuit.
 - Where climbing space is restricted.
8. The Fusing Specialist in Electric Distribution Planning shall coordinate all protective devices according to section B or section E of this standard.
9. Each underground local distribution branch shall have fuses applied at the feeder tap location (figure 2) according to table 1 and the following:
- Fused elbows are required to be surface operable. The fused elbow must "supply" the cable it serves so that removal of the fused elbow will de-energize the fuse.
 - Transformers located in vaults shall be protected with 1) CLF(s) installed in wall mounted fuse cabinets, 2) VISTA switches with fault interrupters, or 3) SCADA Trayer switches with fault interrupting enabled.
 - Fuse cabinets may not be installed:
 - To serve overhead lines when the up cable pole is not equipped with QA Fault Tamer, or SMU-20 fuses which coordinate with the CLF (see note 2).
 - On unimproved streets unless they are placed in a permanent location outside of future improvements.
 - When either fused cable poles or fused elbows may be used (see table 1 for limitations).
 - Fusing is not required:
 - On a temporary transformer installation (removal expected within 1 year) that requires the installation of a new fuse cabinet.
 - On a padmounted capacitor station.
10. Branch fuses shall be installed on the overhead system at the feeder tap location (figure 2) based on the criteria provided in Table 1.

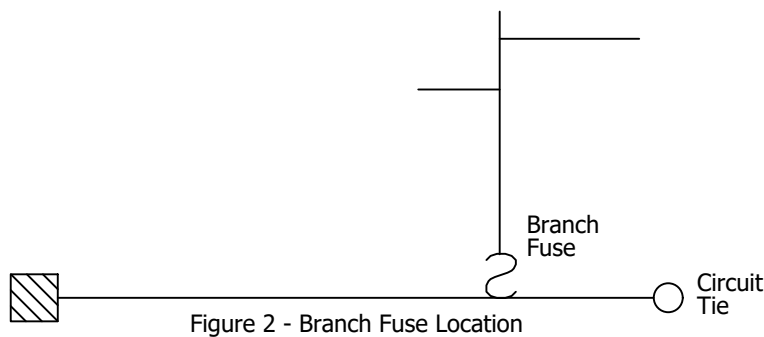

© 1998 - 2018 San Diego Gas & Electric Company. All rights reserved. Removal of this copyright notice without permission is not permitted under law.

REV	CHANGE	BY	DSGN	APPV	DATE	REV	CHANGE	BY	DSGN	APPV	DATE
C						F					
B	EDITORIAL CHANGES	ML	ML	CZH	9/1/2018	E					
A	REVISION			JCE/DW	1/11/2013	D					

SHEET 3 OF 12	Indicates Latest Revision	Completely Revised	New Page	Information Removed	DM 6121.3
	SDG&E DISTRIBUTION DESIGN MANUAL				
	FUZE APPLICATION CRITERIA				

11. Sub-branch fuses shall be installed on overhead or underground branches at the local distribution sub-branch tap (figure 3) based on the criteria provided in table 3.

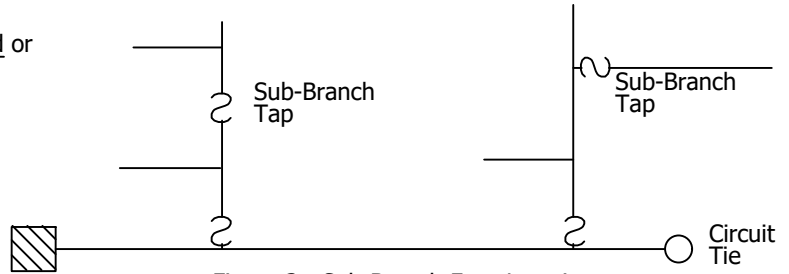

Figure 3 - Sub-Branch Fuse Location

Table 1 - FUSED DEVICE USAGE LIMITS - UNDERGROUND

Device	Usage Limit Based On Fuse
1Ø Fuse Cabinet CLF	$0 < \text{connected kVA} \leq 350 \text{ kVA}$, with largest single XFMR 75kVA
1Ø Fused Pole (6.9kV)	$0 < \text{connected kVA} \leq 350 \text{ kVA}$
1Ø Fused Pole (12kV)	$0 < \text{connected kVA} \leq 700 \text{ kVA}$
2Ø Fused Pole (6.9kV)	$0 < \text{connected kVA} \leq 700 \text{ kVA}$
3Ø Fused Pole CLF	$0 < \text{connected kVA} \leq 2,080 \text{ kVA}$ ①
3Ø Fuse Cabinet CLF	$0 < \text{connected kVA} \leq 2,080 \text{ kVA}$ ④
3Ø PME Fuse Compartment CLF-140 Amp X-limiter	$0 < \text{connected kVA} \leq 1,940 \text{ kVA}$
Fused Elbow CLF (only avail. at 30 Amp)	maximum of 3-1Ø transformers and no more than 135 kVA total maximum of 2-3Ø transformers and no more than 300 kVA total
3Ø PME Fuse Compartment expulsion - 200 amp S&C SM4 fuse ⑫	$0 < \text{connected kVA} \leq 2,770 \text{ kVA}$
CLF Fuse	kV system ≤ 8.3 ② <u>and</u> $I_f \text{ L-G} \geq 1,050\text{A}$
QA Fuse/Fault Tamer/SMU-20	$I_f \text{ L-G} < 1,050\text{A}$ / or when coordination is required up or down stream

NOTE: For connected load >2,080, kVA, see Design Manual 6205.3 (electronic sectionalizer).

Table 2 - BRANCH FUSE REQUIREMENTS - OVERHEAD

Minimum Branch Exposure ⑥	Usage Limitation
2,000 feet	none ⑦
1,200 feet	likelihood of severe weather, tree or animal/vehicle contact
none ⑧	experienced 3 or more outages in past 3 years

© 1998 - 2018 San Diego Gas & Electric Company. All rights reserved. Removal of this copyright notice without permission is not permitted under law.

REV	CHANGE	BY	DSGN	APPV	DATE	REV	CHANGE	BY	DSGN	APPV	DATE
C						F					
B	EDITORIAL CHANGES	ML	ML	CZH	9/1/2018	E					
A	REVISION			JCE/DW	1/11/2013	D					

Indicates Latest Revision Completely Revised New Page Information Removed

SHEET
4 OF 12

SDG&E DISTRIBUTION DESIGN MANUAL

FUSE APPLICATION CRITERIA

DM 6121.4

Table 3 - SUB-BRANCH FUSE REQUIREMENTS (OH & UG)

Minimum Branch Exposure	⑥	Usage Limitation
10,000 feet	⑨	75% of load (branch and sub-branch included) must be on substation side of sub-branch fuse and the fused sub-branch must be either 2000 feet long without limitation or 1200 feet provided there is a likelihood of severe weather, tree or animal/vehicle contact
none	⑧	branch experienced 3 or more outages in past year

NOTES:

- ① Cable pole fusing often represents the lowest installed cost alternative, but is limited to a single run of local distribution cable. When the area load may ultimately exceed the capacity of a single fused cable pole it is necessary to install multiple fuse cabinets served from an unfused cable pole, multiple fused cable poles, or an electronic sectionalizer.
- ② Use of a CLF may be extended to the 12kV system when an expulsion fuse is between the CLF and the 12kV load. This is the case for overhead lines that have a QA, Fault Tamer or SMU-20 fuse installed on the up cable pole and Three-Phase transformers protected by SM-4, weak link or bay-o-net fuses. In the absence of an expulsion fuse, the CLF is likely to sustain an eventful failure while trying to interrupt a 12kV fault, as they are rated @ 8.3 kV.
- ③ Fuses with wire elements (such as the fused elbow & EJO) may not be used on 4kV systems because they are capable of producing 25kV during operation. All QA, Combined Tech, ELF, & Kearney B type fuses can be used on 4 kV systems.
- ④ Fuse cabinets (whose available I L-G > 1,050A) that are presently equipped with S&C fuses and mini-rupter switch are to be retrofitted with CLF(s). This retrofit will be primarily on new business jobs and only requires adapters for the Kearney type B CLF to fit in the SM-4 or SM-5 fuse holder.
- ⑤ G&W and D&W oil fused cutouts are rated 5.2kV and, therefore, may only be applied to the 4kV system. The G&W cutout has limited fault interrupting compatibility and should be applied as follows: $I_f < 4200A$ for 100A cutouts, $T_f < 8350A$ for 200A cutouts and, $I_f < 8550A$ for 300A cutouts. These cutouts incorporate an expulsion fuse and may be used to provide additional protection, but they may not replace other fused devices that provide CLF protection.
- ⑥ Minimum branch exposure refers to the total branch circuit served by the fuse (main branch and sub-branch included) including overhead and underground areas.
- ⑦ The minimum exposure is based on the historical number of interruptions originating on the local distribution branches that are caused by equipment failure and other non-environmental influences.
- ⑧ A fuse/electronic sectionalizer shall be installed when the cause of the interruption cannot be eliminated. A service restorer may be specified instead of fuse/electronic sectionalizer when the fault is of a self-clearing nature.

© 1998 - 2018 San Diego Gas & Electric Company. All rights reserved. Removal of this copyright notice without permission is not permitted under law.

REV	CHANGE	BY	DSGN	APPV	DATE	REV	CHANGE	BY	DSGN	APPV	DATE
C						F					
B	EDITORIAL CHANGES	ML	ML	CZH	9/1/2018	E					
A	REVISION			JCE/DW	1/11/2013	D					

<p>SHEET 5 OF 12</p>	<p>X Indicates Latest Revision</p>	<p>Completely Revised</p>	<p>New Page</p>	<p>Information Removed</p>	<p>DM 6121.5</p>
	<p>SDG&E DISTRIBUTION DESIGN MANUAL</p>				
	<p>FUSE APPLICATION CRITERIA</p>				

- 9 A cascaded sub-branch fuse beyond the local distribution branch fuse is not generally warranted as an economic means to improve circuit reliability. To insure that a significant number of customers would not be affected by a fault beyond the sub-branch fuse, only 25 percent of the branch load is permitted beyond the sub-branch fuse. Additionally, sub-branch fuses on more than one tap should be avoided, unless requested by O&E/C&O Engineering.
- 10 No cutout shall be installed where the fault duty exceeds 14,000 Amps sym.
- 11 An NX type fuse may be installed on the 4kV system.
- 12 All installations of 200 Amp fuses shall be approved by the Fusing Specialist in Electric Distribution Planning and Protection Engineering.

B. New Fuse Installation

A fuse coordination study must be performed by the Fusing Specialist in Electric Distribution Planning each time a new fuse is installed, the substation relay settings change, load is transferred on a fused branch, the size of the largest transformer changes or the size of an existing sectionalizing fuse changes. The fuse coordination study shall consider 3Ø fault current on overhead branches, however, it is acceptable to perform underground studies using calculated line-to-ground fault currents.

1. The coordination study shall include:

- a. A circuit fault analysis to insure the end-of-line fault current within the zone-of-protection of a fuse or relay will exceed the fuse rating or relay setting by the following margins:

3 times (L-G)
2 times (3Ø)

- (1) The margin (L-G) may be reduced to 2.5 provided the circuit or branch being considered for reduction is underground with a continuous neutral conductor tied solidly to the substation. Further, the protective device may not protect an overhead line via an up cable pole unless the up cable pole is fused with QA, Fault Tamer, or SMU-20 fuses.
- (2) The end-of-line fault current in the relay's zone-of-protection shall be reduced by 100 amps for each grounding bank between the substation and end-of-line. Reduction is not required to insure that adequate fuse coordination exists. (Contact Design Planning if a more precise calculation is desired)

- b. Application of fuse/fuse coordination table(s) to insure that proper coordination exists between sectionalizing fuses.
- c. Application of relay/fuse coordination table to insure proper coordination exists between relays and sectionalizing fuses.

- 2. Protection Engineering shall be responsible for coordinating customer owned protection (primary metered customers) to SDG&E relays.
- 3. The Fusing Specialist in Electric Distribution Planning shall specify fuses (properly sized and located to sense the available fault current) at the point on the feeder or local distribution branch where the required fault current margins (B.1.a) exist.
- 4. CLF protection is not permitted when 12kV overhead lines or 3Ø transformers are served, unless coordination is obtained between the CLF and an expulsion fuse installed between the CLF and the 12kV load.

© 1998 - 2018 San Diego Gas & Electric Company. All rights reserved. Removal of this copyright notice without permission is not permitted under law.

REV	CHANGE	BY	DSGN	APPV	DATE	REV	CHANGE	BY	DSGN	APPV	DATE
C						F					
B	EDITORIAL CHANGES	ML	ML	CZH	9/1/2018	E					
A	REVISION			JCE/DW	1/11/2013	D					

SHEET 6 OF 12	Indicates Latest Revision	Completely Revised	New Page	Information Removed	DM 6121.6
	SDG&E DISTRIBUTION DESIGN MANUAL				
	FUSE APPLICATION CRITERIA				

5. Mis-coordination between a fused cable pole and fuse cabinet is not permitted, therefore, when mis-coordination exists the fuse cabinet shall be bridged.
6. When a 150A CLF cable pole fuse required for transformer coordination would result in bridging a 150A type QA sectionalizing fuse the following should be considered:
 - a. Install a smaller QA or Fault Tamer cable pole fuse for $I_f < 2,080A$, or;
 - b. Bridge the cable pole if a smaller fuse cannot be used or;
 - c. Bridge the sectionalizing fuse for $I_f > 2,080A$

C. New Fuse Size Selection

The minimum fuse size (current limiting or expulsion) is determined by multiplying the inrush factor by the connected kVA attached to the fuse. The following equations and tables 4 and 5 are used to determine the minimum permissible fuse size.

1. Balanced three-phase system

$$\text{Fuse size, min} = \frac{(\text{Inrush Factor}) (\text{Total kVA})}{kV_{D3\phi}}$$

2. Unbalanced three-phase system and single phase system (the 3φ factor zeros out)

$$\text{Fuse size, min} = (\text{Inrush Factor}) \left(\frac{3\phi \text{ kVA}}{kV_{D3\phi}} + \frac{1\phi \text{ kVA of highest phase}}{kV_{D1\phi}} \right)$$

3. Open Delta three-phase transformer station and single phase system

$$\text{Fuse size, min} = \frac{(\text{Inrush Factor}) (2/3(3\phi \text{ kVA}) + \text{largest } 1\phi \text{ kVA})}{kV_{D1\phi}^*}$$

* $kV_{D1\phi}$ Could be (L-G) or (L-L)

Table 4 - System Voltage Factors

kV _D	12kV-System	4.16kV-System	2.4kV Delta-System
1φ (L-G)	6.9/7.2	2.4	--
1φ (L-L)	N&Y-Type Xfmrs 13.8	4.8	2.4
	H-Type Xfmrs 12		
3φ	20.8	7.2	4.16

Table 5 - Inrush Factor

Fuse Type/Size	Inrush Factor
Bussman/all sizes	1.5
Combined Tech/all sizes	1.5
D&W/30A & below	2.0
D&W/40A & above	1.5
EJO/all sizes	1.5
ELF/all sizes	1.5
Fault Tamer/all sizes	1.5
FE/all sizes	1.5
KA/40A & below	2.0
KA/50A & above	1.5
KB/all sizes	1.5
NX/all sizes	1.5
QA/all sizes	1.5
RTE/150A	1.5
SM4/all sizes	1.5
SMU-4/ all sizes	1.5

© 1998 - 2018 San Diego Gas & Electric Company. All rights reserved. Removal of this copyright notice without permission is not permitted under law.

REV	CHANGE	BY	DSGN	APPV	DATE	REV	CHANGE	BY	DSGN	APPV	DATE
C						F					
B	EDITORIAL CHANGES	ML	ML	CZH	9/1/2018	E					
A	REVISION			JCE/DW	1/11/2013	D					

SHEET 7 OF 12	Indicates Latest Revision	Completely Revised	New Page	Information Removed	DM 6121.7
	SDG&E DISTRIBUTION DESIGN MANUAL				
	FUSE APPLICATION CRITERIA				

5. Mis-coordination between a fused cable pole and fuse cabinet is not permitted, therefore, when mis-coordination exists the fuse cabinet shall be bridged.
6. When a 150A CLF cable pole fuse required for transformer coordination would result in bridging a 150A type QA sectionalizing fuse the following should be considered:
 - a. Install a smaller QA or Fault Tamer cable pole fuse for $I_f < 2,080A$, or;
 - b. Bridge the cable pole if a smaller fuse cannot be used or;
 - c. Bridge the sectionalizing fuse for $I_f > 2,080A$

C. New Fuse Size Selection

The minimum fuse size (current limiting or expulsion) is determined by multiplying the inrush factor by the connected kVA attached to the fuse. The following equations and tables 4 and 5 are used to determine the minimum permissible fuse size.

1. Balanced three-phase system

$$\text{Fuse size, min} = \frac{(\text{Inrush Factor}) (\text{Total kVA})}{kV_{D3\phi}}$$

2. Unbalanced three-phase system and single phase system (the 3 ϕ factor zeros out)

$$\text{Fuse size, min} = (\text{Inrush Factor}) \left(\frac{3\phi \text{ kVA}}{kV_{D3\phi}} + \frac{1\phi \text{ kVA of highest phase}}{kV_{D1\phi}} \right)$$

3. Open Delta three-phase transformer station and single phase system

$$\text{Fuse size, min} = \frac{(\text{Inrush Factor}) (2/3(3\phi \text{ kVA}) + \text{largest } 1\phi \text{ kVA})}{kV_{D1\phi}^*}$$

* $kV_{D1\phi}$ Could be (L-G) or (L-L)

Table 4 - System Voltage Factors

kV _D	12kV-System	4.16kV-System	2.4kV Delta-System
1 ϕ (L-G)	6.9/7.2	2.4	--
1 ϕ (L-L)	N&Y-Type Xfmrs 13.8	4.8	2.4
	H-Type Xfmrs 12		
3 ϕ	20.8	7.2	4.16

Table 5 - Inrush Factor

Fuse Type/Size	Inrush Factor
Bussman/all sizes	1.5
Combined Tech/all sizes	1.5
D&W/30A & below	2.0
D&W/40A & above	1.5
EJO/all sizes	1.5
ELF/all sizes	1.5
Fault Tamer/all sizes	1.5
FE/all sizes	1.5
KA/40A & below	2.0
KA/50A & above	1.5
KB/all sizes	1.5
NX/all sizes	1.5
QA/all sizes	1.5
RTE/150A	1.5
SM4/all sizes	1.5
SMU-4/ all sizes	1.5

© 1998 - 2018 San Diego Gas & Electric Company. All rights reserved. Removal of this copyright notice without permission is not permitted under law.

REV	CHANGE	BY	DSGN	APPV	DATE	REV	CHANGE	BY	DSGN	APPV	DATE
C						F					
B	EDITORIAL CHANGES	ML	ML	CZH	9/1/2018	E					
A	REVISION			JCE/DW	1/11/2013	D					

SHEET 8 OF 12	Indicates Latest Revision	Completely Revised	New Page	Information Removed	DM 6121.8
	SDG&E DISTRIBUTION DESIGN MANUAL				
	FUSE APPLICATION CRITERIA				

E. Fuse Coordination - Existing Electric Distribution System

A fuse coordination study must be performed by the fusing specialist in Electric Distribution Planning each time a new fuse is installed, the substation relay settings change, load is transferred on a fused branch, the size of the largest transformer changes or the size of an existing sectionalizing fuse changes. The fuse coordination study shall consider 3ø fault current on overhead branches, however, it is acceptable to perform underground studies using calculated line-to-ground fault currents.

When selecting fuse sizes that serve customer load that already exist the "Fuse Loading Tool" will be used.

This tool makes use of available meter data (including smart meters). The user indicates a starting point, either an existing fuse or a structure, and the tool collects kilowatt hour (kWh) data at each transformer beyond the starting point. The tool records how many meters are reporting and how many are expected to be on the transformer. When meters are not reporting for the particular date range, the most recent thirteen month maximum value for that meter will be used if it is available. Once collected, the kwh data is converted to Amps per phase using the following calculation, and be displayed as "max kWh".

For Fuse Qty 1:
 $[(\text{Summed Single Phase kWh} + \text{max kWh} + \text{Planned Single Phase kWh}) / 6.93] \times 1.265$
 (cold load & growth factor)

For Fuse Qty 2:
 $[(((\text{summed single phase kWh} + (\text{max kWh} / 2)) \times 1.2) + \text{planned single phase kWh}) / 12] \times 1.265$

For Fuse Qty 3:
 $[(((\text{Summed Three Phase kWh} + \text{Max Three Phase kWh} + \text{Planned Three Phase kWh}) / 3) \times 1.2) + (\text{summed Single Phase kWh} + \text{max kWh} + \text{Planned Single Phase kWh}) / 20.8] \times 1.265$

Recommended fuse sizes are based on a table provided by System Protection and Control Engineering (SPACE) and uses OH/UG designation and the Single Phase plus Growth value.

© 1998 - 2018 San Diego Gas & Electric Company. All rights reserved. Removal of this copyright notice without permission is not permitted under law.

REV	CHANGE	BY	DSGN	APPV	DATE	REV	CHANGE	BY	DSGN	APPV	DATE
C						F					
B	EDITORIAL CHANGES	ML	ML	CZH	9/1/2018	E					
A	REVISION			JCE/DW	1/11/2013	D					

SHEET 9 OF 12	 Indicates Latest Revision	Completely Revised	New Page	Information Removed	DM 6121.9
	SDG&E DISTRIBUTION DESIGN MANUAL				
	FUZE APPLICATION CRITERIA				

FUSE LOADING TOOL

NOTE: Numbers below correspond to the numbers shown in the example above.

- ① Enter Circuit ID and the pole or pad ID of the existing fuse location or Circuit ID and Transformer (Xfmr) ID. This item is manually input by the Fusing Specialist.
 - ② To capture peak load downstream of the input device, start date is defaulted to 1/1/2010 and end date is defaulted to two days prior to current date.
- Items 3 through 7 are auto populated after the "Run" button is selected.
- ③ This calculation is the total amps downstream of the selected fuse based on Smart Meter data. "Amps Sp + Growth" factors is cold load pick-up and a growth factor.
 - ④ Recommended size for all fuse types currently in the stock table. The Fusing Specialist will determine the proper fuse size and type for the given location.
 - ⑤ Connected kVA of transformers (both three phase and single phase) downstream of the given location.
 - ⑥ Service points downstream of given location, and the number used in the "Amp Calculation".
 - ⑦ Breakdown of customer count (residential and commercial) downstream of selected fuse.

© 1998 - 2018 San Diego Gas & Electric Company. All rights reserved. Removal of this copyright notice without permission is not permitted under law.

REV	CHANGE	BY	DSGN	APPV	DATE	REV	CHANGE	BY	DSGN	APPV	DATE
C						F					
B	EDITORIAL CHANGES	ML	ML	CZH	9/1/2018	E					
A	REVISION			JCE/DW	1/11/2013	D					

<p>SHEET 10 OF 12</p>	<p>X Indicates Latest Revision</p>	<p>Completely Revised</p>	<p>New Page</p>	<p>Information Removed</p>	<p>DM 6121.10</p>
	<p>SDG&E DISTRIBUTION DESIGN MANUAL</p>				
	<p>FUSE APPLICATION CRITERIA</p>				

Examples

- Determine the minimum fuse size to possibly downsize existing 3-65A fuses on pole Z272813 on Circuit 283.

- Input Circuit ID and the pole number of the fuse location.
- The start date is defaulted to 1/1/2010 and the end date is defaulted to two days prior to the current date. The current date in this example is 5/5/12.
- Click "Run".

Results

- The Fusing Specialist will determine the proper fuse size from the given selection of fuse recommendations. If a current limiting fuse cannot be installed then the Fault Tamer fuse should be installed whenever possible, especially in High Fire Threat Districts Tier-2 and Tier-3.

© 1998 - 2018 San Diego Gas & Electric Company. All rights reserved. Removal of this copyright notice without permission is not permitted under law.

REV	CHANGE	BY	DSGN	APPV	DATE	REV	CHANGE	BY	DSGN	APPV	DATE
C						F					
B	EDITORIAL CHANGES	ML	ML	CZH	9/1/2018	E					
A	REVISION			JCE/DW	1/11/2013	D					

Indicates Latest Revision Completely Revised New Page Information Removed

SHEET
11 OF 12

SDG&E DISTRIBUTION DESIGN MANUAL

FUSE APPLICATION CRITERIA

DM 6121.11

2. Determine the proper fuse size for a new fuse location directly upstream from pole P870563 on Circuit 283.

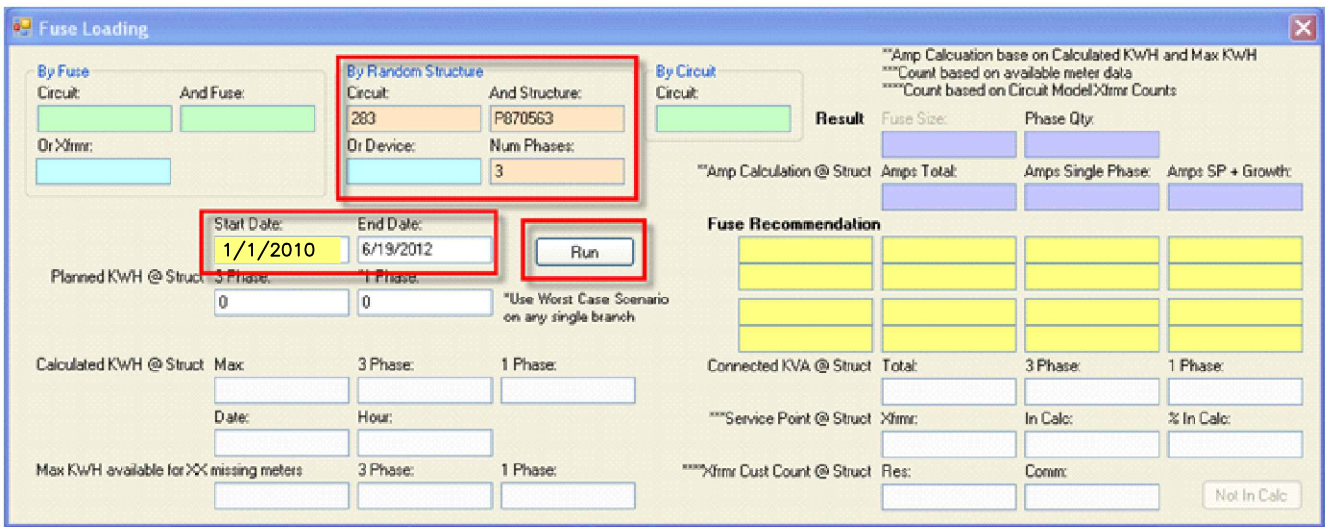

- a. Input Circuit ID and the pole number of the proposed location on the branch in question.
- b. The start date is defaulted to 1/1/2010 and the end date is defaulted to two days prior to the current date. The current date in this example is 6/21/12.
- c. Click "Run".

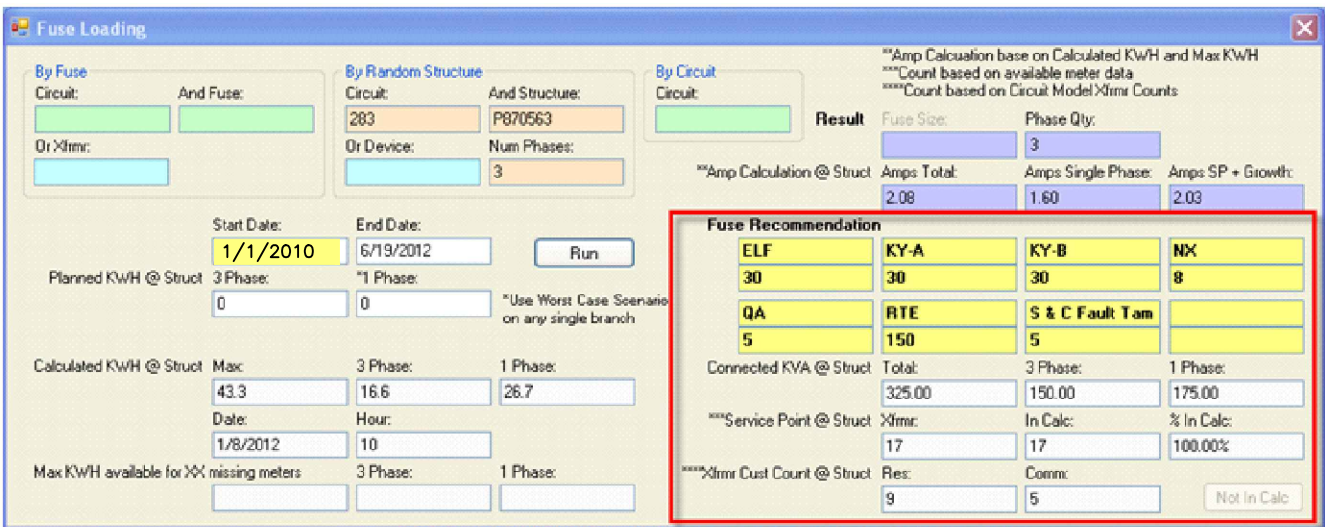

- d. The Fusing Specialist will determine the proper fuse size from the given selection of fuse recommendations. If a current limiting fuse cannot be installed then the Fault Tamer fuse should be installed whenever possible, especially in High Fire Threat Districts Tier-2 and Tier-3.

© 1998 - 2018 San Diego Gas & Electric Company. All rights reserved. Removal of this copyright notice without permission is not permitted under law.

REV	CHANGE	BY	DSGN	APPV	DATE	REV	CHANGE	BY	DSGN	APPV	DATE
C						F					
B	EDITORIAL CHANGES	ML	ML	CZH	9/1/2018	E					
A	REVISION			JCE/DW	1/11/2013	D					

Indicates Latest Revision Completely Revised New Page Information Removed

SHEET
12 OF 12

SDG&E DISTRIBUTION DESIGN MANUAL

FUSE APPLICATION CRITERIA

DM 6121.12

SCOPE

This standard provides criteria for using the transformer/sectionalizing fuse coordination tables. These tables will be used by the Electric Distribution Planning when coordinating sectionalizing fuses on local distribution systems.

TRANSFORMER/SECTIONALIZING FUSE COORDINATION TABLES

Each sectionalizing fuse shall be sized to coordinate with transformer fuses except those situations meeting the single station fusing criteria (table 1). The following procedure is only for obtaining coordination between transformers and sectionalizing fuses.

Table I

Single station installations where coordination is not required with sectionalizing fuses.

Fuse Type and Voltage Rating (kV)	System Type & Voltage	1Ø 2.4 kV		3Ø 2.4, 4.16kV		1Ø 6.9, 7.2kV		1Ø 12kV		3Ø 12kV	
Combined Tech X-Limiter	8.3	x	x	x							
Combined Tech EOD/SD	8.3	x	x	x							
Cooper ELF	8.3	x	x	x			(4)			(4)	
D&W	5.2	x	x	x							
F.E.	8.3	(3)	(3)	x							
GE EJO-1	7.2	(3)	(3)	x							
Kearney QA	14.4	x	x	x			x			x	
Kearney A	8.3	x	x	x							
Kearney B	8.3	x	x	x			(4)			(4)	
McG-Ed NX	8.3	x	x	x							
McG-Ed NX	15.5	x	x	x			x			x	
RTE	8.3	x	x	x			(4)			(4)	
S&C SM-4	14.4	x	x	x			x			x	

Required information:

- 1) The size and type of all underground transformers, connected directly to the sectionalizing fuse, but preceding any downstream sectionalizing fuses. (e.g. 25NDD, 75HZR...)
- 2) The type of sectionalizing fuse to be sized. (e.g. Type "B", EJO-1...)

	 Indicates Latest Revision	Completely Revised	New Page	Information Removed
REVISION	SDG&E ELECTRIC STANDARDS			
DATE 1-1-2000 APPD CVN/vcl	UNDERGROUND TRANSFORMER/FUSE COORDINATION TABLES			
	6131.1			

Required information: Con't

- ③ Fuses with wire elements may not be used on the 4kV system because they are capable of producing 25kV during operation.
- ④ An 8.3kV fuse may serve a 12kV transformer which it does not coordinate with if the fuse is installed on a cable pole. We do not permit miscoordination between a padmounted 8.3kV CLF and a 12kV transformer.
- ⑤ The Fault Tamer should not be used on the 2.4kV or 4kV system because it will not coordinate with the 3kV lightning arrester used on those systems.

Using the above information, determine the minimum sectionalizing fuse required for coordination with each transformer. This is done by locating the specific transformer type and size on the following pages. The required fuse size can then be read from the appropriate column. The minimum required sectionalizing fuse will be the largest of these fuses.

EXAMPLE:

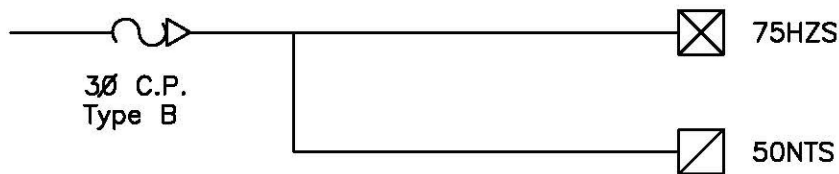

Minimum sectionalizing fuse required for coordination with transformers:

50 NTS – 80 amp Type B from table on page 6131.3

75 HZS – 30 amp Type B from table on page 6131.5

Fuse size required on cable pole for coordination – 80 amp Type B

© 1998 - 2014 San Diego Gas & Electric Company. All rights reserved. Removal of this copyright notice without permission is not permitted under law.

✘	Indicates Latest Revision	Completely Revised	New Page	Information Removed
---	---------------------------	--------------------	----------	---------------------

SDG&E ELECTRIC STANDARDS

6131.2

UNDERGROUND TRANSFORMER/FUSE
COORDINATION TABLES

REVISION

DATE 8-26-2014
APPD JE / DW

MINIMUM SECTIONALIZING FUSE REQUIRED FOR COORDINATION WITH TRANSFORMER (AMPERE RATING)

TRANSF. PREFIX	TYPE OF TRANSF. FUSES	SIZE OF TRANSF. (KVA)	TRANSF. FULL LOAD CURRENT (AMPS)	KEARNEY QA	⑥ FAULT TAKER	S&C SM-4	⑥ GE EJO-1/ COMBINED TECHNOLOGIES EOD/SD	⑥ COOPER ELF	⑥ KEARNEY TYPE B	⑥⑬ COMBINED TECHNOLOGIES X-LIMITER	⑥⑦ KEARNEY TYPE A	⑥⑭ ELASTIMOLD F.E.	⑤⑥ MCG-ED 'NX'	D&W OIL FUSE CUTOFF
NCS	BAY-O-NET													
NDS*	D.E.W.L.	15	2.2	15	15	10	40	30	30	140	40	18 ⑬	25	--
NTS	or	25	3.6	20	15	15	65	30	30	140	50	18 ⑬	25	--
NDL*	INTERNAL	50	7.2	50	20	40	80	65	80	140	50	30	40	--
NSL*	WEAK LINK (6.9kV)1Ø	75	10.8	60	---	50	100	65	80	140	---	---	2X30	--
NTD*	Deadfront	100	14.4	60	---	50	150	65	150 ⑧⑨	140	---	---	2X40	--
NDD*	Livefront													
NSD*														
NEP**														
NTP**	INTERNAL	25	3.6	20	---	15	80	30	30	140	50	18 ⑬	25	--
NDP**	WEAK LINK (6.9kV)1Ø	50	7.2	50	---	30	80	30	30	140	50	18 ⑬	30	--
NTQ*	Deadfront	75	10.8	60	---	50	80	65	80	140	65	30	2X30	--
	Livefront	100	14.4	75	---	65	100	65	150 ⑧⑨	140	---	---	2X30	--
NES	INTERNAL WEAK LINK (6.9kV)1Ø	50	7.2	50	---	40	80	65	80	140	50	30	40	--
⑫	Deadfront	100	14.4	60	---	50	150	65	150 ⑧⑨	140	---	---	2X40	--
YDP*YES*	INTERNAL WEAK LINK (7.2kV)1Ø	15	2.1	20	---	15	80	30	30	140	50	18 ⑬	18	--
YSV*YTP*	Deadfront	25	3.5	25	---	30	80	30	30	140	50	18 ⑬	25	--
YDQ*	Livefront	50	6.9	50	---	40	100	65	80	140	65	---	40	--
YEP**		75	10.4	75	---	65	150	65	150 ⑧⑨	140	---	---	2X30	--
		100	13.9	100	---	80	150	---	150 ⑧⑨	140	---	---	2X40	--
YIS*	BAY-O-NET (7.2kV)1Ø	50	6.9	20	---	15	80	30	80	140	50	30	30	--
	Deadfront													
YP*	EXTERNAL NX FUSES (7.2kV)1Ø	15	2.1	25	---	15	40	30	30	140	30	18 ⑬	12	--
	Livefront	25	3.5	25	---	15	40	30	30	140	30	18 ⑬	18	--
		50	6.9	40	---	30	80	65	80	140	50	30	30	--
		75	10.4	75	---	50	80	65	80	140	50	30	40	--
		100	13.9	100	---	80	80	65	80	140	65	---	2X30	--
		167	23.2	125	---	100	150	---	150 ⑧⑨	140	---	---	2X40	--
WEP**	INTERNAL WEAK LINK (2.4kV)1Ø	15	6.3	40	---	30	80	30	80	140	50	30	40	50
WEQ**	Deadfront	25	10.4	60	---	50	100	65	80	140	65	---	2X30	65
		37.5	15.6	100	---	80	150	65	150 ⑧⑨	140	65	---	2X40	100
		50	20.8	125	---	100	150	65	150 ⑧⑨	140	---	---	2X40	125
		75	31.3	150	---	125	200 ②	---	---	140	---	---	---	150
WUS*		100	41.6	200 ②④	---	200 ②	---	---	---	140	---	---	---	200 ②

*No longer installed as standard unit.

© 1998 - 2014 San Diego Gas & Electric Company. All rights reserved. Removal of this copyright notice without permission is not permitted under law.

<input checked="" type="checkbox"/> Indicates Latest Revision	<input type="checkbox"/> Completely Revised	<input type="checkbox"/> New Page	<input type="checkbox"/> Information Removed
REVISION DATE 7-24-2014 APPD JCE / DW	SDG&E DISTRIBUTION DESIGN MANUAL UNDERGROUND TRANSFORMER/FUSE COORDINATION TABLES		6131.3

MINIMUM SECTIONALIZING FUSE REQUIRED FOR COORDINATION WITH TRANSFORMER (AMPERE RATING)

TRANSF. PREFIX	TYPE OF TRANSF. FUSES	SIZE OF TRANSF. (KVA)	TRANSF. FULL LOAD CURRENT (AMPS)	KEARNEY QA	⑥ FAULT TAKER	S&C SM-4	⑥ GE EJO-1/ COMBINED TECHNOLOGIES EOD/SD	⑥ COOPER ELF	⑥ KEARNEY TYPE B	⑥⑬ COMBINED TECHNOLOGIES X-LIMITER	⑥⑦ KEARNEY TYPE A	⑥⑭ ELASTIMOLD F.E.	⑤⑥ MCG-ED 'NX'	D&W OIL FUSE CUTOFF
NCS	BAY-O-NET													
NDS*	D.E.W.L.	15	2.2	15	15	10	40	30	30	140	40	18 ⑬	25	--
NTS	or	25	3.6	20	15	15	65	30	30	140	50	18 ⑬	25	--
NDL*	INTERNAL	50	7.2	50	20	40	80	65	80	140	50	30	40	--
NSL*	WEAK LINK	75	10.8	60	---	50	100	65	80	140	---	---	2X30	--
NTD*	(6.9KV)1Ø	100	14.4	60	---	50	150	65	150 ⑧⑨	140	---	---	2X40	--
NDD*	Deadfront			60	---									
NSD*	Livefront				---									
NEP**					---									
NTP**	INTERNAL	25	3.6	20	---	15	80	30	30	140	50	18 ⑬	25	--
NDP**	WEAK LINK	50	7.2	50	---	30	80	30	30	140	50	18 ⑬	30	--
NTQ*	(6.9KV)1Ø	75	10.8	60	---	50	80	65	80	140	65	30	2X30	--
	Deadfront	100	14.4	75	---	65	100	65	150 ⑧⑨	140	---	---	2X30	--
NES	INTERNAL	50	7.2	50	---	40	80	65	80	140	50	30	40	--
⑫	WEAK LINK	100	14.4	60	---	50	150	65	150 ⑧⑨	140	---	---	2X40	--
	(6.9KV)1Ø				---									
	Deadfront				---									
YDP*YES*	INTERNAL	15	2.1	20	---	15	80	30	30	140	50	18 ⑬	18	--
YSV*YTP*	WEAK LINK	25	3.5	25	---	30	80	30	30	140	50	18 ⑬	25	--
YDQ*	(7.2KV)1Ø	50	6.9	50	---	40	100	65	80	140	65	---	40	--
	Deadfront	75	10.4	75	---	65	150	65	150 ⑧⑨	140	---	---	2X30	--
YEP**	Livefront	100	13.9	100	---	80	150	---	150 ⑧⑨	140	---	---	2X40	--
YIS*	BAY-O-NET	50	6.9	20	---	15	80	30	80	140	50	30	30	--
	(7.2KV)1Ø				---									
	Deadfront				---									
YP*	EXTERNAL	15	2.1	25	---	15	40	30	30	140	30	18 ⑬	12	--
	NX FUSES	25	3.5	25	---	15	40	30	30	140	30	18 ⑬	18	--
	(7.2KV)1Ø	50	6.9	40	---	30	80	65	80	140	50	30	30	--
	Livefront	75	10.4	75	---	50	80	65	80	140	50	30	40	--
		100	13.9	100	---	80	80	65	80	140	65	---	2X30	--
		167	23.2	125	---	100	150	---	150 ⑧⑨	140	---	---	2X40	--
WEP**	INTERNAL	15	6.3	40	---	30	80	30	80	140	50	30	40	50
WEQ**	WEAK LINK	25	10.4	60	---	50	100	65	80	140	65	---	2X30	65
	(2.4KV)1Ø	37.5	15.6	100	---	80	150	65	150 ⑧⑨	140	65	---	2X40	100
WUS*	Deadfront	50	20.8	125	---	100	150	65	150 ⑧⑨	140	---	---	2X40	125
		75	31.3	150	---	125	200 ②	---	---	140	---	---	---	150
		100	41.6	200 ②④	---	200 ②	---	---	---	140	---	---	---	200 ②

*No longer installed as standard unit.

© 1998 - 2014 San Diego Gas & Electric Company. All rights reserved. Removal of this copyright notice without permission is not permitted under law.

REVISION DATE 7-24-2014 APPD JCE / DW	<input checked="" type="checkbox"/> Indicates Latest Revision	<input type="checkbox"/> Completely Revised	<input type="checkbox"/> New Page	<input type="checkbox"/> Information Removed
	SDG&E DISTRIBUTION DESIGN MANUAL			
UNDERGROUND TRANSFORMER/FUSE COORDINATION TABLES				6131.3

MINIMUM SECTIONALIZING FUSE REQUIRED FOR COORDINATION WITH TRANSFORMER (AMPERE RATING)

TRANSF. PREFIX	TYPE OF TRANSF. FUSES	SIZE OF TRANSF. (KVA)	TRANSF. FULL LOAD CURRENT (AMPS)	KEARNEY QA	⑥ FAULT TAKER	S&C SM-4	⑥ GE EJO-1/ COMBINED TECHNOLOGIES EOD/SD	⑥ COOPER ELF	⑥ KEARNEY TYPE B	⑥⑮ COMBINED TECHNOLOGIES X-LIMITER	⑥⑦ KEARNEY TYPE A	⑥⑭ ELASTIMOLD F.E.	⑤⑥ McG-ED 'NX'	D&W OIL FUSE CUTOFF
SDD* ③ (WDD)	INTERNAL WEAK LINK 2.4/6.9KV 1Ø D.F.	25 50 75	10.4 20.8 31.3	75 100 150	---	50 80 125	150 ② 200 ② ---	65 --- ---	80 ⑧ 150 ⑧ ---	140 140 140	--- --- ---	--- --- ---	30 2X30 2X40	65 125 150
WDS SDS SID* ⑩ 2.4KV	BAY-O-NET D.E.W.L. 2.4/6.9KV 1Ø D.F.	25 50 75	10.4 20.8 31.3	75 100 150	---	50 80 125	150 ② 200 ② ---	65 --- ---	80 ⑧ 150 ⑧ ---	140 140 ---	--- --- ---	--- --- ---	30 2X30 2X40	65 125 150
WDS SDS SID* ⑩ 6.9KV	BAY-O-NET D.E.W.L. 2.4/6.9KV 1Ø D.F.	25 50 75	3.6 7.2 10.8	20 50 60	15 20 ---	15 40 50	80 80 100	30 65 65	30 80 80	140 140 140	50 50 ---	30 30 ---	25 40 2X30	--- --- ---
HEP* HEQ* HJP*	INTERNAL WEAK LINK (12KV)1Ø Livefront	15 25 37.5 50 75 100	1.3 2.1 3.1 4.2 6.2 8.3	10④ 10④ 25 40 50	---	10 10 15 30 30 40	40 40 40 40 80 80	30 30 30 30 30 65	30 30 30 30 80 80	140 140 140 140 140 140	30 30 30 30 50 50	30 30 30 30 30 30	12 12 18 18 30 30	--- --- --- --- --- ---
HDS HTS HJS HDL* HDD* HTD* HSL* HTL* HJD* HJL*	BAY-O-NET D.E.W.L. or INTERNAL WEAK LINK (12KV)1Ø Deadfront	15 25 50 75 100 167	1.3 2.1 4.2 6.2 8.3 13.9	15 15 25 30 50 60	15 15 20 ---	10 10 15 30 40 50	40 40 80 80 150 150	30 30 30 30 65 65	30 30 30 80 150 ⑧ 150 ⑧	140 140 140 140 140 140	30 30 50 50 50 ---	30 30 30 30 30 ---	10 12 20 30 40 2X30	--- --- --- --- --- ---
HP* HQ*	EXTERNAL NX FUSES (12KV)1Ø Livefront	25 50 75 100 167	2.1 4.2 6.2 8.3 13.9	25 25 30 40 75	---	15 15 30 65	40 40 40 80 80	30 30 30 30 65	30 30 30 80 80	140 140 140 140 140	30 30 40 50 50	30 30 30 30 30	12 18 30 30 2X30	--- --- --- --- ---
HSS HST	BAY-O-NET D.E.W.L. or INTERNAL WEAK LINK (12KV)1Ø Deadfront	25 50 75 100	2.1 4.2 6.2 8.3	15 30 40 50	15 15 20 ---	15 20 30 40	40 80 80 80	30 30 30 65	30 80 80 150 ⑧	140 140 140 140	30 50 50 65	30 30 30 ---	18 30 40 2X30	--- --- --- ---

*No longer installed as standard unit.

© 1998 - 2014 San Diego Gas & Electric Company. All rights reserved. Removal of this copyright notice without permission is not permitted under law.

Indicates Latest Revision Completely Revised New Page Information Removed

6131.4

SDG&E DISTRIBUTION DESIGN MANUAL

UNDERGROUND TRANSFORMER/FUSE COORDINATION TABLES

REVISION

DATE 7-24-2014
APPD JCE / DW

MINIMUM SECTIONALIZING FUSE REQUIRED FOR COORDINATION WITH TRANSFORMER (AMPERE RATING)

TRANSF. PREFIX	TYPE OF TRANSF. FUSES	SIZE OF TRANSF. (KVA)	TRANSF. FULL LOAD CURRENT (AMPS)	KEARNEY QA	⑥ FAULT TOLERANT	S&C SM-4	⑥ GE EJO-1/ COMBINED TECHNOLOGIES EOD/SD	⑥ COOPER ELF	⑥ KEARNEY TYPE B	⑥⑬ COMBINED TECHNOLOGIES X-LIMITER	⑥⑦ KEARNEY TYPE A	⑥⑭ ELASTIMOLD F.E.	⑤⑥ McG-ED 'NX'	D&W OIL FUSE CUTOFF
PXS PZS PZR* ⑪ PZB* ④ 4KV	BAY-O-NET D.E.W.L. 4/12KV 3Ø Deadfront	75 150 500	10.4 20.8 69.4	-- -- --	-- -- --	65 100 200 ②	100 150 --	65 -- --	150 ⑧ ⑨ 150 ⑧ ⑨ --	140 140 --	-- -- --	-- -- --	2x30 -- --	75 100 --
PXS PZS PZR* ⑪ PZB* ④ 12KV	BAY-O-NET D.E.W.L. 4/12KV 3Ø Deadfront	75 150 500	3.6 7.2 24.1	15 20 125	15 20 --	15 30 100	80 80 150	30 65 65	30 80 150 ⑧ ⑨	140 140 140	40 50 --	18 ⑬ 30 --	25 40 2x40	-- -- --
WXP*	INTERNAL WEAK LINK (4KV) 3Ø	75 150	10.4 20.8	60 100	-- --	50 80	100 150	65 --	80 150 ⑧ ⑨ 150 ⑧ ⑨	140 140	-- --	-- --	2x30 --	65 125
WZP*	INTERNAL WEAK LINK (4KV) 3Ø Livefront	75 112.5 150	10.4 15.6 20.8	50 75 100	-- -- --	40 65 80	100 150 200 ②	65 -- --	80 150 ⑧ ⑨ 150 ⑧ ⑨	140 140 140	-- -- --	-- -- --	2x30 2x40 --	65 75 125
HNS HZS HPS HBS HKS HAL* HZR* HKR* HZL* HPR* HNL* HAB* HZB* HKB* HNB* HPB*	BAY-O-NET D.E.W.L. (12KV) 3Ø Deadfront	45 75 150 225 300 500	2.2 3.6 7.2 10.8 14.4 24.1	20 20 30 50 75 125	15 15 20 -- -- --	15 15 30 40 65 100	40 80 80 80 100 150	30 30 65 65 65 --	30 30 80 80 80 150 ⑧ ⑨	140 140 140 140 140 140	40 40 50 65 -- --	18 ⑬ 18 ⑬ 30 -- -- --	25 25 40 2x30 2x30 2x40	-- -- -- -- -- --
HMB* HML* HMS	BAY-O-NET D.E.W.L. (12KV) 3Ø Deadfront	75 150 225 300	3.6 7.2 10.8 14.4	20 30 50 75	15 20 -- --	15 30 40 65	80 80 100 150	30 65 65 --	30 80 150 ⑧ ⑨ 150 ⑧ ⑨	140 140 140 140	40 50 65 --	18 ⑬ 30 -- --	25 40 2x30 2x40	-- -- -- --

*No longer installed as standard unit.

© 1998 - 2014 San Diego Gas & Electric Company. All rights reserved. Removal of this copyright notice without permission is not permitted under law.

<input checked="" type="checkbox"/> Indicates Latest Revision	<input type="checkbox"/> Completely Revised	<input type="checkbox"/> New Page	<input type="checkbox"/> Information Removed
REVISION	SDG&E DISTRIBUTION DESIGN MANUAL		
DATE 7-24-2014	UNDERGROUND TRANSFORMER/FUSE COORDINATION TABLES		
APPD JCE / DW	6131.5		

MINIMUM SECTIONALIZING FUSE REQUIRED FOR COORDINATION WITH TRANSFORMER (AMPERE RATING)

TRANSF. PREFIX	TYPE OF TRANSF. FUSES	SIZE OF TRANSF. (KVA)	TRANSF. FULL LOAD CURRENT (AMPS)	KEARNEY QA	⑥ FAULT TAKER	S&C SM-4	GE EJO-1/ COMBINED TECHNOLOGIES EOD/SD	⑥ COOPER ELF	⑥ KEARNEY TYPE B	⑥⑬ COMBINED TECHNOLOGIES X-LIMITER	⑥⑦ KEARNEY TYPE A	⑥⑭ ELASTIMOLD F.E.	⑤⑥ McG-ED 'NX'	D&W OIL FUSE CUTOUT
HPS HBS HNS HPR* HAB* HAL* HNB* HNL*	BAY-O-NET (12kV) 3Ø Deadfront	750 1000	36.1 48.1	200 200 ②④	---	125 125	150 150	---	150 ⑧⑨ 150 ⑧⑨	140 140	---	---	2x40 2x40	---
HZP* HZQ*	INTERNAL WEAK LINK (12kV) 3Ø Livefront	75 112.5 150	3.6 5.4 7.2	20 40 40	---	15 30 40	80 80 80	30 65 65	30 80 80	140 140 140	50 50 65	18 ⑬ 30 30	25 40 2x30	---
HAP* HAG* HAL* HMP* HPP*	EXTERNAL NX FUSES (12kV) 3Ø Livefront	75 150 225 300 500 750 1000	3.6 7.2 10.8 14.4 24.1 36.1 48.1	25 40 75 100 150 150 200 ②④	---	30 30 50 80 125 125 200 ②	40 80 80 100 150 150 200 ②	30 30 65 65 ---	30 80 80 150 ⑧⑨ 150 ⑧⑨ 150 ⑧⑨ ---	140 140 140 140 140 140 ---	30 50 50 65 ---	18 ⑬ 30 ---	20 40 2x30 2x40 2x40 ---	---
HLS HMP* HAP* HPP*	EXTERNAL S&C SM-4 (12kV) 3Ø Livefront	1500 2000 2500 3000	72.2 96.2 120.2 144.4	200 ②④ 200 ②④ --- ---	---	200 ② --- --- ---	---	---	---	---	---	---	---	---
HXP*	INTERNAL WEAK LINK (12kV) 3Ø Livefront	75 112.5 150	3.6 5.4 7.2	20 30 50	---	15 30 30	80 80 80	30 30 65	30 80 80	140 140 140	50 50 50	18 ⑬ 30 30	25 30 40	---
HPS HNS HBS HAB* HNB* HNR* HPR*	HIGH AMPERE BAY-O-NET (12kV) 3Ø Deadfront	1500 2000 2500	72.2 96.2 120.3	200 ②④ 200 ②④ 200 ②④	---	200 ② --- ---	---	---	---	---	---	---	---	---

*No longer installed as standard unit.

© 1998 - 2014 San Diego Gas & Electric Company. All rights reserved. Removal of this copyright notice without permission is not permitted under law.

Indicates Latest Revision Completely Revised New Page Information Removed

6131.6

SDG&E DISTRIBUTION DESIGN MANUAL
UNDERGROUND TRANSFORMER/FUSE
COORDINATION TABLES

REVISION
DATE 7-24-2014
APPD JCE / DW

NOTES:

- ② All installations of 200 amp fuses shall be approved by the Fusing Specialist in Electric Distribution Planning and Protection Engineering.
- ③ Series/multiple primary – fusing listed applies to either 2.4/6.9 or 4/12kV.
- ④ These fuses are Kearney Type 200's, not QA's.
- ⑤ Fuse sizes listed apply to either 8.3 or 15kV rated CLF's (current-limiting fuses).
- ⑥ These fuses are CLF.
- ⑦ These fuses are used only in single-phase fuse cabinets.
- ⑧ The 150 amp Type B CLF is only used in S&C 30 fuse cabinets and vaults.
- ⑨ The RTE Type SD or Combined Technologies B0I 150 amp cable pole CLF should be used for this application.
- ⑩ When changing SID/SDS from 2.4kV to 6.9kV follow Bay-o-net fuse chart listed:

SID/SDS	2.4kV	6.9kV
25kVA	15 amp	6 amp
50kVA	40 amp	12 amp
75kVA	50 amp	15 amp

Series/multiple primary transformers are supplied with 2.4kV fuse.

- ⑪ When changing PZR/PZB/PZS/PXS from 4kV to 12kV follow Bay-o-net fuse chart listed:

PZR/PZB/PZS/PXS	4kV	12kV
75kVA	15 amp	6 amp
150kVA	30 amp	12 amp
225kVA	40 amp	15 amp
500kVA	100 amp	40 amp

Series/multiple primary transformers are supplied with 4160 volt fuse.

- ⑫ NES – replacement for "YES" and "HSS"
- ⑬ 18A Fused elbow is no longer purchased.
- ⑭ Fused elbows should never be installed to serve unfused 12kV transformers.
- ⑮ This fuse is only used in PME 9 and PME 11 switchgear.

© 1998 - 2012 San Diego Gas & Electric Company. All rights reserved. Removal of this copyright notice without permission is not permitted under law.

<input checked="" type="checkbox"/>	Indicates Latest Revision	<input type="checkbox"/>	Completely Revised	<input type="checkbox"/>	New Page	<input type="checkbox"/>	Information Removed
REVISION	SDG&E DISTRIBUTION DESIGN MANUAL						6131.7
DATE 2-8-2012	UNDERGROUND TRANSFORMER/FUSE						
APPD JCE /MJC	COORDINATION TABLES						

SCOPE

The following criteria shall be followed when using current-limiting protecting fuse coordination tables.

DEFINITION

Protecting Fuse – refers to the fuse closest to the load with respect to the "protected" fuse.

CURRENT-LIMITING PROTECTING FUSE COORDINATION TABLE

To insure that proper coordination is obtained between protecting and protected fuses, the following information is required:

1. The size and type of current-limiting fuse, (e.g., 30 amp EOD/EJO-1)
2. The type of protected sectionalizing fuse to be sized, (e.g., SM-4)
3. The maximum available fault current at the protecting fuse location.

Example:

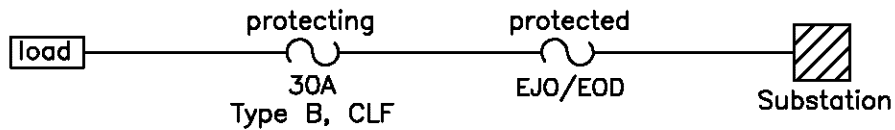

Maximum protecting available fault current at the 30 amp fuse is 1200 amps.

The minimum size protected fuse required for coordination is a 100 amp, EJO/EOD (refer to page 6132.2).

	Indicates Latest Revision	Completely Revised	New Page	Information Removed
REVISION	SDG&E ELECTRIC STANDARDS			6132.1
DATE 1-1-2000	CURRENT-LIMITING PROTECTING FUSE COORDINATION TABLES			
APPD JCE/ <i>vd</i>				

PROTECTING FUSE TYPE LINK RATING (AMPERES)	PROTECTED FUSE TYPE & LINK RATING (AMPERES)													
	GE EJO-1 COMBINED TECHNOLOGIES EOD/SD								KEARNEY TYPE A				COOPER X-LIMITER	
	30	40	50	65	80	100	150	200	30	40	50	65	140A	
	(A)		(A)	(A)					(A)		(A)			
I_f , MAXIMUM R.M.S. AMPERES FOR SAFE COORDINATION														
GE EJO-1 COMBINED TECHNOLOGIES EOD/SD	30	-	-	250	680	1200	1500	*	*	-	-	700	1000	*
	40	-	-	-	510	1000	1400	*	*	-	-	650	900	*
	50	-	-	-	-	720	1250	2700	*	-	-	-	800	*
	65	-	-	-	-	-	780	2500	*	-	-	-	-	*
	80	-	-	-	-	-	-	2000	3500	-	-	-	-	4100
	100	-	-	-	-	-	-	1500	3000	-	-	-	-	-
	150	-	-	-	-	-	-	-	-	-	-	-	-	-
	200	-	-	-	-	-	-	-	-	-	-	-	-	-
KEARNEY TYPE B	30	-	-	-	-	-	*	*	*	-	-	100	*	*
	80	-	-	-	-	-	250	*	*	-	-	-	-	-
	150	-	-	-	-	-	-	-	-	-	-	-	-	-
KEARNEY TYPE A	30	-	-	130	*	*	*	*	*	-	-	*	*	*
	40	-	-	100	*	*	*	*	*	-	-	850	*	*
	50	-	-	-	-	-	-	*	*	-	-	-	-	*
	65	-	-	-	-	-	-	*	*	-	-	-	-	*
McGRAW-EDISON/COOPER NX	8	*	*	*	*	*	*	*	*	*	*	*	*	*
	10	130	400	*	*	*	*	*	*	180	400	*	*	*
	12	70	120	450	*	*	*	*	*	120	200	*	*	*
	18	-	-	-	*	*	*	*	*	55	90	*	*	*
	20	-	-	-	150	*	*	*	*	50	80	*	*	*
	25	-	-	-	-	200	*	*	*	-	70	800	*	*
	30	-	-	-	-	-	250	*	*	-	-	150	850	*
	40	-	-	-	-	-	-	*	*	-	-	-	160	*
ELASTIMOLD FUSED ELBOW	18	-	-	-	170	*	*	*	*	55	100	*	*	*
	30	-	-	-	-	-	310	*	*	-	-	230	500	*

NOTES:

- Both protecting and protected fuses are at the same voltage level.
- * Will coordinate for all I_f .
- Will not coordinate for any I_f .
- (A) NOT BEING ORDERED

	Indicates Latest Revision	Completely Revised	New Page
6132.2	SDG&E DISTRIBUTION DESIGN MANUAL		
	CURRENT-LIMITING PROTECTING FUSE COORDINATION TABLES		
	REVISION		
	DATE 1-1-2000		
	APPD JCE / <i>vdh</i>		

PROTECTING FUSE TYPE LINK RATING (AMPERES)	PROTECTED FUSE TYPE & LINK RATING (AMPERES)																
	S&C SM-4											KEARNEY TYPE B			COOPER ELF		
	10	15	30	40	50	65	80	100	125	150	200	30	80	150	30	65	
	I_f , MAXIMUM R.M.S. AMPERES FOR SAFE COORDINATION																
GE EJO-1 COMBINED TECHNOLOGIES EOD/SD	30	-	-	-	1400	*	*	*	*	*	*	*	-	-	2000	-	1500
	40	-	-	-	-	-	*	*	*	*	*	*	-	-	1900	-	1300
	50	-	-	-	-	-	-	*	*	*	*	*	-	-	1700	-	1200
	65	-	-	-	-	-	-	-	3700	*	*	*	-	-	1600	-	-
	80	-	-	-	-	-	-	-	-	5000	*	*	-	-	1500	-	-
	100	-	-	-	-	-	-	-	-	4500	6000	-	-	-	1400	-	-
	150	-	-	-	-	-	-	-	-	-	-	-	-	-	-	-	-
	200	-	-	-	-	-	-	-	-	-	-	-	-	-	-	-	-
KEARNEY TYPE B	30	-	-	-	-	-	*	*	*	*	*	*	-	-	*	-	-
	80	-	-	-	-	-	-	*	*	*	*	-	-	*	-	-	
	150	-	-	-	-	-	-	-	-	-	-	-	-	-	-	-	
KEARNEY TYPE A	30	-	-	-	-	*	*	*	*	*	*	*	-	*	*	-	*
	40	-	-	-	-	-	*	*	*	*	*	*	-	*	*	-	*
	50	-	-	-	-	-	-	-	*	*	*	-	-	*	-	-	
	65	-	-	-	-	-	-	-	-	*	*	-	-	*	-	-	
McGRAW-EDISON/COOPER NX	8	-	-	*	*	*	*	*	*	*	*	*	*	*	*	*	*
	10	-	-	*	*	*	*	*	*	*	*	*	-	*	*	*	*
	12	-	-	*	*	*	*	*	*	*	*	*	-	*	*	*	*
	18	-	-	-	-	*	*	*	*	*	*	*	-	*	*	50	*
	20	-	-	-	-	-	*	*	*	*	*	*	-	*	*	55	*
	25	-	-	-	-	-	-	*	*	*	*	*	-	*	*	-	*
	30	-	-	-	-	-	-	-	*	*	*	*	-	-	*	-	*
	40	-	-	-	-	-	-	-	-	*	*	*	-	-	*	-	-
ELASTIMOLD FUDED ELBOW	18	-	-	-	-	*	*	*	*	*	*	*	-	*	*	57	*
	30	-	-	-	-	-	-	*	*	*	*	*	-	-	*	-	*

NOTES:

- Both protecting and protected fuses are at the same voltage level.
- * Will coordinate for all I_f .
 - Will not coordinate within current-limiting region.

	Indicates Latest Revision	Completely Revised	New Page
REVISION	SDG&E DISTRIBUTION DESIGN MANUAL		
DATE 1-1-2000 APPD JCE / <i>vd</i>	CURRENT-LIMITING PROTECTING FUSE COORDINATION TABLES		6132.3

PROTECTING FUSE TYPE LINK RATING (AMPERES)	PROTECTED FUSE TYPE & LINK RATING (AMPERES)													
	KEARNEY QA													RTE
	15	20	25	30	40	50	60	75	100	125	150	200	150	
	I_f , MAXIMUM R.M.S. AMPERES FOR SAFE COORDINATION													
GE EJO-1 COMBINED TECHNOLOGIES EOD/SD	30	-	-	-	-	-	-	1700	*	*	*	*	*	*
	40	-	-	-	-	-	-	-	*	*	*	*	*	*
	50	-	-	-	-	-	-	-	-	*	*	*	*	*
	65	-	-	-	-	-	-	-	-	-	*	*	*	*
	80	-	-	-	-	-	-	-	-	-	-	5000	*	2000
	100	-	-	-	-	-	-	-	-	-	-	-	*	-
	150	-	-	-	-	-	-	-	-	-	-	-	-	7500
	200	-	-	-	-	-	-	-	-	-	-	-	-	-
KEARNEY TYPE B	30	-	-	-	-	-	-	-	-	*	*	*	*	*
	80	-	-	-	-	-	-	-	-	-	-	*	*	*
	150	-	-	-	-	-	-	-	-	-	-	-	-	-
KEARNEY TYPE A	30	-	-	-	-	-	-	*	*	*	*	*	*	*
	40	-	-	-	-	-	-	-	*	*	*	*	*	*
	50	-	-	-	-	-	-	-	-	-	*	*	*	*
	65	-	-	-	-	-	-	-	-	-	-	-	-	*
McGRAW-EDISON/COOPER NX	8	-	-	*	*	*	*	*	*	*	*	*	*	*
	10	-	-	-	*	*	*	*	*	*	*	*	*	*
	12	-	-	-	-	*	*	*	*	*	*	*	*	*
	18	-	-	-	-	-	-	-	*	*	*	*	*	*
	20	-	-	-	-	-	-	-	*	*	*	*	*	*
	25	-	-	-	-	-	-	-	-	*	*	*	*	*
	30	-	-	-	-	-	-	-	-	-	*	*	*	*
	40	-	-	-	-	-	-	-	-	-	-	*	*	*
ELASTIMOLD FUUSED ELBOW	18	-	-	-	-	-	-	*	*	*	*	*	*	*
	30	-	-	-	-	-	-	-	-	*	*	*	*	*
RTE	150	-	-	-	-	-	-	-	-	-	-	*	-	
COOPER ELF	30	-	-	-	-	-	-	-	*	*	*	*	*	*
	65	-	-	-	-	-	-	-	-	-	-	*	*	*

NOTES:

- Both protecting and protected fuses are at the same voltage level.
- * Will coordinate for all I_f .
 - Will not coordinate within current-limiting region.

	Indicates Latest Revision	Completely Revised	New Page
6132.4	SDG&E DISTRIBUTION DESIGN MANUAL		REVISION
	CURRENT-LIMITING PROTECTING FUSE COORDINATION TABLES		DATE 1-1-2000 APPD JCE / <i>vd</i>

PROTECTING FUSE TYPE LINK RATING (AMPERES)		PROTECTED FUSE TYPE & LINK RATING (AMPERES)									
		McGRAW-EDISON/COOPER NX								ELASTIMOLD FUSED ELBOW	
		8	10	12	18	20	25	30	40	18 ^(A)	30
		I_f , MAXIMUM R.M.S. AMPERES FOR SAFE COORDINATION									
KEARNEY TYPE A	30	-	-	-	-	-	-	*	*	-	-
	40	-	-	-	-	-	-	-	*	-	-
	50	-	-	-	-	-	-	-	-	-	-
	65	-	-	-	-	-	-	-	-	-	-
McGRAW-EDISON/COOPER NX	8	-	*	*	*	*	*	*	*	*	*
	10	-	-	-	-	-	-	*	*	-	*
	12	-	-	-	-	-	-	-	*	-	*
	18	-	-	-	-	-	-	-	*	-	*
	20	-	-	-	-	-	-	-	*	-	-
	25	-	-	-	-	-	-	-	-	-	-
	30	-	-	-	-	-	-	-	-	-	-
	40	-	-	-	-	-	-	-	-	-	-
ELASTIMOLD FUSED ELBOW	18	-	-	-	-	-	-	-	*	-	*
	30	-	-	-	-	-	-	-	-	-	-

NOTES:

- Both protecting and protected fuses are at the same voltage level.
- * Will coordinate for all I_f .
 - Will not coordinate within current-limiting region.

(A) NOT BEING ORDERED

	Indicates Latest Revision	Completely Revised	New Page
REVISION	SDG&E DISTRIBUTION DESIGN MANUAL		6132.5
DATE 1-1-2000 APPD JCE / <i>Vcl</i>	CURRENT-LIMITING PROTECTING FUSE COORDINATION TABLES		

SCOPE

The following criteria shall be followed when using the expulsion protecting fuse coordination tables.

DEFINITION

Protecting Fuse – refers to the fuse closest to the load with respect to the "protected" fuse.

EXPULSION PROTECTING FUSE COORDINATION TABLE

To insure that proper coordination is obtained between protecting and protected fuses, the following information is required:

1. The size and type of the protecting expulsion fuse, (e.g., 40 amp QA)
2. The type of protected sectionalizing fuse to be sized, (e.g., QA)
3. The maximum available fault current at the protecting fuse location.

Example:

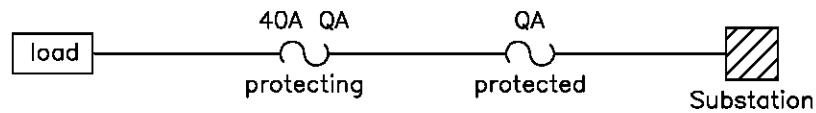

Maximum available fault current at the 40 amp protecting fuse is – 3,100 amps.

The minimum size protected fuse required for coordination is a 125 amp QA (refer to page 6133.4).

	Indicates Latest Revision	Completely Revised	New Page
REVISION	SDG&E DISTRIBUTION DESIGN MANUAL		6133.1
DATE 1-1-87	EXPULSION PROTECTING FUSE		
APPD CVN/ROJ	COORDINATION TABLES		

PROTECTING FUSE TYPE LINK RATING (AMPERES)		PROTECTED FUSE TYPE & LINK RATING (AMPERES)													
		GE EJO-1 COMBINED TECHNOLOGIES EOD/SD								KEARNEY TYPE A				COOPER X-LIMITER	
		30	40	50	65	80	100	150	200	30	40	50	65	140A	
		(A)	(A)	(A)	(A)	(A)	(A)	(A)	(A)	(A)	(A)	(A)	(A)		
		I_f , MAXIMUM R.M.S. AMPERES FOR SAFE COORDINATION													
KEARNEY QA	5	250	300	450	750	1000	1300	2500	3000	200	300	760	1000	3800	
	10 ⁽²⁾	70	100	220	550	975	1300	2500	3000	110	160	640	900	3800	
	15	-	95	200	500	910	1250	2420	3000	100	150	630	890	3800	
	20	-	85	140	250	710	1100	2400	3000	80	130	550	800	3800	
	25	-	-	130	200	500	980	2300	2900	75	120	500	700	3800	
	30	-	-	120	180	270	800	2100	2800	70	100	450	600	3800	
	40	-	-	-	160	230	450	2000	2500	-	90	350	500	3700	
	50	-	-	-	-	200	350	1750	2400	-	-	300	430	3600	
	60	-	-	-	-	190	300	1300	2000	-	-	250	350	3400	
	75	-	-	-	-	-	260	610	1100	-	-	-	300	2800	
	100	-	-	-	-	-	-	510	800	-	-	-	-	2300	
	125	-	-	-	-	-	-	450	700	-	-	-	-	1700	
	150	-	-	-	-	-	-	-	600	-	-	-	-	250	
S&C SM-4	10	70	110	200	320	600	820	1700	2000	110	150	520	700	*	
	15	60	90	140	250	500	800	1600	2000	90	130	500	620	*	
	30	-	80	120	170	230	400	1500	1800	-	-	350	450	*	
	40	-	-	110	160	220	360	1400	1600	-	-	320	430	*	
	50	-	-	-	150	200	320	1100	1400	-	-	-	370	*	
	65	-	-	-	-	-	270	700	900	-	-	-	-	*	
	80	-	-	-	-	-	-	560	700	-	-	-	-	*	
	100	-	-	-	-	-	-	500	600	-	-	-	-	*	
	125	-	-	-	-	-	-	-	500	-	-	-	-	*	
	150	-	-	-	-	-	-	-	-	-	-	-	-	*	
	200	-	-	-	-	-	-	-	-	-	-	-	-	*	

NOTES:

1. Both protecting and protected fuses are at the same voltage level.
- * Will coordinate for all I_f ,
- Will not coordinate for any I_f .
- (2) Kearney type 200
- (A) No longer purchased.

	Indicates Latest Revision	Completely Revised	New Page
6133.2	SDG&E DISTRIBUTION DESIGN MANUAL		
	EXPULSION PROTECTING FUSE COORDINATION TABLES		
	REVISION		
	DATE 1-1-2000		
	APPD JCE / <i>vel</i>		

PROTECTING FUSE TYPE LINK RATING (AMPERES)	PROTECTED FUSE TYPE & LINK RATING (AMPERES)														
	S&C SM-4											KEARNEY TYPE B			
	10	15	30	40	50	65	80	100	125	150	200	30	80	150	
	I_f , MAXIMUM R.M.S. AMPERES FOR SAFE COORDINATION														
KEARNEY QA	5	280	500	1100	1400	1500	2300	2700	3500	4500	5500	8000	340	860	1800
	10 ⁽²⁾	-	-	850	1300	1500	2300	2700	3500	4500	5500	8000	260	800	1800
	15	-	65	950	1300	1500	2300	2700	3500	4500	5500	8000	260	800	1750
	20	-	-	700	1100	1400	2200	2600	3500	4500	5500	8000	230	740	1750
	25	-	-	510	900	1300	2100	2600	3500	4500	5500	8000	220	680	1700
	30	-	-	-	700	1200	2000	2600	3500	4500	5500	8000	200	640	1600
	40	-	-	-	-	800	1900	2500	3400	4500	5500	8000	-	560	1500
	50	-	-	-	-	-	1500	2200	3400	4500	5500	8000	-	400	1450
	60	-	-	-	-	-	300	1600	3300	4000	5200	7900	-	240	1350
	75	-	-	-	-	-	-	220	2700	3500	4900	7300	-	170	1050
	100	-	-	-	-	-	-	-	1300	2000	4000	6800	-	-	640
	125	-	-	-	-	-	-	-	200	330	2300	6000	-	-	440
	150	-	-	-	-	-	-	-	-	-	-	4500	-	-	-
S&C SM-4	10	-	150	600	760	1000	1500	2000	2500	3300	4000	6100	250	700	1500
	15	-	-	470	700	900	1400	1800	2300	3300	4000	6100	220	640	1400
	30	-	-	-	120	420	1100	1500	2200	3300	4000	6000	180	470	1350
	40	-	-	-	-	180	900	1400	2100	3000	4000	6000	-	360	1300
	50	-	-	-	-	-	390	1100	1800	2900	3900	5800	-	250	1300
	65	-	-	-	-	-	-	230	1100	2400	3900	5300	-	-	1000
	80	-	-	-	-	-	-	-	280	1900	3200	5100	-	-	700
	100	-	-	-	-	-	-	-	-	540	2300	4700	-	-	500
	125	-	-	-	-	-	-	-	-	-	450	3400	-	-	-
	150	-	-	-	-	-	-	-	-	-	-	1900	-	-	-
200	-	-	-	-	-	-	-	-	-	-	-	-	-	-	

NOTES:

1. Both protecting and protected fuses are at the same voltage level.

* Will coordinate for all I_f .

- Will not coordinate for any I_f .

(2) Kearney type 200.

	Indicates Latest Revision	Completely Revised	New Page
REVISION	SDG&E DISTRIBUTION DESIGN MANUAL		
DATE 1-1-2000 APPD JCE / <i>vel</i>	EXPULSION PROTECTING FUSE COORDINATION TABLES		6133.3

PROTECTING FUSE TYPE LINK RATING (AMPERES)	PROTECTED FUSE TYPE & LINK RATING (AMPERES)														
	KEARNEY QA														RTE
	10	15	20	25	30	40	50	60	75	100	125	150	200	150	
	I_f , MAXIMUM R.M.S. AMPERES FOR SAFE COORDINATION														
KEARNEY QA	5	180	290	500	600	800	1000	1300	1500	2200	2800	3500	4500	7000	2500
	10 ^②	-	-	90	350	540	810	1250	1500	2200	2800	3500	4500	7000	2500
	15	-	-	70	260	500	800	1200	1500	2200	2800	3500	4500	7000	2400
	20	-	-	-	-	140	550	900	1300	2100	2800	3500	4500	7000	2300
	25	-	-	-	-	50	300	750	1200	2000	2700	3500	4500	7000	2300
	30	-	-	-	-	-	85	450	950	1800	2600	3500	4500	7000	2200
	40	-	-	-	-	-	-	70	550	1600	2400	3300	4400	7000	2050
	50	-	-	-	-	-	-	-	-	1300	2200	3000	4100	7000	1900
	60	-	-	-	-	-	-	-	-	150	1600	2600	3900	6700	1600
	75	-	-	-	-	-	-	-	-	-	200	1400	3000	6200	1100
	100	-	-	-	-	-	-	-	-	-	-	210	1900	5500	800
	125	-	-	-	-	-	-	-	-	-	-	-	-	4000	600
	150	-	-	-	-	-	-	-	-	-	-	-	-	3300	-
S&C SM-4	10	-	-	110	220	330	480	660	880	1350	1850	2400	3200	5000	1700
	15	-	-	-	-	160	400	620	850	1350	1850	2400	3200	5000	1650
	30	-	-	-	-	-	-	-	350	1050	1600	2250	3000	5000	1600
	40	-	-	-	-	-	-	-	-	800	1400	2100	2900	4900	1500
	50	-	-	-	-	-	-	-	-	-	1150	1900	2800	4800	1350
	65	-	-	-	-	-	-	-	-	-	-	1300	2400	4500	1050
	80	-	-	-	-	-	-	-	-	-	-	-	1900	4100	890
	100	-	-	-	-	-	-	-	-	-	-	-	-	3500	-
	125	-	-	-	-	-	-	-	-	-	-	-	-	1800	-
	150	-	-	-	-	-	-	-	-	-	-	-	-	-	-
200	-	-	-	-	-	-	-	-	-	-	-	-	-	-	

NOTES:

1. Both protecting and protected fuses are at the same voltage level.
- * Will coordinate for all I_f .
- Will not coordinate for any I_f .
- ② Kearney type 200.

	Indicates Latest Revision	Completely Revised	New Page
6133.4	SDG&E DISTRIBUTION DESIGN MANUAL		REVISION
	EXPULSION PROTECTING FUSE COORDINATION TABLES		DATE 1-1-2000 APPD JCE / <i>vd</i>

PROTECTING FUSE TYPE LINK RATING (AMPERES)	PROTECTED FUSE TYPE & LINK RATING (AMPERES)												
	McGRAW-EDISON/COOPER NX								ELASTIMOLD FUUSED ELBOW		COPPER ELF		
	8	10	12	18	20	25	30	40	18 ^(A)	30	30	65	
	I_f , MAXIMUM R.M.S. AMPERES FOR SAFE COORDINATION												
KEARNEY QA	5	32	70	150	240	300	350	580	800	350	700	*	*
	10 ⁽²⁾	-	-	50	140	190	250	470	750	250	650	*	*
	15	-	-	45	130	170	220	430	690	220	600	*	*
	20	-	-	-	110	140	190	370	590	170	500	*	*
	25	-	-	-	100	130	160	330	500	140	400	*	*
	30	-	-	-	-	-	150	290	460	-	270	*	*
	40	-	-	-	-	-	-	250	400	-	220	-	*
	50	-	-	-	-	-	-	-	350	-	-	-	*
	60	-	-	-	-	-	-	-	-	-	-	-	*
	75	-	-	-	-	-	-	-	-	-	-	-	-
	100	-	-	-	-	-	-	-	-	-	-	-	-
	125	-	-	-	-	-	-	-	-	-	-	-	-
	150	-	-	-	-	-	-	-	-	-	-	-	-
S&C SM-4	10	-	-	54	150	180	230	400	580	240	500	520	1400
	15	-	-	-	120	150	200	320	520	190	450	450	1200
	30	-	-	-	-	-	-	-	430	-	-	-	900
	40	-	-	-	-	-	-	-	-	-	-	-	880
	50	-	-	-	-	-	-	-	-	-	-	-	-
	65	-	-	-	-	-	-	-	-	-	-	-	-
	80	-	-	-	-	-	-	-	-	-	-	-	-
	100	-	-	-	-	-	-	-	-	-	-	-	-
	125	-	-	-	-	-	-	-	-	-	-	-	-
	150	-	-	-	-	-	-	-	-	-	-	-	-
	200	-	-	-	-	-	-	-	-	-	-	-	-

NOTES:

1. Both protecting and protected fuses are at the same voltage level.

* Will coordinate for all I_f .

- Will not coordinate for any I_f .

(2) Kearney type 200.

(A) Not being ordered

	 Indicates Latest Revision	Completely Revised	New Page
REVISION	SDG&E DISTRIBUTION DESIGN MANUAL		
DATE 1-1-2000	EXPULSION PROTECTING FUSE		
APPD JCE/ <i>vdh</i>	COORDINATION TABLES		
			6133.5

PROTECTING FUSE TYPE LINK RATING (AMPERES)		PROTECTED FUSE TYPE & LINK RATING (AMPERES)											
		GE EJO-1 COMBINED TECHNOLOGIES EOD/SD								KEARNEY TYPE A			
		30	40	50	65	80	100	150	200	30	40	50	65
		I_f , MAXIMUM R.M.S. AMPERES FOR SAFE COORDINATION											
GE D&W (at 4kV)	6	*	*	*	*	*	*	*	*	*	*	*	*
	10	*	*	*	*	*	*	*	*	*	*	*	*
	15	*	*	*	*	*	*	*	*	*	*	*	*
	20	*	*	*	*	*	*	*	*	*	*	*	*
	25	180	*	*	*	*	*	*	*	190	*	*	*
	30	90	190	*	*	*	*	*	*	140	230	*	*
	40	70	120	300	*	*	*	*	*	120	170	*	*
	50	-	95	170	500	*	*	*	*	95	140	670	*
	65	-	-	140	250	600	1500	*	*	80	130	500	710
	75	-	-	-	180	260	620	*	*	-	110	400	600
	100	-	-	-	170	250	440	2000	*	-	100	370	500
	125	-	-	-	-	210	370	1600	*	-	-	330	450
	150	-	-	-	-	-	300	900	2200	-	-	250	340

NOTES:

- Both protecting and protected fuses are at the same voltage level.
- * Will coordinate for all I_f .
 - Will not coordinate for any I_f .

	Indicates Latest Revision	Completely Revised	New Page
6133.6	SDG&E DISTRIBUTION DESIGN MANUAL		REVISION
	EXPULSION PROTECTING FUSE COORDINATION TABLES		DATE 1-1-2000 APPD JCE/ <i>JK</i>

PROTECTING FUSE TYPE LINK RATING (AMPERES)	PROTECTED FUSE TYPE & LINK RATING (AMPERES)														
	S&C SM-4											KEARNEY TYPE B			
	10	15	30	40	50	65	80	100	125	150	200	30	80	150	
	I_f , MAXIMUM R.M.S. AMPERES FOR SAFE COORDINATION														
GE D&W (at 4kV)	6	*	*	*	*	*	*	*	*	*	*	*	*	*	*
	10	*	*	*	*	*	*	*	*	*	*	*	*	*	*
	15	*	*	*	*	*	*	*	*	*	*	*	*	*	*
	20	*	*	*	*	*	*	*	*	*	*	*	*	*	*
	25	*	*	*	*	*	*	*	*	*	*	*	*	*	*
	30	-	*	*	*	*	*	*	*	*	*	*	330	*	*
	40	-	270	*	*	*	*	*	*	*	*	*	270	*	*
	50	-	-	*	*	*	*	*	*	*	*	*	250	850	*
	65	-	-	600	1100	*	*	*	*	*	*	*	230	700	*
	75	-	-	-	440	1000	*	*	*	*	*	*	190	650	1700
	100	-	-	-	200	560	1500	*	*	*	*	*	180	500	1500
	125	-	-	-	-	200	1200	2100	*	*	*	*	170	440	1400
	150	-	-	-	-	-	150	1000	8000	*	*	*	-	200	1300

NOTES:

- Protecting fuse is on 4kV and protected fuses on 12kV.
- * Will coordinate for all I_f .
 - Will not coordinate for any I_f .

	 Indicates Latest Revision	Completely Revised	New Page
REVISION	SDG&E DISTRIBUTION DESIGN MANUAL		
DATE 1-1-2000 APPD JCE/ <i>vd</i>	EXPULSION PROTECTING FUSE COORDINATING TABLES		6133.7

PROTECTING FUSE TYPE LINK RATING (AMPERES)	PROTECTED FUSE TYPE & LINK RATING (AMPERES) AT 12KV														
	KEARNEY QA													RTE	COOPER X-LIMITER
	10 ^②	15	20	25	30	40	50	60	75	100	125	150	150	140	
	I_f , MAXIMUM R.M.S. AMPERES FOR SAFE COORDINATION (at 12kV)														
GE D&W (at 4kV)	6	*	*	*	*	*	*	*	*	*	*	*	*	*	
	10	*	*	*	*	*	*	*	*	*	*	*	*	*	
	15	*	*	*	*	*	*	*	*	*	*	*	*	*	
	20	*	*	*	*	*	*	*	*	*	*	*	*	*	
	25	*	*	*	*	*	*	*	*	*	*	*	*	*	
	30	120	-	*	*	*	*	*	*	*	*	*	*	*	
	40	-	-	250	*	*	*	*	*	*	*	*	*	*	
	50	-	-	-	-	450	*	*	*	*	*	*	*	*	
	65	-	-	-	-	-	430	*	*	*	*	*	*	2600	
	75	-	-	-	-	-	-	300	*	*	*	*	*	1800	
	100	-	-	-	-	-	-	110	*	*	*	*	*	1400	
	125	-	-	-	-	-	-	-	-	1000	*	*	*	1250	
	150	-	-	-	-	-	-	-	-	-	1100	*	*	850	4300

NOTES:

- Protecting fuse is on 4kV and protected fuses are on 12kV.
- * Will coordinate for all I_f .
 - Will not coordinate for any I_f .

② Kearney type 200

Indicates Latest Revision Completely Revised New Page

6133.8

SDG&E DISTRIBUTION DESIGN MANUAL
EXPULSION PROTECTING FUSE
COORDINATION TABLES

REVISION
DATE 1-1-2000
APPD JCE / *JK*

PROTECTING FUSE TYPE LINK RATING (AMPERES)	PROTECTED FUSE TYPE & LINK RATING (AMPERES)												
	McGRAW-EDISON/COOPER NX								ELASTIMOLD FUSED ELBOW		COOPER ELF		
	8	10	12	18	20	25	30	40	18	30	30	65	
	I_f , MAXIMUM R.M.S. AMPERES FOR SAFE COORDINATION												
GE D&W (at 4kV)	6	100	*	*	*	*	*	*	*	*	*	*	*
	10	50	*	*	*	*	*	*	*	*	*	*	*
	15	35	140	*	*	*	*	*	*	*	*	*	*
	20	30	70	*	*	*	*	*	*	*	*	*	*
	25	25	40	120	250	*	*	*	*	*	*	*	*
	30	-	-	60	180	250	350	*	*	340	*	*	*
	40	-	-	50	150	200	280	600	*	270	*	800	*
	50	-	-	-	140	160	220	450	*	230	680	600	*
	65	-	-	-	120	150	200	360	590	180	470	500	1400
	75	-	-	-	-	-	150	300	490	-	280	-	1200
	100	-	-	-	-	-	-	290	450	-	260	-	1000
	125	-	-	-	-	-	-	-	400	-	-	-	900
	150	-	-	-	-	-	-	-	-	-	-	-	-

NOTES:

1. Protecting fuse is on 4kV and protected fuses are on 12kV.
- * Will coordinate for all I_f .
 - Will not coordinate for any I_f .

	Indicates Latest Revision	Completely Revised	New Page
REVISION	SDG&E DISTRIBUTION DESIGN MANUAL		
DATE 1-1-2000 APPD JCE / <i>Vel</i>	EXPULSION PROTECTING FUSE COORDINATING TABLES		6133.9

QA PROTECTING FUSE LINK RATING (Amperes) (at 4kV)	QA Protected Fuse Link Rating (Amperes) 12kV										
	15	20	25	30	40	50	60	75	100	125	150
	I_f , Maximum R.M.S. Amperes for Safe Coordination (at 12kV)										
10 (2)	325	500	620	780	1000	1250	1500	2200	2900	3500	4500
15	320	500	620	760	980	1200	1500	2200	2800	3500	4400
20	220	440	570	720	920	1200	1500	2200	2800	3500	4400
25	130	400	540	700	920	1200	1500	2200	2800	3500	4400
30	–	320	490	640	880	1200	1500	2200	2800	3500	4400
40	–	80	370	560	820	1150	1450	2200	2800	3500	4400
50	–	–	70	470	760	1100	1450	2200	2800	3500	4400
60	–	–	–	90	600	980	1300	2100	2700	3500	4400
75	–	–	–	–	100	550	1000	1900	2600	3400	4400
100	–	–	–	–	–	90	600	1600	2350	3200	4200
125	–	–	–	–	–	–	110	1200	2100	3000	4100
150	–	–	–	–	–	–	–	130	1700	2600	3800

NOTES:

1. Protecting QA fuse is on 4kV and protected QA fuse is on 12kV.
 - Will not coordinate for any I_f .
- (2) Kearney type 200.

	 Indicates Latest Revision	Completely Revised	New Page
6133.10	SDG&E DISTRIBUTION DESIGN MANUAL		REVISION
	EXPULSION PROTECTING FUSE COORDINATION TABLES		DATE 9-4-84 APPD CVN / <i>RDJ</i>

PROTECTED FUSE TYPE & LINK RATING (AMPERES) (AT 4KV)

GE D&W Protecting Fuse Link Rating (Amperes) (at 4kV)	RTE SD	S&C SM-4										
	150	10	15	30	40	50	65	80	100	125	150	200
	I _f , MAX. RMS AMPS FOR SAFE COORDINATION											
6	2600	*	*	*	*	*	*	*	*	*	*	*
10	2600	*	*	*	*	*	*	*	*	*	*	*
15	2600	260	*	*	*	*	*	*	*	*	*	*
20	2600	-	*	*	*	*	*	*	*	*	*	*
25	2600	-	-	*	*	*	*	*	*	*	*	*
30	2600	-	-	*	*	*	*	*	*	*	*	*
40	2600	-	-	600	*	*	*	*	*	*	*	*
50	2300	-	-	-	-	1300	*	*	*	*	*	*
65	1400	-	-	-	-	-	1400	2750	*	*	*	*
75	1000	-	-	-	-	-	-	720	2600	*	*	*
100	870	-	-	-	-	-	-	-	1500	3600	7200	*
125	-	-	-	-	-	-	-	-	-	2900	7000	*
150	-	-	-	-	-	-	-	-	-	-	-	*

NOTES:

- Both protecting and protected fuses are 4kV.
- Will not coordinate for any I_f.

	 Indicates Latest Revision	Completely Revised	New Page
REVISION	SDG&E DISTRIBUTION DESIGN MANUAL		6133.11
DATE 1-1-2000	EXPULSION PROTECTING FUSE		
APPD JCE / <i>vdh</i>	COORDINATION TABLES		

GE D&W Protecting Fuse Link Rating (Amperes) (at 4kV)	QA Protected Fuse Link Rating at 4kV (Amperes)												
	10 ^②	15	20	25	30	40	50	60	75	100	125	150	
	I _f , Maximum R.M.S. Amperes for Safe Coordination												
6	350	630	530	650	770	980	1250	1550	2250	2800	3600	4400	
10	130	610	530	650	770	980	1250	1550	2250	2800	3600	4400	
15	-	-	400	650	770	980	1250	1550	2250	2800	3600	4400	
20	-	-	-	-	770	980	1250	1550	2250	2800	3600	4400	
25	-	-	-	-	-	980	1250	1550	2250	2800	3600	4400	
30	-	-	-	-	-	-	900	1550	2250	2800	3600	4400	
40	-	-	-	-	-	-	-	800	2250	2800	3600	4400	
50	-	-	-	-	-	-	-	-	1300	2800	3600	4400	
65	-	-	-	-	-	-	-	-	-	1200	2800	4400	
75	-	-	-	-	-	-	-	-	-	-	600	2900	
100	-	-	-	-	-	-	-	-	-	-	-	1500	
125	-	-	-	-	-	-	-	-	-	-	-	-	
150	-	-	-	-	-	-	-	-	-	-	-	-	

NOTES:

1. Both protecting and protected fuses are on 4kV.
 - Will not coordinate at any I_f.

② Kearney type 200.

	Indicates Latest Revision	Completely Revised	New Page
6133.12	SDG&E DISTRIBUTION DESIGN MANUAL		REVISION
	EXPULSION PROTECTING FUSE COORDINATION TABLES		DATE 1-1-2000 APPD JCE / <i>vd</i>

GE D&W Protecting Fuse Link Rating (Amperes) (at 4kV)	QA Protected Fuse Link Rating at 4kV (Amperes)													
	6	10	15	20	25	30	40	50	65	75	100	125	150	
	I_f , Maximum R.M.S. Amperes for Safe Coordination													
6	-	23	90	230	*	*	*	*	*	*	*	*	*	*
10	-	-	29	100	450	*	*	*	*	*	*	*	*	*
15	-	-	-	45	200	*	*	*	*	*	*	*	*	*
20	-	-	-	-	60	400	*	*	*	*	*	*	*	*
25	-	-	-	-	-	-	420	*	*	*	*	*	*	*
30	-	-	-	-	-	-	-	520	*	*	*	*	*	*
40	-	-	-	-	-	-	-	-	590	*	*	*	*	*
50	-	-	-	-	-	-	-	-	-	*	*	*	*	*
65	-	-	-	-	-	-	-	-	-	200	700	1700	5000	
75	-	-	-	-	-	-	-	-	-	-	-	500	2000	
100	-	-	-	-	-	-	-	-	-	-	-	-	-	1500
125	-	-	-	-	-	-	-	-	-	-	-	-	-	900
150	-	-	-	-	-	-	-	-	-	-	-	-	-	-

NOTES:

- Both protecting and protected fuses are on 4kV.
 - Will not coordinate at any I_f .

② Kearney type 200.

	 Indicates Latest Revision	Completely Revised	New Page
REVISION	SDG&E DISTRIBUTION DESIGN MANUAL		
DATE 1-1-2000 APPD JCE / <i>vdh</i>	EXPULSION PROTECTING FUSE COORDINATION TABLES		6133.13

GE D&W Protecting Fuse Link Rating (Amperes) (at 4kV)	GE D&W Protected Fuse Type & Link Rating at 4kV (Amperes)															
	6	10	15	20	25	30	40	50	65	75	100	125	140	150	200	
	I _f , Maximum R.M.S. Amperes for Safe Coordination															
6	-	75	180	*	*	*	*	*	*	*	*	*	*	*	*	
10	-	-	55	170	*	*	*	*	*	*	*	*	*	*	*	
15	-	-	-	70	*	*	*	*	*	*	*	*	*	*	*	
20	-	-	-	-	180	*	*	*	*	*	*	*	*	*	*	
25	-	-	-	-	-	-	1000	*	*	*	*	*	*	*	*	
30	-	-	-	-	-	-	-	*	*	*	*	*	*	*	*	
40	-	-	-	-	-	-	-	-	250	*	*	*	*	*	*	
50	-	-	-	-	-	-	-	-	-	*	*	*	*	*	*	
65	-	-	-	-	-	-	-	-	-	-	700	*	*	*	*	
75	-	-	-	-	-	-	-	-	-	-	-	900	5000	*	*	
100	-	-	-	-	-	-	-	-	-	-	-	-	500	1500	2500	*
125	-	-	-	-	-	-	-	-	-	-	-	-	-	800	1300	4600
140	-	-	-	-	-	-	-	-	-	-	-	-	-	-	-	3000
150	-	-	-	-	-	-	-	-	-	-	-	-	-	-	-	-
200	-	-	-	-	-	-	-	-	-	-	-	-	-	-	-	-

NOTES:

- Both protecting and protected fuses are on 4kV.
- Will not coordinate for any I_f.
- * Will coordinate for all I_f.





	<input type="checkbox"/> Indicates Latest Revision	<input type="checkbox"/> Completely Revised	<input checked="" type="checkbox"/> New Page
6133.14	SDG&E DISTRIBUTION DESIGN MANUAL		REVISION
	EXPULSION PROTECTING FUSE COORDINATION TABLES		DATE 3-1-02 APPD JCE / <i>vd</i>

PROTECTING FUSE TYPE LINK RATING (AMPERES)		MVI QA PROTECTED FUSE TYPE (AMPERES)								
		20	30	40	50	65	80	100	125	150
		I_f , MAXIMUM R.M.S. AMPERES FOR SAFE COORDINATION								
GE EJO-1 COMBINED TECHNOLOGIES EOD/SD	30	-	-	*	*	*	*	*	*	*
	40	-	-	-	-	*	*	*	*	*
	50	-	-	-	-	*	*	*	*	*
	65	-	-	-	-	-	-	*	*	*
	80	-	-	-	-	-	-	-	*	*
	100	-	-	-	-	-	-	-	-	-
	150	-	-	-	-	-	-	-	-	-
	200	-	-	-	-	-	-	-	-	-
MCGRAW-EDISON COOPER NX	8	*	*	*	*	*	*	*	*	*
	10	-	*	*	*	*	*	*	*	*
	12	-	*	*	*	*	*	*	*	*
	18	-	-	-	*	*	*	*	*	*
	20	-	-	-	-	*	*	*	*	*
	25	-	-	-	-	*	*	*	*	*
	30	-	-	-	-	-	-	*	*	*
	40	-	-	-	-	-	-	-	*	*
ELASTIMOLD FUSED ELBOW	18	-	*	*	*	*	*	*	*	*
	30	-	-	-	-	*	*	*	*	*
COOPER ELF	30	-	-	-	-	*	*	*	*	*
	65	-	-	-	-	-	-	-	*	*

NOTES:

- Both protecting and protected fuses are at the same voltage level.
- * Will coordinate for all I_f .
 - Will not coordinate for any I_f .
- MVI needs a minimum 15A current to operate.

© 1998 - 2009 San Diego Gas & Electric Company. All rights reserved. Removal of this copyright notice without permission is not permitted under law.

	 Indicates Latest Revision	 Completely Revised	 New Page	 Information Removed
REVISION	SDG&E DISTRIBUTION DESIGN MANUAL			
DATE 6-8-09 APPD BV / MC	MVI FUSE COORDINATION TABLES			6133.15

MVI QA PROTECTING FUSE LINK (AMPERES)	MVI QA PROTECTED FUSE TYPE (AMPERES)								
	20	30	40	50	65	80	100	125	150
	I _f , MAXIMUM R.M.S. AMPERES FOR SAFE COORDINATION								
20	–	*	*	*	*	*	*	*	*
30	–	–	–	*	*	*	*	*	*
40	–	–	–	–	*	*	*	*	*
50	–	–	–	–	–	*	*	*	*
65	–	–	–	–	–	800	*	*	*
80	–	–	–	–	–	–	1000	*	*
100	–	–	–	–	–	–	–	1800	*
125	–	–	–	–	–	–	–	–	1600
150	–	–	–	–	–	–	–	–	–

NOTES:

- Both protecting and protected fuses are at the same voltage level.
- * Will coordinate for all I_f .
 - Will not coordinate for any I_f .
- MVI needs a minimum 15A current to operate.

MVI QA PROTECTING (AT 4KV) (AMPERES)	MVI QA PROTECTED FUSE TYPE 12KV (AMPERES)								
	20	30	40	50	65	80	100	125	150
	I _f , MAXIMUM R.M.S. AMPERES FOR SAFE COORDINATION								
15	950	1380	1900	2360	3100	3700	4750	6500	7800
20	950	1380	1900	2360	3100	3700	4750	6500	7800
25	950	1380	1900	2360	3100	3700	4750	6500	7800
30	950	1380	1900	2360	3100	3700	4750	6500	7800
40	950	1380	1900	2360	3100	3700	4750	6500	7800
50	760	1380	1900	2360	3100	3700	4750	6500	7800
60	–	1380	1900	2360	3100	3700	4750	6500	7800
75	–	990	1800	2360	3100	3700	4750	6500	7800
100	–	–	1350	2250	3100	3700	4750	6500	7800
125	–	–	–	1450	3000	3500	4750	6500	7800
150	–	–	–	–	2500	3550	4750	6500	7800

NOTES:

- Protecting fuse is on 4kv and protected fuses are on 12kv.
- * Will coordinate for all I_f .
 - Will not coordinate for any I_f .

© 1998 - 2010 San Diego Gas & Electric Company. All rights reserved. Removal of this copyright notice without permission is not permitted under law.

	 Indicates Latest Revision	Completely Revised	<input checked="" type="checkbox"/> New Page	Information Removed
6133.16	SDG&E DISTRIBUTION DESIGN MANUAL			REVISION
	MVI FUSE COORDINATION TABLES			DATE 2-17-10 APPD BV / MC

QA PROTECTING FUSE LINK (AMPERES)	MVI QA PROTECTED FUSE CURVE TYPE (AMPERES)								
	20	30	40	50	65	80	100	125	150
	I _f , MAXIMUM R.M.S. AMPERES FOR SAFE COORDINATION								
15	290	460	620	770	990	1235	1535	2080	2560
20	–	440	620	770	990	1235	1535	2080	2560
25	–	340	620	770	990	1235	1535	2080	2560
30	–	–	545	770	990	1235	1535	2080	2560
40	–	–	–	645	990	1235	1535	2080	2560
50	–	–	–	–	930	1235	1535	2080	2560
60	–	–	–	–	550	1135	1535	2080	2560
75	–	–	–	–	–	–	1315	2080	2560
100	–	–	–	–	–	–	–	1875	2560
125	–	–	–	–	–	–	–	–	1975
150	–	–	–	–	–	–	–	–	–

NOTES:

- Both protecting and protected fuses/devices are at the same voltage level.
- * Will coordinate for all I_f .
 - Will not coordinate for any I_f .

QA PROTECTING FUSE LINK (at 4kV (AMPERES)	MVI QA PROTECTED FUSE CURVE TYPE 12 kV (AMPERES)								
	20	30	40	50	65	80	100	125	150
	I _f , MAXIMUM R.M.S. AMPERES FOR SAFE COORDINATION								
15	950	1380	1900	2360	3100	3700	4750	6500	7800
20	950	1380	1900	2360	3100	3700	4750	6500	7800
25	950	1380	1900	2360	3100	3700	4750	6500	7800
30	950	1380	1900	2360	3100	3700	4750	6500	7800
40	950	1380	1900	2360	3100	3700	4750	6500	7800
50	760	1380	1900	2360	3100	3700	4750	6500	7800
60	–	1380	1900	2360	3100	3700	4750	6500	7800
75	–	990	1800	2360	3100	3700	4750	6500	7800
100	–	–	1350	2250	3100	3700	4750	6500	7800
125	–	–	–	1450	3000	3500	4750	6500	7800
150	–	–	–	–	2500	3550	4750	6500	7800

NOTES:

- Protecting fuse/device is on 4kV and protected fuse/device is on 12kV.
- * Will coordinate for all I_f .
 - Will not coordinate for any I_f .

© 1998 - 2010 San Diego Gas & Electric Company. All rights reserved. Removal of this copyright notice without permission is not permitted under law.

	Indicates Latest Revision	Completely Revised	<input checked="" type="checkbox"/> New Page	Information Removed
REVISION	SDG&E DISTRIBUTION DESIGN MANUAL			
DATE 5-7-10	MVI FUSE			6133.17
APPD BV / MC	COORDINATION TABLES			

MVI QA PROTECTING FUSE CURVE LINK (AMPERES) (AT 4KV)	MVI QA PROTECTED FUSE CURVE TYPE 12KV (AMPERES)								
	20	30	40	50	65	80	100	125	150
	I_f , MAXIMUM R.M.S. AMPERES FOR SAFE COORDINATION								
20	*	*	*	*	*	*	*	*	*
30	*	*	*	*	*	*	*	*	*
40	*	*	*	*	*	*	*	*	*
50	640	*	*	*	*	*	*	*	*
65	–	1250	*	*	*	*	*	*	*
80	–	650	*	*	*	*	*	*	*
100	–	–	1200	*	*	*	*	*	*
125	–	–	–	800	*	*	*	*	*
150	–	–	–	–	1800	*	*	*	*

NOTES:

- Protecting fuse/device is on 4kV and protected fuse/device are on 12kV.
- * Will coordinate for all I_f .
 - Will not coordinate for any I_f .
- MVI needs a minimum 15A current to operate.

MVI QA PROTECTING FUSE CURVE LINK (AMPERES)	QA PROTECTED FUSE CURVE TYPE (AMPERES)										
	15	20	25	30	40	50	60	75	100	125	150
	I_f , MAXIMUM R.M.S. AMPERES FOR SAFE COORDINATION										
20	–	–	–	–	595	745	950	1330	1690	2170	2730
30	–	–	–	–	–	745	950	1330	1690	2170	2730
40	–	–	–	–	–	–	–	1330	1690	2170	2730
50	–	–	–	–	–	–	–	–	1690	2170	2730
65	–	–	–	–	–	–	–	–	–	2170	2730
80	–	–	–	–	–	–	–	–	–	–	2730
100	–	–	–	–	–	–	–	–	–	–	–
125	–	–	–	–	–	–	–	–	–	–	–
150	–	–	–	–	–	–	–	–	–	–	–

NOTES:

- Both protecting and protected fuses/devices are at the same voltage level.
- * Will coordinate for all I_f .
 - Will not coordinate for any I_f .

© 1998 - 2010 San Diego Gas & Electric Company. All rights reserved. Removal of this copyright notice without permission is not permitted under law.



	<input type="checkbox"/> Indicates Latest Revision	<input type="checkbox"/> Completely Revised	<input checked="" type="checkbox"/> New Page	<input type="checkbox"/> Information Removed
6133.18	SDG&E DISTRIBUTION DESIGN MANUAL			REVISION
	MVI FUSE COORDINATION TABLES			DATE 4-28-10 APPD BV / MC

MVI QA PROTECTING FUSE LINK (AMPERES) (at 4kV)	QA PROTECTED FUSE TYPE 12kV (AMPERES)										
	15	20	25	30	40	50	60	75	100	125	150
	I_f , MAXIMUM R.M.S. AMPERES FOR SAFE COORDINATION										
20	640	910	1100	1375	1750	2150	2700	3800	4850	6300	8000
30	–	910	1100	1375	1750	2150	2700	3800	4850	6300	8000
40	–	–	1100	1375	1750	2150	2700	3800	4850	6300	8000
50	–	–	–	1375	1750	2150	2700	3800	4850	6300	8000
65	–	–	–	–	1750	2150	2700	3800	4850	6300	8000
80	–	–	–	–	–	2150	2700	3800	4850	6300	8000
100	–	–	–	–	–	–	2700	3800	4850	6300	8000
125	–	–	–	–	–	–	–	3800	4850	6300	8000
150	–	–	–	–	–	–	–	–	4850	6300	8000

NOTES:

1. Protecting fuse is on 4kV and protected fuses are on 12kV.
- * Will coordinate for all I_f .
 - Will not coordinate for any I_f .
- MVI needs a minimum 15A current to operate.

© 1998 - 2010 San Diego Gas & Electric Company. All rights reserved. Removal of this copyright notice without permission is not permitted under law.



		Indicates Latest Revision		Completely Revised		New Page		Information Removed
REVISION	SDG&E DISTRIBUTION DESIGN MANUAL							
DATE 6-10-09	MVI FUSE							
APPD BV / MC	COORDINATION TABLES							
								6133.19

MVI QA PROTECTING FUSE LINK (AMPERES)	GE EJO-1 PROTECTED FUSE LINK RATING (AMPERES)								COOPER X-LIMITER
	30	40	50	65	80	100	150	200	140
	I _f , MAXIMUM R.M.S. AMPERES FOR SAFE COORDINATION								
20	–	90	145	310	640	840	1490	1895	1950
30	–	–	115	190	325	840	1490	1895	1950
40	–	–	–	165	230	430	1490	1895	1950
50	–	–	–	155	210	345	1490	1895	1950
65	–	–	–	–	195	290	1490	1895	1950
80	–	–	–	–	–	270	690	1895	1950
100	–	–	–	–	–	–	545	975	1320
125	–	–	–	–	–	–	475	750	–
150	–	–	–	–	–	–	–	655	–

NOTES:

1. Both protecting and protected fuses are at the same voltage level.
- * Will coordinate for all I_f .
 - Will not coordinate for any I_f .
- MVI needs a minimum 15A current to operate.

© 1998 - 2009 San Diego Gas & Electric Company. All rights reserved. Removal of this copyright notice without permission is not permitted under law.

	 Indicates Latest Revision	Completely Revised	 New Page	Information Removed
6133.20	SDG&E DISTRIBUTION DESIGN MANUAL			REVISION
	MVI FUSE COORDINATION TABLES			DATE 6-10-09 APPD BV / MC

MVI QA PROTECTING FUSE LINK (AMPERES)	S & C SM-4 PROTECTED FUSE LINK RATING (AMPERES)											RTE	COOPER ELF	
	10	15	30	40	50	65	80	100	125	150	200	150	30	65
	I _f , MAXIMUM R.M.S. AMPERES FOR SAFE COORDINATION													
20	–	–	670	805	970	1350	1620	2020	2675	3260	3965	870	405	1000
30	–	–	240	805	970	1350	1620	2020	2675	3260	3965	870	–	1000
40	–	–	–	–	970	1350	1620	2020	2675	3260	3965	700	–	1000
50	–	–	–	–	–	1350	1620	2020	2675	3260	3965	495	–	850
65	–	–	–	–	–	–	1620	2020	2675	3260	3965	400	–	–
80	–	–	–	–	–	–	–	2020	2675	3260	3965	350	–	–
100	–	–	–	–	–	–	–	–	2675	3260	3965	315	–	–
125	–	–	–	–	–	–	–	–	–	3260	3965	–	–	–
150	–	–	–	–	–	–	–	–	–	–	3965	–	–	–

NOTES:

1. Both protecting and protected fuses are at the same voltage level.
- * Will coordinate for all I_f .
 - Will not coordinate for any I_f .

MVI needs a minimum 15A current to operate.

© 1998 - 2010 San Diego Gas & Electric Company. All rights reserved. Removal of this copyright notice without permission is not permitted under law.



		Indicates Latest Revision		Completely Revised	<input checked="" type="checkbox"/>	New Page		Information Removed
REVISION	SDG&E DISTRIBUTION DESIGN MANUAL							
DATE 6-10-09	MVI FUSE							
APPD BV / MC	COORDINATION TABLES							
								6133.21

MVI QA PROTECTING FUSE LINK (AMPERES)	COPPER NX PROTECTED FUSE LINK RATING (AMPERES)								ELASTIMOLD FUSED ELBOW	
	8	10	12	18	20	25	30	40	18	30
	I _f , MAXIMUM R.M.S. AMPERES FOR SAFE COORDINATION									
20	-	-	-	-	-	210	405	615	-	600
30	-	-	-	-	-	-	325	525	-	-
40	-	-	-	-	-	-	-	435	-	-
50	-	-	-	-	-	-	-	-	-	-
65	-	-	-	-	-	-	-	-	-	-
80	-	-	-	-	-	-	-	-	-	-
100	-	-	-	-	-	-	-	-	-	-
125	-	-	-	-	-	-	-	-	-	-
150	-	-	-	-	-	-	-	-	-	-

NOTES:

1. Both protecting and protected fuses are at the same voltage level.
- * Will coordinate for all I_f .
 - Will not coordinate for any I_f.
- MVI needs a minimum 15A current to operate.

© 1998 - 2010 San Diego Gas & Electric Company. All rights reserved. Removal of this copyright notice without permission is not permitted under law.

		Indicates Latest Revision		Completely Revised		New Page		Information Removed
6133.22	SDG&E DISTRIBUTION DESIGN MANUAL							REVISION
	MVI FUSE COORDINATION TABLES							DATE 6-10-09 APPD BV / MC

MVI D & W PROTECTING FUSE LINK (AMPERES) (at 4kV)	MVI D & W PROTECTED FUSE TYPE 4kV (AMPERES)								
	30	40	50	65	75	100	125	150	200
	I _f , MAXIMUM R.M.S. AMPERES FOR SAFE COORDINATION								
30	–	*	*	*	*	*	*	*	*
40	–	–	*	*	*	*	*	*	*
50	–	–	–	*	*	*	*	*	*
65	–	–	–	–	*	*	*	*	*
75	–	–	–	–	–	*	*	*	*
100	–	–	–	–	–	–	*	*	*
125	–	–	–	–	–	–	–	*	*
150	–	–	–	–	–	–	–	–	*
200	–	–	–	–	–	–	–	–	–

NOTES:

1. Both protecting and protected fuses are on 4kV.
- * Will coordinate for all I_f .
 - Will not coordinate for any I_f .
- MVI needs a minimum 15A current to operate.

© 1998 - 2010 San Diego Gas & Electric Company. All rights reserved. Removal of this copyright notice without permission is not permitted under law.

		Indicates Latest Revision		Completely Revised	<input checked="" type="checkbox"/>	New Page		Information Removed
REVISION	SDG&E DISTRIBUTION DESIGN MANUAL							6133.23
DATE 6-10-09	MVI FUSE							
APPD BV / MC	COORDINATION TABLES							

MVI D & W PROTECTING FUSE LINK (AMPERES) (at 4kV)	MVI D & W PROTECTED FUSE TYPE 12kV (AMPERES)								
	30	40	50	65	75	100	125	150	200
	I _f , MAXIMUM R.M.S. AMPERES FOR SAFE COORDINATION								
30	*	*	*	*	*	*	*	*	*
40	*	*	*	*	*	*	*	*	*
50	*	*	*	*	*	*	*	*	*
65	*	*	*	*	*	*	*	*	*
75	—	*	*	*	*	*	*	*	*
100	—	—	*	*	*	*	*	*	*
125	—	—	*	*	*	*	*	*	*
150	—	—	—	—	*	*	*	*	*
200	—	—	—	—	*	*	*	*	*

NOTES:

- Protecting fuse is on 4kV and protected fuses are on 12kV.
- * Will coordinate for all I_f .
 - Will not coordinate for any I_f .
- MVI needs a minimum 15A current to operate.

© 1998 - 2010 San Diego Gas & Electric Company. All rights reserved. Removal of this copyright notice without permission is not permitted under law.



	Indicates Latest Revision	Completely Revised	<input checked="" type="checkbox"/> New Page	Information Removed
6133.24	SDG&E DISTRIBUTION DESIGN MANUAL			REVISION
	MVI FUSE COORDINATION TABLES			DATE 6-10-09 APPD BV / MC

MVI D & W PROTECTING FUSE LINK (AMPERES) (at 4kV)	GE D & W PROTECTED FUSE TYPE 4kV (AMPERES)												
	10	15	20	25	30	40	50	65	75	100	125	150	200
	I_f , MAXIMUM R.M.S. AMPERES FOR SAFE COORDINATION												
30	-	-	-	-	-	-	705	950	1325	1500	1940	2790	3900
40	-	-	-	-	-	-	300	950	1325	1500	1940	2790	3900
50	-	-	-	-	-	-	-	-	1325	1500	1940	2790	3900
65	-	-	-	-	-	-	-	-	910	1500	1940	2790	3900
75	-	-	-	-	-	-	-	-	-	-	1010	2790	3900
100	-	-	-	-	-	-	-	-	-	-	625	2790	3900
125	-	-	-	-	-	-	-	-	-	-	-	1900	3900
150	-	-	-	-	-	-	-	-	-	-	-	-	-
200	-	-	-	-	-	-	-	-	-	-	-	-	-

NOTES:

1. Both protecting and protected fuses are on 4kV.
- * Will coordinate for all I_f .
 - Will not coordinate for any I_f .
- MVI needs a minimum 15A current to operate.

© 1998 - 2010 San Diego Gas & Electric Company. All rights reserved. Removal of this copyright notice without permission is not permitted under law.

		Indicates Latest Revision		Completely Revised		New Page		Information Removed
REVISION	SDG&E DISTRIBUTION DESIGN MANUAL							6133.25
DATE 6-10-09	MVI FUSE							
APPD BV / MC	COORDINATION TABLES							

MVI D & W PROTECTING FUSE LINK (AMPERES) (at 4kV)	GE D & W PROTECTED FUSE TYPE 12kV (AMPERES)												
	10	15	20	25	30	40	50	65	75	100	125	150	200
	I _f , MAXIMUM R.M.S. AMPERES FOR SAFE COORDINATION												
30	-	-	420	800	1125	1500	2000	2800	4000	4500	5800	8500	11500
40	-	-	-	800	1125	1500	2000	2800	4000	4500	5800	8500	11500
50	-	-	-	175	1125	1500	2000	2800	4000	4500	5800	8500	11500
65	-	-	-	-	230	1230	2000	2800	4000	4500	5800	8500	11500
75	-	-	-	-	-	-	1500	2800	4000	4500	5800	8500	11500
100	-	-	-	-	-	-	950	2800	4000	4500	5800	8500	11500
125	-	-	-	-	-	-	-	1800	4000	4500	5800	8500	11500
150	-	-	-	-	-	-	-	-	3400	4500	5800	8500	11500
200	-	-	-	-	-	-	-	-	-	950	5800	8500	11500

NOTES:

1. Protecting fuse is on 4kV and protected fuses are on 12kV.
- * Will coordinate for all I_f .
 - Will not coordinate for any I_f .
- MVI needs a minimum 15A current to operate.

© 1998 - 2010 San Diego Gas & Electric Company. All rights reserved. Removal of this copyright notice without permission is not permitted under law.





		Indicates Latest Revision	Completely Revised	<input checked="" type="checkbox"/>	New Page	Information Removed
6133.26	SDG&E DISTRIBUTION DESIGN MANUAL					REVISION
	MVI FUSE COORDINATION TABLES					DATE 6-10-09 APPD BV / MC

MVI D & W PROTECTING FUSE LINK (AMPERES) (at 4kV)	QA PROTECTED FUSE LINK RATING 4kV (AMPERES)										
	15	20	25	30	40	50	60	75	100	125	150
	I_f , MAXIMUM R.M.S. AMPERES FOR SAFE COORDINATION										
30	-	-	-	-	-	730	915	1300	1700	2140	2700
40	-	-	-	-	-	-	915	1300	1700	2140	2700
50	-	-	-	-	-	-	-	1300	1700	2140	2700
65	-	-	-	-	-	-	-	-	1700	2140	2700
75	-	-	-	-	-	-	-	-	-	1450	2700
100	-	-	-	-	-	-	-	-	-	-	2350
125	-	-	-	-	-	-	-	-	-	-	-
150	-	-	-	-	-	-	-	-	-	-	-
200	-	-	-	-	-	-	-	-	-	-	-

NOTES:

1. Both protecting protected fuses are on 4kV.
- * Will coordinate for all I_f .
 - Will not coordinate for any I_f .
- MVI needs a minimum 15A current to operate.

© 1998 - 2010 San Diego Gas & Electric Company. All rights reserved. Removal of this copyright notice without permission is not permitted under law.

		Indicates Latest Revision		Completely Revised		New Page		Information Removed
REVISION	SDG&E DISTRIBUTION DESIGN MANUAL							6133.27
DATE 6-10-09	MVI FUSE							
APPD BV / MC	COORDINATION TABLES							

MVI D & W PROTECTING FUSE LINK (AMPERES) (at 4kV)	QA PROTECTED FUSE LINK RATING AT 12kV (AMPERES)										
	15	20	25	30	40	50	60	75	100	125	150
	I_f , MAXIMUM R.M.S. AMPERES FOR SAFE COORDINATION										
30	–	950	1150	1400	1750	2200	2750	3900	5000	6300	8000
40	–	950	1150	1400	1750	2200	2750	3900	5000	6300	8000
50	–	–	–	1400	1750	2200	2750	3900	5000	6300	8000
65	–	–	–	1025	1750	2200	2750	3900	5000	6300	8000
75	–	–	–	–	–	2200	2750	3900	5000	6300	8000
100	–	–	–	–	–	1050	2750	3900	5000	6300	8000
125	–	–	–	–	–	–	–	3900	5000	6300	8000
150	–	–	–	–	–	–	–	–	5000	6300	8000
200	–	–	–	–	–	–	–	–	–	6300	8000

NOTES:

1. Protecting fuse is on 4kV and protected fuses are on 12kV.
- * Will coordinate for all I_f .
 - Will not coordinate for any I_f .
- MVI needs a minimum 15A current to operate.

© 1998 - 2010 San Diego Gas & Electric Company. All rights reserved. Removal of this copyright notice without permission is not permitted under law.





	 Indicates Latest Revision	Completely Revised	<input checked="" type="checkbox"/> New Page	Information Removed
6133.28	SDG&E DISTRIBUTION DESIGN MANUAL			REVISION
	MVI FUSE COORDINATION TABLES			DATE 6–10–09 APPD BV / MC

MVI D & W PROTECTING FUSE LINK (AMPERES) (at 4kV)	S&C SM-4 PROTECTED FUSE LINK RATING AT 4kV (AMPERES)											RTE
	10	15	30	40	50	65	80	100	125	150	200	
	I_f , MAXIMUM R.M.S. AMPERES FOR SAFE COORDINATION											
30	-	-	670	805	970	1350	1620	2020	2675	3260	3965	870
40	-	-	-	805	970	1350	1620	2020	2675	3260	3965	870
50	-	-	-	-	-	1350	1620	2020	2675	3260	3965	550
65	-	-	-	-	-	-	1620	2020	2675	3260	3965	425
75	-	-	-	-	-	-	-	1350	2675	3260	3965	-
100	-	-	-	-	-	-	-	-	2300	3260	3965	-
125	-	-	-	-	-	-	-	-	-	3260	3965	-
150	-	-	-	-	-	-	-	-	-	-	2950	-
200	-	-	-	-	-	-	-	-	-	-	-	-

NOTES:

1. Both protecting and protected fuses are on 4kV.
- * Will coordinate for all I_f .
 - Will not coordinate for any I_f .
- MVI needs a minimum 15A current to operate.

© 1998 - 2010 San Diego Gas & Electric Company. All rights reserved. Removal of this copyright notice without permission is not permitted under law.

	 Indicates Latest Revision	 Completely Revised	 New Page	 Information Removed
REVISION	SDG&E DISTRIBUTION DESIGN MANUAL			
DATE 6-10-09 APPD BV / MC	MVI FUSE COORDINATION TABLES			6133.29

MVI D & W PROTECTING FUSE LINK (AMPERES) (at 4kV)	S&C SM-4 PROTECTED FUSE LINK RATING AT 12kV (AMPERES)											RTE	COOPER X-LIMITER
	10	15	30	40	50	65	80	100	125	150	200	150	140
	I _f , MAXIMUM R.M.S. AMPERES FOR SAFE COORDINATION												
30	-	950	1950	2350	2800	4000	4700	6000	8000	9900	11800	2500	5800
40	-	950	1950	2350	2800	4000	4700	6000	8000	9900	11800	2500	5800
50	-	-	1950	2350	2800	4000	4700	6000	8000	9900	11800	2500	5800
65	-	-	1950	2350	2800	4000	4700	6000	8000	9900	11800	2500	5800
75	-	-	-	2350	2800	4000	4700	6000	8000	9900	11800	2500	5800
100	-	-	-	1520	2800	4000	4700	6000	8000	9900	11800	2240	5800
125	-	-	-	-	2200	4000	4700	6000	8000	9900	11800	1900	5800
150	-	-	-	-	-	3100	4700	6000	8000	9900	11800	1300	5800
200	-	-	-	-	-	-	-	6000	8000	9900	11800	1030	5800

NOTES:

1. Protecting fuse is on 4kV and protected fuses are on 12kV.
- * Will coordinate for all I_f .
 - Will not coordinate for any I_f .
- MVI needs a minimum 15A current to operate.

© 1998 - 2010 San Diego Gas & Electric Company. All rights reserved. Removal of this copyright notice without permission is not permitted under law.

	 Indicates Latest Revision	Completely Revised	<input checked="" type="checkbox"/> New Page	Information Removed
6133.30	SDG&E DISTRIBUTION DESIGN MANUAL			REVISION
	MVI FUSE COORDINATION TABLES			DATE 6-10-09 APPD BV / MC

MVI D & W PROTECTING FUSE LINK (AMPERES) (at 4kV)	GE EJO-1 PROTECTED FUSE LINK RATING AT 4kV (AMPERES)							
	30	40	50	65	80	100	150	200
	I _f , MAXIMUM R.M.S. AMPERES FOR SAFE COORDINATION							
30	-	-	120	225	640	840	1490	1895
40	-	-	-	175	280	840	1490	1895
50	-	-	-	-	215	370	1490	1895
65	-	-	-	-	-	295	1220	1895
75	-	-	-	-	-	-	640	1100
100	-	-	-	-	-	-	-	980
125	-	-	-	-	-	-	-	-
150	-	-	-	-	-	-	-	-
200	-	-	-	-	-	-	-	-

NOTES:

1. Both protecting and protected fuses are on 4kV.
- * Will coordinate for all I_f .
 - Will not coordinate for any I_f .
- MVI needs a minimum 15A current to operate.

© 1998 - 2010 San Diego Gas & Electric Company. All rights reserved. Removal of this copyright notice without permission is not permitted under law.

		Indicates Latest Revision		Completely Revised	<input checked="" type="checkbox"/>	New Page		Information Removed
REVISION	SDG&E DISTRIBUTION DESIGN MANUAL							6133.31
DATE 6-10-09	MVI FUSE							
APPD BV / MC	COORDINATION TABLES							

PROTECTING FUSE TYPE LINK RATING (AMPERES)		PROTECTED FUSE TYPE & LINK RATING (AMPERES)			
		S & C FAULT TAMER			
		5	10	15	20
		I_f , MAXIMUM R.M.S. AMPERES FOR SAFE COORDINATION			
S & C FAULT TAMER	5	–	240	300	300
	10	–	–	115	125
	15	–	–	–	–
	20	–	–	–	–

PROTECTING FUSE TYPE LINK RATING (AMPERES)		PROTECTED FUSE TYPE & LINK RATING (AMPERES)													
		KEARNY QA													
		5	10	15	20	25	30	40	50	60	75	100	125	150	200
		I_f , MAXIMUM R.M.S. AMPERES FOR SAFE COORDINATION													
S & C FAULT TAMER	5	–	140	225	380	485	610	*	*	*	*	*	*	*	
	10	–	–	–	250	390	520	*	*	*	*	*	*	*	
	15	–	–	–	–	–	470	670	*	*	*	*	*	*	
	20	–	–	–	–	–	–	685	*	*	*	*	*	*	

PROTECTING FUSE TYPE LINK RATING (AMPERES)		PROTECTED FUSE TYPE & LINK RATING (AMPERES)							
		McGRAW-EDISON/COOPER NX							
		8	10	12	18	20	25	30	40
		I_f , MAXIMUM R.M.S. AMPERES FOR SAFE COORDINATION							
S & C FAULT TAMER	5	–	–	130	215	265	315	500	735
	10	–	–	–	170	210	270	465	685
	15	–	–	–	145	185	245	445	660
	20	–	–	–	–	185	245	445	655

NOTES:

- Both protecting and protected fuses are at the same voltage level.
- * Will coordinate for all I_f .
- Will not coordinate for any I_f .

© 1998 - 2010 San Diego Gas & Electric Company. All rights reserved. Removal of this copyright notice without permission is not permitted under law.

	Indicates Latest Revision	Completely Revised	<input checked="" type="checkbox"/> New Page	Information Removed
REVISION	SDG&E DISTRIBUTION DESIGN MANUAL			
DATE 6-2-10 APPD BV / MC	FAULT TAMER FUSE COORDINATION TABLES			6133.40

PROTECTING FUSE TYPE LINK RATING (AMPERES)		PROTECTED FUSE TYPE & LINK RATING (AMPERES)										
		S & C SM-4										
		10	15	30	40	50	65	80	100	125	150	200
		I_f , MAXIMUM R.M.S. AMPERES FOR SAFE COORDINATION										
S & C FAULT TAMER	5	220	395	*	*	*	*	*	*	*	*	*
	10	–	270	*	*	*	*	*	*	*	*	*
	15	–	–	*	*	*	*	*	*	*	*	*
	20	–	–	*	*	*	*	*	*	*	*	*

PROTECTING FUSE TYPE LINK RATING (AMPERES)		PROTECTED FUSE TYPE & LINK RATING (AMPERES)							
		GE EJO-1							
		30	40	50	65	80	100	150	200
		I_f , MAXIMUM R.M.S. AMPERES FOR SAFE COORDINATION							
S & C FAULT TAMER	5	160	240	380	580	*	*	*	*
	10	–	135	270	500	*	*	*	*
	15	–	–	200	450	*	*	*	*
	20	–	–	200	445	*	*	*	*

PROTECTING FUSE TYPE LINK RATING (AMPERES)		PROTECTED FUSE TYPE & LINK RATING (AMPERES)	
		COOPER ELF	
		30	65
		I_f , MAXIMUM R.M.S. AMPERES FOR SAFE COORDINATION	
S & C FAULT TAMER	5	500	*
	10	460	*
	15	440	*
	20	440	*

NOTES:

- Both protecting and protected fuses are at the same voltage level.
- * Will coordinate for all I_f .
- Will not coordinate for any I_f .

© 1998 - 2010 San Diego Gas & Electric Company. All rights reserved. Removal of this copyright notice without permission is not permitted under law.

	Indicates Latest Revision	Completely Revised	<input checked="" type="checkbox"/> New Page	Information Removed
6133.41	SDG&E DISTRIBUTION DESIGN MANUAL			REVISION
	FAULT TAMER FUSE COORDINATION TABLES			DATE 6-2-10 APPD BV / MC

PROTECTING FUZE TYPE LINK RATING (AMPERES)		PROTECTED FUZE TYPE & LINK RATING (AMPERES)	
		ELASTIMOLD FUSED ELBOW	
		18	30
		I_f , MAXIMUM R.M.S. AMPERES FOR SAFE COORDINATION	
S & C FAULT TAMER	5	320	685
	10	285	655
	15	–	645
	20	–	635

PROTECTING FUZE TYPE LINK RATING (AMPERES)		PROTECTED FUZE TYPE & LINK RATING (AMPERES)	
		RTE	
		150	
		I_f , MAXIMUM R.M.S. AMPERES FOR SAFE COORDINATION	
S & C FAULT TAMER	5	*	
	10	*	
	15	*	
	20	*	

PROTECTING FUZE TYPE LINK RATING (AMPERES)		PROTECTED FUZE TYPE & LINK RATING (AMPERES)	
		COOPER X-LIMITER	
		140	
		I_f , MAXIMUM R.M.S. AMPERES FOR SAFE COORDINATION	
S & C FAULT TAMER	5	*	
	10	*	
	15	*	
	20	*	

NOTES:

1. Both protecting and protected fuses are at the same voltage level.
- * Will coordinate for all I_f .
- Will not coordinate for any I_f .

© 1998 - 2010 San Diego Gas & Electric Company. All rights reserved. Removal of this copyright notice without permission is not permitted under law.





	 Indicates Latest Revision	Completely Revised	<input checked="" type="checkbox"/> New Page	Information Removed
REVISION	SDG&E DISTRIBUTION DESIGN MANUAL			
DATE 6-2-10 APPD BV / MC	FAULT TAMER FUZE COORDINATION TABLES			6133.42

PROTECTING FUSE TYPE LINK RATING (AMPERES)		PROTECTED FUSE TYPE & LINK RATING (AMPERES)			
		S & C FAULT TAMER			
		5	10	15	20
		I_f , MAXIMUM R.M.S. AMPERES FOR SAFE COORDINATION			
McGRAW-EDISON COOPER NX	8	–	–	*	*
	10	–	–	–	350
	12	–	–	–	–
	18	–	–	–	–
	20	–	–	–	–
	25	–	–	–	–
	30	–	–	–	–
	40	–	–	–	–
KEARNY QA	5	55	240	300	300
	10	–	70	155	155
	15	–	–	70	75
	20	–	–	–	–
	25	–	–	–	–
	30	–	–	–	–
	40	–	–	–	–
	50	–	–	–	–
	60	–	–	–	–
	75	–	–	–	–
	100	–	–	–	–
	125	–	–	–	–
	150	–	–	–	–
	200	–	–	–	–

NOTES:

1. Both protecting and protected fuses are at the same voltage level.
- * Will coordinate for all I_f .
- Will not coordinate for any I_f .

© 1998 - 2010 San Diego Gas & Electric Company. All rights reserved. Removal of this copyright notice without permission is not permitted under law.

	 Indicates Latest Revision	 Completely Revised	 New Page	 Information Removed
6133.43	SDG&E DISTRIBUTION DESIGN MANUAL			REVISION
	FAULT TAMER FUSE COORDINATION TABLES			DATE 6-2-10 APPD BV / MC

PROTECTING FUSE TYPE LINK RATING (AMPERES) 4kV		PROTECTED FUSE TYPE & LINK RATING (AMPERES) 12kV			
		S & C FAULT TAMER			
		5	10	15	20
		I_f , MAXIMUM R.M.S. AMPERES FOR SAFE COORDINATION			
S & C FAULT TAMER (at 4kV)	5	325	*	*	*
	10	160	*	*	*
	15	—	*	*	*
	20	—	*	*	*

PROTECTING FUSE TYPE LINK RATING (AMPERES) 4kV		PROTECTED FUSE TYPE & LINK RATING (AMPERES) 12kV													
		KEARNY QA													
		5	10	15	20	25	30	40	50	60	75	100	125	150	200
		I_f , MAXIMUM R.M.S. AMPERES FOR SAFE COORDINATION													
S & C FAULT TAMER (at 4kV)	5	150	650	*	*	*	*	*	*	*	*	*	*	*	
	10	—	560	*	*	*	*	*	*	*	*	*	*	*	
	15	—	520	*	*	*	*	*	*	*	*	*	*	*	
	20	—	—	*	*	*	*	*	*	*	*	*	*	*	

NOTES:

- Protecting Fuse is on 4kV and protected fuse are on 12kV.
- * Will coordinate for all I_f .
 - Will not coordinate for any I_f .

© 1998 - 2010 San Diego Gas & Electric Company. All rights reserved. Removal of this copyright notice without permission is not permitted under law.

	Indicates Latest Revision	Completely Revised	<input checked="" type="checkbox"/> New Page	Information Removed
REVISION	SDG&E DISTRIBUTION DESIGN MANUAL			
DATE 6-2-10 APPD BV / MC	FAULT TAMER FUSE COORDINATION TABLES			6133.44

PROTECTING FUSE TYPE LINK RATING (AMPERES)		PROTECTED FUSE TYPE & LINK RATING (AMPERES)									
		SMU-20									
		25	30	40	50	65	80	100	125	150	200
		If MAXIMUM R.M.S. AMPERES FOR SAFE COORDINATION									
SMU-20	25	---	100	500	900	1400	1900	2400	3000	3900	4800
	30	---	---	400	800	1300	1800	2300	2900	3800	4800
	40	---	---	---	500	1200	1700	2200	2900	3700	4700
	50	---	---	---	---	900	1400	2100	2800	3600	4600
	65	---	---	---	---	---	800	1600	2100	3400	4400
	80	---	---	---	---	---	---	1100	2100	3100	4300
	100	---	---	---	---	---	---	---	1400	2700	3900
	125	---	---	---	---	---	---	---	---	1700	3500
	150	---	---	---	---	---	---	---	---	---	2400
	200	---	---	---	---	---	---	---	---	---	---

PROTECTING FUSE TYPE LINK RATING (AMPERES)		PROTECTED FUSE TYPE & LINK RATING (AMPERES)													
		KEARNY QA												RTE	
		② 10	15	20	25	30	40	50	60	75	100	125	150	200	150
		If MAXIMUM R.M.S. AMPERES FOR SAFE COORDINATION													
SMU-20	25	---	---	---	---	---	200	500	800	1400	1900	2400	3200	4900	800
	30	---	---	---	---	---	---	300	800	1300	1700	2400	3100	4800	700
	40	---	---	---	---	---	---	---	400	1200	1700	2300	3000	4700	600
	50	---	---	---	---	---	---	---	---	800	1400	2200	3000	4700	500
	65	---	---	---	---	---	---	---	---	---	900	1700	2600	4400	300
	80	---	---	---	---	---	---	---	---	---	---	1100	2300	4300	300
	100	---	---	---	---	---	---	---	---	---	---	---	1700	3900	300
	125	---	---	---	---	---	---	---	---	---	---	---	---	3300	---
	150	---	---	---	---	---	---	---	---	---	---	---	---	2400	---
	200	---	---	---	---	---	---	---	---	---	---	---	---	---	---

NOTES:

1. Both protecting and protected fuses are at the same voltage level.
- * Will coordinate for all I_f .
- Will not coordinate for any I_f .
- ② Kearney type 200.

© 1998 - 2014 San Diego Gas & Electric Company. All rights reserved. Removal of this copyright notice without permission is not permitted under law.

	Indicates Latest Revision	Completely Revised	<input checked="" type="checkbox"/> New Page	Information Removed
REVISION	SDG&E DISTRIBUTION DESIGN MANUAL			
DATE 8-18-2014 APPD JCE / DW	SMU-20 FUSE COORDINATION TABLES			6133.45

PROTECTING FUSE TYPE LINK RATING (AMPERES)		PROTECTED FUSE TYPE & LINK RATING (AMPERES)														
		S&C SM-4												KEARNEY TYPE B		
		10	15	30	40	50	65	80	100	125	150	200	30	80	150	
		If MAXIMUM R.M.S. AMPERES FOR SAFE COORDINATION														
SMU-20	25	---	---	200	600	900	1400	1800	2300	3100	3800	4700	200	680	1600	
	30	---	---	---	500	800	1300	1700	2300	3000	3800	4700	180	680	1500	
	40	---	---	---	---	500	1200	1600	2200	3000	3800	4900	---	630	1400	
	50	---	---	---	---	---	900	1400	2000	3000	3700	4300	---	580	1200	
	65	---	---	---	---	---	---	800	1500	2600	3400	4300	---	560	1000	
	80	---	---	---	---	---	---	---	---	2200	3200	4200	---	520	700	
	100	---	---	---	---	---	---	---	---	1600	2700	3800	---	480	400	
	125	---	---	---	---	---	---	---	---	---	1700	3100	---	---	400	
	150	---	---	---	---	---	---	---	---	---	---	2000	---	---	---	
	200	---	---	---	---	---	---	---	---	---	---	---	---	---	---	

PROTECTING FUSE TYPE LINK RATING (AMPERES)		PROTECTED FUSE TYPE & LINK RATING (AMPERES)														
		S&C SM-4												KEARNEY TYPE B		
		10	15	30	40	50	65	80	100	125	150	200	30	80	150	
		If MAXIMUM R.M.S. AMPERES FOR SAFE COORDINATION														
SMU-20	25	---	---	200	600	900	1400	1800	2300	3100	3800	4700	200	680	1600	
	30	---	---	---	500	800	1300	1700	2300	3000	3800	4700	180	680	1500	
	40	---	---	---	---	500	1200	1600	2200	3000	3800	4900	---	630	1400	
	50	---	---	---	---	---	900	1400	2000	3000	3700	4300	---	580	1200	
	65	---	---	---	---	---	---	800	1500	2600	3400	4300	---	560	1000	
	80	---	---	---	---	---	---	---	---	2200	3200	4200	---	520	700	
	100	---	---	---	---	---	---	---	---	1600	2700	3800	---	480	400	
	125	---	---	---	---	---	---	---	---	---	1700	3100	---	---	400	
	150	---	---	---	---	---	---	---	---	---	---	2000	---	---	---	
	200	---	---	---	---	---	---	---	---	---	---	---	---	---	---	

NOTES:

- Both protecting and protected fuses are at the same voltage level.
- * Will coordinate for all I_f .
 - Will not coordinate for any I_f .

© 1998 - 2014 San Diego Gas & Electric Company. All rights reserved. Removal of this copyright notice without permission is not permitted under law.

	Indicates Latest Revision	Completely Revised	<input checked="" type="checkbox"/> New Page	Information Removed
REVISION	SDG&E DISTRIBUTION DESIGN MANUAL			
DATE 8-18-2014 APPD JCE / DW	SMU-20 FUSE COORDINATION TABLES			6133.46

PROTECTING FUSE TYPE LINK RATING (AMPERES)		PROTECTED FUSE TYPE & LINK RATING (AMPERES)											
		McGraw-Edison/Cooper NX								Elastimold Fused Elbow		Cooper ELF	
		8	10	12	18	20	25	30	40	18	30	30	65
		If MAXIMUM R.M.S. AMPERES FOR SAFE COORDINATION											
SMU-20	25	----	----	----	----	----	180	320	500	----	500	----	900
	30	----	----	----	----	----	----	300	475	----	----	----	900
	40	----	----	----	----	----	----	----	420	----	----	----	850
	50	----	----	----	----	----	----	----	----	----	----	----	800
	65	----	----	----	----	----	----	----	----	----	----	----	700
	80	----	----	----	----	----	----	----	----	----	----	----	----
	100	----	----	----	----	----	----	----	----	----	----	----	----
	125	----	----	----	----	----	----	----	----	----	----	----	----
	150	----	----	----	----	----	----	----	----	----	----	----	----
	200	----	----	----	----	----	----	----	----	----	----	----	----

NOTES:

1. Both protecting and protected fuses are at the same voltage level.
- * Will coordinate for all I_f .
 - Will not coordinate for any I_f .

© 1998 - 2014 San Diego Gas & Electric Company. All rights reserved. Removal of this copyright notice without permission is not permitted under law.

	<input type="checkbox"/> Indicates Latest Revision	<input type="checkbox"/> Completely Revised	<input checked="" type="checkbox"/> New Page	<input type="checkbox"/> Information Removed
REVISION	SDG&E DISTRIBUTION DESIGN MANUAL			
DATE 8-22-2014	SMU-20 FUSE COORDINATION TABLES			6133.47
APPD JCE / DW				

PROTECTING FUSE TYPE LINK RATING (AMPERES)		PROTECTED FUSE TYPE & LINK RATING (AMPERES)									
		SMU-20									
		25	30	40	50	65	80	100	125	150	200
		I _f MAXIMUM R.M.S. AMPERES FOR SAFE COORDINATION									
KEARNY QA	5 ^②	700	800	1100	1300	1900	2200	2800	3500	4400	5600
	10 ^②	600	700	1000	1200	1800	2200	2800	3500	4400	5600
	15	600	700	1000	1200	1700	2300	2900	3600	4500	5500
	20	500	600	900	1100	1700	2200	2800	3500	4400	5500
	25	300	500	800	1100	1600	2200	2700	3500	4400	5500
	30	---	300	700	1000	1600	2100	2700	3400	4200	5400
	40	---	---	300	800	1400	2000	2600	3300	4400	5300
	50	---	---	---	400	1200	1800	2600	3300	4300	5300
	60	---	---	---	---	900	1600	2300	3200	4100	5100
	75	---	---	---	---	---	400	1800	2700	3700	4900
	100	---	---	---	---	---	---	800	2200	3400	4700
	125	---	---	---	---	---	---	---	600	2700	4000
150	---	---	---	---	---	---	---	300	600	3300	

PROTECTING FUSE TYPE LINK RATING (AMPERES)		PROTECTED FUSE TYPE & LINK RATING (AMPERES)									
		SMU-20									
		25	30	40	50	65	80	100	125	150	200
		I _f MAXIMUM R.M.S. AMPERES FOR SAFE COORDINATION									
S&C FAULT TIMER	5	*	*	*	*	*	*	*	*	*	*
	10	*	*	*	*	*	*	*	*	*	*
	15	*	*	*	*	*	*	*	*	*	*
	20	*	*	*	*	*	*	*	*	*	*

NOTES:

- Both protecting and protected fuses are at the same voltage level.
- * Will coordinate for all I_f .
 - Will not coordinate for any I_f .
- ② Kearney type 200.

© 1998 - 2014 San Diego Gas & Electric Company. All rights reserved. Removal of this copyright notice without permission is not permitted under law.

	Indicates Latest Revision	Completely Revised	<input checked="" type="checkbox"/> New Page	Information Removed
REVISION	SDG&E DISTRIBUTION DESIGN MANUAL			6133.48
DATE 9-19-2014	SMU-20 FUSE COORDINATION TABLES			
APPD JCE / DW				

PROTECTING FUSE TYPE LINK RATING (AMPERES)		PROTECTED FUSE TYPE & LINK RATING (AMPERES)									
		SMU-20									
		25	30	40	50	65	80	100	125	150	200
		If MAXIMUM R.M.S. AMPERES FOR SAFE COORDINATION									
GE EJO-1 COMBINED TECHNOLOGIES EOD/SD	30	---	---	1000	1300	*	*	*	*	*	*
	40	---	---	---	1300	1800	*	*	*	*	*
	50	---	---	---	---	1700	2400	*	*	*	*
	65	---	---	---	---	---	---	2900	*	*	*
	80	---	---	---	---	---	---	2700	3700	3000	*
	100	---	---	---	---	---	---	---	3500	---	3900
	150	---	---	---	---	---	---	---	---	---	5100
	200	---	---	---	---	---	---	---	---	---	---
KEARNEY TYPE B	30	---	---	---	---	100	*	*	*	*	*
	80	---	---	---	---	---	---	---	250	400	*
	150	---	---	---	---	---	---	---	---	---	*
KEARNEY TYPE A	30	---	---	*	*	*	*	*	*	*	*
	40	---	---	---	100	*	*	*	*	*	*
	50	---	---	---	---	---	150	*	*	*	*
	65	---	---	---	---	---	---	200	*	*	*
McGRAW- EDISON/COOPER NX	8	*	*	*	*	*	*	*	*	*	*
	10	*	*	*	*	*	*	*	*	*	*
	12	50	*	*	*	*	*	*	*	*	*
	18	50	60	90	*	*	*	*	*	*	*
	20	50	60	80	*	*	*	*	*	*	*
	25	---	---	80	100	130	*	*	*	*	*
	30	---	---	---	95	130	*	*	*	*	*
	40	---	---	---	---	130	150	*	*	*	*
ELASTIMOLD FUSED ELBOW	18	40	*	*	*	*	*	*	*	*	*
	30	---	---	80	100	*	*	*	*	*	*
RTE	150	---	---	---	---	---	---	---	---	---	*
COOPER ELF	30	---	---	90	130	*	*	*	*	*	*
	65	---	---	---	---	---	170	250	*	*	*

NOTES:

- Both protecting and protected fuses are at the same voltage level.
- * Will coordinate for all I_f .
 - Will not coordinate for any I_f .

© 1998 - 2014 San Diego Gas & Electric Company. All rights reserved. Removal of this copyright notice without permission is not permitted under law.

	Indicates Latest Revision	Completely Revised	<input checked="" type="checkbox"/> New Page	Information Removed
REVISION	SDG&E DISTRIBUTION DESIGN MANUAL			
DATE 8-14-2014 APPD JCE / DW	SMU-20 FUSE COORDINATION TABLES			6133.49

MINIMUM LINE-TO-GROUND FAULT CURRENT REQUIRED FOR COORDINATION

Relay Type	KEARNY QA					S&C SM-4					FUSE					TYPE/SIZE					EOD/SD EJO-1					KB		RTE	FE
	75	100	125	150	200	65	80	100	125	150	200	80	100	150	200	80	150	200	80	150	200	80	150	150	30				
CO-8																													
1	1950	3300	4800	8400	8400	*	2100	3300	5100	6600	8400	*	1050	2700	3900	750	2850							3900	*				
2	*	1350	2730	5400	5400	*	*	1200	2700	3900	4800	*	900	2040	2910	*	2070							2460	*				
3	*	*	1800	3900	3900	*	*	840	1590	2550	3450	*	*	1830	2670	*	1770							2100	*				
4	*	*	*	1500	3300	*	*	*	1260	1860	2820	*	*	1770	2490	*	1350							1650	*				
5	*	*	*	1260	2700	*	*	*	1110	1560	2460	*	*	1710	2400	*	1320							1290	*				
IAC53																													
1	1350	2640	3750	5250	9000	660	2700	3900	5700	7200	8700	675	1200	3000	4200	900	3300							4200	700				
2	*	*	2250	3750	6750	*	750	2100	3300	4800	6300	*	960	2250	3300	*	2160							3600	*				
3	*	*	1110	2700	5400	*	*	1140	2700	3900	5100	*	900	2040	2850	*	1800						2400	*					
4	*	*	900	2100	4500	*	*	900	1920	3300	4200	*	840	1890	2700	*	1560						2100	*					
5	*	*	*	1500	3900	*	*	840	1350	2350	3450	*	*	1800	2550	*	1350						1800	*					
CO																													
1	*	2100	3750	6600	6600	*	810	2100	3600	4800	5850	*	*	2250	3300	*	2160							3300	*				
2	*	840	2100	4500	4500	*	*	840	1980	3000	4500	*	*	1950	2700	*	1620							2100	*				
3	*	*	1350	3750	3750	*	*	*	1290	2100	3300	*	*	1800	2550	*	1350							1650	*				
4	*	*	*	1230	3000	*	*	*	1140	1680	2700	*	*	1740	2400	*	1290							1500	*				
5	*	*	*	1200	2550	*	*	*	1050	1500	2340	*	*	1650	2370	*	1260							1350	*				
CO-AI																													
1	*	2400	5400	7200	11700	*	2100	3300	4800	6300	7500	720	1200	3000	3900	900	3300							4200	700				
2	*	*	2100	3000	5100	*	*	1380	2700	3900	4800	*	990	2250	3030	*	2400							3300	*				
3	*	*	1050	2100	4500	*	*	*	1650	2700	3600	*	900	2010	2730	*	1950							2230	*				
4	*	*	*	1680	3600	*	*	*	1320	2040	2850	*	*	1860	2640	*	1740							1950	*				
5	*	*	*	1350	2800	*	*	*	1140	1650	2400	*	*	1800	2460	*	1500							1750	*				
IAC51																													
1	1500	2100	3000	4050	6600	1560	2100	3000	3900	4800	6000	900	1350	2750	3600	1250	3000							3600	900				
2	1050	1500	2100	2700	4650	960	1380	1800	2490	3600	4050	800	1125	2250	3000	1000	2400							2700	750				
3	650	1125	1650	2250	4050	660	990	1350	2030	2700	3150	750	1050	2000	2700	800	2100							2400	600				
4	*	975	1350	1900	3600	*	840	1110	1710	2100	2700	680	1000	1900	2600	750	1800							2100	*				
5	*	840	1200	1750	3000	*	750	1020	1500	2010	2550	675	975	1800	2500	675	1650							1900	*				
IT >	1250	1500	2000	2500	3750	1300	1600	2000	2500	3100	3700	650	800	1500	1800	800	1700							2000	550				

Indicates Latest Revision Completely Revised New Page

REVISION
 DATE 1-1-2000
 APPD JCE / *vd*

SDG&E DISTRIBUTION DESIGN MANUAL
 RELAY/FUSE COORDINATION TABLE
 150 AMP GROUND RELAY SETTING

6134.1

MINIMUM LINE-TO-GROUND FAULT CURRENT REQUIRED FOR COORDINATION

Relay Type	KEARNY QA					S&C SM-4					FUSE					TYPE/SIZE	EOD/SD EJO-1					KB		RTE	FE
	75	100	125	150	200	65	80	100	125	150	200	80	100	150	200		80	150	150	30					
CO-8	1	*	*	2100	3900	7800	*	*	*	3300	5100	6900	*	*	2160	3600	*	2040	3300	*					
	2	*	*	*	1500	4800	*	*	*	1140	1950	3900	*	*	1830	2700	*	1410	1800	*					
	3	*	*	*	1200	3600	*	*	*	*	1410	2340	*	*	1740	2460	*	1290	1350	*					
	4	*	*	*	*	*	2430	*	*	*	*	1980	*	*	1650	2340	*	*	*	*					
	5	*	*	*	*	*	2100	*	*	*	*	1800	*	*	1530	2250	*	*	*	*					
IAC53	1	*	1350	3300	4800	8400	*	*	2520	4500	6000	7800	*	900	2670	3750	*	2700	3750	*					
	2	*	*	*	2700	6000	*	*	*	1200	3600	5400	*	*	1980	2850	*	1560	2340	*					
	3	*	*	*	1500	5100	*	*	*	1050	1500	3600	*	*	1830	2670	*	1380	1800	*					
	4	*	*	*	1275	4200	3000	*	*	*	1400	2550	*	*	1800	2460	*	1320	1650	*					
	5	*	*	*	*	*	3000	*	*	*	1320	2190	*	*	1710	2400	*	1260	1290	*					
CO-1	1	*	*	*	2460	6000	*	*	*	1320	3300	5100	*	*	1980	2940	*	1560	2250	*					
	2	*	*	*	1200	4200	*	*	*	*	1380	2850	*	*	1770	2550	*	1290	1500	*					
	3	*	*	*	*	2700	*	*	*	*	1320	2040	*	*	1650	2400	*	1260	1275	*					
	4	*	*	*	*	2100	*	*	*	*	*	1920	*	*	1560	2280	*	*	*	*					
	5	*	*	*	*	1890	*	*	*	*	*	1680	*	*	1500	2160	*	*	*	*					
CO-A1	1	*	*	2100	3900	7500	*	*	*	3300	5400	6600	*	*	2310	3300	*	2430	3300	*					
	2	*	*	*	1350	4800	*	*	*	2250	3600	3600	*	*	1830	2700	*	1500	1950	*					
	3	*	*	*	*	3300	*	*	*	1350	2200	2200	*	*	1725	2430	*	*	1330	*					
	4	*	*	*	*	2400	*	*	*	*	1950	1950	*	*	2590	2370	*	*	*	*					
	5	*	*	*	*	1950	*	*	*	*	1770	1770	*	*	2250	2250	*	*	*	*					
IAC51	1	*	1800	2550	3700	6000	*	1500	2100	3300	4200	5400	*	1200	2400	3150	*	2700	3200	*					
	2	*	*	*	2400	4500	*	*	*	2100	2760	3600	*	*	2100	2750	*	2100	2400	*					
	3	*	*	*	1200	3600	*	*	*	1500	2100	3000	*	*	1000	2675	*	1800	2000	*					
	4	*	*	900	1650	2400	*	*	*	1330	1800	2500	*	900	1850	2500	*	1650	1800	*					
	5	*	*	*	1450	2100	*	*	*	1260	1530	2150	*	*	1800	2400	*	1500	1700	*					
IT >	1250	1500	2000	2500	3750	1300	1600	2000	2500	3100	3700	650	800	1500	1800	800	1700	2000	550						

Indicates Latest Revision	Completely Revised	New Page
SDG&E DISTRIBUTION DESIGN MANUAL		
RELAY/FUSE COORDINATION TABLE 240 AMP GROUND RELAY SETTING		REVISION DATE 1-1-2000 APPD JCE / <i>WJL</i>

6134.2

MINIMUM LINE-TO-GROUND FAULT CURRENT REQUIRED FOR COORDINATION

Relay Type	KEARNY QA					S&C SM-4					FUSE					TYPE/SIZE					EOD/SD EJO-1					KB					RTE					FE				
	75	100	125	150	200	65	80	100	125	150	200	80	100	150	200	80	100	150	200	80	150	80	150	200	80	150	80	150	200	80	150	80	150	200						
CO-8	*	*	*	*	*	*	*	*	*	*	1950	4050	6000	*	*	*	*	*	1950	2940	*	*	*	*	*	1425	2250	*	*	*	*	*	*	*	*	*	*			
1	*	*	*	*	*	*	*	*	*	*	1680	1300	2400	*	*	*	*	*	1680	2490	*	*	*	*	*	*	*	*	*	*	*	*	*	*	*					
2	*	*	*	*	*	*	*	*	*	*	1530	*	1920	*	*	*	*	*	1530	2340	*	*	*	*	*	*	*	*	*	*	*	*	*	*	*					
3	*	*	*	*	*	*	*	*	*	*	*	*	1740	*	*	*	*	*	*	2190	*	*	*	*	*	*	*	*	*	*	*	*	*	*	*					
4	*	*	*	*	*	*	*	*	*	*	*	*	1650	*	*	*	*	*	*	2100	*	*	*	*	*	*	*	*	*	*	*	*	*	*	*					
5	*	*	*	*	*	*	*	*	*	*				*	*	*	*	*			*	*	*	*	*	*	*	*	*	*	*	*	*	*	*					
IAC53	*	*	*	*	*	*	*	*	*	*	3600	4800	6900	*	*	*	*	*	2190	3000	*	*	*	*	*	2040	3450	*	*	*	*	*	*	*	*	*	*			
1	*	*	*	*	*	*	*	*	*	*	*	1350	3600	*	*	*	*	*	1800	2700	*	*	*	*	*	1290	1650	*	*	*	*	*	*	*	*	*	*			
2	*	*	*	*	*	*	*	*	*	*	*	*	2220	*	*	*	*	*	1650	2430	*	*	*	*	*	*	*	*	*	*	*	*	*	*	*					
3	*	*	*	*	*	*	*	*	*	*	*	*	1920	*	*	*	*	*	1560	2400	*	*	*	*	*	*	*	*	*	*	*	*	*	*	*					
4	*	*	*	*	*	*	*	*	*	*	*	*	1740	*	*	*	*	*	*	2280	*	*	*	*	*	*	*	*	*	*	*	*	*	*	*					
5	*	*	*	*	*	*	*	*	*	*				*	*	*	*	*			*	*	*	*	*	*	*	*	*	*	*	*	*	*	*					
CO	*	*	*	*	*	*	*	*	*	*	1380	4200	4200	*	*	*	*	*	1800	2670	*	*	*	*	*	1290	1650	*	*	*	*	*	*	*	*	*	*			
1	*	*	*	*	*	*	*	*	*	*	*	1920	1920	*	*	*	*	*	1560	2370	*	*	*	*	*	*	*	*	*	*	*	*	*	*	*					
2	*	*	*	*	*	*	*	*	*	*	*	*	1680	*	*	*	*	*	*	2250	*	*	*	*	*	*	*	*	*	*	*	*	*	*	*					
3	*	*	*	*	*	*	*	*	*	*	*	*	1650	*	*	*	*	*	*	2100	*	*	*	*	*	*	*	*	*	*	*	*	*	*	*					
4	*	*	*	*	*	*	*	*	*	*	*	*	1630	*	*	*	*	*	*	2100	*	*	*	*	*	*	*	*	*	*	*	*	*	*	*					
5	*	*	*	*	*	*	*	*	*	*				*	*	*	*	*			*	*	*	*	*	*	*	*	*	*	*	*	*	*	*					
CO-A1	*	*	*	*	*	*	*	*	*	*	4200	5900	5900	*	*	*	*	*	1950	3000	*	*	*	*	*	1700	2100	*	*	*	*	*	*	*	*	*	*			
1	*	*	*	*	*	*	*	*	*	*	*	2700	2700	*	*	*	*	*	1700	2550	*	*	*	*	*	*	*	*	*	*	*	*	*	*	*					
2	*	*	*	*	*	*	*	*	*	*	*	1800	1800	*	*	*	*	*	1500	2350	*	*	*	*	*	*	*	*	*	*	*	*	*	*	*					
3	*	*	*	*	*	*	*	*	*	*	*	*	*	*	*	*	*	*	*	2200	*	*	*	*	*	*	*	*	*	*	*	*	*	*	*					
4	*	*	*	*	*	*	*	*	*	*	*	*	*	*	*	*	*	*	*	2100	*	*	*	*	*	*	*	*	*	*	*	*	*	*	*					
5	*	*	*	*	*	*	*	*	*	*				*	*	*	*	*			*	*	*	*	*	*	*	*	*	*	*	*	*	*	*					
IAC51	*	*	*	*	*	*	*	*	*	*	3000	3700	5150	*	*	*	*	*	2250	3000	*	*	*	*	*	2550	3000	*	*	*	*	*	*	*	*	*	*			
1	*	*	*	*	*	*	*	*	*	*	1880	2700	3400	*	*	*	*	*	2000	2700	*	*	*	*	*	1950	2250	*	*	*	*	*	*	*	*	*	*			
2	*	*	*	*	*	*	*	*	*	*	1320	1920	2700	*	*	*	*	*	1850	2500	*	*	*	*	*	1650	1900	*	*	*	*	*	*	*	*	*	*			
3	*	*	*	*	*	*	*	*	*	*	*	1600	2300	*	*	*	*	*	1800	2400	*	*	*	*	*	1500	1750	*	*	*	*	*	*	*	*	*	*			
4	*	*	*	*	*	*	*	*	*	*	*	1470	2100	*	*	*	*	*	1700	2250	*	*	*	*	*	1350	1500	*	*	*	*	*	*	*	*	*	*			
5	*	*	*	*	*	*	*	*	*	*				*	*	*	*	*			*	*	*	*	*	*	*	*	*	*	*	*	*	*	*					
IT >	1250	1500	2000	2500	3750	1300	1600	2000	2500	3100	3700	650	800	1500	1800	800	1700	2000	550																					

Indicates Latest Revision Completely Revised New Page

REVISION
DATE 1-1-2000
APPD JCE / *val*

SDG&E DISTRIBUTION DESIGN MANUAL
RELAY/FUSE COORDINATION TABLE
300 AMP GROUND RELAY SETTING

MINIMUM LINE-TO-GROUND FAULT CURRENT REQUIRED FOR COORDINATION

Relay Type	KEARNY QA					S&C SM-4					FUSE					TYPE/SIZE					EOD/SD EJO-1					KB		RTE	FE	
	75	100	125	150	200	65	80	100	125	150	200	80	100	125	150	200	80	100	150	200	80	100	150	200	80	150	150	30		
CO-8	1	*	*	*	6000	*	*	*	*	*	*	*	*	*	4800	*	*	*	1740	2700	*	*	*	*	*	*	*	*	*	
	2	*	*	*	2100	*	*	*	*	*	*	*	*	*	1800	*	*	*	*	2330	2200	*	*	*	*	*	*	*	*	
	3	*	*	*	*	*	*	*	*	*	*	*	*	*	*	*	*	*	*	2100	*	*	*	*	*	*	*	*	*	
	4	*	*	*	*	*	*	*	*	*	*	*	*	*	*	*	*	*	*	*	*	*	*	*	*	*	*	*	*	*
	5	*	*	*	*	*	*	*	*	*	*	*	*	*	*	*	*	*	*	*	*	*	*	*	*	*	*	*	*	*
IAC53	1	*	*	*	6400	*	*	*	*	*	*	*	*	4500	6000	*	*	*	1980	3000	*	*	*	*	*	*	*	*	*	
	2	*	*	*	3670	*	*	*	*	*	*	*	*	*	2040	*	*	*	1550	2400	*	*	*	*	*	*	*	*	2100	
	3	*	*	*	1860	*	*	*	*	*	*	*	*	*	1800	*	*	*	*	2280	2160	*	*	*	*	*	*	*	*	*
	4	*	*	*	*	*	*	*	*	*	*	*	*	*	*	*	*	*	*	*	*	*	*	*	*	*	*	*	*	*
	5	*	*	*	*	*	*	*	*	*	*	*	*	*	*	*	*	*	*	*	*	*	*	*	*	*	*	*	*	*
CO	1	*	*	*	3750	*	*	*	*	*	*	*	*	*	2100	*	*	*	1530	2400	*	*	*	*	*	*	*	*	*	
	2	*	*	*	*	*	*	*	*	*	*	*	*	*	*	*	*	*	*	2200	2100	*	*	*	*	*	*	*	*	*
	3	*	*	*	*	*	*	*	*	*	*	*	*	*	*	*	*	*	*	*	*	*	*	*	*	*	*	*	*	*
	4	*	*	*	*	*	*	*	*	*	*	*	*	*	*	*	*	*	*	*	*	*	*	*	*	*	*	*	*	*
	5	*	*	*	*	*	*	*	*	*	*	*	*	*	*	*	*	*	*	*	*	*	*	*	*	*	*	*	*	*
CO-A1	1	*	*	*	6000	*	*	*	*	*	*	*	*	*	5250	*	*	*	1725	2700	*	*	*	*	*	*	*	*	*	
	2	*	*	*	1950	*	*	*	*	*	*	*	*	*	1800	*	*	*	*	2400	2100	*	*	*	*	*	*	*	*	*
	3	*	*	*	*	*	*	*	*	*	*	*	*	*	*	*	*	*	*	*	*	*	*	*	*	*	*	*	*	*
	4	*	*	*	*	*	*	*	*	*	*	*	*	*	*	*	*	*	*	*	*	*	*	*	*	*	*	*	*	*
	5	*	*	*	*	*	*	*	*	*	*	*	*	*	*	*	*	*	*	*	*	*	*	*	*	*	*	*	*	*
IAC51	1	*	*	*	1950	3000	5400	*	*	*	*	*	*	*	4800	*	*	*	2200	3000	*	*	*	*	*	*	*	*	*	
	2	*	*	*	*	1650	3750	*	*	*	*	*	*	*	3000	*	*	*	1950	2700	*	*	*	*	*	*	*	*	2700	
	3	*	*	*	*	*	2900	*	*	*	*	*	*	*	2400	*	*	*	1800	2500	*	*	*	*	*	*	*	*	1650	
	4	*	*	*	*	*	2400	*	*	*	*	*	*	*	2100	*	*	*	1740	2400	*	*	*	*	*	*	*	*	*	
	5	*	*	*	*	*	2100	*	*	*	*	*	*	*	1950	*	*	*	1700	2300	*	*	*	*	*	*	*	*	*	*
IT >	1250	1500	2000	2500	3750	1300	1600	2000	2500	3100	3700	650	800	1500	1800	800	1700	2000	550											

SCOPE: This standard shows the minimum line to ground fault current required for safe coordination between service restorers and fuses.

Service Restorer	Ground Slow Setting Curve	Fuse Type/Size												Kearney Type B		
		QA														
		15	20	25	30	40	50	60	75	100	125	150	200	30	80	150
14	18	125	300	400	525	675	875	1050	1500	1975	2725	3300	4800	750	1250	2700
14	14	250	425	450	575	750	925	1200	1550	2100	2700	3250	5100	825	1350	2700
14	8	450	600	750	900	1150	1550	1750	2400	3000	3900	4800	7500	850	1800	3600
14	3	125	225	275	375	525	625	825	1125	1500	1800	2400	3750	700	1050	2100
14	2	175	300	400	525	650	825	1050	1350	1800	2400	3000	4500	725	1200	2475
14	K	300	1500	1800	2250	2700	3200	4400	6000	7600	10000	12000	18000	1050	2550	5400
70	18	*	*	*	*	225	325	450	1050	1725	2325	3000	4650	600	1050	2550
70	14	*	*	*	225	450	750	975	1450	1950	2475	3150	5100	725	1200	2650
70	8	*	*	*	600	975	1275	1550	2400	3000	3900	4800	7500	650	1500	3000
70	3	*	*	*	*	250	375	450	750	1175	1575	2175	3750	550	900	1950
70	2	*	*	*	*	275	400	550	1075	1575	2175	2925	4500	600	1050	2400
70	K	*	*	*	*	*	*	*	1800	4500	10000	12000	18000	550	1050	4500
100	18	*	*	*	*	*	*	325	525	1050	2000	2700	4500	525	750	2325
100	14	*	*	*	*	*	425	750	1350	1825	2425	3100	5100	700	1150	2625
100	8	*	*	*	*	600	1050	1425	2250	3000	3900	4800	7500	750	1650	3600
100	3	*	*	*	*	*	*	375	600	900	1350	1950	3600	525	750	1850
100	2	*	*	*	*	*	300	425	750	1350	1900	2700	4500	575	875	2250
100	K	*	*	*	*	*	*	*	*	600	5200	9000	18000	*	650	3300
140	18	*	*	*	*	*	275	375	600	1350	2100	2850	4500	450	650	2050
140	14	*	*	*	*	*	*	425	1150	1725	2400	3000	5100	600	1050	2500
140	8	*	*	*	*	*	450	1200	2100	3000	3900	4800	7500	700	1500	3600
140	3	*	*	*	*	*	*	*	475	750	1050	1775	3300	*	450	1350
140	2	*	*	*	*	*	*	*	550	900	1500	2400	4500	400	725	2100
140	K	*	*	*	*	*	*	*	*	*	825	4200	19500	525	675	2250
170	18	*	*	*	*	*	*	*	*	600	900	1800	4500	*	600	1650
170	14	*	*	*	*	*	*	*	750	1500	2100	3000	4900	550	900	2400
170	8	*	*	*	*	*	*	750	1350	2700	3750	4800	7500	675	1250	3300
170	3	*	*	*	*	*	*	*	*	675	925	1500	2800	*	600	1500
170	2	*	*	*	*	*	*	*	*	725	1075	2050	4450	*	675	1800
170	K	*	*	*	*	*	*	*	*	*	*	1200	13500	*	*	1350
200	18	*	*	*	*	*	*	*	*	*	775	1350	4200	*	*	1500
200	14	*	*	*	*	*	*	*	*	1200	2050	2725	4600	*	750	2350
200	8	*	*	*	*	*	*	*	1500	2550	3650	4500	7500	600	1350	3300
200	3	*	*	*	*	*	*	*	*	600	850	1350	2700	*	600	1400
200	2	*	*	*	*	*	*	*	*	600	900	1725	4200	*	650	1725
200	K	*	*	*	*	*	*	*	*	*	*	1050	8500	*	*	1425
240	18	*	*	*	*	*	*	*	*	*	*	1200	3400	*	*	1425
240	14	*	*	*	*	*	*	*	*	750	1725	2700	4600	*	*	2200
240	8	*	*	*	*	*	*	*	*	2100	3300	4500	7500	*	950	3200
240	3	*	*	*	*	*	*	*	*	*	750	1250	2600	*	*	1350
240	2	*	*	*	*	*	*	*	*	*	825	1350	3900	*	*	1500
240	K	*	*	*	*	*	*	*	*	*	*	*	6000	*	*	*
280	18	*	*	*	*	*	*	*	*	*	*	1050	2300	*	*	1275
280	14	*	*	*	*	*	*	*	*	*	1200	2400	4500	*	*	2100
280	8	*	*	*	*	*	*	*	*	1700	3000	4200	7500	*	*	3000
280	3	*	*	*	*	*	*	*	*	*	*	1150	2100	*	*	1300
280	2	*	*	*	*	*	*	*	*	*	*	1225	3000	*	*	1350
280	K	*	*	*	*	*	*	*	*	*	*	*	1500	*	*	*

NOTES:

* Will coordinate for all fault current values.

	Indicates Latest Revision	Completely Revised	New Page
REVISION	SDG&E DISTRIBUTION DESIGN MANUAL		
DATE 1-1-2000 APPD JCE / <i>vd</i>	SERVICE RESTORER/FUSE COORDINATION TABLE		6136.1

Service Restorer	Ground Slow Setting Curve	Fuse type/size															
		EOD/SD EJO-1					RTE	S&C SM-4									
		40	80	100	125	150	150	25	30	40	50	65	80	100	125	150	200
14	18	375	1000	1350	2000	2400	3100	600	720	900	1100	1500	1800	2400	3000	3800	4800
14	14	425	1050	1375	2100	2500	3150	625	750	975	1200	1625	2100	2550	3300	3900	5100
14	8	575	1350	1800	2700	3200	4350	1050	1275	1500	1825	2550	3000	3900	5100	6000	8100
14	3	375	875	1200	1650	2100	2350	400	475	625	725	1050	1350	1675	2100	2600	3300
14	2	375	975	1300	1850	2300	2800	550	750	800	1000	1400	1650	2100	2750	3300	4200
14	K	575	3000	3900	5700	6600	8400	4200	5100	6000	6600	8700	10500	12500	16500	19200	30000
70	18	325	775	1200	1800	2350	2850	*	*	300	450	650	1450	2025	2750	3600	4600
70	14	350	975	1300	1950	2400	3000	225	450	675	975	1500	1800	2325	3000	3900	4800
70	8	270	870	1320	1890	2400	4500	750	1050	1350	1750	2400	3000	3800	5100	6000	7800
70	3	325	750	1050	1500	2000	2250	*	225	300	450	725	1000	1400	1900	2400	3300
70	2	350	800	1175	1750	2250	2700	*	225	325	525	1000	1425	1900	2700	3450	4200
70	K	*	750	1200	2600	3900	7500	*	*	*	375	975	4200	10500	14100	16800	30000
100	18	*	700	1050	1650	2250	2700	*	*	*	375	550	800	1650	2575	3300	4500
100	14	350	900	1275	1950	2400	3000	*	*	375	775	1350	1775	2175	3000	3900	4800
100	8	375	1200	1775	2700	3400	4400	*	700	1175	1575	2400	3000	3800	5100	6000	7800
100	3	300	725	1050	1500	1950	2100	*	*	*	375	575	775	1075	1675	2225	3000
100	2	300	750	1075	1650	2150	2650	*	*	*	400	700	1050	1650	2500	3200	4200
100	K	*	675	1325	1800	2800	4900	*	*	*	*	*	650	3300	12600	16800	29400
140	18	*	675	950	1475	2075	2400	*	*	*	*	475	675	850	1800	2850	3900
140	14	*	825	1200	1800	2400	3000	*	*	*	425	1050	1500	2100	3000	3600	4800
140	8	*	1025	1500	2400	3300	4250	*	*	*	1150	2100	2800	3600	4800	6000	7800
140	3	*	510	800	1150	1500	1950	*	*	*	*	525	700	900	1350	1950	2700
140	2	*	700	1025	1500	2050	2400	*	*	*	*	600	725	1100	2000	2850	3900
140	K	*	*	825	1350	2100	3000	*	*	*	*	*	*	725	2550	6250	29400
170	18	*	600	900	2700	3700	2100	*	*	*	*	*	600	810	1250	2250	3600
170	14	*	750	1150	1700	2300	2850	*	*	*	*	700	1275	1925	2825	3600	4500
170	8	*	875	1425	2400	3050	4250	*	*	*	550	1950	2550	3600	4800	6000	7800
170	3	*	675	900	1300	1800	1800	*	*	*	*	*	625	775	1225	1600	2400
170	2	*	700	950	1400	1900	2100	*	*	*	*	*	700	900	1650	2400	3600
170	K	*	*	*	1200	1800	2100	*	*	*	*	*	*	*	1050	3300	29400
200	18	*	*	925	1950	3600	1800	*	*	*	*	*	*	750	1100	1550	3000
200	14	*	725	1050	1650	2150	2700	*	*	*	*	*	900	1725	2700	3500	4200
200	8	*	825	1300	2250	3000	4200	*	*	*	*	1500	2400	3300	4800	6000	7800
200	3	*	*	700	1000	1325	1650	*	*	*	*	*	600	775	1150	1600	2100
200	2	*	650	900	1350	1850	1950	*	*	*	*	*	650	850	1350	2100	3300
200	K	*	*	*	1125	1725	1725	*	*	*	*	*	*	*	1000	1300	7200
240	18	*	*	925	1200	1700	1500	*	*	*	*	*	*	*	1050	1400	2280
240	14	*	*	1025	1550	2100	2650	*	*	*	*	*	*	1275	2400	3300	4200
240	8	*	750	1200	2100	2850	3900	*	*	*	*	*	1950	3000	4500	5700	7800
240	3	*	*	825	1200	1700	1500	*	*	*	*	*	*	750	1050	1375	1950
240	2	*	*	850	1250	1800	1800	*	*	*	*	*	*	775	1150	1700	2700
240	K	*	*	*	*	1550	*	*	*	*	*	*	*	*	*	1200	1800
280	18	*	*	*	1125	1625	1200	*	*	*	*	*	*	*	1000	1325	1860
280	14	*	*	*	1400	2050	2400	*	*	*	*	*	*	840	1050	3000	3900
280	8	*	*	1050	1800	2650	3750	*	*	*	*	*	1000	2550	4200	5100	7500
280	3	*	*	*	1150	1625	1275	*	*	*	*	*	*	*	1050	1350	1860
280	2	*	*	*	1200	1750	1500	*	*	*	*	*	*	*	1100	1500	2250
280	K	*	*	*	1425	*	*	*	*	*	*	*	*	*	*	*	1560

NOTES:

- a. Contact Distribution Workflow & Planning for service restorer/fuse types not given in table.
 - b. Service Restorer phase setting does not effect fuse coordination.
 - c. Coordination values are 3 times higher than curve crossing to provide adequate sensitivity margin.
- * Will coordinate for all fault current values.

	Indicates Latest Revision	Completely Revised	New Page
6136.2	SDG&E DISTRIBUTION DESIGN MANUAL		REVISION
	SERVICE RESTORER/FUSE COORDINATION TABLE		DATE 1-1-2000 APPD JCE / <i>vel</i>

The California Electrical Code requires the installation of service equipment with overcurrent protective devices with a short circuit current rating equal to, or not less than, the available fault current provided by the Utility, and when applicable, the contribution to fault current from customer's motor contribution.

SDG&E's maximum contribution to fault current is stated as follows:

1. Residential – Applicable to a single family residence or duplex as defined in Rule 1 (which may include a house meter for a total of 3 meters), multi-family residential service consisting of 3 or more dwelling units, or a mobile home. Also applicable to service used in common for residential purposes in a multi-family dwelling, on a single premises, whether separately metered or combined with service to an individual dwelling unit. The Utility's contribution to the available fault current at the point of connection of SDG&E's service conductors to the customer's facilities will not exceed the values listed in Table 1.

TABLE 1

Phase	Serving Voltage	Service Entrance Ampacity	Utility's Contribution to Fault Current Will Not Exceed
1Ø	120/240	225 amps or less	10,000 amps
1Ø	120/240	226 – 600 amps	22,000 amps
1Ø	120/208	200 amps or less	42,000 amps
*1Ø	120/240	800 amps	42,000 amps
3Ø	120/240	600 amps or less (See Note 4)	42,000 amps
3Ø	208Y/120	201 – 3000 amps or less	42,000 amps
3Ø	208Y/120	3001 – 4000 amps	65,000 amps

* Deviation required for 800 ampere, or above, single-phase service requests.

2. Non-Residential – Applicable to all non-residential occupancies such as, but not limited to, commercial, industrial, agricultural, governmental, educational institutions, hospitals, medical clinics, etc.. The Utility's contribution to the available fault current at the point of connection of SDG&E's service conductors to the customer's facilities will not exceed the values listed in Table 2.

TABLE 2

Phase	Serving Voltage	Service Entrance Ampacity	Utility's Contribution to Fault Current Will Not Exceed
1Ø	120/208	200 amps or less	42,000 amps
1Ø	120/240	400 amps or less	42,000 amps
1Ø	240/480	200 amps or less	10,000 amps
3Ø	120/240	600 amps or less (See Note 4)	42,000 amps
3Ø	208Y/120	3000 amps or less	42,000 amps
3Ø	208Y/120	3001 amps – 4000 amps	65,000 amps
3Ø	480	600 amps or less (See Note 5)	30,000 amps
3Ø	480Y/277	2000 amps or less	30,000 amps
3Ø	480Y/277	2001 amps – 3000 amps	45,000 amps
3Ø	480Y/277	3001 amps – 4000 amps	65,000 amps

3. SDG&E's available fault current for medium and high voltage services will be calculated on an individual basis and will be quoted for both the initial and ultimate three-phase, line to line, and line to ground fault current values.
4. Maximum service panel size allowed to be served by a 120/240 volt, three-phase delta transformer installation, overhead or underground, is 600 amperes.
5. Maximum service panel size allowed to be served by an overhead 480 volt, three-phase delta transformer installation is 600 amperes.

© 1998 - 2014 San Diego Gas & Electric Company. All rights reserved. Removal of this copyright notice without permission is not permitted under law.

Service Guide 006	<input checked="" type="checkbox"/> Indicates Latest Revision	<input type="checkbox"/> Completely Revised	<input type="checkbox"/> New Page	<input type="checkbox"/> Information Removed
REVISION	SDG&E DISTRIBUTION DESIGN MANUAL			6142.1
DATE 8-22-2014	SECONDARY FAULT CURRENT CALCULATIONS			
APPD JCE / DW				

7. Electric Distribution Standards will provide a detailed calculation for available fault current for service entrance ampacities not covered in items 1, 2, and 2 above. The following EQUATIONS can be used to calculate maximum available fault current by converting Z% (see Z% in tables below) substituting for Z. Select a transformer size, for the calculation, with a full load current greater than or equal to the service entrance ampacity. Underground Standard 3706 lists transformer full load currents. (Fault current values are directly proportional to the transformer size used in the calculation. Select the maximum transformer size applicable to a given situation)

$$I_F = \frac{kVA}{\sqrt{3} (kV) (Z_T)}$$

3Ø EQUATION

$$I_F = \frac{kVA}{(kV) (Z_T)}$$

1Ø EQUATION

WHERE:

- I_F = Fault Current (in amperes)
- kVA = Transformer nameplate rating
- kV = Transformer secondary voltage, line to line (120/240v = 240v line to line = .24kV)
- Z% = Transformer impedance. Convert to decimal form ($\frac{Z\%}{100}$) and substitute for Z_T to calculate maximum available fault current.
- Z_T = Total system impedance.

Transformer Impedances for Fault Calculation

Single Phase Transformers (Overhead or Underground)				Three Phase Transformers 208Y/120 or 240/120 (Delta)			
kVA	R%	X%	Z%	kVA	R%	X%	Z%
25	0.73	0.95	1.2	75	0.41	1.23	1.3
50	0.95	1.53	1.8	150	0.41	1.23	1.3
75	0.95	1.53	1.8	225	0.39	1.55	1.6
100	0.95	1.53	1.8	300	0.48	2.15	2.2
167	1.06	1.81	2.1	500	0.58	3.45	3.5
				750-1500	0.59	5.28	5.32

Three Phase Transformers 480Y/277				Three Phase Transformers 2400/4160 Y/2400 2400/4160 Grd Y/2400			
kVA	R%	X%	Z%	kVA	R%	X%	Z%
75	0.41	1.23	1.3	150	.78	4.56	4.63
150	0.41	1.23	1.3	225	.78	4.56	4.63
225	0.32	1.26	1.3	300	.78	4.56	4.63
300	0.28	1.27	1.3	500	.78	4.56	4.63
500	0.36	2.17	2.2	750-2500	.59	5.28	5.32
750-3000	0.59	5.28	5.32				

© 1998 - 2014 San Diego Gas & Electric Company. All rights reserved. Removal of this copyright notice without permission is not permitted under law.

	<input checked="" type="checkbox"/> Indicates Latest Revision	<input type="checkbox"/> Completely Revised	<input type="checkbox"/> New Page	<input type="checkbox"/> Information Removed
6142.2	SDG&E ELECTRIC STANDARDS			REVISION
	SECONDARY FAULT CURRENT CALCULATIONS			DATE 8-7-2014 APPD JCE / DW

Limiting Secondary Short Circuit
Current For Residential Services

The following tables, applicable to single-phase transformer installations through 100 kVA, show minimum service length required according to conductor size.

Overhead Service

<u>Triplex Conductor Size</u>	<u>Minimum Length Service Required To Limit ISC to 10,000 Amperes</u>
#4 AL or #6 CU	19 ft
#2 AL or #4 CU	30 ft
#1/0 AL or #2 CU	45 ft
#3/0 AL	67 ft

Underground Service

<u>Cable Size</u>	<u>Minimum Length Service Required To Limit ISC to 10,000 Amperes</u>
#2	32 ft
#1/0	50 ft
#3/0	74 ft
350 kcmil	119 ft
500 kcmil	173 ft

- (1) Where more than a single wire size separates the transformer from the customer's service equipment, and no segment in the combination of lengths is long enough to satisfy the table values, consult Electric Distribution Standards or Support.
- (2) Minimum lengths are measured from the transformer secondary lugs to the point of connection with the customer's service equipment.

	Indicates Latest Revision	Completely Revised	New Page	Information Removed
REVISION	SDG&E ELECTRIC STANDARDS			6142.3
DATE 1-1-94	SECONDARY FAULT CURRENT CALCULATIONS			
APPD <i>MF/RSJ</i>				

SCOPE

This procedure defines the steps that Electric Distribution Planning personnel should follow to insure that a distribution circuit is adequately protected.

PURPOSE

This procedure is intended to supplement Design Standards 6111 and 6121.

SUGGESTED ANALYTICAL STEPS

A. Fault Detection

The protective device must "see" the fault current available at the furthest point in the device's zone-of-protection in order to detect a fault.

The minimum allowable short circuit current at the end of a protective device's zone-of-protection in order to detect a fault.

The minimum allowable short circuit current at the end of a protective device's zone-of-protection shall not be less than 2 or 3 times the protective device rating/setting to account for increased impedance due to trees, asphalt, extremely dry conditions, etc. These factors are known as sensitivity margins and are established as:

- 3 - GND FAULTS
- 2 - PHASE FAULTS

In addition to the sensitivity margins, the use of a grounding bank also reduces the available short circuit current seen by the substation relay. To account for this, subtract 100 amps from the available line-to-ground fault current that has been calculated for each grounding bank installed between the substation and the end of the relay's zone-of-protection.

Relay and Fuse Sensitivity Margin Review

1. Obtain the circuit relay settings (PHASE and GND) from the current "Relay Test Record" (attachment A) and compare the settings to those shown on the most recent "Relay Setting Change Notice".
2. Calculate the minimum short circuit current required to insure adequate protective device sensitivity margins as follows:

$$I_{fL-G, \text{ MIN}} = 3 \times (\text{relay setting})_{\text{GND}}$$

$$I_{f3\phi, \text{ MIN}} = 2 \times (\text{relay setting})_{\text{PHASE}}$$

$$I_{fL-G, \text{ MIN}} = 3 \times (\text{fuse size})$$

3. Use the PTI/PSSU program "Short Circuit Analysis" to check the available end-of-line* short circuit current on feeder line segment and local distribution branches. The available short circuit current shall be equal to the line-to-neutral current obtained from RAP.

*refers to the available fault current at the furthest point on the circuit from the protective device (in its zone-of-protection).

	Indicates Latest Revision	Completely Revised	New Page
REVISION	SDG&E DISTRIBUTION DESIGN MANUAL		
DATE 1-1-87 APPD CVN / <i>ROJ</i>	DISTRIBUTION CIRCUIT PROTECTION ANALYSIS		6144.1

When there is insufficient end-of-line short circuit current to insure adequate protective device sensitivity margins (step A.2), the following alternatives are suggested. Protection Engineering should be consulted if none of the alternatives are desirable.

- a. Sectionalizing fuses may be installed at the point where the short circuit current falls below the amount required to insure adequate relay sensitivity margin, thus limiting the zone-of-protection. The fuse should be sized as follows:

$$\text{fuse size, MAX} = 1/3 \times I_{fL-G, \text{ END OF LINE}}$$

- b. The relay settings may be lowered provided that coordination is maintained between the relay and sectionalizing fuses as described in section C – Protective Device Coordination. If this is the desired alternative, Protection Engineering approval should be requested by submitting a completed "Relay Setting Change Notice" along with confirmation that relay/fuse coordination is maintained.

- c. The existing branch fuse size may be reduced when available end-of-line short circuit current falls below the amount required to insure adequate fuse sensitivity margin. This reduction is possible only if fuse/fuse coordination is maintained. The replacement fuse should be sized as follows:

$$\text{fuse size, MAX} = 1/3 \times I_{fL-G, \text{ END OF LINE}}$$

- d. A sub-branch fuse may be installed at the point on the branch where the short circuit current falls below the amount required to insure adequate fuse sensitivity margin for the branch fuse. This reduces the branch fuse's zone-of-protection and raises the available fault current that the branch fuse must detect.
- e. The minimum line-to-ground short circuit current required to insure adequate protective device sensitivity margin may be reduced provided the circuit or branch being considered for reduced margin is an underground circuit or branch with a continuous neutral conductor tied solidly to the substation.

Example:

$$I_{fL-G, \text{ MIN}} = 2.5 \times (\text{relay setting})_{\text{GND}}$$

$$I_{fL-G, \text{ MIN}} = 2.5 \times (\text{fuse size})$$

Further, a current-limiting fuse may not protect an overhead line via an up cable pole unless the up cable pole QA fuse coordinates with the CLF.

B. Individual Distribution Circuit Reliability

Design Standards 6111 "Feeder Circuit Sectionalizing & Protection", 6112 "Service Restorer Application Criteria" and 6121 "Fuse Application Criteria" provide the basic principals necessary to achieve a reliable distribution circuit. Through the application of these standards it is anticipated that the reliability goals established for the Company will be met.

	 Indicates Latest Revision	Completely Revised	New Page
6144.2	SDG&E DISTRIBUTION DESIGN MANUAL		REVISION
	DISTRIBUTION CIRCUIT PROTECTION ANALYSIS		DATE 1-1-87 APPD CVN / <i>BJ</i>

Design standards listed above are intended to reduce the impact of a failure such that:

1. Failures originating on local distribution branches that are isolated by the substation breaker will not exceed one per year.
2. Failures originating on local distribution sub-branches that are isolated by a branch fuse will not exceed three per year.

Design Standard 6111 – Review

1. Use the PTI/PSSU program "Short Circuit Analysis" to determine feeder line segment's load and distance; check for existing switches:
 - a. within the main feeder line segment, provided that
 $50A \leq \text{load} \leq 100A$ and $2,600' \leq \text{distance} \leq 5,300'$
 - b. around the feeder split points, provided that
 $50A \leq \text{load on each feeder line segment}$
2. Use an accurate circuit operating map; check for existing switches:
 - a. around major critical customers
 - b. at feeder cable poles
 - c. around inaccessible geographic areas

Design Standard 6121 – Review

1. Use the circuit operating map; verify that:
 - a. each local distribution cable pole is fused.
 - b. fuses are installed around each inaccessible geographic area.
 - c. fuse cabinets that are equipped with CLF(S) do not serve overhead lines that are not protected by QA fuses which coordinate with the CLF.
 - d. each padmounted capacitor station is either fused with a 150A CLF or is not fused.
2. Using the circuit operating map and the circuit interruption data for the past 3 years; determine if fuses are installed:
 - a. on each local distribution branch of at least 2000 feet.
 - b. on each local distribution branch of at least 1200 feet (subject to environmental influences).

	Indicates Latest Revision	Completely Revised	New Page
REVISION	SDG&E DISTRIBUTION DESIGN MANUAL		
DATE 1-1-87 APPD CVN / <i>RDJ</i>	DISTRIBUTION CIRCUIT PROTECTION ANALYSIS		6144.3

- c. on each local distribution branch that experienced 3 or more outages in the past 3 years.
- d. on each local distribution sub-branch of at least 10,000 feet.
- e. on each local distribution sub-branch that experienced 3 or more outages in the past year.

C. Protective Device Coordination

1. Protection Engineering shall be responsible for the coordination of primary metered customer-owned protective equipment with SDG&E protective equipment. Electric Distribution Planning shall supply Protection Engineering with the current circuit operating map showing the location of the primary metered customer. In addition, Electric Distribution Planning shall obtain the following information from the customer:
 - a. One-line diagram of the customer-owned equipment which includes relay functional assignment and customer load or transformer kVA.
 - b. Coordination curves (TCC) for customer-owned protective devices including size and type of fuses and relay settings.
 - c. DC schematic of control scheme equipment showing size and type of protective devices in use if relays and breakers are utilized.
2. Use the relay/fuse coordination table (Design Standard 6134) and the PTI/PSSU program "Short Circuit Analysis" to confirm that the available line-to-ground short circuit current at the end of the fuse's zone-of-protection is not less than the fault current value given in the table.

When coordination between the substation relay and sectionalizing fuse does not exist, the following alternatives are suggested. If none of these alternatives are desirable, Protection Engineering should be consulted.

- a. The existing branch fuse size may be reduced provided fuse/fuse coordination is maintained.
- b. A sub-branch fuse may be installed at the point on the branch where the short circuit current falls below the amount required to insure fuse sensitivity margin for the branch fuse.
- c. The substation ground relay setting may be raised provided the required short circuit current to insure adequate relay sensitivity margin on the feeder line segments and unfused local distribution branches is maintained. If this is the desired alternative, Protection Engineering approval should be requested by submitting a completed "Relay Setting Change Notice" along with confirmation that relay sensitivity margin is maintained.

	Indicates Latest Revision	Completely Revised	New Page
6144.4	SDG&E DISTRIBUTION DESIGN MANUAL		REVISION
	DISTRIBUTION CIRCUIT PROTECTION ANALYSIS		DATE 1-1-87 APPD CVN <i>RDJ</i>

- d. The minimum line-to-ground short circuit current provided in the relay/fuse coordination table may be reduced provided the branch is strictly underground with a continuous neutral conductor tied solidly to the substation.

Example:

$$I_{fL-G, \text{ REDUCED}} = .83 \times (I_{fL-G}) \text{ TABLE}$$

The fuse may not protect an overhead line via an up cable pole unless the up cable pole QA fuse coordinates with the CLF.

- 3. Use the relay/fuse coordination table to confirm that the relay's instantaneous trip (IT) setting for both phase and GND is higher than the value provided in the table for a given fuse size and type. If the IT is lower than the value provided, notify Protection Engineering that the IT value needs to be raised.
- 4. Use the fuse/fuse coordination tables and the RAP program "Short Circuit Analysis" to confirm that the available short circuit current at the protecting fuse is not more than the fault current value given in the appropriate table.

When coordination between sectionalizing fuses does not exist, the following alternatives are suggested. If none of these alternatives are desirable, Design Planning should be consulted.

- a. The size of the fuse in the protected position may be raised provided the relay/fuse coordination is maintained.
- b. The size of the fuse in the protecting position may be lowered provided fuse/transformer coordination is maintained.
- c. A different type of fuse (substituting an expulsion fuse for a CLF) may be used provided the available fault current is low enough.
- d. The fuse device in the protecting position may be bridged.

	Indicates Latest Revision	Completely Revised	New Page
REVISION	SDG&E DISTRIBUTION DESIGN MANUAL		
DATE 1-1-87 APPD CVN/ <i>BBJ</i>	DISTRIBUTION CIRCUIT PROTECTION ANALYSIS		6144.5

EXAMPLE:

Perform a Distribution Circuit Performance Analysis for 12kV circuit 460. The required circuit operating map is shown in attachment B, the Relay Test Record in attachment A and the RAP program output in attachment D.

STEP 1 – Fault Detection

a. Refer to the "Relay Test Record". The phase relay is type CO-8 (attachment A, reference 1) set at 600 amps (reference 2) on lever 1 (reference 3). The ground relay is type CO-8 (reference 4) set at 240 amps (reference 5) on lever 3 (reference 6).

b. The minimum permissible short circuit current in the relay's zone-of-protection is:

$$I_f \text{ GND, min} = 3(240) = 720 \text{ amps}$$

$$I_f \text{ PHASE, min} = 2(600) = 1200 \text{ amps}$$

c. Refer to the RAP program "Short Circuit Analysis" (attachment D). The available short circuit current at the end of the relay's zone-of-protection on the feeder line segments and the unfused local distribution branches does not fall below 720A L-NEUT or 1200A 3-PHASE.

EXAMPLE: At switch 152-T3-460 (attachment B1, reference 166) the available short circuit currents at the end of the zone-of-protection are $I_f \text{ GND} = 2,019\text{A}$ and $I_f \text{ PHASE} = 2,911\text{A}$ (attachment D, reference 1).

d. Circuit 460 is protected with 150A fuses and, therefore, fuse protection of these branches requires a minimum L-NEUT short circuit current of 450 amps. Scan the RAP program "Short Circuit Analysis" to see if any branches have a L-NEUT fault current below 450A. The 60A fuse (attachment D, reference 2) has only 311A at the end of its zone-of-protection (reference 401). The 60A fuse requires at least 180A fault current for adequate protection therefore, no changes are required.

STEP 2 – Individual Distribution Circuit Reliability

a. Refer to the circuit operating map (attachment B). The only potential for an additional switch is at the intersection north of the substation (reference 1). Because there is negligible load between the intersection and existing switches surrounding the intersection (references 2 & 13), additional switches are not required.

b. The up cable pole (reference 1581) requires an expulsion fuse which coordinates with the CLF at Del Sol Blvd.

c. Branch 20 (reference 20) is 3,300 feet long according to the RAP program and therefore requires a fuse.

	Indicates Latest Revision	Completely Revised	New Page
6144.6	SDG&E DISTRIBUTION DESIGN MANUAL		REVISION
	DISTRIBUTION CIRCUIT PROTECTION ANALYSIS		DATE 1-1-87 APPD CVN / <i>RDJ</i>

STEP 3 – Protective Device Coordination

- a. The circuit does not have any primary metered customers which would require coordination review by Protection Engineering.
- b. According to the relay/fuse coordination table, a 150A type QA fuse must have at least 1200 amps of available short circuit current at the end of the fuse's zone-of-protection to coordinate with a CO-8 relay set on lever 3 at 240A (attachment C, reference 1). The 150A QA fuse at section 20 (attachment B1, reference 20) has only 862 amps available. Because the full load current on the fuse is only 72 amps, the fuse size may be reduced to 125A which will coordinate with the relay.

The 150A type EJO-1 fuses at section 167 (attachment B2, reference 167) require 1,740 amps of short circuit current (attachment C, reference 2) and only 1,543 amps are available. To increase the available short circuit current within the fuse's zone-of-protection, a fuse cabinet may be installed where the terminator is presently located (attachment B2, reference 1800). The new fuse cabinet must sense 1,543 amps while the existing fuses will see at least 1,800 amps. This is sufficient for relay coordination.

- c. Refer to the "Relay Test Record" (attachment A). The IT setting for the phase relay (reference 7) is 2,640 amps and is equal to the ground relay setting (reference 8). In order to coordinate with the 150A type QA fuse, the relay IT setting must be at least 2,500A (reference 3). Because the IT setting is 2,640A, no change is required.
- d. Use the fuse/fuse coordination tables (Design Standards 6131, 6132, 6133) to be sure that the fuses coordinate.

	 Indicates Latest Revision	Completely Revised	New Page
REVISION	SDG&E DISTRIBUTION DESIGN MANUAL		
DATE 9-4-84	DISTRIBUTION CIRCUIT PROTECTION ANALYSIS		6144.7
APPD CVN / <i>CVN</i>			

RELAY TEST RECORD
FORM 111-244

STATION SAN YSIDRO	12.5	KV CIRCUIT	460	SH. NO. 1
---------------------------	------	------------	-----	-----------

PROT	TYPE	AMP/VOLT	ITA	MODEL/STYLE	SERIAL NO.	LOCATION	I.B. NO.
OC A ①	CO-8	4-12	10-40				
B	"	"	"				
C	"	"	"				
C D ④	"	2-6	"				
RECLSR	KSV						
DIR. PWR							
CT. TYPE	1200/5	AMM. SCALE					

CT. RATIO		600/5		AMM. MULT ⑦		PT. RATIO									
② PHASE				OVERCURRENT RELAY											
IF	TV	600	1200	1800	2640	-	2640	2400	-	RECLSR SETTING	0-20	SEC	120	SEC	CYCLE
% I		100	200	300	440 ③	TLS	ITA.			REMARKS					
IRLY	TAP	5	10	15	22	1	22	20	-						
	TIME	1.9	.80	.45			SPU	NPU	SCALE	TEST BY	DATE				
P.U. AND TIME TESTS	A														
	B														
	C														
	A														
	B														
	C														
	A														
	B														
	C														
	A														
	B														
	C														
															8-16-73
															KARL A. BERLIN

⑤ RESIDUAL		GROUND RELAY ⑧									
IF	TV	240	480	1200	2640	-	2640	2400	-	REMARKS	
% I		100	200	500	1100 ⑥	TLS	ITA.				
IRLY	TAP	2	4	12	22	3	22	20	-		
	TIME	6.0	1.2	.68			SPU	NPU	SCALE	TEST BY	DATE
TESTS	G										
	G										
	G										
	G										
	G										

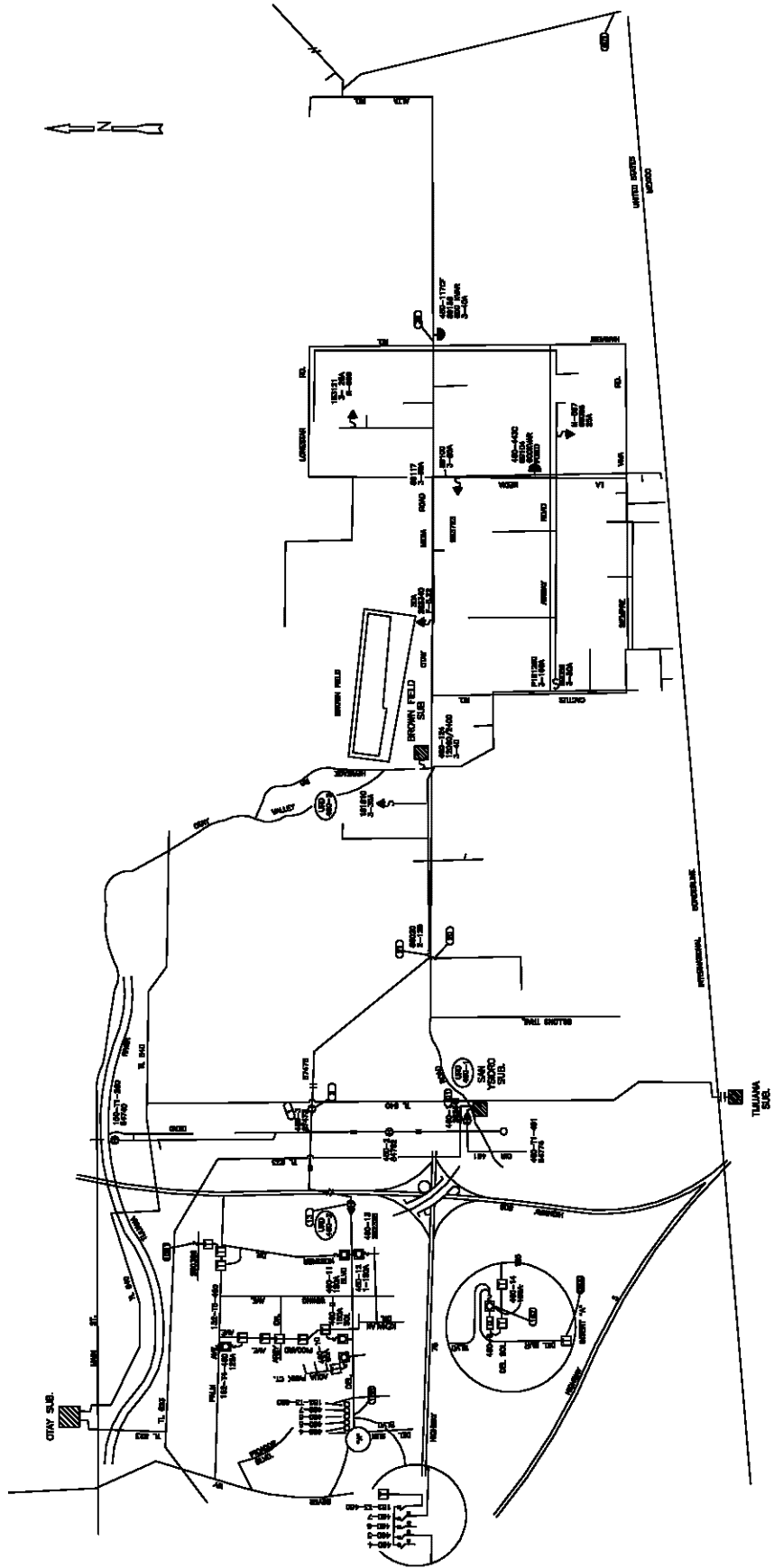

SAN DIEGO GAS & ELECTRIC COMPANY SAN DIEGO, CALIFORNIA			
12KV CIR.460 SAN YSIDRO SUB			
DESIGNED BY	DATE	REV. NO.	REV. DATE
L. CLINE	8-1-74	8	2-17-83
DRAWN BY	DATE	BY	CHKD.
B.M. GIBBELL	8-1-74		
PROJECT NO.			
			CIR. 460

	Indicates Latest Revision	Completely Revised	New Page
REVISION	SDG&E DISTRIBUTION DESIGN MANUAL		
DATE 1-1-91	ATTACHMENT B1		
APPD CVN/BJ			

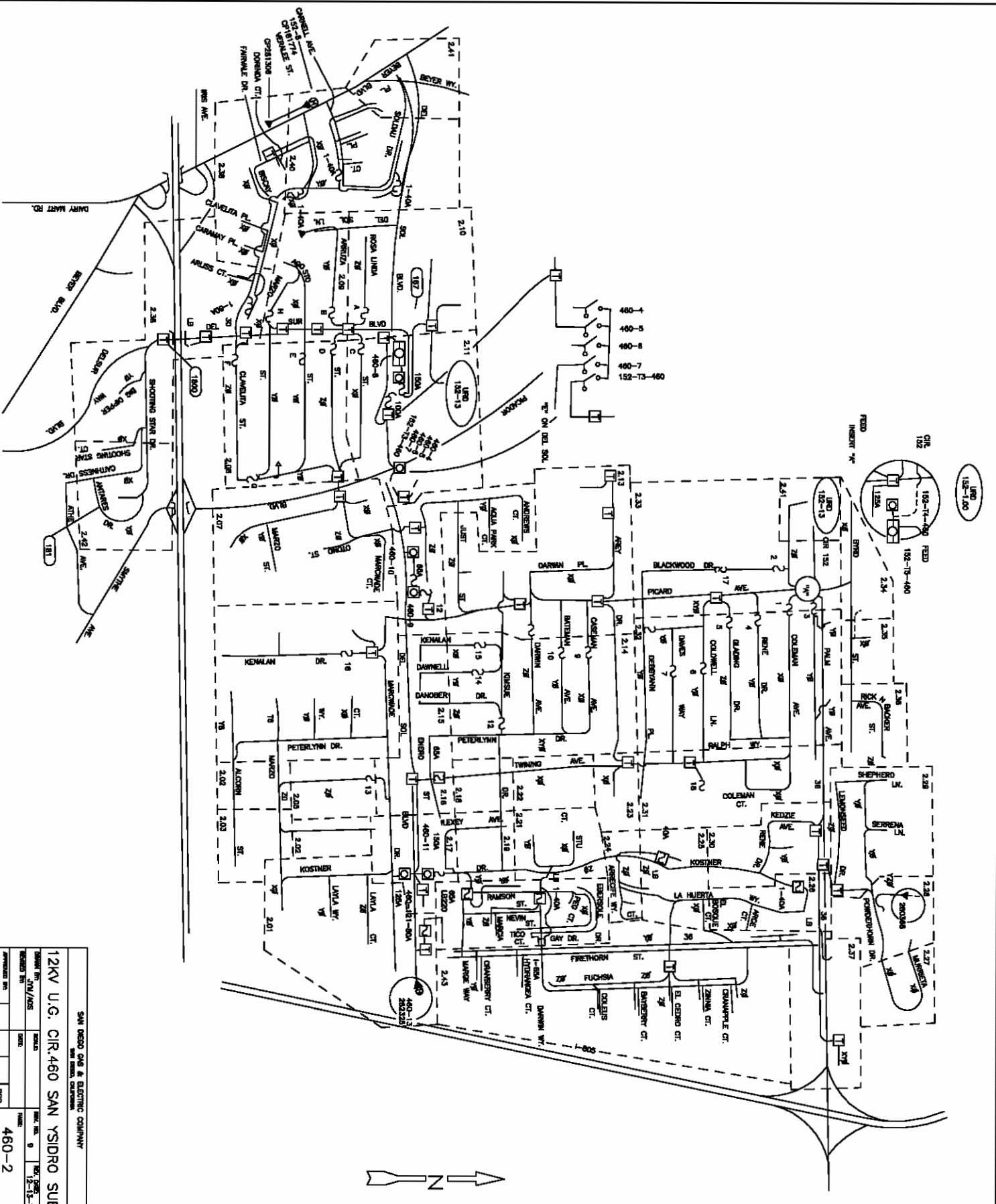

SAN DIEGO GAS & ELECTRIC COMPANY
 12KV U.G. CIR.460 SAN YSIDRO SUB
 SHEET NO. 1/11/4/05
 DATE: 12/15/78
 APPROVED BY: [Signature]
 460-2

Indicates Latest Revision	Completely Revised	New Page
SDG&E DISTRIBUTION DESIGN MANUAL		
ATTACHMENT B2		REVISION DATE 1-1-91 APPD CVN / [Signature]

MINIMUM R.M.S. AMPERES FOR SAFE COORDINATION ⓐ

RELAY TYPE	GROUND RELAY SET AT 150 AMP													GROUND RELAY SET AT 240 AMP						GROUND RELAY SET AT 300 AMP															
	QA					EJO-1				KB	S&C	RTE	QA				EJO-1	KB	S&C	RTE	QA		EJO-1	KB	S&C	RTE									
CO-8 Lever	75	100	125	150	200 ⓐ	80	100	150	200 ⓐ	80	150	200	150	100	125 ①	150	200 ⓐ	100	150	200	150	200	150	150	200	150	150	200 ⓐ	150	200 ⓐ	150	200	150	200	150
1	*	1950	3300	4800	8400	*	1050	2700	3900	750	2850	8400	3900	*	2100	3900	7800	*	2160	3600	2040	6900	3300	2700	7200	1950	2940	1425	6000	2250	*	*	*	*	
2	*	*	1350	2730	5400	*	900	2040	2910	*	2070	4800	2460	*	*	1500	4800	*	1830	2700	1410	3900	1800	*	3900	1680	2490	*	2400	*	*	*	*	*	
3	*	*	*	1800	3900	*	*	1830	2670	*	1770	3450	2100	*	*	1200	3600	*	1740	2460	1290	2340	1350	*	2220	1530	2340	*	1920	*	*	*	*	*	
4	*	*	*	1500	3300	*	*	1770	2490	*	1350	2820	1650	*	*	*	2430	*	1650	2340	*	1980	*	*	1800	*	2190	*	1740	*	*	*	*	*	
5	*	*	*	1260	2700	*	*	1710	2400	*	1320	2460	1290	*	*	*	2100	*	1530	2250	*	1800	*	*	1650	*	2100	*	1650	*	*	*	*	*	
IACS3 Lever																																			
1	1350	2640	3750	5250	9000	675	1200	3000	4200	900	3300	8700	4200	1350	3300	4800	8400	900	2670	3750	2700	7800	3750	3900	8100	2190	3000	2040	6900	3450					
2	*	*	2250	3750	6750	*	960	2250	3300	*	2160	6300	3600	*	*	2700	6000	*	1980	2650	1560	5400	2340	*	5100	1800	2700	1290	3600	1650					
3	*	*	1110	2700	5400	*	900	2040	2850	*	1800	5100	2400	*	*	1500	5100	*	1830	2670	1380	3600	1800	*	2640	1650	2430	*	2220	*					
4	*	*	900	2100	4500	*	840	1890	2700	*	1560	4200	2100	*	*	1275	4300	*	1800	2460	1320	2550	1650	*	2040	1560	2400	*	1920	*					
5	*	*	*	1500	3900	*	*	1800	2550	*	1350	3450	1800	*	*	*	3000	*	1710	2400	1260	2190	1290	*	1800	*	2280	*	1740	*					
CO ① Lever																																			
1	*	*	2100	3750	6600	*	*	2250	3300	*	2160	5850	3300	*	*	2460	6000	*	1980	2940	1560	5100	2250	1170	5400	1800	2670	1290	4200	1650					
2	*	*	840	2100	4500	*	*	1950	2700	*	1620	4500	2100	*	*	1200	4200	*	1770	2550	1290	2850	1500	*	2490	1560	2370	*	1920	8					
3	*	*	*	1350	3750	*	*	1800	2550	*	1350	3300	1650	*	*	2700	*	1650	2400	1260	2040	1275	*	*	1890	*	2250	*	1680	*					
4	*	*	*	1230	3000	*	*	1740	2400	*	1290	2700	1500	*	*	2100	*	1560	2280	*	1920	*	*	*	1740	*	2100	*	1650	*					
5	*	*	*	1200	2550	*	*	1650	2370	*	1260	2340	1350	*	*	*	1890	*	1500	2160	*	1680	*	*	*	*	2100	*	1630	*					
IT>	1250	1500	2000	2500	3750	650	800	1500	1800	800	1700			2000	1500	2000	2500	3750	800	1500	1800	1700			2000	2500	3750	1500	1800	1700			2000		

NOTES:

- ⓐ Permission from Protection Engineering must be acquired prior to use.
- b. For settings below those given in the table and for the relay types not mentioned in the table contact Protection Engineering.
- c. If the relay time lever setting is between the two given values (i.e., TL = 1-1/2) pick the lower time lever (i.e., TL = 1)
- d. If the ground relay setting (TV) is between the two given values (i.e., TV = 200A) choose the lower setting (i.e., TV = 180A)
- ⓐ Coordination values are 3 times higher than curve crossing to provide adequate sensitivity margin. Values may be reduced (.83 multiple) for an underground fuse provided a continuous neutral solidly tied to the substation exists to the fuse location.

REFERENCE:

1. Design Standard 6144, Distribution Circuit Analysis

* Will coordinate for all I_f (T < 1 ⌀ SEC)

	Indicates Latest Revision	Completely Revised	New Page
REVISION	SDG&E DISTRIBUTION DESIGN MANUAL		
DATE 1-1-91	ATTACHMENT C		
APPD CVN / <i>BJ</i>			

----- SHORT CIRCUIT ANALYSIS -----
 460 SAN YSIDRO NONCVR VOLTAGE. 3-3-83
 BASE CASE

FEEDER NUMBER: 460 INPUT DATA SET = ED.ED505RAPM(N)R CASE = 105

SECTION- FROM	TO	KV	PHASE	CONDUCTOR OR	TFMR	SECT	K-FT	ACCUM	METER	SHORT CIRCUIT CURRENT-			PER UNIT IMPEDANCE ON 1MVA BASE--			
										3-PHASE	L-L	L-NEUT	POSITIVE	SEQUENCE-	SEQUENCE-	ZERO
									AMPS	AMPS	AMPS	R	X	R	X	
165	166	12.47	3-Y	#2	CU	PECN	0.13	15.91	41	3008	2605	2077	0.00508	0.01453	0.01145	0.0342
166	167	12.47	3-Y	#2	CU	PECN	0.70	16.61	41	2911	2521	2019	0.00595	0.01475	0.01307	0.0345
167	17	12.47	3-Y	#2	CU	PECN	0.34	16.95	35	2863	2480	1991	0.00638	0.01486	0.01386	0.0341
17	170	12.47	3-Y	#2	CU	PECN	0.90	17.85	21	2739	2372	1916	0.00750	0.01515	0.01595	0.0351
170	18	12.47	3-Y	1C#2	AL	PECN	0.23	18.08	5	2683	2324	1880	0.00801	0.01528	0.01688	0.0352
18	1800	12.47	3-Y	2/0	AL	PECN	0.28	18.36	5	2646	2292	1868	0.00829	0.01541	0.01688	0.0352
1800	180	12.47	L-N	1C#2	AL	PECN	0.44	18.80	13	.	.	1800	0.00926	0.01567	0.01867	0.0363
180	181	12.47	L-N	1C#2	AL	PECN	1.87	20.67	6	.	.	1543	0.01338	0.01676	0.02625	0.0392
170	171	12.47	3-Y	2/0	AL	PECN	1.10	18.95	11	2594	2247	1869	0.00862	0.01563	0.01595	0.0352
171	172	12.47	3-Y	2/0	AL	PECN	0.70	19.65	8	2507	2171	1840	0.00933	0.01594	0.01595	0.0352
172	173	12.47	3-Y	2/0	AL	PECN	0.20	19.85	5	2483	2151	1831	0.00953	0.01602	0.01595	0.0352
173	174	12.47	3-Y	2/0	AL	PECN	0.55	20.40	2	2419	2095	1809	0.01009	0.01627	0.01595	0.0352
174	175	12.47	3-Y	2/0	AL	PECN	1.20	21.60	1	2287	1981	1761	0.01131	0.01679	0.01595	0.0352

460 SAN YSIDRO NONCVR VOLTAGE. 3-3-83 SHORT CIRCUIT ANALYSIS BASE CASE

FEEDER NUMBER: 460 INPUT DATA SET = ED.ED505RAPM(N)R CASE = 105

SECTION FROM TO	KV PHASE	CONDUCTOR OR TFMR	SECT K-FT	ACCUM K-FT	METER AMPS	--SHORT CIRCUIT CURRENT--			--PER UNIT IMPEDANCE ON 1MVA BASE--		
						3-PHASE AMPS	L-L AMPS	L-NEUT AMPS	POSITIVE SEQUENCE R	ZERO SEQUENCE X	
33 34	12.47 3-Y	#4 CU	1.70	35.30	24	733	635	545	0.03697	0.06386	0.1190
34 340	12.47 3-Y	#6 CU	3.45	38.75	8	636	551	481	0.04050	0.07436	0.1320
34 35	12.47 3-Y	#4 CU	1.77	37.07	25	695	602	517	0.03871	0.06747	0.1256
35 36	12.47 3-Y	#4 CU	1.80	38.87	25	660	572	491	0.04048	0.07114	0.1320
36 360	12.47 3-Y	#6 CU	3.95	42.82	2	571	494	431(2)	0.04452	0.08316	0.1470
360 361	12.47 3-Y	#2 AL	3.20	46.02	1	529	458	400	0.04765	0.08976	0.1592
36 362	12.47 3-Y	#6 CU	2.60	41.47	2	598	518	450	0.04314	0.07905	0.1422
362 363	12.47 3-Y	#6 CU	2.40	43.87	1	551	477	418	0.04559	0.08635	0.1513
36 37	12.47 3-Y	#4 CU	0.25	39.12	26	656	568	488	0.04073	0.07165	0.1333
37 38	12.47 3-Y	#4 CU	4.95	44.07	3	577	500	429	0.04560	0.08174	0.1518
38 39	12.47 3-Y	#4 CU	3.72	47.79	2	529	458	393	0.04926	0.08933	0.1658
39 390	12.47 3-Y	#4 CU	0.80	48.59	0	520	450	387	0.05005	0.09096	0.1688
39 40	12.47 L-N	#4 CU	1.00	48.79	4	.	.	385	0.05028	0.09137	0.1695
40 41	12.47 L-N	#4 CU	3.83	52.62	1	.	.	355	0.05416	0.09917	0.1699
40 401	12.47 L-N	#4 CU	10.86	59.65	3	.	.	311(3)	0.06131	0.11351	0.2093
1 12	12.47 3-Y	336 AL	3.60	11.70	209	3409	2952	2381	0.01301	0.00839	0.0300
12 13	12.47 3-Y	336 AL	1.00	12.70	209	3205	2775	2181	0.01381	0.00908	0.0330
13 14	12.47 3-Y	750ALXLEPJ	0.20	12.90	209	3192	2765	2175	0.01385	0.00922	0.0330
14 140	12.47 3-Y	750ALXLEPJ	0.58	13.48	207	3158	2735	2157	0.01398	0.00960	0.0330
140 1400	12.47 3-Y	2/0 CU PEEN	0.58	14.06	19	3072	2661	2108	0.01417	0.01095	0.0340

Indicates Latest Revision Completely Revised New Page Information Removed

REVISION
DATE 1-1-91
APPD CVN *[Signature]*

SDG&E DISTRIBUTION DESIGN MANUAL

ATTACHMENT D2

SCOPE

This standard defines the steps Electric Distribution personnel should follow when performing a benefit/cost reliability analysis.

PURPOSE

The reliability analysis discussed herein is used to compare the cost effectiveness of construction alternatives and to prioritize projects. Special consideration may be given may be given to certain loads.

CRITERIA

SAIDI, SAIFI, and MAIFI are the primary indices used for reliability analysis and are defined below. Based on a circuit's historical and predicted performance in SAIDI, SAIFI, and MAIFI, it shall be prioritized among other circuits for analysis and potential improvements. Reliability analysis shall study the historical and predicted performances of the distribution circuits and identify potential improvements.

SAIDI =
$$\frac{\text{Number of Customer - Minutes Interrupted from Sustained Interruptions}}{\text{Number of Customers Served}}$$

SAIFI =
$$\frac{\text{Number of Customers Interrupted from Sustained Interruptions}}{\text{Number of Customers Served}}$$

MAIFI =
$$\frac{\text{Number of Customers Interrupted from Momentary Interruptions}}{\text{Number of Customers Served}}$$

BACKGROUND

SDG&E has been measuring distribution circuit performance using SAIDI, SAIFI, and MAIFI for many years. Measuring system performance in this way has resulted in standards designed to reduce the number of customers affected by sustained or momentary outages (e.g. fuse and service restorer application) and reduce the length of sustained outages (e.g. line and tie switch and fault indicator application). The following equipment application standards were developed to be used conjunctively with this section by Distribution System Standards personnel:

- 6111 – Feeder Circuit Sectionalizing and Protection (Switch Application Criteria)
- 6112 & 6114 – Service Restorer Application Criteria
- 6113 – Automatic Self-Resetting Fault Indicator
- 6121 – Fuse Application Criteria
- 6144 – Distribution Circuit Protection Analysis
- 6232 – Circuit Tie Capacity Planning

APPLICATION

Historical and Predicted Analysis:

The two stages of the reliability analysis are Historical and Predicted; they provide a means to validate each other. The historical data is obtained through outage history databases and district records. Predicted quantities and impacts are derived from circuit modeling as described later in this section. The following components should be compared for differences between the two stages:

- * Outage Duration
- * Outage Frequency
- * Momentary Frequency
- * Failure Modes
- * Customer Complaints
- * Magnitude of Affected Load
 - MW
 - Number of Customers
- * Key Loads
- * Load Transfer Capability During Outages

	<input checked="" type="checkbox"/> Indicates Latest Revision	<input type="checkbox"/> Completely Revised	<input type="checkbox"/> New Page
REVISION	SDG&E DISTRIBUTION DESIGN MANUAL		6145.1
DATE 1-1-2000 APPD AMD, CQT/VGL	DISTRIBUTION CIRCUIT RELIABILITY ANALYSIS		

Project Development and Evaluation Methodology:

A benefit/cost analysis is used to compare the cost effectiveness of construction alternatives and prioritize projects. Reliability benefit is derived from the predicted annual improvement in the key indices, SAIDI, SAIFI, and MAIFI. The project cost is annualized by multiplying the capital cost by the current LACC (Levelized Annual Carrying Charges) factor. The benefit/cost (B/C) ratios are defined as:

$$\text{SAIDI B/C} = \frac{(\text{Predicted System SAIDI Improvement}) * (\text{Total System Customers})}{[(\text{Capital Project Cost}) * \text{LACC}]}$$

$$\text{SAIFI B/C} = \frac{(\text{Predicted System SAIFI Improvement}) * (\text{Total System Customers})}{[(\text{Capital Project Cost}) * \text{LACC}]}$$

$$\text{MAIFI B/C} = \frac{(\text{Predicted System MAIFI Improvement}) * (\text{Total System Customers})}{[(\text{Capital Project Cost}) * \text{LACC}]}$$

The predicted reliability improvements are calculated using the present average failure rates, restoration times, and customers affected. Failure rates vary by exposure, type, condition, and age of equipment and are typically projected from historical trends. Average rates are usually applied to classes of construction (e.g. underground and overhead) and may be more discretely defined with sufficient data. Restoration times are also estimated by past performance and should be modified for special conditions, such as rural circuits requiring lengthy travel time or remote SCADA operation. A sample predicted improvement calculation is shown below.

Assuming Current Failure Rate for Unjacketed Cable System = 0.4 failures/mile/year

Assuming Current Failure Rate for Jacketed Cable System = 0.01 failures/mile/year

Cable Considered for Replacement = 2000 feet

Assuming Estimated CAIDI (Customer Average Interruption Duration Index) Based on Configuration and Past Performance = 90 minutes

Customers Exposed to Sustained Outage = 3000

Total System Customers = 1,200,000

LACC = 0.1515

Prior to Improvements:

$$\text{Predicted System SAIDI Impact} = \frac{(0.4) * (2000/5280) * (90) * (3000)}{(1200000)} = 0.0341$$

After replacing the 2000 feet of unjacketed cable with jacketed cable:

$$\text{Predicted System SAIDI Impact} = \frac{(0.01) * (2000/5280) * (90) * (3000)}{(1200000)} = 0.000852$$

System SAIDI Improvement = 0.0340

Assuming \$30/foot for cable replacement, the benefit/cost is:

$$\text{SAIDI B/C} = \frac{(0.0340) * (1200000)}{[(2000) * (30) * (0.1515)]} = 4.488$$

	Indicates Latest Revision	Completely Revised	New Page
6145.2	SDG&E DISTRIBUTION DESIGN MANUAL		REVISION
	DISTRIBUTION CIRCUIT RELIABILITY ANALYSIS		DATE 1-1-2000 APPD AMD, CQT <i>/vcl</i>

This predicted SAIDI and benefit/cost calculation is performed more comprehensively and efficiently using circuit modeling computer software. The currently used application is described below.

Circuit Modeling Software:

The Reliability Analysis Program performs predicted SAIDI and SAIFI calculations, based on a circuit model. In addition, it contains a Tie Capacity Worksheet for verifying the adequacy of potential circuit ties in the model, as explained in Design Manual section 6232. The current Software, Software Users Manual, and Additional Tips document are available to SDG&E employees through Electric Reliability Improvement. The Main Menu, shown in Figure 1, provides push button access to the data entry and analysis worksheets. The circuit is modeled and predicted reliability calculated through entry of conductor data in the Conductor Lengths worksheet (see Figure 2) and sectionalizing equipment in the Circuit Analysis worksheet (see Figure 3). The Equipment Listing worksheet (see Figure 5) lists standard equipment with estimated installation costs. The Switching/Repair Times worksheet (see Figure 4) contains average restoration times based on historical results. These can be adjusted for higher accuracy when modeling circuits in remote locations that require longer personnel travel time. For alternative cases, construction costs can be entered in the Circuit Analysis worksheet for benefit/cost calculation. SAIDI B/C is labeled VR and the SAIFI B/C is labeled VB (see Figure 3).

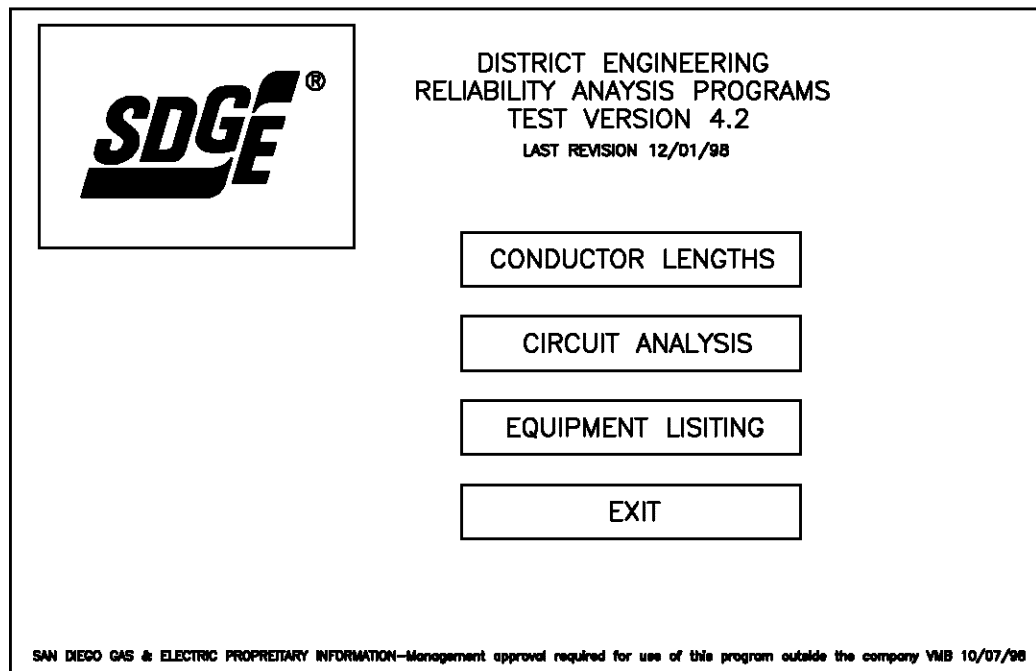

Figure 1 – Main Menu

	Indicates Latest Revision	Completely Revised	New Page
REVISION	SDG&E DISTRIBUTION DESIGN MANUAL		
DATE 1-1-2000 APPD AMD, CQT/Vcl	DISTRIBUTION CIRCUIT RELIABILITY ANALYSIS		6145.3

OC	CIRCUIT	310	BY:	Alan Dulgeroff								DATE:	*****		
FEEDER 1			FEEDER 2				FEEDER 3				FEEDER 4				
CB			FROM -35				FROM -21				FROM SA				
-34			TO -18				TO -16				TO -50				
PECN	XLPE	XLPEPJ	OVERHEAD	PECN	XLPE	XLPEPJ	OVERHEAD	PECN	XLPE	XLPEPJ	OVERHEAD	PECN	XLPE	XLPEPJ	
0	0	5,083	0	0	1,685	832	0	10	625	2,377	0	0	494	0	
0	2,640	3,500	0	0	0	0	1,970	0	0	0	2,510	0	0	0	
0	0	0	0	0	0	0	0	0	1,095	0	0	10	490	0	
0	0	0	0	0	0	0	0	0	0	0	0	100	1,015	884	
0	0	0	0	0	0	0	0	0	0	0	0	685	0	0	
0	0	0	0	0	0	0	0	0	0	0	0	0	680	280	
0	0	0	0	0	0	0	0	0	0	0	0	0	0	0	
0	0	0	0	0	0	0	0	0	0	0	0	0	0	0	
0	0	0	0	0	0	0	0	0	0	0	0	0	0	0	
0	0	0	0	0	0	0	0	0	0	0	0	0	0	0	

BRANCH B1			BRANCH B3				BRANCH B5				BRANCH B7			
-33			FROM -20				FROM -28				FROM -49			
-14			TO END				TO FUSE				TO T4-794			
PECN	XLPE	XLPEPJ	OVERHEAD	PECN	XLPE	XLPEPJ	OVERHEAD	PECN	XLPE	XLPEPJ	OVERHEAD	PECN	XLPE	XLPEPJ
287	0	1,843	0	25	990	112	0	0	535	0	0	25	3,772	617
0	2,640	3,500	0	450	1,673	45	1,300	0	0	0	0	0	0	0
0	0	0	0	120	1,359	45	0	0	0	0	0	0	0	0
0	0	0	0	0	0	0	0	0	0	0	0	0	0	0
0	0	0	0	0	0	0	0	0	0	0	0	0	0	0

BRANCH B2			BRANCH B4				BRANCH B6				BRANCH B8			
-32			FROM				FROM -22				FROM -48			
T3-312			TO				TO FUSE				TO FUSE			
PECN	XLPE	XLPEPJ	OVERHEAD	PECN	XLPE	XLPEPJ	OVERHEAD	PECN	XLPE	XLPEPJ	OVERHEAD	PECN	XLPE	XLPEPJ
0	0	1,250	0	0	0	0	0	0	536	0	0	0	330	280
0	0	0	0	0	0	0	1,430	0	0	0	880	0	0	0
0	0	0	0	0	0	0	0	0	0	0	0	0	0	0
0	0	0	0	0	0	0	0	0	0	0	0	0	0	0
0	0	0	0	0	0	0	0	0	0	0	0	0	0	0

F1	B1	B2	F2	B3	B4	F3	B5	B6	F4	B7	B8	TOTALS	Print Analysis
0	0	0	0	0	0	1,970	1,300	1,430	2,510	0	880	8,090	
0	287	0	0	595	0	10	0	0	795	25	0	1,712	
2,640	0	0	1,685	4,022	0	1,720	535	536	2,619	3,772	330	17,859	
8,583	1,843	1,250	832	202	0	2,377	0	0	1,164	617	280	17,148	

SDGE PROPRIETARY INFORMATION—Management approval required for use of this program outside the company VMB 10/07/98 - VER 4.2 REVISED

Reset All values

Transfer Values To Model

Figure 2 - Conductor Lengths

	Indicates Latest Revision	Completely Revised	New Page
6145.4	SDG&E DISTRIBUTION DESIGN MANUAL		REVISION
	DISTRIBUTION CIRCUIT RELIABILITY ANALYSIS		DATE 1-1-2000 APPD AMD, CQT/Vcl

Main Menu

SWITCH 1		SWITCH 2		SWITCH 3		SWITCH 4						
BASE	CASE 1	BASE	CASE 1	BASE	CASE 1	BASE	G					
\$1-1	\$	\$		\$2-5	G	G	\$3-9	G	G	\$4-13	G	G
\$1-2	\$	\$		\$2-6	G	G	\$3-10	G	G	\$4-14	G	G
\$1-3	\$	\$		\$2-7	G	G	\$3-11	G	G	\$4-15	G	G
\$1-4	\$	\$		\$2-8	G	G	\$3-12	R	R	T-4	G	G
T-1	\$	\$		T-2	N	N	T-3	N	N			

OUTAGE IMPACT BY SWITCHING/REPAIR TIMES ON LOAD POINTS

COMPONENT FAILURE	FEEDER 1		BRANCH 1		BRANCH 2		FEEDER 2		BRANCH 3		BRANCH 4	
	BASE	CASE 1	BASE	CASE 1	BASE	CASE 1	BASE	CASE 1	BASE	CASE 1	BASE	CASE 1
F1	3.50	3.50	0.25	0.25	0.25	0.25	0.25	0.25	0.25	0.25	0.25	0.25
B1	0.25	0.25	2.50	2.50	0.25	0.25	0.25	0.25	0.25	0.25	0.25	0.25
B2	0.25	0.25	0.25	0.25	2.50	2.50	0.25	0.25	0.25	0.25	0.25	0.25
F2	0.25	0.25	0.25	0.25	0.25	0.25	3.50	3.50	1.00	1.00	1.00	1.00
B3	0.25	0.25	0.25	0.25	0.25	0.25	1.00	1.00	2.50	2.50	1.00	1.00
B4	0.25	0.25	0.25	0.25	0.25	0.25	1.00	1.00	1.00	1.00	2.50	2.50
F3	0.25	0.25	0.25	0.25	0.25	0.25	1.00	1.00	1.00	1.00	1.00	1.00
B5	0.25	0.25	0.25	0.25	0.25	0.25	1.00	1.00	1.00	1.00	1.00	1.00
B6	0.25	0.25	0.25	0.25	0.25	0.25	1.00	1.00	1.00	1.00	1.00	1.00
F4	0.00	0.00	0.00	0.00	0.00	0.00	0.00	0.00	1.00	1.00	0.00	0.00
B7	0.00	0.00	0.00	0.00	0.00	0.00	0.00	0.00	0.00	0.00	0.00	0.00
B8	0.00	0.00	0.00	0.00	0.00	0.00	0.00	0.00	0.00	0.00	0.00	0.00

OUTAGE IMPACT BY SWITCHING/REPAIR TIMES ON LOAD POINTS

COMPONENT FAILURE	FEEDER 3		BRANCH 5		BRANCH 6		FEEDER 4		BRANCH 7		BRANCH 8	
	BASE	CASE 1	BASE	CASE 1	BASE	CASE 1	BASE	CASE 1	BASE	CASE 1	BASE	CASE 1
F1	0.25	0.25	0.25	0.25	0.25	0.25	0.25	0.25	0.25	0.25	0.25	0.25
B1	0.25	0.25	0.25	0.25	0.25	0.25	0.25	0.25	0.25	0.25	0.25	0.25
B2	0.25	0.25	0.25	0.25	0.25	0.25	0.25	0.25	0.25	0.25	0.25	0.25
F2	1.00	1.00	1.00	1.00	1.00	1.00	1.00	1.00	1.00	1.00	1.00	1.00
B3	1.00	1.00	1.00	1.00	1.00	1.00	1.00	1.00	1.00	1.00	1.00	1.00
B4	1.00	1.00	1.00	1.00	1.00	1.00	1.00	1.00	1.00	1.00	1.00	1.00
F3	3.50	3.50	1.00	1.00	1.00	1.00	1.00	1.00	1.00	1.00	1.00	1.00
B5	1.00	1.00	2.50	2.50	1.00	1.00	1.00	1.00	1.00	1.00	1.00	1.00
B6	1.00	1.00	1.00	1.00	2.50	2.50	1.00	1.00	1.00	1.00	1.00	1.00
F4	0.00	0.00	0.00	0.00	0.00	0.00	3.50	3.50	1.00	1.00	1.00	1.00
B7	0.00	0.00	0.00	0.00	0.00	0.00	1.00	1.00	2.50	2.50	1.00	1.00
B8	0.00	0.00	0.00	0.00	0.00	0.00	1.00	1.00	1.00	1.00	2.50	2.50

SDGE PROPRIETARY INFORMATION—Management approval required for use of this program outside the company. Last Revision VMB 12/01/98

Figure 4 - Switching/Repair Times

6145.6	Indicates Latest Revision	Completely Revised	New Page
	SDG&E DISTRIBUTION DESIGN MANUAL		
DISTRIBUTION CIRCUIT RELIABILITY ANALYSIS			REVISION DATE 1-1-2000 APPD AMD, CQT/VGL

SECTIONALIZING DEVICE	EQUIPMENT CODE	SWITCHING REPAIR/HRS	QTY REQ'D	UNIT COST	LACC	TOTAL COST	ANNUALIZED COST
OH SERVICE RESTORER	OHSR	0.00	0		0.1515	\$0	\$0
OH SCADA SWITCH	OHS	0.25	0		0.1515	\$0	\$0
OH ELECTRIC SECTIONALIZER	ESEC	0.00	0		0.1515	\$0	\$0
OH GANG OPERATED SWITCH	G	0.75	0		0.1515	\$0	\$0
OH HOOK STICK SWITCH	H	0.75	0		0.1515	\$0	\$0
OH FUSE/CUT OUT	F	0.00	0		0.1515	\$0	\$0
UG SERVICE RESTORER	UGSR	0.00	0		0.1515	\$0	\$0
NON SCADA SWITCH							
PME3	PME3	1.00	0		0.1515	\$0	\$0
PME9	PME9	1.00	0		0.1515	\$0	\$0
PME10	PME10	1.00	0		0.1515	\$0	\$0
PME11	PME11	1.00	0		0.1515	\$0	\$0
PADMOUNT SCADA EXISTING 3316							
PME3	SPME3	\$.25	0		0.1515	\$0	\$0
PME9	SPME9	\$.25	0		0.1515	\$0	\$0
PME10	SPME10	\$.25	0		0.1515	\$0	\$0
PME11	SPME11	\$.25	0		0.1515	\$0	\$0
PADMOUNT SCADA EXISTING 3315							
PME3	SPME3	\$.25	0		0.1515	\$0	\$0
PME9	SPME9	\$.25	0		0.1515	\$0	\$0
PME10	SPME10	\$.25	0		0.1515	\$0	\$0
PME11	SPME11	\$.25	0		0.1515	\$0	\$0
RETROFIT PADMOUNT SCADA PME TO SCADA PME							
PME3	SPME3	\$.25	0		0.1515	\$0	\$0
PME9	SPME9	\$.25	0		0.1515	\$0	\$0
PME10	SPME10	\$.25	0		0.1515	\$0	\$0
PME11	SPME11	\$.25	0		0.1515	\$0	\$0
RETROFIT PADMOUNT OIL/SF4 TO SCADA PME							
PME3	SPME3	\$.25	0		0.1515	\$0	\$0
PME9	SPME9	\$.25	0		0.1515	\$0	\$0
PME10	SPME10	\$.25	0		0.1515	\$0	\$0
PME11	SPME11	\$.25	0		0.1515	\$0	\$0
PAD MOUNT OH/OFF VISTA	YI	0.00	0		0.1515	\$0	\$0
UG SUBMERSIBLE SWITCH	UG	1.00	0		0.1515	\$0	\$0
UG FUSE INDICATORS	FC	0.00	0		0.1515	\$0	\$0
OH FAULT INDICATORS	OHFI		0		0.1515	\$0	\$0
UG FAULT INDICATORS	UGFI		0		0.1515	\$0	\$0
WIRE/CABLE REPLACEMENTS	REPAIR TIME IN HRS	QTY IN FT		\$/FT	LACC	TOTAL COST	ANNUALIZED
OH RECONDUCTORING >=1/0	2.00	0			0.1515	\$0	\$0
OH RECONDUCTORING <1/0	2.00	0			0.1515	\$0	\$0
UG CABLE REPLACEMENT >2/0	2.00	0			0.1515	\$0	\$0
UG CABLE REPLACEMENT <=2/0	2.00	0			0.1515	\$0	\$0
MISCELLANEOUS							
			0		0.0000	\$0	\$0
			0		0.0000	\$0	\$0
			0		0.0000	\$0	\$0
			0		0.0000	\$0	\$0
Main Menu	Print	Exit	GRAND TOTAL			\$0	\$0

Figure 5 - Equipment Listing

Numerous alternatives should be modeled as different cases for comparison and optimization. A suggested procedure for optimization is outlined below. Consult the Software Users Manual and Additional Tips document for further modeling instructions.

	Indicates Latest Revision	Completely Revised	New Page
REVISION	SDG&E DISTRIBUTION DESIGN MANUAL		
DATE 1-1-2000	DISTRIBUTION CIRCUIT RELIABILITY ANALYSIS		
APPD AMD, CQT/VGL	6145.7		

Distribution Circuit Reliability Modeling, Analysis, and Review Procedure:

Tie Capacity Analysis

- * If two good ties are available based on the Design Manual section 6232 criteria, activate the ties on model.
- * Consider circuit and customer locations.
- * Assume a maximum of two ties to pick-up the whole circuit.

Accuracy of Base Case Comparison

- * Provide GFMS predicted SAIDI, Base Case predicted SAIDI, and historical three year average SAIDI for ECO (Entire Circuit Outages) and number of ECO by type (e.g. two by cable failure and two by car-pole contact).
- * If SAIDI differs significantly in the GFMS and Base Case models, verify that the total customers and unfused footages by wire type match. Only CAIDI should vary. If the CAIDI (SAIDI/SAIFI) for each differ, ensure the appropriate switches are modeled and ties activated on base case.

Alternatives

- * Prioritize cable replacement based on SAIDI improvement. High number of customers attached to cable maximizes SAIDI improvement.
- * When replacing cable between switch positions, do entire run.
- * While still focusing on SAIDI improvement, identify the benefits to major customers.
- * Check with Planning Engineer on future circuit plans.
- * Use Vista switches only if another switch alternative is not viable.
- * If circuit will be split in near future, choose one of the following options using sound engineering judgment:
 1. Model circuit as is today, or
 2. Model existing circuit, accounting for transfers to or away from circuit. Other affected circuits need not be modeled.
 3. Model all changes.

Alternative Comparisons – Run separate cases for #2, #5, and #6, if applicable

1. Identify applicable fusing and electronic sectionalizers.
2. Replace all unjacketed cable that may interrupt entire circuit.
3. Prioritize cable replacement by benefit/cost ratios.
4. Identify additional switches, service restorers, SCADA switches, etc.
5. Produce two combined alternatives with the highest benefit/cost ratios.
6. Provide at least one alternative with benefit/cost ratios significantly higher than target.

Review

- * For presentation to the Reliability Action Team or other approval body, use a large summary operating map or overhead transparency, with the equivalent circuit highlighted, to explain alternatives.
- * Provide a package including:
 - Summary sheet for alternatives
 - Base Case analysis sheet
 - Alternative analysis sheets
 - Circuit Map(s)
- * Identify the location of high failure rate cable on the circuit; do not simply use calculated footages.
- * Attach large unfused branches over 500 feet to a switch.
- * Consider using padmounted switches, instead of subsurface, when selecting which switches to model.

	Indicates Latest Revision	Completely Revised	New Page
6145.8	SDG&E DISTRIBUTION DESIGN MANUAL		REVISION
	DISTRIBUTION CIRCUIT RELIABILITY ANALYSIS		DATE 1-1-2000 APPD AMD, CQT / <i>lcl</i>

**6200
SYSTEM
ENGINEERING**

**6200
SYSTEM
ENGINEERING**

PAGE

SUBJECT

6205 SECTIONALIZING DEVICES ON DISTRIBUTION CIRCUITS

6211 DISTRIBUTION CIRCUIT VOLTAGE PROFILE:
6211.1 – 6211.2 ALLOWABLE VOLTAGE BANDWIDTH

6212 EFFECTS OF VOLTAGE UNBALANCE ON CUSTOMER EQUIPMENT:
6212.1 CRITERIA
6212.2 EXAMPLE – FIGURE 1
6212.3 FIGURE 2

6213 TRANSFORMER PRIMARY VOLTAGE SELECTION:
6213.1 BOOSTED AREA, UN-BOOSTED AREA
6213.2 EXAMPLE

6214 EXPANSION OF THE 4KV SYSTEM

6221 APPLICATION OF PRIMARY NEUTRAL:
6221.1 REASON FOR GROUNDED SYSTEM, TYPES OF NEUTRAL SOURCES
6221.1 – 6221.3 WHEN SHOULD GROUNDED NEUTRALS BE USED

6222 APPLICATION OF GROUNDING BANKS
6221.1 – 6222.2 PURPOSE, DESIGN CONSIDERATIONS

6230 SUBSTATION DISTRIBUTION FIELD TIE EVALUATION

6231 GENERAL FEEDER CIRCUIT ANALYSIS GUIDELINE:
6231.1 SEQUENCE, ANALYSIS PROCEDURE
6231.2 JUSTIFICATION, SERVICE RELIABILITY, LOW VOLTAGE

6232 RURAL DISTRIBUTION CIRCUIT REBUILDING ANALYSIS

6233 TIE CAPACITY PLANNING

6234 LOAD MONITOR ALTERNATIVES FOR ELECTRIC DISTRIBUTION

6241 PRIMARY CABLE COST COMPARISON

6242 ECONOMIC EVALUATION OF ALTERNATIVES

© 1998 - 2021 San Diego Gas & Electric Company. All rights reserved. Removal of this copyright notice without permission is not permitted under law.

REV	CHANGE	DR	BY	DSN	APV	DATE	REV	CHANGE	DR	BY	DSN	APV	DATE
C							F						
B	EDITORIAL CHANGES	JIK	JIK	FRC	CZH	09/03/2021	E						
A	ORIGINAL ISSUE	-	-	JCE	MJC	11/29/2012	D						

SHEET 1 OF 1	X Indicates Latest Revision	Completely Revised	New Page	Information Removed	DM6201.1
	SDG&E ELECTRIC DISTRIBUTION DESIGN MANUAL				
	TABLE OF CONTENTS SYSTEM ENGINEERING				

SCOPE

This standard describes the use of sectionalizing devices on distribution circuits.

PURPOSE

This standard was established to explain the use of sectionalizing equipment on a typical distribution circuit. It is meant only to accompany the more specific application descriptions provided later in this section.

CRITERIA

Certain guidelines must be followed when considering the selection and placement of sectionalizing devices. Refer to the table of contents, page 6101, for details on the application criteria of specific devices.

INTRODUCTION

Fuses, service restorers, and switches are used to sectionalize distribution circuits. These devices provide flexibility in configuration and help to limit service interruptions. Supervisory Control And Data Acquisition (SCADA) is used in substations for circuit breaker operations, voltage control, and load voltage control, and load monitoring. SCADA is also used to remotely control switches, in addition to collecting analog line data (Volts, Amps, Watts, etc.)

The purpose of the following diagram is to illustrate the types of sectionalizing devices and their application on a distribution circuit. It is not intended to depict a typical circuit.

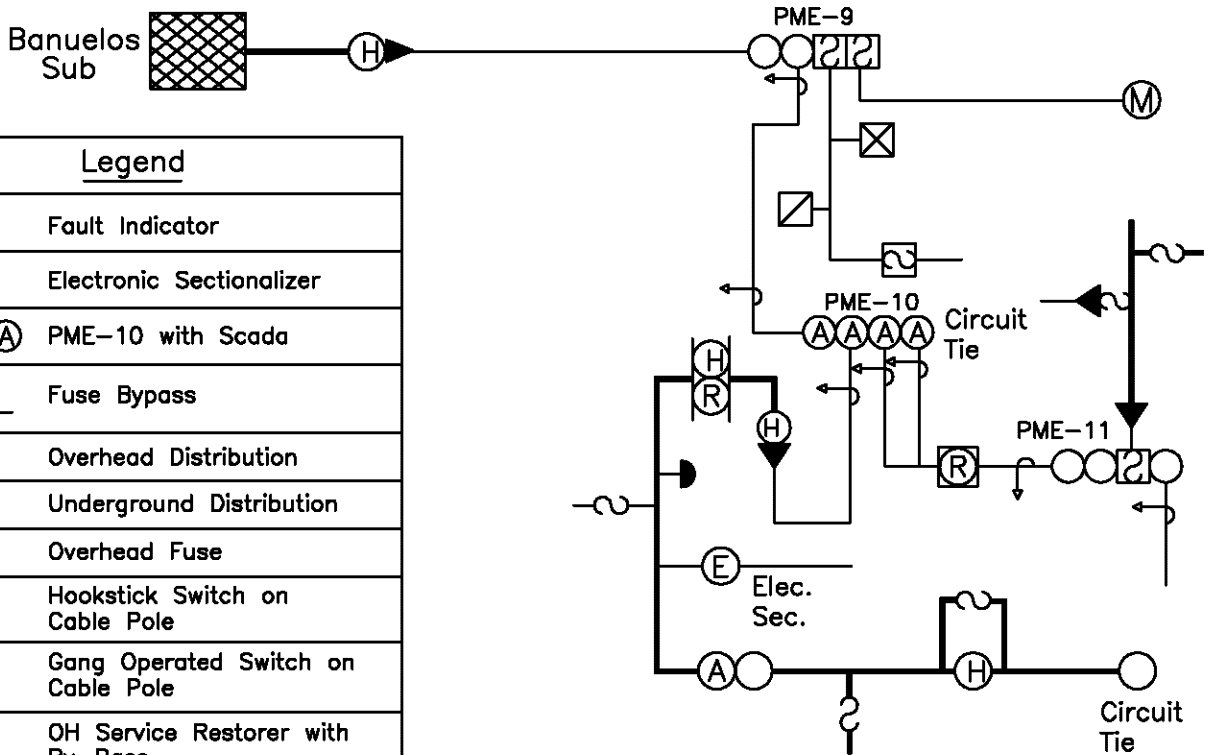

Legend	
	Fault Indicator
	Electronic Sectionalizer
	PME-10 with Scada
	Fuse Bypass
	Overhead Distribution
	Underground Distribution
	Overhead Fuse
	Hookstick Switch on Cable Pole
	Gang Operated Switch on Cable Pole
	OH Service Restorer with By-Pass

	PME-9 Cabinet		Fuse Cabinet
	Gang Operated Switch		Fused Cable Pole
	Three Phase Transformer		Scada-Mate
	Primary Metering Station		Padmount Service Restorer
	Capacitor		PME-11

	Indicates Latest Revision	Completely Revised	New Page
REVISION DATE 1-1-2000 APPD MJC / <i>vd</i>	SDG&E DISTRIBUTION DESIGN MANUAL SECTIONALIZING DEVICES ON DISTRIBUTION CIRCUITS		6205.1

APPLICATION

A. Fuses

Fuses are used to isolate the distribution feeder from permanent faults on local distribution branches. Expulsion fuses are used to isolate the overhead feeder from faulted overhead or underground branches. Current limiting fuses isolate underground distribution from faulted equipment and protect unfaulted equipment from additional stress damage. SM-4 expulsion fuses can be used in PME-9 and PME-11 cabinets and can be applied in selected underground projects to accommodate higher loads, inrush, or primary service. Since fuses must be coordinated with other protective devices, the fusing specialist in Distribution Planning will specify all fuse sizes and types via the fusing request.

B. Service Restorers

A service restorer is composed of two primary parts; the recloser and the control. Service restorers are available in OH or UG (padmount) configurations. The service restorer can minimize the number of customers affected by an outage. This device can also be used to separate the rural and urban portions of a circuit. It can also isolate a bulk of circuit load from probable cable failure. Service restorers are usually installed such that one half of the circuit load, or more, is upstream of the device.

A service restorer serving overhead lines is usually set for one instantaneous trip operation, then two or three delayed operations prior to locking-out, in case of a permanent fault. These settings vary depending upon the application. Since underground faults are rarely temporary, a service restorer serving underground lines is normally set to lockout immediately upon sensing a fault. This mode of operation reduces stress on circuit components and minimizes power quality impact.

SCADA functionality is expected to be available on all new service restorers beginning calander year 2000. Selected existing installations will also be eligible for control replacement providing SCADA functionality. Contact Distribution Standards for details.

Applications should be limited to cases where the feeder breaker is not yet on SCADA and the protected load is mostly commercial/industrial.

C. Switches

Manual padmounted switches and equipment are relatively easy and quick to operate, while subsurface equipment is the most difficult to access and operate quickly. Manual gang-operated overhead switches are equivilent in operability to pad mounted equipment.

SCADA equipment is by far the easiest and quickest to operate, as the Switching Center has direct, continous control of all SCADA switches and equipment. See part E.

D. SCADA-Substation

SCADA is used for substation operations, data gathering, and distribution switching.

E. SCADA LINE/TIE SWITCH : THE OVERALL FAMILY OF SCADA LINE/TIE SWITCHES INCLUDES THE FOLLOWING:

- A) Overhead SCADA -MATE
- B) PME cabinet with SCADA (-3, -9, -10, -11 configurations)
- C) PME source-transfer cabinet with SCADA
- D) Vista switch with SCADA

All of the above devices except C can implement an autosectionalizing feature, providing automatic isolation of faulted feeder segments from the balance of the feeder within a minute. This feature does NOT require SCADA at the feeder breaker.

All the above devices provide continuous analog data, along with status and control of each switch. With the exception of the Vista switch supplied with fault interrupter modules, these devices do NOT have the ability to interrupt faults.

	<input checked="" type="checkbox"/> Indicates Latest Revision	Completely Revised	New Page
6205.2	SDG&E DISTRIBUTION DESIGN MANUAL		REVISION
	SECTIONALIZING DEVICES ON DISTRIBUTION CIRCUITS		DATE 3-1-02 APPD JCE / <i>vd</i>

APPLICATION

The application of the Vista switch with fault interrupting modules is limited to the downtown San Diego area, where a dry vault houses the switch and the interrupters serve loads in a radial manner only. Other Vista switch applications, with or without SCADA, are appropriate elsewhere if easement constraints preclude the ability to obtain easement for PME cabinet. This generally requires a deviation with evidence of easement with evidence of easement turndown by property owners. The installed cost of the Vista switch is significantly higher than that of the PME cabinet, in all cases. Other constraints allowing Vista application include 1) retaining walls greater than 8 feet high for the PME cabinet, and 2) areas with zero structure set-backs.

F. ELECTRONIC SECTIONALIZER:

An overhead device, installed much like a fuse, that isolates faulted segments of the line automatically. Self contained, line powered electronics count the number of times fault current passes within a specified period. If the count meets or exceeds the value set by the manufacturer, the device will initiate an isolation of the line in between energized intervals. Upstream reclosing then closes and holds, restoring service to the balance of the circuit. Relatively economical, but limited ability to carry load (200 amps max.). Customers on the load side may be subject to single phase conditions when the sectionalizer operates. Requires Electric Troubleshooter (ETS) response to reset once operated. Does not prevent line side customers from experiencing a momentary outage for load side faults; only prevents sustained outage.

G. FUSE-BYPASS:

Overhead installation including fuses in parallel with a hookstick switch or solid blade cutouts, providing the means to protect the feeder from load side faults while maintaining the functionality of tie switches. However, when the tie switch is used, ETS must also be dispatched to the fuse-bypass, some what complicating routine switching (parallels). Relatively economical, but obviously limited to less than 150-200 amps load. Will single phase load side customers.

H. CAM-LINK:

UG device providing the ability to quickly isolate UG feeder segments or equipment. Operable by a single ETS, the cam-link is a molded connector assembly including a removable, current carrying part that can be replaced with a non-current carrying counterpart. Can be operated only after both sides are tested deenergized. Can be installed within a 600 amp deadfront terminator to provide some basic feeder sectionalizing ability. Very economical and able to carry full line current. Installed on padmounted service restorers to provide a visible open that can be tagged as part of a line authorization. Also installed on PME-3 SCADA cabinets to allow quick isolation of voltage sensors prior to thumping or high-potting.

LEGACY SCADA SITES:

- i. Existing "Legacy" SCADA systems—installed on selected oil and SF6 subsurface and padmount switches between 1989 and 1996, to provide basic SCADA functionality (open/close status & control, plus fault indication). These sites do not have the ability to autosectionalize, nor is it feasible to add that feature. Analog line data not normally available. There are no plans to install additional sites using this kind of system. Examples include SCADA sites 98, 66, 43, etc. Contact Distribution Standards for more information.

	<input checked="" type="checkbox"/> Indicates Latest Revision	<input type="checkbox"/> Completely Revised	<input type="checkbox"/> New Page
REVISION	SDG&E DISTRIBUTION DESIGN MANUAL		6205.3
DATE 3-1-02 APPD JCE / <i>JKL</i>	SECTIONALIZING DEVICES ON DISTRIBUTION CIRCUITS		

SCOPE THIS STANDARD IS TO BE USED BY ENGINEERING AND OPERATING PERSONNEL CONCERNED WITH THE ALLOWABLE VOLTAGE BANDWIDTH.

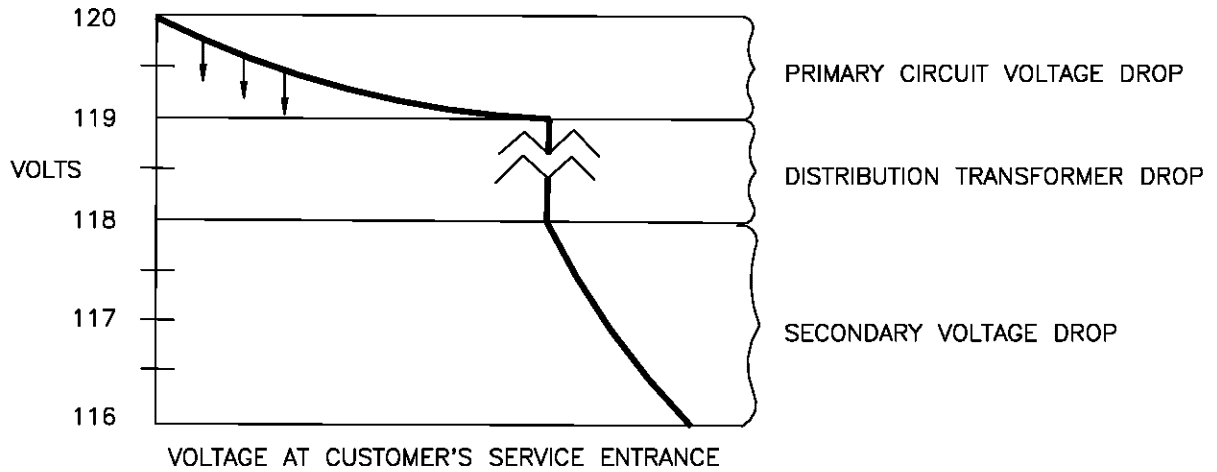

CVR VOLTAGE PROFILE – LIGHT LOAD
(CONSERVATION VOLTAGE REGULATION)

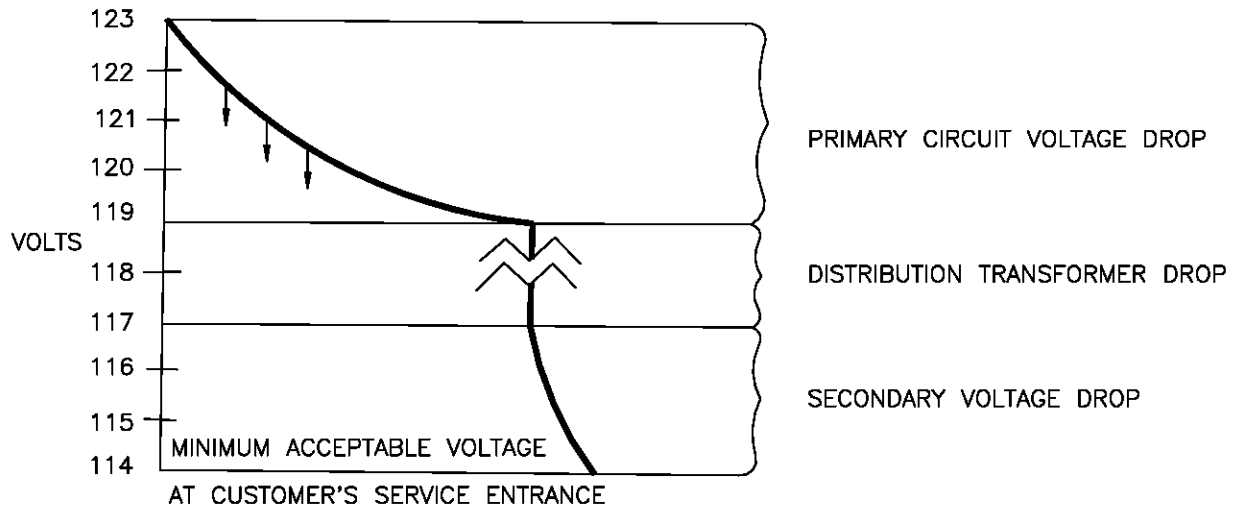

CVR VOLTAGE PROFILE – PEAK LOAD

	Indicates Latest Revision	Completely Revised	New Page
REVISION	SDG&E DISTRIBUTION DESIGN MANUAL		
DATE 1-1-96 APPD CVN / <i>ROJ</i>	DISTRIBUTION CIRCUIT VOLTAGE PROFILE		6211.1

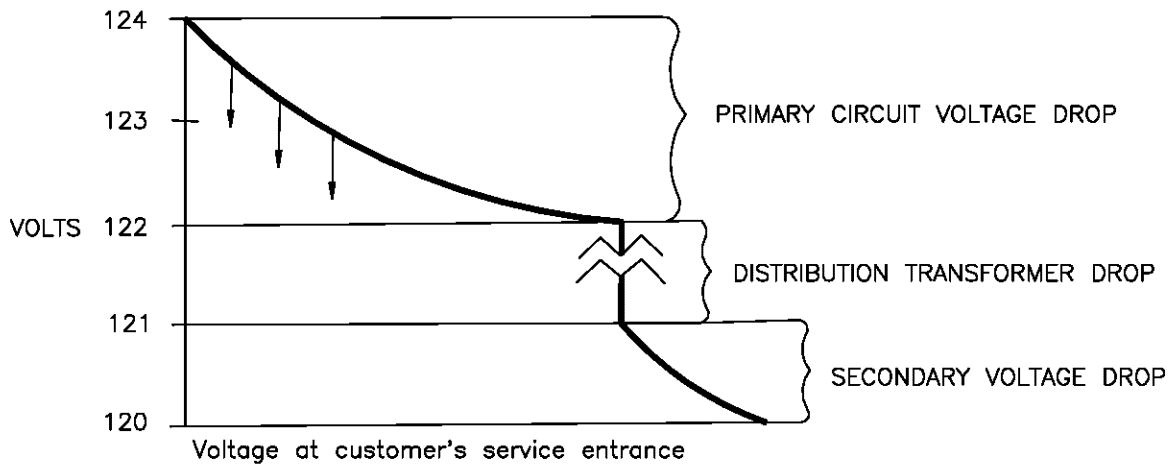

NON - CVR VOLTAGE PROFILE - LIGHT LOAD

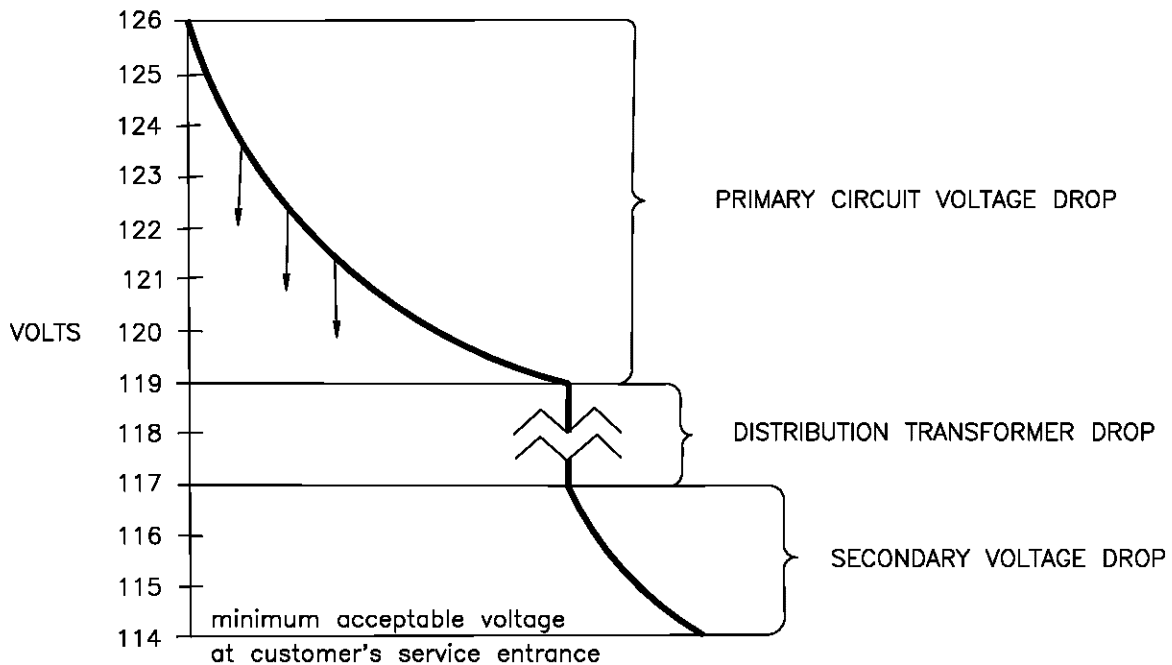

NON - CVR VOLTAGE PROFILE - PEAK LOAD

The voltage profile computer program is a tool that the Distribution Workflow & Planning can use to determine distribution circuit conditions for future load levels. Output from this program include circuit voltage, current, impedance, losses, conductor sizes, distances and connected loads along the circuit. Base cases are constructed by using transformer sizes and conductor footage that is taken from circuit wall maps and other Company documents. For information on constructing base cases and running studies, see "Procedure for Conducting Voltage Profile Studies" triad file END 300.

Updated profile studies should be run annually for distribution circuits showing growth. It is best to start with load level projects for two or three years in the future. Analysis of the output data and application of the appropriate criteria will indicate problem areas of low voltage and/or conductor overloads. The output of this program is also used for tie capacity calculations (Design Standard 6232).

	Indicates Latest Revision	Completely Revised	New Page
6211.2	SDG&E DISTRIBUTION DESIGN MANUAL		REVISION
	DISTRIBUTION CIRCUIT VOLTAGE PROFILE		DATE 9-4-84 APPD CVN <i>BJ</i>

SCOPE

This design standard provides discussion of the effects of voltage unbalance on three-phase induction motors.

PURPOSE

This standard was created to inform Distribution Standards & Cost Management personnel of the effects of supplying three-phase induction motors with an unbalanced set of voltages.

DEFINITIONS

Voltage Unbalance – the maximum voltage deviation from the average voltage as a percent of the average voltage.

$$\% \text{ Voltage unbalance} = 100 \times \frac{\text{max. voltage deviation from average}}{\text{average voltage}}$$

Motor Derating – the term applied to a reduction in a motor's rated output.

CRITERIA

1. Distribution Standards & Cost Management approval is required whenever an open-wye transformer station is intended to be installed more than five miles beyond the substation. They will determine if the open-wye station may be installed without causing a voltage unbalance problem.
2. Distribution Standards & Cost Management should improve the voltage balance on a secondary system whenever they determine that a voltage unbalance may cause equipment damage.

DISCUSSION:

Unbalanced voltage may effect a three-phase induction motor in the following way:

1. Increased Heating – An industry "rule of thumb" states that the increase in motor heating due to voltage unbalance is approximately equal to two times the voltage unbalance squared. If the voltage unbalance is 4.3% then the increased heating is approximately:

$$2 \times (4.3 \times 4.3) = 37\%$$

To prevent motor damage due to voltage unbalance, NEMA Standard MG1-14.34 or ANSI Standard C84.1-1982 suggest that a three-phase induction motor be derated according to figure 1 (page 6212.2).

2. Winding Currents – Unbalanced voltage will result in unbalanced motor winding currents of a larger magnitude. For example, a 4.3% voltage unbalance on a 10hp three-phase motor may result in line currents of 132%, 92%, and 85% of the rated current under balanced conditions depending on the individual characteristics of the motor.
3. Efficiency – Figure 2 (page 6212.3) illustrates the impact of voltage unbalance on the efficiency of a typical 10hp induction motor. As shown, an induction motor operating with an average voltage of 230 volts and 4.3% voltage unbalance will have an efficiency of approximately 84.6%.
4. Sump pumps – three-phase submersible sump pumps of any size should not be fed from open-delta stations. (Refer to page 5413.4 note 6.d.)



Indicates Latest Revision

Completely Revised

New Page

REVISION

DATE 3-1-02

APPD JCE / *Vel*

SDG&E DISTRIBUTION DESIGN MANUAL

EFFECTS OF VOLTAGE UNBALANCE ON CUSTOMER EQUIPMENT

6212.1

4. Decreased Speed

The decrease in shaft speed is dependent on the degree of voltage unbalance and the resulting average voltage. If the voltage unbalance is excessive, the motor will stall.

EXAMPLE:

Determine the voltage unbalance for the following set of secondary voltage readings:

$V_{a-b} = 220V$

$V_{b-c} = 230V$

$V_{a-c} = 240V$

average voltage = $(220 + 230 + 240)/3 = 230V$

voltage unbalance = $(230 - 220)/230 = .043$ or 4.3%

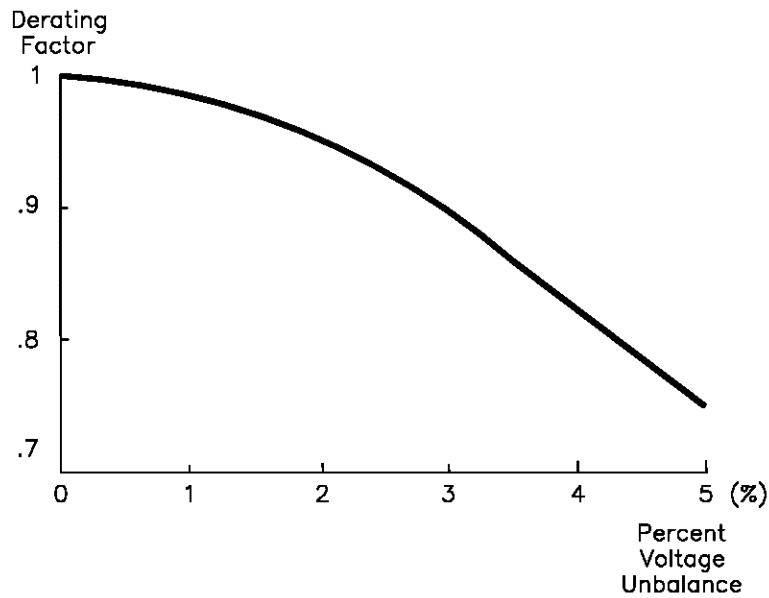

INDUCTION MOTOR
DERATING FACTOR
-VS-
VOLTAGE UNBALANCE

Figure 1

	Indicates Latest Revision	Completely Revised	New Page
6212.2	SDG&E DISTRIBUTION DESIGN MANUAL		REVISION
	EFFECTS OF VOLTAGE UNBALANCE ON CUSTOMER EQUIPMENT		DATE 3-30-84 APPD CVN/BJ

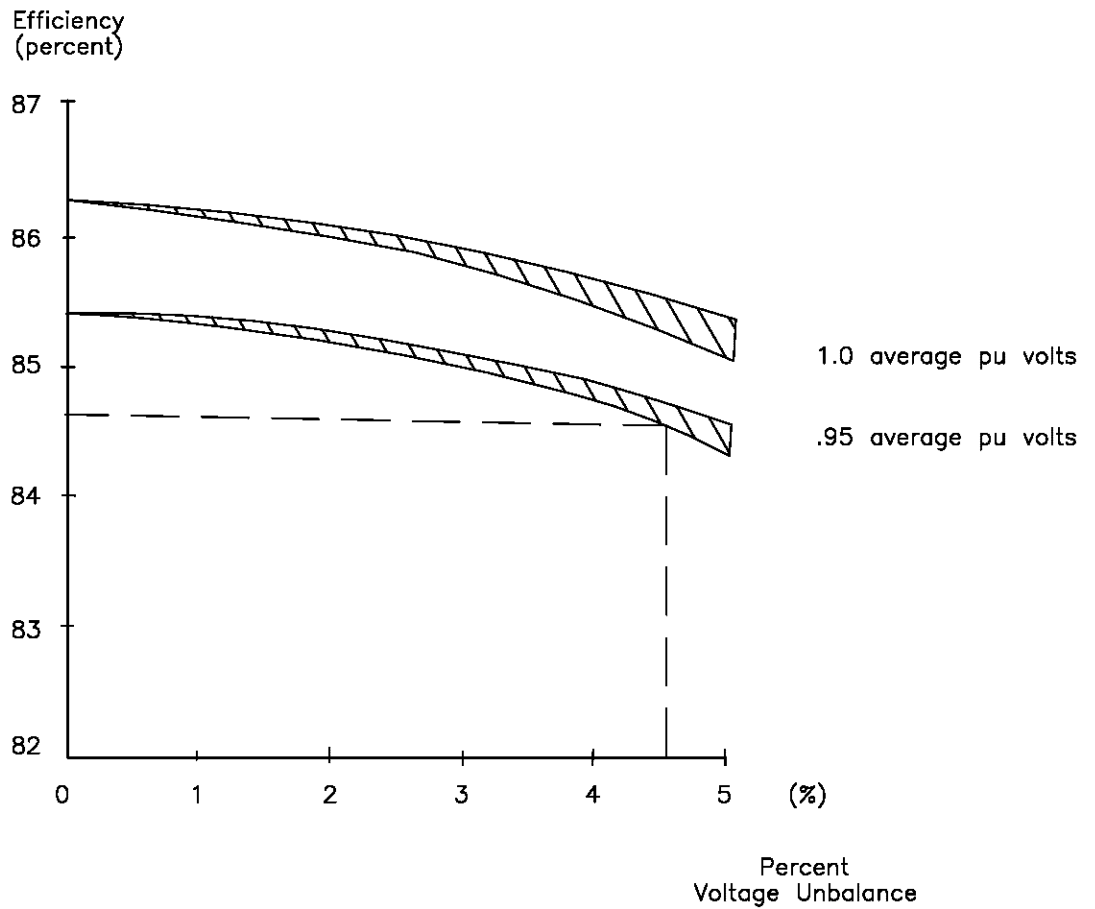

INDUCTION MOTOR
VOLTAGE UNBALANCE
-VS-
MOTOR EFFICIENCY

Figure 2

	Indicates Latest Revision	Completely Revised	New Page
REVISION	SDG&E DISTRIBUTION DESIGN MANUAL		
DATE 3-30-84 APPD CVN/ROJ	EFFECTS OF VOLTAGE UNBALANCE ON CUSTOMER EQUIPMENT		6212.3

SCOPE

This standard provides the proper single-phase primary transformer voltage selection for boosted and unboosted areas on 12kV distribution circuits.

PURPOSE

This standard was developed to maintain 114 volts minimum (phase to neutral) at the customer's service entrance, based on the Distribution Circuit Profile (Design Standard 6211)

DEFINITIONS

Boosted Area – a physical location on a 12kV circuit served by a booster to provide 7,200 volts from a 12,000/6,930 volt source for proper operation of 7,200 volt transformers.

Boosted Rating – the kVA nameplate rating of 100 or 333 kVA–1Ø and 1875 or 3750 kVA–3Ø.

Booster Ultimate Loading – the maximum allowable peak loading of a booster is established as 100 percent of booster rating.

STANDARD

A. Boosted Area

Transformers rated 7,200 volts should be selected for boosted areas, provided the booster connected kVA will not exceed 90 percent of the booster rating with the kVA additions included.

- When exceeding 90 percent booster rating, Electric Distribution Planning approval is required for 7,200V transformer additions.

B. Unboosted Areas

1. Transformers rated 6,930 volts will always be selected for new installations in unboosted areas.
2. Transformers rated 6,930 volts will always be selected to replace existing 7,200V transformers in unboosted areas more than 1-1/2 miles from the distribution substation.
3. Transformers rated 6,930 volts will always be selected to replace existing 7,200V transformers in unboosted areas less than 1-1/2 miles from the distribution substation, provided the cost associated with converting live front (7,200V) to deadfront (6,930V) transformers is moderate and the interruption of service does not exceed 1 hour for commercial or 6 hours for residential customers. Where a high cost and/or extended outage time for the conversion is required, the replacement use of 7,200V transformers is acceptable.

	 Indicates Latest Revision	Completely Revised	New Page
REVISION	SDG&E DISTRIBUTION DESIGN MANUAL		
DATE 3-30-84 APPD CVN/ <i>ROJ</i>	TRANSFORMER PRIMARY VOLTAGE SELECTION		6213.1

Example:

Select the proper transformer primary voltage for the addition of 12–25 kVA single-phase transformers in a boosted area served by a 1875 kVA booster with 1400 kVA already connected.

1. Determine the booster loading requiring Electric Distribution Planning approval; 1875 kVA, booster rating (.9) = 1688 kVA
2. Determine total proposed connected kVA on the booster; 1400 kVA, existing + 300 kVA, proposed = 1700 kVA
3. Obtain Electric Distribution Planning approval for the proposed 7,200V transformer additions. Electric Distribution Planning should consider:
 - If the proposed additional transformers will result in the booster exceeding the booster ultimate loading due to actual demand.
 - If a 6,930 volt source should be brought into the area to serve the proposed additional transformers.

References:

1. Design Standard 6211, Distribution Circuit Voltage Profile
2. Service Planning Manual 353, Planned and Requested Outages

	 Indicates Latest Revision	Completely Revised	New Page
6213.2	SDG&E DISTRIBUTION DESIGN MANUAL		REVISION
	TRANSFORMER PRIMARY VOLTAGE SELECTION		DATE 3-30-84 APPD CVN / <i>RDG</i>

SCOPE

This design standard outlines criteria for the expansion of 4kV systems.

Purpose

PRIMARY LINE EXTENSION - 4kV System

The general policy for expansion of the electric distribution system is to contain the 4kV areas and to cutover small selected areas from 4kV (or 2.4kV) to 12kV operation so as not to require expansion of the existing 4kV system. This will allow continued use of the existing equipment and at the same time use the more economical 12kV system for as much of the new load as possible.

All new distribution lines are to be built to 12kV standards to avoid major improvements or additions in the future when cutover to 12kV takes place.

The circuit selection for new loads will be based on the size of the load and its proximity to existing circuits. **Electric Load Studies are required for any load addition to the 2.4kV or 4kV system.** Other new loads within mixed voltage areas will be served by new lines built to 12kV standards. Although 12kV cutovers within these areas are not anticipated, they will be made if the economics can be proven or if required to serve a large new load at 12kV.

There are several small substations serving isolated 2.4 or 4kV systems. Some of these systems must be left in place because they serve underground cables or **4kV primary metered customers.** In general, it is preferred not to extend any of these local 2.4 or 4kV systems; however, from the practical standpoint, short extensions may be necessary.

The following considerations should be reviewed by Electric Distribution Planning prior to recommending that an area be cutover from 4kV to 12kV:

1. **Cost associated with complying to grade of construction (G.O. 95 Rule 42, Table 3, class of poles (G.O. 95, Rule 49.1B) and clearance for 12kV (G.O. 95, Rule 38, Table 2).**
2. Number of customers on each transformer station
3. High voltage signs
4. Reconductoring
5. Lightning arrestors on 100 kVA transformers
6. Replacement of #6 WP and #6 Bare Strand on main lines
7. Retagging of the stations on the cutover as a supplement to the main job
8. Notes on the sketch such as: "Foreman note: Check phase balance before and after cutover. Rebalance circuits if warranted." and "Customer outages are to be kept to a minimum. If an outage of more than 5 minutes is necessary, contact the appropriate Region Planning Department."
9. Temporary shooflies are to be discussed with Region Design Review foreman before issuing the Cutover.
10. Primary metering stations on 4kV either overhead or underground require a memorandum to the Region Planning Department stating that the circuit is being cutover to 12kV.

© 1998 - 2022 San Diego Gas & Electric Company. All rights reserved. Removal of this copyright notice without permission is not permitted under law.

REV	CHANGE	DR	BY	DSN	APV	DATE	REV	CHANGE	DR	BY	DSN	APV	DATE
C							F						
B	EDITORIAL CHANGE	EPC	FRC	JAS	FRC	03/01/2022	E						
A	ORIGINAL ISSUE				CVN	03/30/1984	D						

SHEET 1 OF 2	X Indicates Latest Revision	Completely Revised	New Page	Information Removed	DM6214.1
	SDG&E ELECTRIC DISTRIBUTION DESIGN MANUAL				
	EXPANSION OF THE 4KV SYSTEM				

11. Replacement of all Weatherproof copper wire. See DM 5124.1.4.

12. Review with either the primary or if applicable alternate 12kV circuit to determine if any additional reliability concerns will materialize (ex. Modifications to existing midpoint or tie switch locations).

© 1998 - 2022 San Diego Gas & Electric Company. All rights reserved. Removal of this copyright notice without permission is not permitted under law.

REV	CHANGE	DR	BY	DSN	APV	DATE	REV	CHANGE	DR	BY	DSN	APV	DATE
C							F						
B	EDITORIAL CHANGE	EPC	FRC	JAS	FRC	03/01/2022	E						
A	ORIGINAL ISSUE				CVN	03/30/1984	D						

SHEET 2 OF 2	X Indicates Latest Revision	Completely Revised	X New Page	Information Removed
	SDG&E ELECTRIC DISTRIBUTION DESIGN MANUAL			
	EXPANSION OF THE 4KV SYSTEM			

DM6214.2

SCOPE

This standard establishes the criteria for application of grounded neutral systems to serve single-phase 6.9kV or 7.2kV primary systems.

APPLICATION OF GROUNDED NEUTRAL PRIMARY SYSTEMS

A. Reason for Using a Grounded Neutral System

A grounded neutral system allows the application of line-to-neutral transformers (6.9kV or 7.2kV primary voltage) on underground residential systems. This application results in significant cost savings over the use of line-to-line transformers (12kV primary voltage) due to one less cable, fewer connectors, lower-cost transformers and smaller substructures.

B. Types of Neutral Sources

1. Substation Neutral

The substation neutral is the preferred neutral source. The recommended limit on cost expenditures for extending the substation neutral is two times the cost of installing a new grounding bank.

2. Grounding Banks (see Design Standard 6222)

Grounding banks are an alternate method of supplying a grounded neutral source. A grounding bank may be installed when a grounded neutral source is required and;

- a. The cost of extending the neutral from the substation or from an existing grounding bank is double the cost of a new grounding bank installation.
- b. The new load will not cause an overload or imbalance to the grounding bank.

Design Standards' approval is required prior to the addition of a fourth grounding bank to a distribution circuit. When there are three existing grounding banks, new load must be served from one of the existing grounding banks or substation neutral.

C. When Should Grounded Neutrals Be Used?

1. A job involving single-phase loads shall be served using 6.9kV transformers when any of the following is true:
 - a. The estimated cost of using 6.9kV transformers including neutral bring-up costs and/or a grounding bank is less than or equal to the cost of using 12kV transformers.

	 Indicates Latest Revision	Completely Revised	New Page
REVISION	SDG&E DISTRIBUTION DESIGN MANUAL		
DATE 1-1-87 APPD CVN / <i>ROJ</i>	APPLICATION OF PRIMARY NEUTRAL		6221.1

- b. There is potential for future single-phase load additions to this circuit within a half-mile radius of the project location, and the estimated cost of providing a grounded neutral system is less than three times the cost savings obtainable by installing a 6.9kV system instead of a 12kV system.

Note: The allowable cost of the neutral bring-up will be put on the fuse request by District Engineering. If the cost estimated by the designer exceeds this cost, he or she should return to District Engineering for further approval.

- 2. In addition to jobs issued specifically to install a neutral conductor on the primary overhead system, either neutral conductors shall be included or poles shall be framed for neutral conductors in the following jobs:
 - a. The fourth conductor (neutral) shall be installed on all new or reconductored distribution feeders. The neutral conductor must be connected to a grounded neutral. If the neutral conductor cannot be connected to the substation ground without major expense, the use of an existing or new grounding bank neutral may be considered (see Design Standard 6222 on grounding bank information).

NOTE: Contact Electric Distribution Planning Engineer when conditions indicate framing for the neutral conductor may be preferred on reconductored or new feeders. Framing should be compatible with overall system integrity, a viable construction option, and economically advisable. Some concepts for consideration are: Fault current advantages having the neutral conductor, tie compatibility between circuits, ability to transfer load between circuits (temporary or permanent).

- b. On local distribution branch work, poles shall be framed for the fourth conductor. This will minimize the cost of installing the neutral conductor at a later time.
- c. Work to bring-up a phase conductor to serve a new grounding bank shall include the extension of the neutral conductor from the grounding bank to the point where the new phase conductor originates.
- d. All new or reconductored three-phase local distribution branch work shall include the neutral conductor when an existing neutral is in the area.

D. Application

- 1. A neutral being used to supply transformers on a circuit may not originate from a different substation than the one supplying the circuit.
- 2. The neutral must be continuous, therefore, no fusing is permitted within a primary neutral circuit.

	Indicates Latest Revision	Completely Revised	New Page
6221.2	SDG&E DISTRIBUTION DESIGN MANUAL		REVISION
	APPLICATION OF PRIMARY NEUTRAL		DATE 1-1-87 APPD MF/ROJ

D. Application (con't)

3. Neutrals shall be solidly tied together at all switches regardless whether they are normally open or closed. This includes tie switches to circuits emanating from different substations. This also includes a neutral that comes from a grounding bank.
4. The neutral in a 4-wire overhead system shall be connected to the neutral of an underground system that is tapped to the overhead. This applies even if only three-phase transformers are connected to the underground.

	<input checked="" type="checkbox"/> Indicates Latest Revision	<input type="checkbox"/> Completely Revised	<input type="checkbox"/> New Page
REVISION	SDG&E DISTRIBUTION DESIGN MANUAL		6221.3
DATE 3-1-02 APPD JCE / <i>Vcl</i>	APPLICATION OF PRIMARY NEUTRAL		

SCOPE

This criteria shall be used for the application of grounding banks. Grounding banks provide a grounded neutral source that is required by load additions which are served by 6.9kV transformers.

DEFINITIONS

A grounding bank installation consists of three-phase transformers connected grounded wye-delta and is used to provide a ground source for the primary neutral wire. The primary voltage rating of the transformers used can be 12 or 6.9kV. The secondary voltage shall be rated 480 volts or higher (see O.H. Standards page 1195).

APPLICATION OF GROUNDING BANKS

A. Why Grounding Banks?

A grounding bank may be installed to serve single-phase load additions using 6.9kV transformers when there are two or fewer grounding banks on a circuit and:

1. Extension of an existing neutral wire, beyond the proper location for a grounding bank, is double the cost of a new grounding bank installation.
2. A neutral connected to an existing grounding bank is available, but additional single-phase load will exceed the recommended kVA limit on the existing grounding bank (see paragraph B.5).

B. Design Considerations

The following lists several design considerations related to the application of grounding banks.

1. The available short-circuit current sensed by a protective device is reduced approximately 100 amps for each grounding bank between the fault location and the substation. To prevent desensitization of the substation ground relays, the number of grounding banks on a circuit is limited to three installations.
2. A grounding bank should be installed at a central location to enable future loads to take advantage of this neutral source. Since there will normally be a maximum of three grounding banks per circuit, each grounding bank should be located to cover one third of the area served by the circuit.

	 Indicates Latest Revision	Completely Revised	New Page
REVISION	SDG&E DISTRIBUTION DESIGN MANUAL		6222.1
DATE 1-1-87	APPLICATION OF GROUNDING BANKS		
APPD CVN/ <i>RDJ</i>			

3. The recommended location for a grounding bank is on the unfused portion of a circuit, preferably on the feeder because the load on the grounding bank will be served by an energized neutral source except during times when the circuit is interrupted or the grounding bank has failed.
4. Neutrals established by grounding banks should only be used to serve transformers fed from the same circuit.
5. The following are approved grounding bank installations, allowable connected kVA unbalance between phases and maximum connected kVA loading.

Grounding Bank Installation	Allowable Connected kVA unbalance Between Phases	Maximum Connected kVA Loading (a)
3 – 50 kVA's	150 kVA	1500 kVA
3 – 75 kVA's	225 kVA	2250 kVA

- (a) The maximum connected kVA allowed was set at 10 times the unbalance which a grounding bank may tolerate because the load unbalance on the average circuit is 10 percent.
 - b. For more information on overhead grounding banks, refer to O.H. Standards Page 1195.
6. Single-phase loads served from a grounding bank should be divided equally among the three phases to balance the total load as much as possible.

If the amount of unbalance cannot be kept within the limits set above, one of the following must be done:

- a. Extend the neutral from the substation and remove the grounding bank. This alternative is recommended if there is significant load growth potential in the area.
- b. Serve part of the load with 12kV single-phase transformers. Use enough 12kV transformers to reduce the amount of 6.9kV connected kVA below the recommended limit.
- c. Extend the neutral from another grounding bank, either new or existing, and transfer some 6.9kV load to this neutral. These neutrals are not to be connected to each other.

	Indicates Latest Revision	Completely Revised	New Page
6222.2	SDG&E DISTRIBUTION DESIGN MANUAL		REVISION
	APPLICATION OF GROUNDING BANKS		DATE 1-1-87 APPD CVN/RD

1.0 PURPOSE

This document provides a standard for evaluating and coordinating the review of distribution field ties to improve substation reliability during a substation upgrade scope development. The intent is to increase the number of circuits that can be restored via ties to surrounding substations in the event of a substation outage. With the ability to off load circuits to adjacent substations, this would also reduce customers impacted by planned outages for maintenance work. This standard establishes the framework to evaluate the benefits of installing new distribution field ties and upgrading existing distribution field ties as part of substation upgrade projects. It covers priority factors that should be taken into consideration and goes through the process of looking at various distribution field tie opportunities associated with a specific substation. It also provides guidance for developing and executing the project.

2.0 REFERENCES

- OUA for number of substation outages:
https://oua.sdge.com/analytics/saw.dll?dashboard&PortalPath=%2Fshared%2FSDGE%20Analytics%2F_portal%2FOutages
- Grid Ops for system operating diagram (SOD):
<https://gridops.sdge.com/gc/DOCS/sods.asp>
- Business Warehouse for customer type by substation:
<https://biprod.sempira.com:8443/BOE/BI>
- SED SharePoint for substation distance from Kearny:
<https://sempira.sharepoint.com/teams/sed/SitePages/Home.aspx>

3.0 ACRONYMS/DEFINITIONS

- Kearny – Substation & transmission operations and maintenance department
- EDO – Electric Distribution Operations
- EDP – Electric Distribution Planning
- ERO – Electric Regional Operations
- ESH – Electric System Hardening
- HFTD – High Fire Threat District
- IFC – Issued for construction
- OUA – Oracle Utility Analytics
- RTR – RAT Team Rating (Reliability Assessment Team Team Rating)
- SAIDI – System Average Interruption Duration Index
- SCADA – Supervisory Control and Data Acquisition

© 1998 - 2021 San Diego Gas & Electric Company. All rights reserved. Removal of this copyright notice without permission is not permitted under law.

REV	CHANGE	DR	BY	DSN	APV	DATE	REV	CHANGE	DR	BY	DSN	APV	DATE
C							F						
B							E						
A	ORIGINAL ISSUE	JIK	FRC	CZH	SP	09/03/2021	D						

SHEET 1 OF 5	Indicates Latest Revision	Completely Revised	X	New Page	Information Removed	DM6230.1
	SDG&E ELECTRIC DISTRIBUTION DESIGN MANUAL					
	SUBSTATION DISTRIBUTION FIELD TIE EVALUATION					

- SDR – Substation Design Request
- SED – Substation Engineering and Design
- SOD – System Operating Diagram
- SPACE – System Protection and Controls Engineering
- TED – Transmission Engineering and Design
- TRC – Technical Review Committee
- TST – Technical Support Team, distribution engineering support at EDO

4.0 GENERAL

This standard provides general guidance for evaluating field ties as part of substation upgrade projects. In addition to the technical merits of a project, there may be factors to consider outside the scope of this standard. Other factors may include available budget, upcoming projects in the area, or various other factors that may affect distribution field tie scope of work.

5.0 INITIATION, TRIGGERS, AND CONSIDERATIONS

5.1. Initiation

- 5.1.1. Upon scoping a substation distribution project, prior to the TRC presentation, the substation engineer must consider if this project will require a reconfiguration of distribution circuits. If a reconfiguration is necessary, then the substation engineer will notify the planning engineer of the respective operating district, so a distribution field tie evaluation, as it relates to a substation level outage, can be conducted.

5.2. Trigger - Substation Upgrade

- 5.2.1. All substation work that will alter the configuration or create new distribution getaways into the substation should be considered for field tie improvements. Examples of getaway work: Substation Rebuild, Switchgear Replacement, 12kV Rack rebuild/extension, 12kV circuit reconfiguration.

5.3. Considerations

5.3.1. 12kV Bus Tie at the Substation

- 5.3.1.1. A bus tie circuit breaker separates two sections of the substation bus. In the event of a 12kV bus outage, a 12kV bus tie isolates the fault and allows the other section of the bus to be restored. This can have significant effects on minimizing SAIDI impacts.

5.3.2. 12kV Bus Customer Count

- 5.3.2.1. The higher the customer count on a 12kV bus section, the higher the SAIDI impact will be in the event of an outage on that bus.

© 1998 - 2021 San Diego Gas & Electric Company. All rights reserved. Removal of this copyright notice without permission is not permitted under law.

REV	CHANGE	DR	BY	DSN	APV	DATE	REV	CHANGE	DR	BY	DSN	APV	DATE
C							F						
B							E						
A	ORIGINAL ISSUE	JIK	FRC	CZH	SP	09/03/2021	D						

SHEET 2 OF 5	Indicates Latest Revision	Completely Revised	X	New Page	Information Removed	DM6230.2
	SDG&E ELECTRIC DISTRIBUTION DESIGN MANUAL					
	SUBSTATION DISTRIBUTION FIELD TIE EVALUATION					

5.3.3. Customer Restoration

- 5.3.3.1. The number of customers that can be restored via field ties in the event the entire substation is out of service.
- 5.3.3.2. Documentation can be obtained by emailing a TST member at EDO for a contingency plan for that substation.

5.3.4. Customer Classification

- 5.3.4.1. Customers are classified in Business Warehouse as either Residential or Commercial. These customers are classified a step further as "Major," "Life," "Essential," "Urgent" or "Sensitive."

5.3.5. Substation Accessibility

- 5.3.5.1. The distance in minutes from Kearny to the Substation.
- 5.3.5.2. The address for Kearny is 5844 Overland Ave.

6.0 PROJECT DEVELOPMENT

- 6.1. Once a substation has been chosen, the process for identifying and selecting opportunities to update tie capacity begins. Several considerations are outlined in the sections below.
- 6.2. The distribution planning engineer will inquire about other projects in the area that could help or hinder the opportunity. SDG&E has many different projects and programs that could be performing work in the same area. A list of business units that should be contacted to inquire about potential projects or programs includes, but is not limited to, ERO, ESH, EDP, TED, SED, SPACE, Major Projects, and New Business. This can be done by contacting the P6 Scheduler for the respective groups. The distribution planning engineer will evaluate opportunities for project benefits and alternatives with regards to scope combination with other concurrent/proposed projects.
- 6.3. The distribution planning engineer will identify all configurations where a circuit of the subject substation ties with a circuit of an adjacent substation.
 - 6.3.1. Identify any section(s) of those two circuits that produce ampacity restrictions when the adjacent circuit would need to restore the subject circuit in the case of a substation outage.
 - 6.3.1.1. Identify how many additional customers can be picked up by increasing ampacity ratings via reconductor. This could extend to include customers of another subject circuit that could be picked up through an existing tie.
- 6.4. The distribution planning engineer will look for areas where the tie between the subject circuit and an adjacent circuit does not currently exist.
 - 6.4.1. This analysis should start by looking at circuits in close geographic proximity, location, access, and permitting to limit the scope of work needed but could expand as needed.
 - 6.4.2. Once the proposed tie is deemed feasible, it should follow the same process as outlined in 6.3.1.
- 6.5. The distribution planning engineer will request the district engineer to see if the existing ties should be upgraded to the latest SCADA using an RTR calculation and historical SAIDI values for those particular circuits.

© 1998 - 2021 San Diego Gas & Electric Company. All rights reserved. Removal of this copyright notice without permission is not permitted under law.

REV	CHANGE	DR	BY	DSN	APV	DATE	REV	CHANGE	DR	BY	DSN	APV	DATE
C							F						
B							E						
A	ORIGINAL ISSUE	JIK	FRC	CZH	SP	09/03/2021	D						

SHEET 3 OF 5	Indicates Latest Revision	Completely Revised	<input checked="" type="checkbox"/> New Page	Information Removed	DM6230.3
	SDG&E ELECTRIC DISTRIBUTION DESIGN MANUAL				
	SUBSTATION DISTRIBUTION FIELD TIE EVALUATION				

7.0 PROJECT EXECUTION

- 7.1. Once a substation upgrade project is identified, the substation engineer contacts the TRC and requests a time slot for presentation of the project.
- 7.2. The substation engineer and the distribution planning engineer prepare a presentation. The substation engineer will present on the substation upgrades. The distribution planning engineer will present the field tie scope, including the following topics:
- 7.2.1. Overall Project Scope
- 7.2.1.1. Project description
- 7.2.1.2. Purpose and concerns that initiated the project scoping process
- 7.2.1.3. The objective of the project and timeframe
- 7.2.2. Primary Project Proposal
- 7.2.2.1. Project Scope, budget, schedule, and pros/cons
- 7.2.3. Alternative Project Proposal(s) if any
- 7.2.3.1. Project Scope, budget, schedule, and pros/cons
- 7.2.4. Appendix stating the evaluation processes used and any documentation supporting the proposals.
- 7.3. Budget Creation
- 7.3.1. After approval from the TRC, if the project budget is authorized, the substation engineer shall request a budget number for this project. After it is authorized, a work order for the distribution scope of work that includes the field tie improvements shall be created by the distribution planning engineer utilizing the substation budget.
- 7.3.1.1. The distribution planning engineer should verify if the costs from the initial distribution estimate are still applicable or if they should be adjusted. If an adjustment is needed, the distribution planning engineer shall notify the substation engineer.
- 7.4. Design
- 7.4.1. The substation engineer will work with the distribution planning engineer to determine the approved project's planned in service date. After project approval, the distribution planning engineer submits a new design service request, referencing the approved budget provided by the substation engineer, in the EDP SharePoint site for project execution. If the project is in the HFTD, the distribution planning engineer should notify the ESH Project Engineering Team Lead for informational purposes.

© 1998 - 2021 San Diego Gas & Electric Company. All rights reserved. Removal of this copyright notice without permission is not permitted under law.

REV	CHANGE	DR	BY	DSN	APV	DATE	REV	CHANGE	DR	BY	DSN	APV	DATE
C							F						
B							E						
A	ORIGINAL ISSUE	JIK	FRC	CZH	SP	09/03/2021	D						

SHEET 4 OF 5	Indicates Latest Revision	Completely Revised	<input checked="" type="checkbox"/> New Page	Information Removed	DM6230.4
	SDG&E ELECTRIC DISTRIBUTION DESIGN MANUAL				
	SUBSTATION DISTRIBUTION FIELD TIE EVALUATION				

8.0 INITIAL DOCUMENT AUTHORS AND REVIEWERS

DEPARTMENT	NAME
AUTHORED BY OR REVISED BY: Substation Reliability Field Tie Initiative Team	Andrew Gazdziak Mary Innamorato
REVIEWED BY: Manager – Electric Distribution Engineering	Christian Henderson
REVIEWED BY: Manager – Substation Engineering & Design	Sneha Parmar
REVIEWED BY: Manager – Electric System Hardening	Paul Greco
REVIEWED BY: Manager – Electric Distribution Planning	Matt Belden
REVIEWED BY: Operations and Engineering Manager – Electric Regional Operations	Shanna Dee
ISSUED BY: Team Lead – Equipment Engineering	Fidel Castro

9.0 REVISION APPROVALS

DEPARTMENT	NAME	APPROVED
REVIEWED BY: Manager – Substation Engineering & Design	Sneha Parmar	09/03/2021

* Any future revisions will only require Substation Engineering approval.

© 1998 - 2021 San Diego Gas & Electric Company. All rights reserved. Removal of this copyright notice without permission is not permitted under law.

REV	CHANGE	DR	BY	DSN	APV	DATE	REV	CHANGE	DR	BY	DSN	APV	DATE
C							F						
B							E						
A	ORIGINAL ISSUE	JIK	FRC	CZH	SP	09/03/2021	D						

SHEET 5 OF 5	Indicates Latest Revision	Completely Revised	<input checked="" type="checkbox"/> New Page	Information Removed	DM6230.5
	SDG&E ELECTRIC DISTRIBUTION DESIGN MANUAL				
	SUBSTATION DISTRIBUTION FIELD TIE EVALUATION				

CAPACITY ANALYSIS GUIDELINE

Planning Engineer should make a yearly analysis of the distribution system to determine possible system capacity deficiencies and propose suitable solutions for any problem areas. In general, the following sequence is suggested for analyzing an area:

1. Make load projections
2. Identify substation capacity problems
3. Identify circuit capacity problems
4. Develop alternative solutions
5. Calculate costs for alternatives
6. Compare alternatives

Among the objectives of a well planned solution are the following:

- Eliminate low voltage and/or overload
- Minimum cost solution
- Consider customer impacts
- Provide adequate sectionalizing
- Improve system operability
- Use existing equipment effectively
- Increase substation and circuit reliability
- Delay major construction
- Avoid parallel feeder runs.
- Maintain proper load balance on substation 12kV bus

An area is usually studied to develop system expansion plans for a five year period with particular attention being placed on circuit projects required in the initial three years and substation projects required in the next five or even ten years, if possible.

Analysis Procedure

The following should be used as a guide for preparing supplementary information when proposed construction projects are documented or discussed:

- A. Description of Project
 1. Single-line diagrams
 2. Maps
 3. Sketches
 4. Photographs
 5. Narrative description
 6. Economic analysis that compares proposed construction with alternatives.

	Indicates Latest Revision	Completely Revised	New Page
REVISION	SDG&E DISTRIBUTION DESIGN MANUAL		6231.1
DATE 1-1-2000	CAPACITY PLANNING GUIDELINE		
APPD AMD, CQT <i>WGL</i>			

B. Project Justification

1. Equipment Overload

- a. Season and year of overload
- b. Magnitude of affected load
 - (1) MW
 - (2) Number of customers
- c. Key loads affected
- d. Identification of equipment capacity
- e. Magnitude of overload based on nameplate and/or guideline rating
- f. Basis for overload determination
 - (1) Trend data
 - (2) New customer information
 - (3) Co-generation status
 - (4) Other
- g. Load transfer capability limitations
- h. Location of future load areas

2. Service Reliability

Reliability analysis per design manual 6145

3. Low voltage

- a. Season and year of low voltage
- b. Location of problems
- c. Primary feeder voltage
- d. Basis for low voltage determination
 - (1) Trend data
 - (2) New customer information
 - (3) Voltage profile studies
 - (4) Voltmeter reads or charts
- e. Magnitude of affected load
 - (1) MW
 - (2) Number of customers
- f. Key loads affected

	 Indicates Latest Revision	Completely Revised	New Page
6231.2	SDG&E DISTRIBUTION DESIGN MANUAL		REVISION
	CAPACITY PLANNING GUIDELINE		DATE 1-1-2000 APPD AMD, CQT/vcl

SCOPE

This standard provides a guideline for electric distribution personnel to follow in preparing circuit improvement projects within the **High Fire Threat District**.

PURPOSE

- Reduce likelihood of the power distribution system being the cause of a fire event
- Reduce impact of power-line related fire
- Increase the ability of the distribution system to withstand wild land fire conditions
- Increase reliability in the backcountry areas

DEFINITIONS

Clear Recovery Zone (CRZ) – Area adjacent to unimproved roadways extending from the edge of driven way.

Edge of Driven Way (EDW) – On an unimproved roadway (without a concrete curb and gutter), the EDW is defined as follows:

1. If there is an asphalt berm, EDW is the edge of the berm farthest from the roadway.
2. If there is no berm but there is a white fog line, EDW is the edge of the fog line farthest from the roadway.
3. If there is no berm or fog line, EDW is the edge of the pavement.

High Fire Threat District Tier-2 – The broad area that has been determined by SDG&E to be at heightened risk for wild fire based on vegetation, land topology, and prevailing wind conditions. Boundaries are not generally changed.

High Fire Threat District Tier-3 – An area which designates a higher level of risk compared to areas within the **High Fire Threat District Tier-2**. Boundaries of the **High Fire Threat District Tier-3** may change annually.

Risk Matrix – Ranking spreadsheet evaluating multiple risk factors. This matrix is used to determine the order for project analysis.

Wireless Fault Indicator (WFI) – An overhead fault indicating device that senses and reports faults (along with load) with the ability to adjust the fault detection trigger point based on steady state load.

REFERENCES

1. Design Manual 5129 Distribution Phase Spacing
2. Design Manual 6111 Feeder Circuit Sectionalizing and Protection
3. Design Manual 6112 Overhead Service Restorer Application Criteria
4. Design Manual 6113 Automatic Self-Resetting Fault Indicator

© 1998-2018 San Diego Gas & Electric Company. All rights reserved. Removal of this copyright notice without permission is not permitted under law.

REV	CHANGE	BY	DS GN	APPV	DATE	REV	CHANGE	BY	DSGN	APPV	DATE
A	EDITORIAL CHANGES	JCE	JCE	9/1/2018		D					
B						E					
C						F					

SHEET 1 OF 7	X Indicates Latest Revision	Completely Revised	New Page	Information Removed	DM 6232.1
	SDG&E ELECTRIC DISTRIBUTION DESIGN MANUAL				
	RURAL DISTRIBUTION CIRCUIT REBUILDING ANALYSIS				

5. Design Manual 6121 Fuse Application Criteria
6. Electric Standard Practice 322 SEL Overhead Fault Indicators
7. Overhead Construction Standard 788 Hot Line Clamps and Stirrups
8. Overhead Construction Standard 1276 Overhead Autoranging Fault Indicator
9. Overhead Construction Standard 1600 Wildlife Protection

APPLICATION

The methods and procedures described herein apply to any distribution work (Reliability or Capacity) within the High Fire Threat District Tier-2 that involves pole work or reconductor work.

PROCEDURE

1. Project Development
 - a. Initial analysis will be conducted on a circuit-section basis. Sections have been identified and reviewed by the key groups (District & Planning Engineers, Operations, Vegetation Management, Fire Coordinator, Environmental, and Cultural). The order of analysis will be determined by the risk matrix. Large sections may be divided into smaller sections to facilitate project development at the discretion of the District Engineer. Developed projects will then be prioritized for construction by the risk matrix. Prior to detailed engineering analysis, the study sections are to be fielded to confirm mapping accuracy and to evaluate exposure.
 - b. The recommended process is for the District Engineer to review the study segment for broad modification with input from the Planning Engineer. Detailed equipment review and change determination should be accomplished by a Project Designer, Electric Construction Supervisor, and Line Checker, or Electric Troubleshooter (ETS) under the direction of the District Engineer and O&E Manager.
 - i. District Engineer – broad engineering approach, considering:
 - Transfer load out of, and sectionalize along, High Fire Threat District Tier-2 border and the border of portions of High Fire Threat District Tier-3 that are not adjacent to High Fire Threat District Tier-2.
 - Cutover lower distribution voltages to 12kV, improving protection.
 - Evaluate adding additional phase conductor(s) to improve load balance.
 - Review capacitor installation (pad-mount, SCADA control, relocate).
 - Evaluate appropriate circuit hardening method.
 - Single stations off long branches:
 - 1) Notify Land Department of stations with no connected load.

© 1998-2018 San Diego Gas & Electric Company. All rights reserved. Removal of this copyright notice without permission is not permitted under law.

REV	CHANGE	BY	DS GN	APPV	DATE	REV	CHANGE	BY	DSGN	APPV	DATE
A	EDITORIAL CHANGES	JCE	JCE	9/1/2018		D					
B						E					
C						F					

SHEET 2 OF 7	X Indicates Latest Revision	Completely Revised	New Page	Information Removed	DM 6232.2
	SDG&E ELECTRIC DISTRIBUTION DESIGN MANUAL				
	RURAL DISTRIBUTION CIRCUIT REBUILDING ANALYSIS				

- 2) Evaluate loaded stations for possible off-grid solution.
 - Determine locations for fault indicators.
 - Determine switch locations and type.
 - Electronic sectionalizers – remove/replace with more advanced devices.
 - Review coordination for all protective devices.
- ii. Line Checker/ETS/Designer/Construction Supervisor – detailed review, considering:
 - Replace transformers without pressure relief valves. Transformers installed prior to 1973 did not have pressure relief valves.
 - Replace porcelain insulators where wood construction is to remain.
 - Replace porcelain lightning arresters.
 - Replace hot line clamps connected directly to the line (i.e. without stirrups.)
 - Reconductor span(s) with more than three splices on the same phase in the span.
 - Spans with dissimilar conductors (size or material type).
 - Cutouts with solid blades – replace with "cutout style" 900 Amp disconnect switch (Stock number S707006) and WFI.
 - Initiate Engineering review for all spans where phase spacing/wire slop is a concern.
- c. Project naming convention. For tracking data analysis purposes, name the projects as follows:

circuit number:year_CFSP_description

Description key: WS = wood to steel conversion
 TW = steel poles with tree wire
 SC = steel poles with spacer cable
 UG = traditional UG construction
 CIC = UG using cable in conduit construction
 Plus any other brief descriptive narrative needed

Example: C440:2011_CFSP_WS, CIC, SCADA SWITCH (2)

2. General Considerations

- a. The goal is to maximize the effectiveness of the circuit hardening budget. For all construction options consider:
 - Rerouting the circuit and/or transferring loads to adjacent circuits.

© 1998-2018 San Diego Gas & Electric Company. All rights reserved. Removal of this copyright notice without permission is not permitted under law.

REV	CHANGE	BY	DS GN	APPV	DATE	REV	CHANGE	BY	DSGN	APPV	DATE
A	EDITORIAL CHANGES	JCE	JCE	9/1/2018		D					
B						E					
C						F					

SHEET 3 OF 7	X Indicates Latest Revision	Completely Revised	New Page	Information Removed	DM 6232.3
	SDG&E ELECTRIC DISTRIBUTION DESIGN MANUAL				
	RURAL DISTRIBUTION CIRCUIT REBUILDING ANALYSIS				

- Possible off-grid approach for small loads at the end of long branches.
- Cutover to eliminate 2400V and 4160V distribution.
- Elimination of boosters.
- Future expansion plans (review with the area Planning Engineer).
- Work with appropriate contact in District to review any specific concerns they might have (e.g. lines that are difficult to inspect and patrol, location of frequent outages, etc.).
- Elimination of light duty wire (lower tensile strength, i.e., #6 copper, #4 copper), especially in high wind areas.

b. Interdepartmental Coordination:

Contact must be made early in the process with Environmental Services, Land Services, Vegetation Management, and the Fire Coordinator for input and coordination. It has proven to be very beneficial to have all the interested groups (Engineering, Land, Design, Survey and Environmental) perform the initial detailed field survey together. If LIDAR data is to be incorporated submit the request early in the process as lead times for LIDAR data can be several months.

c. Fielding:

- Vehicles must stay on access roads. Vehicles must turn around in established or designated areas only.
- Avoid disturbing all vernal pools.
- Driving through drainage areas is okay.
- Parking or driving underneath oak trees is not allowed except in established traffic areas.
- Avoid ground disturbance in public areas.
- Contact Environmental Services for any questions regarding field work.

d. Avian Protection:

Check Overhead Construction Standard 1610 to determine if the area is in an Avian Protection Zone. Include required avian protection for proposed area of hardening in these zones.

3. Hardening Approach

The recommended construction approach, in general, is determined by the geographic/vegetation topology encountered:

Situation	Construction
High tree impact with suitable road ①	Convert to UG (paragraph 3.a.)
High tree impact with no useable roads	Hendrix Spacer cable on steel poles (paragraph 3.b.)

© 1998-2018 San Diego Gas & Electric Company. All rights reserved. Removal of this copyright notice without permission is not permitted under law.

REV	CHANGE	BY	DS GN	APPV	DATE	REV	CHANGE	BY	DSGN	APPV	DATE
A	EDITORIAL CHANGES	JCE	JCE	9/1/2018		D					
B						E					
C						F					

SHEET 4 OF 7	X Indicates Latest Revision	Completely Revised	New Page	Information Removed
	SDG&E ELECTRIC DISTRIBUTION DESIGN MANUAL			
	RURAL DISTRIBUTION CIRCUIT REBUILDING ANALYSIS			

DM 6232.4

Moderate tree impact with no useable roads	Tree wire on steel poles (paragraph 3.c.)
Low tree impact with suitable road	Convert to UG or steel pole bare-wire (paragraph 3.d.)
Other fire area construction	Steel pole bare-wire (paragraph 3.d.)

① San Diego County or Orange County maintained road.

a. Undergrounding

When the route for underground circuitry is established, contact Land Services to verify permitting and easement issues for the route chosen.

Note that a CRZ is required along unimproved roadways. The County of San Diego has a desired minimum CRZ of eight feet. Caltrans has a desired CRZ of 30 feet for high speed (>45 mph) roadways and 20 feet on conventional highways. For slopes greater than 1:4 (up or down) some jurisdictions do not enforce the CRZ. In these installations, facilities should be placed within the sloped area as far as possible from the EDW. When placing equipment, every attempt should be made to locate padmounted equipment and poles as far from the EDW as possible. Traffic bollards should not be placed on unimproved roadways. Visibility strips should be placed on equipment.

If the equipment is not readily visible or may be obscured by vegetation, traffic bollards may be placed near the equipment as long as they are designed to break away and have visibility strips on them. Bollards may not be placed within eight feet of the EDW.

b. Spacer Cable (1/0 aluminum, 336 aluminum, 636 aluminum)

Spacer cable has many advantages over standard open wire construction. These include greater strength, insulated cable protection, compact construction and capability for longer spans.

This option is less aesthetically pleasing due to the unusual configuration and should be avoided in residential or urban areas with significant traffic.

c. Tree Wire (1/0 ACSR, 336 ACSR, 636 ACSR)

Tree wire is a useful option in areas where there is the possibility of incidental contact (palm fronds, small tree limbs, birds etc.) and where spacer cable would be visually obtrusive. The increased strength of spacer cable (nearly twice that of tree wire), is preferred in areas where contact with heavy limbs or entire trees is possible, even if all required tree trimming is done.

d. Conductor Sizing

Conductor sizes for overhead construction will be based on required strength for the **High Fire Threat District Tier-2** and **High Fire Threat District Tier-3**. Electrical loading is not the sole consideration.

Feeder: Utilize 336 ACSR or 636 ACSR depending on current and future loading needs, and tie capacity (check with Distribution Planning for information on future loads and tie capacity).

Branch:

i. Bare Wire: Utilize #2 5/2 Alumoweld Aluminum Conductor (AWAC) for branches equal to and below

© 1998-2018 San Diego Gas & Electric Company. All rights reserved. Removal of this copyright notice without permission is not permitted under law.

REV	CHANGE	BY	DS GN	APPV	DATE	REV	CHANGE	BY	DSGN	APPV	DATE
A	EDITORIAL CHANGES	JCE	JCE	9/1/2018		D					
B						E					
C						F					

SHEET 5 OF 7	X Indicates Latest Revision	Completely Revised	New Page	Information Removed	DM 6232.5
	SDG&E ELECTRIC DISTRIBUTION DESIGN MANUAL				
	RURAL DISTRIBUTION CIRCUIT REBUILDING ANALYSIS				

5000-foot elevation. Utilize #2 3/4 AWAC for branches over 5000-foot elevation. The AWAC conductor provides greater tensile strength than the ACSR due to its multiple steel stranding and Alumoweld composition.

ii. Insulated Wire (Spacer Cable, Tree Wire): Use 1/0 for all insulated-wire branches.

e. Re-Routing

Consider re-routing lines when there is an opportunity to lower fire risk or to improve reliability and maintenance access. Re-routing refers to a minor or major change in current alignments. Typical re-routes involve moving equipment closer to accessible roads and away from trees and vegetation, or out of cross-country runs.

f. Equipment Considerations

i. SCADA Operated Switching/Service Restorer (Recloser)

Verify Sensitive Ground Fault (SGF) protection is enabled on any upstream service restorer (SR). If the SR is an older model that does not allow SGF protection, remove or replace. If the SGF setting is greater than 10 amps, review the segment for load balancing, to enable SGF of 10 amps or less, once balanced.

Check for the amount of OH exposure downstream of a SCADA SR or other fault interrupting device. Install SCADA operated sectionalizing in areas where there is more than **one mile** of three-phase OH exposure between existing SCADA sectionalizing devices.

ii. Switches

Ensure sufficient switching per DM 6111 (no more than one mile between switching devices).

iii. Overhead Transformers

Identify all 7200V WYE transformers in the proposed area to be hardened and replace them with 12.0 kV line-to-line transformers, except where there is single-phase construction only and installing a second phase is cost prohibitive. Changing the transformers for line-to-line operation will help to balance load, allowing reduction of the SGF settings and may allow for smaller fuses. Customer voltage will be somewhat higher, but still within limits.

Transformers **without** pressure relief valves **shall** be replaced. **Transformers installed prior to 1973 did not have pressure relief valves.**

iv. Capacitors

Evaluate the existing capacitors with the area Planning Engineer to determine the need to retain. Overhead capacitors have been identified as the most problematic device in rural distribution.

Evaluate circuit modifications that would facilitate capacitor bank elimination or relocation. (In wood-to-steel areas, the increase in conductor size may allow removal. Confirm with Distribution Planning.)

© 1998-2018 San Diego Gas & Electric Company. All rights reserved. Removal of this copyright notice without permission is not permitted under law.

REV	CHANGE	BY	DS GN	APPV	DATE	REV	CHANGE	BY	DSGN	APPV	DATE
A	EDITORIAL CHANGES	JCE	JCE	9/1/2018		D					
B						E					
C						F					

SHEET 6 OF 7	X Indicates Latest Revision	Completely Revised	New Page	Information Removed	DM 6232.6
	SDG&E ELECTRIC DISTRIBUTION DESIGN MANUAL				
	RURAL DISTRIBUTION CIRCUIT REBUILDING ANALYSIS				

If the area is subject to extreme winds and/or heavy vegetation, replace existing capacitors with SCADA controlled capacitors or review for possible pad-mount SCADA capacitor application. Consider relocation of overhead banks to areas of lesser risk, preferably a paved area.

v. Regulators

Review all proposed regulator installations with the area Planning Engineer. All new regulators will include SCADA.

vi. Fuses

Review fusing on the segment and upstream devices for compliance with DM 6121. The objective is fire risk reduction, and this may require that some devices will not coordinate. Consult with the Fusing Specialist.

Replace expulsion fuses with SMU-20 type fuses.

vii. Fault Indicators

Analyze circuit for fault indication – non-fused cable poles, long un-fused branches, or downstream of any un-fused branch, or areas where patrol may be difficult due to terrain, etc., or on the feeder where fault interrupting devices may be mis-coordinated. WFIs may be used in all areas, including where steady state load is five Amps or less at all times.

When considering a location for a WFI, LPCN communication coverage should be confirmed with the C&O District Engineer. If communication is not present, contact Electric Distribution Engineering for assistance. (See Electric Standard Practice 322 for installation guidelines.) All manually operated, normally closed switches should include a WFI.

© 1998-2018 San Diego Gas & Electric Company. All rights reserved. Removal of this copyright notice without permission is not permitted under law.

REV	CHANGE	BY	DS GN	APPV	DATE	REV	CHANGE	BY	DSGN	APPV	DATE
A	EDITORIAL CHANGES	JCE	JCE	9/1/2018		D					
B						E					
C						F					

SHEET 7 OF 7	X Indicates Latest Revision	Completely Revised	New Page	Information Removed	DM 6232.7
	SDG&E ELECTRIC DISTRIBUTION DESIGN MANUAL				
	RURAL DISTRIBUTION CIRCUIT REBUILDING ANALYSIS				

SCOPE:

This standard provides the analytical method necessary to assess whether a tie deficiency exists on a distribution circuit.

PURPOSE

Tie capacity analysis is performed to identify feeder segments that will be subjected to an extended outage if additional tie capacity is not provided.

CRITERIA

The distribution feeder system is generally planned as an open loop with sufficient spare capacity in the conductors to allow a reasonable amount of load to be transferred from one circuit to another. The capacity of each circuit tie is the additional load that could be served using the adverse forecast scaled by the appropriate tie utilization factor without exceeding the emergency load rating of the conductor or causing the resultant primary voltages to be below the tolerable level of 115 volts (on a 120V base). The tie utilization factor is the % of load which will not be exceeded for a specific majority portion of the year.

In order to calculate tie deficiency, it is assumed that in the event of a feeder outage, a maximum of three ties can be used to restore service to a faulted circuit. Total tie deficiency is estimated using the worst case outage (which may not necessarily be an outage to the entire circuit). To determine the deficiency, calculate the amount of load that can be restored coincidentally by using not more than three switches, then subtract this amount from the total load subjected to the outage. Do not overlook the fact that the capability of ties to restore service is dependent not only on the capacity of the tie but also on the configuration of the circuit suffering the outage. For example, line switches are critical for effective use of the capacity of a tie switch.

A. Tie Capacity

Circuit reliability analysis described in design standard 6145 will identify tie deficiencies. Tie capacity improvement projects shall be prioritized in the same manner as other reliability projects.

B. Service Restoration Projects

Feeder segments which can be served by adjacent circuits (with adequate tie capacity) can be restored in advance of repairs. Feeder segments which cannot be served by adjacent circuits (tie deficient) will be restored as repairs progress.

Service conditions following the use of line and tie switches shall not violate the following guidelines.

1. Resultant conductor loadings shall not exceed ratings for emergency or short-time operation.
2. Resultant primary (12kV) voltages shall not be below the tolerable level of 11,500 volts (115V on 120V base).

© 1998 - 2012 San Diego Gas & Electric Company. All rights reserved. Removal of this copyright notice without permission is not permitted under law.

	 Indicates Latest Revision	Completely Revised	New Page	Information Removed
REVISION	SDG&E DISTRIBUTION DESIGN MANUAL			
DATE 5-3-2012 APPD JCE/MJC	CIRCUIT TIE CAPACITY PLANNING			6233

INTRODUCTION

Computer models of distribution circuits are often used to predict when capital improvements must be made, to avoid overload, low voltage, or reliability problems. These models make certain assumptions about load density and demand factor that, in some cases, may not accurately reflect line conditions. The ability to gather actual data from the line, on a continuous basis, can improve the timing of capital improvements. The deferral of significant capital improvements can result in substantial savings by avoiding the installation of excess capacity.

The quantities monitored can include current, voltage, real and reactive power, and power factor.

PROCEDURE

There are two alternatives for monitoring distribution lines:

- A. Dedicated line monitors that provide current, voltage, real and reactive power, and power factor, continuously, through the distribution SCADA master computer. — These are described in OH standard 540.1. A construction standard for underground distribution has not been developed: contact standards for information. Data from these devices is downloaded to DWP from the SCADA master computer, along with data from substations.
- B. Installation of a modem and dial-up phone line connection to later model service restorers. — In some cases, this can be done at a much lower cost than the separate, dedicated line monitor. The dial-up phone allows retrieval of data from the control at any time, with a PC, software, and modem, including the following:
1. real time instantaneous and thermal (15 minute average) current
 2. draghand current (since last reset)
 3. status of AC power to the control, recloser contacts, reclosing, ground protection, alternate minimum trip, and local/supervisory switch.
 4. total number of operations
 5. a log of the last 50 events, including loss and restoration of AC (control) power, overcurrent trip, reset, and manual trip or close. Fault currents, or load currents are recorded with each event.

Use of the dial-up feature requires that the service restorer use the "4C" digital control. Service restorers installed since the beginning of 1994 use the 4C digital control exclusively. control exclusively. But, any recloser with a serial number of 11,199 or later, is directly compatible with the 4C control. ALL padmounted service restorers use the 4C control. On existing overhead service restorers with a serial number of 11,199 or later, the 4C control can be used to replace the older 3A analog control directly, with no work required on the poletop recloser unit. Contact Distribution Standards for cost and ordering cost and ordering information for the 4C digital control. Contact Electric Construction & Maintenance (Kearny) to confirm the serial number of any existing service restorer, and to confirm and to confirm the model of control installed.

	 Indicates Latest Revision	Completely Revised	New Page
REVISION	SDG&E DISTRIBUTION DESIGN MANUAL		6234.1
DATE 1-1-96	LOAD MONITOR ALTERNATIVES FOR ELECTRIC DISTRIBUTION		
APPD JW / <i>[Signature]</i>			

When a service restorer is used in this manner, none of the other operating features are affected. With the local/supervisory switch in the local position, it is not possible to change the status of the service restorer, or change any of the control settings.

Note that the dial-up feature on service restorers does not provide voltage, real or reactive power, or power factor data. All service restorers operate solely through information gathered from internally mounted current transformers. No voltage sensing elements are present, other than those confirming the presence of secondary power in the control.

DESIGN REQUIREMENTS

Early in the design process, the planner should contact electric standards to confirm the requirements for these installations. Some aspects of the SCADA Design Checklist apply, for the dedicated line monitor. For the service restorer dial-up option, telecommunications must confirm the availability of a telco phone line for the site. Not all service restorers are located close to an existing telco line. The use of cellular phone service to retrieve data from service restorers may be an option, but as of this writing has not been attempted. not been attempted. Materials for the dial-up option must be special ordered, as none are M&S stock items.

	 Indicates Latest Revision	Completely Revised	New Page
6234.2	SDG&E DISTRIBUTION DESIGN MANUAL		REVISION
	LOAD MONITOR ALTERNATIVES FOR ELECTRIC DISTRIBUTION		DATE 1-1-96 APPD JW / <i>[Signature]</i>

SCOPE

This standard uses graphic representation to illustrate the total owning cost (installation plus losses) of different conductor sizes operating at specific load levels. The information presented in this standard is supplemental to Design Standard 5923, "Preferred UG Cable Installation Criteria".

PURPOSE

This standard was prepared so District Engineering personnel would be able to select the least costly conductor size based on the amount of load which the conductor would serve. The graphs also make it possible for the district engineer to determine the cost penalty associated with installing a larger conductor than necessary to provide adequate tie capacity.

CRITERIA

The cost illustrated in the graphs below represent the PWARR to install 1000 feet of conductor plus the demand and energy charges associated with distribution system losses. In addition to the conductor cost the Underground Cable Cost Comparison includes the cost of connectors while the Overhead Conductor Cost Comparison includes the cost of poles, crossarms and anchors.

The graphs were constructed assuming the peak load is constant over the physical life of the conductor (20 years for UG, 30 years for OH). An average peak load to be expected over the life of the conductor must be calculated prior to using the graphs if the peak load is not constant (e.g. due to load growth, specific load additions, etc.).

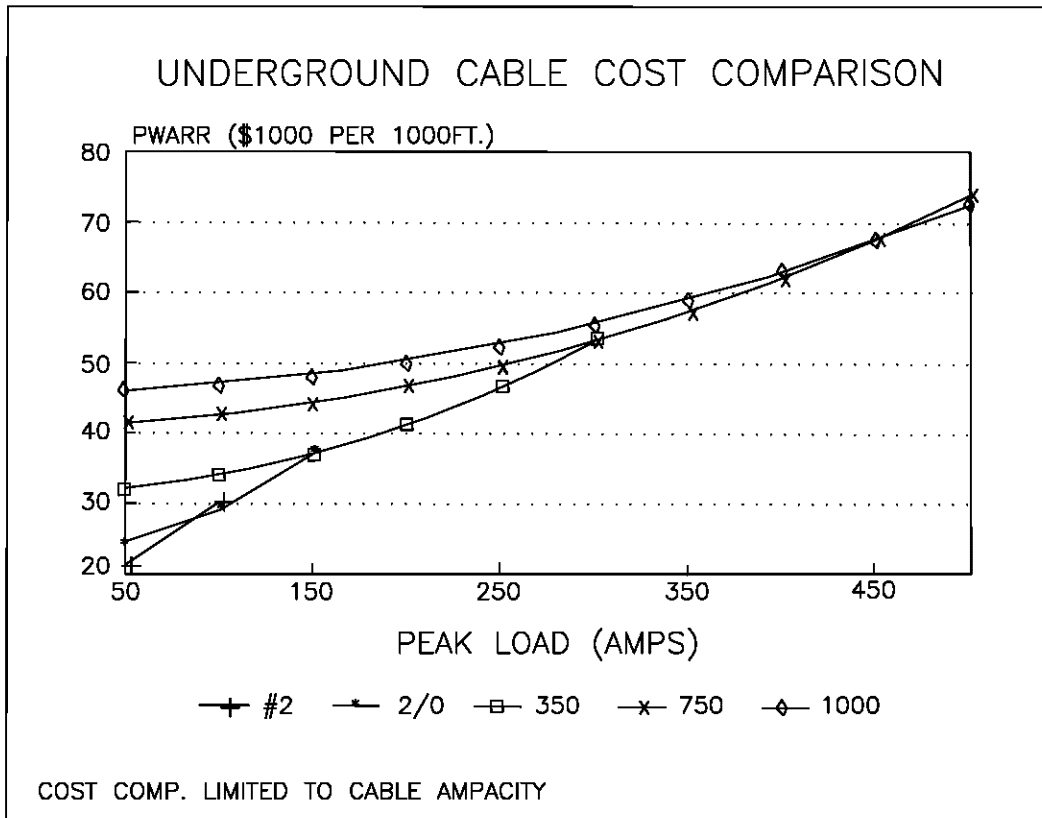

	Indicates Latest Revision	Completely Revised	New Page
REVISION	SDG&E DISTRIBUTION DESIGN MANUAL		
DATE 1-1-89	PRIMARY CABLE COST COMPARISON		6241.1
APPD CVN/BJ			

OVERHEAD CONDUCTOR COST COMPARISON

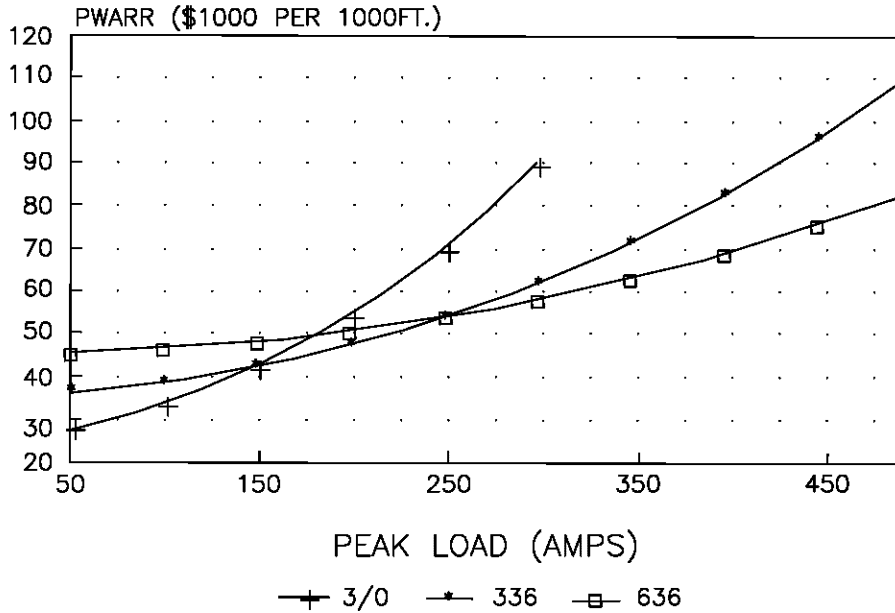

COST COMP. LIMITED TO CABLE AMPACITY

Note: PWARR is for overhead conductor on newly constructed pole line and includes the installed cost of the conductor, poles, crossarms and anchors.

	Indicates Latest Revision	Completely Revised	New Page
6241.2	SDG&E DISTRIBUTION DESIGN MANUAL		REVISION
	PRIMARY CONDUCTOR COST COMPARISON		DATE 1-1-89
			APPD CVN <i>[Signature]</i>

The following constants and assumptions were used to develop the graphs:

1. LACC UG = 16.7% OH = 16.13%
2. Physical Life UG = 20 yrs OH = 30 yrs
3. Energy Charge UG = 4.62¢/kWH OH = 5.44¢/kWH
4. Demand Charge UG = \$97.63/kW OH = 112.5/kW
5. Loss Factor = 0.25
6. Peak Responsibility Factor = 0.80
7. Construction Cost Contingencies = 20%
8. Underground Conductor Parameters:

3-1/c #2 PECN-PEJ	PWARR = \$18,042/1000'	R = .3339 ohms/1000'
3/c #2/0 PECN-PEJ	PWARR = \$22,656/1000'	R = .1663 ohms/1000'
3/c 350 XLPECN-PEJ	PWARR = \$31,504/1000'	R = .0649 ohms/1000'
3/c 750 XLPECN-PEJ	PWARR = \$41,225/1000'	R = .0345 ohms/1000'
3/c 1000 XLPECN-PEJ	PWARR = \$45,625/1000'	R = .0286 ohms/1000'
9. Overhead Conductor Parameters:

3/0 AWG ACSR/AW	PWARR = \$25,726/1000'	R = .1500 ohms/1000'
336 AWG ACSR/AW	PWARR = \$35,335/1000'	R = .0630 ohms/1000'
636 AWG ACSR/AW	PWARR = \$44,633/1000'	R = .0330 ohms/1000'
10. The book life, which is usually the physical life, is 28 years for UG cable and 36 years for OH conductor. PWARR figures used in this standard incorporated these book lives. However, the energy and demand charges used in this standard reflect historical conductor performance, 20 years for UG cable and 30 years for OH conductors.

The table below present the optimum conductor loading for each conductor size in tabular form:

Underground Cable Size Optimum Conductor Peak Loading

3-1/c #2	0 - 84 amps
3/c #2/0	85 - 151 amps
3/c 350	152 - 290 amps
3/c 750	291 - 445 amps
3/c 1000	> 445 amps

overhead Cable Size Optimum Conductor Peak Loading

3/0	0 - 151 amps
336	152 - 254 amps
636	> 254 amps

	Indicates Latest Revision	Completely Revised	New Page
REVISION	SDG&E DISTRIBUTION DESIGN MANUAL		
DATE 1-1-89	PRIMARY CONDUCTOR COST COMPARISON		
APPD CVN/ <i>BJ</i>	6241.3		

SCOPE

This standard provides a method of evaluating various alternatives so that the most economical one is identified. The advancement of an overload project to improve reliability is also discussed. For the latest calculation tools used to determine the present value of electric distribution projects, contact Distribution Planning.

PURPOSE

Present Worth of Annual Revenue Requirements (PWARR) has been selected by the Financial and Economic Analysis section as the appropriate analytical tool for distribution engineering projects. This is because it measures the total impact of a project on SDG&E's customers given the regulated environment of the utility.

DEFINITIONS

LACC (Levelized Annual Capital Cost) – A factor applied to the installed equipment costs to account for the annual levelized depreciation, return on investment, income taxes, property taxes and salvage.

A/P,n – Converts a present value into an annual series of payments over n years. Refer to the Economic Assumptions Manual, Table 2-1, for the current value.

P/A,n – Provides the present value of an annual series of payments made for n years. Refer to the Economic Assumption Manual, Table 2-1, for the current value.

P/F,n – Provides the present value of a future payment made n years from today. Refer to the Economic Assumption Manual, Table 2-1, for the current value.

Inflation Factor – Accounts for the rise in the price of goods and services over n years.

CRITERIA

The capital portion of Equation 1 below converts the equipment installed cost (Cost) into an annual series using the LACC Factor to account for taxes and return on investment. Then it sums all these payments into a present value at the time of construction using the P/A factor. In contrast, the O&M portion accounts for those non-capitalized expenditures which are included at the time of installation (O&M) and so the LACC and P/A factors are not applied.

$$\text{PWARR} = [(\text{Inflation Factor})(P/F,n)][(\text{Cost})(\text{LACC})(P/A,n) + (\text{O\&M})] \quad \text{Equation 1}$$

$$\text{Inflation Factor} = (1+i)^n \quad \text{Equation 2}$$

where: i = rate of inflation

	<input checked="" type="checkbox"/> Indicates Latest Revision	Completely Revised	New Page
REVISION	SDG&E DISTRIBUTION DESIGN MANUAL		6242.1
DATE 3-1-02	PWARR ANALYSIS		
APPD JCE <i>1/6/02</i>			

APPLICATION

PWARR analysis is used to compare alternative construction projects economically. Normally there are benefits associated with each project which have not been assigned a dollar amount and, therefore have not been considered. When the PWARR of one alternative is within 5 percent of another alternative it is appropriate to consider unassigned benefits (i.e. improvements in customer service, sensitivity to changes in input variables, lowest installed cost, etc.) in the decision.

A typical application of the PWARR analysis is shown in Example 1. It considers delaying the construction of a new circuit for two years by increasing tie capacity, thus allowing a load transfer to occur. The alternative is to construct the new circuit next year. Although the lives of the two alternatives are not the same (one ends in 28 years, the other 30), the Finance and Economic Analysis section feels Equation 1 provides a good approximation provided the difference in lives does not exceed 5 years.

Example 1

One feeder in a 4-EB5" duct is rated at 475 amps but has a projected load of 500 amps next year. To eliminate the projected overload consider shedding 100 amps to an adjacent circuit by constructing a tie next year for \$75k. This will delay having to construct a new circuit, at a cost of \$450k for an additional 2 years. The alternative is to construct the new circuit next year. Which alternative is the least costly considering all costs were provided in next year's dollars?

The following factors were obtained from the economic Assumptions Manual:

- LACC = 0.167, FERC account E367 (book life = 28 yrs)
- P/A, 28 = 8.2217
- P/F, 2 = 0.8029
- A/P, 2 = 0.5886
- i = 5%

ALTERNATIVE 1: Construct a tie next year and defer the new circuit 2 years.

$$\text{Inflation Factor} = (1.05)^2 = 1.1025$$

$$\text{Construct tie PWARR} = (75k)(0.167)(8.2217) = \$102,976$$

$$\text{Construct circuit 2 yrs later PWARR} = (1.1025)(.8029)(450k)(0.167)(8.2217) = \$546,929$$

$$\text{Total Cost } \$649,905$$

ALTERNATIVE 2:

$$\text{Construct circuit next year PWARR} = (450k)(0.167)(8.2217) = \$617,861$$

Conclusion Alternative 2 is approximately 5% less expensive and it should be selected unless there are sufficient unassigned benefits to favor alternative 1.

	Indicates Latest Revision	Completely Revised	New Page
6242.2	SDG&E DISTRIBUTION DESIGN MANUAL		REVISION
	PWARR ANALYSIS		DATE 1-1-89 APPD CVN / <i>BJ</i>

Example 2

Consider advancing the construction of a new circuit 2 years to achieve an annual reliability benefit of \$100,000. The circuit cost is the same as in Example 1. Is this cost effective?

$$\text{Construct line next year} - (450k)(0.167)(8.2217) = \$617,861$$

$$\text{Construct line 2 yrs later} - (1.1025)(0.8029)(450k)(0.167)(8.2217) = \$546,929$$

$$\text{PWARR of advancement} = 617,861 - 546,929 = \$70,932$$

$$\text{C/B ratio} = (70,929)(A/P, 2) / 100,000 = 0.4175$$

Conclusion: It is cost effective to move the project ahead 2 years.

Example 3

Consider the effect of adding O&M expenditures to the construction in Example 1. O&M associated with constructing the new line is \$75k, \$15k for constructing the tie.

ALTERNATIVE 1:

$$\text{Construct tie line next year} \quad \text{PWARR} = \$102,976 + \$15,000 = \$117,976$$

$$\text{Construct ckt 2 yrs later} \quad \text{PWARR} = \$546,929 - (75k)(1.1025)(.0829) = \$613,319$$

$$\text{Total cost} = \$731,295$$

ALTERNATIVE 2:

$$\text{Construct new circuit next year} \quad \text{PWARR} = \$617,861 + \$75,000 = \$692,861$$

Conclusion: Alternative 2 is still approximately 5% less expensive and should be selected unless there are sufficient unassigned benefits to favor alternative 1.

	 Indicates Latest Revision	Completely Revised	New Page
REVISION	SDG&E DISTRIBUTION DESIGN MANUAL		6242.3
DATE 1-1-89	PWARR ANALYSIS		
APPD CVN <i>RSJ</i>			

**6300
SUBSTATION
ENGINEERING**

**6300
SUBSTATION
ENGINEERING**

PAGE(S)

SUBJECT

6311 Substation Transformer Loading
6311.1–6311.4 Criteria:
Substations without Gas Turbines
Maximum Substation Load Allowance
Substations with Gas Turbines

6312 Substation Capacity Criteria:
6312.1–6312.5 Station Capacity, Station Getaways,
Four-wire, Bus Capacitors,
Equipment
System Planning One Line Diagrams

6321 Distribution Substation Reliability
6321.1–6321.2 Criteria:
Single Bank Substations.
Radial Supply Substations,
Maximum Fault Current Allowance

6330 Substation Siting Procedure
6330.1–6330.6

	 Indicates Latest Revision	Completely Revised	New Page
REVISION	SDG&E DISTRIBUTION DESIGN MANUAL		6301
DATE 1-1-89	TABLE OF CONTENTS		
APPD CVN/ <i>CVN</i>	SUBSTATION ENGINEERING		

SCOPE

This standard establishes firm capacity and short term overload ratings for distribution substation transformers based on temperature rise of the transformer core and coils. The Transformer Loading Guide appearing on page 3 does not consider limitations imposed by substation ancillary equipment such as tap changers, bushings, breakers, etc.

PURPOSE

This standard is to be used as a guide for planning capacity additions to distribution substations to prevent excessive loss of life of substation transformers. However, the District Engineering staff must determine the ratings of other substation equipment which may prevent designing the substation to the values provided in the Transformer Loading Guide.

DISCUSSION



A. Guideline Background And Application

The Transformer Loading Guide is based on ANSI guidelines for transformer operation under normal and contingency conditions. Specifically, the following criteria were used to generate the Transformer Loading Guide:

1. Transformer maximum hot spot temperatures:
180 Degrees C for 65 Degrees C rise banks
150 Degrees C for 55 Degrees C rise banks
2. Transformer maximum top oil temperature: 110 Degrees C
3. Maximum permissible loss-of-life per transformer:
per contingency 2.5%
4. Maximum seasonal loss-of-life under normal conditions: 1%
5. Nameplate capacity assumes substation transformers have similar impedances so that the load is shared equally among the banks. When this is not the case the nameplate capacity must be reduced so that no transformer serves more load than the value permitted for a single bank substation.

In addition, peak load values were developed with the assumption that, after the failure of one transformer in a substation, the following system operating procedures are implemented:

1. By the operation of automatic control equipment, sufficient load is dropped within 15 minutes to prevent excessive loss-of-life on the remaining transformer(s).

	 Indicates Latest Revision	Completely Revised	New Page
REVISION	SDG&E DISTRIBUTION DESIGN MANUAL		6311.1
DATE 1-1-89 APPD CVN / 	SUBSTATION TRANSFORMER LOADING GUIDE		

2. Additional load is transferred to an adjacent substation within four hours to prevent excessive loss-of-life on the remaining transformer(s).
3. Load is reduced to normal limits within 12 hours by picking up the surplus load on a portable power transformer.

Load levels at which load-shedding equipment is to be installed at a substation are given in the Transformer Loading Guide under the heading "Note 2". The Planning Engineer is responsible for the following action regarding the load-shedding and load transfer procedures:

1. With the cooperation and approval of Distribution Operations one or more 12kV circuits that may be dropped by automatic relay operation are to be selected.
2. Substation Engineering will be requested to install appropriate load-shedding equipment on the preselected 12kV circuits.
3. Distribution Operations will be advised of the location and amount of load that will be transferred to an adjacent substation using available tie switches.

B. Distribution Substations With Gas Turbines

For distribution substations with one or more gas turbines, the total substation peak load will be limited to a value such that for the loss of one power transformer:

1. The short-time loading on the remaining transformer(s), before the gas turbine can be started, will not exceed 200 percent of the maximum nameplate rating; and
2. The loading on the remaining transformer(s), after the gas turbine is started and loaded to its normal peak rating, will not exceed the contingency condition loading limits as specified in the Transformer Loading Guide.

At locations where more than one gas turbine is installed, only one will be considered available for reducing transformer loadings during a contingency condition.

C. Other Considerations

1. Values contained in the Transformer Loading Guide are based on oil and hot spot temperature rise occurring within the transformer core and coils and do not consider ancillary equipment loading limitations that may exist. Substation Engineering and Substation Construction and Maintenance should be consulted to identify these limitations. Possible loading limitations associated with circuit breaker and bus overload ratings should also be identified.

	Indicates Latest Revision	Completely Revised	New Page
6311.2	SDG&E DISTRIBUTION DESIGN MANUAL		REVISION
	SUBSTATION TRANSFORMER LOADING GUIDE		DATE 1-1-89 APPD CVN/BJ

Distribution Substation Transformer Loading Guide

Nameplate Rating Of Each Bank MVA	Number of Transformer Banks In Substation	Nameplate Capacity (MVA)	Firm Substation Peak MVA Load Summer(adverse)/ Winter	W/in 15 min. Immediate Load Shed MVA Level Summer(normal)/ Winter	W/in 4 Hrs Secondary Load Shed MVA Level Summer(normal)/ Winter	Maximum Sustained Load on Any Transformer (Summer/Winter %)
6/7.5	1	7.5	8.5/9.5			113/127
	2	15	17/19	11/13	8.5/9.5	147/173
	3	22.5	25.5/28.5	21/15	17/19	140/167
	4	30	34/38	30/37	26/29	133/164
10/12.5	1	12.5	14.5/17	-	-	116/136
	2	25	29/34	25/25	19/22	200/200
15/20/25(28)	1	28	30/37	-	-	107/125
	2	56	60/74	38/43	32/37	136/154
	3	84	90/111	76/81	70/75	136/145
	4	112	120/148	110/115	104/109	131/137

Notes:

- ① Installation of additional transformer capacity is required at this MVA Load Level.
- ② When one transformer fails, load must be immediately shed within 15 minutes to reduce loading to or below this MVA level.
- ③ After transformer failure, substation load must be shed or transferred to this MVA level within four hours.
- ④ This value is the maximum percent load at any time each of the remaining transformers for loss of a single transformer. In this context "sustained" means longer than momentary, i.e. longer than 5 minutes.

The actual substation rating may be less than the value published in the Transformer Loading Guide due to limitations in other substation equipment such as tap changers, bushings, breakers, etc.

	Indicates Latest Revision	Completely Revised	New Page	Information Removed
REVISION	SDG&E ELECTRIC STANDARDS			
DATE 1-1-89 APPD CVN/ <i>BJ</i>	SUBSTATION TRANSFORMER LOADING CRITERIA			6311.3

2. Values contained in the Transformer Loading Guide are based on the characteristics of a typical, relatively modern transformer and average load and temperature cycles. Occasionally it will be desirable to establish a more precise rating for a unit having specific designs and load/temperature cycle characteristics.

This can be done using a computer model based on industry adopted equations for computing temperature rise within power transformers and associated loss-of-life, (NEMA TR98). Substation Engineering is willing to perform this analysis on request, provided sufficient data on the transformer in question is available.

	 Indicates Latest Revision	Completely Revised	New Page	Information Removed
6311.4	SDG&E ELECTRIC STANDARDS			REVISION
	SUBSTATION TRANSFORMER LOADING GUIDE			DATE 1-1-89 APPD CVN / <i>BJ</i>

SCOPE

This standard shows typical distribution substation equipment arrangements and provides guidance on the type of equipment used.

PURPOSE

The purpose of this standard is to provide guidelines for the general arrangement and ratings of equipment in typical distribution substations. It is to be used for planning new substations, and expansions to existing ones. Coordination between District Engineering, Substation Engineering, and Transmission Planning is needed.

GUIDELINES FOR DISTRIBUTION SUBSTATION

A. Station Capacity

Property purchased for a new 12kV distribution substation should be adequate for a total nominal capacity of 100, 75 or 50 MVA, using 15/20/25 (28) MVA transformers. Remote areas and special locations are exceptions. Selection of the substation property is discussed in Design Standard 6330, titled "Distribution Substation Siting Procedures". The ultimate one-line diagrams for 50, 75 and 100 MVA distribution substation are shown in the diagrams on pages 6312.3 thru 6312.5. These diagrams are intended to guide the district engineer in planning activities and not to dictate the actual substation design.

B. Station Getaways

New 12kV circuit getaways will normally be underground. The standard getaway will be one run of 1000 kcmil aluminum cable. Overhead getaways may be installed at rural substations where only a few circuits are planned and area aesthetics are not materially affected. The number of circuits installed in a duct bank is dependent on the economics of reducing cable ampacity. Design Standards 5521, "Feeder Cable Ampacities Based On Thermal Loading Limits", and 5522, "Cable Ampacity Program" provide guidance on determining cable ampacity.

C. Four-Wire Distribution

All new 12kV substation are to be designed for compatibility with four-wire operation requirements according to Design Standard 6621, "Application Of Primary Neutral". New circuit construction is to include installation of a neutral conductor.

D. Bus Capacitors

All new 12kV substations are to be designed with an ultimate capacitor rating of 6 MVAR for each 28 MVA transformer bank. Substation capacitors for var load requirements should be installed in accordance with the "Capacitor Application Criteria". Design standard page 5811.

	 Indicates Latest Revision	Completely Revised	New Page
REVISION	SDG&E DISTRIBUTION DESIGN MANUAL		6312.1
DATE 1-1-89	DISTRIBUTION SUBSTATION PLANNING GUIDELINES		
APPD CVN / <i>CVN</i>			

E. Equipment

Substation equipment, unless acquired from existing stock, should ultimately conform to the following:

1. The 138kV and 69kV switchyard equipment will be rated as specified by Transmission Planning and will have minimum capacity sufficient to accommodate the ultimate load of the distribution substation.
2. The transformer bank will be three phase, 15/20/25 (28) MVA, 65°C rise OV/FA/FA within ? ten percent LTC.
3. The 12kV switchyard will provide 2,000 amp main bus capacity with a 2,000 amp bus tie breaker. Low side transformer breaker positions will have a short time overload capability compatible with transformer loading standard 6311. The 12kV feeder breakers will be rated 1,200 amps with an 18–20kA short circuit interrupting capability.
4. All new substations will include substation SCADA (status and control) in lieu of DPR equipment.

Typical ultimate equipment arrangements for distribution substations are shown on the following pages. Actual arrangements of new or existing substations may be planned differently depending on physical, economic and reliability considerations.

	Indicates Latest Revision	Completely Revised	New Page
6312.2	SDG&E DISTRIBUTION DESIGN MANUAL		REVISION
	DISTRIBUTION SUBSTATION PLANNING GUIDELINES		DATE 1-1-89 APPD CVN / <i>ROJ</i>

ONE TRANSFORMER BANK SUBSTATION

CONFIGURATION

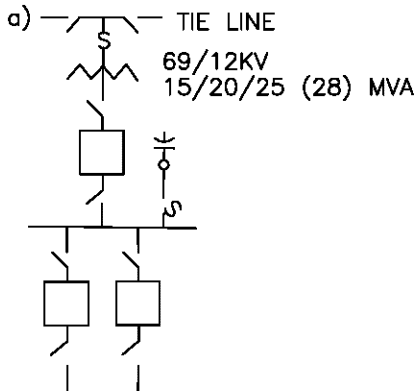

CONFIGURATION

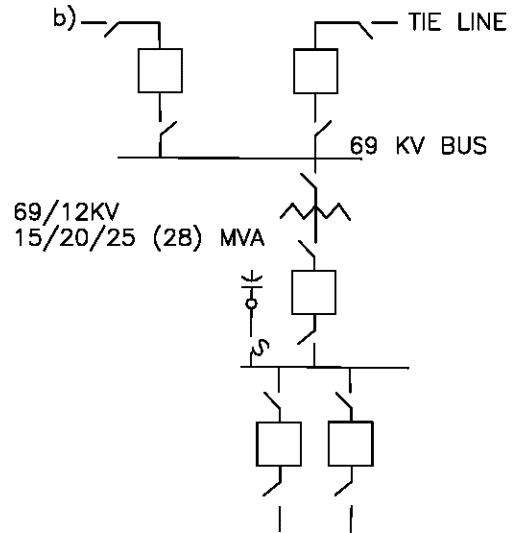

Notes:

- Config. a) Fuses are installed on the high side of 25 MVA banks only if all of the following three conditions exist:
1. The transmission source to the substation is tapped off a tie line, i.e., where there is no isolation device in the tie line within the substation perimeter; only an isolation device in the connection from the tie line to the sub.
 2. There is transfer trip capability at the substations at the ends of the tie line (so the fuse only provides secondary protection to the bank).
 3. The tie line is not critical.
- Config. b) A mod switch is installed on the high side of the transformer only when justified by Transmission Planning.

	Indicates Latest Revision	Completely Revised	New Page
REVISION	SDG&E DISTRIBUTION DESIGN MANUAL		
DATE 1-1-89	EQUIPMENT SYSTEM PLANNING		
APPD CVN/RD	ONE LINE DIAGRAM		
			6312.3

TWO TRANSFORMER BANK SUBSTATION

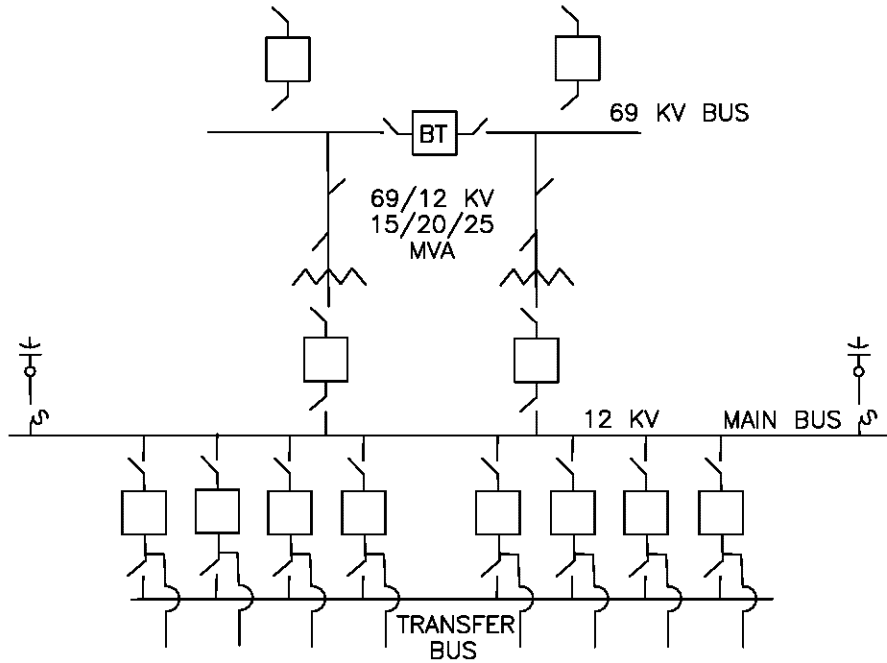

THREE TRANSFORMER BANK SUBSTATION

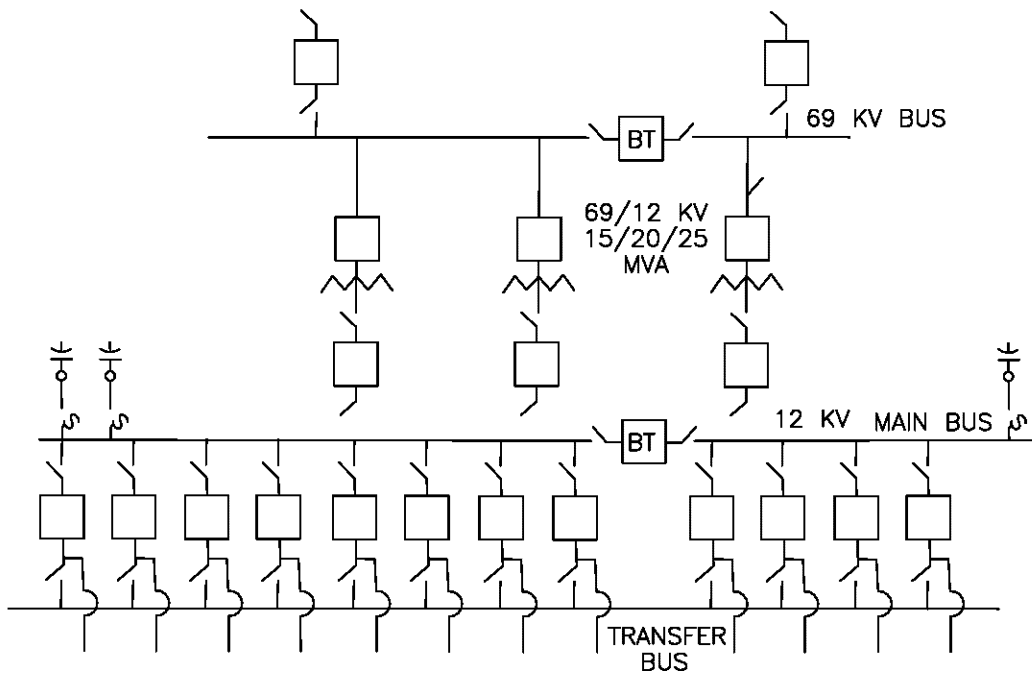

	Indicates Latest Revision	Completely Revised	New Page
6312.4	SDG&E DISTRIBUTION DESIGN MANUAL		REVISION
	EQUIPMENT SYSTEM PLANNING ONE LINE DIAGRAM		DATE 1-1-89 APPD CVN/BJ

FOUR TRANSFORMER BANK SUBSTATION

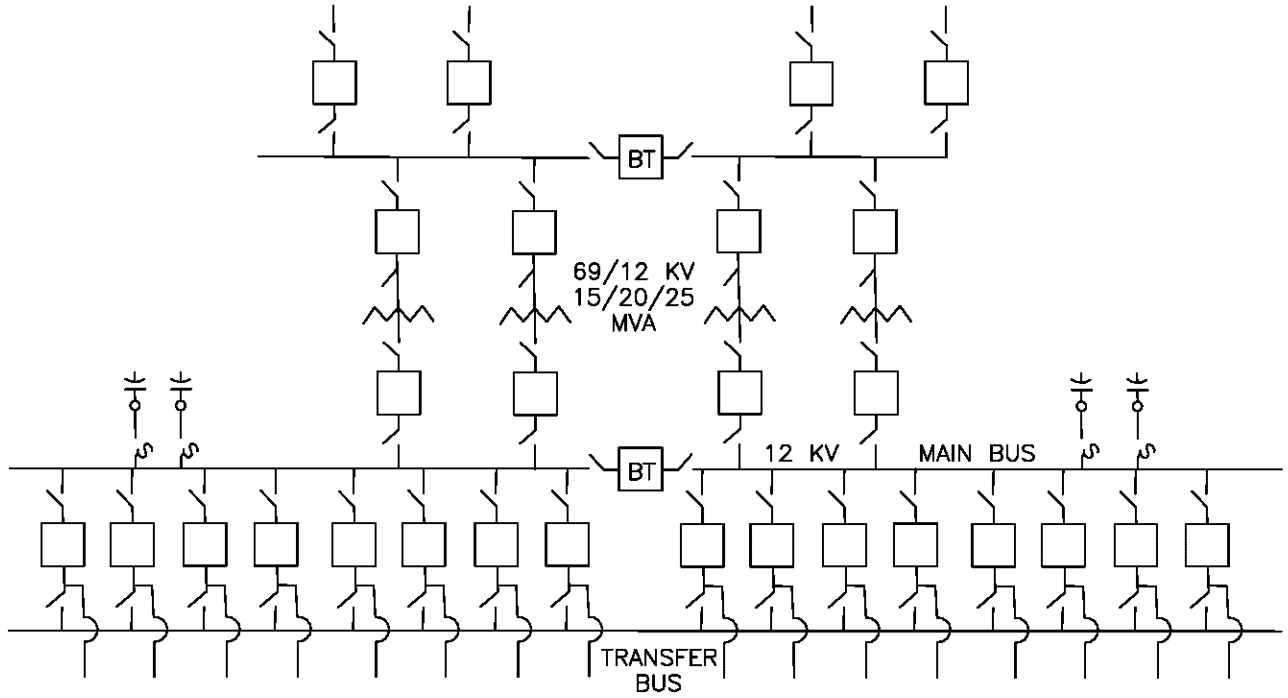

	Indicates Latest Revision	Completely Revised	New Page
REVISION	SDG&E DISTRIBUTION DESIGN MANUAL		6312.5
DATE 1-1-91	EQUIPMENT SYSTEM PLANNING		
APPD CVN <i>[Signature]</i>	ONE LINE DIAGRAM		

- A. The following criteria shall be applied to the design and development of distribution substations to ensure reliability of service:
1. Substation Transformers – Additional transformer capacity will be considered when:
 - a. Loss of a single transformer may cause an interruption to major commercial/industrial load that cannot be restored through use of 12Kv circuit ties to other substations.
 - b. Loss of a single transformer may cause an interruption to more than an acceptable amount of load that cannot be restored through use of 12Kv circuit ties to other substations within a reasonable period of time.
 - c. Substations serving single customers are exceptions to the above criteria.
 2. Substations With Radial Supply – A second transmission source to a distribution substation will be considered when:
 - a. Loss of a single overhead source may cause an interruption to major commercial/industrial load that cannot be restored through use of 12Kv circuit ties to other substations. Substations serving single customers are an exception.
 - b. The normal peak load of the substation exceeds 15 MW.
 - c. The frequency outage rate of the single transmission source exceeds the system average by 100 percent. The system average frequency outage rate may be obtained from transmission.

	 Indicates Latest Revision	Completely Revised	New Page
REVISION	SDG&E DISTRIBUTION DESIGN MANUAL		6321.1
DATE 1-1-2000 APPD MT <i>VGP</i>	DISTRIBUTION SUBSTATION RELIABILITY CRITERIA		

- B. The guidelines listed below shall be followed during the design, development and normal operation of distribution substations in order to limit fault currents on the distribution system to acceptable values.

The guidelines are as follows:

1. Maximum of 10,000 amp (symmetrical line-to-ground fault current).
2. Maximum of two units (transformers or gas turbines, each with impedance equivalent to or greater than ten percent on a 20 MVA base) paralleled per bus section during normal conditions.
3. Maximum of three units paralleled during contingency conditions (not to exceed 12 hours per occurrence).

NOTES:

Guideline B.1. requires the installation of neutral reactors at substations where line-to-ground fault currents are greater than the specified value. One neutral reactor per transformer will be provided during the development of the standard 100 MVA ultimate distribution substation. Distribution substations with gas turbine installations will also require neutral reactors for the gas turbine generators.

Guideline B.2. limits fault currents for all three-phase faults to a typical value of 13,600 amps. This presumes a typical system impedance of 1.8 percent on a 20 MVA base. This guideline requires the 12kV bus tie breaker to be operated normally open to isolate two units on each 12kV bus section.

In order to meet the requirements of guideline B.3., relaying scheme will be provided which automatically closes the 12kV bus tie breaker following a transformer failure in a three or four bank substation. This procedure is required to obtain uniform loading and avoid dropping load immediately following a transformer failure.

For additional information, refer to "Application Guidelines for Limiting Distribution Fault Currents" (ELI 230).

	Indicates Latest Revision	Completely Revised	New Page
6321.2	SDG&E DISTRIBUTION DESIGN MANUAL		REVISION
	DISTRIBUTION SUBSTATION RELIABILITY CRITERIA		DATE 1-1-91 APPD CVN / <i>CVN</i>

SCOPE

This standard states the complete procedure for selecting, evaluating and obtaining sites for distribution substations.

PURPOSE

The selection of an appropriate site for a new distribution substation is a complex process involving advance planning studies of system expansion alternatives, followed by detailed evaluations of specific candidate sites. The selection of an optimal site requires consideration of technical, economic, environmental and political factors. The purpose of these procedures is to assure an organized and thorough evaluation of all relevant factors, and to promote clear communication between the various groups that must participate in such an evaluation. The final result of the site evaluation study should be recommendations of preferred and alternative sites for the proposed new substation.

METHODOLOGY

I. ADVANCE PLANNING PHASE

1. Area Planning Study



District Engineering conducts an area system planning study to identify need for a new substation at least 5 years in advance of need. Preliminary estimates of the following parameters are to be determined:

- a. In-Service Date
- b. Substation one-line diagram and approximate land requirements
- c. Load Center
- d. Preferred transmission voltages

Transmission Planning, Substation Engineering, Land Services, Environmental Dept., and other appropriate groups will provide input to the area planning study. Timely support from each group involved in the study is critical to the success of the process. Input from Land Services will include a recommendation on timing of a detailed site selection study. The study report must be reviewed by all study participants and Distribution Engineering and approved by District Management.

2. Capital Project Development

If substation construction and/or substation site acquisition is to occur within the 5 year period following completion of the area study, a capital project is to be developed and submitted to the Transmission and Distribution Planning Committee for approval. Estimates of all expenditures anticipated within the 5 year period are to be shown on the Capital Project Summary Form. The capital project will be presented to the Capital Budget Committee by the sponsoring district engineering group.

	 Indicates Latest Revision	Completely Revised	New Page
REVISION	SDG&E DISTRIBUTION DESIGN MANUAL		
DATE 1-1-89	DISTRIBUTION SUBSTATION SITING PROCEDURES		6330.1
APPD CVN/ 			

For capital budgeting purposes, the project manager for site acquisition will be assigned as follows:

- a. Land Services if land purchase only is approved.
- b. Substation Engineering if land purchase and substation construction is approved.

II. SITE SELECTION PHASE



1. Formation of a Study Team

The number of siting issues that must be considered in the selection of a substation site warrants the formation of a study team. The size and type of substation will generally dictate the number of Company department/sections that become part of the study team. The Land Planner will serve as the study team leader, and will be responsible for requesting Substation Engineering to open a work order for the purpose of collecting the charges of the study team. Participating departments/sections on the study team could include:

- Transmission Planning
- Substation Engineering & Design
- District Engineering
- Civil/Structural Engineering
- Transmission Engineering
- Land Services
- Environmental Department

The Land Planner should set up a study team meeting after receiving load center and other relevant information. The purpose of the meeting should be to establish responsibilities, develop a schedule for completion of the site selection, and identify project criteria, objectives, and any assumptions and biases that need to be factored into the process. Once the study parameters are defined, Land Services will identify a study area within which the search for candidate sites will occur and identify preliminary candidate sites. The study area is arrived at through a logical process based upon recognition of topographical, political, man made, or other obvious boundaries.

The following are typical site feasibility factors that will be evaluated in the site selection study and the department or section responsibility for each:

	 Indicates Latest Revision	Completely Revised	New Page
6330.2	SDG&E DISTRIBUTION DESIGN MANUAL		REVISION
	DISTRIBUTION SUBSTATION SITING PROCEDURES		DATE 1-1-89 APPD CVN/ 

SITE FEASIBILITY CRITERIA

RESPONSIBILITY

Physical Substation Requirements

- Site size and shape
- Equipment arrangement
- Construction costs

Substation Engineering

Site Access

Substation Engineering
Civil Engineering
Land Services

Site Development & Associated Costs

- Grading
- Drainage
- Soil Quality
- Seismic Potential
- Street Improvements

Civil Engineering

Distribution System Considerations

- Substation transformer and low-side bus arrangement
- Distribution circuit arrangements & circuit costs
- Future system requirements - distribution
- Overall study economic analysis

District Engineering

Transmission System Considerations

- Tie line specification (voltage, routing)
- Future system requirements - transmission
- Substation high-side bus arrangement

Transmission Planning

	<input checked="" type="checkbox"/> Indicates Latest Revision	<input type="checkbox"/> Completely Revised	<input type="checkbox"/> New Page
REVISION	SDG&E DISTRIBUTION DESIGN MANUAL		6330.3
DATE 1-1-89 APPD CVN/ <i>RG</i>	DISTRIBUTION SUBSTATION SITING PROCEDURES		

SITE FEASIBILITY CRITERIA

RESPONSIBILITY

Environmental Considerations & Associated Costs

Land Services
Environmental

- Archaeology
- Biology
- Geology
- Paleontology
- Aesthetic/Visual Considerations
- Noise*
- CEQA Requirements*

*Substation Engineering may also be involved from a technical standpoint.

Land Use Issues & Associated Costs

Land Services

- Building Setbacks
- Deed Restrictions
- Community/Specific Plan Compliance
- Tentative Map Regulations/Improvements
- Performance Standards (Noise, etc.)
- Landscaping Requirements
- Governmental Agency Requirements
- Land Use Compatibility
- Political Constraints/Issues
- Public participation and input

Site and R/W Acquisition

Real Property
Acquisition

- Land Cost
- Condemnation Issues
- Severance Costs
- Ownerships

2. Identification of Candidate Sites

Given the project study area, criterion and objectives, and assumptions and biases, the Land Planner can begin the search for candidate sites. Area topographical maps, area Land Use & Environmental maps, knowledge of the study area on the part of Company Lease Agents or Property Inspectors and knowledge gained from personal field trips should be utilized to help identify candidate sites. The sites should be mapped on a base map and ownership data compiled. Field trips and follow-up meetings with study team members should occur to eliminate candidate sites that have undesirable characteristics. The decision to eliminate a candidate site should occur by concensus of the study team members. Once the study group agrees upon the final candidate sites, the Land Planner should produce a memo noting this fact. The memo should also explain the reasons why other candidate sites were eliminated.

	Indicates Latest Revision	Completely Revised	New Page
6330.4	SDG&E DISTRIBUTION DESIGN MANUAL		REVISION
	DISTRIBUTION SUBSTATION SITING PROCEDURES		DATE 1-1-89 APPD CVN / <i>RDJ</i>

3. Candidate Site Analysis

Final candidate sites undergo a detailed evaluation by each respective member (section) of the study team based upon the feasibility factors. For example, the engineering groups evaluate each candidate site in terms of functional operation, site development cost, and transmission and distribution system development costs. Land Services and the Environmental Dept. evaluate the land use, environmental, political and permitting implications of each site given the precise substation development scenario, i.e. arrangement of equipment, access, site topography, viewsheds, etc. Real Property Acquisition determines specific site and R/W costs. This detailed information shall become part of the decision-making analysis employed to select the preferred and alternative substation site.

Land Services is responsible for coordinating all the non-economic site analyses. District Engineering is responsible for coordinating the overall economic analysis of the alternative sites.

The detailed site selection study may identify costs and other factors significantly different than those assumed in the area planning study. Therefore, District Engineering is also responsible for review of the area planning study assumptions and results to reaffirm the need for a new substation.

4. Selection of Preferred and Alternative Site(s)

A decision-making analysis involving study team members should be employed in most instances for selecting the preferred and alternative sites from the list of final candidate sites. A Kepner-Tregoe analysis is an example of a suitable decision-making exercise. The Land Planner will coordinate the selected decision-making exercise. All memorandum required to explain and assist study team members through the exercise will be the responsibility of the Land Planner. All economic evaluations will be reviewed by the Finance and Economic Analysis Section. Obtaining consensus on what the decision-making criteria will be and how each candidate site measures up to the decision-making criteria (usually through a "scoring" system) should be the goal of the exercise.

5. Written Report

Upon completion of the decision exercise, a final report will be prepared for appropriate company management detailing the site selection recommendations.

	 Indicates Latest Revision	Completely Revised	New Page
REVISION	SDG&E DISTRIBUTION DESIGN MANUAL		
DATE 1-1-89 APPD CVN/ <i>BJJ</i>	DISTRIBUTION SUBSTATION SITING PROCEDURES		6330.5

The Land Planner will write the site selection report. The contents of the report, at a minimum, should be:

- A Summary and Recommendation Section including the justification for recommendations.
- Project Description
- Project Objectives
- Analysis of Candidate Sites (Decision Exercise)
- Supplementary Exhibits:
 - Assessor Sheets
 - Topo Maps
 - Grading Plans
 - Load Center Maps
 - Site Location Maps
 - Economic Analysis Summary
 - Decision Analysis
 - Constraint and Opportunity Maps

6. Approvals

The study report will be considered complete and "approved" when it has received signed approvals from study team participants and district management. Final approval authority and responsibility for report content rests with district management.

7. Governmental Agency and Community Involvement

Following management approval, the site selection recommendations normally will be presented by Land Planning to the Community Planning Group and/or other organized groups that may be affected by or interested in the siting of a substation. Discussion of the preferred site and transmission corridor, if necessary, along with the Company's justification for such will be the purpose of the presentation. Input from an organized group should be carefully considered because the intent of the involvement is to get community support for the project. As well, community input may have the potential to alter a recommendation if unforeseen or unknown circumstances are made known.

At the permitting stage, additional community involvement normally occurs in complying with governmental agency regulatory requirements. Public hearings on the fulfillment of use permit, parcel map, zone change, general plan amendment, etc. requirements will be handled by the Land Planner.

	 Indicates Latest Revision	Completely Revised	New Page
6330.6	SDG&E DISTRIBUTION DESIGN MANUAL		REVISION
	DISTRIBUTION SUBSTATION SITING PROCEDURES		DATE 1-1-89 APPD CVN / 