



SEBO AIRBELT K

MADE IN GERMANY

OWNER'S MANUAL

For Household Use Only



TABLE OF CONTENTS

Technical Details	2
How To Contact SEBO	2
Important Safety Instructions	3
Special AIRBELT K Product Features	4
AIRBELT K2 Kombi Features	5
AIRBELT K3 Premium Features	5
Optional Attachments, Accessories, Bags and Filters	6
Standard Features of All SEBO Vacuums	7
Identification of Parts	8
Standard Attachments	8
Brushes and Heads	8
Assembly	8
Operating Instructions	9
Starting the Machine	9
Suction Control	9
Operating the Machine	9
Additional Operating Instructions for K3 PREMIUM with Power Head	10
Starting the Machine and Suction Control	10
Operating the Machine	10
Using the Telescopic Tube, Hose & Attachments	11
Use and Maintenance of Brushes and Heads	11
The Parquet Brush.....	11
The Kombi Nozzle	11
The Turbo Brush.....	11
Vacuum Maintenance	12
Changing the Filter Bag	12
Changing the Exhaust Filter.....	12
Changing the Pre-motor Microfilter.....	12
Changing the AIRBELT	12
Clog Removal	13
Clogs in the Head or Brush	13
Clogs in the Telescopic Tube	13
Clogs in the Hose	13
Clogs in Entrance to Filter Bag	13
Trouble-shooting Guide	14
AIRBELT K2 Kombi Schematic and Part Numbers	15
AIRBELT K3 Premium Schematic and Part Numbers	16

TECHNICAL DETAILS

Vacuum motor	1250 watts (10.6 amps)
Water lift (at motor)	95 inches
Airflow (at motor)	120 CFM
Filter bag capacity	.8 gallons
Sound level	63 dBA
Body weight	12 lbs.
Motor protection	thermal cut-out
Cord length	25 feet
Range	37 feet

Technical details may be subject to change.

HOW TO CONTACT SEBO

To contact SEBO in the United States of America:

SEBO America, LLC
 Telephone: (800) 334-6614
 Fax: (303) 792-9196
 Website: www.sebo.us

To contact SEBO in Canada:

SEBO Canada
 Telephone: (877) 258-5005
 Fax: (800) 270-4807
 Website: www.sebocanada.ca

IMPORTANT SAFETY INSTRUCTIONS



READ ALL INSTRUCTIONS BEFORE USING THIS MACHINE

When using an electrical appliance, basic precautions must always be followed.

To reduce the risk of electric shock, this vacuum cleaner has a polarized plug; one blade is wider than the other. This plug will fit in a polarized outlet only one way. If the plug does not fit fully in the outlet, reverse the plug. If it still does not fit, contact a qualified electrician to install the proper outlet. Do not change the plug in any way. Connect only to the outlet type specified on the serial number plate underneath the machine.

SAVE THESE INSTRUCTIONS.

WARNING: To reduce the risk of fire, electric shock, or injury:

1. Do not leave vacuum while plugged in. Unplug from outlet when not in use and before servicing.
2. Do not use outdoors or on wet surfaces.
3. Do not use near small children or pets. Do not allow to be used as a toy. Use of this product by children should always be supervised by an adult.
4. Use only as described in this manual. Use only manufacturer-recommended attachments.
5. Do not use with a damaged cord or plug. If vacuum is not working as it should, has been dropped, damaged, left outdoors, or dropped into water, take it to a SEBO service center.
6. Do not pull or carry by cord, use cord as a handle, close a door on cord, or pull cord around sharp edges or corners. Do not run vacuum over cord. Keep cord away from heated surfaces.
7. Do not unplug by pulling on cord. To unplug, grasp the plug – not the cord.
8. Do not use outlets above counters to plug in vacuum – damage to items in the surrounding area could occur.
9. Always carry the vacuum over steps and sills.
10. Do not handle plug or vacuum handle with wet hands.
11. Do not put any object into vacuum openings. Do not use machine with any openings blocked. Keep openings free of lint, hair, and anything that may reduce air flow.
12. Do not re-use filter bags or wash the filters.
13. Do not remove any screws from vacuum.
14. Do not vacuum up anything that is burning or smoking, such as cigarettes, matches, or hot ashes.
15. Do not use vacuum without filter bag and/or filters in place.
16. Turn off all machine controls before unplugging.
17. Use extra care when cleaning on stairs.
18. Do not use machine to vacuum up flammable or combustible liquids such as gasoline or use in areas where they may be present.
19. Machines can cause a fire when operated near flammable vapors or materials. Do not operate this vacuum near flammable fluids, dust or vapors.
20. Maintenance and repairs must be done by authorized personnel.
21. Use only original SEBO replacement parts.
22. Do not use vacuum as a step.
23. If vacuum is used on plush carpet or carpet with thick padding, do not leave machine standing in one place with machine turned on.
24. While the vacuum is in use, the power cord should be unwound from the cable reel at least two thirds of its length. Hold plug when rewinding onto the cord reel. Do not allow plug to whip while rewinding.
25. Keep hair, loose clothing, fingers, and all parts of body away from vacuum openings and moving parts. Do not place fingers or other body parts under vacuum unless it is unplugged.
26. Do not place the power head over rug or carpet edges.
27. The vacuum has a manual reset thermal protector. The protector is reset by switching off the vacuum. The thermal protector needs some time to cool down after switching off! Check the vacuum for air blockages or mechanical failures before switching on.
28. Store the vacuum in a dry place at room temperature. When the vacuum is not in use, you should rewind the cord onto the cord reel.
29. The K3 hose contains electrical wires. Do not use if damaged, cut, or punctured. Avoid picking up sharp objects.
30. Always unplug vacuum before connecting or disconnecting either hose or power head.
31. Use a SEBO power head only in combination with a SEBO vacuum cleaner.
32. Do not connect power head to a malfunctioning or damaged vacuum.

SEBO AIRBELT K PRODUCT FEATURES

Bag Full or Clog Light & Auto Shut Off – A warning light will illuminate and the machine will automatically shut off, when it senses a full bag, a clog in the airflow pathway, or an excessively dirty microfilter. If the vacuum's airflow pathway becomes restricted due to a full bag or the existence of a clog, the amber "BAG FULL OR CLOG" light (located on top of the canister near the ON/OFF power control knob) will illuminate. If the user ignores this warning, the suction motor will heat up due to the lack of cooling provided by the airflow. Once the motor reaches a certain temperature it will shut off to protect itself from damage. The user should turn the switch off, unplug the machine and immediately insert a new bag or remove the clog (to remove a clog, refer to the Clog Removal section on page 13). After approximately 30 minutes, the motor will have cooled and the vacuum can be restarted. If the airflow is still restricted, the "BAG FULL OR CLOG" light will again illuminate and the machine will shut off. This feature prevents damage to the motor due to overheating.



Shock Absorber Provides Furniture and Wall Protection – The "AIRBELT" bumper that surrounds the K canisters acts as a protective barrier. The soft foam bumper with its durable covering protects furniture, walls and the vacuum itself from damage during use.



Personalized Vacuums – AIRBELT canister vacuums can be personalized with a replacement AIRBELT bumper cover available in eight patterns and colors.

Large Operating Range – A 37-foot operating range saves time because it minimizes the number of electrical outlets needed during use.

Quick-release Connections – The AIRBELT K models allow for quick and convenient connection of telescopic tubes, power brush heads, accessory cleaning heads and on-board tools.

Comfortable Ergonomic Handle – The AIRBELT handles are ergonomically designed and positioned to reduce wrist and arm fatigue. For extra comfort, an additional swivel is built into the handle-to-hose connection.

Mid-sized Canister Vacuum – The SEBO AIRBELT K3 and K2 are considered mid-size canister vacuums, which means they are machines medium in size that offer mid-sized, on-board attachments and a mid-sized filter bag with a dirt capacity of .8 gallons.

Rubber-coated Wheels and High Quality Castors – The quality of the wheels and castors on SEBO canisters prevent damage to floors and rotate 360° for easy maneuverability.

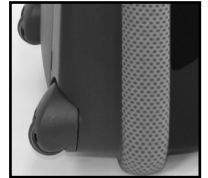

Three On-board Tools – The vacuum comes standard with a crevice nozzle, dusting brush and upholstery nozzle. The dusting brush is mounted on the telescopic tube, and the crevice and upholstery nozzles are on the canister. Many optional accessories are also available.



Dusting Brush Crevice Nozzle
Upholstery Nozzle

AIRBELT K2 KOMBI

AIRBELT K2 Kombi: The SEBO AIRBELT K2 Kombi is a straight-suction vacuum. As a result, it differs from the AIRBELT K3 Premium in the following two ways:



Can Not Use a Power Brush – The AIRBELT K2 Kombi does not have an electrified telescopic tube and hose; therefore, it does not accommodate an electrified power brush. Instead, your K2 model comes standard with a Kombi Nozzle for rugs and carpet.



Kombi Nozzle

Variable Power Control on Canister Body – Because the AIRBELT K2 Kombi does not have an electrified hose and telescopic tube, its variable power control switch is located on the canister body, not the handle.



AIRBELT K3 PREMIUM

Designed for All Floor Surfaces. AIRBELT K3 Premium:

The AIRBELT K3 Premium has an electrified hose and telescopic tube designed to accommodate the ET-1 power head. The ET-1 is designed to provide thorough brushing for optimal cleaning of carpets.

Both Carpet and Hard Floor Cleaning – With a power brush to clean carpets and a parquet brush to clean hard floors, the AIRBELT K3 provides all the flexibility needed to care for a variety of floor surfaces. The parquet brush comes standard.



Parquet Brush

High-quality Telescopic Tube and Hose – On the K3, the power cord is built inside the telescopic tube and suction hose. This eliminates unsightly external wires and enables unobstructed and convenient handle height adjustment.

Variable Power Control on Handle – The vacuum's suction power can be adjusted from 0 to 1,250 watts by a slider switch conveniently located on the handle.



Powerful Vacuum Motors Provide Excellent Cleaning – The canister suction motor is 1,250 watts, and the power head motor is 175 watts (ET-1), for a total of 1,425 watts.



The SEBO ET-1 (12" wide, 10 1/2" cleaning width) – This power head delivers cleaning flexibility because its brush action aggressively cleans carpeting, but the brush roller may be switched off by pressing the green illuminated on/off button, so delicate rugs and hard floors can be cleaned with straight suction. Its amazing 180° steering ability provides maneuverability around furniture, and the extension side of the L-shaped head makes cleaning edges and under counters easy.

Brush Obstruction Light & Auto Shut Off –

If an obstruction becomes jammed in the brush roller, a red brush-warning light will quickly flash, the brush roller will immediately stop spinning and the vacuum will shut off. The user should turn the power switch off, unplug the machine, and immediately remove the obstruction. If the user restarts the machine without removing the obstruction, the power head will again shut off and the red light will flash. This prevents the belt from breaking and protects the motor and carpet from damage.





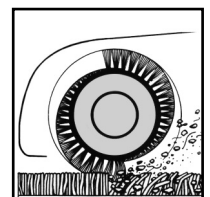































Incorrect Height Setting or Brush Deterioration Light – To ensure optimum cleaning at all times, a red brush-warning light will illuminate, to indicate when the brush height is set too high for effective cleaning or when the brush roller should be replaced due to excessive wear.



OPTIONAL ATTACHMENTS, ACCESSORIES, BAGS & FILTERS

In addition to the standard on-board tools, a variety of optional attachments are available. The nine-foot extension hose (extends suction hoses) and the 22-inch extension wand are very popular because they create useful tools for cleaning stairs and out-of-reach areas. Another popular attachment is the hand-held turbo brush for removing pet hair from upholstery.

SEBO filter bags can be purchased in boxes of eight and filters are sold separately. Also, bags and filters can be purchased together in model-specific kits called "Service Boxes." SEBO bags, filters and accessories are reasonably priced and widely available. To create a fresh scent while vacuuming, "SEBO FRESH" is available. To use, deposit a scented stick in the filter bag.

ATTACHMENTS					
Included K3 Premium					
	ET-1 Power Head included with K3 models. Colors: Red or Black	Crevice Nozzle #1092GS	Dusting Brush with Horsehair Bristles #1387GS	Upholstery Nozzle #6627GS	Parquet Brush #6391DA
Included K2 Kombi					
	Kombi Nozzle #1397GS	Crevice Nozzle #1092GS	Dusting Brush Horsehair Bristles #1387GS	Upholstery Nozzle #6627GS	
Optional Attachments					
	9-Foot Extension Hose #1495AM	22" Extension Wand #1084GS	Hand-held Turbo Brush #6179ER	Flat Upholstery Nozzle #1090HG	Radiator Brush #1496GS
					
	Wall & Floor Brush #1325GS	Kombi Nozzle #1397GS	Premium Kombi Nozzle #7260GS	Premium Parquet Brush #7200GS	
					
	Parquet Brush #6391DA	Turn and Clean Parquet Brush #1327WS	Turbo Brush #8365GS	Dusting Brush Large Opening, Nylon Bristles #1094GS	Dusting Brush Nylon Bristles #1329GS
BAGS, FILTERS, ACCESSORIES AND WEAR ITEMS					
					
8 AeraPure™ Bags* #6629AM	S-class, Pre-motor Microfilter* #6191AM	Exhaust Filter* #6608ER	Service Box #6695AM		
<p>*All three items are also available as a Service Box #6695AM, containing 8 AeraPure™ Bags, an Exhaust Filter and an S-class Pre-motor Microfilter.</p>					
					
		Filter Set #6696AM	HEPA Service Box contains 8 AeraPure™ Bags, an Exhaust Filter, and a HEPA Pre-motor Microfilter. #6431ER		
					
AIRBELT Cover Dark Gray #6047AM/01	AIRBELT Replacement Textile Black/Silver #6047AM/07	12" Brush Roller #5010AM	12" Brush Roller (soft bristle) #5010GE	SEBO FRESH 1 Pkg. of 5 #0496AM	

STANDARD FEATURES OF ALL SEBO VACUUMS

SEBO's FILTRATION SYSTEM:

Bagged vs. Bagless . . . Bags are Better! – Top-fill, three-layer AeraPure™ Bags are an integral part of SEBO's filtration system because they hold virtually all the dirt captured by the vacuum, which improves the effectiveness and useful life of the microfilters. They also ensure continuously strong suction because dirt enters from the top, deposits at the bottom, accumulates upward, and air exits through the sides, which allows unimpeded airflow as they fill to capacity. And they can be tightly sealed with a hygiene cap when full, so no dust can escape into the air during bag removal and disposal.

In contrast, without bags to hold nearly all the captured dirt, the microfilters on bagless vacuums quickly clog from excessive dirt build-up and must be replaced often, or a loss of suction and cleaning effectiveness will occur. In addition, dust and other allergens become airborne when emptying bagless dirt containers. Lastly, bagless vacuum microfilters are expensive, usually costing more than a multi-year supply of SEBO filter bags.

S-class, Pre-motor and/or Exhaust Microfilters – S-class, Pre-motor and Exhaust Microfilters (S = "Schwebstoff" = airborne particles) are made from electrostatically charged, micro-fiber material, which attracts and captures dust particles from the airflow of the vacuum before and after it passes over the motor to cool it. Cooling the motor with super-clean air increases motor life and reduces the possibility of maintenance, even after many years of use. Also, the exhaust air is cleaned to the highest level before being emitted from the machine. The S-class Standard requires filters to absorb greater than 99.9% of particles down to 0.3 microns in diameter. For comparison, 100 microns is the diameter of a human hair. Their advantages are a relatively open texture that allows smoother airflow for better suction performance, a longer life expectancy, and they cost less than HEPA filters.



Designed and Manufactured in Germany – Legendary quality, reliability and performance make SEBO vacuums the first choice of cleaning professionals throughout the world.

World's Best Pet Vacuums – Because of superior power-head and brush-roller technology, SEBO vacuums are the world's best for pet hair removal!

Excellent for Users With Allergies or Asthma – The British Allergy Foundation recommends SEBO filters.

Tightly Sealed Vacuums Ensure Effective Filtration – Dirty air, which flows through a vacuum, can only be filtered completely if it does not escape into the room through seams or seals in the machine. This is why all SEBO vacuums have tight seals throughout.

Many vacuum companies with high-filtration claims are actually quoting specifications made by the manufacturer of the filter material, as measured in the laboratory, not the filtration effectiveness of the vacuum itself while operating. Whether or not dirty air can escape through leaks in the body of the machine is not considered. The filtration effectiveness of SEBO vacuums is tested while they operate.

Reliable, Commercial-grade Components – All SEBO vacuums are constructed with thick, reinforced, ABS plastic, aluminum and metal parts, steel axles and bearings, and high-end, quality motors. Therefore, SEBO users own reliable, long-lasting vacuum cleaners. Competing vacuums are made with thin, flimsy, inexpensive, plastic materials, none of which are reinforced, and typically have useful lifespans of one or two years.

Rubber Wheels and Soft Bumpers Protect Homes – Smooth-gliding, rubber wheels protect hard floors and provide exceptional maneuverability. In addition, the bumpers that surround the power heads and the soft AIRBELT bumpers that surround SEBO's canisters protect furniture, walls, and vacuum housings from incurring scuffs and scratches during use.

Advanced, Brush-Roller Technology – SEBO's brush rollers are uniquely designed to funnel hair and debris into the power head's airflow channel, which improves vacuum cleaning performance on all flooring surfaces.

Changing Bags is Easy and Clean – SEBO filter bags can be changed in just a few seconds, and a hygiene cap keeps dust sealed inside during removal and disposal.

Save Money! SEBO Vacuums Last for Years and Extend Carpet Life! – If properly maintained, SEBO vacuums save ordinary, residential users hundreds of dollars, by providing excellent performance for ten to fifteen years or more, and their deep-cleaning, power-brush technology extends the life of carpets. Typical vacuums perform poorly, even when new, and usually do not last beyond two years. So six or seven "disposable vacuums" must be purchased during the average life expectancy of just one SEBO machine.

Incredible Warranty Coverage – All SEBO models include a FREE seven-year warranty on the motor and five-years on non-wear parts and labor charges.

IDENTIFICATION OF PARTS

- | | |
|-----------------------------------|------------------------------------|
| 1. Handle grip | 14. Exhaust filter cover |
| 2. Power control slider (K3 only) | 15. AIRBELT shock absorber |
| 3. Handle release button | 16. Carrying handle |
| 4. Telescopic tube | 17. Suction opening |
| 5. Slide button | 18. Hose release button (K3 only) |
| 6. Power cable | 19. Hose neck |
| 7. Tool release button | 20. Crevice nozzle |
| 8. Kombi nozzle | 21. Parking attachment holder |
| 9. On/Off power control knob | 22. Power cable shroud |
| 10. Warning light | 23. AIRBELT clip |
| 11. Upholstery Nozzle | 24. Parking attachment holder |
| 12. Mains cable (K3 only) | 25. Filter bag cover release catch |
| 13. Hose | 26. Filter bag cover |

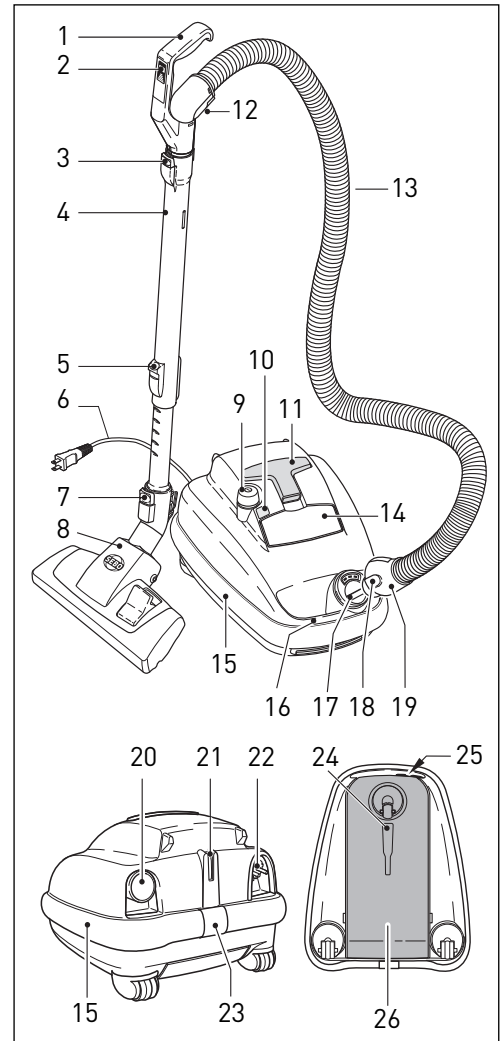

Standard Attachments

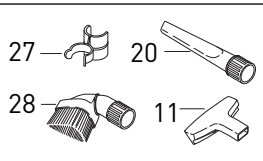

- | | |
|-----------------------|------------------------|
| 20. Crevice nozzle | 27. Dusting brush clip |
| 11. Upholstery nozzle | 28. Dusting brush |

Brushes and Heads

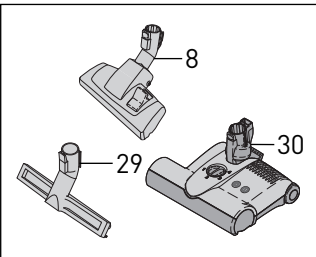

- | |
|---|
| 8. Kombi nozzle - standard for the K2 Kombi
Optional for K3 Premium - Part #1397GS |
| 29. Parquet brush - standard for K3 Premium
Optional for the K2 Kombi - Part #6391DA |
| 30. ET-1 Power Head - standard for K3 Premium |

ASSEMBLY

Push the neck (19) of the hose (13) into the suction opening of the canister (17). **K3:** The notch in the suction opening will line up with the raised bar on the neck. When the notches are lined up correctly, the neck will snap firmly into place. To release the hose from the suction opening, press the release tab (18) on the neck of the hose (19), and pull the neck out. **K2:** To release the hose from the suction opening, squeeze the tabs (37) on the retaining ring and pull the neck out.

Attach the short mains cable (12 - K3 only) on the underside of the handle by connecting one cable plug where the hose connects to the handle and the other where the handle connects to the telescopic tube.

Connect the handle (1) to the top of the telescopic tube (4). Snap in place. To release the telescopic tube (4) from the handle, push the handle release button (3) and slide the handle out.

Attach the head or brush to the bottom of the telescopic tube (4). Insert the bottom of the telescopic tube into the neck of the head or brush (38) until it locks into place; or line up the square hole in the telescopic tube with the notches in the front of the neck, and snap firmly into place. To release a head or brush from the telescopic tube (4), push the release button (7), and pull the head or brush tool off the end of the telescopic tool. The release button (7) is in the same position on all of the heads, brushes and power heads.

To attach the dusting brush clip (27), locate the two raised ridges on the upper end of the telescopic tube (4) just below the handle. Push the clip onto the tube directly below the ridges then slide the clip up until it locks onto the ridges. Snap the dusting brush (28) into the holder.

NOTE: To attach the ET-1 power head to your K3 Premium, please refer to your power head owner's manual for instructions. Attaching incorrectly could cause damage.

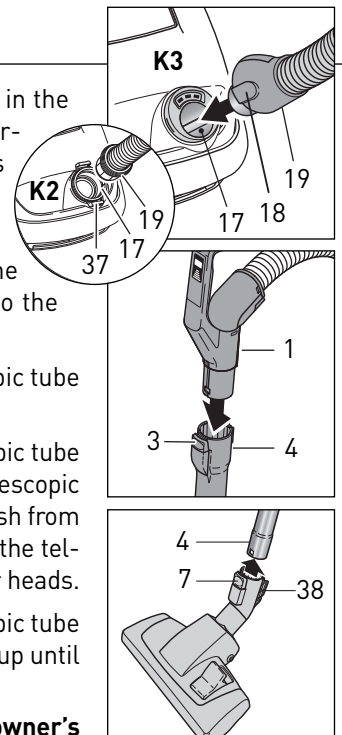

OPERATING INSTRUCTIONS ALL K VACUUMS

Starting The Machine - Figures 1, 2 & 3

Before turning on your canister, make sure that you have a firm hold on the handle grip to keep the machine from moving forward.

1. With the canister main power control knob (9) in the OFF position, grasp the plug and pull the power cord (6) out from the power cable recess (22). The power cord (6) should be unwound from the cable reel at least two thirds of its length. **Note:** do not over-extend the cord.
2. Plug the polarized power cord into a 120 volt wall outlet located near the floor.
3. Press the main power control knob on the base of the canister (9) gently with your foot or hand. The green light (10) will illuminate indicating that the power is on (K3 model only).

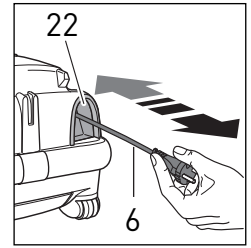

Figure 1

Suction Control - Figure 3

K2 Kombi users: the suction control dial is located on the top side of the canister on the power control knob (9). Rotate the dial counter-clockwise for maximum suction. Rotate clockwise to reduce suction for vacuuming curtains or delicate fabrics.

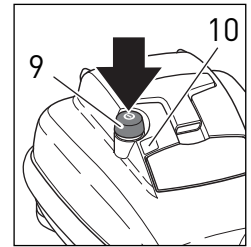

Figure 2 - K3

K3 Premium users: for information on suction control, refer to page 9 of this manual.

Operating the Machine - Figures 4, 5, 6 & 7

Adjust the telescopic tube (4) to the correct height by pushing the slide button (5) and gently pulling the tube out to lengthen, or pushing it in to shorten. Release the slide button (5) to lock the tube to the adjusted height.

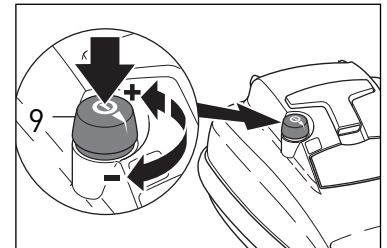

Figure 3 - K2

When changing heads, always switch the vacuum off with the power control knob (9), and then unplug the power cord.

The "bag full or clog" light (#10, figure 2) works correctly only at full power. At lower power levels, the "bag full or clog" light may illuminate incorrectly. Check the status of the filter bag regularly at full power. If the light remains illuminated at full power, and the filter bag is not full, check for clogs (see page 12).

To retract the cord, switch the vacuum off, unplug it from the outlet, then gently pull on the cord near the plug recess (22) and the mechanism will automatically rewind. Before rewinding the cable, always switch off and unplug the vacuum. Hold the plug while rewinding the cord onto the cord reel. Avoid letting the plug whip while rewinding.

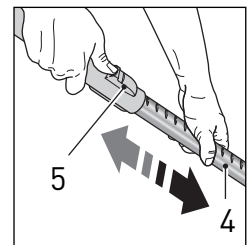

Figure 4

The vacuum can be stored with the canister in a horizontal or vertical position. The Parquet brush, Kombi nozzle and Turbo brush have a parking tab located on the front of the neck (39). Insert the parking tab into the upper side of the parking groove and slide down firmly. For vertical storage, or for easy carrying, use the parking slot on the underside (24). For horizontal storage, use the parking slot on the end of the canister (21).

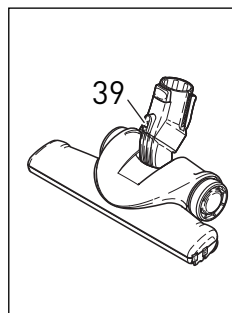

Figure 5

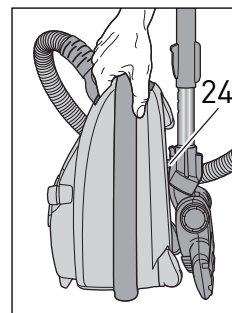

Figure 6

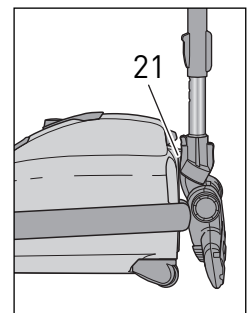

Figure 7



WARNING!

The quality, condition, coating, texture, age and manufacturing technique of all floor surfaces vary. Therefore, vacuums with rotating brushes, including your SEBO, may damage some floor coverings or surfaces. Some types of high-gloss hardwood floors, cushion vinyl, berber carpets, long shag, and delicate or hand-woven carpets are particularly vulnerable to damage by rotating brushes. When possible, consult the materials supplied by your flooring manufacturer for information on proper upkeep and cleaning. **To ensure that your new SEBO vacuum cleaner is compatible with your floor, please test the vacuum cleaner on each type of flooring surface in a small inconspicuous area to determine if any damage occurs. If damage occurs, stop using the vacuum cleaner immediately!**

ADDITIONAL OPERATING INSTRUCTIONS FOR K3 PREMIUM WITH POWER HEAD

Please refer to your ET-1 power head owner's manual for more information

Starting The Machine and Suction Control - Figures 1, 2, 8, 9 & 10

Before turning on your canister, make sure that the vacuum handle is in its upright locked position (figure 8).

1. With the canister main power control knob (9) in the OFF position, and the power control slider on the handle (#2, figure 9) in the OFF position, pull the power cord out from the base of the canister (figure 1). The power cord should be unwound from the cable reel at least two thirds of its length. **Note:** do not over-extend the cord.
2. Plug the polarized power cord into a 120 volt wall outlet located near the floor.
3. Press the main power control knob (9) on the base of the canister gently with your foot or hand. The green light (10) will illuminate indicating that the power is on (figure 2).
4. Slide the Power Control Slider (#2, figure 9) toward the MAX position. It will move freely between 0 suction and MAX suction. Set the slider to the suction desired. Release the foot pedal (#41, figure 10) on the ET-1 power head.

Operating The Machine - Figure 10

When the power head is on with the handle in the upright locked position (see figure 8 above), the brush roller will not spin.

To release the ET-1 power head from the upright locked position, press down on the foot pedal, (#41, figure 10) lower the handle into the normal operating position and push the button on the top of the power head (#40, figure 8) to engage the brush roller. The green light on the power head will illuminate.

The handle can be lowered to a horizontal position useful for vacuuming under beds.

You may adjust the suction control with the power control slider (2) as you vacuum different surfaces or when using the accessory tools. For optimal cleaning and brushing, operate the machine at the maximum suction power setting and push the power head slowly over the carpet.

When the canister's main power control knob is in the ON position, you may turn the power head off and on with the power control slider (2). To turn the power head off using the power control slider, pull the slider to 0 suction, then continue pulling the slider up until it "clicks" into the OFF position. The green power head light will then shut off (the green light on the canister (10) will remain illuminated until the vacuum is powered off using the main power control knob).

Always turn the power off on both the canister and the power head when changing heads or unplugging the vacuum. Slide the power control slider on the handle to its OFF position, press the power control knob on the base of the canister (9) gently with your foot or hand, then unplug the canister to completely shut down the power when changing heads or storing the vacuum.

To retract the cord, switch the vacuum off, unplug it from the outlet, then gently pull on the cord near the plug recess (22) and the mechanism will automatically rewind. Before rewinding the cable, always switch off and unplug the vacuum. Hold the plug while rewinding the cord onto the cord reel. Avoid letting the plug whip while rewinding.

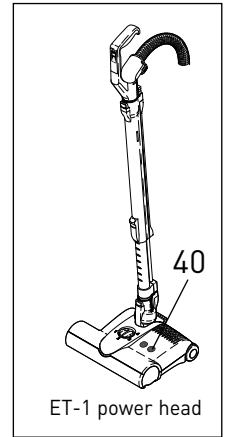

Figure 8

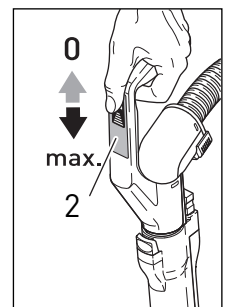

Figure 9

0 = Zero Suction
MAX = Maximum Suction

ON position - Move the slider toward MAX.

OFF position - Pull the slider up to 0 suction then continue pulling the slider up until it "clicks" into the OFF position.

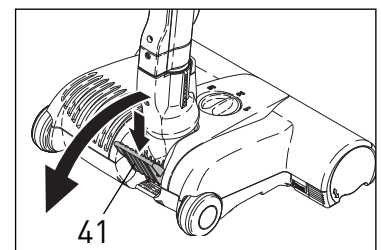

Figure 10

USING THE TELESCOPIC TUBE, HOSE & ATTACHMENTS

Using the Telescopic Tube, Hose & Attachments - Figures 11 & 12

The telescopic tube (4) is useful for vacuuming corners and hard-to-reach areas. You may use the telescopic tube without a brush, power head or attachment. To remove a brush or power head, switch off the power control knob (9) and unplug the vacuum. Then, press the tool release button (7) and pull the tube out. The crevice nozzle (20) and dusting brush (28) may be inserted onto the end of the tube. To use the upholstery nozzle (11), fit it onto the end of the crevice nozzle (20). It is not necessary to turn off the vacuum while switching the **standard** attachments (the crevice nozzle, upholstery nozzle or dusting brush). After use, switch off the power, unplug the vacuum and remove attachment. Re-insert the telescopic tube into the power head or brush, turning the tube if needed, until you hear it click into place.

NOTE! K3 Premium users with ET-1 power head, please refer to your power head user's manual for more detailed instructions for connecting your power head.

To use the hose without the telescopic tube, switch off the power and unplug the vacuum. Push the handle release button (3) and pull the HANDLE out of the end of the telescopic tube. Do not try to separate the hose from the handle! Insert the crevice nozzle (20) or dusting brush (28) onto the end of the handle. To use the upholstery nozzle (11), fit it onto the end of the crevice nozzle (20). After use, switch off the power, unplug the vacuum and remove the attachment. Re-insert the handle into the telescopic tube making sure it is seated correctly and snap it into place.

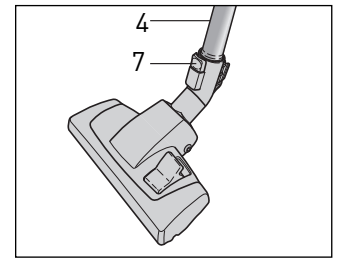

Figure 11

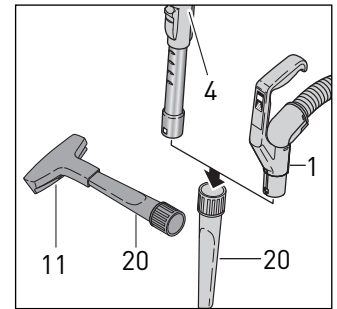

Figure 12

USE AND MAINTENANCE OF BRUSHES AND HEADS

! Always unplug vacuum from outlet before dismantling any part of machine!

To remove a brush or power head, switch off the power and unplug the vacuum. Then, press the tool release button (7) and pull the tube out.

NOTE! K3 Premium users with the ET-1 power head, please refer to your power head user's manual for more detailed instructions for operating and maintaining your power head.

Parquet Brush - Figure 13

The Parquet Brush (29) is specially designed for use on hard surfaces. It is lightweight with soft bristles, so it glides gently over floors and provides easy maneuverability. Fibers and hair can be pulled out of the bristles manually, or vacuum the bristles with the telescopic tube.

Kombi Nozzle - Figure 14

The Kombi Nozzle (8) is adjustable for carpet or hard floors. To set for hard floors, push the back end of the toggle button (42) downward until it clicks into place. The brush will lower to gently sweep your floors. To set for carpet, push the front end of the toggle button (42) downward until it clicks into place. The brush will raise up allowing the head to move over the carpet. **The toggle button in Figure 14 is set in the position for carpet.** The brush should be cleaned regularly. Remove the Kombi nozzle from the telescopic tube to clean. Fibers and hair can be pulled out of the bristles manually, or vacuum the bristles with the telescopic tube.

Turbo Brush (Optional) - Figure 15

The optional Turbo Brush has an air-driven rotating brush for gentle brushing of carpets. The Turbo brush can be adjusted for high and low pile carpet. To adjust the head for high pile carpet, push the slider button (44) upward. For low pile carpet, push the slider button (44) downward. The rotating brush should be cleaned regularly. Remove the Turbo brush from the telescopic tube to clean. Remove fibers and hair from the brush manually.

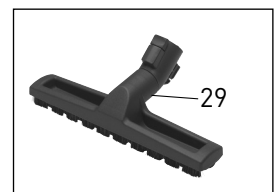

Figure 13



Figure 14

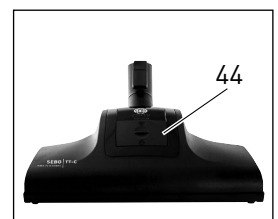

Figure 15

VACUUM MAINTENANCE



Always unplug vacuum from outlet before dismantling any part of machine!

Changing the Filter Bag - Figure 16

To change the filter bag (45), set the canister upright (as shown in figure 13), press the cover release catch (25) and lower the filter bag cover (26). Grasp the green filter bag sealing plate (46), slide the plate from the holder (48) and push the filter bag cap (47) on to seal the bag. Slide the sealing plate (46) of a new bag into the bag holder slots (48) and push it in firmly until it locks into place. Close the cover, making sure it snaps shut completely. You may find it convenient to store the bag cap inside the filter bag housing below the filter bag. Do not re-use the filter bags. Note: the nature of the contents of the filter bag will affect the point at which it needs changing. Fine dust may require an earlier change even though the bag is not full. Fluff or hair allows air to pass through easily, so the filter bag may overflow before the amber "bag full" light illuminates.

The "bag full or clog" light works correctly only at full power. At lower power levels, the "bag full or clog" light may illuminate incorrectly. Check the status of the filter bag regularly at full power.

Changing the Exhaust Filter - Figure 17

The exhaust filter (51) needs to be changed when it becomes extremely dirty or clogged with dust, or after approximately 10 to 20 filter bags have been used. To change the exhaust filter, set the canister flat on the floor as shown in figure 17. Remove the printed cover on top of the machine (14) by lifting the catch (49) in the upholstery nozzle recess (see inset, figure 17). Pull out the filter using the handle (50) and fit the new filter into the same position. The filter handle should point toward the upholstery nozzle when it is folded down. Fit the tabs on the bottom of the cover (14) into the grooves and snap the cover down firmly.

Changing the Pre-motor Microfilter - Figures 16 & 18

After 10 to 20 bags have been used, change the pre-motor microfilter (52). To remove the microfilter, set the canister upright (as shown in figure 16). Press the cover release catch (25) and lower the filter bag cover (26). Remove the filter bag, then remove the cover by sliding it up and out of the grooves (53). Pull the old filter out (52) and slide the new filter into the same position. Replace the filter bag, then re-insert the cover by fitting the tabs into the grooves (53) on both sides and sliding it in and down. Push the cover closed, making sure it snaps shut completely.

K Service Box - 8 AeraPure™ Filter Bags, Exhaust Filter and an S-Class Pre-motor Microfilter Part #6695AM

Changing the AIRBELT - Figure 19

If damage occurs to the AIRBELT cover, it will need to be replaced. To remove the AIRBELT (15), pry off the clip (55) by inserting the tip of a slot-head screwdriver under the bottom side of the clip. Push downward on the screwdriver until the clip pops off. Grasp the end of the AIRBELT cover and pull - the AIRBELT cover will peel off. The foam bumper (54) remains on the vacuum. To replace the AIRBELT, insert the side ribs of the AIRBELT into the grooves (56). Start at the back, insert rib into one groove (56), and while holding it down, stretch the AIRBELT cover around the foam (54) into the opposite groove (56). Continue around the vacuum. Secure the ends with the clip (55).

SEBO AIRBELT covers are available in a variety of colors and patterns. See your SEBO dealer for available selection.

Note: Never operate the vacuum with incorrectly attached filters or without filters, bag, AIRBELT or filter bag housing cover (26). Do not re-use filter bags. Do not wash and re-use filters.

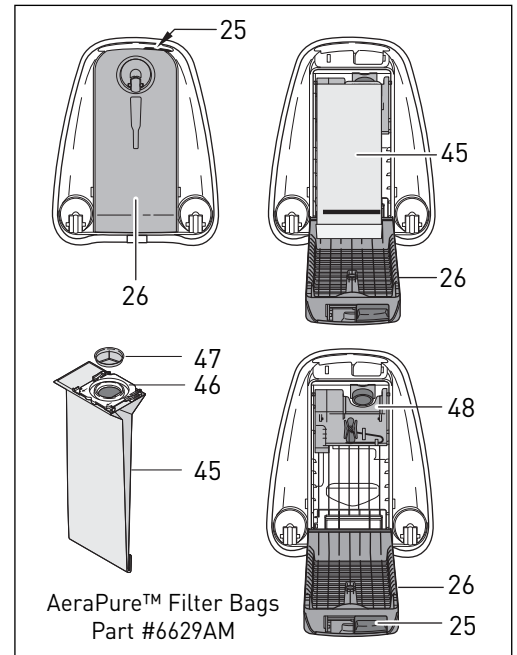

Figure 16

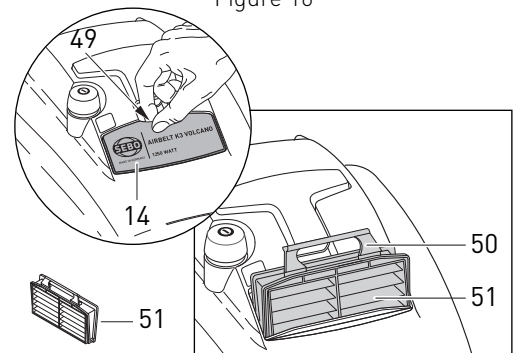

Figure 17

K Filter Set:
Exhaust Filter
and
Pre-motor
Microfilter
Part #6696AM

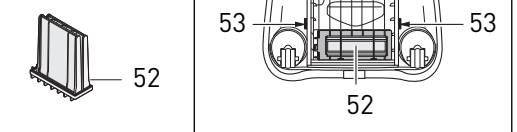

Figure 18

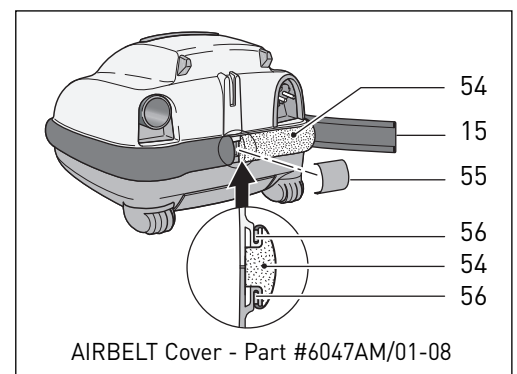

Figure 19

CLOG REMOVAL



Always unplug vacuum from outlet before removing any clogs!

NOTE! K3 Premium users with ET-1 power heads, please refer to your power head user's manual for more detailed instructions for removing clogs in your power head.

If the "bag full or clog" warning light (10) remains illuminated after the filter bag has been changed and the filters are in good condition, there is likely a clog in the system.

Clogs in the Head or Brush - Figure 20

Clogs in the swivel neck (57) of a head or brush can be cleared by first pressing the tool release button (7) and removing the brush or head. Check inside the swivel neck channel (56), and clean out pathway.

Clogs in the Telescopic Tube - Figure 20

Remove head from telescopic tube (4) by pushing the tool release button (7) and pulling the tube out. Remove the hose from the top of the telescopic tube by pushing the handle release button (3). A stiff wire or stick can be used to push the clog out of the tube.

Clogs in the Hose - Figures 21, 22 & 23

Check for suction at the end of the hose (19). If you feel reduced suction, the blockage is in the hose. To clear blockages in the hose (13), remove the telescopic tube (4) by pushing the tool release button (7) and pulling the tube out. Hold the hose upright with one hand blocking the top and switch on the machine. If necessary, quickly lift your hand on and off the end of the hose. If that does not clear the clog, you may also clear clogs by reversing the hose. **K3 Premium** After removing the telescopic tube, push the release button (18) on the hose neck (6) and remove the hose from the machine.

K2 Kombi: After removing the telescopic tube, squeeze the tabs (37) on the retaining ring and pull the hose neck out.

Remove the hose handle (1) from the telescopic tube by pressing the handle release button (2). Insert the handle end of the hose (1) into the suction opening (17). Hold the hose upright with one hand blocking the top and switch on the machine. If necessary, quickly lift your hand on and off the end of the hose.

Note: Do not insert a wire or stick into the hose. Doing so may cause damage to the hose.

Clogs in Entrance to Filter Bag - Figure 21

Remove hose (10) from vacuum cleaner (see figure 21), open the filter bag cover and remove the filter bag. (figure 16, page 9). Clean out entrance to bag (58).

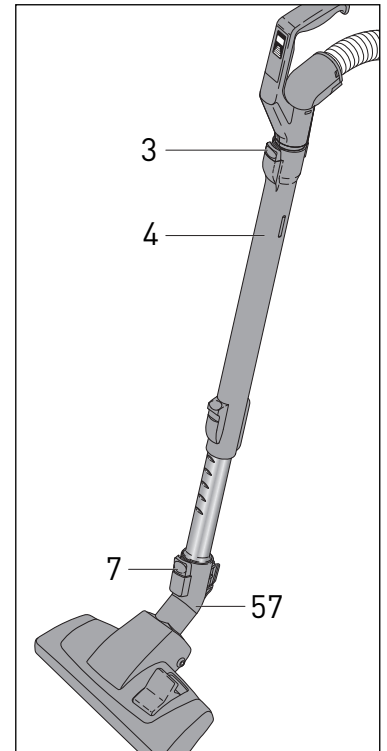
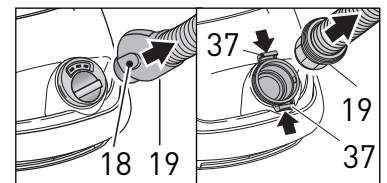

Figure 20



K3

Figure 21

K2

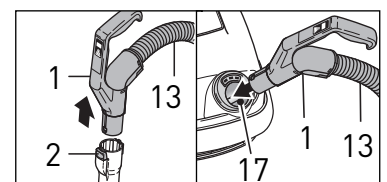

Figure 22

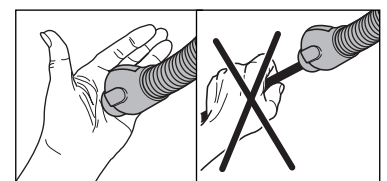

Figure 23

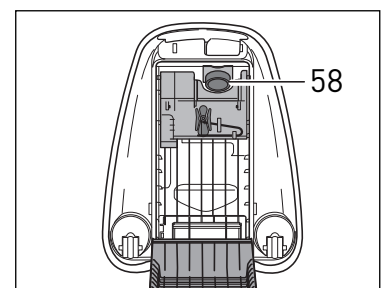

Figure 24

TROUBLE-SHOOTING GUIDE



Always unplug vacuum from outlet before dismantling any part of the machine!

PROBLEM	REASON	SOLUTION
Does not turn on	1. Telescopic tube not inserted properly.	1. See page 8.
	2. Not plugged into working outlet.	2. Use another outlet.
	3. Cable worn.	3. Replace cable.
	4. K3: The power control slider switch is set to "0" ("off" position).	4. K3: Set slider switch to "on" position. See page 10.
Bag full or clog light on Bag full or clog light on & machine shuts off	1. Bag full.	1. Replace filter bag. See page 12.
	2. Clog in hose, telescopic tube, brush or head, or entrance to filter bag.	2. See Clog Removal on page 13. K3 users with clog in power head attachment: refer to clog removal in the ET-1 owner's manual.
	3. Pre-motor microfilter is dirty.	3. Replace pre-motor microfilter. See page 12.
	4. Exhaust filter dirty.	4. Replace exhaust filter. See page 12.
Does not pick up	1. Hose/handle assembly not correctly inserted.	1. Re-insert hose/handle assembly making sure that it is lined up properly and is snapped into place. See page 8.
	2. The suction control dial is rotated to no suction setting	2. K2: Rotate suction control dial to yellow setting. See page 9.
	3. Filter bag cover not closed.	3. See below.
Filter bag door won't fully close	1. Filter bag cover not fully closed.	1. Re-insert bag. Lock the cover down firmly.
	2. Bag not inserted properly	2. Re-insert bag. Lock the cover down firmly.
	3. Pre-motor microfilter not properly inserted.	3. Remove the filter bag cover (26) and make sure the pre-motor microfilter housing is seated firmly in place (see pg. 12, figure 18).

NOTE: E3 Premium users, please see the ET-1 Power Head Owner's Manual for additional trouble shooting guide information.

AIRBELT K2 KOMBI SCHEMATIC AND PARTS LIST

#9679AM AIRBELT K2 Kombi - Midnight Blue

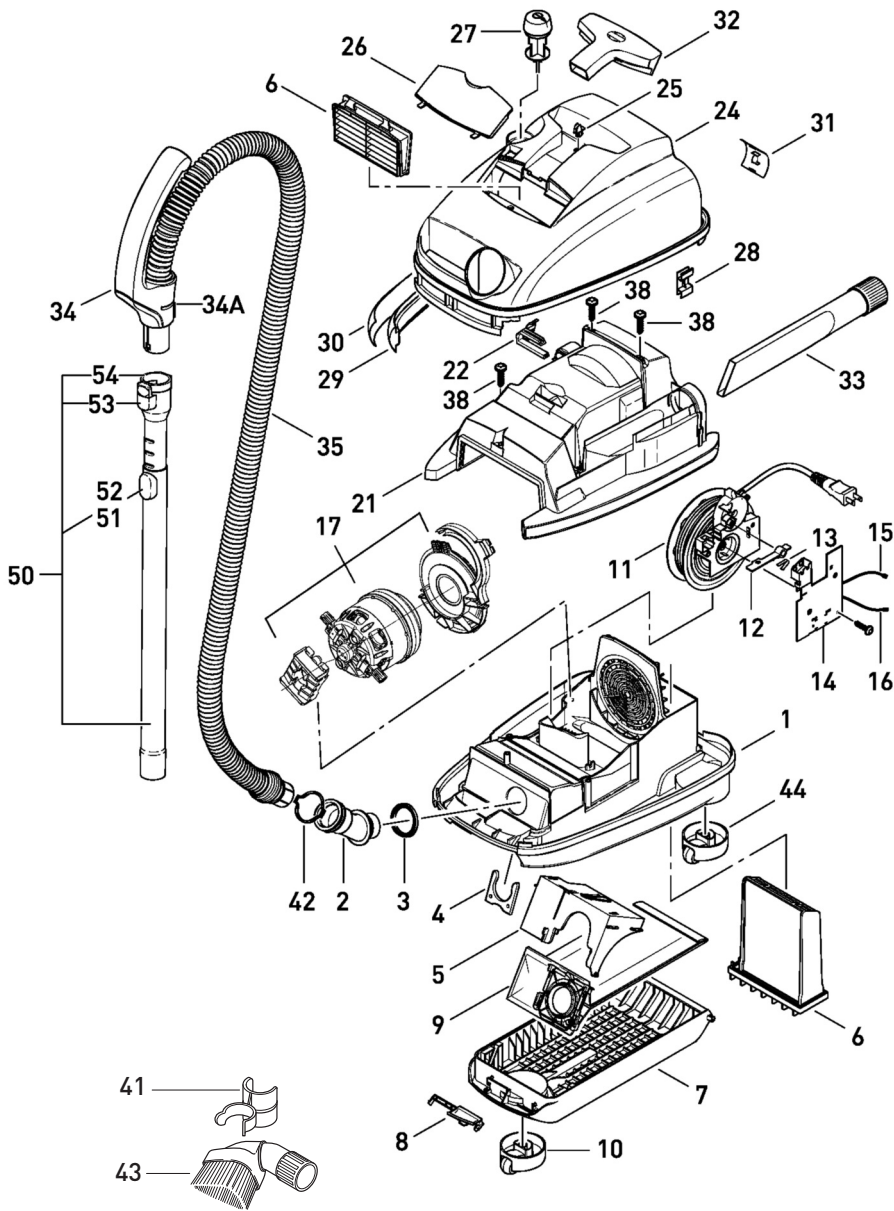

Kombi Nozzle
included with
K2 Kombi
8351GS

Canister with Handle/Hose

#9679AM K2 Midnight Blue Machine

Pos.	Part #	Description
1	6754GS	Bottom casing w/castors (44)
2	6675GS	Suction neck - K2
3	6014	Seal
4	6042WS	Spring lock
5	6681HG	Bag holder, complete
6	6696AM	Pre-motor microfilter & exhaust filter set
7	6756GS	Bag cover w/castor (10)
8	6607GS	Cover release
9	6629AM	AeraPure™ filter bag
10	6752GS	Castor for bag cover
11	665603E	Cord reel w/lever & leaf spring (12&13)
12	6621	Switch lever w/leaf spring (13)
13	1739	Leaf spring
14	6641ER	Electronic controller K2 w/switch
15	6637	Internal cable w/ thermal cut-off (inc. w/pos. 17)
16	6638	Internal cable, white
17	6631ER	Vac motor 1250W includes motor mount, adaptor, internal cable w/thermal cut-off (pos. 15)
21	6679GS	Motor cover
22	6622GS	Plug surround
24	6680DB1	Top Casing, K2 midnight blue (25)
25	6625ER	Release clip w/screw
26	6424AM	Exhaust filter cover, midnight blue
27	60613WE	On/Off knob, K2 midnight blue
28	6086HG	Casing clip
29	6623UL	Foam bumper - K Series
30	6047AM/01	AIRBELT textile, dark gray (incl. pos. 31)
31	6048GS	AIRBELT clip
32	6627GS	Upholstery nozzle - K Series
33	1092GS	Crevice nozzle
34	6300GS	Handle grip K2, cpl. (incl. pos. 34A)
34A	6303GS	Retaining ring
35	6447GS	7' hose w/couplings & handle K2 (34&34A)
36	8351GS	Kombi nozzle
38	0105	Screw 3.9 x 19
41	6694GS	Clip for dusting brush
42	6612GS	Retaining ring
43	1387GS	Dusting brush
44	6751GS	Castor for bottom casing
50	6237ER	Telescopic tube stainless steel, cpl. (incl. pos. 51-54)
51	6425ER	Sliding knob
52	6238ER	Locking mechanism
53	1735ER	Release button cpl.
54	1736GS	Fitting neck

AIRBELT K3 PREMIUM SCHEMATIC AND PARTS LIST

#9687AM AIRBELT K3 Premium - Red
 #9688AM AIRBELT K3 Premium - Onyx (Black)

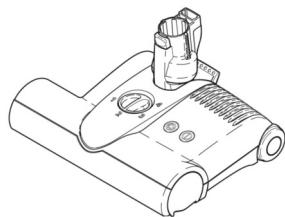
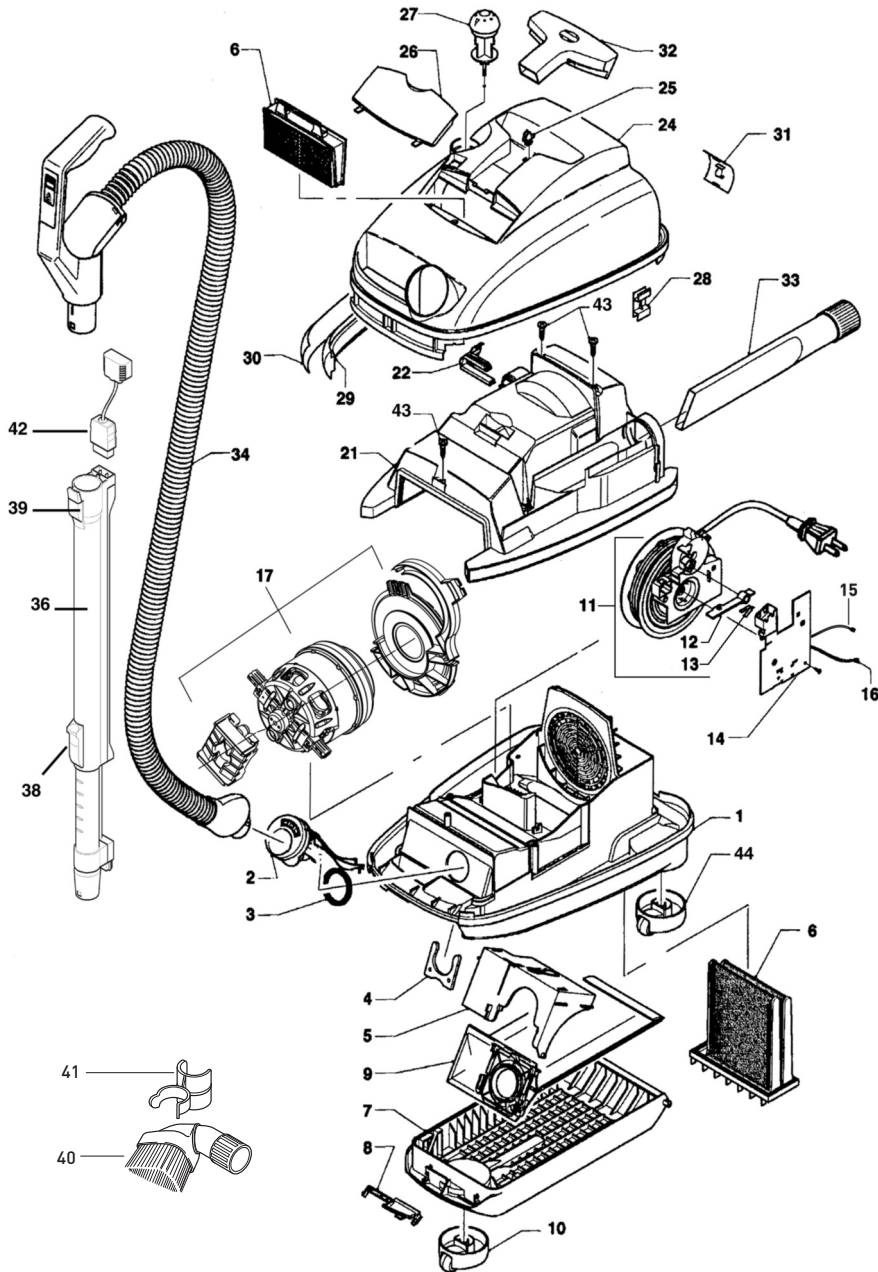

ET-1 Power Head included with K3 Premium
 Refer to ET-1 Manual for parts identification



Parquet Brush included with K3 Premium
 #6391DA

Canister with Handle/Hose

#9687AM K3 Premium Red Machine

Pos.	Part #	Description
1	6754GS	Bottom casing w/castors (44)
2	6677GS	Suction neck - K3
3	6014	Seal
4	6042WS	Spring lock
5	6681HG	Bag holder, complete
6	6696AM	Pre-motor microfilter & exhaust filter set
7	6756GS	Bag cover w/castor (10)
8	6607GS	Cover release
9	6629AM	AeraPure™ filter bag
10	6752GS	Castor for bag cover
11	665603E	Cord reel w/lever & leaf spring (12&13)
12	6621	Switch lever w/leaf spring (13)
13	1739	Leaf spring
14	6645ER	Electronic controller K3 w/switch
15	6637	Internal cable w/ thermal cut-off (inc. w/pos. 17)
16	6638	Internal cable, white
17	6631ER	Vac motor 1250W includes motor mount, adaptor, internal cable w/thermal cut-off (pos. 15)
21	6679GS	Motor cover
22	6622GS	Plug surround
24	6680DR1	Top Casing, K, red (25)
25	6625ER	Release clip w/screw
26	6444AM	Exhaust filter cover, red
27	60666WE	On/Off knob, K3, white
28	6086HG	Casing clip
29	6623UL	Foam bumper - K Series
30	6047AM/01	AIRBELT textile, dark gray (incl. pos. 31)
31	6048GS	AIRBELT clip
32	6627GS	Upholstery nozzle - K Series
33	1092GS	Crevice nozzle
34	6349AM	7' hose w/couplings & handle K3
36	60237UC	Telescoping tube w/ brush adaptor 60238AD (incl. pos. 38&39)
37	6391DA	Parquet brush
38	6421GS	Slider button w/hardware (for 6270GS telescopic tube only)
39	6420GS	Release button w/leaf spring & cap (for 6270GS telescopic tube only)
40	1387GS	Dusting brush
41	6694GS	Clip for dusting brush
42	6369G1	Mains cable
43	0105	Screw 3.9 x 19
44	6751GS	Castor for bottom casing

#9688AM K3 Premium Onyx (Black) Machine Exceptions

24	6680SW1	Top Casing, K, black (25)
26	6422AM	Exhaust filter cover, black
30	6047AM/07	AIRBELT textile, silver/black (incl. pos. 31)