

# **Gryphon I GFS4400**

## **Fixed Mount Area Imager Bar Code Reader**



**Product Reference Guide**

**Datalogic ADC, Inc.**

959 Terry Street

Eugene, Oregon 97402

USA

Telephone: (541) 683-5700

Fax: (541) 345-7140

An Unpublished Work - All rights reserved. No part of the contents of this documentation or the procedures described therein may be reproduced or transmitted in any form or by any means without prior written permission of Datalogic ADC, Inc. or its subsidiaries or affiliates ("Datalogic" or "Datalogic ADC"). Owners of Datalogic products are hereby granted a non-exclusive, revocable license to reproduce and transmit this documentation for the purchaser's own internal business purposes. Purchaser shall not remove or alter any proprietary notices, including copyright notices, contained in this documentation and shall ensure that all notices appear on any reproductions of the documentation.

Should future revisions of this manual be published, you can acquire printed versions by contacting your Datalogic representative. Electronic versions may either be downloadable from the Datalogic website ([www.datalogic.com](http://www.datalogic.com)) or provided on appropriate media. If you visit our website and would like to make comments or suggestions about this or other Datalogic publications, please let us know via the "Contact Datalogic" page.

**Disclaimer**

Datalogic has taken reasonable measures to provide information in this manual that is complete and accurate, however, Datalogic reserves the right to change any specification at any time without prior notice.

Datalogic and the Datalogic logo are registered trademarks of Datalogic S.p.A. in many countries, including the U.S.A. and the E.U. All other brand and product names may be trademarks of their respective owners.

**Patents**

This product is covered by one or more of the following patents:

US Pat.: 5,311,000; 5,481,098; 5,929,421; 5,992,740; 6,098,883; 6,260,764; 6,443,360 B1;

6,808,114 B1; 6,997,385 B2; 7,075,663 B2; 7,387,246 B2.

European Pat.: 789,315 B1; 926,620 B1; 997,760 B1; 1,128,315 B1; 1,217,571 B1; 1,396,811

B1; 1,413,971 B1.

Additional patents pending.

# Table of Contents

<b>INTRODUCTION</b>	<b>9</b>
<b>About this Manual</b>	<b>9</b>
Overview	9
Manual Conventions	10
<b>References</b>	<b>10</b>
<b>Technical Support</b>	<b>10</b>
Datalogic Website Support	10
Reseller Technical Support	10
Telephone Technical Support	10
<b>About the Reader</b>	<b>11</b>
<b>Programming the Reader</b>	<b>11</b>
Configuration Methods	11
<b>SETUP</b>	<b>13</b>
<b>Unpacking</b>	<b>13</b>
<b>Setting Up the Reader</b>	<b>13</b>
<b>Attaching Reader to Host</b>	<b>14</b>
<b>Interface Selection</b>	<b>15</b>
<b>Custom Configuration Settings</b>	<b>18</b>
Configure Interface Settings	18
Global Interface Features	18
Configuring Other Features	18
Software Version Transmission	18
Resetting the Product Configuration to Defaults	19
<b>CONFIGURATION USING BAR CODES</b>	<b>21</b>
Configuration Parameters	21
<b>GLOBAL INTERFACE FEATURES</b>	<b>23</b>
Host Commands — Obey/Ignore	23
<b>RS-232 Only Interface</b>	<b>25</b>
Baud Rate	26
Data Bits	27
Stop Bits	27
Parity	28
Handshaking Control	29
<b>RS-232/USB-Com Interfaces</b>	<b>30</b>
Intercharacter Delay	31
Beep On ASCII BEL	31
Beep On Not on File	32
ACK NAK Options	32
ACK Character	33
NAK Character	33
ACK NAK Timeout Value	34
ACK NAK Retry Count	34
ACK NAK Error Handling	35
Indicate Transmission Failure	35
Disable Character	36
Enable Character	36
<b>USB Keyboard Settings</b>	<b>37</b>
Country Mode	38
Send Control Characters	42
Intercode Delay	43
Caps Lock State	43
USB Keyboard Speed	44
USB Keyboard Numeric Keypad	45
<b>USB-OEM Interface</b>	<b>47</b>

USB-OEM Device Usage .....	48
Transmit Labels in Code 39 Format .....	49
Interface Options .....	49
<b>Data Format .....</b>	<b>51</b>
<b>Global Prefix/Suffix .....</b>	<b>52</b>
<b>Global AIM ID .....</b>	<b>53</b>
Set AIM ID Individually for GS1-128 .....	55
<b>Label ID .....</b>	<b>56</b>
Label ID: Pre-Loaded Sets .....	56
Individually Set Label ID .....	57
Label ID Control .....	57
Label ID Symbology Selection – 1D Symbologies .....	58
No Read Message .....	63
No Read String .....	63
<b>CODE VERIFIER .....</b>	<b>64</b>
Code Verifier Mode .....	64
Match String .....	65
Wrong Code String .....	65
Label Transmit Mode .....	66
Advanced Formatting: User Label Edit .....	66
Case Conversion .....	67
Character Conversion .....	67
<b>Digital Output .....</b>	<b>69</b>
Activation Event .....	70
Deactivation Event .....	71
Deactivation Timeout .....	71
Activation State .....	72
<b>Reading Parameters .....</b>	<b>73</b>
Double Read Timeout .....	74
<b>LED AND BEEPER INDICATORS .....</b>	<b>75</b>
Power On Alert .....	75
Good Read: When to Indicate .....	75
Good Read Beep Type .....	76
Good Read Beep Frequency .....	76
Good Read Beep Length .....	77
Good Read Beep Volume .....	78
Good Read LED Duration .....	79
<b>SCANNING FEATURES .....</b>	<b>80</b>
Operating Mode .....	80
Phase Off Event .....	81
Phase Off Timeout .....	81
Serial Start Character .....	82
Serial Stop Character .....	82
Presentation Mode Indication .....	83
Manual Trigger Control .....	83
Central Code Only .....	84
Illumination Off Time .....	84
Illumination On Time .....	85
Scanning Active Time .....	85
Presentation Illumination Control .....	86
Aiming Pointer .....	86
Aiming Duration Timer .....	87
Green Spot Duration .....	87
Mobile Phone Mode .....	88
Mobile Bias .....	88
Partial Label Reading Control .....	89
Mirror Reading Mode .....	89
Decode Negative Image .....	90
Image Capture .....	90
<b>MULTIPLE LABEL READING .....</b>	<b>91</b>
Multiple Labels per Frame .....	91
Multiple Labels Ordering by Code Symbology .....	92

Multiple Labels Ordering by Code Length .....	92
<b>Symbologies .....</b>	<b>93</b>
<b>1D Code Selection .....</b>	<b>93</b>
<b>DISABLE ALL SYMBOLOGIES .....</b>	<b>94</b>
<b>CODE EAN/UPC .....</b>	<b>95</b>
Coupon Control .....	95
UPC-A .....	96
UPC-A Enable/Disable .....	96
UPC-A Check Character Transmission .....	96
Expand UPC-A to EAN-13 .....	97
UPC-A Number System Character Transmission .....	97
UPC-A 2D Component .....	98
<b>UPC-E .....</b>	<b>98</b>
UPC-E Enable/Disable .....	98
UPC-E Check Character Transmission .....	99
UPC-E 2D Component .....	99
Expand UPC-E to EAN-13 .....	100
Expand UPC-E to UPC-A .....	100
UPC-E Number System Character Transmission .....	101
<b>GTIN FORMATTING .....</b>	<b>101</b>
<b>EAN 13 (JAN 13) .....</b>	<b>102</b>
EAN 13 Enable/Disable .....	102
EAN 13 Check Character Transmission .....	102
EAN-13 Flag 1 Character .....	103
EAN-13 ISBN Conversion .....	103
EAN-13 2D Component .....	104
<b>ISSN .....</b>	<b>104</b>
ISSN Enable/Disable .....	104
<b>EAN 8 (JAN 8) .....</b>	<b>105</b>
EAN 8 Enable/Disable .....	105
EAN 8 Check Character Transmission .....	105
Expand EAN 8 to EAN 13 .....	106
EAN 8 2D Component .....	106
<b>UPC/EAN GLOBAL SETTINGS .....</b>	<b>107</b>
UPC/EAN Price Weight Check .....	107
UPC/EAN Quiet Zones .....	108
<b>ADD-ONS .....</b>	<b>109</b>
Optional Add-ons .....	109
Optional Add-On Timer .....	110
Optional GS1-128 Add-On Timer .....	113
<b>CODE 39 .....</b>	<b>116</b>
Code 39 Enable/Disable .....	116
Code 39 Check Character Calculation .....	116
Code 39 Check Character Transmission .....	117
Code 39 Start/Stop Character Transmission .....	118
Code 39 Full ASCII .....	118
Code 39 Quiet Zones .....	119
Code 39 Length Control .....	119
Code 39 Set Length 1 .....	120
Code 39 Set Length 2 .....	121
<b>TRIOPTIC CODE .....</b>	<b>122</b>
Trioptic Code Enable/Disable .....	122
<b>CODE 32 (ITAL PHARMACEUTICAL CODE) .....</b>	<b>122</b>
Code 32 Enable/Disable .....	122
Code 32 Feature Setting Exceptions .....	123
Code 32 Check Char Transmission .....	123
Code 32 Start/Stop Character Transmission .....	123
<b>CODE 39 CIP (FRENCH PHARMACEUTICAL) .....</b>	<b>124</b>
Code 39 CIP Enable/Disable .....	124
<b>CODE 39 DANISH PPT .....</b>	<b>124</b>
Code 39 Danish PPT Enable/Disable .....	124
<b>CODE 39 LAPOSTE .....</b>	<b>125</b>

Code 39 LaPoste Enable/Disable .....	125
<b>CODE 39 PZN .....</b>	<b>125</b>
Code 39 PZN Enable/Disable .....	125
<b>CODE 128 .....</b>	<b>126</b>
Code 128 Enable/Disable .....	126
Expand Code 128 to Code 39 .....	126
Code 128 Check Character Transmission .....	127
Code 128 Function Character Transmission .....	127
Code 128 Sub-Code Exchange Transmission .....	128
Code 128 Quiet Zones .....	128
Code 128 Length Control .....	129
Code 128 Set Length 1 .....	130
Code 128 Set Length 2 .....	131
<b>GS1-128 .....</b>	<b>132</b>
GS1-128 Enable .....	132
GS1-128 2D Component .....	132
<b>CODE ISBT 128 .....</b>	<b>133</b>
ISBT 128 Concatenation .....	133
ISBT 128 Force Concatenation .....	133
ISBT 128 Concatenation Mode .....	134
ISBT 128 Dynamic Concatenation Timeout .....	135
ISBT 128 Advanced Concatenation Options .....	135
<b>INTERLEAVED 2 OF 5 (I 2 OF 5) .....</b>	<b>136</b>
I 2 of 5 Enable/Disable .....	136
I 2 of 5 Check Character Calculation .....	137
I 2 of 5 Check Character Transmission .....	138
I 2 of 5 Length Control .....	138
I 2 of 5 Set Length 1 .....	139
I 2 of 5 Set Length 2 .....	140
<b>INTERLEAVED 2 OF 5 CIP HR .....</b>	<b>141</b>
Interleaved 2 of 5 CIP HR Enable/Disable .....	141
<b>FOLLETT 2 OF 5 .....</b>	<b>141</b>
Follett 2 of 5 Enable/Disable .....	141
<b>STANDARD 2 OF 5 .....</b>	<b>142</b>
Standard 2 of 5 Enable/Disable .....	142
Standard 2 of 5 Check Character Calculation .....	142
Standard 2 of 5 Check Character Transmission .....	143
Standard 2 of 5 Length Control .....	143
Standard 2 of 5 Set Length 1 .....	144
Standard 2 of 5 Set Length 2 .....	145
<b>INDUSTRIAL 2 OF 5 .....</b>	<b>146</b>
Industrial 2 of 5 Enable/Disable .....	146
Industrial 2 of 5 Check Character Calculation .....	146
Industrial 2 of 5 Check Character Transmission .....	147
Industrial 2 of 5 Length Control .....	147
Industrial 2 of 5 Set Length 1 .....	148
Industrial 2 of 5 Set Length 2 .....	149
<b>CODE IATA .....</b>	<b>150</b>
IATA Enable/Disable .....	150
IATA Check Character Transmission .....	150
<b>CODABAR .....</b>	<b>151</b>
Codabar Enable/Disable .....	151
Codabar Check Character Calculation .....	151
Codabar Check Character Transmission .....	152
Codabar Start/Stop Character Transmission .....	152
Codabar Start/Stop Character Set .....	153
Codabar Start/Stop Character Match .....	153
Codabar Quiet Zones .....	154
Codabar Length Control .....	154
Codabar Set Length 1 .....	155
Codabar Set Length 2 .....	156
<b>ABC CODABAR .....</b>	<b>157</b>

ABC Codabar Enable/Disable .....	157
ABC Codabar Concatenation Mode .....	157
ABC Codabar Dynamic Concatenation Timeout .....	158
ABC Codabar Force Concatenation .....	159
<b>CODE 11 .....</b>	<b>160</b>
Code 11 Enable/Disable .....	160
Code 11 Check Character Calculation .....	160
Code 11 Check Character Transmission .....	161
Code 11 Length Control .....	161
Code 11 Set Length 1 .....	162
Code 11 Set Length 2 .....	163
<b>GS1 DATABAR™ OMNIDIRECTIONAL .....</b>	<b>164</b>
GS1 DataBar™ Omnidirectional Enable/Disable .....	164
GS1 DataBar™ Omnidirectional GS1-128 Emulation .....	164
GS1 DataBar™ Omnidirectional 2D Component .....	165
<b>GS1 DATABAR™ EXPANDED .....</b>	<b>165</b>
GS1 DataBar™ Expanded Enable/Disable .....	165
GS1 DataBar™ Expanded GS1-128 Emulation .....	166
GS1 DataBar™ Expanded 2D Component .....	166
GS1 DataBar™ Expanded Length Control .....	167
GS1 DataBar™ Expanded Set Length 1 .....	168
GS1 DataBar™ Expanded Set Length 2 .....	169
<b>GS1 DATABAR™ LIMITED .....</b>	<b>170</b>
GS1 DataBar™ Limited Enable/Disable .....	170
GS1 DataBar™ Limited GS1-128 Emulation .....	170
GS1 DataBar™ Limited 2D Component .....	171
<b>CODE 93 .....</b>	<b>171</b>
Code 93 Enable/Disable .....	171
Code 93 Check Character Calculation .....	172
Code 93 Check Character Transmission .....	172
Code 93 Length Control .....	173
Code 93 Set Length 1 .....	174
Code 93 Set Length 2 .....	175
Code 93 Quiet Zones .....	176
<b>MSI .....</b>	<b>176</b>
MSI Enable/Disable .....	176
MSI Check Character Calculation .....	177
MSI Check Character Transmission .....	177
MSI Length Control .....	178
MSI Set Length 1 .....	179
MSI Set Length 2 .....	180
<b>PLESSEY .....</b>	<b>181</b>
Plessey Enable/Disable .....	181
Plessey Check Character Calculation .....	181
Plessey Check Character Transmission .....	182
Plessey Length Control .....	182
Plessey Set Length 1 .....	183
Plessey Set Length 2 .....	184
<b>2D Symbolologies .....</b>	<b>185</b>
<b>2D Global Features .....</b>	<b>185</b>
2D Maximum Decoding Time .....	186
2D Structured Append .....	187
2D Normal/Inverse Symbol Control .....	187
<b>Aztec Code .....</b>	<b>188</b>
Aztec Code Enable / Disable .....	188
Aztec Code Length Control .....	188
Aztec Code Set Length 1 .....	189
Aztec Code Set Length 2 .....	190
<b>China Sensible Code .....</b>	<b>191</b>
China Sensible Code Enable / Disable .....	191
China Sensible Code Length Control .....	191
China Sensible Code Set Length 1 .....	192

China Sensible Code Set Length 2 .....	193
<b>Data Matrix .....</b>	<b>194</b>
Data Matrix Enable / Disable .....	194
Data Matrix Square/Rectangular Style .....	194
Data Matrix Length Control .....	195
Data Matrix Set Length 1 .....	195
Data Matrix Set Length 2 .....	196
<b>Maxicode .....</b>	<b>197</b>
Maxicode Enable / Disable .....	197
Maxicode Primary Message Transmission .....	197
Maxicode Length Control .....	198
Maxicode Set Length 1 .....	198
Maxicode Set Length 2 .....	199
<b>PDF417 .....</b>	<b>200</b>
PDF417 Enable / Disable .....	200
PDF417 Length Control .....	200
PDF417 Set Length 1 .....	201
PDF417 Set Length 2 .....	202
<b>Micro PDF417 .....</b>	<b>203</b>
Micro PDF417 Enable / Disable .....	203
Micro PDF417 Code 128 GS1-128 Emulation .....	203
Micro PDF417 Length Control .....	204
Micro PDF417 Set Length 1 .....	204
Micro PDF417 Set Length 2 .....	205
<b>QR Code .....</b>	<b>206</b>
QR Code Enable / Disable .....	206
QR Code Length Control .....	206
QR Code Set Length 1 .....	207
QR Code Set Length 2 .....	208
<b>Micro QR Code .....</b>	<b>209</b>
Micro QR Code Enable/Disable .....	209
Micro QR Code Length Control .....	209
Micro QR Code Set Length 1 .....	210
Micro QR Code Set Length 2 .....	211
<b>UCC Composite .....</b>	<b>212</b>
UCC Composite Enable / Disable .....	212
UCC Optional Composite Timer .....	213
<b>Postal Code Selection .....</b>	<b>214</b>
Postnet BB Control .....	215
<b>SOFTWARE CONFIGURATION STRINGS .....</b>	<b>217</b>
Command Syntax .....	218
SERIAL CONFIGURATION STRINGS .....	220
<b>REFERENCES.....</b>	<b>243</b>
<b>RS-232 Parameters .....</b>	<b>244</b>
RS-232 Only .....	244
RS-232/USB COM Parameters .....	245
USB Intercode Delay .....	252
<b>Symbologies .....</b>	<b>253</b>
Set Length .....	253
<b>Data Editing .....</b>	<b>254</b>
Global Prefix/Suffix .....	255
Global AIM ID .....	256
Label ID .....	257
Character Conversion .....	262
Scanner Data Formatting Control .....	263
<b>Digital Output .....</b>	<b>265</b>
<b>Reading Parameters .....</b>	<b>266</b>
Double Read Timeout .....	266
Good Read LED Duration .....	267
<b>Scanning Features .....</b>	<b>268</b>
Operating Mode .....	268



---

Digital Output .....	269
Scanning Active Time .....	270
Aiming Duration Time .....	271
Multiple Labels Ordering by Code Symbology .....	272
<b>TECHNICAL SPECIFICATIONS.....</b>	<b>275</b>
<b>Imager Labeling .....</b>	<b>280</b>
Aiming System .....	280
<b>LED and Beeper Indications .....</b>	<b>281</b>
Button and LED Status .....	281
Indicators .....	281
<b>Error Codes .....</b>	<b>283</b>
<b>AIMER CALIBRATION .....</b>	<b>285</b>
<b>STANDARD DEFAULTS .....</b>	<b>289</b>
<b>Sample Bar Codes.....</b>	<b>301</b>
<b>KEYPAD .....</b>	<b>305</b>
<b>RESERVED CHARACTERS.....</b>	<b>307</b>
<b>SCANCODE TABLES .....</b>	<b>309</b>
<b>Control Character Emulation .....</b>	<b>309</b>
Single Press and Release Keys .....	309
<b>Interface Type PC AT PS/2, USB-Keyboard or USB-Keyboard for APPLE .....</b>	<b>310</b>
<b>Interface type PC AT PS/2 Alt Mode or USB-Keyboard Alt Mode .....</b>	<b>312</b>
<b>Digital Interface .....</b>	<b>314</b>
<b>IBM31xx 102-key .....</b>	<b>315</b>
<b>IBM XT .....</b>	<b>316</b>
<b>Microsoft Windows Codepage 1252 .....</b>	<b>317</b>

# NOTES

# Chapter 1

## Introduction

### About this Manual

This Product Reference Guide (PRG) is provided for users seeking advanced technical information, including connection, programming, maintenance and specifications. The Quick Reference Guide (QRG) and other publications associated with this product are downloadable free of charge from the website listed on the back cover of this manual.

### Overview

[Chapter 1](#), (this chapter) presents information about manual conventions, and an overview of the reader, its features and operation.

[Chapter 2, Setup](#) presents information about unpacking, cable connection information and setting up the reader.

[Chapter 3, Configuration Using Bar Codes](#) provides instructions and bar code labels for customizing your reader. There are different sections for interface types, general features, data formatting, symbology-specific and model-specific features.

[Chapter 4, Software Configuration Strings](#) provides background information and detailed instructions for more complex programming items.

[Chapter 5, References](#) provides background information and detailed instructions for more complex programming items.

[Appendix A, Technical Specifications](#) lists physical and performance characteristics, as well as environmental and regulatory specifications. It also provides standard cable pinouts and LED/Beeper functions.

[Chapter B, Aimer Calibration](#) describes the procedures for calibrating the aiming system in the scan modules.

[Appendix C, Standard Defaults](#) references common factory default settings for reader features and options.

[Appendix D, Sample Bar Codes](#) offers sample bar codes for several common symbologies.

[Appendix E, Keypad](#) includes numeric bar codes to be scanned for certain parameter settings.

[Appendix F, Reserved Characters](#) provides a table of reserved characters.

[Appendix G, Scancode Tables](#) lists control character emulation information for USB Keyboard interfaces.

## Manual Conventions

The following conventions are used in this document:

The symbols listed below are used in this manual to notify the reader of key issues or procedures that must be observed when using the reader:



**Notes contain information necessary for properly diagnosing, repairing and operating the reader.**



**The CAUTION symbol advises you of actions that could damage equipment or property.**

**CAUTION**

## References

Current versions of this Product Reference Guide (PRG), Quick Reference Guide (QRG), the Datalogic Aladdin™ Configuration application, and any other manuals, instruction sheets and utilities for this product can be downloaded from the website listed below. Alternatively, printed copies or product support CDs for most products can be purchased through your Datalogic reseller.

## Technical Support

### Datalogic Website Support

The Datalogic website ([www.datalogic.com](http://www.datalogic.com)) is the complete source for technical support and information for Datalogic products. The site offers product support, product registration, warranty information, product manuals, product tech notes, software updates, demos, and instructions for returning products for repair.

### Reseller Technical Support

An excellent source for technical assistance and information is an authorized Datalogic reseller. A reseller is acquainted with specific types of businesses, application software, and computer systems and can provide individualized assistance.

### Telephone Technical Support

If you do not have internet or email access, you may contact Datalogic technical support at (541) 349-8283 or check the back cover of your manual for more contact information.

## About the Reader

The Gryphon GFS4400 is a fully self-contained standard range 2D bar code scanning module for use in OEM applications such as self service kiosks or other semi-automated equipment requiring the ability to read a bar code. It is intended to be an easy integration by system designers with little expertise in scanning technology. Unlike currently available products, the GFS4400 uses the latest and fastest imaging technology and offers Datalogic's Green Spot for targeting and good read feedback.

The scanning technology is essentially the same as the Gryphon I 4400 handheld scanner family of area imagers, with some enhancements for presentation reading and improved motion tolerance. The enclosure is designed for ease of integration, is sealed to IP54 for cleaning, and is constructed of a solvent- and disinfectant-tolerant resin for health care applications.

Advancements in the LED technology used in the imager-based readers significantly improve the illumination of the target field of view, resulting in higher scan efficiency.

The GFS4400 is available in two different data interface versions:

- Gryphon I GFS4470 Gryphon Fixed Scanner 2D Imager USB
- Gryphon I GFS4450-9 Gryphon Fixed Scanner 2D Imager RS-232 9-pin connector

## Programming the Reader

### Configuration Methods

#### Programming Bar Codes

The reader is factory-configured with a standard set of default features. After scanning the interface bar code, you can select other options and customize your reader through use of the instructions and programming bar code labels available in the corresponding features section for your interface. Customizable settings for many features are found in "[Configuration Parameters](#)" starting on page 21.

Some programming labels, like "[Restore Custom Defaults](#)" on page 19, require only the scan of the single label to enact the change. Most, however, require the reader to be placed in Programming Mode prior to scanning them. Scan an ENTER/EXIT bar code once to enter Programming Mode. Once the reader is in Programming Mode, scan a number of parameter settings before scanning the ENTER/EXIT bar code a second time, which will then accept your changes, exit Programming Mode and return the reader to normal operation.



**There are some exceptions to the typical programming sequence described above. Please read the description and setting instructions carefully when configuring each programmable feature.**

## Datalogic Aladdin™

Programming can alternatively be performed using the Datalogic Aladdin™ Configuration application. Aladdin™ is a multi-platform utility program providing a quick and user-friendly configuration method via the RS-232/USB-COM interface. It communicates to the device through a user-friendly graphical interface running on a PC. Selected configuration commands are sent to the reader over the selected communication interface using a serial or USB cable, or they can be printed as bar codes to be scanned.

Aladdin also provides the ability to perform a software upgrade for the connected device (see the Datalogic Aladdin™ Help On-Line for more details).

Aladdin is available for free download from the Datalogic website.

## Software Configuration Strings

The reader can also be configured by using command strings. These strings can be sent via the RS232/USB-COM interface using a terminal emulator such as HyperTerminal.

Refer to "[Software Configuration Strings](#)" starting on page 217 for configuration procedures using Serial Strings sent by the Host."

# Chapter 2

## Setup

---

### Unpacking

Check carefully to ensure the reader and any accessories ordered are present and undamaged. If any damage occurred during shipment, contact Datalogic Technical Support. Information is shown on [page 10](#).

**KEEP THE PACKAGING.** Should the unit ever require service, it should be returned in its original shipping container.

### Setting Up the Reader

Follow the steps provided in this section to connect and get your reader up and communicating with its host.

1. Begin by connecting the scan module to the host. The correct Interface Selection will occur automatically.
2. If modifications are needed, go to [Interface Selection](#) and set the desired interface.
3. [Configure Interface Settings](#) (only if not using factory settings for that interface)
4. Go to [Configuring Other Features](#) (if modifications are needed from factory settings)

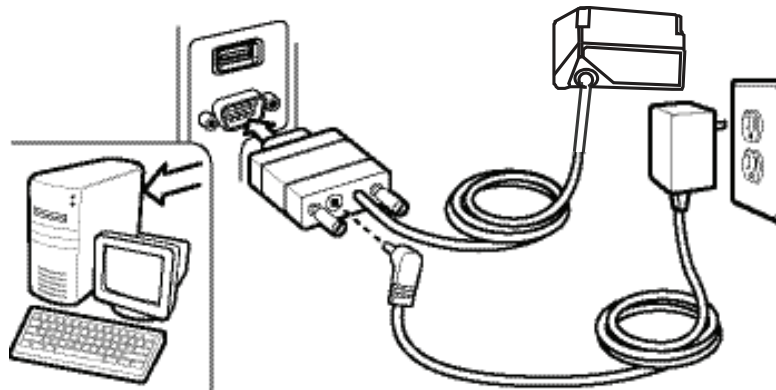
## Attaching Reader to Host

### RS-232 Serial Connection



Turn off power to the terminal/PC and connect the reader to the terminal/PC serial port via the RS-232 cable as shown in [Figure 1](#). If the terminal will not support POT (Power Off the Terminal) to supply reader power, use the approved power supply (AC Adapter). Plug the AC Adapter barrel connector into the socket on the RS-232 cable connector and the AC Adapter plug into a standard power outlet.

**Figure 1. RS-232 Connection**

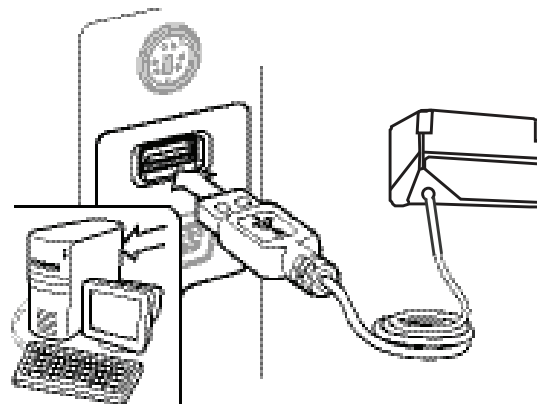


### USB Connection



Connect the reader to a USB port on the terminal/PC. Reference [Figure 2](#).

**Figure 2. USB connection**





## Interface Selection

Since your scanner should have shipped with the correct interface cable (RS-232 or USB), the interface type should already be defined. If you need to change the interface type, go to [Table 1 starting on page 16](#) and scan the appropriate bar code in that section.

Each reader model will support one of the following sets of host interfaces:

### GFS4450-9 Model

- RS-232-STD
- RS-232 Wincor-Nixdorf

### GFS4470 Model

- USB-COM, USB-OEM, USB-KBD, USB\_KBD-ALT, USB-KBD-Apple





If your installation requires you to select options to customize your reader, turn to the appropriate section for your interface type in "[Configuration Using Bar Codes](#)" starting on [page 21](#) (also listed beside each interface type in [Table 1 on page 16](#)).




**Unlike some programming features and options, interface selections require that you scan only one programming bar code label. DO NOT scan an ENTER/EXIT bar code prior to scanning an interface selection bar code.**




**Some interfaces require the scanner to start in the disabled state when powered up. If additional scanner configuration is desired while in this state, pull the trigger and hold it for five seconds. The scanner will change to a state that allows programming with bar codes.**

**Table 1. Available Interfaces**

RS-232		FEATURES
RS-232 standard interface	 Select RS232-STD	Set RS-232 Interface Features starting on page 25
 Select RS232-WN	RS-232 Wincor-Nixdorf	
RS-232 for use with OPOS/UPOS/JavaPOS	 Select RS-232 OPOS	
 Select USB-COM-STD <sup>a</sup>	USB Com to simulate RS-232 standard interface	

a. Download the correct USB Com driver from [www.adc.datalogic.com](http://www.adc.datalogic.com)

USB-OEM		FEATURES
 Select USB-OEM	USB-OEM (can be used for OPOS/UPOS/JavaPOS)	Set USB-OEM Interface Features starting on page 47

KEYBOARD	FEATURES
 <p>Select USB Keyboard</p> <p>USB Keyboard with standard key encoding</p>	<p>Set KEYBOARD Interface Features starting on page 37</p>
<p>USB Keyboard for Apple computers</p>  <p>Select USB-KBD-APPLE</p>	
 <p>Select USB Alternate Keyboard</p> <p>USB Keyboard with alternate key encoding</p>	

# Custom Configuration Settings

## Configure Interface Settings

If your installation requires you to select options to customize your reader, turn to the appropriate section for your interface type in ["Configuration Using Bar Codes" starting on page 21](#).

- ["RS-232 Only Interface" on page 25](#)
- ["RS-232/USB-Com Interfaces" on page 30](#)
- ["USB Keyboard Settings" on page 37](#)

## Global Interface Features

See ["Global Interface Features" on page 23](#) for settings configurable by all interface types.

## Configuring Other Features

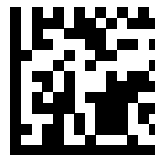
If your installation requires different programming than the standard factory default settings, the following sections of this manual allow configuration of non-interface-specific settings you might require:

**Reading Parameters:** Reading Parameters include programming for scanning, beeper and LED indicators and other universal settings.

**Symbologies:** Includes options concerning the bar code label types (symbologies). These settings allow you to enable/disable symbologies, set label lengths, require check digit, etc.

## Software Version Transmission

The software version of the device can be transmitted over the interface by scanning the following label.



Transmit Software Version

## Resetting the Product Configuration to Defaults

### Restore Custom Defaults

If you aren't sure what programming options are in your imager, or you've changed some options and want to restore the Custom Default Configuration that may have been saved in the scanner, scan the Restore Custom Default Configuration bar code below. This will restore the custom configuration for the currently active interface.



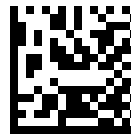
**Custom defaults are based on the interface type. Configure the imager for the correct interface before scanning this label.**



Restore Custom Default Configuration

### Restore Factory Configuration

If you want to restore the Factory Configuration for your imager, scan either the Restore USA Factory Configuration bar code or the Restore EU Factory Configuration bar code below. Both labels restore the scanner configuration to the factory settings, including the interface type. The USA label restores Label IDs to those historically used in the USA. The EU label restores Label IDs to those historically used in Europe. The Label ID sets for USA and EU are shown in the [“Label ID Control” section on page 57](#) of this manual.



Restore USA Factory Configuration



Restore EU Factory Configuration

The programming items listed in the following sections show the factory default settings for each of the menu commands.

# NOTES

# Chapter 3

## Configuration Using Bar Codes

This and following sections provide programming bar codes to configure your reader by changing the default settings. For details about additional methods of programming, see "Configuration Methods" on page 11.



**You must first enable your reader to read bar codes in order to use this section. If you have not done this, go to Setup, starting on page 13 and complete the appropriate procedure.**

### Configuration Parameters

Once the reader is set up, you can change the default parameters to meet your application needs. Refer to "Standard Defaults" starting on page 289 for initial configuration in order to set the default values and select the interface for your application.

The following configuration parameters are divided into logical groups, making it easy to find the desired function based on its reference group.

#### Interface Configuration:

- "Global Interface Features" on page 23
- "RS-232 Only Interface" on page 25
- "RS-232/USB-Com Interfaces" on page 30
- "USB Keyboard Settings" on page 37
- "USB-OEM Interface" on page 47

#### Parameters common to all interface applications:

- "Data Format" on page 51 gives options to control the messages sent to the Host system.
- "Reading Parameters" on page 73 control various operating modes and indicators status functioning.

#### Symbology-specific parameters:

- "Symbologies" on page 93 provides configuration of a personalized mix of 1D codes, code families and their options.
- "2D Symbologies" on page 185 provides configuration of a personalized mix of 2D codes, code families and their options.



**You must first enable your reader to read bar codes in order to use this section. If you have not done this, go to [Setup](#), starting on page 13 and complete the appropriate procedure.**

### To program features:

1. Scan the ENTER/EXIT PROGRAMMING bar code, available at the top of each programming page, when applicable.
2. Scan the bar code to set the desired programming feature. You may need to cover unused bar codes on the page, and possibly the facing page, to ensure that the reader reads only the bar code you intend to scan.
3. If additional input parameters are needed, go to [Appendix E, Keypad](#), and scan the appropriate characters from the keypad.



**Additional information about many features can be found in the “References” chapter.**

**If you make a mistake before the last character, scan the CANCEL bar code to abort and not save the entry string. You can then start again at the beginning.**

4. Complete the programming sequence by scanning the ENTER/EXIT PROGRAMMING bar code to exit Programming Mode.

For more detailed descriptions, programming information and examples for setting selected configuration items, see [References](#), starting on page 243.





---

## GLOBAL INTERFACE FEATURES

The following interface features are configurable by all interface types.

### Host Commands — Obey/Ignore

This option specifies whether the reader will obey or ignore host commands. When set to ignore, the reader will ignore all host commands except for those necessary for:

- service mode
- flash programming mode
- keeping the interface active
- transmission of labels.



Host Commands = Obey  
(Do Not Ignore Host Commands)



Host Commands = Ignore



Enter/Exit Programming Mode

---

# NOTES

# RS-232 ONLY INTERFACE

<b>BAUD RATE</b> on page 26
<b>DATA BITS</b> on page 27
<b>STOP BITS</b> on page 27
<b>PARITY</b> on page 28
<b>HANDSHAKING CONTROL</b> on page 29

Use the programming bar codes in this section if modifications to the standard RS-232 interface settings are necessary to meet your system's requirements. Additional settings which apply to both the RS-232 and USB interfaces are available in the next section, "RS-232/USB-Com Interfaces" starting on page 30.

Reference [Appendix C, Standard Defaults](#) for a listing of standard factory settings.



## Baud Rate

See [page 244](#) for information on this feature.



Baud Rate = 1200



Baud Rate = 2400



Baud Rate = 4800



Baud Rate = 9600



Baud Rate = 19,200



Baud Rate = 38,400



Baud Rate = 57,600



Baud Rate = 115,200

## Data Bits

This parameter allows the reader to interface with devices requiring a 7-bit or 8-bit ASCII protocol for sending and receiving data.



8 Data Bits

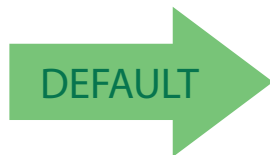


7 Data Bits



## Stop Bits

Set the number of stop bits to match host device requirements. See [page 244](#) for more information on this feature.



1 Stop Bit

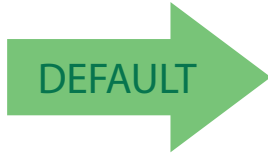


2 Stop Bits



## Parity

This feature specifies parity required for sending and receiving data. Select the parity type according to host device requirements. See [page 244](#) for more information.



Parity = None



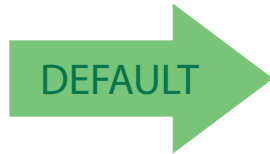
Parity = Even



Parity = Odd

## Handshaking Control

See [page 244](#) for more information about this feature.



Handshaking Control = RTS



Handshaking Control = RTS/CTS



Handshaking Control = RTS/XON/XOFF



Handshaking Control = RTS On/CTS



Handshaking Control = RTS/CTS Scan Control

# RS-232/USB-COM INTERFACES

<b>INTERCHARACTER DELAY</b> on page 31
<b>BEEP ON ASCII BEL</b> on page 31
<b>BEEP ON NOT ON FILE</b> on page 32
<b>ACK NAK OPTIONS</b> on page 32
<b>ACK CHARACTER</b> on page 33
<b>NAK CHARACTER</b> on page 33
<b>ACK NAK TIMEOUT VALUE</b> on page 34
<b>ACK NAK RETRY COUNT</b> on page 34
<b>ACK NAK ERROR HANDLING</b> on page 35
<b>INDICATE TRANSMISSION FAILURE</b> on page 35
<b>DISABLE CHARACTER</b> on page 36
<b>ENABLE CHARACTER</b> on page 36

The programming bar codes in this chapter allow modifications to the standard RS-232 and USB-Com interfaces. Reference [Appendix C, Standard Defaults](#) for a listing of standard factory settings.



## Intercharacter Delay

This parameter specifies the intercharacter delay between the end of one character and the beginning of the next. The delay can be set within a range of zero (0) to 990 milliseconds in 10ms increments. A setting of zero specifies no delay.



Select Intercharacter Delay Setting



Intercharacter Delay = No Delay

To configure this feature, scan the ENTER/EXIT PROGRAMMING MODE bar code above, then the bar code at left followed by the digits from the Alphanumeric characters in [Appendix E, Keypad](#) representing your desired character(s). End by scanning the ENTER/EXIT bar code again.

Make a mistake? Scan the CANCEL bar code to abort and not save the entry string. You can then start again at the beginning.



CANCEL



**00 = No Intercharacter Delay**

## Beep On ASCII BEL

When this parameter is enabled, the reader issues a beep when a <BEL> character is detected on the RS-232 serial line. <BEL> is issued to gain a user's attention to an illegal entry or other important event.



Beep On ASCII BEL = Disable



Beep On ASCII BEL = Enable

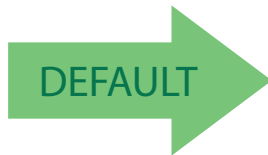


### Beep On Not on File

This option enables/disables the action of the reader to sound a three beep sequence upon receiving a Not-On-File (NOF) host command.



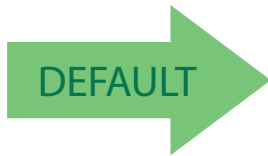
Beep On Not On File = Disable



Beep On Not On File = Enable

### ACK NAK Options

This enables/disables the ability of the reader to support the RS-232 ACK/NAK protocol. See [page 246](#) for more information.



ACK/NAK Protocol = Disable ACK/NAK



ACK/NAK Protocol = Enable for label transmission



ACK/NAK Protocol = Enable for host-command acknowledge



ACK/NAK Protocol = Enable for label transmission and host-command acknowledge

## ACK Character

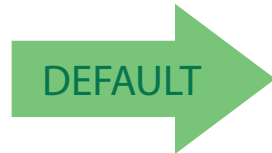
This setting specifies an ASCII character or hex value to be used as the ACK character. ASCII characters or any hex value from 0 to 0xFF can be selected. See [page 246](#) for more information.



**Setting to previously defined characters such as XON, XOFF, or host commands conflicts with normal operation of these characters. 8-bit data is not recognized when the option [Data Bits](#) has been set as 7 Data Bits.**



Select ACK Character Setting



**0x06 'ACK' Character**

## NAK Character

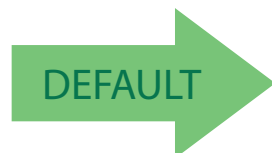
This setting specifies an ASCII character or hex value to be used as the NAK character. ASCII characters or any hex value from 0 to 0xFF can be selected. See [page 247](#) for more information.



**Setting to previously defined characters such as XON, XOFF, or host commands conflicts with normal operation of these characters. 8-bit data is not recognized when the option [Data Bits](#) has been set as 7 Data Bits.**



Select NAK Character Setting



**0x15 'NAK' Character**



### ACK NAK Timeout Value

This option specifies the amount of time the reader waits for an ACK character from the host following label transmission. The selectable timeout range is 200 milliseconds to 15,000ms (15 seconds) in 200ms increments. A selection of 0 disables the timeout.

See [page 248](#) for more information on setting this feature.



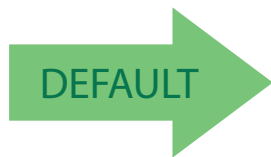
Select ACK NAK Timeout Value Setting

To configure this feature, scan the ENTER/EXIT PROGRAMMING MODE bar code above, then the bar code at left followed by the digits from the Alphanumeric characters in [Appendix E, Keypad](#) representing your desired character(s). End by scanning the ENTER/EXIT bar code again.

Make a mistake? Scan the CANCEL bar code to abort and not save the entry string. You can then start again at the beginning.



CANCEL



**01 ACK NAK Timeout value is 200ms**

### ACK NAK Retry Count

This feature specifies the number of times the reader retries a label transmission due to a retry condition. The selectable range is from 1 to 254 retries. A selection of 0 disables the count, and a selection of 255 specifies unlimited retries. See [page 249](#) for more information.



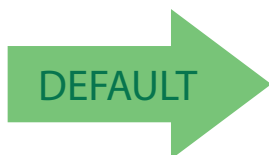
Select ACK NAK Retry Count Setting

To configure this feature, scan the ENTER/EXIT PROGRAMMING MODE bar code above, then the bar code at left followed by the digits from the Alphanumeric characters in [Appendix E, Keypad](#) representing your desired character(s). End by scanning the ENTER/EXIT bar code again.

Make a mistake? Scan the CANCEL bar code to abort and not save the entry string. You can then start again at the beginning.



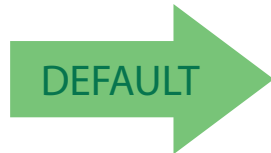
CANCEL



**003 = 3 Retries**

## ACK NAK Error Handling

This feature specifies the method the reader uses to handle receive errors detected while waiting for an ACK character from the host.



ACK NAK Error Handling = Ignore Errors Detected



ACK NAK Error Handling = Process Error as Valid ACK Character



ACK NAK Error Handling = Process Error as Valid NAK Character

## Indicate Transmission Failure

This option enables/disables the reader's ability to sound an error beep to indicate a transmission failure while in ACK/NAK mode.



Indicate Transmission Failure = Disable Indication



Indicate Transmission Failure = Enable Indication





### Disable Character

Specifies the value of the RS-232 host command used to disable the reader.  
ASCII characters or any hex value from 0 to 0xFF can be selected.

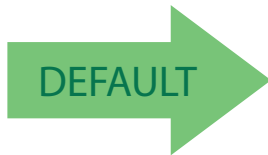


**Setting to previously defined characters such as XON, XOFF, or host commands conflicts with normal operation of these characters. 8-bit data is not recognized when the option Data Bits has been set as 7 Data Bits.**

See [page 250](#) for more information on setting this feature.



Select Disable Character Setting



**0x44 = Disable Character is 'D'**

### Enable Character

Specifies the value of the RS-232 host command used to enable the reader.  
ASCII characters or any hex value from 0 to 0xFF can be selected.

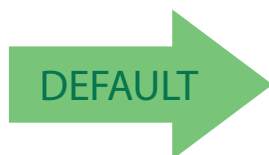


**Setting to previously defined characters such as XON, XOFF, or host commands conflicts with normal operation of these characters. 8-bit data is not recognized when the option Data Bits has been set as 7 Data Bits.**

See [page 251](#) in “References” for more information on setting this feature.



Select Enable Character Setting



**0x45 = Enable Character is 'E'**

# USB KEYBOARD SETTINGS

<b>COUNTRY MODE</b> on page 38
<b>SEND CONTROL CHARACTERS</b> on page 42
<b>INTERCODE DELAY</b> on page 43
<b>CAPS LOCK STATE</b> on page 43
<b>USB KEYBOARD SPEED</b> on page 44
<b>USB KEYBOARD NUMERIC KEYPAD</b> on page 45

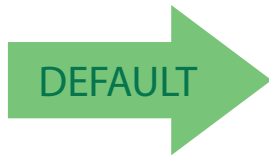
Use the programming bar codes in this chapter to select options for USB Keyboard Interface. Reference [Appendix C, Standard Defaults](#) for a listing of standard factory settings.

Information about control character emulation which applies to keyboard interfaces is listed in [Appendix G, Scancode Tables](#).



### Country Mode

This feature specifies the country/language supported by the keyboard. Several languages are supported:



Country Mode = U.S.



Country Mode = Belgium



Country Mode = Britain



Country Mode = Croatia

Supports only the interfaces listed in the Country Mode feature description.

Supports only the interfaces listed in the Country Mode feature description.



Country Mode = Czech Republic



Country Mode = Denmark

Supports only the interfaces listed in the Country Mode feature description.



## Country Mode (continued)



Country Mode = France

Supports only the interfaces listed in the Country Mode feature description.



Country Mode = French Canadian



Country Mode = Germany

Supports only the interfaces listed in the Country Mode feature description.



Country Mode = Hungary



Country Mode = Italy

Supports only the interfaces listed in the Country Mode feature description.



Country Mode = Japanese 106-key



## Country Mode (continued)



Country Mode = Lithuanian

Supports only the interfaces listed in the Country Mode feature description.



Country Mode = Norway



Country Mode = Poland

Supports only the interfaces listed in the Country Mode feature description.

Supports only the interfaces listed in the Country Mode feature description.



Country Mode = Portugal



Country Mode = Romania

Supports only the interfaces listed in the Country Mode feature description.

Supports only the interfaces listed in the Country Mode feature description.



Country Mode = Slovakia



## Country Mode (continued)



Country Mode = Spain



Country Mode = Sweden



Country Mode = Switzerland

Supports only the interfaces listed in the Country Mode feature description.



## Send Control Characters

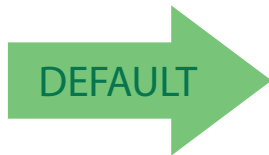
This feature specifies how the reader transmits ASCII control characters to the host. Reference [Appendix G, Scancode Tables](#) for more information about control characters.

Options are as follows:

**Control Character 00 :** Characters from 00 to 0x1F are sent as control character Ctrl+Keys, special keys are located from 0x80 to 0xA1.

**Control Character 01 :** Characters from 00 to 0x1F are sent as control character Ctrl+Shift, special keys are located from 0x80 to 0xA1.

**Control Character 02 :** Special keys are located from 00 to 0x1F and characters from 0x80 to 0xFE are intended as an extended ASCII table (see "[Microsoft Windows Codepage 1252](#)" on page 317).



Reader Send Control Characters = 00



Reader Send Control Characters = 01



Reader Send Control Characters = 02

### Intercode Delay

Specifies the delay between labels transmitted to the host for this interface. The selectable range for this feature is from 0 to 99 seconds.

See [page 252](#) in “References” for detailed information and examples for setting this feature.



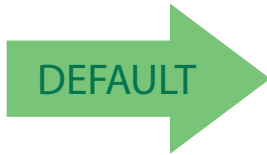
Set Intercode Delay

To configure this feature, scan the ENTER/EXIT PROGRAMMING MODE bar code above, then the bar code at left followed by the digits from the Alphanumeric characters in [Appendix E, Keypad](#) representing your desired character(s). End by scanning the ENTER/EXIT bar code again.

Make a mistake? Scan the CANCEL bar code to abort and not save the entry string. You can then start again at the beginning.



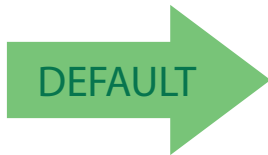
CANCEL



**00 = No Intercode Delay**

### Caps Lock State

This option specifies the format in which the reader sends character data. This does not apply when an alternate key encoding keyboard is selected.



Caps Lock State = Caps Lock OFF



Caps Lock State = Caps Lock ON



Caps Lock State = AUTO Caps Lock Enable

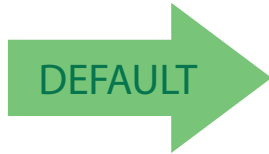


## USB Keyboard Speed

This option specifies the USB poll rate for a USB keyboard.



**This feature applies ONLY to the USB Keyboard interface.**



USB Keyboard Speed = 1ms



USB Keyboard Speed = 2ms



USB Keyboard Speed = 3ms



USB Keyboard Speed = 4ms



USB Keyboard Speed = 5ms



USB Keyboard Speed = 6ms

## USB Keyboard Speed (continued)



USB Keyboard Speed = 7ms



USB Keyboard Speed = 8ms



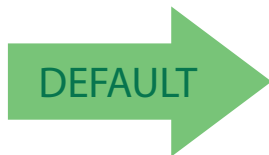
USB Keyboard Speed = 9ms



USB Keyboard Speed = 10ms

## USB Keyboard Numeric Keypad

This option Controls whether numeric characters will be sent using standard keys or the numeric keypad.



Standard Keys



Numeric Keypad



# NOTES



# USB-OEM INTERFACE

<b>USB-OEM DEVICE USAGE</b> on page 48
<b>TRANSMIT LABELS IN CODE 39 FORMAT</b> on page 49
<b>INTERFACE OPTIONS</b> on page 49

Feature settings for USB interfaces differ depending upon which host type the reader will be connected with. Use the feature settings in this chapter to specifically configure for the USB-OEM interface. Other USB interfaces are included in the appropriate chapter for their host type.

Reference [Appendix C](#) for a listing of standard factory settings.



## USB-OEM Device Usage

The USB-OEM protocol allows for the reader to be identified as one of two different types of bar code scanners. Depending on what other scanners you may already have connected to a USB-OEM POS, you may need to change this setting to enable all devices to communicate.

Options are:

- Table Top Scanner
- Handheld Scanner



**It may be necessary to switch device usage when connecting two readers/scanners of the same type to a POS system.**



USB-OEM Device Usage = Table Top Scanner



USB-OEM Device Usage = Handheld Scanner



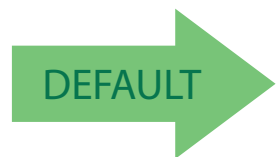
## Transmit Labels in Code 39 Format

This feature enable/disables translation to Code 39 before transmitting label data to a USB-OEM host. Only the symbology identifier is modified for the translation. The data is not converted to Code 39 or verified to be valid for Code 39.

Options are:

**Code 39 Format:** Translate the following symbologies to Code 39:

- USB-OEM: Code128, Code 93, and Codabar



Transmit Labels in Code 39 Format =  
IBM Standard Format



Transmit Labels in Code 39 Format = Code 39 Format

## Interface Options

This feature provides for an interface-specific control mechanism.



Obey Scanner Configuration Host Commands



Ignore Scanner Configuration Host Commands



# NOTES

# DATA FORMAT

<b>GLOBAL PREFIX/SUFFIX</b> on page 52
<b>GLOBAL AIM ID</b> on page 53
<b>SET AIM ID INDIVIDUALLY FOR GS1-128</b> on page 55
<b>LABEL ID</b> starting on page 56 <ul style="list-style-type: none"><li>•Label ID: Pre-Loaded Sets</li><li>•Individually Set Label ID</li><li>•Label ID Control</li><li>•Label ID Symbology Selection • 1D Symbologies</li><li>•Label ID Symbology Selection • 2D Symbologies</li></ul>
<b>NO READ MESSAGE</b> starting on page 63
<b>NO READ STRING</b> starting on page 63
<b>CODE VERIFIER MODE</b> starting on page 64 <ul style="list-style-type: none"><li>•Code Verifier Mode</li><li>•Match String</li><li>•Wrong Code String</li></ul>
<b>CASE CONVERSION</b> on page 67
<b>CHARACTER CONVERSION</b> on page 67

The features in this chapter can be used to build specific user-defined data into a message string. See “References” starting on page 254 for more detailed instructions on setting these features.

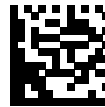
Reference [Appendix C](#) for a listing of standard factory settings.



## Global Prefix/Suffix

This option sets up to 20 characters each from the set of ASCII characters or any hex value from 00 to FF. The characters may be added as a prefix (in a position before the bar code data, also called a header) and/or as a suffix (in a position following the bar code data, also called a footer). See [page 255](#) for more detailed instructions on setting this feature.

To configure this feature, scan the ENTER/EXIT PROGRAMMING MODE bar code above to place the unit in Programming Mode, then the “Set Global Prefix” or “Set Global Suffix,” bar code followed by the digits (in hex) from the Alphanumeric characters in [Appendix E Keypad](#) representing your desired character(s). If less than the expected string of 20 characters are selected, scan the ENTER/EXIT bar code to terminate the string. Exit programming mode by scanning the ENTER/EXIT bar code again.



Set Global Prefix

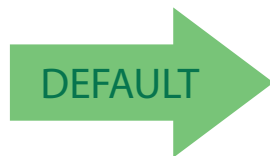


Set Global Suffix

Make a mistake? Scan the CANCEL bar code to abort and not save the entry string. You can then start again at the beginning.



CANCEL



**No Global Prefix**  
**Global Suffix = 0x0D (CR)**

## Global AIM ID

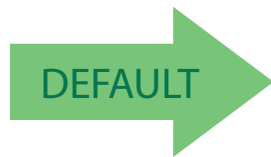


This feature enables/disables addition of AIM IDs for all symbology types.

AIM label identifiers (as opposed to custom characters you select yourself as with label identifiers) can be included with scanned bar code data. See Table 2 on page 3-53 for a listing of AIM IDs.

AIM label identifiers consist of three characters as follows:

- A close brace character (ASCII '['), followed by...
- A code character (see some samples in the table below), followed by...
- A modifier character (the modifier character is symbol dependent).



Global AIM ID = Disable



Global AIM ID = Enable

**Table 2. AIM IDs**

Tag Name	AIM ID code character	AIM ID code ASCII value
ABC CODABAR	X	58
ANKER PLESSEY	N	4E
AZTEC	z	7A
CHINA SENSIBLE CODE	X	58
CODABAR	F	46
CODE11	H	48
CODE128	C	43
CODE32	A	41
CODE39	A	41
CODE39 CIP	X	58
CODE39 DANISH PPT	X	58
CODE39 LAPOSTE	X	58
CODE39 PZN	X	58
CODE93	G	47
DATABAR 14	e	65
DATABAR 14 COMPOSITE	e	65
DATABAR EXPANDED	e	65



DATABAR EXPANDED COMPOSITE	e	65
DATABAR LIMITED	e	65
DATABAR LIMITED COMPOSITE	e	65
DATA MATRIX	d	64
EAN128	C	43
EAN128 COMPOSITE	C	43
EAN13	E	45
EAN13 P2	E	45
EAN13 P5	E	45
EAN13 COMPOSITE	E	45
EAN8	E	45
EAN8 P2	E	45
EAN8 P5	E	45
EAN8 COMPOSITE	E	45
FOLLET 2OF5	X	58
I2OF5	I	49
IATA INDUSTRIAL 2OF5	X	58
INDUSTRIAL 2OF5	X	58
ISBN	X	58
ISBT128 CONCAT	X	58
ISSN	X	58
MAXICODE	U	55
MICRO QR	Q	51
MICRO PDF	L	4C
MSI	M	4D
PDF417	L	4C
PLESSEY	P	50
POSTAL AUSTRALIAN	X	58
POSTAL IMB	X	58
POSTAL JAPANESE	X	58
POSTAL KIX	X	58
POSTAL PLANET	X	58
POSTAL PORTUGAL	X	58
POSTAL POSTNET BB	X	58
POSTAL ROYAL MAIL	X	58
POSTAL SWEDISH	X	58
POSTNET	X	58
QR CODE	Q	51
S25	S	53
TRIOPTIC	X	58
UPCA	E	45
UPCA P2	E	45
UPCA P5	E	45
UPCA COMPOSITE	E	45
UPCE	E	45
UPCE P2	E	45
UPCE P5	E	45
UPCE COMPOSITE	E	45



## Set AIM ID Individually for GS1-128

This feature configures a Label ID individually for the GS1-128 symbology and the programming for this works the same way as Label ID. See [Label ID: Set Individually Per Symbology, starting on page 260](#) for detailed instructions on setting this feature.



Set AIM ID Individually for GS1-128 = Disable



Set AIM ID Individually for GS1-128 = Enable



## Label ID

A Label ID is a customizable code of up to three ASCII characters (convert to Hex using the ASCII Chart on the inside back cover of this manual), used to identify a bar code symbology type. It can be appended previous to or following the transmitted bar code data depending upon how this option is enabled. This feature provides options for configuring custom Label IDs or individually per symbology (see "Individually Set Label ID" on page 57). If you wish to program the reader to always include an industry standard label identifier for ALL symbology types, see the previous feature "Global AIM ID" on page 53.

See [Label ID, starting on page 257](#) of "References" for more information on setting this feature.

### Label ID: Pre-Loaded Sets

The reader supports two pre-loaded sets of Label IDs. See [Label ID: Pre-loaded Sets, starting on page 257](#) for details on the USA set and EU set.

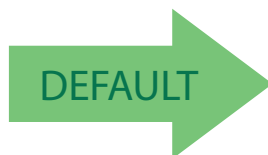


**Unlike some programming features and options, this feature requires that you scan only one programming bar code label. DO NOT scan an ENTER/EXIT bar code prior to scanning the bar codes below.**



**CAUTION**

**When changing from one Label ID set to another, all other reader configuration settings, including the host interface type, will be erased and set to the standard factory defaults. Any custom configuration or custom defaults will be lost.**



Label ID Pre-loaded Set = USA Set



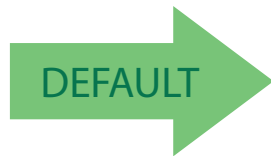
Label ID Pre-loaded Set = EU Set

## Individually Set Label ID

This feature configures a Label ID individually for a single symbology. To set, first define whether you want it as a prefix or suffix by scanning a label below. Then turn to [Label ID Symbology Selection • 1D Symbologies](#), starting on page 58 to select the symbology you want to set, followed by up to 3 characters from the ASCII Chart at the back of this manual. See "Label ID: Set Individually Per Symbology" on page 260 for detailed instructions on setting this feature.

### Label ID Control

This option controls whether a Label ID is disabled, or sent as a prefix or suffix for a given symbology type.



Label ID Transmission = Disable



Label ID Transmission = Enable as Prefix



Label ID Transmission = Enable as Suffix



### Label ID Symbology Selection – 1D Symbologies

This option selects the symbology for which a Label ID is to be configured. See "Label ID" on page 56 or page 260 in "References" for more detailed instructions.



**If less than the expected string of 3 characters are selected, scan the ENTER/EXIT bar code twice to accept the selection and exit Programming Mode.**



Set ABC Codabar Label ID Character(s)



Set Code 32 Pharmacode Label ID Character(s)



Set Anker Plessey Label ID Character(s)



Set Code 93 Label ID Character(s)



Set Australian Postal Code Label ID Character(s)



Set Concatenated ISBT 128 Label ID Character(s)



Set Codabar Label ID Character(s)



Set Danish PPT Label ID Character(s)



Set Code 11 Label ID Character(s)



Set EAN 13 Label ID Character(s)



Set Code 128 Label ID Character(s)



Set EAN 13 Composite Label ID Character(s)



Set Code 39 Label ID Character(s)



Set EAN 13 P2 Label ID Character(s)

## Label ID Symbology Selection – 1D Symbologies (continued)



Set Code 39 CIP Label ID Character(s)



Set EAN 13 P5 Label ID Character(s)



Set EAN 8 Label ID Character(s)



Set GS1 DataBar Expanded Composite Label ID Character(s)



Set EAN 8 Composite Label ID Character(s)



Set GS1-128 Label ID Character(s)



Set EAN 8 P2 Label ID Character(s)



Set GS1-128 Composite Label ID Character(s)



Set EAN 8 P5 Label ID Character(s)



Set GSI DataBar Limited Label ID Character(s)



Set Follett 2 of 5 Label ID Character(s)



GSI DataBar Limited Composite Label ID Character(s)



Set GS1 DataBar 14 Label ID Character(s)



Set GTIN 2 Label ID Character(s)



Set GS1 DataBar 14 Composite Label ID Character(s)



Set GTIN 5 Label ID Character(s)



## Label ID Symbology Selection – 1D Symbologies (continued)



Set GS1 DataBar Expanded Label ID Character(s)



Set GTIN 8 Label ID Character(s)



Set IATA Industrial 2 of 5 Label ID Character(s)



Set LaPoste Code 39 Label ID Character(s)



Set IMB Postal Code Label ID Character(s)



Set MSI Label ID Character(s)



Set Industrial 2 of 5 Label ID Character(s)



Set Planet Postal Code Label ID Character(s)



Set Interleaved 2 of 5 Label ID Character(s)



Set Plessey Label ID Character(s)



Set ISBN Label ID Character(s)



Set Portugal Postal Code Label ID Character(s)



Set ISSN Label ID Character(s)



Set Postnet Label ID Character(s)



Set Japan Postal Code Label ID Character(s)



Set Kix Postal Code Label ID Character(s)

## Label ID Symbology Selection – 1D Symbologies (continued)



Set PZN Code Label ID Character(s)



Set Postnet BB Label ID Character(s)



Set Royal Postal Code Label ID Character(s)



Set UPC-A Composite Label ID Character(s)



Set Standard 2 of 5 Label ID Character(s)



Set UPC-A P2 Label ID Character(s)



Set Swedish Postal Code Label ID Character(s)



Set UPC-A P5 Label ID Character(s)



Set Trioptic Code Label ID Character(s)



Set UPC-E Label ID Character(s)



Set UPC-A Label ID Character(s)



Set UPC-E P5 Label ID Character(s)



## Label ID Symbology Selection – 2D Symbologies



Set Aztec Label ID Character(s)



Set Maxicode Label ID Character(s)



Set China Sensible Label ID Character(s)



Set PDF 417 Label ID Character(s)



Set Codablock F Label ID Character(s)



Set Micro PDF 417 Label ID Character(s)



Set Data Matrix Label ID Character(s)



Set QR Code Label ID Character(s)



Set Micro QR Label ID Character(s)



## No Read Message

This feature Enables/Disables the No Read Message feature. When Disabled, nothing is sent if the trigger is pressed and released when no code has been decoded during a reading phase. Otherwise, the No Read String is sent. (See "No Read String" on page 263 to configure No Read String data)



Disabled



Enabled

## No Read String

This feature defines the string or character to be displayed in case of No Read during a reading phase (On Line and Serial On Line Modes only). It allows up to 20 characters, from the set of ASCII characters or any hex value from 00 to FE.



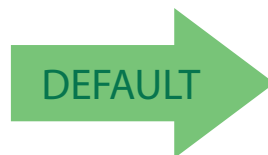
Select No Read String

To configure this feature, scan the ENTER/EXIT PROGRAMMING MODE barcode above, then the barcode at left followed by the digits (in hex) from the Alphanumeric characters in [Appendix E Keypad](#) representing your desired character(s). If less than the expected string of 20 characters are selected, scan the ENTER/EXIT barcode to terminate the string. End by scanning the ENTER/EXIT barcode again.

Make a mistake? Scan the CANCEL barcode to abort and not save the entry string. You can then start again at the beginning.



CANCEL



**0x18 = (CAN)**

See "No Read String" on page 263 for more information on setting this feature.



## CODE VERIFIER

This feature allows the scanner to verify that all codes read and decoded match a defined string saved in its memory. It is valid when in On Line, Serial On Line, Automatic and Automatic (Object Sense) Operating Modes.

If the code read matches the code verifier Match String, then it is sent to the host through the configured port. If it does not match the code verifier Match String, you can specify whether to send either the Wrong Code or a defined Wrong String message to indicate the error.

See "Code Verifier" on page 263 in References for more information about these features.

### Code Verifier Mode

Disable or specify parameters for Code Verifier Mode. See "Code Verifier Mode" on page 263 in References for more information.



Disabled



Transmit Wrong String



Transmit Wrong Code

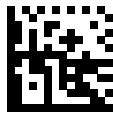
## Match String

This feature allows you to define the string to be used as the match code for Code Verification. The Match String must be configured to include start/stop characters and check digits if their transmission is enabled. See "[Match String](#)" on page 263 in References for more information.

It is possible to define the Match string by inserting:

- all printable characters
- non printable ASCII characters

No wild card characters are supported.



Set Match String

To configure this feature, scan the ENTER/EXIT PROGRAMMING MODE barcode above, then the barcode at left followed by the digits (in hex) from the Alphanumeric characters in [Appendix E Keypad](#) representing your desired character(s). End by scanning the ENTER/EXIT barcode again.

Make a mistake? Scan the CANCEL barcode to abort and not save the entry string. You can then start again at the beginning.



CANCEL

## Wrong Code String

See "[Wrong Code String](#)" on page 264 in References for more information about this feature.



Set Wrong Code String

To configure this feature, scan the ENTER/EXIT PROGRAMMING MODE barcode above, then the barcode at left followed by the digits (in hex) from the Alphanumeric characters in [Appendix E Keypad](#) representing your desired character(s). End by scanning the ENTER/EXIT barcode again.

Make a mistake? Scan the CANCEL barcode to abort and not save the entry string. You can then start again at the beginning.



CANCEL

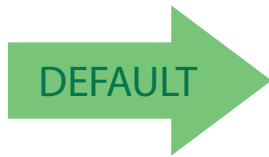


### Label Transmit Mode

Specifies whether the decoded label must be transmitted to the host as it has been decoded or after the reading phase has been deactivated (Phase Off).



Phase Off



On Decode

### Advanced Formatting: User Label Edit

Advanced formatting is available to create user label edit scripts. See the Datalogic Aladdin configuration application or contact Technical Support.

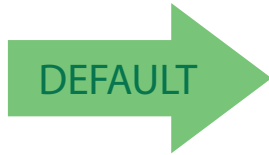


### Case Conversion

This feature allows conversion of the case of all alphabetic characters to upper or lower case.



**Case conversion affects ONLY scanned bar code data, and does not affect Label ID, Prefix, Suffix, or other appended data.**



Case Conversion = Disable (no case conversion)



Case Conversion = Convert to upper case



Case Conversion = Convert to lower case

### Character Conversion

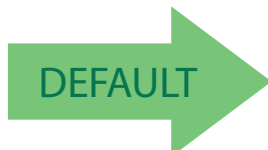
Character conversion is an eight byte configuration item. The eight bytes are 4 character pairs represented in hexadecimal ASCII values. The first character in the pair is the character that will be converted. The second character in the pair is the character to convert to. If the character to convert in a pair is FF, then no conversion is done.



**If less than the expected string of 16 characters are selected, scan the ENTER/EXIT bar code twice to accept the selections and exit Programming Mode.**



Configure Character Conversion



**0xFFFFFFFFFFFFFFFF  
(No character conversion)**



# NOTES

# DIGITAL OUTPUT



Digital Output only pertains to the GFS4450-9 RS232 interface.

<b>ACTIVATION EVENT</b> on page 70
<b>DEACTIVATION EVENT</b> on page 71
<b>DEACTIVATION TIMEOUT</b> on page 71
<b>ACTIVATION STATE</b> on page 72

See “References” starting on [page 254](#) for more information about Digital Output.

Use the programming barcodes in this chapter to select options for Digital Outputs. Reference [Appendix C](#), for a listing of standard factory settings.



## Activation Event

Defines the event activating the output.



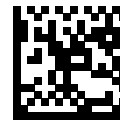
Disable



Good Read



No Read

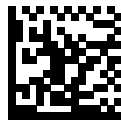


Wrong Code



## Deactivation Event

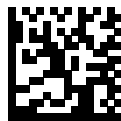
Defines the event deactivating the output. See "Wrong Code String" on page 264 in "References" for more information about this feature.



Disable



Timeout



Reading Phase Active

## Deactivation Timeout

When Timeout is the selected Deactivation Event, this specifies the maximum duration of the output pulse.



Set Deactivation Timeout

To configure this feature, scan the ENTER/EXIT PROGRAMMING MODE barcode above, then the barcode at left followed by the digits (in hex) from the Alphanumeric characters in [Appendix E, Keypad](#) representing your desired character(s). Exit programming mode by scanning the ENTER/EXIT barcode again.

Make a mistake? Scan the CANCEL barcode to abort and not save the entry string. You can then start again at the beginning.



CANCEL



**005 = 500 msec**



## Activation State

Determines the active state of the output.



Closed



Open

## READING PARAMETERS

<b>DOUBLE READ TIMEOUT</b> on page 74	<b>GOOD READ BEEP FREQUENCY</b> on page 76
<b>LED AND BEEPER INDICATORS</b> on page 75	<b>GOOD READ BEEP LENGTH</b> on page 77
<b>POWER ON ALERT</b> on page 75	<b>GOOD READ BEEP VOLUME</b> on page 78
<b>GOOD READ: WHEN TO INDICATE</b> on page 75	<b>GOOD READ LED DURATION</b> on page 79
<b>GOOD READ BEEP TYPE</b> on page 76	
<b>SCANNING FEATURES</b>	
<b>OPERATING MODE</b> on page 80	<b>AIMING POINTER</b> on page 86
<b>PHASE OFF EVENT</b> on page 81	<b>AIMING DURATION TIMER</b> on page 87
<b>PHASE OFF TIMEOUT</b> on page 81	<b>GREEN SPOT DURATION</b> on page 87
<b>SERIAL START CHARACTER</b> on page 82	<b>MOBILE PHONE MODE</b> on page 88
<b>SERIAL STOP CHARACTER</b> on page 82	<b>MOBILE BIAS</b> on page 88
<b>PRESENTATION MODE INDICATION</b> on page 83	<b>PARTIAL LABEL READING CONTROL</b> on page 89
<b>MANUAL TRIGGER CONTROL</b> on page 83	<b>MIRROR READING MODE</b> on page 89
<b>CENTRAL CODE ONLY</b> on page 84	<b>DECODE NEGATIVE IMAGE</b> on page 90
<b>ILLUMINATION OFF TIME</b> on page 84	<b>IMAGE CAPTURE</b> on page 90
<b>ILLUMINATION ON TIME</b> on page 85	<b>MULTIPLE LABELS PER FRAME</b> on page 91
<b>SCANNING ACTIVE TIME</b> on page 85	<b>MULTIPLE LABELS ORDERING BY CODE SYMBOLOGY</b> on page 92
<b>PRESENTATION ILLUMINATION CONTROL</b> on page 86	<b>MULTIPLE LABELS ORDERING BY CODE LENGTH</b> on page 92



### Double Read Timeout

Double Read Timeout specifies the minimum time between consecutive good reads of labels of the same symbology and data. This prevents a double read of the same label. If the unit reads a label and sees the same label again within the specified timeout, the second read is ignored. Double Read Timeout does not apply to scan modes that require a trigger pull for each label read. The timeout can be set within a range of 20 milliseconds to 2,550 milliseconds (2.55 seconds) in 10ms increments.



Double Read Timeout = 0.1 Second



Double Read Timeout = 0.5 Second



Double Read Timeout = 1 Second



To specify your own setting, scan the bar code below followed by the appropriate characters from [Appendix E, Keypad](#). See [page 266](#) in “References” for detailed instructions and examples for setting this feature.



Select Double Read Timeout Setting

Make a mistake? Scan the CANCEL bar code to abort and not save the entry string. You can then start again at the beginning.



CANCEL

## LED AND BEEPER INDICATORS

### Power On Alert

Disables or enables the indication (from the Beeper) that the reader is receiving power.



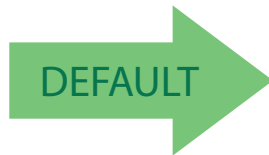
Power On Alert = Disable (No Audible Indication)



Power On Alert = Power-up Beep

### Good Read: When to Indicate

This feature specifies when the reader will provide indication (beep and/or flash its green LED) upon successfully reading a bar code.



Indicate Good Read = After Decode



Indicate Good Read = After Transmit

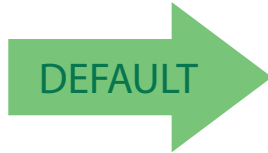


Indicate Good Read =  
After CTS goes inactive then active



### Good Read Beep Type

Specifies whether the good read beep has a mono or bitonal beep sound.



Good Read Beep Type = Mono



Good Read Beep Type = Bitonal

### Good Read Beep Frequency

Adjusts the good read beep to sound at a selectable low, medium or high frequency, selectable from the list below. (Controls the beeper's pitch/tone.)



Good Read Beep Frequency = Low

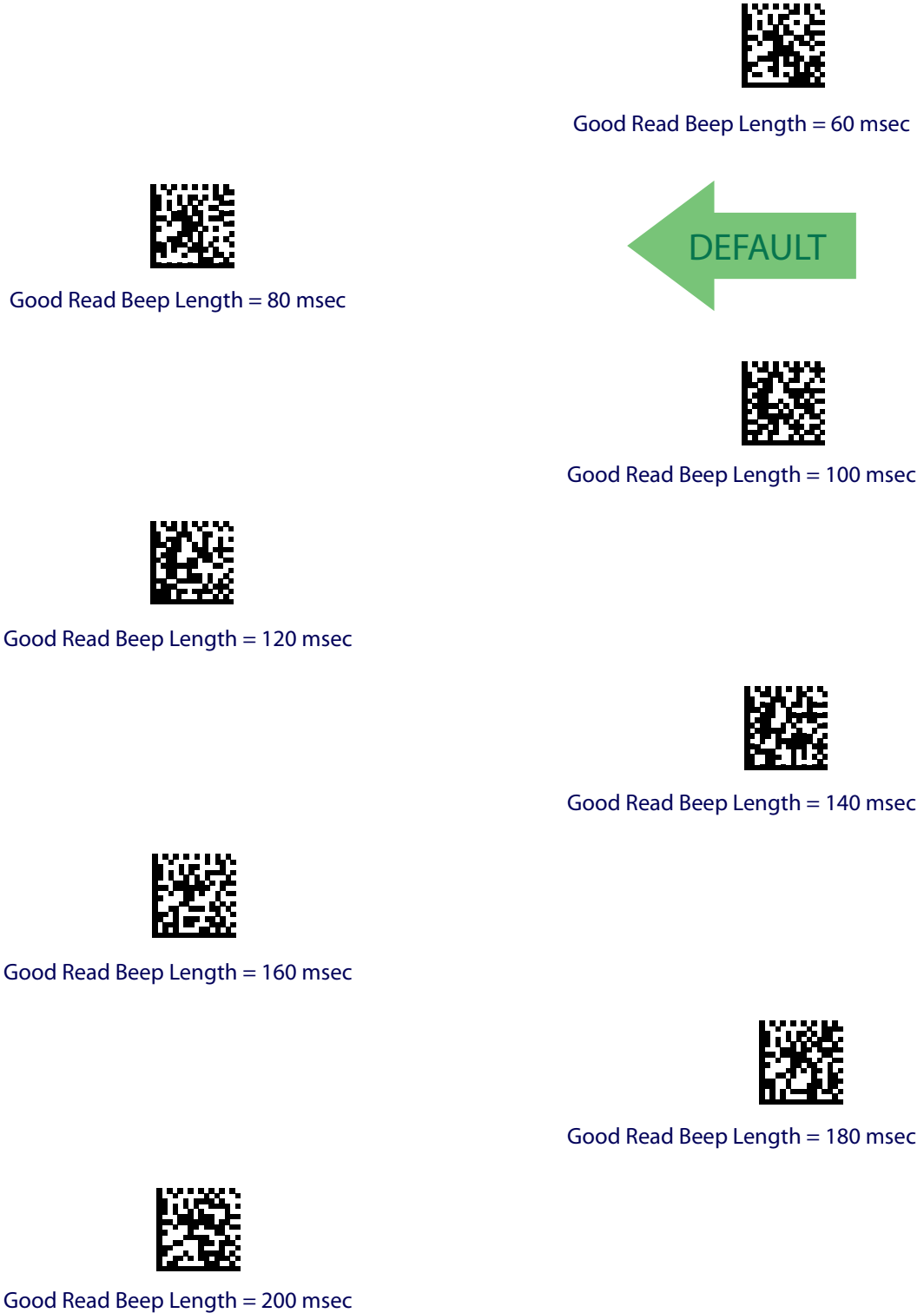


Good Read Beep Frequency = Medium



Good Read Beep Frequency = High

## Good Read Beep Length





## Good Read Beep Volume

Selects the beeper volume (loudness) upon a good read beep. There are three selectable volume levels.



Good Read Beep Volume = Beeper Off



Good Read Beep Volume = Low



Good Read Beep Volume = Medium



Good Read Beep Volume = High





### Good Read LED Duration

This feature specifies the amount of time that the Good Read LED remains on following a good read. The good read LED on time can be set within a range of 100 milliseconds to 25,500 milliseconds (0.1 to 25.5 seconds) in 100ms increments. A setting of 00 keeps the LED on until the next trigger push.

See [page 267](#) in “References” for detailed instructions and examples for setting this feature.



Good Read LED Duration Setting =  
Keep LED on until next trigger push



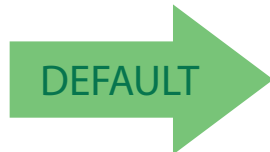
Select Good Read LED Duration Setting

To configure this feature, scan the ENTER/EXIT PROGRAMMING MODE bar code above, then the bar code at left followed by the digits from the Alphanumeric characters in [Appendix E, Keypad](#) representing your desired character(s). End by scanning the ENTER/EXIT bar code again.

Make a mistake? Scan the CANCEL bar code to abort and not save the entry string. You can then start again at the beginning.



CANCEL



**003 = Good Read LED stays on for 300 ms.**



## SCANNING FEATURES

### Operating Mode

Selects the reader's scan operating mode. See [page 268](#) in "References" for descriptions.



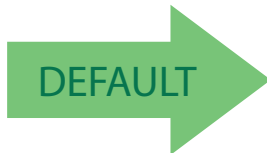
On Line



Serial On Line



Automatic



Automatic (Object Sense)

## Phase Off Event



Trigger Stop



Timeout



Trigger Stop - Timeout

## Phase Off Timeout

Timeout can be set within a range of 1 second to 255 seconds in 1 second intervals.



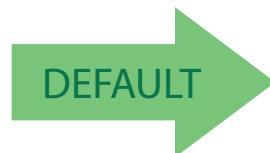
Scanning Active Time

To configure this feature scan the ENTER/EXIT PROGRAMMING MODE barcode above, then the barcode at left, followed by the digits (in hex) from the Alphanumeric characters in [Appendix E, Keypad](#) representing your desired character(s). End by scanning the ENTER/EXIT barcode again.

Make a mistake? Scan the CANCEL barcode to abort and not save the entry string. You can then start again at the beginning.



CANCEL



**5 = Timeout set for 5 seconds**



### Serial Start Character

See page 268 in “References” for more information.



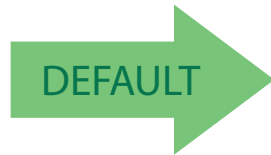
Select Serial Start Characters

To configure this feature scan the ENTER/EXIT PROGRAMMING MODE barcode above, then the barcode at left, followed by the digits (in hex) from the Alphanumeric characters in [Appendix E, Keypad](#) representing your desired character(s). End by scanning the ENTER/EXIT barcode again.

Make a mistake? Scan the CANCEL barcode to abort and not save the entry string. You can then start again at the beginning.



CANCEL



**0x02 = Serial Start Character is [02 STX]**

### Serial Stop Character

See page 268 in “References” for more information.



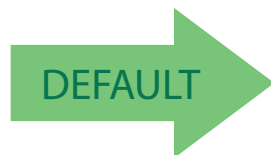
Select Serial Stop Characters

To configure this feature scan the ENTER/EXIT PROGRAMMING MODE barcode above, then the barcode at left, followed by the digits (in hex) from the Alphanumeric characters in [Appendix E, Keypad](#) representing your desired character(s). End by scanning the ENTER/EXIT barcode again.

Make a mistake? Scan the CANCEL barcode to abort and not save the entry string. You can then start again at the beginning.



CANCEL



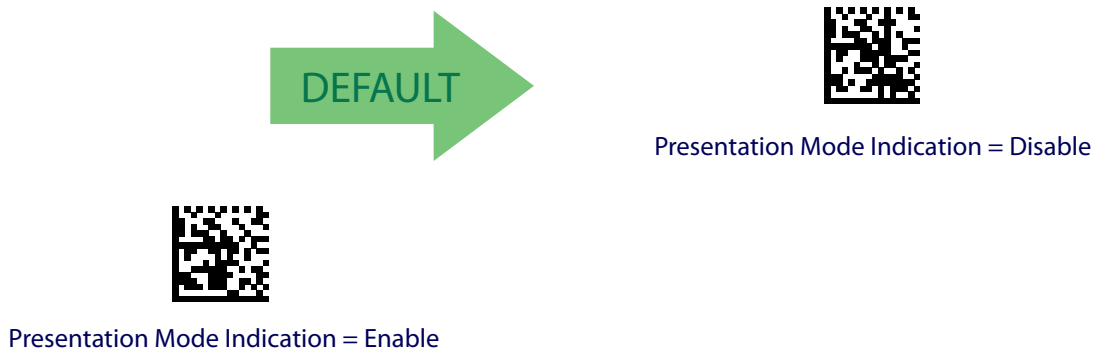
**0x03 = Serial Stop Character is [03 ETX]**



**The Serial Start/Stop Characters must be different and must not contain reserved characters (see [Appendix F, Reserved Characters](#))**

## Presentation Mode Indication

This operation is useful for indicating when the reader is in Automatic/Triggered Object Sense Operating Mode. If enabled, the blue indicator will blink when Presentation Mode scanning is active.



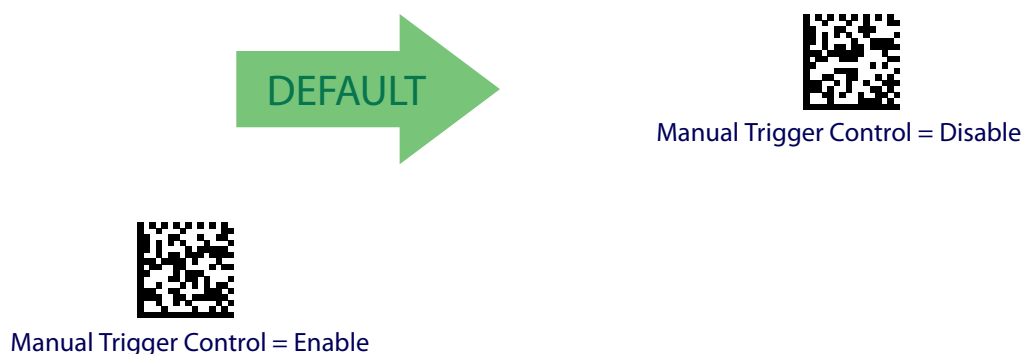
## Manual Trigger Control



This feature is available in Serial On Line mode only.

This feature is used to enable/disable manual trigger when the reader is in Serial On Line reading mode.

- Enable: allows a manual trigger push to start a reading phase.
- Disable: (default) locks out the trigger button and does not allow manual triggering to start a reading phase. When disabled, the trigger can still be activated once by pressing and holding the trigger for 5 seconds to enter Debug Mode.





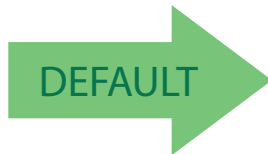
### Central Code Only

Specifies the ability of the reader to decode labels only when they are close to the center of the aiming pattern. This allows the reader to accurately target labels when they are placed close together, such as on a pick sheet.

See [Appendix B, Aimer Calibration](#) starting on page 285 for information about setting the aiming coordinates.



**This feature is not compatible with Multiple Labels Reading in a Volume.**



Central Code Only = Disable



Central Code Only = Enable

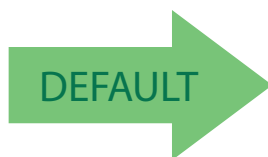
### Illumination Off Time

This feature defines the amount of time illumination is kept OFF after Illumination ON timeout. When illumination OFF expires, Object Sense is resumed. This configuration is available in Automatic (Object Sense) only. Range is 0 millisecond to 25.5 milliseconds in 100 millisecond intervals.



Select Presentation Mode Time Setting

To configure this feature, scan the ENTER/EXIT PROGRAMMING MODE bar code above, then the bar code at left followed by the digits from the Alphanumeric characters in [Appendix E, Keypad](#) representing your desired character(s). End by scanning the ENTER/EXIT bar code again.



**0 milliseconds**

### Illumination On Time

Defines the amount of time illumination is kept ON after a label is decoded. If an object is detected before Illumination ON expires, the timer is refreshed with the Object Gone timeout value. Range is 0 millisecond to 25.5 milliseconds in 100 millisecond intervals.

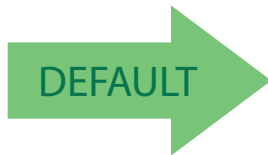


**This configuration is available in Automatic (Object Sense) only.**



Select Presentation Mode Time Setting

To configure this feature, scan the ENTER/EXIT PROGRAMMING MODE bar code above, then the bar code at left followed by the digits from the Alphanumeric characters in [Appendix E, Keypad](#) representing your desired character(s). End by scanning the ENTER/EXIT bar code again.



**1 Second**

### Scanning Active Time

This setting specifies the amount of time that the reader stays in scan ON state once the state is entered. The range for this setting is from 1 to 255 seconds in 1-second increments. See [page 270](#) in “References” for further description of this feature.



**Scanning Active Time works in On Line and Serial On Line Read modes as the Timeout Phase Off Event. See also "Phase Off Timeout" on [page 81](#).**



Scanning Active Time = 3 seconds



Scanning Active Time = 5 seconds

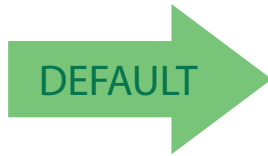


Scanning Active Time = 8 seconds



### Presentation Illumination Control

Controls the illumination status while the reading mode is Automatic Trigger Object Sense Operating Mode and the reader is attempting to detect objects.



Illumination Control = OFF



Illumination Control = ON



Illumination Control = Dim

### Aiming Pointer

Enables/disables the aiming pointer for all symbologies.



Aiming Pointer = Disable



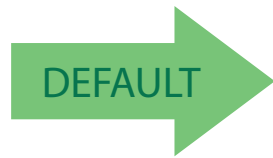
Aiming Pointer = Enable





## Aiming Duration Timer

Specifies the frame of time the aiming pointer remains on after decoding a label, when in On Line or Serial On Line mode. The range for this setting is from 1 to 255 seconds in 1-second increments. See [page 271](#) in “References” for a description of this feature.



Set Aiming Duration Timer



Aiming Off After Decoding

To configure, scan the ENTER/EXIT PROGRAMMING MODE bar code above, then the bar code at left followed by the digits from the Alphanumeric characters in [Appendix E, Keypad](#) representing your desired character(s). End by scanning the ENTER/EXIT bar code.

Make a mistake? Scan the CANCEL bar code to abort and not save the entry string. You can then start again at the beginning.



CANCEL

## Green Spot Duration

Specifies the duration of the good read pointer beam after a good read.



Green Spot Duration = Short (300 msec)



Green Spot Duration = Disable (Green Spot is Off)



Green Spot Duration = Medium (500 msec)



Green Spot Duration = Long (800 msec)



### Mobile Phone Mode

This mode is useful for scanning bar codes displayed on a mobile phone. Other options for this feature can be configured using the Datalogic Aladdin application.



Mobile Phone Mode = Disable



Mobile Phone Mode = Enable



### Mobile Bias

This variable mode alters scan module operation, optimizing barcode scanning for reading from mobile device displays rather than standard labels. The range for this setting is from 0 to 255.



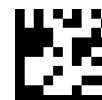
No Mobile Bias



Set Mobile Bias

To configure, scan the ENTER/EXIT PROGRAMMING MODE bar code above, then the bar code at left followed by the digits from the Alphanumeric characters in [Appendix E, Keypad](#) representing your desired character(s). End by scanning the ENTER/EXIT bar code.

Make a mistake? Scan the CANCEL bar code to abort and not save the entry string. You can then start again at the beginning.



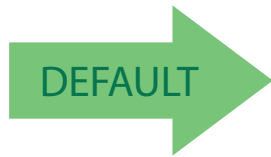
CANCEL

## Partial Label Reading Control

Enable/Disable the option to ignore partial labels to be read within the boundary of the field of view.



Partial Label Reading Control = Disable



Partial Label Reading Control = Enable

## Mirror Reading Mode

Enable/Disable the ability to decode the mirror image of a bar code label. This feature pertains mainly to 2D barcodes: Data Matrix, Maxicode, QR Code Aztec and PDF-417. All 1D codes can be read backwards without changing settings.



**Unlike some programming features and options, Mirror Reading Mode requires that you scan only one programming bar code label. DO NOT scan an ENTER/EXIT bar code prior to scanning a Mirror Reading Mode bar code.**



**CAUTION**

**When this feature is enabled, you will be unable to read other programming labels in this manual.**



Mirror Reading Mode = Disable



Mirror Reading Mode = Enable



### Decode Negative Image

Enable/Disable the ability to decode a negative image for all symbologies. When this feature is enabled, you will be unable to read normally-printed labels or programming labels in this manual. Scan the “Disable” bar code below to return the scanner to its default for this feature. To set the reader to decode only 2D codes, go to "2D Normal/Inverse Symbol Control" on page 187.

For additional options, see the Aladdin configuration application.

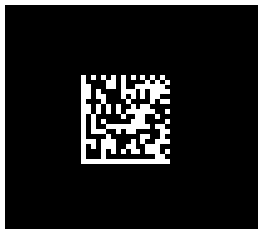


Unlike some programming features and options, Decode Negative Image selections require that you scan only one programming bar code label. DO NOT scan an ENTER/EXIT bar code prior to scanning a Decode Negative Image bar code.



CAUTION

When this feature is enabled, you will be unable to read other programming labels in this manual.



Decode Negative Image = Disable



DEFAULT



Decode Negative Image = Enable

### Image Capture

For information and a list of options for Image Capture, use the Datalogic Aladdin configuration application, available for free download from the Datalogic website.

## MULTIPLE LABEL READING

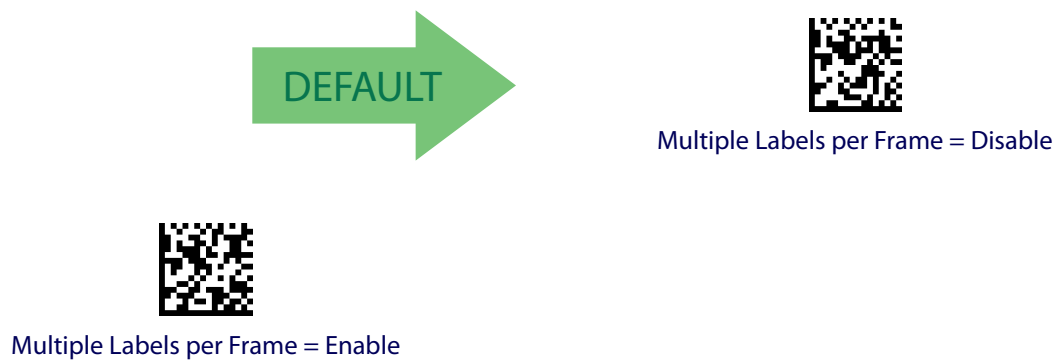
When the reader's aiming system is activated by a trigger push or other method (depending on the mode), it then acquires and processes each image in the area in front of it (the Volume). In this case, the scanner stops processing the image once it decodes a label. If several labels are present in the volume, only the first label encountered is decoded and sent.

When Multiple Reading Mode is enabled, the scanner keeps on processing the image until all the labels present are decoded. The reader then sorts the data from all the bar codes (if configured to do so) before transmitting it.

### Multiple Labels per Frame

Specifies the ability of the reader to decode and transmit a set of code labels in a specific volume and in a single frame of time. When in Multiple Labels per Frame the reader beeps and turns on the good read LED indication for each code read in a frame.

When Multiple Labels Mode is enabled, ISBT pairing, ABC Codabar pairing, and composites are not allowed.



## Multiple Labels Ordering by Code Symbology

This feature allows you to specify the order multiple labels are transmitted by symbology type, when Multiple Labels per Frame is enabled. See page 272 in “References” for detailed information on setting this feature.



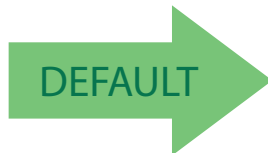
Select Symbologies for Multiple Labels Ordering

To configure this feature, scan the ENTER/EXIT PROGRAMMING MODE bar code above, then the bar code at left followed by the digits From the alphanumeric characters In Appendix d, keypad representing your desired Character(s). End by scanning the enter/exit bar code again.

Make a mistake? Scan the CANCEL bar code to abort and not save the entry string. You can then start again at the beginning.



CANCEL



00000000000 = Random order

## Multiple Labels Ordering by Code Length

Specifies the transmission ordering by code length, when Multiple Labels per Frame is enabled.



Multiple Labels Ordering = Disable



Transmit Increasing Length Order



Transmit Decreasing Length Order

# SYMBOLOGIES

## 1D Code Selection

The reader supports the following 1D symbologies (bar code types). See "2D Symbologies" starting on page 185 for 2D bar codes. Symbology-dependent options are included in each chapter.

- Disable All Symbologies on page 94
- Code EAN/UPC on page 95
- UPC-E on page 98
- GTIN Formatting on page 101
- EAN 13 (Jan 13) on page 102
- ISSN on page 104
- EAN 8 (Jan 8) on page 105
- UPC/EAN Global Settings on page 107
- Add-Ons on page 109
- Code 39 on page 116
- Trioptic Code on page 122
- Code 32 (Ital Pharmaceutical Code) on page 122
- Code 39 CIP (French Pharmaceutical) on page 124
- Code 39 Danish PPT on page 124
- Code 39 LaPoste on page 125
- Code 39 PZN on page 125
- Code 128 on page 126
- GS1-128 on page 132
- Code ISBT 128 on page 133
- Interleaved 2 of 5 (I 2 of 5) on page 136
- Interleaved 2 of 5 CIP HR on page 141
- "Follett 2 of 5" on page 141
- Standard 2 of 5 on page 142
- Industrial 2 of 5 on page 146
- Code IATA on page 150
- Codabar on page 151
- ABC Codabar on page 157
- Code 11 on page 160
- GS1 DataBar™ Omnidirectional on page 164
- GS1 DataBar™ Expanded on page 165
- GS1 DataBar™ Limited on page 170
- Code 93 on page 171
- MSI on page 176
- Plessey on page 181

Default settings are indicated at each feature/option with a green arrow. Also reference [Appendix C, Standard Defaults](#) for a listing of the most widely used set of standard factory settings. That section also provides space to record any custom settings needed or implemented for your system.

To set most features:

1. Scan the ENTER/EXIT PROGRAMMING bar code at the top of applicable programming pages.
2. Scan the correct bar code to set the desired programming feature or parameter. You may need to cover unused bar codes on the page, and possibly the facing page, to ensure that the reader reads only the bar code you intend to scan.
3. If additional input parameters are needed, go to [Appendix E, Keypad](#), and scan the appropriate characters from the keypad.



**Additional information about many features can be found in the "References" chapter.**

**If you make a mistake before the last character, scan the CANCEL bar code to abort and not save the entry string. You can then start again at the beginning.**

4. Complete the programming sequence by scanning the ENTER/EXIT PROGRAMMING bar code to exit Programming Mode.



## DISABLE ALL SYMBOLOGIES

Use this feature to disable all symbologies.

1. Scan the ENTER/EXIT PROGRAMMING Mode bar code.
2. Scan the Disable All Symbologies bar code.
3. Complete the programming sequence by scanning the ENTER/EXIT PROGRAMMING bar code.



Disable All Symbologies



**This does not disable the reading of programming labels.**





## CODE EAN/UPC

### Coupon Control

This feature is used to control the reader's method of processing coupon labels.



Coupon Control = Allow all coupon bar codes to be decoded



Coupon Control = Enable only UPCA coupon decoding



Coupon Control = Enable only GS1 DataBar™ coupon decoding



## UPC-A

The following options apply to the UPC-A symbology.

### UPC-A Enable/Disable

When disabled, the reader will not read UPC-A bar codes.



UPC-A = Enable



UPC-A = Disable



### UPC-A Check Character Transmission

Enable this option to transmit the check character along with UPC-A bar code data.



UPC-A Check Character Transmission = Send

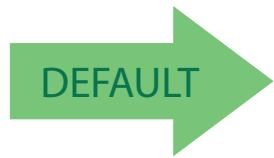


UPC-A Check Character Transmission = Don't Send



## Expand UPC-A to EAN-13

Expands UPC-A data to the EAN-13 data format. Selecting this feature also changes the symbology ID to match those required for EAN-13.



UPC-A to EAN-13 = Don't Expand



UPC-A to EAN-13 = Expand

## UPC-A Number System Character Transmission

This feature enables/disables transmission of the UPC-A number system character.



UPC-A Number System Character = Do not transmit



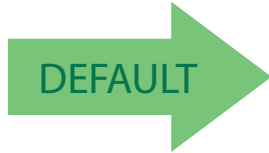
UPC-A Number System Character = Transmit





### UPC-A 2D Component

This feature enables/disables a requirement that a 2D label component be decoded when a base label of this symbology is decoded.



EAN-13 2D Component =  
Disable (2D component not required)



EAN-13 2D Component =  
2D component must be decoded

### UPC-E

The following options apply to the UPC-E symbology.

#### UPC-E Enable/Disable

When disabled, the reader will not read UPC-E bar codes.



UPC-E = Disable

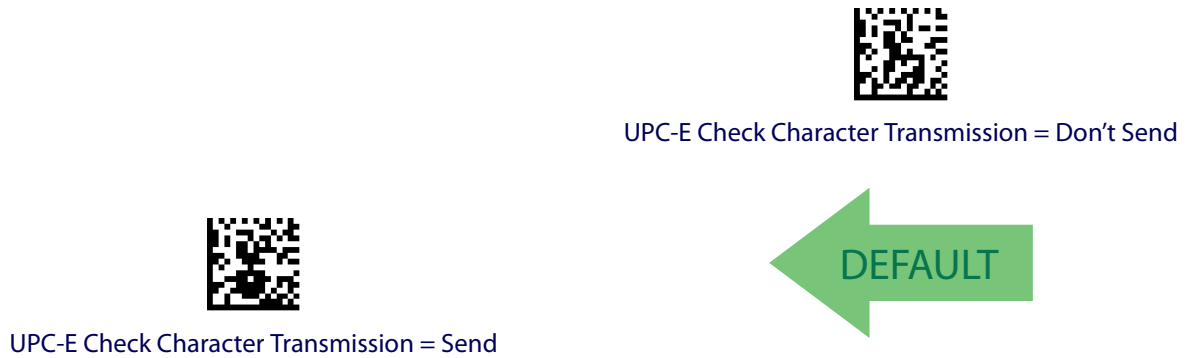


UPC-E = Enable



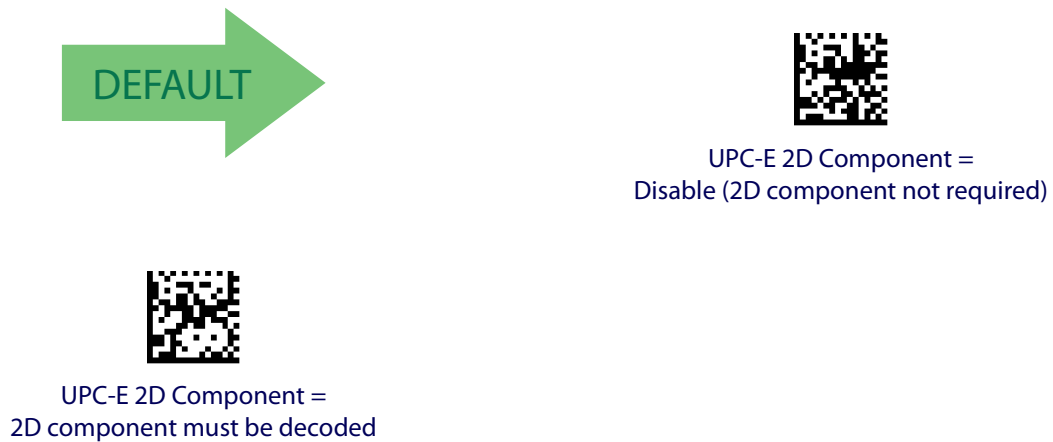
## UPC-E Check Character Transmission

Enable this option to transmit the check character along with UPC-E bar code data.



## UPC-E 2D Component

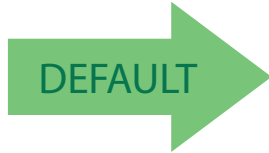
This feature enables/disables a requirement that a 2D label component be decoded when a base label for this symbology is decoded.





### Expand UPC-E to EAN-13

Expands UPC-E data to the EAN-13 data format. Selecting this feature also changes the symbology ID to match those required for EAN-13.



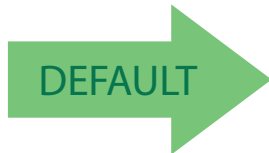
UPC-E to EAN-13 = Don't Expand



UPC-E to EAN-13 = Expand

### Expand UPC-E to UPC-A

Expands UPC-E data to the UPC-A data format.



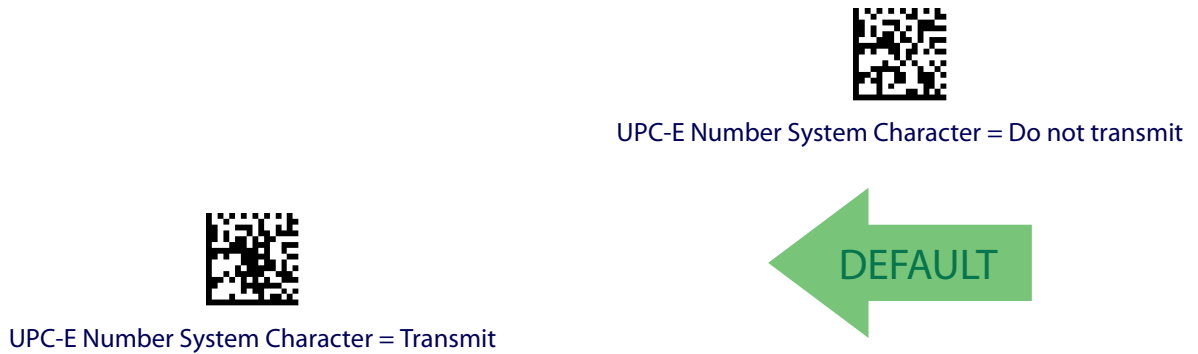
UPC-E to UPC-A = Don't Expand



UPC-E to UPC-A = Expand

## UPC-E Number System Character Transmission

This feature enables/disables transmission of the UPC-E system number character.



## GTIN FORMATTING

This feature enables/disables the ability to convert UPC-E, UPC-A, EAN 8, and EAN 13 labels into the GTIN 14-character format.



**If add-on information is present on the base label prior to the conversion taking place, the add-on information will be appended to the converted GTIN label.**





## EAN 13 (JAN 13)

The following options apply to the EAN 13 (Jan 13) symbology.

### EAN 13 Enable/Disable

When disabled, the reader will not read EAN 13/JAN 13 bar codes.



EAN 13 = Enable



EAN 13 = Disable



### EAN 13 Check Character Transmission

Enable this option to transmit the check character along with EAN 13 bar code data.



EAN 13 Check Character Transmission = Send



EAN 13 Check Character Transmission = Don't Send





## EAN-13 Flag 1 Character

Enables/disables transmission of an EAN/JAN13 Flag1 character. The Flag 1 character is the first character of the label.



## EAN-13 ISBN Conversion

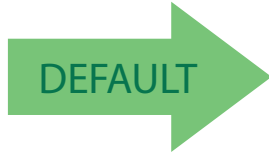
This option enables/disables conversion of EAN 13/JAN 13 Bookland labels starting with 978 to ISBN labels.





### **EAN-13 2D Component**

This feature enables/disables a requirement that a 2D label component be decoded when a base label of this symbology is decoded.



EAN-13 2D Component =  
Disable (2D component not required)



EAN-13 2D Component =  
2D component must be decoded

### **ISSN**

The following options apply to the ISSN symbology.

#### **ISSN Enable/Disable**

Enables/disables conversion of EAN/JAN13 Bookland labels starting with 977 to ISSN labels.



ISSN = Disable



ISSN = Enable

## EAN 8 (JAN 8)

The following options apply to the EAN 8 (Jan 8) symbology.

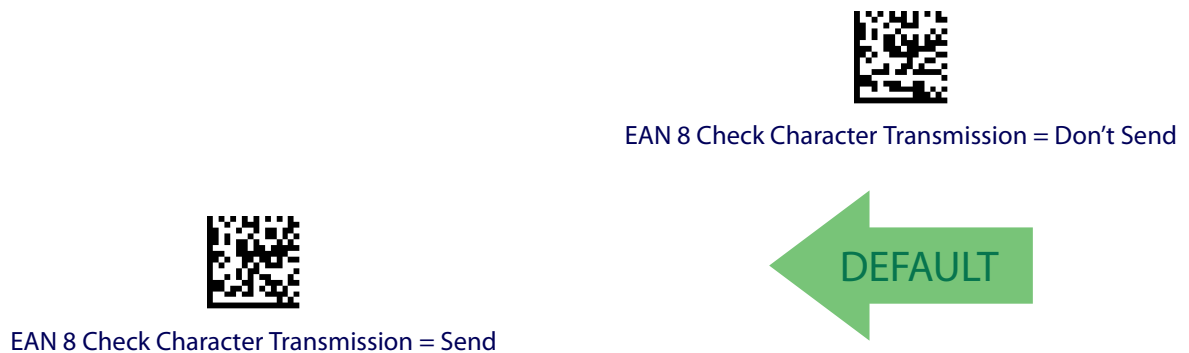
### EAN 8 Enable/Disable

When disabled, the reader will not read EAN 8/JAN 8 bar codes.



### EAN 8 Check Character Transmission

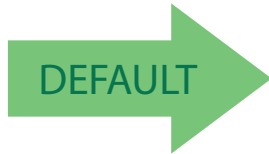
Enable this option to transmit the check character along with EAN 8 bar code data.





### Expand EAN 8 to EAN 13

Enable this option to expand EAN 8/JAN 8 labels to EAN 13/JAN 13.



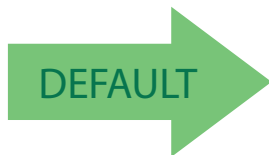
Expand EAN 8 to EAN 13 = Disable



Expand EAN 8 to EAN 13 = Enable

### EAN 8 2D Component

This feature enables/disables a requirement that a 2D label component be decoded when a base label for this symbology is decoded.



EAN 8 2D Component =  
Disable (2D component not required)



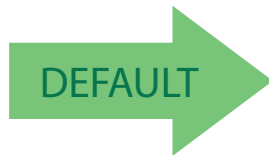
EAN 8 2D Component =  
2D component must be decoded

## UPC/EAN GLOBAL SETTINGS

This section provides configuration settings for UPC-A, UPC-E, EAN 13 and EAN 8 symbologies, and affects all of these unless otherwise marked for each feature description.

### UPC/EAN Price Weight Check

This feature enables/disables calculation and verification of price/weight check digits.



Price Weight Check = Disabled



Price Weight Check = 4-digit price-weight check



Price Weight Check = 5-digit price-weight check



Price Weight Check = European 4-digit price-weight check

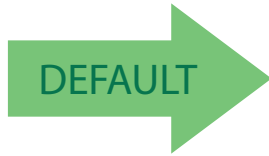


Price Weight Check = European 5-digit price-weight check



### UPC/EAN Quiet Zones

This feature specifies the number of quiet zones for UPC/EAN labels. Quiet zones are blank areas at the ends of a bar code, typically 10 times the width of the narrowest bar or space in the label. The property applies to all EAN-UPC symbologies globally and to the ADDONs.



UPC/EAN Quiet Zones = Two Modules



UPC/EAN Quiet Zones = Three Modules

## ADD-ONS

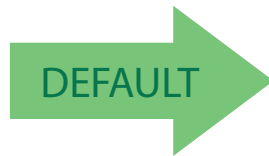
Contact Customer Support for advanced programming of optional and conditional add-ons.

### Optional Add-ons

The reader can be enabled to optionally read the following add-ons (supplementals):



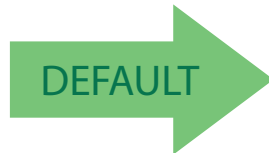
**If a UPC/EAN base label and an add-on are both decoded, the reader will transmit the base label and add-on. If a UPC/EAN base label is decoded without an add-on, the base label will be transmitted without an add-on. Conditional add-on settings (if enabled) are considered by the reader before optional add-on settings.**



Optional Add-Ons = Disable P2



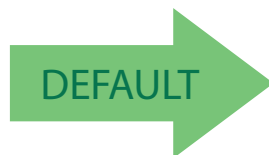
Optional Add-Ons = Enable P2



Optional Add-Ons = Disable P5



Optional Add-Ons = Enable P5



Optional Add-Ons = Disable GS1-128



Optional Add-Ons = Enable GS1-128



### Optional Add-On Timer

This option sets the time the reader will look for an add-on when an add-on fragment has been seen and optional add-ons are enabled. (Also see "Optional GS1-128 Add-On Timer" on page 113.)



Optional Add-on Timer = 10ms



Optional Add-on Timer = 20ms



Optional Add-on Timer = 30ms



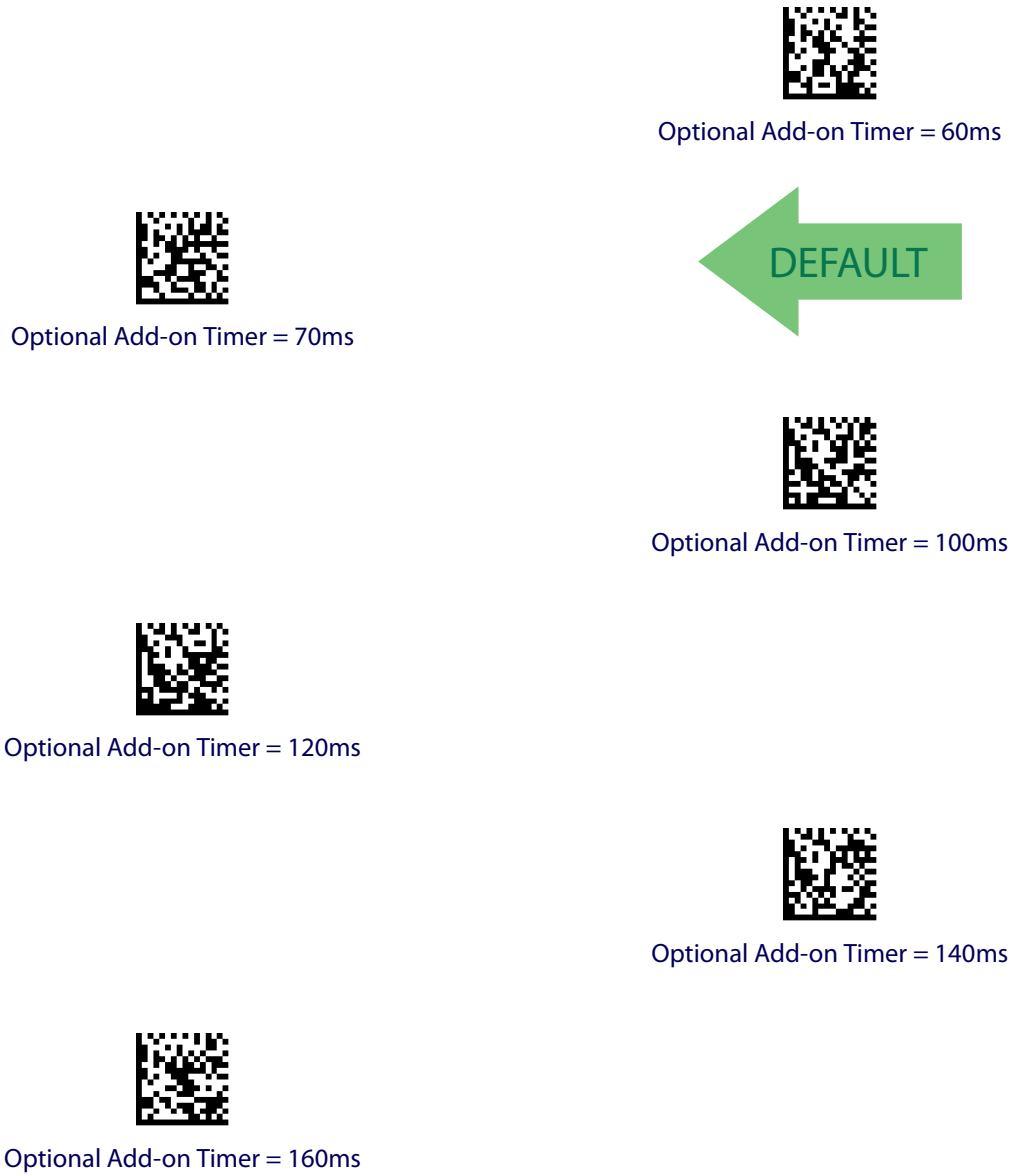
Optional Add-on Timer = 40ms



Optional Add-on Timer = 50ms



**Optional Add-On Timer — cont.**





## Optional Add-On Timer — cont.



Optional Add-on Timer = 180ms



Optional Add-on Timer = 200ms



Optional Add-on Timer = 220ms



Optional Add-on Timer = 240ms



Optional Add-on Timer = 260ms



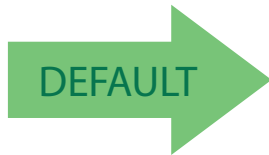
Optional Add-on Timer = 280ms



Optional Add-on Timer = 300ms

## Optional GS1-128 Add-On Timer

This option sets the timer expiration value to read the added part after reading the linear EAN/UPC part. For UPC/EAN add-ons other than those of that type, see "Optional Add-On Timer" on page 110.



Optional GS1-128 Add-On Timer = Disable



Optional GS1-128 Add-On Timer = 10ms



Optional GS1-128 Add-On Timer = 20ms



Optional GS1-128 Add-On Timer = 30ms



Optional GS1-128 Add-On Timer = 40ms



Optional GS1-128 Add-On Timer = 50ms



---

## Optional GS1-128 Add-On Timer — cont.



Optional GS1-128 Add-On Timer = 60ms



Optional GS1-128 Add-On Timer = 70ms



Optional GS1-128 Add-On Timer = 100ms



Optional GS1-128 Add-On Timer = 120ms



Optional GS1-128 Add-On Timer = 140ms



Optional GS1-128 Add-On Timer = 160ms

### Optional GS1-128 Add-On Timer — cont.



Optional GS1-128 Add-On Timer = 180ms



Optional GS1-128 Add-On Timer = 200ms



Optional GS1-128 Add-On Timer = 220ms



Optional GS1-128 Add-On Timer = 240ms



Optional GS1-128 Add-On Timer = 260ms



Optional GS1-128 Add-On Timer = 280ms



Optional GS1-128 Add-On Timer = 300ms



## CODE 39

The following options apply to the Code 39 symbology.

### Code 39 Enable/Disable



Code 39 = Enable



Code 39 = Disable



### Code 39 Check Character Calculation

Enable this option to enables/disables calculation and verification of an optional Code 39 check character. When disabled, any check character in the label is treated as a data character



Code 39 Check Character Calculation =  
Calculate Std Check



Code 39 Check Character Calculation = Don't Calculate



Code 39 Check Character Calculation =  
Calculate Mod 7 Check

### Code 39 Check Character Calculation — cont.



Code 39 Check Character Calculation =  
Enable Italian Post Check



Code 39 Check Character Calculation =  
Enable Daimler Chrysler Check

### Code 39 Check Character Transmission

Enable this option to transmit the check character along with Code 39 bar code data.



Code 39 Check Character Transmission = Don't Send



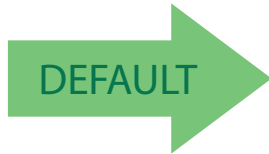
Code 39 Check Character Transmission = Send





### Code 39 Start/Stop Character Transmission

Enable this option to enable/disable transmission of Code 39 start and stop characters.



Code 39 Start/Stop Character Transmission =  
Don't Transmit



Code 39 Start/Stop Character Transmission = Transmit

### Code 39 Full ASCII

Enables/disables the translation of Code 39 characters to Code 39 full-ASCII characters.



Code 39 Full ASCII = Disable



Code 39 Full ASCII = Enable



## Code 39 Quiet Zones

This feature specifies the number of quiet zones for Code 39 labels. Quiet zones are blank areas at the ends of a bar code, typically 10 times the width of the narrowest bar or space in the label.



Code 39 Quiet Zones = Quiet Zones on two sides



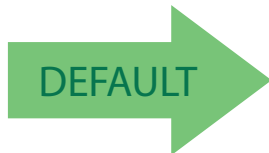
Code 39 Quiet Zones = Small Quiet Zones on two sides

## Code 39 Length Control

This feature specifies either variable length decoding or fixed length decoding for the Code 39 symbology.

**Variable Length:** For variable length decoding, a minimum and maximum length may be set.

**Fixed Length:** For fixed length decoding, two different lengths may be set.



Code 39 Length Control = Variable Length



Code 39 Length Control = Fixed Length



### Code 39 Set Length 1

This feature specifies one of the bar code lengths for [Code 39 Length Control](#). Length 1 is the minimum label length if in [Variable Length Mode](#), or the first fixed length if in [Fixed Length Mode](#). Length includes the bar code’s data characters only. The length can be set from 0 to 50 characters.

[Table 3](#) provides examples for setting Length 1. See [page 253](#) for detailed instructions on setting this feature.

**Table 3. Code 39 Length 1 Setting Examples**

STEP	ACTION	EXAMPLES			
1	<b>Desired Setting</b>	00 Characters	07 Characters	15 Characters	50 Characters
2	<b>Scan ENTER/EXIT PROGRAMMING MODE</b>				
3	<b>Scan SELECT CODE 39 LENGTH 1 SETTING</b>				
4	<b>Scan Two Characters From</b> <a href="#">Appendix E, Keypad</a>	'0' and '0'	'0' and '7'	'1' and '5'	'5' AND '0'
5	<b>Scan ENTER/EXIT PROGRAMMING MODE</b>				

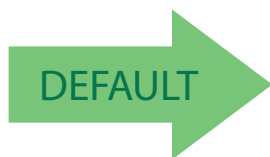


Select Code 39 Set Length 1 Setting

Make a mistake? Scan the CANCEL bar code to abort and not save the entry string. You can then start again at the beginning.



CANCEL



**02 = Length 1 is 2 Characters**

## Code 39 Set Length 2

This feature specifies one of the bar code lengths for [Code 39 Length Control](#). Length 2 is the maximum label length if in [Variable Length Mode](#), or the second fixed length if in [Fixed Length Mode](#). Length includes the bar code's check, data, and full-ASCII shift characters. The length does not include start/stop characters.

[Table 4](#) provides examples for setting Length 2. See [page 253](#) for detailed instructions on setting this feature.

**Table 4. Code 39 Length 2 Setting Examples**

STEP	ACTION	EXAMPLES			
1	<b>Desired Setting</b>	00 (Ignore This Length)	07 Characters	15 Characters	50 Characters
2	<b>Scan ENTER/EXIT PROGRAMMING MODE</b>				
3	<b>Scan SELECT CODE 39 LENGTH 2 SETTING</b>				
4	<b>Scan Two Characters From <a href="#">Appendix E, Keypad</a></b>	'0' and '0'	'0' and '7'	'1' and '5'	'5' AND '0'
5	<b>Scan ENTER/EXIT PROGRAMMING .MODE</b>				

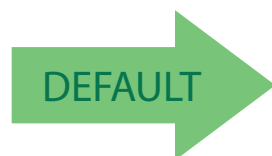


Select Code 39 Length 2 Setting

Make a mistake? Scan the CANCEL bar code to abort and not save the entry string. You can then start again at the beginning.



CANCEL



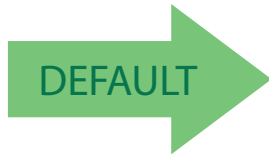
**50 = Length 2 is 50 Characters**



## TRIOPTIC CODE

The following options apply to the Trioptic symbology.

### Trioptic Code Enable/Disable



Trioptic Code = Disable



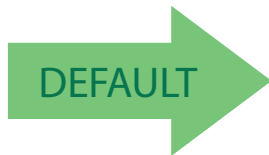
Trioptic Code = Enable

## CODE 32 (ITAL PHARMACEUTICAL CODE)

The following options apply to the Code 32 (Italian Pharmaceutical Code) symbology.

### Code 32 Enable/Disable

When disabled, the reader will not read Code 32 bar codes.



Code 32 = Disable



Code 32 = Enable

## Code 32 Feature Setting Exceptions



The following features are set for Code 32 by using these Code 39 settings:

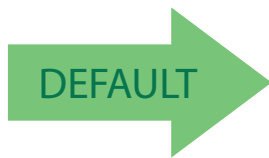
"Code 39 Quiet Zones" on page 119

"Code 39 Length Control" on page 119

"Trioptic Code" on page 122

## Code 32 Check Char Transmission

Enable this option to transmit the check character along with Code 32 bar code data.



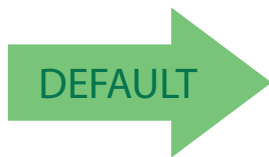
Code 32 Check Character Transmission = Don't Send



Code 32 Check Character Transmission = Send

## Code 32 Start/Stop Character Transmission

This option enables/disables transmission of Code 32 start and stop characters.



Code 32 Start/Stop Character Transmission = Don't Transmit



Code 32 Start/Stop Character Transmission = Transmit

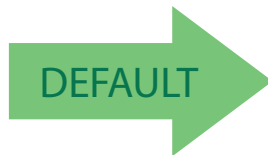


## CODE 39 CIP (FRENCH PHARMACEUTICAL)

The following options apply to the Code 39 CIP symbology.

### Code 39 CIP Enable/Disable

Enables/Disables ability of the reader to decode Code 39 CIP labels.



Code 39 CIP = Disable



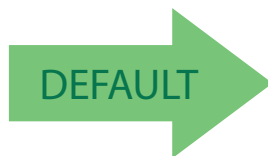
Code 39 CIP = Enable

## CODE 39 DANISH PPT

The following options apply to the Code 39 Danish PPT symbology.

### Code 39 Danish PPT Enable/Disable

Enables/Disables AIM ID for Code 39 Danish PPT Codes.



Code 39 Danish PPT = Disable



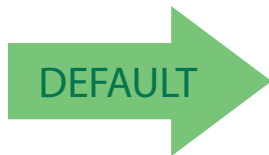
Code 39 Danish PPT = Enable

## CODE 39 LAPOSTE

The following options apply to the Code 39 LaPoste symbology.

### Code 39 LaPoste Enable/Disable

Enables/disables the ability of the scanner to decode Code39 La Poste labels.



Code 39 LaPoste = Disable



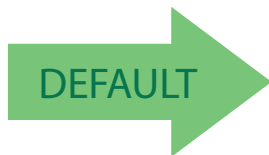
Code 39 LaPoste = Enable

## CODE 39 PZN

The following options apply to the Code 39 PZN symbology.

### Code 39 PZN Enable/Disable

Enables/disables the ability of the scanner to decode Code39 PZN labels.



Code 39 PZN = Disable



Code 39 PZN = Enable



## CODE 128

The following options apply to the Code 128 symbology.

### Code 128 Enable/Disable

When disabled, the reader will not read Code 128 bar codes.



Code 128 = Enable

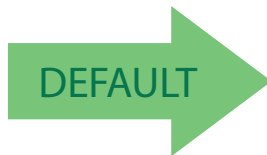


Code 128 = Disable



### Expand Code 128 to Code 39

This feature enables/disables expansion of Code 128 labels to Code 39 labels.



Code 128 to Code 39 = Don't Expand

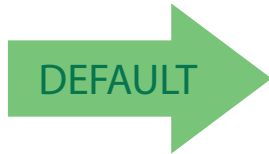


Code 128 to Code 39 = Expand



## Code 128 Check Character Transmission

Enable this option to transmit the check character along with Code 128 bar code data.



Code 128 Check Character Transmission = Don't Send



Code 128 Check Character Transmission = Send

## Code 128 Function Character Transmission

Enables/disables transmission of Code128 function characters 1, 2, 3, and 4.



Code 128 Function Character Transmission = Don't Send

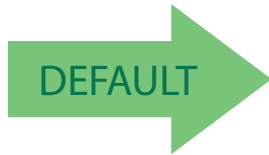


Code 128 Function Character Transmission = Send



### Code 128 Sub-Code Exchange Transmission

Enables/disables the transmission of “Sub-Code Exchange” characters (NOT transmitted by standard decoding).



Code 128 Sub-Code Exchange Transmission = Disable



Code 128 Sub-Code Exchange Transmission = Enable

### Code 128 Quiet Zones

This feature specifies the number of quiet zones for Code 128 labels. Quiet zones are blank areas at the ends of a bar code and are typically 10 times the width of the narrowest bar or space in the label.



Code 128 Quiet Zones = Quiet Zones on two sides

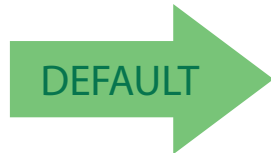


Code 128 Quiet Zones = Small Quiet Zones on two sides



## Code 128 Length Control

This feature specifies either variable length decoding or fixed length decoding for the Code 128 symbology. See [page 253](#) for more information.



Code 128 Length Control = Variable Length



Code 128 Length Control = Fixed Length



### Code 128 Set Length 1

Specifies one of the bar code lengths for [Code 128 Length Control](#). Length 1 is the minimum label length if in [Variable Length Mode](#), or the first fixed length if in [Fixed Length Mode](#). Length includes the bar code's data characters only. The length can be set from 1 to 80 characters.

[Table 5](#) provides some examples for setting Length 1. See [page 253](#) for detailed instructions on setting this feature.

**Table 5. Code 128 Length 1 Setting Examples**

STEP	ACTION	EXAMPLES			
1	<b>Desired Setting</b>	01 Character	07 Characters	15 Characters	80 Characters
2	<b>Scan ENTER/EXIT PROGRAMMING MODE</b>				
3	<b>Scan SELECT CODE 128 LENGTH 1 SETTING</b>				
4	<b>Scan Two Characters From</b> <a href="#">Appendix E, Keypad</a>	'0' and '1'	'0' and '7'	'1' and '5'	'8' AND '0'
5	<b>Scan ENTER/EXIT PROGRAMMING MODE</b>				

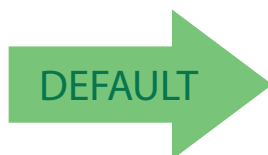


Select Code 128 Set Length 1 Setting

Make a mistake? Scan the CANCEL bar code to abort and not save the entry string. You can then start again at the beginning.



CANCEL



**01 = Length 1 is 1 Character**

## Code 128 Set Length 2

This feature specifies one of the bar code lengths for [Code 128 Length Control](#). Length 2 is the maximum label length if in [Variable Length Mode](#), or the second fixed length if in [Fixed Length Mode](#). Length includes the bar code’s data characters only.

The length can be set from 1 to 80 characters. A setting of 0 specifies to ignore this length (only one fixed length).

[Table 6](#) provides examples for setting Length 2. See [page 253](#) for detailed instructions on setting this feature.

**Table 6. Code 128 Length 2 Setting Examples**

STEP	ACTION	EXAMPLES			
1	<b>Desired Setting</b>	00 (Ignore This Length)	07 Characters	15 Characters	80 Characters
2	<b>Scan ENTER/EXIT PROGRAMMING MODE</b>				
3	<b>Scan SELECT CODE 128 LENGTH 2 SETTING</b>				
4	<b>Scan Two Characters From <a href="#">Appendix E, Keypad</a></b>	'0' and '0'	'0' and '7'	'1' and '5'	'8' and '0'
5	<b>Scan ENTER/EXIT PROGRAMMING MODE</b>				

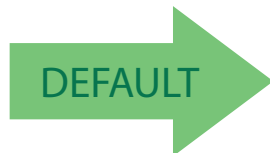


Select Code 128 Length 2 Setting

Make a mistake? Scan the CANCEL bar code to abort and not save the entry string. You can then start again at the beginning.



CANCEL



**80 = Length 2 is 80 Characters**



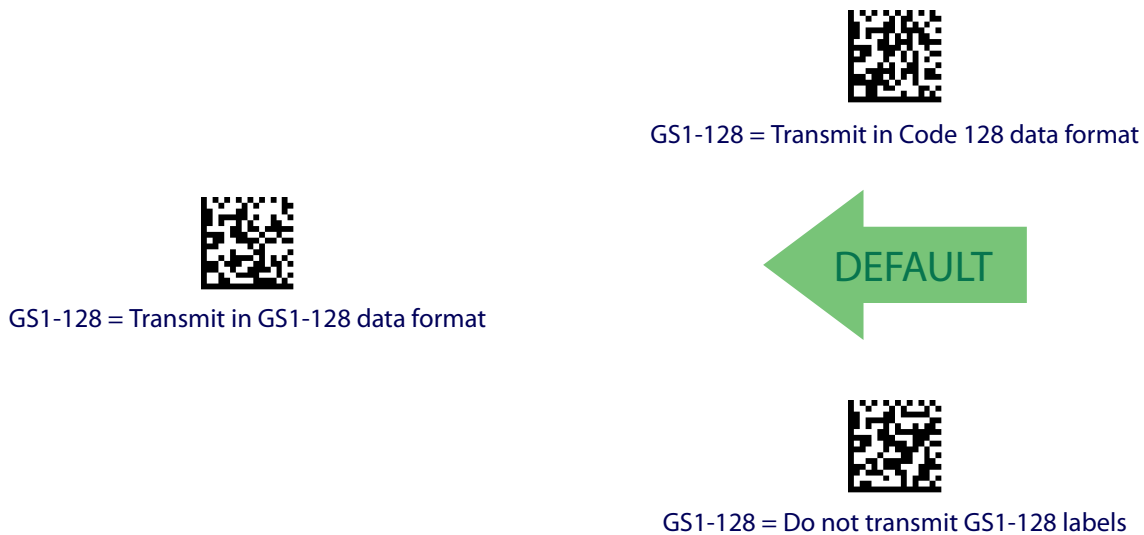
### GS1-128

The following options apply to the GS1-128 symbology. (Also known as USS-128, GS1-128, GTIN-128, UCC-128, EAN-128.)

#### GS1-128 Enable

This option enables/disables the ability of the reader to translate GS1-128 labels to the GS1-128 data format. Options are:

- Transmit GS1-128 labels in Code 128 data format.
- Transmit GS1-128 labels in GS1-128 data format.
- Do not transmit GS1-128 labels.



#### GS1-128 2D Component

This feature enables/disables a requirement that a 2D label component be decoded when a base label of this symbology is decoded.

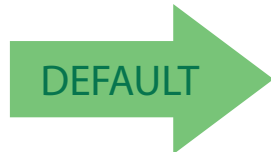


## CODE ISBT 128

The following options apply to the ISBT 128 symbology.

### ISBT 128 Concatenation

Use this option to enable/disable ISBT128 concatenation of 2 labels.



ISBN 128 Concatenation = Disable



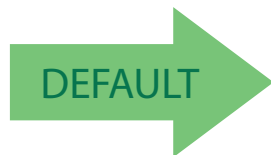
ISBN 128 Concatenation = Enable

### ISBT 128 Force Concatenation

When enabled, this feature forces concatenation for ISBT.



**This option is only valid when ISBT 128 Concatenation is enabled.**



ISBN 128 Force Concatenation = Disable



ISBN 128 Force Concatenation = Enable

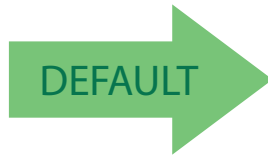


## ISBT 128 Concatenation Mode

Specifies the concatenation mode between Static and Dynamic.



**This option is only valid when ISBT 128 Concatenation is enabled (see "ISBT 128 Concatenation" on page 133).**



ISBT 128 Concatenation Mode = Static



ISBT 128 Concatenation Mode = Dynamic



## ISBT 128 Dynamic Concatenation Timeout

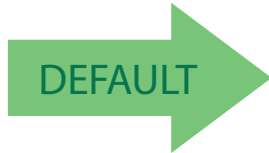
Specifies the timeout used by the ISBT 128 Dynamic Concatenation Mode.



ISBT 128 Dynamic Concatenation Timeout = 50 msec



ISBT 128 Dynamic Concatenation Timeout = 100 msec



ISBT 128 Dynamic Concatenation Timeout = 200 msec



ISBT 128 Dynamic Concatenation Timeout = 500 msec



ISBT 128 Dynamic Concatenation Timeout = 750 msec



ISBT 128 Dynamic Concatenation Timeout = 1 second

## ISBT 128 Advanced Concatenation Options



To set up pairs of label types for concatenation, use the Datalogic Aladdin configuration application or contact Datalogic Technical Support, as described on [page 10](#).

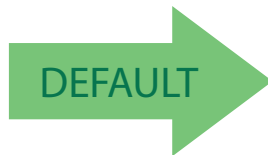


## INTERLEAVED 2 OF 5 (I 2 OF 5)

The following options apply to the I 2 of 5 symbology.

### I 2 of 5 Enable/Disable

When disabled, the reader will not read I 2 of 5 bar codes.



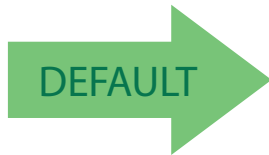
I 2 of 5 = Disable



I 2 of 5 = Enable

## I 2 of 5 Check Character Calculation

This option enables/disables calculation and verification of an optional I 2 of 5 check character. Combinations of these settings are possible via the Aladdin configuration utility, or contact Technical Support.



I 2 of 5 Check Character Calculation = Disable



I 2 of 5 Check Character Calculation = Check Standard  
(Modulo 10)



I 2 of 5 Check Character Calculation = Check German Parcel



I 2 of 5 Check Character Calculation = Check DHL



I 2 of 5 Check Character Calculation = Check Daimler Chrysler



I 2 of 5 Check Character Calculation = Check Bosch



I 2 of 5 Check Character Calculation = Italian Post



### I 2 of 5 Check Character Transmission

Enable this option to transmit the check character along with I 2 of 5 bar code data.



I 2 of 5 Check Character Transmission = Don't Send



I 2 of 5 Check Character Transmission = Send

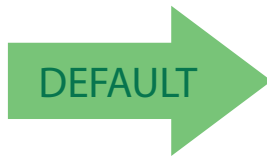


### I 2 of 5 Length Control

This feature specifies either variable length decoding or fixed length decoding for the I 2 of 5 symbology.

**Variable Length:** For variable length decoding, a minimum and maximum length may be set.

**Fixed Length:** For fixed length decoding, two different lengths may be set.



I 2 of 5 Length Control = Variable Length



I 2 of 5 Length Control = Fixed Length

## I 2 of 5 Set Length 1

This feature specifies one of the bar code lengths for **I 2 of 5 Length Control**. Length 1 is the minimum label length if in Variable Length Mode, or the first fixed length if in Fixed Length Mode. The length includes the bar code's check and data characters. The length can be set from 2 to 50 characters in increments of two.

Table 7 provides some examples for setting Length 1. See [page 253](#) for detailed instructions on setting this feature.

**Table 7. I 2 of 5 Length 1 Setting Examples**

STEP	ACTION	EXAMPLES			
1	<b>Desired Setting</b>	2 Characters	6 Characters	14 Characters	50 Characters
2	<b>Pad with leading zeroes to yield two digits</b>	02	06	14	50
3	<b>Scan ENTER/EXIT PROGRAMMING MODE</b>				
4	<b>Scan SELECT I 2 of 5 LENGTH 1 SETTING</b>				
5	<b>Scan Two Characters From Appendix E, Keypad</b>	'0' and '2'	'0' and '6'	'1' and '4'	'5' AND '0'
6	<b>Scan ENTER/EXIT PROGRAMMING MODE</b>				

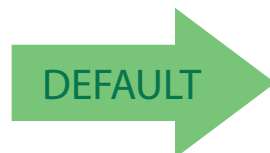


Select I 2 of 5 Length 1 Setting

Make a mistake? Scan the CANCEL bar code to abort and not save the entry string. You can then start again at the beginning.



CANCEL



**06 = Length 1 is 6 Characters**



## I 2 of 5 Set Length 2

This feature specifies one of the bar code lengths for I 2 of 5 Length Control. Length 2 is the maximum label length if in Variable Length Mode, or the second fixed length if in Fixed Length Mode. The length includes the bar code's check and data characters.

The length can be set from 2 to 50 characters. A setting of 0 specifies to ignore this length (only one fixed length).

Table 8 provides examples for setting Length 2. See page 253 for detailed instructions on setting this feature.

**Table 8. I 2 of 5 Length 2 Setting Examples**

STEP	ACTION	EXAMPLES			
1	<b>Desired Setting</b>	Ignore This Length	4 Characters	14 Characters	50 Characters
2	<b>Pad with leading zeroes to yield two digits</b>	00	04	14	50
3	<b>Scan ENTER/EXIT PROGRAMMING MODE</b>				
4	<b>Scan SELECT I 2 OF 5 LENGTH 2 SETTING</b>				
5	<b>Scan Two Characters From Appendix E, Keypad</b>	'0' and '0'	'0' and '4'	'1' and '4'	'5' AND '0'
6	<b>Scan ENTER/EXIT PROGRAMMING MODE</b>				

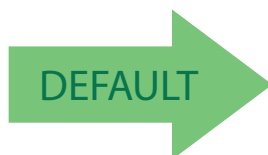


Select I 2 of 5 Length 2 Setting

Make a mistake? Scan the CANCEL bar code to abort and not save the entry string. You can then start again at the beginning.



CANCEL



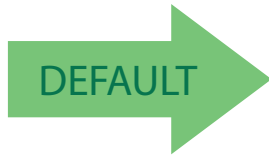
**50 = Length 2 is 50 Characters**

## INTERLEAVED 2 OF 5 CIP HR

The following options apply to the Interleaved 2 of 5 CIP HR symbology.

### Interleaved 2 of 5 CIP HR Enable/Disable

Enables/Disables ability of reader to decode Interleaved 2 of 5 CIP HR labels.



Interleaved 2 of 5 CIP HR = Disable



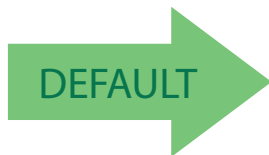
Interleaved 2 of 5 CIP HR = Enable

## FOLLETT 2 OF 5

The following options apply to the Follett 2 of 5 symbology.

### Follett 2 of 5 Enable/Disable

Enables/Disables ability of reader to decode Plessey labels.



Follett 2 of 5 = Disable



Follett 2 of 5 = Enable

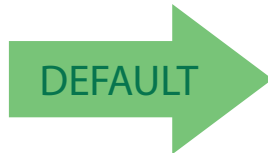


## STANDARD 2 OF 5

The following options apply to the Standard 2 of 5 symbology.

### Standard 2 of 5 Enable/Disable

When disabled, the reader will not read Standard 2 of 5 bar codes.



Standard 2 of 5 = Disable



Standard 2 of 5 = Enable

### Standard 2 of 5 Check Character Calculation

This option enables/disables calculation and verification of an optional Standard 2 of 5 check character.



Standard 2 of 5 Check Character Calculation = Disable



Standard 2 of 5 Check Character Calculation = Enable



## Standard 2 of 5 Check Character Transmission

This feature enables/disables transmission of an optional Standard 2 of 5 check character.



Standard 2 of 5 Check Character Transmission = Don't Send



Standard 2 of 5 Check Character Transmission = Send

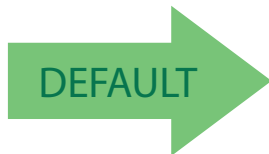


## Standard 2 of 5 Length Control

This feature specifies either variable length decoding or fixed length decoding for the Standard 2 of 5 symbology.

**Variable Length:** For variable length decoding, a minimum and maximum length may be set.

**Fixed Length:** For fixed length decoding, two different lengths may be set.



Standard 2 of 5 Length Control = Variable Length



Standard 2 of 5 Length Control = Fixed Length



### Standard 2 of 5 Set Length 1

This feature specifies one of the bar code lengths for [Standard 2 of 5 Length Control](#). Length 1 is the minimum label length if in [Variable Length Mode](#), or the first fixed length if in [Fixed Length Mode](#). Length includes the bar code’s check and data characters. The length can be set from 1 to 50 characters.

[Table 9](#) provides some examples for setting Length 1. See [page 253](#) if you want detailed instructions on setting this feature.

**Table 9. Standard 2 of 5 Length 1 Setting Examples**

STEP	ACTION	EXAMPLES			
1	<b>Desired Setting</b>	01 Character	07 Characters	15 Characters	50 Characters
2	<b>Scan ENTER/EXIT PROGRAMMING MODE</b>				
3	<b>Scan SELECT STANDARD 2 OF 5 LENGTH 1 SETTING</b>				
4	<b>Scan Two Characters From</b> <a href="#">Appendix E, Keypad</a>	'0' and '1'	'0' and '7'	'1' and '5'	'5' AND '0'
5	<b>Scan ENTER/EXIT PROGRAMMING MODE</b>				

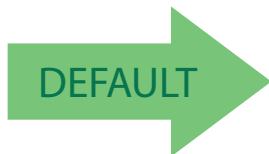


Select Standard 2 of 5 Length 1 Setting

Make a mistake? Scan the CANCEL bar code to abort and not save the entry string. You can then start again at the beginning.



CANCEL



**08 = Length 1 is 8 Characters**

## Standard 2 of 5 Set Length 2

This feature specifies one of the bar code lengths for [Standard 2 of 5 Length Control](#). Length 2 is the maximum label length if in [Variable Length Mode](#), or the second fixed length if in [Fixed Length Mode](#). Length includes the bar code’s check and data characters.

The length can be set from 1 to 50 characters. A setting of 0 specifies to ignore this length (only one fixed length).

[Table 10](#) provides examples for setting Length 2. See [page 253](#) for detailed instructions on setting this feature.

**Table 10. Standard 2 of 5 Length 2 Setting Examples**

STEP	ACTION	EXAMPLES			
1	<b>Desired Setting (pad with leading zeroes)</b>	00 (Ignore This Length)	07 Characters	15 Characters	50 Characters
2	<b>Scan ENTER/EXIT PROGRAMMING MODE</b>				
3	<b>Scan SELECT STANDARD 2 OF 5 LENGTH 2 SETTING</b>				
4	<b>Scan Two Characters From <a href="#">Appendix E, Keypad</a></b>	'0' and '0'	'0' and '7'	'1' and '5'	'5' AND '0'
5	<b>Scan ENTER/EXIT PROGRAMMING MODE</b>				

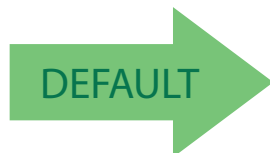


Select Standard 2 of 5 Length 2 Setting

Make a mistake? Scan the CANCEL bar code to abort and not save the entry string. You can then start again at the beginning.



CANCEL



**50 = Length 2 is 50 Characters**

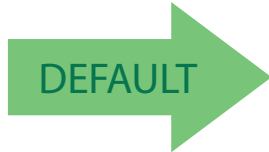


## INDUSTRIAL 2 OF 5

The following options apply to the Industrial 2 of 5 symbology.

### Industrial 2 of 5 Enable/Disable

Enables/Disables ability of reader to decode Industrial 2 of 5 labels.



Industrial 2 of 5 = Disable



Industrial 2 of 5 = Enable

### Industrial 2 of 5 Check Character Calculation

Enables/Disables calculation and verification of an optional Industrial 2 of 5 check character.



Industrial 2 of 5 Check Character Calculation = Disable



Industrial 2 of 5 Check Character Calculation = Enable

## Industrial 2 of 5 Check Character Transmission

Enables/disables transmission of an Industrial 2 of 5 check character.



Industrial 2 of 5 Check Character Transmission = Disable



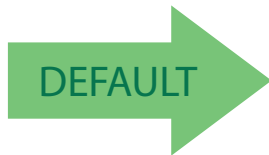
Industrial 2 of 5 Check Character Transmission = Enable

## Industrial 2 of 5 Length Control

This feature specifies either variable length decoding or fixed length decoding for the Industrial 2 of 5 symbology.

**Variable Length:** For variable length decoding, a minimum and maximum length may be set.

**Fixed Length:** For fixed length decoding, two different lengths may be set.



Industrial 2 of 5 Length Control = Variable Length



Industrial 2 of 5 = Fixed Length



### Industrial 2 of 5 Set Length 1

This feature specifies one of the bar code lengths for **Industrial 2 of 5 Length Control**. Length 1 is the minimum label length if in **Variable Length Mode**, or the first fixed length if in **Fixed Length Mode**. Length includes the bar code’s data characters only. The length can be set from 0 to 50 characters.

Table 11 provides some examples for setting Length 1. See page 253 if you want detailed instructions on setting this feature.

**Table 11. Industrial 2 of 5 Length 1 Setting Examples**

STEP	ACTION	EXAMPLES			
1	<b>Desired Setting</b>	00 Characters	07 Characters	15 Characters	50 Characters
2	<b>Scan ENTER/EXIT PROGRAMMING MODE</b>				
3	<b>Scan SELECT INDUSTRIAL 2 OF 5 LENGTH 1 SETTING</b>				
4	<b>Scan Two Characters From Appendix E, Keypad</b>	'0' and '0'	'0' and '7'	'1' and '5'	'5' AND '0'
5	<b>Scan ENTER/EXIT PROGRAMMING MODE</b>				

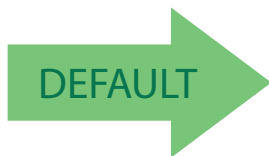


Select Industrial 2 of 5 Set Length 1 Setting

Make a mistake? Scan the CANCEL bar code to abort and not save the entry string. You can then start again at the beginning.



CANCEL



**01 = Length 1 is 1 Character**

## Industrial 2 of 5 Set Length 2

This feature specifies one of the bar code lengths for [Industrial 2 of 5 Length Control](#). Length 2 is the maximum label length if in [Variable Length Mode](#), or the second fixed length if in [Fixed Length Mode](#). Length includes the bar code's check, data, and full-ASCII shift characters. The length does not include start/stop characters.

The length can be set from 1 to 50 characters. A setting of 0 specifies to ignore this length (only one fixed length).

[Table 12](#) provides examples for setting Length 2. See [page 253](#) for detailed instructions on setting this feature.

**Table 12. Industrial 2 of 5 Length 2 Setting Examples**

STEP	ACTION	EXAMPLES			
1	Desired Setting	00 (Ignore This Length)	07 Characters	15 Characters	50 Characters
2	Scan ENTER/EXIT PROGRAMMING MODE				
3	Scan SELECT INDUSTRIAL 2 OF 5 LENGTH 2 SETTING				
4	Scan Two Characters From <a href="#">Appendix E, Keypad</a>	'0' and '0'	'0' and '7'	'1' and '5'	'5' AND '0'
5	Scan ENTER/EXIT PROGRAMMING MODE				

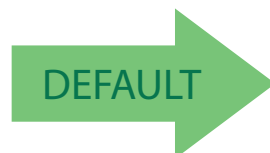


Select Industrial 2 of 5 Length 2 Setting

Make a mistake? Scan the CANCEL bar code to abort and not save the entry string. You can then start again at the beginning.



CANCEL



**50 = Length 2 is 50 Characters**

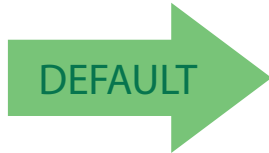


## CODE IATA

The following options apply to the IATA symbology.

### IATA Enable/Disable

Enables/Disables the ability of the reader to decode IATA labels.



IATA = Disable



IATA = Enable

### IATA Check Character Transmission

Enables/Disables calculation and verification of an optional Industrial 2 of 5 check character.



IATA Check Character Transmission = Disable



IATA Check Character Transmission = Enable



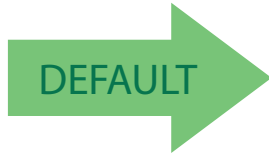


## CODABAR

The following options apply to the Codabar symbology.

### Codabar Enable/Disable

When disabled, the reader will not read Codabar bar codes.



Codabar = Disable



Codabar = Enable

### Codabar Check Character Calculation

Enable this option to enables/disables calculation and verification of an optional Codabar check character. When disabled, any check character in the label is treated as a data character



Codabar Check Character Calculation = Don't Calculate



Codabar Check Character Calculation = Enable AIM standard check char.



Codabar Check Character Calculation = Enable Modulo 10 check char.



### Codabar Check Character Transmission

Enable this option to transmit the check character along with Codabar bar code data.



Codabar Check Character Transmission = Don't Send



Codabar Check Character Transmission = Send



### Codabar Start/Stop Character Transmission

Enable this option to enable/disable transmission of Codabar start and stop characters.



Codabar Start/Stop Character Transmission = Don't Transmit



Codabar Start/Stop Character Transmission = Transmit



### Codabar Start/Stop Character Set

This option specifies the format of transmitted Codabar start/stop characters.



Codabar Check Character Set = ABCD/TN\*E



Codabar Check Character Set = ABCD/ABCD



Codabar Check Character Set = abcd/tn\*e

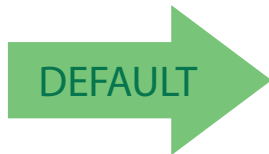


Codabar Check Character Set = abcd/abcd



### Codabar Start/Stop Character Match

When enabled, this option requires that start and stop characters match.



Codabar Start/Stop Character Match = Don't Require Match



Codabar Start/Stop Character Match = Require Match



### Codabar Quiet Zones

Specifies the number of quiet zones for Codabar labels. Quiet zones are blank areas at the ends of a bar code and are typically 10 times the width of the narrowest bar or space in the label.



Codabar Quiet Zones = Quiet Zones on two sides



Codabar Quiet Zones = Small Quiet Zones on two sides

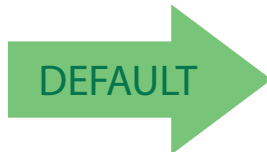


### Codabar Length Control

This feature specifies either variable length decoding or fixed length decoding for the Codabar symbology.

**Variable Length:** For variable length decoding, a minimum and maximum length may be set.

**Fixed Length:** For fixed length decoding, two different lengths may be set.



Codabar Length Control = Variable Length



Codabar Length Control = Fixed Length

## Codabar Set Length 1

This feature specifies one of the bar code lengths for [Codabar Length Control](#) [Codabar Length Control](#). Length 1 is the minimum label length if in [Variable Length Mode](#), or the first fixed length if in [Fixed Length Mode](#). Length includes the bar code's start, stop, check and data characters. The length must include at least one data character. The length can be set from 3 to 50 characters.

[Table 13](#) provides some examples for setting Length 1. See [page 253](#) for detailed instructions on setting this feature.

**Table 13. Codabar Length 1 Setting Examples**

STEP	ACTION	EXAMPLES			
1	<b>Desired Setting (and pad with leading zeroes)</b>	03 Characters	09 Characters	15 Characters	50 Characters
2	<b>Scan ENTER/EXIT PROGRAMMING MODE</b>				
3	<b>Scan SELECT CODABAR LENGTH 1 SETTING</b>				
4	<b>Scan Two Characters From</b> <a href="#">Appendix E, Keypad</a>	'0' and '3'	'0' and '9'	'1' and '5'	'5' AND '0'
5	<b>Scan ENTER/EXIT PROGRAMMING MODE</b>				

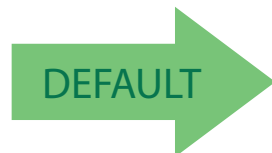


Select Codabar Length 1 Setting

Make a mistake? Scan the CANCEL bar code to abort and not save the entry string. You can then start again at the beginning.



CANCEL



**03 = Length 1 is 3 Characters**



### Codabar Set Length 2

This feature specifies one of the bar code lengths for Codabar Length Control Codabar Length Control. Length 2 is the maximum label length if in Variable Length Mode, or the second fixed length if in Fixed Length Mode. The length includes the bar code's start, stop, check and data characters. The length must include at least one data character.

The length can be set from 3 to 50 characters. A setting of 0 specifies to ignore this length (only one fixed length).

Table 14 provides examples for setting Length 2. See page 253 for detailed instructions on setting this feature.

Table 14. Codabar Length 2 Setting Examples

STEP	ACTION	EXAMPLES			
1	Desired Setting (and pad with leading zeroes)	00 Ignore This Length	07 Characters	15 Characters	50 Characters
2	Scan ENTER/EXIT PROGRAMMING MODE				
3	Scan SELECT CODABAR LENGTH 2 SETTING				
4	Scan Two Characters From Appendix E, Keypad	'0' and '0'	'0' and '7'	'1' and '5'	'5' AND '0'
5	Scan ENTER/EXIT PROGRAMMING MODE				

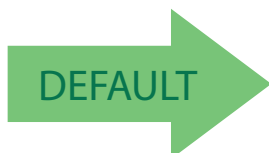


Select Codabar Length 2 Setting

Make a mistake? Scan the CANCEL bar code to abort and not save the entry string. You can then start again at the beginning.



CANCEL



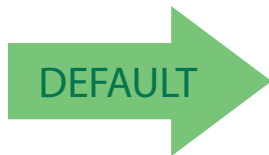
50 = Length 2 is 50 Characters

## ABC CODABAR

The following options apply to the ABC Codabar symbology.

### ABC Codabar Enable/Disable

Enables/Disables ability of reader to decode ABC Codabar labels.



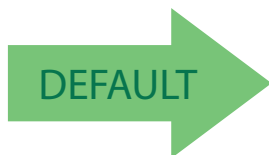
ABC Codabar = Disable



ABC Codabar = Enable

### ABC Codabar Concatenation Mode

Specifies the concatenation mode between Static and Dynamic.



ABC Codabar Concatenation Mode = Static



ABC Codabar Concatenation Mode = Dynamic



## ABC Codabar Dynamic Concatenation Timeout

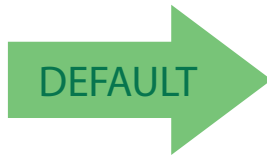
Specifies the timeout in 10-millisecond ticks used by the ABC Codabar Dynamic Concatenation Mode.



ABC Codabar Dynamic Concatenation Timeout = 50 msec



ABC Codabar Dynamic Concatenation Timeout = 100 msec



ABC Codabar Dynamic Concatenation Timeout = 200 msec



ABC Codabar Dynamic Concatenation Timeout = 500 msec



ABC Codabar Dynamic Concatenation Timeout = 750 msec

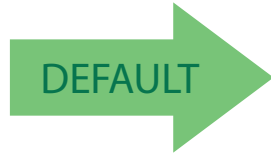


ABC Codabar Dynamic Concatenation Timeout = 1 Second



## ABC Codabar Force Concatenation

Forces labels starting or ending with D to be concatenated.



ABC Codabar Force Concatenation = Disable



ABC Codabar Force Concatenation = Enable

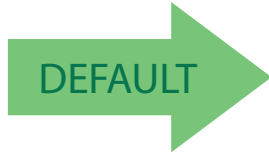


### CODE 11

The following options apply to the Code 11 symbology.

#### Code 11 Enable/Disable

When disabled, the reader will not read Code 11 bar codes.



Code 11 = Disable



Code 11 = Enable

#### Code 11 Check Character Calculation

This option enables/disables calculation and verification of optional Code 11 check character.



Code 11 Check Character Calculation = Disable



Code 11 Check Character Calculation = Check C



Code 11 Check Character Calculation = Check K



Code 11 Check Character Calculation = Check C and K



## Code 11 Check Character Transmission

This feature enables/disables transmission of an optional Code 11 check character.

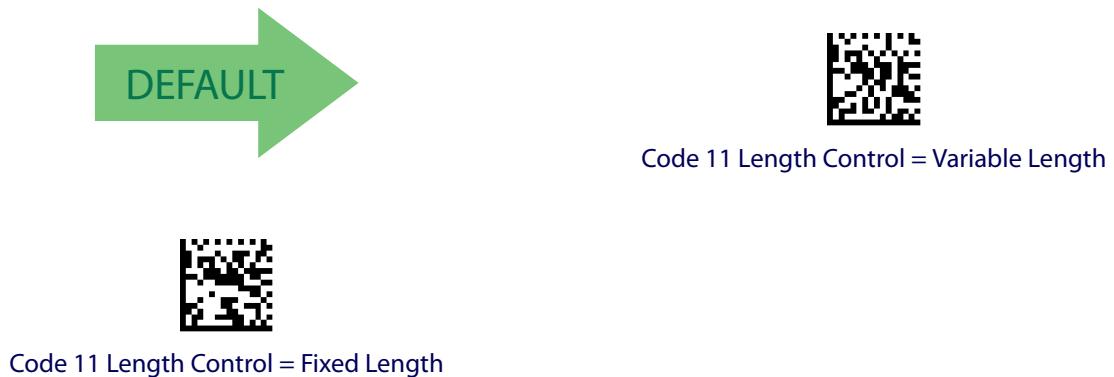


## Code 11 Length Control

This feature specifies either variable length decoding or fixed length decoding for the Code 11 symbology.

**Variable Length:** For variable length decoding, a minimum and maximum length may be set.

**Fixed Length:** For fixed length decoding, two different lengths may be set.





### Code 11 Set Length 1

This feature specifies one of the bar code lengths for [Code 11 Length Control](#). Length 1 is the minimum label length if in [Variable Length Mode](#), or the first fixed length if in [Fixed Length Mode](#). Length includes the bar code’s check and data characters. The length can be set from 2 to 50 characters.

[Table 15](#) provides some examples for setting Length 1. See [page 253](#) for detailed instructions on setting this feature.

**Table 15. Code 11 Length 1 Setting Examples**

STEP	ACTION	EXAMPLES			
1	<b>Desired Setting (pad with leading zeroes)</b>	02 Characters	07 Characters	15 Characters	50 Characters
2	<b>Scan ENTER/EXIT PROGRAMMING MODE</b>				
3	<b>Scan SELECT CODE 11 LENGTH 1 SETTING</b>				
4	<b>Scan Two Characters From <a href="#">Appendix E, Keypad</a></b>	'0' and '2'	'0' and '7'	'1' and '5'	'5' AND '0'
5	<b>Scan ENTER/EXIT PROGRAMMING MODE</b>				

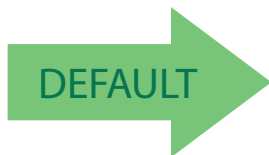


Select Code 11 Set Length 1 Setting

Make a mistake? Scan the CANCEL bar code to abort and not save the entry string. You can then start again at the beginning.



CANCEL



**04 = Length 1 is 4 Characters**

## Code 11 Set Length 2

This feature specifies one of the bar code lengths for [Code 11 Length Control](#). Length 2 is the maximum label length if in [Variable Length Mode](#), or the second fixed length if in [Fixed Length Mode](#). Length includes the bar code’s check and data characters.

The length can be set from 2 to 50 characters. A setting of 0 specifies to ignore this length (only one fixed length).

[Table 16](#) provides examples for setting Length 2. See [page 253](#) for detailed instructions on setting this feature.

**Table 16. Code 11 Length 2 Setting Examples**

STEP	ACTION	EXAMPLES			
1	<b>Desired Setting (pad with leading zeroes)</b>	00 (Ignore This Length)	07 Characters	15 Characters	50 Characters
2	<b>Scan ENTER/EXIT PROGRAMMING MODE</b>				
3	<b>Scan SELECT CODE 11 LENGTH 2 SETTING</b>				
4	<b>Scan Two Characters From <a href="#">Appendix E, Keypad</a></b>	'0' and '0'	'0' and '7'	'1' and '5'	'5' and '0'
5	<b>Scan ENTER/EXIT PROGRAMMING MODE</b>				

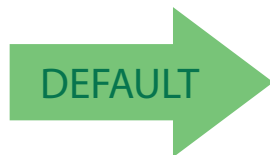


Select Code 11 Length 2 Setting

Make a mistake? Scan the CANCEL bar code to abort and not save the entry string. You can then start again at the beginning.



CANCEL



**50 = Length 2 is 50 Characters**

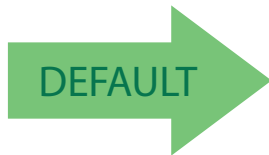


## GS1 DATABAR™ OMNIDIRECTIONAL

The following options apply to the GS1 DataBar™ Omnidirectional (formerly RSS-14) symbology.

### GS1 DataBar™ Omnidirectional Enable/Disable

When disabled, the reader will not read GS1 DataBar™ Omnidirectional bar codes.



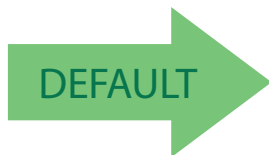
GS1 DataBar™ Omnidirectional = Disable



GS1 DataBar™ Omnidirectional = Enable

### GS1 DataBar™ Omnidirectional GS1-128 Emulation

When enabled, GS1 DataBar™ Omnidirectional bar codes will be translated to the GS1-128 label data format.



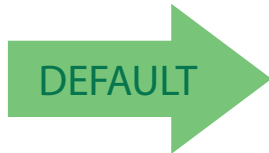
GS1 DataBar™ Omnidirectional GS1-128 Emulation = Disable



GS1 DataBar™ Omnidirectional GS1-128 Emulation = Enable

## GS1 DataBar™ Omnidirectional 2D Component

This feature enables/disables a requirement that a 2D label component be decoded when a base label for this symbology is decoded.



GS1 DataBar™ Omnidirectional 2D Component =  
Disable (2D component not required)



GS1 DataBar™ Omnidirectional 2D Component =  
2D component must be decoded

## GS1 DATABAR™ EXPANDED

The following options apply to the GS1 DataBar™ Expanded (formerly RSS Expanded) symbology.

### GS1 DataBar™ Expanded Enable/Disable

When disabled, the reader will not read GS1 DataBar™ Expanded bar codes.



GS1 DataBar™ Expanded = Disable

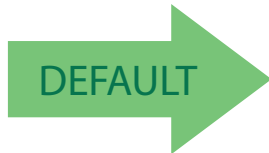


GS1 DataBar™ Expanded = Enable



### GS1 DataBar™ Expanded GS1-128 Emulation

When enabled, GS1 DataBar™ Expanded bar codes will be translated to the GS1-128 label data format.



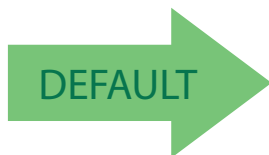
GS1 DataBar™ Expanded GS1-128 Emulation = Disable



GS1 DataBar™ Expanded GS1-128 Emulation = Enable

### GS1 DataBar™ Expanded 2D Component

This feature enables/disables a requirement that a 2D label component be decoded when a base label of this symbology is decoded.



GS1 DataBar™ Expanded 2D Component = Disable



GS1 DataBar™ Expanded 2D Component = Enable

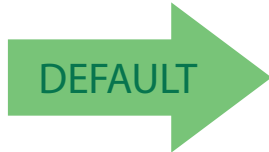


## GS1 DataBar™ Expanded Length Control

This feature specifies either variable length decoding or fixed length decoding for the GS1 DataBar™ Expanded symbology.

**Variable Length:** For variable-length decoding, a minimum length may be set.

**Fixed Length:** For fixed-length decoding, two different lengths may be set.



GS1 DataBar™ Expanded Length Control = Variable Length



GS1 DataBar™ Expanded Length Control = Fixed Length



### GS1 DataBar™ Expanded Set Length 1

This feature specifies one of the bar code lengths for GS1 DataBar™ Expanded Length Control. Length 1 is the minimum label length if in Variable Length Mode, or the first fixed length if in Fixed Length Mode. Length includes the bar code’s data characters only. The length can be set from 1 to 74 characters.

Table 17 provides some examples for setting Length 1. See page 253 for detailed instructions on setting this feature.

**Table 17. GS1 DataBar™ Expanded Length 1 Setting Examples**

STEP	ACTION	EXAMPLES			
1	<b>Desired Setting</b>	01 Character	07 Characters	52 Characters	74 Characters
2	<b>Scan ENTER/EXIT PROGRAMMING MODE</b>				
3	<b>Scan SELECT GS1 DataBar™ EXPANDED LENGTH 1SETTING</b>				
4	<b>Scan Two Characters From Appendix E, Keypad</b>	'0' and '1'	'0' and '7'	'5' and '2'	'7' AND '4'
5	<b>Scan ENTER/EXIT PROGRAMMING MODE</b>				

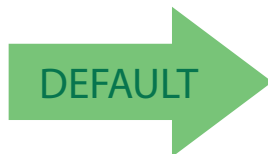


Select GS1 DataBar™ Expanded Set Length 1 Setting

Make a mistake? Scan the CANCEL bar code to abort and not save the entry string. You can then start again at the beginning.



CANCEL



**01 = Length 1 is 1 Character**

## GS1 DataBar™ Expanded Set Length 2

This feature specifies one of the bar code lengths for GS1 DataBar™ Expanded Length Control. Length 2 is the maximum label length if in Variable Length Mode, or the second fixed length if in Fixed Length Mode. Length includes the bar code’s data characters only. The length can be set from 1 to 74 characters. A setting of 0 specifies to ignore this length (only one fixed length).

Table 18 provides examples for setting Length 2. See page 253 for detailed instructions on setting this feature.

**Table 18. GS1 DataBar™ Expanded Length 2 Setting Examples**

STEP	ACTION	EXAMPLES			
1	<b>Desired Setting</b>	00 (ignore second length)	07 Characters	52 Characters	74 Characters
2	<b>Scan ENTER/EXIT PROGRAMMING MODE</b>				
3	<b>Scan SELECT GS1 DataBar™ EXPANDED LENGTH 2 SETTING</b>				
4	<b>Scan Two Characters From Appendix E, Keypad</b>	'0' and '0'	'0' and '7'	'5' and '2'	'7' and '4'
5	<b>Scan ENTER/EXIT PROGRAMMING MODE</b>				

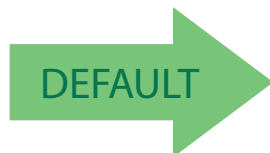


Select GS1 DataBar™ Expanded Set Length 2 Setting

Make a mistake? Scan the CANCEL bar code to abort and not save the entry string. You can then start again at the beginning.



CANCEL



**74 = Length 2 is 74 Characters**

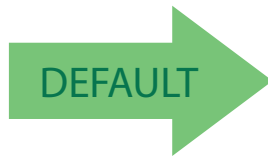


## GS1 DATABAR™ LIMITED

The following options apply to the GS1 DataBar™ Limited (formerly RSS Limited) symbology.

### GS1 DataBar™ Limited Enable/Disable

When disabled, the reader will not read GS1 DataBar™ Limited bar codes.



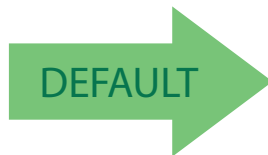
GS1 DataBar™ Limited = Disable



GS1 DataBar™ Limited = Enable

### GS1 DataBar™ Limited GS1-128 Emulation

When enabled, GS1 DataBar™ Limited bar codes will be translated to the GS1-128 label data format.



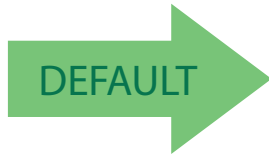
GS1 DataBar™ Limited GS1-128 Emulation = Disable



GS1 DataBar™ Limited GS1-128 Emulation = Enable

## GS1 DataBar™ Limited 2D Component

This feature enables/disables a requirement that a 2D label component be decoded when a base label of this symbology is decoded.



GS1 DataBar™ Limited 2D Component =  
Disable (2D component not required)



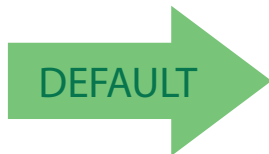
GS1 DataBar™ Limited 2D Component =  
2D component must be decoded

## CODE 93

The following options apply to the Code 93 symbology.

### Code 93 Enable/Disable

Enables/Disables ability of reader to decode Code 93 labels.



Code 93 = Disable



Code 93 = Enable



## Code 93 Check Character Calculation

Enables/disables calculation and verification of an optional Code 93 check character.



Code 93 Check Character Calculation = Disable



Code 93 Check Character Calculation = Enable Check C



Code 93 Check Character Calculation = Enable Check K



Code 93 Check Character Calculation = Enable Check C  
and K



## Code 93 Check Character Transmission

Enables/disables transmission of an optional Code 93 check character.



Code 93 Check Character Transmission = Disable



Code 93 Check Character Transmission = Enable

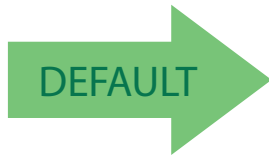


## Code 93 Length Control

This feature specifies either variable length decoding or fixed length decoding for the Code 93 symbology.

**Variable Length:** For variable length decoding, a minimum and maximum length may be set.

**Fixed Length:** For fixed length decoding, two different lengths may be set.



Code 93 Length Control = Variable Length



Code 93 = Fixed Length



### Code 93 Set Length 1

Specifies one of the bar code lengths for [Code 93 Length Control](#). Length 1 is the minimum label length if in [Variable Length Mode](#), or the first fixed length if in [Fixed Length Mode](#). Length includes the bar code’s data characters only. The length can be set from 01 to 50 characters.

[Table 19](#) provides some examples for setting Length 1. See [page 253](#) for detailed instructions on setting this feature.

**Table 19. Code 93 Length 1 Setting Examples**

STEP	ACTION	EXAMPLES			
1	<b>Desired Setting</b>	01 Characters	07 Characters	15 Characters	50 Characters
2	<b>Scan ENTER/EXIT PROGRAMMING MODE</b>				
3	<b>Scan SELECT CODE 93 LENGTH 1 SETTING</b>				
4	<b>Scan Two Characters From <a href="#">Appendix E, Keypad</a></b>	'0' and '1'	'0' and '7'	'1' and '5'	'5' AND '0'
5	<b>Scan ENTER/EXIT PROGRAMMING MODE</b>				

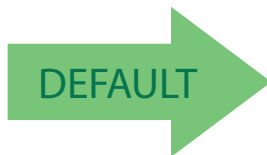


Select Code 93 Set Length 1 Setting

Make a mistake? Scan the CANCEL bar code to abort and not save the entry string. You can then start again at the beginning.



CANCEL



**01 = Length 1 is 1 Character**





## Code 93 Set Length 2

This feature specifies one of the bar code lengths for [Code 93 Length Control](#). Length 2 is the maximum label length if in [Variable Length Mode](#), or the second fixed length if in [Fixed Length Mode](#). Length includes the bar code's check, data, and full-ASCII shift characters. The length does not include start/stop characters. The length can be set from 1 to 50 characters. A setting of 0 specifies to ignore this length (only one fixed length).

[Table 20](#) provides examples for setting Length 2. See [page 253](#) for detailed instructions on setting this feature.

**Table 20. CODE 93 Length 2 Setting Examples**

STEP	ACTION	EXAMPLES			
1	Desired Setting	00 (Ignore This Length)	07 Characters	15 Characters	50 Characters
2	Scan ENTER/EXIT PROGRAMMING MODE				
3	Scan SELECT CODE 93 LENGTH 2 SETTING				
4	Scan Two Characters From <a href="#">Appendix E, Keypad</a>	'0' and '0'	'0' and '7'	'1' and '5'	'5' AND '0'
5	Scan ENTER/EXIT PROGRAMMING MODE				

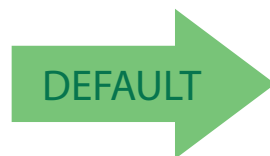


Select Code 93 Length 2 Setting

Make a mistake? Scan the CANCEL bar code to abort and not save the entry string. You can then start again at the beginning.



CANCEL



50 = Length 2 is 50 Characters



### Code 93 Quiet Zones

Enables/disables quiet zones for Code 93.



Code 93 Quiet Zones = Quiet Zones on two sides



Code 93 Quiet Zones = Small Quiet Zones on two sides

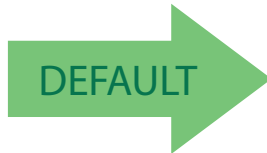


### MSI

The following options apply to the MSI symbology.

#### MSI Enable/Disable

Enables/Disables ability of reader to decode MSI labels.



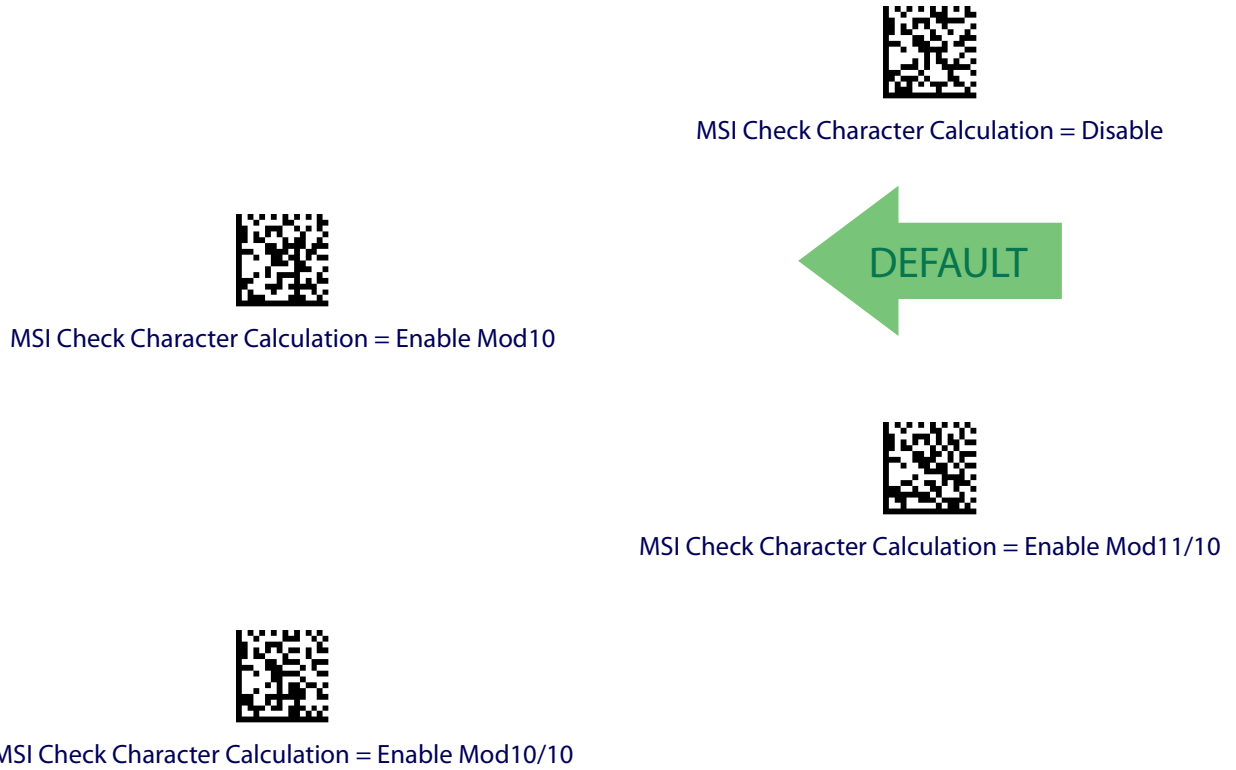
MSI = Disable



MSI = Enable

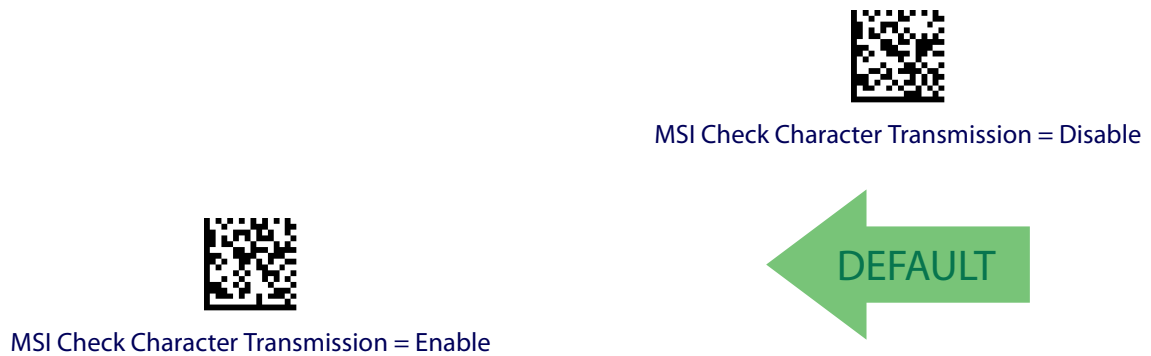
### MSI Check Character Calculation

Enables/Disables calculation and verification of an optional MSI check character.



### MSI Check Character Transmission

Enables/disables transmission of an MSI check character.



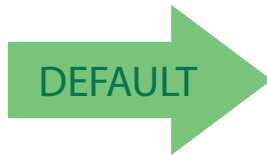


### MSI Length Control

This feature specifies either variable length decoding or fixed length decoding for the MSI symbology.

**Variable Length:** For variable length decoding, a minimum and maximum length may be set.

**Fixed Length:** For fixed length decoding, two different lengths may be set.



MSI Length Control = Variable Length



MSI = Fixed Length

## MSI Set Length 1

This feature specifies one of the bar code lengths for [MSI Length Control](#). Length 1 is the minimum label length if in [Variable Length Mode](#), or the first fixed length if in [Fixed Length Mode](#). Length includes the bar code's data characters only. The length can be set from 01 to 50 characters.

[Table 21](#) provides some examples for setting Length 1. See [page 253](#) for detailed instructions on setting this feature.

**Table 21. MSI Length 1 Setting Examples**

STEP	ACTION	EXAMPLES			
1	<b>Desired Setting</b>	01 Characters	07 Characters	15 Characters	50 Characters
2	<b>Scan ENTER/EXIT PROGRAMMING MODE</b>				
3	<b>Scan SELECT MSI LENGTH 1 SETTING</b>				
4	<b>Scan Two Characters From <a href="#">Appendix E, Keypad</a></b>	'0' and '1'	'0' and '7'	'1' and '5'	'5' AND '0'
5	<b>Scan ENTER/EXIT PROGRAMMING MODE</b>				

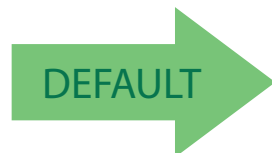


Select MSI Set Length 1 Setting

Make a mistake? Scan the CANCEL bar code to abort and not save the entry string. You can then start again at the beginning.



CANCEL



**01 = Length 1 is 1 Character**



### MSI Set Length 2

This feature specifies one of the bar code lengths for MSI Length Control. Length 2 is the maximum label length if in Variable Length Mode, or the second fixed length if in Fixed Length Mode. Length includes the bar code’s check, data, and full-ASCII shift characters. The length does not include start/stop characters. The length can be set from 1 to 50 characters. A setting of 0 specifies to ignore this length (only one fixed length).

Table 22 provides examples for setting Length 2. See page 253 for detailed instructions on setting this feature.

**Table 22. MSI Length 2 Setting Examples**

STEP	ACTION	EXAMPLES			
1	Desired Setting	00 (Ignore This Length)	07 Characters	15 Characters	50 Characters
2	Scan ENTER/EXIT PROGRAMMING MODE				
3	Scan SELECT MSI LENGTH 2 SETTING				
4	Scan Two Characters From Appendix E, Keypad	'0' and '0'	'0' and '7'	'1' and '5'	'5' AND '0'
5	Scan ENTER/EXIT PROGRAMMING MODE				

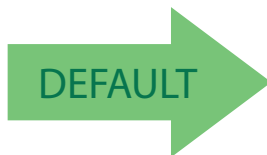


Select MSI Length 2 Setting

Make a mistake? Scan the CANCEL bar code to abort and not save the entry string. You can then start again at the beginning.



CANCEL



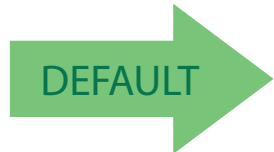
**50 = Length 2 is 50 Characters**

## PLESSEY

The following options apply to the Plessey symbology.

### Plessey Enable/Disable

Enables/Disables ability of reader to decode Plessey labels.



Plessey = Disable



Plessey = Enable

### Plessey Check Character Calculation

Enables/Disables calculation and verification of an optional Plessey check character.



Plessey Check Character Calculation = Disable



Plessey Check Character Calculation =  
Enable Plessey std. check char. verification



Plessey Check Character Calculation =  
Enable Anker check char. verification



Plessey Check Character Calculation =  
Enable Plessey std. and Anker check char verification



## Plessey Check Character Transmission

Enables/disables transmission of an MSI check character.



Plessey Check Character Transmission = Disable



Plessey Check Character Transmission = Enable

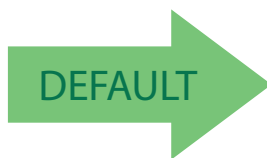


## Plessey Length Control

This feature specifies either variable length decoding or fixed length decoding for the Plessey symbology.

**Variable Length:** For variable length decoding, a minimum and maximum length may be set.

**Fixed Length:** For fixed length decoding, two different lengths may be set.



Plessey Length Control = Variable Length



Plessey = Fixed Length



## Plessey Set Length 1

This feature specifies one of the bar code lengths for [Plessey Length Control](#). Length 1 is the minimum label length if in [Variable Length Mode](#), or the first fixed length if in [Fixed Length Mode](#). Length includes the bar code's data characters only. The length can be set from 01 to 50 characters.

[Table 23](#) provides some examples for setting Length 1. See [page 253](#) for detailed instructions on setting this feature.

**Table 23. Plessey Length 1 Setting Examples**

STEP	ACTION	EXAMPLES			
1	<b>Desired Setting</b>	01 Characters	07 Characters	15 Characters	50 Characters
2	<b>Scan ENTER/EXIT PROGRAMMING MODE</b>				
3	<b>Scan SELECT Plessey LENGTH 1 SETTING</b>				
4	<b>Scan Two Characters From <a href="#">Appendix E, Keypad</a></b>	'0' and '1'	'0' and '7'	'1' and '5'	'5' AND '0'
5	<b>Scan ENTER/EXIT PROGRAMMING MODE</b>				

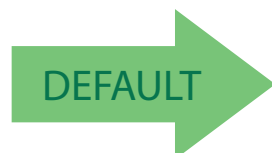


Select Plessey Set Length 1 Setting

Make a mistake? Scan the CANCEL bar code to abort and not save the entry string. You can then start again at the beginning.



CANCEL



**01 = Length 1 is 1 Character**



### Plessey Set Length 2

This feature specifies one of the bar code lengths for Plessey Length Control. Length 2 is the maximum label length if in Variable Length Mode, or the second fixed length if in Fixed Length Mode. Length includes the bar code’s check, data, and full-ASCII shift characters. The length does not include start/stop characters.

The length can be set from 1 to 50 characters. A setting of 0 specifies to ignore this length (only one fixed length).

Table 24 provides examples for setting Length 2. See page 253 for detailed instructions on setting this feature.

**Table 24. Plessey Length 2 Setting Examples**

STEP	ACTION	EXAMPLES			
1	Desired Setting	00 (Ignore This Length)	07 Characters	15 Characters	50 Characters
2	Scan ENTER/EXIT PROGRAMMING MODE				
3	Scan SELECT PLESSEY LENGTH 2 SETTING				
4	Scan Two Characters From Appendix E, Keypad	'0' and '0'	'0' and '7'	'1' and '5'	'5' AND '0'
5	Scan ENTER/EXIT PROGRAMMING MODE				

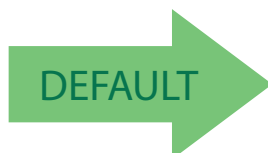


Select Plessey Length 2 Setting

Make a mistake? Scan the CANCEL bar code to abort and not save the entry string. You can then start again at the beginning.



CANCEL



**50 = Length 2 is 50 Characters**

# 2D SYMBOLOGIES

## 2D Global Features

- 2D Maximum Decoding Time on page 186
- 2D Normal/Inverse Symbol Control on page 187
- 2D Structured Append on page 187

## 2D Symbologies

The reader supports the following 2D symbologies (bar code types). Symbology-dependent options for each symbology are included in this chapter. See "1D Code Selection" starting on page 93 for configuration of 1D bar codes.

- Aztec Code on page 188
- China Sensible Code on page 191
- Data Matrix on page 194
- Maxicode on page 197
- PDF417 on page 200
- Micro PDF417 on page 203
- QR Code on page 206
- Micro QR Code on page 209
- UCC Composite on page 212
- Postal Code Selection on page 214



To enable the reader for Mirrored or Negative Image 2D bar codes, see [Mirror Reading Mode](#) on page 89 or [Decode Negative Image](#) on page 90.

## 2D Global Features

The following features are common to all, or in some cases, most of the available 2D symbologies. Default settings are indicated at each feature/option with a green arrow. Also reference [Appendix C, Standard Defaults](#) for a listing of the most widely used set of standard factory settings. That section also provides space to record any custom settings needed or implemented for your system.

To set most features:

1. Scan the ENTER/EXIT PROGRAMMING bar code at the top of applicable programming pages.
2. Scan the correct bar code to set the desired programming feature or parameter. You may need to cover unused bar codes on the page, and possibly the facing page, to ensure that the reader reads only the bar code you intend to scan.
3. If additional input parameters are needed, go to [Appendix E, Keypad](#), and scan the appropriate characters from the keypad.



**Additional information about many features can be found in the "References" chapter.**

**If you make a mistake before the last character, scan the CANCEL bar code to abort and not save the entry string. You can then start again at the beginning.**

Complete the programming sequence by scanning the ENTER/EXIT PROGRAMMING bar code to exit Programming Mode.



## 2D Maximum Decoding Time

This feature specifies the maximum amount of time the software will spend attempting to decode a 2D label. The selectable range is 10 milliseconds to 2.55 milliseconds.



2D Maximum Decoding Time = 100 msec



2D Maximum Decoding Time = 200 msec



2D Maximum Decoding Time = 350 msec



2D Maximum Decoding Time = 500 msec



2D Maximum Decoding Time = 1 Second



2D Maximum Decoding Time = 2 Seconds

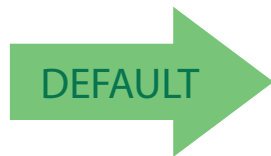


2D Maximum Decoding Time = 2.55 Seconds

## 2D Structured Append

Enables/disables ability of reader to append multiple 2D Codes labels in a structured format. The structured append property is globally applied to the following symbologies, if these are enabled:

- Data Matrix
- QR Code
- Aztec
- PDF 417



Structured Append = Disable

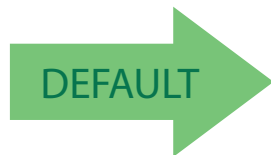


Structured Append = Enable

## 2D Normal/Inverse Symbol Control

Specifies the options available for decoding normal/negative printed 2D symbols. This configuration item applies globally to all the 2D symbologies that support that feature according to Standard AIM Specification: Data Matrix, QR, MicroQR, Aztec and Chinese Sensible Code.

To set decoding of mirrored images, see "[Mirror Reading Mode](#)" on page 89. To decode all symbologies, including linear symbologies, refer to "[Decode Negative Image](#)" on page 90.



Normal/Inverse Symbol Control = Normal



Normal/Inverse Symbol Control = Inverse



Normal/Inverse Symbol Control =  
Both Normal and Inverse



## Aztec Code

### Aztec Code Enable / Disable

Enables/disables the ability of the reader to decode Aztec Code labels.

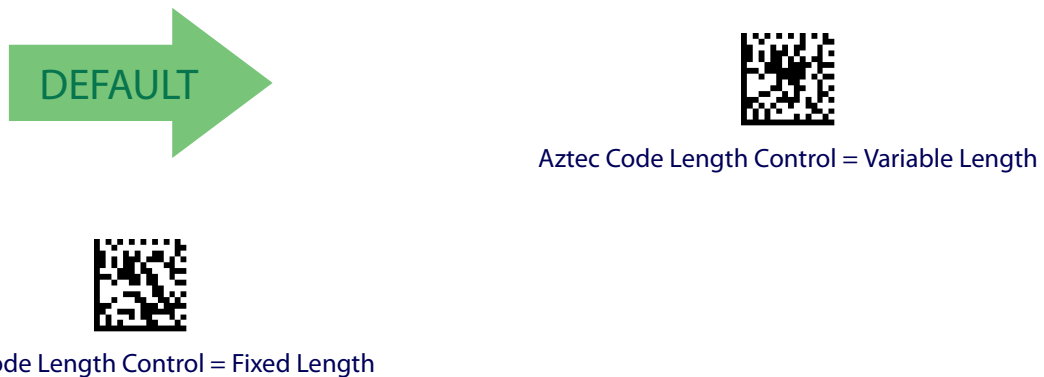


### Aztec Code Length Control

This feature specifies either variable length decoding or fixed length decoding for this symbology.

**Variable Length:** For variable length decoding, a minimum and maximum length may be set.

**Fixed Length:** For fixed length decoding, two different lengths may be set.



## Aztec Code Set Length 1

Specifies one of the bar code lengths for [Aztec Code Length Control](#). Length 1 is the minimum label length if in Variable Length Mode, or the first fixed length if in Fixed Length Mode. Characters can be set from 0001 to 3,832 characters in increments of 0001 (pad with zeroes).

See [page 253](#) for detailed instructions on setting this feature.



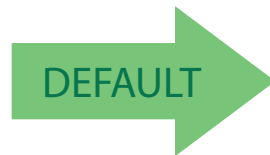
Select Aztec Code Length 1 Setting

To configure this feature, scan the ENTER/EXIT PROGRAMMING MODE bar code above, then the bar code at left followed by the digits from the Alphanumeric characters in [Appendix E, Keypad](#) representing your desired character(s). End by scanning the ENTER/EXIT bar code again.

Make a mistake? Scan the CANCEL bar code to abort and not save the entry string. You can then start again at the beginning.



CANCEL



**0001 = Length 1 is 1 Character**



### Aztec Code Set Length 2

This feature specifies one of the bar code lengths for [Aztec Code Length Control](#). Length 2 is the maximum label length if in Variable Length Mode, or the second fixed length if in Fixed Length Mode. Characters can be set from 0001 to 3,832 characters in increments of 0001 (pad with zeroes).

See [page 253](#) for detailed instructions on setting this feature.



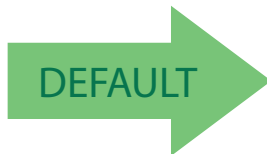
Select Aztec Code Length 2 Setting

To configure this feature, scan the ENTER/EXIT PROGRAMMING MODE bar code above, then the bar code at left followed by the digits from the Alphanumeric characters in [Appendix E, Keypad](#) representing your desired character(s). End by scanning the ENTER/EXIT bar code again.

Make a mistake? Scan the CANCEL bar code to abort and not save the entry string. You can then start again at the beginning.



CANCEL



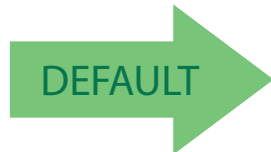
**Length 2 is 3,832 Characters**



## China Sensible Code

### China Sensible Code Enable / Disable

Enables/disables the ability of the reader to decode China Sensible Code labels.



China Sensible Code = Disable



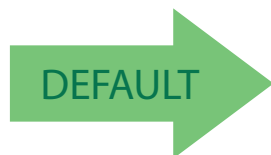
China Sensible Code = Enable

### China Sensible Code Length Control

This feature specifies either variable length decoding or fixed length decoding for this symbology.

**Variable Length:** For variable length decoding, a minimum and maximum length may be set.

**Fixed Length:** For fixed length decoding, two different lengths may be set.



China Sensible Code Length Control = Variable Length



China Sensible Code Length Control = Fixed Length



### China Sensible Code Set Length 1

Specifies one of the bar code lengths for [China Sensible Code Length Control](#). Length 1 is the minimum label length if in Variable Length Mode, or the first fixed length if in Fixed Length Mode. Characters can be set from 0001 to 7,827 characters in increments of 0001 (pad with zeroes).

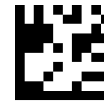
See [page 253](#) for detailed instructions on setting this feature.



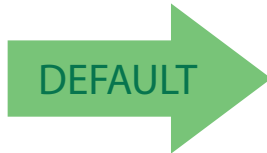
Select China Sensible Code Length 1 Setting

To configure this feature, scan the ENTER/EXIT PROGRAMMING MODE bar code above, then the bar code at left followed by the digits from the Alphanumeric characters in [Appendix E, Keypad](#) representing your desired character(s). End by scanning the ENTER/EXIT bar code again.

Make a mistake? Scan the CANCEL bar code to abort and not save the entry string. You can then start again at the beginning.



CANCEL



**0001 = Length 1 is 1 Character**

## China Sensible Code Set Length 2

This feature specifies one of the bar code lengths for [China Sensible Code Length Control](#). Length 2 is the maximum label length if in Variable Length Mode, or the second fixed length if in Fixed Length Mode. Characters can be set from 0001 to 7,827 characters in increments of 0001 (pad with zeroes).

See [page 253](#) for detailed instructions on setting this feature.



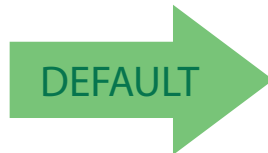
Select China Sensible Code Length 2 Setting

To configure this feature, scan the ENTER/EXIT PROGRAMMING MODE bar code above, then the bar code at left followed by the digits from the Alphanumeric characters in [Appendix E, Keypad](#) representing your desired character(s). End by scanning the ENTER/EXIT bar code again.

Make a mistake? Scan the CANCEL bar code to abort and not save the entry string. You can then start again at the beginning.



CANCEL



**Length 2 is 7,827 Characters**



## Data Matrix

### Data Matrix Enable / Disable

Enables/disables ability of reader to decode Data Matrix labels.



Data Matrix = Disable



Data Matrix = Enable



### Data Matrix Square/Rectangular Style

Specifies the options available when reading Data Matrix with different form factors. Choices are:

- Square Style
- Rectangular Style
- Both Square and Rectangular Style

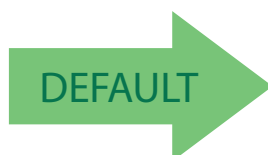
The configuration item can also be configured as a bit mask to filter one or more Data Matrix labels with different symbol size AND shape styles.



Data Matrix Dimensions Mask = Square Style



Data Matrix Dimensions Mask = Rectangular Style



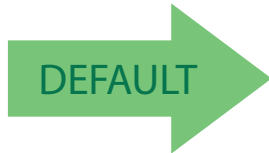
Data Matrix Dimensions Mask = Both Square and Rectangular Style

## Data Matrix Length Control

This feature specifies either variable length decoding or fixed length decoding for this symbology.

**Variable Length:** For variable length decoding, a minimum and maximum length may be set.

**Fixed Length:** For fixed length decoding, two different lengths may be set.



Data Matrix Length Control = Variable Length



Data Matrix Length Control = Fixed Length

## Data Matrix Set Length 1

Specifies one of the bar code lengths for [Data Matrix Length Control](#). Length 1 is the minimum label length if in Variable Length Mode, or the first fixed length if in Fixed Length Mode. Characters can be set from 0001 to 3,116 characters in increments of 0001 (pad with zeroes).

See [page 253](#) for detailed instructions on setting this feature.



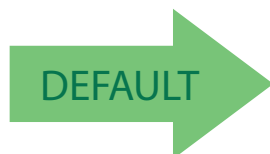
Select Data Matrix Length 1 Setting

To configure this feature, scan the ENTER/EXIT PROGRAMMING MODE bar code above, then the bar code at left followed by the digits from the Alphanumeric characters in [Appendix E, Keypad](#) representing your desired character(s). End by scanning the ENTER/EXIT bar code again.

Make a mistake? Scan the CANCEL bar code to abort and not save the entry string. You can then start again at the beginning.



CANCEL



**0001 = Length 1 is 1 Character**



### Data Matrix Set Length 2

This feature specifies one of the bar code lengths for [Data Matrix Length Control](#). Length 2 is the maximum label length if in Variable Length Mode, or the second fixed length if in Fixed Length Mode. Characters can be set from 0001 to 3,116 characters in increments of 0001 (pad with zeroes).

See [page 253](#) for detailed instructions on setting this feature.



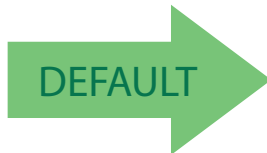
Select Data Matrix Length 2 Setting

To configure this feature, scan the ENTER/EXIT PROGRAMMING MODE bar code above, then the bar code at left followed by the digits from the Alphanumeric characters in [Appendix E, Keypad](#) representing your desired character(s). End by scanning the ENTER/EXIT bar code again.

Make a mistake? Scan the CANCEL bar code to abort and not save the entry string. You can then start again at the beginning.



CANCEL



**Length 2 is 3,116 Characters**

## Maxicode

### Maxicode Enable / Disable

Enables/disables ability of reader to decode Maxicode labels.



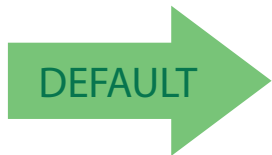
Maxicode = Disable



Maxicode = Enable

### Maxicode Primary Message Transmission

Enables/disables the transmission of only the Primary Message when the Secondary Message is not readable.



Maxicode Primary Message Transmission = Disable



Maxicode Primary Message Transmission = Enable

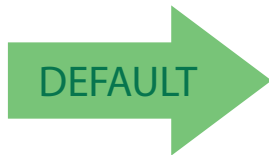


### Maxicode Length Control

This feature specifies either variable length decoding or fixed length decoding for this symbology.

**Variable Length:** For variable length decoding, a minimum and maximum length may be set.

**Fixed Length:** For fixed length decoding, two different lengths may be set.



Maxicode Length Control = Variable Length



Maxicode Length Control = Fixed Length

### Maxicode Set Length 1

Specifies one of the bar code lengths for [Maxicode Length Control](#). Length 1 is the minimum label length if in Variable Length Mode, or the first fixed length if in Fixed Length Mode. Characters can be set from 0001 to 0145 characters in increments of 0001 (pad with zeroes).

See [page 253](#) for detailed instructions on setting this feature.



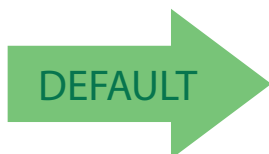
Select Maxicode Length 1 Setting

To configure this feature, scan the ENTER/EXIT PROGRAMMING MODE bar code above, then the bar code at left followed by the digits from the Alphanumeric characters in [Appendix E, Keypad](#) representing your desired character(s). End by scanning the ENTER/EXIT bar code again.

Make a mistake? Scan the CANCEL bar code to abort and not save the entry string. You can then start again at the beginning.



CANCEL



0001 = Length 1 is 1 Character



## Maxicode Set Length 2

This feature specifies one of the bar code lengths for [Maxicode Length Control](#). Length 2 is the maximum label length if in Variable Length Mode, or the second fixed length if in Fixed Length Mode. Characters can be set from 0001 to 0145 characters in increments of 0001 (pad with zeroes).

See [page 253](#) for detailed instructions on setting this feature.



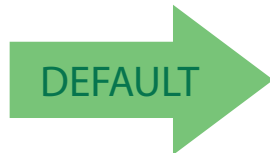
Select Maxicode Length 2 Setting

To configure this feature, scan the ENTER/EXIT PROGRAMMING MODE bar code above, then the bar code at left followed by the digits from the Alphanumeric characters in [Appendix E, Keypad](#) representing your desired character(s). End by scanning the ENTER/EXIT bar code again.

Make a mistake? Scan the CANCEL bar code to abort and not save the entry string. You can then start again at the beginning.



CANCEL



**Length 2 is 0145 Characters**



## PDF417

### PDF417 Enable / Disable

Enables/disables the ability of the reader to decode PDF417 labels.



### PDF417 Length Control

This feature specifies either variable length decoding or fixed length decoding for this symbology.

**Variable Length:** For variable length decoding, a minimum and maximum length may be set.

**Fixed Length:** For fixed length decoding, two different lengths may be set.



## PDF417 Set Length 1

Specifies one of the bar code lengths for [PDF417 Length Control](#). Length 1 is the minimum label length if in Variable Length Mode, or the first fixed length if in Fixed Length Mode. Length includes the bar code's data characters only. Characters can be set from 0001 to 2,710 characters (pad with zeroes) in increments of 01. Any value greater than 2,710 will be considered to be 2,710.

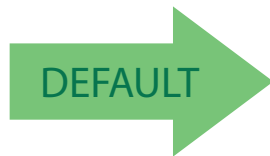
See [page 253](#) for detailed instructions on setting this feature.



Select PDF417 Length 1 Setting

To configure this feature, scan the ENTER/EXIT PROGRAMMING MODE bar code above, then the bar code at left followed by the digits from the Alphanumeric characters in [Appendix E, Keypad](#) representing your desired character(s). End by scanning the ENTER/EXIT bar code again.

Make a mistake? Scan the CANCEL bar code to abort and not save the entry string. You can then start again at the beginning.



**0001 = Length 1 is 1 Character**



### PDF417 Set Length 2

This feature specifies one of the bar code lengths for PDF417 Length Control. Length 2 is the maximum label length if in Variable Length Mode, or the second fixed length if in Fixed Length Mode. Length includes the bar code's check, data, and full-ASCII shift characters. The length does not include start/stop characters. Characters can be set from 01 to 2,710 characters (pad with zeroes) in increments of 01. Any value greater than 2,710 will be considered to be 2,710.

See [page 253](#) for detailed instructions on setting this feature.



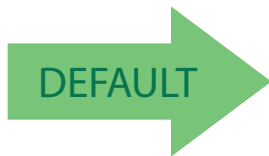
Select PDF417 Length 2 Setting

To configure this feature, scan the ENTER/EXIT PROGRAMMING MODE bar code above, then the bar code at left followed by the digits from the Alphanumeric characters in [Appendix E, Keypad](#) representing your desired character(s). End by scanning the ENTER/EXIT bar code again.

Make a mistake? Scan the CANCEL bar code to abort and not save the entry string. You can then start again at the beginning.



CANCEL

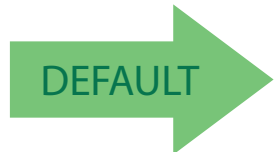


**Length 2 is 2,710 Characters**

## Micro PDF417

### Micro PDF417 Enable / Disable

Enables/disables the ability of the reader to decode Micro PDF417 labels.



Micro PDF417 = Disable



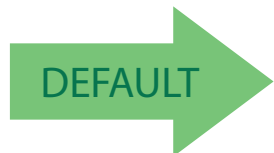
Micro PDF417 = Enable

### Micro PDF417 Code 128 GS1-128 Emulation

Specifies which AIM ID to use for MicroPDF labels when doing Code 128 or GS1-128 emulation.

Emulation choices are:

- Micro PDF AIM ID and label type
- Code 128 / EAN128 AIM Id and label type



Micro PDF417 Code 128 GS1-128 Emulation =  
Micro PDF AIM ID and label type



Micro PDF417 Code 128 GS1-128 Emulation =  
Code 128 / EAN128 AIM ID and label type

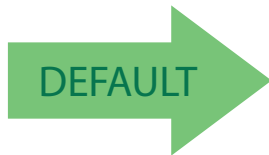


## Micro PDF417 Length Control

This feature specifies either variable length decoding or fixed length decoding for this symbology.

**Variable Length:** For variable length decoding, a minimum and maximum length may be set.

**Fixed Length:** For fixed length decoding, two different lengths may be set.



Micro PDF417 Length Control = Variable Length



Micro PDF417 Length Control = Fixed Length

## Micro PDF417 Set Length 1

Specifies one of the bar code lengths for [Micro PDF417 Length Control](#). Length 1 is the minimum label length if in Variable Length Mode, or the first fixed length if in Fixed Length Mode. Length includes the bar code's data characters only. Characters can be set from 0001 to 0366 characters (pad with zeroes) in increments of 01. Any value greater than 0366 will be considered to be 0366.

See [page 253](#) for detailed instructions on setting this feature.



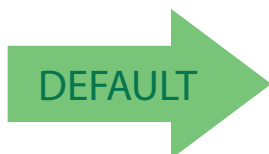
Select Micro PDF417 Length 1 Setting

To configure this feature, scan the ENTER/EXIT PROGRAMMING MODE bar code above, then the bar code at left followed by the digits from the Alphanumeric characters in [Appendix E, Keypad](#) representing your desired character(s). End by scanning the ENTER/EXIT bar code again.

Make a mistake? Scan the CANCEL bar code to abort and not save the entry string. You can then start again at the beginning.



CANCEL



0001 = Length 1 is 1 Character

## Micro PDF417 Set Length 2

This feature specifies one of the bar code lengths for [Micro PDF417 Length Control](#). Length 2 is the maximum label length if in Variable Length Mode, or the second fixed length if in Fixed Length includes the bar code's data characters only. Characters can be set from 0001 to 0366 characters (pad with zeroes) in increments of 01. Any value greater than 0366 will be considered to be 0366.

See [page 253](#) for detailed instructions on setting this feature.



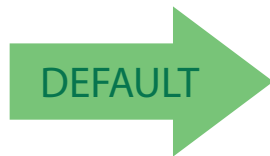
Select Micro PDF417 Length 2 Setting

To configure this feature, scan the ENTER/EXIT PROGRAMMING MODE bar code above, then the bar code at left followed by the digits from the Alphanumeric characters in [Appendix E, Keypad](#) representing your desired character(s). End by scanning the ENTER/EXIT bar code again.

Make a mistake? Scan the CANCEL bar code to abort and not save the entry string. You can then start again at the beginning.



CANCEL



**Length 2 is 0366 Characters**



## QR Code

### QR Code Enable / Disable

Enables/disables the ability of the reader to decode QR Code labels.

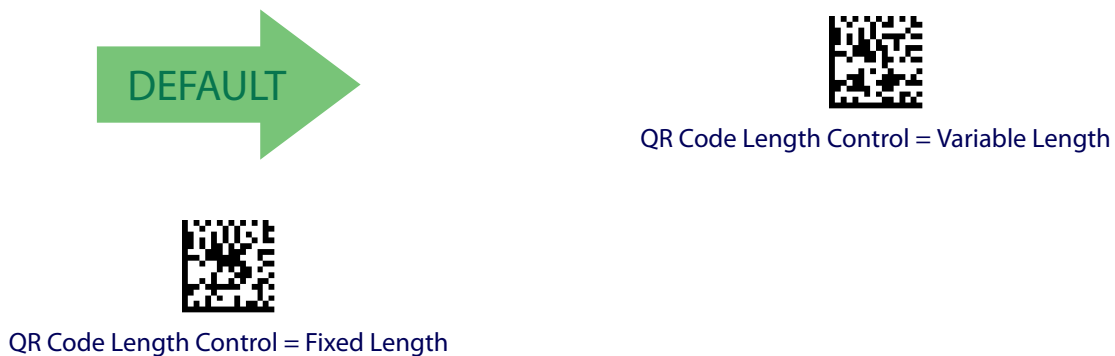


### QR Code Length Control

This feature specifies either variable length decoding or fixed length decoding for this symbology.

**Variable Length:** For variable length decoding, a minimum and maximum length may be set.

**Fixed Length:** For fixed length decoding, two different lengths may be set.





## QR Code Set Length 1

Specifies one of the bar code lengths for [QR Code Length Control](#). Length 1 is the minimum label length if in Variable Length Mode, or the first fixed length if in Fixed Length Mode. Characters can be set from 0001 to 7,089 characters in increments of 0001 (pad with zeroes).

See [page 253](#) for detailed instructions on setting this feature.



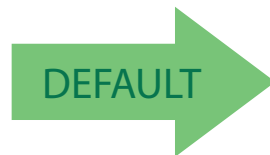
Select QR Code Length 1 Setting

To configure this feature, scan the ENTER/EXIT PROGRAMMING MODE bar code above, then the bar code at left followed by the digits from the Alphanumeric characters in [Appendix E, Keypad](#) representing your desired character(s). End by scanning the ENTER/EXIT bar code again.

Make a mistake? Scan the CANCEL bar code to abort and not save the entry string. You can then start again at the beginning.



CANCEL



**0001 = Length 1 is 1 Character**



## QR Code Set Length 2

This feature specifies one of the bar code lengths for [QR Code Length Control](#). Length 2 is the maximum label length if in Variable Length Mode, or the second fixed length if in Fixed Length Mode. Characters can be set from 0001 to 7,089 characters in increments of 0001 (pad with zeroes).

See [page 253](#) for detailed instructions on setting this feature.



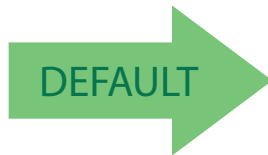
Select QR Code Length 2 Setting

To configure this feature, scan the ENTER/EXIT PROGRAMMING MODE bar code above, then the bar code at left followed by the digits from the Alphanumeric characters in [Appendix E, Keypad](#) representing your desired character(s). End by scanning the ENTER/EXIT bar code again.

Make a mistake? Scan the CANCEL bar code to abort and not save the entry string. You can then start again at the beginning.



CANCEL

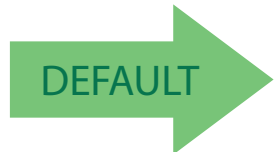


**Length 2 is 7,089 Characters**

## Micro QR Code

### Micro QR Code Enable/Disable

Enables/disables the ability of the reader to decode Micro QR Code labels.



Micro QR Code = Disable



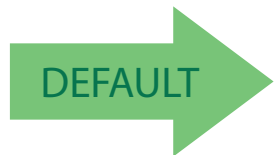
Micro QR Code = Enable

### Micro QR Code Length Control

This feature specifies either variable length decoding or fixed length decoding for this symbology.

**Variable Length:** For variable length decoding, a minimum and maximum length may be set.

**Fixed Length:** For fixed length decoding, two different lengths may be set.



Micro QR Code Length Control = Variable Length



Micro QR Code Length Control = Fixed Length



### Micro QR Code Set Length 1

Specifies one of the bar code lengths for Micro QR Code Length Control. Length 1 is the minimum label length if in Variable Length Mode, or the first fixed length if in Fixed Length Mode. Characters can be set from 0001 to 0035 characters in increments of 0001 (pad with zeroes).

See [page 253](#) for detailed instructions on setting this feature.



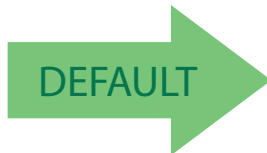
Select Micro QR Code Length 1 Setting

To configure this feature, scan the ENTER/EXIT PROGRAMMING MODE bar code above, then the bar code at left followed by the digits from the Alphanumeric characters in [Appendix E, Keypad](#) representing your desired character(s). End by scanning the ENTER/EXIT bar code again.

Make a mistake? Scan the CANCEL bar code to abort and not save the entry string. You can then start again at the beginning.



CANCEL



**0001 = Length 1 is 1 Character**

## Micro QR Code Set Length 2

This feature specifies one of the bar code lengths for Micro QR Code Length Control. Length 2 is the maximum label length if in Variable Length Mode, or the second fixed length if in Fixed Length Mode. Characters can be set from 0001 to 0035 characters in increments of 0001 (pad with zeroes).

See [page 253](#) for detailed instructions on setting this feature.



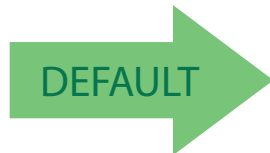
Select QR Code Length 2 Setting

To configure this feature, scan the ENTER/EXIT PROGRAMMING MODE bar code above, then the bar code at left followed by the digits from the Alphanumeric characters in [Appendix E, Keypad](#) representing your desired character(s). End by scanning the ENTER/EXIT bar code again.

Make a mistake? Scan the CANCEL bar code to abort and not save the entry string. You can then start again at the beginning.



CANCEL



**Length 2 is 0035 Characters**



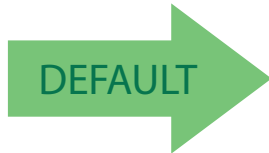
## UCC Composite

### UCC Composite Enable / Disable

Enables/disables the ability of the reader to decode the stacked part of a UCC Composite label.



**This feature is not effective when Global AIM IDs are enabled (see "Global AIM ID" on page 53).**



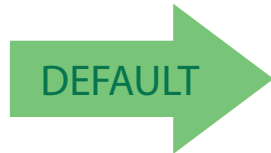
UCC Composite = Disable



UCC Composite = Enable

## UCC Optional Composite Timer

Specifies the amount of time the system will wait for the stacked part of a UCC Composite label before transmitting the linear label without an add-on.



UCC Optional Composite Timer = Timer Disabled



UCC Optional Composite Timer = 100msec



UCC Optional Composite Timer = 200msec



UCC Optional Composite Timer = 300msec



UCC Optional Composite Timer = 400msec



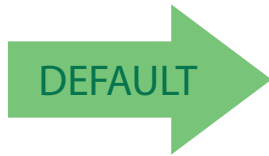
UCC Optional Composite Timer = 500msec



## Postal Code Selection

Enables/disables the ability of the scanner to decode labels of a specific postal symbology.

- Disable All Postal Codes
- Postnet
- Planet
- Royal Mail
- Kix
- Australia Post
- Japan Post
- IMB
- Sweden Post
- Portugal Post



Postal Code Selection = Disable All Postal Codes



Postal Code Selection = Enable Postnet



Postal Code Selection = Enable Planet



Postal Code Selection = Enable Royal Mail



Postal Code Selection = Enable Kix



Postal Code Selection = Enable Australia Post



### Postal Code Selection — cont.



Postal Code Selection = Enable Japan Post



Postal Code Selection = Enable IMB



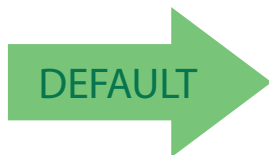
Postal Code Selection = Enable Sweden Post



Postal Code Selection = Enable Portugal Post

### Postnet BB Control

Controls the ability of the scanner to decode B and B' fields of Postnet labels.



Postnet BB Control = Disable



Postnet BB Control = Enable

# NOTES

# Chapter 4

## Software Configuration Strings

RS-232 models (as well as USB models with the USB-COM Interface selected) can be configured using the serial strings contained in this chapter.

To configure RS-232 models by using the configuration strings:

1. Connect your reader to a PC RS-232 port according to the information in [Attaching Reader to Host, starting on page 14](#). Set the PC serial port to the default RS-232 communication parameters (see [, starting on page 289](#)).



**To configure the reader using configuration strings you must enter Service Mode, which automatically sets the reader communication to 115200 baud rate. You must therefore set the host accordingly for RS-232 communications. Upon exiting Service Mode, the programmed baud rate will be restored.**

2. Using Datalogic Aladdin (available on the Datalogic website) or a Terminal Emulation Program, send the Restore Current Interface (Custom) Default string to the reader using the syntax described on the next page.
3. Send all the necessary command strings according to your application's requirements.

To configure USB models (only for USB-COM Interface) by using the configuration strings:



**USB models by default have the USB-COM Interface selected. They can be easily configured by reading the barcodes in [Interface Selection, starting on page 15](#).**

1. Download and install the USB-COM driver from [www.adc.datalogic.com](http://www.adc.datalogic.com).
2. Connect your reader to a PC USB port according to the information in [Attaching Reader to Host, starting on page 14](#).
3. Change the interface to USB-COM by reading the barcode below.

**USB-COM**



4. Using a Terminal Emulation Program, send the Restore Current Interface (Custom) Default string to the reader using the syntax described on the next page.

- Send all the necessary command strings according to your application's requirements.

## Command Syntax

- Enter Service (Serial String Programming) Mode

**\$\$<CR>**



**This command automatically sets the reader communication to 115200 baud rate. Before continuing, please set the baud rate of the Terminal Emulation Program to 115200.**

- Send Command

\$	Command	Parameter	Value	<CR>
----	---------	-----------	-------	------

Where:

### Command:

### Description

<b>H</b> <i>AXX</i>	Interface Selection
<b>AA</b>	Enable All Symbologies
<b>AD</b>	Disable All Symbologies
<b>R</b>	Reset Reader
<b>C</b> <i>XXXXXX</i>	Write Single Configuration Item to RAM

### Parameter:

<b>X</b> <i>XXX</i>	A 4-character ASCII string See Serial Configuration Strings Table
---------------------	--

### Value:

<b>X</b> <i>X</i>	A 2-character Hex string See Serial Configuration Strings Table
-------------------	--

- Apply and Save Configuration to FLASH (permanent memory) and Exit Service Mode

**\$Ar<CR>**



**This command automatically returns to the programmed baud rate. Before continuing, please set the baud rate of the Terminal Emulation Program to the programmed baud rate.**



## SERIAL CONFIGURATION STRINGS

ENTER/EXIT CONFIGURATION COMMANDS	
Description	Command
Enter Service Mode (configuration) fixed 115200 Baud rate	<b>S</b>
Exit Service Mode (configuration) return to programmed Baud rate	<b>s</b>
Apply Configuration to RAM (temporary memory) and Exit Service Mode	<b>r01</b>
Apply and Save Configuration to FLASH (permanent memory) and Exit Service Mode	<b>Ar</b>



To configure the reader using configuration strings, it must be placed into Service Mode, which automatically sets the reader communication to 115200 baud rate. You must therefore set the host accordingly for RS-232 communications. Upon exiting Service Mode, the programmed baud rate will be restored.

CONFIGURATION COMMANDS	
Description	Command
Write Single Configuration Item to RAM (temporary memory)	<b>Cxxxxxx</b>
Read Single Configuration Item from RAM (temporary memory)	<b>cxxxx</b>
Reset Reader	<b>R</b>
Read Application Software Release (does not require Enter/Exit Service Mode)	<b>\$+\$!</b>
Host Commands Obey	<b>CIFIH00</b>
Host Commands Ignore	<b>CIFIH01</b>
Enable All Symbologies	<b>AA</b>
Disable All Symbologies	<b>AD</b>



The Interface Selection commands store and load the new interface type with its factory defaults into the current configuration.

INTERFACE SELECTION COMMANDS	
Description	Command
Restore Current Interface (Custom) Default Configuration	HA00
RS232-STD	HA05
USB-COM	HA47
RS232-Wincor-Nixdorf	HA12
USB-KBD	HA35
USB-KBD-ALT	HA2B
USB KBD-APPLE	HA2C



To read a particular parameter setting from the reader, send the read parameter command without any value. The reader will respond with its currently configured value.

The Read Application Software Release command is a direct command that does not require entering Service Mode.

RS-232 ONLY PARAMETERS			
Description		Parameter	Value
Baud Rate	1200	R2BA	00
	2400		01
	4800		02
	9600		03
	19200		04
	38400		05
	57600		06
	115200		07
Parity	none	R2PA	00
	even		01
	odd		02
Data Bits	7	R2DA	00
	8		01
Stop Bits	1	R2ST	00
	2		01
Handshaking Control	RTS	R2HC	00
	RTS/CTS	R2HC	01
	RTS/Xon/Xoff	R2HC	02
	RTS On/CTS	R2HC	03
	RTS/CTS Scan Control	R2HC	04

RS-232/USB-COM PARAMETERS			
Description		Parameter	Value
Intercharacter Delay	No delay or from 10 to 990 ms	<b>R2IC</b>	<b>a</b>
Disable Character	Host command character which disables the reader	<b>R2DC</b>	<b>b</b>
Enable Character	Host command character which enables the reader	<b>R2EC</b>	<b>b</b>
ACK/NAK Options	Disable	<b>R2AE</b>	<b>00</b>
	Enable for label transmission		<b>01</b>
	Enable for host command acknowledge		<b>02</b>
	Enable for label transmission and host command acknowledge		<b>03</b>
ACK Character	Selects character to be used as ACK	<b>R2AC</b>	<b>c</b>
NAK Character	Selects character to be used as NAK	<b>R2NA</b>	<b>c</b>
ACK/NAK Timeout Value	No timeout or from 200 to 15000 ms	<b>R2AT</b>	<b>d</b>
ACK/NAK Retry Count	From 0 to unlimited retries	<b>R2AR</b>	<b>e</b>
ACK/NAK Error Handling	Ignore errors detected	<b>R2EH</b>	<b>00</b>
	Process errors as valid ACK character		<b>01</b>
	Process errors as valid NAK character		<b>02</b>
Beep On ASCII BEL	Disable	<b>R2BB</b>	<b>00</b>
	Enable		<b>01</b>
Beep On Not-On-File	Disable	<b>BPNF</b>	<b>00</b>
	Enable		<b>01</b>
Indicate Transmission Failure	Disable	<b>R2TF</b>	<b>00</b>
	Enable		<b>01</b>

**a** = Hex value from **00** to **63** representing the decimal number (*00 = no delay; all others x10 ms*)

**b** = Hex value from **00** to **FE** representing the ASCII character

**c** = Hex value from **00** to **FF** representing the ASCII character

**d** = Hex value from **00** to **4B** representing the decimal number (*00 = timeout disabled; all others x200 ms*)

**e** = Hex value from **00** to **FF** representing the number of retries (*00 = no retries; 01-FE = 1-254 retries; FF = unlimited retries*)



USB-KBD / USB-KBD-ALT / USB-KBD-APPLE PARAMETERS			
Description		Parameter	Value
Keyboard Country Mode	*US	<b>KBCO</b>	<b>00</b>
	*Belgium		<b>01</b>
	*Britain		<b>02</b>
	Croatia		<b>11</b>
	Czechoslovakia		<b>0E</b>
	Denmark		<b>03</b>
	*France		<b>04</b>
	*Germany		<b>05</b>
	Hungary		<b>0D</b>
	*Italy		<b>06</b>
	Japanese (106 key)		<b>0C</b>
	Norway		<b>07</b>
	Poland		<b>12</b>
	Portugal		<b>08</b>
	Romania		<b>10</b>
	Slovakia		<b>0F</b>
	*Spain		<b>09</b>
	*Sweden		<b>0A</b>
	Switzerland		<b>0B</b>
	Send Control Characters	CTRL + KEY	<b>KBSC</b>
CTRL + SHIFT + KEY			<b>01</b>
Special Function KEY			<b>02</b>
USB Keyboard Speed	1 ms	<b>KBSP</b>	<b>01</b>
	2 ms		<b>02</b>
	3 ms		<b>03</b>
	4 ms		<b>04</b>
	5 ms		<b>05</b>
	6 ms		<b>06</b>
	7 ms		<b>07</b>
	8 ms		<b>08</b>
	9 ms		<b>09</b>
	10 ms		<b>0A</b>

\* = Valid for USB-KBD-APPLE

READING PARAMETERS			
Description		Parameter	Value
Double Read Timeout	20 to 2,550 milliseconds (2.55 seconds) in 10ms increments	<b>SNDR</b>	<b><i>f</i></b>
Illumination Mode	Disabled	<b>SPIL</b>	<b>00</b>
	Triggered		<b>01</b>
	Enabled		<b>02</b>
Operating Modes	On Line	<b>SNRM</b>	<b>00</b>
	Serial On Line		<b>01</b>
	Automatic		<b>02</b>
	Automatic (Object Sense)		<b>03</b>
Phase Off Event	Trigger Stop	<b>SPTO</b>	<b>00</b>
	Timeout		<b>01</b>
	Trigger Stop-Timeout		<b>02</b>
Timeout (Scan Active Time)	1 to 255 seconds in 1 second intervals.	<b>SNET</b>	<b><i>h</i></b>
Serial Start	Any string of characters (max 20) between 00-FE	<b>STON</b>	<b><i>i</i></b>
Serial Stop	Any string of characters (max 20) between 00-FE	<b>STOF</b>	<b><i>i</i></b>
Label Programming Mode	Disabled	<b>FAPM</b>	<b>00</b>
	Enabled		<b>01</b>

***f*** = Hex value from **02** to **FF** representing the minimum time between same labels

***h*** = Hex value from **02** to **FF** representing the decimal number ( $\times 20$  ms)

***i*** = Hex value from **00** to **FE** representing the ASCII character

DATA FORMAT			
Description		Parameter	Value
Data Transmission	On Decode	LFTX	01
	After Phase Off		00
Code Verifier Mode	Disabled	LFCV	00
	Transmit Wrong String		01
	Transmit Wrong Code		02
Match String	Any string of characters (max 20) between 00-FE	COVS	k
Wrong Code String	Any string of characters (max 20) between 00-FE	WCVS	k
Case Conversion	Disable	LFCA	00
	Upper Case		01
	Lower Case		02
Global Prefix (Header)	Any string of characters (max 20) between 00-FE	LFPR	k
Global Suffix (Terminator)	Any string of characters (max 20) between 00-FE	LFSU	k
No Read String	Any string of characters (max 20) between 00-FE	NORS	k
	Disable		00
	Enable		01
Character Conversion	An 8-character string between 00-FF	LFCH	m
Transmit AIM IDs	Disable	AIEN	00
	Enable		01
Transmit Custom Label IDs	Disable	IDCO	00
	Prefix		01
	Suffix		02
GS1-128 AIM ID	Disable	U8AI	00
	Enable		01

**k** = Hex value from **00** to **FE** representing the ASCII character

**m** = 8 Hex values from **00** to **FF** representing the 8 ASCII characters (*FF = no replacement or ignore*)

<b>Custom Code Identifiers</b>	Any string of characters (max 3) between 00-FE		
UPC-A		<b>ABID</b>	<i>k</i>
UPC-E		<b>EBID</b>	<i>k</i>
EAN-8		<b>8BID</b>	<i>k</i>
EAN-13		<b>3BID</b>	<i>k</i>
UPC-A/P2		<b>A2ID</b>	<i>k</i>
UPC-A/P5		<b>A5ID</b>	<i>k</i>
UPC-E/P2		<b>E2ID</b>	<i>k</i>
UPC-E/P5		<b>E5ID</b>	<i>k</i>
EAN-8/P2		<b>82ID</b>	<i>k</i>
EAN-8/P5		<b>85ID</b>	<i>k</i>
EAN-13/P2		<b>32ID</b>	<i>k</i>
EAN-13/P5		<b>35ID</b>	<i>k</i>
ISBN		<b>ISID</b>	<i>k</i>
ISSN		<b>INID</b>	<i>k</i>
GTIN for EAN/UPC w/o Add-On		<b>GBID</b>	<i>k</i>
GTIN for EAN/UPC w P2		<b>G2ID</b>	<i>k</i>
GTIN for EAN/UPC w P5		<b>G5ID</b>	<i>k</i>
Code 39		<b>C3ID</b>	<i>k</i>
Code 32		<b>P3ID</b>	<i>k</i>
Code 128		<b>C8ID</b>	<i>k</i>
GS1-128		<b>U8ID</b>	<i>k</i>
ISBT 128		<b>I8ID</b>	<i>k</i>
Interleaved 2 of 5		<b>I2ID</b>	<i>k</i>
Standard 2 of 5		<b>S2ID</b>	<i>k</i>
Industrial 2 of 5		<b>U2ID</b>	<i>k</i>
Datalogic 2 of 5		<b>D2ID</b>	<i>k</i>
IATA		<b>IAID</b>	<i>k</i>
Codabar		<b>CBID</b>	<i>k</i>
ABC Codabar		<b>ACID</b>	<i>k</i>
GS1 Databar 14 (Omnidirectional)		<b>4BID</b>	<i>k</i>
GS1 Databar Expanded		<b>XBID</b>	<i>k</i>
GS1 Databar Limited		<b>LBID</b>	<i>k</i>

<b>Custom Code Identifiers</b>	Any string of characters (max 3) between 00-FE		
Code 93		<b>C9ID</b>	<i>k</i>
MSI		<b>MSID</b>	<i>k</i>
Plessey		<b>PLID</b>	<i>k</i>

*k* = Hex value from **00** to **FE** representing the ASCII character

<b>DIGITAL OUTPUT</b>			
<b>Description</b>		<b>Parameter</b>	<b>Value</b>
OUTPUT			
Activation Event	Disable	<b>OUA1</b>	<b>00</b>
	Good Read		<b>01</b>
	No Read		<b>02</b>
	Wrong Code		<b>03</b>
Deactivation Event	Disable	<b>ODU1</b>	<b>00</b>
	Timeout		<b>01</b>
	Reading Phase Active		<b>02</b>
Deactivation Timeout	100 to 25500 ms	<b>OUT1</b>	<i>n</i>
Active Level	Closed	<b>OUL1</b>	<b>00</b>
	Open		<b>01</b>

*n* = Hex value from **01** to **FF** representing the decimal number (*x100 ms*)

LED AND BEEPER INDICATORS			
Description		Parameter	Value
Power On Alert	Disable	<b>BPPU</b>	<b>00</b>
	Enable		<b>01</b>
Indicate Good Read	On Decode	<b>BPIN</b>	<b>00</b>
	After Transmit		<b>01</b>
Good Read Beep	Disable	<b>BPVO</b>	<b>00</b>
	Enable		<b>01</b>
Good Read Beep Length	Time length from 10 to 2550 ms	<b>BPLE</b>	<b>o</b>
Good Read Led Duration	Time length from 0 to 25,500 ms	<b>LAGL</b>	<b>f</b>
Green Spot Duration	Disable	<b>LSSP</b>	<b>00</b>
	Short 300ms		<b>01</b>
	Medium 500ms		<b>02</b>
	Long 800ms		<b>03</b>
Led Indication	On Decode	<b>BPIN</b>	<b>00</b>
	After Transmit		<b>01</b>

**o** = Hex value from **01** to **FF** representing the decimal number ( $\times 10$  ms)

**f** = Hex value from **00** to **FF** representing the decimal number (**00** = Disable; others  $\times 100$ ms)

CODE SELECTION			
Description		Parameter	Value
<b>UPC-A</b>			
UPC-A	Disable	<b>ABEN</b>	<b>00</b>
	Enable		<b>01</b>
Check Character Tx	Disable	<b>ABCT</b>	<b>00</b>
	Enable		<b>01</b>
Expand to EAN-13	Disable	<b>AB3B</b>	<b>00</b>
	Enable		<b>01</b>
Number System Tx	Disable	<b>ABNS</b>	<b>00</b>
	Enable		<b>01</b>
Minimum Reads	One Read	<b>ABMR</b>	<b>01</b>
	Two Reads		<b>02</b>
	Three Reads		<b>03</b>
	Four Reads		<b>04</b>
Coupon Control	Allow all coupon barcodes to be decoded	<b>CPCL</b>	<b>00</b>
	Enable only UPC-A coupon decoding		<b>01</b>
	Enable only GS1 Databar coupon decoding		<b>02</b>
<b>UPC-E</b>			
UPC-E	Disable	<b>EBEN</b>	<b>00</b>
	Enable		<b>01</b>
Check Character Tx	Disable	<b>EBCT</b>	<b>00</b>
	Enable		<b>01</b>
Expand to UPC-A	Disable	<b>EBAB</b>	<b>00</b>
	Enable		<b>01</b>
Expand to EAN-13	Disable	<b>EB3B</b>	<b>00</b>
	Enable		<b>01</b>
Number System Tx	Disable	<b>EBNS</b>	<b>00</b>
	Enable		<b>01</b>
Minimum Reads	One Read	<b>EBMR</b>	<b>01</b>
	Two Reads		<b>02</b>
	Three Reads		<b>03</b>
	Four Reads		<b>04</b>
<b>EAN-13</b>			
EAN-13	Disable	<b>3BEN</b>	<b>00</b>
	Enable		<b>01</b>
Check Character Tx	Disable	<b>3BCT</b>	<b>00</b>
	Enable		<b>01</b>
ISBN Conversion	Disable	<b>3BIS</b>	<b>00</b>

CODE SELECTION			
Description		Parameter	Value
	Enable		01
ISSN Conversion	Disable	3BIN	00
	Enable		01
Flag 1 Character	Disable	3BF1	00
	Enable		01
Minimum Reads	One Read	3BMR	01
	Two Reads		02
	Three Reads		03
	Four Reads		04
Coupon Control	Allow all coupon barcodes to be decoded	CPCL	00
	Enable only UPC-A coupon decoding		01
	Enable only GS1 Databar coupon decoding		02
<b>EAN-8</b>			
EAN-8	Disable	8BEN	00
	Enable		01
Check Character Tx	Disable	8BCT	00
	Enable		01
Expand to EAN-13	Disable	8B3B	00
	Enable		01
Minimum Reads	One Read	8BMR	01
	Two Reads		02
	Three Reads		03
	Four Reads		04
<b>Add-Ons</b>			
P2 Add-On	Disable	ADO2	00
	Enable		01
P5 Add-On	Disable	ADO5	00
	Enable		01
P2 Minimum Reads	One Read	ADM2	01
	Two Reads		02
	Three Reads		03
	Four Reads		04
P5 Minimum Reads	One Read	ADM5	01
	Two Reads		02
	Three Reads		03
	Four Reads		04
Optional Add-On Timer	Timer disabled or from 10 to 300 ms	ADOT	p

p = Hex value from 00 to 1E representing the decimal number (00 = Timer disabled; all others x10 ms)



CODE SELECTION			
Description		Parameter	Value
<b>EAN/UPC Global Settings</b>			
GTIN Format	Disable	<b>GBEN</b>	<b>00</b>
	Enable		<b>01</b>
Decoding Level	Disable	<b>UNDL</b>	<b>00</b>
	Level 1		<b>01</b>
	Level 2		<b>02</b>
	Level 3		<b>03</b>
	Level 4		<b>04</b>
Character Correlation	Disable	<b>UNCO</b>	<b>00</b>
	Enable		<b>01</b>
In-Store Minimum Reads	One Read	<b>INMR</b>	<b>01</b>
	Two Reads		<b>02</b>
	Three Reads		<b>03</b>
	Four Reads		<b>04</b>
<b>Code 39</b>			
Code 39	Disable	<b>C3EN</b>	<b>00</b>
	Enable		<b>01</b>
Code 39 Full ASCII	Disable	<b>C3FA</b>	<b>00</b>
	Enable		<b>01</b>
Code Length Control	Variable	<b>C3LC</b>	<b>00</b>
	Fixed		<b>01</b>
Set Length	Length 1 (or Min Length) from 1 to 50 characters	<b>C3L1</b>	<b>q</b>
	Length 2 (or Max Length) 0 or from 1 to 50 characters	<b>C3L2</b>	<b>q</b>
Code 32 (Italian Pharma)	Disable	<b>P3EN</b>	<b>00</b>
	Enable		<b>01</b>
Code 32 Check Tx	Disable	<b>P3CT</b>	<b>00</b>
	Enable		<b>01</b>
Code 32 Start/Stop Tx	Disable	<b>P3SS</b>	<b>00</b>
	Enable		<b>01</b>
Check Options			
Check Calculation	Disable	<b>C3CC</b>	<b>00</b>
	Enable Standard Check		<b>01</b>
	Enable Mod-7 Check		<b>02</b>
	Enable Italian Post Check		<b>04</b>
	Enable Daimler Chrysler Check		<b>08</b>

**q** = Hex value from **00** to **32** representing the decimal number

CODE SELECTION			
Description		Parameter	Value
Code 39 Check Tx	Disable	<b>C3CT</b>	<b>00</b>
	Enable		<b>01</b>
Code 39 Start/Stop Tx	Disable	<b>C3SS</b>	<b>00</b>
	Enable		<b>01</b>
Decoding Options			
Minimum Reads	One Read	<b>C3MR</b>	<b>01</b>
	Two Reads		<b>02</b>
	Three Reads		<b>03</b>
	Four Reads		<b>04</b>
Decoding Level	Disable	<b>C3DL</b>	<b>00</b>
	Level 1		<b>01</b>
	Level 2		<b>02</b>
	Level 3		<b>03</b>
	Level 4		<b>04</b>
	Level 5		<b>05</b>
Interdigit Ratio	Any ratio or 1 to 10	<b>C3IR</b>	<i>r</i>
Character Correlation	Disable	<b>C3CO</b>	<b>00</b>
	Enable		<b>01</b>
Quiet Zones	Quiet Zone on One Side	<b>C3LO</b>	<b>01</b>
	Quiet Zones on Two Sides		<b>02</b>
	Auto		<b>03</b>
	Virtual Quiet Zones on Two Sides		<b>04</b>
	Small Quiet Zones on Two Sides		<b>05</b>
Stitching	Disable	<b>C3ST</b>	<b>00</b>
	Enable		<b>01</b>
<b>Code 128 (GS1-128)</b>			
Code 128	Disable	<b>C8EN</b>	<b>00</b>
	Enable		<b>01</b>
GS1-128 Enable	Enable (transmit labels in Code 128 data format)	<b>U8EN</b>	<b>00</b>
	Enable (transmit labels in GS1-128 data format)		<b>01</b>
	Disable		<b>02</b>
Code Length Control	Variable	<b>C8LC</b>	<b>00</b>
	Fixed		<b>01</b>
Set Length	Length 1 (or Min Length) from 1 to 80 characters	<b>C8L1</b>	<i>s</i>
	Length 2 (or Max Length) 0 or from 1 to 80 characters	<b>C8L2</b>	<i>s</i>

*r* = Hex value from **00** to **0A** representing the decimal number of the interdigit space/module ratio (*00* = any ratio)

*s* = Hex value from **00** to **50** representing the decimal number

CODE SELECTION			
Description		Parameter	Value
Expand to Code 39	Disable	<b>C8C3</b>	<b>00</b>
	Enable		<b>01</b>
Check Options			
Check Tx	Disable	<b>C8CT</b>	<b>00</b>
	Enable		<b>01</b>
Function Character Tx	Disable	<b>C8TF</b>	<b>00</b>
	Enable		<b>01</b>
Sub-Code Change Tx	Disable	<b>C8SC</b>	<b>00</b>
	Enable		<b>01</b>
Decoding Options			
Minimum Reads	One Read	<b>C8MR</b>	<b>01</b>
	Two Reads		<b>02</b>
	Three Reads		<b>03</b>
	Four Reads		<b>04</b>
Decoding Level	Disable	<b>C8DL</b>	<b>00</b>
	Level 1		<b>01</b>
	Level 2		<b>02</b>
	Level 3		<b>03</b>
	Level 4		<b>04</b>
	Level 5		<b>05</b>
Character Correlation	Disable	<b>C8CO</b>	<b>00</b>
	Enable		<b>01</b>
Quiet Zones	No Quiet Zones	<b>C8LO</b>	<b>00</b>
	Quiet Zone on One Side		<b>01</b>
	Quiet Zones on Two Sides		<b>02</b>
	Auto		<b>03</b>
	Virtual Quiet Zones on Two Sides		<b>04</b>
Stitching	Disable	<b>C8ST</b>	<b>00</b>
	Enable		<b>01</b>
<b>ISBT 128</b>			
ISBT 128 Concatenation	Disable	<b>I8CE</b>	<b>00</b>
	Enable		<b>01</b>
Concatenation Mode	Static	<b>I8CM</b>	<b>00</b>
	Dynamic		<b>01</b>
Dynamic Concat. Timeout	From 50 to 2550 ms	<b>I8DT</b>	<b>t</b>
Chain 0 - Chain 15	Contact Datalogic		

**t** = Hex value from **05** to **FF** representing the decimal number ( $\times 10$  ms)

CODE SELECTION			
Description		Parameter	Value
<b>Interleaved 2 of 5 (I 2 of 5)</b>			
I 2 of 5	Disable	<b>I2EN</b>	<b>00</b>
	Enable		<b>01</b>
Code Length Control	Variable	<b>I2LC</b>	<b>00</b>
	Fixed		<b>01</b>
Set Length	Length 1 (or Min Length) from 2 to 50 characters (only even numbers)	<b>I2L1</b>	<b>v</b>
	Length 2 (or Max Length) from 0 or from 2 to 50 characters (only even numbers)	<b>I2L2</b>	<b>v</b>
Check Options			
Check Calculation	Disable	<b>I2CC</b>	<b>00</b>
	Enable Standard(Mod 10)		<b>01</b>
	Enable German Parcel		<b>02</b>
	Enable DHL		<b>04</b>
	Enable Daimler Chrysler		<b>08</b>
	Enable Bosch		<b>10</b>
	Enable Italian Post		<b>20</b>
Check Tx	Disable	<b>I2CT</b>	<b>00</b>
	Enable		<b>01</b>
<b>Decoding Options</b>			
Minimum Reads	One Read	<b>I2MR</b>	<b>01</b>
	Two Reads		<b>02</b>
	Three Reads		<b>03</b>
	Four Reads		<b>04</b>
Decoding Level	Disable	<b>I2DL</b>	<b>00</b>
	Level 1		<b>01</b>
	Level 2		<b>02</b>
	Level 3		<b>03</b>
	Level 4		<b>04</b>
	Level 5		<b>05</b>
Character Correlation	Disable	<b>I2CO</b>	<b>00</b>
	Enable		<b>01</b>
Stitching	Disable	<b>I2ST</b>	<b>00</b>
	Enable		<b>01</b>
Zero Pattern	Disable	<b>I2ZP</b>	<b>00</b>
	Enable		<b>01</b>

**v** = Hex value from **00** or **02** to **32** representing the decimal number

CODE SELECTION			
Description		Parameter	Value
<b>Standard 2 of 5</b>			
Standard 2 of 5	Disable	<b>S2EN</b>	<b>00</b>
	Enable		<b>01</b>
Code Length Control	Variable	<b>S2LC</b>	<b>00</b>
	Fixed		<b>01</b>
Set Length	Length 1 (or Min Length) from 1 to 50 characters	<b>S2L1</b>	<b>v</b>
	Length 2 (or Max Length) 0 or from 1 to 50 characters	<b>S2L2</b>	<b>v</b>
Check Options			
Check Calculation	Disable	<b>S2CC</b>	<b>00</b>
	Enable		<b>01</b>
Check Tx	Disable	<b>S2CT</b>	<b>00</b>
	Enable		<b>01</b>
Decoding Options			
Minimum Reads	One Read	<b>S2MR</b>	<b>01</b>
	Two Reads		<b>02</b>
	Three Reads		<b>03</b>
	Four Reads		<b>04</b>
Decoding Level	Disable	<b>S2DL</b>	<b>00</b>
	Level 1		<b>01</b>
	Level 2		<b>02</b>
	Level 3		<b>03</b>
	Level 4		<b>04</b>
	Level 5		<b>05</b>
Character Correlation	Disable	<b>S2CO</b>	<b>00</b>
	Enable		<b>01</b>
Stitching	Disable	<b>S2ST</b>	<b>00</b>
	Enable		<b>01</b>
<b>Industrial 2 of 5</b>			
Industrial 2 of 5	Disable	<b>U2EN</b>	<b>00</b>
	Enable		<b>01</b>
Code Length Control	Variable	<b>U2LC</b>	<b>00</b>
	Fixed		<b>01</b>
Set Length	Length 1 (or Min Length) from 1 to 50 characters	<b>U2L1</b>	<b>v</b>
	Length 2 (or Max Length) 0 or from 1 to 50 characters	<b>U2L2</b>	<b>v</b>
Check Options			
Check Calculation	Disable	<b>U2CC</b>	<b>00</b>
	Enable		<b>01</b>

**v** = Hex value from **00** or **02** to **32** representing the decimal number

<b>CODE SELECTION</b>			
<b>Description</b>		<b>Parameter</b>	<b>Value</b>
Check Tx	Disable	<b>U2CT</b>	<b>00</b>
	Enable		<b>01</b>
Decoding Options			
Minimum Reads	One Read	<b>U2MR</b>	<b>01</b>
	Two Reads		<b>02</b>
	Three Reads		<b>03</b>
	Four Reads		<b>04</b>
Character Correlation	Disable	<b>U2CO</b>	<b>00</b>
	Enable		<b>01</b>
Stitching	Disable	<b>U2ST</b>	<b>00</b>
	Enable		<b>01</b>
<b>IATA</b>			
IATA	Disable	<b>IAEN</b>	<b>00</b>
	Enable		<b>01</b>
Check Tx	Disable	<b>IACT</b>	<b>00</b>
	Enable		<b>01</b>
<b>Datalogic 2 of 5</b>			
Datalogic 2 of 5	Disable	<b>D2EN</b>	<b>00</b>
	Enable		<b>01</b>
Code Length Control	Variable	<b>D2LC</b>	<b>00</b>
	Fixed		<b>01</b>
Set Length	Length 1 (or Min Length) from 1 to 50 characters	<b>D2L1</b>	<b>v</b>
	Length 2 (or Max Length) 0 or from 1 to 50 characters	<b>D2L2</b>	<b>v</b>
Check Options			
Check Calculation	Disable	<b>D2CC</b>	<b>00</b>
	Enable		<b>01</b>
Check Tx	Disable	<b>D2CT</b>	<b>00</b>
	Enable		<b>01</b>
Decoding Options			
Minimum Reads	One Read	<b>D2MR</b>	<b>01</b>
	Two Reads		<b>02</b>
	Three Reads		<b>03</b>
	Four Reads		<b>04</b>
Decoding Level	Disable	<b>D2DL</b>	<b>00</b>
	Level 1		<b>01</b>
	Level 2		<b>02</b>
	Level 3		<b>03</b>

**v** = Hex value from **00** or **02** to **32** representing the decimal number

CODE SELECTION			
Description		Parameter	Value
	Level 4		04
	Level 5		05
Character Correlation	Disable	D2CO	00
	Enable		01
Stitching	Disable	D2ST	00
	Enable		01
<b>Codabar</b>			
Codabar	Disable	CBEN	00
	Enable		01
Code Length Control	Variable	CBLC	00
	Fixed		01
Set Length	Length 1 (or Min Length) from 3 to 50 characters	CBL1	v
	Length 2 (or Max Length) 0 or from 3 to 50 characters	CBL2	v
<b>ABC Codabar</b>			
ABC Codabar	Disable	CBAB	00
	Enable		01
Concatenation Mode	Static	CBCM	00
	Dynamic		01
Dynamic Concat. Timeout	From 50 to 2550 ms	CBDT	t
Check Options			
Check Calculation	Disable	CBCC	00
	Enable AIM Standard Check		01
	Enable Mod-10 Check		02
Check Tx	Disable	CBCT	00
	Enable		01
Start/Stop Set	ABCD/TN*E	CBSC	00
	ABCD/ABCD		01
	abcd/tn*e		02
	abcd/abcd		03
Start/Stop Tx	Disable	CBSS	00
	Enable		01
Start/Stop Match	Disable	CBSM	00
	Enable		01
Decoding Options			
Minimum Reads	One Read	CBMR	01
	Two Reads		02

v = Hex value from 00 or 02 to 32 representing the decimal number

t = Hex value from 05 to FF representing the decimal number ( $\times 10$  ms)

CODE SELECTION			
Description		Parameter	Value
	Three Reads		03
	Four Reads		04
Decoding Level	Disable	CBDL	00
	Level 1		01
	Level 2		02
	Level 3		03
	Level 4		04
	Level 5		05
Character Correlation	Disable	CBCO	00
	Enable		01
Interdigit Ratio	Any ratio or 1 to 10	CBIR	<i>r</i>
Quiet Zones	Quiet Zone on One Side	CBLO	01
	Quiet Zones on Two Sides		02
	Auto		03
	Virtual Quiet Zones on Two Sides		04
	Small Quiet Zones on Two Sides		05
Stitching	Disable	CBST	00
	Enable		01
<b>GS1 Databar Omnidirectional</b>			
GS1 Databar Omnidirectional	Disable	4BEN	00
	Enable		01
GS1-128 Emulation	Disable	4BU8	00
	Enable		01
Omnidirectional Decoding Options			
Minimum Reads	One Read	4BMR	01
	Two Reads		02
	Three Reads		03
	Four Reads		04
<b>GS1 Databar Expanded</b>			
GS1 Databar Expanded	Disable	XBEN	00
	Enable		01
GS1-128 Emulation	Disable	XBU8	00
	Enable		01
Code Length Control	Variable	XBLC	00
	Fixed		01

*r* = Hex value from 00 to 0A representing the decimal number of the interdigit space/module ratio (00 = any ratio)



<b>CODE SELECTION</b>			
<b>Description</b>		<b>Parameter</b>	<b>Value</b>
Set Length	Length 1 (or Min Length) from 1 to 74 characters	<b>XBL1</b>	<b>w</b>
	Length 2 (or Max Length) 0 or from 1 to 74 characters	<b>XBL2</b>	<b>w</b>
<b>Expanded Decoding Options</b>			
Minimum Reads	One Read	<b>XBMR</b>	<b>01</b>
	Two Reads		<b>02</b>
	Three Reads		<b>03</b>
	Four Reads		<b>04</b>
Coupon Control	Allow all coupon barcodes to be decoded	<b>CPCL</b>	<b>00</b>
	Enable only UPC-A coupon decoding		<b>01</b>
	Enable only GS1 Databar coupon decoding		<b>02</b>
<b>GS1 Databar Limited</b>			
GS1 Databar Limited	Disable	<b>LBEN</b>	<b>00</b>
	Enable		<b>01</b>
GS1-128 Emulation	Disable	<b>LBU8</b>	<b>00</b>
	Enable		<b>01</b>
<b>Limited Decoding Options</b>			
Minimum Reads	One Read	<b>LBMR</b>	<b>01</b>
	Two Reads		<b>02</b>
	Three Reads		<b>03</b>
	Four Reads		<b>04</b>
<b>Code 93</b>			
Code 93	Disable	<b>C9EN</b>	<b>00</b>
	Enable		<b>01</b>
Code Length Control	Variable	<b>C9LC</b>	<b>00</b>
	Fixed		<b>01</b>
Set Length	Length 1 (or Min Length) from 1 to 50 characters	<b>C9L1</b>	<b>v</b>
	Length 2 (or Max Length) 0 or from 1 to 50 characters	<b>C9L2</b>	<b>v</b>
<b>Check Options</b>			
Check Calculation	Disable	<b>C9CC</b>	<b>00</b>
	Enable Check C		<b>01</b>
	Enable Check K		<b>02</b>
	Enable Check C and K		<b>03</b>
Check Tx	Disable	<b>C9CT</b>	<b>00</b>
	Enable		<b>01</b>
<b>Decoding Options</b>			
Minimum Reads	One Read	<b>C9MR</b>	<b>01</b>

**w** = Hex value from **00** to **4A** representing the decimal number

**v** = Hex value from **00** or **02** to **32** representing the decimal number

CODE SELECTION			
Description		Parameter	Value
	Two Reads		02
	Three Reads		03
	Four Reads		04
Decoding Level	Disable	C9DL	00
	Level 1		01
	Level 2		02
	Level 3		03
	Level 4		04
	Level 5		05
Character Correlation	Disable	C9CO	00
	Enable		01
Quiet Zones	No Quiet Zones	C9LO	00
	Quiet Zone on One Side		01
	Quiet Zones on Two Sides		02
	Auto		03
	Virtual Quiet Zones on Two Sides		04
Stitching	Disable	C9ST	00
	Enable		01
<b>MSI</b>			
MSI	Disable	MSEN	00
	Enable		01
Code Length Control	Variable	MSLC	00
	Fixed		01
Set Length	Length 1 (or Min Length) from 1 to 50 characters	MSL1	v
	Length 2 (or Max Length) 0 or from 1 to 50 characters	MSL2	v
Check Options			
Check Calculation	Disable	MSCC	00
	Enable Mod 10		01
	Enable Mod 11/10		02
	Enable Mod 10/10		03
Check Tx	Disable	MSCT	00
	Enable		01
Decoding Options			
Minimum Reads	One Read	MSMR	01
	Two Reads		02
	Three Reads		03
	Four Reads		04

v = Hex value from 00 or 02 to 32 representing the decimal number

CODE SELECTION			
Description		Parameter	Value
Decoding Level	Disable	<b>MSDL</b>	<b>00</b>
	Level 1		<b>01</b>
	Level 2		<b>02</b>
	Level 3		<b>03</b>
	Level 4		<b>04</b>
	Level 5		<b>05</b>
Stitching	Disable	<b>MSST</b>	<b>00</b>
	Enable		<b>01</b>
<b>Plessey</b>			
Plessey	Disable	<b>PLEN</b>	<b>00</b>
	Enable		<b>01</b>
Code Length Control	Variable	<b>PLLC</b>	<b>00</b>
	Fixed		<b>01</b>
Set Length	Length 1 (or Min Length) from 1 to 50 characters	<b>PLL1</b>	<b>v</b>
	Length 2 (or Max Length) 0 or from 1 to 50 characters	<b>PLL2</b>	<b>v</b>
Check Options			
Check Calculation	Disable	<b>PLCC</b>	<b>00</b>
	Standard		<b>01</b>
	Anker Calculation		<b>02</b>
	Standard and Anker Calculation		<b>03</b>
Check Tx	Disable	<b>PLCT</b>	<b>00</b>
	Enable		<b>01</b>
Decoding Options			
Minimum Reads	One Read	<b>PLMR</b>	<b>01</b>
	Two Reads		<b>02</b>
	Three Reads		<b>03</b>
	Four Reads		<b>04</b>
Decoding Level	Disable	<b>PLDL</b>	<b>00</b>
	Level 1		<b>01</b>
	Level 2		<b>02</b>
	Level 3		<b>03</b>
	Level 4		<b>04</b>
	Level 5		<b>05</b>
Character Correlation	Disable	<b>PLCO</b>	<b>00</b>
	Enable		<b>01</b>
Stitching	Disable	<b>PLST</b>	<b>00</b>
	Enable		<b>01</b>

v = Hex value from **00** or **02** to **32** representing the decimal number

# NOTES

# Chapter 5

## References

This section contains explanations and examples of selected bar code features. See [Configuration Using Bar Codes, starting on page 21](#) for the actual bar code labels used to configure the reader.

RS-232 Parameters .....	244
RS-232 Only .....	244
RS-232/USB COM Parameters .....	245
USB Intercode Delay .....	252
Symbologies.....	253
Set Length.....	253
Data Editing.....	254
Global Prefix/Suffix.....	255
Global AIM ID.....	256
Label ID .....	257
Character Conversion .....	262
Scanner Data Formatting Control.....	263
Digital Output.....	265
Reading Parameters .....	266
Double Read Timeout.....	266
Good Read LED Duration .....	267
Scanning Features.....	268
Operating Mode .....	268
Digital Output .....	269
Scanning Active Time .....	270
Aiming Duration Time.....	271
Multiple Labels Ordering by Code Symbology .....	272

## RS-232 Parameters

### RS-232 Only

#### Baud Rate

Baud rate is the number of bits of data transmitted per second. Set the reader's baud rate to match the baud rate setting of the host device. With an improper baud rate setting, data may not reach the host correctly.

#### Stop Bits

The stop bit(s) at the end of each transmitted character marks the end of transmission of one character and prepares the receiving device for the next character in the serial data stream. The number of stop bits selected (one or two) depends on the number the receiving terminal is programmed to accommodate. Set the number of stop bits to match host device requirements.

#### Parity

This feature specifies parity required for sending and receiving data. A parity check bit is the most significant bit of each ASCII coded character. Select the parity type according to host device requirements.

- Select None when no parity bit is required.
- Select Odd parity and the parity bit value is set to 0 or 1, based on data, to ensure that an odd number of 1 bits are contained in the coded character.
- Select Even parity and the parity bit value is set to 0 or 1, based on data, to ensure that an even number of 1 bits are contained in the coded character.

#### Handshaking Control

The data interface consists of an RS-232 port designed to operate either with or without the hardware handshaking lines, *Request to Send* (RTS), and *Clear to Send* (CTS). Handshaking Control includes the following options:

- RTS — RTS is asserted during transmissions. CTS is ignored.
- RTS/CTS — RTS is asserted during transmissions. CTS gates transmissions.
- RTS/XON/XOFF — RTS is asserted during transmissions. CTS is ignored. XON and XOFF gate transmissions.
- RTS On/CTS — RTS is always asserted. CTS gates transmissions.

RTS/CTS Scan Control — RTS is asserted during transmissions. CTS gates transmissions and controls enable and disable state of scanner.

## RS-232/USB COM Parameters

### Intercharacter Delay

This parameter specifies the intercharacter delay between the end of one character and the beginning of the next. The delay can be set within a range of zero (0) to 990 milliseconds in 10ms increments. A setting of zero specifies no delay.

To set the delay:

1. Determine the desired setting in milliseconds.
2. Divide the desired setting by 10 (setting is in 10ms increments). Pad the result with leading zeroes to yield two digits. For example: 0 = 00, 5 = 05, 20 = 20, etc.
3. Scan the ENTER/EXIT PROGRAMMING MODE bar code to enter Programming Mode.
4. Go to [page 31](#) and scan the bar code: SELECT INTERCHARACTER DELAY SETTING.
5. Scan the appropriate two digits from the keypad in [Appendix E, Keypad](#), that represent the duration which was determined in the steps above. You will hear a two-beep indication after the last character.



**If you make a mistake before the last character, scan the CANCEL bar code to abort and not save the entry string. You can then start again at the beginning.**

6. Scan the ENTER/EXIT PROGRAMMING MODE bar code to exit.

This completes the procedure. See [Table 25](#) for some examples of how to set this feature.

**Table 25. Intercharacter Delay Setting Examples**

STEP	ACTION	EXAMPLES			
1	<b>Desired Setting</b>	50ms	150ms	600ms	850ms
2	<b>Divide by 10 (pad with leading zeroes to yield two-digits)</b>	05	15	60	85
3	<b>Scan ENTER/EXIT PROGRAMMING MODE</b>				
4	<b>Scan SELECT INTERCHARACTER DELAY SETTING</b>				
5	<b>Scan Two Characters From</b> <a href="#">Appendix E, Keypad</a>	'0' and '5'	'5' and '0'	'6' and '0'	'8' and '5'
6	<b>Scan ENTER/EXIT PROGRAMMING MODE</b>				

## ACK NAK Options

This enables/disables the ability of the reader to support the RS-232 ACK/NAK protocol. When configured, the reader and/or host sends an “ACK” when it receives data properly, and sends “NAK” when the data is in error.

Options are:

- Disable
- Enable for label transmission — The reader expects an ACK/NAK response from the host when a label is sent.
- Enable for host-command acknowledge — The reader will respond with ACK/NAK when the host sends a command.
- Enable for label transmission and host-command acknowledge

## ACK Character

This setting specifies an ASCII character or hex value to be used as the ACK character. ASCII characters or any hex value from 0 to 0xFF can be selected.



**Setting to previously defined characters such as XON, XOFF, or host commands conflicts with normal operation of these characters. 8-bit data is not recognized when the option [Data Bits](#) has been set as 7 Data Bits.**

1. Determine the desired character or value.
2. Use the [ASCII Chart](#) on the inside back cover of this manual to find the hex equivalent for the desired character/value.
3. Go to [page 33](#) and scan ENTER/EXIT PROGRAMMING MODE to enter Programming Mode.
4. Scan the bar code: SELECT ACK CHARACTER SETTING.
5. Scan the appropriate two alphanumeric characters from the keypad in [Appendix E, Keypad](#), that represent the desired character/value in step 1 above. The second character will cause a two-beep indication.
6. Scan the ENTER/EXIT PROGRAMMING MODE bar code to exit.

See [Table 26](#) for some examples of how to set this feature.

**Table 26. ACK Character Setting Examples**

STEP	ACTION	EXAMPLES			
1	Desired Character/Value	ACK	\$	@	>
2	Hex equivalent from <a href="#">ASCII Chart</a>	0x06	0x24	0x40	0x3E
3	Scan ENTER/EXIT PROGRAMMING MODE				
4	Scan SELECT ACK CHARACTER SETTING				
5	Scan Two Characters from <a href="#">Appendix E, Keypad</a>	'0' and '6'	'2' and '4'	'4' and '0'	'3' AND 'E'
6	Scan ENTER/EXIT PROGRAMMING MODE				



## NAK Character

This setting specifies an ASCII character or hex value to be used as the NAK character. ASCII characters or any hex value from 0 to 0xFF can be selected.



**Setting to previously defined characters such as XON, XOFF, or host commands conflicts with normal operation of these characters. 8-bit data is not recognized when the option Data Bits has been set as 7 Data Bits.**

To set this feature:

1. Determine the desired character or value.
2. Use the [ASCII Chart](#) on the inside back cover of this manual to find the hex equivalent for the desired character/value.
3. Go to [page 33](#) and scan the ENTER/EXIT PROGRAMMING MODE bar code to enter Programming Mode.
4. Scan the bar code: SELECT NAK CHARACTER SETTING.
5. Scan the appropriate two alphanumeric characters from the keypad in [Appendix E, Keypad](#), that represent the desired character/value in step 1 above. The second character will cause a two-beep indication.
6. Scan the ENTER/EXIT PROGRAMMING MODE bar code to exit Programming Mode.

This completes the procedure. See [Table 27](#) for some examples of how to set this feature.

**Table 27. NAK Character Setting Examples**

STEP	ACTION	EXAMPLES			
1	Desired Character/Value	NAK	\$	@	>
2	Hex equivalent from <a href="#">ASCII Chart</a>	0x15	0x24	0x40	0x3E
3	Scan ENTER/EXIT PROGRAMMING MODE				
4	Scan SELECT NAK CHARACTER SETTING				
5	Scan Two Characters From <a href="#">Appendix E, Keypad</a>	'1' and '5'	'2' and '4'	'4' and '0'	'3' AND 'E'
6	Scan ENTER/EXIT PROGRAMMING MODE				

## ACK NAK Timeout Value

This option specifies the amount of time the reader waits for an ACK character from the host following label transmission. The selectable timeout range is 200 milliseconds to 15,000ms (15 seconds) in 200ms increments. A selection of 0 disables the timeout.

To set this value:

1. Determine the desired setting in milliseconds.
2. Divide the desired setting by 200 (setting is in 200ms increments). Pad the result with leading zeroes to yield two digits. For example: 0 = 00, 5 = 05, 20 = 20, etc.
3. Go to [page 34](#) and scan the ENTER/EXIT PROGRAMMING MODE bar code to enter Programming Mode.
4. Scan the bar code: SELECT ACK NAK TIMEOUT VALUE SETTING.
5. Scan the appropriate two digits from the keypad in [Appendix E, Keypad](#), that represent the duration which was determined in the steps above. You will hear a two-beep indication after the last character.



**If you make a mistake before the last character, scan the CANCEL bar code to abort and not save the entry string. You can then start again at the beginning.**

6. Scan the ENTER/EXIT PROGRAMMING MODE bar code to exit Programming Mode.

This completes the procedure. See [Table 28](#) for some examples of how to set this feature.

**Table 28. ACK NAK Timeout Value Setting Examples**

STEP	ACTION	EXAMPLES			
1	<b>Desired Setting</b>	200ms	1,000ms (1 sec.)	5200ms (5.2 sec.)	15,000ms (15 sec.)
2	<b>Divide by 200</b>	01	05	26	75
3	<b>Scan ENTER/EXIT PROGRAMMING MODE</b>				
4	<b>Scan SELECT ACK NAK TIMEOUT VALUE SETTING</b>				
5	<b>Scan Two Characters From</b> <a href="#">Appendix E, Keypad</a>	'0' and '1'	'0' and '5'	'2' and '6'	'7' and '5'
6	<b>Scan ENTER/EXIT PROGRAMMING MODE</b>				

## ACK NAK Retry Count

This feature specifies the number of times the reader retries a label transmission due to a retry condition. The selectable range is from 1 to 254 retries. A selection of 0 disables the count, and a selection of 255 specifies unlimited retries.

To set this feature:

1. Determine the desired setting.
2. Pad the number with leading zeroes to yield three digits. For example: 0 = 000, 5 = 005, 20 = 020, etc.
3. Go to [page 34](#) and scan the ENTER/EXIT PROGRAMMING MODE bar code to enter Programming Mode.
4. Scan the bar code: SELECT ACK NAK RETRY COUNT SETTING.
5. Scan the appropriate three digits from the keypad in [Appendix E, Keypad](#), that represent the number which was determined in the steps above. You will hear a two-beep indication after the last character.



**If you make a mistake before the last character, scan the CANCEL bar code to abort and not save the entry string. You can then start again at the beginning.**

6. Scan the ENTER/EXIT PROGRAMMING MODE bar code to exit Programming Mode.

This completes the procedure. See [Table 29](#) for some examples of how to set this feature.

**Table 29. ACK NAK Retry Count Setting Examples**

STEP	ACTION	EXAMPLES			
1	<b>Desired Setting</b>	Disable Retry Count	3 Retries	54 Retries	Unlimited Retries
2	<b>Pad with leading zero(es)</b>	000	003	054	255
3	<b>Scan ENTER/EXIT PROGRAMMING MODE</b>				
4	<b>Scan SELECT ACK NAK RETRY COUNT SETTING</b>				
5	<b>Scan Three Characters From</b> <a href="#">Appendix E, Keypad</a>	'0', '0' and '0'	'0', '0' and '3'	'0', '5' and '4'	'2', '5' and '5'
6	<b>Scan ENTER/EXIT PROGRAMMING MODE</b>				

## Disable Character

Specifies the value of the RS-232 host command used to disable the reader.

ASCII characters or any hex value from 0 to 0xFF can be selected.



**Setting to previously defined characters such as XON, XOFF, or host commands conflicts with normal operation of these characters. 8-bit data is not recognized when the option [Data Bits](#) has been set as 7 Data Bits.**

To set the value:

1. Determine the desired character or value. A setting of 0xFF indicates the Disable Character is not used (not available).
2. Use the [ASCII Chart](#) on the inside back cover of this manual to find the hex equivalent for the desired character/value.
3. Go to [page 36](#) and scan the ENTER/EXIT PROGRAMMING MODE bar code to enter Programming Mode.
4. Scan the bar code: SELECT DISABLE CHARACTER SETTING.
5. Scan the appropriate two alphanumeric characters from the keypad in [Appendix E, Keypad](#), that represent the desired character/value in step 1 above. The second character will cause a two-beep indication.
6. Scan the ENTER/EXIT PROGRAMMING MODE bar code to exit Programming Mode.

This completes the procedure. See [Table 30](#) for some examples of how to set this feature.

**Table 30. Disable Character Setting Examples**

STEP	ACTION	EXAMPLES			
1	Desired character/value	'd'	'}'	'D'	Disable Command Not Used
2	Hex equivalent from <a href="#">ASCII Chart</a>	0x64	0x7D	0x44	0xFF
3	<b>Scan ENTER/EXIT PROGRAMMING MODE</b>				
4	<b>Scan SELECT DISABLE CHARACTER VALUE SETTING</b>				
5	Scan Two Characters From <a href="#">Appendix E, Keypad</a>	'6' and '4'	'7' and 'D'	'4' and '4'	'F' AND 'F'
6	<b>Scan ENTER/EXIT PROGRAMMING MODE</b>				

## Enable Character

Specifies the value of the RS-232 host command used to enable the reader.

ASCII characters or any hex value from 0 to 0xFF can be selected.



**Setting to previously defined characters such as XON, XOFF, or host commands conflicts with normal operation of these characters. 8-bit data is not recognized when the option [Data Bits](#) has been set as 7 Data Bits.**

To set this feature:

Determine the desired character or value. A setting of 0xFF indicates the Enable Character is not used (not available).

1. Determine the desired character or value.
2. Use the [ASCII Chart](#) on the inside back cover of this manual to find the hex equivalent for the desired character/value.
3. Go to [page 36](#) and scan the ENTER/EXIT PROGRAMMING MODE bar code to enter Programming Mode.
4. Scan the bar code: SELECT ENABLE CHARACTER SETTING.
5. Scan the appropriate two alphanumeric characters from the keypad in [Appendix E, Keypad](#), that represent the desired character/value in step 2 above. The second character will cause a two-beep indication.
6. Scan the ENTER/EXIT PROGRAMMING MODE bar code to exit Programming Mode.

This completes the procedure. See [Table 31](#) for some examples of how to set this feature.

**Table 31. Enable Character Setting Examples**

STEP	ACTION	EXAMPLES			
1	Desired character/value	'e'	'}'	'E'	Enable Command Not Used
2	Hex equivalent from <a href="#">ASCII Chart</a>	0x65	0x7D	0x45	0xFF
3	<b>Scan ENTER/EXIT PROGRAMMING MODE</b>				
4	<b>Scan SELECT ENABLE CHARACTER VALUE SETTING</b>				
5	Scan Two Characters From <a href="#">Appendix E, Keypad</a>	'6' and '5'	'7' and 'D'	'4' and '5'	'F' AND 'F'
6	<b>Scan ENTER/EXIT PROGRAMMING MODE</b>				

## USB Intercode Delay

Specifies the delay between labels transmitted to the host for this interface. The selectable range for this feature is from 0 to 99 seconds.

Follow these instructions to set this feature:

1. Determine the desired setting.
2. Pad the number with leading zeroes to yield two digits. For example: 0 = 00, 5 = 05, 20 = 20, etc
3. Go to [page 43](#) and scan the ENTER/EXIT PROGRAMMING MODE bar code to enter Programming Mode.
4. Scan the bar code: SELECT INTERCODE DELAY SETTING.
5. Scan the appropriate two digits from the keypad in [Appendix E, Keypad](#), that represent the duration which was determined in the steps above. You will hear a two-beep indication after the last character.



**If you make a mistake before the last character, scan the CANCEL bar code to abort and not save the entry string. You can then start again at the beginning.**

6. Scan the ENTER/EXIT PROGRAMMING MODE bar code to exit Programming Mode.

This completes the procedure. See [Table 32](#) for some examples of how to set this feature.

**Table 32. USB Intercode Delay Examples**

STEP	ACTION	EXAMPLES			
1	<b>Desired Setting</b>	No Delay	5 Seconds	60 Seconds	99 Seconds
2	<b>Pad with leading zero(es)</b>	00	05	60	99
3	<b>Scan ENTER/EXIT PROGRAMMING MODE</b>				
4	<b>Scan SELECT INTERCODE DELAY SETTING</b>				
5	<b>Scan Two Characters From</b> <a href="#">Appendix E, Keypad</a>	'0' and '0'	'0' and '5'	'6' and '0'	'9' AND '9'
6	<b>Scan ENTER/EXIT PROGRAMMING MODE</b>				

# Symbologies

## Set Length

Length Control allows you to select either variable length decoding or fixed length decoding for the specified symbology.

**Variable Length:** For variable length decoding, a minimum and maximum length may be set.

**Fixed Length:** For fixed length decoding, two different lengths may be set.

### Set Length 1

This feature specifies one of the bar code lengths for Length Control. Length 1 is the minimum label length if in Variable Length Mode, or the first fixed length if in Fixed Length Mode. Length includes the bar code's data characters only.

The number of characters that can be set varies, depending on the symbology. Reference the page for your selected symbology to see specific variables.

1. Determine the desired character length (varies depending on symbology). Pad the number with leading zeroes to yield two digits. For example: 0 = 00, 5 = 05, 20 = 20, etc.
2. Go to the Set Length page for your selected symbology and scan the ENTER/EXIT PROGRAMMING MODE bar code to enter Programming Mode.
3. Scan the bar code to SELECT LENGTH 1 SETTING for your selected symbology.
4. Scan the appropriate two digits from the keypad in [Appendix E, Keypad](#), that represent the length setting which was determined in the steps above. You will hear a two-beep indication after the last character.



**If you make a mistake before the last character, scan the CANCEL bar code to abort and not save the entry string. You can then start again at the beginning.**

5. Scan the ENTER/EXIT PROGRAMMING MODE bar code to exit Prog Mode.

### Set Length 2

This feature allows you to set one of the bar code lengths for the specified symbology. Length 2 is the maximum label length if in Variable Length Mode, or the second fixed length if in Fixed Length Mode. See the page for the specific symbology for parameters.

The length that can be set varies depending on the symbology. A setting of 0 specifies to ignore this length (only one fixed length).

Follow these instructions to set this feature:

1. Determine the desired character length (from 1 to 50 — or 0 to ignore this length). Pad the number with leading zeroes to yield two digits. For example: 0 = 00, 5 = 05, 20 = 20, etc.
2. Go to the Set Length page for your selected symbology and scan the ENTER/EXIT PROGRAMMING MODE bar code to enter Programming Mode.

3. Scan the bar code to SELECT LENGTH 2 SETTING for your selected symbology.
4. Scan the appropriate two digits from the keypad in [Appendix E, Keypad](#) that represent the length setting which was determined in the steps above. You will hear a two-beep indication after the last character.



**If you make a mistake, before the last character scan the CANCEL bar code to abort and not save the entry string. You can then start again at the beginning.**

5. Scan the ENTER/EXIT PROGRAMMING MODE bar code to exit Programming Mode.

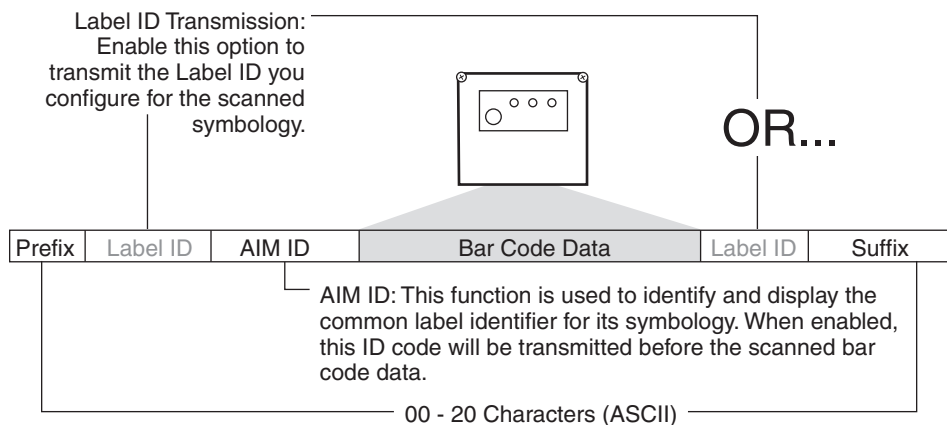
This completes the procedure.

## Data Editing

When a bar code is scanned, additional information can be sent to the host computer along with the bar code data. This combination of bar code data and supplementary user-defined data is called a “message string.” The Data Editing features can be used to build specific user-defined data into a message string.

There are several types of selectable data characters that can be sent before and after scanned data. You can specify if they should be sent with all symbologies, or only with specific symbologies. [Figure 3](#) shows the available elements you can add to a message string:

**Figure 3. Breakdown of a Message String**



**Additional advanced editing is available. See the Advanced formatting features in the Datalogic Aladdin configuration software, or contact Technical Support (as described on [page 10](#)) for more information.**

### Please Keep In Mind...

- Modifying a message string is not a mandatory requirement. Data editing is a sophisticated feature allowing highly customizable output for advanced users. Factory default settings for data editing is typically set to NONE.

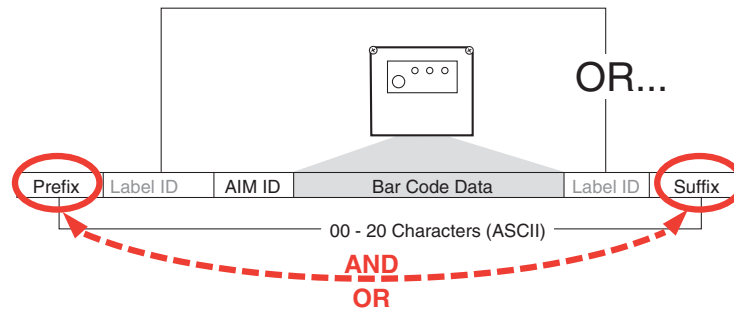


- A prefix or suffix may be applied only to a specified symbology (reference [1D Code Selection, starting on page 93](#)) or across all symbologies (set via the Global features in this chapter).
- You can add any character from the [ASCII Chart](#) (from 00-FF) on the inside back cover of this manual as a prefix, suffix or Label ID.
- Enter prefixes and suffixes in the order in which you want them to appear on the output.

## Global Prefix/Suffix

Up to 20 ASCII characters may be added as a prefix (in a position before the bar code data) and/or as a suffix (in a position following the bar code data) as indicated in [Figure 4](#).

**Figure 4. Prefix and Suffix Positions**



### Example: Setting a Prefix

In this example, we'll set a prefix for all symbologies.

1. Determine which ASCII character(s) are to be added to scanned bar code data. In this example, we'll add a dollar sign ('\$') as a prefix.
2. Go to [page 52](#) and scan the ENTER/EXIT PROGRAMMING MODE bar code, then scan the SET GLOBAL PREFIX bar code.
3. Reference the [ASCII Chart](#) on the inside back cover of this manual to find the hex value assigned to the desired character. The corresponding hex number for the '\$' character is 24. To enter this selection code, scan the '2' and '4' bar codes from [Appendix E, Keypad](#).



**If you make a mistake before the last character, scan the CANCEL bar code to abort and not save the entry string. You can then start again at the beginning.**

4. If less than the expected string of 20 characters are selected, scan the ENTER/EXIT bar code to terminate the string.
5. Scan the ENTER/EXIT bar code once again to exit Programming Mode.
6. The resulting message string would appear as follows:  
Scanned bar code data: **12345**  
Resulting message string output: **\$12345**

## Global AIM ID



This feature enables/disables addition of AIM IDs for all symbology types.

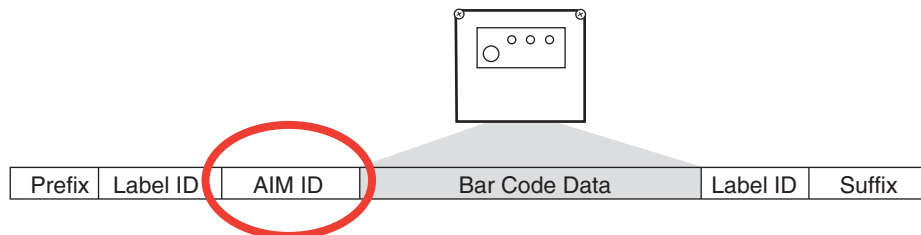
AIM label identifiers (as opposed to custom characters you select yourself as with label identifiers) can be included with scanned bar code data. AIM label identifiers consist of three characters as follows:

- A close brace character (ASCII '['), followed by...
- A code character (see the table below), followed by...
- A modifier character (the modifier character is symbol dependent).

SYMBOLGY	CHAR	SYMBOLGY	CHAR
UPC/EAN	E <sup>a</sup>	Code 128/GS1-128	C
Code 39 and Code 32	A	DataBar Omnidirectional, DataBar Expanded	e
Codabar	F	Standard 2 of 5	S
Interleaved 2 of 5	I	ISBN	X <sup>b</sup>
Code 93	G	Code 11	H

- UPC-A and UPC-E labels are converted to EAN 13 when adding AIM IDs.
- ISBN (X with a 0 modifier character)

**Figure 5. AIM ID**



## Label ID

A Label ID is a customizable code of up to three ASCII characters (each can be one of hex 0x01-0xFF), used to identify a bar code (symbology) type. It can be appended previous to or following the transmitted bar code data depending upon how this option is enabled. This feature provides options for configuring custom Label IDs as a pre-loaded set (see "Label ID: Pre-loaded Sets" below) or individually per symbology (see "Label ID: Set Individually Per Symbology" on page 260). If you wish to program the reader to always include an industry standard label identifier for ALL symbology types, see "Global AIM ID" on page 53.

### Label ID: Pre-loaded Sets

The reader supports two pre-loaded sets of Label IDs. Table 33 shows the USA and the EU sets.



#### CAUTION

**When changing from one Label ID set to another, all other reader configuration settings, including the host interface type, will be erased and set to the standard factory defaults. Any custom configuration or custom defaults will be lost.**

**Table 33. Label ID Pre-loaded Sets**

Symbology	USA Label ID set		EU Label ID set	
	Default Character	Default ASCII	Default Character	Default ASCII
ABC CODABAR	S	530000	S	530000
ANKER PLESSEY	o	6F0000	o	6F0000
AZTEC	Az	417A00	!	210000
CHINA SENSIBLE CODE	\$S	245300	\$S	245300
CODABAR	%	250000	R	520000
CODE11	CE	434500	b	620000
CODE128	#	230000	T	540000
CODE32	A	410000	X	580000
CODE39	*	2A0000	V	560000
CODE39 CIP	Y	590000	Y	590000
CODE39 DANISH PPT	\$Y	245900	\$Y	245900
CODE39 LAPOSTE	\$a	246100	\$a	246100
CODE39 PZN	\$Z	245A00	\$Z	245A00
CODE93	&	260000	U	550000
DATABAR 14	R4	523400	u	750000

Symbology	USA Label ID set		EU Label ID set	
	Default Character	Default ASCII	Default Character	Default ASCII
DATABAR 14 COMPOSITE	R4	523400	c	523400
DATABAR EXPANDED	RX	525800	t	740000
DATABAR EXPANDED COMPOSITE	RX	525800	d	525800
DATABAR LIMITED	RL	524C00	v	760000
DATABAR LIMITED COMPOSITE	RL	524C00	i	524C00
DATA MATRIX	Dm	446D00	w	770000
EAN128		000000	k	6B0000
EAN128 COMPOSITE		000000	\$E	244500
EAN13	F	460000	B	420000
EAN13 P2	F	460000	L	4C0000
EAN13 P5	F	460000	M	4D0000
EAN13 COMPOSITE	F	460000	\$F	244600
EAN8	FF	464600	A	410000
EAN8 P2	FF	464600	J	4A0000
EAN8 P5	FF	464600	K	4B0000
EAN8 COMPOSITE	FF	464600	\$G	244700
FOLLET 2OF5	O	4F0000	O	4F0000
GTIN	G	470000	\$A	244100
GTIN2	G2	473200	\$B	244200
GTIN5	G5	473500	\$C	244300
I2OF5	i	690000	N	4E0000
IATA INDUSTRIAL 2OF5	IA	494100	&	260000
INDUSTRIAL 2OF5	W	570000	W	570000
ISBN	I	490000	@	400000
ISBT128 CONCAT	f	660000	f	660000
ISSN	n	6E0000	n	6E0000
MAXICODE	MC	4D4300	x	780000
MICRO QR	\$Q	245100	\$Q	245100
MICRO PDF	mP	6D5000	8	380000

Symbology	USA Label ID set		EU Label ID set	
	Default Character	Default ASCII	Default Character	Default ASCII
MSI	@	400000	Z	5A0000
PDF417	P	500000	r	720000
PLESSEY	a	610000	a	610000
POSTAL AUSTRALIAN	\$K	244B00	\$K	244B00
POSTAL IMB	\$V	245600	\$V	245600
POSTAL JAPANESE	\$R	245200	\$R	245200
POSTAL KIX	\$U	245500	\$U	245500
POSTAL PLANET	\$W	245700	\$W	245700
POSTAL PORTUGAL	\$P	245000	\$P	245000
POSTAL POSTNET BB	\$L	244C00	\$L	244C00
POSTAL ROYAL MAIL	\$M	244D00	\$M	244D00
POSTAL SWEDISH	\$X	245800	\$X	245800
POSTNET	1	310000	1	310000
QR CODE	QR	515200	y	790000
S25	s	730000	P	500000
TRIOPTIC	\$T	245400	\$T	245400
UPCA	A	410000	C	430000
UPCA P2	A	410000	F	460000
UPCA P5	A	410000	G	470000
UPCA COMPOSITE	A	410000	\$H	244800
UPCE	E	450000	D	440000
UPCE P2	E	450000	H	480000
UPCE P5	E	450000	I	490000
UPCE COMPOSITE	E	450000	\$J	244A00

## Label ID: Set Individually Per Symbology

To configure a Label ID individually for a single symbology:

1. Go to [page 57](#) and scan the ENTER/EXIT bar code.
2. Select Label ID position as either BEFORE (Enable as Prefix) or AFTER (Enable as suffix) by scanning the appropriate bar code in the section "Label ID Control" on [page 57](#). Reference [Figure 6](#) for Label ID positioning options if multiple identification features are enabled.
3. Scan a bar code to select the symbology for which you wish to configure a custom Label ID from the section "Label ID Symbology Selection – 1D Symbologies" on [page 58](#).
4. Determine the desired character(s) (you may choose up to three) which will represent the Label ID for the selected symbology.
5. Turn to the [ASCII Chart](#) on the inside back cover of this manual and find the equivalent hex digits associated with your choice of Label ID. For example, if you wish to select an equal sign (=) as a Label ID, the chart indicates its associated hex characters as 3D. Turn to [Keypad](#), starting on [page 305](#) and scan the bar codes representing the hex characters determined. For the example given, the characters '3' and 'D' would be scanned. More examples of Label ID settings are provided in [Table 34](#).

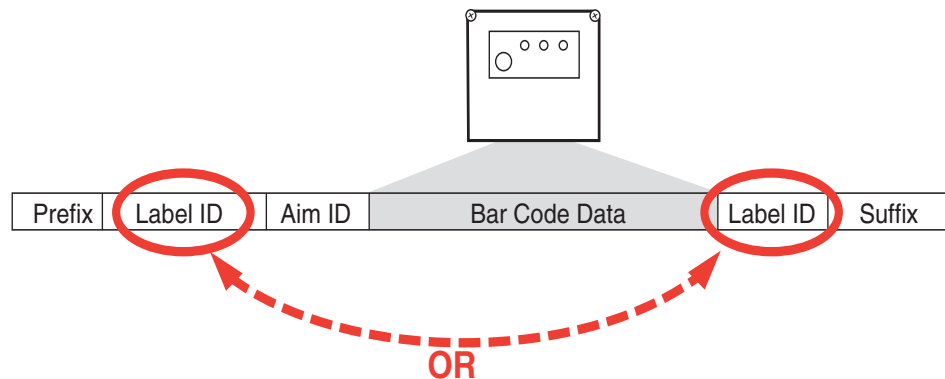


**If you make a mistake before the last character, scan the CANCEL bar code to abort and not save the entry string. You can then start again at the beginning.**

6. Scan the ENTER/EXIT bar code to exit Label ID entry.
7. Scan the ENTER/EXIT bar code once again to exit Programming Mode.

This completes the steps to configure a Label ID for a given symbology.

**Figure 6. Label ID Position Options**



**Table 34. Label ID Examples**

STEP	ACTION	EXAMPLES			
1.	<b>Scan the ENTER/EXIT bar code</b>	(Scanner enters Programming Mode)			
2.	<b>Determine placement of the Label ID characters BEFORE or AFTER with regard to scanned data using Label ID Control, starting on page 57</b>	Enable as Prefix	Enable as Suffix	Enable as Prefix	Enable as Suffix
3.	<b>Scan the bar code selecting the symbology type you wish to designate label ID characters for using Label ID Symbology Selection – 1D Symbologies, starting on page 58.</b>	DataBar Omnidirectional	Code 39	Interleaved 2 of 5	Code 32
4.	<b>Custom Label ID example (desired characters):</b>	D B *	= C 3	+	P H
5.	<b>Find hex equivalents from the ASCII Chart (inside back cover), then scan in these digits/characters using the bar codes in the section: Keypad, starting on page 305. If you make a mistake before the last character, scan the CANCEL bar code to abort and not save the entry string. You can then start again at the beginning.</b>	44 42 2A	3D 43 33	2B	50 48
6.	<b>Scan the ENTER/EXIT bar code</b>	(Scanner exits Label ID entry)			
7.	<b>Scan the ENTER/EXIT bar code once again</b>	(Scanner exits Programming Mode)			
<b>Result:</b>	DB*[bar code data]	[bar code data]=C3	+[bar code data]	[bar code data]PH	

## Character Conversion

Character conversion is an eight byte configuration item. The eight bytes are 4 character pairs represented in hexadecimal ASCII values. The first character in the pair is the character that will be converted. The second character in the pair is the character to convert to. If the character to convert in a pair is FF, then no conversion is done.

For example, if you have the character conversion configuration item set to the following:  
41423132FFFFFFFF

The first pair is 4142 or AB (41 hex is an ASCII capital A, 42 hex is an ASCII capital B) and the second pair is 3132 or 12 (31 hex is an ASCII 1, 32 is an ASCII 2). The other two pairs are FFFF and FFFF.

With the label, AB12BA21, it would look as follows after the character conversion: BB22BB22.

The A characters were converted to B characters and the 1 characters were converted to 2 characters. Nothing is done with the last two character pairs, since they are all FF.

To set Character Conversion:

1. Go to [page 67](#) and scan the ENTER/EXIT bar code.
2. Scan the “Configure Character Conversion” bar code.
3. Determine the desired string. Sixteen positions must be determined as in the above example. Next, turn to the [ASCII Chart](#) on the inside back cover of this manual and find the equivalent hex digits needed to fulfill the string.
4. Turn to [Appendix E, Keypad](#) and scan the bar codes representing the hex characters determined in the previous step.
5. Scan the ENTER/EXIT bar code to exit Programming Mode.



**If less than the expected string of 16 characters are selected, scan the ENTER/EXIT bar code twice to accept the selections and exit Programming Mode.**



## Scanner Data Formatting Control

### No Read String

This feature allows the transmission of a programmable character or string when no code has been decoded (No read) during a reading phase (On Line Mode only).

To set this feature:

1. Determine the desired character string (maximum 20).
2. Reference the ASCII Chart on the inside back cover of this manual to find the hex value assigned to the desired character.
3. Go to "[No Read String](#)" on page 63 and scan ENTER/EXIT PROGRAMMING MODE to enter Programming Mode
4. Scan the barcode: "Select No Read String."
5. Scan the hex equivalent characters from the keypad in Appendix D that represent the desired character string in step 1 above.
6. If less than the expected string of 20 characters is selected, scan the ENTER/EXIT barcode to terminate the string.
7. Scan the ENTER/EXIT PROGRAMMING MODE barcode once again to exit Programming Mode.

This completes the procedure.

### Code Verifier

Code Verifier is available in On Line or Serial On Line and Automatic modes only. A programmable character or string is transmitted after a successful reading phase depending on the result of a comparison between the decoded label and a user specified label.

#### Code Verifier Mode

Options for this feature are:

- **Disable:** disable the Code Verifier functionality
- **Transmit Wrong String:** the reader will transmit the wrong string to the Host.
- **Transmit Wrong Code:** the reader will transmit the wrong code to the Host.

If the code read matches the code verifier Match String then it is sent to the host through the configured port. If it does not match the code verifier Match String, either the Wrong Code can be sent or the defined Wrong String message can be sent indicating the error.

#### Match String

The string used as the match code for code verification. The Match String must be configured to include start/stop characters and check digits, if their transmission is enabled.

It is possible to define the Match string by inserting:

- any printable characters
- non-printable ASCII characters available in the list inside the parameter edit box

No wild card characters are supported.

To set this feature:

1. Determine the desired character string (max 32).
2. Reference the ASCII Chart on the inside back cover of this manual to find the hex value assigned to the desired character.
3. Go to "[Match String](#)" on page 65 and scan ENTER/EXIT PROGRAMMING MODE to enter Programming Mode.
4. Scan the barcode: SELECT MATCH STRING.
5. Turn to [Appendix E, Keypad](#) and scan the barcodes representing the hex characters determined in step 1 above.
6. If less than the expected string of 32 characters are selected, scan the ENTER/EXIT barcode to terminate the string.
7. Scan the ENTER/EXIT PROGRAMMING MODE barcode to exit Programming Mode.

This completes the procedure.

## Wrong Code String

The string sent in case of a mismatch (wrong code read).

To set this feature:

1. Determine the desired character string (max 20).
2. Reference the ASCII Chart on the inside back cover of this manual to find the hex value assigned to the desired character.
3. Go to "[Wrong Code String](#)" on page 65 and scan ENTER/EXIT PROGRAMMING MODE to enter Programming Mode.
4. Scan the barcode: SELECT WRONG CODE STRING.
5. Turn to [Appendix E, Keypad](#) and scan the barcodes representing the hex characters determined in step 1 above.
6. If less than the expected string of 20 characters are selected, scan the ENTER/EXIT barcode to terminate the string.
7. Scan the ENTER/EXIT PROGRAMMING MODE barcode to exit Programming Mode.

This completes the procedure.

## Label Transmit Mode

Specifies whether the decoded label must be transmitted over the host interface as it has been decoded or after the reading phase has been deactivated (phase off). This does not apply to Test Mode.

---

# Digital Output

**Output Activation:**

Digital Output can set to be Activated/Deactivated when specified events occur.

**Line State:** Selects whether the line is Active Low or Active High.

**Activation Event:** Selects the event the line is activated on. Selectable events: Disabled, Good Read, No Read, Right Code, Wrong Code. Right Code and Wrong Code are available only if Code Verifier functionality is enabled.

**Deactivation Event:** Selects the event the line is deactivated on. Selectable events: Disabled, Timeout, Reading Phase On.

**Deactivation Timeout:** Related to the previous parameter, sets the deactivation timeout for the output.

# Reading Parameters

## Double Read Timeout

Double Read Timeout prevents a double read of the same label by setting the minimum time allowed between reads of labels of the same symbology and data. If the unit reads a label and sees the same label again within the specified timeout, the second read is ignored. Double Read Timeout does not apply to scan modes that require a trigger pull for each label read.

Follow these instructions to set this feature:

1. Determine the desired setting in milliseconds.
2. Divide the desired setting by 10 (setting is in 10ms increments). Pad the result with leading zeroes to yield three digits. For example: 0 = 000, 5 = 005, 20 = 020, etc.
3. Go to [page 74](#) and scan the ENTER/EXIT PROGRAMMING MODE bar code to enter Programming Mode.
4. Scan the bar code: SET DOUBLE READ TIMEOUT SETTING.
5. Scan the appropriate three alphanumeric characters from the keypad in [Appendix E, Keypad](#) representing the duration which was determined in the steps above. You will hear a two-beep indication after the last character.



**If you make a mistake before the last character, scan the CANCEL bar code to abort and not save the entry string. You can then start again at the beginning.**

6. Scan the ENTER/EXIT PROGRAMMING MODE bar code to exit Programming Mode.

This completes the procedure. See [Table 35](#) for some examples of how to set this feature.

**Table 35. Double Read Timeout Setting Examples**

STEP	ACTION	EXAMPLES			
1	<b>Desired Setting</b>	50ms	150ms	1800ms (1.8 sec.)	2550ms (2.55 sec.)
2	<b>Divide by 10 (and pad with leading zeroes)</b>	005	015	180	255
3	<b>Scan ENTER/EXIT PROGRAMMING MODE</b>				
4	<b>Scan SET DOUBLE READ TIMEOUT SETTING</b>				
5	<b>Scan Three Characters From</b> <a href="#">Appendix E, Keypad</a>	'0', '0' and '5'	'0', '1' and '5'	'1', '8' and '0'	"2', '5' and '5'
6	<b>Scan ENTER/EXIT PROGRAMMING MODE</b>				

## Good Read LED Duration

This feature specifies the amount of time that the Good Read LED remains on following a good read. The good read LED on time can be set within a range of 10 milliseconds to 2,550 milliseconds (0.001 to 2.55 seconds) in 100ms increments.

Follow these instructions to set this feature:

1. Determine the desired setting in milliseconds. A setting of 0 means that the good read LED stays on until the next time the trigger is pulled.
2. Divide the desired setting by 10 (setting is in 100ms increments). Pad the result with leading zeroes to yield three digits. For example: 0 = 000, 5 = 000, 20 = 020, etc.
3. Go to [page 79](#) and scan the ENTER/EXIT PROGRAMMING MODE bar code to enter Programming Mode.
4. Scan the bar code: SELECT GOOD READ LED DURATION SETTING.
5. Scan the appropriate three digits from the keypad in [Appendix E, Keypad](#) representing the duration which was determined in the steps above. You will hear a two-beep indication after the last character.



**If you make a mistake before the last character, scan the CANCEL bar code to abort and not save the entry string. You can then start again at the beginning.**

6. Scan the ENTER/EXIT PROGRAMMING MODE bar code to exit Programming Mode.

This completes the procedure. See [Table 36](#) for some examples of how to set this feature.

**Table 36. Good Read LED Duration Setting Examples**

STEP	ACTION	EXAMPLES			
1	<b>Desired Setting</b>	Good Read LED stays on until next trigger pull (00)	20ms	150ms	2550ms (2.55 sec.)
2	<b>Divide by 10 (and pad with leading zeroes)</b>	000	002	015	255
3	<b>Scan ENTER/EXIT PROGRAMMING MODE</b>				
4	<b>Scan SELECT GOOD READ LED DURATION SETTING</b>				
5	<b>Scan Three Characters From <a href="#">Appendix E, Keypad</a></b>	'0', '0' and '0'	'0', '0' and '2'	'0', '1' and '5'	'2', '5' and '5'
6	<b>Scan ENTER/EXIT PROGRAMMING MODE</b>				

# Scanning Features

## Operating Mode

The following Operating Modes (Reading Modes) are supported:

### On Line

In On Line mode, the reading phase is defined as the time between the Phase ON and Phase OFF events. The Phase events can be generated by an external input (trigger) or by the Trigger button. While in this mode the scanner activates reading only during a reading phase. The Phase events can be signals coming from the trigger button (or external presence sensor connected to the scanner input for RS-232 models).

On Line mode allows the following configurations:

**Phase Off Event:** Specifies whether the reading phase is closed on a timeout or phase off event. The following selections are available:

- Trigger Stop: the reading phase ends when the trigger event stops. Timeout is disabled.
- Timeout: the reading phase ends when the timeout is expired. Trigger stop is ignored.
- Trigger Stop - Timeout: the reading phase ends when the first event occurred.

**Timeout:** Specifies the maximum duration for the reading phase. Selections: from 1 to 255 seconds in 1 second increments.

### Serial On Line

In Serial On Line mode, a reading phase is defined as the time between two events: phase on and phase off, generated by a message sent from the host interface to the scanner. While in this mode the scanner activates reading only during a reading phase. The message (character or string) is user programmable.

Serial On Line mode configurations:

**Serial Start Character (or String):** Specifies the string message to be sent over the host interface to activate the reading phase.

**Serial Stop Character (or String):** Specifies the string message to be sent over the host interface to stop the reading phase.



**The Serial Start/Stop Characters must be different and must not contain reserved characters (see [Appendix F, Reserved Characters](#)).**

**See "Manual Trigger Control" on page 83 to configure control of manual triggering.**

**Phase Off Event:** Specifies whether the reading phase is closed on a timeout or phase off event.

The following selections are available:

- **Trigger Stop:** the reading phase ends when the serial stop character (or string) is received. Timeout is disabled.
- **Timeout:** the reading phase ends when the timeout is expired. Serial stop character (or string) is ignored.
- **Trigger Stop - Timeout:** the reading phase ends when the first event occurred.

**Timeout (Scanning Active Time option):** Specifies the maximum duration for the reading phase. Selections: from 1 to 255 seconds in 1 second increments.

## Automatic Mode

In Automatic mode, the scanner is continuously scanning. When a label enters the reading zone and is decoded, no more decodes and reading phases are allowed until the label has left the reading area. In order to guarantee identification of the code in the reading zone, a threshold specifies the number of scans after the successful decode that the scanner will wait before rearming the reading phase. The transmission of the decoded label depends on the configuration of the Transmission Mode parameter.

## Automatic/Trigger Object Sense

Automatic/TOS mode is the same as Automatic mode but with the illumination system normally off\*. As an object or bar code enters the reading area, illumination is turned ON. Illumination will return to the Presentation Illumination Control setting as the reading phase is closed (see Automatic Mode above).

\*Default. The illumination can be programmed for several different operation states (off, dim or on) while the reading phase is not active. See "[Presentation Illumination Control](#)" on page 86.

## Digital Output

### Output Activation:

Digital Output can be set to be Activated/Deactivated when specified events occur.

**Line State:** Selects whether the line is Active Low or Active High.

**Activation Event:** Selects the event the line is activated on. Selectable events are Disabled, Good Read, No Read, Right Code, Wrong Code. Right Code and Wrong Code are available only if Code Verifier functionality is enabled.

**Deactivation Event:** Selects the event the line is deactivated on. Selectable events are Disabled, Timeout, Reading Phase On.

**Deactivation Timeout:** Related to the previous parameter, this feature sets the deactivation timeout for the output.

## Scanning Active Time

This setting specifies the amount of time that the reader stays in scan ON state once the state is entered. It controls the Timeout within On Line & Serial On Line read modes Phase Off Event. The range for this setting is from 1 to 255 seconds in 1-second increments.

Follow these instructions to set this feature:

1. Determine the desired setting.
2. Pad the result with leading zeroes to yield three digits. For example: 0 = 000, 5 = 005, 20 = 020, etc.
3. Go to [page 85](#) and scan the ENTER/EXIT PROGRAMMING MODE bar code to enter Programming Mode.
4. Scan the bar code: SELECT SCANNING ACTIVE TIME SETTING.
5. Scan the appropriate three digits from the keypad in [Appendix E, Keypad](#), that represent the duration which was determined in the steps above. You will hear a two-beep indication after the last character.



**If you make a mistake before the last character, scan the CANCEL bar code to abort and not save the entry string. You can then start again at the beginning.**

6. Scan the ENTER/EXIT PROGRAMMING MODE bar code to exit Programming Mode.

This completes the procedure. See [Table 37](#) for some examples of how to set this feature.

**Table 37. Scanning Active Time Setting Examples**

STEP	ACTION	EXAMPLES			
1	<b>Desired Setting</b>	1 Second	90 Sec. (1.5 min.)	180 Sec. (3 min.)	255 Seconds (4.25 min.)
2	<b>Pad leading zero(es)</b>	001	090	180	255
3	<b>Scan ENTER/EXIT PROGRAMMING MODE</b>				
4	<b>Scan SELECT SCANNING ACTIVE TIME SETTING</b>				
5	<b>Scan Three Characters From</b> <a href="#">Appendix E, Keypad</a>	'0', '0' and '1'	'0', '9' and '0'	'1', '8' and '0'	'2', '5' and '5'
6	<b>Scan ENTER/EXIT PROGRAMMING MODE</b>				



## Aiming Duration Time

Specifies the frame of time the aiming pointer remains on after decoding a label, when in On Line or Serial On Line mode. The range for this setting is from 1 to 255 seconds in 1-second increments.

Follow these instructions to set this feature:

1. Determine the desired setting.
2. Pad the result with leading zeroes to yield three digits. For example: 0 = 000, 5 = 005, 20 = 020, etc.
3. Go to [page 87](#) and scan the ENTER/EXIT PROGRAMMING MODE bar code to enter Programming Mode.
4. Scan the bar code: SELECT AIMING DURATION TIME SETTING.
5. Scan the appropriate three digits from the keypad in [Appendix E, Keypad](#), that represent the duration which was determined in the steps above. You will hear a two-beep indication after the last character.



**If you make a mistake before the last character, scan the CANCEL bar code to abort and not save the entry string. You can then start again at the beginning.**

6. Scan the ENTER/EXIT PROGRAMMING MODE bar code to exit Programming Mode.

This completes the procedure. See [Table 38](#) for some examples of how to set this feature.

**Table 38. Aiming Duration Time Setting Examples**

STEP	ACTION	EXAMPLES			
1	<b>Desired Setting</b>	1 Second	90 Sec. (1.5 min.)	180 Sec. (3 min.)	255 Seconds (4.25 min.)
2	<b>Pad leading zero(es)</b>	001	090	180	255
3	<b>Scan ENTER/EXIT PROGRAMMING MODE</b>				
4	<b>Scan SELECT AIMING DURATION TIME SETTING</b>				
5	<b>Scan Three Characters From</b> <a href="#">Appendix E, Keypad</a>	'0', '0' and '1'	'0', '9' and '0'	'1', '8' and '0'	'2', '5' and '5'
6	<b>Scan ENTER/EXIT PROGRAMMING MODE</b>				

## Multiple Labels Ordering by Code Symbology

This feature Specifies the transmission ordering by symbology type, when Multiple Labels per Frame is enabled. Up to six symbologies can be selected. Zeroes must be added to pad the string to 12 characters if not using all six symbologies.

The labels are ordered first as specified in the output mask. Labels present in the volume but not specified will be transmitted as unspecified symbologies in random order as allowed by the reading time sequence. For each label decoded in the volume the reader signals the standard beeper and LED indications.

To specify the symbology order:

1. Determine the symbologies and order you want to specify.
2. Use [Table 40 on page 273](#) to find the hex values for up to six symbologies.
3. Go to [page 92](#) and scan the ENTER/EXIT PROGRAMMING MODE bar code to enter Programming Mode.
4. Scan the bar code: “SELECT SYMBOLOGIES FOR MULTIPLE LABELS ORDERING”.
5. Scan the appropriate two alphanumeric characters from the keypad in [Appendix E, Keypad](#), that represent the desired character/value in step 2 above.
6. Scan zeroes if needed to make a 12-character string.
7. When finished, scan the ENTER/EXIT PROGRAMMING MODE bar code to exit Programming Mode.

This completes the procedure. See [Table 39](#) for some examples of how to set this feature.

**Table 39. Multiple Labels Ordering by Code Symbology Examples**

STEP	ACTION	EXAMPLES			
1	Desired symbology	Code 39	Data Matrix	Code 128	Aztec
2	Hex equivalent from <a href="#">Table 40</a>	24	0E	0C	4E
3	Scan ENTER/EXIT PROGRAMMING MODE				
4	Scan SELECT SYMBOLOGIES FOR MULTIPLE LABELS ORDERING				
5	Scan Two Characters From <a href="#">Appendix E, Keypad</a>	'2' and '4'	'0' and 'E'	'0' and 'C'	'4' and 'E'
	RESULT	<b>0x240E0C4E0000</b>			
6	Scan ENTER/EXIT PROGRAMMING MODE				

[Table 40 on page 273](#) shows the hex value associated with each symbology.

**Table 40. Symbology Hex Values**

Hex Value	Symbology ID	Hex Value	Symbology ID
00	Don't care	2C	GTIN5
01	UPC-A	2D	GTIN8
02	UPC-E	2E	S2OF5
03	EAN8	2F	PDF417
04	EAN13	30	CODE11
05	UPC2	31	IATA
06	UPC5	32	MICRO_PDF
07	C128_ADDON	33	GS1 DataBar_LIM_ID
0A	EAN128	34	GS1 DataBar_LIM_COMP
0B	C128_PROGRAMMING_LABEL	35	GS1 DataBar_Omnidirectional_COMP
0C	CODE128	36	GS1 DataBar_EXP_COMP
0D	FNC3_C128_LABEL	37	GENERIC_DATA
0E	DATA MATRIX	38	CC_A
0F	MAXICODE	39	CC_B
10	QRCODE	3A	CC_C
11	Reserved	3B	LABELIMAGE
12	Reserved	3C	CAPTURE_IMAGE_LABEL
13	CODE49	3D	Reserved
14	UPC-E2	3E	M2OF5
15	UPC-E5	3F	D2OF5
16	Reserved	40	PLESSEY65
17	UPC-A2	42	ISSN
18	UPC-A5	43	ISBT
19	Reserved	44	Reserved
1A	EAN82	45	TIMER_EXPIRED_EVENT
1B	EAN85	46	FOLLETT_2OF5
1C	Reserved	47	Reserved
1D	EAN132	48	Reserved
1E	EAN135	49	CODE39_CIP
1F	EAN138	4A	ABC_CODABAR
20	ISBN_ID	4B	I2OF5_CIP
21	TWO_LABEL_PAIR	4C	C2OF5
22	I2OF5	4D	IND2OF5
23	CODABAR	4E	AZTEC
24	CODE39	4F	UPC-E_COMP
25	PHARMAC39	50	UPC-A_COMP
26	MSI_PLESSEY	51	EAN8_COMP
27	CODE93	52	EAN13_COMP
28	RSS_EXP_ID	53	EAN128_COMP
29	RSS_14_ID	54	DATA MATRIX_PROGRAMMING_LABEL
2A	GTIN	55	LABEL_ID_MAX
2B	GTIN2	FF	INVALID_LABEL_TYPE

---

# NOTES

# Appendix A

## Technical Specifications

Table 41 contains Physical and Performance Characteristics, User Environment and Regulatory information.

**Table 41. Technical Specifications**

Item	Description
<b>Physical Characteristics</b>	
Color	Grey
Dimensions	Height 1.54" / 39mm Length 2.24" / 57mm Width 2.28" / 58 mm
Weight (with cable, without bracket)	USB version - Approximately 6.3 ounces/170 g RS-232 version - Approximately 7.2 ounces/204 g
<b>Electrical Characteristics</b>	
Input Voltage	5 VDC $\pm$ 5% Overvoltage tolerant to 14VDC
External Trigger Input (Only GFS4450-9): 1V - 5V Current Consumption for 1V = 2mA max	
	5V = 10mA max
	Min Pulse Duration = 25ms *
Output (Only GFS4450-9): 14VDC	
Vout	14VDC
Vce	20 VDC max
Collector Current	40 mA continuous max
Vce Saturation	0.3 V max at 15 mA
Power Dissipation	80 mW max at 50 °C (ambient temperature)
* Although the scan engine can respond to this minimum pulse width for triggering, bar code decoding time is dependent on several factors. External Trigger should be held active until there is a good read decode or a determined timeout period.	

Item	Description
Current & Power Consumption	
Input current at 5V in Automatic (Object Sense) Reading Mode	
Operating (typical)	180 mA
Operating (max)	250 mA
Idle/standby (typical)	65 mA (On Line & Serial On Line Modes) 115 mA (Automatic Object Sense Mode) No idle in Automatic Mode
<b>Performance Characteristics</b>	
Nominal Frame Rate	53 frames/second
Light Source	Dual Red LEDs
Roll (Tilt) Tolerance	Up to $\pm 180^\circ$
Pitch Tolerance	$\pm 70^\circ$ *
Skew (Yaw) Tolerance	$\pm 80^\circ$ *
Print Contrast Minimum	25% minimum reflectance
Field of View	40° H x 26° V

\*EAN 13 mil

Depth of Field (Typical)				
	cm		inches	
	NF	FF	NF	FF
Code 39 5mil	4.7	17.7	1.8	7.0
Code 39 10mil	1.7	33.2	0.7	13.1
Code 39 20mil	1.1	49.2	0.4	19.4
EAN 7.5mil	2.8	27.3	1.1	10.8
EAN 13mil	2.5	41.9	1.0	16.5
PDF-417 6.6mil	3.3	15.4	1.3	6.0
PDF-417 10mil	2.2	23.9	0.9	9.4
PDF-417 15mil	2.5	35.6	1.0	14.0

DataMatrix 10mil	2.7	17.1	1.1	6.7
DataMatrix 15mil	1.2	24.6	0.5	9.7
QR Code 10mil	3.5	16.0	1.4	6.3
QR Code 15mil	0.5	24.3	0.2	9.6

Item	Description
Minimum Element Width	1D Min Resolution = 4 mil PDF-417 Min Resolution = 5 mil Datamatrix Min Resolution= 7 mil
<b>Decode Capability</b>	
<b>1D Bar Codes</b>	UPC/EAN/JAN (A, E, 13, 8); UPC/EAN/JAN (including P2 /P5); UPC/EAN/JAN (including; ISBN / Bookland & ISSN); UPC/EAN Coupons; Code 39 (including full ASCII); Code 39 Trioptic; Code39 CIP (French Pharmaceutical); LOGMARS (Code 39 w/ standard check digit enabled); Danish PPT; Code 32 (Italian Pharmacode 39); Code 128; Code 128 ISBT; Interleaved 2 of 5 ; Standard 2 of 5; Interleaved 2 of 5 CIP (HR); Industrial 2 of 5; Discrete 2 of 5; Datalogic 2 of 5 (China Post Code/Chinese 2 of 5); IATA 2of5 Air cargo code; Code 11; Codabar; Codabar (NW7); ABC Codabar; EAN 128; Code 93 ; MSI; PZN; Plessey; Anker Plessey; GS1 DataBar Omnidirectional; GS1 DataBar Limited; GS1 DataBar Expanded; GS1 DataBar Truncated; DATABAR Expanded Coupon.
<b>2D / Stacked Codes</b>	The Gryphon I GFS4400 scanner is capable of decoding the following symbologies using multiple frames (i.e. Multi-Frame Decoding): Datamatrix; Inverse Datamatrix; Datamatrix is configurable for the following parameters:; Normal or Inverted; Square or Rectangular Style; Data length (1 - 3600 characters); Maxicode; QR Codes (QR, Micro QR and Multiple QR Codes); Aztec; Postal Codes - (Australian Post; Japanese Post; KIX Post; Planet Code; Postnet; Royal Mail Code (RM45CC); Intelligent Mail Barcode (IMB); Sweden Post; Portugal Post); LaPoste A/R 39; 4-State Canada; PDF-417; MacroPDF; Micro PDF417; GS1 Composites (1 - 12); Codablock F; French CIP13 <sup>a</sup> ; GS1 DataBar Stacked; GS1 DataBar Stacked Omnidirectional; GS1 DataBar Expanded Stacked; GS1 Databar Composites; Chinese Sensible Code; Inverted 2D codes <sup>b</sup> .  <sup>a</sup> It is acceptable to handle this with ULE  <sup>b</sup> The SW can apply the Normal/Reverse Decoding Control to the following symbologies: Datamatrix, QR, Micro QR, Aztec and Chinese Sensible Code.

NOTE: The Scanner can also decode mirrored images of 2D matrix codes Datamatrix, QR Code and Maxicode.	
Interfaces Supported	GFS4450-9 version: RS-232 Standard GFS4470 version:USB-COM, USB-Keyboard, USB-OEM
<b>User Environment</b>	
Operating Temperature	-4° to 122° F (-20° to 50° C)
Storage Temperature	-4° to 158° F (-20° to 70° C)
Humidity	Operating: 5% to 90% relative humidity, non condensing
Drop specifications	5 drops from 30 inches (0.76 mt.) to concrete
Ambient Light immunity	Up to 100,000 Lux
Contaminants	IEC529-IP54
ESD Level	+/-16Kv
<b>Regulatory</b>	
LED Emission Class	(IEC-62471:2006-07) Exempt (No Risk) IEC60825-1: 2007
Electrical Safety	IEC 60950-1 , CAN/CSA C22.2 No. 60950-1-07; UL 60950-1
EMI/RFI	North America (FCC) : Part 15 Class B, Canada ( IC) : ICES-003 Class B, European Union EMC Directive, Australian (C-tick), Russia (Gost)

**RS-232 Electrical Connections**

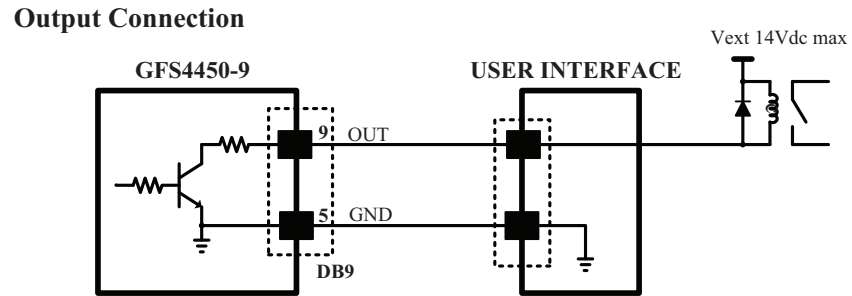
**9-pin connector**

1	Trigger	Trigger signal input (see <a href="#">Figure 8</a> and <a href="#">Figure 9</a> on next page)
2	TX	Transmit Data (output from scanner)
3	RX	Receive Data (input to scanner)
4	NC	Not connected
5	GND	Ground
6	VCC	+5Vdc
7	CTS	Clear To Send (input to scanner)
8	RTS	Request To Send (output from scanner)
9	DIGITAL OUTPUT	Output signal (see <a href="#">Figure 7</a> )

Default configuration is RS-232: 9600, 8, N, 1, no handshaking, ACK/NAK disabled.

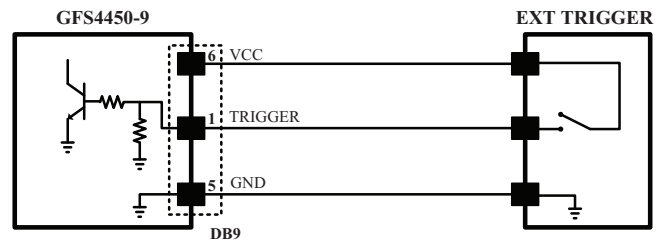


**Figure 7. Output Connection**



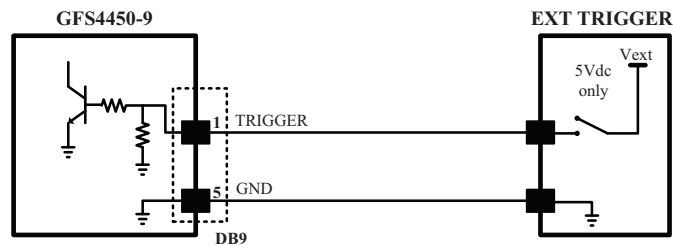
**Figure 8. Using GFS4450-9 Power**

Input Trigger Using  
GFS4450-9 Power



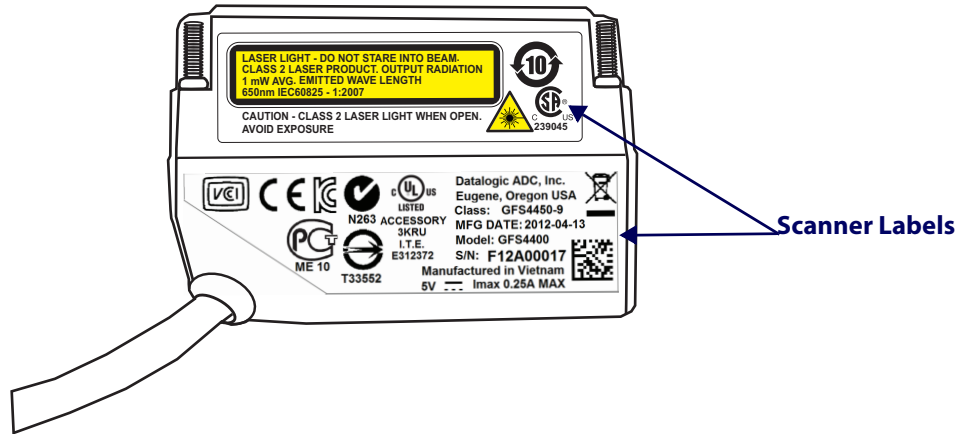
**Figure 9. Using External Power Supply**

Input Trigger Using  
External Power



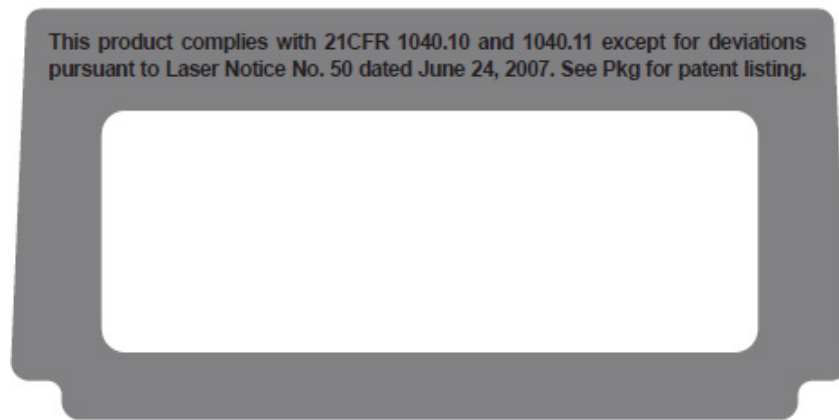
## Imager Labeling

The sample labels shown below are for illustrative purposes only. Please view the labels on your product for actual details, as they may vary.



## Aiming System


The Gryphon™ aiming system meets the Class 2 requirements for laser safety. The laser information is located on the window of the Scanner and is shown below.



## LED and Beeper Indications

### Button and LED Status

The top of the product has a button and three indicator LEDs:

	POWER (yellow LED)	ON = Power ON OFF = Power OFF or standby (only USB version)
	GOOD (green LED)	ON = Good Read Blinks = USB enumeration or interface inactive or waiting for change of configuration
	TRIGGER (blue LED)	ON = External trigger or button pressed or phase active Blinks = During transfer of captured image, during Flash memory updates, or as Presentation Mode indication
	Button	Press for manual trigger

### Indicators

The reader's beeper sounds and its LED illuminates to indicate various functions or errors on the reader. An optional "Green Spot" also performs useful functions. The following tables list these indications. One exception to the behaviors listed in the tables is that the reader's functions are programmable, and so may or may not be turned on. For example, certain indications such as the power-up beep can be disabled using programming bar code labels.

Indicator	Description	LED	Beeper
Power-up Beep	The reader is in the process of powering-up.	N/A	Reader beeps four times at highest frequency and volume upon power-up.
Good Read Beep	A label has been successfully scanned by the reader.	LED behavior for this indication is configurable via the feature "Good Read: When to Indicate" (see the PRG for information.)	The reader will beep once at current frequency, volume, mono/bi-tonal setting and duration upon a successful label scan.
ROM Failure	There is an error in the reader's software/programming	Flashes	Reader sounds one error beep at highest volume.

Indicator	Description	LED	Beeper
Limited Scanning Label Read	Indicates that a host connection is not established.	N/A	Reader 'chirps' six times at the highest frequency and current volume.
Reader Active Mode	The reader is active and ready to scan.	The LED is lit steadily <sup>a</sup>	N/A
Reader Disabled	The reader has been disabled by the host.	The LED blinks continuously	N/A
Green Spot <sup>a</sup> flashes momentarily	Upon successful read of a label, the software shall turn the green spot on for the time specified by the configured value.	N/A	N/A
Image Capture	On when ready to capture image	Blue LED on	N/A
Flash Memory Update	Occurs while update is in progress	Blue LED blinks	

<sup>a</sup>Except when in sleep mode or when a Good Read LED Duration other than 00 is selected

**Programming Mode**-The following indications ONLY occur when the reader is in Programming Mode.

Indicator	Description	LED	Beeper
Label Programming Mode Entry	A valid programming label has been scanned.	LED blinks continuously	Reader sounds four low frequency beeps.
Label Programming Mode Rejection of Label	A label has been rejected.	N/A	Reader sounds three times at lowest frequency and current volume.
Label Programming Mode Acceptance of Partial Label	In cases where multiple labels must be scanned to program one feature, this indication acknowledges each portion as it is successfully scanned.	N/A	Reader sounds one short beep at highest frequency and current volume.
Label Programming Mode Acceptance of Programming	Configuration option(s) have been successfully programmed via labels and the reader has exited Programming Mode.	N/A	Reader sounds one high frequency beep and 4 low frequency beeps followed by reset beeps.
Label Programming Mode Cancel Item Entry	Cancel label has been scanned.	N/A	Reader sounds two times at low frequency and current volume.

## Error Codes

Upon startup, if the reader sounds a long tone, this means the reader has not passed its automatic Selftest and has entered FRU (Field Replaceable Unit) isolation mode. If the reader is reset, the sequence will be repeated. Press and release the trigger to hear the FRU indication code.

The following table describes the LED flashes/beep codes associated with an error found.

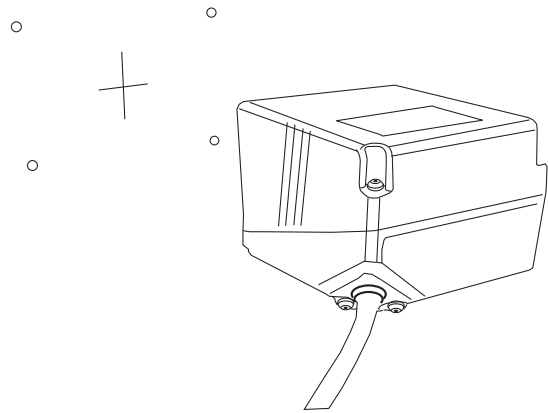
Number of LED Flashes/Beeps	Error	Corrective Action
1	Configuration	Contact Helpdesk for assistance
2	Interface PCB	
6	Digital PCB	
11	Imager	

# NOTES

# Appendix B

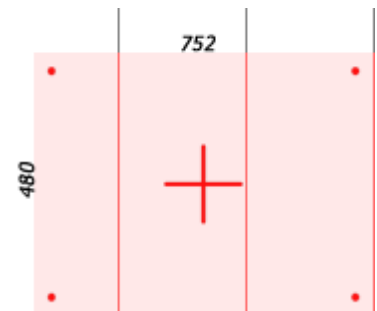
## Aimer Calibration

The Scan Modules in the GFS4400 series contain a laser-based aiming system consisting of four corner dots and a center crosshair pattern that helps define the reading volume. The center cross location in the imager's Field Of View (FOV) is recorded and logged in the system's non-volatile memory (calibration process), and facilitates the Central Code Only operation. Central Code Only is a programmable mode of operation which controls the scan module's ability to decode labels only when they are close to the center of the aiming pattern. This allows the reader to accurately target a particular label when there are multiple bar codes placed close together, such as on a pick sheet.



The imager's sensor has a resolution of WVGA (752H x 480V) and typical 'aimer coordinates' will be in the realm of 03350235, which translates to a location 335H x 235V in the FOV. These coordinate values will change slightly from scanner to scanner, and are also dependent upon Depth of Field (DOF) when calibration is performed.

Aimer calibration can be done using simple Command Strings within the reader's Service Mode of operation (described in "[Software Configuration Strings](#)" starting on page 217). Recalibration of the reader's aimer can be done if it is believed that performance can be improved by calibrating at a specific depth of field (a recalibration), or if some special application would benefit by custom configuring and writing in 'phantom coordinates'<sup>1</sup>.



Below are the commands available for aimer calibration, followed by examples.

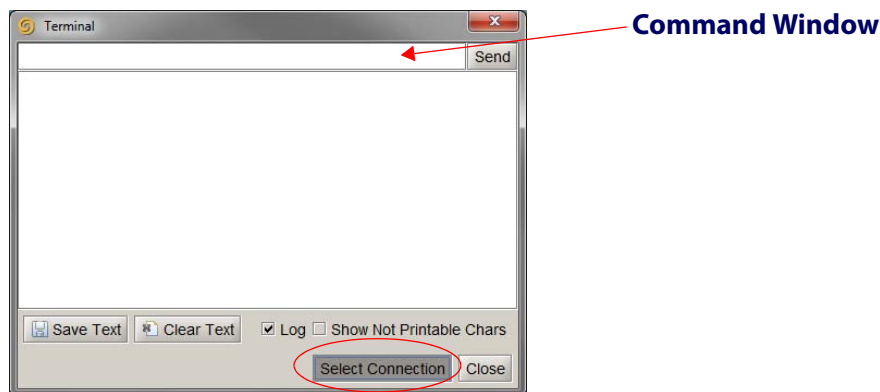
**Fx - Aiming Auto Calibration.** The reader will switch on the laser aimer, determine the coordinates of the center cross, and store into the factory non-volatile memory area (Aimer Calibration).

**Fa - Aiming Read Coordinates.** Returns the coordinates of the center of the aiming pattern or the custom coordinates set from user defined (FA).

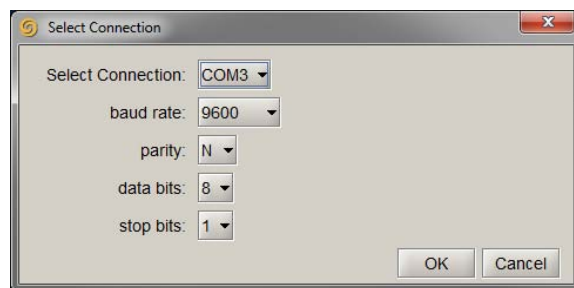
1. Phantom Coordinates - aimer coordinates custom programmed into a scanner's Field of View location rather than at the aimer's center crosshairs.

**FA - Aiming Write Coordinates.** Writes specified coordinates into the factory non-volatile memory area. Use this command if you wish to override any other previously written; factory, user or custom calibration or setting.

Examples shown use the terminal window tool provided within Datalogic Aladdin configuration utility (available from the Datalogic website), or any other serial terminal utility. In Aladdin with terminal window opened, check the Log box and then click on Select Connection to provide the reader's COM port information.



The Select Connection dialog box will open:



To perform any of the Aiming commands, use the following steps:

1. Set the reader into Service Mode<sup>2</sup> with the initial command of **\$\$ <CR>**.  
The reader will respond with an ascending set of beeps. While in this mode the green indicator will stay on, communication is at 115K baud, and the reader will respond to proper commands with **\$>**.
2. When finished, exit Service Mode with the command **\$s <CR>**.  
The reader will respond with a descending set of beeps, and the green indicator will turn off.
3. Reset baud rate (if necessary).  
The reader will now be back to normal operation.

<sup>2</sup> While in Service Mode, the reader communicates at 115K baud. Upon entering into this mode, you must immediately change to this speed (if not already set), then change back to the original rate after exiting Service Mode.



---

## Auto Calibration

To Auto Calibrate the scanner, do the following:

1. Position and steady the reader in front of a plain flat sheet of paper or surface at a Depth of Field (distance) that is most appropriate for the application.
2. Send the command **\$Fx**. The reader will turn the aimer on for an instant, then beep. The reader will reply with one of the following beep types in response to the auto calibration result:
  - Loud/ Long Beep = crosshair detected and new coordinates recorded into a non-volatile memory location (\$> )
  - Loud/Short Beep = crosshair detected with same coordinates as already stored (\$> )
  - Quiet/Short Beep = Execution error, the procedure failed to determine the crosshair coordinates (\$@)

## Reading Coordinates

To read the aimer coordinates currently set, simply send the command **\$Fa**. The reader will return a set of numbers in the following format: **\$>xxxxyyyy**, which translates to **xxxx** as the horizontal position and **yyyy** being the vertical position.

A complete sequence [enter—autocalibrate—read coordinates—exit] would look similar to the following:

```
$S  
$> (ensure baud rate is set to 115K)  
$Fx  
$>  
$Fa  
$>03350235  
$s  
$> (reset baud rate if necessary)
```

## Writing Coordinates

To write custom coordinates into the reader's memory, overwriting previous values, use the command **\$FAxxxxyyyy**, where **xxxx** is a four-digit decimal value in the range of 0-752 and **yyyy** is a four digit decimal value in the range of 0-480.

A complete sequence [enter—write 200 100—read coordinates—exit] would look similar to the following:

```
$S  
$> (ensure baud rate is set for 115K)  
$FA02000100  
$>  
$Fa  
$>02000100  
$s  
$> (reset baud rate if necessary)
```

# NOTES

# Appendix C

## Standard Defaults

The most common configuration settings are listed in the “Default” column of the table below. Page references are also provided for feature descriptions and programming bar codes for each parameter. A column has also been provided for recording of your preferred default settings for these same configurable features.

**Table 42. Standard Defaults**

Parameter	Default	Your Setting	Page Number
<b>GLOBAL INTERFACE FEATURES</b>			
Host Commands — Obey/Ignore	Obey		23
<b>RS-232 ONLY</b>			
Baud Rate	9600		26
Data Bits	8 Data Bits		27
Stop Bits	1 Stop Bit		27
Parity	None		28
Handshaking Control	RTS		29
<b>RS-232/USB-Com</b>			
Intercharacter Delay	No Delay		31
Beep On ASCII BEL	Disable		31
Beep On Not on File	Enable		32
ACK NAK Options	Disable		32
ACK Character	'ACK'		33
NAK Character	'NAK'		33
ACK NAK Timeout Value	200 ms		34
ACK NAK Retry Count	3 Retries		34
ACK NAK Error Handling	Ignore Errors Detected		35
Indicate Transmission Failure	Enable		35
Disable Character	'D'		36

Parameter	Default	Your Setting	Page Number
Enable Character	'E'		36
<b>USB KEYBOARD</b>			
Country Mode	U.S. Keyboard		38
Send Control Characters	00		42
Intercode Delay	100 ms		43
Intercode Delay	No Delay		43
Caps Lock State	Caps Lock OFF		43
USB Keyboard Speed	1 ms		44
USB Keyboard Numeric Keypad	Standard Keys		45
<b>USB-OEM</b>			
USB-OEM Device Usage	Handheld		48
Transmit Labels in Code 39 Format	IBM Standard Format		49
Interface Options	Ignore Scanner Configuration Host Commands		49
<b>DATA FORMAT</b>			
Global Prefix/Suffix	No Global Prefix Global Suffix = 0x0D (CR)		52
Global AIM ID	Disable		53
Set AIM ID Individually for GS1-128	Enable		55
Label ID: Pre-Loaded Sets	USA Set		56
Individually Set Label ID	Disable		57
No Read String	0x18 = (CAN)		63
Code Verifier Mode	Disable		64
Match String	Disable		65
Wrong Code String	Disable		65
Label Transmit Mode	Disable		66
Advanced Formatting: User Label Edit	Disable		66
Case Conversion	Disable		67
Character Conversion	No Char Conversion		67

Parameter	Default	Your Setting	Page Number
<b>DIGITAL OUTPUT</b>			
Activation Event	Disable		70
Deactivation Event	Disable		71
Deactivation Timeout	005 = 500 msec		71
Activation State	Closed		72
<b>READING PARAMETERS</b>			
Double Read Timeout	1 Second		73
Power On Alert	Power-up Beep		75
Good Read: When to Indicate	After Decode		75
Good Read Beep Type	Mono		76
Good Read Beep Frequency	High		76
Good Read Beep Length	80 ms		77
Good Read Beep Volume	High		78
Good Read LED Duration	300 ms		79
<b>Scanning Features</b>			
Operating Mode	On Line		80
Phase Off Event	Trigger Stop		81
Phase Off Timeout	5 = Timeout set for 5 seconds		81
Serial Start Character	0x02 = Serial Start Character is [02 STX]		82
Serial Stop Character	0x03 = Serial Stop Character is [03 ETX]		82
Presentation Mode Indication	Disable		83
Manual Trigger Control	Disable		83
Central Code Only	Disable		84
Illumination Off Time	Disable		84
Illumination On Time	Disable		85
Scanning Active Time	5 Seconds		85
Presentation Illumination Control	OFF		86
Aiming Pointer	Enable		86

Parameter	Default	Your Setting	Page Number
Aiming Duration Timer	Aiming Off After Decoding		87
Green Spot Duration	300 ms		87
Mobile Phone Mode	Enable		88
Mobile Bias	No Mobile Bias		88
Partial Label Reading Control	Enable		89
Mirror Reading Mode	Disable		89
Decode Negative Image	Disable		90
<b>Multiple Label Reading</b>			
Multiple Labels per Frame	Disable		91
Multiple Labels Ordering by Code Symbology	Random Order		92
Multiple Labels Ordering by Code Length	Disable		92
<b>CODE SELECTION - 1D SYMBOLOGIES</b>			
<b>Code EAN/UPC</b>			
Coupon Control	Enable only UPCA coupon decoding		95
UPC-A			
UPC-A Enable/Disable	Enable		96
UPC-A Check Character Transmission	Send		96
Expand UPC-A to EAN-13	Don't Expand		97
UPC-A Number System Character Transmission	Transmit		97
UPC-A 2D Component	2D Component Not Required		98
UPC-E			
UPC-E Enable/Disable	Enable		98
UPC-E Check Character Transmission	Send		99
UPC-E 2D Component	2D Component Not Required		99
Expand UPC-E to EAN-13	Don't Expand		100
Expand UPC-E to UPC-A	Don't Expand		100
UPC-E Number System Character Transmission	Transmit		101
GTIN			

Parameter	Default	Your Setting	Page Number
GTIN Formatting	Disable		101
EAN 13 (Jan 13)			
EAN 13 Enable/Disable	Enable		102
EAN 13 Check Character Transmission	Send		102
EAN-13 Flag 1 Character	Transmit		103
EAN-13 ISBN Conversion	Disable		103
EAN-13 2D Component	2D Component Not Required		104
ISSN			
ISSN Enable/Disable	Disable		104
EAN 8			
EAN 8 Enable/Disable	Enable		105
EAN 8 Check Character Transmission	Send		105
Expand EAN 8 to EAN 13	Disable		106
EAN 8 2D Component	2D Component Not Required		106
UPC/EAN Global Settings			
UPC/EAN Price Weight Check	Disable		107
UPC/EAN Quiet Zones	Two Modules		108
Add-Ons			
Optional Add-ons	Disable P2, P5 and P8		109
Optional Add-On Timer	70 ms		110
Optional GS1-128 Add-On Timer	Disable		113
Code 39			
Code 39 Enable/Disable	Enable		116
Code 39 Check Character Calculation	Calculate Std Check		116
Code 39 Check Character Transmission	Send		117
Code 39 Start/Stop Character Transmission	Don't Transmit		118
Code 39 Full ASCII	Disable		118
Code 39 Quiet Zones	Small Quiet Zones on two sides		119
Code 39 Length Control	Variable		119

Parameter	Default	Your Setting	Page Number
Code 39 Set Length 1	2		120
Code 39 Set Length 2	50		121
Trioptic Code			
Trioptic Code Enable/Disable	Disable		122
Code 32 (Italian Pharmaceutical Code)			
Code 32 Enable/Disable	Disable		122
Code 32 Check Char Transmission	Don't Send		123
Code 32 Start/Stop Character Transmission	Don't Transmit		123
Code 39 CIP (French Pharmaceutical Code)			
Code 39 CIP Enable/Disable	Disable		124
Special Codes			
Code 39 Danish PPT Enable/Disable	Disable		124
Code 39 LaPoste Enable/Disable	Disable		125
Code 39 PZN Enable/Disable	Disable		125
Code 128			
Code 128 Enable/Disable	Enable		126
Expand Code 128 to Code 39	Don't Expand		126
Code 128 Check Character Transmission	Don't Send		127
Code 128 Function Character Transmission	Don't Send		127
Code 128 Sub-Code Exchange Transmission	Disable		128
Code 128 Quiet Zones	Small Quiet Zones on two sides		128
Code 128 Length Control	Variable		129
Code 128 Set Length 1	1		130
Code 128 Set Length 2	80		131
GS1-128			
GS1-128 Enable	Transmit in Code 128 Data Format		132
GS1-128 2D Component	Disable		132
ISBT 128			
ISBT 128 Concatenation	Disable		133



Parameter	Default	Your Setting	Page Number
ISBT 128 Force Concatenation	Disable		133
ISBT 128 Concatenation Mode	Static		134
ISBT 128 Dynamic Concatenation Timeout	200 msec		135
Interleaved 2 of 5			
I 2 of 5 Enable/Disable	Disable		136
I 2 of 5 Check Character Calculation	Disable		137
I 2 of 5 Check Character Transmission	Send		138
I 2 of 5 Length Control	Variable		138
I 2 of 5 Set Length 1	6		139
I 2 of 5 Set Length 2	50		140
Interleaved 2 of 5 CIP HR			
Interleaved 2 of 5 CIP HR Enable/Disable	Disable		141
Follett 2 of 5			
Follett 2 of 5 Enable/Disable	Disable		141
Standard 2 of 5			
Standard 2 of 5 Enable/Disable	Disable		142
Standard 2 of 5 Check Character Calculation	Disable		142
Standard 2 of 5 Check Character Transmission	Send		143
Standard 2 of 5 Length Control	Variable		143
Standard 2 of 5 Set Length 1	8		144
Standard 2 of 5 Set Length 2	50		145
Industrial 2 of 5			
Industrial 2 of 5 Enable/Disable	Disable		146
Industrial 2 of 5 Check Character Calculation	Disable		146
Industrial 2 of 5 Check Character Transmission	Enable		147
Industrial 2 of 5 Length Control	Variable		147
Industrial 2 of 5 Set Length 1	1		148
Industrial 2 of 5 Set Length 2	50		149
Code IATA			
IATA Enable/Disable	Disable		150

Parameter	Default	Your Setting	Page Number
IATA Check Character Transmission	Enable		150
Codabar			
Codabar Enable/Disable	Disable		151
Codabar Check Character Calculation	Don't Calculate		151
Codabar Check Character Transmission	Send		152
Codabar Start/Stop Character Transmission	Transmit		152
Codabar Start/Stop Character Set	abcd/abcd		153
Codabar Start/Stop Character Match	Don't Require Match		153
Codabar Quiet Zones	Small Quiet Zones on two sides		154
Codabar Length Control	Variable		154
Codabar Set Length 1	3		155
Codabar Set Length 2	50		156
ABC Codabar	Disable		157
ABC Codabar			
ABC Codabar Enable/Disable	Disable		157
ABC Codabar Concatenation Mode	Static		157
ABC Codabar Dynamic Concatenation Timeout	200 msec		158
ABC Codabar Force Concatenation	Disable		159
Code 11			
Code 11 Enable/Disable	Disable		160
Code 11 Check Character Calculation	Check C and K		160
Code 11 Check Character Transmission	Send		161
Code 11 Length Control	Variable		161
Code 11 Set Length 1	4		162
Code 11 Set Length 2	50		163
GS1 DataBar™ Omnidirectional			
GS1 DataBar™ Omnidirectional Enable/Disable	Disable		164
GS1 DataBar™ Omnidirectional GS1-128 Emulation	Disable		164
GS1 DataBar™ Omnidirectional 2D Component	2D component not required		165

Parameter	Default	Your Setting	Page Number
GS1 DataBar™ Expanded			
GS1 DataBar™ Expanded Enable/Disable	Disable		165
GS1 DataBar™ Expanded GS1-128 Emulation	Disable		166
GS1 DataBar™ Expanded 2D Component	2D component not required		166
GS1 DataBar™ Expanded Length Control	Variable		167
GS1 DataBar™ Expanded Set Length 1	1		168
GS1 DataBar™ Expanded Set Length 2	74		169
GS1 DataBar™ Limited			
GS1 DataBar™ Limited Enable/Disable	Disable		170
GS1 DataBar™ Limited GS1-128 Emulation	Disable		170
GS1 DataBar™ Limited 2D Component	2D component not required		171
Code 93			
Code 93 Enable/Disable	Disable		171
Code 93 Check Character Calculation	Enable Check C and K		172
Code 93 Check Character Transmission	Enable		172
Code 93 Length Control	Variable		173
Code 93 Set Length 1	1		174
Code 93 Set Length 2	50		175
Code 93 Quiet Zones	Small Quiet Zones on two sides		176
MSI			
MSI Enable/Disable	Disable		176
MSI Check Character Calculation	Enable Mod10		177
MSI Check Character Transmission	Enable		177
MSI Length Control	Variable		179
MSI Set Length 1	1		179
MSI Set Length 2	50		180
Plessey			
Plessey Enable/Disable	Disable		181

Parameter	Default	Your Setting	Page Number
Plessey Check Character Calculation	Enable Plessey std. check char. verification		181
Plessey Check Character Transmission	Enable		182
Plessey Length Control	Variable		182
Plessey Set Length 1	1		183
Plessey Set Length 2	50		184
<b>CODE SELECTION - 2D SYMBOLOGIES</b>			
2D Maximum Decoding Time	350msec		186
2D Structured Append	Disable		187
2D Normal/Inverse Symbol Control	Normal		187
Aztec Code Enable / Disable	Enable		188
Aztec Code Length Control	Enable		188
Aztec Code Length Control	Variable		188
Aztec Code Set Length 1	1		189
China Sensible Code Enable / Disable	Disable		191
China Sensible Code Length Control	Variable		191
China Sensible Code Set Length 1	1		192
China Sensible Code Set Length 2	7,827		193
Data Matrix Enable / Disable	Enable		194
Data Matrix Square/Rectangular Style	Both Square and Rectangular style		194
Data Matrix Length Control	Variable		195
Data Matrix Set Length 1	1		195
Data Matrix Set Length 2	3,116		196
Maxicode Enable / Disable	Disable		197
Maxicode Primary Message Transmission	Disable		197
Maxicode Length Control	Variable		198
Maxicode Set Length 1	1		198
Maxicode Set Length 2	0145		199
PDF417 Enable / Disable	Enable		200
PDF417 Length Control	Variable		200

Parameter	Default	Your Setting	Page Number
PDF417 Set Length 1	1		201
PDF417 Set Length 2	2,710		202
Micro PDF417 Enable / Disable	Disable		203
Micro PDF417 Code 128 GS1-128 Emulation	Micro PDF AIM ID and label type		203
Micro PDF417 Length Control	Variable		204
Micro PDF417 Set Length 1	1		204
Micro PDF417 Set Length 2	0366		205
QR Code Enable / Disable	Enable		206
QR Code Length Control	Variable		206
QR Code Set Length 1	1		207
QR Code Set Length 2	7,089		208
Micro QR Code Enable/Disable	Disable		209
Micro QR Code Length Control	Variable		209
Micro QR Code Set Length 1	0001		210
Micro QR Code Set Length 2	0035		211
UCC Composite Enable / Disable	Disable		212
UCC Optional Composite Timer	Timer Disabled		213
Postal Code Selection	Disable all Postal codes		214
Postnet BB Control	Disable		215

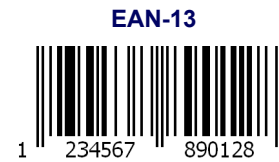
# NOTES

# Appendix D

## Sample Bar Codes

The sample bar codes in this appendix are typical representations for their symbology types.

### 1D Bar Codes



## 1D Bar Codes — continued

**Code 32**



**Codabar**



**Code 93**



**Code 11**





## GS1 DataBar™



GS1 DataBar™ variants must be enabled to read the bar codes below (see [GS1 DataBar™ Omnidirectional](#) on page 164).

### GS1 DataBar™ 14



### GS1 DataBar™ Expanded



### GS1 DataBar™ Limited



### GS1 DataBar™ Truncated



### GS1 DataBar™ Stacked



(01)12345678901231

### GS1 DataBar™ Omnidirectional Stacked



(01)12345678901231

### GS1 DataBar™ Expanded Stacked



## 2D Bar Codes

**Aztec**



ABCabc

**Datamatrix**

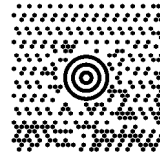


ABCabc

**China Sensible Code**



**MaxiCode**



ABCabc

**PDF 417**



ABCabc

**Micro PDF 417**



12345678

**QR Code**



ABCabc

**Micro QR Code**



ABCDEF

## Composite Codes

**DataBar™ Expanded Stacked Composite**

(17) 050923  
(10) ABC123  
(21) 2153641167



(04) 01234567890

**GS1-128 Composite**

(17) 050923 (10) ABC123

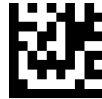


(01) 0 4012345 67890 1 1

# Appendix E

## Keypad

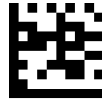
Use the bar codes in this appendix to enter numbers as you would select digits/characters from a keypad.



0



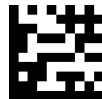
1



2



3



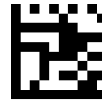
4



5



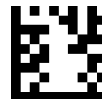
6



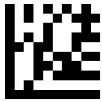
7



8



9



A



B



C



D



E



F

# Appendix F

## Reserved Characters

Reserved Characters	Hex Value	Notes
[SOH]	0x01	
[BEL]	0x07	
#	0x23	
\$	0x24	
0	0x30	
3	0x33	
B	0X42	
D	0X44	
E	0X45	
F	0X46	
R	0X52	
S	0X53	
h	0x68	
i	0x69	
s	0x73	
t	0x74	
[FF]	0xFF	
Reserved Strings		
C<up to 36 chars>[CR]	0x43 <xxx> 0x0D	C can be used without [CR] or inside a string (not the first character)
01[CR]	0x30 0x31 0x0D	
34[CR]	0x33 0x34 0x0D	

---

# NOTES

# Appendix G

## Scancode Tables

### Control Character Emulation

Control character emulation selects from different scancode tables as listed in this appendix. Each of the control character sets below are detailed by interface type in the tables. These apply to USB Keyboard platforms.

**Control Character 00 :** Characters from 00 to 0x1F are sent as control character Ctrl+Keys, special keys are located from 0x80 to 0xA1.

**Control Character 01 :** Characters from 00 to 0x1F are sent as control character Ctrl+Capital Key, special keys are located from 0x80 to 0xA1.

**Control Character 02 :** Special keys are located from 00 to 0x1F and characters from 0x80 to 0xFE are intended as an extended ASCII table (Microsoft Windows Codepage 1252 — See page -316.)

### Single Press and Release Keys

In the following tables, Ar↓ means Alt right pressed and Ar↑ means Alt right released and so on. Definitions for other keys are Al (Alt left ), Cr (Control Right ) Cl (Control Left ) Sh (shift). This method can be used for combining Alt, Control or Shift with other keys.

Example: Consider a Control character set to 00. If AltRight+A is required before sending a label to the host, it could be done by setting three Prefix keys in this way: 0x99 0x41 0x9A.

# Interface Type PC AT PS/2, USB-Keyboard or USB-Keyboard for APPLE

Table 43. Scancode Set When Control Character is 00 or 01

	x0	x1	x2	x3	x4	x5	x6	x7	x8	x9	xA	xB	xC	xD	xE	xF
0x	NULL C+@	SOH C(S)+A	STX C(S)+B	ETX C(S)+C	EOT C(S)+D	ENQ C(S)+E	ACK C(S)+F	BEL C(S)+G	BS HT TAB	LF C(S)+J	VT C(S)+K	FF C(S)+L	CR Enter	SO C(S)+N	SI C(S)+O	
1x	DLE C(S)+P	DC1 C(S)+Q	DC2 C(S)+R	DC3 C(S)+S	DC4 C(S)+T	NAK C(S)+U	SYN C(S)+V	ETB C(S)+W	CAN C(S)+X	EM C(S)+Y	SUB C(S)+Z	ESC Esc	FS C+\	GS C+]	RS C+^	US C(S)+_
2x	<u>SP</u>	!	"	#	\$	%	&	'	(	)	*	±	.	=	-	/
3x	<u>0</u>	<u>1</u>	<u>2</u>	<u>3</u>	<u>4</u>	<u>5</u>	<u>6</u>	<u>7</u>	<u>8</u>	<u>9</u>	:	;	<=	=	>=	?=
4x	@	A	B	C	D	E	F	G	H	I	J	K	L	M	N	O
5x	P	Q	R	S	T	U	V	W	X	Y	Z	[	\	]	^	_
6x	`	a	b	c	d	e	f	g	h	i	j	k	l	m	n	o
7x	p	q	r	s	t	u	v	w	x	y	z	{		}	~	Del
8x	€	Sh↓	Sh↑	Ins	Ent (keyp)	F1	F2	F3	F4	F5	F6	F7	F8	F9	F10	F11
9x	F12	Home	End	Pg Up	Pg Dwn	↑	↓	←	→	Ar↓	Ar↑	Al↓	Al↑	Cl↓	Cl↑	Cr↓
Ax	Cr↑		‘	f	„	...	†	‡	^	%o	Š	<	Š	<	Œ	
Bx	°	±	²	³	´	µ	¶	·	,	¹	º	»	¼	½	¾	¿
Cx	À	Á	Â	Ã	Ä	Å	Æ	Ç	È	É	Ê	Ë	Ì	Í	Î	Ï
Dx	Ð		Ò	Ó	Ô	Õ	Ö	×	Ø	Ù	Ú	Û	Ü	Ý	Þ	ß
Ex	à	á	â	ã	ä	å	æ	ç	è	é	ê	ë	ì	í	î	ï
Fx	ð	ñ	ò	ó	ô	õ	ö	÷	ø	ù	ú	û	ü	ý	þ	ÿ

Extended characters (sky blue) are sent through dedicated keys (when available in the selected country mode) or by using an Alt Mode sequence.



## Interface Type PC AT PS/2, USB-Keyboard or USB-Keyboard for APPLE — cont.

Table 44. Scancode Set When Control Character is 02

	x0	x1	x2	x3	x4	x5	X6	x7	x8	x9	xA	xB	xC	xD	xE	xF
0x	Ar↓	Ar↑	Al↓	Al↑	Cl↓	Cl↑	Cr↓	Cr↑	BS	Tab	→	S+ Tab	Enter Keyprd	Enter	Ins	Pg Up
1x	Pg Dwn	Home	←	↓	↑	F6	F1	F2	F3	F4	F5	ESC	F7	F8	F9	F10
2x	Space	!	“	#	\$	%	&	‘	(	)	*	+	,	-	.	/
3x	0	1	2	3	4	5	6	7	8	9	:	;	<	=	>	?
4x	@	A	B	C	D	E	F	G	H	I	J	K	L	M	N	O
5x	P	Q	R	S	T	U	V	W	X	Y	Z	[	\	]	^	_
6x	`	a	b	c	d	e	f	g	h	i	j	k	l	m	n	o
7x	p	q	r	s	t	u	v	w	x	y	z	{		}	~	<i>Del</i>
8x	€		‘	<i>f</i>	„	...	†	‡	^	%o	Š	◀	Ś	◀	Œ	
9x		‘	’	“	”	•	–	—	~	™	š	›	œ		ž	ÿ
Ax	NBSP	ı	ç	£	□	¥		§	¨	©	ª	«	¬	-	®	¯
Bx	°	±	²	³	´	µ	¶	·	,	¹	º	»	¼	½	¾	¿
Cx	À	Á	Â	Ã	Ä	Å	Æ	Ç	È	É	Ê	Ë	Ì	Í	Î	Ï
Dx	Ð		Ò	Ó	Ô	Õ	Ö	×	Ø	Ù	Ú	Û	Ü	Ý	Þ	ß
Ex	à	á	â	ã	ä	å	æ	ç	è	é	ê	ë	ì	í	î	ï
Fx	ð	ñ	ò	ó	ô	õ	ö	÷	ø	ù	ú	û	ü	ý	þ	ÿ

# Interface type PC AT PS/2 Alt Mode or USB-Keyboard Alt Mode

Table 45. Scancode Set When Control Character is 00 or 01

	x0	x1	x2	x3	x4	x5	X6	x7	x8	x9	xA	xB	xC	xD	xE	Xf
0x	Alt+000	Alt+001	Alt+002	Alt+003	Alt+004	Alt+005	Alt+006	Alt+007	BS	HT TAB	Alt+010	Alt+011	Alt+012	CR Enter	Alt+014	Alt+015
1x	Alt+016	Alt+017	Alt+018	Alt+019	Alt+020	Alt+021	Alt+022	Alt+023	Alt+024	Alt+025	Alt+026	ESC Esc	Alt+028	Alt+029	Alt+030	Alt+031
2x	A+032	A+033	A+034	A+035	A+036	A+037	A+038	A+039	A+040	A+041	A+042	A+043	A+044	A+045	A+046	A+047
3x	A+048	A+049	A+050	A+051	A+052	A+053	A+054	A+055	A+056	A+057	A+058	A+059	A+060	A+061	A+062	A+063
4x	A+064	A+065	A+066	A+067	A+068	A+069	A+070	A+071	A+072	A+073	A+074	A+075	A+076	A+077	A+078	A+079
5x	A+080	A+081	A+082	A+083	A+084	A+085	A+086	A+087	A+088	A+089	A+090	A+091	A+092	A+093	A+094	A+095
6x	A+096	A+097	A+098	A+099	A+100	A+101	A+102	A+103	A+104	A+105	A+106	A+107	A+108	A+109	A+110	A+111
7x	A+112	A+113	A+114	A+115	A+116	A+117	A+118	A+119	A+120	A+121	A+122	A+123	A+124	A+125	A+126	A+127
8x	€	Sh↓	Sh↑	Ins	Ent (keyp)	F1	F2	F3	F4	F5	F6	F7	F8	F9	F10	F11
9x	F12	Home	End	Pg Up	Pg Dwn	↑	↓	←	→	Ar↓	Ar↑	Al↓	Al↑	Cl↓	Cl↑	Cr↓
Ax	Cr↑	A+0161	A+0162	A+0163	A+0164	A+0165	A+0166	A+0167	A+0168	A+0169	A+0170	A+0171	A+0172	A+0173	A+0174	A+0175
Bx	A+0176	A+0177	A+0178	A+0179	A+0180	A+0181	A+0182	A+0183	A+0184	A+0185	A+0186	A+0187	A+0188	A+0189	A+0190	A+0191
Cx	A+0192	A+0193	A+0194	A+0195	A+0196	A+0197	A+0198	A+0199	A+0200	A+0201	A+0202	A+0203	A+0204	A+0205	A+0206	A+0207
Dx	A+0208	A+0209	A+0210	A+0211	A+0212	A+0213	A+0214	A+0215	A+0216	A+0217	A+0218	A+0219	A+0220	A+0221	A+0222	A+0223
Ex	A+0224	A+0225	A+0226	A+0227	A+0228	A+0229	A+0230	A+0231	A+0232	A+0233	A+0234	A+0235	A+0236	A+0237	A+0238	A+0239
Fx	A+0240	A+0241	A+0242	A+0243	A+0244	A+0245	A+0246	A+0247	A+0248	A+0249	A+0250	A+0251	A+0252	A+0253	A+0254	A+0255

## Interface type PC AT PS/2 Alt Mode or USB-Keyboard Alt Mode — cont.

Table 46. Scancode Set When Control Character is 02

	x0	x1	x2	x3	x4	x5	X6	x7	x8	x9	xA	xB	xC	xD	xE	xF
0x	Ar↓	Ar↑	Al↓	Al↑	Cl↓	Cl↑	Cr↓	Cr↑	BS	Tab	→	S+ Tab	Enter Keyprd	Enter	Ins	Pg Up
1x	Pg Dwn	Home	←	↓	↑	F6	F1	F2	F3	F4	F5	ESC	F7	F8	F9	F10
2x	A+032	A+033	A+034	A+035	A+036	A+037	A+038	A+039	A+040	A+041	A+042	A+043	A+044	A+045	A+046	A+047
3x	A+048	A+049	A+050	A+051	A+052	A+053	A+054	A+055	A+056	A+057	A+058	A+059	A+060	A+061	A+062	A+063
4x	A+064	A+065	A+066	A+067	A+068	A+069	A+070	A+071	A+072	A+073	A+074	A+075	A+076	A+077	A+078	A+079
5x	A+080	A+081	A+082	A+083	A+084	A+085	A+086	A+087	A+088	A+089	A+090	A+091	A+092	A+093	A+094	A+095
6x	A+096	A+097	A+098	A+099	A+100	A+101	A+102	A+103	A+104	A+105	A+106	A+107	A+108	A+109	A+110	A+111
7x	A+112	A+113	A+114	A+115	A+116	A+117	A+118	A+119	A+120	A+121	A+122	A+123	A+124	A+125	A+126	A+127
8x	A+0128	A+0129	A+0130	A+0131	A+0132	A+0133	A+0134	A+0135	A+0136	A+0137	A+0138	A+0139	A+0140	A+0141	A+0142	A+0143
9x	A+0144	A+0145	A+0146	A+0147	A+0148	A+0149	A+0150	A+0151	A+0152	A+0153	A+0154	A+0155	A+0156	A+0157	A+0158	A+0159
Ax	A+0160	A+0161	A+0162	A+0163	A+0164	A+0165	A+0166	A+0167	A+0168	A+0169	A+0170	A+0171	A+0172	A+0173	A+0174	A+0175
Bx	A+0176	A+0177	A+0178	A+0179	A+0180	A+0181	A+0182	A+0183	A+0184	A+0185	A+0186	A+0187	A+0188	A+0189	A+0190	A+0191
Cx	A+0192	A+0193	A+0194	A+0195	A+0196	A+0197	A+0198	A+0199	A+0200	A+0201	A+0202	A+0203	A+0204	A+0205	A+0206	A+0207
Dx	A+0208	A+0209	A+0210	A+0211	A+0212	A+0213	A+0214	A+0215	A+0216	A+0217	A+0218	A+0219	A+0220	A+0221	A+0222	A+0223
Ex	A+0224	A+0225	A+0226	A+0227	A+0228	A+0229	A+0230	A+0231	A+0232	A+0233	A+0234	A+0235	A+0236	A+0237	A+0238	A+0239
Fx	A+0240	A+0241	A+0242	A+0243	A+0244	A+0245	A+0246	A+0247	A+0248	A+0249	A+0250	A+0251	A+0252	A+0253	A+0254	A+0255

# Digital Interface

Table 47. Scancode Set When Control Character is 00 or 01

	X0	x1	x2	x3	x4	x5	x6	x7	x8	x9	xA	xB	xC	xD	xE	xF
0x	NULL C+@	SOH C(S)+A	STX C(S)+B	ETX C(S)+C	EOT C+D	ENQ C(S)+E	ACK C(S)+F	BEL C(S)+G	BS	HT TAB	LF C(S)+J	VT C(S)+K	FF C(S)+L	CR Enter	SO C(S)+N	SI C(S)+O
1x	DLE C(S)+P	DC1 C(S)+Q	DC2 C(S)+R	DC3 C(S)+S	DC4 C(S)+T	NAK C(S)+U	SYN C(S)+V	ETB C(S)+W	CAN C(S)+X	EM C(S)+Y	SUB C(S)+Z	ESC Esc	FS C(S)+\	GS C+]	RS C(S)+^	US C(S)+_
2x	Space	!	“	#	\$	%	&	‘	(	)	*	+	,	-	.	/
3x	0	1	2	3	4	5	6	7	8	9	:	;	<	=	>	?
4x	@	A	B	C	D	E	F	G	H	I	J	K	L	M	N	O
5x	P	Q	R	S	T	U	V	W	X	Y	Z	[	\	]	^	_
6x	`	a	b	c	d	e	f	g	h	i	j	k	l	m	n	o
7x	p	q	r	s	t	u	v	w	x	y	z	{		}	~	Del
8x		Sh↓	Sh↑	Ins	Ent (keyp)	F1	F2	F3	F4	F5	F6	F7	F8	F9	F10	F11
9x	F12	F13	F14	F15	F16	↑	↓	←	→					Cl↓	Cl↑	

Table 48. Scancode Set When Control Character is 02

	X0	x1	x2	x3	x4	x5	x6	x7	x8	x9	xA	xB	xC	xD	xE	xF
0x					Cl↓	Cl↑			BS	Tab	à	S+ Tab	Enter Keyprd	Enter	Ins	
1x			←	↓	↑	F6	F1	F2	F3	F4	F5	ESC	F7	F8	F9	F10
2x	Space	!	“	#	\$	%	&	‘	(	)	*	+	,	-	.	/
3x	0	1	2	3	4	5	6	7	8	9	:	;	<	=	>	?
4x	@	A	B	C	D	E	F	G	H	I	J	K	L	M	N	O
5x	P	Q	R	S	T	U	V	W	X	Y	Z	[	\	]	^	_
6x	`	a	b	c	d	e	f	g	h	i	j	k	l	m	n	o
7x	p	q	r	s	t	u	v	w	x	y	z	{		}	~	Del

# IBM31xx 102-key

Table 49. Scancode Set When Control Character is 00 or 01

	X0	x1	x2	x3	x4	x5	x6	x7	x8	x9	xA	xB	xC	xD	xE	xF
0x	NULL C+@	SOH C(S)+A	STX C(S)+B	ETX C(S)+C	EOT C+D	ENQ C(S)+E	ACK C(S)+F	BEL C(S)+G	BS	HT TAB	LF C(S)+J	VT C(S)+K	FF C(S)+L	CR Enter	SO C(S)+N	SI C(S)+O
1x	DLE C(S)+P	DC1 C(S)+Q	DC2 C(S)+R	DC3 C(S)+S	DC4 C(S)+T	NAK C(S)+U	SYN C(S)+V	ETB C(S)+W	CAN C(S)+X	EM C(S)+Y	SUB C(S)+Z	ESC Esc	FS C(S)+\	GS C+]	RS C(S)+^	US C(S)+_
2x	Space	!	“	#	\$	%	&	‘	(	)	*	+	,	-	.	/
3x	0	1	2	3	4	5	6	7	8	9	:	;	<	=	>	?
4x	@	A	B	C	D	E	F	G	H	I	J	K	L	M	N	O
5x	P	Q	R	S	T	U	V	W	X	Y	Z	[	\	]	^	_
6x	‘	a	B	c	d	e	f	g	h	i	j	k	l	m	n	o
7x	p	q	R	s	t	u	v	w	x	y	z	{		}		Del
8x		Sh↓	Sh↑	Ins	Ent (keyp)	F1	F2	F3	F4	F5	F6	F7	F8	F9	F10	F11
9x	F12	Enter	Reset	Insert	Delete	Field -	Field +	Enter paddle	Printl	Ar↓	Ar↑	Al↓	Al↑	Cl↓	Cl↑	Cr↓
Ax	Cr↑															

Table 50. Scancode Set When Control Character is 02

	X0	x1	x2	x3	x4	x5	x6	x7	x8	x9	xA	xB	xC	xD	xE	xF
0x	Ar↓	Ar↑	Al↓	Al↑	Cl↓	Cl↑	Cr↓	Cr↑	BS	Tab	→	S+ Tab	Enter Keypd	Enter	Ins	Pg Up
1x	Pg Dwn	Home	←	↓	↑	F6	F1	F2	F3	F4	F5	ESC	F7	F8	F9	F10
2x	Space	!	“	#	\$	%	&	‘	(	)	*	+	,	-	.	/
3x	0	1	2	3	4	5	6	7	8	9	:	;	<	=	>	?
4x	@	A	B	C	D	E	F	G	H	I	J	K	L	M	N	O
5x	P	Q	R	S	T	U	V	W	X	Y	Z	[	\	]	^	_
6x	‘	a	B	c	d	e	f	g	h	i	j	k	l	m	n	o
7x	p	q	R	s	t	u	v	w	x	y	z	{		}		Del

# IBM XT

**Table 51. Scancode Set When Control Character is 00 or 01**

	X0	x1	x2	x3	x4	x5	x6	x7	x8	x9	xA	xB	xC	xD	xE	xF
0x	NULL C+@	SOH C(S)+A	STX C(S)+B	ETX C(S)+C	EOT C+D	ENQ C(S)+E	ACK C(S)+F	BEL C(S)+G	BS C(S)+H	HT TAB	LF C(S)+J	VT C(S)+K	FF C(S)+L	CR Enter	SO C(S)+N	SI C(S)+O
1x	DLE C(S)+P	DC1 C(S)+Q	DC2 C(S)+R	DC3 C(S)+S	DC4 C(S)+T	NAK C(S)+U	SYN C(S)+V	ETB C(S)+W	CAN C(S)+X	EM C(S)+Y	SUB C(S)+Z	ESC Esc	FS C(S)+\	GS C+]	RS C(S)+^	US C(S)+_
2x	Space	!	“	#	\$	%	&	‘	(	)	*	+	,	-	.	/
3x	0	1	2	3	4	5	6	7	8	9	:	;	<	=	>	?
4x	@	A	B	C	D	E	F	G	H	I	J	K	L	M	N	O
5x	P	Q	R	S	T	U	V	W	X	Y	Z	[	\	]	^	_
6x	‘	a	B	c	d	e	f	g	h	i	j	k	l	m	n	o
7x	p	q	R	s	t	u	v	w	x	y	z	{		}		Del
8x		Sh↓	Sh↑	Ins	Ent (keyp)	F1	F2	F3	F4	F5	F6	F7	F8	F9	F10	F11
9x	F12	Home	End	Pg Up	Pg Dwn	↑	↓	←	→	Ar↓	Ar↑	Al↓	Al↑	Cl↓	Cl↑	Cr↓
Ax	Cr↑															

**Table 52. Scancode Set when Control Character 02**

	X0	x1	x2	x3	x4	x5	x6	x7	x8	x9	xA	xB	xC	xD	xE	xF
0x	Ar↓	Ar↑	Al↓	Al↑	Cl↓	Cl↑	Cr↓	Cr↑	BS	Tab	→	S+ Tab	Enter Keyprd	Enter	Ins	Pg Up
1x	Pg Dwn	Home	←	↓	↑	F6	F1	F2	F3	F4	F5	ESC	F7	F8	F9	F10
2x	Space	!	“	#	\$	%	&	‘	(	)	*	+	,	-	.	/
3x	0	1	2	3	4	5	6	7	8	9	:	;	<	=	>	?
4x	@	A	B	C	D	E	F	G	H	I	J	K	L	M	N	O
5x	P	Q	R	S	T	U	V	W	X	Y	Z	[	\	]	^	_
6x	‘	a	B	c	d	e	f	g	h	i	j	k	l	m	n	o
7x	p	q	R	s	t	u	v	w	x	y	z	{		}		Del

# Microsoft Windows Codepage 1252

Windows-1252 is a character encoding of the Latin alphabet, used by default in the legacy components of Microsoft Windows in English and some other Western languages.

	00	01	02	03	04	05	06	07	08	09	0A	0B	0C	0D	0E	0F
00	NUL 0000	STX 0001	SOT 0002	ETX 0003	EOT 0004	ENO 0005	ACK 0006	BEL 0007	BS 0008	HT 0009	LF 000A	VT 000B	FF 000C	CR 000D	SO 000E	SI 000F
10	DLE 0010	DC1 0011	DC2 0012	DC3 0013	DC4 0014	NAK 0015	SYN 0016	ETB 0017	CAN 0018	EM 0019	SUB 001A	ESC 001B	FS 001C	GS 001D	RS 001E	US 001F
20	SP 0020	! 0021	" 0022	# 0023	\$ 0024	% 0025	& 0026	* 0027	( 0028	) 0029	* 002A	+ 002B	, 002C	- 002D	. 002E	/ 002F
30	0 0030	1 0031	2 0032	3 0033	4 0034	5 0035	6 0036	7 0037	8 0038	9 0039	: 003A	; 003B	< 003C	= 003D	> 003E	? 003F
40	@ 0040	A 0041	B 0042	C 0043	D 0044	E 0045	F 0046	G 0047	H 0048	I 0049	J 004A	K 004B	L 004C	M 004D	N 004E	O 004F
50	P 0050	Q 0051	R 0052	S 0053	T 0054	U 0055	V 0056	W 0057	X 0058	Y 0059	Z 005A	[ 005B	\ 005C	] 005D	^ 005E	_ 005F
60	` 0060	a 0061	b 0062	c 0063	d 0064	e 0065	f 0066	g 0067	h 0068	i 0069	j 006A	k 006B	l 006C	m 006D	n 006E	o 006F
70	p 0070	q 0071	r 0072	s 0073	t 0074	u 0075	v 0076	w 0077	x 0078	y 0079	z 007A	{ 007B	 007C	} 007D	~ 007E	DEL 007F
80	€ 20AC	• 2018	ƒ 201A	ſ 0192	ˆ 201E	˜ 2025	† 2020	‡ 2021	ˆ 02C6	‰ 2030	Š 0160	< 2039	Œ 0152	• 017D	Ž 017D	• 017D
90	• 0177	ˆ 2018	ˆ 2019	ˆ 201C	ˆ 201D	• 2022	— 2013	— 2014	ˆ 02DC	• 2122	Š 0161	› 203A	œ 0153	• 017E	Ž 017E	Ÿ 0178
A0	NSP 00A0	ı 00A1	ı 00A2	£ 00A3	¤ 00A4	¥ 00A5	ı 00A6	ı 00A7	ı 00A8	ı 00A9	ı 00AA	ı 00AB	ı 00AC	ı 00AD	ı 00AE	ı 00AF
B0	• 00B0	± 00B1	ˆ 00B2	ˆ 00B3	ˆ 00B4	ı 00B5	ı 00B6	ı 00B7	ı 00B8	ı 00B9	ı 00BA	ı 00BB	ı 00BC	ı 00BD	ı 00BE	ı 00BF
C0	À 00C0	Á 00C1	Â 00C2	Ã 00C3	Ä 00C4	Å 00C5	Æ 00C6	Ç 00C7	È 00C8	É 00C9	Ê 00CA	Ë 00CB	Ì 00CC	Í 00CD	Î 00CE	Ï 00CF
D0	Ð 00D0	Ñ 00D1	Ò 00D2	Ó 00D3	Ô 00D4	Õ 00D5	Ö 00D6	× 00D7	Ø 00D8	Ù 00D9	Ú 00DA	Û 00DB	Ü 00DC	Ý 00DD	Þ 00DE	ß 00DF
E0	à 00E0	á 00E1	â 00E2	ã 00E3	ä 00E4	å 00E5	æ 00E6	ç 00E7	è 00E8	é 00E9	ê 00EA	ë 00EB	ì 00EC	í 00ED	î 00EE	ï 00EF
F0	ø 00F0	ñ 00F1	ò 00F2	ó 00F3	ô 00F4	õ 00F5	ö 00F6	÷ 00F7	ø 00F8	ù 00F9	ú 00FA	û 00FB	ü 00FC	ý 00FD	þ 00FE	ÿ 00FF

---

# NOTES



---

# NOTES

---

# NOTES

# ASCII Chart

ASCII Char.	Hex No.	ASCII Char.	Hex No.	ASCII Char.	Hex No.	ASCII Char.	Hex No.
NUL	00	SP	20	@	40	'	60
SOH	01	!	21	A	41	a	61
STX	02	"	22	B	42	b	62
ETX	03	#	23	C	43	c	63
EOT	04	\$	24	D	44	d	64
ENQ	05	%	25	E	45	e	65
ACK	06	&	26	F	46	f	66
BEL	07	'	27	G	47	g	67
BS	08	(	28	H	48	h	68
HT	09	)	29	I	49	i	69
LF	0A	*	2A	J	4A	j	6A
VT	0B	+	2B	K	4B	k	6B
FF	0C	,	2C	L	4C	l	6C
CR	0D	-	2D	M	4D	m	6D
SO	0E	.	2E	N	4E	n	6E
SI	0F	/	2F	O	4F	o	6F
DLE	10	0	30	P	50	p	70
DC1	11	1	31	Q	51	q	71
DC2	12	2	32	R	52	r	72
DC3	13	3	33	S	53	s	73
DC4	14	4	34	T	54	t	74
NAK	15	5	35	U	55	u	75
SYN	16	6	36	V	56	v	76
ETB	17	7	37	W	57	w	77
CAN	18	8	38	X	58	x	78
EM	19	9	39	Y	59	y	79
SUB	1A	:	3A	Z	5A	z	7A
ESC	1B	;	3B	[	5B	{	7B
FS	1C	<	3C	\	5C		7C
GS	1D	=	3D	]	5D	}	7D
RS	1E	>	3E	^	5E	~	7E
US	1F	?	3F	_	5F	DEL	7F



[www.datalogic.com](http://www.datalogic.com)

**Datalogic ADC, Inc.**

959 Terry Street

Eugene, OR 97402

USA

Telephone: (541) 683-5700

Fax: (541) 345-7140

