

Phylogenetic revision of the parasitoid wasp family Trigonalidae (Hymenoptera)

DAVID CARMEAN and LYNN KIMSEY* Department of Biological Sciences,
Simon Fraser University, Burnaby, BC, Canada and *Bohart Museum, Department of Entomology, University of California,
Davis, U.S.A.

Abstract. A phylogenetic analysis of generic relationships and revised generic concepts for the Trigonalidae is presented. The Trigonalidae is divided into two subfamilies, the Orthogonalinae and the Trigonalinae. Orthogonalinae consists of a single primitive genus, *Orthogonalys*, sharing many generalized apocritan characters, but lacking advanced trigonalid characters including antennal tyloids and female metasomal armature. No synapomorphies have been detected for the Orthogonalinae. Trigonalinae are characterized by the presence of tyloids. The Trigonalinae were originally defined by the absence of female armature, and were therefore polyphyletic because armature has been lost several times. Within the revised concept of Trigonalinae, the tribe Trigonalini is characterized by the presence of elongate parameres and an intertorulus distance subequal to the distance between the torulus and the eye. A second tribe, Nomadinini, is based on the secondary loss of tyloids, and comprises the previous subfamilies Seminotinae, Nomadininae, Bareogonalinae and Lycogastrinae. The two tribes Trigonalini and Nomadinini share the presence of female armature, although in some Trigonalini it has been secondarily lost. The genera *Labidogonals* Schulz, *Lycogastroides* Strand, *Lycogonals* Bischoff, *Nanogonals* Schulz, *Poecilogonals* Schulz and *Taiwanogonals* Tsuneki are synonymised under *Taeniogonals* Schulz. The species *Lycogaster zimmeri* Bischoff, *Tapinogonals maschuna* Schulz, and *Trigonalys pictifrons* Smith (placed in *Lycogaster* by Schulz, 1906a) are transferred to *Taeniogonals*. The genera *Discenea* Enderlein and *Stygnogonals* Schulz are synonymised under *Trigonalys* Westwood. The species *Labidogonals flavescens* Bischoff, *L. sanctaecatharinae* Schulz, *Trigonalys lachrymosa* Westwood (placed in *Lycogaster* by Bischoff, 1938), *T. maculifrons* Cameron (placed in *Labidogonals* by Bischoff, 1938) and *T. rufiventris* Magretti (placed in *Lycogaster* by Schulz, 1907a) are transferred to *Trigonalys*. *Trigonalys costalis* Cresson is synonymised with *Taeniogonals gundlachii* (Cresson). *Xanthogonals fasciatus* Bertoni and *X. severini* Schulz are synonymised with *Trigonalys sanctaecatharinae* (Schulz). *Mimelogonals partiglabra* Riek and *M. punctulata* Riek are synonymised with *M. bouvieri* Schulz. Lectotypes are designated for *Trigonalys melanoleuca* Westwood and *Taeniogonals fasciatipennis* (Cameron). The author of *Trigonalys maculifrons* is Sharp (1895), not Cameron (1897), and the author of *Taeniogonals enderleini* is De Santis (1980), not Schulz 1906. Viereck (1914) designated *Trigonalys pulchella* Cresson as type of the genus *Tapinogonals* Schulz, preceding Bischoff's (1938) designation, making *Tapinogonals* a synonym of *Orthogonalys*. A new genus, *Afrigonalys*, is proposed for the three species that were described in '*Tapinogonals*' *sensu* Bischoff, *nec* Viereck.

Correspondence: David Carmean, Department of Biological
Sciences, Simon Fraser University, Burnaby, BC, Canada V5A 1S6.
E-mail: carmean@sfu.ca

Introduction

Trigonalids have a biology unique within the Hymenoptera. Thousands of eggs are laid on foliage (Figs 1–5) and these eggs will not hatch unless consumed by a herbivorous caterpillar or sawfly larva. The ultimate hosts of trigonalids are the parasitoids or predators which attack the herbivore, although some species will directly parasitise sawflies. Some species of trigonalids may parasitise hosts of different orders and sizes, resulting in a great deal of intraspecific variation and confusion. Weinstein & Austin (1991) recognized about 100 valid species and here we recognize sixteen genera and eighty-eight species, and have seen approximately twelve additional undescribed species. This group is rarely collected; and the hosts for most species, and many other aspects of the biology remains unknown. The biology of trigonalids was reviewed in detail by Clausen (1940), Carmean (1991) and Weinstein & Austin (1991, 1995). Teranishi (1929), Chen (1949), Riek (1954, 1962a), Townes (1956), Tsuneki (1991) and Smith (1996) are important regional references with keys, although they cover a limited number of taxa.

Most Trigonalidae are relatively large (5–15 mm long), though some are as small as 3 mm. Some species are thin and elongate, mimicking ichneumonids (Fig. 6), whereas others are relatively stout-bodied, mimicking vespids (Figs 4, 5). Superficial convergence among phylogenetically distant trigonalids is common and appears to be due to unrelated species mimicking a common wasp model.

Schulz (1907a) undertook the only global study of trigonalid generic relationships, and regional studies consistently mention the need for generic revision. Schulz probably had about 250 specimens available to him, about half of which were *Pseudogonalos hahnii* (Spinola), and most of his specific and generic descriptions were based on one or two specimens. As a result, his genera tended to be narrowly defined and based on variable characters. Bischoff (1933) remarked that under Schulz's system a new genus would be necessary for each new species. Benoit (1951) stressed the need for broadening generic concepts. Strand (1912) stated that Schulz had gone too far in his classification of genera and that his subfamilies were built on a weak foundation of variable characters. Weinstein & Austin (1991) noted 'that many genera are poorly defined and that their monophyly, and that of some subfamilies, is questionable.'

Since 1907, the numbers of Trigonalidae collected, mainly through Malaise traps and rearing, have greatly increased. Because Schulz's genera were poorly defined and his generic keys confusing, different workers have placed species in unrelated genera, or have created new genera synonymous with existing ones. The purpose of this study is to revise generic concepts, to resolve some of the taxonomic confusion which resulted from a lack of understanding of the variability of genera and species, and to propose monophyletic higher taxa based on shared derived characters.

Monophyly and distinguishing characters of the Trigonalidae

Despite the diversity of form within the family, the Trigonalidae is clearly monophyletic, and is well-defined by a suite of derived

morphological and behavioural characters. These characters clearly distinguish and separate the family from other groups so that, despite superficial mimicry, there are no extant taxa that can be confused with Trigonalidae. One feature unique to all members of the family is the presence of sparse white scales or setae on the outside of the middle flagellomeres of the female antenna (Fig. 13). At magnifications of $\times 30$ – 50 they usually appear as an oval patch of sparse white spots. On dirty, wet or greasy specimens they may not be visible. Additional features, apparently unique to trigonalids but secondarily lost in *Nomadina* Westwood, *Bakeronymus* Rohwer, and *Pseudonomadina* Yamane & Kojima are: mandibles asymmetrical (Fig. 19), hind trochantellus diagonally divided and appearing 2-segmented (= hind trochanters apparently 3-segmented) and propodeal spiracle covered by a prominent flap. *Bareogonalos*, as well as *Nomadina*, *Bakeronymus* and *Pseudonomadina*, always have the hind trochantellus undivided, and some species of *Bareogonalos* have symmetrical mandibles. Trigonalids are also characterized by a supra-antennal elevation or raised area above and mesad of the torulus that may be reduced to absent in some *Bareogonalos* and related genera (Figs 14–20). Other, possibly plesiomorphic, diagnostic characters are: maxillary palps longer than mandibles and 6-segmented, with first segment very small (maxillary palps as long as mandible and 4-segmented in *Bakeronymus*, rudimentary and four or fewer segments in *Nomadina* and *Pseudonomadina*); tarsi with plantar lobes (Fig. 21); tarsal claws cleft (Fig. 21); forewing with pronounced costal cell and complete wing venation (generally ten closed cells), hindwing with two closed cells; propodeal foramen open ventrally; and metasomal terga with short dorsolateral sutures (visible on tergum II and often covered on the following terga). Most trigonalids have 18–28 antennal segments (16–26 flagellomeres), although some have as few as thirteen segments and one specimen has been found with thirty-two segments. Tyloids (raised areas without pubescence) (Figs 10–12) on the outside of the middle antennal segments of males of many species are not part of the groundplan but are derived within the family. Females of many species have 'metasomal armature' (Figs 1–3), i.e. projections or raised ledges, posteriorly on sternum II or III or both, a feature also derived within the family and not part of the groundplan.

Distribution

Trigonalidae have a cosmopolitan distribution, with the exception of arctic and alpine regions. The greatest abundance of taxa occurs in the tropics and only one species is found in Europe. Most genera are widely distributed. For example, *Orthogonalys* Schulz is known from Japan, Taiwan, north-western Vietnam, north-eastern India, Madagascar, Tanzania, eastern South America and eastern North America. *Taeniogonalos* Schulz is even more widespread, and is found in these areas as well as in Australia, Papua New Guinea, the Solomon Islands, Indonesia, Sri Lanka and throughout India. Some genera are more restricted, e.g. *Mimelogonalos* Schulz from Australia (with an undescribed close relative in Papua

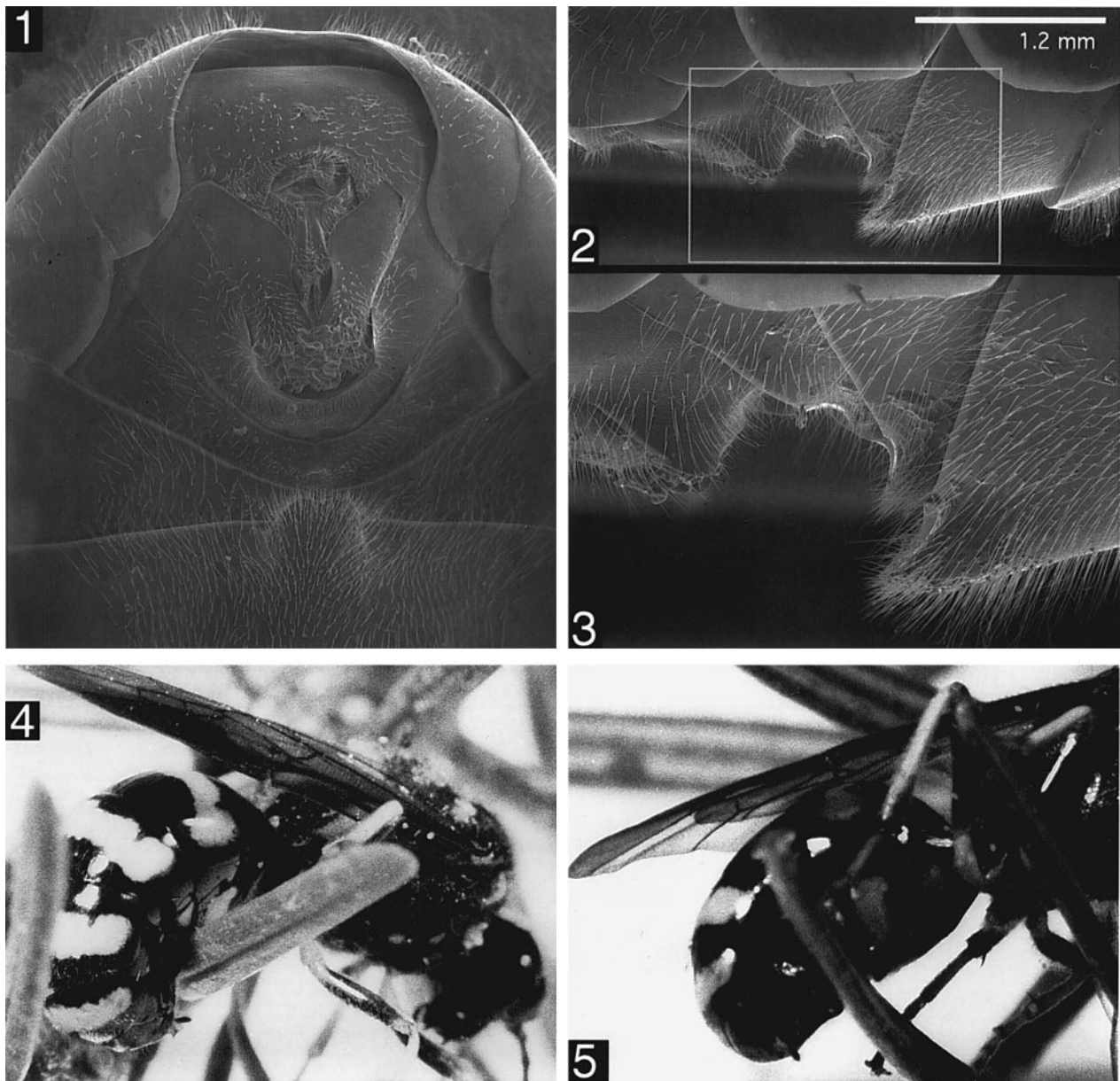

Figs 1–5. Oviposition of *Bareogonales canadensis*, morphology and behaviour. 1–3, Female abdomen; 1, ventral view, the capsule envelops the awl which is partially covered with eggs, the armature is at the bottom of the micrograph; 2,3, lateral view, left side is capsule, right side is metasomal armature and the anterior portion. 4,5, Oviposition in Douglas fir foliage. The female braces the leaf between the awl and the armature during oviposition. Scanning-electron micrographs by L. Coote.

New Guinea) and *Seminota* Spinola from the neotropics. *Nomadina* is also known only from the neotropics, but there are two closely related Asian genera, *Bakeronymus*, with a single species known only from the Philippines and Taiwan, and *Pseudonomadina*, known only from the Philippines. *Bareogonales* is found around the perimeter of the Pacific Ocean, in western Mexico, north-western North America, eastern Siberia, Japan, Taiwan, Java and Sumatra. The same

species of *Bareogonales* is found in Siberia, Japan and Java. Other trigonalid species found in Indonesia may be distributed as far away as India, *Taeniogonales thwaitesii* (Westwood), and China, *Lycogaster celebesiensis* (Szepligeti) and *Taeniogonales fasciata* (Strand).

Distributions of trigonalid genera linking widely separated regions are supporting evidence for the ancient origins of the group and appear to be relictual. However, none of the known

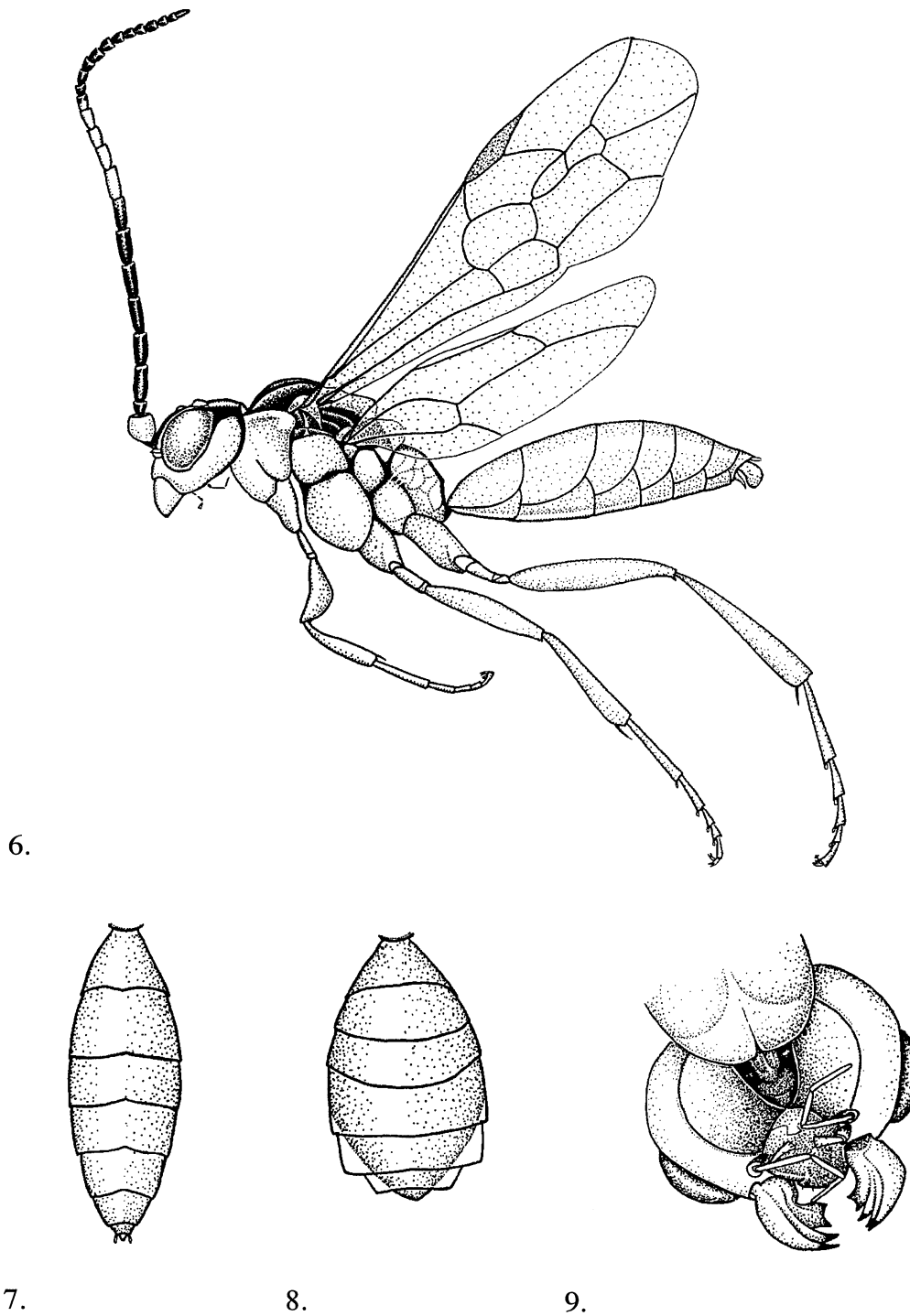

Figs 6–9. *Orthogonalys pulchella*. 6, Habitus, side view. 7, 8, Dorsal view of metasoma; 7, Male. 8, Female. 9, Posterior view of head. Shaded drawings by Micki Yuval.

hosts, except for sawflies, can be considered ancient. The most widely distributed trigonalid, *Taeniogonalos*, is a relatively derived genus known to parasitise sawflies directly as well as tachinids and ichneumonids indirectly (Weinstein & Austin, 1991). The apparently less derived trigonalid, *Orthogonalys*,

is widely distributed, absent only from Europe and Australia. Host information for the genus is limited to a few rearings from Lepidoptera pupae which are believed to be intermediate hosts and a tachinid parasitoid of Lepidoptera (see generic discussion).

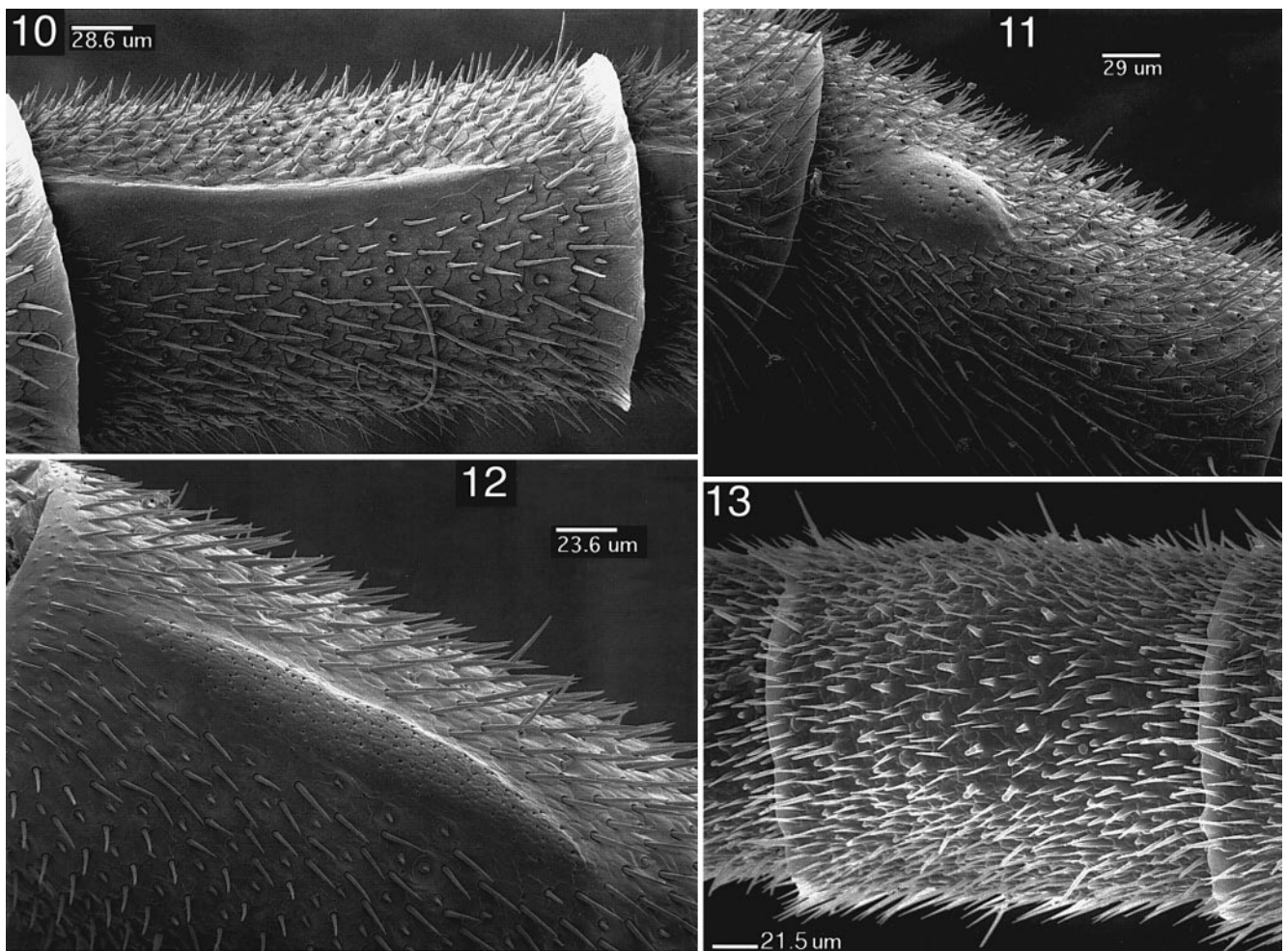

Figs 10–13. Tyloids on the flagellomeres. 10, Elongate-narrow, linear (*Taeniogonalos gundlachii*). 11, Short, oval-round (*Pseudogonalos hahnii*). 12, Elongate-broadly oval (*Mimetogonalos* sp.). 13, Female flagellomere, with specialized setae on protuberant area in middle of micrograph (*Bareogonalos canadensis*). Scanning-electron micrographs 10–12 by P.S. Ward; 13 by L. Coote.

Systematics

What little systematic stability this family has enjoyed historically has been an artefact due to its obscurity and the difficulty in developing adequate generic concepts. Schulz (1907a) and those who followed him placed the most distinct and autapomorphic genera, e.g. *Bareogonalos*, *Seminota* (with *Xanthogonalos* Schulz) and *Nomadina* (with *Bakeronymus*) in their own subfamilies. The remaining genera were either united in one subfamily (Bischoff, 1938), or divided into two subfamilies, based on the presence or absence of female metasomal armature (Schulz, 1907a; Benoit, 1951; Weinstein & Austin, 1991). Although the armature is an obvious character unique to the trigonalids, it has been lost independently in some species of the genera *Taeniogonalos* and *Trigonalys*. In addition, armature presence or absence varies geographically in the species *Taeniogonalos thwaitesii*, and Riek (1962a) used a series of figures to show that the armature of *Taeniogonalos venatoria* Riek also varies from prominent to reduced. Therefore, it is clear that other characters, in addition to

armature, must be considered in assigning species to subfamilies, tribes and genera.

Previously, venational characters were given considerable weight in defining genera (Cameron, 1899) and subfamilies (Schulz, 1905). Some of these characters are now known to vary even between the left and right side of individual specimens. Indeed, Benoit (1951) argued against using the form and size of the submarginal cells as an important systematic character. However, if many specimens are available, some generalizations may be informative. For example, although there are exceptions, most *Orthogonalyis* have a petiolate submarginal cell II, as do most *Nomadina* that we examined. *Mimetogonalos*, *Lycogaster* and *Bareogonalos* consistently have submarginal cell II broadly attached, but many *Taeniogonalos* and *Trigonalys* are intermediate, so that Rs meets 1 m-cu, with enough variation so that the submarginal cell is sometimes petiolate or broadly attached.

Because the ultimate host is not selected at oviposition, the size of the host can vary considerably, and thus the size of individuals within a trigonalid species can also vary greatly.

The extent of markings can also vary. Tsuneki (1991) illustrated and discussed the range of variation possible in the size and markings of *Taeniogonalos sauteri* Bischoff. Series of specimens collected at the same location and time often have individuals that depart from the norm for what is considered a definitive character. For example, a specimen of *Seminota marginata* (Westwood) has symmetrical mandibles (BMNH) or one *Bareogonalos jezoensis* (Uchida) has a flat dorsellum (CARM). This variation and anomaly makes it difficult to establish valid differences among species, especially when few specimens are available.

Finally, most earlier workers incorrectly believed that the metasomal armature was found on males only (Westwood, 1841, 1843; Smith, 1851; Cresson, 1865; Buysson & Marshall, 1892; Cameron, 1897, 1899; Magretti, 1897; Harrington, 1898; Schrottky, 1906; Banks, 1908) and thus identified females with metasomal armature as males. Even Schulz (1905) initially made this error, although his later works were accurate.

Materials and methods

Morphological terminology follows that of Gauld & Bolton (1988), except that the terms *mesosoma*, *metasoma*, *sternum* and *tergum* are used here. The term metasomal *armature* is used for the various modifications (projections, stout spines or raised posterior edges) found on sterna II and/or III of some females. The *awl* is the sclerotised tip of the terminal sternum of the female that is shaped and functions like a hypodermic needle to pierce foliage for the oviposition of eggs (Yamane & Yamane, 1975: Fig. 16). In many cases it is held in the preceding sterna which are flattened into a *capsule* (Figs 1–3). The term *supra-antennal elevation* (SAE) is used for any elevation or modification above and mesad of the torulus (Tsuneki, 1991). The number of antennal 'segments' includes the scape, pedicel and flagellomeres. Malar space is 'short' if it is shorter than the width of the first flagellomere and 'long' if it is longer. Only the metasomal segments are used for counting sterna and terga. Forewing (FW) length is measured from the break between the costal vein and the humeral plate to the wing tip. Body length is measured from the antennal insertion to the furthest point of the metasoma, and is not standardized due to changes in alignment of the head and metasomal segments. To see the angle of the gena in the horizontal plane, the termination of the genal carina, and whether the genal carina is mesad of or on the genal angle, the head must be orientated so that it is viewed ventrally (Figs 22, 23).

Clausen (1940), Cooper (1954), Carlson (1979) and Gelhaus (1987) used the term secondary host for the folivore whereas Gauld & Bolton (1988) and Weinstein & Austin (1991) used the term primary host. Because of this ambiguity, we use the

terms *intermediate host* when a trigonalid needs to develop to adulthood in a second host, and *ultimate host* for the host that the larva uses to complete its development.

Although trigonalids from key geographical regions, including South-east Asia, Africa and South and Central America remain undercollected, we have had about 2300 specimens from over fifty collections available for study. Most genera were represented by series of forty or more specimens. Even so, many species and some genera are represented by only one to a few specimens, often of one sex, and many other species originally described from one to a few specimens remain unknown to us. We have seen the types, holotypes (designated by '*' in the species lists), syntypes or lectotypes, of thirty-seven species, including eleven types previously listed as missing or with their deposition unknown (Weinstein & Austin, 1991). We have seen paratypes of an additional nine species. The types of many species are apparently lost (Weinstein & Austin, 1991), and the species descriptions are often inadequate to determine their identity.

The characters in the data matrix (Table 1) are identified by numbers assigned in the section on character analysis; these numbers serve to identify the characters in the cladograms (Figs 24–30). The terminal taxa used in the analyses are the hypothetical ancestor and the genera of Trigonalidae. So that results from the phylogenetic analysis would challenge our generic definitions and synonymizations, we also included species representing the previously recognized (and here synonymised) genera *Labidogonalos*, *Nanogonalos* and *Poecilogonalos* Schulz, as well as taxa whose placement is tentative, including *Taeniogonalos flavocincta* (Teranishi) and *T. maga* (Teranishi). Due to the small number of specimens and in some cases their poor condition, it may not be possible to evaluate the relationships of Tsuneki's new genera and species until more specimens are collected (Tsuneki, 1991).

Parsimony analyses were carried out using MacClade 3.01 (Maddison & Maddison, 1992) and PAUP 3.0s (Swofford, 1991). MacClade was used for entering data and comparing different phylogenetic hypotheses (cladograms) and character evolution and PAUP was used for finding the most parsimonious trees and their statistics. PAUP's default heuristic search settings were used with more than fourteen taxa, and 100 random stepwise-addition replicates were used to search for additional parsimonious trees. With fewer than fourteen taxa, we used the branch and bound search, which will find all the most parsimonious trees.

Hennig86 ver. 1.5 (Farris, 1988) was also used for parsimony analyses. Polymorphic characters in the data matrix (Table 1) were converted to monomorphic characters using the ACCTRAN option in MacClade on the tree in Fig. 28. In the case of the propodeal scutellum of *Xanthogonalos* the polymorphism was not resolved, so the character state was

Figs 14–20. Heads, anterior views (all bars 1 mm). 14, *Orthogonalyx pulchella*; 15, *Seminota*; 16, *Pseudogonalos hahnii*; 17, *Taeniogonalos gundlachii*; 18, *Bareogonalos canadensis*; 19, *Taeniogonalos venatoria*; 20, *Nomadina*.

Fig. 21. Tarsi, with plantar lobes (broken from penultimate tarsus) and cleft tarsal claws (*Bareogonalos canadensis*).

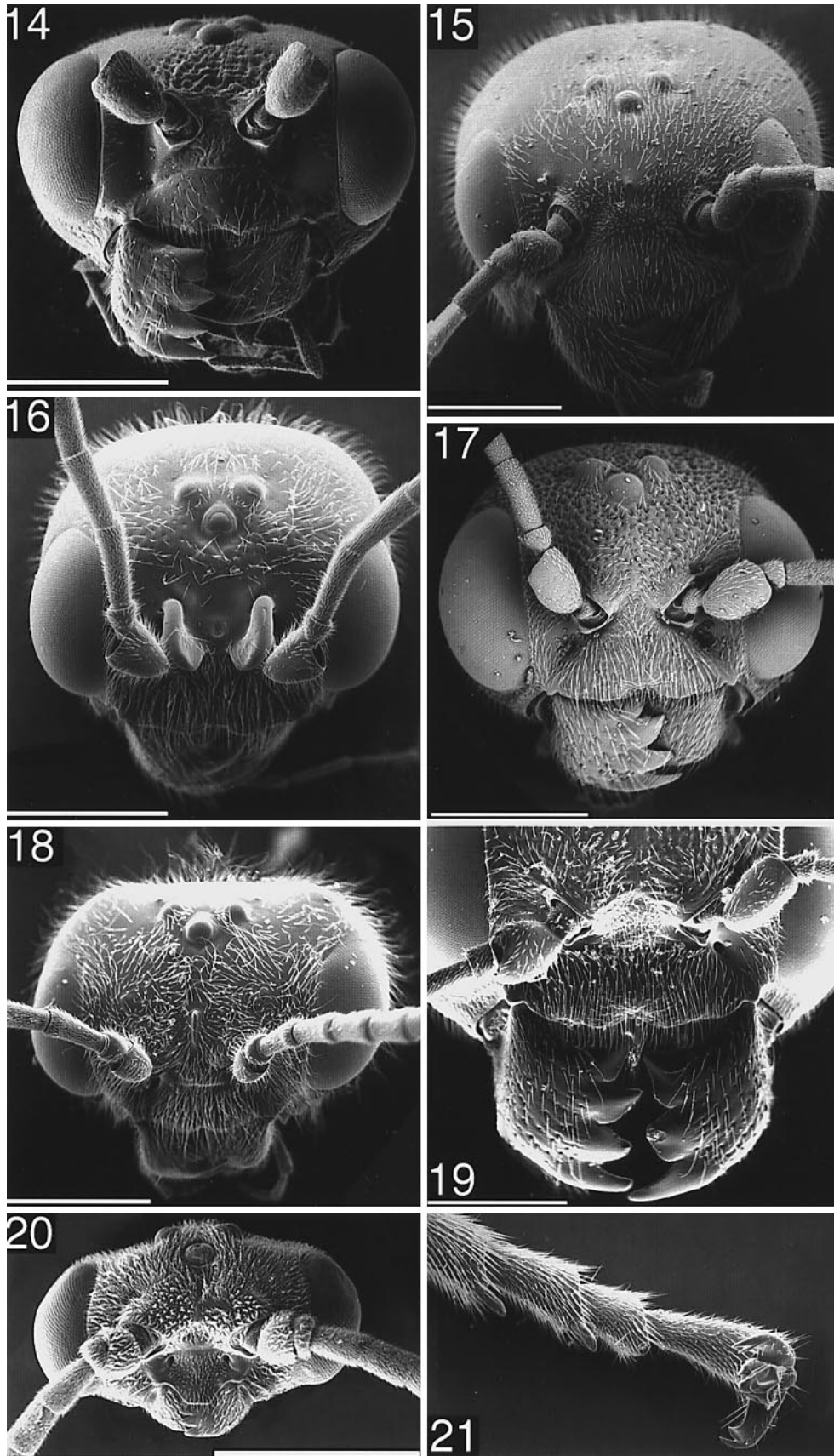

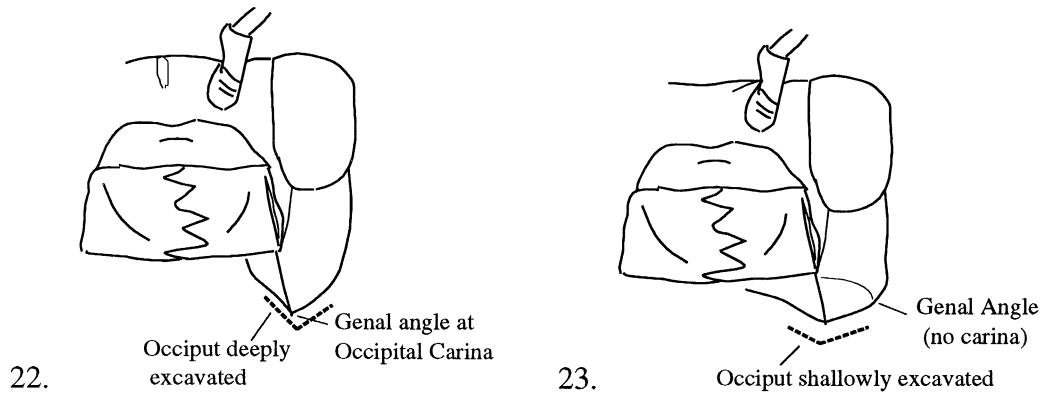

Figs 22–23. Ventral view of head. Genal carina and genal angle. 22, *Trigonalys*; 23, *Taeniogonalos*.

Table 1. Data matrix for the cladistic analyses. Characters that are polymorphic in a taxon where the groundplan is uncertain are recorded on two lines. Numbers and coding for characters correspond to those in the Character Analysis section of the text.

Taxon	Character		
	1 1234567890	2 1234567890	3 1234567890
Outgroup (Evaniomorpha)	00400100?0	000100?10?	?000000???
Ancestor (trigonalid groundplan)	00?00000?0	000000?000	?000000???
<i>Afrigonalys</i>	0042000??1	100?002022	20??1111??
<i>Bakeronymus</i>	11421110?1	3 0011111111	2000111212
<i>Bareogonalos</i>	104100?0??	2 0001002140	1001111133
<i>Lycogaster</i> (Asian)	00420010?1	1000002022	210211113?
<i>Lycogaster pullata</i>	00420010?0	3 1000002022	2102111133
<i>Mimelogonalos</i>	0010000121	1000002020	2102100?12
<i>Nomadina</i>	10420110??	0001101130	2000111213
<i>Orthogonaly</i>	00100000?0	0000001000	1000000?11
<i>Pseudogonalos</i>	0010000110	200000?012	1001000?21
<i>Pseudonomadina</i>	11421110??	0011111130	2000111212
<i>Seminota</i>	00420010?1	000000?021	2102111113
<i>Taeniogonalos enderleini</i>	0031000131	100000?022	2102100?22
<i>Taeniogonalos fasciata</i>	0031000131	100000?022	2122100?2?
<i>Taeniogonalos fasciatipennis</i>	0031000??1	100000?022	21??100???
<i>Taeniogonalos flavocincta</i>	00310001?1	100000?022	212210122?
<i>Taeniogonalos gundlachii</i>	0031000131	100000?022	2121101122
<i>Taeniogonalos maga</i>	0021000131	1000002022	2 2102100?22
<i>Taeniogonalos ornata</i>	3 0031000131	1000002022	2101100?22
<i>Teranishia</i>	0020000??0	3 0000002012	2 10??000???
<i>Trigonalys</i>	0011000111	310000?022	21021?1222
<i>Xanthogonalos</i>	00410000?1	1000001011	2101111133
Genus 1 (Japan)	0020000??0	3 0000001040	?0?1010???
Genus 2 (New Guinea)	0010000120	1000002010	1001000?12
	1	3	2

changed to unknown, resulting in a tree one step shorter. This file was exported to Hennig86, and then analysed using the implicit enumeration option, which will find all the most parsimonious trees, and successive approximations character weighting (Farris, 1969). The Hennig86 file was imported back in to PAUP and reanalysed, giving the same results as the original PAUP input file with polymorphic characters.

In the species lists, no attempt is made to duplicate the catalogues of Bischoff (1938) and Weinstein & Austin (1991). Synonymies and bibliographic details listed by them are not repeated except for clarification. Type repository information is based on Weinstein & Austin (1991) and our correspondence with the collections. Repository and label information is given in Carmean (1993) for specimens examined of less common species. In a few cases we transferred or synonymised species without seeing the types because the type species of the genus in which they were placed (*Poecilognalos*, *Nanognalos* and *Disceneia*) was also transferred, or because, based on the description, they were obviously misplaced.

Collection abbreviations

Specimens were obtained from the following collections and individuals, using standard abbreviations from Arnett *et al.* (1993) for institutions and the first four letters of the last name for personal collections:

AEIC	American Entomological Institute, Gainesville, D. Wahl	INBIO	Instituto Nacional de Biodiversidad, Costa Rica, D. Janzen
AMNH	American Museum of Natural History, New York, E.L. Quinter	INHS	Illinois Natural History Survey, Champaign, K.C. McGiffen
ANIC	Australian National Insect Collection, Canberra, I. Naumann	ISNB	Institut Royal des Sciences Naturelles de Belgique, Brussels, P. Dessart
ANSP	The Academy of Natural Sciences of Philadelphia, D. Azuma	ITLJ	National Institute of Agro-Environmental Sciences, Tsukuba, Japan, K. Konishi
BMNH	Natural History Museum, London, L. Ficken, T. Huddleston, I. Gauld and M.C. Day	IZAV	Universidad Central de Venezuela, Maracay, Venezuela, J.L. Garcia R.
BPBM	Bishop Museum, Honolulu, K. Arakaki	KIMS	L. Kimsey personal collection, Davis
CARM	D. Carmean personal collection	LACM	Natural History Museum of Los Angeles County, Los Angeles, R.R. Snelling
CASC	California Academy of Sciences, San Francisco, W.J. Pulawski	LEMQ	Lyman Entomological Museum, McGill University, Quebec, P.M. Sanborne
CDAE	California Department of Food and Agriculture, M. Wasbauer	LSUC	Louisiana State University, V. Mosely and C.B. Barr
CMNH	The Carnegie Museum of Natural History, J. Rawlins	MACN	Museo Argentino de Ciencias Naturales 'Bernardino Rivadavia', Buenos Aires, A. Bachmann
CNCI	Canadian National Collection, Ottawa, L. Masner and J. Huber	MAMU	Macleay Museum, Sydney, Australia, D.S. Horning, Jr.
CUIC	Cornell University, Ithaca, J.K. Liebherr	MCZC	Harvard Museum of Comparative Zoology, Cambridge, Massachusetts, D. Furth
DENH	University of New Hampshire, D.S. Chandler	MEMU	Mississippi Entomological Museum, Mississippi State University, T.L. Schiefer
EMUS	Utah State University, T. Griswold and F.D. Parker	MLPA	Universidad Nacional de La Plata, Ricardo A. Ronderos
FSAG	Collections Zoologiques, Gembloux, J. Leclercq	MNHN	Museum National d'Histoire Naturelle, Paris, J.C. Weulersse
FSCA	Florida State Collection of Arthropods, Gainesville, J. Wiley	MRAC	Musee Royal de l'Afrique Centrale, Tervuren, E. De Coninck
HNHM	Hungarian National Museum of History, Budapest, J. Papp	MRSN	Spinola Collection, Museo Regionale di Scienze Naturali, Torino
IMLA	Fundacion Miquel Lillo, San Miguel de Tucuman, A. Willink	MZSP	Museu de Zoologia da Universidade de São Paulo, C.R.F. Brandio
		NCSU	North Carolina State University, Raleigh, R.L. Blinn
		NHMW	Naturhistorisches Museum, Vienna, M. Fisher
		NHRS	Naturhistoriska Riksmuseet, Stockholm, B. Gustafsson
		OMNH	Osaka Museum of Natural History
		OSUO	Oregon State University, Corvallis, G. Ferguson and J.A. DiGiulio
		OXUM	Oxford Museum (Hope Entomological Collections), Oxford, C. O'Toole
		PAGL	G. Pagliano personal collection, Torino
		PORT	C.C. Porter personal collection, Gainesville
		PSUC	Frost Entomological Museum, Pennsylvania State University, D.W. Love
		RMNH	Rijksmuseum van Natuurlijke Historie, Leiden, C. van Achterberg
		ROME	Royal Ontario Museum, Toronto, C. Darling
		SCAR	L. Scaramozzino personal collection, Torino
		TAMU	Texas A & M University, E.G. Riley
		TARI	Taiwan Agricultural Research Institute, L.Y. Chou
		TMSA	Transvaal Museum, Pretoria, K.N. Dower
		UCDC	Bohart Museum of Entomology, University of California, Davis, S. Heydon
		UCRC	University of California, Riverside, S. Frommer
		UOPJ	University of Osaka, T. Hirowatari

UMMZ	University of Michigan, Ann Arbor, M. O'Brien and B.M. OConnor
USNM	United States National Museum, Washington D.C., D.R. Smith and G.F. Hevel
WSUC	Washington State University, Pullman, R.S. Zack
YAMA	Sk. Yamane personal collection, Kagoshima
ZMHB	Zoological Museum of Humboldt University, Berlin, F. Koch
ZMUC	Universitets Zoologiske Museum, Copenhagen, B. Petersen
ZSMC	Zoologische Staatssammlung, Munich, E. Diller.

Abbreviations for other institutions mentioned in the text are: EIHU Hokkaido University, Sapporo; MCSN Museo Civico di Storia Naturale, Genoa; MLUH Universität Halle, Halle.

Outgroup analysis

Trigonalidae have been placed in or near most other major lineages of apocritan hymenopterans at one time or another. Recently, Whitfield (1992), Rasnitsyn (1988) and Johnson (1988) placed the Trigonalidae in the Evaniomorpha, along with the Evanioidea, Ceraphronoidea and the Megalyridae. Rasnitsyn (1988) considered the Stephanidae also to be evaniomorphs but Whitfield (1992) placed the Stephanidae basal to all other Apocrita. Whitfield (1992) also considered a second possibility, with the Trigonalidae part of an unresolved trichotomy between Trigonalidae, Evaniomorpha and the 'Microhymenoptera'. Dowton & Austin (1994), using DNA sequence from the mitochondrial 16S rRNA gene, found the Trigonalidae close to the base of the Apocrita along with the Evanioidea, but otherwise unresolved. Basibuyuk & Quicke (1995) found the structure of the basitarsal comb in the Trigonalidae and Evaniidae, but not other proposed Evaniomorpha, to be almost identical. Like the other families in the Evaniomorpha, trigonalids have the derived character of an elongated mesal lobe on the surface of the mesocoxa (Johnson, 1988).

The Trigonalidae are so divergent morphologically from all the other Hymenoptera that outgroup analysis for most characters is speculative. Of the thirty characters used in this study, twenty-three can be found in the outgroups and contribute to outgroup analysis, including two of the twenty morphological characters that Shaw (1990) used in his analysis of the Megalyridae. The ancestral states of these later two characters are areolate-rugose propodeal sculpturing and elongate flagellomeres. Elongate body-form is the ancestral state for megalyrids (Shaw, 1990) and appears ancestral in trigonalids, but because of intermediate states was not used in our analysis. Comparing trigonalids with other Evaniomorpha, the Ceraphronoidea have metasomal tergum I longer than all the following terga, the antennae close to the mandibles, reduced wing venation, a long malar space and the genal carina meeting the hypostomal carina. The Evaniidae have a long malar space, with the genal carina just mesad of the relatively sharp genal angle, and ending at the mandibular base. Aulacidae have a long malar space, genal carina usually meeting the hypostomal

carina (in some taxa ending at the mandibular base instead), and a propodeal foramen that is evenly curved or 'U'-shaped dorsally. Stephanidae have a long malar space, genal carina ending near the hypostomal carina, and a 'U'-shaped propodeal foramen (which is otherwise very different from the form in Trigonalidae). No trigonalids have reduced wing venation or an elongate first metasomal segment. In addition, trigonalids have the antenna far removed from the mandible, except the derived *Pseudonomadina* and *Bakeronymus*. We conclude that the ancestral trigonalid, as in most evaniomorphs, had the genal carina ending near the hypostomal carina, a 'U'-shaped propodeal foramen, and a long malar space, although this feature is too ambiguous in most taxa to be included in the analysis. The ancestor probably lacked such advanced trigonalid characters as male tyloids, female armature, and sclerotization in the last female abdominal sternum.

We used two outgroups separately: one is based on the presumed primitive Evaniomorpha and is here called the *Evaniomorph* whereas the other is based on the hypothetical ancestral trigonalid groundplan and is called the *Ancestor*. The Evaniomorph is based on the families Stephanidae, Aulacidae, Evaniidae, Gasteruptiidae and Megalyridae. Characters for Megalyridae were taken from the literature (Shaw, 1990; Naumann, 1991). The Ancestor is similar but is influenced by *Orthogonalys* and has the family synapomorphies of asymmetrical mandibles and trochantellus divided; the character state for the SAE is unknown in the ancestor, whereas in the evaniomorph outgroup it is flattened. The number of antennal segments is greater than seventeen in the ancestral trigonalid and less than seventeen in the evaniomorph. The shape of the propodeal foramen is a low 'U' shape in the ancestor and unknown in the evaniomorph. The remaining characters have the same state in the ancestor and the evaniomorph. The ancestor and the outgroup were used separately in the parsimony analyses, and the exact same results were obtained from each, with *Orthogonalys* basal to the rest of the Trigonalidae (Fig. 24).

Character analysis

Characteristics used in this analysis are discussed below. Their inferred primitive and derived states are discussed below and in the previous section on outgroup analysis. When the evaniomorph or ancestral outgroup state could not be deduced, it has been coded as unknown (?) because it contributes no information about polarity of character state change. Characters were treated as unordered and reversible, and not weighted except in one analysis using *a posteriori* successive approximation character weighting (Farris, 1969). Inferences about polarity, based upon outgroup comparison, are given below; but ultimately polarity was determined after the cladistic analysis as a consequence of outgroup rooting of the trees. The data matrix is presented in Table 1.

1. *Head shape*: (0) rounded, normal (Figs 14–17; Tsuneki, 1991, Figs 49 and 156); (1) subrectangular and wide (in anterior view) (Figs 18 and 20; Yamane & Yamane, 1975,

- Fig. 5; Yamane & Kojima, 1982, Figs 1a and 2a; Tsuneki, 1991, Figs 2 and 9). Heads of evaniomorphs are generally rounded and tall. Bareogonalos, Nomadina, Pseudonomadina and Bakeronymus have the derived state.
2. *Vertex shape*: (0) normal, convex, or flat (Figs 14–18, 20); (1) concave. Only two Asian genera, *Bakeronymus* and *Pseudonomadina*, have their head deeply indented along the dorsal sagittal plane, and this is apparently the derived condition.
 3. *Supra-antennal elevation* (SAE): (1) prominent, meeting or nearly meeting at midline (Fig. 14); (2) prominent, not meeting at midline; (3) reduced to small triangular protuberance and extending toward midline (Fig. 17); (4) flattened, not extending toward midline, flat between toruli (Figs 15, 18). This character was used extensively by Schulz (1907a) and Tsuneki (1991). In all other evaniomorphs there is no SAE: the area above and mesad of the torulus is flat, or the torulus is on a shelf. The ancestral condition is unknown, and the evaniomorph outgroup is coded as SAE flattened with the area between the toruli flat. In *Orthogonalys* the SAE is generally prominent, projecting forward, and slightly separated at the midline. In *Taeniogonalos* the SAE is reduced so that the dorsal edge of the torulus forms a small triangular lip, and the intertorulus area is relatively flattened. In the Nomadinini the SAE is reduced and the intertorulus area is generally very flattened.
 4. *Intertorulus Distance*: (0) short, distance between toruli less than $0.9 \times$ the shortest distance between the inner eye margin and the torulus; (1) medium, the two distances about equal; (2) long, toruli set far apart, shortest distance between inner margins of the toruli greater than the shortest distance between the inner eye margin and the outer edge of the torulus. In most evaniomorphs, and *Orthogonalys*, the intertorulus distance is short; this is assumed to be the ancestral condition. The distance is long in the Stephanidae.
 5. *Toruli placement*: (0) distant from mandibular base; (1) next to mandibular base. The toruli are above the clypeus, far removed from the mandibular base in most evaniomorphs and in most Trigonaliidae. The derived condition is only found in *Bakeronymus* and *Pseudonomadina*.
 6. *Number of antennal segments*: (0) greater than 17 segments (including scape and pedicel in count); (1) 13–16 segments. There is a great amount of variability in antennal segment number but no overlap between these states. Most Trigonaliidae have greater than 17 segments and this is considered the ancestral condition. Only *Nomadina*, *Bakeronymus* and *Pseudonomadina* have 13–16 antennal segments and, as they are otherwise relatively derived genera, this is assumed to be the derived condition. However, the evaniomorph outgroup taxon is coded as having 13–16 segments as most evaniomorphs, except the Stephanidae, have their antennae with 13–14 segments or less.
 7. *Antennal shape*: (0) filiform; (1) thickened or spindleform. The evaniomorphs and most Trigonaliidae have filiform antennae of even thickness, though the Stephanidae have much thinner flagellomeres. The derived state occurs in *Seminota*, *Lycogaster*, *Nomadina* and related genera. A single undescribed male from Costa Rica with tyloids has spindleform antennae (AEIC), but in other respects it is close to *Taeniogonalos*, and its antennal shape is considered convergent.
 8. *Tyloids*: (0) absent; (1) present. Tyloids (Figs 10–12) are not present in the evaniomorphs or *Orthogonalys* and their presence is considered derived.
 9. *Tyloid shape*: (1) short, oval-round (Fig. 11); (2) elongate-broadly oval (Fig. 12); (3) elongate-narrow (Fig. 10). The shape of the tyloids has been generally ignored by previous authors but is valuable phylogenetically. The states are not ordered. To avoid giving additional weight to the absence of tyloids, this character is coded as unknown for taxa that lack tyloids, including the ancestor. We separated the character of tyloid presence from tyloid shape because we believe that change between different shapes is a different process than the gain or loss of tyloids. However, the topology of the strict and majority rule consensus trees was unchanged when these characters were combined (at the same time characters 27 and 28 were similarly combined) and when the ancestral state was 'tyloids absent', and the three tyloid shapes were treated as unordered and derived.
 10. *Genal carina*: (0) meets (or ends near) hypostomal carina (Fig. 9; Tsuneki, 1991, Fig. 64); (1) meets (or ends near) lateral edge of mandibular base (Figs 22, 23). The primitive state occurs in *Orthogonalys* and most evaniomorphs.
 11. *Occiput excavation*: (0) occiput not excavated (Fig. 9; Tsuneki, 1991, Fig. 64); (1) occiput slightly excavated (Fig. 23); (2) occiput deeply excavated but not near mandible; (3) occiput deeply excavated all the way to mandible (Fig. 22). In the ancestral condition, shared by *Orthogonalys* and the evaniomorphs, the genal carina is on a flat plane, and the occiput is not excavated. In *Pseudogonalos* the occiput is deeply excavated, but this ends in a flat plane before the mandible. The occiput of *Trigonalys* is deeply excavated all the way to the mandible. In *Taeniogonalos* the occiput is only slightly excavated.
 12. *Genal angle*: (0) located laterad of genal carina; (1) at genal carina. In most Trigonaliidae and evaniomorphs the genal angle is located laterad of the genal carina (Figs 9, 23). The genal angle and genal carina only overlap in *Trigonalys* (Fig. 22); this is the derived state.
 13. *Clypeal width*: (0) wider than base of antennae; (1) as wide as base of antennae. The derived state is only found in the most specialized of Trigonaliidae: *Nomadina*, *Bakeronymus* and *Pseudonomadina*. In the ancestral condition and the normal apocritan condition, the clypeus is wider than the distance between the base of the antennae.
 14. *Mandible symmetry*: (0) asymmetrical; (1) symmetrical. In

- most Trigonalidae there are three teeth on the left mandible and four on the right mandible (Fig. 19), rarely, there are four on the left and five on the right. The normal apocritan condition is symmetrical, and in several taxa within the Nomadinini the mandibular teeth are symmetrical. No other hymenopteran families are known to have asymmetrical mandibles as their groundplan. The groundplan synapomorphy for the family is believed to be asymmetrical and the evaniomorph outgroup condition is symmetrical.
15. *Maxillary palps*: (0) normal, 6-segmented, as long or longer than mandibles; (1) 4-segmented, shortened or rudimentary. In most taxa the palps are much longer than the mandibles and this is considered the ancestral condition for Trigonalidae. In *Bakeronymus*, *Nomadina* and *Pseudonomadina* the palps are usually 4-segmented, but in the latter two genera they are rudimentary and may be indistinctly segmented.
 16. *Notauli of mesoscutum*: (0) straight; (1) parallel at base and then diverging strongly. Only *Bakeronymus* and *Pseudonomadina* have curved notauli, making the median mesoscutal area nearly heart-shaped (Yamane & Kojima, 1982: Fig. 9). The evaniomorphs and most trigonalids have relatively straight notauli.
 17. *Submarginal cell II*: (1) petiolate; (2) not petiolate. This character has been over-emphasized in the past, and is somewhat variable within genera, but it is still phylogenetically informative. In most evaniomorphs venation is not comparable, except in the Aulacidae where the submarginal cell II is petiolate. Thus the ancestral and outgroup states are unknown. In *Trigonalys* and *Taeniogonalos* this character is variable, and was coded as unknown.
 18. *Hind trochantellus*: (0) divided; (1) undivided. Most Trigonalidae have the trochantellus diagonally divided into two apparent segments and this is believed to be the ancestral condition for the Trigonalidae. The evaniomorph outgroup was coded as undivided because they have the trochantellus undivided as do the derived genera *Bareogonalos*, *Nomadina*, *Bakeronymus* and *Pseudonomadina*.
 19. *Propodeal sculpturing*: (0) areolate-rugose; (1) rugose; (2) punctate; (3) smooth; (4) areolate. Shaw (1990), using Ceraphronoidea, Evanioidea and Trigonalidae as outgroups, found that the primitive state for megalyrids is areolate-rugose, as is found in *Orthogonalys*. Most trigonalids are punctate but some are rugose or very smooth. *Bareogonalos* is strongly areolate.
 20. *Propodeal foramen*: (0) low 'U' shape (wider than high); (1) high 'U' shape (at least as high as wide); (2) 'V' shape (acute angle at apex). In most evaniomorphs the foramen is 'U' shaped, but it is also closed ventrally, whereas in all the Trigonalidae it is open ventrally, so comparison with these taxa may not be useful. However, within the Trigonalidae the propodeal foramen of *Orthogonalys* is a low 'U' shape, and there appears to be a transition from a low 'U'-shaped to 'V'-shaped foramen. The evaniomorph outgroup was coded as unknown and the ancestral trigonalid outgroup was coded as a low 'U' shape.
 21. *Propodeal foramen carina*: (1) thick and double-walled; (2) narrow and single walled. Several taxa, including *Orthogonalys*, *Pseudogonalos*, *Bareogonalos*, and an undescribed genus from Papua New Guinea have a thick double-walled carina whereas most taxa have a thin carina. The carina in the evaniomorphs does not appear analogous and the ancestral state is considered unknown.
 22. *Tergal plate thickness*: (0) thin, with transparent to translucent edges folding over sterna; (1) not thin, and meeting sterna laterally with little overlap. Several evaniomorphs and *Orthogonalys* have very thin metasomal plates. Their terga overlap the sterna ventrally, and are distinctly transparent not just at the very margin but over a wide area. *Bareogonalos*, *Nomadina* and *Pseudonomadina* also have the ancestral condition of thin terga, apparently secondarily.
 23. *Metasomal sternum II* (male): (0) rounded medially; (1) flattened or concave medially. Most trigonalids and evaniomorphs have the metasoma rounded ventrally. This character has been used in the past to separate genera which are synonymised herein under *Taeniogonalos*, but are included separately in the cladistic analysis.
 24. *Metasomal segment lengths*: (0) segments II & III subequal in length; (1) segment II slightly longer; (2) segment II approximately long as all following combined. This character was determined using male specimens when possible but generally applies to both sexes. It is difficult to determine in some specimens of taxa (especially *Orthogonalys*) with thin terga that distort during drying. Many evaniomorphs have an elongated first segment, which is unknown among the Trigonalidae, but most have segments II and III the same length, so the evaniomorph outgroup and ancestor were coded as segments II and III subequal in length.
 25. *Female awl*: (0) no awl; (1) awl present. The awl (Yamane & Yamane, 1975: Fig. 16) is apparently unique to the Trigonalidae, and seems to have evolved after tyloids originated.
 26. *Female capsule*: (0) no capsule present; (1) capsule present. In the derived state, the terminal and penultimate sterna are flattened and often lyre-shaped, forming a capsule that positions the apical sternum to point anteriorly. No evaniomorphs have a capsule and the ancestral condition is assumed to be without a capsule. As this character may be linked to armature presence it was experimentally deleted without affecting the outcome of the analysis.
 27. *Female armature*: (0) absent; (1) female armature present in some members. Because of the complexity of this character it is most parsimonious to assume that armature only originated once, and that the groundplan for taxa with more than one state is presence of armature. Armature is variable, i.e. present or absent, in two genera, *Taeniogonalos* and *Trigonalys*. In the data matrix, *Taeniogonalos* is divided into several representative species, for each of which armature is not variable. Experimentally coding *Trigonalys* as 'armature absent'

did not affect the topology of the strict or majority rule consensus trees. Armature is absent in all evaniomorphs. Those trigonalid taxa assumed to have secondarily lost their armature have their metasoma more strongly sclerotised ventrally, and often have the second sternum ventrally swollen or expanded.

28. *Sternal armature location*: (1) present on sternum II; (2) present on sternum III. If the armature is present on sternum III there are usually traces of armature on sternum II, except in *Trigonalys*. To avoid giving the absence of armature additional weight, this character is coded as unknown for taxa that always lack armature, including the ancestor and outgroup taxon. In experiments where character 27 was combined with this character (similarly and simultaneously with characters 8 and 9 being combined) and the ancestral state was 'armature absent' and the unordered derived states were 'armature present on sternum II' and 'armature present on sternum III' the topology of the strict and majority rule consensus trees was unchanged.
29. *Paramere*: (1) rounded (about as long as wide); (2) elongate (longer than wide); (3) angulate. The parameres are either relatively short and wide, as is the case in *Orthogonalys* and several Nomadinini; narrow and elongate, as in *Pseudogonalos*, *Trigonalys*, and *Taeniogonalos*; or sharply angled near the base, as in many Nomadinini. Male genitalia are figured by Tsuneki (1991). The parameres are fused to the basiparamere in Aulacidae, Evaniidae, Gasteruptiidae, and Stephanidae, and although in these taxa the parameres appear about as long as wide, they are not considered comparable. Thus the ancestral and outgroup states are unknown.
30. *Aedeagus*: (1) cylindrical, not bilaterally flattened, apex capitate; (2) elongate-thin; (3) strongly bilaterally flattened with the tip expanded, 'T' or plough-shaped. In *Orthogonalys*, the aedeagus is rod-shaped and not bilaterally flattened, and the tip is capitate or slightly expanded into a bulb. In *Trigonalys* and *Taeniogonalos*, the aedeagus is elongate-thin, and slightly bilaterally flattened with the tip variously shaped but not capitate. In most Nomadinini it is strongly bilaterally flattened and the tip shaped like a plough or length-wise 'T' shape. In the evaniomorphs, the aedeagus of Gasteruptiidae, Aulacidae, and Evaniidae is cylindrical but not capitate; in Stephanidae it is apically slightly flattened but the shaft is cylindrical. The aedeagus of the ancestor may be assumed to be a simple cylindrical shaft, closest to the condition in *Orthogonalys*, but without further evidence we are considering the ancestral and outgroup states unknown.

Phylogenetic analysis

The amount of homoplasy in the Trigonaliidae is a challenge to any method of analysis. Some characters that initially appear monomorphic within a taxon, such as the length of the malar space or the presence of a petiolate second submarginal cell,

become increasingly variable as more specimens and taxa are studied.

There are at least two phylogenetically significant, structurally complex features that have arisen within the Trigonaliidae, tyloids and metasomal armature. As some species have armature but do not have tyloids and some species have tyloids but do not have armature, and other species have both, it is necessary to resolve which taxa have secondarily lost or convergently gained these characters. Despite the variety of forms of armature and tyloids, we believe that they are too complex to have arisen more than once. Most taxa that fall within the Trigonaliini have either armature, traces of armature, or a swollen sternum II, which may be a remnant of armature. Based on this evidence we assume that when both states are present within a taxon, the groundplan for that taxon is presence of armature. In the data matrix this assumption only applies to *Trigonalys*, and experimentally changing the coding for *Trigonalys* does not change the results. It is also more parsimonious to assume that the female capsule arose only once and in tandem with the armature. The capsule serves as a guide to point the ovipositor anteriorly, and the armature serves as a brace for oviposition into a leaf (Carmean, 1988, 1991). Experimentally deleting this character also did not change the results.

The results of the phylogenetic analyses are shown in Figs 24–30. Exactly the same thirty-two trees resulted from using the trigonalid groundplan (trigonalid ancestor), the evaniomorph outgroup, or only the trigonalid taxa. Using the hypothetical ancestor in the analysis resulted in a tree seventy-two steps long, C. I. 0.597; excluding the single uninformative character, C. I. 0.592. Using the hypothetical outgroup taxon resulted in four additional steps (seventy-six steps), reflecting four synapomorphies for the family (characters 3, 6, 14 and 18), with a consistency index of 0.566 (excluding uninformative characters, 0.560). The large number of trees is partially a result of including several species of *Taeniogonalos* that were previously separated into different genera and are not strongly differentiated. Including only *T. gundlachii* from *Taeniogonalos* resulted in only seventeen trees, seventy-one steps (using ancestral taxon for rooting).

Table 2 compares the classification from Weinstein & Austin (1991), which is primarily based on Schulz (1907a), Bischoff (1938) and Benoit (1951), with the classification proposed in this study, which is based on the results of a cladistic analysis (Figs 24–28). Several taxa within the Trigonaliinae remain with their status uncertain. They do not share the defining characters of the two tribes, nor do they have any characters unambiguously uniting them or clarifying their relationships with other Trigonaliinae. Use of scanning-electron micrographs of the tyloids or DNA sequence data may help establish clades including these taxa.

In the consensus trees (Figs 24, 25), the Trigonaliini are paraphyletic with the Nomadinini. This may be in part because several species of *Taeniogonalos* secondarily lack armature. Further study is required to ascertain if *Taeniogonalos* and *Trigonalys* together form a monophyletic group, and what their relationships are to other taxa. With a reduced number of taxa,

the bootstrap consensus tree (Fig. 26) generally agrees with the proposed phylogeny, and the Trigonalini are not paraphyletic.

Successive approximations character weighting (Farris, 1969) provides an objective method of *a posteriori* character weighting when confronted with several equally parsimonious cladograms. Applied to the characters in this study, the successive approximations character weighting reduces the number of equally most parsimonious cladograms from thirty-two to twelve and increases the consistency index from 0.59 to 0.71 (Fig. 25). Table 3 shows the final weights assigned each character by this procedure. One major difference between the unweighted and weighted consensus trees is at the base: *Teranishia* joins with *Pseudogonalos* in the unweighted tree (Fig. 24) but with an undescribed genus from Japan in the weighted tree (Fig. 25).

One alternative to *Orthogonalys* being the most primitive of the trigonalids is that *Bareogonalos*, *Nomadina*, *Pseudonomadina* and *Bakeronymus* are the most primitive Trigonalidae. *Bareogonalos*, *Nomadina*, *Pseudonomadina* and *Bakeronymus* share three generalized apocritan traits, flat SAE, symmetrical mandibles, and undivided hind trochantellus, which are absent from most trigonalids. These four genera are, however, highly derived in other respects, and their 'primitive' character states may have arisen secondarily. If a genus in the *Bareogonalos-Nomadina* group is assigned to a basal position in the Trigonalidae (Figs 29, 30), then unique trigonalid characters including the awl, sclerotization of the capsule, and female armature would have to be interpreted as primitive familial characters lost in various lineages. Rerooting the most parsimonious tree so that *Bareogonalos* is basal gives the unlikely result of the evaniomorph outgroup nesting well within the ingroup (Fig. 29). Alternatively, experimentally constraining the Nomadinini to be basal (= the sister group) to all other Trigonalidae required three more steps than the most parsimonious tree (Fig. 30).

The tribe Nomadinini now includes several taxa previously treated as separate subfamilies. Although the Nomadininae under Schulz's (1907a) and Weinstein & Austin's (1991) classification is a monophyletic group, the other taxa in their classification are either polyphyletic (Lycogastrinae), too narrowly defined (Bareogonaloinae), or at best, paraphyletic (Seminotinae). Removing the unrelated taxa previously placed in the Lycogastrinae and treating these taxa together as a single tribe eliminates these problems.

Keys to Trigonalidae by region

Key to the species of Canada and the United States

1. Dorsellum pyramidal, distinctly raised, usually bifid and yellow; hind trochanters 2-segmented; parasitoids of yellowjackets *Bareogonalos canadensis* (Figs 1–5)
- Dorsellum flat; hind trochanters 3-segmented; from solitary hosts 2
- 2(1). Dorsellum and propodeum all black (or very dark brown), without light markings; antenna spindle-form *Lycogaster pullata*

- Dorsellum and usually propodeum with light markings; antenna filiform 3
- 3(2). Antennae black with white (or light yellow) band in middle; metasoma thin, often entire metasoma orange; the only North American species without female armature; male without tyloids *Orthogonalys pulchella* (Figs 6–9)
- Antennae without light-coloured band; metasoma stout, dark, with transverse yellow stripes; female with armature; the only North American species in which the male has tyloids (Fig. 10) *Taeniogonalos gundlachii* (Fig. 17)

Key to New World genera

1. Tyloids not present, or female; antennae filiform or thickened 2
- Tyloids present; antennae filiform¹ (males only) 8
- 2(1). Maxillary and labial palpi rudimentary; antenna 16-segmented *Nomadina*
- Maxillary palpus extending beyond mandibles, labial palpus normal; antenna with 17–28 segments 3
- 3(2). Antenna with 17–20 (rarely 21) segments; metasoma smooth, shiny and thorax strongly areolate; hind trochanter two-segmented *Bareogonalos*
- Antenna with 21–28 segments; if metasoma smooth and shiny then thorax not strongly punctate; hind trochanter apparently 3-segmented (second segment diagonally divided) 4
- 4(3). Metasomal terga and sterna very smooth and thin (may be partially transparent), terga folded under, intercalating with sterna; propodeum areolate-rugose, covered with network of lines; carina around propodeal foramen thick, partially double-walled, 'U' or half circle shaped; ichneumonid-like, antenna banded, when viewed dorsally head and thorax black with markings white (females and faded males) or yellowish white (males), metasoma orange, may have extensive light or dark markings *Orthogonalys*
- Metasomal terga and sterna often punctate, thick, terga overlap sterna laterally in a straight line, without overlapping sterna ventrally; propodeum punctate, or smooth, sometimes with concentric lines around foramen, but not covered with network of lines; carina around propodeal foramen thin (though sometimes tall) and 'V' or 'U' shaped; colouration various, not as above 5
- 5(4). Eye with sparse pubescence visible at 30×; eye in lateral view often with posterior margin behind mandibular insertion (Fig. 34); propleuron and mesopleuron yellow and entire forewing pale amber, in some species vertex behind ocelli flat, posteriorly abruptly angled towards genal carina; propodeal foramen evenly curved dorsally; very rare in collections *Xanthogonalos*

¹One male from Costa Rica has antennae like *Lycogaster* but with tyloids, the rest of its characters as in Trigonalini.

- Eye not pubescent; eye with posterior margin even with middle of mandibular insertion (Fig. 33), less commonly at posterior edge of mandibular base; propleuron dark, mesopleuron dark or dark with yellow markings (except *Taeniogonalos ornata* and some *Trigonalys*, which also have only the leading half of the forewing pale amber) 6
- 6(5). Antenna spindle-shaped; no yellow or light markings on propodeum; supra-antennal elevation reduced, never lobed; frons between antennae broad and flat, wider than the length of the first flagellomere; tyloids absent 7
- Antenna filiform; often with yellow on propodeum; supra-antennal elevation variable; frons between antennae usually narrower and not flat; tyloids present in males 8
- 7(6). Wings amber or hyaline, not very dark; head punctate, vertex curving evenly towards occipital carina; parasitoids of solitary wasps and of parasitoids of Lepidoptera *Lycogaster*
- Wings, or part of wings, very dark or violaceous; head smooth, vertex sharply angled above occipital carina; parasitoids of social wasps *Seminota*
- 8(1,6). Genal carina not forming a sharp ridge between gena and occiput, occiput not sharply excavated (Fig. 23); frons flat or slightly angled between antennae in side view; punctate above clypeus; gena usually narrow (Fig. 33), often punctate, immediately above mandible and behind lower third of eye; female armature, if present, on sternum II; male tyloids elongate, usually more than half flagellomere length *Taeniogonalos*
- Genal carina forming a sharp ridge between gena and occiput when viewed from below, occiput usually sharply excavated all the way to mandible (Fig. 22); frons strongly angled between antennae in side view; glossy above clypeus between antennae; gena wide and shining immediately above mandible and behind lower third of eye; female armature, if present, on sternum III; male tyloids oval or round, less than half the flagellomere length 9
9. Genal carina pointing towards hypostomal carina and then bending parallel to hypostomal carina to reach mandibular base; occiput not sharply excavated near mandible; Mexico; known only from females Undescribed Genus
- Genal carina extending straight to mandibular base; occiput sharply excavated along genal carina all the way to mandible; central and South America *Trigonalys*
- predominately orange; metasoma without armature; metasomal plates thin and may dry distorted *Orthogonaly*
- Antennae not banded; other characters various, but not fitting above description; wings often with dark markings; females often with armature; males often with tyloids 2
- 2(1). Area immediately above clypeal suture smooth and shiny, not punctate; frons usually with strong ledge between antennae; gena wide (Fig. 35), genal carina at top of genal angle (Fig. 22); thorax and abdomen predominately black, tergum II often with ivory diagonal markings or all black; female armature various, usually present; wings darkened or smoky ... *Trigonalys*
- Area immediately above clypeal suture as punctate as frons immediately above antennae; frons relatively flat; metasoma dark with transverse light markings or entirely orange; female armature on sternum II; other characters variable 3
- 3(2). Shortest distance between toruli (antennal sockets) about the same as the shortest distance between the inner eye margin and the torulus; marginal cell and area distal of marginal cell much darker than discal cell; female with bluntly bifid armature on sternum II, armature on sternum III forms a flat ledge under sternum II and does not project; male with flattened sterna and with 5 or more narrow elongate tyloids on outside of antennae *Taeniogonalos*
- Shortest distance between toruli is almost twice the shortest distance between the inner eye margin and the torulus; wing hyaline or evenly coloured, marginal cell not darker than rest of wing; metasoma orange except darker near petiole; female armature with 2 parallel sharp ‘fins’ on sternum II, armature on sternum III forms a flat projecting ledge under sternum II; male unknown, possibly without tyloids *Afrigonaly*

Key to Eurasian and Indo-Australian genera²

1. Vertex cleft at midline; antennae with 13–15 segments 2
- Vertex normal; antennae with 17–32 segments 3
- 2(1). Maxillary palps rudimentary *Pseudonomadina*
- Maxillary palps about as long as mandibles and distinctly segmented *Bakeronymus*
- 3(1). Males (with parameres which appear as paired paddle-shaped appendages sometimes projecting ventrally from abdomen and not to be confused with cerci(?), which are dorsal, short and rounded; tyloids may be present on antennal segments 10 through 13–18; never with medial projection at or near apex of sternum II or III, though sternum II sometimes with a projection

²Europe has only one species, *Pseudogonalos hahnii*. The key excludes Tsuneki's genus *Jezonogonalos* and the males of *Teranishia*.

Key to African genera

1. Antenna banded; propodeum, at least above propodeal foramen, rugose reticulate (wrinkled network); genal carina fading before hypostomal carina, not ending at mandibular base; males without tyloids; wings hyaline, submarginal cell II petiolate to subpetiolate; mesosoma

- on the anterior half before a flattened area in *Taeniogonalos*, or with 2 small preapical lateral spines in *Lycogaster*) 4
- Females (often with armature, never with tyloids on several flagellomeres, but flagellomeres always with, though not always visible, a circular area of white spots in same location as tyloids are on male) 11
- 4(3). Tyloids absent 5
- Tyloids present 7
- 5(4). Terga opaque where they overlap sterna laterally, not folding over sterna ventrally; sternum II with 2 small preapical spines, just lateral of midline; vertex rounded *Lycogaster*
- Terga with wide translucent to transparent lateral margins that reach ventrally and overlap sterna; sternum II without ventral spines; vertex flat and rectangular 6
- 6(5). Stout bodied, vespine-like; thorax strongly areolate; antennae not banded, sometimes thickened, with 18–23 segments *Bareogonalos*
- Body slender and elongate, ichneumonid-like; thorax sparsely punctate; antennae filiform, often banded, with 22–32 segments; metasoma thin, and generally tubular *Orthogonalys*
- 7(4). Tyloids linear *Taeniogonalos*
- Tyloids not linear but broadened or rounded 8
- 8(7). Tyloids almost round, globular shape 9
- Tyloids oval-elongate; grey colour, with dull lustre 10
- 9(8). Genal carina ending at lateral edge of mandibular base; frons forms a horizontal ‘shelf’ between antennae, the line from the median ocellus to the clypeus strongly angled in side view; no large vertical lobes over scape *Trigonalys*
- Genal carina ending at hypostomal carina; frons medially flat, with large vertical lobes covering the scape *Pseudogonalos*
- 10(8). Tyloids with broad flat top surface, with dull velvet-like lustre .. Genus 2 (two undescribed species from New Guinea)
- Tyloids keel shaped, top surface not flat, with dull lead-like lustre; Australia *Mimelogonalos*
- 11(3). Distinct armature present on second or third metasomal sternum 12
- Armature not present 16
- 12(11). Armature only on sternum III 13
- Armature on sternum II, if also on sternum III, smaller and covered by armature on sternum II 14
- 13(12). Gena smooth, shining; frons strongly angled in side view *Trigonalys*
- Gena punctate; frons relatively flat *Taeniogonalos flavocincta*
- 14(12). Top of head rectangular, flattened; sternum III with small posteriomedial projection often under sternum II; propodeum strongly areolate, metasoma generally smooth and usually shining *Bareogonalos*
- Top of head rounded, not flattened; sternum III may form a ledge but does not project posteriorly; propodeum not strongly areolate, metasoma various, often punctate and dull 15
- 15(14). Armature consisting of flat vertical ledge at apex of sternum II with 2 small indistinct lateral spines slightly more raised than the centre ledge; the anterior part of sternum III forms a wide but not very tall ledge under sternum II; antennae spindleform *Lycogaster*
- Armature various but not as above; antennae filiform *Taeniogonalos* (in part)
- 16(11). Supra-antennal elevation reduced, intertorulus area is relatively flattened, without projecting lobes; toruli (bases of antennae) as far apart as length of first flagellomere; propodeal foramen usually ‘V’ shaped, taller than wide, with a weak, thin carina around it; sternum II swollen ventrally and may have slight medial elevation in front of posterior edge; terminal sternum pointing anteriorly toward sternum II or straight down, tip sclerotised, forming short hypodermic needle-like structure *Taeniogonalos* (in part)
- Supra-antennal elevation prominent, often forming distinct lobe; intertorulus distance variable, often close together; propodeal foramen usually ‘U’ shaped, generally wider than tall and usually bordered with a thick carina; sternum II not swollen ventrally and without medial elevation; terminal sternum in undistorted specimens pointing down or posteriorly, usually not more sclerotised at tip than rest of sternum 17
- 17(16). Genal carina ending at lateral edge of mandibular base; terminal sternum modified into cylindrical tube generally pointing straight down ventrally; mesosoma and metasoma compact, not elongate; Australia *Mimelogonalos*
- Genal carina ending at hypostomal carina; terminal sternum not cylindrical, generally pointing straight back posteriorly; body elongate; not known from Australia 18
- 18(17). Propodeal carina ‘U’ shaped, foramen ‘V’ 19
- Propodeal carina and foramen both ‘U’ shaped ... 20
- 19(18). Frons with large shiny vertical lobes mesad of the scape that are generally all black *Pseudogonalos*
- Frons with punctate lobes, not shiny, and generally with light markings *Teranishia*
- 20(18). Dorsellum pyramidal; petiole strongly constricted and distinctly different from second metasomal segment; tergum II much longer than tergum III; wings hyaline, infusate, or fasciate Genus 2 (New Guinea)
- Dorsellum flat; petiole not constricted, sternum I similar to sternum II; tergum II slightly longer than tergum III in undistorted specimens; wings hyaline *Orthogonalys*

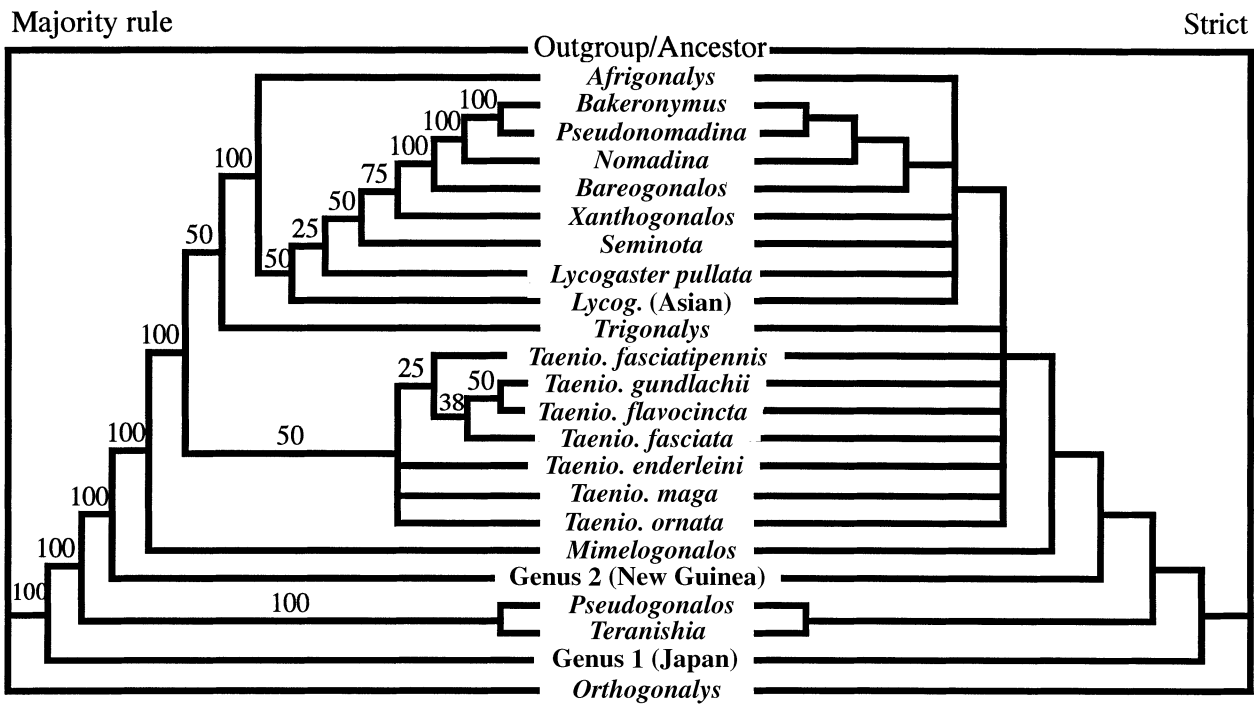

Fig. 24. Majority rule and strict consensus of thirty-two most parsimonious trees.

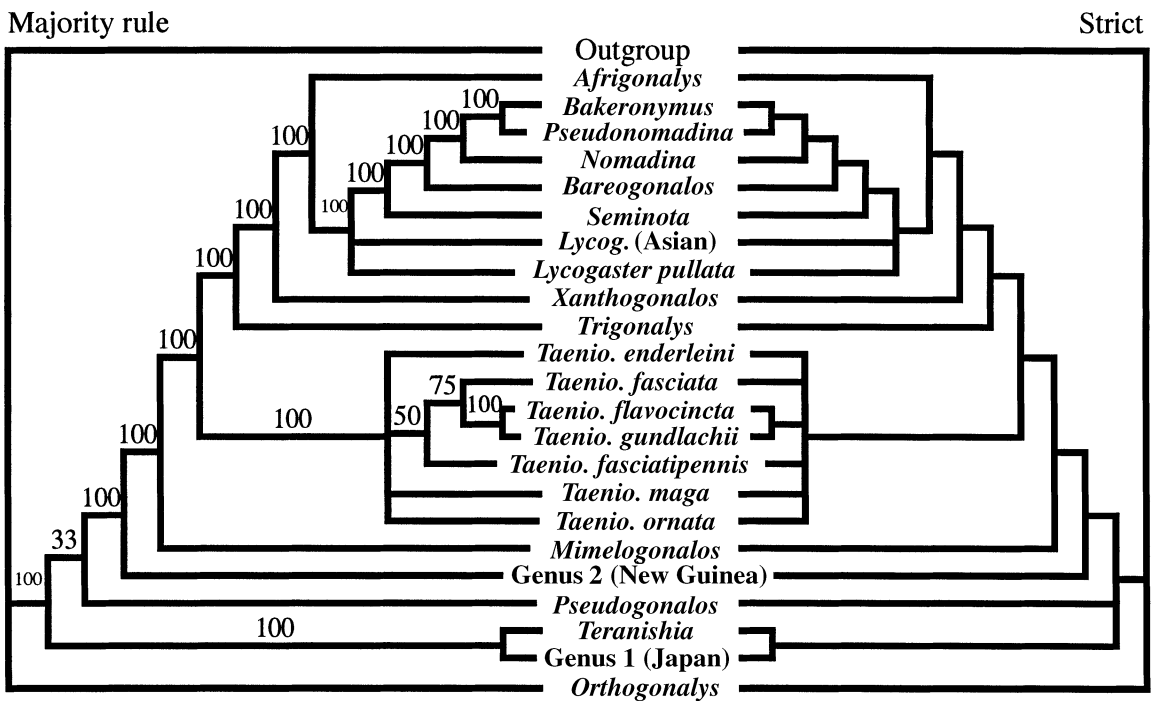

Fig. 25. Majority rule and strict consensus of twelve most parsimonious trees generated from successive approximations character weighting (Farris, 1969), starting with thirty-two trees.

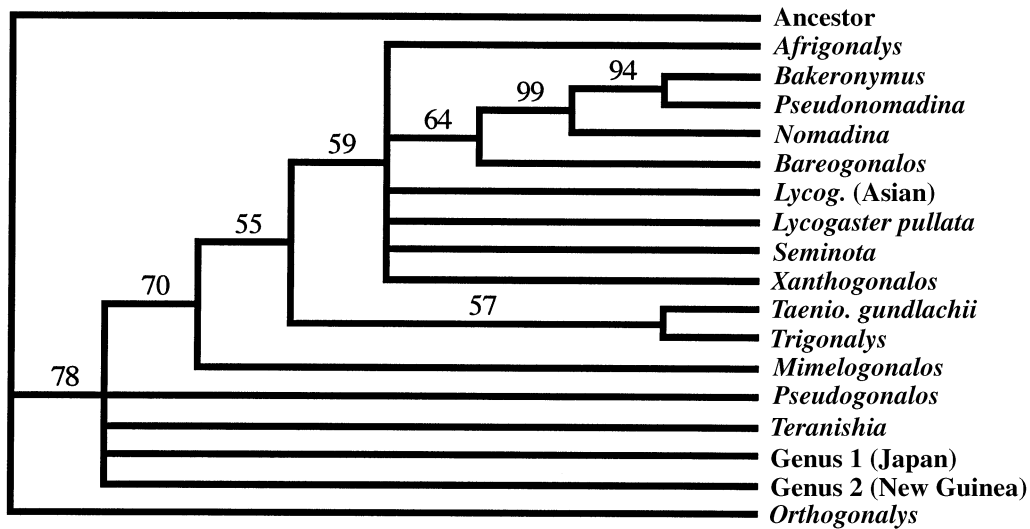

Fig. 26. Bootstrap consensus tree (all genera), 100 heuristic replicates, number of taxa reduced by excluding all but one of the *Taenio* species. 78 steps, C. I. 0.551, excluding uninformative characters, 0.539.

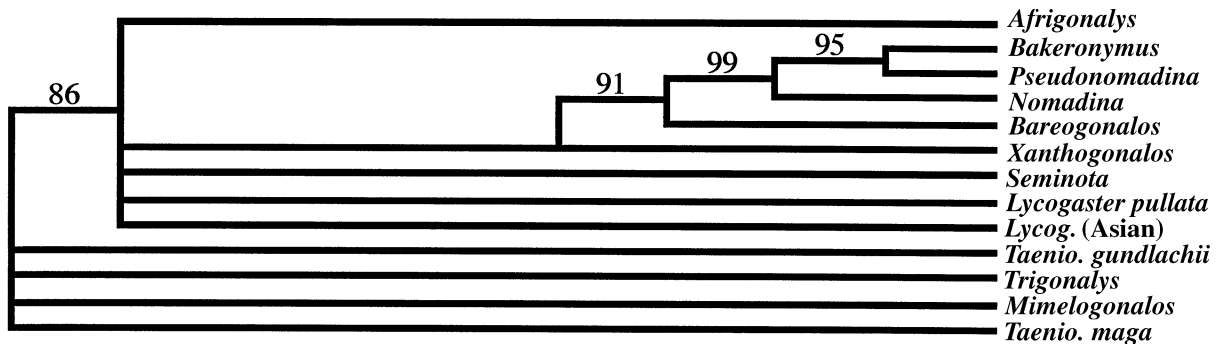

Fig. 27. Bootstrap consensus tree, 100 branch & bound replicates; Nomadinini, rooted with several trigonalids. Length 51 steps; consistency index 0.725, excluding uninformative characters, 0.689.

Trigonalidae Cresson, 1887

Trigonalidae Cresson, 1887: 183.
 Trigonalidae Krieger, 1894: 23.

Förster (1877) placed *Trigonalys* alone in the taxon ‘Diplomorpha’ which was treated equivalently to other Hymenoptera now recognized as families. Cresson (1887) was the first to use *Trigonalys* to form a family rank name (Trigonalidae) but this was apparently overlooked by others. Bischoff (1938) attributed the family to Krieger (1894). Many spelling variants have been proposed (listed in Bischoff, 1938 and Weinstein & Austin, 1991) due to the ambiguity of the root of *Trigonalys*. Based on Westwood’s definition of the genus *Nomadina*: ‘genus novum . . . Trigonalys proximum’ (Westwood, 1868) the stem of *Trigonalys* is Trigonalys-, which would make Trigonalysidae the correct spelling (H. D. Cameron, personal communication). As the root is ambiguous, we have used the first and most commonly used spelling, Trigonalidae.

Orthogonalinae sub.n.

Type genus: *Orthogonalys* Schulz, 1905.

***Orthogonalys* Schulz**

Orthogonalys Schulz, 1905: 76. Type species *O. boliviana* Schulz (1905) (by monotypy), repository: ZSMC.
Orthogonalos Schulz, 1907a (unjustified emendation).

Tapinogonalos Schulz, 1907a: 14. Type species *Trigonalys pulchella* Cresson (1867) designated by Viereck (1914), lost (Cresson, 1916). **Syn.n.**

Satogonalos Teranishi, 1931: 10. Type species *S. debilis* Teranishi by original designation, OMNH (Tsuneki, 1992).
 Synonymy by Tsuneki, 1991.

Diagnosis. Body slender, elongate; length 3.5–14.1 mm; FW 3.5–13.5 mm, most species \mp 9 mm long, FW 8 mm. Genal carina mesad of sharp genal angle, reaching or fading away before hypostomal carina; gena smooth, narrow behind eyes and generally strongly angled in ventral view; malar space generally long; antennae long, filiform, with 21–32 (most species 26–28) segments, often banded, tyloids absent; toruli close together, shortest distance between toruli less than $0.9 \times$ the shortest distance between the inner eye margin and the torulus; wings hyaline, submarginal cell 2 often petiolate; propodeal foramen low, 'U' shaped, with wide carina; metasomal terga II & III roughly same length (distortion of thin plates occurs); tergum II generally with posterior medial indentation; terga mostly thin and transparent, wrapping ventrally over sterna. Aedeagus with capitate tip; parameres various, generally not much longer than wide; sterna flat, female without armature or ventral swelling and not strongly sclerotised.

Discussion. *Orthogonalys* contrasts with most other trigonalids in several ways. Members of this genus are slender and delicate, with hyaline wings, and often banded antennae (Fig. 6). New World and African species have either their metasoma or mesosoma, or both, mostly orange, and the remainder of the body black and white. Asian species are mostly black with some white or brown markings. The outgroup analysis shows *Orthogonalys* is defined by primitive rather than derived characters.

Orthogonalys has a greater number of the ancestral apocritan characters than other trigonalid genera. Like the presumed primitive evaniomorph, *Orthogonalys* has areolate-rugose propodeal sculpturing, an elongate body form, thin metasomal terga that fold ventrally and overlap the sterna, a long malar space, and a genal carina ending near the hypostomal carina (rather than at the mandibular base). *Orthogonalys* cannot be assigned any unique, derived characters partly because the available outgroups are too distant to provide information about ancestral character states. Male *Orthogonalys* lack tyloids. The metasoma of female *Orthogonalys* is unsclerotised, lacks armature or traces of armature, and lacks modifications for piercing and oviposition in leaves.

Schulz (1905) described *Orthogonalys* as having only five maxillary palps, when in fact they have six. Schulz (1907a) also characterized the genus as having the metasomal terga 'klaffend' or wide apart at the lateral posterior edges. However, this is a sexually dimorphic character in *Orthogonalys*. Females have a broad, generally flattened metasoma (Fig. 8), which is not much longer than wide, and is wider than the thorax. Schulz, deceived by the dimorphism, placed males in a different subfamily, because of their elongate, almost tubular, metasoma, which is narrower than the thorax (Fig. 7). The lightly sclerotised metasomal plates are easily distorted, which adds to the confusion.

The genus *Orthogonalys* includes some of the longest as well as shortest bodied Trigonaliidae. *Orthogonalys centrimaculta* is known from a single specimen collected from northern Vietnam and is among the longest trigonalids: the body is 14.1 mm long and the forewing is 13.5 mm long. Size varies greatly within

a species. One female *O. formosana* is 9 mm long (TARI) whereas another female of the same species is only 3.5 mm long (AEIC).

Because of the intraspecific variation in size and wing venation as well as the sexual dimorphism and possible abdominal distortion due to the thin metasomal plates, some of the species described from individuals or short series are probably synonymous. *Orthogonalys gigantea* appears to be a large *O. hova*. Tsuneki (1991) discussed the similarities of *O. fukuensis* with *O. elongata* as well as the confusion caused by variation within *O. elongata*.

Tsuneki (1991) suggested that *O. formosana*, which he knew only from the holotype description, may represent an undescribed genus, whereas our study shows that the species shares all the features of *Orthogonalys*. *Orthogonalys formosana* is the only *Orthogonalys* from Asia with the following characters: hind femur and base of hind tibia amber, remainder of hind tibia dark brown; opaque white parameres (parameres of all other Trigonaliidae we have seen are dark to amber); and the midline of thorax and propodeum with white spots of varying size and intensity. *Orthogonalys formosana* is known only from Taiwan. *Orthogonalys debilis* (limited to Japan) has light markings on the scutellum and dorsellum but the hind femur is dark and there are no light markings on the midline of the propodeum. A species of *Lycogaster* from Java has the mesonotum similarly marked but it would not be confused with *Orthogonalys*. Whereas the holotype has the mandibles each with four well-developed mandibular teeth, this is not normal for the species. Symmetrical mandibles have been seen in individual *O. boliviana* and other species with typically asymmetrical mandibles.

Some trigonalids in other genera may appear similar to species of *Orthogonalys*. *Taeniogonalos maga* (Teranishi) resembles dark *Orthogonalys* but lacks the thin metasomal terga, and has tyloids. The propodeal foramen of *Taeniogonalos* is 'V' shaped, whereas in *Orthogonalys* it is squat and generally 'U' shaped. *Afrigonalys* species may also resemble *Orthogonalys* but has female armature and does not have banded antennae. The toruli are far apart and the SAE are less prominent in *Taeniogonalos* and *Afrigonalys* than in *Orthogonalys*. The SAE are generally lobed and projecting in *Orthogonalys* but in the North American species *O. pulchella* the SAE may be reduced.

We are synonymising *Tapinogonalos* under *Orthogonalys* because Viereck (1914) designated *Trigonalys pulchella* as the type species of *Tapinogonalos* and Bischoff (1938) transferred *Trigonalys pulchella* to *Orthogonalys*. Bischoff (1938), unaware of Viereck's designations, designated the unrelated *Tapinogonalos maschuna* Schulz as the type species of the genus. *Tapinogonalos* is thus a junior synonym of *Orthogonalys*.

Distribution. There are two disjunct but closely related New World species, *O. pulchella* in North America (eastern United States, Mexico and Canada) and *O. boliviana* in South America (Bolivia, Brazil, Argentina and Peru). In the Old World the genus is well-represented in Japan. Several *Orthogonalys* species known from one to a few specimens come from eastern

Africa and Madagascar, north-eastern India, northern Vietnam and Taiwan.

Biology. Smith (1996) discusses the seasonal flight activity of *O. pulchella*. In North America, the records of *O. pulchella* parasitising *Nilea* (= *Zenillia*) *lobeliae* (Tachinidae) in *Acronicta lobeliae* (Noctuidae) (Bischoff, 1909; Townes, 1956; Weinstein & Austin, 1991) are incorrect and result from taxonomic confusion. Schulz (1907a) synonymised *O. pulchella* with *Trigonalys costalis* Cresson (= *Taeniogonolos gundlachii*), and then reported Riley & Howard's (1891) rearing of *T. gundlachii* as a host record from *O. pulchella*. Bischoff (1938) correctly attributed this rearing record to *T. costalis* (= *gundlachii*) when he removed *O. pulchella* from synonymy with *T. costalis*. However, according to Carlson (1979), *O. pulchella* has been reared from Tachinidae parasitising Lepidoptera. *Orthogonalys seyrigi* was reared from a limacodid moth, which was presumably its intermediate host (Benoit, 1951).

Species included

Orthogonalys albomaculata Bischoff, 1951. Examined ♂ from INDIA (BMNH*).

Orthogonalys boliviana Schulz, 1905. Examined from South America (44 AEIC, 3 CNCI, 5 BMNH, ZSMC*).

Orthogonalys centrimaculta Bischoff, 1951. Examined ♂ from VIETNAM (BMNH*).

Orthogonalys elongata Teranishi, 1929.

= *Orthogonalys hirsana* Teranishi, 1929 (syn. by Marsakov, 1981).

= *Orthogonalys debilis* Teranishi, 1929 (syn. by Tsuneki 1991).

Examined from JAPAN (39 AEIC, 5 CNCI).

Orthogonalys formosana Teranishi, 1931. Examined 10♂, 3♀ from TAIWAN (AEIC, TARI, UOPJ*).

Orthogonalys fukuensis Tsuneki, 1991.

Orthogonalys gigantea Benoit, 1951.

Orthogonalys hagoromonis Teranishi, 1929. Examined 127 specimens from JAPAN (AEIC, CNCI).

Orthogonalys hova Bischoff, 1933. Examined 1♂, 3♀, 1? from MADAGASCAR, TANZANIA (AEIC, MRAC, NHMW, ZMUC).

Orthogonalys pulchella (Cresson, 1867). Numerous specimens from eastern North America (USNM, CNCI, AEIC, ZSMC, TAMU, CASC, FSCA, others).

Orthogonalys seyrigi Bischoff, 1933. Examined ♀ from TANZANIA (tentative identification, species described from Madagascar) (AEIC).

Trigonalinae Cresson, 1887

The subfamily Trigonalinae, unlike the Orthogonalinae, comprises all taxa possessing tyloids. The tribe Nomadinini, within the Trigonalinae, is assumed to have lost tyloids secondarily. Previously this subfamily was characterized by the absence of female armature (Schulz, 1907a) and included all such taxa (+ *Discenea*!). According to the current analysis, female metasomal armature is not part of the groundplan for the family and has been lost repeatedly within the tribe Trigonalini. Thus, the presence or absence of metasomal armature is not by itself a distinguishing character for any monophyletic group. Schulz (1905) and Bischoff (1938) attributed the Trigonalinae to Cameron (1899) who stated that he was establishing a new tribe and then gave the diagnostic features of 'Trigonalidae' (?misspelling for Trigonalini) and 'Nomadinae' (?misspelling for Nomadininae or Nomadinini). Apparently because of the confusion surrounding the spelling and ranking of Cameron's groups, Weinstein & Austin (1991) attributed the name to Schulz (1907a). However, as all family group names are equivalent in status, the first used family group name takes precedence for all family group names (*International Code of Zoological Nomenclature*, 1985, Article 36a). Thus Cresson (1887), even though he never used the name Trigonalinae at the subfamily level, is the correct author of this subfamily.

Several genera in the Trigonalinae, including *Pseudogonolos* and *Mimelogonolos*, have not been included in any tribe. This approach was taken because they do not possess the apomorphies defining the two tribes and, further, they have no characters uniting them beyond those of the subfamily. Some specimens, possibly representing undescribed genera, require additional specimens for satisfactory description and placement. A single undescribed female from Japan (Genus 1 in data matrix, Table 1, CNCI) has an unsclerotised structure that appears similar to a capsule. This specimen is close to *Orthogonalys* in most other respects (thin overlapping metasomal plates, genal carina ending before hypostomal carina, and hind trochantellus divided), except for a strongly areolate propodeum similar to that of *Bareogonolos*. A partial fusion of metasomal terga I & II is unique to this specimen. The male, and whether it has tyloids, is unknown. Because the 'capsule' is not sclerotised and the specimen does not have other derived features in common with the taxa that have capsules, we do not consider it homologous with a capsule. However, in the data matrix it has been conservatively coded as being a capsule. Two unidentified species from New Guinea (Genus 2, BPBM, AEIC, BMNH) with some primitive characteristics of *Orthogonalys*, such as the terga thin and folding ventrally, have broad elongate tyloids similar to, but not the same as *Mimelogonolos*. These taxa, as well as *Teranishia* are all placed in the Trigonalinae. More work on the Asian fauna

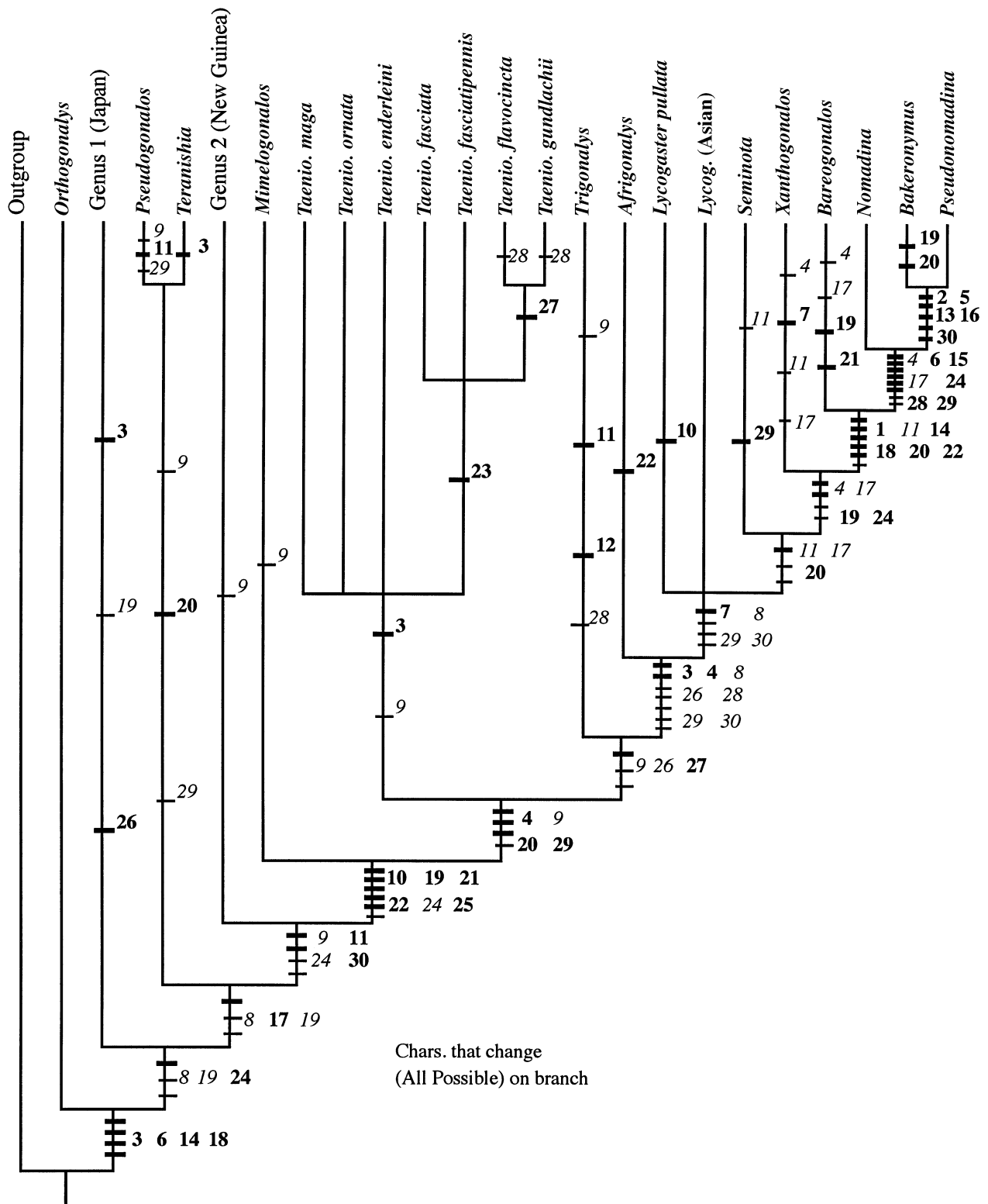

Fig. 28. Characters mapped on one of the thirty-two most parsimonious trees. Tree length: 76 steps (using Evaniomorph outgroup; if rooted with Ancestor the tree would be 72 steps). Bold numbers indicate unambiguous mapping of characters whereas italicised numbers indicate ambiguous mapping of characters, usually due to one sex being unknown. The italicised numbers appear on two or more branches for every single origination of the character state.

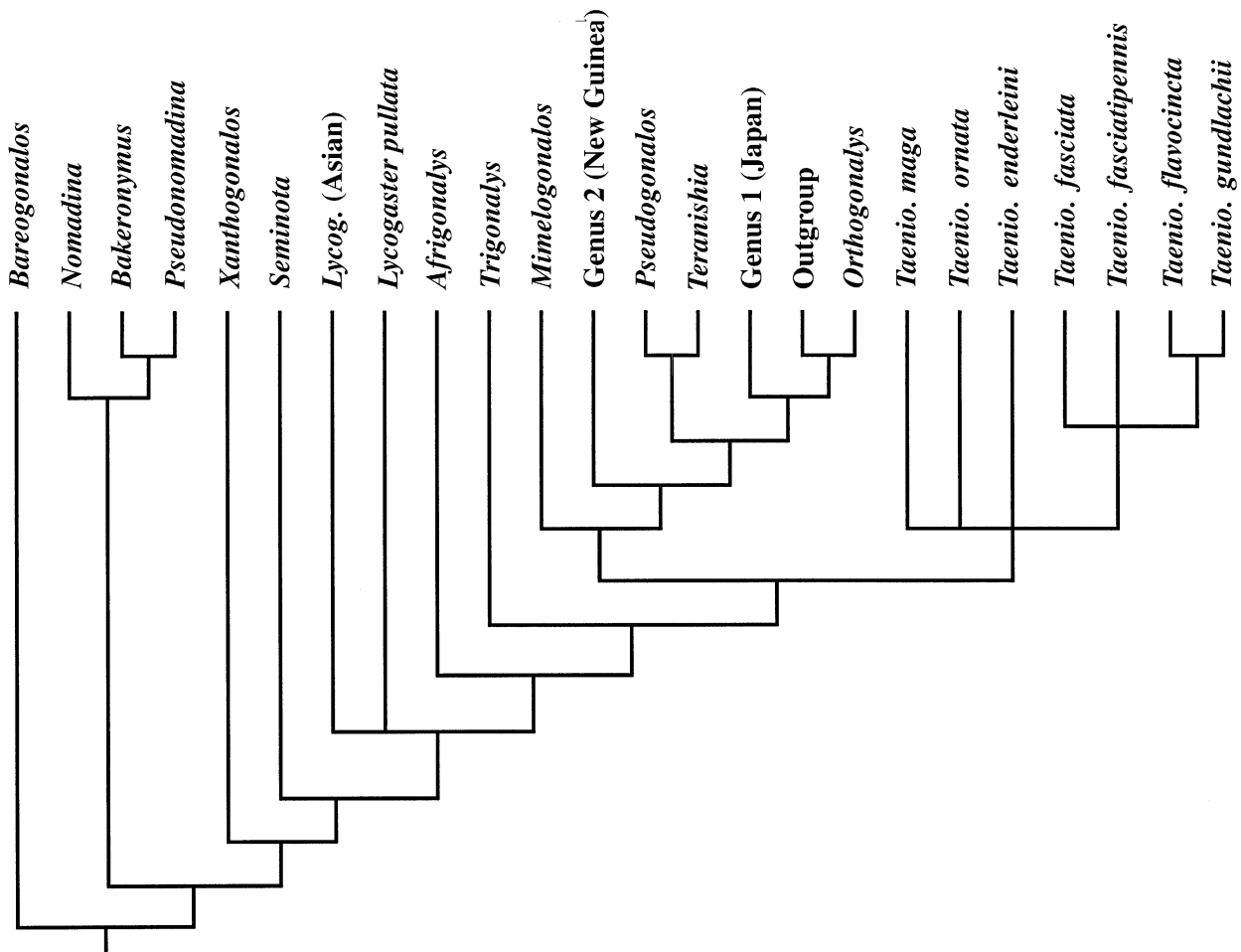

Fig. 29. Same tree as in Fig. 12, rooted at *Bareogonalos*. The outgroup is nested well within the ingroup, suggesting the improbability of this rooting.

is required to develop a more satisfactory understanding of the basal relationships within the Trigonalidae.

Nomadinini Cameron, 1899

Type genus: *Nomadina* Westwood, 1868

Diagnosis. Body shape variable but never appearing slender and delicate. Antennal segments generally thickened; tyloids never present; shortest distance between toruli 1.7–2 × shortest distance between inner eye margin and torulus; SAE reduced and intertorulus area generally very flattened; genal carina reaching or ending immediately before mandibular base; metasomal plates often strongly sclerotised; female metasomal armature always present on sternum II and usually with a reduced armature on sternum III, sometimes under projection of sternum II; parameres variable but generally elongate.

Discussion. The genera in this tribe are characterized by the females with the primary armature ordinarily on sternum II and secondary armature on sternum III, and the males with a

secondary loss of tyloids. All parasitise social wasps, except *Lycogaster* which parasitises both ichneumonids attacking Lepidoptera and solitary wasps (Eumeninae). Hosts are unknown for *Afrigonalys* and *Xanthogonalos*.

Bakeronymus, *Nomadina* and *Pseudonomadina* form a distinctive monophyletic group (the old subfamily Nomadininae) (Fig. 27) having only rudimentary armature on sternum II, and their primary armature on sternum III. They also have short rounded parameres. These genera group with *Bareogonalos* based on their undivided hind trochantellus and symmetrical mandibles, although not all *Bareogonalos* have symmetrical mandibles. *Bakeronymus* and *Pseudonomadina* are sister groups sharing many complex derived features as well as having an overlapping distribution. These genera both have the vertex concave and the antenna low on the face, adjacent to the mandible. *Nomadina* and *Pseudonomadina* have rudimentary maxillary palps, but this appears to be convergent based on cladistic analysis. Another interesting, apparently convergent character is the contraction of the head posteriorly into a neck (Fig. 37) in both the *Bakeronymus typicus* Rohwer female from Taiwan and in *Nomadina cisandina* Schulz. It is not found in the *B. typicus* male from the Philippines or in any other *Nomadina* (Fig. 38).

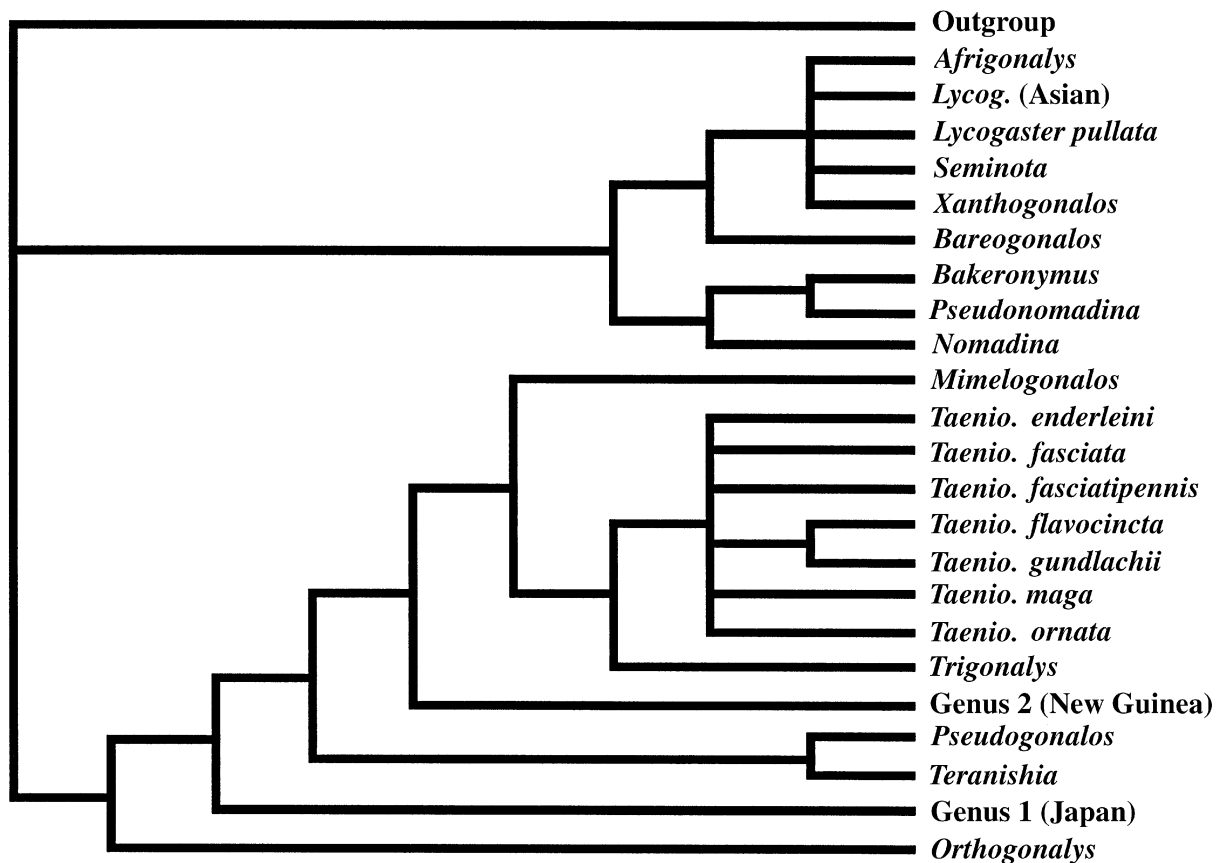

Fig. 30. Strict consensus tree from twenty-four most parsimonious trees, constrained to Outgroup + Nomadinini + (all other taxa). Tree length: 79 steps, three steps longer than without this constraint. The same topology resulted in the majority rule consensus tree from the constraint (outgroup, Nomadinini) + (all other taxa).

Afrigonalys gen.n.

Type species: *Tapinogonalos erythromelaina* Benoit, 1951; holotype repository, MRAC.

Diagnosis (female only). Length: 6–9.2 mm, FW 6.7–7.4 mm. Genal carina ending at mandibular base; malar space short; gena behind base of eye swollen and extending in a transverse plane out from genal carina; gena and vertex shiny, punctures and pubescence sparse; antennae filiform; toruli set far apart, shortest distance between inner margins of toruli almost $2 \times$ shortest distance between inner eye margin and outer edge of torulus; maxillary palps longer than mandibles; propodeal foramen 'V' shaped bordered by a narrow carina; tergum II about as long as remaining terga; armature with 2 parallel, sharp 'fins' on sternum II, armature on sternum III forming a flat ledge under sternum II; genitalia in flattened capsule, pointing towards armature. Male unknown.

Discussion. The vertex of *Afrigonalys* is tall and rounded, and its surface, as well as that of the genae, is shiny and smooth. Species of *Afrigonalys* are black and orange with white markings. The metasoma in *A. ornatissima* and *A.*

erythromelaina is orange except near the petiole. *Afrigonalys ornatissima* is white on the scutellum and the middle of the dorsellum, with extensive white markings on the head, resembling *Orthogonalys seyrigi* and suggesting they mimic a third wasp. The head and mesosoma of *A. erythromelaina* is all black except for the mandibles and a small intraorbital white mark. In both species the orange metasoma with thin terga, elongate shape, and shiny head create a superficial resemblance to *Orthogonalys*. However, *Orthogonalys* has a narrower space between the toruli than *Afrigonalys*, and *Orthogonalys* females lack armature that is present in *Afrigonalys*. *Afrigonalys* also resembles *Trigonalys rufiventris* but it does not have the typical *Trigonalys* ledge between the antennae. *Afrigonalys semirubra* has an orange-brown head and thorax and black metasoma with ivory markings. *Taeniolonalos* species have a punctate, dull vertex.

Based on the phylogenetic analysis, *Afrigonalys* is basal to the rest of the Nomadinini. Characters uniting *Afrigonalys* with the Nomadinini include the flat area between the reduced SAE, intertorulus distance greater than eye to torulus distance, and the presence of female armature and capsule. Male *Afrigonalys* are unknown, and *Afrigonalys* males may, like the rest of the Nomadinini, lack tyloids. The position of *Afrigonalys* in the

Table 2. Comparison of previous and current classifications of the family Trigonalidae.

Classification from Weinstein & Austin (1991)	Current classification
Bareogonaloinae	Trigonalidae Cresson, 1887
1. <i>Bareogonalos</i> Schulz, 1907	Status uncertain, within Trigonalidae
= <i>Nippogonalos</i> Uchida, 1929	1. <i>Teranishia</i> Tsuneki, 1991
Disceneinae	Orthogonalinae subf.n.
2. <i>Discenea</i> Enderlein, 1905	2. <i>Orthogonalys</i> Schulz, 1905
= <i>Stygnogonalooides</i> Strand, 1912	= <i>Satogonalos</i> Teranishi, 1931
= <i>Lycogastrula</i> Strand, 1912	Trigonalinae Cresson, 1887
3. <i>Lycogastroides</i> Strand, 1912	Status uncertain, within Trigonalinae
Lycogastrinae	3. <i>Jezonogonalos</i> Tsuneki, 1991
4. <i>Ischnogonalos</i> Schulz, 1907	4. <i>Mimelogonalos</i> Schulz, 1907
5. <i>Labidogonalos</i> Schulz, 1906	5. <i>Pseudogonalos</i> Schulz, 1906
6. <i>Lycogaster</i> Shuckard, 1841	Nomadinini Cameron, 1899
7. <i>Lycogonalos</i> Bischoff, 1913a	6. <i>Afrigonalyis</i> gen.n. (tentative placement)
8. <i>Stygnogonalos</i> Schulz, 1907	7. <i>Bakeronymus</i> Rohwer, 1922
9. <i>Taeniogonalos</i> Schulz, 1906	8. <i>Bareogonalos</i> Schulz, 1907
10. <i>Tapinogonalos</i> Schulz, 1907	9. <i>Lycogaster</i> Shuckard, 1841
Nomadininae	10. <i>Nomadina</i> Westwood, 1868
11. <i>Bakeronymus</i> Rohwer, 1922	11. <i>Pseudonomadina</i> Yamane & Kojima, 1982
12. <i>Nomadina</i> Westwood, 1868	12. <i>Seminota</i> Spinola, 1840
= <i>Liaba</i> Cameron, 1899	13. <i>Xanthogonalos</i> Schulz, 1907
= <i>Platygonalyis</i> Schulz, 1905	Trigonalini Cresson, 1887, stat.n.
13. <i>Pseudonomadina</i> Yamane & Kojima, 1982	14. <i>Ischnogonalos</i> Schulz, 1907 (tentative placement)
Seminotinae	15. <i>Taeniogonalos</i> Schulz, 1906
14. <i>Seminota</i> Spinola, 1840	= <i>Labidogonalos</i> Schulz, 1906
= <i>Bertonia</i> Schrottky, 1906	= <i>Poecilogonalos</i> Schulz, 1906
15. <i>Xanthogonalos</i> Schulz, 1907	= <i>Nanogonalos</i> Schulz, 1906
Trigonalinae	= <i>Lycogastroides</i> Strand, 1912
16. <i>Mimelogonalos</i> Schulz, 1907	= <i>Lycogonalos</i> Bischoff, 1913
17. <i>Nanogonalos</i> Schulz, 1906	= <i>Taiwanogonalos</i> Tsuneki, 1991
18. <i>Orthogonalys</i> Schulz, 1905	16. <i>Trigonalys</i> Westwood, 1835
19. <i>Poecilogonalos</i> Schulz, 1906	= <i>Stygnogonalos</i> Schulz, 1907
20. <i>Satogonalos</i> Teranishi, 1931	= <i>Discenea</i> Enderlein, 1905
21. <i>Pseudogonalos</i> Schulz, 1906	
= <i>Trigonalis</i> Spinola, 1840, incorrect subsequent spelling	
22. <i>Trigonalys</i> Westwood, 1835	
Genera of Tsuneki (1991) (placed in Trigonalinae)	
23. <i>Taiwanogonalos</i> Tsuneki, 1991	
24. <i>Jezonogonalos</i> Tsuneki, 1991	
25. <i>Teranishia</i> Tsuneki, 1991	

Table 3. Final weights assigned each character by successive approximations weighting procedure. Characters are defined in the Character analysis section.

Character	1	2	3	4	5	6	7	8	9	10	11	12	13	14	15
Weight	10	10	6	6	18	3	10	4	3	4	6	10	10	3	10
Character	16	17	18	19	20	21	22	23	24	25	26	27	28	29	30
Weight	10	1	3	4	1	3	2	10	2	10	4	4	1	2	5

phylogenetic analysis remains unchanged even if the missing antennal character is experimentally coded as 'linear tyloids present'.

Etymology. The name of this genus is derived from the Latin for dwellers in Africa combined with the common ending for trigonalids as originally spelled by Westwood.

Distribution. This genus is only known from South Africa, Zaire and Zimbabwe.

Biology. Unknown.

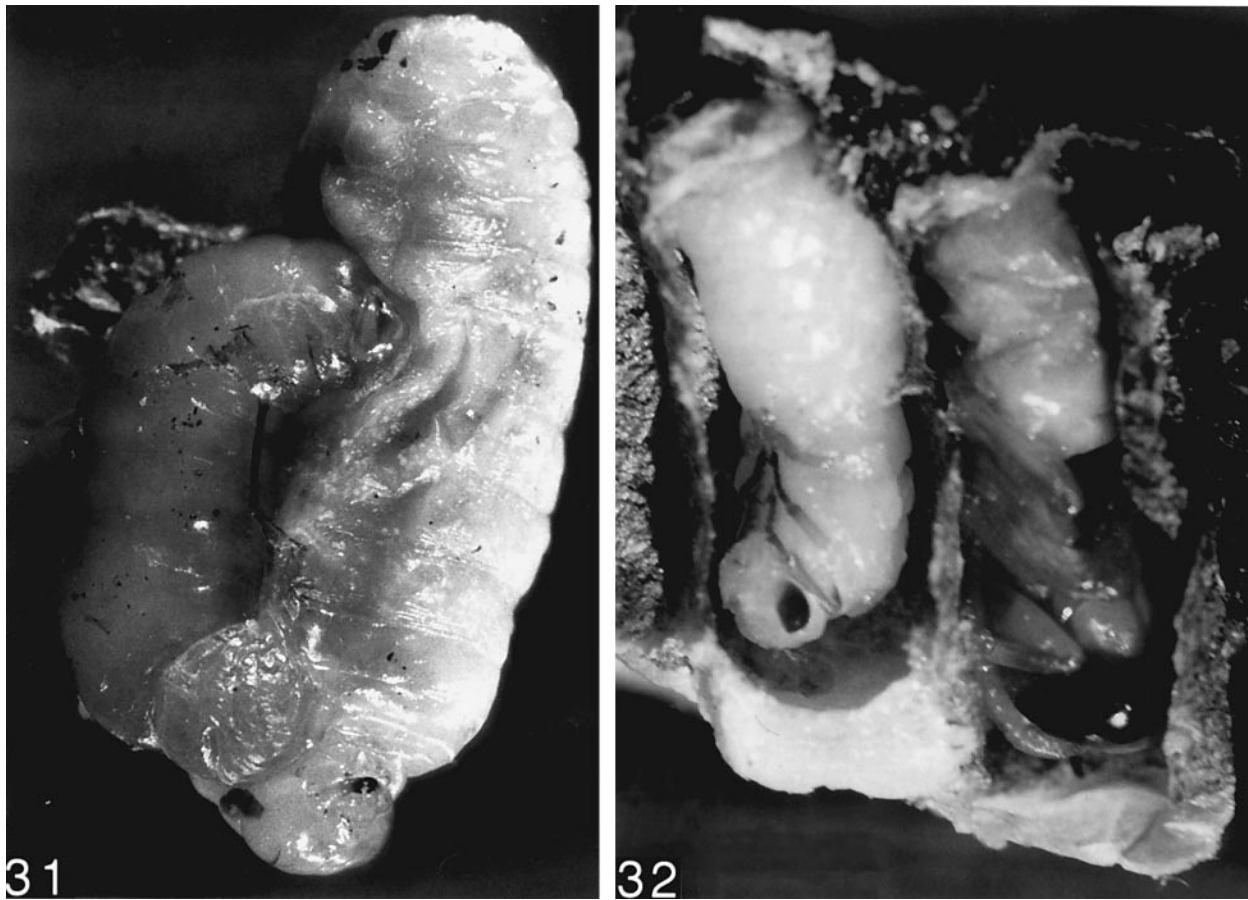

Figs 31–32. *Bareogonalos canadensis* and host *Vespula vulgaris* (Vespidae). 31, Parasitoid larva (left) feeding externally; 32, pupa (left) is quite large compared to its host.

Species included

Afrigonalyis erythromelaina (Benoit, 1951). Transferred from *Tapinogonalos*. **Comb.n.** Examined ♀ from ZAIRE (MRAC*).

Afrigonalyis ornatissima (Benoit, 1950). Transferred from *Tapinogonalos*. **Comb.n.** Examined ♀ from ZAIRE (MRAC*).

Afrigonalyis semirubra (Bischoff, 1913b). Transferred from *Tapinogonalos*. **Comb.n.** Examined ♀ from SOUTH AFRICA (ZMHB).

Bakeronymus Rohwer

Bakeronymus Rohwer, 1922: 417. Type species *B. typicus* Rohwer, 1922 (by monotypy). Repository: USNM.

Diagnosis. Body elongate, dark reddish brown with extensive yellow markings, length 7.7–9.5 mm, FW 6.1–8 mm. Head wide, rectangular both in anterior and dorsal view, width $2.8 \times$ length, measured from hind edge vertex to front of median ocellus, strongly cleft at vertex; entire head smooth and shining; antenna adjacent to mandible, clypeus between

antennal insertions; maxillary palps very short, approximately length of mandible, 4-segmented (first segment short); malar space short, at least in male; genal carina indistinct, ending at mandibular base; mandibles symmetrical, basal tooth wide, almost as wide as 3 remaining teeth; antenna 14–15 segmented, first 2 flagellomeres elongate and thin, remaining flagellomeres thicker and cylindrical, not beadlike; antennal insertions wide apart, intertorulus distance about $2.5 \times$ the shortest distance between inner eye margin and torulus; wing with marginal cell darkened; 2 closed submarginal cells (the one female examined has part of 3rs-m cross vein); propodeal spiracle not covered; metasoma spatulate, petiole laterally slightly flattened. Parameres in side view short, $0.2 \times$ length of basiparamere, and as wide as basiparamere; aedeagus not clearly visible, but appears elongate as in *Pseudonomadina*; female sternum I indented apicomediaally, sternum II similarly indented but sclerotised and appearing like small bifid tooth or rudimentary armature; sternum III with prominent bifid armature projecting over smaller armature on sternum IV, and out over terminal sternum; genitalia enclosed in capsule and tip of metasoma modified into a sharp hollow awl.

Discussion. The distinctive head immediately distinguishes this genus from all other Trigonaliidae except the closely related

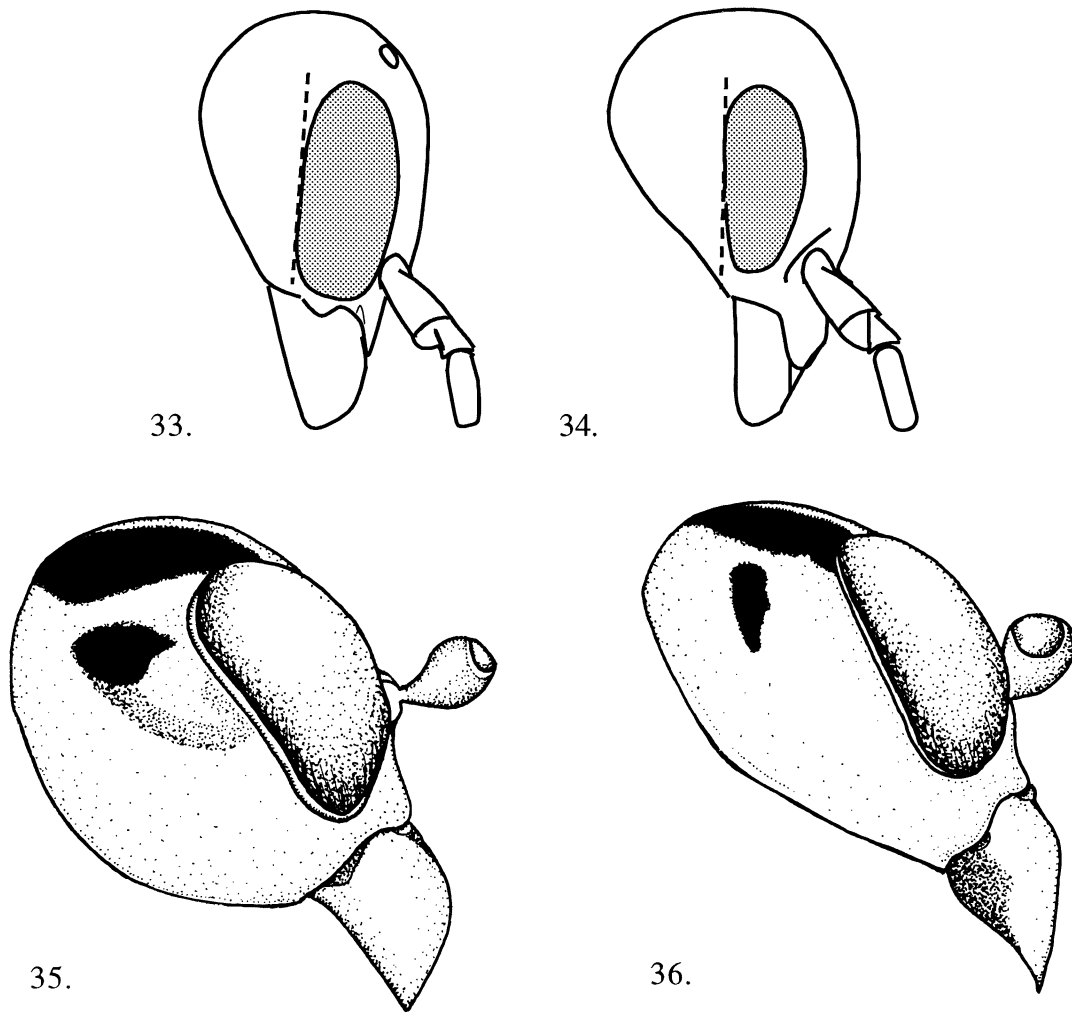

Figs 33–34. Right lateral view. 33, Most Trigonidae (eye with posterior margin near middle of mandibular base); 34, *Xanthogonalos* (eye with posterior margin behind or at mandibular base).

Figs 35–36. Heads, lateral view. 35, *Trigonalyys maculifrons*; 36, *Taeniogonalos ornata*.

Pseudonomadina. The head is shiny, transverse, with the midline at least slightly concave from the back of the vertex to the clypeus. The antennal insertions are adjacent to the mandibular base, and the clypeus is situated between the antennae. The easily visible maxillary palps that are about as long as the mandibles will distinguish this genus from *Pseudonomadina*, which has vestigial palps. An anterior view of the head is given in Yamane & Kojima (1982). In dorsal view the female from Taiwan has a distinct neck, as in Fig. 37, that is not found in the male from the Philippines. Unfortunately, the only specimens known are two males from the Philippines and four females from Taiwan, and the variation may be due to sexual or geographical variation, as well as species differences (Yamane & Terayama, 1983).

Distribution. *Bakeronymus* has been collected in the Philippines and Taiwan.

Biology. The genus was reared in Taiwan from *Parapolybia varia* Fabricius (Polistini, Vespidae) (Yamane & Terayama, 1983).

Species included

Bakeronymus typicus Rohwer, 1922. Examined ♂, ♀ from PHILIPPINES, TAIWAN (USNM*, YAMA).

***Bareogonalos* Schulz**

Bareogonalos Schulz, 1907a: 18. Type species *Trigonalyys canadensis* Harrington, 1896; designated by Schulz (1907b) *nec* Viereck (1914). Repository ZMHB, see Carmean (1989).

Nippogonolos Uchida, 1929: 79. Type species *N. jezoensis* Uchida (1929) by monotypy. Repository: EIHU (Yamane, 1973).

Diagnosis. Mesosoma and metasoma stout and thick; body length: 8.3–13+ mm (forewing 7.5–13.1 mm); head small and rectangular, with long pubescence; malar space long; genal carina obsolescent near hypostomal carina; antenna 18–23 segmented; intertorulus distance variable, usually about equal to torulus to inner eye distance, half as wide in *B. huisuni* and an undescribed species from Sumatra; mandibles symmetrical (except in *B. jezoensis*); scutellum raised; hind trochantellus undivided; thorax and propodeum coarsely areolate, contrasting with smooth, generally shining metasoma; terga transparent at sides; metasoma sexually dimorphic, in female almost as high as wide, semirectangular and blunt posteriorly in dorsal view, in male elongate fusiform, pointed posteriorly; paramere short and wide, forming right angle to basiparamere, width $3.3 \times$ length and $1.3 \times$ width basiparamere; aedeagus laterally flattened, expanded at tip into symmetrical club or 'T', width $3.6 \times$ width of base, each side of 'T' about same height as width of base. Female primary armature on sternum II, projects over sternum III which has a similarly shaped though slightly smaller armature; genitalia held in capsule.

Discussion. The species of *Bareogonolos* form a monophyletic group united by their parasitism of vespines, and by their dorsally transverse heads with long pubescence, generally stout shape, sexual dimorphism, deeply areolate propodeum and smooth, often shining metasoma. The female metasoma is almost as high as it is wide with the main armature on sternum II. *Bareogonolos* has the hind trochantellus undivided and maxillary palps as long or longer than the mandibles. The antennal insertions are above the clypeus, remote from the mandibular base. Other genera with the hind trochantellus undivided have relatively slender metasomas with the main armature on sternum III. These other genera also have greatly modified heads including vestigial palps and/or antennal insertions at the level of the mandibular base with the clypeus between the insertions.

Koenigsmann (1976), apparently based on Schulz (1907a), stated that *Bareogonolos* females characteristically have one more antennal segment than the males. However, the number of flagellomeres depends primarily on the size of the individual, and thus the host size (Yamane & Yamane, 1975; Carmean, 1988).

Distribution. Species of *Bareogonolos* are found around the perimeter of the Pacific including SW Mexico, NW United States and SW Canada, E Siberia, Japan, Taiwan and Indonesia (Java and Sumatra).

Biology. *Bareogonolos* species are the only confirmed trigonalid parasitoids of Vespinae (Vespidae), including *Dolichovespula*, *Vespa* and *Vespula* (van der Vecht, 1934; Stage & Slobodchikoff, 1962; Carmean *et al.*, 1981; Ono, 1987, 1988; Carmean, 1988, 1991; Yamane, 1973; Yamane &

Yamane, 1975). In addition, an undescribed species from Indonesia was reared from *Provespa* (YAMA).

Bareogonolos canadensis larvae initially feed internally and then emerge to feed externally and pupate under a thickened cap (Figs 31, 32).

Species included

Bareogonolos canadensis (Harrington, 1896). Examined numerous specimens from CANADA and USA (CARM, CASC, CNCI, USNM, ZMHB*).

Bareogonolos huisuni Sk. & S. Yamane, 1975. Examined 1 ♀, 1? from TAIWAN (YAMA).

Bareogonolos jezoensis (Uchida, 1929). Examined 3 ♂, 4 ♀, from INDONESIA and JAPAN (ZMHB, MCZC, USNM, CARM).

Bareogonolos scutellaris (Cameron, 1897). Examined holotype ♂, and holotype ♀ of *Trigonalys flavonotata* Cameron, 1897; from MEXICO (BMNH*).

Undescribed *Bareogonolos* sp. from INDONESIA, ♂, ♀ (YAMA).

Lycogaster Shuckard

Lycogaster Shuckard, 1841: 121. Type species *L. pullata* Shuckard, 1841 (by monotypy). Repository: lost.

Diagnosis. Body stout, length 5.5–13 mm, FW 4.8–11.2 mm (most 9–10 mm long, FW 8.5 mm). Genal carina meeting lateral edge of mandibular base in Asian species and hypostomal carina in New World species; malar space short; antenna spindleform or thickened, with 22–24 segments, lacking tyloids; shortest distance between toruli $1.7\text{--}2 \times$ shortest distance between inner eye margin and torulus; anterior tentorial pits large; clypeal suture (= epistomal suture) indistinct; forewing with submarginal cell II ordinarily not petiolate; entire forewing smoky (not dark); tergum I relatively broad; tergum II about as long as following terga together. Paramere making almost a 45 degree angle to basiparamere, and short and wide ($2.7 \times$ wider than tall); basiparamere $1.7 \times$ longer than wide; aedeagus laterally flattened, tip drawn out to a dorsal point, height of tip $1.25 \times$ the height of shaft; anterior transverse groove on sternum III & IV of male; female sternum II with high posterior ledge, central projection distinct in New World species and slight in Asian species, sternum III with anterior ledge, often under ledge of sternum II.

Discussion. *Lycogaster* can be identified by the stout, usually punctate body, and the short spindleform antenna with the flagellomeres cylindrical rather than knobbed as in *Bareogonolos*. The second metasomal segment is longer than the following segments which are slightly attenuated and in

the female, strongly curved ventrally and anteriorly. The female armature is composed of a ledge on the second sternum which does not project posteriorly over the following segments. *Lycogaster* may be most closely related to the neotropical genus *Seminota*. However, *Seminota* species have shiny heads with long, posteriorly angulate vertices, whereas those of *Lycogaster* have punctate heads with rounded vertices.

Asian *Lycogaster* species group together due to the armature of the female having slightly uplifted prongs on either side, and the male with two lateral subapical prongs on sternum II. However, these modifications could be derived features within *Lycogaster*, and there is otherwise not sufficient evidence to warrant dividing the Asian species from the North American species as a new genus. We have not seen the male antenna of any Asian species, but Chen (1949) described *L. violaceipennis* as lacking tyloids.

Bischoff's concept of *Lycogaster* was very broad, as he included a species with tyloids, *Lycogaster zimmeri* Bischoff, which we have transferred to *Taeniogonolos*, and a species with filiform antennae, *Lycogaster semibrunnea* Bischoff, which Riek (1954) transferred to *Taeniogonolos*.

Distribution. *Lycogaster pullata* is known from North America (Mexico, United States and Canada) and *L. apicipennis* is known from Central America (Mexico and Costa Rica). The other species are from eastern Asia (Indonesia, China, Burma).

Biology. North American species have been reared from Ichneumonidae parasitising Saturniidae (Lepidoptera) (Bischoff, 1909), from Eumeninae, Vespidae (Hymenoptera) (Cooper, 1954; Parker & Bohart, 1966) and Arctiidae (Lepidoptera) (intermediate host) (LACM) (Townes, 1956). D.H. Janzen (personal communication) has reared *L. apicipennis* from *Enicospilus* (Ichneumonidae, Hymenoptera) parasitising Notodontidae (Lepidoptera).

Species included

Lycogaster apicipennis (Cameron, 1897). Specimens examined, COSTA RICA, 12♀ (EMUS, INBIO, RMNH, NHMW); MEXICO, 2♀ (LACM, NHMW).

Lycogaster celebesiensis (Szepligeti, 1902). Type material examined: ♀, lectotype hereby designated to formally recognize the unpublished designation by J. Papp; INDONESIA: S. Celebes, Bua-Kraeng, 5000 ft, ii.1896 (*H. Fruhstorfer*) (HNHM). Condition, left wings broken off and glued to card (det. as ♂ by Szepl.). Also examined ♂, 3♀ from INDONESIA, CHINA (RMNH, CASC).

Lycogaster heinrichi Bischoff, 1933.

Lycogaster pullata Shuckard, 1841. 74 specimens from UNITED STATES, CANADA, and MEXICO: 42 EMUS, ZSMC, UMMZ, MCZC, AMNH, UCDC, CNCI and others.

Lycogaster violaceipennis Chen, 1949. Examined ♀ from CHINA (ZMHB).

Undetermined *Lycogaster* sp., 5♀ from INDONESIA, MALAYSIA (FSAG, ANIC, USNM).

Nomadina Westwood

Nomadina Westwood, 1868: 328. Type species *N. smithii* Westwood (by monotypy). Repository: BMNH.

Liaba Cameron, 1899: 3. Type species *L. balteata* Cameron, 1899 (by monotypy). Repository: BMNH.

Platygonalys Schulz, 1905: 86. Type species *P. phylogenetica* Schulz, 1905 (by monotypy). Repository: ZMHB?.

Diagnosis. Length: 5.5–11 mm, FW 4.6–10.5 mm. Antennae thickened, 16-segmented; intertorulus distance about 1.2–1.9 × torulus to inner eye distance; maxillary palps rudimentary; clypeal suture below antennal insertions; clypeus longer than wide, projecting over base of mandibles; head relatively smooth and shiny, covered with dense short pubescence; mesosoma very smooth; FW with one closed submarginal cell (2 in *N. smithii*); mesothoracic and propodeal spiracles uncovered; propodeal foramen broadly 'U' shaped, wider than tall; metasoma dorsoventrally flattened, terga and sterna very thin. Parameres rounded, 2 × wider than tall but not angled or extending past basiparamere; aedeagus expanded apically, making a 'V' perpendicular to shaft and pointing anteriorly, shaft quite stout; female sternum II sclerotised apicomediaally, armature appearing vestigial; main armature on sternum III, generally projecting over sternum IV and reaching terminal sterna; genitalia contained in elongate flattened capsule with prominent sclerotised 'awl' pointing anteriorly.

Discussion. *Nomadina* is the only genus with sixteen antennal segments, and may be the only genus in which the antennal segment number does not vary with size. The mesothoracic and propodeal spiracles of *Nomadina* (as well as *Bakeronymus* and *Pseudonomadina*) are uncovered whereas other trigonalid genera have their mesothoracic spiracle covered by a pronotal lobe.

Nomadina and *Pseudonomadina* differ in some aspects of their male genitalia. The basiparameres (large and stout) and parameres (reduced) are similar, but the aedeagus of the *Nomadina* is clubbed, whereas it is asymmetrical and knife-shaped in *Pseudonomadina*. *Xanthogonolos* has parameres that are narrowly transverse, but the aedeagus is clubbed as in *Nomadina*.

Distribution. This genus is neotropical, occurring in Costa Rica, Panama, Venezuela, Ecuador and Brazil. Although *N. balteata* is described from Chile, all known collections are from Venezuela and Ecuador. The type locality, 'Chili', is probably an error.

Biology. *Nomadina* have been reared from colonies of *Polybia* and *Agelaia* (Polistini, Vespidae) (BMNH). Sean O'Donnell (personal communication) observed *Nomadina*

smithii acting as a mimic of small workers in a colony of *Agelaia xanthopus* (Vespidae) it was reared from.

Species included

Nomadina balteata (Cameron, 1899).

= *Nomadina nasuta* Bischoff, 1933. **Syn.n.**

Examined 2♂, 3♀, 'Chili'?, ECUADOR, VENEZUELA (BMNH*, AEIC, IZAV).

Nomadina cisandina (Schulz, 1905). Examined 7♀, BRAZIL (BMNH, MCZC).

Nomadina phylogenetica (Schulz, 1905).

Nomadina smithii Westwood, 1868. Examined 1♂, 3♀, 'Amaz.', COSTA RICA (BMNH*, CARM, UMMZ).

Pseudonomadina Yamane & Kojima

Pseudonomadina Yamane & Kojima, 1982: 183. Type species *P. biceps* Yamane & Kojima (by monotypy).

Diagnosis. Length 6 mm; FW in female 5.5 mm; male FW unusually short, 3.8 mm. Head wide, almost $5 \times$ as wide as long (length measured from hind edge to front of median ocellus), rectangular when viewed from above, strongly cleft at vertex; head, including vertex and frons, smooth and shining; eye small compared to eye in *Bakeronymus*; antennae 13–14 segmented, each flagellomere conical, expanded apically; torulus adjacent to mandible, clypeus located between toruli, intertorulus distance about $2 \times$ inner eye to outer torulus distance; maxillary palps rudimentary, 4-segmented, although segments sometimes indistinct; malar space long, receiving antenna; mandibles symmetrical, basal tooth wide, almost as wide as 3 remaining teeth; the hind trochantellus undivided; legs stout in male and slender in female; marginal cell slightly darkened; number of submarginal cells may be a variable character as male has incomplete 2 and 3rs-m cross veins; wings projecting past abdomen at rest in female but not in male; propodeal spiracle not covered; petiole only slightly laterally flattened; parameres (as exposed in side view) short, $0.25 \times$ as long as wide, same width as basiparamere; basiparamere $2 \times$ as long as wide; aedeagus laterally flattened, not expanded apically; female sternum II with small bifid tooth or rudimentary armature; sternum III with prominent bifid armature, projecting over inconspicuous armature on sternum IV and over terminal sternum; genitalia enclosed in capsule formed by flattened sternum VI and the tip modified into a sharp hollow awl set in sternum V.

Discussion. *Pseudonomadina* has the general appearance of a small bee with a greatly modified head. *Pseudonomadina* is the only trigonalid in which the width of the head exceeds the length of the mesosoma. The midline of the head is strongly cleft, and each side is slightly bulbous, giving it the appearance

of parts of two heads joined at the centre. The antenna is 14-segmented in the male and 13-segmented in the female, and the flagellomeres are conical, with each flagellomere coming from the centre of the one preceding. These characteristics, plus the vestigial maxillary palps, will distinguish this genus from all others. *Pseudonomadina* is similar to *Bakeronymus* and *Nomadina* in many characteristics as described above.

Biology and distribution. This species was found in two of eight nests of *Ropalidia (Icarielia) flavobrunnea* (Polistini, Vespidae), from a total of about 100 nests examined in a study of Philippine *Ropalidia* (Yamane & Kojima, 1982). It is only known from these two rearings.

Species included

Pseudonomadina biceps Yamane & Kojima, 1982. Examined paratype ♂, ♀, PHILIPPINES (USNM, RMNH). Holotype repository EIHU.

Seminota Spinola

Seminota Spinola, 1840: 6, pl. 41. Type species *S. leprieurii* Spinola (by monotypy).

Bertonia Schrottky, 1906: 349. Type species *B. nigra* Schrottky (by monotypy). Repository: lost. Synonymy by Schulz (1906c).

Diagnosis. Body stout; head shining, rest of body except petiole punctate, dull; all black, except one species usually with small yellow spots on petiole; wings with black markings; length: 7–15 mm; FW 6.5–12.5 mm. Genal carina meeting hypostomal carina, except genal and occipital carina absent in *S. depressa*; malar space long; vertex sharply angled behind ocelli toward top of occipital carina, or where it would be in *S. depressa*; clypeal suture indicated by indistinct line; suture between anterior tentorial pits below antennae forming an upside down 'V' with a noticeable bump or pit (much smaller than an ocellus) at apex at about level of top of the torulus, similar bump above each antenna; antennae spindleform, 21–24 segments; toruli far apart, shortest distance between toruli $2-4 \times$ shortest distance between inner eye margin and torulus; mandibles asymmetrical (one individual of *S. marginata* in a reared series of 6 (BMNH) with mandibles symmetrical); propodeum with deep medial groove; tergum II about as long as following terga together. Paramere about as wide as long, dorsally squared and ventrally rounded; male sternum III & IV with transverse grooves; female with armature on sternum II.

Discussion. *Seminota* is a distinctive genus. The species are stout and all black, except for *S. depressa* which usually has two light marks near the posterior margin of tergum I. The head is smooth and shining, although pubescent, and has a long flattened vertex which is angulate posteriorly just above the middle of the occipital carina. The antennae are strongly

spindle-form. *Seminota* is probably closest to *Lycogaster*, but can be easily distinguished by the punctate head of *Lycogaster* which contrasts with the smooth, shiny head of *Seminota*.

The holotype of the type species, *S. leprieurii*, is missing the metasoma but differs from other *Seminota* in its wing markings. The illustration and description of the holotype (Spinola, 1840) and the damaged holotype have the main characters of the genus but not the specific metasomal characters we have used. It appears allied to, and possibly the same as *S. marginata*.

Schulz states that *S. inquirenda* is very similar to *S. marginata* but smaller, with finer and more sporadic punctures, and a third submarginal cell that is decidedly shorter than the second. These characters vary intraspecifically in other Trigonaliidae and do not justify maintenance of two separate species names. Thus we are synonymising *S. inquirenda* with *S. marginata*.

Distribution. *Seminota* is only known from the neotropics (Mexico, Costa Rica, Panama, Brazil and Argentina).

Biology. *Seminota* species have been reared from Polistini (Vespidae) including *Apoica* (BMNH), *Mischocyttarus* (BMNH, IMLA), *Parachartergus* (CARM), *Polistes*, and *Pseudopolybia* (Weinstein & Austin, 1991).

Species included

Seminota depressa (De Geer, 1773). Examined 5♂, 10♀, 1? (holotype) from BRAZIL, BOLIVIA, PERU, COSTA RICA (BMNH, IMLA, NHMW, OSUO, AMNH, ZMHB, OXUM, NHRS*).

Seminota laeviceps (Cresson, 1879). Examined 2♂, 7♀, 'Mex', COSTA RICA, PANAMA (KIMS, MCZC, ANSP*).

Seminota leprieurii Spinola, 1840. *Nec leprieuri* Spinola of Schulz (1907a); Bischoff (1938); and Weinstein & Austin (1991). Examined 1? (metasoma missing), FRENCH GUIANA (MRSN*).

Seminota marginata (Westwood, 1874).

= *Seminota inquirenda* Schulz, 1907b. Holotype repository: MLUH? **Syn.n.**

= *Seminota taschenbergi* Schulz, 1906b. Holotype repository: MLUH (M. Dorn, personal communication).

Examined holotype *S. marginata*, ♀, and 9♂, 23♀ from BRAZIL, ARGENTINA, VENEZUELA, PARAGUAY, COLOMBIA (USNM, UCDC, NHMW, CASC, MCZC, BMNH*, ANSP, IZAV, IMLA, AEIC, USNM, ZMHB, MLPA).

Seminota mexicana (Cresson, 1879). Examined paratype ♂ (ANSP) and ♂, 7♀, MEXICO (EMUS, UCDC, LACM, CNCI).

Unplaced specimens: ♀, possibly *S. laeviceps*., MEXICO (ZMHB); ♀, asymmetrical petiole, protruding clypeus, VENEZUELA (BMNH).

Xanthogonalos Schulz

Xanthogonalos Schulz, 1907a: 17. Type species *X. robertibuyssoni* Schulz, 1938 designated by Viereck (1914). Holotype repository MNHN, but loaned to Schulz and not returned according to notes of Berland (J. Casevitz-Weulersse, personal communication).

Diagnosis. Body elongate, smooth, with dense short erect pubescence; length 9.4–10.2 mm, FW 9.0–9.3 mm. Head transverse in anterior view (especially in male); frons and vertex forming a flat sloping plane from the antennae to back of head; eyes with sparse pubescence; genal carina extending straight towards edge of mandibular base, sometimes obsolescent near end; no genal angle between genal carina and base of eye; prominent suture above each antenna ending in a small round bump; intertorulus distance and torulus to eye distance about equal; submarginal cell III square, about one third length of long, narrow submarginal cell II; propodeal foramen 'U' shaped. Parameres and aedeagus very similar to *Nomadina*; aedeagal shaft laterally flattened, 0.3 × width paramere; female sternum II with thin medioapical projection overlapping sterna III & IV; sternum III with small medioapical projection.

Discussion. *Xanthogonalos* is the only trigonalid genus with pubescent eyes. This pubescence consists of short, erect, sparse bristles distinctly visible at magnification of × 30 although some specimens may require searching for the right angle that highlights an area with hairs. Other characters are more difficult to use for diagnosis and too few specimens are available to distinguish among interspecific, sex specific and intraspecific differences. *Xanthogonalos* is characterized by an elongate shape, females with strongly projecting armature on an elongate sternum II, and the males lack tyloids. In the male, sternum II is only slightly longer than sternum III. In most trigonalids the back of the eye is even with the middle of the mandibular base, whereas in the South American specimens of *Xanthogonalos* the posterior margin of the eye is behind or parallel to the mandibular base (Figs 33, 34). Females have a long malar space whereas males have a short malar space resulting from having a larger eye. All specimens are covered by short pubescence. In undescribed species No. 1, the pubescence is very dense and short, giving the body a plush appearance.

Xanthogonalos fits well within the *Nomadini*, due to its armature and lack of tyloids. Schulz (1907a) placed the genus with *Seminota*, probably due to the angulate vertex and elongate submarginal cells, but the male genitalia is more similar to *Nomadina*, not *Seminota*.

The generic description in Schulz (1907a) appears to be of a composite of *Xanthogonalos* and *Trigonalys*. Schulz (1907a) described *Xanthogonalos* from three specimens: *Xanthogonalos robertibuyssoni*, the type species, from a single female from Mexico, and *X. severini* from two males with tyloids from 'South America'. We have identified two males without tyloids as representing an undescribed species of *Xanthogonalos*: they share the pubescent eyes and other characters of *Xanthogonalos*. The species *severini* does not belong to *Xanthogonalos* as

presence or absence of tyloids does not vary intra-generically. *Xanthogonalos* species are superficially similar in colouration and elongate shape to the xanthic forms of the unrelated South American *Trigonalys sanctaecatharinae* (Schulz). We are synonymising *X. severini* and *X. fasciatus* Bertoni with *T. sanctaecatharinae*.

Distribution. Neotropics.

Biology. Unknown.

Species included

Xanthogonalos robertibuyssoni Schulz, 1907a. Examined ♀, COSTA RICA (BMNH).

Undescribed species No. 1: 2♀, VENEZUELA, ARGENTINA (IMLA).

Undescribed species No. 2: 2♂, COLOMBIA (BMNH).

Trigonalini Cresson, 1887

Type genus: *Trigonalys* Westwood, 1835.

Diagnosis. Body shape variable but never appearing slender and delicate. Antennae generally elongate and filiform; tyloids present, elongate-linear or oval to round, usually on more than 5–6 flagellomeres; genal carina reaching or ending immediately before mandibular base; propodeal foramen 'V' shaped, sharply angled at apex; metasomal plates strongly sclerotised; female armature, if present, on sternum II or III, only rarely both; male sternum II either flattened, concave, or convex, if flattened or convex may have a small bump or projection anteriorly; parameres variable but generally elongate.

Discussion. The Trigonalini includes *Taeniogonalos* and *Trigonalys*, and tentatively, *Ischnogonalos*. These taxa are generally stout bodied and males have tyloids, and at least in the groundplan, female metasomal armature. Although host data are very limited, none are known to parasitise aculeate wasps. *Taeniogonalos* and *Trigonalys* are easy to distinguish from each other by the shapes of their heads (Figs 22, 23). *Ischnogonalos* may be distinguished from them by its petiolate metasoma and thickened flagellomeres (Schulz, 1907a, 1908). Several genera, previously differentiated by variable characters, are synonymised under *Taeniogonalos* and *Trigonalys*.

***Ischnogonalos* Schulz**

Ischnogonalos Schulz, 1907a: 12. Type species *Trigonalys dubia* Magretti (by monotypy).

Diagnosis (from Schulz, 1907a, 1908; Magretti, 1897). Body small, 6 mm long, stature petite, with dense and coarse wrinkles, low-lustre sheen except vertex which is glossy; pubescence

erect; SAE slightly pyramid-shaped, not connected at midline; middle flagellomeres swollen, with linear tyloids. Male with bidentate 'armature' on second sternum.

Discussion. Schulz (1908) described the genus as having thin elongate tyloids, and from his illustration it appears typical of *Taeniogonalos*, except for the narrow petiole and swollen flagellomeres. This species is apparently only known from the holotype, which was apparently deposited in the MCSN and lost (V. Raineri, personal communication), and the status of this genus is unclear.

Distribution. Possibly Burma.

Biology. Unknown.

Species included

Ischnogonalos dubia (Magretti, 1897).

***Taeniogonalos* Schulz**

Taeniogonalos Schulz, 1906b: 212. Type species *Trigonalys maculata* Smith (by monotypy).

Labidogonalos Schulz, 1906b: 207. Type species: *Trigonalys ornata* Smith (by monotypy). **Syn.n.**

Poecilogonalos Schulz, 1906b: 212. Type species *Trigonalys thwaitesii* Westwood (by monotypy). **Syn.n.**

Lycogastroides Strand, 1912: 129. Type species *L. gracilicornis* Strand (by monotypy). **Syn.n.**

Lycogonalos Bischoff, 1913a: 155. Type species *L. flavicincta* Bischoff (by monotypy). **Syn.n.**

Nanogonalos Schulz, 1906b: 211. Type species *N. enderleini* De Santis, 1980 (by monotypy). **Syn.n.**

Taiwanogonalos Tsuneki, 1991: 35. Type species *T. alishana* Tsuneki by original designation. **Syn.n.**

Diagnosis. Entire body punctate, including gena and vertex; length 4.3–13 mm, FW 3.8–11.5 mm. Genal carina ending near outside edge of mandibular base, often dividing or fading into sculpturing at end; antenna filiform, tyloids linear and parallel-sided, with distinct edges; SAE present but reduced, forming triangular brow over each torulus, not connected to each other nor forming ledge above clypeus; frons between antennae flattened, only slightly angled in side view; intertorulus distance about same as shortest distance from torulus to eye; wings often with smoky or dark markings; metasomal plates strongly sclerotised, meeting laterally with little overlap; female sternum II expanded and often with armature either bifid or not, armature usually does not extend posteriorly over more than half of sternum III, except in New Guinea and Australian

species; sternum III without projection or ledge; male sternum II often flattened; parameres usually elongate.

Discussion. This genus is characterized by the parallel-sided, usually elongate tyloids, and reduced SAE that often has a light-coloured mark. The intertorulus area is relatively flattened and the dorsal edge of each torulus is slightly raised: in anterior view the dorsal edge forms a 45–60° angle to the horizontal plane and in dorsal view the dorsal edge of the torulus forms a small projecting triangle (Fig. 17). The metasomal plates are always strongly sclerotised. The armature, if present, is located on the second sternum, and not on the third. *Taeniogonalos flavocincta*, tentatively placed in this genus, is exceptional in that its main armature is on the third sternum with a distinct protrusion on the second. The frons is not angled either in lateral or dorsal view. The gena is punctate, as is the rest of the body in most specimens.

A number of other taxa can be confused with members of *Taeniogonalos*. *Trigonalys maculifrons* superficially resembles the sympatric *Taeniogonalos ornata* in shape and colour pattern. The shape of the gena distinguishes the two genera (Figs 22, 23). In addition, in *T. ornata* the basal two-thirds of tergum I is dark brown and the remainder is yellow, the vertex and frons are evenly punctate, and a dark longitudinal line completely divides scutellum into two yellow lateral sides. In *Trigonalys maculifrons* the basal third or less of tergum I is dark brown and the remainder is yellow, the vertex is smooth, the frons above the antennae is textured, and the dark central line does not reach the anterior edge of the scutellum (i.e. both sides and the anterior third of the scutellum are yellow). *Xanthogonalos* species are also superficially similar to *Taeniogonalos ornata*. However, *T. ornata* females lack armature whereas *Xanthogonalos* females have armature on sternum II, and *T. ornata* males have tyloids, which are lacking in *Xanthogonalos* males. These species probably all mimic *Agelais* species (Vespidae).

As discussed in the introduction, previous workers believed in the stability of armature as a taxonomic character and divided genera into subfamilies based in part on the presence or absence of armature. *Poecilogonalos* (without armature) was therefore separated from *Taeniogonalos* (with armature). We are synonymising *Poecilogonalos* and *Taeniogonalos* after finding that the armature can vary not only within closely related species, but also within a species, and that the species previously separated into these two genera form part of a monophyletic group that does not warrant subdivision. *Taeniogonalos thwaitesii* is found from India to Malaya with closely related or the same species found in the Philippines and New Guinea. Specimens from west of Laos have a swollen sternum II but no armature, and east of Laos have sternum II with armature. Both forms are found in Laos (specimens in BPBM). *Nanogonalos* is also being synonymised under *Taeniogonalos*. *Nanogonalos* had been separated from *Taeniogonalos* by the absence of armature and an elongate body shape. However, these characteristics are insufficient to distinguish genera and *Nanogonalos* clusters with *Taeniogonalos* in the phylogenetic analysis.

Tsuneki (1991) described *Taiwanogonalos* as closely allied

to *Orthogonalos*, but having tyloids. He based this relationship on the similarity of the SAE to that of *Orthogonalos*, without considering the form of the gena, genal carina, propodeal foramen, or the form of the metasomal terga. Tsuneki (1991) described the seven species of his *Taiwanogonalos* from eight specimens that Teranishi had identified as *Taeniogonalos maga*. Five of these specimens, representing four of Tsuneki's species, were collected at the same time and location. We are following Teranishi's determination.

The female of *Taeniogonalos flavocincta* was previously unknown. Tentatively placed in *Taeniogonalos*, *T. flavocincta* shares the critical synapomorphies with the group: tyloids present (Teranishi, 1929), narrow, punctate genae, and typical reduced supra-antennal elevation, but is distinct because its main armature is on sternum III, with only a small projection on sternum II.

There are other sources of confusion in this group. When Schulz (1906b) described the new genus *Nanogonalos* he used a specimen from Bolivia. In the description he said he initially planned to give the specimen the species name '*enderleini*' but before publishing decided the specimen was the same as the Mexican *Trigonalys fasciatipennis* Cameron. Schulz (1906b) then described *Nanogonalos* based on the Bolivian specimen, and due to mistaken identity, Cameron's species became the type of the genus. Later, when Schulz (1907b) was able to examine Cameron's syntypes, he realised that it was not the same genus as his Bolivian specimen. Schulz's response was to call the Bolivian specimen *Nanogonalos fasciatipennis* Schulz. This decision violates Article 49 of the *International Code of Zoological Nomenclature*, which prohibits the re-use of a species-group name wrongly applied through misidentification even if the species are later assigned to different genera. To correct Schulz's error, De Santis (1980) replaced *Nanogonalos fasciatipennis* Schulz with *N. enderleini* Schulz. However, as *enderleini* was at that time a *nomen nudum* and unavailable De Santis (1980) becomes the author as he has given the species the replacement name. Furthermore, *Taeniogonalos fasciatipennis* (Cameron, 1897) was described from two specimens from separate locations. As the female is actually *T. gundlachii*, we are designating the male as lectotype. Females of *T. fasciatipennis* do not have armature, and the males have a convex sternum.

Synonymy of *Lycogastroides* under *Taeniogonalos* is based on the examination of the holotype of the type species, *Lycogastroides gracilicornis* Strand, and the study of paratypes of Benoit's two species in that genus, all of which are unambiguously *Taeniogonalos*. Benoit (1950) correctly described *Lycogastroides maynei* as having the armature on sternum II, but later (1951) incorrectly stated that in *Lycogastroides* sternum III is armed. Synonymy of the genus *Lycogonalos*, described from a single male specimen (Bischoff, 1913a), is based on the examination of that specimen. Although this specimen is missing the metasoma, Bischoff (1913a) described the 'armature' as located anterior of a flattened area on sternum II, a feature known only from male *Taeniogonalos*.

We are synonymising *T. costalis* under *T. gundlachii*. Specimens of '*T. costalis*' from North and central America have less extensive yellow markings than *T. gundlachii* from

Cuba, but specimens from Florida are intermediate. This is the only species of *Taeniogonalos* known in the U.S. and Canada. In the drawing of the *T. gundlachii* (= *costalis*) head in Townes (1956), the antennae are too far apart and the SAE is reduced, so that except for the distinct clypeal suture, the head resembles that of *Lycogaster*. Schulz (1907a) synonymised the female *Trigonalys costalis* Cresson with the male of the completely unrelated species *Trigonalys pulchella* Cresson, and placed *pulchella* in the genus *Tapinogonalos*. Bischoff (1938) removed *costalis* from synonymy with *pulchella* and placed *costalis* in *Lycogaster*. Townes (1951) moved *costalis* into *Poecilogonalos*. The presence of armature in the female and tyloids in the male places this species in *Taeniogonalos* under Schulz's system as well as in the current classification. Schulz (1907a) left *Trigonalys gundlachii* as a species whose generic placement was doubtful, and Bischoff (1938) and Weinstein & Austin (1991) placed the species in *Lycogaster*. Alayo (1974), recognizing the close relation of *gundlachii* to *costalis*, followed Townes (1956) and placed the species in *Poecilogonalos*.

Distribution. *Taeniogonalos*, is the most widely distributed of all trigonalid genera, and is found everywhere trigonalids occur, except Europe and western North America. Most species are from eastern Asia and South America.

Biology. *Taeniogonalos* species have been reared from a variety of tachinid and ichneumonid parasitoids of Lepidoptera. *Taeniogonalos thwaitesii* has been reared from an ichneumonid parasitoid of *Lygropia quaternalis* (Pyrilidae) (USNM) and from cocoons of *Henicospilus rufus* (Ichneumonidae) collected in the soil of a tea plantation (USNM, LACM) (Clausen, 1929). *Taeniogonalos gundlachii* has been reared from a tachinid, *Nilea lobeliae*, parasitising a noctuid *Acrionicta lobeliae* (Riley & Howard, 1891; Schulz, 1907a) and another tachinid, *Lespesia* sp. from a noctuid, *Phosphila turbulenta* (Carlson, 1979). It has also been reared from unidentified tachinids from *Anisota senatoria* (Saturniidae) (TAMU) and *Megalopyge opercularis* (Megalopygidae) (NCSU). A specimen from North Carolina (NCSU) has the label information that it was reared from a larva of *Apantesis anna* (Arctiidae). In Costa Rica, *T. gundlachii* has been reared from both tachinid (*Lespesia*, *Blepharipa*, *Winthemia*, *Zizyphomyia* and *Drino*) and ichneumonid (*Enicospilus* and *?Trogus*) parasitoids of various large-bodied Lepidoptera (D. H. Janzen, personal communication). In Kansas, this species was reared from the tachinid, *Allophorocera arator*, parasitising a detritivore tipulid, *Tipula ?flavoumbrosa* (Gelhaus, 1987). *Taeniogonalos maynei* was reared from pupae of *Latoia albipunctata* (Lamacodidae), presumably an intermediate host (Benoit, 1950). In Australia, *Taeniogonalos maculata* and *T. venatoria* have been reared directly from pergid sawfly hosts including *Perga condiei*, *P. dorsalis*, *P. nemoralis* and *P. affinis* (Raff, 1934; Carne, 1969; Weinstein & Austin, 1991, 1995, 1996). In some cases this parasitism was apparently host density-dependent, and caused a significant reduction of the pest sawfly numbers (Carne, 1969). Riek

(1962b) reared an unidentified *Taeniogonalos* from an ichneumonid parasitising an antherid (Lepidoptera) and a male and female *T. ?maculata* were reared from *Panacela lewini* (Eupterotidae, Lepidoptera) (ANIC). The report of *Taeniogonalos* directly parasitising geometrid and tortricid cocoons (Weinstein & Austin, 1991) was not confirmed (A. Austin, personal communication; I. D. Naumann, personal communication).

Species included

Taeniogonalos chadwicki Riek, 1954.

Taeniogonalos enderleini (De Santis, 1980). Transferred from *Nanogonalos*. **Comb.n.**

Examined 58♂, 36♀ from South America (AEIC, CNCI, MCZC, OSUO, NHMW, UCDC, BMNH, PORT, IMLA, CUIIC, ISNB, CDFA, ZMHB*).

Taeniogonalos fasciata (Strand, 1913). Transferred from *Poecilogonalos*. **Comb.n.**

= *Poecilogonalos magnifica* Teranishi, 1929. **Syn.n.**

Examined 2♂, 18♀ from TAIWAN, JAPAN, CHINA, INDONESIA, MALAYSIA (AEIC, NHMW, RMNH, BMNH, CNCI, ZMUC, CARM, CMNH, TARI).

Taeniogonalos fasciatipennis (Cameron, 1897).

Type material examined, lectotype hereby designated, ♀ syntype of *T. fasciatipennis* examined, = *T. gundlachii*. (BMNH). Examined: 11♂, 9♀ from MEXICO (BMNH*, CUIIC, CNCI, EMUS). Same or closely related species from COSTA RICA and HONDURAS (4♀; USNM, FSCA, PORT, CARM).

Taeniogonalos flavicineta (Bischoff, 1913a). Transferred from *Lycogonalos*. **Comb.n.**

Holotype examined, ♂, no locality (ZMHB*).

Taeniogonalos flavocincta (Teranishi, 1929). Tentative placement, transferred from *Nanogonalos*. **Comb.n.**

Examined ♂, ♀, KOREA (USNM, HNHM).

Taeniogonalos formosana (Bischoff, 1913a). Transferred from *Poecilogonalos*. **Comb.n.**

Taeniogonalos fulvoscutellata (Ayyar, 1919). Transferred from *Poecilogonalos*. **Comb.n.**

Examined 3♂, 7♀, INDIA (USNM, RMNH, BMNH, OSUO).

Taeniogonalos gracilicornis (Strand, 1912). Transferred from *Lycogastroides*. **Comb.n.**

Holotype examined, ♀, EQUATORIAL GUINEA (ZMHB*).

Taeniogonalos gundlachii (Cresson, 1865). Transferred from *Poecilogonalos*. **Comb.n.**

= *Trigonalys costalis* Cresson, 1867. Transferred from

Poecilogonalos. Described in *Trigonallys* and also placed in *Lycogaster*. **Syn.n.**

Numerous specimens from CANADA, COSTA RICA, CUBA, UNITED STATES (MEMU, NCSU, INBIO, TAMU, USNM, ZSMC).

Taeniogonalos henicospili (Rohwer, 1929). Transferred from *Poecilogonalos*. **Comb.n.**

Taeniogonalos intermedia (Chen, 1949). Transferred from *Poecilogonalos*. **Comb.n.**

Taeniogonalos javana (Bischoff, 1933). Transferred from *Poecilogonalos*. **Comb.n.**

Holotype examined, ♀, INDONESIA (ZMHB).

Taeniogonalos jucunda (Westwood, 1868). Examined 2♀, 'Amazons', COLOMBIA (OXUM*, BMNH).

Taeniogonalos kerala (Ayyar, 1919). Transferred from *Poecilogonalos*. **Comb.n.**

Taeniogonalos lugubris (Westwood, 1868). Examined ♀, 'Amazons' (OXUM*).

Taeniogonalos maculata (Smith, 1851). Examined 19 specimens from Australia (ANIC).

Type repository, BMNH.

Taeniogonalos maga (Teranishi, 1929). Tentative generic placement, transferred from *Poecilogonalos*. **Comb.n.**

= *Poecilogonalos yuasai* Teranishi, 1938 (syn. by Tsuneki, 1991).

Holotype examined, ♀, JAPAN (ITLJ*).

= *Taiwanogonalos alishana* Tsuneki, 1991. Holotype examined, ♀, TAIWAN (OMNH*).

= *Taiwanogonalos alticola* Tsuneki, 1991

= *Taiwanogonalos claripennis* Tsuneki, 1991

= *Taiwanogonalos laeviceps* Tsuneki, 1991

= *Taiwanogonalos minima* Tsuneki, 1991

= *Taiwanogonalos satoi* Tsuneki, 1991

= *Taiwanogonalos similis* Tsuneki, 1991

Examined 82 specimens from JAPAN and TAIWAN (AEIC, CNCI, TARI).

Taeniogonalos maschuna (Schulz, 1907a). Tentative placement, transferred from *Tapinogonalos*. **Comb.n.**

Holotype examined, ♀, missing head, ZIMBABWE (ZMHB*).

Taeniogonalos maynei (Benoit, 1950). Transferred from *Lycogastroides*. **Comb.n.**

Examined ♂ paratype, ZAIRE (MRAC).

Taeniogonalos ornata (Smith, 1861a). Transferred from *Labidogonalos*. **Comb.n.**

Examined 19♂, 21♀ from COSTA RICA and MEXICO (BMNH*, ZMHB, AEIC, UMMZ, EMUS, UCDC, TMSA).

Taeniogonalos pictifrons (Smith, 1861b). Described in 'Trygonallys' [sic] and here transferred from *Lycogaster*. **Comb.n.**

Examined 2♀, INDONESIA (OXUM, syntype; RMNH).

Taeniogonalos raymenti, **new replacement name.**

Taeniogonalos tricolour Rayment, 1952.

Taeniogonalos rufofasciata (Chen, 1949). Transferred from *Poecilogonalos*. **Comb.n.**

Taeniogonalos sauteri Bischoff, 1913a.

= *Poecilogonalos flavoscutellata* Chen, 1949 (syn. by Tsuneki, 1991).

= *Taeniogonalos pictipennis* Strand, 1914 (syn. by Tsuneki, 1991).

Examined 7 ♀ from PHILIPPINES, TAIWAN (AEIC, USNM, CASC).

Taeniogonalos schulzi (Bischoff, 1933). Transferred from *Nanogonalos*. **Comb.n.**

Taeniogonalos semibrunea (Bischoff, 1951). Tentative identification, 3♂, 10♀ from AUSTRALIA (MAMU).

Taeniogonalos taihorina (Bischoff, 1914). Transferred from *Nanogonalos*. **Comb.n.**

Taeniogonalos tenebrosa Riek, 1954.

Taeniogonalos thwaitesii (Westwood, 1874). Described in *Trigonallys* and here transferred from *Poecilogonalos*. **Comb.n.**

Examined 9♂, 30♀ from INDIA, SRI LANKA, THAILAND, LAOS, MALAYSIA, PAPUA NEW GUINEA, TAIWAN (BMNH, BPBM, USNM, LACM, OSUO, AEIC, OXUM*).

Taeniogonalos tricolour (Chen, 1949). Transferred from *Poecilogonalos*. **Comb.n.**

Examined 6♀, CHINA, THAILAND, KOREA (USNM, HNHM).

Taeniogonalos venatoria Riek, 1962. 215 specimens from AUSTRALIA (ANIC, AEIC).

Taeniogonalos zairensis (Benoit, 1950). Transferred from *Lycogastroides*. **Comb.n.**

Examined ♀ paratype, ZAIRE (MRAC).

Taeniogonalos zimmeri (Bischoff, 1933). Transferred from *Lycogaster* based on male having tyloids (Bischoff, 1933). **Comb.n.**

Unplaced specimens: *Taeniogonalos* sp. 1: ARGENTINA, 2♂, ♀ (IMLA, AEIC). *Taeniogonalos* sp. 2: ♂, PAPUA NEW GUINEA (UCDC). *Taeniogonalos* sp. 3: ♀, INDONESIA (RMNH). *Taeniogonalos* sp. 4: 21♂, 16♀, PAPUA NEW GUINEA (ANIC).

Trigonalys Westwood

Trigonalys Westwood, 1835: 52. Type species *T. melanoleuca* Westwood (by monotypy). *Trigonalos* Schulz, 1906a; emended without justification; *Trigonalis* Spinola, 1840; incorrect subsequent spelling.

Stygnogonalos Schulz, 1907b:305. Type species *Trigonalys championi* Cameron (by monotypy). **Syn.n.**

Discenea Enderlein, 1905: 200. Type species *Trigonalys natalensis* Kreichbaumer (by monotypy). **Syn.n.**

Lycogastrula Strand, 1912: 130. Type species *L. micanticeps* Strand (by monotypy).

Stygnogonaloidea Strand, 1912: 128. Type species *S. crassiceps* Strand (by monotypy).

Diagnosis. Length 6.2–13 mm, commonly 8–10 mm, FW 4.9–10.6 mm. Occiput strongly excavated to mandibular base; genal carina extending straight and unbranched to lateral edge of mandibular base without getting smaller; genal carina on genal angle (Fig. 22), area around the end of carina smooth, not rough; gena wide in side view and shining behind lower part of eye; malar space short; antennae elongate and filiform; tyloids small, rounded and often glistening; intertorulus distance about equal or a little less than distance from torulus to inner margin of eye; lower face above clypeal suture and area between antennae not punctate, usually shining; frons sharply angled in side view, with slight carina between antennae; female armature present or absent, if present generally on sternum III, rarely on II or II & III; female tergum V often hoodlike, with flange over posterior segments; male metasoma rounded ventrally.

Discussion. Members of this genus are the only trigonalids that have the genal carina located on the genal angle, and have the occiput strongly excavated all the way to the mandibular base (Fig. 22). The SAE join together forming a ledge between the base of the antennae and the area between the ledge and the clypeal suture is shiny, as is the gena.

A number of *Trigonalys* species resemble those of other genera. *Trigonalys flavescens*, with its smooth metasoma, orange colour and elongate shape, superficially resembles *Orthogonalys*. However, in *T. flavescens*, the genal carina ends at the mandible base whereas in *Orthogonalys* the genal carina fades before reaching the hypostomal carina, and in *Trigonalys* the head is more hemispherical. *Trigonalys maculifrons* can be separated from the superficially similar *Taeniogonalos ornata* by the generic differences in head shape and the slight differences in colour patterns described in the discussion of *Taeniogonalos*, the Key to New World genera, and Figs 22, 23.

We are synonymising *Discenea* and *Lycogastrula* with *Trigonalys*. These genera were erected for species known only from Africa, but these species share the generic characteristics of *Trigonalys*. Bischoff (1951) argued for the synonymy of *Lycogastrula* within *Discenea* whereas Benoit (1950, 1951)

placed *Lycogastrula* in the subfamily Lycogastrinae and erected the subfamily Disceneinae. Weinstein & Austin (1991) recognized Benoit's subfamily Disceneinae but not Benoit's acceptance of the genus *Lycogastrula*.

Trigonalys melanoleuca is represented by two syntypes (BMNH, OXUM). We are designating the BMNH specimen, a female, as lectotype. The wings of the lectotype are spread and it is missing the left hind leg, both middle legs, and the tips of both antennae.

Sharp (1895) illustrated *Trigonalys maculifrons* with the caption '*Trigonalys maculifrons* Cam. i.l. Mexico.' prior to Cameron's (1897) description of the species. Since the illustration clearly depicts the holotype specimen described in Cameron (1897), Sharp is therefore the legitimate author of this species rather than Cameron.

We have seen three undescribed species allied to *Trigonalys championi* Cameron represented by four specimens (CNCI, BMNH, EMUS, PAGL). The similar looking *Trigonalys melanoleuca* has tergum I with the apex rounded (Fig. 39) and the female without armature. *Trigonalys championi* has tergum I with the apex nearly straight across (Fig. 40) and the female with armature on sternum III. Additional variation within the genus can be seen comparing Figs 41, 42.

The figure in Schulz's monograph (1907a) labelled *Labidogonalos ornata* is actually *Trigonalys sanctaecatharinae* from South America. In *T. sanctaecatharinae*, some females have one to three extremely reduced tyloid-like structures, instead of the normal 4–8 tyloids per antenna found in males.

Distribution. *Trigonalys* is known from South and Central America, subsaharan Africa and Asia (India and Philippines).

Biology. Although *T. melanoleuca* is one of the most commonly collected trigonalids, its host is unknown. *Trigonalys natalensis* has been reared from an unidentified lepidopteran pupa (Schulz, 1910) and *T. ?micanticeps* has been recorded from a larva of *Achaea catacoloides* (Noctuidae) (BMNH).

Species included

Trigonalys championi Cameron, 1897. Restored from *Stygnogonalos*. **Comb. reviv.**

Examined 2♀, GUATEMALA, COSTA RICA (BMNH*, USNM).

Trigonalys crassiceps (Strand, 1912). Transferred from *Discenea*. **Comb.n.**

Examined ♀, EQUATORIAL GUINEA (ZMHB*).

Trigonalys flavescens (Bischoff, 1951). Transferred from *Labidogonalos*. **Comb.n.**

Examined 3♂, MEXICO (BMNH*, EMUS, PORT).

Trigonalys lachrymosa Westwood, 1874. Restored from *Lycogaster*. **Comb. reviv.**

Examined ♀, PHILIPPINES (USNM).

Trigonalys maculifrons Sharp, 1895. Restored from *Labidogonalos*. **Comb. reviv.**

Examined 5♂, 19♀, MEXICO, COSTA RICA, HONDURAS, GUATEMALA (BMNH*, AMNH, ANSP, LACM, EMUS, MCZC, FSCA, UCDC, USNM).

Trigonalys melanoleuca Westwood, 1835.

Type material examined: lectotype hereby designated, ♀, BRAZIL (BMNH). Condition: missing very tip of both antennae, wings spread, missing left hind and middle legs. 1♀ paralectotype, no collection data (OXUM). Also examined 183 specimens from South America including ARGENTINA, BOLIVIA, BRAZIL, ECUADOR, GUYANA, PARAGUAY, PERU, TRINIDAD, VENEZUELA (MCZC, IMLA, BMNH, FSCA, AEIC, CNCI, UCDC, CDFA, and others).

Trigonalys micanticeps (Strand, 1912). Transferred from *Discenea*. **Comb.n.**

Examined, tentative identification, 6♂, 13♀ from CAMEROON, GHANA, IVORY COAST, GABON, ZAIRE, ANGOLA (BMNH, FSAG, MRAC, CNCI).

Trigonalys natalensis Kreichbaumer, 1894. Restored from *Discenea*. **Comb. reviv.**

Examined 2♂, 10♀ from SOUTH AFRICA, MADAGASCAR, KENYA, ZIMBABWE, ANGOLA (AEIC, BMNH, ZMHB, CNCI, UCDC, MRAC).

Trigonalys rufiventris Magretti, 1897. Restored from *Lycogaster*. **Comb. reviv.**

Holotype not found in MCSN (V. Raineri, personal communication). Examined ♂, 2♀, INDIA (MCZC, OSUO).

Trigonalys sanctaecatharinae (Schulz, 1907a). Transferred from *Labidogonalos*. **Comb.n.**

= *Xanthogonalos fasciatus* Bertoni, 1912. **Syn.n.**

Xanthic form of *T. sanctaecatharinae*.

= *Xanthogonalos severini* Schulz, 1907a. **Syn.n.**

Examined *X. fasciatus* paratype ♀, PARAGUAY (USNM). Also examined 81♂, 25♀, 9? from BRAZIL, ARGENTINA, PARAGUAY (MCZC, CNCI, AEIC, UCDC, OSUC, BMNH and others).

Genera not assigned to tribes (within Trigonalinae)

Jezonegonalos Tsuneki

Jezonegonalos Tsuneki, 1991: 32. Type species *J. marujamae* Tsuneki (by monotypy). Repository: OMNH. Described from a single female (not male) without antennae. Tentative placement.

Diagnosis (from Tsuneki, 1991). Head from above with SAE strongly produced anteriorly, at least as long as wide at base; SAE directly rising from frons (not from indentation); gaster

robust, slightly less than 2 × as long as wide, forewing weakly fasciated.

Discussion. Tsuneki (1991) distinguished *Jezonegonalos* from *Taeniogonalos maga* by the slightly more anteriorly produced SAE. The single specimen on which the genus is based is inadequate, and more specimens in better condition are needed to evaluate its generic status.

Distribution. The specimen described by Tsuneki (1991) is from Japan.

Biology. Unknown.

Species included

Jezonegonalos marujamae Tsuneki, 1991.

Jezonegonalos marujamanae Tsuneki, 1991 (variant spelling in original work, *J. marujamae* chosen by Tsuneki, 1992. Examined ♀ from JAPAN (OMNH*).

Mimelogonalos Schulz

Mimelogonalos Schulz, 1907a: 8. Type species *M. bouvieri* Schulz (by monotypy).

Diagnosis. Body punctate and shiny black, with yellow clypeus and parts of legs, sometimes spots on scutellum, dorsellum, and metasoma; length 5–9 mm, forewing 4.2–7.9 mm. Genal carina meeting mandibular base; malar space long; antennae with 22–25 segments, almost as long as body; tyloids broad and elongate, with a dull lead-like lustre, surface keel shaped; toruli close together: shortest distance between toruli 0.6–0.9 × less than shortest distance between inner eye margin and torulus; wings hyaline or yellowed but without dark markings; mesosoma and metasoma compact, not elongate; tergum II about as long as following terga together; parameres are truncate apically; aedeagus rectangular, in side view broader and more squared at tip than in any other known trigonalid. Female without armature, terminal sternum modified into cylindrical tube that often points straight down out of metasoma.

Discussion. This genus can be recognized by its black body with yellow markings, and shiny metasoma without ventral modifications. *Taeniogonalos*, the only other genus in Australia, has a dull-coloured and punctate integument, and males have flattened metasomal sterna whereas females have armature. *Taeniogonalos* is often reported as black with lighter markings (Teranishi, 1929; Chen, 1949; Riek, 1954; Townes, 1956), but the 'black' is actually fuscous. In *Mimelogonalos* the metasoma is either all black or black with two dorsolateral yellow spots, whereas in *Taeniogonalos* the metasoma is usually transversely striped.

The holotype of *Mimelogonalos bouvieri* Schulz, 1907a was reported as lost and the species redescribed by Riek (1954) but a neotype not designated (Article 75, *International Code of Zoological Nomenclature*). Berland recorded that the

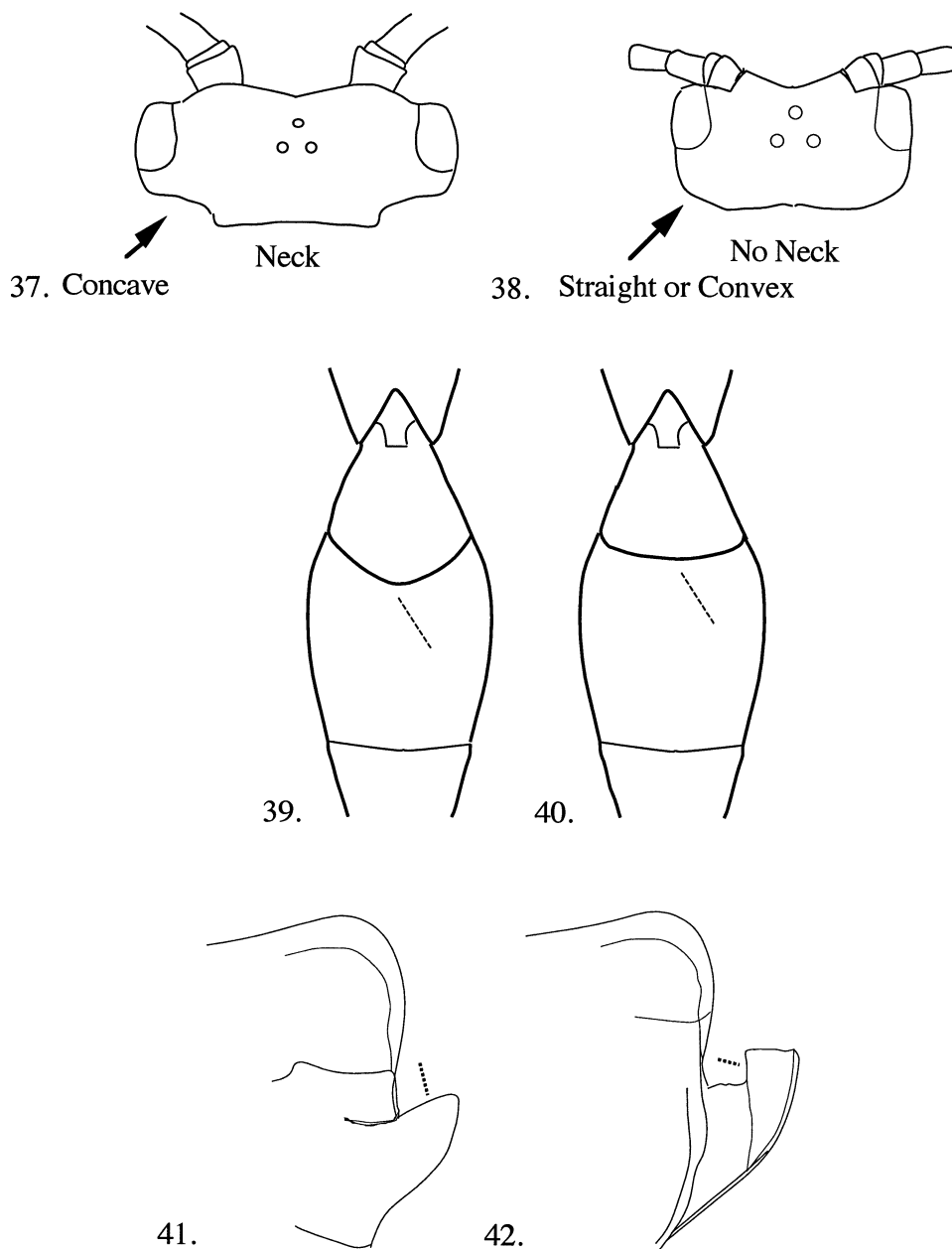

Figs 37–38. *Nomadina* heads, dorsal view. 37, Neck, *N. cisandina*; 38, normal *Nomadina* without neck.

Figs 39–40. Dorsal view, tergum I. 39, *Trigonalys melanoleuca*; 40, *Trigonalys championi* and related species. The apex of the tergum I (dashed line) is rounded in *T. melanoleuca*.

Figs 41–42. Right lateral view. Pronotal collar, *Trigonalys*. 41, The dorsal surface (dashed line) rises gently toward head; 42, the dorsal surface rises vertically so as to form a posterior facing surface.

holotype was loaned to Schulz and not returned (J. Casevitz-Weulersse, personal communication).

Mimelogonalos contained only *M. bouvieri* until Rayment (1952) described a second species, and Riek (1954) added four others. All six appear closely related. Riek (1954) separated species using characters including the number of antennal segments and the extent of colour markings. These characters

vary within a single species in other genera. Because Riek based his species on one or two specimens, and as he was only able to examine two specimens of *M. bouvieri*, he was unable to assess the extent to which the species varied. Thus, many specimens now available do not fit his key. Based on our study of Riek's *Mimelogonalos* type material, we have synonymised *M. punctulata* and *M. partiglabra* under *M.*

bouvieri. Additional specimens of this rarely collected genus are required to evaluate the status of the remaining species.

Two undescribed females (ANIC, ZMHB) of the smallest trigonalids we have seen may belong to *Mimelogonalos*. They are from Australia and are about 3 mm long (forewing 2.7 mm). These differ from other *Mimelogonalos* in that the genal carina ends inside of the mandibular base instead of bending at the end toward the mandibular base, and their mandibles are symmetrical. These differences could be due to their small size. More specimens, especially males, are needed before their relationships can be confirmed.

Distribution. *Mimelogonalos* species are known only from eastern Australia including Tasmania.

Biology. Unknown.

Species included

Mimelogonalos bouvieri Schulz, 1907a.

= *Mimelogonalos partiglabra* Riek, 1954. **syn.n.**

= *Mimelogonalos punctulata* Riek, 1954. **syn.n.**

Examined holotype *M. punctulata*, ♀ (ANIC); holotype *M. partiglabra*, ♀ (ANIC) and 10♂, 11♀, all from AUSTRALIA (ANIC, AEIC).

Mimelogonalos minuta (Rayment, 1952). Examined ♂, 7♀, AUSTRALIA (ANIC, BPBM).

Mimelogonalos nigricauda Riek, 1954. Examined ♂, AUSTRALIA (ANIC*).

Mimelogonalos nigrithorax Riek, 1954. Examined ♀, AUSTRALIA (ANIC*).

Undescribed, small species, from Australia, tentatively placed, 2♀ (ANIC).

Pseudogonalos Schulz

Pseudogonalos Schulz, 1906b: 209. Type species *Trigonalis* [*sic*] *hahnii* Spinola (by monotypy). Repository: MRSN (Scaramozzino & Pagliano, 1989).

Diagnosis. Body slender, elongate, shiny black; metasoma and head sparsely punctate, mesosoma punctate to rugose; length 5.5–13.9 mm, FW 4.3–9.4 mm. Genal carina meeting hypostomal carina with occiput deeply excavated; malar space short; SAE large vertical ligulate lobes whose upper and mesal parts are rounded, smooth and shiny whereas lower and distal portions form torulus; antennae very close together, shortest distance between toruli 0.4–0.7 × shortest distance between inner eye margin and torulus; tyloids present, round to slightly ovoid; terga slightly overlapping sterna (not meeting laterally); tergum II longer than tergum III but not as long as following terga together; paramere as wide as basiparamere and 1.4 ×

as long as wide; basiparamere slightly longer (1.3 ×) than paramere; aedeagus similar to *Orthogonalyis*, cylindrical with a capitate tip; female terminalia without armature and sternum not expanded; terminal sternum in female pointing backwards, not strongly sclerotised or sharply pointed.

Discussion. The SAE in the shape of a thin anteriorly projecting lobe mesad of the torulus and the fasciate forewing are diagnostic for this genus. The genal carina ending at the hypostomal carina, with the occiput deeply excavated at the genal carina posteriorly but flattened near the hypostomal carina are also distinctive features. The relationships of the genus are obscure: the tyloids are closest in shape to *Trigonalys*, but that genus has the SAE meeting at the midline and the genal carina going straight to the mandibular base. The terga are thickened and do not wrap around ventrally as is characteristic of *Orthogonalyis*.

Oehlke (1983) recognized the name *Trigonalis* Spinola, 1840 as a generic name distinct from *Trigonalys* Westwood, 1835, making *Pseudogonalos* a junior synonym of *Trigonalis*. Scaramozzino & Pagliano (1989) pointed out that *Trigonalis* was a misspelling of *Trigonalys*. Spinola (1840) attributed *Trigonalis* to Klug, indicating his intent was not to describe a new genus, and later noted his error (Spinola, 1841). *Trigonalis* is an 'incorrect subsequent spelling' (*International Code of Zoological Nomenclature*, Article 33c) and is not an available name. Thus the name *Pseudogonalos* stands.

Distribution. *Pseudogonalos hahnii* is known from Europe and parts of Asia, including Siberia. Reports of this species from Japan are actually of the genus *Teranishia* (Tsuneki, 1991). *Pseudogonalos harmandi* was known from a single specimen from Darjeeling, north-eastern India (Schulz, 1907a), now apparently lost.

Biology. *Pseudogonalos hahnii* lays eggs on the exterior of foliage (Bischoff, 1936b) and has been reared from *Diprion similis* (Diprionidae) (CNCI), and ichneumonids parasitising Lepidoptera (Bischoff, 1938). Other host records are unconfirmed. Reports that *P. hahnii* parasitises yellowjackets (or their parasitoids) (Clausen, 1940; Thompson, 1958; Weinstein & Austin, 1991) apparently started with speculation of Dours (1873) that was never confirmed (Reichert, 1911; Bischoff, 1936a,b). The reports (Rayment, 1948; Weinstein & Austin, 1991) of this palearctic species as a parasitoid of the neotropical *Polistes lanio* are clearly improbable and stem from a misreading of Sharp (1895). Again, through a misreading of the original text, Weinstein & Austin's (1991) citation of Popov (1945) reporting that *P. harmandi* parasitises ichneumonids is erroneous.

Species included

Pseudogonalos hahnii (Spinola, 1840). Examined ♂ 90 specimens from Europe and Asia Minor (ZSMC, MNHN, CNCI, FSAG, TMSA, CASC, NHMW, PAGL).

Pseudogonalos harmandi Schulz, 1907a.

***Teranishia* Tsuneki**

Teranishia Tsuneki, 1991: 15. Type species *T. nipponica* Tsuneki (by monotypy). Repository: OMNH.

Diagnosis. Body slender, elongate, head and metasoma shiny black, thorax deeply punctate; metasoma fusiform; length 8 mm (10–12 mm, Tsuneki, 1991) FW 6.8 mm. Genal carina ending before hypostomal carina; gena shiny with sparse long white pubescence emerging from punctures; malar space narrower than or approximately equalling width of first flagellomere; antennae long, filiform, with 25 (24–27, Tsuneki, 1991) segments, not banded; toruli closer together than shortest distance between torulus and inner eye margin; SAE strongly lobed and pointing anteriorly, dorsal margin slightly indented; FW lightly fasciated behind stigma, darkest anteriorly at either side of 2r-rs; submarginal cell 2 rarely petiolate; propodeal foramen 'V' shaped with a 'U' shaped carina around it (similar to *Pseudogonalos*); terga thin, wrapping laterally but not ventrally; tergum II slightly longer than III; terminal female sternum tightly folded and pointing posteriorly, not strongly sclerotised or awl-like.

Discussion. According to Tsuneki (1991), who described *Teranishia* from a series of nine males and seven females, this genus has a lobed SAE on the frons similar to *Pseudogonalos* but lacks tyloids. We have not seen males in this genus but the females do appear very close to *Pseudogonalos hahnii*. Females in the genus *Teranishia* Tsuneki appear to share many primitive traits with *Orthogonalys*, but more importantly, share derived character states with *Pseudogonalos*. As males of *Teranishia* were not available for this study we were only able to tentatively evaluate the phylogenetic position of this genus.

Distribution. The specimen described by Tsuneki (1991) is from Japan.

Biology. Unknown.

Species included

Teranishia nipponica Tsuneki, 1991. Examined 2♀ from JAPAN (AEIC, CNCI).

Acknowledgements

The people in the Bohart Museum, University of California, Davis (Richard Bohart, Guolin Chen, Steve Heydon and Phil Ward) helped us on a daily basis. Early encouragement for this study came from Lubomir Masner, A. P. Rasnitsyn and David R. Smith. Seiki Yamane entrusted his personal types and undescribed specimens to us. We are indebted to all the people mentioned earlier who loaned their specimens. We especially wish to thank those who gave us access to type specimens: Donald Azuma (ANSP); E. De Coninck (MRAC); E. Diller (ZSMC); Laraine Ficken, Ian Gauld and Tom Huddleston

(BMNH); Bert Gustafsson (NHRS); F. Koch (ZMHB); Ian Naumann (ANIC); Chris O'Toole (OXUM); J. Papp (HNHM) and David R. Smith (USNM). Micki Yuval produced most of the illustrations. Phil Ward produced the scanning-electron micrographs 10–12 and L. Coote, with support from D.C. Darling and his NSERC operating grant, produced micrographs 1–3 and 13. Erika Allen translated some of the very difficult older German works beautifully. Melissa Bennett, Mary Berbee, Martin Dieterich, Brian Fisher, Guolin Chen and Kei Majima helped with additional translations. Laurence Mound and Andrew Austin gave important suggestions for improving the manuscript. H.D. Cameron, Professor of Classical Languages at University of Michigan, helped with the stem of the family name. This work was supported in part by University of California, Davis Jastro-Shields and Natural Reserve System grants.

References

- Alayo, D.P. (1974) Introduccion al estudio de los Himenopteros de Cuba, superfamilia Bethyloidea. *Serie Biologica. Academia de Ciencias de Cuba*, **52**, 1–24.
- Arnett, R.H., Jr, Samuelson, G.A. & Nishida, G.M. (1993) *The Insect and Spider Collections of the World*. Second edition. Sandhill Crane Press, Gainesville, Florida.
- Ayyar, T.V.R. (1919) Records of Trigonaliidae from South India. *Records of the Indian Museum (Calcutta)*, **16**, 471–474.
- Banks, N. (1908) *Trigonalys* and *Ropronia* in Virginia. *Entomological News*, **19**, 436.
- Basibuyuk, H.H. & Quicke, D.L.J. (1995) Morphology of the antenna cleaner in the Hymenoptera with particular reference to non-aculeate families (Insecta). *Zoologica Scripta*, **24**, 157–177.
- Benoit, P.L.G. (1950) Les Trigonaloidea du Congo Belge (Hym. - Terebr.). *Revue de Zoologie et de Botanique Africaines*, **43**, 216–221.
- Benoit, P.L.G. (1951) La systematique des Trigonaloidea (Hym.) ethiopiens. *Revue de Zoologie et de Botanique Africaines*, **44**, 141–147.
- Bertoni, A.W. (1912) Contribucion a la biologia de las avispa y abejas del Paraguay (Hymenoptera). *Annales Museo Nacional de Buenos Aires*, **22**, 97–146.
- Bischoff, H. (1909) Neue Beiträge zur Lebensweise der Trigonaloidea. *Berliner Entomologische Zeitschrift*, **54**, 76–80.
- Bischoff, H. (1913a) Trigonaloidea aus Formosa. *Archiv für Naturgeschichte Berlin*, **79**(2), A, 150–156.
- Bischoff, H. (1913b) Neue Trigonaloidea. *Archiv für Naturgeschichte. Berlin*, **79**(7), A, 180–184.
- Bischoff, H. (1914) Eine weitere neue Trigonaloidea von Formosa. *Archiv für Naturgeschichte. Berlin*, **80**(2), A, 93–96.
- Bischoff, H. (1933) Beiträge zur Kenntnis der Trigonaloidea. *Mitteilungen aus dem Zoologischen Museum. Berlin*, **19**, 480–496.
- Bischoff, H. (1936a) Beiträge zur Lebensgeschichte der *Pseudogonalos hahnii* (Spin.). *Sitzungsberichte der Gesellschaft Naturforschender Freunde zu Berlin*, **1936**, 51–63.
- Bischoff, H. (1936b) Über *Trigonalys prudnicensis* Torka und *Tr. hahnii* var. *Enslini* Torka. *Arbeiten über Morphologische und Taxonomische Entomologie*, **3**, 223–224.
- Bischoff, H. (1938) Trigonaloidea. *Hymenopterorum Catalogus*, **5**, 1–18.
- Bischoff, H. (1951) Über einige Trigonaloidea des British Museum (Natural History) (Hymenoptera). *Annals and Magazine of Natural History*, **12**(4), 908–914.

- Buysson, R. & Marshall, T.A. (1892) Voyage de M. E. Simon au Venezuela (Decembre 1887–Avril 1888) 17c Memoire (1). Hymenopteres. Planches 3 et 4. *Annales de la Soci t  Entomologique de France*, **61**, 53–76.
- Cameron, P. (1897) New species of Hymenoptera from Central America. *Annals and Magazine of Natural History* **6**(19), 261–276, 368–79.
- Cameron, P. (1899) Description of a genus and species, probably representing a new tribe of Hymenoptera from Chili. *Memoirs of the Literary and Philosophical Society of Manchester*, **43**(9), 1–5.
- Carlson, R.W. (1979) Superfamily Trigonaloidea. *Catalog of Hymenoptera in America North of Mexico*, 1. (ed. by K. V. Krombein *et al.*), pp. 1197–1198. Smithsonian Press, Washington, D.C.
- Carmean, D. (1988) *Biology of the yellowjacket parasitoid Bareogonals canadensis (Harrington) (Hymenoptera: Trigonalyidae)*. Master's Thesis, Oregon State University.
- Carmean, D. (1989) Sex and deposition of the holotype of *Bareogonals canadensis* (Harrington) (Hymenoptera: Trigonalyidae). *Proceedings of the Entomological Society of Washington*, **91**, 287–288.
- Carmean, D. (1991) Biology of the Trigonalyidae (Hymenoptera), with notes on the vespine parasitoid *Bareogonals canadensis*. *New Zealand Journal of Zoology*, **18**, 209–214.
- Carmean, D. (1993) *A Generic Revision of the Trigonalyid Wasps (Hymenoptera) and a Molecular Study of 18S rDNA and the Holometabolous Insects*. Doctoral dissertation, University of California, Davis.
- Carmean, D., Akre, R.D., Zack, R.S. & Reed, H.C. (1981) Notes on the yellowjacket parasite *Bareogonals* (sic) *canadensis* (Hymenoptera: Trigonalyidae). *Entomological News*, **92**, 23–26.
- Carne, P.B. (1969) On the population dynamics of the *Eucalyptus*-defoliating sawfly *Perga affinis affinis* Kirby (Hymenoptera). *Australian Journal of Zoology*, **17**, 113–141.
- Chen, S.H. (1949) Records of Chinese Trigonaloidea (Hymenoptera). *Sinensia*, **20**, 7–18.
- Clausen, C.P. (1929) Biological studies on *Poecilogonals thwaitesii* (Westw.), parasitic in the cocoons of *Henicospilus* (Hymen.: Trigonalyidae). *Proceedings of the Entomological Society of Washington*, **31**, 67–79.
- Clausen, C.P. (1940) *Entomophagous Insects*. McGraw-Hill, New York.
- Cooper, K.W. (1954) Biology of eumenine wasps. IV. A trigonalid wasp parasitic on *Rygius rugosum* (Saussure) (Hymenoptera: Trigonalyidae). *Proceedings of the Entomological Society of Washington*, **56**, 280–288.
- Cresson, E.T. (1865) On the Hymenoptera of Cuba. *Proceedings of the Entomological Society of Philadelphia*, **4**, 1–200.
- Cresson, E.T. (1867) Descriptions of two new species of *Trigonalys*. *Proceedings of the Entomological Society of Philadelphia*, **6**, 351–352.
- Cresson, E.T. (1887) Synopsis of the families and genera of the Hymenoptera of America, north of Mexico, together with a catalogue of the described species and bibliography. *Transactions of the American Entomological Society, Suppl.* **14**, 350.
- Cresson, E.T. (1916) The Cresson types of Hymenoptera. *Memoirs of the American Entomological Society*, **1**, 1–141.
- De Geer, C. (1773) *M moires pour servir a l'histoire des insectes*, 3. Pierre Hasselberg, Stockholm.
- De Santis, L. (1980) *Catalogo de los Himenopteros Brasile os de la serie Parasitica incluyendo Bethyloidea*. Universidade Federal do Para na, Curitiba.
- Dours, J.A. (1873) Catalogue synonymique des Hym nopt res de France. *M moires de la Soci t  Linn enne de Nord de la France (Amiens)*, **3**, 1–230.
- Downton, M. & Austin, A.D. (1994) Molecular phylogeny of the insect order Hymenoptera: apocritan relationships. *Proceedings National Academy of Science, U.S.A.*, **91**, 9911–9915.
- Enderlein, G. (1905) 7. Einige Bemerkungen zur kenntnis der Trigonalyiden. *Zoologischer Anzeiger*, **29**, 198–200.
- Farris, J.S. (1969) A successive approximations approach to character weighting. *Systematic Zoology*, **18**, 374–385.
- Farris, J.S. (1988) *Hennig86*. Ver. 1.5. Port Jefferson, New York.
- F rster, A. (1877) *Ueber den systematischen Werth des Fl gelgeaders bei den Hymenopteren*. Rudolph Barth, Aachen.
- Gauld, I. & Bolton, B. (1988) *The Hymenoptera*. British Museum (Natural History) and Oxford University Press, Oxford.
- Gelhaus, J.K. (1987) A detritivore *Tipula* (Diptera: Tipulidae) as a secondary host of *Poecilogonals costalis* (Hymenoptera: Trigonalyidae). *Entomological News*, **98**, 161–162.
- Harrington, W.H. (1896) A Canadian *Trigonalys*. *Canadian Entomologist*, **28**, 108.
- Harrington, W.H. (1898) Addendum by W.H. Harrington. F.R.S.C.. Ottawa. *Canadian Entomologist*, **30**, 15–16.
- International Code of Zoological Nomenclature* (1985) Third edition. International Trust for Zoological Nomenclature, London.
- Johnson, N.F. (1988) Midcoxal articulations and the phylogeny of the order Hymenoptera. *Annals of the Entomological Society of America*, **81**(6), 870–881.
- Koenigsmann, E. (1976) Das phylogenetische System der Hymenoptera. *Deutsche Entomologische Zeitschrift N.S.*, **23**(4–5), 253–279.
- Kreichbaumer, J. (1894) Hymenoptera Ichneumonoidea. *Berliner Entomologische Zeitschrift*, **39**, 297–318.
- Kreiger, R. (1894) Ein Beitrag zur Kenntniss der Hymenopterenfauna des Koenigreichs-Sachsen. Verzeichniss der bis jetzt in Sachsen aufgefundenen Grabwespen und Bienen. *Beilage Jahresbericht Nicolaigymnasium Leipzig* (**542**), 1–49.
- Maddison, W. & Maddison, D. (1992) *MacClade* Ver. 3.01. Sinauer, Sunderland, Massachusetts.
- Magretti, P. (1897) Viaggio di Leonardo Fea in Birmania e regioni vicine LXXIV. Imenotteri. Parte seconda. Trigonalyidi. Betilidi. Crisididi colla descrizione di parecchie nuove specie. *Annali del Museo Civico di Storia Naturale di Genova* (2), **17** (37), 308–326.
- Marsakov, V.G. (1981) Pereponcatokrylyje semejstva Trigonalyidae (Hymenoptera) fauny SSSR. (Hymenoptera of the family Trigonalyidae in the fauna of the USSR). *Trudy Zoologicheskii Instituti (Akademiia nauk SSSR)*, **92**, 100–107.
- Naumann, I.D. (1991) Hymenoptera. *The Insects of Australia*. II. (ed. by CSIRO), pp. 916–1000. Melbourne University Press, Melbourne.
- Oehlke, J. (1983) Zur Nomenklatur der gattungen *Trigonalis*, *Stephanus* und *Brachygaster* (Hymenoptera, Trigonalyoidea, Stephanoidea et Evanioidea). *Reichenbachia*, **21**, 91–93.
- Ono, M. (1987) Note on *Bareogonals jezoensis* (Hymenoptera, Trigonalyidae) discovered from a nest of *Vespa simillima xanthoptera* (Hymenoptera, Vespidae). *Kontyu*, **55**, 162–163.
- Ono, M. (1988) A new host record of *Bareogonals jezoensis* (Hymenoptera, Trigonalyidae) from Japan. *Kontyu*, **56**, 191–192.
- Parker, F.D. & Bohart, R.M. (1966) Host-parasite associations in some twig-nesting Hymenoptera from western North America. *Pan-Pacific Entomologist*, **42**, 91–98.
- Popov, V.V. (1945) Zoogeography and some morphological peculiarities of the family Trigonaloidea (Hymenoptera). *Comptes Rendus (Doklady) de l'Acad mie des Sciences de l'Union des R publiques Sovi tiques Socialistes. Moscow. N.S.*, **48**(1), 72–74.
- Raff, J.W. (1934) Observations on sawflies of the genus *Perga*, with notes on some reared primary parasites of the families Trigonalyidae, Ichneumonidae, and Tachinidae. *Proceedings of the Royal Society of Victoria*, **47**, 54–77.

- Rasnitsyn, A.P. (1988) An outline of evolution of the hymenopterous insects (Order Vespida). *Oriental Insects*, **22**, 115–145.
- Rayment, T. (1948) Notes on remarkable wasps and bees, with specific descriptions. *Australian Zoologist*, **11**, 238–254.
- Rayment, T. (1952) New bees and wasps. XVII. Rare parasitic wasps. *Victorian Naturalist*, **69**, 93–99.
- Reichert, A. (1911) Beitrag zur Lebensweise von *Pseudogonolus hahni* Spin. *Berliner Entomologische Zeitschrift*, **56**, 109–112.
- Riek, E.F. (1954) Australian Trigonalidae (Hymenoptera: Ichneumonoidea). *Australian Journal of Zoology*, **2**, 296–307.
- Riek, E.F. (1962a) A new species of trigonalid wasp parasitic on the sawfly *Perga affinis* Kirby (Hymenoptera). *Proceedings of the Linnean Society of New South Wales*, **87**, 92–95.
- Riek, E.F. (1962b) A trigonalid wasp (Hymenoptera, Trigonalidae) from an anthelid cocoon (Lepidoptera, Anthelidae). *Proceedings of the Linnean Society of New South Wales*, **87**, 148–150.
- Riley, C.V. & Howard, L.O. (1891) Some of the bred parasitic Hymenoptera in the National Museum. *Insect Life*, **3**, 460–464.
- Rohwer, S.A. (1922) Philippine parasites of the family Trigonalidae. *Philippine Journal of Science*, **21**, 417–419.
- Scaramozzino, L. & Pagliano, G. (1989) Presenza in piemonte de *Pseudogonolus hahni* (Spinola) e note sui Trigonalidae (Hymenoptera, Trigonalidae). *Fragmenta Entomologica (Rome)*, **21**(2), 275–282.
- Schrottky, C. (1906) Ein neues genus aus der familie der Trigonalidae von Paraguay. (Hym.). *Zeitschrift für Hymenopterologie und Dipterologie*, **6**, 348–350.
- Schulz, W.A. (1905) *Hymenopteren-Studien*. Engelmann, Leipzig.
- Schulz, W.A. (1906a) *Spolia Hymenopterologica*. Pape, Paderborn.
- Schulz, W.A. (1906b) Die trigonaloiden des Königlichen Zoologischen museums in Berlin. *Mitteilungen aus dem Zoologischen Museum. Berlin*, **3**, 203–212.
- Schulz, W.A. (1906c) Die Trigonaloiden des zoologischen museums der Universität Halle. *Zeitschrift für Hymenopterologie und Dipterologie*, **6**, 389–393.
- Schulz, W.A. (1907a) *Genera Insectorum. Hymenoptera, Fam. Trigonalidae*. (ed. by P. Wytsman), 61, 24. Desmet-Verteneul, Bruxelles.
- Schulz, W.A. (1907b) Alte Hymenopteren. *Berliner Entomologische Zeitschrift*, **51**, 303–333.
- Schulz, W.A. (1908) Die Trigonaloiden des Genueser Naturhistorischen Museums. *Annali del Museo Civico di Storia Naturale di Genova Series 3*, **4**(44), 23–37.
- Schulz, W.A. (1910) Ein Beitrag zur Kenntnis der Lebensweise, systematik und geographischen Verbreitung der Trigonaloiden. *Entomologisk Tidskrift*, **31**, 103–108.
- Sharp, D. (1895) Insects. *Cambridge Natural History Vol. 5* (ed. by S. F. Harmer and A. E. Shipley), pp. 83–584. Macmillan, London.
- Shaw, S.R. (1990) Phylogeny and biogeography of the parasitoid wasp family Megalynidae (Hymenoptera). *Journal of Biogeography*, **17**, 569–581.
- Shuckard, W.E. (1841) On the Aulacidae, a family of Hymenoptera Pupivora; and that *Trigonalys* is one of its components: with the description of a British species of this genus, and incidental remarks upon their collateral affinities. *The Entomologist*, **1**, 115–125.
- Smith, F. (1851a) Descriptions of some new species of exotic Hymenoptera in the British Museum and other collections. *Annals and Magazine of Natural History, Series 2*(7), 28–33.
- Smith, F. (1851b) On the nest of *Polistes lanio*, Fab. and a parasite found therein, and on a nest of a social wasp. *Transactions of the Entomological Society of London*, **1**(N.S.), 176–178.
- Smith, F. (1861a) (dated 1860) Descriptions of new genera and species of exotic Hymenoptera. *Journal of Entomology*, **1**, 65–84, 146–155.
- Smith, F. (1861b) (suppl. to 4, 1860). Descriptions of new species of hymenopterous insects collected by Mr. A. R. Wallace at Celebes. *Journal of the Proceedings of the Linnean Society of London*, **5**, 57–93.
- Smith, D.R. (1996) Trigonalidae (Hymenoptera) in the eastern United States: seasonal flight activity, distributions, hosts. *Proceedings of the Entomological Society of Washington*, **98**, 109–118.
- Spinola, M.M. (1840) Description de trois Hymenopteres nouveaux recueillis par M. Leprieur a Cayenne. *Magasin de Zoologie*, **10**, 1–20 (pls 41–43).
- Spinola, M.M. (1841) Note. *Revue Zoologique*, **4**, 32.
- Stage, G.I. & Slobodchikoff, C.N. (1962) New distribution and host record of *Bareogonolus canadensis* (Harrington) (Hymenoptera: Trigonalidae and Vespidae). *Pan-Pacific Entomologist*, **38**, 97–98.
- Strand, E. (1912) Zoologische Ergebnisse der Expedn des Herrn G. Tessman nach Süd-Kamerun und Spanisch-Guinea. Trigonalidae. *Mitteilungen aus dem Zoologischen Museum. Berlin*, **6**, 127–132.
- Strand, E. (1913) H. Sauter's Formosa-Ausbeute. Trigonalidae (Hym.). *Separatabdruck aus Supplementa Entomologica*, **2**, 97–98.
- Strand, E. (1914) H. Sauter's Formosa-Ausbeute. Trigonalidae II (Hym.). *Separatabdruck aus Supplementa Entomologica*, **3**, 32–33.
- Swofford, D. (1991) PAUP (*Phylogenetic Analysis Using Parsimony*). Ver. 3.0s. Illinois Natural History Survey, Champaign, Illinois.
- Szepligeti, G. (1902) Neue *Trigonalys*-, *Megalyn*- und *Stephanus*-arten aus der Sammlung des Ungarischen National-Museums. *Természetráji Füzetek*, **25**, 525–534.
- Teranishi, C. (1929) Trigonalidae from Japan and Korea (Hym.). *Insecta Matsumurana*, **3**, 143–151 (2 pl.).
- Teranishi, C. (1931) A new species of the Trigonalidae (Hym.) with description of a new genus. *Transactions of the Kansai Entomological Society*, **2**, 9–11 (pl. III).
- Thompson, W.R. (1958) *A Catalogue of the Parasites and Predators of Insect Pests. Section 2, Host Parasite Catalogue, Part 5*. Commonwealth Institute of Biological Control, Ottawa.
- Townes, H. (1951) Trigonalidae. *Hymenoptera of America North of Mexico, Synoptic Catalog*. (ed. by C. F. W. Muesebeck et al.), pp. 734–735. USDA, Washington, DC.
- Townes, H. (1956) The nearctic species of trigonalid wasps. *Proceedings of the United States National Museum*, **106**, 295–304.
- Tsuneke, K. (1991) Revision of the Trigonalidae of Japan and her adjacent territories (Hymenoptera). *Special Publications of the Japan Hymenopterist's Association*, **37**.
- Tsuneke, K. (1992) Corrigenda. *Special publications of the Japan Hymenopterist's Association*, **38**, 54.
- Uchida, T. (1929) Über die Trigonaloiden Japans (Hym.). *Insecta Matsumurana*, **3**, 77–80 (Taff. II).
- van der Vecht, J. (1934) Zur Kenntnis der Indo-Malayischen Trigonalidae. *Zoologische Mededeelingen*, **17**, 290–296.
- Viereck, H.L. (1914) Type species of the genera of ichneumon flies. *Bulletin of the United States National Museum*, **83**.
- Weinstein, P. & Austin, A.D. (1991) The host-relationships of trigonalid wasps (Hymenoptera: Trigonalidae), with a review of their biology and catalogue to world species. *Journal of Natural History*, **18**, 209–214.
- Weinstein, P. & Austin, A.D. (1995) Primary parasitism, development and adult biology in the wasp *Taeniogonolus venatoria* Riek (Hymenoptera: Trigonalidae). *Australian Journal of Zoology*, **43**, 541–555.
- Weinstein, P. & Austin, A.D. (1996) Thelytoky in *Taeniogonolus venatoria* Riek (Hymenoptera: Trigonalidae), with notes on its distribution and first description of males. *Australian Journal of Entomology*, **35**, 81–84.
- Westwood, J.O. (1835) Characters of new genera and species of

- hymenopterous insects. *Proceedings of the Zoological Society of London*, **3**, 51–54.
- Westwood, J.O. (1841) Communication to the Entomological Society. *Annals and Magazine of Natural History*, **7**, 535–539.
- Westwood, J.O. (1843) On *Evania* and some allied genera of Hymenopterous Insects. *Transactions of the Entomological Society of London*, **3**, 237–278.
- Westwood, J.O. (1868) Descriptions of new genera and species of exotic Hymenoptera. *Transactions of the Entomological Society of London*, **1868**, 327–332.
- Westwood, J.O. (1874) *Thesaurus Entomologicus Oxoniensis*. Clarendon Press, Oxford.
- Whitfield, J.B. (1992) Phylogeny of the non-aculeate Apocrita and the evolution of parasitism in the Hymenoptera. *Journal of Hymenoptera Research*, **1**(1), 3–14.
- Yamane, S. (1973) Descriptions of the second to final instar larvae of *Bareogonalos jezoensis* with some notes on its biology (Hymenoptera, Trigonalidae). *Kontyu*, **41**, 194–202.
- Yamane, S. & Kojima, J. (1982) *Pseudonomadina* new genus, with a description of a new species from the Philippines (Hymenoptera, Trigonalidae). *Kontyu*, **50**, 183–188.
- Yamane, S. & Terayama, M. (1983) Description of a new subspecies of *Bakeronymus typicus* Rohwer parasitic on the social wasp *Parapolybia varia* Fabricius in Taiwan (Hymenoptera: Trigonalidae). *Memoirs of the Kagoshima University Research Center for the South Pacific*, **3**, 169–173.
- Yamane, S. & Yamane, S. (1975) A new trigonalid parasite (Hymenoptera, Trigonalidae) obtained from *Vespula* nests in Taiwan. *Kontyu*, **43**, 456–462.

Accepted 7 April 1997