

S.I. Distributing

Successful Innovations for Agriculture Since 1979



Spring
2024

800-368-7773

www.sidist.com 419-647-4909

TABLE OF CONTENTS

Regular type indicates product line; **Bold type indicates brand name**

PLANTING & SEEDING

4AG Gauge Wheel Tires.....	48
Acra-Plant Planter Attachments.....	40, 53
Acre Plus Seed Box Extensions.....	53
Air Design Planter Scrapers and Drill Scrapers	40
Air Seeder Down Pressure System, Hydra-Maxx	57
CleanSweep Row Cleaner Control Systems	33-35
Closing Wheel Brackets	52
Closing Wheels	8, 25-29, 32, 48, 62-67
Cover Crop/Small Grains Seed Plates, SeedRight	9-11
Depth-A-Matic Seed Depth Control	55
Down Pressure Spring Kits	54
DUST Graphite/Talc Replacement, DUST products	18-19
E-Flow 80% Talc / 20% Graphite Mix	18
Fertilizer Opener Systems	30-31, 55
Finger-Till Closing Wheel	8
Firming Wheel (Deere Drills).....	58
Gauge Wheel Arm Kits	7, 62-67
Gauge Wheel Tires and Assemblies	45-48, 62-67
Gauge Wheel Cover	54
Graphite/Talc; Graphite/Talc Replacement	18
Keeton Seed Firmer	12-16
Kinze Brush Meter Adapter	54
M3 Monitor Population Monitor	56
Marker Disc Blades (Notched).....	53
Marker Weight, Sure Mark	53
Martin-Till Planter Attachments.....	20-35
Meters & Parts	36-39
Mojo Wire Seed Firmer Stiffener	17
Mudsmith Gauge Wheels	46-47
Mur-Lok Tube Quick Connect Fittings	16
Needham Ag V8 Firming Wheel	58
Norseman Gauge Wheel Arm Kits	7
OneWrench Drill Depth Adjustor Tool (Deere Drills).....	59
Otico Gauge Wheel Assemblies	45
Parallel Arms, Parallel Linkage Rebuild Kits	1-5, 49
Planter & Seeder Replacement Parts	62-67
Planter Depth Calibration Tool, Set-N-Seed	144
Planter Weight Transfer System, Martin-Till	20-21
Precision Planter Solutions	1-6
Precision Planting	12-16, 33-39
Quick Crank Trash Whipper Adjustor	54
Rebounder Seed Deflectors	50-51
Row Cleaners	22-24, 30, 32
Row Cleaner Control Systems	33-35
Scraper Rings, Norseman	7
S.I. Belt Meters Population Control	60-61
Seed Bounce Flap, Exapta Ninja (Deere Drills)	59
Seed Box Extensions, Acre Plus	53
Seed Pro Box Funnel System, Pro Chute	57
Seed Disc Openers	40, 42-43
SeedRight Cover Crop/Small Grains Seed Plates.....	9-11
Seed Tube Guards	44, 62-67
Seed Tubes, BullsEye and WaveVision	41
SmartClean Row Cleaner Control Systems	33-35
Terrasym + DUST Microbial Inoculants / PPFMs	19
TrailJet Planter Fertilizer Opener System.....	55
Trash Guard Closing Wheel Frame	53
Valion, Exapta Seed Tube Guards	44
V-Closing Wheel Bracket Update Kits (CIH/White Planters)	52
WearParts Seed Disc Openers.....	42-43
Yetter Twister Closing Wheels.....	48

HARVEST

Auger Extensions and Tubes for Combines.....	78-79
Auger Fingers	91
Auger Trough Liners	89-90
Bushel Plus MAD Concaves	81
Bushel Plus Mini Combine	77
Bushel Plus SmartPan System	98-99
Chaffers and Sieves	77
Concaves	(Bushel Plus MAD Concaves) 81, (Thrash Master) 80
Crop Lifters	100-101
Flip Reel Kit	85
Grain Bin Monitoring System, STEPS	136
Grain Handling Alignment, The Sure Stop	136
Guards & Sections.....	(SCH) 110-112, (OEM) 124-127
HCC	77, 82, 84-85
Kernel Keeper	93
Knife Assemblies	(SCH) 108-109, (OEM) 126-127
MayWes	86-92, 94-97
Orbit Trac II Reel Kit	84
Paddle Tines	82
Platform OEM Refurbished Runner (CIH 1020)	129
Platform Replacement Parts	(SCH) 100-123 (OEM) 124-128
Platform Stabilizer Kit (Deere 900 Series Flex)	123
Poly Skid Shoes	86-88
Radura Cutterbar Replacement Parts.....	124-127
Reel Tines	82-83
Reel Bundles	85
SCH EasyCut II Cutterbar Conversion Kits	102-123
SCH Pro-Drive Kits & Parts	120-123
Stalk Stompers	94-97
Tailboard Trash Blower Tube (Deere S-Series Combines)	99
Thrash Master Concaves.....	80

MOWING & BALING

Baler Poly Pickup Bands, May Wes	74-75
Baler Knotters, Rasspe	76
Disc Mower Blades, Radura	70-73

TILLAGE

Acra-Plant Blu-Jet Parts	69
Smart-Till Replacement Parts	69
WearParts High Speed Compact Discs	68
WearParts Vertical Tillage Blades.....	68

OTHER SUCCESSFUL INNOVATIONS

Air Filter Blaster	136
Biological Innovations, NewFields Ag	132-133
Camera Systems	(VisionWorks) 138-140, (ReadyVision) 141
Hitches, Schuck	137
Hitch Pin (Locking), Lockease	136
Hydraulic Hose Markers and Wraps, Outback Wrap	142-143
Poly Cutting Edge, May Wes	135
Plastic Roller Chain Wear Blocks	129
Performance-Enhancing Tunes, AgroEcoPower	144
Ride Tamer for Zero Turn Mowers	134
SCH Hedge and Branch Trimmers	134
Skid Steer Hitch, May Wes	135
Toolboxes, Montezuma	137
Weed Control, A1 Mini Weeder	129
Weed Control, Super Sponge Weed Wiper	130-131

PRICES & SPECIFICATIONS: Prices and specifications are subject to change without notice. All shipments are billed at the price at the time of shipment. All prices are F.O.B. Spencerville, Ohio.

PRECISION PLANTER SOLUTIONS

PREMIUM COMPLETE PARALLEL ARM KITS



Eliminate ALL Areas of Unwanted Movement in the Parallel Arms!

Worn parallel linkage arms and bushings are a common problem with today's planters. Since the implementation of down-pressure enhancing products, this problem has only gotten worse.

The PPS Premium Complete Parallel Arm Kits, which come with upper and lower parallel arms that already have the hardened flange bushings installed, eliminate ALL areas of unwanted movement in the arms.



Best Option for Optimal Planter Repair

- All of the wear takes place on replaceable parts instead of on your planter's parallel linkage arms.
- Robust welded steel arms, designed to handle excessive down pressures and adverse planting conditions.
- Best option for optimal planter repair
- Two-bushing system, with increased surface area, collectively prolongs wear life
- Eliminates parallel arm wear
- Less planter maintenance for long-term cost reduction



Flange Bushing

Hex Bushing

Stop the Slop!

Brand New OEM Bushing

PPS Flange Bushing Pressed into Arm

VS

To ensure OPTIMAL fit, especially where worn support plate and row unit holes are prevalent, premium arm kits include 11/16" shouldered 5/8" bolts as part of the hardware package. You will need an 11/16" reamer to enlarge the planter support plate and row unit.

No-Ream Complete Arm Rebuild Kits: This is an option available for customers who prefer not to ream the support plate and row unit holes. These rebuild kits come with flange-bushing-installed parallel arms and shoulder-less bolts. No reamers are needed for these kits. They are ideal for narrow row planters and econo-fold planters where clearance around support plates is exceptionally tight.

PPS COMPLETE PARALLEL ARM KITS

UPPER & LOWER ARMS WITH INSTALLED FLANGE BUSHINGS



The PPS Complete Parallel Arm Kits come with upper and lower parallel arms that already have the hardened flange bushings installed. The rebuild kit also includes all of the necessary hardware to complete installation.

PPS Complete Parallel Arm Kits (Premium Arm Kits or No-Ream Arm Kits)

John Deere		Premium Kits			No-Ream Kits	
MaxEmerge 7000, 7100	Arm Length	Parallel Arm/Support Plate Mounting	Product ID	Price/Row	Product ID	Price/Row
1.6 Bushel Fiberglass Box	16"	parallel arms mount on outside of support plate	PPK213611	\$290.00	PPK214611	\$290.00
MaxEmerge 2 7200, 7300, early 1700	Arm Length	Parallel Arm/Support Plate Mounting	Product ID	Price/Row	Product ID	Price/Row
1.6 Bushel Fiberglass Box	16"	parallel arms mount on inside of support plate	PPK223321	\$325.00	PPK224321	\$325.00
1.6 Bushel Poly Box	16"	parallel arms mount on inside of support plate	PPK233321	\$325.00	PPK234321	\$325.00
		parallel arms mount on outside of support plate	PPK233221	\$325.00	PPK234221	\$325.00
	23"	parallel arms mount on inside of support plate	PPK233521	\$430.00	PPK234521	\$430.00
		parallel arms mount on outside of support plate	PPK233421	\$430.00	PPK234421	\$430.00
Planters running MaxEmerge 2 row units with OEM down pressure springs that have brackets that bolt in the same holes as the parallel arms on the support plate, add ".05" to above part numbers.						
MaxEmerge Plus, ME XP, ME 5 1700, 1705, DB	Arm Length	Parallel Arm/Support Plate Mounting	Product ID	Price/Row	Product ID	Price/Row
• 1.6 Bushel Poly Box • 3 Bushel Poly/Fiberglass Box	16"	parallel arms mount on inside of support plate	PPK233321	\$325.00	PPK234321	\$325.00
		parallel arms mount on outside of support plate	PPK233221	\$325.00	PPK234221	\$325.00
• Precision Planting mSet Hopper	23"	parallel arms mount on inside of support plate	PPK233521	\$430.00	PPK234521	\$430.00
		parallel arms mount on outside of support plate	PPK233421	\$430.00	PPK234421	\$430.00
Pro-Series, Pro-Series XP 1700, DB	Arm Length	Parallel Arm/Support Plate Mounting	Product ID	Price/Row	Product ID	Price/Row
• Pro-Series/Pro-Series XP CCS Mini Hopper	16"	parallel arms mount on inside of support plate	PPK243321	\$325.00	PPK244321	\$325.00
		parallel arms mount on outside of support plate	PPK243221	\$325.00	PPK244221	\$325.00
• Precision Planting vSet Mini Hopper	23"	parallel arms mount on inside of support plate	PPK243521	\$430.00	PPK244521	\$430.00
		parallel arms mount on outside of support plate	PPK243421	\$430.00	PPK244421	\$430.00
MaxEmerge 5, ExactEmerge 1705, DB	Arm Length	Parallel Arm/Support Plate Mounting	Product ID	Price/Row	Product ID	Price/Row
• MaxEmerge 5 Mini Hopper	16"	parallel arms mount on inside of support plate	PPK253321	\$325.00	PPK254321	\$325.00
		parallel arms mount on outside of support plate	PPK253221	\$325.00	PPK254221	\$325.00
• ExactEmerge Mini Hopper	23"	parallel arms mount on inside of support plate	PPK253521	\$430.00	PPK254521	\$430.00
		parallel arms mount on outside of support plate	PPK253421	\$430.00	PPK254421	\$430.00
John Deere DeltaForce Brackets	Description				Product ID	Price/Row
Support Plate Cylinder Bracket with hardware	Installed on row unit support plate for top of DeltaForce cylinder.				PPS299823	\$62.00
Parallel Arm Cylinder Bracket with hardware	Installed on the lower parallel arm for bottom of DeltaForce cylinder.				PPS299923	\$110.00

Any make planters running Dawn GFX, Precision Planting Reveal, or similar row cleaners with brackets that bolt in the same holes as the parallel arm on the support plate will require a modified kit when ordering. Call 1-800-368-7773 for details.

PPS COMPLETE PARALLEL ARM KITS

UPPER & LOWER ARMS WITH INSTALLED FLANGE BUSHINGS

PPS Complete Parallel Arm Kits (Continued) (Premium Arm Kits or No-Ream Arm Kits)

Case-IH			Premium Arm Kits		No-Ream Kits		
Model	Down Pressure System	Arm Length	Product ID	Price/Row	Product ID	Price/Row	
800, 900, 950, 955 5400SS, 5500SS	2 spring down pressure	14"	PPK014411	\$325.00	PPK013411	\$325.00	
		20"	PPK014511	\$345.00	PPK013511	\$345.00	
1200, 1205 Series	1 spring or air down pressure	14"	PPK014211	\$325.00	PPK013211	\$325.00	
		20"	PPK014311	\$345.00	PPK013311	\$345.00	
	2 spring down pressure	14"	PPK014411	\$325.00	PPK013411	\$325.00	
		20"	PPK014511	\$345.00	PPK013511	\$345.00	
	DeltaForce (lower holes in support plate and row unit get reamed)	14"	PPK014611	\$380.00	-	-	
	Lower parallel arms come with cylinder bracket built in, see below for upper cylinder brackets for new DeltaForce installs.						
	SureForce (lower holes in support plate and row unit get reamed)	14"	PPK014711	\$325.00	-	-	
		24"	PPK014811	\$470.00	-	-	
Lower parallel arms come with cylinder bracket built in, see below for upper cylinder brackets for new SureForce installs.							
Case-IH DeltaForce and SureForce Upper Cylinder Brackets					Product ID	Price/Row	
DeltaForce upper cylinder bracket kit, purchase this bracket with above PPS Arm kit for cost savings on new DeltaForce installs.					PPK851140	\$53.00	
SureForce upper cylinder bracket & hydraulic valve mount kit, purchase this bracket with above PPS Arm kit for cost savings on new SureForce installs.					PPK851150	\$87.00	
Kinze			Premium Arm Kits		No-Ream Arm Kits		
Model	Standard Row	Arm Length	Product ID	Price/Row	Product ID	Price/Row	
2000 Series 1989 & newer	Standard Row/Pull Unit	16"	PPK413211	\$305.00	PPK414211	\$305.00	
	Standard Row/Pull Unit with DeltaForce	16"	PPK413211.01	\$330.00	-	-	
3000 Series	Standard Row/Pull Unit	16"	PPK433211	\$305.00	PPK434211	\$305.00	
	Standard Row/Pull Unit with DeltaForce	16"	PPK433211.01	\$330.00	PPK434211.01	\$330.00	
	Standard Row/Pull Unit With SureForce	16"	PPK433211.02	\$330.00	PPK434211.02	\$330.00	
Model	Split Row	Arm Length	Product ID	Price/Row	Product ID	Price/Row	
2000 Series	Split Row/Push Unit	16"	PPK423211	\$350.00	PPK424211	\$350.00	
3000 Series	Split Row/Push Unit	16"	PPK443211	\$350.00	PPK444211	\$350.00	
	Split Row/Push Unit with DeltaForce	16"	PPK443211.01	\$380.00	PPK444211.01	\$380.00	
	Split Row/Push Unit with SureForce	16"	PPK443211.02	\$380.00	PPK444211.02	\$380.00	
Kinze Setback Brackets					Product ID	Price/Row	
Setback Bracket, replacement for excessively worn OEM brackets. Made with 11/16" holes for shouldered bolt.					PPS005912	\$31.50	
Precision Planting			Premium Arm Kits		No-Ream Arm Kits		
Model	Hopper Style	Arm Length	Product ID	Price/Row	Product ID	Price/Row	
Ready Row Unit	1.6 Bushel Box, Mini Hopper	16"	PPK633311	\$325.00	PPK634311	\$325.00	
White/Massey Ferguson			Premium Kits		No Ream Kits		
Model	Hopper Style	Arm Length	Product ID	Price/Row	Product ID	Price/Row	
6000, 8000 Series	2 Bushel Box, 3 Bushel Box, CFS Mini Hopper	16"	PPK613211	\$325.00	PPK614211	\$325.00	
9000 Series	CFS Mini Hopper	16"	PPK623211	\$325.00	PPK624211	\$325.00	
	2 Bushel Box, 3 Bushel Box	16"	PPK633211	\$325.00	PPK634211	\$325.00	
9000VE Series (vSet)	1.6 Bushel Box, CFS Mini Hopper	16"	PPK633211	\$325.00	PPK634211	\$325.00	

Any make planters running Dawn GFX, Precision Planting Reveal, or similar row cleaners with brackets that bolt in the same holes as the parallel arm on the support plate will require a modified kit when ordering. Call 1-800-368-7773 for details.

Reamer Bit Assembly Package

Descripton	Product ID	Price
Premium Ream Kit, 11/16" Bit Package, John Deere, Kinze, Precision Planting, White	PPS688011	\$50.00
Premium Ream Kit, 11/16" Bit Package, Case-IH	PPS688012	\$76.00

PPS FLANGE BUSHING KITS

REBUILD-YOUR-EXISTING-PARALLEL-ARMS KITS

Make Your Current Parallel Linkage Arms Better than New!

Stop the Slop!

**Full Rebuild Kits
(Using Your
Current Arms)**



**Brand New
OEM Bushing**

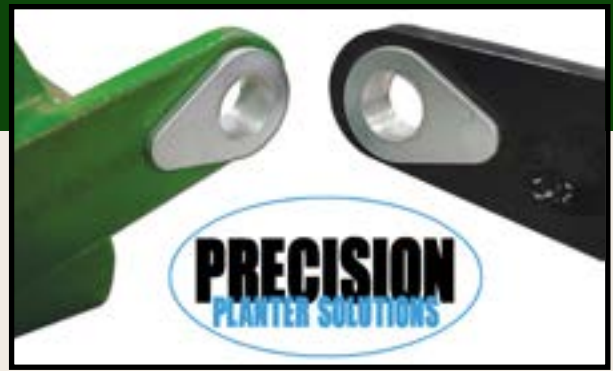

Excellent Option for Reduced Costs!

Eliminate ALL Areas of Unwanted Movement in the Parallel Arms!

The PPS Flange Bushing "Rebuild Your Own" kits for planters make your old and worn parallel linkage arms better than new! **All of the wear takes place on replaceable parts instead of on your planter's parallel linkage arms.**

Worn parallel linkage arms and bushings are a common problem with today's planters. Since the implementation of down-pressure enhancing products, this problem has only gotten worse. In the past, worn parallel linkage arms and bushings have always had to be replaced with new ones. With the PPS Flange Bushing "Rebuild Your Own" Kits, there is no longer any wear on the parallel linkage arms. All of the wear is on the kit's replaceable parts. These parts include a hardened flange bushing and a threaded hex bushing that fits into the flange bushing. The installer reams out the existing worn hole in the arm a little larger for a more precise fit for the bushings.

- Excellent option for reduced costs
- Two-bushing system, with increased surface area, collectively prolongs wear life
- Eliminates parallel arm wear
- Less planter maintenance for long-term cost reduction
- Shouldered bolts are included for optimal fit in worn support plate and row unit holes

Flange Bushing



Hex Bushing



VIDEOS

YouTube "S.I. Distributing Planting Innovations" Channel.

"Demonstration of Why You Need Tight Bushings in Planters' Parallel Arms"



Demonstration Video



Working on First Row Video

"PPS Rebuild-Your-Existing-Arms Kits - Working on First Row Unit"



Case-IH / New Holland (PPK011111)



John Deere Box Planter (PPK231131)



John Deere 1700 Mini Hopper (PPK241131)

PPS "REBUILD-YOUR-EXISTING" KITS



PPS "Rebuild-Your-Existing" Kits for Parallel Linkage Arms

Case-IH/New Holland					
Model	Description	Product ID	Price/Row	Bit Package	Price/Pack
800, 900, 955, 1200, 5400SS, 5500SS SP280, SP380 SP480, SP580	1-1/16" Repair	PPK011111	\$135.00	PPS688049	\$108.00
1200 with DeltaForce or SureForce (lower holes in support plate and row unit get reamed)	1-1/16" Repair	PPK012111	\$135.00	PPS688120	\$167.00
2000 Series Planters that have worn through nylon bushing into parallel arm holes	Oversized Bushing Kit	PPK022000	\$99.00	PPS688021	\$131.00
2000 Series Planters that have not worn through nylon bushings and show no wear in parallel arm holes	Standard Bushing Kit	PPK021000	\$99.00	n/a	n/a
Great Plains					
Model	Description	Product ID	Price/Row	Bit Package	Price/Pack
For Great Plains planters with green nylon bushings	Bushing Kit	PPK811000	\$83.00	n/a	n/a
John Deere					
MaxEmerge; 7000, 7100	Description	Product ID	Price/Row	Bit Package	Price/Pack
1.6 Bushel Fiberglass Box	1-1/16" Repair	PPK211111	\$135.00	PPS688116	\$140.00
MaxEmerge 2; 7200, 7300, early 1700	Description	Product ID	Price/Row	Bit Package	Price/Pack
1.6 Bushel Fiberglass Box	1-3/16" Repair	PPK221131	\$135.00	PPS688316	\$164.00
1.6 Bushel Poly Box	1-3/16" Repair	PPK231131	\$135.00	PPS688316	\$164.00
Planters running MaxEmerge 2 row units with OEM down pressure springs that have brackets that bolt in the same holes as the parallel arms on the support plate, add ".05" to above part numbers.					
MaxEmerge Plus, MaxEmerge XP, MaxEmerge 5: 1700, 1705, DB	Description	Product ID	Price/Row	Bit Package	Price/Pack
• 1.6 Bushel Poly Box • 3 Bushel Poly/Fiberglass Box • Precision Planting mSet Hopper	1-3/16" Repair	PPK231131	\$135.00	PPS688316	\$164.00
Pro-Series, Pro-Series XP: 1700, DB	Description	Product ID	Price/Row	Bit Package	Price/Pack
• Pro-Series/Pro-Series XP Mini-Hopper • Precision Planting vSet Mini Hopper	1-3/16" Repair	PPK241131	\$135.00	PPS688316	\$164.00
MaxEmerge 5, ExactEmerge: 1705, DB	Description	Product ID	Price/Row	Bit Package	Price/Pack
• MaxEmerge 5 Mini Hopper • ExactEmerge Mini Hopper	1-3/16" Repair	PPK251131	\$135.00	PPS688316	\$164.00
Kinze					
Standard Row	Description	Product ID	Price/Row	Bit Package	Price/Pack
2000 Series; Standard Row/Pull Unit	1-1/16" Repair	PPK411111	\$135.00	PPS688116	\$140.00
2000 Series; Standard Row/Pull Unit, with DeltaForce	1-1/16" Repair	PPK411111.01	\$135.00	PPS688116	\$140.00
3000 Series; Standard Row/Pull Unit	1-1/16" Repair	PPK431111	\$135.00	PPS688116	\$140.00
3000 Series; Standard Row/Pull Unit, with DeltaForce	1-1/16" Repair	PPK431111.01	\$135.00	PPS688116	\$140.00
3000 Series; Standard Row/Pull Unit, with SureForce	1-1/16" Repair	PPK431111.02	\$135.00	PPS688116	\$140.00
4900 Series	1-1/16" Repair	PPK452111	\$135.00	PPS688049	\$108.00
Split Row	Description	Product ID	Price/Row	Bit Package	Price/Pack
2000 Series; Split Row, Push Unit	1-1/16" Repair	PPK421111	\$135.00	PPS688116	\$140.00
3000 Series; Split Row, Push Unit	1-1/16" Repair	PPK441111	\$135.00	PPS688116	\$140.00
Kinze Setback Brackets				Product ID	Price/Row
Setback Bracket, replacement for excessively worn OEM brackets. Made with 11/16" holes for shouldered bolt.				PPS005912	\$31.50
Precision Planting					
Model	Description	Product ID	Price/Row	Bit Package	Price/Pack
Ready Row Unit; 1.6 Bushel Box & Mini Hopper	1-1/16" Repair	PPK631111	\$135.00	PPS688116	\$140.00
White/Massey Ferguson					
Model	Description	Product ID	Price/Row	Bit Package	Price/Pack
5000, 6000, 8000 Series	1-1/16" Repair	PPK611111	\$135.00	PPS688116	\$140.00
9000 Series; mini hopper	1-1/16" Repair	PPK621111	\$135.00	PPS688116	\$140.00
9000 Series; 2 Bushel Box, 3 Bushel Box	1-1/16" Repair	PPK631111	\$135.00	PPS688116	\$140.00
9000VE Series (vSet); 1.6 Bushel Box & Mini Hopper	1-1/16" Repair	PPK631111	\$135.00	PPS688116	\$140.00

Any make planters running Dawn GFX, Precision Planting Reveal, or similar row cleaners with brackets that bolt in the same holes as the parallel arm on the support plate will require a modified kit when ordering. Call 1-800-368-7773 for details.



OTHER PPS BUSHING REBUILD KITS

PPS CLOSING WHEEL ARM KITS

Cast Closing Wheel Bracket Repair Kit & Spring Hole Repair Bushing



PPS840170
Cast Closing Wheel Bracket Repair Kit



Description	Product ID	Prc/Row	Bit Package
John Deere, cast closing wheel bracket; 1-11/16" repair kit	PPS840170	\$25.00	PPS688111
John Deere, spring hole repair bushing; 11/16" repair	PPS233001	\$2.50	PPS688178
White 9000	PPS840900	\$21.00	PPS688119

PPS DOWN PRESSURE REPAIR KIT FOR JOHN DEERE

Description	Product ID	Price/Row	Bit Package
John Deere, air bag down pressure support arm; 1-1/8" repair kit	PPS860881	\$20.40	PPS688222



CASE-IH BUSHING KIT FOR CLOSING WHEEL ARMS

Slide the PPS sleeve on over the existing worn out pin and weld it on the end only. This new hardened pin can now be used with the PPS bushings that you install in the arms.

Description	Product ID	Price/Row	Bit Package
Case-IH, 1200 series closing wheel arm; 1-1/4" repair kit	PPS840114	\$65.00	PPS688114



PPS FLANGE BUSHING REBUILD KIT FOR ROW CLEANERS

Description	Product ID	Price/Row	Bit Package
Martin-Till WA1345, WA1360, C125; 1-1/16" repair kit	PPS841316	\$30.00	PPS688116
Yetter 2967; 1-1/16" repair kit	PPS840416	\$23.00	PPS688049



PPS841316

Reamer & Drill Bit Assembly Packages

Includes Required Reamer and Bits Needed For Assembly

Description	Product ID	Price
1-1/16" Yetter row cleaner repair, bit package	PPS688049	\$108.00
1-1/16" Martin-Till row cleaner repair, bit package	PPS688116	\$140.00
1-1/4" Case-IH closing wheel repair, bit package	PPS688114	\$118.00
1-1/8" White 9000 closing wheel bracket kit, bit package	PPS688119	\$130.00
1-11/16" John Deere closing wheel bracket kit, bit package	PPS688111	\$239.00
11/16" John Deere closing wheel spring hole repair, bit package	PPS688178	\$102.00
1-1/8" John Deere air bag support repair, bit package	PPS688222	\$128.00

REAMER & DRILL BIT ASSEMBLY PACKAGES

REAMER BITS, PPS REPLACEMENT PARTS & ACCESSORIES

Reamer Bits		
Description	Product ID	Prc/Ea
11/16"	PPS681116	\$42.00
11/16", Case-IH 1200	PPS601116	\$63.00
3/4"	PPS601134	\$60.00
1-1/16"	PPS680116	\$90.00
1-1/8"	PPS680118	\$106.00
1-3/16"	PPS680316	\$116.00
1-1/4"	PPS680114	\$114.00
1-11/16"	PPS680016	\$210.00

Drill Bits		
Description	Product ID	Prc/Ea
7/16"	PPS610716	\$8.00
Step Bit	PPS699102	\$39.00

Other Accessories		
Description	Product ID	Price/Ea
Cutting Fluid, 16 oz	PPS699100	\$11.25
Retaining Compound, 50ml	PPS699101	\$19.95

Replacement Parts		
Description	Product ID	Prc/Ea
1-1/16" Flange Bushing	PPS100116	\$3.84
1-1/8" Flange Bushing	PPS100118	\$3.84
1-3/16" Flange Bushing	PPS100316	\$3.84
Hex Bushing (JD, Kinze, White)	PPS320078	\$4.90
Hex Bushing (CIH/NH)	PPS310078	\$5.32
5/8" Jam Nut	PPS505818	\$0.36

ROLLER BEARING GAUGE WHEEL ARM KITS



Now Available for Kinze 3000, 4000 Series



Made in USA

5203KYY2 sealed double-roller bearing



These gauge wheel arm kits **WILL OUTLAST** any gauge wheel arm on the market today! Here's why:

Cast replacement arms, from Norseman, feature the industry-standard 5203KYY2 sealed bearing. This double-roller bearing **stays tight and withstands the abuse**, unlike the OEM threaded bushings.

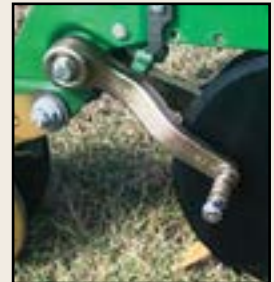

"Try a row" ... purchase a Norseman Roller Bearing Gauge Wheel Arm Kit (includes two arms) for a single row to see how it performs in your fields.



NMI136000



NMI226000



Australian-Quality Reputation - Made in USA

Since 1980, Norseman is a family owned and operated company in Australia, with a reputation of manufacturing high-quality, longer-lasting planter replacement parts.

The Norseman gauge wheel arms, that are distributed by S.I. Distributing, are made in the USA, with the same standard of excellence.

Norseman Gauge Wheel Arm Kit			
Make	Model	Product ID	Price/Row
John Deere	XP, XP Pro, MaxEmerge 5, ExactEmerge	NMI226000	\$159.00
Kinze	3000, 4000 series	NMI136000	\$189.00

NORSEMAN SCRAPER RINGS

Clean opener blades produce a well-defined seed trench.

- Its conical profile keeps the scraper ring securely mounted and maintains optimal angle of attack to clean mud from disc opener blades.
- Use in conjunction with the Norseman roller bearing gauge wheel arms to dramatically reduce maintenance intervals.
- Unique mounting method allows flex to avoid mud build-up.
- Prevent premature tire wear.

Norseman Conical Scraper Rings

Description	Product ID	Price/Each
Scraper Ring	NMI131000	\$38.00



FINGER-TILL CLOSING WHEELS

S.I. Distributing's

FINGER-TILL CLOSING WHEELS

Finger-Till Cast Closing Wheels crumble sidewalls and close the furrow for optimum seed-to-soil contact.

- Side fins provide depth control and fine-tune the soil.
- Better in wet, no-till conditions



More Aggressive!

"These soybeans were planted on May 25th. This picture was taken on May 29th. Soybean on the left was planted with the S.I. Distributing Finger-Till Closing Wheel. It is already out of the ground, while the other one isn't."

- M.H., Farmington, PA



"PFR Proven" Status: If a product has been tested in Beck's Practical Farm Research and found to provide annual yield gains and averages a positive ROI over a minimum of three years, that product earns the status of "PFR Proven."

PFR PROVEN

- More aggressive
- Better in wet, no-till conditions
- Reduces sidewall compaction
- 15" in diameter
- Lightly tills the soil



Recommended Distance Between Points: 2-1/2"

Finger-Till Cast Closing Wheels

Description	Make/Model	Product ID	Price
5/8"/16mm Wheels attach with bolt and nut.	John Deere - ME Plus, XP, ME5, EE Kinze - '93 and later White - 6000, 8000, 9000 Monosem - late plus Great Plains - with bolt on wheels	PLT110061	\$121.00
17mm Wheels slide on threaded stud and held on with nut.	John Deere - MaxEmerge 2	PLT110070	\$121.00
Roll pin (water pump style); Wheels attach with roll pin through bearing stem.	John Deere - MaxEmerge Kinze - pre '93 Monosem - early plus	PLT110081	\$121.00
Older planters with upgraded closing wheel brackets will typically use 5/8"/16mm bolt on wheels (PLT110061).			
*It is recommended to run two Finger-Till Closing Wheels per row.			
Finger-Till Closing Wheels weigh 15.75 lbs each.			



SEED PLATES

Plant Cover Crops, Wheat & Other Small Grains with your **Planter!**



These patented seed plates allow growers with John Deere, Precision Planting, and Kinze vacuum meters, as well as Kinze Brush Meters, the flexibility to accurately plant cover crops, wheat and other small grains.



Your Planter + SeedRight = Higher Efficiency

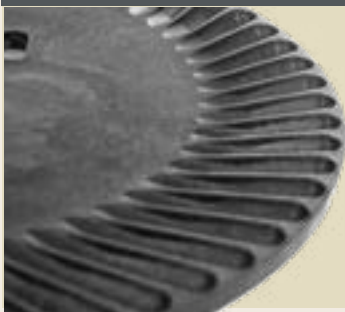

Cover more acres in less time, while enjoying more control over depth and population.

All of this will result in less seed, less fuel, reduced seeding rates, increased germination and an overall better stand.

SeedRight Advantages

There are proven significant agronomic advantages to using a planter, compared to a grain drill:



Improve Planting

Improve emergence, stand uniformity and accuracy and increase germination.



Increase Efficiency

Cover more acres in less time.



Save On Inputs

Less seed and fuel.



Increase Capability

Expand your planter's capability, especially if you do not own a drill or are looking to replace one.

John Deere, Kinze EdgeVac & Precision Planting Vacuum Meters

Simple Retrofit for Vacuum Planters



John Deere Large Cell Disc

John Deere Small Cell Disc

Kinze EdgeVac Large Cell Disc

Kinze EdgeVac Small Cell Disc

Precision Planting Large Cell Disc

SeedRight Large Cell Discs

Accurately plant small grains including wheat, oats, triticale, cereal rye, and cover crop mixes based in cereal rye. For larger sized seeds, commonly less than 35,000 seeds per pound.



SeedRight Small Cell Discs

Accurately plant cover crops including radishes, turnips, crimson clover, rape seed and rye grasses. For smaller sized seeds, commonly greater than 35,000 seeds per pound.



Testimonials

"We wanted something that would do small seed along with barley. They worked perfectly. Absolutely perfect. Recommend to anybody." - R.F., NE

"I chose the SeedRight plates because I needed to utilize the equipment I had. The rate charts were dead on. Very accurate and helped me get set up very well." - M.S., OH



YouTube.com
"S.I. Distributing Cover Crops"



Demonstration and Installation Videos



SeedRight Large Cell Vacuum Meter Disc

Wheat, Oats, Cereal Rye, Triticale

9K-35K Seeds Per Pound

Description	Product ID	Vendor ID	Price
John Deere - Vacuum Meter	SRP230090	PLJD-AA0030L	\$46.00
Kinze - EdgeVac	SRP460061	PLKZ-AA0060L	\$46.00
Precision Planting - vSet	SRP612110	PLPP-AA0012L	\$39.00

SeedRight Small Cell Vacuum Meter Disc

Radish, Turnips, Crimson Clover, Rye Grasses, Rape Seed

35K-300K Seeds Per Pound

Description	Product ID	Vendor ID	Price
John Deere - Vacuum Meter	SRP236050	PLJD-AA0036S	\$46.00
Kinze - EdgeVac	SRP460062	PLKZ-AA0060S	\$46.00

SEEDRIGHT SEED PLATES

Tested and Proven Now distributed by S.I. Distributing, the SeedRight Seed Plates have been tested and proven repeatedly.

Rate Charts by Transmission Rate charts were created, based on the testing of numerous transmissions, seed and crop variations.

Rate Charts Web Page On this web page is a drop-down menu of all rate charts based on transmissions. (Scan this QR code for the web page.) www.sidist.com/cover-crop-seed-plates.htm



Kinze Brush Meters - Backer Plate

These backer plates are for use with Kinze Brush Type mechanical meters. The backer plate works together with the OEM plates to enable the Brush Type meter to accurately plant small grains and cover crops. It helps to create a seal around the edge of your plate to avoid small seed leaking out.

The backer plate fits on top of your existing plate, with the foam side facing in and against the plate. Used to plant wheat, buckwheat, oats, cereal rye, annual rye, sorghum, sorghum Sudangrass, teff grass, triticale, radish, turnips, crimson clover and alfalfa.



Kinze Brush Meter Backer Plate (inside)
#SRP400011

OEM 48 Cell Large Bean Disc: Wheat, Cereal Rye, Oats

OEM 60 Cell Milo Disc: Radish, Crimson Clover, Turnips, Alfalfa

OEM 30 Cell Milo Disc: Radish, Crimson Clover, Turnips, Alfalfa



Testimonials / Recommendations

"Performed great. I would recommend getting a scale to measure the seeds per pound. My shed space is a premium and after I saw these plates, I got rid of my drill. SeedRight plates let me do that." -- S.R., IL, who used a backer plate with a 48-cell bean plate and averaged 100 bushels of wheat per acre.

"Got a perfect stand and it did a perfect job. I recommend that you do a diamond-shape when planting. If you are set up to do no-till, the planter works great. If you already have the high-priced equipment, why not use it?" -- Western IL Customer, who used a backer plate with a 48 cell bean plate to plant cereal rye (31 row KZ split row).

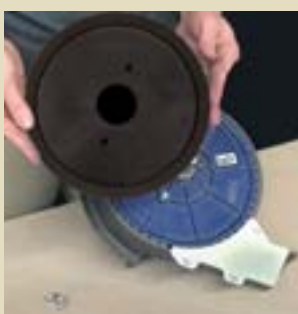

Demonstration and Installation Videos

YouTube.com "S.I. Distributing Cover Crops"



SeedRight Kinze Brush Meter Backer Plate			
Description	Product ID	Vendor ID	Price
Backer Plate, Kinze Brush Meter	SRP400011	PLKZ-AA0001A	\$37.00

Backer Plate/Seed Disc Combo Pack		
Description	Product ID	Price
Backer Plate & Soybean 48 Cell Disc	SRP410048	\$51.75
Backer Plate & Milo 60 Cell Disc	SRP410060	\$51.75
Backer Plate & Milo 30 Cell Disc	SRP410030	\$51.75

KEETON SEED FIRMERS

Keeton Seed Firmers firm the seed to the bottom of the furrow and improve seed-to-soil contact.

Proven average of 6-bushel increase in corn yield, due to better stands because:

- Pushes the seed to the bottom of the seed trench
- Hits depth set on your planter
- Ensures uniform seed-to-soil contact, uniform seed germination and uniform emergence

Seed-to-Soil Contact Made Easy

Seeds don't always land in the bottom of the trench where they belong.

This can leave an air pocket underneath them, not allowing them to take up moisture as fast as they could. That leads to late germination and emergence, and finally, loss of yield. The Keeton Seed Firmer firms the seed to the bottom of the furrow and improves seed-to-soil contact.

Firmer contact leads to uniform emergence leads to 1,000 more ears per acre or 6 bushels per acre.

Uneven seed germination and uneven plant emergence sap yields. Plants coming up even a little late can't compete with their neighbors for resources and they're vulnerable to heat stress and insects. Keeton Seed Firmers set the seed at the right depth and create consistent seed-to-soil contact. That leads to uniform germination and uniform emergence.

Studies have shown that leads to an average increase of 1,000 more ears of corn or six bushels per acre in corn yield.

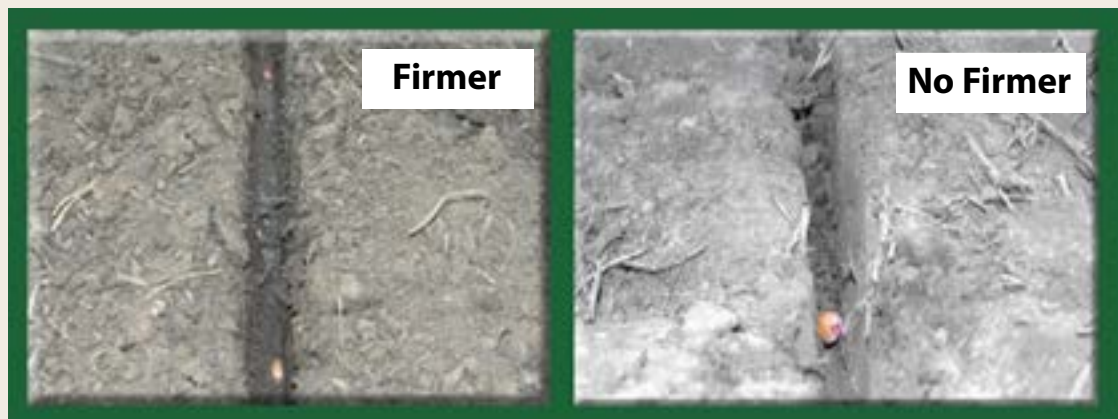

Apply In-furrow Liquid



The Keeton seed firmer can also act as a liquid application tool for insecticides, fungicides, and proper in-furrow fertilizers. Get the benefits of firming, as well as liquid application in a single device.

Determine the Effectiveness of Your Keeton Seed Firmer

To optimize the performance of the Keeton Seed Firmer, it is important to verify tension. Using a small hanging scale or a fish scale to measure tension, **1.25 lbs of tension is ideal.**

For complete information on how to measure the tension, as well as how to ensure that the Keeton Seed Firmer is set up to perform to its potential, please go to www.sidist.com/Keeton-Seed-Firmer-Preparation-for-Planting.pdf



Quick Attach Bracket Mount



KEETON SEED FIRMERS - QUICK ATTACH

Quick Attach tails are fast and easy to replace

- Design allows the tail to be snapped into place and be changed without removing seed openers or gauge wheels.
- Improved bracket design; contains more metal than Universal brackets.
- Replacement tails are more affordable than Universal replacement tails.

Keeton Seed Firmer - Quick Attach

Model	Type	Description	Firmer Options	Product ID	Price
John Deere					
7000, 7100, 7200, 7300, 1700, 1530 Drill, 1535 Drill, DB Planters	Quick Attach	Mounts to seed disc opener shafts and lower seed tube pin Will fit all MaxEmerge row units including ME5 Will NOT fit ExactEmerge row units	QA, low profile, single tube	KTN109044	\$40.00
			QA, standard, single tube	KTN109045	\$40.00
			QA, low stick, single tube	KTN109100	\$75.00
1705/DB ExactEmerge	Quick Attach	Will move the closing system 5.4 inches rearward Will ONLY fit ExactEmerge row units	QA, low profile, single tube	KTN180044	\$90.00
			QA, standard, single tube	KTN180045	\$90.00
			QA, low stick, single tube	KTN180100	\$125.00
Kinze					
2000	Quick Attach	Mounts to seed disc opener shafts and lower seed tube pin	QA, low profile, single tube	KTN109044	\$40.00
			QA, standard, single tube	KTN109045	\$40.00
			QA, low stick, single tube	KTN109100	\$75.00
3000	Quick Attach	Mounts to seed disc opener bolts and lower seed tube pin Will NOT work with large OEM seed tubes Will work with Precision Planting seed tubes	QA, low profile, single tube	KTN120044	\$40.00
			QA, standard, single tube	KTN120045	\$40.00
			QA, low stick, single tube	KTN120100	\$75.00
2000, 3000, 4000	Quick Attach	Mounts inside row unit between scrapers Will work with large OEM seed tubes Will NOT work with spring loaded disk scrapers	QA, low profile, single tube	KTN130044	\$48.50
			QA, standard, single tube	KTN130045	\$48.50
			QA, low stick, single tube	KTN130100	\$83.50
White					
8000	Quick Attach	Mounts to bracket behind seed tube	QA, low profile, single tube	KTN135044	\$55.00
			QA, standard, single tube	KTN135045	\$55.00
			QA, low stick, single tube	KTN135100	\$90.00
9000	Quick Attach	Mounts to seed disc opener bolts and lower seed tube pin	QA, low profile, single tube	KTN111044	\$40.00
			QA, standard, single tube	KTN111045	\$40.00
			QA, low stick, single tube	KTN111100	\$75.00

KEETON SEED FIRMERS - UNIVERSAL BRACKET

- Bracket mounts to seed disk opener shafts and around row unit shank.
- Has an adjustable tension screw.
- Available with dual liquid tube tail, dry tail or low profile tail
- Not for use with Precision Planting SpeedTube®.

Universal Bracket Mount



KEETON SEED FIRMERS - KINZE BRACKET

- Mounts inside row unit between scrapers.
- Has an adjustable tension screw.
- Will not work with rotary disk scrapers.
- Available with dual liquid tube tail, dry tail or low profile tail
- Not for use with Precision Planting SpeedTube®.

Kinze Bracket Mount



Keeton Seed Firmers - Universal Bracket & Kinze Bracket

Model	Type	Description	Firmer Options	Product ID	Price
John Deere					
7000, 7100, 7200, 7300, 1700, 1530 Drill, 1535 Drill	Universal Bracket	Bracket mounts to seed disk opener shafts and around row unit shank Will fit MaxEmerge, ME2, ME Plus, ME Pro, ME XP Will NOT fit MaxEmerge 5 or ExactEmerge row units	Standard dry	KTN125012	\$34.00
			Standard dual liquid tube	KTN115011	\$34.00
			Short low profile tail, single liquid tube	KTN126008	\$34.00
Kinze					
2000, 3000	Kinze Bracket	Mounts inside row unit between scrapers Will NOT work with spring loaded disk scrapers	Standard dry	KTN125014	\$34.00
			Standard dual liquid tube	KTN115014	\$34.00
			Short low profile tail, single liquid tail	KTN126011	\$34.00
White					
6000, 8000, 9000	Universal Bracket	Bracket mounts to seed disk opener bolts Bracket modification is required	Standard dry	KTN125012	\$34.00
			Standard dual liquid tube	KTN115011	\$34.00
			Short low profile tail, single liquid tube	KTN126008	\$34.00

KEETON PLANTER REPLACEMENT TAILS

Keeton Planter Replacement Tails

All are compatible with WaveVision seed tubes.

Standard Dry Tail		Standard Liquid Tail		Short Low Profile Tail		Quick Attach Standard Tail		Quick Attach Low-Profile Tail		Quick Attach Low Stick Tail	
For Universal and Kinze Mounting Brackets						For Quick Attach Mounting Brackets					
Standard replacement tail with no liquid application tube. Recommended in non-sticky soil types and all planting environments.		Standard replacement tail with two liquid application tubes. Recommended in non-sticky soil types and all planting environments.		Low profile replacement tail with one liquid application tube. Recommended in sticky soil types and no-till or minimum-till planting environments. Not recommended in sandy soil types.		Standard replacement tail with one liquid application tube. Recommended in non-sticky soil types and all planting environments		Low profile replacement tail with one liquid application tube. Recommended in sticky soil types and no-till or minimum-till planting environments. Not recommended in sandy soil types.		Low stick replacement tail with one liquid application tube. Recommended in sticky soil types and no-till or minimum-till planting. Not recommended in sandy soil types.	
Product ID	Price	Product ID	Price	Product ID	Price	Product ID	Price	Product ID	Price	Product ID	Price
KTN125011	\$29.00	KTN115013	\$29.00	KTN126010	\$29.00	KTN140045	\$20.00	KTN140044	\$20.00	KTN140100	\$55.00

KEETON SEED FIRMERS

Seed Tube Mount



KEETON SEED FIRMERS - SEED TUBE MOUNT

- Mounts directly to the seed tube.
- Available with dry tail or liquid tail.
- Has an adjustable tension screw.

Keeton Seed Firmers - Seed Tube Mount

Model	Type	Description	Firmer Options	Product ID	Price
Great Plains					
Yield-Pro	Seed Tube Mount	Mounts to seed tube	Standard dry	KTN101000	\$31.50
			Standard single liquid tube	KTN101001	\$32.50
John Deere					
7000, 7100, 7200, 7300, 1700, 1530 Drill, 1535 Drill	Seed Tube Mount	Mounts to seed tube Will NOT fit ExactEmerge row units	Standard dry	KTN101000	\$31.50
			Standard single liquid tube	KTN101001	\$32.50
Kinze					
2000, 3000	Seed Tube Mount	Mounts to seed tube. Will NOT fit EdgeVac, Will NOT fit large OEM seed tube	Standard dry	KTN101000	\$31.50
			Standard single liquid tube	KTN101001	\$32.50
Monosem					
All	Seed Tube Mount	Mounts to seed tube	Standard dry	KTN101000	\$31.50
			Standard single liquid tube	KTN101001	\$32.50
White					
5000, 6000, 8000, 9000	Seed Tube Mount	Mounts to seed tube	Standard dry	KTN101000	\$31.50
			Standard single liquid tube	KTN101001	\$32.50

Keeton Brackets

Description	Product ID	Price
John Deere		
Bracket, Quick Attach, John Deere Exact Emerge	KTN141180	\$70.00
Bracket, Quick Attach, John Deere ME, ME2, ME+, Pro, XP, ME5	KTN150109	\$20.00
Bracket, Universal, John Deere ME, ME2, ME+, Pro, XP	KTN131500	\$10.50
Kinze		
Bracket, Quick Attach, Kinze 3000. Will NOT work with large OEM seed tubes. Mounts around seed tube, fastens to seed opener bolts.	KTN150120	\$20.00
Bracket, Quick Attach, Kinze 2000, 3000, 4000. Will work with large OEM seed tubes. Mounts behind seed tube, fastens to disc scraper bolts.	KTN150130	\$28.50
Bracket, Quick Attach, Kinze 4000. Will NOT work with large OEM seed tubes. Mounts around seed tube, fastens to seed opener bolts.	KTN150150	\$20.00
Bracket, Kinze, 2000, 3000	KTN111505	\$20.00
White		
Bracket, Quick Attach, White 8000	KTN150135	\$35.00
Bracket, Quick Attach, White 9000	KTN150111	\$20.00
Bracket, Universal, White 6000, 8000, 9000	KTN131500	\$10.50

Keeton Replacement Parts

Nozzle Kit, includes 1 splitter nozzle and 1 single stream nozzle, Quick Attach & Low Stick	KTN140105	\$6.00
Package of 4, splitter and insert, Quick Attach	KTN140049	\$15.00
Splitter insert, Universal, Kinze	KTN900004	\$0.55
Tubing, blue, 1/4" diameter, per foot	KTN900000	\$0.25
Tubing, red, 1/4" diameter, per foot	KTN900024	\$0.25



KTN141180



KTN150109



KTN131500



KTN111505

Get the money-making advantages of Keeton Seed Firmers for your drill too.

- Reduced seed costs. Improved germination means you get better stands with fewer seeds. On average, tests show a 9.4% increase in soybean germination.
- Field tests show an average soybean field yield increase of over 7%.

DRILLS

Drill firmers are only available with liquid tails.



Standard Liquid Drill Tail

Keeton Seed Firmer Drill Application Guide

Models	Notes	Bracket and Tail	Price	Replacement Tail Only	Price
Case-IH					
5100, 5400	Mounts to scraper housing.	KTN210006	\$29.50	KTN210054	\$27.50
Crustbuster					
3700, 3800 3400 w/o parallel arms	Mounts on scraper bracket. Will not fit 3400 All-Plant or 3400 Min-Till openers.	KTN210002	\$30.50	KTN210054	\$27.50
3400, 4000	Mounts to scraper support rod. Fits All-Plant & Min-Till openers.	KTN210004	\$30.50	KTN210054	\$27.50
Great Plains					
Fluted Metering Wheel Drills: 00, 05, 06, 07, 10 Series; 20 Series (-2003)	Mounts to scraper bracket.	KTN210008	\$29.50	KTN210054	\$27.50
Precision Drills (singulating & volumetric metering wheel): 10, 20 Series	Mounts to scraper bracket.	KTN210010	\$29.50	KTN210055	\$27.50
15, 25 Series Planter Style Row Units and HD10 Series Row Units	Mounts to scraper bracket.	KTN210027	\$29.50	KTN210055	\$27.50
All 00HD Series Row Units	Mounts to scraper bracket.	KTN210028	\$29.50	KTN210055	\$27.50
John Deere					
1560, 1860, 1590, 1890, 1690, 1990	Mounts to back of t-handle slotted bracket.	KTN210012	\$50.00	KTN210054	\$27.50
450, 455, 1520	Mounts to seed disk scraper.	KTN210014	\$29.50	KTN210054	\$27.50
750, 1850	Mounts to seed disk scraper.	KTN210016	\$65.00	KTN210054	\$27.50
Krause					
Most	Mounts to fertilizer opener.; Will not fit 5200 and 5400.	KTN210018	\$30.50	KTN210054	\$27.50
Marliss					
Most	Mounts to seed disk opener. Will not fit 2038.	KTN210020	\$30.50	KTN210054	\$27.50
Sunflower					
9411, 9412, 9421	Mounts to back of disk opener casting.	KTN210024	\$30.50	KTN210025	\$30.50
Tye					
All	Mounts to seed disk scraper.	KTN210023	\$30.50	KTN210054	\$27.50

MUR-LOK FITTINGS

- Leak Resistant Dual EPDM O-Rings
- Chemical Resistant Polypropylene
- NSF Standard 58 Certified
- 150 psi @ 70°F • 60 psi @ 140°F
- For Use with Plastic or Soft Metal Tubing



Mur-lok® Union

Mur-lok® Divider



Mur-Lok Fittings

Description	Product ID	Price
Mur-Lok union, 1/4" to 1/4"	KTN500000	\$2.44
Mur-Lok union, 3/8" to 1/4"	KTN500001	\$3.34
Mur-Lok union, 3/8" to 3/8"	KTN500002	\$3.32
Mur-Lok union, 1/2" to 3/8"	KTN500003	\$4.49
Mur-Lok union, 1/2" to 1/2"	KTN500004	\$3.80
Mur-Lok union, 5/16" to 1/4"	KTN500005	\$2.69
Mur-Lok union, 5/16" to 5/16"	KTN500006	\$2.60
Mur-Lok divider, 1/4" to 1/4"	KTN500100	\$3.84
Mur-Lok divider, 3/8" to 3/8"	KTN500101	\$4.45

EXAPTA MOJO WIRE



Put some **mojo** in your planting!

wire™



Torsion Loop



Improve the performance of your Keeton Seed Firmers in wet soil conditions with the Exapta Mojo Wire's self-cleaning action of the Keeton against the furrow sidewalls.

The Exapta Mojo Wire stiffener supplies up to 3 times the pressure to the standard Keeton. In testing and customers' experience, there has been a much better germination consistency — both in terms of higher percentages of seeds emerging, and in uniformity of timing of emergence.



Why the Mojo Wire?

- Up to 3x pressure of standard Keeton
- Ensures fast, uniform germination
- Large payback potential, especially in resilient no-till soils
- Quick fix for limp, aging Keeton firmers



Mojo Wire Kits		
Description	Product ID	Price
Mojo Wire, for Quick Attach mount, dry & liquid tails	KTN400315	\$19.00
Mojo Wire, for Universal bracket mount, liquid tails only	KTN400211	\$20.00
Mojo Wire, for Universal bracket mount, dry tails only	KTN400212	\$11.50
Mojo Wire, for Keeton seed tube mount	KTN400100	\$23.00
Mojo Wire, for Keeton drill firmer	KTN400600	\$11.00
Mojo Wire, for CNH Keeton drill firmer	KTN400608	\$13.00

DRILL FIRMERS WITH MOJO WIRE KITS

Models	Notes	Firmer Option	Bracket & Tail	Price	Tail Only	Price
Case-IH/New Holland						
CIH P-500 NH 2080, 2085	Mounts to opener on RIGHT side of drill. Only works with Exapta closing wheel upgrade kit.	Standard liquid tail w/o mojo wire	KTN210060	\$56.55	KTN210056	\$45.80
CIH P-500 NH 2080, 2085	Mounts to opener on LEFT side of drill. Only works with Exapta closing wheel upgrade kit.	Standard liquid tail w/o mojo wire	KTN210061	\$56.55	KTN210056	\$45.80
CIH P-500 NH 2080, 2085	Mounts to opener on RIGHT side of drill. Only works with Exapta closing wheel upgrade kit.	Standard liquid tail w/ mojo wire	KTN210064	\$56.55	KTN210156	\$45.80
CIH P-500 NH 2080, 2085	Mounts to opener on LEFT side of drill. Only works with Exapta closing wheel upgrade kit.	Standard liquid tail w/ mojo wire	KTN210065	\$56.55	KTN210156	\$45.80
CIH P-500 NH 2080, 2085	Mounts to opener on RIGHT side of drill. Works with OEM packer wheel.	Dry tail w/ mojo wire	KTN210062	\$56.55	KTN210159	\$45.80
CIH P-500 NH 2080, 2085	Mounts to opener on LEFT side of drill. Works with OEM packer wheel.	Dry tail w/ mojo wire	KTN210063	\$56.55	KTN210159	\$45.80

SEED & MECHANICAL LUBRICANTS



DUST Improves Seed Flow!

DUST Soy-Protein Lubricant provides top-end singulation and is less abrasive to seeds than dirty talc and graphite. DUST is cleaner, safer, non-carcinogenic, and made from U.S. Soybeans.

This is your Soy Check-Off Dollars at work!

This innovative, microplastic-free lubricant provides the needed lubricity for proper seed flow for any seed. DUST is proven to reduce static and to be up to 20 times less abrasive to seed than Talc (SGS Labs Study).

Talc and graphite are designed to lubricate seeds and planter equipment. DUST does the same thing but is safer for the farmer and the seed.

DUST is created from **U.S.-sourced soybeans**. It takes one bushel of soybeans to make 11 lbs. of DUST. Since it is made from soy protein, it will break down within 28 days from the furrow and provide more green-up and early plant viability.



LMT531914



LMT501901

Cleaner. Safer. Soy.[®] Solution

CLEANER: no more having to clean your hands, face or clothing from talc / graphite grime.



Graphite/Talc (left) vs. DUST

DUST is a low-use rate product. Generally, the starting rate should be no greater than one-half to one ounce per unit of seed.

PLEASE COMPARE COST PER UNIT.

To calculate how many pounds of DUST you need, please visit the DUST page on www.sidist.com or scan the QR code at right.



One pound of DUST treats an average of 32 to 50 units of seed.

DUST Soy Protein Lubricant

Product ID	Description	Price
LMT501901	DUST, 1-lb. container	\$16.50
LMT531914	DUST, 14-lb. container	\$130.00

eFLOW 80% TALC & 20% GRAPHITE MIX

This special blend of talc and graphite improves seed loading and seed release – and that improves seed spacing. eFlow improves the flow of seed from the hopper to the meter. In the meter, eFlow ensures that seeds release consistently once the vac is shut off and seeds drop to the seed tube. The addition of graphite, especially in smaller seeds, helps seeds slide off the disk like clockwork.



PPM930004

PPM930006



Graphite, eFlow and Dispenser Lid			
Description	Product ID	Price	
Graphite, 1-lb. bottle	BMP001775	\$5.95	
Graphite, 5-lb. jug	PPM930015	\$18.95	
Eflow, 80% talc, 20% graphite, 8-lb. container	PPM930004	\$25.95	
Dispenser lid, works with 8-lb. jugs of Precision Planting eFlow & talc; CNH 8-lb. talc/graphite & graphite; EZ Slide 8-lb. talc; Rural King 8-lb. talc/graphite. Does NOT fit John Deere containers.	PPM930006	\$12.95	



BMP001775



PPM930015



DUST Seed Lubricant + TERRASYM®

Terrasym® + DUST Improves Seed Flow, Nutrient Uptake, Root Development and Yield – NATURALLY!

DUST + Terrasym® 450 + TS201
 DUST + Terrasym® 450 for Corn
 DUST + Terrasym® 401 + for Soybeans

Microbial inoculants enhance nutrient uptake and increase yield, from planting through harvest.

DUST + Terrasym® 450 + TS201 BioStax™

SEASON-LONG BIOCONTROL PROTECTION
 Planting → Emergence → Mid-Season → Late Season → Harvest

Novel mode of action for insect biocontrol

This EPA-Registered Biopesticide provides increased plant health and root growth under varying insect pressure.

Terrasym-treated corn has enhanced root systems, even when under Rootworm pressure:

- Longer root, further soil depth and anchorage
- Broader circumference of root, greater standability

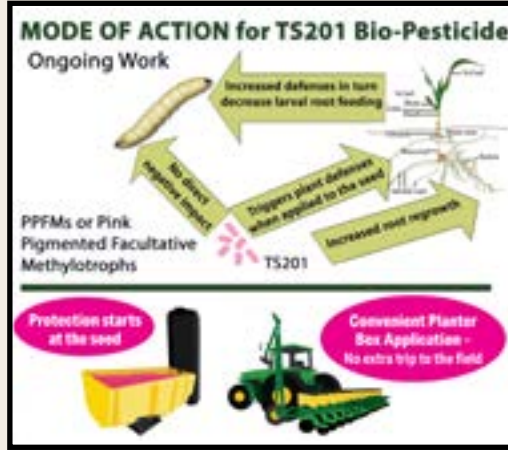

DUST + Terrasym 450 + TS201				
Description	Product ID	Price/Ea	Container Qty	Application Rate
DUST + Terrasym 450 + TS201	NFA100205	\$1,740.50	1.56 lb bag	0.5 oz per unit
One bag treats 50 units of corn @ 34K population				



DUST + Terrasym® 450 for Corn DUST + Terrasym® 401 for Soybeans

DUST™ + Terrasym® 450 for corn and DUST™ + Terrasym® 401 + for soybeans are designed to deliver improved nutrient uptake leading to robust early season root development, enhanced tolerance of abiotic stress throughout the growing season, and higher yields at harvest.



PPFMs Pink pigmented facultative methylobacteria, or PPFMs, are a unique class of microbes that reduce stress, improve early plant vigor and nutrient uptake.

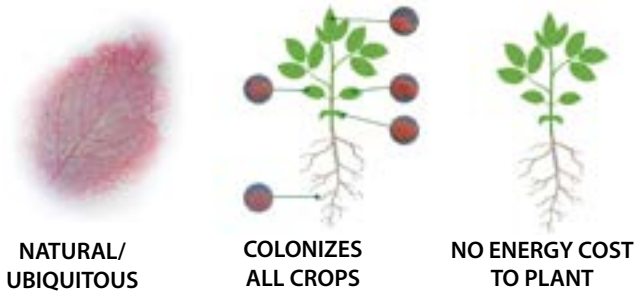

For more information, including research, and validations please visit the DUST + Terrasym page on www.sidist.com or scan the QR code at right.

Terrasym + DUST				
Description	Product ID	Price/Ea	Cost/Acre	Application
DUST + Terrasym 401 for Soybeans	LMT100401	\$270.00	\$6.75	One bag treats 40 units or 40 acres @ 140k population, 0.5 oz per unit
DUST + Terrasym 450 for Corn	LMT100450	\$796.50	\$6.75	One bag treats 50 units or 117.5 acres @ 34K population, 0.5 oz per unit



DUST + B4 DUST + B4 Increases the Availability of Phosphorous, Zinc and Iron that are in your Soil and Make it Available to your Crop

DUST™+B4 (blend of 4 Beneficials plus DUST) combines all the great benefits of DUST seed lubricant with a blend of highly beneficial bacillus microorganisms for use in agriculture for all crops. B4 solubilizes phosphorus, zinc, and iron that are in the soil and make it available to the crop. B4 rapidly creates a biofilm on the root of the plant. This biofilm is what contacts the soil and solubilizes P, Zn, and Fe. Because B4 is growing season long, it is increasing the availability of and uptake of P, Zn, and Fe throughout the growing season. DUST+B4 is recommended for dry planter box applications looking to increase nutrient uptake while initially providing seed lubricity.

DUST + B4				
Description	Product ID	Price/Ea	Container Qty	Application Rate
DUST + B4	NFA100901	\$826.00	1.56 lb bag	0.5 oz per unit
One bag treats 50 units of corn @ 34K population				



Re-distributes Weight from the Center of the Planter to the Wings

TRANSFER THE WEIGHT

Worried about the changing downforce fluctuations as you plant seed and apply fertilizer?

Does Your Planter Have a “Weight Problem”?

Excess weight in the center of a planter or improper weight distribution often leads to yield-robbing compaction, shallow or inconsistent planting, and reduced plant vigor. In addition, the natural reduction in weight that occurs during planting contributes to the problem of down force fluctuations that can negatively impact the accuracy of seed and fertilizer placement.

Irregular soil tilth, wet conditions and bumpy or rolling terrain can also wreak havoc with planting accuracy, resulting in uneven emergence and inconsistent stands.

The Martin-Till Weight Transfer System addresses this weight problem by redistributing excess weight from the center of the planter to the wings.

Keeping the wings level and the row units in the ground will keep planting depth consistent through changing conditions.

Eliminate Pinch Row Compaction



- Pinch row compaction leads to shorter, stunted plants, restricted roots and ultimately yield loss. Pinch row compaction can have a negative consequence to getting crops off to the right start.
- Restricted root growth will negatively impact nutrient uptake even when soil test values indicate sufficient nutrition.



Stunted roots from pinch rows, on the left, are dramatically smaller than the roots from corn planted by the planter wings, on the right.



WEIGHT TRANSFER SYSTEM



Keeping the wings level and the row units in the ground will keep planting depth consistent through changing conditions.

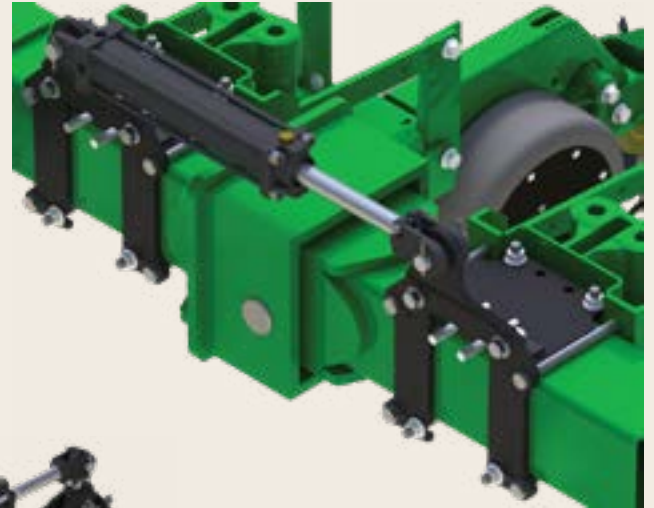

The transfer of the weight from the center of the planter to the wings reduces compaction and ground pressure, which more evenly distributes the weight to where it is needed most.

Kit Includes:

- In-Cab Control Box with harness (electronic PWM version)
- Hydraulic cylinders and durable hydraulic valves
- Bolt-on brackets
- Grade 8 mounting hardware



Featured in
NO-TILL
FARMER



NOTE: Can be used with Frame Mounted Opener

NOTE: Kit does not include custom hydraulic hoses or fittings

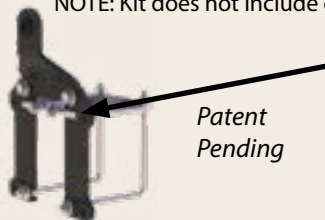

Patent Pending

Interlocking tab and slot design fit together to transfer load across the tool bar.



- **In-Cab Control Box**—Allows for easy adjustment as you plant. This rugged control box allows for fine tuning of the industry-standard hydraulic valve.

- **Hydraulic Control Kit** provides durable and quick adjustment

Weight Transfer System			
Model	Description	Product ID	Price
Case-IH 1255	24 Row, 30"	MRT900454	\$9,000.00
Harvest International Laser Pro 1	12 row, 16 Row 30" on JD 1770/1775 Bar	MRT900220	\$7,800.00
John Deere 1770	12 Row, 30"	MRT900356	\$7,800.00
	16 Row, 30"	MRT900083	\$7,800.00
	24 Row, 30"	MRT900244	\$9,000.00
John Deere 1775	12 Row, 30"	MRT900356	\$7,800.00
	16 Row, 30"	MRT900083	\$7,800.00
	24 Row, 30"	MRT900244	\$9,000.00
John Deere 1790	16-31/32 Row, 15"	MRT900079	\$7,800.00
	24 Row, 20"	MRT900320	\$7,800.00
John Deere 1795	16-31/32 Row, 15"	MRT900283	\$7,800.00
John Deere DB60	All row configurations Stacked bar only	MRT900441	\$9,000.00



YouTube.com
"S.I. Distributing Planting Innovations"

VIDEO: Weight Transfer System - Benefits Explained and In Action





COMPACT CLEAN RIDE™ (ACCR) ROW CLEANER

Improves planter performance with innovative cast parallel linkage design.

The **ACCR1360 floating row cleaner** measures less than 14" from the face plate. It uses the HA44270D heavy-duty greaseable tapered roller bearing hub with a triple-lip seal.



ACCR1360 Row Cleaner

The **ACCR1345 floating row cleaner** is perfect for **high speed or narrow rows**. It measures less than 16" from the face plate. It uses CHU44C cast hubs and maintenance-free, long-life 5205 double row bearing with a six-lip seal.



ACCR1345 Row Cleaner

ACCR1345

* Treader Wheels are sold separately.

- 4" vertical travel
- Parallel linkage allows for easy floating action, especially when paired with Martin-Till® Smart-Clean or Precision Planting Clean Sweep®
- Compatible with front frame mounted nitrogen coulters or where full-size row cleaners can't be used due to clearance issues
- Factory pre-assembled chassis saves time and makes it a cinch to install
- Choice of Spike or Razor wheels can be installed, intersected or offset

Please see spike wheel and razor wheel comparison on page 24.



#MRT007111 - 13" Depth Blade (Filler Plate)



#MRT900409 CIH 2000 Series Adapter Bracket

ACCR1360 Wide Floating Row Cleaner Compact Clean Ride™

Case-IH	Vendor ID	Spiked	Razor	Price
800, 900, 1200	ACCR1360-1200	MRT141360	MRT241360	\$849.50
2000 (1)	ACCR1360	MRT101360	MRT201360	\$789.50
Fendt	Vendor ID	Spiked	Razor	Price
Momentum	ACCR1360	MRT101360	MRT201360	\$789.50
John Deere	Vendor ID	Spiked	Razor	Price
7000, 7100, 7200, 7300, 1700, DB	ACCR1360	MRT101360	MRT201360	\$789.50
Kinze	Vendor ID	Spiked	Razor	Price
2000, 3000, 4000, 5000	ACCR1360	MRT101360	MRT201360	\$789.50
White, Massey Ferguson	Vendor ID	Spiked	Razor	Price
6000, 8000, 9000	ACCR1360	MRT101360	MRT201360	\$789.50

It is recommended to run a Clean Sweep system or a Smart Clean Air System with ACCR Row Cleaners.

ACCR1345 Narrow Floating Row Cleaner Compact Clean Ride™

Case-IH	Vendor ID	Spiked	Razor	Price
800, 900, 1200	ACCR1345-1200	MRT141345	MRT241345	\$849.50
2000 (1)	ACCR1345	MRT101345	MRT201345	\$789.50
Fendt	Vendor ID	Spiked	Razor	Price
Momentum	ACCR1360	MRT101360	MRT201360	\$789.50
John Deere	Vendor ID	Spiked	Razor	Price
7000, 7100, 7200, 7300, 1700, DB	ACCR1345	MRT101345	MRT201345	\$789.50
Kinze	Vendor ID	Spiked	Razor	Price
2000, 3000, 4000, 5000	ACCR1345	MRT101345	MRT201345	\$789.50
White, Massey Ferguson	Vendor ID	Spiked	Razor	Price
6000, 8000, 9000	ACCR1345	MRT101345	MRT201345	\$789.50

It is recommended to run a Clean Sweep system or a Smart Clean Air System with ACCR Row Cleaners.

ACCR1360/ACCR1345 Optional Accessories	Vendor ID	Product ID	Price
Aluminum Side Treader Wheel (2 required per row); Reduces trenching in soft soils and provides traction in loosely-worked ground.	STW-04A	MRT003003	\$50.00
Depth blade/filler plate (2 required per row) for 12.5" razor or 13" spiked wheels - eliminates wrapping when planting in to cover crops	BLD10.5	MRT007111	\$40.00
(1) CIH 2000 series adapter bracket (needed if planter is NOT equipped with CIH#4854385)	900409	MRT900409	\$38.00

WA 1360 ROW CLEANERS



WA 1360 FLOATING ROW CLEANER

- Only requires 19" of clearance from planter face plate, 22" when using with a no-till couler, 25" when using with single UMO-150 fertilizer opener, 30" with dual UMO-150.

Please see spike wheel and razor wheel comparison on page 24.



WA

60-degree heavy-duty frame

Shown with side treader wheels, razor wheels and bracket

- Choice of Spike or Razor wheels can be installed, intersected or offset
- HA44270D Heavy Duty Greaseable Tapered Roller Bearing Hub with triple-lip seal

*** Treader Wheels are sold separately.**

WA1360 Floating Row Cleaner For Coulters and Without Coulters					
Case-IH		Vendor ID	Spiked	Razor	Price
800, 900, 1200	without no-till coulters	BCIH1360	MRT101385	MRT201385	\$664.00
2000 (1)		BA1360	MRT101386	MRT201386	\$626.00
Fendt		Vendor ID	Spiked	Razor	Price
Momentum	without no-till coulters	BA1360	MRT101386	MRT201386	\$626.00
Harvest International		Vendor ID	Spiked	Razor	Price
Laser Pro	without no-till coulters	BA1360	MRT101386	MRT201386	\$626.00
Horsch		Vendor ID	Spiked	Razor	Price
Maestro	without no-till coulters	BH1360	MRT101383	MRT201383	\$626.00
John Deere		Vendor ID	Spiked	Razor	Price
7000, 7100	without no-till coulters	BA1360	MRT101386	MRT201386	\$626.00
7200, 7300, 1700, DB	without no-till coulters	BA1360	MRT101386	MRT201386	\$626.00
	with OEM unit mount no-till couler	BDC1360	MRT101368	MRT201368	\$626.00
	with OEM double disc fertilizer openers	BDD1360	MRT101376	MRT201376	\$632.50
Kinze		Vendor ID	Spiked	Razor	Price
2000, 3000, 4000, 5000	without no-till coulters	BA1360	MRT101386	MRT201386	\$626.00
2000, 3000	with OEM double arm, unit mount no-till couler	BKC1360	MRT101367	MRT201367	\$626.00
4000	with OEM double arm, unit mount no-till couler	BKC41360	MRT101378	MRT201378	\$626.00
White, Massey Ferguson		Vendor ID	Spiked	Razor	Price
6000, 8000, 9000	without no-till coulters	BA1360	MRT101386	MRT201386	\$626.00
WA 1360 Optional Accessories		Vendor ID	Product ID	Price	
Aluminum Side Treader Wheel (2 required per row)		STW-04A	MRT003003	\$50.00	
Cam Adjust Kit, WA1360, all models except Kinze with OEM dual arm no-till couler		CA-03D	MRT003154	\$90.50	
Cam Adjust Kit, WA1360 for Kinze 2000, 3000 with OEM dual arm no-till couler only		CA-03K	MRT003155	\$98.50	
Depth blade/filler plate (2 per row) for 12.5" razor or 13" spiked wheels - eliminates wrapping when planting in to cover crops		BLD10.5	MRT007111	\$40.00	
WA 1360 Exceptions		Vendor ID	Product ID	Price	
(1) CIH 2000 series bracket (needed if planter is NOT equipped with CIH#4854385)		900409	MRT900409	\$38.00	
Unit set back bracket, John Deere 7000, 7100; all Kinze except 4900		USB-70	MRT003500	\$115.50	
Unit set back bracket, John Deere 7200, 7300, 1700, DB		USB-72	MRT003510	\$164.00	



- Smart Clean, Precision CleanSweep and Cam Adjust compatible

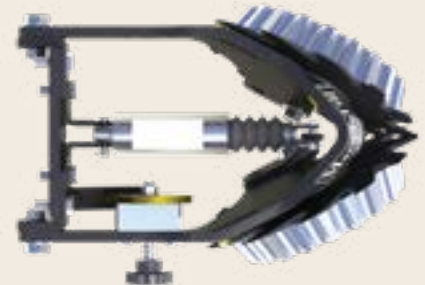

"On our farm, we use the 1360 row cleaner on two Kinze planters. We have been using them for more than five years and they have required little to no maintenance. I recommend Martin row cleaners, with confidence, because of their durability and dependability."

Aaron Wolf - Dixon, IL

WA1345 ROW CLEANERS

WA1345 NARROW FLOATING ROW CLEANER

As planters get faster and row width narrower, a less aggressive row cleaner is needed.

- **Narrow 45-degree frame, ideal for high speed planting or narrow rows**
- CHU44C cast hubs and long life PEER SEEDXTREME 5205 double row bearing with a six-lip seal

*** Treader Wheels are sold separately.**



- Choice of Spike or Razor wheels can be installed, intersected or offset
- Smart Clean, Precision CleanSweep and Cam Adjust compatible

WA1345 Narrow Floating Row Cleaner For Use Without Coulters					
Case-IH		Vendor ID	Spiked	Razor	Price
800, 900, 1200, 2000	without no-till coulters	BCIH1345	MRT301385	MRT401385	\$664.00
2000 (1)		BA1345	MRT301386	MRT401386	\$626.00
Fendt		Vendor ID	Spiked	Razor	Price
Momentum	without no-till coulters	BKW1345	MRT301386	MRT401386	\$626.00
Harvest International		Vendor ID	Spiked	Razor	Price
Laser Pro	without no-till coulters	BA1345	MRT301386	MRT401386	\$626.00
Horsch		Vendor ID	Razor	Price	Price
Maestro	without no-till coulters	BH1345	MRT101383	MRT201383	\$626.00
John Deere		Vendor ID	Spiked	Razor	Price
7000, 7100	without no-till coulters	BA1345	MRT301386	MRT401386	\$626.00
7200, 7300, 1700, DB	without no-till coulters	BA1345	MRT301386	MRT401386	\$626.00
Kinze		Vendor ID	Spiked	Razor	Price
2000, 3000, 4000, 5000	without no-till coulters	BA1345	MRT301386	MRT401386	\$626.00
White, Massey Ferguson		Vendor ID	Spiked	Razor	Price
6000, 8000, 9000	without no-till coulters	BA1345	MRT301386	MRT401386	\$626.00
WA1345 Optional Accessories			Vendor ID	Product ID	Price
Aluminum Side Treader Wheel (2 required per row)			STW-04A	MRT003003	\$50.00
Cam Adjust Kit, WA1345, all models			CA-45	MRT003176	\$90.50
Depth blade/filler plate (2 per row) for 12.5" razor or 13" spiked wheels - eliminates wrapping when planting in to cover crops			BLD10.5	MRT007111	\$40.00
WA1345 Exceptions			Vendor ID	Product ID	Price
(1) CIH 2000 series bracket (needed if planter is NOT equipped with CIH#4854385)			900409	MRT900409	\$38.00
Unit set back bracket, John Deere 7000, 7100; all Kinze except 4900			USB-70	MRT003500	\$115.50
Unit set back bracket, John Deere 7200, 7300, 1700, DB			USB-72	MRT003510	\$164.00

Choose Spike or Razor Wheel for All Row Cleaners

SPIKE WHEELS' intersecting spike teeth lightly till the seed zone.

- Moves the least amount of soil.
- The larger soil window between the teeth allows residue to be moved without moving vital soil away from the row center.
- Performs well in green material, when combined with an internal scraper and a depth blade (filler plate).



RAZOR WHEELS cut through tough crop residue and cover crops with ease.

- Made from 1/4" T-1, and heat treated a second time for extended long life.
- The angled teeth drop material as the wheel exits the ground preventing wrapping and, when combined with the scraper, it remains wrap-free even in standing cover crops.



With Scraper **Without Scraper**

Scrapers come standard with all row cleaners

MARTIN CLOSING WHEELS

fCRUSHER CLOSING WHEEL

Firms and Crumbles at the Same Time

- **Tapered tooth design** allows firming on one side and crumbling on the other.
- No more wearing one side of plastic until it has to be flipped.
- Long-life ductile cast iron will run for years and years.
- Can be ran in pairs to crumble both sides of seed trench or matched with rubber/cast wheel for economical alternative.

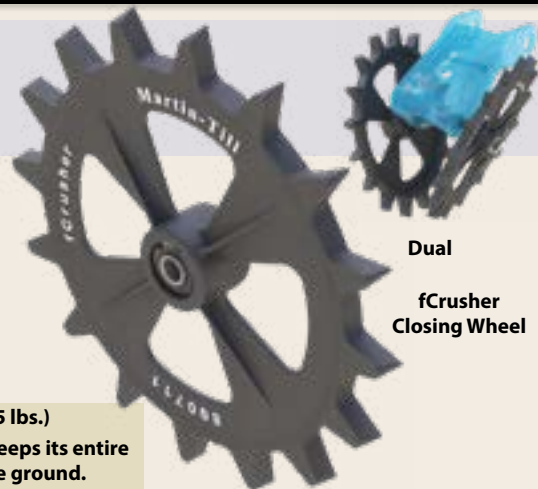

Dual
fCrusher
Closing Wheel

fCrusher Closing Wheel	Vendor ID	Product ID	Price
Single 5/8" bearing or 16mm bolt on	800711	MRT800711	\$128.00

Lightweight (9.5 lbs.)
Drafted tooth keeps its entire
foot print on the ground.

DUAL 14" 14-TOOTH CUPPED RAZOR CLOSING WHEEL SET

Works Well in Cover Crops - Prevents Wrapping - Standard Planting Depths

- Razor teeth crumble sidewalls while the cupped design **squeezes** the soil towards the seed ensuring good seed-to-soil contact
- 1/4" thick, heat-treated T-1 wheels, with 14 beveled razor teeth
- Excellent for varying conditions; works well from high-moisture soils to dryer conditions



Works
Great in
Cover Crops!

BSCW1444C -
14" 14-Tooth
Cupped Razor
Wheels

Dual 14" 14-Tooth Cupped Razor Closing Wheel Set	Vendor ID	Product ID	Price
5/8" bearing or 16mm bolt on	BSCW1444C	MRT141844	\$368.00
17mm Wheels slide on threaded stud	BSCW1443C	MRT141843	\$368.00
Water pump style bearing (roll pin)	BSCW1441C	MRT141841	\$408.00

DUAL 14" 18-TOOTH CUPPED RAZOR CLOSING WHEEL SET

Works Well in Cover Crops - Prevents Wrapping - Shallow Planting Depths



Works
Great in
Cover Crops!

MRT181844 -
14" 18-Tooth
Cupped Razor
Wheels

- Razor teeth crumble sidewalls while the cupped design **squeezes** the soil towards the seed ensuring good seed to soil contact
- 1/4" thick, heat-treated T-1 wheels, with 18 beveled razor teeth
- **A good choice for shallow-planted crops**

Dual 14" 18-Tooth Cupped Razor Closing Wheel Set	Product ID	Price
5/8" bearing or 16mm bolt on	MRT181844	\$368.00
17mm Wheels slide on threaded stud	MRT181843	\$368.00
Water pump style bearing (roll pin)	MRT181841	\$408.00

DUAL 13" SPADING (SPIKE) CLOSING WHEEL SET

For compaction-free closing of the seed trench in wet or harsh conditions



BSCW1344
13" Spike Wheels

- Moves soil toward the seed at planting depth while lifting and fracturing the surface layer
- Forms soil around the seed from each side and loosens the surface layer, enabling crops to emerge sooner and allows planting at the proper depth, without sidewall compaction
- 3/8" thick, right and left toothed steel wheels with 14 teeth & diamond shaped points

Dual 13" Spading Closing Wheel Set	Vendor ID	Product ID	Price
5/8" bearing or 16mm bolt on	BSCW1344	MRT001344	\$340.00
17mm Wheels slide on threaded stud	BSCW1343	MRT001343	\$340.00
Water pump style bearing (roll pin)	BSCW1341	MRT001341	\$380.00
White 5100, Compatible with single 4" x 12" factory closing wheel	BSCW514	MRT005104	\$398.00
White 6100, Compatible with single 4" x 12" factory closing wheel	BSCW614	MRT006104	\$398.00

SINGLE 15" SPADING (SPIKE) CLOSING WHEEL

For compaction-free closing of the seed trench in wet or harsh conditions

- 15" spading closing wheel should be paired with a 12" rubber or cast wheel
- Consistently outperforms two solid rubber closing wheels
- 3/8" thick, 15" diameter right and left toothed steel wheels with diamond shaped points



BSCW1544R
15" Spike Wheel

Single 15" Spading Closing Wheel	Vendor ID	Product ID	Price
5/8" bearing or 16mm bolt on, left side of row	BSCW1544SL	MRT101544	\$184.00
5/8" bearing or 16mm bolt on, right side of row	BSCW1544SR	MRT201544	\$184.00
17mm Wheels slide on threaded stud, left side of row	BSCW1543SL	MRT101543	\$184.00
17mm Wheels slide on threaded stud, right side of row	BSCW1543SR	MRT201543	\$184.00
Water pump style bearing (roll pin), left side of row	BSCW1541SL	MRT101541	\$204.00
Water pump style bearing (roll pin), right side of row	BSCW1541SR	MRT201541	\$204.00



Spading Closing Wheels Options	Vendor ID	Product ID	Price
Leveling kit, drop down brackets are designed for paired 13" wheels to help maintain a level closing wheel arm assembly in loose soils. For Deere or Kinze with bolt-on 13" spading wheels.	DK-01	MRT004191	\$30.00
Internal deflectors (scrapers) for 13" and 15", 5/8" bolt-on style spading closing wheels. Reduces buildup of mud and residue to insure fractured soil is placed evenly over seed trench.	ITDSCWSET	MRT003149	\$53.00
Filler blade for 15" spading wheels in heavy residue or cover crops.	BLD-12	MRT007110	\$40.00
Filler blade for 13" spiked wheels in heavy residue or cover crops.	BLD10.5	MRT007111	\$40.00



DUAL 13" CUPPED DIMPLE CLOSING WHEEL SET

DUAL 13" DIMPLE CLOSING WHEEL SET

For medium moisture to dry conditions, and hard conditions



BSCW1344DC 13"
Cupped Dimple Wheels

BSCW1344D
13" Dimple
Wheels

- 20 Rounded Points Crumble Sidewalls
- Less aggressive than spike closing wheels.
- Works well on high speed planters, drills and seeders

Dual 13" Cupped Dimple Closing Wheel Set	Vendor ID	Product ID	Price
5/8" bearing or 16mm bolt on	BSCW1344DC	MRT111344	\$340.00
17mm Wheels slide on threaded stud	BSCW1343DC	MRT111343	\$340.00
Water pump style bearing (roll pin)	BSCW1341DC	MRT111341	\$380.00
Dual 13" Dimple Closing Wheel Set	Vendor ID	Product ID	Price
5/8" bearing or 16mm bolt on	BSCW1344D	MRT011344	\$313.00
17mm Wheels slide on threaded stud	BSCW1343D	MRT011343	\$313.00
Water pump style bearing (roll pin)	BSCW1341D	MRT011341	\$353.00

MARTIN-TILL CLOSING WHEEL ENHANCEMENTS

TWISTED DRAG CHAIN

*Crumbles, fills unclosed areas
and levels soil above the seed slot*



- Heavy-duty, square-edged cross chain and brackets
- Attaches to closing wheel brackets
- Bolts to all John Deere Max-Emerge units
- Fits Kinze and White units with bolt-on wheels
- Units with roll pin attached closing wheels will need holes drilled for mounting

Martin-Till Drag Chain Kit

Description	Product ID	Price
Drag Chain Kit	MRT003600	\$58.00



2ND STAGE CLOSER *Seals and levels air pockets*

*Seals and levels air pockets left in seed
trench to ensure ideal seed-to-soil contact*



MRT900296
2nd Stage Closer
Bracket



(Shown with 6"
Rubber Packing
Wheel, sold
separately.)



(Shown with 4" Rubber
Packing Wheel, sold
separately. Also shown
with optional Martin-Till
cupped razor wheels.)



The **fCrumbler** mulches and firms the seed trench without smearing or packing and reduces crusting. This cleat design prevents mud build up from wet conditions or fertilizer application.

2nd Stage Closer Bracket	Product ID	Price
John Deere XP, ME5 (fits cast brackets only)	MRT900296	\$295.50
Kinze (fits bolt on style brackets only)	MRT900311	\$295.50
White 9000	MRT900312	\$319.50

Packing wheel sold separate, see options below. 2nd Stage Closer is compatible with most closing wheels.

2nd Stage Closer Packing Wheel	Product ID	Price
4" fCrumbler	MRT900397	\$161.00
4" Rubber	MRT800451	\$98.00
6" Rubber	MRT800419	\$98.00

- Add the optional Martin-Till 14 inch Cupped Razors (BSCW1444C) that will break the side wall compaction and SQUEEZES soil toward seed ensuring the best seed-to-soil contact.
- Easily mounts to most Double V Style OEM closing wheel brackets.
- Cam Adjust allows adjustment of pressure applied to press wheel.



(Shown with (MRT800419)
6" rubber packing wheel and
(MRT011344) dimple closing
wheel set.)

CASE-IH CLOSING WHEELS

Moist soil is moved toward the seed at seeding depth. In wet conditions, the soil is prevented from forming a continuous ribbon by the lifting action of the teeth as they rotate up out of the soil.

Martin-Till's Case-IH closing wheels replace the solid closing discs on Case-IH planters.



Benefits include:

- Closing wheel arm pressure can be greatly reduced
- Seeding depth does not have to be raised to ensure emergence
- Soil above the seed is loose, allowing quicker emergence in a compaction-free environment
- Sidewall compaction is eliminated



CASE-IH 9" SPADING (SPIKE) CLOSING WHEEL SET

- Heavy-duty PEER Seed Extreme bearing

Spading Closing Wheel Set	Vendor ID	Product ID	Price
Case-IH 800, 900, 1200; (9" spading wheels) Fits Deere or Kinze with shallow closing attachment	BSCW899	MRT089903	\$194.00



CASE-IH CUPPED RAZOR CLOSING WHEEL SETS



- Heavy-duty PEER Seed Extreme bearing

Cupped Razor Closing Wheel Set	Vendor ID	Product ID	Price
Case-IH 800, 900, 1200; (9" cupped wheels) Fits Deere or Kinze with shallow closing attachment	BSCW9ZC-1200	MRT900472	\$194.00
Case-IH 2000 series (9" cupped wheels)	BSCW9ZC-2000	MRT089922	\$194.00

CASE-IH 9" CAMBER ADJUST CLOSING KIT

Changes angle of Case standard stance to V-style for better gathering action

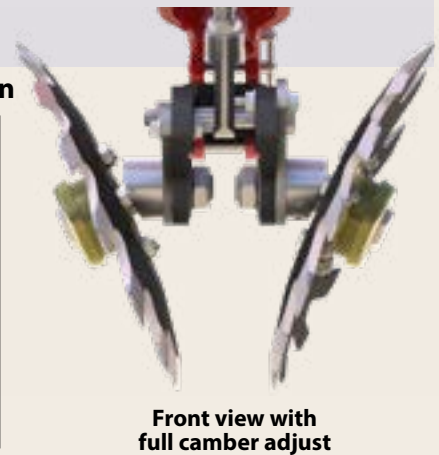

Packing wheel and closing wheel are not included.

- New axles allow fine adjustment of Toe-in to fit your specific environmental needs
- The sharpened teeth chip the side wall while forcing soil towards the seed to close the furrow
- Updated swing arm with more clearance means less plugging

- Recommended for use with 9" cupped razor wheels sold separately.
- If new packing wheel is needed or upgrading to fCrumbler, see options below.

Case-IH Camber Adjust V-Style Closing Kit	Vendor ID	Product ID	Price
Case-IH 2000	900252	MRT900252	\$487.00

Case-IH Packing Wheel Options	Vendor ID	Product ID	Price
4" fCrumbler	900397	MRT900397	\$161.00
4" Rubber	800451	MRT800451	\$98.00
6" Rubber	800419	MRT800419	\$98.00

MARTIN-TILL CLOSING WHEELS FOR DRILLS

- 1/2" thick, 13" diameter with 20 rounded points crumbles side walls
- 13" Spading Closing Wheels work well in high moisture conditions



Drill/Seeder Spading Closing Wheels	Vendor ID	Product ID	Price	
Deere 750, 1850	13" single spiked closing wheel, LH	BSCW75BL	MRT175404	\$185.50
	13" single spiked closing wheel, RH	BSCW75BR	MRT275404	\$185.50
Deere 1560, 1590, 1690, 1860, 1890, 1895, 1990	13" single spiked closing wheel, LH	BSCW156L	MRT115604	\$117.50
	13" single spiked closing wheel, RH	BSCW156R	MRT215604	\$117.50



MRT075104
13" 20-Point
Dimple-
Closing Wheel

Drill/Seeder Dimple Closing Wheels	Vendor ID	Product ID	Price	
Deere 750, 1850	13" single 20 pt. dimple closing wheel, LH	BSCW75BDL	MRT075204	\$172.00
	13" single 20 pt. dimple closing wheel, RH	BSCW75BDR	MRT075104	\$172.00
Deere 1560, 1590, 1690, 1860, 1890, 1895, 1990	13" single 20 pt. dimple closing wheel	BSCW156D	MRT315604	\$104.00



MRT315604
13" 20-Point
Dimple
Closing Wheel

CLOSING WHEEL ANGLE CHANGER FOR CNH AIR DRILLS

Adjustable Angle Changer for CNH 500T Air Drills.
0-11 degree adjustments with quick adjust knob.



CNH Air Drill Closing Wheel Angle Changer	Product ID	Price
CNH 500T Closing wheel angle changer, Left Hand	MRT900307	\$197.50
CNH 500T Closing wheel angle changer, Right Hand	MRT900308	\$197.50



YouTube.com "S.I. Distributing Planting Innovations"

EIGHT VIDEOS: Martin-Till Planting Attachments - Benefits Explained and In Action

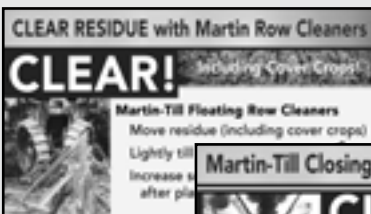

Martin-Till Planting Attachments

CLEAR! Floating Row Cleaners	CONTROL! Smart Clean Row Cleaner Adjustment System	TRANSFER THE WEIGHT! Weight Transfer System
FERTILIZE! Unit Mounted Fertilizer Opener (UMOs)	CLOSE! Closing Wheels	SEAL AND LEVEL! 2nd-Stage Closer Twisted Drag Chain

PIN-ADJUST/RIGID ROW CLEANERS

The Martin original style row cleaner clears the widest path of any tooth wheel row cleaner on the market.

The 15" diameter, 3/8" thick, T-1 heat-treated wheels are made left and right in order to shed the residue better.

Step 1 Martin Pin-Adjust Row Cleaners			
Description	Product ID	Vendor ID	Price
Pin-adjust row cleaner, narrow row, 1-1/2" stem, 13" wheels	MRT001320	WA1320N	\$486.00
Pin-adjust row cleaner, 1-1/2" stem, 13" wheels	MRT001332	WA1332	\$488.50
Pin-adjust row cleaner, 2" stem for Case-IH planters, 13" wheels	MRT001334	WA1334	\$488.50
Pin-adjust row cleaner, 1-1/2" stem, 15" wheels	MRT001532	WA1532	\$516.50
Step 2 Martin Pin-Adjust Mounting Brackets			
Description	Product ID	Vendor ID	Price
Case-IH 800, 900 series without heavy duty down pressure springs, accepts 2" stem wheel assemblies	MRT000892	MT892	\$89.50
Case-IH 1200, 1300 series, accepts 2" stem wheel assemblies	MRT001250	MT1250	\$89.50
Deutz-Allis Quadra Disk, Landoll, accepts 1-1/2" stem wheel assemblies	MRT002400	MT385	\$91.50
John Deere, Kinze, White EARLY 6000 series with REGULAR down pressure springs and White 9000, accepts 1-1/2" stem wheel assemblies	MRT002000	MT772	\$113.00
Kinze 4900 w/o pneumatic down pressure, accepts 1-1/2" stem wheel assemblies	MRT004772	MT4772	\$113.00
White 5000 series, accepts 1-1/2" stem wheel assemblies	MRT002200	MT512	\$91.50
White EARLY 6000 series with HEAVY duty down pressure springs, accepts 1-1/2" stem wheel assemblies	MRT000610	MT610	\$113.00
White LATE 6000 series and all 8000 series, accepts 1-1/2" stem wheel assemblies	MRT002100	MT810	\$113.00

Pin-Adjust Row Cleaner (MRT001320) shown with Mounting Bracket (MRT002000)



- Intersecting teeth reach the entire row middle and aid in cleaning one another.
- Can be set offset or intersecting with your choice of 13" or 15" or 12.5" razor wheels.

TWIN ROW CLEANERS

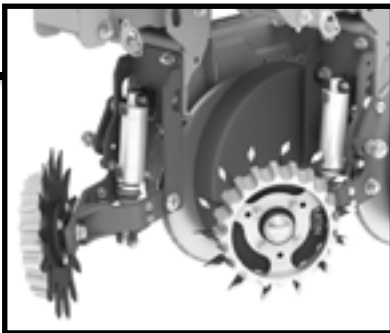

- Compact design - just 15 1/2" from row unit faceplate!
- Uses HA44270D heavy-duty greasable tapered roller bearing hub with 2 lip seal
- Over 5" travel while maintaining a consistent wheel stance when riding over uneven ground.

Make/Model	Spiked	Razor	Price
Great Plains; Harvest International John Deere; Kinze	Left Hand	MRT900463	\$521.00
	Right Hand	MRT900464	
It is recommended to run a Clean Sweep system or a Smart Clean Air System with Twin Row Cleaners.			

Optional Accessories	Vendor ID	Product ID	Price
Aluminum Side Treader Wheel (1 required per row). Reduces trenching in soft soils and provides traction in loosely-worked ground.	STW-04A	MRT003003	\$50.00
Depth blade/filler plate (1 per row) for 12.5" razor or 13" spiked wheels - eliminates wrapping when planting into cover crops	BLD10.5	MRT007111	\$40.00

DUAL UMO-150 *Compatible with 1360 & 1345 Row Cleaners*

Dual UMOs Allow for Yield-Enhancing 2 x 3 x 2 Fertilizer Application

Places nutrients at various depths 3" on BOTH sides of seed for maximum usage!

Dual UMO-150

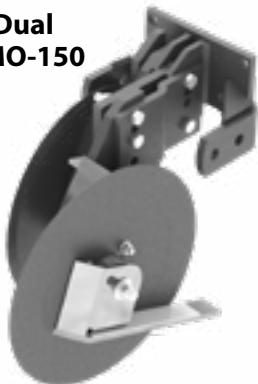

- Allows more nutrients to be applied
- Increases root mass
- Promotes faster growth
- Improves yields

Pricing on page 31

Enhances plant size and strength

Shown with optional side treader wheels, cam adjust and Smart Clean

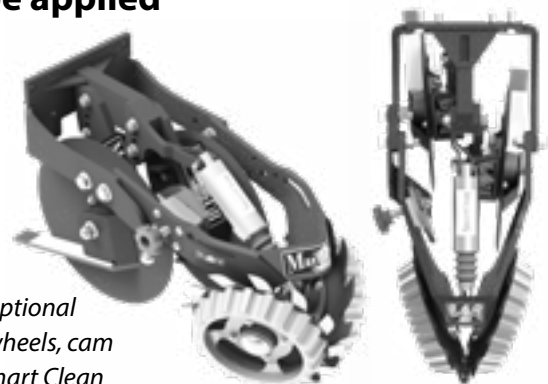

UNIT-MOUNTED FERTILIZER OPENER (UMO)

Single
UMO-150

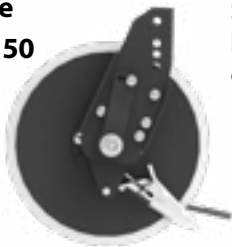

Standard 14" smooth blade for use in no-till conditions...

OR

Notched 15" blade for use in min-till or conventional till

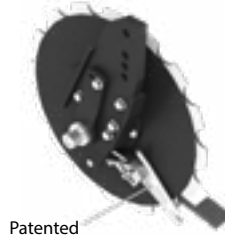

Patented

Consistently places fertilizer in the ground without splattering it on the planter!

Adjustable Furrow Control Strap keeps soil in place. It prevents the blow-out of furrow walls.



IMPROVED design allows more ground clearance with a more narrow profile

Furrow control strap reduces furrow blow-out while minimizing erosion and fertilizer splattering.

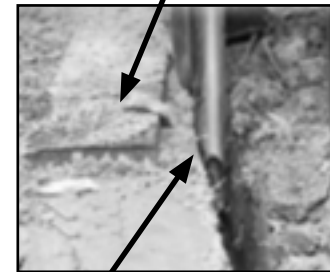

Spring loaded furrow shoe places liquid in the ground not on the planter.

FEATURES OF UMO-150:

- Sturdy compact design
- Greaseable Double tapered bearing hub with two triple lip seals
- 5mm thick (0.197") 14" smooth blade or 15" notched blade
- Updated & improved placement shoe for less friction
- Adjustable furrow control strap keeps soil in place
- Can be set to place liquids 1", 2", or 3" from seed row
- Can also be set to place liquids 3/4" above, even with seed depth or 3/4" below

Unit-Mounted Fertilizer Opener				
Step 1A UMO-150 for no-till	Vendor ID	Product ID	Price	
Single UMO-150, standard 14" smooth blade, left	UMO-150L	MRT100150	\$538.00	
Single UMO-15, standard 14" smooth blade, right	UMO-150R	MRT200150	\$538.00	
Double UMO-150, standard 14" smooth blade, left		MRT300150	\$1,076.00	
Double UMO-150, standard 14" smooth blade, right		MRT400150	\$1,076.00	
Step 1B UMO-150 for min-till/conventional-till	Vendor ID	Product ID	Price	
Single UMO-150, 15" notched blade, left	900171	MRT900171	\$552.50	
Single UMO-150, 15" notched blade, right	900172	MRT900172	\$552.50	
Double UMO-150, 15" notched blade, left		MRT300171	\$1,102.00	
Double UMO-150, 15" notched blade, right		MRT400172	\$1,102.00	
Step 2A Single UMO Mounting Bracket	Vendor ID	Product ID	Price	
John Deere 7200-1700, White 9000; single UMO	UMO-MTJ	MRT000300	\$52.00	
John Deere 7000, 7100 and Kinze 2000, 3000; single UMO	UMO-MTA	MRT000301	\$52.00	
White 8000; single UMO	UMO-MTW	MRT000302	\$52.00	
Step 2B Single UMO Mounting Bracket (row cleaner ready)	Vendor ID	Product ID	Price	
Case-IH 1200, 2000; single UMO	MT1360CU	MRT001371	\$130.00	
John Deere 7200-1700, White 9000; single UMO	MT1360DU	MRT001365	\$111.50	
John Deere 7000, 7100; Kinze 2000, 3000; White 6000, 8000; single UMO	MT1360KU/WU	MRT001363	\$111.50	
Kinze 4900	MT1360K4U	MRT001379	\$111.50	
Step 2C Dual UMO Mounting Bracket (row cleaner ready)	Vendor ID	Product ID	Price	
CIH 1200, 2000; dual UMO; requires CIH#48054385	MT1360DDU	MRT001381	\$142.00	
John Deere 7200-1700; White 9000 dual; dual UMO	MT1360DDU	MRT001381	\$142.00	
John Deere 7000, 7100; Kinze; White 6000, 8000; dual UMO	MT1360KDU	MRT001380	\$142.00	
Step 3A Optional WA1360 Row Cleaner	Vendor ID	Product ID	Price	
WA1360 row cleaner with 13" spiked wheels	WA1360	MRT001360	\$529.00	
WA1360 row cleaner with 12.5" razor wheels	WA1360Z	MRT136017	\$529.00	
Step 3B Optional WA1345 Row Cleaner	Vendor ID	Product ID	Price	
WA1345 row cleaner with 13" spiked wheels	WA1345	MRT001345	\$529.00	
WA1345 row cleaner with 12.5" razor wheels	WA1345Z	MRT134517	\$529.00	
Step 4 Optional Accessories	Vendor ID	Product ID	Price	
Aluminum Side Treader Wheel (2 required per row)	STW-04A	MRT003003	\$50.00	
(1) CIH 2000 series heavy duty adapter bracket (needed if planter is NOT equipped with CIH#4854385)	900023	MRT003945	\$66.00	
Case-IH 1200, Heavy duty lower parallel linkage set	HDP-CIH01	MRT007106	\$163.00	

UMO Replacement Parts	Vendor ID	Product ID	Price
Bearing, row cleaner, UMO	L44643	MRT003917	\$10.00
Bearing kit, UMO (includes two bearings, two seals and two races)	UMO-HRKIT	MRT003937	\$33.00
Poly strap, UMO	UMO-FCS01	MRT007101	\$16.50
Metal strap, UMO	UMO-FCS02	MRT007102	\$21.00
14" standard blade, UMO	UMO-BLD01	MRT007104	\$52.00
15" notched blade, UMO	800249	MRT800249	\$65.00
Hub, UMO	HU44-F	MRT007107	\$63.00
Spring, UMO, LH	UMO-SPG01L	MRT100301	\$20.00
Spring, UMO, RH	UMO-SPG01R	MRT200301	\$20.00
Furrow Shoe, LH, UMO	UMO-041L	MRT100305	\$96.00
Furrow Shoe, RH, UMO	UMO-041R	MRT200305	\$96.00

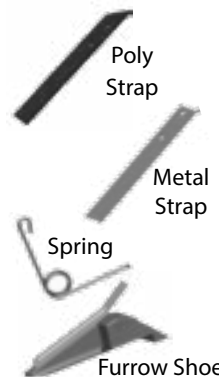

MARTIN REPLACEMENT PARTS

Standard
(Spike)
Wheel



Razor
Wheel



Dimple
Wheel



Cupped
Razor
Wheel

Hub & Axle
MRT003907



Hub & Axle
MRT900101



Hub 3-Bolt,
MRT003903

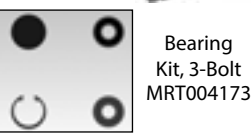

Bearing
Kit, 3-Bolt
MRT004173



Bearing
Kit, 4-Bolt
MRT004184



Dust Cap, 3-Bolt
MRT004163



Row Cleaner
Mount
MT1360CIH



Row Cleaner
Frame C125FR



Scrapers Set
MRT003149



Replacement Wheels	Vendor ID	Product ID	Price
Standard wheel, 13" 3 & 4-bolt, LH on row cleaner, RH on closing wheels	TW3813-L	MRT343905	\$79.50
Standard wheel, 13" 3 & 4-bolt, RH on row cleaner, LH on closing wheels	TW3813-R	MRT343906	\$79.50
Standard wheel, 15" 3 & 4-bolt, LH on row cleaner, RH on closing wheels	TW3815-L4	MRT344177	\$93.50
Standard wheel, 15" 3 & 4-bolt, RH on row cleaner, LH on closing wheels	TW3815-R4	MRT344178	\$93.50
Standard wheel, 13" 6-bolt (Kinze hole pattern)	TW3813-LK	MRT003909	\$87.00
Standard wheel, 13" 6-bolt (Kinze hole pattern)	TW3813-RK	MRT003910	\$87.00
Razor wheel, 12.5" 3 & 4-bolt, RH on row cleaner	RTW1412.5R4	MRT141250	\$79.50
Razor wheel, 12.5" 3 & 4-bolt, LH on row cleaner	RTW1412.5L4	MRT141251	\$79.50
Razor wheel, 12.5" 6-bolt, LH on row cleaner (Kinze hole pattern)	TW1412.5LK	MRT141252	\$87.00
Razor wheel, 12.5" 6-bolt, RH on row cleaner (Kinze hole pattern)	TW1412.5RK	MRT141253	\$87.00
Cupped razor wheel, 14", 4-bolt, RH on closing wheels	RTW1414L	MRT004207	\$93.50
Cupped razor wheel, 14", 4-bolt, LH on closing wheels	RTW1414R	MRT004208	\$93.50
Cupped razor wheel, 14", 18 tooth, 4-bolt, RH on closing wheels	RTW141418LC	MRT004213	\$93.50
Cupped razor wheel, 14", 18 tooth, 4-bolt, LH on closing wheels	RTW141418RC	MRT004214	\$93.50
Dimple wheel, 13", 4-bolt, LH and RH on closing wheels	DW2013-4	MRT003923	\$66.00
Treader Wheel, 3 & 4-BOLT	STW-04A	MRT003003	\$50.00
Treader Wheel, 6 bolt (Kinze hole pattern)	STW-01K	MRT003001	\$58.00
Note: 13" wheels should be replaced when 12" or less and 15" wheels when 13-3/4" or less			
Hub & Axles	Vendor ID	Product ID	Price
Hub & Axle, 3-bolt, for pin adjust row cleaners, WA1317, WA1330	HA13305-D	MRT003908	\$114.50
Hub & Axle, 3-bolt, for floating row cleaners, C125	HA13270-D	MRT003902	\$114.50
Hub & Axle, 4-bolt, for row cleaners, C125, ACCR1360, WA1360, WA1332, WA1334, WA1532	HA44270-D	MRT003907	\$114.50
Hub with hardware, 4-bolt, for floating row cleaners, WA1345, ACCR1345	CHU44-C	MRT900101	\$114.50
Hub, 3-bolt, for closing wheels with single bearing, 5/8" or 16 mm I.D.	CHU024	MRT003903	\$63.00
Hub, 3-bolt, for closing wheels with two bearings, 17mm I.D.	CHU022	MRT004167	\$63.00
Hub, 4-bolt, for closing wheels with single bearing, 5/8" or 16 mm I.D.	CHU44-B2	MRT004190	\$90.50
Hub, 4-bolt, for closing wheels with two bearings, 17mm I.D.	CHU44-A	MRT004175	\$90.50
Bearings/Bearing Kits	Vendor ID	Product ID	Price
Bearing, for row cleaner, WA1345	800248	MRT800248	\$46.50
Bearing kit, for row cleaner, C125, ACCR1360, WA1360, WA1332, WA1334, WA1532	HR KIT	MRT003912	\$40.00
Bearing kit, 3-bolt, for closing wheels with two bearings, 17mm I.D.	CHU022BK	MRT004173	\$36.00
Bearing kit, 4-bolt, for closing wheels with single bearing, 5/8" or 16mm I.D.	CHU44B-BK	MRT004184	\$35.00
Bearing kit, 4-bolt, for closing wheels with two bearings, 17mm I.D.	CHU44A BK	MRT004197	\$38.00
Dust Caps	Vendor ID	Product ID	Price
Dust cap, 3-bolt, closing wheels	HS1080	MRT004163	\$2.50
Dust cap, 4-bolt closing wheels, C125, ACCR1360, WA1360, WA1332, WA1334, WA1532	HS1328	MRT004174	\$4.50
Dust cap, WA1345, ACCR1345	800244	MRT800244	\$4.50
WA Row Cleaner Mounts	Vendor ID	Product ID	Price
CIH 800, 900, 1200, 2000; without no-till couler	MT1360CIH	MRT001369	\$135.00
HI Laser Pro; JD 7000, 7100; Kinze 2000, 3000; White 6000, 8000, 9000; without no-till couler	MT1360KS	MRT001361	\$97.00
JD 7200, 7300, 1700, DB; without no-till couler	MT1360DS	MRT001362	\$97.00
Horsch Maestro without no-till couler	MRT001383	MRT001383	\$97.00
JD 7200, 7300, 1700, DB; with OEM unit mount no-till couler	MT1360DC	MRT001368	\$97.00
JD 7200, 7300, 1700, DB; with OEM double disc fertilizer opener	MT1360DD	MRT001376	\$103.50
Kinze 2000, 3000; with OEM double arm unit mount no-till couler	MT1360KC	MRT001367	\$97.00
Kinze 4900; without no-till couler	MT1360K4	MRT001377	\$97.00
Kinze 4900; with OEM double arm unit mount no-till couler	MT1360K4C	MRT001378	\$97.00
Row Cleaner Parts	Vendor ID	Product ID	Price
Row cleaner frame, C125	C125FR	MRT003958	\$141.00
Row cleaner frame, WA1345, Requires 2 MRT800510 bushing	FR1345	MRT003952	\$141.00
Row cleaner frame, WA1360, Requires 2 MRT800510 bushing	900174	MRT900174	\$141.00
Bushing, row cleaner pivot point, old style; 7/8" OD	BU7858	MRT004171	\$4.50
Bushing, row cleaner pivot point, current style; 1-3/32 OD	800510	MRT800510	\$4.50
Flange Bolt, row cleaner pivot, 5/8 X 2" GR8	783620	MRT783620	\$7.00
Flange Lock Nut, row cleaner pivot, 5/8-11 GR8	785600	MRT785600	\$5.50
Scraper Sets/Parts	Vendor ID	Product ID	Price
Scraper set row cleaner; C125, WA1360	DLD-02 SET	MRT003160	\$53.00
Scraper LH row cleaner; C125, WA1360	DLD-02L	MRT003162	\$26.50
Scraper RH row cleaner; C125, WA1360	DLD-02R	MRT003163	\$26.50
Scrapers set, spiked closing wheel	ITDSCWSET	MRT003149	\$53.00
Scraper LH, spiked closing wheel	ITDSCWL	MRT003150	\$26.50
Scraper RH, spiked closing wheel	ITDSCWR	MRT003151	\$26.50

ROW CLEANER

— AIR CONTROL SYSTEMS —

The following three Row Cleaner Air Control Systems allow the operator to raise and lower floating row units on-the-go by varying the amount of air pressure in the cylinders. Since adjustments are easy, you will make adjustments when you should.

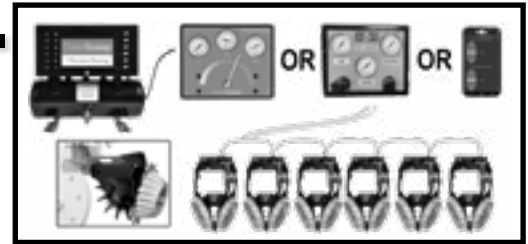

CleanSweep[®] Air Control System

Manage your row cleaner performance, from the cab, on the go.

CleanSweep is a dual air cylinder that lets you set and adjust your row cleaners' down pressure from the cab.

Have heavy residue? Add more pressure to sweep away the debris. Have light residue or soft ground? Lighten the pressure and keep the row cleaner floating across the top.

The cylinders have a control box mounted in the cab. You set the pounds of pressure from your cab based on the conditions you are in. Plus, the pressurized cylinder gives the row cleaner the ability to adjust or "float" across the small changes you encounter such as terrain or varying amounts of debris.



Martin-Till[®] Manual Bidirectional Air Control System

Adjust your row cleaners on-the-go from the cab.

The Martin-Till Manual Bidirectional Air Control System allows for pressurizing both sides of the cylinder at the same time.

Providing additional PSI to the opposing end of the cylinder reduces bounce and allows for fine tuning. The kit includes the control box,

a compressor (if required), the necessary air line kit and air cylinders.



Control box and air line

Bidirectional

Adjust row cleaners on-the-go with your smartphone, tablet or ISOBUS-compatible in-cab monitor



Air Control System

The exclusive Martin-Till[®] Smart Clean[™] Row Cleaner Adjustment System combines a wireless connection with an easy-to-use mobile app.

- Electronic Proportional Control valves automatically adjust to maintain desired PSI.
- Wireless control allows for less equipment in the cab.

ISOBUS connection for easy control through your in-cab monitor



Consider High Flow Air Line Kits for faster response on larger planters.

Charts for row cleaner air control systems are on page 34-35. Cylinder parts and accessories; compressor/controller components; and air line kits are on page 35.

Step 1: CleanSweep/Smart Clean System Kit (1 Kit Per Planter)

Kits Without Compressor (includes, controller, air line/fittings kit, and air cylinders)

Planter Rows	Precision Planting CleanSweep		Martin Manual Bidirectional Control		Martin-Till SmartClean Bidirectional - Standard Flow		Martin-Till SmartClean Bidirectional - High Flow	
	Product ID	Price	Product ID	Price	Product ID	Price	Product ID	Price
6	PPM855006	\$1,860.00	MRT858706	\$2,021.00	MRT908106	\$6,205.00	-	-
8	PPM855008	\$2,200.00	MRT858708	\$2,361.00	MRT908108	\$6,545.00	-	-
12	PPM855012	\$2,975.00	MRT858712	\$3,136.00	MRT908112	\$7,320.00	MRT988112	\$8,659.00
16	PPM855016	\$3,725.00	MRT858716	\$3,886.00	MRT908116	\$8,070.00	MRT988116	\$9,692.00
23	PPM855023	\$5,085.00	MRT858723	\$5,246.00	MRT908123	\$9,430.00	MRT988123	\$11,411.00
24	PPM855024	\$5,255.00	MRT858724	\$5,416.00	MRT908124	\$9,600.00	MRT988124	\$11,581.00
31	PPM855031	\$6,685.00	MRT858731	\$6,846.00	MRT908131	\$11,030.00	MRT988131	\$13,359.50
32	PPM855032	\$6,855.00	MRT858732	\$7,016.00	MRT908132	\$11,200.00	MRT988132	\$13,529.50
36	PPM855036	\$7,535.00	MRT858736	\$7,696.00	MRT908136	\$11,880.00	MRT988136	\$15,033.50
48	PPM855048	\$9,815.00	MRT858748	\$9,976.00	MRT908148	\$14,160.00	MRT988148	\$18,310.00
54	PPM855054	\$10,985.00	MRT858754	\$11,146.00	MRT908154	\$15,330.00	MRT988154	\$21,090.00

Kits With Compressor (includes compressor, controller, air line/fittings kit, and air cylinders)

Planter Rows	Precision Planting CleanSweep		Martin Manual Bidirectional Control		Martin-Till SmartClean Bidirectional - Standard Flow		Martin-Till SmartClean Bidirectional - High Flow	
	Product ID	Price	Product ID	Price	Product ID	Price	Product ID	Price
6	PPM825006	\$3,020.00	MRT828706	\$3,181.00	MRT918106	\$7,455.00	-	-
8	PPM825008	\$3,360.00	MRT828708	\$3,521.00	MRT918108	\$7,795.00	-	-
12	PPM825012	\$4,135.00	MRT828712	\$4,296.00	MRT918112	\$8,570.00	MRT998112	\$9,909.00
16	PPM825016	\$4,885.00	MRT828716	\$5,046.00	MRT918116	\$9,320.00	MRT998116	\$10,942.00
23	PPM825023	\$6,245.00	MRT828723	\$6,406.00	MRT918123	\$10,680.00	MRT998123	\$12,661.00
24	PPM825024	\$6,415.00	MRT828724	\$6,576.00	MRT918124	\$10,850.00	MRT998124	\$12,831.00
31	PPM825031	\$7,845.00	MRT828731	\$8,006.00	MRT918131	\$12,280.00	MRT998131	\$14,609.50
32	PPM825032	\$8,015.00	MRT828732	\$8,176.00	MRT918132	\$12,450.00	MRT998132	\$14,779.50
36	PPM825036	\$8,695.00	MRT828736	\$8,856.00	MRT918136	\$13,130.00	MRT998136	\$16,283.50
48	PPM825048	\$10,975.00	MRT828748	\$11,136.00	MRT918148	\$15,410.00	MRT998148	\$19,560.00
54	PPM825054	\$12,145.00	MRT828754	\$12,306.00	MRT918154	\$16,580.00	MRT998154	\$22,340.00

Step 2: Cylinder Bracket (1 Kit Per Row)

Martin ACCR1360/1345	Make/Model	Product ID	Price
ACCR1360, ACCR1345	All models, cylinder bracket is integrated on row cleaner, no additional bracket is needed.	-	-
Martin WA1360	Make/Model	Product ID	Price
W/out no-till coulter; BD, BK, BW, BC1H (5)	Case-IH 800, 900, 1200, 2000; John Deere 7000, 7200, 7300, 1700, DB; Kinze 2000, 3000, 4000; White 6000, 8000, 9000	PPM755200	\$45.00
With no-till coulter; BDC (1)	John Deere 7200, 1700, DB	PPM755205	\$45.00
With UMO	RH bracket, All models with WA1360 and UMO's	MRT803973	\$76.00
	LH bracket, All models with WA1360 and UMO's	MRT803974	\$76.00
With no-till coulter; BKC	Kinze models with OEM double arm no-till coulter	MRT803977	\$87.00
Martin WA1345	Make/Model	Product ID	Price
W/out no-till coulter; BD (5)	Case-IH 800, 900, 1200, 2000; Harvest Int ; John Deere 7200, 7300, 1700, DB	MRT803975	\$45.00
W/out no-till coulter; BK, BW	John Deere 7000, 7100; Kinze 2000, 3000; White 6000, 8000, 9000	MRT803976	\$45.00
With UMO	LH bracket, All models with WA1345 and UMO's	MRT803978	\$76.00
	RH bracket, All models with WA1345 and UMO's	MRT803979	\$76.00
Martin C125	Make/Model	Product ID	Price
With no-till coulter; MTR, MTR-XP (1,3)	John Deere 7200, 7300, 1700, DB; White 6000, 9000	PPM755195	\$55.00
With no-till coulter; MTR, MTR-81 (5)	Case-IH 800, 900, 1200; John Deere 7000, 7100; White 5000, 6000, 8000	PPM755225	\$50.00

ROW CLEANER CONTROL SYSTEMS

Step 2: Cylinder Bracket (1 Kit Per Row)- Continued

Martin C125 (Continued)	Make/Model	Product ID	Price
Without no-till coulter MTS, MTR, MTS-XP, MTS-81, MTS-IH (5)	Case-IH 800, 900, 1200; John Deere 7000, 7200, 7300, 1700, DB; Kinze 2000, 3000, 4000	PPM755190	\$60.00
With UMO, pack of two	All models with C125 and UMO's, includes 1 LH & 1 RH bracket	PPM755924	\$132.00
Kinze OEM Row Cleaner	Make/Model	Product ID	Price
Double arm coulter, welded style	Kinze 2000, 3000	PPM755925	\$65.00
Double arm coulter, cast style	Kinze 2000, 3000	PPM755926	\$70.00
Row cleaner/coulter combo	Kinze 4900	PPM755932	\$75.00
Yetter Residue Manager	Make/Model	Product ID	Price
2967-007 (2)	John Deere 7000, 7200, 7300, 1700, DB; Kinze 2000, 3000, 4000; White 6000, 9000	PPM755185	\$45.00
2967-008 (5)	Case-IH 800, 900, 1200, 2000	PPM755930	\$65.00
2967-013 (4)	John Deere 7000, 7200, 7300, 1700, DB; Kinze 2000, 3000, 4000; White 6000, 8000, 9000	PPM755270	\$85.00
2967-014 (4,5)	Case-IH 800, 900, 1200, 2000	PPM755250	\$55.00
2967-029 (4)	John Deere 7000, 7200, 7300, 1700, DB; Kinze 2000, 3000, 4000; White 6000, 8000, 9000	PPM755265	\$75.00
2967-035 (2,3)	John Deere 7200, 7300, 1700, DB; Kinze 2000, 3000, 4000; with no-till coulter	PPM755180	\$75.00
2967-035	John Deere 7000, White 6000, 8000, 9000	PPM755230	\$70.00
2967-035; with short bracket	John Deere 7000, 7200, 7300, 1700, DB; Kinze 2000, 3000, 4000; White 6000, 8000, 9000	PPM755175	\$45.00
2967-042 (2,5)	John Deere 7000, 7200, 7300, 1700, DB	PPM755160	\$45.00
2967-097 (5)	Case-IH 800, 900, 1200, 2000	PPM755245	\$70.00
2967-115	John Deere 7200, 7300, 1700, DB; Kinze 2000, 3000, 4000	PPM755170	\$45.00

Cylinder Bracket Accessories	Product ID	Price
(1) Stop Kit, required on John Deere 7200 & 1700 with long parallel arms and row unit mounted fertilizer or no-till coulter.	PPM726530	\$40.00
(2) Stop Kit, required on John Deere 7200 & 1700 with long parallel arms and row unit mounted fertilizer or no-till coulter.	PPM755202	\$30.00
(3) Cylinder Base Mount Shim, required when using a John Deere cast coulter.	PPM755159	\$8.00
(4) Pin Kit, Yetter Residue Manager Models 2967-013A, 2967-14A, 2967-029A, 2967-097A, made 2016 and after. These models come equipped with cylinder brackets and only require this pin kit to install cylinder.	PPM755255	\$6.00
(5) CleanSweep is not compatible with Case-IH 12X5 series planters unless DeltaForce is installed. May require additional stop kit.		

Step 3: Optional Accessories

Optional ISOBUS Harness For SmartClean Control (control system through existing display)	Product ID	Price
ISOBUS harness, John Deere planter with ISOBUS	MRT800535	\$975.00
ISOBUS harness, All planters without ISOBUS, must have ISOBUS connection at the tractor	MRT900384	\$1,400.00
ISOBUS harness, All planters other than John Deere with ISOBUS	MRT900383	\$1,400.00
Optional Compressor Mounting Kit	Product ID	Price
John Deere 7000, 7200, 1770, 1770NT, 1790 (mounts on draft tube)	PPM726050	\$55.00
Kinze 2600, 3600, 12R (mounts to tongue)	PPM726058	\$155.00
John Deere 7100, 7300, 1700, 1710, 1720; Kinze 2140, 3140 (mounts in front of bar) Kinze 3800 (mounts to side of hitch)	PPM726060	\$175.00
Universal Mount; fits 3 x 3 tube up to 9 x 10 tube	PPM726450	\$155.00
John Deere 7000, 7200, 1770, 1770NT, 1790 (mounts on cross bar of 3-point hitch)	PPM726515	\$300.00
Other compressor mounts are available or you can fabricate your own. Reference CleanSweep owners manual for more details.		

Cylinder Parts & Accessories			Air Control Compressor/ Controller Components			Air Control Airline Kits		
Description	Product ID	Price	Description	Product ID	Price	Description	Product ID	Price
CleanSweep Air Cylinder	PPM755271	\$170.00	Compressor Air Filter	PPM726546	\$30.14	8-row, Air Line & Fittings Kit	PPM755035	\$205.00
Air Cylinder Boot Kit	PPM755257	\$13.00	Compressor Tank Filter/Water Separator	PPM726744	\$35.00	12-row, Air Line & Fittings Kit	PPM755040	\$310.00
Elbow, CleanSweep Cylinder (2 per cylinder)	PPM755272	\$11.50	Cleansweep Controller Only	PPM755277	\$595.00	16-row, Air Line & Fittings Kit	PPM755085	\$380.00
Spacer (2 per cylinder)	PPM755017	\$1.25	Martin Manual Bidirectional Controller	MRT800887	\$726.00	24-row, Air Line & Fittings Kit	PPM755045	\$570.00
Pin, Cylinder Base	PPM755018	\$2.00	Compressor Kit Only	PPM755279	\$1,250.00	36-row, Air Line & Fittings Kit	PPM755050	\$810.00
Pin, Cylinder Rod	PPM755019	\$1.00	Cleansweep Control Kit, W/O Compressor	PPM855055	\$690.00	48-row, Air Line & Fittings Kit	PPM755065	\$1,050.00
			Cleansweep Control Kit, With Compressor	PPM855025	\$1,845.00	54-row, Air Line & Fittings Kit	PPM755070	\$1,200.00
			Martin Control Kit, W/O Compressor	MRT858755	\$821.00			
			Martin Control Kit, With Compressor	MRT828755	\$1,976.00			

Improve Planter Performance Where it Counts - In the Meter!

A Better Finger Meter!



Better Seed Spacing for More Harvestable Ears

At 65 rpm, precision matters. Springs, fingers, cams, backing plates, belts, housings, covers, brushes, bearings – everything must work together to get seed to the ground evenly spaced. In the Precision Meter, every part is precisely designed, engineered and manufactured to work together.

Compared to ordinary, less precise meters, this instantly produces more ears, 6+ bushels more, from every acre.

When everything works together, every seed ends up where it belongs, producing picket fence stands, maximum yields and extra bushels for you.

At 5 mph on 30-inch rows, your meter is turning at 65 rpm. At that speed, precision matters. Ordinary finger meters have a hard time singulating, especially with a wide variety of seeds. They'll miss one, then grab two, resulting in skips and doubles. That not only wastes seeds, it cuts your yield.

Because the components all mesh perfectly, Precision Meters hold one seed at a time, then release it. They're engineered and built to do it again and again. You'll see fewer skips and doubles – and higher yield.

Precision Finger Set Complete Meter

John Deere 7000, 7100; Kinze 2000 series		
Description	Product ID	Price
Field Corn, 12-fingers, 30" or greater row spacing	PPM343022	\$230.00
Field Corn, 6-fingers, 15-20" row spacing	PPM343072	\$235.00
Sweetcorn, 12-fingers, 30" or greater row spacing	PPM343063	\$260.00
Popcorn, 12-fingers, 30" or greater row spacing	PPM343113	\$290.00
Pumpkin, 6-fingers	PPM343116	\$290.00
Sunflower, 12-fingers	PPM343110	\$310.00
John Deere 7200, 7300, 1700 series		
Description	Product ID	Price
Field Corn, 12-fingers, 30" or greater row spacing	PPM343025	\$230.00
Field Corn, 6-fingers, 15-20" row spacing	PPM343099	\$235.00
Sweetcorn, 12-fingers, 30" or greater row spacing	PPM343101	\$260.00
Popcorn, 12-fingers, 30" or greater row spacing	PPM343114	\$290.00
Pumpkin, 6-fingers	PPM343117	\$290.00
Sunflower, 12-fingers	PPM343111	\$310.00
Kinze 3000 series		
Description	Product ID	Price
Field Corn, 12-fingers, 30" or greater row spacing	PPM343030	\$230.00
Field Corn, 6-fingers, 15-20" row spacing	PPM343071	\$235.00
Sweetcorn, 12-fingers, 30" or greater row spacing	PPM343109	\$260.00
Popcorn, 12-fingers, 30" or greater row spacing	PPM343112	\$290.00
Pumpkin, 6-fingers	PPM343115	\$290.00
Sunflower, 12-fingers	PPM343105	\$310.00
Great Plains planters		
Description	Product ID	Price
Field Corn, 12-fingers, 30" or greater row spacing	PPM343050	\$230.00
Field Corn, 6-fingers, 15-20" row spacing	PPM343051	\$230.00
Sunflower, 12-fingers	PPM343055	\$290.00

Precision Finger Set Meter & Universal Bullseye Seed Tube Kits Save \$9.50 per row

Make/Model	Description	Product ID	Price
John Deere 7000, 7100; Kinze 2000 series	Precision Meter (PPM343022) & Bullseye (PPM700150)	PPM345020	\$237.00
John Deere 7200, 7300, 1700 series	Precision Meter (PPM343025) & Bullseye (PPM700160)	PPM345021	\$237.00
Kinze 3000 series	Precision Meter (PPM343030) & Bullseye (PPM700150)	PPM345022	\$237.00

Precision Finger Set Meter & Wave Vision Seed Tube Kits Save \$17.00 per row

Make/Model	Description	Product ID	Price
John Deere 7000, 7100; Kinze 2000 series	Precision Meter (PPM343022) & Wave Vision (PPM700250)	PPM345026	\$408.00
John Deere 7200, 7300, 1700 series	Precision Meter (PPM343025) & Wave Vision (PPM700200)	PPM345027	\$408.00
Kinze 3000 series	Precision Meter (PPM343030) & Wave Vision (PPM700250)	PPM345028	\$408.00

Note: For planters with Keeton Seed Firmers the new WaveVision firmer tail is required.

PRECISION PLANTING METER PARTS

If you don't need a whole new meter, you can still improve your spacing with Precision Meter finger sets, backing plates or belts.

Precision Finger Set

The shape and design of the finger determines how well it can singulate and hold a single seed – round or flat. The Precision Finger Set's unique finger shape locks both flat and round seeds under the flang for secure delivery to the seed belt.

Precision Finger Sets		
Description	Product ID	Price
Precision Finger set, 12-finger, corn	PPM343029	\$60.00
Precision Finger set, 6-finger, narrow row corn	PPM343053	\$62.00
Precision Finger set, 12-finger, sweetcorn	PPM343064	\$82.00
Precision Finger set, 6-finger, pumpkin	PPM343065	\$82.00
Precision Finger set, 12-finger, sunflower	PPM343067	\$160.00
Precision Finger set, 12-finger, popcorn	PPM343104	\$115.00



Precision Finger Set

Precision Population Max Backing Plate

This special Kevlar® impregnated poly backing plate has big advantages over metal plates. It's flatter – eliminating the skips that occur as fingers rock and roll over the warped spots on stamped metal plates. It matches seed size – swap inserts and you can change the aggressiveness of the backing plate to match flats and rounds. The smaller exit hole reduces the chances that seeds can ricochet back into the meter.

Precision PopulationMax Backing Plate		
Description	Product ID	Price
Precision PopulationMax Backing Plate with "A" insert & adjustable brush	PPM342103	\$50.00
Precision PopulationMax Backing Plate with "C" insert & brushless blank	PPM342111	\$48.00
Replacement "A" Insert, most field corn and larger popcorn	PPM342110	\$7.00
Replacement "B" Insert, flat field corn with heavy seed treatment and small to medium popcorn	PPM342107	\$7.00
Replacement "C" Insert, sunflower, sweetcorn and edible beans	PPM342108	\$7.00



Population Max Backing Plate

Precision Brushes

Set the brush toward the outside of the finger for large seeds so they don't dislodge. Set the brush further inside the finger for small seeds so it can aggressively remove doubles.

Precision Brushes		
Description	Product ID	Price
Precision Adjustable Brush	PPM343052	\$10.00
Pkg of 2, Precision Maroon Brush, Non-Adjustable, for Precision PopulationMax plate	PPM343049	\$5.50
T-Handle for Adjustable Brush	PPM343060	\$4.25



Adjustable Brush

Precision SkipStop Cover

With its patented cushioning system, the SkipStop cover eliminates seed ricochets, which produce skips that you see in other finger pick-up meters. When seeds hit the cushion, they drop directly onto the seed belt for delivery to the seed tube. Includes cushion.

Precision SkipStop Cover		
Description	Product ID	Price
Precision SkipStop Cover, with cushion, all except Great Plains	PPM343024	\$28.00
Replacement SkipStop Cushion	PPM343014	\$16.50
Replacement SkipStop Cushion, Great Plains	PPM343073	\$17.00



SkipStop Cover

Precision SureFire Seed Belt

The new SureFire™ cupped seed belt releases seed down the center every time for sure spacing and more ears.

Precision SureFire Seed Belt		
Description	Product ID	Price
Precision SureFire Seed Belt	PPM343066	\$15.00



SureFire Seed Belt

Meter Re-Power Plus Kit

Includes: Precision Finger Set, Population Max Backing Plate with Adjustable Brush, Skipstop Cover, SureFire Seed Belt, Bullseye Seed Tube and T-Handle for Adjustable Brush.

Precision Re-Power Kits Save \$6.75 Per Row		
Description	Product ID	Price
Precision Re-Power Kit, John Deere 7000, 7100; Kinze with PPM700150 Bullseye	PPM345024	\$167.00
Precision Re-Power Kit, John Deere 7200, 7300, 1700 series with PPM700160 Bullseye	PPM345025	\$167.00

Miscellaneous Service Parts		
Description	Product ID	Price
Drive Wheel for seed belt	PPM343062	\$7.50
Cover for Precision Meter, John Deere 7000, Kinze 2000	PPM343098	\$10.90
Ash Tray, finger holder	PPM343102	\$8.00

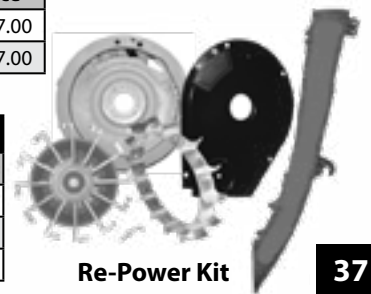

Re-Power Kit

Every Seed, Every Time Simple Upgrade, Big Change in Your Stands

You want a picket fence stand that doesn't require a lot of headaches, but the adjustments you have to make on your meters are time consuming and don't give you the results you want.

The eSet meter is a retrofit system that goes inside of a John Deere vacuum meter and uses a flat disk without cells that are sensitive to seed size and shape, paired with a floating singulator that doesn't need adjustments. You simply set your vacuum, fill the planter with seed, and go. Whether you are running Pro Series row units or standard row hoppers, the eSet system will fit your planter.



PPM720136

PPM720370

Impeccable Singulation for John Deere Meters Without Adjustment

eSet Complete Kit

Description	Product ID	Price
John Deere Mini Hopper Pro-Series eSet; ME Pro, Pro-Series XP, MaxEmerge5	PPM720136	\$150.00
John Deere Box Planter Standard eSet; MaxEmerge, MaxEmerge 2, MaxEmerge Plus MaxEmerge XP, MaxEmerge5	PPM720370	\$150.00

eSet Pro Series; CCS Mini-Hopper



Precision Planting eSet Pro-Series Options

Description	Product ID	Price
Step Kit, JD 1790 with 20" rows. Moves OEM steps out & away from ProFlo hoppers.	PPM720196	\$125.00
Package of 4, Elbow Kit, JD 1790 with 15" or 30" rows. Reroutes supply tube to ProFlo hopper on 4 center rows	PPM720206	\$35.00
Package of 4, Flap Kit, JD 1790 with 15" or 20" rows. Prevents seed from flowing out of hopper when folded. It is recommended to install flaps in all meters on every row.	PPM720244	\$15.00
Y-Tube Kit, DB 32-rows or more. One kit required for each row over 32	PPM720245	\$36.00
Package of 4, Stop Kit, JD 1790 with 15" split rows. Limits over-extension of parallel arms. Includes stop for 4 rows.	PPM720248	\$125.00

eSet Standard; Box Planter

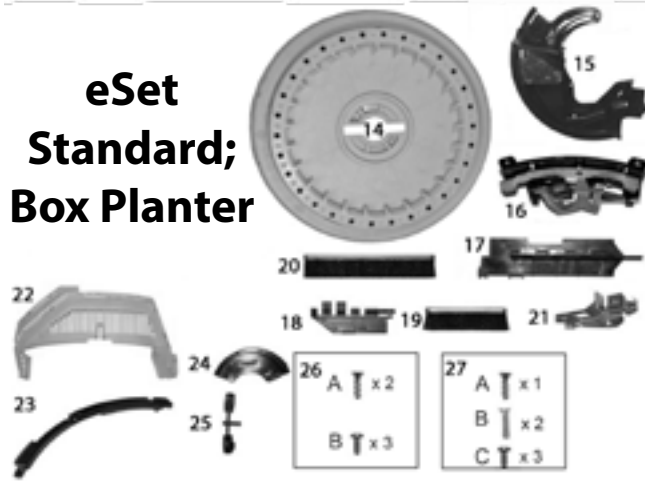

eSet Service Parts

Key

Description	Product ID	Price	Pro-Series	Standard
Disk	PPM720003	\$50.00	2	14
Pro-Series Liner	PPM720251	\$8.25	3	n/a
Standard Liner	PPM720149	\$8.10	n/a	15
Singulator	PPM720372	\$50.00	4	16
Mini Hopper	PPM720209	\$19.00	5	n/a
Long Brush Holder	PPM720371	\$5.50	n/a	17
Short Brush Holder	PPM720023	\$2.75	6	18
Short Brush	**	\$-	7	19
Long Brush	**	\$-	8	20
Singulator Shim	PPM720067	\$1.30	9	n/a
Fragment Extractor	PPM720185	\$6.00	10	21
Pro-Series Vent	PPM720177	\$5.50	11	n/a
Standard Vent	PPM720235	\$6.00	n/a	22
Shim	PPM720374	\$5.50	n/a	23
D-Tube Assembly	PPM720270	\$10.00	12	n/a
Wedge	PPM720033	\$1.30	n/a	24
Vented Hopper Lid	PPM720225	\$9.00	13	n/a
T-Shaped Retainer	PPM720045	\$1.95	n/a	25
Hardware Kit (Standard) ME-ME XP	PPM720377	\$1.00	n/a	26
Hardware Kit (Standard) ME5	PPM720392	\$1.00	n/a	27
**Brush Kit (long & short)	PPM720384	\$6.00		

Other eSet Service Parts

Seed Deflector Kit, includes 4 liner springs and 4 screws.	PPM720268	\$4.00
Seed Deflector Tube, small crops	PPM720281	\$0.75
30" Vacuum Gauge with Filter	PPM730169	\$110.00

eSet Replacement Parts, Specific for Specialty Crops

S.I. Distributing offers eSet replacement parts, including seed discs, singulators and extractors for specialty crops. These crops include canola, chili, cotton, cucumbers, gourds, peanuts, popcorn, pumpkins, snap beans, sorghum, squash, sugar beets, sunflowers and sweet corn.



Cotton



**PPM720285
(Cotton)**



Canola



**PPM720301
(Canola)**



Cucumbers



**PPM720284
(Chili, Cucumber,
Sugar Beet)**



Pumpkins

Please see complete chart of the e-set meter setup by crop, including Singulator Position, Lower Brush Position, Deflector Position "Paperclip" and JD Wiper Used at www.sidist.com/eset-meter-setup.pdf

Precision Planting eSet Meter Setup by Crop

Crop	Size & Seeds/LB	Row Spacing	Vacuum Setting	Seed Disc Product ID	Seed Disc Price	Singulator	Singulator Price	Extractor	Extractor Price
Canola	60,000-100,000 seeds/lb	N/A	18"-20"	PPM720301	\$70.00	PPM720386	\$50.00	PPM720295 Pro-Series	\$30.00
								PPM720305 Standard	\$30.00
Chili	12 seeds/ft - 30" row	N/A	15"	PPM720284	\$70.00	PPM720386	\$50.00	PPM720117	\$6.00
Cotton	50,000-60,000 population	N/A	18"-20"	PPM720285	\$60.00	PPM720372	\$50.00	PPM720117	\$6.00
Cucumbers	N/A	N/A	10"	PPM720284	\$70.00	PPM720386	\$50.00	PPM720117	\$6.00
Field Corn	N/A	All	18"-20"	PPM720003	\$50.00	PPM720372	\$50.00	PPM720185	\$6.00
Gourds	N/A	N/A	10"	PPM729931	\$60.00	PPM720372	\$50.00	PPM720117	\$6.00
Peanuts	Medium (Spanish or Runner)	N/A	10"	JD H136092	-	N/A	-	N/A	N/A
Popcorn	Small	N/A	18"	PPM729931	\$60.00	PPM720372	\$50.00	PPM720117	\$6.00
	Medium	N/A	18"	PPM729932	\$60.00	PPM720372	\$50.00	PPM720117	\$6.00
	Large	N/A	18"	PPM729933	\$60.00	PPM720372	\$50.00	PPM720117	\$6.00
Pumpkins	Del Monte/Libby	60"	13"	PPM729931	\$60.00	PPM720372	\$50.00	PPM720117	\$6.00
	Ornamental	60"	14"	PPM729932	\$60.00	PPM720372	\$50.00	PPM720117	\$6.00
Snap Beans	100,000 Population / 30" rows	N/A	18"-20"	PPM720286	\$60.00	PPM720386	\$50.00	PPM720117	\$6.00
Sorghum	13,000-16,000 seeds/lb	N/A	11"-12"	PPM720282	\$70.00	PPM720372	\$50.00	PPM720117	\$6.00
	Population: 40,000 Non-Irrigated	N/A	11"-12"	PPM720282	\$70.00	PPM720372	\$50.00	PPM720117	\$6.00
	Population: 80,000 Irrigated	N/A	11"-12"	PPM720282	\$70.00	PPM720372	\$50.00	PPM720117	\$6.00
Soybeans	N/A	N/A	15"-20"	PPM720286	\$60.00	PPM720386	\$50.00	PPM720117	\$6.00
	N/A	N/A	30"	JD A42586	-	N/A	-	N/A	N/A
Squash	N/A	N/A	15"	PPM729932	\$60.00	PPM720372	\$50.00	PPM720117	\$6.00
Sugar Beets	15,000-18,000 seeds/lb	N/A	18"	PPM720284	\$70.00	PPM720386	\$50.00	PPM720117	\$6.00
	13,000-15,000 seeds/lb	N/A	20"	PPM720282	\$70.00	PPM720386	\$50.00	PPM720117	\$6.00
Sunflowers	Confectionary/ Edible	30"	12"	PPM720003	\$50.00	PPM720372	\$50.00	PPM720185	\$6.00
	#1	30"	13"-14"	PPM729932	\$60.00	PPM720372	\$50.00	PPM720117	\$6.00
	#2	30"	12"-13"	PPM729932	\$60.00	PPM720372	\$50.00	PPM720117	\$6.00
	#3, #4	30"	7"-8"	PPM729931	\$60.00	PPM720372	\$50.00	PPM720117	\$6.00
Sweet Corn	Small	30"	15"-18"	PPM729932	\$60.00	PPM720386	\$50.00	PPM720117	\$6.00
	Medium	30"	15"-18"	PPM729933	\$60.00	PPM720386	\$50.00	PPM720117	\$6.00
	Large	30"	15"-18"	PPM729934	\$60.00	PPM720386	\$50.00	PPM720117	\$6.00

eFlow Lubricant - PPM930004: Use on all seeds at 1/8 - 1/4 cup per bag of seed depending on seed size. Do not over apply.



**PPM729931
(Gourds, Small
Popcorn, Del
Monte/Libby
Pumpkins)**



**PPM729932
(Ornamental
Pumpkins)**



**PPM720003
(Field Corn,
Sunflower)**



**PPM729933
(Large Popcorn,
Med Sweet Corn)**



**PPM720386
Singulator**



**PPM720117
Extractor**

ACRA-PLANT NOTCHED DISC OPENERS



Convert your standard planter to a No-Till machine without increasing row unit down-pressure and without the high cost of residue management systems or coulters. Select one 11-notch and one 15-notch for each row unit.

Acra-Plant Notched Disc Openers				
Product ID	Description	Make	Model	Price
APL101711	Acra-Plant notched disc opener, 15"-11 notch	John Deere Kinze White	All except XP row units 2000, 3000 series 6000, 8000 series	\$130.25
APL101715	Acra-Plant notched disc opener, 15"-15 notch	John Deere Kinze White	All except XP row units 2000, 3000 series 6000, 8000 series	\$130.25
APL201711	Acra-Plant notched disc opener, 15"-11 notch	John Deere	XP, XP Pro, ME 5	\$130.25
APL201715	Acra-Plant notched disc opener, 15"-15 notch	John Deere	XP, XP Pro, ME 5	\$130.25
APL109811	Acra-Plant notched disc opener, 14"-11 notch	Case-IH White	400, 500, 800, 900, 1200 series; 5000 series	\$130.25
APL109815	Acra-Plant notched disc opener, 14"-15 notch	Case-IH White	400, 500, 800, 900, 1200 series; 5000 series	\$130.25
APL001760	Bearing & flange repair kit, notched disc openers			\$74.75

Note: A firming point must be installed when using notched disc openers.

AIR DESIGN PLANTER SCRAPERS

The Air Design scrapers feature an extremely simple design with a **special tungsten carbide edge**. The tungsten carbide provides outstanding abrasion resistance along with toughness to give superior, long-lasting performance and reduces the need for replacement.



- Aggressive cleaning action
 - Enhances seed depth placement accuracy
- Tungsten carbide edge will outlast OEM steel scrapers by a factor of 100 to 1.**

AIR DESIGN DRILL SCRAPERS

Save time, labor and money. **The Air Design scraper will outlast and outwear standard cast scrapers** and they can't flip over and fall off.

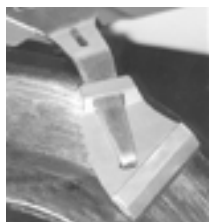

The scraper features a special tungsten carbide cutting edge.

Air Design Planter Scrapers				
Make	Model	Description	Product ID	Price
Case-IH	800, 900	Scraper kit, outside. Includes 2 scrapers. Reuse original Case-IH arms and rivets.	ADC210560	\$33.95
Case-IH	800, 900, 1200	Scraper kit, outside. Includes 2 scrapers & arms.	ADC210570	\$45.95
Case-IH	800, 900	Scraper kit, inside, left disc. Scraper only.	ADC210670	\$25.95
Case-IH	800, 900	Scraper kit, inside, right disc. Scraper only.	ADC210680	\$25.95
Case-IH	800, 900, 1200	Scraper kit, inside, left & right discs. Scrapers only.	ADC210580	\$32.95
Kinze	4000 series	Scraper kit, outside. Includes 2 scrapers.	ADC210480	\$45.95
John Deere Kinze	7000, 7100 series 2000, 3000 series	Scraper kit, outside. 1-piece design. Includes 2 scraper/arm assemblies & 1 spring	ADC210490	\$42.95
John Deere Kinze	7000, 7100 series 2000, 3000 series	Scraper kit, outside. 2-piece design. Includes 2 scrapers, 2 arms & 1 spring.	ADC210500	\$42.95
John Deere	7200, 7300, 1700 series	Scraper kit, outside. 1-piece design. Includes 2 scraper/arm assemblies & 1 spring.	ADC210880	\$44.95
John Deere	7200, 7300, 1700 series	Scraper kit, outside. 2-piece design. Includes 2 scrapers. Reuse original John Deere arms and spring.	ADC210510	\$31.49
John Deere	MaxEmerge 5, Exact Emerge	Scraper kit, outside Includes 2 scrapers, 2 springs & 2 bolts	ADC210890	\$52.95
John Deere	7200, 7300, 1700; non-cast shank	Scraper kit, inside	ADC210700	\$37.95
John Deere	7200, 7300, 1700; cast shank	Scraper kit, inside	ADC210740	\$37.95
White	6000, 8000 series	Scraper kit, outside. Includes 2 scrapers, 2 adapter plates & 2 shims. Reuse original White arms.	ADC210530	\$34.95
White	9000 series	Scraper kit, outside. Includes 2 scraper/arm assemblies & 1 spring.	ADC210540	\$45.95

Air Design Drill Scrapers				
Make	Model	Description	Product ID	Price
Case-IH	500 series	Scraper kit, right disc	ADC210821	\$44.95
Case-IH	500 series	Scraper kit, left disc	ADC210822	\$44.95
Case-IH	620, 6200	Scraper kit	ADC700000	\$23.95
Case-IH	5400, 5500	Scraper kit, left leading disc	ADC700200	\$27.95
Case-IH	5400, 5500	Scraper kit, right leading disc	ADC700300	\$27.95
Case-IH	SDX series	Scraper kit, right disc	ADC210801	\$44.95
Case-IH	SDX series	Scraper kit, left disc	ADC210802	\$44.95
Great Plains	00HD opener series	Scraper kit	ADC210950	\$31.95
John Deere	455, 730, 1060, 8300, 9350	Scraper kit	ADC800000	\$23.95
John Deere	1590, 1890, 1895, 1990	Scraper kit, right disc	ADC210601	\$44.95
John Deere	1590, 1890, 1895, 1990	Scraper kit, left disc	ADC210602	\$44.95
Krause	All	Scraper kit. Includes 2 scrapers. Reuse original Krause arms.	ADC210750	\$31.49
New Holland	2080, 2085	Scraper kit, right disc	ADC210821	\$44.95
New Holland	2080, 2085	Scraper kit, left disc	ADC210822	\$44.95
Salford	500 series air drills	Scraper kit	ADC210920	\$89.95

SEED TUBES

For measuring population, seed spacing, skips and doubles, you depend on the accuracy of your seed sensors. But optical sensors have four big problems:

- Dust looks just like seeds
- Doubles look like singles
- Dust coats the eyes
- Sensor mounts in middle of seed tube



COUNT JUST THE SEED NOT DUST AND DEBRIS

Better information in. Better information out.

WaveVision

WaveVision Advantages:

- Uses high frequency radio waves
- Sensors see 3-dimensional mass, not shapes
- Can distinguish doubles
- Sensors see through dust for more accuracy
- Sensor mounts at bottom of seed tube



- Not compatible with these monitors: AGCO GTA, SM400SE, Kinze® Vision, KPM I, II, III, Monosem MPM, SM3000.

Seed Tubes						
Make	Model	Seed Tube Opening	Bullseye	Price	WaveVision	Price
Case-IH	1200 Series (2009+ & vSet only)	3" x 2"	Not Available		PPM700269	\$205.00
Great Plains	Yield Pro Planters	2-1/4" x 1-1/2"	PPM700150	\$16.50	PPM700250	\$195.00
John Deere	7000, 7100 series	2-1/4" x 1-1/2"	PPM700150	\$16.50	PPM700250	\$195.00
John Deere	7200, 7300 series	2-1/4" x 1-1/2"	PPM700150	\$16.50	PPM700250	\$195.00
John Deere	7200, 7300 series	3" x 2-1/4"	PPM700160	\$16.50	PPM700200	\$195.00
John Deere	1700 series including MaxEmerge 5	3" x 2-1/4"	PPM700160	\$16.50	PPM700200	\$195.00
Kinze	2000 Series	2-1/4" x 1-1/2"	PPM700150	\$16.50	PPM700250	\$195.00
Kinze	3000 Series	2-1/4" x 1-1/2"	PPM700150	\$16.50	PPM700250	\$195.00
Kinze	3000 Series	3" x 2-1/4"	PPM700160	\$16.50	PPM700200	\$195.00
Monosem	All	2-1/4" x 1-1/2"	PPM700158	\$16.50	PPM700290	\$195.00
White	5000, 6000, 8000, 9000 series	2-1/4" x 1-1/2"	PPM700155	\$16.50	PPM700255	\$195.00

Bullseye Seed Tubes accept 1/2" and 3/4" diameter sensors

BullsEye Seed Tubes

Bullseye Advantages:

- Reduces seed tube bounce
- Reduces excessive wear
- Long life with the tungsten-carbide tip
- Smooth path to the trench



No Sensor Interference Sensor Interference

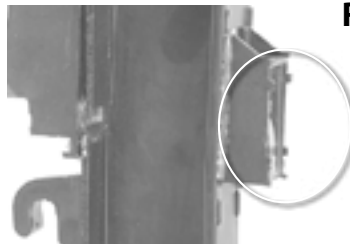

Offset Sensor to Reduce Seed Catchpoints

Seed Tube Mounting Accessories

Product ID	Description		Price
PPM700279	Pin & clip for John Deere 7200, 1700 series model year -2006 For Bullseye seed tubes on planters with mounting holes in shank. Pin is 1/4" x 2-5/8" long.		\$1.50
PPM700167	Pkg of 4, spring pin for John Deere 7200, 1700 series model year 2007- For Bullseye seed tubes on planters without mounting holes in shank		\$12.00
PPM700266	WaveVision Power Module for Planters without 2020 SeedSense		\$495.00

Redesigned Tip for Less Wear

- Bullseye (left)
- Conventional (right)

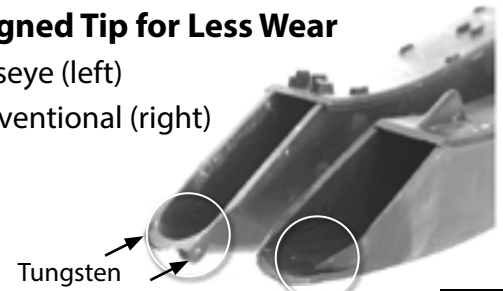

Tungsten

Achieves 30-40% Longer Wear than Competing Openers!

Improved life with sharp cutting-edge retention due to high hardness.

3 ZONES OF HARDNESS

- 1** Increased Flexibility (49-50 HRC)
- 2** Increased Durability (50-55 HRC)
- 3** Maximum Wear (55-58 HRC)



Assembled in the USA

Created with high-grade, quality boron steel, this opener fits nearly all brands of planter and drill applications and is protected with a lifetime warranty on breakage.

- Better blade to soil contact
- Blades do not roll over or break in rocky soils

- **Patented 3-stage induction heat-treating process for a harder edge**
- **Retains a sharp cutting edge to ensure accurate seed placement**
- **Excellent resistance to breakage**
- **Lifetime warranty on breakage**

These seed disc openers are assembled with a Forges De Niaux 200 blade.



LONG LASTING: Thanks to a very high hardness in the working area, Niaux 200 discs have the longest lifespan on the market.

EFFECTIVE: Niaux 200 disk blades ensure a perfect cutting quality throughout their lifetime.

ROBUST: Very resilient and designed to resist extreme shocks and deformations.

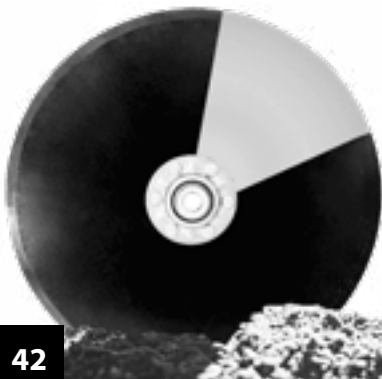
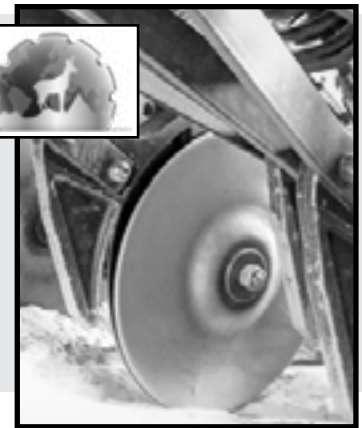

Opener for Landoll 38808	Acres Covered (Total Row)	Blade Diameter - New	Blade Diameter - After 4,500 Acres	Difference	Percentage of Blade Life* Remaining
Competitor	4,500	15.8125"	15.40625"	-0.40625"	50%
Niaux 200	4,500	15.8125"	15.6250"	-0.1875"	77%

SEED DISC OPENERS



WPT015019



WPT015063



WPT015077



WPT015043 with Washer

Wearparts Disc Openers featuring Forges de Niaux Blades

Model	Diameter	Bearing	Thickness	Product ID	OEM ID	Price/Ea
Case-IH						
800, 900, 1200 series planters 5400, 5500 Soybean Special drills 5/8" x 1-5/8" bolt required	14.00" - leading	Single 204	3.5mm	WPT014087	84389196, 90850C92	\$52.46
	14.00" - trailing			WPT014587		
800, 900, 1200 series planters (standard duty) 5400, 5500 Soybean Special drills 5/8" x 2" bolt required	14.00" - leading	Hybrid 204/205	3.5mm	WPT014077	84398745, 47828496	\$71.24
	14.00" - trailing			WPT014577		
800, 900, 1200 series planters (heavy duty) 5400, 5500 Soybean Special drills 5/8" x 2" bolt required	14.00" - leading	Hybrid 204/205	4.5mm	WPT014044	84416318	\$74.37
	14.00" - trailing			WPT014544		
2100 series	15.00"	Double 205	4.5mm	WPT015061	47592277	\$83.76
500, 500T (will NOT fit SDX series)	18.00"	N/A	5mm	WPT018099	87488385	\$68.60
Great Plains						
13-1/2 double disc opener drills	13.50"	Double 205	4mm	WPT013566	107-138	\$60.47
Yield Pro Planters 1999 & Newer HD Drills 1999 & Newer	15.00"	Double 205	4mm	WPT015022	404-072S, 404-121S	\$62.93
Harvest International						
Laser Pro 1	15.00"	Double 204	3.5mm	WPT015019	95009	\$53.89
John Deere						
MaxEmerge, MaxEmerge2, Plus, Pro	15.00"	Single 204	3.5mm	WPT015037	AA53860	\$52.79
XP, XP Pro, ME5, Exact Emerge (standard duty)	15.00"	Double 204	3.5mm	WPT015019	AA65248	\$53.89
XP, XP Pro, ME5, Exact Emerge (heavy duty)	15.00"	Double 205	3.5mm	WPT015063	AA65248	\$71.17
XP, XP Pro, ME5, Exact Emerge (low profile cast hub with washer cover)	15.00"	Double 205	3.5mm	WPT015043	AA65248	\$78.23
XP, XP Pro, ME5, Exact Emerge (cast hub) (Forges de Niaux)	15.00"	Hybrid 204/205	3.5mm	WPT015077	AA65248	\$73.21
XP, XP Pro, ME5, Exact Emerge (cast hub) (Celsan)	15.00"	Hybrid 204/205	3.5mm	WPT915077	AA65248	\$60.51
750, 1560, 1565, 1590, 1690, 1835, 1850, 1860, 1890, 1895, 1990 (Forges de Niaux)	18.00"	N/A	5mm	WPT018052	N283804, N214190	\$63.56
750, 1560, 1565, 1590, 1690, 1835, 1850, 1860, 1890, 1895, 1990 (Celsan)	18.00"	N/A	5mm	WPT918052	N283804, N214190	\$32.00
Kinze						
2000, 3000, 4000 series (standard duty)	15.00"	Single 204	3.5mm	WPT015011	GA8324	\$52.79
3000, 4000 series (heavy duty); 1-3/4" bolt required	15.00"	Double 204	3.5mm	WPT015019	GA8324	\$53.89
3000, 4000 series (low profile cast hub w/ washer cover) 1-3/4" bolt required	15.00"	Hybrid 204/205	3.5mm	WPT015043	GA8324	\$78.23
Landoll						
5210, 5211, 5530, 5531, 5540, 5550 Drills	15.75"	Double 205	3.5mm	WPT015741	143880	\$76.66
Monosem						
Plus Series	15.00"	Double 205	4mm	WPT015047	900263, 7068	\$84.06
New Holland						
P2080, P2085 (will NOT fit SDX series)	18.00"	N/A	5mm	WPT018099	87488385	\$68.60
White						
5000 series	13.50"	Single 204	3mm	WPT013577	700732975, 700164109, 247169BS, 852628	\$50.40
6000, 8000 series	15.00"	Single 204	3.5mm	WPT015011	700155037, 700164107, 700732973	\$52.79
9000 series (cast hub)	15.80"	Double 204	3.5mm	WPT015088	700172776	\$94.96

Wearparts Hardware Kit

Model	Product ID	Description	Price
Kinze 3000, 4900 series	HDW220049	HHCS, 5/8-11 X 1-3/4, Includes Left and Right Hand Threaded Bolts	\$8.00

VALION SEED TUBE GUARDS

Valion seed tube guards will eliminate seed tube wear and greatly reduce blade flex to create a properly shaped furrow and improved planting depth control. These guards are perfect for no-till or high-wear conditions, or anyone who is simply tired of replacing seed tube guards so often.

2x - 4x wear life of OEM

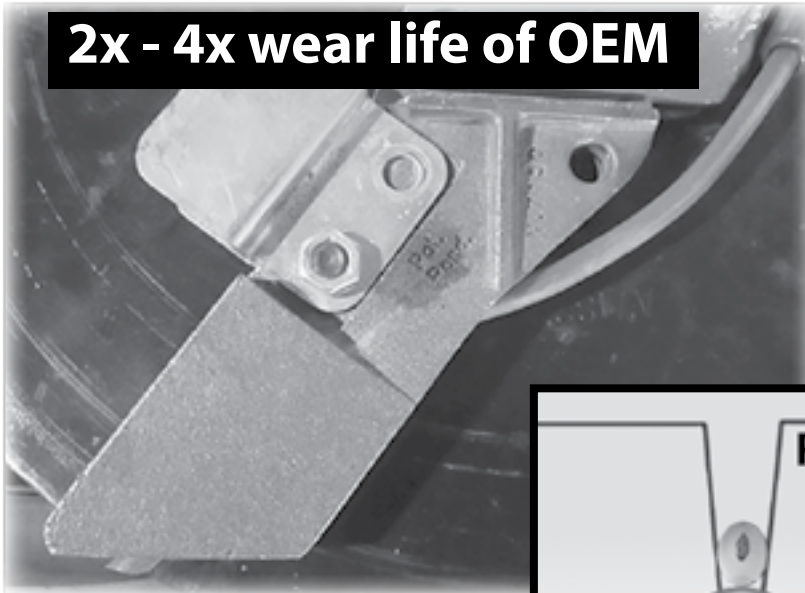

While intended to limit blade flex, standard OEM seed tube guards can wear substantially in just a few hours of use.

These chrome Valions will outlast OEM guards by 2 to 4 times, so that furrows are properly shaped and seeds placed at the correct depth continuously down the row, and all the way through the planting season.

- Prevent blade flex
- Avoid pinched furrows
- Get consistent seed depth
- Doesn't drag below blades

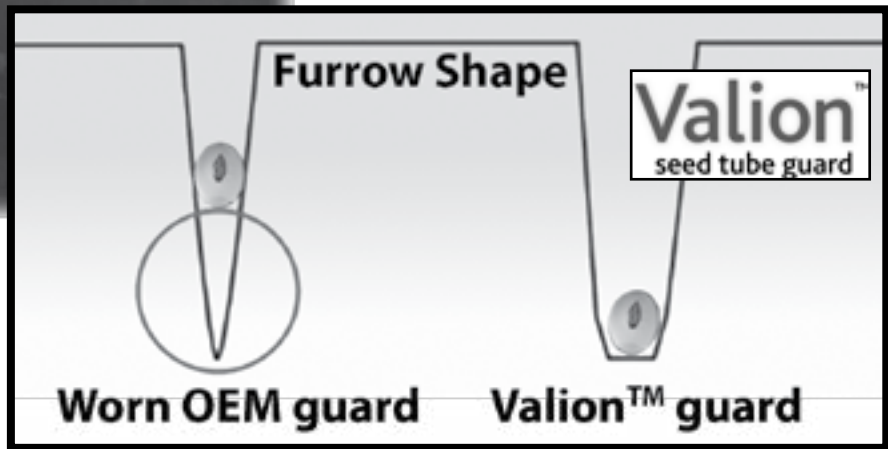

Valions					
Make	Model	Valions w/o fertilizer	Price	Valions w/ fertilizer	Price
John Deere	MaxEmerge 7000, 7100	EXP100150	\$53.59	EXP200150	\$86.82
John Deere	MaxEmerge 7000, 7100 with oversize rivets	EXP100153	\$53.59	EXP200153	\$86.82
John Deere	MaxEmerge 2, Plus, Pro	EXP100150	\$53.59	EXP201150	\$86.82
John Deere	MaxEmerge 2, Plus, Pro with oversize rivets	EXP100153	\$53.59	EXP201153	\$86.82
John Deere	XP, XP Pro, MaxEmerge 5	EXP100450	\$52.22	EXP200450	\$85.45
Kinze	2000 series	EXP100150	\$53.59	EXP200150	\$86.82
Kinze	2000 series with oversize rivets	EXP100153	\$53.59	EXP200153	\$86.82
Kinze	3000 series	EXP100350	\$43.57	Not available	



EXP100150

Liquid Capability Valions are also a slick way to apply liquids into the seed furrow. Here's how to make this setup as trouble-free as possible and more affordable and durable than competitor systems:

- Stainless steel liquid tube holders
- No drilling - installs with existing bolt holes
- Secures plastic 1/4" line for liquids
- Keeps the tubing away from the blades
- Prevents damage from stalks or tree limbs
- Stainless steel for low corrosion
- Thick-wall pipe

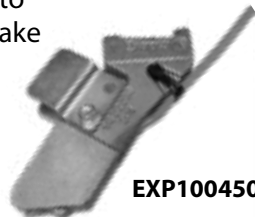

EXP100450



EXP100350



EXP100133

Valion Liquid Components		
Product ID	Product Description	Price
EXP100133	Tube holder, JD MaxEmerge 7000, 7100; Kinze 2000	\$25.00
EXP100433	Tube holder, JD MaxEmerge 2, Plus, Pro	\$25.00
EXP100454	Tube holder, JD XP, ME5	\$25.00
EXP111228	Tubing, 1/4"x28"	\$8.23

OTICO FARMFLEX GAUGE WHEEL ASSEMBLIES



Otico FARMFLEX® Gauge Wheels are the industry leaders in agronomic performance and wear resistance. Their wheel technology and rim & bearing design is unmatched for strength and efficiency.

The FARMFLEX® Concept

OTICO tires, wheels and rollers are all based on FARMFLEX® technology.

The FARMFLEX® concept is based on the use of semi-hollow tires, that offer major benefits in farming applications.

The semi-hollow structure of these tires makes OTICO products especially effective, regardless of the conditions in which they operate. FARMFLEX® is a registered trademark owned by OTICO since 1995.

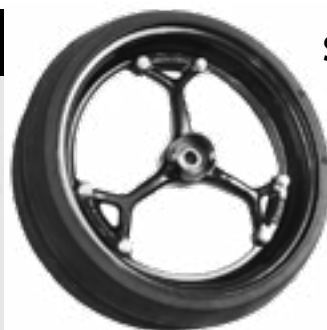

Spoked Gauge Wheel Assembly

- 16" diameter x 3" or 4.5" width
- Fits most makes and models



Solid Gauge Wheel Assembly

- 16" diameter x 3" or 4.5" width
- Fits most makes and models

FARMFLEX GAUGE WHEELS UNMATCHED RELIABILITY

UNMATCHED RELIABILITY

Puncture-proof due to the semi-hollow structure.



Otico Gauge Wheel Assemblies

Make/Model	Description	Product ID	Prc/Each
5/8" / 16mm bearing			
Case-IH: 1200, 2000	4.5 X 16, 5/8", spoked gauge wheel assembly, RID	OTC860474	\$175.00
	4.5 X 16, 5/8", solid gauge wheel assembly, RID	OTC876047	\$125.00
	4.5 X 16, Otico, RID tire only	OTC087604	\$81.00
Case-IH: 500, 500T Great Plains: YP Series; 15, 25 series with 15" openers	4.5 X 16, 5/8", spoked gauge wheel assembly	OTC888055	\$175.00
	4.5 X 16, 5/8", solid gauge wheel assembly	OTC866604	\$125.00
John Deere: 1700/DB with XP, ME5, EE; 750, 1560, 1590, 1850, 1860, 1890, 1895, 1990	4.5 X 16, Otico, standard tire only *	OTC084062	\$67.00
	3 X 16, 5/8", spoked gauge wheel assembly	OTC898188	\$175.00
Kinze: 2000 '93 & after, 3000, 4000	3 X 16, 5/8", solid gauge wheel assembly	OTC866988	\$140.00
Monosem: Plus Series	3 X 16, Otico, standard tire only *	OTC098188	\$43.57
New Holland: P2080, P2085			
White: 8000, 9000			

Assemblies will fit older Deere planters that have upgraded to 5/8"/16mm bolt on gauge wheel arms

*Otico tires are designed to allow them to fit Deere ME XP, ME 5, & EE style rims

SELF-CLEANING Specific rubber formulations and wheel shapes facilitate self-cleaning.

SHOCK ABSORPTION Rubber shock absorption means more consistent sowing and depth control. Rims and bearings last longer due to better shock absorption.

QUALITY Very high quality rubber specially designed to meet increasing demands for longevity.

MUDSMITH GAUGE WHEELS

**Greatly Improve Planting Efficiency
During Wet Soil Conditions!**



**Open Rim
Gauge Wheels**

**GAUGE WHEELS
REINVENTED**

American Made

Get in the Field Sooner with MudSmith Gauge Wheels

These wheels are crafted with a patented open rim design, to reduce mud and debris build-up, that allows you to get in your fields early, regardless of moisture levels.



3 Spoke Open Rim Design: Reduces wheel plugging that causes delays, repairs and stress.

Modular Design: The modular design allows every part to be field replaceable.

Single Piece Cast Hub: Keeps wheel stable - extending bearing life, and cuts down on time spent changing bearings, in one complete, durable housing.

HD Rubber: Thicker rubber lasts 20% longer.



The MudSmith Gauge Wheel was created on the Smith family farm in Northeastern South Dakota. Duane Smith, and his sons Jacob and Matt, began no-tilling in the early 1990's, and the combination of no-till and living in the prairie-pot-hole region caused wheel plugging, which caused delays, repairs and stress.

They were sick and tired of having to constantly clean out the wheels on their Air Seeder and their 24 row planter. After trying different designs, they progressed to the 3 spoke open rim wheel with a single piece cast hub. This wheel has proven to be the most plug-free design available in addition to offering outstanding durability.

MudSmith offers a variety of wheels to fit any planter from conventional 4.5" wheels, to 3" wheels for better ride and less row unit bounce, to 2.5" wheels to fit twin-row planters.

"We were thinking of trading our air drill because we had so many problems with gauge wheels being plugged up. We were spending as much time cleaning wheels as seeding. So we gave it one more try and changed them over to MudSmith Gauge Wheels. We didn't have problems again! Thanks."

"We were in the field days ahead of everybody in our area. The reason being, we had the MudSmith Gauge Wheels on our air drill."

MUDSMITH GAUGE WHEELS



Spoked Wheel
 Sizes: 4.5", 3", 2.5"
\$175.00



Spoked Hardware Kit
 Sizes: 4.5", 3", 2.5"
\$140.00



Solid Wheel
 Sizes: 4.5", 3"
\$110.00

MudSmith Gauge Wheel Assemblies						MudSmith Components			
5/8" or 16mm Bearing	Style	Tire Profile	Size	Product ID	Price/Ea	Tire Only	Price/Ea	Hub/Bearing	Price/Ea
Case-IH: 1200, 2000	Spoked Gauge Wheel	RID Tire <i>Reduced Inner Diameter</i>	4.5" x 16"	MSW653450	\$175.00	MSW446000	\$60.00	MSW260000	\$41.22
			3" x 16"	MSW810300	\$175.00	MSW333000	\$60.00		
		Gauge Wheel Hardware Kit <i>Wheel Assembly Only, No Tire</i>	4.5" x 16"	MSW613000	\$140.00	-	-		
			3" x 16"	MSW810000	\$140.00	-	-		
Case-IH: 500, 500T Great Plains: YP Series; 15, 25 series with 15" openers John Deere: 1700/DB with XP, ME5, EE; 750, 1560, 1590, 1850, 1860, 1890, 1895, 1990 Kinze: 2000 '93 & after, 3000, 4000 Monosem: Plus Series New Holland: P2080, P2085 White: 8000, 9000	Spoked Gauge Wheel	Standard Profile Tire	4.5" x 16"	MSW630450	\$175.00	MSW445000	\$55.00		
			3" x 16"	MSW850300	\$175.00	MSW331000	\$55.00		
		Twin Row Tire	2.5" x 16"	MSW750250	\$175.00	MSW250000	\$55.00		
		RID Tire <i>Reduced Inner Diameter</i>	4.5" x 16"	MSW630451	\$175.00	MSW446000	\$60.00		
			3" x 16"	MSW850301	\$175.00	MSW333000	\$60.00		
		Gauge Wheel Hardware Kit <i>Wheel Assembly Only, No Tire</i>	4.5" x 16"	MSW630000	\$140.00	-	-		
	3" x 16"		MSW850000	\$140.00	-	-			
	HD Solid Wheel	Standard Profile Tire	4.5" x 16"	MSW620000	\$110.00	MSW445000	\$55.00		
3" x 16"			MSW840300	\$110.00	MSW331000	\$55.00			
Set Screw Bearing	Style	Tire Profile	Size	Product ID	Price/Ea	Tire Only	Price/Ea	Hub/Bearing	Price/Ea
John Deere: late 7200, late 7300, early 1700, early 1530, early 1535, White: 6000	Spoked Gauge Wheel	Standard Profile Tire	4.5" x 16"	MSW530450	\$175.00	MSW445000	\$55.00	MSW200000	\$41.22
			3" x 16"	MSW830300	\$175.00	MSW331000	\$55.00		
		RID Tire <i>Reduced Inner Diameter</i>	4.5" x 16"	MSW530451	\$175.00	MSW446000	\$60.00		
			3" x 16"	MSW830301	\$175.00	MSW333000	\$60.00		
Gauge Wheel Hardware Kit <i>Wheel Assembly Only, No Tire</i>	4.5" x 16"	MSW530000	\$140.00	-	-				
	3" x 16"	MSW830000	\$140.00	-	-				
Roll Pin Bearing	Style	Tire Profile	Size	Product ID	Price/Ea	Tire Only	Price/Ea	Hub/Bearing	Price/Ea
Case-IH	Spoked Gauge Wheel	RID Tire <i>Reduced Inner Diameter</i>	4.5" x 16"	MSW553450	\$175.00	MSW446000	\$60.00	MSW205000	\$41.22
			3" x 16"	MSW873300	\$175.00	MSW333000	\$60.00		
		Gauge Wheel Hardware Kit <i>Wheel Assembly Only, No Tire</i>	4.5" x 16"	MSW553000	\$140.00	-	-		
			3" x 16"	MSW873000	\$140.00	-	-		
John Deere: 7000, early 7200, early 7300 Kinze: 2000 '92 & prior Monosem: early models	Spoked Gauge Wheel	Standard Profile Tire	4.5" x 16"	MSW535450	\$175.00	MSW445000	\$55.00		
			3" x 16"	MSW870300	\$175.00	MSW331000	\$55.00		
		RID Tire <i>Reduced Inner Diameter</i>	4.5" x 16"	MSW535451	\$175.00	MSW446000	\$60.00		
			3" x 16"	MSW870301	\$175.00	MSW333000	\$60.00		
		Gauge Wheel Hardware Kit <i>Wheel Assembly Only, No Tire</i>	4.5" x 16"	MSW535000	\$140.00	-	-		
			3" x 16"	MSW870000	\$140.00	-	-		
RID (Reduced inner diameter) tire allows seed trench to lift and fracture. Not recommended for use in tilled soil conditions.									
3" wide tires are designed for no-till and high speed planters so less residue is contacting the tire, improving the seed depth consistency.									
2.5" wide tires are designed for no-till and twin row planters so less residue is contacting the tire, improving the seed depth consistency.									



Spoke Covers	Product ID	Price
Mud Flap, Spoked Wheel Cover	MSW000100	\$50.00



4AG PLANTER GAUGE WHEEL TIRES

The Most Durable on the Market!



4AG tire - 1,233 acres per tire (to date)

OEM tire 146 acres per tire

3" Planter Tire

4.5" Planter Tire

- Durable to sharp stubble and rocks
- No lip wear, keeping dry soil out of seed trench
- Easy installation with no press required
- Solid tire made from patent-pending tough proprietary composition

Created for No-Till Planting into Cotton Stubble

4AG Gauge Wheel Tires

Make	Model	Description	Product ID	Price/ Ea
JD Kinze White	ME, ME2, ME Plus, ME Pro 2000, 3000, 4900	4.5" x 16	PLT040451	\$125.00
		3" x 16	PLT040301	\$115.00
	5100, 5700, 6000, 8000, 9000			
JD	XP, XP Pro, ME5, ExactEmerge	4.5" x 16	PLT040452	\$125.00
		3" x 16	PLT040302	\$115.00

YETTER TWISTER CLOSING WHEELS

Yetter 6200 Twister Closing Wheels have a twisted-spike design that breaks up sidewall compaction and is effective in a wide range of soil conditions. Whatever your tillage practice or soil type, Twister Closing Wheels seal the seed trench, ensuring seed-to-soil contact for optimal seed germination and uniform emergence.

Since its introduction, the Twister Closing Wheel has received positive feedback. In Beck's Practical Farm Research studies, the Twister increased yields by an average of **6.4 bushels per acre**. (Please remember yield results vary based on many factors each year.)

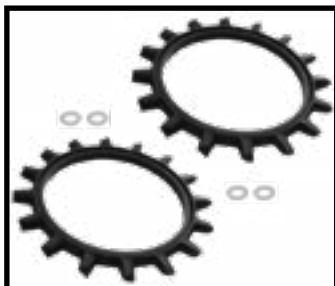

THE TWISTER DIFFERENCE

Crumbles and firms soil simultaneously: Twisted spikes enhance seed-to-soil contact and help create the ideal seed environment, leading to even crop emergence and higher yields. The rounded center ring—sized 12" to match the size of rubber closing wheels—maintains consistent depth.

Works in diverse field conditions, cover crops, and tillage practices: Optimize performance for minimum-till, conventional, strip-till, vertical tillage, or no-till by adjusting down pressure on the tail wheel closing arm.

Fractures the sidewall: In wet, unfavorable planting conditions, the Twister fractures the sidewall. This reduces the potential for crusting and the seed trench drying out and cracking open.

Prevents mud buildup: A smooth surface and a rounded center design help prevent problematic mud buildup, which can interfere with seed trench closure.

Cost-effective and easy to install: The Twister Poly Closing Wheel is built for durability with ultra-high molecular weight (UHMW) plastic. It takes as little as five minutes per row unit to install.

Yetter Twister Closing Wheel Set	Vendor ID	Product ID	Price
5/8" bearing or 16mm bolt on - poly	6200-005	YTR6200005	\$250.00
5/8" bearing or 16mm bolt on - cast	6200-009	YTR6200009	\$280.00
Yetter Twister Closing Wheel Inserts	Vendor ID	Product ID	Price
Insert, LH & RH	6200-006	YTR6200006	\$150.00

OEM Replacement Parallel Arms

John Deere				
Model	Description	Product ID	OEM #	Price/Ea
MaxEmerge2, Plus, Pro, XP, XP Pro, 5, ExactEmerge 1530, 1535 with MaxEmerge row units	Upper parallel arm, 16" standard length	PLT762230	A76223	\$19.95
MaxEmerge2, Plus, Pro, XP, XP Pro, 5, ExactEmerge 1530, 1535 with MaxEmerge row units	Lower parallel arm, 16" standard length	PLT520920	A52092	\$114.95
MaxEmerge2, Plus, Pro, XP, XP Pro, 5, ExactEmerge 1530, 1535 with MaxEmerge row units	Upper parallel arm, 23" extended length	PLT615710	A61571	\$24.95
MaxEmerge2, Plus, Pro, XP, XP Pro, 5, ExactEmerge 1530, 1535 with MaxEmerge row units	Lower parallel arm, 23" extended length	PLT843820	A84382, A65304	\$209.95



PLT762230

- Made in the USA
- Holes are machined, not punched
- Powder coated
- Steel



PLT843820

- Cast

PARALLEL LINKAGE REBUILD KITS

S.I. DISTRIBUTING'S PARALLEL LINKAGE REBUILD KITS FOR JD 7000, 7100; KINZE 2000, 3000

- Replaces worn bushings in parallel linkage
- Oversized bushings last up to four times longer
- Special designed bolts have a shoulder so the bushings don't wear on the bolt threads
- No need to replace parallel linkage because holes are enlarged to accept the new bushings
- Insures a precise fit to eliminate movement between the bushing and the bolt



Special shouldered grade 5 bolts

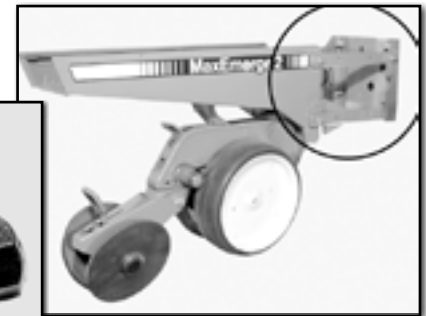

Kit includes:

- 8 oversized bushings, JD 7000, 7100; Kinze
- 8 special shouldered grade 5 bolts
- 8 grade 5 locknuts

For John Deere 7000, 7100 and Kinze planters MUST DRILL OUT PARALLEL LINKAGE TO 1-3/32".

Parallel Linkage Rebuild Kit, John Deere 7000, 7100; Kinze			
Per Row Kit	Product ID	Price/Kit	
Parallel linkage rebuild kit, per row (must drill to 1-3/32")	PLT131100	\$45.00	
Drill Bit	Product ID	Price Ea	
Drill Bit, 1-3/32"	PLT130105	\$98.77	
Parallel Linkage Rebuild Kit Components			
Individual Hardware	Qty Per Kit	Product ID	Price Ea
Bushing, each	8	PLT130101	\$1.90
Bolt, 5/8-18 x 1-3/4, each (support plate & lower row unit)	6	PLT131102	\$4.10
Bolt, 5/8-18 x 2-1/4, each (upper row unit)	2	PLT131103	\$4.35
Nut, 5/8-18 lock, each	8	PLT131104	\$0.55

S.I. DISTRIBUTING'S PARALLEL LINKAGE REBUILD KITS FOR JD 7200, 7300, 1700

For John Deere 7200, 7300, 1700 series planters NO DRILLING IS REQUIRED. Kit includes same size bushing as original.

Kit includes:

- 8 original-sized bushings, JD 7200, 7300, 1700
- 8 special shouldered grade 5 bolts
- 8 grade 5 locknuts

Parallel Linkage Rebuild Kit, John Deere 7200, 7300, 1700			
Per Row Kit	Product ID	Price/Kit	
Parallel linkage rebuild kit, per row (no drilling required)	PLT241100	\$45.00	
Parallel Linkage Rebuild Kit Components			
Individual Hardware	Qty Per Kit	Product ID	Price Ea
Bushing, each (support plate & upper row unit)	6	PLT130101	\$1.90
Bushing, each (lower row unit)	2	PLT130160	\$1.95
Bolt, 5/8-18 x 1-3/4, each (support plate)	4	PLT131102	\$4.10
Bolt, 5/8-18, each (upper & lower row unit)	4	PLT131103	\$4.35
Nut, 5/8-18 lock, each	8	PLT131104	\$0.55

REBOUNDER SEED DEFLECTORS

Rebounder seed deflectors funnel all seeds to the center of the seed trench.

The Rebounder is especially helpful on Case-IH planters, which have fewer options as far as planter attachments.

On most planters, the Rebounder attaches to the seed tube, utilizing two furnished cable ties.

The Rebounder is a simple-yet-effective planting attachment that improves the accuracy and uniformity of in-furrow seed placement by funneling all seeds to the center of the seed V. This eliminates seed bounce, resulting in seeds being flipped on top of the soil.

The Rebounder has a unique, spoon shape design that forms to the V-shape of the furrow. This works in conjunction with the furrow's V-shape rather than against it.

The Rebounder's spoon shape design flows gently down the furrow, not disturbing the soil or creating any additional compaction around the seed. The spoon shape design gradually narrows as it drops below the topsoil surface to follow the V-shape that is created by the double disc openers.

Uneven seed spacing and inconsistent depth placement are two of the top contributors to decreased yields. Inconsistent depth placement occurs with seeds landing 3/4" to 1-3/4" deep. Shallow-planted seeds can cause poor root structure and reduced yields.

As the double discs on a planter open a seed V in wetter, heavier soils, they tend to "orange peel" the side wall. Seeds can lodge on the side wall and not get all the way to the bottom of the seed V.

Rebounders For Planters

Case IH	Product ID	Price
800, 900, 950 ,955; will not work with Y-Not Splitter (if updating seed boot refer to SMS810003)	SMS810001	\$30.00
1200 (prior to 2009)	SMS810002	\$42.50
1200 (2009 & after)	SMS810003	\$42.50
1200 (with speedtube)	SMS810004	\$44.50
Great Plains	Product ID	Price
YP, 3PYP, 25 series (Clear-Shot seed tubes)	SMS810011	\$30.00
Horsch	Product ID	Price
Maestro	SMS810021	\$30.00
John Deere	Product ID	Price
7000, 7100, 7200, 7300 1700 (MaxEmerge, MaxEmerge 2, ME Plus, ME XP, ME 5)	SMS810031	\$30.00
1700, ExactEmerge without pneumatic down pressure	SMS810033	\$51.95
1700, ExactEmerge with pneumatic down pressure	SMS810032	\$56.95
Kinze	Product ID	Price
2000, 3000; with smaller seed tubes (non EdgeVac & seed tubes prior to 2012)	SMS810031	\$30.00
3000, 4000; with larger seed tubes (EdgeVac & seed tubes 2012 & after)	SMS810041	\$42.50
Monosem	Product ID	Price
NG Series	SMS810031	\$30.00
Precision Planting	Product ID	Price
BullsEye seed tube	SMS810021	\$30.00
WaveVision seed tube	SMS810061	\$42.50
Universal Keeton seed firmer bracket	SMS810062	\$42.50
Quick Attach Keeton seed firmer bracket	SMS810063	\$42.50
White	Product ID	Price
5000, 6000, 8000	SMS810031	\$30.00
9000	SMS810071	\$44.50

REBOUNDER SEED DEFLECTORS

The Rebounder funnels seeds to the center of the seed V, eliminating seed bounce, resulting in seeds being flipped on top of the soil.

The distinct half-moon notch on the bottom tip of the Rebounder allows it to run 3/8" off the bottom of the furrow. Because the Rebounder does not drag the bottom of the seed bed, it will not build up with mud.

On most planters, the Rebounder attaches to the seed tube, utilizing two furnished cable ties. The Rebounder is designed to serve as an extension of the seed tube, and works with the seed tube rather

than against it. The Rebounder functions as a stabilizer that keeps the seed tube in the center of the furrow. When mounted to the seed tube, the Rebounder puts less than one pound of pressure on the seed tube while planting. This small amount of pressure in the seed furrow eliminates mud from building up when planting in heavy, wet and textured soils.



Rebounders For Drills		
Amity	Product ID	Price
Amity Drills	SMS910001	\$30.00
Case IH	Product ID	Price
5400, 5500 Soybean Special Drills (if updating seed boot refer to SMS810003)	SMS910011	\$30.00
SDX	SMS910012	\$30.00
5100, 5300, 5400, 5500, 500T, Left Hand	SMS910015	\$42.50
5100, 5300, 5400, 5500, 500T, Right Hand	SMS910016	\$42.50
CrustBuster	Product ID	Price
3400, 3700, 4000	SMS910021	\$48.00
3400, 3700, 4000 with dry fertilizer	SMS910022	\$48.00
FSO (Flexi Coil)	Product ID	Price
FSO Drills; Left	SMS910031	\$42.50
FSO Drills; Right	SMS910032	\$42.50
Great Plains	Product ID	Price
00HD-10HD Heavy Duty & Precision Drills (15" disc)	SMS910041	\$42.50
Solid Stand Drills (13.5" disc)	SMS910042	\$42.50
Krause Drill	Product ID	Price
5200, 5250, 5500	SMS910051	\$42.50
John Deere	Product ID	Price
450, 455, 515, 520, 1520, 830 (press wheel units)	SMS910061	\$42.50
750, 1590, 1690, 1850, 1890, 1990 (9" or 10" press wheel; 10" requires stop kit)	SMS910062	\$10.00
JD press wheel stop kit for 10" wheels 750	SMS090003	\$16.00
JD press wheel stop kit for 10" wheels 1590, 1690, 1850, 1890, 1990	SMS090004	\$11.25
Landoll	Product ID	Price
5500 & Newer	SMS910071	\$42.50
Salford	Product ID	Price
Salford Drills	SMS910081	\$42.50
Sunflower	Product ID	Price
Sunflower Drills	SMS910091	\$42.50
Tye	Product ID	Price
IV, V, 2000	SMS910101	\$42.50
Soybean/Rice special drills	SMS910102	\$42.50

Rebounder Liquid Placement Attachments

Y-Not Split-It

The Y-Not Split-It places fertilizer halfway up the sidewall.

The Y-Not Split-It allows fertilizer to soak into the sidewall and keeps it from going directly onto the seed. It is insurance against fertilizer burn.

Straight Shot

The Straight Shot places fertilizer or inoculants directly on the seed from under the Rebounder.

This keeps the fertilizer from caking up on the press wheel.



Rebounder Liquid Placement Attachments		
Description	Product ID	Price
Y-Not Split-It; Great Plains, Horsch, John Deere, Kinze, Monosem, Precision Planting, White planters; applies liquid to furrow sidewalls	SMS090000	\$6.75
Y-Not Split-It, Case-IH; applies liquid to furrow sidewalls	SMS090006	\$6.75
Y-Not Split-It, drills; applies liquid to furrow sidewalls	SMS090026	\$6.75
Straight Shot; applies liquid directly to seed	SMS090001	\$7.50

Manufactured by S.I. Distributing,
for accurate closing wheel angle
for optimum closing.

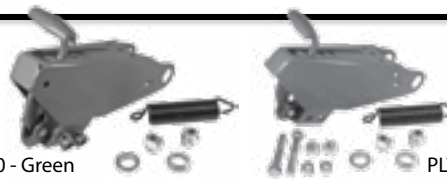

PLT120700 - Green
PLT120710 - Black

PLT120720 - Black
PLT120730 - Green
PLT120740 - Green

Closing Wheel Bracket Kits / Brackets Only

John Deere					
Model	Description	Bracket Kit	Price	Bracket Only	Price
7000, 7100; roll pin style	Closing Wheel Bracket Kit, for roll pin attached closing wheels.	PLT120700	\$69.95	PLT120757	\$43.95
7000, 7100; bolt-on conversion	Closing Wheel Bracket Kit, for bolt-on closing wheels. Includes hardware kit to bolt wheels on bracket.	PLT120730	\$67.95	PLT120760	\$36.95
7200, 7300; bolt-on conversion 1700: bolt-on	Closing Wheel Bracket Kit, for bolt-on closing wheels. Includes hardware kit to bolt wheels on bracket.	PLT120740	\$67.95	PLT120762	\$36.95

Kinze					
Model	Description	Bracket Kit	Price	Bracket Only	Price
Kinze 1993 and earlier; roll pin style	Closing Wheel Bracket Kit, for roll pin attached closing wheels	PLT120710	\$69.95	PLT120758	\$43.95
Kinze 1994 and newer; bolt on wheels	Closing Wheel Bracket Kit, for bolt-on closing wheels	PLT120720	\$67.95	PLT120761	\$36.95

Note: Bracket kit includes bracket, t-handle, spring, eccentric bushings and hardware

Closing Wheel Bracket Replacement Parts

Description	Product ID	Price
Eccentric bushing, for 1/8" ears, OEM replacement, each	PLT120550	\$2.39
Eccentric bushing, for 1/4" hardened ears, each	PLT120650	\$5.95
Eccentric bushing, for hex style ears, current style, each	PLT120660	\$3.95
Hex step bushing, each	PLT120661	\$1.95
T-handle, painted green, each	PLT120750	\$9.50
T-handle, painted black, each	PLT120753	\$9.50
Spring, each	PLT120751	\$8.50



White 6000 Series Bracket

White Closing Wheel Bracket Rebuild Kit

White			
Model	Description	Product ID	Price
6000	Rebuild Kit, closing wheel bracket. Kit includes new bolt-on arms, eccentric bushings, hex bushings and hardware.	PLT120618	\$29.95

Have S.I. Distributing Rebuild Your OEM Closing Wheel Bracket

S.I. Distributing offers a service to rebuild existing John Deere V-Closing wheel brackets. The old worn-out ears are cut off and new hex style ears are welded on while in a jig to insure proper alignment. Includes hex step bushings and new eccentric bushings.

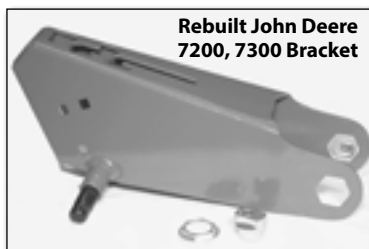

Rebuilt John Deere 7200, 7300 Bracket

Closing Wheel Bracket Rebuild Service

John Deere			
Model	Description	Product ID	Price
7200, 7300	Rebuild; closing wheel bracket	PLT120610	\$34.95
1700	Rebuild; cast closing wheel bracket	PLT120630	\$34.95
Kinze			
Model	Description	Product ID	Price
Kinze	Rebuild; closing wheel bracket with bolt-on closing wheels	PLT120640	\$34.95

Closing wheel bracket is sent to S.I. Distributing where the old worn-out ears are cut off and new hex style ears are welded on in a jig to ensure proper alignment. Price includes new eccentric bushings, hex step bushings and repainting.

V-CLOSING WHEEL CONVERSION BRACKET

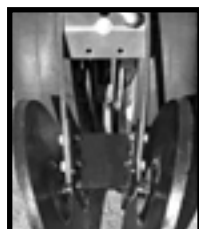

White Planter



Case-IH Planter



PLT125001



PLT125101

V-Closing Wheel Bracket Upgrade Kit

White			
Model	Description	Product ID	Price
5000, 6000	Bracket kit, to convert planter to v-closing wheels. Includes shim washers for spacing wheels to desired width. Will only fit planters if H-bracket arm is straight and down pressure springs are on the inside.	PLT125001	\$44.95
Case-IH			
Model	Description	Product ID	Price
800, 900, 1200	Bracket kit, to convert planter to v-closing wheels. Includes shim washers for spacing wheels to desired width.	PLT125101	\$84.95

TRASH GUARD

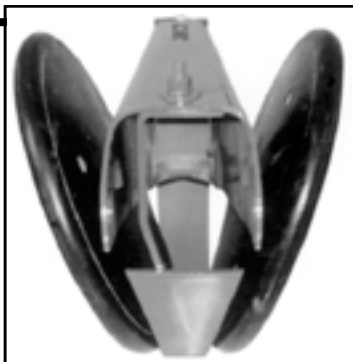

Keeps your planter v-closing wheels free of old stalks, lumps of soil and other field debris.

- Improves planting results
- Saves time and money on maintenance
- For all John Deere, Kinze and White planters
- Bolts easily between the closing wheels
- Includes installation hardware

Trash Guard

Product ID	Description	Price
PLT126000	Trash guard kit, John Deere, Kinze and White planters	\$11.95

ACRE PLUS SEED BOX TOPPER

Adds one bushel to seed box capacity. Plant more acres between fills!



John Deere

Acre Plus - Seed Box Extensions fits John Deere (models listed below) poly seed boxes. Yellow in color.



Kinze

Acre Plus - Seed Box Extensions fits Kinze (models listed below) poly seed boxes. White in color.

The one-piece plastic snap-on extensions require no modifications to the original box and uses the existing seed box lid, and are available in original equipment colors.

Acre Plus Seed Box Topper

Make	Model	Description	Product ID	Price
John Deere	7200, 7300 (1995 & newer with poly boxes) 1700 series	Seed Box Extensions	PDM030000	\$43.95
Kinze	3000 series (2001 & newer with poly boxes)	Seed Box Extensions	PDM033000	\$43.95

NOTCHED MARKER DISCS

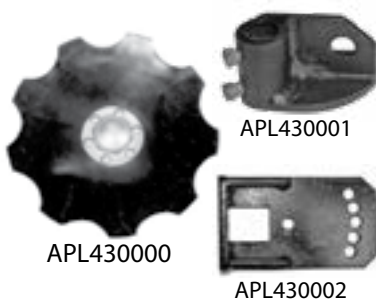

Acra-Plant Notched Marker Discs

Product ID	Description	Make	Model/Notes	Price
APL430000	Acra-Plant 13" notched marker disc Note: For John Deere prior to 1974, must purchase AA27924 from dealer. Note: For Case-IH must purchase additional bracket shown below.	John Deere Kinze Case-IH	7000, 7100, 7200, 7300, 1700 series 2000, 3000 series 800, 900 series	\$171.95
APL430001	Marker bracket, Case-IH with folding markers and round shaft	Case-IH	Round shaft	\$63.75
APL430002	Marker bracket, Case-IH with non-folding markers and flat plate	Case-IH	Flat plate	\$68.25

SURE MARK MARKER WEIGHT

Marker Weight For No-Till

SURE MARK is a 12-1/2 pound weight that simply bolts on the dish of your marker disk. The additional weight of SURE MARK will assist the disk to cut a much deeper furrow in No-Till planting. For extremely hard No-Till conditions, another weight can be added.

Measurements are required when placing an order.

Longer bolts for installation are not included.

Sure Mark Marker Weight

Description	Price
Sure Mark Please specify make, model and hub bolt pattern when ordering.	\$79.95



OTHER PLANTING INNOVATIONS

DOWN PRESSURE SPRING PACKAGE

Equals or exceeds competitive designs in DOWN FORCE in normal working ranges

Each package includes:

- 4 Detent pins
- 4 Anchors
- 4 Heavy duty down pressure springs

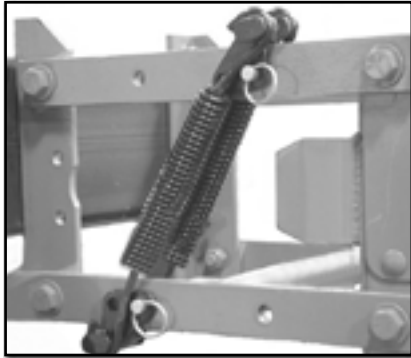

Down Pressure Spring Kit

Product ID	Description	Price
PLT141000	Down pressure spring kit, per row	\$109.95
PLT141001	Down pressure spring kit with plate, per row Note: The spring kit with plate is for planter row units that currently do not have a plate installed to hold the u-bolts square and keep the parallel linkage arms from twisting.	\$129.95

Down Pressure Spring Kit Components

Product ID	Description	Price
PLT141010	Detent pin, 4 per kit, each	\$5.25
PLT141011	Anchor, 4 per kit, each	\$13.25
PLT141012	Spring, 4 per kit, each	\$8.75

KINZE BRUSH METER ADAPTER

The Kinze brush meter adapter is a conversion kit to adapt a Kinze brush-type seed meter to fit a John Deere 7200, 7300 and 1700 Series Finger pick-up seed box.

Conversion kit includes:

1. Seed block for finger pick-up seed box
2. Metric bolt and nut
3. Detailed instructions for complete installation

NOTE: Can switch back to a finger pick-up meter

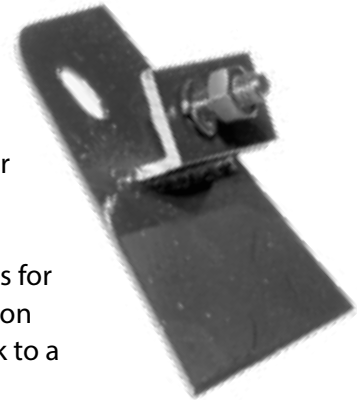

Kinze Brush Meter Adapter

Product ID	Description	Price
PLT000100	Adapter kit, to install Kinze brush meter on John Deere 7200, 7300 and 1700 series planter	\$13.75

Note: Will not work with Kinze Brush Meters manufactured after July 2010 because the shaft is now hardened and very difficult to modify.

GAUGE WHEEL COVER KIT

Prevents rocks from bending planter units and twisting depth control arms

- Reduces bending and breaking of depth gauge wheels and helps prevent plugging of rocks and residue between depth gauge wheel and planter drive wheel.



For John Deere, Kinze and White Planters

Gauge Wheel Cover - PRICE REDUCED!

Product ID	Description	Price
PLT130500	Gauge wheel cover, each	\$9.95

QUICK CRANK TRASHWHIPPER ADJUSTER

Converts fixed pin-adjust Yetter Residue Managers to screw adjust, to raise an additional 3/4".

It only takes approximately 60 seconds to adjust 12 rows, while standing in front of the planter.

NOTE: Will only work with Yetter model #2967-15 fixed row cleaners.

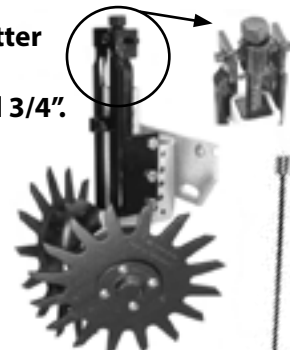

PLT130601

Quick Crank Trashwhipper Adjuster - PRICE REDUCED!

Product ID	Description	Price
PLT130602	Quick Crank Trashwhipper Adjuster	\$59.95
PLT130601	Crank Handle	\$20.00

TRAIL-JET FERTILIZER OPENER



Applies liquid fertilizer behind the planter, freeing up the front of the planter for other attachments

- Allows for split applications of two different types of fertilizer
- Mounts directly on the planter unit – no extra tool bars required
- High pressure assures excellent placement of fertilizer
- No sideways movement of residue
 - Low maintenance and low draft
 - 13" double-beveled coulters blade
 - Applies fertilizer 1-3" to either side of the row
 - Requires a constant pressure pump

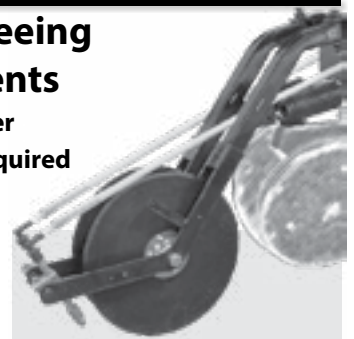

Optional dual application available for John Deere Series 7000-7300, 1700; Kinze Series 2000, 3000; Case-IH Series 800, 900, 1200; White Series 6000, 8000



Trail-Jet Fertilizer Opener

Make	Model	Single Trail Jet	Price	Dual Trail Jet	Price
Case-IH	800, 900 series	TJT008000	\$269.00	TJT228000	\$449.00
Case-IH	1200 series, except 1220	TJT001200	\$249.00	TJT221200	\$429.00
Case-IH	1215-1265 series	TJT001255	\$249.00	TJT221255	\$429.00
John Deere	7000, 7100 series with MaxEmerge row units	TJT007000	\$235.00	TJT227000	\$415.00
John Deere	7200, 7300, 1700 series with MaxEmerge 2 row units	TJT007200	\$235.00	TJT227200	\$415.00
John Deere	1700 series with MaxEmerge Plus row units	TJT007500	\$249.00	TJT227500	\$429.00
John Deere	1700 series with MaxEmerge XP row units	TJT007600	\$251.00	TJT227600	\$431.00
John Deere	1700 series with Pro-Series XP row units	TJT007700	\$251.00	TJT227700	\$431.00
John Deere	1700 series with MaxEmerge 5, ExactEmerge row units	TJT007800	\$251.00	TJT227800	\$431.00
Kinze	2000 series	TJT007000	\$235.00	TJT227000	\$415.00
Kinze	3000 series	TJT003000	\$249.00	TJT223000	\$429.00
Monosem	All row units	TJT001000	\$259.00	TJT221000	\$439.00
White	6000 series	TJT006000	\$249.00	TJT226000	\$429.00
White	8000 series	TJT008100	\$249.00	TJT228100	\$429.00

Note: Price is per row and does not include pump or hoses. Nozzles are sold separately.

Product ID	Description	Price
TJT830002	Stainless steel nozzle, 5 gallons per acre	\$17.16
TJT830003	Stainless steel nozzle, 10 gallons per acre	\$17.16
TJT830004	Stainless steel nozzle, 15 gallons per acre	\$17.16
TJT830005	Stainless steel nozzle, 20 gallons per acre	\$17.16
TJT830006	Stainless steel nozzle, 25 gallons per acre	\$17.16
TJT830008	Stainless steel nozzle, 30 gallons per acre	\$17.16
TJT830010	Stainless steel nozzle, 40 gallons per acre	\$17.16
TJT830012	Stainless steel nozzle, 50 gallons per acre	\$17.16

DEPTH-A-MATIC

Consistent Seed Depth Control

Allows the depth gauge wheels to follow the ground terrain allowing the unit to travel smoothly in all field conditions.

- More equal compaction on either side of the disk enhances seed to soil contact and equal emergence
- Less bearing failure on depth gauge wheels

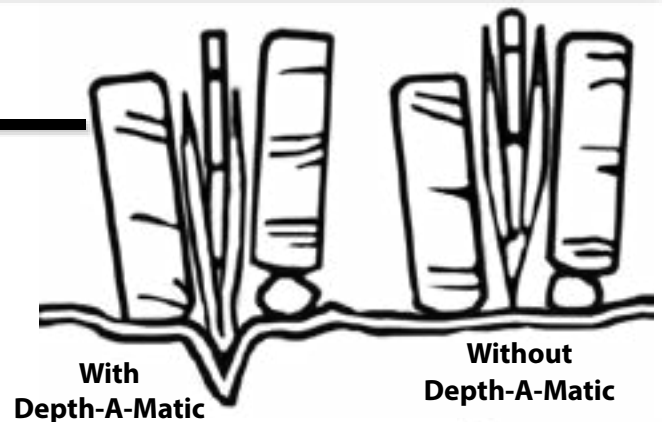
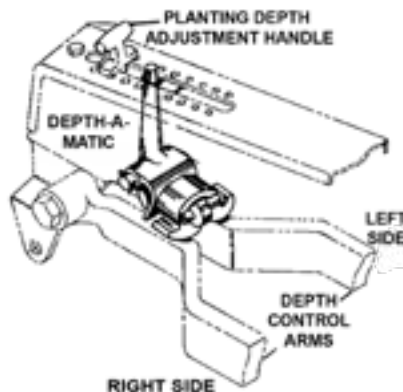

Product ID	Description	Price
DAM001000	Depth-A-Matic, John Deere 7000, 7100; Kinze & New Idea planters. Does not fit Kinze 3000 series row units.	\$38.95
DAM002000	Depth-A-Matic, JD 7200, 7300 & 1700 series. Does not fit John Deere XP, XP Pro row units.	\$52.95
Depth-A-Matic Replacement Parts		
DAM003100	Rocker, for Depth-A-Matic	\$14.95
DAM003200	Roll pin, for Depth-A-Matic	\$0.50

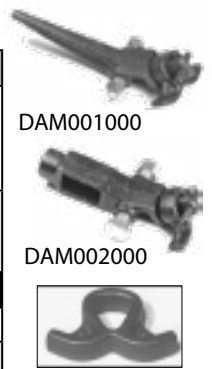

M3 MONITOR SYSTEM

Population Monitor for Planters and Grain Drills

Designed to be accurate, user friendly, dependable and affordable.

M3 Monitor Kits

Grain Drill Kits

Description	Product ID	Price
4-row drill, rigid, 10-20'	AGT30040102	\$1,882.00
4-row drill, folding, 20-25'	AGT30040202	\$2,101.00
4-row drill, folding, 30'	AGT30040302	\$2,186.00
4-row drill, tandem, 10-15'	AGT30040402	\$2,270.00
6-row drill, rigid, 10-20'	AGT30060102	\$2,522.00
6-row drill, 3-fold, 30'	AGT30060302	\$2,522.00
8-row drill, rigid, 10-20'	AGT30080102	\$2,942.00
8-row drill, front fold, 30'	AGT30080302	\$3,111.00
8-row drill, tandem, 10-15'	AGT30080402	\$3,111.00
12-row drill, rigid, 10-20'	AGT30120102	\$3,783.00
16-row drill, folding, 20-25'	AGT30160202	\$4,792.00
16-row drill, folding, 30'	AGT30160203	\$4,792.00

Requires speed sensor - sold separately - chart right

Planter Kits; John Deere 7000, 7100; Kinze 2000, 3000

Description	Product ID	Price
4-row planter, rigid	AGT30045051	\$2,101.00
6-row planter, rigid	AGT30065051	\$2,284.00
8-row planter, rigid	AGT30085051	\$2,942.00
8-row planter, rear fold	AGT30085251	\$3,111.00
8-row planter, front fold	AGT30085351	\$3,111.00
12-row planter, rigid	AGT30125051	\$3,783.00
12-row planter, rear fold	AGT30125251	\$3,950.00
12-row planter, front fold	AGT30125351	\$3,950.00
16-row planter, rigid	AGT30165051	\$4,624.00
16-row planter, rear fold	AGT30165251	\$4,792.00
16-row planter, front fold	AGT30165351	\$4,792.00

Requires speed sensor - sold separately - chart right

Planter Kits; John Deere 7200, 7300, 1700

Description	Product ID	Price
4-row planter, rigid	AGT30045052	\$2,101.00
6-row planter, rigid	AGT30065052	\$2,522.00
8-row planter, rigid	AGT30085052	\$2,942.00
8-row planter, rear fold	AGT30085252	\$3,111.00
8-row planter, front fold	AGT30085352	\$3,111.00
12-row planter, rigid	AGT30125052	\$3,783.00
12-row planter, rear fold	AGT30125252	\$3,950.00
12-row planter, front fold	AGT30125352	\$3,950.00
16-row planter, rigid	AGT30165052	\$4,624.00
16-row planter, rear fold	AGT30165252	\$4,792.00
16-row planter, front fold	AGT30165352	\$4,792.00

Requires speed sensor - sold separately - chart right

Using an Intel® microprocessor, the M3 monitors speed, area, population, hopper levels, limit switch status, seed spacing, and row failure to keep the operator informed of the current status of the planter or drill. The M3 has two separate sets of setup parameters that may be entered and retained, eliminating the need to re-enter values when switching planters or drills. Every feature of the M3 has been designed to be as simple to operate as possible, thereby eliminating confusion and unnecessary down time.

- Saves time and money by not over seeding
- Display two different sets of data on the screen
- Choose from MPH, field acres, total acres, acres per hour, row population, average population, row seed spacing and average seed spacing

Loud Alarm sounds when a row fails and notifies you which row failed. Silence with a push of the button

Bright Backlit Display You can see this display in a bright light or in darkness.



Anodized Aluminum Bracket Mount the M3 either on the dash with bracket beneath or from the cab ceiling with the bracket above.

Sealed Enclosure protects the unit from the elements and allows for years of reliable service.

Easy Click Wheel No small keys or fine print, it's as easy as adjusting the volume on your radio.

M3 Monitor Speed Sensors

Description	Product ID	Price
Gear tooth sensor kit, for RPM or ground speed sensing	AGT10006525	\$137.50
Astro 5 GPS Speed Sensor, 5Hz update rate	MTS901428	\$676.00

M3 Monitor Accessories

Description	Product ID	Price
Limit switch kit (disables acre counter when implement is raised)	AGT10006518	\$195.00
Sensor, planter, DICKEY-john, high-rate	AGT10002640	\$126.00
Sensor, drill, DICKEY-john, high-rate	AGT10003389	\$142.00

M3 Monitor Replacement Components

Description	Product ID	Price
M3 console, includes DICKEY-john cab cable	AGT1050300001	\$1,095.00
M3 console, includes Computer-Trak cab cable	AGT1050300002	\$1,095.00
Cab cable, M3 monitor, DICKEY-john pinout, 12'	AGT10009000	\$122.00
Cab cable, M3 monitor, Computer-Trak pinout, 12'	AGT10005800	\$122.00
Power cable, M3 monitor, 18'	AGT10003795	\$47.00
Adapter kit, John Deere drill seed tubes	AGT10006552	\$23.10

Each Kit Includes:

- M3 Monitor Console
- Power Cable
- Cab Harness
- Planter or Grain Drill Harness
- DICKEY-john® High-Rate Seed Sensors
- New Seed Tubes for Planters
- Seed Tube Adapters for Drills (if required)



DOWN PRESSURE SYSTEM FOR AIR SEEDERS



Put the Weight Where It Belongs!

The Hydra-Maxx Down Pressure System Equally Distributes Weight Across the Entire Air Seeder.



Patent Pending

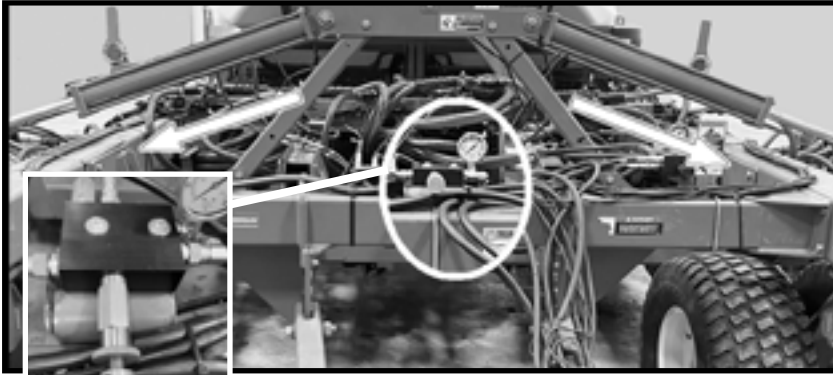

Better and More Consistent Depth Control!



- No more need for suitcase weights on the wings, which means less stress on frame bolts
- Built-in relief valve added for cylinder protection
- Easy to install, no drilling or welding

Hydra-Maxx Down Pressure System			
Make/Model	Width	Product ID	Price
Case-IH			
500T, 500DS	25', 30', 40'	HMX030040	\$2,895
John Deere			
1690, 1860, 1890, 1895, 1990	30'	HMX010030	\$2,195

Only fits single-fold air seeders.

PRO CHUTE

Empty your seed boxes directly, smoothly and quickly into your planter

In as little as two to four minutes you can empty 50 units of soybeans

Use for loading and unloading your planter

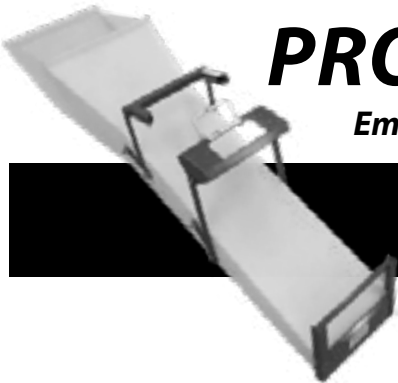

- Seed flows smoothly and quickly when you attach the PRO Chute to your bulk seek box. The funnel system is made of poly for durability, wear resistance, and slick properties.
- Our PRO Chute snaps into your seed box in under five seconds, without looking underneath to line up brackets. Never stand underneath a raised box again. There is a full 79" of clearance from the lift to the end of the PRO Chute giving you maximum clearance.
- Quick attach for safe unloading
- Slide Gate controls the seed flow.



Quick attach for safe unloading



Product ID	Description	Price
PLT082652	Pro Chute, Yellow, 7.5" x 62"; 4 min	\$525.00
PLT082653	Pro Chute, Blue, 10.5" x 62"; 2 min	\$525.00

NEEDHAM AG V8 DRILL FIRMING WHEEL

Improve Crop Emergence by ensuring seed placement

The Needham Ag V8 Firming Wheel's proven profile, the only one on the market which matches the shape of the seed slot, combines with the flexible green urethane tire.

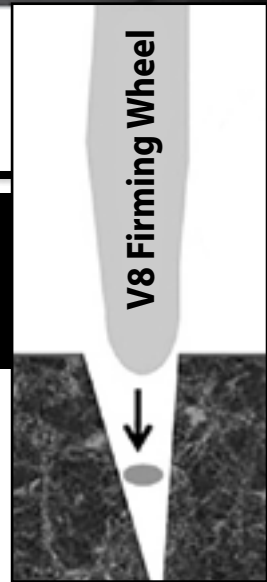

Flexible!



Benefits of the urethane tire:

- Increased durability
- Flexibility to help shed mud, especially in moist clay soils.
- Helps keep the firming wheel down within the seed slot, especially when operating on hillsides and when making slight turns.
- Uses button head bolts to help improve residue flow, especially in no-till conditions.

The V8 tire profile is specifically designed to match the offset tapered profile of the John Deere single disc seed slot. The tire collects seeds and presses them down into moisture, which is critical for uniform emergence, especially when seeding into low soil moisture conditions.

Firming Wheels Compared

Wheel Information	Tire Design Profile	Maximum Width (Inches)	Durometer (compound hardness)	Wheel Design Characteristics	Ability to Flex Within Seed Slot
John Deere Part Number AN281359		0.982	82	Rubber tire with 2 steel wheel halves	No
John Deere Part Number AN282296		0.831	80	Rubber tire with 2 plastic wheel halves	No
Needham Ag V8 Firming Wheel		0.596	95	Urethane rubber wheel design with tapered shape to match seed slot	Yes

The Needham Ag V8 features the Peer SeedXTreme heavy duty bearing to extend service life further. It incorporates 12 seals (6 each end) to better keep dust and other materials out.



NOTE: Each V8 wheel is shipped with a longer (3.5") Grade 8 x 5/8" low profile head bolt, nylon lock nut and washer, to mount the V8 firming wheel to the existing firming wheel arm. (A longer bolt is required, because the long-life bearing is wider than all other firming wheel bearings).

Needham Ag V8 Firming Wheel

Product ID	Description	Price
DRL400010	Needham Ag V8 firming wheel, JD drill	\$49.00

NINJA SEED BOUNCE FLAP



CLOSE THE GAP!

Keep More Seeds in the Furrow!

Proven to Outlast Other Flaps by Five Times!

The unique 20° forward bend closes the gap left by OEM flaps, keeping more seeds in the furrow. Since it is flexible and less likely to break in the field, it is *proven to outlast other flaps by five times*.

The flap on the seed boot is what keeps seeds from bouncing out of the furrow, and this is even more critical on air drills, since the air stream is also trying to escape and may carry seeds along with it. JD & aftermarket flap suppliers use a straight flap, made from materials that are too brittle—often snapping off in the field. The issue with straight flaps is that it leaves a triangular gap for seeds to escape, and this gap gets larger when the straight flaps bend upward during use, due to riding on the sidewall.

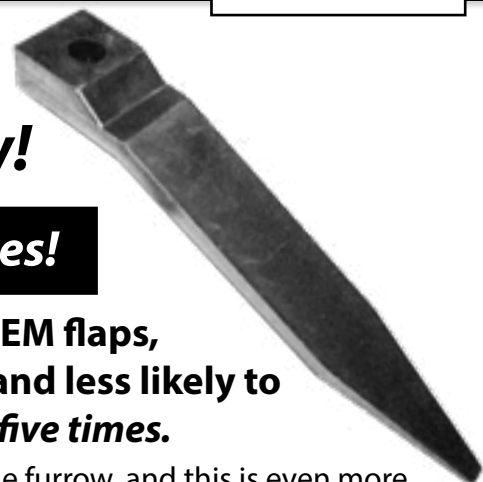

Testimonials:

“The Ninjas hardly wore at all. They fit down in the furrow so much better than other flaps on the market. I really appreciate what you guys are doing for the farmer.” - Ed Meng, Oregon, MO (Ninjas on JD 750)

“The Ninja seed tabs have made a huge difference to our seed placement and accuracy—before, we had a lot of seed near and on top of the soil. Also finding we don’t need to run the discs as deep to achieve optimum seed depth and placement.” - Ben Wilson, Tocumwal, NSW, Australia (Ninjas on JD 1895 drill)

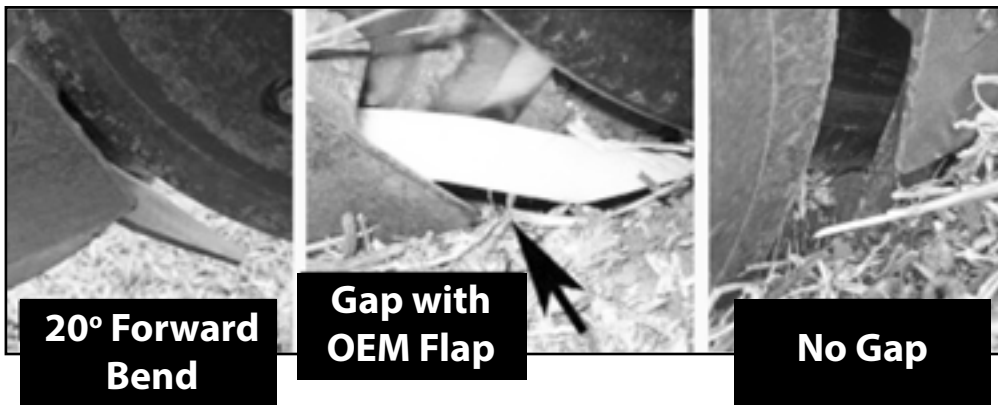

20° Forward Bend

Gap with OEM Flap

No Gap



- Doesn't break off
- For 50 & 90-series drill boots
- Fits standard and extended wear boots

Ninja Seed Bounce Flap		
Product ID	Description	Price
EXP004708	Ninja Seed Bounce Flap - John Deere 50, 90 series	\$7.30

ONE WRENCH Works in Seconds - One Hand, One Motion



Adjusts John Deere 750 & 1850 Grain Drills Depth Using Only One Hand and One Wrench

The unique design of the One Wrench™ incorporates several pads that are used to depress the locking pin of the adjusting plate. Upon releasing the locking pin you can adjust the grain drill to the desired depth.

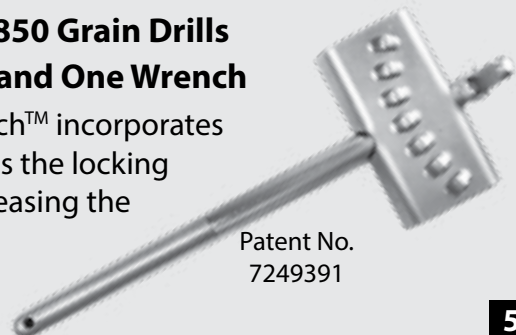

Patent No. 7249391

Product ID	Description	Price
DRL010001	One Wrench	\$59.95

S.I. BELT METER

Maintain Accurate Population Control!

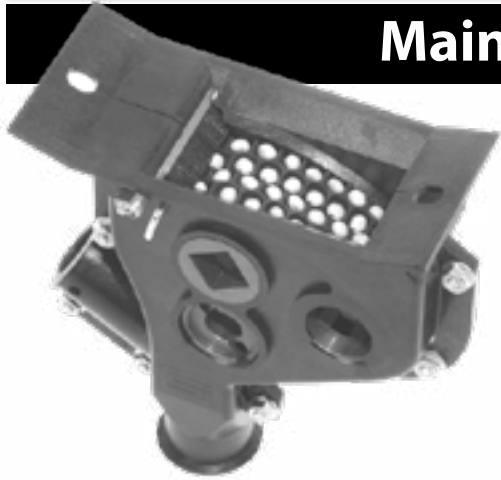

The S.I. Belt Meter allows you to seed with one setting at a determined, regularly-even rate of flow.

- A regular even rate of seed flowing from the meter at all times
- Seed damage at the meter is greatly reduced or eliminated
- There is a positive setting by adjusting meter speed
- The flow rate remains constant up to 10 mph
- Plants soybeans, wheat and oats

Now you can plant the seed population per acre you choose without guessing. Accurate population control is possible even on large seed crops such as soybeans. The S.I. Belt Meter, when mounted on a grain drill, will singulate the seed and maintain accurate population control over a wide range of seed sizes (**2,000 to 4,000 actual seeds per pound**).

The S.I. Belt Meter is designed to primarily plant the following crops: Soybeans at 2,000 to 4,000 actual seeds per pound, wheat and oats. The S.I. Belt Meter is not designed (and does not work well) on crops planted at low rate or of a non-symmetrical shape such as milo/sorghum, corn, sunflower, cotton and edible beans.

Any guess work in setting rate is eliminated. For most seed sizes, the meter will plant your seed at the rate you establish. The conversion pays for itself through seed savings and virtually eliminating seed damage.

- **SAVE MONEY - no over seeding**
- **MAKE MONEY due to no under seeding**
- **Any variation in seeding rate is eliminated**

S.I. BELT METER KITS

All kits include:

- S.I. Belt Meter for each opener
- Transmission conversion kit(s)
- New seed charts
- Installation instructions
- Extra belt meter, cutoff brush, cotter pin

S.I. BELT METER PARTS

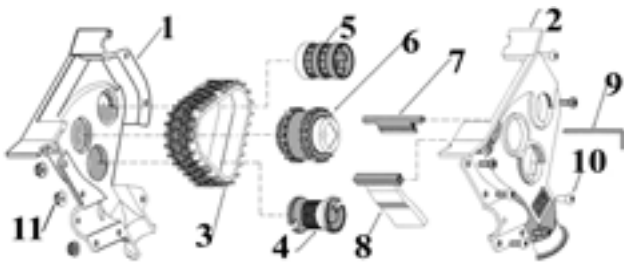

S.I. Belt Meter Service Parts		
Product ID	Description	Prc/Ea
BMP006169	Soybean screen, used to accurately check seed size	\$17.50
BMP008100	S.I. Distributing will disassemble, inspect, repair and reassemble your meters. Parts not included in price.	\$8.00
BMP008151	Steel meter fixture holds the meter and nuts in place to ensure easier meter repair for do-it-yourselfers.	\$36.95

BMP006169

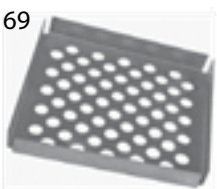

BMP008151

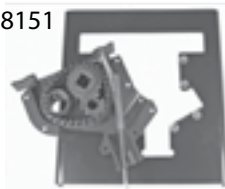

S.I. Belt Meter Parts

Key	Product ID	Description	Qty/Meter	Prc/Each
	BMP001000	Belt Meter, John Deere, complete		\$79.00
	BMP001005	Retaining cap, John Deere*; fits on top of meter	1	\$7.20
	BMP001500	Belt Meter, clear, with handle, for display purposes only, complete		\$79.00
	BMP002000	Belt Meter, Great Plains, angled top, complete		\$79.00
	BMP002005	Retaining cap, angled top; fits on top of meter	1	\$7.20
	BMP003000	Belt Meter, Great Plains, Case-IH, flat top, complete		\$79.00
	BMP003005	Retaining cap, Great Plains, Case-IH, flat top*; fits on top of meter	1	\$7.20
1	BMP005000	Meter housing, John Deere, right hand	1	\$11.85
2	BMP005001	Meter housing, John Deere, left hand	1	\$11.85
	BMP005002	Meter housing, Great Plains, Case-IH, flat top, right hand	1	\$11.85
	BMP005003	Meter housing, Great Plains, Case-IH, flat top, left hand	1	\$11.85
	BMP005004	Meter housing, Great Plains, angled top, left hand	1	\$11.85
	BMP005005	Meter housing, Great Plains, angled top, right hand	1	\$11.85
3	BMP005008	Seed belt	2	\$5.95
4	BMP005014	Lower idler	1	\$3.25
5	BMP005013	Spool	1	\$3.25
6	BMP005012	Drive sprocket	1	\$18.75
7	BMP005009	Brush, cutoff	1	\$6.95
8	BMP005011	Brush, drop	1	\$9.95
9	BMP005022	Cotter pin, humped	1	\$0.95
10	BMP005015	Screw, Phillips head, #10-24 x 1/2	7	\$0.12
11	BMP005016	Flange nut, #10-24	7	\$0.25
	BMP005018	Cap, plastic, for grass seed tube*	1	\$0.60

*not shown

S.I. BELT METER KITS

Each kit includes an extra belt meter, cutoff brush & cotter pin!

John Deere Belt Meter Kits						
Product ID	Model	Width			Drives	Kit Prices
		Model	Spacing	Meters		
BMK12560455	455	25'	6"	49	2	\$4,696.00
BMK12575455	455	25'	7.5"	40	2	\$4,029.00
BMK12510455	455	25'	10"	30	2	\$3,292.00
BMK12515455	455	25'	15"	20	2	\$2,555.00
BMK13060455	455	30'	6"	60	3	\$6,044.00
BMK13075455	455	30'	7.5"	48	3	\$5,160.00
BMK13010455	455	30'	10"	36	3	\$4,275.00
BMK13015455	455	30'	15"	24	3	\$3,391.00
BMK13575455	455	35'	7.5"	56	3	\$5,749.00
BMK13510455	455	35'	10"	42	3	\$4,717.00
BMK11075750	750	10'	7.5"	16	1	\$1,720.00
BMK11010750	750	10'	10"	12	1	\$1,425.00
BMK11015750	750	10'	15"	8	1	\$1,130.00
BMK11575750	750	15'	7.5"	24	1	\$2,310.00
BMK11510750	750	15'	10"	18	1	\$1,867.00
BMK11515750	750	15'	15"	12	1	\$1,425.00
BMK12075750	750	20'	7.5"	32	2	\$3,440.00
BMK12010750	750	20'	10"	24	2	\$2,850.00
BMK12015750	750	20'	15"	16	2	\$2,260.00
BMK13075750	750	30'	7.5"	48	2	\$4,619.00
BMK13010750	750	30'	10"	36	2	\$3,735.00
BMK13015750	750	30'	15"	24	2	\$2,850.00
BMK115751520	1520	15'	7.5"	24	1	\$2,310.00
BMK120751520	1520	20'	7.5"	32	2	\$3,440.00
BMK120101520	1520	20'	10"	24	2	\$2,850.00
BMK115151530	1530	15'	15"	12	1	\$1,425.00
BMK120151530	1530	20'	15"	16	1	\$1,720.00
BMK110751560	1560	10'	7.5"	16	1	\$1,720.00
BMK110151560	1560	10'	15"	8	1	\$1,130.00
BMK115751560	1560	15'	7.5"	24	1	\$2,310.00
BMK115101560	1560	15'	10"	18	1	\$1,867.00
BMK115151560	1560	15'	15"	12	1	\$1,425.00
BMK120751560	1560	20'	7.5"	32	2	\$3,440.00
BMK120101560	1560	20'	10"	24	2	\$2,850.00
BMK120151560	1560	20'	15"	16	2	\$2,260.00
BMK130751560	1560	30'	7.5"	48	2	\$4,619.00
BMK130101560	1560	30'	10"	36	2	\$3,735.00
BMK130151560	1560	30'	15"	24	2	\$2,850.00
BMK110751590	1590	10'	7.5"	16	1	\$1,720.00
BMK110151590	1590	10'	15"	8	1	\$1,130.00
BMK115751590	1590	15'	7.5"	24	1	\$2,310.00
BMK115101590	1590	15'	10"	18	1	\$1,867.00
BMK115151590	1590	15'	15"	12	1	\$1,425.00
BMK120751590	1590	20'	7.5"	32	2	\$3,440.00
BMK120101590	1590	20'	10"	24	2	\$2,850.00
BMK120151590	1590	20'	15"	16	2	\$2,260.00
BMK130751590	1590	30'	7.5"	48	2	\$4,619.00
BMK130101590	1590	30'	10"	36	2	\$3,735.00
BMK130151590	1590	30'	15"	24	2	\$2,850.00

Great Plains Belt Meter Kits						
Product ID	Model	Width			Drives	Kit Prices
		Model	Spacing	Meters		
BMK212601200	1200	12'	6"	24	1	\$2,310.00
BMK212701200	1200	12'	7"	20	1	\$2,015.00
BMK212751200	1200	12'	7.5"	19	1	\$1,944.00
BMK212801200	1200	12'	8"	18	1	\$1,867.00
BMK212101200	1200	12'	10"	14	1	\$1,572.00
BMK212701205	1205	12'	7"	20	1	\$2,015.00
BMK212701210	1210	12'	7"	20	1	\$2,179.00
BMK212751210	1210	12'	7.5"	19	1	\$2,108.00
BMK212801210	1210	12'	8"	18	1	\$2,031.00
BMK212101210	1210	12'	10"	14	1	\$1,736.00
BMK215601500	1500	15'	6"	30	1	\$2,752.00
BMK215701500	1500	15'	7"	26	1	\$2,457.00
BMK215751500	1500	15'	7.5"	24	1	\$2,310.00
BMK215801500	1500	15'	8"	22	1	\$2,162.00
BMK215101500	1500	15'	10"	18	1	\$1,867.00
BMK215151500	1500	15'	15"	12	1	\$1,425.00
BMK215161500	1500	15'	16"	12	1	\$1,425.00
BMK215701510	1510	15'	7"	26	1	\$2,621.00
BMK215751510	1510	15'	7.5"	24	1	\$2,473.00
BMK215801510	1510	15'	8"	22	1	\$2,326.00
BMK215101510	1510	15'	10"	18	1	\$2,031.00
BMK220602000	2000	20'	6"	40	2	\$4,029.00
BMK220702000	2000	20'	7"	34	2	\$3,587.00
BMK220752000	2000	20'	7.5"	32	2	\$3,440.00
BMK220802000	2000	20'	8"	30	2	\$3,292.00
BMK220102000	2000	20'	10"	24	2	\$2,850.00
BMK220142000	2000	20'	14"	17	2	\$2,337.00
BMK220152000	2000	20'	15"	16	2	\$2,260.00
BMK220702010	2010	20'	7"	34	2	\$3,751.00
BMK220752010	2010	20'	7.5"	32	2	\$3,604.00
BMK220802010	2010	20'	8"	30	2	\$3,456.00
BMK220102010	2010	20'	10"	24	2	\$3,014.00
BMK220152015	2015	20'	15"	16	2	\$2,260.00
BMK224602400	2400	24'	6"	48	2	\$4,619.00
BMK224702400	2400	24'	7"	40	2	\$4,029.00
BMK224752400	2400	24'	7.5"	38	2	\$3,882.00
BMK224802400	2400	24'	8"	36	2	\$3,735.00
BMK224102400	2400	24'	10"	28	2	\$3,145.00
BMK224152400	2400	24'	15"	19	2	\$2,484.00
BMK224752410	2410	24'	7.5"	38	2	\$4,046.00
BMK224802410	2410	24'	8"	36	2	\$3,898.00
BMK224102410	2410	24'	10"	28	2	\$3,309.00
BMK224152410	2410	24'	15"	19	2	\$2,648.00
BMK230753010	3010	30'	7.5"	48	2	\$4,783.00
BMK230803010	3010	30'	8"	44	2	\$4,488.00
BMK230103010	3010	30'	10"	36	2	\$3,898.00
BMK230153010	3010	30'	15"	24	2	\$3,014.00
BMK2247525F24	25F24	24'	7.5"	38	2	\$3,882.00
BMK212603PD12	3PD12	12'	6"	24	1	\$2,310.00
BMK212703PD12	3PD12	12'	7"	20	1	\$2,015.00
BMK212753PD12	3PD12	12'	7.5"	19	1	\$1,944.00
BMK212803PD12	3PD12	12'	8"	18	1	\$1,867.00
BMK212103PD12	3PD12	12'	10"	14	1	\$1,572.00

* With markers. *Continued on next column*

Great Plains Belt Meter Kits (Cont.)						
Product ID	Model	Width			Drives	Kit Prices
		Model	Spacing	Meters		
BMK214083PD14	3PD14	14'	8"	20	1	\$2,015.00
BMK214083PD14-1*	3PD14	14'	8"	20	1	\$2,015.00
BMK215603PD15	3PD15	15'	6"	30	1	\$2,752.00
BMK215703PD15	3PD15	15'	7"	26	1	\$2,457.00
BMK215703PD15-1	3PD15	15'	7"	26	1	\$2,457.00
BMK215753PD15	3PD15	15'	7.5"	24	1	\$2,310.00
BMK215753PD15-1	3PD15	15'	7.5"	24	1	\$2,310.00
BMK215803PD15	3PD15	15'	8"	22	1	\$2,162.00
BMK215803PD15-1*	3PD15	15'	8"	22	1	\$2,162.00
BMK215103PD15	3PD15	15'	10"	18	1	\$1,867.00
BMK215153PD15	3PD15	15'	15"	12	1	\$1,425.00
BMK220753PD20	3PD20	20'	7.5"	32	2	\$3,440.00
BMK220803PD20	3PD20	20'	8"	30	2	\$3,292.00
BMK220803PD20-1*	3PD20	20'	8"	30	2	\$3,292.00
BMK220103PD20-1*	3PD20	20'	10"	24	2	\$2,850.00
BMK220153PD20	3PD20	20'	15"	16	2	\$2,260.00
BMK230702SF30	SF30	30'	7"	52	2	\$4,914.00
BMK24580SS45	SS45	45'	8"	66	3	\$6,044.00
BMK23075SS87	SS87	30'	7.5"	48	2	\$4,619.00
BMK23015SS87	SS87	30'	15"	24	2	\$2,850.00

* With markers.

Case-IH Belt Meter Kits						
Product ID	Model	Width			Drives	Kit Prices
		Model	Spacing	Meters		
BMK415705400	5400	15'	7"	26	1	\$2,457.00
BMK415755400	5400	15'	7.5"	24	1	\$2,310.00
BMK415805400	5400	15'	8"	22	1	\$2,162.00
BMK415105400	5400	15'	10"	18	1	\$1,867.00
BMK415155400	5400	15'	15"	12	1	\$1,425.00
BMK420705400	5400	20'	7"	34	2	\$3,587.00
BMK420755400	5400	20'	7.5"	32	2	\$3,440.00
BMK420805400	5400	20'	8"	30	2	\$3,292.00
BMK420105400	5400	20'	10"	24	1	\$2,310.00
BMK420205400	5400	20'	20"	12	1	\$1,425.00
BMK430705500	5500	30'	7"	52	2	\$4,914.00
BMK430755500	5500	30'	7.5"	48	2	\$4,619.00
BMK430105500	5500	30'	10"	36	2	\$3,735.00
BMK415155400-11	5400SS	15'	15"	11	1	\$1,354.00
BMK415155400-12	5400SS	15'	15"	12	1	\$1,425.00
BMK420155400-14	5400SS	20'	15"	14	1	\$1,572.00
BMK420155400-15	5400SS	20'	15"	15	1	\$1,649.00
BMK420155400-16	5400SS	20'	15"	16	1	\$1,720.00
BMK430155500	5500SS	30'	15"	24	2	\$2,850.00

IMPORTANT: The S.I. Belt Meter is not designed nor will it work properly when planting soybeans that are larger than 2,000 actual seeds per pound. Soybeans must be properly graded so as to not contain soybeans that are larger than 2,000 actual seeds per pound. Larger beans such as tofu and edible beans generally will not work with the S.I. Belt Meter because of the size of the bean.

OEM REPLACEMENT PARTS FOR PLANTERS AND SEEDERS/DRILLS

CASE-IH



PLT110250
Double row
bearing



PLT035951
Bearing with Sleeve



MRT003730



WPT447730



WPT212788



WPT247730

Case-IH

Model	Description	Product ID	OEM#	Price
Gauge Wheel Tires				
Planters 800, 900, 950, 955, 1200; Seeders SDX30, SDX40	Gauge Wheel Tire, Reduced inner diameter (RID), 4.5" x 16", 3/8" flange	MRT003730	128633C1 87602293	41.95
Closing Wheels				
Late 800, 900, 1200 series	8" Smooth Closing Disc Assembly, does NOT include bolt & dust cap	WPT277897	1277891C91	\$32.87
	8" Shark Tooth Closing Disc Assembly, LH	WPT112778	n/a	\$60.39
	8" Shark Tooth Closing Disc Assembly, RH	WPT212788	n/a	
	8" Wavy Closing Disc Assembly, two required per row	WPT341624	n/a	\$60.39
2100 series	9" Smooth Closing Disc Assembly, two required per row	WPT447730	n/a	\$44.80
	9" Wavy Closing Disc Assembly, LH	WPT147730	n/a	\$64.24
	9" Wavy Closing Disc Assembly, RH	WPT247730	n/a	
800, 900, 1200, 2100 series	Press Wheel Assembly, 5/8" ID bearing	WPT210034	87610678	\$136.79
Replacement Bearings				
800, 900, 950, 955, 5400, 5500 SS 1200 series to S/N CBJ0001610	Roll Pin style bearing with sleeve , gauge wheels	PLT035951	n/a	\$8.95
	Roll Pin style bearing without sleeve , gauge wheels	PLT110001	128558C91	\$6.50
1200 S/N CBJ0001611 & above 2000 series	5/8" Bolt On style, gauge wheels and closing wheels, Standard	PLT110250	324461A1 306007A1	\$7.95
	5/8" Bolt On style, gauge wheels and closing wheels, Peer	PLT110024		\$14.95
	5/8" Bolt On style, gauge wheels and closing wheels, Peer SeedXtreme	PLT110025		\$19.95

GREAT PLAINS

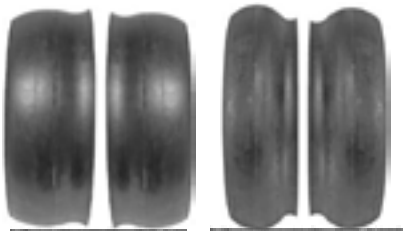

Standard Tire

RID Tire

RID (Reduced inner diameter) tire allows seed trench to lift & fracture. Not recommended for use in tilled soil conditions.



MRT003730



PLT204008



PLT446604



Cast Iron Closing
Wheels

Great Plains

Model	Description	Product ID	OEM#	Price
Gauge Wheel Assemblies				
YP Series	4.5" x 16" standard profile, rubber tire one metal rim and one nylon rim, 5/8" bearing or 16mm	PLT446604	814-173C	\$95.00
Gauge Wheel Tires				
YP Series	Standard profile offset, 4.5" x 16", 3/8" flange	PLT204008	n/a	\$41.95
	Reduced inner diameter (RID), 4.5" x 16", 3/8" flange	MRT003730	n/a	\$41.95

OEM REPLACEMENT PARTS FOR PLANTERS AND SEEDERS/DRILLS

Great Plains (Continued)

Model	Description	Product ID	OEM#	Price
Closing Wheels				
YP Series	12" cast iron closing wheel, 5/8"/16mm bolt on	PLT110021	n/a	\$79.00
	12" Rubber closing wheel assembly, 5/8"/16mm bolt on	PLT039968	814-174C	\$36.25



John Deere

Model	Description	Product ID	OEM#	Price
Disc Openers				
750, 1560, 1565, 1590, 1690, 1835, 1850, 1860, 1890, 1895, 1990; drill/seeders	18" x 5mm	WPT918052	N283804 N214190	\$32.00
Seed Tube Guards				
7000, 7200, 7300, 1700; MaxEmerge, ME 2, ME Plus, ME Pro	For curved seed tube, Seed tube guide welded to guard	PLT061577	A41692, A61577, AA54755	\$9.95
1700, 1705, DB; MaxEmerge XP, XP Pro, ME5	For curved seed tubes, Seed tube guide welded to guard	PLT080203	A80203	\$9.95
Gauge Wheel Arm Kits				
7200, 7300 (after 92), early 1700; MaxEmerge 2 (retrofit)	Gauge Wheel Arm (new style bushing retrofit) arm mounts on 1" diameter pin, wheel mounts with set screw	PLT182684	AA41968	\$31.95
1700; MaxEmerge Plus, MaxEmerge Pro (retrofit)	Gauge Wheel Arm (new style bushing retrofit) arm mounts with 16mm x 100mm bolt, wheel mounts set screw	PLT179647	A79647	\$31.95
1700, DB; MaxEmerge XP and XP Pro (retrofit); 1705, DB; MaxEmerge 5, & Exact Emerge (OEM replacement)	Gauge Wheel Arm (new style bushing, retrofit for XP) arm mounts with 16mm x 100mm bolt, wheel mounts with M16 bolt	PLT192817	A92817	\$31.95
Gauge Wheel Arm Bushings				
7200, 7300 and early 1700; MaxEmerge 2	New Style Self Aligning Bushing, 1" inside diameter Used in PLT082684, PLT016614 arms	PLT197867	n/a	\$9.95
1705, DB; ME 5, & Exact Emerge Retrofitted 1700 series; Max Emerge Plus, MaxEmerge Pro, Max-Emerge XP and XP Pro	New Style Self Aligning Bushing, 16mm (5/8") inside diameter Used in PLT192817 arms. Will NOT work in OEM XP arm	PLT192818	A92818	\$9.95
7200, 7300, early 1700 series; MaxEmerge 2	Full Thread Self Aligning Bushing, 1" inside diameter Used in PLT006614, PLT041968 arms	PLT141968	A57057	\$9.95
1700, DB; Max Emerge Plus, MaxEmerge Pro, MaxEmerge XP and XP Pro	Full Thread Self Aligning Bushing, 16mm (5/8") inside diameter Used in PLT079648 and PLT054179 kits	PLT154179	A57058 A92818	\$9.95
Gauge Wheel Assemblies				
7000, MaxEmerge 7200, 7300; MaxEmerge 2 prior to 1992	4.5" x 16" standard profile, rubber tire yellow metal halves, roll pin style bearing	PLT432046	AA35392 AA32046	\$95.00
1700, 1530, 1535; MaxEmerge Plus, MaxEmerge Pro 7200, 7300; MaxEmerge 2 1993 and after	4.5" x 16" standard profile, rubber tire black metal halves, black nylon hub cap, set screw style bearing	PLT441359	AA41359	\$95.00
1700, DB, 1530, 1535; MaxEmerge XP, XP Pro 1705, DB; MaxEmerge 5, ExactEmerge	4.5" x 16" standard profile, rubber tire black metal halves, black nylon hub cap, 5/8" bearing or 16mm	PLT446604	AA66604	\$95.00
750, 1850; drill/seeders	4.5" x 16" standard profile, rubber tire yellow metal halves, 5/8" bearing or 16mm	PLT411864	AN211864	\$95.00

(Continued on next page)

JOHN DEERE



PLT035951
Bearing
with Sleeve



PLT885154
Double row
bearing



PLT192818



PLT197867



MRT003730



Standard Tire



RID Tire

RID (Reduced inner diameter) tire allows seed trench to lift & fracture. Not recommended for use in tilled soil conditions.

John Deere (Continued)

Model	Description	Product ID	OEM#	Price
Gauge Wheel Assemblies (Continued)				
750, 1560, 1565, 1590, 1690, 1835, 1850, 1860, 1890, 1895, 1990; drill/seeder	4.5" x 16" standard profile, rubber tire one metal rim and one nylon rim, 5/8" bearing or 16mm	PLT446604	AN281630	\$ 95.00
Gauge Wheel Tires				
7000; MaxEmerge; 7200, 7300; MaxEmerge 2 1700, 1530, 1535; ME Plus; 1700 ME Pro 750, 1560, 1850, 1860, Early 1590, 1690, 1835, 1890, 1895, 1990	Standard profile offset, 4.5" x 16", 3/8" flange	PLT204008	A22884 A84050	\$41.95
	Reduced inner diameter (RID), 4.5" x 16", 3/8" flange	MRT003730	A84450	\$41.95
1700, DB, 1530, 1535; MaxEmerge XP, XP Pro 1705, DB MaxEmerge 5, ExactEmerge Late 1590, 1690, 1835, 1890, 1895, 1990	Standard profile offset, 4.5" x 16", 7/8" flange	PLT204095	A84062 A77881	\$41.95
	Reduced inner diameter (RID), 4.5" x 16", 7/8" flange	MRT003731	A84451 A82253	\$44.95
Closing Wheels				
7000; MaxEmerge	12" cast iron closing wheel, Wheels attach with roll pin	PLT110000	n/a	\$79.00
	12" Rubber closing wheel assembly, Wheels attach with roll pin	PLT043899	AA43899	\$36.25
7200, 7300, 1700; MaxEmerge 2	12" Rubber closing wheel assembly, Wheels slide over 17mm threaded stud	PLT043898	AA43898 AA34211	\$36.25
1700, DB; ME Plus, ME Pro, MaxEmerge XP, XP Pro, 1705, DB, MaxEmerge 5, ExactEmerge	12" cast iron closing wheel, 5/8"/16mm bolt on	PLT110021	n/a	\$79.00
	12" Rubber closing wheel assembly, 5/8"/16mm bolt on	PLT039968	AA39968 GA6434 854262 87695406 7071.N	\$36.25
Replacement Bearings				
7000; MaxEmerge (gauge wheels, closing wheels); 7200, 7300; ME 2 prior to 1992 (gauge wheels)	Roll Pin style with sleeve , gauge wheels and closing wheels	PLT035951	AA35951	\$8.95
	Roll Pin style without sleeve , gauge wheels and closing wheels	PLT110001	AA35741	\$6.50
7200, 7300, 1700; ME 2 1992 & after (gauge wheel) 1700; ME Plus (gauge wheels), ME Pro (gauge wheels)	Set Screw style with sleeve , gauge wheels	PLT838106	AA38106	\$7.95
	Set Screw style without sleeve , gauge wheels	PLT885154	AN131668	\$6.50
7200, 7300, 1700; MaxEmerge 2 (closing wheel) (1 outside & 1 inside bearing per wheel)	17mm Bolt On style, outside bearing, closing wheels, 1 per wheel	PLT110011	JD8535	\$7.50
	17mm Bolt On style, inside bearing, closing wheels, 1 per wheel	PLT110022	AA34132	\$10.95
1700; ME Plus (closing wheels), ME Pro (closing wheels), 1700, DB; ME XP, XP Pro (gauge wheels, closing wheels) 1705, DB; ME 5, ExactEmerge (gauge wheels, closing wheels)	5/8" Bolt On style, gauge wheels and closing wheels, Standard	PLT110250	AN212132	\$7.95
	5/8" Bolt On style, gauge wheels and closing wheels, Peer	PLT110024	AN212132	\$14.95
	5/8" Bolt On style, gauge wheels and closing wheels, Peer SeedXtreme	PLT110025	AN212132	\$19.95

(Continued on next page)

OEM REPLACEMENT PARTS

PLANTING OEM

DRL280446



DRL280447



DRL282788



DRL282789



DRL283432



DRL283433



JOHN DEERE

John Deere (Continued)

Model	Description	Product ID	OEM#	Price
Seeder/Drill Seed Boots				
750, 1850	Seed Boot, right hand	DRL280446	N280446	\$39.95
	Seed Boot, left hand	DRL280447	N280447	\$39.95
1560, 1565, 1860	Seed Boot, top right hand	DRL282788	N282788	\$17.95
	Seed Boot, top left hand	DRL282789	N282789	\$17.95
	Seed Boot, bottom right hand	DRL283432	N283432	\$17.95
	Seed Boot, bottom left hand	DRL283433	N283433	\$17.95



PLT016614

PLT007975

PLT000302

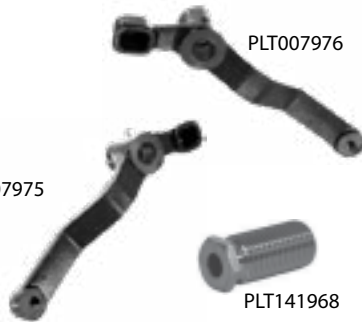

PLT007976

PLT141968



PLT061577

PLT197867



KINZE

PLT016614

Kinze

Model	Description	Product ID	OEM#	Price
Seed Tube Guards				
2000 series planter	For curved seed tubes, Seed tube guide welded to guard	PLT061577	GB0241	\$9.95
3000 series planter	Seed Tube Guard, Kinze inner guard scraper	PLT000302	GB0301	\$9.95
Gauge Wheel Arm Kits				
2000 series, 1993-1999	Gauge Wheel Arm (new style bushing retrofit) arm mounts on 1" diameter pin, wheel mounts with M16 bolt	PLT016614	GA6614	\$31.95
3000 series, 4000 series	Gauge Wheel Arm Left Hand, Direct OEM replacement	PLT007975	GA21677 GA7975	\$43.90
	Gauge Wheel Arm Right Hand, Direct OEM replacement	PLT007976	GA21676 GA7976	\$43.90
Gauge Wheel Arm Bushings				
2000 series, 1993-1999	New Style Self Aligning Bushing, 1" inside diameter; Used in PLT082684, PLT016614 arms	PLT197867	n/a	\$9.95
2000 series, 1993-1999	Full Thread Self Aligning Bushing, 1" inside diameter; Used in PLT006614 arms	PLT141968	n/a	\$9.95
Gauge Wheel Assemblies				
2000 series, 1993 and newer	4.5" x 16" standard profile, rubber tire one metal rim and one nylon rim, 5/8" bearing or 16mm	PLT446604	GA6615	\$95.00
3000, 4000 series	4.5" x 16" standard profile, rubber tire black metal halves, White nylon hub cap, 5/8" bearing or 16mm	PLT007949	GA7949	\$130.20

(Continued on next page)

VISIT OUR WEBSITE FOR THE MOST CURRENT PRODUCT PRICING www.sidist.com

KINZE



PLT035951
Bearing
with Sleeve



PLT110250
Double
row bearing



PLT204008



Rubber Closing
Wheels



Cast Iron Closing
Wheels



MRT003730



PLT446604

Kinze (Continued)

Model	Description	Product ID	OEM#	Price
Gauge Wheel Tires				
All	Standard profile offset, 4.5" x 16", 3/8" flange	PLT204008	GD1086	\$41.95
	Reduced inner diameter (RID), 4.5" x 16", 3/8" flange	MRT003730	n/a	\$41.95
Closing Wheels				
Kinze planters 1992 and older	12" cast iron closing wheel, Wheels attach with roll pin	PLT110000		\$79.00
	12" Rubber closing wheel assembly, Wheels attach with roll pin	PLT043899	GA3086	\$36.25
Kinze planter 1993 and newer	12" cast iron closing wheel, 5/8"/16mm bolt on	PLT110021		\$79.00
	12" Rubber closing wheel assembly, 5/8"/16mm bolt on	PLT039968	GA6434	\$36.25
Replacement Bearings				
Kinze planters 1992 and older	Roll Pin style with sleeve , gauge wheels	PLT035951	n/a	\$8.95
	Roll Pin style without sleeve , gauge wheels and closing wheels	PLT110001	GA2022	\$6.50
Kinze planters 1993 and newer	5/8" Bolt On style, gauge wheels and closing wheels, Standard	PLT110250	GA6171	\$7.95
	5/8" Bolt On style, gauge wheels and closing wheels, Peer	PLT110024	GA6171	\$14.95
	5/8" Bolt On style, gauge wheels and closing wheels, Peer SeedXtreme	PLT110025	GA6171	\$19.95

MONOSEM



MRT003730



PLT446604



PLT204008



Rubber Closing
Wheels



Cast Iron
Closing
Wheels

Monosem

Model	Description	Product ID	OEM#	Price
Gauge Wheel Assemblies				
Late model Plus series	4.5" x 16" standard profile, rubber tire one metal rim and one nylon rim, 5/8" bearing or 16mm	PLT446604	7073.N	\$95.00
Gauge Wheel Tires				
Late model Plus series	Standard profile offset, 4.5" x 16", 3/8" flange	PLT204008	n/a	\$41.95
	Reduced inner diameter (RID), 4.5" x 16", 3/8" flange	MRT003730	n/a	\$41.95
Closing Wheels				
Monosem with bolt-on wheels	12" cast iron closing wheel, 5/8"/16mm bolt on	PLT110021		\$79.00
	12" Rubber closing wheel assembly, 5/8"/16mm bolt on	PLT039968	7074.N	\$36.25

(Continued on next page)

OEM REPLACEMENT PARTS

— FOR PLANTERS AND SEEDERS/DRILLS

New Holland

Model	Description	Product ID	OEM#	Price
Gauge Wheel Tires				
SP280, SP380, SP480, SP580	Gauge Wheel Tire, Reduced inner diameter (RID), 4.5" x 16", 3/8" flange	MRT003730	n/a	\$41.95

RID (Reduced inner diameter) tire allows seed trench to lift & fracture. Not recommended for use in tilled soil conditions.

NEW HOLLAND



MRT003730



Standard Tire



RID Tire



PLT441359



PLT204008



MRT003730



PLT446604



PLT035951
Bearing
with Sleeve



PLT110250
Double row
bearing



PLT885154
Double row
bearing

WHITE

White

Model	Description	Product ID	OEM#	Price
Gauge Wheel Assemblies				
6000 series	4.5" x 16" standard profile, rubber tire black metal halves, black nylon hub cap, set screw style bearing	PLT441359	853998	\$99.95
8000 series	4.5" x 16" standard profile, rubber tire one metal rim and one nylon rim, 5/8" bearing or 16mm	PLT446604	700727657 700725744	\$95.00
Gauge Wheel Tires				
5100, 5700, 6000, 8000, 9000	Standard profile offset, 4.5" x 16", 3/8" flange	PLT204008	GD1086	\$41.95
	Reduced inner diameter (RID), 4.5" x 16", 3/8" flange	MRT003730	n/a	\$41.95
Closing Wheels				
Late 6000, 8000, 9000; dual closing wheels	12" cast iron closing wheel, 5/8"/16mm bolt on	PLT110021	n/a	\$79.00
	12" Rubber closing wheel assembly, 5/8"/16mm bolt on	PLT039968	700727676	\$36.25
Replacement Bearings				
5100 series 5700 series	Roll Pin style with sleeve , gauge wheels	PLT035951	854147	\$8.95
	Roll Pin style without sleeve , gauge wheels	PLT110001	70593891-8	\$6.50
6000 series (gauge wheels)	Set Screw style with sleeve , gauge wheels	PLT838106	n/a	\$7.95
	Set Screw style without sleeve , gauge wheels	PLT885154	AN131668	\$6.50
6000 series (closing wheels), 8000, 9000	5/8" Bolt On style, gauge wheels and closing wheels, Standard	PLT110250	854003	\$7.95
	5/8" Bolt On style, gauge wheels and closing wheels, Peer	PLT110024	854003	\$14.95
	5/8" Bolt On style, gauge wheels and closing wheels, Peer SeedXtreme	PLT110025	854003	\$19.95

VERTICAL TILLAGE BLADES



3 ZONES OF HARDNESS

- 1** Increased Flexibility
(49-50 HRC)
- 2** Increased Durability
(50-55 HRC)
- 3** Maximum Wear
(55-58 HRC)



- Razor Edge
- Double Bevel
- Reverse Crimp Center
- Thickness: 5mm & 6.5 mm

Wearparts Vertical Tillage Blades

Model	Diameter	Thickness	OEM ID	FDN 200	Price	Celsan	Price
Case-IH							
330, 335 - Right Front, Left Rear	20"	6.5mm	87630572, 47654438	WPT126557	\$99.36	WPT926557	\$84.46
330, 335 - Left Front, Right Rear	20"	6.5mm	87630573, 47654439	WPT226557	\$99.36	WPT996557	\$84.46
Great Plains							
Turbo-Till	20"	5mm	820-261C	-	-	WPT925040	\$84.00
Turbo-Till, Turbo-Max, Turbo Chopper, Verti-Till	20"	6.5mm	820-011C, 820-261C	WPT126540	\$100.90	WPT926540	\$90.64
Turbo Chisel	22"	6.5mm	820-430C	-	-	WPT936540	\$96.51
Krause							
Excelerator 8000 series	22"	6.5mm	Q8014420, 30-257	WPT136570	\$139.84	WPT936570	\$112.36
Landoll							
7000 Series	22"	6mm	155617	WPT136010	\$95.56	WPT936010	*
	24"	6mm	155617	WPT156010	\$101.07	WPT956010	*
7000 Series (extra life, rollable)	22"	6mm	155617	-	-	WPT993601	\$73.49
	24"	6mm	155617	-	-	WPT995601	\$88.81
McFarlane							
Reel Disc	20"	5mm	RD4477	-	-	WPT926056	\$71.94
Sunflower							
6000 Series	22.25"	5mm	SN16844	WPT135058	\$114.66	WPT935058	\$88.09

*Call for price and availability

HIGH SPEED COMPACT DISCS



Specially formulated boron steel outwears leading competitors.

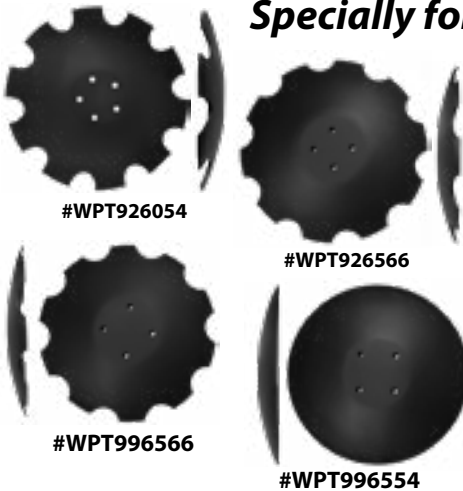

Wearparts High Speed Compact Disc Blades							
Model	Diameter	Thickness	Blade Type	Blade ID	Price	Bearing/Hub ID	Price
Horsch							
Joker	20"	6mm	Notched	WPT926054	\$80.23	WPT090006	\$167.39
John Deere/Norwood							
2680H, Kwik-Till	20"	6.5mm	Notched	WPT926566	\$85.61	WPT090007	\$148.81
	20"	6.5mm	Smooth	WPT996566	\$82.51	WPT090007	\$148.81
Degelman/Kinze							
Pro-Till, Mach Till	20"	6.5mm	Notched	WPT926554	\$85.61	WPT090000	\$142.27
	20"	6.5mm	Smooth	WPT996554	\$82.51	WPT090000	\$142.27
	22"	6.5mm	Notched	WPT936542	\$115.53	WPT090000	\$142.27
	22"	6.5mm	Smooth	WPT996542	\$115.53	WPT090000	\$142.27
Case-IH/K-Line							
Speed-Tiller, Speedtiller	22"	6mm	Notched	WPT936005	\$74.44	-	-
	24"	6mm	Notched	WPT956005	\$114.55	-	-
Landoll							
HSL (Celsan)	24"	6.5mm	Notched	WPT956569	\$135.59	-	-
HSL (FDN 200)	24"	6.5mm	Notched	WPT156569	\$150.64	-	*

*Call for price and availability

The Celsan blade is made of a durable, high-quality steel that is quenched and tempered to provide a longer lasting wear life. It is powder-coated to provide a lasting surface finish.

The FDN 200 blade is a patented 3 zones of hardness blade which will provide a 30-40% longer wear life to any competitor on the market while a Celsan Blade will provide a 15% longer wear life to any competitor on the market besides FDN.

High-Speed Hubs/Bearings: Maintenance-free, Durable

#WPT090000



#WPT090006 #WPT090007

SMART-TILL PARTS

S.I. Distributing stocks replacement tines, bearings and other wear items for the Smart-Till residue management tool.

Smart-Till Replacement Parts		
Description	Product ID	Price
Tine, Left Hand Carriage, Casting Mark: LF/RR	HCC231250	\$34.65
Tine, Right Hand Carriage, Casting Mark: RF/LR	HCC231251	\$34.65
Tine Bolt (two required per tine)	HCC202925	\$2.80
Tine Lock Nut (two required per tine)	HDW212500	\$1.22
Heavy Duty Spindle & Hub Assembly	HCC226334	\$178.64
Pillow Block Housing	HCC243748	\$38.43
Pillow Block Bearing	HCC243749	\$80.50
Roller Thrust Plate	HCC553001	\$6.88
C-Flex, 1" x 3", 3-Hole, For 2010 and newer models; serial number beginning with 310xxx	HCC553237	\$131.41
C-Flex, 1" x 3", 4-Hole, For 2009 and earlier models; serial number prior to 310xxx	HCC553183	\$136.95
Rock Guard	HCC553238	\$62.92
Rock Guard Retainer	HCC553239	\$8.80

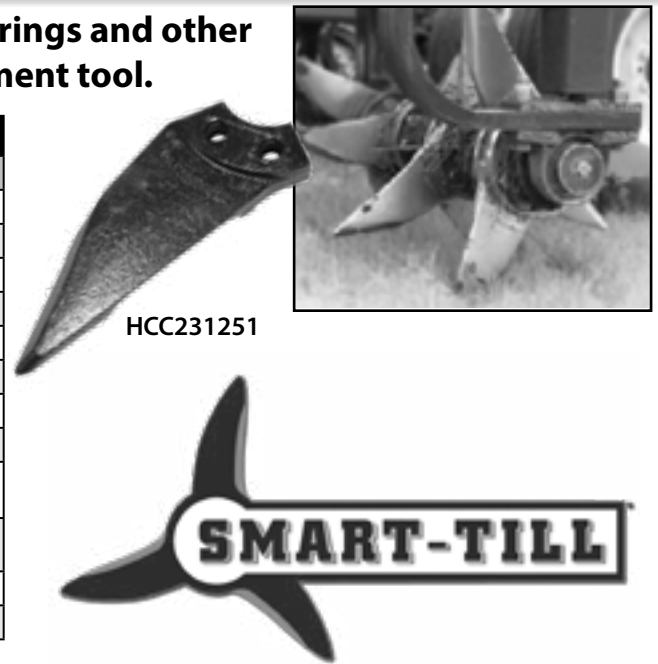

ACRA-PLANT BLU-JET PARTS



Blu-Jet Parts

**Made of 26% Chrome-Alloy
for Longer Life**



**V-Crown ripper "Spring"
point APL801300**



**V-Crown ripper "Fall"
point APL801400**



Shin Guard APL801600

V-Crown ripper "Spring" point (APL801300) Blu-Jet Sub-Tiller II with 1-1/2" shank. Narrow point is 2" wide and 14" long for deep tillage. Heavy duty; weighs 11 lbs. vs. 7 lbs. for OEM.

V-Crown ripper "Fall" point (APL801400) Blu-Jet Sub-Tiller II with 1-1/2" shank. Wider point is 2-7/8" wide and 15-1/2" long for deeper tillage and more shattering action. Heavy duty; weighs 16 lbs. vs. 13.6 lbs. for OEM.

Shin Guard (APL801600) Blu-Jet Sub-Tiller II with 1-1/2" shank.

Acra-Plant Blu-Jet Parts		
Product ID	Description	Price
APL801300	V-crown ripper "Spring" point, Blu-Jet Sub-Tiller II with 1-1/2" shank. Narrow point is 2" wide and 14" long for deep tillage. Heavy duty; weighs 11 lbs. vs. 7 lbs. for OEM.	\$186.00
APL801400	V-crown ripper "Fall" point, Blu-Jet Sub-Tiller II with 1-1/2" shank. Wider point is 2-7/8" wide and 15-1/2" long for deeper tillage and more shattering action. Heavy duty; weighs 16 lbs. vs. 13.6 lbs. for OEM.	\$235.00
APL801600	Shin guard, Blu-Jet Sub-Tiller II with 1-1/2" shank.	\$253.00

CAUTION: S.I. Distributing Inc. warrants these products to be free of defects in material and workmanship. Liability under warranty shall extend to replacement or credit of product found to be defective on examination by S.I. Distributing Inc. This warranty does not extend to misuse or damage by accident or negligence. Chrome castings are not guaranteed for use in rocky, stony or frozen ground. S.I. Distributing Inc. will not honor any claim for warranty on chrome castings that have been altered or welded on in any way. S.I. Distributing Inc. will not recognize any claims for consequential or incidental damages.

RADURA DISC MOWER BLADES

**Superior Performance and Safety,
and INCREASES SERVICE LIFE.**



PROBLEM: Disc mower blades, that are prematurely worn and weakened, as well as being chipped, provide inferior cutting quality.

SOLUTION: The design and precise craftsmanship of Radura disc mower blades provide superior performance and safety, and increases service life.

Competitor's blade - 63 hours



Radura blade - 63 hours



A Very Affordable Upgrade!

radura
Highest Quality
Replacement Parts
Priced Right for Your Operation



Unique Cold Rolled Cutting Edges are more wear resistant than ground or shaved edges. They also offer more stability.

The competition's edge feels sharp but wears much faster than a rolled edge.

Radura Cold Rolled Edge

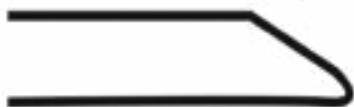

Competition's Grounded Edge



- Superior Cutting Quality
- Precise Quality Control for Performance and Safety
- Increased Service Life



Radura disc mower blades have been used to cut hay, alfalfa and grass for over 50 years.

The Radura blade features a **cold rolled cutting edge**, whereas most other competitors grind their cutting edge. This grinding method weakens the steel and causes the blade to chip and wear prematurely. **With the special cold rolled process** used on the cutting edge of the Radura blade, the results are a **more wear-resistant edge that maintains its sharpness longer**. Each batch of Radura rotary disc mower blades is subjected to a rigorous quality control program, ensuring they meet DIN 11250 / ISO 5718-2 standards.



YouTube.com "S.I. Distributing Harvesting Innovations" channel

A third-party reviewer, Ted Kahler, discusses his comparison test of the Radura disc mower blade versus serrated blades.



RADURA DISC MOWER BLADES

Radura Disc Mower Blades									
	Left	Right	Angle	Bevel	Shape	Price	Bolt	Nut	
AGCO									
3006, 3007, 3008, 3009, 3010, 3309	RSP042059	RSP042057	11°	Top	10	\$2.33	RSP042134	RSP051061	
	RSP052698	RSP052697	18°	Top	10	\$2.66			
3312, 3315, 9170, 9180, 9190, 9192	RSP042022	RSP042026	10°	Both	9	\$1.88	RSP052668	RSP052669	
	RSP042031	RSP042030	11°	Bottom	10	\$2.16			
	RSP042011	RSP042010	11°	Top	10	\$2.37			
	RSP042050	RSP042049	18°	Bottom	10	\$2.14			
	RSP052497	RSP052498	18°	Top	10	\$2.54			
Bush Hog									
DM7, DM8, DM9, DM18, DM19, HM5, HM7, HM8	RSP042064	RSP042066	11°	Top	10	\$2.01	RSP052234	RSP052235	
DM70, DM80, DM90, DM180, DM190, DM5406, DM5407, DM5408, DM5409	RSP042059	RSP042057	11°	Top	10	\$2.33	RSP042134	RSP051061	
	RSP052698	RSP052697	18°	Top	10	\$2.66			
Case-IH									
725, 8309, 8312, 8315, 8850, DC515	RSP042022	RSP042026	10°	Both	9	\$1.88	RSP052668	RSP052669	
	RSP042031	RSP042030	11°	Bottom	10	\$2.16			
	RSP042011	RSP042010	11°	Top	10	\$2.37			
	RSP042050	RSP042049	18°	Bottom	10	\$2.14			
	RSP052497	RSP052498	18°	Top	10	\$2.54			
DC92, DC92F, DC132, DC132F, DC162, DC162F, DX91, DCX101, DCX131, DCX131F, DCX161, RD132, RD162, RD182, RDX131, RDX161, RDX181, TD102, MD72, MD82, MD92, MDX71, MDX81, MDX91	RSP042056	RSP042055	7°	Top	10	\$2.29	w/o lifters RSP052673, w/ lifters RSP052939	RSP052674	
	RSP041986	RSP041987	14°	Top	10	\$2.43			
DC93, DC103, DC133, DC163, RD193, RD163	RSP343225	RSP343226	7°	Top	10	\$2.91	w/o lifters RSP052673, w/ lifters n/a	RSP052674	
	RSP255700	RSP255699	14°	Top	10	\$2.91			
	RSP271205	RSP271203	18°	Top	10	\$2.91			
3204 (SD), 3205 (SD), 3206 (SD), 3309 (SD)	RSP042064	RSP042066	11°	Top	10	\$2.01	RSP052234	RSP052235	
3204 (HD), 3205 (HD), 3206 (HD), 3309 (HD)	RSP042056	RSP042055	7°	Top	10	\$2.29	n/a	n/a	
	RSP052698	RSP052697	18°	Top	10	\$2.66			
DC101F, DC102, DC102F, DC103, DC132, DC132F, DC162, DC162F, DC92, DC92F, DC93, DCX101, DCX131, DCX131F, DCX161, DCX91, MD72, MD73, MD82, MD92, MD93, MDX71, MDX81, MDX91, RD132, RD16, RD182, RDX131, RDX161, RDX181, TD102, TD103	RSP054144	RSP054142	7°	Top	10	\$3.99	n/a	n/a	
	RSP054136	RSP054133	14°	Top	10	\$3.99			
Challenger									
9195, 9196, 9283, 9286, 9295, 9296, DKH12, DKH15, DKHB, DKHC, DKHCT, DKHD, DKHDT, DKHE, DKHET, PTD10, PTD10B, PTD12, PTD12B, PTD15, PTD15B	RSP042022	RSP042026	10°	Both	9	\$1.88	RSP052668	RSP052669	
	RSP042031	RSP042030	11°	Bottom	10	\$2.16			
	RSP042011	RSP042010	11°	Top	10	\$2.37			
	RSP042050	RSP042049	18°	Bottom	10	\$2.14			
	RSP052497	RSP052498	18°	Top	10	\$2.54			
HTD7, HTD7B, HTD8, HTD8B, HTD9, HTD9B, PTD9	RSP042059	RSP042057	11°	Top	10	\$2.33	RSP042134	RSP051061	
	RSP052698	RSP052697	18°	Top	10	\$2.66			
1316S, 1373, 1376, 1393, 9313D, 9313S, 9316D, 9316S	RSP002500	RSP002400	11°	Top	10	\$2.57	RSP060022	RSP219970	
	RSP002300	RSP002200	11°	Bottom	10	\$2.57			
	RSP009040	RSP008040	18°	Top	10	\$2.69			
	RSP002700	RSP002600	18°	Bottom	10	\$2.57			
Claas									
210, 250, 260, 290, 300, 340, 1100, 2650, 2700, 2750, 2800, 3000, 3050, 3100, 3200, 3450, 3500, 3550, 3600, 3900, 4000, 8400, 8500, 8550, 8600, 8700, 9100, 9200, 9300, 9400	RSP042015	RSP042014	10°	Top	10	\$2.35	n/a	n/a	
Deutz-Fahr									
KM20, KM22, KM24, KM25, KM25F, KM2.17, KM2.19, KM2.33, KM222, KM252	RSP041864		Flat	Both	1	\$1.06	RSP042096	RSP042093	
	RSP041870		Flat	Both	3	\$1.34			
	RSP041874		Flat	Both	1	\$0.92			
KM2.27, SM40, SM45, SM50, SM50F, SM55F	RSP041888	RSP041887	15°	Both	9	\$1.66	n/a	n/a	
Fella									
SM165, SM206, SM215, SM216, SM240	RSP042018	RSP042019	10°	Top	10	\$2.24	n/a	n/a	
SM120	RSP042064	RSP042066	11°	Top	10	\$2.01	RSP42096	RSP45702	
KM20, KM22	RSP041864		Flat	Both	1	\$1.06	n/a	n/a	

Continued on next page

Shape Reference:

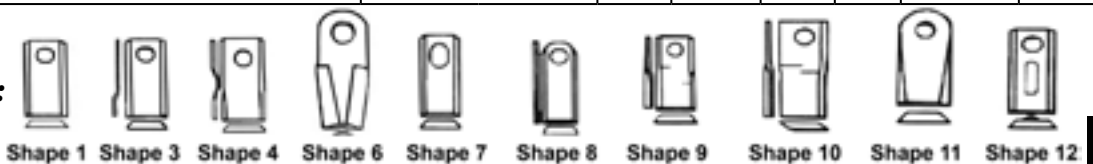

Radura Disc Mower Blades (Continued)

	Left	Right	Angle	Bevel	Shape	Price	Bolt	Nut
Gehl								
162 (SD)	RSP041926	RSP041928	10°	Both	9	\$1.64	RSP042104	RSP042093
1162, 1165, DC2345, DC2365, DC2412, DC2415, DC2418	RSP042022	RSP042026	10°	Both	9	\$1.88	RSP042122	RSP053367
162(HD), 165, 2340 (BSN7602), 2360 (BSN7602), DC2340, DC2360	RSP042034	RSP042037	10°	Both	9	\$2.27	RSP042122	RSP053367
2310, DC2330 (BSN2227), DC1080, DC2350, DM140, DM160	RSP042064	RSP042066	11°	Top	10	\$2.01	RSP042096	RSP045702
Hesston								
870, 1320, 1340, 1345, 1355, 1360, 1365, 1375, 3312, 3315, 8070, 8500, 9070, 9075, 9080, 9170, 9180, 9183, 9185, 9190, 9192, 9195, 9196	RSP042022	RSP042026	10°	Both	9	\$1.88	RSP052668	RSP052669
	RSP042031	RSP042030	11°	Bottom	10	\$2.16		
	RSP042011	RSP042010	11°	Top	10	\$2.37		
	RSP042050	RSP042049	18°	Bottom	10	\$2.14		
	RSP052497	RSP052498	18°	Top	10	\$2.54		
1004, 1005, 1006, 1007, 1008, 3006, 3007, 3008, 3009, 3010, 3309	RSP042059	RSP042057	11°	Top	10	\$2.33	RSP042134	RSP051061
	RSP052698	RSP052697	18°	Top	10	\$2.66		
1030, 1040, 1050, 1060	RSP041978	RSP041979	11°	Top	10	\$1.78	N/A	N/A
Frontier								
DM1140, DM1150, DM1160, DM1270	RSP042034	RSP042037	10°	Both	9	\$2.27	RSP042122	RSP053367
John Deere								
240, 260, 1314, 1315, 1320 (Std. Disc), 1326 (Std. Disc), 1327 (Std. Disc)	RSP041926	RSP041928	10°	Both	9	\$1.64	RSP042104	RSP042093
1314, 1315	RSP041879	RSP041882	11°	Both	9	\$1.30	n/a	n/a
265 (BSN150001), 275 (BSN152001), 1350, 1360, 1460, 1470	RSP042022	RSP042026	10°	Both	9	\$1.88	RSP042122	RSP053367
500R, 525, 530, 535, 625, 630, 635, 730, 735, 830, 835, 915, 916, 925, 926, 935, 936, 945, 946, 955, 956, 990, 994, 995	RSP042022	RSP042026	10°	Both	9	\$1.88	RSP052670	RSP052671
	RSP308234	RSP308235	18°	Both	9	\$2.05		
265 (ASN150001), 270, 275 (ASN152001), 285 (check blade length), 1320 (HD Disc), 1326 (HD Disc), 1327 (HD Disc), R160, R200, R240, R280, R310	RSP042034	RSP042037	10°	Both	9	\$2.27	RSP042122	RSP053367
1320 (HD Disc), 1326 (HD Disc), 1327 (HD Disc)	RSP042074		Dome	Both	4	\$3.11	RSP042122	RSP053367
Krone								
AM203, AM243, AFA243, AM283, AFA283, AFL283, AMT283, AM323, AMT323, AM403, Big M, Big Mill	RSP041974	RSP041973	10°	Top	10	\$1.99	n/a	n/a
AM167, AM202, AM242, AM282, AFA243RS, AFA283RS, AFA323RS, AFL- 243CV, AFL283CV, AFL243RS, AFL283RS, AFL323RS, AFL343RS, AM203S, AM243S, AM283S, 323S, AM243RS, AMT	RSP042051	RSP042052	7°	Top	10	\$1.99	RSP042128	RSP042109
Kuhn								
FC44, FC55, GMD33, GMD44, GMD55, GMD66, GMD77	RSP041926	RSP041928	10°	Both	9	\$1.64	RSP042104	RSP042093
	RSP041879	RSP041882	11°	Both	9	\$1.30		
	RSP041889		Flat	Both	1	\$1.43		
GMD283TG, GMD313TG, GMD400, GMD500, GMD600, GMD600GII, GMD700, GMD700GII, GMD702, GMD800, GMD800GII, GMD802, GMD802F, GMD883, GMD2850TL, GMD3150TL, GMD3550TL, GMD4050TL, FC200, FC202, FC240P, FC243, FC243RTG, FC243TG, FC250, FC280, FC280F, FC280P, FC280RTG, FC280TG, FC283, FC300, FC301, FC302, FC303, FC313, FC313F, FC350, FC352, FC353, FC813, FC883, FC4000, Alterna 400, Alterna 500	RSP042022	RSP042026	10°	Both	9	\$1.88	RSP042122	RSP053367
GMD44HD, GMD55HD, GMD66HD, GMD77HD, GMD240HD, GMD280HD, GMD310HD, GMD600HD, GMD600GIIHD, GMD700HD, GMD700GIIHD, GMD800HD, GMD800GIIHD	RSP042034	RSP042037	10°	Both	9	\$2.27	RSP042122	RSP053367
	RSP042035		Flat	Both	1	\$2.27		
GMD16, GMD20, GMD24, GMD28 s/n A1633 to A9999	RSP053400	RSP053401	11°	Both	9	\$2.03	n/a	n/a
FC2860, FC3160, FC3560, FC4060, FC3525DF, FD10030, GMD3151TL, GMD3510, GMD3525F, GMD3551TL, GMD4051TL, GMD5251TC, GMD10030	RSP053729	RSP053728	11°	Bottom	10	\$3.45	n/a	n/a
Lely								
Optimo 165, Optimo 205, Optimo 240, Optimo 280, Splendimo 320	RSP042064	RSP042066	11°	Top	10	\$2.01	n/a	n/a
MacDon								
R116	RSP052216	RSP052215	11°	Top	10	\$2.40	n/a	n/a
Massey Ferguson								
408, 411, 412, 415, 1345, 1355, 1363, 1365, 1366, 1372, 1375, 1383, 1386, 9070, 9075, 9080, 9175, 9183, 9185, 9186, 9190, 9192, 9195, 9196, 9283, 9295, 9296	RSP042022	RSP042026	10°	Both	9	\$1.88	RSP052668	RSP052669
1345, 1355, 1363, 1365, 1366, 1372, 1375, 1383, 1386, 9070, 9075, 9080, 9175, 9183, 9185, 9186, 9190, 9192, 9195, 9196, 9283, 9286, 9295, 9296	RSP042031	RSP042030	11°	Bottom	10	\$2.16	RSP052668	RSP052669
	RSP042011	RSP042010	11°	Top	10	\$2.37		
	RSP042050	RSP042049	18°	Bottom	10	\$2.14		
	RSP052497	RSP052498	18°	Top	10	\$2.54		

RADURA DISC MOWER BLADES

MOWING

Radura Disc Mower Blades (Continued)

	Left	Right	Angle	Bevel	Shape	Price	Bolt	Nut
Massey Ferguson (Continued)								
1306, 1307, 1308, 1309, 1310, 1326, 1327, 1328, 1329, 1330, 1339, 1359, 5209 (SN>16012), 5212 (SN>16012), 5312, 5406, 5407, 5408, 5409, 5410	RSP042059	RSP042057	11°	Top	10	\$2.33	RSP042134	RSP051061
	RSP052698	RSP052697	18°	Top	10	\$2.66		
1316S, 1373, 1376, 1393, 9313D, 9313S, 9316D, 9316S	RSP002500	RSP002400	11°	Top	10	\$2.57	RSP060022	RSP219970
	RSP002300	RSP002200	11°	Bottom	10	\$2.57		
	RSP009040	RSP008040	18°	Top	10	\$2.69		
	RSP002700	RSP002600	18°	Bottom	10	\$2.57		
127	RSP042064	RSP042066	11°	Top	10	\$2.01	n/a	n/a
New Holland								
442 (BSNZ4750), 452, 462 (BSNZ1643)	RSP041879	RSP041882	11°	Both	9	\$1.30	RSP042104	RSP042093
442 (ASNZ4751), 462 (ASNZ1644), 463	RSP041926	RSP041928	10°	Both	9	\$1.64	RSP042104	RSP042093
408, 411, 412, 415	RSP042022	RSP042026	10°	Both	9	\$1.88	RSP042122	RSP053367
442 (HD Disc), 452 (HD Disc), 462 (HD Disc), 463 (HD Disc)	RSP042034	RSP042037	10°	Both	9	\$2.27	RSP042122	RSP053367
615, 616, 617, 720TD, 720HD, 750 HD, 820TD, 1409, 1410, 1411, 1412, 1431, 1432, 1441, 1442, 2331, 2332, 2353, 2355, 2358, H6730, H6740, H6750, H6830, H7220, H7230, H7320, H7330, H7450, H7460, H7550, H7560	RSP042056	RSP042055	7°	Top	10	\$2.29	w/o lifters RSP052673, w/ lifters RSP052939	RSP052674
	RSP041986	RSP041987	14°	Top	10	\$2.43		
313, 316, 416, 419	RSP343225	RSP343226	7°	Top	10	\$2.91	n/a	RSP052674
	RSP255700	RSP255699	14°	Top	10	\$2.91		
	RSP271205	RSP271203	18°	Top	10	\$2.91		
	RSP375859		Dome	Both	4	\$5.46		
DC101F, DC102, DC102F, DC103, DC132, DC132F, DC162, DC162F, DC92, DC92F, DC93, DCX101, DCX131, DCX131F, DCX161, DCX91, MD72, MD73, MD82, DM92, MD93, MDX71, MDX81, MDX91, RD132, RD16, RD182, RDX131, RDX161, RDX181, TD102, TD103	RSP054144	RSP054142	7°	Top	10	\$3.99	n/a	n/a
	RSP054136	RSP054133	14°	Top	10	\$3.99		
New Idea								
1345, 1355, 1365, 1372, 1375, 9070, 9075, 9080, 9175, 9185, 9190, 9192, 5070, 5512, 5515, 6070	RSP042022	RSP042026	10°	Both	9	\$1.88	RSP052668	RSP052669
	RSP042031	RSP042030	11°	Bottom	10	\$2.16		
	RSP042011	RSP042010	11°	Top	10	\$2.37		
	RSP042050	RSP042049	18°	Bottom	10	\$2.14		
	RSP052497	RSP052498	18°	Top	10	\$2.54		
5209 (ASN16012), 5212 (ASN16012), 5312, 5406, 5407, 5408, 5409, 5410 (SN>1007481), 5512	RSP052698	RSP052697	18°	Top	10	\$2.66	RSP042134	RSP051061
	RSP042059	RSP042057	11°	Top	10	\$2.33		
5209 (BSN16013), 5212 (BSN16012)	RSP042064	RSP042066	11°	Top	10	\$2.01	RSP052234	RSP052235
526, 527, 528, 5207, 5406 (SN 1001159-1007480), 5407 (SN 1001159-1007480), 5408 (SN 1001159-1007480), 5409 (SN 1001159-1007480), 5410 (SN<1007480), 5412	RSP042064	RSP042066	11°	Top	10	\$2.01	n/a	n/a
PZ Zweegers								
CM135, CM165, CM167, CM168, CM170, CM210, CM211, CM212, CM220	RSP041899		Dome	Both	4	\$1.37	n/a	n/a
CM215, 135, 164, 166, 167, 168, 170, 184, 210	RSP041892		Flat	Both	1	\$1.54	n/a	n/a
Vermeer								
5020, 6020, 7020, 8020, M5030, M5040, M6030, M6040, M7030, M7040, M8030, M8040, MC830, MC840, MC1030, MC2800, MC3300, MC3700, MC4500, RC5120, RC7120, RC9120, TM600, TM700, TM800, TM850, TM1200, TM1210, TM1400, TM1410	RSP596001	RSP596002	11°	Top	10	\$2.81	n/a	n/a
Vicon								
AM2800, CM216, CM217, CM2200, CM2800, DMP2800, GMR2800, KM281 (late model), KM216, KM391CP, KM2800, OM216, OM281	RSP042006	RSP042007	11°	Top	10	\$2.17	n/a	n/a
AM3200, CM165, CM167, CM240, CM247, CM1700, CM2400, KM165, KM240, KM241, KM281 (Early Model), KM321, KM3200, KM4000, KMR3800, KMT3001, DMP2400, DMP3200, GMR2400, GMR3200, OM165, OM241	RSP042064	RSP042066	11°	Top	10	\$2.01	RSP042096	RSP045702

Radura Disc Mower Blade Hardware		
Product ID	Description	Price
RSP042093	Nut	\$1.62
RSP042096	Bolt	\$2.07
RSP042100	Bolt	\$2.31
RSP042104	Bolt	\$2.17
RSP042109	Nut	\$1.44
RSP042122	Bolt	\$2.42
RSP042128	Bolt	\$2.96
RSP042134	Bolt	\$1.01

Radura Disc Mower Blade Hardware		
Product ID	Description	Price
RSP045702	Nut	\$0.27
RSP051061	Nut	\$3.16
RSP052234	Bolt	\$1.75
RSP052235	Nut	\$2.24
RSP052668	Bolt	\$1.01
RSP052669	Nut	\$2.63
RSP052670	Bolt	\$2.70

Radura Disc Mower Blade Hardware		
Product ID	Description	Price
RSP052671	Nut	\$0.35
RSP052673	Bolt (w/o Lifter)	\$2.48
RSP052674	Nut	\$2.63
RSP052939	Bolt (with Lifter)	\$3.35
RSP053367	Nut	\$1.96
RSP060022	Bolt	\$1.47
RSP219970	Nut	\$0.58

Don't Settle for Metal!

Replace your baler's metal bands with May Wes poly pickup bands. These bands are manufactured from impact-resistant plastic and will not bend or break when you hit rocks or other objects in the field.

These pickup bands are a 1/2 inch thick and have an additional 1/4 inch thick reinforced support ring on the inside to strengthen and **maintain their shape** along with making them **impact resistant**.



Each band comes complete with hardware. Installation is easy. You can replace just the worn out metal bands or replace all of them at once.

May Wes Poly Pickup Bands

Case IH Square Balers					
Model	Head Size	Qty Req	OEM #	Product ID	Price/Ea
LB324, LB333, LB334, LB424, LB433, LB434, LBX322, LBX331, LBX332, LBX421, LBX422 (with standard and packer cutter head)	-	-	84468627, 84607815, 84801631, 84214800, 84274387	MYW083483	\$22.50
LB324, LB333, LB334, LB424, LB433, LB434, LBX322, LBX331, LBX332, LBX421, LBX422 (with roto cutter head)	-	-	84607781, 84274384	MYW083484	\$22.50
8550, 8570, 8575, 8585	-	-	700108607	MYW083480	\$29.95
SB521, SB531, SB541, SB551, SBX520, SBX530, SBX540, SBX550	-	-	86635483	MYW083676	\$29.95
Case IH Round Balers					
Model	Head Size	Qty Req	OEM #	Product ID	Price/Ea
RBX442, RBX443, RB444	-	11	86619049	MYW083589	\$29.95
RBX441	-	17	86619049	MYW083589	\$29.95
RBX443	-	11	86637150	MYW083590	\$29.95
RBX451, RBX452, RBX453, RBX461, RBX462, RBX463, RB454, RB464	1.5M	23	86618417	MYW083704	\$29.95
RBX453	1.8M	27	86618417	MYW083704	\$29.95
RB564	Standard	23	86643381	MYW083485	\$29.95
RBX452, RBX462, RBX463, RB454, RB464	1.8M	27	86643381	MYW083485	\$29.95
RBX452, RBX453, RBX462, RBX463, RB454, RB464	2.0M	31	86643381	MYW083485	\$29.95
RBX552, RBX562, RBX563, RB564	2.0M	Outer 10	86643381	MYW083485	\$29.95
		Middle 21	87055363	MYW083486	\$29.95
RBX552, RBX553, RBX561, RBX562, RBX563, RB554	Standard	23	87041202	MYW083591	\$29.95
RB565	1.5M	23	84370744	MYW083650	\$29.95
RB565	2.0M	31	84310057	MYW083651	\$29.95
RB455, RB465	1.8M	27	84329282	MYW083817	\$29.95
RB455, RB465	2.0M	31	84329282	MYW083817	\$29.95
Claas Balers and Self-Propelled					
Model	Head Size	Qty Req	OEM #	Product ID	Price/Ea
Jaguar, Quadrant, Quantum, Rollant, Variant	-	-	987770, 986434	MYW083819	\$29.95
John Deere Round Balers					
Model	Head Size	Qty Req	OEM #	Product ID	Price/Ea
330, 335, 375, 385, 430, 435, 447, 448, 449, 456, 458, 459, 466, 467, 468, 469, 535, 545, 546, 547, 550, 556, 558, 559, 566, 567, 568, 569, 570, 572, 580, 582, 590, 592	-	-	CC32669, E85043, FH311772	MYW083478	\$29.95

MAY WES POLY PICKUP BANDS

BALING

John Deere Round Balers (Continued)					
447, 448, 449, 456, 458, 459, 466, 467, 468, 469, 535, 545, 546, 547, 550, 556, 558, 559, 566, 567, 568, 569	-	-	FH311995	MYW083845	\$29.95
Mega Wide Head - Outer 3	-	-	FH311994, E96760	MYW083701	\$29.95
John Deere Self-Propelled Harvester					
Model	Head Size	Qty Req	OEM #	Product ID	Price/Ea
630A, 640A, 645A, 630B, 640B, 645B, 630C, 640C, 645C	-	-	CC32669, E85043, FH311772	MYW083479	\$29.95
New Holland Square Balers					
Model	Head Size	Qty Req	OEM #	Product ID	Price/Ea
27P, 29P, 707W, 717W, 770W, 790W, 880W, 890W, 900W, 919W3, 919W4, 990W	-	-	86625275	MYW083489	\$29.95
590, 595, BB940, BB960, BB9050, BB9060, BB9070, BB9080, 230, 330, 340 (with roto cutter head)	-	-	84074345, 84214794, 84274385	MYW083482	\$22.50
276, 311, 315, 316, 320, 326, 565, 568, 570, 575, 580, BC5050, BC5060, BC5070, BC5080 (with roto cutter head)	-	-	86635482, 184550	MYW083677	\$29.95
585 (with roto cutter head)	-	-	-	MYW083489	\$29.95
590, 595, BB940, BB960, BB9050, BB9060, BB9070, BB9080, 230, 330, 340 (with standard and packer cutter head)	-	-	84801630, 89837845, 85005357, 84214799, 84274388	MYW083481	\$22.50
New Holland Round Balers					
Model	Head Size	Qty Req	OEM #	Product ID	Price/Ea
634,638	Standard	11	86619048	MYW083586	\$29.95
630, BR7050, BR7060, BR730, BR730A	Standard	17	86619048	MYW083586	\$29.95
640, 650, 660	Standard	23	86619048	MYW083586	\$29.95
640, 644, 648, 650, 654, 658, BR7060, BR7070, BR740, BR740A, BR750, BR750A, RB450, RB460	Wide/1.5M	23	86618414	MYW083703	\$29.95
644, 648, 654, 658, BR730A, BR740, BR740A	Standard	17	86637149, 86512793	MYW083587	\$29.95
664, 678, 688	Standard	23	86637149	MYW083587	\$29.95
BR7080, BR7090, BR770, BR770A, BR780, BR780A	Standard	23	87041203	MYW083588	\$29.95
BR7060, BR7070	1.8M	Outer 10	86643380	MYW083487	\$29.95
	1.8M	Middle 21	87055364	MYW083488	\$29.95
BR740, BR740A, BR750, BR750A	1.8M x.s.	Outer 10	86643380	MYW083487	\$29.95
	1.8M x.s.	Middle 17	87055364	MYW083488	\$29.95
BR7060, BR7070, BR740, BR740A, BR750, BR750A, BR780	2.0M	31	86643380	MYW083487	\$29.95
BR7090, BR780A	2.0M x.s.	Outer 10	86643380	MYW083487	\$29.95
	2.0M x.s.	Middle 21	87055364	MYW083488	\$29.95
RB450, RB460	1.8M	27	84329281	MYW083648	\$29.95
RB450, RB460	2.0M	31	84329281	MYW083648	\$29.95
RB550, RB560	1.5M	23	84370743	MYW083648	\$29.95
RB550, RB560	2.0M	31	84310058	MYW083649	\$29.95
New Holland Self-Propelled Chopper					
Model	Head Size	Qty Req	OEM #	Product ID	Price/Ea
280FP, 290FP, 380FPA, 380FPE, 346W, 356W, 366W	-	-	87696240, 86631272, 87584380	MYW083592	\$29.95
Vermeer Round Balers					
Model	Head Size	Qty Req	OEM #	Product ID	Price/Ea
I, Super I, J, Super J, K, L, XL, Super M, N, Rancher, Rebel	-	-	89982001	MYW083706	\$29.95
Pro Baler	-	-	510547156	MYW083818	\$29.95

RASSPE™ BALER KNOTTERS

for Square Balers

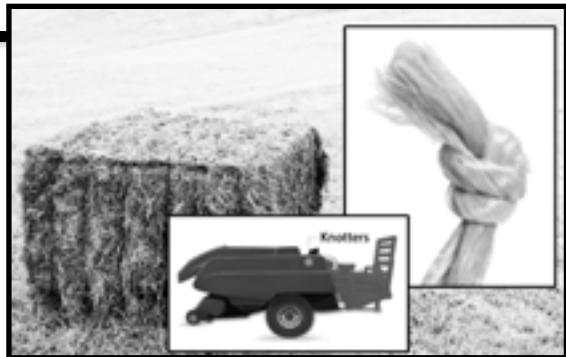

**The Specialist for
Knotter Technology**

The processes of knotting and tying have a major impact on the overall performance and efficiency of a square baler. Bale twine has to withstand enormous strain as the baled material

rebounds after binding. **Therefore, knot strength is the be-all and end-all in the tying process.** RASSPE™ has a long-standing tradition of superior reliability and durability in twine knotters for square balers.

RS 1450 High Density Double Knotter

This HD double knotter's minimal twine spacing of 6.8 inches / 172 mm makes it possible to use 4-6 knotters on 31.5-47.2 inches / 800-1200 mm chamber machines.

- Split hub for easy service and maintenance
- Great resistance to wear
- For hay, straw, corn stalks and silage bales
- Ties up to 120 lbf twines
- For high-density bales
- Designed for square balers

RS 1450 Heavy Density Double Knotter

Make/Models	Without Cam Gear			With Cam Gear		
	OEM #	Product ID	Price	OEM #	Product ID	Price
Case-IH- 8570, 8575, 8576, 8580, 8585, 8590	700113321 700204084	RSB700321	\$1,118.63	-	RSB700084	\$1,371.88
Challenger- 2240, 2250, 2260, 2270, 2270XD, 2290						
Fendt- 12130, 1270N, 1270S, 1290N, 1290S						
Hesston- 4750, 4755, 4760, 4790, 4900, 4910						
Massey Ferguson- 2150, 2160, 2170, 2170XD, 2240, 2250, 2260, 2270, 2270XD, 2290						
New Holland- BB980						

RS 6003 Single Knotter

The RS 6003 is a more rugged version of the single knotter and offers outstanding durability for use on high-performance balers. It is typically used on balers that produce small packs at high annual output rates.

- Great resistance to wear
- Split hub
- For hay, straw and silage bales
- 2-3 knotter modules
- Easy maintenance

RS 6003 Single Knotter

Make/Models	Without Cam Gear			With Cam Gear		
	OEM #	Product ID	Price	OEM #	Product ID	Price
AGCO- 1841, 7120	700709740	RSB042951	\$1,063.86	700709845	RSB042997	\$1,245.76
Case-IH 8555						
Challenger- 1842, SB44						
Hesston- 4655, 4690, 4690S						
Massey Ferguson- 1841, 1842, 1843N, 1843S, 1844N, 1844S						



#RSB700321 - RS 1450 High Density Double Knotter



#RSB700084 - RS 1450 High Density Double Knotter with Cam Gear



#RSB042997- RS 6003 Single Knotter with Cam Gear

BUSHEL PLUS MINI COMBINE

Identical Crop Samples to a Combine, Only Portable!

Mini Combine

QUICK ACCURATE CROP COLLECTION.

SAVE FUEL AND TIME!

Leave the Large Expensive Combine in the Shed!

Accurate Crop Samples in Less than 5 Minutes!

Bushel Plus' Mini Combine is a portable tool, comprised of a picker/threshing drum and an aerator/blower, for taking samples of wheat, barley, canola, sorghum, oats, soya, peas, field beans, and flax.

Samples collected are identical to a combine giving you the perfect sample size for moisture content tests and quality analysis.

This self-contained, electric unit comes with four interchangeable concaves (no tools required), a lithium-ion battery and a variable-speed brushless motor.



Product Video



www.youtube.com/watch?v=nnOBZYkGVJM

Save Time and Fuel

Every farmer wants to get harvesting as soon as the crop is ready, but it can be time-consuming to test your crop to make sure conditions are right. The Mini Combine gives you accurate grain samples in minutes, without the time and expense of taking your combine to the field.

Mini Combine		
Product ID	Description	Price
BPS144000	Mini Combine, Portable Crop Sampling Tool	\$1,510

HCC GATEWAY CHAFFERS & SIEVES - SERVICE PARTS



All components of the HCC Gateway Chaffers and Sieves are replaceable for quick and economic repair.

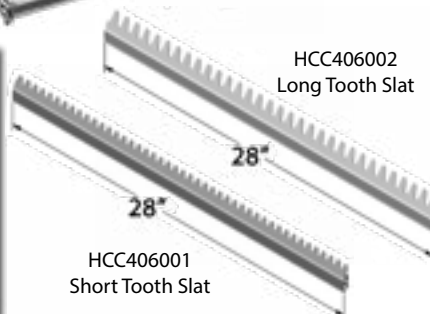
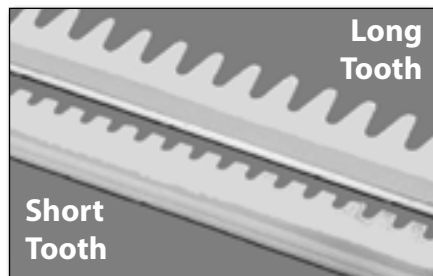

Gateway Service Parts		
Product ID	Description	Price
HCC406001	Slat, Short Tooth, 28"	\$10.25
HCC406002	Slat, Long Tooth, 28"	\$10.25
HCC909050	Slat, Flat, Long, 28"	\$10.25
HCC909051	Slat, Flat, Short, 28"	\$10.25
HCC409000	Connector, Female	\$3.00
HCC409001	Connector, Male	\$3.00
HCC409002	Center Connector, Long	\$1.90
HCC409003	Center Connector, Short	\$1.90
HCC409004	End Connector, RH	\$3.00
HCC409005	End Connector, LH	\$3.00
HCC212366	Push Nut, .25 diameter	\$0.65
HCC002641	Gateway Riser Kit, Hillside Divider	\$47.61



HCC409000 Female Connector



HCC409001 Male Connector



HCC409002 Long Center Connector



HCC409003 Short Center Connector



HCC409004 End Connector, RH



HCC409005 End Connector, LH



HCC212366 Push Nut

AUGER EXTENSIONS KITS FOR COMBINES



Gleaner Unloading Auger Extension Kit - #HRV130101



John Deere Unloading Auger Extension Kit - #HRV130106

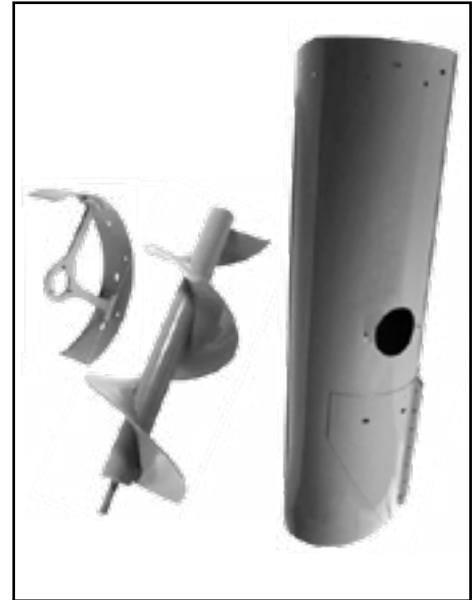

John Deere Unloading Auger Extension Kit - #HRV130109

All unloading auger extensions kits come with complete hardware and instructions.

Unloading Auger Extension Kits		
Case-IH	Product ID	Price
1400, 1600 series, 36" Auger Extension (round drive)	HRV130104	\$1,125.28
1600, 2100, 2300 series, 36" Auger Extension (splined drive)	HRV130105	\$1,184.45
Gleaner	Product ID	Price
L, M, N & Early R Series, 30" Auger Extension, 12" Diameter	HRV130101	\$1,065.89
Late R Series, 30" Auger Extension, 12" Diameter	HRV130102	\$1,255.59
Late R & S Series, 36" Auger Extension, 14" Diameter	HRV130103	\$1,155.39
John Deere	Product ID	Price
6620 - 9750, 36" Unloading Auger Extension	HRV130106	\$1,026.91
6620 - 9750, 24" - 30" Unloading Auger Extension	HRV130107	\$1,130.64
9560, 9660, 9760, 9750 Unloading Auger with end discharge - Standard Rate, 36" Auger Extension	HRV130108	\$1,175.90
9660STS, 9760STS, 9860STS, 9670STS, 9770STS, 9870STS - High Rate, 36" Auger Extension	HRV130109	\$1,331.22
9660STS, 9760STS, 9860STS, S660, S670, S680, S690 - High Rate, 36" Auger Extension for folding system	HRV130110	\$3,018.05

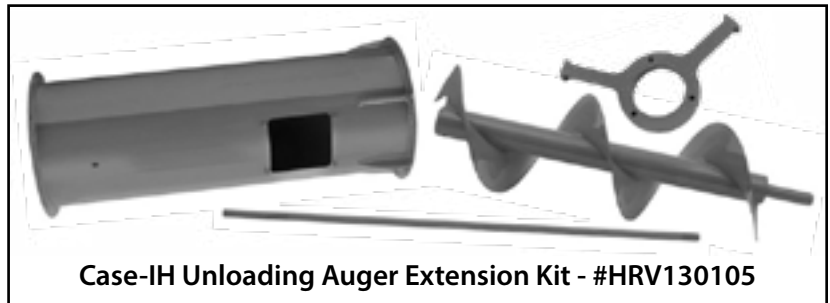

Case-IH Unloading Auger Extension Kit - #HRV130105

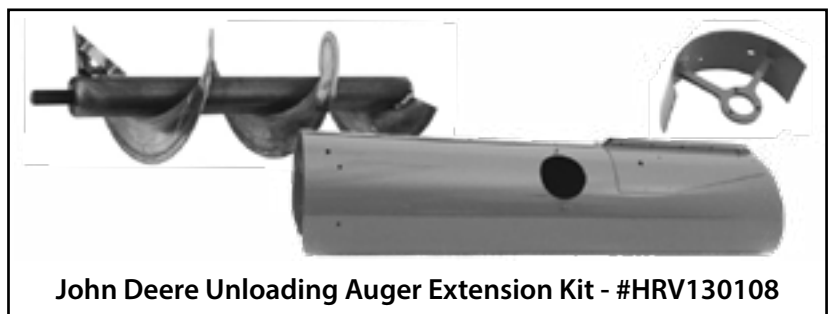

John Deere Unloading Auger Extension Kit - #HRV130108

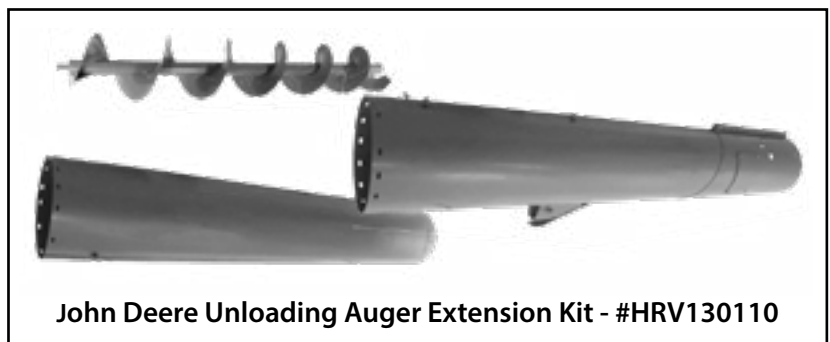

John Deere Unloading Auger Extension Kit - #HRV130110

UNLOADING AUGER TUBES

Unloading Auger Tubes						
Case-IH	Description	Overall Length	Piece Length	OEM Number	Product ID	Price
1620, 1640, 1644, 1660, 1666, 1670, 1680, 1688, 2144, 2166, 2188, 2344, 2365, 2366, 2377, 2388 BSN HAJ300001	Inner Solid Unloading Tube	136", 172", 208"	90"	1317738C1	HRV180030	\$745.72
	Inner Perforated Unloading Tube	136", 172", 208"	90"	1317783C2	HRV131787	\$567.79
	Outer Unloading Tube	136"	46-1/2"	1317734C2	HRV131773	\$554.40
	Outer Unloading Tube	172"	82-1/2"	1317783C4	HRV180031	\$567.79
2388 ASN HAJ300001, 2577 ASN HAJ300001, 2588 ASN HAJ300001	Outer Unloading Tube	208"	118-1/2"	1317899C3	HRV180032	\$640.15
	Inner Solid Unloading Tube	18', 21'	126"	87557135	HRV875135	\$1,052.41
	Inner Perforated Unloading Tube	18', 21'	126"	87557138	HRV875138	\$1,288.02
	Outer Unloading Tube	18'	82-1/2"	87581650	HRV875650	\$1,020.58
5088, 6088, 7088, 5130, 5140, 5150, 6130, 6140, 6150, 7130, 7140, 7150, 7230, 7240, 7250, 8230, 8240, 8250, 9230, 9240, 9250	Outer Unloading Tube, Standard Rate		198-1/4"	87743673	HRV877673	\$706.05
	7230, 7240, 8230, 8240, 9230, 9240	Outer Unloading Tube, High Rate	21'	194-5/8"	47405760	HRV474760
7230, 7240, 7250, 8230, 8240, 8250, 9230, 9240, 9250	Outer Unloading Tube, High Rate, Folding		87-1/2"	47407783	HRV474783	\$1,452.82
7230, 7240 BSN YEG227001, 8230, 8240 BSN YEG227001, 9230, 9240 BSN YEG227001	Inner Unloading Tube, High Rate, Folding		172"	47439287	HRV474287	\$3,066.26
7240 ASN YEG227001, 7250, 8240ASN YEG227001, 8250, 9240ASN YEG227001, 9250	Inner Unloading Tube, High Rate, Folding		172"	47551157	HRV475157	\$2,943.23
Challenger	Description	Overall Length	Piece Length	OEM Number	Product ID	Price
660, 670	Unloading Tube		213-1/2"	71399669	HRV713669	\$2,057.58
Gleaner	Description	Overall Length	Piece Length	OEM Number	Product ID	Price
L, M, N, R	Unloading Tube, Silver		145-5/8"	71383428	HRV180020	\$719.04
	Unloading Tube, Galvanized		145-5/8"	71368075	HRV180021	\$707.35
A65, A75	Unloading Tube, Silver		213-1/2"	71399669	HRV180024	\$2,057.58
R62, R72, R65, R75	Unloading Tube, Chassis Gray		180-3/4"	71390923	HRV180022	\$2,136.74
S67, S77	Unloading Tube		216-3/4"	71444325	HRV180023	\$2,985.92
John Deere	Description	Overall Length	Piece Length	OEM Number	Product ID	Price
6620, 7720, 8820 BSN 600001 -14' 8820 ASN 600001, 9400, 9410, 9450, 9500, 9510, 9550, 9600, 9610, 9650, 9650CTS, 9650STS, 9750STS -17'	Unloading Tube	14', 17'	144-1/2"	AH145049	HRV180010	\$838.61
7720, 8820 BSN 600001 -17' 8820 ASN 600001, 9400, 9410, 9500, 9510, 9550, 9600, 9610, 9650, 9650CTS, 9650STS, 9750STS -20'	Unloading Tube	17', 20'	180-1/2"	AH145050	HRV180011	\$1,016.15
9560, 9560STS	Outer Unloading Tube	18-1/2'	144"	AH210024	HRV180012	\$1,081.50
9560, 9560STS, 9570STS, 9660, 9660CTS, 9660STS, 9670STS, 9760STS, S550, S660	Outer Unloading Tube	21-1/2'	180-1/4"	AH210023	HRV180013	\$1,190.80
9660STS, 9760STS, 9860STS, 9670STS, 9770STS, 9870STS, S660 BSN 775000, S670 BSN 775000, S680 BSN 775000, S690 BSN 775000	Outer Unloading Tube, High Rate	22-1/2'	184"	AH203020	HRV803020	\$1,951.85
S660 ASN775000, S670 ASN775000, S680 ASN775000, S690 ASN775000, S760, S770, S780, S790	Outer Unloading Tube, High Rate	22-1/2'	161-5/8"	AXE68706	HRV868706	\$3,431.71
S660ASN765172, S670ASN765172, S680ASN765172, S690ASN765172, S760, S770, S780, S790	Middle Unloading Tube, High Rate	26', 28-1/2'	93-3/8"	AXE68701	HRV868701	\$2,739.66
9670STS, 9770STS, 9870STS, S660, S670, S680, S690, S760, S770, S780, S790	Outer Unloading Tube, High Rate	26'	112-1/4"	AXE68700	HRV868700	\$1,625.80
S660ASN765172, S670ASN765172, S680ASN765172, S690ASN765172, S760, S770, S780, S790	Outer Unloading Tube, High Rate	28-1/2'	130-7/8"	AXE68702	HRV868702	\$2,737.12
9670STS, 9770STS, 9870STS, S660 BSN 775000, S670 BSN 775000, S680 BSN 775000, S690 BSN 775000	Middle Unloading Tube, High Rate, Folding	22-1/2'	115-13/16"	AH209128	HRV809128	\$1,839.01
9670STS, 9770STS, 9870STS, S660 BSN 765171, S670 BSN 7765252, S680 BSN 766006, S690 BSN 765249	Outer Unloading Tube, High Rate, Folding	22-1/2'	66"	AXE28972	HRV828972	\$840.69
Massey Ferguson	Description	Overall Length	Piece Length	OEM Number	Product ID	Price
8570, 8780, 9690, 9790	Early Unloading Tube		178-1/2"	71396414	HRV180041	\$1,747.91
8560, 8780	Unloading Tube		142-1/2"		HRV180040	\$1,209.97
9690, 9790	Unloading Tube		213-1/2"	71399669	HRV180042	\$2,057.58

THRASH MASTER CONCAVE SYSTEM

The Thrash Master Concave System increases the thrashing surface area which gives your machine the ability to thrash better and more aggressively.

The increase of thrashing area is accomplished without sacrificing the grains ability to escape the rotor and prevents damage to the grain. The Thrash Master Concave System has a patent pending latch system that enables you to quickly make settings adjustments to your concaves as you switch to different crop types.



- 30% more thrashing surface area than a factory concave
- Increased thrashing surface area without sacrificing grain and increasing the ease of flow by 20 degrees
- 10%+ less cracked and damaged grain
- Increased harvest speeds by 5-10%
- Can be used in all crops
- Works with stripper headers

Angled bars, in different directions, improve thrashing

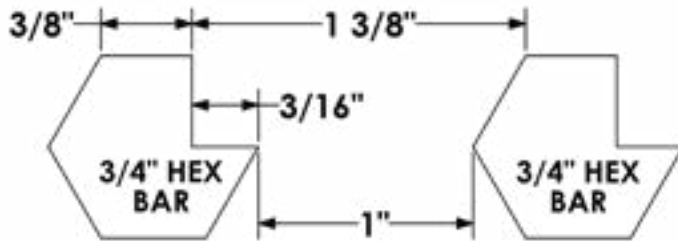

Thrash Master Hexagon Bars

- Closer threshing point to point (1-3/8") prevent cob breakage.
- Angle bars keep cob moving for better thrashing and easier separation.
- Wider threshing surface (3/8") for improved, cleaner threshing.
- No radiused edge allows grain to escape concave sooner with less obstruction.



Competitors' Round Bars

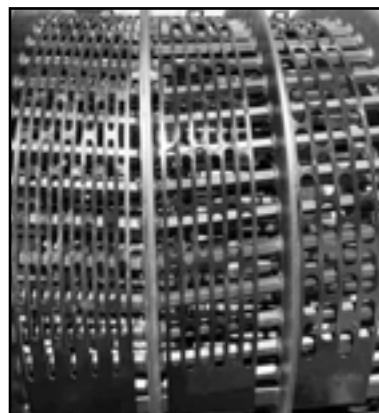

John Deere

Concave Packages	Product ID	Price
JD STS-S Series Concave, Corn and Soybean; 4 large cover plates	MRT900482	\$7,500.00
JD STS-S Series Concave, All Crops; 3 large, 3 medium & 4 small cover plates	MRT900483	\$7,800.00
JD STS-S Series Concave, w/ stripper header; 2 large cover plates	MRT900555	\$8,500.00
Concave Individual Components	Product ID	Price
Concave, JD STS-S Series #1 Front	MRT850340	\$2,400.00
Concave, JD STS-S Series #2 Front	MRT850341	\$2,400.00
Concave, JD STS-S Series #3 Front	MRT850342	\$2,400.00
Plate, JD STS-S Series Large Cover	MRT850343	\$75.00
Plate, JD STS-S Series Medium Cover	MRT850344	\$75.00
Plate, JD STS-S Series Small Cover	MRT850345	\$75.00

Case-IH

Concave Packages	Product ID	Price
Case-IH Flagship Concave, Corn & Soybean; 6 large cover plates	MRT900485	\$7,500.00
Case-IH Flagship Concave, All Crops; 4 large, 4 medium & 4 small cover plates	MRT900486	\$7,800.00
Concave Individual Components	Product ID	Price
Concave, CIH Flagship #1 Front Left	MRT850347	\$1,800.00
Concave, CIH Flagship #1 Rear Left	MRT850348	\$1,800.00
Concave, CIH Flagship #1 Front Right	MRT850349	\$1,800.00
Concave, Case IH Flagship #1 Rear Right	MRT850350	\$1,800.00
Plate, CIH Flagship Series Large Cover	MRT850351	\$50.00
Plate, CIH Flagship Series Medium Cover	MRT850352	\$50.00
Plate, CIH Flagship Series Small Cover	MRT850353	\$50.00

BUSHEL PLUS MAD CONCAVES

Designed to be aggressive with quality, reliability and durability top of mind!



Swapping out traditional round wire combine concaves for these innovative bar-and-grate style modular Bushel Plus MAD Concaves™ results in more efficient threshing, getting your grain out of the head and into the hopper quicker for decreased rotor loss and less dockage. This means higher quality crops and more money in your pocket.

Maximize Performance

Maximize your combine's performance efficiency with Bushel Plus MAD Concaves™. They are easy-to-change, allowing you to quickly swap out inserts in minutes and save valuable time - critical in a busy harvest season. They are designed to be aggressive to reduce dockage and losses for higher quality and better returns.



- Reduce Dockage & Losses
- Quick & Easy to Change
- Gain Operational Efficiency
- Increase Grain Quality

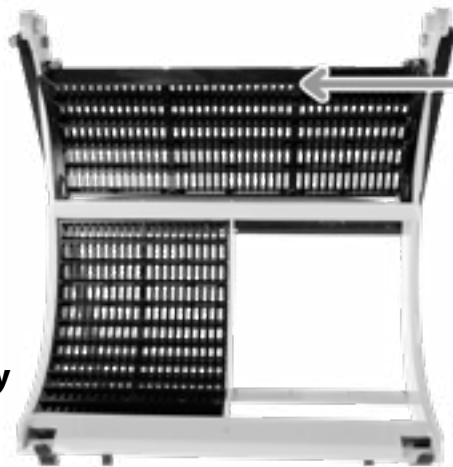

Product shown is New Holland.

Changing concaves now means to only change out "concave inserts" (black).

A modular frame (gray) replaces the original concave, fits into the original concave position in the combine, and always stays in place.

Case IH			
Concave Kits	Product ID	Price	
2004 & Newer Flagship (concaves only, no frame needed)	Wheat, flax, barley, soybeans, canola, peas and corn	MDC202101	\$7,450.00
	Barley, soybeans, canola, peas and corn	MDC202102	\$4,450.00
	Speciality crop inserts available upon request - call for pricing.		
1680, 1688, 2188, 2388, 2588, 7088, 7130, & 7140	Wheat, flax, durum, canola, peas, corn, soybeans, barley and oats	MDC201101	\$6,075.00
	Canola, peas, soybeans, barley and oats	MDC201102	\$3,915.00
	Wheat, flax and durum	MDC201103	\$3,915.00
	Speciality crop inserts available upon request - call for pricing.		
John Deere			
STS 9650, 9750, 9660, 9760, 9860, 9670, 9770, 9870 S-Series S650, S660, S670, S680, S690, S760, S770, S780, S790	Canola, peas, soybeans, barley, oats, wheat, cereals and corn	MDC101101	\$6,881.00
	Canola, peas, soybeans, barley and oats	MDC101102	\$4,721.00
	Wheat and cereals	MDC101103	\$4,721.00
	Speciality crop inserts available upon request - call for pricing.		
X9 (concaves only, no frame needed)	Wheat and flax	MDC109101	\$9,420.00
	Canola, barley, oats, peas, soybeans, chickpeas and lentils	MDC109102	\$9,420.00
	Canola, barley, oats, peas, soybeans, chickpeas, lentils, wheat and flax.	MDC109103	\$10,990.00
	Speciality crop inserts available upon request - call for pricing.		
New Holland			
All 22" twin rotor	Wheat, flax, corn, barley, soybeans, canola and peas	MDC301101	\$8,620.00
	Corn	MDC301102	\$5,220.00
	Corn, barley, soybeans, canola and peas	MDC301103	\$7,540.00
	Speciality crop inserts available upon request - call for pricing.		



Case-IH 88 Series

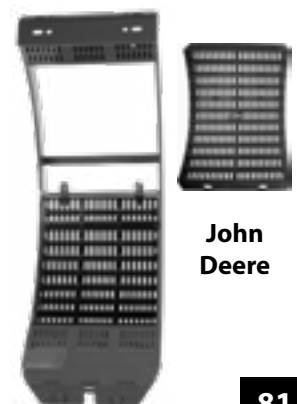

John Deere

REPLACEMENT REEL TINES

HCC STANDARD REEL TINES



HCC has a variety of tines that will replace most worn-out components to make sure you get the most out of your harvest.

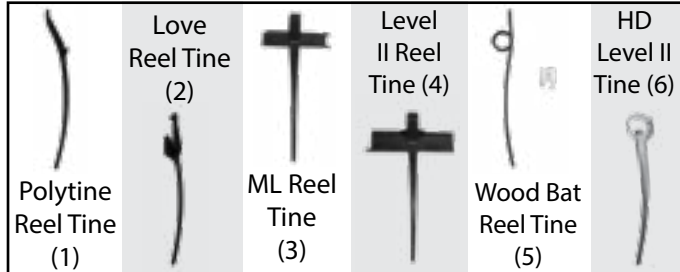

NOTE: You can purchase the double wing ML or Level II tines cheaper and then cut the wings off for the right hand, left hand and no wing tines.

(1) Polytime Reels have a teardrop shaped metal bat with notches spaced 4.5" (114 mm) apart. The tines fit into the notches and are fastened to the back of the metal bat approximately 3" (76 mm) above the notch. Supplied from 1984-1989.

(2) Love Reels have a sheet metal bat and the tine fastens over the bottom edge. There is a projection that fits into a hole on the front of the bat approximately 2.5" (64 mm) above the edge. The Love Reel was not manufactured by HCC Inc.

(3) ML Reels have a 1.375" (35 mm) tube with 0.4" (10 mm) round holes spaced approximately 4.5" (114 mm) apart. The tines have a round nub that fits into a round hole in the tube. Supplied from 1989-1999.

(4) Level II Reels have a 1.375" (35 mm) tube with 0.5" (12.7 mm) hex holes spaced 6.0" (152 mm) apart. The tines have a hex nub that fits into a hex hole in the tube. Standard since 1999/2000. **(6) is a heavy-duty alternative.**

(5) Wood Bat Reels have a wood bat with steel tines spaced approximately 4.5" (114 mm) apart. The tines are pressed into the bat and there is a metal clip riveted to the bat to provide support to the tine.

(6) Level II Reels, Heavy-Duty are a heavy-duty alternative to (4) Level II Reels. The overall length of the heavy duty tine is 11-7/8" (302 mm) and the strap width is 1-1/8" (29 mm).

Replacement Reel Tines		
Product ID	Description	Price/Each
HCC224014	Polytime reel tine (1)	\$1.49
HCC224015	Love reel tine (2)	\$2.29
HCC224016	ML reel tine, double wing (3)	\$1.99
HCC224017	ML reel tine, right hand wing (3)	\$2.59
HCC224018	ML reel tine, left hand wing (3)	\$2.59
HCC224019	ML reel tine, no wing (3)	\$2.59
HCC224047	Level II reel tine, full wing (4)	\$2.39
HCC224048	Level II reel tine, left hand wing (4)	\$2.69
HCC224049	Level II reel tine, right hand wing (4)	\$2.69
HCC224050	Level II reel tine, no wing (4)	\$2.69
HCC224081	Level II heavy duty reel tine, no wing (6)	\$3.69
HCC480056	Wood bat steel tine (5)	\$2.57
HCC480057	Clip, for wood bat steel tine (5)	\$0.30
Installation hardware included.		

The Paddle's six-inch width lifts and feeds crop that standard tines miss.



PADDLE THE PADDLE REPLACEMENT REEL TINES

The proven "Paddle" offers these advantages over standard tines:

- Increased harvest
- Improved feeding
- Cleaner cutterbar
- Faster harvesting

- When crop conditions make harvesting difficult and inefficient, the Paddle is the cost-effective alternative to standard tines.
- The Paddle provides full crop contact, even with short crop, and delivers positive and even feeding into the header.
- Helps reduce or eliminate the need for an expensive air reel.
- The patented tine mounting system makes installation fast and easy.

The "Paddle" is sold individually and includes "Paddle", screws and complete installation instructions.



The Paddle is designed to provide a complete sweep of the header with each rotation. By limiting the number of Paddles used, you save installation time and money.



Original Tine Spacing	Paddle Tines Per Reel Width				
	18'	20'	25'	30'	36'
4.5"	40	40	50	60	N/A
6.0"	30	40	40	50	60

Paddle Tines		
Product ID	Description	Price/Each
HCC983950	Paddle Tine, Polytime reel (1)	\$12.25
HCC983845	Paddle Tine, ML reel (3)	\$9.75
HCC983846	Paddle Tine, Level II reel (4)	\$9.75
HCC983949	Paddle Tine, wood bat reel (5)	\$12.25

REPLACEMENT REEL TINES

The unique 5-finger design "grabs" short, sparse or specialty crops more consistently and evenly.

5-FINGER QUICK TINES



- Designed for use in soybeans, wheat, canola, chickpeas, lupins, and flax.
- Easily slips over the existing finger, attaching directly to the bar. No tools needed.



#HRV983834 is designed to fit over: Case-IH 2162, 2152, 2142; MacDon FD70, FD75, FD1; New Holland 86C, 83C, 82C

#HRV983836 is designed to fit over: John Deere 630FD, 635FD, 640FD, 645FD serial# 785,000 and above, 730FD, 735FD, 740FD, 745FD

#HRV983849 is designed to fit over: Case-IH 3162, 3152; New Holland 840CD, 880CF

#HRV983838 is designed to fit over: AGCO 300-800, 8000, 8200, 9250; Case-IH 1010, 1020, 2010, 2020, 3020; John Deere 900, 600, 600FD (before serial number 785000); Massey Ferguson 8000, 8200, 9250, 9700, 9750, 9800, 9850; New Holland 971, 973, 71C, 72C, 73C, 74C, 92C, 94C, 740CF

5 Finger Quick Tine		
Product ID	Description	Price/Ea
HRV983834	5 Finger Quick Tine, Case IH, MacDon, ND; FD - 5-1/2" wide	\$7.64
HRV983836	5 Finger Quick Tine, JD 600FD, 700FD - 5-1/2" wide	\$7.64
HRV983849	5 Finger Quick Tine, Case-IH, NH; 5-1/2" wide	\$7.64
HRV983838	5 Finger Quick Tine, AGCO, CIH, JD, M/F, NH - 4" wide	\$6.42

Make	Quick Tines Per Reel Width			
	30'	35'	40'	45'
John Deere	120	140	160	180
MacDon	105	125	140	155

Simply slide over the top of a shortened or broken tine and snap into place.

SNAP-ON & QUICK FINGER REPLACEMENT TINES



- QUICK Repair
- EASY Installation; No Tools Required

SNAP-ON REPLACEMENT TINES

Snap On Replacement Tines		
Product ID	Description	Price/Ea
HRV983835	Replacement Snap On Tine, CIH, MacDon, NH; FD	\$5.49
HRV983837	Replacement Snap On Tine, JD 600FD, 700FD	\$5.49

#HRV983835 is designed to fit over: Case-IH 2162, 2152, 2142; MacDon FD70, FD75, FD1; New Holland 86C, 83C, 82C

#HRV983837 is designed to fit over: John Deere 630FD, 635FD, 640FD, 645FD serial# 785,000 and above, 730FD, 735FD, 740FD, 745FD

QUICK FINGER REPLACEMENT TINES

Quick Finger Replacement Tines		
Product ID	Description	Price/Ea
PDM010000	Quick Finger	\$2.35

The Quick Finger will fit the following pipe reels:

AGCO: 300, 400, 500, 700, 800 series heads
 CASE-IH: 1010, 1020, 2020, series heads
 Caterpillar 1998 and later
 John Deere 900, 600, early 600FD series heads
 Massey Ferguson 9700, 9750, 9800, 9850 series heads
 New Holland 971, 973, 71C, 73C, 72C, 74C series heads

Note: Will only properly fit Level II pipe reels with 6" tine spacing. Quick Finger will fit ML reels with 4.5" tine spacing but it will be 3/8" shorter than the original tine.



HCC ORBIT TRAC II REEL KIT

Now With All Steel Tracks



HCC has closed that gap with the Orbit™ Trac II Reel.

Its revolutionary reel design brings the tines right up to the auger to positively place crop into the auger, providing true continuous crop flow.

It allows you to harvest more crop in less time.

Unique design allows tines to swing directly past auger.

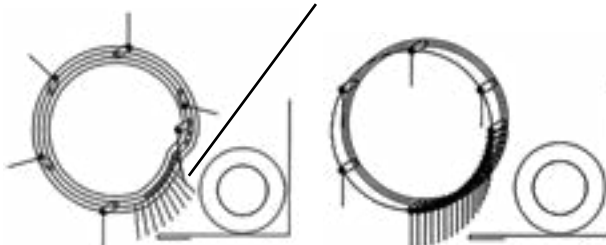

Orbit Reel™

Standard Reel

- Eliminates the Reel - Auger Gap
- Positively places crop into auger
- Reduces or eliminates slugging
- Resists wrapping in green crop
- On-farm installation in a few hours

HCC Orbit Trac II Reel Kit

Product ID	Product Description	Price
AGCO 400-8000 Series		
HCC131371	AGCO, 400, 500, 800, 8000 series, 25-35'	\$3,665.04
HCC131372	AGCO, 400, 500, 800, 8000 series, 22' & shorter	\$1,922.81
AGCO 8200		
HCC131373	AGCO, 8200 series, 25-35'	\$3,662.86
HCC131396	AGCO, 8200 series, 20' & shorter	\$1,921.78
Case-IH 1010 & 1020 (Verify single eccentric or double eccentric reel.)		
HCC131382	Case-IH, 1994 & prior, 22' & longer 1010 headers (-JJC0200000) & 1020 headers (-JJC0215000)	\$3,664.50
HCC131383	Case-IH, 1994 & prior, 20' & shorter 1010 headers (-JJC0200000) & 1020 headers (-JJC0215000)	\$1,922.57
HCC131380	Case-IH, 1995-1997, 22' & longer 1010 headers (JJC0200001-JJC0300000) & 1020 headers (JJC0215001-JJC0315000)	\$3,701.78
HCC131381	Case-IH, 1995-1997, 20' & shorter 1010 headers (JJC0200001-JJC0300000) & 1020 headers (JJC0215001-JJC0315000)	\$1,941.97
HCC131369	Case-IH, 1998 & newer, 22' & longer 1010 headers (JJC0300001- & CBJ023001-) & 1020 headers (JJC0315001- & CBJ023003-)	\$3,701.56
HCC131370	Case-IH, 1998 & newer, 20' & shorter 1010 headers (JJC0300001- & CBJ023001-) & 1020 headers (JJC0315001- & CBJ023003-)	\$1,923.10
Case-IH 2010 & 2020		
HCC131376	Case-IH, 2010, 2020, 22-35'	\$3,664.34
HCC131377	Case-IH, 2010, 2020, 20' & shorter	\$1,922.42
Case-IH 3020		
HCC131532	Case-IH, 3020, 25-35'	\$3,842.71
HCC131533	Case-IH, 3020, 20'	\$1,959.78
Honey Bee		
HCC131385	Honey Bee, double eccentric	\$3,698.52
John Deere 600 Series		
HCC131374	John Deere, 600 series, 25' & longer (Will not fit Flex Draper)	\$3,698.14
HCC131375	John Deere, 600 series, 22' & shorter (Will not fit Flex Draper)	\$1,942.15
HCC131603	John Deere 640FD, 40'	\$3,661.92
John Deere 900 Series		
HCC131367	John Deere, 900 series, (serial # 645301-) 25' & longer	\$3,700.13
HCC131368	John Deere, 900 series, (serial # 645301-) 22' & shorter	\$2,131.68
Massey Ferguson		
HCC131388	Massey Ferguson, draper, double eccentric	\$3,662.93
HCC131384	Massey Ferguson, 1859, single eccentric	\$1,921.87
HCC131373	Massey Ferguson, 8200 series, 25-35'	\$3,662.86
HCC131396	Massey Ferguson, 8200 series, 20' & shorter	\$1,921.78
New Holland		
HCC131378	New Holland, 970-973, 25' & longer	\$3,664.97
HCC131379	New Holland, 970-973, 22' & shorter	\$1,922.76
HCC131376	New Holland 72C, 74C, 22-35'	\$3,664.34
HCC131377	New Holland 72C, 74C, 20' & shorter	\$1,922.42
HCC131400	New Holland 73C, 22' & longer	\$3,664.38
HCC131401	New Holland 73C, 20' & shorter	\$1,922.47
HCC131532	New Holland 740CF, 22' & longer	\$3,842.71
HCC131533	New Holland 740CF, 20' & shorter	\$1,959.78

Orbit Trac II Service Parts

Product ID	Product Description	Price
HCC031410	Orbit Trac II Update Kit, 22' and longer (Steel track for bottom half of Orbit Reel)	\$727.34
HCC031411	Orbit Trac II Update Kit, 20' and shorter, LH (Steel track for bottom half of Orbit Reel)	\$363.68
HCC031412	Orbit Trac II Update Kit, 20' and shorter, RH (Steel track for bottom half of Orbit Reel)	\$363.68
HCC031413	Orbit Trac II Update Kit, 22' and longer (Steel track for top half of Orbit Reel)	\$1,290.15
HCC031414	Orbit Trac II Update Kit, 20' and shorter, (Steel track for top half of Orbit Reel)	\$645.08
HCC483993	Steel Track, Inside	\$153.82
HCC483994	Steel Track, Outside	\$168.72
HCC243719	Roller, Orbit Reel	\$28.27
HCC212412	Nut, for Orbit Reel Roller	\$0.68
HCC243736	Bearing, Reel Arm, ML & Level II reels, req 2	\$1.84
HCC481776	Strap, Reel Arm Bearing, ML & Level II	\$2.11

Note: The Orbit Trac II Reel kit has all of the track made out of steel. The Orbit Trac II Reel kit is designed only for HCC Inc. Level II and ML tube-type reels. They have been original equipment on most headers since 1990.

HCC FLIP REEL KIT

Eliminate Crop Wrapping Around Bat Tubes

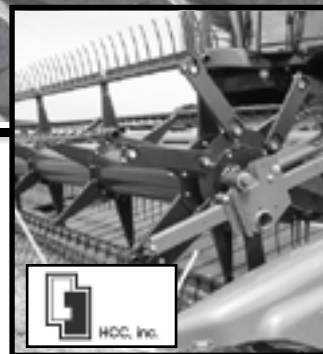

HCC Flip Reel Kit		
Product ID	Product Description	Price
AGCO		
HCC031515	AGCO, 400, 500, 800, 8000 series, 25' & longer	\$2,490.53
HCC031520	AGCO, 400, 500, 800, 8000 series, 22' & shorter	\$1,352.96
HCC031510	AGCO, 8200, 9250 series, 25' & longer	\$2,707.41
HCC031521	AGCO, 8200, 9250 series, 22' & shorter	\$1,460.68
HCC031511	AGCO, 5100, 5200 draper, 25' & longer	\$2,558.40
HCC031522	AGCO 5100, 5200 draper, 22' & shorter	\$1,386.91
Case-IH		
HCC031516	Case-IH, 1010, 1020, 3020, 25' & longer	\$2,517.08
HCC031520	Case-IH, 1010, 1020, 3020, 22' & shorter	\$1,352.96
HCC031517	Case-IH, 2010, 2020, 25' & longer	\$2,517.08
HCC031523	Case-IH, 2010, 2020, 22' & shorter	\$1,378.05
Honey Bee		
HCC031357	Honey Bee, clamp mounted, 25' & longer	\$2,744.31
HCC031513	Honey Bee, bracket mounted, 25' & longer	\$2,770.87
John Deere		
HCC031518	John Deere, 600 flex series, 900 draper, 25' & longer	\$2,633.64
HCC031524	John Deere, 600 flex series, 22' & shorter	\$1,419.36
HCC031519	John Deere, 900 series, 25' & longer	\$3,237.10
HCC031525	John Deere, 900 series, 22' & shorter	\$1,993.20
HCC031365	John Deere, flex draper; 630FD, 635FD, 730FD, 735FD	\$2,687.71
HCC031351	John Deere, flex draper; 640FD, 645FD, 740FD, 745FD	\$2,677.02
New Holland		
HCC031515	New Holland, 971, 973, 25' & longer	\$2,490.53
HCC031520	New Holland, 971, 973, 22' & shorter	\$1,352.96
HCC031517	New Holland 72C, 74C, 25' & longer	\$2,517.08
HCC031523	New Holland 72C, 74C, 22' & shorter	\$1,378.05
HCC031515	New Holland 73C, 25' & longer	\$2,490.53
HCC031520	New Holland 73C, 22' & shorter	\$1,352.96
HCC031516	New Holland 740 CF, 25' & longer	\$2,517.08
HCC031520	New Holland 740 CF, 22' & shorter	\$1,352.96
End Shield Kit (Recommended)		
HCC031591	End Shield Kit, 25' & longer	\$868.84
HCC031600	End Shield Kit, 22' & shorter	\$495.60

The Flip Reel Kit enhances reel performance with its tine flipping action that feeds heavy-duty crops into the header.

Particularly effective with canola and other tall, stringy crops

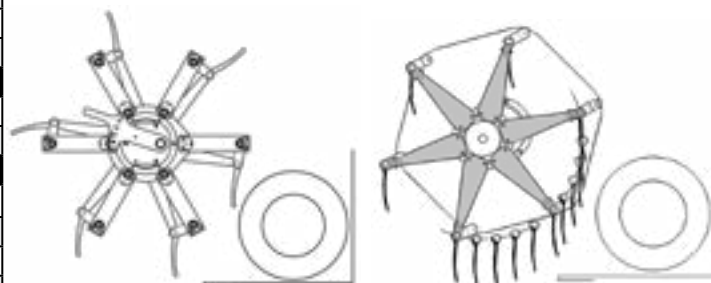

HCC Flip Reel

Standard Reel

Installation is easy and can be done on equipment you already own. You can install it yourself in a few hours.

Designed as a retro-fit for all HCC tube-type reels built since 1990. ML 4-1/2" tine spacing or Level II 6" tine spacings are designed to work with the Flip Reel Kit.

- Designed to fit HCC tube type reels built since 1990
- Fits Honey Bee headers equipped with HCC tube-type

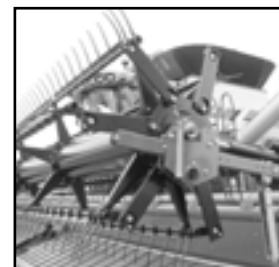

HCC REPLACEMENT REEL BUNDLES

HCC Replacement Reel Bundle				
Make	Model	Length	Product ID	Price
AGCO	400, 500, 700, 800, 8000 series	20'	HCC030541	\$2,318.20
		25'	HCC030561	\$3,062.70
		30'	HCC030581	\$3,545.16
		35'	HCC032082	\$5,116.16
	7200/ 8200/ 9250	20'	HCC030541	\$2,318.20
		25'	HCC030561	\$3,062.70
30'		HCC030581	\$3,545.16	
Case-IH	1020 (1)	20'	HCC030541	\$2,318.20
		25'	HCC030561	\$3,062.70
		30'	HCC030581	\$3,545.23
	2010/2020	20'	HCC030540	\$2,576.40
		25'	HCC030560	\$3,000.48
		30'	HCC030580	\$3,337.86
		35'	HCC032023	\$5,125.36
		3020	25'	HCC030562
	30'		HCC030582	\$3,569.64
	35'		HCC032023	\$5,125.35

HCC Replacement Reel Bundle				
Make	Model	Length	Product ID	Price
John Deere	900F	20'	HCC031956	\$2,320.08
		25'	HCC030562	\$2,847.79
		30'	HCC030580	\$3,337.83
	600F	20'	HCC030542	\$2,352.12
		25'	HCC030562	\$2,847.79
		30'	HCC030582	\$3,569.64
New Holland	72C/74C	20'	HCC030540	\$2,576.40
		25'	HCC030560	\$3,000.48
		30'	HCC030580	\$3,337.83
		35'	HCC032023	\$5,125.36
	740CF	25'	HCC030562	\$2,847.79
		30'	HCC030582	\$3,569.64
		35'	HCC032023	\$5,125.35

1) For Case-IH headers 1998 and newer with serial #JJC0315001 & CBJ023003 & up
Please call for complete Reel replacement options for other models not listed above

If, for any reason, you are in need of a replacement reel, please consider HCC Replacement Reel Bundles. HCC Replacement Reel Bundles consist of the reel's center tube and the six bat tubes with the tines already installed.

- Lower Weight
- Stronger Construction
- Increased Visibility
- More Effective Crop Movement

Please note that the HCC Replacement Reel Bundles only fit HCC manufactured Level II reels which are defined by 6" tine spacing.

MAY WES POLY SKID SHOES

PUT MORE CROP IN THE COMBINE!

Run your head closer to the ground without pushing and piling soil, leaving little to no crop in the field.

Even in Wet, Sticky Conditions

Machine cut from solid sheets of solid virgin UHMW poly and formed to fit your head.

Designed for a perfect fit.

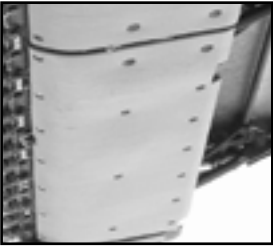
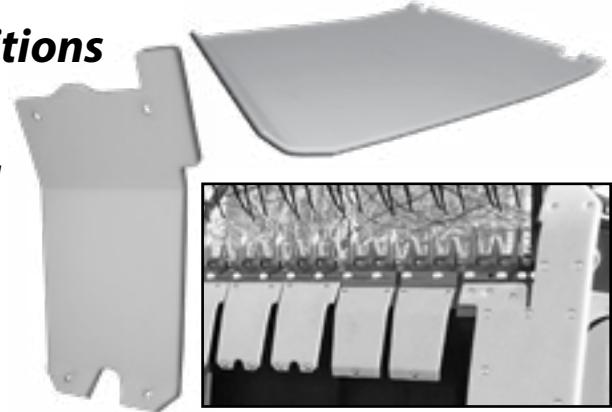

- Sold in complete kits, but are also available as individual replacement parts

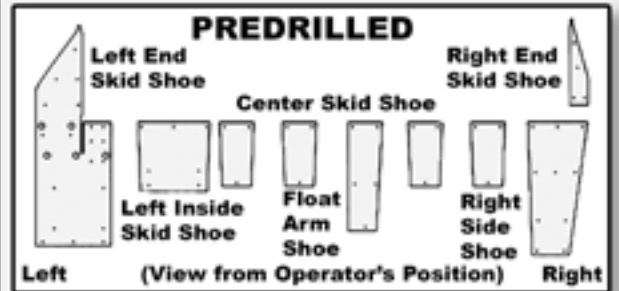

- Available as Pre-drilled or Undrilled for Easy Replacement



- Pre-drilled skid shoes are counter bored, allowing rivets or bolts to be recessed into the skid shoes

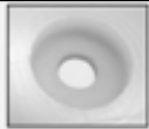

Predrilled and Undrilled for Easy Replacement

PREDRILLED: Computerized drilling of counterbored holes makes them with .01" of factory drilled holes, making replacement easy and saving hours of labor compared to undrilled skid shoes. Counterboring holes allow for rivets or bolts to be recessed into skid shoes, keeping soil from building up on bolts or rivets.

UNDRILLED: Choose undrilled skid shoes when you need to match holes already drilled in metal shoes. For accuracy in drilling new poly skid shoes to match previous holes drilled, just position new shoes on factory metal shoe. Shine a light from behind the drilled metal shoe through white poly skid shoe. The light will shine through the hole, providing a marker for the placement of the new hole.

May Wes Poly Skid Shoes

Make/Model/Thickness	Length	Product ID	Kit Price
AGCO Series III (pre-1987) 1/4" Pre-drilled	13'	MYW080183	\$519.00
	15'	MYW080186	\$578.00
	16'	MYW080189	\$596.00
	18'	MYW080192	\$623.00
	20'	MYW080195	\$731.00
	22'	MYW080198	\$770.00
	24'	MYW080201	\$822.00
AGCO 400, 500, 700/700C, 800/800C, 7000, 8000, Series III (1987 & newer) 1/4" Pre-drilled	13'	MYW081678	\$519.00
	15'	MYW081677	\$578.00
	16'	MYW081676	\$596.00
	18'	MYW081675	\$625.00
	20'	MYW081674	\$721.00
	22'	MYW081673	\$770.00
	24'	MYW081672	\$822.00
	25'	MYW081671	\$822.00
	30'	MYW081669	\$1,071.00
	AGCO 7200/8200 1/4" Pre-drilled	20'	MYW083511
25'		MYW083512	\$930.00
30'		MYW083513	\$1,076.00
35'		MYW083514	\$1,234.00
AGCO 9250 (AHD01001-CHD01100) High Profile 9250 (AHD01101-FHD01100) Low Profile High profile is determined by having 2-3/8" rise Low profile is determined by having 1" rise 1/4" Pre-drilled	25'	MYW083503	\$897.00
	30'	MYW083504	\$1,056.00
	35'	MYW083505	\$1,220.00
	40'	MYW083506	\$1,386.00
AGCO 9250 (CHD01101-FHD01100) High Profile High profile is determined by having 2-3/8" rise 1/4" Pre-drilled	25'	MYW083507	\$898.00
	30'	MYW083508	\$1,055.00
	35'	MYW083509	\$1,220.00
	40'	MYW083510	\$1,386.00
AGCO 9250 (after FHD01101) High Profile High profile is determined by having 2-3/8" rise 1/4" Pre-drilled	25'	MYW083572	\$897.00
	30'	MYW083573	\$1,055.00
	35'	MYW083574	\$1,220.00
	40'	MYW083575	\$1,386.00

MAY WES POLY SKID SHOES

HARVESTING

Make/Model/Thickness	Length	Product ID	Kit Price
AGCO 1/4" Pre-drilled 9250 (after FHD01101) Low Profile Low profile is determined by having 1" rise	25'	MYW083576	\$897.00
	30'	MYW083577	\$1,055.00
	35'	MYW083578	\$1,220.00
	40'	MYW083579	\$1,386.00
AGCO 9255 (prior to serial number HHD01101) 1/4" Pre-drilled	25'	MYW083678	\$1,000.00
	30'	MYW083679	\$1,176.00
	35'	MYW083680	\$1,428.00
	40'	MYW083681	\$1,628.00
AGCO 9255 (after serial number HHD01101) Standard Skid 1/4" Pre-drilled	25'	MYW083894	\$1,000.00
	30'	MYW083895	\$1,176.00
	35'	MYW083896	\$1,428.00
	40'	MYW083897	\$1,628.00
	45'	MYW083898	\$1,820.00
AGCO 9255 (after serial number HHD01101) Low Skid 1/4" Pre-drilled	25'	MYW083899	\$1,000.00
	30'	MYW083900	\$1,176.00
	35'	MYW083901	\$1,428.00
	40'	MYW083902	\$1,628.00
	45'	MYW083903	\$1,820.00
Case-IH 1020 3/8 Molded Cutterbars 1/4" Center/Ends Pre-drilled	15'	MYW081735	\$447.00
	16.5'	MYW081736	\$499.00
	17.5'	MYW081737	\$552.00
	20'	MYW081738	\$604.00
	22.5'	MYW081739	\$657.00
	25'	MYW081740	\$709.00
	30'	MYW081741	\$788.00
Case-IH 2020 (before CBJ02000, all HAJ) New Holland 74C (before PNL017183, all HAJ) 1/4" Pre-drilled	20'	MYW082183	\$809.00
	25'	MYW082180	\$998.00
Case-IH 2020 (CBJ020001 - CBJ020700) New Holland 74C (PNL017183 - PNL017800) 1/4" Pre-drilled	20'	MYW082913	\$809.00
	25'	MYW082912	\$998.00
Case-IH 2020 (CBJ020701 - CBJ021300) New Holland 74C (PNL017801 - PNL018300) 1/4" Pre-drilled	30'	MYW082911	\$1,175.00
	20'	MYW082917	\$809.00
Case-IH 2020 - single drive CBJ021301 & later, Y9ZL, YAZL New Holland 74C - single drive PNL018301 & later, Y9ZL, YAZL 1/4" Pre-drilled	25'	MYW082916	\$998.00
	30'	MYW082915	\$1,180.00
Case-IH 2020 - single drive CBJ021301 & later, Y9ZL, YAZL New Holland 74C - single drive PNL018301 & later, Y9ZL, YAZL 1/4" Pre-drilled	20'	MYW082923	\$809.00
	25'	MYW082922	\$998.00
Case-IH 2020 - double drive CBJ021301 & later, Y9ZL, YAZL New Holland 74C - double drive (PNL018301 & later, Y9ZL, YAZL 1/4" Pre-drilled	20'	MYW082921	\$809.00
	25'	MYW082920	\$998.00
	30'	MYW082919	\$1,180.00
	35'	MYW082918	\$1,375.00
Case-IH 2052 (before CCC0014710) MacDon 973 (2005 & before) 3/8" Pre-drilled	21'	MYW083495	\$796.00
	25'	MYW083496	\$930.00
	30'	MYW083497	\$1,110.00
	36'	MYW083498	\$1,290.00
	39'	MYW083499	\$1,601.25

Make/Model/Thickness	Length	Product ID	Kit Price	
Case-IH 2062 (before CCC0015328) MacDon 974 (2005 & before) New Holland 84C (before PPP01119) 3/8" Pre-drilled	30'	MYW082577	\$1,150.00	
	36'	MYW082576	\$1,320.00	
Case-IH 2062 (after CCC0015328) MacDon 974 (2006 & after) New Holland 84C (after PPP01119) 3/8" Pre-drilled	30', 36'	MYW083502	\$534.00	
	Case-IH 3020 - single drive New Holland 740CF - single drive 3/8 Molded Centers 1/4" Center/Ends Pre-Drilled	20'	MYW083317	\$533.00
25'		MYW083316	\$639.00	
30'		MYW083315	\$746.00	
35'		MYW083314	\$854.00	
Case-IH 3020 - double drive New Holland 740CF - double drive 3/8 Molded Centers 1/4" Center/Ends Pre-Drilled	20'	MYW083561	\$533.00	
	25'	MYW083560	\$639.00	
	30'	MYW083559	\$746.00	
	35'	MYW083558	\$854.00	
Case-IH 3152, 3162 New Holland 840CD, 880CF 3/8 Molded Centers 1/4" Center/Ends Pre-Drilled	25'	MYW083470	\$669.00	
	30'	MYW083473	\$788.00	
	35'	MYW083474	\$935.00	
	40'	MYW083475	\$1,075.00	
	45'	MYW083476	\$1,235.00	
Case-IH 2142, 2152, 2162 MacDon D50, D60, FD70 New Holland 82C, 83C, 86C 3/8" Pre-drilled	30', 35', 40', 45'	MYW083490	\$349.00	
	MacDon 974 (2005 & before) 3/8" Pre-drilled	21'	MYW083493	\$815.00
		25'	MYW083494	\$1,015.00
	MacDon 974 (2006 & newer) 3/8" Pre-drilled	21', 25'	MYW083501	\$213.00
Claas/Lexion/Caterpillar F900, F750, F530, F525, F30, F20 1/4" Pre-drilled		15'	MYW082015	\$689.00
	17'	MYW082014	\$774.00	
	20'	MYW082013	\$915.00	
	25'	MYW082012	\$1,150.00	
	30'	MYW082011	\$1,350.00	
New Holland 973/73C 1/4" Pre-drilled	13'	MYW082187	\$538.00	
	15'	MYW082186	\$619.00	
	16'	MYW082185	\$648.00	
	18'	MYW082184	\$739.00	
	20'	MYW082183	\$809.00	
	22'	MYW082182	\$888.00	
	24'	MYW082181	\$966.00	
	25'	MYW082180	\$998.00	
	30'	MYW082179	\$1,175.00	

Continued on next page.

May Wes Poly Skid Shoes							
Make/Model/Thickness	Length	Product ID	Price/Ea	Make/Model/Thickness	Length	Product ID	Price/Ea
John Deere 200F 1/4" Pre-drilled Also available in 3/8"	13'	MYW081066	\$735.00	John Deere 200F 3/8" Pre-drilled Also available in 1/4"	13'	MYW090110	\$830.00
	15'	MYW081065	\$762.00		15'	MYW090109	\$882.00
	16'	MYW080858	\$788.00		16'	MYW090107	\$914.00
	18'	MYW080020	\$814.00		18'	MYW090106	\$977.00
	20'	MYW080024	\$840.00		20'	MYW090105	\$1,080.00
	22'	MYW080792	\$860.00		22'	MYW090104	\$1,050.00
	24'	MYW080552	\$893.00		24'	MYW090102	\$1,198.00
John Deere 900F 1/4" Pre-drilled Also available in 3/8"	13'	MYW081066	\$735.00	John Deere 900F 3/8" Pre-drilled Also available in 1/4"	13'	MYW090110	\$830.00
	15'	MYW080016	\$569.00		15'	MYW090108	\$919.00
	18'	MYW080020	\$814.00		18'	MYW090106	\$977.00
	20'	MYW080024	\$840.00		20'	MYW090105	\$1,080.00
	22'	MYW080171	\$758.00		22'	MYW090103	\$1,105.00
	24'	MYW080552	\$893.00		24'	MYW090102	\$1,198.00
	25'	MYW080036	\$897.00		25'	MYW090101	\$1,280.00
30'	MYW080040	\$998.00	30'	MYW090100	\$1,400.00		
John Deere 600F 1/4" Pre-drilled Also available in 3/8"	18'	MYW082641	\$403.00	John Deere 600F 3/8" Pre-drilled Also available in 1/4"	18'	MYW090073	\$500.00
	20'	MYW082468	\$429.00		20'	MYW090072	\$549.00
	22'	MYW083310	\$467.00		22'	MYW090074	\$606.00
	25'	MYW082467	\$515.00		25'	MYW090071	\$671.00
	30'	MYW082466	\$604.00		30'	MYW090070	\$788.00
	35'	MYW082465	\$711.00		35'	MYW090069	\$903.00
John Deere 600FD 2012 1/4" Pre-drilled Also available in 3/8"	30'	MYW083631	\$643.00	John Deere 600FD 2012 3/8" Pre-drilled Also available in 1/4"	30'	MYW090083	\$830.00
	35'	MYW083632	\$671.00		35'	MYW090084	\$903.00
	40'	MYW083633	\$856.00		40'	MYW090085	\$975.00
Draper Skid Plate sold separately		MYW042196	\$326.00	Draper Skid Plate sold separately		MYW042196	\$326.00
John Deere 600FD 2013/2014 1/4" Pre-drilled Also available in 3/8"	30'	MYW083585	\$645.00	John Deere 600FD 2013/2014 3/8" Pre-drilled Also available in 1/4"	30'	MYW090082	\$830.00
	35'	MYW083567	\$752.00		35'	MYW090075	\$935.00
	40'	MYW083568	\$860.00		40'	MYW090076	\$1,040.00
Draper Skid Plate sold separately		MYW042196	\$326.00	Draper Skid Plate sold separately		MYW042196	\$326.00
John Deere 600FD 2015 1/4" Pre-drilled Also available in 3/8"	30'	MYW083634	\$643.00	John Deere 600FD 2015 3/8" Pre-drilled Also available in 1/4"	30'	MYW090086	\$830.00
	35'	MYW083635	\$752.00		35'	MYW090087	\$903.00
	40'	MYW083636	\$857.00		40'	MYW090088	\$1,098.00
	45'	MYW083637	\$966.00		45'	MYW090089	\$1,210.00
Draper Skid Plate sold separately		MYW042196	\$326.00	Draper Skid Plate sold separately		MYW042196	\$326.00
John Deere 600FD, 700FD 2016 & Newer After s/n 785000 1/4" Pre-drilled Also available in 3/8"	30'	MYW083672	\$643.00	John Deere 600FD, 700FD 2016 & Newer After s/n 785000 3/8" Pre-drilled Also available in 1/4"	30'	MYW090090	\$828.00
	35'	MYW083673	\$752.00		35'	MYW090091	\$901.00
	40'	MYW083674	\$857.00		40'	MYW090092	\$972.00
	45'	MYW083675	\$966.00		45'	MYW090093	\$1,098.00
Draper Skid Plate sold separately		MYW042289	\$336.00	Draper Skid Plate sold separately		MYW042289	\$336.00

POLY AUGER TROUGH LINERS



FOR GRAIN HEADS AND CORN HEADS

Do You Have Holes in Your (Grain or Corn) Head?

May Wes Poly Auger Trough Liners provide a smooth, slick surface for the grain to flow out PLUS guard against corrosion!

Durable Poly Won't Rust!

When the head is covered with the 1/8" thick UHMW poly May Wes Auger Trough Liners, wet grain and moisture will not cause corrosion.

- Exceptional wear characteristics of the ultra high molecular weight (UHMW) poly.
- The 1/8" thick UHMW poly lining is much easier to replace than factory metal. Simply bolt and rivet into place.

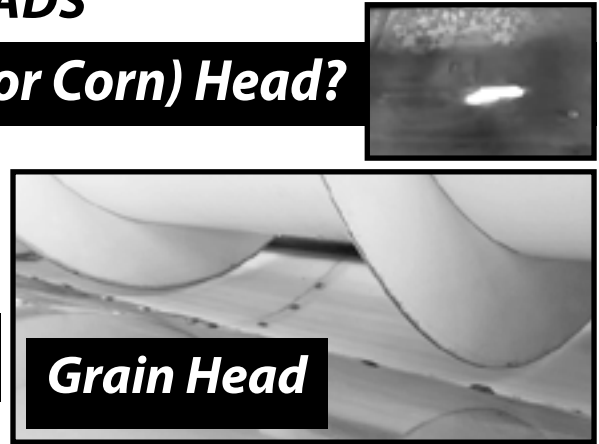

Grain Head Auger Trough Liners			
Make/Model	Product ID	Length	Price/Ea
Case-IH 1020 series	MYW083715	15'	\$475.00
	MYW083716	17.5'	\$560.00
	MYW083716	20'	\$560.00
	MYW083717	22.5'	\$710.00
	MYW083718	25'	\$760.00
Case-IH 2020 series	MYW083719	30'	\$925.00
	MYW083725	20'	\$560.00
	MYW083726	25'	\$760.00
John Deere 200, 900 series 58" Center Panel	MYW083727	30'	\$925.00
	MYW083728	35'	\$1,025.00
	MYW083593	13' - 16'	\$475.00
	MYW083594	18' - 20'	\$590.00
	MYW083595	22' - 24'	\$700.00
John Deere 200, 900 series 46" Center Panel	MYW083596	25'	\$760.00
	MYW083597	30'	\$925.00
	MYW080631	13' - 16'	\$475.00
	MYW080632	18' - 20'	\$590.00
	MYW080633	22' - 24'	\$700.00
John Deere 600 series	MYW081825	25'	\$760.00
	MYW081686	30'	\$925.00
	MYW082706	20'	\$560.00
	MYW082707	22'	\$670.00
	MYW082708	25'	\$750.00
New Holland 74C series	MYW082709	30'	\$875.00
	MYW082710	35'	\$1,025.00
	MYW083725	20'	\$560.00
	MYW083726	25'	\$760.00

Save Money on Repairs!

Cornhead Auger Trough Liners			
Make/Model	Product ID	Description	Prc/Ea
Case-IH 800 series	MYW082061	4-row	\$310.00
	MYW082062	6-row	\$355.00
	MYW082063	8-row	\$485.00
	MYW082272	12-row	\$710.00
	MYW082643	4-row	\$310.00
Case-IH 900, 1000 series	MYW082644	6-row	\$355.00
	MYW082645	8-row	\$485.00
	MYW082646	12-row	\$710.00
Case-IH 2200, 2400, 3200, 3400	MYW082647	4-row	\$310.00
	MYW082648	6-row	\$355.00
	MYW082649	8-row	\$485.00
	MYW082650	12-row	\$710.00
New Holland 96C, 96D, 98C, 98D	MYW083850	16-row	\$930.00
	MYW083854	6-row	\$355.00
	MYW083855	8-row	\$485.00
Case-IH 2600, 4200, 4400	MYW083856	12-row	\$710.00
	MYW083857	16-row	\$930.00
	MYW082075	4-row	\$310.00
John Deere 40/90 series	MYW082076	6-row	\$355.00
	MYW082077	8-row	\$490.00
	MYW082078	12-row	\$715.00
John Deere 50 series	MYW082490	6-row	\$355.00
	MYW082491	8-row	\$480.00
John Deere 600 series	MYW082727	6-row	\$355.00
	MYW082728	8-row	\$485.00
	MYW082729	12-row	\$710.00

At 1/8" thick UHMW poly, May Wes auger trough liners cover the full length of the floor under the auger, not just the feed opening.



"S.I. Distributing Harvesting Innovations"

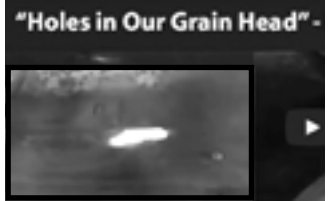

POLY AUGER TROUGH LINERS FOR GRAIN TANKS

Provides a smooth, slick surface for the grain to flow out PLUS guard against corrosion! Full coverage of the trough underneath the auger keeps grain in the tank for maximum harvest potential.



Save Money on Grain Tank Trough Repair:

Protect the area in your grain tank that needs it the most and wears out the quickest. Install the May Wes Grain Tank Auger Trough Liner over new or worn tank floor.

Grain Tank Repair & Coverage:

Instead of trying to cut, weld or patch the floor of your grain tank, use the May Wes Grain Tank Auger Trough Liner. These kits contain all you need to cover the worn areas under the auger(s). Lead edges are covered with stainless steel for smooth flow of grain.

Grain Tank Auger Trough Liners			
Make	Product ID	Description	Prc/Ea
Case-IH (covers both augers)	MYW083313	7230, 8230, 9230	\$500.00
	MYW083383	5088, 5130, 6088, 6130, 7088, 7130	\$500.00
	MYW083311	7010, 7120, 8010, 8120, 9120	\$550.00
	MYW082582	2300 series, 2588	\$495.00
	MYW082581	2100 series	\$495.00
	MYW082580	1600 series (except 1620)	\$495.00
Gleaner	MYW082579	1400 series	\$495.00
	MYW082642	All Models	\$275.00
John Deere (covers both augers)	MYW083327	9660STS, 9670STS, 9760STS, 9770STS, 9860STS, 9870STS, S550, S660, S670, S680, S690	\$500.00
	MYW083199	9560STS, 9570STS, 9650STS, 9750STS	\$500.00
	MYW082584	9450, 9550, 9560, 9600, 9610, 9650, 9660	\$540.00
	MYW082583	9400, 9410, 9500, 9510	\$540.00
New Holland	MYW082799	All single auger TR Models	\$275.00
	MYW083399	NH CR920, CR940, CR960, CR970, CR980, CR9040, CR9070	\$550.00

CROP DIVIDERS

UHMW poly grain platform Crop Dividers are sold as pairs, and are available with or without marker rods. Replacement marker rods are available.



Crop Dividers		
Case-IH	Product ID	Price/Pair
Red Crop Divider with Rods	MYW083843	\$205.00
Red Crop Divider without Rods	MYW083844	\$195.00
John Deere - 900F, 600F, 600D, 600FD	Product ID	Price/Pair
Green Crop Divider with Rods	MYW083841	\$205.00
Green Crop Divider without Rods	MYW083842	\$195.00
Replacement Parts	Product ID	Price/Pair
Marker Rod, Pair	MYW042432	\$18.00

POLY-CAPPED ELEVATOR BOLTS

UHMW-PE poly capped bolts are an excellent solution for applications where there is excessive friction and wear or high velocity. They excel at protecting steel, aluminum and wood surfaces. The entire bolt head is covered with compression molded Ultra High Molecular Weight Polyethylene (UHMW-PE), with a minimum 1/4" seal, greatly reducing the possibility of detachment, unlike snap-on caps which can easily detach.



Poly-Capped Bolts		
White - 12 Pack	Product ID	Price/Pk
1/4"X1"	MYW083638	\$29.50
5/16"X1"	MYW083639	\$47.50
3/8"X1"	MYW083640	\$40.00
Black - 12 Pack	Product ID	Price/Pk
1/4"X1"	MYW083733	\$29.50
5/16"X1"	MYW083734	\$47.50
3/8"X1"	MYW083735	\$40.00

POLY AUGER FINGERS

Keep your Auger Feeding Smoothly and Efficiently with NO Harm to the Combine!

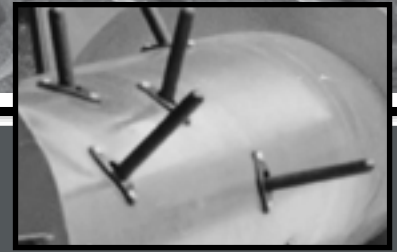

The Common Sense Auger Finger Replacement Choice

The May Wes Poly Retractable Fingers are an ideal alternative to metal fingers because they are far less damaging when a metal finger breaks and is fed through the combine.



No Harm to Your Combine!

Bent metal fingers can gouge and poke through the auger. Broken metal fingers do costly damage to the drum and thrasher system. The advantage of poly fingers over metal is when the poly fingers eventually break, the poly will disintegrate as it passes through the combine and will not damage the internal workings (i.e. rotors and cylinders).

Strong & Resilient

May Wes Poly Retractable Fingers will not fray with heavy usage. These fingers are flexible and will bend past the breaking point of metal fingers.



If they do break, the poly will disintegrate as it passes through the combine and will not damage the threshing system.

Retractable Poly Fingers

Make	Model	Product ID	Description	Price/Ea
AGCO	700, 800, 7000, 7200, 8000, 8200	MYW082620	Poly Finger Kit - 10-15/16" Long	\$17.00
		MYW083439	Poly Finger Kit - 11-7/16" Long	\$17.00
Case-IH	1010, 1020, 2142, 2152, 2162	MYW080646	Poly Finger Kit - 9-1/8" Long	\$17.00
	1020, 2020 - before CBJ020701	MYW083468	Poly Finger Kit - 10-5/8" Long	\$17.00
	2020 - CBJ020701 & later	MYW082481	Poly Finger Kit - 10-5/8" Long	\$17.00
	2042, 2052, 2062	MYW082615	Poly Finger Kit - 7-7/16" Long	\$20.00
	3016, 3020, 3152, 3162	MYW082131	Poly Finger Kit - 10-1/4" Long	\$17.00
Challenger	FH, FHB	MYW082620	Poly Finger Kit - 10-15/16" Long	\$17.00
		MYW083439	Poly Finger Kit - 11-7/16" Long	\$17.00
John Deere	200, 900	MYW080650	Poly Finger Kit - 10-1/4" Long	\$17.00
	600F, 600R, 600P	MYW082475	Poly Finger Kit - 11-1/4" Long	\$17.00
	600FD, 600D, 700FD	MYW083527	Poly Finger Kit - 10-5/8" Long	\$17.00
Lexion	V525, V530, V535, V540, V750, V900, F25, F30, F525, F530, F750, F900, G30, G525	MYW083472	Poly Finger Kit - 9-5/8" Long	\$17.00
	V1050, V1200, F535, F540, G535, G540	MYW082925	Poly Finger Kit - 10-7/8" Long	\$17.00
MacDon	872/873 combine adapter (with 11" auger drum)	MYW082615	Poly Finger Kit - 7-7/16" Long	\$20.00
	872/873 combine adapter (with 12" auger drum)	MYW083382	Poly Finger Kit - 8-3/16" Long	\$20.00
	FM100 Float Module	MYW083831	Poly Finger Kit - 9-1/8" Long	\$20.00
	CA20/CA25 combine adapter	MYW080646	Poly Finger Kit - 9-1/8" Long	\$17.00
New Holland	740CF, 760CG, 790CP, 880CF, 840CD	MYW082131	Poly Finger Kit - 10-1/4" Long	\$17.00
	74C - before PNL01781	MYW083468	Poly Finger Kit - 10-5/8" Long	\$17.00
	74C - PNL01781 & later	MYW082481	Poly Finger Kit - 10-5/8" Long	\$17.00
	82C, 83C, 86C	MYW080646	Poly Finger Kit - 9-1/8" Long	\$17.00
	84C	MYW082615	Poly Finger Kit - 7-7/16" Long	\$20.00
	971, 972, 973	MYW081366	Poly Finger Kit - 10-1/4" Long	\$17.00

All poly finger kits include poly finger, guide and hardware.

MAY WES INNOVATIONS

SNOUT SAVERS — Prevent damage to your combine snouts! —

MayWes UHMW Poly Snout Savers' curved design for hollow points is used to lift the point off the ground and create a larger surface area for ground contact. This feature keeps the snout from digging into the dirt and wrinkling the snout, which results in costly replacement or repair and downtime. When ordering Snout Savers, you will need one fewer inside snout savers than the total number of rows on your corn head. For example: A 12-row corn head will need 11 inside (center) snout savers and two outside (end) snout savers.

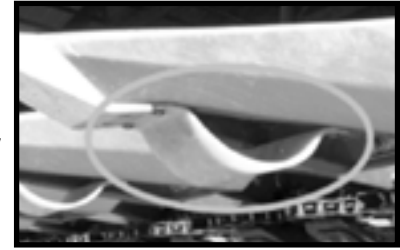

Poly Snout Savers		
Case-IH	Product ID	Price
2200, 2400, 3200, 3400; Inside Snout	MYW083795	\$26.00
2200, 2400, 3200, 3400; Outside Snout	MYW083797	\$26.00
2200, 2400, 3200, 3400; Inside Snout with cutout for Height Control Sensor	MYW083796	\$26.00
2200, 2400, 3200, 3400; Outside Snout with cutout for Height Control Sensor	MYW083798	\$26.00
Metal Head; Inside Snout	MYW080837	\$26.00
Metal Head; Outside Snout	MYW080838	\$26.00
4400; Inside Snout	MYW083928	\$26.00
4400; Outside Snout	MYW083929	\$26.00

Poly Snout Savers		
Drago	Product ID	Price
Inside Snout	MYW082606	\$26.00
Outside Snout	MYW082607	\$26.00
John Deere		
Product ID	Price	
600, 700, C-Series 30"; Inside Snout	MYW083624	\$26.00
600, 700, C-Series 20", 22"; Inside Snout	MYW084030	\$26.00
600, 700 Series 30"; Outside Snout	MYW083625	\$26.00
600, 700 Series 20", 22"; Outside Snout	MYW084032	\$26.00
Metal Head; Inside Snout	MYW080839	\$26.00
Metal Head; Outside Snout	MYW080840	\$26.00
Poly Heads		
Product ID	Price	
Inside Snout	MYW082606	\$26.00
Outside Snout	MYW082607	\$26.00

ROW DIVIDER SHIELDS

These UHMW poly Row Divider Shields protect row dividers on John Deere 600/700/C Series Chopping Heads. They reinforce the divider and cover worn spots as well as heightens the effectiveness of the divider's purpose and eliminates windrowing of the trash. The pre-drilled shield is a fraction of the cost of replacing the OEM part.

John Deere Row Divider Shields			
Description	Row Spacing	Product ID	Price/Ea
600/700 Series (OEM #AXE19102)	20"/22"	MYW042124	\$63.00
600/700 Series (OEM #AXE18146)	30"	MYW042125	\$63.00
C-Series	30"	MYW042760	\$72.50



EAR SAVERS

UHMW poly Ear Savers prevent loose corn ears from sliding over the gathering chains to the ground. MayWes Ear Savers will not fold back like factory ear gates. They stay rigid, working like a gate, yet soft enough to let corn go through without knocking the ears off the corn stalk. MayWes Ear Savers are made of black soft polyurethane and last longer than OEM rubber.



Corn Head Ear Savers			
Case-IH	Row Size	Product ID	Price/Ea
4400 Inside	30"	MYW084400	\$17.00
4400 Outside		MYW084401	\$17.00
4400 Inside	20"/22"	MYW084402	\$17.00
4400 Outside		MYW084403	\$17.00
2200, 2400, 2600, 3200, 3400	30"	MYW082045	\$17.00
800, 900, 1000, & GVL Poly Head	30"	MYW080652	\$17.00
Cat/Lexion	Row Size	Product ID	Price/Ea
Cat/Lexion Inside	-	MYW082625	\$17.00
Cat/Lexion Outside	-	MYW082873	\$30.00
GVL Poly Snouts	Row Size	Product ID	Price/Ea
GVL Poly Snouts	-	MYW042880	\$16.00

Corn Head Ear Savers			
John Deere	Row Size	Product ID	Price/Ea
600 Series Inside	22"	MYW082780	\$17.00
600 Series Outside		MYW082779	\$17.00
600 Series Inside	30"	MYW082715	\$17.00
600 Series Outside		MYW082714	\$17.00
90 Series Poly Head; 1998 & Newer	30"	MYW082002	\$17.00
90 Series Poly Head Inside; 1997 & Older	30"	MYW082059	\$17.00
90 Series Poly Head Outside; 1997 & Older		MYW082060	\$17.00
40 Series	30"	MYW082664	\$17.00
New Holland	Row Size	Product ID	Price/Ea
96C, 96D, 98C, 98D, 996	-	MYW082045	\$17.00

KERNEL KEEPER



Just One Kernel Makes a Difference!

If you save just one kernel per ear per acre, that's 1/2 bushel per acre!

- The patent-pending Kernel Keeper system dampens the ear impact with impact absorbing rails.
- Loose kernels are then captured by the rails and brushes collect the kernels sweeping them into the auger trough.
- Easy retrofit to current deck plates.
- All hardware is included for installation along with drill bit and rail alignment guides.



◀ **Keeper Rails cushion ears, reduce shelling, and guide loose kernels into the auger bed.**



▶ **Finger Brushes mounted on each gathering chain lug sweep loose kernels into the auger bed.**



Kernel Keeper		
Product ID	Vendor ID	Price/Row
Case-IH 800, 900, 1000 Series		
KKR005550	HSKK-AA0555A	\$195.00
John Deere 40/90 Series		
KKR005550	HSKK-AA0555A	\$195.00
John Deere 600 Series (without RowMax Gathering Chain)		
KKR006200	HSKK-AA0620M	\$195.00
John Deere 600 with RowMax, 700, C-Series		
KKR006270	HSKK-AA0627D	\$195.00
New Holland 96C, 974, 98C, 98D thru 2010, 996		
KKR005550	HSKK-AA0555A	\$195.00

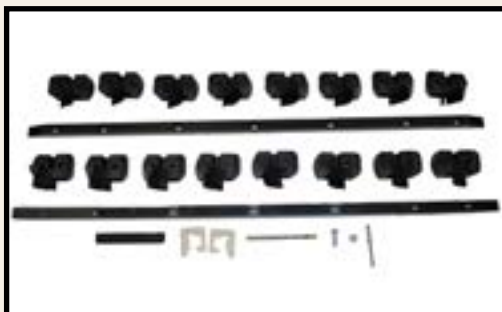

STALK STOMPERS FOR TRACTORS

Stubble Damage Protection

May Wes Tractor Stalk Stompers – Now featuring Durable Compression Molded UHMW G4 Stalk Stompers!

Stalk Stompers Promote Residue Decomposition!

May Wes G4 Tractor Stalk Stompers are designed to work off of existing tractor hydraulics. They are quickly assembled and typically doesn't require welding or drilling.

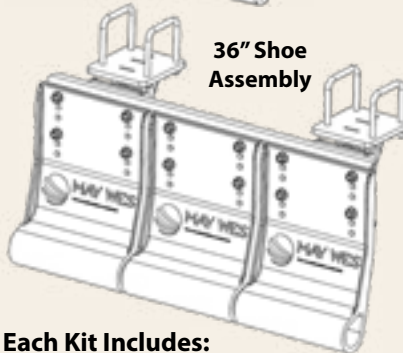
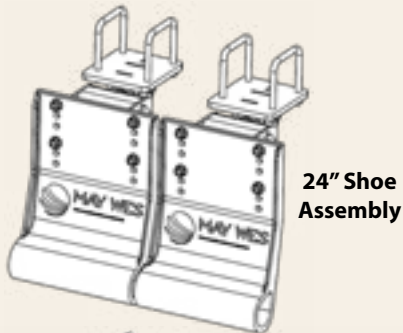
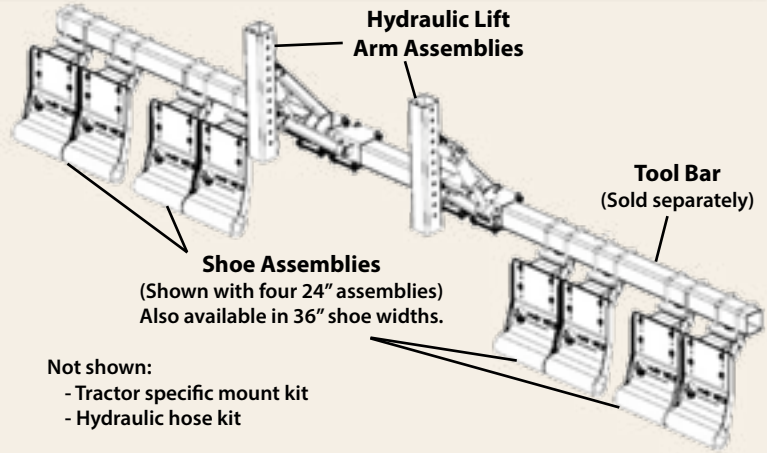

Each Kit Includes:

- Skid Shoe Assemblies
- Tractor Specific Mount Kit
- Lift Arm Assemblies
- Hydraulic Hose Kit

Toolbars are required and are sold separately. They can be purchased locally to save on shipping costs. They are available through S.I. Distributing if one can not be obtained locally.

OVERSIZE SHIPPING CHARGES WILL APPLY.

Case-IH	Description	Product ID	Price
Magnum 235, 250, 260, 280, 290, 310, 315, 340, 370, 380	24" Shoe, Qty 2	MYW083765	\$5,800.00
	24" Shoe, Qty 4	MYW083766	\$6,730.00
Quadtrac 450, 500, 540, 550, 580, 600, 620; 2012 & Newer	36" Shoe, Qty 2	MYW083767	\$6,275.00
Steiger 500, 540, 550, 580, 600, 620; 2012 & Newer	36" Shoe, Qty 4	MYW083768	\$7,650.00
Steiger 350, 370, 400, 420, 450, 470; 2012 & Newer (w/o front ballast)	36" Shoe, Qty 4	MYW083769	\$7,650.00
Steiger 350, 370, 400, 420, 450, 470; 2012 & Newer (with front ballast, not compatible w' front weight carrier)	36" Shoe, Qty 2	MYW083770	\$6,310.00
	36" Shoe, Qty 4	MYW083771	\$7,610.00
Steiger/Quadtrac 485, 535; 2011 & Older	24" Shoe, Qty 4	MYW083779	\$6,800.00
	36" Shoe, Qty 2	MYW083772	\$6,275.00
	36" Shoe, Qty 4	MYW083773	\$7,610.00
Challenger	Description	Product ID	Price
700, 700B, 700C, 700D Series; All Models	24" Shoe, Qty 2	MYW083748	\$5,725.00
	36" Shoe, Qty 2	MYW083750	\$6,100.00
800 Series; All Models	24" Shoe, Qty 2	MYW083751	\$6,100.00
	36" Shoe, Qty 2	MYW083879	\$6,275.00
John Deere	Description	Product ID	Price
9RX Series; 2016 & Newer	24" Shoe, Qty 2	MYW083712	\$6,150.00
	36" Shoe, Qty 2	MYW083711	\$6,475.00
9R Series; 2015 & Newer	36" Shoe, Qty 4	MYW083713	\$8,050.00
9R Series; 2012 - 2014	24" Shoe, Qty 4	MYW083714	\$7,325.00
	36" Shoe, Qty 4	MYW083736	\$8,050.00
9RT Series; 2012 - 2014	36" Shoe, Qty 2	MYW083737	\$6,450.00
9030 Series; All Models (not compatible with front weight bracket)	24" Shoe, Qty 4	MYW083738	\$7,325.00
	36" Shoe, Qty 4	MYW083739	\$8,000.00
8000, 8010, 8020, 8030, 8R Series; All Models (including track models, except 8RX)	24" Shoe, Qty 2	MYW083744	\$6,250.00
	24" Shoe, Qty 4	MYW083745	\$7,800.00
	36" Shoe, Qty 2	MYW083746	\$6,550.00
New Holland	Description	Product ID	Price
T9.615, T9.670 with Smarttrax	36" Shoe, Qty 2	MYW083774	\$6,350.00
T9.600, T9.615, T9.645, T9.670, T9.700	36" Shoe, Qty 4	MYW083775	\$7,650.00
T9.390, T9.435, T9.450, T9.480, T9.505, T9.530, T9.560, T9.565 (without front ballast)	36" Shoe, Qty 4	MYW083776	\$7,650.00
T9.390, T9.435, T9.450, T9.480, T9.505, T9.530, T9.560, T9.565 (with front ballast, not compable w' front weight carrier)	36" Shoe, Qty 2	MYW083777	\$6,275.00
	36" Shoe, Qty 4	MYW083778	\$7,610.00
Universal Kits (does not include tractor specific mount bracket or toolbar)	Description	Product ID	Price
Universal Kit- 24"X2	24" Shoe, Qty 2	MYW083889	\$5,250.00
Universal Kit- 24"X4	24" Shoe, Qty 4	MYW083890	\$6,275.00
Universal Kit- 36"X2	36" Shoe, Qty 2	MYW083891	\$5,775.00
Universal Kit- 36"X4	36" Shoe, Qty 4	MYW083892	\$7,125.00

Accessories	Product ID	Price
Toolbar- 4"X4" square, 12', 1/4" sidewall	MYW022263	\$575.00

MAY WES G4 STALK STOMPERS

Knock down corn stalks ahead of combine and tractor tires, preventing tire stubble damage.



Make/Model	Description	12" Shoe w/ Toolbar	Price	12" Shoe w/o Toolbar	Price
AGCO Challenger 3000	2-row	MYW084711	\$1,750.00	MYW084716	\$1,550.00
	4-row	MYW084712	\$2,325.00	MYW084717	\$2,050.00
	6-row	MYW084713	\$3,050.00	MYW084718	\$2,875.00
	8-row	MYW084714	\$3,850.00	MYW084719	\$3,575.00
	12-row	MYW084715	\$5,125.00	MYW084720	\$4,675.00
Capello Diamant	2-row	MYW084819	\$2,175.00	MYW084824	\$1,975.00
	4-row	MYW084820	\$2,825.00	MYW084825	\$2,700.00
	6-row	MYW084821	\$3,550.00	MYW084826	\$3,325.00
	8-row	MYW084822	\$4,450.00	MYW084827	\$4,150.00
	12-row (rigid head only)	MYW084823	\$5,700.00	MYW084828	\$5,350.00
Capello Quasar	2-row	MYW084739	\$1,700.00	MYW084745	\$1,525.00
	4-row	MYW084740	\$2,300.00	MYW084746	\$2,050.00
	6-row	MYW084741	\$3,025.00	MYW084747	\$2,875.00
	8-row	MYW084742	\$3,850.00	MYW084748	\$3,550.00
	12-row	MYW084743	\$5,150.00	MYW084749	\$4,675.00
	16-row	MYW084744	\$6,050.00	MYW084750	\$5,425.00
Case-IH 900/1000 Series 6 Row ONLY	2-row	MYW084981	\$1,250.00	MYW084857	\$1,100.00
	4-row	MYW084983	\$1,875.00	MYW084859	\$1,700.00
	6-row	MYW084984	\$2,800.00	MYW084860	\$2,600.00
Case-IH 900/1000 Series 8 Row ONLY	2-row	MYW084985	\$1,450.00	MYW084861	\$1,275.00
	4-row	MYW084986	\$2,050.00	MYW084862	\$1,875.00
	6-row	MYW084989	\$2,700.00	MYW084865	\$2,500.00
	8-row	MYW084990	\$3,600.00	MYW084866	\$3,425.00
Case-IH 2600, 4200, 4400 series New Holland 99C, 980 series	2-row	MYW084891	\$1,950.00	MYW084898	\$1,800.00
	4-row	MYW084892	\$2,575.00	MYW084899	\$2,425.00
	6-row	MYW084893	\$3,200.00	MYW084900	\$3,000.00
	8-row	MYW084894	\$3,800.00	MYW084901	\$3,450.00
	12-row	MYW084895	\$5,050.00	MYW084902	\$4,650.00
	12-row (folding heads)	MYW084943	\$5,975.00	MYW084944	\$5,550.00
	16-row	MYW084896	\$6,775.00	MYW084903	\$6,275.00
	18-row	MYW084897	\$7,475.00	MYW084904	\$6,975.00

Stalks Damaging Your Tires?

Today's corn stubble is as tough as nails. Don't let it damage your expensive combine tires and tracks. May Wes G4 Stalk Stompers feature heavy duty Ultra-High-Molecular-Weight poly shoes and high quality steel.

UHMW is one of the slickest and toughest plastics in the world, and is even used to make armor plating!

G4 Stalk Stompers' Advantages

- **Simplified Design**
 - Torsion spring to handle shock
- **Closed tail** prevents accidental reverse damage
- **Reduced Weight by 25%** – ½" thick UHMW poly instead of steel
- **12" shoe width** – optimal width for knocking down stalks
- **Easier to remove** and reposition for transport



Chart continued on next page.



Winner of the 2018 Made in Minnesota Manufacturing Awards Best Game-Changing B2C Product!

YouTube.com "S.I. Distributing Harvesting Innovations" channel



G4 Stalk Stompers Explained and In Action

Several videos, including installation videos

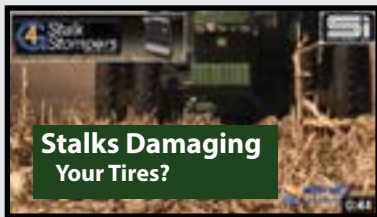

**FARMERS TESTED.
FARMERS APPROVED.**

"I ran the May Wes G4 Stalk Stompers on 2,500 acres with heavier down pressure at 5.5 mph. The new light-weight stomper shoes wore better than the Quick Disconnect version.

I like the ease in handling the shoes and the ability to rotate the shoes for storage on the head. The G4 is less bulky and a cleaner, more efficient stalk leveling design." -

Josh K. Hutchinson, MN

Make/Model	Description	12" Shoe w/ Toolbar	Price	12" Shoe w/o Toolbar	Price
Case-IH 2200, 2400, 3200, 3400 New Holland 96C, 98C, 98D, 996 6 Row ONLY	2-row	MYW084908	\$1,700.00	MYW084924	\$1,450.00
	4-row (all rows except 3 & 4)	MYW084909	\$2,205.00	MYW084925	\$2,000.00
	6-row	MYW084911	\$3,375.00	MYW084927	\$3,100.00
Case-IH 2200, 2400, 3200, 3400 New Holland 96C, 98C, 98D, 996 8 & 12 Row ONLY	2-row	MYW084912	\$1,950.00	MYW084928	\$1,775.00
	4-row - no coverage under feeder-house	MYW084913	\$2,525.00	MYW084929	\$2,375.00
	4-row	MYW084914	\$2,625.00	MYW084930	\$2,475.00
	6-row	MYW084915	\$3,425.00	MYW084931	\$3,200.00
	6-row - no coverage under feeder-house	MYW084916	\$3,350.00	MYW084932	\$3,125.00
	8-row	MYW084917	\$4,100.00	MYW084933	\$3,800.00
	12-row	MYW084918	\$5,425.00	MYW084934	\$4,925.00
	16-row	Available Upon Request			
18-row	Available Upon Request				
Drago Series I & II	2-row	MYW084653	\$1,650.00	MYW084662	\$1,425.00
	4-row	MYW084654	\$2,125.00	MYW084663	\$1,950.00
	6-row (requires MYW041958)	MYW084655	\$2,925.00	MYW084664	\$2,775.00
	8-row	MYW084656	\$3,750.00	MYW084665	\$3,450.00
	12-row (20", 22", 30" spacing)	MYW084657	\$4,925.00	MYW084666	\$4,450.00
	12-row (folding heads)	MYW084659	\$5,700.00	MYW084668	\$5,225.00
	16-row	MYW084660	\$5,700.00	MYW084669	\$5,450.00
	18-row	MYW084661	\$6,775.00	MYW084670	\$6,250.00
Drago GT Series	2-row	MYW084639	\$1,750.00	MYW084646	\$1,575.00
	4-row	MYW084640	\$2,300.00	MYW084647	\$2,075.00
	6-row	MYW084641	\$3,150.00	MYW084648	\$2,900.00
	8-row	MYW084642	\$3,850.00	MYW084649	\$3,600.00
	8-row (folding heads)	MYW084802	\$4,050.00	MYW084803	\$3,800.00
	12-row	MYW084643	\$5,150.00	MYW084650	\$4,725.00
	12-row (folding heads)	MYW084753	\$5,625.00	MYW084754	\$5,100.00
	16-row	MYW084644	\$6,150.00	MYW084651	\$5,500.00
18-row	MYW084645	\$6,775.00	MYW084652	\$6,300.00	
Fantini	2-row	MYW084729	\$1,750.00	MYW084734	\$1,550.00
	4-row	MYW084730	\$2,300.00	MYW084735	\$2,050.00
	6-row	MYW084731	\$3,050.00	MYW084736	\$2,875.00
	8-row	MYW084732	\$3,850.00	MYW084737	\$3,575.00
	12-row	MYW084733	\$5,025.00	MYW084738	\$4,575.00
Geringhoff Horizon Series	2-row	MYW084685	\$1,275.00	MYW084692	\$1,100.00
	4-row	MYW084686	\$1,875.00	MYW084693	\$1,675.00
	6-row	MYW084687	\$2,800.00	MYW084694	\$2,600.00
	8-row	MYW084688	\$3,750.00	MYW084695	\$3,450.00
	12-row	MYW084689	\$4,900.00	MYW084696	\$4,400.00
	16-row	MYW084690	\$5,800.00	MYW084697	\$5,275.00
Geringhoff Patriot Northstar Rota Disc	18-row	MYW084691	\$6,625.00	MYW084698	\$6,050.00
	2-row	MYW084671	\$1,275.00	MYW084678	\$1,100.00
	4-row	MYW084672	\$1,875.00	MYW084679	\$1,675.00
	6-row	MYW084673	\$2,800.00	MYW084680	\$2,600.00
	8-row	MYW084674	\$3,750.00	MYW084681	\$3,450.00
	12-row	MYW084675	\$4,900.00	MYW084682	\$4,400.00
	16-row	MYW084676	\$5,800.00	MYW084683	\$5,275.00
18-row	MYW084677	\$6,700.00	MYW084684	\$6,175.00	

Continued on next page.

MAY WES G4 STALK STOMPERS

HARVESTING



Make/Model	Description	12" Shoe w/ Toolbar	Price	12" Shoe w/o Toolbar	Price
Harvestec 5000 6000	2-row	-	-	MYW084721	\$1,050.00
	4-row	-	-	MYW084722	\$1,875.00
	6-row	MYW084723	\$2,800.00	MYW084726	\$2,600.00
	8-row	MYW084724	\$3,750.00	MYW084727	\$3,425.00
	12-row	MYW084725	\$4,900.00	MYW084728	\$4,450.00
John Deere 443/493 643/693 843/893 1243/1293	2-row (2 outer rows)	MYW084965	\$1,550.00	MYW084973	\$1,300.00
	4-row (4 outer rows)	MYW084966	\$2,050.00	MYW084974	\$1,875.00
	6-row (4 outer & 2 inner rows)	MYW084968	\$2,900.00	MYW084976	\$2,600.00
	6-row (outer rows)	MYW084969	\$2,700.00	MYW084977	\$2,525.00
	8-row	MYW084970	\$3,600.00	MYW084978	\$3,325.00
	12-row	MYW084971	\$5,100.00	MYW084979	\$4,650.00
John Deere 606C, 706C 608C, 708C 612C, 712C 616C, 716C 618C, 718C	2-row	MYW084624	\$1,750.00	MYW084631	\$1,550.00
	4-row	MYW084625	\$2,300.00	MYW084632	\$2,050.00
	6-row	MYW084626	\$3,050.00	MYW084633	\$2,875.00
	8-row	MYW084627	\$3,800.00	MYW084634	\$3,575.00
	12-row	MYW084628	\$5,200.00	MYW084635	\$4,675.00
	12-row (folding heads)	MYW084870	\$5,600.00	MYW084871	\$5,100.00
	16-row	MYW084629	\$6,450.00	MYW084636	\$5,850.00
	18-row	MYW084630	\$6,775.00	MYW084637	\$6,225.00
John Deere C6R C8F, C8R C12F, C12R C16F, C16R C18F, C18R	2-row	MYW084767	\$1,900.00	MYW084779	\$1,700.00
	4-row	MYW084768	\$2,400.00	MYW084780	\$2,300.00
	6-row	MYW084769	\$3,075.00	MYW084781	\$2,875.00
	8-row	MYW084771	\$3,900.00	MYW084783	\$3,625.00
	12-row	MYW084772	\$5,250.00	MYW084784	\$4,850.00
	12-row (folding heads)	MYW084773	\$5,625.00	MYW084785	\$5,200.00
	16-row	MYW084774	\$6,975.00	MYW084786	\$6,525.00
	16-row (folding heads)	MYW084775	\$7,525.00	MYW084787	\$7,075.00
	18-row	MYW084776	\$7,575.00	MYW084788	\$7,100.00
	18-row (folding heads)	MYW084777	\$7,875.00	MYW084789	\$7,350.00
Lexion	2-row	MYW084699	\$1,750.00	MYW084705	\$1,550.00
	4-row	MYW084700	\$2,300.00	MYW084706	\$2,050.00
	6-row	MYW084701	\$3,050.00	MYW084707	\$2,875.00
	8-row	MYW084702	\$3,850.00	MYW084708	\$3,550.00
	12-row	MYW084703	\$5,025.00	MYW084709	\$4,575.00
	16-row	MYW084704	\$5,925.00	MYW084710	\$5,400.00
MacDon C-Series	2-row	-	-	MYW084756	\$1,050.00
	4-row	-	-	MYW084757	\$1,875.00
	6-row	MYW084758	\$2,800.00	MYW084761	\$2,600.00
	8-row	MYW084759	\$3,750.00	MYW084762	\$3,450.00
	12-row	MYW084760	\$4,925.00	MYW084763	\$4,450.00

Based on farmer feedback, the G4 Stalk Stomper features a simplified and space-saving torsion design that eliminates the spring, chain, pivot bolt and other bulky features found in most Stalk Stompers, making it easier for one person to install, remove and reposition for transport or storage.



The G4 is more compact with an 11.5" shorter length than previous models, providing more clearance for track combines and hassle-free storage and transport on folding corn heads.

May Wes widened the G4's shoe to 12" for optimal stalk leveling and reduced its weight by 25 percent.



To reduce cost, the 2x2 toolbar can be removed from the kit. This is standard 2x2 square 3/16" sidewall tubing.

If you don't see the make and model of your cornhead, contact us at 800-368-7773 for possible availability.



BUSHEL PLUS SMARTPAN SYSTEM GRAIN LOSS MANAGEMENT SYSTEM

**MORE GRAIN
IN THE BIN!**

**LESS IN
THE FIELD!**

Harvest Lost:

Before

After

**8 BU/Acre
Grain Loss**

**0.8 BU/Acre
Grain Loss**



**Savings from farmers have been reported
anywhere from 2% to more than 10%.**

One System – 4 Simple Steps to Save You Thousands of Dollars!

This drop pan system attaches magnetically to the underside of the combine. The pan is dropped remotely during harvesting and collects a sample of chaff and straw from the back of the combine. After the sample is cleaned with the separator, the remaining grain is weighed and the BP app will quantify your bu/ac grain loss. You can then make adjustments to the combine to reduce your grain loss.

The Flagship: 40" BP System – with 40" long drop pans (wide & narrow) - BPS100401 The most popular system! Handy size to carry around in your pick up or grain truck — perfect when working with a lot of different combines. 40" is the ideal size to mount higher, under feederhouse, to avoid tall stalks or stubble. A good choice for corn and soybean growers.

The Wide Setup: 60" BP System – with 60" long drop pans (wide & narrow) - BPS100601 If you are a fan of windrowing straw when checking your grain loss and want to catch a sample from the entire width of your sieves then this is the fit for you.

The BP Mini: 20" BP System – with 20" long drop pan (wide only) - BPS100200 Designed for use in 30" row crops when leaving high cut stubble (ex. corn & sorghum - falls in between stubble without tipping over). Also used with plot and research combines.



The Bushel Plus SmartPan System has revolutionized the checking- for-harvest-loss process. As featured on CORN WARRIORS USA – you can now quantify your grain loss and calibrate your loss monitor for immediate improvement! **Savings from farmers have been reported anywhere from 2% to more than 10%.** The Bushel Plus SmartPan System is PROVEN for corn, soybeans, and small grain such as wheat, oats, barley, canola and rice.



1) Magnetic system attaches to any combine.



2) Remotely release drop pan

(Patented system is the only one where the drop pan is protected by a cover underneath the machine.)



3) Clean sample within seconds with the optional Bushel Plus Air Separator

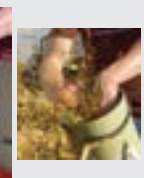

4) Weigh grain with the Bushel Plus scale and quantify results with the Bushel Plus app

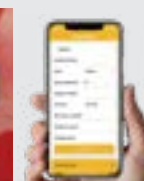

BUSHEL PLUS SMARTPAN SYSTEM

What's Included in the Kit: BPS100401 and BPS100601 come with two different size (wide and narrow) drop pans for different stubble conditions – no tipping over in long stubble!

- Carrier (Attaches to the Combine)
- Wide Drop Pan
- Narrow Drop Pan
- Downloadable Bushel Plus App
- Pan-Drop Remote/Lanyard
- Durable Field Scale
- Smart Charger
- User Manual



Bushel Plus SmartPan System			
System	Description	Product ID	Price/Each
The Flagship	40" SmartPan	BPS100401	\$1,820.00
The Wide Setup	60" SmartPan	BPS100601	\$2,010.00
The Mini	20" SmartPan (Chaff Deck Version)	BPS100200	\$950.00
Accessory			
Air Separator		BPS200101	\$755.00

Bushel Plus SmartPan System plus Air Separator			
System	Description	Product ID	Price/Each
The Flagship	40" SmartPan plus Air Separator	BPS200401	\$2,524.00
The Wide Setup	60" SmartPan plus Air Separator	BPS200601	\$2,710.00
The Mini	20" SmartPan plus Air Separator (Chaff Deck Version)	BPS200201	\$1,671.00



YouTube.com
"S.I. Distributing
Harvesting Innovations"

Eleven total
videos



Grain Loss Test - Start to Finish



TAILBOARD TRASH BLOWER TUBE

Farmers Agree: "A Very Affordable Difference Maker!"



The Tailboard Trash Blower Tube keeps crop residue from accumulating on the combine tailboard.

- Since the tube is slotted to direct air across the tailboard, the tailboard stays clean at all times.
- The manufacturer tested it as 26 MPH wind at center of the tailboard compared to 0-5 MPH without.

No More Daily Tailboard Cleaning!

- *Keeps the tailboard free of crop residue*
- *Eliminates fire hazards*



A tailboard, with Tailboard Trash Blower Tube, after a full season of harvesting soybeans.



Without the Tailboard Trash Blower Tube



Installs in minutes, without any drilling or cutting

Tailboard Trash Blower Tube		
Product ID	Description	Price
SMT201600	Tailboard Trash Blower Tube, John Deere S650, S660, S670, S680, S690, S760, S770, S780, S790	\$169.00



Tailboard Trash Blower Tube - Explained and In Action

YouTube.com "S.I. Distributing
Harvesting Innovations" channel



PROBLEM: "DOWNED" CROPS



SOLUTION: **PRO FLEX LIFTER** by SCHUMACHER.

The SCH Pro Flex Lifter is specially designed, and often times essential, for the harvest of "downed" crops, whether it be because of snow, wind or heavy rains.



**Recommended
for flex heads**

The Pro Flex Lifter is fully adjustable so the length and angle can be set to the best position to lift crops into the cutterbar.

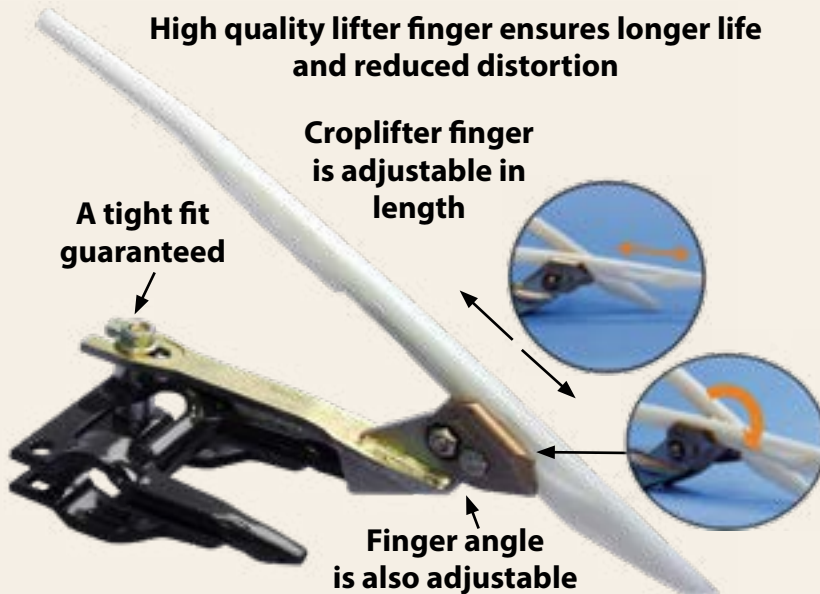

The white color of the lifter finger provides maximum visibility in all crop conditions.



Mike Johnson,

In Canada grows 1,000 + acres of various types of edible beans.

"In comparison to other lifters, the PRO FLEX lifter is much stronger and experienced longer wear along with less breakage on the finger. The simple adjustment, combined with the easy removal and mounting, reduces any unnecessary downtime. The white color of the PRO FLEX finger was much easier to see in the crop."



YouTube.com "S.I. Distributing Harvesting Innovations" channel

Two Videos: The SCH Pro Flex Crop Lifter explained and in action.



PRO FLEX Crop Lifters

A simple design is combined with durability for a productive pulse crop harvest.



SCH Pro Flex Lifter		
Product ID	Description	Price
SCP017646	SCH Pro Flex Lifter, with spacer	\$65.95
SCP017937	Replacement Finger	\$13.24

Pro Flex Lifter Hardware Guide

Make	Model	Guard	Hardware Kit	Price
AGCO	300, 400, 500, 700, 800, 5100, 7000, 8000, 8200, 9250	71386962	SCP980179	\$0.76
	5200	66603, 113400M1	SCP980181	\$1.57
	All	SCH EasyCut II	SCP980178	\$0.97
CAT/Claas	Maxflo, Flex Head, Vario	519600, 767265.1, 519600	SCP980179	\$0.76
	MaxFlex	521282	SCP980178	\$0.97
	Maxflo, Flex Head, Vario, MaxFlex	SCH EasyCut II	SCP980178	\$0.97
Challenger	DHW	66603, 113400M1	SCP980181	\$1.57
	FHB, RHB, FDH	71386962	SCP980179	\$0.76
	DHW, FHB, RHB, FDH	SCH EasyCut II	SCP980178	\$0.97
Case-IH	1010, 1020, 2010, 2020	87442324	SCP980178	\$0.97
	1042, 1052, 2042, 2052, 2062, 2142, 2152, 2162 without poly skid shoes	87421451, 87560324	SCP980181	\$1.57
	1042, 1052, 2042, 2052, 2062, 2142, 2152, 2162 with OEM poly skid shoes	87421451, 87560324	SCP980180	\$2.05
	3020	87702974/ 84409307	SCP980178	\$0.97
	4000, 5000, 5500	613838R3	SCP980181	\$1.57
	8220	700700845	SCP980178	\$0.97
	1010, 1020, 2010, 2020, 3020, 4000, 5000, 8220	SCH EasyCut II	SCP980178	\$0.97
	1042, 1052, 2042, 2052, 2062, 2142, 2152, 2162 with SCH poly skid shoes	SCH EasyCut II	SCP980181	\$1.57
Crary		7228, 7222M	SCP980178	\$0.97
		SCH EasyCut II	SCP980178	\$0.97
Harvestmore	Rigid, Flex	All	SCP980178	\$0.97
Hesston	5000, 5200	66603, 113400M1	SCP980181	\$1.57
	All	SCH EasyCut II	SCP980178	\$0.97
Honey Bee	Rigid, Flex	SCH EasyCut II	SCP980178	\$0.97
John Deere	200, 900, 900D*	H145791, H229539	SCP980179	\$0.76
	600F*, 600D*, 600FD*, 700FD*	H229537, H218702, H229539	SCP980178	\$0.97
	All	SCH EasyCut II	SCP980178	\$0.97
*Can only space lifters every 12"				
MacDon	960, 962, 963, 972, 973, 974, D50, D60, D65, FD70, FD75 without poly skid shoes	23064, 118344	SCP980181	\$1.57
	960, 962, 963, 972, 973, 974, D50, D60, D65, FD70, FD75 with OEM poly skid shoes	23064, 118344	SCP980180	\$2.05
	960, 962, 963, 972, 973, 974, D50, D60, D65, FD70, FD75	SCH EasyCut II	SCP980181	\$1.57
New Holland	71C, 72C, 73C, 74C, 88C, 92C, 94C	86561686, 87442324, 86615982	SCP980178	\$0.97
	All	SCH EasyCut II	SCP980178	\$0.97
Versatile	400, 4400, 4700, 4800	9705050, 65327	SCP980178	\$0.97
	All	SCH EasyCut II	SCP980178	\$0.97

AS Series Crop Lifters

Optimum performance in difficult conditions and lodged crops

- Helps lift and feed down crops
- Crop lifters are essential in the harvest of different crops such as down wheat, oats, milo and other common cereal grains.
- Spring steel
- Secure and quick attachment
- Closed slimProfile to prevent reel tine interference
- **For use on rigid headers and locked flex headers**



Improved concave sliding skid allows for better sliding dynamics.

SCH AS Series Crop Lifters

Product ID	Description	Price
SCP216445	SCH ASK-100 croplifter; guards that are 5.7 - 6.0" long; SCH Easy-Cut I & II; will not work with EC II short guards	\$36.95
SCP116588	SCH ASK-121 croplifter; guards that are 5.75 - 6.125" long	\$36.95
SCP016587	SCH ASK-120 croplifter; guards that are 6.1 - 6.4" long	\$36.95
SCP116589	SCH ASK-127 croplifter; guards that are 6.5 - 6.7" long	\$36.95
SCP010142	SCH AS-100/2 croplifter; JD 600 series rigid & draper, 900 series draper with 4" OEM long guards; H213405, H229539	\$36.95
SCP213549	SCH AS-100/5 croplifter; guards that are 5.4 - 5.8" long; JD 200, 900 series auger platforms with OEM guards, H113571, H145791, H153719, H171031	\$36.95
SCP010658	SCH spool fastener, required to install croplifters	\$2.50

Note: Croplifters for other guards not listed above may be available. Call with measurement from tip of guard point to the center of the guard bolt hole for correct fit.

A Great Cut

is the first step in a successful harvest!

Perfect for
Forage
Harvesting!



Perfect for Crop
Harvesting!



EASY CUT II
by SCHUMACHER.
Cutterbar Systems

Exceptionally cuts soybeans, cereals, canola, legumes & grass

IT ALL STARTS HERE: The Cutting System is the First Part to Touch your Crop

Despite all technological advances around the combine and platform, the cutting system is still the first part to touch your crop and determines your harvest success. The Schumacher cutting system is an essential component for successful combining and supports maximum performance of combine harvesters.

EasyCut systems are deployed all around the world when it comes to harvesting soybeans, cereal and rice. All parts are bolted for easy handling and replacement.

As far as U.S. Distribution, it All Started With S.I. Distributing

In 1988, the company began selling the SCH Easy Cut cutting system, which was being manufactured in Germany for German made equipment. Along with Schumacher, S.I. Distributing adapted the parts to fit most combines, swathers, mower conditioners, and sickle bar mowers manufactured in the U.S. S.I. Distributing was the first distributor in the U.S. for the Schumacher Company and today is still their largest aftermarket distributor in the States.

Superior Cutting, More Uptime and Less Maintenance

High quality spring steel guards, completely hardened sections and roller guides give the system durability and low maintenance. The EasyCut II system eliminates the need for any adjustments, meaning less downtime and provides high-cutting performance in the toughest conditions.

- **No Adjustments** - With the enclosed design of the guards, hold downs are eliminated, along with all the adjustments that come with them
- **Choices to Suit Every Harvest Condition** - Roller guides or wear plates; short or long guards; course or fine tooth sickle sections
- **Easy Handling** - Most conversion kits and sectional knife assemblies can be shipped as a small parcel carrier

SCH EASYCUT II

SCH Easy Cut II owners were asked:

“What one feature convinced you to buy the SCH Easy Cut II Kit?”

The new rollers! -

R.S., Eldorado, WI

Ease of in-field repair -

J.S., Bloomberg, PA

Less friction -

D.S., St. Marys, KS

No hold downs needed -

P.H., Lake City, MN

No adjusting -

R.B., South Hearst, ND

Less wear on knife, faster

cutting - C.R., Gibsonburg, OH

Ease of installation - A.Q., Troy, NY

No shims - G. W., Fairfax, MO

Old one wore out in less

than 2 years so quality -

R.K., Elgin, NE

It works! - J.F., Minford, OH

A “Worth-Every-Penny Improvement”

- M.M., Ottawa, OH

- EasyCut II blunt guard eliminates spearing of residue
- EasyCut II guard gets more crop through the cutting system
- SCH guards bolt to top and bottom of platform
- SCH guards are fully heat treated
- SCH sections are fully heat treated
- SCH sections will not bend

MORE UPTIME!



Rollers increase platform flexibility

- less friction
- less vibration
- less power requirements

Short Guards improve crop flow in no-till soybeans. They are recommended for flex platforms.



- SCH guards have two beveled cutting edges
- Optional SCH rollers improve performance
- Optional SCH rollers reduce friction & vibration

YouTube.com “S.I. Distributing Harvesting Innovations” channel



Several Videos!

Easy Cut II Explained and In Action



What's Included?

Each kit includes all the necessary parts to convert your current header into an Easy Cut II cutting system. Along with this, each kit includes installation instructions on how to assemble the kit.

Every conversion kit also includes 2 extra standard guards and a 10-pack of sections with mounting hardware.

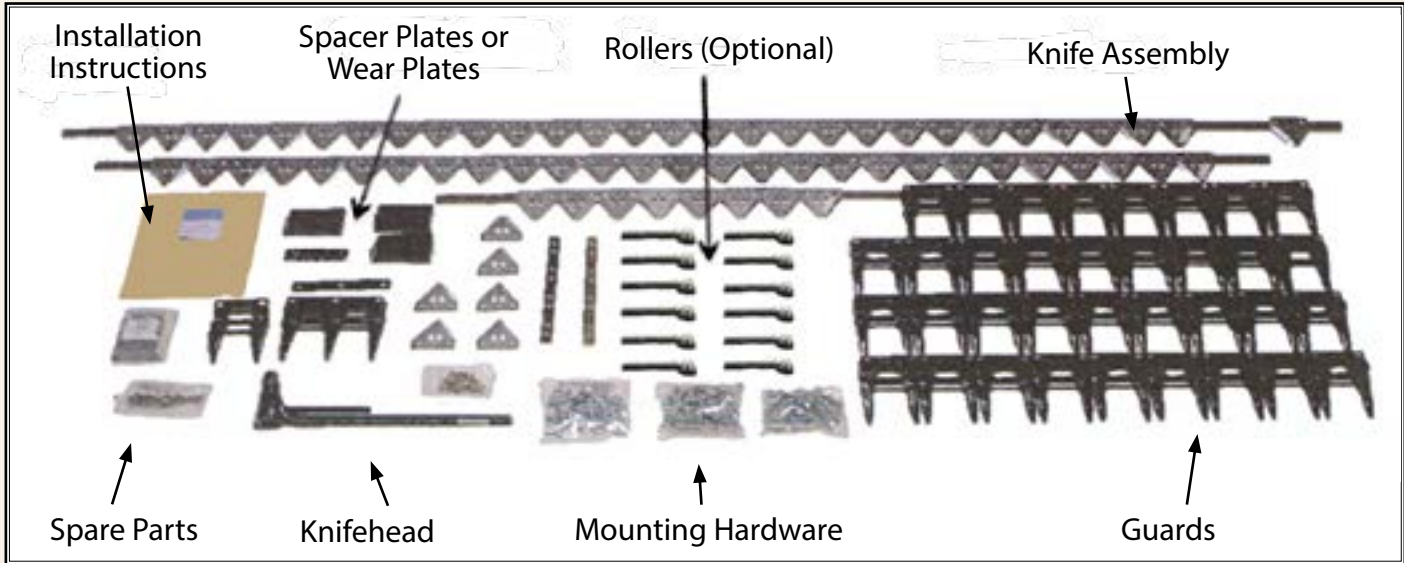

Each kit includes:

- Knife assembly
- Rollers (if roller kit ordered)
- Knifehead
- Guards
- Spacer plates or wear plates
- Mounting hardware
- Spare parts
- Installation instructions



**Check for
Guard Wear**



SCH Multi-Tool: Call 800-368-7773 to receive a free SCH multi-tool to check your SCH guards.

SCH EASYCUT II CONVERSION KITS

Kit price includes all parts to convert to the **SCH EasyCut II SYSTEM**, including one pre-assembled knife with knifehead (without bearing), all guards and hardware, plus ten extra replacement sections with hardware and two extra guards. Please specify coarse (7 serrations per inch) or fine (11 serrations per inch) knife sections. Coarse is recommended for soybeans and alfalfa; fine is recommended for wheat and grasses. Also includes 10mm socket and 10mm wrench for section bolts.

Note: The ideal cutter bar speed is 540 RPM for optimum cutting performance.

SCH EasyCut Conversion Kit Prices

Width	SCH Kit w/ Wear Plates	SCH Kit w/ Rollers	SCH Roller Guide Kit*	Width	SCH Kit w/ Wear Plates	SCH Kit w/ Rollers	SCH Roller Guide Kit*
7	\$944.00	\$1,029.00	\$123.00	21	\$1,989.00	\$2,233.00	\$335.00
8	\$1,012.00	\$1,105.00	\$128.00	21 DD	\$2,310.00	\$2,552.00	\$335.00
9	\$1,079.00	\$1,188.00	\$148.00	22	\$2,056.00	\$2,318.00	\$359.00
10	\$1,145.00	\$1,267.00	\$172.00	22 DD	\$2,375.00	\$2,638.00	\$359.00
11	\$1,213.00	\$1,343.00	\$172.00	22.5	\$2,116.00	\$2,387.00	\$359.00
12	\$1,287.00	\$1,433.00	\$198.00	24	\$2,183.00	\$2,471.00	\$378.00
12 DD	\$1,607.00	\$1,752.00	\$198.00	24 DD	\$2,503.00	\$2,790.00	\$378.00
13	\$1,357.00	\$1,510.00	\$213.00	25	\$2,243.00	\$2,537.00	\$401.00
14	\$1,442.00	\$1,612.00	\$229.00	25 DD	\$2,562.00	\$2,857.00	\$401.00
14 DD	\$1,763.00	\$1,930.00	\$229.00	27	\$2,362.00	\$2,692.00	\$425.00
15	\$1,536.00	\$1,712.00	\$245.00	30	\$2,522.00	\$2,874.00	\$483.00
16	\$1,612.00	\$1,796.00	\$263.00	30 DD	\$2,840.00	\$3,193.00	\$483.00
16 DD	\$1,930.00	\$2,114.00	\$263.00	35	\$2,790.00	\$3,204.00	\$563.00
16.5	\$1,653.00	\$1,846.00	\$263.00	35 DD	\$3,109.00	\$3,524.00	\$563.00
17	\$1,695.00	\$1,896.00	\$270.00	36	\$2,858.00	\$3,279.00	\$582.00
17.5	\$1,738.00	\$1,940.00	\$278.00	36 DD	\$3,177.00	\$3,599.00	\$582.00
18	\$1,780.00	\$1,989.00	\$278.00	39	\$3,100.00	\$3,626.00	\$632.00
18 DD	\$2,098.00	\$2,310.00	\$278.00	40	\$3,179.00	\$3,702.00	\$648.00
18.5	\$1,820.00	\$2,040.00	\$294.00	40 DD	\$3,498.00	\$4,020.00	\$648.00
19	\$1,865.00	\$2,084.00	\$312.00	42	\$3,310.00	\$3,855.00	\$676.00
20	\$1,931.00	\$2,166.00	\$312.00	45	\$3,476.00	\$3,889.00	\$707.00
20 DD	\$2,251.00	\$2,484.00	\$312.00	45 DD	\$3,796.00	\$4,209.00	\$707.00

*Installing a roller guide kit on an existing SCH EasyCut cutting system requires a new knifeback.

Price Adjustments to SCH EasyCut Kits

Description	Adjustment	Price
AGCO 5300, 5400 drapers	Add	\$200.00
Case-IH 3020, New Holland 740 grain platforms	Add	\$200.00
Case-IH 2052, 2062, 2152, 2162; 2 skid plates required per foot (SCP082817)	Add	\$37.52/ft
MacDon 973, 974, FD60, FD70, FD75, D60 (2006 & after) 2 skid plates required per foot (SCP082817)	Add	\$37.52/ft
New Holland 84C; 2 skid plates required per foot (SCP082817)	Add	\$37.52/ft
SCP083690: Optional 540 RPM, 11-1/2" backshaft pulley for Case-IH 1020 oil bath header.		\$111.00

SCH EasyCut Sickle Bar Mower Kit Prices

Width	SCH Kit with Wear Plates	SCH Kit with Rollers
5	\$431.00	\$495.00
6	\$532.00	\$612.00
7	\$614.00	\$699.00
8	\$699.00	\$797.00
9	\$783.00	\$897.00
10	\$869.00	\$996.00

Kit price includes pre-assembled knife, without knifehead, all guards and hardware. Must re-use original equipment manufacturer (OEM) knifehead. No extra replacement parts are included. Please specify coarse (7 serrations per inch) or fine (11 serrations per inch) knife sections. Coarse is recommended for soybeans and alfalfa; fine is recommended for wheat and grasses.

Schumacher Pro Cut knife sections are completely thru-hardened, therefore extremely tough. **They don't bend.** Therefore, when hitting large stones or other objects, damage to guards is eliminated which is not the case with regular sections.

SECTIONS

Cut-Outs
help clean residue buildup and also reduces overall knife weight

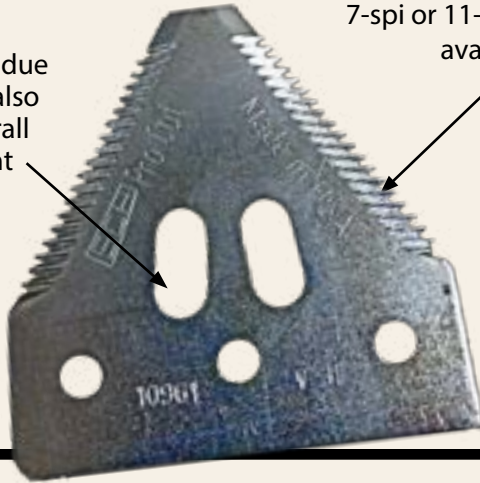

Various Serrations
7-spi or 11-spi serrations available

Secure Fit
Serrated shoulder of bolt securely fastens section to knifeback



What makes the SCH Easy Cut II steel guard so special?

The SCH Easy Cut guard is manufactured using a special alloy steel. A subsequent special hardening process gives the guard extremely high hardness, durability and wear life. The angled cutting edges of the guard holds the crop material better, resulting in a cleaner cut and a better flow of material. This also results in less power needed to cut the material.

Blunt Tip
less spearing of crop and residue

Top & Bottom Cutting Edge
double cutting edges for balanced knife guidance



Increased Stability
guard is bolted on top and bottom of cutterbar, increasing the durability against all impacts

Smooth Knife Movement
design of guard makes it possible to insert knives with connector bars already mounted

SCH roller guides offer a high performance alternative to the standard wear plates that are used on many machines in the market today.

Almost all SCH Easy Cut systems can be updated with roller guides.

ROLLER GUIDES

Top Roller

holds knife straight to prevent section from tipping downward



Bottom Roller

reduces vibration and wear of knifeback, prevents section from tipping upward



SCH EASYCUT II OPTIONS

Option 1) Roller Guide Conversion Kits

SCH roller guides greatly reduce the amount of force required from the knife drive to power the knife. On conventional cutting systems the knife runs against a wear plate. With the SCH roller guides, the knife runs against the top and bottom roller guides allowing the knife to move more freely. This also reduces the amount of wear on the knifeback. The top and bottom roller guides are alternated, which allows the knife to move more smoothly across the entire header.

Roller guide kits are a simple solution for end users that already have an SCH Easy Cut system with the conventional wear plates. These kits include the parts needed to convert an SCH wear plate cutting system to use the rollers guides. **Each roller guide kit includes:** top & bottom roller guides, spacer plates, and instructions.

NOTE: When installing a new roller guide kit on an existing SCH cutting system, a new knife assembly is recommended.



Top Roller - #SCP019035



Bottom Roller - #SCP019036

Option 2) Wear Plate Conversion Kits

SCH wear plates have a similar concept to the conventional cutting systems on the market today but require less adjusting. The hardened wear plates



support the knifeback from behind, while the section rides on top of the wear plate. This feature along with using the SCH guard creates a tight fit and eliminates the need for hold downs and any adjustments.



SCH Parts Bags / Packages

S.I. Distributing has created parts packages to make it easier for you to stock spare parts. These kits include a range of spare parts that vary depending on the platform. For SCP399100 and SCP399200, the bag is included at no charge. **SCH Parts Bags are customized for your make and model.**

Product ID	Description	Price
SCP399100	SCH Wear Plates Parts Bag	\$325.00
SCP399200	SCH Roller Guides Parts Bag	\$410.00
SCP399300	SCH Double Drive Parts Package	\$195.00

NOTE: Please specify make, model and length of platform.



An Inexpensive Insurance Policy!

Sectionalized Knife Assemblies

Today platforms are 30 feet or wider. Knife assemblies in one piece are very difficult to handle and transport. The SCH sectionalized knife assemblies eliminate this problem. The sectionalized knife assemblies are made up of individual sections - a head piece, middle pieces, a tail piece and connector bars. The longest single piece is less than 9 feet long and can be transported in a car, truck or shipped by courier.

The special connector bar joins the pieces fast and securely. SCH EasyCut sectional knife assemblies have only bolted sections. This also makes for a quick and easy replacement of individual knife sections or whole knife assembly segments. This is cost effective, and the individual parts are easy to replace.

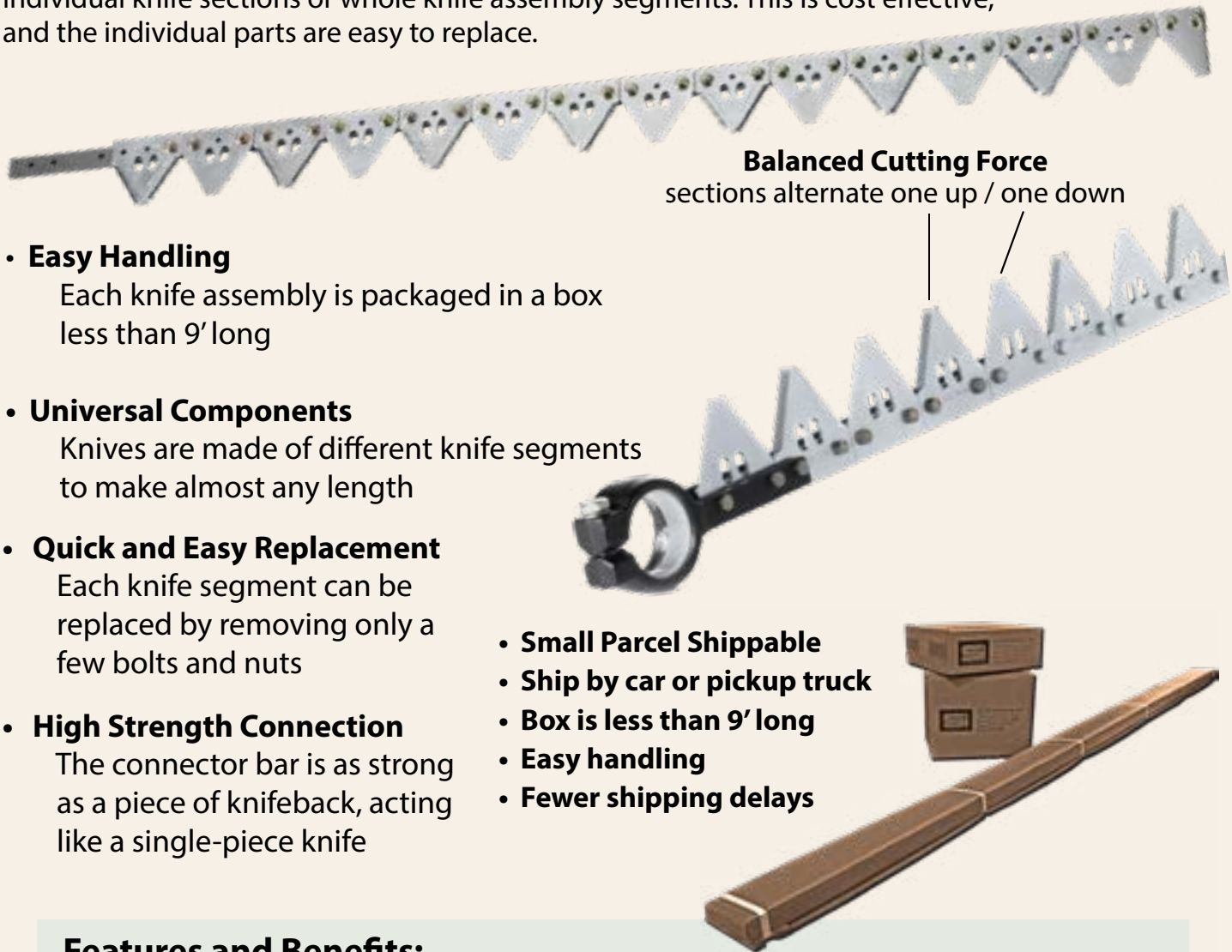

Balanced Cutting Force
sections alternate one up / one down

- **Easy Handling**

Each knife assembly is packaged in a box less than 9' long

- **Universal Components**

Knives are made of different knife segments to make almost any length

- **Quick and Easy Replacement**

Each knife segment can be replaced by removing only a few bolts and nuts

- **High Strength Connection**

The connector bar is as strong as a piece of knifeback, acting like a single-piece knife

- **Small Parcel Shippable**
- **Ship by car or pickup truck**
- **Box is less than 9' long**
- **Easy handling**
- **Fewer shipping delays**

Features and Benefits:

- Sectional knife for flexible shipping options and easy handling
- High strength connector which performs like a single-piece knife
- Secure section mounting so sections remain tight on the knifeback
- Alternated section mounting for balanced cutting forces

SCH KNIFE ASSEMBLIES

HARVESTING

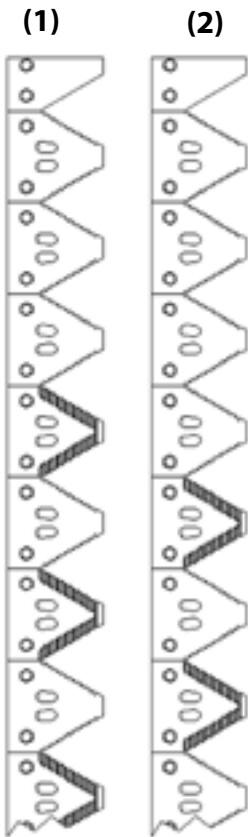

SCH Knife Assemblies Starting With A HALF Section					SCH Knife Assemblies Starting With A FULL Section				
Knife Assembly Length	Number of Sections	Original Knife Assembly Product ID (1)	Replacement Knife Assembly Product ID (2)	Price	Knife Assembly Length	Number of Sections	Original Knife Assembly Product ID (3)	Replacement Knife Assembly Product ID (4)	Price
7'	1/2 + 30	SCB210300	SCB210301	\$174.32	7'	30	SCB220300	SCB220301	\$174.32
8'	1/2 + 34	SCB210340	SCB210341	\$197.55	8'	34	SCB220340	SCB220341	\$197.55
9'	1/2 + 38	SCB210380	SCB210381	\$220.81	9'	38	SCB220380	SCB220381	\$220.81
10'	1/2 + 42	SCB210420	SCB210421	\$244.05	10'	42	SCB220420	SCB220421	\$244.05
11'	1/2 + 46	SCB210460	SCB210461	\$267.29	11'	46	SCB220460	SCB220461	\$267.29
12'	1/2 + 50	SCB210500	SCB210501	\$290.54	12'	50	SCB220500	SCB220501	\$290.54
13'	1/2 + 54	SCB210540	SCB210541	\$313.77	13'	54	SCB220540	SCB220541	\$313.77
15'	1/2 + 62	SCB210620	SCB210621	\$360.24	15'	62	SCB220620	SCB220621	\$360.24
16'	1/2 + 66	SCB210660	SCB210661	\$383.51	16'	66	SCB220660	SCB220661	\$383.51
17'	1/2 + 70	SCB210700	SCB210701	\$406.76	17'	70	SCB220700	SCB220701	\$406.76
18'	1/2 + 74	SCB210740	SCB210741	\$429.98	18'	74	SCB220740	SCB220741	\$429.98
20'	1/2 + 82	SCB210820	SCB210821	\$476.46	20'	82	SCB220820	SCB220821	\$476.46
22'	1/2 + 90	SCB210900	SCB210901	\$522.97	22'	90	SCB220900	SCB220901	\$522.97
24'	1/2 + 98	SCB210980	SCB210981	\$569.44	24'	98	SCB220980	SCB220981	\$569.44
25'	1/2 + 102	SCB211020	SCB211021	\$592.67	25'	102	SCB221020	SCB221021	\$592.67
27'	1/2 + 110	SCB211100	SCB211101	\$639.17	27'	110	SCB221100	SCB221101	\$639.17
30'	1/2 + 122	SCB211220	SCB211221	\$708.88	30'	122	SCB221220	SCB221221	\$708.88
35'	1/2 + 142	SCB211420	SCB211421	\$825.08	35'	142	SCB221420	SCB221421	\$825.08
36'	1/2 + 146	SCB211460	SCB211461	\$848.35	36'	146	SCB221460	SCB221461	\$848.35
40'	1/2 + 162	SCB211620	SCB211621	\$983.49	40'	162	SCB221620	SCB221621	\$983.49
45'	1/2 + 182	SCB211820	SCB211821	\$1,057.49	45'	182	SCB221820	SCB221821	\$1,057.49

Knifehead **NOT** Included
NOTE: Add \$40 for all double drive kits.

- (1) & (3) Original knife assembly has the knife sections installed the same way as the original knife assembly.
- (2) & (4) Replacement knife assembly has the knife sections installed the opposite way as the original knife assembly.
- If unsure how the knife assembly starts, order the knife with a half section because the half section can be easily removed.
- Some knife assemblies may need cut to length to match original knife.
- Please specify coarse (7 serrations per inch) or fine (11 serrations per inch) knife sections.
- Coarse is recommended for soybeans and alfalfa; fine is recommended for wheat and grasses.

SCH Knife Assembly Pieces and SCH Knifebacks

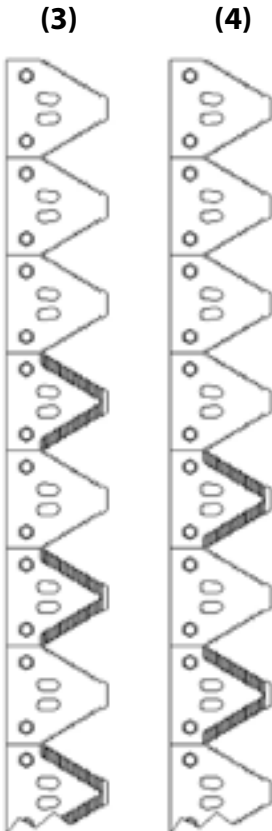

SCH Knife Assembly Pieces				
Product ID	Description	Length	Where Used	Price
SCB081602	Knife Assembly, #1 Bar	102.25"	Left hand drive end, 32 sections + 1/2 section, original	\$176.40
SCB081603	Knife Assembly, #1R Bar	99.25"	Left hand drive end, 31 sections + 1/2 section, replacement	\$171.58
SCB081604	Knife Assembly, #2 Bar	100.25"	Left hand drive end, 32 sections, original	\$172.95
SCB081605	Knife Assembly, #2R Bar	97.25"	Left hand drive end, 31 sections, replacement	\$168.15
SCB081606	Knife Assembly, #3 Bar	89.75"	Middle piece, 27 sections	\$155.19
SCB081607	Knife Assembly, #4 Bar	106.25"	Right hand end, 28 sections	\$166.74
SCB081608	Knife Assembly, #5 Bar	82.25"	Right hand end, 22 sections	\$130.38
SCB081609	Knife Assembly, #6 Bar	58.25"	Right hand end, 14 sections	\$93.82
SCB081610	Knife Assembly, #7 Bar	34.25"	Right hand end, 8 sections	\$49.51
SCB081611	Knife Assembly, #8 Bar	22.25"	Right hand end, 4 sections	\$28.39
SCB081612	Knife Assembly, #9 Bar	102.25"	Right hand drive end, 32 sections + 1/2 section, original	\$176.40
SCB081613	Knife Assembly, #9R Bar	99.25"	Right hand drive end, 31 sections + 1/2 section, replacement	\$176.40

Where used is in reference to left hand single-drive platforms.

SCH Knifeback				
Product ID	Description	Length	Where Used	Price
SCP012022	Knifeback, #1 Bar	102.25"	Left hand end, drilled for 1/2 section, original	\$70.05
SCP012031	Knifeback, #1R Bar	99.25"	Left hand end, drilled for 1/2 section, replacement	\$68.77
SCP012023	Knifeback, #2 Bar	100.25"	Left hand end, drilled for full section, original	\$70.05
SCP012032	Knifeback, #2R Bar	97.25"	Left hand end, drilled for full section, replacement	\$68.77
SCP012024	Knifeback, #3 Bar	89.75"	Middle piece	\$65.96
SCP012025	Knifeback, #4 Bar	106.25"	Right hand end	\$74.16
SCP012026	Knifeback, #5 Bar	82.25"	Right hand end	\$57.72
SCP012027	Knifeback, #6 Bar	58.25"	Right hand end	\$49.45
SCP012030	Knifeback, #7 Bar	34.25"	Right hand end	\$23.91
SCP012028	Knifeback, #8 Bar	22.25"	Right hand end	\$16.50

Where used is in reference to left hand single-drive platforms.

SCH EASYCUT II REPLACEMENT PARTS

7-spi
or
11-spi

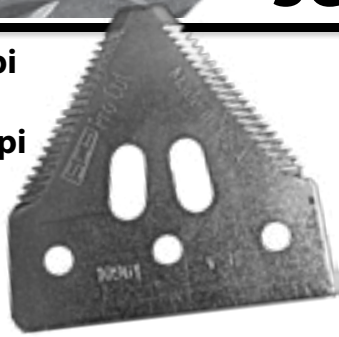

REPLACEMENT SCH SECTIONS

Coarse sections (7 serrations per inch) are recommended for soybeans and alfalfa. Fine sections (11 serrations per inch) are recommended for wheat and grasses.

SCH Knife Section Hardware

Description	Product ID	Price
Hardware, SCH Bolt & Nut 50-Pack (hardware for 25 SCH sections)	SCP080503	\$19.03
Standard Section Bolt, 6mm x 16mm (individual)	SCP010931	\$0.24
Countersunk Section Bolt, 6mm x 16mm (individual)	SCP010045	\$0.27
Flange Nut, 6mm (individual)	SCP013961	\$0.11

SCH Coarse Cut Knife Sections

Description	Product ID	Price
Box of 25 Sections (standard on all SCH kits)	SCP110978	\$53.78
10-pack Sections (includes hardware)	SCP080502	\$27.94
Countersunk Section, coarse (individual)	SCP016223	\$3.78
Half Section (individual)	SCP013935	\$1.84
2.5" Section, for center divider assemblies (individual)	SCP018792	\$7.96

Coarse sections (7 serrations per inch) are recommended for soybeans and alfalfa.

SCH Fine Cut Knife Sections

Description	Product ID	Price
Box of 25 Sections (wheat or grass only applications)	SCP110961	\$53.78
10-Pack Sections (includes hardware)	SCP080504	\$27.94
Countersunk Section, fine (individual)	SCP016222	\$3.78
Half Section (individual)	SCP013935	\$1.84
2.5" Section, for center divider assemblies (individual)	SCP018334	\$7.96

Fine sections (11 serrations per inch) are recommended for wheat and grasses.

REPLACEMENT SCH GUARDS



Short Guard



Long Guard

Short guards are recommended for flex grain platforms.

Long guards are recommended for rigid grain platforms and hay machines.

Length is measured from the tip of the guard to back of guard; overall length.

Description	Short 5-1/4" Long	Standard 5-3/4" Long	Long 6-1/8" Long	Price/ Each
12mm 2-point guard	SCP017744	---	SCP016500	\$26.97
12mm 2-point open top guard	SCP017750	---	SCP010701	\$45.35
12mm 2-point open top center guard	SCP018051	SCP016519	SCP010637	\$47.51
12mm 3-point guard	SCP019092	SCP016541	SCP016503	\$54.00
14mm 2-point guard	SCP017745	SCP016539	SCP016501	\$26.97
14mm 2-point open top guard	SCP017751	SCP016518	SCP010702	\$45.35
14mm 2-point open top center guard	SCP018052	SCP016520	SCP010638	\$47.51
14mm 3-point guard	SCP019093	SCP016542	SCP016504	\$54.00
17mm 2-point guard	SCP017746	---	SCP016502	\$26.97
17mm 2-point open top guard	SCP017752	SCP016470	SCP010703	\$45.35
17mm 2-point open top center guard	SCP018053	---	SCP010639	\$47.51
17mm 2-point head guard, for Case-IH 1020*	SCP019158	SCP017573	---	\$49.67
17mm 3-point guard	SCP019094	SCP016543	SCP016505	\$54.00

*For most other models an open top guard can be used instead of a head guard.

Identify Your Guard

Mark	Guard Type	Guard Color
2	12mm Guard	Black
4	14mm Guard	Red
7	17mm Guard	Gray



Check for Guard Wear

Use only genuine SCH replacement parts to reduce costly downtime. Worn cutting parts not only decrease cutting speeds, but also cause crop losses, use more power and fuel, increase wear and tear and cause extra downtime.

Guard wear. Check the gap.

Guards should be checked regularly for wear. A new guard has a gap of 0.15 – 0.17 inches (3.8 – 4.2 mm).

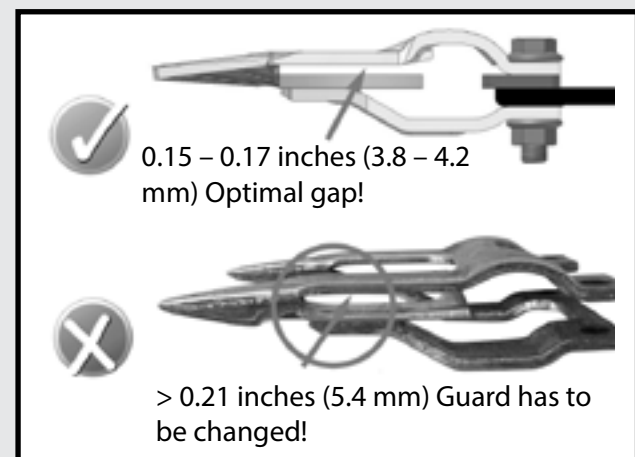

Wear with over 0.21 inches (5.4 mm) causes floating of the knife in the cutting gap. The rounded cutting edges will cause increased power requirements to drive the knife.

SCH EASYCUT II REPLACEMENT PARTS

REPLACEMENT SCH ROLLER GUIDES

SCH roller guides offer a high performance alternative to the standard wear plates that are used on many machines in the market today.

Almost all SCH Easy Cut systems can be updated with roller guides.



Top Roller - #SCP019035



Bottom Roller - #SCP019036

SCH Roller Guides		
Product ID	Description	Price
SCP019035	SCH top roller guide, bolts on top of guard and edge of roller rides on top of section.	\$22.50
SCP019036	SCH bottom roller guide, bolts on top of guard and edge of roller rides on bottom of section.	\$22.50

SCH Spacer Plates



SCH Spacer Plates, Used with Roller Guides		
Product ID	Description	Price
SCP015810	4mm, 2-hole, used with roller guide (brown)	\$1.48
SCP015811	4mm, 3-hole, used with roller guide (brown)	\$1.81
SCP015813	5mm, 2-hole, used with roller guide (blue)	\$1.61
SCP015814	5mm, 3-hole, used with roller guide (blue)	\$2.08
SCP015816	6mm, 2-hole, used with roller guide (black)	\$1.78
SCP015817	6mm, 3-hole, used with roller guide (black)	\$2.23
SCP083789	8mm, 2-hole used with roller guide (black)	\$3.69
SCP083790	8mm, 3-hole used with roller guide (black)	\$6.48

Note: Number stamped on top of spacer plate indicates thickness in millimeters. Color also indicates thickness. See above.

SCH Wear Plates



SCH Wear Plates		
Product ID	Description	Price
SCP017011	4mm, 2-hole, (brown)	\$3.08
SCP017014	4mm, 3-hole, (brown)	\$4.29
SCP010741	4mm, 4-hole, (brown)	\$4.15
SCP017012	5mm, 2-hole, (blue)	\$3.61
SCP017015	5mm, 3-hole, (blue)	\$4.82
SCP010742	5mm, 4-hole, (blue)	\$4.82
SCP017013	6mm, 2-hole, (black)	\$4.96
SCP017016	6mm, 3-hole, (black)	\$5.63
SCP010743	6mm, 4-hole, (black)	\$5.63
SCP010753	5mm, 4-hole, double sided, (blue)	\$7.43

Note: Number stamped on top of wear plate indicates thickness in millimeters. Color also indicates thickness. See above.

SCH Guard Hardware



SCH Guard Hardware		
Product ID	Description	Price
HDW220029	Carriage bolt, 10-1.5mm x 35mm	\$0.40
HDW220002	Carriage bolt, 10-1.5mm x 40mm	\$0.45
HDW220015	Carriage bolt, 10-1.5mm x 45mm	\$0.50
HDW220016	Carriage bolt, 10-1.5mm x 50mm	\$0.55
HDW220027	Carriage bolt, 10-1.5mm x 55mm	\$0.65
HDW220034	Carriage bolt, 10-1.5mm x 60mm	\$0.70
SCP080549	Carriage bolt, 10-1.5mm x 45mm, for use with SCH skid plate	\$1.21
SCP080550	Carriage bolt, 10-1.5mm x 55mm, for use with SCH skid plate	\$1.42
SCP080560	Carriage bolt, 10-1.5mm x 45mm, AGCO 5300, 5400	\$2.75
SCP080561	Carriage bolt, 10-1.5mm x 60mm, AGCO 5300, 5400	\$2.92
HDW210221	Hex Head, 10-1.5mm x 40mm	\$0.36
HDW210222	Hex Head, 10-1.5mm x 45mm	\$0.46
HDW210223	Hex Head, 10-1.5mm x 50mm	\$0.52
HDW210225	Hex Head, 10-1.5mm x 60mm	\$0.56
HDW210224	Hex Head, 10-1.5mm x 70mm	\$0.66
HDW220003	Nut, flange, 10-1.5mm	\$0.14



SCH Multi-Tool: Call 800-368-7773 to receive a free SCH multi-tool to check your SCH guards.

SCH EASYCUT II REPLACEMENT PARTS

SCH Knife Hardware

SCH Knife Hardware		
Product ID	Description	Price
SCP010931	Bolt, 6mm x 16mm, for section	\$0.26
SCP010067	Bolt, 6mm x 18mm, for knifehead & connector	\$0.23
SCP083610	Bolt, 6mm x 20mm, for knifehead	\$0.31
SCP010071	Bolt, 6mm x 25mm, for knifehead & overlap strap	\$0.43
SCP010072	Bolt, 6mm x 28mm, for knifeheads with top strap	\$0.24
SCP010045	Bolt, countersunk, 6mm x 16mm	\$0.27
SCP013961	Nut, flange, 6mm	\$0.11
SCP010937	Insert, for connector kit	\$0.81
SCP010941	Insert, for knifehead	\$0.44

SCH Knifehead Hardware Pack



SCP083601
SCH Knifehead
Hardware Pack



SCP083784
SCH Knifehead
Hardware Pack



SCP083889
SCH Knifehead
Hardware Pack

SCH Knifehead Hardware Packs

Product ID	Description	Price
SCP083601	Knifeheads with top strap	\$5.53
SCP083784	Knifeheads without top strap	\$5.53
SCP083731	AGCO 5300, 5400, 8200, 9250, 9255, 9300 knifeheads	\$5.53
SCP083730	Claas Maxflex knifeheads	\$5.53
SCP083889	John Deere 600F auger platform knifeheads	\$5.53

SCH Skid Plates



SCP082817
Skid Plate



SCH Skid Plates

Product ID	Description	Price
SCP082817	Skid Plate, fits model year 2006 and after, MacDon 973, 974, FD60, FD70, FD75, D60; Case-IH 2052, 2062, 2152, 2162; Required when installing SCH EasyCut on these headers.	\$18.76
SCP080549	Carriage bolt, 10-1.5mm x 45mm, SCH skid plate	\$1.31
SCP080550	Carriage bolt, 10-1.5mm x 55mm, for use with SCH skid plate	\$1.42
HDW220003	Nut, flange, 10-1.5mm, SCH skid plate	\$0.15

SCH Knifehead Hardware

SCH Knifehead Hardware		
Product ID	Description	Price
SCP010941	Insert, for knifehead	\$0.44
SCP010050	Nut, 16mm for ball joint knifeheads	\$3.39
SCP010660	Washer, for ball joint knifeheads	\$2.29
SCP083613	Bottom strap for H/C 2-piece head	\$60.48
SCP083611	Screw, 1/4" x 1" flat head, for H/C 2 piece head	\$0.44
SCP083612	Nut, 1/4"-20 center lock, for H/C 2 piece head	\$0.15

SCH Double Drive Parts



SCP013665 Three-Section Overlap Strap



SCP013666 Two-Section Overlap Strap

SCH Double Drive Parts

Product ID	Description	Price
SCP013666	Overlap strap, 2 sections	\$24.48
SCP013665	Overlap strap, 3 sections	\$24.48
SCP016222	Section, countersunk, fine	\$3.78
SCP016223	Section, countersunk, coarse	\$3.78
SCP016004	Overlap roller	\$36.58
SCP010662	Spacer bushing, overlap roller, 2 required	\$2.01
SCP010045	Bolt, countersunk, 6mm x 16mm	\$0.27
SCP010071	Bolt, 6mm x 25mm, for overlap strap	\$0.43
SCP013961	Nut, flange, 6mm	\$0.11
SCP083893	Center Divider	32.38

SCH Knife Connector Kits

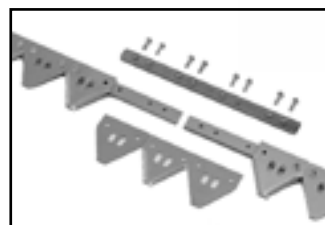



















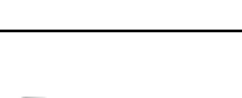







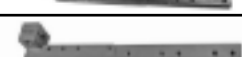







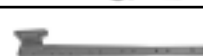

SCP083607
SCH Knife
Connector Kit

SCH Knife Connector Kits & Knifeback

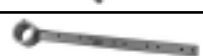

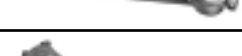







Product ID	Description	Price
SCP083607	Connector bar, includes two extra bolts & inserts	\$28.95
SCP080000	Connector bar with three sections, includes two extra bolts & inserts	\$32.70
SCP010067	Bolt, 6mm x 18mm, for knifehead & connector	\$0.23
SCP010937	Insert, for connector kit	\$0.81
N/A	SCH knifeback (without sections); average cost per foot	\$8.56

SCH EASYCUT II KNIFEHEADS



HARVESTING

AGCO				Case-IH Continued			
Product ID	Description	Price		Product ID	Description	Price	
SCP002584	AGCO 8200, 9250, LH	\$168.66		SCP083792	Case-IH, 2020, double drive early style, LH	\$148.23	
SCP002585	AGCO 9250, RH	\$168.66		SCP083793	Case-IH, 2020, double drive early style, double drive, RH	\$148.23	
SCP081363	AGCO, 5100, 5200 draper, LH	\$186.48		SCP014266	Case-IH, 1010, 1020, LH	\$205.47	
SCP013997	AGCO, 300 series flex, late model, LH; 400 series rigid, LH; 500, 800, 8000 series flex; 7/8" tie rod style, LH Note: Replaces OEM knifeheads with adjustable register	\$161.40		SCP011226	Case-IH, 820, LH	\$152.02	
SCP011222	AGCO, 300 series flex, late model, LH; 400 series rigid, LH; 500, 800, 8000 series flex; 3/4" tie rod style, LH; Note: Replaces OEM knifeheads with adjustable register	\$161.40		SCP011227	Case-IH, 810, 5" from center of knifehead bearing to center of first full section, LH	\$152.02	
SCP011195	AGCO, 300 series flex, early model bushing style, 300 & 700 rigid, LH	\$154.15		SCP011252	Case-IH, 810, 4-1/4" from center of knifehead bearing to center of first full section, LH	\$153.96	
SCP011252	AGCO, Hart Carter Series 2 floating cutter bar, LH	\$153.96		SCP011185	Case-IH, 230, 1190, 4000, 5000, LH	\$203.74	
SCP011279	AGCO, Hiniker floating cutter bar, LH	\$247.98		SCP011259	Case-IH, 990, LH	\$152.02	
SCP011266	AGCO, crank arm style, rigid, LH	\$155.24		SCP011186	Case-IH, 1490, 1590, LH	\$204.31	
Case-IH				Caterpillar			
Product ID	Description	Price		Product ID	Description	Price	
SCP002401	Case-IH, 3020, LH	\$346.63		SCP016326	Caterpillar, flex head, LH	\$265.27	
SCP002896	Case-IH, 3020, double drive, RH	\$346.63		Claas			
SCP181379	Case-IH, 2142, 2152, 2162, all, 5 degree, LH, w/ bearing	\$195.00		Product ID	Description	Price	
SCP181380	Case-IH, 2142, 2152, 2162, all, 5 degree, RH, w/ bearing	\$195.00		SCP016326	Claas, 8450, 8460, 20' and more, bearing not included, LH	\$265.27	
SCP113667	Case-IH, 2142, 2152, 2162, 25' & shorter, 0 degree, LH, w/ bearing	\$156.56		SCP015949	Claas, bearing for SCP016326 knifehead	\$186.23	
SCP113668	Case-IH, 2142, 2152, 2162, 25' & shorter, 0 degree, RH, w/ bearing	\$156.56		SCP011125	Claas 642, 8450, 8460, S450, 15' and less, bearing not included, LH	\$189.47	
SCP181373	Case-IH, 2052, 2062, 10 degree, LH, w/ bearing	\$195.00		SCP011127	Claas, bearing for SCP011125 knifehead	\$169.38	
SCP181381	Case-IH, 2052, 2062, 10 degree, RH, w/ bearing	\$195.00		SCP011252	Claas, Hart Carter Series 2 floating cutter bar, LH	\$153.96	
SCP083815	Case-IH, 2020, S/N CBJ021301 and after, all "Y9ZL", LH	\$154.89		Gehl			
SCP083816	Case-IH, 2020, S/N CBJ021301 and after, all "Y9ZL", double drive, RH	\$154.89		Product ID	Description	Price	
SCP011213	Case-IH, 2020, S/N all "HAJ" & up to CBJ021301, LH	\$130.18		SCP083618	Gehl, 1070, 1090, LH	\$129.69	
SCP011214	Case-IH, 2020, S/N all "HAJ" & up to CBJ021301, double drive, RH	\$130.18		SCP011229	Gehl, 2230, 2650, 2850, LH	\$143.87	
				SCH Hardware Kits for Knifeheads			
				Product ID	Description	Price	
				SCP083601	Parts package, for knifeheads with top strap	\$5.53	
				SCP083784	Parts package, for knifeheads without top strap	\$5.53	









Hesston

Product ID	Description	Price	
SCP113668	Hesston, 9300, lap double drive, RH, w/ bearing	\$156.56	
SCP081363	Hesston, 5100, 5200 draper, LH	\$186.48	
SCP014534	Hesston, 500, 520, 1070, 1071, 1085, 1090, 1091, 1095, 1110, 1150, 6450, 6455, 6465, 6550, 6655, 6665, LH	\$118.11	
SCP014535	Hesston, 1014+2, 6450, 6455, 6550, 6655, 6665, double drive, RH	\$118.11	
SCP083616	Hesston, 1170, 1275, 1160, 8400, 8450, 8840, 8870, 9125 LH	\$206.05	
SCP083617	Hesston, 1170, 1275, 8400, 8450, 8840, 8870, 9125, double drive, RH	\$206.05	
SCP011229	Hesston, 320, 420, 1014, 1260, 1265, 6400, 6600, 6610, LH	\$143.87	
SCP011258	Hesston, 600, 1010, PT-7, PT-10, LH	\$124.46	
SCP015474	Hesston, 1120, 1160, 8100, 8200, 8400, LH	\$126.48	
SCP015475	Hesston, 1120, 1160, 8100, 8200, 8400, double drive, RH	\$126.48	







Honey Bee

Product ID	Description	Price	
SCP014226	Honey Bee, model year 2002-2010, LH	\$188.25	
SCP014227	Honey Bee, model year 2002-2010, double drive, RH	\$188.25	



John Deere

Product ID	Description	Price	
SCP103187	John Deere 600FD, 700FD hydraflex draper, LH	\$217.89	
SCP103188	John Deere 600FD, 700FD hydraflex draper, double drive, RH	\$217.89	
SCP002557	John Deere 600F Auger Platform, Cast top mount, requires 2 open top guards	\$138.26	
SCP015421	John Deere, 600F Auger Platform, Steel bottom mount with top strap, Requires 1 open top guard	\$198.57	
SCP081352	John Deere, 900 series draper, LH	\$224.07	
SCP011207	John Deere, 200 & 900 series flex & rigid, LH	\$198.57	
SCP011121	John Deere, crank arm style, rigid, bearing not included, LH	\$112.09	
SCP011122	John Deere, bearing for SCP011121 knifehead	\$227.05	
SCP011196	John Deere, 130, 300, 1207, 1209, 1219, 1380, 1424, bushing style (serial #285000-), LH	\$145.69	





John Deere Continued

Product ID	Description	Price	
SCP011197	John Deere, 300 double drives, bushing style (serial #285000-), double drive, RH	\$145.69	
SCP115427	John Deere, 130, 160, 230, 300, 710, 720, 820, 890, 895, 1207, 1209, 1219, 1380, 1424, 1600, 2280, 2320, 2420, needle bearing style, LH, w/ bearing	\$151.83	
SCP181378	John Deere, 300, 890, 895, 1600 double drives, needle bearing style, double drive, RH, w/ bearing	\$195.00	
SCP011220	John Deere, 78, 220, 230, 485, 710, 800, 830, 880, 1207, 1209, 2250, 2270, ball joint style (serial # -285000), LH	\$198.57	
SCP083663	John Deere, 50, 250, 350, 450, 3700, bearing style, LH	\$129.69	
SCP083662	John Deere, 50, 250, 350, 450, bushing style, LH	\$129.69	
SCP115428	John Deere 2360, LH, w/ bearing	\$151.83	

Lexion

Product ID	Description	Price	
SCP002413	Lexion, F535, F540, LH	\$357.05	
SCP002412	Lexion, F535, F540, double drive, RH	\$357.05	
SCP016326	Lexion, F30, F530, LH	\$265.27	

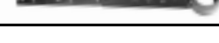













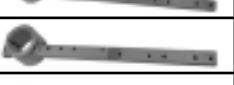

MacDon

Product ID	Description	Price	
SCP181379	MacDon, D50, D60, D65, FD70, 30' & longer; D130, D135, D140, D145, FD75 FD130, FD135, FD140, FD145, all/ LH, w/ bearing	\$195.00	
SCP181380	MacDon, D50, D60, D65, FD70, 30' & longer; D130, D135, D140, D145, FD75 FD130, FD135, FD140, FD145, all/ RH, w/ bearing	\$195.00	
SCP181373	MacDon, 973, 974, 10 degree, LH, w/ bearing	\$195.00	
SCP181381	MacDon, 973, 974, 10 degree, RH, w/ bearing	\$195.00	
SCP113667	MacDon, 972, all; D50, D60, D65, FD70, 25' & shorter / LH, w/ bearing	\$156.56	
SCP113668	MacDon, 972, all; D50, D60, D65, FD70, 25' & shorter /RH, w/bearing	\$156.56	
SCP115428	MacDon, 910, 920 lap double drive, 942, 960, 973, 7000, LH, w/ bearing	\$151.83	
SCP181351	MacDon, 920 lap double drive, 942 double drive, RH, w/ bearing	\$189.36	
SCP115427	MacDon, 920, LH, w/ bearing	\$151.83	
SCP181378	MacDon, 920, double drive, RH, w/ bearing	\$195.00	
SCP183669	MacDon, 4000, LH, w/ bearing	\$254.89	



SCH EASYCUT II KNIFEHEADS

HARVESTING





Massey-Ferguson			
Product ID	Description	Price	
SCP002584	Massey-Ferguson 8200, 9250, LH	\$168.66	
SCP002585	Massey-Ferguson 9250, RH	\$168.66	
SCP013997	Massey-Ferguson, 7000, 9850, LH	\$161.40	
SCP011255	Massey-Ferguson, 8560, 8920, 9300, 9520, 9750, Rotary, LH	\$172.46	
SCP016326	Massey-Ferguson, 8450, 8460, 20' and more, bearing not included, LH	\$265.27	
SCP015949	Massey-Ferguson, bearing for SCP016326 knifehead	\$186.23	
SCP011125	Massey-Ferguson, 642, 8450, 8460, S450, 15' and less, bearing not included, LH	\$189.47	
SCP011127	Massey-Ferguson, bearing for SCP011125 knifehead	\$169.38	
SCP011211	Massey-Ferguson, Hart Carter & Hiniker floating cutter bar, knifehead bushing at 0-degree angle, LH Note: For replacement only. New kits will reuse the OEM knifehead.	\$209.17	
SCP011212	Massey-Ferguson, Hart Carter & Hiniker floating cutter bar, knifehead bushing at 5-degree angle, LH Note: For replacement only. New kits will reuse the OEM knifehead.	\$209.17	
SCP011263	Massey-Ferguson, 725, 925, LH	\$152.01	
SCP011188	Massey-Ferguson, 655, 675, 775, 785, LH	\$115.23	
SCP115428	Massey-Ferguson, 885, LH, w/ bearing	\$151.83	
SCP081363	Massey-Ferguson, 220 windrower, LH	\$186.48	

New Holland Continued			
Product ID	Description	Price	
SCP011214	New Holland, 73C; 74C S/N all "HAJ" & up to PNL018301; 970, 971, 972, 973, double drive, RH	\$130.18	
SCP181373	New Holland, 84C, 10 degree, LH, w/ bearing	\$195.00	
SCP181381	New Holland, 84C, 10 degree, RH, w/ bearing	\$195.00	
SCP083815	New Holland, 74C S/N PNL018301 and after, double drives, LH	\$154.89	
SCP083816	New Holland, 74C S/N PNL018301 and after, double drive, RH	\$154.89	
SCP014226	New Holland 88C, model year 2002-2010, LH	\$188.25	
SCP014227	New Holland 88C, model year 2002-2010, double drive, RH	\$188.25	
SCP011191	New Holland, 474, 489, 492, 1465, LH	\$175.53	
SCP011192	New Holland, 472, 477, 478, 479, 488, LH	\$214.79	
SCP083678	New Holland, 114 windrower, LH	\$151.60	
SCP083679	New Holland, 114 windrower, double drive, RH	\$151.60	
SCP011276	New Holland, 116, 910, 912, 1100, 1112, 1114, 1116, 1118, LH	\$115.23	
SCP011277	New Holland, 116, 910, 912, 1112, 1114, 1116, 1118, double drive, RH	\$115.23	
SCP011219	New Holland, 461, 467, 469, 490, LH	\$232.03	
SCP011224	New Holland, 495, 1495, LH	\$130.18	
SCP083614	New Holland, 1475, 2216, 2300, 2326, 2450, 2550, H7150, LH	\$206.05	
SCP083615	New Holland, 1475, 2216, 2300, 2326, 2450, 2550, H7150, double drive, RH	\$206.05	

Owatonna

Product ID	Description	Price	
SCP011280	Owatonna, 200, 206, 217, 235, 260, 265, 270, 275, 285, 7/8-18 threads per inch, LH	\$143.87	
SCP011281	Owatonna, 260, 280, 7/8-14 threads per inch, LH	\$143.87	

Versatile

Product ID	Description	Price	
SCP083677	Versatile, 4030, LH	\$129.69	
SCP083680	Versatile, 4030, double drive, RH	\$129.69	
SCP011193	Versatile, 10, 400, 3-1/2" from center of knifehead bearing to center of first full section, LH	\$115.23	
SCP011217	Versatile, 400, 4400, 3" from center of knifehead bearing to center of first full section, LH	\$115.23	

Mfg.	Type	Model Description	Guard	Wear Plate, Spacer	Lefthand Knifehead	Righthand Knifehead	Mfg.	Type	Model Description	Guard	Wear Plate, Spacer	Lefthand Knifehead	Righthand Knifehead
AGCO	Draper	9250	12mm	6mm	SCP002584	SCP002585	Case-IH	Flex	2020, S/N CBJ021301 and after	14mm	6mm	SCP083815	SCP083816
AGCO	Flex	300 Series, Early Style	12mm	6mm	SCP011195		Case-IH	Flex	3020	17mm	6mm	SCP002401	
AGCO	Flex	500, 800, 8000, 300 Series, 3/4" knifehead	12mm	6mm	SCP011222		Case-IH	Rigid	403 Hiniker	12mm	6mm	OEM	
AGCO	Flex	500, 800, 8000, 300 Series, 7/8" knifehead	12mm	6mm	SCP013997		Case-IH	Rigid	1010	14mm	5mm	SCP014266	
AGCO	Flex	7200, 8200	12mm	6mm	SCP002584		Case-IH	Windrower	201	17mm	6mm	OEM	
AGCO	Flex	Hart Carter, Pitman Drive (1pc head)	14mm	5mm	OEM		Case-IH	Windrower	230	14mm	5mm	SCP011185	
AGCO	Flex	Hart Carter, Pitman Drive (2pc head)	14mm	5mm	OEM		Case-IH	Windrower	275	14mm	5mm	OEM	
AGCO	Flex	Hart Carter, Series 2	14mm	5mm	SCP011252		Case-IH	Windrower	375	14mm	5mm	OEM	
AGCO	Rigid	300, 700 Series, Rigid	12mm	6mm	SCP011195		Case-IH	Windrower	721	17mm	5mm	OEM	
AGCO	Windrower	5100, 5200	12mm	6mm	SCP081363		Case-IH	Windrower	725	17mm	5mm	OEM	
Case-IH	Mower	#9, 7/16" BB	17mm	6mm	OEM		Case-IH	Windrower	1275	14mm	5mm	SCP011229	
Case-IH	Mower	#9, 1/2" BB	17mm	5mm	OEM		Case-IH	Windrower	5000, 7/16" BB	17mm	6mm	SCP011185	
Case-IH	Mower	#31	17mm	4mm	OEM		Case-IH	Windrower	5000, 1/2" BB	17mm	5mm	SCP011185	
Case-IH	Mower	1100, 100, 7/16" BB	17mm	6mm	OEM		Case-IH	Windrower	6000	17mm	6mm	SCP015428	
Case-IH	Mower	1100, 100, 1/2" BB	17mm	5mm	OEM		Case-IH	Windrower	8220	14mm	5mm	SCP015474	
Case-IH	Mower	1200	17mm	6mm	OEM		Case-IH	Windrower	8340	14mm	5mm	SCP015474	
Case-IH	Mower	1300	17mm	6mm	OEM		Case-IH	Windrower	8360, 7/16" BB	17mm	6mm	SCP015474	
Case-IH	Mo-Co	990	14mm	5mm	SCP011259		Case-IH	Windrower	8370, 8830, 3/8" BB	14mm	5mm	SCP015474	
Case-IH	Mo-Co	1190	17mm	6mm	SCP011185		Case-IH	Windrower	8370, 8830, 7/16" BB	17mm	6mm	SCP015474	
Case-IH	Mo-Co	1490, 1590	17mm	6mm	SCP011186		Case-IH	Windrower	8380, 8840, 8870, 7/16" BB	17mm	6mm	SCP083616	SCP083617
Case-IH	Mo-Co	8330	17mm	6mm	SCP015474		Case-IH	Windrower	8820	17mm	6mm	SCP015474	SCP015475
Case-IH	Mo-Co	SC414	17mm	6mm	SCP015474		Case-IH	Windrower	HDX162	14mm	5mm	SCP083614	SCP083615
Case-IH	Draper	2042, 2052, 2062 Flex, SCH skid plates required	14mm	5mm	SCP081373		Caterpillar	Flex	Caterpillar, 3/8" BB	14mm	5mm	SCP016326	
Case-IH	Draper	2142, 2152, 2162 Rigid, SCH skid plates required	14mm	5mm	SCP081379	SCP081380	Caterpillar	Flex	Caterpillar, 5/16" BB	12mm	5mm	SCP016326	
Case-IH	Draper	4000	14mm	6mm	SCP011185		Caterpillar	Flex	Caterpillar, 1/2" BB	17mm	5mm	SCP016326	
Case-IH	Flex	503	14mm	5mm	OEM		Claas	Windrower	5450	12mm	6mm	SCP011125	
Case-IH	Flex	810 (4-1/4" center of first section)	14mm	5mm	SCP011252		Ford	Mower	501	17mm	6mm	OEM	
Case-IH	Flex	810 (5" center of first section)	14mm	5mm	SCP011227		Ford	Mower	505	17mm	6mm	OEM	
Case-IH	Flex	810 Hiniker	12mm	6mm	SCP011227		Ford	Mower	515	17mm	6mm	OEM	
Case-IH	Flex	810 Pitman Drive	14mm	5mm	OEM		Ford	Mower	642	12mm	6mm	OEM	
Case-IH	Flex	820	17mm	6mm	SCP011226		Frontier	Mower	1477	17mm	6mm	OEM	
Case-IH	Flex	1020	17mm	5mm	SCP014266		Gehl	Mo-Co	1070	17mm	6mm	SCP083618	
Case-IH	Flex	2020, early style	14mm	5mm	SCP083792	SCP083793	Gehl	Mo-Co	1090	17mm	6mm	SCP083618	
Case-IH	Flex	2020, S/N all "HAJ" & up to CBJ021301	14mm	5mm	SCP011213	SCP011214	Gehl	Mo-Co	1216 Hydra Swing	14mm	5mm	SCP013667	
							Gehl	Mo-Co	2130	12mm	6mm	SCP014534	
							Gehl	Mo-Co	2160, 1/4" BB	12mm	6mm	SCP014534	
							Gehl	Mo-Co	2160, 7/16" BB	17mm	6mm	SCP014534	
							Gehl	Mo-Co	2170	12mm	6mm	SCP011280	
							Gehl	Mo-Co	2270	12mm	6mm	SCP011280	
							Gehl	Mo-Co	2650	12mm	6mm	SCP011229	

The SCH EasyCut II Kits pages are a list of the most common machines that can be converted to the SCH EasyCut II cutter bar system. This may also be helpful in determining which parts to order for certain machines.

If your machine is not listed, this does not mean that we do not fit that machine. Please call for assistance.

SCH EASYCUT II KITS

Mfg.	Type	Model Description	Guard	Wear Plate, Spacer	Left-hand Knifehead	Right-hand Knifehead	Mfg.	Type	Model Description	Guard	Wear Plate, Spacer	Left-hand Knifehead	Right-hand Knifehead
Gehl	Mo-Co	2850	12mm	6mm	SCP011229		Hesston	Windrower	9300	14mm	5mm	SCP013667	SCP013668
Gehl	Mo-Co	HK108	12mm	6mm	OEM		Honey Bee	Draper	Draper	12mm	6mm	SCP014226	
Gehl	Windrower	2230	17mm	5mm	SCP011229		Honey Bee	Draper	Draper, 8mm wear plates	12mm	8mm	SCP014226	
Gehl	Windrower	2240	12mm	6mm	SCP011280		Honey Bee	Flex	3/16" BB, 8mm wear plates	12mm	8mm	SCP014226	SCP014227
Hesston	Mo-Co	1010	12mm	6mm	SCP011258		Honey Bee	Flex	1/4" BB	12mm	6mm	SCP014226	SCP014227
Hesston	Mo-Co	1070, 1071, 3/8" BB	14mm	5mm	SCP014534		Honey Bee	Flex	Series 3	12mm	6mm	OEM	
Hesston	Mo-Co	1070, 1071, 1/2" BB	17mm	5mm	SCP014534		John Deere	Mower	#5, 3/8" BB	14mm	5mm	OEM	
Hesston	Mo-Co	1085, 1090, 1091, 1095	14mm	5mm	SCP014534		John Deere	Mower	#5, 7/16" BB	17mm	6mm	OEM	
Hesston	Mo-Co	1110	17mm	5mm	SCP014534		John Deere	Mower	#8, #38, #39	14mm	5mm	OEM	
Hesston	Mo-Co	1120	17mm	6mm	SCP015474		John Deere	Mower	#8W	14mm	5mm	OEM	
Hesston	Mo-Co	1150	14mm	5mm	SCP014534		John Deere	Mower	#9	17mm	5mm	OEM	
Hesston	Mo-Co	1160, 8200, 1/4" BB	12mm	6mm	SCP015474		John Deere	Mower	#10	17mm	6mm	OEM	
Hesston	Mo-Co	1160, 8200, 7/16" BB	17mm	6mm	SCP015474		John Deere	Mower	#11	14mm	5mm	OEM	
Hesston	Mo-Co	1170	14mm	5mm	SCP083616	SCP083617	John Deere	Mower	#37	17mm	6mm	OEM	
Hesston	Mo-Co	1260, 7/16" BB	17mm	6mm	SCP011229		John Deere	Mower	50 (Bushing Knifehead)	17mm	6mm	SCP083662	
Hesston	Mo-Co	1265 Hydra Swing	17mm	6mm	SCP011229		John Deere	Mower	250, 350, 450, 3700 (Bearing Knifehead)	14mm	4mm	SCP083663	
Hesston	Mo-Co	1275	17mm	6mm	SCP083616	SCP083617	John Deere	Mower	250, 350, 450 (Bushing Knifehead)	14mm	4mm	SCP083662	
Hesston	Mo-Co	1660, 1/4" BB	12mm	6mm	SCP083616		John Deere	Mo-Co	485 (Ball Joint Knifehead)	14mm	5mm	SCP011220	
Hesston	Mo-Co	PT 10	14mm	5mm	SCP011258		John Deere	Mo-Co	710	17mm	5mm	SCP011220	
Hesston	Windrower	320	17mm	6mm	SCP011229		John Deere	Mo-Co	720 (Ball Joint Knifehead)	17mm	5mm	SCP011220	
Hesston	Windrower	420	17mm	6mm	SCP011229		John Deere	Mo-Co	720, 820, 7/16" BB	17mm	6mm	SCP015427	
Hesston	Windrower	500, 1/2" BB	17mm	5mm	SCP014534		John Deere	Mo-Co	720, 820, 1/2" BB	17mm	5mm	SCP015427	
Hesston	Windrower	520, 7/16" BB	17mm	6mm	SCP014534		John Deere	Mo-Co	820, 1/2" BB (Ball Joint Knifehead)	17mm	5mm	SCP011220	
Hesston	Windrower	600	14mm	5mm	SCP011258		John Deere	Mo-Co	1207, 1209, 1219 (Ball Joint Knifehead)	14mm	5mm	SCP011220	
Hesston	Windrower	1014 Hydra Swing	14mm	5mm	SCP011229		John Deere	Mo-Co	1207, 1209, 1219 (Bearing Knifehead)	14mm	5mm	SCP015427	
Hesston	Windrower	2262, 1/2" BB	17mm	5mm	SCP014534	SCP014535	John Deere	Mo-Co	1207, 1209, 1219 (Bushing Knifehead)	14mm	5mm	SCP011196	
Hesston	Windrower	5100, 5200	12mm	6mm	SCP081363		John Deere	Mo-Co	1380, 1424 (K10)	14mm	5mm	SCP011196	
Hesston	Windrower	6400, 6600, 5/16" BB	12mm	5mm	SCP011229		John Deere	Mo-Co	1380, 1424 (K42)	14mm	5mm	SCP015427	
Hesston	Windrower	6400, 6600, 3/8" BB	14mm	5mm	SCP011229		John Deere	Mo-Co	1600 (Bearing Knifehead)	14mm	5mm	SCP015427	SCP081378
Hesston	Windrower	6400, 6600, 7/16" BB	17mm	5mm	SCP011229		John Deere	Draper	78	14mm	5mm	SCP011220	
Hesston	Windrower	6450, 6465	17mm	6mm	SCP014534	SCP014535	John Deere	Draper	160	14mm	5mm	SCP015427	
Hesston	Windrower	6455	14mm	5mm	SCP014534	SCP014535	John Deere	Draper	130, 3/8" BB	14mm	5mm	SCP011196	
Hesston	Windrower	6550	17mm	5mm	SCP014534	SCP014535	John Deere	Draper	130, 7/16" BB	17mm	6mm	SCP011196	
Hesston	Windrower	6600, 6610, 3/8" BB	14mm	5mm	SCP011229		John Deere	Auger	220, 230 (Ball Joint Knifehead)	14mm	5mm	SCP011220	
Hesston	Windrower	6600, 7/16" BB	17mm	6mm	SCP011229		John Deere	Auger	230, 240 (Needle Bearing)	14mm	5mm	SCP015427	
Hesston	Windrower	6655, 6665	14mm	5mm	SCP014534	SCP014535							
Hesston	Windrower	8100	17mm	5mm	SCP015474	SCP015475							
Hesston	Windrower	8400, 9125, 3/8" BB	14mm	5mm	SCP083616	SCP083617							
Hesston	Windrower	8400, 9125, 7/16" BB	17mm	6mm	SCP083616	SCP083617							
Hesston	Windrower	8450, 3/8" BB	14mm	5mm	SCP083616	SCP083617							
Hesston	Windrower	8450, 8840, 8870, 7/16" BB	17mm	6mm	SCP083616								

If your machine is not listed, this does not mean that we do not fit that machine. Please call for assistance.

Mfg.	Type	Model Description	Guard	Wear Plate, Spacer	Lefthand Knifehead	Righthand Knifehead	Mfg.	Type	Model Description	Guard	Wear Plate, Spacer	Lefthand Knifehead	Righthand Knifehead
John Deere	Draper	930, 936	12mm	6mm	SCP081352		M/F	Draper	885	14mm	5mm	SCP015428	
John Deere	Flex	200 Series	12mm	6mm	SCP011207		M/F	Draper	9250	12mm	6mm	SCP002584	SCP002585
John Deere	Flex	600F Series HydraFlex	12mm	6mm	SCP015421		M/F	Flex	1859, 9100 Series; Hart Carter	14mm	5mm	OEM	
John Deere	Draper	600FD; 700FD HydraFlex Draper	12mm	5mm	SCP0103187	SCP103188	M/F	Flex	7200, 8200	12mm	6mm	OEM	
John Deere	Flex	900 Series	12mm	6mm	SCP011207		M/F	Flex	9224 Rotary	12mm	6mm	SCP011255	
John Deere	Flex	Hart Carter, Pitman Drive	14mm	5mm	OEM		M/F	Flex	9850 (AGCO Manufactured)	12mm	6mm	SCP013997	
John Deere	Rigid	55	12mm	6mm	SCP011207		M/F	Windrower	35	12mm	4mm	OEM	
John Deere	Rigid	55, Hart Carter, Pitman Drive	14mm	5mm	OEM		M/F	Windrower	200	12mm	6mm	OEM	
John Deere	Rigid	200 Series	12mm	6mm	SCP011207		M/F	Windrower	775	12mm	5mm	SCP011220	
John Deere	Rigid	900 Series	12mm	6mm	SCP011207		M/F	Windrower	785	12mm	5mm	SCP011188	
John Deere	Windrower	300 (Bushing Knifehead)	14mm	5mm	SCP011196	SCP011197	M/F	Windrower	3850	12mm	6mm	SCP011222	
John Deere	Windrower	300, 1380, 1424 (Bearing Knifehead)	14mm	5mm	SCP015427	SCP081378	M/F-Claas	Windrower	36, 44	12mm	6mm	OEM	
John Deere	Windrower	580, 1/4" BB	12mm	6mm	OEM		M/F-Claas	Flex	8450, 8460	12mm	6mm	SCP011125	
John Deere	Windrower	580, 5/16" BB	12mm	4mm	OEM		M/F-White	Flex	8560, 9520, 1/4" BB	12mm	6mm	SCP011255	
John Deere	Windrower	590, 3/8" BB	14mm	5mm	OEM		M/F-White	Flex	8560, 8920, 9300, 9330, 9520, 9750, 3/8" BB	14mm	5mm	SCP011255	
John Deere	Windrower	800, 2250, 2270, 3/8" BB	14mm	5mm	SCP011220		M/F-Claas	Rigid	8460	12mm	6mm	SCP011125	
John Deere	Windrower	800, 7/16" BB	17mm	6mm	SCP011220		MacDon	Mo-Co	4000	14mm	5mm	SCP083669	
John Deere	Windrower	800, 1/2" BB	17mm	5mm	SCP011220		MacDon	Mo-Co	A30-5	17mm	6mm	SCP081379	
John Deere	Windrower	830	14mm	5mm	SCP011220		MacDon	Auger	920	14mm	5mm	SCP015428	SCP081351
John Deere	Windrower	880	14mm	5mm	SCP011220		MacDon	Draper	942	14mm	5mm	SCP015428	SCP081351
John Deere	Windrower	890	17mm	5mm	SCP015427		MacDon	Draper	972	14mm	5mm	SCP013667	SCP013668
John Deere	Windrower	2250	14mm	5mm	SCP011220		MacDon	Draper	974 Flex, SCH skid plates required	14mm	5mm	SCP081373	
John Deere	Windrower	2270	14mm	5mm	SCP011220		MacDon	Draper	FD70 Flex, SCH skid plates required	14mm	5mm	SCP081379	SCP081380
John Deere	Windrower	2280	14mm	5mm	SCP011196		MacDon	Draper	FD75 Flex, SCH skid plates required	14mm	5mm	SCP081379	SCP081380
John Deere	Windrower	2320, 2420	14mm	5mm	SCP015427		MacDon	Draper	D60 Rigid, SCH skid plates required	14mm	5mm	SCP081379	SCP081380
John Deere	Windrower	2360	14mm	5mm	SCP015428		MacDon	Draper	D60 Rigid, SCH skid plates required	14mm	5mm	SCP081379	SCP081380
John Deere	Windrower	2420, 1/2" BB	17mm	6mm	SCP015427		MacDon	Flex	973, SCH skid plates required	14mm	5mm	SCP015428	
Kosch	Mower	4840	17mm	6mm	OEM		MacDon	Windrower	910	14mm	5mm	SCP015428	
Lexion	Flex	F30, F530	12mm	6mm	SCP016326		MacDon	Windrower	920	14mm	5mm	SCP015428	SCP081351
Lexion	Flex	F535, F540; 8mm plates	12mm	4mm	SCP002413	SCP002412	MacDon	Windrower	960	14mm	5mm	SCP015428	
Love	Flex	Love Bar	14mm	5mm	OEM		MacDon	Windrower	3000	14mm	5mm	OEM	
M/F	Mower	#41	17mm	6mm	OEM		MacDon	Windrower	5000, 5020	14mm	5mm	SCP013667	
M/F	Mower	#42	17mm	5mm	OEM		MacDon	Windrower	5010	17mm	5mm	SCP013667	
M/F	Mower	410	14mm	5mm	OEM		MacDon	Windrower	7000	14mm	5mm	SCP015428	
M/F	Mo-Co	81	17mm	6mm	OEM		Mccormick	Mower	Mower, 7/16" BB	17mm	6mm	OEM	
M/F	Mo-Co	725	14mm	5mm	SCP011263		New Holland	Mower	405	17mm	5mm	OEM	
M/F	Mo-Co	925	14mm	5mm	SCP011263		New Holland	Mower	450, 455, 1/4" BB	12mm	6mm	OEM	
M/F	Auger	1880	14mm	5mm	OEM		New Holland	Mower	450, 455, 3/8" BB	14mm	6mm	OEM	
M/F	Draper	220	12mm	6mm	OEM								
M/F	Draper	655, 675, 775, 785	12mm	4mm	SCP011188								

The SCH EasyCut II Kits pages are a list of the most common machines that can be converted to the SCH EasyCut II cutter bar system. This may also be helpful in determining which parts to order for certain machines.

SCH EASYCUT II KITS

Mfg.	Type	Model Description	Guard	Wear Plate, Spacer	Leffhand Knifehead	Righthand Knifehead	Mfg.	Type	Model Description	Guard	Wear Plate, Spacer	Leffhand Knifehead	Righthand Knifehead
New Holland	Mower	450, 455, 7/16" BB	17mm	6mm	OEM		New Idea	Mower	251, 254	17mm	6mm	OEM	
New Holland	Mower	451, 456, 1/4" BB	12mm	6mm	OEM		New Idea	Mower	252	14mm	5mm	OEM	
New Holland	Mower	451, 456, 3/8" BB	14mm	5mm	OEM		New Idea	Mower	522, 3/8" BB	14mm	5mm	OEM	
New Holland	Mower	451, 456, 7/16" BB	17mm	6mm	OEM		New Idea	Mower	522, 7/16" BB	17mm	6mm	OEM	
New Holland	Mower	451, 456, 1/2" BB	17mm	5mm	OEM		New Idea	Mower	522, 1/2" BB	17mm	5mm	OEM	
New Holland	Mo-Co	467	17mm	6mm	SCP011219		New Idea	Mo-Co	290	17mm	6mm	OEM	
New Holland	Mo-Co	461, 469, 7/16" BB	17mm	6mm	SCP011219		New Idea	Mo-Co	299	14mm	5mm	OEM	
New Holland	Mo-Co	472, 477, 478	17mm	6mm	SCP011192		New Idea	Mo-Co	509	14mm	5mm	SCP011186	
New Holland	Mo-Co	474, 3/8" BB	14mm	5mm	SCP011191		New Idea	Mo-Co	5107	17mm	6mm	OEM	
New Holland	Mo-Co	488, 479	17mm	6mm	SCP011192		New Idea	Mo-Co	5109	17mm	6mm	OEM	
New Holland	Mo-Co	489, 3/8" BB	14mm	5mm	SCP011191		New Idea	Mo-Co	5112	14mm	5mm	SCP011186	
New Holland	Mo-Co	489, 7/16" BB	17mm	6mm	SCP011191		New Idea	Mo-Co	5114	14mm	5mm	SCP011186	
New Holland	Mo-Co	490	17mm	6mm	SCP011219		New Idea	Flex	711	17mm	6mm	SCP011282	
New Holland	Mo-Co	492, 3/8" BB	14mm	5mm	SCP011191		New Idea	Flex	713, 813 Uni Harvester	12mm	6mm	OEM	
New Holland	Mo-Co	492, 7/16" BB	17mm	6mm	SCP011191		New Idea	Flex	715 Uni Harvester	12mm	6mm	OEM	
New Holland	Mo-Co	495, 1495	17mm	6mm	SCP011224		New Idea	Flex	7165	12mm	6mm	SCP011282	
New Holland	Mo-Co	880	14mm	5mm	OEM		New Idea	Flex	815	12mm	6mm	SCP011282	
New Holland	Mo-Co	1496	14mm	5mm	OEM	OEM	Oliver	Mower	82	17mm	5mm	OEM	
New Holland	Mo-Co	H7150	12mm	5mm	SCP083614	SCP083615	Oliver	Flex	525	14mm	5mm	OEM	
New Holland	Flex	73C	14mm	5mm	SCP011213	SCP011214	Oliver	Flex	7600	14mm	5mm	OEM	
New Holland	Flex	74C, 5/N all HAJ & up to PNL018301	14mm	5mm	SCP011213	SCP011214	Owatonna	Mower	20, Pitman Drive	12mm	6mm	OEM	
New Holland	Flex	74C, 5/N PNL018301 and after	14mm	6mm	SCP083815	SCP083816	Owatonna	Mo-Co	200	12mm	6mm	SCP011280	
New Holland	Flex	740CF	17mm	6mm	SCP002401		Owatonna	Windrower	235	12mm	6mm	SCP011280	
New Holland	Draper	84C Flex	14mm	5mm	SCP081373		Owatonna	Windrower	260, 270, 280	12mm	6mm	SCP011280	
New Holland	Draper	88C Flex, 1/4" BB	12mm	6mm	SCP014226	SCO014227	Owatonna	Windrower	265, 275, 285	12mm	6mm	SCP011280	
New Holland	Flex	94C, 8mm Plates	12mm	8mm	SCP014226		Owatonna	Windrower	280	14mm	5mm	SCP015428	
New Holland	Flex	972	14mm	5mm	SCP011213	SCP011214	Owatonna	Windrower	280, 7/8"-18 Threaded Knifehead	12mm	6mm	SCP011281	
New Holland	Flex	973	14mm	5mm	SCP011213		Renn	Windrower	2000	12mm	6mm	SCP011220	
New Holland	Flex	9750 Rotary	14mm	5mm	SCP011255		Rowse	Mower	3/8" BB	14mm	5mm	OEM	
New Holland	Rigid	971	12mm	6mm	SCP011213		Rowse	Mower	7/16" BB	17mm	6mm	OEM	
New Holland	Windrower	114	14mm	5mm	SCP083678	SCP083679	Sickle Bar Mower	Mower	1/4" BB	12mm	6mm	OEM	
New Holland	Windrower	116, 1116	14mm	5mm	SCP011276	SCP011277	Sickle Bar Mower	Mower	5/16" BB	12mm	4mm	OEM	
New Holland	Windrower	499, 1469, 1499	14mm	5mm	OEM	OEM	Sickle Bar Mower	Mower	3/8" BB	14mm	5mm	OEM	
New Holland	Windrower	905	14mm	5mm	OEM		Sickle Bar Mower	Mower	7/16" BB	17mm	6mm	OEM	
New Holland	Windrower	910, 3/8" BB	14mm	5mm	SCP011276	SCP011277	Sickle Bar Mower	Mower	1/2" BB	17mm	5mm	OEM	
New Holland	Windrower	910, 7/16" BB	17mm	6mm	SCP011276		Sickle Bar Mower	Mower	17/32" BB	17mm	4mm	OEM	
New Holland	Windrower	912	14mm	5mm	SCP011276	SCP011277	Versatile	Windrower	#10	12mm	6mm	SCP011193	
New Holland	Windrower	1100	14mm	5mm	SCP011276		Versatile	Windrower	400, 3" C.O.F.S.	12mm	6mm	SCP011217	
New Holland	Windrower	1112	14mm	5mm	SCP011276	SCP011277	Versatile	Windrower	400, 3/1/2" C.O.F.S.	12mm	6mm	SCP011193	
New Holland	Windrower	1114	14mm	5mm	SCP011276	SCP011277	Versatile	Windrower	2800, 4018, 4020, 4022, 4025, 4750	12mm	6mm	OEM	OEM
New Holland	Windrower	1118	14mm	5mm	SCP011276	SCP011277	Versatile	Windrower	4030	12mm	6mm	SCP083677	SCP083680
New Holland	Windrower	1465, 3/8" BB	14mm	5mm	SCP011191		Versatile	Windrower	4400	12mm	6mm	SCP011217	
New Holland	Windrower	1475, 3/8" BB	14mm	5mm	SCP083614		Vicon	Windrower	722	12mm	6mm	SCP011188	
New Holland	Windrower	1475, 2450, 2550, 2300	14mm	5mm	SCP083614	SCP083615	White	Flex	Kwik Cut	14mm	5mm	OEM	
New Holland	Windrower	2216	14mm	5mm	SCP083614	SCP083615	White	Windrower	6200	12mm	6mm	SCP011188	
New Holland	Windrower	2326	14mm	5mm	SCP083614	SCP083615							
New Idea	Mower	#40	17mm	6mm	OEM								

PROBLEM: Most knife drives lose stroke length and force.

SOLUTION: The SCH Pro Drive's planetary gear system is in rotation at all times. This produces a 100% linear knife movement, compared with wobble boxes or other oscillating and pendulum drives.



SCH Vertical Belt Driven Pro-Drive

The design of the PRO-DRIVE ensures a 100% linear knife movement:

- Less wear on all components
- Less vibrations
- Low power demand

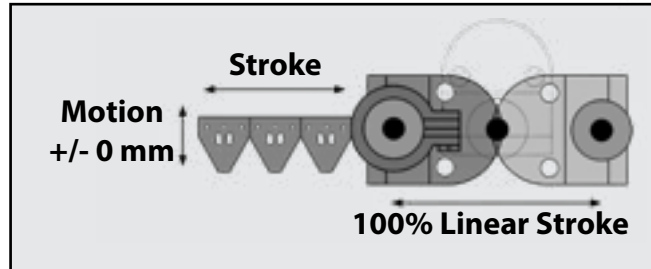

- Higher Cutting Speed
- High Output Forces Using Lower Torque
- Low Maintenance Uses grease lubrication instead of conventional oil bath

Higher Ground-Travel Cutting Speeds

Testimonial from Huron County, Michigan:

I bought a SCH ProDrive knife for my 1020 header this spring. Put 500 acres on it and couldn't be happier! Ground speed was faster by .5 mph to 1 mph, even with worn-out dull guards. I can't wait to see what it will do with brand new knives and guards next fall.



All SCH Pro-Drive Conversion Kits Include:

- SCH Pro-Drive, vertical, 85mm (3.3") stroke
- Drive pulley for SCH Pro-Drive
- Mounting bracket(s) for SCH Pro-Drive
- Knifehead
- Extra nylon ring for knifehead



Warranty: SCH Pro-Drives have a 1 year warranty on parts and labor from date in service.

Makes Changing Knives, Even in the Field, a Breeze

The SCH engineers have devised a brilliant method of attaching the knifehead to the drive that is a major advancement. Designed as a trapezoidal claw, the connection is easy and accurate. No bolts to line up, no bearings to adjust or shim, no fear that dirt might get into bearings, bushings, etc. **Makes changing knives even in the field a breeze.**

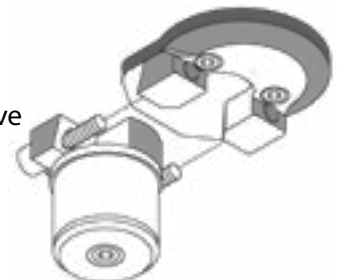

SCH PRO-DRIVE KITS

HARVESTING



AGCO SERIES FLEX HEADERS

AGCO 300, 500, 800, 8000 Series Flex Headers			
Description	With SCH Cutter Bar	With AGCO Cutter Bar	Price
300, 500, 800, 8000 Series Headers	SCK100150	SCK100155	\$2,650.00

Note: Please specify the tie rod bolt size (3/4" or 7/8") with AGCO cutter bar.

CASE-IH 1010 RIGID & 1020 FLEX HEADERS

Case-IH 1020 Flex Headers			
Description	With SCH Cutter Bar	With CIH Cutter Bar	Price
Greaseable wobble box, S/N JJC0215000 and lower	SCK100130	SCK100140	\$3,845.00
Oil bath wobble box, S/N JJC0215001 - JJC0323604	SCK100131	SCK100141	\$3,845.00
Oil bath wobble box, S/N JJC0323605 and up; CBJ023001 & up	SCK100132	SCK100142	\$3,845.00

Note: All Case-IH 1020 kits require a runner exchange because the Pro-Drive mounting bracket is welded to the runner in a jig. A \$1,195.00 core charge for the runner is included in the above kit price. When original runner is returned, you will be reimbursed the core charge, less the value of any parts if needed for repairs.

Case-IH 1010 Rigid Header			
Description	With SCH Cutter Bar	With CIH Cutter Bar	Price
Rigid, 1010	SCK100133	SCK100143	\$2,600.00

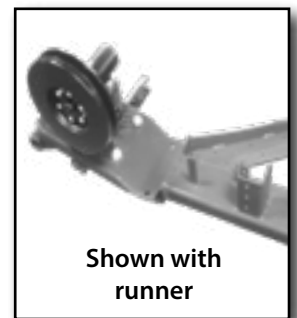

JOHN DEERE 200, 900 SERIES FLEX & RIGID HEADERS

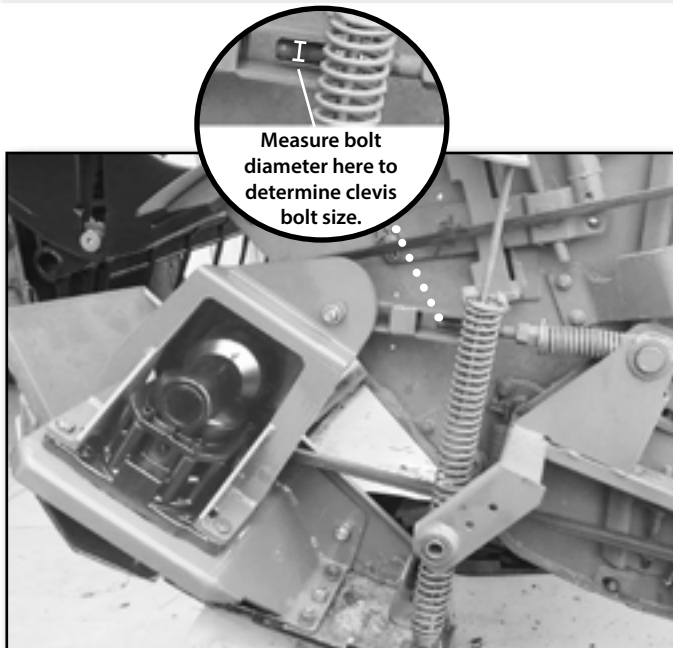

John Deere 200, 900 Series Flex Headers				
Description	Clevis Bolt Size*	With SCH Cutter Bar	With JD Cutter Bar	Price
4420, 6620 & 7720 Combines through 1985; All 9000 Series Combines	1/2"	SCK100100	SCK100110	\$2,650.00
	12mm	SCK100102	SCK100112	\$2,650.00
	16mm	SCK100104	SCK100114	\$2,650.00
6620 & 7720 Combines after 1985; All 8820 Combines	1/2"	SCK100101	SCK100111	\$2,650.00
	12mm	SCK100103	SCK100113	\$2,650.00
	16mm	SCK100105	SCK100115	\$2,650.00

Note: *The clevis bolt size refers to the size of the bolt used on the flex knife drive horizontal stabilizer spring.

John Deere 200, 900 Series Rigid Headers			
Description	With SCH Cutter Bar	With JD Cutter Bar	Price
4420, 6620 & 7720 Combines through 1985; All 9000 Series Combines	SCK100106	SCK100116	\$2,600.00
6620 & 7720 Combines after 1985; All 8820 Combines	SCK100107	SCK100117	\$2,600.00

MASSEY-WHITE 9750 FLEX HEADERS

Massey-White 9750 Flex Headers			
Description	With SCH Cutter Bar	With M/F Cutter Bar	Price
9750 Headers	SCK100160	SCK100162	\$2,650.00

Note: Knifehead for Massey-White cutting system is not available. A knifehead clamp is provided that must be welded to original knifehead strap.

SCH Vertical Belt Driven Pro-Drive

Description	Product ID	Price
SCH Pro-Drive 85V, vertical, 85mm (3.3") stroke; Replaces drive on SI Distributing's aftermarket Pro-Drive Kits; AGCO 300-8000; CIH 1010, 1020; JD 200-900; MF-White 9750 Note: Does not include pulley; Includes SCP012766 bearing block assembly.	SCP014869	\$1,940.00
SCH Pro-Drive 89V, vertical, 89mm (3.5") stroke Replaces John Deere #DE19785 on 620F, 622F, 625F, 630F, 635F flex platforms & 622R, 625R, 630R rigid platforms. Note: Does not include pulley; Includes SCP014230 bearing block assembly.	SCP014714	\$2,110.00
SCH Pro-Drive 89V, vertical, 89mm (3.5") stroke Replaces John Deere #DE19786 on 925D, 930D, 936D draper platforms. Note: Does not include pulley; Includes SCP014230 bearing block assembly.	SCP014697	\$1,895.00
SCH Pro-Drive 85V, vertical, 85mm (3.3") stroke Replaces drive on AGCO & Massey Ferguson 7200, 8200. Note: Does not include pulley; Includes SCP014230 bearing block assembly.	SCP014811	\$2,245.00



Vertical Pro-Drive

SCH Pro-Drive Bearing Blocks and Bearing Block Replacement Parts

Description	Product ID	Price
Bearing block assembly 17mm, greaseable bearing; Includes: nylon ring & 10mm allen head bolts; SCH Pro-Drive 85V, 85H, 130V, 130H	SCP012766	\$157.77
Bearing block assembly 17mm, sealed bearing; Includes: nylon ring & 10mm allen head bolts; SCH Pro-Drive 85V, 85H, 130V, 130H	SCP014739	\$157.77
Bearing block assembly 27mm, greaseable bearing; Includes: nylon ring & 12mm hex head bolts; AGCO/MF 7200, 8200, 9250 (#71416424), Claas Maxi Flex, JD 600F, 600R, 600D, 600FD, 700FD, 925D, 930D, 936D	SCP014230	\$212.48
Bearing block assembly 27mm, sealed bearing; Includes: nylon ring & 12mm hex head bolts; AGCO/MF 7200, 8200, 9250 (#71416424), Claas Maxi Flex, JD 600F, 600R, 600D, 600FD, 700FD, 925D, 930D, 936D,	SCP014742	\$212.48
Bolt, 10mm x 35mm allen head	SCP010099	\$0.54
Bolt, 12mm x 45mm hex head	SCP010114	\$3.08
Bearing, for greaseable bearing block	SCP010258	\$119.71
Nylon ring, for Pro-Drive knifehead	SCP012543	\$10.09



Bearing Block Assembly #SCP012766

SCH Knifeheads for Pro-Drive With SCH Cutter Bar

Description	Product ID	Price
AGCO flex and rigid knifehead	SCP011341	\$188.31
Case-IH flex and rigid knifehead	SCP011340	\$188.31
John Deere 200, 900 series knifehead	SCP011339	\$188.31
Massey-Ferguson/Hart Carter knifehead	SCP011329	\$188.31
Massey-White 9750 knifehead	SCP083748	\$188.31



#SCP083748



#SCP011339



#SCP011340



#SCP081359

SCH Knifeheads for Pro-Drive With OEM Cutter Bar

Description	Product ID	Price
AGCO 300-800 series, 3/4" Clamp	SCP081353	\$85.96
AGCO 300-800 series, 7/8" Clamp,	SCP081354	\$85.96
Claas Knifehead	SCP083629	\$224.20
Case-IH 3" system Knifehead	SCP081355	\$228.50
John Deere 200, 900 series knifehead	SCP081359	\$224.06
Weld-on Clamp for Custom Knifehead	SCP011236	\$49.55

SCH Pulleys for Vertical Pro-Drive

Description	Product ID	Price
Pulley, 6-bolt, 180mm	SCP012775	\$153.50
Pulley, 6-bolt, 190mm	SCP083744	\$153.50
Pulley, 6-bolt, 200mm	SCP012780	\$153.50
Pulley, 6-bolt, 210mm	SCP012782	\$153.50
Pulley, 6-bolt, 220mm	SCP012785	\$153.50
Pulley, 6-bolt, 230mm	SCP012788	\$153.50
Pulley, 6-bolt, 240mm	SCP012802	\$153.50
Hub, required if replacing keyed pulley w/ 6-bolt pulley	SCP012579	\$57.60



Pulley



Mounting Bracket #SCP083817

SCH Pro-Drive Mounts and Other Components

Description	Product ID	Price
AGCO Flex Mounting Bracket	SCP082715	\$303.76
AGCO U-bracket, for flex mount	SCP082705	\$167.94
John Deere Flex mounting bracket	SCP083817	\$341.22
John Deere U-bracket, for flex mount	SCP082702	\$167.94
John Deere late 900 series Clevis, 16mm	SCP083626	\$39.61
John Deere for early 900 series Clevis, 12mm	SCP083627	\$39.61
John Deere 200 series Clevis, 1/2"	SCP083628	\$39.61
Mounting plate, used to manufacture custom bracket	SCP083625	\$91.60



SCH Horizontal Hydraulic Motor Driven Pro-Drive

Description	Product ID	Price
SCH Pro-Drive 85H, horizontal, 85mm (3.3") stroke; Replaces Honey Bee #27884; Note: Does not include motor adaptor; Includes flywheel & SCP012766 bearing block assembly.	SCP012466	\$1,525.00
SCH Pro-Drive 85H, horizontal, 85mm (3.3") stroke; Replaces Honey Bee #27884; Note: Includes flywheel, 1" motor adaptor & SCP012766 bearing block assembly	SCP002430	\$1,650.00
SCH Pro-Drive 85H, horizontal, 85mm (3.3") stroke; Replaces Honey Bee #27884; Note: Includes flywheel, 1-1/4" motor adaptor & SCP012766 bearing block assembly	SCP015744	\$1,650.00

Warranty: SCH Pro-Drives have a 1 year warranty on parts and labor from date in service.

SCH Pro-Drive Bearing Blocks and Bearing Block Replacement Parts

Description	Product ID	Price
Bearing block assembly 17mm, greaseable bearing; Includes: nylon ring & 10mm allen head bolts; SCH Pro-Drive 85V, 85H, 130V, 130H	SCP012766	\$157.77
Bearing block assembly 17mm, sealed bearing; Includes: nylon ring & 10mm allen head bolts; SCH Pro-Drive 85V, 85H, 130V, 130H	SCP014739	\$157.77
Bearing block assembly 27mm, greaseable bearing; Includes: nylon ring & 12mm hex head bolts; AGCO/MF 7200, 8200, 9250 (#71416424), Claas Maxi Flex, JD 600F, 600R, 600D, 600FD, 700FD, 925D, 930D, 936D	SCP014230	\$212.48
Bearing block assembly 27mm, sealed bearing; Includes: nylon ring & 12mm hex head bolts; AGCO/MF 7200, 8200, 9250 (#71416424), Claas Maxi Flex, JD 600F, 600R, 600D, 600FD, 700FD, 925D, 930D, 936D,	SCP014742	\$212.48
Bolt, 10mm x 35mm allen head	SCP010099	\$0.54
Bolt, 12mm x 45mm hex head	SCP010114	\$3.08
Bearing, for greaseable bearing block	SCP010258	\$119.71
Nylon ring, for Pro-Drive knifehead	SCP012543	\$10.09

SCH Pro-Drive Hydraulic Motor Adapters

Description	Product ID	Price
Adapter, for 25.4mm (1") shaft	SCP012573	\$77.01
Adapter, for 31.7mm (1-1/4") shaft	SCP012563	\$77.01
Adapter, for 32.0mm shaft	SCP012564	\$77.01
Only Used with Horizontal Pro-Drives		



"S.I. Distributing
Harvesting Innovations"
Channel



**SCH Pro Drive Explained
and In Action**



SCH PRO-DRIVE KIT FOR CUSTOM APPLICATIONS

Kit includes: SCH horizontal or vertical pro-drive, mounting plate, knifehead, and a hydraulic motor mounting bracket.

SCH Pro-Drive Kits For Custom Applications

Description	Product ID	Price
SCH Horizontal Pro-Drive custom kit, for hydraulic motor driven applications.	SCK100180	\$2,150.00
Hydraulic Motor, 100cc, 1.25" shaft (optional)	SCP027906	\$625.00
SCH Vertical Pro-Drive custom kit, for belt driven applications.	SCK100190	\$2,295.00
Note: Custom Pro-Drive kits must be used in conjunction with a SCH EasyCut II cutting system.		



Horizontal drive shown

Reduce Vibration

JOHN DEERE STABILIZER KIT

**Recommended for John
Deere 25' - 30' Flex Heads
to Reduce Vibration**

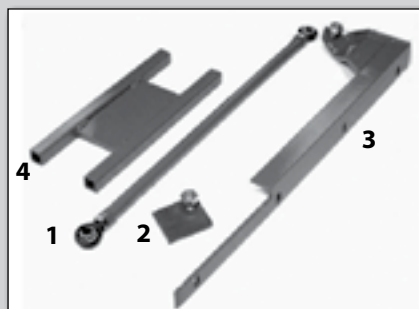

John Deere Stabilizer Kit

Description	Product ID	Price
Stabilizer kit, for John Deere 900 series flex heads	SCP082802	\$281.00

Stabilizer Replacement Parts

Description	Product ID	Price
Tie rod assembly (1)	SCP082706	\$119.00
Bracket, anchor (2)	SCP082707	\$23.00
Bracket, angle (3)	SCP082708	\$160.00
"H" bracket (4)	SCP082709	\$34.00

RADURA REPLACEMENT GUARDS

Forged Replacement Guards



John Deere
HRV133982

- High wear resistance
- High stability
- Great strength



Case IH
HRV129901



Case IH
HRV121501



John Deere
HRV124002



John Deere
HRV134000



John Deere
HRV187011



John Deere
HRV134051



MacDon
HRV000301

Radura Guards

Model	Product ID	Description	OEM#	Price
AGCO				
Series 3, 300, 400, 500, 700, 800, 7000, 8000, 8200, 9250	HRV122500	Guard, 2-point, double hardened	71341601, 71116504 71386962	\$12.70
Case-IH				
820, 1010, 1020, 2010, 2020 (CBJ020001 & up)	HRV000329	Head guard, 2-point, double hardened	1326787C3, 87442329	\$24.48
1010, 1020, 2010, 2020 (CBJ020001 & up)	HRV129901	Guard, 2-point, without trash bar, double hardened	1307299C2, 877442324 334305A1	\$15.62
2010, 2020 (prior to CBJ020000 & all HAJ)	HRV121501	Guard, 2-point, with trash bar, 4-1/4" long, double hardened	86615982, 700707147	\$15.73
1042, 1052, 2042, 2052, 2062, 2142, 2152, 2162	HRV183442	Guard, 2-point, double hardened	47687886, 87421451	\$14.43
	HRV118301	Guard, LH end guard, 2-point, double hardened	47709129, 87422039	\$17.50
	HRV118302	Guard, RH end guard, 2-point, double hardened	47709128, 87422040	\$17.50
	HRV118345	Head guard, 2-point, double hardened	47709127, 87422041	\$16.95
2142, 2152, 2162	HRV124338	Guard, bottom center guard, overlap, 2-point, double hardened	47709132, 87561546	\$22.69
	HRV124344	Guard, top center guard, overlap, 2-point, double hardened	47709134, 87561096	\$22.65
3020, 3152, 3162	HRV129730	Guard, 2-point, double hardened	87702973	\$16.16
	HRV129740	Head guard, 2-point, double hardened	87702974	\$24.38
John Deere				
200, 900	HRV124002	Guard, 2-point, double hardened	H113571, H145791 H153719, H171031	\$13.13
	HRV134000	Guard, 3-point, double hardened	H25603, H171032 H153855	\$22.00
600F, 600FD, 700FD, HDF, RDF Standard blunt point guard	HRV133982	Guard, 3-point, double hardened, long-short-long	H213398, H229537	\$21.03
	HRV135072	Guard, 3-point, double hardened, short-long-short	H213507, H229538	
600F, 600FD, 700FD No-till blunt point (no cross bar)	HRV187021	Guard, 3-point, double hardened, long-short-long	H218702	\$17.03
	HRV187011	Guard, 3-point, double hardened, short-long-short	H218701	
600F, 600FD, 700FD Blunt point non-clog guard (no cross bar)	HRV187030	Guard, 3-point, double hardened, long-long-long Used in conditions where crop gets tangled	H218703	\$17.57
600FD, 700FD, HDF, HDR, RDF	HRV180141	Guard, 3-point, double hardened, overlap, RH	HXE19625	\$29.67
	HRV180143	Guard, 3-point, double hardened, overlap, LH	HXE18172	\$29.67
	HRV180142	Guard, 3-point, double hardened, center guard	AH226928	\$29.67
600D, 600R, 900D Long point guard	HRV134051	Guard, 3-point, double hardened, long-short-long	H213405, H229539	\$18.32
	HRV135081	Guard, 3-point, double hardened, short-long-short	H213508, H229540	

Continued on next page.

RADURA REPLACEMENT PARTS

HARVESTING

Radura Guards (Continued)

Model	Product ID	Description	OEM#	Price
John Deere Continued				
600D, 600R, 900D Long point non-clog guard (no cross bar)	HRV187030	Guard, 3-point, double hardened, long-long-long Used in conditions where crop gets tangled	H218703	\$17.57
MacDon				
960, 962, 963, 972, 973, 974, D40, D50, D60, D65, D1, FD70, FD75, FD1	HRV183442	Guard, 2-point, double hardened	118344, 118484	\$14.43
	HRV118301	Guard, LH end guard, 2-point, double hardened	118301	\$17.50
	HRV118302	Guard, RH end guard, 2-point, double hardened	118302	\$17.50
	HRV118345	Head guard, 2-point.	118345	\$16.95
D50, D60, D65, D1, FD70, FD75, FD1	HRV124338	Guard, bottom center guard, overlap, 2-point, double hardened	124338	\$22.69
	HRV124344	Guard, top center guard, overlap, 2-point, double hardened	124344	\$22.65
Massey Ferguson				
9250	HRV122500	Guard, 2-point, double hardened	71341601, 71116504 71386962	\$12.70
New Holland				
84C, 86C	HRV183442	Guard, 2-point, double hardened	47687886, 87421451	\$14.43
	HRV118301	Guard, LH end guard, 2-point, double hardened	47709129, 87422039	\$17.50
	HRV118302	Guard, RH end guard, 2-point, double hardened	47709128, 87422040	\$17.50
	HRV118345	Head guard, 2-point, double hardened	47709127, 87422041	\$16.95
72C, 74C	HRV000329	Head guard, 2-point, double hardened	1326787C3, 87442329	\$24.48
740CF, 840CD, 880CF	HRV129730	Guard, 2-point, double hardened	87702973	\$16.16
	HRV129740	Head guard, 2-point, double hardened	87702974	\$24.27

RADURA REPLACEMENT SECTIONS

GREAT RESULTS whether it is grain,
soybeans, or grass crops

- Self-sharpening cutting edges
- Made from high quality steel
- Various serrations available



Radura Sections

Model	Description	Product ID	OEM#	Price
AGCO				
Series 3, 300, 400, 500, 700, 800, 7000, 8000, 8200, 9250	Box of 25, coarse, 7 serrations per inch	SCP011003	71135135, 71348175	\$53.78
	Box of 25, fine, 11 serrations per inch	SCP011001	71135135, 71348175	\$53.78
	Hardware, pkg of 50, 5/8" long ribbed bolts & locknuts	RSP042737	n/a	\$16.76
Case-IH				
820, 1010, 1020, 2010, 2020	Box of 25, 9 serrations per inch	RSP080140	112074A1	\$41.08
	Hardware, pkg of 50, 5/8" long ribbed bolts & locknuts	RSP042737	n/a	\$16.76
1042, 1052, 2042, 2052, 2062, 2142, 2152, 2162	Box of 25, coarse, 7 serrations per inch	RSP041830	87422066	\$48.10
	Box of 25, fine, 14 serrations per inch	RSP041826	1327448C1	\$48.10
	Hardware, pkg of 50, 5/8" long ribbed bolts & locknuts	RSP042737	n/a	\$16.76
3020, 3152, 3162	Box of 25, 10 serrations per inch	RSP054340	87728905	\$48.92
Claas				
	Box of 25, coarse, 7 serrations per inch	RSP052494	7679360	\$50.00

Continued on next page.

VISIT OUR WEBSITE FOR THE MOST CURRENT PRODUCT PRICING www.sidist.com

Radura Sections (Continued)				
Model	Description	Product ID	OEM#	Price
John Deere				
200, 900	Box of 25, coarse, 7 serrations per inch	RSP010992	H160251, H168316, H207930	\$41.08
	Box of 25, fine, 14 serrations per inch	RSP080017	H136807, H207929	\$41.62
	Hardware, pkg of 50, 5/8" long ribbed bolts & locknuts	RSP042737	n/a	\$16.76
600F, 600R, 600D, 600FD 700D, 700FD, 900D HDF, HDR, RDF	Box of 25, coarse, 7 serrations per inch, plated	RSP080010	H163131	\$78.64
	Box of 25, fine, 14 serrations per inch, plated	RSP080011	H153329	\$78.64
	Box of 25, fine, 14 serrations per inch, unplated	RSP080013	H153329	\$35.62
	Hardware, pkg of 50, 6mm long bolts & locknuts	RSP080079	n/a	\$27.84
MacDon				
960, 962, 963, 972, 973, 974, D50, D60, D65, D1, FD70, FD75, FD1	Box of 25, coarse, 7 serrations per inch	RSP041830	102053, 158516	\$43.78
	Box of 25, fine, 14 serrations per inch	RSP041826	174852, 174853, 118491	\$43.78
	Hardware, pkg of 50' 5/8" long ribbed bolts & locknuts	RSP042737	n/a	\$16.76
New Holland				
970, 971, 972, 973	Box of 25, coarse, 7 serrations per inch	SCP011007	848091	\$53.78
	Box of 25, fine, 11 serrations per inch	SCP011005	848091	\$53.78
	Hardware, pkg of 50, 5/8" long ribbed bolts & locknuts	RSP042737	n/a	\$16.76
84C, 86C	Box of 25, coarse, 7 serrations per inch	RSP041830	87422066	\$48.10
	Box of 25, fine, 14 serrations per inch	RSP041826	1327448C1	\$48.10
	Hardware, pkg of 50, 5/8" long ribbed bolts & locknuts	RSP042737	n/a	\$16.76
740CF, 840CD, 880CF	Box of 25, fine, 11 serrations per inch	RSP054340	87728905	\$48.92

RADURA COMPLETE KNIFE ASSEMBLIES, KNIFEHEADS, KNIFEHEAD HARDWARE & REPLACEMENT CONNECTOR KITS



Knife Assemblies

- Available in coarse or fine serrated sections
- Small parcel shippable
- Hardware is included
- OEM quality parts
- Sectionalized for easy transport

Case-IH	Complete Knife Assemblies				Knifeheads		Knifehead Hdw.		Replacement Connector Kits		
Model	Description	Coarse	Fine	Price	Knifehead	Price	Hardware	Price	Coarse	Fine	Price
1010, 1020 Series with 3" knife sections. Knifehead included	17.5' Single Drive	RSP080159	n/a	\$469.52	RSP051520	\$128.79	RSP042739	\$16.22	RSP080174 (9-SPI)	n/a	\$32.21
	20' Single Drive	RSP080160	n/a	\$514.57							
	22.5' Single Drive	RSP080161	n/a	\$555.51							
	25' Single Drive	RSP080162	n/a	\$573.50							
	30' Single Drive	RSP080163	n/a	\$678.04							

Continued on next page.

RADURA REPLACEMENT PARTS

HARVESTING

RADURA COMPLETE KNIFE ASSEMBLIES, KNIFEHEADS, KNIFEHEAD HARDWARE & REPLACEMENT CONNECTOR KITS

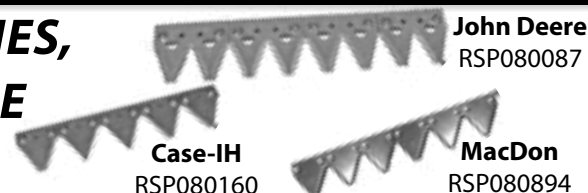

Case-IH
RSP080160

John Deere
RSP080087

MacDon
RSP080894

Case-IH/ MacDon	Complete Knife Assemblies					Knifeheads		Knifehead Hdw.		Replacement Connector Kits								
Model	Description	Coarse	Fine	Price	Knifehead	Price	Hardware	Price	Coarse	Fine	Price							
Case-IH: 2142, 2152, 2162 with 3" knife sections. Knifehead NOT included	15' Single Drive	RSP080972	RSP080973	\$333.55	RSP080967	\$122.90	RSP042739	\$16.22	RSP080901 (7-SPI)	RSP080902 (14-SPI)	\$36.82							
	20' Single Drive	RSP080974	RSP080981	\$459.37														
	25' Single Drive	RSP080871	RSP080886	\$539.62														
	30' Single Drive	RSP080872	RSP080887	\$689.06														
	35' Single Drive	RSP080873	RSP080888	\$818.88														
	40' Single Drive	RSP080874	RSP080889	\$950.04														
MacDon: D50, D60, D65, D1, FD70, FD75, FD1 with 3" knife sections. Knifehead NOT included	20' Double Drive, LH	RSP080978	RSP080985	\$259.30	RSP080967	\$122.90	RSP042739	\$16.22	RSP080901 (7-SPI)	RSP080902 (14-SPI)	\$36.82							
		Double Drive, RH	RSP080979	RSP080986								\$225.01						
	25' Double Drive, LH	RSP080876	RSP080891	\$347.58														
		Double Drive, RH	RSP080877	RSP080892								\$287.33						
	30' Double Drive, LH	RSP080878	RSP080893	\$435.87								RSP080968	\$130.63	RSP042739	\$16.22	RSP080901 (7-SPI)	RSP080902 (14-SPI)	\$36.82
		Double Drive, RH	RSP080879	RSP080894								\$349.66	RSP080969					
	35' Double Drive, LH	RSP080880	RSP080895	\$437.03								RSP080968	\$130.63	RSP042739	\$16.22	RSP080901 (7-SPI)	RSP080902 (14-SPI)	\$36.82
		Double Drive, RH	RSP080881	RSP080896								\$402.76	RSP080969					
	40' Double Drive, LH	RSP080882	RSP080897	\$525.33								RSP080968	\$130.63	RSP042739	\$16.22	RSP080901 (7-SPI)	RSP080902 (14-SPI)	\$36.82
		Double Drive, RH	RSP080883	RSP080898								\$465.08	RSP080969					
	45' Double Drive, LH	RSP080884	RSP080899	\$613.63								RSP080968	\$130.63	RSP042739	\$16.22	RSP080901 (7-SPI)	RSP080902 (14-SPI)	\$36.82
		Double Drive, RH	RSP080885	RSP080900								\$527.41	RSP080969					

John Deere	Complete Knife Assemblies					Knifeheads		Knifehead Hdw.		Replacement Connector Kits		
Model	Description	Coarse	Fine	Price	Knifehead	Price	Hardware	Price	Coarse	Fine	Price	
200, 900 Series with 3" knife sections. Knifehead included	18' Single Drive	RSP080044	RSP080019	\$420.58	RSP052094	\$108.78	RSP042739	\$16.22	RSP080057 (7-SPI)	RSP080040 (11-SPI)	\$32.21	
	20' Single Drive	RSP080045	RSP080020	\$452.47								
	22' Single Drive	RSP080046	RSP080021	\$481.76								
	24' Single Drive	RSP080047	RSP080022	\$510.98								
	25' Single Drive	RSP080048	RSP080023	\$551.75								
600 Flex Series with 4" knife sections. Knifehead NOT included	30' Single Drive	RSP080049	RSP080024	\$622.42	RSP002559	\$143.11	RSP080080	\$6.59	RSP080094 (7-SPI)	RSP080076 (14-SPI)	\$46.52	
	20' Single Drive	RSP080084	RSP080059	\$527.57								
	25' Single Drive	RSP080085	RSP080060	\$669.57								
	30' Single Drive	RSP080086	RSP080061	\$831.93								
600FD, 700FD, RDF Flex Draper Series with 4" knife sections. Knifehead NOT included	30' Single Drive	RSP080086	RSP080061	\$831.93	HRV450125	\$125.95	RSP080080	\$6.59	RSP080094 (7-SPI)	RSP080076 (14-SPI)	\$46.52	
	30' Double Drive, LH	RSP080727	RSP080729	\$492.95	HRV450125	\$125.95	RSP080080	\$6.59	RSP080094 (7-SPI)	RSP080076 (14-SPI)	\$46.52	
		Double Drive, RH	RSP080728	RSP080730								\$449.32
	35' Double Drive, LH	RSP080731	RSP080733	\$544.13	HRV450125	\$125.95	RSP080080	\$6.59	RSP080094 (7-SPI)	RSP080076 (14-SPI)	\$46.52	
		Double Drive, RH	RSP080732	RSP080734								\$489.64
	40' Double Drive, LH	RSP080735	RSP080737	\$558.83	HRV450125	\$125.95	RSP080080	\$6.59	RSP080094 (7-SPI)	RSP080076 (14-SPI)	\$46.52	
		Double Drive, RH	RSP080736	RSP080738								\$513.06
	45' Double Drive, LH	RSP080812	RSP080816	\$706.26	HRV450125	\$125.95	RSP080080	\$6.59	RSP080094 (7-SPI)	RSP080076 (14-SPI)	\$46.52	
Double Drive, RH		RSP080813	RSP080817	\$642.06								
900 Draper Series with 4" knife sections. Knifehead NOT included	25' Single Drive	n/a	RSP080060	\$669.57	RSP080573	\$165.85	RSP080080	\$6.59	RSP080094 (7-SPI)	RSP080076 (14-SPI)	\$46.52	
	30' Single Drive	n/a	RSP080061	\$831.93								
	36' Single Drive	n/a	RSP080609	\$981.63								



Platform Replacement Parts				
Make/Model	Description	Product ID	OEM#	Price
AGCO				
Series 3, 300, 400, 500, 800, 8000, 9250	Wear plate	HRV457001	71116532, 71176537	\$1.99
	Hold down, universal, steel	HRV457055	71346158	\$5.50
7200, 8200, 9250	Bearing block assembly, greaseable	SCP014230	ACP012440	\$212.48
	Bearing block assembly, sealed	SCP014742	71416424	\$212.48
	Nylon ring, for knifehead bearing	SCP012543	700719594	\$10.09
	Knifehead Clamp 7/8" (includes nylon ring)	SCP015056	700719594	\$103.44
Case-IH				
810, 820, 1010, 1020	Wear plate	HRV457001	179759C1	\$1.99
1010, 1020	Knifehead	RSP051520	1313795C95	\$128.79
2010, 2020, SMX91	Bearing assembly	HRV455053	701401	\$76.65
1042, 1052, 2042, 2052, 2062, 2142, 2152, 2162	Head pin	HRV455032	345893A1	\$30.75
	Needle bearing, knifehead	HRV455033	A27827	\$20.50
	Seal, knifehead	HRV455027	345892A1	\$9.99
	Plug, knifehead	HRV455028	395820A1	\$1.89
	Hold down	HRV052483	338591A1, 87407812	\$7.99
2142, 2152, 2162	Cutterbar skid shoe	MYW983840	129297	\$10.50
	Knifehead (LH or RH 25' and shorter)	RSP080967		\$122.90
	Knifehead (LH 30' and larger)	RSP080968	87561157	\$130.63
	Knifehead (RH 30' and larger)	RSP080969	87561158	\$133.91
John Deere				
200	Wear plate (1 on drive end)	HRV457002	E47954	\$1.99
200, 900	Wear plate (1 per foot)	HRV457005	H153157	\$1.99
	Hold down, steel	HRV457055	H84412	\$5.50
	Hold down, cast	HRV457094	H127801	\$3.75
	Hold down, cast (1 on drive end)	HRV457095	H129024	\$3.95
	Knifehead	RSP052094	AH121075	\$108.78
	600F, 600D, 600R, 600FD, 700FD, 900D	Hold down-high (2 used)	HRV000625	AH218548, H218950
Hold down-low (1 per foot)		HRV000627	AH218547, H218949	\$6.25
Bearing block assembly, greaseable		SCP014230		\$212.48
Bearing block assembly, sealed		SCP014742	AXE24816	\$212.48
600F	Nylon ring, for knifehead bearing	SCP012543	H157812	\$10.09
	Knifehead	RSP002559	AH220051	\$143.11
900D	Knifehead	RSP080573	AH220050	\$165.85
600FD, 700FD	Knifehead, LH & RH	HRV450125	AH231842	\$125.95
	Oval head bolt, M6-1mmx16mm	HRV458095	H158341	\$0.33
	Oval head bolt, M6-1mmx20mm	HRV458096	H158342	\$0.38
	Oval head bolt, M6-1mmx25mm	HRV458097	H158343	\$0.43
MacDon				
960, 962, 963, 972, 973, 974, D50, D60, D65, D1, FD70, FD75, FD130, FD135, FD140, FD145	Head pin	HRV455032	113299	\$37.50
	Needle bearing, knifehead	HRV455033	100500	\$20.50
	Seal, knifehead	HRV455027	113222	\$9.99
	Plug, knifehead	HRV455028	113937	\$4.25
	Hold down	HRV052483	118499, 118199	\$7.99
D50, D60, D65, FD70, FD75, FD130, FD135, FD140, FD145	Cutterbar skid shoe	MYW983840	129297	\$10.50
	Knifehead (LH or RH 25' and shorter)	RSP080967	120832	\$122.90
	Knifehead (LH 30' and larger)	RSP080968	132896	\$130.63
	Knifehead (RH 30' and larger)	RSP080969	132897	\$133.91
New Holland				
71C, 72C, 73C, 74C, 970, 971, 972, 973, 1465	Bearing assembly	HRV455053	701401	\$76.65
82C, 83C, 84C, 86C	Head pin	HRV455032	345893A1	\$37.50
	Needle bearing, knifehead	HRV455033	A27827	\$20.50
	Seal, knifehead	HRV455027	345892A1	\$9.99
	Plug, knifehead	HRV455028	395820A1	\$4.25
	Hold down	HRV052483	338591A1, 87407812	\$7.99
86C	Cutterbar skid shoe	MYW983840	129297	\$10.50
	Knifehead (LH or RH 25' and shorter)	RSP080967		\$122.90
	Knifehead (LH 30' and larger)	RSP080968	87561157	\$130.63
	Knifehead (RH 30' and larger)	RSP080969	87561158	\$133.91
Universal				
Universal	Hold down, universal	HRV457051	70804075	\$11.99
	Hold down, universal	HRV457070		\$10.99

A1 MINI WEEDER

Weed Control the New and Improved Way!



- **Faster Weed Control**
- **Designed by Farmers**
- **Saves Money**
- **No More Plastic**
- **No More Chopping Weeds Manually**
- **Less Labor**
- **Ideal for Crops such as Vegetables, Squash, Pumpkin, Watermelon, Tobacco, and more!**



A1 Mini Weeder:

- Single row
- Three point mount with 3x3 toolbar
- Two hydraulic driven heads
- Available with two 6" heads with 3 tines or two 10" heads with 4 tines
- For 30" minimum row spacing



A1 Mini Weeder

Product ID	Description	Price
AOW000600	A1 Mini Weeder, 6" Heads, No Sweeps	\$5,995.00
AOW001000	A1 Mini Weeder, 10" Heads, No Sweeps	\$5,995.00

CASE-IH 1020 OEM REFURBISHED RUNNERS & STUB SHAFTS



Case-IH 1020 OEM Refurbished Runners

Product ID	Description	Price
SCP083684	Runner, Generation I, Greaseable, S/N JJC0215000 & lower	\$1,195.00
SCP083683	Runner, Generation II, Oil Bath, S/N JJC0215001 - JJC0323604	\$1,195.00
SCP083685	Runner, Generation III, Oil Bath, S/N JJC0323605 & up; CBJ023001 & up	\$1,195.00

Purchase our refurbished runners and send your runners to S.I. Distributing. Upon inspection, your runners may have value.

Stub Shafts

Product ID	Description	Price
SCP083862	Stub shaft, Case-IH 1020 runner	\$50.50

PLASTIC WEAR BLOCKS

Long-Lasting Self-Lubricating Plastic Chain Tightner and/or Wear Block with 9/16" Hole

- Decreases wood block replacement
- Reduces chain wear and friction
- Saves labor, money and downtime
- Increases chain life and keeps chain tight
- Lasts 4 to 5 times longer than wood blocks
- Replaces any idler on chain driven equipment



Plastic Wear Blocks

Product ID	Description	Price
CBM500000	Plastic wear block	\$8.50

Cost Effective Weed Control with NO Drift!



Problem: With the rise of resistant weeds in GMO and conventional crops, taller growing weeds need to be attacked without damaging your crop.

Solution: Super Sponge Weed Wipers' pump-fed sponges hold and put more material on undesired weeds, without drift.



Before



After

Consider for Roundup Resistant Weed Control!



Target Taller-Growing Resistant Weeds!

Super Sponge Weed Wipers' pump-fed sponges hold and put more material on undesired weeds, without drift.

"I get \$5 more per bale when I use my weed wiper to get rid of the Johnson Grass in my hay."

- Jamie Elliot, Denton, NC



S.I. Distributing Planting Innovations Four Videos



Super Sponge Weed Wipers			
Description	Length	Product ID	Price
Sprayer Boom	5'	WWP119005	\$399.00
	10'	WWP119010	\$699.00
	15'	WWP119015	\$1,285.00
	20'	WWP119020	\$1,595.00
	30'	WWP119030	\$2,699.00
	60'	WWP119060	\$4,599.00
	80'	WWP119080	\$6,699.00
	90'	WWP119090	\$7,199.00
	100'	WWP119100	\$7,850.00
Top Crop	5'	WWP219005	\$339.00
	10'	WWP219010	\$615.00
	15'	WWP219015	\$885.00
	Build Your Own Boom	20'	WWP219020
30'		WWP219030	\$1,649.00
40'		WWP219040	\$2,059.00
3-Point Hitch		10'	WWP319010
	15'	WWP319015	\$3,079.00
	20'	WWP319020	\$3,399.00
	25'	WWP319025	\$3,799.00
	30'	WWP319030	\$4,629.00
Pull Type	10'	WWP419010	\$2,779.00
	15'	WWP419015	\$3,999.00
	20'	WWP419020	\$4,119.00
	25'	WWP419025	\$4,599.00
	30'	WWP419030	\$5,149.00
	40'	WWP419040	\$6,150.00
ATV	5'	WWP519005	\$599.00
	10'	WWP519010	\$1,175.00
	15'	WWP519015	\$1,799.00
Front Bucket	10'	WWP619010	\$1,175.00
	15'	WWP619015	\$1,799.00
	20'	WWP619020	\$2,159.00



20-Ft Sprayer Boom Kit

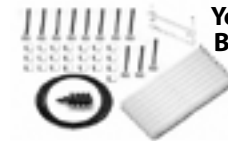

15-Ft Build Your Own Boom Kit



10-Ft 3-Point Hitch

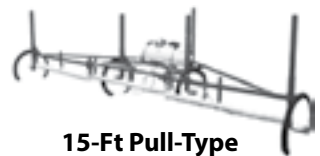

15-Ft Pull-Type

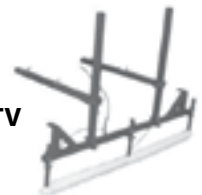

5-Ft ATV

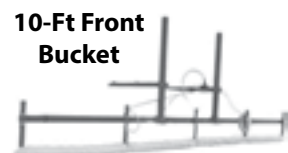

10-Ft Front Bucket

SUPER SPONGE WEED WIPERS

WEED CONTROL

Applicators have reported less than \$1 of chemical cost per acre.

The key to weed wiping is getting enough material on the weeds. These pump-fed sponges hold more material and put more material on the undesired weeds.

Consider for Non-GMO weed control!

Eliminate taller weeds like: Roundup Resistant Pigweed, Waterhemp, Ragweed, Kochia, Thistle, Marestalk, Shattercane, Mustard, Rye in Wheat, and Johnson Grass in pastures.

ATV / Front Bucket



Great for pastures, orchards and areas that you need the versatility of an ATV. Manually adjust the height, or adjust with electric Powerlift.

12v pump and tank not included

Build Your Own / DIY



Build your own boom to meet your needs. Kits include sponges in 30" sections, risers to attach to boom, a manifold and plumbing.

12v pump and tank not included

Three-Point Hitch



Best for row crop applications. Heavy duty frame. The wings fold for road position. Adjust the height on the go with your 3-point hitch.

Includes 12v pump and tank

Kits for Sprayer Booms



Adapts to any size boom, connects to TeeJet and Hypro bodies, no welding required, brackets bolt on, easily change from wiper to sprayer.

Pull Type

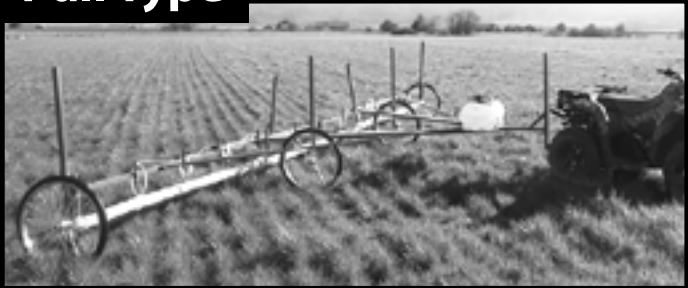

Wheels and a flex frame design contour to the terrain, maintaining uniform sponge height

Includes 12v pump and tank

SPONGE GUN "PRO SERIES"

Ag & Landscaping Application



Product ID	Description	Prc/Ea
LAG010000	Sponge Gun, Ag & Landscaping Application	\$99.00



Since 1979, S.I. Distributing has been providing successful innovations in agriculture to improve farming overall as well as your bottom line. S.I. Distributing has teamed with NewFields Ag and Low Mu Tech, to offer biological innovations, utilizing nature as a key to profitable and sustainable farming.

Please review the products below and visit www.sidist.com for more information on any product. Additional information includes field studies, crop comparison pictures, complete product explanation/benefits and much more.



Envita (Systemic Nitrogen Fixation)

Envita is an N-fixing bacteria that works from within the plant applied in-furrow OR foliar and across crops to supplement nitrogen where and when it's needed.

Envita Systemic Nitrogen Fixation is an innovative and efficient system for nitrogen fixation. Its patented technology enables it to deliver reliable and consistent fixes of nitrogen into the environment, making it an ideal choice for any agricultural operation. Envita's systemic activities result in improved soil fertility, increased plant growth, and greater yields.



- **Flexible Use** - can be used on row crops, soybeans, alfalfa, hay, and specialty crops
- **Ease of Use** - compatible with most herbicides, insecticides, and fungicides. Perform a jar test to confirm compatibility.

Product	Application Method	Product ID	Price	Container Volume	Application Rate	Cost Per Unit per Acre
Envita LiF/F	In Furrow/Foliar	NFA931005	\$598.00	32 oz	0.80 oz/acre	\$14.95 / Acre



PheNom™ is a blend of two endophytes bacteria. One lives in the plant above ground and supplies nitrogen from the air, the other increases the efficiency of how the plant uses phosphorous.

For best results, apply to your crop as early as possible to get season long nitrogen.

- **Patented two-species biological blend**
- **Highly effective endophyte nitrogen fixing bacteria**
- **Highly effective phosphorous solubilizing bacteria**
- **Endophyte bacteria live inside the plant**
- **Works on all crops**

Product	Application Method	Product ID	Price	Container Volume	Application Rate	Cost Per Unit of Seed or Acre
db PheNom ST	Seed Treatment	NFA911011	\$1,735.59	2.5 gal	1 oz/unit	\$7.23 / Unit
db PheNom LiF/F	In Furrow	NFA911012	\$330.63	2.5 gal	16 oz/acre	\$16.53 / Acre



For Corn, Soybeans

B4 Increases the Availability of Phosphorous, Zinc and Iron that are in your Soil and Unavailable to your Crops.

B4 is a blend of 4 highly beneficial bacillus microorganisms. B4 solubilizes phosphorus, zinc, and iron that are in the soil and make it available to the crop. B4 rapidly creates a biofilm on the root of the plant. This biofilm is what contacts the soil and solubilizes P, Zn, and Fe. Because B4 is growing all year season long, it is increasing the availability of and uptake of P, Zn, and Fe throughout the growing season.



Product	Application Method	Product ID	Price	Container Volume	Application Rate	Cost Per Unit of Seed or Acre
B4 ST	Seed Treatment	NFA911001	\$2,262.00	2.5 gal	0.5 oz/unit	\$3.53 / Unit
B4 LiF	In Furrow	NFA911002	\$330.00	2.5 gal	16 oz/acre	\$8.25 / Acre
B4 LiF ORGANIC	In Furrow	NFA911100	\$205.88	2.5 gal	16 oz/acre	\$10.29 / Acre

BIOLOGICAL INNOVATIONS

BAC AG - BOTANICAL ANTIMICROBIAL CLEANER

99.9999% Effective Against Odor Causing and Surface Damaging Microbes

This product utilizes plant oils that are non-toxic and biodegradable. No rinse or wiping needed. Use for cleaning any agricultural and veterinary locations, food-use sites, commercial businesses and residencies. Use on any porous or non-porous surface.



- Prevents mold and removes hard water deposits
- Non-toxic, non-irritating on skin
- Will clean concrete, wood, plastic and metal
- For pens, equipment, food-processing equipment, vehicles and bedding materials
- Made in the USA



GROWN ORGANICALLY!

Product	Product ID	Price	Container Volume
BAC AG	NFA961006	\$24.00	32 oz
BAC AG	NFA961007	\$49.00	128 oz



BIGSHOT MAXIM Botanical Agricultural Pest and Mosquito Control



Organic sources, no harsh chemicals.

- Safe around pets, the environment, children and adults when used as directed.
- Bee and butterfly friendly (saves beneficial pollinators)



BigShot Maxim controls: beetles, sucking insects, mites, flies, cotton pests, moths, spider mites, fungus gnats, leaf webbers, loopers, fleas, ticks, leafhoppers, mealybugs, grubs, armyworms, mosquitoes, whiteflies, sandflies, houseflies, cutworms, lawn and root grubs, fruit flies, bed bugs, locusts, midges, aphids – root aphid, aphids, ants and scale insects.

Product	Product ID	Price	Container Volume
Big Shot Maxim	NFA961016	\$12.00	4 oz
Big Shot Maxim	NFA961017	\$23.00	8 oz
Big Shot Maxim	NFA961018	\$70.00	32 oz
Big Shot Maxim	NFA961019	\$261.00	128 oz

Residue Breakdown/Soil Remediation & Manure and Compost Management



Stalk Degradation/Soil Remediation

- Increased soil remediation across all soil types
- Healthier soils - contributes to the building of organic matter
- Reduced stalk residue for seedlings to work through

Manure and Compost Management

- Digests sludge and crust from lagoons and manure pits and liquifies the solids for easier pumping into machines and out of machines.



NutriPhi is designed for beef, dairy, and hog operations to help manage biosolids, reduce run-off, and diminish harmful odors in barns, houses, and lagoons.

In row crops, NutriPhi is used to promote efficient breakdown of crop residue.

Product	Product ID	Price	Container Volume	Application Method	Application Rate	Cost Per Acre
NutriPhi	NFA931012	\$138.73	2.5 gallon	Soil Amendment	32 oz	\$13.87 / Acre
				Manure Management	-	-

GROWTHFUL™ Corn, Soybeans, Hay, Vegetables

EFFECTIVE GROWTH PROMOTION: Growthful™ is the auxiliary soil amendment that helps you grow more, faster and can be applied broadcast, in furrow or foliar.

- Increase crop yields
- Grow bigger crops faster
- No added application costs
- Improves and increases water/nutrient availability, use, efficiency, processing, and retention



Product	Application Method	Product ID	Price	Container Volume	Application Rate	Cost Per Acre
Growthful PE	Pre Emerge	NFA951001	\$75.00	5 gal	256 oz/acre	\$30.00 / Acre
Growthful LIF	In Furrow	NFA951002	\$75.00	5 gal	16 oz/acre	\$1.88 / Acre
Growthful F	Foliar	NFA951003	\$200.00	5 gal	12.8 oz/acre	\$4.00 / Acre



RIDE TAMER™



Bumpy Ride?

Tired of being beat up on your zero turn mower? The Ride Tamer is a simple retrofit for zero turn mowers that provides significant ride improvement as well as reducing frame stress.

- Improves ride dramatically by soothing out bumps and depressions in terrain
- Patented trailing arm design provides support in the vertical direction
- Improves stability on slopes and ditch banks while reducing frame stress
- Installs in less than 15 minutes per wheel
- Wear parts are servicable.



Ride Tamer		
Description	Product ID	Price
Ride Tamer (for 2 wheels)	RTR100000	\$649.00

The Ride Tamer fits most major makes and models of zero turn mowers. Endurance tested for durability, the components are built for, and ideal for, large properties and commercial lawn services.

SCH HEDGE & BRANCH TRIMMERS

FOR HEDGE/SHRUB MANAGEMENT, SPECIALTY CROPS & ORCHARDS

Straight, Smooth and Precision Cuts Encourage a Healthy Re-growth

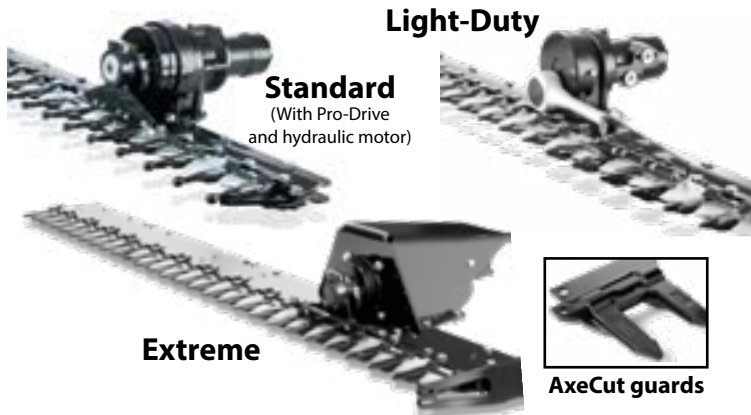

Application Ranges:

- Orchard vegetation management
- Specialty crop harvesting
- Hedge/shrub cutters; Roadside management

Features:

- Easy attachment to hydraulic reach arms, front loader and excavator arms.
- Individual positioning of knife drive; Customizable working widths & drive concepts

Light-Duty Version:

- Great stability and precision to cut up to 0.8 inch branches
- Lightweight design, for use on small machines; Compact build for optimum flow
- C-Drive system with a hydraulic motor for excellent performance in wet conditions due to reduced weight and compact build

Standard Version:

- Ability to cut one-inch branches
- Extra short SCH guards are bolted to the top and bottom of the bar
- High-efficiency Pro-Drive planetary knife driver combines with a hydraulic motor

Extreme Version:

- Ability to cut 2.4 inch branches
- Sturdy AxeCut guards are bolted to the cutterbar top & bottom. Serrated guard fingers ensure a firm grip and prevent branches from slipping off the cutter bar

SCH Hedge and Branch Trimmers

Product ID	Description	Price
EWM120470	Hedge Trimmer, Light-Duty, 4'	\$3,325.00
EWM150590	Hedge Trimmer, Light-Duty, 5'	\$3,485.00
EWM120047	Hedge Trimmer, Standard, 4'	\$4,275.00
EWM150059	Hedge Trimmer, Standard, 5'	\$4,425.00
EWM180071	Hedge Trimmer, Standard, 6'	\$4,595.00
EWM210083	Hedge Trimmer, Standard, 7'	\$4,750.00
EWM240095	Hedge Trimmer, Standard, 8'	\$4,900.00
EWM270106	Hedge Trimmer, Standard, 9'	\$5,125.00
EWM300118	Hedge Trimmer, Standard, 10'	\$5,205.00
EWM170067	Branch Trimmer, Extreme, 6'	\$13,475.00
EWM200079	Branch Trimmer, Extreme, 7'	\$14,445.00
EWM240094	Branch Trimmer, Extreme, 8'	\$15,190.00

POLY CUTTING EDGE



Stop Scratching Your Asphalt, Pavement..and More! Also known as Poly Blades, May Wes UHMW Poly Cutting Edges protect smooth, hard surfaces such as cobblestone and pavements that can be damaged by equipment while plowing. Applications include ATV & truck mounted plow blades, skid loaders, snow pushers and other bucket-mounted equipment.

UHMW Poly Cutting Edges are Superior for Ag Buckets and Skid Loaders; Residential, Commercial & Municipal Snow Removal:

- Heavy-Duty, High-Impact Virgin UHMW Plastic
- Non-Stick Surface Reduces Snow & Debris Build-Up
- Excellent Abrasion Resistance
- Withstands Severe Winter Temperatures
- Widely Used by Commercial Plowing Services, DOTs and Municipalities
- Will Not Scuff Pavement
- Much Quieter than Steel
- Lightweight and Easy to Install
- Reduces Shock to Equipment and Operator on Uneven Pavement

VERTICAL POLY CUTTING EDGE

For Snow Pushers and Plows

Unbeveled. Optional Straight Holes.

A long winter of snowplowing can leave your driveway and parking lot scuffed and scratched. Avoid this expensive and unsightly snow removal damage with a May Wes UHMW Poly Cutting Edge.



HORIZONTAL POLY CUTTING EDGE

For Buckets and Skid Loaders

Beveled on Both Sides. Optional Counterbored Holes.

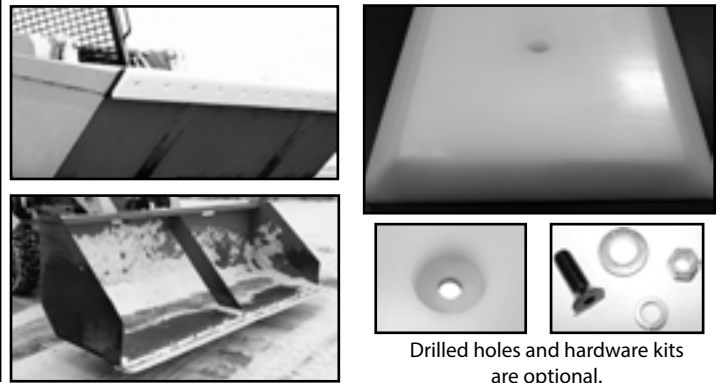

Drilled holes and hardware kits are optional.

Vertical Poly Cutting Edge		
Product ID	Description	Prc/ln
Step 1: Determine size of cutting edge		
MYW083873	6" wide x 1" thick - per running inch	\$3.30
MYW083874	6" wide x 1-1/2" thick - per running inch	\$4.80
MYW083875	8" wide x 1" thick - per running inch	\$4.35
MYW083876	8" wide x 1-1/2" thick - per running inch	\$6.10
Step 2: Optional drilling of holes		
MYW083877	Drilling of each straight hole	\$4.25
Step 3: Optional hardware kit		
MYW081724	2" Hardware Kit	\$5.70
MYW083686	3" Hardware Kit	\$5.70
A longer mounting bolt is often required for thicker blades.		

Horizontal Poly Cutting Edge		
Product ID	Description	Prc/ln
Step 1: Determine size of cutting edge		
MYW082133	4" wide x 3/4" thick - per running inch	\$2.00
MYW083521	4" wide x 1" thick - per running inch	\$2.40
MYW083522	4" wide x 1-1/2" thick - per running inch	\$3.50
MYW083518	6" wide x 3/4" thick - per running inch	\$2.65
MYW083519	6" wide x 1" thick - per running inch	\$3.30
MYW083520	6" wide x 1-1/2" thick - per running inch	\$4.80
MYW081732	8" wide x 3/4" thick - per running inch	\$3.35
MYW081733	8" wide x 1" thick - per running inch	\$4.35
MYW082126	8" wide x 1-1/2" thick - per running inch	\$6.10
Step 2: Optional drilling of holes		
MYW081734	Drilling of each counterbored hole	\$4.65
Step 3: Optional hardware kit		
MYW081724	2" Hardware Kit	\$5.70
MYW083686	3" Hardware Kit	\$5.70
A longer mounting bolt is often required for thicker blades.		

How to Order Vertical or Horizontal Cutting Edges

Information to know before calling.

- A. Cutting Edge Length _____
- B. Quantity of holes _____
- C. Distance from edge to center of each hole _____

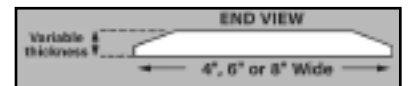
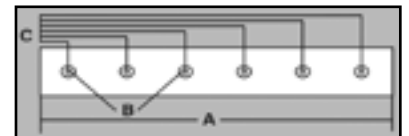

Blades over 94" will be shipped in two pieces unless specified. If you request a seamless blade over 94", it will be shipped freight. Freight shipments are subject to higher rates.

No Returns Accepted on Custom Orders

SKID STEER HITCH



This handy attachment allows you to quickly add a standard 2" trailer hitch receiver (not included) to your skid loader so you can move trailers around your farm yard with your skid steer. Lightweight and easy to install and remove, it will fit right in your truck toolbox! NOTE: 2" standard receiver and ball hitch sold separately.

Skid Hitch		
Description	Product ID	Price
Skid Hitch	MYW083884	\$185.00

THE SURE STOP



Grain Handling Alignment Sensor

Get it Right the First Time!



90 Decibel Alarm and LED light signals your exact stopping position.

- Perfect alignment every time.
- Save time and save steps.



Tri-Pod Not Included

Product ID	Description	Price
WPS100000	The Sure Stop Kit	\$675.00
WPS200000	Reflective Tape, 8" piece	\$1.50

LOCKEASE HITCH PINS

"Never Look Back!"



Lockease Hitch Pins		
Product ID	Description	Price
LEP010001	Lockease hitch pin, 3/4" x 6"	\$25.95
LEP010002	Lockease hitch pin, 7/8" x 6"	\$27.25
LEP010003	Lockease hitch pin, 1" x 6"	\$30.75
LEP010004	Lockease hitch pin, 1-1/8" x 7"	\$34.95
LEP010005	Lockease hitch pin, 1-1/4" x 7"	\$38.25
LEP010006	Lockease hitch pin, 1-1/2" x 8"	\$43.95
LEP010008	Lockease hitch pin, 3/4" x 4-1/2"	\$22.75
LEP010009	Lockease hitch pin, 7/8" x 4-1/2"	\$26.25
LEP010010	Lockease hitch pin, 5/8" x 4-1/2"	\$22.25
LEP080005	Lockease repair kit, includes thumb latch, spring & roll pin	\$7.25

Heavy duty hinged handle and lock helps prevent damage and injury from disengaged pins.

Patented locked mechanism on top of pin operates with one hand and keeps pin securely in drawbar

Large collar prevents pin damage

Heavy duty coating resists corrosion

Heavy duty heat treated pin with superior strength and exceptional field performance

Large handle provides more leverage for easy removal

AIR FILTER BLASTER

Reduce fuel consumption and extend the life of filters.

Air Filter Blaster		
Product ID	Description	Price
MYW083685	Air Filter Blaster, 6" Rotor included	\$299.00
Optional Accessories		
MYW042311	3" Rotor, 3" - 4.5" inside diameter filter	\$59.00
MYW042312	4.5" rotor, 4.5" - 6" inside diameter filter	\$59.00
MYW042313	6" rotor, 6" - 9" inside diameter filter	\$59.00
MYW042314	9" rotor, 9" and greater inside diameter filter	\$59.00
MYW042315	12" extended shaft, filters with depths above 26"	\$59.00
MYW042316	Cage Assembly, 3" rotor	\$59.00

- Increases engine performance and equipment life.
- Safe for filters.
- Distribution of air only allows a maximum of 48 psi to come out of any one air jacket in the Filter Blaster.



Grain Management Made Simple & AFFORDABLE!

STEPS GMS Smart Switch & Bin Monitor

Description	Product ID	Price
Smart Switch Fan Control	STS101100	\$395.00
Bin Monitor w/ 18' cable	STS201118	\$595.00
Bin Monitor w/ 24' cable	STS201124	\$595.00
Bin Monitor w/ 32' cable	STS201132	\$595.00
Additional Bin Monitor Temperature Sensor	STS201900	\$215.00



BIN MONITOR
Help Identify Potential Problems Before They Arise



SMART SWITCH
Turn ANYTHING on/off from ANYWHERE



Grain Management

Control Your Bins from the Beach!

Montezuma TOOL BOXES

- 5-Year Warranty
- Weather stripping creates a tight seal against dust and moisture
- 16 gauge steel or .100" thick tread aluminum construction
- Welded seams, no spot welding
- Powder coated with a tough, scratch resistance, textured, powder paint

DX411B

*Tools not included

XL450B

Mount to combine, tractor, truck, ATV and much more.

Montezuma Portable Steel Tool Boxes			
Product ID	Vendor ID	Description	Price
CPL411000	DX411B	Tool Box, 41" x 18" x 21-5/8"; Black Steel; 107 lbs; Organizes 280+ Tools/Accessories; Power Socket; Personal Locker Space	\$829.99
CPL364500	XL450B	Tool Box - 36"W x 17-3/8"D x 21-1/2"H; Black Steel; 91 lbs; Organizes 280+ Tools	\$699.99
CPL003100	LA400B	Tool Box - 30"W x 19"D x 20-1/8"H; Black Steel; 89 lbs; Organizes 269+ Tools/Accessories	\$649.99
CPL002203	ME300AL	Tool Box - 30"W x 15"D x 18-1/8"H, Brite Aluminum; 51 lbs; Organizes 140+ Tools/Accessories	\$649.99
CPL002200	ME300B	Tool Box - 30"W x 15"D x 18-1/8"H; Black Steel; 65 lbs; Organizes 140+ Tools/Accessories	\$499.99
CPL001200	SM200B	Tool Box - 22-1/2"W x 13"D x 14-1/8"H; Black; Organizes 129+ Tools/Accessories	\$419.99

Montezuma Toolbox Replacement Parts		
Product ID	Description	Price
CPL009106	Cylinder, SM 200	\$25.00
CPL009105	Cylinder, ME300	\$30.00
CPL009107	Cylinder, LA400, XL450	\$30.00
CPL009112	Latch, Square Handle	\$47.35

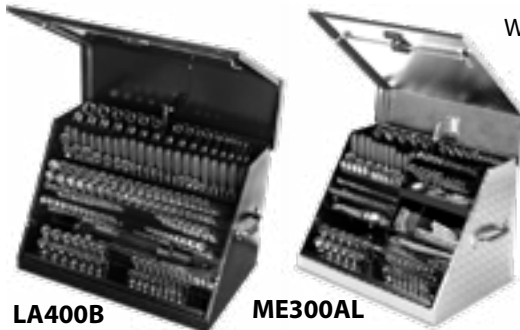

LA400B

ME300AL

When open, Montezuma tool boxes allow you to organize up to 280 metric and/or S.A.E. tools and see them all at a glance.

When closed, the trademarked locking lid design holds tools in position, creating protection, security and organization.



ME300B

SM200B

SCHUCK CUSHION HITCHES

Schuck 300 Series Hitches		
750 lbs tongue weight, 20,000 lbs. pulling capacity		
Product ID	Description	Price
SHU103400	Model 340, 2" receiver tube cushion hitch	\$425.00
SHU103401	Model 340, 2.5" receiver tube cushion hitch	\$475.00
Schuck 700 Series Hitches		
1,000 lbs tongue weight, 40,000 lbs. pulling capacity		
SHU107402	Model 740, 2" receiver tube cushion hitch	\$610.00
SHU107403	Model 740, 2.5" receiver tube cushion hitch	\$655.00
SHU107507	Model 750 RTR, 2" receiver tube cushion hitch with pullout swivel; 3-1/2" drop from center of receiver tube to top of tongue	\$1,025.00
SHU107509	Model 750 RTR, 2.5" receiver tube cushion hitch with pullout swivel; 3-1/2" drop from center of receiver tube to top of tongue	\$1,060.00
SHU107505	Model 750 RT, 2" receiver tube cushion hitch with pullout swivel; 5-1/2" drop from center of receiver tube to top of tongue	\$1,025.00
SHU107510	Model 750 RT, 2.5" receiver tube cushion hitch with pullout swivel; 5-1/2" drop from center of receiver tube to top of tongue	\$1,060.00
Schuck 800 Series Hitches		
2,000 lbs tongue weight, 50,000 lbs. pulling capacity		
SHU108400	Model 840, 2" receiver tube cushion hitch	\$820.00
SHU108401	Model 840, 2.5" receiver tube cushion hitch	\$860.00
Schuck Parts & Accessories		
SHU900300	300 Series replacement kit; 2 cushions, 3 bearings	\$75.00
SHU900700	700 Series replacement kit; 4 cushions, 5 bearings	\$135.00
SHU900800	800 Series replacement kit; 6 cushions, 7 bearings	\$180.00

Swivel Tongue For Quick, Easy Hook-ups

Eliminate the frustrating job of backing into an exact position for hookup.

The telescoping, swivel cushion tongue extends out a full (7) seven inches beyond the "Tow" position and swivels 60° laterally (or 12" left to right) for fast, easy hook-ups. **Save time and effort on every hook-up**, and that means saving money for you.



Absorbs Minor and Major Shocks

A Urethane Tips "Compress" to Absorb Minor Shocks!

B Urethane Cushions

"Compress" to Absorb Major Shocks!



Schuck Bumper		
Product ID	Description	Price
SHU001000	Model 1000 heavy duty bumper; Must order mounting brackets, stone shield and hitch to complete	\$785.00
SHU900001	Stone shield, for Schuck bumper	\$83.00
	Mounting brackets, for Schuck bumper; specify frame measurement	\$246.00

VISIONWORKS CAMERA SYSTEMS



VISIONWORKS
Camera Systems



Increase Safety and Productivity!

High-Resolution, Durable Camera Systems at Affordable Prices

- Complete systems come with the standard 700 TVL picture quality camera.
- Each camera is equipped with a 65-lb magnet, metal visor, and a protective bracket to ensure durability*.
- IP68 rating ensures protection from both total dust ingress and water submersion.
- All cameras come equipped with a night vision setting for late-night surveillance.



- **Eliminate Blind Spots**
Extremely Durable

Safety Matters!

It's a small price to pay that can save you a lot more than money!



*Recommendation of upgrading your brackets to stainless steel for fertilizer applications.



VISIONWORKS
Camera Systems

Increase Productivity and Safety

Back-Up Camera System - 5" License Plate Cam



BACK UP VIEW:
From your license plate



Truck Load-Out Camera System Kit



TRUCK(S) LOADING:
Watch from the top of the auger



Skid Steer Loader Camera System Kit



SKID STEER LOADERS:
Increase safety by eliminating blind spots



Grain Cart / Combine Camera System Kit



GRAIN CARTS / COMBINES:
Prevent spills and increase productivity



Baler (& More) Camera System Kit



BALERS:
Watch your twine and see areas that were previously blind spots



VISIONWORKS CAMERA SYSTEMS

High-Resolution, Durable Camera Systems at Affordable Prices

DURABILITY: All Cameras receive an IP rating or code based on the International Electrotechnical Commission's (IEC) standards. The rating is essentially a classification process that rates the degree of protection offered from the camera in regards to any intrusion by solid and/or liquid matter. All of our cameras are submersion tested

and receive an IP68 rating or higher.

RESOLUTION: All of the standard cameras have a 700 or greater TVL resolution rating. Compare that to the other cameras in the industry, and you will find that our cameras will provide you a crisp and clear image for your application.

Wired Camera Systems						Additional Camera/Cable Packages			
Description	Camera(s) Included	Camera Input(s)	Cable Length	Product ID	Price	30' Cable & Camera		30' Cable & Wide View Camera	
5" Standard System	1	1	30'	VWC500001	\$279.00	-	-	-	-
5" Heavy Duty System (Skid- Steer Special)	1	3	15'	VWC500003	\$329.00	VWC901030	\$159.00	VWC903730	\$182.00
7" Standard System	1	2	30'	VWC700000	\$329.00	VWC901030	\$159.00	VWC903730	\$182.00
7" High Definition System (1080P System w/ DVR)	1	4	30'	VWC704000	\$499.00	VWC904330	\$222.00	VWC908330	\$222.00
7" Weatherproof System	1	2	30'	VWC706000	\$589.00	VWC901030	\$159.00	VWC903730	\$182.00
10" Standard System	2	4	30'	VWC104000	\$729.00	VWC901030	\$159.00	VWC903730	\$182.00
10" High Definition System (1080P System w/ DVR)	1	8	30'	VWC104210	\$799.00	VWC904330	\$222.00	VWC908330	\$222.00
Wired Back Up Camera Systems						Additional Camera/Cable Packages			
Description	Camera(s) Included	Camera Input(s)	Cable Length	Product ID	Price	30' Cable & Standard Camera		30' Cable & Wide View Camera	
5" License Plate Cam System	1	1	30'	VWC500000	\$199.00	-	-	-	-
7" License Plate Cam System	1	2	30'	VWC701100	\$259.00	VWC901030	\$162.00	VWC908330	\$222.00
Wireless Camera Systems						Additional Wireless Camera			
Description	Camera(s) Included	Camera Input(s)	Cable Length	Product ID	Price	Standard Wireless Camera		Wide View Wireless Camera	
5" Wireless HD System w/ DVR	1	4	n/a	VWC503000	\$429.00	VWC900058	\$199.00	VWC900045	\$199.00
7" Wireless HD System w/ DVR	1	4	n/a	VWC705000	\$529.00	VWC900058	\$199.00	VWC900045	\$199.00
9" Wireless HD System w/DVR	1	4	n/a	VWC900400	\$629.00	VWC900058	\$199.00	VWC900045	\$199.00
Wireless Grain Truck Load Out Camera System						Extra Screen			
Description	Camera(s) Included	Camera Input(s)	Cable Length	Product ID	Price	Additional Screen/ Receiver			
7" Truck Load Out System	1	2	n/a	VWC700121	\$429.00	VWC900053	\$236.50		



Cameras/Cables/Adapters/Accessories						
Wired Standard Definition Cameras/Accessories				Camera Cables		
Description	Product ID	Price	Description	Product ID	Price	
Standard Definition License Plate, Camera	VWC900110	\$99.00	15' cable	VWC901500	\$28.00	
Standard Definition, Camera (90°)	VWC901000	\$129.00	30' cable	VWC903000	\$33.00	
Standard Definition Side View, Camera (120°)	VWC904000	\$129.00	65' cable	VWC906500	\$44.00	
Standard Definition Wide View, Camera (140°)	VWC900037	\$149.00	Adapters			
Standard Definition Wireless Transmitter (allows wired cameras to transmit wirelessly)	VWC900011	\$219.00	"Y" Adapter (splits signal for wireless transmitter)	VWC900014	\$89.00	
Wired High Definition Cameras/Accessories				Power Adapter (connects to 110v receptacle converts to 12v)	VWC900013	\$12.00
High Definition, Camera (90°)	VWC900043	\$189.00	Brackets/Mounts			
High Definition Side View, Camera (120°)	VWC900044	\$189.00	Stainless Steel Camera Bracket (upgrade for fertilizer applications)	VWC900010	\$9.00	
High Definition Wide View, Camera (170°)	VWC900083	\$189.00	Suction Cup Mount (works with 7" monitors)	VWC900018	\$19.99	
High Definition Wireless Transmitter (allows wired cameras to transmit wirelessly)	VWC900042	\$219.00	Cup Holder Mount (works with phone or 5"/7" display)	VWC900035	\$24.99	
Wireless Standard Definition Cameras				Magnetic Cup Holder	VWC900036	\$12.00
Standard Definition, Wireless Camera (90°)	VWC902000	\$289.00				
Wireless High Definition Cameras						
High Definition, Wireless Camera (90°)	VWC900058	\$199.00				
High Definition Wide View, Wireless Camera (140°)	VWC900045	\$199.00				
Wireless Cameras Accessories						
Rechargeable Battery Pack (12v power for wireless cameras)	VWC900019	\$149.00				
Omni Directional Antenna (long-range booster antenna)	VWC240014	\$29.00				



GPS/OEM SYSTEM CAMERA ADAPTER KITS

Use What You Have for Less Clutter in the Cab: These kits include a camera, cable, and adapter which allows you to easily plug into your existing screen / guidance system. Options available for most camera-capable GPS Systems.

All kits included one camera and one 30' cable with appropriate connection or adapter. Kits for factory pre-wired machines do not come with cable only adapter.				Only one harness required per machine.	
AGCO		Product ID	Price	Harness	Price
C1000	Requires 1 input harness AC-A1C from AGCO.	VWC806000	\$199.00	OEM	-
C2000	Requires 2 input harness AC-A2C from AGCO.	VWC806110	\$199.00	OEM	-
C2200, C3000	Requires 2 input harness BUSB1-TC from AGCO.	VWC806100	\$199.00	OEM	-
Fendt Tractors	Connects to tractors with Vairo Terminals	VWC807300	\$199.00	N/A	-
Datatronic 5, Fieldstar 5, NT03	Connects to existing male 5-Video input on back of armrest.	VWC806130	\$199.00	N/A	-
	Connects to input on display.	VWC806140	\$199.00	N/A	-
Ag Leader		Product ID	Price	Harness	Price
Integra; Versa	Requires 4 input harness 4002671-12 or 4100816 from Ag Leader.	VWC808000	\$199.00	OEM	-
	Requires 4 input harness VWC900029 from SI Distributing.	VWC801000	\$159.00	VWC900029	\$220.00
In Command	Requires 2 or 4 input harness 4004493-12 or 4004494-12 from Ag Leader.	VWC808200	\$199.00	OEM	-
	Requires 4 input harness VWC900030 from SI Distributing.	VWC801100	\$159.00	VWC900030	\$253.00
Case-IH/New Holland		Product ID	Price	Harness	Price
PRO 700; Intelliview III, IV	Connects to input on display.	VWC809000	\$199.00	N/A	-
	Requires 3 input harness VWC900024 from SI Distributing.	VWC801200	\$159.00	VWC900024	\$152.90
PRO 1200	Includes 2 input harness that connects to display.	VWC803100	\$229.00	N/A	-
	Additional camera & cable, to purchase as add-on to VWC803100.	VWC901030	\$159.00	N/A	-
Flagship Combines	2014 to 2021 camera ready. Connects to existing inputs, 2 behind drive tire on left side, 1 in grain tank.	VWC803000	\$199.00	N/A	-
	2022 & newer camera ready. Connects to existing inputs, 2 behind drive tire on left side, 1 in grain tank.	VWC803010	\$199.00	N/A	-
Mid-Range Combines	2014 & newer camera ready. Connects to existing inputs, 2 behind drive tire on left side, 1 in grain tank.	VWC804000	\$199.00	N/A	-
FM1000, XCN2050, FM750	XCN2050 requires TM-200 module, others connect to input(s) on display	VWC802000	\$199.00	OEM/NA	-
Claas		Product ID	Price	Harness	Price
Lexion Combines 670-780	Camera ready machines, connects to existing inputs on machine.	VWC802110	\$199.00	NA	-
Jaguar Choppers 930-980, 880-840	2015 and newer camera ready machines, connects to existing inputs on machine.	VWC802120	\$199.00	NA	-
John Deere		Product ID	Price	Harness	Price
R-Series Tractors 6000R	CommandCenter (touch screen). Requires 1 input harness VWC900026 from SI Distributing. Connects to socket between controls & window.	VWC801600	\$159.00	VWC900026	\$93.50
R Series Tractors 7000R, 8000R, & 9000R	CommandCenter (touch screen) or 2630/4640 (factory installed) Connects to 4-pin connectors behind panel under back window .	VWC807000	\$199.00	N/A	-
	Connects to 4-pin connectors found on right side of cab	VWC807000	\$199.00	N/A	-
S-Series Combines	2017 & newer (factory prewired). Connects to existing connectors, 1 on rear of machine, 1 on auger, 1 in grain tank.	VWC805000	\$199.00	N/A	-
R-Series Sprayers R4000 (early)	Includes 2 input harness that connects to 6 pin connector behind panel under back window.	VWC805100	\$229.00	N/A	-
	Additional camera & cable, to purchase as add-on to VWC805100.	VWC901030	\$159.00	N/A	-
R-Series Sprayers R4000 (late), 400R, 600R	Connects to 4-pin connectors behind panel under back window.	VWC807000	\$199.00	N/A	-
2630 Display	Requires 3 input harness VWC900023(combine) or VWC900022(tractor) from SI Distributing. For screens that do not have factory video harness.	VWC801300	\$159.00	VWC900023 VWC900022	\$152.90
4600 Display	Requires 4 input harness VWC900027(combine) or VWC900028(tractor) from SI Distributing. For screens that do not have factory video harness.	VWC801700	\$159.00	VWC900027 VWC900028	\$173.25
Outback		Product ID	Price	Harness	Price
Outback Max	Requires 4 input harness 051-0285-000 from Outback.	VWC808300	\$199.00	OEM	-
Raven		Product ID	Price	Harness	Price
Viper 4	Requires 4 input harness 115-0172-077 from Raven.	VWC808400	\$199.00	OEM	-
	Requires 4 input harness VWC900031 from SI Distributing.	VWC801900	\$159.00	VWC900031	\$273.35
TeeJet		Product ID	Price	Harness	Price
Matrix Pro	Connects to input on display.	VWC808100	\$199.00	N/A	-
Trimble		Product ID	Price	Harness	Price
FMX1000, TMX2050, CFX750	Connects to input(s) on display.	VWC802100	\$199.00	N/A	-

READYVISION CAMERAS



View Wirelessly on Your Phone or Tablet!

ReadyVision Cameras are wireless cameras that connect directly to your mobile Android or iOS devices via a dedicated app and Wi-Fi signal. **No network or data access required!**

With a powerful magnetic base and high-quality video monitoring, it is the perfect solution for monitoring beyond what your eyes can see. Actually, the only limitation to the applications for ReadyVision Cameras is your imagination!

- Wi-Fi Broadcasting
- IP68 Waterproof and Shockproof
- 150-Degree Viewing Angle
- Multiple Users
- Dedicated ReadyVision App

**Easy to Install,
Simple to Use**



Mobile device not included

One Year Standard Warranty



Heavy-Duty Wi-Fi Camera

\$179

The ReadyVision heavy-duty metal housing camera, with a constant power supply connector and AC/DC adapter, can be operated continuously. It also has an optional magnet base included as well as an external antenna for longer range.

- 12V Constant Power Supply
- Night Vision (6-Infrared LEDs)
- 65lb Magnet Base & Universal Mount



ReadyVision WiFi Wired Camera

Description	Product ID	Price
Camera, Wired	RVC100000	\$179.00

Battery-Powered Wi-Fi Camera

\$199

The ReadyVision Battery-Powered Wi-Fi Camera features a rechargeable internal battery pack that is capable of powering the camera for up to eight hours without recharging. It also has an optional AC/DC adapter and 12V power lead are available so you can power this camera without the need to recharge the battery.

- Internal Rechargeable Battery
- Two Power Sources
- Built-In Magnet Base
- Night Vision (8-Infrared LEDs)



Battery Powered

Approximately 8 Hours of Use Per Charge

ReadyVision WiFi Battery Camera

Description	Product ID	Price
Camera, Battery	RVC200000	\$199.00



NOTE: Real-Time Video Is Not Guaranteed The FPS (circled at right) indicates your frames per second. If this is lower than 20, you will NOT have "Real Time" video and should NOT use this camera to safely back up a vehicle. We cannot control how many apps you have open or the speed your device is using to process the video. We also cannot guarantee that you will always have a strong signal.



OUTBACK WRAP HYDRAULIC HOSE MARKERS

End Criss-Crossed Hoses!

A Simple Hose Identification System that's SIMPLY INGENIOUS!

Outback Wrap is a "one-size-fits-all" identification wrap for hydraulic hoses that are **1/4" to 1-1/2"**.



- Can withstand temperatures to -60°F (-50°C) to 212°F (100°C)
- Not affected by grease, oil or dirt; it can be cleaned with any soap
- Made of polyethylene; the color is part of the molding process, so they will not fade or crack like other tags or identifiers
- No tools are required for installation.

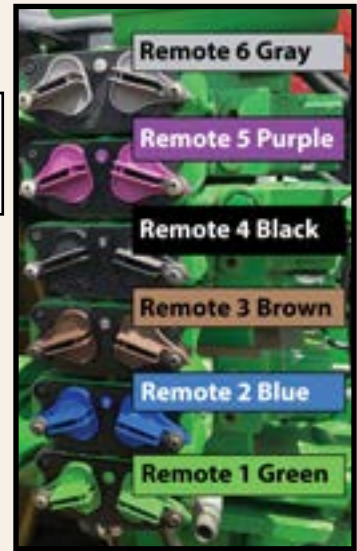

Outback Wrap Hose Markers		
Description	Product ID	Price/Ea
Hydraulic Hose Markers- Fits 1/4" to 1-1/2" hose		
4 pairs/pack; for remotes 1-green, 2-blue, 3-brown, 4-black	OBW002119	\$20.99
2 pairs/pack; for remotes 1-green, 2-blue	OBW002102	\$10.99
2 pairs/pack; for remotes 5-purple, 6-gray	OBW002140	\$10.99
Power Beyond Pack, (brake-pink, tank-orange, load sense-white, case drain-red, PB pressure/return-yellow)	OBW002164	\$15.99

Outback Wraps are marked 1-6 and use the ISO color system for agricultural hydraulics: 1=Green; 2=Blue; 3=Brown; 4=Black; 5=Purple and 6=Gray. Also "A" & "B" is lasered into the wrap to give a "left" and a "right", or an "above" and "below" indicator when hooking up. (A & B wraps are also cut to different lengths, giving an addition visual aid when looking at the hoses.)

OUTBACK WRAP BULK WRAP "THE SNAKE COLLECTION"

Wrap your entire planter, other implements or electrical cables.

The Snake Collection can be used to bundle and contain hoses, wires, cables and cords on the farm, on equipment or at your business! Easy installation, no tools required! The Snake Collection is available in 80', 20', 15' and 10' (please see charts).



Outback Wrap "Snake Collection" Bulk Wrap - 80'		
Description	Product ID	Price/Ea
80' of Bulk Wrap - (16mm) 5/8" Diameter		
Constrictor Wrap, Green	OBW003123	\$109.00
Constrictor Wrap, Blue	OBW003130	
Constrictor Wrap, Red	OBW003147	
Constrictor Wrap, Yellow	OBW003154	
Constrictor Wrap, Orange	OBW003345	
80' of Bulk Wrap - (20mm) 13/16" Diameter		
Python Wrap, Green	OBW003086	\$149.99
Python Wrap, Blue	OBW003093	
Python Wrap, Red	OBW003109	
Python Wrap, Yellow	OBW003116	
Python Wrap, Orange	OBW003369	
80' of Bulk Wrap - (32mm) 1-1/4" Diameter		
Anaconda Wrap, Green	OBW003048	\$189.99
Anaconda Wrap, Blue	OBW003055	
Anaconda Wrap, Red	OBW003062	
Anaconda Wrap, Yellow	OBW003079	
Anaconda Wrap, Orange	OBW003352	

"Snake Collection" Bulk Wrap - 20', 15' and 10'		
Description	Product ID	Price/Ea
20' of Bulk Wrap - (16mm) 5/8" Diameter		
Constrictor Wrap, Green	OBW003550	\$32.99
Constrictor Wrap, Blue	OBW003567	
Constrictor Wrap, Red	OBW003574	
Constrictor Wrap, Yellow	OBW003581	
Constrictor Wrap, Orange	OBW003598	
15' of Bulk Wrap - (20mm) 13/16" Diameter		
Python Wrap, Green	OBW003505	\$32.99
Python Wrap, Blue	OBW003512	
Python Wrap, Red	OBW003529	
Python Wrap, Yellow	OBW003536	
Python Wrap, Orange	OBW003543	
10' of Bulk Wrap - (32mm) 1-1/4" Diameter		
Anaconda Wrap, Green	OBW003451	\$32.99
Anaconda Wrap, Blue	OBW003468	
Anaconda Wrap, Red	OBW003475	
Anaconda Wrap, Yellow	OBW003482	
Anaconda Wrap, Orange	OBW003499	

HYDRAULIC HOSE TAMERS

**Multiple-Hose Containment Wraps
that Tame up to 14 Hoses!**



Outback Wrap Hose Tamer is the answer to messy and unruly hoses! The Hose Tamer is 1.5" (40mm) in diameter and 18" in length.



Outback Wrap offers the Hose Tamer and the Hose Boss to bundle hoses, cables, cords and wires to keep them neat, organized and protected!



Outback Wrap Hose Tamers		
Description	Product ID	Price/Ea
Hose Tamer, Green	OBW002157	\$12.99
Hose Tamer, Blue	OBW002158	
Hose Tamer, Red	OBW002159	
Hose Tamer, Yellow	OBW002160	
Hose Tamer, Brown	OBW002161	
Hose Tamer, Black	OBW002162	
Hose Tamer, Purple	OBW002163	
Hose Tamer, Gray	OBW002165	
Hose Tamer, White	OBW002166	
Hose Tamer, Pink	OBW002167	
Hose Tamer, Orange	OBW003437	

OUTBACK WRAP HOSE BOSS

The Outback Wrap Hose Boss is indeed a "step up" from the Hose Tamer! The Hose Boss is a 4-foot long wrap, which is 3" in diameter (75mm). Made from heavy-duty polyethylene plastic, it is thick enough to contain a large number of hoses. It also features a punched hole in the end to strap hoses up.



Outback Wrap Hose Boss		
Description	Product ID	Price/Ea
Hose Boss, Green	OBW003000	\$31.99
Hose Boss, Blue	OBW003017	
Hose Boss, Red	OBW003024	
Hose Boss, Yellow	OBW003031	

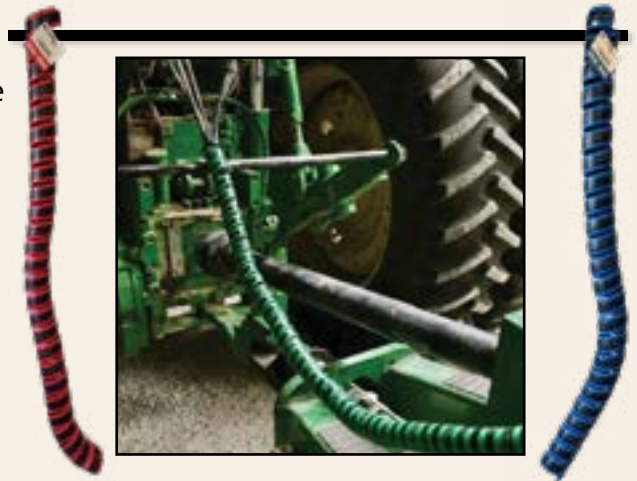

OUTBACK WRAP BAT WRAP

The Outback Wrap Bat Wrap is a heavy duty velcro wrap used to bundle and lift hoses, cables or wires, up to 700 pounds, out of the way. It is very easy to use. Just wrap the Bat Wrap around the hoses, cables or wires and secure with a tarp strap or rope. (Tarp strap or rope is not included.)



Bat Wrap is made from polypropylene and is 21" x 1-1/2". It has velcro fasteners and includes a stainless steel loop. Outback Wrap Bat Wrap can lift up to 700 pounds (318kg). The maximum bundle diameter is up to 5".



Outback Wrap Bat Wrap		
Description	Product ID	Price/Ea
Bat Wrap	OBW003420	\$12.99

OUTBACK WRAP FUEL FINDER

The Outback Wrap Fuel Finder is designed to identify your fuel tank hoses and makes fueling up easy! Outback Wrap can withstand temperatures from -60°F (-50°C) to 212°F (100°C). The wraps are 20mm (13/16") in diameter and 11" long. It fits hoses 1/2" to 3" in diameter.

- Green = Road Diesel
- Red = Dyed Diesel
- Yellow = Gasoline



Outback Wrap Fuel Finder		
Description	Product ID	Price/Ea
Fuel Finder	OBW003376	\$12.99

Outback Wrap, located in Faulkton, South Dakota, was created in 2018 by David Hedt, an Australian-born entrepreneur, who came up with the idea after he got tired of the frustrations of hooking up hydraulic hoses.

PERFORMANCE-ENHANCING TUNES



- Optimizes air-to-fuel ratio, injection duration, fuel consumption, and torque limiter parameters.
- Lowers fuel consumption by 5 to 18%
- Increases performance by up to 30% and torque by up to 25% in diesel engines.
- Provides better torque acquisition in low to mid RPM ranges.



AGROECOPOWER

- 20 Years of Experience
- Custom-Made Tunes
- Tune Done in Less than an Hour
- Equipment Diagnostics
- All Brands Covered
- On-Site Installation
- 30-Day Trial Period
- Lifetime Guarantee

AgroEcoPower tune examples and results are available at www.sidist.com/AgroEcoPowerResults.pdf

Tunes available for: Tractors, Combines, Self-Propelled Sprayers, Forage Harvesters, Skid Loaders, Semi-Trucks, Construction Equipment



YouTube.com "S.I. Distributing Harvesting Innovations" channel

VIDEO #1:
"Benefits,
Examples &
RESULTS"



VIDEO #2:
"What
Customers
Are Saying"



AgroEcoPower Tune

Description	Product ID	Prc/Ea
AgroEcoPower Performance-Enhancing Equipment Tune	AGR100000	\$2,500.00

SET-N-SEED PLANTER DEPTH CALIBRATION TOOL

Eliminate Variances in Planter Row Unit Depth - Accurately and quickly set the desired depth, across your planter, from 1" to 2.5" using a 1" main block and multiple 1/2" stackable inserts

Keep It Calibrated: Planter depth can vary across the planter depending on the wear of the planter unit. Disk openers, gauge wheel arms, and rocker arms are just a few of the vital parts that determine your seed's depth. By utilizing the Set-N-Seed, variations in disk size and wear will be eliminated with this planter depth calibration tool. **No More 4x4's:** 4x4 blocks only show depth that the unit is currently set to. Set-N-Seed will automatically place the unit to your specified depth.



20-Second Process of Setting Each Row Unit to Your Desired Depth



Set-N-Seed Planter Row Unit Calibration - Utilizing a Floor Jack - Animated Video

YouTube.com "S.I. Distributing Planting Innovations" channel



Product ID	Description	Price/Ea
SNS009001	Set-N-Seed	\$185.00

2024 Show Schedule

January 9-11, 2024
Keystone Farm Show
York, Pennsylvania
Booth 1036, 1037, 1038, 1039

January 16-18, 2024
Fort Wayne Farm Show
Fort Wayne, Indiana
Booth 760

January 24-25, 2024
Midwest Ag Expo-Illinois
Gordyville USA,
Gifford, Illinois
Booth 225

Jan. 30 - Feb. 1, 2024
Iowa Ag Expo
Des Moines, Iowa
Booth 1241

Jan. 31 - Feb. 2, 2024
Southern Farm Show
Raleigh, North Carolina
Booth 3305

February 14-17, 2024
National Farm Machinery
Show
Louisville, Kentucky
West Wing, Booth 2242

February 23-25, 2024
Western Farm Show
Kansas City, Missouri
Booth 2024

Feb. 27 - 29, 2024
Hawkeye Farm Show
UNI-Dome, Cedar Falls, Iowa
Booth 406-412

March 1-2, 2024
Mid-South Farm &
Gin Show
Memphis, Tennessee
3409 Main Hall

March 26-28, 2024
WPS Farm Show
Oshkosh, Wisconsin
Booth D6538-D6541

April 4-6, 2024
Oklahoma City Farm Show
Oklahoma City, Oklahoma
Booth 1031, 1033, 2030, 2031

May 17-19, 2024
Four State Farm Show
Pittsburg, Kansas
Booth I103, I104, I105, I106

August 6-8, 2024
Farm Fest
Redwood County,
Minnesota
Lot 412

August 13-15, 2024
Ag Progress Days
Rock Springs,
Pennsylvania
W212, West 2nd St

August 13-15, 2024
Wisconsin Farm
Technology Days
Chippewa County,
Wisconsin
Booth 361-363

August 20-22, 2024
Dakotafest
Mitchell, South Dakota
Lot 532

August 27-29, 2024
Farm Progress Show
Boone, Iowa
Lot 857

September 7-15, 2024
Clay County Fair
Spencer, Iowa
7th Avenue and 2nd St,
Block 17

September 10-12, 2024
Big Iron Farm Show &
Exposition
West Fargo, North Dakota
Ag Building, Booth A32-A34

September 10-12, 2024
Husker Harvest Days
Grand Island, Nebraska
Lot 856

September 17-19, 2024
Farm Science Review
Columbus, Ohio
Lot 581 Soybean Avenue

Nov. 26-28, 2024
Amarillo Farm & Ranch
Show
Amarillo, Texas
N107

December 3-5, 2024
Nebraska Ag Expo
Lincoln, Nebraska
Booth 1430

December 5-7, 2024
Tulsa Farm Show
Tulsa, Oklahoma
Booth 125



S.I. Distributing would like to thank you for your business.

TERMS: All orders must be paid before shipment unless a line of credit has been established. All returned payments will be charged \$25 per occurrence.

Orders may be placed in the following ways:

Call: 800-368-7773 or 419-647-4909

Online: www.sidist.com

Email: orders@sidist.com

Fax: 877-398-8074 or 419-647-6290

Mail:
S.I. Distributing
13540 Spencerville Road
Spencerville, Ohio 45887



SHIPMENT: All orders will be shipped in the order they are received. Most orders are shipped the same day if they are received before 12:00 p.m. EST. Orders can be shipped ground, second day air, next day air, or any other available means.

Orders will be shipped UPS ground or FedEx ground unless specified differently by the customer. Truck freight will be used when price competitive. An expedited order charge of \$10.00 will be added to all orders received after 12:00 p.m. that request same day shipment by ground.

SHORTAGES & DAMAGES: S.I. Distributing Inc. is not responsible for goods damaged or lost in transit. All claims of freight shortages and/or damages must be noted on the bill of lading or with the driver at the time of delivery. Failure to note any freight shortages and/or damages makes the consignee responsible for all shortages and/or damages to that shipment. S.I. Distributing Inc. will assist the consignee in filing freight shortage and/or damage claims when the consignee noted such at time of delivery.

RETURN POLICY: Any merchandise being returned must have a Return Goods Authorization number (RGA#) printed clearly on the outside of the box. A Return Goods Authorization number can be obtained by calling S.I. Distributing Inc. Authorized returns must be returned freight prepaid and will be subject to a minimum restocking fee of 15%. A copy of the original sales invoice must be included with all returns. No exceptions. An additional charge will be made if the merchandise is received in less than saleable condition. All merchandise shipped to S.I. Distributing without prior authorization is subject to refusal and may be returned freight collect. Warranty returns must fully explain the nature of the defect and the Return Goods Authorization number must be present.

PRICES & SPECIFICATIONS: Prices and specifications are subject to change without notice. All shipments are billed at the price prevailing at the time of shipment. All prices are F.O.B. Spencerville, Ohio.

Every effort was made to ensure accuracy in information and pricing. We reserve the right to correct errors.



800-368-7773
 419-647-4909
 13540 Spencerville Road
 Spencerville, Ohio 45887



[facebook.com/sidistributing](https://www.facebook.com/sidistributing)

www.sidist.com



**SCH EasyCut II
 Cutterbar
 Kits - Pg 102**



**PPS Complete Parallel
 Arm Kits - Pg 1**



**Finger-Till Closing
 Wheel - Pg 8**



**Martin-Till ACCR1360
 Row Cleaner - Pg 22**

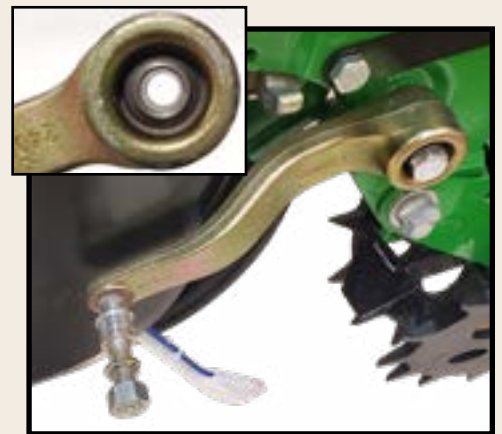

**Norseman Roller Bearing
 Gauge Wheel Arm
 Kits - Pg 7**

Successful Innovations for Agriculture Since 1979