

The **2022**
Tool
Promotion
JULY - SEPTEMBER



www.sealey.co.uk

★ Trustpilot



OVER 140 NEW LINES INSIDE!

See
Page
130



6 Drawer Topchest
& Rollcab Combos

List Price £229.95

£189.95 Exc. VAT

£227.94 Inc. VAT

SEE PAGE 3 FOR
OUR LATEST
COMPETITION.

**SEE INSIDE
FOR OFFERS ON
LIGHTING, HAND TOOLS,
POWER TOOLS, COMPRESSORS,
WORKSHOP STORAGE,
WELDING EQUIPMENT,
VEHICLE SERVICE TOOLS & MORE**

WHY CHOOSE SEALEY....

- ✓ A comprehensive, continuously expanding product range.
- ✓ Huge stock levels and fast despatch.
- ✓ Value for money – but never at the expense of quality.
- ✓ No quibble long-term and lifetime guarantees*.
- ✓ Unrivalled aftersales service envied throughout the industry.
- ✓ Innovation and continuous product development as standard.
- ✓ Meticulous quality control.
- ✓ Full spare parts back-up service including discontinued products.



Register a **MY SEALEY** account with us today, allowing you access to competitions, promotions and more.

www.sealey.co.uk/register

HUGE STOCKS & FAST DESPATCH

We hold over £30million worth of stock. Modern, computer controlled warehousing enables, on average, 99.8% of our entire product range to be despatched straightaway.



+44 (0)1284 757500



+44 (0)1284 767626



sales@sealey.co.uk



www.sealey.co.uk

Find your local stockist by visiting

www.sealey.co.uk/stockist-locator

Or give us a call!

OUR BRANDS AND GUARANTEES



Made for the Trade, the Sealey brand is defined by traditional designs and proven workshop reliability. Our core range, trusted for over 40 years, is one of the UK's market leaders in tools and equipment.



Manufactured from the highest quality materials to exacting standards for a long and durable life, our Premier range delivers exceptional performance at a competitive price.



Offering you impressive reliability with exceptional value for money. Our Siegen range is backed up with the same professional aftersales service as the Sealey and Premier ranges.

LONG-TERM GUARANTEES*

At Sealey we have some of the best guarantees* in the business. All Premier and Siegen Hand Tools are covered by our no-quibble lifetime guarantee* against manufacturing defects, with many other products benefiting from our 2, 3 or 5 Year guarantees* where indicated on the product in the catalogue and on our website.

Please see www.sealey.co.uk/guarantee for more information, terms and exclusions. To make a claim on your guarantee, simply return your product to the place of purchase along with your sales receipt.



Our no quibble guarantee covers individual items within sets. Excludes TRX-Star T40 bits, breaker bar knuckles, drill bits, cutting blades and taps and dies. Repair kits will be sent out for most ratchet wrenches. Please refer to www.sealey.co.uk/guarantee for more information on guarantees.



A 20V GARDEN BUNDLE

WORTH
OVER
£500 LIST
PRICE

ENTER NOW
FOR YOUR CHANCE TO WIN



COMPETITION CLOSSES 30TH SEPTEMBER 2022

CONTENTS

HAND TOOLS	4 - 23
JACKING & LIFTING	24 - 31
MOTORCYCLE TOOLS	32 - 35
BATTERY CHARGERS	36 - 37
VEHICLE SERVICE TOOLS	38 - 51
LUBRICATION	52 - 55
BODYSHOP	56 - 61
AIR POWER TOOLS	62 - 63
COMPRESSORS	64 - 67
WELDING & CUTTING	68 - 71
ELECTRIC POWER TOOLS	72 - 85
POWER TOOL ACCESSORIES	86 - 91
LIGHTING & POWER	92 - 97
STORAGE & WORKSTATIONS	98 - 141
HEATING & COOLING	142 - 147
JANITORIAL, MATERIAL HANDLING & LEISURE	148 - 157
MACHINE SHOP	158 - 167
SAFETY PRODUCTS	168 - 169
CONSUMABLES	170 - 171
CLEARANCE	172 - 179



LONG-TERM AFTERSALES SUPPORT

We have a dedicated team of experienced Technical Advisors, paired with **20 Service Engineers** and a full provision of spare parts, even if a model is discontinued.

SPARE PARTS

We currently hold over 130,000 different spare parts for our products.

FOLLOW US ON OUR SOCIALS



SUBSCRIBE TO OUR YOUTUBE CHANNEL
find us by searching "Sealey Tools"

Mechanic's Tool Kits

Premier



CAR
MECHANICS
BEST BUY

- Comprehensive range of frequently used hand tools.
- 1/4" and 1/2" Sq drive 72-Tooth offset comfort grip ratchet wrenches.
- Includes 1/4", 3/8" and 1/2" Sq drive sockets, hex keys, spanners, screwdrivers, pliers, bits and accessories.
- Housed in a sturdy storage case with reinforced corners, aluminium trim and lockable metal catches.

NEW
PRODUCT AVAILABLE
Mid July

Model No.	Qty	Colour	List Price	Exc. VAT	Inc. VAT
AK7980HV	144pc	Hi-Vis Green	£299.95	£189.95	£227.94
AK7980	136pc	Red	£299.95	£189.95	£227.94



1/4" 3/8" &
1/2" Sq. Drive
72-Tooth

135pc Mechanic's Tool Kit

Siegen

MM

6pt

WALLDRIVE

1/4" & 1/2"
Sq. Drive

+

+

+

+

+

+

+

+

+

+

+

+

+



- 1/4" and 1/2" Sq drive reversible ratchet wrenches.
- Includes 1/4", 3/8" and 1/2" Sq drive sockets, hex keys, combination spanners, screwdrivers, pliers, utility knife, bit set and accessories.
- Tools feature soft grip handles for comfort and control.
- See www.sealey.co.uk for full contents and details.
- Model No. S01214
- List Price £229.95

£139.95 Exc. VAT
£167.94 Inc. VAT

Socket Sets

Siegen

NEW
PRODUCTS



A 1/4" Sq. Drive



B 1/4" Sq. Drive



C 3/8" Sq. Drive



MM

6pt
WALLDRIVE

MIRROR
FINISH

AVAILABLE
Mid July

- Professional socket sets manufactured from hardened and heat treated Chrome Vanadium steel.
- Fully polished with a mirror finish.



D 3/8" Sq. Drive



E 1/2" Sq. Drive

Ref.	Model No.	Qty	Drive	Contents	List Price	Exc. VAT	Inc. VAT
A	S01233	25pc	1/4" Sq	1/4" Sq Drive Standard Sockets; 4-13mm, 1/4" Sq Drive Bits; TRX-Star* - T10-T40, Phillips - #1, #2, Hex - 5, 6mm, 1/4" Sq Drive Extension Bar; 100mm, 1/4" Sq Drive Adaptor, 1/4" Sq Drive Ratchet Wrench	£24.95	£17.95	£21.54
B	S01234	26pc	1/4" Sq	1/4" Sq Drive Standard Sockets; 4-14mm, 1/4" Sq Drive Deep Sockets; 6-13mm, 1/4" Sq Drive Extension Bars; 75, 150mm, 1/4" Sq Drive Universal Joint, 1/4" Sq Drive Spinner, 1/4" Sq Drive Ratchet Wrench	£39.95	£28.95	£34.74
C	S01235	19pc	3/8" Sq	3/8" Sq Drive Standard Sockets; 8-22mm, 3/8" Sq Drive Extension Bars; 75, 150mm, 3/8" Sq Universal Joint, 3/8" Sq Drive Adaptor, 3/8" Sq Drive Ratchet Wrench	£44.95	£31.95	£38.34
D	S01236	28pc	3/8" Sq	Standard Sockets; 8-22mm, Deep Sockets; 10-19mm, 3/8" Sq Drive Flip Release Quick Release Ratchet Wrench, Extension Bars; 75, 150mm, Universal Joint	£59.95	£42.95	£51.54
E	S01237	21pc	1/2" Sq	1/2" Sq Drive Standard Sockets; 10-32mm, 1/2" Sq Drive Extension Bars; 125, 250mm, 1/2" Sq Universal Joint, 1/2" Sq Drive Adaptor, 1/2" Sq Drive Ratchet Wrench	£74.95	£53.95	£64.74

Socket Sets

Siegen



All models supplied on storage/carry rack.

A 1/4" Sq. Drive

B 1/4" Sq. Drive

NEW PRODUCTS

C 3/8" Sq. Drive

D 3/8" Sq. Drive

E 1/2" Sq. Drive

F 1/2" Sq. Drive



72-Tooth

AVAILABLE
Mid July

- Chrome Vanadium steel socket sets, hardened and tempered for strength with a fully polished finish for corrosion resistance.
- 72-Tooth pear-head flip reverse ratchet wrench with quick socket release and comfort grip handle.
- Knurled ring on sockets for extra grip with greasy fingers.
- All models supplied on storage/carry rack.

Ref.	Model No.	Qty	Drive	Contents	List Price	Exc. VAT	Inc. VAT
A	S01240	12pc	1/4" Sq	4-13mm Sockets, Ratchet Wrench & Extension Bar	£21.95	£13.95	£16.74
B	S01241	27pc	1/4" Sq	4-13mm Sockets, Socket Bits; Slotted - 4, 5, 7mm, Phillips - #1, #2, TRX-Star* - T10, T15, T20, T25, T30, Hex - 3, 4, 5, 6mm, 1/4" Sq Drive Ratchet Wrench	£32.95	£21.95	£26.34
C	S01242	12pc	3/8" Sq	10-19mm Sockets, Ratchet Wrench & Extension Bar	£31.95	£20.95	£25.14
D	S01243	19pc	3/8" Sq	6-24mm Sockets, 3/8" Sq Drive Flip Reverse Ratchet Wrench	£42.95	£27.95	£33.54
E	S01244	12pc	1/2" Sq	10-24mm Sockets, Ratchet Wrench & Extension Bar	£44.95	£29.95	£35.94
F	S01245	17pc	1/2" Sq	10-32mm Sockets, 1/2" Sq Drive Flip Reverse Ratchet Wrench	£62.95	£42.95	£51.54

Ratchet Wrenches - Black Series

Premier Black

NEW PRODUCTS



AVAILABLE
Mid July

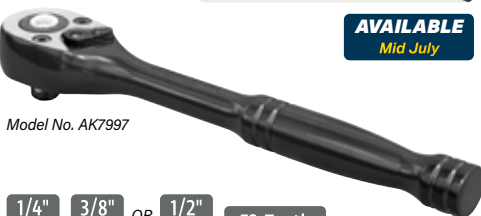

Model No. AK7997

1/4" Sq. Drive 3/8" Sq. Drive OR 1/2" Sq. Drive 72-Tooth

- Heat treated and hardened Chrome Vanadium steel.
- Fully polished black chrome finish with machined and lacquered heads.
- 72-tooth flip reverse ratchet wrench with push-button quick release.

Model No.	Drive	List Price	Exc. VAT	Inc. VAT
AK7997	1/4" Sq	£22.95	£15.95	£19.14
AK7998	3/8" Sq	£29.95	£21.95	£26.34
AK7999	1/2" Sq	£37.95	£26.95	£32.34

28pc 1/2" Sq Drive Socket Set Black Series

Premier Black

1/2" Sq. Drive MM 6pt WALLDRIVE®



- Professional socket set with heat treated Chrome Vanadium steel sockets and accessories.
- Fully polished black chrome finish with machined and lacquered surfaces.
- Contents: Sockets; 8-32mm, Spark Plug Sockets; 16, 21mm, Extension Bars; 75, 125, 250mm, 1/2" Sq Drive 72-Tooth Flip Reverse Ratchet Wrench with Quick Release, Universal Joint, 1/2" Sq Drive - 3/8" Sq Drive Male T-Bar Adaptor.
- **Model No. AK7972**
- List Price £159.95

£99.95 Exc. VAT
£119.94 Inc. VAT

13pc 3/8" Sq Drive Total Drive® Socket Set - Black Series

Premier Black

3/8" Sq. Drive MM TOTAL DRIVE®



- Manufactured from hardened and tempered heat treated Chrome Vanadium steel.
- Fully polished black chrome finish with machined and lacquered surfaces.
- All are suitable for Spline, Metric Hex and Bi-Hex, with many also equivalent to TRX-Star*, Whitworth, Imperial Hex and Imperial Bi-Hex.
- Features 72-tooth flip reverse ratchet wrench with push-button quick release.
- Contents: 8-19mm.
- **Model No. AK7973**
- List Price £54.95

£28.95 Exc. VAT
£34.74 Inc. VAT

Socket Sets - Platinum Series

Premier Platinum series

MM



NEW PRODUCTS

- Hardened and heat treated Chrome Vanadium steel with a fully polished micro satin finish.
- Colour-coded for fast identification.
- Knurled rings assist the gripping of the sockets with oily fingers.
- Both sets are supplied with composite socket rail.

Model No.	Qty	Drive	Contents	List Price	Exc. VAT	Inc. VAT
AK2660	12pc	3/8" Sq	8-19mm	£36.95	£26.95	£32.34
AK2661	13pc	1/2" Sq	10-24mm	£49.95	£35.95	£43.14

9pc 3/8" Sq Drive Socket Bit Sets Platinum Series

Premier Platinum series

3/8" Sq. Drive



NEW PRODUCTS

- Forged Chrome Vanadium steel sockets with S2 steel hex bits.
- Sockets are heat treated and chrome plated with a fully polished micro satin finish.
- Colour-coded rings for fast identification.
- Knurled rings assist the gripping of the sockets with oily fingers.
- Both sets are supplied with composite socket rail.

Model No.	Qty	Drive	Contents	List Price	Exc. VAT	Inc. VAT
AK6250	9pc	3/8" Sq Hex	4-12mm	£29.95	£20.95	£25.14
AK6251	9pc	3/8" Sq TRX-Star	T10-T50	£28.45	£19.95	£23.94

1/2" Sq Drive Impact Socket Sets

Premier

1/2" Sq. Drive

MM



NEW PRODUCTS



- Manufactured from Chrome Vanadium steel, hardened, tempered and with a phosphate finish for added corrosion resistance.
- 6-point WallDrive® sockets allows a transfer of up to 30% more torque to the fixing.
- Colour-coded rings for fast identification.
- AK5617M and AK5818M are supplied in storage case.
- AK5618M is supplied with composite socket rail.

Model No.	Qty	Drive	Depth	Contents	List Price	Exc. VAT	Inc. VAT
AK5617M	13pc	1/2" Sq	Standard	10, 11, 12, 13, 14, 15, 16, 17, 18, 19, 21, 22, 24mm	£59.95	£39.95	£47.94
AK5618M	9pc	1/2" Sq	Standard	10, 13, 15, 16, 17, 18, 19, 21, 24mm	£41.95	£26.95	£32.34
AK5818M	16pc	1/2" Sq	Deep	10, 11, 12, 13, 14, 15, 16, 17, 18, 19, 21, 22, 24, 27, 30, 32	£109.95	£69.95	£83.94

13pc 1/2" Sq Drive Lock-On™ Impact Socket Set

Premier

1/2" Sq. Drive

MM

10-24mm



- Manufactured from Chrome Molybdenum steel with manganese phosphate finish for added corrosion resistance.
- Features specially machined flutes in the walls of the socket to enable use on up to 85% rounded fasteners.
- Suitable for use with air/electric impact guns.
- Sizes: 10-24mm.
- Model No. AK5616M
- List Price £61.45

£39.95 Exc. VAT
£47.94 Inc. VAT

16pc 1/2" Sq Drive Deep Lock-On™ Impact Socket Set

Premier

1/2" Sq. Drive

MM

10-32mm Deep



- Manufactured from Chrome Molybdenum steel with manganese phosphate finish for added corrosion resistance.
- Features specially machined flutes in the walls of the socket to enable use on up to 85% rounded fasteners.
- Suitable for use with air/electric impact guns.
- Sizes: 10-32mm.
- Model No. AK5817M
- List Price £159.95

£99.95 Exc. VAT
£119.94 Inc. VAT

24pc Fine Tooth Stubby Ratchet Screwdriver Socket & Bit Set

Premier

Stubby



- Fine tooth reversible stubby ratchet driver with soft comfort grip handle and integral bit storage.
- Twist-reverse and ratchet lock mechanism.
- Contents: Reversible Ratchet Driver, 25mm Bits; Slotted - 3, 4, 5, 6mm, Phillips - #0, #1, #2, #3, Pozi - #1, #2, #3, TRX-Star* - T15, T20, T25, T30, 75mm 1/4"Hex Bit Holder, 1/4"Sq Drive Adaptor, 1/4"Sq Drive Sockets; 4, 5, 6, 7, 8, 10mm.
- **Model No. AK64906**
- List Price £22.95

£13.95 Exc. VAT
£16.74 Inc. VAT

51pc Fine Tooth Ratchet Screwdriver Socket & Bit Set

Premier



Impact Grade Torsion Bits

- Fine 48-tooth reversible ratchet driver with soft comfort grip handle and spring loaded integral bit storage.
- Twist-reverse and ratchet lock mechanism.
- Chrome Molybdenum steel shaft with magnetic bit retention.
- Features popular range of 25mm and 75mm impact grade torsion bits for the professional user, colour-coded for fast identification.
- Bits: 25mm Bits; Slotted - 3, 4, 5, 6mm, Phillips - #1, #2 (x2), #3, Pozi - #1, #2 (x2), #3, TRX-Star* - T10, T15, T20, T25, T30, T40, Security TRX-Star* - T10H, T15H, T20H, T25H, T30H, T40H, Hex - 3, 4, 5, 6mm, 75mm Bits; Slotted - 4, 6mm, Phillips - #1, #2, #3, Pozi; #1, #2, TRX-Star* - T20, T25.
- 75mm Bits feature no shoulder for easier access to recessed fixings.
- Includes sockets from 4-13mm, 1/4"Sq drive socket adaptor and 1/4"Hex quick release bit holder.
- **Model No. AK64903**
- List Price £99.95



£54.95 Exc. VAT
£65.94 Inc. VAT

12pc Ratchet Screwdriver Set

Premier



- Twist-reverse and ratchet lock mechanism.
- Chrome Vanadium steel shaft with magnetic bit retention.
- Features spring loaded integral bit storage.
- Supplied with 12-piece S2 steel bit set.
- Bits: Slotted; 4, 5, 6mm, Phillips; #1, #2, Pozi; #2, Hex; 3, 4, 5mm, TRX-Star*; T15, T20, T25.
- **Model No. AK64909**
- List Price £17.95



£10.95 Exc. VAT
£13.14 Inc. VAT

25pc 1/2"Sq Drive Impact TRX-Star*/Hex/Spline Bit Set

Premier



- Comprehensive set of TRX-Star*, Hex and Spline bits in Chrome Molybdenum steel, including a 1/2"Sq Drive bit holder with 2mm grub screw.
- Phosphate finish for corrosion resistance.
- Suitable for use with any impact tool.
- Contents: Bits; TRX-Star* - T30, T40, T45, T47, T50, T55, T60, T70, Hex - 6, 7, 8, 10, 12, 14, 17, 19mm, Spline - M6, M8, M9, M10, M12, M14, M16, M18, 1/2"Sq Drive Bit Holder.
- Supplied in a storage case with EVA foam tray.
- **Model No. AK5612**
- List Price £82.45



£43.95 Exc. VAT
£52.74 Inc. VAT

7pc Impact Socket Adaptor Set

Premier

NEW PRODUCT

1/4" Sq. Drive 3/8" Sq. Drive 1/2" Sq. Drive

- Manufactured from Chrome Vanadium and Chrome Molybdenum steel with manganese phosphate finish for added resistance from corrosion.
- Includes three hex shank power tool socket adaptors and four square drive socket adaptors.
- Contents: 65mm 1/4"Hex x 1/4"Sq Drive, 65mm 1/4"Hex x 3/8"Sq Drive, 75mm 1/4"Hex x 1/2"Sq Drive, 3/8"(F) x 1/4"(M), 1/4"(F) x 3/8"(M), 3/8"(F) x 1/2"(M), 1/2"(F) x 3/8"(M).
- **Model No. AK5522**
- List Price £28.95



£19.95 Exc. VAT
£23.94 Inc. VAT

9pc 1/4" & 3/8"Sq Drive Low Profile Hex Impact Socket Bit Set

NEW PRODUCT

Premier

1/4" & 3/8" Sq. Drive MM Low Profile

- Manufactured from Chrome Molybdenum steel with manganese phosphate finish for added resistance from corrosion.
- Low profile for use in areas that may otherwise be inaccessible.
- Contents: 1/4"Sq Drive; 6, 7, 8, 10mm, 3/8"Sq Drive; 12, 14, 17, 18, 19mm.
- Supplied in an EVA storage tray.
- **Model No. AK5525**
- List Price £38.95



£23.95 Exc. VAT
£28.74 Inc. VAT

10pc 1/4" & 3/8"Sq Drive Low Profile Impact TRX-Star* Socket Bit Set

NEW PRODUCT

Premier

1/4" & 3/8" Sq. Drive T10 - T50 Low Profile

- Manufactured from Chrome Molybdenum steel with manganese phosphate finish for added resistance from corrosion.
- Low profile for use in areas that may otherwise be inaccessible.
- Contents: 1/4"Sq Drive; T10, T15, T20, T25, T27, T30, 3/8"Sq Drive; T40, T45, T47, T50.
- Supplied in an EVA storage tray.
- **Model No. AK5526**
- List Price £32.45

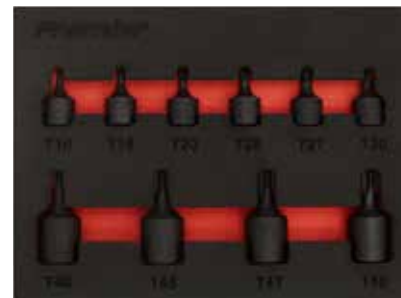

£19.95 Exc. VAT
£23.94 Inc. VAT

56pc 3/8" & 1/2" Sq Drive Security TRX-Star*/Hex/ Ribe/Spline Bit Set

Premier

3/8" & 1/2" Sq. Drive



- Manufactured from Chrome Vanadium 6150 steel.
- Convenient high-impact storage case presents bits at an angle for easy selection.
- Contents: Security TRX-Star* Bits; T20H, T25H, T30H, T40H, T45H, T50H, T55H, T60H (1 each 30 and 75mm), Hex Bits; 4, 5, 6, 7, 8, 10, 12mm (1 each 30 and 75mm), Ribe Bits; M5, M6, M7, M8, M10, M12, M14 (1 each 30 and 75mm), Spline Bits; M5, M6, M8, M10, M12 (1 each 30 and 75mm), Drive Adaptors; 3/8" Sq x 10mm Hex, 1/2" Sq x 10mm Hex.
- **Model No. AK21956**
- List Price £49.95

£34.95 Exc. VAT
£41.94 Inc. VAT

40pc 3/8" & 1/2" Sq Drive TRX-Star*/Hex/Spline Bit Set

Siegen

3/8" & 1/2" Sq. Drive



- Chrome Vanadium steel bits.
- Hardened and tempered for added strength.
- Contents: TRX-Star* Bits; T20, T25, T30, T40, T45, T50, T55 (1 each 30 and 75mm), Hex Bits; 4, 5, 6, 7, 8, 10, 12mm (1 each 30 and 75mm), Spline Bits; M5, M6, M8, M10, M12 (1 each 30 and 75mm), Drive Adaptors; 3/8" Sq x 10mm Hex, 1/2" Sq x 10mm Hex.
- **Model No. S0982**
- List Price £25.95

£16.95 Exc. VAT
£20.34 Inc. VAT

42 Bit Capacity Magnetic Bit Holder

Premier



- Storage for 10mm hex drive bits.
- Composite holder with strong magnetic base helps maintain a tidy workstation.
- Ideal for tool chests or any ferrous surface.
- Holds up to 42 bits.
- **Model No. BH42**
- List Price £26.95

£19.95 Exc. VAT
£23.94 Inc. VAT

7pc 3/8" Sq Drive Lock-On™ TRX-Star* Socket Bit Set

Premier

3/8" Sq. Drive TRX-Star*
T10 - T40



- Professional heat treated Chrome Vanadium steel sockets.
- S2 Steel bits with a satin chrome finish.
- Designed for extracting TRX-Star* screw heads and fasteners that have become damaged, cross-threaded or jammed.
- Sizes: T10, T15, T20, T25, T27, T30, T40.
- **Model No. AK62263**
- List Price £19.45

£12.95 Exc. VAT
£15.54 Inc. VAT

Ø110mm Magnetic Collector

Premier

Magnetic

- Ø110mm Stainless steel tray with Ø60mm magnet in non-marking cover.
- Ideal for storing nuts, bolts, screws, washers and sockets during disassembly/assembly.
- Attaches to any ferrous surface and even works upside-down.
- **Model No. AK2311**
- List Price £5.45

£3.95 Exc. VAT
£4.74 Inc. VAT



38pc 1/4", 3/8" & 1/2" Sq Drive TRX-Star* Socket & Security Socket Bit Set

Premier

1/4" 3/8" & 1/2" Sq. Drive

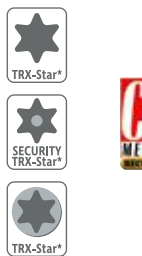

- Drop-forged Chrome Vanadium steel sockets with S2 steel TRX-Star* bits.
- Sockets heat treated and chrome plated for resistance to corrosion.
- Fully polished mirror finish with knurled ring to assist gripping with oily fingers.
- Contents: TRX-Star* Socket Bits; 1/4" Sq Drive - T8, T10, T15, T20, T25, T27, T30, 3/8" Sq Drive - T40, T45, T47, T50, T55, 1/2" Sq Drive - T60, Security TRX-Star* Socket Bits; 1/4" Sq Drive - T7H, T8H, T9H, T10H, T15H, T20H, T25H, T30H, 3/8" Sq Drive - T40H, T45H, T50H, T55H, TRX-Star* Sockets; 1/4" Sq Drive - E4, E5, E6, E7, E8, 3/8" Sq Drive - E10, E12, E14, E16, 1/2" Sq Drive - E18, E20, E22, E24.
- **Model No. AK6197**
- List Price £78.95

£39.95 Exc. VAT
£47.94 Inc. VAT

34pc Impact Grade Power Tool Bit Set

Premier



- Forged from high quality S2 steel.
- Specially heat treated CNC precision machined tips reduce stress and prevent cam-out under load.
- Torsion bits absorb impact and transfer maximum torque to the fixing.
- Contents: 25mm Bits; Phillips - #2, #3, Pozi - #1, #2, #3, TRX-Star* - T20, T25, T30, 50mm Bits; Slotted - 5.5mm, Phillips - #1, #2 (x3), #3, Pozi; #1, #2 (x4), #3, TRX-Star* - T15, T20 (x2), T25 (x2), T30 (x2), Hex - 5, 6mm, 60mm Bit Holder, Quick Release Bit Holder, Socket Adaptor - 1/4" Sq Drive, 3/8" Sq Drive, 1/2" Sq Drive.
- **Model No. AK8285**
- List Price £39.95

£26.95 Exc. VAT
£32.34 Inc. VAT

15pc 3/4" Sq Drive 12-point WallDrive® Socket Set

NEW
PRODUCT

Premier

3/4"
Sq. Drive

MM

12pt



- Manufactured from heat treated drop-forged Chrome Vanadium steel.
- Hardened and tempered with dual satin chrome finish.
- WallDrive® sockets grip the flats of the fixing giving maximum torque transfer.
- Contents: Standard Sockets; 19, 22, 24, 27, 30, 32, 36, 38, 41, 46, 50mm, 3/4" Sq Drive 500mm Flip Reverse Quick Release Ratchet Wrench, Extension Bars; 100, 200mm, 450mm Sliding T-bar.
- **Model No. AK2583**
- List Price £259.95

£189.95 Exc. VAT
£227.94 Inc. VAT

26pc 3/4" Sq Drive 12-point WallDrive® Socket Set Metric/Imperial

NEW
PRODUCT

Premier

3/4"
Sq. Drive

MM & IMP

12pt



AVAILABLE
Mid July

- Manufactured from heat treated drop-forged Chrome Vanadium steel.
- Hardened and tempered with dual satin chrome finish.
- WallDrive® sockets grip the flats of the fixing giving maximum torque transfer.
- Features pear-head flip reverse ratchet wrench with quick release.
- Includes sliding T-bar and extension bars.
- **Model No. AK2584**
- List Price £319.95

£229.95 Exc. VAT
£275.94 Inc. VAT

Locking Flexi-Head Extendable Ratchet Wrenches Platinum Series

Premier
Platinum series



Flexi-Head

3/8" OR 1/2"
Sq. Drive 72-Tooth



Extendable

- Chrome Vanadium steel ratchet wrenches.
- Hardened and tempered with a fully polished micro satin finish.
- Extension retained at set increments with a quick release locking ring giving six different shaft lengths.
- Features 180° locking flexi-head.
- Compact head design and ultra-smooth 72-tooth ratchet action allowing ratcheting in increments of 5° for ease of use in restricted areas.
- Textured soft grip handle for comfort and control.
- Features flip reverse and quick release mechanism.

Model No.	Drive	List Price	Exc. VAT	Inc. VAT
AK8983	3/8" Sq	£61.95	£34.95	£41.94
AK8984	1/2" Sq	£72.95	£42.95	£51.54

Dust-Free Ratchet Wrenches with Flip Reverse Platinum Series

Premier
Platinum series

1/4" 3/8" OR 1/2"
Sq. Drive

Gear 2 Gear 72-Tooth



Model No. AK8976

- Chrome Vanadium steel ratchet wrenches.
- Hardened and tempered with a fully polished micro satin finish.
- Textured soft grip handle for comfort and control.
- 72-Tooth gear-to-gear ratchet with flip reverse and quick release mechanism.
- Sealed head keeps dirt and other contaminants out of the ratchet mechanism.

Model No.	Drive	Length	List Price	Exc. VAT	Inc. VAT
AK8976	1/4" Sq	140mm	£29.95	£19.95	£23.94
AK8977	3/8" Sq	200mm	£36.95	£22.95	£27.54
AK8978	1/2" Sq	255mm	£46.95	£29.95	£35.94

5pc Wobble Extension Bar Sets

Premier

3/8" OR 1/2"
Sq. Drive



Model No. AK767



Model No. AK768

- Forged Chrome Vanadium steel shafts, heat treated and chrome plated with mirror finish.
- Cut-away tips allow sockets to be driven when shaft offset is up to 10° from its axis.
- Deep knurling on shafts allows extra grip when spinning off fixings.
- Spring-ball socket retainers.

Model No.	Drive	Lengths	List Price	Exc. VAT	Inc. VAT
AK767	3/8" Sq	38, 75, 150, 250, 450mm	£37.95	£24.95	£29.94
AK768	1/2" Sq	50, 125, 250, 375, 500mm	£79.95	£46.95	£56.34

6pc Socket Adaptor Set

Premier

1/4" 3/8" 1/2"
& 3/4" Sq. Drive



- Chrome Vanadium socket adaptor set.
- Hardened, tempered and chrome plated.
- Fitted with spring-ball socket retainer.
- Contents: 1/4"(M) x 3/8"(F), 3/8"(M) x 1/4"(F), 3/8"(M) x 1/2"(F), 1/2"(M) x 3/8"(F), 1/2"(M) x 3/4"(F), 3/4"(M) x 1/2"(F) Sq Drive.
- Supplied in storage case.
- **Model No. AK2736**
- List Price £24.95

£15.95 Exc. VAT
£19.14 Inc. VAT

3pc Ball Pein Hammer Set with Fibreglass Shafts

Premier



- Professional engineer's set.
- Contents: 340g(12oz), 450g(1lb), 680g(1.5lb).
- High quality drop-forged steel heads.
- Fitted with fibreglass shafts.
- Manufactured in accordance with BS 876.
- Model No. **AK2031**
- List Price £61.95

£39.95 Exc. VAT
£47.94 Inc. VAT

One-Piece Ball Pein Hammers

Premier



- Forged one-piece steel hammer head and shaft.
- Lightweight design yet incredibly strong.
- Shock reducing textured rubber grip.
- Manufactured and tested to BS 876.



Model No.	Weight	List Price	Exc. VAT	Inc. VAT
BPHX16	450g(16oz)	£31.95	£21.95	£26.34
BPHX24	680g(24oz)	£34.95	£23.95	£28.74
BPHX32	907g(32oz)	£37.45	£24.95	£29.94

15oz One-Piece Claw Hammer

Premier



- Forged one-piece steel for strength and durability.
- Magnetic nail starter for easy one-hand operation.
- Lightweight design yet incredibly strong.
- Shock reducing textured rubber grip.
- Manufactured and tested to BS 876.
- Model No. **CLHX15**
- List Price £32.95

£23.95 Exc. VAT
£28.74 Inc. VAT

Hammers with Hickory Shaft

Premier



- Manufactured from drop-forged fine grained carbon steel.
- Heat treated, hardened and tempered with precision ground polished striking face.
- Straight-grain hickory handle.
- Manufactured and tested to BS 876.

Model No.	Type	Weight	List Price	Exc. VAT	Inc. VAT
CHH301	Club Hammer	1.36kg(3lb)	£26.95	£18.95	£22.74
SLH041	Sledge Hammer	1.8kg(4lb)	£34.95	£22.95	£27.54

Ball Pein Hammers with Hickory Shaft

Premier



- Drop-forged steel head and fitted with straight-grained hickory shaft.
- Manufactured in accordance with BS 876.

Model No.	Weight	List Price	Exc. VAT	Inc. VAT
BPH12	340g(12oz)	£14.45	£8.95	£10.74
BPH16	450g(1lb)	£16.95	£10.95	£13.14
BPH24	680g(1.5lb)	£21.45	£13.95	£16.74
BPH32	900g(2lb)	£23.95	£15.95	£19.14

Dead Blow Hammers

Premier



- Shot-loaded head produces heavy, controlled and effective blows without rebound.
- Manufactured from Nitrile rubber.

Model No.	Weight	List Price	Exc. VAT	Inc. VAT
DBH630	630g(1.3lb)	£21.45	£13.95	£16.74
DBH1000	1kg(2.2lb)	£31.45	£19.95	£23.94

4pc Hammer-Thru Wood Chisel Set

Premier



- Chrome Vanadium steel.
- Bevel edged blades.
- Full length hammer-thru shafts with striking cap.
- Contoured handles with soft grips for added comfort and control.
- Supplied with storage pouch.
- Contents: 6, 12, 19, 25mm.
- Model No. **AK9239**
- List Price £31.95

£22.95 Exc. VAT
£27.54 Inc. VAT



ALWAYS WEAR SAFETY GOGGLES WHEN USING THESE TOOLS

**15 Spanners Capacity
Spanner Rack**

Premier

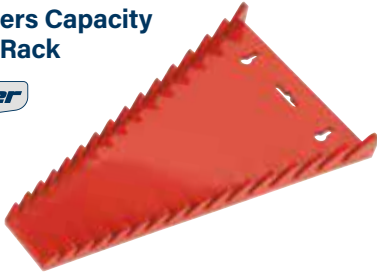

- Durable composite spanner rack helps maintain an organized toolbox or workstation.
- Can also be carried or hung on a wall.
- **Model No. WR05**
- List Price £13.45

£8.95 Exc. VAT
£10.74 Inc. VAT

1/4", 3/8" & 1/2" Sq Drive Socket Rail Tray

Premier



- Steel panel with 5 x 430mm rails.
- Supplied with clips suitable for retaining 1/4", 3/8" and 1/2" Sq drive sockets plus two 10-piece power bit holders.
- Fitted with carry handles and hanging holes.
- **Model No. AK272**
- List Price £46.95

1/4" 3/8" &
1/2" Sq. Drive

£27.95 Exc. VAT
£33.54 Inc. VAT

10 Spanner Capacity Magnetic Spanner Rack

Premier



Magnetic



- Durable composite spanner rack with strong magnetic backing.
- Ideal for tool chests or any ferrous surface.
- Length: 235mm.
- **Model No. WR06**
- List Price £21.95

£14.95 Exc. VAT
£17.94 Inc. VAT

**1/4" Hex Torque Screwdriver
Digital 0-20Nm**

Premier

1/4"
Hex Drive

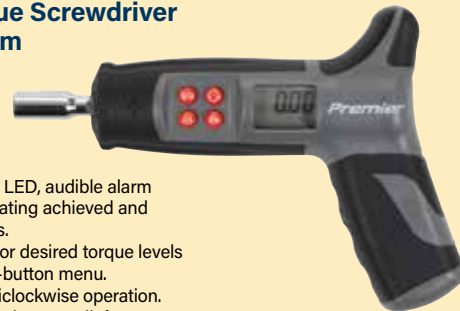

- LCD read-out with LED, audible alarm and vibration indicating achieved and target torque levels.
- Preset track, peak or desired torque levels using simple push-button menu.
- Clockwise and anticlockwise operation.
- Selectable read-out in Nm or lb.ft.
- Accurate to ±1% of stated capacity.
- Supplied with 2 x AAA batteries and test certificate.
- **Model No. STS104**
- List Price £109.95

0-20Nm

TORQUES IN
BOTH DIRECTIONS

£73.95 Exc. VAT
£88.74 Inc. VAT

16pc Reversible Spanner Racks

Premier

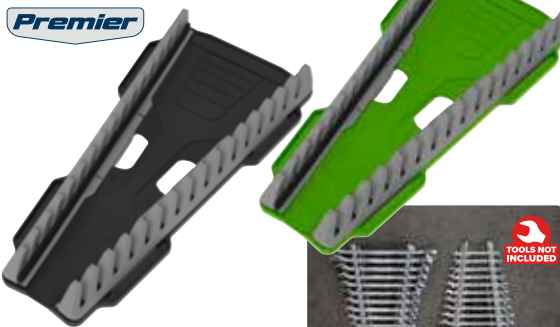

- Reversible side rails with quick change design.
- Spanners always face forward for easy selection and size identification.
- **Model No. WR11** - Black/Grey
- **Model No. WR11HV** - Hi-Vis Green
- List Price £19.95

£12.95 Exc. VAT
£15.54 Inc. VAT

1/2" Sq Drive Digital Torque Adaptor with Angle Function 20-200Nm

Premier

1/2"
Sq. Drive



- Designed for use with a standard ratchet or breaker bar.
- Ideal for work around the engine bay and the tightening of wheel nuts to factory specifications.
- Large LCD display with LED/audible alarm indicating achieved and target torque levels.
- Selectable readings in Nm, lb.ft, lb.in or kgf.m.
- Accurate to ±2% of stated capacity and operates in either direction.
- Features angle mode, eliminating the need for angle gauges and protractors providing an accurate and fast way to measure torque plus angle tightening sequences.
- Supplied with test certificate and storage case.
- **Model No. STW291**
- List Price £128.95

20-200Nm

TORQUES IN
BOTH DIRECTIONS

£76.95 Exc. VAT
£92.34 Inc. VAT

**3/4" Sq Push-Through Drive Micrometer Torque Wrench
237-983Nm**

Premier

3/4"
Sq. Drive



Push-Through Drive

237-983Nm

TORQUES IN
BOTH DIRECTIONS

- Range: 237-983Nm(150-750lb.ft).
- Length: 1225mm.
- Manufactured from Chrome Vanadium steel.
- Hardened and tempered with a chrome plated polished finish.
- Ratchet head features flip reverse action and push-through drive to allow torquing either clockwise or anticlockwise.
- Comfort grip with easy-to-use torque adjustment, locks when required setting is selected.
- Calibration tolerance in accordance with BS EN ISO 6789:2017.
- Scales graduated in both lb.ft and Nm.
- Individually tested for ±4% accuracy and issued with an individually numbered calibration certificate.
- Supplied in storage case with padlock.

£479.95 Exc. VAT
£575.94 Inc. VAT

- **Model No. STW601**
- List Price £649.95

**3/4" Sq Drive Micrometer Style Torque Wrench
160-800Nm**

Premier

3/4"
Sq. Drive



160-800Nm



- Range: 160-800Nm(118.1-590.4lb.ft).
- Flip reverse Chrome Vanadium steel ratchet head with smooth action mechanism.
- Scale graduated in Nm and lb.ft.
- Calibration tolerance in accordance with BS EN ISO 6789-1:2017.
- Wrenches are individually tested to standards with ±4% accuracy and each wrench is issued with an individually numbered test certificate.
- Aluminium knurled handle for comfort and control.
- Supplied in storage case.
- **Model No. STW907**
- List Price £529.95

£299.95 Exc. VAT
£359.94 Inc. VAT

GripMAX® Screwdriver Sets

Premier

Includes hanging hole (except Hammer-Thru models).



Shot blasted and magnetized tips.

Chrome Vanadium steel, satin finished shafts.



Each size clearly marked for quick and easy identification (except Hammer-Thru models).



Polypropylene and TPV rubber soft grip handles.

Available in **Red** or **Hi-Vis Green**



8pc GripMAX® Security TRX-Star* Screwdriver Sets



- Contents: TRX-Star*; T8H x 60, T10H x 80, T15H x 80, T20H x 100, T25H x 100, T27H x 100, T30H x 100, T40H x 125mm.
- Model No. AK4323 - Red
- Model No. AK4323HV - Hi-Vis Green
- List Price £32.95

£21.95 Exc. VAT
£26.34 Inc. VAT

10pc GripMAX® TRX-Star* Screwdriver Sets



- Contents: TRX-Star*; T7 x 75, T8 x 75, T9 x 75, T10 x 100, T15 x 100, T20 x 100, T25 x 100, T27 x 100, T30 x 100, T40 x 125mm.
- Model No. AK4324 - Red
- Model No. AK4324HV - Hi-Vis Green
- List Price £39.95

£24.95 Exc. VAT
£29.94 Inc. VAT

33pc GripMAX® Screwdriver & Bit Sets



NEW PRODUCTS

- Contents: Screwdrivers; Slotted - 6 x 38, 3 x 75, 4 x 100, 6 x 150, 8 x 200mm, Phillips - #2 x 38, #1 x 75, #2 x 100mm, Pozi - #2 x 38, #1 x 75, #2 x 100mm; Bits; Slotted - 3, 4, 5, 6mm, Phillips - #0, #1, #2, #3, Pozi; #0, #1, #2, #3 TRX-Star* - T10, T15, T20, T25, T30, Hex; 3, 4, 5mm, Bit Drivers; 38, 150mm.
- Model No. AK4370 - Red
- Model No. AK4370HV - Hi-Vis Green
- List Price £54.95

£34.95 Exc. VAT
£41.94 Inc. VAT

6pc Hammer-Thru Screwdriver Sets

AVAILABLE Mid July

NEW PRODUCTS



- Features hexagonal bolster for use with a wrench.
- Contents: Slotted; 5 x 100, 6 x 150, 8 x 175mm, Phillips; #1 x 75, #2 x 100, #3 x 150mm.
- Model No. AK4940 - Red
- Model No. AK4940HV - Hi-Vis Green
- List Price £47.95

£29.95 Exc. VAT
£35.94 Inc. VAT

9pc Hammer-Thru Screwdriver Sets

AVAILABLE Mid July

NEW PRODUCTS



- Features hexagonal bolster for use with a wrench.
- Contents: Slotted; 5 x 100, 6 x 150, 8 x 175mm, Phillips; #1 x 75, #2 x 100, #3 x 150mm, Pozi; #1 x 75, #2 x 100, #3 x 150mm.
- Model No. AK4941 - Red
- Model No. AK4941HV - Hi-Vis Green
- List Price £72.95

£44.95 Exc. VAT
£53.94 Inc. VAT

3pc 450mm Extra-Long Hammer-Thru Screwdriver Sets

AVAILABLE Mid July

NEW PRODUCTS



450mm Length



- Features hexagonal bolster for use with a wrench.
- Contents: Slotted; 8 x 450mm, Phillips; #2 x 450, #3 x 450mm.
- Model No. AK4942 - Red
- Model No. AK4942HV - Hi-Vis Green
- List Price £46.95

£29.95 Exc. VAT
£35.94 Inc. VAT

49pc 1/2" Sq Drive 1000V Insulated Tool Kit VDE Approved



Premier

1/2" Sq. Drive



- Hardened and tempered Chrome Vanadium steel sockets and accessories.
- Chrome plated for resistance to corrosion.
- Each component is fully insulated to VDE and EN 60900 standards to protect from electric shocks up to 1500V DC and 1000V AC.
- Features 45-tooth flip reverse comfort grip ratchet wrench with push-button quick release, sockets, socket bits, extension bars, T-bar, open-end wrenches, pliers, cable knife, voltage tester, nut drivers, screwdrivers and hex keys.
- Ideal for technicians working on modern hybrid and electrical vehicles (1500V DC safe live working).
- Also suitable for electricians and other trades (1000V AC safe live working).
- **Model No. AK7939**
- List Price £729.95

£519.95 Exc. VAT
£623.94 Inc. VAT

27pc Insulated Tool Kit VDE Approved



Premier

3/8" Sq. Drive

- Manufactured from hardened and tempered Chrome Vanadium steel.
- Each tool is fully insulated to VDE and EN 60900 standards to protect from electric shocks up to 1500V DC and 1000V AC.
- Contents: 3/8" Sq Drive Sockets; 7, 8, 10, 12, 13, 14, 17, 19, 22mm, 3/8" Sq Drive Reversible Ratchet, 3/8" Sq Drive 100mm Extension Bar, 3/8" Sq Drive T-Handle, Open-End Spanners; 7, 8, 10, 12, 13, 14, 17, 19mm, Screwdrivers; Slotted - 4 x 100, 5.5 x 125mm, Phillips - #1 x 100, #2 x 100mm, Pliers; 200mm Combination, 160mm Diagonal Side Cutters, Cable Knife.
- **Model No. AK7945**
- List Price £349.95

£239.95 Exc. VAT
£287.94 Inc. VAT



7pc Screwdriver Set - VDE Approved

Siegen

- Chrome Vanadium shafts with magnetic and corrosion resistant precision tips.
- Insulated and VDE approved for use up to 1500V DC and 1000V AC.
- Contents: Slotted; 3 x 75, 4 x 100, 5.5 x 125, 6.5 x 150mm, Phillips; #0 x 75, #1 x 80, #2 x 100mm.
- Features hanging holes for easy storage.
- **Model No. S0756**
- List Price £23.95

£14.95 Exc. VAT
£17.94 Inc. VAT



Calibrated Insulated Torque Wrenches

60-Tooth



Premier



- Chrome Vanadium steel reversible 60-tooth ratchet heads.
- Impact resistant polycarbonate tubing combined with injection moulded nylon thermoplastic for total insulation.
- Torques in both directions.
- Calibration tolerance in accordance with BS EN ISO 6789:2017.
- Accuracy of ±1% at 21°C. Easy-to-read dual scale graduated in both Nm and lb.ft.
- Cold and heat resistant -40°C to +70°C.
- Fully insulated to BS EN IEC 60900:2018 to protect from electric shocks up to 1500V DC and 1000V AC.
- Ideal for technicians working on modern hybrid and electrical vehicles (1500V DC safe live working).
- Includes test and calibration certificate.



Model No.	Drive	Range	Length	List Price	Exc. VAT	Inc. VAT
STW803	3/8" Sq	12-60Nm	350mm	£379.95	£269.95	£323.94
STW804	1/2" Sq	12-60Nm	350mm	£379.95	£269.95	£323.94
STW805	3/8" Sq	5-25Nm	285mm	£499.95	£349.95	£419.94

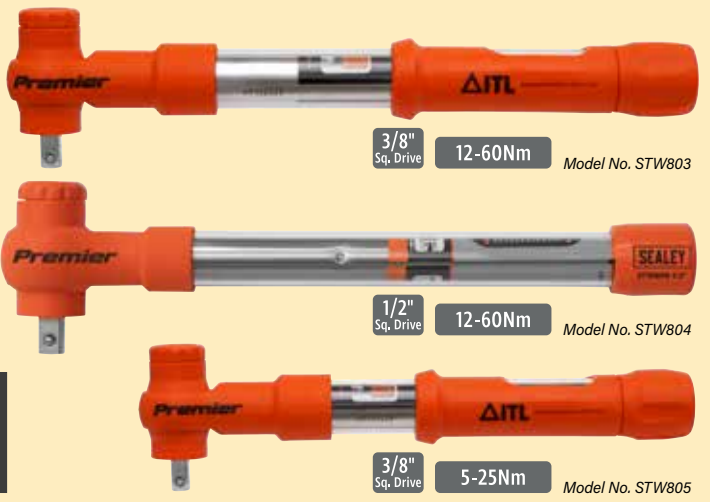

29pc Insulated Tool Kit

Premier

1/2" Sq. Drive

- Hardened and tempered Chrome Vanadium steel sockets and accessories.
- Chrome plated for resistance to corrosion.
- Each component is fully insulated to IEC 60900 Category C standards to protect from electric shocks up to 1500V DC and 1000V AC.
- 1/2" Sq drive reversible ratchet, sockets, extensions, spanners, hex socket bits, screwdrivers, pliers, cable knife.
- Ideal for technicians working on modern hybrid and electrical vehicles (1500V DC safe live working).
- Also suitable for electricians and other trades (1000V AC safe live working).
- **Model No. AK7910**
- List Price £699.95

£499.95 Exc. VAT
£599.94 Inc. VAT



11pc Electrical VDE Tool Kit

Siegen

- Manufactured from hardened and tempered Chrome Vanadium steel.
- Each tool is fully insulated to VDE and EN 60900 standards to protect from electric shocks up to 1500V DC and 1000V AC.
- Ideal for technicians working on modern hybrid and electrical vehicles (1500V DC safe live working).
- Also suitable for electricians and other trades (1000V AC safe live working).
- Contents: Screwdrivers: Slotted - 3 x 75mm, 4 x 100mm, 5.5 x 125mm, 6.5 x 150mm, Phillips - #0 x 75mm, #1 x 80mm, #2 x 100mm, 175mm Combination Pliers, 150mm Side Cutters, 200mm Long Nose Pliers, Voltage Tester.
- **Model No. S01219**
- List Price £81.95

£53.95 Exc. VAT
£64.74 Inc. VAT



8pc T-Handle Hex Key Set

Premier



MM



2-10mm

- Hardened and tempered Chrome Vanadium steel shafts with a fully polished satin finish.
- Tough, composite handle with rubberised comfort grip.
- Long and short shafts for each size.
- Contents: 2-10mm.
- Includes hanging holes and storage stand.
- **Model No. AK7143**
- List Price £44.95

£27.95 Exc. VAT
£33.54 Inc. VAT

8pc T-Handle Ball-End Hex Key Set

Premier



MM



2-10mm

- Hardened and tempered Chrome Vanadium steel shafts with a fully polished satin finish.
- Tough, composite handle with rubberised comfort grip.
- Long shaft has ball-end, allowing fixing to be driven at up to 30° from its axis.
- Short element is standard hex.
- Contents: 2-10mm.
- Includes hanging holes and storage stand.
- **Model No. AK7144**
- List Price £47.95

£29.95 Exc. VAT
£35.94 Inc. VAT

8pc T-Handle TRX-Star* Key Set

Premier



MM



T10 - T50

- Hardened and tempered Chrome Vanadium steel shafts with a fully polished satin finish.
- Tough, composite handle with rubberised comfort grip.
- Long and short shafts for each size.
- Contents: T10, T15, T20, T25, T27, T30, T40, T50.
- Includes hanging holes and storage stand.
- **Model No. AK7145**
- List Price £49.95

£31.95 Exc. VAT
£38.34 Inc. VAT

27pc Master Hex Key Set

Premier

AVAILABLE Mid July

NEW PRODUCT



- One of a comprehensive range of Premier Hand Tools, suitable for daily professional use.
- Manufactured from heat treated and hardened Chrome Vanadium steel with a fully polished finish.
- Anti-slip coating for comfort and control.
- Each key set is supplied in easy-access case for safe storage and quick key selection.
- Supplied in an EVA storage tray.
- **Model No. AK7179**
- List Price £59.95

£39.95 Exc. VAT
£47.94 Inc. VAT

9pc Lock-On™ Ball-End Hex Key Set

Premier

LOCK-ON™



MM

1,5-10mm

- Manufactured from Chrome Molybdenum steel with a polished satin finish.
- Removes rusted, damaged and severely rounded hex head fasteners with ease.
- Patented twist design on short-arm grips tighter as they turn.
- Prevents fasteners from rounding.
- Keys range in length from 88mm to 225mm and in size from 1.5mm to 10mm.
- Ball-end allows key to drive fixing at up to 25°.
- **Model No. AK7180**
- List Price £39.95

£26.95 Exc. VAT
£32.34 Inc. VAT

13pc Extra-Long Anti-Slip Jumbo Key Sets

Premier

Extra-Long

Anti-Slip

Jumbo Keys

Magnetic

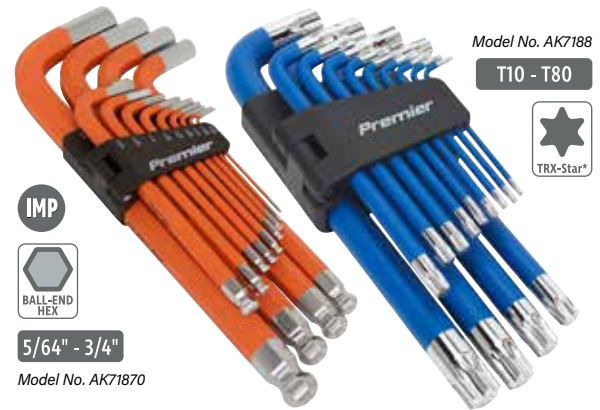

Model No. AK7188

T10 - T80

IMP



5/64" - 3/4"

Model No. AK71870

- Manufactured from heat treated and hardened Chrome Vanadium steel with a fully polished finish.
- Anti-slip coating for comfort and control.
- Includes magnets on the long element.
- Supplied in easy-access case for safe storage and quick key selection.

Model No.	Contents	Length	List Price	Exc. VAT	Inc. VAT
AK71870	5/64"-3/4"	83-280mm	£89.95	£54.95	£65.94
AK7188	T10-T80	75-270mm	£99.95	£59.95	£71.94

Combination Spanner Sets

Premier



SATIN FINISH



Model No. AK63255

MM



Model No. AK63265

MM

NEW PRODUCT



Model No. AK63266

IMP

NEW PRODUCT



- Chrome Vanadium steel combination spanners.
- Hardened, tempered and nickel chrome plated for corrosion resistance.
- Fully polished mirror finish.
- Open-end and 12-point WallDrive® ring combination.
- Supplied in an EVA storage tray.

Model No.	Qty	Contents	List Price	Exc. VAT	Inc. VAT
AK63255	16pc	6, 7, 8, 9, 10, 11, 12, 13, 14, 15, 16, 17, 18, 19, 21, 22mm	£47.95	£29.95	£35.94
AK63265	12pc	8, 9, 10, 11, 12, 13, 14, 15, 16, 17, 18, 19mm	£44.95	£27.95	£33.54
AK63266	11pc	1/4", 5/16", 3/8", 7/16", 1/2", 9/16", 5/8", 11/16", 3/4", 13/16", 7/8"	£44.95	£27.95	£33.54

10pc Stubby Combination Spanner Set

Premier



Stubby

MM 10-19mm



- Drop-forged Chrome Vanadium steel spanners.
- Hardened, tempered and chrome plated for corrosion resistance.
- Fully polished mirror finish.
- WallDrive® rings.
- Sizes: 10, 11, 12, 13, 14, 15, 16, 17, 18, 19mm.
- Stubby configuration gives improved access in confined spaces.
- **Model No. AK633**
- List Price £37.45

£22.95 Exc. VAT
£27.54 Inc. VAT

8pc Combination Ratchet Spanner Set Imperial

Siegen



IMP

72-Tooth

5/16"-3/4"



- Chrome Vanadium steel combination ratchet spanner set.
- 72-Tooth ratchet ring and gear set requiring only 5° rotation to pick up next ratchet tooth.
- Ideal for applications where space is limited.
- Sizes: 5/16", 3/8", 7/16", 1/2", 9/16", 5/8", 11/16", 3/4".
- **Model No. S0984**
- List Price £69.95

£44.95 Exc. VAT
£53.94 Inc. VAT

7pc Combination Ratchet Spanner Set

Siegen



MM

72-Tooth

8-19mm



- Chrome Vanadium steel ratchet combination spanner set.
- Sizes: 8, 10, 12, 13, 14, 17, 19mm.
- 72-Tooth ratchet ring and gear set requiring only 5° rotation to pick up the next tooth, ideal for applications where space is limited.
- **Model No. S01142**
- List Price £49.95

£32.95 Exc. VAT
£39.54 Inc. VAT

12pc Combination Ratchet Spanner Set

Siegen



MM

72-Tooth

8-19mm



- Chrome Vanadium steel ratchet combination spanner set.
- 72-Tooth ratchet ring and gear set requiring only 5° rotation to pick up the next tooth, ideal for applications where space is limited.
- Sizes: 8, 9, 10, 11, 12, 13, 14, 15, 16, 17, 18, 19mm.
- **Model No. S0634**
- List Price £89.95

£59.95 Exc. VAT
£71.94 Inc. VAT

7pc Flexi-Head Combination Ratchet Spanner Set

Siegen



MM

Flexi-Head

72-Tooth

8-19mm



- Chrome Vanadium steel flexi-head ratchet combination spanner set.
- Sizes: 8, 10, 12, 13, 14, 17, 19mm.
- 72-Tooth ratchet ring and gear set requiring only 5° rotation to pick up the next tooth, ideal for applications where space is limited.
- **Model No. S01433**
- List Price £69.95

£39.95 Exc. VAT
£47.94 Inc. VAT

10 x 13mm Stubby Offset Double End Ring Spanner

Premier



MM

Stubby



- Manufactured from drop-forged Chrome Vanadium steel.
- Hardened and tempered with a fully polished mirror finish.
- Stubby, compact configuration and 45° offset WallDrive® rings give improved access in confined spaces.
- Combines the most common fastener sizes (10 x 13mm).
- Essential for rowers as a rigger jigger, undoes every nut in a European boat - 10mm for riggers and 13mm for top nuts.
- Length: 120mm.
- **Model No. AK63221**
- List Price £9.95

£5.95 Exc. VAT
£7.14 Inc. VAT

14pc Stubby Combination Spanner Set

Siegen



Stubby



MM

6-19mm



- Drop-forged Chrome Vanadium steel combination spanners heat treated and chrome plated for corrosion resistance.
- Open-end and 12-point WallDrive® ring combination.
- Sizes: 6-19mm.
- **Model No. S01232**
- List Price £35.95

£22.95 Exc. VAT
£27.54 Inc. VAT

7pc Extra-Long Double End Ring Spanner Set

Premier

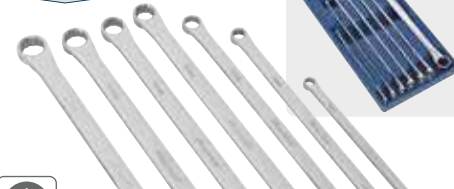

MM

8-24mm

Extra-Long

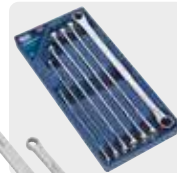

- Extra-long, drop-forged, Chrome Vanadium steel 12-point WallDrive® ring spanners.
- Hardened, tempered and chrome plated with a fully polished mirror finish.
- Sizes: 8 x 10, 11 x 13, 14 x 15, 16 x 17, 18 x 19, 20 x 21, 22 x 24mm.
- **Model No. AK6311**
- List Price £109.95

£64.95 Exc. VAT
£77.94 Inc. VAT

14pc 1/2" Sq Drive Crow's Foot Spanner Set

Siegen



1/2" Sq. Drive

MM

27-50mm



- Manufactured from carbon steel with a fully polished finish.
- Suitable for limited access applications.
- Sizes: 27, 29, 30, 32, 33, 34, 36, 38, 42, 43, 44, 46, 48, 50mm.
- **Model No. S01109**
- List Price £159.95

£94.95 Exc. VAT
£113.94 Inc. VAT

190mm Heavy-Duty High Leverage Side Cutter

Premier

HEAVY DUTY



- Manufactured from hardened and tempered drop-forged Chrome Vanadium steel.
- Finely ground polished heads.
- Precision ground cutting edges, induction-hardened 55-65 HRC for cutting hard and soft wires.
- Dual material comfort grip handles and black oxide finish for corrosion protection.
- **Model No. AK8375**
- List Price £16.95

£11.95 Exc. VAT
£14.34 Inc. VAT

3pc High Leverage Pliers Set

- Manufactured from hardened and tempered drop-forged Chrome Vanadium steel.
- Finely ground polished heads.
- Serrated jaws and precision ground cutting edges, induction-hardened 55-65 HRC for cutting hard and soft wires.
- Dual material comfort grip handles and black oxide finish for corrosion protection.
- Contents: 200mm Long Nose Pliers, 175mm Combination Pliers, 160mm Side Cutters.
- **Model No. AK8376**
- List Price £47.95

£32.95 Exc. VAT
£39.54 Inc. VAT



Premier

6pc Mini Pliers Set

- Manufactured from hardened and tempered drop-forged Chrome Vanadium steel.
- Finely ground polished heads.
- Serrated jaws and precision ground cutting edges, induction-hardened 55-65 HRC for cutting hard and soft wires.
- Dual material comfort grip handles.
- Contents: 105mm End Cutters, 115mm Side Cutters, 115mm Combination Pliers, 125mm Bent Nose Pliers, 125mm Long Nose Pliers, 145mm Needle Nose Pliers.
- **Model No. AK8381**
- List Price £41.95

£26.95 Exc. VAT
£32.34 Inc. VAT



Premier

3pc 400mm Extra-Long Needle Nose Pliers Set

Premier

Extra-Long



- Manufactured from hardened and heat treated Chrome Vanadium steel.
- Finely ground heads with a fully polished finish.
- Serrated, machined jaws for a positive grip.
- Vinyl dipped handles for comfort and control.
- **Model No. AK8576**
- List Price £81.45

£49.95 Exc. VAT
£59.94 Inc. VAT

3pc 150mm Pliers Set

Siegen



- Contents: S0439 - 150mm Side Cutters.
- S0442 - 150mm Long Nose Pliers.
- S0444 - 150mm Combination Pliers.
- Manufactured from drop-forged, heat treated steel.
- Induction-hardened cutting edges.
- Fully polished finish with non-slip foam cushion grip handles.
- **Model No. S0447**
- List Price £17.95

£9.95 Exc. VAT
£11.94 Inc. VAT

17pc Punch Set

Premier

MM

ALWAYS WEAR SAFETY GOGGLES WHEN USING THESE TOOLS



- Hardened, tempered and mirror polished Chrome Vanadium steel.
- Contents: 6 x Long Pin Punches, 6 x Pin Punches, 5 x Taper Punches.
- Punches and Chisels are excluded from lifetime guarantee*.
- **Model No. AK9130**
- List Price £92.45

£61.95 Exc. VAT
£74.34 Inc. VAT

6pc Parallel Pin Punch Set

Premier

MM

- Hardened, tempered and fully polished Chrome Vanadium steel punches.
- Supplied with composite retainer.
- Sizes: 2, 3, 4, 5, 6, 8mm.
- Punches and Chisels are excluded from lifetime guarantee*.
- **Model No. AK9128**
- List Price £27.95

£17.95 Exc. VAT
£21.54 Inc. VAT



ALWAYS WEAR SAFETY GOGGLES WHEN USING THESE TOOLS

11pc Sheathed Punch & Chisel Set

Premier

MM

- Hardened and tempered Chrome Molybdenum steel punches and chisels with a fully polished mirror finish.
- Contoured foam grips for improved comfort and control.
- Contents: Pin Punches; Ø3, Ø4, Ø5, Ø6, Ø8mm, Chisels; 12, 16, 19, 22, 24mm, Centre Punch; 4mm.
- Supplied in storage tray.
- Punches and Chisels are excluded from lifetime guarantee*.
- **Model No. AK9135**
- List Price £109.95

£63.95 Exc. VAT
£76.74 Inc. VAT

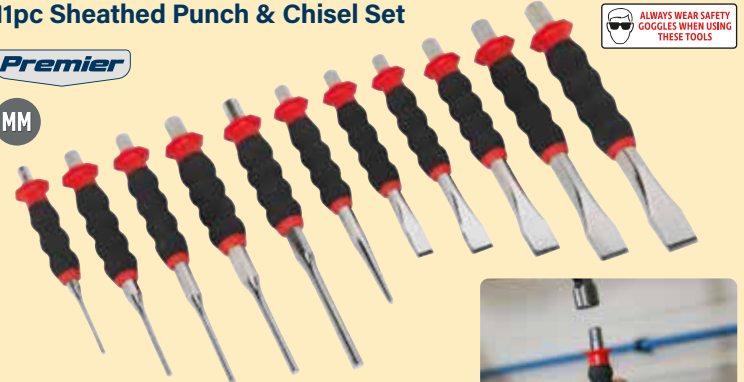

ALWAYS WEAR SAFETY GOGGLES WHEN USING THESE TOOLS

Sheathed Automatic Centre Punch

Premier

- Impact adjustment from 15 to 25kg.
- Simply push-down to release the spring.
- Tip hardened to 57-60 HRC.
- Length: 160mm.
- Punches and Chisels are excluded from lifetime guarantee*.
- **Model No. AK91320**
- List Price £29.95

£16.95 Exc. VAT
£20.34 Inc. VAT



ALWAYS WEAR SAFETY GOGGLES WHEN USING THESE TOOLS



60W

60W Soldering Station



- 60W Soldering station with rapid heat up.
- MCU Controlled temperature calibration.
- LCD Display screen showing current temperature.
- Maintains temperatures between 50-480°C.
- Supplied with soldering sponge and soldering iron stand.

- **Model No. SD006**
- List Price £89.95

£69.95 Exc. VAT
£83.94 Inc. VAT



6W Rechargeable Lithium-ion Soldering Iron

Premier

Lithium RECHARGEABLE



- Professional Lithium-ion cordless soldering iron.
- Ideal for multiple applications including automotive soldering in-and-around engine bays.
- Much safer than using conventional gas powered soldering irons.
- Powered using the latest Lithium-ion battery technology which enables faster heating times and improved battery life.
- Heats up to maximum temperature in 25 seconds.
- Unit is charged and stored in the base and is supplied with a mains charger.
- Charging Time: 3-4hr.
- Operating Time: 90mins.
- Maximum Temperature: 510°C.

- **Model No. SDL6**
- List Price £69.95

£49.95 Exc. VAT
£59.94 Inc. VAT

Butane Hot Air Gun 450/550°C

Premier



HEAVY DUTY



- Heavy-duty butane powered hot air gun.
- Fitted with piezoelectric ignition with anti-flare burner, ignition lock and continuous flame switch.
- Produces an adjustable flame with a maximum temperature of 550°C and will operate on a single fill for up to 3 hours.
- Suitable for numerous automotive applications.
- Supplied with a deflector nozzle ideal for use with heat shrink tubing and concentrator nozzle for use when paint stripping.
- Includes integrated hands-free collar.

- **Model No. AK2935**
- List Price £142.95

£94.95 Exc. VAT
£113.94 Inc. VAT

Micro Butane Heating Torch

Premier



- Stylish design with piezoelectric ignition.
- Produces a flame of approximately 1300°C.
- Powered by Butane (lighter fuel) and when full can produce a flame for up to 30 minutes (not to be used continuously for more than 5 minutes).
- Suitable for use in extreme weather conditions.
- Ideal for soft soldering, camping, household repairs and a variety of general-purpose uses.
- Supplied with key chain.

- **Model No. AK4041**
- List Price £20.95



£13.95 Exc. VAT
£16.74 Inc. VAT

8W USB Soldering Irons

Premier

8W



Model No. SDL12



Model No. SDL13

- Heats up to working temperature in just 15 seconds.
- Compact and lightweight design makes these devices extremely portable.
- Inbuilt LED to illuminate welding area in low light conditions.
- Maximum temperature of 400°C.

Model No.	Applications	List Price	Exc. VAT	Inc. VAT
SDL12	Welding circuit boards and hobbyist soldering	£13.95	£8.95	£10.74
SDL13	Welding plastic or 3D printed items	£13.95	£8.95	£10.74

40W/12V Soldering Iron

12V

- Supplied with replaceable soldering tips - chisel and pointed.
- Ultra-slim textured handle for added grip and comfort.
- Includes two insulated crocodile clips with 1.5m cable.

- **Model No. SD1240**
- List Price £18.45

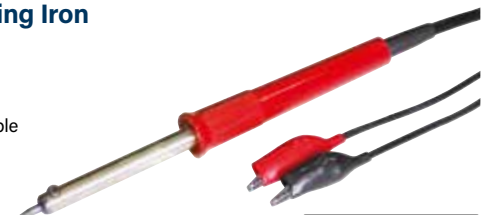

£12.95 Exc. VAT
£15.54 Inc. VAT

Professional Soldering/Heating Torch

Premier



- High quality, lightweight torch.
- Suitable for heating, soldering and shrinking.
- Powered by butane (lighter fuel) and features a piezoelectric ignition switch.
- Supplied with an anti-ignition cap and features an adjustable gas/flame control.
- Torch is fitted with a retractable stand.
- Operating Time: 80-100mins.

- **Model No. AK2961**
- List Price £49.95



£34.95 Exc. VAT
£41.94 Inc. VAT

Socket Sets - Black Series



Model No. AK7990

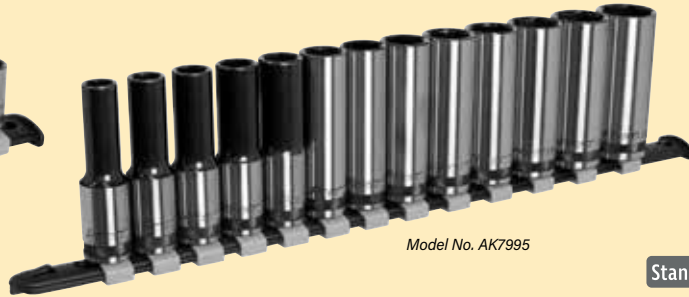

Model No. AK7995

NEW PRODUCTS

Standard OR Deep

1/4" Sq. Drive OR 3/8" Sq. Drive OR 1/2" Sq. Drive

- Manufactured from hardened and tempered high grade Chrome Vanadium steel.
- Fully polished black chrome finish for resistance to corrosion.
- Includes knurled ring for extra grip with oily fingers.
- All sets supplied on socket rail.

Model No.	Qty	Drive	Depth	Contents	List Price	Exc. VAT	Inc. VAT
AK7990	13pc	1/4" Sq	Standard	4-14mm	£26.95	£19.95	£23.94
AK7991	13pc	1/4" Sq	Deep	4-14mm	£34.95	£24.95	£29.94
AK7992	12pc	3/8" Sq	Standard	8-19mm	£31.95	£22.95	£27.54
AK7993	12pc	3/8" Sq	Deep	8-19mm	£48.95	£34.95	£41.94
AK7994	13pc	1/2" Sq	Standard	10-24mm	£46.95	£33.95	£40.74
AK7995	13pc	1/2" Sq	Deep	10-24mm	£65.95	£46.95	£56.34

900mm Heavy-Duty 25° Pry Bar with Hammer Cap



HEAVY DUTY



- Chrome Molybdenum 16mm steel shaft with satin chrome finish and comfortable soft grip handle.
- 900mm x 16mm Square - 25°.
- Model No. AK9104
- List Price £62.45

£36.95 Exc. VAT
£44.34 Inc. VAT

4pc Heavy-Duty Pry Bar Set with Hammer Cap



HEAVY DUTY

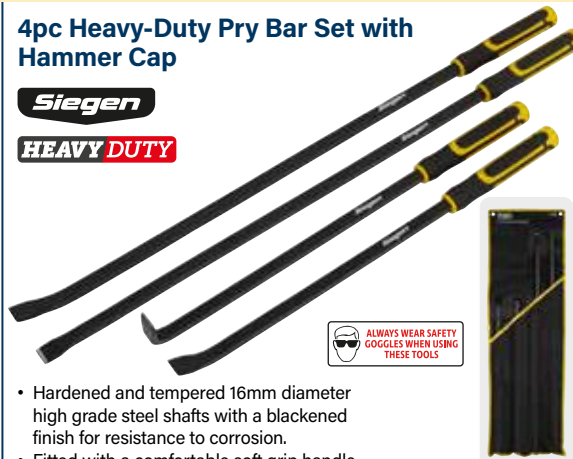

- Hardened and tempered 16mm diameter high grade steel shafts with a blackened finish for resistance to corrosion.
- Fitted with a comfortable soft grip handle.
- Contents: 600mm - 75° and 90°, 900mm - 25° and Straight.
- Supplied in a heavy-duty tool roll.
- Model No. S01193
- List Price £89.95

£64.95 Exc. VAT
£77.94 Inc. VAT

4pc Heavy-Duty Angled Pry Bar Set with Hammer Cap



HEAVY DUTY



- Manufactured from hardened and tempered Chrome Vanadium steel.
- Phosphate finish for resistance to corrosion.
- Fitted with comfortable soft grip handle and hammer cap.
- Contents: 200, 300, 460, 610mm.
- Model No. S01138
- List Price £42.95

£25.95 Exc. VAT
£31.14 Inc. VAT

Wheel Fitting & Alignment Tool



- Designed to assist with the lifting and locating of road wheels on to vehicle hubs and intended to be used where there is no access to a vehicle lift, such as by the roadside.
- Significantly reduces lifting strain whilst notably improving body posture.
- Supplied with four CNC machined stainless steel adaptor pegs complete with storage holder.
- Manufactured from high quality stainless steel.
- For use on alloy or steel wheels up to 35kg.
- Patent Pending.
- Model No. AK7500
- List Price £39.95



£31.95 Exc. VAT
£38.34 Inc. VAT

450mm 1/2" Sq Drive Breaker Bar



450mm Length

1/2" Sq. Drive



*Note: Knuckle joints are not covered by the lifetime guarantee and are treated as consumable items.

- Hardened and tempered Chrome Vanadium steel bar with high chrome finish.
- Long, slim style handle with spring loaded socket retention.
- Fully replaceable knuckle joint*.
- Model No. AK7301
- List Price £22.45

£13.95 Exc. VAT
£16.74 Inc. VAT

1/2" Sq Drive Breaker Bars



1/2" Sq. Drive

NEW PRODUCTS AVAILABLE Mid July

- Hardened and tempered Chrome Vanadium steel bars.
- Long, slim style handle and spring loaded socket retention.
- Comfortable soft grip handle.
- Fully replaceable knuckle joint*.

Model No.	Length	Colour	List Price	Exc. VAT	Inc. VAT
AK7306	600mm	Red	£34.95	£17.95	£21.54
AK7306HV	600mm	Hi-Vis Green	£34.95	£17.95	£21.54
AK7307	750mm	Red	£39.95	£23.95	£28.74
AK7307HV	750mm	Hi-Vis Green	£39.95	£23.95	£28.74



600mm Length OR 750mm Length

*Note: Knuckle joints are not covered by the lifetime guarantee and are treated as consumable items.

Ratchet Crimper & Assorted Insulated Terminal Set with Tool Tray

Premier



- Contents: Ratchet Crimper, 325 Assorted Insulated Terminals; Male Blade Blue 6.3mm Size 16-14 (x50), Female Blade Blue 6.3mm Size 16-14 (x50), Butt Red Size 22-16 (x25), Butt Blue Size 16-14 (x25), Ring Blue 3mm Size 16-14 (x50), Ring Blue 5mm Size 16-14 (x50), Male Bullet Blue Size 16-14 (x50), Female Bullet Blue Size 16-14 (x25).
- Tray Size (W x D x H): 176.5 x 397 x 55mm.
- **Model No. TBT16**
- List Price £99.95

£59.95 Exc. VAT
£71.94 Inc. VAT

12pc Flare Nut & Ratchet Ring Spanner Set with Tool Tray

Premier

MM



- Contents: Flare Nut Spanners; 6 x 8, 9 x 11, 10 x 12, 13 x 14, 15 x 17, 19 x 21mm, Ratchet Ring Spanners; 8 x 9, 10 x 11, 12 x 13, 14 x 15, 16 x 18, 17 x 19mm.
- Tray Size (W x D x H): 176.5 x 397 x 55mm.
- **Model No. TBT13**
- List Price £219.95

£119.95 Exc. VAT
£143.94 Inc. VAT

25pc Impact Driver & Punch Set with Tool Tray

Premier

MM



- Contents: 1/2" Sq Drive Impact Driver, Slotted Bits; 5, 6, 8, 10, 12mm, Phillips Bits; #1, #2, #3, #4mm, Hex Bits; 4, 5, 6, 8mm, Adaptor; 1/2" Sq Drive x 8mm Hex, Centre Punch #2 x 9.5 x 120mm, Taper Pin Punch Ø3 x 9.5 x 120mm, Cold Chisel 12 x 9.5 x 130mm, Utility Chisel 5 x 9.5 x 130mm, Parallel Pin Punches; Ø2 x 8 x 115, Ø3 x 8 x 125, Ø4 x 9.5 x 150mm, Ø5 x 9.5 x 165, Ø6 x 12.7 x 180, Ø8 x 12.7 x 180mm.
- Tray Size (W x D x H): 176.5 x 397 x 55mm.
- **Model No. TBT18**
- List Price £104.95

£61.95 Exc. VAT
£74.34 Inc. VAT

33pc Tap & Die Set with Tool Tray

Premier



- Contents: Taps & Dies; 3 x 0.5, 4 x 0.7, 5 x 0.8, 6 x 1, 8 x 1.25, 10 x 1.5, 12 x 1.75mm, 1/4"-28, 5/16"-24, 3/8"-24, 7/16"-20, 1/2"-20UNF, 1/8"-28, 1/4"-19BSP. Tap Wrench, T-Bar Tap Wrench, Die Holder, Thread Gauge, Screwdriver
- Tray Size (W x D x H): 176.5 x 397 x 55mm.
- **Model No. TBT26**
- List Price £105.95

£62.95 Exc. VAT
£75.54 Inc. VAT

6pc Pry Bar, Hammer & Hacksaw Set with Tool Tray

Premier



- Contents: Pry Bars; 300, 460mm, 400mm Heel Bar, 1lb Ball Pein Hammer, 300mm Hacksaw, 150mm Junior Hacksaw.
- Tray Size (W x D x H): 530 x 397 x 55mm.
- **Model No. TBT30**
- List Price £124.95

£74.95 Exc. VAT
£89.94 Inc. VAT

91pc 1/4", 3/8" & 1/2" Sq Drive Socket Set with Tool Tray

Premier Platinum series

1/4" 3/8" & 1/2" Sq. Drive

MM



- Contents: 1/4" Sq Drive Sockets; 4- 13mm, 1/4" Sq Drive Deep Sockets; 4-13mm, 3/8" Sq Drive Sockets; 10-19mm, 3/8" Sq Drive Deep Sockets; 10-19mm, 1/2" Sq Drive Sockets; 13-32mm, 1/2" Sq Drive Deep Sockets; 17-32mm, 3/8" Sq Drive Spark Plug Sockets; 14-21mm, Flip Reverse Ratchet Wrench; 1/4", 3/8" and 1/2" Sq Drive, Universal Joints; 1/4", 3/8" and 1/2" Sq Drive, 1/4" Sq Drive Extension Bars; 50, 100, 150mm, 150mm Flexible Extension, Spinner Handle, 115mm Sliding T-Bar, 3/8" Sq Drive Extension Bars; 75, 150mm, 1/2" Sq Drive Extension Bars; 75, 200mm, 1/2" Sq Drive 450mm Breaker Bar, 1/2"(F)-3/8"(M) Sliding T-Bar Adaptor.
- Tray Size (W x D x H): 530 x 397 x 55mm.
- **Model No. TBTPO2**
- List Price £379.95

£239.95 Exc. VAT
£287.94 Inc. VAT

15pc Precision Screwdriver Set

Siegen



- Chrome Vanadium steel shafts with blackened tips.
- Contoured handles with soft grips for added comfort.
- Spinner top enables fingertip control of driver.
- Contents: Slotted; 1.5, 2, 2.5, 3mm, Phillips; #000, #00, #0, #1, TRX-Star*; T5, T6, Security TRX-Star*; T7H, T8H, T9H, T10H, T15H.
- **Model No. S0898**
- List Price £23.45

£9.95 Exc. VAT
£11.94 Inc. VAT

9pc Scraper & Hook Set

Siegen



- Four short (165mm) picks with knurled, satin finish steel shafts.
- Four long (260mm) picks and one scraper with black finished steel shafts.
- Suitable for pin/clip picking, hose removal and gasket scraping.
- Ergonomically styled handles for comfort, grip and accuracy.
- **Model No. S01103**
- List Price £24.95

£16.95 Exc. VAT
£20.34 Inc. VAT

8pc Microtip Screwdriver Set

Siegen



- Chrome Vanadium steel shafts with blackened tips.
- Contoured handles with soft grips for added comfort.
- Spinner top enables fingertip control of driver.
- Contents: Slotted; 2 x 50, 2.5 x 50, 3 x 50mm, Phillips; #00 x 50, #0 x 50, #1 x 50mm, TRX-Star*; T10 x 50, T15 x 50mm.
- Supplied in storage case.
- **Model No. S0618**
- List Price £12.45

£4.95 Exc. VAT
£5.94 Inc. VAT

6pc Mini Pick & Screwdriver Set

Siegen



- Chrome Vanadium shafts and contoured soft grip handles with colour-coding for fast identification.
- Hooks and picks suitable for removal of bushings, cotter pins, O-rings and seals.
- Also features mini Phillips and slotted screwdrivers.
- **Model No. S0774**
- List Price £9.45

£6.95 Exc. VAT
£8.34 Inc. VAT

32pc Precision Extendable Screwdriver Set

Premier



- High quality Chrome Molybdenum steel bits with satin finish.
- Contoured handle with soft rubber grip and spinner top for fingertip control.
- 30 x 4mm Hex bits for slotted, Phillips, TRX-Star* and hex, plus extension bar.
- **Model No. AK97322**
- List Price £27.45

£11.95 Exc. VAT
£14.34 Inc. VAT

6pc Precision Screwdriver Set

Premier



- High quality Chrome Molybdenum driver shafts.
- Contoured handle with soft rubber grip for added control, includes hanging holes.
- Spinner top enables fingertip control of driver.
- Shot blasted and blackened tips.
- Contents: Slotted; 1.5, 2, 3mm, Phillips; #00, #0, #1.
- **Model No. AK97302**
- List Price £24.95

£9.95 Exc. VAT
£11.94 Inc. VAT

6pc Precision TRX-Star* Driver Set

Premier



- High quality Chrome Molybdenum driver shafts.
- Contoured handle with soft rubber grip for added control, includes hanging holes.
- Spinner top enables fingertip control of driver.
- Shot blasted and blackened tips.
- Contents: T5, T6, T7, T8, T10, T15.
- **Model No. AK97303**
- List Price £24.95

£9.95 Exc. VAT
£11.94 Inc. VAT

6pc Precision Security TRX-Star* Driver Set

Premier



- High quality Chrome Molybdenum driver shafts.
- Contoured handle with soft rubber grip for added control, includes hanging holes.
- Shot blasted and blackened tips.
- Contents: T5H, T6H, T7H, T8H, T10H, T15H.
- **Model No. AK97304**
- List Price £25.95

£10.95 Exc. VAT
£13.14 Inc. VAT

Flexible Magnetic Pick-Up Tools

Premier

HEAVY DUTY

Magnetic



Model No. AK6532



Model No. AK6534



- Chrome plated flexible shaft fitted with high quality strong magnets.
- Contoured and textured handle fits perfectly in the hand providing comfort and control.
- Length: 510mm.

Model No.	Pick-up Capacity	Magnet	List Price	Exc. VAT	Inc. VAT
AK6532	1kg	Ø10mm	£16.95	£11.95	£14.34
AK6534	3kg	Ø16mm	£18.95	£13.95	£16.74

Telescopic Magnetic Pick-Up Tool 1.5kg Capacity

Premier

130-650mm Extending

Magnetic



- Telescopes to less than pen size for convenient pocket storage.
- 1.5kg Pick-up capacity from Ø10mm magnet.
- Min./Max. Length: 130/650mm.
- **Model No. AK6511**
- List Price £13.95

£9.95 Exc. VAT
£11.94 Inc. VAT

2pc Pick-Up Tool Set

Siegen

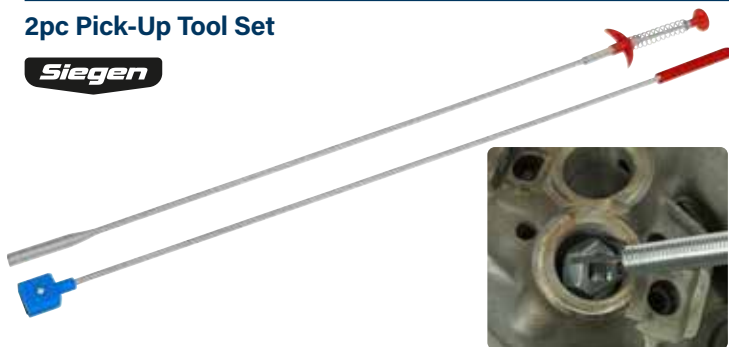

- Set of two flexible, lightweight pick-up tools.
- One with spring loaded claw grab and Bowden cable construction, the other with magnetic head to suit different applications.
- Length (x2): 610mm.
- **Model No. S0610**
- List Price £5.95

£4.25 Exc. VAT
£5.10 Inc. VAT

4pc Magnetic Pick-Up & Inspection Tool Kit

Siegen

175-655mm Extending

Magnetic



- Two heavy-duty 5-section telescopic extending shafts.
- Textured grip for comfort and control.
- Fully adjustable 50 x 80mm inspection mirror.
- Includes three magnetic heads; 1.5kg and 2.3kg fixed and one 2.3kg fully adjustable.
- **Model No. S0556**
- List Price £16.95

£11.95 Exc. VAT
£14.34 Inc. VAT

2pc Telescopic Magnetic Pick-Up Tool & Inspection Mirror Set

Siegen

Magnetic



- 5-Section stainless steel magnetic pick-up tool with textured grip and pocket-clip.
- Ø13mm Magnet with 3.6kg capacity.
- 5-Section stainless steel inspection mirror with textured grip and pocket-clip.
- Ø50mm Mirror is mounted on twin ball joints for maximum articulation.
- **Model No. S0940**
- List Price £12.95

£7.45 Exc. VAT
£8.94 Inc. VAT

3pc Magnetic Pick-Up, Flexible Claw & Inspection Tool Set

Siegen Magnetic

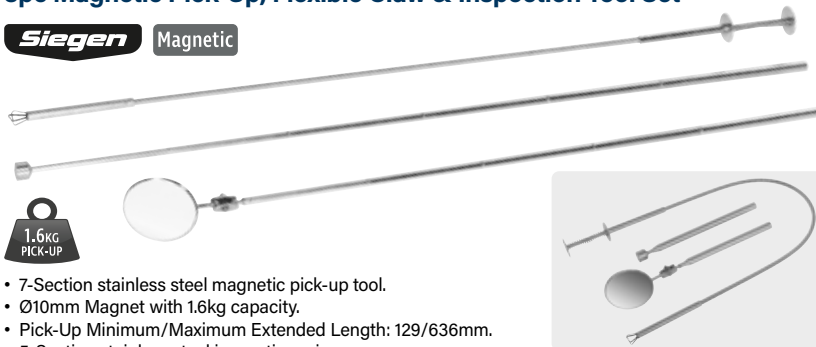

- 7-Section stainless steel magnetic pick-up tool.
- Ø10mm Magnet with 1.6kg capacity.
- Pick-Up Minimum/Maximum Extended Length: 129/636mm.
- 5-Section stainless steel inspection mirror.
- Ø50mm Mirror is mounted on twin ball joints for maximum articulation.
- Mirror Minimum/Maximum Extended Length: 200/550mm.
- Flexible pick-up tool with Bowden cable construction and spring loaded claw grab.
- **Model No. S0949**
- List Price £14.95

£9.95 Exc. VAT
£11.94 Inc. VAT

Magnetic Pick-Up Tool - 1.6kg Capacity

Premier

160-590mm Extending

Magnetic

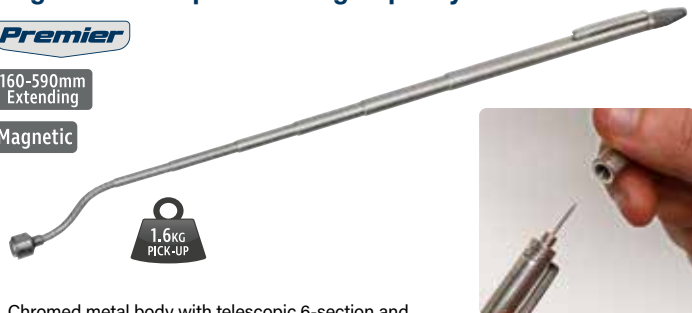

- Chromed metal body with telescopic 6-section and flexible shaft pick-up tool.
- Features a scribe/washer jet tool, pocket-clip and knurled cap.
- 1.6kg Pick-up capacity from Ø13mm magnet.
- Minimum/Maximum Length: 160/590mm.
- **Model No. AK6516**
- List Price £13.95

£9.95 Exc. VAT
£11.94 Inc. VAT

Ø60mm Flexible Shaft Inspection Mirror

Premier

HEAVY DUTY

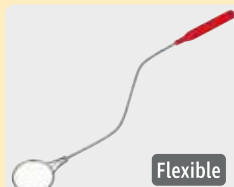

Flexible

- Rubber grip and strong, spring steel flexible shaft.
- Ø60mm Mirror.
- Suitable for use in confined areas.
- Length: 485mm.
- **Model No. AK6503**
- List Price £15.95

£11.45 Exc. VAT
£13.74 Inc. VAT

Tape Measures - Metric/Imperial

TRIPLE
BLADE
LOCKS

Metric/
Imperial
Scale



Model No. AK989

- High-visibility composite case with rubber cover, wrist strap and belt clip.
- Steel blade with Metric and Imperial scale and magnetic tip.
- Strong rewind mechanism with slide-button lock plus side and base mounted push-button locks for added versatility.

Model No.	Tape Length	Tape Width	List Price	Exc. VAT	Inc. VAT
AK988	3m(10ft)	16mm	£4.45	£2.95	£3.54
AK989	5m(16ft)	19mm	£5.95	£3.95	£4.74
AK990	7.5m(25ft)	25mm	£9.95	£6.95	£8.34

Spirit Levels

Premier



Model No. AK9863

- 1mm Aluminium ribbed box section level.
- Powder coated for corrosion resistance.
- Accuracy 1mm in 1m (0.057°).
- Model includes UV resistant and shockproof vials, one horizontal with side view, one vertical and one 45°.
- Base with precision milled face.



Accuracy 0.057° = 1mm/m 3 angles 45°, 90°

Model No.	Length	List Price	Exc. VAT	Inc. VAT
AK9863	600mm	£12.45	£6.95	£8.34
AK9864	900mm	£15.95	£7.95	£9.54
AK9865	1200mm	£19.95	£9.95	£11.94

80-1000V Non-Contact Voltage Detector

Premier



LED

- Non-contact voltage detector with LED/audible indication.
- Designed for quickly identifying wire and cable breaks as well as detecting voltage in fuses, cables, switches, outlets, lighting fixtures and many more.
- Features two selectable voltage settings, low voltage ranges from 80V and high voltage from 220V.
- Ideal for microwave applications and phase detection in sockets.
- Requires 2 x AAA batteries (not included).
- Model No. AK1998
- List Price £29.95

£19.95 Exc. VAT
£23.94 Inc. VAT

3-in-1 Metal, Voltage & Stud Detector



- Combined unit to accurately detect live or dead electricity cables, water or gas pipes and wood studs or battens with ease.
- Powered by a 9V battery (supplied).
- The detector will, with a red and green LED display and an audible signal, show the presence of metal, electricity and wooden studs or battens.
- Supplied with full instructions.
- Model No. AK2018
- List Price £33.95

£19.95 Exc. VAT
£23.94 Inc. VAT

Mains Testers



Model No. AK1990



Model No. AK1991

- VDE Approved mains voltage testers with screwdriver blade.
- Fully insulated with moulded transparent plastic handle and blade sheath.

Model No.	Testing Range	Length	List Price	Exc. VAT	Inc. VAT
AK1990	100-250V	140mm	£2.45	£1.75	£2.10
AK1991	100-250V	190mm	£3.95	£2.75	£3.30

Heavy-Duty Staple & Brad Nail Gun

HEAVY
DUTY



- 3-in-1 Staple and nail gun.
- Fitted with adjustable power control and staple remover.
- Features removable sole plate for easy clearance of blockages.
- Supplied with starter pack of 1500 nails and staples.
- Model No. AK7061
- List Price £29.95

£19.95 Exc. VAT
£23.94 Inc. VAT

Heavy-Duty Staple Remover

HEAVY
DUTY



- Easily removes heavy-duty staples.
- Large footprint minimizes the risk of surface damage.
- Model No. AK707
- List Price £8.45

£5.95 Exc. VAT
£7.14 Inc. VAT

Tool Kits with Cantilever Toolbox

Siegen

6pt WALLDRIVE®

MM



Kits are supplied in a metal cantilever toolbox.

- Comprehensive range of frequently used hand tools.
- Tools feature soft grip handles for comfort and control.



Model No. S01215
1/4" & 3/8" Sq. Drive



Model No. S01216
1/4" & 1/2" Sq. Drive



Model No.	Qty	Drive	Contents	List Price	Exc. VAT	Inc. VAT
S01215	70pc	1/4" & 3/8" Sq	1/4" and 3/8" Sq drive reversible ratchet wrenches. Includes 1/4" and 3/8" Sq drive sockets, hex keys, combination spanners, screwdrivers, bit set and accessories.	£171.95	£99.95	£119.94
S01216	86pc	1/4" & 1/2" Sq	1/4" and 1/2" Sq Drive Reversible ratchet wrenches. Includes 1/4" and 1/2" Sq drive sockets, hex keys, combination spanners, screwdrivers, pliers, utility knife, measuring tape, bit set and accessories.	£254.95	£154.95	£185.94

101pc Tool Kit with Cordless Drill

Siegen

6pt WALLDRIVE®



- Kit also includes screwdrivers, pliers, wire stripper/cutter, claw hammer, hacksaw, measuring tape, utility knife, hex keys, sockets, PVC tape, spirit level, torch, masonry and wood drill bits, digital voltage tester, bits, screws and accessories.
- Tools feature soft grip handles for comfort and control.
- Supplied in storage case.
- See www.sealey.co.uk for full contents and details.
- Lifetime guarantee* (applies to all hand tools within this kit. The cordless drill, battery and charger all have 1 Year guarantee).

• **Model No. S01224**
• List Price £229.95
£149.95 Exc. VAT
£179.94 Inc. VAT



172pc 1/4", 3/8" & 1/2" Sq Drive Socket Set

Premier

6pt WALLDRIVE®



MM 1/4" 3/8" & 1/2" Sq. Drive SATIN FINISH

- Deluxe professional socket set with hardened and heat treated Chrome Vanadium steel sockets.
- Fully polished satin finish.
- Covers sizes from 4 to 32mm.
- Includes comfort grip ratchet wrenches, spark plug sockets, extension bars, female TRX-Star* sockets, socket bits, hex keys, bits, spinner handle and accessories.
- Supplied in storage case.
- See www.sealey.co.uk for full contents and details.

• **Model No. AK7955EU**
• List Price £259.95
£159.95 Exc. VAT
£191.94 Inc. VAT



Socket Sets

Siegen

6pt WALLDRIVE®

MM

MIRROR FINISH

- Professional socket sets manufactured from hardened and heat treated Chrome Vanadium steel.
- Fully polished with a mirror finish.
- All sets are supplied in storage cases.
- See www.sealey.co.uk for full contents and details.



Model No. S01210
1/4" & 1/2" Sq. Drive

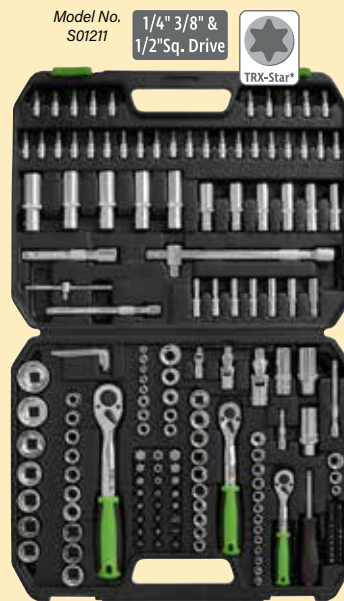

Model No. S01211
1/4" 3/8" & 1/2" Sq. Drive

TRX-Star®



Model No. S01212
1/4" 3/8" & 1/2" Sq. Drive

TRX-Star®



Model No.	Qty	Drive	Contents	List Price	Exc. VAT	Inc. VAT
S01210	94pc	1/4" & 1/2" Sq	Covers sizes from 4 to 32mm. Includes 72-tooth comfort grip ratchet wrenches, spark plug sockets, extension bars, socket bits, spinner handle and accessories	£131.95	£74.95	£89.94
S01211	171pc	1/4", 3/8" & 1/2" Sq	Covers sizes from 4 to 32mm. Includes 72-tooth comfort grip ratchet wrenches, spark plug sockets, extension bars, socket bits, spinner handle and accessories	£209.95	£124.95	£149.94
S01212	219pc	1/4", 3/8" & 1/2" Sq	Covers sizes from 4 to 32mm. Includes 72-tooth ratchet wrenches, spark plug sockets, extension bars, female TRX-Star* sockets, socket bits, combination spanners, bits, hex keys and accessories	£259.95	£154.95	£185.94

2tonne Low Entry Short Chassis Trolley Jacks

2tonne



LOW PROFILE
85mm



- Min./Max. Saddle Height: 85/385mm.
- Chassis Length: 563mm.
- Heavy-duty chassis with strengthening flanges along the top edge for extra torsional rigidity under load.
- Profiled lifting arm allows low clearance height of just 85mm making these jacks suitable for sports and custom cars.
- Fitted with heavy-duty one-piece hydraulic unit with pump-through action preventing handle locking at maximum ram extension.



Trolley Jack Combos Include:

- 1020LE Range - 2tonne Low Entry Short Chassis Trolley Jack
- AP600JB - 600mm Trolley Jack Bag
- AS2000F - Folding Axle Stands (Pair) 2tonne Capacity per Stand
- WCF01 - Folding Wheel Chocks - Pair
- S0472 - 3pc 1/2" Sq Drive Extendable L-Bar Wrench Set.

Jack Only Model No.	Colour	List Price	Exc. VAT	Inc. VAT	Combo Model No.	Colour	List Price	Exc. VAT	Inc. VAT
1020LEB	Blue	£74.95	£57.95	£69.54	1020LEBAGCOMBO	Blue	£179.95	£99.95	£119.94
1020LEHV	Hi-Vis Green	£74.95	£57.95	£69.54	1020LEHVAGCOMBO	Hi-Vis Green	£179.95	£99.95	£119.94
1020LEO	Orange	£74.95	£57.95	£69.54	1020LEOAGCOMBO	Orange	£179.95	£99.95	£119.94
1020LE	Red	£74.95	£57.95	£69.54	1020LEAGCOMBO	Red	£179.95	£99.95	£119.94

Ratchet Type Axle Stands (Pair) 2tonne Capacity per Stands

2tonne

- Min./Max. Working Height: 276/410mm (Model VS2002 - 275/425mm).
- Capacity: 4tonne per pair.
- Ratchet type axle stand with cast iron support post and tough steel-plate welded base.
- Angled teeth in post prevent accidental release of load - the more weight applied, the tighter the post is locked.
- Sold in pairs.

Model No.	Colour	List Price	Exc. VAT	Inc. VAT
VS2002BL	Blue	£44.95	£36.95	£44.34
VS2002HV	Hi-Vis Green	£44.95	£36.95	£44.34
VS2002OR	Orange	£44.95	£36.95	£44.34
VS2002	Red	£44.95	£36.95	£44.34



2.25tonne Low Entry Rocket Lift Trolley Jack Combos

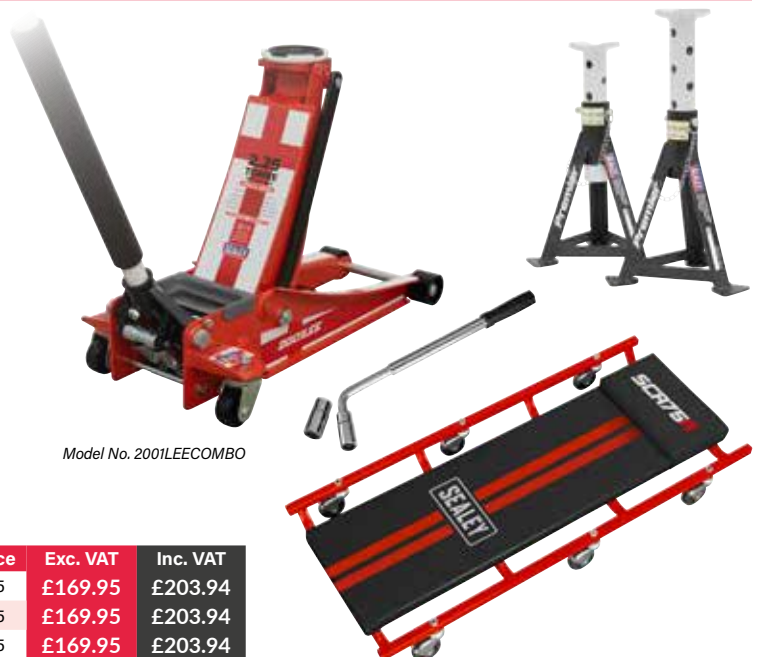
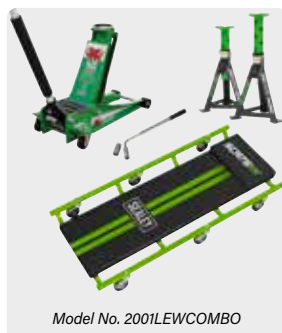

Trolley Jack Combos Include:

- 2001LE Range - 2.25tonne Low Entry Trolley Jack with Rocket Lift
- AS3 Range - Axle Stands (Pair) 3tonne Capacity per Stand
- SCR75 Range - 36" American-Style Creeper with Steel Frame & 6 Wheels
- S0472 - 3pc 1/2" Sq Drive Extendable L-Bar Wrench Set

Model No.	Flag	Contents	List Price	Exc. VAT	Inc. VAT
2001LESCOMBO	St. Andrew's Cross	2001LES, AS3, SCR75B, S0472	£349.95	£169.95	£203.94
2001LEWCOMBO	Welsh Dragon	2001LEW, AS3G, SCR75HV, S0472	£349.95	£169.95	£203.94
2001LEECOMBO	St. George's Cross	2001LEE, AS3, SCR75, S0472	£349.95	£169.95	£203.94

2tonne Low Entry Short Chassis Trolley Jack with 180° Handle

2tonne
LOW PROFILE 100mm

NEW PRODUCT

180° turning handle.

- Min./Max. Saddle Height: 100/350mm.
- Chassis Length: 490mm.
- Heavy-duty chassis with strengthening flanges along the top edge for extra torsional rigidity under load.
- Fitted with innovative 180° turning handle to allow you to jack the car up even in tight spaces.
- Fitted with heavy-duty one-piece hydraulic unit with pump-through action preventing handle locking at maximum ram extension.
- White saddle aids positioning under vehicle and safety valve prevents overloading.
- **Model No. 2180LE**
- List Price £79.95

£64.95 Exc. VAT
£77.94 Inc. VAT

3tonne Trolley Jack with Foot Pedal

3tonne

Foot Pedal.

- Min./Max. Saddle Height: 117/460mm.
- Chassis Length: 703mm.
- Single-piece hydraulic unit with heavy base design.
- Foot pedal as fast lifting alternative method of raising saddle, especially useful in restricted spaces.
- Universal joint release mechanism and long 2-piece handle.
- Heavy-duty castors and extra-large saddle design ease positioning under vehicle.
- Protective jack handle sleeve helps prevent accidental damage to car bodywork when pumping the handle.
- Fitted with safety overload valve and pump-through valve to prevent handle locking at maximum ram extension.
- **Model No. 3001CXP**
- List Price £184.95

£139.95 Exc. VAT
£167.94 Inc. VAT

3tonne Trolley Jack with Super Rocket Lift & Axle Stands (Pair) - Hi-Vis Green

3tonne
SUPER ROCKET LIFT

Polyurethane Wheels

- Min./Max. Saddle Height: 120/456mm.
- Single-piece hydraulic unit with heavy chassis design and large jacking saddle (pad available as optional extra - Model No. JP17).
- Universal joint release mechanism allows safer, more controlled lowering of the jack.
- Twin piston Super Rocket Lift feature brings lifting arm straight into contact with the jacking point.
- Fitted with safety overload valve and pump-through valve to prevent handle locking at maximum ram extension.
- Supplied with Pin Type Axle Stands, 3tonne (3000kg) capacity per stand (6tonne (6000kg) per pair).
- Min./Max. Working Height: 290/435mm.
- **Model No. 3015CXHV**
- List Price £239.95

£159.95 Exc. VAT
£191.94 Inc. VAT

3tonne Long Reach High Lift Trolley Jack

Premier

3tonne

Long Reach

HIGH LIFT

- Min./Max. Saddle Height: 140/670mm.
- High lift jack arm ideal when lifting a light commercial vehicle.
- Fitted with quick lift foot pedal.
- Heavy-duty long steel chassis provides easy-access to deep set jacking points.
- Fitted with one-piece hydraulic unit with built-in safety overload protection.
- **Model No. 3000HLC**
- List Price £399.95

£279.95 Exc. VAT
£335.94 Inc. VAT

150kg Floor Transmission Jack

150kg



- Min./Max. Saddle Height: 195/585mm.
- Base Dimensions: 400 x 420mm.
- The saddle is fitted with a webbing strap with metal roller buckle to securely hold the load and has a 5° tilt adjustment.
- Four heavy-duty swivel castors provide flexibility of movement within the workplace.
- **Model No. TJ150E**
- List Price £159.95

£129.95 Exc. VAT
£155.94 Inc. VAT

10tonne Air Jack

10tonne

Lift Lock
Manual Safety System



- Min./Max. Height: 447/1300mm.
- Extension: 561mm.
- Max. Capacity: 10tonne.
- Ideal for heavy plant, tractors and commercial vehicles.
- Multiple lifting and locking positions achieved using extension tube with multi-position pin support.
- Removable 2-piece handle aids easy storage.
- Requires 200psi of air pressure to reach optimum performance.
- **Model No. AJS10000**
- List Price £799.95



This item is heavy. Extra assistance must be provided at the delivery point to help its safe delivery.

£699.95 Exc. VAT
£839.94 Inc. VAT



20tonne Air Operated Trolley Jack Single Stage

20tonne



- Min./Max. Height: 215/456mm.
- Air Consumption: 10.5cfm.
- Powerful and reliable.
- Lifts heavy plant, tractors and commercial vehicles.
- Extensions: 20, 50, 100mm.
- **Model No. YAJ201**
- List Price £749.95

£629.95 Exc. VAT
£755.94 Inc. VAT

30tonne Single Stage Air Operated Jacks

Premier

30tonne

- Ideal for workshop or roadside use, these jacks take the effort out of lifting heavy plant, tractors and commercial vehicles.
- For extra safety, features dead man's handle which also aids controlled lowering speed.
- Supplied with extensions that close the gap between the saddle of the jack and the jacking point.



Model No. YAJ301

Model No. YAJ30H

Extensions



Weight Control



Model No. YAJ30H is heavy. Extra assistance must be provided at the delivery point to help its safe delivery.

Model No.	Maximum Capacity	Min./Max. Height	Air Consumption	Extensions	List Price	Exc. VAT	Inc. VAT
YAJ301	30tonne	210/463mm	10.5cfm	45, 75mm	£929.95	£799.95	£959.94
YAJ30H	30tonne	360/750mm	11.5cfm	45, 100mm	£1,999.95	£1,499.95	£1,799.94

18tonne Air Operated Bottle Jack

18tonne



- Min./Max. Height: 260/520mm.
- Air Consumption: 9.5cfm.
- Powerful and reliable.
- Ideal for workshop or roadside use.
- Features dead man's control and sectional pump handle for manual operation.
- Takes the effort out of lifting heavy plant, tractors and commercial vehicles.
- **Model No. YAJ18S**
- List Price £299.95

£249.95 Exc. VAT
£299.94 Inc. VAT

1200kg Wheel Removal Trolley

1200kg Capacity



- Min./Max. Wheel Diameter: 1000/2200mm.
- Eight adjustable rollers (four each side), allow for easy turning of large deep tread tyres.
- Extra-large jacking handle and hydraulic foot pedal allow for one-person operation.
- Safety bar with composite guard goes around wheel to ensure stability during transportation.
- Locking mechanism allows rollers to be fixed at eight preset positions.
- Mounted on two locking and two non-locking swivel castors for improved stability and easy manoeuvrability.
- Overall Size (W x D x H): 1300 x 1015 x 1500mm.
- **Model No. W1200T**
- List Price £999.95



This item is heavy. Extra assistance must be provided at the delivery point to help its safe delivery.

£729.95 Exc. VAT
£875.94 Inc. VAT



PORTABLE ADJUSTABLE GANTRY CRANES

NEW PRODUCTS



2tonne

Model No. SG2000W

Model No. PT2000

Model No. CB2000



These items are heavy. Extra assistance must be provided at the delivery point to help safe delivery.

- Portable adjustable gantry cranes ideal for shops where level lifting is essential.
- Four swivel locking castors.
- All steel construction.
- 1' Beam cross member for added strength.
- Ideal for maintenance, manufacturing, repairs and other material-handling tasks.
- Quick assembly and disassembly for easy transport within a workplace or from site to site.
- Gantry crane is NOT to be moved while loaded.
- Lifting tackle not included.



Model No. SG2000W
Locking Wheels System.

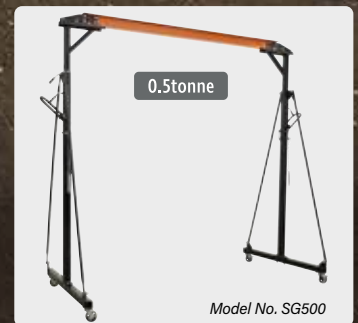

0.5tonne

Model No. SG500

OR BUY AS KITS

Model No.	Maximum Load Capacity	Height-Adjustable (Unladen)	List Price	Exc. VAT	Inc. VAT
SG500	0.5tonne	2400-3600mm in 100mm increments	£599.95	£499.95	£599.94
SG2000W	2tonne	2400-3600mm in 100mm increments	£1,299.95	£999.95	£1,199.94

Model No.	Kit Contents	List Price	Exc. VAT	Inc. VAT
SG500KIT	SG500 - 0.5tonne Portable Adjustable Gantry Crane PT500 - 0.5tonne Trolley Plain CB500 - 2.5m 0.5tonne Chain Block	£764.95	£599.95	£719.94
SG2000KIT	SG2000W - 2tonne Portable Gantry Crane Adjustable PT2000 - 2tonne Trolley Plain CB2000 - 3m 2tonne Chain Block	£1,594.95	£1,199.95	£1,439.94

AVAILABLE
Mid July

EV Battery Lift/Hydraulic Platform Truck High Lift 700kg Capacity

- Heavy-duty construction.
- Fitted with four composite wheels, two fixed and two locking castors for easy-rolling over rough workshop floors.
- One-piece hydraulic unit controlled by large rear mounted foot pedal.
- Designed to assist with removing and installing batteries in electric vehicles.
- Can also be used for assisting with many other day-to-day workshop tasks such as removing/installing engines, transmissions, fuel tanks and subframes etc.
- Safety release mechanism positioned on handlebar for smooth controlled descent.
- May also be used as a mobile service bench.
- Platform Size: 610 x 1220mm.
- Minimum/Maximum Platform Height: 445/1500mm.
- **Model No. EVBT700**
- List Price £1,399.95



This item is heavy. Extra assistance must be provided at the delivery point to help its safe delivery.

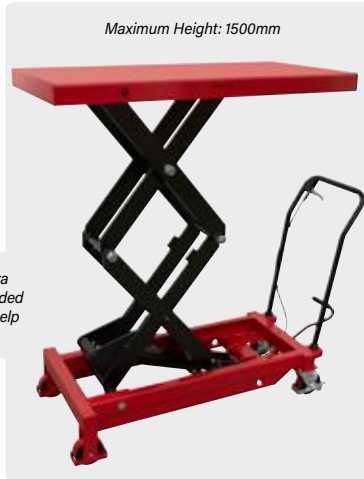

NEW
PRODUCT

700kg
Capacity



£1,199.95 Exc. VAT

£1,439.94 Inc. VAT

450kg Folding 360° Rotating Engine Stand with Geared Handle Drive



Assembled with clevis pins and clips so the stand can be folded for storage.

- This engine stand accepts a wide variety of engines and transmissions.
- The Geared Handle Drive allows for easy and accurate 360° rotation in order to access all parts of the engine.
- Mounting head has four fully adjustable arms with bolt holes to accommodate various load sizes.
- Fitted with screw lock to ensure load is secured.
- Swivel castors provide excellent manoeuvrability.
- Size (W x D x H): 990 x 930 x 925mm.
- **Model No. ES480D**
- List Price £349.95



450kg
Capacity



£299.95 Exc. VAT

£359.94 Inc. VAT

900kg Static Mounted Crane



900kg

Self
Assemble

- Heavy-duty steel.
- Powder coated finish.
- Unique 360° swivel base.
- Threaded locking arm.
- Mounts easily onto any strong and stable surface.
- Robust lifting ram.
- Max. Capacity (lifting boom retracted): 900kg.
- Max. Capacity (lifting boom extended): 250kg.
- Heavy-duty chain and hook.
- Hook features safety clip.
- **Model No. SSC900**
- List Price £339.95

£259.95 Exc. VAT

£311.94 Inc. VAT

Deluxe Steel Creeper



- Heavy-duty steel frame.
- Powder coat paint finish.
- Ø75mm Swivel castors.
- Vinyl covered back and headrest.
- Size (L x W x H): 1135 x 510 x 185mm.
- **Model No. SCR84**
- List Price £129.95

£79.95 Exc. VAT

£95.94 Inc. VAT

PREMIER HYDRAULIC PRESSES

- Manufactured in Europe with the professional in mind.
- With innovative safety and labour saving features, including guided V-blocks and press pin storage.
- Model No. PPF301 also features gas assisted press tables.



Model No. PPB15
15tonne
 Bench Mounting
Hydraulic



Model No. PPF20
20tonne
 Floor Standing
Hydraulic



3 YEAR GUARANTEE*

Model No. PPF30
30tonne
 Floor Standing
Hydraulic



Scan for our full range of **PRESSES**

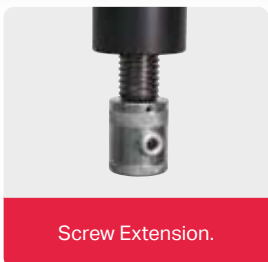
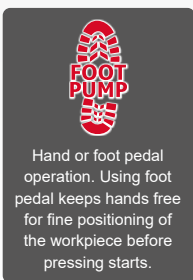
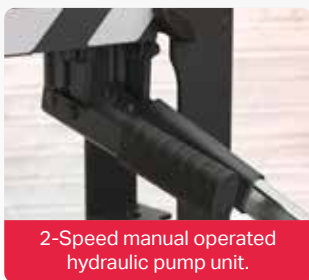
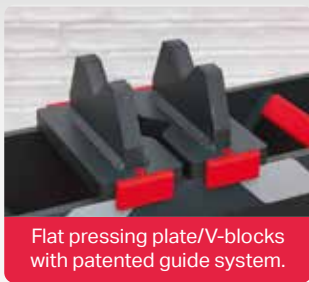
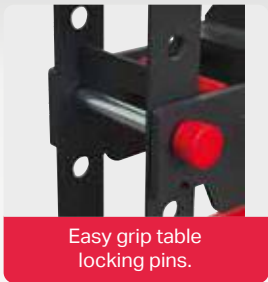

75+ KG HEAVY ITEM
 Model No's PPF20, PPF30, PPF301 are heavy. Extra assistance must be provided at the delivery point to help safe delivery.

Model No. PPF301
SLIDING RAM
FOOT PUMP
30tonne
 Floor Standing
AIR Hydraulic

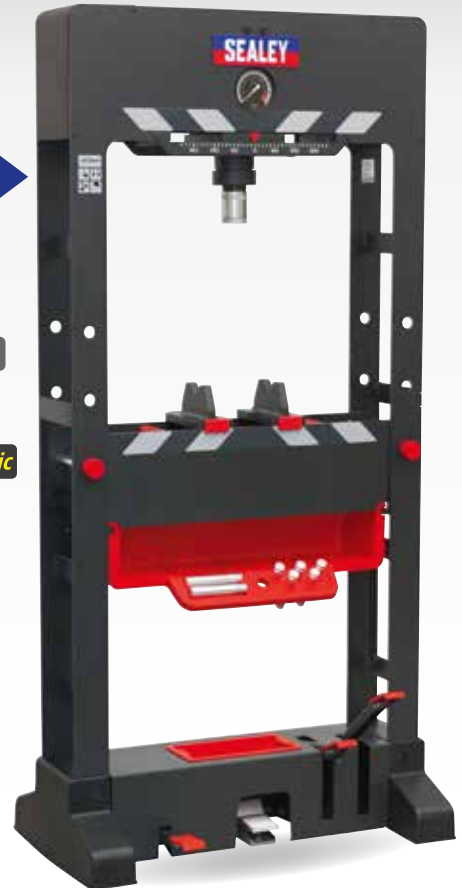

GAS ASSISTED TABLES

Model No.	Bench or Floor	Capacity	Min./Max. Height	Overall Height	Ram Diameter	Ram Stroke	Table Aperture	Type	Working Table Depth	Working Table Width	List Price	Exc. VAT	Inc. VAT
PPB15	Bench	15tonne	95/338mm	800mm	Ø45mm	170mm	132mm	Hydraulic	168mm	350mm	£759.95	£499.95	£599.94
PPF20	Floor	20tonne	120/858mm	1850mm	Ø51mm	195mm	132mm	Hydraulic	172mm	448mm	£1,299.95	£899.95	£1,079.94
PPF30	Floor	30tonne	120/854mm	1850mm	Ø58mm	195mm	132mm	Hydraulic	172mm	448mm	£1,599.95	£1,199.95	£1,439.94
PPF301	Floor	30tonne	120/470mm	1920mm	Ø58mm	252mm	195mm	Air/Hydraulic	191mm	490mm	£2,949.95	£1,999.95	£2,399.94

Car Ramps 1tonne Capacity per Ramp 2tonne Capacity per Pair

2000kg

BS Approved

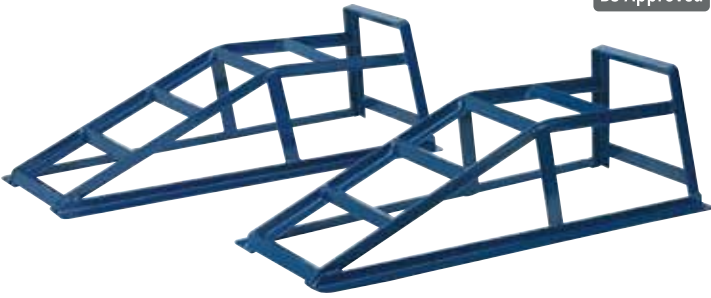

- Manufactured from 3.5mm steel section.
- Ramps coated with corrosion resistant finish.
- Ramps stack together and will stand upright for easy storage.
- Maximum Tyre Width: 200mm.
- BS Approved.
- **Model No. CAR2000**
- List Price £79.95

£67.95 Exc. VAT

£81.54 Inc. VAT

Car Ramp Extensions 400kg per Ramp 800kg per Pair

800kg

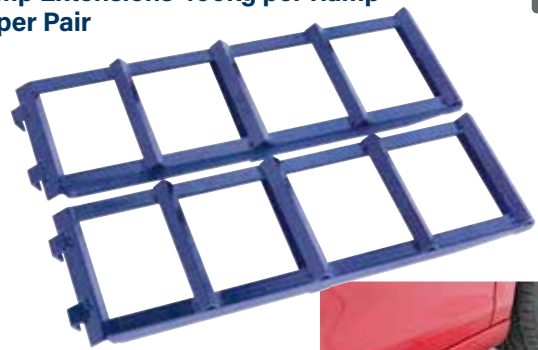

Model No. CAR2001 attached to Model No. CAR2000 sold separately.

- Steel construction car ramp extensions to decrease ascent angle.
- Ideal for cars with low ground clearance.
- Attaches to standard car ramps with a minimum width of 195mm.
- Suitable for use with Model No. CAR2000.
- Length: 630mm.
- **Model No. CAR2001**
- List Price £44.95

£37.95 Exc. VAT

£45.54 Inc. VAT

3tonne Car Lift/Ramp

AVAILABLE
Late July



3tonne



This item is heavy. Extra assistance must be provided at the delivery point to help its safe delivery.



MR1® Dimensions

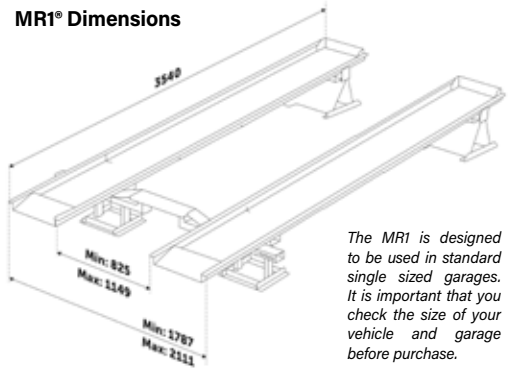

The MR1 is designed to be used in standard single sized garages. It is important that you check the size of your vehicle and garage before purchase.

- Compact, convenient and innovative 3tonne (pair) rated car ramps (maximum single axle weight of 1800kg), supplied with four stands and removable lifting beam, capable of raising a vehicle completely off the ground giving a clear workspace between vehicle and floor.
- Designed so the track width can be adjusted to fit various makes and model of cars with maximum tyre width of 380mm.
- Excellent for general servicing, exhaust work repairing damaged jacking points, sills, floor panels and undersealing.
- Will fit within confined areas such as garages and workshops.
- Safe and efficient operation, gives a clear workspace between the raised vehicle and floor.
- Requires a jack with a maximum saddle height of 100mm and maximum jacking height of 435mm to lift its jacking beam to a position where its stands can be inserted.
- Maximum jack pad diameter of Ø120mm.
- **Model No. MR1**
- List Price £2,149.95

£1,399.95 Exc. VAT

£1,679.94 Inc. VAT

**Car Ramps 1.5tonne Capacity per Ramp
3tonne Capacity per Pair**

3tonne

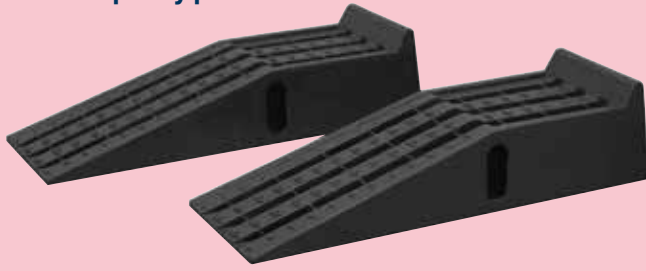

- 3tonne Capacity per pair.
- Manufactured from durable polypropylene.
- Overall Dimensions (L x W x H): 900 x 300 x 215mm.
- Maximum Tyre Width: 260mm.
- **Model No. CAR3000C**
- List Price £89.95

£54.95 Exc. VAT
£65.94 Inc. VAT

**Car Ramps Low Entry 1.5tonne Capacity per Ramp
3tonne Capacity per Pair**

3tonne



- 3tonne Capacity per pair.
- Made from durable polypropylene.
- These ramps are designed to allow jacking access to suitable jacking points on the vehicle.
- Not intended to raise a vehicle enough for under vehicle servicing.
- Overall Dimensions (L x W x H): 700 x 200 x 80mm.
- **Model No. CAR3000LR**
- List Price £43.95

£36.95 Exc. VAT
£44.34 Inc. VAT

LOW LEVEL CREEPER, SEAT & KNEELER



Heavy-duty steel framework.

- Powder coated paint finish.
- Ø70mm Composite castors with ball-bearing swivels.
- Vinyl covered seat pad and adjustable backrest.
- Size (L x W x H): 730 x 320 x 610mm.
- **Model No. SCR85**
- List Price £89.95

£69.95 Exc. VAT
£83.94 Inc. VAT



Converts from creeper seat to a traditional creeper and to a kneeler.

Under Dash Creeper Board

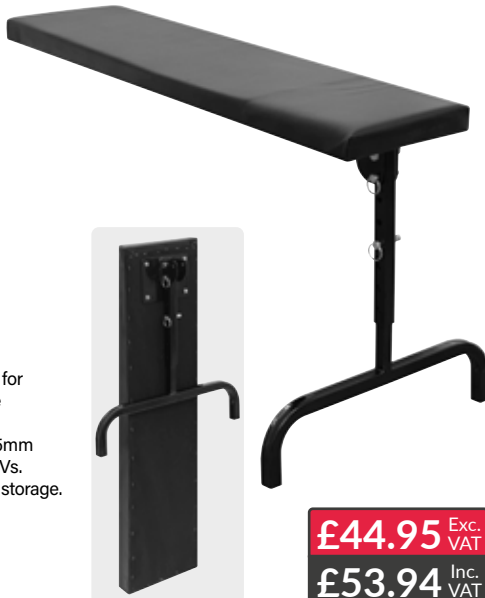

- Provides a comfortable work position for technicians who work under a vehicle dashboard.
- Adjustable height from 490mm to 665mm to accommodate cars, trucks, and SUVs.
- Heavy-duty steel frame folds easily for storage.
- Eases stress on back and neck while working under the dash.
- Maximum Capacity: 100kg.
- **Model No. SCRBB**
- List Price £59.95

£44.95 Exc. VAT
£53.94 Inc. VAT

Folding Wheel Chocks Pair



- Compact automotive wheel chocks for use during emergency wheel change.
- To be used on a flat surface only.
- Fold flat for easy storage in glove box or door pocket.
- Folded (W x D x H): 83 x 167 x 28mm (x2).
- Open: 83 x 167 x 133mm (x2).
- **Model No. WCF01**
- List Price £21.45

£11.95 Exc. VAT
£14.34 Inc. VAT

454KG HYDRAULIC MOTORCYCLE LIFTS

- Min./Max. Height: 190/710mm.
- Platform Width/Length; 690/2200mm.
- All steel construction with heavy-duty, foot operated, integral hydraulic pump and ram assembly. MC401A also features air pump.
- Air Consumption: 7.06cfm (Model No. MC401A only).
- Fitted with platform safety lock device to fix platform at two working heights of 490 and 710mm to prevent accidental lowering.
- Front wheel clamp for stability and sliding panel for easy rear wheel removal.
- Support platform fitted with full width loading ramp.
- Base assembly fitted with transport wheels and lock-downs to prevent lift from moving during use.
- Suitable for use with centre stand motorcycles or with paddock stand.



Model No. MC401

454kg

Hydraulic



All of our motorcycle lifts feature removable ramps.



Model No. MC401A

454kg

AIR Hydraulic



Model No.	Type	List Price	Exc. VAT	Inc. VAT
MC401	Hydraulic	£899.95	£799.95	£959.94
MC401A	Air/Hydraulic	£999.95	£899.95	£1,079.94

Scan for our full range of **MOTORCYCLE LIFTS**



These items are heavy. Extra assistance must be provided at the delivery point to help safe delivery.

450KG SINGLE POST HYDRAULIC MOTORCYCLE LIFT



- Space-saving design maximizes the space in the garage or workshop.
- Two locking positions for supporting the motorcycle over extended periods on the lift.
- With this lift it is possible to remove both wheels, front forks, steering assembly, rear swing arm and suspension units as well as the engine.
- Benefits from being portable and can be used anywhere with a hard level floor, thus making this suitable for mobile motorcycle mechanics.
- Ideal for use with the Sealey range of wheel chocks to assist supporting the motorcycle, whilst adjusting the frame supports and securing to the lift.
- Min./Max. Lift Height (without Frame Supports): 65/740mm.
- Min./Max. Lift Height (with Frame Supports): 165/840mm.
- Frame Height: 920mm.
- Maximum Frame Width: 980mm.
- **Model No. MCL500**
- List Price £449.95

£349.95 Exc. VAT
£419.94 Inc. VAT

680KG AIR/HYDRAULIC MOTORCYCLE LIFT



680kg

AIR Hydraulic

HEAVY DUTY

- Min./Max. Height: 190/790mm.
- Width: 710mm.
- Length: 2000mm.
- All steel construction.
- Combined air and foot pump separate from main lift for choice of operation.
- Air Consumption 7.06cfm.
- Ramp and platform made with chequer plate surface to ease loading and positioning of mini tractor.
- Overrun guard at front of platform and safety lock to prevent accidental lowering.
- Suitable for use with centre stand motorcycles or with paddock stand.
- **Model No. MC680A**
- List Price £1,649.95

£1,499.95 Exc. VAT
£1,799.94 Inc. VAT



75+ KG
HEAVY ITEM

This item is heavy. Extra assistance must be provided at the delivery point to help its safe delivery.

Motorcycle Centre Stand Moving Dolly



- Use to manoeuvre motorcycles (maximum 300kg vehicle weight) with centre-stands.
- The dolly is made from 4mm thick hardened steel-plate.
- Perfect for places where space is restrictive.
- Covered with anti-slip rubber pad.
- Foot/hand operated built-in brake mechanism.
- **Model No. MS0651**
- List Price £84.95



£64.95 Exc. VAT
£77.94 Inc. VAT

Motorcycle Dolly Rear Wheel - Side Stand Type



- Motorcycle dolly holds a single motorcycle with a side stand (Maximum overall vehicle weight of 500kg).
- Easy to manoeuvre around the workshop or garage.
- Front wheel stays in contact with the ground allowing the motorcycle to be steered into the desired position.
- Pivoting feature allows flexibility in side stand designs.
- Side stand holder can be adjusted to cater to the majority of motorbikes.
- **Model No. MS0630**
- List Price £99.95

£79.95 Exc. VAT
£95.94 Inc. VAT

Handlebar Tie Down Clamp Pair



- Handlebar tie down clamp used to minimise possible damage to motorcycle handlebars and grips.
- Provides a secure fixing point to tie down motorcycle whilst in transit.
- **Model No. TDC01**
- List Price £19.95

£14.95 Exc. VAT
£17.94 Inc. VAT

Anti-Dive Fork Brace



- Device designed to stop the over-compression of motorcycle forks whilst in transit.
- For use on off-road style motorcycles with a minimum front wheel to mudguard clearance of 255mm.
- **Model No. SMC56**
- List Price £10.45

£7.95 Exc. VAT
£9.54 Inc. VAT

36-42mm/45-50mm Double Hook-End C-Spanner



- Combination hook-end C-spanner for use with headstock adjustment and rear suspension adjustment.
- Suitable for a variety of motorcycles.
- Small End 36-42mm, Large End 45-50mm.
- **Model No. SMC38**
- List Price £16.95

£11.95 Exc. VAT
£14.34 Inc. VAT

14pc Motorcycle Brake Piston Removal Kit



- Designed to reduce the time taken when removing piston from motorcycle brake calipers.
- Extract brake caliper pistons without risk of damage to outer face of piston.
- Includes 12 adaptors to suit different sized pistons.
- Detachable slide hammer for impact removal.
- Capacity: Ø19-30mm.
- **Model No. MS162**
- List Price £79.95

£64.95 Exc. VAT
£77.94 Inc. VAT

Heavy-Duty Motorcycle Chain Splitter & Riveting Tool Set



- Comprehensive set designed to shorten and lengthen motorcycle chains by removing or replacing links.
- Set is also ideal for use on horticultural and agricultural machinery.
- Includes tools designed for riveting and plate holder for connecting links accurately.
- Suitable for use on 520, 525, 530 and 532 chains.
- **Model No. SMC4**
- List Price £55.95

£42.95 Exc. VAT
£51.54 Inc. VAT

Motorcycle CO₂ Emergency Tyre Inflator Kit

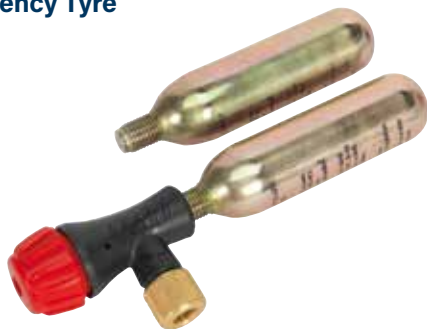

- CO₂ Tyre inflator kit including adaptor for Schrader type valves (used by most cars and motorcycles and some bicycles).
- 2 x 16g Canisters of CO₂.
- Supplied in zipped storage pouch.
- **Model No. MS087**
- List Price £23.95

£17.95 Exc. VAT
£21.54 Inc. VAT

10pc Bridge Bearing Puller Set



- 10-Piece screw-type bridge extractor set.
- The thin tapered lips on the collets secure a positive grip on the curved surface of the internal bearing bore.
- Gently removes blind bearings where the use of a slide hammer may damage the surrounding material.
- Bearing extractor collets with internal capacity from 8 to 27mm.
- **Model No. AK7160**
- List Price £107.45

£79.95 Exc. VAT
£95.94 Inc. VAT

Ø12-38mm Wheel Bearing Puller 3-Jaw



- 3-Jaw design applies even pressure preventing damage to bearings.
- Designed to remove bearings with Ø12-38mm internal diameter.
- Forged and heat treated steel jaws for greater strength.
- Corrosion resistant black oxide finish.
- **Model No. MS0621**
- List Price £37.45

£29.95 Exc. VAT
£35.94 Inc. VAT

18pc Socket & JIS Bit Set



- Small compact kit comprises a selection of essential sockets and bits for use on motorcycles.
- Contents: 3/8" Sq Drive Bit Holder, 3/8" Sq Drive Socket Bits; 8, 10, 12, 13, 15mm, 1/4" Hex Bits; Slotted - 4, 5, 6mm, JIS - #1, #2, TRX-Star* - T10, T15, T20, Hex - 2, 3, 4mm, 1/4" Sq Drive Adaptor.
- **Model No. SMC31**
- List Price £31.95

£19.95 Exc. VAT
£23.94 Inc. VAT

28pc Compact Motorcycle Tool Kit

LIFETIME GUARANTEE*



- Small compact kit comprises a selection of essential motorcycle maintenance tools.
- Supplied in small storage case, ideal for storage under a motorcycle seat.
- **Model No. MS164**
- List Price £28.95

£21.95 Exc. VAT
£26.34 Inc. VAT

Motorcycle Helmet Hooks

Model No. MS0812

Model No. MS0811



- Wall and door mountable helmet hooks suitable for all motorcycle helmets.
- Designed in order to keep your helmet safe and out of the way when not in use.

Model No.	Hook Type	List Price	Exc. VAT	Inc. VAT
MS0812	Helmet & Jacket	£21.95	£16.95	£20.34
MS0811	Helmet	£9.95	£7.95	£9.54

10-Pocket Tool Roll

- Heavy-duty water-resistant canvas tool roll.
- Ideal for organising tools and taking them on the go.
- 10-Pockets of various sizes for an array of tools.
- Fitted with adjustable strap.
- **Model No. SMC45**
- List Price £10.45

£7.45 Exc. VAT
£8.94 Inc. VAT



Schumacher® Intelligent Battery Chargers



**2 YEAR
GUARANTEE***



Multi-Languages on Model No's SPI3S, SPI6S, SPI10S and SPI224S.

Suitable for all these vehicles:

- Fully automatic microprocessor controlled dual voltage battery chargers and maintainers, featuring patented Speed Charge technology.
- These models can charge the battery up to three times faster than conventional chargers without causing damage.
- Heavy-duty sturdy case with no-nonsense controls and LED status indicators.
- Battery presets include conventional lead acid, calcium, AGM/GEL, leisure, stop/start and lithium batteries (SPI3S only).
- Fully automatic float mode ensures the battery is kept fully charged, maintained and ready-to-use.

CHARGES UP TO 3X FASTER

Speed Charge Patented technology actively monitors the charge acceptance of the battery, along with the temperature. It then adjusts the charge accordingly, ensuring the battery is charged as fast and safely as possible - up to three times faster than traditional chargers.

AUTO VOLTAGE DETECTION

Automatic voltage detection of 6V or 12V battery where applicable (12V or 24V on Model No. SPI224S).

MICROPROCESSOR CONTROLLED

Automatic microprocessor controlled battery charger/maintainer.

Charges conventional lead acid, calcium, AGM/GEL, leisure, stop/start batteries and with Model No. SPI3S only, Lithium vehicle batteries.



Scan for our full range of **BATTERY MAINTENANCE**

Ref.	Model No.	Output Charge	Battery Range	Output	Cable Length	Supply	IP Rating	List Price	Exc. VAT	Inc. VAT
A	SPI1S	1A	Lead Acid 12Ah(6V), 12-35Ah(12V)	6/12V	1.8m	230V	IP54	£49.95	£29.95	£35.94
B	SPI2S	2A	Lead Acid 12Ah(6V), 12-35Ah(12V)	6/12V	1.8m	230V	IP54	£62.45	£44.95	£53.94
C	SPI3S	3A	Lead Acid 12-59Ah, LiFePO4 3-50Ah	12V	2m	230V	IP64	£79.95	£57.95	£69.54
D	SPI6S	6A	6-130Ah Lead Acid	12V	1.8m	230V	IP20	£93.95	£69.95	£83.94
E	SPI10S	10A	10-230Ah Lead Acid	12V	1.8m	230V	IP20	£114.95	£79.95	£95.94
F	SPI224S	15A/10A	40-230Ah Lead Acid	12/24V	1.9m	230V	IP20	£142.95	£99.95	£119.94

RoadStart® Compact Jump Starters



12V

- All units feature high output sealed AGM battery with clamp storage and rope carry handle.
- Front panel includes an integral LED work light.
- Reverse polarity and short circuit protection with audible warning.
- Mains charger with automatic power cut-off prevents damage to battery whilst charging.
- Inbuilt MOSFET circuit protection.
- Single 5V 2.4A USB output.
- Supplied with mains charger.



All units are supplied in durable storage cases.

Ref.	Model No.	Cold Cranking Amps	Peak Amps	Engine Capacity	List Price	Exc. VAT	Inc. VAT
A	RS1C	130A	800A	4-cylinder petrol engines up to 2L or diesel 1.6L	£119.95	£84.95	£101.94
B	RS102C	280A	1200A	6-cylinder petrol engines up to 3L and 4-cylinder diesel engines up to 2.5L	£169.95	£109.95	£131.94
C	RS103C	400A	1700A	8-cylinder petrol engines up to 5L and 6-cylinder diesel engines up to 3.5L	£219.95	£159.95	£191.94

ElectroStart® Batteryless Jump Starters

- Vehicle jump starting made easy with innovative technology. Unlike traditional boosters does not require an internal battery.
- Simply connect to a flat vehicle battery and the unit will draw power from it and energise itself fully in a matter of minutes. It then pushes full power safely back through the starting system, jump starting the vehicle.
- If the vehicle battery is faulty or is holding less than 5 volts the ElectroStart® can be pre-charged via another vehicle's battery, a Micro USB charging cable (not supplied) or the 12V accessory lead (*excludes E/START1224).
- No internal battery means no storage issues. Compact and lightweight for easier handling and storage, yet still delivers the same result as heavy, bulky, lead acid battery equivalents.
- Ideal for both professional mechanics and DIY users. Supplied in storage bag.



PATENTED TECHNOLOGY



E HYBRID TECHNOLOGY

Integral lithium battery pack for use when battery voltage is below 5V.

Digital display indicates battery voltage, capacitor charge and faults.



LIMITED STOCK

Ref.	Model No.	Output	Output Start Peak (EN)	Max. Starting Capacity	Weight	List Price	Exc. VAT	Inc. VAT
A	E/START800	12V	800A(400A)	3L Petrol/2L Diesel	1.4kg	£164.95	£119.95	£143.94
B	E/START1100	12V	1100A(550A)	5L Petrol/3L Diesel	1.8kg	£219.95	£149.95	£179.94
C	E/START1600	12V	1600A(800A)	6L Petrol/4L Diesel	2.3kg	£279.95	£179.95	£215.94
D	E/START1224	12V/24V	12V 1000A(500A) 24V 1600A(800A)	Petrol; 6L(24V) 5L(12V), Diesel; 7L(24V) 3L(12V)	5.2kg	£599.95	£199.95	£239.94
E	E/START800HY	12V	800A(400A)	3L Petrol/2L Diesel	1.4kg	£174.95	£79.95	£95.94

Tablet Video Borescopes



Model No. VS8114

NEW
PRODUCTS



Camera Ø3.9mm Camera Ø5.5mm OR Camera Ø8mm



- Large 110mm LCD screen with a resolution up to 1080p full HD for video recording, playback and still images.
- Tablet design makes the image incredibly clear but also very portable.
- Features controls for light intensity, digital zoom and image rotation.
- Waterproof probe pod with IP67 rating.
- Powered by 2600mAh rechargeable with 5 hour working time (USB Charging cable supplied).
- SD card can be installed to achieve file storage (not supplied).
- Kit includes 45° mirror, hook and magnetic pick-up.
- Cable Length: 2m.

Model No.	Camera	List Price	Exc. VAT	Inc. VAT
VS8114	Ø3.9mm	£119.95	£99.95	£119.94
VS8115	Ø5.5mm	£109.95	£89.95	£107.94
VS8116	Ø8mm	£99.95	£79.95	£95.94

Ø8mm Wi-Fi Borescope



NEW
PRODUCT

Wireless

Camera
Ø8mm

- Wifi - App.
- Application: IOS, Android and Windows.
- Waterproof Level: IP67 (RIBU).
- Camera Head: Ø8mm.
- Camera Lens: 6 LEDs.
- Resolutions: 640 x 480, 1280 x 720.
- Transmission Distance: 5-30m.
- Cable Length: 5m.
- Record and screen shot.
- Screen rotation function.
- Viewing Angle: 70°
- Kit Includes charging cable, hook, magnet, and side mirror.
- **Model No. VS8113**
- List Price £44.95



£37.95 Exc. VAT
£45.54 Inc. VAT

Professional Auto-Ranging Digital Multimeter



- Lightweight, auto-ranging digital multimeter with double moulded plastic housing and a 2000 counts LCD display.
- Features forward facing work light, data-hold and non-contact voltage detection.
- Conforms to EN 61010-1 CAT IV 600V safety standard.
- **Model No. MM102**
- List Price £54.95

£39.95 Exc. VAT
£47.94 Inc. VAT

7-Function Multimeter

- High quality general-purpose multimeter with a large (46 x 25mm), clear and easy-to-read LCD display.
- Measures:
 - AC and DC Voltage
 - DC Current
 - Resistance
 - Audible Continuity
 - Diode/Transistor
 - Verification Mode
- **Model No. MM19**
- List Price £21.45



£15.95 Exc. VAT
£19.14 Inc. VAT

15pc Test Lead Set



- Professional set of test leads and components suitable for testing and evaluating automotive electronic circuits on modern vehicles.
- Features 0.7mm back probes ideal for testing vehicle sensors and dual colour LEDs for directional polarity testing.
- Set includes standard Ø4mm banana style plugs and sockets suitable for use with most diagnostic multimeters and test equipment.
- **Model No. TA112**
- List Price £109.95

£89.95 Exc. VAT
£107.94 Inc. VAT

AC/DC Clamp Meter & Multimeter



- Designed for the automotive electrician and conforms to EN 61010 CAT III 600V.
- Ideal for measuring current draw from vehicle components in situ.
- Features 10mm clamp.
- Supplied in pouch.
- **Model No. TA305**
- List Price £109.95

£76.95 Exc. VAT
£92.34 Inc. VAT

3-42V DC Auto Probe with LCD Display

3V to 42V

- A range of functions allow automotive electricians and mechanics the ability to effectively diagnose short circuits and bad earths.
- The 4.6m lead connects to a 12V battery supply and reaches to all areas of the vehicle.
- Fly lead allows continuity and polarity testing with a high-contrast LCD display with 9mm high (3V-42V) read-out.
- Activate components in situ or prior to installation.
- Features audible and positive/negative voltage indicator plus two integral work lights.
- Kit includes three probe extension leads, two wire piercing probes, two lead adaptors and a crocodile clip.
- **Model No. PP7**
- List Price £159.95

£119.95 Exc. VAT
£143.94 Inc. VAT



Automotive Induction Probe

- Quick and easy-to-use.
- Ideal for testing ignition coils, fuel injectors and relays.
- Powered by 2 x AA batteries (not included).
- Not suitable for piezo energised fuel injectors.
- **Model No. VS5272**
- List Price £39.95

£19.95 Exc. VAT
£23.94 Inc. VAT



6-24V DC Auto Probe Excel Kit

6V to 24V

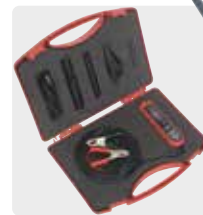

- Comprehensive 6-24V DC test kit.
- Find bad earths, breaks in continuity and short circuits quickly and easily.
- Can even power-up components on and off the vehicle.
- Kit includes flexible extension cable, crocodile clip, wire probe and back-probe.
- **Model No. PPLK**
- List Price £81.95

£59.95 Exc. VAT
£71.94 Inc. VAT

80A Automotive Current Tester - Mini, Standard & Maxi Blade Fuses

80A

Mini

Standard

Maxi



- Fast, accurate and safe current measurement at the fuse box.
- Ideal for fault-finding on car and commercial vehicle electrical circuits.
- Includes hold and peak functions for detecting current surges.
- Features large LCD display with digital and graphical current read-out.
- Plugs straight into the vehicle's fuse board and supplied with Mini, Standard and Maxi style blade adaptors.
- Range: 0-80A - 0-48V.
- **Model No. TA125**
- List Price £124.95

£89.95 Exc. VAT
£107.94 Inc. VAT

110mm Cutting Nippers

LIFETIME GUARANTEE

- Manufactured from high quality stainless steel with spring-return.
- Suitable for cutting soft wires and plastic e.g. cable ties.
- Sturdy handles for added grip and comfort.
- Maximum Cutting Capacity: Ø4.5mm.
- **Model No. AK2254**
- List Price £12.95

£8.95 Exc. VAT
£10.74 Inc. VAT



15pc Universal Cable Ejection Tool Set

- Reduce time spent on, and damage to, vehicle electrical systems with these connector tools.
- Set consists of cable extraction, contact ejection and contact dismantling tools.
- Covers a wide range of connectors, including Kabelex.
- Vehicle coverage: BMW, Daimler/Chrysler, Fiat, Ford, MAN, Mazda, Porsche, PSA, Renault, Saab, Seat, Skoda, VAG, Vauxhall/Opel.
- **Model No. VS9201**
- List Price £139.95

£99.95 Exc. VAT
£119.94 Inc. VAT



Terminal Tool - VAG

VAG

- Designed to remove terminals frequently used on many VAG group vehicles.
- **Model No. VS9200**
- List Price £12.95

£8.95 Exc. VAT
£10.74 Inc. VAT



6/12V Handheld Battery Tester



6V
12V

- Tests 6 and 12V batteries.
- Applies load across terminals and reads voltage performance.
- Checks charging voltage.
- Fitted with moving-coil meter.
- Pistol grip handle for ease of use.
- **Model No. BT91/10**
- List Price £73.95

£53.95 Exc. VAT
£64.74 Inc. VAT

12V Digital Battery & Alternator Tester with Printer



12V
Battery & Alternator

- Fast and accurate diagnosis of battery and alternator faults with facility to print the results.
- Large LCD display shows charging and starting system status and returns decision making information in seconds.
- Results need no interpretation and the tester will work on batteries with as little as 1.5V of residual charge.
- **Model No. BT2012**
- List Price £269.95

£199.95 Exc. VAT
£239.94 Inc. VAT

12V Digital Battery & Alternator Tester

12V Battery & Alternator



- Compact device which accurately tests battery, cranking and alternator.
- No heat, no sparks and no misdiagnosis.
- Just key in the battery rating from the top of the battery and results are displayed on LED control panel.
- No internal battery and will test batteries with a residual charge of just 7V.
- **Model No. BT01**
- List Price £69.95

£49.95 Exc. VAT
£59.94 Inc. VAT

12V Battery Drop Tester

12V



- Traditional style drop tester for all 12V automotive batteries.
- Applies load across cells and measures output on meter.
- Accurate indication of battery voltage, faulty cell and short circuited cell.
- **Model No. BT91/3**
- List Price £184.95

£149.95 Exc. VAT
£179.94 Inc. VAT

Diagnostic Socket Memory Safe - EOBD

12V



- Professional low cost tool saves all the vehicle settings to prevent loss and expensive reprogramming, not just for radio codes but for immobilisers, traction control, engine management and satellite navigation.
- Bright, easy-to-read LEDs for at-a-glance confirmation of connection.
- Cable Length: 1.8m.
- Can be used with any existing booster packs with a vehicle accessory power socket or even vehicle-to-vehicle.
- **Model No. VS2073**
- List Price £61.95

£44.95 Exc. VAT
£53.94 Inc. VAT

12V Battery & Alternator Tester LCD Screen



12V
Battery & Alternator

- LCD display verifies the condition of battery and alternator output.
- Suitable for 12V DC systems and connects to vehicle via the vehicle accessory power socket.
- Fitted with 2500mm cable and powered by connection to vehicle.
- **Model No. AK500**
- List Price £29.95

£19.95 Exc. VAT
£23.94 Inc. VAT

12V LED Battery/Alternator Tester

12V
Battery & Alternator



- LED Indicators verify condition of battery and alternator.
- Suitable for 12V DC systems.
- Magnetic backing sticks to metal surfaces for hands-free operation.
- Fitted with 900mm of cable, probe and crocodile clips.
- **Model No. AK400**
- List Price £19.95

£13.95 Exc. VAT
£16.74 Inc. VAT

Diagnostic Socket Memory Safe - EOBD

12V Surge Protected



- Attaches to a 12V slave battery and provides power via the EOBD socket to on-board electronics whilst vehicle's own battery is disconnected.
- Features LED to indicate back-up battery power supply status.
- Saves valuable time spent re-programming lost codes.
- **Model No. VS2072**
- List Price £34.95

£26.95 Exc. VAT
£32.34 Inc. VAT

35pc Alternator Freewheel Pulley Removal Set

1/2" Sq. Drive



- Comprehensive set for easy removal of freewheel alternator pulley, either on or off the vehicle.
- Allows alternator shaft to be held while pulley retainer is removed.

• **Model No. SX404**
• List Price £159.95

£124.95 Exc. VAT
£149.94 Inc. VAT



10pc Valve Seat Cutter Set



- Suitable for re-cutting inlet/exhaust valve seats concentric to the valve guides.
- Features tungsten carbide cutting blades, expandable pilots and double end cutters for increased application.

• Cutter Sizes: Ø28-37mm 30°, Ø28-37mm 45° & 75°, Ø37-44mm 75°, Ø37-46mm 45° & 60°.

• **Model No. VS1823**
• List Price £649.95

£469.95 Exc. VAT
£563.94 Inc. VAT

6/12/24V Battery Fluid Tester Tube Type



6V
12V
24V

- Professional battery hydrometer.
- Tests 6, 12 and 24V batteries.
- Float gauge and thermometer built-in.
- Tube construction with thermometer for temperature compensation.

• **Model No. AK414**
• List Price £11.45

£7.45 Exc. VAT
£8.94 Inc. VAT

Battery Post & Terminal Cleaner



- Wire brushes remove corrosion build-up on battery posts and terminals for improved electrical contact.

• **Model No. AK417**
• List Price £6.95

£4.45 Exc. VAT
£5.34 Inc. VAT

2pc Valve Grinder Set



- Set of two valve grinders with wooden shafts.
- Suitable for grinding most engine valves.
- Features four sizes of rubber suction cup.

• **Model No. VS1653**
• List Price £12.95

£7.95 Exc. VAT
£9.54 Inc. VAT

610mm Technician's Straight Edge



- Suitable for testing for distortion on cylinder heads and engine blocks during engine overhauls and rebuilds.
- May be used with feeler gauges for high precision work.
- Supplied with protective edging for when not in use.

• **Model No. VS1481**
• List Price £72.95

£49.95 Exc. VAT
£59.94 Inc. VAT

2pc Air Conditioning & Fuel Disconnection Tool Set

LIFETIME GUARANTEE



- Die-cast tools suitable for press-type quick disconnection joints found on Chrysler, Ford and Vauxhall/Opel vehicles.
- Swivel action allows quick selection of correct sized tool.

• **Model No. VS045**
• List Price £18.45

£12.95 Exc. VAT
£15.54 Inc. VAT

4pc Air Conditioning Spring Lock Coupling Tool Set



- Spring type coupling connectors for air conditioning lines.
- Locking action prevents spray when disconnecting lines.
- Suitable for most Chrysler, Ford and Vauxhall/Opel vehicles.

• **Model No. VS0454**
• List Price £10.45

£7.45 Exc. VAT
£8.94 Inc. VAT

10-120mm² Copper Lug Terminal Crimping Tool

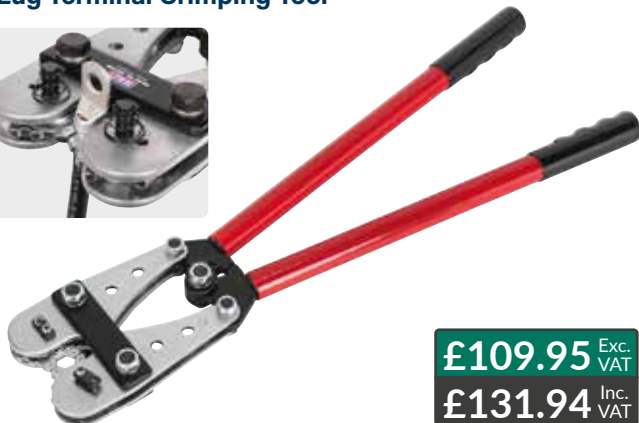

- Copper lug terminal tool.
- Crimp range 10-120mm².
- BS Standard type terminal.
- Made from SCM40 hard tool steel.

• **Model No. AK120B**
• List Price £164.95

£109.95 Exc. VAT
£131.94 Inc. VAT

10pc Gasket Punch Set



- Carbon steel body with spring loaded centring pin.
- Suitable for cutting gasket material, cork or leather.

• **Model No. AK709**
• List Price £53.95

£33.95 Exc. VAT
£40.74 Inc. VAT

Autel MaxiSYS® Multi-Manufacturer Diagnostic Tool

- Samsung Exynos Hexa-core processor.
- 8" 1024 x 768 LED-backlit glossy Multi-Touch capacitive display.
- Internal 32GB SSD.
- 8-Megapixel rear camera with auto-focus and flashlight.
- Wi-Fi to access web resources.
- Rubberized outer protection and a rugged internal housing.
- Built-in rechargeable lithium-polymer battery for up to 6 hours of continuous operation.
- Android Operating System for fast boot-up and multitasking.
- Extensive vehicle coverage for more than 80 US, Asian and European vehicle makes.
- Exceptional OE-Level system coverage for all electronic systems.
- Complete capabilities for codes, live data, active test, ECU information, adaptation, matching, etc.
- Automatic system and software updates via Wi-Fi.
- MaxiFix online community provides a vast database of diagnostic and repair tips and proven fixed fixes.
- Workshop operations to keep all data files, customer info., and vehicle records well organized.
- UK Telephone support.
- **Model No. MS906**
- List Price £1,599.95



£1,399.95 Exc. VAT
£1,679.94 Inc. VAT

Autel MaxiSYS® - Multi-Manufacturer Diagnostic Tool



- Extraordinarily powerful Cortex-A9 quad-core processor.
- 9.7 Inch 1024 x 768 LED-backlit glossy Multi-Touch capacitive display with IPS technology.
- Built-in 5-megapixel rear camera with auto-focus and flashlight.
- Unique workshop-tough ergonomic design features strong rubber protection and housing.
- The VCI connects wirelessly to the main unit with Long-Range Class 1 Bluetooth.
- Extensive vehicle coverage for more than 80 US, Asian and European vehicle makes.
- Complete capabilities for codes, live data, actuation tests, adaptations and ECU coding.
- Displays live data in text, graph, analogue and digital gauge for easy data review and analysis.
- Cloud-based Data Manager.
- Remote technical support for convenient demonstration and training.
- Prints out recorded data anytime and anywhere with Wi-Fi technology.
- 12 Months' free updates (often one a week).
- No lockout when updates expire.
- UK Telephone support.
- **Model No. MS908**
- List Price £2,599.95

£2,199.95 Exc. VAT
£2,639.94 Inc. VAT

Autel MaxiScope Automotive Oscilloscope



- 4-Channel automotive oscilloscope suitable for professional applications.
- Works in conjunction with MaxiSYS® Tablets, Model No's MS905 and MS908, to provide a powerful diagnostic tool.
- Powered directly from a USB port, with no need for batteries or power leads, making it versatile and portable.
- The 4-channel function allows multiple components to be compared simultaneously.
- The scope is supplied with a wide selection of automotive type test leads, connectors and probes.
- Accessories (supplied): 1.5m USB Cable, 3m Screened Test Lead (x4), Secondary Ignition Pickup, 2-Pin Breakout Lead, Attenuators 20:1 (x2), Large Crocodile Clip Set (Pair), Small Crocodile Clip Set (Pair), Acupuncture Probe Set, Multimeter Probes (Pair).
- PC software can be downloaded from the Sealey or Autel website.

£799.95 Exc. VAT
£959.94 Inc. VAT



**EOBD Code Reader
Oil & Service Reset Tool**



- Combines an EOBD code reader and oil service tool in one unit.
- Extensive vehicle coverage for resetting the oil service/inspection lights.
- Sets Inspection 1 Service Interval.
- Sets Inspection 2 Service Interval.
- Sets Inspection Mileage.
- Also includes manual reset using clear step-by-step on-screen instructions.
- Suitable for any EOBD compliant vehicle to read EOBD diagnostic codes (Engine/Transmission) and enables the cause of the illuminated engine check light (MIL) to be established.
- Includes all the usual features expected in a quality EOBD code reader.
- Updateable via web-based downloads.
- Supplied with operating instructions, CD and USB cable in storage pouch.
- Visit www.auteltech.com and register, download instruction or contact technical sales for concise model applications.
- **Model No. OLS301**
- List Price £269.95

£229.95 Exc. VAT
£275.94 Inc. VAT

**MOT Pro II® - Multi-Manufacturer
Diagnostic Tool**



- Highly functional, the MOT Pro II® provides 40+ manufacturer coverage offering diagnostics on the most common modules such as EOBD, Transmission, ABS, Airbag, Battery testing/coding, DPF service and regeneration, Electronic Parking Brake (EPB), Oil Service Reset, some TPMS, some steering control sensors, climate, audio and more.
- Can be updated via web-based downloads.
- Supplied with operating instructions and USB cable in storage case.
- Visit www.auteltech.com for concise model applications.
- **Model No. EU908PRO**
- List Price £469.95

£429.95 Exc. VAT
£515.94 Inc. VAT

EOBD Code Readers

Allows the interrogation of the vehicle's ECU to determine the performance of essential emission-based information, to read and clear Diagnostic Trouble Codes (DTCs) and to obtain vital performance data from the vehicle's engine and transmission (Petrol 2001on and Diesel 2004on). The competitively priced AL301 EOBD tool works with OBDII/EOBD compliant vehicles and is supplied with a code reference manual with over 7,000 DTC definitions. The sophisticated AL419 EOBD tool delivers in-depth data with added features not found on other tools at the same price. The unit is loaded with troubleshooter code tips and repair information to help the technician fault find and diagnose problems more quickly and effectively. There is also a built-in data library lookup. AL539B supports new extended sensor list (SAE J1979 2007), troubleshooter code tips and repair information to identify root cause of the DTC, so saving time. Auto-ranging automotive diagnostic multimeter with volts, current and resistance. Scope function to visually test component signals, with the added benefit of maximum/minimum volts, frequency and duty cycle displayed. Starter test function allows testing of the battery and charging system. Internal battery back-up for off-vehicle data review/analysis. Supplied with operating instructions, CD, USB cable and test leads in storage pouch. The AL539B feature battery clamps for non-load battery testing. All models can be updated via web-based downloads using the USB cable supplied.



Model No. AL301



Battery



Model No. AL419



Model No. AL539B

SPECIFICATION	AL301	AL419	AL539B
Works with all (Petrol 2001 and Diesel 2004 onwards) OBDII / EOBD compliant vehicles	✓	✓	✓
Scans for Diagnostic Trouble Codes (DTC) - The cause of the 'Engine and Transmission' Malfunction Indicator Light (MIL)	✓	✓	✓
Scans for pending DTCs	✓	✓	✓
Retrieves generic (P0, P2, P3 & U10) and manufacturer specific (P1, P3 & U1) DTCs	✓	✓	✓
Turns off MIL light, clears DTCs and resets monitors	✓	✓	✓
Displays DTC definitions on screen	✗	✓	✓
View freeze-frame data	✗	✓	✓
Displays monitor and I/M readiness status (emissions)	✓	✓	✓
Patented One-Click I/M readiness button (emissions)	✗	✓	✓
Retrieves vehicle information (VIN, CID & CVN)	✓	✓	✓
Supports CAN and other current EOBD Protocols	✓	✓	✓
Supports the new extended sensor list (SAE J1979 - 2007)	✗	✓	✓
Reads live ECU/PCM data stream	✗	✓	✓
Displays live O ₂ sensor data	✗	✓	✓
Graphing function for live data	✗	✗	✓
Read, store and playback live sensor data	✗	✗	✓
Performs 'modules present' test	✗	✓	✓
Print out data via PC - Compatibility: Win7, 8 & 10	✗	✓	✓
Update software via the internet - Compatibility: Win7, 8 & 10	✗	✓	✓
Built-in EOBD library lookup	✗	✓	✓
Troubleshooter code tips and repair information guide	✗	✓	✓
Multimeter (Voltage & Resistance)	✗	✗	✓
Multimeter (Amps)	✗	✗	✓
Scope with Max., Min., Frequency, Duty Cycle	✗	✗	✓
12V Charging and battery starter test	✗	✗	✓
Battery test ranges CCA: DIN, SAE, IEC, EN	✗	✗	✓

Model No.	List Price	Exc. VAT	Inc. VAT
AL301	£41.45	£34.95	£41.94
AL419	£104.95	£89.95	£107.94
AL539B	£239.95	£189.95	£227.94

Front Wheel Bearing Puller - Ford Transit

- Engineered for safe, in situ removal of drive flange with wheel bearing/hub assembly and wheel bearing from drive flange.
- Essential tool when replacing brake discs allowing the drive flange to be split from the hub assembly.
- Features a cleverly designed impact force screw.
- **Model No. VS2386**
- List Price £239.95



£184.95 Exc. VAT
£221.94 Inc. VAT

Wheel Bearing Removal/Installation Kit

- Comprehensive kit of tools for the fast and effective removal and installation of wheel bearings on front-wheel drive vehicles.
- Reduces chances of damage to hub and bearing.
- Heavy-duty steel drifts with phosphate coating to prevent corrosion.
- Heavyweight drive screw for use with impact tools.
- Also suitable for removing and installing large industrial bearings.
- **Model No. VS7020**
- List Price £199.95



£164.95 Exc. VAT
£197.94 Inc. VAT

3pc Axle Bearing Puller Set

NEW
PRODUCT



- 3-Piece axle bearing remover set is designed for easy removal of rear axle bearings.
- Use with Sealey slide hammer PS983 or PS992 (sold separately).
- Puller head sizes: 20, 24, 30mm.
- **Model No. VS7033**
- List Price £39.95

£32.95 Exc. VAT
£39.54 Inc. VAT

Professional Coil Spring Compressor Kit Right-Hand

Model No. RE229

2500kg

Right-Hand



Professional Coil Spring Compressor Kit Right-Hand/Left-Hand

Model No. RE249

2500kg

Right-Hand

Left-Hand



- Suitable for MacPherson strut coil springs.
- Plastic yoke protectors that protect the spring coating from damage, which can invalidate the vehicle manufacturer's guarantee.
- Safety yokes carefully shaped to stop the spring bowing while under compression.
- RE259 suitable for MacPherson strut LH coil springs and is compatible with RE229, RE239 and RE249.

Yokes	Right-Hand Ø80-105mm	Right-Hand Ø105-140mm	Right-Hand Ø145-190mm	Left-Hand Ø105-140mm	Left-Hand Ø145-190mm
RE229	✓	✓	✓	✗	✗
RE239	✗	✗	✗	✓	✓
RE249	✓	✓	✓	✓	✓
RE259	✗	✗	✗	✓	✓

Model No.	Capacity	Maximum Jaw Opening	Drive	List Price	Exc. VAT	Inc. VAT
RE229	2500kg	265mm	21mm Hex	£379.95	£219.95	£263.94
RE239	2500kg	265mm	21mm Hex	£279.95	£179.95	£215.94
RE249	2500kg	265mm	21mm Hex	£439.95	£299.95	£359.94
RE259	n/a	n/a	n/a	£129.95	£79.95	£95.94

Professional Coil Spring Compressor Kit Left-Hand

Model No. RE239

2500kg

Left-Hand



Coil Spring Yokes Left-Hand

Model No. RE259

2500kg

Left-Hand



All Coil Spring Compressor Kits on this page are supplied in a storage case.

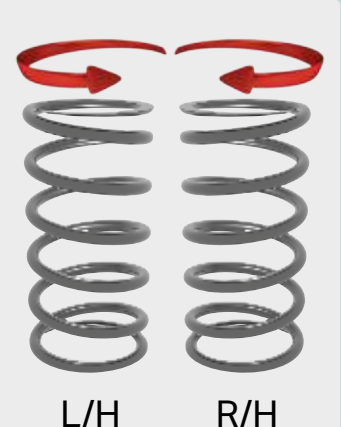

Hydraulic Bearing Separator/Puller Sets

- Cast puller yoke with forged separator.
- 10tonne Hydraulic ram interchangeable with other units in the series.
- Maximum Puller Depth: 420mm.
- Supplied in steel case.



Model No.	Qty	Applications	Contents	List Price	Exc. VAT	Inc. VAT
PS980	8pc	Vehicle Size Bearings from Ø75-105mm	10tonne Hydraulic Ram, Ø75-105mm Separator, 5/8" Bolt, 200mm Extension Rod (x4), Cross Beam	£189.95	£129.95	£155.94
PS985	10pc	Vehicle Size Bearings from Ø105-200mm	10tonne Hydraulic Ram, Separator Ø105-200mm, Plug, Extension Rod 250mm (x4), Cross Beam	£299.95	£199.95	£239.94

19pc Hydraulic Puller Set

10tonne
Hydraulic



- Forged steel 2-way yoke allows twin or triple leg pulls.
- 10tonne Hydraulic power unit with tommy bar.
- Suitable for pulling hubs, flanges, gears and bearings.
- Supplied with three 3-position puller arms and three sets of extension plates.
- Maximum reach: 250mm.
- Model No. PS981
- List Price £199.95

£139.95 Exc. VAT
£167.94 Inc. VAT

Triple Leg Hydraulic Pullers

5tonne
OR
10tonne
Hydraulic
HEAVY
DUTY

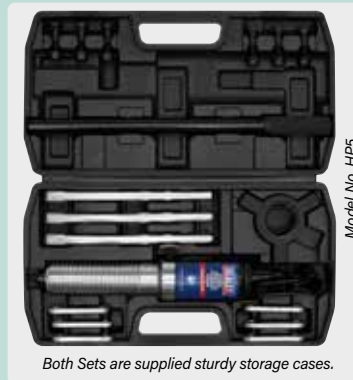

- Suitable for pulling hubs, flanges, gears and bearings.
- Supplied with three 2-position puller legs and storage case.

Model No.	Capacity	Contents	List Price	Exc. VAT	Inc. VAT
HP5	5tonne	230mm Leg (x3), Triple Head, 5tonne Ram & Handle, 80mm Leg Connector (x6), Nut & Bolt (x6)	£156.95	£99.95	£119.94
HP10	10tonne	325mm Leg (x3), Triple Head, 10tonne Ram & Handle, 115mm Leg Connector (x6), Nut & Bolt (x6)	£214.95	£149.95	£179.94

Twin Leg Reversible Puller Bars



- Heavy-duty twin leg bar type pullers, suitable for easy removal of pulleys, flywheels, bearings and gears.
- Drop-forged Chrome Vanadium steel.
- Heat treated for added strength.
- Zinc plated for corrosion resistance.
- Thrust bearing prevents wear and damage to shaft.

Model No.	Size/Spread	Reach	List Price	Exc. VAT	Inc. VAT
AK46080	80mm	100mm	£18.95	£13.95	£16.74
AK46120	120mm	100mm	£23.95	£17.95	£21.54
AK46150	150mm	150mm	£43.95	£32.95	£39.54
AK46200	200mm	150mm	£59.95	£44.95	£53.94

42pc Re-Threader Master Kit Metric/UNF/UNC

MM IMP

- Taps and dies are suitable for chasing out damaged threads and the removal of nicks and burrs without undercutting good threads.
- Thread file restores damaged external threads on any diameter, right or left-hand.

- Model No. AK311
- List Price £119.95

£89.95 Exc. VAT
£107.94 Inc. VAT



Thread Repair Master Kit

MM

- Suitable for five common sizes of thread (M5 x 0.8mm, M6 x 1mm, M8 x 1.25mm, M10 x 1.5mm and M12 x 1.75mm).
- Creates a stronger internal thread in soft metals.
- Ideal for repairing damaged or stripped internal threads.
- Protects tapped threads against wear and damage.
- Includes drill bits, thread taps, stainless steel thread inserts, insert installation and lug breaking tools.
- Model No. TRMK
- List Price £159.95

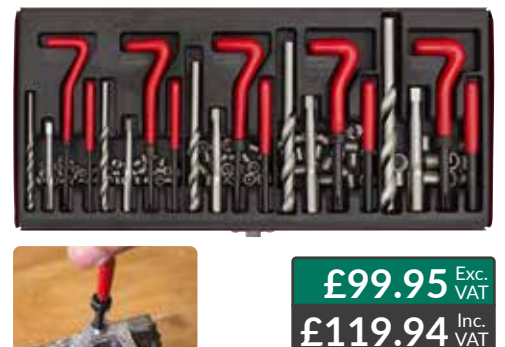

Diesel Fuel Priming Set



- A comprehensive fuel priming set fitted with the latest male and female quick connectors found on Fiat, Ford, Land Rover, Mercedes, PSA, Renault, Rover and Vauxhall/Opel vehicles.
- Designed to work in conjunction with the low pressure fuel circuit, to reintroduce fuel back up to the fuel line after maintenance.
- Clear pipes allow visual detection of any air within the fuel system or being inadvertently drawn into the fuel line.
- Two universal connectors and one clear pipe allow connection to older vehicles not fitted with quick release connectors.
- **Model No. VS555**
- List Price £247.45

£174.95 Exc. VAT
£209.94 Inc. VAT

Fuel Pressure Gauge Set



- Comprising of two gauges for positive/negative and main pressure testing on low-pressure delivery fuel circuit found on common rail systems.
- Compatible with 9.98mm button type connection system.
- Suitable for use with Model No's VS555 and VS552 for those systems not supported by 9.98mm button type connections.
- Can be connected in situ with fuel line for real time running pressure.
- **Model No. VS550**
- List Price £159.95

£99.95 Exc. VAT
£119.94 Inc. VAT

Fuel Priming Kit - Vauxhall/Opel



- Essential for reintroduction of fuel into fuel pump following maintenance such as fitting of new diesel filter, or following drainage of fuel tank.
- Must be used whenever fuel system is disturbed.
- **Model No. VS055**
- List Price £20.95

£14.95 Exc. VAT
£17.94 Inc. VAT

Diesel & Petrol Fuel Pump Priming Tool



- Required for priming injection pump.
- Use after diesel filter change, drainage of fuel tank or any other disturbance of the fuel system.
- Supplied with two fuel pipe clips.
- Suitable for 9mm bore hose.
- **Model No. VSE055**
- List Price £17.45

£13.95 Exc. VAT
£16.74 Inc. VAT

Diesel Injector Flow Test Kit - Common Rail

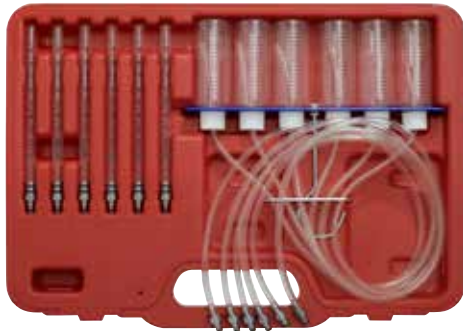

- Designed to measure return fuel flow on diesel vehicles up to 6-cylinders fitted with common rail injection system.
- Identifies worn, blocked or inoperative injectors quickly and easily.
- Supplied with measurement tubes for short term tests and measurement bottles for long term, more accurate evaluation.
- **Model No. VS2046**
- List Price £99.95

£69.95 Exc. VAT
£83.94 Inc. VAT

Diesel & Petrol Compression, Leakage & TDC Kit



- A comprehensive kit for testing the compression and leakage on both diesel and petrol vehicles.
- Features 600psi gauge with large rubber bumper, straight and right angled quick connect fittings and an extensive range of spark/glow plug and injector adaptors.
- Includes TDC finder, ideal for use when the engine has no crankshaft timing marks.
- See Sealey website for complete vehicle applications.
- **Model No. VSE3156**
- List Price £429.95

£269.95 Exc. VAT
£323.94 Inc. VAT

Fuel Injection Pressure Test Kit



- Comprehensive kit of hoses, adaptors and fittings for testing the pressure on modern petrol fuel injection systems.
- Fitted with quick couplings and safety valve to prevent inadvertent discharge of fuel under pressure.
- Supplied with Ø92mm single high pressure gauge with rubber bumper, reading 0-140psi and 0-10bar.
- Pressure release valve fitted with long drain hose allows safe recovery of fuel.
- **Model No. VSE212**
- List Price £399.95

£289.95 Exc. VAT
£347.94 Inc. VAT

38pc Injector Bore Cleaning Brush Set



- Ideal for cleaning and decarbonising areas with limited access, especially injector apertures before refitting.
- 38-Piece set includes brass, steel and nylon brushes 8-19mm.
- Soft grip handle.
- One-Piece 150mm Extension.
- Storage case included.
- **Model No. VS1910**
- List Price £49.95

£39.95 Exc. VAT
£47.94 Inc. VAT

40L Air Operated Fuel Drainer - Stainless Steel

- 40L
- AIR Operated
- STAINLESS STEEL
-
-



- Stainless steel fuel drainer with venturi type suction.
- 40L Capacity tank suitable for petrol or diesel.
- Supplied with suction tubes and adaptors for breaking into vehicle fuel system.
- CE Certified (ATEX 2014/34/EU).
- Model No. TP200S
- List Price £999.95

£779.95 Exc. VAT
£935.94 Inc. VAT

Ford Emergency Fuel Funnels

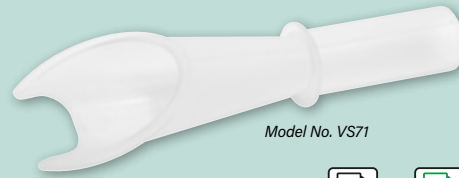

Model No. VS71



- Fuel funnels for capless filler systems found on Ford vehicles.
- Securely fits in filler neck, opening two valve security system.

Model No.	Type	List Price	Exc. VAT	Inc. VAT
VS71	Diesel	£4.95	£3.55	£4.26
VS72	Petrol	£4.95	£3.55	£4.26

Vacuum & Pressure Test/Bleeding Kit

- Professional vacuum/pressure diagnostic tool helps identify a variety of faults on vehicle systems including fuel, ignition, transmission, emission and air conditioning/heating.
- Kit also includes reservoirs, hoses and adaptors for bleeding brake and clutch systems.
- Features simple push/pull function for choice of pressure or vacuum testing.
- Large rubber easy-to-read gauge.
- Model No. VS403
- List Price £129.95

£89.95 Exc. VAT
£107.94 Inc. VAT



Petrol Engine Vacuum & Fuel Pump Tester

- Fitted with Ø63mm gauge.
- Checks for leaks in fuel line, vacuum chokes and heating.
- Also suitable for diagnosing valve problems.
- Includes long flexible hose with universal cone adaptor.
- Model No. CT952
- List Price £25.95

£18.95 Exc. VAT
£22.74 Inc. VAT



20pc Cooling System Pressure Tester Kit

- Cooling system pressure testing kit with an updated selection of adaptors to fit popular European and Japanese vehicles including Alfa, Audi, BMW, Chrysler, Citroen, Daewoo, Fiat, Ford, Honda, Hyundai, Kia, Lancia, Mazda, Mercedes, Mitsubishi, Nissan, Peugeot, Renault, Rover, Saab, Seat, Skoda, Suzuki, Toyota, Vauxhall/Opel, Volvo, VW.
- Includes non-specific adaptors for other makes.
- Locate leaking head gasket, header tank, radiator, heater cores, water pump plugs, hoses and housings.
- Model No. VS001
- List Price £239.95



£169.95 Exc. VAT
£203.94 Inc. VAT

5pc Cooling System Pressure Test Kit



- Capless tester uses cone adaptor system to seal and pressurise the cooling system.
- Adaptors may be used to replace both screw and bayonet type cap fittings.
- Kit includes pump with gauge and four system adaptors for use on a wide range of vehicle applications.
- Model No. VS0033
- List Price £199.95

£144.95 Exc. VAT
£173.94 Inc. VAT

Combustion Leak Detector



- Diagnose blown gaskets, cracked blocks and cylinder heads on both petrol and diesel vehicles.
- Checks for CO₂ in cooling system and indicates its presence by test fluid colour change.
- Use with cone adaptor or in conjunction with radiator caps from Model No's VS001, VS0011, VS0013, VS0014, VS0033 and VS006.
- For Test Fluid Refill order Model No. VS0061F.
- Model No. VS0061
- List Price £107.45

£74.95 Exc. VAT
£89.94 Inc. VAT

Refractometer Antifreeze/Battery Fluid/Screenwash/AdBlue®



- Tests:
- Antifreeze
 - Battery Fluid
 - Screenwash
 - AdBlue®

- Accurately measures the strength of battery fluid, screenwash, antifreeze and AdBlue® by measuring the refractive index of light passing through the mixture.
- Suitable for synthetic antifreeze mixtures including long-life OAT (Organic Acid Technology), G13 and aqueous/urea content of AdBlue®.
- Temperature corrected prism ensures accuracy.
- Eye-piece with adjustable focus.
- Supplied with pipette and storage case.
- Model No. VS0052
- List Price £97.45

£64.95 Exc. VAT
£77.94 Inc. VAT

7pc Hose Clip Removal Tool Set

NEW PRODUCT

- The kit consists of the following pliers:
 - Space saver hose clip plier for areas where clip contact is restricted. Jaw opening 0-70mm.
 - Swivel Clic-R® type plier. Jaw opening 0-34mm.
 - Multipurpose hose clamp plier. Jaw opening 0-40mm.
 - Remote action flexi clamp plier. Jaw opening 3-54mm.
 - Hose clamp interchangeable head plier. Jaw opening 0-60mm.
 - Hose clamp compressor. Jaw opening 6-68mm. Use with 14mm spanner.
 - Ear type CV boot/hose clip plier. Jaw opening 0-20mm.
- Model No. VS2662
- List Price £149.95



£114.95 Exc. VAT
£137.94 Inc. VAT

EV/Hybrid Master Tool Kit

Package includes:

- APPD70 - 7 Drawer Push-To-Open Rollcab Orange
- SF30OR - 1200 x 550 x 30mm Easy Peel Shadow Foam® Orange/Black (x3)
- SF50OR - 1200 x 550 x 50mm Easy Peel Shadow Foam® Orange/Black (x3)
- PPHY - CAT IV 1000V High Voltage Tester Hybrid/Electric Vehicles
- BYSBKIT - 25m Black/Yellow Post & Chain Kit
- HVG1000VL - 1kV Electrician's Safety Gloves - Pair
- HVM17K02 - Electrician's Insulating Rubber Safety Mat
- TA319 - Digital Insulation Tester
- HVSA4 - 200 x 300mm High Voltage Warning Sign
- HYBRIDTAG - Hybrid/Electric Vehicle Keyring Warning Tag
- HYBRIDSIGN - Hybrid/Electric Vehicle Warning Sign
- AK83452 - 3pc Pliers Set - VDE Approved
- AK6124 - 8pc Screwdriver Set - VDE Approved.
- AK63171 - 7pc Insulated Open-End Spanner Set - VDE Approved
- AK7940 - 16pc 3/8" Sq Drive Insulated Socket Set - VDE Approved
- STW803 - 3/8" Sq Drive Calibrated Insulated Torque Wrench 12-60Nm
- AK7177 - 6pc Extra-Long Hex Key Set - VDE Approved
- AK7178 - 9pc Extra-Long TRX-Star* Key Set - VDE Approved
- HRP45 - High Voltage Rescue Pole

• **Model No. HVCOM1**
• List Price £2,724.95



£1,799.95 Exc. VAT
£2,159.94 Inc. VAT



Personal Protection Kit



Package includes:

- HRP45 - High Voltage Rescue Pole
- HVG1000VL - 1kV Electrician's Safety Gloves
- HVM17K02 - Electrician's Insulating Rubber Safety Mat
- Ideal for technicians working on modern hybrid and electrical vehicles
- **Model No. HP55K2COMBO**
- List Price £319.95

£269.95 Exc. VAT
£323.94 Inc. VAT

Exclusion Zone Kit



Package includes:

- RWSBKIT - 25m Red/White Post & Chain Kit
- HVSA4 - 200 x 300mm High Voltage Warning Sign
- HYBRIDSIGN - Hybrid/Electric Vehicle Warning Sign (x2)
- HYBRIDTAG - Hybrid/Electric Vehicle Keyring Warning Tag
- Ideal for technicians working on modern hybrid and electrical vehicles
- **Model No. HP55K1COMBO**
- List Price £189.95

£127.95 Exc. VAT
£153.54 Inc. VAT

Pneumatic Glove Tester



Gloves not included.

- Pneumatic glove tester used to carry out a pressure test on electrician's high voltage gloves.
- Suitable for use with Model No. HVG1000VL Gloves.
- **Model No. GT117**
- List Price £227.45

£189.95 Exc. VAT
£227.94 Inc. VAT

Exclusion Zone Extension Kit

Package includes:

- HSC25M - 25m x 6mm Red/White Plastic Chain
- RCC10 - Chain Connectors - Pack of 10
- RSH10 - Plastic Chain S-Hook - Pack of 10
- RWPB01 - Red/White Post with Base (x2)
- Ideal for technicians working on modern hybrid and electrical vehicles.
- **Model No. HP55KECOMBO**
- List Price £104.95

£69.95 Exc. VAT
£83.94 Inc. VAT



Smoke Diagnostic Tool - Leak Detector

12V



- Allows the technician to pinpoint all manner of system leaks including the air intake, cooling, evaporation, fuel, exhaust and vacuum systems.
- Fast and simple-to-use, maximising earning potential.
- Features single button operation, flow control valve and auto-power-off.
- Uses mineral oil and workshop air to generate smoke at low pressure while connected to a vehicle.
- System is clean and quick to use and connects to a 12V vehicle battery.
- Rubber Cones Sizes: Ø10-45, 30-65, 50-85, 70-100mm.
- Mineral oil not supplied.
- **Model No. VS870**
- List Price £999.95

£729.95 Exc. VAT
£875.94 Inc. VAT

Turbo System Leakage Tester



- Designed to charge the turbo system with a low pressure of regulated workshop air to show the presence of leaks within the system.
- Kit supplied with four pairs of stepped adaptors to fit most sizes of hose.
- Adaptor Sizes: 35-90mm.
- Features a pressure gauge, shut-off valve and pressure release valve.
- Can also be used on cooling system hoses.
- Supplied in storage case.
- **Model No. VS2030**
- List Price £134.95

£89.95 Exc. VAT
£107.94 Inc. VAT

Turbo System Leakage Tester - Commercial



- Designed to charge the turbo/intercooler system with a low pressure of regulated workshop air to show the presence of leaks within the system.
- Features a pressure gauge, shut-off valve and pressure release valve.
- Kit supplied with three pairs of stepped adaptors to fit most sizes of hose found on heavy commercial vehicles.
- Adaptor Sizes: 105-110, 115-120, 125-130mm.
- Supplied in storage case.
- **Model No. CV2030**
- List Price £134.95

£89.95 Exc. VAT
£107.94 Inc. VAT



Accessories included.

230V HHO Engine Carbon Cleaner

600L/hr

Auto Shut-Off

- The Sealey CC230V uses cutting edge HHO engine cleaning technology.
- Each unit uses electrolysis to split water molecules into the composite elements of oxygen and hydrogen to produce oxyhydrogen or HHO gas.
- Simple-to-use machine feeds HHO into the engine through the vehicle air inlet breaking down any carbon build-up on its way.
- Removing carbon build-up from the engine can improve performance, raise mpg, reduce emissions and oil consumption.
- The CC230V runs on tap water with no expensive refills making the process a great revenue boost for any workshop.
- Fitted with CAMS (Charge Activated Machine Shutdown) designed to safely cut-out if the engine stops running during treatment. Also meaning the unit can be left to run without supervision, allowing the user to continue with other work.
- **Model No. CC230V**
- List Price £5,799.95



£3,999.95 Exc. VAT
£4,799.94 Inc. VAT



2300W Induction Heater - Rapid Heat

- Mobile induction heater for fast heat delivery.
- Install appropriate coil and place over or around ferrous metal.
- Ideal for loosening stubborn and seized fixings.
- Supplied with special dent induction block for panel expansion and induction pad for plastic trim/sticker removal.
- Induction element delivers high heat rapidly and effectively.
- Contents: Direct Coil; Ø20mm, Direct Coil; Ø30mm, Side Coil; Ø20mm, Side Coil; Ø30mm, Pad Coil; Ø55mm, Flex Coil; 740mm, Induction Block; Ø32mm x 45mm.
- Supplied in storage case.
- **Model No. VS250**
- List Price £1,099.95

£799.95 Exc. VAT
£959.94 Inc. VAT



230V

Induction Coils



Ref.	Model No.	Description	Applications	List Price	Exc. VAT	Inc. VAT
A	VS2301	Ø15mm Induction Coil - Direct	VS230 & VS250	£17.95	£14.95	£17.94
B	VS2302	Ø15mm Induction Coil - Side	VS230 & VS250	£17.95	£14.95	£17.94
C	VS2303	Ø20mm Induction Coil - Direct	VS230 & VS250	£17.95	£14.95	£17.94
D	VS2304	Ø20mm Induction Coil - Side	VS230 & VS250	£17.95	£14.95	£17.94
E	VS2309	Ø55mm Induction Coil - Pad	VS230 & VS250	£17.95	£14.95	£17.94
F	VS2407	Ø32mm Induction Coil - Direct	VS240	£17.95	£14.95	£17.94
G	VS2410	830mm Induction Coil - Flex	VS240	£17.95	£14.95	£17.94
H	VS2411	430mm Induction U-Coil	VS240	£17.95	£14.95	£17.94

Exhaust Pipe Cutter



- Suitable for cutting thin wall tubing up to 2.5mm thick.
- Designed to enable access where space is restricted.
- Ideal for cutting stainless steel exhaust pipes.
- **Model No. AK6838**
- List Price £84.95

£59.95 Exc. VAT
£71.94 Inc. VAT

Catalytic Converter Back Pressure Test Kit



- Contents: Oxygen Sensor Adaptors; M12 x 1.25, M18 x 1.5mm, Small and Large Brass Cone Adaptors, Plastic Double End Cone, Plastic 'T' Piece, Gauge Hanging Chain.
- Used to establish the working condition of the catalytic converter and silencer by measuring the relative back pressure of the system.
- Gauge features a colour-coded scale for easy diagnosis and reads both pressure (0-10psi) and vacuum (0-60cmHg) so can be used on other areas of the vehicle allowing testing of low pressure fuel systems or engine vacuum.
- Supplied with gauge hanging chain to allow hands-free operation.
- **Model No. VSE953**
- List Price £49.95

£31.95 Exc. VAT
£38.34 Inc. VAT

5pc 3/8" & 1/2" Sq Drive Oxygen Sensor & Thread Chaser Set



3/8" & 1/2" Sq Drive

- Suitable for oxygen sensors found on most modern vehicles.
- Cut-out and slots enable sockets to be fitted over wiring harness.
- Includes two chasers for cleaning and repairing damaged threads.
- **Model No. SX0320**
- List Price £47.95

£31.95 Exc. VAT
£38.34 Inc. VAT

Exhaust Pipe Cutter Pliers



- Suitable for cutting exhaust pipes and steel or copper tubing up to Ø83mm.
- 90° Handle movement produces a 360° cut.
- Handle Length: 200mm.
- Maximum Thickness: 2.5mm.
- **Model No. VS16372**
- List Price £55.95

£39.95 Exc. VAT
£47.94 Inc. VAT

Exhaust Doughnut Puller



- Steel construction with dipped vinyl handle.
- Enables fast removal and installation of rubber anti-vibration mountings found on exhaust systems.
- **Model No. VS1631**
- List Price £13.95

£9.95 Exc. VAT
£11.94 Inc. VAT

Exhaust Hanger Removal Pliers



- Enables fast, one-handed removal of exhaust brackets from rubber hangers.
- Suitable for a wide range of cars and light commercial vehicles.
- **Model No. VS1631**
- List Price £36.95

£24.95 Exc. VAT
£29.94 Inc. VAT

Panel Bag Sets

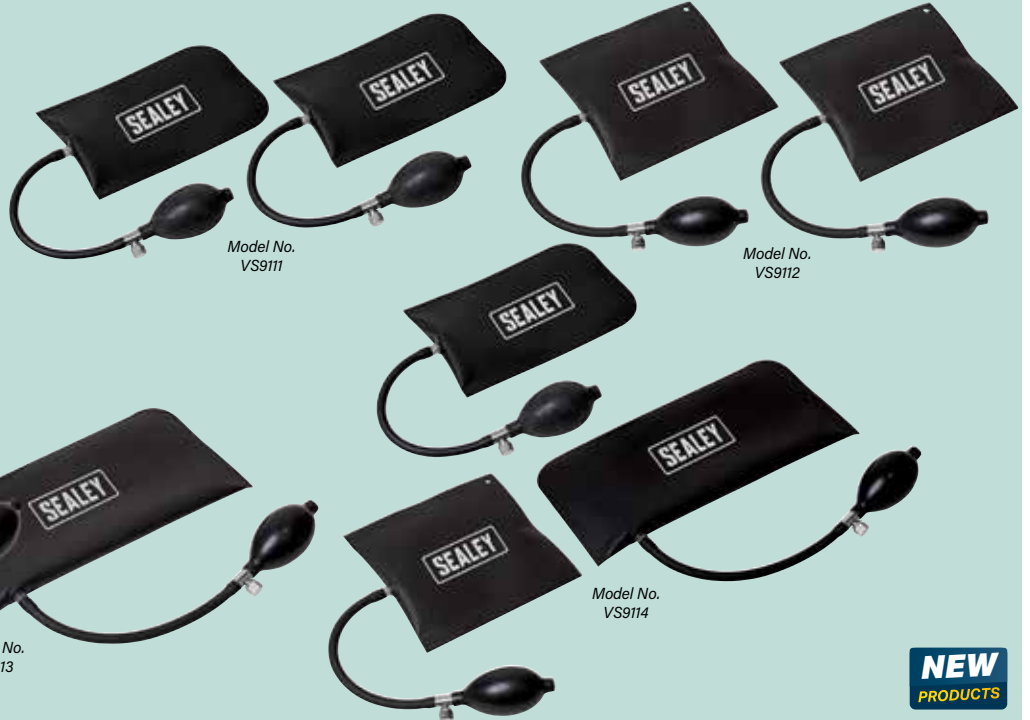

- Multipurpose durable air cushion devices with rigid edges and fine air control valve.
- Suitable for positioning panels (bonnets and boots) prior to fitment.
- Can be used to improve access for emergency vehicle opening tools.
- Soft air cushion is gentle on paintwork, frame, beadings and glass.
- Can also be used for positioning kitchen units, windows and doors.

Model No. VS9113

Model No. VS9111

Model No. VS9112

Model No. VS9114

NEW
PRODUCTS

Model No.	Qty	Dimensions (W x H)	Minimum/Maximum Thickness	List Price	Exc. VAT	Inc. VAT
VS9111	2pc	115 x 190mm	2mm - 60mm	£14.95	£9.95	£11.94
VS9112	2pc	150 x 165mm	2mm - 70mm	£14.95	£9.95	£11.94
VS9113	2pc	128 x 270mm	2mm - 80mm	£19.95	£13.95	£16.74
VS9114	3pc	128 x 270, 150 x 165, 115 x 190mm	2mm - 80mm	£24.95	£17.95	£21.54

Emergency Breakout Tool With Tyre Tread Depth Gauge

NEW
PRODUCT



- Trigger action and hardened tip shatters glass with minimum effort.
- Designed for 5mm automotive tempered glass.
- Recessed seat belt cutter provides fast and effective method of escape.
- Tyre tread depth gauge offers a quick and easy check of tread level.

£7.95 Exc. VAT
£9.54 Inc. VAT

- Model No. TST19
- List Price £9.95

Exhaust Fume Extractor with 3m Ducting

- Features soft rubber cylindrical cone to suit most exhausts.
- Adjustable height for use on small cars or commercial vehicles.
- Air inlet valve creates vortex within extractor to ensure all fumes are dispersed (requires air supply).
- 1.2m Body length with additional 3m flexible ducting.
- Mounted vertically on trolley with integral duct compartment for easy manoeuvrability and compact storage.



£379.95 Exc. VAT
£455.94 Inc. VAT

- Model No. EFS07
- List Price £599.95

Exhaust Fume Extractor with 6m Ducting



- Excellent as a back-up machine for garages with purpose-built fume extraction units.
- Suitable for cars and small commercials up to 10tonne GVW.
- Fitted with exhaust pipe cone that includes a port to allow use with gas analyser probes.
- Supplied with 6m flexible ducting.

- Model No. EFS/93
- List Price £1,999.95



£1,299.95 Exc. VAT
£1,559.94 Inc. VAT

Exhaust Adaptor for Twin Pipes

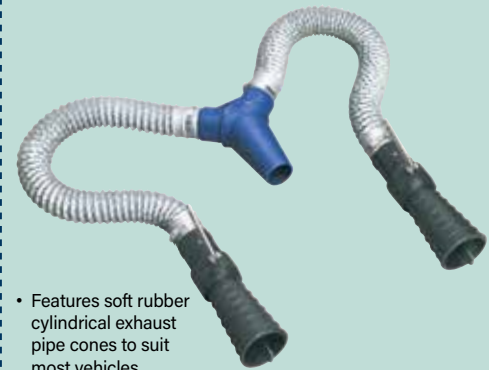

- Features soft rubber cylindrical exhaust pipe cones to suit most vehicles.
- Allows exhaust fume extractor to be used on twin exhaust vehicles.
- Suitable for use with EFS07 Exhaust Fume Extractor.
- Extractor Connector: Ø65-90mm Male Taper.

£139.95 Exc. VAT
£167.94 Inc. VAT

- Model No. EFS07DE
- List Price £189.95

Clip-On Funnel with Spout

- Suitable for use with detergent, antifreeze, coolants, oil, petrol and diesel.
- Funnel clips on bottle necks of most bottles to prevent spills using a Ø25-60mm opening.
- Supplied with 170mm flexible hose.
- **Model No. F12S**
- List Price £3.95



£2.95 Exc. VAT
£3.54 Inc. VAT

Ø240mm Funnel with Closing Lid

- Heavy-duty polyethylene funnel resistant to oil, fuel and some acids.
- Supplied with 2" BSP drum adaptor for direct fitting to 205L drum.
- Features contoured body for easy handling, dust cover and flexible spout.
- Fitted with integral wire mesh filter to keep contaminants out.
- **Model No. F99240**
- List Price £21.45



HEAVY DUTY
£14.95 Exc. VAT
£17.94 Inc. VAT

2L Measuring Funnel with Lid and Base

- A jug and funnel built into one.
- Graduations that can be used for transferring a measured quantity of fluid without any spills or splashes.
- Simple press of a lever dispenses liquid through a built-in metal sieve to ensure contaminant-free transfer.
- Replace funnel back into base in between use, no need to pour unwanted liquids back into original storage container.
- Recommended for use with oils and other similar viscosity liquids.
- Do not use with water based media.
- **Model No. MF2/BC**
- List Price £39.95



2L
£32.95 Exc. VAT
£39.54 Inc. VAT

Ø160mm Valved Funnel with Flexible Spout & Filter

- Heavy-duty polyethylene funnel resistant to oil, fuel and some acids.
- Features lockable valve nozzle and integral wire mesh filter to keep contaminants out.
- Supplied with detachable flexible hose with end cap.
- Fitted with handle for safe and easy pouring.
- **Model No. VFF1**
- List Price £21.95



HEAVY DUTY
£14.95 Exc. VAT
£17.94 Inc. VAT

Ø160mm Funnel with Fixed Offset Spout & Filter

- Polyethylene funnel resistant to oil, fuel and some acids.
- Fitted with offset rigid spout.
- Ideal for vehicles with smaller diameter unleaded filler necks.
- Fitted with handle and removable brass filter.
- **Model No. F16**
- List Price £11.95



£8.95 Exc. VAT
£10.74 Inc. VAT

3pc Fixed Spout Funnel Set

- Polyethylene funnel set suitable for many fluids including detergents, pesticides, diesel and petrol.
- Contains Ø75mm, Ø150mm and Ø250mm funnels with hanging tabs.
- Not suitable for acetone, gun wash or thinners.
- **Model No. F98**
- List Price £17.95



£12.95 Exc. VAT
£15.54 Inc. VAT

500ml Translucent Measuring Jug

- Translucent polypropylene.
- Easy-to-read scale for accurate measurement (±1%).
- **Model No. JT0500**
- List Price £7.45



500ml
£5.45 Exc. VAT
£6.54 Inc. VAT

500ml Mixture Measuring Jug

- Translucent measuring jug with 500ml capacity.
- Easy-to-read scale in litres, millilitres and mixture percentage levels.
- Accurate to ±1%.
- **Model No. JM500**
- List Price £8.95



500ml
£6.45 Exc. VAT
£7.74 Inc. VAT

Measuring Jugs

- Opaque, low density polythene measuring jug with scales for indication purposes only.

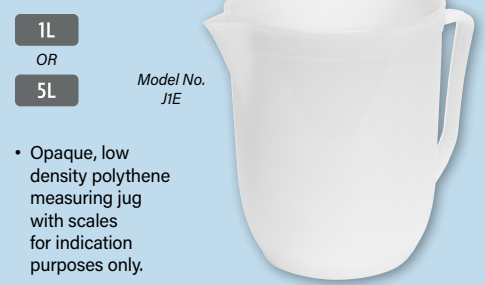

Model No.	Capacity	List Price	Exc. VAT	Inc. VAT
J1E	1L	£6.45	£4.95	£5.94
J5E	5L	£12.95	£9.95	£11.94

Metal Funnel with Filter

- Manufactured from tin-plate with handle for safe and easy pouring.
- Removable brass filter.
- High rim acts as splash guard.

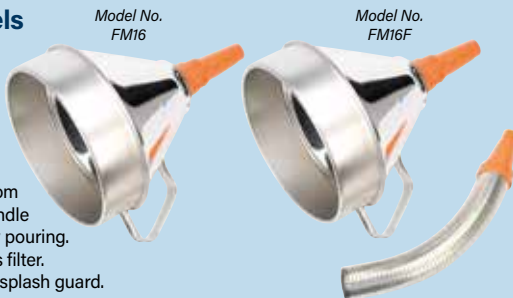

Model No.	Diameter	Flexible Spout	List Price	Exc. VAT	Inc. VAT
FM16	Ø160mm	✗	£18.95	£13.95	£16.74
FM20	Ø200mm	✗	£24.95	£17.95	£21.54
FM16F	Ø160mm	✓	£29.95	£21.95	£26.34
FM20F	Ø200mm	✓	£35.95	£25.95	£31.14

5L Container Hand Pump

- Hand pump that fits 5L containers with a 38mm screw top.
- Features quick-fit nozzle.
- Suitable for a wide variety of viscous products, such as engine oil, coolant and detergents etc.
- Includes a set of three clear hoses; 8, 13.5, 59cm.
- Dispenses 30ml per stroke.
- **Model No. TP5000**
- List Price £8.95



30ml per stroke
5L



NEW PRODUCT
£6.95 Exc. VAT
£8.34 Inc. VAT

Quick Release 3-Way Fill Pistol Type Grease Gun



- Pistol style grease gun with contoured handle.
- Die-cast aluminium pump head.
- Air-bleed valve.
- Innovative quick release mechanism.
- 3-Way fill with cartridge, bulk and manual capability.
- Supplied with a rigid delivery tube, push-on hydraulic 4-jaw coupling.
- Accepts standard 400g cartridges.
- **Model No. AK481**
- List Price £59.95

£39.95 Exc. VAT
£47.94 Inc. VAT

Cordless Grease Guns

12V OR 18V



Model No. CPG18V



Model No. CPG12VBP

LITHIUM RECHARGEABLE

- High power, professional, cordless grease guns.
- Ideal for in-field lubrication where power and speed are required.
- Suitable for screw-type and standard 400g cartridges, manual or bulk filling.
- Features LCD battery condition indicator, air bleed and heavy-duty aluminium pressure head.
- Supplied with battery and mains charger in storage case.

Model No.	Description	List Price	Exc. VAT	Inc. VAT
CPG12V	12V Cordless Grease Gun	£184.95	£139.95	£167.94
CPG12VBP	12V 2Ah Battery	£52.95	£39.95	£47.94
CPG18V	18V Cordless Grease Gun	£209.95	£159.95	£191.94
CPG18VBP	18V 2Ah Battery	£72.95	£54.95	£65.94



Model No. CPG12V

2-Way Fill Heavy-Duty Adjustable Flow Grease Gun

HEAVY DUTY

Adjustable Flow



- Highly durable die-cast aluminium alloy pump head, features dual piston design ideal for a variety of applications.
- 2-Way fill with cartridge or manual capability.
- Fitted with adjustable pressure switch on lever allowing user to select between low-pressure/high-volume or high pressure/low-volume, depending on the particular application.
- Supplied with rigid delivery tube and push-on hydraulic 4-jaw coupling.
- Rubber gripped grease tube and handle for easy grip.
- Delivery per stroke: 2.14cm³.
- Accepts standard 400g cartridges.
- **Model No. AK49**
- List Price £56.95

£29.95 Exc. VAT
£35.94 Inc. VAT

12pc Grease Gun Adaptor Kit



- For use with all brands of manual grease guns.
- Contents: 300mm Flexible Hose with Spring, Needle Tip Adaptor, Grease Injection Needle, Grease Needle Nozzle, 90° Connector, 90° Slotted Connector, Rubber Tipped Nozzle, 1/8"NPT Female/Female Connector, Standard Grease Coupler, 100mm Grease Gun Needle Nozzle Adaptor with Small and Large Quick Connectors.
- **Model No. AK4482**
- List Price £49.95

£34.95 Exc. VAT
£41.94 Inc. VAT

3-Way Fill Side Lever Grease Gun



- Die-cast pump head.
- 3-Way fill with cartridge, bulk or manual capability.
- Supplied with rigid delivery tube and push-on hydraulic 4-jaw coupling.
- Contoured pump handle.
- Accepts standard 400g cartridges.
- Optional 300mm Flexible Delivery Tube - order Model No. GGH300.
- **Model No. AK443**
- List Price £23.95

£15.95 Exc. VAT
£19.14 Inc. VAT

Mini Grease Gun



- Mini push-action hand greaser.
- Ideal for limited access areas or where small amounts of grease are required.
- Rigid extension tube and delivery nozzle.
- Length: 270mm.
- **Model No. AK442**
- List Price £14.95

£9.95 Exc. VAT
£11.94 Inc. VAT

Needle Nose Grease Dispenser

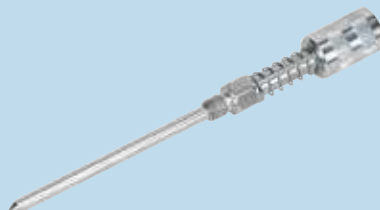

- For use with all brands of manual grease gun (not for use with power greasers).
- Dispenses a fine bead of grease.
- Long nozzle provides access for hard-to-reach areas.
- Ideal for lubricating constant velocity joints.
- **Model No. AK447**
- List Price £14.95

£10.95 Exc. VAT
£13.14 Inc. VAT

500ml Oil Suction Syringe Metal Body

500ml



- Painted cast steel tube with T-Bar type plunger.
- Particularly useful for removal of oil from gearboxes and differentials.
- Supplied with 300mm flexible suction hose.
- **Model No. AK46**
- List Price £17.45

£11.95 Exc. VAT
£14.34 Inc. VAT

1L Multipurpose Mini Pump

1L



- Multipurpose pump perfect for topping up difficult to access points on motor vehicles, lawnmowers, chainsaws and other jobs around the workshop and home.
- Suitable for all engine oils, transmission fluids, brake fluids and general-purpose cleaners.
- **Model No. TP6804**
- List Price £24.95

£17.95 Exc. VAT
£21.54 Inc. VAT

Heavy-Duty High Flow Lever Pump

HEAVY DUTY

High Flow

400ml per stroke

- Steel barrelled, self-priming lever pump.
- Supplied with 2" BSP adaptor and dip tube suitable for 50 to 205L drums.
- Suitable for oils, antifreeze, degreasers and other non-corrosive fluids.
- High flow unit delivers approximately 400ml per stroke.
- Supplied with two delivery nozzles, one standard swan neck and one with filter for removing impurities from fluids.

- **Model No. TP6801**
- List Price £99.95



£79.95 Exc. VAT
£95.94 Inc. VAT

Lever Action Pump



- Polypropylene lever pump with steel rod and dip tube, suitable for use with oils, antifreeze and other non-corrosive fluids.
- Features polyoxymethylene handle for prevention of aggressive fluids melting the handle.
- Fitted with 360° outlet nozzle.
- Suitable for 205L drums.
- Delivers approximately 300ml per stroke.
- **Model No. TP6803**
- List Price £43.95

£34.95 Exc. VAT
£41.94 Inc. VAT

Solvent Transfer Pump for 205L Drums

- Manufactured from nylon and polypropylene with PTFE seals and features a stainless steel plunger rod.
- Ready-to-go self-priming pump makes the unit quick and easy-to-use.
- Suitable for use with cellulose thinners, antifreeze, AdBlue®, brake cleaner, detergents, mild acids and gun wash.
- Universal adaptor (Model No. TP99/1) is available for drums fitted with a plastic pouring spout.
- Delivery: 400ml/stroke.
- **Model No. TP99/205**
- List Price £71.45



£52.95 Exc. VAT
£63.54 Inc. VAT

AdBlue® Lever Action Pump

AdBlue®

- Lever action pump specifically for use with AdBlue®.
- The dip tube extends from 350mm to 980mm to fit 100L to 205L drums or barrels, or 1000L IBC tank.
- Specially constructed with Viton® seals for transferring AdBlue®.
- 1.6m Delivery hose for hands-free applications.
- Approximately 500ml per stroke discharge.
- Can also be used with water, antifreeze, windshield washer fluid or mild detergents.
- **Model No. TP6809**
- List Price £53.95

£39.95 Exc. VAT
£47.94 Inc. VAT



AdBlue® Automatic Delivery Nozzle

AdBlue®

HEAVY DUTY

- Heavy-duty automatic AdBlue® nozzle manufactured from stainless steel.
- Fitted with micro-touch valve for instant shut-off when tank is full.
- Designed and manufactured using AdBlue® compliant materials.
- Fitted with 3/4" BSP hose inlet.
- Maximum Flow Rate: 60L/min.
- Suitable for use with Sealey AdBlue® pumps.
- **Model No. ADB04**
- List Price £249.95

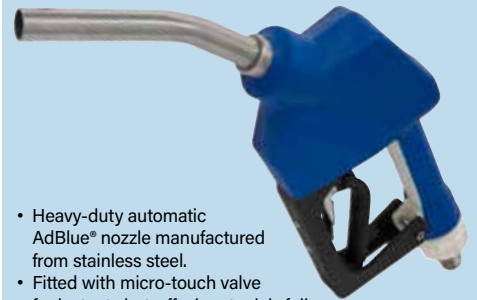

£199.95 Exc. VAT
£239.94 Inc. VAT

12V High Volume Diesel & Fluid Transfer Pump

12V High Flow



- Electric 12V pump kit with battery clips.
- High flow pump unit with bypass valve, suitable for filling diesel vehicles in the field.
- Cast iron pump body with anti-corrosion finish.
- Includes integrated on/off switch, delivery hose with manual delivery nozzle and filter.
- **Model No. TP98**
- List Price £719.95

£579.95 Exc. VAT
£695.94 Inc. VAT

53L Gravity Fed Mobile Dispensing Tank

53L Gravity Feed Diesel

- Manufactured from high-density polyethylene.
- 53L Capacity suitable for the distribution of diesel, oil and water.
- Fitted with two roller wheels, hose holder and vent valve.
- Gravity fed system features a 3m delivery hose and manual dispensing nozzle.
- Ideal for refilling on site equipment used in locations such as agricultural, boatyards and marinas.
- Not suitable for petrol.
- **Model No. DT53**
- List Price £239.95



£199.95 Exc. VAT
£239.94 Inc. VAT

10L Jerry Cans



Lead Replacement

Unleaded

Diesel

- Manufactured from 0.9mm pickled steel sheet with fuel resistant lining.
- Includes unique wide channel breather for smoother pouring.
- Leak-proof bayonet closure allows storage of the can in any position.
- Lined inner tank to prevent rusting from petrol, diesel, oil, water or alcohol.
- The bayonet is additionally secured with a locking pin to prevent accidental opening.
- Manufactured and tested to comply with UN Dangerous Goods and DIN standards.

Model No.	Type	Colour	List Price	Exc. VAT	Inc. VAT
JC10	Lead Replacement	Red	£43.95	£27.95	£33.54
JC10G	Unleaded	Green	£43.95	£27.95	£33.54
JC10B	Diesel	Black	£43.95	£27.95	£33.54

10L

Vehicle Bracket for 10L Jerry Cans



- Lockable vehicle mounting bracket with anti-vibration mounts for 10L jerry can.
- Ideal for a variety of vehicles including agricultural, 4x4 and commercial.
- Padlock not included.
- **Model No. JC10VB**
- List Price £45.95



Jerry Can not included.

£31.95 Exc. VAT
£38.34 Inc. VAT

54L Wheeled Oil/Fluid Drain & Recycling Container



54L

- Ensures safe and clean collection, transportation and temporary storage of waste oil.
- Features heavy-duty construction with wheeled undercarriage for easier transportation of full drainer.
- Includes four integral oil filter drain positions.
- Stores flat or in upright position.
- **Model No. DRP09**
- List Price £319.95

£239.95 Exc. VAT
£287.94 Inc. VAT

Jerry Can Adaptors

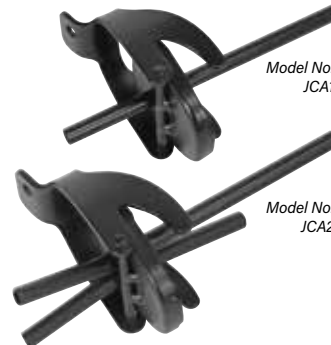

- Jerry can adaptors suitable for converting standard fuel cans into portable fuel tanks for generators, engines and other equipment.
- Ideal for testing/running engines on alternative fuel sources.
- Features breather hole and bayonet style fitting to attach onto all Sealey metal fuel cans.
- Suitable for use with 8mm hose (not included).

Model No.	Type	List Price	Exc. VAT	Inc. VAT
JCA1	Single Tube	£15.95	£12.95	£15.54
JCA2	Double Tube	£18.95	£14.95	£17.94

Dispensing/Storage Drum Rack Unit

2 x 205L Drum Capacity



- High-density polyethylene construction, suitable for storing 2 x 205L drums.
- Moulded with gradual decline and recesses to secure drum.
- Horizontal storage of drums provides access to dispense contents into smaller containers.
- Fitted with 450L spill tray ideal for catching and preventing spillages.
- Can be easily moved by forklifts and pallet trucks.
- **Model No. DRP22**
- List Price £459.95



£419.95 Exc. VAT
£503.94 Inc. VAT

Drum Adaptors



Model No. TPA04



Model No. TPA05

- Polypropylene drum adaptors.
- Manufactured with 2" BSP thread and drum closure diameter fitting.

Model No.	Type	Drum Closure Diameter	List Price	Exc. VAT	Inc. VAT
TPA04	Mauser	69mm	£10.45	£8.95	£10.74
TPA05	Berg	58mm	£10.45	£8.95	£10.74

Drum Wrench



- Universal wrench suitable for opening a variety of drums.
- Made from a tough composite material.
- **Model No. TP122**
- List Price £7.45

£5.95 Exc. VAT
£7.14 Inc. VAT

900KG ADJUSTABLE 4 POST VEHICLE MOVING DOLLY

900kg

- Heavy-duty steel frame suitable for supporting partly dismantled or badly damaged vehicles.
- Enables easy movement around workshop or bodyshop.
- Adjustable frame allows you to change the length and width as required.
- Three types of height adjustment.
- Fitted with four Ø200mm nylon locking castors.
- **Model No. VMD002**
- List Price £479.95

£349.95 Exc. VAT
£419.94 Inc. VAT



Interchangeable supports, rubber support pads, shallow and deep crutches



Model No. VMD002

454KG WHEEL DOLLY SET

454kg

- Two pressed steel wheel dollies.
- Ø90mm Metal castors.
- Handles tyres up to 355mm profile.
- **Model No. WS454**
- List Price £129.95

£94.95 Exc. VAT
£113.94 Inc. VAT



DUST-FREE SANDING KIT

DAS150PS features 7-Stage variable speed control and digital display.



RE4011 and RE4012 feature hook-and-loop foam pad and ergonomic soft grip.

Package includes:

- PC35230V - 35L Wet/Dry Vacuum Cleaner Industrial 1200W/230V Plastic Drum
- DAS150PS - Ø150mm Electric Palm Sander Variable Speed 350W/230V
- RE4011 - 70 x 120mm Dust-Free Sanding Block
- RE4012 - 70 x 198mm Dust-Free Sanding Block
- Please see www.sealey.co.uk for full specification of individual models

- **Model No. DFSK02**
- List Price £849.95



£649.95 Exc. VAT
£779.94 Inc. VAT

POWER TOOLS

35L INDUSTRIAL VACUUM CLEANER PLASTIC DRUM M CLASS



- **Model No. PC35230V**
- List Price £619.95

£459.95 Exc. VAT
£551.94 Inc. VAT



35L

1200W

Dust-Free



PC35230V FEATURES INDUSTRIAL WET & DRY VACUUM WITH M CLASS DUST EXTRACTION, CONTINUOUS OR SYNCHRONISED SUCTION AND SELF-CLEANING FILTER.

4-Level Bumper Rack

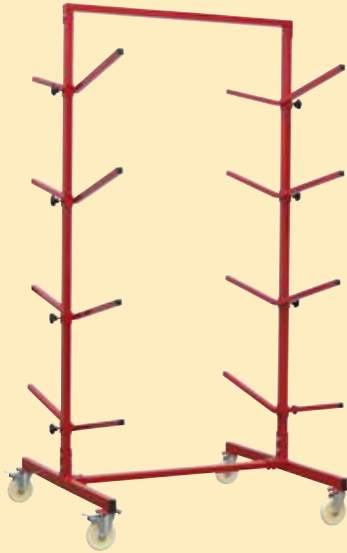

- Double-sided rack for safe and tidy workshop storage of most vehicle bumpers.
- Heavy-duty construction ideal for use in bodyshops.
- Four pairs of height-adjustable support arms for maximum capacity and flexibility.
- Fitted with four castors, two with brake, for manoeuvrability and safe positioning.
- Safe Working Load: 160kg.
- **Model No. RE55**
- List Price £229.95

£179.95 Exc. VAT
£215.94 Inc. VAT

Alloy Wheel Repair/Painting Stand - 4 Wheel Capacity



- Will take four alloy wheels and enable the user to rotate the wheels on cones so the wheels can be repaired or painted without the need to lift and reposition them.
- Both supporting bars and cones have adjustable heights in order to provide the most comfortable position for the user.
- Fitted with four castors, two with brakes for maximum manoeuvrability and safe positioning.
- **Model No. MK74**
- List Price £179.95

£139.95 Exc. VAT
£167.94 Inc. VAT

Spray Booth Stand



- Ideal for holding small vehicle body parts such as grilles, spoilers, wings and mirror housings during preparation and spraying.
- Height: 1105mm.
- Width: 740mm.
- **Model No. MK61**
- List Price £64.95

£49.95 Exc. VAT
£59.94 Inc. VAT

Folding Bumper/Panel Stand



- Ideal for storage of bumpers prior to preparation and spraying.
- Adjustable stand width with extendable arms.
- Suitable for holding various types and styles of bumpers.
- Folds away for easy storage.
- **Model No. MK54**
- List Price £89.95

£64.95 Exc. VAT
£77.94 Inc. VAT

Paint Thickness Gauge



- For the professional bodyshop or valeting bay to accurately verify the thickness of paint and check for accident damage.
- Uses magnetic induction to provide accurate and consistent readings to 0.1µm.
- Suitable for steel and aluminium panels.
- Easy to calibrate with test plates and precision standards.
- USB interface for downloading data to PC.
- Powered by 2 x 1.5V batteries (supplied).
- **Model No. TA090**
- List Price £289.95

£199.95 Exc. VAT
£239.94 Inc. VAT

Masking Paper Dispenser Trolley
2 x 900mm



- Two roll dispenser accepts rolls up to 900mm and features storage tray underneath dispenser unit.
- Automatically applies adhesive tape to edges of masking paper.
- Papers and tapes not included.
- **Model No. MK67**
- List Price £169.95

£119.95 Exc. VAT
£143.94 Inc. VAT

SPRAY GUNS

Premier



SUITABLE FOR WATER BASED PAINTS.

FEATURE AIR AND PAINT FLOW CONTROLS FOR FINE ADJUSTMENT OF SPRAY PATTERN.

1MM NOZZLE WITH SMALLER BODY, PERFECT FOR TOUCH-UP WORK.

IDEAL FOR FINE CONTROL OF PAINT AND AIR.



- Model No. HVLP04
- List Price £107.45

£69.95 Exc. VAT
£83.94 Inc. VAT

HVLP

Scan for our full range of **SPRAY GUNS**



Model No. HVLP731

HVLP731 IDEAL FOR BLOWING-IN SMALL AREAS OF PANEL WHERE FINE CONTROL OF PAINT AND AIR IS NECESSARY.

HVLP741 IDEAL FOR APPLYING TOP COATS.

HVLP742 IDEAL FOR APPLYING HIGH VISCOSITY PAINTS SUCH AS PRIMER OR UNDERCOAT.



Model No. HVLP741



Model No. HVLP742

Model No.	Set-Up	Available Set-Ups	Air Cap	List Price	Exc. VAT	Inc. VAT
HVLP731	0.8mm	1mm	Brass	£39.95	£27.95	£33.54
HVLP741	1.3mm	1.2, 1.4, 1.7, 2mm	Brass	£47.95	£29.95	£35.94
HVLP742	2mm	1.4, 1.7mm	Aluminium	£43.95	£28.95	£34.74

20pc Spray Gun Cleaning Set



- Various sized brushes and probes suitable for many cleaning applications.
- Contents: Bristle Brushes; 115, 135 (Small), 200 (Medium), 200mm (Large), Soft Brushes; 150 (x2), 210mm, 180mm Brush with 45mm Soft-Fill, Wire Probe, Wooden Probe (x10), Needle Lubricant.
- **Model No. BSGC2**
- List Price £13.45

£9.95 Exc. VAT
£11.94 Inc. VAT

Paint Dirt Removal Pen with Needle Set



- Aluminium pen with quick change needles.
- Designed to remove particles from wet paint and prevent bubbles.
- Replacement needle set order Model No. BSC01 (Pack of 10).
- **Model No. MK78**
- List Price £16.95

£12.95 Exc. VAT
£15.54 Inc. VAT

260mm Skeleton Type Manual Caulking Gun

LIFETIME GUARANTEE



- Suitable for 310-380ml cartridges up to 260mm length.
- Hook end suitable for attaching to user's belt.
- **Model No. AK3901**
- List Price £8.95

£5.95 Exc. VAT
£7.14 Inc. VAT

Magnetic Spray Gun Holder - 2 Gun



- Heavy-duty magnetic bracket with six large magnets which will adhere to any ferrous surface.
- Composite covered magnets and PVC bumper help prevent against damaging surface.
- Dimensions (W X H): 200 x 120mm.
- **Model No. MSH03**
- List Price £21.45

£15.95 Exc. VAT
£19.14 Inc. VAT

On-Gun Pressure Regulator/Gauge

- Just one of a comprehensive range of quality spray gun accessories.
- **Model No. ILF/RG**
- List Price £24.45



£15.95 Exc. VAT
£19.14 Inc. VAT

HVLP Gravity Feed Spray Guns

HVLP

Gravity Feed



- HVLP Design gives a high transfer efficiency of paint, saving on costs.
- Brass air cap with stainless steel needle and nozzle suitable for water based paints.
- Features air and paint flow controls for fine adjustment of spray pattern.
- Fully polished body resists corrosion and makes for easy cleaning.



Model No.	Standard Set-Up	Available Set-Ups	Pot Capacity	List Price	Exc. VAT	Inc. VAT
HVLP736	0.8mm	1mm	125ml	£69.95	£49.95	£59.94
HVLP746	1.3mm	1.7, 2mm	600ml	£89.95	£59.95	£71.94

Air Operated Underbody Coating Gun



- Regulator allows even deposits of material.
- Inlet: 1/4" BSP.
- Supply: 90psi.
- Air Consumption: 5cfm.
- **Model No. AK42**
- List Price £41.95

£32.95 Exc. VAT
£39.54 Inc. VAT

HVLP Top Coat/Touch-Up Gravity Feed Spray Gun Set

HVLP

Gravity Feed



- Professional gravity feed spray gun set comprising of Model No's HVLP736 and HVLP746.
- Brass air cap with stainless steel needle and nozzle suitable for water based paints.
- Fully polished body resists corrosion and makes for easy cleaning.
- Alternative set-ups available separately.
- **Model No. HVLP774**
- List Price £159.95



£124.95 Exc. VAT
£149.94 Inc. VAT



65 x 120mm Sanding Block



- Accepts 100mm wide abrasive strips.
- Comfortable contoured grip.
- Abrasive firmly retained by integral pins.
- Size: 65 x 120mm.
- **Model No. SB65**
- List Price £5.95

£4.65 Exc. VAT
£5.58 Inc. VAT

70 x 130mm Sanding Block

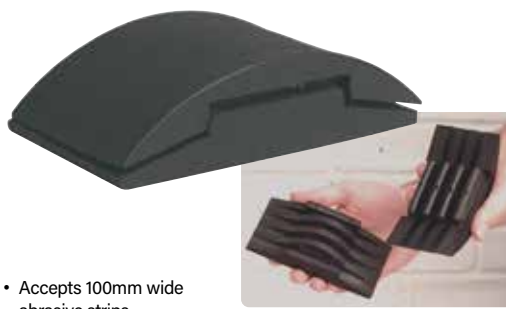

- Accepts 100mm wide abrasive strips.
- Comfortable contoured grip.
- Interlocking grip and base separate completely for very simple and fast abrasive changes.
- **Model No. SB66**
- List Price £7.25

£5.45 Exc. VAT
£6.54 Inc. VAT

Plastic Filler Spreader - Pack of 25



- Manufactured from composite material.
- Suitable for the application of body filler.
- Size: 10.5cm x 7cm.
- **Model No. PA03**
- List Price £6.95

£5.45 Exc. VAT
£6.54 Inc. VAT

Ø150mm Curved Hook-and-Loop Sanding Block

- Resilient block with hook-and-loop surface.
- Suitable for Ø150mm abrasive sheets.
- **Model No. RE4001**
- List Price £12.95

£7.95 Exc. VAT
£9.54 Inc. VAT



75 x 440mm 2-Handed Hook-and-Loop Sanding Block

- Flexible 2-handed block.
- 75 x 440mm Hook-and-loop surface.
- **Model No. RE4002**
- List Price £29.95



£19.95 Exc. VAT
£23.94 Inc. VAT

3pc Paintless Dent Repair Kit

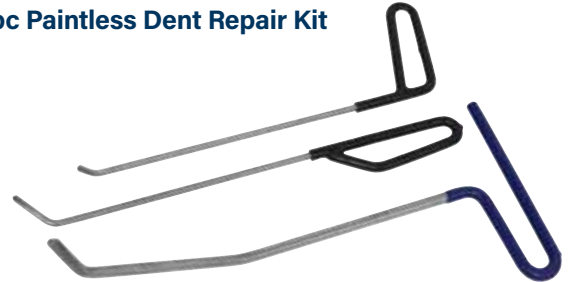

- Time-saving kit.
- Heavyweight, heat treated, high quality steel components are carefully shaped and finished to allow the technician (with practice) to coax out all manner of dents and creases from behind the body panel, without the need to respray/refinish the painted surface.
- Results achieved with this kit will depend on the skill of the operator.
- **Model No. RE104**
- List Price £31.95

£25.95 Exc. VAT
£31.14 Inc. VAT

2pc Panel Gap Setting Tool



- Panel gap setting tool with 10 plastic gauges and a suction cup for damage-free mounting and use.
- Each gauge is 1mm thick with alternating colours for easy selection.
- Ideal for use on panels gaps and windscreen mounting to ensure even gaps.
- Range of 1-10 mm.
- **Model No. PST01**
- List Price £29.95

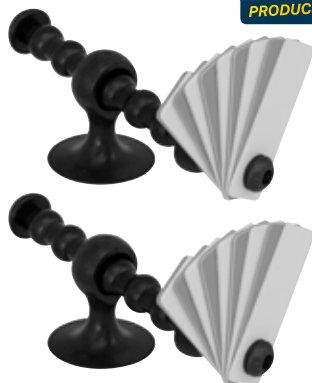

£21.95 Exc. VAT
£26.34 Inc. VAT

NEW
PRODUCT

Hot Glue Paintless Dent Repair Kit



- High quality kit for the removal of small dents without the need for respraying/refinishing the painted surface.
- Pulling tool, with large rubber feet, rotates 360° to allow use in more restricted areas.
- Slide hammer for use on bigger dents and dents on corners or curves.
- 12 Plastic tabs of varying sizes and shapes are included to cover a wide range of dents.
- Kit includes plastic scraper and glue removal spray to avoid damage to surface.
- **Model No. RE105**
- List Price £174.95

£139.95 Exc. VAT
£167.94 Inc. VAT

9pc 2kg Slide Hammer Kit



- Slide hammer kit with 2.04kg sliding weight.
- Comfortable rubber grip handle for added control.
- Attachments include: Small and Large Flat Hooks, Small and Large Round Hooks, Screw Holder, Adaptor, Self-Tapping Screw, Taper Screw.
- Supplied in super tough storage case with storage for set of attachments.
- **Model No. DP9/5B**
- List Price £59.95

£44.95 Exc. VAT
£53.94 Inc. VAT

Hand Nibbler Shears

LIFETIME GUARANTEE



- Quickly cuts through sheet metal and will handle up to 18 gauge sheet.
- Excellent for bodyshop and steel fabricator use.
- Fitted with comfortable, insulated handles.
- **Model No. AK327**
- List Price £23.95

£16.95 Exc. VAT
£20.34 Inc. VAT

250mm Spring Loaded Tin Snips/Shears

LIFETIME GUARANTEE



- One-piece, drop-forged blades with spring loaded handles.
- Suitable for cutting narrow gauge ferrous and non-ferrous metal sheet.
- Capacity: 0.8mm, Overall Length: 250mm.
- **Model No. AK6910**
- List Price £12.95

£8.95 Exc. VAT
£10.74 Inc. VAT

Ø5mm Punch Tool

LIFETIME GUARANTEE



- All steel construction with spring loaded handles.
- Ø5mm Holes are suitable for preparing panels for MIG/spot welding.
- Fitted with non-slip PVC grips.
- **Model No. RE92/35**
- List Price £79.95

£64.95 Exc. VAT
£77.94 Inc. VAT

Threaded Nut Riveter



- Curve design provides integral strength.
- Rubber grip handle for added comfort.
- Suitable for aluminium, steel and stainless steel nuts.
- **Model No. AK3986**
- List Price £61.95

£39.95 Exc. VAT
£47.94 Inc. VAT

Riveter



- Curved design provides integral strength.
- Rubber grip handle for added comfort.
- Supplied with four rivet nozzles to accept 2.4mm(3/32"), 3.2mm(1/8"), 4mm(5/32") and 4.8mm(3/16") rivets.
- **Model No. AK3987**
- List Price £37.95

£22.95 Exc. VAT
£27.54 Inc. VAT

Shot Blasting Kit 22.6kg Capacity



22.6kg

- Compact and portable shot blasting kit.
- Large capacity hopper with handle and heavy-duty rubber wheels for easy manoeuvrability.
- Supplied with 3m grit hose, fitted with a heavy-duty shot blasting gun and four ceramic nozzles.
- **Model No. SB994**
- List Price £143.95

£109.95 Exc. VAT
£131.94 Inc. VAT

7pc Drop-Forged Panel Beating Set with Hickory Shafts

LIFETIME GUARANTEE



- Polished, drop-forged steel dollies.
- Professional hickory handled hammers.
- **Model No. CB507**
- List Price £99.95

£59.95 Exc. VAT
£71.94 Inc. VAT

Sandblasting Gun with 6mm Nozzle

- Suitable for cleaning small areas such as wheels or chassis members.
- Accepts a variety of abrasives including sand, chilled iron grit and other proprietary types of bead.
- **Model No. SSG8**
- List Price £47.45



£32.95 Exc. VAT
£39.54 Inc. VAT

Air Blow Guns Side Outlet with 1/4" BSP Air Inlet

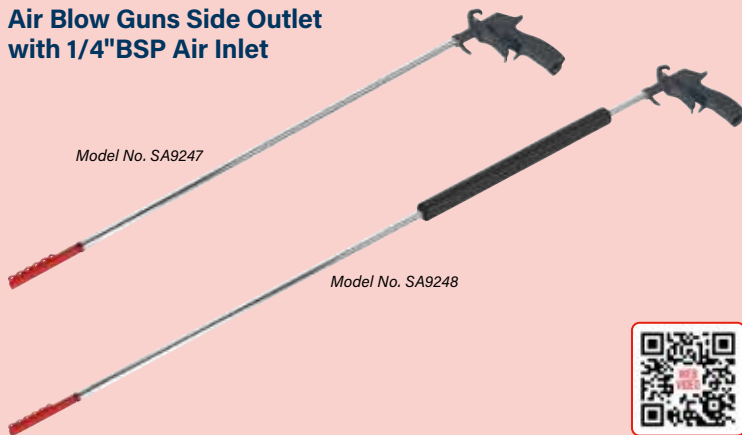

- Trigger operated side outlet blow guns with extended lance.
- Suitable for the removal of dust and other particulates from air filters, radiators, condensers and other surfaces.
- Ideal for the commercial, agricultural and bodyshop environment.
- Lance allows projection of airflow directly to required area at a 90° angle to the body.
- Nozzle is fitted with six safety outlets.
- Maximum operating pressure: 90psi.



Model No.	Length	List Price	Exc. VAT	Inc. VAT
SA9247	715mm	£49.95	£34.95	£41.94
SA9248	1095mm	£62.95	£44.95	£53.94

19pc Air Blow Gun Kit



- Die-cast metal body with moulded handle and hanging point.
- Palm type gun with thumb trigger control.
- Supplied with jet and safety nozzle.
- Quick release coupling/adaptor kit and tyre pressure gauge.
- Ø1/4"(6mm) x 7m PE air hose with 1/4" BSP Male connectors.
- Maximum Operating Pressure: 110psi.
- **Model No. SA320K**
- List Price £31.95

£19.95	Exc. VAT
£23.94	Inc. VAT

1/2" Sq Drive Composite Air Impact Wrench Twin Hammer



- Breakaway Torque: 590lb.ft(800Nm).
- Maximum Torque: 450lb.ft(610Nm).
- Combination of composite materials, alloyed metals and twin hammer design, result in a lightweight, durable and powerful air impact wrench.
- Composite handle helps reduce the effects of vibration and chill.
- Handle exhaust reduces noise output and limits the circulation of brake dust on wheel applications.
- Fingertip Control of power and direction via lever on rear of wrench.

- **Model No. SA201**
- List Price £89.95

£69.95	Exc. VAT
£83.94	Inc. VAT

3/8" Sq Drive Heavy-Duty Air Impact Wrench



- Maximum Torque: 190lb.ft(258Nm).
- Breakaway Torque: 200lb.ft(271Nm).
- Pistol type wrench with rocking-dog clutch and hardened anvil assembly.
- Fitted with 4-position air/torque control and push-through reverse control.
- Compact and lightweight tool suitable for engine bay work.

- **Model No. SA912**
- List Price £54.95

£34.95	Exc. VAT
£41.94	Inc. VAT

Air Ratchet Wrenches



- Hardened steel anvil and twist-reverse mechanism.
- Trigger operated power control.
- Maximum Torque: 45lb.ft (61Nm).
- Air Supply: 90psi - 5cfm.

Model No.	Drive	List Price	Exc. VAT	Inc. VAT
SA20/S	3/8" Sq	£43.95	£34.95	£41.94
SA21/S	1/2" Sq	£43.95	£34.95	£41.94

Air Needle Scaler - Pistol Type

NEW PRODUCT



- Pistol type scaler suitable for cleaning heavy paint and rust scale from metal surfaces.
- Removable needle head allows use as a standard air hammer but requires additional chisel set and spring retainer (not included).
- Features variable speed trigger control.

- **Model No. SA501**
- List Price £44.95

£36.95	Exc. VAT
£44.34	Inc. VAT

Ø75mm Air Cut-Off Tool

Ø75mm



- Versatile tool, suitable for cutting car panel thickness material and exhaust brackets.
- Fitted with metal safety guard and throttle safety device to prevent accidental operation.

- **Model No. SA25**
- List Price £34.95

£27.95	Exc. VAT
£33.54	Inc. VAT

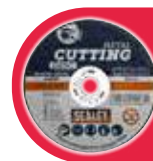

Cutting disc not included. Order Model No. PTC/3C.

Ø150mm Air Palm Orbital Sanders

- Polycarbonate outer housing with soft rubber hand grip reduces chill and vibration.
- Fitted with dual bearings in eccentric assembly to maximize working life.
- Exhaust muffler helps reduce noise emission.
- Free Speed: 10000rpm.
- Orbit Size: Ø5mm.
- Weight: 1kg.
- Supplied with Ø150mm hook-and-loop pad.

Ø150mm

Model No. SA09

Model No. SA08



Model No. SA09
Dust-free outlet for use with centralised dust extraction systems.

Dust-Free

Model No.	Dust-Free	List Price	Exc. VAT	Inc. VAT
SA08	X	£61.45	£49.95	£59.94
SA09	✓	£66.95	£52.95	£63.54

Air Operated Flat Bed Sander

165 x 90mm

- Orbital flat bed sander with counter-balanced drive shaft for smooth operation.
- Palm type trigger with rubber head ring allows comfortable, one-handed operation.
- Pad Size: 165 x 90mm.
- Orbit Size: Ø5mm.
- Suitable for sanding body panels, wood, metals and plastics.
- **Model No. SA22**
- List Price £54.95



£44.95 Exc. VAT
£53.94 Inc. VAT

Ø50mm Disc Air Orbital Sander

Ø50mm

Sander

- Lightweight sanding tool with aluminium housing suitable for use with Ø50mm sanding discs.
- Air motor with quality bearings for smooth and powerful operation.
- Fitted with safety trigger to prevent inadvertent operation and rear exhaust for quiet operation.
- Supplied with Ø50mm pad and spanner.
- **Model No. SA70**
- List Price £39.95



£31.95 Exc. VAT
£38.34 Inc. VAT

Ø150mm Random Orbital Air Sander

Ø150mm

QUIET RUNNING

- Lightweight, modern design.
- Housing fitted with composite cap and internal baffle for quiet operation.
- Equipped with airflow control valve.
- Supplied with Ø150mm hook-and-loop backing pad.
- Free Speed: 10,000rpm.
- **Model No. SA77**
- List Price £56.95



£45.95 Exc. VAT
£55.14 Inc. VAT

Ø10mm Reversible Air Drill

Ø10mm

Reversible

- Reverse action suitable for driving fixings.
- Fitted with Ø10mm chuck and key.
- Built-in muffler to reduce noise.
- Suitable for general workshop use.
- **Model No. SA24**
- List Price £44.95



£36.95 Exc. VAT
£44.34 Inc. VAT

16pc Air Die Grinder Kit

- Built-in air regulator.
- Fitted with safety trigger device.
- Collet Size: Ø3mm, Ø6mm.
- Contents: Grinder, 10pc Mounted Stones, 2pc Open-End Spanner, 2pc Collets, High Flow 1/4" BSP Male Threaded Adaptor.
- **Model No. SA67**
- List Price £42.95



£32.95 Exc. VAT
£39.54 Inc. VAT

90° Angle Air Die Grinder

Midi

- One-handed 90° angle die grinder with aluminium body and trigger with safety catch.
- Chuck accepts grinding points with Ø6mm shanks.
- Fitted with safety trigger to prevent inadvertent operation.
- Supplied with chuck spanners.
- **Model No. SA674**
- List Price £39.95



£31.95 Exc. VAT
£38.34 Inc. VAT

50L **12.6 cfm**
Model No. SAC05030

100L **12.7 cfm**
Model No. SAC10030

Scan for our full range of Direct Drive Compressors.

V-Twin Direct Drive Air Compressors 3hp

- Maximum Pressure: 130psi(9bar).
- V-Twin pump with aluminium cylinders and cast iron liners for reduced weight and improved resistance to wear.
- Pump directly coupled to heavy-duty induction motor for reliable and quiet operation.
- Precision welded receiver tank manufactured to meet Pressure Vessel Directive.
- Fitted with fully automatic pressure cut-out switch, air regulator and pressure gauges for tank and supply.

3hp **V-Twin Pump**

Model No.	Capacity	Air Displacement	Max. Free Air Delivery	List Price	Exc. VAT	Inc. VAT
SAC05030	50L	12.6cfm(357L/min)	8.75cfm(248L/min)	£449.95	£359.95	£431.94
SAC10030	100L	12.7cfm(360L/min)	8.8cfm(249L/min)	£639.95	£499.95	£599.94

Direct Drive Air Compressors

24L **1.5hp** **6 cfm**

OR

50L **2hp** **7 cfm**

Model No. SA2415

- Maximum Pressure: 116psi(8bar).
- Aluminium head with cast iron cylinder gives added resistance to wear.
- Pump head directly coupled to heavy-duty induction motor for reliable and quiet operation.
- Welded tank complies with latest European standards.
- Fitted with fully automatic pressure cut-out switch and twin gauges displaying tank and working pressures.

Model No.	Capacity	Air Displacement	Max. Free Air Delivery	List Price	Exc. VAT	Inc. VAT
SA2415	24L	6cfm(170L/min)	4.2cfm(119L/min)	£229.95	£179.95	£215.94
SA5020	50L	7cfm(200L/min)	4.8cfm(135L/min)	£279.95	£219.95	£263.94

2pc Hose Guide Set

NEW PRODUCT

- 2-Piece set of hose guides helps stop air hoses, water hoses and electric cables from catching on tyres.
- Can be mounted on a wall so hoses and cables can be stored.
- **Model No. SHG01**
- List Price £9.95

£6.95 Exc. VAT
£8.34 Inc. VAT

24L Direct Drive Air Compressor 2hp 110V

24L

2hp

110V

6.3 cfm

Model No. SAC2420E110V

- Air Displacement: 6.3cfm(178L/min).
- Maximum Free Air Delivery: 4.6cfm(130L/min).
- Maximum Pressure: 116psi(8bar).
- Aluminium cylinder head with cast iron cylinder gives added resistance to wear.
- Fitted with fully automatic pressure cut-out switch and twin gauges displaying tank and working pressures.
- **Model No. SAC2420E110V**
- List Price £224.95

£179.95 Exc. VAT
£215.94 Inc. VAT

8m Retractable Air Hose Metal Reel Ø10mm ID Rubber Hose

8m

Steel Reel

Ø10 mm ID

300psi

HEAVY DUTY

- Heavy-duty steel construction with corrosion resistant powder coated finish.
- 9-Position guide arm with four non-sag rollers.
- Multi-position ratchet lock.
- L-Shaped bracket enables the unit to be wall, floor or ceiling mounted.
- **Model No. SA84**
- List Price £134.95

£89.95 Exc. VAT
£107.94 Inc. VAT

200L Belt Drive Air Compressors 3ph

Premier

2 YEAR GUARANTEE

3 PHASE

Made in France
200L

75+ KG HEAVY ITEM
These items are heavy. Extra assistance must be provided at the delivery point to help their safe delivery.



Model No. SAC3203B3PH



Model No. SAC32055B

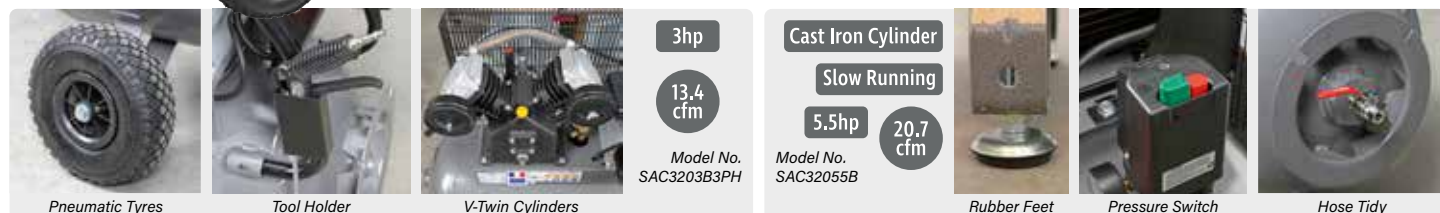

- Heavy-duty 3-phase units, suitable for professional workshops, these units are fitted with genuine 3hp or 5.5hp motors.
- Twin capacitors and a centrifugal switch aid trouble free start up on a good 13A supply.
- **SAC3203B3PH** features an easy to use control panel with two outlets, one regulated and one direct, along with heavy-duty pneumatic wheels with single front castor.
- 3-Cylinder unit, **SAC32055B**, gives extra cfm pound for pound compared to standard 2-cylinder units.
- All pumps feature heavy-duty full cast cylinders, capped by alloy heads for improved heat dissipation and long-life.
- Each unit includes a drain valve for easy release of condensed water build-up in the tank.

Model No.	Horsepower	Air Displacement	Max. Free Air Delivery	List Price	Exc. VAT	Inc. VAT
SAC3203B3PH	3hp	13.4cfm(380L/min)	10.9cfm(310L/min)	£1,239.95	£999.95	£1,199.94
SAC32055B	5.5hp	20.7cfm(585L/min)	15.9cfm(450L/min)	£1,649.95	£1,199.95	£1,439.94

270L Low Noise Screw Air Compressor 10hp 3ph



270L 67dB(A) 10hp

3 PHASE

FREE AIR 30.2 cfm



MADE IN ITALY

- Maximum Free Air Delivery: 30.2cfm(860L/min).
- Maximum Pressure: 145psi(10bar).
- Insulated Class F 10hp motor with IP54 protected control box, which is easy to operate with digital display showing key information like air pressure, oil temperature and maintenance schedules.
- Features an insulated outer casing to minimize noise (67dB(A) at 1m) and offers protection to inner components.
- Fitted with a drain valve tap at base of unit.
- **Model No. SSC12710**
- List Price £5,999.95

£4,699.95 Exc. VAT
£5,639.94 Inc. VAT

75+ KG HEAVY ITEM
This item is heavy. Extra assistance must be provided at the delivery point to help its safe delivery.

1/4" BSP Z-Swivel Air Hose Connector with Regulator

- Suitable for all air tools with 1/4" BSP connection.
- Swivel assembly gives greater freedom of movement to tool when connected to air line.
- Fitted with air valve for extra control over speed of power tool.
- **Model No. SA900**
- List Price £21.95

£14.95 Exc. VAT
£17.94 Inc. VAT



Extra-Heavy-Duty Air Hoses

5m Silicone-Free



- High quality rubber air hoses with protective wrap manufactured to EN 2398.
- Fitted with bend restrictors and female swivel unions.
- Guaranteed silicon-free for use in the bodyshop.

Model No.	Diameter	BSP	List Price	Exc. VAT	Inc. VAT
AH5R	Ø8mm	1/4"	£22.95	£16.95	£20.34
AH5R/38	Ø10mm	1/4"	£26.95	£19.95	£23.94
AH5R/12	Ø13mm	1/2"	£40.95	£29.95	£35.94

1/4" BSP Mini In-Line Air Tool Oiler with Filler

- Oil mist lubrication for all 1/4" BSP inlet tools.
- Supplied with filler bottle.
- **Model No. SA111**
- List Price £9.95

£6.45 Exc. VAT
£7.74 Inc. VAT



Air Supply Ring Main System



Install your own workshop compressed air ring main quickly, easily and competitively with these compressed air systems. A complete professional compressed air system can be installed quickly and easily, considerably reducing the need for specialist staff. Avoids extensive disruption and downtime. Simple push-action pipe fittings do away with preparing threaded tubes or applying solvents. Complex pipe and fitting configurations are also assembled more rapidly since the fittings can be disassembled and reconfigured quickly. Both our Speedfit® and Sharkbite® ranges of compressed air systems are fully compatible with each other and can be connected to existing ring main even if made of galvanized steel.



For illustration purposes only.

Lightweight yet strong acetal copolymer fittings and nylon pipe runs.



For illustration purposes only.

Brass fittings and aluminium pipe.

- ✓ Quick to install - save up to 40% in time and cost.
- ✓ Corrosion resistant and maintenance-free.
- ✓ Safe, secure and leak-proof.
- ✓ Simple to reconfigure.
- ✓ Easy to handle.

Kits available in
SharkBite® or
JG Speedfit®

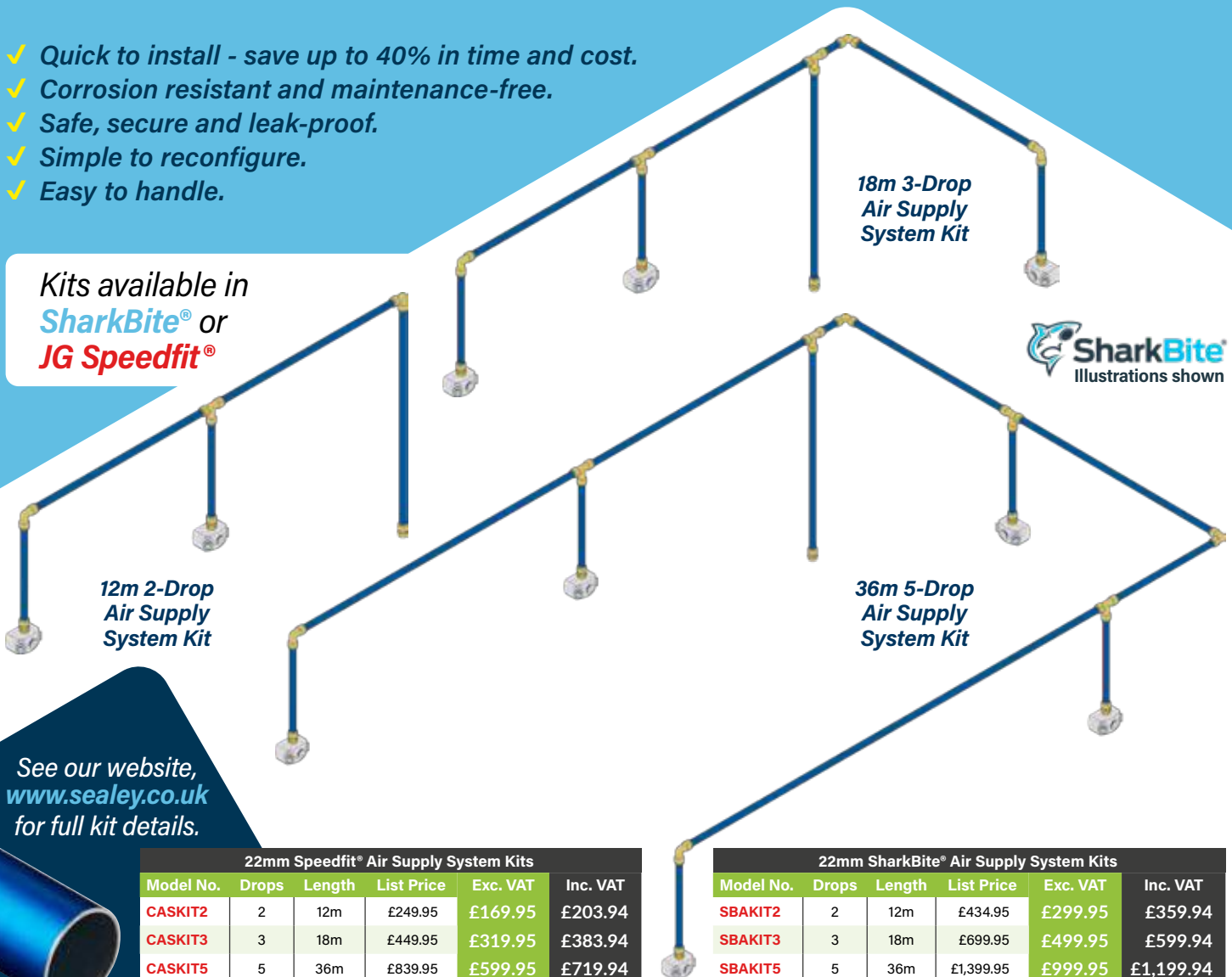

See our website,
www.sealey.co.uk
for full kit details.

22mm Speedfit® Air Supply System Kits					
Model No.	Drops	Length	List Price	Exc. VAT	Inc. VAT
CASKIT2	2	12m	£249.95	£169.95	£203.94
CASKIT3	3	18m	£449.95	£319.95	£383.94
CASKIT5	5	36m	£839.95	£599.95	£719.94

22mm SharkBite® Air Supply System Kits					
Model No.	Drops	Length	List Price	Exc. VAT	Inc. VAT
SBAKIT2	2	12m	£434.95	£299.95	£359.94
SBAKIT3	3	18m	£699.95	£499.95	£599.94
SBAKIT5	5	36m	£1,399.95	£999.95	£1,199.94

Inside SharkBite® Technology

SharkBite® push-fit fittings use grip and seal technology. The stainless steel grab ring grips the pipe and the O-Ring provides an airtight seal.

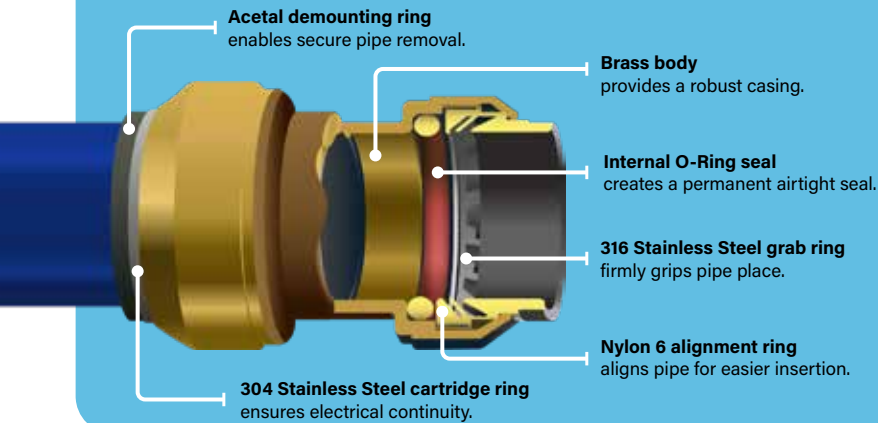

A Up to three outputs for connecting air lines/cable reels.

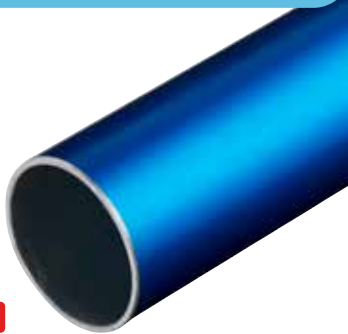

B



C



D



E



F



G



H



I



J



K



L



M

A		Wall Boxes		
Model No.	Thread	List Price	Exc. VAT	Inc. VAT
CAS12WB	1/2"	£53.95	£44.95	£53.94
CAS34WB	3/4"	£53.95	£44.95	£53.94

B		3m Anodised Aluminium Pipes		
Model No.	Pipe OD	List Price	Exc. VAT	Inc. VAT
SBA15AP	Ø15mm	£27.95	£22.95	£27.54
SBA22AP	Ø22mm	£51.95	£42.95	£51.54
SBA28AP	Ø28mm	£69.95	£57.95	£69.54

C		Disconnect Clip & Depth Gauges		
Model No.	Pipe OD	List Price	Exc. VAT	Inc. VAT
SBA15DC	Ø15mm	£2.45	£2.15	£2.58
SBA22DC	Ø22mm	£2.95	£2.65	£3.18
SBA28DC	Ø28mm	£3.45	£2.95	£3.54

D		Ball Valves		
Model No.	Pipe OD	List Price	Exc. VAT	Inc. VAT
SBA15BV	Ø15mm	£19.95	£16.45	£19.74
SBA22BV	Ø22mm	£27.95	£22.95	£27.54
SBA28BV	Ø28mm	£66.95	£54.95	£65.94

E		Equal Elbows		
Model No.	Pipe OD	List Price	Exc. VAT	Inc. VAT
SBA15EE	Ø15mm	£19.95	£16.45	£19.74
SBA22EE	Ø22mm	£28.95	£23.95	£28.74
SBA28EE	Ø28mm	£32.95	£26.95	£32.34

F		Equal Tees		
Model No.	Pipe OD	List Price	Exc. VAT	Inc. VAT
SBA15ET	Ø15mm	£20.95	£16.95	£20.34
SBA22ET	Ø22mm	£29.95	£24.95	£29.94
SBA28ET	Ø28mm	£39.95	£32.95	£39.54

G		Line End Plugs		
Model No.	Pipe OD	List Price	Exc. VAT	Inc. VAT
SBA15P	Ø15mm	£6.95	£5.75	£6.90
SBA22P	Ø22mm	£8.95	£7.45	£8.94
SBA28P	Ø28mm	£13.95	£11.45	£13.74

H		Pipe Clips - Packs of 10		
Model No.	Pipe OD	List Price	Exc. VAT	Inc. VAT
SBA15PC	15mm	£15.95	£12.95	£15.54
SBA22PC	22mm	£22.95	£18.95	£22.74
SBA28PC	28mm	£16.95	£13.95	£16.74

I		Straight Connectors		
Model No.	Pipe OD	List Price	Exc. VAT	Inc. VAT
SBA15SC	Ø15mm	£18.95	£15.45	£18.54
SBA22SC	Ø22mm	£25.95	£21.45	£25.74
SBA28SC	Ø28mm	£38.95	£31.95	£38.34

J		Reducing Couplings		
Model No.	Pipe Reduction	List Price	Exc. VAT	Inc. VAT
SBA2215	Ø22mm down to Ø15mm	£33.95	£27.95	£33.54
SBA2822	Ø28mm down to Ø22mm	£42.95	£34.95	£41.94

K		Brass Straight Adaptor		
Model No.	Pipe OD	List Price	Exc. VAT	Inc. VAT
SBA22BSA	Ø22mm x 3/4"BSPT	£33.95	£27.95	£33.54
SBA28BSA	Ø28mm x 1"BSPT	£43.95	£35.95	£43.14

L		Reducing Tees		
Model No.	Pipe Reduction	List Price	Exc. VAT	Inc. VAT
SBA2215T	Ø22mm down to Ø15mm	£29.95	£24.95	£29.94
SBA2822T	Ø28mm down to Ø22mm	£37.95	£29.95	£35.94

M		Brass Straight Adaptor		
Model No.	Pipe OD	List Price	Exc. VAT	Inc. VAT
SBA15BWE	Ø15mm x 1/2"BSPT	£37.95	£29.95	£35.94
SBA22BWE	Ø22mm x 3/4"BSPT	£62.95	£51.95	£62.34

THE SEALEY BUYING GUIDE TO MIG WELDERS



View our current range of MIG Welders here:

MIG welding involves a wire fed from a spool in the welder unit, which runs through a hose to a handheld torch. The wire performs two jobs; it supplies voltage to melt the metal being welded, and acts as a filler. The process offers high productivity, as the wire is continuously fed.

Gas is used to shield the weld from impurities which would cause the weld to be porous and weak. The gas is fed from a gas bottle mounted on the welder unit, up through the hose to a gas cup at the end of the torch. The gas can be easily blown away, particularly if you are working outdoors, resulting in poor quality welds. In recent years, Gasless MIG welders have become popular. They use a specialised flux coated wire to shield the weld, enabling them to be used outside.

WIRE

The wire performs two jobs; it supplies voltage to melt the metal being welded, and acts as a filler.

The main difference between flux-core and MIG welding is that flux-core welding does not require a shielding gas which makes it more portable. The self-shielding flux-cored wire provides the shielding gas when burned. This makes flux-core more suited to welding in windy conditions.



- FLUX-CORED WIRE**
- ✓ No gas bottle required.
 - ✓ Can be used outdoors.
 - ✓ Works through paint, rust and dirt.
 - ✗ Produces slag and splatter.
 - ✗ Can't weld Aluminium.
 - ✗ More expensive.



- SOLID MIG WIRE**
- ✓ No slag, little spatter.
 - ✓ Handles thin metal well.
 - ✓ Produces cleaner welds.
 - ✗ Longer to set-up.
 - ✗ Needs clean surface.
 - ✗ Requires gas bottle.



TYPES OF GAS & INDUSTRIAL GAS SUPPLY



CO₂
CO₂ CARBON DIOXIDE
 Used for mild steel.

CO₂/ARGON
 A mixture of 20% Carbon Dioxide and 80% Argon which gives a smoother and cleaner weld than pure CO₂.

ARGON
ARGON
 Used for aluminium.

THERE ARE THREE TYPES OF GAS USED:
 If you plan to run your machine on gas, you need to consider how much welding you plan to do. Lower amperage machines tend to use small disposable or re-fillable bottles. If you plan to do a lot of welding, a large industrial gas bottle will be more economical. However, your welder will need to be converted to cater for the larger bottles. Larger amperage welders are designed for use with industrial gas bottles.

ENVIRONMENT & POWER SUPPLY

Location **Gasless** **Gas**

The first consideration when purchasing a MIG welder is where you intend to weld. If you plan to work outdoors, you need to purchase a MIG capable of gasless welding. Usually, these machines can be easily converted to run with or without gas.



Secondly, you need to consider the power supply available in your workplace. Some machines can be run on a conventional 13Amp domestic supply, while others may require a 30Amp or even three phase supply. If you plan to weld thin metal, such as car bodywork, a lower amperage is all that's required, therefore 13Amps is sufficient.



TORCH & HOSE



EURO CONNECTION ENABLES QUICK AND SIMPLE PLUG CONNECTION TO WELDER.

EURO TORCH

NON LIVE TORCH



Larger MIG welders include welding torches and hoses with a bayonet type connector. This allows the user to easily change between hoses/torches, which is particularly important if you frequently weld different types of metal i.e., mild steel to aluminium. Old school MIG welders have a permanently live torch, but most modern machines have a switch in the torch to turn on the voltage, feed the wire and turn on the gas supply. This is a safer and easier method and used in all Sealey MIG welders.

DUTY CYCLE

The duty cycle of a welder reflects how long it can weld in a 10-minute period before it must cool down. For example, with a duty cycle of 60% at 100 amps the welder can be operated continuously for 6 minutes before it will need a 4 minute cool down period.

Generally duty cycle isn't important for automotive repair work, as the amps tend to be low (higher duty cycle at lower amps). If you plan to carry out a lot of welding, the duty cycle is a very important consideration when comparing welders.

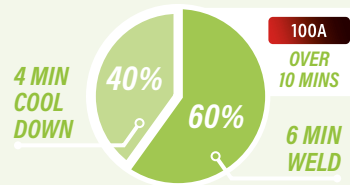

SAFETY

Safety First! MIG welders create very hot temperatures and emit a very bright light, which can cause severe damage to both exposed skin and eyesight. Therefore, it is essential to wear the correct safety equipment.



- ✓ Welding Helmet
- ✓ Leather Welding Gauntlets
- ✓ Leather Welding Apron
- ✓ Spark Proof Welding Blanket
- ✓ Welding Curtain
- ✓ Fire Extinguishers
- ✓ Respiratory Protection

Please refer to our guide on PPE.



Professional MIG Welders 415V 3ph with BINZEL® Euro Torch

- Tried and trusted by fabricators and professional car repair shops across the UK.
- Superb quality, heavy-duty electronic wire drive motors and industrial transformers make these machines unmatched in performance and value.
- Ideal for industrial use where 415V 3-phase supply is not a problem.
- These four top-of-the-range 3-phase units, are covered by a lifetime guarantee on the transformer as well as 1 year unconditional parts and labour on all parts, conditional on registering your purchase with us online at www.sealey.co.uk.
- **POWERMIG6025S** and **POWERMIG6035S** both feature portable wire drive system with two and four touch on/off mechanism and 5m umbilical extension, to allow access in to high or tight areas where the welder will not fit.
- Each unit is supplied with 0.8mm steel wire, non-live torch and industrial Argon/CO₂ regulator.
- All can be used with CO₂, Argon or CO₂/Argon mix and accept any bottle size.



3 YEAR GUARANTEE*

LIFETIME GUARANTEE*
Main Power TRANSFORMER

75+ KG HEAVY ITEM
These items are heavy. Extra assistance must be provided at the delivery point to help their safe delivery.

250A
300A
OR
350A



Model No. POWERMIG3525



Model No. POWERMIG3530



Model No. POWERMIG6035S



Model No. POWERMIG6035S

Model No.	Welding Current	Duty Cycle	Wire Capacity	Absorbed Power	Portable Wire Drive	Weight	List Price	Exc. VAT	Inc. VAT
POWERMIG3525	40-250A	100% @ 148A, 60% @ 190A, 35% @ 250A	15kg	9.2kW	X	78kg	£1,349.95	£1,049.95	£1,259.94
POWERMIG3530	56-300A	100% @ 177A, 60% @ 229A, 35% @ 300A	15kg	11.5kW	X	89kg	£1,499.95	£1,199.95	£1,439.94
POWERMIG6025S	50-250A	100% @ 194A, 80% @ 217A, 60% @ 250A	15kg	11.5kW	✓	133kg	£1,999.95	£1,399.95	£1,679.94
POWERMIG6035S	60-350A	100% @ 270A, 80% @ 303A, 60% @ 350A	15kg	15.9kW	✓	139kg	£2,399.95	£1,699.95	£2,039.94

200A MMA Inverter Welder

200A



NEW PRODUCT



Premier

3 YEAR GUARANTEE



Optional TIG accessory kit available Model No. TIG10S.

- Compact and lightweight unit, suitable for arc welding and TIG using the lift start method.
- Can weld a variety of rods including rutile, basic and stainless from Ø1.6mm up to Ø5mm.
- Includes thermal cut-out and mains voltage LEDs.
- Supplied with 2m 16mm² cable with electrode holder and 2m 16mm² earth clamp and cable, both with 35-70 quick connectors.
- **Model No. MW2001**
- List Price £289.95

£239.95 Exc. VAT
£287.94 Inc. VAT

200A TIG/MMA HF AC/DC Inverter Welder 230V



200A

TIG

MMA

AC/DC



- Fan-cooled AC/DC power supply for pulse TIG and MMA welding applications.
- Suitable for welding aluminium, magnesium, stainless steel, steel, copper, nickel and titanium.
- TIG cycle includes post gas and current down-slope regulation.
- Features regulated high frequency (HF) push-button arc that prevents having to touch the workpiece to start, keeping the tip in good condition for longer.
- **Model No. TIG200HFACDC**
- List Price £1,499.95

£1,099.95 Exc. VAT
£1,319.94 Inc. VAT

TIG Foot Pedal Power Control

- Permits hands-free feathering of power output when used with Model No. TIG200HFACDC.
- Supplied with 4.5m cable.
- **Model No. TIG200HFACDCF**
- List Price £107.45



£89.95 Exc. VAT
£107.94 Inc. VAT

Workshop Welding Curtains

- Amber welding screens manufactured to EN ISO 25980:2014.
- Suitable for use in workshops where the glare from welding and cutting may be a hazard to others.
- Curtain and frame supplied flat-packed.
- Assembles with ease.

Model No.	Frame Size	List Price	Exc. VAT	Inc. VAT
SSP99	1.3 x 1.75m	£159.95	£109.95	£131.94
SSP992	1.8 x 1.75m	£199.95	£134.95	£161.94
SSP993	2.4 x 1.75m	£239.95	£159.95	£191.94



Model No. SSP99 1.3m Wide

Model No. SSP992 1.8m Wide

Model No. SSP993 2.4m Wide

SEE MORE OF OUR WELDING HELMETS ON PAGE 167



Auto Darkening Welding Helmets - Shade 9-13

SHADE 9-13 Variable

Grinding Function

TRUE COLOUR

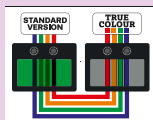

Scan for our full range of Welding Helmets.



- Welding helmets with infinitely adjustable shade control between 9-13.
- Complies with BS EN 379, BS EN 175 and DIN standards.
- Features True Colour technology for improved visibility, less eye strain and realistic colour recognition.
- Fully automatic switching from light to dark on striking arc.
- Shade is selected by a rotary knob on side of helmet.
- Grinding function enables user to grind without removing mask.
- Solar panel power supply.
- Features sensitivity and delay controls for switching light to dark.
- Contoured design with adjustable headband for added comfort.
- Suitable for MIG, TIG and arc welding.
- **Model No. PWH610 - Black**
- **Model No. PWH611 - Blue**
- **Model No. PWH612 - Red**
- **Model No. PWH613 - Silver**
- List Price £64.95

£44.95 Exc. VAT
£53.94 Inc. VAT



LAND ROVER PROPERTY DIY WINNER PRODUCT TEST

250A Magnetic Ground Clamp



- Easy set-up; place on clean surface, connect earth and start welding.
- No more tacking on tabs or searching for grounds.
- Rated to 250A.
- Grips firmly on flat or round surfaces.
- **Model No. MGC946**
- List Price £32.95

£22.95 Exc. VAT
£27.54 Inc. VAT

Magnetic Adjustable Link

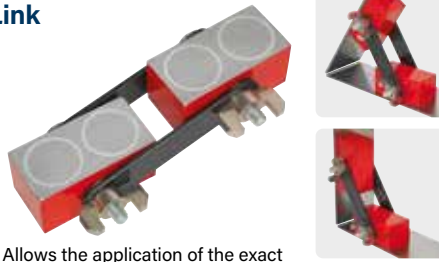

- Allows the application of the exact angle and positioning of metal to be welded.
- Can be set at any angle by adjustment and locking wing nut.
- Compact in size for holding work in confined spaces.
- Angle Range: 180°.
- **Model No. MAL945**
- List Price £36.95

£25.95 Exc. VAT
£31.14 Inc. VAT

Gas Welding Goggles with Flip-Up Lenses



- Clear polycarbonate safety lenses with shade 5 flip-up lenses.
- Indirect ventilation in goggle frame.
- Conforms to BS EN 175.
- **Model No. SSP6**
- List Price £14.95

£9.95 Exc. VAT
£11.94 Inc. VAT

MIG Gas Regulator Kit No Gauge Regulator Industrial



- Convert the small-bore hosing (normally Ø4mm OD) found on portable MIGs for use with industrial size gas regulators and cylinders.
- Kit includes industrial regulator Model No. REG/MZ.
- **Model No. REG/KIT/MZ**
- List Price £75.95

£52.95 Exc. VAT
£63.54 Inc. VAT

MIG Gas Regulator Kit 1 Gauge Regulator Industrial



- Convert the small-bore hosing (normally Ø4mm OD) found on portable MIGs for use with industrial size gas regulators and cylinders.
- Kit includes single gauge industrial regulator Model No. REG/MO.
- **Model No. REG/KIT/MO**
- List Price £99.95

£69.95 Exc. VAT
£83.94 Inc. VAT

Spark Lighter



- Single flint spark lighter suitable for lighting gas torches.
- Features cup shape shield to trap gas and ensure ignition.
- **Model No. SGA1.L**
- List Price £7.45

£6.45 Exc. VAT
£7.74 Inc. VAT

Welding Table



- Heavy-duty galvanized welding table with 30mm MIG torch mounting point.
- Sturdy locking pin system and adjustable foot for eliminating wobble when in use.
- Portable and foldable for ease of transportation and storage.
- Size (W x D x H): 1120 x 610 x 915mm.
- Weight capacity 100kg maximum.
- **Model No. SWT1120**
- List Price £199.95

£139.95 Exc. VAT
£167.94 Inc. VAT

Welder's French Chalk Holder with 4 Chalk Sticks



- Stainless steel chalk holder with four pieces of soapstone chalk.
- Ideal for marking metals prior to welding, cutting or grinding.
- Chalk Stick Dimensions: 127 x 12.7 x 4.8mm.
- **Model No. WFC4**
- List Price £3.75

£3.25 Exc. VAT
£3.90 Inc. VAT

Welding Pliers



- Spring loaded, fully insulated pliers.
- Seven uses for the welder: nozzle/tip cleaner, nozzle/tip remover, wire cutter, flux chipper, long nose pliers.
- **Model No. WP94**
- List Price £31.45

£19.95 Exc. VAT
£23.94 Inc. VAT

Welding Vices

- Cast iron welding vices aid welding a 90° angle.
- Self-centring swivel jaw allows two different size workpieces to be accurately welded.
- Copper plated spindle for resistance to weld spatter.
- Can be bench mounted through holes in the base.



Model No. SWV165

Model No.	Size	Throat Depth	Jaw Opening	List Price	Exc. VAT	Inc. VAT
SWV165	165mm	35mm	75mm	£71.95	£44.95	£53.94
SWV215	215mm	65mm	110mm	£94.95	£64.95	£77.94

SV12 SERIES

The SV12 Series offers a range of compact and lightweight tools, ideal for use in tight spaces. Lithium-ion battery technology delivers more power and better performance than traditional nickel-cadmium batteries. Ergonomic composite housings reduce vibration, providing operator comfort.

FAST CHARGE



12V SV12 Series Ø10mm Hammer Drill/Driver Kit 2 Batteries

STORAGE BAG INCLUDED

- Ø0.8-10mm Keyless chuck.
- 2-Speed settings and 21 torque settings gives control to complete various tasks.
- Integral LED battery level indicator and LED work light.
- Belt hook for safer storage while not in use.
- Supplied with 1 hour mains charger, 2 x 1.5Ah Lithium-ion batteries and canvas storage bag.
- **Model No. CP1201KIT**
- List Price £124.95



10mm **VARIABLE SPEED**
£93.95 Exc. VAT
£112.74 Inc. VAT

BODY ONLY



• **Model No. CP1201** **£43.95** Exc. VAT
 • List Price **£52.74** Inc. VAT
 £54.95

12V SV12 Series 1/4"Hex Drive Impact Driver Kit 2 Batteries

STORAGE BAG INCLUDED

- Variable speed control trigger with lock function gives more control during application.
- Integrated LED battery level indicator and LED work light.
- Supplied with belt hook for safer storage while not in use.
- Supplied with 1 hour mains charger, 2 x 1.5Ah Lithium-ion batteries and canvas storage bag.
- **Model No. CP1203KIT**
- List Price £134.95



For 1/4" Hex Bits
 80Nm Torque **VARIABLE SPEED**
£99.95 Exc. VAT
£119.94 Inc. VAT

BODY ONLY



• **Model No. CP1203** **£51.95** Exc. VAT
 • List Price **£62.34** Inc. VAT
 £64.95

12V SV12 Series Cordless Multipurpose Rotary Tool & Engraver Kit 2 Batteries

STORAGE BAG INCLUDED

- 6-Speed settings.
- Quick release collet and spindle lock for fast tool changes.
- Supplied with a full range of tips, wheels, sanding discs, dressing stones and a chuck spanner.
- Integral LED battery level indicator.
- Supplied with 1 hour mains charger, 2 x 1.5Ah Lithium-ion batteries and canvas storage bag.
- **Model No. CP1207KIT**
- List Price £99.95



VARIABLE SPEED
£74.95 Exc. VAT
£89.94 Inc. VAT

BODY ONLY



• **Model No. CP1207** **£23.95** Exc. VAT
 • List Price **£28.74** Inc. VAT
 £29.95

12V SV12 Series Cordless Reciprocating Saw Kit 2 Batteries

STORAGE BAG INCLUDED

- Quick blade change system.
- Variable speed trigger for greater control.
- Integral LED battery level indicator and LED work light.
- Supplied with metal and wood cutting blades.
- Trigger-lock for added safety.
- Supplied with 1 hour mains charger, 2 x 1.5Ah Lithium-ion batteries and canvas storage bag.
- **Model No. CP1208KIT**
- List Price £139.95



£104.95 Exc. VAT
£125.94 Inc. VAT

BODY ONLY



• **Model No. CP1208** **£55.95** Exc. VAT
 • List Price **£67.14** Inc. VAT
 £69.95

12V SV12 Series 1/2" Sq Drive Cordless Ratchet Wrench Kit 2 Batteries

STORAGE BAG INCLUDED

- Variable speed trigger with safety lock.
- Heavy-duty mechanical steel ratchet head with forward and reverse control.
- Integrated LED battery level indicator and LED work light.
- Supplied with 1 hour mains charger, 2 x 1.5Ah Lithium-ion batteries and canvas storage bag.
- **Model No. CP1209KIT**
- List Price £199.95



1/2" Sq. Drive

80Nm Torque



£149.95 Exc. VAT
£179.94 Inc. VAT

BODY ONLY



• **Model No. CP1209** **£103.95** Exc. VAT
 • List Price **£124.74** Inc. VAT
 £129.95

12V SV12 Series Ø75mm Angle Grinder Kit
2 Batteries

STORAGE BAG INCLUDED

- Brushless motor allows for a longer lasting tool requiring less maintenance.
- Spindle lock for easy disc changes.
- Built-in battery charge level indicator.
- Cutting disc not included.
- Supplied with 1 hour mains charger, 2 x 1.5Ah Lithium-ion batteries and canvas storage bag.
- **Model No. CP1210KIT**
- List Price £149.95



Ø75mm

200W

£112.95 Exc. VAT
£135.54 Inc. VAT

BODY ONLY



• **Model No. CP1210**
• List Price £79.95

£63.95 Exc. VAT
£76.74 Inc. VAT

12V SV12 Series 3/8" Sq Drive Ratchet Wrench Kit
3 Batteries

STORAGE BAG INCLUDED

- Features a lockable variable speed control trigger.
- Heavy-duty mechanical steel ratchet head with forward and reverse control.
- Integrated LED battery level indicator and LED work light.
- Supplied with 1 hour mains charger, 2 x 1.5Ah and 1 x 3Ah Lithium-ion batteries and canvas storage bag.
- **Model No. CP1202KITB**
- List Price £174.95



3/8" Sq. Drive

VARIABLE SPEED

£104.95 Exc. VAT
£125.94 Inc. VAT



12V SV12 Series 3/8" Sq Drive Impact Wrench Kit
3 Batteries

STORAGE BAG INCLUDED

- Comfortable composite housing with soft grip to reduce vibration.
- Variable speed control trigger with lock function gives more control during application.
- Integrated LED battery level indicator and LED work light.
- Supplied with belt hook for safer storage while not in use.
- Supplied with 1 hour mains charger, 2 x 1.5Ah and 1 x 3Ah Lithium-ion batteries and canvas storage bag.
- **Model No. CP1204KITB**
- List Price £169.95



3/8" Sq. Drive

VARIABLE SPEED

£104.95 Exc. VAT
£125.94 Inc. VAT



12V SV12 Series Ø71mm Cordless Polisher Kit
3 Batteries

STORAGE BAG INCLUDED

- Compact, lightweight cordless polisher.
- Comfortable composite housing with soft grip to reduce vibration.
- 2-Speed settings and variable speed control trigger.
- Integral LED battery level indicator.
- Supplied with side handle, two foam pads and one wool polishing pad.
- Supplied with 1 hour mains charger, 2 x 1.5Ah and 1 x 3Ah Lithium-ion batteries and canvas storage bag.
- **Model No. CP1205KITB**
- List Price £154.95



Ø71mm

VARIABLE SPEED

£94.95 Exc. VAT
£113.94 Inc. VAT



4A 12V Lithium-ion Fast Charge Battery Charger for SV12 Series

NEW PRODUCT



- 4A For faster recharging of the SV12 Series.
- Compatible with battery pack Model No's CP1200BP and CP1200BP4.
- **Model No. CP1200MC4A**
- List Price £31.95

£24.95 Exc. VAT
£29.94 Inc. VAT

Canvas Tool Storage Bag



- Ideal storage solution for designing your own unique tool profile.
- Stores up to four tools, a mains charger and multiple batteries from the Sealey SV12 and CP6000 Series.
- **Model No. CP1200CB**
- List Price £19.95

£15.95 Exc. VAT
£19.14 Inc. VAT

SV12 SERIES

The SV12 Series offers a range of compact and lightweight tools, ideal for use in tight spaces. Lithium-ion battery technology delivers more power and better performance than traditional nickel-cadmium batteries. Ergonomic composite housings reduce vibration, providing operator comfort.

FAST CHARGE



2 x 12V SV12 Series Cordless Power Tool Combo Kit 2 Batteries



Package includes:

- CP1201 - 12V 10mm Hammer Drill/Driver Lithium-ion - Body Only.
- CP1203 - 12V 80Nm 1/4"Hex Drive Impact Driver Lithium-ion - Body Only
- CP1200BP - 12V 1.5Ah Lithium-ion Power Tool Battery.
- CP1200BP3 - 12V 3Ah Lithium-ion Power Tool Battery.
- CP1200MC - 12V Lithium-ion Battery Charger.
- CP1200CB - Canvas Tool Storage Bag.

- Model No. **CP1200COMBO6**
- List Price £194.95

STORAGE BAG INCLUDED

£139.95 Exc. VAT
£167.94 Inc. VAT

2 x 12V SV12 Series Cordless Power Tool Combo Kit 2 Batteries



Package includes:

- CP1204 - 12V 80Nm 3/8"Sq Drive Impact Wrench Lithium-ion - Body Only.
- CP1209 - 12V 1/2"Sq Drive Ratchet Wrench Lithium-ion - Body Only.
- CP1200BP - 12V 1.5Ah Lithium-ion Power Tool Battery.
- CP1200BP3 - 12V 3Ah Lithium-ion Power Tool Battery.
- CP1200MC - 12V Lithium-ion Battery Charger.
- CP1200CB - Canvas Tool Storage Bag.

- Model No. **CP1200COMBO8**
- List Price £263.95

STORAGE BAG INCLUDED

£194.95 Exc. VAT
£233.94 Inc. VAT

3 x 12V SV12 Series Cordless Power Tool Combo Kit 2 Batteries



Package includes:

- CP1201 - 12V 10mm Hammer Drill/Driver Lithium-ion - Body Only.
- CP1205 - 12V Ø71mm Polisher Lithium-ion - Body Only.
- CP1210 - 12V Ø75mm Angle Grinder Lithium-ion - Body Only.
- CP1200BP - 12V 1.5Ah Lithium-ion Power Tool Battery.
- CP1200BP3 - 12V 3Ah Lithium-ion Power Tool Battery.
- CP1200MC - 12V Lithium-ion Battery Charger.
- CP1200CB - Canvas Tool Storage Bag.

- Model No. **CP1200COMBO7**
- List Price £256.95

STORAGE BAG INCLUDED

£189.95 Exc. VAT
£227.94 Inc. VAT

4 x 12V SV12 Series Cordless Power Tool Combo Kit 3 Batteries



Package includes:

- CP1201 - 12V Ø10mm Hammer Drill/Driver - Body Only.
- CP1202 - 12V 3/8"Sq Drive Ratchet Wrench - Body Only.
- CP1203 - 12V 1/4"Hex Drive Impact Driver 80Nm - Body Only.
- CP1204 - 12V 3/8"Sq Drive Impact Wrench 80Nm - Body Only.
- CP1200BP - 12V 1.5Ah Lithium-ion Power Tool Battery.
- CP1200BP3 - 12V 3Ah Lithium-ion Power Tool Battery.
- CP1200BP4 - 12V 4Ah Lithium-ion Power Tool Battery.
- CP1200MC - 12V Lithium-ion Battery Charger.
- CP1200CB - Canvas Tool Storage Bag.

- Model No. **CP1200COMBOB**
- List Price £354.95

STORAGE BAG INCLUDED

£249.95 Exc. VAT
£299.94 Inc. VAT

6 x 12V SV12 Series Cordless Power Tool Kit 3 Batteries

VARIABLE SPEED



Package includes:

- CP1201 - 12V 10mm Hammer Drill/Driver - Body Only.
- CP1202 - 12V 3/8"Sq Drive Ratchet Wrench - Body Only.
- CP1203 - 12V 1/4"Hex Drive Impact Driver 80Nm - Body Only.
- CP1204 - 12V 3/8"Sq Drive Impact Wrench 80Nm - Body Only.
- CP1205 - 12V Ø71mm Polisher - Body Only.
- CP1207 - 12V 49pc Rotary Tool & Engraver Kit - Body Only.
- CP1200BP - 12V 1.5Ah Li-ion Power Tool Battery.
- CP1200BP3 - 12V 3Ah Lithium-ion Power Tool Battery.
- CP1200BP4 - 12V 4Ah Lithium-ion Power Tool Battery.
- CP1200MC - 12V Lithium-ion Battery Charger.
- CP1200CB - Canvas Tool Storage Bag.

- Model No. **CP1200COMBO2B**
- List Price £429.95

STORAGE BAG INCLUDED

£299.95 Exc. VAT
£359.94 Inc. VAT



SV20 SERIES

The SV20 Series offers quality, stylish, lightweight tools designed with composite housing and a soft grip, making them comfortable and easy to use. Highly suited to heavy-duty tasks, these tools deliver powerful outputs without compromising on operating time. The series provides a choice of three lithium batteries ranging from 2Ah, for a faster charge, up to 6Ah for a longer lasting runtime.



BRUSHLESS MOTOR Brushless motor, which gives an improved performance and requires less maintenance than the brushed equivalent, giving you a more efficient, longer lasting tool.



20V SV20 Series Ø13mm Brushless Hammer Drill/Driver Kits

Ø13mm **VARIABLE SPEED**

- Durable composite housing with soft grip for added comfort.
- Ø2-13mm Keyless chuck.
- Three drill functions and 21 torque settings provide the control required to complete various tasks.
- Built-in LED work light.
- Forward, reverse and trigger-lock.
- Supplied with belt hook for safer storage whilst not in use.
- Kits are supplied with a mains fast charger and canvas storage bag.



Model No. CP20VDDXKIT1

STORAGE BAG INCLUDED

Model No.	Type	Batteries in Kit	List Price	Exc. VAT	Inc. VAT
CP20VDDXKIT1	Kit	1 x 2Ah	£184.95	£129.95	£155.94
CP20VDDXKIT	Kit	1 x 2Ah, 1 x 4Ah	£256.95	£179.95	£215.94
CP20VDDX	Body Only	-	£109.95	£87.95	£105.54

20V SV20 Series 1/4" Hex Brushless Impact Driver 200Nm Kits

For 1/4" Hex Bits **200Nm Torque** **VARIABLE SPEED**

- Durable composite housing with soft grip for added comfort.
- 1/4" Hex quick release chuck.
- Variable speed control trigger.
- Three speed options in forward and two speed options in reverse.
- Trigger-lock.
- Built-in LED work light.
- Supplied with belt hook for safer storage whilst not in use.
- Kits are supplied with a mains fast charger and canvas storage bag.



Model No. CP20VIDXKIT1

STORAGE BAG INCLUDED

Model No.	Type	Batteries in Kit	List Price	Exc. VAT	Inc. VAT
CP20VIDXKIT1	Kit	1 x 2Ah	£182.45	£127.95	£153.54
CP20VIDXKIT	Kit	1 x 2Ah, 1 x 4Ah	£254.45	£177.95	£213.54
CP20VIDX	Body Only	-	£107.45	£85.95	£103.14

20V SV20 Series Ø180mm Brushless Rotary Polisher Kits

Ø180mm **VARIABLE SPEED**
NEW PRODUCT

- Ø180mm backing pad.
- 6-Speed settings.
- No load speed: 800-2300rpm.
- Thread size: M14.
- Variable speed trigger with lock.
- Supplied with two interchangeable polishing pad heads and key for quick backing pad changes.
- Kits are supplied with a mains fast charger and canvas storage bag.



Model No. CP20VRPXKIT1

STORAGE BAG INCLUDED

Model No.	Type	Batteries in Kit	List Price	Exc. VAT	Inc. VAT
CP20VRPXKIT1	Kit	1 x 4Ah	£224.95	£156.95	£188.34
CP20VRPXKIT	Kit	2 x 4Ah	£249.95	£174.95	£209.94
CP20VRPX	Body Only	-	£149.95	£119.95	£143.94

20V SV20 Series Brushless Reciprocating Saw Kits

VARIABLE SPEED
NEW PRODUCT

- Suitable for cutting wood, board and soft metals.
- No load speed 0-3100spm.
- Stroke length: 28mm
- Variable speed trigger switch.
- 2-Stage operation switch for added safety.
- Keyless blade change system.
- LED work light.
- Kits are supplied with a mains fast charger and canvas storage bag.



Model No. CP20VRSXKIT1

STORAGE BAG INCLUDED

Model No.	Type	Batteries in Kit	List Price	Exc. VAT	Inc. VAT
CP20VRSXKIT1	Kit	1 x 4Ah	£244.95	£169.95	£203.94
CP20VRSXKIT	Kit	2 x 4Ah	£315.95	£219.95	£263.94
CP20VRSX	Body Only	-	£144.95	£115.95	£139.14

20V SV20 Series Lithium-ion Power Tool Batteries



- Lithium-ion battery packs compatible with CP20V Series.
- Features LED battery level indicator.



Model No.	Power	Charging Time	List Price	Exc. VAT	Inc. VAT
CP20VBP2	2Ah	45mins	£44.95	£35.95	£43.14
CP20VBP4	4Ah	90mins	£76.95	£59.95	£71.94
CP20VBP6	6Ah	130mins	£99.95	£79.95	£95.94

20V SV20 Series Battery Chargers

- Mains charger for Model No's CP20VBP2, CP20VBP, CP20VBP4, CP20VBP6 power tool batteries.
- LED indicates status of battery from charging to full.



Model No. CP20VMC2

Model No. CP20VMC

Model No.	Battery Capacity	List Price	Exc. VAT	Inc. VAT
CP20VMC	Single	£23.95	£18.95	£22.74
CP20VMC2	Dual	£43.95	£32.95	£39.54

USB Charge Port for SV20 Series

- Slides onto Sealey 20V batteries to provide a 5V USB charging output for mobile devices.
- Built-in 30 Lumen LED light controlled by on/off switch.
- Fitted with belt hook for charging on the go.
- **Model No. CP20VCP**
- List Price £18.95



£9.95 Exc. VAT
£11.94 Inc. VAT



Rear USB Port.



Battery not included.

SV20 SERIES

The SV20 Series offers quality, stylish, lightweight tools designed with composite housing and a soft grip, making them comfortable and easy to use. Highly suited to heavy-duty tasks, these tools deliver powerful outputs without compromising on operating time. The series provides a choice of three lithium batteries ranging from 2Ah, for a faster charge, up to 6Ah for a longer lasting runtime.

FAST CHARGE



5 x 20V SV20 Series Cordless Tool Combo 2 Batteries



Package includes:

- CP20VDD - 20V Hammer Drill/Driver - Body Only.
- CP20VIW - 20V 1/2" Sq Drive Impact Wrench 230Nm - Body Only.
- CP20VAGB - 20V Ø115mm Cordless Angle Grinder - Body Only.
- CP20VRS - 20V Reciprocating Saw - Body Only.
- CP20VOS - 20V Ø125mm Orbital Palm Sander - Body Only.
- CP20VBP2 - 20V 2Ah Lithium-ion Power Tool Battery.
- CP20VBP4 - 20V 4Ah Lithium-ion Power Tool Battery.
- CP20VMC - 20V Lithium-ion Battery Charger.
- AP8250 - ABS Stackable Click Together Toolbox - Large.

£319.95 Exc. VAT
£383.94 Inc. VAT

- Model No. CP20VCOMBO2
- List Price £449.95

8 x 20V SV20 Series Cordless Tool Combo 4 Batteries



Package includes:

- CP20VDD - 20V Hammer Drill/Driver - Body Only.
- CP20VID - 20V 1/4" Hex Impact Driver Drive 180Nm - Body Only.
- CP20VIW - 20V 1/2" Sq Drive Impact Wrench 230Nm - Body Only.
- CP20VAGB - 20V Ø115mm Cordless Angle Grinder - Body Only.
- CP20VMT - 20V Oscillating Multi-Tool - Body Only.
- CP20VRS - 20V Reciprocating Saw - Body Only.
- CP20VOS - 20V Ø125mm Orbital Palm Sander - Body Only.
- PC20SD20V - 20V 20L Cordless Wet & Dry Vacuum Cleaner - Body Only.
- CP20VBP2 - 20V 2Ah Lithium-ion Power Tool Battery (x2).
- CP20VBP4 - 20V 4Ah Lithium-ion Power Tool Battery (x2).
- CP20VMC2 - 20V Dual Battery Charger for SV20 Series.
- AP8250 - ABS Stackable Click Together Toolbox - Large.
- AP8130 - ABS Stackable Click Together Toolbox - Small.

£569.95 Exc. VAT
£683.94 Inc. VAT

- Model No. CP20VCOMBO4
- List Price £799.95

20V SV20 Series 3 x Garden Power Tool Kit - 2 Batteries



Package includes:

- CS20V - 20V SV20 Series Cordless Strimmer - Body Only.
- CB20V - 20V SV20 Series Cordless Leaf Blower - Body Only.
- CHT20V - 20V SV20 Series Cordless Hedge Trimmer - Body Only.
- CP20VBP2 - 20V 2Ah Lithium-ion Power Tool Battery.
- CP20VBP4 - 20V 4Ah Lithium-ion Power Tool Battery.
- CP20VMC - 20V Lithium-ion Battery Charger.

£199.95 Exc. VAT
£239.94 Inc. VAT

- Model No. CP20VCOMBO6
- List Price £284.95

20V SV20 Series 15L Cordless Garden Backpack Sprayer Kits

NEW PRODUCT

- 15L water tank with a lance holder clip.
- Water flow: 1.3L/min.
- Max Pressure: 1.6bar.
- Spraying lance including hose is 2.53m.
- Supplied with three different nozzles to meet different needs and an auto-cut-off function.
- Strong durable back straps to ensure comfort when worn.
- Added filter to prevent larger particles clogging the machine.
- Kits are supplied with a mains fast charger and canvas accessory storage bag.



Model No. CP20VGBSKIT1



Model No.	Type	Batteries in Kit	List Price	Exc. VAT	Inc. VAT
CP20VGBSKIT1	Kit	1 x 2Ah	£194.95	£134.95	£161.94
CP20VGBSKIT	Kit	1 x 2Ah, 1 x 4Ah	£265.95	£184.95	£221.94
CP20VGBS	Body Only	-	£119.95	£95.95	£115.14

20V SV20 Series Cordless 3-in-1 Garden Tool Kits

NEW PRODUCT



Model No. CP20VGT3KIT1

STORAGE BAG INCLUDED

- Ergonomic design and lock-in function make it comfortable and easy to use.
- Three tool-less interchangeable functions.
- Grass shearing blade cutting width 90mm.
- Hedge trimmer blade for light trimming, cutting length 200mm.
- Raker length 100mm.
- Kits are supplied with a mains fast charger and canvas storage bag.

Model No.	Type	Batteries in Kit	List Price	Exc. VAT	Inc. VAT
CP20VGT3KIT1	Kit	1 x 2Ah	£124.95	£87.95	£105.54
CP20VGT3KIT	Kit	1 x 2Ah, 1 x 4Ah	£194.95	£134.95	£161.94
CP20VGT3	Body Only	-	£49.95	£39.95	£47.94

20V 2Ah SV20 Series Telescopic Cordless Hedge Trimmer Kit - 1 Battery

- No-Load Speed: 1300spm.
- Cutting Depth: 15mm.
- Cutting Length: 450mm.
- 90° Rotating head.



NEW PRODUCT

Package includes:

- CP20VTP - 20V SV20 Series Cordless Telescopic Pole for CP20VPSH/CP20VPHT.
- CP20VPHT - 20V SV20 Series Cordless Pole Hedge Trimmer - Body Only.
- CP20VBP2 - 20V 2Ah Lithium-ion Power Tool Battery.
- CP20VMC - 20V Lithium-ion Battery Charger.

- Model No. CP20VTP01
- List Price £229.95

£159.95 Exc. VAT
£191.94 Inc. VAT

20V 4Ah SV20 Series Telescopic Cordless 20cm Chainsaw Kit - 1 Battery

- 200mm Chainsaw bar length.
- 8m/s Cutting speed.
- Chain Pitch: 3/8".
- 90° Pivoting head.
- Automatic chain lubrication with 100ml capacity oil tank.



NEW PRODUCT

Package includes:

- CP20VTP - 20V SV20 Series Cordless Telescopic Pole for CP20VPSH/CP20VPHT.
- CP20VPSH - 20V SV20 Series 20cm Cordless Chainsaw Head - Body Only.
- CP20VBP4 - 20V 4Ah Lithium-ion Power Tool Battery.
- CP20VMC - 20V Lithium-ion Battery Charger.

- Model No. CP20VTP02
- List Price £264.95

£184.95 Exc. VAT
£221.94 Inc. VAT

20V SV20 Series Telescopic Cordless Hedge Trimmer & Chainsaw Kit - 2 Batteries

NEW PRODUCT



Model No. CP20VTP/CP20VPSH Shown

Package includes:

- CP20VTP - 20V SV20 Series Cordless Telescopic Pole for CP20VPSH/CP20VPHT.
- CP20VPHT - 20V SV20 Series Cordless Pole Hedge Trimmer - Body Only
- CP20VPSH - 20V SV20 Series 20cm Cordless Chainsaw Head - Body Only.
- CP20VBP2 - 20V 2Ah Lithium-ion Power Tool Battery.
- CP20VBP4 - 20V 4Ah Lithium-ion Power Tool Battery.
- CP20VMC - Battery Charger 20V Lithium-ion.

- Model No. CP20VTPCOMBO
- List Price £306.95



£214.95 Exc. VAT
£257.94 Inc. VAT

Ø150mm Variable Speed Brushless Electric Palm Sander 350W/230V

Ø150mm
VARIABLE SPEED
 350W



- Ergonomic and compact lightweight sander.
- Brushless motor with constant speed control even whilst under load.
- 7-Stage variable speed control.
- Digital display.
- Supplied with dust-free Ø150mm backing pad, four sanding discs and dust extraction hose.
- **Model No. DAS150PS**
- List Price £214.95

£169.95 Exc. VAT
£203.94 Inc. VAT

Ø150mm Dual Action Variable Speed Sander 710W

Ø150mm
 Dual Action
VARIABLE SPEED
 710W



- Patented eccentric assembly with sealed double bearings give Ø9mm orbital diameter.
- Variable speed control from 2000-4600rpm.
- Fitted with 2m mains cable and 3-pin plug.
- Alloy bevel gear head with smooth composite motor housing for added comfort.
- Side mounted slider type power control with power lock.
- Supplied with Ø150mm hook-and-loop pad and handle.
- **Model No. DAS150T**
- List Price £149.95

£119.95 Exc. VAT
£143.94 Inc. VAT

Ø150mm Dual Action Variable Speed Dust-Free Sander 750W

Ø150mm
VARIABLE SPEED
 750W



- Features variable speed control ranging from 4000-7000rpm.
- Rotating self-contained dust extraction.
- Alloy bevel gear head with composite motor housing.
- Supplied with Ø150mm hook-and-loop backing pad and side handle.
- **Model No. DAS151**
- List Price £144.95

£89.95 Exc. VAT
£107.94 Inc. VAT



Ø230mm Car Polisher 110W

- Random orbital polisher with Ø230mm 5-ply foam pad and two polishing bonnets.
- Smooth operation provides even buffing/polishing with no hot spots.
- High impact, durable ABS housing with 360° grip.
- Supplied with 4m cable and 3-pin plug.
- **Model No. ER230P**
- List Price £63.95

£46.95 Exc. VAT
£56.34 Inc. VAT



Ø230mm

Ø125mm Dual Action Palm Sander 240W

- Compact, ergonomic and lightweight design finished with soft grip.
- Powered by a 240W motor with on/off switch.
- Dual action orbit of Ø3mm allows use for various sanding applications.
- Features a self-contained dust extraction port with dust collection bag.
- Fitted with Ø125mm hook-and-loop backing pad and supplied with two sanding discs.
- **Model No. S0125**
- List Price £47.95

£36.95 Exc. VAT
£44.34 Inc. VAT



Siegen

Ø125mm
 240W

600W Spot Polisher Kit

Premier 600W
3 YEAR GUARANTEE
VARIABLE SPEED

- Rotary spot polisher kit.
- Ergonomic slim body design.
- 6-Stage variable speed control from 700-2500rpm.
- Spindle lock for easy pad and shaft changes.
- Soft start for greater control.
- Fitted with 5m mains cable.
- Supplied with a selection of polishing pads, side handle and spare brushes.
- **Model No. SPK600**
- List Price £199.95



£164.95 Exc. VAT
£197.94 Inc. VAT

SEE PAGE 88 FOR ADDITIONAL POLISHER PAD KITS



Ø180mm Variable Speed Sander/Polisher 1200W

Ø180mm **VARIABLE SPEED** 1200W

- Variable speed control from 600-3300rpm.
- Choice of two side handles - traditional or over-the-top style.
- Spindle lock for fast and easy pad/foam head changes.
- Supplied with backing pad, polishing bonnet, spare brushes and hex spanner.

• **Model No. MS875PS**
• List Price £107.45



£74.95 Exc. VAT
£89.94 Inc. VAT



Ø170mm Variable Speed Sander/Polisher 1300W

Ø170mm **VARIABLE SPEED** 1300W

- 1300W Professional sander/polisher.
- 6-Position electronic variable speed control.
- Speed Range: 1400-3000rpm.
- Supplied with side handle, backing pad and disc spanner.

• Also available with Schuko plug - Model No. MS900PSEU.

• **Model No. MS900PS**
• List Price £119.95



£84.95 Exc. VAT
£101.94 Inc. VAT



Ø180mm Variable Speed Sander/Polisher 1400W

Ø180mm **VARIABLE SPEED** 1400W

- Heavy-duty 1400W motor enclosed in a robust composite housing.
- Soft start, constant power motor ideal for polishing or sanding.
- Variable speed control from 600-3000rpm, in 6-speed settings.
- Alloy gear head with protective rubber casing.
- Supplied with side handle, 'D' Handle, backing pad and bonnet.

• **Model No. MS925PS**
• List Price £129.95



£89.95 Exc. VAT
£107.94 Inc. VAT



Ø180mm Lightweight Polisher 1100W

Ø180mm **VARIABLE SPEED** 1100W

- Powerful 1100W motor enclosed in a lightweight housing.
- Maintains high torque levels at low speeds, ideal for polishing.
- Variable speed control from 600-3000rpm.
- Pad Size/Thread Size: Ø180mm/M14 x 2mm.
- Spindle lock for fast and easy pad/foam head changes.
- Supplied with side handle, backing pad and polishing bonnet.
- Fitted with 3m mains cable.



Model No. ER1700P

Model No.	Digital	List Price	Exc. VAT	Inc. VAT
ER1700P	X	£107.95	£79.95	£95.94
ER1700PD	✓	£124.95	£89.95	£107.94

Ø180mm Lightweight Digital Polisher 1100W



Model No. ER1700PD

- Digital display for variable speed control from 1000-3000rpm, stepping-up in 500rpm increments.

8/12mm Variable Speed Belt Sander 400W

VARIABLE SPEED
400W



- Features three different sanding arms using 8 or 12mm belts to suit the working area.
- Self-contained dust collection bag to fit exhaust.
- Variable speed power control.
- Belt tension release lever for simple removal/replacement.
- Supplied in storage case.

• **Model No. SBS35**
• List Price £87.45

£62.95 Exc. VAT
£75.54 Inc. VAT

12mm Variable Speed Belt Sander 260W

VARIABLE SPEED
260W



- Angle of sanding arm can be adjusted by up to 60°.
- Removable exhaust supplied for use with extraction systems.
- Variable speed power control.
- Push to lock, with button release for quick and simple belt replacement.
- Belt Size (W x L): 12 x 456mm.
- No-Load Speed: 772-1200rpm.
- Weight: 1.15kg.
- Replacement belts readily available.

• **Model No. SBS260**
• List Price £73.95

£53.95 Exc. VAT
£64.74 Inc. VAT



SANDERS & POLISHERS

Premier

VARIABLE SPEED

Ø150mm

5m

Ø150mm Rotary Polisher 1050W/230V

A



1050W

- 6-Stage variable speed control from 700-2500rpm.
- Soft start for greater control.
- Vibration reducing motor to allow for longer working times with reduced fatigue.
- Spindle lock for fast and easy pad changes.
- Double-torque gearing system.
- Fitted with 5m mains cable.
- Supplied with Ø150mm backing pad, side handle, wrench and spare brushes.

£134.95 Exc. VAT

£161.94 Inc. VAT

- **Model No. RP1500**
- List Price £179.95

3 YEAR
GUARANTEE*

Ø150mm Orbital Polisher 750W/230V

B



750W

- 6-Stage variable speed control ranging from 2000-4500rpm.
- Vibration reducing motor and rubberised gear head cover allow for greater comfort and reduce user fatigue.
- Soft start for greater control.
- Speed stabilizer to ensure constant speed output.
- Ø21mm Orbit specifically designed for use in the bodyshop.
- Supplied with Ø150mm backing pad, Ø180mm foam polishing pads (x2), side handle, wrench and spare brushes.

£159.95 Exc. VAT

£191.94 Inc. VAT

- **Model No. OP7500**
- List Price £239.95

Ø150mm Random Orbital Electric Sander 600W

C



600W

- 6-Stage variable speed control from 3200-7200rpm.
- Ergonomic rubberised gear head casing for added comfort and grip during use.
- Ø9mm Orbit designed specifically for use on car body repairs.
- Supplied with Ø150mm hook-and-loop backing pad, side handle, spare brushes and hex key.

£149.95 Exc. VAT

£179.94 Inc. VAT

- **Model No. OS600**
- List Price £219.95

Ø150mm Random Orbital Electric Sander 400W

D



400W

- 6-Stage variable speed control from 4000-10000rpm.
- Ergonomic rubberised gear head casing for added comfort and grip during use.
- Ø5mm Orbit designed specifically for use on car body repairs.
- Supplied with Ø150mm hook-and-loop backing pad, spare brushes and hex key.

£139.95 Exc. VAT

£167.94 Inc. VAT

- **Model No. OS400**
- List Price £199.95



A

B

C

D

Angle Grinders



Grinding discs not included, order Model No's
 Ø100mm - PTC/100G
 Ø125mm - PTC/125G
 Ø230mm - PTC/230G

- Suitable for a variety of trade applications.
- Features heavy-duty alloy bevel gear head with spindle lock for fast loading/unloading of discs.
- Vibration reducing double injection composite body with rubber coating for added comfort.
- Tool-less wheel guard adjustment.
- Built-in LED power indicator.
- Supplied with side handle and spanner.
- Fitted with over 2m of power cable and 3-pin plug.
- Model No. SAG230 features 2-stage trigger for added safety.

Ref.	Model No.	Size	Power	RPM	List Price	Exc. VAT	Inc. VAT
A	SAG101	Ø100mm	750W	12000	£49.95	£35.95	£43.14
B	SAG125	Ø125mm	1100W	12000	£59.95	£43.95	£52.74
C	SAG230	Ø230mm	2000W	6500	£109.95	£79.95	£95.94

300W Variable Speed Quick Change Oscillating Multi-Tool 230V



SEE PAGE 89 FOR UNIVERSAL MULTI-TOOL ACCESSORIES.

300W VARIABLE SPEED Quick Change

- One tool suitable for multiple tasks such as sanding, scraping and cutting various materials.
- Variable speed with 300W motor and sealed bearings.
- Quick release lever makes changing blades fast and simple.
- Includes four sanding discs, backing pad, cutting blade, scraper blade and dust extraction pipe.
- Supplied in a handy storage case.
- Full range of additional quick change accessories available.
- Model No. SMT300Q
- List Price £69.95

£49.95 Exc. VAT
 £59.94 Inc. VAT



Drill Powered Rivet Nut Adaptor



- Suitable for use with electric drills with torque in excess of 15Nm.
- 1/4" Shank for easy fitting in to the drill chuck.
- Supplied with M3, M4, M5, M6 and M8 rivet nut mandrels.
- Suitable for use with aluminium, steel and stainless steel rivet nuts.
- Model No. DRA02
- List Price £64.95

£44.95 Exc. VAT
 £53.94 Inc. VAT

Drill Powered Water Pump



- Suitable for use with electric drill with output of 350W or more.
- Composite housing supplied with 2 x 1/2" quick release couplings.
- Model No. TP51
- List Price £27.45

£18.95 Exc. VAT
 £22.74 Inc. VAT

Heavy-Duty Drill Powered Water Pump



HEAVY DUTY

- Delivers up to 220L/hr of fluid at 3000rpm.
- Housed in a durable composite casing with 21mm inlet/outlet.
- Requires an electric drill with output of 350W or more.
- Suitable for water, organic solvents, motor oil, heating oil, insecticides, pesticides, liquid fertilizers and other non-aggressive liquids.
- Model No. TP53
- List Price £43.95

£29.95 Exc. VAT
 £35.94 Inc. VAT

20V 2Ah Cordless Riveter



20V

FAST CHARGE

- Suitable for aluminium, steel and stainless steel rivets from 2.4 to 5mm.
- Powered by a 20V 2Ah Lithium-ion battery with a pulling force of up to 9000N.
- Four selectable power settings help preserve battery by only supplying the force required.
- LED battery level indicator.
- Four riveting nozzle: 2.4, 3.2, 4, 4.8mm.
- Supplied in durable plastic storage case with mains charger and 2Ah Lithium-ion battery.
- **Model No. CP314**
- List Price £329.95

£139.95 Exc. VAT
£167.94 Inc. VAT

20V 2Ah Lithium-ion Battery for CP314 & CP316

20V



Lithium RECHARGEABLE

- Battery pack for Model No. CP314 Cordless Riveter and Model No. CP316 Cordless Nut Riveter.
- **Model No. CP3BP**
- List Price £49.95

£39.95 Exc. VAT
£47.94 Inc. VAT

14.4V Ø10mm Cordless Drill/Driver



14.4V

28Nm Torque

VARIABLE SPEED

- Compact, cordless drill/driver with Ø0.8-10mm keyless chuck.
- Forward, reverse and lock function with high/low speed selection and 18 torque settings.
- Integral LED work light and LED battery level indicator.
- Drilling Capacity: 20mm Wood/10mm Metal.
- Maximum Torque: 28Nm.
- Battery: 14.4V 1.3Ah Lithium-ion.
- Supplied in storage case with battery and mains charger.
- **Model No. CP14VLD**
- List Price £69.95

£49.95 Exc. VAT
£59.94 Inc. VAT

1/2" Sq Drive Impact Wrench 230V

1/2" Sq. Drive

300Nm Torque

VARIABLE SPEED

230V



- Powerful, ergonomic and capable of removing the most stubborn of wheel nuts.
- Produces up to 300Nm(222lb.ft) of torque in both directions.
- Fitted with a 2m heavy-duty rubberised cable.
- Features a rubber grip for added comfort and forward/reverse rocker switch.
- Supplied in a storage case with four impact sockets (17, 19, 21, 22mm).
- **Model No. IW230V**
- List Price £83.95

£19.95 Exc. VAT
£23.94 Inc. VAT

£44.95 Exc. VAT
£53.94 Inc. VAT

14.4V 1.3Ah Lithium-ion Power Tool Battery for CP14VLD

14.4V

Lithium RECHARGEABLE

- Battery pack for Model No. CP14VLD Ø10mm 14.4V Cordless Drill/Driver.
- **Model No. CP14VLDDBP**
- List Price £26.95



18V 1/2" Sq Drive Cordless Impact Wrench

- Brushless motor produces maximum torque of up to 1000Nm(738lb.ft).
- Variable speed trigger for greater control.
- Three selectable speed settings.
- Cast aluminium gearbox.
- Double injection body with rubber grips for added comfort.
- Fitted with electronic brake.
- LED Work light illuminates work area when trigger is pressed.
- Supplied in storage case with 4Ah Lithium-ion battery and mains charger.
- Charging Time: 2hr.
- **Model No. CP1812**
- List Price £299.95

£239.95 Exc. VAT
£287.94 Inc. VAT

18V 4Ah Lithium-ion Power Tool Battery for CP1812

18V

Lithium RECHARGEABLE

- Battery pack for Model No. CP1812 Cordless Impact Wrench.
- **Model No. CP1812BP**
- List Price £79.95



£54.95 Exc. VAT
£65.94 Inc. VAT



18V

1/2" Sq. Drive

1000Nm Torque

VARIABLE SPEED



40W Electric Glue Gun - 230V



- Composite housing with comfortable handle and trigger feed control.
- Fitted with 1.1m cable and 3-pin plug.
- Suitable for hardwoods, softwoods, plastics and other similar materials.
- Includes two glue sticks.
- **Model No. AK292**
- List Price £12.95

£8.95 Exc. VAT
£10.74 Inc. VAT

80W Glue Gun - 230V



- Ready to use in less than 5 minutes.
- Unplug for cordless use once fully heated.
- On/off switch and trigger feed control.
- Composite housing with folding stand.
- Suitable for Ø11 x 100mm glue sticks.
- Two glue sticks can be loaded at once.
- 25pc Glue stick packs available separately - Model No. AK292/2.
- **Model No. AK292**
- List Price £26.95

£16.95 Exc. VAT
£20.34 Inc. VAT

3.7V Cordless Glue Gun



3.7V

Lithium RECHARGEABLE

- Powered by a 3.7V 1.3Ah Lithium-ion battery.
- Features LED light indicators to show when tool is ready to use.
- Ready to use in just 20 seconds.
- Operating time of 30 minutes on a full charge.
- Supplied with four glue sticks and USB charging cable.
- Suitable for Ø7.2mm glue sticks.
- **Model No. AK2923**
- List Price £37.45

£24.95 Exc. VAT
£29.94 Inc. VAT

1800W 3-Speed Hot Air Gun 50/420/650°C



Premier

Variable Temperature

- Equipped with 3-speed and temperature control.
- Suitable for paint stripping, soft soldering, removing sticky labels and defrosting frozen pipes.
- Supplied with four nozzles and a scraper.
- Gun is designed to stand vertically, allowing use as a safe Bunsen burner alternative.
- Fitted 3-pin plug.
- **Model No. HS100**
- List Price £69.95

£54.95 Exc. VAT
£65.94 Inc. VAT



2000W Variable Temperature Hot Air Gun Kit



Variable Temperature

- 2-Step airflow control switch, with variable temperature range on both levels.
- Temperature Range: 50-450°C/90-600°C.
- Gun is designed to stand vertically, allowing use as a safe Bunsen burner alternative.
- Suitable for paint stripping, soft soldering, removing sticky labels and defrosting frozen pipes.
- Fitted 3-pin plug.
- Airflow: 250, 500L/min.
- **Model No. HS107K**
- List Price £65.95

£49.95 Exc. VAT
£59.94 Inc. VAT



26pc 3.6V Cordless Screwdriver Set



3.6V

VARIABLE SPEED Lithium RECHARGEABLE



- Compact, lightweight and comfortable to use.
- Features locking swivel adjustment from pistol to straight grip.
- Forward, reverse and trigger-lock with soft grip handle.
- Eight adjustable torque settings coupled with a quick release bit holder.
- Features LED work light and three colour battery indicator.
- Supplied with 24 assorted bits and mains charging cable.
- **Model No. CP36B**
- List Price £34.95

£26.95 Exc. VAT
£32.34 Inc. VAT

14pc 3.7V Quick Select Cordless Screwdriver



3.7V

VARIABLE SPEED Lithium RECHARGEABLE



- Compact, lightweight and comfortable to use.
- Quick bit selection combined with six bit magazine storage system.
- Pull-out bit selection system - pull-out, select bit, pull-back.
- Forward, reverse and trigger-lock with soft grip handle.
- Features LED work light and three colour battery indicator.
- Contents: Screwdriver Bits; Slotted - 3, 4, 5mm, Phillips - #1, #2, #3, Pozi - #1, #2, #3, TRX-Star* - T10, T15, T20, USB Charging Cable.
- **Model No. CP36MS**
- List Price £39.95

£29.95 Exc. VAT
£35.94 Inc. VAT

26mm SDS Plus Rotary Hammer Drill 900W/230V



26mm
SDS Plus
 900W
 230V

- Powerful rotary hammer drill with SDS Plus chuck.
- Three drilling functions.
- Safety clutch system.
- Supplied in storage case with 8mm, 10mm and 12mm masonry drill bits, pin and cold chisels and PVC dust cap.
- Fitted with 360° auxiliary handle.
- **Model No. SDSPLUS26**
- List Price £69.95

£54.95 Exc. VAT
£65.94 Inc. VAT

Ø13mm Variable Speed Hammer Drill with Reverse 850W



13mm
VARIABLE SPEED
 850W
 230V

- Professional 850W hammer drill with variable speed and reverse controls.
- Suitable for driving and removing screws.
- Hammer action allows up to Ø13mm capacity in masonry.
- Features high quality Ø13mm chuck with soft grip handle and body for added comfort.
- Supplied with adjustable side handle, depth stop and 2m cable with 3-pin plug.
- **Model No. SD800**
- List Price £69.95

£49.95 Exc. VAT
£59.94 Inc. VAT

80L Electric Paddle Mixer 1220W

1220W
 230V



- Powerful electric mixer with a mixing volume of up to 80L.
- 2-Speed settings and soft start allow for greater control when mixing.
- Supplied with two mixing paddles capable of mixing paint, varnish, tile adhesive, cement, plaster, mortar, as well as a number of other liquid and dense materials.
- Lightweight at only 4.7kg.
- Fitted with over 2m of power cable.
- **Model No. PM80L**
- List Price £99.95

£69.95 Exc. VAT
£83.94 Inc. VAT

120L Electric Paddle Mixers 1400W



1400W



230V
 Model No. PM120L



110V
 Model No. PM120L110V

- Powerful electric mixers with a mixing volume of up to 120L.
- 6-Speed settings and soft start allow for greater control when mixing.
- Supplied with two mixing paddles capable of mixing paint, varnish, tile adhesive, cement, plaster, mortar, as well as a number of other liquid and dense materials.
- Lightweight at only 7.5kg.
- Fitted with over 2m of power cable.

Model No.	Supply	List Price	Exc. VAT	Inc. VAT
PM120L	230V	£119.95	£79.95	£95.94
PM120L110V	110V	£123.95	£89.95	£107.94

DEMOLITION BREAKER HAMMERS

VIBRATION REDUCING SHOCK ABSORBERS BUILT INTO BODY.

SUPPLIED IN STORAGE CASE WITH CHISELS.

360° AUXILIARY HANDLE.

VARIABLE ⇌ **SPEED** TRIGGER.



1300W



MODEL NO.

DHB1300

£99.95 Exc. VAT
£119.94 Inc. VAT

LIST PRICE £129.95



1600W



MODEL NO.

DHB1600

£159.95 Exc. VAT
£191.94 Inc. VAT

LIST PRICE £199.95

Silver Easy Cut Diamond Blades



Model No.
WDEC115

- Suitable for cutting most type of building materials.

Model No.	Size	List Price	Exc. VAT	Inc. VAT
WDEC115	Ø115 x 22mm	£4.95	£3.95	£4.74
WDEC300/20	Ø300 x 20mm	£37.95	£19.95	£23.94

Ø115 x 1.6mm Universal Cutting Disc Ø22.2mm Bore

Ø115mm



- Model No. PTC/115MC
- List Price £1.85

£1.25 Exc. VAT
£1.50 Inc. VAT

Ø115 x 13mm Polycarbide Abrasive Cup Wheel Ø22mm Bore

Ø115mm



- Versatile abrasive wheel for use with Sealey and other leading makes of grinding and cutting power tools.
- Suitable for removal of paint/rust and other flaking materials when a less harsh abrasive is needed.
- Model No. PTC/CW115
- List Price £11.95

£7.95 Exc. VAT
£9.54 Inc. VAT

Cutting Discs - Packs of 5



Model No.
PTC/100CET5

- General-purpose flat cutting discs recommended for use with Sealey and other makes of grinding and cutting power tools.

Model No.	Size	Bore	List Price	Exc. VAT	Inc. VAT
PTC/100CET5	Ø100 x 1.2mm	Ø16mm	£4.60	£3.15	£3.78
PTC/115CET5	Ø115 x 1.2mm	Ø22mm	£5.95	£3.95	£4.74

Cutting Discs Ø22mm Bore



- General-purpose flat cutting discs recommended for use with Sealey and other makes of grinding and cutting power tools.
- Suitable for cutting stainless steel.

Model No.	Size	List Price	Exc. VAT	Inc. VAT
PTC/115CET	Ø115 x 1.2mm	£1.35	£0.95	£1.14
PTC/115CT	Ø115 x 1.6mm	£1.35	£0.95	£1.14
PTC/115C	Ø115 x 3mm	£1.45	£1.05	£1.26

63pc Rotary Tool Sanding Bands Set



- For sanding, shaping and surface preparation in small confined areas.
- Compatible with Sealey and most popular branded rotary tools.

- Model No. RTA63SB
- List Price £6.95

£4.95 Exc. VAT
£5.94 Inc. VAT

Ø100 x 13mm Polycarbide Spindle Wheel



- Suitable for removal of paint/rust and other flaking materials when a less harsh abrasive is needed.

- Model No. PTC/SW100
- List Price £9.35

£6.55 Exc. VAT
£7.86 Inc. VAT



M14 Quick Change Angle Grinder Locking Nut

M14

- Easy-to-use, can tighten and release discs by hand.
- Suitable for Sealey and most popular branded angle grinders.
- Thread: M14 x 2mm.
- Model No. PTC/QCNM14
- List Price £14.95

£11.95 Exc. VAT
£14.34 Inc. VAT



SUITABLE FOR:

- DESCALING
- DERUSTING
- WELD PREPARATION
- WELD CLEANING
- GENERAL SURFACE PREPARATION

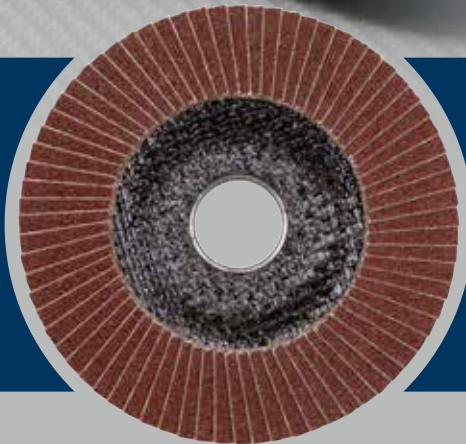

Abrasive flaps attached to rigid disc with epoxy adhesive - does not require backing pad.

Depressed centre disc suitable for electric and air tools.

ALUMINIUM OXIDE FLAP DISCS

Ideal for occasional trade use.

Model No.	Size	Bore	Grit	List Price	Exc. VAT	Inc. VAT
FD10040E	Ø100mm	Ø16mm	40	£1.95	£1.40	£1.68
FD10060E	Ø100mm	Ø16mm	60	£1.95	£1.40	£1.68
FD10080E	Ø100mm	Ø16mm	80	£1.95	£1.40	£1.68
FD100120E	Ø100mm	Ø16mm	120	£1.95	£1.40	£1.68
FD11540E	Ø115mm	Ø22mm	40	£2.45	£1.75	£2.10
FD11560E	Ø115mm	Ø22mm	60	£2.45	£1.75	£2.10
FD11580E	Ø115mm	Ø22mm	80	£2.45	£1.75	£2.10
FD115120E	Ø115mm	Ø22mm	120	£2.45	£1.75	£2.10
FD12540E	Ø125mm	Ø22mm	40	£2.85	£1.95	£2.34
FD12560E	Ø125mm	Ø22mm	60	£2.85	£1.95	£2.34
FD12580E	Ø125mm	Ø22mm	80	£2.85	£1.95	£2.34
FD125120E	Ø125mm	Ø22mm	120	£2.85	£1.95	£2.34

ZIRCONIUM FLAP DISCS

Recommended for frequent professional use.

Model No.	Size	Bore	Grit	List Price	Exc. VAT	Inc. VAT
FD10040	Ø100mm	Ø16mm	40	£2.95	£1.95	£2.34
FD10060	Ø100mm	Ø16mm	60	£2.95	£1.95	£2.34
FD10080	Ø100mm	Ø16mm	80	£2.95	£1.95	£2.34
FD100120	Ø100mm	Ø16mm	120	£2.95	£1.95	£2.34
FD11540	Ø115mm	Ø22mm	40	£3.75	£2.60	£3.12
FD11560	Ø115mm	Ø22mm	60	£3.75	£2.60	£3.12
FD11580	Ø115mm	Ø22mm	80	£3.75	£2.60	£3.12
FD115120	Ø115mm	Ø22mm	120	£3.75	£2.60	£3.12
FD12540	Ø125mm	Ø22mm	40	£4.25	£2.95	£3.54
FD12560	Ø125mm	Ø22mm	60	£4.25	£2.95	£3.54
FD12580	Ø125mm	Ø22mm	80	£4.25	£2.95	£3.54
FD125120	Ø125mm	Ø22mm	120	£4.25	£2.95	£3.54

COLOUR GUIDE

Each colour represents a different foam density. The guide below details which colour head to use for which job.

RED FOAM Ultra-soft foam for final finish. Ideal for car valeting.

BLACK FOAM Soft polishing foam. Ideal for work on dark colours.

BLUE FOAM Medium density, all purpose foam.

WHITE FOAM Dense and firm. Ideal for compounding all modern paint systems.

YELLOW FOAM Coarse foam with open cell for aggressive jobs. Ideal for LV paint.

ORANGE FOAM Firm density.

Polisher Pad Kits

NEW PRODUCTS



Model No. SPK600ACC2

Ø40mm

OR

Ø56mm

- Assorted packs containing six different pads.
- Contents: Green Foam (x2), Blue Foam (x2), Orange Foam (x2), Red Foam (x2), Microfibre Pad (x2), Wool Pad (x2).
- Colour guide for these pads is as follows: Green is firm and for heavy cutting, blue is medium density all-purpose foam, orange is for polishing, red is soft foam for a final finish, microfibre is slightly more aggressive than foam but is also a finishing pad.

Model No.	Size	List Price	Exc. VAT	Inc. VAT
SPK600ACC1	Ø40	£13.95	£11.45	£13.74
SPK600ACC2	Ø56	£19.95	£16.45	£19.74

115mm Production Sanding Rolls

WORKSAFE
SEALEY

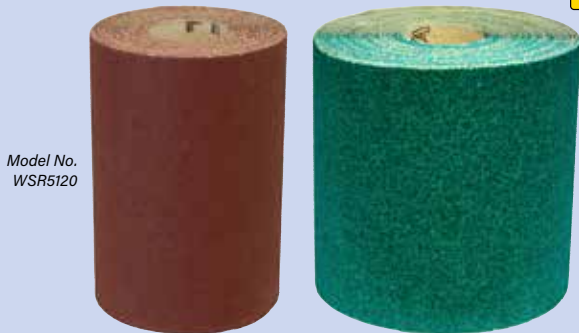

Model No. WSR5120

Model No. WSR1060

- Long lasting, heavy backing paper, suitable for orbital sanders.
- Industrial aluminium abrasive for use on wood, paint, plaster and fillers.

Model No.	Length	Type	Grit	List Price	Exc. VAT	Inc. VAT
WSR540	5m	Extra Coarse	40	£5.45	£3.95	£4.74
WSR1040	10m	Extra Coarse	40	£9.95	£6.95	£8.34
WSR560	5m	Coarse	60	£5.45	£3.95	£4.74
WSR1060	10m	Coarse	60	£9.95	£6.95	£8.34
WSR580	5m	Medium	80	£5.45	£3.95	£4.74
WSR1080	10m	Medium	80	£9.95	£6.95	£8.34
WSR5120	5m	Fine	120	£4.95	£3.65	£4.38
WSR10120	10m	Fine	120	£9.45	£6.45	£7.74
WSR5180	5m	Extra Fine	180	£4.95	£3.65	£4.38
WSR10180	10m	Extra Fine	180	£9.45	£6.45	£7.74
WSR5240	5m	Ultra-Fine	240	£4.95	£3.65	£4.38
WSR10240	10m	Ultra-Fine	240	£9.45	£6.45	£7.74

Ø150 x 50mm Buffing & Polishing Foam Heads



Ø150mm

- Premium foam buffing and polishing heads, colour-coded according to intended use.
- Made in UK for use with Sealey and other popular machines.

Model No.	Thread	Colour	Type	List Price	Exc. VAT	Inc. VAT
PTC/CH/M14-P	M14 x 2mm	Black	Soft	£18.95	£12.95	£15.54
PTC/CH/M14-Y	M14 x 2mm	Yellow	Coarse	£22.95	£14.95	£17.94
PTC/CH/M14-W	M14 x 2mm	White	Dense	£20.95	£14.45	£17.34
PTC/CH/5/8-W	5/8"UNC	White	Dense	£20.95	£14.45	£17.34
PTC/CH/M14-B	M14 x 2mm	Blue	Medium	£18.95	£12.95	£15.54
PTC/CH/5/8-B	5/8"UNC	Blue	Medium	£18.95	£12.95	£15.54
PTC/CH/M14-R	M14 x 2mm	Red	Ultra-Soft	£20.95	£14.45	£17.34

Hook-and-Loop Buffing & Polishing Foam Heads



Ø80mm

Ø150mm

- Hook-and-loop backed, premium foam buffing and polishing heads.
- Colour-coded according to intended use.
- Made in UK for use with Sealey and other popular machines.



Model No.	Thread	Colour	Type	List Price	Exc. VAT	Inc. VAT
PTCCHV79P	Ø80 x 25mm	Black	Soft	£9.45	£6.45	£7.74
PTCCHV150P	Ø150 x 50mm	Black	Soft	£15.45	£10.95	£13.14
PTCCHW80O	Ø80 x 25mm	Orange	Firm	£9.45	£6.45	£7.74
PTCCHW150O	Ø150 x 25mm	Orange	Firm	£14.95	£10.45	£12.54
PTCCHW80R	Ø80 x 25mm	Red	Ultra-Soft	£9.45	£6.45	£7.74
PTCCHW150R	Ø150 x 25mm	Red	Ultra-Soft	£14.95	£10.45	£12.54

Jigsaw Blades

Packs of 5

Model No.
SJBT144D



- Works with most popular brands of jigsaws.

Model No.	Applications	TPI	Length	List Price	Exc. VAT	Inc. VAT
SJBT101AO	Wood - Hard	18	83mm	£4.45	£2.95	£3.54
SJBT101B	Wood - Hard	10	100mm	£5.95	£3.95	£4.74
SJBT101BR	Wood - Hard	10	100mm	£4.95	£3.25	£3.90
SJBT101D	Wood - Hard	6	100mm	£4.45	£2.95	£3.54
SJBT111C	General - Wood	8	100mm	£2.95	£1.95	£2.34
SJBT118A	Metal	17-24	92mm	£4.95	£3.25	£3.90
SJBT118AF	Metal	21	75mm	£4.95	£3.25	£3.90
SJBT118B	Metal	11-14	92mm	£5.45	£3.45	£4.14
SJBT118BF	Metal	12	75mm	£4.95	£3.25	£3.90
SJBT118G	Metal	32	75mm	£4.95	£3.25	£3.90
SJBT119BO	General - Wood	12	75mm	£3.45	£2.25	£2.70
SJBT127D	Aluminium	8	100mm	£6.45	£4.45	£5.34
SJBT144D	General - Wood	6	100mm	£3.95	£2.75	£3.30

Reciprocating Saw Blades

Packs of 5

Model No.
SRBR922F

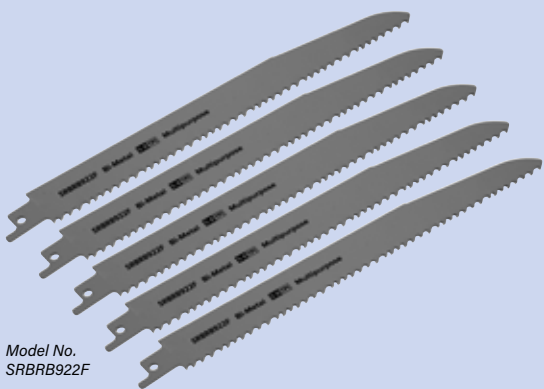

- Works with most popular brands of reciprocating saws.

Model No.	Applications	TPI	Length	List Price	Exc. VAT	Inc. VAT
SRBR617K	Pruning & Coarse Wood	3	150mm	£8.95	£6.45	£7.74
SRBR1217K	Pruning & Coarse Wood	3	300mm	£15.95	£10.95	£13.14
SRBS644D	Clean Wood	6	150mm	£8.95	£6.45	£7.74
SRBS644H	Clean Wood	10	150mm	£9.95	£6.95	£8.34
SRBS811D	Clean Wood	6	200mm	£11.45	£7.95	£9.54
SRBS911D	Clean Wood	6	230mm	£12.95	£8.95	£10.74
SRBS1211D	Clean Wood	6	250mm	£16.95	£11.95	£14.34
SRBR622HF	Wood & Plastics	10	150mm	£13.95	£9.45	£11.34
SRBR922HF	Wood & Plastics	10	230mm	£19.95	£13.95	£16.74
SRBR611DF	Wood & Nail	6	150mm	£15.95	£10.45	£12.54
SRBR922DF	Wood & Nail	6	230mm	£19.95	£13.95	£16.74
SRBR1211DF	Wood & Nail	6	300mm	£21.95	£15.95	£19.14
SRBR622EF	Metal	18	150mm	£13.95	£9.45	£11.34
SRBR622AF	Metal	24	150mm	£12.95	£8.95	£10.74
SRBR922EF	Metal	18	230mm	£19.95	£13.95	£16.74
SRBR922AF	Metal	24	230mm	£19.95	£13.95	£16.74
SRBRB611F	Multipurpose	5-8	150mm	£21.95	£14.95	£17.94
SRBRB922F	Multipurpose	5-8	230mm	£29.95	£19.95	£23.94
SRBRB1222F	Multipurpose	5-8	300mm	£33.95	£23.95	£28.74

3pc Quick Change Multi-Tool Cutting Blade Set



- Includes 10mm cutting blade, 32mm offset cutting blade and a 65mm offset cutting blade.

- **Model No. SMTC3**
- List Price £12.95

£9.95 Exc. VAT
£11.94 Inc. VAT

3pc Quick Change Multi-Tool Scraper Blade Set



- Includes 28 x 50mm sharp scraper blade, 52 x 45mm flexible scraper blade and a 52 x 26mm rigid scraper blade.

- **Model No. SMTB3**
- List Price £9.95

£7.95 Exc. VAT
£9.54 Inc. VAT

7pc Multi-Tool Blade Set Metal & Wood



- 7-Piece oscillating multifunction tool accessories set.

- Titanium coated.
- Supplied in storage case.
- **Model No. WMTSET**
- List Price £36.95

£21.95 Exc. VAT
£26.34 Inc. VAT

3pc Multi-Tool Blade Set



- Includes offset cutting blade, offset scraper and a straight scraper.

- **Model No. SMTA1**
- List Price £7.30

£5.45 Exc. VAT
£6.54 Inc. VAT

20pc Multi-Tool 90mm Sanding Sheet Set



- Includes 5-piece of each grit P60, P80, P120 and P240 with hook-and-loop backing.

- **Model No. SMTA7**
- List Price £3.95

£2.95 Exc. VAT
£3.54 Inc. VAT

Multi-Tool Carbide Tipped Half-Moon Cutting Blade



- Suitable for cutting channels in porous concrete and removing tile grout.

- **Model No. SMTA3**
- List Price £8.35

£6.25 Exc. VAT
£7.50 Inc. VAT

HSS Roll Forged Drill Bit Sets

Model No. DBS19RF



Model No. DBS25RF

MM

- HSS Roll forged drill bits manufactured to DIN 338.
- 118° Point tip.
- Efficient clog-free swarf clearance.
- Sizes in 0.5mm increments.
- Supplied in flip-up metal storage case.

Model No.	Qty	Sizes	List Price	Exc. VAT	Inc. VAT
DBS19RF	19pc	Ø1-10mm	£17.45	£12.45	£14.94
DBS25RF	25pc	Ø1-13mm	£29.95	£19.95	£23.94

Ø8mm Solid Carbide Spot Weld Drill Bit

- Solid carbide.
- Suitable for Boron steel.
- Supplied in high-density case.
- Model No. AK4740
- List Price £33.95



£22.95 Exc. VAT
£27.54 Inc. VAT

99pc Fully Ground Drill Bit Set

Fully Ground



- 135° Split point is self-centring which helps to reduce thrust, friction and heat and aids easier penetration.
- Efficient clog-free swarf clearance.
- Contents Ø1.5 (x16), 2 (x16), 2.5 (x15), 3 (x10), 3.2 (x10), 3.5 (x8), 4 (x8), 4.5 (x3), 5 (x3), 5.5 (x2), 6 (x2), 6.5 (x2), 8 (x2), 10mm (x2).
- Model No. DBS99FG
- List Price £54.95

£39.95 Exc. VAT
£47.94 Inc. VAT

35pc Drill & Bit Accessory Set

- Manufactured to DIN 3126 specification.
- Contents: Drill Bits; HSS Coated - Ø1.5, 2, 3, 4, 5, 6mm. Masonry - Ø3, 4, 5, 6, 7, 8mm. Wood - Ø3, 4, 5, 6, 7, 8mm Bits; Slotted - 4, 5, 6mm, Phillips - #1, #2, #3, Pozi - #1, #2, #3, TRX-Star* - T20, T25, T30, Magnetic Nut Holders; 6, 8, 10mm, Stainless Steel Bit Holder, Counter sink bit.
- Model No. AK3735
- List Price £19.95



£15.95 Exc. VAT
£19.14 Inc. VAT

NEW PRODUCT

15pc Masonry Drill Bit Set

MM

- Set consists of 15 tungsten steel masonry drills.
- Sizes: Ø3 (x3), 4 (x3), 5 (x3), 6 (x2), 8 (x2), 10mm (x2).
- Supplied in plastic storage box with rubberised, non-slip coating.
- Model No. AK3715M
- List Price £13.95



£8.95 Exc. VAT
£10.74 Inc. VAT

17pc HSS/Masonry Drill Bit Set

MM

- Set consists of 12 titanium nitride coated high-speed steel drills and 5 tungsten steel masonry drills.
- Sizes: HSS; Ø1.5, 2, 2.5, 3, 3.2, 3.5, 4, 4.5, 4.8, 5, 5.5, 6mm. Masonry; Ø3, 5, 6, 8, 10mm.
- Model No. AK3717TCM
- List Price £14.95



£8.95 Exc. VAT
£10.74 Inc. VAT

18pc Wood/Masonry Drill Bit Set

- Set consists of nine bradpoint drills and nine tungsten steel masonry drills.
- Sizes: Masonry; Ø3, 3, 4, 4, 5, 5, 6, 8, 10mm. Wood; Ø3, 3, 4, 4, 5, 5, 6, 8, 10mm.
- Supplied in plastic storage box with rubberised, non-slip coating.
- Model No. AK3718MW
- List Price £14.95



£11.95 Exc. VAT
£14.34 Inc. VAT

NEW PRODUCT

4pc Multifunction Drill Bit Set

- Multifunction drill bit set to cover most of your drilling needs.
- Drill saw bit can be used as a drill, saw, rotary file, reamer and router.
- Contents: Ø4-12mm Step Drill, Ø8-20mm Tube Drill, Ø6mm Drill Saw, Ø12.4mm Countersink.
- Model No. AK4704
- List Price £16.95



£11.95 Exc. VAT
£14.34 Inc. VAT

10pc 1/8" Double End Drill Bit Set



- High-speed steel double end drill bits.
- 1/8" Size for pop riveting.
- Supplied in plastic tube.
- Model No. AK9910
- List Price £5.45

£3.95 Exc. VAT
£4.74 Inc. VAT

6pc 90° Countersink Bit Set 3 x V Flutes



- 90° 3 x V Flute design.
- Suitable for light metals and wood.
- Set includes the popular sizes; Ø6.3, 8.3, 10.4, 12.4, 16.5, 20.5mm.
- **Model No. CSSET6V**
- List Price £23.95

£18.95 Exc. VAT
£22.74 Inc. VAT



3pc Double Flute HSS M2 Step Drill Bit Set

HSS M2
High Wear Resistance

MM

- Double straight flutes for efficient swarf clearance.
- Allows clog-free, precision drilling of 18 different size holes with just three bits.
- Size #1: Ø4-12mm.
- Size #2: Ø4-22mm in 2mm increments.
- Size #3: Ø4-30mm in 2mm increments.
- **Model No. AK4733**
- List Price £89.95

£54.95 Exc. VAT
£65.94 Inc. VAT



5pc Micro Burr Set

Ø3mm

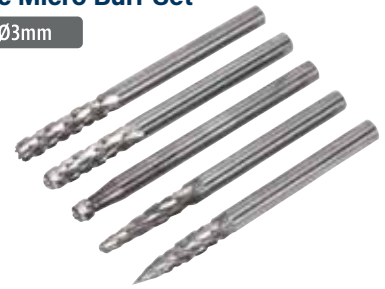

- Ø3mm Burrs made from Tungsten Carbide.
- Head Shapes: Cylindrical Front End Cut, Cylindrical Ball Nose, Ball, Ball Nose Taper, Pointed Tree.
- For use on soft and hard metals, including welded seams.
- Supplied in a plastic storage box.
- **Model No. MCBSET01**
- List Price £22.45

£15.45 Exc. VAT
£18.54 Inc. VAT

9pc Downlight Hole Saw Kit

WORKSAFE
SEALEY



- Fits most common sizes of downlights.
- Contents: Hole Saws; Ø51, 60, 65, 72, 75, 86mm, Mandrel and Pilot Drive, Hex Key.
- **Model No. WDLK**
- List Price £9.95

£6.95 Exc. VAT
£8.34 Inc. VAT

9pc Electrician's Hole Saw Kit

WORKSAFE
SEALEY



- Bi-Metal blades.
- Professional quality kit.
- Sturdy storage case.
- Contents: Hole Saws (1 of each); Ø16, 20, 25, 32, 40, 51mm, 1 x Simple Arbor, 1 x Quick Release Arbor, 1 x Adaptor.
- **Model No. WSEHSK**
- List Price £37.95

£24.95 Exc. VAT
£29.94 Inc. VAT

Points - SDS MAX

WORKSAFE
SEALEY

Model No. X1PT



SDS MAX

Model No.	Length	List Price	Exc. VAT	Inc. VAT
X1PT	300mm	£7.45	£4.95	£5.94
X2PT	400mm	£8.95	£6.45	£7.74
X3PT	450mm	£9.95	£6.95	£8.34
X4PT	600mm	£12.95	£8.95	£10.74

5pc Tungsten Carbide Rotary Burr Set Ripper/Coarse

Ø10mm



- Head Shapes: Cylindrical Front End Cut, Cylindrical Ball Nose, Arc Round Nose, Oval, Conical Ball.
- Shaft Size: Ø6mm.
- Head Diameter: Ø10mm.
- Overall Length: 65mm.
- **Model No. SDBCK5**
- List Price £99.95

£69.95 Exc. VAT
£83.94 Inc. VAT

Wide Chisels - SDS MAX

WORKSAFE
SEALEY

Model No. X1WC



SDS MAX

Model No.	Size	List Price	Exc. VAT	Inc. VAT
X1WC	50 x 400mm	£12.95	£8.95	£10.74
X2WC	75 x 400mm	£15.95	£10.95	£13.14

5pc SDS MAX Demolition Kit

WORKSAFE
SEALEY



- Five SDS MAX chisels supplied in a sturdy storage case.
- Contents: Pointed Chisels; Ø18 x 280, 18 x 400mm, Flat Chisels; 24 x 280, 24 x 400, 50 x 360mm.
- **Model No. 314C**
- List Price £27.95

£19.95 Exc. VAT
£23.94 Inc. VAT

Points - Wacker EHB10

WORKSAFE
SEALEY

Model No. W1PT



Model No.	Length	List Price	Exc. VAT	Inc. VAT
W1PT	400mm	£15.95	£11.45	£13.74
W2PT	450mm	£17.95	£12.95	£15.54

Wide Chisels - Makita HK1800

WORKSAFE
SEALEY

Model No. E2WC



Model No.	Size	List Price	Exc. VAT	Inc. VAT
E1WC	30 x 150mm	£12.45	£8.95	£10.74
E2WC	50 x 160mm	£13.95	£9.95	£11.94

5W Inspection Light & Single Wireless Charging Base



5W
500 LUMENS



- Lumen output on side light 50-500lm with dimming function and 300lm on top light.
- Operating time is 3-10hr on side light and 5hr on the top light.
- Charging time is 5hrs.

Package includes:

- LEDWC02 - 5W + 3W COB LED Inspection Light - Wireless Rechargeable.
- WCB1 - 5V=1A Single Wireless Charging Base.

- Model No. **LEDWCOMBO2**
- List Price £83.95

£49.95 Exc. VAT
£59.94 Inc. VAT

Heavy-duty inspection light with dimming function.

Supplied with one strong magnet on the base and two on the back.

COB LED



Model No. LEDWCOMBO2



48 SMD LED Bench Mounting Magnifying Work Light



SMD LED

- Powerful 3 dioptre 120mm precision lens gives high quality magnifying capabilities.
- Features 48 SMD LEDs to illuminate the object for improved detailed work.
- Multi-position swing arm allows simple positioning of lamp to suit task.
- Features a G-clamp base to secure to a workbench or table.
- Ideal for electrical engineers, engravers and fine detail work.
- Supplied with 3-pin plug.
- **Model No. WL483D**
- List Price £84.95

£69.95 Exc. VAT
£83.94 Inc. VAT

45 SMD LED Dimmable Dual Mounting Magnifying Work Light

SMD LED

550 LUMENS



- Powerful 3 dioptre 85mm and 8 dioptre 22mm precision lens gives high quality magnifying capabilities.
- Features 45 SMD LEDs producing up to 550 lumens to illuminate the object for improved detailed work.
- Built-in touch sensitive dimmer switch.
- Extremely strong and flexible neck allowing ease of positioning.
- Also includes a sturdy base which the magnifier can sit in.
- Ideal for electrical engineers, engravers and fine detail work.
- Supplied with 3-pin plug.
- **Model No. WL53/8D**
- List Price £51.95

£39.95 Exc. VAT
£47.94 Inc. VAT

6 SMD LED Dimmable Rechargeable Dual Mounting Magnifying Work Light

SMD LED

60 LUMENS



- Powerful 3 dioptre 109mm and 8 dioptre 24mm precision lens gives high quality magnifying capabilities.
- Features 6 SMD LEDs producing up to 60 lumens to illuminate the object for improved detailed work.
- Built-in touch sensitive dimmer switch.
- Magnifier can detach from its sturdy base and spring clamp to a work bench up to 45mm thick.
- Rechargeable 3.7V 400mAh Lithium cell battery.
- Supplied with USB cable.
- **Model No. WL63/8D**
- List Price £25.95

£19.95 Exc. VAT
£23.94 Inc. VAT

SMD LED Work Lights with Mounting Brackets



Model No. LED1R

960 LUMENS



Model No. LED3R

2160 LUMENS



Model No. LED4R

3360 LUMENS



Model No. LED2S

1200 LUMENS

- Epistar™ high power LEDs.
- Operating Voltage: 10-30V DC.
- Waterproof rating of IP68.
- ECE R10 Certified and E-Marked.
- Adjustable grade 201 shock-resistant stainless steel bracket.

SMD LED

Model No.	Power	Output	Size	List Price	Exc. VAT	Inc. VAT
LED1R	12W	960lm	Ø80mm	£16.95	£11.95	£14.34
LED3R	27W	2160lm	Ø115mm	£19.95	£13.45	£16.14
LED4R	42W	3360lm	Ø115mm	£26.95	£19.95	£23.94
LED2S	15W	1200lm	83 x 83mm	£17.95	£12.95	£15.54

12/24V 80 LED Mini Light Bars

12V/24V



Approved for Highway use



Model No. MLB80SB



Model No. MLB80MB

- Extremely bright 80 amber LED high intensity mini light bar.
- 10 Modules fitted with 8 LEDs allowing a 360° light.
- Built-in 10 option flash pattern.
- Built-in memory recalls last pattern selected.
- ECE R65 & R10 Approved for highway use.
- CE Approved and E-Marked.
- IP56 rated.



Model No.	Fixing Type	List Price	Exc. VAT	Inc. VAT
MLB80SB	10mm Single Bolt Fixing	£74.95	£59.95	£71.94
MLB80MB	Magnetic Base	£79.95	£64.95	£77.94

20V SV20 Series Cordless SMD LED 1800lm Work Light

SV20 SERIES

1800 LUMENS

Work Light

SMD LED



20V

- Part of the SV20 Series offering a one-battery-fits-all solution, keeping costs down without compromising on performance.
- 360° Lightweight cordless clip work light.
- 70 SMD LED 6500K Lights.
- 1800lm With four levels of brightness.
- IP20 Rated.
- Kit supplied with a mains fast charger and canvas storage bag.

Model No.	Type	Batteries In Kit	List Price	Exc. VAT	Inc. VAT
CP20VCLKIT1	Kit	1 x 4Ah	£144.95	£99.95	£119.94
CP20VCL	Body Only	-	£44.95	£37.95	£45.54



SEE OUR FULL ONE-BATTERY-FITS-ALL

SV20 SERIES

ON PAGES 75-77



20V SV20 Series 2-in-1 Cordless/Corded SMD LED 4000lm Work Light

SV20 SERIES

UP TO 4000 LUMENS

Work Light

SMD LED

20V



- Cordless work light useful in any workspace with integrated AC and DC power.
- 360° Movement.
- SMD LED Technology for ultra-bright illumination.
- 96 SMD LED Lights producing up to 4000 lumens using mains cable (2700lm using 20V battery pack supplied with kit option).
- Robust design with integrated carry handle and side lights to illuminate the darkest spaces.
- Up to 4.5hrs running time when used in conjunction with 4Ah battery (supplied with kit option).

Model No.	Type	Batteries In Kit	List Price	Exc. VAT	Inc. VAT
CP20VWLKIT1	Kit	1 x 4Ah	£164.95	£114.95	£137.94
CP20VWL	Body Only	-	£64.95	£57.95	£69.54

10W SMD LED 1000lm Under-Bonnet Cordless Rechargeable Light

- Robust aluminium design with built-in spring loaded telescopic mounting brackets.
- Both brackets can rotate 360° individually making it easy to direct the light where required.
- 10W SMD LEDs have two options on light settings; full - 1000lm, half - 500lm.
- Includes battery level indicator, mains charger and USB lead.
- Min./Max. Bonnet Width: 1200/1800mm.
- Battery: 3.7V - 4.4Ah Lithium-ion.
- **Model No. LED138**
- List Price £93.95

£69.95 Exc. VAT
£83.94 Inc. VAT



SMD LED **1000 LUMENS** **Lithium RECHARGEABLE**

70W SMD LED Portable Floodlight - 110V

- Portable floodlight with on/off switch and stand.
- SMD LED technology allows ultra-bright illumination.
- 110° Spread of light.
- Lumen Output: 5600lm.
- IP54 Rated.
- Supplied with power cable and 16A 110V plug.
- **Model No. LED097**
- List Price £75.95

£29.95 Exc. VAT
£35.94 Inc. VAT



70W
SMD LED
5600 LUMENS
110V

20W COB LED Rechargeable Portable Floodlight & Power Bank

- Aluminium housing.
- Integral 180° adjustable stand.
- On/off (economy setting) switch.
- COB LED technology allows ultra-bright illumination.
- USB 5V=1A output for charging electronic devices.
- Battery level indicator.
- Three brightness settings producing up to 1900 lumens.
- IPX4 Rated.
- **Model No. LED184**
- List Price £46.95



RECHARGEABLE USB CHARGING DEVICE
1900 LUMENS

£34.95 Exc. VAT
£41.94 Inc. VAT

0.5W LED Spotlight



- Lens Diameter: Ø89mm.
- Lumens: 35lm.
- Simple, strong and bright.
- Accepts 1 x PJ996 battery (not included).
- **Model No. AK427**
- List Price £8.45



£5.95 Exc. VAT
£7.14 Inc. VAT

20W COB LED Lithium-ion Rechargeable Floodlight Colour Matching CRI 96

- Rechargeable professional work light with super bright COB LED light source.
- Suitable for accurate colour matching and identifying bodywork imperfections.
- Five colour temperature options, 2700K, 3500K, 4500K, 5500K and 6500K.
- Produces up to 2000 lumens with a CRI (Colour Rendering Index) of 96 which gives an effect of daylight.
- Three settings allow for 20, 50 or 100% brightness to suit task.
- Built-in battery: 11.1V - 4.4Ah Lithium-ion.
- Features a five LED battery level indicator.
- Operating (Charging) Time: 8/4/2hr(3.5hr).
- **Model No. LED068**
- List Price £171.95

20W **Colour Match**
COB LED **CRI 96**
Lithium RECHARGEABLE
2000 LUMENS



£99.95 Exc. VAT
£119.94 Inc. VAT

360° 14W COB LED Rechargeable Pocket Floodlights with Magnet

- Incredibly tough aluminium housing with sturdy handle which can rotate through 360°.
- Virtually indestructible and one of the most durable floodlights available.
- Also fitted with a strong magnet, making it simple and easy to direct up to 1400 lumens of light.
- Three light output settings: 350/700/1400 lumens.
- Features three LED battery level indicator.
- Fitted with a high quality 3.7V 5.2Ah Lithium-ion battery.
- Charges via a USB Type-C lead (Supplied with USB Type-C Cable).
- **Model No. LED1400PR - Red**
- **Model No. LED1400P - Green**
- List Price £73.95



COB LED
Lithium RECHARGEABLE
1400 LUMENS
360°

£44.95 Exc. VAT
£53.94 Inc. VAT

360° 36W SMD LED Rechargeable Portable Floodlight

- Features patented 360° swivel and tilt function enabling light source to be positioned in any direction.
- Work light houses 72 super bright SMD LEDs providing up to 3000 lumens.
- Provides a powerful light to any work area.
- Features high quality 4.4Ah Lithium-ion battery with battery level indicator.
- 2.1A USB output for use as a power bank.
- Supplied with mains charger.
- **Model No. LED360FR**
- List Price £92.45



36W **SMD LED** **Lithium RECHARGEABLE**
3000 LUMENS
PATENTED DESIGN
RECHARGEABLE
RECHARGEABLE USB CHARGING DEVICE
£64.95 Exc. VAT
£77.94 Inc. VAT

60W COB Folding Floodlight & Stand

- Twin adjustable super bright 30W COB Epistar™ LEDs producing up to 4800 lumens.
 - IP44 rated.
 - Floodlight can be folded shut to protect lights when being transported or stored.
 - Supplied with plug and 3m cable.
- Package includes:**
- LED192T - 60W COB Folding Case Floodlight.
 - LED193ST - Telescopic Stand for Folding Floodlights.
- **Model No. LED192TCOMBO1**
• List Price £129.95



60W
COB LED
4800 LUMENS

£59.95 Exc. VAT
£71.94 Inc. VAT

SMD LED Intrinsically Safe ATEX/IECEX Approved Head Torch

SMD LED

216 LUMENS

For full safety directives and specifications, see our website www.sealey.co.uk.



- Single high power SMD LED produces extremely bright, white light with an output of 216/100 lumens (high/low) and a working range up to 100/75m.
- Three mode (high/low/off) push-button for high and low settings.
- Intrinsically safe for use in hazardous locations.
- Light angle adjustable by up to 90° to suit every situation.
- Adjustable headband attaches to hard hat or head.
- Built-in gas release vent.
- Operating Time (High/Low): 5hr/12hr.
- **Model No. HT452IS**
- List Price £59.95

£44.95 Exc. VAT
£53.94 Inc. VAT

SMD LED Intrinsically Safe ATEX/IECEX Approved Flashlight

SMD LED

120 LUMENS

For full safety directives and specifications, see our website www.sealey.co.uk.



- Single high power SMD LED produces extremely bright, white light with an output of 120/32 lumens (high/low) and a working range up to 172/85m.
- Three mode (high/low/off) push-button for high and low settings.
- Intrinsically safe flashlight for use in hazardous locations.
- Lightweight, tough and durable casing which will sustain high impacts and drops.
- Built-in gas release vent.
- Features wrist lanyard connection.
- Operating Time: Low; 69hr, High; 6hr.
- **Model No. LED452IS**
- List Price £54.95

£34.95 Exc. VAT
£41.94 Inc. VAT

5W SMD LED Rechargeable Head Torch with Auto-Sensor

5W



SMD LED

Lithium RECHARGEABLE

360 LUMENS

- Hands-free 5W SMD LED spotlight with adjustable inclination to direct light as required.
- Lumen Output (High/Low): 360/100lm.
- Two Outputs: 100% and 30%.
- Auto-sensor to switch on/off just by waving hand in front.
- Alternatively can be overridden to stay on/off by push-button.
- Adjustable headband.
- Powered by rechargeable 3.7V 2Ah Lithium-ion battery.
- **Model No. HT108LED**
- List Price £38.95



£25.95 Exc. VAT
£31.14 Inc. VAT

5W COB LED Head Torch with Auto-Sensor

5W

COB LED

- Hands-free 5W COB LED spotlight with 40° angle adjustment.
- Dimmer switch allows brightness to be adjusted from 20% to 100%.
- Main light has one switch with four functions, on, flash, auto-sensor and off.
- Hold down switch to enable auto-sensor function which will allow turning on/off just by waving hand in front.
- Rear of strap includes a red LED warning light which has two functions, flash or on, ideal for a cycling light.
- Adjustable headband and foam brow for added comfort.
- Powered by 3 x AA batteries (not included).
- **Model No. HT111LED**
- List Price £34.95



£24.95 Exc. VAT
£29.94 Inc. VAT

3 LED Wind-Up Rechargeable Torch

LED

Rechargeable

- Bright LED light available under all conditions.
- 30 Minutes illumination from 1 minute's winding.
- Ideal for outdoor activities and as an emergency torch in the home or car.
- Includes a charging outlet port with adaptors to micro USB.
- Two switchable levels of brightness.
- No batteries or bulbs to replace.
- **Model No. AK3305**
- List Price £13.95



£8.95 Exc. VAT
£10.74 Inc. VAT

3W COB LED Penlight Torch

COB LED

280 LUMENS

- Professional aluminium design.
- Features pocket/belt clip with integrated magnet for hands-free operation.
- Top mounted push-button on/off switch.
- Ideal for use in workshops, garage and home.
- Lumen Output: 280lm.
- Length: 162mm.
- Battery: 3 x AAA (not included).
- **Model No. LED125**
- List Price £7.95



£5.95 Exc. VAT
£7.14 Inc. VAT

3W SMD LED Aluminium Torch with Adjustable Focus

3W

SMD LED

- Produces extremely bright, white light.
- Adjustable focus from spotlight to wide area by a slide action of the head.
- Lightweight aluminium housing.
- Two power settings - 100% and 30%.
- Lumen Output (High/Low): 140/45lm.
- Working Range: 100m.
- Powered by 3 x AAA batteries (not included).
- **Model No. LED444**
- List Price £13.95



£8.95 Exc. VAT
£10.74 Inc. VAT

3W LED & 3W COB LED Torch/Inspection Light

3W

COB LED

150 LUMENS

- Twin function light.
- Features a powerful 3W LED directional torch and, by extending the body of the torch, an automatic on/off 3W COB LED inspection light.
- A strong magnet in the base allows for hands-free use.
- Powered by 4 x AAA batteries (not included).
- **Model No. LED069**
- List Price £11.95



£7.95 Exc. VAT
£9.54 Inc. VAT

25m Heavy-Duty Cable Reels with Thermal Trip



- Thermal overload protection.
- Tough impact resistant drum.
- Frame incorporates a carrying handle.
- Includes a cable clip to secure plug whilst not in use and brake to stop drum spinning.

Model No.	Supply	List Price	Exc. VAT	Inc. VAT
CR12515	2 x 110V	£89.95	£69.95	£83.94
CR22525	4 x 230V	£119.95	£94.95	£113.94

50m Heavy-Duty Cable Reel with Thermal Trip - 230V



- 4 x 230V Power sockets.
- Thermal overload protection.
- Tough impact resistant drum.
- Frame incorporates a carrying handle.
- Includes a cable clip to secure plug whilst not in use.
- Fitted with 3-pin plug.
- Model No. CR50/1.5
- List Price £129.95

£99.95	Exc. VAT
£119.94	Inc. VAT

Cable Reels with Thermal Trip 4 x 230V Sockets



- Durable composite drum on steel stand.
- Fitted with 3-pin plug and thermal trip.
- 4 x 230V Power sockets.

Model No.	Length	List Price	Exc. VAT	Inc. VAT
BCR2525	25m	£119.95	£94.95	£113.94
BCR50	50m	£109.95	£89.95	£107.94

25m Cable Reel with Thermal Trip & RCD Plug 4 x 230V



- Durable composite drum on steel stand.
- Fitted with RCD and thermal trip.
- Particularly recommended for use with pressure washers, water pumps, hedge trimmers and all workshop power tools.
- 25m 3 x 1.25mm² PVC Cable.
- 4 x 230V Power sockets.
- Model No. BCR25RCD
- List Price £87.45

£69.95	Exc. VAT
£83.94	Inc. VAT

2.6m Extension Cable 2 x 230V + 2 x USB Sockets



- Suitable for garage, workshop and office applications.
- Features 2 x 230V sockets and 2 x 5V (2.4A) USB sockets.
- Fitted with 3-pin heavy-duty plug.
- Length: 2.6m.
- Model No. EL32USBW
- List Price £23.95

£15.95	Exc. VAT
£19.14	Inc. VAT

14m Extension Lead 240V 13A 1.5mm²



- Extension cable fitted with 13A 240V plug and single 240V socket.
- Model No. EL15240
- List Price £29.95

£21.95	Exc. VAT
£26.34	Inc. VAT

110V 4-Way Splitter Box



- 4-Way 16A Splitter Box with 1.5mm cable and 16A plug.
- CEE Connector.
- IP44 Rated.
- Model No. WSSB16
- List Price £39.95

£32.95	Exc. VAT
£39.54	Inc. VAT

110V 2P+E Plugs



110V



Model No.
WP11016

16A



Model No.
WP11032

32A

- 110V Plug, IP44 rated.
- 2P+E connector.
- Conforms to BS EN 60309.

Model No.	Power	List Price	Exc. VAT	Inc. VAT
WP11016	16A	£4.45	£2.95	£3.54
WP11032	32A	£7.45	£5.45	£6.54

13A/16A Trailing Socket & Cable Set



230V



- Trailing socket and cable fitted with a 230V~50Hz 13A standard UK plug and 2P+E socket rated at 230V~50Hz 16A.
- H05VV-F 3G 1.5mm Section cable, 350mm in length.
- IP20 Rated.
- **Model No. WSP1316**
- List Price £8.45

£6.75	Exc. VAT
£8.10	Inc. VAT

110V 3-Way Splitter



110V

16A



- 110V 3-Way Splitter, 16A.
- Rated IP44.
- 2P+E Connector.
- **Model No. WSTWA**
- List Price £22.95

£15.95	Exc. VAT
£19.14	Inc. VAT

230V 3-Way Splitter



230V

16A



- 3-Way splitter 230V~50Hz, allows splitting of a maximum current of 16A.
- Fitted with one 2P+E input and three output connectors.
- IP44 Rated.
- **Model No. WTWS16A**
- List Price £22.95

£15.95	Exc. VAT
£19.14	Inc. VAT

110V Yellow Sockets



110V



Model No.
WC11016

16A



Model No.
WC11032

32A

- 110V Sockets with 2P+E connectors.
- IP44 Rated.

Model No.	Power	List Price	Exc. VAT	Inc. VAT
WC11016	16A	£4.75	£3.45	£4.14
WC11032	32A	£7.95	£5.75	£6.90

230V Blue Sockets



230V



Model No.
WC24016

16A



Model No.
WC24032

32A

- 230V Sockets with 2P+E connectors.
- IP44 Rated.

Model No.	Power	List Price	Exc. VAT	Inc. VAT
WC24016	16A	£4.75	£3.45	£4.14
WC24032	32A	£7.95	£5.75	£6.90

5kVA Portable Vented Transformer 16/32A Outlets



110V



- 110V Transformer with continuous 3000VA output which is ideal for 110V heaters and power tools that require a continuous load.
- IP20 Rated unit with steel casing and insulated to class 1 with ventilated outlets.
- Fitted with thermal overload protection.
- Supplied with 1 x 16A and 1 x 32A/110V output socket.
- **Model No. WST5000MV/2**
- List Price £259.95

£189.95	Exc. VAT
£227.94	Inc. VAT

16A/13A Trailing Twin Socket & Cable Set



230V



- Trailing twin socket and cable fitted with 230V ~ 50Hz 13A Standard UK sockets and 2P+E plug rated at 230V ~ 50Hz 16A.
- H05VV-F 3G 1.5mm Section cable, 350mm in length.
- IP20 Rated.
- **Model No. WPS16132**
- List Price £10.45

£8.45	Exc. VAT
£10.14	Inc. VAT

The storage systems on this page benefit from a hinged flat pack design making them quick and easy to assemble. They additionally feature:

- Stylish black MDF worktops and adjustable feet on base units.
- Magnetic door latches.
- Pegboard back panels for additional storage (except on stacking cabinet).
- Drawers feature ball-bearing drawer runners for smooth opening.
- Additional units are available to extend the storage system if required.



All of our modular units are heavy. Extra assistance must be provided at the delivery point to help safe delivery.

Some simple assembly required.



Modular Base & Wall Cabinet



- Overall Size (W x D x H): 775 x 460 x 2080mm.
- Model No. APMS2HFP
- List Price £629.95

£499.95 Exc. VAT
£599.94 Inc. VAT

Modular Base & Wall Cabinet with Drawer



- Overall Size (W x D x H): 775 x 460 x 2080mm.
- Model No. APMS2HFDP
- List Price £719.95

£579.95 Exc. VAT
£695.94 Inc. VAT

Modular Stacking Cabinet



- Comprises of two stackable units.
- Overall Size (W x D x H): 775 x 460 x 2080mm.
- Model No. APMS2HFPS
- List Price £549.95

£439.95 Exc. VAT
£527.94 Inc. VAT



10pc Garage Storage System



- Can be freestanding or fixed to the wall.
- All 10 units supplied on a single pallet.
- Overall Size (W x D x H): 3100 x 460 x 2080mm.
- Model No. APMS10HFP
- List Price £2,199.95

£1,799.95 Exc. VAT
£2,159.94 Inc. VAT

The Superline PRO® storage systems on the following pages have a tough and durable construction that will last for many years. Their modular design provides flexibility and easy upgrading. The 38mm worktops come in a choice of stainless steel and wood finishes. Floor cabinets feature adjustable shelves. Gas struts on wall cabinet doors (except tambour fronted) and ball-bearing slides on cabinet drawers for ease of use. All floor standing units are supplied with a lock and two keys.



COMES WITH YOUR CHOICE OF WORKTOP, PRESSED WOOD OR STAINLESS STEEL.

Superline Pro® 4.9m Storage System

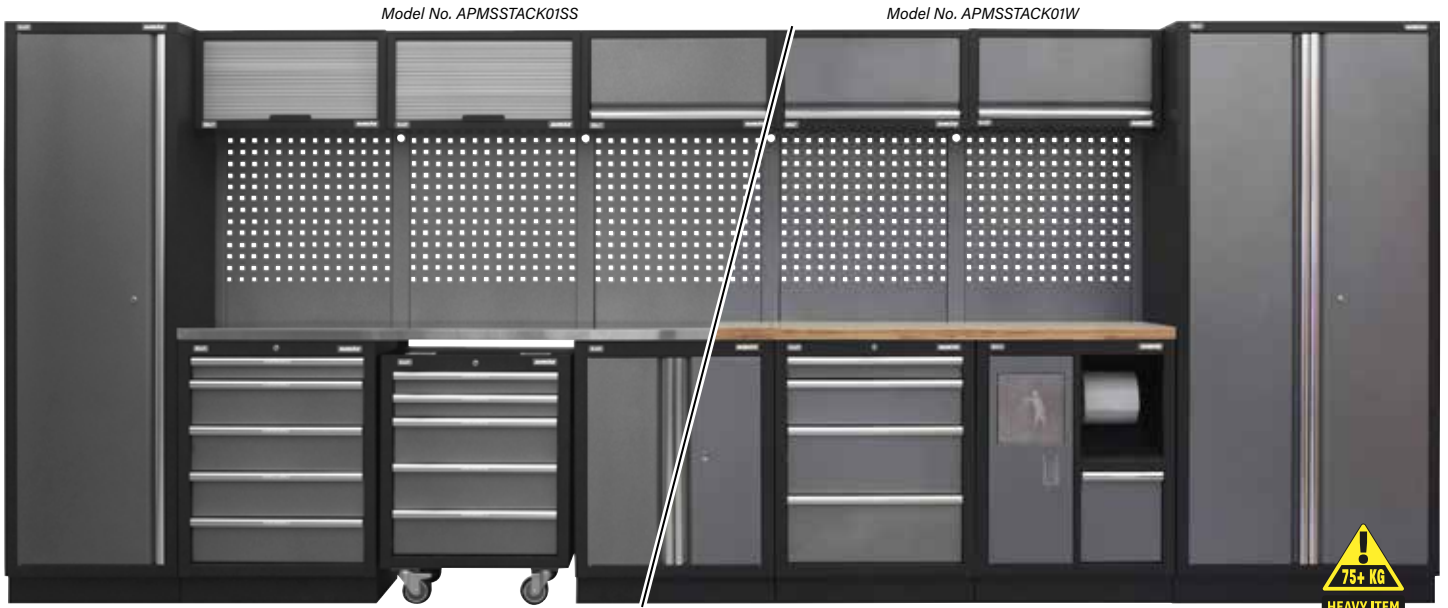

Package includes:

- APMS50SSB - 1360mm Stainless Steel Worktop
- APMS50SSC - 2040mm Stainless Steel Worktop
- or
- APMS50WB - 1360mm Pressed Wood Worktop
- APMS50WC - 2040mm Pressed Wood Worktop

- APMS56 - 915mm Modular 2 Door Full Height Floor Cabinet
- APMS53 - 680mm Modular Wall Cabinet (x3)
- APMS54 - 680mm Modular Wall Cabinet Tambour Front (x2)
- APMS59 - 680mm Modular 5 Drawer Cabinet
- APMS52 - 680mm Modular 2 Door Floor Cabinet
- APMS58 - 650mm Modular 5 Drawer Mobile Cabinet

- APMS57 - 680mm Modular Multifunction Cabinet
- APMS51 - 680mm Modular 4 Drawer Cabinet
- APMS55 - 600mm Modular Full Height Floor Cabinet
- APMS50UCD - Modular Upright Connector Double (x4)
- APMS50UCS - Modular Upright Connector Single (x2)
- APMS50BP - 615mm Modular Back Panel (x5)

£2,999.95 Exc. VAT
£3,599.94 Inc. VAT

Stainless Steel Worktop
• Model No. **APMSSTACK01SS**
• List Price £4,199.95

Pressed Wood Worktop
• Model No. **APMSSTACK01W**
• List Price £4,069.95

£2,899.95 Exc. VAT
£3,479.94 Inc. VAT

Superline Pro® 4.9m Storage System

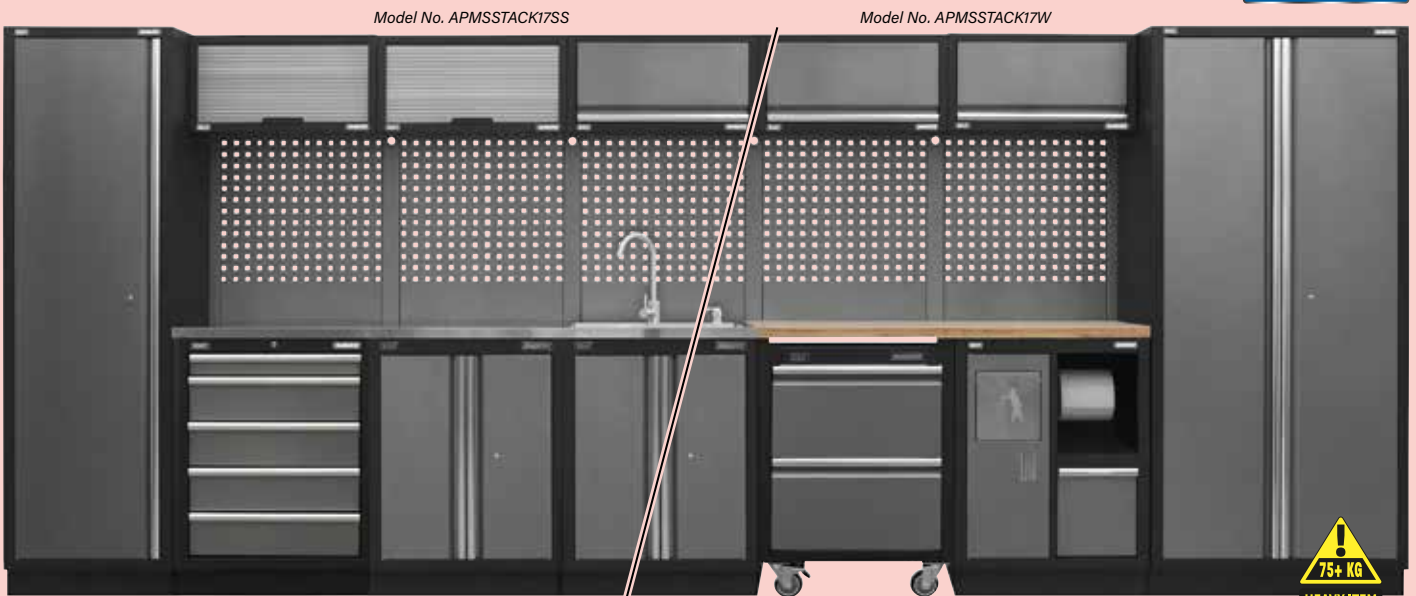

Package includes:

- APMS50SSC - 2040mm Stainless Steel Worktop
- APMS50SSA - 680mm Stainless Steel Worktop
- or
- APMS50WC - 2040mm Wood Worktop
- APMS50WA - 680mm Wood Worktop

- APMS56 - 915mm Modular 2 Door Floor Cabinet Full Height
- APMS54 - 680mm Modular Wall Cabinet Tambour Front (x2)
- APMS53 - 680mm Modular Wall Cabinet (x3)
- APMS59 - 680mm Modular 5 Drawer Cabinet
- APMS52 - 680mm Modular 2 Door Floor Cabinet
- APMS58 - 650mm Modular 5 Drawer Mobile Cabinet

- APMS51 - 680mm Modular 4 Drawer Cabinet
- APMS55 - 600mm Modular Floor Cabinet Full Height
- APMS67 - 680mm Modular Sink Unit
- APMS50BP - 615mm Modular Back Panel (x5)
- APMS50UCD - Modular Upright Connector Double (x4)
- APMS50UCS - Modular Upright Connector Single (x2)

£3,199.95 Exc. VAT
£3,839.94 Inc. VAT

Stainless Steel Worktop
• Model No. **APMSSTACK17SS**
• List Price £4,674.95



Pressed Wood Worktop
• Model No. **APMSSTACK17W**
• List Price £4,564.95

£3,149.95 Exc. VAT
£3,779.94 Inc. VAT

Superline Pro® 4.9m Storage System

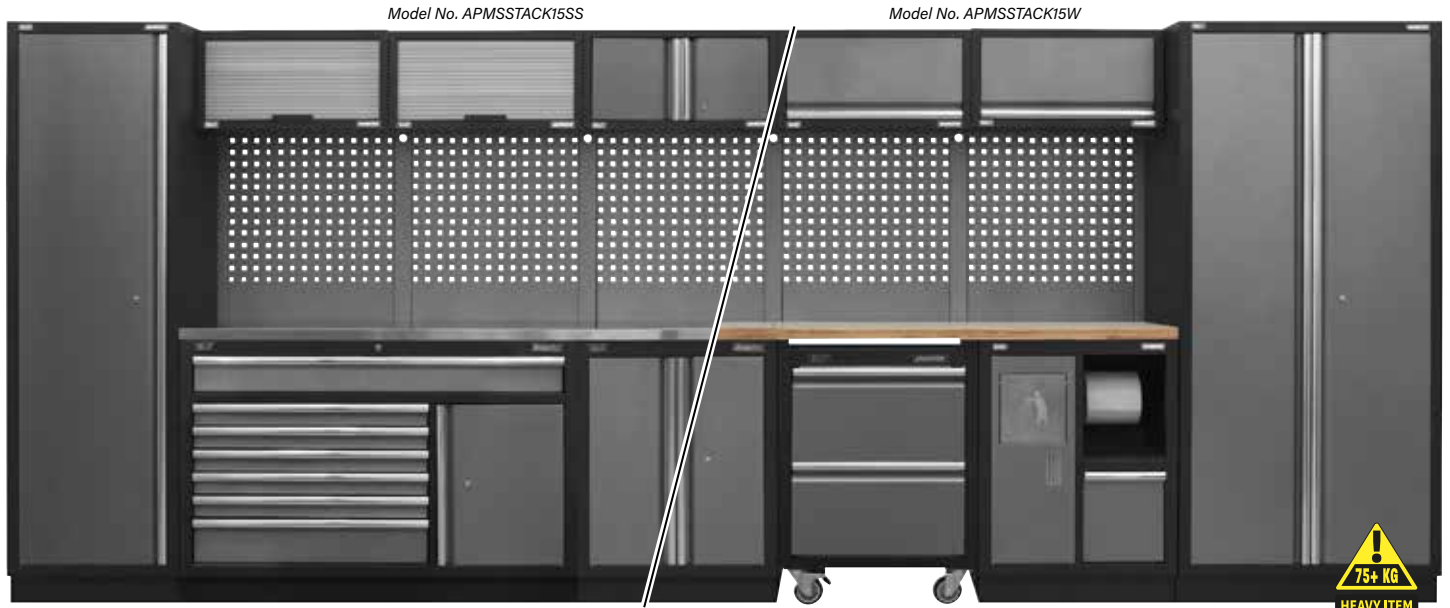

Package includes:

- APMS50SSB - 1360mm Stainless Steel Worktop
- APMS50SSC - 2040mm Stainless Steel Worktop
- or
- APMS50WB - 1360mm Pressed Wood Worktop
- APMS50WC - 2040mm Pressed Wood Worktop

- APMS64 - 1360mm 7 Drawer Modular Floor Cabinet
- APMS52 - 680mm 2 Door Modular Floor Cabinet
- APMS57 - 680mm Modular Multifunction Cabinet
- APMS66 - Modular Mobile Workshop Trolley
- APMS55 - 600mm Full Height Modular Floor Cabinet
- APMS56 - 915mm 2 Door Full Height Modular Floor Cabinet

- APMS54 - 680mm Modular Wall Cabinet Tambour Front (x2)
- APMS65 - 680mm 2 Door Modular Wall Cabinet
- APMS53 - 680mm Modular Wall Cabinet (x2)
- APMS50BP - 615mm Modular Back Panel (x5)
- APMS50UCD - Modular Upright Connector Double (x4)
- APMS50UCS - Modular Upright Connector Single (x2)



COMES WITH YOUR CHOICE OF WORKTOP, PRESSED WOOD OR STAINLESS STEEL.

£2,899.95 Exc. VAT
£3,479.94 Inc. VAT

Stainless Steel Worktop

- **Model No. APMSSTACK15SS**
- List Price £3,999.95

Pressed Wood Worktop

- **Model No. APMSSTACK15W**
- List Price £3,864.95

£2,849.95 Exc. VAT
£3,419.94 Inc. VAT

Superline Pro® 4.9m Storage System

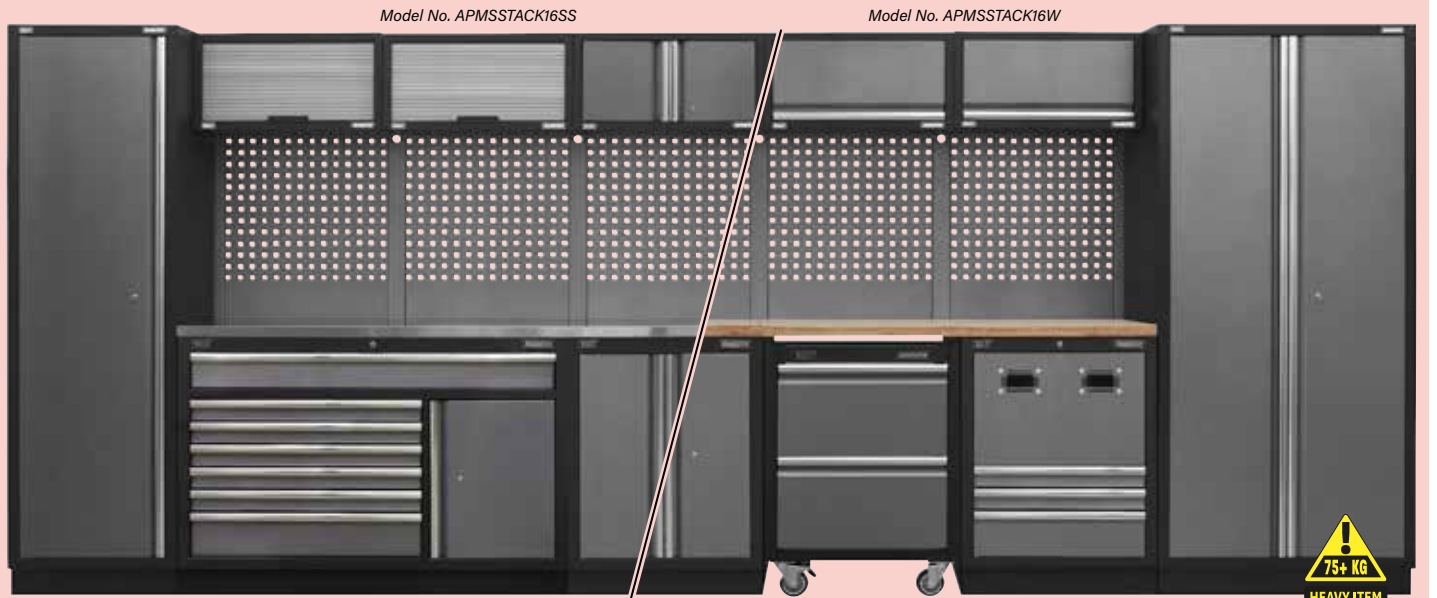

Package includes:

- APMS50SSB - 1360mm Stainless Steel Worktop
- APMS50SSC - 2040mm Stainless Steel Worktop
- or
- APMS50WB - 1360mm Pressed Wood Worktop
- APMS50WC - 2040mm Pressed Wood Worktop

- APMS64 - 1360mm 7 Drawer Modular Floor Cabinet
- APMS52 - 680mm 2 Door Modular Floor Cabinet
- APMS63 - 680mm Modular Reel Cabinet
- APMS66 - Modular Mobile Workshop Trolley
- APMS55 - 600mm Modular Full Height Floor Cabinet
- APMS56 - 915mm 2 Door Full Height Modular Floor Cabinet

- APMS54 - 680mm Modular Wall Cabinet Tambour Front (x2)
- APMS65 - 680mm 2 Door Modular Wall Cabinet
- APMS53 - 680mm Modular Wall Cabinet (x2)
- APMS50BP - 615mm Modular Back Panel (x5)
- APMS50UCD - Modular Upright Connector Double (x4)
- APMS50UCS - Modular Upright Connector Single (x2)

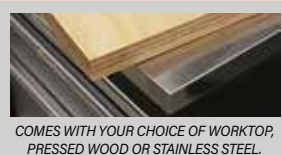

COMES WITH YOUR CHOICE OF WORKTOP, PRESSED WOOD OR STAINLESS STEEL.

£2,899.95 Exc. VAT
£3,479.94 Inc. VAT

Stainless Steel Worktop

- **Model No. APMSSTACK16SS**
- List Price £4,049.95

Pressed Wood Worktop

- **Model No. APMSSTACK16W**
- List Price £3,914.95

£2,849.95 Exc. VAT
£3,419.94 Inc. VAT

Superline Pro® 3.2m Storage System

Model No. APMSSTACK03SS

Model No. APMSSTACK03W



Package includes:

- APMS50SSC - 2040mm Stainless Steel Worktop or
- APMS50WC - 2040mm Pressed Wood Worktop

- APMS55 - 600mm Modular Floor Cabinet Full Height (x2)
- APMS54 - 680mm Modular Wall Cabinet Tambour Front
- APMS53 - 680mm Modular Wall Cabinet (x2)
- APMS59 - 680mm Modular 5 Drawer Cabinet
- APMS58 - 650mm Modular 5 Drawer Mobile Cabinet

- APMS52 - 680mm Modular 2 Door Floor Cabinet
- APMS50BP - 615mm Modular Back Panel (x3)
- APMS50UCD - Modular Upright Connector Double (x2)
- APMS50UCS - Modular Upright Connector Single (x2)

£1,999.95 Exc. VAT
£2,399.94 Inc. VAT

Stainless Steel Worktop

- Model No. APMSSTACK03SS
- List Price £2,729.95



COMES WITH YOUR CHOICE OF WORKTOP,
PRESSED WOOD OR STAINLESS STEEL.

Pressed Wood Worktop

- Model No. APMSSTACK03W
- List Price £2,649.95

£1,949.95 Exc. VAT
£2,339.94 Inc. VAT

Superline Pro® 3.24m Storage System

Model No. APMSSTACK13SS

Model No. APMSSTACK13W

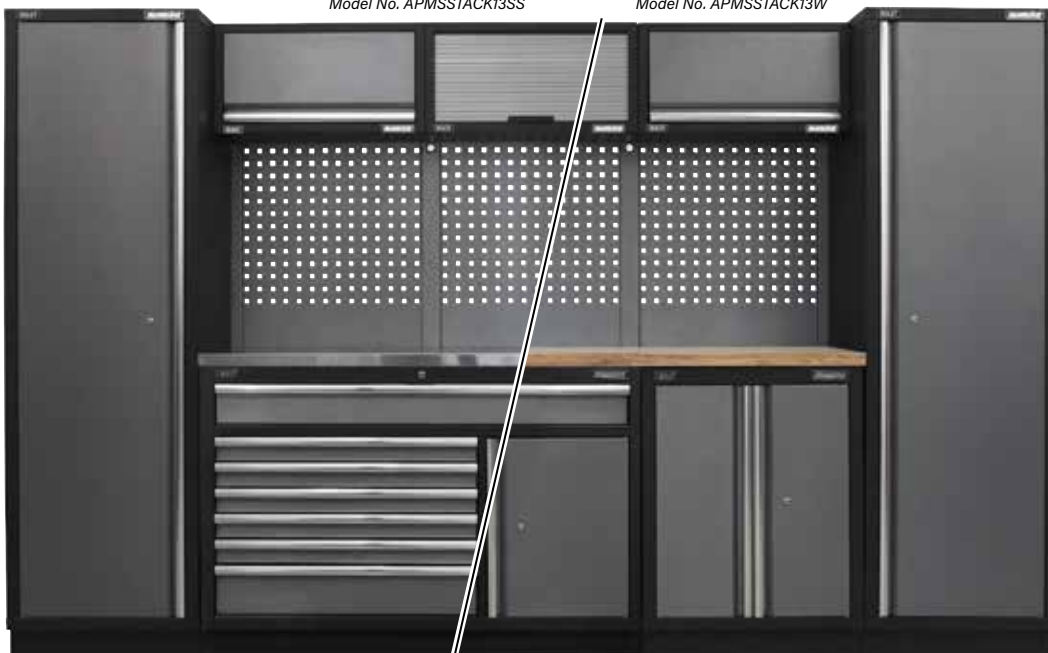

Package includes:

- APMS50SSC - 2040mm Stainless Steel Worktop or
- APMS50WC - 2040mm Pressed Wood Worktop

- APMS55 - 600mm Full Height Modular Floor Cabinet (x2)
- APMS54 - 680mm Modular Wall Cabinet Tambour Front
- APMS53 - 680mm Modular Wall Cabinet (x2)
- APMS50BP - 615mm Modular Back Panel (x3)

- APMS50UCD - Modular Upright Connector Double (x2)
- APMS50UCS - Modular Upright Connector Single (x2)
- APMS64 - 1360mm 7 Drawer Modular Floor Cabinet
- APMS52 - 680mm 2 Door Modular Floor Cabinet

£1,999.95 Exc. VAT
£2,399.94 Inc. VAT

Stainless Steel Worktop

- Model No. APMSSTACK13SS
- List Price £2,729.95



COMES WITH YOUR CHOICE OF WORKTOP,
PRESSED WOOD OR STAINLESS STEEL.

Pressed Wood Worktop

- Model No. APMSSTACK13W
- List Price £2,654.95

£1,949.95 Exc. VAT
£2,339.94 Inc. VAT

Superline Pro® 2.0m Storage System



Package includes:

- APMS50SSB - 1360mm Stainless Steel Worktop
- or
- APMS50WB - 1360mm Pressed Wood Worktop

- APMS53 - 680mm Modular Wall Cabinet (x2)
- APMS59 - 680mm Modular 5 Drawer Cabinet
- APMS52 - 680mm Modular 2 Door Floor Cabinet
- APMS55 - 600mm Modular Floor Cabinet Full Height

- APMS50UCD - Modular Upright Connector Double
- APMS50UCS - Modular Upright Connector Single (x2)
- APMS50BP - 615mm Modular Back Panel (x2)

£1,199.95 Exc. VAT
£1,439.94 Inc. VAT

Stainless Steel Worktop

- Model No. APMSSTACK02SS
- List Price £1,669.95



COMES WITH YOUR CHOICE OF WORKTOP, PRESSED WOOD OR STAINLESS STEEL.

Pressed Wood Worktop

- Model No. APMSSTACK02W
- List Price £1,609.95

£1,149.95 Exc. VAT
£1,379.94 Inc. VAT

Superline Pro® 1.96m Storage System



Package includes:

- APMS50SSB - 1360mm Stainless Steel Worktop
- or
- APMS50WB - 1360mm Pressed Wood Worktop

- APMS55 - 600mm Full Height Modular Floor Cabinet
- APMS53 - 680mm Modular Wall Cabinet (x2)
- APMS64 - 1360mm Modular 7 Drawer Floor Cabinet
- APMS50BP - 615mm Modular Back Panel (x2)

- APMS50UCD - Double Modular Upright Connector
- APMS50UCS - Single Modular Upright Connector (x2)

£1,349.95 Exc. VAT
£1,619.94 Inc. VAT

Stainless Steel Worktop

- Model No. APMSSTACK09SS
- List Price £1,769.95



COMES WITH YOUR CHOICE OF WORKTOP, PRESSED WOOD OR STAINLESS STEEL.

Pressed Wood Worktop

- Model No. APMSSTACK09W
- List Price £1,709.95

£1,299.95 Exc. VAT
£1,559.94 Inc. VAT

Superline Pro® 2.04m Storage System



Model No. APMSSTACK11SS

Model No. APMSSTACK11W



Package includes:

- APMS50SSC - 2040mm Stainless Steel Worktop
- or
- APMS50WC - 2040mm Pressed Wood Worktop

- APMS64 - 1360mm 7 Drawer Modular Floor Cabinet
- APMS65 - 680mm 2 Door Modular Wall Cabinet (x2)
- APMS54 - 680mm Modular Wall Cabinet Tambour Front
- APMS52 - 680mm 2 Door Modular Floor Cabinet
- APMS50BP - 615mm Modular Back Panel (x3)
- APMS50UCD - Modular System Upright Connector Double (x2)
- APMS50UCS - Modular System Upright Connector Single (x2)

£1,499.95 Exc. VAT
£1,799.94 Inc. VAT

Stainless Steel Worktop

- Model No. APMSSTACK11SS
- List Price £1,919.95



COMES WITH YOUR CHOICE OF WORKTOP, PRESSED WOOD OR STAINLESS STEEL.

Pressed Wood Worktop

- Model No. APMSSTACK11W
- List Price £1,844.95

£1,449.95 Exc. VAT
£1,739.94 Inc. VAT

Superline Pro® 2.04m Storage System



Model No. APMSSTACK12SS

Model No. APMSSTACK12W



Package includes:

- AAPMS50SSC - 2040mm Stainless Steel Worktop
- or
- APMS50WC - 2040mm Pressed Wood Worktop

- APMS53 - 680mm Modular Wall Cabinet
- APMS54 - 680mm Modular Wall Cabinet Tambour Front
- APMS66 - Modular Mobile Workshop Trolley
- APMS50BP - 615mm Modular Back Panel (x3)
- APMS62 - 680mm 7 Drawer Modular Floor Cabinet
- APMS52 - 680mm 2 Door Modular Floor Cabinet
- APMS65 - 680mm 2 Door Modular Wall Cabinet
- APMS50UCD - Modular Upright Connector Double (x2)
- APMS50UCS - Modular Upright Connector Single (x2)

£1,249.95 Exc. VAT
£1,499.94 Inc. VAT

Stainless Steel Worktop

- Model No. APMSSTACK12SS
- List Price £1,744.95



COMES WITH YOUR CHOICE OF WORKTOP, PRESSED WOOD OR STAINLESS STEEL.

Pressed Wood Worktop

- Model No. APMSSTACK12W
- List Price £1,669.95

£1,199.95 Exc. VAT
£1,439.94 Inc. VAT

Superline Pro® 2.0m Storage System



Model No. APMSSTACK07SS



Model No. APMSSTACK07W



Package includes:

- APMS50SSC - 2040mm Stainless Steel Worktop
- or
- APMS50WC - 2040mm Pressed Wood Worktop

- APMS52 - 680mm Modular 2 Door Floor Cabinet
- APMS53 - 680mm Modular Wall Cabinet (x2)
- APMS54 - 680mm Modular Wall Cabinet Tambour Front
- APMS51 - 680mm Modular 4 Drawer Cabinet

- APMS62 - 680mm Modular 7 Drawer Cabinet
- APMS50BP - 615mm Modular Back Panel (x3)
- APMS50UCD - Modular System Connector Double (x2)
- APMS50UCS - Modular System Connector Single (x2)

£1,399.95 Exc. VAT
£1,679.94 Inc. VAT

Stainless Steel Worktop

- Model No. APMSSTACK07SS
- List Price £1,949.95

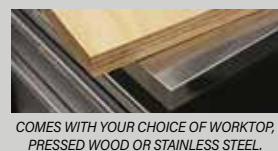

COMES WITH YOUR CHOICE OF WORKTOP,
PRESSED WOOD OR STAINLESS STEEL.

Pressed Wood Worktop

- Model No. APMSSTACK07W
- List Price £1,874.95

£1,349.95 Exc. VAT
£1,619.94 Inc. VAT

Superline Pro® 2.0m Storage System



Model No. APMSSTACK14SS



Model No. APMSSTACK14W



Package includes:

- APMS50SSC - 2040mm Stainless Steel Worktop
- or
- APMS50WC - 2040mm Pressed Wood Worktop

- APMS53 - 680mm Modular Wall Cabinet
- APMS54 - 680mm Modular Wall Cabinet Tambour Front
- APMS65 - 680mm 2 Door Modular Wall Cabinet
- APMS64 - 1360mm 7 Drawer Modular Floor Cabinet

- APMS63 - 680mm Modular Reel Cabinet
- APMS50BP - 615mm Modular Back Panel (x3)
- APMS50UCD - Modular Upright Connector Double (x2)
- APMS50UCS - Modular Upright Connector Single (x2)

£1,599.95 Exc. VAT
£1,919.94 Inc. VAT

Stainless Steel Worktop

- Model No. APMSSTACK14SS
- List Price £2,024.95

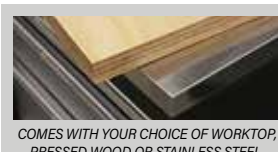

COMES WITH YOUR CHOICE OF WORKTOP,
PRESSED WOOD OR STAINLESS STEEL.

Pressed Wood Worktop

- Model No. APMSSTACK14W
- List Price £1,949.95

£1,549.95 Exc. VAT
£1,859.94 Inc. VAT

Superline Pro® 1.96m Storage System



Package includes:

- APMS50SSB - 1360mm Stainless Steel Worktop
- or
- APMS50WB - 1360mm Pressed Wood Worktop

- APMS64 - 1360mm 7 Drawer Modular Floor Cabinet
- APMS65 - 680mm Modular Wall Cabinet (x2)
- APMS55 - 600mm Modular Full Height Floor Cabinet
- APMS50BP - 615mm Modular Back Panel (x2)

- APMS50UCD - Double Modular Upright Connector
- APMS50UCS - Single Modular Upright Connector (x2)

£1,399.95 Exc. VAT
£1,679.94 Inc. VAT

Stainless Steel Worktop

- Model No. APMSSTACK10SS
- List Price £1,759.95



COMES WITH YOUR CHOICE OF WORKTOP, PRESSED WOOD OR STAINLESS STEEL.

Pressed Wood Worktop

- Model No. APMSSTACK10W
- List Price £1,699.95

£1,349.95 Exc. VAT
£1,619.94 Inc. VAT

Superline Pro® 1.6m Corner Storage System



Package includes:

- APMS50SSA - 680mm Stainless Steel Worktop (x2)
- APMS60SS - 865mm Stainless Steel Worktop for Modular Corner Cabinet
- or
- APMS50WA - 680mm Pressed Wood Worktop (x2)
- APMS60PW - 865mm Pressed Wood Worktop for Modular Corner Cabinet

- APMS62 - 680mm Modular 7 Drawer Cabinet
- APMS53 - 680mm Modular Wall Cabinet (x2)
- APMS57 - 680mm Modular Multifunction Cabinet
- APMS60 - 865mm Modular Corner Floor Cabinet
- APMS61 - 865mm Modular Corner Wall Cabinet

- APMS50BP - 615mm Modular Back Panel (x2)
- APMS50UCD - Modular Upright Connector Double (x2)
- APMS50UCS - Modular Upright Connector Single (x4)
- APMS60BP - Back Panel for Modular Corner Unit (x2)

£1,649.95 Exc. VAT
£1,979.94 Inc. VAT

Stainless Steel Worktop

- Model No. APMSSTACK08SS
- List Price £2,384.95



COMES WITH YOUR CHOICE OF WORKTOP, PRESSED WOOD OR STAINLESS STEEL.

Pressed Wood Worktop

- Model No. APMSSTACK08W
- List Price £2,274.95

£1,599.95 Exc. VAT
£1,919.94 Inc. VAT

Superline Pro® Workshop Island

- APMS60 - 865mm Modular Corner Floor Cabinet (x4).

Model No.
APMSCOMBOCSS

Model No.
APMSCOMBOCPW



COMES WITH YOUR CHOICE OF WORKTOP,
PRESSED WOOD OR STAINLESS STEEL.

- APMS60SS - 865mm **Stainless Steel Worktop** for Modular Corner Cabinet (x4).

- **Model No. APMSCOMBOCSS**
- List Price £1,999.95

£1,399.95 Exc. VAT
£1,679.94 Inc. VAT

- APMS60PW - 865mm **Pressed Wood Worktop** for Modular Corner Cabinet 865mm (x4).

- **Model No. APMSCOMBOCPW**
- List Price £1,899.95

£1,329.95 Exc. VAT
£1,595.94 Inc. VAT



1360mm Modular Wall Cabinet

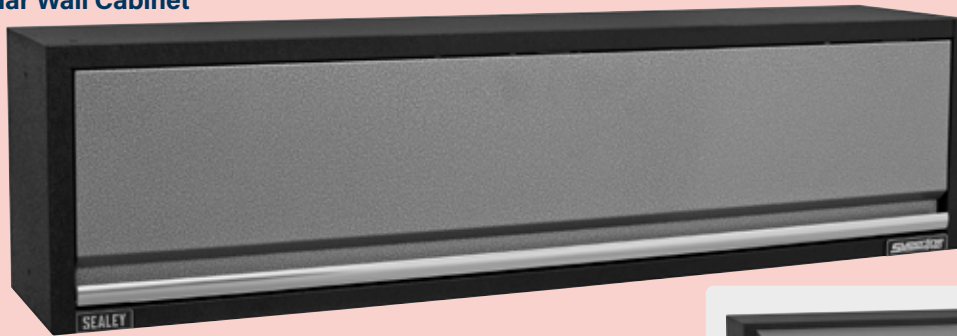

HEAVY DUTY

NEW PRODUCT

- Use as part of a complete garage storage system or as an individual storage unit.
- Supplied with appropriate fixings to make integral self-supporting unit or use in conjunction with Model No. APMS50BP Back Panel and upright supports if part of a larger modular system.
- Lift-up door is supported by gas struts.
- Aluminium drawer pulls.
- Supplied fully assembled.
- Overall Size (W x D x H): 1360 x 280 x 350mm.
- This item is heavy. Extra assistance must be provided at the delivery point to help its safe delivery.
- **Model No. APMS68**
- List Price £239.95



£199.95 Exc. VAT
£239.94 Inc. VAT

680mm Modular 4 Drawer Floor Cabinet



Worktop not included.



ORDER WITH YOUR CHOICE OF WORKTOP,
PRESSED WOOD OR STAINLESS STEEL.
SEE PAGE 109.



4 Drawer

- Use as part of a complete garage storage system or as an individual storage unit.
- Four drawers fitted with ball-bearing slides.
- Aluminium drawer pulls.
- High quality lock with two keys.
- Overall Size (W x D x H): 680 x 460 x 910mm.
- **Model No. APMS51**
- List Price £389.95

£339.95 Exc. VAT
£407.94 Inc. VAT

680mm Modular 5 Drawer Floor Cabinet



Worktop not included.



ORDER WITH YOUR CHOICE OF WORKTOP,
PRESSED WOOD OR STAINLESS STEEL.
SEE PAGE 109.

5 Drawer

- Use as part of a complete garage storage system or as an individual storage unit.
- Five drawers fitted with ball-bearing slides.
- Aluminium drawer pulls.
- High quality lock with two keys.
- Overall Size (W x D x H): 680 x 460 x 910mm.
- **Model No. APMS59**
- List Price £399.95

£329.95 Exc. VAT
£395.94 Inc. VAT

680mm Modular 7 Drawer Floor Cabinet



Worktop not included.



ORDER WITH YOUR CHOICE OF WORKTOP,
PRESSED WOOD OR STAINLESS STEEL.
SEE PAGE 109.

7 Drawer

- Use as part of a complete garage storage system or as an individual storage unit.
- Seven drawers fitted with ball-bearing slides.
- Aluminium drawer pulls.
- High quality lock with two keys.
- Overall Size (W x D x H): 680 x 460 x 910mm.
- **Model No. APMS62**
- List Price £429.95

£369.95 Exc. VAT
£443.94 Inc. VAT

680mm Modular 2 Door Floor Cabinet



Worktop not included.



ORDER WITH YOUR CHOICE OF WORKTOP. PRESSED WOOD OR STAINLESS STEEL. SEE PAGE 109.



- Use as part of a complete garage storage system or as an individual storage unit.
- Supplied with an adjustable shelf.
- Aluminium handles.
- High quality lock with two keys.
- Overall Size (W x D x H): 680 x 460 x 910mm.
- **Model No. APMS52**
- List Price £299.95

£249.95 Exc. VAT
£299.94 Inc. VAT

680mm Modular Reel Cabinet



Worktop not included.



ORDER WITH YOUR CHOICE OF WORKTOP. PRESSED WOOD OR STAINLESS STEEL. SEE PAGE 109.

- Solid reel cabinet for the convenient and tidy use of cable reels and air hose reels.
- Aluminium handles.
- Overall Size (W x D x H): 680 x 460 x 910mm.
- Suitable for use with Sealey Air Reel SA895 and Cable Reels CRM101 and CRM151.
- **Model No. APMS63**
- List Price £399.95

£329.95 Exc. VAT
£395.94 Inc. VAT

680mm Modular Multifunction Cabinet



Worktop not included.



ORDER WITH YOUR CHOICE OF WORKTOP. PRESSED WOOD OR STAINLESS STEEL. SEE PAGE 109.

- Use as part of a complete garage storage system or as an individual storage unit.
- Solid multifunction modular cabinet includes rubbish bin, paper roll holder and a deep drawer.
- Aluminium handles.
- Overall Size (W x D x H): 680 x 460 x 910mm.
- **Model No. APMS57**
- List Price £349.95

£289.95 Exc. VAT
£347.94 Inc. VAT

650mm 5 Drawer Modular Mobile Cabinet



5 Drawer

- Use as part of a complete garage storage system or as an individual storage unit.
- Five drawer mobile cabinet.
- Four swivel castors with one brake.
- Aluminium handles.
- High quality lock with two keys.
- Overall Size (W x D x H): 650 x 460 x 860mm.
- **Model No. APMS58**
- List Price £399.95

£329.95 Exc. VAT
£395.94 Inc. VAT

Modular Mobile Workshop Trolley



- Use as part of a complete garage storage system or as an individual storage unit.
- Mobile 3-tiered trolley.
- Four swivel castors with one brake.
- Aluminium handles.
- Top tier is supplied with a non-slip liner.
- Overall Size (W x D x H): 646 x 460 x 866mm.
- **Model No. APMS66**
- List Price £189.95

£159.95 Exc. VAT
£191.94 Inc. VAT

680mm Modular Wall Cabinet Tambour Front



- For use with Model No's APMS51, APMS52, APMS57 and APMS59 Floor Cabinets.
- Supplied with appropriate fixings to make integral self supporting unit, or use in conjunction with Model No. APMS50BP Back Panel and upright supports if part of a larger modular system.
- Tambour style front for easy-access.
- Aluminium handles.
- Overall Size (W x D x H): 680 x 280 x 350mm.
- **Model No. APMS54**
- List Price £117.45

£99.95 Exc. VAT
£119.94 Inc. VAT

680mm Modular Wall Cabinet



- For use with Model No's APMS51, APMS52, APMS57 and APMS59 Floor Cabinets.
- Supplied with appropriate fixings to make integral self supporting unit, or use in conjunction with Model No. APMS50BP Back Panel and upright supports if part of a larger modular system.
- Lift-up door is supported by gas struts.
- Aluminium handles.
- Overall Size (W x D x H): 680 x 280 x 350mm.
- **Model No. APMS53**
- List Price £124.95

£104.95 Exc. VAT
£125.94 Inc. VAT

680mm 2 Door Modular Wall Cabinet



- For use with Model No's APMS51, APMS52, APMS57, APMS59 and APMS64 Floor Cabinets.
- Supplied with appropriate fixings to make integral self-supporting unit, or use in conjunction with Model No. APMS50BP Back Panel and upright supports if part of a larger modular system.
- Double door cabinet for easy-access with a high quality lock supplied with two keys.
- Aluminium handles.
- Overall Size (W x D x H): 680 x 280 x 350mm.
- **Model No. APMS65**
- List Price £119.95

£99.95 Exc. VAT
£119.94 Inc. VAT

680mm Modular Sink Unit



- Use as part of a complete garage storage system or as an individual unit.
- Includes a brushed aluminium mono block mixer tap and matching soap dispenser.
- Supplied with flexible hot and cold-water tap connectors, service valves, plus a waste trap.
- Lockable cabinet with high quality lock and two keys.
- Overall Size (W x D x H): 680 x 430 x 600mm.
- **Model No. APMS67**
- List Price £899.95

£699.95 Exc. VAT
£839.94 Inc. VAT

1360mm 7 Drawer Modular Floor Cabinet



Worktop not included.

- Use as part of a complete garage storage system or as an individual storage unit.
- Seven drawers fitted with ball-bearing slides.
- Aluminium drawer pulls.
- All drawers come with protective drawer liners.
- High quality lock with two keys.
- Overall Size (W x D x H): 1360 x 460 x 910mm.
- **Model No. APMS64**
- List Price £799.95

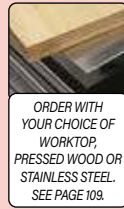

ORDER WITH YOUR CHOICE OF WORKTOP. PRESSED WOOD OR STAINLESS STEEL. SEE PAGE 109.



This item is heavy. Extra assistance must be provided at the delivery point to help safe delivery.

£679.95 Exc. VAT
£815.94 Inc. VAT

865mm Modular Corner Wall Cabinet



- For use with Model No. APMS60 corner floor cabinet.
- Supplied with the appropriate fixings to make integral self supporting unit, or use in conjunction with Model No's APMS60BP (x2), APMS50UCS (x2) and APMS50UCD (x2) to link to APMS60 and create a full corner system.
- Lift-up door is supported by gas struts.
- Aluminium handles.
- Overall Size (W x D x H): 865 x 865 x 350mm.
- **Model No. APMS61**
- List Price £299.95

£239.95 Exc. VAT
£287.94 Inc. VAT

600mm Full Height Modular Floor Cabinet



- Use as part of a complete garage storage system or as an individual storage unit.
- Full height single door floor cabinet.
- Four fully adjustable shelves.
- High quality lock with two keys.
- Supplied flat-packed for ease of transportation and requires some self-assembly.
- Overall Size (W x D x H): 600 x 460 x 2000mm.
- **Model No. APMS55**
- List Price £399.95

£339.95 Exc. VAT
£407.94 Inc. VAT

915mm Full Height Modular 2 Door Floor Cabinet



- Use as part of a complete garage storage system or as an individual storage unit.
- Full height double door floor cabinet.
- Four fully adjustable shelves.
- High quality lock with two keys.
- Supplied flat-packed for ease of transportation and requires some self-assembly.
- Overall Size (W x D x H): 915 x 460 x 2000mm.
- **Model No. APMS56**
- List Price £579.95

£499.95 Exc. VAT
£599.94 Inc. VAT



This item is heavy. Extra assistance must be provided at the delivery point to help safe delivery.

865mm Modular Corner Floor Cabinet



Worktop not included.

ADJUSTABLE SHELF



ORDER WITH YOUR CHOICE OF WORKTOP. PRESSED WOOD OR STAINLESS STEEL. SEE BELOW.



- Use as part of a complete garage storage system or as an individual storage unit.
- Aluminium handle.
- Features one adjustable shelf.
- Supplied flat-packed for ease of transportation and requires some self-assembly.
- High quality lock with two keys.
- Overall Size (W x D x H): 865 x 865 x 910mm.
- **Model No. APMS60**
- List Price £379.95

£299.95 Exc. VAT
£359.94 Inc. VAT

865mm Worktops for Modular Corner Cabinets



- Stainless steel worktop for use with Model No. APMS60 Corner Cabinet.
- Overall Size (W x D x H): 865 x 865 x 38mm.
- **Model No. APMS60SS**
- List Price £169.95

£139.95 Exc. VAT
£167.94 Inc. VAT



- Pressed wood worktop for use with Model No. APMS60 Corner Cabinet.
- Overall Size (W x D x H): 865 x 865 x 36mm.
- **Model No. APMS60PW**
- List Price £129.95

£109.95 Exc. VAT
£131.94 Inc. VAT

680mm Modular Power Tool Rack



NEW
PRODUCT

AVAILABLE
Mid July



- Five open fronted power tool storage bays.
- Fully welded with a hammered metal finish.
- Specifically designed to fit APMS wall cabinets.
- Suitable for use with APMS53 and APMS65.
- Minimal assembly required.
- **Model No. APMS69**
- List Price £89.95

£65.95 Exc. VAT
£79.14 Inc. VAT

645mm Modular Shelf



NEW
PRODUCT

AVAILABLE
Mid July



- Tough and durable easy fit shelf with hammered metal finish.
- To be used specifically with APMS50BP or APMS60BP.
- Suitable to fit on the back panel of the APMS Superline Pro® Wall Cabinets and Storage Systems.
- Ideal for storing small components and keeping work areas clean and tidy.
- Some simple assembly required.
- **Model No. APMS70**
- List Price £39.95

£26.95 Exc. VAT
£32.34 Inc. VAT

Modular Back Panels

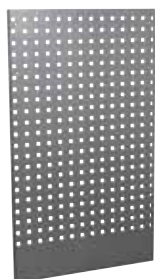

Model No.
APMS50BP

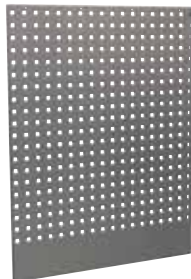

Model No.
APMS60BP

- Back panels to connect wall cabinets to base cabinets in the APMS50/APMS60 Series.
- Must be used in conjunction with either Model No. APMS50UCS or APMS50UCD Upright Connectors.
- Features hanging holes for quick and easy-access to workshop tools.

Model No.	Size (W x D x H)	List Price	Exc. VAT	Inc. VAT
APMS50BP	615 x 25 x 1050mm	£49.95	£39.95	£47.94
APMS60BP	800 x 25 x 1050mm	£59.95	£49.95	£59.94

Modular System Upright Connectors

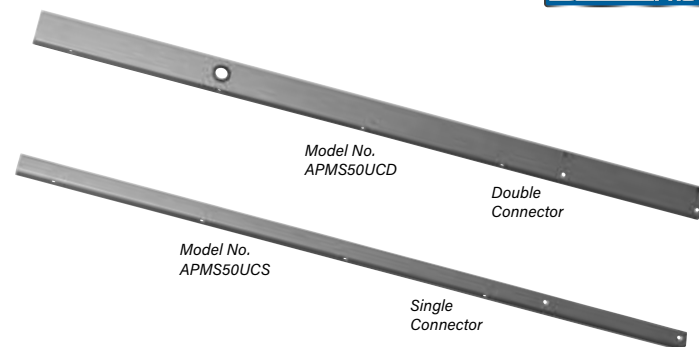

- Supports/connects wall cabinets and Model No's APMS50BP and APMS60BP hanging Back Panel at end of run.

Model No.	Size (W x D x H)	List Price	Exc. VAT	Inc. VAT
APMS50UCS	32.5 x 30 x 1420mm	£13.95	£10.95	£13.14
APMS50UCD	65 x 30 x 1420mm	£18.45	£14.95	£17.94

Choose your finish!
Complement your cabinets with either stainless steel or pressed wood worktops. See below for details.

Stainless Steel Worktops



- Stainless steel worktop for use with all APMS Floor Cabinets (except APMS67).
- Model No. APMS50SSA covers a single base cabinet, Model No. APMS50SSB covers two base cabinets, Model No. APMS50SSC covers three base cabinets.

Model No.	Size (W x D x H)	List Price	Exc. VAT	Inc. VAT
APMS50SSA	680 x 463 x 38mm	£97.45	£79.95	£95.94
APMS50SSB	1360 x 463 x 38mm	£174.95	£139.95	£167.94
APMS50SSC	2040 x 463 x 38mm	£249.95	£199.95	£239.94

Pressed Wood Worktops



- Pressed wood worktop for use with all APMS Floor Cabinets (except APMS67).
- Model No. APMS50WA covers a single base cabinet, Model No. APMS50WB covers two base cabinets, Model No. APMS50WC covers three base cabinets.

Model No.	Size (W x D x H)	List Price	Exc. VAT	Inc. VAT
APMS50WA	680 x 463 x 36mm	£61.95	£49.95	£59.94
APMS50WB	1360 x 463 x 36mm	£117.45	£94.95	£113.94
APMS50WC	2040 x 463 x 36mm	£176.45	£139.95	£167.94

Topchests with Ball-Bearing Slides



- All heavy gauged steel construction and manufactured with steel inner walls for extra strength and durability.
- Heavy-duty 45mm ball-bearing drawer slides provide superior performance and carry heavier loads.
- Full height rear locking mechanism, locks full-length drawers in multiple locations.
- Added security provided by tumbler lock, supplied with two folding keys.
- Rust and solvent resistant powder coat paint finish.
- Fitted with heavy-duty side handles.
- Each drawer features aluminium drawer pulls and non-slip liners.
- Overall Size (W x D x H): 1025 x 435 x 495mm.



Model No.	Colour	Drawers	List Price	Exc. VAT	Inc. VAT
AP41110	Red	10	£639.95	£499.95	£599.94
AP41110B	Black	10	£639.95	£499.95	£599.94
AP41149	Red	14	£699.95	£499.95	£599.94
AP41149B	Black	14	£699.95	£499.95	£599.94

1 Drawer Mid-Boxes with Ball-Bearing Slides

- All heavy gauged steel construction and manufactured with steel inner walls for extra strength and durability.
- Heavy-duty 45mm ball-bearing drawer slides provide superior performance and carry heavier loads.
- Full height rear locking mechanism, locks full-length drawers in multiple locations.
- Added security provided by tumbler lock, supplied with two folding keys.
- Rust and solvent resistant powder coat paint finish.
- Drawer features aluminium drawer pulls and non-slip liners.
- Overall Size (W x D x H): 1030 x 440 x 170mm.



Model No. AP41119



Model No. AP41119B

Model No.	Colour	List Price	Exc. VAT	Inc. VAT
AP41119	Red	£179.95	£139.95	£167.94
AP41119B	Black	£179.95	£139.95	£167.94

12 Drawer Rollcabs with Ball-Bearing Slides



- All heavy gauged steel construction and manufactured with steel inner walls for extra strength and durability.
- Heavy-duty 45mm ball-bearing drawer slides provide superior performance and carry heavier loads.
- Full height rear locking mechanism, locks full-length drawers in multiple locations.
- Added security provided by tumbler lock, supplied with two folding keys.
- Rust and solvent resistant powder coat paint finish.
- Includes four extra-heavy-duty Ø125mm PU/PP alloy wheels, two swivel castors with large toe locks and two fixed wheels.
- Features a highly polished chrome handle to enable smooth manoeuvrability.
- Also includes a 10mm thick top mat.
- Each drawer features aluminium drawer pulls and non-slip liners.
- Overall Size (W x D x H): 1050 x 465 x 1005mm.

Model No.	Colour	List Price	Exc. VAT	Inc. VAT
AP41120	Red	£939.95	£699.95	£839.94
AP41120B	Black	£939.95	£699.95	£839.94

16 Drawer Rollcabs with Ball-Bearing Slides



- All heavy gauged steel construction and manufactured with steel inner walls for extra strength and durability.
- Heavy-duty 45mm ball-bearing drawer slides provide superior performance and carry heavier loads.
- Full height rear locking mechanism, locks full-length drawers in multiple locations.
- Added security provided by tumbler lock, supplied with two folding keys.
- Rust and solvent resistant powder coat paint finish.
- Includes four extra-heavy-duty Ø125mm PU/PP alloy wheels, two swivel castors with large toe locks and two fixed wheels.
- Features a high polished chrome handle to enable smooth manoeuvrability.
- Also includes a 10mm thick top mat.
- Each drawer features aluminium drawer pulls and non-slip liners.
- Overall Size (W x D x H): 1050 x 465 x 1005mm.

Model No.	Colour	List Price	Exc. VAT	Inc. VAT
AP41169	Red	£1,049.95	£799.95	£959.94
AP41169B	Black	£1,049.95	£799.95	£959.94

10 Drawer Topchests with Ball-Bearing Slides

- Extra-wide Topchests designed to take our modular tool trays.
- Overall Size (W x D x H): 1265 x 435 x 490mm.

Model No.	Colour	List Price	Exc. VAT	Inc. VAT
AP5210T	Red	£799.95	£599.95	£719.94
AP5210TB	Black	£799.95	£599.95	£719.94

13 Drawer Rollcabs with Ball-Bearing Slides

- Extra-wide Rollcabs designed to take our modular tool trays.
- Overall Size (W x D x H): 1290 x 465 x 1005mm.

Model No.	Colour	List Price	Exc. VAT	Inc. VAT
AP5213T	Red	£1,249.95	£999.95	£1,199.94
AP5213TB	Black	£1,249.95	£999.95	£1,199.94

OR BUY AS A 23 DRAWER COMBINATION

Packages include:

- **AP52COMBO1** includes AP5210T and AP5213T - *Red*
- **AP52COMBO2** includes AP5210TB and AP5213TB - *Black*

Model No.	Colour	List Price	Exc. VAT	Inc. VAT
AP52COMBO1	Red	£1,949.95	£1,399.95	£1,679.94
AP52COMBO2	Black	£1,949.95	£1,399.95	£1,679.94



Model No.
AP52COMBO1



Model No.
AP52COMBO2



These items are heavy. Extra assistance must be provided at the delivery point to help safe delivery.

10 Drawer Topchest with Ball-Bearing Slides

10 Drawer

- All steel construction and manufactured with steel inner walls for extra strength and durability.
- Heavy-duty 45mm ball-bearing drawer slides provide superior performance and carry heavier loads.
- Split drawers for extra storage flexibility.
- Non-slip liners for all drawers and under-lid compartment are provided.
- Full height rear locking mechanism, locks drawers in multiple locations.
- Added security provided by cylinder locks, each supplied with two keys.
- Rust and solvent resistant powder coat paint finish.
- Twin gas dampers keeps lid open for easy-access.
- Overall Size (W x D x H): 1655 x 435 x 495mm.
- **Model No. AP6610**
- List Price £999.95



£759.95 Exc. VAT
£911.94 Inc. VAT

1 Drawer Mid-Box with Ball-Bearing Slides

1 Drawer

- Added security provided by tumbler lock, supplied with two folding keys.
- Drawer features aluminium drawer pulls and non-slip liners.
- Overall Size (W x D x H): 1665 x 440 x 170mm.
- **Model No. AP6601**
- List Price £299.95



£229.95 Exc. VAT
£275.94 Inc. VAT

12 Drawer Rollcab with Ball-Bearing Slides

12 Drawer

1680mm Super-Extra-Wide

- Added security provided by tumbler lock, supplied with two folding keys.
- Includes six extra-heavy-duty Ø125mm PU/PP alloy wheels, two fixed wheels and four swivel castors two of which are lockable.
- Features a highly polished chrome handle to enable smooth manoeuvrability.
- Also includes a 10mm thick top mat.
- Each drawer features aluminium drawer pulls and non-slip liners.
- Overall Size (W x D x H): 1680 x 465 x 1005mm.
- **Model No. AP6612**
- List Price £1,599.95



£1,249.95 Exc. VAT
£1,499.94 Inc. VAT

Hang-On Lockers



Model No. AP33519



1 Drawer

- All heavy gauged steel construction and manufactured with steel inner walls for extra strength and durability.
- Full height rear locking mechanism, locks full-length drawers in multiple locations.
- Added security provided by tumbler lock, supplied with two folding keys.
- Rust and solvent resistant powder coat paint finish.
- Hang-on locker suitable for Superline PRO® 12 and 16 drawer rollcabs.
- Features two adjustable shelves and a lockable drawer
- Overall Size (W x D x H): 390 x 460 x 1325mm.
- **Model No. AP33519 - Red**
- **Model No. AP33519B - Black**
- List Price £439.95



Model No. AP33519B

£344.95 Exc. VAT
£413.94 Inc. VAT

MULTIPURPOSE STORAGE HOOKS

The quick access, organised storage solution.

PVC WRAPPED.

POWDER COATED.

110KG RAIL CAPACITY.

20KG HOOK CAPACITY.

Model No. APHKIT2



Model No.	Description	Dimensions (W x D x H)	List Price	Exc. VAT	Inc. VAT
APH01	Wall Mountable Storage Rail	610 x 18 x 100mm	£7.95	£6.45	£7.74
APH02	Power Tool Storage Hook	166 x 238 x 90mm	£7.45	£5.95	£7.14
APH03	Large J Storage Hook	77 x 182 x 230mm	£7.75	£5.95	£7.14
APH04	Double Prong Storage Hook	75 x 220 x 90mm	£5.95	£4.75	£5.70
APH05	Large Loop Storage Hook	190 x 260 x 105mm	£8.95	£6.95	£8.34
APH06	Sports Equipment Storage Hook	76 x 200 x 90mm	£5.95	£4.75	£5.70
APH07	Closed End Storage Hook	90 x 230 x 90mm	£7.25	£5.75	£6.90
APH08	Double S Storage Hook	220 x 40 x 195mm	£8.95	£6.95	£8.34
APH09	Single Prong Storage Hook	40 x 140 x 90mm	£4.45	£3.45	£4.14
APH10	Single J Prong Storage Hook	40 x 60 x 120mm	£4.45	£3.45	£4.14
APH11	Single S Prong Storage Hook	80 x 30 x 150mm	£4.95	£3.95	£4.74
APH12	Dual Utility Storage Hook	80 x 265 x 115mm	£7.45	£5.95	£7.14
APH13	4-Way Storage Hook	215 x 130 x 90mm	£8.95	£6.95	£8.34
APH14	Storage Basket	300 x 230 x 220mm	£27.95	£21.95	£26.34
APHKIT1	APH01, APH03, APH04, APH12		£26.95	£20.95	£25.14
APHKIT2	APH01(x3), APH03(x2), APH04(x2), APH08(x1), APH09(x2)		£61.95	£49.95	£59.94

Scan for our full range of Wall Storage Solutions.



Model No. APH02



Model No. APH05



Model No. APH06

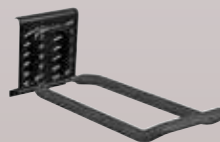

Model No. APH07



Model No. APH11



PREMIER™ STORAGE SYSTEMS

All steel construction with graphite powder coat finish. Brushed aluminium drawer pulls and handles. Heavy-duty drawers with rubber liners and precision ball-bearing drawer slides. Concealed snap-close magnets on doors. 25mm worktop. Gas struts on wall cabinet doors. Adjustable feet to ensure cabinets sit 'true' even on floors that are not level. Each unit supplied with high quality cylinder locks and two keys where applicable.

Premier™ 5.6m Storage System



Model No. APMSSTEEL

Model No. APMSOAK



Package includes:

- APMS05 - 930mm Heavy-Duty Modular Full Height Floor Cabinet
- APMS13 - 775mm Heavy-Duty Modular Wall Cabinet (x2)
- APMS14 - 1550mm Heavy-Duty Modular Wall Cabinet (x2)
- APMS01 - 775mm Heavy-Duty Modular 1 Door Floor Cabinet
- APMS02 - 1550mm Heavy-Duty Modular 2 Door Floor Cabinet

Includes your choice of worktop, Stainless Steel or Oak:

- APMS08 - 775mm Stainless Steel Worktop (x2)
 - APMS09 - 1550mm Stainless Steel Worktop (x2)
- or**
- APMS06 - 775mm Oak Worktop (x2)
 - APMS07 - 1550mm Oak Worktop (x2)

- APMS04 - 1550mm Heavy-Duty Modular 11 Drawer Floor Cabinet
- APMS03 - 775mm Heavy-Duty Modular 6 Drawer Floor Cabinet
- APMS10 - 775mm Modular Back Panel (x2)
- APMS11 - 1550mm Modular Back Panel (x2)



Model No.	Worktop Material	List Price	Exc. VAT	Inc. VAT
APMSSTEEL	Stainless Steel	£7,499.95	£5,999.95	£7,199.94
APMSOAK	Oak	£7,084.95	£5,599.95	£6,719.94

Premier™ 3.3m Storage Systems



Model No. APMSCOMBO7SS

Model No. APMSCOMBO7W



Package includes:

- APMS13 - 775mm Heavy-Duty Modular Wall Cabinet
- APMS14 - 1550mm Heavy-Duty Modular Wall Cabinet
- APMS01 - 775mm Heavy-Duty Modular Floor Cabinet
- APMS04 - 1550mm Heavy-Duty 11 Drawer Modular Floor Cabinet
- APMS21 - 2108mm Heavy-Duty Modular Full Height Floor Cabinet (x2)
- APMS10 - 775mm Modular Back Panel
- APMS11 - 1550mm Modular Back Panel

Includes your choice of worktop, Stainless Steel or Oak:

- APMS08 - 775mm Stainless Steel Worktop
 - APMS09 - 1550mm Stainless Steel Worktop
- or**
- APMS06 - 775mm Oak Worktop
 - APMS07 - 1550mm Oak Worktop



Model No.	Worktop Material	List Price	Exc. VAT	Inc. VAT
APMSCOMBO7SS	Stainless Steel	£4,499.95	£3,399.95	£4,079.94
APMSCOMBO7W	Oak	£4,299.95	£3,199.95	£3,839.94

Premier™ 2.5m Storage System

Premier™

Model No. APMSCOMBO1SS

Model No. APMSCOMBO1W



Package includes:

- APMS05 - 930mm Heavy-Duty Modular Full Height Floor Cabinet
- APMS13 - 775mm Heavy-Duty Modular Wall Cabinet (x2)
- APMS10 - 775mm Modular Back Panel (x2)
- APMS01 - 775mm Heavy-Duty Modular Floor Cabinet
- APMS03 - 775mm Heavy-Duty Modular 6 Drawer Floor Cabinet

Includes your choice of worktop, Stainless Steel or Oak:

- APMS08 - 775mm Stainless Steel Worktop 775mm (x2)
- or
- APMS06 - 775mm Oak Worktop (x2)

Model No.	Worktop Material	List Price	Exc. VAT	Inc. VAT
APMSCOMBO1SS	Stainless Steel	£3,034.95	£2,499.95	£2,999.94
APMSCOMBO1W	Oak	£2,894.95	£2,399.95	£2,879.94

Premier™ 3.3m Storage System

Premier™

Model No. APMSCOMBO2SS

Model No. APMSCOMBO2W



Package includes:

- APMS05 - 930mm Heavy-Duty Modular Full Height Floor Cabinet
- APMS13 - 775mm Heavy-Duty Modular Wall Cabinet
- APMS14 - 1550mm Heavy-Duty Modular Wall Cabinet
- APMS10 - 775mm Modular Back Panel
- APMS11 - 1550mm Modular Back Panel
- APMS01 - 775mm Heavy-Duty Modular Floor Cabinet
- APMS04 - 1550mm Heavy-Duty Modular 11 Drawer Floor Cabinet

Includes your choice of worktop, Stainless Steel or Oak:

- APMS08 - 775mm Stainless Steel Worktop
- APMS09 - 1550mm Stainless Steel Worktop
- or
- APMS06 - 775mm Oak Worktop
- APMS07 - 1550mm Oak Worktop.

Model No.	Worktop Material	List Price	Exc. VAT	Inc. VAT
APMSCOMBO2SS	Stainless Steel	£4,074.95	£3,299.95	£3,959.94
APMSCOMBO2W	Oak	£3,864.95	£3,099.95	£3,719.94

Premier™ 2.3m Storage System

Model No. APMSCOMBO4SS



Model No. APMSCOMBO4W



Package includes:

- APMS13 - 775mm Heavy-Duty Modular Wall Cabinet
- APMS14 - 1550mm Heavy-Duty Modular Wall Cabinet
- APMS10 - 775mm Modular Back Panel
- APMS11 - 1550mm Modular Back Panel
- APMS01 - 775mm Heavy-Duty Modular Floor Cabinet
- APMS04 - 1550mm Heavy-Duty 11 Drawer Modular Floor Cabinet



Includes your choice of worktop, Stainless Steel or Oak:

- APMS08 - 775mm Stainless Steel Worktop
- APMS09 - 1550mm Stainless Steel Worktop
- or
- APMS06 - 775mm Oak Worktop
- APMS07 - 1550mm Oak Worktop

Model No.	Worktop Material	List Price	Exc. VAT	Inc. VAT
APMSCOMBO4SS	Stainless Steel	£3,174.95	£2,599.95	£3,119.94
APMSCOMBO4W	Oak	£2,964.95	£2,499.95	£2,999.94

Premier™ 1.7m Corner Storage System

Model No. APMSCOMBO6SS



Model No. APMSCOMBO6W



Package includes:

- APMS15 - 930mm Heavy-Duty Modular Corner Floor Cabinet
- APMS16 - 930mm Heavy-Duty Modular Corner Wall Cabinet
- APMS17 - 930mm Back Panel Assembly for Modular Corner Wall Cabinet
- APMS20 - 775mm Heavy-Duty Modular Multifunction Floor Cabinet
- APMS03 - 775mm Heavy-Duty Modular 6 Drawer Floor Cabinet
- APMS13 - 775mm Heavy-Duty Modular Wall Cabinet (x2)
- APMS10 - 775mm Modular Back Panel (x2)



Includes your choice of worktop, Stainless Steel or Oak:

- APMS19 - 930mm Stainless Steel Corner Worktop
- APMS08 - 775mm Stainless Steel Worktop (x2)
- or
- APMS18 - 930mm Oak Corner Worktop
- APMS06 - 775mm Oak Worktop (x2)

Model No.	Worktop Material	List Price	Exc. VAT	Inc. VAT
APMSCOMBO6SS	Stainless Steel	£4,074.95	£3,199.95	£3,839.94
APMSCOMBO6W	Oak	£3,834.95	£2,999.95	£3,599.94

775mm Heavy-Duty Modular Floor Cabinet



Premier™

HEAVY DUTY

ADJUSTABLE SHELF



ORDER WITH YOUR CHOICE OF WORKTOP, HARDWOOD OR STAINLESS STEEL AS AN OPTIONAL EXTRA.

- Use as part of a complete professional garage storage system or as an individual storage unit.
- All steel construction with a graphite powder coat finish.
- Brushed aluminium handles.
- Worktop not included.
- Features one adjustable shelf and four level-adjusting feet.
- High quality lock with two keys.
- Supplied fully assembled.
- Overall Size (W x D x H): 775 x 610 x 955mm.
- **Model No. APMS01**
- List Price £529.95



£459.95 Exc. VAT
£551.94 Inc. VAT

6 Drawer 775mm Heavy-Duty Modular Floor Cabinet



Premier™

Ball Bearing Drawer Slides

HEAVY DUTY

6 Drawer



ORDER WITH YOUR CHOICE OF WORKTOP, HARDWOOD OR STAINLESS STEEL AS AN OPTIONAL EXTRA.

- Use as part of a complete professional garage storage system or as an individual storage unit.
- All steel construction with a graphite powder coat finish.
- Worktop not included.
- Six heavy-duty drawers with precision ball-bearing slides.
- Rubber protective drawer liners.
- Four Level-adjusting feet.
- High quality lock with two keys.
- Overall Size (W x D x H): 775 x 610 x 955mm.
- **Model No. APMS03**
- List Price £799.95



£699.95 Exc. VAT
£839.94 Inc. VAT

775mm Heavy-Duty Modular Multifunction Floor Cabinet



Premier™

Ball Bearing Drawer Slides

HEAVY DUTY



ORDER WITH YOUR CHOICE OF WORKTOP, HARDWOOD OR STAINLESS STEEL

- Use as part of a complete professional garage storage system or as an individual storage unit.
- All steel construction with graphite powder coated finish.
- Brushed aluminium handles.
- Cabinet includes rubbish bin, paper roll holder and a deep drawer.
- Four adjustable feet.
- Paper roll holder has three locking positions.
- Supplied fully assembled.
- Overall Size (W x D x H): 775 x 610 x 955mm.
- **Model No. APMS20**
- List Price £769.95



£659.95 Exc. VAT
£791.94 Inc. VAT

1550mm Heavy-Duty Modular 2 Door Floor Cabinet



Premier™

HEAVY DUTY

ADJUSTABLE SHELF



ORDER WITH YOUR CHOICE OF WORKTOP, HARDWOOD OR STAINLESS STEEL AS AN OPTIONAL EXTRA.

- Use as part of a complete professional garage storage system or as an individual storage unit.
- All steel construction with a graphite powder coat finish.
- Brushed aluminium handles.
- Worktop not included.
- Features one adjustable shelf and six level-adjusting feet.
- High quality lock with two keys.
- Supplied fully assembled.
- Overall Size (W x D x H): 1550 x 610 x 955mm.
- **Model No. APMS02**
- List Price £979.95

£849.95 Exc. VAT
£1,019.94 Inc. VAT

11 Drawer 1550mm Heavy-Duty Modular Floor Cabinet



Premier™

Ball Bearing Drawer Slides

HEAVY DUTY

11 Drawer



ORDER WITH YOUR CHOICE OF WORKTOP, HARDWOOD OR STAINLESS STEEL AS AN OPTIONAL EXTRA.

- Use as part of a complete professional garage storage system or as an individual storage unit.
- All steel construction with a graphite powder coat finish.
- Worktop not included.
- 11 Heavy-duty drawers with precision ball-bearing slides.
- Rubber protective drawer liners.
- Six level-adjusting feet.
- High quality lock with two keys.
- Supplied fully assembled.
- Overall Size (W x D x H): 1550 x 610 x 955mm.
- **Model No. APMS04**
- List Price £1,499.95



£1,299.95 Exc. VAT
£1,559.94 Inc. VAT

930mm Heavy-Duty Modular Full Height Floor Cabinet



Premier™

HEAVY DUTY

ADJUSTABLE SHELVES



- Use as part of a complete professional garage storage system or as an individual storage unit.
- All steel construction with a graphite powder coat finish.
- Heavy-duty full height two door cabinet.
- Three Adjustable shelves.
- Four level-adjusting feet.
- Added security provided by cylinder lock, supplied with two keys.
- Requires some self-assembly.
- Supplied flat-packed for ease of transportation.
- Overall Size (W x D x H): 930 x 610 x 2110mm.
- **Model No. APMS05**
- List Price £899.95

£779.95 Exc. VAT
£935.94 Inc. VAT

1550mm Heavy-Duty Modular Wall Cabinet



Premier™

HEAVY DUTY

- For use with Model No's APMS02 and APMS04 floor cabinets.
- Supplied with appropriate fixings to make integral self-supporting unit.
- All steel construction with a graphite powder coat finish.
- Brushed aluminium door handle.
- Lift-up door supported on gas struts.
- High quality lock with two keys.
- Offers fixing for Model No. APMS11 back panel.
- Overall Size (W x D x H): 1550 x 380 x 510mm.
- **Model No. APMS14**
- List Price £429.95

£369.95 Exc. VAT
£443.94 Inc. VAT

775mm Heavy-Duty Modular Wall Cabinet

Premier™



HEAVY DUTY



- For use with Model No's APMS01 and APMS03 Floor Cabinets.
- Supplied with appropriate fixings to make integral self-supporting unit.
- All steel construction with a graphite powder coat finish.
- Brushed aluminium door handle.
- Lift-up door supported on gas struts.
- High quality lock with two keys.
- Offers fixing for Model No. APMS10 back panel.
- Overall Size (W x D x H): 775 x 380 x 510mm.
- **Model No. APMS13**
- List Price £279.95

£239.95 Exc. VAT
£287.94 Inc. VAT

930mm Heavy-Duty Modular Corner Floor Cabinet

Premier™



HEAVY DUTY

ADJUSTABLE SHELF



ORDER WITH YOUR CHOICE OF WORKTOP. HARDWOOD OR STAINLESS STEEL AS AN OPTIONAL EXTRA.

- Brushed aluminium handle.
- Worktop not included.
- Use as part of a complete professional garage storage system or as an individual storage unit.
- Features 1 adjustable shelf.
- Five level-adjusting feet.
- High quality lock with two keys.
- Supplied fully assembled.
- Overall Size (W x D x H): 930 x 930 x 955mm.
- **Model No. APMS15**
- List Price £949.95

£799.95 Exc. VAT
£959.94 Inc. VAT



930mm Heavy-Duty Modular Corner Wall Cabinet

Premier™

HEAVY DUTY



- For use with Model No. APMS15 Corner Floor Cabinet.
- Supplied with the appropriate fixings to make integral self supporting unit.
- All steel construction with a graphite powder coat finish.
- Includes fixings and support posts for APMS17 Back Panel.
- Overall Size (W x D x H): 930 x 930 x 510mm.
- **Model No. APMS16**
- List Price £549.95

£469.95 Exc. VAT
£563.94 Inc. VAT

775mm Modular Back Panel

Premier™



- Back panel for use with Model No. APMS13 Wall Cabinet.
- Overall Size (W x H): 775 x 615mm.
- **Model No. APMS10**
- List Price £59.95

£49.95 Exc. VAT
£59.94 Inc. VAT

1550mm Modular Back Panel

Premier™



- Back panel for use with Model No. APMS14 Wall Cabinet.
- Overall Size (W x H): 1550 x 615mm.
- **Model No. APMS11**
- List Price £119.95

£99.95 Exc. VAT
£119.94 Inc. VAT

930mm Back Panel Assembly for Modular Corner Wall Storage Unit

Premier™



- Back panel (x2) to connect Model No. APMS16 Corner Wall storage Unit to Model No. APMS15 Corner Floor Cabinet.
- Overall Size (W x H): 930 x 615mm.
- **Model No. APMS17**
- List Price £139.95

£119.95 Exc. VAT
£143.94 Inc. VAT

Choose your finish!
Complement your cabinets with either stainless steel or hardwood worktops. See below for details.

930mm Stainless Steel Corner Worktop

Premier™



- Stainless steel worktop for use with Model No. APMS15 Corner Floor Cabinet.
- Overall Size (W x D x H): 930 x 930 x 25mm.
- **Model No. APMS19**
- List Price £289.95

£249.95 Exc. VAT
£299.94 Inc. VAT

930mm Hardwood Corner Worktop

Premier™



- Hardwood worktop for use with Model No. APMS15 Corner Floor Cabinet.
- Overall Size (W x D x H): 930 x 930 x 25mm.
- **Model No. APMS18**
- List Price £189.95

£159.95 Exc. VAT
£191.94 Inc. VAT

Stainless Steel Worktops



Premier™

STAINLESS STEEL

- Stainless steel worktop for use with Model No's APMS01, APMS03 and APMS20 Floor Cabinets.
- Overall Size (W x D x H): 775 x 640 x 25mm.
- **Model No. APMS08**
- List Price £169.95
- Stainless steel worktop for use with Model No's APMS02 and APMS04 Floor Cabinets.
- Overall Size (W x D x H): 1550 x 640 x 25mm.
- **Model No. APMS09**
- List Price £339.95

£149.95 Exc. VAT
£179.94 Inc. VAT

£289.95 Exc. VAT
£347.94 Inc. VAT

Hardwood Worktops



Premier™

- Hardwood worktop for use with Model No's APMS01, APMS03 and APMS20 Floor Cabinets.
- Overall Size (W x D x H): 775 x 640 x 25mm.
- **Model No. APMS06**
- List Price £99.95
- Hardwood worktop for use with Model No's APMS02 and APMS04 Floor Cabinets.
- Overall Size (W x D x H): 1550 x 640 x 25mm.
- **Model No. APMS07**
- List Price £199.95

£84.95 Exc. VAT
£101.94 Inc. VAT

£169.95 Exc. VAT
£203.94 Inc. VAT



PREMIER™ TOOL CHESTS Premier™

Heavy-duty welded steel construction for strength and durability. Textured powder coat finish, both solvent and rust resistant. Ball-bearing drawer slides provide superior performance and carry heavier loads, double sets on large drawers. All drawers have full width sand blasted aluminium 'Lift & Latch' drawer pulls. Supplied with non-slip drawer liners fitted to each drawer. Integral locking system locks all drawers with the turn of a key. Topchests feature heavy-duty exterior side handles. Gas struts fitted on lids for easy opening. Rollcabs feature heavy-duty Ø125mm Mag style castors, two swivel with toe brakes and two fixed.



8 Drawer

Model No. PTB91508



4 Drawer

Model No. PTB66004

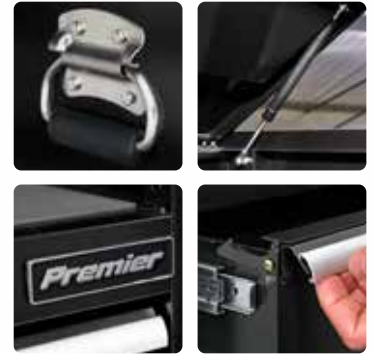

- Supplied with two keys.
- Model No. PTB66004 can be used with Model No. PTB67506 Rollcab or can be a standalone unit.
- Model No. PTB91508 can be used with Model No. PTB93006 Rollcab or can be a standalone unit.

Model No.	Drawers	Size (W x D x H)	List Price	Exc. VAT	Inc. VAT
PTB66004	4	660 x 450 x 565mm	£429.95	£329.95	£395.94
PTB91508	8	915 x 450 x 565mm	£599.95	£449.95	£539.94

Heavy-Duty Hang-On Locker & Chest

- Supplied with two keys.
- Model No. PTB39003 Hang-On locker suitable for heavy-duty Premier rollcabs.
- Model No. PTB40506 Hang-On chest suitable for heavy-duty Premier rollcabs (except Model No. PTB183015).



Model No. PTB39003



Model No. PTB40506

Model No.	Drawers	Shelves	Size (W x D x H)	List Price	Exc. VAT	Inc. VAT
PTB39003	3	2	390 x 460 x 1390mm	£599.95	£489.95	£587.94
PTB40506	6	-	405 x 460 x 885mm	£459.95	£359.95	£431.94

6 Drawer Heavy-Duty Rollcabs



- Supplied with two keys.
- Supplied with 12mm PVC coated MDF worktop for use as a workbench when not used with a topchest.
- Model No. PTB67506 can be used with Model No. PTB66004 Topchest or as a standalone unit.
- Model No. PTB93006 can be used with Model No. PTB91508 Topchest or can be a standalone unit.



6 Drawer

Model No. PTB67506



6 Drawer

Model No. PTB93006

Model No.	Size (W x D x H)	List Price	Exc. VAT	Inc. VAT
PTB67506	675 x 460 x 1050mm	£679.95	£499.95	£599.94
PTB93006	930 x 460 x 1050mm	£849.95	£649.95	£779.94



Heavy-Duty Topchests



7 Drawer

Model No. PTB141507



10 Drawer

Model No. PTB181510



8 Drawer

Model No. PTB104008



- Supplied with two keys.
- Model No. PTB141507 can be used with Model No. PTB143011 Rollcab or can be a standalone unit.
- Model No. PTB104008 can be used with Model No. PTB105511 Rollcab or can be a standalone unit.
- Model No. PTB181510 can be used with Model No. PTB183015 Rollcab or can be a standalone unit.

Model No.	Drawers	Size (W x D x H)	List Price	Exc. VAT	Inc. VAT
PTB141507	7	1415 x 450 x 565mm	£779.95	£649.95	£779.94
PTB104008	8	1040 x 450 x 570mm	£649.95	£499.95	£599.95
PTB181510	10	1830 x 500 x 565mm	£1,199.95	£979.95	£1,175.94

Heavy-Duty Rollcabs

11 Drawer

1055mm Extra-Wide

Model No. PTB105511



15 Drawer

1845mm Super-Extra-Wide

Model No. PTB183015

11 Drawer

1430mm Super-Extra-Wide

Model No. PTB143011



These items are heavy. Extra assistance must be provided at the delivery point to help safe delivery.

- Supplied with two keys.
- Supplied with 12mm PVC coated MDF worktop for use as a workbench when not used with a topchest.
- Model No. PTB105511 can be used with Model No. PTB104008 Topchest or as a standalone unit.
- Model No. PTB143011 can be used with Model No. PTB141507 Topchest or as a standalone unit.
- Model No. PTB183015 can be used with Model No. PTB181510 Topchest or as a standalone unit.

Model No.	Drawers	Size (W x D x H)	List Price	Exc. VAT	Inc. VAT
PTB105511	11	1055 x 460 x 1050mm	£969.95	£799.95	£959.94
PTB143011	11	1430 x 460 x 1050mm	£1,249.95	£999.95	£1,199.94
PTB183015	15	1845 x 510 x 1125mm	£1,999.95	£1,699.95	£2,039.94

6 Drawer Topchest with Ball-Bearing Slides

Premier™

Ball Bearing Drawer Slides

6 Drawer

Extra Deep Topchest

HEAVY DUTY



- Heavy gauge steel with double wall construction for extra strength and durability.
- Ball-bearing drawer slides provide superior performance and carry heavier loads.
- Each drawer fitted with catch to prevent unexpected opening, when being transported around the workshop.
- Added security provided by side mounted cylinder locks, supplied with two keys.
- Recessed handles permit units to be slotted into work environments where space is tight.
- Rust and solvent resistant powder coated finish.
- Fitted with anti-shock protection on all four corners to prevent accidental damage.
- Tough composite top.
- Overall Size (W x D x H): 690 x 465 x 535mm.
- **Model No. AP2403**
- List Price £429.95

£364.95 Exc. VAT

£437.94 Inc. VAT

Rollcabs with Ball-Bearing Slides

6 Drawer

Premier™

Ball Bearing Drawer Slides

8 Drawer

HEAVY DUTY



Model No. AP2406



Model No. AP2408

- Ball-bearing drawer slides provide superior performance and carry heavier loads.
- Each drawer fitted with catch to prevent unexpected opening when being transported around the workshop.
- Added security provided by side mounted cylinder lock, supplied with two keys.
- Rubber grip side handles for comfort and ease when manoeuvring.
- Rust and solvent resistant powder coated finish.
- Fitted with anti-shock protection on all four corners to prevent accidental damage.
- Rollcabs feature two Ø125mm swivel castors with large toe locks and two fixed wheels.
- Tough composite top for fitting and securing topchest or can be used as a workstation.
- Overall Size (W x D x H): 765 x 465 x 960mm.

Model No.	Drawers	List Price	Exc. VAT	Inc. VAT
AP2406	6	£619.95	£499.95	£599.94
AP2408	8	£669.95	£519.95	£623.94

6 Drawer Rollcab with Ball-Bearing Slides & 298pc Tool Kit

Premier™

Ball Bearing Drawer Slides



75+ KG HEAVY ITEM

Package includes:

- Model No. AP2406
- 6 Drawer Rollcab with Ball-Bearing Slides
- Overall Size (W x D x H): 765 x 465 x 960mm

298pc Tool Kit includes:

- TBT01 - Tool Tray with 13pc Combination Spanner Set
- TBT02 - Tool Tray with 4pc Pliers Set
- TBT03 - Tool Tray with 4pc Circlip Pliers Set
- TBT07 - Tool Tray with 29pc Hex/Ball-End Hex Keys & Socket Bit Set
- TBT08 - Tool Tray with 35pc TRX-Star* Key, Socket Bit & Socket Set
- TBT09 - Tool Tray with 5pc Engineer's File Set
- TBT11 - Tool Tray with 60pc Security TRX-Star*/Hex/Ribe/Spline Bit Set
- TBT14 - Tool Tray with 6pc Screwdriver Set
- TBT17 - Tool Tray with 38pc Precision & Pick-Up Tool Set
- TBT19 - Tool Tray with 43pc 1/4" Sq Drive Socket Set
- TBT20 - Tool Tray with 35pc 3/8" Sq Drive Socket Set
- TBT21 - Tool Tray with 26pc 1/2" Sq Drive Socket Set
- **Model No. AP2406TTC01**
- List Price £1,629.95

£899.95 Exc. VAT

£1,079.94 Inc. VAT

8 Drawer Rollcab with Ball-Bearing Slides & 707pc Tool Kit

Premier™

Ball Bearing Drawer Slides

HEAVY DUTY

8 Drawer



75+ KG HEAVY ITEM

Package includes:

- Model No. AP2408
- 8 Drawer Rollcab with Ball-Bearing Slides
- Overall Size (W x D x H): 765 x 465 x 960mm

707pc Tool Kit arranged in 18 Modular Tool Trays, includes:

- Model No's: TBT01, TBT02, TBT03, TBT04, TBT07, TBT08, TBT09, TBT11, TBT13, TBT14, TBT16, TBT17, TBT18, TBT19, TBT20, TBT21, TBT23, TBT26
- **Model No. AP2408TTC08**
- List Price £2,299.95

£1,199.95 Exc. VAT

£1,439.94 Inc. VAT

14 Drawer Tool Chest Combination with 1233pc Tool Kit



This item is heavy. Extra assistance must be provided at the delivery point to help safe delivery.

Premier™



HEAVY DUTY

Extra Deep Topchest

6 Drawer

8 Drawer

- Heavy gauge steel with double wall construction for extra strength and durability.
- Rust and solvent resistant powder coat paint finish.
- Ball-bearing drawer slides provide superior performance and carry heavier loads.
- Each drawer fitted with catch to prevent unexpected opening.
- Side mounted cylinder locks, supplied with two keys.
- Perforated side panels for hanging tools and accessories.

Package includes:

- Model No. AP2403
- 6 Drawer Topchest with Ball-Bearing Slides.
- Overall Size (W x D x H): 690 x 465 x 535mm
- Model No. AP2408
- 8 Drawer Rollcab with Ball-Bearing Slides
- Overall Size (W x D x H): 766 x 465 x 960mm

1233pc Tool Kit arranged in 28 Themed Tool Trays includes:

- Model No's: TBT01, TBT02, TBT03, TBT04, TBT05, TBT06, TBT07, TBT08, TBT09, TBT11, TBT12, TBT13, TBT14, TBT15, TBT16, TBT17, TBT18, TBT19, TBT23, TBT24, TBT25, TBT26, TBT27, TBT28, TBT29, TBT30, TBT31, TBT32, TBTB (x2)
- **Model No. APTTC02**
- List Price £3,999.95

£2,499.95 Exc. VAT

£2,999.94 Inc. VAT

PerfoTool Storage Panel for AP24 Series Rollcabs

Premier™



- PerfoTool storage panel can be fitted to all Rollcabs in our AP24 Series when a Topchest is not required and allows Rollcab top to be used as a workbench.
- Fixes securely via reinforced poles, that keep unit sturdy.
- Suitable for hanging some of the most frequently used tools, allowing easy selection.
- Supplied with an assortment of hanging hooks.
- **Model No. AP24ACC1**
- List Price £74.95

£39.95 Exc. VAT

£47.94 Inc. VAT

Side Shelf & Roll Holder for AP24 Series Tool Chests

Premier™



- Easy fix shelf with raised edge and paper roll holder.
- Ideal for small components, helping to prevent the loss of parts and keeping work area tidy.
- Tray Size: 305 x 305mm.
- Roll holder underneath shelf for easy-access to paper when required. (Paper roll and tools not included).
- **Model No. AP24ACC2**
- List Price £43.95

£34.95 Exc. VAT

£41.94 Inc. VAT

Document Holder for AP24 Series Tool Chests

Premier™



- Easy fix document holder helps keep paperwork from getting lost or dirty and means it is always to hand when needed for the job.
- Suitable for all AP24 Series tool chests (except Model No's AP2401 and AP2401M).
- **Model No. AP24ACC3**
- List Price £13.95

£9.95 Exc. VAT

£11.94 Inc. VAT

Can & Bottle Holder for AP24 Series Tool Chests

Premier™



- Easy fix can and bottle holder for storing aerosols, maintenance spray and other frequently used products.
- **Model No. AP24ACC5**
- List Price £10.95

£8.95 Exc. VAT

£10.74 Inc. VAT

Drawer Divider for AP24 Series Rollcabs & Topchests

Premier™

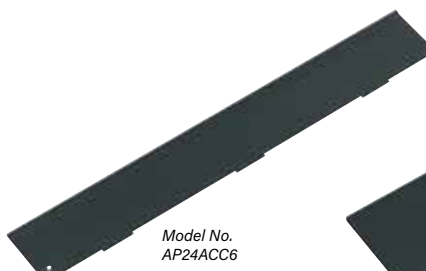

Model No. AP24ACC6



Model No. AP24ACC7

- Drawer dividers suitable for all drawers on the AP24 Series topchests, rollcabs and workstations.
- Designed to keep tools and parts in a neat and easily accessible order.

Model No.	Size (W x D x H)	List Price	Exc. VAT	Inc. VAT
AP24ACC6	3 x 395 x 58mm	£3.95	£2.95	£3.54
AP24ACC7	3 x 395 x 120mm	£4.95	£3.45	£4.14



PREMIER™ TOOL CHESTS Premier™

Retro Style Topchests, Mid-Boxes and Rollcabs with modern day functionality.

10 Drawer Retro Style Topchest, Mid-Box & Rollcab Combinations



4 DRAWER TOPCHEST

Overall Size (W x D x H):
700 x 450 x 495mm.

2 DRAWER MID-BOX

Overall Size (W x D x H):
710 x 460 x 270mm.

4 DRAWER ROLLCAB

Overall Size (W x D x H):
730 x 460 x 825mm.



Package includes:

- AP28104BWS - 4 Drawer Retro Style Topchest.
- AP28102BWS - 2 Drawer Retro Style Mid-Box.
- AP28204BWS - 4 Drawer Retro Style Rollcab.
- **Model No. AP28COMBO2BWS** - Blue with White Stripes
- List Price £1,199.95

or

- AP28104BR - 4 Drawer Retro Style Topchest
- AP28102BR - 2 Drawer Retro Style Mid-Box
- AP28204BR - 4 Drawer Retro Style Rollcab
- **Model No. AP28COMBO2BR** - Black with Red Anodised Drawer Pulls
- List Price £1,149.95

or

- AP28104 - Topchest 4 Drawer Retro Style
- AP28102 - Mid-Box 2 Drawer Retro Style
- AP28204 - Rollcab 4 Drawer Retro Style
- **Model No. AP28COMBO2** - Cream
- List Price £1,099.95



£899.95 Exc. VAT
£1,079.94 Inc. VAT

£799.95 Exc. VAT
£959.94 Inc. VAT

£799.95 Exc. VAT
£959.94 Inc. VAT



10 Drawer Retro Style Extra-Wide Topchest & Rollcab Combinations



4 DRAWER TOPCHEST

Overall Size (W x D x H):
1080 x 450 x 495mm.



6 DRAWER ROLLCAB

Overall Size (W x D x H):
1100 x 460 x 1040mm.

Package includes:

- AP41104BWS - 4 Drawer Wide Retro Style Topchest
- AP41206BWS - 6 Drawer Wide Retro Style Rollcab
- **Model No. AP41COMBOBWS** - Blue with White Stripes

or

- AP41104BR - 4 Drawer Wide Retro Style Topchest
- AP41206BR - 6 Drawer Wide Retro Style Rollcab
- **Model No. AP41COMBOBR** - Black with Red Anodised Drawer Pulls
- List Price £1,539.95

£1,199.95 Exc. VAT
£1,439.94 Inc. VAT



Industrial Cabinets



Premier INDUSTRIAL™

Ball Bearing Drawer Slides

HEAVY DUTY

5 Drawer

Model No. API5655A

5 Drawer

Model No. API5655AB

6 Drawer

Model No. API5656



- Drawers run on heavy-duty drawer slides with load bearing of up to 100kg and are fitted with safety locking catches.
- Each drawer is fitted with fixed dividers running back to front and supplied with cross dividers for personalised storage layout.
- Fits perfectly underneath the workbenches in this range.
- Fitted with high quality lock and two coded keys.
- Overall Size (W x D x H): 565 x 580 x 700mm.

Model No.	Drawers	List Price	Exc. VAT	Inc. VAT
API5655A	5	£529.95	£439.95	£527.94
API5655B	5	£529.95	£439.95	£527.94
API5656	6	£659.95	£499.95	£599.94

Industrial Handle & Wheel Kit for 565mm Cabinets

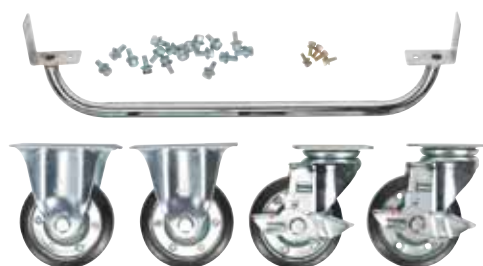

Premier INDUSTRIAL™

- Industrial quality handle and wheels kit for 565mm industrial cabinets in the API range.
- Model No. API565KIT
- List Price £119.95

£74.95 Exc. VAT
£89.94 Inc. VAT

Industrial Cabinets



Premier INDUSTRIAL™

Ball Bearing Drawer Slides

HEAVY DUTY



5 Drawer

Model No. API9005

7 Drawer

Model No. API90057

8 Drawer

Model No. API5658

8 Drawer

Model No. API7238

- Industrial quality, freestanding cabinets.
- Drawers run on heavy-duty ball-bearing slides with load bearing of up to 75kg and are fitted with safety locking catches.
- Each drawer is fitted with removable dividers running front to back and then supplied with cross dividers for personalised storage layout.
- Fitted with high quality lock and two coded keys.

Model No.	Drawers	Overall Size (W x D x H)	List Price	Exc. VAT	Inc. VAT
API9005	5	900 x 450 x 900mm	£869.95	£599.95	£719.94
API9007	7	900 x 450 x 900mm	£969.95	£729.95	£875.94
API5658	8	565 x 655 x 1000mm	£849.95	£599.95	£719.94
API7238	8	725 x 655 x 1000mm	£999.95	£799.95	£959.94

Industrial Cabinets



Premier INDUSTRIAL™

ADJUSTABLE SHELVES

Ball Bearing Drawer Slides

HEAVY DUTY

2 Shelves

Model No. APICCOMBOH2

4 Shelves

Model No. APICCOMBOHF4

2 Drawer

3 Shelves

Model No. APICCOMBO2

5 Drawer

3 Shelves

Model No. APICCOMBO5

7 Drawer

3 Shelves

Model No. APICCOMBO7

- Industrial quality, double door, freestanding cabinets.
- Cabinets are easy to assemble with minimal tools required.
- Durable, scuff resistant, adjustable shelves, each holding up to 150kg.
- Drawers run on heavy-duty ball-bearing drawer slides with a load bearing of up to 75kg.
- Reinforced steel doors with zinc plated locking bars providing 3-point locking mechanism.
- Supplied with two coded keys.
- Ideal for home, office, garage or workshop use.

These items are heavy. Extra assistance must be provided at the delivery point to help safe delivery.

Model No.	Drawers	Shelves	Overall Size (W x D x H)	List Price	Exc. VAT	Inc. VAT
APICCOMBOH2	-	2	900 x 450 x 900mm	£289.95	£229.95	£275.94
APICCOMBOHF4	-	4	900 x 450 x 1800mm	£569.95	£469.95	£563.94
APICCOMBO2	2	3	900 x 450 x 1800mm	£779.95	£629.95	£755.94
APICCOMBO5	5	3	900 x 450 x 1800mm	£1,039.95	£829.95	£995.94
APICCOMBO7	7	3	900 x 450 x 1800mm	£1,199.95	£959.95	£1,151.94

Drawer Units for API Series Workbenches



HEAVY DUTY



1 Drawer
Model No. API8



2 Drawer
Model No. API9

- Optional drawer units for our API Series of Industrial Workbenches.
- Supplied with fixing kit allowing units to be securely mounted.
- Drawer runs on heavy-duty ball-bearing drawer slides with a load bearing of up to 40kg.
- Fitted with fixed dividers running front to back and supplied with cross dividers for personal storage layout.
- Supplied with high quality lock and two coded keys.
- Model No. API8 Overall Size (W x D x H): 565 x 580 x 180mm.
- Model No. API9 Overall Size (W x D x H): 565 x 580 x 280mm.

Model No.	Drawers	List Price	Exc. VAT	Inc. VAT
API8	1	£149.95	£99.95	£119.94
API9	2	£229.95	£159.95	£191.94

Drawer Units for API Series Workbenches



HEAVY DUTY



1 Drawer
Model No. API14



2 Drawer
Model No. API15



3 Drawer
Model No. API16

- Slim-width drawer units for our API Series of Industrial Workbenches, to give the option of more under bench access.
- Supplied with fixing kit allowing units to be securely mounted.
- Drawer runs on heavy-duty ball-bearing drawer slides with a load bearing of up to 40kg.
- Fitted with fixed dividers running front to back and supplied with cross dividers for personalised storage layout.
- Supplied with high quality lock and two coded keys.

Model No.	Drawers	Size (W x D x H)	List Price	Exc. VAT	Inc. VAT
API14	1	405 x 580 x 180mm	£124.95	£94.95	£113.94
API15	2	405 x 580 x 280mm	£186.95	£124.95	£149.94
API16	3	405 x 580 x 450mm	£319.95	£239.95	£287.94

Steel Industrial Workbenches

HEAVY DUTY



Model No. API1500



Model No. API1800



Model No. API2100



- Manufactured from heavy gauge steel, these workbenches are at the top end of our range with a weight capacity of 1000kg (evenly distributed).
- Fitted with adjustable feet to ensure work surface is level, even if your floor is not.
- 40mm Thick laminate worktop is edged with double thick trim.
- Optional drawer units, vice support or back panels easily attach converting the workbenches into a workstation.

Model No.	Size (W x D x H)	List Price	Exc. VAT	Inc. VAT
API1500	1500 x 750 x 850mm	£449.95	£294.95	£353.94
API1800	1800 x 750 x 850mm	£489.95	£324.95	£389.94
API2100	2100 x 750 x 850mm	£529.95	£359.95	£431.94

Complete Industrial Workstations & Cabinet Combos

- Professional Garage Storage Systems offer a superb combination to kit out your workshop.
- Blue/Grey Industrial finish gives a robust appearance which reflects the construction of the units.
- Workbenches, back panel assemblies and back panel shelves available in 1.5, 1.8, 2.1m versions.
- All items available individually allowing you to build as you go or purchase a complete workstation system.

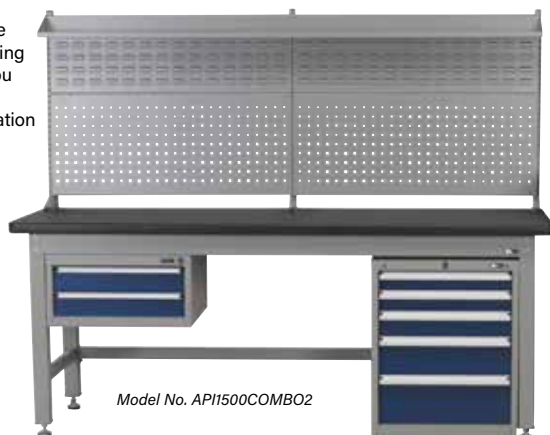

Model No. API1500COMBO2

1000kg



1.5m Version Package includes:

- API1500 - 1.5m Steel Industrial Workbench
- APIBP1500 - Back Panel Assembly for API1500
- API11 - Shelf for APIBP1500
- API9 - Double Drawer Unit for API Series Workbenches
- API5655B - 5 Drawer Industrial Cabinet
- **Model No. API1500COMBO2**
- List Price £1,374.95

£999.95 Exc. VAT
£1,199.94 Inc. VAT

1.8m Version Package includes:

- API1800 - 1.8m Steel Industrial Workbench
- APIBP1800 - Back Panel Assembly for API1800
- API12 - Shelf for APIBP1800
- API9 - Double Drawer Unit for API Series Workbenches
- API5655B - 5 Drawer Industrial Cabinet
- **Model No. API1800COMBO2**
- List Price £1,449.95

£1,099.95 Exc. VAT
£1,319.94 Inc. VAT

2.1m Version Package includes:

- API2100 - 2.1m Steel Industrial Workbench
- APIBP2100 - Back Panel Assembly for API2100
- API13 - Shelf for APIBP2100
- API9 - Double Drawer Unit for API Series Workbenches
- API5655B - 5 Drawer Industrial Cabinet
- **Model No. API2100COMBO2**
- List Price £1,499.95

£1,099.95 Exc. VAT
£1,319.94 Inc. VAT

1 Shelf Locker Mobile Industrial Cabinet



HEAVY DUTY

1 Shelf



- Industrial quality single shelf cabinet suitable for storing larger items.
- Fitted with a safety locking catch to prevent inadvertent opening.
- Fits perfectly underneath workbenches in this range.
- Features four Ø60mm wheels - two locking castors and two fixed.
- Fitted high quality lock with two coded keys.
- Overall Size (W x D x H): 565 x 580 x 675mm.
- **Model No. API5659**
- List Price £319.95

£219.95 Exc. VAT
£263.94 Inc. VAT

Mobile Industrial Cabinets



Ball Bearing Drawer Slides

HEAVY DUTY

5 Drawer

Model No. API5657A

Model No. API5657AB

- Drawers run on heavy-duty ball-bearing drawer slides with a load bearing of up to 40kg.
- Each drawer is fitted with fixed dividers running back to front and then supplied with cross dividers for personalised storage layout.
- Fits perfectly underneath the workbenches in this range.
- Fitted high quality lock with two coded keys.
- Features four 60mm wheels - two locking castors and two fixed.
- Overall Size (W x D x H): 565 x 580 x 675mm.

Model No.	Drawers	List Price	Exc. VAT	Inc. VAT
API5657A	5	£529.95	£349.95	£419.94
API5657B	5	£529.95	£349.95	£419.94

5 Drawer & 1 Shelf Industrial Cabinet



Ball Bearing Drawer Slides

HEAVY DUTY

5 Drawer

ADJUSTABLE SHELF



- Drawers run on heavy-duty drawer slides with load bearing of up to 100kg.
- Single door shelved locker suitable for storing larger items.
- Each drawer is fitted with fixed dividers running back to front and then supplied with cross dividers for personalised storage layout.
- Supplied with high quality locks and four coded keys.
- Overall Size (W x D x H): 1105 x 580 x 800mm.
- **Model No. API1103B**
- List Price £1,099.95

£749.95 Exc. VAT
£899.94 Inc. VAT

2 Drawer & 1 Shelf Double Industrial Locker Cabinet



Ball Bearing Drawer Slides

HEAVY DUTY

2 Drawer

ADJUSTABLE SHELF



- Drawers run on heavy-duty drawer slides with load bearing of up to 100kg.
- Double door locker suitable for storing larger items.
- Each drawer is fitted with fixed dividers running back to front and then supplied with cross dividers for personalised storage layout.
- Supplied with high quality locks and four coded keys.
- Overall Size (W x D x H): 900 x 450 x 1000mm.
- **Model No. API8810**
- List Price £799.95

£519.95 Exc. VAT
£623.94 Inc. VAT

5 Drawer & 1 Shelf Industrial Mobile Workstation



Ball Bearing Drawer Slides

HEAVY DUTY

5 Drawer

ADJUSTABLE SHELF



- Perforated rear panel ideal for hanging frequently used tools so they are at hand when needed.
- Drawers run on heavy-duty drawer slides with load bearing of up to 100kg.
- Single door shelved locker suitable for storing larger items.
- Each drawer is fitted with fixed dividers running back to front and supplied with cross dividers for personalised storage layout.
- Fitted with four 60mm wheels two locking castors and two fixed to allow unit to be taken to the work area.
- Supplied with two high quality locks and four coded keys.
- Overall Size (W x D x H): 1170 x 580 x 1450mm.
- **Model No. API1103A**
- List Price £1,199.95

£799.95 Exc. VAT
£959.94 Inc. VAT

Industrial Mobile Storage System with Shelf



- Industrial quality mobile storage system for use in the garage or workshop environment.
- Supplied with six panels; three louvred panels, to accept storage bins, and three perforated panels which can be used with Sealey TTS Series clips for tool storage.
- These can be mounted in any configuration, allowing the user to customise the design to suit their needs.
- It also includes a single shelf, which can be mounted at various heights.
- Four heavy-duty castors, of which two are fitted with toe locks, give smooth manoeuvrability around the workplace.
- Overall Size (W x D x H): 960 x 640 x 1605mm.
- **Model No. APICCOMBO1**
- List Price £469.95

£329.95 Exc. VAT
£395.94 Inc. VAT

3-Level Industrial Workshop Trolley

Premier INDUSTRIAL™

HEAVY DUTY

- Industrial quality workshop trolley, ideal for use in any garage or workshop environment.
- Two deep-walled shelves give tool and component security.
- Adjustable legs on trolley allow the user to set at their desired height.
- Worktop is installed by placing the top shelf base up, creating a sturdy work surface.
- Optionally, install the top shelf base down to allow extra storage.
- Features four swivel castors, two of which have toe locks.
- Size (W x D x H): 750 x 445 x 940mm.
- Capacity: 300kg(100kg/level).
- **Model No. API2103**
- List Price £229.95



£189.95 Exc. VAT
£227.94 Inc. VAT

Drawer Dividers

Model No. API-DIV06



Model No. API-DIV09

- Model No. API-DIV06 suitable for small drawer: API5655A, API5655B, API5656, API7238, API5657A, API5657B, API5658.
- Model No. API-DIV07 suitable for medium drawer: API5656, API5655B, API5657A, API5657B, API5658, API7238, API8810, API1103B, API1103A, API8, API9.
- Model No. API-DIV08 suitable for large drawer: API5655A, API5655B, API5656, API5657B, API5658, API7238.
- Model No. API-DIV09 suitable for extra-large drawer: API5655B, API5658, API7238, API1103B, API1103A.

Model No.	Size	List Price	Exc. VAT	Inc. VAT
API-DIV06	155 x 45mm	£0.75	£0.65	£0.78
API-DIV07	155 x 65mm	£0.95	£0.75	£0.90
API-DIV08	155 x 115mm	£1.55	£1.25	£1.50
API-DIV09	155 x 165mm	£1.85	£1.55	£1.86

Single Shelves

Premier INDUSTRIAL™

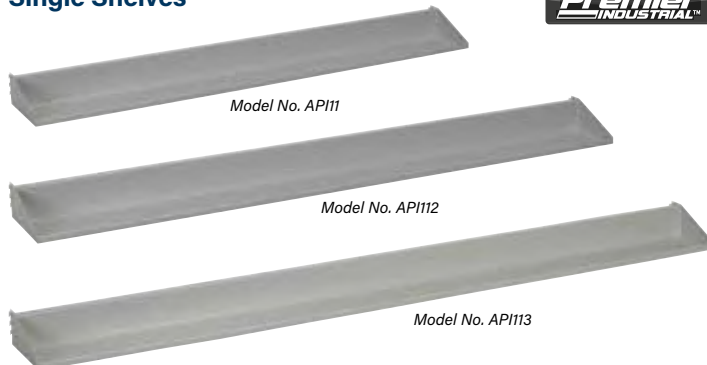

Model No. API11

Model No. API12

Model No. API13

- Single shelves that can be positioned at various heights on back panel assemblies.

Model No.	Width	Compatibility	List Price	Exc. VAT	Inc. VAT
API11	1440mm	APIBP1500	£43.95	£37.95	£45.54
API12	1720mm	APIBP1800	£51.95	£44.95	£53.94
API13	2040mm	APIBP2100	£59.95	£51.95	£62.34

API Industrial Cabinet Base Unit



- Optional base for Model No's APICCOMBOF4, APICCOMBO2, APICCOMBO5 and APICCOMBO7.
- Features four height-adjustable rubber feet for levelling on uneven floors, giving added stability to the unit.
- Size (W x D x H): 840 x 405 x 50mm.
- **Model No. APICB**
- List Price £69.95

£49.95 Exc. VAT
£59.94 Inc. VAT

Vice Mounting Plate for API Series Workbenches



VICE NOT INCLUDED



- Suitable for use with the API workbenches.
- Simply fixes to the workbench and is ready for the vice to be mounted on the base plate.
- Enables the vice to be stored out of the way when not in use leaving a full free work surface.
- **Model No. API10**
- List Price £119.95

£89.95 Exc. VAT
£107.94 Inc. VAT

Back Panel Assemblies

Premier INDUSTRIAL™

HEAVY DUTY

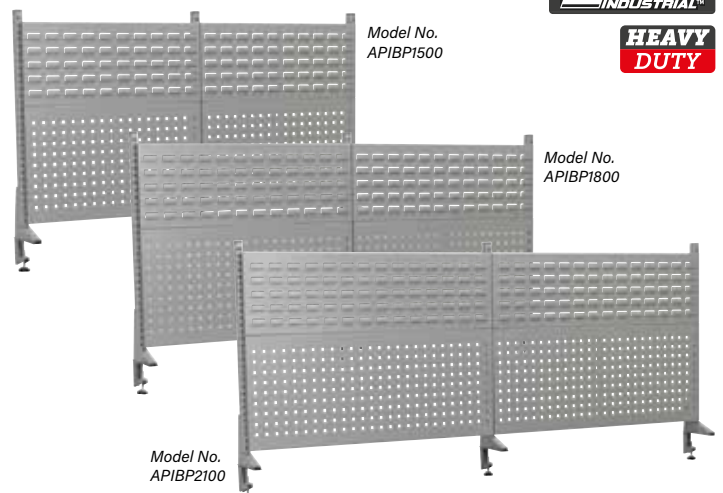

Model No. APIBP1500

Model No. APIBP1800

Model No. APIBP2100

- Mounts simply onto workbench top.
- Supplied with two louvred panels and two PerfoTool storage back panels that help to keep work area free and tidy.
- Storage bins and hooks supplied separately.

Model No.	Overall Size (W x H)	Compatibility	List Price	Exc. VAT	Inc. VAT
APIBP1500	1455 x 825mm	API1500	£194.95	£169.95	£203.94
APIBP1800	1735 x 825mm	API1800	£219.95	£189.95	£227.94
APIBP2100	2055 x 825mm	API2100	£244.95	£209.95	£251.94

3 Drawer Portable Tool Chests with Ball-Bearing Slides



3 Drawer



Model No. AP9243BB

- Storage capacity of a tool chest coupled with the versatility of a carry-type toolbox.
- Features tough composite top handle, smooth 25mm ball-bearing drawer slides and two strong locking hasps which can be locked using a padlock (not included).
- Overall Size (W x D x H): 510 x 225 x 300mm.
- Medium Drawer (x3): 455 x 190 x 45mm.



Model No. AP9243BBHV

Model No.	Colour	List Price	Exc. VAT	Inc. VAT
AP9243BB	Red	£99.95	£79.95	£95.94
AP9243BBHV	Hi-Vis Green	£99.95	£79.95	£95.94

6 Drawer Topchest with Ball-Bearing Slides & 98pc Tool Kit



6 Drawer



Package includes:

- Model No. AP2201BB
- 6 Drawer Topchest
- Overall Size (W x D x H): 600 x 260 x 340mm
- **98pc Tool Kit includes:**
- LED016 - 1W COB Aluminium Penlight
- S0447 - 3pc Pliers Set
- S0450 - 150mm Adjustable Wrench
- S0465 - 25pc Hex Key Set
- S0481 - 300mm Hacksaw
- S0615 - 6pc Soft Grip Screwdriver Set
- S0527 - 150mm Junior Hacksaw with Spare Blade
- S0562 - 11pc Combination Spanner Set
- S0725 - 37pc 1/4" & 3/8" Sq Drive Socket Set
- S0775 - 12pc Ratchet Driver Bit Set
- **Model No. AP2201BBCOMBO**
- List Price £284.95



£179.95	Exc. VAT
£215.94	Inc. VAT

14 Drawer Topchest & Rollcab Combination with Ball-Bearing Slides & 239pc Tool Kit



14 Drawer Combination



Package includes:

- Model No. AP22509BB
- 9 Drawer Topchest with Ball-Bearing Slides - Red/Grey
- Overall Size (W x D x H): 600 x 260 x 380mm
- Model No. AP22505BB
- 5 Drawer Rollcab with Ball-Bearing Slides - Red/Grey
- Overall Size (W x D x H): 620 x 330 x 770mm
- **239pc Tool Kit includes:**
- LED307, S0433, S0437, S0447, S0448, S0465, S0473, S0865, S0488, S0562, S0598, S0610, S0711, S0775
- **Model No. AP2250BBCOMBO**
- List Price £734.95

£469.95	Exc. VAT
£563.94	Inc. VAT

10 Drawer Mobile Workstation with Backboard



10 Drawer



- 20mm Thick wooden worktop.
- 10 Drawers with a 40kg capacity each with non-slip liners and aluminium pull handles.
- Six large castor wheels (four fixed and two swivel) that include brakes.
- Pegboard back panel compatible with Sealey TTS range of hooks.
- 14 Storage Bins: Small (x10) and Large (x4).
- Heavy-duty side handle for comfort and control when manoeuvring.
- Supplied with locks and two keys for the cabinet and drawers.
- Overall Size Inc. Handle (W x D x H): 1690 x 490 x 1432mm.
- This item is heavy. Extra assistance must be provided at the delivery point to help its safe delivery.
- **Model No. AP6310**
- List Price £1,099.95

£949.95	Exc. VAT
£1,139.94	Inc. VAT

American PRO® 3.3m Storage System



- Ball-bearing drawer slides throughout.
- Base cabinets supplied with a worktop as standard.
- Floor cabinets feature adjustable shelves.
- Each unit is supplied with a lock and two keys.
- Supplied flat-packed and will require some simple assembly.

Package includes:

- APMS83 - 665mm Modular 2 Door Full Height Cabinet (x2)
- APMS85 - 665mm Modular 2 Door Wall Cabinet (x3)
- APMS82 - 665mm Modular 3 Drawer Cabinet with Worktop
- APMS81 - 665mm Modular 2 Door Cabinet with Worktop
- APMS84 - 665mm Modular 4 Drawer Cabinet with Worktop
- APMS80BP - 665mm Modular Back Panel (x3)
- **Model No. APMS80COMBO1**
- List Price £2,149.95



£1,549.95 Exc. VAT
£1,859.94 Inc. VAT

American Pro® 2.6m Storage System



- Ball-bearing drawer slides throughout.
- Base cabinets supplied with a worktop as standard.
- Floor cabinets feature adjustable shelves.
- Each unit is supplied with a lock and two keys.
- Supplied flat-packed and will require some simple assembly.

Package includes:

- APMS83 - 665mm Modular 2 Door Full Height Cabinet (x2)
- APMS85 - 665mm Modular 2 Door Wall Cabinet (x2)
- APMS82 - 665mm Modular 3 Drawer Cabinet with Worktop
- APMS84 - 665mm Modular 4 Drawer Cabinet with Worktop
- APMS80BP - 665mm Modular Back Panel (x2)
- **Model No. APMS80COMBO2**
- List Price £1,769.95



More information on individual Models can be found on www.sealey.co.uk

£1,299.95 Exc. VAT
£1,559.94 Inc. VAT

2108mm Heavy-Duty Modular Full Height Floor Cabinet

NEW
PRODUCT

Premier™

HEAVY
DUTY



- Use as part of a complete professional garage storage system or as an individual storage unit.
- All steel construction with a graphite powder coat finish.
- Heavy-duty full height single door cabinet.
- Three adjustable shelves.
- Four level-adjusting feet.
- Added security provided by cylinder lock, supplied with two keys.
- Requires some self-assembly.
- Supplied flat-packed for ease of transportation.
- Overall Size (W x D x H): 610 x 610 x 2108mm.
- **Model No. APMS21**
- List Price £629.95

£539.95 Exc. VAT
£647.94 Inc. VAT

1830mm Heavy-Duty Steel Adjustable Workbenches

Premier™

HEAVY
DUTY

1.8m
Table Width

NEW
PRODUCTS



Model No. APMS22

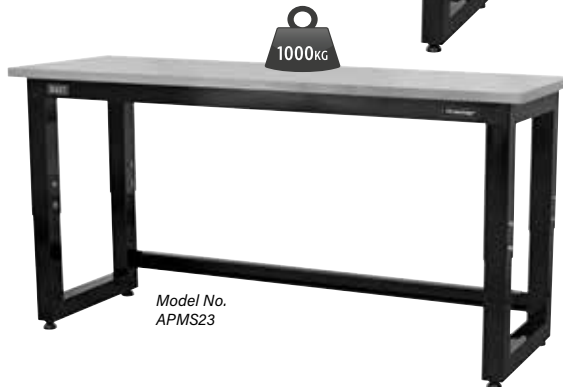

Model No. APMS23

- Manufactured from heavy gauge powder-coated steel and is at the top end of our range with a weight capacity of 1000kg (evenly distributed).
- Adjustable leg extensions allow worktop height to range from 680 to 1030mm.
- Base units can be placed underneath the worktop.
- Fitted with adjustable feet to ensure work surface is level, even if your floor is not.
- Order with your choice of worktop, Solid Wood or Stainless Steel.

Model No.	Worktop Material	List Price	Exc. VAT	Inc. VAT
APMS22	32mm Thick Solid Wood	£599.95	£509.95	£611.94
APMS23	Stainless Steel	£699.95	£599.95	£719.94

American PRO® 2.0m Storage System

American PRO®

Ball Bearing
Drawer Slides

More information on individual Models can be found on www.sealey.co.uk



This item is heavy. Extra assistance must be provided at the delivery point to help safe delivery.



- Ball-bearing drawer slides throughout.
- Base cabinets supplied with a worktop as standard.
- Floor cabinets feature adjustable shelves.
- Each unit is supplied with a lock and two keys.
- Supplied flat-packed and will require some simple assembly.

Package includes:

- APMS83 - 665mm Modular 2 Door Full Height Cabinet
- APMS85 - 665mm Modular 2 Door Wall Cabinet (x2)
- APMS84 - 665mm Modular 4 Drawer Cabinet with Worktop
- APMS81 - 665mm Modular 2 Door Cabinet with Worktop
- APMS80BP - 665mm Modular Back Panel (x2)
- **Model No. APMS80COMBO3**
- List Price £1,259.95

£899.95 Exc. VAT
£1,079.94 Inc. VAT

AMERICAN PRO® TOOL CHESTS



6 Drawer Topchest and Rollcab Combinations with Ball-Bearing Slides. The economical way to buy American PRO® Ball-Bearing quality Tool Chests. Supplied packed one inside the other. This mid-size combo has smooth 25mm ball-bearing slides and all the features of the professional chests, except that the rollcab is not lockable and the castors are Ø75mm.

NEW
PRODUCTS

Ball Bearing
Drawer Slides

6 Drawer & Cupboard
Combination



Model No.
AP22B



Model No.
AP22HVG



Model No.
AP22O



Model No.
AP22R



Model No.
AP22Y



Model No.
AP22BK

Model No.	Colour	List Price	Exc. VAT	Inc. VAT
AP22B	Blue	£229.95	£189.95	£227.94
AP22HVG	Hi-Vis Green	£229.95	£189.95	£227.94
AP22O	Orange	£229.95	£189.95	£227.94
AP22R	Red	£229.95	£189.95	£227.94
AP22Y	Yellow	£229.95	£189.95	£227.94
AP22BK	Black	£229.95	£189.95	£227.94

- Overall Sizes (W x D x H):
Topchest - 612 x 260 x 340mm,
Rollcab - 615 x 295 x 700mm.
- Not interchangeable with the rest of the American PRO® Range.

14 Drawer Topchest, Mid-Box & Rollcab Combinations with Ball-Bearing Slides



14 Drawer Combination



These items are heavy. Extra assistance must be provided at the delivery point to help safe delivery.



Model No. APSTACKTR



Model No. APSTACKTB

Model No. APSTACKTO

Model No. APSTACKTC

Package includes:

- Model No. AP26059T 5 Drawer Topchest with Ball-Bearing Slides
- Overall Size (W x D x H): 660 x 435 x 490mm
- Model No. AP26029T 2 Drawer Mid-Box with Ball-Bearing Slides
- Overall Size (W x D x H): 670 x 440 x 210mm
- Model No. AP26479T 7 Drawer Rollcab with Ball-Bearing Slides
- Overall Size (W x D x H): 685 x 465 x 1005mm

Model No.	Colour	List Price	Exc. VAT	Inc. VAT
APSTACKTR	Red	£969.95	£739.95	£887.94
APSTACKTB	Black	£969.95	£739.95	£887.94
APSTACKTO	Orange	£969.95	£739.95	£887.94
APSTACKTC	Blue	£969.95	£739.95	£887.94

14 Drawer Tool Chest Combinations with 1179pc Tool Kit



14 Drawer Combination



Model No. SPTCOMBO1

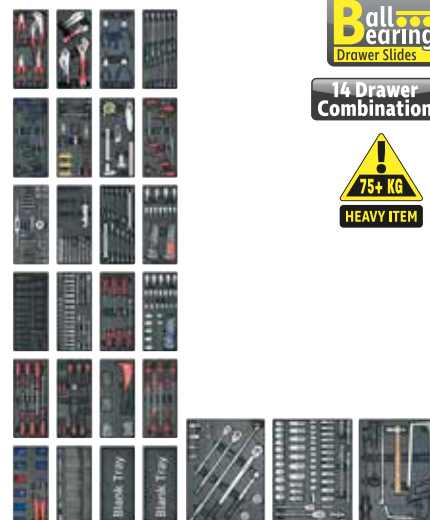

Package includes:

- Model No. AP26059T 5 Drawer Topchest with Ball-Bearing Slides
- Overall Size (W x D x H): 660 x 435 x 490mm
- Model No. AP26029T 2 Drawer Mid-Box with Ball-Bearing Slides
- Overall Size (W x D x H): 670 x 440 x 210mm
- Model No. AP26479T 7 Drawer Rollcab with Ball-Bearing Slides
- Overall Size (W x D x H): 685 x 465 x 1005mm

1179pc Tool Kit includes:

- Model No's: TBT01, TBT02, TBT03, TBT04, TBT05, TBT06, TBT07, TBT08, TBT09, TBT11, TBT12, TBT13, TBT14, TBT15, TBT16, TBT17, TBT18, TBT19, TBT23, TBT24, TBT26, TBT29, TBT30, TBT31, TBT32, TBTB (x2)

Model No.	Colour	List Price	Exc. VAT	Inc. VAT
SPTCOMBO1	Red	£2,999.95	£1,999.95	£2,399.94
SPTCOMBO2	Black	£2,999.95	£1,999.95	£2,399.94
SPTCOMBO1	Orange	£2,999.95	£1,999.95	£2,399.94
SPTCOMBO1	Blue	£2,999.95	£1,999.95	£2,399.94

Toolbox Graphics Packs



Rollcab not included.



Model No. APTBG01



Model No. APTBG02



Model No. APTBG03



Model No. APTBG04



Model No. APTBG05

- Toolbox graphics packs compatible with Model No. AP26479T range of Rollcabs.
- Fully resistant to water and oil.
- Two adhesive strips on the back of each piece make these easy to apply.

Model No.	Design	List Price	Exc. VAT	Inc. VAT
APTBG01	England	£84.95	£59.95	£71.94
APTBG02	Scotland	£84.95	£59.95	£71.94
APTBG03	Wales	£84.95	£59.95	£71.94
APTBG04	Ireland	£84.95	£59.95	£71.94
APTBG05	Union Jack	£84.95	£59.95	£71.94

7 Drawer Rollcab with Graphic Pack Combos



Model No. AP26479TUJ



Model No. AP26479TENG



Model No. AP26479TCSCOT



Model No. AP26479TBWALES



Model No. AP26479TOIRE

Graphics are not pre-applied, but can be attached to the Rollcab easily using the two adhesive strips on the back of each piece.

Package includes:

- Toolbox Graphics Pack
- AP26479T - 7 Drawer Rollcab with Ball-Bearing Slides

Model No.	Design	Rollcab Colour	List Price	Exc. VAT	Inc. VAT
AP26479TENG	England	Red	£599.95	£399.95	£479.94
AP26479TCSCOT	Scotland	Blue	£599.95	£399.95	£479.94
AP26479TBWALES	Wales	Black	£599.95	£399.95	£479.94
AP26479TOIRE	Ireland	Orange	£599.95	£399.95	£479.94
AP26479TUJ	Union Jack	Red	£599.95	£399.95	£479.94

Heavy-Duty Trolleys



Model No. CX102



Model No. CX103



American PRO

HEAVY DUTY

- Garage or workshop trolley.
- Deep-walled shelves, which may be installed base down or base up to give either tool and component security or unobstructed access.
- Four large castors, two fitted with a brake.
- Size (W x D x H): 775 x 410 x 900mm.

Model No.	Levels	Capacity Per Shelf	List Price	Exc. VAT	Inc. VAT
CX102	2	75kg	£119.95	£94.95	£113.94
CX103	3	50kg	£149.95	£99.95	£119.94

2-Level Heavy-Duty Trolley with Lockable Drawer



80KG PER LEVEL



Superline PRO

Ball Bearing Drawer Slides HEAVY DUTY

- Garage or workshop trolley with an 80kg capacity per shelf.
- Deep-walled shelves, which may be installed base down or base up to give either tool and component security or unobstructed access.
- Full-width, lockable drawer with ball-bearing slides.
- Four large castors, two fitted with a brake.
- Size (W x D x H): 760 x 410 x 900mm.
- **Model No. CX101D**
- List Price £199.95

£164.95 Exc. VAT
£197.94 Inc. VAT

2-Level Heavy-Duty Trolley with Lockable Top & 2 Drawers

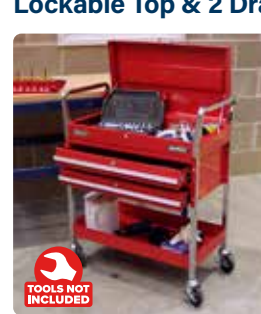

80KG PER LEVEL

Superline PRO

HEAVY DUTY

- Garage or workshop trolley with an 80kg capacity per shelf.
- Upper shelf has liner and lockable top.
- Lower shelf may be installed base down or base up to give either tool and component security or unobstructed access.
- Two lockable drawers with ball-bearing slides and liners, give additional tool security.
- Four large castors, two fitted with a brake.
- Size (W x D x H): 815 x 410 x 985mm.
- **Model No. CX1042D**
- List Price £269.95

£219.95 Exc. VAT
£263.94 Inc. VAT

3-Level Composite Workshop Trolley



40KG PER LEVEL

- Composite garage workshop trolley with a 40kg capacity per shelf.
- Walls on only three sides of each shelf allow easy-access when adding or removing items.
- Four large castors, two locking.
- May also be used as a janitorial trolley.
- Overall Size (W x D x H): 1140 x 513 x 960mm.
- Capacity: 120kg (40kg/level).
- **Model No. CX310**
- List Price £299.95

£229.95 Exc. VAT
£275.94 Inc. VAT

3-Level Folding Workshop Trolley



25KG PER LEVEL

Folding

- Folding composite garage workshop trolley with a 25kg capacity per shelf.
- Walls on all four sides to stop items from sliding off the trolley.
- Four large castors, two locking.
- Can also be used as a janitorial trolley.
- Folds up in seconds for easy storage when not in use.
- Overall Size (W x D x H): 670 x 430 x 855mm.
- **Model No. CX314**
- List Price £126.95

£99.95 Exc. VAT
£119.94 Inc. VAT

3-Level Composite Workshop Trolley



- Composite garage workshop trolley with a 30kg capacity per shelf.
- Walls on only three sides of shelf allow easy-access when adding or removing items to and from trolley.
- Four large castors, two locking.
- Can also be used as a janitorial trolley.
- Overall Size (W x D x H): 800 x 410 x 930mm.
- **Model No. CX308**
- List Price £124.95

£79.95 Exc. VAT
£95.94 Inc. VAT

1.52m Woodworking Bench

1.39m
Table Width



- Made from birchwood with a varnished finish.
- Features tool well, shelf, tool drawer, front and end vices, four metal bench stops and four wooden board jacks.
- Vice Dimensions (x2): 280mm Wide x 190mm Opening.
- Bench Dimensions (W x D x H): 1520 x 620 x 850mm.
- Worktop Dimensions (W x D): 1390 x 355mm.
- **Model No. AP1520**
- List Price £249.95

£189.95 Exc. VAT
£227.94 Inc. VAT

Truck Boxes

- Welded steel construction with folded lips for added strength and rigidity.
- Features recessed heavy-duty handles on the sides and front to aid manoeuvrability.
- Lid is supported by gas struts.
- Anti-Jemmy seams on the inside and outside of the boxes.
- Suitable for secure storage of tools and heavy equipment, on site, in-vehicle, in the workshop or at home.
- Supplied with two keyed alike locks and six keys.



Model No. STB06



Model No. STB07



Model No.	Size (W x D x H)	List Price	Exc. VAT	Inc. VAT
STB06	935 x 470 x 450mm	£359.95	£289.95	£347.94
STB07	1275 x 470 x 450mm	£449.95	£329.95	£395.94



Rota-Mould Cargo Cases



62L

Model No. RMC710



131L

Model No. RMC870



237L



Model No. RMC1020



- Rotationally moulded from heavy-duty polypropylene material, which is also UV stabilized and impact resistant.
- Features a water and dust-tight rubber seal.
- Recessed latches for added security to help prevent the use of bolt croppers.
- Ideal for the safe storage of tools, electronics and photographic equipment.
- Case will not rust or dent.
- Resistant to water, dust, chemicals and oil.
- Suitable for a variety of applications including pickup trucks, shipping, storage and use with roof racks.
- Specially designed base and lid enables cases to be stacked efficiently and reduces movement when in transit.

Model No.	Size (W x D x H)	Capacity	List Price	Exc. VAT	Inc. VAT
RMC710	710 x 425 x 330mm	62L	£169.95	£129.95	£155.94
RMC870	870 x 530 x 425mm	131L	£249.95	£199.95	£239.94
RMC1020	1020 x 620 x 510mm	237L	£379.95	£309.95	£371.94

2-Level Mobile Workbench



300kg Capacity

Scan for our full range of Workbenches.



- Sturdy steel construction workbench with a capacity of 300kg.
- Two shelves that allow unobstructed access.
- Fitted with two fixed castors, two locking castors and a heavy-duty handle.
- Size inc. Handle (W x D x H): 1180 x 700 x 830mm.
- **Model No. AP1100M**
- List Price £439.95

£349.95 Exc. VAT
£419.94 Inc. VAT

Steel Workbenches with Wooden Top



1.2m Table Width 100kg Capacity

Model No. AP1210



1.53m Table Width 200kg Capacity

Model No. AP1535



- Fully painted steel frame with wooden worktop and shelf.
- No nuts and bolts, means no tools required to assemble.
- Workbench clips together in minutes.
- Maximum Capacity Per Level:
AP1210 - 100kg (evenly distributed).
AP1535 - 200kg (evenly distributed).

Model No.	Size (W x D x H)	List Price	Exc. VAT	Inc. VAT
AP1210	1210 x 610 x 900mm	£107.45	£74.95	£89.94
AP1535	1535 x 620 x 920mm	£159.95	£109.95	£131.94

Steel Workbenches with 1 Drawer



1m Table Width

1 Drawer

Model No. AP1010



2m Table Width

Model No. AP1020

- AP1010 supplied with a single, lockable drawer.
- AP1020 supplied with a single, lockable drawer and drawer slides both sides of centre.
- Manufactured throughout from steel-plate for industrial durability.
- Finished in red gloss to prevent corrosion.
- Includes bottom shelf for additional storage.

Model No.	Size (W x D x H)	List Price	Exc. VAT	Inc. VAT
AP1010	1000 x 650 x 860mm	£369.95	£269.95	£323.94
AP1020	2000 x 650 x 860mm	£589.95	£429.95	£515.94

1.2m Workbench with Drawer

1.2m Table Width | 100kg Capacity | Ball Bearing Drawer Slides



- Boltless design makes the unit easy to assemble, with minimal tools being required.
- One large drawer with ball-bearing slides, fitted with two handles.
- MDF Worktop measures 1210 x 605mm (W x D), and has a comfortable work height of 900mm.
- Maximum Capacity per Level: 100kg (Evenly distributed).
- Fitted with anti-slip foot protectors.
- **Model No. AP12160**
- List Price £149.95

£109.95 Exc. VAT
£131.94 Inc. VAT



1.2m Workstation with Drawers

1.2m Table Width | 100kg Capacity | Ball Bearing Drawer Slides



- Boltless designed frame makes the unit easy to assemble, with minimal tools being required.
- Pegboard rear panel, plus hooks for convenient tool storage.
- Two half drawers, with ball-bearing slides, and shelf below worktop.
- Worktop: 1205 x 600mm.
- Capacity of Worktop & Bottom Shelf: 100kg.
- 230mm Shelf above pegboard.
- Size (W x D x H) [Overall/Worktop]: 1215 x 610 x 1500/900mm.
- **Model No. AP12600**
- List Price £189.95

£119.95 Exc. VAT
£143.94 Inc. VAT



8 Drawer Machinist Toolbox



- Toolbox with two large and six medium drawers, two of which are supplied with dividers, all secured behind a lockable front panel.
- A hinged top lid reveals a large storage area.
- Green felt interior to help protect tools.
- Pull knob, easy slide drawers for quick and easy-access.
- Lockable lid features three catches that add extra strength when toolbox is picked up by the handle.
- Walnut finish.
- Supplied with two keys per lock.
- **Model No. AP1608W**
- List Price £149.95

£119.95 Exc. VAT
£143.94 Inc. VAT

3 Compartment Mobile Steel/Composite Toolbox



- Mobile toolbox with heavy-duty wheels for added manoeuvrability.
- Features an extendable handle allowing easy transportation.
- Separates into three units.
- Top box with tote tray.
- Middle box with two ball-bearing runner drawers.
- Base unit is an open top bin providing storage space for larger items.
- Overall Size (W x D x H): 495 x 280 x 720mm.
- **Model No. AP548**
- List Price £199.95

£149.95 Exc. VAT
£179.94 Inc. VAT

Heavy-Duty HDPE Professional Tool Case



- Lightweight yet hard-wearing tool case with an HDPE (High-density polyethylene) shell which will not bend or dent.
- The interior features a double-sided tool storage surface.
- Adjustable/removable dividers in the main compartment.
- ABS and TPR corner caps.
- Supplied with two keys.
- Size (W x D x H): 460 x 160 x 350mm.
- **Model No. AP616**
- List Price £99.95

£69.95 Exc. VAT
£83.94 Inc. VAT

580mm Toolbox with Locking Carry Handle



- Strong composite toolbox with integral tote tray and small parts storage tray.
- Carry handle locks the lid in position even when clasps are not shut.
- Toolbox can be used as a step with a maximum weight limit of 120kg.
- 510mm Measuring line marked on the toolbox.
- Includes padlock eye for security (padlock not included).
- Size (W x D x H): 580 x 285 x 290mm.
- **Model No. AP580LH**
- List Price £59.95

£36.95 Exc. VAT
£44.34 Inc. VAT

490mm Toolbox with Tote Tray



- Tough composite construction.
- Lid features folding comfort grip carry handle.
- Two flip lid organizers with four fixed compartments in each.
- Main storage compartment suitable for hand tools and small power tools, also includes tote tray.
- Tough clasps hold the toolbox shut with padlocking facility (padlock not included).
- Size (W x D x H): 490 x 240 x 240mm.
- **Model No. AP490**
- List Price £26.95

£17.95 Exc. VAT
£21.54 Inc. VAT

450mm Backpack



- Manufactured from durable polyester.
- Spacious design with two zipped pockets.
- Carry handle.
- Adjustable padded straps.
- Main pocket size (W x D): 280 x 170mm.
- **Model No. RSBP2**
- List Price £21.45

£9.95 Exc. VAT
£11.94 Inc. VAT

480mm Tool Backpack



- Manufactured from heavy-duty polyester.
- Tough plastic base protects tools.
- Nine internal pockets to keep tools organised.
- Separate zipped front pocket with internal small zip pocket.
- Two additional side pockets.
- Adjustable straps.
- Overall Size (W x D x H): 390 x 200 x 480mm.
- Main Pocket Size (W x D): 380 x 170mm.
- **Model No. AP519**
- List Price £48.95

£34.95 Exc. VAT
£41.94 Inc. VAT

490mm Tool Backpack



- Manufactured from heavy-duty polyester.
- Tough plastic base protects tools.
- Main compartment has three zipped pockets and 10 open pockets to keep tools organised.
- Separate zipped front pocket with internal padded laptop pocket.
- Document storage pocket with adjustable clips.
- Padded adjustable straps and back for comfort.
- Overall Size (W x D x H): 390 x 200 x 490mm.
- Main Pocket Size (W x D): 380 x 170mm.
- **Model No. AP520**
- List Price £64.95

£46.95 Exc. VAT
£56.34 Inc. VAT

Double Pouch Leather Tool Belt

NEW
PRODUCT



- Double pocket split leather tool belt.
- 11 pockets including two large pouches, two hammer loops, two nail pouches, a knife holder, measuring tape holder and four screwdriver holders.
- Adjustable 50mm wide webbing belt (maximum 48").
- With side release style buckle fastening.
- **Model No. STBL01**
- List Price £13.95



£9.95 Exc. VAT
£11.94 Inc. VAT

440mm Worksafe® Toolbag



- Heavy-duty tool bag constructed from tough polyester with a hard-wearing plastic base.
- Single internal compartment with built-in pockets enclosed with an industrial grade zip.
- Keeps tools clean, dry and organised at home or on the job.
- External features include carry strap for oversized items such as a spirit level and two end pockets.
- Robust carry handles and a strong shoulder strap with metal clasps for easy portability.
- Main pocket size (W x D): 430 x 250mm.
- **Model No. WTTB19**
- List Price £38.95

WORKSAFE
by SEALEY

£19.95 Exc. VAT
£23.94 Inc. VAT

500mm Tool Storage Bag



- Heavy-duty tool bag constructed of tough polyester with padded base for added durability.
- Adjustable shoulder strap can be hooked onto metal clasps for carrying heavier loads.
- Features 12 inner pockets and 12 outer pockets for optimum organization, cushioned carry handles and metal frame zip.
- **Model No. AP500**
- List Price £36.95

£23.95 Exc. VAT
£28.74 Inc. VAT

500mm Tool Storage Bag



- Heavy-duty tool bag constructed from tough polyester with a rigid waterproof rubber base for added durability.
- Keeps tools clean, dry and organized at home or on the job.
- Two storage compartments feature a total of 15 internal pockets, an aerosol can holder and hook-and-loop retaining strap.
- External features include an adjustable padded shoulder strap, rubber grip hook-and-loop carry handles, four hanging d-rings and nine pockets.
- Size (W x D x H): 500 x 240 x 320mm.
- **Model No. AP513**
- List Price £69.95

£43.95 Exc. VAT
£52.74 Inc. VAT

200mm Technician's Utility/Tool Storage Bag



- Open top design allows the user excellent visibility and access to tools and parts.
- 26 Internal and external pockets.
- Measuring tape and hanging loop clips.
- Base compartment ideal for small power tools or consumables such as drill bit sets.
- Adjustable shoulder strap and PVC carry handle make carrying easier and more comfortable.
- Size (W x D x H): 200 x 220 x 230mm.
- Strap Length: 990mm.
- Outer/Inner Pockets: 18/8.
- **Model No. AP518**
- List Price £37.95

£26.95 Exc. VAT
£32.34 Inc. VAT

Safes



Model No. SCFS04

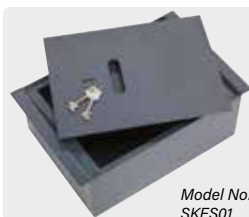

Model No. SKFS01



Model No. SECS01DS

FIRE PROOF

Model No.	Type	Dimensions (W x D x H)	List Price	Exc. VAT	Inc. VAT
SCFS04	Electronic Combination - Fireproof	450 x 380 x 305mm	£249.95	£199.95	£239.94
SKFS01	Key Lock - Floor	260 x 400 x 140mm	£99.95	£79.95	£95.94
SECS01DS	Electronic Combination - Deposit Slot	350 x 250 x 250mm	£86.95	£69.95	£83.94

Steel Body Padlocks

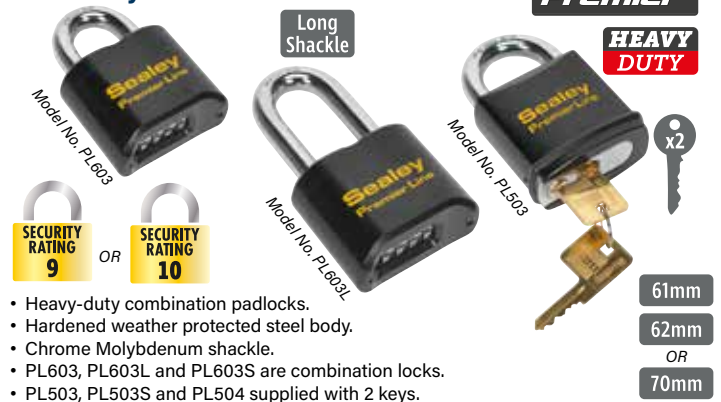

- Heavy-duty combination padlocks.
- Hardened weather protected steel body.
- Chrome Molybdenum shackle.
- PL603, PL603L and PL603S are combination locks.
- PL503, PL503S and PL504 supplied with 2 keys.

Model No.	Security Rating	Shackle Size	Long Shackle	List Price	Exc. VAT	Inc. VAT
PL603	9	62mm	X	£45.95	£29.95	£35.94
PL603L	9	62mm	✓	£49.95	£31.95	£38.34
PL603S	9	62mm	X	£64.95	£39.95	£47.94
PL503	9	61mm	X	£56.95	£36.95	£44.34
PL503S	10	61mm	X	£99.95	£64.95	£77.94
PL504	10	70mm	X	£74.95	£49.95	£59.94

ABS Stackable Click Together Toolboxes



Model No. AP8130



Model No. AP8150



Model No. AP8250

- Durable ABS toolbox with robust fold flat handle.
- Can be used separately or interlocked with other boxes in the range, making any combination to suit your requirements.
- Can be further enhanced with an optional castor set, (Model No's AP8CA and AP8CB) to make your combination more portable.
- Dividers (Model No. AP8D6) are available as an optional extra to help keep small parts separate.

Model No.	Size (W x D x H)	List Price	Exc. VAT	Inc. VAT
AP8130	445 x 310 x 130mm	£36.95	£22.95	£27.54
AP8150	445 x 310 x 150mm	£41.95	£26.95	£32.34
AP8250	445 x 310 x 250mm	£59.95	£43.95	£52.74

3 Compartment Mobile Stainless Steel/ Composite Toolbox



- Fully mobile with two heavy-duty wheels and a retractable handle.
- Separates into three units.
- Top box with tote tray, has two strong clasps and padlock hasp.
- Middle box features two large pull-out drawers.
- Base unit is an open top bin providing storage for larger items and can be secured by padlock (not included).
- Overall Size (W x D x H): 540 x 350 x 840mm (Handle Retracted).
- **Model No. AP855**
- List Price £199.95

£139.95 Exc. VAT
£167.94 Inc. VAT

Professional Mobile Toolbox with 5 Removable Storage Cases



- Fully mobile with two heavy-duty wheels and a retractable handle.
- All five storage boxes slide in to sturdy composite frame.
- All five boxes fitted with strong composite clasps.
- Toolbox can be locked with padlocks on each side (padlocks not included).
- Secure closing with lift and lock latches.
- All five storage boxes slide out of the frame separately for easy-access to the box required.
- Overall Size (W x D x H): 500 x 410 x 770mm (Handle Retracted).
- **Model No. AP860**
- List Price £289.95

£222.95 Exc. VAT
£267.54 Inc. VAT

585mm 3 Drawer Portable Toolbox

3 Drawer



- Has the storage capability of a tool chest coupled with the versatility of a carry-type toolbox.
- Drawers are automatically locked, for transportation, when lid is closed.
- Two tough metal locking clasps, both with padlock eye for extra security.
- Overall Size (W x D x H): 585 x 250 x 340mm.
- **Model No. AP1003**
- List Price £119.95

£84.95 Exc. VAT
£101.94 Inc. VAT

Storage Containers



40L

Model No. AP5040



60L

Model No. AP5040



80L

Model No. AP5080

- Robust composite storage boxes with integral handles.
- Suitable for industrial or domestic use.

Model No.	Size (W x D x H)	Capacity	List Price	Exc. VAT	Inc. VAT
AP5040	710 x 400 x 212mm	40L	£18.45	£12.95	£15.54
AP5060	795 x 395 x 295mm	60L	£21.95	£14.95	£17.94
AP5080	770 x 465 x 292mm	80L	£28.95	£17.95	£21.54

400 x 400mm Polypropylene Treadplate Floor Tiles - Packs of 9



Scan for our full range of Floor Tiles.

- Heavy-duty polypropylene tiles for customising any workshop or garage environment.
- Tiles click together easily without the need for tools.
- Provides an anti-slip and durable surface.
- Supplied in a packs of nine, covering 1.44m².

- **Model No. FT3B** - Black
- **Model No. FT3R** - Red
- **Model No. FT3Y** - Yellow
- **Model No. FT3BL** - Blue
- **Model No. FT3W** - White
- **Model No. FT3GR** - Green
- **Model No. FT3G** - Grey
- List Price £59.95

£49.95 Exc. VAT
£59.94 Inc. VAT

400 x 60mm Polypropylene Floor Tile Edges - Packs of 6

- Buckle edging for Sealey polypropylene floor tiles.

Female

- **Model No. FT3EBF** - Black
- **Model No. FT3ERF** - Red
- **Model No. FT3EYF** - Yellow

Male

- **Model No. FT3EBM** - Black
- **Model No. FT3ERM** - Red
- **Model No. FT3EYM** - Yellow
- List Price £8.95

£6.45 Exc. VAT
£7.74 Inc. VAT

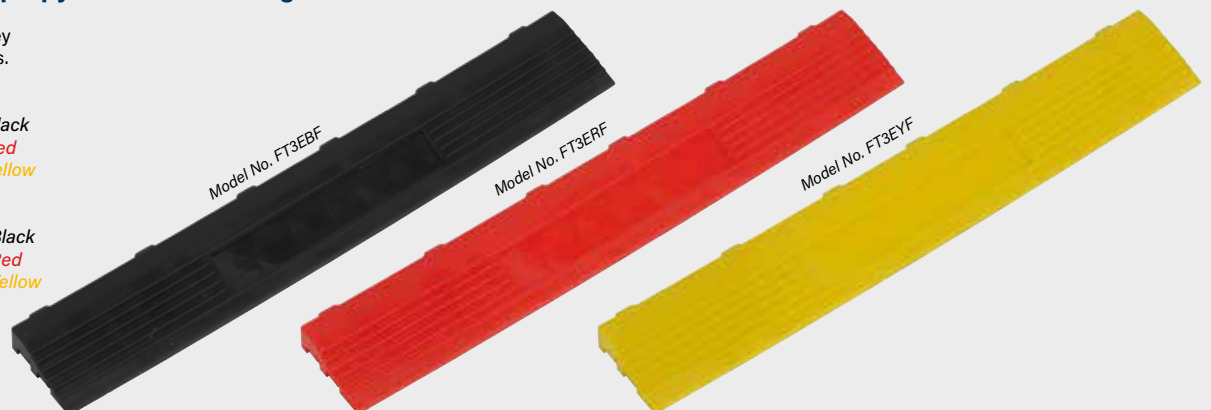

Racking Unit 200kg Capacity Per Level



- Fully painted steel frame with five MDF shelves.
- 200kg Capacity per level giving a maximum capacity of 1000kg per rack.
- Boltless design means no tools required to assemble.
- Slots together in minutes.
- 2-Piece uprights allow use as a single bay rack or split into two separate shelf systems or workstations.
- Use in conjunction with Model No. AP7150C Corner Unit.
- Size (W x D x H): 910 x 410 x 1830mm.
- **Model No. AP7200**
- List Price £119.95

£89.95 Exc. VAT
£107.94 Inc. VAT

Racking Units



Model No. AP900R



Model No. AP1200R

- Fully painted steel frame with five MDF shelves.
- Z Shape beams offer the following capacities:
AP900R 340kg capacity per level giving a maximum capacity of 1700kg per rack.
AP1200R 220kg capacity per level giving a maximum capacity of 1100kg per rack.
- Boltless design means no tools required to assemble.
- Slots together in minutes.
- 2-Piece uprights allow use as a single bay rack or split into two separate shelf systems or workstations.
- **Model No. AP900R**
- List Price £149.95

Model No.	Size (W x D x H)	List Price	Exc. VAT	Inc. VAT
AP900R	915 x 460 x 1830mm	£149.95	£109.95	£131.94
AP1200R	1220 x 460 x 1830mm	£189.95	£129.95	£155.94

Corner Racking Unit 150kg Capacity Per Level



- Fully painted steel frame with five MDF shelves.
- Space-saving corner unit with 150kg capacity per level giving a maximum capacity of 750kg per rack.
- Boltless design means no tools required to assemble.
- Slots together in minutes.
- 2-Piece uprights allow use as a single bay rack or split into two separate shelf systems or workstations.
- Ideal for use in conjunction with Model No. AP7200 Racking Unit.
- Size (W x D x H): 730 x 730 x 1830mm.
- **Model No. AP7150C**
- List Price £154.95

£109.95 Exc. VAT
£131.94 Inc. VAT

Two Level Tyre Rack - 200kg Capacity Per Level



- Two level static tyre rack helps keep working area clear.
- Stores up to 26 tyres, 13 per level, with a total capacity of 400kg (200kg/Level).
- Steel construction with a powder coated finish giving corrosion resistance.
- Overall Size (W x D x H): 1950 x 455 x 2000mm.
- **Model No. STR600**
- List Price £329.95

£269.95 Exc. VAT
£323.94 Inc. VAT

Two Level Tyre Rack Extension 200kg Capacity Per Level

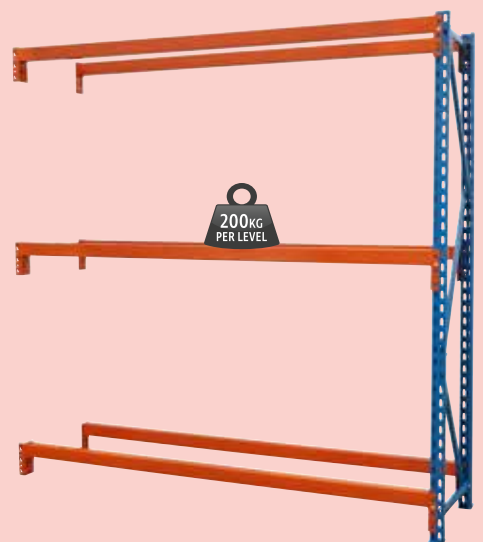

- Extension unit for Model No. STR600.
- Supplied as three pairs of cross beams and a single upright in order to reduce cost when looking to build multiple tyre racks.
- Stores up to 26 tyres, 13 per level, when used with Model No. STR600.
- Overall Size (W x D x H): 1950 x 455 x 2000mm.
- Maximum Capacity: 400kg (200kg/Level).
- **Model No. STR600E**
- List Price £269.95

£219.95 Exc. VAT
£263.94 Inc. VAT

EASY PEEL SHADOW FOAM®

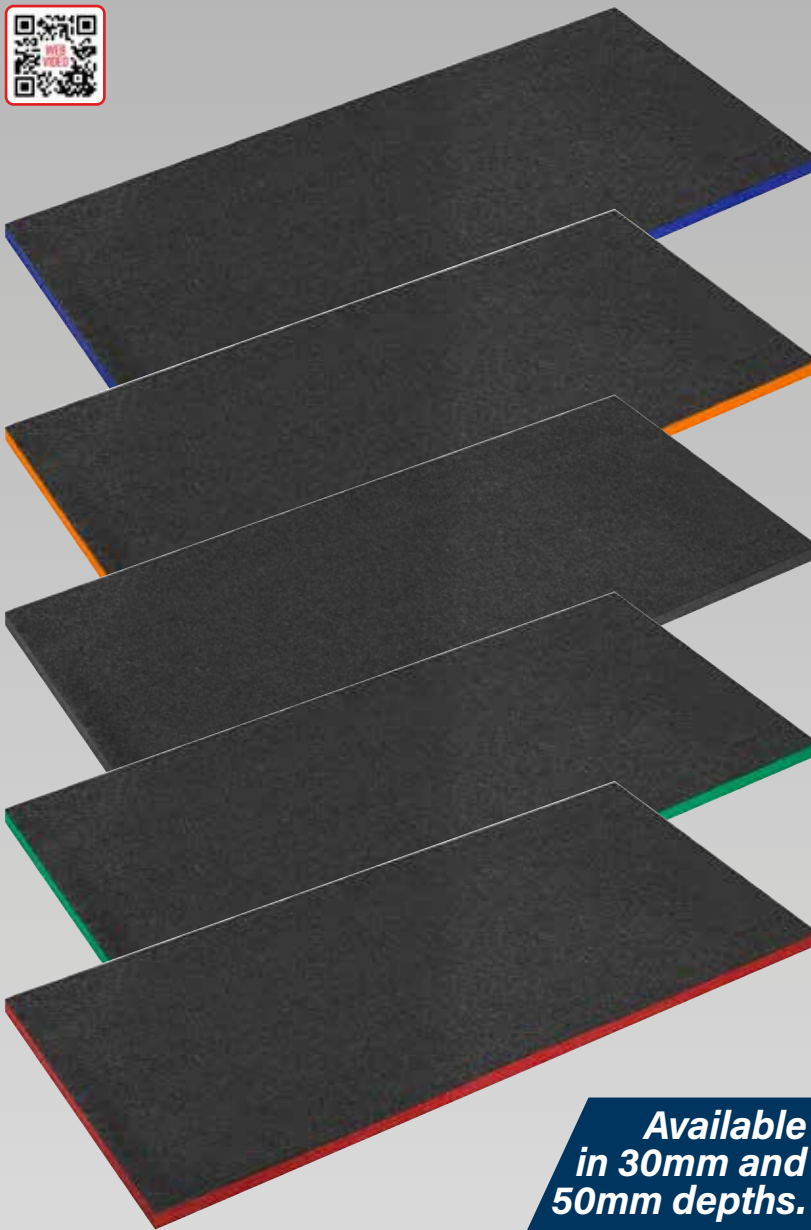

**Available
in 30mm and
50mm depths.**

- Create your own tool tray inserts with this easy peel foam.
- Layered foam allows for depths to be set to suit the tool.
- Bright coloured foam underneath a black top highlights tools for a professional look.
- Can be cut to fit any tool tray or drawer.
- Made from 100% Polyethylene.

Dimensions: 1200 x 550 x 30mm				
Model No.	Colour	List Price	Exc. VAT	Inc. VAT
SF30B	Blue	£22.95	£18.95	£22.74
SF30OR	Orange	£22.95	£18.95	£22.74
SF30BK	Black	£22.95	£18.95	£22.74
SF30G	Green	£22.95	£18.95	£22.74
SF30R	Red	£22.95	£18.95	£22.74
SFPK30R	Red (x3)	£64.95	£49.95	£59.94

Dimensions: 1200 x 550 x 50mm				
Model No.	Colour	List Price	Exc. VAT	Inc. VAT
SF50B	Blue	£28.95	£22.95	£27.54
SF50OR	Orange	£28.95	£22.95	£27.54
SF50BK	Black	£28.95	£22.95	£27.54
SF50G	Green	£28.95	£22.95	£27.54
SF50R	Red	£28.95	£22.95	£27.54
SFPK50R	Red (x3)	£81.95	£59.95	£71.94

MEASURE



TOOLS NOT INCLUDED

CUT



TOOLS NOT INCLUDED

PEEL



TOOLS NOT INCLUDED

ORGANISE



TOOLS NOT INCLUDED

Portable Air Cooler/Purifier/Humidifier

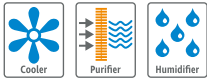

3-Speed



- 3-in-1 Air cooler, air purifier and humidifier.
- Active carbon filter.
- 4L Water tank supplied with two ice packs.
- Adjustable airflow direction.
- Three selectable fan speeds.
- Easy to operate and move around on castors.
- **Model No. SAC04**
- List Price £79.95

£54.95 Exc. VAT
£65.94 Inc. VAT

Portable Air Cooler/Purifier/Humidifier with Remote Control

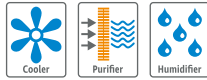

3-Speed

Includes Remote



- 3-in-1 Air cooler, air purifier and humidifier.
- Active carbon filter.
- Large 13L water tank supplied with two ice packs.
- Adjustable timer ranging from 30 minutes - 7.5 hours.
- Adjustable airflow direction.
- Three selectable fan speeds.
- Supplied with electronic remote control.
- Easy to operate and move around on castors.
- **Model No. SAC13**
- List Price £129.95

£99.95 Exc. VAT
£119.94 Inc. VAT

20L Portable Dehumidifier

20L



- Compact, efficient and portable unit that extracts up to 20L of water per day.
- Removes excess moisture from air to prevent build-up of mildew and mould.
- Indicator light on front panel changes colour to show current humidity level in room.
- Touchscreen control panel allows user to set a timer and humidity levels.
- Automatically turns off when tank is full, for safety.
- Refrigerant is environmentally friendly R290.
- Supplied with a 300mm drain hose along with four swivel wheels.
- **Model No. SDH20**
- List Price £279.95

£219.95 Exc. VAT
£263.94 Inc. VAT

90L Industrial Dehumidifier



- Powerful dehumidification capacity, extracts up to 90L of water per day.
- Removes excess moisture from air, preventing build-up of mildew and mould.
- Features auto-defrost function, which activates if the room temperature falls too low.
- 24hr Timer function for delay starting and auto-shut-off.
- Washable air filter.
- Refrigerant is environmentally friendly R290.
- Features a permanent drain hose for continuous operation.
- Mounted on castors for manoeuvrability.
- **Model No. SDH90**
- List Price £1,299.95



£999.95 Exc. VAT
£1,199.94 Inc. VAT

7,000Btu/hr Portable Air Conditioner/Dehumidifier Air Cooler

NEW PRODUCT



2-Speed

Includes Remote



- Thermostatically controlled with built-in 24hr timer and sleep mode.
- Self-evaporating system allows better efficiency, low maintenance and powerful cooling.
- Dehumidifying function capable of removing up to 14.6L per day.
- Water-full indicator with auto-shut-off.
- Supplied with extendable exhaust ducting with window kit for ventilation and continuous drain hose.
- Air conditioning temperature range 16-32°C.
- Washable filter.
- Auto-defrost function at low ambient temperature.
- **Model No. SAC7000**
- List Price £399.95

£279.95 Exc. VAT
£335.94 Inc. VAT

9,000Btu/hr Portable Air Conditioner/Dehumidifier



Includes Remote



- Energy Class: A.
- Air conditioning temperature range: 16-30°C.
- Dehumidifying function capable of removing up to 24L of water per day.
- Thermostatically controlled.
- Supplied with extendable exhaust hose and window kit.
- Features 2-speed fan and electronic remote control.
- Refrigerant is R290.
- Mounted on castors for manoeuvrability.
- Cable storage keeps unit tidy when not in use.
- **Model No. SAC9002**
- List Price £469.95

£339.95 Exc. VAT
£407.94 Inc. VAT

12,000Btu/hr Portable Air Conditioner/Dehumidifier/Heater



3-Speed



- Energy class: A.
- Air Conditioning Temperature Range: 16-30°C.
- Dehumidifying function capable of removing up to 28.8L of water per day.
- Thermostatically controlled.
- Supplied with extendable exhaust hose and window kit.
- Features 3-speed fan and electronic remote control.
- Refrigerant is R290 300g.
- Mounted on castors for manoeuvrability.
- Cable storage keeps unit tidy when not in use.
- **Model No. SAC12000**
- List Price £599.95

£459.95 Exc. VAT
£551.94 Inc. VAT

Portable Air Cooler/Heater/Air Purifier/Humidifier with Remote Control

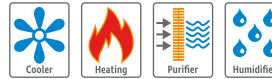

3-Speed



- 8L water tank.
- Remote control and panel control.
- Active carbon filter.
- Germ-free cooling by rotating water curtain.
- Large anti-bacterial water tank.
- Generates negative ions to purify and sterilise output air.
- Hi-tech PTC heating element assures safer and rapid heating with two power options (1000/2000W).
- Two choices of airflow directions.
- Up to 7.5 hour timer.
- Easy to operate and move around on castors.
- **Model No. SAC41**
- List Price £179.95

£139.95 Exc. VAT
£167.94 Inc. VAT

4" Mini Desk Fan



- Manufactured from durable composite material, ergonomically designed to pivot on a 180° axis, maximising the volume and direction of airflow.
- Single speed setting to keep a constant airflow around the room.
- Fitted with 3-pin plug.
- **Model No. SFF04**
- List Price £14.95

£13.45 Exc. VAT
£16.14 Inc. VAT

6" Oscillating USB Desk Fan



- Manufactured from composite materials with a steel fan guard.
- Oscillation control switch and pivot head allow the user to control how the airflow is distributed.
- Brushless motor keeps the fan quiet, making it ideal for office environments.
- 3-Speed settings.
- Supplied with a USB cable for powering by laptop or mobile power bank, alternatively can be powered by 3 x AA batteries (not included).
- **Model No. SFF6USB**
- List Price £23.95

£19.95 Exc. VAT
£23.94 Inc. VAT

12" Desk & Pedestal Fan



- Versatile fan manufactured from durable composite material with three height stages and 3-speeds.
- Adding or removing threaded extension sections converts the fan between a stand, low stand and desk fan with no need for tools.
- Fan head pivots vertically through 180° to control the direction of airflow.
- Fitted with 3-pin plug.
- Adjustable Height: 530/740/1000mm.
- **Model No. SFF12DP**
- List Price £54.95

£41.95 Exc. VAT
£50.34 Inc. VAT

Desk/Floor/Wall Fans

8"



Model No. SFF08

12"



Model No. SFF12

16"



Model No. SFF16



- Manufactured from durable composite material, ergonomically designed to pivot on a 180° axis, maximising the volume and direction of airflow.
- Can also be wall mounted.
- All three fans feature 3-speed settings.
- Fitted with 3-pin plug.

Model No.	Diameter	List Price	Exc. VAT	Inc. VAT
SFF08	Ø200mm(8")	£26.95	£22.95	£27.54
SFF12	Ø300mm(12")	£46.95	£37.95	£45.54
SFF16	Ø400mm(16")	£59.95	£44.95	£53.94

16" Desk & Pedestal Fan



- Versatile fan manufactured from durable composite material with three height stages and 3-speeds.
- Adding or removing threaded extension sections converts the fan between a stand, low stand and desk fan with no need for tools.
- Fan head pivots vertically through 180° to control the direction of airflow.
- Fitted with 3-pin plug.
- Adjustable Height: 750/980/1275mm.
- **Model No. SFF16DP**
- List Price £74.95

£63.95 Exc. VAT
£76.74 Inc. VAT

16" Quiet High Performance Oscillating Pedestal Fan

NEW PRODUCT



- Five carefully programmed modes include - Sleep/Calm/Refresh/Cool/Power.
- Offers quiet oscillation and adjustable fan head allowing great airflow in any room.
- Additional features include an 8hr timer, Auto-dimming LED control panel and fully functional remote control and remote storage.
- Metal grill and height adjustment up to 1.4m(55").
- Weighted base for extra stability and easy-to-assemble, tool-free.
- **Model No. SFF16Q**
- List Price £84.95

£69.95 Exc. VAT
£83.94 Inc. VAT

Wall Fans



Includes Remote



- Both fans feature tilt and oscillating head.
- Sleep mode for gradual reduction of fan speed.
- 3-Speed settings.
- Timer Function: 0.5-4hr.
- Supplied with wall bracket.

Model No.	Diameter	Max. Airflow	Power	List Price	Exc. VAT	Inc. VAT
SWF16WR	Ø400mm(16")	45m ³ /min	40W	£59.95	£43.95	£52.74
SWF18WR	Ø450mm(18")	97m ³ /min	65W	£67.45	£49.95	£59.94

8" Clip-On Fan

8"



- Features tilt and swivel head for optimum air circulation.
- Switch control and fully guarded fan blades for extra safety.
- Smooth running motor powers fan blades.
- Maximum Airflow: 15m³/min.
- **Model No. SCF8W**
- List Price £21.95

£18.95 Exc. VAT
£22.74 Inc. VAT

12" Oscillating Desk Tower Fan

12"

2-Speed



NEW PRODUCT



- Slimline fan design ideal for desktop use.
- Matte finish with 2-speed and oscillating functions.
- Smooth running highly durable copper motor powers fan blades and oscillating motor to aid powerful and even air distribution.
- Fitted with 3-pin plug.
- **Model No. STF12C**
- List Price £29.95

£24.95 Exc. VAT
£29.94 Inc. VAT



30" Oscillating Tower Fan

30"

3-Speed



- Slimline fan design, suitable for floor or desktop.
- Matte finish with built-in carry handle and up to 2hr auto-shut-off timer.
- Smooth running motor powers fan blades and oscillating gearbox to aid powerful and even air distribution.
- Fitted with 3-pin plug.
- **Model No. STF30**
- List Price £49.95

£44.95 Exc. VAT
£53.94 Inc. VAT

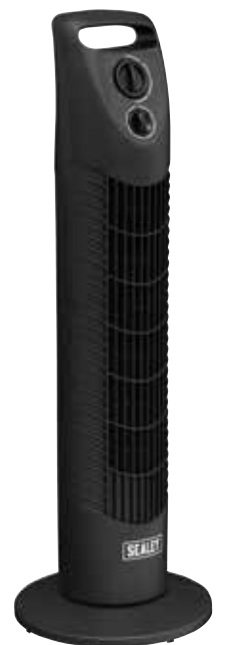

42" Oscillating Tower Fan

42"

3-Speed

Includes Remote



- Slimline fan design, suitable for floor or desktop.
- Remote control operation with 3-speeds and an 8hr timer.
- Smooth running motor powers fan blades and oscillating gearbox to aid even air distribution.
- Fitted with 3-pin plug.
- **Model No. STF42**
- List Price £74.95

£64.95 Exc. VAT
£77.94 Inc. VAT



43" Quiet High Performance Oscillating Tower Fan

43"

QUIET RUNNING

Oscillation Function

5-Speed

Includes Remote



NEW PRODUCT



- High performance tower fan with advanced centrifugal blades for maximum air movement.
- Quiet operation and high durability motor.
- Five carefully programmed modes include - Sleep/Calm/Refresh/Cool/Power.
- Offers quiet 70° oscillation allowing great airflow in any room.
- Additional features include an 8hr timer, Easy-touch, Auto-dimming LED control panel and fully functional remote control and remote storage.
- Built-in handle.
- Ideal for home, bedroom and office environments.
- Easy-to-assemble, tool-free.
- **Model No. STF43Q**
- List Price £109.95

£89.95 Exc. VAT
£107.94 Inc. VAT



18" Industrial High Velocity Floor Fan with Internal Oscillation



- High velocity fan suitable for movement of huge volumes of air.
- Patented design with internally oscillating blades.
- Covers more than twice the area of a conventional non-oscillating fan.
- Provides constant airflow to complete area compared to standard oscillating fan which covers only 1/4 of the area at any one time.
- 3-Speed power selection with switchable oscillation control.
- Maximum Airflow: 55m³/min(1118cfm).
- **Model No. HVF18IS**
- List Price £99.95

£74.95 Exc. VAT
£89.94 Inc. VAT

18" Industrial High Velocity Floor Fan



- 3-Speed high output industrial fan at 1020, 1130 or 1300rpm.
- Balanced three blade propeller.
- Ideal for industrial, commercial, automotive and agricultural use.
- Maximum Airflow: 107m³/min(3,760cfm).
- Fitted with 3-pin plug.
- **Model No. HVF18**
- List Price £89.95

£69.95 Exc. VAT
£83.94 Inc. VAT

20" Industrial High Velocity Floor Fan



- 3-Speed settings at 1100, 1225 or 1350rpm.
- Blade cradle tilts within frame.
- Fully guarded blades for safety.
- Mains cable storage.
- Suitable for industrial, commercial, agricultural, workshop and showroom applications.
- Maximum airflow up to 110m³/min.
- **Model No. HVF20**
- List Price £109.95

£84.95 Exc. VAT
£101.94 Inc. VAT

20" Industrial High Velocity Pedestal Fan



- 3-Speed settings at 1100, 1250 or 1350rpm.
- Blade cradle tilts through 135° angle.
- Height-adjustable stand from 1300 to 1410mm.
- Large diameter base for added stability.
- Fully guarded blades for safety.
- Mains cable storage.
- Suitable for industrial, commercial, agricultural, workshop and showroom applications.
- Maximum airflow up to 138m³/min.
- **Model No. HVF20P**
- List Price £129.95

£99.95 Exc. VAT
£119.94 Inc. VAT

20" Industrial High Velocity Oscillating Pedestal Fan



- 3-Speed settings at 1050, 1150 or 1350rpm.
- Features tilting and oscillating head.
- Height-adjustable stand from 1080 to 1410mm.
- Fully guarded blades for safety.
- Suitable for industrial, commercial, agricultural, workshop and showroom applications.
- Maximum airflow up to 110m³/min.
- **Model No. HVF20PO**
- List Price £159.95

£119.95 Exc. VAT
£143.94 Inc. VAT

30" Industrial High Velocity Oscillating Pedestal Fan



- 2-Speed high output pedestal fan at 800-900rpm.
- Balanced, 3-bladed, 760mm(30") fan.
- Mounted on spring-assisted, height-adjustable stand.
- Switchable 90° head oscillation.
- Ideal for industrial, commercial, automotive and agricultural use.
- Maximum Airflow: 288m³/min.
- Adjustable Height: 1610-2030mm.
- Motor: 230V~50Hz 123W.
- **Model No. HVSF30**
- List Price £299.95

£239.95 Exc. VAT
£287.94 Inc. VAT

Industrial High Velocity Orbital Drum Fans



Model No. HVF20S



Model No. HVF24S



Model No. HVF30S



- High velocity industrial drum fans suitable for movement of huge volumes of air.
- Featuring a 360° tilt function allowing for the direction of airflow to be positioned anywhere on a 360° axis.
- Carefully balanced and fully guarded blades provide safe operation.
- Suitable for industrial, commercial, agricultural, automotive workshop and showroom applications.

Model No.	Diameter	Speeds	Max. Airflow	Power	List Price	Exc. VAT	Inc. VAT
HVF20S	Ø550mm(20")	3	123.5m ³ /min(4361cfm)	108.6W	£159.95	£119.95	£143.94
HVF24S	Ø610mm(24")	2	155.3m ³ /min(5484cfm)	116.32W	£289.95	£219.95	£263.94
HVF30S	Ø760mm(30")	2	283.4m ³ /min(10008cfm)	118.6W	£379.95	£299.95	£359.94

HIGH VELOCITY DRUM FAN

230V/20V SV20 Series 16" 2-in-1 Cordless/Corded High Velocity Drum Fan Kit

20V **VARIABLE SPEED** **NEW PRODUCT**



Model No. HVD16CCOMBO



Model No. HVD16C

- Part of the SV20 Series offering a one-battery-fits-all solution, keeping costs down without compromising on performance.
- Mains or cordless power means increased versatility in positioning cooling where it is most required.
- High velocity continuous variable speed drum fan.
- Lightweight, portable and robust unit fitted with rubber feet for stability.
- Handle and 360° tilting stand allowing control of airflow to exactly where it is needed.
- Carefully balanced and fully guarded aluminium blades provide quiet and safe operation.
- Suitable for use in industrial, commercial, agricultural, automotive workshop, showroom and home applications.
- Running Time: 4Ah - 3.5hr, 6Ah - 5hr (On High Speed).

Package includes:

- HVD16C - 230V/20V 16" 2-in-1 Cordless/Corded High Velocity Drum Fan
- CP20VBP6 - 20V 6Ah Lithium-ion Power Tool Battery for SV20 Series
- CP20VMC - 20V Lithium-ion Battery Charger for SV20 Series

SEE OUR FULL ONE-BATTERY-FITS-ALL

SV20 SERIES

ON PAGES 75-77.

Model No.	Type	Batteries in Kit	List Price	Exc. VAT	Inc. VAT
HVD16CCOMBO	Kit	1 x 6AH	£264.95	£189.95	£227.94
HVD16C	Fan	-	£144.95	£114.95	£137.94

16" High Velocity Drum Fan



- High velocity 3-speed drum fan.
- Lightweight, portable and robust unit fitted with rubber feet for stability.
- Handle and 360° tilting stand allowing control of airflow to exactly where it is needed.
- Carefully balanced and fully guarded aluminium blades provide quiet and safe operation.
- Fitted with 3-pin plug.
- **Model No. HVD16**
- List Price £114.95

£84.95 Exc. VAT
£101.94 Inc. VAT

Industrial High Velocity Drum Fans



- High velocity industrial 2-speed drum fans suitable for movement of huge volumes of air.
- Robust units with heavy-duty gauge steel casing, guard and frame.
- Handle, wheels and fully tiltable cradle allows control of airflow where it is needed.
- Carefully balanced and fully guarded blades provide safe operation.
- Suitable for use in industrial, commercial, agricultural, automotive workshop and showroom applications.
- Fitted with 3-pin plug.

Model No.	Diameter	Max. Airflow	Power	List Price	Exc. VAT	Inc. VAT
HVD24	Ø610mm(24")	155.3m ³ /min(5484cfm)	116.32W	£219.95	£169.95	£203.94
HVD30	Ø760mm(30")	283.4m ³ /min(10008cfm)	118.6W	£299.95	£239.95	£287.94

30" Industrial High Velocity Drum Fan



- High velocity industrial 2-speed drum fan suitable for movement of huge volumes of air.
- Robust unit with heavy-duty gauge steel casing, guard and frame.
- Handle, wheels and fully tiltable cradle allows control of airflow where it is needed.
- Carefully balanced and fully guarded blades provide safe operation.
- Suitable for industrial, commercial, agricultural, automotive workshop and showroom applications.
- Maximum Airflow: 284.8m³/min(10057cfm).
- Fitted with 16A 110V plug.
- **Model No. HVD30110V**
- List Price £339.95



£269.95 Exc. VAT
£323.94 Inc. VAT



Industrial High Velocity Drum Fans



- Robust units with heavy-duty gauge steel casing, guard and frame.
- Handle, wheels and tilt function cradle stand, allow the control of airflow where it is needed.
- Carefully balanced and fully guarded blades provide safe operation.
- Suitable for industrial, commercial, agricultural, automotive and showroom applications.
- Fitted with 3-pin plug.

IMPROVED EFFICIENCY
High efficiency industrial fans with improved motor and blade design, resulting in higher velocity with up to 30% more area coverage and reach.

Model No.	Diameter	Speeds	Max. Airflow	Power	List Price	Exc. VAT	Inc. VAT
HVD24P	Ø610mm(24")	2	266m ³ /min(9,420cfm)	330W	£309.95	£259.95	£311.94
HVD30P	Ø760mm(30")	2	288m ³ /min(10,175cfm)	315W	£429.95	£369.95	£443.94
HVD36P	Ø915mm(36")	2	363m ³ /min(12,855cfm)	410W	£529.95	£439.95	£527.94

12V Portable Pressure Washer Self-Priming Cleaning Kit in Storage Case

12V

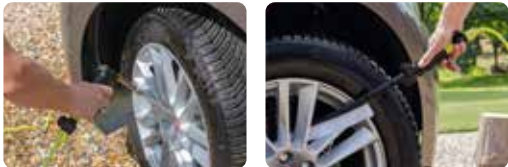

- Lightweight, portable pressure washer with self-priming submersible pump, supplied in a storage case.
- Ideal for many washing applications, especially where mains power or water supply is not available, such as car shows, track days, window cleaning or even garden use.
- Features Automatic Total Stop System (TSS) which switches the motor on and off when the trigger is operated, prolonging motor life.
- Unit is powered using a 4.8m cable fitted with a 12V vehicle accessory socket plug.
- Supplied with 8m hose, variable nozzle lance, detergent bottle and a long fixed brush.
- **Model No. PW12CC**
- List Price £54.95

£39.95 Exc. VAT
£47.94 Inc. VAT

17L 12V Rechargeable Pressure Washer

12V

150L/hr

60W

Rechargeable



- Lightweight (6.8kg), portable cordless pressure washer.
- Suitable for a range of domestic applications including cleaning vehicles, motorcycles and bicycles.
- Features 17L water tank which can be detached from base for easy refilling.
- Unit can be powered using vehicle's 12V socket, but is also fitted with a rechargeable lead acid battery which provides up to 40 minutes of continuous use.
- Ideal pressure washer where no mains electric supply is available, such as classic car shows and track days.
- Supplied with 6m hose, variable nozzle and fixed brush, both of which include built-in detergent bottles.
- Fitted with accessory storage pouch, durable wheels and shoulder strap for easy transportation.
- Output Pressure/Flow Rate: 8.5bar(123psi)/150L/hr.
- Charging/Operating Time: 6hr/20-40min.
- **Model No. PW1712**
- List Price £189.95

£129.95 Exc. VAT
£155.94 Inc. VAT

Scan for our full range of Pressure Washers.



140bar Professional Pressure Washer with TSS & Rotablast® Nozzle

420L/hr



- High performance, professional unit specifically designed for rigorous domestic, industrial and agricultural use.
- Ideal for an extremely wide range of applications including cars, 4x4s, tractors, motorbikes, ATVs, patios and decking.
- Fitted with a 2100W induction motor with a 420L/hr water flow rate and a maximum pressure of 140bar.
- Automatic Total Stop System (TSS) switches the motor on and off when the lance trigger is operated, prolonging the motor life.
- Features innovative accessory storage on back of unit and 8m high pressure hose reel.
- Fitted with brass fittings, aluminium head, integral pressure gauge and water filter system.
- Supplied with 1.2L built-in adjustable detergent tank, variable nozzle and Rotablast® nozzle which helps develop the same effective cleaning power (ECP) as a 240bar/3485psi pressure washer.
- **Model No. PW3500**
- List Price £529.95

£329.95 Exc. VAT
£395.94 Inc. VAT

150bar Professional Pressure Washer with TSS & Nozzle Set

498L/hr



- Ideal for a wide variety of applications including commercial and agricultural use.
- Fitted with a powerful 2500W induction motor and brass pump head and fittings with ceramic pistons.
- 498L/hr water flow rate and a maximum pressure of 150bar.
- Features Automatic Total Stop System (TSS) technology which switches the motor on and off when the lance trigger is operated, prolonging motor life.
- Fitted with 10m hose reel, built-in pressure gauge, adjustable pressure controls and 3L detergent tank.
- Supplied with stainless steel lance, five interchangeable nozzle attachments (Pencil Jet, Fan Jet; 15°, 25°, 40°, Low Pressure).
- Manufactured with a lightweight, durable metal frame and large heavy-duty wheels.
- **Model No. PW5000**
- List Price £1,169.95

£869.95 Exc. VAT
£1,043.94 Inc. VAT

Water Hoses with Fittings



30m
OR
80m

Model No. GH30R



- Green PVC hose with Ø12mm bore.
- Polyester fibre reinforced 3-ply construction for added strength.
- Includes spray/jet nozzle, female connector, waterstop connector and threaded tap connector.

Model No.	Length	List Price	Exc. VAT	Inc. VAT
GH30R	30m	£41.95	£29.95	£35.94
GH80R	80m	£99.95	£64.95	£77.94

15m Water Hose with Fittings



15m



- Green PVC hose with Ø12mm bore.
- Polyester fibre reinforced 3-ply construction for added strength.
- Includes spray/jet nozzle, female connector, waterstop connector and threaded tap connector.
- **Model No. GH15R/12**
- List Price £23.95

£17.95 Exc. VAT
£21.54 Inc. VAT

20m Water Hose Reel

20m

Auto Layering



- Manufactured from durable lightweight material.
- Reinforced PVC hose with Ø13mm bore.
- Auto-layering mechanism distributes water hose evenly back into reel housing preventing it from jamming.
- Incorporates a soft grip handle for easy manoeuvrability.
- Preset holes for wall mounting.
- Suitable for use with pressure washers.
- Supplied with variable nozzle and tap connection.
- **Model No. WR92**
- List Price £89.95

£66.95 Exc. VAT
£80.34 Inc. VAT

18m Retractable Water Hose Reel

18m
HEAVY DUTY



- Durable composite case with carry handle.
- Fitted with 18m Ø12mm PVC hose with spray/jet nozzle.
- Heavy-duty ratchet mechanism enables safe storage and use.
- Wall mounting brackets included.
- **Model No. RGH18**
- List Price £319.95

£219.95 Exc. VAT
£263.94 Inc. VAT

20m Auto-Rewind Control Garden Hose Reel

20m Contolled Rewind Length Control
Auto Layering



- Hose can be extended and stopped at any length.
- Fitted with 20m Ø13mm PVC garden hose with spray/jet nozzle.
- Composite housing with heavy-duty wall mounting swivel bracket.
- Supplied with 2m leader hose with quick coupler and tap connector.
- **Model No. RWH20**
- List Price £169.95

£119.95 Exc. VAT
£143.94 Inc. VAT

Garden Hose Trolley 60m Capacity

60m Capacity



- Lightweight tubular steel frame with tough plastic snap-together parts - no tools required.
- Fitted with two composite wheels for easy manoeuvrability and two angled 1/2" hose connectors.
- Reel holds up to 60m of Ø13mm hose.
- **Model No. GH60**
- List Price £39.95

£28.95 Exc. VAT
£34.74 Inc. VAT

10m Layflat Hoses

10m



Model No. LFH1038

- High quality PVC hoses reinforced with synthetic fibres.
- Suitable for water discharge only.

Model No.	Hose Diameter	List Price	Exc. VAT	Inc. VAT
LFH1025	Ø25mm	£25.95	£19.95	£23.94
LFH1038	Ø38mm	£32.95	£23.95	£28.74
LFH1050	Ø50mm	£39.95	£26.95	£32.34

Water Spray Gun



- Manufactured from lightweight plastic with soft rubber grip handle.
- Features two adjustable pressure settings and flow rate control nozzle.
- Fitted with male inlet coupling.
- **Model No. CC86**
- List Price £10.95

£5.95 Exc. VAT
£7.14 Inc. VAT

8L Dust Suppression Water Tank

8L

WORKSAFE NEW PRODUCT



- Worksafe® dust suppression tank with 8L working capacity.
- Effective at suppressing dust while using cut-off saws, bench saws and floor saws in all working environments.
- Automatic pressure release valve stops pressure building higher than 3bar for optimum use.
- Includes 3m hose with quick release coupling.
- **Model No. DST08**
- List Price £34.95

£19.95 Exc. VAT
£23.94 Inc. VAT

55L/min Stainless Steel Surface Mounting Booster Pump

3300L/hr

Auto Cut-Out

STAINLESS STEEL

- Manufactured from heavy-duty corrosion resistant materials.
- Ideal for boosting or maintaining water pressure within the home or garden water supplies.
- Integrated regulator and pressure gauge.
- Fitted with automatic pressure cut-off valve.
- Suitable for lifting water up to 8m.
- Features four stable feet which can be securely mounted.
- Max. Output: 55L(12gal)/min, 3300L(726gal)/hr.
- Max. Head: 38m.
- Motor Power: 800W.
- 24L Pressure tank.
- **Model No. WPB062S**
- List Price £299.95



£209.95 Exc. VAT
£251.94 Inc. VAT

9-Stage 55m Head Borehole/Deep Well Pump

5580L/hr

9 STAGE PUMP

55m Head

High Flow

STAINLESS STEEL

- Manufactured from high-impact stainless steel for added durability and corrosion resistance.
- Ideal for installing in traditional wells, clean water deposits, boreholes and garden irrigation systems.
- 9-Stage pump enables high flow rates, high heads and ensures a stable performance.
- Max. Output: 93L(20gal)/min.
- Max. Head: 55m.
- Cable Length: 22m.
- **Model No. WPW935S**
- List Price £319.95



£229.95 Exc. VAT
£275.94 Inc. VAT

Ø50mm x 5m Solid Wall Suction Hose for EWP050



- Solid wall hose for use on suction side of water pumps.
- Suitable for use with EWP050.
- Dimensions: Ø50mm ID x Ø60mm OD x 5m.
- **Model No. EWP050SW**
- List Price £65.95

£54.95 Exc. VAT
£65.94 Inc. VAT

Automatic Submersible Dirty Water Pumps

For Dirty Water

Auto Cut-Out



- Manufactured from corrosion resistant materials with stainless steel motor case and Noryl® base cover.
- Min. Water Depth: 40mm.
- Automatic low water cut-out.
- Designed for operation in dense and dirty water.
- Suitable for the effective drainage of cellars, sinks, cisterns, baths and the general transfer of water and dense liquids.



Model No. WPD133A

Model No.	Output/Min	List Price	Exc. VAT	Inc. VAT
WPD133A	133L(30gal)	£85.95	£64.95	£77.94
WPD235A	217L(47gal)	£99.95	£74.95	£89.94

Automatic Submersible Water Pumps

HEAVY DUTY

Auto Cut-Out

- Manufactured from heavy-duty corrosion resistant materials with stainless steel motor case and polypropylene base cover.
- Minimum Water Depth: 5mm.
- Designed for clean water, will accept small particles up to 5mm.
- Adjustable automatic low water cut-out.
- Suitable for the effective drainage of cellars, sinks, cisterns, baths and the general transfer of water.



Model No. WPC100P

Model No.	Output/Min	List Price	Exc. VAT	Inc. VAT
WPC100P	100L(22gal)	£89.95	£67.95	£81.54
WPC150P	183L(40gal)	£99.95	£74.95	£89.94
WPC235P	217L(48gal)	£109.95	£79.95	£95.94

100L/min Submersible Clean Water Pump

6000L/hr

- Manufactured from corrosion resistant materials with stainless steel motor case and Noryl® base cover.
- Max. Output: 100L(22gal)/min, Max. Head: 6m.
- Minimum Water Depth: 20mm.
- Designed for clean water, will accept small particles up to 5mm.
- Suitable for the effective drainage of cellars, sinks, cisterns, baths and the general transfer of water.
- **Model No. WPC100**
- List Price £74.95



£54.95 Exc. VAT
£65.94 Inc. VAT

50L/min Submersible Water Butt Pump

3000L/hr

Auto Cut-Out

- Manufactured from corrosion resistant materials with a stainless steel motor case and Noryl® base cover.
- Ideal for pumping water straight from a water butt directly onto your garden.
- Supplied with a 2-piece aluminium swan neck extension pipe, adjustable flow control feature and snap on connector.
- Max. Output: 50L(13gal)/min.
- Max. Head: 10m.
- **Model No. WPB50A**
- List Price £89.95



£67.95 Exc. VAT
£81.54 Inc. VAT

117L/min Automatic Low Level 2mm Submersible Water Pump

Auto Cut-Out

Low Level

- Manufactured from corrosion resistant materials with stainless steel motor case and Noryl® base cover.
- Max. Output: 117L(26gal)/min.
- Max. Head: 8m.
- Min. Water Depth: 2mm.
- Designed for clean water, will accept small particles up to 5mm.
- Automatic low water cut-out.
- Suitable for the effective drainage of cellars, sinks, cisterns, baths and the general transfer of water.
- **Model No. WPL17A**
- List Price £99.95



£74.95 Exc. VAT
£89.94 Inc. VAT

Automatic Submersible Water Pumps

Auto Cut-Out



Model No. WPC100A

- Manufactured from corrosion resistant materials with stainless steel motor case and Noryl® base cover.
- Minimum Water Depth: 20mm.
- Designed for clean water, will accept small particles up to 5mm.
- Automatic low water cut-out.
- Suitable for the effective drainage of cellars, sinks, cisterns, baths and the general transfer of water.

Model No.	Output/Min	List Price	Exc. VAT	Inc. VAT
WPC100A	100L(22gal)	£79.95	£59.95	£71.94
WPC150A	167L(36gal)	£89.95	£67.95	£81.54

Stainless Steel Submersible Pond Pumps

STAINLESS STEEL



- Manufactured from high-impact stainless steel for added durability and corrosion resistance.
- Pond pump suitable for creating garden water features.
- Also provides the important functions of filtration and water circulation which are necessary to maintain healthy plant and fish life.
- Supplied with three adaptors and 10m of cable.

Model No.	Output/Hr	List Price	Exc. VAT	Inc. VAT
WPP3000S	3000L (600gal)	£74.95	£54.95	£65.94
WPP3600S	3600L (780gal)	£92.45	£69.95	£83.94

45L Plastic Pedal Bin

45L



- Manufactured from heavy-duty polypropylene.
- Square design allows unit to sit flush against almost any wall, ideal for where space is limited.
- Fitted with plastic foot pedal for hands-free operation and carry handle.
- Maximum Capacity: 45L.
- Size (W x D x H): 400 x 390 x 600mm.
- **Model No. BM60**
- List Price £69.95

£49.95 Exc. VAT
£59.94 Inc. VAT

100L Refuse/Wheelie Bins



- Durable refuse/wheelie bins made from polypropylene.
- Model No's BM100PR, BM100PG, BM100P, BM100PB feature a quick release foot pedal.
- Solid rear axle with two Ø200mm wheels and three robust handles allow the bins to be moved easily even when full.
- Dimensions (W x D x H): 595 x 570 x 765mm.

100L

Ref.	Model No.	Colour	List Price	Exc. VAT	Inc. VAT	Ref.	Model No.	Colour	List Price	Exc. VAT	Inc. VAT
A	BM100PR	Red	£59.95	£42.95	£51.54	E	BM100R	Red	£54.95	£37.95	£45.54
B	BM100PG	Green	£59.95	£42.95	£51.54	F	BM100G	Green	£54.95	£37.95	£45.54
C	BM100P	Black	£59.95	£42.95	£51.54	G	BM100	Black	£54.95	£37.95	£45.54
D	BM100PB	Blue	£59.95	£42.95	£51.54	H	BM100B	Blue	£54.95	£37.95	£45.54

Ribbed Workshop Matting

Model No.
MCR1025



- Hard-wearing natural rubber with a slip resistant fluted surface.
- Provides insulation from cold concrete floors.
- Thickness: 3mm.
- Can be used on workbenches to help prevent damage to fragile parts and worktop.

Model No.	Size	List Price	Exc. VAT	Inc. VAT
MCR1025	1000 x 2500mm	£61.95	£38.95	£46.74
MCR10100	1000 x 10000mm	£159.95	£119.95	£143.94

910 x 1980mm Anti-Fatigue Workshop Matting



- Hard-wearing lightweight cushioned anti-fatigue mat.
- Provides insulation from cold concrete floors.
- Slip resistant patterned surface.
- Thickness: 8mm.
- Suitable for use in workshops, garages, kitchens, bars and gyms.
- Model No. MCR0919
- List Price £33.95

£25.95	Exc. VAT
£31.14	Inc. VAT

920 x 920mm Interlocking Anti-Fatigue Matting

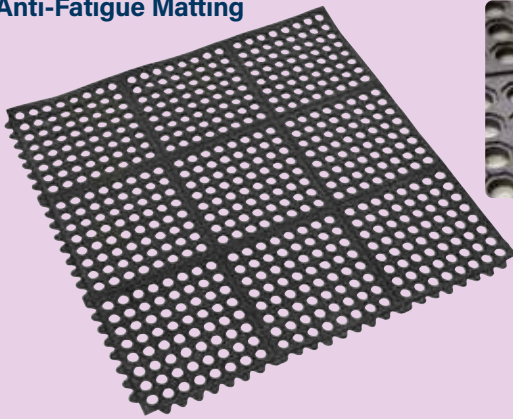

- Hard-wearing rubber anti-slip mat provides fatigue relief and insulation from cold concrete floors.
- Features four interlocking edges to provide desired area coverage.
- Thickness: 12mm.
- Model No. MIC9292
- List Price £38.95

£28.95	Exc. VAT
£34.74	Inc. VAT

1240 x 1825mm Interlocking EVA Foam Workshop Mat Set with Hi-Vis Edges

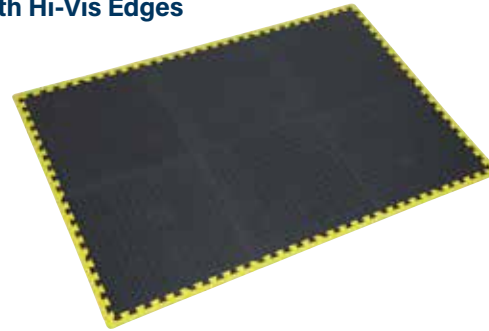

- Hard-wearing EVA Foam anti-slip matting suitable for use in the workshop and machine room.
- Provides fatigue relief and insulation from cold concrete floors.
- All tiles can be interlocked to make one bordered area, alternatively can be laid out as three separate bordered areas of two tiles each.
- The hi-vis border improves visibility, enhancing safety.
- Contents: Tiles x 6, 18 High-Vis Edges.
- Thickness: 10mm.
- Size: 1240 x 1825mm (6 Tiles), 650 x 1240mm (2 Tiles).
- Model No. MIC1218Y3
- List Price £46.95

£34.95	Exc. VAT
£41.94	Inc. VAT

Cigarette Floor Ashtray



- Manufactured from 1mm mild steel and finished for resistance to corrosion.
- Twin openings in concave cover for safe and hygienic use.
- Suitable for use in building entrances and smoking areas.
- Size (W x D x H): 335 x 230 x 112mm.
- Model No. RCB04
- List Price £34.95

£24.95	Exc. VAT
£29.94	Inc. VAT

8L Cigarette Ashtray & Litter Bin

8L



- Metal construction with black powder coated body with side-opening and aluminium lid featuring built-in ashtray.
- Supplied with removable metal inner liner and carry handle making emptying quick and easy.
- Ideal for use in building entrances and smoking areas.
- Size (W x D x H): 270 x 270 x 590mm.
- Model No. RCB06
- List Price £89.95

£53.95	Exc. VAT
£64.74	Inc. VAT

Stainless Steel Wall Mounting Cigarette Bin

STAINLESS STEEL



- 2-Piece design for easy installation, emptying and cleaning.
- Stainless steel construction with Zintec® liner.
- Fitted with high quality lock and supplied with two keys.
- Includes fittings for wall mounting.
- Suitable for use in building entrances and smoking areas.
- Size (W x D x H): 260 x 80 x 320mm.
- Model No. RCB02
- List Price £89.95

£53.95	Exc. VAT
£64.74	Inc. VAT

Heavy-Duty Flexi Tubs - Black

- 30L
- 40L
- OR
- 65L

NEW
PRODUCTS



Model No. SFT30

- Manufactured from heavy-duty polyethylene with a versatile, flexible construction.
- Ideal for a wide range of domestic and industrial applications.

Model No.	Capacity	List Price	Exc. VAT	Inc. VAT
SFT30	30L	£6.45	£4.95	£5.94
SFT40	40L	£8.45	£5.95	£7.14
SFT65	65L	£13.95	£10.95	£13.14

40L Heavy-Duty Flexi Tub - Yellow

40L



- Manufactured from heavy-duty polyethylene with a versatile, flexible construction.
- Fitted with strong carry handles tested to a breaking strain of 350kg.
- Ideal for a wide range of domestic and industrial applications.
- **Model No. SFT40Y**
- List Price £13.95

£8.45 Exc. VAT
£10.14 Inc. VAT

26L Heavy-Duty Flexi Tub with Metal Handle - Black

26L

NEW
PRODUCT



- Manufactured from heavy-duty polyethylene with a versatile, flexible construction.
- Ideal for a wide range of domestic and industrial applications.
- **Model No. SFT26H**
- List Price £6.95

£5.45 Exc. VAT
£6.54 Inc. VAT

Long Handle Dip & Wash Brush



- Fine, split-top bristles gently loosen and brush away dirt.
- Does not mark expensive clear coats or painted finishes.
- Long handle for access to hard-to-reach areas.
- **Model No. CC52**
- List Price £12.95

£7.95 Exc. VAT
£9.54 Inc. VAT

2-in-1 Shaggy Microfibre Sponge or Mitt



Model No. CC77

- Double-sided sponge or mitt with shaggy microfibre strands on one side, which are superb for removing dirt or general cleaning.
- Non-abrasive mesh cloth on the other side, ideal for bugs and obstinate grime.

Model No.	Type	List Price	Exc. VAT	Inc. VAT
CC76	Sponge	£7.95	£5.45	£6.54
CC77	Mitt	£5.95	£4.25	£5.10

Microfibre Clay Bar Cloth

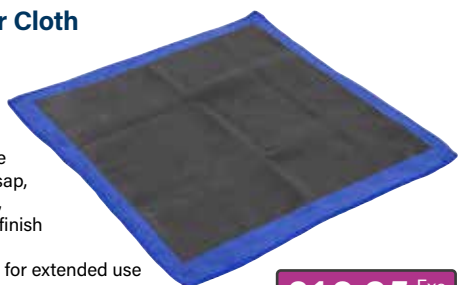

- Clay backed microfibre cloth designed as an alternative to clay bar detailing.
- Perfect for removing surface contaminants such as tree sap, rain stains, light rust, pollen, and bugs leaving a smooth finish to your paint.
- High quality material allows for extended use compared to using a regular clay bar.
- Designed for use with clay bar lubricants.
- **Model No. CBC01**
- List Price £14.95

£10.95 Exc. VAT
£13.14 Inc. VAT

Genuine Chamois



Model No. CC73

- Genuine chamois leathers are a superior professional product, cut, conditioned, sized and 100% cod oil tanned.
- Genuine chamois is soft, supple and will leave surfaces lint and scratch free.

Model No.	Size	List Price	Exc. VAT	Inc. VAT
CC72	2.5ft ²	£17.45	£12.95	£15.54
CC73	3.5ft ²	£21.45	£13.95	£16.74

10L Plastic Watering Can

10L



- Strong and durable 10L plastic watering can with easy carry handle for greater flow control.
- Includes detachable rose.
- **Model No. WCP10**
- List Price £12.95

£9.95 Exc. VAT
£11.94 Inc. VAT

12V ATV Winch 1000kg Line Pull

1000W

1000kg Capacity

12V



- Suitable for ATV mounting.
- 3-Stage planetary gears.
- 12V DC 1.2hp Permanent magnet motor.
- Pull and turn clutch.
- 4-Way roller fairlead for even distribution of cable onto drum.
- Cable Length: 12m.
- **Model No. ATV1000W**
- List Price £139.95

£109.95 Exc. VAT
£131.94 Inc. VAT

1500W Wall Mounting Garage Vacuum with Remote Control

1500W 18L
Remote Function



- Robust, wall mounting, remote control, wet and dry vacuum cleaner.
- Fitted with a powerful 1500W motor and noise diffuser, this unit is ideal for use in garage and workshop environments.
- Features an 8m flexible spring hose, ideal for double garages.
- Also features remote control buttons on nozzle to allow the user to turn the unit on/off without leaving the cleaning area.
- Includes 5m power cable, extension lances (x2), combo brush, round brush, deluxe car nozzle, crevice tool, washable cartridge filter, foam filter and dust bag.
- Innovative design allows these accessories to be stored away, keeping your work area clean and tidy.
- **Model No. GV180WM**
- List Price £299.95

£219.95 Exc. VAT
£263.94 Inc. VAT

Floor Sweepers

700mm 800mm
20L OR 40L

- Suitable for maintaining any hard floor and ideal for removing dirt, dust and debris from large surface areas.
- Features 4-brush system with two side brushes and two further brushes set underneath the unit to easily lift debris into the hopper.
- Fitted with tubular handle and adjustable castor wheel that raises the sweeper 20mm enabling larger pieces of debris to be swept up.



Model No.	Width	Capacity	List Price	Exc. VAT	Inc. VAT
FSW70	700mm	20L	£199.95	£154.95	£185.94
FSW80	800mm	40L	£279.95	£209.95	£251.94

11"(280mm) Indoor Use Broom Soft Bristle



- Lightweight broom ideal for domestic use.
- Fitted with plastic handle and detachable soft PVC bristle head, ideal for cleaning dust and dirt.
- **Model No. BM11S**
- List Price £6.95

£4.95 Exc. VAT
£5.94 Inc. VAT



12"(300mm) Broom Stiff/Hard Bristle



- Hard bristle broom.
- Fitted with handle support bracket.
- Ideal for indoor or outdoor use.
- **Model No. BM12H**
- List Price £10.25

£7.95 Exc. VAT
£9.54 Inc. VAT



13"(325mm) Broom Stiff/Hard Bristle



- Hard bristle broom.
- Saddle back head.
- Fitted with hardwood handle.
- Ideal for indoor or outdoor use.
- Heavy-duty use in yards and gardens.
- **Model No. BM13HX**
- List Price £19.45

£13.95 Exc. VAT
£16.74 Inc. VAT



13"(325mm) Yard Broom Stiff/Hard Bristle



- Hard bristle broom.
- Saddle back head.
- Ideal for indoor or outdoor use.
- Heavy-duty use in yards and gardens.
- **Model No. BM13H**
- List Price £25.75

£17.95 Exc. VAT
£21.54 Inc. VAT



Composite Dustpan & Brush Set



- Manufactured from quality composite material for strength and durability.
- Brush features long-life flexible bristles and locks onto pan for easy storage.
- Pan features rubber squeegee edge to ensure all dirt can be swept up with ease.
- **Model No. BM04**
- List Price £4.95

£3.75 Exc. VAT
£4.50 Inc. VAT



11"(280mm) Hand Brushes



- Manufactured from hardwood with a clear lacquered finish.
- Features ergonomic handle and hanging hole for easy storage.

Model No.	Bristle Type	List Price	Exc. VAT	Inc. VAT
BM25S	Soft	£3.75	£2.75	£3.30
BM25H	Hard	£3.75	£2.75	£3.30



24"(600mm) Floor Dust Sweeper

24"



- Manufactured with 600mm highly absorbent head ideal for gathering dust particles over a large area.
- Fitted with 1390mm aluminium handle and metal locking clip.
- Replacement heads available, order Model No. BM18R.
- **Model No. BM18**
- List Price £23.95

£11.95 Exc. VAT
£14.34 Inc. VAT

8"(200mm) Squeeze Mop



- Plastic housed squeeze mop.
- Supplied with 8"(200mm) super absorbent sponge.
- Fitted with handle mounted lever for effortless wringing of sponge.
- For use on tiles, marble and other smooth surfaces.
- **Model No. BM06**
- List Price £15.95

£7.95 Exc. VAT
£9.54 Inc. VAT

450g Kentucky Mop

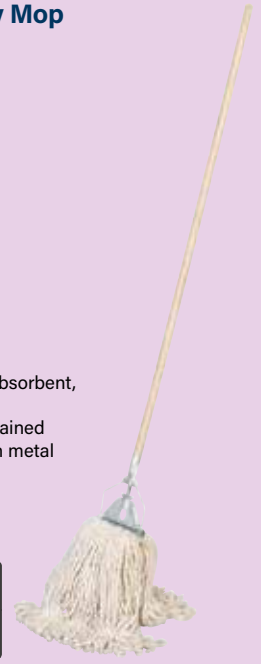

- Extra thick, highly absorbent, 100% cotton head.
- Features straight-grained wooden handle with metal locking clip.
- Head Weight: 450g.
- **Model No. BM03**
- List Price £16.95

£12.95 Exc. VAT
£15.54 Inc. VAT

12L Stainless Steel Mop Bucket

12L

STAINLESS STEEL



- Manufactured from heavy-duty stainless steel grade 202.
- Perfect for domestic and industrial applications.
- 12L capacity.
- **Model No. BM8L**
- List Price £19.95

£15.95 Exc. VAT
£19.14 Inc. VAT

15L Mop Bucket - 2 Compartment

15L



- Manufactured with two compartments featuring removable mop head wringer.
- Ideal for keeping clean water and dirty water separate while cleaning.
- Fitted with carry handles.
- **Model No. BM07**
- List Price £29.95

£21.95 Exc. VAT
£26.34 Inc. VAT

12L Galvanized Bucket

12L



- Manufactured from heavy-duty galvanized steel with a 12L capacity.
- Fitted with carry handle.
- Ideal for domestic and industrial applications.
- **Model No. BM10**
- List Price £19.95

£14.95 Exc. VAT
£17.94 Inc. VAT

450 x 750mm Rubber Disinfection Mat With Removable Polyester Carpet

1L Capacity



- Rubber mat with slip resistant base.
- Removable polyester carpet fits in the mat's ingress, can be easily cleaned or replaced.
- Mat capacity holds up to 1L of disinfectant.
- Suitable for indoor and outdoor use.
- Size (W x L x D): 450 x 750 x 18mm.
- **Model No. DRM01**
- List Price £44.95

£36.95 Exc. VAT
£44.34 Inc. VAT

250mm Window Cleaning Wiper

250mm



- Heavy-duty composite handles fitted with 250mm detachable rubber blade.
- Ideal for removing excess liquid from glass and other similar surfaces.
- Features twist lock system for easy removal of blade.
- **Model No. BM2910**
- List Price £3.75

£3.25 Exc. VAT
£3.90 Inc. VAT

Aqua Flexi-Blade

300mm



- Cuts drying time in half.
- Removes excess water prior to chamoising.
- Blade Length: 300mm.
- **Model No. CC65**
- List Price £13.45

£7.45 Exc. VAT
£8.94 Inc. VAT

Towing Plugs



- Model No. TB53 Features end cap and rubber grommet for added protection.
- Model No. TB54 Features double cable entry for use as a caravan conversion plug.

Model No.	Type	List Price	Exc. VAT	Inc. VAT
TB05	Plastic 12V 7-pin N-type	£3.85	£3.15	£3.78
TB06	Aluminium 12V 7-pin N-type	£5.15	£4.25	£5.10
TB53	Plastic 12V 13-pin Euro	£12.45	£9.95	£11.94
TB54	Plastic 12V 13-pin Euro	£14.45	£11.95	£14.34

Socket Conversion Adaptor 7-Pin N-Type - 13-Pin Euro 12V



- Adaptor plugs into towing vehicle's 7-pin N-type socket to allow connection of a caravan or trailer with 13-pin Euro plug.
- **Model No. TB43**
- List Price £15.95

£12.95 Exc. VAT
£15.54 Inc. VAT

Socket Conversion Adaptor 13-Pin Euro - 7-Pin N-Type 12V



- Adaptor plugs into towing vehicle's 13-pin Euro socket to allow connection of a caravan or trailer with UK standard 7-pin N-type plug.
- **Model No. TB44**
- List Price £14.95

£12.45 Exc. VAT
£14.94 Inc. VAT

12V Plastic Towing Socket N-Type



- Plastic 12V 7-pin N-type towing socket.
- **Model No. TB07**
- List Price £3.85

£3.15 Exc. VAT
£3.78 Inc. VAT

12V Metal Towing Socket N-Type



- Aluminium 12V 7-pin N-type towing socket.
- **Model No. TB08**
- List Price £6.45

£4.95 Exc. VAT
£5.94 Inc. VAT

12V 13-Pin Plastic Euro Towing Socket



- Plastic 12V 13-pin Euro towing socket.
- **Model No. TB52**
- List Price £14.95

£12.45 Exc. VAT
£14.94 Inc. VAT

Conversion Lead - 13-Pin Euro To 7-Pin N & S-Type Plugs



- Converts 13-pin Euro vehicle socket to 7-pin N-type and 7-pin S-type caravan and trailer socket.
- Fitted with 200mm cable.
- **Model No. TB55**
- List Price £34.95

£27.95 Exc. VAT
£33.54 Inc. VAT

12V Towing Socket Assembly N-Type



- Complete assembly includes 1.5m 7-core cable with pre-wired 12V 7-pin N-type socket.
- Metal plate with preformed mounting points at 90mm centres.
- **Model No. TB11**
- List Price £15.95

£12.95 Exc. VAT
£15.54 Inc. VAT

6m Extension Lead 7-Pin N-Type



- 6m Extension lead fitted with 12V 7-pin N-type socket and 12V 7-pin N-type plug.
- Extends existing power supply to your trailer or caravan.
- **Model No. TB57**
- List Price £29.95

£23.95 Exc. VAT
£28.74 Inc. VAT

Scan for our full range of Towing Accessories.



12/24V SMD LED Reverse Lamp

12V/24V

SMD LED



- 19 x SMD LED reverse lamp is waterproof and E-Marked approved.
- Dual voltage 12/24V for car and commercial.
- Transparent lens.
- Lamp supplied with twin cables.
- **Model No. TB13LED**
- List Price £13.95

£10.95 Exc. VAT
£13.14 Inc. VAT

12/24V SMD LED Rear Fog Lamp

12V/24V

SMD LED



- 19 x SMD LED rear fog lamp is waterproof and E-Marked approved.
- Dual voltage 12/24V for car and commercial.
- Transparent lens.
- Lamp supplied with twin cables.
- **Model No. TB14LED**
- List Price £15.95

£11.95 Exc. VAT
£14.34 Inc. VAT

12V SMD LED Rear Square Lamp Cluster

12V

SMD LED



- Easy install and modern direct replacement.
- 5-Function SMD LED rear cluster includes - Stop/Tail/Indicator/Numberplate Illumination/Reflector.
- E-Mark, CE and R10 approved.
- **Model No. TB18LED**
- List Price £15.95

£11.95 Exc. VAT
£14.34 Inc. VAT

12V SMD LED Rear Rectangle Lamp Cluster Pair

12V

SMD LED



- Easy install and modern direct replacement set.
- 6-Function SMD LED rear cluster set includes - Stop/Tail/Indicator/Numberplate Illumination/Reflector/Rear Fog (left)/Reverse (right).
- E-Mark, CE and R10 approved.
- **Model No. TB19LED**
- List Price £84.95

£64.95 Exc. VAT
£77.94 Inc. VAT

12/24V SMD LED Side Marker Lamp Dual Lens

12V/24V

SMD LED



- 6 x SMD LED dual marker lamp.
- Dual voltage for car and commercial.
- EPDM high quality rubber fitted with a white lens on the front and red lens on the rear.
- Fitted with 2-core cable.
- E-Marked approved.
- **Model No. TB44LED**
- List Price £14.95

£11.95 Exc. VAT
£14.34 Inc. VAT

12/24V SMD LED 45° Stalk Side Marker Lamps

12V/24V

SMD LED

Model No. TB45LEDL



- 6 x SMD LED dual marker lamps.
- Dual voltage 12/24V for car and commercial.
- EPDM high quality rubber fitted with a white lens on the front and red lens on the rear.
- Fitted with 2-core cable.
- E-Marked approved.

Model No.	Side	List Price	Exc. VAT	Inc. VAT
TB45LEDL	Left	£19.95	£15.95	£19.14
TB45LEDR	Right	£19.95	£15.95	£19.14

50mm Tow-Ball & Pin Coupling



- 50mm Forged tow-ball with pin coupling assembly.
- Suitable for towing trailers of up to 3.5tonne.
- Pre-drilled M16 mounting points at 90mm centres.
- Ø25mm Diameter pin.
- Regulation 55 approved.
- **Model No. TB042**
- List Price £69.95

£54.95 Exc. VAT
£65.94 Inc. VAT

Bumper Protection Plates



STAINLESS STEEL



Model No. TB30

Model No. TB301

- Designed to protect bumpers when coupling up trailers.
- Pre-drilled mounting points at 90mm centres.

Model No.	Material	List Price	Exc. VAT	Inc. VAT
TB30	Steel	£6.95	£5.75	£6.90
TB301	Stainless Steel	£17.95	£14.45	£17.34

PVC Tow-Ball Cover



- PVC protective cover for 50mm tow-balls.
- Suitable for use with Model No. TB03E.
- **Model No. TB101**
- List Price £2.75

£2.45 Exc. VAT
£2.94 Inc. VAT

1m x 3mm Breakaway Cable



- Applies the handbrake on braked caravans and trailers in the event of accidental unhitching.
- Supplied with heavy-duty split ring and securing clip.
- PVC Coated for extra durability.
- **Model No. TB47**
- List Price £8.45

£6.95 Exc. VAT
£8.34 Inc. VAT

Jockey Wheel & Ø35mm Clamp Ø150mm Solid Wheel



- Heavy-duty jockey wheel with Ø35mm clamp.
- Ø150mm Steel wheel with solid rubber tyre.
- Zinc plated for added corrosion resistance.
- Minimum/Maximum Height: 515/725mm.
- Wheel Size: Ø150 x 24mm.
- **Model No. TB371**
- List Price £39.95

£32.95 Exc. VAT
£39.54 Inc. VAT

Jockey Wheel & Ø48mm Clamp Ø260mm Pneumatic Wheel



- Heavy-duty jockey wheel with Ø48mm clamp.
- Ø260mm Steel wheel with pneumatic tyre.
- Zinc plated for added corrosion resistance.
- Minimum/Maximum Height: 630/860mm.
- Wheel Size: Ø260 x 80mm.
- **Model No. TB372**
- List Price £49.95

£37.95 Exc. VAT
£45.54 Inc. VAT

35mm Magnetic Drilling Machines



Model No. MAG230V



Model No. MAG110V

- Manufactured using high quality components for performance and reliability.
- Lightweight and compact units made from heavy-duty die-cast magnesium alloy.
- Fitted with a powerful magnet to ensure units stay adhered at any angle.
- Includes safety fixing strap, 10mm twist drill chuck and integrated coolant system to extend the life of cutters and increase the quality of the cut.
- Designed for use in fabrication, construction and other applications when drilling ferrous metal.

- **Model No. MAG110V - 110V**
- **Model No. MAG230V - 230V**
- List Price £469.95

£349.95 Exc. VAT
£419.94 Inc. VAT



35mm Low Profile Magnetic Drilling Machines

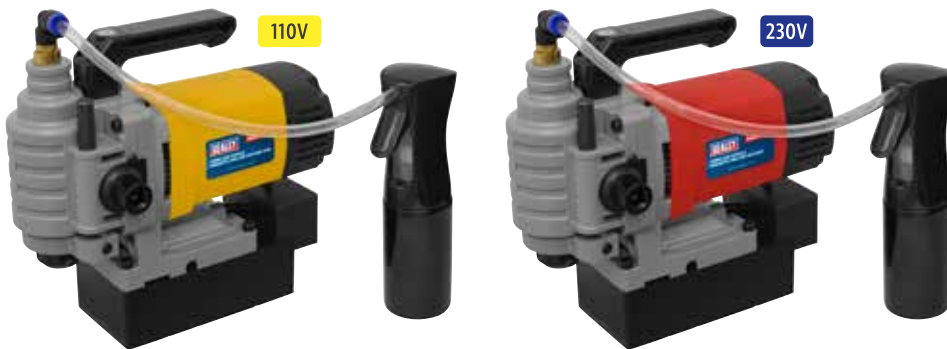

Model No. MAG35110VLP

- Manufactured using high quality components for performance and reliability.
- Lightweight and compact units made with a low profile for those difficult to get to places.
- Fitted with a powerful magnet to ensure units stay adhered at any angle.
- Includes safety fixing strap.
- Designed for use in fabrication, construction and other applications when drilling ferrous metal.

- **Model No. MAG35110VLP - 110V**
- **Model No. MAG35230VLP - 230V**
- List Price £629.95

£479.95 Exc. VAT
£575.94 Inc. VAT



Model No. MAG35230VLP

250mm Metalworking Mini Lathe



VARIABLE SPEED

VARIABLE SPEED

- Light enough to be truly portable.
- Construction is predominately cast iron and steel.
- Fitted with 150W high torque motor.
- Capacities: 150mm swing over bed and 250mm between centres.
- Features variable speed control, manual or powered lead screw feed, overload protection.
- Extensive range of accessories available.
- Supplied with Ø80mm 3-jaw self-centring chuck, tailstock centre and service tools.

- **Model No. SM2503A**
- List Price £949.95

£699.95 Exc. VAT
£839.94 Inc. VAT

Drill Head for Mini Lathe SM2503A

- Transforms Model No. SM2503A into a Lathe/Mill Drill combination.
- Easily retrofitted.
- Offers the flexibility to handle most materials.
- Features 150W motor.
- Drilling/Milling Spindle Speed/Travel: 100-1500rpm/30mm.
- Maximum Drilling/Milling Capacity: 10mm.
- Creates space efficient, versatile lathe mill/drill machine.

- **Model No. SM2503B**
- List Price £519.95



£439.95 Exc. VAT
£527.94 Inc. VAT

60MM MAGNETIC DRILLING MACHINES



- Manufactured using high quality components for performance and reliability.
- Made from heavy-duty die-cast magnesium alloy with a variable speed gearbox for greater accuracy.
- Fitted with a powerful magnet to ensure units stay adhered at any angle.
- Includes safety fixing strap and integrated coolant system to extend the life of cutters and increase the quality of the cut.
- Can be used with a 16mm twist drill chuck.
- Designed for use in fabrication, construction and other applications when drilling ferrous metal.

VARIABLE SPEED

£499.95 Exc. VAT
£599.94 Inc. VAT

60MM HEAVY-DUTY MAGNETIC DRILLING MACHINES

HEAVY DUTY



- Our Heavy-Duty Magnetic Drilling Machines come with all the features of our models above, but also come fitted with a double dovetail groove to increase the stroke length, and can be used with M8 to M20 Tapping chucks.

£779.95 Exc. VAT
£935.94 Inc. VAT

MAGNETIC DRILL TAPPING CHUCKS



- Tapping chucks for Model No's MAG60110VHD and MAG60230VHD Heavy-Duty Magnetic Drilling Machines.

Model No.	Size	List Price	Exc. VAT	Inc. VAT
MDTCM10	M10	£31.95	£17.95	£21.54
MDTCM12	M12	£31.95	£17.95	£21.54
MDTCM14	M14	£31.95	£17.95	£21.54
MDTCM16	M16	£31.95	£17.95	£21.54
MDTCM18	M18	£31.95	£17.95	£21.54
MDTCM20	M20	£31.95	£17.95	£21.54



Bench Pillar Drills



Model No. SDM30 Control Panel.

Model No. SDM30

5-Speed

13mm



Model No. GDM92B

12-Speed

16mm



Model No. GDM120B

16-Speed

16mm



Model No.	Drilling Capacity (Chuck Size)	Height	Motor Power	Speeds	Spindle Centre to Column	Column Diameter	Spindle Travel	List Price	Exc. VAT	Inc. VAT
SDM30	13mm(1/2")	580mm	185W	5	104mm	Ø46mm	50mm	£164.95	£129.95	£155.94
GDM92B	16mm(5/8") MT2	840mm	220W	12	127mm	Ø60mm	60mm	£399.95	£299.95	£359.94
GDM120B	16mm(5/8") MT2	960mm	350W	16	165mm	Ø70mm	80mm	£499.95	£349.95	£419.94

Floor Standing Pillar Drills

- 16mm(5/8") Capacity chuck no. MT2.
- Fitted with no-load voltage switch and locking cover to prevent accidental starting.
- These drills have adjustable tilting tables and rise and fall height adjustment by rack and pinion.



Model No. GDM140F

12-Speed



Model No. GDM160F

16-Speed



Model No. GDM200F

16-Speed



Model No.	Height	Motor Power	Speeds	Spindle Centre to Column	Column Diameter	Spindle Travel	List Price	Exc. VAT	Inc. VAT
GDM140F	1500mm	370W	12	127mm	Ø60mm	60mm	£469.95	£339.95	£407.94
GDM160F	1580mm	550W	16	165mm	Ø70mm	80mm	£579.95	£429.95	£515.94
GDM200F	1630mm	650W	16	178mm	Ø80mm	80mm	£699.95	£499.95	£599.94

Universal Dowelling Jig Set

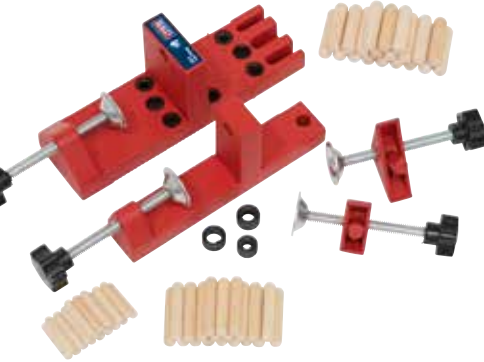

- Jig and clamp dowelling set ideal for making accurate 6, 8 and 10mm dowel holes/joints in MDF and wood.
- Suitable for a number of different styles of dowel joint including edge-to-edge, edge-to-corner and edge-to-surface.
- Contents: Dowelling Jig, Alignment Clamps, Dowel Pins; 6, 8, 10mm (20 of each), Drill Bit Depth Stops; 6, 8, 10mm.
- **Model No. DJ01**
- List Price £31.45

£21.95 Exc. VAT
£26.34 Inc. VAT

Ø200/125mm Wet & Dry Bench Grinder/Sharpener 250W



- Ø200mm Stone
- Ø125mm Stone
- Induction Motor

- Fitted with induction motor suitable for workshop use.
- Ø200mm Sharpening wet stone with adjustable flow rate water bath and drain outlet.
- Features an angle adjustable tool rest to suit workpiece.
- Ø125mm Dry stone with eye shield guard and fixed tool rest.
- Ideal for sharpening tools and knives.
- **Model No. SMS2107**
- List Price £299.95

£239.95 Exc. VAT
£287.94 Inc. VAT

G-Clamps

- Forged bodies with smooth acting threaded clamps.
- Fitted with swivel tip to reduce marking.

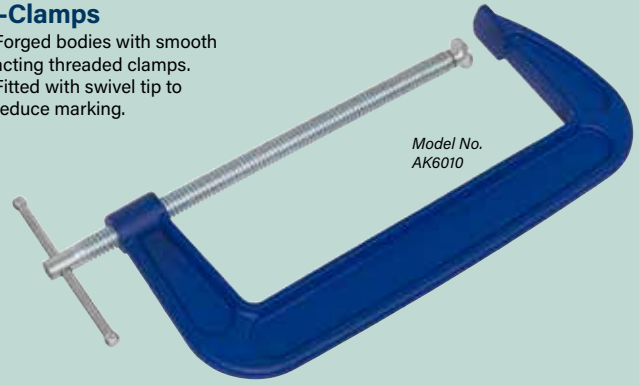

Model No. AK6010

Model No.	Length	Throat Depth	List Price	Exc. VAT	Inc. VAT
AK6002	50mm	25mm	£4.75	£3.25	£3.90
AK6003	75mm	38mm	£7.45	£5.25	£6.30
AK6004	100mm	65mm	£9.45	£6.45	£7.74
AK6006	150mm	70mm	£17.45	£12.45	£14.94
AK6008	200mm	80mm	£23.45	£15.45	£18.54
AK6010	250mm	95mm	£29.95	£18.95	£22.74
AK6012	300mm	100mm	£37.95	£23.95	£28.74

Ø150mm Bench Grinder with Ø200mm Wet Stone 250W



- Ø150mm Stone
- Ø200mm Stone
- Induction Motor

- 250W/230V induction motor.
- Fully guarded.
- Supplied with Ø200mm wet stone and Ø150mm dry stone, ready to use.
- Double insulated for extra operator safety.
- Suitable for sharpening fine blades.
- **Model No. SM521**
- List Price £139.95

£109.95 Exc. VAT
£131.94 Inc. VAT

Ø200mm Sharpener with Honing Wheel



Ø200mm

- 180W Induction motor.
- Adjustable tool rest.
- Leather Honing Wheel: Ø200 x 30mm.
- Grinding Wheel: Ø200 x 40mm (220Grit).
- No-Load Speed: 95rpm.
- Easy carry handle.
- **Model No. SMS2101**
- List Price £229.95

£159.95 Exc. VAT
£191.94 Inc. VAT

Combination Diamond Sharpening Whetstone with Adjustable Stone Holder



- Combination of 400 and 1000 grit surfaces.
- Whetstone will sharpen carbon steel, high-speed steel (HSS) and tungsten carbide.
- Can be used wet (with water as a lubricant) or dry.
- Supplied with an adjustable robust non-slip holder which can be used with stones from 135mm to 215mm in length.
- Dimensions (W x D x H): 285 x 70 x 25mm.
- **Model No. SCS51**
- List Price £49.95

£29.95 Exc. VAT
£35.94 Inc. VAT

Folding Diamond Whetstone



- Diamond whetstone supplied in a handy storage case that unfolds to act as a handle.
- Suitable for the sharpening of knives, scissors, cutting blades, carbon steel, HSS, tungsten and carbide tools.
- Combination of 400 and 600 grit surfaces.
- Can be used dry or with water as a lubricant, no oils are necessary.
- Dimensions (W x D x H): 30 x 15 x 125mm (Folded).
- **Model No. FDW600**
- List Price £10.95

£7.95 Exc. VAT
£9.54 Inc. VAT

28pc Mechanic's Tap & Die Set Split Dies

28pc

Split Dies

MM



- Split dies with machined lead-ins for ease of use.
- Die holder features self-centering mechanism for straight and accurate thread cutting.
- Set includes intermediate and plug taps.
- Sizes: 3-12mm.
- **Model No. AK3028**
- List Price £66.95

£39.95 Exc. VAT
£47.94 Inc. VAT

28pc Tap & Die Set Split Dies - Imperial BSW

28pc

Split Dies

WW



- British Standard Whitworth (BSW) high quality alloy steel taps and dies.
- Split dies with machined lead-ins.
- Die holder features self-centring mechanism for straight and accurate thread cutting.
- Set includes dies and taps (taper and plug) in each size, Tap Wrench, T-Bar Tap Wrench, Die Holder, Thread Gauge.
- Sizes: 1/8"-1/2"
- **Model No. AK3028BSW**
- List Price £69.95

£41.95 Exc. VAT
£50.34 Inc. VAT

32pc Tap & Die Set Split Dies

32pc

Split Dies

MM



- M3 to M12 alloy steel tap and die set.
- Taps supplied in three types for each size, taper (starting), second tap (intermediate) and plug (bottoming).
- Matched by equivalent sized dies.
- Provides all functions required for a professional engineer.
- Includes Tap Wrench, Steel Die Handle, Screw Pitch Gauge and Screwdriver.
- **Model No. AK3015**
- List Price £53.95

£34.95 Exc. VAT
£41.94 Inc. VAT

32pc Professional Tap & Die Set Split Dies - HSS 4341

32pc

Split Dies

MM



- M3 to M12 steel tap and die set.
- Manufactured from HSS 4341 steel providing improved cutting performance and longevity.
- Split dies with machined lead-ins for ease of use.
- Taps supplied in three types for each size, taper (starting), second tap (intermediate) and plug (bottoming).
- Set includes Tap Wrench, Steel Die Handle, Screw Pitch Gauge and Screwdriver.
- **Model No. AK3015HSS**
- List Price £119.95

£84.95 Exc. VAT
£101.94 Inc. VAT

40pc Tap & Die Set Split Dies

40pc

Split Dies

MM



- High carbon steel taps and dies.
- Dies with machined lead-ins for ease of use.
- Set includes one long handled adjustable tap wrench with professional type sliding jaw.
- Steel die holder with retention screw, suitable for dies from M3 up to M12.
- Also includes T-Bar type Tap Wrench, Screwdriver and Thread Gauge.
- **Model No. AK301**
- List Price £61.95

£36.95 Exc. VAT
£44.34 Inc. VAT

39pc Tap & Hex Die Set

39pc

MM



- High quality carbon steel taps and dies.
- Contents: Taps & Dies; M3 x 0.5, M3 x 0.6, M4 x 0.7, M4 x 0.75, M5 x 0.8, M5 x 0.9, M6 x 1, M7 x 1, M8 x 1.25, M9 x 1, M9 x 1.25, M10 x 1.25, M10 x 1.5, M11 x 1.5, M12 x 1.5, M12 x 1.75, 1/8"-28BSP, Tap Wrench, T-Handle Tap Wrench, Die Holder, Metric Thread Gauge, Screwdriver.
- **Model No. AK3039HM**
- List Price £97.45

£67.95 Exc. VAT
£81.54 Inc. VAT

3pc 200mm Engineer's File Set

Premier

LIFETIME GUARANTEE*



- Popular set of assorted second cut coarse files with comfort grip handles.
- Each file is double cut for faster removal of material from workpiece.
- Contents: Half-Round, Round, Flat.
- **Model No. AK572**
- List Price £24.95

£17.45 Exc. VAT
£20.94 Inc. VAT

5pc 200mm Engineer's File Set

Premier

LIFETIME GUARANTEE*



- Popular set of assorted second cut coarse files with comfort grip handles.
- Each file is double cut for faster removal of material from workpiece.
- Contents: Half-Round, Round, Square, 3-Square, Flat.
- **Model No. AK573**
- List Price £40.95

£24.95 Exc. VAT
£29.94 Inc. VAT

10pc Engineer's & Needle File Set

Premier

LIFETIME GUARANTEE*



- Soft grip handles for comfort and control.
- Each file is double cut for faster removal of material from workpiece.
- Contents: Engineer's Files; Half-Round, Round, Flat, 3-Square, Needle Files; Half-Round, Round, Flat, Flat Taper, Square, 3-Square.
- **Model No. AK578**
- List Price £41.95

£25.95 Exc. VAT
£31.14 Inc. VAT

6pc Needle File Set

Siegen

LIFETIME GUARANTEE*



- Selection of popular needle files with soft grip handles for comfort and control.
- Contents; Half-Round, Round, 3-Square, Flat, Square, Equalling.
- **Model No. S0628**
- List Price £13.95

£8.45 Exc. VAT
£10.14 Inc. VAT

10pc Diamond Needle File Set

Siegen

LIFETIME GUARANTEE*



- Comprehensive set of diamond files with soft grip handles.
- Length: 100mm.
- Supplied in storage pouch.
- **Model No. S0896**
- List Price £19.45

£12.95 Exc. VAT
£15.54 Inc. VAT

2pc Nylon Brush Set

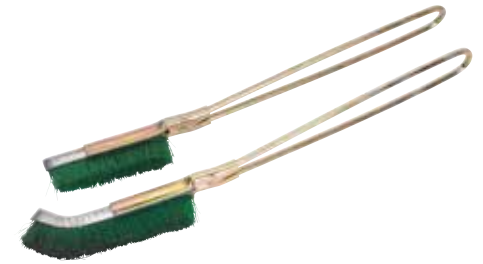

- Skeletal handle with stiff nylon fill.
- Suitable for general-purpose applications.
- **Model No. WB06N**
- List Price £6.95

£4.95 Exc. VAT
£5.94 Inc. VAT

3pc Miniature Wire Brush Set

LIFETIME GUARANTEE*



- Composite stocked brush set with contoured soft grip handles.
- Stainless steel, nylon and brass filled heads suitable for cleaning spark plugs and smaller engineering components.
- Includes hanging hole.
- **Model No. WB100**
- List Price £5.75

£3.95 Exc. VAT
£4.74 Inc. VAT

Wire Brush with Steel Fill

LIFETIME GUARANTEE*



- Composite stocked brush with a contoured soft grip handle.
- Black high carbon steel filled head suitable for general-purpose applications.
- Includes hanging hole.
- **Model No. WB102**
- List Price £4.95

£3.45 Exc. VAT
£4.14 Inc. VAT

Wire Brush with Stainless Steel Fill & Scraper

LIFETIME GUARANTEE*



- Composite stocked brush with a contoured soft grip handle.
- Stainless steel filled head suitable for general-purpose applications.
- Fitted with steel scraper.
- Includes hanging hole.
- **Model No. WB105**
- List Price £7.45

£5.25 Exc. VAT
£6.30 Inc. VAT

Spring Dividers



Model No.
AK97112

- Suitable for transferring or comparing measurements directly, or for scribing an arc, radius or circle.
- Adjusting washer and nut allow fast and positive adjustment.
- Brushed metal finish.

Model No.	Size	List Price	Exc. VAT	Inc. VAT
AK97110	150mm	£10.45	£7.95	£9.54
AK97111	200mm	£12.95	£9.25	£11.10
AK97112	300mm	£16.95	£11.95	£14.34

Internal Spring Calipers



Model No.
AK9782

- For measuring distance between two points, i.e. bore diameter and transfer to rule or micrometer.
- Adjusting washer and nut allow for fast and positive adjustment.
- Brushed metal finish.

Model No.	Size	List Price	Exc. VAT	Inc. VAT
AK9780	100mm	£10.95	£7.75	£9.30
AK9781	200mm	£13.45	£9.75	£11.70
AK9782	300mm	£16.95	£11.75	£14.10

External Spring Calipers



Model No.
AK9772

- For measuring opposite sides of an object for transfer to rule or micrometer.
- Adjusting washer and nut allow for fast positive adjustment.
- Brushed metal finish.

Model No.	Size	List Price	Exc. VAT	Inc. VAT
AK9769	150mm	£11.45	£7.95	£9.54
AK9771	200mm	£13.95	£9.95	£11.94
AK9772	300mm	£17.45	£11.95	£14.34

Mini Mitre Boxes

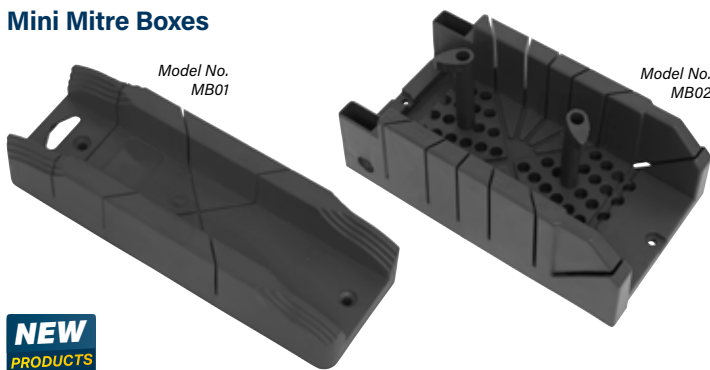

Model No.
MB01

Model No.
MB02

NEW
PRODUCTS

- General-purpose mini mitre boxes, made from high strength plastic.
- Fix the box to the workbench via two fixing holes.

Model No.	Size	Cut Types	List Price	Exc. VAT	Inc. VAT
MB01	250 x 85 x 50mm	45° and 90° Mitre Cuts	£4.95	£3.95	£4.74
MB02	310 x 170 x 110mm	22.5°, 45° and 90° Mitre Cuts 45° Bevel Cut	£13.95	£10.95	£13.14

4pc Taper Bore Gauge 1-30mm

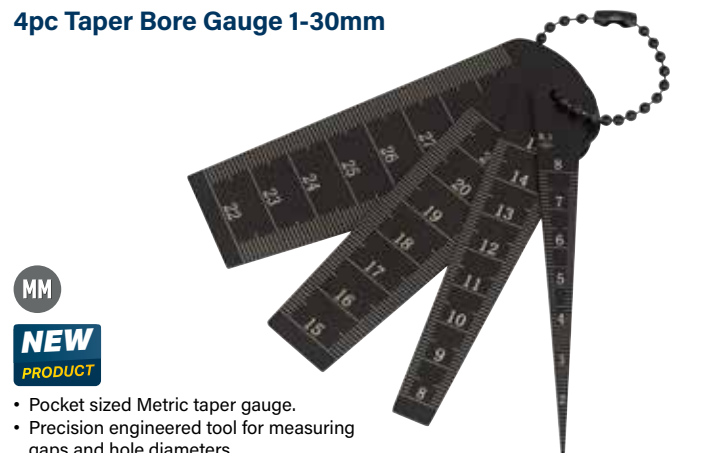

MM

NEW
PRODUCT

- Pocket sized Metric taper gauge.
- Precision engineered tool for measuring gaps and hole diameters.
- Laser cut from stainless steel.
- Measuring range of 1-8mm, 8-15mm, 15-22mm and 22-30mm.
- Features a precision scale for accurate inspections.
- **Model No. AK75TPG**
- List Price £16.95

£11.95 Exc. VAT
£14.34 Inc. VAT

36pc Letter & Number Punch Sets



Model No. AK8298

- High carbon steel punches.
- Hardened, tempered and chemically blackened.
- Full set of alpha-numeric characters including the ampersand symbol (number 6 doubles as number 9).
- 2.5mm Character height.
- Supplied in composite case.

Model No.	Length	Character Height	List Price	Exc. VAT	Inc. VAT
AK8296	60mm	2.5mm	£13.95	£9.95	£11.94
AK9296	60mm	4mm	£21.45	£14.95	£17.94
AK8298	73mm	10mm	£46.95	£32.95	£39.54

26pc Punch & Chisel Set



MM

Premier
ALWAYS WEAR SAFETY GOGGLES WHEN USING PUNCHES AND CHISELS

- Comprehensive set made from hardened, tempered high quality steel.
- Chemically blackened finish for corrosion resistance.
- Contents: Pin Punches; Ø2 x 114, Ø2.5 x 127, Ø3 x 133, Ø4.5 x 146, Ø5 x 152, Ø6.5 x 165mm, Centre Punches; Ø3 x 124, Ø4 x 127, Ø5 x 143mm, Taper Punches; Ø2.5 x 114, Ø3 x 127, Ø3 x 257, Ø5 x 140, Ø5 x 257, Ø5.5 x 152, Ø6.5 x 165, Ø6.5 x 257mm, Cold Chisels; 8 x 133, 9.5 x 146, 11 x 159, 13 x 171, 16 x 184, 19 x 197, 22 x 203, 25 x 205, 30 x 216mm.
- **Model No. AK9298**
- List Price £99.95

£59.95 Exc. VAT
£71.94 Inc. VAT



Benchclaw® Mitre Saw Workbench Clamp

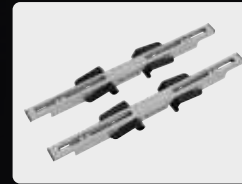

- Patented design enables power tools fitted with Benchclaw® to be quickly and easily mounted to conventional workbenches with a maximum platform thickness of 20mm.
- Suitable for a variety of tools including mitre saws and bench grinders with mounting hole centres between 100mm to 375mm.
- Foldaway claws auto-retract enabling use on ground or flat work surfaces without needing to disconnect Benchclaw® from your chosen tool.
- Required Workbench Jaw Opening: 100mm.
- Supplied with 4 x 6mm Hex key bolts.
- **Model No. SBC01**
- List Price £29.95

£16.95 Exc. VAT
£20.34 Inc. VAT

All Steel Vices

HEAVY DUTY **5 YEAR GUARANTEE***



- Bench mounting, heavy-duty steel vices suitable for workshop, garage and machine shop use.
- Fixed base directly mounts onto workbench and a swivel adaptor plate is available as an optional extra for models up to 200mm.
- 5 Year guarantee* against breakage.

Model No.	Jaw Length	List Price	Exc. VAT	Inc. VAT
ASV100	100mm	£129.95	£89.95	£107.94
ASV150	150mm	£199.95	£139.95	£167.94
ASV200	200mm	£249.95	£179.95	£215.94
ASV250	250mm	£319.95	£229.95	£275.94

Compound Cross Vices

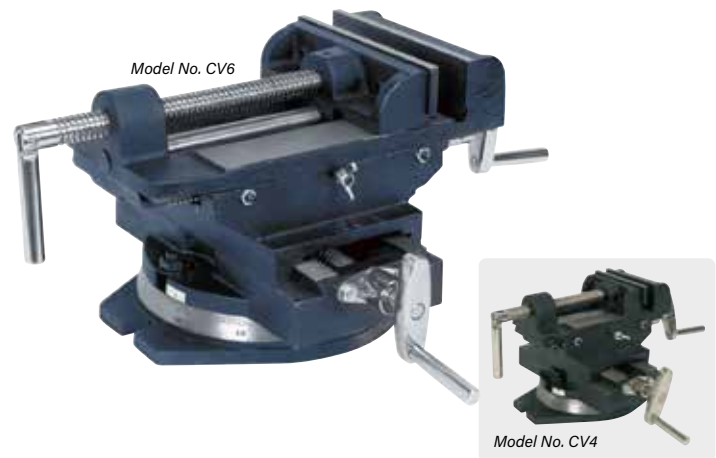

- Swivel base compound cross vices (X + Y Axis) with scale on base.
- Cast construction with precision machined compound slides.
- Fitted with replaceable steel jaws, locking slides and Metric calibrated lead screws.
- Suitable for both drilling and milling tasks.

Model No.	Jaw Length	List Price	Exc. VAT	Inc. VAT
CV4	100mm	£139.95	£114.95	£137.94
CV6	150mm	£189.95	£149.95	£179.94



**Folding Workbench
235mm Capacity**

Folding



- Multifunctional worktop.
- Quick and easy-to-use.
- Strong construction.
- Handy tool storage on fold flat legs.
- Working Height: 785mm.
- Width: 605mm.
- Simple to assemble.
- **Model No. FWB1**
- List Price £39.95

£24.95 Exc. VAT
£29.94 Inc. VAT

Ø254mm Table Saw



- Powder coated aluminium table with one rear and two side extension tables.
- Supplied with 40-tooth TCT blade and 1500W motor.
- Cutting capacity: 80mm at 90° and 55mm at 45°.
- Includes quick lock rip-fence, mitre gauge, dust extraction port, push stick and sturdy metal stand.
- Fitted with 3-pin plug.
- **Model No. TS10P**
- List Price £349.95

£249.95 Exc. VAT
£299.94 Inc. VAT

Heavy-Duty Folding Composite Trestle

HEAVY DUTY

Folding



- Manufactured from 30mm thick heavy-duty composite material, with ribbed rubber feet for added stability.
- Rubber ring anti-slip grips for added workpiece stability.
- Folded (W x D x H): 690 x 60 x 840mm.
- Unfolded (W x D x H): 690 x 520 x 810mm.
- **Model No. FDT4**
- List Price £43.95

£29.95 Exc. VAT
£35.94 Inc. VAT

Fold Down Trestle with Adjustable Legs

- Pressed steel trestle top.
- Features an anti-slip mat and carry handle.
- Adjustable legs manufactured from square section steel tube, ideal for use on uneven ground and steps.
- Fully collapsible for easy storage and transportation.
- Height Range: 630-910mm.
- Width: 995mm.



Folding

£29.95 Exc. VAT
£35.94 Inc. VAT

Ø150mm Bench Grinder 150W

Ø150mm Stones

Induction Motor

- 150W/230V, 2980rpm.
- Ready-to-use.
- Suitable for general workshop use.
- Supplied with one coarse and one fine wheel.
- Eye shields included.
- **Model No. BG150CX**
- List Price £59.95



£46.95 Exc. VAT
£56.34 Inc. VAT

Sliding Compound Mitre Saws

LASER GUIDE



Model No. SMS216

Ø216mm

- Features locking increments at Mitre stops 0°, 15°, 22.5°, 31.6°, 45° Left and Right.
- Cross Cut (0° Bevel x 0° Table): 62 x 310mm.
- Mitre Cut (0° Bevel x 45° Table): 62 x 215mm.
- Bevel Cut (45° Bevel x 45° Table): 34 x 215mm.

Ø255mm

Model No. SMS255

- Features locking increments at mitre stops 0°, 15°, 22.5°, 30°, 45° Left & Right.
- Cross Cut (0° Bevel x 0° Table): 90 x 315mm.
- Mitre Cut (0° Bevel x 45° Table): 90 x 215mm.
- Bevel Cut (45° Bevel x 0° Table): 40 x 215mm.



- Features integral plastic workpiece supports which store inside the aluminium base to save space and prevent loss.
- Fitted with a TCT blade for fresh wood.
- Units are also fitted with a laser guide to help produce accurate cuts.
- Supplied with workpiece clamp, dust extraction bag and fitted with carry handle.

Model No.	Motor	Max. Cut	Tooth	List Price	Exc. VAT	Inc. VAT
SMS216	1450W	310mm	24	£229.95	£169.95	£203.94
SMS255	2000W	315mm	40	£279.95	£224.95	£269.94

Dust & Chip Extractors



Model No. SM47

2hp



Model No. SM46

1hp

Induction Motor

- Mobile workshop extractors suitable for attachment to most static workshop machines including bandsaws, table saws, scroll saws, planers and sanders.
- Supplied with 2m of Ø100mm suction ducting.

Model No.	Power	List Price	Exc. VAT	Inc. VAT
SM46	1hp	£379.95	£279.95	£335.94
SM47	2hp	£549.95	£399.95	£479.94

4-Speed Wood Lathe 1000mm Centres



4-Speed

1000mm
Between Centres

- Ideal for the first time user or as a back-up unit.
- Maximum Turning Capacity: 1000 x 350mm.
- Four turning speed options to suit a variety of jobs.
- NVR Switch prevents restart after the mains power has been interrupted.
- Powered by smooth operating 370W motor.
- Lathe bed with twin bar construction.
- Solid head and tail stocks.
- Fitted with a 3-pin plug and cable.
- **Model No. SM1308**
- List Price £269.95

£219.95 Exc. VAT
£263.94 Inc. VAT

406mm Throat Variable Speed Scroll Saw

VARIABLE SPEED



- Quality cast rounded table, suitable for precise and intricate cuts.
- Features parallel arm design and quick blade changing system.
- Variable speed operation to cut multiple types of material.
- Fitted with adjustable safety guard.
- Flexible dust blower to keep a dust-free work area.
- Supplied with a pinned blade.
- **Model No. SM1302**
- List Price £169.95

£109.95 Exc. VAT
£131.94 Inc. VAT

Professional Bandsaws



Model No. SM1303
200mm



Model No. SM1304
245mm

- Dust Extraction Diameter: Ø40mm.
- Steel chassis with locking blade wheel covers.
- Suitable for cutting wood and plastics.
- Fitted with blade wheel brush to prevent dust accumulation.
- Bearing-mounted blade wheels and direct drive induction motor provide smooth operation.
- Features rip fence, mitre gauge and push stick.

Model No.	Throat Depth	Max. Cutting Height	List Price	Exc. VAT	Inc. VAT
SM1303	200mm	80mm	£219.95	£139.95	£167.94
SM1304	245mm	100mm	£399.95	£249.95	£299.94

10-Speed Wood Lathe 1100mm Centres

10-Speed

1100mm
Between Centres

Induction Motor



Stand Included

75+ KG
HEAVY ITEM

- Powered by smooth operating 550W induction motor.
- Plate clutch allows seamless speed control without the need to stop the motor and adjust belts and pulleys.
- Hollow centred head and tail stocks allow hole boring.
- One-piece machined lathe bed with head stock extension for bowl turning and sanding operations.
- This item is heavy. Extra assistance must be provided at the delivery point to help its safe delivery.
- **Model No. SM1100**
- List Price £749.95

£469.95 Exc. VAT
£563.94 Inc. VAT

8pc Wood Turning Chisel Set

- Long, 2-handed, softwood handles with tool steel shafts and tips.
- Suitable for use with Sealey and other leading brands of wood lathe.
- **Model No. AK60/8**
- List Price £49.95



£29.95 Exc. VAT
£35.94 Inc. VAT

25mm x 762mm/Ø125mm Belt/Disc Sander

25 x 762mm Belt

Ø125mm Disc

- Bench mounting semi-portable belt and disc sander suitable for general woodworking applications.
- Powerful induction motor with smooth, bearing-mounted drive pulleys gives quiet operation.
- 250W/230V Induction motor.
- Belt Size: 25 x 762mm.
- Disc Size: Ø125mm.
- Sanding disc table tilts to 45° and is supplied with mitre gauge for accurate angle sanding.
- Sanding belt is positioned vertically.
- **Model No. SM750**
- List Price £149.95



£109.95 Exc. VAT
£131.94 Inc. VAT

915 x 100mm Belt/Ø150mm Disc Sander 370W

915 x 100mm Belt

Ø150mm Disc

- Powerful induction motor with smooth, bearing-mounted drive pulleys gives quiet operation.
- The sanding belt can be used in a vertical or horizontal position or at any other angle in between.
- The sanding disc table can be tilted to any angle up to 45°, and is supplied with a mitre gauge for accurate angle sanding.
- **Model No. SM914**
- List Price £219.95



£169.95 Exc. VAT
£203.94 Inc. VAT

FFP1 Fold Flat Masks



- Protects against non-toxic dusts and water-based aerosols.
- Fitted with adjustable band, nose liner and aluminium nose clip to fit all face contours.
- Filter Efficiency \geq 80%
- Manufactured to BS EN 149:2001+A1:2009.

Model No.	Pack Qty	List Price	Exc. VAT	Inc. VAT
9329/3	3	£3.75	£2.20	£2.64
9329/10	10	£8.95	£5.45	£6.54

FFP1 Valved Cup Masks



- Protects against non-toxic dusts and water-based aerosols.
- Fitted with nose liner and aluminium nose clip to fit all face contours.
- Also fitted with breathing vent to provide more comfort and better communication as well as reducing heat build-up.
- Filter Efficiency \geq 80%.
- Manufactured to BS EN 149:2001 + A1:2009.

Model No.	Pack Qty	List Price	Exc. VAT	Inc. VAT
9331/3	3	£4.65	£2.75	£3.30
9331/10	10	£11.95	£7.95	£9.54

FFP1 Cup Masks



- Protects against non-toxic dusts and water-based aerosols.
- Fitted with nose liner and aluminium nose clip to fit all face contours.
- Filter Efficiency \geq 80%.
- Manufactured to BS EN 149:2001 + A1:2009.

Model No.	Pack Qty	List Price	Exc. VAT	Inc. VAT
9309/3	3	£3.85	£2.25	£2.70
9309/10	10	£9.45	£5.75	£6.90

FFP2 Fold Flat Masks



- Protects against slightly toxic or irritant aerosols and/or liquids.
- Fitted with adjustable band, nose liner and aluminium nose clip to fit all face contours.
- Filter Efficiency \geq 94%.
- Manufactured to BS EN 149:2001 + A1:2009.

Model No.	Pack Qty	List Price	Exc. VAT	Inc. VAT
9304/3	3	£4.15	£2.45	£2.94
9304/10	10	£10.45	£5.95	£7.14

FFP2 Valved Fold Flat Masks



- Protects against slightly toxic or irritant aerosols and/or liquids.
- Fitted with adjustable band, nose liner and aluminium nose clip to fit all face contours.
- Also fitted with breathing vent to provide more comfort and better communication as well as reducing heat build-up.
- Filter Efficiency \geq 94%.
- Manufactured to BS EN 149:2001 + A1:2009.

Model No.	Pack Qty	List Price	Exc. VAT	Inc. VAT
9305/3	3	£4.65	£2.75	£3.30
9305/10	10	£11.95	£7.95	£9.54

FFP2 Valved Cup Masks



- Protects against slightly toxic or irritant aerosols and/or liquids.
- Fitted with nose liner and aluminium nose clip to fit all face contours.
- Also fitted with breathing vent to provide more comfort and better communication as well as reducing heat build-up.
- Filter Efficiency \geq 94%
- Manufactured to BS EN 149:2001 + A1:2009.

Model No.	Pack Qty	List Price	Exc. VAT	Inc. VAT
9332/3	3	£5.25	£2.95	£3.54
9332/10	10	£13.95	£8.95	£10.74

Disposable Ear Plugs



Model No. 403/100

- Individually wrapped, disposable, single use ear plugs.
- Provides comfortable protection from noise.
- SNR Rating: 38dB.
- Conforms to BS EN 352.

Model No.	Pack Qty	List Price	Exc. VAT	Inc. VAT
403/10	10 Pairs	£2.65	£1.95	£2.34
403/100	100 Pairs	£21.95	£13.95	£16.74
403/200	200 Pairs	£34.95	£23.95	£28.74

FFP3 Valved Fold Flat Masks



- Protects against solid aerosols and/or liquids listed as toxic.
- Fitted with adjustable band, nose liner and aluminium nose clip to fit all face contours.
- Also fitted with breathing vent to provide more comfort and better communication as well as reducing heat build-up.
- Filter Efficiency \geq 99%
- Manufactured to BS EN 149:2001 + A1:2009.

Model No.	Pack Qty	List Price	Exc. VAT	Inc. VAT
9333/3	3	£10.45	£5.45	£6.54
9333/10	10	£31.45	£16.95	£20.34

FFP3 Valved Cup Masks



- Protects against solid aerosols and/or liquids listed as toxic.
- Fitted with adjustable band, nose liner and aluminium nose clip to fit all face contours.
- Also fitted with breathing vent to provide more comfort and better communication as well as reducing heat build-up.
- Filter Efficiency \geq 99%.
- Manufactured to BS EN 149:2001 + A1:2009.

Model No.	Pack Qty	List Price	Exc. VAT	Inc. VAT
9334/3	3	£12.95	£7.95	£9.54
9334/10	10	£38.95	£23.95	£28.74



SHADE 5-8
Variable

SHADE 9-13
Variable



Auto Darkening Welding Helmet with Powered Air Purifying Respirator (PAPR)

- The filter is designed to reduce or remove dust and particles but not vapours and gases.
- Lithium battery powered blower unit gives the user a cooling stream of air to their head and face for up to 8 hours.
- The kit meets performance class TH3 according to EN 12941:1998/A2:2008.
- Features a loud audible and visual alarm to alert user of low battery/low air.
- The welding helmet has adjustable shade control from 9-13.
- Fully automatic switching from light to dark on striking arc.
- Additional shades 5-8 for gas welding/cutting.
- Features sensitivity and delay controls for switching light to dark.
- **Model No. PWH615**
- List Price £599.95



£479.95 Exc. VAT

£575.94 Inc. VAT

Scan for our full range of Welding Helmets.



AUTO DARKENING WELDING HELMETS (PAPR)



SHADE 5-8
Variable

SHADE 9-13
Variable



Auto Darkening Welding Helmet with Powered Air Purifying Respirator (PAPR)

- Lithium battery powered respirator unit provides the user a constant filtered stream of air to their head and face for up to approximately 8 hours.
- The filter is designed to reduce or remove dust and particles but not vapours and gases.
- The kit meets performance class TH1 according to EN 12941:1998/A2:2008.
- Adjustable airflow settings of 150/180/210L/min.
- Features an audible alarm to alert user of low battery/low airflow.
- Inner hood has protective clear visor to BS EN166 standards.
- Welding helmet has adjustable shade control from 9-13 and 5-8.
- Fully automatic switching from light to dark on striking arc @ 1/25,000s.
- Solar panel power supply to welding helmet.
- Contoured design helmet with adjustable headband for added comfort.
- Complies with all BS EN379, EN175, EN166, EN12941 and DIN standards.
- **Model No. PWH616**
- List Price £359.95



£329.95 Exc. VAT

£395.94 Inc. VAT

EN 12941 is the European standard for a complete powered air filtering device incorporating a face helmet or visor. This standard outlines three classes of performance, which define the following maximum levels of inward leakage*: 10% for TH1, 2% for TH2 and 0.2% for TH3 (see individual Model No's for TH classification).

*Inward Leakage estimates the performance of a respiratory device by measuring contaminants that leak through a respirator from various sources, including filter penetration, face seals, valves & gaskets.

MODEL NO. PWH615
MODEL NO. PWH616

Small In-Line Fuel Filter Pack of 10



- In-line fuel filter.
- Inlet/Outlet Diameter: Ø7mm.
- **Model No. ILFS10**
- List Price £13.45

£9.75 Exc. VAT
£11.70 Inc. VAT

Medium In-Line Fuel Filter Pack of 10



- In-line fuel filter.
- Inlet/Outlet Diameter: Ø8mm.
- **Model No. ILFM10**
- List Price £17.95

£13.45 Exc. VAT
£16.14 Inc. VAT

Large In-Line Fuel Filter Pack of 5



- Large in-line fuel filter.
- Inlet/Outlet Diameter: Ø8mm.
- **Model No. ILFL5**
- List Price £12.95

£9.25 Exc. VAT
£11.10 Inc. VAT

In-Line Diesel Fuel Filter Pack of 5



- In-line diesel fuel filter.
- Inlet/Outlet Diameter: Ø7mm.
- **Model No. ILDF5**
- List Price £11.95

£8.75 Exc. VAT
£10.50 Inc. VAT

250pc Diesel Injector Copper Washer Assortment

MM



- Contents (Approximate Quantity): ID x OD x Thickness; Ø6 x Ø10 x 1 (x20), 10 x 13.5 x 1 (x20), 10 x 20 x 1 (x20), 12 x 16 x 1.5 (x20), 14 x 18 x 1.5 (x20), 16 x 20 x 1.5 (x15), 21 x 25 x 1 (x10), 8 x 11.5 x 1 (x20), 10 x 14 x 1 (x20), 10 x 20 x 2 (x20), 12 x 18 x 1.5 (x20), 14 x 20 x 1.5 (x20), 17 x 21 x 1.5 (x15), 22 x 27 x 1mm (x10).
- **Model No. AB027CW**
- List Price £37.95

£26.95 Exc. VAT
£32.34 Inc. VAT

88pc Bonded (Dowty Seals) Assortment

MM



- Contents (Approximate Quantity): M18 (x8), M20 (x5), M22 (x5), M24 (x5), M10 (x20), M12 (x15), M14 (x15), M16 (x15).
- Supplied in partitioned box.
- **Model No. AB010DS**
- List Price £29.95

£19.95 Exc. VAT
£23.94 Inc. VAT

220pc High Tensile Setscrew, Nut & Washer Assortment M8



- Grade 8.8 Setscrews to DIN 933.
- Steel nuts to DIN 934.
- Form A washers to DIN 125.
- Contents (Approximate Quantity): Setscrews; Diameter x Length; M8 x 25 (x20), M8 x 40 (x10), M8 x 50 (x10), M8 x 75mm (x10), Nuts; M8 Steel (x50), Washers; M8 Flat Washer Form A (x120).
- **Model No. AB051SNW**
- List Price £21.45

£15.75 Exc. VAT
£18.90 Inc. VAT

1010pc Spring Washer Assortment DIN 127B - M6-M16



- Metric spring washer assortment.
- DIN 127B.
- Contents (Approximate Quantity): M6 (x400), M8 (x400), M10 (x180), M12 (x10), M14 (x10), M16 (x10).
- **Model No. AB058SW**
- List Price £34.95

£24.95 Exc. VAT
£29.94 Inc. VAT

10m Double-Sided Adhesive Foam Tape Green Backing

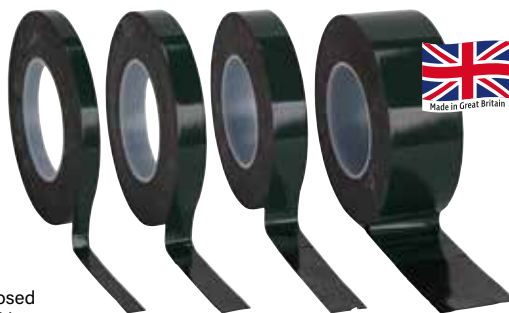

- Double-sided polyethylene closed cell foam tape with green backing.
- Suitable for bonding body-sided trims and emblems in the automotive industry.
- Excellent compression resistance.
- High tack.
- Excellent resistance to plasticizers, oils, UV light, solvent and humidity.

Model No.	Width	List Price	Exc. VAT	Inc. VAT
DSTG1210	12mm	£5.95	£4.25	£5.10
DSTG1910	19mm	£7.45	£5.25	£6.30
DSTG2510	25mm	£9.95	£6.95	£8.34
DSTG5010	50mm	£14.95	£10.45	£12.54

50m General-Purpose Masking Tape - 60°C

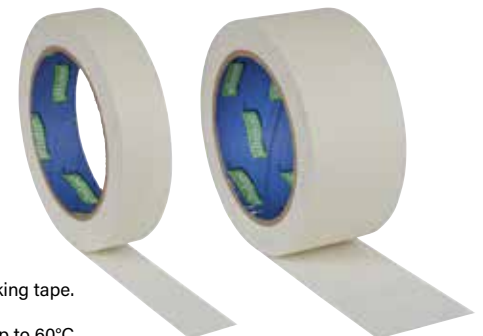

- High quality masking tape.
- General-purpose.
- Suitable for use up to 60°C.

Model No.	Size	List Price	Exc. VAT	Inc. VAT
MTG24P	24mm x 50m	£2.25	£1.70	£2.04
MTG48P	48mm x 50m	£4.45	£3.40	£4.08

Universal CVJ Boot Clamp Kit



- Fast and simple-to-use.
 - Kit includes 56m of high quality stainless steel banding with a tensile strength of 420N/mm².
 - Dispenser case also houses 150* clamp sets and unique pliers with integrated cutters and band tensioner.
 - Never be caught without the right sized boot clamp again.
- * Approximate quantities
- **Model No. BSL102**
 - List Price £70.45

£49.95 Exc. VAT
£59.94 Inc. VAT

Ø56-120mm Universal Split CVJ Boot



- Universal CVJ boot made from high quality neoprene that is resistant to grease, water, ozone, abrasion and extremes of temperature.
- Suitable for 98% of cars and car-derived vans.
- No dismantling of joint/shaft required and can be fitted in 20 minutes.
- Supplied with fitting kit including clips, grease sachet, disposable gloves, glue, cutting guide and fitting instructions.
- Joint Ø: 56-120mm.
- Shaft Ø: 19 - 35mm.
- **Model No. CVS18**
- List Price £16.95

£11.95 Exc. VAT
£14.34 Inc. VAT

Duraboot Stretch CVJ Boots



- Made from high quality neoprene that is resistant to grease, water, ozone, abrasion and extremes of temperature.
- Supplied with fitting kit including clips and grease sachet.

Model No.	Joint Ø	Length	List Price	Exc. VAT	Inc. VAT
DBC100	80-104mm	90mm	£8.75	£6.45	£7.74
DBC200	73-95mm	106mm	£9.25	£6.65	£7.98
DBC300	86-112mm	119mm	£9.25	£6.65	£7.98
DBC400	80-104mm	112mm	£9.95	£6.95	£8.34
DBC500	70-91mm	84mm	£9.95	£6.95	£8.34
DBC600	76-99mm	92mm	£9.95	£6.95	£8.34
DBC700	74-96mm	99mm	£9.95	£6.95	£8.34
DBC800	60-78mm	104mm	£9.95	£6.95	£8.34

25ml Slow-Set 20 Minute Epoxy Adhesive



- A clear drying, slow setting and solvent-free epoxy adhesive.
- Workable for 20 minutes.
- Joins a huge array of materials, metals, most plastics, fibreglass, stone, ceramics and wood.
- Once cured, it can be machined, sanded and even painted.
- **Model No. SCS400**
- List Price £5.95

£4.25 Exc. VAT
£5.10 Inc. VAT

25ml Quick-Set 5 Minute Epoxy Adhesive



- A clear drying, fast setting highly reactive epoxy adhesive.
- Starts to hold in just 5 minutes.
- Suitable for bonding metal and metal alloys, most plastics, fibreglass, stone, ceramics and glass etc.
- Creates an excellent waterproof and impact resistant bond.
- **Model No. SCS401**
- List Price £5.95

£4.25 Exc. VAT
£5.10 Inc. VAT

25ml Quick-Set Liquid Metal



- For the bonding and repair of most metals.
- Great for forming and repairing metal housings and sheet steel.
- When fully cured can be filed, drilled, tapped and painted.
- **Model No. SCS380**
- List Price £6.95

£4.45 Exc. VAT
£5.34 Inc. VAT

114g Quick-Set Putty Metal



- Hand-kneadable, non-rusting, steel reinforced epoxy putty.
- Steel stick repairs or rebuilds almost anything made of metal, excluding aluminium.
- **Model No. SCS390**
- List Price £12.95

£8.75 Exc. VAT
£10.50 Inc. VAT

5L Snow Foam Car Shampoo



- The ultimate high snow foaming traffic film removal solution.
- This thick rich cleaning snow foam will allow longer dwell time to break down dirt and soiling.
- Non wax stripping, easy rinse for a streak-free finish.
- Perfect for car detailing.
- **Model No. SCS090**
- List Price £24.95

£19.95 Exc. VAT
£23.94 Inc. VAT

3pc Pure Bristle Paint Brush Set



- Pure bristles with square cut ends, held by chrome ferrules.
- Painted composite handles.
- Sizes: 25, 38, 50mm.
- **Model No. SPBS3**
- List Price £5.95

£4.25 Exc. VAT
£5.10 Inc. VAT

Premier Industrial Detergent Pressure Sprayer



- Suitable for use with most detergents and acids.
- Safety valve with depressurization option.
- Large 60mm opening for easy refilling and reduced spillage.
- Translucent tank allows easy measuring of contents using side level indicator.
- Supplied with adjustable 'cone' and standard 'fan' nozzles.
- **Model No. SCSG07**
- List Price £39.95

£26.95 Exc. VAT
£32.34 Inc. VAT

12pc Multi-Coloured Combination Spanner Set



Premier

LIFETIME GUARANTEE*

8-19mm



MM



- Model No. AK63915
- List Price £79.95

£29.95 Exc. VAT
£35.94 Inc. VAT

Pear-Head Offset Ratchet Wrenches with Flip Reverse

Premier

LIFETIME GUARANTEE*

Gear 2 Gear

72-Tooth



1/4" Sq. Drive Model No. AK7946



1/2" Sq. Drive Model No. AK7948

Model No.	Drive	List Price	Exc. VAT	Inc. VAT
AK7946	1/4" Sq	£29.95	£12.95	£15.54
AK7948	1/2" Sq	£41.95	£17.95	£21.54

Push-Through Reverse Speed Ratchet Wrenches

Premier

LIFETIME GUARANTEE*

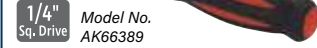

1/4" Sq. Drive Model No. AK66389

Push-Through Reverse

48-Tooth



3/8" Sq. Drive Model No. AK6639



1/2" Sq. Drive Model No. AK66390

Model No.	Drive	List Price	Exc. VAT	Inc. VAT
AK66389	1/4" Sq	£54.95	£24.95	£29.94
AK6639	3/8" Sq	£61.45	£26.95	£32.34
AK66390	1/2" Sq	£67.95	£29.95	£35.94

10pc Socket Sets

4-13mm Standard

Model No. S0497



Model No. S0502

10-24mm Deep

Siegen

LIFETIME GUARANTEE*

MIRROR FINISH



MM

Model No.	Drive	Type	Contents	List Price	Exc. VAT	Inc. VAT
S0497	1/4" Sq	Standard	4, 5, 6, 7, 8, 9, 10, 11, 12, 13mm	£13.45	£5.95	£7.14
S0498	1/4" Sq	Deep	4, 5, 6, 7, 8, 9, 10, 11, 12, 13mm	£20.45	£7.95	£9.54
S0502	1/2" Sq	Deep	10, 13, 14, 15, 16, 17, 18, 19, 21, 24mm	£42.95	£14.95	£17.94

42pc 1/2" Sq Drive Total Drive® Socket & Bit Set

Premier

LIFETIME GUARANTEE*

Gear 2 Gear MIRROR FINISH



1/2" Sq. Drive



MM

£49.95 Exc. VAT
£59.94 Inc. VAT

- Model No. AK706
- List Price £149.95

42pc Impact Wrench, Sockets & Tyre Tool Set with Tool Tray

Premier Platinum series

LIFETIME GUARANTEE*

1/2" Sq. Drive

Twin Hammer

Deep

MM



£139.95 Exc. VAT
£167.94 Inc. VAT

- Model No. TBTP08
- List Price £399.95

Polyurethane Wheel Chocks Single

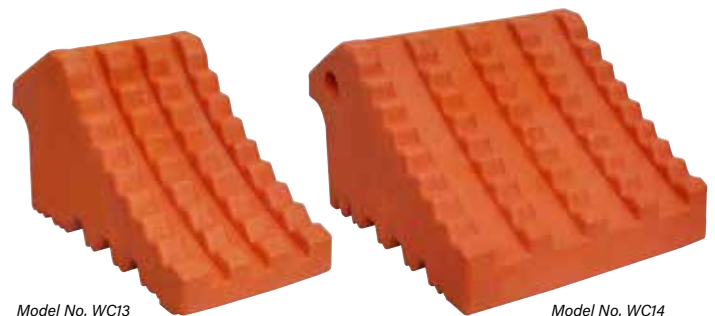

Model No. WC13

Model No. WC14

Model No.	Weight	Size (W x D x H)	List Price	Exc. VAT	Inc. VAT
WC13	0.7kg	120 x 250 x 130mm	£21.95	£5.95	£7.14
WC14	1.5kg	205 x 255 x 145mm	£29.95	£8.95	£10.74

135kg Quick Lift Stand/Moving Dolly



135kg

- Model No. MP5D1
- List Price £99.95

£44.95 Exc. VAT
£53.94 Inc. VAT

Medium Motorcycle Coverall with Solar Panel Pocket



- Model No. MCBM
- List Price £47.95

£14.95 Exc. VAT
£17.94 Inc. VAT

160A Copper Booster Cables 2.5m x 10mm²

COPPER CABLE

- Model No. BC/10/2.5
- List Price £27.95

£9.95 Exc. VAT
£11.94 Inc. VAT



100A Copper Motorcycle Booster Cables 5mm² x 1.5m

COPPER CABLE

- Model No. BC0515
- List Price £13.95

£5.95 Exc. VAT
£7.14 Inc. VAT



12V Motorcycle Digital Battery Tester

12V

Battery



£26.95 Exc. VAT
£32.34 Inc. VAT

- Model No. MC105
- List Price £71.95



Petrol Engine Timing Tool Kit for Jaguar, Land Rover 5.0 Chain Drive



CHAIN



- Model No. VSE3445
- List Price £239.95

£99.95 Exc. VAT
£119.94 Inc. VAT

38pc Automotive Socket Bit Set

LIFETIME GUARANTEE*

Master Set 1/4" & 1/2" Sq. Drive

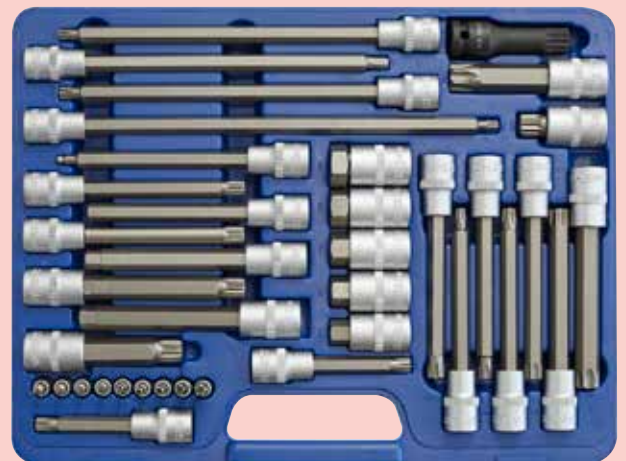

- Model No. SX060
- List Price £97.45

£46.95 Exc. VAT
£56.34 Inc. VAT

Cutting Oil Concentrate



- Model No. OIL02
- List Price £7.95

£2.95 Exc. VAT
£3.54 Inc. VAT

9W B22 SMD LED Bulb 6500K White Light



810 LUMENS



- Model No. LED061
- List Price £6.60

£4.95 Exc. VAT
£5.94 Inc. VAT

Ø22mm x 3.14m Syphon Pump



- Model No. VS565
- List Price £24.95

£9.95 Exc. VAT
£11.94 Inc. VAT

3L Stackable Fuel Cans



- Model No. JC3R - Red
- Model No. JC3G - Green
- Model No. JC3B - Black
- List Price £7.95

£4.95 Exc. VAT
£5.94 Inc. VAT

Oil Filter/Bottle Drain Pan



- Model No. DRP2030
- List Price £18.95

£5.95 Exc. VAT
£7.14 Inc. VAT

5L Measuring Jug

5L



- Model No. VS562
- List Price £24.95

£7.95 Exc. VAT
£9.54 Inc. VAT

205L Drum Tongs - 500kg Capacity



500kg Capacity



- Model No. DG05
- List Price £79.95

£29.95 Exc. VAT
£35.94 Inc. VAT

Bi-Metal Hacksaw Blades HSS Packs of 50

Model No.	Teeth	List Price	Exc. VAT	Inc. VAT
HSB5018	18tpi	£97.95	£27.95	£33.54
HSB5032	32tpi	£97.95	£27.95	£33.54



Model No. HSB5032

24V Low Voltage Submersible Transfer Pump

24V

- Model No. TP9424
- List Price £87.45

£49.95 Exc. VAT
£59.94 Inc. VAT



1" Sq Drive Air Impact Wrench Pin Clutch



2 YEAR GUARANTEE*

1" Sq. Drive
Pin Clutch



£349.95 Exc. VAT
£419.94 Inc. VAT

- Model No. SA682
- List Price £659.95

1/2" Sq Drive Air Impact Wrench Pin Clutch



2 YEAR GUARANTEE*

1/2" Sq. Drive
Pin Clutch



£124.95 Exc. VAT
£149.94 Inc. VAT

- Model No. SA5/S
- List Price £149.95

19pc 1/2" Sq Drive Total Drive® Socket Set



LIFETIME GUARANTEE*

1/2" Sq. Drive
TOTAL DRIVE®
MM 8-32mm



£24.95 Exc. VAT
£29.94 Inc. VAT

- Model No. AK70619
- List Price £72.95

Super Stubby Air Ratchet Wrenches

1/4" Sq. Drive Model No. SA632



2 YEAR GUARANTEE*

Stubby



3/8" Sq. Drive Model No. SA633

Model No.	Drive	List Price	Exc. VAT	Inc. VAT
SA632	1/4" Sq	£99.95	£36.95	£44.34
SA633	3/8" Sq	£99.95	£39.95	£47.94

32pc Air Tool Kit

1/2" Sq. Drive



- Model No. SA2004KIT
- List Price £164.95

£84.95 Exc. VAT
£101.94 Inc. VAT

3/8" Sq Drive Reactionless High Torque Air Ratchet Wrench



2 YEAR GUARANTEE*

3/8" Sq. Drive Reactionless
102Nm Torque

- Model No. SA615
- List Price £129.95



£44.95 Exc. VAT
£53.94 Inc. VAT

Ø150mm Dust-Free Air Random Orbital Sander

Ø150mm
Dust-Free



2 YEAR GUARANTEE*



- Model No. MAT150AS
- List Price £209.95

£114.95 Exc. VAT
£137.94 Inc. VAT

Ø150mm Self-Contained Dust-Free Air Random Orbital Sander

Ø150mm
Self-Contained
Dust-Free



2 YEAR GUARANTEE*



- Model No. MAT150SC
- List Price £219.95

£119.95 Exc. VAT
£143.94 Inc. VAT

Arc Welders with Accessory Kit



Model No. 160XT



3 YEAR GUARANTEE*

140A 160A OR 180A

Model No. 180XT

Model No.	Welding Current	Electrode Capacity	List Price	Exc. VAT	Inc. VAT
140XT	45-140A	Ø1.6-3.2mm	£157.45	£79.95	£95.94
160XT	55-160A	Ø2-4mm	£179.95	£94.95	£113.94
180XT	60-180A	Ø2-4mm	£199.95	£99.95	£119.94

250A Arc Welder 230/415V 3ph with Accessory Kit



3 YEAR GUARANTEE*

250A



Dual Voltage



• Model No. 250XTD
• List Price £319.95

£189.95 Exc. VAT
£227.94 Inc. VAT

MMA Inverter Welders



140A
OR
160A

Model No. MW160A

Model No.	Welding Current	Duty Cycle	List Price	Exc. VAT	Inc. VAT
MW140A	20-140A	100% @ 63A, 60% @ 81A, 20% @ 140A	£219.95	£129.95	£155.94
MW160A	20-160A	100% @ 72A, 60% @ 92A, 20% @ 160A	£249.95	£149.95	£179.94

Ø115 x 1.6mm Multipurpose Cutting Disc Ø22mm Bore Pack of 10



£5.95 Exc. VAT
£7.14 Inc. VAT

• Model No. MCB115/10
• List Price £10.45

Ø190 x 30mm Trade Plus Circular Saw Blade - 24tpu



£3.95 Exc. VAT
£4.74 Inc. VAT

• Model No. TPS19024
• List Price £15.95

Ø305 x 25.4mm Trade Plus Circular Saw Blade - 60tpu



£9.95 Exc. VAT
£11.94 Inc. VAT

• Model No. TPS30560
• List Price £37.95

20V SV20 Series 20L Cordless Wet & Dry Vacuum Cleaner with 4Ah Battery & Charger



• Model No. PC20VCOMBO4
• List Price £161.95



20L



£84.95 Exc. VAT
£101.94 Inc. VAT

Ø250 x 2.4mm/Ø30mm Multipurpose Cut-Off Saw Blade - 60tpu



- Model No. SMS255B
- List Price £59.95

£23.95 Exc. VAT
£28.74 Inc. VAT

Trade Plus Circular Saw Blades - 24tpu



Model No. TS23024

Model No.	Size	List Price	Exc. VAT	Inc. VAT
TS19024	Ø190 x 30mm	£8.95	£2.75	£3.30
TS23024	Ø230 x 30mm	£11.95	£2.95	£3.54

Ø125 x 22mm Platinum Allmat Diamond Blade



- Model No. WDPA125
- List Price £21.45

£3.95 Exc. VAT
£4.74 Inc. VAT

12V SV12 Series LED36012V with Battery & Charger Combo



- Model No. LED36012VCOMBO1
- List Price £79.95

£39.95 Exc. VAT
£47.94 Inc. VAT



6 SMD LED Magnetic Flexi-Head Pocket Lights



- Model No. LED051R - Red
- Model No. LED051B - Blue
- List Price £12.95

£4.95 Exc. VAT
£5.94 Inc. VAT

Under-Bonnet Light Rails



Model No.	Description	List Price	Exc. VAT	Inc. VAT
ULR01COMBO1	ULR01 - Under-Bonnet Light Rail LED700PR (x2) - 360° 7W COB LED Rechargeable Pocket Floodlight with Magnet	£129.95	£79.95	£95.94
ULR01COMBO2	ULR01 - Under-Bonnet Light Rail LED3601R (x2) - 360° 3W COB & 1W SMD LED Rechargeable Inspection Light - Red	£119.95	£69.95	£83.94
ULR01	ULR01 - Under-Bonnet Light Rail	£39.95	£24.95	£29.94



20W SMD LED Rechargeable Portable Floodlight



- Model No. LED085
- List Price £89.95

£29.95 Exc. VAT
£35.94 Inc. VAT

ATV/Quad Bike Self Recovery Kit



- Model No. SRKIT01
- List Price £36.95

£12.95 Exc. VAT
£15.54 Inc. VAT

15L Capacity
1000W



15L Ash Vacuum Cleaner 1000W/230V

- Model No. PC150A
- List Price £67.95

£49.95 Exc. VAT
£59.94 Inc. VAT

Ø9mm Camera Tablet Video Borescope

Camera Ø9mm



- Model No. VS8222
- List Price £169.95

£79.95 Exc. VAT
£95.94 Inc. VAT



Safety Barrier Heavy-Duty Machine Guards

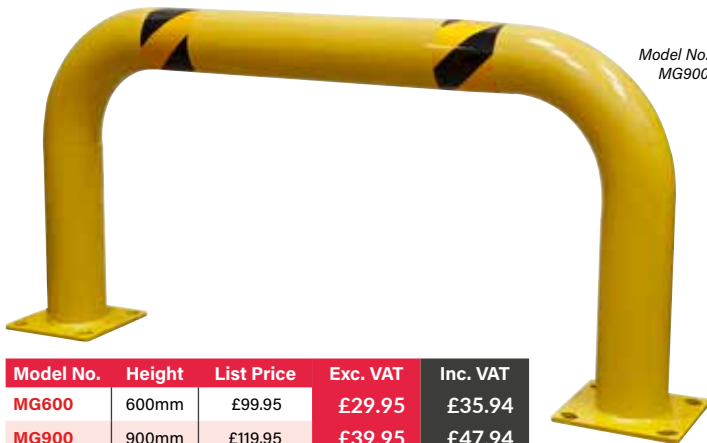

Model No. MG900

Model No.	Height	List Price	Exc. VAT	Inc. VAT
MG600	600mm	£99.95	£29.95	£35.94
MG900	900mm	£119.95	£39.95	£47.94

Professional Water-Resistant Storage Cases



WATER RESISTANT

IP67

Model No. AP626

Model No.	Internal Dimensions (W x D x H)	Wheels	List Price	Exc. VAT	Inc. VAT
AP621	385 x 270 x 85mm	X	£69.95	£36.95	£44.34
AP622	385 x 270 x 155mm	X	£84.95	£41.95	£50.34
AP625	430 x 340 x 200mm	X	£129.95	£79.95	£95.94
AP626	490 x 360 x 165mm	✓	£149.95	£79.95	£95.94

Disinfection Mats



Model No. DIML

Model No.	Size (W x L x D)	List Price	Exc. VAT	Inc. VAT
DIMS	450 x 600 x 20mm	£47.95	£24.95	£29.94
DIML	900 x 1000 x 20mm	£92.45	£49.95	£59.94

900kg Capacity Geared Hand Winches with Brake

900kg
Automatic Brake



Model No. GWE2000B

Model No. GWW2000B

Model No.	8m Webbing Included	List Price	Exc. VAT	Inc. VAT
GWE2000B	X	£99.95	£59.95	£71.94
GWW2000B	✓	£112.45	£79.95	£95.94

Ø16mm x 21mm, Push Rivet, GM, Japanese - Pack of 20



£3.95 Exc. VAT
£4.74 Inc. VAT

- Model No. TCPR1614
- List Price £16.45

300mm Locking Wing Divider



£8.95 Exc. VAT
£10.74 Inc. VAT

- Model No. AK97106
- List Price £16.95

Standard Goggles - Indirect Vent Pack of 10



£17.95 Exc. VAT
£21.54 Inc. VAT

- Model No. 201/10
- List Price £49.50

Bulk Fill Mini Lever Type Grease Gun



- Model No. AK451
- List Price £21.95

£7.95 Exc. VAT
£9.54 Inc. VAT

3tonne European Style Trolley Jack



Premier

3tonne



- Model No. 3000ES
- List Price £449.95

£279.95 Exc. VAT
£335.94 Inc. VAT

50 x 50 x 100mm Floor Grinding Block 120Grit - Pack of 6



£1.45 Exc. VAT
£1.74 Inc. VAT

- Model No. FGB120
- List Price £23.95

Large First Aid Kit for Minibuses & Coaches - BS 8599-2 Compliant

BS 8599-2



£16.95 Exc. VAT
£20.34 Inc. VAT

- Model No. SFA02L
- List Price £32.95

Brow Guard with Full Face Shield



£7.95 Exc. VAT
£9.54 Inc. VAT

- Model No. SSP9E
- List Price £17.95

SEE INSIDE FOR GREAT DEALS...



SEE PAGE **90**

NEW
PRODUCT

**35pc
Drill & Bit
Accessory Set**

SEE PAGE **129**

NEW
PRODUCT

**10 Drawer
Mobile Workstation
with Backboard**



SEE PAGE **4**

NEW
PRODUCT

**144pc
Mechanic's
Tool Kit
Hi-Vis Green**

SEE PAGE **142**

NEW
PRODUCT

**7,000Btu/hr
Portable Air
Conditioner/
Dehumidifier/
Air Cooler**



SEE PAGE **38**

NEW
PRODUCT

**Ø8mm Camera
Tablet Video
Borescope**

SEE PAGES **75-77**

NEW
PRODUCT

**New 20V
One-Battery-Fits-All
Products**



Download, view or
request our full
catalogue at
sealey.co.uk.

YOUR LOCAL STOCKIST

Promotion valid:
1st July to 30th September 2022

Reference Code: TP22Q3

Call +44 (0)1284 757500
Email sales@sealey.co.uk
Web www.sealey.co.uk
Post Sealey Group, Kempson Way,
Suffolk Business Park,
Bury St Edmunds, Suffolk. IP32 7AR



When you have finished
with this magazine
please recycle it.

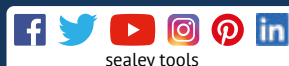

Offers will be withdrawn when stock is sold. Prices exclude VAT unless otherwise stated. We reserve the right to withdraw offers, substitute products and change pricing at any time. Specifications and descriptions on this promotion are given in good faith but may change without notice and do not form any part of a sale contract, E & OE.

*Please refer to www.sealey.co.uk/guarantee for more information on guarantees. TRX-STAR, TRX-TS and TRX-P tools are suitable for driving TORX® and TORX PLUS® fasteners respectively. TORX® and TORX PLUS® are registered trademarks of Acument Intellectual Properties, LLC. CREE LED is the registered trademark of CREE Inc.