

concrete wave

100% SKATEBOARDING

SKATEBOARD
DIRECTORY '09



OVER
165

COMPANY PROFILES

DECKS, WHEELS, TRUCKS & ACCESSORIES

concrete wave

100% SKATEBOARDING

SKATEBOARD
DIRECTORY '09



OVER

165

COMPANY PROFILES

DECKS, WHEELS, TRUCKS & ACCESSORIES

concrete wave

100% SKATEBOARDING

SKATEBOARD
DIRECTORY '09



OVER

165

COMPANY PROFILES

DECKS, WHEELS, TRUCKS & ACCESSORIES

concrete wave

100% SKATEBOARDING

Skateboard Directory '09

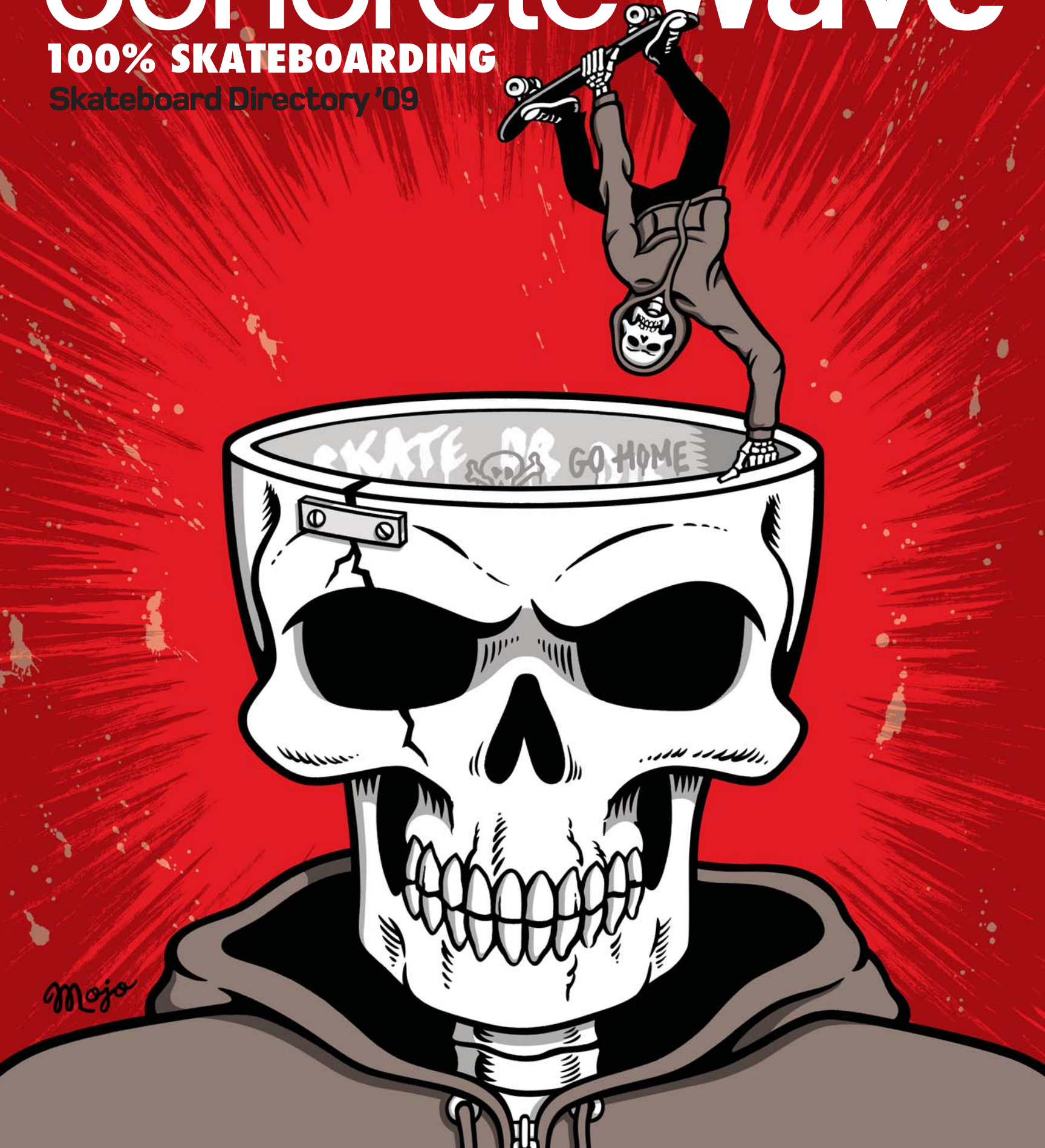

Mojo



10 YEARS



AND WE HAVE JUST BEGUN...

DREGSSKATEBOARDS.COM

myspace.com/dregssk8boards



ABEC 11

Sizes: 60mm to 97mm
Duros: 75a to 98a



REAR

SKATEBOARDS

Sizes: 60mm to 75mm
Duros: & 77a to 99a



pink

Sizes: 52mm to 72mm
Duros: 78a to 98a



subLIME

Sizes: 52mm to 58mm
Duros: 99a



NEW



Q: How can I get ABEC 11's high performance and anti-flatspotting urethane in a smaller shortboard wheel?

A: The all new subLIME series of wheels is perfect for street, park, vert, and sliding. The profile of the SnotShots maximizes the contact patch for increased traction and control to go along with our unparalleled speed. In stores now.

Q: I have the need for speed and traction but I also want a long lasting wheel that drifts smoothly on demand. Can I have it all in one wheel?

A: The FreeRide is the best all around longboard wheel on the market today. The hub diameter is actually smaller so there's more urethane on our 72mm wheel than on a standard 75mm wheel. FreeRides have

great traction when carving but when push comes to shove, the FreeRide slides and drifts smoothly and predictably. FreeRides are poured in our three most popular durometers using our exclusive Reflex Formula. Start thrashing away on an asphalt jungle today. Available now!

SK8TRIP
DISTRIBUTION



Dealer Inquiries: (877) 4-ABEC11 (877) 422-3211

Email: orders@sk8trip.com | Phone: (714) 969-4141 | Fax: (714) 848-8823

www.sk8trip.com

Lester Kasai

photo: Ray Zimmerman



trackertrucks.com



Landyachtz

778.785.6855 Landyachtz.com

blake
STARTUP

photo nateLANG

7 NEW Shapes

WEDGE FLEX
40" x 10"



CHIEF
40" x 10"



MIMMY
33.25" x 9"



POCKET KNIFE
30.5" x 8"



SNOKE
28.5" x 9.5"



DROP CARVE
42" x 9.5"



SWITCH
42" x 9.5"





NEVER SUMMER INDUSTRIES



eclipse
1111 NS FACTORY BUILT 1111

NEVER SUMMER INDUSTRIES
CHAIRMAN

SOLDIER
NEVER SUMMER IND.

NS FACTORY BUILT, DENVER CO.

info@neversummer.com / www.neversummer.com

303.320.1813



**DRIVING TECHNOLOGY
HANDMADE
LONGBOARDS.**

DADDIES BOARD SHOP

DADDIESBOARDSHOP.COM - 1.888.779.7062



Annie, are you sure
this is how the Olsen twins
got started?



Mike Seinberg, winner of the 2008 Daddies Board Shop "Put Words In Our Mouth Contest" proudly showing off his new Loaded Dervish.



**LOADED DERSHISH
COMPLETE - \$245**

Visit Our Retail Store At:
7126 NE SANDY BLVD PORTLAND OREGON 97213

Photo by: Steve Lombardi - Daddies Board Shop & Skate

BEAR TRUCKS



andrew
CHAPMAN

**GRIZZLY
1052.**

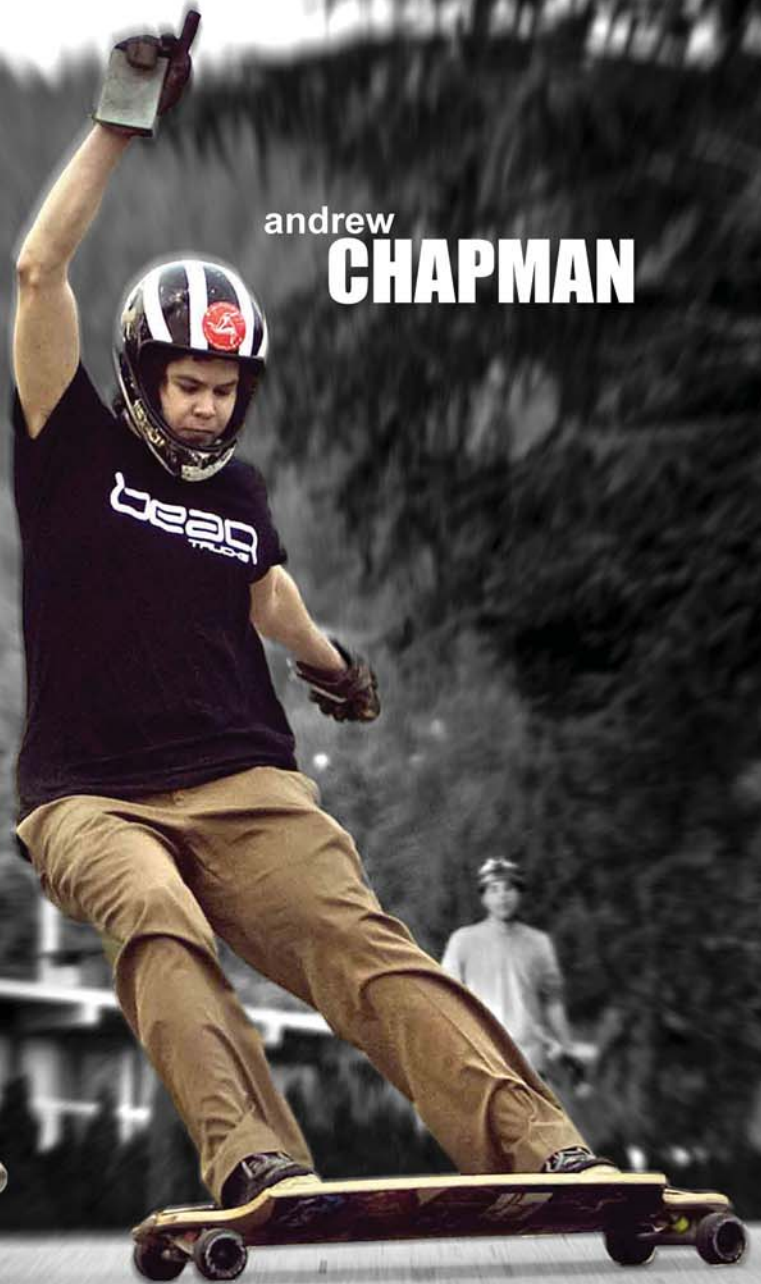

Nate Lang photo

beartrucks.com

778.785.6855

LIVE INVENTORY

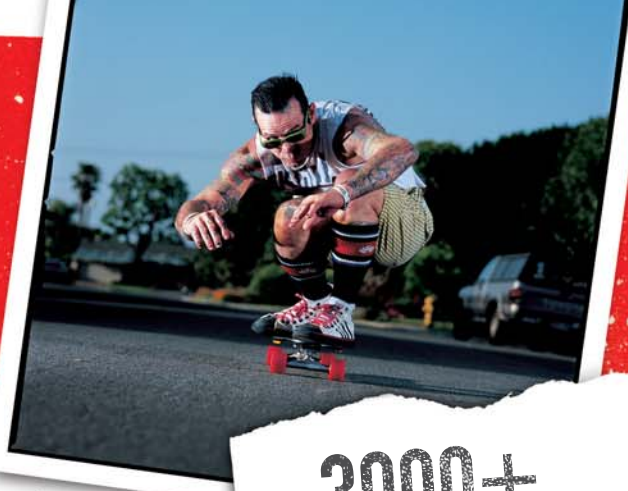
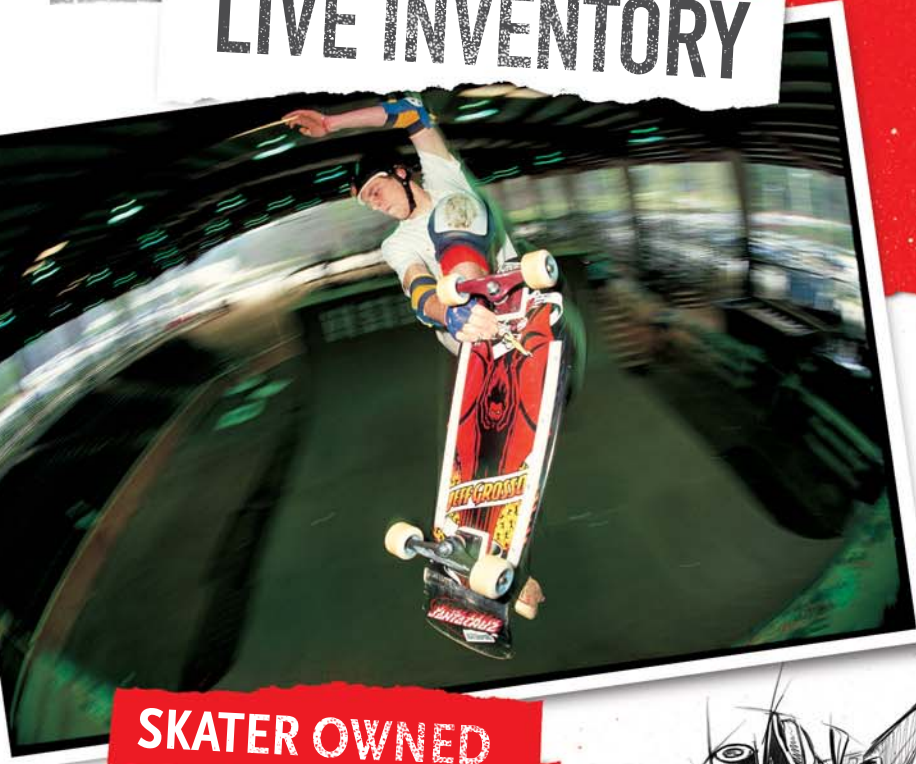

3000+ PRODUCTS

**SKATER OWNED
AND OPERATED**

DANNY MIKI 09
Grindsh 2nd

SO CAL SKATESHOP.COM

Established in 2002 to serve the needs of skateboarders like you!

Please visit SoCal Skateshop and discover the best stocked core online skateshop on the internet! Updated daily with all the newest products and constantly restocked with the products you depend on for your daily skateboarding needs!

949-600-5876

SOCALSKATESHOP.COM

FEATURED BRANDS



- FREE SHIPPING ON ORDERS OVER \$85 (APPLIES TO MAINLAND US CUSTOMERS ONLY)
- FAST EFFICIENT/RELIABLE SHIPPING
- EXCELLENT CUSTOMER SERVICE
- INTERNATIONAL ORDERS WELCOME

Design: Brandon Wong. Photos: J. Grant-Brittain / theskateboardmag.com



bennetttrucks.com

Introducing The APEX

by Original Skateboards 34

Freestyle Longboarding. Evolved.™



Hybrid V-Lam | Bi-Axial Fiberglass | Aspen - Mahogany Core | 34" long x 8.7" wide | 5 pounds, complete.

Have you checked out **Original** lately?

New boards, a new website, and alliances with today's most progressive wheel manufacturers have yielded literally thousands of customizable options that you can use to build your dream longboard, complete, the way you like it. Online. Today.



Add to that Videos (with ride footage) of each and every board we design and Free Shipping on all longboard orders in the United States and Canada and you have a new destination for your next progressive, custom built longboard complete.



We ship to all countries, cheap and quick so international ordering is always easy. Come see the difference an **Original** can make to your riding.



YouTube Subscribers get a Gift Card
Visit us at www.OriginalSkateboards.com or YouTube.com/OriginalSkateboards



Driven to Innovate



TURN

Unparalleled engineering... advanced control and superior rebound with precise steering. Four widths, two geometries (quick and stable), and eight spring strengths to get your comfort zone dialed.

ROLL

Black Ops urethane... the best, bar none. More grip and rebound together, with less rolling resistance, than any other formula ever. Industry-leading core technology for lightweight big wheels with supercharged inside edge rebound.

RIDE

Classic yet progressive shapes for every need: carving, cruising, racing and beyond. Cutting-edge materials and construction. Completes expertly tuned for superb carving performance right off the shelf.

PUBLISHER/EDITOR Michael Brooke • mbrooke@interlog.com
SENIOR EDITOR Blair Watson
ASSOCIATE EDITORS Mike Moore | Buddy Carr
DOWNHILL EDITOR Jon Caftan
DOWNHILL PHOTO EDITOR Jon Huey
QUIVERS EDITOR Dave Hackett
CORRESPONDENTS Jim Kuiack | Mark Kessenich | Kilwag
NORTHERN EUROPE Markus Suchanek
LATIN AMERICA, SPAIN AND PORTUGAL Diana Gracida | Pablo Castro
AUSTRALIA David Pang | William Fonseca | Nick Sable
ART DIRECTOR Mark Tzerelshtein • MarkintoshDesign.com
WEBMASTER Owen Gottschalk
VIDEO EDITORS Brennan Anderson | Stephen Hoff
COPY EDITOR Jonathan Harms
HEAD OFFICE 1054 Center Street Suite 293
Thornhill, Ontario L4J 8E5
Canada ph: 905.738.0804

SKATESHOP DISTRIBUTION Indaba Group
PO Box 1895, Carlsbad, CA 92018
tailtapinfo@yahoo.com

FLORIDA DISTRIBUTION Bob Stack
Paved Wave Promotions
760-229-7336

concretewavemagazine.com

Concrete Wave is published by North of La Jolla Inc.

Subscriptions (5 issues) are US\$26 FIRST CLASS or CAN\$26 (US\$38 outside North America). Address change? Mag not arriving? Email us... don't go postal. We can sort it out. mbrooke@interlog.com. We will notify you when your subscription expires. Publisher's permission is required before reproducing any part of this magazine. The views and opinions expressed in Concrete Wave are not necessarily those of the publisher. We happily accept articles and photos. Please contact the publisher directly at mbrooke@interlog.com before you submit anything. We are looking for a variety of stories and images as long as they are skate related.

OPENING SPREAD: Bud Watt skateboard collection. Photo: TJ Watt.

Printed in Canada
ISSN 1708-3338

Every effort has been made to insure the accuracy of products listed in this guide. However, mistakes can happen. We assume no liability for any errors or omissions.

WELCOME TO THE FINE PRINT: My trusty designer Markintosh tells me I have approximately 380 words to fit in this space — any more than that and I'll jeopardize the size of this very cool opening shot. And what an opener it is! This collection of decks borders on priceless. While there may be many buyers for these skateboards, I can tell you, there are very few sellers.

It's funny to think that 30 years from now, a photo may appear in this guide depicting much the same thing. The only difference is that the skateboards shown will be from this Buyer's Guide. The skateboards will not be pristine — they will have been ridden and each will have a story to tell.

Believe it or not, this is our sixth edition of the Guide. I'd like to think we've come a long way since that snowy day in December 2003 when I came up with the idea of doing something after the January issue while waiting for the snow to melt. This year we've decided to spruce things up a bit. No more staples — it's perfect-bound, just like the regular issue. We've also beefed up the paper stock. This way, you've got a perfect piece of memorabilia that should last at least 30 years.

A lot of times people ask me what is the best way to help Concrete Wave. We've got those folks who take the magazine and move it to the front of the rack at their local Barnes & Noble — a "noble" deed if there ever was one! We also have a number of readers who share their magazine with a friend. Of course, when I mistakenly send out doubles of an issue (as I seem prone to do), some people automatically give the extra copy to a skater in need. Then there are shops that, in an effort to really maximize people's focus on the magazine, leave it in their bathroom. I can think of no better place to absorb the message! But of all the things you can do help Concrete Wave, one stands out above all: If you see something in the magazine that interests you — contact the company and tell them you saw it in CW. It's not a huge task, but it is huge deal!





MADE WITH LOVE



www.loadedboards.com

INTRODUCING

BRENT DUBENDORFF

WELCOME TO THE TEAM DUBES, IT'S ALL DOWNHILL FROM HERE...

PLANTING SEEDS OF OUR OWN.

FOR EVERY SET OF PARIS TRUCKS SOLD, WE
WILL DONATE ONE NICKEL TO THE DUBENDORFF
FOUNDATION FOR STARVING RACERS FOUNDATION.
FOR MORE INFORMATION LOG ON TO
WWW.DUBESFOUNDATION.COM

STOMA
DUBES SPECIAL

 Paris Truck Co

www.paristruckco.com



Artwork by Johnny "Mojo" Munnerlyn.

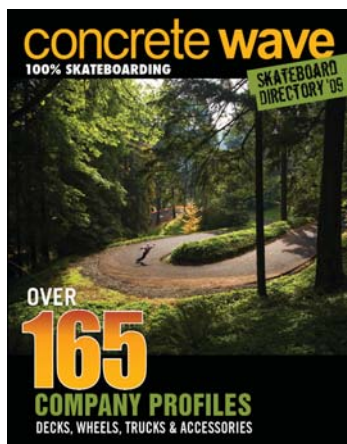

Billy Meiners in Washington Park, Portland, OR. Photo: Jon Huey.



Sergie Ventura, Wellington, New Zealand. Photo: Michael Goetz



Frank Schaffroth at Garden Sk8, New Jersey. Photo: Bryan Karl Lathrop

TIME FOR AN UPGRADE

Welcome to the sixth edition of the Concrete Wave Buyer's Guide. We are proud to publish the most comprehensive listing of skateboard products in the world. You'll note that we've made some changes this year. For one thing, we've decided to upgrade the paper. Yes, it's a little glossier and thicker. Also, we've moved to perfect binding from our traditional staples. We hope that these upgrades give the guide a little more durability and polish. We know many of you refer to the guide on numerous occasions throughout the year. Just be careful you don't drool too much on the guide — the paper, while an upgrade, is not waterproof!

As many of you are aware, 2009 is shaping up to be somewhat of a "trying" year. Since this is a skateboard magazine, I didn't want to discuss the economy. I'll let the experts deal with that. I do, however, want to address a few things from the perspective of what Concrete Wave stands for and where we are going in these turbulent times.

The first thing about Concrete Wave is that we will never waver on our focus of keeping things 100% skateboarding. Our goal is create a truly concentrated magazine that showcases the act of riding a skateboard. We know that the more information we can bring you about new products and new ideas, the more satisfied you'll be as a reader.

Second, we want to continue to expand our coverage of the global skate community. The more we can increase the connections and bonds between skaters worldwide, the more stoked you'll be. We know it's a blast opening up the magazine and identifying folks and companies you know personally.

Third, while 2009 might be a year of retrenching and slowing down for some, we fully intend to push forward. We are working with a number of companies to help spread the word on Concrete Wave. In fact, we are so serious about spreading the word, we even went out and bought a T-shirt press! More on that next issue.

It takes a staggering amount of time and dedication to compile this list of skate companies. I am grateful to my trusty designer Markintosh, who works tirelessly to bring it all together. Jonathan Harms is also taking his eagle eye to the copy this year. I also want to thank all those who help distribute the guide. Without their efforts, we wouldn't reach the 250,000 folks who read the guide annually. A huge thanks to all our advertisers who support Concrete Wave. Readers, be sure to contact these companies and tell them you saw them in CW. Last, but certainly not least, I want to thank you, our loyal readers, who have helped make Concrete Wave flourish.

Enjoy the Guide!

Michael Brooke, Publisher

LANCE MOUNTAIN LADDER JUMP



bonesbearings.com • 30 S. La Patera Lane, Santa Barbara, CA 93117 • 805-964-1330



BURNETT



STOKED SKATEBOARDS

Here is what some of our customers had to say about us:

"Awesome site, great customer service, friendly and knowledgeable. The best longboard shop." — Jolie from Redondo Beach, California

"Everything was excellent. I got the best priced board... got FREE shipping... and I bought my board in just a couple minutes. Their customer service is excellent. ...contacting them is easy and fast, as I received a response in less than a day."

—Stoked Customer Review

"If you are living outside the USA and need to get great longboard equipment delivered to you, look no further than Stoked Skateboards. I bought a complete setup from them and it was the easiest thing I ever did."

— Fazrul from Singapore

"Fastest free shipping ever!!" — Woody from Camarillo, CA

"This is easily the best skateboard/longboard website I have ever ordered from. I will never order anywhere else after this encounter. Thanks again." — Wyatt from Gloucester, MA

"I love stokedskateboards.com. You guys already have some cred in my neighborhood! Who would have thought an e-commerce company could be full of so much love?" — Michael from Mundelein, IL



Concrete Wave readers get 3% off any purchase with coupon code **stoked4stoked**

STOKEDSKATEBOARDS.COM



Leave Road Burn on the Road.



Designed for the extreme skateboarder or in-line skater to carve and slide down the roads.

Slider Gloves

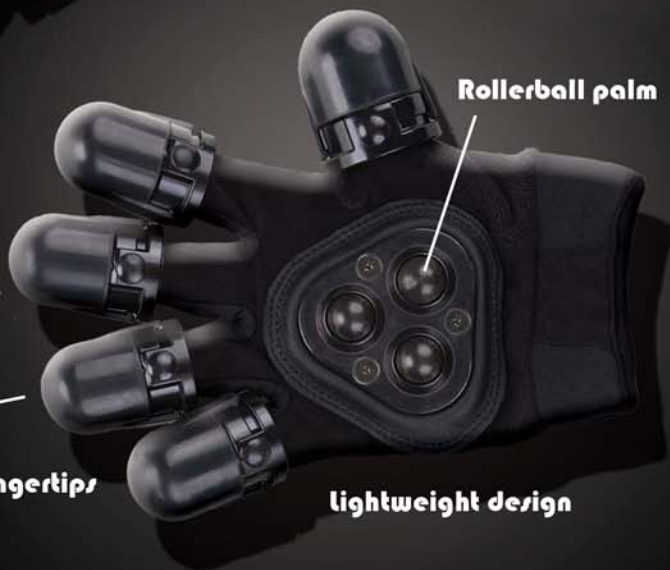

Durable, plastic interchangeable fingertips

Rollerball palm

lightweight design



Get your pair in time for summer at www.bosscointernational.com.
Enter promo code: **CONCRETEWAYE** for **FREE** shipping.



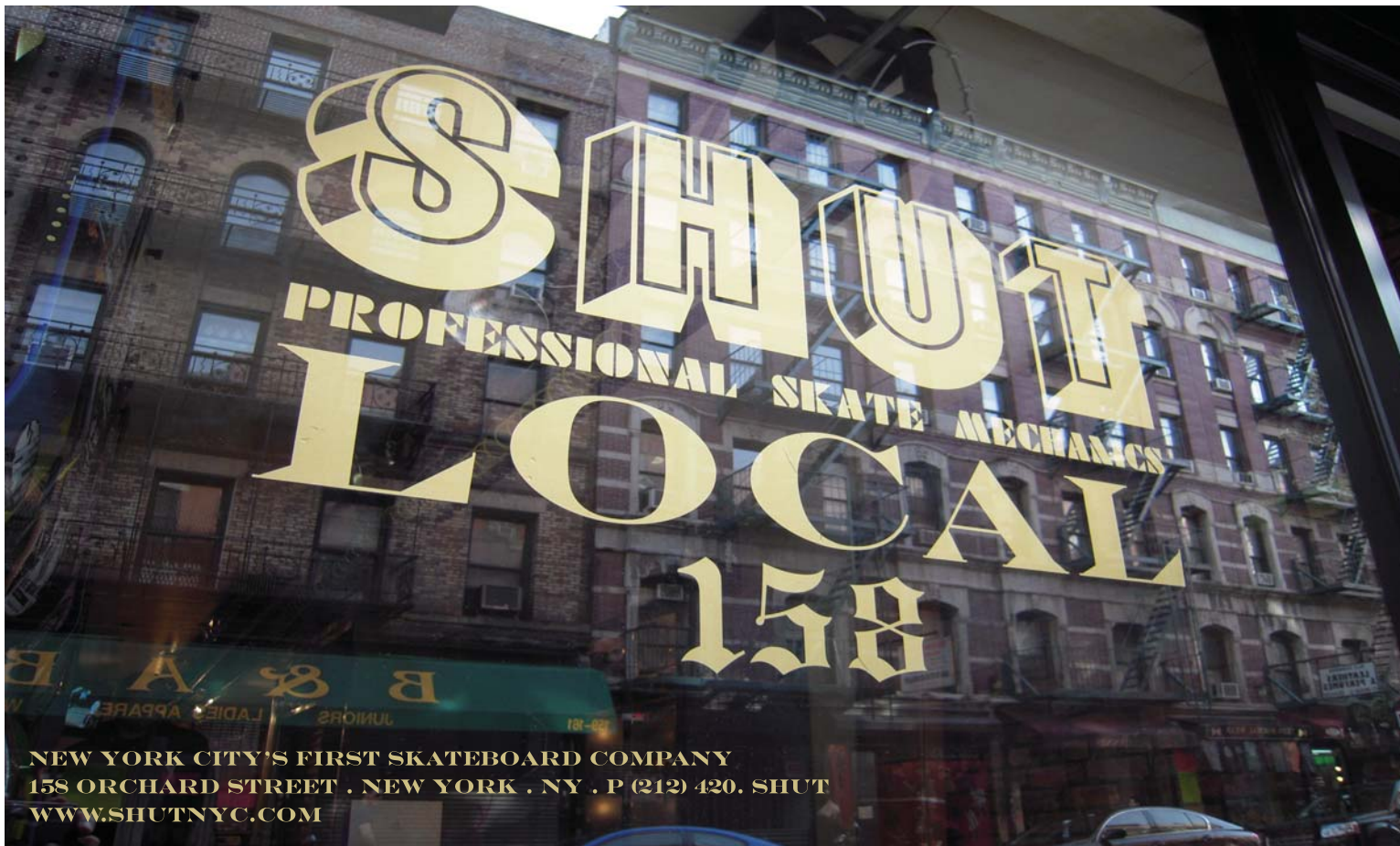

NEW YORK CITY'S FIRST SKATEBOARD COMPANY
158 ORCHARD STREET . NEW YORK . NY . P (212) 420. SHUT
WWW.SHUTNYC.COM

SKATEBOARD SHOPS LIST

Want to know where to find Concrete Wave Magazine? Would you like to find all the amazing skate gear you see in these pages? Look no further than our shop list. If you'd like to have your shop listed here, it's easy. **Simply send a check for \$115 to Indaba Group PO Box 1895 Carlsbad California 92018 or pay pal tailtapinfo@yahoo.com, ph: 760-722-4111.** You'll get 10 copies of 5 issues mailed out along with this complete listing. For international rates, please email us. Yes, shipping is included. If you think your local shop or park should be carrying Concrete Wave, email mbrooke@interlog.com.

ARIZONA

Sidewalk Surfer
2602 N. Scottsdale Road Scottsdale 480.994.1017
admin@sidewalksurfer.com • www.sidewalksurfer.com

CALIFORNIA
Board Gallery 3333 Newport Boulevard Newport Beach 714.902.3769
Cellular Skate 6787 Carnelian Street Alta Loma 909.941.1004
Mike McGills Skate Shop
335 First Street Suite #5 Encinitas 760.943.7730
Mike's Bike Shop
5507 West Pico Blvd. Los Angeles 323.935.4338
Viva Skateboards 1709 Howard Road Madera 559.664.8997
Bill's Wheels Skateshop
1240 Soquel Avenue Santa Cruz 831.469.0904
Purple Skunk Purpleskunk.com
5820 Geary Blvd. San Francisco 415.668.7905
Skate Supply
1135 Garnet Avenue #13 San Diego 866.310.2654
CCMF/Toyland 1260 Palm Street San Luis Obispo, CA 93401 805-801-6653 ccmfjay@yahoo.com
The Trading Post 622 Upham Street San Luis Obispo 805.801.6653 ccmfjay@yahoo.com
Random X Boardshop
13222 Springdale St., Westminster 714.898.7070
Sonoma Old School Skate and Surf
1001 Broadway Sonoma 707.938.5500 skatesos.com
Cellular Skate 287 Mountain Ave Upland Tel: 909.981.8856 cellskate@verizon.net

COLORADO
All Board Sports 1750 30th Street Boulder 303.415.1600
Board Lords Foothills Mall 215 East Foothills Parkway Suite (H-4) Fort Collins 970.225.1109

CONNECTICUT
Skate Pusher 57 McIntosh Drive Bristol 860.593.4550
Skate Valencia 68 Leonard Street, Bristol 203.524.4675

GEORGIA
Feral 190 Park Avenue, Athens 706.369.1084
Skate Madness 1344 Stonefield court, Alpharetta 770.777.0336 skatemadness.com
Woody's Halfpipe
6135 Peachtree Parkway Suite # 603 Norcross

LOUISIANA
Board Lords Mall of Louisiana, 6401 Bluebonnet Blvd. Suite # 2044, Baton Rouge, 225.769.1222

MASSACHUSETTS
Boardroom 6 Armory Street Northampton 413.586.8857
MICHIGAN
Ollies Skate Shop 120 1/2 E Maumee Adrian 517.265.2031

MINNESOTA

Old School Skaters 1119 NW 2nd Street Faribault 612.578.3326 www.oldschoolskaters.net

MISSOURI
Genesis Skateboarding 13 NW Barry Rd. #147 Kansas City 816.456.1307 genesisskateboarding.com

MONTANA
Wheatons
214 1st Avenue West Kalispell 406.257.5808 wheatonscycle.com
BlackTop Surfshop 176 5th Avenue West North Kalispell 406-752-6006

NEBRASKA
Vinny's Skatepark 1112 Applewood Dr. Papillion 402.339.3399

NEW JERSEY
Black Diamond Skatepark 400 Route 38 Unit 1610 Moorestown

NEW MEXICO
Koa Nalu Surf Shop 8254 Menaul Blvd NE Albuquerque 505-332-SURF koanalulu.com
Timeship Raicing 825 Early Street Suite H Sante Fe 505.474.0074 timeshipracing.com

NORTH CAROLINA
Soul Ride Skatepark 6049 Victory Lane Concord 704.454.7433 soulrideskates.com
We're Board Inc Skatepark and Shop 1423 North Church Street, Ste 104 Burlington NC 27217

OHIO
Old Skool Skateboards
19E College Avenue, Westerville roxtar55@hotmail.com

OREGON
The Uprise 1110 NW Van Buren Ave, Corvallis 541.754.4257 541.480.4254 thelongboardstore.com
The Longboard Store 1238 SW Wheeler Place Bend 541.480.4254 thelongboardstore.com
Cascadia Longboards 3366 West 17th Street Eugene 541.729.7392

RHODE ISLAND
Daddies Board Shop
7126 NE Sandy Blvd., Portland 503.281.5123 daddiesboardshop.com
The Mountain Shop 628 NE Broadway Portland
Rebel Skates 1025 SE Sandy Blvd. Portland 503.232.0434
Oregon Skate 38962 Proctor Boulevard Sandy 503.826.8427

TENNESSEE
Seven.Ply 3 Canal Street Westerly 401.348.0656

TENNESSEE
Planet Sk8 7024 East Church Street Suite 2 Brentwood 615.377.1947
Sk8stations Skate Shop 3032 N.John B.Dennis Hwy. Kingsport 423.245.0994 tbec@charter.net

VIRGINIA
EastCoast Boardco. 10358 Fairfax Blvd. Fairfax 703.352.4600 x:8 213 25th Street Va Beach

Black Cat Skateshop

1325 A West Main Street, Charlottesville 434.244.0014

WASHINGTON
Gravity Sports 126 Rainier Ave South Renton 425.255.1874
Mountain Goat Outfitters 12 W. Sprague Avenue Spokane

ALBERTA
Avenue Skateparks
9030.118 Avenue NW Edmonton 780.477.2149
Easy Rider 4211.106 St., #153 Edmonton 780.413.4554
Pipeline Surf Co 10336 111 Street NW Edmonton 780.421.1575
Comasports 10B-200 Barclay Parade SW 403-233-8841 powerinmotion.ca

BRITISH COLUMBIA
Area 51 191 Station Street Duncan 250.746.8869 a51.ca
Raven Skate Shop 411 Campbell Street Tofino 250.725.1280 ravenskateshop.ca
Salton Rides Salt Spring Island, BC 250.537.4984 salttonskate@canada.com

Switchback Longboards 4385B Boban Dr. Nanaimo 250.751.7625

ONTARIO
Orbit 406 Cumberland St., Cornwall, 613.932.9754
Hammer Skate Shop 2225 Queen Street East Toronto, 416.698.0005
Hogtown 401 King Street West, Toronto 416.598.4192
McPhails 98 King Street North, Waterloo 519.886.4340

QUEBEC
DLX/Deluxe 2480, chemin Ste.Foy Ste.Foy 418.653.0783 dlxdeluxe.com

OVERSEAS
New Zealand — Serenity Island Surf & Skate Cafe
202a Wainui road Gisborne serenityisland.com serenityisland.com

Boardshop Australia
boardshop.com.au 04 15883371 friendlyfolks@boardshop.com.au

CreBive Sk8 5/244 Ross river Road Aitkenvale Queensland 4814 Australia

UK — Octanesport.com
skateboardschoice.co.uk
Bath, United Kingdom. Tel: + 44 1249 715811
Germany — seasondistribution.com, concretewave.de
Hackbrett Longskates Im Wechselfeld 12 St. Peter Hack@customlongskates.com
Longboarders.de Gustavstrasse 49 90762 Furth longboarders.de.kontakt@longboarders.de
Tel: 0911 9772500
France : Hawaiiisurf.com
Clover Skateboard shop

1-21-3-1201 Befu Jyounan Fukuoka 8140104 Japan
Y & T Fussa Fussa
2348 Fussa Fussa.City,Tokyo 1970011
Skate of the Nation
Unit 6 GYY building # 1 Tomas Morato 1100 Quezon City, Metro Manila, Philippines www.skateofthenation.com
Netherlands — Sickboards
Fuutlan 45 Delft sickboards@yahoo.com
Soul dh Alameda Picallores 245 San Borja Lima 41 Peru
Indiana Sports GmbH Elbstrasse 14 Wald, 8636 Switzerland Contact: Christof Peller
Clover Skateboard Shop 1-21-3-1201 Befu Jyounan Fukuoka 8140104 Japan
Skate of the Nation Unit 6 GYY building # 1 Tomas Morato, 1100 Quezon City Metro Manila, Philippines; www.skateofthenation.com

ON.LINE RETAILERS

Allboardsports.com
Blackholeboards.com
Bordz.net
CascadiaLongboards.com
Coldwarskateboards.com
Daddiesboardshop.com
Denverskateshop.com
Edsbearings.com (pleasure tools)
Fuegolongboards.com
Genessiskateboarding.com
Longboardskater.com
Latterdayskates.com
Longboardshop.de
Longboardstore.com
Longboardskater.com
Milehighskates.com
Oldschoolskates.net
Pressuredropplongboards.com
Roadkillskates.com
Sk8supply.com
Socalskateshop.com
Solidskate.com
TACTISSK8.COM
Tailtap.com
VSLboardshop.com

CANADA'S LONGBOARD SOURCE



AND MANY MORE
SINCE 1985

S&J

Sales Co. Ltd.

www.goskateboarding.ca

Toll Free: 800.267.6950

Hamboards™

Surf City • Huntington Beach • California



Photo: Kevin Mantei

We're the Hamborgs and we make the **BIGGEST SKATEBOARD** on the planet. We all want you to know that we just don't make Hamboards for their **SIZE**; we make them because how much **FUN** they are to ride!

But don't take our word for it — here's what other people are saying:

"... one of the most responsive and addictive skateboards ever produced"
— *Concrete Wave Magazine, Winter 2008*

"... mimics the feel of a surfboard on the water"
— *The Los Angeles Times, January 12th 2009*

"the board is amazing, it is hard to keep my feet off it!"
— *Matt Hendry, Beverly, New Jersey*

And..

"my husband, a violin maker for 30 years, is impressed with the craftsmanship of my Hamboard"
— *Melanie Lake*

HAMBOARDS.COM
714.726.4407



WWW.GROMBIZ.COM



The New Grom Biz Special Ops



adjust.

koastal
surf to street

Collin O'Rourke

koastalboards.com

RAHSTA



madrid skateboards
 CLASSIC - PERFORMANCE - DOWNHILL
 WWW.MADRIDSKATEBOARDS.COM

Axe Ultimate Series

Spring 2009 Racing Decks

Sk8Kings Raising the Bar Once Again

WWW.SK8KINGS.COM
 PO BOX 20354 FOUNTAIN VALLEY CA 92728 (USA) - (714) 636-7308 - MYSAPCE.COM/SK8KINGS

Octane Sport

(rear truck shown)

VIRAGE

WWW.VIRAGETRUCKS.COM
WWW.OCTANESPORT.COM

SKATEBOARD RACING IS IN OUR BLOOD

INTRODUCING OUR **NEW ATTILA CUSTOM DESIGNED FLAT COMPOSITE DECKS.**
BLITZ 32", 33.5", 36"

NEW IN 2009 - VAN DEMON PRECISION RACE TRUCKS

WWW.HOPKIN.COM.AU **hopkin RACING**

Canada's Longboard Source
Free Shipping in Canada!!

PIPELINE SURF

WWW.PIPELINESURF.CA
1-888-470-5990 INFO@PIPELINESURF.CA

Photo by P. Blakeman - Pipeline Surf Team Rider Zach Kipp at Newton's Playground some conditions apply

≡≡≡

American Sideshow

MODERN RETRO SKATE DESIGNS BY JOHNNY MOJO
Available through Defender Distribution 408-626-7600
www.defender-dist.com www.american-sideshow.com



Shock Treatment
for the Longboard Industry

1-888-9ASYLUM
WWW.IABOARDS.COM

THRUSTER
EARTHWING



Amane Kishida
photo: NOB
courtesy of Funwaves
place: Nogawa bank, Japan

EARTHWINGSKATEBOARDS.COM

Roarokit DIY Kits

- Complete Deck Laminating Kits
- ProBuilder Kits
- Canadian Maple Veneer
- Thin Air Press™ Vacuum Laminating Technology
- Online DIY Tutorials
- School Curriculums
- Worldwide Shipping



ROAROKIT *Pinch*
SKATEBOARD COMPANY.

www.ROAROKIT.com



PINCH Deck by Ted Hunter



The 187 Inc. is dedicated to quality and comfort. We have never stopped improving our product. Our pads are made with the best materials for the best fit and are double stitched for durability. They were designed by people that skate and understand what skaters need. Our Pro Knee pads feature Pro Core impact absorption technology and dual density interior foam. The elbow and fly knee pads have recessed grommets to decrease wear. We also offer two types of re-caps kits to fit almost any pad. The 187 pads work for everything from your hometown park to the mega-ramp. We recently launched an all new website with updated team information, helpful sizing charts, and so much more. the187.com. killerpads@cox.net or call 760-722-1455.



Pro Knee
Small-XLarge



Fly Knee
Medium-XLarge



Fly Knee
XS-Small



Elbow pads
Medium-XLarge



3dm is a legacy wheel brand under the management of Seismic Skate Systems, Inc. Born under the Turner brand, the line of three classic slalom shapes was renamed 3dm in 2003. Seismic assumed control of the line in 2004. For several years the 3dm Cambria, Avalon and Avila shapes utterly dominated international slalom racing. They're still used by elite racers around the world, as well as by cruisers and carvers of every stripe. Seismic continues to pour these three wheels, using the world's finest grip-oriented urethane. However, all new Seismic products are developed under the Seismic brand. The classic 3dm shapes helped inspire the development of the Seismic Hot Spot, Speed Vent and Blast Wave wheels. seismicskate.com



Avalon
68mm x 55mm 77/80/84A



Avalon
68mm x 55mm/73A



Avila
75mm x 65mm/73A



Cambria
62mm x 45mm 80/80/80/84A



ABEC 11 is The Real Wheel. Designed for skateboarding by World Champion Skateboarder Chris Chaput. The wider contact patch provides superior traction at high speed. A variety of sizes and durometers precisely match every skating discipline. Use the softer (72a to 88a) wheels for rougher, porous surfaces like asphalt and the harder (92a to 98a) wheels for smooth and polished surfaces like concrete. Whether carving, cruising, tearing up the parks, pools and pipes or racing downhill, streetluge or slalom, our high-performance urethane will keep you in the game. Abec11.com



Abec11 60mm NØ SkoolZ
75a/78a/81a/88a/92a/94a/96a/98a



Abec11 65mm NØ SkoolZ
75a/78a/81a/88a/92a/94a/96a



Abec11 76mm Gumballs
75a/78a/81a/84a/88a



Abec11 66mm Strikers
75a/78a/81a/84a/88a



Abec11 77mm Strikers
75a/78a/81a/84a/88a



Abec11 70mm Grippins
75a/78a/81a/84a/88a/92a



Abec11 70mm 70's Flashback
75a/78a/81a/84a/88a/92a



Abec11 76mm Flywheels
75a/78a/81a



Abec11 83mm Flywheels
75a/78a/81a



Abec11 90mm Flywheels
75a/78a/81a



Abec11 97mm Flywheels
75a/78a/81a



Biltin
Bearings

AIRFLOW SKATEBOARDS

Airflow Skateboards have been on the streets since 1989. They are well established and produce high-quality boards and axis whilst continuously expanding their assortment. Thanks to the successful Airflow Racing team all newly developed equipment is tested in practice, which enables continuous improvement. In addition to the standard boards, Airflow Skateboards and their team racers develop pro models, which are customized to the racers' requirements. Airflow Skateboards also developed the "C81" board with a foam core for Chris Hart (founder of Airflow Skateboards and team coach) — a board used especially for Giant Slalom. Airflow Skateboards stand for newest technology and old-school skating — for fun and performance, competition and easy cruising — always with enthusiasm. Feel the flow! airflow-skateboards.com



Airflow Wheels



Airflow Offset Truck
110mm



Speedwing
42"



Speedwing
39"



Foxy Pro Model
28"

ALTERED electric skateboards

Altered Electric Skateboards by Exkate takes their 2009 product line to the next level. The new lineup features patented 2G digital wireless controllers, Dwindle epoxy decks and more models to suit all your riding needs! These boards will go up to 20 miles per hour and can even carve up hills. They take four hours to charge and the range is around 10 miles. Watch for a collaboration with both ABEC 11 and Hamboards. Also note: Chris Chaput is busy working on a new 107mm Flywheel. He's determined to make the best electric skateboard wheel on earth! alteredusa.com



M6 800



Wombat 250



Wireless controller



Pro-Line 600



The Drop 600



Alligator Wheels were first introduced by Mr. Bennett in 1977 and at the time were the most sought after new product in the history of skateboarding. Today's Alligator Wheels feature high performance "Total Memory Formula" urethane and have an offset bearing seat, precision core and a rounded outer lip for maximum grip. Designed for park skating, slalom, downhill speed and longboard cruising, Alligator Wheels are available in Clear Green 78a, Orange 79a, Blue 80a, Red 81a and Yellow 84a and in 62mm + 71mm sizes. bennetttruks.com



Orange - 62mm & 71mm/79a



Clear Green - 62mm & 71mm/78a



Blue - 62mm & 71mm/80a



Red - 62mm & 71mm/81a



Yellow
62mm & 71mm/84a

American Sideshow

From the mind of skate artist Johnny Mojo comes American Sideshow — modern retro skate designs for the 21st century. If you're looking for an alternative to the endless parade of mass-produced decks out there, then you've come to the right place. All American Sideshow decks are limited editions and hand screened — not a heat transfer! Each board is laser numbered and hand signed by Johnny Mojo. Check out the Reaper pool & park deck and the Shield street cruiser — both out now. These boards offer no compromises, just quality that speaks for itself. Proudly made in the U.S.A. american-sideshow.com



Reaper



Shield

ARBOR

THE ARBOR COLLECTIVE

Creating performance and design innovation since 1995 through a functional use of environmentally friendly materials, collaborations with the art community, and an unadulterated love for riding. Developing skateboards around certain truths... Time spent skating provides a direct understanding of what's at stake. Protecting the planet is not about some place on TV, it's about the environments we utilize everyday. We need clean air to skate, clean water to surf, and snow to ride. You can't just be green for the sake of being green. Customers expect quality, performance, and relevance, even when choosing a sustainable alternative. Draw on the collective. All the skates in Arbor's 2009 line are collaborations with artist we admire.



OSO

L: 30.00", W: 10.00",
WB: 16.00" S: Concave,
Squared-off Kick Tail
C: Stringer Pattern Deck
with 7-Plys Hardrock
Maple, and Clear Re-Grip.
WH: S9 61mm-82a
T: Indy Stage-9

ARTIST- Rex Holloway



SLATER KOA

L: 37.00", W: 8.75",
WB: 26.3" S: Concave,
Swallowtail C: Hawaiian
Koa Deck with 7-Plys
of Hardrock Maple and
Clear Re-Grip.
WH: Arbor 65mm-78a
T: GW Charger 9"

ARTIST- Jake Pickle



MINDSTATE KOA

L: 38.00", W: 8.75",
WB: 26.25" S: Cambered,
Concave Pintail C: Hawai-
ian Koa Deck with 4-Plys
of Fiberglass-Reinforced
Hardrock Maple. Finished
with Clear Re-Grip.
WH: Arbor 65mm-78a
T: GW Charger 9"

ARTIST- Blaine Fontana



BLUNT KOA

L: 44.00", W: 9.50",
WB: 23.75" S: Concave,
Rounded Kick Tail/Nose
C: Hawaiian Koa Deck
with 7-Plys of Hardrock
Maple and Clear Re-Grip.
WH: Arbor 70mm-78a
T: GW Charger 10"

ARTIST- Dave Kinsey



PIN KOA

L: 46.00", W: 9.50",
WB: 32.25" S: Concave
Pintail C: Hawaiian
Koa Deck with 7-Plys
of Hardrock Maple and
Clear Re-Grip.
WH: Arbor 70mm-78a
T: GW Charger 9"

ARTIST- Blaine Fontana



CROSS STEP

L: 46.00", W: 10.00",
WB: 33.25" S: Rockered
C: Hand-Made Stringer
Pattern Deck with 6-Plys
of Hardrock Maple. Finished
with Clear Re-Grip.
WH: Arbor 70mm-78a
T: Revenge Alpha 2

ARTIST- Rick Rietveld

ARBORCOLLECTIVE.COM



Armada Skateboards was established in 2004 by Al Garcia and Armando Barajas. The brand's mantra is "Going Against The Grain". Its pro Team is comprised of seasoned vets: Jim Bates 2005 (Es Game of Skate winner), Al Garcia 2008 (Freestyle Hall of Fame), Dylan Gardner (Switch Stance innovator) and Armando Barajas (Legendary "Nollie" King). Our AM Team consists of 10 year old vert prodigy Dakota White and street rippers: Jose Medina and Seth Castro. Armada decks are made with 100% Prime Wood USA. armadaskateboards.com



Armando Barajas
7.62" x 31"



Jim Bates
7.5" x 31"



Al Garcia
7.5" x 31"



Dylan Gardner
7.5" x 31"



Ashland Skateboards has been dedicated to progressive skateboarding from the beginning. We are known for quality hand built skateboards from Huntington Beach and solid customer service. Our American-made skateboard collection includes boards for cruising, carving, ramps and pools. Ashland Skateboards focuses on maintaining a grass roots connection with board riding and invites you to experience the beauty of riding an Ashland. We test our boards along California's coast for you to enjoy anywhere you ride. Visit us at AshlandSkateboards.com and become a believer.



Combi
30"



Mini Carver
32"



Carver
39"



Strand Cruiser
48"

BADLANDS

In 1975 Royce and Tay Hunt produced the legendary Pool Tool

skateboard, a solid oak beveled board with a wedge tail. The history of the original Badlands skateboards is available at badlandsskateboards.com. Two new models, the Pro Hog and the Shredder, are now available at tayhuntskateboards.com. The Pro Hog is a similar shape as the original 1978 deck, with current state-of-the-art technology. The Shredder shape includes the original 1977 Shredder tail design with added, unique front canards, giving better foot surface stability for nose slides and excellent grips for air. It has met with rave reviews by skaters who have seen it. Both decks are 7-ply Canadian maple with several thinner internal layers creating a light, strong deck with excellent stability — the ultimate concave, double-kick decks for street and park riding. Tay Hunt Skateboards also features T-shirts, collectible 1978 Badlands skateboard posters as well as stickers and accessories. tayhuntskateboards@gmail.com



BAHNE SKATEBOARDS

Bahne Skateboards has been producing quality skateboards and wheels since 1974. We are proud to offer you our new line of decks. Designed for park skating, slalom, downhill speed and longboard cruising, all of our decks are made in Southern California. Bahne completes are fitted with the best components available: Bahne wheels, Bennett or Tracker trucks, Abec 7 or Swiss bearings, premium hardware and custom die-cut grip tape. Come join us doing what we have been enjoying for over 35 years. Bomb a Bahne! bahneskateboards.com



Bullet
27"

Black Hill
8.75" x 29.25"

Banshee
9.45" x 38.5"

Tikki
9" x 42"

BEAR TRUCKS

Bear knows that precision matters and every detail counts. Bear trucks are designed and tested by some of the world's top longboarders, and made using state of the art technology. There's a reason that Bear products fly off the shelves and past the finish lines at the speed that they do. This year brings a few new additions to the solid line up along with a few visual modifications for that nice finishing touch. Check out Beartrucks.com or Call 778-785-6855.



Black Smokies
40 Degrees 10mm x 174mm or 190mm



Brown Bear
Specs and info coming soon



Silver Smokies
40 Degrees 10mm x 174mm or 190mm



Red Smokies
40 Degrees 10mm x 174mm or 190mm



Grizzly 1040
40 degrees 10mm x 183mm



Grizzly 1052
52 degrees 10mm x 183mm



Black Grizzly 852
52 degrees 8mm x 181mm



Silver Grizzly 852
52 degrees 8mm x 181mm



Said it before and we'll say it again, Beer + Skateboards = Fun. Really, it's OK, the sooner you come to grips with that the better we'll all be. So what we have here is "Thee Keggnaut". This thing was specifically designed for moving not just your fat ass but a keg. A keg? Yep! And next time some old fart tries to tell you how they grew up with an old apple box and 2 x 4 you can laugh straight in their face,

whip out your Keggnaut and offer'em a nice cold beer. From the party to the park this IS THEE KEG MOVER; others may try and claim their boards will help you DO something better, but who will actually help you MOVE something better? The One.The Only. Thee Keggnaut. Voted BEST NEW DECK SHAPE AT ASR JANUARY 2009 BY CONCRETE WAVE MAGAZINE. Best new deck shape at ASR January 2009 by Concrete Wave Magazine. Beerrunskateboards.com



Key to the city Circle star Beer Run Keggernaut



We are a French based company. Our Boards are all hand made by us using only high quality products with visible carbon fiber on the bottom of almost each board. We now have 29 models and 25 different prints to choose from and the most unique shapes on the market! If you're looking for a board that makes the difference in looks and in quality contact us. We speak english! visit us at blackcross.fr.



Mad Evil 9.5" x 47" WB: 32/34"	Mad Pintail 102 9" x 40" WB: 29/31"	Tribal 9.5" x 39" WB: 25/27"	Flea 9.5" x 9" WB: 22"	Poket 6" x 20" WB: 13"
---	--	---	-------------------------------------	-------------------------------------



Established in 1975, Bennett Trucks were the first trucks made specifically for a skateboard. Invented and designed by the iconic Mr. Bennett, the Bennett Pro and Vector models were

the choice of most amateur and professional skateboarders throughout the late 1970's. Today's Bennett Vector Trucks have been improved with high performance urethane bushings, an inverted kingpin and are poured with pure missile grade aluminum. Designed for hard carving and quick turns, Bennett Vectors continue to be on the cutting edge of performance for minis, slalom, long distance pumping and longboard carving. Available in Silver and Black and in 4.3, 5.0 and 6.0 inch hanger widths. bennetttrucks.com



Bennett Vector
Black and Silver — 4.3/5.0/6.0"



BOARDPUSHER.COM BoardPusher Skateboards specializes in custom-printed decks. Put any graphic, text, or photo on a variety of 7-ply Canadian maple skateboard decks. BoardPusher.com hosts an easy-to-use online design tool where you can toss together any graphic and order it right on the site, with no minimums. Longboards, cruisers and popsicle shapes are all available. BoardPusher also provides limited-series art decks to retailers and online customers through a catalog of user-created shops and designs. For more info on BoardPusher Skateboards, visit boardpusher.com or call (888) 615-8704. Skate your own design!





Boardshop Australia is stoked to announce their first product offering. Introducing Boardshop Ceramic Bearings. Our ceramics are designed specifically for skateboarding. They feature silicon nitride ceramic balls — 100%. A chrome steel race and nylon ball cage — high speed and removable. No-contact rubber shields — also removable. Pre-lubricated with our “special sauce” lube. Plus with an MSRP of 105 AUD, they are a considerably better value than comparable bearings from the usual suspects. Pick up a set of Boardshop Ceramics and find out why they are being used by the best downhill skateboard racers in the world. Visit us today at boardshop.com.au.



Ceramic Bearings



BONES WHEELS success begins with over 25 years of experience and dedication. Producing the highest quality urethanes available for the contemporary market and a continued determination to improve technologies, BONES WHEELS generates valid innovations for real skateboarders. Extend that commitment into our diverse line of specific formulations, Street Tech Formula (STF), and Skatepark Formula (SPF). The results are undeniable and impressive. Blended together with an attitude of quality and no compromise you have your equation for long-term customer loyalty, respect and originality. Spread the word and enjoy the reward. BONES WHEELS out perform and out last ALL OTHER BRANDS. boneswheels.com



Skatepark Formula
Buckshot: 53, 54, 55, 56, 58, 60, 62mm/84B



Skatepark Formula Pro
Chris Miller: 58, 60mm/84B



Skatepark Formula Slim
Victory: 54, 56, 58, 60mm/84B



Skatepark Formula Pro
Ben Schroeder: 60mm/84B



Bones Bearings — the standard by which all other bearings are measured. Bones Bearings have the best reputation in the skateboard industry and have had this honor for the past 26 years because of their performance and quality. Everyone who rides Bones knows how fast they are, and most also comment on how long they last — typically several times as long as low-cost bearings. Skaters who use Bones Bearings do so because they want the very best equipment they can get, and they know the difference between ordinary and exceptional. bonesbearings.com



Speed Cream



Bearing Cleaner



Original Bones Swiss
8-pack



Bones REDS
8-pack



Although a fairly new company, some of the original team riders have skated together since the late '80s and early '90s. We have always been a crew-driven operation, so to start we built our local team riders a new ramp: Then we were off to make shirts for all Canadian and international team riders. We now have four boards to choose from, and “bro models” to be released as needed. We have always believed in making boards and product that all skaters can afford; and pride ourselves in keeping skateboarding raw and true. Check out new product as it comes out at myspace.com/oldshred.



Street Dart
8" x 28"



Street Soldier
8" x 31.5"



Park Rat
9" x 32"



Big Rat
10" x 32"

Buddy Carr Skateboards

At Buddy Carr Skateboards the focus has always been on innovation. Be it in design, construction or graphic treatments you can always expect the unexpected. Buddy Carr's philosophy is to create products that push the boundaries in construction, shape and appearance. Partnered with artists and designers from the USA and the European community our products are forward thinking, innovative and available worldwide at better board shops and boutiques. Tailtap.com



Hello
10.5" x 39.5"
WB: 32.5"



Grip Stik Model
9.375" x 31.5"
WB: 15"

CBCBC

At the California Bonzing Company, we are inspired by the intense elation of clearing stairs or mashing hills - the buoyant feeling of skateboarding that we call Bonzing. We design and ride boards made with the best quality wood and constructed to the California Bonzing Co.'s standards of perfection. "Stijl" is the CBC's premiere skateboard: 34 inches long by 8 1/2 wide and made to fly, it drifts perfectly on 180 trucks. Designed to be an all-mountain board that is still light enough to carry around. The unique convex design is responsive and flexible, resulting in a comfortable and pure experience even at gonzo downhill speeds. Bonz or die! What's your style? Enjoy the ride...CaliforniaBonzing.com



BUSTIN
BOARDS CO. NY

Bustin Boards was founded in 2001 by a group of friends who felt there was a creative void in the longboard market. Through seven years of research and development, the Bustin crew has created five ultra-refined models: Complex, Cigar, Strike, Sojourn, and Spliff. Along with their progressively-designed shapes, Bustin is known for its one-of-a-kind custom printing process. Online, the customer is offered a unique opportunity to create a stylistically individualized board, with thousands of graphic and color choices. Bustin also recently launched its Market Place, which includes a colossal array of options for trucks, wheels, and accessories, offering the best components from across the industry. For a completely custom configuration, you can even email their team manager for a setup recommendation based on your riding style and preferred discipline. www.bustinboards.com



Cigar 7.75 x 38"
Complex 8.25" x 41"
Strike 8.75" x 37.5"
Sojourn 2.0 In development - to be released Spring 2009
Spliff 8.75" x 31"

CALIFORNIA skateparks

THE LEADER IN SPECIALTY SKATEPARK CONSTRUCTION

California Skateparks, Inc. is a multi-disciplinary company specializing in the design and construction of landscapes for skateboarding. We have worked on over 120 skateparks and produced some of the most notable, world-premiere facilities ever created. California Skateparks is a fully insured contractor licensed in 12 states. We offer many advantages in the execution of our projects, including extensive experience in skateboarding, design, construction, landscape architecture, civil and structural engineering. We focus on solid construction methodology, sound planning and systematic project costing with the needs and desires of our clients and the community as our main priority. Through the utilization of innovative construction methods and techniques, attention to aesthetics and detail, California Skateparks delivers a focused, cohesive effort from start to finish to create the highest quality skateparks in the world. Californiaskateparks.com



Cadillac Wheels

Developed by Frank Nasworthy in 1973, the Cadillac Skateboard Wheel was the first urethane skateboard wheel. This wheel revolutionized skateboarding and has set the standards for all skateboard wheels to date. In recent years, Cadillac wheels have resurfaced as a staple longboard and cruising wheel. Like the original Cadillac wheels, these wheels have a square profile and a soft compound for maximum performance. Sizes available are 56mm, 65mm and 70mm and are available in multiple colors. Check them out at madridskateboards.com



Cadillac Wheel
56mm/78A



Cadillac Wheel
65mm/78A



Cadillac Wheel
70mm/80A



Cadillac Wheel Neon
70mm/80A



Cadillac Wheel Clear
70mm/80A



Cadillac Bearing



There is nothing on the street that so closely emulates the feeling and “stoke” of surfing or snowboarding. There are just so many down days when you can’t get a surf or snowboard session and you’re just itching to get in some turns. With a little imagination and one of our boards, there is always a couple of feet of fresh powder or 6-8 foot glassy sets coming in right outside your door. Brad Gerlach and his father Joe came up with the idea for a Carveboard almost ten years ago. The main objective was to create a board which enabled beginners to pros, the ability to work on their surfing or snowboarding on the street. Experience the ride and you will understand that these boards are the ultimate carving machines. Carveboardsports.com



Carveboard
43"



Longstik
40"



Surfstik
34"



Twinstik
32"



Skateboarders are ANIMALS! We Hunt for new terrain, we live off the decay of the wasteland, and we are truly some of the most wild individuals in the World. Skateboarders are the FASTEST HUMANS on the planet! The fastest animal on the planet The cheetah (*Acinonyx jubatus*) that hunts by speed and stealth. It is the fastest of all land animals and can reach speeds between 70-75 mph) and has the ability to accelerate from 0-68 mph in three seconds, faster than most supercars! Now, CHETA WHEELS are hand’s down the FASTEST WHEELS on the Planet, made of superior urethane, with the ability to generate speed where all other wheels envy...CHETA WHEELS come in many different sizes, shapes, colors and hardness’ including: 51mm “RIPPERS” at 99 Duro, 53mm “PERFORMERS” at 99 Duro, 54mm “WMD” (Weapons of Mass Destruction) at 99 Duro, 58mm “SPRINTERS” at 101 Duro and the Infamous 60mm “HACKETT SLASH” wheels at 97 Duro with a hardcore Insert! For more info visit our website at chetawheels.com





Like cockroaches after a nuclear war, Cold War Skateboards is still hanging around in the basements and shadows of the skateboarding industry. (Blah blah blah. Insert marketing propaganda. Oh yeah, lifestyle, hardcore, skater owned, etc. No time for this, I have to get back to my real job.) Cold War is not a double-agent brand posing as an independent company. Get black-listed. Ride a Cold War Skateboard. Pressed and hand screened in Portland Oregon! That's got to be worth something, right? ColdWarSkateboards.com



CW Youth ICBM Nuke Park Bomb Strike



Comet boards are pressed one at a time at our factory using proprietary molds. Each board is then carefully tuned to the perfect specs to suit its purpose. For quality assurance, we run every 20th board at our factory through the following tests: three-point bend, lap shear, and hardcore skateboarding by Comet Test Pilots and Team. We have been working with the skateboard community to redesign our line. With your input and our state-of-the-art green manufacturing and regional supply chain, we create the ultimate riding experience for skateboarders worldwide while creating abundance for communities and stewarding the natural environment. Our new pants are a classic work-pant reinforced with thick leather – great for skating hills affordably without overdressing for the casual session. cometskateboards.com



Glove Palm



Skin Savers



Pagan
11" x 42"
WB: 32.25"



Shred City
9.5" x 35"
WB: 17.5"



Voodoo XL
11" x 42"
WB: 32.25"



Carver was founded on the historical connection between Surfing and Skating, and through technological innovation has brought that connection back with our comprehensive line of trucks and boards. For over a decade, Carver has been on the forefront of skateboarding technology, developing equipment designed to excel on this evolving landscape. Carver is the original Surfskate front truck system, now copied all over the world. From our fast pumping C7 to the snappy CX, our patented carving trucks are unmatched in forward drive and thrust. New website with videos, history, technical info, and the Friends section, where we post photos and videos made by skaters riding Carver trucks, at carverskateboards.com.



29 SWALLOW 29" 36 CRUISER 36" 36 WOODIE 36" 42 FLOWMASTER 42"



Carver Truck
C7 6.5"



Carver Truck
CX 6.5"



Carver Truck
C2 6.5"



Carver Truck
C4 5.0"

CONSPIRACY SKATEBOARDS Colorado's Conspiracy Skateboards celebrates 15 years of FUN! Started by Dana "Buckthead" Buck and Lindsey Kuhn, it is now one of the longest-running independent skate companies to date. Team riders include vert rippers Glen Charnoski, legendary Bryan Pennington and concrete master James Hedrick as well as young rippers Otto Pflanz, Michael DeBuano and more. Board graphics this year by Florida's "Stainboy," Lindsey Kuhn and most recently, Italy's "Malleus"! Oh, yeah, they have GREAT wheels too! The "Alien Shot" with graphic by Pushead and the Conspiracy X-wheels are great for all types of skating! Support Independent Skateboarding. conspiracyboards.com



Screamer 8.88" x 32.5"
Samurai 8.5" x 32.25"
Swap Women 8.5" x 32"
Destuco 8.25" x 32"



X-wheel 56mm 100A
Alien Shot 60mm 95/97/99A



In 2004 I [Heiko Schöller] asked Michael Brooke if it was OK with him if I used the name Concretewave for a skateshop in Germany. He said OK. The name is perfect because I wanted to run a skateshop where you can get everything, not just 7.5" decks and shoes. In the beginning it was just a Web shop, but in 2005 the store in Cologne opened, and now we have the biggest old-school and long-board selection in all of Europe. Ninety percent of what we sell is hardware, and some shirts and accessories. It was always a dream to do my own skate shop and with Concretewave this dream became reality. concretewave.de Concretewave Skateshop — Venloer Strasse 502 — 50825 Cologne — Germany Tel.: 0049 (0) 221 3974669. E-mail: info@concretewave.de



Crail has been making superior quality trucks since 1990. Todd Schwartz, the owner of GardenSK8 indoor skatepark, established Crail America after traveling to Brazil last year. The Crail "Speed" downhill trucks have been tested to rave reviews and will be available in new limited color runs. The

entire line of street and park trucks were also tested to rave reviews at GardenSK8, which also hosts the largest indoor bowl on the East Coast. Crail America will now expand US distribution to include the entire line of trucks. Check with your favorite shop for availability. Distribution inquiries only call (973) 287-7626. crailamerica@me.com



Crail "Speed" Downhill Trucks



Daddies Board Shop, a family owned skateboard and snowboard shop lives up to their excellent reputation with a personal shopping experience, even on the Internet. Since 1995 Daddies has filled their cozy niche by providing a reliable source for Longboards, Race Boards, Old School and re-issue decks as well as accessories and knowledge. With fast and accurate shipping as well as responsive customer service you can get almost anything your heart desires. Buy from the family! 7126 NE Sandy Blvd. Portland, Oregon 503-281-5123 Daddiesboardshop.com





Dead Dog skate shorts has two new colors in the classic corduroy style with drawstring back like the shorts we wore back in the day. The new colors are black and grey and blue and tan. The new school style is canvas or cotton with a standard back. The colors in the new school styles are olive green canvas and black and camo cotton. Smaller sizes for kids are also available in sizes 22-40. We are a small company so new colors and style will come in time. Take a look at deaddogclothing.com. Thank you for your support!



DeadDog
Black short



DeadDog
Red-n-Black



DeadDog
Black Backside



Spanning generations of freestylers with different styles, Decomposed caters to your every need to assemble a fully functional complete so you can take on Mullen. New to freestyle? We're here to help with any questions. Riders include Russ Howell, Tim Morris, Keith Butterfield, Ray Meyer, Joe Humeres, Gunter Mokulys, Keith Renna, Joe Flemke, YoYo Schulz, Witter Cheng and Per Canguru. decomposedsk8.com



Keith Butterfield
7.25" x 27"
wb: 12"



Keith Renna
7.5" x 29.25"
wb: 13"



Witter Cheng
7" x 27.5"
wb: 11.8"



Per Canguru
7.25" x 27.5"
wb: 12.25"

DECKCRAFTERS

All Deckcrafters skateboards are hand made by Chuck Hults, the man behind such legendary skateboards as the "Rip Saw," "Chain Saw," "Yard Stix," "Danger Deck" and the "Double Vision" series. The craftsmanship and quality usually reserved for professional skateboarders, along with the function and style derived from years of shaping, designing and skating experience, are now available to you. Choose from one of the many models in the Deckcrafters line, or have a custom deck shaped to your exact specifications. Deckcrafters also offers OEM manufacturing for core brands looking for a superior-quality product. Deckcrafters skateboards are manufactured with top-quality maple, as well as in the new Monocoach composite construction. deckcrafters.tv



Buck Smith Classic
9.75" x 33.75"
WB: 16.25/17"



Dead Wood
9.625" x 33.875"
WB: 16/16.75"



Pool Cue
10" x 33"
WB: 15.75/16.25"



Sharpie
8.375" x 32.625"
WB: 14.5"



Dregs is still about the same things it's always been about. Having fun, riding hard, hauling ass and thrashing ruthlessly with no regard for personal safety. Only recently have we acquired a taste for the finer things, like the pristine peaks and coastlines featured on our 'water division' boards. We have included laser engraved boards in our line w/ clean natural aesthetics and textures as well as inlaid hardwood cruisers with die cut pinstriped griptape and engraved logos, top an bottom. New mid length boards like the Ditch and Teardrop rip on any terrain you throw at 'em. Old school, new school, high speed, just cruising, carving, sliding, you name it. If you just want to have fun get on a Dregs board. dregsskateboards.com



Tiki
8.5" x 28"
WB: 14.5"



3-Palm Bay
9.5" x 44"
WB: 25"



Sunball
10" x 46"
WB: 28.87"



PB Pier
10" x 56.5"
WB: 37.15"

DURANGO BOARDS

DurangoBoards are born in the Colorado community of good times and creative people. We take pride in exposing local artists by showcasing their unique designs on our decks. Environment-friendly construction ensures that the only impact made is from the artwork. Our Canadian hard rock maple boards are cold-pressed at the source, then imprinted to create a true piece of art. Find them at your local skate shop or visit durangoboard.com.



Treads Bonneville Animas Dragon Humming Board

Eastside Longboards

Based on the Eastside of Portland, Oregon, our decks are a true testament to the large and diverse community of skaters here. Since 2003 we've been laying down functional designs made for urban-style transportation and riding a wide variety of hills and terrain. Through our weekly sessions at amazing inner-city parks like Mt. Tabor and Washington Park (Zoo Bomb) to our community events like the Portland Pusher Series, many revisions from rider feedback have been added to the Eastside lineup over the years. We are proud to release the latest for 2009. Check out the rest of them at eastsidelongboards.com.



MiniKicker 8.5" x 30" WB: 29.5"
 The Tabor 9.125" x 36" WB: 20.75"
 DropKick 9.75" x 41" WB: 29.5"
 Rocky Bomber 9.625" x 43" WB: 30.25"



Earthwing is a skateboard company from Brooklyn, N.Y. that has no specific direction, with no employees and no business plan. Brian Petrie just stares out into space and thinks about how to make skateboarding better. This year Earthwing has been playing with new wheel formulas that are much faster than normal, and high-performance unidirectional carbon speedboards that are stiffer, thinner, lighter and less expensive. The Internet said sliding was dead, but they are releasing the new Drifter anyway, along with a new line of softer freerider wheels, so don't listen to the Internet. They are out there on the hills slipping, sliding and bombing 4 life. KILL THE HILL! earthwingskateboards.com



Jail Bird 33"
 Drifter 34.5"
 Boomerang 38"
 Mystery Model 42"



Easy Rider opened its doors on Dec. 6, 1996 and is owned and managed by Warren Currie. Warren has been involved in the action sports industry in Edmonton since 1980, when as a school kid he ordered his first Burton Backhill snowboard from Jake Burton. He began skateboarding in 1969 on a clay wheeled "Surf King" board that he and his brother got at a garage sale. Easy Rider sells all types of skateboards — Longboards, Street decks, Minis, and Old School. We ride what we sell and have a blast doing it. Easy Rider, 4211-106 Street, Edmonton, AB, Canada 780.413.4554 theeasyrider.com





Factory13 experimental skateboard manufacturing is the future of skateboard design and production. Established in 1999, we make the most unique custom boards on the planet. Factory13 makes Pro model boards for J.F.A. and the infamous Godoy brothers, our F.13 stock model boards are killer. Our boards are handmade in Chardon, Ohio by skateboarders, all boards are silk screened by hand as well. Everything from the mold design to final product, all done in house. We offer the most diverse amount of construction options: different species of hardwoods, fiberglass, ruby red epoxies, and carbon fiber laminates. Factory13 records is open and stocking the best skate punk from all over the world. factory13.org / thelastofthebadmen.com



J.F.A. Flathead
8.87" x 32.5"
WB: 15"

Magoo 2
10" x 32"
WB: 17.5"

Art & Steve Godoy
8.75" x 32"
WB: 15.5"

Ripper T.P.S.
10.25" x 31"
WB: 15.5"



Foundation Equipment Corporation (FEC-NYSE) was started in 1989 by skateboarder, Tod Swank. The drive was freedom of creativity and individual expression as well as to free the binds of corporate tyranny on the skateboarding culture. Today Foundation Skateboards continues to push the envelope of creativity, the art of skateboard riding and the biomolecular engineering of interstellar space travel. Foundation enlists supreme Pro and Am team riders such as – Corey Duffel, Gareth Stehr, Don Nguyen, Angel Ramirez, David Reyes, Sierra Fellers Abdias Rivera and more. Recent epic releases are the Foundation Testament Keep On Rolling Box set and Cataclysmic Abyss DVDs. And the new Fiberlam Deck Technology is getting rave reviews and is highly sought after. SkateboardingFoundation.com



Barp
7.75" x 31.75"

Infest
7.75" x 31.75"

Ramirez ZigZag
7.75" x 31.75"

Teapot
9.125" x 32"



Wood is good again. Flexdex has decided to bring back wood — with a twist. Our four new boards range from 33" to 60" with composite decks using a new "Fiber weave" technology. These new decks are strong and flexible, retaining all the qualities Flexdex was built on. Visit flexdex.com for more information on these new boards and to check out our redesigned fiberglass line.



Lust for Life
33"

Mantis
36"

Rubber Soul
40"

Fat Daddy
60"



Developed by pro skaters, Freshpark's durable line of weatherproof, foldable ramps are easy to assemble, easy to move, and easy to store. Used in the interactive villages of the top pro skate tours (X Games, AST Dew Tour, Etnies GvR), recreation departments, schools, backyards, community organizations, summer camps, churches, and military bases, Freshpark has established itself as the leading portable ramp brand. freshpark.com





Fullbag Skates offers today's skaters the "right tool" for the job — whether it is tearing up cones, screaming down a hill, cruising the city or flowing roundwall at your local park — we've got you covered! Our approach is to unify modern shapes, racer-proven designs and top-quality materials and workmanship while preserving an "old-school" flavor into every board we build. Manufactured in Quebec, Canada, using a combination of hard-rock Canadian maple and a range of high-pressure laminates, each deck produced comes with our guarantee of quality. Since their inception in 2007, Fullbag Skates have put racers on the podium across Canada, the United States and Europe. 2009 brings the introduction of a new line of decks, which will join our current line of proven favorites, taking our success to a higher level. We build function, quality and performance into every single deck. To learn more about Fullbag Skates and to watch for the release of our new models – visit our website: fullbagskates.com. For ordering and question – you can reach us at info@fullbagskates.com



The Topmount 10.25" x 40.5"	Speed Styler 10.125" x 40.25" WB: 31.5"	Elise (P-Swiss Model) 10" x 38" WB: 29" - 29.5" - 30" - 30.5"	GS - Death Or Glory 9.125" x 35.25" WB: 21.75"-22.25"- 22.75"-23.25"	HS - Red Baron 9.125" x 33.5" WB: 20"-20.5"-21"- 21.5"	Louis Ricard Slalom 9" x 32.5" WB: 19.5" - 20.25" - 21"	Stinger 10.5" x 35" WB: 17.75"	Pool Slayer 8.5" x 32.25" WB: 15.25"
---------------------------------------	--	---	--	--	--	---	---



Let's face it, times are tight and your money means more to you than ever. You can cut corners or cut out the bullshit. At Funhouse Skateboards, we've gone with the latter. Since 2006, we've been making premium quality, manure-free skateboards by skaters for skaters. Our formula is simple: take the sickly satisfying graphics of Owner/Artist/Janitor JJ Rudisill and add them to uniquely shaped maple decks made in the USA. The end result? Badass decks that are as fun to look at as they are to skate. funhouseskateboards.com



Beer Slave 7.75/8.0/8.25/ 8.5" x 31.75" WB: 14"	Jersey Devil Old School 8.5" x 32.33" WB: 14.75"/15.75"	Jersey Devil Popsicle 7.5/7.75/8/8.25/ 8.5" x 31.75" WB: 14"	War Chief (Coming Soon) 10 x 32.5" WB: 15.5"/16.5"
---	--	--	---



Designed to be the most stable and responsive truck on the market, the EVO 2 accelerates the standards of performance and progression to near perfection. The EVO 2 features 94A durometer premium urethane cap cushions that is ready to go out of the box. This is a Bones® Hardcore Bushing™ technology (U.S. Patent No. 6,739,603) and it is on license from Skate One Corp. Combining strength and slickness, the new forged EVO 2 baseplates features A356 aluminum, a lighter baseplate that can handle more abuse and slide better than your traditional truck. Furytruckcompany.com



Evo 2 (Raw)
Hanger 5.0"
Axle 7.5"

Evo 2 (White/Black)
Hanger 5.0"
Axle 7.75"

Evo 2 (Graphite)
Hanger 4.63"
Axle 8.0"



G&S Skateboards and Fibreflex Skateboards continue into 2008 with quality USA made decks. Original Gordon & Smith Skateboards were developed by surfers for surfers in 1964 from composite (Bo-tuff). Our first team in the 60's included Willie Phillips, Skip Frye, Mike Hynson, Sal Peluso, Sammy Jimenez and young Dennis Shufelt—Extremely innovative and ahead of their time. Recently, Skip Frye has re-discovered skateboarding and has rejoined us to create the new FibreFlex "Perpetual Motion Egg" model. Gordon & Smith continues to produce boards built with quality that perform. We've always built skateboards for Pros, or anyone who wants to be one. G&S Skateboards & Fibreflex Skateboards 4901 Morena Blvd. #1003 San Diego, CA 92117 Ph. 858-581-3045 Fax 858-581-9049 www.gordonandsmith.com



Doug Saladino
Street Cruiser Reissue
9" x 30"
WB: 17.5"



Dennis Martinez
Veteran Vert
9" x 32"
WB: 15.5"



The Islander
9.25" x 38"
WB: 22.5"



Skip Frye
Perpetual Motion
7.25" x 25"
WB: 16 5/8"



YoYo Wheels
64mm 97A
Yellow



GFH Boards has been busy with another year of development, product testing and keeping out of trouble. One of our main focuses this year was to work with products that are actually environmentally friendly so we came up with the GFH Eco Weave. This material is a great alternative to fiberglass and has many of the same qualities just doesn't hurt the environment or leave workers with crazy rashes and diseases that we can't even spell. Check us out at GFHBOARDS.com



Fatties
66mm 83A



Pigme Warrior
7" x 24" WB: 13.5"



Bali Board
8.375" x 38" WB: 26"



Unknown
8.375" x 38" WB: 26"



Scene
9.25" x 42" WB 28"



Garver

Ceramic and steel and faster than ever, Garver has expanded the family, which now includes 10mm and 8mm steel and ceramic. Every set of Garver bearings is manufactured using nylon retainers, high-speed lube and either chrome steel or silicon nitride balls, all built to Garver's exacting tolerances. Also in the coming season, be on the lookout for some boards from Garver, which will include a carvey cruising board and a racing board. Dealer inquires: mail@garverboardsports.com



Ceramic Bearings



Steel Bearings



Competition Calibre Tole

GLADIATOR GHOST

SkateDesigns not only offers a wide variety of skateboards, but their own line of knee gaskets known as the

Gladiator. Dale Smith's knee gasket design revolutionized the way skateboarders wear kneepads. The Gasket is designed to be worn underneath the skateboarding kneepad. The Gasket give the knee extra support while keeping the kneepad in position. The Gladiator Gasket is a neoprene knee support with a foam layer of padding around the patella. The Gladiator Ghost is the new generation of the Gasket. The Ghost offers the same support and protection as the Gasket does, but it features a plastic cap underneath the top layer of neoprene. skatedesignsinc.com



Gasket



Ghost Knee



Ghost Elbow



GPS designs and manufactures a three-piece modular racing wheel. This is the only modular wheel design in the world! The unique features are that we use two taper locking rims that hold the bearings snugly in the urethane wheel, thus making it easy to change wheel sizes from 55mm, 75mm, to 88mm. Multi-colored rims makes for a nice-looking wheel assembly. Check out the website at grandprixskateboards.com.



GForce
75MM/78A

Micro
55MM/99A

Magnum
88MM/80A



Bazooka 120mm Urethane Wheels are engineered for maximum asphalt performance. The wheel mates perfectly with the Vegas core offering a durable and light construction with the performance of high quality urethane. From super sticky to hard and fast this new technology sets a new standard for performance street wheels. These wheels are designed to work best with Bionic Trucks and GI Decks. The lightest wheel core Ground Industries has ever created, the Vegas introduces a whole new approach to high performance wheel design. Its three piece construction promotes a truer more durable ride by targeting key material properties needed to maximize performance in different zones of the wheels assembly. For the first time ever the material properties of the core are dialed in to maximize impact resistance while not interfering with the necessary rigidity of the outer rim. The Vegas also incorporates bite rite wheel security teeth that do just that, secure your Bazookas for an even truer ride at higher speeds and improved stickiness. groundindustries.com



BAZOOKA
120 mm 68A, 74A and 82A



BIONIC TRUCK



Grom Biz (Grommets in Business) has produced a product that has the potential to revolutionize the skateboard industry. Grom Biz has brought a new era to the skateboarding journey with their new Truck and has to date produced 2000 skateboard completes to prove the concept and marketability. The Grom Biz company team has a strong focus on customer service and product education. Currently Grom Biz has product in Australia and the USA and expects to become recognized as a leader in the development of innovative high quality, price competitive skateboard products. Grombiz.com



C2
Special

C2



C11 Scriber



Special Ops Truck



With a focus on quality, performance and progression, the revitalization of Gullwing trucks is in full effect. From the all new high performance Charger to the incredible turning capabilities of the Sidewinders and the stability of the soon to be released Bomber, Gullwing has a truck to take your skateboarding to the next level. Look for some innovative new products coming from Gullwing soon as well as some classic reissues. gullwingtruckco.com



Charger
Black-Black 9/10"

Charger
Black-Rasta 9/10"

Charger
White-Navy 9/10"



Alpine
9/10"

Sidewinder
9"

GRAVITY SKATEBOARDS .COM

GRAVITY SKATEBOARDS has been a dedicated manufacturer of high performance, quality longboard and specialty skateboards since '94. We do our best to provide a wide range of boards, wheels and accessories to stoke out riders of all different styles. So whatever you are into we have the setup for you. Check us out at your local shop or Gravity Skateboards.com and see what happens when quality is number one. GravitySkateboards.com or call 760-591-4144



LOGAN CLASSIC
9" x 31.875"
WB: 17.375"



42" MINI-CARVE
8.25" x 42"
WB: 29"



43" CARVE
9" x 43"
WB: 25"



SPOON NOSE
9.33" x 45"
WB: 28"



46 CARVE
9" x 46"
WB: 28"



HYPER-CARVE
8.75" x 47"
WB: 34"



HYPER-CARVE
8.75" x 47"
WB: 34"



WATER SKI
55"



INDIAN SUNSET
9.25" x 35"
WB: 21.25"



POOL SERIES
32"



POOL SERIES
IMPERIAL 35
9.25" x 35.125"



POOL SERIES
BUD 36
9.25" x 36"



JUTE SERIES
MINI LIONS
29"



JUTE SERIES
BURNING SPEAR
35"



JUTE SERIES
DROP CARVE
40"



DOWNHILL RACE
40"



Sergio Yuppie Slider
60mm/99A



Super Slider
72mm/85A



Super Slider
72mm/90A

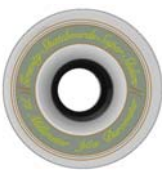

Super Slider
72mm/95A



Street Slider
66mm/97A



Street Slider
73mm/74A



Street Slider
73mm/78A



Street Slider
73mm/80A



Street G
66mm/74A



Street G
66mm/76A



Burner
66mm/72A



Drifter
70mm/72A



High-Grade
76mm/80A



Fu Manchu
76mm/78A



Weel Name
diameter mm/durometer A



This is what happens when a family of surfers from California, screw the expense and start experimenting with the best wheels trucks, bearings, and wood they can find from all over the world. The resulting boards feel so much like surfing and flat out rip that it would be just wrong to not paint and color them into works of wave riding art. So that's why each Hamboard is unique, has a bit of Love, a lot of Soul, a signature, a number, and a family in Huntington Beach, that hopes that whoever gets this next Hamboard is stoked to spend their days carving flowing turns and recreating the feel of their favorite surf spot. The 6' -8" Classics go into a paint oven 6 different times and the 4' -5" Fishes are colored by hand. The amazing two-part rubbery high tech glossy grippy compound results in an incredible looking board with a deck surface that is unique to the industry. Good for riding with shoes, sandals, or the Hamburg Family preference: Barefoot! Hamboard.com



The Classic 15" x 80"

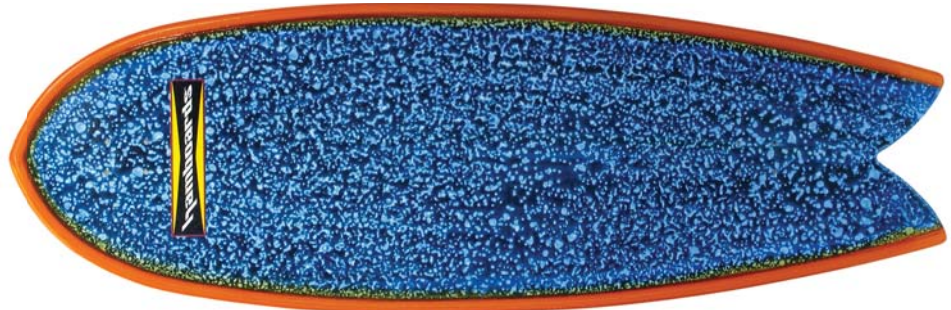

The Fish 17" x 53"

Hawgs

Through countless hours of painful testing we've come up with designs that really work. Combine these designs with amazing urethane and you have Hawgs. For freeriding and general cruising the 76mm and 85mm L series can't be beat. They're sideset stance and rounded edges make them super predictable and butter smooth for drifting.

The monster line introduced in 2008 has many improvement for 09. Already the grippiest wheel on the market, we've made adjustments to our formula to make them faster and wear better. So for whatever type of riding you want to do, Hawgs has the perfect wheel for you. Call 778-785-6855.



Aqua Hawgs
76mm/82A



Aqua Hawgs
85mm/78A



Aqua Hawgs
85mm/82A



Hawgs
85mm/78A



Hawgs
85mm/80A



Hawgs
85mm/82A



Hawgs 76mm
Black 78A Orange 82A



Mini Monster
70mm/78A



Mini Monster
70mm/80A



Monster Hawgs
76mm/80A



Monster Hawgs
76mm/82A



Monster Hawgs
76mm/84A



Herron Trucks are bringing skateboarding up to speed. Weight is the enemy of speed and control. That's why Herron Trucks is introducing the lightest trucks available made out of Carbon Fiber.

100% made in the USA our trucks come with custom bushings and reversed low profile kingpins. You can purchase Herron Trucks in 3 different sizes 7", 8", and 9" each weighing in at 30% less than the industry average. All styles from street skaters to longboarders will benefit from riding Herron Trucks. Another breakthrough in truck technology! Herron is proud to release a great new addition to complement our truck line — the **Progressive Bushings**, which are made with dual hardness in one unit. By sandwiching a soft urethane between a harder top and bottom plastic, the trucks are able to remain stiff with the responsiveness of a softer bushing. The bushings feel firm and have great rebound, allowing you to go for it without the worry of the dreaded wheel bite. This combined with the lightness and grindability of the Herron carbon fiber trucks make for a great upgrade. Herron Progressive Bushings retail for \$5.00 a set and include bushings and shock caps. They are made for Herron trucks but will fit any truck brand. herrontrucks.com

Herron Truck
9"



H-Street Skateboards was founded in 1987 by Professional Skateboarder Tony Mag, visionary Mike Ternasky and Skateboard manufacturer and distributor George

Abuhamad. The trio set out to create an entirely new kind of skateboard company, where riders were in charge of all product design and marketing decisions, and had a governing hand in the structure of the business. After more than a dozen year hiatus, the H-Street company has been reformed by Tony Mag and George Abuhamad, to again offer quality skateboard equipment to all. Shackle Me Not and Hokus Pokus have been re-issued on DVD, and the other classic H-Street films will follow. The Company will release some classic re-issues and some newer boards to cater to kids and older bowl skaters alike. VK Skate, Eastern Skate Supply, S&J Sales.



Ron Allen Fishtail
8.5" x 32"



T-Mag Bat Fishtail
9" x 32"



T-Mag Fishtail
9" x 32"



H-Street Longboard
9" x 36"



Honey Skateboards has built a reputation of quality, both in ride and construction. We continue to build on this reputation with our new Rogue. Honored with "The Best New Board" at the January 2009 Surf Expo, the Rogue takes freeriding to the next level. All

of Honey's boards are made in Southern California by dedicated craftsmen. Our boards have the appearance of a solid wood board with the stringer patterns meticulously matched on top and bottom, but have the ride qualities of a laminated deck. By taking advantage of the latest in laminating technology we are able to design camber, concave and kicktails into the boards while giving us the flex patterns we like to power through a deep carve. Life is about the ride, not the destination. honeyskateboards.com



Pugsley
9" x 29"

Rogue
10" x 38"

Carver
9.625" x 40"

Velocity
10" x 42"



Come experience the worlds best downhill skateboarders as they attack challenging courses at speeds in excess of 70 mph!

2009 IGSA WORLD CUP SCHEDULE

July 15-18	Peyragudes, France
July 22-25	Jungholz, Austria/Germany
July 31-August 2	Padova, Italy
August 21-23	Eastbourne, England
September 2-6	Maryhill, Washington, United States
October 23-25	Teutonia, Brazil
November 25-29	Bathurst, Australia
December 11-13	Kogelburg, South Africa

The 2009 IGSA World Cup Series is comprised of eight races spread over five separate continents. For additional information please visit www.IGSAworldcup.com



Illusion All Terrain Concepts, the small New Hampshire board shop, offers carbon-composite and wood-composite decks. The 43" carbon-composite G2 remains most popular with a 1.5" drop and 33" wheelbase. It's a stiff deck, lighter than 3 lbs., with threaded insert truck mounts. The Vengeancer optimizes grain direction of four wood species for a 4-lb. deck with the strength of 11 plies. This 41" deck has a 32" wheelbase and 10.5" width. Our 125mm Helix Slicks are designed for mountainboard trucks – like our 16.5" ATL Trucks – and mount onto Primo hubs. These 80A slicks are replaceable and 20% lighter than similar slicks. illusionatc.com



Blackbird G2
10" x 43" WB: 33"



Vengeancer
10.5" x 41" WB: 32"



Illusion ATL Truck
16.5"



INSANE ASYLUM LONGBOARDS. With 10 ply Canadian Maple construction, 43" x 9.75". The ILL FIGURE is a silent threat on the race scene. If you like sidewalk surfin', this is not your board! Equipped Veloz X-5 trucks, this is a downhill freak of nature. The Straitjacket is a safety device that uses air to slow or stop a rider before the rider loses control or gets smacked by oncoming traffic. Because you wear the Straitjacket tightly to your body, it increases aerodynamics and allows you to tuck and deploy as needed as you maneuver your way through the course. Use it to train, use it for safety. Iboards.com 888-9asylum



The Straitjacket



ILL Figure
9.75" x 43"



I started Indiana in 1989 to produce slalom skateboards in the garage of my parents house. Since 1997 we have been located in Wald City

Switzerland. All of our boards are 100% Swiss hand made, crafted in our own factory. Our boards are available in different weigh classes. These range from 50-65 kg, 65-75 kg and 75 – 90 kg. indiana.ch



Big Chief Concave
16.5cm x 74.5cm



Sky Chief
17cm x 74cm



Small Chief Concave
16cm x 69.5cm



Always pushing the envelope, Insect has embraced carbon nanotech prepreg composites on our entire line. Stronger, thinner, and lighter than before with an absolutely explosive flex pattern. Skate technology needs to evolve and we're leading the way. Mainline boards feature a hybrid of nanotube enhanced carbon fiber and fiberglass on birch cores. The Ultralight Competition boards are 100% nanotube enhanced carbon fiber on aramid honeycomb cores and feature the highest strength:weight ratio available in a skateboard, period. Weapons-Grade Carbon Nanotube Composites. Intended for Peaceful Bombing Only. www.insectskateboards.com



Wasp
9.625" x 40"
WB: 30/31/32"



Firefly
9.125" x 40"
WB: 29/30/31"



Sidewinder
8.5" x 28"
WB: 18/18.5/19/19.5"



Mosquito
9.25" x 36"
WB: 27"

Kahalani

Kahalani is based in Sweden where the CNC-machined precision trucks are manufactured. They were originally designed in 2001 to master the most technical race courses and highest speeds. The trucks are light, low and stable, but also have great turning ability. The Kahalani trucks hit the podium several times during 2007, and are well known and respected by satisfied riders world wide. Check us out at kahalani.se or call +46 8 6411323.



Kahalani Truck
204 mm



The Hawaiians invented board riding thousands of years ago, resulting in the creation of all board sports today. Those Hawaiian surfers found a purity and freedom that shaped and defined their culture. Kahuna Creations pays tribute to those ancient board riders by fusing the soul of surfing and the Hawaiian spirit into the lineup. Kahuna Board Riders around the world tap into their own "Hawaiian Soul" every day as they carve out their own reality in the world with a Kahuna Board beneath their feet. Kahuna Creations is the creator of the patent-pending Kahuna Big Stick stand up land paddle. kahuna-creations.com



Hukilau 57" Pohaku Surf Rider 48" Haka Pua 45" Hydro Performance 44" Kahuna Big Stick



Our mission at Khiro Skateboard Products has been the same from day one: "To make the highest quality skateboard products using the most advanced manufacturing techniques combined with the best materials to provide our customers and skateboarders with the very best products & service in the World." ALL KHIRO PRODUCTS ARE PROUDLY MADE IN THE U.S.A.!!! For over 15 years now, we have been manufacturing HARDCORE skateboard products for some of the World's Most Hardcore riders such as Duane Peters, Dave Hackett, Christian Hosoi, Steve Olson and a host of some of the best upcoming "HOT AMS" that will soon be household names! Visit our website at khiroskateboardproducts.com



TALL CONE IN 85A



KHIRO'S "TALL CONE" BUSHING KIT

(Part No# 018 - 431)



Khiro Flux Risers

- Blue 12 pack-#018-800-12
24 pack-#018-800-24
- Red 12 pack-#018-802-12
24 pack-#018-802-24
- Green 12 pack-#018-801-12
24 pack-#018-801-24
- White 12 pack-#018-803-12
24 pack-#018-803-24



KHIRO KAHALANI # 018-9128



Not typical, not rich, not dead. Not selling skateboards as a fashion accessory. Not caring if other companies steel their ideas. Not trying to change the world but for some reason they have ended up doing so. KebbeK is the company most sought after brand by first time skateboarders who are planning to go fast instead of planning to skate rails. Why? Who knows... probably because they kick ass and the team riders are as polite and humble as they are talented on wheels. Go ahead and buy someone else's brand, you'll probably come around and get a KebbeK or PM later on. Conceited? Trying not to be, Proud? Certainly. Love skateboarding? This is getting dumb. Just go skate a big hill. kebbeK.com



Ian Comishin
9.75" x 42.25"
WB: 34.625"

JimZ Flushcut
9.5" x 42"
WB: 33.25"

Revenger
10.75" x 43.5"
WB: 32"

Pierre Gravel TS Slalom
7.75" x 31.375"
WB: 19.25-20.375"



Check out the new 2009 mini line from Ladera! 2 redesigned shapes and 4 fresh new graphics from Kevin Walsh and Bedford. 24" super wide Bamboo Monkey set up with Bennett Vector 5.0s and Retro Zig Zags or Bennett Gators. The Temple, Ladera's classic Surf N Turf shape with added concave, nose kick and a new graphic makes this an all around shredder. Available with Indys, Randal 150s or Bennett 5.0" Vectors and Abec 11 No Skoolz, hard or soft for park or cruising. Find them at laderaboards.com and select retailers this spring. Look for our brand new Website and longboard line Summer 2009.



Bamboo Monkey
8" x 24"

Fish
7.25" x 27"

Pelican
7.5" x 29"

Temple
7.75" x 29"



Koastal is a high-end hardwood complete skateboard. Koastal has a balance of function with a very unique style. Koastal completes are primarily commuter skateboards but with the addition of Fiber-Lam on the bottom, these boards will function for the more aggressive skater who likes to step it up. Whether it's downhill, skatepark or just cruising, Koastal has a style that appeals to the younger crowd and shapes that bring the oldest skater back to the street. koastalboards.com



Check Mate
10" x 31" WB: 20"



Meat Loaf 3
9" x 37" WB: 24"



Pin Tail
8.75" x 38" WB: 29.5"



Toss Up
7.5" x 36" WB: 32"



In a price conscious world of skate retail products, no one recognizes price-to-value better than us here at Layback Longboards. With an extensive line of retro and lifestyle graphics, as well as performance driven shapes and high quality components, we strive for excellence by offering cutting edge products at a very affordable price. Whether you're heading down to the liquor store, cruising the boardwalk, or carving some serious downhill lines - Layback Longboards has a style and shape that is ideal for your kind of riding. Carve your way to a better value and throw it down with Layback Longboards. Laybacklongboards.com



LB5



Rising Sun



LB6



Mentawai

Landyachtz

Landyachtz has always prided themselves on cutting-edge designs and high-quality products. 2009 is no exception. The company continues to excel with many tweaks to improve their existing line of boards and adding in a several new models. For over

a decade these boards have been designed and produced by a diverse group of riders, all with a common goal of trying to bring this sport to its full potential. Featuring more new graphics this year than ever before, the boards are as impressive to look at as they are to ride. Have a look at Landyachtz.com or call 778-785-6855.



Cheif
10" x 40"



Bamboo Con Thug
9" x 42"



Pocket Knife
8.75" x 31"



Bamboo Pinner
9.25" x 44"



Ripper
9" x 37"



Stout
10" x 36"



Bamboo totem
10" x 41"



Battle Axe
9.5" x 44"



Wedge Flex
9" x 44"



Chinook
10" x 41.5"



Da Thug
9.5" x 46"



Dh-Race
8.5" X 41.5"



Drop Carve
9" x 42"



Drop Hammer
10" x 36"



Drop Speed
9.5" x 44"



Drop Wedge
9.7" x 39.2"



Totem
10" x 41"



Spud
9" x 36.5"



Evo
9.75" x 41"



Smoke
9.5" x 38.5"



Switch
8.25" x 42"



Lil Thug
9" x 37"



Mummy
9" x 33.25"



Pinner
9.25" x 44"

legendary longboards

Legendary Longboards, stained for your pleasure. Whether your flavor is maple, bamboo or composites, our hand-crafted boards are designed to suit your riding style. Our vibrant colors and glossy finishes stand out in a market filled with stickered, mass-produced planks. You choose the material, you choose the color, you choose the flavor, and we build your dream board. Come see the Flavor of The Day @ legendarylougboards.com.



Carbon Fiber Demon
8.75" x 39"
WB: 31.75"



Griffin
10" x 42"
WB: 35"



Mystery Meat
9.75" x 37"
WB: 30"



Demonix
8.75" x 39"
WB: 31.75"



Launched in 2002 after 2 years of development, Loaded Boards is dedicated to growing skateboarding in all its disciplines. We are stoked on longboarding and believe that the growth of skateboarding (in general) is predicated on developing innovative and creative gear to enhance the riding experience. We build the boards that we want to ride, with an emphasis on performance and functionality as well as minimizing environmental impact.



LittlePaw® Skateboards proudly welcomes Enzo Cautela of Las Vegas, Nevada, Connor Smallwood of Gibsonville, North Carolina and Michael Wu of Elmhurst, New York to the team roster. LittlePaw introduces our new graphics for 2009 — Zodiac. Virgo designs are the inaugural launch, featuring a classic female image as well as an icon image design. In addition, "Year of Monkey" and "M Series" will have additional graphics throughout the year. Find our latest team photos, demos and travel updates at littlepawskateboards.com.



Zodiac Series "Virgo" (F)



Zodiac Series "Virgo" (M)



Pissed Off Monkey



LittlePaw Yellow Monkey



LongBoardLarry is proud to make boards that look as good as they ride. We hand make dancing, carving, pumping and speed boards. Each board is made start to finish in our shop in Salem, Oregon. We are dedicated to building the best boards we can and supporting the longboarding community. Ride safe and have fun. Longboardlarry.com



Bamboo
Old Skool Dancer
8.5" x 59"
WB: 42.5"



Tarpon Hollow Core
10" x 41"
WB: 32"



Eddie
9.5" x 48"
WB: 33.75"



Komodo
9.25" x 48"
WB: 34"



Longboard Living is a lifestyle brand developed in Toronto, Canada to spread the passion for street surfing. It's inspired by the spirit of the Toronto Board Meeting and the NYC Broadway Bomb. LBL is influenced by city traffic, street art and urban diversity, combining Charlie Dunnham's hand cut decks and collaborations with Orbital Arts and Dov Gray. Holding down the East Cost, Longboard Living has linked up with Theseus Williams of Rad Rodz NYC to spread the stoke of the street surfer lifestyle, from Toronto's Bloor & Spadina to New York's 1st St. & 1st Ave. longboardliving@gmail.com



Cosmic Frequency



LBL board



Psychedelic City



Once upon a time in Bend, Oregon, thelongboardstore.com was born. The townspeople whispered of a place teeming with longboards. Travelers flocked to Bend just to catch a glimpse of the fabled custom longboard builders. "Free shipping!" they sang in the streets. Longboarders stole into the night on freshly built completes they had ordered just days before. Captivated with the refreshing and informative site, customers left feeling warm and fuzzy. They spoke confidently of wheel durometers and board shapes while fetching water from the well the next day. Thanks to thelongboardstore.com everybody rode happily ever after. Pictured from left to right: Jon, Scott, Gordon, Grace, and Jennifer



LOTUS Lotus Skate Designs began around the fundamentals of why anyone does the same thing for 20+ years — because it is fun, doesn't cost much and never gets boring. We have combined designs inspired by the original long boards used on the big waves of Hawaii, quality craftsmanship, unique woods, along with an enjoyment of riding a long board no matter what your age. Lotus makes every effort to produce our boards with the environment in mind and resources within the borders of the USA. See and learn more at lotusskatedesigns.com.



Monarch
42"



Monaco
9" x 35"



Fast Back BA
7.25" x 33"



Fast Back HW
7.25" x 33"



Last year was CRAZY. The Lush Race team held it down during the 2008 race season, having more sponsored racers in the IGSA top 30 than any other brand. Now free from the shackles of online retail sales, Lush have shut themselves away in a hidden dark corner of Bristol. From their secret lair they have been busy, secretly busy... 2009 promises to be a memorable year for Lush; look out for us on the hills this summer. www.lushlongboards.com.



Bahari
9" x 44"

Samba
9" x 40"

Revolution Speedboard
10" x 40"

Convert
8.75" x 36"



Kef Design in Portland, Oregon continues to innovate its highly praised "Metroboard" Ultra Light Electric Skateboard! New for 2009 are hi-tech lithium batteries that give the product a super-light and portable 19-lb. weight with an equally impressive 12-mile range! Premium high-rebound Landyachtz wheels are now available, making for a super-smooth ride. We now offer three standard deck options, including a 32" shortboard, a 41" longboard and a new 36" midsize model. We can also custom build with any board, so we can electrify your favorite deck! The "Metroboard" Electric Skateboard is the perfect thrill-ride/alternative transportation solution! metro-board.com



Custom Board



Gravity Midsize
9.5" x 36"



Longboard
10" x 41"



MiniLogo = MORE FOR LESS. MiniLogo skateboards are manufactured by the source of some of the finest brands in the skateboard industry. MiniLogo doesn't skimp on quality materials or workmanship, and most of our decks and all of our wheels are still made in the USA. ML means no-nonsense quality and performance at a rock-bottom price. No frills, no hype, just performance and fun, guaranteed. If you are finished with expensive, dubious-quality skateboard products poorly made in China, and just want to skate, MiniLogo is for you. minilogs skateboards.com



Bearings
8-pack



S-2 white
53mm/101A



Mounting Hardware



112 K12
7.75" x 31.75" WB: 14"



Miramar Longboards was conceived in a dorm room in Southern California. Two college roommates would press and paint longboards for friends, and soon they couldn't produce them fast enough to meet the demand. Three years later, Miramar was born out of a shared love for longboarding and the arts. True to its humble beginnings, Miramar is a company of friends and family who are committed to delivering a quality longboard with the best art in the industry. Miramar is dedicated to artistic innovation and integrity while striving to be a refreshing source of creativity in longboarding. miramarlongboards.com



Through
The Flames
9" x 46"



Pelicans
8.75" x 36.75"



Blow Fish
7.5" x 32"



Aqua Sound
7.5" x 33"

Boards by **madrid**
Since 1976

Since 1976, Madrid Skateboards has been an innovator in skate technology. Made in the USA, quality has always and will continue to define Madrid skateboards for generations. This year, Madrid announces the release of its Classic line, which offers ideal boards for every skater's needs, from basic transportation to high-performance longboards. Madrid is also excited to announce the debut of its Downhill Racing and Performance lines, to be released in April 2009. Keep a lookout for its Downhill racing team on podiums all over the world and the release of new and innovative designs throughout the rest of the year. madridskateboards.com



De Palma One God
9.75" x 42"
WB: 26"



Lucky 13
9.75" x 39.25"
WB: 21.5"



Kustom 4.0
10.365" x 41.25"
WB 24"



Kustom 1.0
9" x 39"
WB 27"



Kustom 2.0
9.5" x 46"
WB 31.5"



Kustom 3.0
9" x 39"
WB 27"



Ice Cream
9" x 39"
WB: 27"



Black Krows
9" x 39"
27"



Palm Tree
9.5" x 42"
WB 29.75"



Surfbiscus
10.25" x 34.75"
WB: 17.25"



Pavement
9" x 46.5"
WB 34.5"



Mad Tiki
9" x 34.75"
WB: 22"



Chixi Stix Pink/Black
9" x 39"
WB: 27"



Stubbie
8" x 23.75"



Rat Fink Mini
Pinstripe
7.5" x 29"



Rat Fink Mini
Sidewalk Surfer
8" x 29"



Rat Fink Mini
8 Ball
8.5" x 29"



Rat Fink Mini
JYK
7.75" x 28"



Mad Dog Mini
8" x 28.5"



Mini 18
7.25" x 18"



Acid Afterlife
7.75" x 24"



Skate 'n Surf Bamboo Mini
7" x 23"



Fly Paper
20 Pack



12" Fly Paper Roll

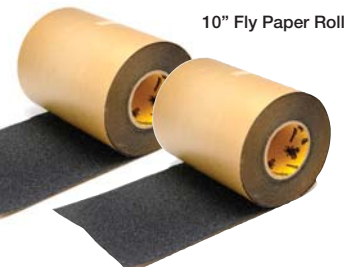

10" Fly Paper Roll

MOTTO

GRIPTAPE

Check out Motto's current Limited Edition Independent Artist Series Griptape at eMotto.com. We are currently accepting new art submissions for 08/09. Motto offers a complete line of griptape including:

- Black, Colors, Camo and Leopard Skin
- 9", 10" and 11" Widths
- Sheets and rolls
- Custom Laser Cut and Printed
- .25mm and .15mm Liners

Contact: 920-997-9512
or eMotto.com or sales@emotto.com



Motto Laser cut griptape



Not all bearings are created equal. NITRO bearings have proven to be among the world's most durable and fastest on the planet. Just ask 4 time Overall World Skateboard Racing Champion Jason Mitchell. He has ridden his NITRO bearings to World Championship titles on 3 continents, and pools, parks, pipes, bowls and schools! The full line of NITRO BEARINGS were designed specifically for skateboarders in mind. Skateboard bearings have to be designed and made to withstand extreme tensional loads caused by high speed directional changes, massive shocks due to hard landings and impacts from gaps or rail stunts, and more. Nitro's come in Abec 3's, 5's, 7's and The High Speed Ceramics for Racing Downhill or High Speed Slalom Racing. Experience the EXPLOSIVE FORCE AND SPEED OF NITRO BEARINGS!! Visit our website at nitrobearings.com for more info or to order now!



NiNjA Bearings don't use the antiquated industrial ABEC ratings, because those ratings are incapable of referencing the superior technical design and performance advantages built into NiNjA Bearings. NiNjA Bearings are specifically designed for skateboarding, providing superior speed, stability, strength and durability during the hardcore stress skateboarding puts your bearings through. NiNjA Z's are for skaters that want "Zero Maintenance" without compromising performance or longevity. NiNjA 9.3's are for skaters wanting speed, strength and durability. NiNjA 9.5's are for advanced or expert skaters. And the Ninja 9.7's are for skaters requiring optimum performance. NiNjA Bearings are now available at fundamentaldistribution.com.

NiNjA 9.3



NiNjA 9.5



NiNjA 9.7



NiNjA Z



NSI VIDEO

The NSI Video Collection from the 80's re-released on DVD has been deemed "The Encyclopedia of Skate History". These historical documents include Danny Way, Hosoi, Hawk, Bill Danforth and all the pros who pioneered skateboarding with their inspiration and their enthusiasm. The collection is a must for current skaters and for those who actually skated in the 80's. This compilation of footage (all 7 volumes: DUEL at DIABLO, STREETSTYLE in TEMPE, OHIO SKATEOUT, GOTCHA GRIND, SAVANNAH SLAMMA III, AND SQT.V. VOL I & II) captures the feeling of what skating was all about during the infancy of the sport. These historical documents captured the history of the NSA Pro/Am contests throughout the U.S. during the 80's. If you don't offer these DVD's in your store...you are not a real skate shop!! <http://stores.ebay.com/Native-Son-International>



Actual screen shots from Savannah Slamma, 1989.





Never Summer is proud to once again offer premium handcrafted Longboard skateboards built from start to finish in our Denver, Colorado factory. Our exclusive composite materials and construction methods have given our snowboards their undisputed reputation of quality, and our longboards are given that same attention to detail. Each longboard features composite construction, P-Tex tip and tail bumpers, advanced engineering and a 3-year warranty. We'll also continue to provide the best hardware available, as we refuse to cut any corners! With a deck for every type of rider and for all skill levels, NS is sure to have something for everyone. Neversummer.com



Eclipse
10" x 47"

Heist
9" x 41"

Descent
8.5" x 39"

Riot
9" x 38"

Swift
9.5" x 46"

Concert
9.5" x 43"

Norad
8.5" x 38"

Ransom
9" x 37"

Kroozer
8.25" x 26"

Soldier
10" x 40"



NHS, INC. **BELL:** With such classics as the Slasher, Rob 1 and Street Creep in the line already, Santa Cruz and Bell have decided to add more favorites to the lineup. You can now protect your bucket with Jessee's Sungod or Roskopp's Face. **BULLET:** From your core skater to your campus cruiser, Bullet offers something for every type of skater. For 2009 Bullet has added more flavor to its line by stepping into the realm of longboarding trucks. **INDEPENDENT TRUCKS:** The long-awaited Danny way signature model is finally here! You can find this Stage 10 Indy in 149, 169 and 215 sizes. **KRUX TRUCKS:** Krux has a new pro model truck in the line. Cairo Foster's new Cairoglyphic truck comes in two sizes. You can rock his truck in either a downlow or a high. **SANTA CRUZ "CRUZERS":** The whole thought process behind this new family from Santa Cruz was simple: Let's have fun with it! For a quick ride down to the corner store to bombing your local hill, SC Cruzers will be sure to get you there in a hurry. **SKATEBOARDING IS NOT A CRIME:** is easily one of the most recognized logos in skateboarding. Let your voice be heard and help support skateboarding by letting people know skateboarding is simply not a crime! For more info on all these products, visit scskate.com or nhs-inc.com.



The Bullet

Skateboarding Is Not A Crime Meanstreak

Skateboarding Is Not A Crime Crime Torn

Santa Cruz Hook Cruiser

Santa Cruz Screaming Hand Cruiser

Santa Cruz Slush Dot Mini Cruiser

Santa Cruz Warf Cruiser

Bell Sundog

Independent Trucks Danny Way Stage 10

Krux "The Man" 9.8"

Octane Sport
Octane VIRAGE

The Octane "Virage" trucks come in front and rear (pictured) versions and are CNC'd in the UK. By using standard components for the kingpin and pivot cup, we have been able to add value in other areas. The axle system gives riders the choice of ordering custom 8mm axles with integrated speed ring, in left- and right-handed threads for peace of mind, or they can also

choose to use off-the-shelf bolts to save on cost. The rear truck features a shallow hanger angle for grip and reduces the need for stacks of risers, adding strength and stiffness. The Octane slalom decks are foam and fibreglass, shaped and made by surfers. Pictured is the Hybrid model, 33", concave, multiple wheelbases and tail lift. Clean lines and bright colors make these stand out from the crowd. Different lengths and widths are available. Octanesport.com



The Octane slalom Hybrid decks 33"

The Octane Virage (rear) truck



Dedicated to the blue collar, working class skateboarder who paves his own path. We are geared towards the older skaters who still skate and share the common stoke for the round wall. Drop into OLDMANARMY.COM and check out the best ever, global skate community. It's all in there—forums, product, photos, videos, interviews, news and the best ever available 100% American made skateboards. So if you're an old fart and you still skate, don't disappoint yourself. Don't settle for anything but the best. (We don't.) Old Man Army—Established before you were born!

Dirtbag for Life 8.25" x 32" WB: 14.5"



Old Style (pool) 8.5" x 32" WB: 15"



Old Man Army Skate Bag



Drain a pool 9" x 33.75" WB: 6"

OIL CITY SKATEPARK

In its seventh year, Oil City Skatepark in Oceanside, Long Island is New York's only indoor skatepark. It is home to an array of ramps, halfpipes, boxes, stairs

and the 12-ft. vert ramp, "The Big Mother." The park is open seven days a week and has greatly expanded its offerings, including summer camp, weekend lessons and upcoming competitions. In 2008 the park hosted teams from 5Boro, Substance and Bodega and visits from Andy Macdonald and Kerry Getz. Stevie Williams also dropped by. The recently expanded shop has more than 150 decks and a large selection of wheels, trucks and accessories. Oil City is located at 3565 Maple Ct., Oceanside. oilcitysk8.com



Deviant Works Inc. presents the launch of OmniBoard, a line of advanced composite skate decks with performance as stunning as their style. Despite appearances, the interweaving composite rods form a board that is stronger than comparable wooden decks and is also much more durable and wears slower. Kevlar pads protect against razor tail while the unique architecture absorbs vibrations, maintains consistent pop and decreases air resistance. Ride OmniBoard and get higher ollies, faster spin and a smoother, more solid ride. Once you ride OmniBoard you'll never go back. Visit us on the web at rideomni.com to find out more.



OmniBoard



Have you checked out Original lately? New boards, a new website, and alliances with today's most progressive wheel manufactures have yielded literally thousands of customizable options that you can use to build your dream longboard, complete, the way you like it. Online. Today. Add to that Videos (with ride footage) of each and every board we design and Free Shipping on all longboard orders in the United States and Canada and you have a new destination for your next progressive, custom-built longboard complete. We ship to all countries, cheap and quick, so international ordering is always easy. Come see the difference an Original can make to your riding. originalskateboards.com or US(973) 579-1800



Apex 34
8.7" x 34"



Apex 37
8.7" x 37"



Custom 35
10" x 35"



Custom 45
10" x 45"



Derringer 28
9" x 28"



Hybrid 35
10" x 35"



Malakai 40
9" x 40"



Manhattan 27
7.5" x 27"



Overhead
7.5" x 25"



Path 37
8.2" x 37"



Terrapin 34
10" x 34"



Torpedo 40
9" x 40"



Original S10
(250mm)
Carving Trucks

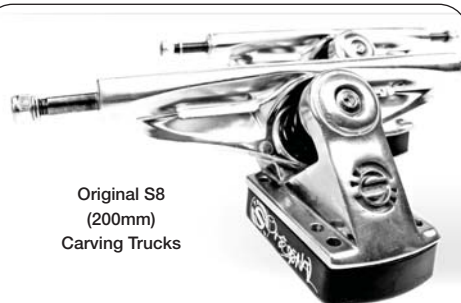

Original S8
(200mm)
Carving Trucks

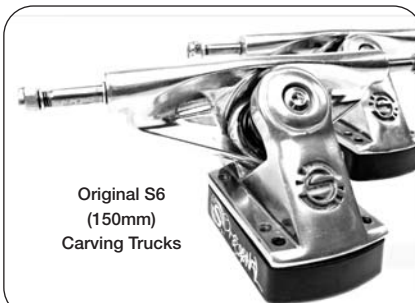

Original S6
(150mm)
Carving Trucks



One Skateboard Co is ready for 2009! Featuring new logo and pro model decks on both standard and P-Tip decks. Be on the lookout for new video offerings dropping soon as well as a new line of apparel! We will also be continuing our support of programs such as Gear for GROMS / Grind for Life and starting with the All Nations Skate Jam! We are planning our tours for this season, so if you are interested in working with us or having us come through, please e-mail us at oneskateboardco@gmail.com or visit us at oneskateboardco.com. Be one with One.



JJ O'Donnell
7.5/7.75/8"



AJ Kohn
7.5/7.75/8"



One
7.5/7.75/8"



Stacked
7.5/7.75/8"



Oust Bearings was started by Carl Lekavich and is a privately held California corporation. The company designed the MOC SERIES bearings for the skateboard industry that now have become the premier bearing. OUST also manufactures its SS Series lightened axle and King Pin line. OUST will continue to release new engineered skateboard products on a regular basis so that all skateboarders will be able to reach their maximum potential – pro or amateur. oustbearings.com

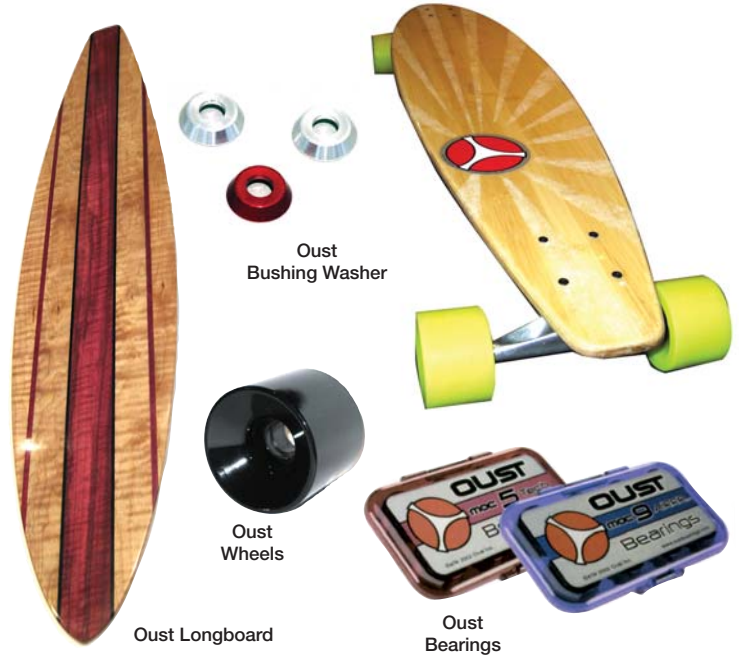

Oust Longboard

Oust Bearings

orangatang

Developed as an outlet for creative expression, Orangatang Wheels are here to wreak havoc on your minds and

bodies. For 2009 we will be creating prom dresses with carbon reinforcement and nanotubes for high-performance badminton. Sorry, Orangatang wheels are here. orangatangwheels.com

In Heat
75mm-56mm/83A



In Heat
75mm-56mm/80A



4President
70mm-53mm/83A



4President
70mm-53mm/80A

PAIN CHEATERS

After destroying countless knee pads, often using two or three together, I decided it was time to design knee pads that would better protect my now old (in skateboard years) knees and to offer my design to others. All skateboarders know the knees suffer the most abuse, especially since falling is part of the process. So, for fourteen years I have been producing PAINCHEATER KNEEPADS. Each pad is individually sewn in Massachusetts, USA; custom fit; has reinforced top straps; tripled-stitched seams; high quality (practically indestructible) Caps over Sorbothane Gel for better protection. More information: paincheaters.com Ordering: Please call (978) 657-7746.



PAINCHEATER KNEEPADS



PARIS DOWNHILL TRUCK!

(ARTIST RENDERING)

- 42 DEGREE BASEPLATE
- USA MADE DOUBLE BARREL BUSHINGS(STOCK)
- 6 HOLE PATTERN
- MOLYBDENUM STEEL AXLES
- TITANIUM KINGPINS(MAYBE)
- 190MM OR 200MM(STILL DON'T KNOW)

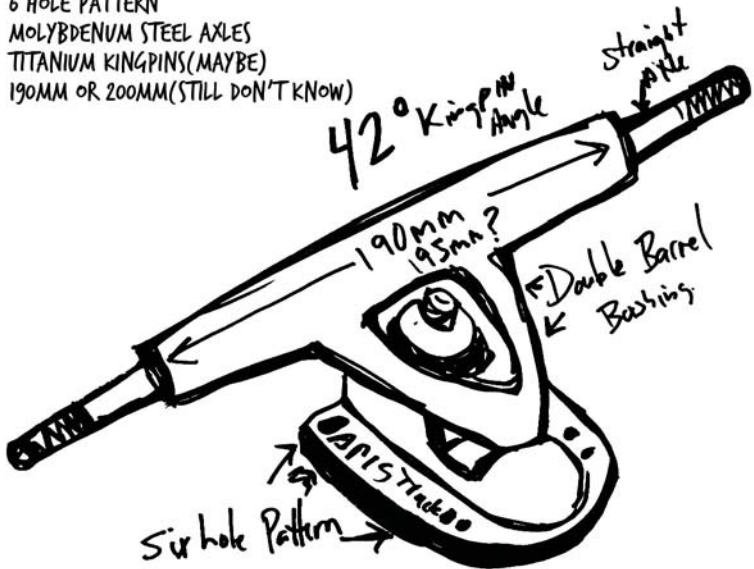

WWW.PARISTRUCKCO.COM

pink

Pink offers a wide range of wheels no matter what type of terrain you want to ride. The 52mm P-52's with a 96A hardness are perfect for the streets and parks. The 72mm PowerBalls with a 78A durometer are great for cruising. Call 800-615-PINK or visit pinkskateboards.com



Sick-Sicks
66mm/78A



Seven-0's
70mm/78A



Power Balls
72mm/78A



Polka Pots
62mm



P-52's
52mm/96A



X-Bolt - Two New School Mounting Plates with Locknuts



Pig, a group of amazing skateboarders laying it down on all terrain, bringing together the most slashing, creative, rippingest team in skateboarding: Abdias Rivera, Adrian Mallory, Corey Duffel, Don Nguyen, Dyson Ramones, John Lupfer, Gareth Stehr, Jason Adams, Jeremy Reeves, Louie Barletta, Matt Ball, Patrick Melcher, Ragdoll, Richie Jackson, etc. A name that delivers respect in this skateboarding world. Pig offers some of the best wheels and products around including wheels, bearings, grip tape, hardware, tools, wax, softgoods and more. Be sure to check out the selection of pig products at PigWheels.com.



Speedline Neon Pink
53mm/101A



Neon Stripes
54/52/56mm/99A



Rallies
51/53/55mm/100A



Blasts
52/54/56mm



Pig skate tool



Plank Skateboards is a small owner-operated company started in San Francisco, California. Old-school craftsmanship from the '70s is used to create beautiful and unique three-layered hardwood skateboards with a superior ride. Each deck is an individual work of art, designed and hand shaped in small batches from exotic and domestic hardwoods, all in their beautiful natural colors – no dyes or stains! Sizes include 48", 36" and 24" decks. Look out for our upcoming release of the new Classic Kick-tail. You've looked at the rest, now it's time for the best. It's Time to Walk the Plank. plankskateboards.com



Super Flex 36
9.5" x 36"



Super Flex 48
9.5" x 48"



Blocktail
9.25" x 48"



Noslider
9.125" x 48"



Pleasure Tool Bearings offer standard 608 steel and ceramic bearings both in shielded and the most popular sealed version. Pleasure Tool bearings have been popular with professional skateboard racers and we sponsor many of them. Bearings are lubricated with long lasting synthetic lubrication. Pleasure Tool bearings have the reputation for long lasting, smooth running performance. Pleasure Tool also offers complete bearing cleaning kits, lubrication, tools, custom stickers and a website that provides instruction on the bearing cleaning process. We currently offer our products wholesale with optional custom packaging for shops and skateboard manufacturers. 360 921-2465 edsbearings.com



Pocket Pistols Skates is blazing into 2009 with an arsenal of killer new graphics and shapes unlike any other company out there. Pocket Pistols Skates has a unique lineup including legendary skaters like Ben Schroeder, Lee Ralph, Rick Blackhart, Tom Groholski, Claus Grabke and Remy Stratton as well as some of skateboarding's more interesting personalities such as Jake Phelps, Don Brown, Chuck Treece, Matt French and a handful of up-and-coming underground rippers that are always down to live fast and skate faster. For videos, photos, news and team info check out pocketpistolsskates.com. Shops can order at fundamentaldistribution.com.



Blackhart
9.25" x 33.75"
WB: 15.5

Cave Lee
9" x 33"
WB: 15.375

Chicken's Pool
8.875" x 33"
WB: 15.375

Sully Splash
9.5" x 32.125"
WB: 15.25"



Stinger Models
10.25x34.75 and 9.5x36 deep concave, steep kicks, polymer composite



Pool King Skateboards continues the quest to design, test, ride and produce the highest quality, most functional skate products possible. We offer core models for Pool, Park, Street, Cruisers and Ditch riders. Currently 12 models are available with more on the way! Jeff Tatum has designed his signature 42" & 37" longboard pool decks to be the highest performance decks on the planet. Check out the full line and watch for exciting new developments @ poolkingskateboards.com



American Underdog 9.25x 37.5 double kick, deep concave, polymer composite

Pirate/Large 10.25x34 7 ply rock maple

Retro Cross/Cruizer 9x37 single kick, spoon nose, polymer composite



Poolside Skateboards, based in Scappoose, Oregon USA is rolling into seven-plus years of producing the highest quality handmade pool decks available. Please note these boards are not mass-produced somewhere else and shipped to Poolside finished in shrink-wrap. Instead the boards are handcrafted in house with many features you won't find elsewhere, including real silk-screened graphics. Nine-ply Poolside Skaterods feature a honeycomb design inner chamber with an integrated rail system. Woven carbon fiber is utilized in the top sheet of the deck along with a metal reinforcement system to keep your hardware from starting premature deck breakdown. Finally, a poured resin nose/tail cap is included, helping keep wear and tear to a minimum. poolsideskateboards.com



The Prime Minister
9" x 33"
WB: 15.5"

The Bull
9.25" x 33"
WB: 15.5"

Poolside custom boards



Positiv Skateboards is the company that focuses on positives in life. We make a high-quality skateboard without the high price tag. Positiv Skateboards utilizes more than 30 years of skateboard manufacturing to bring you the best quality-to-price skateboard possible. Look for the new Andy Macdonald, Carlos de Andrade, Rodney Jones and Sandro Dias Metallic Series in Spring 2009. positivskateboards.com



Andy Macdonald 8" x 32.13"
 Carlos de Andrade 7.625" x 31.63"
 Rodney Jones 7.75" x 31.8"
 Sandro Dias 7.75" x 31.8"



PGD complete skateboards are endorsed by Steve Caballero and provide high quality at an entry-level price. They are the perfect first skateboard for beginners and a smart choice for price-conscious advanced skaters.

Powell Golden Dragon skateboards are created in a Chinese factory that uses our AirLam presses, maple or birch veneer source and glue supplier. The resulting deck is the best produced in Asia, and we stand behind this skateboard with confidence. Just like our successful REDS bearings, Powell Golden Dragon skateboards are well received and respected as a quality Skate One product. powellgoldendragon.com



Globe Stencil Dragon 7.625" x 31.625"
 Loop Stencil Dragon 7.75" x 31.75"
 Samurai Dragon 7.75" x 31.75"
 Striking Dragon 7.625" x 31.625" WB: 13.75



Powell Skateboards will be releasing their first video in nine years this April. The video is titled FUN! It will have new young riders and an all-new team. New graphics, new team, new video, new FUN! and a new deck technology, LIGAMENT. The team says LIGAMENT adds confidence, has more pop and is stiffer and stronger. Check all of this out at powellskateboards.com.

POWELL PERALTA The Next Chapter: George Powell, the Godfather of skateboard manufacturing, and Stacy Peralta, skateboarding legend/film producer, have joined forces once again. Proudly satisfying the needs of skaters and skateboard collectors all over the world, Powell Peralta is re-issuing some of the most popular and classic skateboards of all time, along with wheels, soft goods and many more must-have collectibles. New for Spring: Stacy Peralta Hipster deck and Steve Caballero Happy Skull — the decks they are riding currently. powell-peralta.com



FUN! 7.625" x 31.625" WB: 13.75"
 Mag Letter LIGAMENT 7.75" x 31.75" WB: 14"
 Snow Cone 7.75" x 31.75" WB: 14"
 Tourist Red 8.25" x 32.5" WB: 14.5"



Cab Happy Skull Graffiti 9.125" x 32.5"
 Classic Ripper 10" x 31.75"
 Peralta Hipster 8.5" x 32.875" WB: 15.75"
 G-Bones Green 64mm/97A



Pressure Drop Longboards is a grass roots, skater owned company dedicated to producing and offering top quality, functional longboards. We are excited about the expansion of our line up in 2008, which will include a downhill drop through deck and a giant slalom deck. The addition of these designs will bring our full line of decks to six in Spring '08, with three hardwood decks and three plywood/formica decks. PDL is committed to spreading the stoke by supporting skateboard racing and culture. We look forward to serving the skateboard community in the future. Rollin' since '05. pressuredroplongboards.com



Drop Thru
9.75" x 42"



GS
9.75" x 36"



RD
9.75" x 42"



The 2009 Pro-tec skateboard line features helmets and pads ridden by the world's top riders, including Bob Burnquist, Bucky Lasek, Omar Hassan, Lincoln Ueda, Brian Patch and skate legends Christian Hosoi and Steve Caballero. Pro-tec's patented SXP multiple-impact technology allows for unprecedented protection because the material has memory. SXP has built-in rebound control, with the foam regaining its original shape and maintaining its impact-absorbing qualities. SXP can be found in our B2, a classically styled helmet, as well as our popular Ace skate helmets. Pro-tec also offers a line of pads perfect for street, park or ramp, including the Drop-In and Double Down designed with Pro-tec team riders. pro-tec.net



Ace Black - Bob Burnquist



B2 - Rising Sun



Bucky Lasek Classic



Park pad



Since 1986 Pro Designed Inc. continues to manufacture the highest quality protective products right here in the USA. Such pads as the Super Single Knee Pads (\$125.00 pr.), 1 1/3 (\$135.00 pr.), Mini Ramp Knee Pads (\$105.00 pr.), Recreational Knee Pads (\$70.00 pr.), Recreational Elbow Pads (\$60.00 pr.), Standard Elbow Pads (\$80.00 pr.), Mini P.D. Knee Pads (\$65.00 pr.), Mini Elbow Pads (\$45.00 pr.), Recaps (\$15.00 pr.) and Wrist Guards (\$55.00 pr.) are available for a variety of sports. For more info. go to prodesigned.com or call "Wild Bill" 713-957-0341. P.D.'s for life!



Wrist Guard



Mini Ramp
Knee Pads



Super Single
Knee Pads



Standard
Elbow Pads



Mini
Elbow Pads



Recreational
Knee Pads



Performance SK8 is a skateboard technology provider for skateboard brands and core retailers. We believe the biggest problem facing skateboarding is not blank or shop decks but the fact that standard decks wear out too quickly. Skateboarding is a lifestyle, P-Sk8 believes the best way to promote the skateboarding lifestyle is to produce products that keep kids stoked on skateboarding. P-Tip decks have more pop and they don't chip, when the tips are worn you can replace them. If you are a brand or a core retailer and you want to join the dozens of other companies that market their own P-Tip equipped decks contact us. performancesk8.com



P.SK8
Deck



Blackriver
Pirate Bird
8.5" x 33"



P.SK8
Yellow Pirate



Drunkstar
Militia



Purple Skunk board shop continues to roll, with hands-on, personal customer service since 1993. The friendly and knowledgeable staff can assist you on customizing the best ride to fill your quiver in the shop or through our website. If you're in the hood, come in and demo from our wide range of boards. From longboards to old school to reissues to cruisers to new school, the Skunk has it all. Need wheels? The display case houses more than 600 wheels to choose from. Check out our 9" RVB Pool Deck, 62mm 78A Smokes wheel with the signature purple swirls, PS Roller Bearings and 72mm 78A Purple Summer wheels, to name a few shop items. Visit us at 5820 Geary Blvd, San Francisco, CA 94121, call us at (415) 668-7905, e-mail us at info@purpleskunk.com or check out purpleskunk.com.



Smoke Wheels
62mm/78A

Purple Skunk
Roller Bearings

Grapey Apes
75x65mm/72A

RVB Shop Deck
7.625" x 31.25"
WB: 14"



Rainskates has been making custom old school decks for nearly six years, from the beginning of the "Old School revival", when only N.O.S. decks were around. Hundreds of decks later, we are still putting out original shapes on a variety of concaves, filling in the blanks where the re-issues have not yet gone. The Rainskates wheel line continues to grow and gain fans around the world, as word of the superior performance spreads. The 10th RS wheel, the 65mm/101a "Avalanche" has just been released. Look for them blazing around a Bowl near you, or sliding through a hairpin under a longboard. 907-617-2627 or rainskates.com



Mini-Bee
54mm/98A



Mini-Tsunami
59mm/85A



Stinger
62mm/100A



Hornet
65mm/98A



The Micro Mini ramp is a must have for any skater. It comes prebuilt, assembles in minutes and costs a fraction of what other ramp manufacturers charge. Its built using a steel frame construction and sheeted with premium grade plywood. Its super strong, great fun to skate

whether you are 4 years old or 40 and comes with a full 30 day money back guarantee. Go to railslide.com to for more information.



Classic Mini™
THE ULTIMATE BACK GARDEN MINI RAMP

MICRO MINI RAMP™
THE MINI RAMP THAT'S EASY AND FUN TO SKATE



WWWOOOOOOOOOOHHHHHHHHHHHH SH*T!
The boards coming out of the Rayne factory are going to be off the HIZZEL! OMG! W-CONCAVES, 3D forming, two NEW PRO models... Check out the site or come by and visit our factory

in North Vancouver to see the action for yourself. raynelongboards.com



2009 Hellcat
10" x 41.25"
WB: 32"



2009 Pro Model
4" x 36"
WB: 30"



2009 Pug
9.5" x 41"
WB: 28"



2009 Timeline
9.25" x 33.5"
WB: 25.5/26.5"



For over 32 years now, Randal Truck Co. has been a definitive leader in the downhill and speed truck market. Offering more baseplate combinations and hanger widths than any other company, combined with California manufacturing and an industry-leading lifetime warranty, Randal has created the market for downhill speed trucks. Keep an eye out for more innovations coming from California, including an upcoming 200mm DH truck. New products include our new Bushing Tune-Up Kit with 20 bushing combinations, Titanium Kingpins, a complete line of High Quality Bushings and new iron oxide Black Hardware. Our Charity Line of trucks includes the Pink American Breast Cancer truck and a Green Plant A Tree truck, with more coming soon to help other noble causes. Please visit randal.com for the most complete truck parts store, plus a huge collection of guides, templates and FAQs. Contact us at sales@randal.com or (760) 722-2236.



R-II
125mm 42°



R-II
150mm 50°



R-II
180mm 42°



R-II
180mm 50°



R-II
180mm 50°



R-II Pink
180mm 50°



R-II Green
180mm 50°



DH Downhill Truck
160mm



Military Grade
Titanium Kingpins



Truck
Tune Up Kit



Hardware
Kit



Axle
10mm



With Retro Zigzags there are now 13 ways to roll your own. Wheels from 66mm to 75mm with a durometer from 80A to 89A. Also new for 2008 are Retro Threads.

retroskateboards.com or call 877-422-3211



Retro VertZ
65mm/96A



Retro Vert
65mm/80A



Retro ZigZags 70
70mm/86A



Retro SkwertZ
62mm/96A



Retro ZigZags
70mm/83A



Retro BertZ
60mm/81A



Retro ZigZags 70
70mm/80A



Retro ZigZags
76mm/80A



Retro ZigZags
66mm/80A



Retro Invertz
61mm/99A



Retro ZigZags 70
70mm/78A



Retro ZigZags
76mm/83A



Retro ZigZags
66mm/83A



Retro Invertz
61mm/+



RocknRon's ROCKETS

SKATEBOARD BEARINGS

RocknRon Rockets makes the fastest skateboard bearings in the world. Five years ago, RocknRon Foster thought skaters needed a faster, better bearing. With 27 years as a bearing application and design professional, it was time a bearing pro stepped into the skateboarding world. Ron took his love for skateboarding and designed a better skateboard bearing. RocknRon's Rockets are not made in China and they exist to put to shame the ABEC fraud that resides in the skateboard industry. They are still building and testing bearing application theories daily and have added their Black Hole Wheel line. RocknRon's Rockets will be the fastest bearings and the best bearing value in your store and in skaters' wheels. skatetechnology.com



Ballistech Missile

Ceramic Rockets stage 3

Classic Rockets

Nuclear Missile

Rockets stage 2

ROAROCKET SHATEBOARD COMPANY

Roarocket stocks Canadian maple veneer, foam for molds and Thin Air Press technology to laminate your own custom design. Complete kits come with pre-shaped Street Deck or pintail Long Board Decks, while the ProBuilder Kits have uncut material plus oversize vacuum bags for you to finally build the deck you've always wanted to make. The website has many online tutorials including Ted Hunter's brilliant idea to use rigid foam as a mold. The technology is simple but effective. Excellent for street decks to composite creations, for individuals and groups — it works. roarocket.com

Roarocket stocks Canadian maple veneer, foam for molds and Thin Air Press technology to laminate your own custom design. Complete kits come with pre-shaped Street Deck or pintail Long Board Decks, while the ProBuilder Kits have uncut material plus oversize vacuum bags for you to finally build the deck you've always wanted to make. The website has many online tutorials including Ted Hunter's brilliant idea to use rigid foam as a mold. The technology is simple but effective. Excellent for street decks to composite creations, for individuals and groups — it works. roarocket.com



RoeRacing Slalom Skateboards

roeslalom.com

High-performance skateboards for world champions, world record holders and you! Since early 2001, RoeRacing has been building high-performance skateboards for slalom racing. Although our heritage is firmly planted in the slalom racing realm, due to overwhelming demand we are now also building longboards. By building each and every board using a combination of CNC machining and the hand-crafted finishing process that RoeRacing has become known for, we have been able to increase our production and distribution capabilities significantly for 2009. RoeRacing uses the highest-quality aerospace carbon fiber composite materials, our own engineered cores and a specially formulated epoxy resin in every one of our decks. roeslalom.com



PS Cross-Step
9.875" x 44"
WB: 31.5/32.5"

2007 Mermaid
9.75" x 39"
WB: 28.5/29.5"

Pintail
9.875" x 44"
WB: 31.5/32.5"

PS 3.0
8.875" x 30"
WB: 19.5/20.5"



Roger skateboards is not the biggest skateboard company but it might be just be the worst. Founded by Stacy Lowery and Michael Sieben in the Summer of 2008, Roger has quickly become one of the least relevant skateboarding companies in the entire industry. Roger will most likely be out of business by the time this buyer's guide is printed but in the off chance that we are still around we'll continue to adhere to our commitment of barely trying. Party on. rogerskateboards.com



Bender
8.25" x 32"



Weed & Cobras
8" x 31.5"



Ghost Boner
7.75" x 31.5"



Skate Switch
8" x 31.5"

sasquatch wheels

Hello Concrete Wave readers, it's me Sasquatch! I don't normally do interviews, but I made an exception for Concrete Wave. Let me share with you some truths about the Sasquatch. It is my opinion that there is nothing on this earth tastier than a deep-fried penguin. Believe it or not, but Sean Connery based his accent on my voice. I understand that humans love to pop bubble wrap; I like to do the same thing, but with human heads. For the hip, young, budget conscious person on the go—Sasquatch is a fine choice. sasquatch-wheels.com



Trucks and Bushings

Introducing Sabre Bushings, manufactured with the most advanced urethane formulas in the world. R-Type, X-Type and F-Type (pictured) available now. Also, 190mm, 45-degree truck coming soon. Vous présentons les gommes de Sabre, fabriquées avec le plus avancé des formules d'uréthane dans le monde. Type-R, Type-X et Type-F (en photo) maintenant disponible. Truck 190mm, 45 degrés bientôt disponible. sabratrucks.com



190mm



F-Type



Here at Sector 9 we've gone underground. All we do is survive on past successes and bounce around internet chat-rooms planning and scheming unlimited subterfuge on other skate companies. Actual skateboarding is a thing of the past; um, not likely. In reality we've been working hard at broadening our manufacturing expertise (which takes place in San Diego, CA. USA) to make higher quality original skateboards and delving deeper into the chemistry books in the quest for better wheels. Helping to bring these things together in harmony is our thoroughly committed skate team which you can share a sesh or a ride with at many a grass roots event or secret pool (well lets not blow out the secret pools). So opt out of that forum and hop on a skateboard. (one of ours would be cool) sector9.com or 858-408-0083



Maccas
8" x 33.5"
WB: 17"



Bomb Hills
9.375" x 38"
WB: 26.5"



Carbon Trylam
9.5" x 39"
WB: 29.6"



Kommi
9" x 38"
WB: 29.5"



Race Formula
77mm/71,81A

Ceramic Bearings



Surgeon Slide gloves





Seismic Skate Systems is a 16-year-old company based in Boulder, Colorado. We design and manufacture high-performance trucks, wheels, decks and completes for carving, cruising, racing and beyond. Our patented spring-loaded truck technology brings advanced control and superior rebound with precise turning response. Seismic Black Ops urethane offers more grip and rebound together, with less rolling resistance, than any other formula in the history of skateboarding. Industry-leading core technology makes our larger wheels astoundingly lightweight, with super-charged inside edge rebound. Our classic yet progressive board shapes feature cutting-edge materials and construction, with completes expertly tuned for superb carving performance right off the shelf. Seismic is also the world's primary source for regulation slalom cones. seismicskate.com



Seismic Truck
180mm truck in 45° geometry
(also available in 30° geometry and 105mm, 130mm, 155mm)



Hot Spot
66mm x 49mm 79/82/85/88A
(also in 63mm and 69mm)



Speed Vent
73mm x 54mm 76/80/84A
(also in 77mm and 85mm)



Temple Fish
9" x 36" camber-concave doublekick



Speed Vent
85mmx52mm 75/79A



SHUT Skates from NYC - To know it is to love it. To not know it leads one to learn about it. This iconic company was home grown by a group of hungry teens in 1986 with the desire to provide for their need of functional skateboards. The perception of how one starts a skateboard company was changed forever when SHUT first made its mark on the world and took the industry by storm. With their new flagship store in New York City's historical Lower East Side, SHUT continues to support the growth of NYC skateboarding. Stop by and see us sometime at 158 Orchard Street! SHUT skateboards are proudly made in the U.S.A. shutnyc.com



Gang Throws



2Skulls



Goddess



Wood Type



NEW Bossco International launches SHRED'RS, a revolutionary line of skateboarding products. The line features: Slider Glove – designed for sliding; and the Axelerator skateboard – the smoothest ride on the road, with

shock-resistant engineering and a 45° lean in either direction. You'll feel like you're riding a surfboard. SupaFlya features enlarged wheels and axles in the center in the shape of an arch, which make it automatically propel straight and center for increased speed and smoothness. Check out all products and future innovations at bosscointernational.com.



Street Flyer



Slider Gloves



Strople Insurance Services/sk8insurance.com offers all types of insurance coverage throughout the United States. We provide a variety of coverages specifically tailored for the skateboard, surfboard and snowboard industry. We primarily focus on manufacturers, distributors and retailers. The coverages include product, general and auto liability, property, worker compensation and home insurance, all offered in an exclusive national program with extremely competitive pricing. We also bring more than 35 years of industry and professional experience.





Your complete solution for racing, flatland/freestyle, distance skateboarding gear — and so much more. Supplying the worldwide skateboard community from our headquarters in Southern California — we offer ground-breaking designs, fine-tuned custom completes and only the best components & accessories available. Our pursuit of excellence is proven each year by our team of champion riders from legends to tomorrow's heros. Still having a blast after 11 years! Shop online 24/7 at SK8KINGS.COM or call for assistance at (714) 636-7308.



World Champion
Lynn Kramer Pro Model
8.375" x 31"
WB: 18/19"



Brown Bomber
Richy Carrasco
Pro Model
8.625" x 31" WB: 19.25"



AXE II
8.625" x 32.5"
WB: 20/21"



Skully AXE 2.5
8.625" x 32.5"
WB: 20/21"



Jester AXE III
8.875" x 33.5"
WB: 21/22"



Maximus
"Super G"
9" x 35"
WB: 22/23"



Chris Yandall
Pro Model Dex Series
9.75" x 35"
WB: 23.25"



Jester Retro
7.375" x 27.75"
WB: 12.5"



Diane Desiderio
Pro Model
7" x 26.75"
WB: 11.75"



Primo Desiderio
Pro Model
7.25" x 28.75"
WB: 11.75"



Keith Butterfield
Pro Freestyle
7.25" x 27.5"
WB: 11.5"



Richy Carrasco
Pro Model
7.875" x 28.75"
WB: 13"



Gary Holl
Pro Model
7.625" x 30"
WB: 13.25"



Amoeba Invasion
By CP Kaestner
8" x 31.5"
WB: 14"



Old English
7.75" x 31.50"
WB: 14.5"



Off The Rails TV Vol. One
DVD



Slalom Skateboard Racing
2004 World Championships
DVD



360 King Record Breakers
Steel 360 Spinning Wheels



360 King Spinners
Urethane 360 Spinning
Wheels



"Skandal"
Modified Randal Truck
108mm



King Plates
nose/tail
skids



Racers' Edge Eyewear
Blue Mirror Lens
Light Blue Lens



Padded Zipper Board Bag 9.5" x 38"



Steel Bearing
Spacers
(.437" round .
320" x .400" long)



"Skennett"
Modified Bennett Truck
101mm



Crown Jewel
Wheels
55mm/98A

Crown Jewel
Wheels
55mm/95A

Slasher
Wheels
60mm/98A

Skatedesigns

SkateDesigns offers a variety of skateboards to fit your exact need. One of their newest models is the redesigned Hitchcock World Champion Model. With the size of the deck being 28"x8.5" it is the perfect board for traveling around town, or on a college campus. The Hitchcock comes in blue, green, and black decks, with Tracker RaceTrack 129 Trucks, and the new SkateDesigns Wings Wheel. The SkateDesigns Wings Wheel has been designed with a new high rebound formula. This is just one of the many complete sets SkateDesigns offers. For a full list of SkateDesigns products visit skatedesignsinc.com.



Stinger Fish
8" x 26"
WB: 14"

Black Crown
8.5" x 29"
WB: 15.5"

Hitchcock World Champion Model
8.5" x 28"



sKoSh SkaTeBoaRdS were made specifically to take a BIG beating from smaller, younger, lighter rippers. The term "SKOSH" means "A little Bit" so naturally, these high performance decks are made just for them!! SKOSH SKATES come in three (3) different sizes with different wheel bases; 1) The "Skosh Script" is our smallest deck at 6.75x26.75". The "Grin Reaper" measures 7x28.5" and has the same 12" wheel base as the Skosh Script. The "Skosh Royal" is the largest deck at 7.5x31" with a 14" wheel base. Made of 100% Canadian Hardrock Maple with superior glue, these decks may be small- But they GO BIG! Visit our website at skoshboards.com



Skosh Script
6.75" x 26.75"
WB: 12"

Skosh Reaper
7" x 28.5"
WB: 12"

Skosh Royal
7.5" x 31"
WB: 14"



Back in 2000, veteran Professional Skateboarder Lynn Cooper compiled years of his personal Skateboarding archives and produced his first video depicting legendary moments in Skateboarding History and released "Wheelin' in the Years". Lynn surprised everyone and decided to continue promoting all forms of Skateboarding History to the world, thus Skatelegends.com was born! Seven years later, Lynn has now produced four major movie releases and has provided historical footage and photography to many familiar movies, games, television programs, magazines and books. Skatelegends.com now has its own Skateboard product lines, Clothing, Distribution offerings and an awesome Pro/Am Skateboard demo and coaching team! Check out the SkateShop for articles, new movie productions and products often! skatelegends.com



Live Breathe Learn (Organs)
7.5/7.75/8" x 32.125"
WB: 14"

Live Breathe Learn
7.5/7.75/8" x 32.125"
WB: 14"

Trippy Logo
7.5/7.75/8" x 32.125"
WB: 14"

Reap it
7.5/7.75/8" x 32.125"
WB: 14"



Skull Skates Est. 1978, innovative, steadfast, diehard, dedicated, progressive, traditional, functional, hardcore, diverse, dependable, sincere, solid, committed, reliable, devoted, understated, underground, insubordinate, outcast, proven, legitimate, seventies, eighties, nineties, new millennium, street, transition, cruising, carving, commuting, freestyle, high jump, banked slalom, cross country, barrel jump, spin off, technical, surf style, shred dog, rail kid, bert slide, switch heel, downhill, ditches, pool, parks, ramps, pipes, pros, ams, groms, moms dads, young, old, rich, poor, say what you want just get the name right www.skullskates.com

Craniums
52mm
54mm
56mm
58mm
60mm



Crystal Skull
70mm



All City
9" x 36"
WB: 17.75"



Surfrider
8.875" x 42"
WB: 31.625"



SLINGZ is a unique, hands-free skateboard strap for skaters who face the universal problem... Whether it's a dirt field, walls, or the occasional in-shape security dude, we sometimes gotta pick up and go. "I like to think of it as a guitar strap for my skateboard!" says Dave "HACKMAN" Hackett. SLINGZ hit Action Sports Retailer (ASR) hard and created quite an undeniable buzz. It gathered a national/international crowd of shop owners and distributors, proving its worthiness amongst skaters across the globe. SLINGZ retails for \$9.95. Available in Black, Camo and Pink. Sold at skate shops and at slingzstore.com.



SMA this year has come up with a new line of limited, custom production decks. Each deck is hand stained and no two are the same. It's our belief that since skating is a personal moment, your deck should be yours alone. Also, I got tired of people biting my work. So game on. We will have guys with models come in to do their own take on the process, so a Bennett will be a Bennett; a Ngoho will be done by Pat, etc. Also I will push forward with our full line of composite decks. Like always, we try to do our best. smaskateboards.com



Bennet Harada	Eric "Tuma" Britton	Jesse Martinez	Mark Jones	N13 Longboard
9" x 32.75"	8.1" x 31.625"	9.125" x 32.875"	10" x 34.5"	7.25" x 36"
WB: 15.25"	WB: 15"	WB: 15.6"	WB: 16"	WB: 20.5"



Slip Tape is a light-weight engineered polymer sheet that is 6X more abrasive resistant than steel. It acts like another laminate layer, drastically increasing the performance of your board. Slip Tape gives a consistent smooth slide that feels like a new deck that the paint just won't wear off. Slip Tape protects the bottom layer of wood from being cut. This prevents the board from losing response and preserves the strength for the life of the deck! Yatzy Spray Wax is regular paraffin skate wax put in a can! Spray it on instead of rubbing it on! Also amazing on snowboards – like hot wax in a can! Check out sliptape.net or call (888) 203-0011.

other laminate layer, drastically increasing the performance of your board. Slip Tape gives a consistent smooth slide that feels like a new deck that the paint just won't wear off. Slip Tape protects the bottom layer of wood from being cut. This prevents the board from losing response and preserves the strength for the life of the deck! Yatzy Spray Wax is regular paraffin skate wax put in a can! Spray it on instead of rubbing it on! Also amazing on snowboards – like hot wax in a can! Check out sliptape.net or call (888) 203-0011.



SoCalSkateshop.com (SCS) – Skater-Owned and Operated! Established in 2002 to serve the needs of skateboarders like you! Live inventory, 3000+ products. When you visit SoCal Skateshop you will

discover what thousands of other skateboarders have discovered – the best-stocked and easiest-to-navigate core online skateshop on the Internet! Updated daily with all the newest products and constantly restocked with the products you depend on for your daily skateboarding needs!

- Free shipping on orders over \$85 (applies to mainland US customers only)
- Fast, efficient/reliable shipping
- Excellent customer service
- International orders welcome

Featured brands: Abec 11, Black Label, Creature, Independent, Santa Cruz, Girl, Krooked, Loaded, Khiri and many more. Visit socalskateshop.com or call (949) 600-5876. For the latest skateboarding coverage and skatepark information happening in Southern California, please visit socalskateparks.com. Be sure to check out our comprehensive photo and video coverage from all major pro/am events that take place in Southern California.





Product Design and Development Team: Lester Kasai, Kevin Staab, Steve Steadham, Max DuFour, Rob Lorifice, Adam Taylor, Nolan Johnson, Curren Caples, Al Partanen, Tony Farmer, Adrian DeMain, Julie Kindstrand. Preventing concussions since 1999. S-ONE.COM



Damager Cpsc / Art Collab 1



Damager / Grey Matte



Team Cpsc / Art Collab 2



Triam/Grey Camo



Speed-dealer Distribution – a worldwide distributor – is a skater-owned and operated company based in Calgary, Canada. Bennett Truks, Alligator wheels, Speed Lab Shiftfire wheels, RocknRon's Rockets bearings and Skate Technology Ballistech Missiles bearings, Old Man Army bags, Shivs and Shanks rails and Speed Shop precision skate products are our primary focus. Our retail arm, www.speed-dealer.ca, offers much the same product lines as its parent company but with the aim of serving skaters worldwide who do not have access to our lines via their local shops. At Speed-dealer, our credo is: If we don't rock it, we don't stock it! speed-dealer.ca



Soul ryde

New to the Soul Ryde line up this season, is the addition of these tricked out ply decks. While still offering the hardwood series, Soul

Ryde is now offering three different "ply" decks (only 2 shown below), to fill demand for a more versatile ride. In true Soul Ryde style, these ply decks are far from ordinary. Instead of using heat transfers or screen-printing for the graphics, they use different colored woods and inlay them all together to make one seamless image. Their signature laser etched graphics are then applied to finish off these truly unique rides. For more info or to customize your own ride, visit us at soulryde.com.



Skull king
9" x 30"
WB: 18.5"



Sacred heart
9" x 32"
WB: 15.5"



Hex-root
10" x 37.25"
WB: 19.25"



Rising Sun
8.5" x 40"
WB: 25"



Sketchy tree
9.5" x 47"
WB: 30.25"



Stoked Skateboards is all about spreading the stoke of skateboarding.

Beginning with the support of Loaded Boards, Stoked thrives with great customer service, excellent products and the need to spread the stoked of boarding to as many people as possible. The Stoked Skate Team (also known as SST), an innovative new way to spread the love of boarding, was made just for this purpose and causes the sport to prosper by reaching out to more and more new skaters. Stoked is among the most recognized in specialty skate shops and appeals to customers through innovation and customization. Spread the Stoked! and check us out at stokedskateboards.com.





At Street Swell Inc. we are making exotic hardwood longboards for the rider that does not want to be just one in a crowd. Each board is meticulously crafted using beautiful, hand-selected hardwoods. A fiberglass top with integrated grip ensures years of pleasure without the risk of cracks. Choose from three shapes in six different wood configurations. If you are looking for something totally unique, look into our "one of a kind" custom boards. All of our boards are as much a pleasure to ride as look at. Don't be part of the masses; check us out at streetswell.com.



Cruise Zulu

Cruise Custom

Cruise Charlie



Surf One is coming on strong in 2009 with a multitude of new graphics and shapes, including the all-new Beer Pong board that doubles as a skateboard and mini Beer Pong table. Also new to Surf One are the 40" bamboo pintail Skeleton Surfer, and the 35" Lion of Judah. We build them up in our Santa Barbara factory using the best components available and feature a lifetime warranty on our products. surf-one.com



Beer Pong
8.875" x 43.75"

Beer Poster
8.625" x 43.625"

Skeleton Surfer
40"

Lion of Judah
35"



Founded in 2003 our goal was to create an online company with a proper live inventory and a passion for upfront, personal customer service. Our passion for skateboarding has led us to carry the most extensive, unique line up of products available in the industry. As the years passed more great companies with the same goals have emerged and set a strong foundation for the future of skateboarding. We are proud to be a part of this online community and to share space on these pages. StrangeHouse is skater owned/operated. Online at strange-house.net or call Frank at 703.869.2499.



SH Mutant 8.5
8.5" x 32"
WB: 14.5"

SH Mutant 9.5
9.5" x 33"
WB: 15.5"

SH Mutant 10.5
10.5" x 34"
WB: 16.5"

SH Mutant 11
11" x 34"
WB: 17"

surfRodz



Surf-Rodz is a U.S.-based company specializing in the design and manufacture of custom longboards and snowboards. Our durable, one-of-a-kind decks are hand- and machine-crafted from a variety of materials, but chiefly from natural woods such as organically grown teak, bamboo and birch. Our emphasis on collaboration and product integration allows us to work with individuals and companies who share our passion in not producing more products than the industry or the consumer needs. The Surf-Rodz deck offers riders a high-quality platform to which they can add their own choice of components for their riding pleasure. surf-rodz.com or call 203.530.2668



The Thresher 42"

Freeride 60"

Proteak Gun 72"



Indaba Distribution was first established as the vehicle to circulate Concrete Wave magazine. We choose the name Indaba because in the Zulu language the word Indaba means "a place where people with like minds get together to solve problems." Today Indaba not only distributes thousands of copies of Concrete Wave; we also offer many of the unique and well-designed brands featured in the pages of Concrete Wave. Bennett Truks, Alligator wheels, Tunnel products, 187 Safety equipment, S-one helmets, Pool King skateboards and many other brands can all be found at Indaba Distribution. If you own a shop, we welcome you to our "indaba" and would be happy to help grow your business with the brands we offer. From Boston to Berlin, Portland to Paris, we ship worldwide and offer every client outstanding service, backed with knowledge of product and more than 30 years of skateboarding experience. Call (760) 722-4111 or contact indabadist@yahoo.com.



Thank you! Edwin and I (Mark) want to pass on our sincerest "Thank You" for supporting Texas Longboards! You came to us from far-away places like Thailand, Belgium, Germany, England, Argentina, Australia and across the U.S.A. You gave us your opinions, shared your stories and helped us make decisions. Our philosophy is simple: we ride, sponsor events, watch your sessions as fans and talk to you. From these experiences we decide what to add to our growing list of the greatest longboard products on the planet. Thanks to our partners in business and to Concrete Wave. You rock! texaslongboards.com



TimeShip Racing designs and sells the most progressive safety gear for freeriding and racing. Tracer Slide Gloves are heavily armored with knuckle protection, fireproof Kevlar thumbs and rotatable pucks for palms and fingers. They are the Racer's Choice! New Pyro Pucks throw sparks! TSR Helmets are DOT-rated G-Max helmets fitted with a custom Lexan face shield, sizes Youth - XXL. TSR Pressure Suits offer fully armored protection for your arms, shoulders and spine and can be worn with or without leathers. TimeShip's Skate School is in Santa Fe, N.M. Check timeshipracing.com for upcoming Race Camps, or call (505)-474-0074.



TSR Pressure Suit
Sizes: S, M, L, XL



Jordan Race Glove
Sizes XSmall - Large



Skate Bungee



Tracers Slide Glove
Sizes XSmall - Large



The original skateboard truck since 1975. Only Grade A prime 356 aluminum is used in the sand-casting process. You can count on Tracker's legendary strength. **Axis:** 129mm and 139mm - A low, quick, dependable truck, with Superball cushions. **Fastrack:** 150mm and 180 mm - Oversized, high-rebound upper and lower cushion. New black-yellow colorway for Spring 2009. **MidTrack & FulTrack:** 85mm, 106mm - Hangers and baseplates are cast from original molds, and the baseplates feature the old-school mounting hardware pattern. **Dart series:** 129mm, 139mm, 149mm, 161mm, 184mm, 219mm - The Dart model is a predictable, stable truck that you can trust. Trackertrucks.com



Axis



Dart Series



FullTrack



FastTrack



Triple Eight is one of the fastest-growing action sports companies in the industry. Since 1995, Triple Eight has been developing the best protective gear for skate and snow sports. Professional athletes such as Anthony Furlong, Neal Hendrix, Elliot Sloan, Adam Taylor and Mitchie Brusco choose Triple Eight for all of their protective gear needs. The Sweatsaver liner helmet is made of a high-tech, highly absorbent terry cloth fabric that's fully wrapped around its foam insert to keep the sweat from dripping down into your eyes. Triple Eight Sliders are the newest edition to their innovative line of protective gear. These longboard slide gloves are a full top grain leather glove with tear-resistant Kevlar fingertips. We are proud to have Team Earthwing riding for us and using our Sliders! triple8.com



Black Rubber



Kelly Green Rubber



White Glossy



Slide Gloves



Since 1988, TSG has produced original helmets and pads for skateboarders. Technical Safety Gear designed by riders is what drives the company and brings new gear in 2008. The Evolution helmet with its low and snug fit, anatomically shaped all-around the head, comes with great new graphics. Our Superlight helmet with only 10.5oz is the lightest skate helmet on the market. A large collection of strong knee- and elbowpads offer the right choice for all terrains and levels. Color them up with our new graphic recaps! We have enlarged our skate glove collection for mega ramp enthusiasts. Check the whole collection at www.ridetsg.com.



Elbow pads
Evolution II



Evolution Skyline



Knee pads
Force Evolution



Megaramp Gloves
Long



Founded in 1975, Tunnel continues to build on its reputation with innovative, high-performance skateboard products. The new Tunnel STR (Speed Through Research) Tarantula wheels feature a racing urethane and brand new is the Tunnel "Comp" longboard. Based on an original Tunnel design, it has camber, concave and composite construction and rides as fast as it looks. We haven't forgotten our roots, either, and have a great line of cruisers such as the Marshall Coben, the '70s Retro and the hand-made Waldo Cloud. And the Tunnel Rocks rock! tunnelskateboards.com



Tunnel Comp
9.25" x 38"
WB: 27.25"



Marshall Coben
7.5" x 26"
WB: 14.25"



Tunnel STR Swirl
70mm/78A



Blue Rocks
63mm/75A



Tarantula STR Racing Urethane
70mm/78A



Translucent Red Rocks
63mm/78A



Orange Tarantula
70mm/84A



Blue Tarantula
70mm/75A



Amber Tarantula
70mm/82A



Red Tarantula
70mm/78A



Amber Rocks
63mm/82A



Red Rocks
63mm/90A

VELOZ

Veloz Trucks: "MADE FOR SPEED"

- 180mm
 - Deck mount/drop through or bottom mount versatility.
- X-5 SYSTEM – features the Veloz X rear truck. The non-turning geometry gracefully tracks the front 50° truck.
- Patent pending aerodynamic truck design eliminates speed wobble using advanced geometry.
 - Superior traction at high speeds around hairpin turns.
 - Race tested.
- V-5 SYSTEM
- 50° front and rear specific trucks.
 - Patent pending aerodynamic foiled trucks.
 - A solid choice for carving or slalom.
 - Race tested
- veloztrucks.com (888) 927-9586



Veloz X



Veloz V-5 front



Veloz V-5 rear



Viking Helmets by Rock On Distribution offers a full line of helmets for skaters of all ages. The Viking Youth Helmet is becoming the leader in head protection for children between the ages of 3-7yrs old. The CPSC approved Viking Youth helmet is actually a smaller shelled helmet making it look better, fit better, lighter and safer for the kids to wear, all at affordable prices. With a wide choice of colors and graphics the One Size Fits All Viking Helmets help skaters of all ages push their own personal skill levels.

vikinghelmets.net



Black

Flat Grey

Flat Blue

Flat Green

White

Red

Pink

Blue Hawaiian

Pink Hawaiian

Skull

Youth selection (many colors)

Viking Combo Pad Set

VENOM BUSHINGS

ColorADO skater Zak Maytum started Venom Bushings in early 2008. Since then, Venom has stepped it up in a big way to bring you the highest-performance bushings available.

Bushing packs are available in four configurations: Downhill Pack, Super Carve Pack, Standard Pack and the New Eliminator Pack! With six durometers and off-the-chart rebound and stability, Venom Bushings were landed on countless podiums in both downhill and slalom racing in 2008. They can be found under the feet of just about anyone who wants their board to feel right. We're taking over the world – one kingpin at a time. venombushings.com



Super Carve



Eliminator



Standard



Downhill



Woody's Halfpipe is your source for everything skateboarding — Longboards, Pool Decks, Street Boards, Slalom gear and Freestyle Decks and many hard to find skateboard items are all here in our Norcross, GA store. Located in a suburb of Atlanta, Woody's Halfpipe boardshop offers you a real store with real people and real service — we invite you to visit us. Open 7 days a week and conveniently located near Pickneyville and Brook Run Skatepark; Woodys Halfpipe has what you need to skateboard. Since this site is the work of a small number of hard working people, some items we carry are not on the site, so call us at 770-416-1475 and we might just have the hard to find skateboard item you need.





The legendary Zorlac skateboards is experiencing a resurgence. Zorlac, founded in Dallas, Texas in 1976 and originator of the iconic skate phrase "SHUT UP AND SKATE," is offering a complete range of products including T-shirts, stickers and reissue series boards. The reissue series are true to the original graphics, shape, concave and colors. Zorlac board graphics use the original art film whenever possible and feature the lost art of hand silk-screening. Zorlac also offers current street, pool and ramp boards. The complete Zorlac product range can be found by visiting zorlacsksates.com.

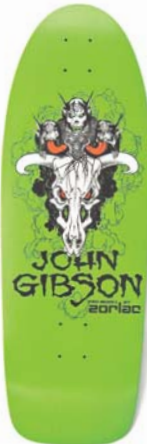

John Gibson
Pig Reissue



Zorlac
Skull Deck



Let's Get Dead



Big Boys
Reissue



SKULLANDBONESKATEBOARDS.COM

Skullandboneskateboards.com was created in 2001 and has grown into one of the largest skateboard communities on the net with an ever-growing roster of 7,326 members. While the site was initially focused on collecting and skateboard history, it has grown to encompass all facets of skateboarding insofar as disciplines, equipment and all aspects of skateboard subcultures. We talk a lot about skateboarding when we're not out there skating. The latest industry news (releases and insider), hot discussions, the raddest skateboard collections you've ever seen, more skate luminaries than you can shake a stick at, list of people to watch out for on eBay, buying, trading, session hook-ups, session reports, rad skate pics and video – it's all here at S&B. skullandboneskateboards.com/forums/

SkullandBonesSkateboards.com

FAQ Search Memberlist Usergroups Profile No new messages

Skull & Bones Jamboree index

View unanswered posts View posts since last visit View your posts Mark all forums read

SkullandBonesSkateboards.com » A COMMUNITY OF SKATEBOARDERS AND SKATEBOARD COLLECTORS

FORUM RULES AND ANNOUNCEMENTS

Forum	Topics	Posts	Last Post
FORUM RULES & ANNOUNCEMENTS	4	4	28 Dec 2008 22:25 sbc.se *

COMMUNITY

Forum	Topics	Posts	Last Post
HOT DISCUSSIONS Skateboard Related Hot Discussions only	2257	32929	10 Feb 2009 10:12 Forumite *
SHIT TALK ONLY Need to talk some shit? Do it here.	3307	91300	10 Feb 2009 11:58 Forumite *
SKAFING MATERIAL We all need to feed...	443	5236	09 Feb 2009 08:47 sbc.se *
B.O.N.O.S.A. Welcome to Buyers Of New Old Stock Anonymous	95	1321	08 Feb 2009 23:38 skateboarder *
POLITICS We are a community and these issues affect us. Try to open your minds rather than close through an agenda.	1499	30302	10 Feb 2009 12:02 skateboarder *
GENERAL DISCUSSION FORUM Everything else	3171	44660	10 Feb 2009 12:03 skateboarder *
ARECTIONS OF INTEREST THE WEIRD, THE WACKY AND THE AMAZING...AND NOT YOURS.	195	1879	08 Feb 2009 23:46 skateboarder *
SKATEBOARD ART Skateboard Art created by and for Forum members.	1184	12343	10 Feb 2009 11:16

boardshop AUSTRALIA

www.boardshop.com.au

- ✓ SKATER OWNED AND FULLY INDEPENDENT
- ✓ SPONSORS COMPETING RIDERS
- ✓ EXPERIENCED SKATE PARK DESIGNERS
- ✓ SUPPORTS UNDERGROUND SKATING COMMUNITY
- ✓ INDUSTRY CONNECTED AND RESPECTED
- ✓ SOURCES RARITIES · CLASSICS · COLLECTABLES
- ✓ DONATES FOR COMPETITIONS
- ✓ SPONSORS AND BACKS EVENTS
- ✓ TWELVE DEMOS IN SIX MONTHS
- ✓ OPERATED BY PEOPLE WHO SKATE!

DEMAND SHOPS AND
DISTRIBUTORS SHOW
YOU THEIR LIST!

"for the love of skateboarding"

boardshop.com.au

ONE OF A KIND
BUSTIN

Sojourn 2.0
Spring 09

Win one of the first Sojourn 2.0's Enter at www.bustinboards.com/concretewave

Easy Rider

Edmonton, AB, Canada
780-413-4554
TheEasyRider.com

concrete wave

100% SKATEBOARDING Clothing Now Available at CalStreets.com!

Longboard Dealers contact
shop@CalStreets.com

Concrete Wave Magazine: Hoodies, Stickers, T's and More at CalStreets.com

We ship all over Europe!

Rider Shop
HawaiiSurf.com
Since 1976

BANZAI Original BLACKKROSS Made in France 80's Original

Biggest French Since 1976 Import

French Board shop

PARIS

Longboards
Pool
Downhill
Cruising
Street

+33 1 46 720 710 skate@hawaiisurf.com
GPS : 2.384°E - 48.814°N
69 av. Danielle Casanova 94200 IVRY^{Seine} FRANCE

"KILLER BEE" AT MARYHILL '08
PHOTO COURTESY OF SILVERFISH

TACTIS SK8 SHOP

ALL DISCIPLINES - FULL PRO SHOP
TACTISSK8SHOP.COM
916.712.7000

BOARDS DESIGNED AROUND THE ENJOYMENT OF RIDING.



LOTUS
SKATEDESIGNS.COM

MONARCH 42 MONACO 35 FAST BACK 33



INSECT



Carbon Nanotech + Honeycomb Core = Pure Aerospace Composite
Stronger • Lighter • Thinner & Guaranteed to be 100% Soybean Free

www.insectskateboards.com

legendary
Longboards



Smooth Drive

www.legendarylougboards.com

Eastside Longboards™

WWW.EASTSIDELONGBOARDS.COM
EASTSIDE OF PORTLAND, OREGON

DECKCRAFTERS

skateboards handmade by
Chuck Hulst

www.deckcrafters.tv
deckcrafters@ca.rr.com



**Buck Smith
Classic**

Custom decks & OEM
also available

Buck Smith
BREAK TIME AT HIS REAL JOB

photo capo

BLACKKROSS

KUSTOM LONGBOARDS



WWW.BLACKKROSS.FR

The Power of the Metroboard

metro | board

Electric Skateboard



www.metro-board.com
Made in Portland, OR, USA

Smooth, Quiet, Fast, Ultralight

BROKEN SK8 CO. BONES



"OUR LOCAL SK8 SHOP"

MYSFACE/OLDSHRED.COM



PHOTO: DANNY STEVENSON
RIDER: LUC DUGAS

CORNWALL ONTARIO CANADA

"THE FUTURE IS LOOKING BRIGHT"

- COMPLETE CARBON FIBER CONSTRUCTION
- SUPER LIGHTWEIGHT
- ULTRA STRONG
- VERY DURABLE
- TURN GREAT & GRIND EVEN BETTER
- AVAILABLE IN 7.625", 8.25" & 9"

WWW.HERRONTRUCKS.COM -
 PH: 619.471.4255 F: 913.294.9901 - 20 S. SILVER ST. PAOLA, KS 66071

www.strange-house.net



Photo : Albert Strange
 skater : Lawrence McDonald
 Arlington, VA



WERE YOU THERE?

NEXT TIME RIDE WITH THE SWITCHBACK ARMY

www.switchbacklongboards.com

Nanaimo, BC, Canada
1-250-751-ROCK (7625)

Photo: Erik Ware

Deep Cove Outdoors
 More Than Just Kayaks!



We now carry
Landyachtz
 longboards!

Photo: Nathan Lang
 Rider: Quinn Dubois

4310 Gallant Ave, Deep Cove, North Vancouver, B.C.
 604 987-2202 www.deepcovekayak.com

SKATEBOARD DIRECTORY INDEX

187 Pads26	Easy Rider37	Lush51	Riviera64
3dm26	Factory 1338	Madrid52	Roarrocket64
Abec 1126	Flexdex38	Metroboard51	Rockin Ron's Rockets64
Airflow27	Foundation38	MiniLogo51	Roe Racing64
Alligator Wheels27	Freshpark38	Miramar51	Roger65
Altered Skate27	Full Bag39	Motto52	Sabre65
American Sideshow27	Fun House39	Neversummer54	Sasquatch65
Arbor28	Fury39	NHS54	Sector 965
Armada28	G&S40	Ninja52	Seismic66
Ashland28	Garver40	Nitro52	Shred'rs66
Badlands29	GFH40	NSI52	Shut66
Bahne29	Gladiator Ghost40	Octane/Virages55	Sk8 Insurance66
Bear29	Grand Prix41	Oil City55	Sk8 Kings67
Beer Run30	Gravity42	Old Man Army55	Skate Designs68
Bennett30	Grom Biz41	Omni55	Skate Legends.com68
Blackross30	Ground Industries41	One57	Skosh68
Boardpusher.com30	Gullwing41	Orangatang57	Skull Skates68
Boardshop Australia31	Hamboard43	Original56	Slingz69
Bones Bearings31	Hawgs43	Oust57	Slip Tape69
Bones Wheels31	Herron44	Paincheaters57	SMA69
Broken Bones31	Honey44	Paris58	Socal Skateshop69
Buddy Carr Skateboards32	H-Street44	Pig58	S-One70
Bustin Boards32	IGSA44	Pink58	Soul Ryde70
Cadillac33	Illusion45	Plank58	Speed Dealer70
California Bonzing32	Indiana45	Pleasure Tools59	Stoked Skateboards70
California Skateparks32	Insane Asylum45	Pocket Pistols59	Strangehouse71
Carve33	Insect45	Pool King59	Street Swell71
Carver34	Kahalani46	Poolside59	Surf One71
Cheta33	Kahuna46	Positiv60	Surf Rodz71
Cold War34	Kebbek47	Powell60	Tailtap72
Comet34	Khiro46	Powell Golden Dragon60	Texas Longboards72
Conspiracy35	Koastal47	Powell-Peralta60	Timeship Racing72
Crail35	Ladera47	Pressure Drop61	Tracker72
Concrete Wave Germany35	Landyatz48	Pro Design61	Triple Eight73
Daddies35	Layback47	Pro-Tec61	TSG73
Dead Dog36	Legendary49	Performance Sk861	Tunnel73
Deckcrafters36	Little Paw49	Purple Skunk62	Veloz74
Decomposed36	Loaded49	Railside62	Venom Bushings74
Dregs36	Longboard Larry50	Rainskates62	Viking74
Durango37	Longboard Living50	Randal63	Woody's Halfpipe74
Earthwing37	longboard Store50	Rayne62	Zorlac75
Eastside37	Lotus50	Retro63	

SUBSCRIBE TO CONCRETE WAVE

5 ISSUES + BUYERS GUIDE = \$26US

International subscriptions are \$32 US. Canadian subscriptions are \$26 CAN.
Send to Concrete Wave 1054 Center Street Suite 293 Thornhill Ontario, L4J 8E5, Canada.

Please allow up to 8 weeks for delivery of your first issue.

Name: _____ Address: _____

City/State/Zip: _____ Email: _____

Please send check for \$26US made payable to Concrete Wave or international money order
or PayPal mbrooke@interlog.com

PRO-DESIGNED, INC.

"World's Best Knee and Elbow Pads"



Super Singles \$125
Mini Ramps \$105
Elbow Pads \$80
Wristguards \$55

Group Discounts Available - Call for Details!

(713) 957-0341

www.prodesigned.com



CBC CaliforniaBonzing.com



Made to the California Bonzing Co.'s Standards of Perfection Internationally Celebrated Since 2006

CBC

Longboard Living
TORONTO



Ryan Rubin, **Founder & RIDER**
Longboardliving@gmail.com
Longboardliving.ca

www.DEADDOGCLTHING.COM
New Colors and Sizes



Dead Dog Skate Shorts
Made In Southern California

A contemporary cut with old school flavor. Legs that go over the tops of your knee pads, rear pocket, belt loops, removable & washable pads. 100% cotton Sizes 22-40

RoeRacing
Slalom Skateboards

We Have You Covered!
Long Distance
Pumping - Racing -
Carving - Cruising

Dealer Inquiries: sales@sbcdistribution.com

STOKED SKATEBOARDS
www.stokedskateboards.com

Featured Streaker: James Peters - LDP World Champ!



Team Rider
Ray Fennessey

Longboards
Pool
Freestyle
Slalom
Street



770-416-1475
www.woodyshalfpipe.com

WOODY'S HALFPiPE

SK8INSURANCE.com

Insurance for :
Retail Skate, Surf, Snowboard Shops, Distributors,
Wholesalers, Suppliers, Manufacturers

Coverages can include:
Property, Liability, Product Liability, Auto, Workers Comp



STROPLE INSURANCE SERVICES
CHRIS STROPLE Owner/Skater
P.O. Box 480, Monrovia, CA 91017 • 626.357.0555 • Sk8insurance@att.net
A Member of The Rule Group

VENOMBUSHINGS.COM



VENOM
BUSHINGS

38" Rogue drop through

Named "**Best New Board**" at Jan. 09 Surf Expo by silverfishlongboarding.com

HONEY SKATEBOARDS



www.honeyskateboards.com

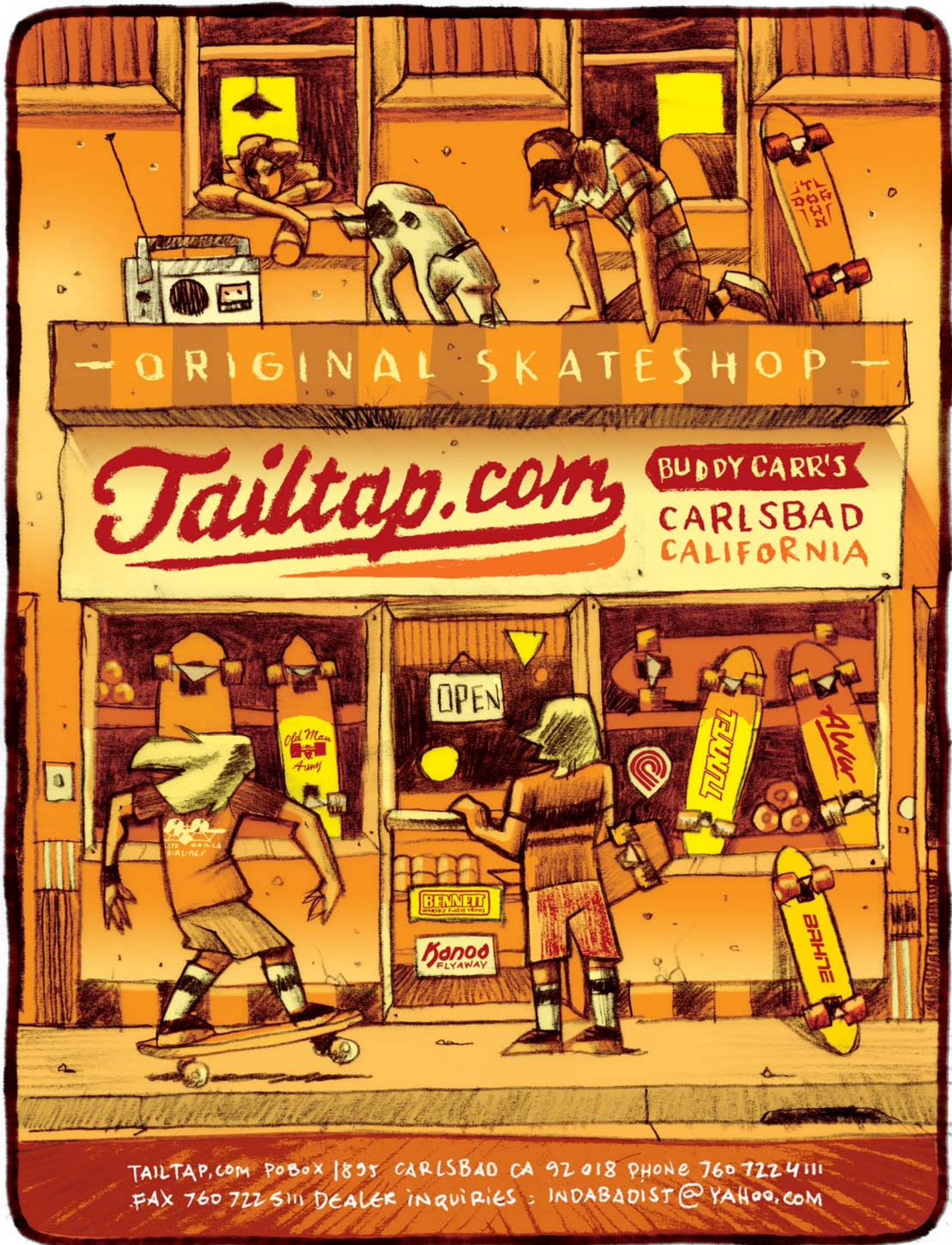

— ORIGINAL SKATESHOP —

Tailtap.com

BUDDY CARR'S
CARLSBAD
CALIFORNIA

OPEN

Old Man
Army

BENNETT
FLYAWAY

KONO
FLYAWAY

TEWELL

AWA

BRIHE

TAILTAP.COM PO BOX 1895 CARLSBAD CA 92018 PHONE 760 722 4111
FAX 760 722 5111 DEALER INQUIRIES : INDABADIST@YAHOO.COM

ARTWORK : PHILIPPE BEAUFRERE