

## Büro & Organisation Products for Office and Organization



Büro & Organisation  
Products for Office and Organisation

Neu / News ..... 04  
Hängeregistraturen / Rack for Suspension Files ..... 06  
Mobilbox & Trolley ..... 07  
Visitenkartenboxen / Business Card Boxes ..... 08  
BeeBox ..... 09  
Karteikästen / Card File Boxes ..... 10  
Schubladen-Boxen / Filing Boxes ..... 15  
Briefablagen / Letter Trays ..... 18  
Stehsammler / Magazine Racks ..... 24  
Schreibtisch-Accessoires / Desk Accessories ..... 26  
Kugelschreiberständer & Fineliner / Pen Bases ..... 30  
Telefonschwenkarm / Telephone Swivel Arm ..... 31

Produktfamilien / Product Families

Economy Transluzent ..... 32  
Economy ..... 33  
Economy Transparent ..... 34  
Ergologic ..... 35  
Linear ..... 36  
Silver ..... 38  
Design Classics ..... 40  
  
Numerisches Produktverzeichnis / Numerical product index ..... 42  
Funktionen und Farben / Functions and colours ..... 46







**H 62538**

Tisch-Organizer  
B 226, T 202, H 136 mm  
VE: 1

Linear Mobil Utensil Box  
W 226, D 202, H 136 mm  
pu: 1

Farbe / Colour

93

**H 61116**

Multibox  
B 305, T 39, H 254 mm  
VE: 1

Multi box  
W 226, D 202, H 136 mm  
pu: 1

Farbe / Colour

93



**H 61117**

Dokumentenablage  
B 201, T 270, H 259 mm  
VE: 1

Document Tray  
W 201, D 270, H 259 mm  
pu: 1

Farbe / Colour

95



**H 61294**

Schubladen-Box  
5 Schubladen  
B 265, T 340, H 250 mm  
VE: 4

Filing-Box  
5 drawers  
W 265, D 340, H 250 mm  
pu: 4

Farbe / Colour

02 20 30 50

82 84 98

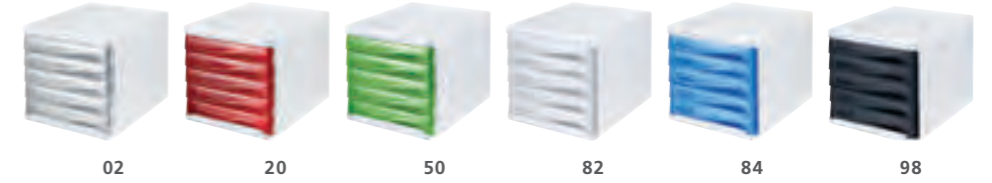

30

**H 61270**

my. doc, Briefablage A4  
B 273, T 355, H 50 mm  
VE: 2

my. dok, Filling Tray A4  
W 273, D 355, H 50 mm  
pu: 2

Farbe / Colour

25 34 50 82 95



geschlossen  
closed

geöffnet  
opened

3 x 2  
gestapelt  
stacked

6 x 1  
gestapelt  
stacked

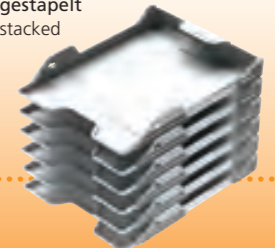
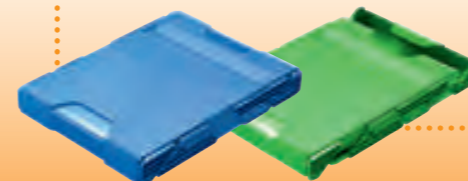



**Hängeregistraturgestell**  
Rack for Suspension Files

**H 61100**  
Hängeregistraturgestell  
B 360, T 380, H 260 mm  
VE: 1

Rack for Suspension Files  
W 360, D 380, H 260 mm  
pu: 1

Farbe / Colour

34 84 92



92



34

84



**H 61101**  
MobilBox + Mobilköcher  
B 425, T 200, H 375 mm  
VE: 1

MobilBox + Mobil utensil Box  
W 425, D 200, H 375 mm  
pu: 1

Farbe / Colour

95 94 93 91

Lieferung erfolgt ohne Utensilien  
Utensils not included



für 25 Hängemappen oder  
2 Aktenordner DIN A4  
for 25 suspension files or  
for 2 folders A4

Integrierter Mobilköcher  
Mobil utensil box included

Platzsparende Nutzung  
durch Rolloverschluss  
With roll-over cover

**Mobilbox & Trolley**

**H25170**  
Trolley

Zusammengeklappt: L 420 x B 252 x H 83 mm  
Aufgeklappt: L 235 x B 252 x H 900 mm  
Ladefähigkeit: 30 kg  
VE: 1

Trolley  
Loading capacity: 30 kg  
Folded: L 420 x W 252 x H 83 mm  
Expanded: L 235 x W 252 x H 900 mm  
pu: 1

Farbe / Colour

95



Schwenkbarer Tragegriff  
Swivelling handle

2 Beschriftungsfelder  
With 2 title blocks





**helit**

Büro & Organisation  
Products for Office  
and Organisation

Der helit-Klassiker mit 8-teiliger  
alphabetischer Unterteilung,  
Rolloverschluss und  
flexibler Rasterung im Boden  
für ca. 300 Visitenkarten.

The helit classic product with 8 sections,  
alphabetically arranged, with roll-over  
cover and flexible positioning of register  
for approx. 300 business cards.



**Der Klassiker**  
The helit classic

mit Beschriftungsfeld  
with labeling



**H 62204**  
Silver Visitenkartenbox  
B 136, T 240, H 67 mm  
VE: 1

Silver Business Card Box  
W 136, D 240, H 67 mm  
pu: 1

Farbe / Colour



**Visitenkartenbox**  
**Business Card Box**



PRODESIGN BERND BRÜSSING

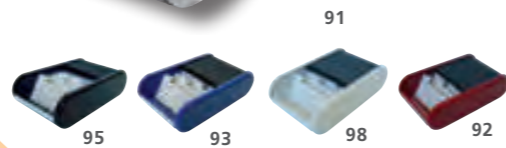

**H 62180**  
Linear Visitenkartenbox  
B 136, T 240, H 67 mm  
VE: 1

Linear Business Card Box  
W 136, D 240, H 67 mm  
pu: 1

Farbe / Colour



**H 75013**  
8-teilige alphabetische Unterteilung  
zusätzlich für H 62180 + H 62204  
VE: 1

Register, 8 sections, alphabetically  
extra for H 62180 + H 62204  
pu: 1

Farbe / Colour

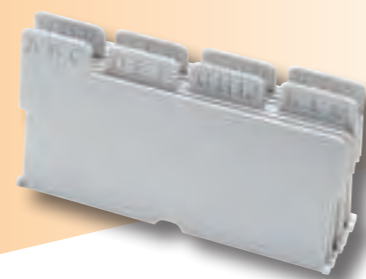

**Formate A8 + A7**  
A8 + A7 formats

**helit**

Büro & Organisation  
Products for Office  
and Organisation

Die Lernkartei und Info-Container. Leichter und schneller lernen mit System!  
Vocabulary and Indexcard Box. Learn more efficiently and quicker!

PRODESIGN BERND BRÜSSING



**BeeBox**

**H 69010**  
BeeBox Lernkartei  
Format A8  
VE: 1

BeeBox Vocabulary and Indexcard Box  
format A8  
pu: 1

Farbe / Colour



**H 69011**  
BeeBox Lernkartei  
Format A7  
VE: 1

BeeBox Vocabulary and Indexcard Box  
format A7  
pu: 1

Farbe / Colour



**BeeBox A8 + BeeBox A7**

Lernkartei, Ideen-Pool, Info-Container 5 variable  
Fächer für bis zu 600 Karten im Format DIN A 8  
und bis zu 800 Karten im Format DIN A 7

Learning index card file Pool for ideas Info container  
5 variable sections for up to 600 index cards A8 and  
up to 800 index cards A7

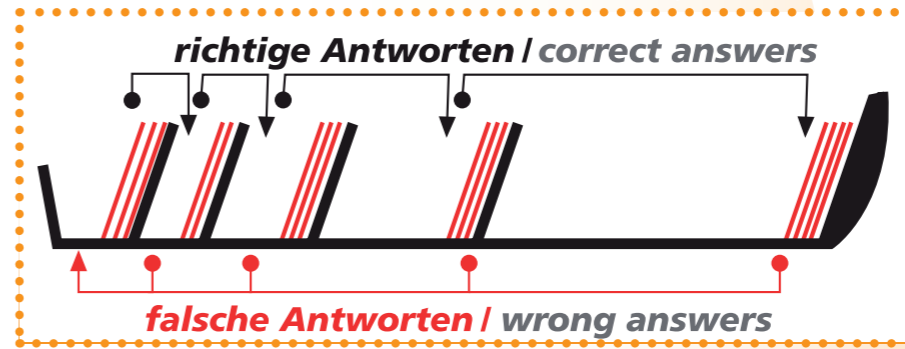

**A5**

für ca. 500 Karten  
for approx. 500 cards

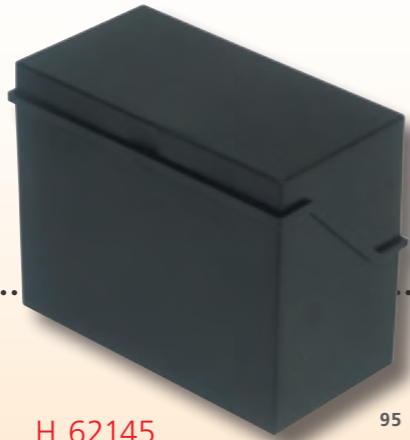

H 62145

95

**A6**

für ca. 400 Karten  
for approx. 400 cards

B 165, T 90, H 130 mm  
W 165, D 90, H 130 mm  
VE / Pu: 1



H 62146

95

**A7**

für ca. 300 Karten  
for approx. 300 cards

B 120, T 73, H 94 mm  
W 120, D 73, H 94 mm  
VE / Pu: 1



H 62147

95

**A8**

für ca. 200 Karten  
gefüllt mit ca. 100 Karten  
und A-Z Register  
for approx. 200 cards  
filled with approx. 100 cards  
and A-Z index

B 85, T 60, H 72 mm  
W 85, D 60, H 72 mm  
VE / Pu: 1



H 62148

95

Farbe / Colour  
25 34 82 95

Farbe / Colour  
25 34 82 95

Kleinkartei A5 quer  
B 228, T 110, H 170 mm  
VE: 1  
Card File Box A5 horizontal  
W 228, D 110, H 170 mm  
pu: 1

Farbe / Colour  
02

H 61146

Gefüllt mit ca. 50 Karten  
und A-Z Register  
Filled with approx. 50 cards  
and A-Z index



H 69046

30

Farbe / Colour  
02

H 61147

Gefüllt mit ca. 50 Karten  
und A-Z Register  
Filled with approx. 50 cards  
and A-Z index



H 69047

30

Farbe / Colour  
02

H 62148



H 69048

30

Farbe / Colour  
10 30 40

Farbe / Colour  
10 30 40





Formate A7 – A5  
stapelbar

DESIGN BY ZEISCHEGG



A5

für ca. 900 Karten, mit 1 Schwenkstütze  
for approx. 900 cards, with 1 divider

H 62120

Karteikasten A5 quer  
B 236, T 253, H 175 mm  
VE: 1

Card File Box A5 horizontal  
W 236, D 253, H 175 mm  
pu: 1

Farbe / Colour

82



82

A5

für ca. 1.200 Karten, mit 2 Schwenkstützen  
for approx. 1,200 cards, with 2 dividers

H 62135

Karteikasten A5 quer  
B 240, T 370, H 175 mm  
VE: 1

Card File Box A5 horizontal  
W 240, D 370, H 175 mm  
pu: 1

Farbe / Colour

82



82

A6

für ca. 900 Karten  
mit 1 Schwenkstütze  
for approx. 900 cards  
with 1 divider

H 62122

Karteikasten A6 quer  
B 173, T 250, H 135 mm  
VE: 1  
Card File Box A6 horizontal  
W 173, D 250, H 135 mm  
pu: 1

Farbe / Colour

82



A6

für ca. 1.200 Karten  
mit 2 Schwenkstützen  
for approx. 1,200 cards  
with 2 dividers

H 62136

Karteikasten A6 quer  
B 172, T 365, H 135 mm  
VE: 1

Card File Box A6 horizontal  
W 172, D 365, H 135 mm  
pu: 1

Farbe / Colour

82

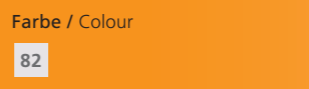

A7–A5 formats  
stackable

H 62128

Komfort-Karteikasten A5 quer  
B 230, T 340, H 150 mm  
VE: 1

Comfort Card File Box A5 horizontal  
W 230, D 340, H 150 mm  
pu: 1

Farbe / Colour

99



99

A5

für ca. 1.000 Karten, mit 2 Schwenkstützen  
for approx. 1,000 cards, with 2 dividers

H 62129

Komfort-Karteikasten A6 quer  
B 170, T 333, H 130 mm  
VE: 1

Comfort Card File Box A6 horizontal  
W 170, D 333, H 130 mm  
pu: 1

Farbe / Colour

99



99

A6

für ca. 1.000 Karten,  
mit 2 Schwenkstützen  
for approx. 1,000 cards,  
with 2 dividers

Schwenkstützen / Divider

A5

H 72078

Schwenkstütze A5 quer  
zusätzlich für H 62120 + H 62135  
VE: 2

Divider A5 horizontal  
extra for H 62120 + H 62135  
pu: 2

Farbe / Colour

82

A7

H 72080

Schwenkstütze A7 quer  
zusätzlich für H 62137  
VE: 2

Divider A7 horizontal  
extra for H 62137  
pu: 2

Farbe / Colour

82



A6

H 72079

Schwenkstütze A6 quer  
zusätzlich für H 62122 + H 62136  
VE: 2

Divider A6 horizontal  
extra for H 62122 + H 62136  
pu: 2

Farbe / Colour

82

Offene Karteikästen & -tröge  
Open File Boxes

H 62010

Karteitrog A4 quer  
B 318, T 350, H 215 mm  
VE: 2

Open Card File Box A4 horizontal  
W 318, D 350, H 215 mm  
pu: 2

Farbe / Colour

82



A4

für ca. 1.200 Karten, mit 2 Schwenkstützen  
Stapelbar, einhängbar in Hängeregistratur-  
gestelle  
for approx. 1,200 cards, with 2 dividers  
Stackable, suitable for suspension file racks

H 62013

Karteitrog A5 quer  
B 227, T 350, H 145 mm  
VE: 2

Open Card File Box A5 horizontal  
W 227, D 350, H 145 mm  
pu: 2

Farbe / Colour

82



A5

für ca. 1.200 Karten, mit 2 Schwenkstützen  
Stapelbar, einhängbar in Hängeregistratur-  
gestelle  
for approximately 1,200 cards, with 2 dividers  
Stackable, suitable for suspension file racks

H 62018

Karteitrog A6 quer  
B 165, T 350, H 115 mm  
VE: 2

Open Card File Box A6 horizontal  
W 165, D 350, H 115 mm  
pu: 2

Farbe / Colour

82



A6

für ca. 1.200 Karten, mit 2 Schwenkstützen  
Stapelbar, einhängbar in Hängeregistratur-  
gestelle  
for approximately 1,200 cards, with 2 dividers  
Stackable, suitable for suspension file racks

H 62023

Karteitrog A7 quer  
B 124, T 350, H 95 mm  
VE: 2

Open Card File Box A7 horizontal  
W 124, D 350, H 95 mm  
pu: 2

Farbe / Colour

82



A7

für ca. 1.200 Karten, mit 2 Schwenkstützen,  
Stapelbar, einhängbar in Hängeregistratur-  
gestelle

for approx. 1,200 cards, with 2 dividers  
Stackable, suitable for suspension file racks

Schwenkstützen / Divider

A4

H 72049

Schwenkstütze A4 quer  
zusätzlich für H 62010  
VE: 2

Divider A4 horizontal  
extra for H 62010  
pu: 2

Farbe / Colour

82

A6

H 72041

Schwenkstütze A6 quer  
zusätzlich für H 62018  
VE: 2

Divider A6 horizontal  
extra for H 62018  
pu: 2

Farbe / Colour

82

A5

H 72045

Schwenkstütze A5 quer  
zusätzlich  
VE: 2

Divider A5 horizontal  
extra  
pu: 2

Farbe / Colour

82

A7

H 72037

Schwenkstütze A7 quer  
zusätzlich für H 62023  
VE: 2

Divider A7 horizontal  
extra for H 62023  
pu: 2

Farbe / Colour

82



Schubladenbox  
Filing Box

H 61294

Schubladen-Box  
5 Schubladen  
B 265, T 340, H 250 mm  
VE: 4

Filing-Box  
5 drawers  
W 265, D 340, H 250 mm  
pu: 4

Farbe / Colour

02 20 30 50

82 84 98



NEU  
NEW





RODESIGN BERND BRÜSSING

stapelbar  
stackable

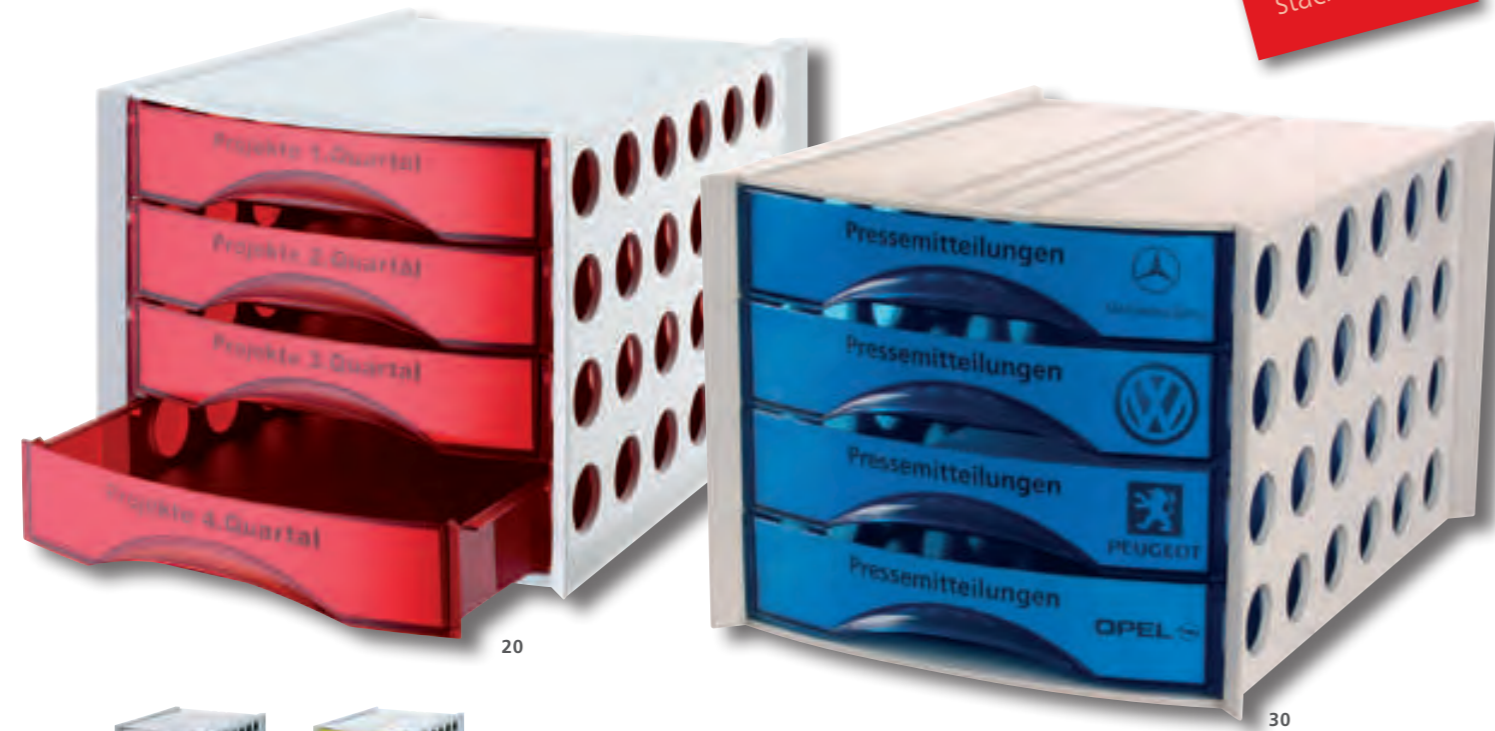

20

30

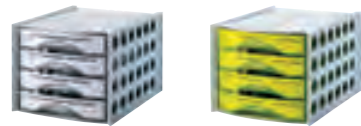

02

50

Beschriftung 240 mm breit  
Labelling 240 mm wide

### H 61292 Economy

Schubladen-Box  
B 289, T 390, H 234 mm  
VE: 1

Economy Filing-Box  
W 289, D 390, H 234 mm  
pu: 1

Farbe / Colour

02 20 30 50



mit cm-Skala auf den Seitenwänden  
with featuring a cm-scale on the side parts



mit Stiftemulden im Deckel  
with recesses on top for pens and utensils

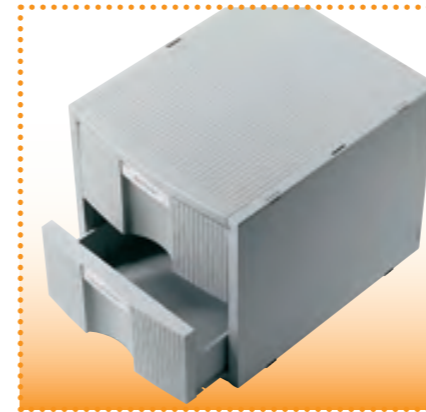

Mit 2 extrahohen (139 mm), geschlossenen Schubladen, mit Beschriftungszubehör und Steckteilesatz  
With 2 extra large closed-front drawers (139 mm), with label strips, windows and set of fittings

### H 61383

plano plus 2er Box  
B 324, T 396, H 324 mm  
VE: 1

plano plus 2-tier Box  
W 324, D 396, H 324 mm  
pu: 1

Farbe / Colour

82

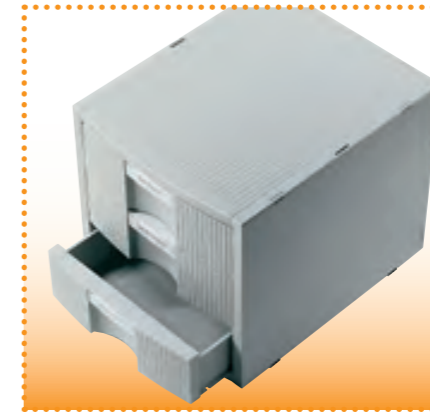

Mit 3 hohen (92 mm), geschlossenen Schubladen, mit Beschriftungszubehör und Steckteilesatz  
With 3 large closed-front drawers (92 mm), with label strips, windows and set of fittings

### H 61382

plano plus 3er Box  
B 324, T 396, H 324 mm  
VE: 1

plano plus 3-tier Box  
W 324, D 396, H 324 mm  
pu: 1

Farbe / Colour

82



Mit 6 mittelhohen (44 mm), geschlossenen Schubladen, mit Beschriftungszubehör und Steckteilesatz  
With 6 closed-front drawers (44 mm), with label strips, windows and set of fittings

### H 61381

plano plus 6er Box  
B 324, T 396, H 324 mm  
VE: 1

plano plus 6-tier Box  
W 324, D 396, H 324 mm  
pu: 1

Farbe / Colour

82



Mit 9 flachen (28 mm), geschlossenen Schubladen, mit Beschriftungszubehör und Steckteilesatz  
With 9 closed-front drawers (28 mm), with label strips, windows and set of fittings

### H 61380

plano plus 9er Box  
B 324, T 396, H 324 mm  
VE: 1

plano plus 9-tier Box  
W 324, D 396, H 324 mm  
pu: 1

Farbe / Colour

82



Schubladen  
in 4 Größen  
Drawers in 4 sizes

### PLANO PLUS VORTEILE

- Schubladen in 4 Größen mit leichtem Lauf, mit Auszugserren und in der Box frei kombinierbar
- Über- und nebeneinander verkettbar
- Beschriftungs-Software auf Anforderung erhältlich oder zum Download unter [www.helit.de](http://www.helit.de)

### PRODUCT FEATURES

- Drawers in 4 sizes on smooth running rails, extraction lock, modular system allows various combinations
- Can be stacked and connected up and sideways
- Labelling software is available upon request or can be downloaded at [www.helit.de](http://www.helit.de)



**REDUZIERT 60 % CO<sup>2</sup> EMISSION DURCH TRANSPORT**

Für einen verantwortungsvollen Umgang mit unseren Ressourcen: Hergestellt aus recycelten PET-Getränkeflaschen. Die neue, innovative Lösung von helit hilft, die CO<sup>2</sup> Emission durch Transport und Lagerung zu reduzieren.

**REDUCES TRANSPORT-RELATED CO<sup>2</sup> EMISSIONS BY 60 %**

Treating our resources responsibly: manufactured from recycled PET drink bottles.

This new, innovative solution from helit helps reduce CO<sup>2</sup> emissions related to transport and storage.

# Greenlogic



**H 23635**

Briefablage A4 – C4  
B 289, T 390, H 234 mm  
VE: 6

PET Letter Tray nestable A4–C4  
W 289, D 390, H 234 mm  
pu: 6

Farbe / Colour

- 08
- 20
- 25
- 30
- 34
- 50
- 55
- 82
- 95

- Kompatibel zu allen Standard-Briefablagen
- Besonders langlebig und nachhaltig
- Compatible with all standard letter trays
- Very long-lasting and durable

\* under normal conditions of use \* dans des conditions normales d'utilisation \* bei normalem Gebrauch

Made in Germany

**kompatibel zu Standard-Briefablagen**



**aus Polystyrol**  
made of polystyrol

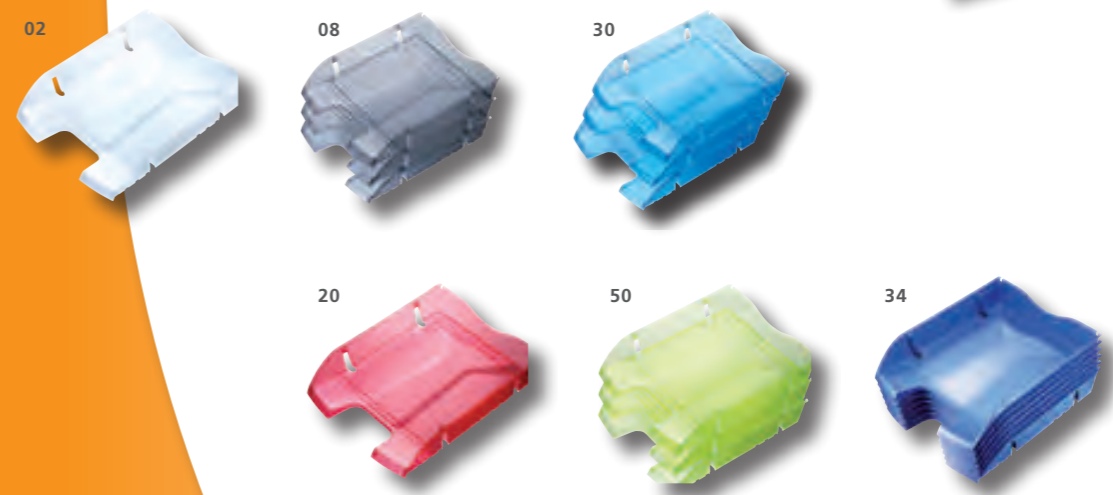

**compatible with all standard filling trays**

Maße der VE-Verpackung:  
L 380, B 290, H 180 mm

Size of pu packaging:  
L 380, W 290, H 180 mm

- Reduzierung der Verpackungskartons, bzw. größere Mengen können auf der Palette verschickt werden
- Kompatibel zu Standard-Briefablagen
- Senkrecht stapelbar
- Versetzt stapelbar

- Reduction of package boards so that larger quantities can be sent on palettes
- Compatible with standard filing trays
- Vertically stackable
- Can be staggered

**H 23630**

Nestbare Briefablage  
L 355, B 275, H 66 mm  
VE: 6

Nestable Filing Tray  
L 355, W 275, H 66 mm  
pu: 6

Farbe / Colour

- 02
- 08
- 20
- 25
- 30
- 34
- 50
- 82
- 95





Formate A4 – C4  
kompatibel zu  
Standard-Briefablagen

H 61015

Briefablage A4 – C4  
B 245, T 350, H 67 mm  
VE: 6

Filing Tray A4–C4  
W 245, D 350, H 67 mm  
pu: 6

Farbe / Colour

- 05 25 34 52
- 82 87 95

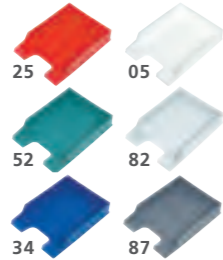

BEST SELLER

mit matter Oberfläche  
with matt surface

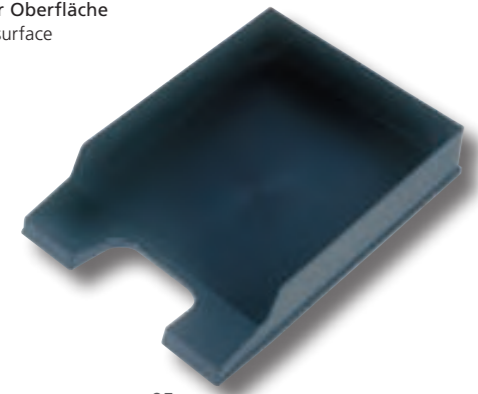

95

H 23616 Economy

Briefablage A4 – C4  
B 245, T 347, H 67 mm  
VE: 5

Economy Filing Tray A4–C4  
W 245, D 347, H 67 mm  
pu: 5

Farbe / Colour

- 05 18 25 34 52
- 75 82 87 95

mit hochglänzender Oberfläche  
with high gloss surface



05  
18  
25  
52  
34  
75  
95

H 61014

Briefablage A4 – C4, brillant  
B 245, T 350, H 67 mm  
VE: 5

Filing Tray A4–C4, glossy  
W 245s, D 347, H 67 mm  
pu: 5

Farbe / Colour

- 02 08

mit hochglänzender Oberfläche  
with high gloss surface

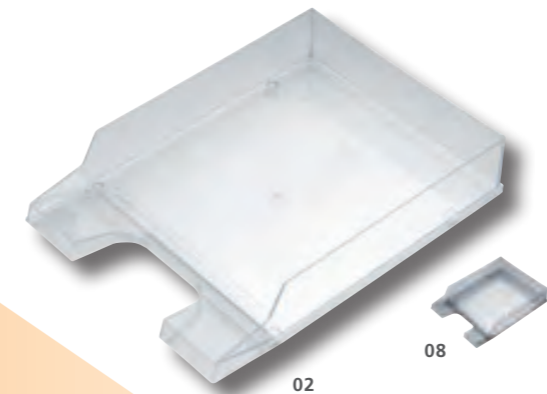

02

08

mit matter Oberfläche  
with matt surface



H 23626 Economy Transluzent

Briefablage A4 – C4  
B 245, T 347, H 67 mm  
VE: 5

Economy Translucent Filing Tray A4–C4  
W 245, D 347, H 67 mm  
pu: 5

Farbe / Colour

- 10 18 26
- 30 45 52

mit matter Oberfläche  
with matt surface



10  
52  
18  
45  
25  
26  
30

A4–C4 formats  
compatible with all  
standard filing trays

H 61013

3er Ablageeinheit  
B 282, T 347, H 234 mm  
VE: 1

3-tier Filing Tray Unit  
W 282, D 347, H 234 mm  
pu: 1

Farbe / Colour

- 02

Herausnehmbare Briefablageeinheit,  
im System erweiterbar mit H 61014  
Removable Filing Tray Unit,  
extendable system with H 61014



H 23615 Economy Transparent

Briefablage A4 – C4  
Standard-Briefablage für Formate A4 – C4  
B 245, T 347, H 67 mm  
VE: 5

Economy Transparent Filing Tray A4–C4  
standard tray for A4–C4 formats  
W 245, D 347, H 67 mm  
pu: 5

Farbe / Colour

- 02 08 11
- 20 30 40

mit hochglänzender Oberfläche  
with high gloss surface

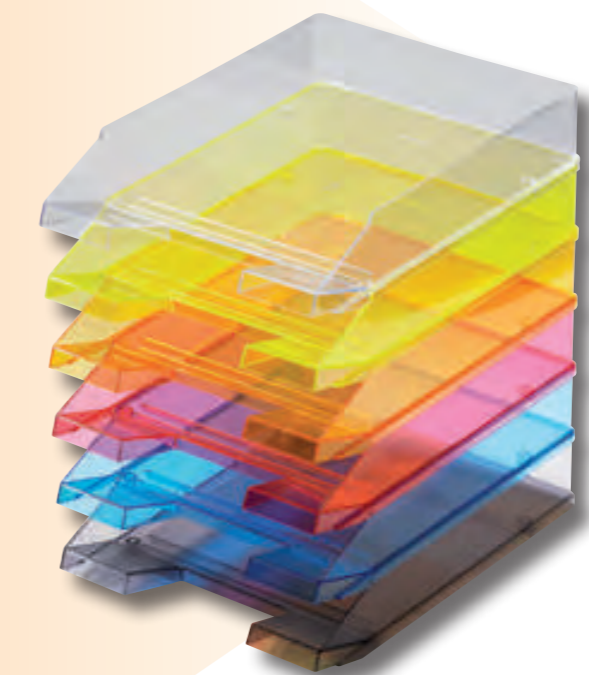

02  
11  
40  
20  
30  
08



**Design Briefablagen**  
**Design Letter Trays**

**H 63911 Linear**

Briefschale  
B 299, T 368, H 90 mm  
VE: 1

Linear Filing Tray  
W 299, D 368, H 90 mm  
pu: 1

Farbe / Colour

34 95



34



mit rutschfesten Gummifüßen  
with rubberelements base pads

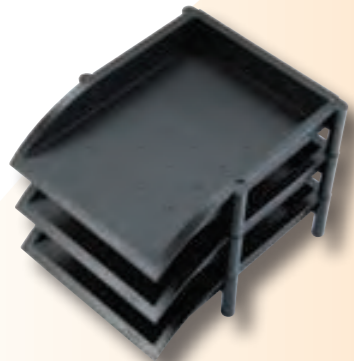

**H 62201 Silver**

2er Ablageeinheit  
B 274, T 355, H 143 mm  
VE: 1

Silver 2-tier Filing Tray Unit  
W 274, D 355, H 143 mm  
pu: 1

Farbe / Colour

99

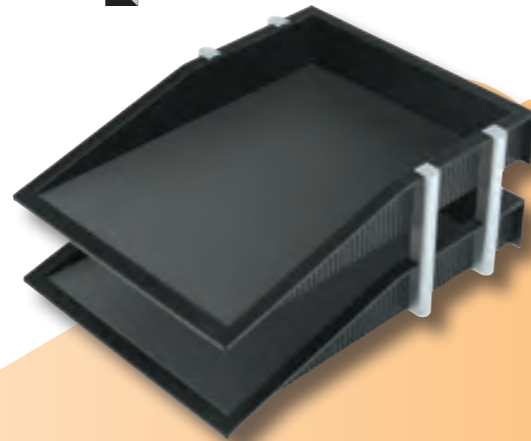

**PRODESIGN BERND BRÜSSING**

mit Beschriftungsmöglichkeit  
with possibility for labelling

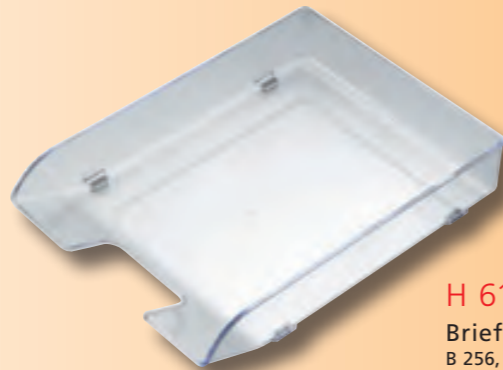

**H 61010**

Briefablage A4 – C4  
B 256, T 350, H 66 mm  
VE: 5

Letter Tray A4–C4  
W 256, D 350, H 66 mm  
pu: 5

Farbe / Colour

02

**H 61011**

Stapelementsatz für  
Ablage H 61010  
VE: 1

Farbe / Colour

02

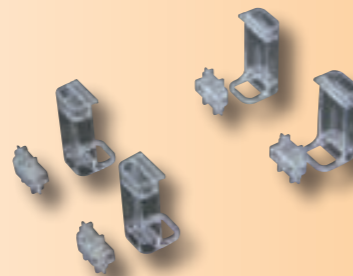

**Spezial Ablagen**  
**Special Trays**

**H 25120**

M-Clip  
100er Pack  
VE: 1

M-Clip  
set of 100 pcs.  
pu: 1

Farbe / Colour

05 25 95

Ordnungsschiene zum  
Abheften von Zeitschriften,  
Katalogen oder Magazinen  
Tidy clip for filing magazines  
or catalogues

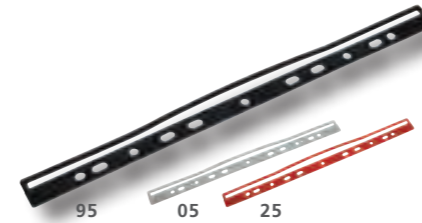

Klemmschiene zum Abheften  
von Loseblatt-Papieren,  
passend für ca. 30 Blatt A4  
Clamp clip to file loose papers,  
suitable for approx. 30 sheets  
of A4 paper

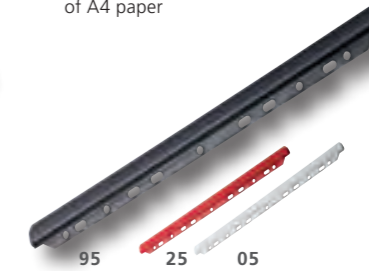

**H 25122**

G-Clip  
100er Pack  
VE: 1

G-Clip  
set of 100 pcs.  
pu: 1

Farbe / Colour

05 25 95



inklusive Beschriftungszubehör  
with labelling



**PRODESIGN BERND BRÜSSING**

inklusive Beschriftungszubehör  
with labelling



**H 61087**

Briefablage A4 – B4, 90 mm, hoch  
B 265, T 350, H 90 mm  
VE: 5

Filing Tray A4–B4, 90 mm  
W 265, D 350, H 90 mm  
pu: 5

Farbe / Colour

95



82

95



30

**H 61089**

Briefablage A4 – C4 quer  
B 365, T 260, H 70 mm  
VE: 5

Filing Tray A4–C4 horizontal  
W 365, D 260, H 70 mm  
pu: 5

Farbe / Colour

30 82 95

**NEU**

**NEW**

**H 61270**

my. doc, Briefablage A4  
B 273, T 355, H 50 mm  
VE: 2

my. dok, Filing Tray A4  
W 273, D 355, H 50 mm  
pu: 2

Farbe / Colour

25 34 50 82 95



**H 63615 Linear**

Büro-Stehsammler  
B 102, T 248, H 290 mm  
VE: 4

Office Catalogue Rack  
W 102, D 248, H 290 mm  
pu: 4

Farbe / Colour

34 82 95

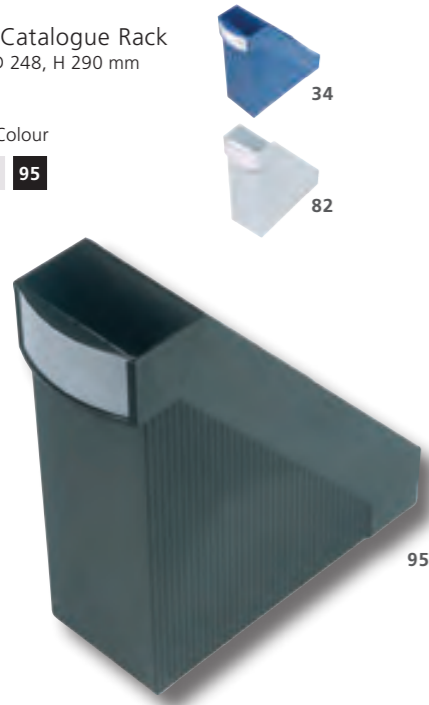

A4



**H 63612**

Stehsammler DIN A4  
B 75, T 251, H 293 mm  
VE: 4

Magazine Rack A4  
W 75, D 251, H 293 mm  
pu: 4

Farbe / Colour

25 34 52  
82 95

A5

**H 63610**

Stehsammler DIN A5  
B 118, T 168, H 190 mm  
VE: 4

Magazine Rack A5  
W 118, D 168, H 190 mm  
pu: 4

Farbe / Colour

82 95

**H 23614 Economy Transparent**

Stehsammler DIN A4 - C4  
B 85, T 240, H 322 mm  
VE: 2

Magazine Rack DIN A4-C4  
W 85, D 240, H 322 mm  
pu: 2

Farbe / Colour

02 08 11 20 30 40 50



mit Beschriftungsmöglichkeit  
with possibility for labelling

A4-C4

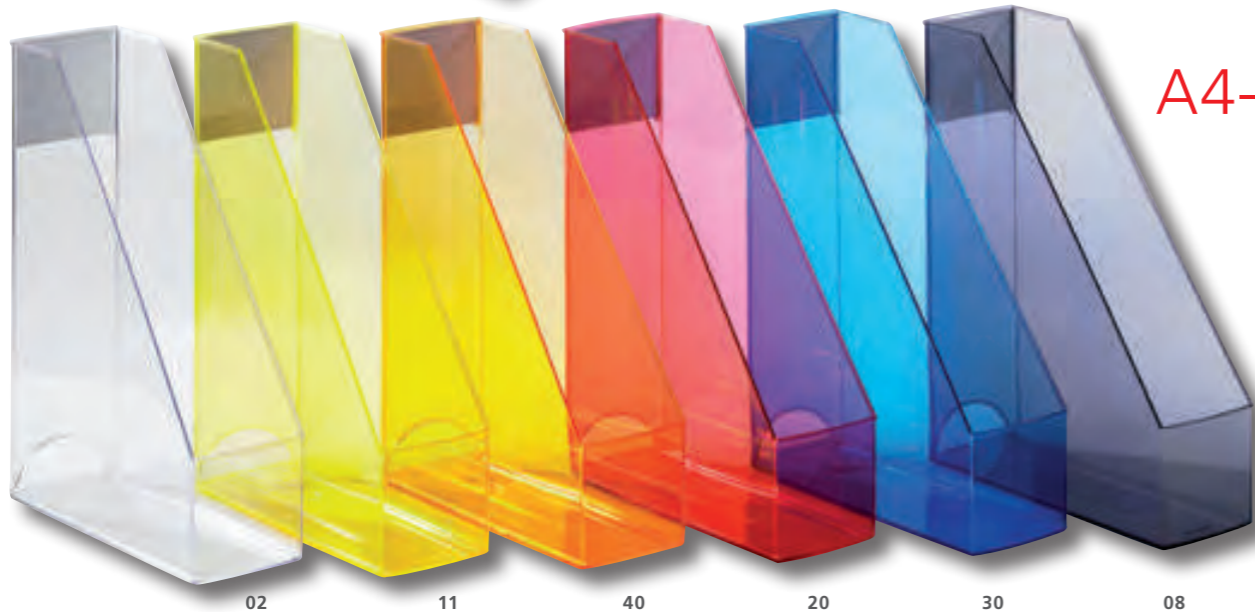

02 11 40 20 30 08

**H 23610 Economy**

Stehsammler DIN A4-C4  
B 75, T 243, H 315 mm  
VE: 4

Magazine Rack DIN A4-C4  
W 75, D 243, H 315 mm  
pu: 4

Farbe / Colour

25 34 82 95



A4-C4

100 % aus recyceltem KUNststoff  
des Dualen-Systems.  
Griffe an der Vorder- und Rückseite  
100 % made of recycled resource  
with grip on front and back

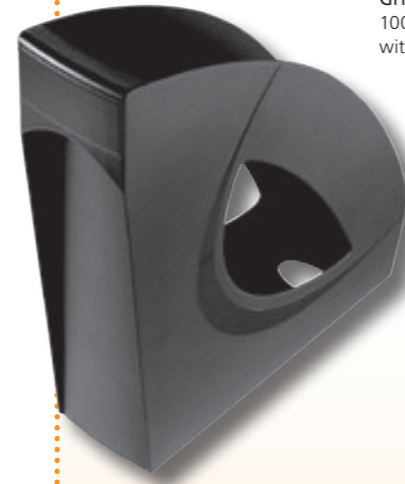

95

**H 63613 Ergologic**

Design-Stehsammler  
B 80, T 286, H 310 mm  
VE: 6

Design Magazine Rack  
W 80, D 286, H 310 mm  
pu: 6

Farbe / Colour

95



**H 23610 Economy Transluzent**

Stehsammler DIN A4 - C4  
B 75, T 243, H 315 mm  
VE: 4

Magazine Rack DIN A4-C4  
W 75, D 243, H 315 mm  
pu: 4

Farbe / Colour

10 11 20 26 30 40 50



A4-C4

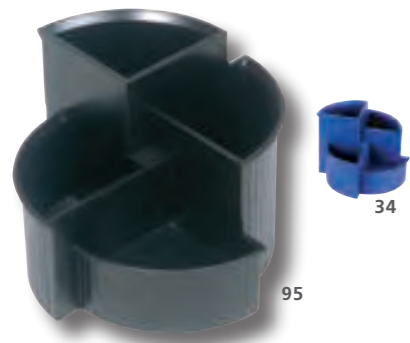

mit rutschfesten Gummifüßen  
with rubberelements base pads

**H 63906 Linear**

Multiköcher  
Ø 140, H 100 mm  
VE: 1

Multi Pen Holder  
Ø 140, H 100 mm  
pu: 1

Farbe / Colour

34 95

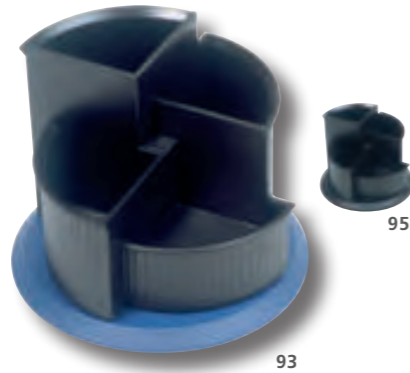

mit rutschfesten Gummifüßen  
with rubberelements base pads

**H 63905 Linear**

Multiköcher  
Ø 150, H 112 mm  
VE: 1

Multi Pen Holder  
Ø 150, H 112 mm  
pu: 1

Farbe / Colour

93 95

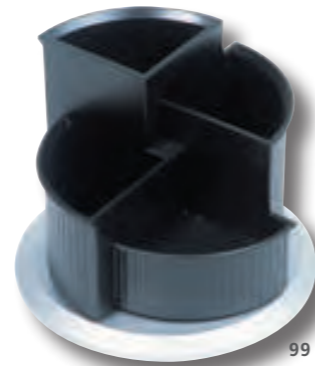

mit rutschfesten Gummifüßen  
with rubberelements base pads

**H 62205 Silver**

Multiköcher  
Ø 150, H 112 mm  
VE: 1

Rotating Multi Pen Holder  
Ø 150, H 112 mm  
pu: 1

Farbe / Colour

99



**H 63907 Linear**

Stifteköcher  
Ø 72, H 108 mm  
VE: 1

Pen Holder  
Ø 72, H 108 mm  
pu: 1

Farbe / Colour

34 95



**H 83900 Design Classics**

Schreibgeräteköcher  
Ø 60, H 110 mm  
VE: 1

Pen and Pencil Holder  
Ø 60, H 110 mm  
pu: 1

Farbe / Colour

95



schwere Ausführung aus Duroplast  
solid design made of Duroplast



**NEU**  
**NEW**

**H 62538**

Tisch-Organizer  
B 226, T 202, H 136 mm  
VE: 1

Linear Mobil Utensil Box  
W 226, D 202, H 136 mm  
pu: 1

Farbe / Colour

93



schwere Ausführung aus Duroplast  
solid design made of Duroplast

**H 82507 Design Classics**

Büroschale  
B 250, T 115, H 20 mm  
VE: 1

Pen and Clip Tray  
W 250, D 115, H 20 mm  
pu: 1

Farbe / Colour

95



**H 62537**

Butler mit Kartenständer  
B 407, T 198, H 72 mm  
VE: 1

Desk Tidy with Letter Rack  
W 407, D 198, H 72 mm  
pu: 1

Farbe / Colour

95

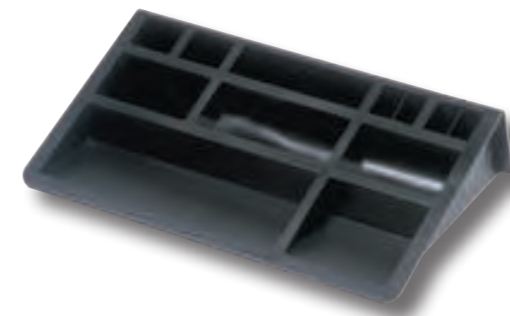

**H 62535**

Butler  
B 307, T 198, H 72 mm  
VE: 1

Desk Tidy  
W 307, D 198, H 72 mm  
pu: 1

Farbe / Colour

95

**H 63902 Economy Transparent**

Multiköcher  
Ø 110 mm, H 105 mm  
VE: 4

Multi Pen Holder  
Ø 110 mm, H 105 mm  
pu: 4

Farbe / Colour

02 08 11  
20 30 40 50

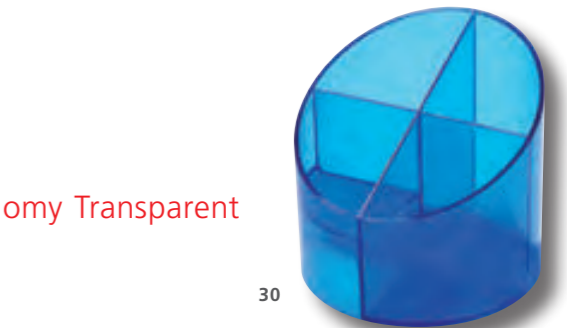



Mit Magnet und Klammern-reservoir im Topf  
With magnet and paper clip reservoir inside the pot



95



95



34

## H 62579 Design Classics

**Klammerspender mit Magnet**  
B 70, T 70, H 70 mm  
VE: 1

Paper Clip Dispenser with magnet  
W 70, D 70, H 70 mm  
pu: 1

Farbe / Colour  
95

## H 63908 Linear

**Klammerspender mit Magnet**  
Ø 72 mm, H 73 mm  
VE: 1

Paper Clip Dispenser with magnet  
Ø 72 mm, H 73 mm  
pu: 1

Farbe / Colour  
34 95

mit Papiervorschub  
with paper support



95



34

## H 63618

**Buchstütze, klein**  
B 110, T 105, H 149 mm  
VE: 10

Small Book-End  
W 110, D 105, H 149 mm  
pu: 10

Farbe / Colour  
95

## H 63608 Design Classics

**Zettelspieß**  
Ø 72, H 150 mm  
VE: 1

Note Paper Spike  
Ø 72, H 150 mm  
pu: 1

Farbe / Colour  
82 95

## H 63058

**Zettelkasten A7**  
B 113, T 103, H 30 mm  
VE: 1

Note Paper Box A7  
W 113, D 103, H 30 mm  
pu: 1

Farbe / Colour  
95

## H 63040 Linear

**Zettelkasten**  
B 127, T 127, H 108 mm  
VE: 1

Note Paper Box  
W 127, D 127, H 108 mm  
pu: 1

Farbe / Colour  
34 95

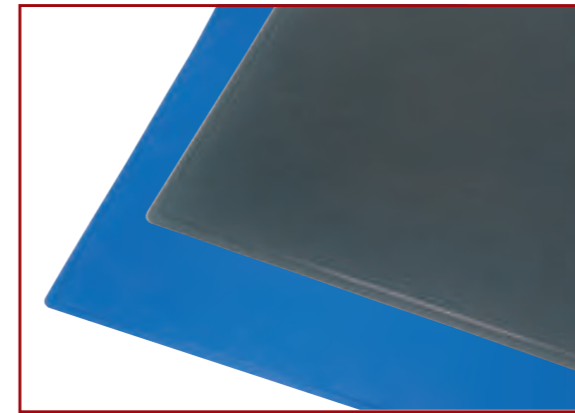

Material: PVC, Rückseite Schaumfolie (flammkaschiert)  
Material: PVC, backside foamfoil (flameretardent laminated)

## H 25225

**Schreibunterlage**  
40 x 53 cm  
VE: 1

Writing Mat  
40 x 53 cm  
pu: 1

Farbe / Colour  
34 82 95

## H 25223

**Schreibunterlage**  
50 x 63 cm  
VE: 1

Writing Mat  
50 x 63 cm  
pu: 1

Farbe / Colour  
34 82

## H 25226

**Schreibunterlage**  
63 x 50 cm  
VE: 15

Writing Mat  
63 x 50 cm  
pu: 15

Farbe / Colour  
25 75 82

## H 25227

**Schreibunterlage**  
63 x 50 cm mit Vollsichtplatte  
VE: 15

Writing Mat  
63 x 50 cm  
pu: 15

Farbe / Colour  
34 82 95

## H 63920 Linear Set

Briefschale (H 63911)  
Multiköcher (H 63906)  
Zettelkasten (H 63040)  
Klammerspender (H 63908)  
Schreibunterlage (H 25225)  
Büro-Stehsammler (H 63615)  
VE: 1

Filing Tray (H 63911)  
Multi Pen Holder (H 63906)  
Note Paper Box (H 63040)  
Paper Clip holder (H 63908)  
Writing Mat (H 25225)  
Filing Tray (H 63615)  
pu: 1

Farbe / Colour  
05 34 95



Kugelschreiberständer & Fineliner  
Pen Bases

H 63590

Kugelschreiberständer  
Ø 100, H 155 mm  
VE: 1

Pen Base  
Ø 100, H 155 mm  
pu: 1

Farbe / Colour



mit rutschfesten Gummifüßen  
with rubber elements base pads



H 62203 Silver

Kugelschreiberständer  
Ø 100, H 155 mm  
VE: 1

Pen Base  
Ø 100, H 155 mm  
pu: 1

Farbe / Colour



schwere Ausführung aus Duroplast  
solid design made of Duroplast

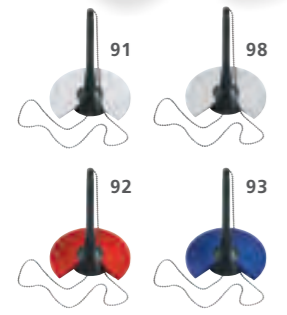

H 83595 Design Classics

Kugelschreiberständer  
B 120, T 75, H 150 mm  
VE: 1

Pen Base  
W 120, D 75, H 150 mm  
pu: 1

Farbe / Colour



Das qualitätsvolle Alugehäuse wird an  
einem Edelstahlseil gehalten. Mit Roller-  
ball-Mine schwarz, 0,7  
The high quality aluminium case holds  
Rollerball mine, 0,7 mm, in black

H 58027

Stifthalter  
B 100, T 80, H 200 mm  
VE: 1

Pen Stand  
W 100, D 80, H 200 mm  
pu: 1

Farbe / Colour

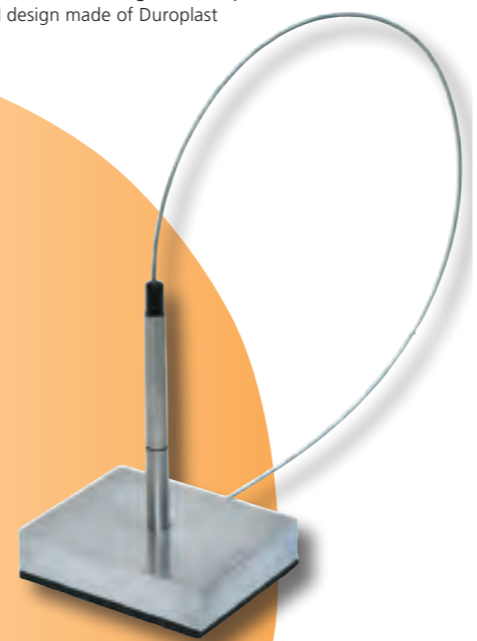

PENXACTA BY DIPLOMAT

H 25123

Penxacta  
VE: 12

Farbe

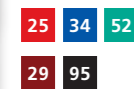

Fineliner 0,5 mm Spitze  
Only available in Germany



95

25 52 34 29

Telefon-Schwenkarm  
Telephone Swivel Arm

H 62553

Telefon-Schwenkarm  
B 255, T 555, H 270 mm  
VE: 1

Telephone Swivel Arm  
W 255, D 555, H 270 mm  
pu: 1

Farbe / Colour



stabiler Klemmfuß  
zur Befestigung an Arbeitsplatten  
von 18 - 75 mm  
solid clamp for desk-tops  
with 18 - 75 mm thickness



82

95





Serie Economy Transluzent

H 23610

Economy Transluzent

Stehsammler DIN A4 – C4  
B 75, T 243, H 315 mm  
VE: 4

Magazine Rack DIN A4–C4  
W 75, D 243, H 315 mm  
pu: 4

Farbe / Colour



H 23602

Economy Transluzent

Papierkorb, 13 Liter  
Ø 280 mm, H 300 mm  
VE: 4

Waste Bin, 13 litres  
Ø 280 mm, H 300 mm  
pu: 4

Farbe / Colour



mit matter Oberfläche  
with matt surface

H 61294

Schubladen-Box  
5 Schubladen  
B 265, T 340, H 250 mm  
VE: 4

Filing-Box  
5 drawers  
W 265, D 340, H 250 mm  
pu: 4

Farbe / Colour



H 23626

Economy Transluzent

Briefablage A4 – C4  
B 245, T 347, H 67 mm  
VE: 5

Filing Tray A4–C4  
W 245, D 347, H 67 mm  
pu: 5

Farbe / Colour



Serie Economy

Das Basisprogramm für jedes Büro – in attraktiven Farben und gutem Design.  
The budget range for every office - attractive colours and good looking design.

H 23610 Economy

Stehsammler DIN A4 – C4  
B 75, T 243, H 315 mm  
VE: 4

Magazine Rack DIN A4–C4  
W 75, D 243, H 315 mm  
pu: 4

Farbe / Colour

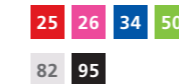

praktisches Griffloch und große  
Etikettierfläche auf der Stirnseite  
with grip handle and labelling field



H 23600 Economy

Objekt-Papierkorb,  
18 Liter  
oberer Ø 310 mm, H 320 mm  
VE: 8

Waste Bin, 18 litres  
Ø 310 mm (top), H 320 mm  
pu: 8

Farbe / Colour

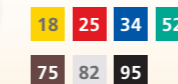

H 23616 Economy

Briefablage A4 – C4  
B 245, T 347, H 67 mm  
VE: 5

Filing Tray A4–C4  
W 245, D 347, H 67 mm  
pu: 5

Farbe / Colour

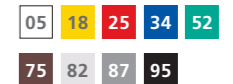

kompatibel zu allen  
Standard-Briefablagen  
compatible with all standard  
filing trays, classic design



H 61294

Schubladen-Box  
5 Schubladen  
B 265, T 340, H 250 mm  
VE: 4

Filing-Box  
5 drawers  
W 265, D 340, H 250 mm  
pu: 4

Farbe / Colour





Serie Economy Transparent

Frische Farben – Transparentes und hochglänzendes Material mit innovativem Design.  
Fresh colours – High gloss transparent material with innovative design.



**H 23602**  
**Economy Transluzent**  
Papierkorb, 13 Liter  
Ø 280 mm, H 300 mm  
VE: 4

Waste Bin, 13 litres  
Ø 280 mm, H 300 mm  
pu: 4

Farbe / Colour  
10 11 20 26 30 40 50

kompatibel zu allen  
Standard-Briefablagen  
compatible with all standard  
filing trays, classic design

**H 23614**  
**Economy Transparent**  
Stehsammler DIN A4 – C4  
B 85, T 240, H 322 mm  
VE: 2

Magazine Rack DIN A4-C4  
W 85, D 240, H 322 mm  
pu: 2

Farbe / Colour  
02 08 11  
20 30 40 50

**H 63902**  
**Economy Transparent**  
Multiköcher  
Ø 110 mm, H 105 mm  
VE: 4

Multi Pen Holder  
Ø 110 mm, H 105 mm  
pu: 4

Farbe / Colour  
02 08 11  
20 30 40 50

**H 23615**  
**Economy Transparent**  
Briefablage A4 – C4  
Standard-Briefablage für  
Formate A4 – C4  
B 245, T 347, H 67 mm  
VE: 5

Filing Tray A4-C4  
standard tray for A4-C4 formats  
W 245, D 347, H 67 mm  
pu: 5

Farbe / Colour  
02 08 11  
20 30 40



Serie Ergologic



Hergestellt aus 100 % recyceltem Kunststoff  
ERGOLOGIC – die ergonomische und umwelt-  
freundliche Serie für das Büro.  
Mit dem Blauen Engel für nachhaltigen Konsum  
durch schonenden Umgang mit Ressourcen aus-  
gezeichnet .

Made of everyday's waste  
ERGOLOGIC – Ergonomic and eco-friendly.  
Made of 100 % post consumer recycling materials.  
Awarded with „Blue Angel“ label for saving resources.

**H 63613 Ergologic**  
**Design-Stehsammler**  
B 80, T 286, H 310 mm  
VE: 6

Design Magazine Rack  
W 80, D 286, H 310 mm  
pu: 6

Farbe / Colour  
95

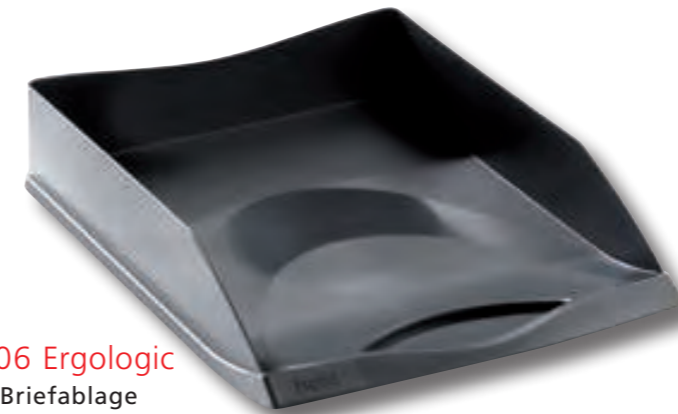

**H 61006 Ergologic**  
**Design-Briefablage**  
B 253, T 344, H 65 mm  
VE: 6

Design Letter Tray  
W 253, D 344, H 65 mm  
pu: 6

Farbe / Colour  
95



**H 61043 Ergologic**  
**Design-Papierkorb,**  
18 Liter  
B 392, T 300, H 310 mm  
VE: 5

Design Waste Bin,  
18 litres  
W 392, D 300, H 310 mm  
pu: 5

Farbe / Colour  
95

Hergestellt aus 100 %  
recyceltem Kunststoff  
Made of everyday's waste



Produktfamilien  
Product Families

Serie Linear

PRODESIGN BERND BRÜSSING

Die größte und vielseitigste, europäische Familie für Designkultur am Schreibtisch.  
The most extensive and diverse European range in designer desktop accessories.

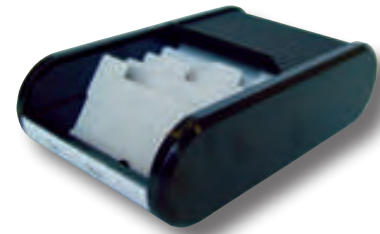

**H 62180 Linear**  
Visitenkartenbox  
B 136, T 240, H 67 mm  
VE: 1

Business Card Box  
W 136, D 240, H 67 mm  
pu: 1

Farbe / Colour



mit rutschfesten  
Gummifüßen  
with rubberelements  
base pads

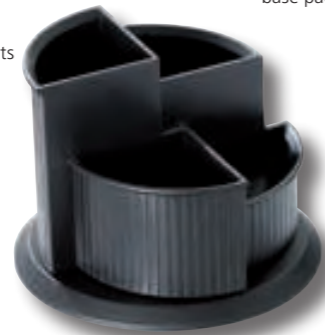

**H 63905 Linear**  
Multiköcher  
Ø 150, H 112 mm  
VE: 1

Multi Pen Holder  
Ø 150, H 112 mm  
pu: 1  
Farbe / Colour



mit rutschfesten  
Gummifüßen  
with rubberelements  
base pads



**H 63906 Linear**  
Multiköcher  
Ø 140, H 100 mm  
VE: 1

Multi Pen Holder  
Ø 140, H 100 mm  
pu: 1

Farbe / Colour



**H 63907 Linear**  
Stifteköcher  
Ø 72, H 108 mm  
VE: 1

Pen Holder  
Ø 72, H 108 mm  
pu: 1

Farbe / Colour



**H 63040 Linear**  
Zettelkasten  
B 127, T 127, H 108 mm  
VE: 1

Note Paper Box  
W 127, D 127, H 108 mm  
pu: 1

Farbe / Colour



**H 63911 Linear**  
Briefschale  
B 299, T 368, H 90 mm  
VE: 1

Filing Tray  
W 299, D 368, H 90 mm  
pu: 1

Farbe / Colour



**H 63615 Linear**  
Büro-Stehsammler  
B 102, T 248, H 290 mm  
VE: 4

Office Catalogue Rack  
W 102, D 248, H 290 mm  
pu: 4

Farbe / Colour

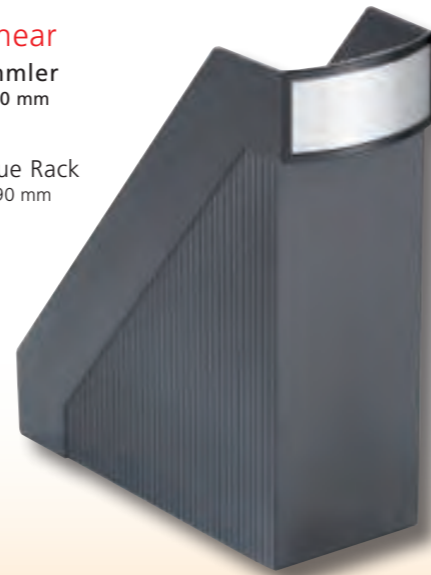

**H 63908 Linear**  
Klammerspender  
mit Magnet  
Ø 72 mm, H 73 mm  
VE: 1

Clip Holder  
Magnetic Paper  
Ø 72 mm, H 73 mm  
pu: 1

Farbe / Colour



34

**H 61057 Linear**  
Objekt-Papierkorb, 18 Liter  
oberer Ø 315 mm, H 320 mm  
VE: 5

Waste Bin, 18 litres  
Ø 315 mm (top), H 320 mm  
pu: 5

Farbe / Colour



95

**H 61052 Linear**  
Objekt-Papierkorb, 13 Liter  
oberer Ø 260 mm, H 270 mm  
VE: 5

Waste Bin, 13 litres  
Ø 260 mm (top), H 270 mm  
pu: 5

Farbe / Colour



95

**H 61055 Linear**  
Ovaler Papierkorb, 22 Liter  
B 250, T 442, H 315 mm  
VE: 2

Oval Waste Bin, 22 litres  
W 250, D 442, H 315 mm  
pu: 2

Farbe / Colour



Dezente Eleganz durch hochwertige Oberflächen mit matt-silberfarbenen Elementen.  
Discreet elegance with a refined look – high quality surfaces with silver-matt parts

### H 62204 Silver

Visitenkartenbox  
B 136, T 240, H 67 mm  
VE: 1

Silver Business Card Box  
W 136, D 240, H 67 mm  
pu: 1

Farbe / Colour



Der helit-Klassiker mit 8-teiliger alphabetischer Unterteilung, Rolloverschluss, für ca. 300 Visitenkarten.  
The helit classic product with 8 sections, alphabetically arranged, with roll-over cover, for approx. 300 business cards.

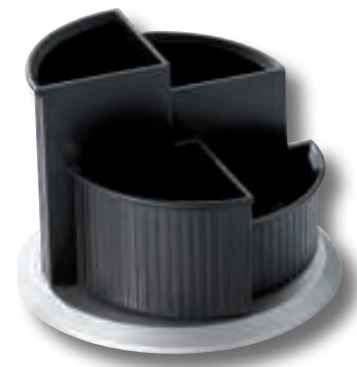

### H 62205 Silver

Multiköcher  
Ø 150, H 112 mm  
VE: 1

Rotating Multi Pen Holder  
Ø 150, H 112 mm  
pu: 1

Farbe / Colour



Mit rutschfesten Gummifüßen  
With rubberelements base pads

### H 62201 Silver

2er Ablageeinheit  
B 274, T 355, H 143 mm  
VE: 1

2-tier Filing Tray Unit  
W 274, D 355, H 143 mm  
pu: 1

Farbe / Colour



für A4 und Überformate,  
mit Griff, inkl. Beschriftungsbehör  
for A4 and oversized formats,  
with grip handle, with labelling



### H 63615 Linear

Büro-Stehsammler  
B 102, T 248, H 290 mm  
VE: 4

Office Catalogue Rack  
W 102, D 248, H 290 mm  
pu: 4

Farbe / Colour



### H 62203 Silver

Kugelschreiberständer  
Ø 100, H 155 mm  
VE: 1

Silver Pen Base  
Ø 100, H 155 mm  
pu: 1

Farbe / Colour



mit rutschfesten Gummifüßen  
with rubberelements base pads



### H 62208 Silver

Ring zur Befestigung eines  
Beutels im Papierkorb  
Für Ø von ca. 310 – 320 mm  
VE: 1

Attachment Ring for Waste Bins  
Ø approx. ca. 310–320 mm  
pu: 1

Farbe / Colour



Ring zur Befestigung eines Beutels  
für H 61057, H 61058 und H 69059 und  
Ø von ca. 310 – 320 mm  
Attachment Ring for H 61057, H 61058 and  
H 69059 and a diameter of approx. 310–320 mm



### PRODESIGN BERND BRÜSSING

### H 62209 Silver

Duo-System-Papierkorb  
B 445, T 280 mm, H 350 mm  
VE: 1

Duo-System Waste Bin  
W 445, D 280 mm, H 350 mm  
pu: 1

Farbe / Colour



1. Teil: für Papieraufnahme, 20 Liter  
2. Teil: für Nass- und sonstige Abfälle, mit Deckel,  
9 Liter, mit umlaufendem Griffband  
with surrounding handling rim, 1st section for paper disposal,  
20 litres, 2nd section for wet waste and others with lid, 9 litres





Produktfamilien  
Product Families

Weltberühmtes, original Zeischegg-Design, heute von helit als Design-Klassiker produziert.  
World famous, original design by Zeischegg, today manufactured by helit as design classics.



Schwere Ausführung  
aus Duroplast  
Solid design  
made of Duroplast

H 83900 Design Classics

Schreibgeräteköcher  
Ø 60, H 110 mm  
VE: 1

Design Classics Pen and Pencil Holder  
Ø 60, H 110 mm  
pu: 1

Farbe / Colour

95



Schwere Ausführung  
aus Duroplast  
Solid design  
made of Duroplast

H 83595 Design Classics

Kugelschreiberständer  
B 120, T 75, H 150 mm  
VE: 1

Design Classics Pen Base  
W 120, D 75, H 150 mm  
pu: 1

Farbe / Colour

95



H 62579 Design Classics

Klammerspender mit Magnet  
B 70, T 70, H 70 mm  
VE: 1

Paper Clip Dispenser with magnet  
W 70, D 70, H 70 mm  
pu: 1

Farbe / Colour

95



DESIGN BY ZEISCHEGG

H 61068 Design Classics

Abfalleinsatz für  
den Papierkorb H 61056  
Inhalt: 2 Liter  
VE: 2

Litter Insert for Waste Bin  
H 61056  
holds 2 litres  
pu: 2

Farbe / Colour

95



schwere Ausführung  
aus Duroplast  
solid design  
made of Duroplast

H 82507 Design Classics

Büroschale  
B 250, T 115, H 20 mm  
VE: 1

Pen and Clip Tray  
W 250, D 115, H 20 mm  
pu: 1

Farbe / Colour

95



Serie Design Classics

H 63608 Design Classics

Zettelspieß  
Ø 72, H 150 mm  
VE: 1

Note Paper Spike  
Ø 72, H 150 mm  
pu: 1

Farbe / Colour

82 95



22 l



H 61056 Design Classics

Ovaler Papierkorb, 22 Liter  
B 180, T 450, H 300 mm  
aVE: 2

Oval Waste Bin, 22 litres  
W 180, D 450, H 300 mm  
pu: 2

Farbe / Colour

95

Art-Nr./SKU	Bezeichnung	Description	Seite/Page
H2360018	Papierkorb, 18L, Economy	Waste Bin, 18l, Economy	33
H2360025	Papierkorb, 18L, Economy	Waste Bin, 18l, Economy	33
H2360034	Papierkorb, 18L, Economy	Waste Bin, 18l, Economy	33
H2360052	Papierkorb, 18L, Economy	Waste Bin, 18l, Economy	33
H2360075	Papierkorb, 18L, Economy	Waste Bin, 18l, Economy	33
H2360082	Papierkorb, 18L, Economy	Waste Bin, 18l, Economy	33
H2360095	Papierkorb, 18L, Economy	Waste Bin, 18l, Economy	33
H2360210	Papierkorb, 13L, Economy	Waste Bin, 13l, Economy	32/34
H2360211	Papierkorb, 13L, Economy	Waste Bin, 13l, Economy	32/34
H2360220	Papierkorb, 13L, Economy	Waste Bin, 13l, Economy	32/34
NEU H2360226	Papierkorb, 13L, Economy	Waste Bin, 13l, Economy	32/34
H2360230	Papierkorb, 13L, Economy	Waste Bin, 13l, Economy	32/34
H2360240	Papierkorb, 13L, Economy	Waste Bin, 13l, Economy	32/34
NEU H2360250	Papierkorb, 13L, Economy	Waste Bin, 13l, Economy	32/34
H2361010	Stehsammler A4 Economy	Magazine Rack A4 Economy	25/32/33
H2361011	Stehsammler A4 Economy	Magazine Rack A4 Economy	25/32/33
H2361020	Stehsammler A4 Economy	Magazine Rack A4 Economy	25/32/33
H2361025	Stehsammler A4 Economy	Magazine Rack A4 Economy	25/32/33
H2361026	Stehsammler A4 Economy	Magazine Rack A4 Economy	25/32/33
H2361030	Stehsammler A4 Economy	Magazine Rack A4 Economy	25/32/33
H2361034	Stehsammler A4 Economy	Magazine Rack A4 Economy	25/32/33
H2361040	Stehsammler A4 Economy	Magazine Rack A4 Economy	25/32/33
H2361050	Stehsammler A4 Economy	Magazine Rack A4 Economy	25/32/33
H2361082	Stehsammler A4 Economy	Magazine Rack A4 Economy	25/32/33
H2361095	Stehsammler A4 Economy	Magazine Rack A4 Economy	25/32/33
H2361402	Stehsammler A4 Economy	Magazine Rack A4 Economy	24/34
H2361408	Stehsammler A4 Economy	Magazine Rack A4 Economy	24/34
H2361411	Stehsammler A4 Economy	Magazine Rack A4 Economy	24/34
H2361420	Stehsammler A4 Economy	Magazine Rack A4 Economy	24/34
H2361430	Stehsammler A4 Economy	Magazine Rack A4 Economy	24/34
H2361440	Stehsammler A4 Economy	Magazine Rack A4 Economy	24/34
NEU H2361450	Stehsammler A4 Economy	Magazine Rack A4 Economy	24/34
H2361502	Briefablage A4-C4 Economy	Filing Tray A4-C4 Economy	21/34
H2361508	Briefablage A4-C4 Economy	Filing Tray A4-C4 Economy	21/34
H2361511	Briefablage A4-C4 Economy	Filing Tray A4-C4 Economy	21/34
H2361520	Briefablage A4-C4 Economy	Filing Tray A4-C4 Economy	21/34
H2361530	Briefablage A4-C4 Economy	Filing Tray A4-C4 Economy	21/34
H2361540	Briefablage A4-C4 Economy	Filing Tray A4-C4 Economy	21/34
H2361605	Briefablage A4-C4 Economy	Filing Tray A4-C4 Economy	20/33
H2361618	Briefablage A4-C4 Economy	Filing Tray A4-C4 Economy	20/33
H2361625	Briefablage A4-C4 Economy	Filing Tray A4-C4 Economy	20/33
H2361634	Briefablage A4-C4 Economy	Filing Tray A4-C4 Economy	20/33
H2361652	Briefablage A4-C4 Economy	Filing Tray A4-C4 Economy	20/33
H2361675	Briefablage A4-C4 Economy	Filing Tray A4-C4 Economy	20/33
H2361682	Briefablage A4-C4 Economy	Filing Tray A4-C4 Economy	20/33
H2361687	Briefablage A4-C4 Economy	Filing Tray A4-C4 Economy	20/33
H2361695	Briefablage A4-C4 Economy	Filing Tray A4-C4 Economy	20/33
H2362610	Briefablage A4-C4 Economy	Filing Tray A4-C4 Economy	21/32
H2362618	Briefablage A4-C4 Economy	Filing Tray A4-C4 Economy	21/32
H2362626	Briefablage A4-C4 Economy	Filing Tray A4-C4 Economy	21/32
H2362630	Briefablage A4-C4 Economy	Filing Tray A4-C4 Economy	21/32
H2362645	Briefablage A4-C4 Economy	Filing Tray A4-C4 Economy	21/32
H2362652	Briefablage A4-C4 Economy	Filing Tray A4-C4 Economy	21/32
H2363002	Briefablage A4-C4 nestbar	Filing Tray A4-C4, nestable	19
H2363008	Briefablage A4-C4 nestbar	Filing Tray A4-C4, nestable	19
H2363020	Briefablage A4-C4 nestbar	Filing Tray A4-C4, nestable	19
H2363025	Briefablage A4-C4 nestbar	Filing Tray A4-C4, nestable	19
H2363030	Briefablage A4-C4 nestbar	Filing Tray A4-C4, nestable	19
H2363034	Briefablage A4-C4 nestbar	Filing Tray A4-C4, nestable	19
H2363050	Briefablage A4-C4 nestbar	Filing Tray A4-C4, nestable	19
H2363082	Briefablage A4-C4 nestbar	Filing Tray A4-C4, nestable	19
H2363095	Briefablage A4-C4 nestbar	Filing Tray A4-C4, nestable	19
H2363508	PET Briefablage Greenlogic A4-C4, nestbar	PET Letter Tray Greenlogic A4-C4, nestable	18
H2363520	PET Briefablage Greenlogic A4-C4, nestbar	PET Letter Tray Greenlogic A4-C4, nestable	18
H2363525	PET Briefablage Greenlogic A4-C4, nestbar	PET Letter Tray Greenlogic A4-C4, nestable	18
H2363530	PET Briefablage Greenlogic A4-C4, nestbar	PET Letter Tray Greenlogic A4-C4, nestable	18
H2363534	PET Briefablage Greenlogic A4-C4, nestbar	PET Letter Tray Greenlogic A4-C4, nestable	18
H2363550	PET Briefablage Greenlogic A4-C4, nestbar	PET Letter Tray Greenlogic A4-C4, nestable	18
H2363555	PET Briefablage Greenlogic A4-C4, nestbar	PET Letter Tray Greenlogic A4-C4, nestable	18
H2363582	PET Briefablage Greenlogic A4-C4, nestbar	PET Letter Tray Greenlogic A4-C4, nestable	18
H2363595	PET Briefablage Greenlogic A4-C4, nestbar	PET Letter Tray Greenlogic A4-C4, nestable	18
H2512005	M-Clip, Display mit 100 Stück	M-Clip, Display with 100 pieces	23
H2512025	M-Clip, Display mit 100 Stück	M-Clip, Display with 100 pieces	23

Art-Nr./SKU	Bezeichnung	Description	Seite/Page
H2512095	M-Clip, Display mit 100 Stück	M-Clip, Display with 100 pieces	23
H2512205	G-Clip, Display mit 100 Stück	G-Clip, Display with 100 pieces	23
H2512225	G-Clip, Display mit 100 Stück	G-Clip, Display with 100 pieces	23
H2512295	G-Clip, Display mit 100 Stück	G-Clip, Display with 100 pieces	23
H2512325	Penxacta 0,5 mm Fineliner	Penxacta 0,5 mm Fineliner	30
H2512334	Penxacta 0,5 mm Fineliner	Penxacta 0,5 mm Fineliner	30
H2512352	Penxacta 0,5 mm Fineliner	Penxacta 0,5 mm Fineliner	30
H2512395	Penxacta 0,5 mm Fineliner	Penxacta 0,5 mm Fineliner	30
H2517095	Trolley	Trolley	7
H2522334	Schreibunterlage, 50 x 63 cm	Writing Mat, 50 x 63cm	29
H2522382	Schreibunterlage, 50 x 63 cm	Writing Mat, 50 x 63cm	29
H2522534	Schreibunterlage, ca. 40 x 53 cm	helit Writing Mat, approx. 40 x 53 cm	29
H2522582	Schreibunterlage, ca. 40 x 53 cm	helit Writing Mat, approx. 40 x 53 cm	29
H2522595	Schreibunterlage, ca. 40 x 53 cm	helit Writing Mat, approx. 40 x 53 cm	29
H2522625	Schreibunterlage, 63 x 50 cm	Writing Mat 63 x 50 cm	29
H2522675	Schreibunterlage, 63 x 50 cm	Writing Mat 63 x 50 cm	29
H2522682	Schreibunterlage, 63 x 50 cm	Writing Mat 63 x 50 cm	29
H2522734	Schreibunterlage, 63 x 50 cm mit Vollsichtplatte	Writing Mat with non-reflecting cover, approx. 50 x 63 cm	29
H2522782	Schreibunterlage, 63 x 50 cm mit Vollsichtplatte	Writing Mat with non-reflecting cover, approx. 50 x 63 cm	29
H2522795	Schreibunterlage, 63 x 50 cm mit Vollsichtplatte	Writing Mat with non-reflecting cover, approx. 50 x 63 cm	29
H5802794	Stifthalter	Pen holder	30
H6100695	Briefablage A4-C4 Ergologic	Filing Tray A4-C4 Ergologic	35
H6101002	Briefablage A4-C4	Letter Tray A4-C4	22
H6101102	Stapelementsatz für Ablage H 61010	Riser Set for tray H 61010	22
H6101302	3er Ablageeinheit, brillant	Filing Tray Unit, glossy	20
H6101402	Briefablage A4-C4, brillant	Filing Tray A4-C4, glossy	21
H6101408	Briefablage A4-C4, brillant	Filing Tray A4-C4, glossy	21
H6101505	Briefablage A4-C4, standard	Filing Tray A4-C4, standard	20
H6101525	Briefablage A4-C4, standard	Filing Tray A4-C4, standard	20
H6101534	Briefablage A4-C4, standard	Filing Tray A4-C4, standard	20
H6101552	Briefablage A4-C4, standard	Filing Tray A4-C4, standard	20
NEU H6101575	Briefablage A4-C4, standard	Filing Tray A4-C4, standard	20
H6101582	Briefablage A4-C4, standard	Filing Tray A4-C4, standard	20
H6101587	Briefablage A4-C4, standard	Filing Tray A4-C4, standard	20
H6101595	Briefablage A4-C4, standard	Filing Tray A4-C4, standard	20
H6104395	Papierkorb, 18L, Ergologic	Waste Bin, 18l, Ergologic	35
H6105225	Objekt-Papierkorb, 13L, Linear	Design Waste Bin, 13l, Linear	37
H6105282	Objekt-Papierkorb, 13L, Linear	Design Waste Bin, 13l, Linear	37
H6105295	Objekt-Papierkorb, 13L, Linear	Design Waste Bin, 13l, Linear	37
H6105595	Ovaler Papierkorb, 22L, Linear	Oval Waste Bin, 22l, Linear	37
H6105695	Ovaler Papierkorb, 22L, Design Classics	Oval Waste Bin, 22l, Design Classics	41
H6105705	Objekt-Papierkorb, 18L, Linear	Design Waste Bin, 18l, Linear	37
H6105734	Objekt-Papierkorb, 18L, Linear	Design Waste Bin, 18l, Linear	37
H6105782	Objekt-Papierkorb, 18L, Linear	Design Waste Bin, 18l, Linear	37
H6105795	Objekt-Papierkorb, 18L, Linear	Design Waste Bin, 18l, Linear	37
H6108795	Briefablage A4-B4, 90 mm hoch	Filing Tray A4-B4, 90 mm	23
NEU H6108930	Briefablage A4-C4 quer, Gitterstruktur	Filing Tray A4-C4 horizontal	23
H6108982	Briefablage A4-C4 quer, Gitterstruktur	Filing Tray A4-C4 horizontal	23
H6108995	Briefablage A4-C4 quer, Gitterstruktur	Filing Tray A4-C4 horizontal	23
H6110034	Hängeregistratur-Gestell	Rack for suspension files	6
H6110084	Hängeregistratur-Gestell	Rack for suspension files	6
H6110092	Hängeregistratur-Gestell	Rack for suspension files	6
H6110191	Mobilbox mit Rolloverschluss	Mobilbox	6
H6110193	Mobilbox mit Rolloverschluss	Mobilbox	6
H6110195	Mobilbox mit Rolloverschluss	Mobilbox	6
H6110198	Mobilbox mit Rolloverschluss	Mobilbox	6
NEU H6111693	Multi box	Multi box	4
NEU H6111795	Dokumentenablage	Document Tray	4
H6114602	Kleinkartei A6, gefüllt mit Karten und Register	Card File Box A6, filled with cards and index	10
H6114702	Kleinkartei A7, gefüllt mit Karten und Register	Card File Box A7, filled with cards and index	11
NEU H6127025	my. doc, Briefablage A4	my. doc, Filing Tray A4	5/23
NEU H6127034	my. doc, Briefablage A4	my. doc, Filing Tray A4	5/23
NEU H6127050	my. doc, Briefablage A4	my. doc, Filing Tray A4	5/23
NEU H6127082	my. doc, Briefablage A4	my. doc, Filing Tray A4	5/23
NEU H6127095	my. doc, Briefablage A4	my. doc, Filing Tray A4	5/23
H6129202	Schubladen-Box, 4 Schubladen	Filing-Box, 4 drawers, Economy	16
H6129220	Schubladen-Box, 4 Schubladen	Filing-Box, 4 drawers, Economy	16
H6129230	Schubladen-Box, 4 Schubladen	Filing-Box, 4 drawers, Economy	16
H6129250	Schubladen-Box, 4 Schubladen	Filing-Box, 4 drawers, Economy	16
NEU H6129402	Schubladen-Box, 5 Schubladen	Filing-Box, 5 drawers	5/15/32/33
NEU H6129420	Schubladen-Box, 5 Schubladen	Filing-Box, 5 drawers	5/15/32/33
NEU H6129430	Schubladen-Box, 5 Schubladen	Filing-Box, 5 drawers	5/15/32/33
NEU H6129450	Schubladen-Box, 5 Schubladen	Filing-Box, 5 drawers	5/15/32/33

































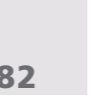

	Art-Nr./SKU	Bezeichnung	Description	Seite/Page
NEU	H6129482	Schubladen-Box, 5 Schubladen	Filing-Box, 5 drawers	5/15/32/33
NEU	H6129484	Schubladen-Box, 5 Schubladen	Filing-Box, 5 drawers	5/15/32/33
NEU	H6129498	Schubladen-Box, 5 Schubladen	Filing-Box, 5 drawers	5/15/32/33
	H6138082	plano plus Box, 9 Schubladen (28 mm)	plano plus Box, 9 closed-front drawers (28 mm)	17
	H6138182	plano plus Box, 6 Schubladen (44 mm)	plano plus Box, 6 closed-front drawers (44 mm)	17
	H6138282	plano plus Box, 3 Schubladen (92 mm)	plano plus Box, 3 closed-front drawers (92 mm)	17
	H6138382	plano plus Box, 2 Schubladen (139 mm)	plano plus Box, 2 closed-front drawers (139 mm)	17
	H6201082	Karteitrog A4 quer	Card File Box A4 horizontal	14
	H6201382	Karteitrog A5 quer	Card File Box A5 horizontal	14
	H6201882	Karteitrog A6 quer	Card File Box A6 horizontal	14
	H6202382	Karteitrog A7 quer	Card File Box A7 horizontal	14
	H6212082	Karteikasten A5 quer	Card File Box A5 horizontal	12
	H6212282	Karteikasten A6 quer	Card File Box A6 horizontal	12
	H6212899	Komfortkarteikasten A5 quer	Comfort Card File Box A5	13
	H6212999	Komfortkarteikasten A6 quer	Comfort Card File Box A6	13
	H6213582	Karteikasten A5 quer	Card File Box A5 horizontal	12
	H6213682	Karteikasten A6 quer	Card File Box A6 horizontal	12
	H6213782	Karteikasten A7 quer	Card File Box A7 horizontal	13
	H6214525	Kleinkartei A5 quer	Card File Box A5 horizontal	10
	H6214534	Kleinkartei A5 quer	Card File Box A5 horizontal	10
	H6214582	Kleinkartei A5 quer	Card File Box A5 horizontal	10
	H6214595	Kleinkartei A5 quer	Card File Box A5 horizontal	10
	H6214625	Kleinkartei A6 quer	Card File Box A6 horizontal	10
	H6214634	Kleinkartei A6 quer	Card File Box A6 horizontal	10
	H6214682	Kleinkartei A6 quer	Card File Box A6 horizontal	10
	H6214695	Kleinkartei A6 quer	Card File Box A6 horizontal	10
	H6214725	Kleinkartei A7 quer	Card File Box A7 horizontal	11
	H6214734	Kleinkartei A7 quer	Card File Box A7 horizontal	11
	H6214782	Kleinkartei A7 quer	Card File Box A7 horizontal	11
	H6214795	Kleinkartei A7 quer	Card File Box A7 horizontal	11
	H6214802	Kleinkartei A8 quer, gefüllt mit Karten und Register	Card File Box A8 horizontal, filled with cards and index	11
	H6214825	Kleinkartei A8 quer, gefüllt mit Karten und Register	Card File Box A8 horizontal, filled with cards and index	11
	H6214834	Kleinkartei A8 quer, gefüllt mit Karten und Register	Card File Box A8 horizontal, filled with cards and index	11
	H6214882	Kleinkartei A8 quer, gefüllt mit Karten und Register	Card File Box A8 horizontal, filled with cards and index	11
	H6214895	Kleinkartei A8 quer, gefüllt mit Karten und Register	Card File Box A8 horizontal, filled with cards and index	11
	H6218091	Visitenkartenbox, für ca. 300 Karten	Business Card Box, for approx. 300 cards	8/36
	H6218092	Visitenkartenbox, für ca. 300 Karten	Business Card Box, for approx. 300 cards	8/36
	H6218093	Visitenkartenbox, für ca. 300 Karten	Business Card Box, for approx. 300 cards	8/36
	H6218095	Visitenkartenbox, für ca. 300 Karten	Business Card Box, for approx. 300 cards	8/36
	H6218098	Visitenkartenbox, für ca. 300 Karten	Business Card Box, for approx. 300 cards	8/36
	H6220199	2er Ablageeinheit, Silver	2-tier Filing Tray Unit, Silver	22/38
	H6220399	Kugelschreiberständer, Silver	Pen Base, Silver	30/39
	H6220499	Visitenkartenbox, für ca. 300 Karten, Silver	Business Card Box for 300 cards, Silver	8/38
	H6220599	Multiköcher, drehbar, Silver	Rotating Multi Pen Holder, Silver	26/38
	H6220899	Ring für Papierkorb zur Beutelbefestigung, Silver	Attachment Ring for Waste Bin Linear, Silver	39
	H6220900	Duo-System-Papierkorb, Silver	Duo-System Waste Bin, Silver	39
	H6253595	Butler	Desk Tidy	27
	H6253795	Butler mit Kartenständer	Desk Tidy with letter rack	26
NEU	H6253893	Tisch-Organizer mit iPhone-Ablage	Desk Organizer	4/27
	H6255382	Telefon-Schwenkarm	Telephone Swivel Arm	31
	H6255395	Telefon-Schwenkarm	Telephone Swivel Arm	31
	H6257995	Klammernspender mit Magnet, Design Classics	Paper Clip Dispenser, Design Classics	28/40
	H6304034	Zettelkasten, mit ca. 200 Zetteln 10 x 10 cm, Linear	Note Paper Box with note paper 10 x 10 cm, Linear	28/37
	H6304095	Zettelkasten, mit ca. 200 Zetteln 10 x 10 cm, Linear	Note Paper Box with note paper 10 x 10 cm, Linear	28/37
	H6305895	Zettelkasten A7, mit Vorschub, ohne Zettel	Note Paper Box A7, with support	28
	H6359092	Kugelschreiberständer mit Kette	Pen Base with pen and chain	30
	H6359093	Kugelschreiberständer mit Kette	Pen Base with pen and chain	30
	H6359095	Kugelschreiberständer mit Kette	Pen Base with pen and chain	30
	H6359098	Kugelschreiberständer mit Kette	Pen Base with pen and chain	30
	H6360895	Zettelspieß	Note Paper Spike	28/41
	H6361082	Stehsammler A5	Magazine Rack A5	24
	H6361095	Stehsammler A5	Magazine Rack A5	24
	H6361225	Stehsammler A4	Magazine Rack A4	24
	H6361252	Stehsammler A4	Magazine Rack A4	24
	H6361234	Stehsammler A4	Magazine Rack A4	24
	H6361282	Stehsammler A4	Magazine Rack A4	24
	H6361295	Stehsammler A4	Magazine Rack A4	24
	H6361395	Stehsammler A4 Ergologic	Magazine Rack A4 Ergologic	25/35
	H6361534	Büro-Stehsammler, Linear	Magazine Rack, large, Linear	24/36/39
	H6361582	Büro-Stehsammler, Linear	Magazine Rack, large, Linear	24/36/39
	H6361595	Büro-Stehsammler, Linear + Silver	Magazine Rack, large, Linear	24/36/39
	H6361895	Buchstütze, Klein	Book End, small	28
	H6390202	Multiköcher Economy	Multi Pen Holder, Economy	27/34
	H6390208	Multiköcher Economy	Multi Pen Holder, Economy	27/34

	Art-Nr./SKU	Bezeichnung	Description	Seite/Page
	H6390211	Multiköcher Economy	Multi Pen Holder, Economy	27/34
	H6390220	Multiköcher Economy	Multi Pen Holder, Economy	27/34
	H6390230	Multiköcher Economy	Multi Pen Holder, Economy	27/34
	H6390240	Multiköcher Economy	Multi Pen Holder, Economy	27/34
NEU	H6390250	Multiköcher Economy	Multi Pen Holder, Economy	27/34
	H6390593	Multiköcher, 4 Kammern, drehbar, Linear	Multi Pen Holder, with 4 sections, turnable, Linear	26/36
	H6390595	Multiköcher, 4 Kammern, drehbar, Linear	Multi Pen Holder, with 4 sections, turnable, Linear	26/36
	H6390634	Multiköcher, 4 Kammern, Linear	Desk Tidy for pens, Linear	26/36
	H6390695	Multiköcher, 4 Kammern, Linear	Desk Tidy for pens, Linear	26/36
	H6390734	Stiftköcher, Linear	Pen Holder, Linear	27/37
	H6390795	Stiftköcher, Linear	Pen Holder, Linear	27/37
	H6390834	Klammernspender mit Magnet, Linear	Magnetic Paper Clip Holder, Linear	28/36
	H6390895	Klammernspender mit Magnet, Linear	Magnetic Paper Clip Holder, Linear	28/36
	H6391134	Briefschale, A4-C4, Linear	Filing Tray, A4-C4, Linear	22/36
	H6391195	Briefschale, A4-C4, Linear	Filing Tray, A4-C4, Linear	22/36
	H6392034	Set Linear, 6 teilig	Set Linear, 6 pieces	29
	H6392095	Set Linear, 6 teilig	Set Linear, 6 pieces	29
NEU	H6901025	BeeBox Lernkartei, A8	BeeBox Card Index Box, A8	9
	H6901030	BeeBox Lernkartei, A8	BeeBox Card Index Box, A8	9
	H6901040	BeeBox Lernkartei, A8	BeeBox Card Index Box, A8	9
NEU	H6901059	BeeBox Lernkartei, A8	BeeBox Card Index Box, A8	9
NEU	H6901125	BeeBox Lernkartei, A7	BeeBox Card Index Box, A7	9
	H6901130	BeeBox Lernkartei, A7	BeeBox Card Index Box, A7	9
	H6901140	BeeBox Lernkartei, A7	BeeBox Card Index Box, A7	9
NEU	H6901159	BeeBox Lernkartei, A7	BeeBox Card Index Box, A7	9
	H6904610	Kleinkartei A6	Card File Box A6	10
	H6904630	Kleinkartei A6	Card File Box A6	10
	H6904640	Kleinkartei A6	Card File Box A6	10
	H6904710	Kleinkartei A7	Card File Box A7	11
	H6904730	Kleinkartei A7	Card File Box A7	11
	H6904740	Kleinkartei A7	Card File Box A7	11
	H6904810	Kleinkartei A8	Card File Box A8	11
	H6904830	Kleinkartei A8	Card File Box A8	11
	H6904840	Kleinkartei A8	Card File Box A8	11
	H7203782	Schwenkstütze A7, quer, für H62023	Divider A7 horizontal, for H62023	14
	H7204182	Schwenkstütze A6, quer, für H62018	Divider A6 vertical, for H62018	14
	H7204582	Schwenkstütze A5, quer, für H62013	Divider A5 vertical, for H62013	14
	H7204982	Schwenkstütze A4, quer, für H62010	Divider A4 vertical, for H62010	14
	H7207882	Schwenkstütze A5, quer, für H62045	Divider A5 horizontal, for H62045	13
	H7207982	Schwenkstütze A6, quer, für H62046	Divider A6 horizontal, for H62046	13
	H7208082	Schwenkstütze A7, quer, für H62047	Divider A7 horizontal, for H62047	13
	H7501382	8-teilige alphabetische Unterteilung für H62180	Register, 8 sections, alphabetical for H62180	8
	H8250795	Büroschale, 6 Unterteilungen, Design Classics	Pen and Clip Tray, 6 sections, Design Classics	26/41
	H8359595	Kugelschreiberständer, Design Classics	Pen Base with pen and chain, Design Classics	30/40
	H8390095	Schreibgeräteköcher, 8-eckig, Design Classics	Pen and Pencil Holder, octagonal, Design Classics	27/40

Farbtabelle  
Colour card

Bei Bestellungen ergänzen Sie bitte die Artikelnummer mit der gewünschten Farbnummer. Diese finden Sie unter der Produktbeschreibung und neben den Produktfotos. Sonderfarben und Farbkombinationen sind auf Anfrage möglich.

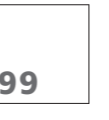
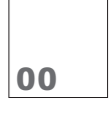
When ordering please also include the colour number with product number. This can be found aside the product description and next to product photos. Other colours and colour combinations are available on request.

 02 glasklar transparent	 05 weiß white	 08 grau transparent grey trasluzent	 10 weiß transluzent white transluzent	 11 gelb transparent yellow transparent	 18 gelb yellow	 11 gelb transluzent yellow transluzent	 20 rot transluzent red transluzent
 20 rot transparent red transparent	 25 rot red	 26 himbeer trasluzent raspberry trasluzent	 30 blau transparent blue transparent	 30 blau transluzent blue transluzent	 34 blau blue	 40 orange transparent orange transparent	 40/45 orange transluzent orange transluzent
 50 grün transluzent green transluzent	 51/52 grün green	 55 dunkelgrün transluzent darkgreen transluzent	 59 limetten grün lime green	 73/75 braun brown	 82 lichtgrau light grey	 84 blau/lichtgrau blue/light grey	 87 mittelgrau mid grey
 91 schwarz/weiß black/white	 92 schwarz/rot black/red	 95 schwarz black	 98 schwarz/lichtgrau black/light grey	 93 schwarz/blau black/blue	 99 schwarz/silber black/silver	 99 silber silver	 99 farbig sortiert assorted colours
 00 farbig sortiert assorted colours	 00 silber silver						

Bei den Produktbeschreibungen befinden sich kleine Symbole, die für folgende Funktionen stehen:  
Symbols can be found next to the product description. These symbols indicate the following:

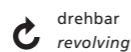
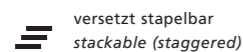
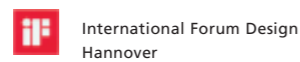

Änderungen des Sortiments und der Farben vorbehalten.  
helit reserves the right to change the assortment and the colour variations.



helit  
innovative Büroprodukte GmbH  
Osemundstraße 23-25  
D - 58566 Kierspe  
Tel + 49 2359 905 - 0  
Fax + 49 2359 905 - 220  
info@helit.de  
www.helit.de