

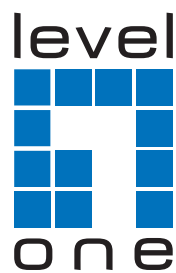

Produkt Katalog

Netzwerk
Sicherheit
Digital Signage

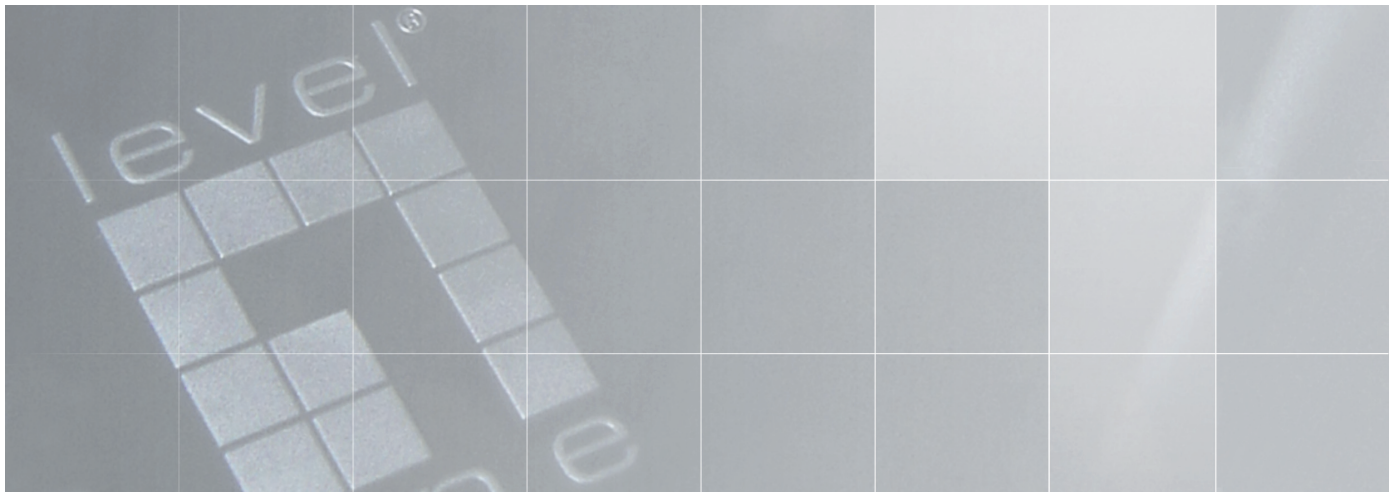

Die Marke LevelOne wurde 1998 von der Digital Data Communications GmbH in Dortmund gegründet. Durch unsere qualitativ hochwertigen Netzwerkprodukte und Lösungen sind wir die letzten Jahre stetig gewachsen, sodass wir heute über 18 Niederlassungen weltweit verfügen.

Das Medium Internet ist sowohl im Geschäft als auch Privatleben ein wichtiger und unverzichtbarer Bestandteil geworden. Unsere langjährige Erfahrung lehrt uns heute noch, dass der einzige Weg an der Spitze zu bleiben, unsere Kunden und ihre Bedürfnisse sind.

Die Digital Data Communications GmbH wurde 1991 gegründet und hat seit dem ihren Hauptsitz in Deutschland. Die verschiedenen Niederlassungen befinden sich überall auf der Welt: Taiwan, Australien, Belgien, Brasilien, Kolumbien, Dänemark, Griechenland, Italien, Kenia, Niederlande, Portugal, Slowenien, Spanien, V.A.E. Zur Zeit schaffen wir es kontinuierlich unsere jährlichen Umsätze zu erhöhen. Unsere Produktion, die Entwicklung sowie unsere Distributionen und Logistikzentren wachsen stetig und setzen neue Qualitätsstandards in der Welt mit starken Markennamen mit hohem Wiedererkennungswert.

Werfen Sie einen Blick in diesen Katalog und scheuen Sie sich nicht sich mit Fragen und Anregungen an uns zu wenden:

sales@level1.com



Inhalte

Home

Netzwerk	Seite 3
Sicherheit	Seite 15

Business

Netzwerk	Seite 20
Sicherheit	Seite 59
Digital Signage	Seite 70

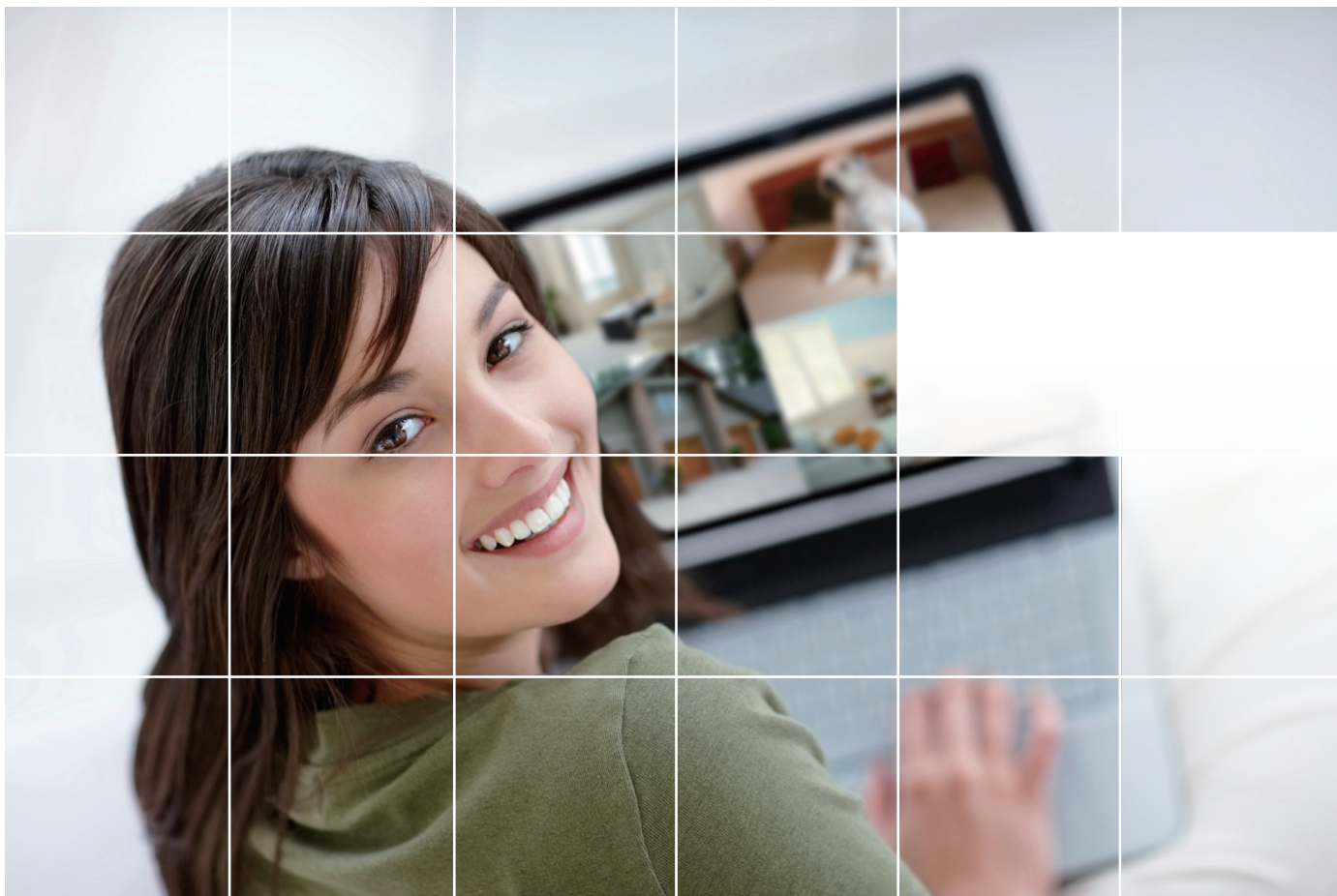

Home

Netzwerk

Ethernet Switches	>03
Router	>04-05
Netzwerk-Adapter	>06-07
Antennen	>08
Powerline Netzwerk	>09-10
Netzwerkspeicher	>11-12
KVM Switches	>13-14

Sicherheit

Fixed Kamera	>15-16
P/T Kamera	>17
Netzwerk Video Recorder	>18

Erlaubt dem Benutzer ein lokales Netzwerk (LAN) zu errichten oder weitere Netzwerkgeräte zu verbinden wie zum Beispiel Kameras, Speichermedien oder Printserver.

Key Features

- Entspricht dem IEEE 802.3(10MBit/s), 802.3u(100MBit/s), 802.3ab (1000MBit/s)
- Unterstützt Store-and-Forward Architektur
- Unterstützt Auto-MDI/MDI-X für jeden Port
- Kontroll-LEDs an der Vorderseite
- Wire-Speed und Non-Blocking Weiterleitungsrate
- Unterstützt IEEE 802.3x Voll-Duplex/Halb-Duplex Kontrolle

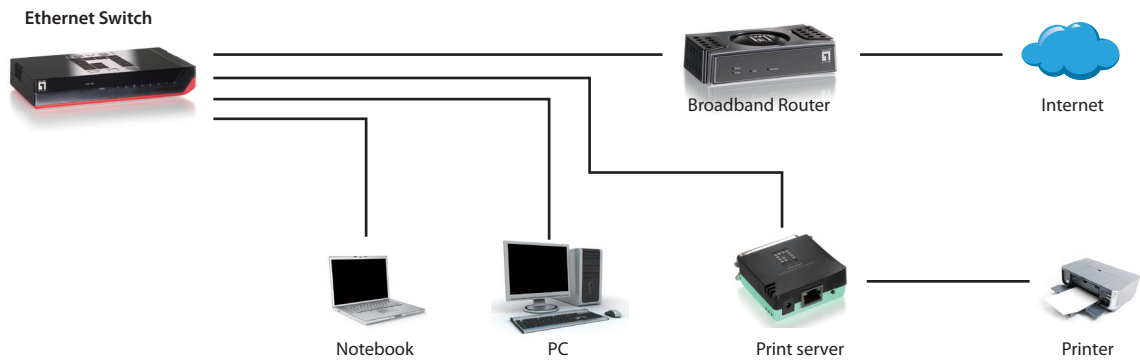

Unmanaged Fast Ethernet Switches



FSW-0508TX
5-Port Fast Ethernet Switch



FSW-0808TX
8-Port Fast Ethernet Switch



FSW-0511
5-Port Fast Ethernet Switch



FSW-0811
8-Port Fast Ethernet Switch

Unmanaged Gigabit Ethernet Switches



GSW-0507
5-Port Gigabit Switch



GSW-0807
8-Port Gigabit Switch



Ethernet Switch Übersicht						
Model	FSW-0508TX	FSW--0808TX	FSW-0511	FSW-0811	GSW-0507	GSW-0807
10/100 Mbps Port	5	8	5	8	-	-
10/100/1000 Mbps Port	-	-	-	-	5	8
Mac Address Table	2K	1K	1K	1K	8K	8K
Jumbo Frame	-	-	-	-	9K	9K
Buffer Memory	48KB	96KB	128KB	96KB	125KB	125KB
Green Technology	-	-	V	V	V	V

LevelOneBreitband-/WLAN-/Modem-/UMTS-Routersind die perfekte Ergänzung zu jedem Netzwerk, egal ob Drahtgebundene oder drahtlos. Nutzer können unter verschiedensten Produkten, mit unterschiedlichst Funktionen, das für ihren Einsatz passende Produkt auswählen.

Key Features

- Sämtliche WLAN-Router unterstützen die automatische Kanalwahl und verhindern somit Interferenzen von benachbarten WLAN Netzwerken.
- Sämtliche WLAN Router unterstützen WPS (Wi-Fi Protected Setup)
- Unterstützt VPN-Durchleitung und DDNS (Dynamic Domain Name System)
- Unterstützt NAT-Firewall mit SPI Modus, DOS-Attacken Erkennung und Zugriffskontrollmanagement
- Schnelle und einfache Installation Wizard

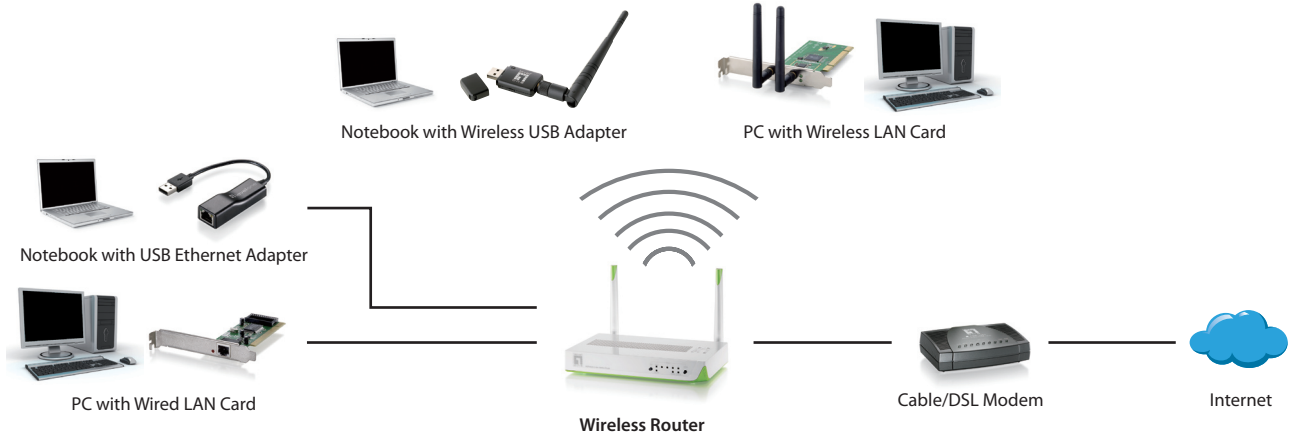

Drahtgebundene/Drahtlos Router



FBR-1418TX



FBR-1430

FBR-1418TX / FBR-1430
Breitband Router /
VPN Breitband Router



WBR-6003
150Mbps Wireless Router



WBR-6020
300Mbps Wireless Router



WGR-6012
300Mbps Wireless Gigabit Router



WBR-6022
300Mbps Wireless HomeGuard22 Router



WBR-6012
300Mbps Drahtlos-Router

Drahtgebundene/Drahtlos Router Übersicht						
Model	FBR-1418TX/ FBR-1430	WBR-6003	WBR-6020	WGR-6012	WBR-6022	WBR-6012
LAN	4 x 10/100Mbps	4 x 10/100Mbps	4 x 10/100Mbps	4 x 10/100/1000Mbps	4 x 10/100Mbps	4 x 10/100Mbps
WAN (Internet)	1 x 10/100Mbps	1 x 10/100Mbps	1 x 10/100Mbps	1 x 10/100/1000Mbps	1 x 10/100Mbps	1 x 10/100Mbps
Wireless	-	150Mbps	300Mbps	300Mbps	300Mbps	300Mbps
Antenna	-	1 x 5dBi (Fixed/ External Detachable)	2 x 2dBi (External Detachable) 1 x 2dBi (Internal)	2 x 2dBi (External Detachable) 1 x 2dBi (Internal)	2 x 2dBi (External Detachable)	2 x 2dBi (External Detachable) (Optional 5dBi)
WDS	-	V	V	V	V	V
WPS	-	V	V	V	V	V
Built-in modem	-	-	-	-	-	-
Wireless Signal On/Off	-	V	V	V	V	-
Green Technology	-	-	V	V	V	V

Drahtgebundene/Drahtlos Router



WGR-6013
300Mbps Wireless Gigabit Router



WBR-6801
150Mbps Wireless 3G Tragbarer Router



WBR-6802
150Mbps Drahtlos-Reise-Router



WBR-6803
150Mbps Wireless 3G Travel Router



WBR-6804
150Mbps Drahtlos-Dual-WAN-3G-Router



WBR-6805
300Mbps Drahtlos-Reise-Router

Drahtgebundene/Drahtlos Router Übersicht						
Model	WGR-6013	WBR-6801	WBR-6802	WBR-6803	WBR-6804	WBR-6805
LAN	4 x 10/100/1000 Mbps	-	1 x 10/100Mbps	1 x 10/100Mbps ,	4 x 10/100Mbps	1 x 10/100Mbps
WAN(Internet)	1 x 10/100/1000 Mbps	1 x USB	1 x 10/100Mbps	1 x USB (WAN Only)	1 x 10/100Mbps	1 x 10/100Mbps / 1 x USB
Wireless	300Mbps	150Mbps	150Mbps	150Mbps	150Mbps	300Mbps
Antenna	2 x 2 dBi(Fixed External) (Optional 5 dBi)	1 x 2dBi (Internal)	1 x 2dBi (Internal)	1 x 2dBi (Internal)	1 x 2dBi (Fixed External)(Optional 5dBi)	1 x 2dBi (Fixed External) 1 x 2dBi (Internal)
WDS	V	-	-	-	V	-
WPS	V	V	V	V	V	V
Built-in modem	-	-	-	-	-	-
Wireless Signal On/Off	V	V	V	V	V	V
Green Technology	V	-	V	-	-	V

Drahtgebundene/Drahtlos Modem Router



FBR-1161 Annex A/B
ADSL2+ Modem Router (1 LAN-, 1 WAN-, 1 USB-Port)



FBR-1461 Annex A/B
ADSL2+ Modem Router mit QOS



WBR-6603
150Mbps Wireless ADSL2+ Modem Router



WBR-6601 Annex A/B
150Mbps Wireless ADSL2+ Modem Router

Drahtgebundene/Drahtlos Modem Router Übersicht				
Model	FBR-1161	FBR-1461	WBR-6603	WBR-6601
LAN	1 x 10/100Mbps	4 x10/100Mbps	4 x 10/100Mbps	4 x10/100Mbps
WAN (Internet)	1 x RJ-11	1 x RJ-11	1 x RJ-11	1 x RJ-11
Wireless	-	-	150Mbps	150Mbps
Antenna	-	-	1 x 2dBi (Fixed External)	1 x (External Detachable)
WDS	-	-	V	V
WPS	-	-	V	V
Built-in modem	ADSL2+	ADSL2+	ADSL2+	ADSL2+
Wireless Signal On/Off	-	-	V	V
Green Technology	-	-	-	-

Die LevelOne USB-Netzwerkadapter erlauben es den Laptop oder die Spielkonsole einfach an das Netzwerk anzuschließen. Die PCI-Netzwerkkarten sind besonders kosteneffektive Lösungen, um PCs und Server an das Netzwerk anzuschließen.

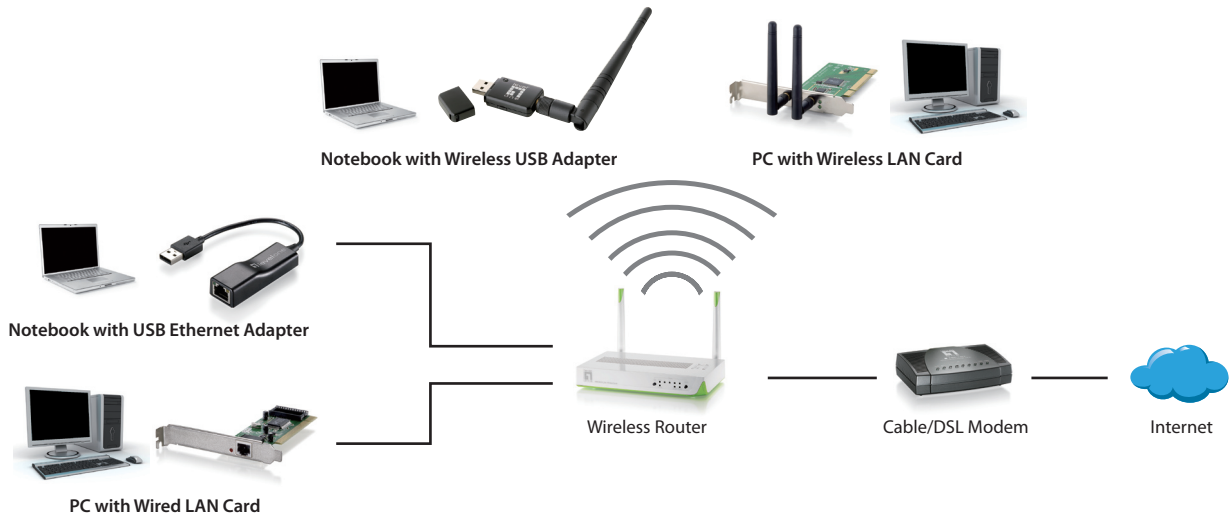

Drahtgebundene Netzwerk-Adapter

- Entspricht dem IEEE 802.3(10MBit/s), 802.3u(100MBit/s), 802.3ab (1000MBit/s)
- Bieten Plug&Play Funktion für einfachste Installation



FNC-0107TX
Fast Ethernet PCI Card (mit Wake-On LAN-Funktion)



FNC-0109TX
Fast Ethernet PCI Card



USB-0301
USB Fast Ethernet Adapter



USB-0401
USB Gigabit Ethernet Adapter



USB-0501
USB Hub and Fast Ethernet Combo Adapter

Drahtgebundene Netzwerk-Adapter Übersicht					
Model	FNC-0107TX	FNC-0109TX	USB-0301	USB-0401	USB-0501
Interface	PCI	PCI	USB 2.0	USB 3.0	USB 2.0
Ethernet Port	1 x 10/100Mbps	1 x 10/100Mbps	1 x 10/100Mbps	1x 10/100/1000Mbps	1 x 10/100Mbps
Jumbo Frame	-	-	-	4K	-
Wake-on-LAN	V	-	V	V	-
Mac OS Compatible	-	-	V	V	V
USB Hub	-	-	-	-	4 x USB

Drahtlos Netzwerk-Adapter

- Unterstützt automatische Kanalwahl und verhindert Interferenzen mit benachbarten Netzwerken
- Unterstützt 64/128 WEP, WPA und WPA2 Verschlüsselung
- Arbeitet im 2.4GHz Standard
- Bieten Plug&Play Funktion für einfachste Installation



WNC-0301
54Mbps Wireless PCI Card



WNC-0601
300Mbps Wireless PCI Karte



WPC-0600
300Mbps Wireless CardBus Adapter



WUA-0606
150Mbps Drahtlos-USB-Adapter

Drahtlos Netzwerk-Adapter Übersicht				
Model	WNC-0301	WNC-0601	WPC-0600	WUA-0606
Interface	PCI	PCI	CardBus	USB 2.0
Antenna	1 x 2 dBi (External Detachable)	2 x 2dBi (External Detachable)	2 x 2dBi (Internal)	1 x 2dBi (Internal)
Wireless	54Mbps (11b/g)	300Mbps (11b/g/n)	300Mbps (11b/g/n)	150Mbps (11b/g/n)
WPS	-	V	V	V
Optional Accessories	-	-	-	SUS-1003 USB stand with Cable Organizer

Wireless Network Adapter



WUA-0614
150Mbps Drahtlos-USB-Adapter (2dBi)



WUA-0624
150Mbps Drahtlos-USB-Adapter (5dBi)



WUA-0605
300Mbps Drahtlos-USB-Adapter



WUA-0616
300Mbps Drahtlos-USB-Adapter



WUA-1610
300Mbps Drahtlos-USB-Adapter



WUA-1610H
300Mbps Drahtlos-USB-Adapter

Drahtlos Netzwerk-Adapter Übersicht						
Model	WUA-0614	WUA-0624	WUA-0605	WUA-0616	WUA-1610	WUA-1610H
Interface	USB 2.0	USB 2.0	USB 2.0	USB 2.0	USB 2.0	USB 2.0
Antenna	1 x 2dBi (External Detachable)	1 x 5dBi (External Detachable)	2 x 2dBi (Internal)	2 x 2dBi (Internal)	2 x 2dBi (External Detachable)	2 x 5dBi (External Detachable)
Wireless	150Mbps (11b/g/n)	150Mbps (11b/g/n)	300Mbps (11b/g/n)	300Mbps (11b/g/n)	300Mbps (11b/g/n)	300Mbps (11b/g/n)
WPS	V	V	V	V	V	V
Optional Accessories	SUS-1003 USB stand with Cable Organizer				-	-

LevelOne Antennen ermöglichen es dem Nutzer die Reichweite des drahtlos Netzwerk zu erweitern. Die Antennen unterstützen IEEE 802.11b/g/n im 2.4GHz Frequenzbereich, sowohl für Router, Access Points als auch WLAN Adapter.

Key Features

- Reverse SMA Anschluss zum einfachen anschließen von Antennen
- Arbeitet Omni-direktional
- Bietet stabiles Signal und erhöhte Reichweite/Abdeckung

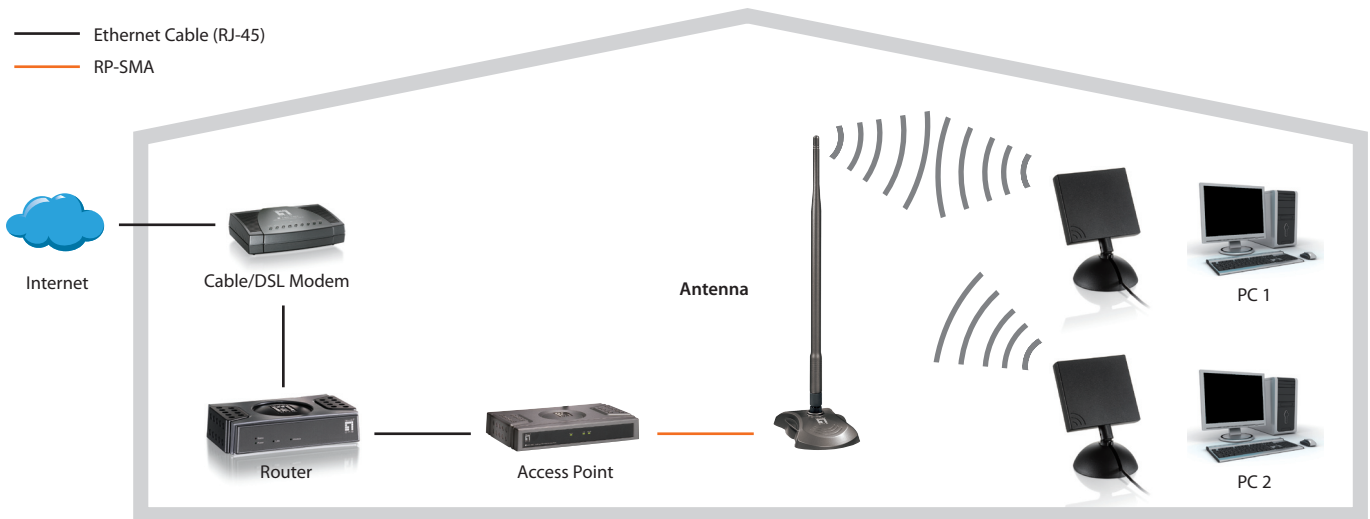

OAN-0501
5dBi Omni-direktionale Antenne



OAN-1070
7dBi Omni-direktionale Antenne

Antennen Übersicht		
Model	OAN-0501	OAN-1070
Gain	5dBi	7dBi
Range (Estimated)	40~200m	60~400m
Extension Cable	-	V

LevelOne Powerline Adapter unterstützen die neuesten HomePlug Powerline A/V Standards und ermöglichen den Aufbau eines Datennetzwerks über die vorhandene Stromverkabelung. Perfekt z.B. für HDTV-Streaming im Haus oder in der Wohnung.

Key Features

- Unterstützt automatische Kanalwahl und verhindert Interferenzen mit benachbarten Netzwerken
- Die AES 128-bit Verschlüsselung bietet höchsten Zugriffsschutz und Sicherheit
- Taste zur Plug&Play Verschlüsselung (WPS Konfiguration)
- Daten über das vorhandene Stromnetzwerk übertragen
- Bietet einfachste Plug&Play Installation
- LED-Anzeigen u.a. zur Kontrolle der Verbindungsqualität

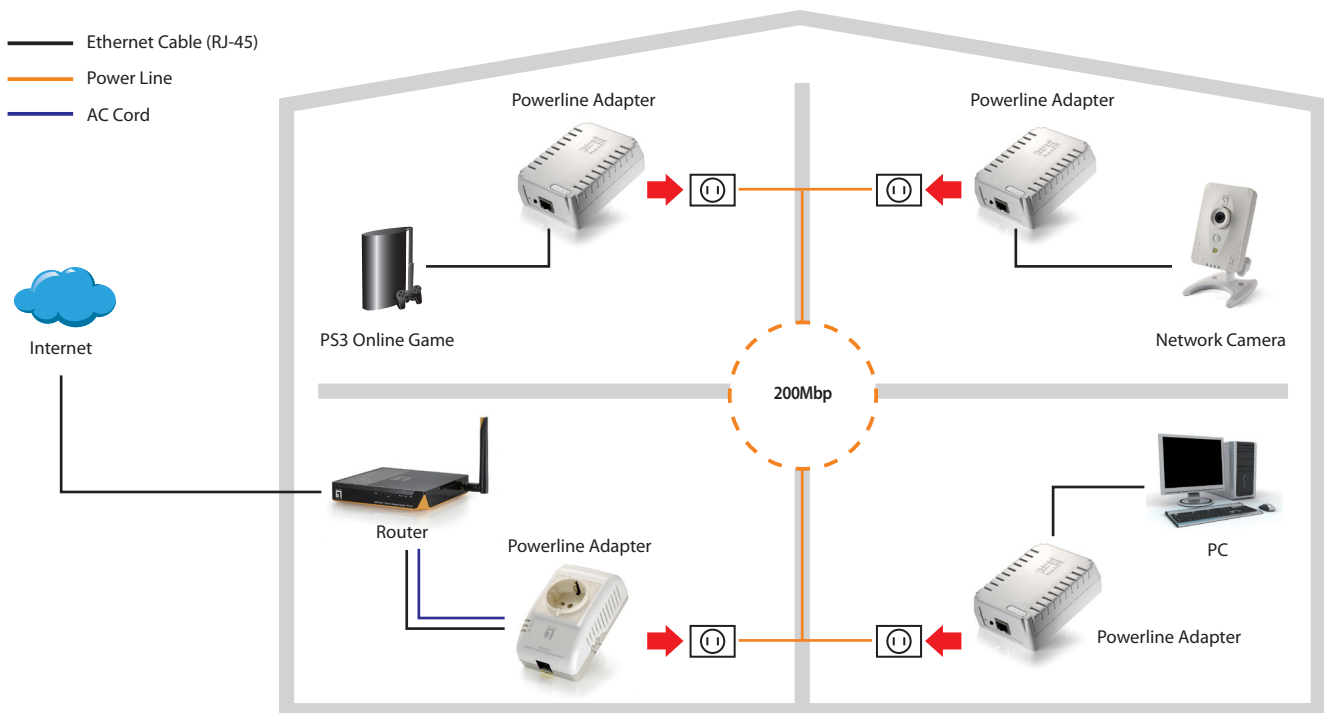
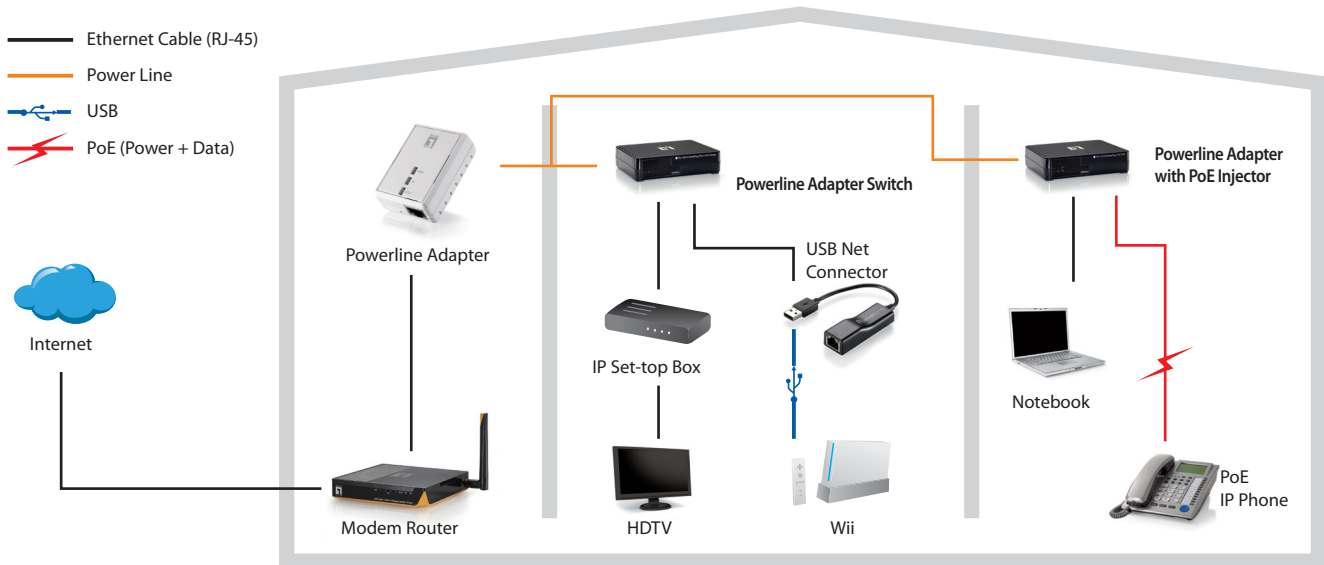

HomePlug Powerline Adapters



PLI-3510
200Mbps Powerline Adapter mit Mains
Pass-Through



PLI-3021
200Mbps Powerline Adapter



PLI-4051
500Mbps Powerline Gigabit Adapter

HomePlug Powerline Adapter Übersicht			
Model	PLI-3510	PLI-3021	PLI-4051
Ethernet Port	1 x 10/100Mbps	1 x 10/100Mbps	1 x 10/100/1000Mbps
Powerline Speed	200Mbps	200Mbps	500Mbps
Wireless Speed	-	-	-
PoE	-	-	-
PoE Power Budget	-	-	-
Green Technology	V	-	-

NEW



PLI-4052
500Mbps Powerline Adapter



PLI-3110
200Mbps Powerline Adapter mit PoE-Injektor

HomePlug Powerline Adapter Übersicht		
Model	PLI-4052	PLI-3110
Ethernet Port	1 x 10/100Mbps	2 x 10/100Mbps 1 x PoE
Powerline Speed	500Mbps	200Mbps
Wireless Speed	-	-
PoE	-	IEEE 802.3af
PoE Power Budget	-	15.4W
Green Technology	-	-

LevelOne bietet Speicherlösungen für den Heim- und Büroeingang. Egal ob Sie eine einfache und schnelle Möglichkeit suchen Ihre Filme und Musik zu Hause gemeinsam zu nutzen, mit anderen zu teilen oder ob Sie Ihren Kollegen im Büro zusammen arbeiten, LevelOne hat die Lösung für Sie.

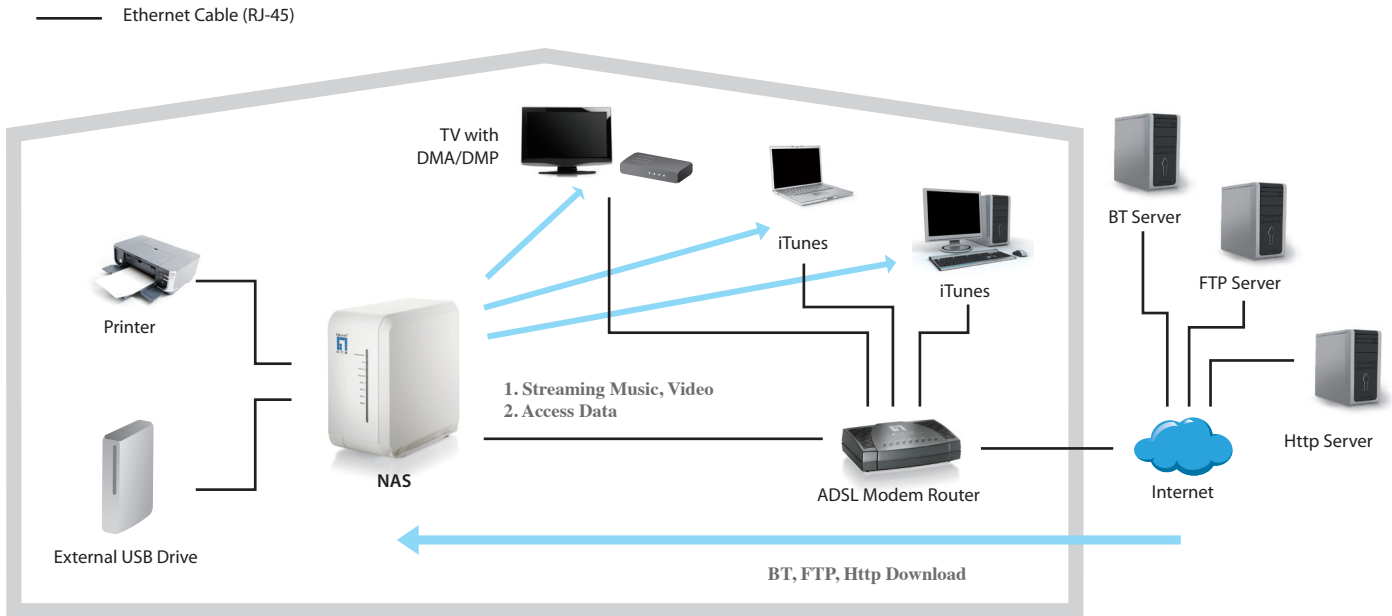

Key Features

- Streamen Sie Musik, Filme zu Ihrem PC Media Player oder der Spiele Konsole
- High-Speed USB 2.0 Anschlüsse für externen Festplatten
- Teilen Sie Daten mittels FTP Server oder Windows Dateifreigabe/Samba
- Einfach zu installieren und zu nutzen



WAP-0008
11b/g 54Mbps Wireless AP Storage (für 3.5" HDD)



FNS-1020
1-Bay Simple Network Storage



GNS-1001
1-Bay Gigabit Network Storage

Netzwerksspeicher Übersicht			
Model	WAP-0008	FNS-1020	GNS-1001
Ethernet Port	10/100Mbps	10/100Mbps	10/100/1000Mbps
DRAM	SDRAM 32MB	SDRAM 32MB	128MB
Disk Bay	1 x 3.5"inch IDE/SATA	1 x 3.5"inch IDE/SATA	1 x 3.5" inch SATA
UPnP Media Server	V	V	-
JBOD /RAID 0/1	-	-	-
Jumbo Frame	-	-	V
Wireless	54Mbps	-	-
One Touch Backup	V	V	-

Network Attached Storage



GNS-2000
2-Bay Gigabit Netzwerkspeicher



GNS-4001
4-Bay Gigabit-Netzwerkspeicher

Netzwerkspeicher Übersicht		
Model	GNS-2000	GNS-4001
Ethernet Port	10/100/1000Mbps	2 x 10/100/1000Mbps
DRAM	SDRAM 64MB	1GB DDR II, up to 4GB
Disk Bay	2 x 3.5"inch SATA	4 x 3.5"inch SATA II
UPnP Media Server	✓	✓
JBOD /RAID 0/1	✓	✓
Jumbo Frame	✓	-
Wireless	-	-
One Touch Backup	-	✓

LevelOne KVM-Lösungen sind einfach zu installieren (Plug&Play) und ermöglichen das Umschalten zwischen PCs. Unterstützt werden PS/2-, USB und VGA- als auch DVI-Anschlüsse.

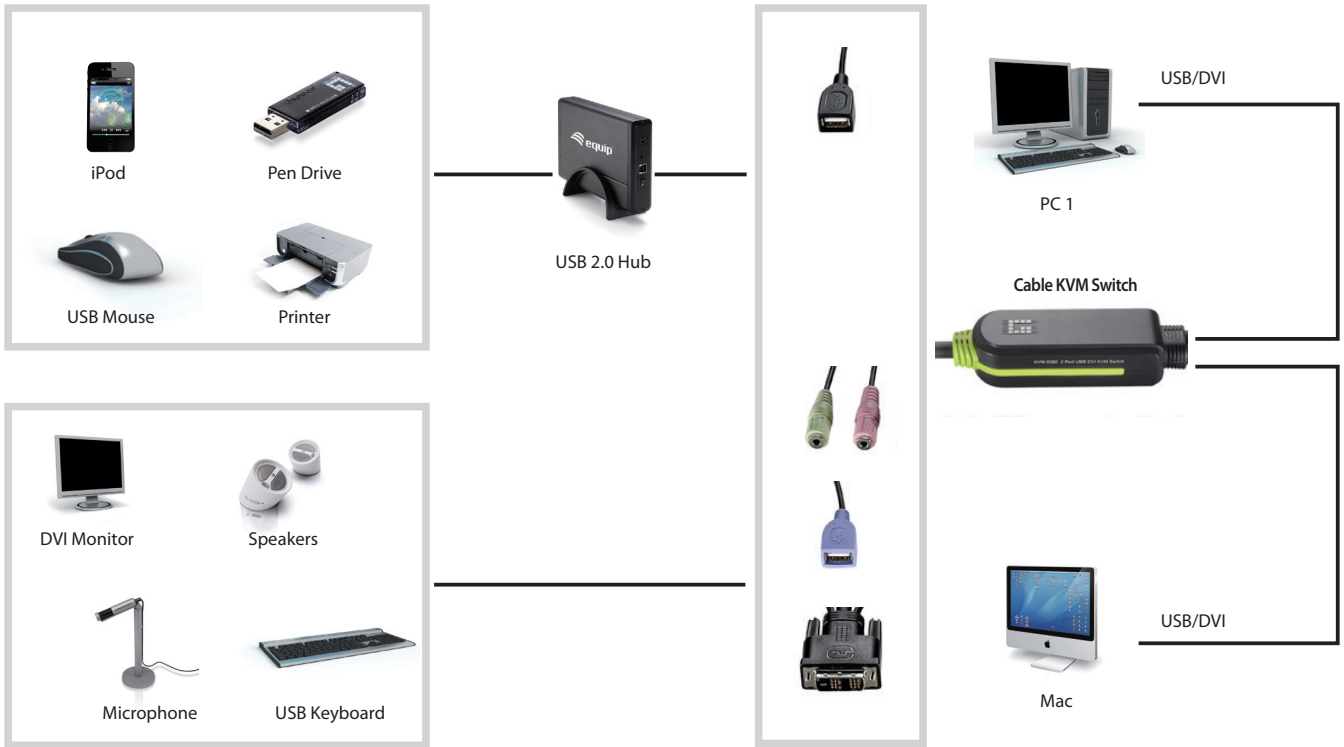

Key Features

- Plug&Play Anwendung, keine Softwareinstallation notwendig
- LED-Anzeigen zur Kontrolle des Status
- Einfaches Umschalten zwischen PCs durch automatischen Umschalten, Tastatur-Hotkeys oder Knopfdruck möglich



KVM-0213
2-Port PS/2 KVM Switch



KVM-0223
2-Port USB KVM Switch



KVM-0260
2-Port USB DVI KVM Switch mit Audio

Kabel KVM Switch Übersicht				
	Model	KVM-0213	KVM-0223	KVM-0260
PC Port	Port for Keyboard/Mouse	PS/2	USB	USB
	Video Port	VGA	VGA	DVI-D
	Audio / Microphone	Audio	Audio	Audio/Microphone
Console Port	Port for Keyboard/Mouse	PS/2	USB	USB
	Video Port	VGA	VGA	DVI-D
	Audio / Microphone	Audio	Audio	Audio/Microphone
Feature	Control and Manage Computers	2	2	2
	Max. Local Resolution	2048 x 1536	2048 x 1536	1920 x 1200

Der LevelOne Desktop KVM Switches verbindet zwei Computer mit einer einzigen PS/2-Tastatur, PS/2-Maus und VGAMonitor. Dieser 2-Port PS/2 KVM-Switch bietet auch Audiounterstützung, indem Sie einfach die Audio-Anschlüsse der einzelnen Computer mit dem KVM-Switch verbinden.

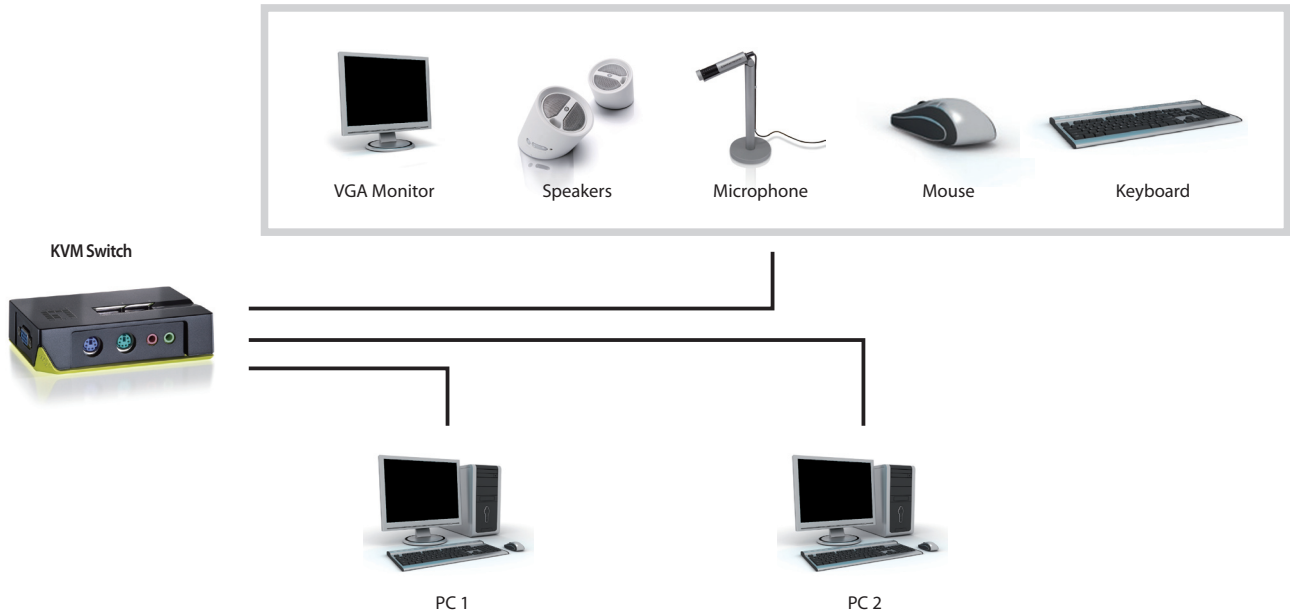

Desktop KVM Switches

- Flexibler Wechsel für ein ununterbrochenes Multimedia Erlebnis
- Plug&Play Anwendung, keine Softwareinstallation notwendig



KVM-0211 / KVM-0212
2-Port PS/2 KVM Switch



KVM-0221 / KVM-0222
2-Port USB KVM Switch



KVM-0261 / KVM-0461
2/4-Port USB DVI KVM Switch mit
Audio & USB Hub



KVM-0306
3-Port DVI KVM Switch mit Audio

Desktop KVM Switch Übersicht					
	Model	KVM-0211 / KVM-0212	KVM-0221 / KVM-0222	KVM-0261 / KVM-0461	KVM-0306
PC Port	Port for Keyboard/Mouse	PS/2	USB	USB	USB
	Video Port	VGA	VGA	DVI	DVI
	Audio / Microphone	Audio/Microphone (KVM-0211)	Audio / Microphone (KVM-0221)	Audio / Microphone	Audio/Microphone
Console Port	Port for Keyboard/Mouse	PS/2	PS/2	USB	USB; PS/2
	Video Port	VGA	VGA	DVI	DVI
	Audio / Microphone	Audio/Microphone (KVM-0211)	Audio / Microphone (KVM-0221)	Audio / Microphone	Audio/Microphone
Feature	Control and Manage Computers	2	2	2 / 4	3
	Max. Local Resolution	2048 x 1536	2048 x 1536	2560x1600	1600 x 1200

Ob Drahtgebundene, drahtlos sowie Tag, Nacht, PTZ, Indoor und Outdoor Kamera, sämtliche Kameramodelle werden mit der kostenfreien 64-Kanal Software iCam Secure ausgeliefert. Die ebenfalls kostenfreie iCamSecure Apple App ermöglicht den remote Zugriff via UMT/WLAN auf das Überwachungssystem.

Indoor Lösung

- Ethernet Cable (RJ-45)
- Power Line

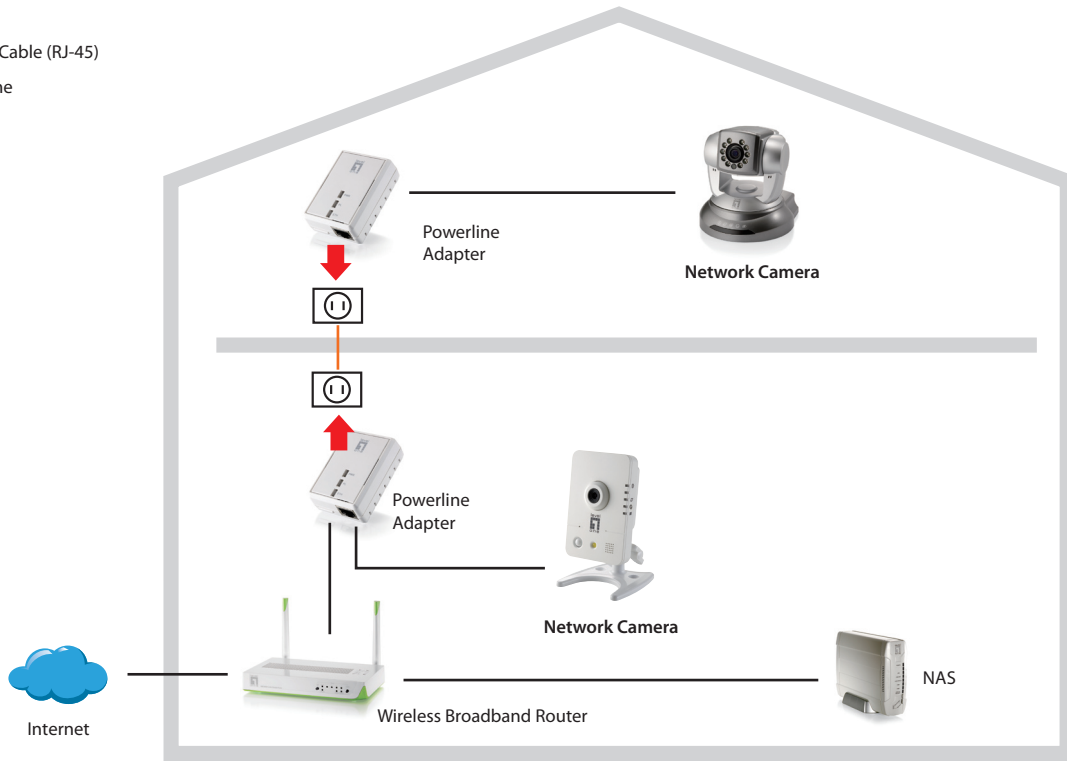

Outdoor Lösung

- Ethernet Cable (RJ-45)
- Phone Line (RJ-11)

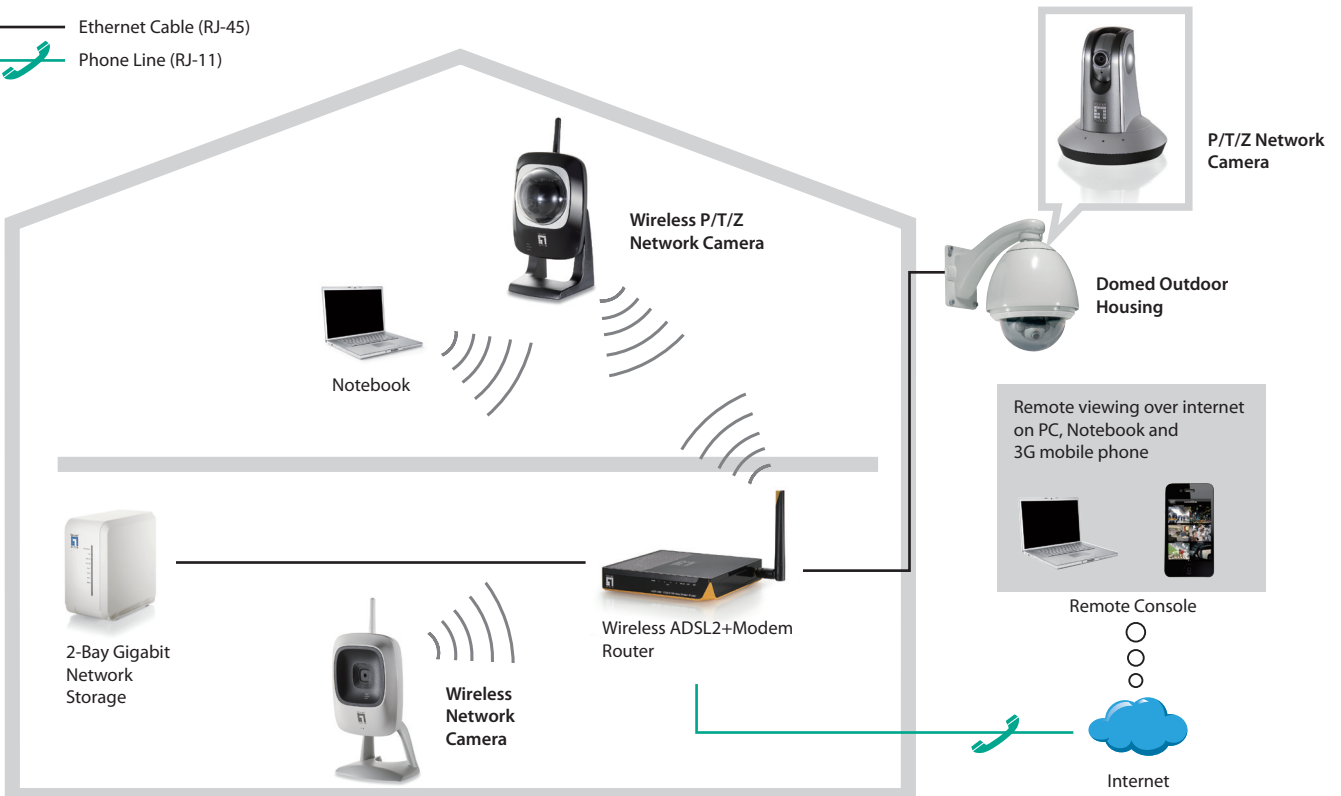

Fixed Cameras

- Integrierter CMOS Sensor
- Unterstützt UPnP für einfache Installation und Konfiguration
- Supports DDNS bei dynamischer IP Adressvergabe



FCS-0010 / WCS-0010
Wired / Wireless Netzwerk Kamera



FCS-1030 / WCS-2030
Wired/Wireless Netzwerk Kamera



FCS-0030 / WCS-0030
Wired / Wireless Megapixel PIR Lighting
Netzwerk Kamera



FCS-0031
Megapixel PIR PoE Netzwerk Kamera



WCS-0050
150Mbps drahtlose Megapixel Netzwerk kamera



FCS-0040 / WCS-0040
Wired / Wireless 1.3 Megapixel Netzwerk Kamera

Fixed Kameras Übersicht					
Model	FCS-0010	WCS-0010	FCS-1030	WCS-2030	FCS-0030
Sensor	CMOS	CMOS	CMOS	CMOS	CMOS Megapixel
Infrared LED	-	-	-	-	-
Max.Resolution	640 x 480	640 x 480	640 x 480	640 x 480	1280 x 800
Wireless	-	54Mbps	-	54Mbps	-
ICR (IR-Cut Filter Removal)	-	-	-	-	-
PIR Sensor	-	-	-	-	V
Built-in Microphone/Speaker	Microphone	Microphone	Microphone	Microphone	Microphone/ Speaker
ePTZ	-	-	-	-	-
Pan/Tilt/Zoom	-	-	-	-	-
PoE	-	-	-	-	-
Power Supply	External	External	External	External	External
Local Storage	-	-	-	-	V
Operation Temperature	0°C ~ 40°C	0°C ~ 40°C	0°C ~ 50°C	0°C ~ 50°C	0°C ~ 50°C
Optional Accessories	-	-	-	-	-

Fixed Kameras Übersicht					
Model	WCS-0030	FCS-0031	WCS-0050	FCS-0040	WCS-0040
Sensor	CMOS Megapixel	CMOS Megapixel	CMOS Megapixel	CMOS Megapixel	CMOS Megapixel
Infrared LED	-	-	-	-	-
Max.Resolution	1280 x 800	1280 x 800	1280 x 800	1280 x 960	1280 x 960
Wireless	150Mbps	-	150Mbps	-	300Mbps
ICR (IR-Cut Filter Removal)	-	-	-	-	-
PIR Sensor	V	V	-	-	-
Built-in Microphone/Speaker	Microphone/Speaker	Microphone/ Speaker	Microphone	Microphone	Microphone
ePTZ	-	-	-	V	V
Pan/Tilt/Zoom	-	-	-	-	-
PoE	-	IEEE 802.3af	-	-	-
Power Supply	External	External/PoE	External	External	External
Local Storage	V	V	-	-	-
Operation Temperature	0°C ~ 50°C	0°C ~ 50°C	0°C ~ 50°C	0°C ~ 40°C	0°C ~ 40°C
Optional Accessories	-	-	-	-	-

P/T Kameras

- Integrierter CMOS Sensor
- Unterstützt UPnP für einfache Installation und Konfiguration
- Supports DDNS bei dynamischer IP Adressvergabe



FCS-0020/WCS-0020
Wired/Wireless P/T Netzwerk Kamera



FCS-1060
10/100Mbps P/T IP Netzwerk Kamera



WCS-2060
11g Wireless P/T IP Netzwerk Kamera



FCS-6010
1.3 Megapixel Tag/Nacht P/T PoE-Netzwerk-Kamera



WCS-6020
2 Megapixel Tag/Nacht Wireless P/T Netzwerk-Kamera



WCS-6050
5 Megapixel Tag/Nacht Wireless P/T Netzwerk-Kamera

P/T Kameras Übersicht					
Model	FCS-0020	WCS-0020	FCS-1060	WCS-2060	FCS-6010
Sensor	CMOS	CMOS	CMOS	CMOS	CMOS Megapixel
Infrared LED	-	-	-	-	V
Max.Resolution	640 x 480	640 x 480	640 x 480	640 x 480	1280 x 1024
Wireless	-	54Mbps (11b/g)	-	54Mbps (11b/g)	* 150Mbps
ICR (IR-Cut Filter Removal)	-	-	-	-	V
PIR Sensor	-	-	-	-	-
Built-in Microphone/Speaker	Microphone	Microphone	Microphone	Microphone	Microphone
ePTZ	-	-	-	-	-
Pan/Tilt/Zoom	P/T	P/T	P/T	P/T	P/T
PoE	-	-	-	-	IEEE 802.3af
Power Supply	External	External	External	External	External/PoE
Local Storage	-	-	-	-	V
Operation Temperature	0°C ~ 40°C	0°C ~ 40°C	0°C ~ 40°C	0°C ~ 40°C	0°C ~ 50°C
Optional Accessories	-	-	-	-	*WUA-0606: 150Mbps Wireless USB Adapter WUA-1610/1610H 300Mbps Wireless USB Adapter

P/T Kameras Übersicht		
Model	WCS-6020	WCS-6050
Sensor	CMOS Megapixel	CMOS Megapixel
Infrared LED	V	V
Max.Resolution	1920 x 1080	2560 x 1920
Wireless	150Mbps (11b/g/n)	150Mbps (11b/g/n)
ICR (IR-Cut Filter Removal)	V	V
PIR Sensor	-	-
Built-in Microphone/Speaker	V	V
ePTZ	-	-
Pan/Tilt/Zoom	P/T	P/T
PoE	-	-
Power Supply	External	External
Local Storage	V	V
Operation Temperature	0°C ~ 40°C	0°C ~ 40°C
Optional Accessories	-	-

Der LevelOne NVR-0104 ist ein Entry-Level Netzwerk Video Recorder zur Anwendung in für private Haushalte, Ladenlokale und kleiner Büros. Das System unterstützt IP Kameras verschiedener Hersteller, ohne die Notwendigkeit weitere spezielle Hardware oder Software.



NVR-0104

4-Kanal-Netzwerkvideorekorder

- 2 x 3,5-Zoll-Festplattensteckplatz (SATA I/II, bis zu 2 x 2 TB)
- Bis zu 4 Netzwerkkameras verwalten und steuern
- Unterstützt lokale HDMI-Anzeige mit 1080p
- Komprimierung: H.264/MPEG-4, Part 2/MJPEG
- Auflösung: Full-HD/Megapixel/FD1/CIF/QCIF
- Unterstützt intelligente Kamerasuche und 2-Wege-Audio
- Unterstützt PTZ/voreingestellten Punkt/voreingestellte Sequenz
- Bewegungserkennung und Ereignisanzeige auf eKarte/Google Maps
- Unterstützt iPhone/Smartphone/PDA-Fernüberwachung über das Internet
- Anzeigemodus: Echtzeitanzeige/Wiedergabe/Vollbild
- Inklusive Fernbedienung
- Kostenlos mitgelieferte NVR-Verwaltungssoftware zur Verwaltung von bis zu 16 NVR-Geräten



NVR-0104

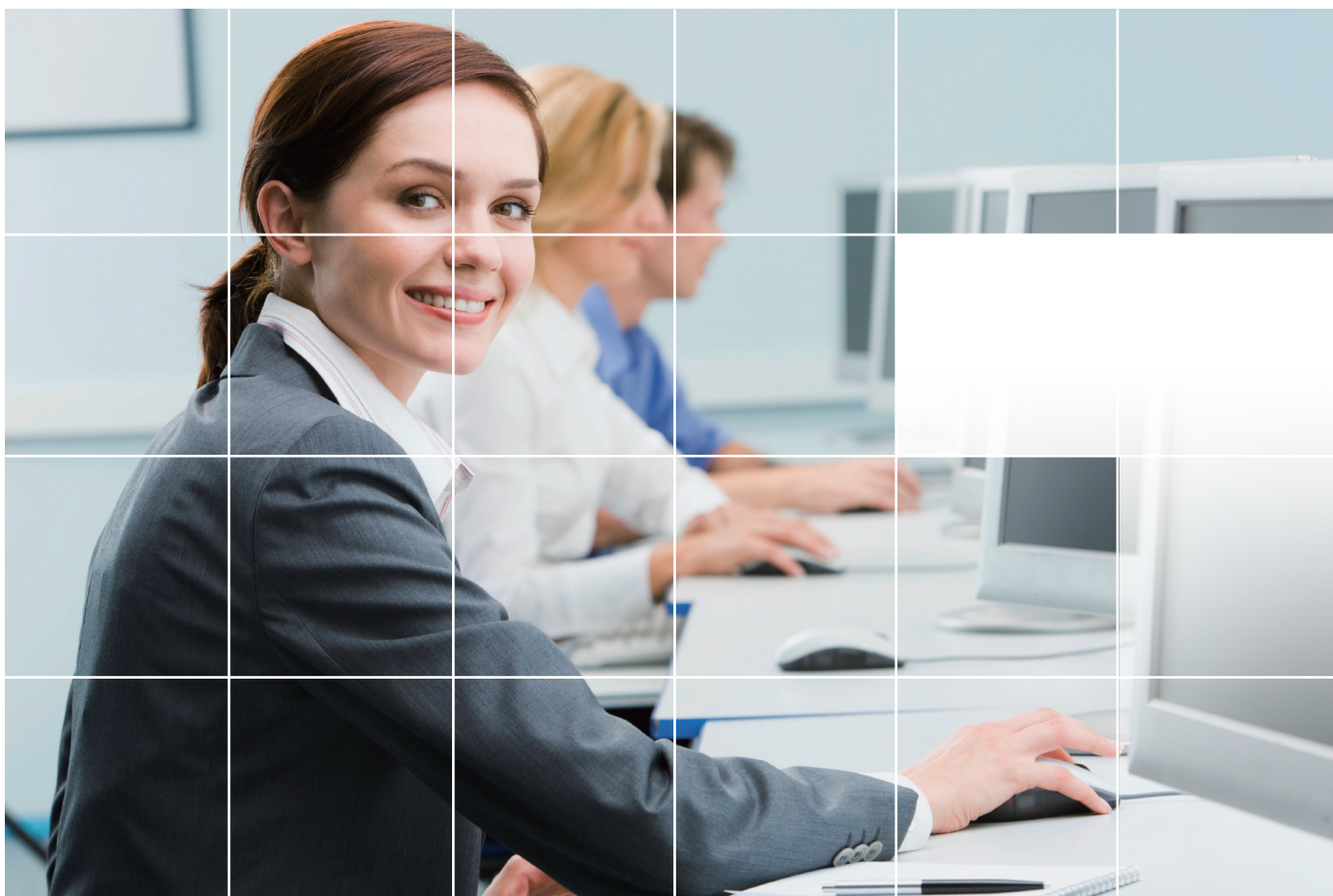

Business

Netzwerk

PoE Ethernet Switches	>20-23
Non-PoE Ethernet Switch	>24-29
Konverter	>30-33
Glasfaser Transceiver	>34-36
IP Power Switch	>37
Breitband Routers	>38
Access Management Gateway	>39
Netzwerk-Adapter	>40-41
Drahtlos Access Point	>42-43
Antennen	>44-45
Antennen Kabel	>46
Überspannungsschutz	>47
PoE PD/PSE/Repeater	>48-50
PoE Power-Messgerät	>51
KVM Switches	>52-54
KVM-Extender	>55
Print Server	>56
Voice over IP (VoIP) Lösungen	>57-58

Sicherheit

Netzwerk Kamera	>59-63
Linse	>64
IP Überwachungs-/Management-Software	>65-66
Video Server/Capture Karte	>67
Netzwerk Video Rekorder	>68-69

Digital Signage

HDMI over IP	>70
HDMI over Cat5	>71
HDMI über Galfaser	>71
A/V (DVI) over Cat5	>72
DVI über Galfaser	>72
A/V (VGA) over Cat5	>73-74
IP Audio Broadcasting	>75

PoE Switches liefern Strom und Daten zu einem Endgerät über das Netzwerkabel. In größeren Netzwerken werden die Stärken der LevelOne PoE Managed Serie deutlich. Die SNMP Layer 2 PoE-Switches bieten ein Web-Management, um z.B. erweiterte Einstellungen wie VLAN, Port-Trunking, Port-Mirroring, QoS und weiteres, nutzen zu können.

Unmanaged PoE Ethernet Switches

- Entspricht dem IEEE 802.3(10MBit/s), 802.3u(100MBit/s), 802.3ab (1000MBit/s)
- Unterstützt IEEE 802.3x Voll-Duplex/Halb-Duplex Kontrolle
- Bieten Auto-MDI/MDIX Funktion
- unterstützen Auto-Negotiation für Geschwindigkeit und Duplex-Modi für jeden Port

- Ethernet Cable (RJ-45)
- == Fiber
- ⚡ PoE (Power + Data)

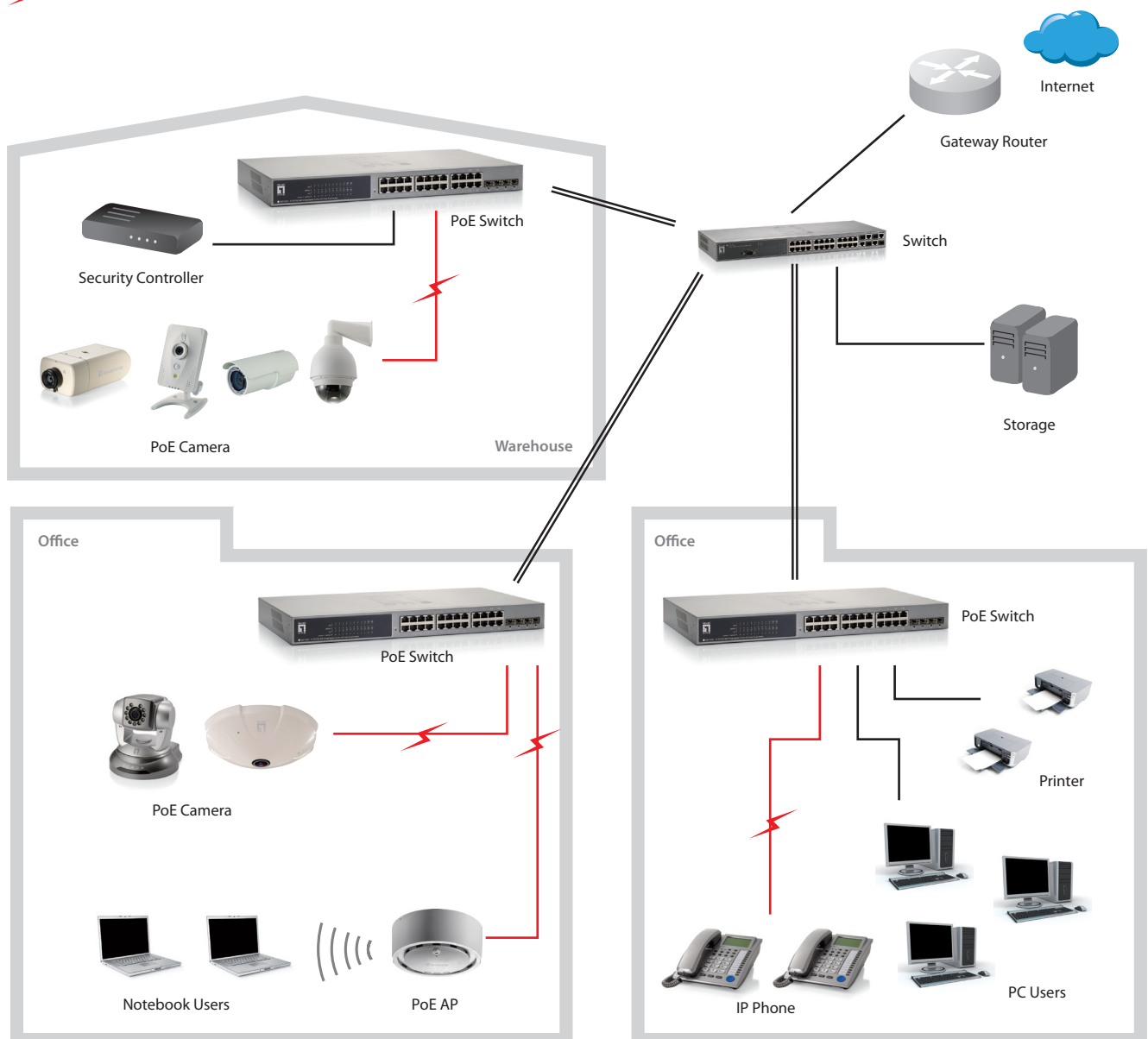

Unmanaged PoE Switches



FSW-0503
4 FE PoE + 1 FE Switch, 61.6W



FSW-0513
4-Port Fast Ethernet High-Power PoE Switch, 120W



GEP-0520
4 GE PoE + 1 GE Switch, 61.6W



FSW-0512
5-Port Fast Ethernet PoE PD Switch



IFE-0500
4 FE PoE + 1 FE Industrie Switch



IFE-0501
4 FE PoE + 1 FE Multi-Mode SC Industrie Switch, 2km

Unmanaged PoE Ethernet Switch Übersicht						
Model	FSW-0503	FSW-0513	GEP-0520	FSW-0512	IFE-0500	IFE-0501
Ethernet Port	1 x 10/100Mbps	1 x 10/100Mbps	1 x 10/100/1000Mbps	4 x 10/100Mbps	1 x 10/100Mbps	-
PoE Port	4 x 10/100Mbps	4 x 10/100Mbps	4 x 10/100/1000Mbps	1 x 10/100Mbps	4 x 10/100Mbps	4 x 10/100Mbps
Fiber Port	-	-	-	-	-	1 x 100BASE-FX MMF SC (2km)
MAC Table	1K	1K	2K	2K	1K	1K
Buffer Memory	48KB	48KB	128KB	128KB	512KB	512KB
Jumbo Frame	-	-	9K	-	-	-
PoE	IEEE 802.3af	IEEE 802.3af	IEEE 802.3af	IEEE 802.3af	IEEE 802.3af	IEEE 802.3af
PoE Power Budget	61.6W	120W	61.6W	-	57W	57W
Output Power Per Port	15.4W	48W	15.4W	-	15.4W	15.4W
Power Supply	External	External	External	External/PoE	External	External
Optional Accessories	POC-6000: 8-Bay High Power PoE Chassis			-	POW-4801 : 48V DC Power Adapter	



IFE-0502
4 FE PoE + 1 FE Single-mode SC Industrie Switch, 30km



FSW-0812
8-Port Fast Ethernet PoE PD Switch



FEP-0812
4 FE PoE-Plus + 4-FE-Switch, 61.6W



FEP-0811
8-Port Fast Ethernet PoE-Plus Switch, 123.2W



GEP-0820
8-Port Gigabit PoE-Plus Switch, 61.6W



GEP-0821
8-Port Gigabit PoE-Plus Switch, 123.2W

Unmanaged PoE Ethernet Switch Übersicht						
Model	IFE-0502	FSW-0812	FEP-0812	FEP-0811	GEP-0820	GEP-0821
Ethernet Port	-	7 x 10/100Mbps	4 x 10/100Mbps	-	-	-
PoE Port	4 x 10/100Mbps	1 x 10/100Mbps	4 x 10/100Mbps	8 x 10/100Mbps	8 x 10/100/1000Mbps	8 x 10/100/1000Mbps
Fiber Port	1 x 100BASE-FX SMF SC (30km)	-	-	-	-	-
MAC Table	1K	2K	1K	1K	8K	8K
Buffer Memory	512KB	128KB	64KB	64KB	128KB	128KB
Jumbo Frame	-	-	-	9K	9K	9K
PoE	IEEE 802.3af	IEEE 802.3af	IEEE 802.3af/at	IEEE 802.3af/at	IEEE 802.3af/at	IEEE 802.3af/at
PoE Power Budget	57W	-	61.6W	123.2W	61.6W	123.2W
Output Power Per Port	15.4W	-	30W	30W	30W	30W
Power Supply	External	External/PoE	Internal	External	External	Internal
Optional Accessories	POW-4801 : 48V DC Power Adapter	-	-	-	-	-

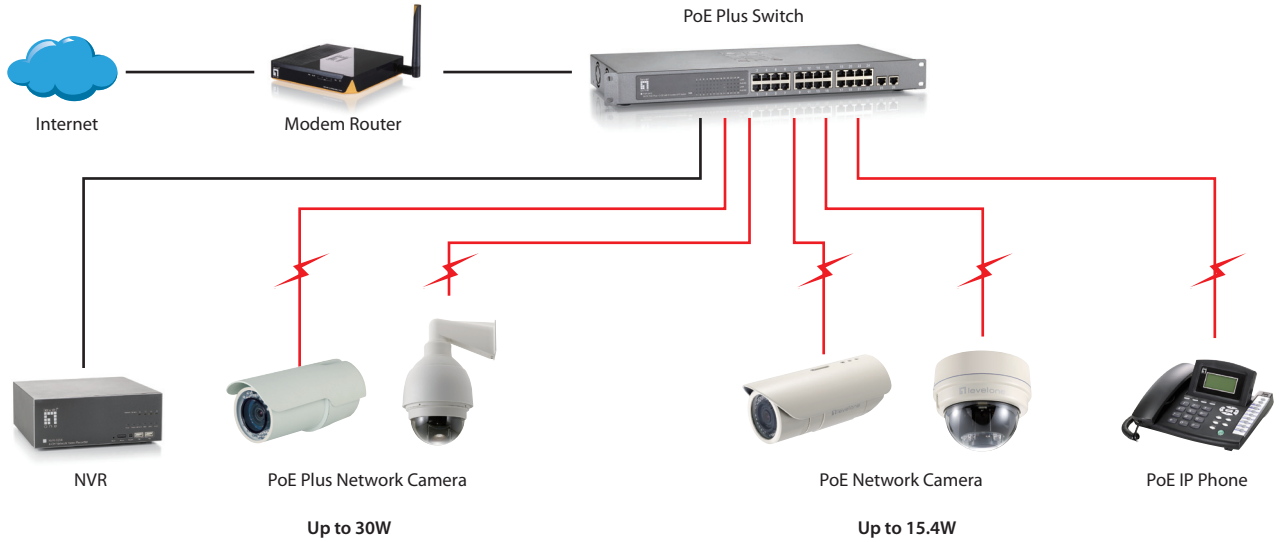
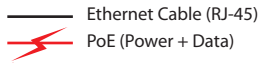

Unmanaged PoE Switches



GEP-0822
8-Port Gigabit PoE-Plus Switch, 240W



FEP-1611
16-Port Fast Ethernet PoE-Plus Switch, 240W



FEP-1612
16-Port Fast Ethernet PoE-Plus Switch, 480W



FGP-2410
24 FE PoE-Plus + 2 GE-Kombi-SFP-Switch, 240W



FGP-2412
24 FE PoE-Plus + 2 GE-Kombi-SFP-Switch, 480W

Unmanaged PoE Ethernet Switch Übersicht					
Model	GEP-0822	FEP-1611	FEP-1612	FGP-2410	FGP-2412
Ethernet Port	-	-	-	2 x 10/100/1000Mbps	2 x 10/100/1000Mbps
PoE Port	8 x 10/100/100Mbps	16 x 10/100Mbps	16 x 10/100Mbps	24 x 10/100Mbps	24 x 10/100Mbps
Fiber Port	-	-	-	-	-
Fiber Slot	-	-	-	2 x 1000BASE-X SFP	2 x 1000BASE-X SFP
MAC Table	8K	4K	4K	4K	4K
Buffer Memory	128KB	160KB	160KB	352KB	352KB
Jumbo Frame	9K	-	-	-	-
PoE	IEEE 802.3af/at	IEEE 802.3af/at	IEEE 802.3af/at	IEEE 802.3af/at	IEEE 802.3af/at
PoE Power Budget	240W	240W	480W	240W	480W
Output Power Per Port	30W	30W	30W	30W	30W
Power Supply	Internal	Internal	Internal	Internal	Internal
Optional Accessories	-	-	-	-	-

Managed PoE Switch

- Entspricht dem IEEE 802.3(10MBit/s), 802.3u(100MBit/s), 802.3ab (1000MBit/s)
- Unterstützt IEEE 802.3x Voll-Duplex/Halb-Duplex Kontrolle
- Kompatibel mit IEEE-802.3af
- Bieten Auto-MDI/MDIX Funktion
- unterstützen Auto-Negotiation für Geschwindigkeit und Duplex-Modi für jeden Port



FGP-1072
8 FE PoE + 2 GE-Kombi-SFP L2 Managed Switch, 130W



FSW-1671
8 FE PoE + 8 FE Web Smart Switch, 123.2W



GEP-2450
20 GE PoE-Plus + 4 GE-Kombi-SFP-Web-Smart-Switch, 185W



GSW-2693
24 FE PoE + 2 GE-Kombi-SFP L2 Managed Switch, 185W



FGP-2472
24 FE PoE + 2 GE-Kombi-SFP L2 Managed Switch, 380W



GTP-2880
20 GE PoE + 4 GE-Kombi-SFP + 4 10GE SFP Plus L2-Plus Managed Switch, 185W

Managed PoE Ethernet Switch Übersicht						
Model	FGP-1072	FSW-1671	GEP-2450	GSW-2693	FGP-2472	GTP-2880
Ethernet Port	-	8 x 10/100Mbps	-	2 x 10/100/1000Mbps	2 x 10/100/1000Mbps	-
PoE Port	8 x 10/100Mbps	8 x 10/100Mbps	24 x 10/100/1000Mbps	24 x 10/100Mbps	24 x 10/100Mbps	24 x 10/100/1000Mbps
Fiber Port	-	-	-	-	-	-
Fiber Slot	2 x 1000BASE-X SFP	-	4 x 100/1000BASE-X SFP	2 x 1000BASE-X SFP	2 x 1000BASE-X SFP	4 x 1000BASE-X SFP 4 x 10G SFP-Plus
MAC Table	8K	4K	8K	8K	8K	8K
Buffer Memory	256KB	192KB	500KB	384KB	256KB	4096KB
Jumbo Frame	-	-	9K	-	-	9.8K
Port Trunking	4 Group	4 Groups	8 Groups	3 Groups	3 Groups	14 Groups
Management	SNMP/Web Based/ RMON	Web Based	SNMP/Web Based	SNMP/Web/Console/ Telnet/RMON	SNMP/Web/Console/ Telnet/RMON	SNMP/Telnet/Web Based/ RMON
VLAN	Port-Based / 802.1Q (up to 4K VID)	Port-Based / 802.1Q (20 Entries, up to 4K VID)	Port Based / 802.1Q (24 Entries, up to 4K VID)	Ported Based / 802.1Q (256 Entries, up to 4K VID)	Port Based / 802.1Q (256 Entries, up to 4K VID)	Port Based / 802.1Q(up to 4K VID)
IGMP Snooping	V1/V2/V3	V1/V2	V1/V2	V1/V2	V1/V2	V1/V2/V3
Spanning Tree	IEEE 802.1D/ 802.1w / 802.1s	-	IEEE 802.1D/ 802.1w	IEEE 802.1D/ 802.1w	IEEE 802.1D/ 802.1w	IEEE 802.1D/ 802.1w / 802.1s
Stacking	* Single IP Management	-	-	** Single IP Management	*** Single IP Management	**** Single IP Management
PoE	IEEE 802.3af	IEEE 802.3af	IEEE 802.3af/at	IEEE 802.3af	IEEE 802.3af	IEEE 802.3af/at
PoE Power Budget	130W	123.2W	184.8W	185W	380W	185W
Power Supply	Internal	Internal	Internal	Internal	Internal	Internal
Output Power Per Port	15.4W	15.4W	30W	15.4W	15.4W	30W
Green Technology	-	-	V	-	-	V

* Unterstützt bis zu 16 Switches (GSW-0890/2693/FGP-1072/FGP-2472)

** Unterstützt bis zu 16 Switches (GSW-0890/2693)

*** Unterstützt bis zu 16 Switches(GSW-0890/2693)

**** Unterstützt bis zu 32 Switches(GEL-1072/GTL-2880/GTP-2880/GTL-5280)

LevelOne bietet eine umfassende Auswahl von Ethernet-Switches. Von Unmanaged Switches mit einfacher Plug&Play Installation, bis hin zu Layer 3 Routing Switches - wir haben den richtigen Switch für Sie.

- Ethernet Cable (RJ-45)
- Fiber
- Stacking Cable

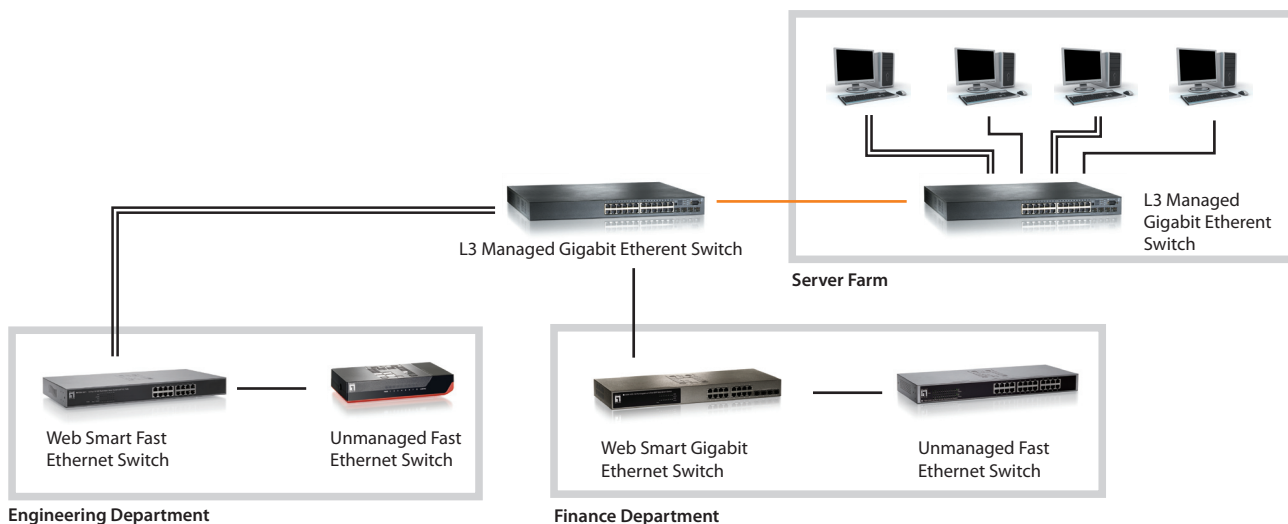

Unmanaged Non-PoE Ethernet Switches

- Entspricht dem IEEE 802.3(10MBit/s), 802.3u(100MBit/s), 802.3ab (1000MBit/s)
- Unterstützt IEEE 802.3x Voll-Duplex/Halb-Duplex Kontrolle
- Bieten Auto-MDI/MDIX Funktion
- unterstützen Auto-Negotiation für Geschwindigkeit und Duplex-Modi für jeden Port



FEU-0510
5-Port Fast Ethernet Switch



FEU-0511
4 Port Fast Ethernet Switch + 1 MMF SC



GSW-0509
5-Port Gigabit Switch (internes Netzteil)



GEU-0520
5-Port Gigabit Switch



GEU-0521
4 GE + 1 GE SFP Switch



FEU-0810
8-Port Fast Ethernet Switch

Unmanaged Non-PoE Ethernet Switch Übersicht						
Model	FEU-0510	FEU-0511	GSW-0509	GEU-0520	GEU-0521	FEU-0810
Ethernet Port	5 x 10/100Mbps	4 x 10/100/1000Mbps	5 x 10/100/1000Mbps	5 x 10/100/1000Mbps	4 x 10/100/1000Mbps	8 x 10/100Mbps
Fiber Port	-	1 x 100BASE-FX MMF SC (2km)	-	-	-	-
Fiber Slot	-	-	-	-	1 x 1000BASE-X SFP	-
Expansion Slot	-	-	-	-	-	-
MAC Table	2K	1K	8K	8K	1K	1K
Buffer Memory	48KB	384KB	125KB	128KB	104KB	96KB
Jumbo Frame	-	-	9K	9K	9K	-
Power Supply	Internal	External	Internal	External	External	Internal
Green Technology	V	-	V	V	-	V

Unmanaged Non-PoE Ethernet Switches



GSW-0809
8-Port Gigabit Switch



GEU-0820
8-Port Gigabit Switch



FEU-1610
16-Port Fast Ethernet Switch



FSW-1602TX
16-Port Fast Ethernet Switch



FSW-1650
16-Port Fast Ethernet Switch



GSW-1657
16-Port Gigabit Switch

Unmanaged Non-PoE Ethernet Switch Übersicht						
Model	GSW-0809	GEU-0820	FEU-1610	FSW-1602TX	FSW-1650	GSW-1657
Ethernet Port	8 x 10/100/1000Mbps	8 x 10/100/1000Mbps	16 x 10/100Mbps	16 x 10/100Mbps	16 x 10/100Mbps	16 x 10/100/1000Mbps
Fiber Port	-	-	-	-	-	-
Expansion Slot	-	-	-	-	-	-
MAC Table	8K	8K	8K	8K	8K	8K
Buffer Memory	125KB	128KB	256KB	512KB	160KB	512KB
Jumbo Frame	9K	9K	-	-	-	10K
Power Supply	Internal	External	Internal	External	Internal	Internal
Green Technology	V	V	V	V	V	-



GEU-1621
16-Port Gigabit Switch



GEU-1628
16 GE + 2 GE SFP Switch



GEU-1629
16 GE + 4 GE SFP Switch



FEU-2410
24-Port Fast Ethernet Switch



FSW-2450
24-Port Fast Ethernet Switch



GEU-2428
24 GE + 2 GE SFP Switch

Unmanaged Non-PoE Ethernet Switch Übersicht						
Model	GEU-1621	GEU-1628	GEU-1629	FEU-2410	FSW-2450	GEU-2428
Ethernet Port	16 x 10/100/1000Mbps	16 x 10/100/1000Mbps	16 x 10/100/1000Mbps	24 x 10/100Mbps	24 x 10/100Mbps	24 x 10/100/1000Mbps
Fiber Port	-	-	-	-	-	-
Fiber Slot	-	2 x 1000BASE-X SFP	4 x 1000BASE-X SFP	-	-	2 x 1000BASE-X SFP
Expansion Slot	-	-	-	-	-	-
MAC Table	8K	16K	16K	8K	8K	16K
Buffer Memory	256KB	448KB	448KB	256KB	160KB	448KB
Jumbo Frame	9K	9K	9K	-	-	9K
Power Supply	Internal	Internal	Internal	Internal	Internal	Internal
Green Technology	V	V	V	V	V	V

Unmanaged Non-PoE Ethernet Switches



GEU-2429
24 GE + 4 GE SFP Switch



GSW-2457
24-Port Gigabit Switch



GSW-5150
48 FE + 2 GE + 1 GE SFP Switch



GSW-2453
3-Slot Gigabit Modular Switch

Unmanaged Non-PoE Ethernet Switch Übersicht				
Model	GEU-2429	GSW-2457	GSW-5150	GSW-2453
Ethernet Port	24 x 10/100/1000Mbps	24 x 10/100/1000Mbps	48 x 10/100Mbps 2 x 10/100/1000Mbps	Up to 24 x 10/100/1000Mbps (Optional)
Fiber Port	-	-	-	-
Fiber Slot	4 x 1000BASE-X SFP	-	1 x 1000BASE-X SFP	Up to 24 x 1000BASE-X SFP (Optional)
Expansion Slot	-	-	-	3
MAC Table	16K	8K	8K	4K
Buffer Memory	448KB	512KB	128KB	256KB
Jumbo Frame	9K	10K	-	9K
Power Supply	Internal	Internal	Internal	Internal
Green Technology	V	-	-	-
Optional Accessories	-	-	-	MDU-2453T : 8-Port 10/100/1000TX Module MDU-2453M : 8-Port SFP Module MDU-2453TM: 4-Port 1000T+ 4-Port SFP Module

Managed Non-PoE Ethernet Switches

- Entspricht dem IEEE 802.3(10MBit/s), 802.3u(100MBit/s), 802.3ab (1000MBit/s)
- Unterstützt IEEE 802.3x Voll-Duplex/Halb-Duplex Kontrolle
- Bieten Auto-MDI/MDIX Funktion
- unterstützen Auto-Negotiation für Geschwindigkeit und Duplex-Modi für jeden Port



GES-0852
7 GE + 1 GE-Kombi-SFP-Web-Smart-Switch



GSW-1290
4 GE-Kombi-SFP + 2 GE Expandable Slots
L2 Managed Switch



GSW-0890
6 GE + 2 GE-Kombi-SFP L2 Managed Switch



GEL-1072
8 GE + 2 GE-Kombi-SFP L2 Managed Switch



GES-1652
16 GE + 2 GE SFP Web Smart Switch

Managed Non-PoE Ethernet Switch Übersicht					
Model	GES-0852	GSW-1290	GSW-0890	GEL-1072	GES-1652
Ethernet Port	8 x 10/100/1000 Mbps	Up to 12 x 10/100/1000Mbps (Optional)	8 x 10/100/1000Mbps	10 x 10/100/1000Mbps	16 x 10/100/1000Mbps
Fiber Port	-	-	-	-	-
Fiber Slot	1 x 1000BASE-X SFP	Up to 12 x 1000BASE-X SFP (Optional)	2 x 1000BASE-X SFP	2 x 1000BASE-X SFP	2 x 1000BASE-X SFP
Expansion Slot	-	2	-	-	-
MAC Table	8K	16K	8K	8K	16K
Buffer Memory	180KB	1024KB	144KB	1024KB	448KB
Port Trunking	4 Groups	6 Groups	4 Groups	5 Groups	8 Groups
Jumbo Frame	9K	9K	9K	9K	9K
Management	SNMP/Web-based	SNMP/Web/Console/ Telnet/RMON	SNMP/Web/Console/ Telnet/RMON	SNMP/Telnet/RMON	SNMP/Web-Based
VLAN	Port Based / 802.1Q (8 Entries, up to 4K VID)	Port Based / 802.1Q (up to 255K)	Port Based / 802.1Q (256 Entries, up to 4K VID)	Port Based / 802.1Q (up to 4K VID)	Port Based / 802.1Q (8 Entries, up to 4K VID)
IGMP Snooping	-	V1 / V2	V1 / V2	V1 / V2	V1 / V2 / V3
Spanning Tree	-	IEEE 802.1D/ 802.1w/ 802.1s	IEEE 802.1D/ 802.1w	IEEE 802.1D/ 802.1w/ 802.1s	IEEE 802.1D/ 802.1s
Stacking	-	Hardware Stacking	* Single IP Management	** Single IP Management	-
Power Supply	Internal	Internal	Internal	Internal	Internal
Green Technology	-	-	-	V	V
Optional Accessories	-	MDU-1290T: 4-Port 10/100/1000TX Module MDU-1290M: 4-Port SFP Module MDU-1290S: 4-Port Stacking Module	-	-	-

* Unterstützt bis zu 16 Switches (GSW-0890/2693)

** Unterstützt bis zu 32 Switches (GEL-1072/GTL-2880/GTP-2880/GTL-5280)

Managed Non-PoE Ethernet Switches



GES-1650
16 GE + 4 GE SFP Web Smart Switch



GES-2452
24 GE + 2 GE SFP Web Smart Switch



FGL-2870
24 FE + 4 GE-Kombi-SFP L2 Managed Switch



GSW-2473
24 FE + 2 GE-Kombi-SFP-Web-Smart-Switch



GES-2450
24 GE + 4 GE SFP Web Smart Switch



GTL-2690
20 GE + 4 GE-Kombi-SFP + 2 10GE XFP Module
Slot L3 Managed Stackable Switch

Managed Non-PoE Ethernet Switch Übersicht						
Model	GES-1650	GES-2452	FGL-2870	GSW-2473	GES-2450	GTL-2690
Ethernet Port	16 x 10/100/1000Mbps	24 x 10/100/1000Mbps	24 x 10/100Mbps 4 x 10/100/1000Mbps	24 x 10/100Mbps 2 x 10/100/1000Mbps	24 x 10/100/1000Mbps	24 x 10/100/1000Mbps
Fiber Port	-	-	-	-	-	-
Fiber Slot	4 x 1000BASE-X SFP	2 x 1000BASE-X SFP	4 x 1000BASE-X SFP	2 x 1000BASE-X SFP	4 x 1000BASE-X SFP	4 x 1000BASE-X SFP Up to 2 x 10GE XFP (Optional)
Expansion Slot	-	-	-	-	-	2
MAC Table	16K	16K	8K	4K	16K	16K
Buffer Memory	448KB	448KB	128KB	256KB	448KB	2048KB
Port Trunking	8 Groups	8 Groups	4 Groups	4 Groups	8 Groups	8 Groups
Jumbo Frame	9K	9K	10K	9K	9K	9K
Management	SNMP/Telnet/ Web-Based/Console	SNMP/Web-Based	SNMP/Telnet/Web-Based Console/RMON	Web-Based	SNMP/Web-Based/RMON	SNMP/Telnet/Web-Based/ Console/RMON
VLAN	Port Based / 802.1Q (256 Entries, up to 4K VID)	Port Based / 802.1Q (8 Entries, up to 4K VID)	Port Based / 802.1Q (255 Entries up to 4K VID)	Port Based / 802.1Q (32 Entries, up to 4K VID)	Port Based / 802.1Q (8 Entries, up to 4K VID)	Port Based / 802.1Q (up to 4K VID)
IGMP Snooping	V1 / V2 / V3	V1 / V2 / V3	V1 / V2	-	V1 / V2 / V3	V1 / V2
Spanning Tree	IEEE 802.1D/ 802.1s	IEEE 802.1D/ 802.1s	IEEE 802.1D/ 802.1w / 802.1s	-	IEEE 802.1D/ 802.1s	IEEE 802.1D/ 802.1w / 802.1s
Stacking	-	-	* Single IP Management	-	-	Hardware Stacking
Power Supply	Internal	Internal	Internal	Internal	Internal	Internal
Green Technology	V	V	-	-	V	-
Optional Accessories	-	-	-	-	-	MDU-0162: 10GE XFP Module ACP-03K2: 30cm Stacking Cable ACP-13K2: 130cm Stacking Cable RPS-04A2: Redundant Power Supply

* Unterstützt bis zu 36 Switches (GEL-2870/GTL-2690)

Managed Non-PoE Ethernet Switches



GEL-2870
24 GE + 4 GE-Kombi-SFP L2 Managed Switch



GTL-2880
20 GE + 4 GE-Kombi-SFP + 4 10GE SFP-Plus L2-Plus Managed Switch



GSW-4876
44 GE + 4 GE-Kombi-SFP-Web-Smart-Switch



GSW-5270
48 FE + 2 GE + 2 GE SFP Web Smart Switch



GTL-5280
44 GE + 4 GE-Kombi-SFP + 4 10GE SFP-Plus L2-Plus Managed Switch



MSL-3579
3-Slot Gigabit Modular L2 Managed Switch

Managed Non-PoE Ethernet Switch Übersicht						
Model	GEL-2870	GTL-2880	GSW-4876	GSW-5270	GTL-5280	MSL-3579
Ethernet Port	28 x 10/100/1000Mbps	24 x 10/100/1000Mbps	48 x 10/100/1000Mbps	48 x 10/100Mbps 4 x 10/100/1000Mbps	48 x 10/100/1000Mbps	Up to 24 x 10/100/1000Mbps (Optional)
Fiber Port	-	-	-	-	-	-
Fiber Slot	4 x 1000BASE-X SFP	4 x 1000BASE-X SFP 4 x 10G SFP-Plus	4 x 1000BASE-X SFP	2 x 1000BASE-X SFP	4 x 1000BASE-X SFP 4 x 10G SFP-Plus	Up to 24 x 1000BASE-X SFP (Optional)
Expansion Slot	-	-	-	-	-	3
MAC Table	8K	8K	8K	4K	8K	16K
Buffer Memory	1792KB	4096KB	512KB	128KB	8192KB	768KB
Port Trunking	14 Group	14 Groups	25 Group	8 Groups	26 Groups	7 Groups
Jumbo Frame	9K	9.8K	9K	-	9.8K	10K
Management	SNMP/Telnet/Web-Based/ Console/RMON	SNMP/Telnet/Web-Based/ RMON	SNMP/Telnet/ Web-Based/RMON	Web-Based	SNMP/Telnet/Web-Based/ RMON	SNMP/Telnet/Web-Based/ Console/RMON
VLAN	Port Based / 802.1Q (255 Entries, up to 4K VID)	Port Based / 802.1Q (up to 4K VID)	Port Based / 802.1Q (256 Entries, up to 4K VID)	Port Based / 802.1Q (256 Entries, up to 4K VID)	Port Based / 802.1Q (up to 4K VID)	Port Based / 802.1Q (256 Entries, up to 4K VID)
IGMP Snooping	V1 / V2	V1 / V2 / V3	V1 / V2 / V3	-	V1 / V2 / V3	V1 / V2
Spanning Tree	IEEE 802.1D/ 802.1w / 802.1s	IEEE 802.1D/ 802.1w / 802.1s	IEEE 802.1D/ 802.1w / 802.1s	-	IEEE 802.1D/ 802.1w / 802.1s	IEEE 802.1D/ 802.1w
Stacking	-	* Single IP Management	-	-	* Single IP Management	-
Power Supply	Internal	Internal	Internal	Internal	Internal	Internal
Green Technology	V	V	-	-	V	-
Optional Accessories	-	-	-	-	-	MDU-2453T: 8-Port 10/100/1000TX Module MDU-2453M: 8-Port SFP Module MDU-2453TM: 4 GE + 4 GE SFP Module

* Unterstützt bis zu 32 Switches (GEL-1072/GTL-2880/GTP-2880/GTL-5280)

LevelOne bietet einzigartige Konverter-Lösungen. Unsere Medien-Konverter machen das Überbrücken von großen Distanzen zum Kinderspiel. Mit integrierter PoE-Funktion tragen unsere Konverter zur Energieeffizienz des Netzwerkes bei und bieten höchste Flexibilität in Sachen Installation. Die neueste Generation der VDSL2 Konverter z.B., bieten die Möglichkeit der Datenübertragung von bis zu 2km über 2-Draht-Leitungen.

Key Features

- Kompatibel mit IEEE-802.3/802.3u
- Unterstützt IEEE 802.3x Voll-Duplex/Halb-Duplex Kontrolle
- Auto-Negotiation und Auto-MDI/MDIX, Halb-/Voll-Duplex Modus
- Unterstützt Link-Loss-Weiterleitung Technologie
- Unterstützt DHCP Client
- Unterstützt ICMP- und ARP-Protokoll

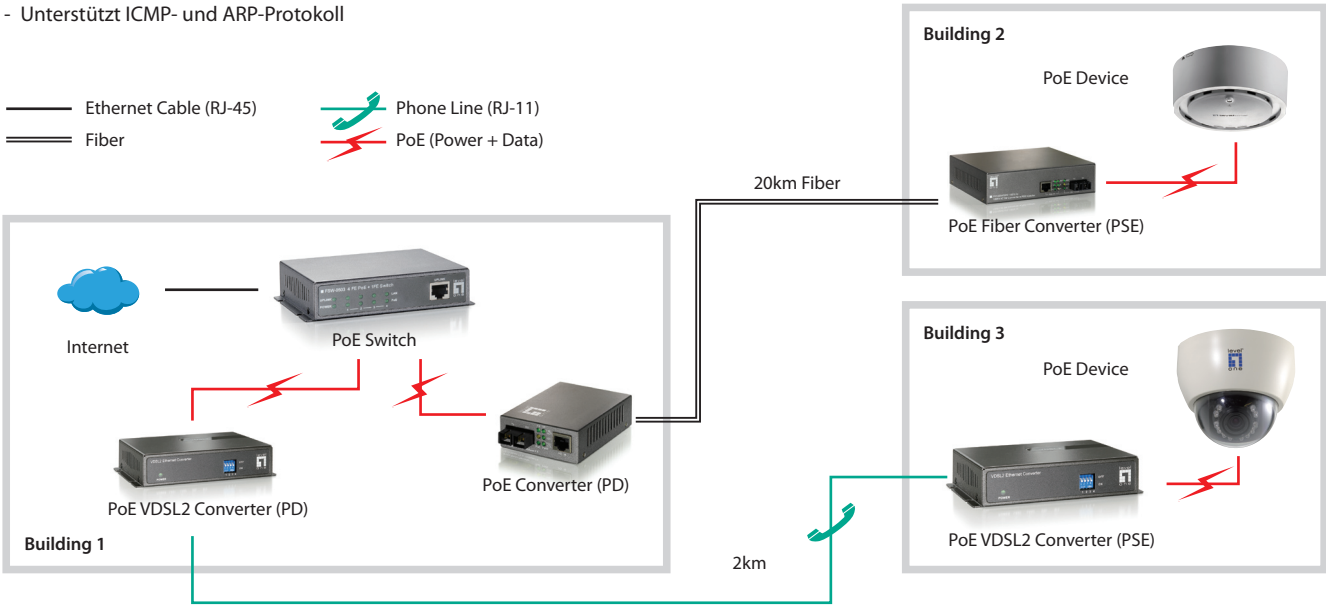
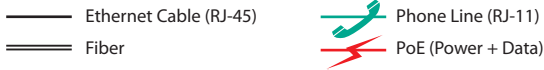

Ethernet Media Konverter



FVS-3800
10/100BASE-TX auf 100BASE-X SFP Konverter



GVS-3800
10/100/1000BASE-T auf 100BASE-X SFP Konverter



FVS-3200
10/100BASE-TX auf 100BASE-FX MMF SC Konverter



GVS-3200
10/100/1000BASE-T auf 1000BASE-SX MMF SC Konverter



FVS-3120
10/100BASE-TX auf 100BASE-LX SMF SC Konverter



GVS-3110
10/100/1000BASE-T auf 1000BASE-LX10 SMF SC Konverter

Ethernet Media Konverter Übersicht						
Model	FVS-3800	GVS-3800	FVS-3200	GVS-3200	FVS-3120	GVS-3110
Media Conversion	RJ-45 to SFP	RJ-45 to SFP	RJ-45 to MMF SC	RJ-45 to MMF SC	RJ-45 to SMF SC	RJ-45 to SMF SC
Max. Speed	100Mbps	1000Mbps	100Mbps	1000Mbps	100Mbps	1000Mbps
Distance	Depends on Transceivers	Depends on Transceivers	2 km	2km	20km	10km
Dip Switches	-	-	-	-	-	-
Optional Accessories	CVH-3000: 12-Slot Media Converter					

Ethernet Media Converters



FVT-0103TXFC
10/100BASE-TX auf 100BASE-FX Multi-Mode SC Fiber Konverter (mit PoE)



FVT-0104TXFC
10/100BASE-TX auf 100BASE-FX Single-Mode SC Fiber Konverter (mit PoE)



FVT-0203TXFC
10/100BASE-TX auf 100BASE-FX Multi-Mode SC Fiber Konverter (mit PoE Injektor)



FVT-0204TXFC
10/100BASE-TX auf 100BASE-FX Single-Mode SC Fiber Konverter (mit PoE Injektor)



FVT-4001 / FVT-4301
10/100BASE-TX auf 100BASE-FX Multi/Single-Mode Fiber Konverter (SC)



FVT-4002
10/100BASE-TX auf 100BASE-FX Multi-Mode Fiber Konverter (ST)

Ethernet Media Konverter Übersicht						
Model	FVT-0103TXFC	FVT-0104TXFC	FVT-0203TXFC	FVT-0204TXFC	FVT-4001 / FVT-4301	FVT-4002
Media Conversion	RJ-45 to MMF SC	RJ-45 to SMF SC	RJ-45 to MMF SC	RJ-45 to SMF SC	RJ-45 to MMF SC / RJ-45 to SMF SC	RJ-45 to MMF ST
Max. Speed	100Mbps	100Mbps	100Mbps	100Mbps	100Mbps	100Mbps
Distance	2km	20km	2km	20km	2km / 30km	2km
PoE	IEEE 802.3af	IEEE 802.3af	IEEE 802.3af	IEEE 802.3af	-	-
PoE Power Budget	-	-	15.4W	15.4W	-	-
Power Supply	External/PoE	External/PoE	External	External	External	External
Dip Switches	V	V	V	V	V	V
Optional Accessories	CVH-3000: 12-Slot Media Converter		-	-	FVT-4000: 10-Slot Media Converter Chassis with Redundant Power Supply	



GVT-4000
10/100/1000BASE-T auf 1000BASE-X Fiber Konverter (SFP)



GVT-4001
10/100/1000BASE-T auf 1000BASE-SX Multi-Mode Fiber Konverter (SC)



FVT-6001 / FVT-6301
10/100BASE-TX auf 100BASE-FX Multi/Single Fiber Konverter (mit TS-1000 Unterstützung)



FVT-5001
10/100BASE-TX to 100BASE-FX Multi-Mode Module with TS-1000 Support (SC)



FVT-5301
10/100BASE-TX to 100BASE-FX Single-Mode Module with TS-1000 Support (SC)



GVT-5000
10/100/1000BASE-TX to 1000BASE-FX-SFP Module

Ethernet Media Konverter Übersicht						
Model	GVT-4000	GVT-4001	FVT-6001/FVT-6301	FVT-5001	FVT-5301	GVT-5000
Media Conversion	RJ-45 to SFP	RJ-45 to MMF SC	RJ-45 to MMF SC / RJ-45 to SMF SC	RJ-45 to MMF SC	RJ-45 to SMF SC	RJ-45 to SFP
Max. Speed	1000Mbps	1000Mbps	100Mbps	100Mbps	100Mbps	1000Mbps
Distance	Depends on Transceivers	Depends on Transceivers	2km / 30km	2km	30km	Depends on Transceiver
Dip Switches	V	V	V	-	-	-
Optional Accessories	FVT-4000: 10-Slot Media Converter Chassis with Redundant Power Supply		FVT-5000: 16-Slot Managed Converter Chassis with Redundant Power Supply			

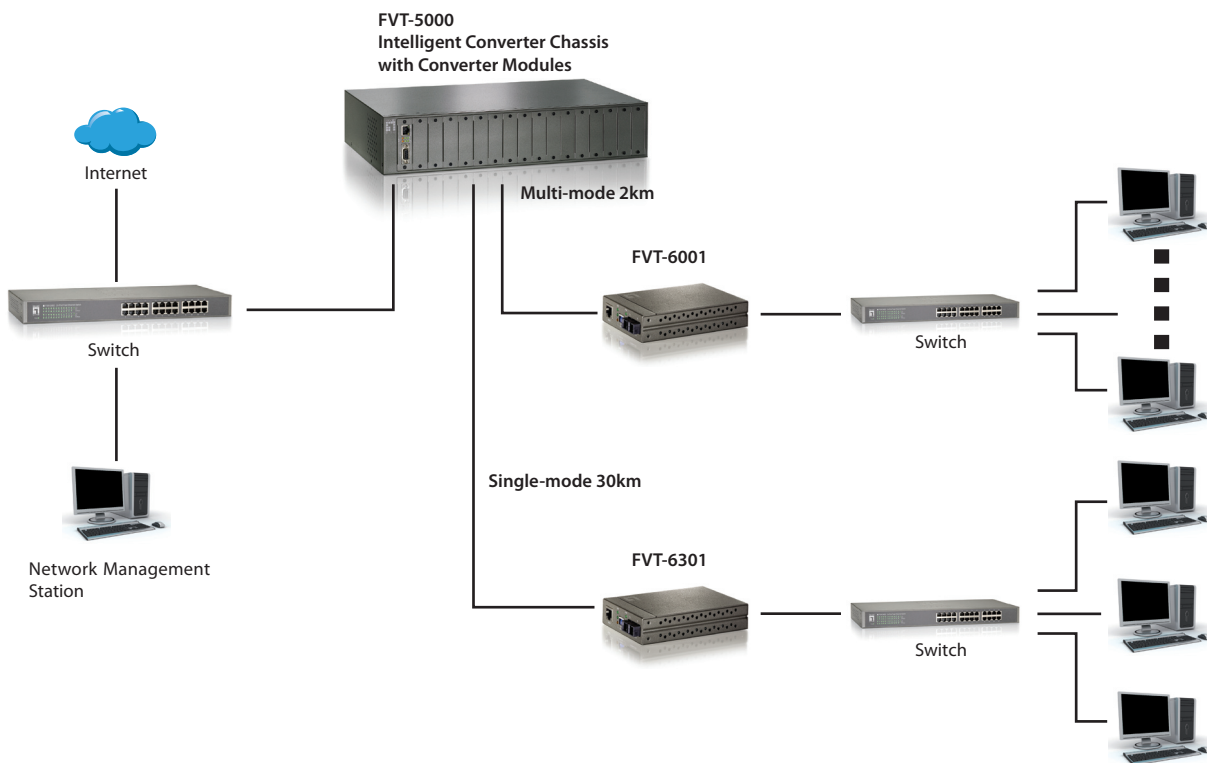

Konverter Chassis mit redundanten Netzteil

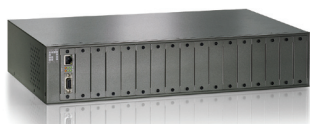

FVT-5000
Managed Konverter Chassis mit redundanten Netzteil



FVT-4000
10-Slot Media Konverter Gehäuse mit redundantem Netzteil

Konverter Gehäuse Übersicht		
Model	FVT-5000	FVT-4000
Slot	16	10
Redundant Power	✓	✓
Management	SNMP/WEB UI/Telnet/Console	-
Optional Converter Module	FVT-5001, FVT-5301, GVT-5000	FVT-4001, FVT-4002, FVT-4301, GVT-400, GVT-4001
Optional SFP Module	GVT-0300, GVT-0301, GVT-0302	GVT-0300, GVT-0301, GVT-0302
Manage Converter	FVT-6001, FVT-6301	-

- Ethernet Cable (RJ-45)
- Phone Line (RJ-11)
- PoE
- BNC

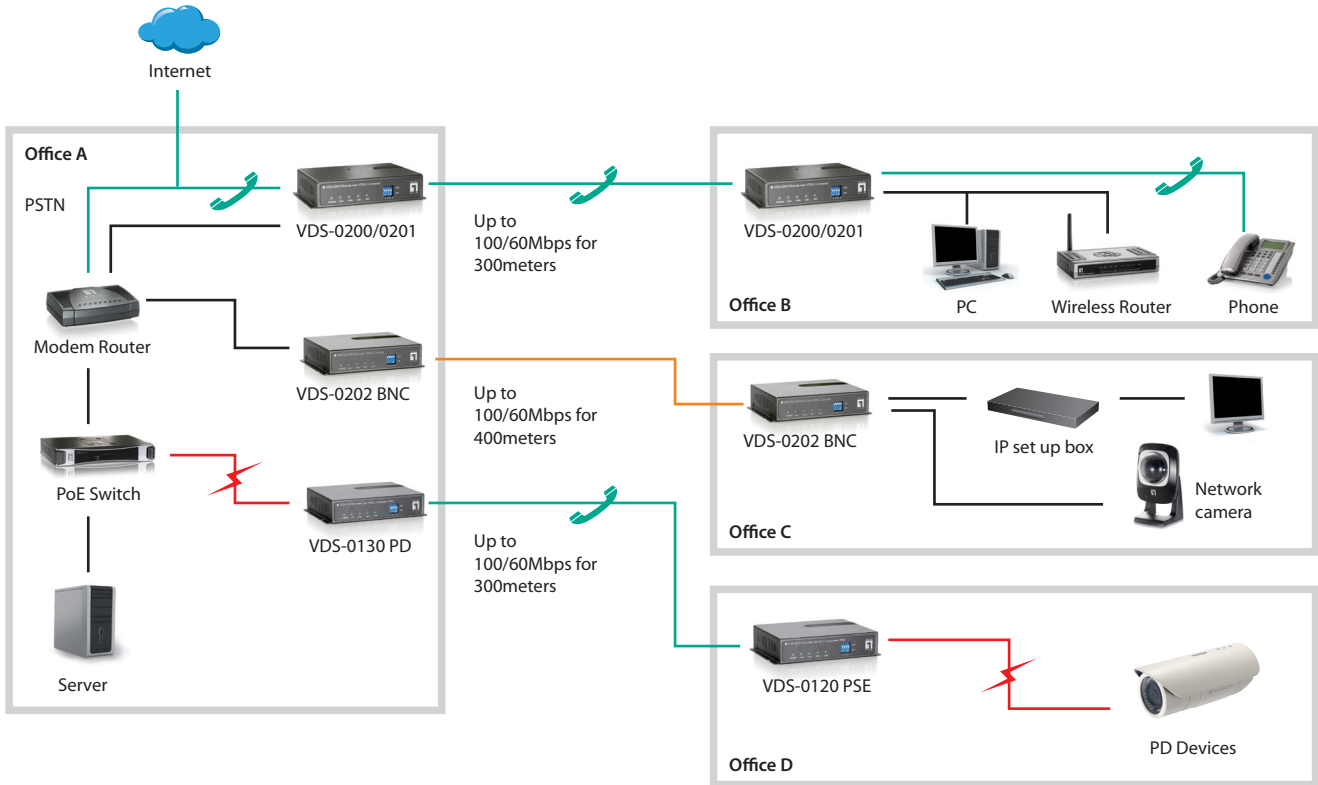

Key Features

- Trellis-Kodierung unterstützt bis zu 1024 diskrete Multi-Ton Ablagen und 4 DIP-Schalter für Konfigurationseinstellungen
- Auto-MDIX für 10/100BaseT Ethernet LAN-Ports
- Niedrige Latenzzeiten für Video-, Sprach- und Datenanwendungen
- Unterstützt Line Powered VDSL2 Verbindungen



VDSL-0200
Ethernet over VDSL2 Konverter (Annex A)



VDSL-0201
Ethernet over VDSL2 Konverter (Annex B)



VDSL-0202
Ethernet over VDSL2 Konverter (BNC)



VDSL-0120
Ethernet over VDSL2 Konverter (PSE)



VDSL-0130
Ethernet over VDSL2 Konverter (PD)



VDSL-0110 / VDSL-0111
Ethernet over VDSL2 Converter
(Sender / Receiver)

VDSL2 Media Konverter Übersicht						
Model	VDS-0200	VDS-0201	VDS-0202	VDS-0120	VDS-0130	VDS-0110 / VDS-0111
Media Conversion	RJ-45 to RJ-11	RJ-45 to RJ-11	RJ-45 to Coaxial	RJ-45 to RJ-11	RJ-45 to RJ-11	RJ-45 to RJ-11
VDSL2 Speeds	100/60Mbps	100/60Mbps	100/60Mbps	100/60Mbps	100/60 Mbps	100/50Mbps
PoE	-	-	-	IEEE 802.3af	IEEE 802.3af	-
PoE Power Budget	-	-	-	15.4W	-	-
Power Supply	External	External	External	External	External/PoE	External
Distance	300m	300m	400m	300m	300m	350m
RJ-11 Telephone Port	1	1	-	-	-	-
Dip Switch	V	V	V	V	V	V
Optional Accessories	POC-4001: 8-Bay Media Converter Chassis			-	-	-

Die BI-DI (bi-direktionale) SFP-Transceiver nutzen die WDM-Technologie. Die WDM (Wave Division Multiplexing)- Technologie ist für Glasfaserübertragungen konzipiert, um mehrere optische Signale über eine Glasfaserleitung bei verschiedenen Wellenlängen zu übertragen. Dies ermöglicht eine Vervielfachung der Kapazität sowie die bi-direktionale Kommunikation über nur eine Glasfaserleitung.

Key Features

- +3.3V Stromversorgung
- Entspricht Laser Klasse 1
- Plug&Play Installation
- Kompatibel mit LevelOne Switches und Konverter

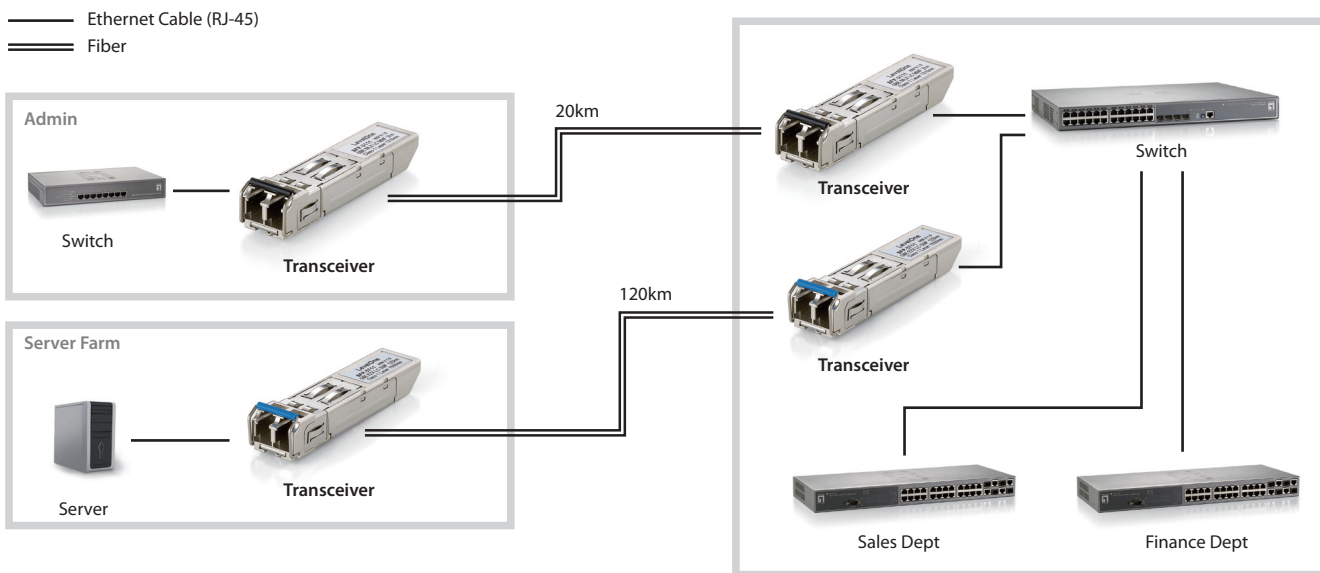

155M SFP Duplex LC Fiber



SFP-1101
155M MMF SFP Transceiver



SFP-1311
155M SMF SFP Transceiver



SFP-1411
155M SMF SFP Transceiver

1.25G SFP Duplex LC Fiber



GVT-0300
1.25G MMF SFP Transceiver



GVT-0301
1.25G SMF SFP Transceiver



GVT-0302
1.25G SMF SFP Transceiver

Transceiver Übersicht						
Model	SFP-1101	SFP-1311	SFP-1411	GVT-0300	GVT-0301	GVT-0302
Single/Multi-Mode	MMF	SMF	SMF	MMF	SMF	SMF
Date Rate	155Mbps	155Mbps	155Mbps	1.25Gbps	1.25Gbps	1.25Gbps
Wavelength	1310nm	1310nm	1310nm	850nm	1310nm	1550nm
Transmission Range	2km (50/125µm)	20km (9/125µm)	40km (9/125µm)	550m (50/125µm)	10km (9/125µm)	80km (9/125µm)
Connector	Duplex LC	Duplex LC	Duplex LC	Duplex LC	Duplex LC	Duplex LC

* LevelOne Transceiver sind kompatibel zu GVT-4000/5000 und den Switchen GSW- 0508/1621/2453/5150/0841/1641/2473/2476/4876/5270/0809/1290/2693/4896/2493/ 2495; FGP-1072/2410/2412/GEL-1072/GEU-0521/1628/GES-0852/FGL-2870/ GEL-2870/ GTL-2690/ GTP-2880/ GTL-2880/ GTL-5280

1.25G SFP Duplex LC Fiber



SFP-3001
1.25G MMF SFP Transceiver



SFP-3211
1.25G SMF SFP Transceiver



SFP-3611
1.25G SMF SFP Transceiver



SFP-3111
1.25G MMF SFP Transceiver



SFP-3711
1.25G SMF SFP Transceiver



SFP-7321
155M SMF BIDI SFP Transceiver

155M BIDI Simplex LC Fiber

Transceiver Übersicht						
Model	SFP-3001	SFP-3211	SFP-3611	SFP-3111	SFP-3711	SFP-7321
Single/Multi-Mode	MMF	SMF	SMF	MMF	SMF	SMF
Date Rate	1.25Gbps	1.25Gbps	1.25Gbps	1.25Gbps	1.25Gbps	155Mbps
Wavelength	850nm	1310nm	1550nm	1310nm	1550nm	1310nm/1550nm
Transmission Range	550m (50/125µm)	10km (9/125µm)	80km (9/125µm)	2km (50/125µm)	120km (50/125µm)	20km (9/125µm)
Connector	Duplex LC	Duplex LC	Duplex LC	Duplex LC	Duplex LC	Simplex LC

* LevelOne Transceiver sind kompatibel zu GVT-4000/5000 und den Switchen GSW- 0508/1621/2453/5150/0841/1641/2473/2476/4876/5270/0809/1290/2693/4896/2493/2495; FGP-1072/2410/2412/GEL-1072/GEU-0521/1628/GES-0852/FGL-2870/ GEL-2870/ GTL-2690/ GTP-2880/ GTL-2880/ GTL-5280

155M BIDI Simplex LC Fiber



SFP-7331
155M SMF BIDI SFP Transceiver



SFP-7421
155M SMF BIDI SFP Transceiver



SFP-7431
155M SMF BIDI SFP Transceiver

1.25G BIDI Simplex LC Fiber



SFP-9221
1.25G SMF BIDI SFP Transceiver



SFP-9231
1.25G SMF BIDI SFP Transceiver



SFP-9321
1.25G SMF BIDI SFP Transceiver

Transceiver Übersicht						
Model	SFP-7331	SFP-7421	SFP-7431	SFP-9221	SFP-9231	SFP-9321
Single/Multi-Mode	SMF	SMF	SMF	SMF	SMF	SMF
Date Rate	155Mbps	155Mbps	155Mbps	1.25Gbps	1.25Gbps	1.25Gbps
Wavelength	1550nm/1310nm	1550nm/1310nm	1550nm/1310nm	1310nm/1550nm	1550nm/1310nm	1550nm/1310nm
Transmission Range	20km (9/125µm)	40km (9/125µm)	40km (9/125µm)	10km (9/125µm)	10km (9/125µm)	20km (9/125µm)
Connector	Simplex LC	Simplex LC	Simplex LC	Simplex LC	Simplex LC	Simplex LC

* LevelOne Transceiver sind kompatibel zu GVT-4000/5000 und den Switchen GSW- 0508/1621/2453/5150/0841/1641/2473/2476/4876/5270/0809/1290/2693/4896/2493/2495; FGP-1072/2410/2412/GEL-1072/GEU-0521/1628/GES-0852/FGL-2870/ GEL-2870/ GTL-2690/ GTP-2880/ GTL-2880/ GTL-5280

1.25G SFP Duplex LC Fiber



SFP-9331
1.25G SMF BIDI SFP Transceiver



SFP-9421
1.25G SMF BIDI SFP Transceiver



SFP-9431
1.25G SMF BIDI SFP Transceiver

1.25G Copper Transceiver



SFP-3841
1.25G Copper Transceiver

10G XFP Duplex LC Fiber



XFP-5901
10G MMF XFP Transceiver



XFP-5211
10G SMF XFP Transceiver

Transceiver Übersicht						
Model	SFP-9331	SFP-9421	SFP-9431	SFP-3841	XFP-5901	XFP-5211
Single/Multi-Mode	SMF	SMF	SMF	-	MMF	SMF
Date Rate	1.25Gbps	1.25Gbps	1.25Gbps	1.25Gbps	10Gbps	10Gbps
Wavelength	1550nm/ 1310nm	1550nm/ 1310nm	1550nm/ 1310nm	-	850nm	1310nm
Transmission Range	20km (9/125µm)	40km (9/125µm)	40km (9/125µm)	100m (Cat. 5 Cable)	300m (OM3 MMF Fiber)	10km
Connector	Simplex LC	Simplex LC	Simplex LC	RJ-45	Duplex LC	Duplex LC

* LevelOne Transceiver sind kompatibel zu GVT-4000/5000 und den Switchen GSW- 0508/1621/2453/5150/0841/1641/2473/2476/4876/5270/0809/1290/2693/4896/2493/2495; FGP-1072/2410/2412/GEL-1072/GEU-0521/1628/GES-0852/FGL-2870/ GEL-2870/ GTL-2690/ GTP-2880/ GTL-2880/ GTL-5280

10G SFP Duplex LC Fiber



SFP-6101
10Gbp MMF SFP-Plus Transceiver



SFP-6121
10Gbps SMF SFP-Plus Transceiver



SFP-6141
10Gbps SMF SFP-Plus Transceiver

Transceiver Übersicht			
Model	SFP-6101	SFP-6121	SFP-6141
Single/Multi-Mode	MMF	SMF	SMF
Date Rate	10Gbps	10Gbps	10Gbps
Wavelength	850nm	1310nm	1310nm
Transmission Range	300m	10km	40km
Connector	Duplex LC	Duplex LC	Duplex LC

*LevelOne 10G SFP Duplex LC Fiber Transceiver work with Switches GTP-2880/GTL-2880/GTL-5280

Der LevelOne IP Power Switch ist ein Managementsystem für Büros und größere Firmen, um Server zu rebooten und andere Netzwerkgeräte per Fernzugriff ein- oder ausschalten zu können.

— Ethernet Cable (RJ-45)
 — Power

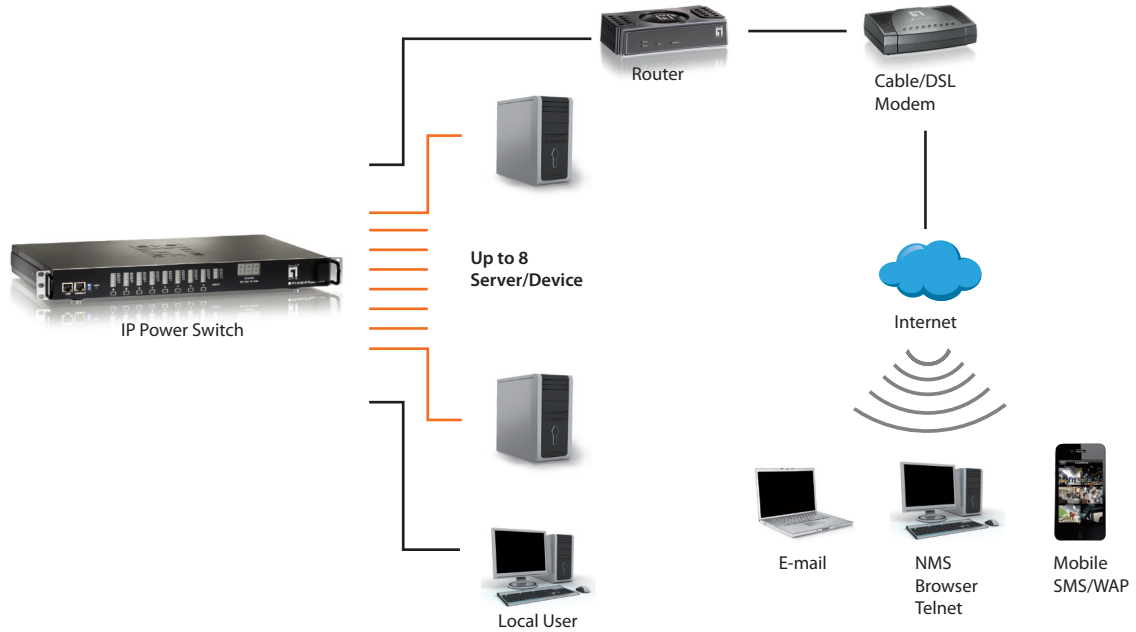

IPS-0008 8-Port IP Power Switch

- 8 Stromausgänge die per Fernsteuerung einund ausgeschaltet werden können
- Intelligentes Ein- oder Ausschalten von Geräten nach Ereignis oder Zeitplan
- Einfache Konfiguration und Verwaltung per Web-Browser, Telnet, SNMP oder Konsole
- Administrator und multiple User mit zweistufigen Benutzernamen- und Passwortschutz
- Unterstützt 2 digitale Ausgänge zur Steuerung der Geräte
- Unterstützt SSL v3 und SSH v1 Protokolle
- Ereignismeldung durch Trap- oder Emailversand
- Überwachung von Temperatur, Feuchtigkeit, Rauchmelder via EMD (Environmental Monitoring Device) optional



LevelOne Router und Gateways bieten höchste Flexibilität. Entweder drahtlos oder drahtgebundene Lösungen, Nutzer können aus vielfältigen Produktangebot das passende Produkt auswählen.

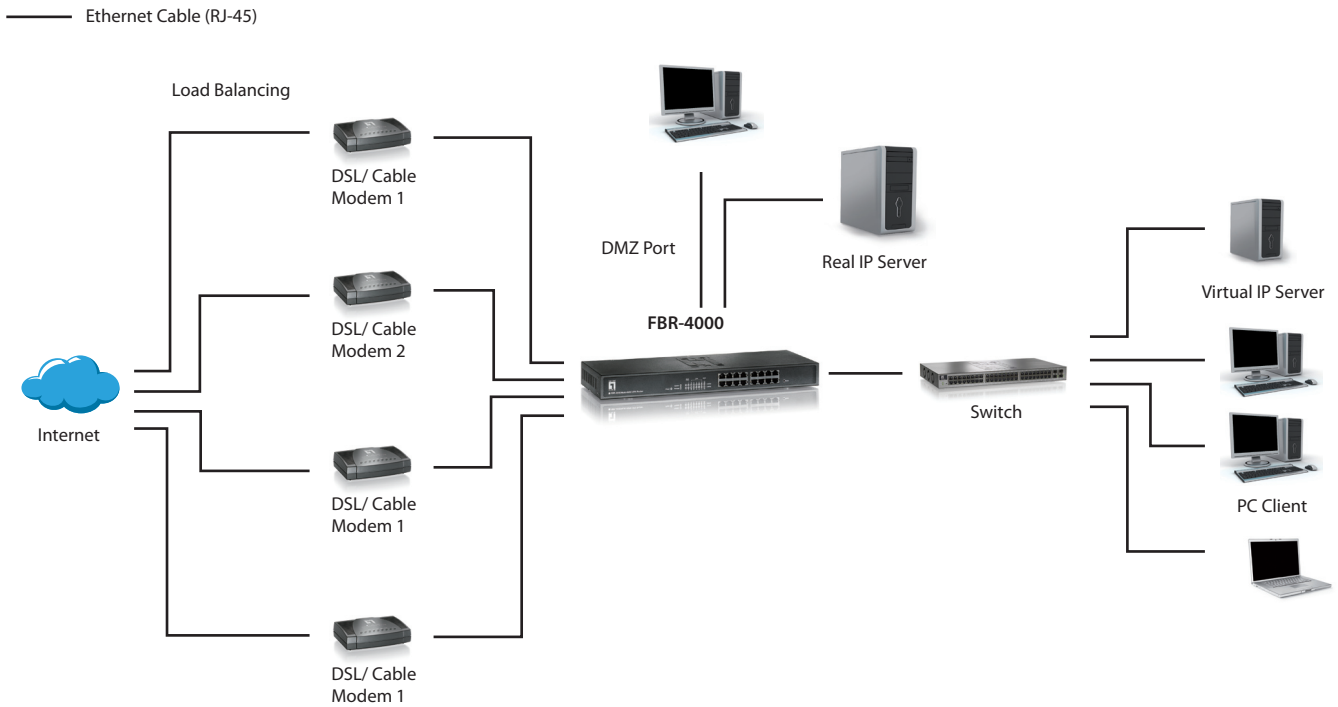

FBR-4000

Multi-WAN Load Balance VPN Router

- Flexible, High-Performance Multi-WAN Unterstützung
- Integriertes Load Balancing und Auto-Failover WAN-Verbindungen
- Bietet fortschrittliche Firewall und VPN-Möglichkeiten
- Zeitgesteuerte Paket- und URL-basierte Filterung
- Unterstützt Multi-DMZ, Virtual Server, SNMP, DDNS- und Access Filtering-Funktionen
- Unterstützt VPN-Sicherheit mit bis zu 40 Tunnel, Hardware-basierter DES-, 3DES IP-Sec und 256 Bit AES-Verschlüsselung
- Bietet bis zu 80.000 konkurrierende Sessions
- Web-Basierte Konfiguration und Management
- 2x dedizierte DMZ-Ports, 10x 10/100Mbps LANPorts
- CPU: CAVIUM NITROX 166MHz
- RAM: 32MB / ROM: 2MB



Das LevelOne WHG-1000 ist ein Multifunktions-, All-in-one Wireless Hotspot Gateway für öffentliche Wireless Hotspot Anwendungen. Das WHG-1000 ist speziell für Hotspot-Dienstleister entwickelt worden, da es dank seiner integrierten Lösungen schnell und leicht den Hotspot-Dienst aufnehmen kann und die Serviceleistungen erhöht.

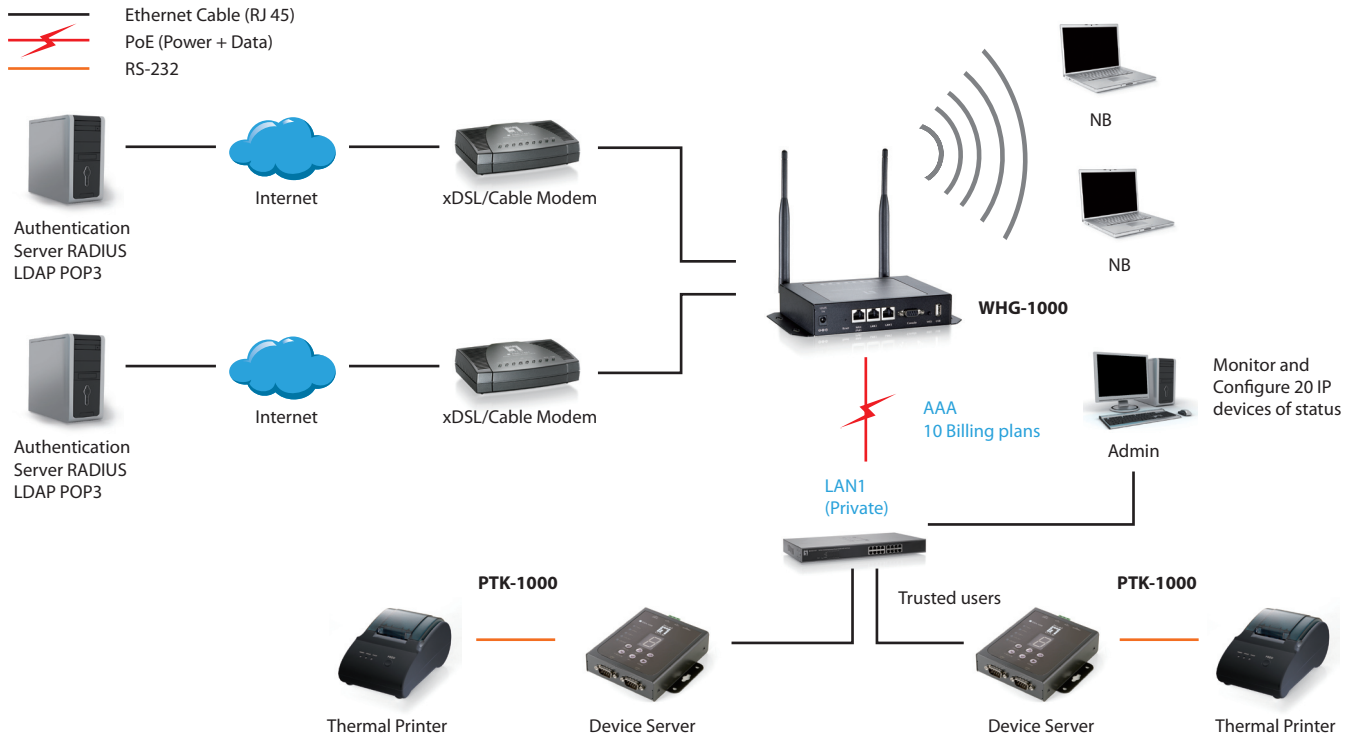

Key Features

- unterstützt programmierbare Abrechnungsprofile und ermöglicht somit eine einfache Abrechnung
- flexibles Abrechnungs- und Bezahlmanagement
- unterstützt WAP2 und IEEE-802.1x zur höchsten Sicherheit der Daten und zur Benutzerauthentifizierung



WHG-1000
 300Mbps Wireless PoE Hotspot Gateway

Optional Accessories: PTK-1000 Ticket Generator Kit



AP Management Gateway Übersicht	
Model	WHG-1000
LAN	1 x 10/100Mbps
WAN (Internet)	2 x 10/100Mbps
USB Port	1
Console Port	1
Local Account	3069
On-Demand Account	3069
PoE	IEEE 802.3af
Power Supply	External/PoE
Optional Accessories	PTK-1000: Ticket Generator Kit

LevelOne Netzwerk-Adapter sind mit verschiedenen Anschlüssen verfügbar, um Ihren Ansprüchen zu entsprechen. Mit hohen Datentransferraten und Unterstützung der aktuellsten IEEE-Standards sowie Protokollen, können Sie ein zuverlässiges Netzwerk mit hoher Performance für anspruchsvolle Anwendungen aufbauen.

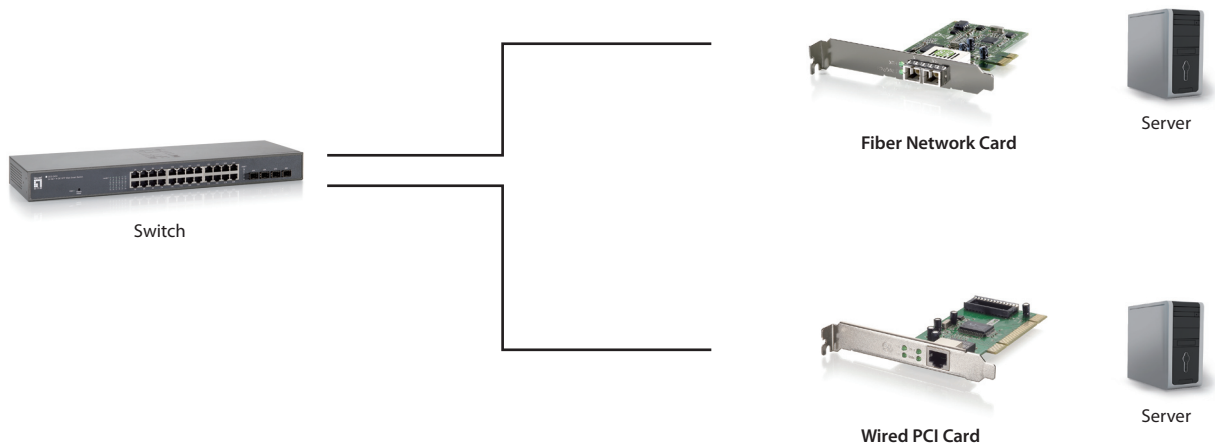

Key Features

- Bitete Plug&Play Installation
- Unterstützt alle gängigen Betriebssysteme
- Erweitert die Netzwerreichweite über weitere Distanzen



FNC-0103FX
100BASE-FX Multi-Mode Glasfaser Optik PCI Karte (ST)

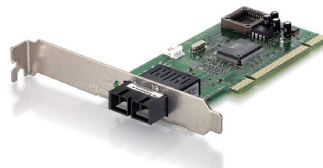

FNC-0104FX
100BASE-FX Multi-Mode Glasfaser Optik PCI Karte (SC)

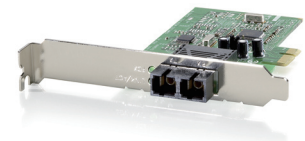

FNC-0115
100BASE-FX Multi-Mode Glasfaser Optik PCI Express Karte (SC)

Netzwerk-Adapter Übersicht			
Model	FNC-0103FX	FNC-0104FX	FNC-0115
Interface	PCI	PCI	PCI-e
Ethernet Port	-	-	-
Fiber Port	1 x 100BASE-FX MMF	1 x 100BASE-FX MMF	1 x 100BASE-FX MMF
Antenna	-	-	-
Wake-on-LAN	-	-	V
IP Rating	-	-	-
Jumbo Frame	-	-	-



GNC-0111
1000BASE-SX Glasfaser Optik PCI Express Karte (SC)



GNC-0105T
32-bit Gigabit Ethernet PCI Card



GNC-0112
Gigabit-Ethernet-PCIe-Karte



FNC-0600TXM
5-Port L2 SNMP Switch Karte



WUA-5600
150Mbps Wireless High Power Outdoor USB Adapter

Netzwerk-Adapter Übersicht					
Model	GNC-0111	GNC-0105T	GNC-0112	FNC-0600TXM	WUA-5600
Interface	PCI-e	PCI	PCI-e	PCI	USB
Ethernet Port	-	1 x 10/100/1000Mbps	1 x 10/100/1000Mbps	5 x 10/100Mbps	-
Fiber Port	1 x 1000BASE-SX MMF	-	-	-	7 dBi Omni-Directional
Antenna	-	-	-	-	150Mbps (11b/g/n)
Wake-on-LAN	-	-	-	-	-
IP Rating	-	-	-	-	IP-67
Jumbo Frame	9K	8K	-	-	-

LevelOne Bridges und Access Points eröffnen einzigartige und flexible Netzwerkarchitekturen und Lösungen. Abhängig von den Anforderungen liefern die LevelOne Access Points WLAN Zugriff bis in den letzten Winkel Ihres Büros. Sei es Indoor oder Outdoor.

— Ethernet Cable (RJ-45)

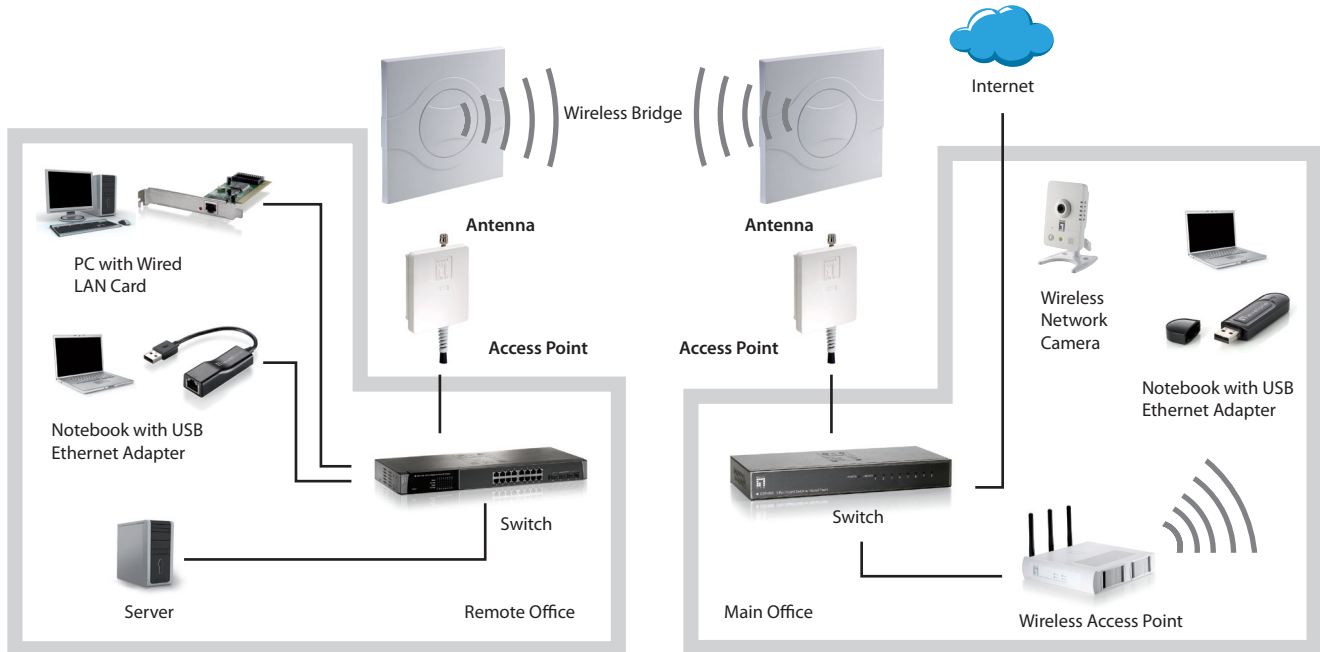

Key Features

- Unterstützt diverse WLAN Betriebsmodi
- Unterstützt 64/128 WEP, WPA und WPA2 Verschlüsselung



WAP-3100
54Mbps Wireless PoE Access Point



WAP-6002
150Mbps Wireless Access Point



WAP-6011
300Mbps Wireless Access Point



WAP-6012
300Mbps Wireless Gigabit PoE Access Point



WAB-6120
150Mbps Wireless Outdoor Passive PoE Access Point



WAB-5120
300Mbps 5G Wireless Outdoor Passive PoE Access Point / Bridge

Wireless Access Point Übersicht

Model	WAP-3100	WAP-6002	WAP-6011	WAP-6012	WAB-6120	WAB-5120
Wireless	54Mbps (11b/g)	150Mbps(11b/g/n)	300Mbps (11b/g/n)	300Mbps (11b/g/n)	150Mbps (11b/g/n)	300Mbps (11a/n)
Antenna/Connector	1 x 2dBi (External Detachable) / RP-SMA	1 x 1.8dBi (External Detachable) / RP-SMA	2 x 1.8dBi (External Detachable) / RP-SMA	3 x 2dBi (External Detachable) / RP-SMA	1 x 8dBi (Internal) / N-type	2 x 16dBi(Internal) / RP-SMA
PoE	IEEE 802.3af	-	-	IEEE 802.3af	V	V
Power Supply	External/PoE	External	External	External/PoE	Passive PoE	Passive PoE
Frequency Range	2.4GHz	2.4GHz	2.4GHz	2.4GHz	2.4GHz	5GHz
Multiple-SSID	-	8	8	8	16	16
AP/ AP Client/WDS Mode	V	V	V	V	V	V
IP Rating	-	-	-	-	IP55	IP55



WAP-1001
108Mbps Wireless Outdoor PoE Access Point



WAB-7400
54Mbps Dual-Radio Outdoor PoE Mesh Access Point



WAP-6003
150-Mb/s-WLAN-Zugangspunkt



WAP-6101
300Mbps Wireless Ceiling PoE Access Point



WAP-6013
300-Mb/s-WLAN-Zugangspunkt

Wireless Access Point Übersicht					
Model	WAP-1001	WAB-7400	WAP-6003	WAP-6101	WAP-6013
Wireless	108Mbps (11b/g, Super G)	54Mbps (11a/b/g)	150Mbps (11b/g/n)	300Mbps (11b/g/n)	300Mbps (11b/g/n)
Antenna/Connector	1 x 12dBi (Internal) / -	N-Type Connector	1 x 3dBi (External) / -	2 x 5dBi (Internal) / -	2 x 3dBi (External) / -
PoE	V	IEEE 802.3af	-	IEEE 802.3af	-
Power Supply	PoE	PoE	External	PoE	External
Frequency Range	2.4GHz	2.4GHz/ 5GHz	2.4GHz	2.4GHz	2.4GHz
Multiple-SSID	-	V	2	4	2
AP/ AP Client/ WDS Mode	V	AP mode	V	V	V
IP Rating	IP65	IP65	-	-	-

LevelOne bietet eine breite Palette and unterschiedlichen direktionalen oder omnidirektionalen Antennen an, die es ermöglichen WLAN Signale über bis zu 5000m zu senden und zu empfangen.

Key Features

- Bietet stabiles Signal und erhöhte Reichweite/Abdeckung
- IEEE 802.11b/g/n konforme Anwendungen im 2.4GHz Frequenzbereich
- IEEE 802.11a/n konforme Anwendungen im 5GHz Frequenzbereich

— Ethernet Cable (RJ-45)

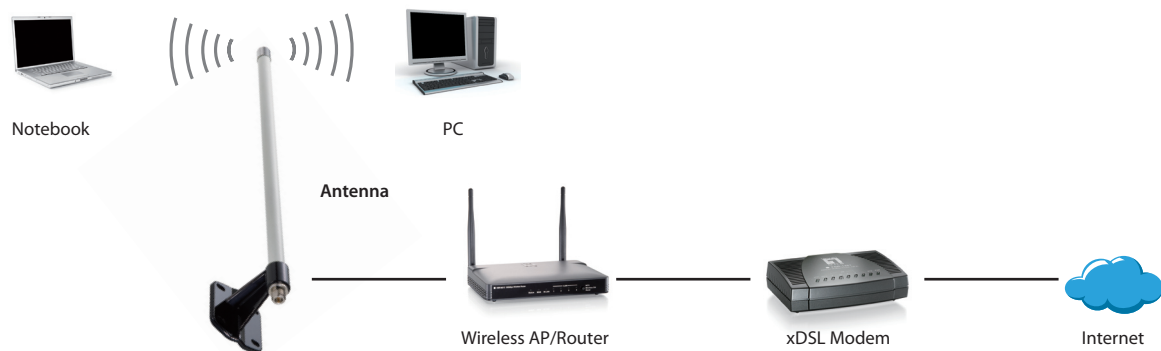

2.4GHz Antennen



OAN-2151
15dBi 2.4GHz Omni-direktionale Outdoor Antenne



OAN-2090
9dBi 2.4GHz Omni-direktionales Indoor/Outdoor Antennen-Kit



WAN-7100
10.5dBi 2.4GHz Direktionales Dual-Polarisation Patch Antennen-Kit



WAN-1112
12dBi 2.4GHz Direktionale Patch Antenne



WAN-2185
8.5dBi 2.4GHz Direktionale Pico Cell Antenne



WAN-2140
14dBi 2.4GHz Direktionale Panel Antenne

Antennen Übersicht						
Model	OAN-2151	OAN-2090	WAN-7100	WAN-1112	WAN-2185	WAN-2140
Description	Omni-Directional	Omni-Directional	Directional Dual-Polarization	Directional Patch	Directional Pico Cell	Directional Panel
Frequency Range	2.4GHz	2.4GHz	2.4GHz	2.4GHz	2.4GHz	2.4GHz
Indoor/Outdoor	Outdoor	Indoor/Outdoor	Indoor/Outdoor	Indoor/Outdoor	Indoor/Outdoor	Outdoor
Gain	15dBi	9dBi	10.5dBi	12dBi	8.5dBi	14dBi
Range (Estimated)	800~3000m	400~1000m	200~800m	200~800m	350~1200m	300~3500m
Extension Cable	Optional	-	3m	-	-	-
IP Rating	IP67	IP67	-	IPX5	IPX5	-
Connector	N-Jack	N-Jack	SMA-RPSMA	SMA-Jack	N-Jack	N-Jack

2.4GHz Antennen



WAN-2181
WAN-2181 18dBi 2.4GHz Direktionale Panel Antenne



WAN-2218
18dBi 2.4GHz Direktionale Yagi Antenne



OAN-4101
10dBi 5GHz Omni-direktionale Antenne



WAN-9150
15dBi 5GHz Direktionale Dual-Polarisation Outdoor Panel Antenne



WAN-9180
18dBi 5GHz Direktionale Dual-Polarisation Outdoor Panel Antenne

Antennen Übersicht					
Model	WAN-2181	WAN-2218	OAN-4101	WAN-9150	WAN-9180
Description	Directional Panel	Directional Yagi	Omni-Directional	Directional Dual-Polarization	Directional Dual-Polarization
Frequency Range	2.4GHz	2.4GHz	5GHz	5GHz	5GHz
Indoor/Outdoor	Outdoor	Outdoor	Outdoor	Outdoor	Outdoor
Gain	18dBi	18dBi	10dBi	15dBi	18dBi
Range (Estimated)	1500~5000m	1500~5000m	600~2400m	1500~5000m	1500~5000m
Extension Cable	-	-	-	-	-
IP Rating	IP67	IPX5	IPX5	IP67	IP67
Connector	N-Jack	N-Jack	N-Jack	N-Jack	N-Jack

Band (2.4/5 GHz) Antennen



WAN-1160
6/8dBi Dual-Band Direktionale Antenne

Antennen Übersicht	
Model	WAN-1160
Description	Directional
Frequency Range	2.4GHz/5GHz
Indoor/Outdoor	Indoor
Gain	6dBi/8dBi
Range (Estimated)	25~180m
Extension Cable	1m
IP Rating	-
Connector	RP-SMA Plug

Key Features

- Arbeitet mit LevelOne Access Points
- Plug&Play Installation
- Einfach zu installieren und stabile Signalverstärkung



ANC-1430 / ANC-1440 / ANC-1470
RPSMA Plug auf RPSMA Jack Antennenkabel



ANC-2210
1m N Plug auf N Plug Antennenkabel
(200-Serie)



ANC-2310
1m RPSMA Plug auf N Plug Antennenkabel
(200-Serie)



ANC-2350
1.5m RPSMA Plug auf N Plug Antennenkabel
(200-Serie)



ANC-2330
3m RPSMA Plug auf N Plug Antennenkabel
(200-Serie)



ANC-4230
3m N Plug auf N Plug Antennenkabel
(400-Serie)



ANC-4130
3m N Plug auf N Jack Antennenkabel
(400-Serie)



ANC-4160
6m N Plug auf N Jack Antennenkabel
(400-Serie)

Antennenkabel Übersicht					
Model	ANC-1430	ANC-1440	ANC-1470	ANC-2210	ANC-2310
Outer Diameter	200 series	200 series	200 Series	200 series	200 series
Cable	Low loss 200 coaxial cable	Low loss 200 coaxial cable	Low loss 200 coaxial cable	CFD-200 coaxial cable	CFD-200 coaxial cable
Connector	RP-SMA Plug/ RP-SMA Jack	RP-SMA Plug/ RP-SMA Jack	RP-SMA Plug/ RP-SMA Jack	N-Plug/N-Plug	N-Plug/RP-SMA
Length	3m	5m	10m	1m	1m
Frequency range	DC~6GHz	DC~6GHz	DC~6GHz	DC~6GHz	DC~3GHz

Antennenkabel Übersicht					
Model	ANC-2350	ANC-2330	ANC-4230	ANC-4130	ANC-4160
Outer Diameter	200 series	200 series	400 series	400 series	400 Series
Cable	CFD-200 cable	CFD-200 cable	CFD-400 coaxial cable	DDC-400 cable	DDC-400 Cable
Connector	N-Plug/RP-SMA	N-Plug/RP-SMA	N-Plug/N-Plug	N-Plug/N-Jack	N-Plug/N-Jack
Length	1.5m	3m	3m	3m	6m
Frequency range	DC~3GHz	DC~6GHz	DC~6GHz	DC~3GHz	DC~6GHz

Die LevelOne Blitzschutz Lösungen bieten optimalen Schutz Ihrer WLAN Outdoor Installation vorden Folgen eines Blitzeinschlags. Um Switches, Access Points und weitere Netzwerkgeräte vor Überspannung zu schützen, installieren Sie das System einfach zwischen Antennekabel und Antenne.



Key Features

- Einfache Wandinstallation
- Plug&Play Installation
- Kompatibel mit LevelOne Outdoor Antennen



ANA-3100
3GHz Outdoor Blitzschutz



ANA-6101
6GHz Outdoor Überspannungsschutz

Überspannungsschutz Übersicht		
Model	ANA-3100	ANA-6101
Connector	N-Plug/N-Jack	N-Plug/N-Jack
Frequency Range	DC~3GHz	DC~6GHz
Voltage Standing Wave Ratio	1.5	1.5
Wi-Fi Compliant	2.4GHz	2.4GHz/ 5GHz

LevelOne PoE-Lösungen (PSE) liefern Strom und Daten zu Endgeräten wie z.B. IP Kameras, Access Points oder VoIPTelefone über ein Datenkabel (Cat.5 oder höher). Hierbei wird zwischen Midspan-Hub und Endspan-Switches unterschieden. Midspan- Hubs werden zur nachträglichen Integration von PoE in bereits vorhandene Netzwerke verwendet und sitzen zwischen Daten-Switch und Endgrät. Der Endspan-Switch ist PSE und Datenswitch in einem Gerät und liefert Daten&Strom direkt zum Endgerät. LevelOne PoE-Outdoor Repeater ermöglichen es größere Distanzen zu überbrücken (bis zu 800m).

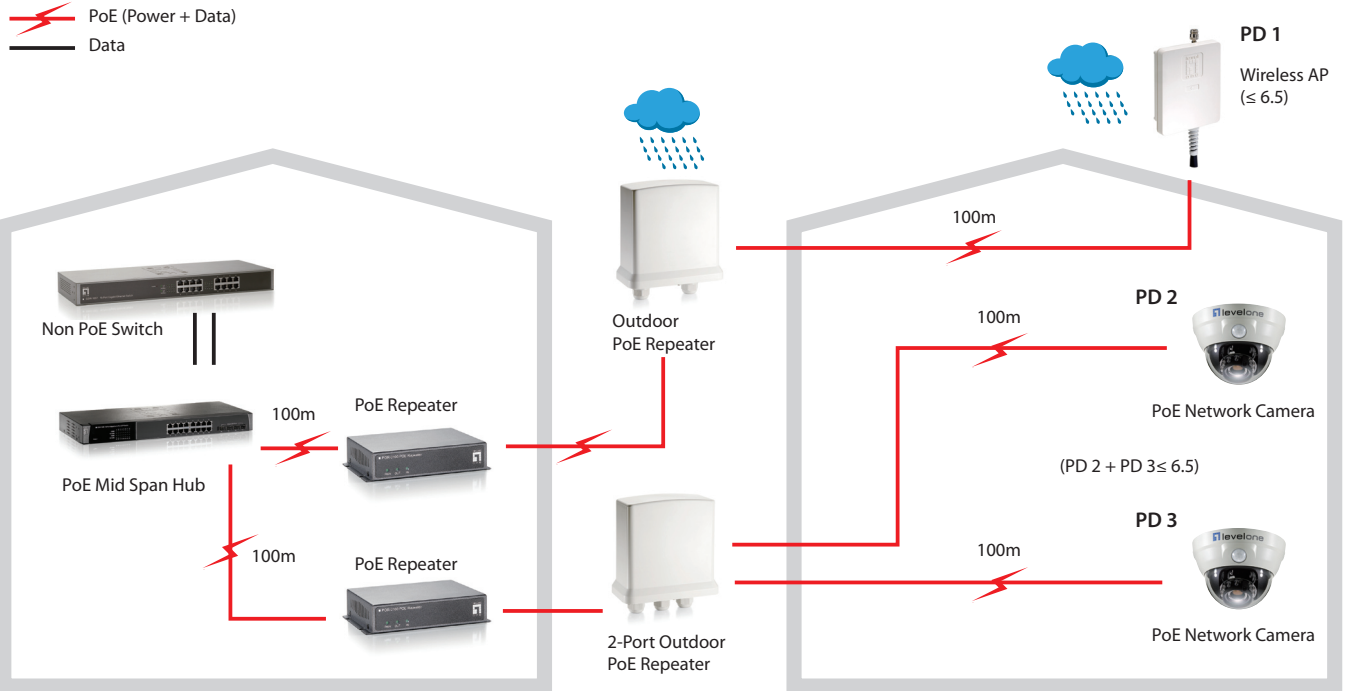

PoE Hubs

- 19" 12 Port Power over Ethernet MidSpan Hub
- Kompatibel mit IEEE-802.3af
- Überspannungs- und Kurzschlusschutz
- Überspannungs-/Überstrom- und Temperaturschutz



POH-1250
12 FE PoE Injektor Hub



POH-1260
12 FE High-Power PoE Injektor Hub

PoE Hubs Übersicht		
Model	POH-1250	POH-1260
PoE Power Budget	200W	375W
Data In Port	12	12
Data + Power Port Out	12	12

PoE Splitter

- Eingebauter Kurzschluss-/Überladungsschutz und Stromlimitierung
- Bieten Plug&Play Funktion für einfachste Installation
- Eliminieren platzraubende Netzteile und erhöhen die Energieeffizienz des Netzwerkes
- Automatische PoE-PD Einteilung in die entsprechende Leistungsklasse



POS-4000
12V DC High Power PoE Splitter



POS-4002
24V AC High Power PoE Splitter



POS-1002
5-12V DC PoE Splitter



POS-1001
5-12V DC Gigabit PoE Splitter



POS-3000
5~12V DC Gigabit PoE-Plus Splitter



POS-4001
3-12V DC High Power Outdoor PoE Splitter

PoE Splitter Übersicht						
Model	POS-4000	POS-4002	POS-1002	POS-1001	POS-3000	POS-4001
PoE	V	V	IEEE 802.3af	IEEE 802.3af	IEEE 802.3af/at	V
Power Output	12VDC	24AC	5-12V DC	5-12V DC	5-12V DC	3-12V DC
Power Supply	PoE	PoE	PoE	PoE	PoE	PoE
IP-Rating	-	-	-	-	-	IP65

PoE Injektor

- Eingebauter Überspannungsschutz
- Bieten Plug&Play Funktion für einfachste Installation



POI-4000
High-Power PoE Injektor



POI-2002
PoE Injektor



POI-2001
Gigabit PoE Injektor



POI-3000
Gigabit PoE-Plus Injektor

PoE Injector Übersicht				
Model	POI-4000	POI-2002	POI-2001	POI-3000
PoE	V	IEEE 802.3af	IEEE 802.3af	IEEE 802.3af/at
RJ-45 Input	1 x 10/100Mbps	1 x 10/100Mbps	1 x 10/100/1000Mbps	1 x 10/100/1000Mbps
RJ-45 Output	1 x 10/100Mbps	1 x 10/100Mbps	1 x 10/100/1000Mbps	1 x 10/100/1000Mbps
PoE Power Budget	56W	15.4W	15.4W	30W
Optional Accessories	POC-4000: 8-Bay High Power PoE Chassis	-	-	-

PoE Repeater

- Unterstützt Power over Ethernet
- Unterstützt alle Netzwerkgeräte



POR-0100
PoE Repeater



POR-0102
PoE Repeater



POR-1100
Outdoor PoE Repeater



POR-1102
2-Port Outdoor PoE Repeater



POR-0120
Gigabit PoE Repeater



POR-0122
2-Port Gigabit PoE Repeater



POT-0100
PoE Repeater over 2-wire (Master)



POT-0110
PoE Repeater over 2-wire (Slave)



POT-1110
Outdoor PoE Repeater over 2-wire (Slave)

PoE Repeater Übersicht					
Model	POR-0100	POR-0102	POR-1100	POR-1102	POR-0120
RJ-45 Input Port	1 x 10/100Mbps	1 x 10/100Mbps	1 x 10/100Mbps	1 x 10/100Mbps	1 x 10/100/1000Mbps
RJ-45 Output Port	1 x 10/100Mbps	2 x 10/100Mbps	1 x 10/100Mbps	2 x 10/100Mbps	1 x 10/100/1000Mbps
RJ-11 Input Port	-	-	-	-	-
RJ-11 Output Port	-	-	-	-	-
PoE	V	V	V	V	V
Power Supply	PoE	PoE	PoE	PoE	PoE
IP-Rating	-	-	IP65	IP65	-

PoE Repeater Übersicht				
Model	POR-0122	POT-0100	POT-0110	POT-1110
RJ-45 Input Port	1 x 10/100/1000Mbps	1 x 10/100Mbps	-	1 (Using RJ-11 Cable with RJ-45 Connector)
RJ-45 Output Port	2 x 10/100/1000Mbps	-	1 x 10/100Mbps	1 x 10/100Mbps
RJ-11 Input Port	-	-	1 x 10/100Mbps	-
RJ-11 Output Port	-	1 x 10/100Mbps	-	-
PoE	V	V	V	V
Power Supply	PoE	PoE	PoE	PoE
IP-Rating	-	-	-	IP65

PPM-1000 is a convenient and compact sized test and measurement device for PoE network installations. It verifies whether there is sufficient power to ensure your PoE device can function correctly, and helps avoid costly downtime or damage to equipment. This is particularly important when using non-PoE standard Power Sourcing Equipments (PSE) such as some High Power injectors.

PPM-1000

PoE Power-Messgerät

- Stellen Sie sicher, dass PoE-Geräte einwandfrei funktionieren
- Messung der zur Verfügung stehenden Leistung (Watt) und Spannung in einer PoE-Verbindung
- Tragbares und kompaktes Gerät
- LED-Anzeige und Indikatoren zeigen den Betriebsstatus an
- Eingebauter Temperatursensor
- Austauschbare externe Batterie für echte Portabilität
- Abnehmbares Umhängeband
- Eingebauter Temperatursensor und LED-Anzeige informieren den Anwender bei - überhitzten Zustand, wenn ein High-Power-Test durchgeführt wird



Connect with High-Power 30W PSE, POI-3000 / 40W PSE, POI-4000 (Refer to page 49)

End to End Distance	Daisy-Chaining (1-Port PoE Repeater)	Power Available	
		30W PSE (POI-3000)	40W PSE (POI-4000)
100m	0	-	-
200m	1	25.5W	28W
300m	2	21W	25.5W
400m	3	16.5W	21W
500m	4	12W	16.5W
600m	5	7.5W	12W
700m	6	3.84W	7.5W
800m	7	Data only No Power	3.84W
900m	8	-	Data only No Power

Die LevelOne KVM-Switches im SoHo-Einsatz bieten ein prämiertes Design für den Einsatz auf dem Schreibtisch. Sie sind platzsparend und unterstützen eine Plug&Play Installation. Einfach zu bedienen und mit PS/2 sowie USB Anschlüssen werden Sie fast jeder Herausforderung gerecht. Die professionellen KVM-Lösungen lassen den Einsatz in 19"-Schränken zu und können bis zu 128 Server gleichzeitig verwalten.

Key Features

- Bietet automatischen Scan und programmierbares, automatisches Umschalten
- Unterstützt sämtliche gängigen Betriebssysteme
- Flexibles Umschalten ohne Zeitverzögerung
- Unterstützt DOS, Netware, Unix, Linux, Win3.x, Win95/98/ 98SE/ 2000/ ME/ XP/ NT

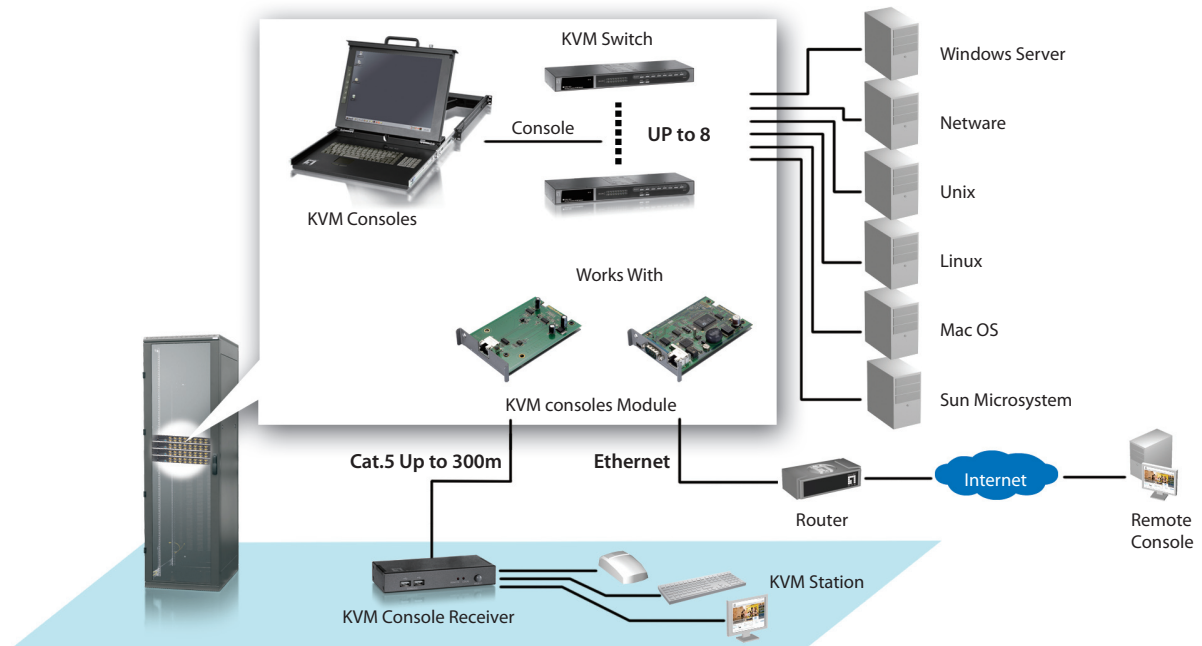

Desktop KVM Switches

Rackmount KVM Switches



KVM-0411



KVM-0412

KVM-0411 / KVM-0412
 4-Port PS/2 KVM Switch

KVM-0421



KVM-0422

KVM-0421 / KVM-0422
 4-Port USB KVM Switch

KVM-0410
 4-Port KVM Switch mit OSD für PS/2

KVM-0420
 4-Port KVM Switch für USB & PS/2

KVM-0811
 8-Port PS/2 KVM Switch

KVM-1611
 16-Port PS/2 KVM Switch

Desktop KVM switches Übersicht					
	Model	KVM-0411	KVM-0412	KVM-0421	KVM-0422
PC Port	Port for Keyboard/Mouse	PS/2	PS/2	USB	USB
	Video port	VGA	VGA	VGA	VGA
	Audio / Microphone	V	-	V	-
Console Port	Port for Keyboard/Mouse	PS/2	PS/2	USB	USB
	Video port	VGA	VGA	VGA	VGA
	Audio / Microphone	V	-	V	-
Feature	Control and Manage computers	4	4	4	4
	Max. Local Resolution	2048 x 1536	2048 x 1536	2048 x 1536	2048 x 1536
	Cascade Control PC No.	-	-	-	-
	Optional Accessories	-	-	-	-

Rackmount KVM Switches Übersicht					
	Model	KVM-0410	KVM-0420	KVM-0811	KVM-1611
PC Port	Port for Keyboard/Mouse	PS/2	PS/2,USB	PS/2	PS/2
	Video port	VGA	VGA	VGA	VGA
	Audio / Microphone	-	-	-	-
Console Port	Port for Keyboard/Mouse	PS/2	PS/2	PS/2	PS/2
	Video port	VGA	VGA	VGA	VGA
	Audio / Microphone	-	-	-	-
Feature	Control and Manage computers	16	16	8	16
	Max. Local Resolution	1920 x 1440	1920 x 1440	1920 x 1440	1920 x 1440
	Cascade Control PC No.	16	16	120	120
	Optional Accessories	ACC-2001 / ACC-2002: 1.8m / 3.0m PS/2 KVM Cable ACC-2006 / ACC-2010: 6.0m / 10.0m PS/2 KVM Cable PS/2 KVM Cable	ACC-2001 / ACC-2002: 1.8m / 3.0m PS/2 KVM Cable ACC-2006 / ACC-2010: 6.0m / 10.0m PS/2 KVM Cable PS/2 KVM Cable ACC-2003 / ACC-2004 / ACC-2005: 1.8m / 3.0m / 5.0m USB KVM Cable	ACC-2009: 90cm Daisy Chain Cable	

Rackmount KVM Switches



KVM-0831
8-Port Combo KVM Switch mit Erweiterungs-Slot



KVM-1631
16-Port Combo KVM Switch mit Erweiterungs-Slot

Rackmount KVM Konsole



KVM-0115US / KVM-0115DE
15" Rackmount KVM Konsole



KVM-0117US / KVM-0117DE
17" Rackmount KVM Konsole



KVM-0217US / KVM-0217DE
17" Modularized KVM Konsole

Rackmount KVM Switches Übersicht			
	Model	KVM-0831	KVM-1631
PC Port	Port for Keyboard/Mouse	PS/2, USB	PS/2, USB
	Video port	VGA	VGA
	Audio / Microphone	-	-
Console Port	Port for Keyboard/Mouse	USB	USB
	Video port	VGA	VGA
	Audio / Microphone	-	-
Feature	Control and Manage computers	8	16
	Max. Local Resolution	1920 x 1440	1920 x 1440
	Cascade Control PC No.	120	128
	Optional Accessories	KVM-9007: KVM Cat.5 Console Receiver; ACC-1000: KVM Cat.5 Console Module; ACC-2000: KVM IP Console Module; KVM-9009: KVM Remote Console Kit; ACC-2101 / ACC-2102 / ACC-2103: 1.8m / 3.0m / 5.0m PS/2 and USB KVM Cable;	

Rackmount KVM Switches Übersicht				
	Model	KVM-0115	KVM-0117	KVM-0217
PC port	Port for Keyboard/Mouse	PS/2, USB	PS/2, USB	8/ 16 (Depends on KVM Module)
	Video port	VGA, DVI	VGA, DVI	8/ 16 (Depends on KVM Module)
	Audio / Microphone	-	-	-
Console Port	Port for Keyboard/Mouse	PS/2, USB	PS/2, USB	(Depends on KVM Module)
	Video port	VGA, DVI	VGA, DVI	(Depends on KVM Module)
	Audio / Microphone	-	-	-
Feature	Control and Manage computers	8,16	8,16	8,16
	Max. Local Resolution	1024 x 1786	1280x1024	1280x1024
	Cascade Control PC No.	-	-	120/128
	Optional Accessories	-	-	KCM-0831: 8-Port D-Sub Combo KVM Module KCM-1631: 16-Port D-Sub Combo KVM Module KVM-9007: KVM Cat.5 Console Receiver

Die LevelOne IP KVM-Extender ermöglichen die Steuerung eines PCs, Servers oder KVM-Switches in bis zu 150m Entfernung zum Gerät. Durch das kompakte Design passen unsere Cat.5 KVM-Extender problemlos auf den Schreibtisch des Administrators.

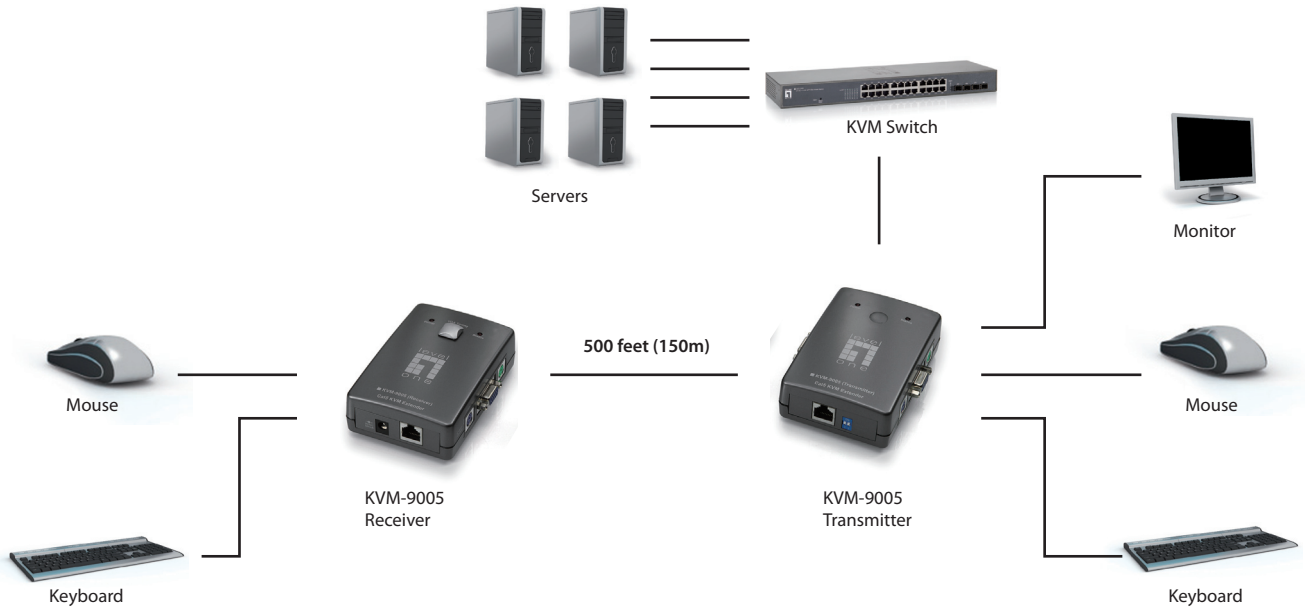

Extending console port or PC port of KVM Switch up to 150m away

Key Features

- Bieten Plug&Play Funktion für einfachste Installation
- Unterstützt Cat.5/5e/6 Ethernet Verkabelung
- Arbeitet mit KVM-Switches und Stand-Alone-PCs



KVM-9000
IP KVM Extender



KVM-9005
PS/2 KVM Extender



KVM-9006
USB KVM Extender

KVM Extenders Übersicht			
Model	KVM-9000	KVM-9005	KVM-9006
Extension distance	No limit	150m	150m@1280x1024
Console Port	PS/2, VGA, USB	PS/2, VGA	USB, VGA
PC Port	PS/2, VGA	PS/2, VGA	USB, VGA
Resolution	1280x1024	1280x1024	1280x1024 1920x1440 (local console)

LevelOne bietet drahtgebundene und drahtlose Print Server. Print Server ermöglichen die gemeinsame Nutzung eines Druckers im Netzwerk.

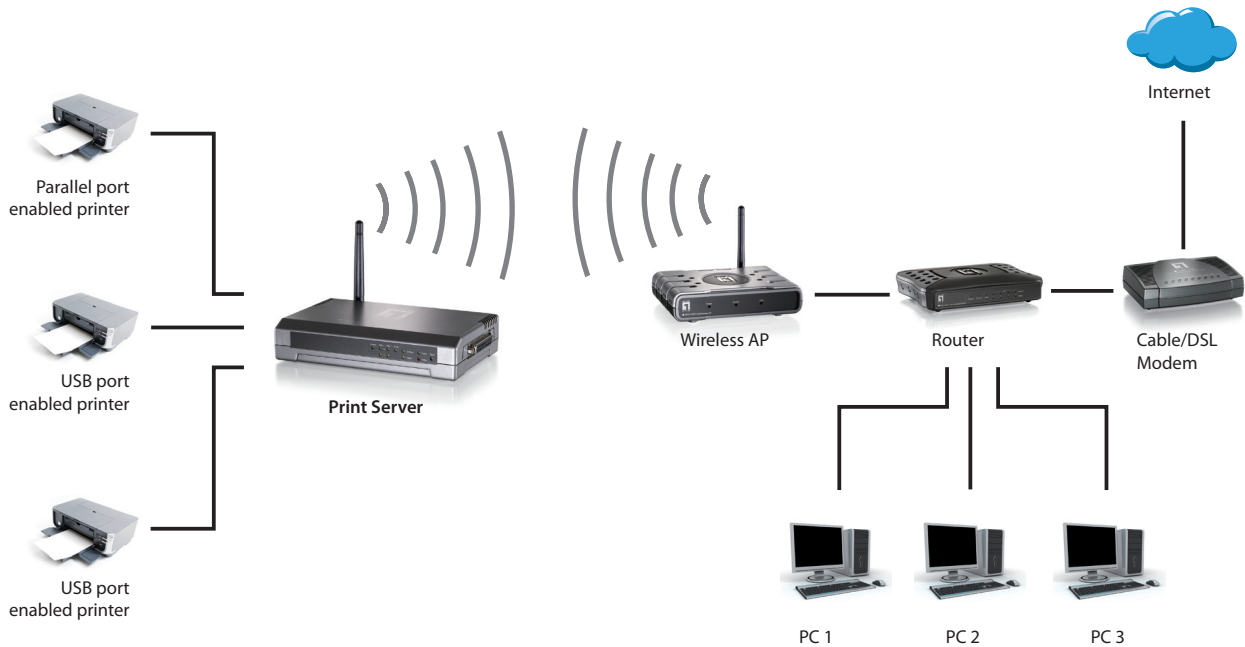

Key Features

- Unterstützt alle gängigen Druckprotokolle
- Unterstützt alle gängigen Betriebssysteme
- Einfaches webbasiertes GUI zur Administration
- Unterstützt IPP



FPS-1031
Parallel Print Server



FPS-1032
USB Print Server



FPS-1033
3-Port USB/Parallel Print Server



WPS-1133
3-Port USB/Parallel Wireless Printer Server

Print Servers Übersicht				
Model	FPS-1031	FPS-1032	FPS-1033	WPS-1133
Multifunction Printer Server Support	-	-	-	-
Parallel/USB Port	1 x Parallel	1x USB	1x Parallel/ 2x USB	1x Parallel/ 2x USB
USB Server	-	-	V	-
Wireless	-	-	-	54Mbps

VoIP-Gateways machen Telefonanrufe übers das Internet möglich, zudem komfortabel und kostengünstig in der Nutzung. LevelOne VoIP Lösungen sind ideal für den Einsatz daheim, in kleinen Büros oder in Unternehmen.

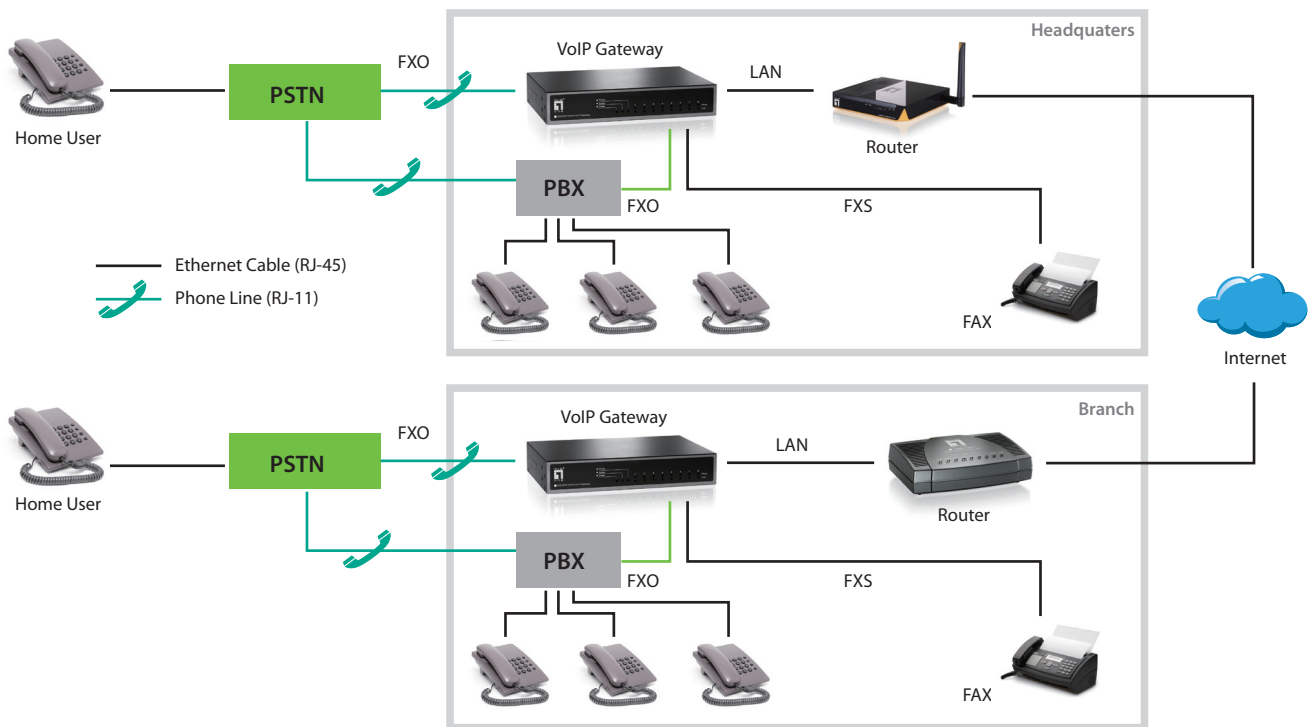

VOI-8001

8-Port FXS H.323/SIP Gateway

- 8 x FXS-Ports
- Verbinden Sie bis zu 8 Telefone, Fax-Geräte oder eine PBX für ein VoIP-Telefon-Netzwerk
- All-In-One Lösung mit VoIP Gateway und Breitband Router
- Webmanagement für einfache Konfiguration
- Kompatibel mit den Standards ITU H.323 und IETF SIPv2
- Unterstützt gleichzeitig H.323 und SIP
- Unterstützt G723.1, G726, G729a/G729b, G711 A/ u-law Codecs
- Registriert gleichzeitig bis zu 4 SIP-Proxy oder Gatekeeper
- Quality of Service priorisiert den VoIP-Datenverkehr
- Verfügt über Outbound Proxy- und STUN-Server für Pass-Through NAT Geräte
- Bietet NAT, DHCP Server und Firewall mit eingebauter Router Funktion



VOI-8001

— Ethernet Cable (RJ-45)
 Phone Line (RJ-11)

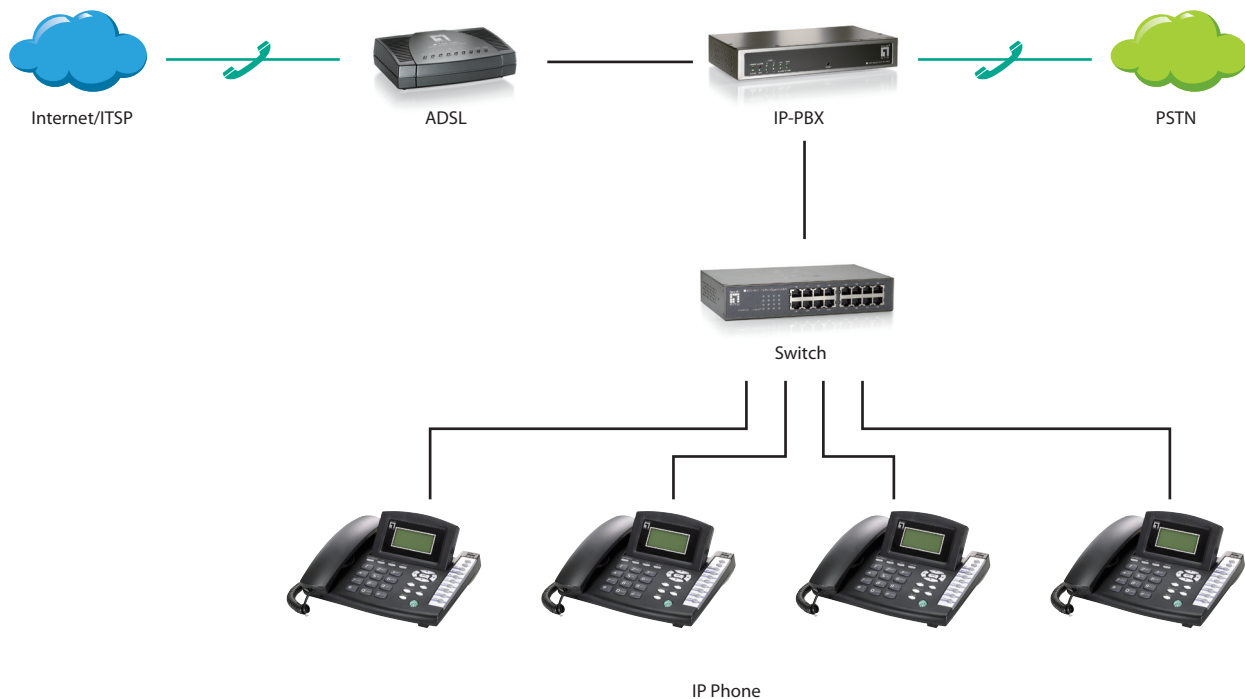

IP Phone

- Analog zu digital Wandler
- Benutzerfreundliches Display
- Kosteneffizientes Telefonieren daheim, im Büro und Unternehmen



VOI-7000
SIP VoIP Telefon



VOI-7100
SIP VoIP Telefon mit PoE-Funktion



VOI-7010
SIP VoIP Office Telefon



VOI-7011
SIP VoIP Office Telefon mit FXO-Port

Voice over IP Übersicht				
Model	VOI-7000	VOI-7100	VOI-7010	VOI-7011
Ethernet Port	1 x 10/100Mbps	1 x 10/100Mbps	1 x 10/100Mbps	1 x 10/100Mbps
FXO Port	-	-	-	1
VoIP Protocol	SIP v1/v2	SIP v1/v2	SIP v1/v2	SIP v1/v2
PoE	-	IEEE 802.3af	-	-
Power Supply	External	External/PoE	External	External
Optional Accessories	-	-	DHM-1000: Light-weight Single Headset with Microphone	

LevelOne bietet eine große Auswahl an IP Netzwerk Kameras. Drahtgebundene, drahtlos, PoE, Tag/Nacht/ Speed Dome, PTZ, Indoor und Outdoor Kameras sind erhältlich. Sämtliche Kameramodelle werden mit der kostenfreien 64-Kanal Software IP CamSecure ausgeliefert. Die ebenfalls kostenfreie iCamSecure Apple App ermöglicht den remote Zugriff via UMTS/WLAN auf das Überwachungssystem.

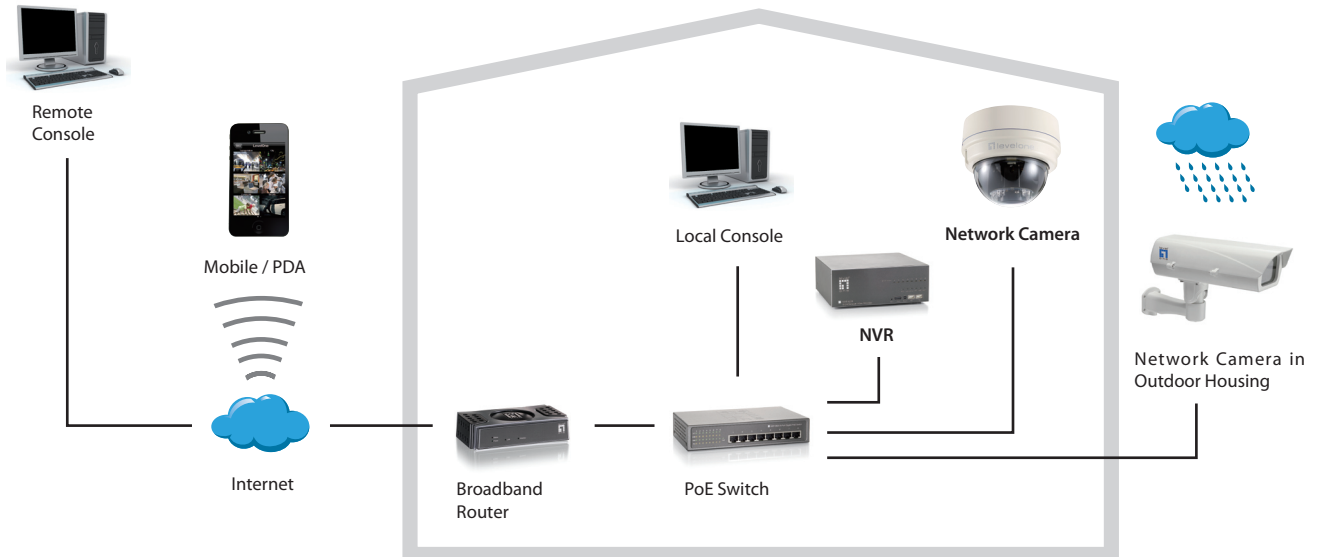

Fixed Kamera

- Unterstützt Dual-Streaming
- Zwei-Wege Audio
- Bundle mit der 64-Kanal LevelOne Software IP CamSecure



FCS-1091
PoE IP Netzwerk-Kamera



FCS-1101
PoE IP Netzwerk-Kamera



FCS-1121
Megapixel-PoE-Netzwerk-Kamera

Fixed Kameras Übersicht			
Model	FCS-1091	FCS-1101	FCS-1121
Sensor	Sony CCD	Color CCD	CMOS Megapixel
Max. Resolution	640 x 480	704x480 (NTSC); 704x576 (PAL)	1280 x 800
AGC/AWB/AES/WDR	AGC/AWB/AES	AGC/AWB/AES	AGC/AWB/AES
PIR Sensor	-	-	-
Infrared LED	-	-	-
ICR (IR-Cut Filter Removal)	V	-	V
3D Noise Reduction	-	-	-
Pan/Tilt/Zoom	-	-	-
PoE	IEEE 802.3af	IEEE 802.3af	IEEE 802.3af
Power Supply	External/PoE	External/PoE	External/PoE
Built in Microphone/ Speaker	Microphone	-	Microphone
Local Storage	-	-	-
IP-Rating	-	-	-
Operation Temperature	0° ~ 40°C	0° ~ 40°C	0° ~ 40°C
Optional Accessories	BOH-1100: PoE Upgradable Outdoor Housing BOH-1200: PoE Upgradable Outdoor Housing with Infrared LEDs		Outdoor Housing:BOH-1100 / BOH-1200 Lens: CAS-1300/CAS-1400

Fixed Kamera



FCS-1122
Megapixel PoE-Netzwerk-Kamera



FCS-5041
Megapixel Tag/Nacht PoE-Außen-Netzwerk-Kamera



FCS-1141
1,3-Megapixel PoE-Netzwerk-Kamera

Fixed Kameras Übersicht			
Model	FCS-1122	FCS-5041	FCS-1141
Sensor	CMOS Megapixel	CMOS Megapixel	Sony CCD
Max. Resolution	1280 x 800	1280 x 800	1280 x 960
AGC/AWB/AES/WDR	AGC/AWB/AES	AGC/AWB/AES	AGC/AWB/AES
PIR Sensor	-	-	-
Infrared LED	-	V	-
ICR (IR-Cut Filter Removal)	V	V	V
3D Noise Reduction	-	-	V
Wireless	-	*150Mbps	-
Pan/Tilt/Zoom	-	Z(4x)	-
PoE	IEEE 802.3af	IEEE 802.3af	IEEE 802.3af
Power Supply	External/PoE	External/PoE	External/PoE
Built in Microphone/ Speaker	Microphone	-	-
Local Storage	-	V	V
IP-Rating	-	IP67	-
Operation Temperature	0° ~ 40°C	-20° ~ 50°C	0° ~ 50°C
Optional Accessories	Outdoor Housing:BOH-1100 / BOH-1200 Lens: CAS-1300/CAS-1400	*WUA-5600: 150Mbps Wireless High Power Outdoor USB Adapter	BOH-1100: PoE Upgradable Outdoor Housing BOH-1200: PoE Upgradable Outdoor Housing with Infrared LEDs



FCS-1151
2-Megapixel PoE-Netzwerk-Kamera



FCS-0071
2-Megapixel Fish-Eye PoE-Netzwerk-Kamera



FCS-1131
2-Megapixel PoE-Netzwerk-Kamera

Fixed Kameras Übersicht			
Model	FCS-1151	FCS-0071	FCS-1131
Sensor	CMOS 2-Megapixel	CMOS 2-Megapixel	CMOS 2-Megapixel
Max. Resolution	1600 x 1200	1600 x 1200	1920 x 1080
AGC/AWB/AES/WDR	AGC/AWB/AES	AGC/AWB/AES	AGC/AWB/AES
PIR Sensor	-	-	-
Infrared LED	-	-	-
ICR (IR-Cut Filter Removal)	V	V	V
3D Noise Reduction	-	-	V
Pan/Tilt/Zoom	-	-	-
ePTZ	-	V	-
PoE	IEEE 802.3af	IEEE 802.3af	IEEE 802.3af
Power Supply	External/PoE	External/PoE	External/PoE
Built in Microphone/ Speaker	Microphone	V	-
Local Storage	V	V	V
IP-Rating	-	-	-
Operation Temperatur	0° ~ 50°C	0° ~ 50°C	-10° ~ 50°C
Optional Accessories	BOH-1100: PoE Upgradable Outdoor Housing BOH-1200: PoE Upgradable Outdoor Housing with Infrared LEDs	-	BOH-1100: PoE Upgradable Outdoor Housing BOH-1200: PoE Upgradable Outdoor Housing with Infrared Lens: CAS-1400

Fixed Kamera



FCS-5051
2-Megapixel Tag/Nacht PoE Outdoor
Netzwerk-Kamera



NEW



FCS-5052
3-Megapixel-Tag/Nacht-PoE-
Netzwerk-kuppelkamera



FCS-5061
5-Megapixel Tag/Nacht PoE-Plus-Außen-
Netzwerk-Kamera

Fixed Kameras Übersicht			
Model	FCS-5051	FCS-5052	FCS-5061
Sensor	CMOS 2-Megapixel	CMOS 3-Megapixel	CMOS 5-Megapixel
Max. Resolution	1920 x 1080	2032x1536	2592 x 1944
AGC/AWB/AES/WDR	AGC/AWB/AES/WDR	AGC/AWB/AES	AGC/AWB/AES/WDR
PIR Sensor	-	-	-
Infrared LED	V	V	V
ICR (IR-Cut Filter Removal)	V	V	V
3D Noise Reduction	V	-	V
Pan/Tilt/Zoom	-	-/-/Digital: 4x	-
PoE	IEEE 802.3af	IEEE 802.3af	IEEE 802.3at
Power Supply	External/PoE	External/PoE	External/PoE
Built in Microphone/ Speaker	Microphone	Microphone	Microphone
Local Storage	V	-	V
IP-Rating	IP66	IP67	IP66
Operation Temperature	-10° ~ 50°C	0°C ~ 40°C	-40°C ~ 50°C (AC 24V / PoE-Plus)
Optional Accessories	-	-	-

Fixed Dome Kamera

- Kompatibel mit IEEE-802.3af
- Zwei-Wege Audio
- Digitale I/O-Anschlüsse für externe Sensoren und Alarmmelder
- Bundle mit der 64-Kanal LevelOne Software IP CamSecure



FCS-3031
PIR PoE-kuppel-Netzwerk-Kamera



FCS-3051
Tag/Nacht PIR PoE-kuppel-
Netzwerk-Kamera



FCS-3061
Megapixel-Tag/Nacht-PoE-Netzwerk
kuppel-Kamera

Fixed Dome Kameras Übersicht			
Model	FCS-3031	FCS-3051	FCS-3061
Sensor	CMOS	CMOS	CMOS Megapixel
Max. Resolution	640 x 480	640 x 480	1280 x 800
AGC/AWB/AES/WDR	AGC/AWB/AES	AGC/AWB/AES	AGC/AWB/AES
PIR Sensor	V	V	-
Infrared LED	-	V	V
ICR (IR-Cut Filter Removal)	-	V	V
3D Noise Reduction	-	-	-
PoE	IEEE 802.3af	IEEE 802.3af	IEEE 802.3af
Power Supply	External/PoE	External/PoE	External/PoE
Built in Microphone/ Speaker	-	-	-
Local Storage	-	-	-
IP-Rating	-	-	-
Operation Temperature	0° ~ 40°C	0° ~ 40°C	0° ~ 50°C
Optional Accessories	-	-	-

Fixed Dome Kamera

ONVIF



FCS-3091
2 Megapixel Fish-Eye-PoE-kuppel-
Netzwerk-Kamera

ONVIF



FCS-3071
2-Megapixel-PoE-kuppel-
Netzwerk-Kamera



FCS-3081
2-Megapixel-Tag/Nacht-PoE-
Netzwerk kuppel-Kamera

ONVIF

NEW

FCS-3052
3-Megapixel-Tag/Nacht-PoE-
Netzwerk kuppelkamera

Fixed Dome Kameras Übersicht				
Model	FCS-3091	FCS-3071	FCS-3081	FCS-3052
Sensor	CMOS 2-Megapixel	CMOS 2-Megapixel	CMOS 2-Megapixel	CMOS 3-Megapixel
Max. Resolution	1600 x 1200	1920 x 1080	1920 x 1080	2032 x 1536
AGC/AWB/AES/WDR	AGC/AWB/AES	AGC/AWB/AES/WDR	AGC/AWB/AES/WDR	AGC/AWB/AES
PIR Sensor	-	-	-	-
Infrared LED	-	-	V	V
ICR (IR-Cut Filter Removal)	V	-	V	V
3D Noise Reduction	-	V	V	-
PoE	IEEE 802.3af	IEEE 802.3af	IEEE 802.3af	IEEE 802.3af
Power Supply	External/PoE	PoE	External/PoE	External/PoE
Built in Microphone/ Speaker	V	-	-	-
Local Storage	V	V	V	-
IP-Rating	-	IP66	IP66	-
Operation Temperature	0° ~ 50°C	-20° ~ 50°C	-10° ~ 50°C (DC 12V/ PoE-Plus) -35° ~ 50°C (AC 24V)	0° ~ 50°C
Optional Accessories	-	-	CAS-3100: T-Bar Ceiling Mount CAS-3101: Interior Corner Mount CAS-3000: Outdoor Housing CAS-3241: Straight Tube 25cm CAS-3242: Straight Tube 50cm CAS-3201: Mini Pendant CAS-3221: Corner Plate Mini CAS-3222: Corner Plate Mount CAS-3223: Corner Thin Box Mount CAS-3261: Pole Thin Direct Mounting CAS-3263: Pole Thin Box Mount CAS-3281: Wall Box Mount	-

P/T/Z Dome Kamera

- 2-Wege Audio
- Digitale I/O-Anschlüsse für externe Sensoren und Alarmmelder
- Bundle mit der 64-Kanal LevelOne Software IP CamSecure



FCS-4400
Tag/Nacht P/T/Z Speed Dome Netzwerk Kamera (26x)



FCS-4041
2-Megapixel Tag/Nacht Outdoor-PoE-Plus-Speed-Dome-Kamera

P/T/Z Dome Kameras Übersicht		
Model	FCS-4400	FCS-4041
Sensor	Exview HAD CCD	Sony CMOS
Max. Resolution	704 x 480 (NTSC) 704 x 576 (PAL)	1920 x 1080
AGC/AWB/AES/WDR	AGC/AWB/AES	AGC/AWB/AES/WDR
PIR Sensor	-	-
Infrared LED	-	-
ICR (IR-Cut Filter Removal)	V	V
3D Noise Reduction	-	V
Pan/Tilt/Zoom	P/T/Z(26x)	P/T/Z(18x)
PoE	-	IEEE 802.3at
Power Supply	External	External/PoE
Local Storage	-	V
IP-Rating	IP66	IP66
Operation Temperature	-20° ~ 50°C	-10°~50°C(PoE-Plus) -40°~50°C (AC 24V)
Optional Accessories	-	CAS-3201: Mini Pendant CAS-3221: Corner Plate Mini CAS-3222: Corner Plate Mount CAS-3223: Corner Thin Box Mount CAS-3241: Straight Tube (25cm) CAS-3242: Straight Tube (50cm) CAS-3261: Pole Thin Direct Mount CAS-3263: Pole Thin Box Mount CAS-3281: Wall Box Mount CAS-3291: Outdoor Power Box (110-115V AC) CAS-3292: Outdoor Power Box (220-230V AC) CAS-4200: USB Joystick for PTZ Network Cameras

Linse

CAS-1001
2,1mm Festbrennweitenobjektiv

- Sensing Area: 1/3" CCD
- Iris: Fixed Iris
- Diagonal: 166°
- Horizontal: 149°
- Vertical: 87.2°

CAS-1101
5~50mm Vari-focal Tag/Nacht Linse

- Sensing Area: 1/3" CCD
- Iris: DC-drive Auto Iris
- Diagonal: 60°~7.4°
- Horizontal: 49°~5.8°
- Vertical: 38°~4.4°

CAS-1200
3~8mm Vari-focal Linse

- Sensing Area: 1/3" CCD
- Iris: DC-drive Auto Iris
- Diagonal: 118.7°~44.1°
- Horizontal: 93.4°~34.6°
- Vertical: 68.7°~26.0°

CAS-1300
2.8~8.5mm Vari-focal Tag/Nacht Megapixel Linse

- Sensing Area: 1/3" CCD
- Iris: DC-drive Auto Iris
- Diagonal: 118.1°~41.7°
- Horizontal: 95.4°~33.5°
- Vertical: 71.3°~25.0°

CAS-1400
2,8-12mm Tag/Nacht 2-Megapixel-Zoom-Objektiv

- Sensing Area: 1/3" CCD
- Iris: DC-drive Auto Iris
- Diagonal: 115°~34°
- Horizontal: 92°~27.2°
- Vertical: 69°~20.4°

Die LevelOne IP CamSecure Serie wurde entwickelt, um erweiterte Funktionen für digitale Überwachungssysteme bieten zu können. Die IP CamSecure ist in der Lage die vollständige Steuerung von Kameras zu ermöglichen und unterstützt alle LevelOne Kameras sowie andere namenhafte Kamerahersteller

IP CamSecure Pro Mega Series		IP CamSecure
Main Features		
Max # of Cameras Live View, Monitor and Record	FC5-94 04/08/16/25/36/64 4/8/16/25/36/64	FC5-9064 64
Multi-Vendor Support	ACTI / Arecont Vision / Atlantis Land / Axis / BASLER / D-Link / Etrovision / FINE / HIKVISION / IQinVision / JVC / Lumenera / Mobotix / Panasonic / Pixord / PLANET / Samsung / Sanyo / Sony / Toshiba / VIVOTEK / Zavio (*Please refer to the model official comparison list from LevelOne Website)	LevelOne
Multi-Language Embedded	Brazil, Bulgaria, Traditional / Simple Chinese, Czech, Danish, Dutch, English, Farsi, Finnish, French, German, Greek, Hebrew, Hungarian, Italian, Japanese, Korean, Norway, Polish, Portuguese, Romanian, Russian, Serbia, Slovak, Slovenian, Spanish, Swedish.	
Hybrid Camera Management	Monitor IP digital and CCTV analog cameras in one surveillance system	
Multiple Monitor display	Up to 3 monitor	Up to 2 monitor
E-Map	Up to 10 layers	Up to 2 layers
Smart Guard	Events triggered by general motion detection, missing/ foreign object detection, signal lost, camera occlusion, lose focus, external input or system status	No
Motion Detection	Camera-based motion detection with image exclude filter for image areas of no interest in specific period status	
Smart Search	Search unusual events with specific parameters from recorded video	General Motion Only
Alarm Notification	Play sound, send emails, PoP up E-MAP on event, make phone calls, P/T/Z PRESET GO, Signal digital output, Send a SMS message, Send Snapshot to FTP/Email, on screen display and instant recording.	Instant recording
Counting Application	Count how many times objects move between different locations	No
Video Compression	MJPEG / MPEG4 / H.264	
Audio	Support full duplex real time audio	
User Account	Multiple user authentication levels with password restriction rules for unlimited users	
Log Viewer	All unusual events ,system events by date/time and/or cameras	
Recording	Continuous recording, manual recording/snapshot, record by schedule, record by digital input or triggered event, and record moving only (pre/post record buffer is up to 60 seconds).	
3GPP	**Monitor in 3G mobile devices which are equipped with 3G video playback.	No
Digital Watermark	Yes	No
DDNS	Support DtDNS and Dynu.	No
UPnP	Search for IP cameras via UPnP	
Playback		
Simultaneously Playback	16-CH	1-CH
Image Enhancer	Improve recorded video to get better image during playback and can be applied during export	
Search for Recordings	Search for recordings based on date, time or specific video parameters	Search for motion in continuous recordings
Playback	Controllable speed 1/16x~16x or frame by frame	
Video Clip Export	Export single BMP/JPEG/GIF/PNG/TIFF images to file or printer; Export video in AVI	
P/T/Z and I/O		
Pan/Tilt/Zoom Support	Control of P/T/Z cameras and preset positions	
Preset Patrolling	Multiple cameras patrolling	
Go to Preset on Event	Yes	No
Input/Output Control	Support digital input/output control	
Remote Access via Remote Client Software		
Remote Client Service	Remote Live Viewer/ Remote Playback	Remote Live Viewer/Remote Playback
Pan/Tilt/Zoom Support	Control of P/T/Z cameras	
Max # of Cameras Live View	Up to 16-CH from different servers	1-CH remote live view
Max # of Cameras Playback	Up to 16-CH	1-CH remote live view
PDA / Smart Phone Client (WM 5.0 or above)	Up to 16-CH, 1-CH live display; P/T/Z and I/O control	1-CH remote live view
Remote Access via Web Browser		
PC/NB IE Browser	Up to 4-CH live view and play back	1-CH / No support Playback
iPhone safari	Up to 16-CH, 6-CH live display and play back	1-CH remote live view
Remote Access via Apps		
iOS	Up to 16-CH, 6-CH live display and P/T/Z	1-CH remote live view
Android	Up to 16-CH, 6-CH live display and P/T/Z	1-CH remote live view
Minimum System Requirements****		
CPU	Intel Core 2 Quad Q9400, Intel Core I5, Intel Core I7	Intel core 2 Duo E5300
RAM	2GB above	
Display	ATI Radeon 4650, nVIDIA GeForce GF-9600, Intel 945G/965G, or above (ATI recommended)	1GB
OS	Windows XP / Server 2003 / Vista / 7	
*Please visit www.level1.com for the compatible product list.		
**This feature depends on the mobile telecom service provided and the mobile phone model. LevelOne does not guarantee that this feature will work in all countries.		
***The specification is subject to change. Please visit www.level1.com for the latest specification. Users can upgrade IP CamSecure Lite(older version) to IP CamSecure(v1.26)		
****Overall hardware resource requirement depends on camera stream setting and software feature definition		

FCS-94xx (H/W: V1.26.1) Überwachungs-Software

- Überwachung von bis zu 64 Kanälen gleichzeitig
 - Dualer Monitor Unterstützt Live-Ansicht und Wiedergabe gleichzeitig Reaktion zur Überwachung größerer Bereiche
 - "Smart search" zur leichten Auffindung von Aufnahmen und auch als Multi-Ereignis-Ansicht / -filter
 - Verbesserte Qualität der Videoaufnahme
 - "zählfunktion" zur Summenkontrolle von Gegenständen
 - Unterstützt Web-basiertes und 3G mobiles Fernüberwachung
 - Komplettes System- und Ereignislogbuch
 - Stützt sich auf Festplatten-Speicherung statt auf Videobänder
 - Broadcast Live-Video über das Internet zur Fernansicht
 - Unterstützt digitale und analoge Kameras in einen System
 - Kontrolliert P/T/Z-Funktionen der Kameras
- * Für LevelOne Kameras, Capture Karten und Videoserver. Es werden auch andere Netzwerk Kameras Unterstützt.



IP CamSecure Pro Mega Series	
Model name	FCS-94 04/08/16/25/36/64
Simultaneous Monitoring	4/8/16/25/36/64
Camera Support	
LevelOne	FCS-0010, FCS-0020, FCS-0030, FCS-0031, FCS-0040, FCS-1010, FCS-1030, FCS-1040, FCS-1050, FCS-1060, FCS-1070, FCS-1081, FCS-1081A, FCS-1091, FCS-1101, FCS-1121, FCS-1131, FCS-1141, FCS-1151, FCS-3000, FCS-3021, FCS-3031, FCS-3051, FCS-3052, FCS-3061, FCS-3071, FCS-3081, FCS-3091, FCS-4010, FCS-4020, FCS-4041, FCS-4x00, FCS-5011, FCS-5030, FCS-5041, FCS-5051, FCS-5052, FCS-5061, FCS-6010, FCS-7011, WCS-0010, WCS-0020, WCS-0030, WCS-0040, WCS-1090, WCS-2010, WCS-2010, WCS-2030, WCS-2040, WCS-2060, WCS-2070
ACTI	ACD2000Q, ACD2100, ACD2200, ACD2300, ACD2400, ACM1011, ACM1231, ACM1232, ACM1311, ACM1431, ACM1432, ACM1511, ACM3001, ACM3011, ACM3211, ACM3311, ACM3401, ACM3411, ACM3511, ACM4000, ACM4100, ACM4200, ACM4201, ACM5001, ACM5601, ACM5611, ACM5711, ACM7411, ACM8201, ACM8211, ACM8511, CAM5130, CAM5140, CAM5150, CAM5200, CAM5201, CAM5221, CAM5300, CAM5301, CAM5321, CAM5500, CAM6100, CAM6200, CAM6220, CAM6500, CAM6510, CAM6520, CAM6600, CAM6610, CAM6620, CAM6630, CAM7100, CAM7120, CAM7200, CAM7220, CAM7300, CAM7301, CAM7320, CAM7321, CAM7322, SED2100, SED2120, SED2140, SED2310Q, SED2320Q, SED2400, SED2420, SED2600, SED2610, SEM1110, TCM4301, TCM5311
Arecont Vision	AV1300, AV1305, AV1355, AV2000, AV2100, AV2105, AV2155, AV3100, AV3105, AV3130, AV3155, AV5100, AV5105, AV5155, AV8180, AV8185, AV8360, AV8365
Atlantis Land	A02-OIPCAM1, A02-OIPCAM2, A02-OIPCAM3, A02-IPCAM5, A02-IPCAM6, A02-IPCAM7, A02-IPCAM8, A02-IPCAM9, A02-IPCAM10, A02-IPCAM11, A02-IPCAM12, A02-IPCAM13, A02-IPCAM14, A02-IPCAM15, A02-IPCAM16, A02-IPCAM17
AXIS	205, 206, 206M, 206W, 207, 207MM, 207W, 209FD, 209FD-R, 209MFD, 209MFD-R, 210, 210A, 211, 211A, 211M, 211W, 212, 213, 214, 215, 216FD, 216FD-V, 216MFD, 216MFD-V, 221, 223M, 225FD, 231D, 231D+, 232D, 232D+, 233D, 240Q, 240Q, 241Q, 241Q, 241S, 241SA, 242S, 243Q, 243SA, 247S, 246Q, M1011, M1011-W, M1031-W, M3011, M3014, P1311, P1343, P1344, P3301-V, P3343, P3343-V, P3343-VE, P3344, P3344-V, P3344-VE, Q1755, Q6032-E, Q7401, Q7404, Q7406
BASLER	BIP-640C, BIP-640C-DN, BIP-1000C, BIP-1000C-DN, BIP-1300C, BIP-1300C-DN, BIP-1600C, BIP-1600C-DN
D-Link	CS-6620, DCS-6620G, DCS-5220, DCS-5300, DCS-5300G, DCS-2120, DCS-3420, DCS-3220, DCS-3220G, DCS-2100, DCS-2100G, DVS-104, DVS-301, DCS-900, DCS-6900, DCS-910, DCS-920, DCS-950, DCS-950G, DCS-3110, DCS-3410, DCS-3415, DCS-5220(TW), DCS-5610, DCS-6110, DCS-6111
ETROVISION	EV3130AW, EV3130A, EV3131, EV3830H/HP, EV6130W, EV6130P, V6131HW, EV6131H/HP, EV6132A, EV6230A, EV6332, EV6333A, EV6530, EV6531A, EV6532A
FINE	TCP-690, TCP-690DN, TCP-HP930, WB-8211SD, WB-8411, CDV-3V930, TCP-690U, TCP-HP930U, WB-8211SDU, CDV-3V930U, EP-936, EP-908, EP-601, EP-201, EP-221, EP-221DN, MD-D1200, TCP670DNU, TCP680DNU
HIKVISION	DS-2DF1, DS-2CD852MF-E, DS-2CD802PF, DS-2CD802NF, DS-2CD812PF, DS-2CD812NF, DS-2CD832PF, DS-2CD832NF, DS-2CD892PF, DS-2CD892NF, DS-2CD802PF-E, DS-2CD802NF-E, DS-2CD812PF-E, DS-2CD812NF-E, DS-2CD832PF-E, DS-2CD832NF-E, DS-2CD892PF-E, DS-2CD892NF-E, DS-2CD812PF-IR1, DS-2CD812NF-IR1, DS-2CD832PF-IR1, DS-2CD832NF-IR1, DS-2CD892PF-IR1, DS-2CD892NF-IR1, DS-2CD812PF-IR3, DS-2CD812NF-IR3, DS-2CD832PF-IR3, DS-2CD832NF-IR3, DS-2CD892PF-IR3, DS-2CD892NF-IR3, DS-2CD702PF, DS-2CD702NF, DS-2CD712PF, DS-2CD712NF, DS-2CD732PF, DS-2CD732NF, DS-2CD792PF, DS-2CD792NF, DS-2CD702PF-FB, DS-2CD702NF-FB, DS-2CD712PF-FB, DS-2CD712NF-FB, DS-2CD732PF-FB, DS-2CD732NF-FB, DS-2CD792PF-FB, DS-2CD792NF-FB, DS-6101HFI-IP, DS-2CD852MF-E, DS-2CD752MF-E, DS-2CD752MF-FB, DS-2CD752MF-FH, DS-2CD862MF-E, DS-2CD762MF-E, DS-2CD762MF-FH, DS-2CD762MF-FB(Hs), DS-2CD812P(N)-IR5, DS-2CD832P(N)-IR5, DS-2CD892P(N)-IR5, DS-2CD852F, DS-2CD752F-E
IQinvision	IQeye301, IQeye301m, IQeye301w, IQeye302, IQeye302w, IQeye303, IQeye303w, IQeye501, IQeye510, IQeye511, IQeye601, IQeye602, IQeye603, IQeye701, IQeye702, IQeye703, IQeye705, IQeye751, IQeye752, IQeye753, IQeye755, IQA255, IQQ425, IQeye855
JVC	VN-C20U, VN-E4(U), VN-C205U, VN-C215U, VN-C655U
Lumenera	le045c, le045c-dn, le075c, le075c-dn, le11059c, le165c, le165c-dn, le175c, le175c-dn, le259c, le275c, le275c-dn, le375c, le375c-dn, li165c
MOBOTIX	D12D-IT, D12D-Sec, D22M-Basic, D22M-IT, D22M-Sec, M10D, M12D-IT, M12D-Sec, M12D-Web, M22M-IT, M22M-Sec, Q22M-Basic, Q22M-Sec, Q24-Basic, Q24-Sec
Panasonic	BB-HCE481, BB-HCM311, BB-HCM331, BB-HCM371, BB-HCM381, BB-HCM403, BB-HCM511, BB-HCM515, BB-HCM527, BB-HCM531, BB-HCM581, BB-HCS301, BL-C1, BL-C10, BL-C111, BL-C131, BL-C20, BL-C30, BL-C101A, BL-C121A, BL-C160, KX-HCM110, KX-HCM280A, DG-NF284, DG-NF302, DG-NP240, DG-NP244, DG-NP304, DG-NS202A, DG-NS202A, DG-NS950, DG-NS954, DG-NW960, DG-NW964, WJ-NT304, WJ-NT314, WV-NF284, WV-NF302, WV-NM100, WV-NP1000, WV-NP1004, WV-NP240, WV-NP244, WV-NP304, WV-NP472, WV-NP502, WV-NS202, WV-NS202A, WV-NS324, WV-NS950, WV-NS954, WV-NW484, WV-NW502S, WV-NW960, WV-NW964
PIXORD	100, 120/126/128, 200/206, 201, 205, 207, 240, 241, 261, 262, 263, 300, 400/42X, 461, 463, 1000, 1401, 2000, 4000, 405, 410, 405M, 411/412, 415M, 416
PLANET	ICA-510, ICA-700, ICA-151W, ICA-151, ICA-750, ICA-107W, ICA-107P, ICA-107, ICA-108, ICA-108W, ICA-120, ICA-230, ICA-230W, ICA-230P, ICA-M230, ICA-310, ICA-310W, ICA-312, ICA-312v2, ICA-350, ICA-350-V2, ICA-501, ICA-525, ICA-530, ICA-651, ICA-601, IVS-110
SAMSUNG	SCC-C6475, SNC-B2315, SNC-B5395, SNC-B2331, SNC-B2335, SNC-B5368, SNC-B5399, SNC-C6225, SNC-C7225, SNC-C7478, SNC-M300
SANYO	VCC-HD4000, VCC-HD4000P, VDC-DP9585P, VDC-DP9584N, VCC-9800P, VCC-9800NA, VCC-ZM600N
SONY	SNC-CM120, SNC-CS10, SNC-CS11, SNC-CS20, SNC-CS3, SNC-CS50, SNC-DF40, SNC-DF50, SNC-DF70, SNC-DF80, SNC-DF85, SNC-DM110, SNC-DM160, SNC-DS10, SNC-DS60, SNC-P1, SNC-P5, SNC-RX530, SNC-RX570, SNC-RX570, SNC-RZ25, SNC-RZ30, SNC-RZ50, SNC-Z20, SNT-V704
TOSHIBA	IK-WB02A, IK-WR01A, IK-WB21A, IK-WB15A
VIVOTEX	FD61x1, FD61x2, FD7130, FD7131, FD7132, FD7141, FD7160, IP21x1, IP21x2, IP3132, IP3133, IP3135, IP3135-PLNK, IP3136, IP3136-PLNK, IP3137, IP31x1, IP31x1TLFN, IP31x2, IP31x7, IP51x2, IP51x4, IP6114, IP6124, IP61x2, IP61x4, IP61X7, IP7130, IP7131, IP7132, IP7133, IP7134, IP7135, IP7137, IP7138, IP7139, IP7142, IP7151, IP7152, IP7153, IP7154, IP7160, IP7161, IP71x7, IP7251, IP7330, IP7361, IZ7151, PT3134, PT31x2, PT31x3, PT31x4, PT31x7, PT7000, PT7135, PT7137, PZ61x2, PZ61x4, PZ7131, PZ7151, PZ7152, PZ71X1, PZ71X2, SD61x2, SD7151, SD73X3, TC5330, TC5331, VS2101, VS2401, VS2402, VS2403, VS3100, VS3101, VS3102, VS3102-XLTH, VS7100
ZAVIO	B5110, B6110, D510E, D520E, D610A, D6111, D611E, F210A, F3100, F3105, F312A, F5100, F5105, F510E, F510W, F5110, F5115, F511E, F511W, F520E, F521E, F531E, F610A, F611E, F721A, F731E, M510E, M510W, M511E, M511W, P5110, P5115, V111T

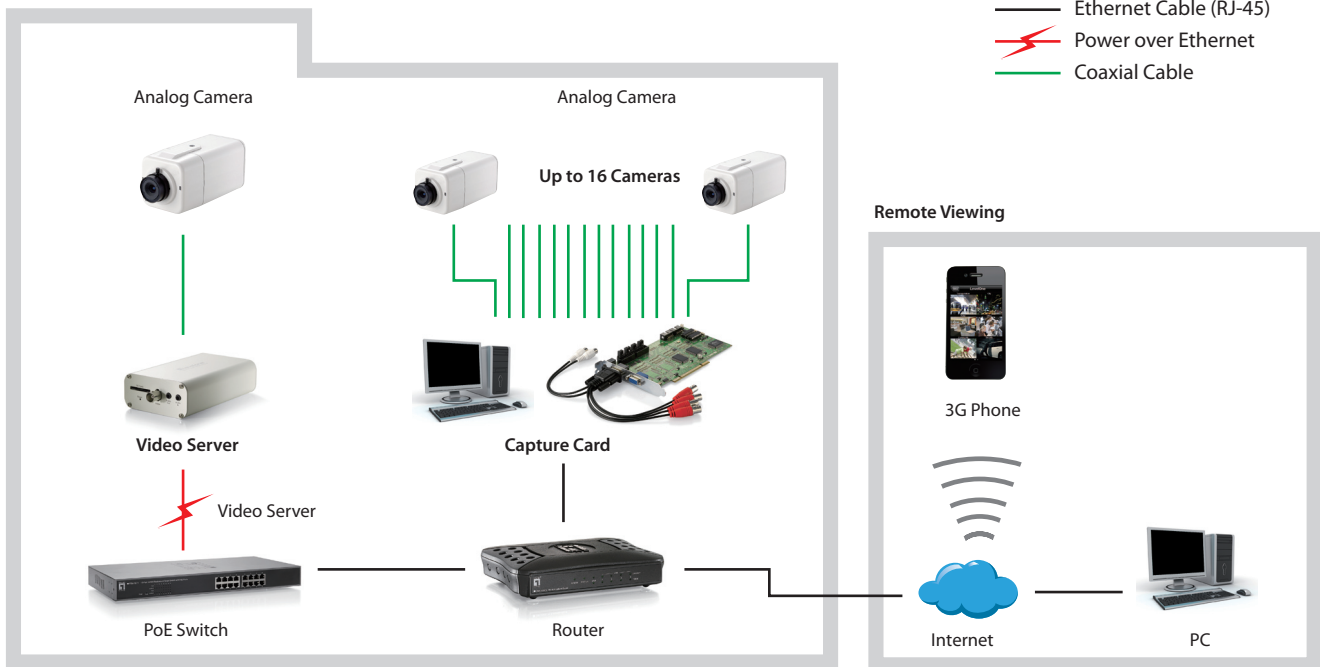

ONVIF



FCS-711

1-Port H.264 PoE Video Server

- Bis zu 30 fps in D1 Auflösung
- Echtzeit H.264, MPEG-4 und MJPEG Kompression (Triple Codec)
- Multiple Streams gleichzeitig
- Kompatibel mit 802.3af PoE
- 2-Wege Audio via SIP-Protokoll
- HTTPS-verschlüsselte Datenübertragung
- IEEE 802.1x port-basierte Authentifizierung zur Netzwerksicherheit
- Digitaler I/O für externe Sensoren und Alarm
- RS-485 Schnittstelle für Scanner, Pan/Tilt
- Eingebauter SD/SDHC-Kartensteckplatz für On-board Speicherung
- Kostenlose Software ist im Lieferumfang enthalten (64-Kanal IP CamSecure™ Software)



FCS-8005

4-Kanal Analoge Kamera Capture Card

- Integriert analoge und digitale Kameras in ein einziges, optimiertes Überwachungssystem.
- Unterstützt 4 analoge Kameras
- Fortschrittliche Motion Detection und Alarmfunktionen
- Bis zu 120(NTSC)/100(PAL) frames per second
- Hochwertige Video-Auflösung bis zu 704x480(NTSC)/704x576(PAL)
- 4 Audio-Eingangsports
- Software-Kompression H.264 (IP CamSecure v1.28 oder höher)
- Kostenlose 64-Kanal Überwachungs-Software (unterstützt iCamSecure Apple App und iOS Safari)
- Unterstützt MS Windows XP/Vista/Server



FCS-8006

16-Kanal Analog Kamera Capture Card

- Integrieren Sie bis zu 16 analoge Überwachungskameras in ein modernes digitales Überwachungssystem
- Bietet Bewegungserkennung (Motion Detection) und Alarmfunktionen
- Insgesamt bis zu 120 (NTSC) / 100 (PAL) fps
- Maximale Auflösungen: 704x480 (NTSC) / 704x576 (PAL)
- 4x Audio-Eingang
- MPEG4 Kompressionsmodus
- Inklusive kostenfreier IP 64-Kanal IP CamSecure Lite Überwachungs-Software

Die LevelOne Netzwerk Video Rekorder (NVR)-Serie ist kompatibel mit LevelOne Kameras sowie mit Kameras anderer namenhafter Hersteller. Die NVR-Serie bietet kosteneffiziente Überwachungslösungen und ermöglicht z.B. die Liv-Aufnahme von Ereignissen, die Live-Wiedergabe von Netzwerk Kameras über das Netzwerk, sogar über das Internet. Es werden keinerlei Hardware oder weitere spezielle Softwarelösungen benötigt. Einfach zu installieren, schnell, flexible und leistungsstark können bis zu 16 Kameras mit einem NVR verwaltet und überwacht werden. Mit einer zusätzlichen (kostenfreien) CMS Software können bis zu 16 NVR-Geräte verwaltet und zentral administriert werden.



Key Features

- Zwei 3.5" Festplatten-Slots (SATA I oder SATA II)
- Gigabit Ethernet (1000 Mbps) Geschwindigkeiten
- Kompression: MJPEG / MPEG-4 (Teil 2) / H.264
- Unterstützt PTZ / Preset Point / Preset Sequence
- Auflösung: HD / MegaPixel / FD1 / CIF / QCIF
- Export und Wiedergabe der Videos in AVI
- Unterstützt vorprogrammierte Aufnahmen, 2-Wege-Audio, externe UPS und DI/DO
- Smart Camera Search und Anzeige auf mobilen Geräten
- Kostenfreie NVR Management-Software zur Verwaltung von bis zu 16 NVR-Geräten enthalten



NVR-0204
4-Kanal Netzwerk Video Rekorder



NVR-0208
8-Kanal Netzwerk Video Rekorder



NVR-0216
16-Kanal Netzwerk Video Rekorder

Netzwerk Video Rekorder Übersicht			
Model	NVR-0204	NVR-0208	NVR-0216
Max. Channel	4	8	16
Full/Split Screen	1/4	1/4/8	1/4/8/16
Monitoring	Live View/Playback	Live View/Playback	Live View/Playback
Frame Rate	120 fps	240 fps	480 fps

	Network Video Recorders
Model name	NVR-0104/NVR-0204/NVR-0208/NVR-0216
Monitoring camera	4/4/8/16
Camera Support	
LevelOne	FCS-0010, FCS-0020, FCS-0030, FCS-0031, FCS-0040, FCS-1010, FCS-1030, FCS-1040, FCS-1050, FCS-1060, FCS-1070, FCS-1081, FCS-1081A, FCS-1091, FCS-1101, FCS-1121, FCS-1131, FCS-1141, FCS-1151, FCS-3000, FCS-3021, FCS-3031, FCS-3051, FCS-3052, FCS-3061, FCS-3071, FCS-3081, FCS-3091, FCS-4010, FCS-4020, FCS-4041, FCS-4x00, FCS-5011, FCS-5030, FCS-5041, FCS-5051, FCS-5052, FCS-5061, FCS-6010, FCS-7011, WCS-0010, WCS-0020, WCS-0030, WCS-0040, WCS-1090, WCS-2010, WCS-2010, WCS-2030, WCS-2040, WCS-2060, WCS-2070
Abus	TV7240, TV7230, TV7203, TV7204, TV7206, TV7220, TV7221, TV7222, TV7223
ACTi	ACM1011, ACM1511, ACM1231, ACM1232, ACM3011, ACM3401, ACM3411, ACM3511, ACM4000, ACM4001, ACM4200, ACM4201, ACM5601, ACM5611, ACM7411, ACD2100, ACD2200, ACD2300, ACD2400, TCM-5311, CAM-6610, CAM-6630, CAM-6510, CAM-7301, CAM-7321, CAM-7322, ACM-8201
ALinking	9122/9122p, 9751/9751w, 9852/9852w, 9451, 9351, 9551, 9552, 9553, 9152, 9652, ALC-9272, ALC-9171, ALC-9153, ALC9371, ALS-7721
A-MTK	AM91xxM, AM92xxM, AM93xxM, AM95xxM, AM96xxM, AM97xxM, AM98xxM, AM90xxM, AM93xx, AM95xx, AM96xx, AM97xx, AM99xx, AM62xx, AM31xM, AM32xM, AM36xM, AM30xx, AM31xx, AM32xx, AM35xx, AM36xx, AM37xx, AM38xx, AM39xx, AM61xx
Arecont Vision	AV1300, AV1305, AV1355, AV2100, AV2105, AV2155, AV3100, AV3105, AV3155, AV3130, AV5100, AV5105, AV5155, AV8180, AV8185, AV8360, AV8365
AVTech	AVI-201, AVI-202, AVI-203, AVN-211, AVN-212, AVN-222, AVN-244, AVN-252, AVN-263, AVN-284, AVN-362
AXIS	All dual-stream and H.264 capable cameras
BrickCom	CB-100Ae-08 (VGA), WCB-100Ae-08 (VGA), CB-100Ae-08, WCB-100Ae-08, CB-101Ae-00, CB-102Ae-00, CB-100Ap-0c, WCB-100Ap-0c, CB-101Ap-04, CB-102Ap-04, FB-100Ae, WFB-100Ae, FB-100Ap, WFB-100Ap, FB-130Ap, WFB-130Ap, FB-130Np, WFB-130Np, FB-300Ap, WFB-300Ap, FD-100Ae, FD-100Ap, FD-130Ap, MD-100Ae, MD-100Ap, OB-100Ae, WOB-100Ae, OB-100Ap, WOB-100Ap, GOB-100Ap, OSD-040D/E 36xp, PZ-040D/E 12xp, VD-100Ae, VD-100Ap, VD-130Ap, VS-04A
Canon	VB-C300, VB-C60, VB-C500D
D-Link	DCS-2102, DCS-2121, DCS-3410, DVS-N3010, DVS-N3014, DVS-N3040, DVS-N3044, DCS-N3530, DCS-N3531, DCS-N3534, DCS-N5440, DCS-N5442, DCS-N5444, DCS-N6240, DCS-N6241, DCS-N6244, DCS-N2100, DCS-N2104, DCS-N40-20H2, DCS-N40M-32H2, DCS-N40M-33H2, DCS-N30-10H2
Etrovision	EV6150, EV6150A, EV6151A, EV6153A, EV6551A, EV6552A, EV6353A, EV6250A, EV3850A, EV3151A, EV3151, EV3150A, EV8180A, EV8580U-C, EV8180U
Hunt	All
IQinvision	WL-2000CAM, POE-100CAM, POE-200CAM, OD-300CAM, POE-100CAMv2, POE-200CAMv2, WL-2600CAM, POE-260CAM, WL-350HD, POE-200HD, OD-600HD, POE-250HD, OD-325HD, POE-100HD
Mobotix	M12, M22, D12, D24
Panasonic	BL-C1, BL-C10, BL-C20, BL-C30, BL-C111, BL-C131, BB-HCS301, BB-HCM100, BB-HCM110, BB-HCM311, BB-HCM331, BB-HCM371, BB-HCM381, KX-HCM110, KX-HCM280A, BB-HCM403, BB-HCE481, BB-HCM511, BB-HCM527, BB-HCM531, BB-HCM547, BB-HCM515, BB-HCM580, BB-HCM581, BB-HCM715, BB-HCM715, BL-C210A, BB-HCM701CE, BB-HCM705CE, BB-HCM735CE, WV-NP1004, WV-NP244, WV-NS202, WV-NF284, WJ-NT304, WV-NW484S, WV-NS202A, WV-NS954, WV-NW964, WJ-NT314, WV-NF302, WV-NP304, GXE-500, WV-NP502, WV-SF336, WV-SP305, WV-NW502S, WV-SP105, WV-SC385, WV-SP102, WV-SP306, WV-SF335, WV-SP336, WV-SP305, WV-NW502S, WV-SP105, WV-SC385, WV-SP102, WV-SP306, WV-SF335
Pixord	P600
Sony	SNC-CS10, SNC-CS11, SNC-CS20, SNC-CS50, SNC-DF40, SNC-DF50, SNC-DF70, SNC-DF80, SNC-DS10, SNC-DS60, SNC-P1, SNC-P5, SNC-RZ25, SNC-RZ50, SNC-RX530, SNC-RX550, SNC-RX570, SNC-CM120, SNC-CS20, SNC-DM110, SNC-DM160, SNC-DS10, SNC-DS60, SNC-RH124, SNC-RH164, SNC-RS46, SNC-RS44, SNC-RS86, SNC-RS84, SNT-EX101, SNT-EX104, SNT-EX154, SNT-EP104, SNT-EP154, SNC-CH140, SNC-CH210, SNC-CH240, SNC-DH140, SNC-DH140T, SNC-DH180, SNC-DH240, SNC-DH240T, SNC-DF85, SNC-CH220, SNC-DH220 / T, SNC-CH160, SNC-DH160, SNC-CH280, SNC-DH280, SNC-CH260, SNC-DH260, SNC-DH210 / T, SNC-CH120, SNC-DH120 / T, SNC-CH180, SNC-CH110, SNC-RH164, SNC-RH124
Toshiba	IK-WD01A, K-WB70A
Vivotek	IP7131 (V1), IP7132 (V1), IP7135 (V1), IP7137 (V1), PT7135 (V1), PT7137 (V1), IP7130, IP7133, P7134, IP7142, IZ7151, IP7153, IP7154, IP7160, IP7161, IP7251, IP7330, PZ7111, PZ7112, PZ7121, PZ7122, PZ7131, PZ7132, PZ7151, PZ7152, PT7135, FD7131, FD7132, FD7141, FD7141V, FD7151, SD73x3, IP8161, VS2403, IP8151, IP8330, IP8332, FD8361, FD8161, FD8134, VS8102, SD8121, MD7560, IP7361, IP8133, IP7361, IP7160
Zavio	F210A, F312A, F611E, F510E/W, F511E/W, F520E, F610A, D611E, D510E, M511E/W, M510W/W, D520E, F731E, F721A, F521E, V111T, F3105, D6111, F3100, F3105, F5100, F5105, F5115, D5111, F7110, F7210, F531E, F3206, F7110, F7210

LevelOne Digital Signage Lösungen bieten eine Fülle an Audio/Video-Extendern und bieten dem Nutzer somit die Möglichkeit auf individuelle Anforderungen des Kunden eingehen zu können. Unterstützt werden HDMI, VGA, DVI Anschlüsse. Zusätzliche Funktionen wie PoE über Cat.5 Kabel und ip basierte Lösungen runde das Paket ab.

HDMI over IP Distribution Solution

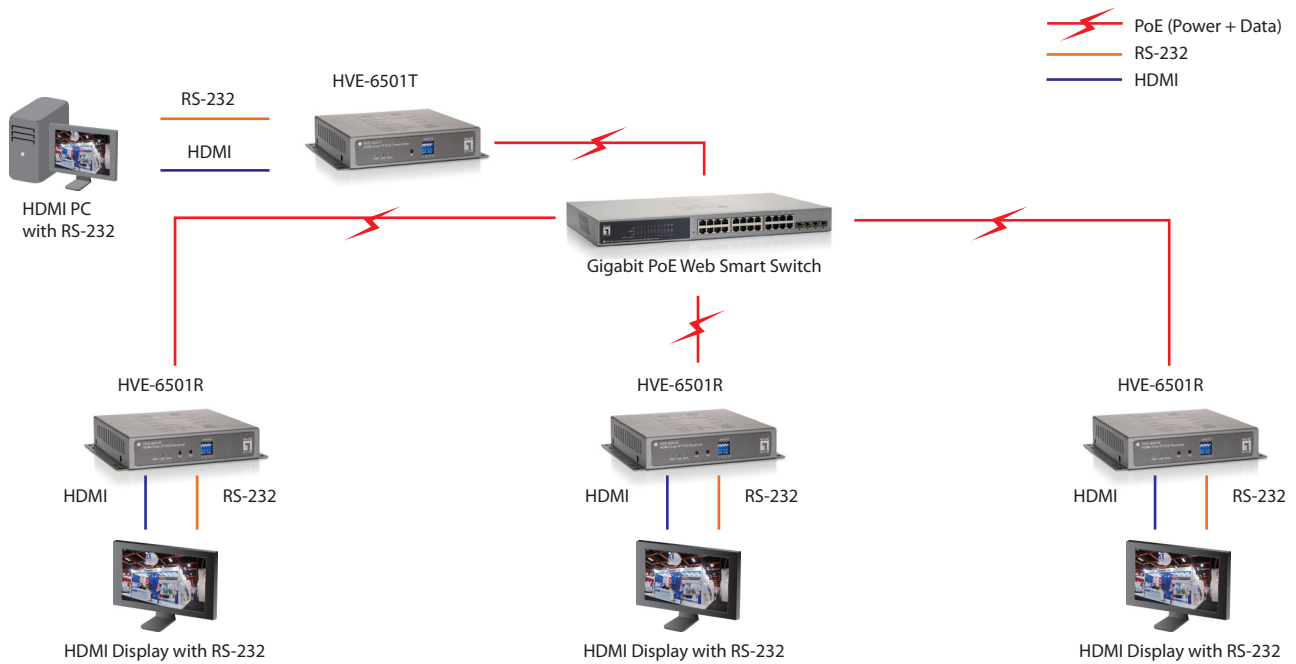

HDMI over IP

- Kompatibel mit IEEE-802.3af
- Plug and Play Installation, automatisches Erkennen von Sender und Empfänger im selben Netzwerk
- Multi-Cast Gruppen mit Gigabit Switch (erfordert IEEE-802.1Q VLAN & IGMP Funktion)
- Unterstützt Point-to-Point, Point-to-Many, Many-to-Many Verbindungen
- Bis zu 16 Sender und bis zu 200 Empfänger in einer Lösung möglich (HVE-6501T/HVE-6501R)
- Bis zu 9 Sender und bis zu 81 Empfänger in einer Lösung möglich (HVE-6601T/HVE-6601R)



HVE-6501T / HVE-6501R
HDMI over IP PoE Transmitter / Receiver



HVE-6601T / HVE-6601R
HDMI Video Wall over IP PoE Transmitter / Receiver

HDMI over IP Übersicht				
Model	HVE-6501T	HVE-6501R	HVE-6601T	HVE-6601R
Transmitter / Receiver / Repeater	Transmitter	Receiver	Transmitter	Receiver
HDMI Input	1	-	1	-
HDMI Output	-	1	-	1
Ethernet Port	1 x 10/100/1000Mbps	1 x 10/100/1000Mbps	1 x 10/100/1000Mbps	1 x 10/100/1000Mbps
Resolution	1080p	1080p	1080p	1080p

HDMI over Cat5

- Distanzen von bis zu 60m für 1080i oder 40m für 1080p
- Einfache Installation ohne weitere Software
- Flexibles Audio-/Video Broadcasting von Digital Signage Inhalten in verschiedenen Locations möglich
- HDMI 1.3 Ermöglicht das ansteuern von bis zu 200 Displays
- HDMI 1.3c konform



HVE-9001
HDSpider™ Long Range Cat.5
HDMI Sender



HVE-9002/HVE-9003
HDSpider™ HDMI Cat.5 Sender
(kaskadierbar-HVE-9003)



HVE-9004
HDSpider™ 4-Port Cat.5 HDMI Sender



HVE-9008
HDSpider™ 8-Port Cat.5 HDMI Sender



HVE-9000
HDSpider™ Long Range Cat.5
HDMI Receiver



HVE-9900
HDSpider™ Short Range Cat.5
HDMI Receiver

HDMI over Cat.5 Übersicht						
Model	HVE-9001	HVE-9002/HVE-9003	HVE-9004	HVE-9008	HVE-9000	HVE-9900
Transmitter /Receiver/ Repeater	Transmitter	Transmitter	Transmitter	Transmitter	Receiver	Receiver
RJ-45 Input	-	- / 1	-	-	1	1
RJ-45 Output	1	1	4	8	-	-
HDMI Input	1	1 / -	1	1	-	-
HDMI Output	-	1	-	1	1	1
Audio Support	V	V	V	V	V	V

HVE-0201

HDMI Extender über Glasfaser

- Bietet Übertragung von HDMI-Signalen über Glasfaserkabel bis zu 200m
- Bietet hohe Auflösung von 1920x1200
- Komplette HDCP/CEC fähig, keine Kupferverdrahtung notwendig
- Glasfaserverbindung arbeitet ohne RF-Interferenzen
- Kompatibel mit Class 1 Laser Produkt mit EN 60825-1

Multi-mode Fiber
 HDMI Cable

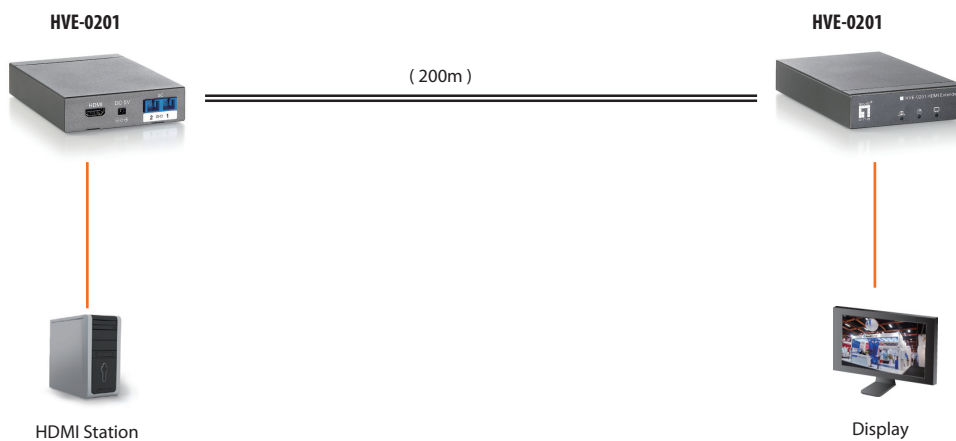

A/V (DVI) over Cat5

- Einfache Installation ohne weitere Software
- Flexibles Audio-/Video Broadcasting von Digital Signage Inhalten in verschiedenen Locations möglich



ADE-8011
Audio Transmitter/Receiver



ADE-8201
Single-Port DVI Transmitter



ADE-8202
2-Port DVI Broadcaster mit Audio



ADE-8204/ADE-8208
4/8 -Port DVI Broadcaster mit Audio



ADE-8001
Short Range DVI-D Receiver





ADE-8002
Long Range DVI-D Receiver

A/V (DVI) over Cat5 Übersicht						
Model	ADE-8011	ADE-8201	ADE-8202	ADE-8204/ADE-8208	ADE-8001	ADE-8002
Transmitter /Receiver/ Repeater	Transmitter /Receiver	Transmitter	Transmitter	Transmitter	Receiver	Receiver
RJ-45 Input	-	-	-	-	1	1
RJ-45 Output	-	1	2	4 / 8	-	-
RJ-11 Input	1	-	-	-	-	-
RJ-11 Output	-	-	2	4 / 8	-	-
DVI Input	-	1	1	1	-	-
DVI Output	-	-	1	1	1	1
Resolution	-	1024 x 768	1024 x 768	1024 x 768	1024 x 768	1024 x 768
Audio Support	V	V	V	V	V	V
Distance	100m	15m/70m@1024x768 with ADE-8001/8002			15m@ 1024 x 768	35m@ 1920 x 1200
Optional Accessories	-	-	-	-	-	-

DVE-0500**DVI Extender über 4 optische Kabel (LC 500m)**

- Bietet Übertragung von digitalen DVI-Signalen über Glasfaserkabel bis zu 500m
- Bietet eine hohe Bildqualität
- Unterstützt VGA-, SVGA-, XGA-, SXGA- und UXGA-Auflösung
- Signal wird nicht durch elektrische Interferenzen beeinflusst
- Glasfaser hat eine niedrige Dämpfung wodurch große Entfernungen erreicht werden LC-Anschluss

 Multi-mode Fiber (2c)
 DVI Cable

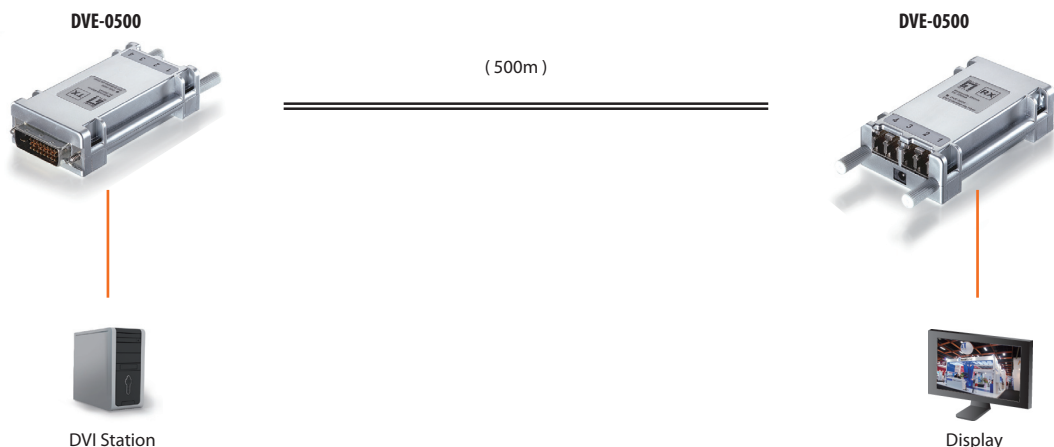

A/V (VGA) over Cat5

- VGA Cable
- AVC-0011
- Audio
- Cat.5/6/7

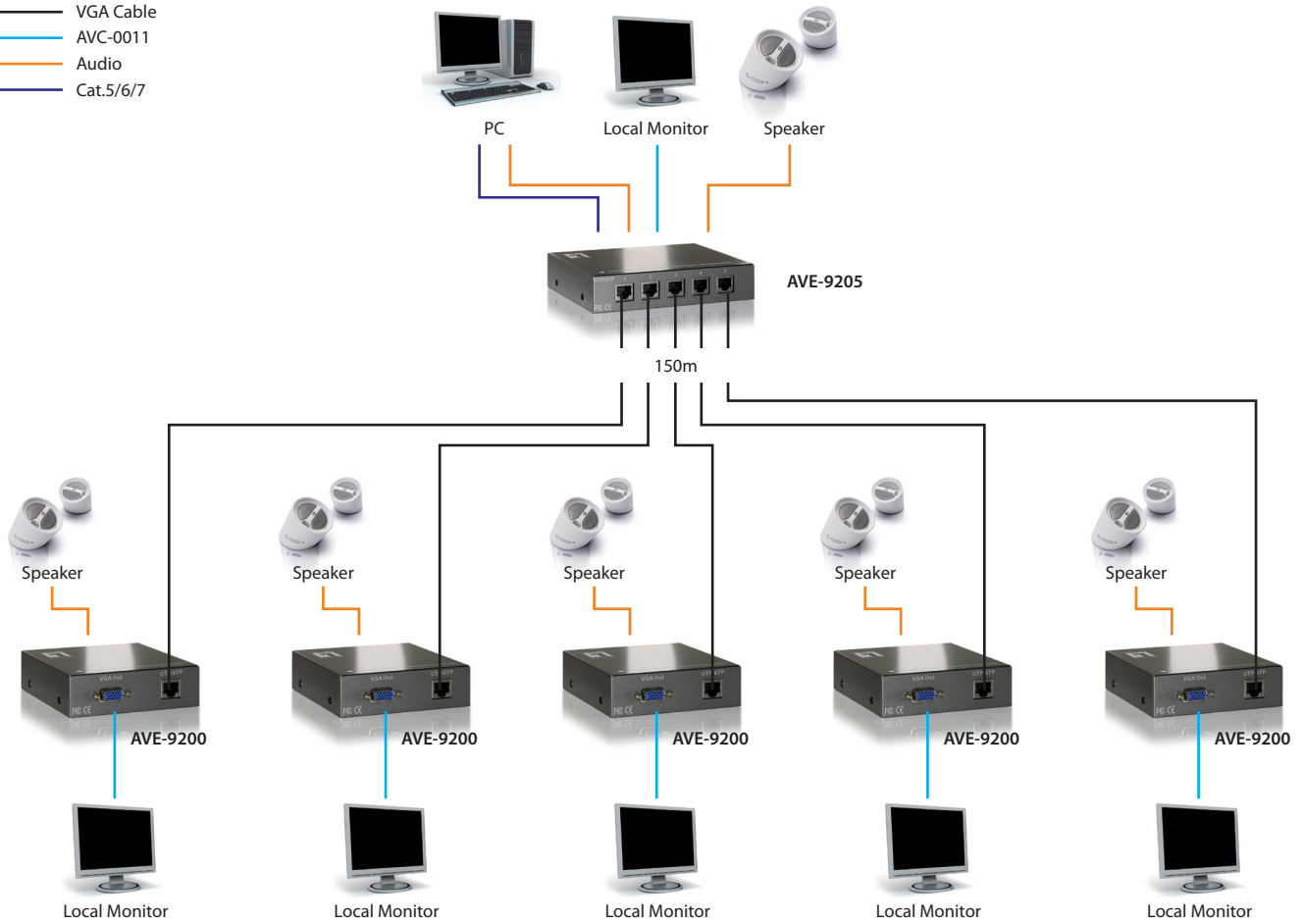

A/V (VGA) over Cat5 - (9200 Series)

- Einfache Installation ohne weitere Software
- Unterstützt Cat.5/5e/6 Ethernet Verkabelung
- SuperVGA Auflösung bis zu 1280 x 1024
- Flexibles Audio-/Video Broadcasting von Digital Signage Inhalten in verschiedenen Locations möglich
- Kompatibel mit DOS, MS Windows, Linux, Unix und Netware



AVE-9201
1-Port Cat.5 Audio/Video Broadcaster



AVE-9205
5-Port Cat.5 Audio/Video Broadcaster



AVE-9200
Cat.5 Audio/Video Receiver

VGA 9200 series Extender Übersicht			
Model	AVE-9201	AVE-9205	AVE-9200
Transmitter /Receiver	Transmitter	Transmitter	Receiver
VGA Input	1	1	-
VGA Output	1	1	1
RJ-45 Input	-	-	1
RJ-45 Output	1	5	-
Audio Support	V	V	V
Distance	150m	150m	150m

A/V (VGA) over Cat5 (9300 Series)

- Einfache Installation ohne weitere Software
- Unterstützt Cat.5 Ethernet Verkabelung
- Super VGA Auflösung bis zu 2048 x 1536
- Flexibles Audio-/Video Broadcasting von Digital Signage Inhalten in verschiedenen Locations möglich
- (AVE-9304/9308.9316) Können bis zu 3x kaskadiert werden (with AVE-9304A) um eine Distanz von bis zu 900m überbrücken zu können



AVE-9300
1-Port Cat.5 VGA Receiver



AVE-9301
1-Port Cat.5 VGA Transmitter



AVE-9304
4-Port Cat.5 VGA Transmitter



AVE-9308
8-Port Cat.5 VGA Transmitter



AVE-9316
16-Port Cat.5 VGA Transmitter



AVE-9304A
4-Port Cat.5 VGA Repeater

VGA 9300 Series Extender Übersicht			
Model	AVE-9300	AVE-9301	AVE-9304
Transmitter /Receiver/Repeater	Receiver	Transmitter	Transmitter
RJ-45 Input	1	-	-
RJ-45 Output	-	1	4
VGA Input/Output	1 x Output	1 x Input/Output	1 x Input/Output
Audio Support	V	V	V
Distance	300m	300m	300m
Optional Accessories	RCA-9018: 1.8m VGA to RCA cable (receiver to video display) YCC-9018: 1.8m VGA to YCBCR cable (receiver to video display, supports HD up to 720p) AVC-0010: 1m VGA + Audio cable (receiver to video display, VGA male to VGA female) AVC-0011: 1m VGA + Audio cable (receiver to video display, VGA male to VGA male)	RCA-9007: 0.7m RCA to VGA cable (video source to transmitter) YCC-9007: 0.7m YCBCR to VGA cable (video source to transmitter, supports HD up to 720p) VGA-0011: 1m Audio and Video cable (USB cable only)	RCA-9007: 0.7m RCA to VGA cable (video source to transmitter) YCC-9007: 0.7m YCBCR to VGA cable (video source to transmitter, supports HD up to 720p) VGA-0011: 1m Audio and Video cable

VGA 9300 Series Extender Übersicht			
Model	AVE-9308	AVE-9316	AVE-9304A
Transmitter /Receiver/Repeater	Transmitter	Transmitter	Repeater
RJ-45 Input	-	-	1
RJ-45 Output	8	16	4
VGA Input/Output	1 x Input/Output	1 x Input/Output	1 x Output
Audio Support	V	V	V
Distance	300m	300m	300M
Optional Accessories	RCA-9007: 0.7m RCA to VGA cable (video source to transmitter) YCC-9007: 0.7m YCBCR to VGA cable (video source to transmitter, supports HD up to 720p) VGA-0011: 1m Audio and Video cable	RCA-9007: 0.7m RCA to VGA cable (video source to transmitter) YCC-9007: 0.7m YCBCR to VGA cable (video source to transmitter, supports HD up to 720p) VGA-0011: 1m Audio and Video cable	RCA-9018: 1.8m VGA to RCA cable (receiver to video display) YCC-9018: 1.8m VGA to YCBCR cable (receiver to video display, supports HD up to 720p) AVC-0010: 1m VGA + Audio cable (receiver to video display, VGA male to VGA female) AVC-0011: 1m VGA + Audio cable (receiver to video display, VGA male to VGA male)

Das LevelOne IP Audio Broadcasting System dient zum Aufbau von Public Announcing Systemen in Schulen, Discountern und großen Einkaufszentren. Es können mehrer Zonen eingerichtet werden und unterschiedlich beschallt werden. Da die Lösung IP basiert ist, kann das vorhanden Netzwerk zum Aufbau genutzt werden. Zudem kann das Netzwerk, mittels Managed-Switches von LevelOne in verschieden Broadcast Domains unterteilt werden. Somit ist der normale Datenverkehr vom Public Announcing System abgehottet und die Durchsagen werden in Echtzeit an den Ausgabegeräte (Lautsprecher) ausgegeben.

IAT-1000

IP Audiocast Terminal

- Einfach zu benutzendes Auto-Terminal für Durchsagen und Hintergrundmusik über IP Netzwerke
- Zeitgesteuertes Audio in verschiedenen Zonen möglich
- Suchen, konfigurieren und verwalten aller Audiocast Terminal von einem zentralen Punkt aus
- Inklusive Software zur Verwaltung bis zu 7 Audiocast Terminals
- Systemvoraussetzung: CPU Intel Pentium IX 2.4G oder besser, RAM 1GB oder mehr, Festplattenplatz 30MB oder mehr, OS MS Windows 2000/XP/2003/Vista



Shopping Mall(single level drawing)

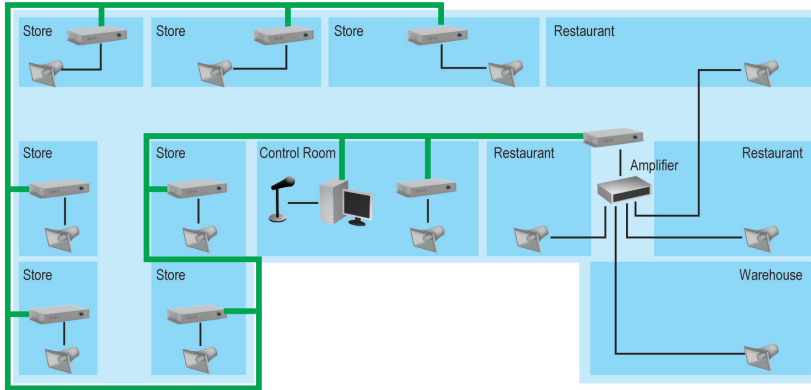

Illustrations

- Level1 IAT Terminal
- PC to Run Level1 Audiocast Manager
- Microphone For Announce
- Installed Standard Ethernet Network

LevelOne IP Audiocast Manager

Die Verwaltung des Public Announcing Systems war niemals einfacher. Die LevelOne Audio Broadcasting Software bietet zusammen mit den IP Audiocast Terminals eine robuste und flexible Lösung. Die Software sendet sämtliche Inhalte an die im Netzwerk befindlichen IAT-1000. Sämtliche Formate können ausgegeben werden (MP3-, WAV-, M3U-Playlists) sowie Live-Durchsagen mittels Mikrofons. Unterteilt in verschiedene Zonen, können die Inhalte an die richtige Zielgruppe wiedergegeben werden.



	Manager Lite	IAT-1920	IAT-1900
Main Features			
Max of Terminal View, Monitor and Configure	7	20	Unlimited
Smart Search	Yes	Yes	Yes
Broadcast tech.	Yes	Yes	Yes
Streaming tech.	Yes	Yes	Yes
Schedule Control	N/A	Yes	Yes
Live Announcement	Yes	Yes	Yes
Multiple Zone View, Monitor and Configure	N/A	Yes	Yes
Music's Format Support MP3 / WAV	Yes	Yes	Yes
Music's Control Play/Stop/Next/Forward	Yes	Yes	Yes
Playlist (M3U) Create/Edit/Save	Yes	Yes	Yes
USB Key Protection	N/A	Yes	Yes
OS	Windows 2000/XP/2003/Vista		
Terminal Configuration			
Active/Inactive Terminals	Yes	Yes	Yes
DHCP/Static IP	Yes	Yes	Yes
Firmware upgrade	Yes	Yes	Yes

* The IP Audiocast Manager Lite is the free version that comes with the IAT-1000
 * Please note that the Ethernet environment has to support broadcast streaming
 * The IAT-1900/1920 software has to run with USB Key license

INDEX

A

ADE-8001	Short-Range DVI-D Receiver	72	FBR-4000	Multi-WAN Load Balance VPN Router	37
ADE-8002	Long Range DVI-D Receiver	72	FCS-0010	Netzwerk Kamera (MPEG4/MJPEG)	16
ADE-8011	Audio Transmitter/Receiver	72	FCS-0020	P/T IP Netzwerk Kamera	17
ADE-8201	Single-Port DVI Transmitter	72	FCS-0030	Megapixel PIR Netzwerk Kamera	16
ADE-8202	2-Port DVI Broadcaster mit Audio	72	FCS-0031	Megapixel PIR PoE Netzwerk Kamera	16
ADE-8204	4-Port DVI Broadcaster mit Audio	72	FCS-0040	1.3 Megapixel Netzwerk Kamera	16
ADE-8208	8-Port DVI Broadcaster mit Audio	72	FCS-0071	2-Megapixel Fish-Eye PoE-Netzwerk-Kamera	60
ANA-3100	3GHz Outdoor Blitzschutz	47	FCS-1030	10/100Mbps Netzwerk Camera (MPEG4)	16
ANA-6101	6GHz Outdoor Überspannungsschutz	47	FCS-1060	10/100Mbps P/T IP Netzwerk Kamera	17
ANC-1430	3m RPSMA Plug auf RPSMA Jack Antennenkabel	46	FCS-1091	PoE IP Netzwerk-Kamera	59
ANC-1440	5m RPSMA Plug auf RPSMA Jack Antennenkabel	46	FCS-1101	PoE IP Netzwerk-Kamera	59
ANC-1470	10m RPSMA Plug auf RPSMA Jack Antennenkabel	46	FCS-1121	Megapixel-PoE-Netzwerk-Kamera	60
ANC-2210	1m N Plug auf N Plug Antennenkabel (200-Serie)	46	FCS-1122	Megapixel PoE-Netzwerk-Kamera	60
ANC-2310	1m RPSMA Plug auf N Plug Antennenkabel (200-Serie)	46	FCS-1131	2-Megapixel PoE-Netzwerk-kamera	60
ANC-2330	3m RPSMA Plug auf N Plug Antennenkabel (200-Serie)	46	FCS-1141	1,3-Megapixel PoE-Netzwerk-kamera	60
ANC-2350	1.5m RPSMA Plug auf N Plug Antennenkabel (200-Serie)	46	FCS-1151	2-Megapixel PoE-Netzwerk-kamera	60
ANC-4130	3m N Plug auf N Jack Antennenkabel (400-Serie)	46	FCS-3031	PIR PoE-kuppel-Netzwerk-Kamera	61
ANC-4160	6m N Plug auf N Jack Antennenkabel (400-Serie)	46	FCS-3051	Tag/Nacht PIR PoE-kuppel-Netzwerk-Kamera	61
ANC-4230	3m N Plug auf N Plug Antennenkabel (400-Serie)	73	FCS-3052	3-Megapixel-Tag/Nacht-PoE-Netzwerk-kuppelkamera	62
AVE-9200	Cat.5 Audio/Video Receiver	73	FCS-3061	Megapixel-Tag/Nacht-PoE-Netzwerk kuppel-Kamera	61
AVE-9201	1-Port Cat.5 Audio/Video Broadcaster (inkl. Kabel)	74	FCS-3071	2-Megapixel-PoE-kuppel-Netzwerk-Kamera	62
AVE-9205	5-Port Cat.5 Audio/Video Broadcaster (inkl. Kabel)	74	FCS-3081	2-Megapixel-Tag/Nacht-PoE-Netzwerk kuppel-Kamera	62
AVE-9300	1-Port Cat.5 VGA Receiver	74	FCS-3091	2 Megapixel Fish-Eye-PoE-kuppel-Netzwerk-Kamera	62
AVE-9301	1-Port Cat.5 VGA Transmitter	74	FCS-4041	2-Megapixel Tag/Nacht Outdoor-PoE-Plus-Speed-Dome-Kamera	63
AVE-9304	4-Port Cat.5 VGA Transmitter	74	FCS-4400	Tag/Nacht P/T/Z Speed Dome Netzwerk Kamera (26x)	63
AVE-9304A	4-Port Cat.5 VGA Repeater	74	FCS-5041	Megapixel Tag/Nacht PoE-Außen-Netzwerk-Kamera	60
AVE-9308	8-Port Cat.5 VGA Transmitter	74	FCS-5051	2 Megapixel Tag/Nacht PoE Outdoor Netzwerk-Kamera	61
AVE-9316	Port Cat.5 VGA Transmitter	74	FCS-5052	3-Megapixel-Tag/Nacht-PoE-Netzwerk-kuppelkamera	61
			FCS-5061	5-Megapixel Tag/Nacht PoE-Plus-Außen-Netzwerk-Kamera	61
			FCS-6010	1.3 Megapixel Tag/Nacht P/T PoE-Netzwerk-Kamera	17
			FCS-7111	1-Port H.264 PoE Video Server	67
			FCS-8005	4-Kanal Analoge Kamera Capture Card	67
			FCS-8006	16-Kanal Analog Kamera Capture Card	67
			FCS-9404	IP CamSecure Pro4 Mega	66
			FEP-0811	8-Port Fast Ethernet PoE-Plus Switch, 123.2W	21
			FEP-0812	4 FE PoE-Plus + 4-FE-Switch, 61.6W	21
			FEP-1611	16-Port Fast Ethernet PoE-Plus Switch, 240W	22
			FEP-1612	16-Port Fast Ethernet PoE-Plus Switch, 480W	22
			FEU-0510	5-Port Fast Ethernet Switch	24

C

CAS-1001	2,1mm Festbrennweitenobjektiv	64
CAS-1101	5~50mm Vari-focal Tag/Nacht Linse	64
CAS-1200	3~8mm Vari-focal Linse	64
CAS-1300	2.8~8.5mm Vari-focal Tag/Nacht Megapixel Linse	64
CAS-1400	2,8-12mm Tag/Nacht 2-Megapixel-Zoom-Objektiv	64

F

FBR-1161	ADSL2+ Modem Router (1 LAN-, 1 WAN-, 1 USB-Port)	5
FBR-1418TX	Breitband Router	4
FBR-1430	VPN Breitband Router	4
FBR-1461	ADSL2+ Modem Router mit QOS	5

FEU-0511	4 Port Fast Ethernet Switch + 1 MMF SC -----	24	VVT-0204TXFC	10/100BASE-TX auf 100BASE-FX Single-Mode SC Fiber Konverter (mit PoE Injektor)-----	31
FEU-0810	8-Port Fast Ethernet Switch-----	24	VVT-4000	10-Slot Media Konverter Gehäuse mit redundantem Netzteil-----	32
FEU-1610	16-Port Fast Ethernet Switch-----	25	VVT-4001	10/100BASE-TX auf 100BASE-FX Multi-Mode Fiber Konverter (SC)-----	31
FEU-2410	24-Port Fast Ethernet Switch-----	25	VVT-4002	10/100BASE-TX auf 100BASE-FX Multi-Mode Fiber Konverter (ST)-----	31
FGL-2870	24 FE + 4 GE-Kombi-SFP L2 Managed Switch-----	28	VVT-4301	10/100BASE-TX auf 100BASE-FX Single-Mode Fiber Konverter (SC)-----	32
FGP-1072	8 FE PoE + 2 GE-Kombi-SFP L2 Managed Switch, 130W-----	23	VVT-5000	16-Slot Managed Konverter Gehäuse mit redundantem Netzteil-----	32
FGP-2410	24 FE PoE-Plus + 2 GE-Kombi-SFP-Switch, 240W-----	22	VVT-5001	10/100TX zu Multi-mode 100FX-SC Modul für VVT-5000-----	31
FGP-2412	24 FE PoE-Plus + 2 GE-Kombi-SFP-Switch, 480W-----	22	VVT-5301	10/100TX zu Single-mode 100FX-SC Modul für VVT-5000-----	31
FGP-2472	24 FE PoE + 2 GE-Kombi-SFP L2 Managed Switch, 380W-----	23	VVT-6001	10/100BASE-TX to 100BASE-FX Multi-Mode Fiber Konverter (mit TS-1000 Unterstützung)-----	31
FNC-0103FX	100BASE-FX Multi-Mode Glasfaser Optik PCI Karte (ST)-----	39	VVT-6301	10/100BASE-TX auf 100BASE-FX Single-Mode Fiber Konverter (mit TS-1000 Unterstützung)-----	31
FNC-0104FX	-----				
	100BASE-FX Multi-Mode Glasfaser Optik PCI Karte (SC)-----	39			
FNC-0107TX	Fast Ethernet PCI Card (mit Wake-On LAN-Funktion)-----	6			
FNC-0109TX	Fast Ethernet PCI Card-----	6			
FNC-0115	100BASE-FX Multi-Mode Glasfaser Optik PCI Express Karte (SC)-----	39			
FNC-0600TXM	5-Port L2 SNMP Switch Karte-----	40			
FNS-1020	1-Bay Simple Network Storage-----	11			
FPS-1031	Parallel Print Server (1-Port)-----	56			
FPS-1032	USB Print Server (1-Port)-----	56			
FPS-1033	3-Port USB/Parallel Print Server-----	56			
FSW-0503	4 FE PoE + 1 FE Switch, 61.6W-----	21			
FSW-0508TX	5-Port Fast Ethernet Switch-----	3			
FSW-0511	5-Port Fast Ethernet Switch-----	3			
FSW-0512	5-Port Fast Ethernet PoE PD Switch-----	21			
FSW-0513	4-Port Fast Ethernet High-Power PoE Switch, 120W-----	21			
FSW-0808TX	8-Port Fast Ethernet Switch-----	3			
FSW-0811	8-Port Fast Ethernet Switch-----	3			
FSW-0812	8-Port Fast Ethernet PoE PD Switch-----	21			
FSW-1602TX	16-Port Fast Ethernet Switch-----	25			
FSW-1650	16-Port Fast Ethernet Switch-----	25			
FSW-1671	8 FE PoE + 8 FE Web Smart Switch, 123.2W-----	23			
FSW-2450	24-Port Fast Ethernet Switch-----	25			
FVS-3120	10/100BASE-TX auf 100BASE-LX SMF SC Konverter-----	30			
FVS-3200	10/100BASE-TX auf 100BASE-FX MMF SC Konverter-----	30			
FVS-3800	10/100BASE-TX auf 100BASE-X SFP Konverter-----	30			
FVT-0103TXFC	10/100BASE-TX auf 100BASE-FX Multi-Mode SC Fiber Konverter (mit PoE)-----	31			
FVT-0104TXFC	10/100BASE-TX auf 100BASE-FX Single-Mode SC Fiber Konverter (mit PoE)-----	31			
FVT-0203TXFC	10/100BASE-TX auf 100BASE-FX Multi-Mode SC Fiber Konverter (mit PoE Injektor)-----	31			
			G		
			GEL-1072	8 GE + 2 GE-Kombi-SFP L2 Managed Switch-----	27
			GEL-2870	24 GE + 4 GE-Kombi-SFP L2 Managed Switch-----	29
			GEP-0520	4 GE PoE + 1 GE Switch, 61.6W-----	21
			GEP-0820	8-Port Gigabit PoE-Plus Switch, 61.6W-----	21
			GEP-0821	8-Port Gigabit PoE-Plus Switch, 123.2W-----	21
			GEP-0822	8-Port Gigabit PoE-Plus Switch, 240W-----	22
			GEP-2450	20 GE PoE-Plus + 4 GE-Kombi-SFP-Web-Smart-Switch, 185W-----	23
			GES-0852	7 GE + 1 GE-Kombi-SFP-Web-Smart-Switch-----	27
			GES-1650	-----	16
				GE + 4 GE SFP Web Smart Switch-----	28
			GES-1652	16 GE + 2 GE SFP Web Smart Switch-----	27
			GES-2450	24 GE + 4 GE SFP Web Smart Switch-----	28
			GES-2452	24 GE + 2 GE SFP Web Smart Switch-----	28
			GEU-0520	5-Port Gigabit Switch-----	24
			GEU-0521	4GE + 1 GE SFP Switch-----	24
			GEU-0820	8-Port Gigabit Switch-----	25
			GEU-1621	16-Port Gigabit Switch-----	25
			GEU-1628	16 Port Gigabit Ethernet + 2 Slot SFP Switch-----	25
			GEU-1629	-----	16
				Port Gigabit Ethernet + 4 Slot SFP Switch-----	25
			GEU-2428	24 Port Gigabit Ethernet + 2 Slot SFP Switch-----	25
			GEU-2429	24 Port Gigabit Ethernet + 4 Slot SFP Switch-----	26
			GNC-0105T	Gigabit Ethernet PCI Adapter-----	40
			GNC-0107	100BASE-SX Fiber Optic PCI Card (SC)-----	40

GNC-0111	1000BASE-SX Glasfaser Optik PCI Express Karte (SC)-----	40	HVE-6601R	HDMI Video Wall over IP PoE Receiver-----	70
GNC-0112	Gigabit-Ethernet-PCIe-Karte-----	40	HVE-6601T	HDMI Video Wall over IP PoE Transmitter-----	70
GNS-1001	1-Bay Gigabit Network Storage-----	11	HVE-9000	HDSpider™ HDMI Cat.5 Receiver (Long-Range)-----	71
GNS-2000	2-Bay Gigabit Netzwerkspeicher-----	12	HVE-9001	HDSpider™ HDMI Cat.5 Sender-----	71
GNS-4001	4-Bay Gigabit-Netzwerkspeicher-----	12	HVE-9002	HDSpider™ HDMI Cat.5 Sender-----	71
GSW-0507	5-Port-Gigabit-Switch-----	3	HVE-9003	HDSpider™ HDMI Cat.5 Sender (kaskadierbar)-----	71
GSW-0509	5-Port Gigabit Switch-----	24	HVE-9004	HDSpider™ 4-Port HDMI Cat.5 Sender-----	71
GSW-0807	8-Port-Gigabit-Switch-----	3	HVE-9008	HDSpider™ 8-Port HDMI Cat.5 Sender-----	71
GSW-0809	8-Port Gigabit Switch-----	25	HVE-9900	HDSpider™ HDMI Cat.5 Receiver (Short-Range)-----	71
GSW-0890	6 GE + 2 GE-Kombi-SFP L2 Managed Switch-----	27			
GSW-1290	4 GE-Kombi-SFP + 2 GE Expandable Slots L2 Managed Switch-----	27	I		
GSW-1657	16-Port-Gigabit-Switch-----	25	IAT-1000	IP Audiocast Terminal-----	75
GSW-2453	3-Slot Gigabit Modular Switch-----	26	IFE-0500	4 FE PoE + 1 FE Industrie Switch-----	21
GSW-2457	24-Port-Gigabit-Switch-----	26	IFE-0501	4 FE PoE + 1 FE Multi-Mode SC Industrie Switch, 2km-----	21
GSW-2473	24 FE + 2 GE-Kombi-SFP-Web-Smart-Switch-----	28	IFE-0502	4 FE PoE + 1 FE Single-mode SC Industrie Switch, 30km-----	21
GSW-2693	24 FE PoE + 2 GE-Kombi-SFP L2 Managed Switch, 185W-----	23	IPS-0008	IP Power Switch-----	37
GSW-4876	44 GE + 4 GE-Kombi-SFP-Web-Smart-Switch-----	29			
GSW-5150	48 FE + 2 GE + 1 GE SFP Switch-----	26	K		
GSW-5270	48 FE + 2 GE + 2 GE SFP Web Smart Switch-----	29	KVM-0115	15" Rackmount KVM Konsole-----	53
GTL-2690	20 GE + 4 GE-Kombi-SFP + 2 10GE XFP Module Slot L3 Managed Stackable Switch-----	28	KVM-0117	17" Rackmount KVM Konsole-----	53
GTL-2880	20 GE + 4 GE-Kombi-SFP + 4 10GE SFP-Plus L2-Plus Managed Switch-----	29	KVM-0211	2-Port PS/2 KVM Switch mit Audio-----	14
GTL-5280	44 GE + 4 GE-Kombi-SFP + 4 10GE SFP-Plus L2-Plus Managed Switch-----	29	KVM-0212	2-Port PS/2 KVM Switch-----	14
GTP-2880	20 GE PoE + 4 GE Combo SFP + 4 10GE SFP-Plus L2-Plus Managed Switch, 185W-----	23	KVM-0213	2-Port PS/2 KVM Switch-----	13
GVS-3110	10/100/1000BASE-T auf 1000BASE-LX10 SMF SC Konverter-----	30	KVM-0217	17" Modularized KVM Konsole-----	53
GVS-3200	10/100/1000BASE-T auf 1000BASE-SX MMF SC Konverter-----	30	KVM-0221	2-Port USB KVM Switch mit Audio-----	14
GVS-3800	10/100/1000BASE-T auf 1000BASE-X SFP Konverter-----	30	KVM-0222	2-Port USB KVM Switch-----	14
GVT-0300	1.25G Multi-Mode SFP Transceiver (bis zu 550m)-----	34	KVM-0223	2-Port USB KVM Switch-----	13
GVT-0301	1.25G Single-Mode SFP Transceiver (bis zu 10 km)-----	34	KVM-0260	2-Port USB DVI KVM Switch mit Audio-----	13
GVT-0302	1.25G Single-Mode SFP Transceiver (80km)-----	34	KVM-0261	2-Port USB DVI KVM Switch mit Audio & USB Hub-----	14
GVT-4000	10/100/1000BASE-T auf 1000BASE-X Fiber Konverter (SFP)-----	31	KVM-0306	3-Port DVI KVM Switch mit Audio-----	14
GVT-4001	10/100/1000BASE-T auf 1000BASE-SX Multi-Mode Fiber Konverter (SC)-----	31	KVM-0410	4-Port KVM Switch mit OSD für PS/2-----	53
GVT-5000	10/100/1000TX zu 1000FX-SFP Modul für FVT-5000-----	31	KVM-0411	4-Port PS/2 KVM Switch mit Audio-----	53
H			KVM-0412	4-Port PS/2 KVM Switch-----	53
HVE-0201	HDMI Extender über Glasfaser-----	71	KVM-0420	4-Port KVM Switch für USB & PS/2-----	53
HVE-6501R	HDMI over PoE Receiver-----	70	KVM-0421	4-Port USB KVM Switch mit Audio-----	53
HVE-6501T	HDMI over IP PoE Transmitter-----	70	KVM-0422	4-Port USB KVM Switch-----	53
			KVM-0461	4-Port USB DVI KVM Switch mit Audio & USB Hub-----	14
			KVM-0811	8-Port PS/2 KVM Switch-----	53
			KVM-0831	8-Port Combo KVM Switch mit Erweiterungs-Slot-----	53
			KVM-1611	16-Port PS2 KVM Switch-----	53
			KVM-1631	16-Port Combo KVM Switch mit Erweiterungs-Slot-----	53
			KVM-9000	IP KVM Extender-----	53

KVM-9005	PS/2 KVM Extender -----	53	POS-4000	12V DC High-Power PoE Splitter -----	49
KVM-9006	USB KVM Extender -----	53	POS-4001	3~12V DC High-Power Outdoor PoE Splitter -----	49
M					
MSL-3S79	3-Slot Gigabit Modular L2 Managed Switch -----	29	POS-4002	24V AC High-Power PoE Splitter -----	49
N					
NVR-0104	4-Kanal-Netzwerkvideorekorder -----	18	POT-0100	PoE Repeater over 2-wire (Master) -----	50
NVR-0204	4-Kanal-Netzwerkvideorekorder -----	68	POT-0110	PoE Repeater over 2-wire (Slave) -----	50
NVR-0208	8-Kanal-Netzwerkvideorekorder -----	68	POT-1110	Outdoor PoE Repeater over 2-wire (Slave) -----	50
NVR-0216	16-Kanal-Netzwerkvideorekorder -----	68	PPM-1000	PoE Power-Messgerät -----	51
O					
OAN-0501	5dBi 2.4GHz Omni-directional Antenna -----	8	S		
OAN-1070	7dBi Omni-direktionale Antenne -----	8	SFP-1101	155M Multi-Mode SFP Transceiver (2km) -----	34
OAN-2090	9dBi Omni-direktionales Indoor/Outdoor Antennen-Kit (2.4GHz) -----	44	SFP-1311	155M Single-Mode SFP Transceiver (20km) -----	34
OAN-2151	15dBi Omni-direktionale Outdoor Antenne (2.4GHz) -----	44	SFP-1411	155M Single-Mode SFP Transceiver (40km) -----	34
OAN-4101	10dBi Omni-direktionale Antenne (5GHz) -----	45	SFP-3001	1.25G Multi-Mode SFP Transceiver (550m, 850nm) -----	35
P					
PLI-3021	00-Mb/s-Powerline-Adapter -----	10	SFP-3111	1.25G Multi-Mode SFP Transceiver (2km, 1310nm) -----	35
PLI-3110	200Mbps Powerline Adapter mit PoE-Injektor -----	10	SFP-3211	1.25G Single-mode SFP Transceiver (10km, 1310nm FP-LD) -----	35
PLI-3411	200Mbps Powerline Drahtlos-Zugriffspunkt -----	10	SFP-3611	1.25G Single-Mode SFP Transceiver (80km) -----	35
PLI-3510	200Mbps Powerline Adapter mit Mains Pass-Through -----	10	SFP-3711	1.25G Single-Mode SFP Transceiver (120km) -----	35
PLI-4051	500-Mb/s-Gigabit-Powerline-Adapter -----	10	SFP-3841	1.25G Kupfer Transceiver (RJ-45, 100m) -----	36
PLI-4052	500-Mb/s-Nano-Powerline-Adapter -----	10	SFP-6101	10Gbps Multi-Modus-SFP-Plus-Transceiver (300m) -----	36
POH-1250	12 FE PoE Injektor Hub -----	48	SFP-6121	10Gbps Single-Modus-SFP-Plus-Transceiver (10km) -----	36
POH-1260	12 FE High-Power PoE Injektor Hub -----	48	SFP-6141	10Gbps Single-Modus-SFP-Plus-Transceiver (40km) -----	36
POI-2001	Gigabit PoE Injektor -----	49	SFP-7321	155M Single-Mode BIDI SFP Transceiver (20km, TX/RX mit 1310/1550nm) -----	35
POI-2002	PoE Injektor -----	49	SFP-7331	155M Single-Mode BIDI SFP Transceiver (20km, TX/RX mit 1550/1310nm) -----	35
POI-3000	Gigabit PoE-Plus Injektor -----	49	SFP-7421	155M Single-Mode BIDI SFP Transceiver (40km, TX/RX mit 1310/1550nm) -----	35
POI-4000	High-Power PoE Injektor (56W) -----	49	SFP-7431	155M Single-Mode BIDI SFP Transceiver (40km, TX/RX mit 1550/1310nm) -----	35
POR-0100	PoE Repeater -----	50	SFP-9221	1.25G Single-Mode BIDI SFP Transceiver (10km, TX/RX mit 1310/1550nm) -----	35
POR-0102	2-Port PoE Repeater -----	50	SFP-9231	1.25G Single-Mode BIDI SFP Transceiver (10km, TX/RX mit 1550/1310nm) -----	35
POR-0120	Gigabit PoE-Repeater -----	50	SFP-9321	1.25G Single-Mode BIDI SFP Transceiver (20km, TX/RX mit 1310/1550nm) -----	35
POR-0122	2-Port Gigabit PoE-Repeater -----	50	SFP-9331	1.25G Single-Mode BIDI SFP Transceiver (20km, TX/RX mit 1550/1310nm) -----	36
POR-1100	Outdoor PoE Repeater -----	50	SFP-9421	1.25G Single-Mode BIDI SFP Transceiver (40km, TX/RX mit 1310/1550nm) -----	36
POR-1102	2-Port Outdoor PoE Repeater -----	50	SFP-9431	1.25G Single-Mode BIDI SFP Transceiver (40km, TX/RX mit 1550/1310nm) -----	36
POS-1001	5~12V DC Gigabit PoE Splitter -----	49	U		
POS-1002	5~12V DC PoE Splitter -----	49	USB-0301	USB Fast Ethernet Adapter -----	6
POS-3000	5~12V DC Gigabit PoE-Plus Splitter -----	49	USB-0401	USB Gigabit Ethernet Adapter -----	6
			USB-0501	USB Hub und Fast Ethernet Combo Adapter -----	6

V

VDS-0110	Ethernet over VDSL2 Converter (Sender)-----	33
VDS-0111	Ethernet over VDSL2 Converter (Receiver)-----	33
VDS-0120	Ethernet over VDSL2 Konverter (PSE)-----	33
VDS-0130	Ethernet over VDSL2 Konverter (PD)-----	33
VDS-0200	Ethernet over VDSL2 Konverter (Annex A)-----	33
VDS-0201	Ethernet over VDSL2 Konverter (Annex B)-----	33
VDS-0202	Ethernet over VDSL2 Konverter (BNC)-----	33
VOI-7000	SIP VoIP Telefon-----	58
VOI-7010	SIP VoIP Office Telefon-----	58
VOI-7011	SIP VoIP Office Telefon mit FXO-Port-----	58
VOI-7100	SIP VoIP Telefon mit PoE-Funktion-----	58
VOI-8001	8-Port FXS H.323/SIP Gateway-----	57

W

WAB-5120	300Mbps 5G Wireless Outdoor Passive PoE Access Point / Bridge-----	42
WAB-6120	150Mbps Wireless Outdoor Passive PoE Access Point-----	42
WAB-7400	54Mbps Dual-Radio Outdoor PoE Mesh AP (11a/b/g)-----	43
WAN-1112	12dBi Direktionale Patch Antenne (2.4GHz)-----	44
WAN-1160	6/8dBi Dual-Band Direktionale Antenne-----	45
WAN-2140	14dBi Direktionale Panel Antenne (2.4GHz)-----	44
WAN-2181	18dBi Direktionale Panel Antenne (2.4GHz)-----	45
WAN-2185	8.5dBi Direktionale Pico Cell Antenne (2.4GHz)-----	44
WAN-2218	18dBi Direktionale Yagi Antenne (2.4GHz)-----	45
WAN-7100	10.5dBi 2.4GHz Direktionales Dual-Polarisation Patch Antennen-Kit-----	45
WAN-9150	15dBi 5GHz Direktionale Dual-Polarisation Outdoor Panel Antenne-----	45
WAN-9180	18dBi 5GHz Direktionale Dual-Polarisation Outdoor Panel Antenne-----	45
WAP-0008	11b/g 54Mbps Wireless AP Storage (für 3.5" HDD)-----	11
WAP-1001	108Mbps Wireless Outdoor Access Point-----	43
WAP-3100	54Mbps Wireless PoE Access Point-----	42
WAP-6002	150Mbps Wireless Access Point-----	42
WAP-6003	150-Mb/s-WLAN-Zugangspunkt-----	43
WAP-6011	300Mbps Wireless Access Point-----	42
WAP-6012	300Mbps Wireless Gigabit PoE Access Point-----	42
WAP-6013	300-Mb/s-WLAN-Zugangspunkt-----	43
WAP-6101	300Mbps Wireless Ceiling PoE Access Point-----	43
WBR-6003	150Mbps Drahtlos-Router-----	4
WBR-6012	300Mbps Drahtlos-Router-----	4
WBR-6020	300Mbps Wireless Router-----	4
WBR-6022	300Mbps Wireless HomeGuard 22 Router-----	4

WBR-6601	150Mbps Wireless ADSL2+ Modem Router-----	5
WBR-6603	150Mbps Wireless ADSL2+ Modem Router-----	5
WBR-6801	150Mbps Wireless 3G Tragbarer Router-----	5
WBR-6802	150Mbps Drahtlos-Reise-Router-----	5
WBR-6803	150Mbps Wireless 3G Travel Router-----	5
WBR-6804	150Mbps Drahtlos-Dual-WAN-3G-Router-----	5
WBR-6805	300Mbps Drahtlos-Reise-Router-----	5
WCS-0010	Wireless Network Camera (MPEG4/MJPEG)-----	16
WCS-0020	11g Wireless P/T IP Netzwerk Kamera-----	17
WCS-0030	Wireless H.264 Megapixel PIR Netzwerk Kamera-----	16
WCS-0040	Wireless 1.3 Megapixel Netzwerk Kamera-----	16
WCS-0050	150Mbps drahtlose Megapixel Netzwerkkamera-----	16
WCS-2030	11g Wireless IP Netzwerk Kamera-----	16
WCS-2060	11g Wireless P/T IP Netzwerk Kamera-----	17
WCS-6020	2-Megapixel-Tag/Nacht-WLAN-P/T-Netzwerkkamera-----	17
WCS-6050	5-Megapixel-Tag/Nacht-WLAN-P/T-Netzwerkkamera-----	17
WGR-6012	300Mbps N_Max Wireless Gigabit Router-----	4
WGR-6013	300-Mb/s-WLAN-Gigabit-Router-----	5
WHG-1000	300Mbps Wireless PoE Hotspot Gateway-----	38
WNC-0301	54Mbps Wireless PCI Karte-----	7
WNC-0600	N_One Wireless PCI Card-----	7
WNC-0601	300Mbps Wireless PCI Karte-----	7
WPC-0600	300Mbps Wireless CardBus Adapter-----	7
WPS-1133	3-Port USB / Parallel Wireless Print Server-----	56
WUA-0605	300Mbps Drahtlos-USB-Adapter-----	7
WUA-0606	150Mbps Drahtlos-USB-Adapter-----	7
WUA-0614	150Mbps Nano-Drahtlos-USB-Adapter (2dBi)-----	7
WUA-0616	300Mbps Wireless USB Adapter-----	7
WUA-0624	150Mbps Nano-Drahtlos-USB-Adapter (5dBi)-----	7
WUA-1610	300Mbps Drahtlos-USB-Adapter-----	40
WUA-5600	150Mbps Wireless High-Power Outdoor USB-Adapter-----	40

X

XFP-5211	10G Single-Mode XFP Transceiver (10km)-----	36
XFP-5901	10G Multi-Mode XFP Transceiver (300m)-----	36





Digital Data Communications Group

www.level1.com

Global Headquarters:

Digital Data Communications GmbH, Germany

Global Offices:

Germany, Taiwan, Australia, Belgium, Brasil, Colombia, Denmark, Greece, Italy, Kenya, the Netherlands, Portugal, Slovenia, Spain, U.A.E

Distributed By:

2012.12.20-DE