

Overview

HP StorageWorks DAT drives are based on the Digital Data Storage (DDS) format. In fact, DAT is the most successful tape backup technology of all time with more than 17 million DAT drives shipped since its introduction in 1989, and with a current world-wide installed base of over 6 million drives. A number of vendors manufacture DDS format DAT drives, but HP has long been the market leader in DAT technology.

This remarkable tape technology continues to flourish because of its ability to meet the needs of the Small and Medium Business (SMB) market for reliable, cost-effective backup better than any other technology available.

The HP StorageWorks family of DAT drives is the first choice for data protection for many small and medium businesses with low-end and mid-range servers and workstations. HP StorageWorks DAT drives are also frequently used for operating system backup and software loading on mission-critical servers in many large enterprises.

HP StorageWorks DAT drives are available with a range of capacities (from 40GB to 160GB) and a choice of interfaces. Customers can benefit from native USB 2.0 for plug-and-play installation: from out of the box to backup in less than 60 seconds. Other interface choices include SCSI for servers requiring SCSI connectivity and the recent addition of a SAS interface now provides the very latest server connectivity.

Each member of the HP StorageWorks DAT family offers a complete backup solution including HP's unique One-Button-Disaster-Recovery (OBDR) feature providing customers with the ability to restore their systems quickly and effortlessly with the touch of a single button. HP's unique Library and Tape Tools (L&TT) utilities provide HP StorageWorks DAT customers with a comprehensive suite of tape drive management utilities and HP's extensive testing program ensures that customers benefit from the broadest connectivity and compatibility with HP and third-party servers, operating systems and software in the industry.

Also includes HP Data Protector Express Single Server Edition software and its Bare Metal Disaster Recovery option, providing a backup application to protect a single Windows, Linux or NetWare server.

What's New

HP StorageWorks DAT 160 Tape Drive

- 160GB of data on one data cartridge
- 49.3GB/hr transfer rate/completes back up in about 3 hours
- Features new front panel design
- Now available with SAS in addition to USB and SCSI interfaces

QuickSpecs

HP StorageWorks Tape Drives

Overview

HP StorageWorks DAT 160 SAS Tape Drive

Protecting the needs of small or medium business, the highest capacity and performance DAT drive with up to 160GB compressed data per cartridge and speeds of around 50GB/hr (assuming 2:1 data compression)

The HP DAT 160 SAS drive is available with a native SAS interface, for latest server connectivity, in a range of models including internal to fit servers, workstations, rack-mount kits and external enclosures.

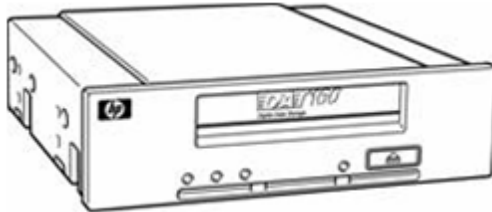

DAT 160 SAS internal module

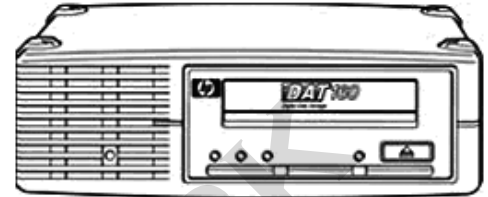

DAT 160 SAS External Tape Drive

HP StorageWorks DAT 160 SCSI Tape Drive

Protecting the needs of small or medium business, the highest capacity and performance DAT drive with up to 160GB compressed data per cartridge and speeds of around 50GB/hr (assuming 2:1 data compression)

The HP DAT 160 SCSI drive is available with a native SCSI interface in a range of models including internal to fit servers, workstations and rack-mount kits, external and array modules.

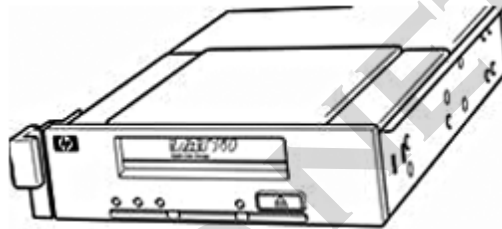

DAT 160 SCSI array module

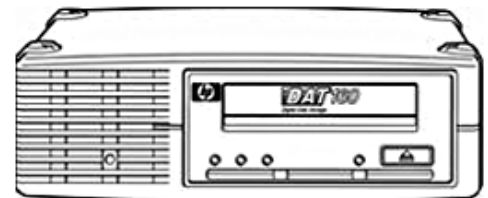

DAT 160 SCSI External Tape Drive

HP StorageWorks DAT 160 USB Tape Drive

Protecting the needs of small or medium business, the highest capacity and performance DAT drive with up to 160GB compressed data per cartridge and speeds of around 50GB/hr (assuming 2:1 data compression)

The USB 2.0 interface provides plug-and-play connectivity, enabling backup to be initiated from straight out-of-the-box in less than 60 seconds.

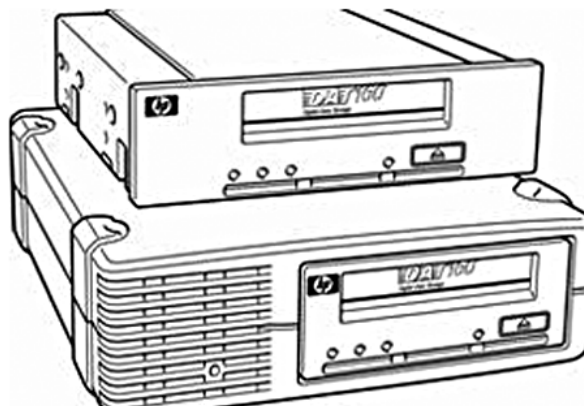

QuickSpecs

HP StorageWorks Tape Drives

Overview

DAT 160 USB Internal Tape Drive
 DAT 160 USB External Tape Drive

HP StorageWorks DAT 72 SCSI Tape Drive Protect your small or medium business, remote office or workgroup with the HP StorageWorks DAT 72 SCSI Tape Drive, providing a balance of price and performance with up to 72GB of compressed data on a single cartridge at speeds of up to 23GB/hr (assuming 2:1 data compression).

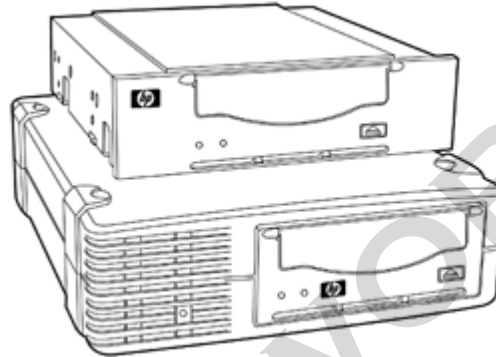

DAT 72 SCSI Internal Tape Drive
 DAT 72 SCSI External Tape Drive

HP StorageWorks DAT 72 USB Tape Drive Protect your small or medium business, remote office or workgroup with the HP StorageWorks DAT 72 USB Tape Drive providing a balance of price and performance with up to 72GB of compressed data on a single cartridge at speeds of up to 23GB/hr (assuming 2:1 data compression).

The USB 2.0 interface provides plug-and-play connectivity, enabling backup to be initiated from straight out-of-the-box in less than 60 seconds.

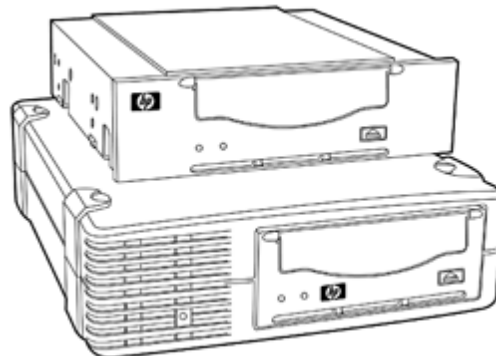

DAT 72 USB Internal Tape Drive
 DAT 72 USB External Tape Drive

QuickSpecs

HP StorageWorks Tape Drives

Overview

HP StorageWorks DAT 40 SCSI Tape Drive Meeting the needs of small businesses, remote office or workgroups with the HP StorageWorks DAT 40 SCSI Tape Drive providing entry-level price and performance with up to 40GB of compressed data on a single cartridge at speeds of up to 23GB/hr (assuming 2:1 data compression).

The HP DAT 40 SCSI drive is available with a native SCSI interface in a range of models including internal to fit servers, workstations and rack-mount kits, external and array modules.

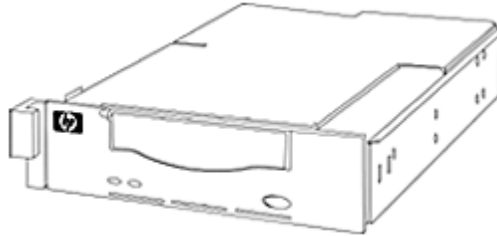

DAT 40 SCSI Array Module

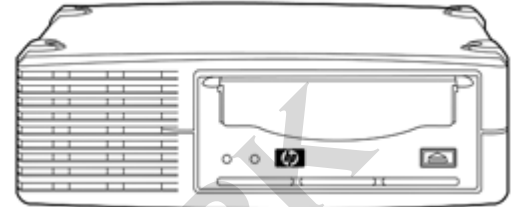

DAT 40 SCSI External Tape Drive

HP StorageWorks DAT 40 USB Tape Drive Meeting the needs of small businesses, remote office or workgroups with the HP StorageWorks DAT 40 USB Tape Drive providing entry-level price and performance with up to 40GB of compressed data on a single cartridge at speeds of up to 23GB/hr (assuming 2:1 data compression).

The USB 2.0 interface provides plug-and-play connectivity, enabling backup to be initiated from straight out-of-the-box in less than 60 seconds.

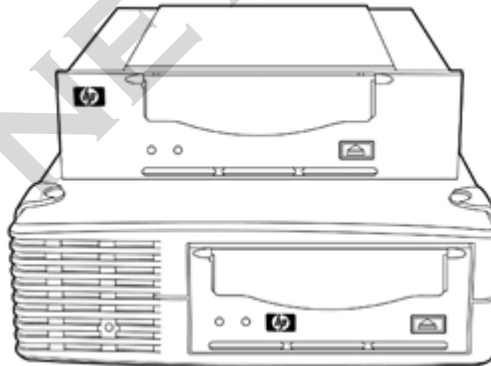

DAT 40 USB Internal Tape Drive
DAT 40 USB External Tape Drive

QuickSpecs

HP StorageWorks Tape Drives

Overview

Models

DAT 160 SAS Tape Drive	DAT 160 SAS Internal Tape Drive	Q1587A
	NOTE: OD1 will appear after this part number on your sales order if factory integration is indicated.	
	DAT 160 SAS External Tape Drive	Q1588A
DAT 160 SCSI Tape Drive	DAT 160 SCSI Internal Tape Drive	Q1573A
	NOTE: OD1 will appear after this part number on your sales order if factory integration is indicated.	
	DAT 160 SCSI External Tape Drive	Q1574A
	DAT 160 SCSI Array Module	Q1575A
	NOTE: DAT 160 array modules fit into the HP Tape Array 5300 (C7508B).	
	NOTE: OD1 will appear after this part number on your sales order if factory integration is indicated.	
DAT 160 USB Tape Drive	DAT 160 USB Internal Tape Drive	Q1580A
	NOTE: OD1 will appear after this part number on your sales order if factory integration is indicated.	
	DAT 160 USB External Tape Drive	Q1581A
	1U USB Rack-Mount Kit with one DAT 160 USB drive	AG703A
DAT 72 SCSI Tape Drive	DAT 72 SCSI Internal Tape Drive	Q1522B
	NOTE: OD1 will appear after this part number on your sales order if factory integration is indicated.	
	DAT 72 SCSI External Tape Drive	Q1523B
	DAT 72 SCSI Array Module Field-integrated	Q1524C
	NOTE: DAT 72 array modules fit into the HP Tape Array 5300 (C7508B).	
	NOTE: OD1 will appear after this part number on your sales order if factory integration is indicated.	
DAT 72 USB Tape Drive	DAT 72 USB Internal Tape Drive	DW026A
	NOTE: OD1 will appear after this part number on your sales order if factory integration is indicated.	
	DAT 72 USB External Tape Drive	DW027A
	1U USB Rack-Mount Kit with one DAT 72 USB drive	AG594A
DAT 40 SCSI Tape Drive	DAT 40 SCSI Internal Tape Drive	C5686C
	NOTE: OD1 will appear after this part number on your sales order if factory integration is indicated.	
	DAT 40 SCSI External Tape Drive	C5687D
	DAT 40 SCSI Array Module	C7497C
	NOTE: DAT 40 array modules fit into the HP Tape Array 5300 (C7508B).	
	NOTE: OD1 will appear after this part number on your sales order if factory integration is indicated.	
DAT 40 USB Tape Drive	DAT 40 USB Internal Tape Drive	DW022A
	NOTE: OD1 will appear after this part number on your sales order if factory integration is indicated.	
	DAT 40 USB External Tape Drive	DW023A

QuickSpecs

HP StorageWorks Tape Drives

Overview

Key Features

- Based on industry-standard DDS technology -- the most popular server backup technology of all time, providing customers will all the benefits of an open standard including better pricing, wider availability and faster development cycles
- Proven reliability -- HP has increased reliability specifications for HP DAT drives based on real field data. Mean-Time-Between-Failure rates (MTBF) are now more than 1 million hours at a typical duty cycle of 12%
- Low-cost of ownership - Lowest media price (in \$/GB) of any tape backup technology
- Up to 80GB native capacity on a single tape -- 160GB at 2:1 compression -- with DAT 160 tape drive
- Up to 6.9 MB/s* native data transfer rate -- 13.8 MB/s* with 2:1 compression -- with DAT 160 tape drives * **Where 1KB = 1,000 Bytes**
- Plug and play -- USB 2.0 interface available for on all drives provides universal native plug-and-play capability and enabling customers to be ready for backup in less than 60 seconds straight out of the box
- SCSI interface available to enable SCSI system connectivity if required
- SAS interface also available for the latest server connectivity
- Flexibility of solutions through a wide choice of models - internal, external, USB, offline hot-swap array module, and rack-mount configurations
- Small size drives and media for easy physical storage - small, 5.25-inch form-factor internal drives.
- Low ongoing maintenance -- automatic head cleaning minimizes the need for cleaning. Intelligent cleaning monitors the performance of the drive and cleans accordingly when a cleaning tape is loaded
- Dependable disaster recovery -- HP StorageWorks One-Button Disaster Recovery (OBDR) for Proliant Systems restores your entire system at the touch of a button
- Supporting tools -- HP StorageWorks Library and Tape Tools available as a download with the drive to make installation, performance tuning and trouble-shooting even easier
- Broad compatibility with a wide range of servers, operating systems, and backup software
- Includes HP Data Protector Express Single Server Edition software and its Bare Metal Disaster Recovery option, see <http://www.hp.com/go/dataprotectorexpress/sse>.

Customer Benefits

- **Dependable:** a long track record of proven reliability
- **Easy:** supports One-Button Disaster Recovery, simply the easiest way to restore data in the event of a disaster
- **Affordable:** inexpensive media contributes to an exceptionally low cost of ownership
- **Manageable:** includes superior management capabilities that makes it easy to install, use and support
- **Low-maintenance:** automatic head cleaning system reduces the need for cleaning
- **Well-connected:** compatible with leading operating systems, backup software and servers
- **Future-proof:** the tape technology with an illustrious past also has a solid roadmap for the future
- **Complete:** comes with an easy-to-use backup solution that includes disaster recovery capabilities

Product Highlights

DDS Technology

Within the tape market there is a wide range of tape technologies, the question for SMB customers is which one to choose. The answer is clear - DDS/DAT continues to be the unit volume leader in the tape drive market for small and medium businesses with a current installed base of over 6 million units and over 17 million DAT drives shipped since its introduction in 1989. This remarkable tape technology continues to flourish because it meets the needs of the SMB market for cost-effective, reliable backup better than any other technology available. Of the 1.4 million backup tape drives shipped in 2006, IDC estimates that approximately 40% were DAT drives.

Unlike AIT, VXA, ADR, SLR, DLT and SDLT, DDS/DAT is based on an open standard format for data interchange. The influential DAT manufacturers group presides over this open standard with verification processes that ensure compliance. With multiple manufacturers developing and shipping DDS/DAT products, customers benefit from increased competition, which leads to better prices, faster development and more choice.

DDS format for DAT is a helical scan format where data is written diagonally across the width of the tape. The advantage is that, by allowing subsequent tracks to have different writing angles and to overlap, a much greater capacity can be achieved for a given length of tape because no guard bands are necessary. The data format also allows for fast location of tracks and data. To achieve this, the rotating drum is tilted at a slight angle (6°) from the vertical. The drum has four heads (two write heads and two read heads), located at 90° intervals. For each rotation of the drum, two tracks are written. The read heads verify the data that has been written (recorded) and the drive rewrites if necessary. The open format ensures interchangeability between different DDS format drives.

HP has been involved in the design and development of DAT drives since the beginning and applies these many years of experience to its current line of DAT products. Not only does an investment in DAT technology provide the security of a format with a history of outstanding reliability, the legacy of backward compatibility also provides the potential for future expansion without compromising your investment in the technology.

The target market for DAT continues to be direct-attach backup. In small and medium sized businesses cost of ownership, ease of use and a proven history (i.e. low risk) are paramount. DAT technology provides the capacity and performance needed in a tape backup solution for workstations and entry-level servers.

Specific Note on DAT 160

The DAT 160 drive employs the same technology as previous DAT products, and uses DAT 160 wide media in order to achieve higher capacities. However, it maintains the 2 generation backward compatibility promise and can still read and write data to DAT 72 and DAT 40 (DDS-4) cartridges. It does this by recognizing the different tapes (wider DAT 160 and the narrower DAT 72/DDS-4).

QuickSpecs

HP StorageWorks Tape Drives

Product Highlights

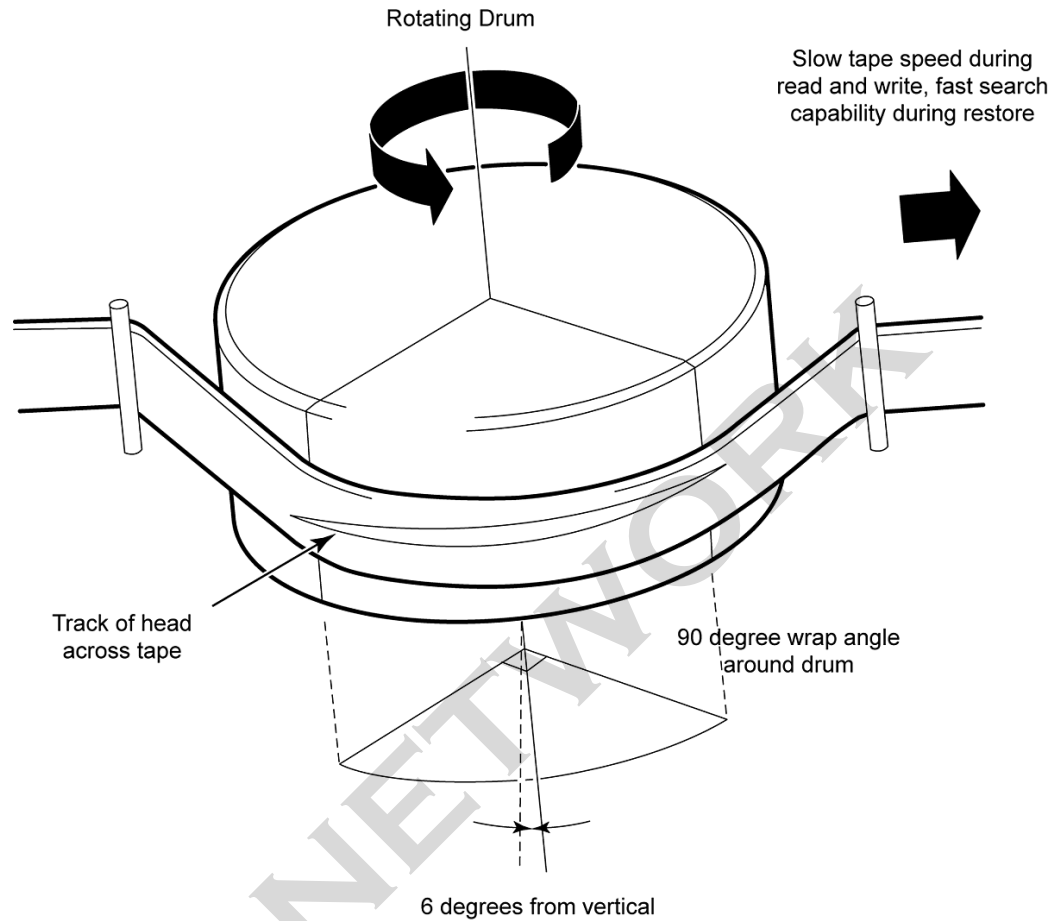

NOTE: The DAT 160 has 180o wrap angle around the drum

Backwards Compatibility HP DAT tape drives are backward read-write compatible with two previous generations, thus:

- DAT 160 also reads and writes DAT 72 and DDS-4
- DAT 72 also reads and writes DDS-4 and DDS-3
- DAT 40 also reads and writes DDS-3 and DDS-2

Product Highlights

Proven Reliability

HP DAT drives have proven to be exceptionally reliable. The drives have demonstrated exceptional performance with customers over many years and across different generations and this has underpinned their popularity.

The drives are designed with reliability in mind and with the security of customer's data as a priority. Hardware reliability is typically measured as MTBF (Mean Time Between Failures) associated with duty cycles which suggests the amount the drive is typically used e.g. 100% duty cycle means the drive is used for 24 hours per day. As a result of field data, the specification for HP DDS products is stated as 125,000 hours at 100% duty cycle, or 1 million hours at a more typical 12% duty cycle (drive used on average for 3 hours per day).

Unlike other manufacturers' DAT drives, this specification is not generated in the laboratory with limited numbers of prototype drives and assumptions on customer use; it is generated from real customer data for the products concerned.

Automated Head Cleaning/Intelligent cleaning

HP DDS derives benefit from an automatic head cleaning "sweeper" that can be used during the write or read recovery procedure to dislodge debris from the tape path and recording heads and drive. This feature reduces the need to use a DDS cleaning cartridge for manual cleaning.

Intelligent cleaning determines the cleaning provided by a cleaning cartridge when loaded by monitoring the drive performance when in use. If the drive is performing well, a routine maintenance clean is performed. If the drive has degraded performance the cleaning is automatically made more robust to recover the drive to optimum performance.

Interfaces

HP offers a range of interface options with our DAT Tape Drives in order to meet the varying needs of our customers. HP DAT drives are available with a choice of: the standard SCSI interface where legacy SCSI connectivity is required, USB 2.0 interface for universal plug and play connectivity and a SAS interface option for the very latest in server connectivity.

Native SAS – Serial Attached SCSI

As its name suggests, SAS delivers a new generation of technology based on a development of the classic SCSI interface. First introduced in May 2002, the SAS interface leverages the proven SCSI protocol to deliver new levels of scalability, flexibility, and cost-effectiveness for today's system connectivity, data transport, and data storage.

HP has introduced DAT 160 with a native SAS interface that allows customers to directly connect and backup SAS configured servers and take advantage of the latest connectivity trends.

Why SAS?

For over 20 years, the parallel bus interface has been the mainstream storage interconnect for most storage systems. While technologies like parallel SCSI meet most performance requirements of today's enterprise solutions, continued demands for higher speeds, increasingly robust data integrity, smaller designs and wider standardization have cast doubt on the ability of parallel technologies to economically keep pace with increasing CPU processing power and disk drive speeds. SAS is the new evolution of SCSI technology designed to overcome the limitations of the SCSI architecture and delivers a number of benefits to enterprise systems:

New levels of performance – SAS is capable of moving data at speeds of up to 3Gigabits per second, with a clear roadmap to 12Gbs in the future. A SAS connection can support four SAS wide lanes or potentially 4 x 300MB/s per connection.

Product Highlights

Increased availability – another benefit of SAS-based storage subsystems is the native dual port capability of each SAS drive, providing a redundant path to each drive in the event of a controller failover. In addition, since each drive is on a separate point-to-point connection, losing a drive connection only affects a single drive. Compare this to parallel SCSI in which losing a bus affects all the drives on the bus. Point-to-point also means that each device has the ability to connect multiple initiators, allowing peripherals to be shared between several servers.

Greater flexibility – probably the best known benefit of SAS for external storage is its configuration flexibility. A SATA drive can be plugged into a SAS mid-plane without any modifications or changes, the controller and the software will seamlessly support a system with a mix of SATA and SAS disk drives.

Why choose a SAS interface DAT drive?

The above benefits of SAS explain why system manufacturers, including HP, are rapidly moving to SAS interfaces to connect internal peripherals. Customers purchasing a HP DAT Tape Drive with native SAS interface can benefit from:

Wide availability of SAS ports – SAS interfaces are now widely available on servers and systems. Furthermore with server I/O bus technology moving from PCI-X to PCI-Express (PCI-e), customers may find it difficult to obtain Parallel SCSI host bus adapters for the PCI-Express bus.

Increased flexibility – SAS has the ability to connect multiple initiators, allowing the tape drive to be shared between several servers.

Investment protection – this new generation interface is supported by a robust multi-vendor roadmap and already boasts a clear future out to 12GB/s.

Installing SAS tape drives

HP StorageWorks SAS tape drives are available as internal and external models. Both models are supplied with a special split cable that allows you to connect to an internal port (if available) on the embedded SAS controller inside the server. While connection via the split cable provides the most cost-effective way of connecting the tape drive to an HP ProLiant server, this will require a clear understanding of your server's current SAS configuration before installing.

For the most up-to-date information about recommended SAS HBAs and supported cabling configurations with your make and model of server, always refer to <http://www.hp.com/go/connect>. A full installation guide is included with the product.

Native USB

The USB (Universal Systems Bus) interface was conceived out of a need to simplify computer peripheral device connection. It has been so successful that the majority of computer systems and servers shipped today offer multiple native USB 2.0 ports.

HP is the first company to develop a native USB DDS/DAT tape drive. Where other "USB tape drives" rely on a USB converter, HP's USB interface is fully integrated with the drive and uses the SCSI command set within the USB payload. The benefit of this implementation is that it gives the drive full SCSI functionality and the flexibility of USB without the additional cost of a converter.

By offering native USB 2.0 DAT drives, HP aims to provide customers with a number of benefits:

- Greater usability
- Plug-and-play connectivity - the system automatically detects and configures the tape drive.
- The DAT drive is installed and ready to backup in less than 60 seconds.
- Microsoft fully supports USB devices natively in their operating systems providing robust, secure

Product Highlights

- configuration and installation wizards.
- Cables are easily identifiable, easy to attach without the need for thumb-screw and robust enough to ensure reliable retention.
- Resource abundance
- Native USB ports are universally available in systems and servers
- Multiple ports ensure that port resources are widely available, reducing the conflict between devices over scarce connectors.
- Port expansion is easy, USB hubs can be installed to add additional ports supporting up to 127 devices on a system
- Low cost, reliable connectivity
- By providing native USB DDS/DAT drives there is no need for customers to purchase additional host-bus adapters
- HP's USB 2.0 implementation benefits from the built-in reliability and failure recovery inherent in the underlying SCSI protocol
- USB 2.0 has multiple levels of physical error detection and recovery which ensure reliability on a par with SCSI and Fibre-channel interfaces.
- USB 2.0 compliance certification provides thorough, ongoing reliability and quality control. A well implemented USB network should use only USB 2.0 compliant components, including USB 2.0 certified cables.
- Sustainable performance
- In HP tests it has been shown that USB 2.0 can sustain the performance of an HP DDS/DAT drive at around 30MB/sec, a bandwidth that would sustain the HP DAT 72 drive operating with a compression ratio of 9:1!
- USB 2.0 performance provides sufficient bandwidth to support all future generations of DDS/DAT drives specified on the DAT Manufacturers Group Roadmap

Native SCSI

In addition to offering native USB and SAS connectivity, HP remain committed to producing DAT drives with SCSI interfaces for the foreseeable future. This widely respected interface continues to meet mainstream server requirements for performance and reliability.

Compression

DDS uses built-in hardware compression using the 'DCLZ' data compression algorithm. Data compression is host-selectable with the default that compression is turned on. Typical data compression is 2:1, but actual compression depends on the type of data being compressed and can be more or less than 2:1.

QuickSpecs

HP StorageWorks Tape Drives

Product Highlights

SCSI Offline Hot-Swap Technology

NOTE: this feature is available for SCSI products. USB variants of HP DAT drives already benefit from hot-plug capability through the USB 2.0 interface.

The HP StorageWorks DAT SCSI tape drives are available as offline hot-swap models to increase your uptime. With these models, you never have to take down your system to replace a failed or non-responding tape device.

The HP StorageWorks Tape Array 5300 supports "offline hot-swap" (sometimes referred to as "warm-swap") array modules, including DAT drives. This means the drives can be removed and replaced with the power on and the SCSI cables attached to the server. Because the array's SCSI buses are not buffered, however, drive replacement should only take place while the SCSI bus is quiescent (no SCSI activity from the tape drive or any other device on the same bus).

With the HP StorageWorks DAT or array modules, the server does not need to be taken offline to install the tape drive. Simply insert the tape drive into the server's Tape Array 5300's drive bay and install or configure the backup software.

Rack-Mount Tape Options

HP DAT SCSI drives are supported on the HP StorageWorks 1U and 3U Rack-Mount Kits and the HP StorageWorks Tape Array 5300. The 3U Rack-Mount Kit and the Tape Array 5300 allow up to four internal DAT drives to be installed in 3U of rack space, while the 1U Rack-Mount Kit holds two DAT drives in 1U of space. 1U rack-mount kits use standard internal DAT USB and SCSI drives for a low-cost solution. 3U rack-mount kits use standard internal DAT SCSI drives while the Tape Array 5300 uses DAT array modules that provide offline hot-swap capabilities and redundant components for high-availability environments.

Either of these rack enclosures can be configured with separate SCSI buses (channels) for each drive or two or more drives per bus using the optional cable kits.

NOTE: Please refer to the QuickSpecs for HP StorageWorks Rack-Mount Kits at http://h18000.www1.hp.com/products/quickspecs/10854_div/10854_div.html or the HP StorageWorks Tape Array 5300 web page at <http://www.hp.com/products1/storage/products/tapebackup/tapearrays/tapearray5300/index.html> for further information.

HP StorageWorks OBDR (One-Button Disaster Recovery)

With HP One-Button Disaster Recovery, you can quickly, reliably and simply restore your entire ProLiant system just by inserting the most recent backup tape and pushing one button on the tape drive. Your HP StorageWorks DAT drive will restore your operating system, configuration, applications, drivers and data files. There's no longer a need to search for software disks and manuals. And with downtime reduced, the costs of recovery are minimized too. There's no need to make a new set of disaster recovery disks each time the network configuration is altered or a peripheral is added. Recovering from a disaster manually at a stressful time makes for an error-prone process. The sheer simplicity of HP One-Button Disaster Recovery means less human error. Backup and disaster recovery preparation -- previously two separate tasks -- become one process. OBDR is simply the best disaster recovery product for small to medium systems. For a current list of servers, workstations, and software that support OBDR, check the tape backup compatibility pages at: <http://www.hp.com/go/obdr>

QuickSpecs

HP StorageWorks Tape Drives

Product Highlights

Software in the Box

The HP StorageWorks DDS/DAT tape drives include HP Data Protector Express Single Server Edition software. This easy to use backup application, based on Data Protector Express, robustly protects a single Windows, Linux or NetWare server. Also included is the Data Protector Express Bare Metal Disaster Recovery (BMDR) option which provides automated system recovery of the server following a major hardware or software failure. The fastest method to recovery the server is to use the Data Protector Express BMDR option and the One Button Disaster Recovery feature of the HP StorageWorks DDS/DAT tape drives. For more information about Data Protector Express Single Server Edition please visit: <http://www.hp.com/go/dataprotectorexpress/sse>.

As well as getting the Data Protector Express Single Server Edition software as part of the HP StorageWorks DDS/DAT tape drives solution, purchasers can easily and economically upgrade to the class-leading Data Protector Express backup/recovery software. This is a special part number, only available for registered users of Data Protector Express Single Server Edition for that gives a significant discount off the regular price of Data Protector Express, to recognize the value of the in-box software.. For more information upgrading Data Protector Express Single Server Edition to Data Protector Express visit: <http://www.hp.com/go/dataprotectorexpress/sse/upgrade>.

If the HP StorageWorks DDS/DAT tape drive is for a large environment that requires UNIX support and/or enterprise class application and feature support then HP Data Protector is the recommended backup/recovery software. For more information and evaluation software please visit <http://www.hp.com/go/dataprotector>.

HP StorageWorks Library and Tape Tools (L&TT)

HP StorageWorks DAT drives are supported on HP's industry-leading diagnostic tool -- HP StorageWorks Library and Tape Tools (L&TT). L&TT is a single, convenient program that's a snap to install and simple to operate. L&TT's intuitive user interface eliminates the need for training and deploys in less than five minutes. This robust diagnostic tool is designed for both the experienced professional and the untrained administrator. It ensures product integrity through self-diagnostics and fast resolution to device concerns. To download and obtain additional information on L&TT go to <http://www.hp.com/support/tapetools>

HP DDS Media

HP's test program for HP DAT media is probably the most thorough and comprehensive in the industry. HP data cartridges must satisfy an exhaustive battery of additional tests that relate directly to real life situations, where real data and real businesses are at stake. Over 1 million test hours on media and drives per year ensure that HP data cartridges will always offer maximum reliability even in the most extreme conditions. HP recommends that customers always use HP branded media to ensure stress-free backup and complete peace of mind.

Compatibility

HP's extensive compatibility testing program assures that HP StorageWorks DAT drives work with leading servers, operating systems, and backup applications -- and not just those sold by HP. HP DAT drives work seamlessly in many environments, making them especially suitable if you have a mixed system environment. For the latest list of servers, workstations, operating systems, and backup software that support HP DAT drives, check the tape backup compatibility pages at: <http://www.hp.com/go/connect>.

HP Server and Workstation Compatibility with SAS drives

HP StorageWorks DAT SAS drives are compatible with HP ProLiant servers, Integrity Servers, and HP Workstations, as well as many third-party servers. HP StorageWorks DAT SAS drives are supported on the following classes of HP systems:

- HP ProLiant DL servers
- HP ProLiant ML servers
- HP Integrity servers
- HP Personal Workstations

For details of which tape drive models work with which systems, including third-party systems, visit <http://www.hp.com/go/connect> for the latest hardware compatibility information.

HP Server and Workstation Compatibility with SCSI drives

HP StorageWorks DAT SCSI drives are compatible with HP ProLiant servers, HP 9000 servers, Integrity Servers, Alpha Servers and HP Workstations, as well as many third-party servers. HP StorageWorks DAT SCSI drives are supported on the following classes of HP systems:

- HP ProLiant DL servers
- HP ProLiant ML servers
- HP Alpha Servers
- HP 9000 servers
- HP Integrity servers
- HP Personal and RISC Workstations

For details of which tape drive models work with which systems, including third-party systems, visit <http://www.hp.com/go/connect> for the latest hardware compatibility information.

HP Server Compatibility with USB drives

HP StorageWorks DAT USB drives are compatible with HP ProLiant servers and HP workstations, as well as many third-party servers. HP StorageWorks DAT USB drives are supported on the following classes of HP systems:

- HP ProLiant DL servers
- HP ProLiant ML servers
- HP Personal Workstations

For details of which tape drive models work with which systems, including third-party systems, visit <http://www.hp.com/go/connect> for the latest hardware compatibility information.

NOTE: HP recommends that no more than one DAT USB tape drive be connected to a system at a time.

QuickSpecs

HP StorageWorks Tape Drives

Compatibility

OS Support for SAS DAT drives	Microsoft® Windows®, Linux (various distributions) and other operating systems NOTE: Please visit http://www.hp.com/go/connect for the latest compatibility information.
OS Support for SCSI DAT drives	Microsoft® Windows®, Novell NetWare, HP-UX, Linux (various distributions), HP Tru64, HP OVMS, IBM AIX, Sun Solaris, and other operating systems NOTE: Please visit http://www.hp.com/go/connect for the latest compatibility information.
OS Support for USB DAT drives	Microsoft® Windows®, Linux (various distributions) NOTE: Please visit http://www.hp.com/go/connect for the latest compatibility information.
Backup Software Support for SAS drives	HP Data Protector Software, HP Data Protector Express Software, Symantec Backup Exec, CA BrightStor ARCserve Backup and other backup applications NOTE: Please visit http://www.hp.com/go/connect for the latest compatibility information.
Backup Software Support for SCSI drives	HP Data Protector Software, HP Data Protector Express Software, Symantec Backup Exec, CA BrightStor ARCserve Backup and other backup applications NOTE: Please visit http://www.hp.com/go/connect for the latest compatibility information.
Backup Software Support for USB drives	HP Data Protector Express, CA BrightStor ARCserve Backup, Symantec Backup Exec, and other backup applications NOTE: Please visit http://www.hp.com/go/connect for the latest compatibility information.

SOLO NETWORK

Service and Support, HP Care Pack, and Warranty Information

HP Care Pack Information HP Care Pack Services offer upgraded service levels to extend and expand your standard product warranty with easy to buy, easy to use support packages that help you make the most of your hardware and software investments. They let you choose the support levels that meet your business requirements, from basic to mission-critical. They help you contain total cost of ownership.

HP Care Pack warranty extensions can be purchased along with HP products to cost-effectively upgrade or extend your warranty. For many products, post-warranty HP Care Pack Services are available when your original warranty has expired.

Why purchase an HP Care Pack service?

Your standard warranty protects against product defects. HP Care Pack Services help you guard against unplanned downtime, which can reduce your productivity and profitability. These convenient service packages:

- Protect your investment in HP products
- Provide consistent, predictable levels of support across your entire department or business
- Ease budget planning with fixed-cost support that includes parts and labor
- Give you direct access to proven technical and problem-solving expertise
- Offer a choice of response-time and repair-time commitments
- Deliver prompt, measurable results
- Are available whenever and wherever you do business

HP Care Pack availability may vary by country and product.

Supporting your Adaptive Enterprise journey

HP Services helps you make the Adaptive Enterprise real for your organization. The breadth, depth, and quality of HP hardware and software support services can help you improve the performance of your IT support processes and resolve the complex software and hardware problems that tax user productivity. HP Care Pack services help you increase IT environment stability, efficiency, and agility from the desktop to the data center, and improve the productivity of your employees.

Warranty and Services Included with the HP StorageWorks DAT Products

Hewlett-Packard provides a 3-year, next-day, product exchange, limited warranty, for all **StorageWorks DAT Tape Drives** (excluding the StorageWorks DAT24 USB Tape Drive), plus 9x5 phone--support for the duration of the warranty.

For more information about HP's Global Limited Warranty and Technical Support, visit:
ftp://ftp.compaq.com/pub/products/storageworks/warranty/EN_321708-008.pdf

Service and Support, HP Care Pack, and Warranty Information

Recommended Services

In order to maximize ROI and product uptime, and minimize the cost of ownership, Hewlett Packard recommends:

3 years 24 x 7 Hardware Support

- Guards against downtime, which reduces productivity and profitability
- Eases budget planning with fixed-cost support that includes parts and labor
- Direct access to proven technical and problem-solving expertise

3 years 24 x 7 Software Support

- Improve the productivity of system managers and operators
- Improve system performance and reduce downtime due to software defects
- Expedite problem resolution through expert-level technical resources
- Enjoy consistent service coverage across geographically dispersed sites
- Update HP and selected third-party software at a predictable cost
- Take advantage of subscription savings on software updates
- Keep your license compliancy up-to-date

Available HP Care Pack Services Extend your product warranty with a wide choice of cost-saving support packages.

HP Care Pack services are sold by HP and HP authorized enterprise and commercial resellers. Services for customers purchasing via direct and enterprise resellers are quoted using HP order configuration tools. Additional information about HP Care Pack service features and benefits is available at <http://www.hp.com/hps/carepack/services/>.

Key for HP Care Pack service availability in the table below:

E = Service available for customers purchasing direct and via enterprise resellers

C = Service available for customers purchasing via commercial resellers

N/A = Service not applicable

HP Care Pack Services Deployment and Per Event Services	Service Available
HP Installation	E/C
HP Installation & Startup	N/A
HP Implementation	N/A

For more information about deployment and per event services for HP storage products, visit <http://www.hp.com/hps/storage/>.

QuickSpecs

HP StorageWorks Tape Drives

Service and Support, HP Care Pack, and Warranty Information

HP Care Pack Services Availability Services	1 yr	3 yr	4 yr	5 yr
HP Next Day Hardware Support	E/C	E/C	C	C
HP 4 Hr, 9x5 Hardware Support	E/C	E/C	C	C
HP 4 Hr, 13x5 Hardware Support	E/C	E/C	C	C
HP 4 Hr, 24x7 Hardware Support	E/C	E/C	C	C
HP 6 HR Call-to-Repair Hardware Support	E/C	E/C	C	C
HP Software Support	E/C	E/C	C	C
HP Software Support 24x7	E/C	E/C	C	C
HP Support Plus	E/C	E/C	C	C
HP Support Plus 24	E/C	E/C	E/C	E/C
HP Proactive Essentials 9x5, 10 Software Incidents	NA	NA	NA	NA
HP Proactive Essentials 9x5, 25 Software Incidents	NA	NA	NA	NA
HP Proactive Essentials 9x5 Unlimited	NA	NA	NA	NA
HP Proactive Essentials 24x7, 25 Software Incidents	NA	NA	NA	NA
HP Proactive Essentials 24x7, 50 Software Incidents	NA	NA	NA	NA
HP Proactive Essentials 24x7 Unlimited	NA	NA	NA	NA
HP Proactive 24 Service*	E/C	E/C	NA	NA
HP Critical Service*	E/C	E/C	NA	NA

***NOTE:** Both Proactive 24 & Critical Service only relate to 'reactive elements'. 'Proactive elements' are available on time & materials basis. (SW is supported separately per package).

Important Notice for Tape Drives Installed in a 1U or 3U Rack Mount Kit **NOTE:** These Care Packs do not apply to Tape Drives mounted in a 1U or 3U Rack Mount Kit. The HP Rack Mount Kit Care Pack covers the all possible configurations of Tape Drives. Hence the Care Packs for 1U & 3U Rack Mount Kit covers all encumberant drives.

Please follow the following URL for the correct Care Pack Services and descriptions.

http://h18000.www1.hp.com/products/quickspecs/10854_div/10854_div.PDF

Important Notice for Internal Tape Drives Installed in an HP Server **NOTE:** These Care Packs do not apply to Internal Tape Drives because they do not have Care Packs associated with them if they are mounted in an HP Server. Hence the Care Packs for the HP Server covers all encumberant drives.

Please follow the following URL for the correct Care Pack Services and descriptions.

For Proliant use - <http://h18000.www1.hp.com/products/quickspecs/ProductBulletin.html>

For BCS use - <http://h18000.www1.hp.com/products/quickspecs/ProductBulletin.html>

QuickSpecs

HP StorageWorks Tape Drives

Service and Support, HP Care Pack, and Warranty Information

Important Notice for Tape Drive Modules Installed in an HP Tape Array **NOTE:** These Care Packs do not apply to Tape Drives mounted in an HP Tape Array because they do not have Care Packs associated with them. Hence the Care Packs for the HP Tape Array covers all encumberant drives.

Please follow the following url for the correct Care Pack Services and descriptions.
http://h18000.www1.hp.com/products/quickspecs/11878_div/11878_div.PDF

HP Care Pack Service Product Numbers

Enterprise & Commercial Purchased Care Packs

('A' stands for physical Care Pack, 'E' for electronic Care Pack)

For DAT 40 Range, DAT 72 Range and DAT 160 Range Only

Product Description	Product Number
Tape Installation Hardware Installation Only	U2090A/E
Hardware, "3-year", "Next Business Day", "9x5", "on-site"	H3155A/E
Hardware, "3-year", "4-hour", "13x5", "on-site"	H4616A/E
Hardware, "3-year", "4-hour", "24x7", "on-site"	U2068A/E
Hardware, "3-year", "6hr Call-to-Repair", "24x7", "on-site"	U6358A/E
Hardware, "4-year", "4-hour", "13x5", "on-site"	U9338A/E
Hardware, "4-year", "4-hour", "24x7", "on-site"	U9339A/E
Hardware, "5-year", "4-hour", "13x5", "on-site"	U9340A/E
Hardware, "5-year", "4-hour", "24x7", "on-site"	U9341A/E
Hardware, "1-year", "Next Business Day", "9x5", "on-site", "Post Warranty"	UA450PE
Hardware, "1-year", "4-hour", "13x5", "on-site", "Post Warranty"	UA451PE
Hardware, "1-year", "4-hour", "24x7", "on-site", "Post Warranty"	UA452PE
Hardware, "1-year", "6hr Call-to-Repair", "24x7", "on-site", "Post Warranty"	UA453PE

Enterprise Purchased Care Packs

For DAT 40 Range, DAT 72 Range and DAT 160 Range Only

Product Description	Drive Band	Install Band	Product Number
Tape Installation Hardware Installation Only	N/A	596	HA113A1
Hardware, "3-year", "next-day", "13x5", "on-site"	455	N/A	HA101A3
Hardware, "3-year", "4-hour", "13x5", "on-site"	455	N/A	HA103A3
Hardware, "3-year", "4-hour", "24x7", "on-site"	455	N/A	HA104A3
Hardware, "3-year", "6hr Call-to-Repair", "24x7", "on-site"	455	N/A	HA105A3
SW, "3-year", "Phone-in", "9x5"	N/A	N/A	HA106A3
SW, "3-year", "Phone-in", "24x7"	N/A	N/A	HA107A3
Hardware Only, Support Plus, "3-year", "13x5"	455	N/A	HA109A3
Hardware Only, Support Plus 24, "3-year", "24x7"	455	N/A	HA110A3
Hardware Only, Proactive 24, "3-year", "24x7"	455	N/A	HA111A3
Hardware Only, Critical Service, "3-year", "24x7"	455	N/A	HA112A3

*Both Proactive 24 & Critical Service only relate to 'reactive elements', 'proactive elements' are available on time & materials basis. (SW is supported separately per package).

The Care Pack information quoted above relates to 3 year offerings only, 1yr / 4yr & 5yr packs are available for each offering (replace A3 with A1, A4 or A5).

Service and Support, HP Care Pack, and Warranty Information

eSupport

HP eSupport is a portfolio of technology-based services that assist you with managing your business environment - from the desktop to the data center.

Support Portal

The HP support portal provides one-stop access to the information, tools and services you need to manage the daily operations of your IT environment.

Features include:

- Access to self-solve tools (including search technical knowledge base)
- Efficient logging and tracking of support cases
- Collaboration with other business and IT professionals
- Download of patches and drivers
- Access to diagnostic tools
- Proactive notification of relevant information

Access to certain features of the support portal requires an HP service agreement. To access the support portal, visit <http://www.hp.com/support>.

HP Education Services

For more information about HP Education Services for Storage and SAN, visit <http://education.hp.com/curr-storsan.html>

Additional Services Information

For more information about Deployment, Per Event, Consulting and Education services for HP Storage, visit: <http://www.hp.com/hps/storage/>

For more information about HP Care Pack services for storage products, visit: http://www.hp.com/hps/carepack/storage/cp_networked.html

For more information about HP storage software, services and updates, visit: <http://h18006.www1.hp.com/storage/software.html>

If you have specific questions, contact your local HP representative. Contact information for a representative in your area can be found at "Contact HP" <http://www.hp.com/>

QuickSpecs

HP StorageWorks Tape Drives

Kit Contents

HP StorageWorks DAT 40 Tape Drives

Model	Description	Part Number
DAT 40 SCSI Internal	DAT 40 SCSI Internal Tape Drive, installation poster, HP StorageWorks CD (containing electronic user's guide and drivers), HP Data Protector Express Single Server Edition software and its Bare Metal Disaster Recovery option, SCSI ribbon cable, screws, HP DDS-4 data cartridge, HP DDS cleaning cartridge. NOTE: 0D1 will appear after this part number on your sales order if factory integration is indicated.	C5686C
DAT 40 SCSI External	DAT 40 SCSI External Tape Drive, installation poster, HP StorageWorks CD (containing electronic user's guide, drivers, and HP Library and Tape Tools software diagnostics, HP Data Protector Express Single Server Edition software and its Bare Metal Disaster Recovery option, SCSI cable (68-pin HD to 68-pin VHD, LVD/SE Ultra2, 2.5m), LVD/SE SCSI multi-mode terminator, power cord, HP DDS-4 data cartridge, HP DDS cleaning cartridge.	C5687D
DAT 40 Array Module for Tape Array 5300	DAT 40 SCSI Array Module, installation poster, HP StorageWorks CD (containing electronic user's guide, drivers, and HP Library and Tape Tools software diagnostics, HP Data Protector Express Single Server Edition software and its Bare Metal Disaster Recovery option, HP DDS-4 data cartridge, HP DDS cleaning cartridge. NOTE: 0D1 will appear after this part number on your sales order if factory integration is indicated.	C7497C
DAT 40 USB Internal	DAT 40 USB Internal Tape Drive, installation poster, HP StorageWorks CD (containing electronic user's guide and drivers), HP Data Protector Express Single Server Edition software and its Bare Metal Disaster Recovery option, standard USB cable, USB cable for internal ProLiant connect, USB cable for internal connect to an Intel motherboard header, cable routing kit (for connection to external USB 2.0 ports), screws, HP DDS-4 data cartridge, HP DDS cleaning cartridge. NOTE: 0D1 will appear after this part number on your sales order if factory integration is indicated.	DW022A
DAT 40 USB External	DAT 40 USB External Tape Drive, installation poster, HP StorageWorks CD (containing electronic user's guide and drivers), HP Data Protector Express Single Server Edition software and its Bare Metal Disaster Recovery option, integral USB cable, power cord, HP DDS-4 data cartridge, HP DDS cleaning cartridge.	DW023A

QuickSpecs

HP StorageWorks Tape Drives

Kit Contents

HP StorageWorks DAT 72 Tape Drives

Model	Description	Part Number
DAT 72 SCSI Internal	DAT 72 SCSI Internal Tape Drive, installation poster, HP StorageWorks CD (containing electronic user's guide and drivers), HP Data Protector Express Single Server Edition software and its Bare Metal Disaster Recovery option, SCSI ribbon cable (68-pin wide HD LVD), HP DAT 72 data cartridge, HP DDS cleaning cartridge. NOTE: 0D1 will appear after this part number on your sales order if factory integration is indicated.	Q1522B
DAT 72 SCSI External	DAT 72 SCSI External Tape Drive, installation poster, HP StorageWorks CD (containing electronic user's guide and drivers), HP Data Protector Express Single Server Edition software and its Bare Metal Disaster Recovery option, SCSI cable (68-pin Wide VHD-HD LVD), LVD/SE SCSI multi-mode terminator, power cord, HP DAT 72 data cartridge, HP DDS cleaning cartridge.	Q1523B
DAT 72 SCSI Array Module for Tape Array 5300	DAT 72 SCSI Array Module, installation poster, HP StorageWorks CD (containing electronic user's guide and drivers), HP Data Protector Express Single Server Edition software and its Bare Metal Disaster Recovery option, HP DAT 72 data cartridge, HP DDS cleaning cartridge. NOTE: 0D1 will appear after this part number on your sales order if factory integration is indicated.	Q1524C
DAT 72 USB Internal	DAT 72 USB Internal Tape Drive, installation poster, HP StorageWorks CD (containing electronic user's guide and drivers), HP Data Protector Express Single Server Edition software and its Bare Metal Disaster Recovery option, standard USB cable, USB cable for internal ProLiant connect, USB cable for internal connect to an Intel motherboard header, cable routing kit (for connection to external USB 2.0 ports), screws, HP DAT 72 data cartridge, HP DDS cleaning cartridge. NOTE: 0D1 will appear after this part number on your sales order if factory integration is indicated.	DW026A
DAT 72 USB External	DAT 72 USB External Tape Drive, installation poster, HP StorageWorks CD (containing electronic user's guide and drivers), HP Data Protector Express Single Server Edition software and its Bare Metal Disaster Recovery option, integral USB cable, power cord, HP DAT 72 data cartridge, HP DDS cleaning cartridge.	DW027A
DAT 72 USB 1U USB Rack-Mount Kit	Single DAT 72 integrated in a 1U USB Rack-Mount enclosure with power supply and fan (up to 2 half-height tape drives supported), installation poster, HP StorageWorks CD (containing electronic user's guide and drivers), HP Data Protector Express Single Server Edition software and its Bare Metal Disaster Recovery option, integral USB cable, power cord, rail kit, HP DAT 72 data cartridge, HP DDS cleaning cartridge. NOTE: Single drive installed in a 1U Rack-mount kit NOTE: 0D1 will appear after this part number on your sales order if factory integration into a rack is indicated.	AG594A

HP StorageWorks DAT 160 Tape Drives

Model	Description	Part Number
DAT 160 SAS Internal	DAT 160 SAS Internal Tape Drive, installation poster, HP StorageWorks CD (containing electronic user's guide and drivers), HP Data Protector Express Single Server Edition backup/recovery software CD and the HP Data Protector Express Bare Metal Disaster Recovery option, SAS cable (SFF-8484/SFF-8482), HP DAT 160 data cartridge, HP DAT cleaning cartridge II NOTE: 0D1 will appear after this part number on your sales order if factory integration is indicated.	Q1587A



QuickSpecs

HP StorageWorks Tape Drives

Kit Contents

DAT 160 SAS External	DAT 160 SCSI External Tape Drive, installation poster, HP StorageWorks CD (containing electronic user's guide and drivers), HP Data Protector Express Single Server Edition backup/recovery software CD and the HP Data Protector Express Bare Metal Disaster Recovery option, 3x/1x external split SAS cable (SFF-8484/SFF-8088), power cord, HP DAT 160 data cartridge, HP DAT cleaning cartridge II.	Q1588A
DAT 160 SCSI Internal	DAT 160 SCSI Internal Tape Drive, installation poster, HP StorageWorks CD (containing electronic user's guide and drivers), HP Data Protector Express Single Server Edition backup/recovery software CD and the HP Data Protector Express Bare Metal Disaster Recovery option, SCSI ribbon cable (68-pin wide HD LVD), HP DAT 160 data cartridge, HP DAT cleaning cartridge II. NOTE: 0D1 will appear after this part number on your sales order if factory integration is indicated.	Q1573A
DAT 160 SCSI External	DAT 160 SCSI External Tape Drive, installation poster, HP StorageWorks CD (containing electronic user's guide and drivers), HP Data Protector Express Single Server Edition backup/recovery software CD and the HP Data Protector Express Bare Metal Disaster Recovery option, SCSI cable (68-pin Wide VHD-HD LVD), LVD/SE SCSI multi-mode terminator, power cord, HP DAT 160 data cartridge, HP DAT cleaning cartridge II.	Q1574A
DAT 160 SCSI Array Module for Tape Array 5300	DAT 160 SCSI Array Module, installation poster, HP StorageWorks CD (containing electronic user's guide and drivers), HP Data Protector Express Single Server Edition backup/recovery software CD and the HP Data Protector Express Bare Metal Disaster Recovery option, HP DAT 160 data cartridge, HP DAT cleaning cartridge II NOTE: 0D1 will appear after this part number on your sales order if factory integration is indicated.	Q1575A
DAT 160 USB Internal	DAT 160 USB Internal Tape Drive, installation poster, HP StorageWorks CD (containing electronic user's guide and drivers), HP Data Protector Express Single Server Edition backup/recovery software CD and the HP Data Protector Express Bare Metal Disaster Recovery option, standard USB cable, USB cable for internal ProLiant connect, USB cable for internal connect to an Intel motherboard header, cable routing kit (for connection to external USB 2.0 ports), screws, HP DAT 160 data cartridge, HP DAT cleaning cartridge II. NOTE: 0D1 will appear after this part number on your sales order if factory integration is indicated.	Q1580A
DAT 160 USB External	DAT 160 USB External Tape Drive, installation poster, HP StorageWorks CD (containing electronic user's guide and drivers), HP Data Protector Express Single Server Edition backup/recovery software CD and the HP Data Protector Express Bare Metal Disaster Recovery option, integral USB cable, power cord, HP DAT 160 data cartridge, HP DAT cleaning cartridge II.	Q1581A
DAT 160 USB 1U USB Rack-Mount Kit	Single DAT 160 integrated in a 1U USB Rack-Mount enclosure with power supply and fan (up to 2 half-height tape drives supported), installation poster, HP StorageWorks CD (containing electronic user's guide and drivers), HP Data Protector Express Server Edition software and its Bare Metal Disaster Recovery option, integral USB cable, power cord, rail kit, HP DAT 160 data cartridge, HP DAT cleaning cartridge II. NOTE: Single drive installed in a 1U Rack-mount kit NOTE: 0D1 will appear after this part number on your sales order if factory integration into a rack is indicated.	AG703A

QuickSpecs

HP StorageWorks Tape Drives

Options

NOTE: This is a list of related options. Some may be discontinued.

Host Bus Adapters and Controllers for ProLiant Servers	SCSI Controllers	
	64-Bit/133-MHz Single-Channel Ultra320 SCSI Adapter	374654-B21
	HP Single channel U320 PCI-e SC11Xe Host Bus Adapter	412911-B21
	NOTE: Please refer to the following web page for further information: http://www.hp.com/go/connect	
	SAS Controllers	
	HP SC44Ge Host Bus Adapter	416096-B21
	NOTE: Recommended SAS HBA for connecting HP StorageWorks tape drives to HP ProLiant servers	
	HP Smart Array P400/256MB Controller	405132-B21
	HP Smart Array P400/512MB Controller	411064-B21
	HP 8 Internal Port SAS HBA with RAID 0/1	347786-B21
NOTE: PCI-X interface		
HP Smart Array P800/512 BBWC Controller	381513-B21	
HP Smart Array E500 Controller	435129-B21	
Host Bus Adapters and Controllers for AlphaServers	32-bit to LVD Single-Channel SCSI	3X-KZPCA-AA
	64-bit Dual-Channel Ultra 3 LVD SCSI Adapter	3X-KZPEA-DB
	NOTE: Please refer to the following web page for further information: http://www.hp.com/go/connect	
Controllers for Third-Party Servers	HP Single channel U320 PCI-e SC11Xe Host Bus Adapter	412911-B21
	64-Bit/133-MHz Single-Channel Ultra320 SCSI Adapter	374654-B21
	NOTE: Please refer to the following web page for further information: http://www.hp.com/go/connect	
	HP SC44Ge Host Bus Adapter	416096-B21
NOTE: Recommended SAS HBA for connecting HP StorageWorks tape drives		
Media	HP DDS-2 Data Cartridge, 8GB	C5707A
	HP DDS-3 Data Cartridge, 24GB	C5708A
	HP DDS-4 Data Cartridge, 40GB	C5718A
	HP DAT 72 Data Cartridge, 72GB	C8010A
	HP DAT 160 Data Cartridge, 160GB	C8011A
	HP DDS Cleaning Cartridge	C5709A
	HP DDS/DAT Cleaning Cartridge II	C8015A

QuickSpecs

HP StorageWorks Tape Drives

Options

Rack-Mount Options	<p>IU SAS Rack-Mount KIT AE459A</p> <p>NOTE: 1U SAS Rack-Mount Kit holds up to two internal DAT SAS drives (and other SAS tape technologies).</p> <p>NOTE: Please refer to the following web page for further information: http://h18006.www1.hp.com/storage/tapestorage/rackmount.html</p>
	<p>3U SAS Rack-Mount KIT AG576A</p> <p>NOTE: 3U SAS Rack-Mount Kit holds up to four internal DAT SAS drives (and other SAS tape technologies).</p> <p>NOTE: Please refer to the following web page for further information: http://h18006.www1.hp.com/storage/tapestorage/rackmount.html</p>
	<p>1U Rack-Mount Kit A7445B</p> <p>NOTE: 1U Rack-Mount Kit holds up to two internal DAT drives (and other tape technologies).</p> <p>NOTE: Please refer to the following web page for further information: http://h18006.www1.hp.com/products/storageworks/1urackmount/index.html</p>
	<p>1U USB Rack-Mount Kit A8007A</p> <p>NOTE: Please refer to the following web page for further information: http://h18006.www1.hp.com/products/storageworks/1urackmount/index.html</p>
	<p>1U USB Cable Option Kit 396114-B21</p> <p>NOTE: This cable kit can be purchased to convert a 1U SCSI rack-mount kit to a USB interface to support the DAT USB drives. It includes 1 - 5 meter USB cable, 1- plastic grommet, 1- metallic panel, and documentation. All pieces are pre-assembled for easy implementation.</p>
	<p>3U Rack-Mount Kit 274338-B22</p> <p>NOTE: 3U Rack-Mount Kit holds up to four internal SCSI DAT drives (and other tape technologies).</p> <p>NOTE: Please refer to the following web page for further information: http://h18006.www1.hp.com/products/storageworks/3urackmount/index.html</p>
	<p>Tape Array 5300 C7508B</p> <p>NOTE: Tape Array 5300 holds up to four offline hot-swap DAT array modules (and other tape technologies).</p> <p>NOTE: Please refer to the following web page for further information: http://www.hp.com/products1/storage/products/tapebackup/tapearrays/tapearray5300/index.html</p>

QuickSpecs

HP StorageWorks Tape Drives

Options

SCSI Cable Kits	External SCSI Cable, 68-pin HD/68-pin VHDCI, 12ft/3.66m	341177-B21
	SCSI Cable LVD, HVD or SE (Multimd) HDTS68 connector 0.5m	C2978B
	External SCSI Cable, 68-pin HD/68-Pin HD, 16.4ft/5m	C2911C
	SCSI Cable LVD, HVD or SE (Multimd) HDTS68 connector 2.5m	C2924C
	SCSI Cable LVD, HVD or SE (Multimd) HDTS68 connector 5m	C7521A
	SCSI Cable LVD, HVD or SE (Multimd) HDTS68 connector 10m	C7522A
	SCSI Cable LVD, HVD or SE (Multimd) VHDS68/HDTS68 1m	C2361B
	SCSI Cable LVD, HVD or SE (Multimd) VHDS68/HDTS68 2.5m	C2362B
	SCSI Cable LVD, HVD or SE (Multimd) VHDS68/HDTS68 5m	C2365B
SCSI Cable LVD, HVD or SE (Multimd) VHDS68/HDTS6810m	C2363B	
SAS Cable Kits	4M Internal SAS (SFF-8484) to Mini SAS (SFF-8088) 3x/1x External Split SAS Cable NOTE: This split cable connects internally to SAS Hard Drive Cage (3x) and externally to a HP StorageWorks SAS tape drive (1x) with other connector going to internal SAS Controller port inside the server. Requires additional PCI slot on server for threading 1x split cable to SAS tape drive.	AE464A
	2M External Infiniband (SFF-8470) to Mini SAS (SFF-8088) 1x SAS Cable NOTE: Use this cable to connect HP StorageWorks SAS External Tape Drives to SAS Controllers with Infiniband (SFF-8470) connectors.	AE466A
	4M External Infiniband (SFF-8470) to Mini SAS (SFF-8088) 1x SAS Cable NOTE: Use this cable to connect HP StorageWorks SAS External Tape Drives to SAS Controllers with Infiniband (SFF-8470) connectors.	AE468A
	2M External Mini SAS (SFF-8088) to Mini SAS (SFF-8088) 1x SAS Cable NOTE: Use this cable to connect HP StorageWorks SAS External Tape Drives to SAS Controllers with Mini SAS (SFF-8088) connectors.	AE470A
	4M External Mini SAS (SFF-8088) to Mini SAS (SFF-8088) 1x SAS Cable NOTE: Use this cable to connect HP StorageWorks SAS External Tape Drives to SAS Controllers with Mini SAS (SFF-8088) connectors.	AE465A

QuickSpecs

HP StorageWorks Tape Drives

Technical Specifications

Dimensions

	DAT 40	DAT 72	DAT 160
Form Factor	Half-height, 5¼ inches (internal and array module)	Half-height, 5¼ inches (internal and array module)	Half-height, 5¼ inches (internal and array module)
Physical (HxWxD) SAS Internal	n/a	n/a	1.6 x 5.7 x 7.2 in (4.0 x 14.5 x 18.3 cm)
Physical (HxWxD) SCSI Internal	1.6 x 5.7 x 6.1 in (4.0 x 14.5 x 15.5 cm)	1.6 x 5.7 x 6.1 in (4.0 x 14.5 x 15.5 cm)	1.6 x 5.7 x 7 in (4.0 x 14.5 x 17.7 cm)
Physical (HxWxD) USB Internal	1.6 x 5.7 x 6.1 in (4.0 x 14.5 x 15.5 cm)	1.6 x 5.7 x 6.1 in (4.0 x 14.5 x 15.5 cm)	1.6 x 5.7 x 7.2 in (4.0 x 14.5 x 18.3 cm)
Physical (HxWxD) SCSI/USB External	2.2 x 7.1 x 8.7 in (5.7 x 18.1 x 22.2 cm)	2.2 x 7.1 x 8.7 in (5.7 x 18.1 x 22.2 cm)	2.6 x 7.1 x 9.3 in (6.7 x 18.1 x 23.6 cm)
Physical (HxWxD) SAS External	n/a	n/a	2.6 x 7.1 x 9.3 in (6.7 x 18.1 x 23.6 cm)
Physical (HxWxD) Array Module	1.6 x 6.3 x 11.2 in (4.0 x 16.0 x 28.5 cm)	1.6 x 6.3 x 11.2 in (4.0 x 16.0 x 28.5 cm)	1.6 x 6.3 x 11.2 in (4.0 x 16.0 x 28.5 cm)
Shipping (HxWxD) SAS Internal	n/a	n/a	6.3 x 9.25 x 9.05 in (16.0 x 23.5 x 23.0 cm)
Shipping (HxWxD) SCSI Internal	9.5 x 9.25 x 9.5 in (24.0 x 23.5 x 24.0 cm)	9.5 x 9.25 x 9.5 in (24.0 x 23.5 x 24.0 cm)	6.3 x 9.25 x 9.05 in (16.0 x 23.5 x 23.0 cm)
Shipping (HxWxD) USB Internal	9.5 x 9.25 x 9.5 in (24.0 x 23.5 x 24.0 cm)	9.5 x 9.25 x 9.5 in (24.0 x 23.5 x 24.0 cm)	6.3 x 9.25 x 9.05 in (16.0 x 23.5 x 23.0 cm)
Shipping (HxWxD) SAS External	n/a	n/a	8.85 x 12.6 x 11.02 in (22.5 x 32.0 x 28.0 cm)
Shipping (HxWxD) SCSI External	11.8 x 11.02 x 12.6 in (30.0 x 28.0 x 32.0 cm)	11.8 x 11.02 x 12.6 in (30.0 x 28.0 x 32.0 cm)	8.85 x 12.6 x 11.02 in (22.5 x 32.0 x 28.0 cm)
Shipping (HxWxD) USB External	11.8 x 11.02 x 12.6 in (30.0 x 28.0 x 32.0 cm)	11.8 x 11.02 x 12.6 in (30.0 x 28.0 x 32.0 cm)	8.85 x 12.6 x 11.02 in (22.5 x 32.0 x 28.0 cm)
Shipping (HxWxD) Array Module	11.4 x 17.7 x 12.2 in (29.0 x 45.0 x 31.0 cm)	11.4 x 17.7 x 12.2 in (29.0 x 45.0 x 31.0 cm)	10.6 x 17.3 x 11.8 in (27.0 x 44.0 x 30.0 cm)

Weight

	DAT 40	DAT 72	DAT 160
Out of box SAS Internal	n/a	n/a	2.7 lb (1.2 kg)
Out of box SCSI/USB Internal	2.1 lb (.95 kg)	2.1 lb (.95 kg)	2.7 lb (1.2 kg)
Out of box SAS External	n/a	n/a	5 lb (2.25 kg)
Out of box SCSI/ USB External	4.2 lb (1.90 kg)	4.2 lb (1.90 kg)	5 lb (2.25 kg)
Out of box Array Module	3.2 lb (1.45 kg)	3.1 lb (1.40 kg)	3.1 lb (1.40 kg)
Shipping USB/SCSI Internal	3.2 lb (1.44 kg)	3.2 lb (1.44 kg)	3.2 lb (1.44 kg)
Shipping USB/SCSI External	6.4 lb (2.9 kg)	6.4 lb (2.9 kg)	6.4 lb (2.9 kg)
Shipping Array Module	7.9 lb (3.6 kg)	7.9 lb (3.6 kg)	7.9 lb (3.6 kg)

QuickSpecs

HP StorageWorks Tape Drives

Technical Specifications

Capacity	DAT 40	DAT 72	DAT 160
Native	20 GB	36 GB	80GB
Compressed (assumes 2:1 data compression)	40 GB	72GB	160GB
Buffer Size	8 MB	8 MB	16 MB
<hr/>			
Performance	DAT 40	DAT 72	DAT 160
Sustained Transfer Rate (native) Where 1KB = 1,000 Bytes	3.2 MB/s*	3.2 MB/s*	6.9 MB/s*
Sustained Transfer Rate (with 2:1 data compression) Where 1KB = 1,000 Bytes	6.4 MB/s*	6.4 MB/s*	13.8 MB/s*
Burst Transfer Rate (SAS interface) Where 1KB = 1,000 Bytes	n/a	n/a	6.9 MB/s (asynchronous) 3 Gb/s (synchronous)
Burst Transfer Rate (SCSI interface) Where 1KB = 1,000 Bytes	6.4 MB/s (asynchronous) 160 MB/s (synchronous)	6.4 MB/s (asynchronous) 160 MB/s (synchronous)	6.9 MB/s (asynchronous) 160 MB/s (synchronous)
Burst Transfer Rate (USB interface) Where 1KB = 1,000 Bytes	6.4MB/s (asynchronous) 40 MB/s (synchronous)	6.4MB/s (asynchronous) 40 MB/s (synchronous)	6.9MB/s (asynchronous) 40 MB/s (synchronous)
Data Access Time	50 s	68 s	50 s
Average Load Time	15 s	15 s	35 s
Average Unload Time	15 s	15 s	35 s
Rewind Time	110 s (end to end)	120 s (end to end)	92 s (end to end)
<hr/>			
Reliability	DAT 40	DAT 72	DAT 160
MTBF	125,000 hours at 100% duty cycle	125,000 hours at 100% duty cycle	125,000 hours at 100% duty cycle
Uncorrected Error Rate	1x10 ⁻¹⁷ bits read	1x10 ⁻¹⁷ bits read	1x10 ⁻¹⁷ bits read
<hr/>			
Media	DAT 40	DAT 72	DAT 160
Recommended media	DDS-4 (155m)	DAT 72 (170m)	DAT 160 (150m, wide tape)
Backward read-write compatibility	DDS-3 (125m) DDS-2 (120m)	DDS-4 (155m) DDS-3 (125m)	DAT 72 (170m) DDS-4 (155m)

QuickSpecs

HP StorageWorks Tape Drives

Technical Specifications

Tape Format		DAT 40	DAT 72	DAT 160
Recording Method		4 mm helical scan	4 mm helical scan	8 mm helical scan
Recording Format		DDS-4, DDS-3, and DDS-2 (ANSI/ISO/ECMA)	DAT 72, DDS-4, DDS-3 (ANSI/ISO/ECMA)	DAT 160, DAT 72, DDS-4,
Data Compression		Lempel-Ziv (DCLZ)	Lempel-Ziv (DCLZ)	Lempel-Ziv (DCLZ)
Error Detection/Correction		Reed-Solomon	Reed-Solomon	Reed-Solomon
Data Encoding Method		Partial Response Maximum Likelihood (PRML)	Partial Response Maximum Likelihood (PRML)	Partial Response Maximum Likelihood (PRML)

Interface		DAT 40	DAT 72	DAT 160
SAS Interface		n/a	n/a	SAS 1.1
SAS Connector		n/a	n/a	SAS Internal: mini-SAS SFF8482 SAS External: mini-SAS SFF8088
SCSI Interface		SCSI-3 Ultra 160 LVD	SCSI-3 Ultra 160 LVD	SCSI-3 Ultra 160 LVD
SCSI Connector		Internal: 68-pin wide HD LVD External: 68-pin wide HDLVD, thumbscrew Hot-plug: 80-pin SCA-2 (SCSI and power) Array module: 80-pin EBBI	Internal: 68-pin wide HD LVD External: 68-pin wide LVDS, thumbscrew Hot-plug: 80-pin SCA-2 (SCSI and power) Array module: 80-pin EBBI	Internal: 68-pin wide HD LVD External: 68-pin wide LVDS, thumbscrew Array module: 80-pin EBBI
USB Interface		USB 2.0	USB 2.0	USB 2.0
USB Connector		USB standard series B receptacle	USB standard series B receptacle	USB standard series B receptacle
Termination - is only required for the SCSI product		No terminator is required for internal model (assumes use of terminated cable). External model requires termination with multimode terminator (included with product). SCSI Array module requires termination with multimode terminator (ordered separately - p/n C2364A).		

QuickSpecs

HP StorageWorks Tape Drives

Technical Specifications

Power Specifications

	DAT 40	DAT 72	DAT 160
Power Requirements (SCSI-2 internal, hot-plug, and array module)	+5V ± 5% (100mV Max ripple) @0.6A +12V ± 10% (150mV Max ripple) @1.2A	+5V ± 5% (100mV Max ripple) @0.6A +12V ± 10% (150mV Max ripple) @1.2A	n/a
Power Requirements (USB, SCSI-3 internal and SAS and array module)	+5V ± 5% (100mV Max ripple) @0.8A +12V ± 10% (150mV Max ripple) @0.3A	+5V ± 5% (100mV Max ripple) @0.8A +12V ± 10% (150mV Max ripple) @0.3A	+5V ± 5% (100mV Max ripple) @1.1A +12V ± 10% (150mV Max ripple) @0.4A
Power Requirements (external)	100 to 240 VAC, 50-60 Hz, auto-ranging	100 to 240 VAC, 50-60 Hz, auto-ranging	100 to 240 VAC, 50-60 Hz, auto-ranging
Power consumption (SAS) (average)	n/a	n/a	10.3 Watts
Power consumption (SCSI) (average)	7.3 Watts	7.1 Watts	10.3 Watts
Power consumption (USB) (average)	7.3 Watts	7.1 Watts	10.3 Watts

Environmental Specifications (all models)

Relative Humidity	Storage	5% to 95%
	Operating	20% to 80%
Temperature Range	Storage	-40° to 158° F/(-40° to 70° C)
	Operating	41° to 104° F/(5° to 40° C)

Standards Compliance

cCSAus Certification to C22.2, No. 60950, TÜV EN60950 (IEC 60950), FCC and CE Declaration of Conformity, C-TICK Approved (AS/NZS CISPR22), VCCI Approved, RRL Approved, BSMI Approved, GOSH Approved

DAT 72 and DAT 40 drive LED Indicators (with 2 LED indicators)

	Tape LED	Clean LED	Meaning
Tape Ready Signal	On steady	Off	The data cartridge is loaded and the drive is ready.
Tape Loading Signal	Flashing slowly	Off	The cartridge is loading or unloading, or power-on self-test is in progress
Tape Activity Signal	Flashing rapidly	Off	The cartridge is loaded, activity is occurring.

QuickSpecs

HP StorageWorks Tape Drives

Technical Specifications

Media Caution Signal	Off or flashing	Flashing slowly	If the media caution signal is displayed: <ul style="list-style-type: none"> The drive has detected that cleaning is required to maintain good performance. Wait for the current operation to finish and clean the drive with an appropriate cleaning media, ensuring it has not expired. Continue to use the drive as before. If the signal repeats, consider changing the data media for new media when convenient. Regular cleaning (every 24 hours of tape pulling or weekly) can prevent this signal being shown.
Error Condition Signal	Off	On steady	HP DAT drives perform a comprehensive self-test during power-up. If a hard error causes the self-test to fail, the clean light changes to steady amber. Run HP Library & Tape Tools to help diagnose the problem.
OBDR Signal	Both flashing slowly in an alternating pattern		The tape drive is in disaster recovery mode, restoring the operating system.

DAT 160 drive LED Indicators (with 4 LED indicators)

	Ready LED	Clean LED	Tape LED	Drive LED	Meaning
Tape Ready Signal	On steady	Off	Off	Off	The data cartridge is loaded and the drive is ready.
Tape Loading Signal	Flashing slowly	Off	Off	Off	The cartridge is loading or unloading, or power-on self-test is in progress
Tape Activity Signal	Flashing rapidly	Off	Off	Off	The cartridge is loaded, activity is occurring.
Cleaning Advisory Signal	Off or flashing	Flashing slowly	Off	Off	If the cleaning advisory signal is displayed: <ul style="list-style-type: none"> The drive has detected that cleaning is required to maintain good performance. Wait for the current operation to finish and clean the drive with an appropriate cleaning media, ensuring it has not expired. Continue to use the drive as before. If the signal repeats, consider changing the data media for new media when convenient. Regular cleaning (every 24 hours of tape pulling or weekly) can prevent this signal being shown.



QuickSpecs

HP StorageWorks Tape Drives

Technical Specifications

Media Caution Signal	Off or flashing	Off	Flashing slowly	Off	<p>If the media caution signal is displayed:</p> <ul style="list-style-type: none"> The drive has detected that the data media being used is likely to be nearing the end of its life, damaged or degraded. It is recommended that once the current operation is complete, the drive is cleaned with appropriate media and the data media changed. If required, the data from the media flagged as suspect should be transferred to a new media cartridge.
Drive Caution Signal	Off or flashing	Off	Off	Flashing slowly	<p>If the drive caution signal is displayed:</p> <ul style="list-style-type: none"> The drive has detected that the performance of the drive has become degraded. The is an unusual state which is only triggered when there have been issues with multiple data media and the drive has been cleaned regularly. If this occurs, please use Library and Tape Tools to perform further diagnosis or contact HP support for further advice.
Error Condition Signal	Off			On steady	<p>HP DAT drives perform a comprehensive self-test during power-up. If a hard error causes the self-test to fail, the clean light changes to steady amber. Run HP Library & Tape Tools to help diagnose the problem.</p>
OBDR Signal	Pulsing (2 flashes followed by a pause)				<p>The tape drive is in disaster recovery mode, restoring the operating system.</p>

© Copyright 2008 Hewlett-Packard Development Company, L.P.

The information contained herein is subject to change without notice.

Microsoft and Windows are US registered trademarks of Microsoft Corporation. Intel is a US registered trademark of Intel Corporation. Unix is a registered trademark of The Open Group.

The only warranties for HP products and services are set forth in the express warranty statements accompanying such products and services. Nothing herein should be construed as constituting an additional warranty. HP shall not be liable for technical or editorial errors or omissions contained herein.

For tape drives and media, 1 GB = 1 billion bytes. Actual formatted capacity is less.



QuickSpecs

Technical Specifications

SOLO NETWORK