

B52



PRODUCT LINE UP
CAR AUDIO

B52

DIGITAL
PLAYERS

INDEX SERIES

After a history of 25 years, **B52** is pleased to announce, once again, new products and a new line. Applying as always the highest manufacturing standards, along with the latest technology, outstanding material innovation and a rigorous quality control process, **B52** is today, more than ever, a leader in sales of vehicle product offerings in terms of audio, comfort, and security.

Conceived and designed in the USA, **B52** brings to international markets and consumers around the World the best products and systems, always making a priority to meet the rigorous demands of end users and to provide high quality products that set new limits that our competitors try to match.

Through the years, **B52** has proven to be a pioneer in the industry with a long history, outstanding know how, and "that something more" that makes us stand out: the passion for what we do.

Now it is time to appreciate a very complete catalogue full of products with a very attractive, modern and professional design featuring new lines of players with endless features, great connectivity and visualization. The amplifier lines renew their technology and build, strengthening their performance. The extensive lines of full range speakers and subwoofers provide maximum power accompanied by high quality materials and a very modern and yet elegant design. **B52** follows a philosophy of focusing on hard diligent teamwork, constant innovation and always going the extra mile, with passion.

CAPACITORS
AMPLIFIERS



W O O F E R S

2 • DIGITAL PLAYERS *DDC*

- 4 • *DLC*
- 5 • *DV*
- 6 • *MP*
- 7 • *MP*

10 • FULL RANGE SPEAKERS *ELS*

- 18 • *WA*
- 22 • *ELK*

26 • WOOFERS *SW*

- 28 • *ETR*
- 30 • *FLM*

34 • TURBO SPEAKERS *ATR*

38 • AMPLIFIERS *ELP*

- 42 • *RC*

46 • CAPACITORS *DPF*

48 • VIEW COLOR CAMERAS *CCD*

50 • AUDIO CABLES

53 • OTROS

CAR AUDIO

S P E A K E R S



H I G H
D E F I N I T I O N



Activate your senses with new line of **B52** multimedia players and meet our extensive line of audio and video players. Maximum connectivity and data transmission. More power than previous lines. Enjoy entertainment with more features, all that you need to make your vehicle "your own place".

DIGITAL PLAYERS SERIES



COD. 9205206
DDC-9017

6.2" MULTIMEDIA
PLAYER

4x52 WATTS



SPECIFICATIONS

- Support MP3/WMA audio files playback from USB/microSD Card
- Video Player (Support: HD/DIVX/ AVI/MPG/ MPEG/MOV)
- Video System: AUTO PAL/NTSC
- Picture support JPG
- ID3 Tag support
- 2 Din
- 6.2" TFT Display
- Rear Camera video input
- 208W (4 X 52 Watts) Output Power
- Full AM/FM PLL Synthesized Tuner
- 30 Station Pre-sets 12AM/18FM, Station Seek, Preset Scan
- Automatic Memory Preset Store Function
- Electronic Vol/Bal/Fad/Bass/ Tre Control
- Electronic Preset Equalizer Pop/Rock/Classic/Jazz/Flat
- Low-impedance RCA Line Out Plugs
- Aux Input Jack
- Bluetooth® Connection
- RGB Function
- Subwoofer Line Output

ACCESORIES



LOGISTICS INFORMATION

- Master Dimensions: 54,5 x 53,6 x 18,8 cm / 21,5 x 21,1 x 7,4 In
- Gross weight: 8,2 Kg / 18,1 Lb • Master pieces: 4u



COD. 9205205

DLC-8017

7" MULTIMEDIA
PLAYER

4x52 WATTS

ACCESSORIES

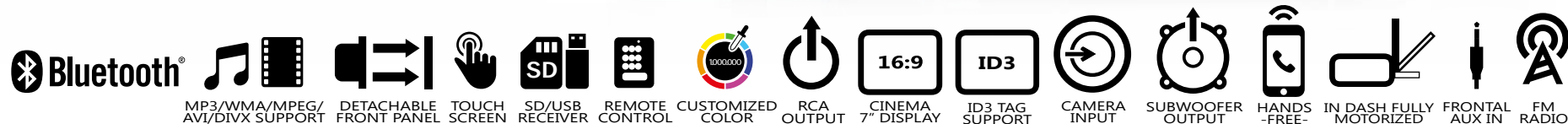
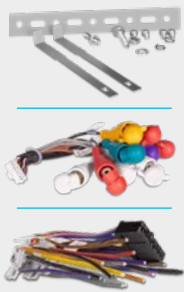

SPECIFICATIONS

FULLY MOTORIZED
IN-DASH
MULTIMEDIA PLAYER

- Support MP3/WMA audio files playback from USB/SD/MMC Card
- Video Player (Support: MPG/MPEG/DIVX/AVI/MOV)
- Video System: AUTO PAL/NTSC
- Picture support JPG
- ID3 Tag support

- 2 Din
- 7" TFT Touch Display
- Hands free phone function
- 208W (4 X 52 Watts) Output Power
- Full AM/FM PLL Synthesized Tuner
- 30 Station Pre-sets 12AM/18FM, Station Seek, Preset Scan
- Wireless Remote Control Included

- Automatic Memory Preset Store Function
- Electronic Vol/Bal/Fad/Bass/Tre Control
- Rear Camera input
- Aux Input Jack
- Bluetooth® Connection
- Subwoofer Line Output

LOGISTICS INFORMATION

- Master Dimensions: 55,2 x 25,0 x 30,8 cm / 21,7 x 9,8 x 12,1 in
- Gross weight: 9,9 Kg / 21,8 Lb
- Master pieces: 4u

COD. 9205203

DV-8617

MULTIMEDIA
PLAYER

3"
4x52 WATTS

DIGITAL PLAYER SERIES
DV



- Bluetooth®**
- MP3/WMA/MPEG/AVI
DIVX SUPPORT
- SD/USB
RECEIVER
- REMOTE
CONTROL
- CUSTOMIZED
COLOR
- RCA
OUTPUT
- 3" DISPLAY
- ID3
TAG SUPPORT
- VIDEO
OUTPUT
- HANDS-FREE
- DETACHABLE
FRONT PANEL
- FRONTAL
AUX IN
- EQUALIZER
PRESET
- FM
RADIO

LOGISTICS INFORMATION

- Master Dimensions:
44,5 x 24,1 x 27,0 cm
/ 17,5 x 9,5 x 10,6 in
- Gross weight: 6,3 Kg / 13,9 Lb
- Master pieces: 5u

- Support MP3/WMA audio files playback from USB/SD/MMC Card
- Video Player
(Support: MPG/MPEG/DIVX/AVI/MOV)
- Video System: AUTO PAL/NTSC
- Picture support JPG
- ID3 Tag support
- Detachable Front Panel

- 3" TFT Display
- Hands free phone function
- 208W (4 X 52 Watts) Output Power
- Full AM/FM PLL Synthesized Tuner
- 30 Station Pre-sets 12AM/18FM, Station Seek, Preset Scan
- Wireless Remote Control Included
- Automatic Memory Preset Store Function

- Electronic Vol/Bal/Fad/Bass/Tre Control
- Electronic Preset Equalizer: Pop/Rock/Classic/Jazz/Flat
- Low-impedance RCA Line Out Plugs
- Aux Input Jack
- Bluetooth® Connection
- Video Out
- RGB Function

SPECIFICATIONS

**FULL DETACHABLE
FRONT PANEL
MP3 PLAYER**

COD. 9205201

RM-3017BT

DIGITAL
PLAYER

4x52 WATTS

DIGITAL PLAYER SERIES

RM

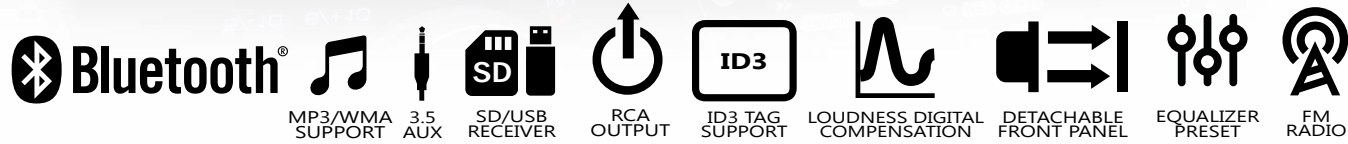
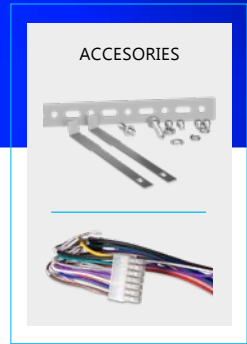

SPECIFICATIONS

FULL DETACHABLE FRONT PANEL MP3 PLAYER

- Support MP3 files playback from USB/SD/MMC Card
- ID3 Tag support
- Detachable Front Panel
- LCD Display with Power Level Meter
- 208W (4 X 52 Watts) Output Power
- Full AM/FM PLL Synthesized Tuner
- Built-in Loudness Function
- 30 Station Pre-sets 12AM/18FM, Station Seek, Preset Scan
- Automatic Memory Preset Store Function
- Electronic Vol/Bal/Fad/Bass/Tre Control
- Electronic Preset Equalizer: Pop/Rock/Classic/Flat
- Real TIME Clock Function
- Low-impedance RCA Line Out Plugs
- Aux Input Jack
- Bluetooth® Connection

LOGISTICS INFORMATION

- Master Dimensions: 44,5 x 24,1 x 27,0 cm / 17,5 x 9,5 x 10,6 in
- Gross weight: 5,6 Kg / 12,3 Lb
- Master pieces: 5u

COD. 9205200
RM-2018BT

**DIGITAL
 PLAYER**

4x52 WATTS

DIGITAL PLAYER SERIES
RM



LATERAL VIEW

REAR VIEW



ACCESSORIES



MP3/WMA
 SUPPORT



3.5
 AUX



SD/USB
 RECEIVER



FLIP DOWN
 DETACHABLE



RCA
 OUTPUT



ID3
 SUPPORT



LOUDNESS DIGITAL
 COMPENSATION



EQUALIZER
 PRESET



FM
 RADIO

LOGISTICS INFORMATION

- Master Dimensions:
 44,5 x 24,1 x 27,0 cm
 / 17,5 x 9,5 x 10,6 in
- Gross weight: 5,6 Kg / 12,3 Lb
- Master pieces: 5u

- Support MP3 files playback from USB/SD Card
- ID3 Tag support
- Detachable Front Panel
- LCD Display with Power Level Meter
- 208W (4 X 52 Watts) Output Power

- Full AM/FM PLL Synthesized Tuner
- 30 Station Pre-sets 12AM/18FM, Station Seek, Preset Scan
- Automatic Memory Preset Store Function
- Electronic Vol/Bal/Fad/Bass/Tre Control

- Built-in Loudness Function
- Electronic Preset Equalizer: Pop/Rock/Classic/Flat
- Real TIME Clock Function
- Low-impedance RCA Line Out Plugs
- Aux Input Jack

SPECIFICATIONS

**FULL DETACHABLE
 FRONT PANEL
 MP3 PLAYER**

COD. 9205212

RM-2008BT

DIGITAL
PLAYER

4x52 WATTS

DIGITAL PLAYER SERIES
RM

HIGH
DEFINITION



SPECIFICATIONS

FULL DETACHABLE FRONT PANEL MP3 PLAYER

- Support MP3 files playback from USB/SD Card
- ID3 Tag support
- Detachable Front Panel
- LCD Display with Power Level Meter
- 208W (4 X 52 Watts) Output Power
- Full AM/FM PLL Synthesized Tuner
- 30 Station Pre-sets 12AM/18FM, Station Seek, Preset Scan
- Automatic Memory Preset Store Function
- Electronic Vol/Bal/Fad/Bass/Tre Control
- Built-in Loudness Function
- Electronic Preset Equalizer: Pop/Rock/Classic/Flat
- Real TIME Clock Function
- Low-impedance RCA Line Out Plugs
- Aux Input Jack

LOGISTICS INFORMATION

- Master Dimensions:
44,5 x 24,1 x 27,0 cm
/ 17,5 x 9,5 x 10,6 In
- Gross weight: 5,6 Kg / 12,3 Lb
- Master pieces: 5u

COD. 9205800
RM-1018

**DIGITAL
PLAYER**

120 WATTS

DIGITAL PLAYER SERIES
RM



ACCESSORIES



MP3/WMA
SUPPORT



3.5
AUX



SD/USB
RECEIVER



FM
RADIO



EQUALIZER
PRESET



RCA
OUTPUT

LOGISTICS INFORMATION

- Master Dimensions:
44,5 x 21,5 x 38,0 cm
/ 17,5 x 8,5 x 15,0 in
- Gross weight: 6,9 Kg / 15,2 Lb
- Master pieces: 5u

- FM PLL Tuning Radio
- Non-Detachable Fixed Chassis
- Auto Seek/Auto Store stations
- 18 Preset Memory Stations
- Built-In USB/SD/ports
- Built-In AUX-IN on front
- Large LCD Digital display

- Treble/Bass EQ
- Preset EQ (Jazz/Pop/Rock/Classic/Flat)
- Intro/Repeat/Random functions
- Digital Clock
- 60W (4x15W) Output Power
- 120W (4x30W) Peak Power
- RCA Line Out

■ SPECIFICATIONS

**FULL DETACHABLE
FRONT PANEL
MP3 PLAYER**



E L E M E N T - 5

ELS is the ideal line to optimize your audio system and take it to the place that you always dreamed of. Full range speakers of high sensitivity and components that allow to distribute audio the way that you desire. B52 shows its rugged built in this series with strong aluminum protection and a unique and furious design.

FULL RANGE SPEAKERS ELS SERIES



COD. 1054414
ELS-691

1200 WATTS | 4 WAY-6x9"

My MATCHLESS QUALITY
MYLAR DOME

IC STRONGEST SURFACE
INJECTION CONE

118
dB
MAXIMUM
SPL

HIGH
SENSITIVITY

FREQUENCY
RESPONSE
45HZ-20KHZ

MAGNET
SIZE

6x9"
LARGER
CONE SIZE



▣ RUGGED PROTECTION

▣ DIE CAST ALUMINIUM BASKET

■ SPECIFICATIONS

LOGISTICS INFORMATION

- Master Dimensions:
29 x 45,5 x 62,5 cm
/ 11,4 x 17,9 x 24,6 in
- Gross weight: 20,5 Kg / 45,2 Lb
- Master pieces: 4u

- Size & Type _____ 6 x 9" 4-Way
- Peak Power Handling _____ 600w (per unit)
- Rated Power Handling _____ 100w (per unit)
- Impedance _____ 4 Ω
- Frequency Response _____ 45 Hz – 20 KHz
- Sensitivity (1W/1m) _____ 90dB

- Magnet _____ 30 oz Strontium
- Voice coil _____ 1½" Aluminium
- Woofer _____ Injection one
- Midrange _____ 2" Mylar Dome Tweeter
and Tweeter
- _____ 3/4" Piezo Tweeter
- _____ Pair pack



COD. 1054416
ELS-2651

1000 WATTS 2 WAY-6½"

COD. 1054415
ELS-2501

600 WATTS 2 WAY-5¼"



ELP-2651/2501
SERIES INCLUDES



□ SUPERIOR
CLARITY
TWEETER



□ EXTERNAL
HIGH QUALITY
CROSSOVER



FREQUENCY
RESPONSE
50HZ – 22KHZ

My MATCHLESS QUALITY
MYLAR DOME

IC STRONGEST SURFACE
INJECTION CONE



MORE ACCURATE
SOUND



HIGH
SENSITIVITY



FREQUENCY
RESPONSE
70HZ – 22KHZ

SPECIFICATIONS

- Size & Type _____ 6½" Component
- Peak Power Handling _____ 500w (per unit)
- Rated Power Handling _____ 65w (per unit)
- Impedance _____ 4 Ω
- Frequency Response _____ 50 Hz – 22 KHz
- Sensitivity (1W/1m) _____ 90dB
- Way _____ 2
- Magnet _____ 13 oz Strontium
- Voice coil _____ 1¼"
- Woofer _____ Injection Cone
- Midrange and Tweeter _____ 25 mm PEI Dome Tweeter

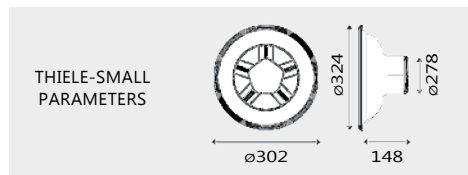

THIELE-SMALL
PARAMETERS

LOGISTICS INFORMATION

- Master Dimensions:
53,2 x 38,7 x 45,0 cm
/ 21,0 x 15,2 x 17,7 in
- Gross weight: 30,1 Kg / 66,4 Lb
- Master pieces: 6u

LOGISTICS INFORMATION

- Master Dimensions:
66,5 x 34,0 x 40,8 cm
/ 26,2 x 13,4 x 16,1 in
- Gross weight: 25,7 Kg / 56,6 Lb
- Master pieces: 10u

SPECIFICATIONS

- Size & Type _____ 5¼" Component
- Peak Power Handling _____ 300w (per unit)
- Rated Power Handling _____ 45w (per unit)
- Impedance _____ 4 Ω
- Frequency Response _____ 70 Hz – 22 KHz
- Sensitivity (1W/1m) _____ 90dB
- Magnet _____ 10 oz Strontium
- Voice coil _____ 1"
- Woofer _____ Injection Cone
- Midrange and Tweeter _____ 25 mm PEI Dome Tweeter

COD. 1054413
ELS-651

800 WATTS
3 WAY-6½"

FULL RANGE SPEAKERS SERIES
ELS



IC STRONGEST SURFACE
INJECTION CONE

My MATCHLESS QUALITY
MYLAR DOME

SPECIFICATIONS

- Size & Type _____ 6½" Component
- Peak Power Handling _____ 400w (per unit)
- Rated Power Handling _____ 70w (per unit)
- Impedance _____ 4 Ω
- Frequency Response _____ 65 Hz – 20 KHz
- Sensitivity (1W/1m) _____ 93dB
- Magnet _____ 22 oz Strontium
- Voice coil _____ 1¼" Aluminium
- Midrange _____ 1¼" Mylar Dome
- Tweeter _____ ½" Piezo

LOGISTICS INFORMATION

- Master Dimensions: 53,2 x 38,7 x 45,0 cm / 21,0 x 15,2 x 17,7 in
- Gross weight: 31,2 Kg / 68,8 Lb
- Master pieces: 6u

THIELE-SMALL
PARAMETERS

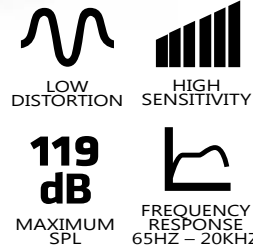
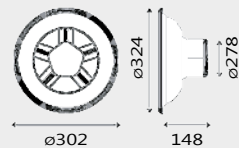

COD. 1054412
ELS-526

560 WATTS
3 WAY-5 1/4"

COD. 1054411
ELS-401

400 WATTS
3 WAY-4"



117 dB
MAXIMUM SPL



My MATCHLESS QUALITY
MYLAR DOME

Ei GREATER SPL
ELECTROPLATE INJECTION



115 dB
MAXIMUM SPL



SPECIFICATIONS

- Size & Type _____ 5 1/4" 3-Way
- Peak Power Handling _____ 280w (per unit)
- Rated Power Handling _____ 50w (per unit)
- Impedance _____ 4 Ω
- Frequency Response _____ 80 Hz - 20 KHz
- Sensitivity (1W/1m) _____ 92dB
- Cone Material _____ Electroplate Injection PP
- Magnet _____ 18 oz Strontium
- Voice coil _____ 1" Aluminium
- Midrange _____ 1 1/4" Mylar Dome
- Tweeter(s) _____ 1/2" Piezo

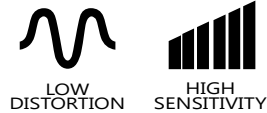

LOGISTICS INFORMATION

- Master Dimensions: 66,5 x 34,0 x 40,8 cm / 26,2 x 13,4 x 16,1 in
- Gross weight: 27,3 Kg / 60,2 Lb
- Master pieces: 10u

LOGISTICS INFORMATION

- Master Dimensions: 62,0 x 30,0 x 35,4 cm / 24,4 x 11,8 x 13,5 in
- Gross weight: 19,5 Kg / 42,9 Lb
- Master pieces: 10u

SPECIFICATIONS

- Size & Type _____ 4" 3-Way
- Peak Power Handling _____ 200w (per unit)
- Rated Power Handling _____ 40w (per unit)
- Impedance _____ 4 Ω
- Frequency Response _____ 100 Hz - 20 KHz
- Sensitivity (1W/1m) _____ 92dB
- Cone Material _____ Electroplate Injection PP
- Magnet _____ 10 oz Strontium
- Voice coil _____ 1" Aluminium
- Midrange _____ 1 1/4" Mylar Dome
- Tweeter(s) _____ 1/2" Piezo

COD. 1054421
ELS-2654

800 WATTS 2 WAY-6½"

COD. 1054420
ELS-2520

600 WATTS 2 WAY-5¼"



Ei GREATER SPL
ELECTROPLATE INJECTION

My MATCHLESS QUALITY
MYLAR DOME



121
dB

MAXIMUM SPL

117
dB

MAXIMUM SPL

ELP-2654 & ELP-2520 SERIES includes

SPECIFICATIONS

- Size & Type _____ 6½" 2-Way
- Peak Power Handling _____ 400w (per unit)
- Rated Power Handling _____ 80w (per unit)
- Impedance _____ 4 Ω
- Frequency Response _____ 60 Hz – 20 KHz
- Sensitivity (1W/1m) _____ 95dB
- Cone Material _____ Electroplated Injection
- Magnet _____ 10 oz Strontium
- Voice coil _____ 1" (25mm)
- Midrange _____ With Aluminium Bullet
- Tweeter(s) _____ 1" (25mm) Mylar Dome
- Crossover Network Unit _____ 3,5KHz - 12dB/Oct
- Presentation _____ Pair Pack Kit

▣ EXTERNAL
HIGH QUALITY
CROSSOVER



▣ SUPERIOR
CLARITY
TWEETER



ALUMINIUM BULLET

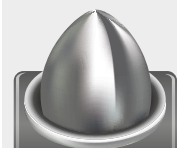

LOGISTICS INFORMATION

- Master Dimensions:
53,2 x 38,7 x 45,0 cm
/ 21,0 x 15,2 x 17,7 in
- Gross weight: 21,9 Kg / 48,3 Lb
- Master pieces: 10u

LOGISTICS INFORMATION

- Master Dimensions:
23,0 x 43,0 x 54,0 cm
/ 9,1 x 16,9 x 21,3 in
- Gross weight: 4,4 Kg / 9,7 Lb
- Master pieces: 4u

SPECIFICATIONS

- Size & Type _____ 5¼" 2-Way
- Peak Power Handling _____ 300w (per unit)
- Rated Power Handling _____ 60w (per unit)
- Impedance _____ 4 Ω
- Frequency Response _____ 80 Hz – 20 KHz
- Sensitivity (1W/1m) _____ 92dB
- Cone Material _____ Electroplated Injection
- Magnet _____ 10 oz (Barium Ferrite)
- Voice coil _____ 1" (25mm)
- Midrange _____ With Aluminium Bullet
- Tweeter(s) _____ 1" (25mm) Mylar Dome
- Crossover Network Unit _____ 3,5KHz - 12dB/Oct
- Presentation _____ Pair Pack Kit

ELS FULL RANGE SPEAKERS SERIES



ELEMENT - 5

ELS is the ideal line to optimize your audio system and take it to the place that you always dreamed of. Full range speakers of high sensitivity and components that allow to distribute audio the way that you desire. B52 shows its rugged built in this series with strong aluminum protection and a unique and furious design.

FULL RANGE SPEAKERS ELS SERIES



COD. 1054457
ELS-6.9II

1400 WATTS | 4 WAY-6x9"

Gi EXTENDED BASS
GRAPHITE INJECTION PP
My MATCHLESS QUALITY
MYLAR DOME



E L E M E N T - 5

LOGISTICS INFORMATION

- Master Dimensions:
57,6 x 37,2 x 31,2 cm
/ 22,7 x 14,6 x 12,3 In
- Gross weight: 16,2 Kg / 35,7 Lb
- Master pieces: 4u



- Size & Type _____ 6 x 9" 4-Way
- Peak Power Handling _____ 700w (per unit)
- Rated Power Handling _____ 120w (per unit)
- Impedance _____ 4 Ω
- Frequency Response _____ 60 Hz – 20 KHz
- Sensitivity (1W/1m) _____ 93dB

■ SPECIFICATIONS

- Cone Material _____ Graphite Injection PP
- Magnet _____ 20 oz Strontium
- Voice coil _____ 1" Aluminium
- Midrange _____ 1/3" Mylar Dome
- Tweeter(s) _____ 2 x 1/8" Piezo

COD. 1054458
ELS-1654II

600 WATTS
2 WAY-6½"

COD. 1054456
ELS-6.5II

1000 WATTS
4 WAY-6.5"



Ei GREATER SPL
ELECTROPLATE INJECTION

HIGH SENSITIVITY FLAT RESPONSE

My MATCHLESS QUALITY
MYLAR DOME

Gi EXTENDED BASS
GRAPHITE INJECTION PP

HIGH DURABILITY
DESPITE LIGHTWEIGHT

WIDE APPLICATION HIGH SENSITIVITY MAGNET SIZE LOW DISTORTION

■ SPECIFICATIONS

- Size & Type _____ 6½ 2-Way
- Peak Power Handling _____ 300w (per unit)
- Rated Power Handling _____ 60w (per unit)
- Impedance _____ 4 Ω
- Frequency Response _____ 100 Hz – 8 KHz
- Sensitivity (1W/1m) _____ 92dB
- Cone Material _____ Electroplated Injection
- Magnet _____ 35 oz
- Voice coil _____ 2"
- Midrange _____ With Aluminium Bullet

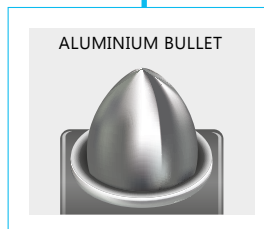

LOGISTICS INFORMATION

- Master Dimensions:
53,2 x 38,7 x 45,0 cm
/ 21,0 x 15,2 x 17,7 in
- Gross weight: 24,8 Kg / 54,7 Lb
- Master pieces: 10u



LOGISTICS INFORMATION

- Master Dimensions:
53,2 x 38,7 x 45,0 cm
/ 21,0 x 15,2 x 17,7 in
- Gross weight: 23,2 Kg / 51,1 Lb
- Master pieces: 10u

■ SPECIFICATIONS

- Size & Type _____ 6.5" 4-Way
- Peak Power Handling _____ 500w (per unit)
- Rated Power Handling _____ 80w (per unit)
- Impedance _____ 4 Ω
- Frequency Response _____ 60 Hz – 20 KHz
- Sensitivity (1W/1m) _____ 92dB
- Cone Material _____ Graphite Injection PP
- Magnet _____ 15 oz Strontium
- Voice coil _____ 1" Aluminium
- Midrange _____ 1¾" Mylar Dome
- Tweeter(s) _____ 2 x ½" Piezo

COD. 1054455

ELS-5.2II

520 WATTS
4 WAY-5¼"

COD. 1054454

ELS-4.0II

360 WATTS
4 WAY-4"

ELEMENT - 5



FULL RANGE SPEAKERS SERIES
ELS



My MATCHLESS QUALITY
MYLAR DOME

Gi EXTENDED BASS
GRAPHITE INJECTION PP

HIGH DURABILITY
DESPITE LIGHTWEIGHT

SPECIFICATIONS

- Size & Type _____ 5¼" 4-Way
- Peak Power Handling _____ 260w (per unit)
- Rated Power Handling _____ 45w (per unit)
- Impedance _____ 4 Ω
- Frequency Response _____ 80 Hz – 20 KHz
- Sensitivity (1W/1m) _____ 90dB
- Cone Material _____ Graphite Injection PP
- Magnet _____ 10 oz Strontium
- Voice coil _____ 1" Aluminium
- Midrange _____ 1¼" Mylar Dome
- Tweeter(s) _____ 2 x ½" Piezo



LOGISTICS INFORMATION

- Master Dimensions: 66,5 x 34,0 x 40,8 cm / 26,2 x 13,4 x 16,1 In
- Gross weight: 20,9 Kg / 46,1 Lb
- Master pieces: 12u



LOGISTICS INFORMATION

- Master Dimensions: 62,0 x 30,0 x 35,4 cm / 24,4 x 11,8 x 13,9 In
- Gross weight: 15,7 Kg / 34,6 Lb
- Master pieces: 12u

SPECIFICATIONS

- Size & Type _____ 4" 4-Way
- Peak Power Handling _____ 180w (per unit)
- Rated Power Handling _____ 35w (per unit)
- Impedance _____ 4 Ω
- Frequency Response _____ 100 Hz – 20 KHz
- Sensitivity (1W/1m) _____ 89dB
- Cone Material _____ Graphite Injection PP
- Magnet _____ 5.3 oz Strontium
- Voice coil _____ 1" Aluminium
- Midrange _____ 1¼" Mylar Dome
- Tweeter(s) _____ 2 x ½" Piezo



The new line of Wave full range speakers becomes furious with a renewed and attractive design. It has improved components carefully selected to ensure a high level of sound pressure for a longer period of time.

FULL RANGE SPEAKERS WA SERIES



COD. 1054453

WA-9312 | 700 WATTS | 5 WAY-6x9"

IC STRONGEST SURFACE
INJECTION CONE
MY MATCHLESS QUALITY
MYLAR DOME



CLEAR
BASS



EASY
INSTALLATION



LIGHTWEIGHT



LOW
DISTORTION



**HIGH
DURABILITY**



LOGISTICS INFORMATION

- Master Dimensions:
57,6 x 37,2 x 31,2 cm
/ 22,7 x 14,6 x 8,3 In
- Gross weight: 12,6 Kg / 27,8 Lb
- Master pieces: 4u

■ SPECIFICATIONS

- Size & Type _____ 6 x 9" 5-Way
- Peak Power Handling _____ 350w (per unit)
- Rated Power Handling _____ 70w (per unit)
- Impedance _____ 4 Ω
- Frequency Response _____ 40 Hz – 20000 Hz
- Sensitivity (1W/1m) _____ 93dB
- Magnet _____ 20 oz
- Voice coil _____ 1"
- Woofer _____ Injection Cone (Blue)
- Midrange and Tweeter _____ 1.4" Mylar DomeTweeter and 1.1"+0.8"+0.5" Piezo Tweeter

COD. 1054452
WA-6192

500 WATTS 4 WAY-6.5"

W A V E



SPECIFICATIONS

- Size & Type _____ 4 Way Speaker 6.5"
- Peak Power Handling _____ 250w (per unit)
- Rated Power Handling _____ 60w (per unit)
- Impedance _____ 4 Ω
- Frequency Response _____ 55-20000 Hz
- Sensitivity (1W/1m) _____ 92dB
- Magnet _____ 10 oz
- Voice coil _____ 1"
- Woofer _____ Injection Cone (Blue)
- Midrange and Tweeter _____ 1.4" Mylar Dome Tweeter and 2x0.6" Piezo Tweeter



WIDE APPLICATION



LIGHTWEIGHT



LOW DISTORTION

IC STRONGEST SURFACE
INJECTION CONE

My MATCHLESS QUALITY
MYLAR DOME



HIGH DURABILITY

LOGISTICS INFORMATION

- Master Dimensions:
51,8 x 36,8 x 39,2 cm
/ 20,4 x 14,5 x 15,4 In
- Gross weight: 17,0 Kg / 37,5 Lb
- Master pieces: 10u

COD. 1054451
WA-5162

300 WATTS 4 WAY-5"



COD. 1054450
WA-4142

300 WATTS 4 WAY-4"



FULL RANGE SPEAKERS SERIES
WA

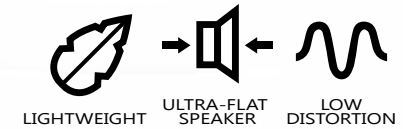

SPECIFICATIONS

- Size & Type _____ 4 Way Speaker 5"
- Peak Power Handling _____ 150w (per unit)
- Rated Power Handling _____ 30w (per unit)
- Impedance _____ 4Ω
- Frequency Response _____ 80-20000Hz
- Sensitivity (1W/1m) _____ 91dB
- Magnet _____ 10 oz
- Voice coil _____ 0.8"
- Woofer _____ Injection Cone (Blue)
- Midrange and Tweeter _____ 1.2" Mylar Dome Tweeter and 2x0.5" Piezo Tweeter



LOGISTICS INFORMATION

- Master Dimensions: 61,6 x 40,8 x 34,9 cm / 24,3 x 16,1 x 13,7 in
- Gross weight: 19,2 Kg / 42,3 Lb
- Master pieces: 12u



LOGISTICS INFORMATION

- Master Dimensions: 58,3 x 30,2 x 35,4 cm / 23,0 x 11,9 x 13,9 in
- Gross weight: 14,5 Kg / 32,0 Lb
- Master pieces: 12u

SPECIFICATIONS

- Size & Type _____ 4 Way Speaker 4"
- Peak Power Handling _____ 150w (per unit)
- Rated Power Handling _____ 30w (per unit)
- Impedance _____ 4Ω
- Frequency Response _____ 90-20000Hz
- Sensitivity (1W/1m) _____ 90dB/W/m
- Magnet _____ 7 oz
- Voice coil _____ 0.8"
- Woofer _____ Injection Cone (Blue)
- Midrange and Tweeter _____ 1.2" Mylar Dome Tweeter and 2x0.5" Piezo Tweeter



You don't need anything else. You have your combo to install players of high quality and audio fidelity, multiple functions and maximum connectivity. Powerful and roaring full range speakers of up to 5 ways that adapt themselves to the system ensuring maximum power and sound quality.

FULL RANGE SPEAKERS ELK SERIES



**114
dB**

MAXIMUM
SPL

KIT S

COD. 9205722
ELK-1067BT

800 WATTS
5 WAY-6x9"

600 WATTS
4 WAY-6½"



MP3/WMA
SUPPORT

3.5
AUX

SD/USB
RECEIVER

RCA
OUTPUT

ID3 TAG
SUPPORT

LOUDNESS DIGITAL
COMPENSATION

DETACHABLE
FRONT PANEL

EQUALIZER
PRESET

FM
RADIO

SPECIFICATIONS

FULL DETACHABLE FRONT PANEL MP3 PLAYER

5 way - 6x9"

- Size & Type _____ 6 x 9" 5-Way
- Frequency Response _____ 40 Hz – 20 KHz
- Sensitivity (1W/1m) _____ 89dB
- Maximun Power _____ 400w (per unit)
- RMS Power _____ 80w (per unit)
- Magnet _____ 20oz
- Voice coil _____ 25mm
- Woofer _____ Cone injected
- Midrange and Tweeter _____ 35mm Mylar dome tweeter and 27 + 20 + 12mm

4 way - 6 1/2"

- Size & Type _____ 6.½" 4-Way
- Frequency Response _____ 55 Hz – 20 KHz
- Sensitivity (1W/1m) _____ 92dB
- Maximun Power _____ 300w (per unit)
- RMS Power _____ 60w (per unit)
- Magnet _____ 10oz
- Voice coil _____ 1"
- Woofer _____ Cone injected
- Midrange and Tweeter _____ 35mm Mylar dome 2x15mm piezo tweeter

- Support MP3 files playback from USB/SD Card
- ID3 Tag support
- Detachable Front Panel
- LCD Display with Power Level Meter
- 208W (4 X 52 Watts) Output Power
- Full AM/FM PLL Synthesized Tuner
- Automatic Memory Preset Store Function

- 30 Station Pre-sets 12AM/18FM, Station Seek, Preset Scan
- Electronic Vol/Bal/Fad/Bass/Tre Control
- Electronic Preset Equalizer: Pop/Rock/Classic/Flat
- Built-in Loudness Function
- Real TIME Clock Function
- Low-impedance RCA Line Out Plugs
- Aux Input Jack

LOGISTICS INFORMATION

• Master Dimensions: 25,3 x 51,2 x 57,6 cm / 10,0 x 20,2 x 22,7 In • Gross weight: 9,5 Kg / 20,9 Lb • Master pieces: 2u

COD. 9205214

ELK-958BT 700 WATTS 5 WAY-6x9"

109 dB
MAXIMUM SPL

FULL RANGE SPEAKERS SERIES

ELK



My MATCHLESS QUALITY
MYLAR DOME

IC STRONGEST SURFACE
INJECTION CONE



SPECIFICATIONS

FULL DETACHABLE
FRONT PANEL MP3 PLAYER

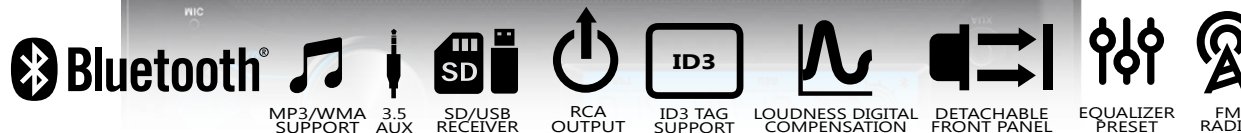

- Support MP3 files playback from USB/SD/MMC Card
- ID3 Tag support
- Detachable Front Panel
- LCD Display with Power Level Meter
- 208W (4 X 52 Watts) Output Power
- Full AM/FM PLL Synthesized Tuner
- 30 Station Pre-sets 12AM/18FM, Station Seek, Preset Scan

- Automatic Memory Preset Store Function
- Electronic Vol/Bal/Fad/Bass/ Tre Control
- Electronic Preset Equalizer: Pop/Rock/Classic/Flat
- Built-in Loudness Function
- Real TIME Clock Function
- Low-impedance RCA Line Out Plugs
- Aux Input Jack
- Bluetooth® Connection

- Size & Type _____ 6.9" 5-Way
- Frequency Response _____ 40 Hz – 20 KHz
- Sensitivity (1W/1m) _____ 89dB
- Maximun Power _____ 350w (per unit)
- RMS Power _____ 80w (per unit)
- Magnet _____ 20oz
- Voice coil _____ 25mm
- Woofer _____ Cone injected
- Midrange and Tweeter _____ 35mm Mylar dome tweeter and 27 + 20 + 12mm

LOGISTICS INFORMATION

- Master Dimensions: 25,3 x 33,8 x 57,6 cm / 10 x 13,3 x 22,7 in
- Gross weight: 9,5 Kg / 20,9 Lb
- Master pieces: 2u

112
dB
MAXIMUM
SPL



COD. 9205213

ELK-638BT
500 WATTS
4 WAY-6½"

FULL RANGE SPEAKERS SERIES

ELK



My MATCHLESS QUALITY
MYLAR DOME

IC STRONGEST SURFACE
INJECTION CONE

SPECIFICATIONS ■

**FULL DETACHABLE
FRONT PANEL MP3 PLAYER**



- Size & Type _____ 6½" 4-Way
- Frequency Response _____ 55 Hz – 20 KHz
- Sensitivity (1W/1m) _____ 92dB
- Maximun Power _____ 250w (per unit)
- RMS Power _____ 60w (per unit)
- Magnet _____ 10oz
- Voice coil _____ 1"
- Woofer _____ Cone injected
- Midrange and Tweeter _____ 35mm Mylar dome 2x15mm piezo tweeter

- Support MP3 files playback from USB/SD Card
- ID3 Tag support
- Detachable Front Panel
- LCD Display with Power Level Meter
- 208W (4 X 52 Watts) Output Power
- Full AM/FM PLL Synthesized Tuner
- 30 Station Pre-sets 12AM/18FM, Station Seek, Preset Scan

- Automatic Memory Preset Store Function
- Electronic Vol/Bal/Fad/Bass/ Tre Control
- Electronic Preset Equalizer: Pop/Rock/Classic/Flat
- Built-in Loudness Function
- Real TIME Clock Function
- Low-impedance RCA Line Out Plugs
- Aux Input Jack

LOGISTICS INFORMATION

- Master Dimensions: 25,3 x 28,8 x 52,4 mm / 10 x 11,3 x 20,6 in
- Gross weight: 6,1 Kg / 13,4 Lb
- Master pieces: 2u



ELEMENTS
TRANSIT

New line of SW subwoofers. Make a difference and generate a great impact at a distance. Totally resistant build, greater speaker protection and a unique design. Components and magnet selected, exclusively to attain high sensitivity and unmatched distortion-free power.

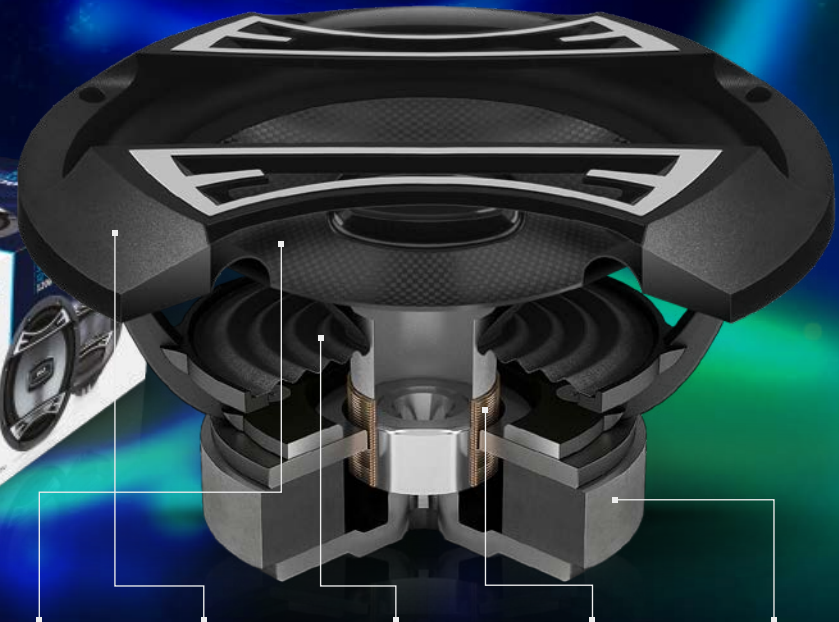

WOOFERS SW SERIES

NON PRESS PAPER

Subsonic sensation, reinforced cone allows maximum champion SPL

HARD CASE

Combines a rigid carcass with a unique desing, an elegant solution to protect a big speaker

PROGRESSIVE SUSPENSION

It is the best option to control the cone excursion, absorbing mechanics movement that causes harmonics distortion

DOUBLE VOICE COIL

Designed to be the best option in bass performance

STRONG MAGNET

Generates large magnetic fields, getting a big sensitivity without audible distortion and more bass Energy

COD. 1054531
SW-1250

1200 WATTS 12"-DUAL VOICE COIL

COD. 1054530
SW-1030

900 WATTS 10"-DUAL VOICE COIL

ELEMENT
TRANSIST



**119
dB**
MAXIMUM



Np SUBSONIC SENSATION
NON PRESSED PAPER



**118
dB**
MAXIMUM

THIELE SMALL PARAMETERS

- Re _____ 2 Ω
- Fo _____ 30.5Hz
- SD _____ 51.5m²
- Md _____ 205g
- Bl _____ 8T
- Qms _____ 5.58
- Qes _____ 1.25
- Qts _____ 1.02
- No _____ 0.11%
- Vas _____ 50.3m³
- Cms _____ 135m/N
- Krm _____ 3.7Ω
- Erm _____ 0.79
- Mms _____ 204g
- Mmd _____ 196g
- Kxm _____ 11.6mH
- Exm _____ 0.7

SPECIFICATIONS

- Subwoofer _____ 12"
- Fr. Response _____ 25-1500Hz
- Sensitivity _____ 88dB/W/m
- Max power _____ 1200W
- Magnet _____ 50oz
- Voice coil _____ 50mm
- Cone _____ Non Press Paper
- Impedance _____ 4 Ω / 2 Ω
- Prog. Power _____ 400W
- Voice coil _____ Dual

LOGISTICS INFORMATION

- Master Dimensions:
40,2 x 37,6 x 44,0 cm
/ 15,8 x 14,8 x 17,3 in
- Gross weight: 11,2 Kg / 24,7 Lb
- Master pieces: 2u



2/4OHM
SELECTABLE



LOW
DISTORTION



MORE RIGID
BASKET

THIELE SMALL PARAMETERS

- Re _____ 2 Ω
- Fo _____ 37Hz
- SD _____ 31.7m²
- Md _____ 130g
- Bl _____ 7T
- Qms _____ 5.88
- Qes _____ 1.14
- Qts _____ 0.95
- No _____ 0.097%
- Vas _____ 21.5m³
- Cms _____ 150m/N
- Krm _____ 1.75Ω
- Erm _____ 0.86
- Mms _____ 120g
- Mmd _____ 115g
- Kxm _____ 12.3mH
- Exm _____ 0.69

SPECIFICATIONS

- Subwoofer _____ 10"
- Fr. Response _____ 25-1500Hz
- Sensitivity _____ 88dB/W/m
- Max power _____ 900W
- Magnet _____ 40oz
- Voice coil _____ 2"
- Cone _____ Non Press Paper
- Impedance _____ 4 Ω / 2 Ω
- Prog. Power _____ 300W
- Voice coil _____ Dual

LOGISTICS INFORMATION

- Master Dimensions:
30,8 x 30,0 x 41,2 cm / 12,1 x 11,8 x 16,2 in
- Gross weight: 8,6 Kg / 19,0 Lb • Master pieces: 2u



ELEMENT TRANSIT

The spirit of **B52** is maintained with the classic ETR line of great and high bass performance praised by users and competitors alike. With our ETR line, not only do you hear, you feel the low frequencies completely free of distortion.



WOOFERS ETR SERIES

PROLIPOPELENE CONE

Specifically built for zero distortion

HIGH COMPLIANCE

Improves durability and speaker response in maximum volume situations

SPECIFIC SUSPENSION

Designed to absorb the vibrations and unwanted movements, to achieve a wide range of frequencies

VOICE COIL

With heat dissipation

STRONG MAGNET

Generates large magnetic fields, getting a big sensitivity without audible distortion

COD. 1054423
ETR-1260

800 WATTS 12"

COD. 1054422
ETR-1040

400 WATTS 10"



**119
dB**
MAXIMUM
SPL



Np SUBSONIC SENSATION
NON PRESSED PAPER



**118
dB**
MAXIMUM
SPL

SPECIFICATIONS

- Subwoofer _____ 12"
- Fr. Response _____ 25-1500Hz
- Sensitivity _____ 88dB/W/m
- Max power _____ 800W
- Prog. Power _____ 400w
- Magnet _____ 42oz
- Voice coil _____ 50mm
- Cone _____ PP Cone
- Impedance _____ 4 Ω

LOGISTICS INFORMATION

- Master Dimensions: 44 x 37,6 x 39,8 cm / 17,3 x 14,8 x 15,7 In
- Gross weight: 11 Kg / 24,3 Lb • Master pieces: 2u

THIELE SMALL PARAMETERS

- Re _____ 3.40 Ω
- Fo _____ 25.961Hz
- SD _____ 50.671m
- Md _____ 198.370g
- Bl _____ 13.262Tm
- Qms _____ 5.874
- Qes _____ 0.547
- Qts _____ 0.501
- No _____ 0.244%
- SPLo _____ 85.9Db
- Vas _____ 78.949mM
- Cms _____ 216.5u M/n
- Krm _____ 5.324p M
- Erm _____ 0.820
- Mms _____ 173.560g
- Mmd _____ 167.001m Kg
- Kxm _____ 57.084m H
- Exm _____ 0.605

SPECIFICATIONS

- Subwoofer _____ 10"
- Fr. Response _____ 25-1500Hz
- Sensitivity _____ 88dB/W/m
- Max power _____ 400W
- Prog. Power _____ 200w
- Magnet _____ 40oz
- Voice coil _____ 50mm
- Cone _____ PP Cone
- Impedance _____ 4 Ω

LOGISTICS INFORMATION

- Master Dimensions: 33,2 x 31,2 x 44,0 cm / 13,1 x 12,3 x 17,3 In
- Gross weight: 8,7 Kg / 19,2 Lb • Master pieces: 2u

THIELE SMALL PARAMETERS

- Re _____ 3.40 Ω
- Fo _____ 25.293Hz
- SD _____ 33.979m
- Md _____ 97.840g
- Bl _____ 8.339Tm
- Qms _____ 3.576
- Qes _____ 0.986
- Qts _____ 0.773
- No _____ 0.167%
- SPLo _____ 84.2Db
- Vas _____ 35.634mM
- Cms _____ 217.34uM/n
- Krm _____ 4.857p M
- Erm _____ 0.752
- Mms _____ 84.877g
- Mmd _____ 167.001m Kg
- Kxm _____ 49.489m H
- Exm _____ 0.531



FLAME



FLM is **B52's** champion line. When it comes to sound pressure, FLM is the ideal product to reach the highest level. Protected by a unique heat dissipation system that allows the maximum performance of the two coils. Its high energy magnet ensures a huge magnetic field that produces large, clear and deep bass with no distortion.



WOOFERS FLM SERIES

NON PRESS PAPER

Subsonic sensation, reinforced cone allows maximum champion SPL

2 1/2" VOICE COIL

Designed to obtain specific vibrations, to produce clarity bass, more energy and lows harmonic distortion

CONE

Rigid and Light weight Cone engineered to support max SPL

PROGRESSIVE SUSPENSION

It is the best option to control the cone excursion, absorbing mechanics movement that causes harmonics distortion

HIGH ENERGY MAGNETS

Designed to obtain an ultra magnetic field with the power to create more bass energy

**119
dB**

119dB
MAXIMUM SPL

COD. 1054426

FLM-915 | 1000 WATTS | 15"



Np **SUBSONIC SENSATION**
NON PRESSED PAPER

■ SPECIFICATIONS

- Diameter _____ 15"
- Max Power _____ 1000W
- RMS Power _____ 500W
- Frequency _____ 25-1500Hz
- Sensitivity _____ 89dB/W/M
- Magnet _____ 100oz
- Voice coil _____ 65mm
- Cone _____ Non Pressed Paper
- Impedance _____ 2/4/8Ω

THIELE SMALL PARAMETERS

- Re _____ 3.40 Ω
- Fo _____ 29.025Hz
- SD _____ 70.686m
- Md _____ 200.410g
- Bl _____ 9.803Tm
- Qms _____ 5.798
- Qes _____ 1.328
- Qts _____ 1.081
- No _____ 0.184%
- SPLo _____ 84.7Db
- Vas _____ 103.609mM
- Cms _____ 146.030u M/n
- Krm _____ 2.494m-Ω0.843
- Erm _____ 205.893g
- Mms _____ 195.087m Kg
- Mmd _____ 24.497m H
- Kxm _____ 0.649
- Exm _____

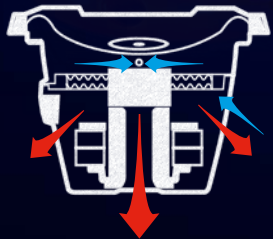

HEAT
DISSIPATION

LOGISTICS INFORMATION

- Master Dimensions: 33,8 x 46,4 x 46,4 cm / 13,3 x 18,3 x 18,3 In
- Gross weight: 12 Kg / 26,5 Lb • Master pieces: 1u

FLAME

WOOFERS SERIES

FLM

COD. 1054525

FLM-812

800 WATTS

12"

FLAME

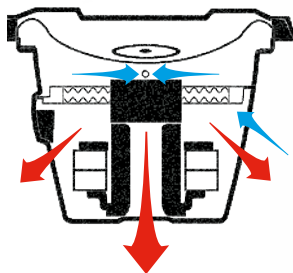

HEAT
DISSIPATION

SPECIFICATIONS

- Diameter _____ 12"
- Max Power _____ 800W
- RMS Power _____ 400W
- Frequency _____ 25-1500Hz
- Sensitivity _____ 88dB/W/M
- Magnet _____ 80oz
- Voice coil _____ 50mm
- Cone _____ Non Pressed Paper
- Impedance _____ 2/4/8Ω

Np SUBSONIC SENSATION
NON PRESSED PAPER



117
dB
MAXIMUM SPL

MORE ACCURATE
SOUND

LOW
DISTORTION

THIELE SMALL PARAMETERS

- Re _____ 3.40 Ω
- Fo _____ 42.541Hz
- SD _____ 51.4724m
- Md _____ 199.580g
- Bl _____ 9.102Tm
- Qms _____ 5.263
- Qes _____ 1.683
- Qts _____ 1.275
- No _____ 0.152%
- SPLo _____ 83.8Db
- Vas _____ 34.317mM
- Cms _____ 91.218u M/n
- Krm _____ 4.261m Ω0.770
- Erm _____ 153.444g
- Mms _____ 146.729m Kg
- Mmd _____ 29.095m H
- Kxm _____ 0.601
- Exm _____

LOGISTICS INFORMATION

- Master Dimensions: 40,0 x 39,8 x 32,1 cm / 15,7 x 15,7 x 12,6 In
- Gross weight: 9,4 Kg / 20,7 Lb • Master pieces: 1u

COD. 1054524

FLM-710 600 WATTS 10"

WOOFERS SERIES

FLM



THIELE SMALL PARAMETERS

- Re _____ 3.40 Ω
- Fo _____ 52.262Hz
- SD _____ 36.64m
- Md _____ 118.290g
- Bl _____ 7.432Tm
- Qms _____ 6130
- Qes _____ 2.312
- Qts _____ 1.679
- No _____ 0.092%
- SPLo _____ 8.17Db
- Vas _____ 15.459mM
- Cms _____ 81.077u M/n
- Krm _____ 1.166m Ω0.891
- Erm _____ 114.386g
- Mms _____ 110.353m Kg
- Mmd _____ 17.996m H
- Kxm _____ 0.658
- Exm _____

LOGISTICS INFORMATION

- Master Dimensions: 36,0 x 34,7 x 55,5 cm / 14,2 x 13,7 x 21,9 In
- Gross weight: 12,5 Kg / 27,6 Lb • Master pieces: 2u

No SUBSONIC SENSATION NON PRESSED PAPER



120 dB
120dB
MAXIMUM SPL



HEAT
DISSIPATION

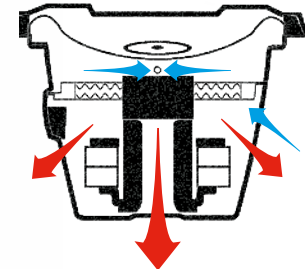

SPECIFICATIONS

- Size & Type _____ 6 - 9" 4-Way
- Peak Power Handling _____ 600w
- Rated Power Handling _____ 100w
- Impedance _____ 4 Ω
- Frequency Response _____ 60 Hz – 20 KHz
- Sensitivity (1W/1m) _____ 93dB
- Cone Material _____ Graphite Injection PP
- Magnet _____ 20oz Strontium
- Voice coil _____ 1 - 1/4" Aluminium
- Midrange _____ 2 - 1/4' Mylar Dome
- Tweeter(s) _____ 2 x 1/2" Piezo

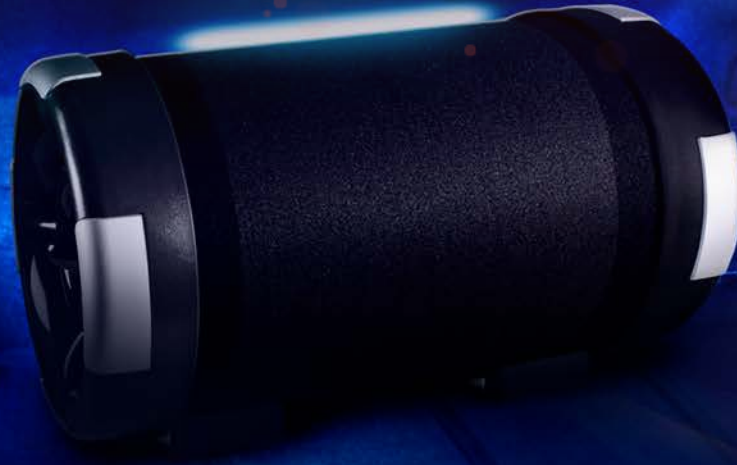

LOW PASS
PERFORMANCE

Turbo speaker is the ideal line to convert your system quickly and easily into a complete audio system with extreme low frequency reproduction. Amplified subwoofer with bass reflex cabinet ensures an extensive and powerful reproduction.

TURBO SPEAKERS ATR SERIES



ACTIVE

COD. 5303969

ATR-1250

500 WATTS

12"



RCA INPUT



PHASE ADJUST



EASY INSTALLATION



MORE BASS ENERGY!

LOGISTICS INFORMATION

- Master Dimensions: 44,0 x 42,0 x 66,0 cm / 17,3 x 16,5 x 26,0 in
- Gross weight: 7,2 Kg / 15,9 Lb
- Master pieces: 1u

MOUNTING KIT

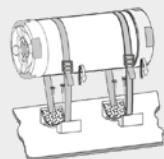

THIELE-SMALL PARAMETERS

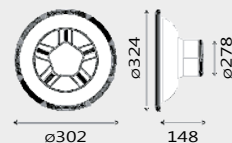

ACCESSORIES



SPECIFICATIONS

- Woofer _____ 300mm paper coated cone foam edge
- Max power _____ 500w
- RMS power _____ 140w
- Frequency response _____ 20-2000Hz
- Output _____ 80-120 Hz (adjustable)
- Power source _____ DC 12v-14v negative ground
- Phase _____ 0° - 180°

COD. 5303951

ATR-1045

450 WATTS
10"

ACTIVE



SPECIFICATIONS

- Woofer _____ 250mm paper coated cone
foam edge
- Max power _____ 450w
- RMS power _____ 120w
- Frequency response _____ 20-2000Hz
- Output _____ 80-120 Hz (adjustable)
- Power source _____ DC 12v-14v negative ground
- Phase _____ 0° - 180°

MOUNTING KIT

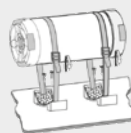

THIELE-SMALL PARAMETERS

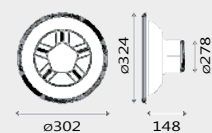

ACCESORIES



LOGISTICS INFORMATION

- Master Dimensions:
37,0 x 37,0 x 57,0 cm
/ 14,6 x 14,6 x 22,4 in
- Gross weight: 7,2 Kg / 15,9 Lb
- Master pieces: 1u

COD. 5303942
ATR-835

350 WATTS
8"

COD. 5303939
ATR-625

300 WATTS
6.5"

LOW PASS
PERFORMANCE



TURBO SPEAKERS SERIES

ATR



SPECIFICATIONS

- Woofer _____ 200mm paper coated cone foam edge
- Max power _____ 350w
- RMS power _____ 100w
- Frequency response _____ 20-2000Hz
- Output _____ 80-120 Hz (adjustable)
- Power source _____ DC 12v-14v negative ground
- Phase _____ 0° - 180°

LOGISTICS INFORMATION

- Master Dimensions: 31,0 x 29,0 x 48,0 cm / 12,2 x 11,4 x 18,9 in
- Gross weight: 5,3 Kg / 11,7 Lb • Master pieces: 1u

MOUNTING KIT

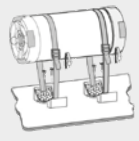

THIELE-SMALL PARAMETERS

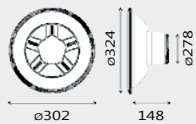

ACCESORIES



SPECIFICATIONS

- Woofer _____ 150mm paper coated cone foam edge
- Max power _____ 300w
- RMS power _____ 80w
- Frequency response _____ 20-2000Hz
- Output _____ 80-120 Hz (adjustable)
- Power source _____ DC 12v-14v negative ground
- Phase _____ 0° - 180°

LOGISTICS INFORMATION

- Master Dimensions: 30,0 x 47,0 x 29,0 cm / 11,8 x 18,6 x 11,4 in
- Gross weight: 16,4 Kg / 36,0 Lb • Master pieces: 1u



ELEMENT-5

B52

ELP-9.2

ELEMENT-5

900W
450 x 2

B52

ELEMENT-5

900W
450 x 2

Our ELP series is renewed with the most advanced technology in signal processing and audio amplification. The perfect combination of power, audio quality and the ability to generate the highest SLP with a unique and very attractive design. High reliability in a series of elite amplifiers with unique engineering that ensures the lowest possible distortion and unsurpassed audio quality.

AMPLIFIERS ELP SERIES



COD. 5209415
ELP-40.4

4000 WATTS | 4 CHANNEL



MOSFET
TECH



ULTRA LOW
DISTORTION



BASS
BOOST



X-OVER



2 OHM MINIMUM
IMPEDANCE



HIGH DURABILITY
DESPITE
LIGHTWEIGHT

SPECIFICATIONS

EXTERNAL
SUBWOOFER
CONTROL

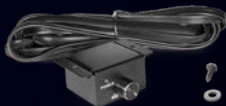

ACCESSORIES



- Bridged Max Power @4 Ω _____ 2000W x 2
- Continuous Power @4 Ω s _____ 375W x 4
- Max Power@2 Ω s _____ 1000W x 4
- Min. Speaker Impedance _____ 2 Ω
- THD Distortion _____ 0.08%
- Frequency Response _____ 20 Hz-20 KHz

- Input Sensitivity _____ 0.2V~+6V
- Signal-to-Noise Ratio _____ 90dB
- Channel Separation _____ 50dB
- Low Pass Filter _____ 50Hz~500Hz
- Bass Boost _____ 0 dB/ +6dB/ +12 dB
- High Pass Filter _____ 50Hz~500Hz

PRODUCT DIMENSIONS:
54,4 x 19,2 x 5,5 cm

LOGISTICS INFORMATION

- Master Dimensions: 70,5 x 36 x 23 cm / 27,8 x 14,2 x 9,1 In
- Gross weight: 22,3 Kg / 49,2 Lb
- Master pieces: 4u

LATERAL VIEW



REAR PANEL



FRONT PANEL



COD. 5209416
ELP-60.1D

450 WATTS
10"



COD. 5209414
ELP-20.4

1800 WATTS
4 CHANNEL



PANEL
VIEWS



SPECIFICATIONS

- Bridged Max Power @4 Ω _____ 900W x 2
- Continuous Power @4 Ω _____ 185W x 4
- Max Power@2 Ωs _____ 450W x 4
- Min. Speaker Impedance _____ 2 Ω
- THD Distortion _____ 0.08%
- Frequency Response _____ 20 Hz-20 KHz
- Input Sensitivity _____ 0.2V~+6V
- Signal-to-Noise Ratio _____ 90dB
- Channel Separation _____ 50dB
- Low Pass Filter _____ 50Hz~500Hz
- Bass Boost _____ 0 dB/ +6dB/ +12 dB
- High Pass Filter _____ 50Hz~500Hz

PRODUCT DIMENSIONS: 65,3 x 19,2 x 5,5 cm

LOGISTICS INFORMATION

- Master Dimensions: 22,0 x 54,0 x 8,0 cm / 8,6 x 21,3 x 3,1 In
- Gross weight: 3,8 Kg / 8,4 Lb • Master pieces: 1u

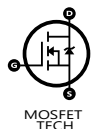

MOSFET
TECH



2 OHM MINIMUM
IMPEDANCE



ULTRA LOW
DISTORTION



X-OVER



BASS
BOOST

ACCESORIES



EXTERNAL
SUBWOOFER
CONTROL



SPECIFICATIONS

- Bridged Max Power @4 Ω _____ 900W x 2
- Continuous Power @4 Ω _____ 185W x 4
- Max Power@2 Ωs _____ 450W x 4
- Min. Speaker Impedance _____ 2 Ω
- THD Distortion _____ 0.08%
- Frequency Response _____ 20 Hz-20 KHz
- Input Sensitivity _____ 0.2V~+6V
- Signal-to-Noise Ratio _____ 90dB
- Channel Separation _____ 50dB
- Low Pass Filter _____ 50Hz~500Hz
- Bass Boost _____ 0 dB/ +6dB/ +12 dB
- High Pass Filter _____ 50Hz~500Hz

PRODUCT DIMENSIONS: 43,5 x 19,2 x 5,5 cm

LOGISTICS INFORMATION

- Master Dimensions: 59,5 x 36 x 23 cm / 23,4 x 14,2 x 9,1 In
- Gross weight: 17,3 Kg / 38,1 Lb • Master pieces: 4u

FOR ALL ELP SERIES

COD. 5209413 | **1400 WATTS**
ELP-15.4 | 4 CHANNEL

COD. 5209412 | **3600 WATTS**
ELP-36.2 | 2 CHANNEL

COD. 5209411 | **1400 WATTS**
ELP-14.2 | 2 CHANNEL

COD. 5209410 | **900 WATTS**
ELP-9.2 | 2 CHANNEL



FOR 36.2
& 14.2
ELP SERIES



SPECIFICATIONS

- Bridged Max Power — 700W x 2 @4 Ω
- Continuous Power — 140W x 4 @4 Ω
- Max Power — 350W x 4 @2 Ω
- Speaker Impedance — 2 Ω (minimum)
- THD Distortion — 0.08%
- Frequency Response — 20 Hz-20 KHz
- Input Sensitivity — 0.2V~+6V
- Signal-to-Noise Ratio — 90dB
- Channel Separation — 50dB
- Low Pass Filter — 50Hz~500Hz
- Bass Boost — 0 dB/ +6dB/ +12 dB
- High Pass Filter — 50Hz~500Hz

PRODUCT DIMENSIONS: 38,5 x 19,2 x 5,5 cm

LOGISTICS INFORMATION

- Master Dimensions: 54,5 x 36 x 23 cm / 21,8 x 14,2 x 9,1 In
- Gross weight: 15,3 Kg / 33,7 Lb • Master pieces: 4u

- Bridged Max Power — 3600W x 1 @4 Ω
- Continuous Power — 500W x 2 @4 Ω
- Max Power — 1800W x 2 @2 Ω
- Speaker Impedance — 2 Ω (minimum)
- THD Distortion — 0.08%
- Frequency Response — 20 Hz-20 KHz
- Input Sensitivity — 0.2V~+6V
- Signal-to-Noise Ratio — 90dB
- Channel Separation — 50dB
- Low Pass Filter — 50Hz~500Hz
- Bass Boost — 0 dB/ +6dB/ +12 dB
- High Pass Filter — 50Hz~500Hz

PRODUCT DIMENSIONS: 43,5 x 19,2 x 5,5 cm

LOGISTICS INFORMATION

- Master Dimensions: 59,5 x 36 x 23 cm / 23,4 x 14,2 x 9,1 In
- Gross weight: 17,4 Kg / 38,4 Lb • Master pieces: 4u

- Bridged Max Power — 1400W x 1 @4 Ω
- Continuous Power — 175W x 2 @4 Ω
- Max Power — 700W x 2 @2 Ω
- Speaker Impedance — 2 Ω (minimum)
- THD Distortion — 0.08%
- Frequency Response — 20 Hz-20 KHz
- Input Sensitivity — 0.2V~+6V
- Signal-to-Noise Ratio — 90dB
- Channel Separation — 50dB
- Low Pass Filter — 50Hz~500Hz
- Bass Boost — 0 dB/ +6dB/ +12 dB
- High Pass Filter — 50Hz~500Hz

PRODUCT DIMENSIONS: 40 x 19,2 x 5,5 cm

LOGISTICS INFORMATION

- Master Dimensions: 56,5 x 36 x 23 cm / 22,2 x 14,2 x 9,1 In
- Gross weight: 16 Kg / 35,3 Lb • Master pieces: 4u

- Bridged Max Power — 900W x 1 @4 Ω
- Continuous Power — 130W x 2 @4 Ω
- Max Power — 450W x 2 @2 Ω
- Speaker Impedance — 2 Ω (minimum)
- THD Distortion — 0.08%
- Frequency Response — 20 Hz-20 KHz
- Input Sensitivity — 0.2V~+6V
- Signal-to-Noise Ratio — 90dB
- Channel Separation — 50dB
- Low Pass Filter — 50Hz~500Hz
- Bass Boost — 0 dB/ +6dB/ +12 dB
- High Pass Filter — 50Hz~500Hz

PRODUCT DIMENSIONS: 33 x 19,2 x 5,5 cm

LOGISTICS INFORMATION

- Master Dimensions: 49,5 x 36 x 23 cm / 19,5 x 14,2 x 9,1 In
- Gross weight: 13 Kg / 28,7 Lb • Master pieces: 4u

AMPLIFIERS SERIES

ELP

LATERAL VIEWS



The RC line incorporates a renewed design, which is more robust and lightweight, and it is ready to be installed quickly and easily. The advanced technology applied in the treatment of signals of this amplifier enables a pure and high amplitude signal to handle maximum power and high pressure levels with no distortion.

AMPLIFIERS RC SERIES



COD. 5209403

RC-1804

1800 WATTS | 4 CHANNEL



SPECIFICATIONS

- Bridged Max Power @4 Ω — 900W x 2
- Continuous Power @4 Ωs — 200W x 4
- Max Power@2 Ωs — 450W x 4
- Min. Speaker Impedance — 2 Ω
- THD Distortion — 0.01%
- Frequency Response — 20 Hz~20 KHz
- Input Sensitivity — 0.2V~+6V
- Signal-to-Noise Ratio — 98dB
- Channel Separation — 50dB
- Low Pass Filter — 50Hz~250Hz
- Bass Boost — 0 dB/ +6dB/ +12 dB
- High Pass Filter — 60Hz~1.2KHz/100Hz~2.2KHz

LATERAL VIEW



FRONT PANEL



REAR PANEL



PRODUCT DIMENSIONS: 37 x 26,5 x 5,4 cm

LOGISTICS INFORMATION

- Master Dimensions: 45 x 44,5 x 32,3 cm / 17,7 x 17,5 x 12,7 In
- Gross weight: 14,3 Kg / 31,6 Lb • Master pieces: 4u



COD. 5209404
RC-3001D

3000 WATTS 1 CHANNEL

COD. 5209402
RC-1404

1400 WATTS 4 CHANNEL

RACE

CLASS D



EXTERNAL
SUBWOOFER
CONTROL

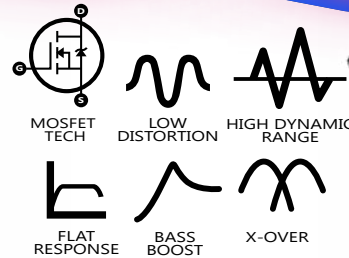

PANEL
VIEWS



SPECIFICATIONS

- Bridged Max Power @1 Ω — 3000W x 1
- Continuous Power @4 Ωs — 400W x 1
- Max Power@2 Ωs — 1600W x 1
- Min. Speaker Impedance — 1 Ω
- THD Distortion — 0.01%
- Frequency Response — 20 Hz-20 KHz
- Input Sensitivity — 0.2V~+6V
- Signal-to-Noise Ratio — 98dB
- Channel Separation — 50dB
- Low Pass Filter — 40Hz~180Hz
- Bass Boost — 0 dB to +12 dB
- Subsonic — 17Hz~50Hz



PRODUCT DIMENSIONS: 29,5 x 26,5 x 5,4 cm

LOGISTICS INFORMATION

- Master Dimensions: 45 x 37,5 x 32,3 cm / 17,7 x 14,8 x 12,7 In
- Gross weight: 12,6 Kg / 27,8 Lb
- Master pieces: 4u

SPECIFICATIONS

- Bridged Max Power @4 Ω — 700W x 2
- Continuous Power @4 Ω — 150W x 4
- Max Power@2 Ωs — 350W x 4
- Min. Speaker Impedance — 2 Ω
- THD Distortion — 0.01%
- Frequency Response — 20 Hz-20 KHz
- Input Sensitivity — 0.2V~+6V
- Signal-to-Noise Ratio — 98dB
- Channel Separation — 50dB
- Low Pass Filter — 50Hz~250Hz
- Bass Boost — 0 dB/ +6dB/ +12 dB
- High Pass Filter — 60Hz~1.2KHz/100Hz~2.2KHz



PRODUCT DIMENSIONS: 34,5 x 26,5 x 5,4 cm

LOGISTICS INFORMATION

- Master Dimensions: 45 x 42,5 x 32,3 cm / 17,7 x 16,7 x 12,7 In
- Gross weight: 13,9 Kg / 30,6 Lb
- Master pieces: 4u

COD. 5209401

RC-802

800 WATTS 2 CHANNEL

COD. 5209400

RC-602

600 WATTS 2 CHANNEL

AMPLIFIERS SERIES

RC

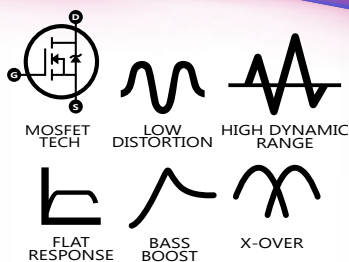

PANEL VIEWS



SPECIFICATIONS

- Bridged Max Power @4 Ω — 800W x 1
- Continuous Power @4 Ω — 175W x 2
- Max Power@2 Ωs — 400W x 2
- Min. Speaker Impedance — 2 Ω
- THD Distortion — 0.01%
- Frequency Response — 20 Hz~20 KHz
- Input Sensitivity — 0.2V~+6V
- Signal-to-Noise Ratio — 98dB
- Channel Separation — 50dB
- Low Pass Filter — 50Hz~250Hz
- Bass Boost — 0 dB/ +6dB/ +12 dB
- High Pass Filter — 100Hz~2.2KHz



PRODUCT DIMENSIONS: 29,5 x 26,5 x 5,4 cm

LOGISTICS INFORMATION

- Master Dimensions: 45 x 37,5 x 32,3 cm / 17,7 x 14,8 x 12,7 in
- Gross weight: 11 Kg / 24,3 Lb
- Master pieces: 4u



PRODUCT DIMENSIONS: 24,5 x 26,5 x 5,4 cm

LOGISTICS INFORMATION

- Master Dimensions: 45 x 32,5 x 32,3 cm / 17,7 x 12,8 x 12,7 in
- Gross weight: 9,8 Kg / 21,6 Lb
- Master pieces: 4u

SPECIFICATIONS

- Bridged Max Power @4 Ω — 600W x 1
- Continuous Power @4 Ω — 110W x 2
- Max Power@2 Ωs — 300W x 2
- Min. Speaker Impedance — 2 Ω
- THD Distortion — 0.01%
- Frequency Response — 20 Hz~20 KHz
- Input Sensitivity — 0.2V~+6V
- Signal-to-Noise Ratio — 98dB
- Channel Separation — 50dB
- Low Pass Filter — 50Hz~250Hz
- Bass Boost — 0 dB/ +6dB/ +12 dB
- High Pass Filter — 100Hz~2.2KHz



COD. 625120
DPF-12

12 FARAD DIGITAL POWER

High power **B52** capacitors prepared to compete are essential to provide the energy needed by the subwoofers to reproduce the lowest frequencies and to protect the vehicle's electrical system in the most extreme conditions.



CAPACITORS SERIES

SPECIFICATIONS

- Innovative design concept
- 12 farad capacity
- 20-24 volt surge
- Extreme low E.S.R.: less than 0.002 Ω
- Auto on/off
- Four-digit UV voltmeter display
- Wonderful & stable performance with Hi security
- Electronic polarity protection circuit
- Over-voltage protection circuit
- Normal working temperature: - 49°F to 203°F (-40°C to 95°C)
- Multiple choices for cabling
- Mounting brackets & hardware included
- LED indicator lights
- Super bright UV LED light

LOGISTICS INFORMATION

- Master Dimensions: 27,5 x 33 x 46 cm / 10,8 x 13 x 18,1 in
- Gross weight: 14 Kg / 30,9 Lb
- Master pieces: 6u

COD. 625112

DPF-6

6 FARAD DIGITAL POWER

AUDIO
POWER



SPECIFICATIONS

- Innovative design concept
- 6 farad capacity
- 20-24 volt surge
- Extreme low E.S.R.: less than 0.002 Ω
- Auto on/off
- Four-digit UV voltmeter display
- Wonderful & stable performance with Hi security
- Electronic polarity protection circuit
- Over-voltage protection circuit
- Normal working temperature:- 49°F to 203°F (-40°C to 95°C)
- Multiple choices for cabling
- Mounting brackets & hardware included
- LED indicator lights
- Super bright UV LED light

LOGISTICS INFORMATION

- Master Dimensions: 36,5 x 33,5 x 37 cm / 14,4 x 13,2 x 14,6 In
- Gross weight: 12 Kg / 26,5 Lb
- Master pieces: 6u

COD. 625109

DPF-3

3 FARAD DIGITAL POWER

SPECIFICATIONS

- Compact design concept
- 3 farad capacity
- 20-24 volt surge
- Extreme low E.S.R.: less than 0.002 Ω
- Auto on/off
- Four-digit UV voltmeter display
- Wonderful & stable performance with Hi security
- Electronic polarity protection circuit
- Over-voltage protection circuit
- Normal working temperature:- 49°F to 203°F (-40°C to 95°C)
- Multiple choices for cabling
- Mounting brackets & hardware included
- LED indicator lights



MOUNTING KIT



LOGISTICS INFORMATION

- Master Dimensions: 38 x 25 x 41 cm / 15 x 9,8 x 16,1 In
- Gross weight: 12 Kg / 26,5 Lb
- Master pieces: 6u



COD. 9205888
CCD-384 IR

NIGHT VISION REAR/LATERAL VIEW 12 VOLT SURFACE MOUNT

B52 has the most complete line of cameras on the market. A camera for each type of assembly that is needed, compatible with all kinds of makes of vehicles. Special features such as night vision, wide viewing angles and high quality video transmission.



NIGHT VISION

VIEW COLOR CAMERAS CCD SERIES

PRODUCT DIMENSIONS: 3 cm
VISION ANGLE: 170°



LOGISTICS INFORMATION

- Master Dimensions: 49,5 x 36,5 x 27,5 cm / 19,5 x 14,4 x 10,8 in
- Gross weight: 15,1 Kg / 33,3 Lb
- Master pieces: 50u

COD. 9205887

CCD-367 IR

NIGHT VISION
REAR VIEW
12 VOLT
MOUNTED INSIDE



PRODUCT DIMENSIONS: 3 cm
VISION ANGLE: 170°

COD. 9205886

CCD-346

REAR VIEW
12 VOLT
MOUNTED INSIDE



PRODUCT DIMENSIONS: 2,5 cm
VISION ANGLE: 170°

COD. 9205885

CCD-325

REAR VIEW
12 VOLT
MOUNTED INSIDE



PRODUCT DIMENSIONS: 2 cm
VISION ANGLE: 170°

COD. 9205884

CCD-300

REAR VIEW
12 VOLT
SURFACE MOUNT



PRODUCT DIMENSIONS: 1,8 cm (Base: 3,8 cm)
VISION ANGLE: 170°

INSTALL KIT INCLUDES



CCD-346/325/300 SERIES INCLUDES: VIDEO CABLE RCA-RCA (6m) and POWER SUPPLY CABLE (1.5m)

LOGISTICS INFORMATION

- Master Dimensions (All CCD series):
49,5 x 36,5 x 27,5 cm
/ 19,5 x 14,4 x 10,8 In
- Gross weight:
CCD-367IR: 13,2 Kg / 29,1 Lb
CCD-346: 14,0 Kg / 30,9 Lb
CCD-325: 11,5 Kg / 25,4 Lb
CCD-300: 12,0 Kg / 26,5 Lb
- Master pieces:
50u (CCD-367IR/346/325)
10u (CCD-300)

ALL CCD SERIES SPECIFICATIONS

WATERPROOF EFFECT
LOW POWER CONSUMPTION
¼ CMOS COLOUR SENSOR
SURFACE MOUNT
HIGH SENSITIVITY
/ LOW MAINTENANCE

- TV System _____ PAL
- Sensor _____ CMOS
- Effective Pixel _____ 628*480
- Horizontal Sync Fre _____ 15625kHz
- Vertical Sync Fre _____ 50Hz
- Scanning System _____ 2:1 Interlace
- Sync System _____ Internal
- AGC _____ Auto
- BLC _____ Auto
- Resolution _____ 420TV Lines

- Video out _____ 1.0Vp-p.75 Ω
- S/N Ratio _____ >48dB
- Current Consumption _____ <150mA
- Power Supply _____ DC12V±10%
- Operating Temperature _____ -20°C~70°C RH95% MAX
- Storage temperature _____ -30°C~70°C RH95% MAX
- Lens angel _____ F:3.6/2.8/2.5/1.7 MM
- Horizontal Angel _____ 170°
- Water-proof _____ Ip67-Ip68



*Every sound system needs terminals and cables that are adequate to maintain audio quality and to express the maximum possible power. Through the years, **B52** has characterized itself for providing whatever is needed to build the best possible system. Go ahead and select the complete line of cables and accessories.*

AUDIO CABLES SERIES

ALL ITEMS DELIVERED ONLY IN BLISTER.



COD. 1508701
20-GA-R/B

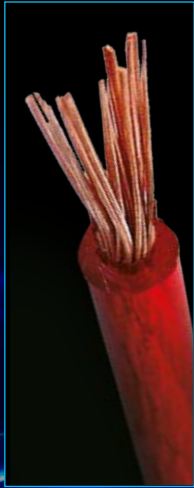

- Power cable
- Precision engineered to maximize performance
- Competition use
- Oxygen-free
- 20 gauge (0,50mm²)
- Spool x 300ft. (91,5m)
- Available in red & black

LOGISTICS INFORMATION

- Master Dimensions:
26 x 14 x 12,5 cm
/ 10,2 x 5,5 x 4,9 In
- Gross weight: 3 Kg / 6,6 Lb
- Master pieces: 2u

COD. 1508603
16-GA-R/B

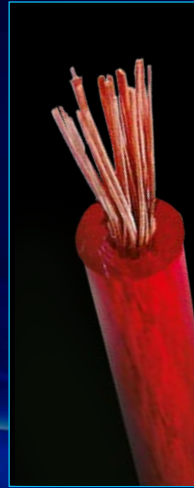

- Power cable
- Precision engineered to maximize performance
- Competition use
- Oxygen-free
- 16 gauge (1,50mm²)
- Spool x 300ft. (91,5m)
- Available in red & black

LOGISTICS INFORMATION

- Master Dimensions:
26 x 14 x 14 cm
/ 10,2 x 5,5 x 5,5 In
- Gross weight: 7 Kg / 15,4 Lb
- Master pieces: 2u

COD. 1508505
14-GA-R/B

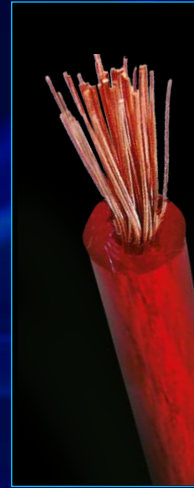

- Power cable
- Precision engineered to maximize performance
- Competition use
- Oxygen-free
- 14 gauge (2,50mm²)
- Spool x 300ft. (91,5m)
- Available in red & black

LOGISTICS INFORMATION

- Master Dimensions:
35 x 26 x 26 cm
/ 13,8 x 10,2 x 10,2 In
- Gross weight: 8 Kg / 17,6 Lb
- Master pieces: 4u

COD. 1508407
12-GA-R/B

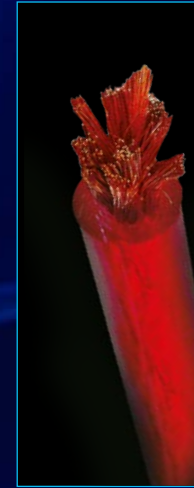

- Power cable
- Precision engineered to maximize performance
- Competition use
- Oxygen-free
- 12 gauge (4mm²)
- Spool x 100ft. (30,5m)
- Available in red & black

LOGISTICS INFORMATION

- Master Dimensions:
26 x 14 x 19 cm
/ 10,2 x 5,5 x 7,5 In
- Gross weight: 9 Kg / 19,8 Lb
- Master pieces: 4u

COD. 1508309
10-GA-R/B



- Power cable
- Precision engineered to maximize performance
- Competition use
- Oxygen-free
- 10 gauge (6mm²)
- Spool x 100ft. (30,5m)
- Available in red & black

LOGISTICS INFORMATION

- Master Dimensions:
26 x 14 x 27 cm
/ 10,2 x 5,5 x 10,6 In
- Gross weight: 8 Kg / 17,6 Lb
- Master pieces: 4u

COD. 1508201
8-GA-R/B

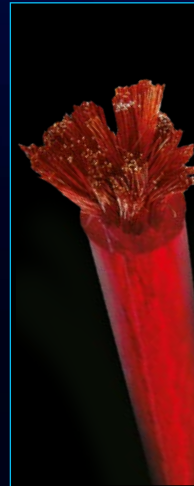

- Power cable
- Precision engineered to maximize performance
- Competition use
- Oxygen-free
- 8 gauge (6mm²)
- Spool x 100ft. (30,5m)
- Available in red & black

LOGISTICS INFORMATION

- Master Dimensions:
36 x 18,5 x 23 cm
/ 14,2 x 7,3 x 9,1 In
- Gross weight: 11 Kg / 24,3 Lb
- Master pieces: 4u

COD. 1508096
4-GA-R/B



- Power cable
- Precision engineered to maximize performance
- Competition use
- Oxygen-free
- 4 gauge (6mm²)
- Spool x 100ft. (30,5m)
- Available in red & black

LOGISTICS INFORMATION

- Master Dimensions:
42 x 22 x 36 cm
/ 16,5 x 8,7 x 14,2 In
- Gross weight: 16 Kg / 35,3 Lb
- Master pieces: 4u

COD. 1508014
BP-24

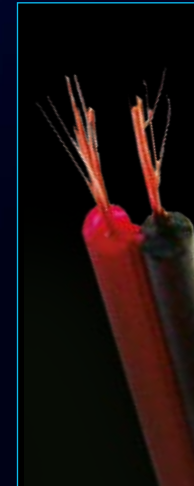

- Ultraflex speaker wire
- Precision engineered to maximize performance
- Professional use
- 24 gauge x 2 (2 x 0,25mm²)
- Roll x 328ft. (100m)
- Cable red & black

LOGISTICS INFORMATION

- Master Dimensions:
40 x 21 x 31 cm
/ 15,7 x 8,3 x 12,2 In
- Gross weight: 12 Kg / 26,5 Lb
- Master pieces: 10u

COD. 1508023

BP-22



- Ultraflex speaker wire
- Precision engineered to maximize performance
- Professional use
- 22 gauge x 2 (2 x 0,35mm²)
- Roll x 328ft. (100m)
- Cable red & black

LOGISTICS INFORMATION

- Master Dimensions: 42 x 22 x 31,5 cm / 16,5 x 8,7 x 12,4 in
- Gross weight: 14 Kg / 30,9 Lb
- Master pieces: 10u

COD. 1508032

BP-20



- Ultraflex speaker wire
- Precision engineered to maximize performance
- Professional use
- 20 gauge x 2 (2 x 0,50mm²)
- Roll x 328ft. (100m)
- Cable red & black

LOGISTICS INFORMATION

- Master Dimensions: 42 x 22,5 x 31 cm / 16,5 x 8,9 x 12,2 in
- Gross weight: 13 Kg / 28,7 Lb
- Master pieces: 10u

COD. 1508038 (Roll)

COD. 1508039 (Spool)

BP-18



- Ultraflex speaker wire
- Precision engineered to maximize performance
- Professional use
- 18 gauge x 2 (2 x 0,75mm²)
- Roll x 328ft. (100m)
- Spool x 1000ft. (305m)
- Cable red & black

LOGISTICS INFORMATION

- Master Dimensions: 46 x 24 x 31 cm / 18,1 x 9,4 x 12,2 in
- Gross weight: 17 Kg / 37,5 Lb
- Master pieces: 10u

COD. 1508041

BP-17



- Ultraflex speaker wire
- Precision engineered to maximize performance
- Professional use
- 17 gauge x 2 (2 x 1mm²)
- Roll x 328ft. (100m)
- Cable red & black

LOGISTICS INFORMATION

- Master Dimensions: 47 x 25 x 31 cm / 18,5 x 9,8 x 12,2 in
- Gross weight: 24 Kg / 52,9 Lb
- Master pieces: 10u

COD. 1508045 (Roll)

COD. 1508046 (Spool)

BP-16

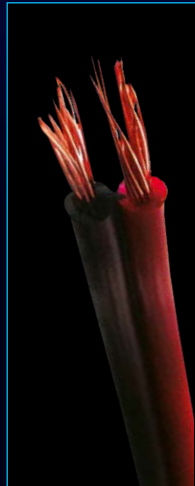

- Ultraflex speaker wire
- Precision engineered to maximize performance
- Professional use
- 16 gauge x 2 (2 x 1,5mm²)
- Roll x 328ft. (100m)
- Spool x 1000ft. (305m)
- Cable red & black

LOGISTICS INFORMATION

- Master Dimensions: 25 x 25 x 31,5 cm / 9,8 x 9,8 x 12,4 in
- Gross weight: 15 Kg / 33,1 Lb
- Master pieces: 5u

COD. 1508176

BP-15

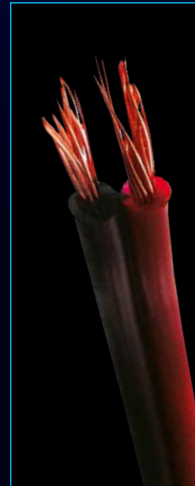

- Ultraflex speaker wire
- Precision engineered to maximize performance
- Professional use
- 15 gauge x 2 (2 x 2mm²)
- Roll x 328ft. (100m)
- Cable red & black

LOGISTICS INFORMATION

- Master Dimensions: 25 x 25 x 31 cm / 9,8 x 9,8 x 12,2 in
- Gross weight: 17 Kg / 37,5 Lb
- Master pieces: 5u

COD. 1508172 (Roll)

COD. 1508173 (Spool)

BP-12



- Ultraflex speaker wire
- Precision engineered to maximize performance
- Professional use
- 12 gauge x 2 (2 x 4mm²)
- Roll x 328ft. (100m)
- Spool x 500ft. (152m)
- Cable red & black

LOGISTICS INFORMATION

- Master Dimensions: 35 x 35 x 30 cm / 13,8 x 13,8 x 11,8 in
- Gross weight: 15 Kg / 33,1 Lb
- Master pieces: 4u

COD. 1508050

CBP-20



- Ultraflex speaker wire
- Precision engineered to maximize performance
- Professional use
- 20 gauge x 2 (2 x 0,5mm²)
- Roll x 328ft. (100m)
- Clear cable

LOGISTICS INFORMATION

- Master Dimensions: 43 x 22,5 x 31,5 cm / 16,9 x 8,9 x 12,4 in
- Gross weight: 12 Kg / 26,5 Lb
- Master pieces: 10u

COD. 1508069 (Roll)
 COD. 1508070 (Spool)
CBP-18



- Ultraflex speaker wire
- Precision engineered to maximize performance
- Professional use
- 18 gauge x 2 (2 x 0,75mm²)
- Roll x 328ft. (100m)
- Spool x 1000ft. (305m)
- Clear cable

LOGISTICS INFORMATION

- Master Dimensions: 24 x 24 x 31,5 cm / 9,4 x 9,4 x 12,4 in
- Gross weight: 11 Kg/ 24,3 Lb
- Master pieces: 5u

COD. 1508078
CBP-17



- Ultraflex speaker wire
- Precision engineered to maximize performance
- Professional use
- 17 gauge x 2 (2 x 1mm²)
- Roll x 328ft. (100m)
- Clear cable

LOGISTICS INFORMATION

- Master Dimensions: 44 x 23 x 23,5 cm / 17,3 x 9,1 x 9,3 in
- Gross weight: 16 Kg/ 35,3 Lb
- Master pieces: 10u

COD. 1508087
CBP-416



- Ultraflex speaker wire
- Precision engineered to maximize performance
- Professional use
- 16 gauge x 4 (4 x 1,5mm²)
- Roll x 328ft. (100m)
- Clear cable

LOGISTICS INFORMATION

- Master Dimensions: 35 x 35 x 21,5 cm / 13,8 x 13,8 x 8,5 in
- Gross weight: 12 Kg/ 26,5 Lb • Master pieces: 2u

COD. 1508185 (Roll)
 COD. 1508186 (Spool)
CBP-16

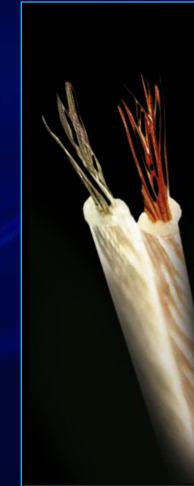

- Ultraflex speaker wire
- Precision engineered to maximize performance
- Professional use
- 16 gauge x 2 (2 x 1,5mm²)
- Roll x 328ft. (100m)
- Spool x 1000ft. (305m)
- Clear cable

LOGISTICS INFORMATION

- Master Dimensions: 36 x 19 x 23 cm / 14,2 x 7,5 x 9,1 in
- Gross weight: 16 Kg/ 35,3 Lb
- Master pieces: 4u

COD. 1508194
CBP-15

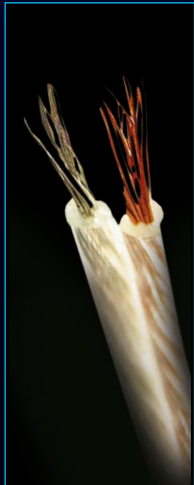

- Ultraflex speaker wire
- Precision engineered to maximize performance
- Professional use
- 15 gauge x 2 (2 x 2mm²)
- Roll x 328ft. (100m)
- Clear cable

LOGISTICS INFORMATION

- Master Dimensions: 25 x 25 x 31,5 cm / 9,8 x 9,8 x 12,4 in
- Gross weight: 13 Kg/ 28,7 Lb
- Master pieces: 5u

COD. 1508190 (Roll)
 COD. 1508191 (Spool)
CBP-12

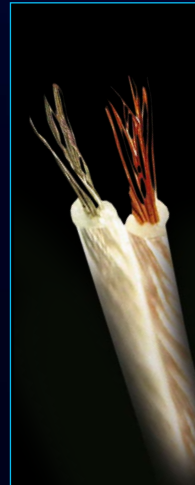

- Ultraflex speaker wire
- Precision engineered to maximize performance
- Professional use
- 12 gauge x 2 (2 x 4mm²)
- Roll x 328ft. (100m)
- Spool x 500ft. (152m)
- Clear cable

LOGISTICS INFORMATION

- Master Dimensions: 45 x 24 x 20 cm / 17,7 x 9,4 x 7,9 in
- Gross weight: 16 Kg/ 35,3 Lb
- Master pieces: 2u

COD. 0713340
F-800



- Circuit breaker
- For Hi-current operation
- High quality
- ABS body
- 80 Amp
- One 2/4 GA input & output

LOGISTICS INFORMATION

- Master Dimensions: 42 x 22 x 36 cm / 16,5 x 8,7 x 14,2 in
- Gross weight: 16 Kg / 35,3 Lb • Master pieces: 4u

COD. 0713347
F-640



- Power distribution block & Circuit breaker
- Combination
- High quality
- ABS body
- 60 + 40 Amp
- 4 GA x 3 in to 8 x 2 GA out

LOGISTICS INFORMATION

- Master Dimensions: 42 x 22 x 36 cm / 16,5 x 8,7 x 14,2 in
- Gross weight: 16 Kg / 35,3 Lb • Master pieces: 4u

COD. 0713338
F-600



- Circuit breaker
- High quality
- ABS body
- 60 Amp
- 8 GA in to 8 GA out

LOGISTICS INFORMATION

- Master Dimensions: 42 x 22 x 36 cm / 16,5 x 8,7 x 14,2 In
- Gross weight: 16 Kg / 35,3 Lb • Master pieces: 4u

COD. 0713329
F-400



- Circuit breaker
- High quality
- ABS body
- 40 Amp
- 8 GA in to 8 GA out

LOGISTICS INFORMATION

- Master Dimensions: 42 x 22 x 36 cm / 16,5 x 8,7 x 14,2 In
- Gross weight: 16 Kg / 35,3 Lb • Master pieces: 4u

COD. 0713428
F-48

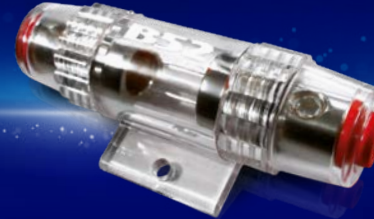

- AGU fuse holder
- High quality
- ABS body
- For standard AGU fuse
- 4/8 GA in to 4/8 GA out

LOGISTICS INFORMATION

- Master Dimensions: 42 x 22 x 36 cm / 16,5 x 8,7 x 14,2 In
- Gross weight: 16 Kg / 35,3 Lb • Master pieces: 4u

COD. 0713432
F-42



- ANL fuse holder
- High quality
- ABS body
- Gold & satin nickel
- 1/0 GA input & output

LOGISTICS INFORMATION

- Master Dimensions: 40,5 x 40,5 x 27,5 cm / 15,9 x 15,9 x 10,8 in
- Gross weight: 10 Kg / 22 Lb • Master pieces: 80u

COD. 4204300
F-AGU 25



- Standard AGU fuse
 - High quality
 - Gold fuse
 - Available in packages of 5 pieces.
- 4204300 F-AGU 25: 25A
4204408 F-AGU 30: 30A
4204506 F-AGU 40: 40A
4204604 F-AGU 50: 50A
4204702 F-AGU 60: 60A

LOGISTICS INFORMATION

- Master Dimensions: 42 x 22 x 36 cm / 16,5 x 8,7 x 14,2 In
- Gross weight: 16 Kg / 35,3 Lb • Master pieces: 4u

COD. 4204909
F-ANL 70

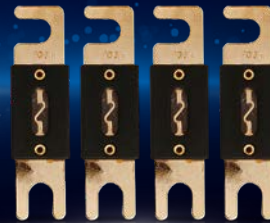

- Standard ANL fuse
 - High quality
 - Stain nickel fuse
 - Available in packages of 4 pieces.
- 4204909 F-ANL 70: 70A
4204918 F-ANL 100: 100A
4204927 F-ANL 140: 140A
4204936 F-ANL 200: 200A

LOGISTICS INFORMATION

- Master Dimensions: 42 x 22 x 36 cm / 16,5 x 8,7 x 14,2 In
- Gross weight: 16 Kg / 35,3 Lb • Master pieces: 4u

COD. 0713213
D-3448



- Distribution fuse block
- For standard AGU fuse
- Transparent ABS body
- High quality
- 4 GA x 3 in to 8 GA x 4 out

LOGISTICS INFORMATION

- Master Dimensions: 42 x 22 x 36 cm / 16,5 x 8,7 x 14,2 In
- Gross weight: 16 Kg / 35,3 Lb • Master pieces: 4u

COD. 0713222
D-4848



- Distribution fuse block
- For standard AGU fuse
- Transparent ABS body
- High quality
- 4 GA x 3 in to 8 GA x 3 out

LOGISTICS INFORMATION

- Master Dimensions: 42 x 22 x 36 cm / 16,5 x 8,7 x 14,2 In
- Gross weight: 16 Kg / 35,3 Lb • Master pieces: 4u

COD. 0713311
D-2828



- Distribution fuse block
- For standard AGU fuse
- Transparent ABS body
- High quality
- 4 GA x 2 in to 8 GA x 2 out

LOGISTICS INFORMATION

- Master Dimensions: 42 x 22 x 36 cm / 16,5 x 8,7 x 14,2 In
- Gross weight: 16 Kg / 35,3 Lb • Master pieces: 4u

COD. 0713455
DB-84



- Distribution block
- High temperature resistance
- Eliminates multiple power supply leads
- from the battery or ground accepts
- High quality
- 4 GA in to 8 GA x 2 out

LOGISTICS INFORMATION

- Master Dimensions: 43,5 x 29,5 x 26,7 cm / 17,1 x 11,6 x 10,5 in
- Gross weight: 12 Kg / 26,5 Lb • Master pieces: 80u

COD. 7500341
TB-82P



- Battery terminal
- High temperature resistance
- (+) Positive terminal
- High quality
- Accepts (2) 8 GA cables

LOGISTICS INFORMATION

- Master Dimensions: 42 x 22 x 36 cm / 16,5 x 8,7 x 14,2 In
- Gross weight: 16 Kg / 35,3 Lb • Master pieces: 4u

COD. 7500350
TB-82N



- Battery terminal
- High temperature resistance
- (-) Negative terminal
- High quality
- Accepts (2) 8 GA cables

LOGISTICS INFORMATION

- Master Dimensions: 42 x 22 x 36 cm / 16,5 x 8,7 x 14,2 In
- Gross weight: 16 Kg / 35,3 Lb • Master pieces: 4u

COD. 7500361
TB-24P



- Battery terminal
- High temperature resistance
- (+) Positive terminal
- High quality
- 4 GA x 2 in to 8 GA x 1 out

LOGISTICS INFORMATION

- Master Dimensions: 42 x 22 x 36 cm / 16,5 x 8,7 x 14,2 In
- Gross weight: 16 Kg / 35,3 Lb • Master pieces: 4u

COD. 7500370
TB-24N



- Battery terminal
- High temperature resistance
- (-) Negative terminal
- High quality
- 4 GA x 2 in to 8 GA x 1 out

LOGISTICS INFORMATION

- Master Dimensions: 42 x 22 x 36 cm / 16,5 x 8,7 x 14,2 In
- Gross weight: 16 Kg / 35,3 Lb • Master pieces: 4u

COD. 7500412
PB-82



- Battery caps
- Rubber cover
- For battery terminal
- Positive & negative caps
- High quality
- Blister packed with 4 red & 4 black cables

LOGISTICS INFORMATION

- Master Dimensions: 42 x 22 x 36 cm / 16,5 x 8,7 x 14,2 In
- Gross weight: 16 Kg / 35,3 Lb • Master pieces: 4u

COD. 7500430
PB-24



- Battery caps
- Rubber cover
- For battery terminal
- Positive & negative caps
- High quality
- Blister packed with 4 red & 4 black cables

LOGISTICS INFORMATION

- Master Dimensions: 42 x 22 x 36 cm / 16,5 x 8,7 x 14,2 In
- Gross weight: 16 Kg / 35,3 Lb • Master pieces: 4u

COD. 7500627
TM-28



- Gold spade terminals
- Accepts 8 GA cables
- Tapered ends to fit amp terminal strip
- Blister packed with 4 red & 4 black cables

LOGISTICS INFORMATION

- Master Dimensions: 42 x 22 x 36 cm / 16,5 x 8,7 x 14,2 In
- Gross weight: 16 Kg / 35,3 Lb • Master pieces: 4u

COD. 7500636
TM-24



- Gold spade terminals
- Accepts 4 GA cables
- Tapered ends to fit amp terminal strip
- Blister packed with 4 red & 4 black cables

LOGISTICS INFORMATION

- Master Dimensions: 42 x 22 x 36 cm / 16,5 x 8,7 x 14,2 In
- Gross weight: 16 Kg / 35,3 Lb • Master pieces: 4u

COD. 7500609
TM-18



- Gold ring terminals
- Accepts 8 GA cables
- Tapered ends to fit amp terminal strip
- Blister packed with 4 red & 4 black cables

LOGISTICS INFORMATION

- Master Dimensions: 42 x 22 x 36 cm / 16,5 x 8,7 x 14,2 In
- Gross weight: 16 Kg / 35,3 Lb • Master pieces: 4u

COD. 7500618
TM-14



- Gold ring terminals
- Accepts 4 GA cables
- Tapered ends to fit amp terminal strip
- Blister packed with 4 red & 4 black cables

LOGISTICS INFORMATION

- Master Dimensions: 40,5 x 40,5 x 27,5 cm / 15,9 x 15,9 x 10,8 In
- Gross weight: 10 Kg / 22 Lb • Master pieces: 80u

COD. 7500663
PTM-28



- Power terminals
- Spade terminals
- Accepts 8 GA cables
- Blister packed with 1 red & 1 black cables

LOGISTICS INFORMATION

- Master Dimensions: 42 x 22 x 36 cm / 16,5 x 8,7 x 14,2 In
- Gross weight: 16 Kg / 35,3 Lb • Master pieces: 4u

COD. 7500672
PTM-24



- Power terminals
- Spade terminals
- Accepts 4 GA cables
- Blister packed with 1 red & 1 black cables

LOGISTICS INFORMATION

- Master Dimensions: 42 x 22 x 36 cm / 16,5 x 8,7 x 14,2 In
- Gross weight: 16 Kg / 35,3 Lb • Master pieces: 4u

COD. 7500645
PTM-18



- Power terminals
- Ring terminals
- Accepts 8 GA cables
- Blister packed with 1 red & 1 black cables

LOGISTICS INFORMATION

- Master Dimensions: 42 x 22 x 36 cm / 16,5 x 8,7 x 14,2 In
- Gross weight: 16 Kg / 35,3 Lb • Master pieces: 4u

COD. 7500654
PTM-14



- Power terminals
- Ring terminals
- Accepts 4 GA cables
- Blister packed with 1 red & 1 black cables

LOGISTICS INFORMATION

- Master Dimensions: 42 x 22 x 36 cm / 16,5 x 8,7 x 14,2 In
- Gross weight: 16 Kg / 35,3 Lb • Master pieces: 4u

B52