

DISRUPTING BINARIES

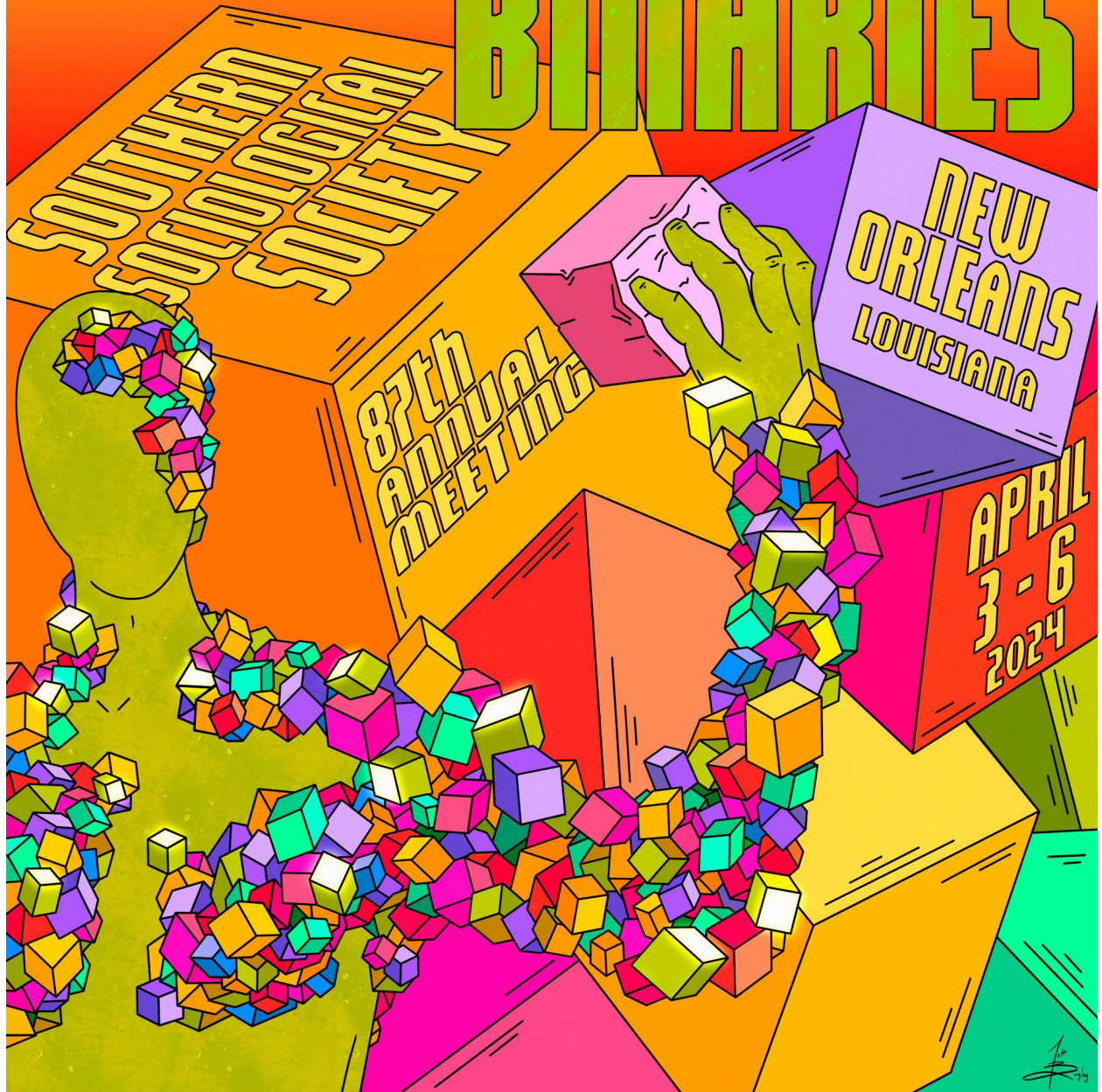

About the Art and the Artist

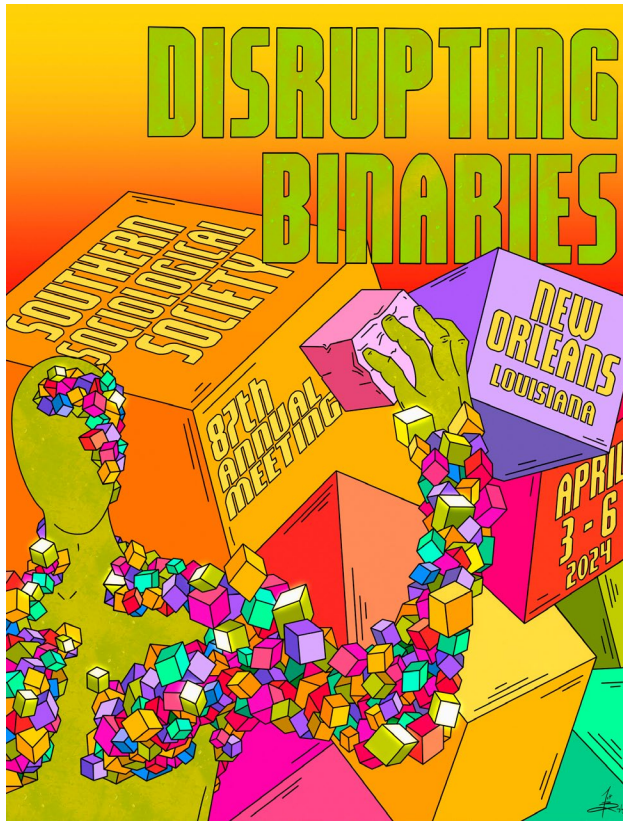

When exploring this year's theme of Disrupting Binaries I wanted to showcase a sense of identity and self. People often put themselves into categorical boxes like race, gender, sexual orientation, etc., and quite frequently people can be put into those boxes by others. The reality is that you as an individual get to decide who you are, and what makes you, you. The main figure in the cover is made to resemble no one, and in turn it could resemble anyone. It is covered with literal boxes, some permanently a part of the person, some everchanging. The idea with this is that you as an individual get to decide what boxes you are a part of and which you are not, hence the crushed cube. This amalgamation of different boxes will always be unique to you because no two people are ever exactly the same. The aesthetic of the cover is inspired by a few things. Comic books, which can be an excellent example of diverse inclusion and representation. The color palette, geared towards the vibrant and lively atmosphere of New Orleans. And Pop Art, an art movement that was and is an advocate for many different ideas.

Jett Bingley
Email: jettbnglyart@gmail.com
Instagram: [@jettbngly_art](https://www.instagram.com/jettbngly_art)

Southern Sociological Society
87th Annual Meeting
“**Disrupting Binaries**”

New Orleans, Louisiana
Sheraton New Orleans Hotel
April 3-6, 2024

Final Program

Table of Contents

Welcome Message from SSS President, Gayle Kaufman	5
Welcome Message from SSS Program Chairs, D’Lane Compton and Hiromi Taniguchi	6
Message from our Mini-conference Organizers, Sancha Medwinter, Tannuja Rozario, and Monisha Jackson	7
Message from our Mini-conference Organizers: Adam M. Straub, Kevin Smiley, and Liesel A. Ritchie	8
Southern Sociological Society Committees.....	9
Social Currents	13
Past Presidents, 1936-1979	14
Past Presidents, 1980-Present.....	15
Previous SSS Award Recipients	16
Departmental Members, Donors, and Sustaining Members.....	18
Session Glossary.....	19
Southern Sociological Society Anti-Harassment Policy	20
SSS 2024 Book Signing Schedule	21
Program at a Glance.....	22
Wednesday, April 3, 2024	33
Thursday, April 4, 2024.....	34
Friday, April 5, 2024.....	61
Saturday, April 6, 2024.....	89
Index	101
Maps.....	115

Welcome Message from SSS President, Gayle Kaufman

Welcome SSSers!

I am excited to be here with you in New Orleans for the 87th meeting of the Southern Sociological Society! The conference theme “Disrupting Binaries” is intended to encourage critical examination of the many boxes we put ourselves and others into. This threads through the plenaries on “Resisting Sociology’s Binaries” by S.L. Crawley, “Troubling the Public During Troubled Times” by Tressie McMillan Cottom, and “The Utility of Categorizing Genders” with Kristen Schilt moderating a conversation with D’Lane Compton, Michelle Johns, and Danya Lagos.

Like all SSS conferences, most of the conference is made up of your papers, panels, posters, roundtables, and workshops. Whether you want to learn more about race, racism, and racial justice; gender and sexuality; immigrants and immigration; health disparities and mental health; violence and victimization; schools and education; rural and urban spaces; popular culture; indigenous women’s movements; or climate change and disasters, you’ll find a session. If you need a little help writing, publishing, getting a grant, teaching, or finding a job, there’s a session for you.

I am deeply grateful for the tireless efforts of so many SSSers working behind the scenes. This includes the Program Co-Chairs Hiromi Taniguchi and D’Lane Compton and program committee members – Aarushi Bhandari, Blu Buchanan, Felicia Casanova, Melanie Escue, Won-tak Joo, Nik Lampe, Braden Leap, Gabriela Leon-Perez, Corey Miles, Ugur Orak, Ryan Parsons, Elizabeth Rahilly, Kapriskie Seide, Jaclyn Wong, and Sam Yuan – the Executive Officer David Brunsma and Assistant Executive Officer Elizabeth Roberts, Local Arrangements Co-Chairs Heather O’Connell and Kevin Smiley and committee members Yoon Jung Jeong, KayLynn Larrison, Jazmin Robinson-Smith, and Xinying (Nunnally) Zou. And all the volunteers!

I hope you’ll find time to make new friends whether that’s over coffee in between sessions or during one of our receptions. I would love to personally welcome you to the conference on Wednesday night during the Welcome Reception or on Thursday morning during the Coffee with the President. Wherever it is, come and say hi to me!

Gayle Kaufman
President, Southern Sociological Society
Davidson College



Welcome Message from SSS Program Chairs, D’Lane Compton and Hiromi Taniguchi

Greetings colleagues,

We are excited to announce that we have nearly 200 sessions and 700 presentations included in this year’s program built around President Kaufman’s conference theme of “Disrupting Binaries.” As noted in our charter, “the Southern Sociological Society promotes sociology as a profession and scientific discipline through maintaining high standards, encouraging effective teaching and research, applying sociological knowledge to societal problems, cooperating with related disciplines, recruiting and training sociologists, and developing sociology programs in educational and other agencies.” As such, we made it our goal to create spaces in the program for thoughtful and engaging papers, posters, panels, and session topics, in addition to activities that would spur comradery and micro-creativity for further work and revitalization.

In preparation for this meeting, please note:

1. First and foremost, if you have any concerns or need help onsite, please swing by registration.
2. While all those at SSS 2024 will have access to Wi-Fi in all the conference spaces, sometimes with so many people on the same system, things can run intermittently and inconsistently. Please be prepared by bringing your presentation on a USB drive and/or emailing it to your presenter to download onto their laptop in advance of your session.
3. Specific to NOLA, it is always a good idea to hydrate and no one ever needs more than two hand grenades in a day! We strongly suggest wearing comfortable shoes, loud and decadent flair, and always watching where you step.
4. We are excited to plan an in-person 2024 conference. All those attending SSS will be required to follow any COVID 19-related protocols mandated by local authorities at the time of the meeting. We strongly recommend that attendees receive a COVID-19 vaccination or booster in advance of the conference. Mask use is optional but encouraged. Please do your best to consider your own health and that of your colleagues. Depending on circumstances closer to our meeting in April, SSS Executive Committee may enact stricter protocols.

Lastly, we would like to further thank all those that helped and contributed to building this program from last minute submitters to the extraordinary committee of experts for their dedication and work in seeing this program come to be. Likewise, we greatly appreciate our Executive Office for always having an answer and the technical support over the last nine months.

We hope you enjoy your time in NOLA, and *Laissez le bon temps rouler!*

D’Lane Compton, University of New Orleans
Hiromi Taniguchi, University of Louisville



Message from our Mini-conference Organizers, Sancha Medwinter, Tannuja Rozario, and Monisha Jackson

Have you heard about our Diasporic Womanisms and Indigenous Women's Movements of the Global South Mini-Conferences at SSS? Come and join us for deep, reflexive decolonial, antiracist, antipatriarchal dialogues and a chance to be part of a community of like-minded BIPOC, QTPOC, and Global South scholars!

All our sessions are held in Gallier AB, 4th Floor on Thursday and Napoleon A2, 3rd Floor on Friday. We have an exciting slate of panels for you. Plan ahead and add to your calendar! Thursday Sessions: If you're looking to be part of a community, don't miss our laid back, kick off introductions, and the session organizers' presentation of our DW framework, "Diasporic Womanist Sociology: The Framework" (1:00 pm - 2:15 pm); "Diasporic Womanisms II: Decolonial Womanist Methodologies" (2:30 pm - 3:45 pm); "Diasporic Womanisms III: Navigating Academic Exclusions" (4:00 pm-5:15 pm). Friday: "Diasporic Womanisms IV: Womanism and Life-Death Ecologies" (8:30 am-9:45 am); "Diasporic Womanisms V: Decolonizing Identity, Sexuality, and Self-Care" (10:00 am - 11:15 am).

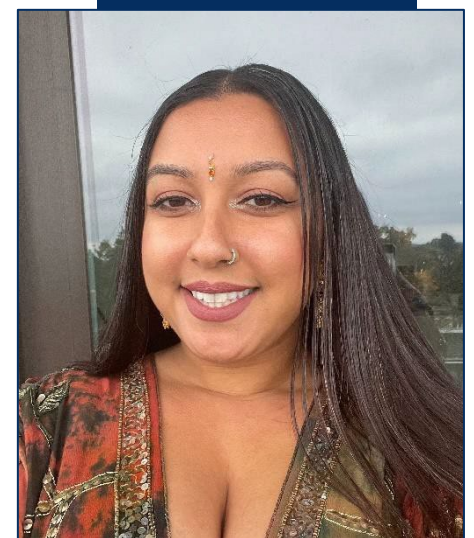

Message from our Mini-conference Organizers: Adam M. Straub, Kevin Smiley, and Liesel A. Ritchie

We would like to invite you to the **Challenging Dichotomies in the Context of Hazards/Disasters Mini-Conference.**

Traditionally, hazards and disasters have been categorized as “natural” or “technological” events. However, this reduces the complexity of these events and their effects on individuals, communities, institutions, and society. Join us as we blur these binaries and explore the complex social dynamics, technological challenges, and environmental changes that increasingly shape our world. All our sessions will take place on Friday, April 5th in Bayside B, 4th floor.

8:30-9:45a – Community (in)Action I:

1. I just called to say...it flooded: Flooding and governance seen through 311 calls in Baton Rouge
2. Community based organizational response after the Pearl River Flood (2022)
3. Citizen sewists?: The (unexpected) mutual aid workers of COVID-19
4. Engaging the community to address disaster food and nutrition insecurity

10:00-11:15a – Community (in)Action II:

1. Experiences with Winter Storm Uri and perceptions of recreancy
2. Beyond boundaries: An analysis of the impact of water and power outages from Winter Storm URI
3. Feeling the burn: A pilot study of heat wave perceptions and preparedness
4. Challenging the moderate/radical dichotomy Through an ecosystem of tactics model: the Mountain Valley Pipeline resistance

1:00-2:15p – Institution and Organization (in)Actions:

1. Measuring recreancy in the context of a na-tech disaster
2. Long-term resilience of vulnerable communities in Southeast Louisiana
3. Disrupting “crisis”: The case of the declining Dead Sea
4. A culture of recreancy before, during, and after the Pearl River Flood

2:30-3:45p – Taking Stock, Moving Forward with panelists:

S. Kroll-Smith, K. Tierney, D. Miller, D. Gill, and S. Domingue

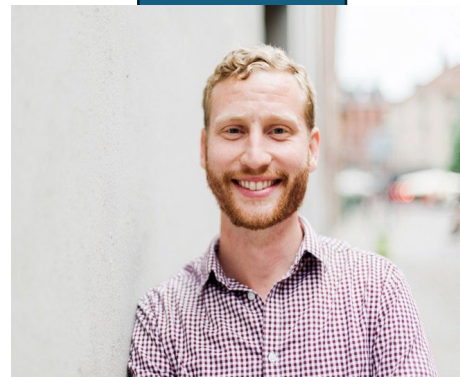

Southern Sociological Society Committees

Executive Committee

Gayle Kaufman, Davidson College
Irene Browne, Emory University
David Brunσμα, Virginia Tech
Rhiannon Leebrick, Wofford College
Dawn T. Robinson, University of Georgia
Anthony Peguero, Arizona State University
Earl Wright II, Rhodes College
Stephanie Bohon, University of Tennessee

Megan R. Underhill, University of North Carolina Asheville
Ali Sewell, Emory University
Juan Jose Bustamante, University of Arkansas
David Embrick, University of Connecticut
James "JT" Thomas, The University of Mississippi

Publications Committee

Shantel Buggs, Florida State University
Natalia Ruiz-Junco, Auburn University
Victor Ray, University of Iowa
Daniel Delgado, Texas A&M University-San Antonio
Gretchen Peterson, The University of Memphis
Baker Rogers, Georgia Southern University

Earl Wright II, Rhodes College
David Brunσμα, Virginia Tech
Elizabeth Roberts, Virginia Tech
Jennifer March Augustine, University of South Carolina
Amanda Koontz, University of Central Florida
Nadya Vera, University of Tennessee

Program Committee

D'Lane Compton, University of New Orleans
Hiromi Taniguchi, University of Louisville
Aarushi Bhandari, Davidson College
Blu Buchanan, UNC Asheville
Felicia Casanova, University of Miami
Melanie Escue, UNC Pembroke
Won-tak Joo, University of Florida
Nik Lampe, University of South Florida
Braden Leap, Mississippi State

Gabriela Leon-Perez, VCU
Corey Miles, Tulane
Ugur Orak, Middle Tennessee State
Ryan Parsons, University of Mississippi
Elizabeth Rahilly, Georgia Southern
Kapriskie Seide, Davidson College
Jaclyn Wong, University of South Carolina
Sam Yuan, Georgia Tech

Local Arrangements

Heather O'Connell, Louisiana State University
Kevin Smiley, Louisiana State University
Yoon Jung Jeong, Louisiana State University
KayLynn Larrison, Louisiana State University

Jazmin Robinson-Smith, Louisiana State University
Xinying (Nunnally) Zou, Louisiana State University

Finance Committee

David Brunσμα, Virginia Tech
Gayle Kaufman, Davidson College
Dawn T. Robinson, University of Georgia

Christy Erving, Vanderbilt University
Jon Shefner, University of Tennessee
Karen Powell, Sears Denison University



Nominations Committee

Irene Brown, Emory University
Joseph Lariscy, University of Memphis
Celeste Lee, Spelman College
Dresden Lackey, Wofford College
Barbara Combs, Clark Atlanta University

Tina Deshotels, Jacksonville State University
James Ainsworth, Georgia State University
J. Micah Roos, Virginia Tech
Adria Welcher, Morehouse College
Makeela Wells, Auburn University

Election Committee

David Brunσμα, Virginia Tech
Rhiannon Leebrick, Wofford College

Elizabeth Roberts, Virginia Tech

Committee on Honors

Verna Keith, University of Alabama at Birmingham
Ali Sewell, Emory University
Jody Clay-Warner, University of Georgia
Daniel Harrison, Lander University

Shannon Davis, George Mason University
Marlese Durr, Wright State University
Matthew Ward, University of Southern Mississippi

Site Selection Committee

Earl Wright II, Rhodes College
Gayle Kaufman, Davidson College
Dawn T Robinson, University of Georgia
Marissa Crame, Helms-Briscoe

David Brunσμα, Virginia Tech
D'Lane Compton, University of New Orleans
Hiromi Taniguchi, University of Louisville

Committee on Racial and Ethnic Minorities

Derrick R. Brooms, Morehouse College
Juan Jose Bustamante, University of Arkansas
Guadalupe Marquez Velarde, Utah State
Littisha Bates, University of Cincinnati

Maryann Erigha, University of Georgia
Ray Von Robertson, Florida A&M University
Eileen O'Brien, Saint Leo University

Committee on Professions

John Boulahanis, Southeastern Louisiana University
David Brunσμα, Virginia Tech
Stephanie Teixeira Poit, North Carolina A&T
Nikhil Deb, California Polytechnic State University

Deadric Williams, University of Tennessee
John Boulahanis, Southeastern Louisiana University
Margaret Ralston, Mississippi State University
Jasmine Whiteside, University of Louisville

Committee on Sociological Practice

Mamadi Corra, East Carolina University
Megan R Underhill, University of North Carolina Asheville
Yasmiyn Irizarry, University of Texas-Austin
Jonathan Cox, University of Central Florida

Mary Barr, Clemson University
Jamekia Collins, Human Services Research Institute
Dale Wimberly, Virginia Tech

Committee on Sociology in Community and Small Colleges

Melencia Johnson, University of South Carolina - Aiken
Rhiannon Leebrick, Wofford College
Jenna Lamphere, University of Texas-Galveston

Evelyn Perry, Rhodes College
Catina Galloway, Guildford Technical Community College
Laura Atkins, Jacksonville University
Myra Doyle, Winston Salem State University

Membership Committee

Abigail Reiter, University of North Carolina-Pembroke
David Embrick, University of Connecticut
Nicole Lucas, Fayetteville State University
Sevsem Cicek-Okay, Niagara University

Hadi Khoshnevis, Rhodes College
Alana Anton, North Carolina Agricultural and Technical State University
Jamel Catoe, UNC-Charlotte

Committee on the Status of Students

Kierra Toney, University of Cincinnati
Anthony Stone, University of Cincinnati
Irene Brown, Emory University

Sarah Gaby, University of North Carolina-Wilmington
Sarah Castillo, University of Tennessee

Committee on Gender and Sexuality

Brittany Slatton, Texas Southern University
Anthony Peguero, Arizona State University
Amie Hess, Meredith College
Anne McGlynn-Wright, Tulane University
Jean-Anne Sutherland, University of North Carolina - Wilmington

Jeremy Brenner-Levoy, University of Cincinnati
Siti Kusujarti Warren, Wilson College
Jeannette Wade, North Carolina Agricultural and Technical State University

The Southern Sociologist

Nadya Vera, University of Tennessee
Jason D'Amours, Florida State University
Tyler Bruefach, Florida State University
Heather Sue M. Rosen, University of Georgia

Kelsey Mischke, North Carolina State University
Manuel Ramirez, University of Connecticut
Rachel Sparkman, Florida State University
Taylor Jackson, Florida State University

Harassment Task Force

Brianna Turgeon, Jacksonville State University
Daniel Delgado, Texas A&M University - San Antonio
Carmel Price, University of Michigan

Barbara Combs, Emory University
Jeannette Wade, North Carolina A&T
Christopher Rogers, University of Tennessee

Justice, Equity, Diversity & Inclusion

Joanna Hunter, Radford University
James "JT" Thomas, The University of Mississippi
Courtney Williams, Louisiana State University
Marisela Martinez-Cola, Morehouse College
Lisette Garcia, Hispanic Association on Corporate Responsibility
CC Cannon, Georgia State University
Marni Brown, Georgia Gwinnett College

Derrick R. Brooms, Morehouse College
Brittany Slatton, Texas Southern University
Melencia Johnson, University of South Carolina - Aiken
Abigail Reiter, University of North Carolina-Pembroke
Kierra Toney, University of Cincinnati
Anthony Stone, University of Cincinnati

Assistant Executive Officer

Elizabeth Roberts, Virginia Tech

Archivist

Ruth Bryan, University of Kentucky

Electronics Communication Coordinator

Elizabeth Roberts, Virginia Tech

Audio-Visual Coordinator

Jacob Robinson, Virginia Tech

Consortium of Social Science Associations (COSSA) Liaison

Roberta Spalter-Roth, ASA

Organizational Liaison

Kirsten Dellinger, University of Mississippi

Parliamentarian

Thomas C. Hood, University of Tennessee-Knoxville



Social Currents

Social Currents, the official journal of the Southern Sociological Society, is a broad-ranging social science journal that focuses on cutting-edge research from all methodological and theoretical orientations with implications for national and international sociological communities. The uniqueness of *Social Currents* lies in its format. The front end of every issue is devoted to short, theoretical, agenda-setting contributions and brief, empirical and policy-related pieces. The back end of every issue includes standard journal articles that cover topics within specific subfields of sociology, as well as across the social sciences more broadly.

Editors

Jennifer March Augustine	University of South Carolina
Amanda Koontz	University of Central Florida

Graduate Editorial Associates

Paola Merchán Tamayo	University of South Carolina
Andrea Olmeda	University of Central Florida

Editorial Board

Daniel Augustine	Florida Atlantic University
Shawn Bauldry	Purdue University
Shantel Buggs	Florida State University
Mary Campbell	Texas A&M University
Sergio Chavez	Rice University
Harry Dahms	University of Tennessee, Knoxville
Laurel Graham	University of South Florida
Andrea Henderson-Platt	University of South Carolina
Kirk Johnson	University of Mississippi
Verna Keith	University of Alabama at Birmingham
Ellen Lamont	Appalachian State University
Amalia Leguizamón	Tulane University
Brian Levy	George Mason University
Anna Mueller	Indiana University
Kei Nomaguchi	Bowling Green State University
Deirdre Oakley	Georgia State University
Marisa Omori	University of MO - St. Louis
Anthony Peguero	Arizona State University
Nick Petersen	University of Miami
Gretchen Peterson	University of Memphis
Allison Pugh	University of Virginia
Scott Schieman	University of Toronto, Canada
Vaughn Schmutz	University of North Carolina, Charlotte
Stef Shuster	Michigan State University
Bhoomi Thakore	University of Connecticut
Will Tyson	University of South Florida
Christopher Wildeman	Duke University
Morgan Koziol	University of South Carolina

Past Presidents, 1936-1979

1936 E.T. Krueger, Vanderbilt University
1937 Wilson Gee, University of North Carolina-Chapel Hill
1938 Rupert B. Vance, North Carolina-Chapel Hill
1939 E.W. Gregory, University of Alabama
1940 Fred C. Frey, Louisiana State University
1941 B.O. Williams, University of Georgia
1942 William E. Cole, University of Tennessee-Knoxville
1943 Katharine Jocher, University of North Carolina-Chapel Hill
1944 Katharine Jocher, University of North Carolina-Chapel Hill
1945 Howard Beers, University of Kentucky
1946 Charles S. Johnson, Fisk University
1947 T. Lynn Smith, Louisiana State University
1948 Coyle E. Moore, Florida State University
1949 Wayland J. Hayes, Vanderbilt University
1950 Lee M. Brooks, University of North Carolina-Chapel Hill
1951 H.C. Brearley, George Peabody College for Teachers
1952 Rudolf Heberle, Louisiana State University
1953 Leland B. Tate, Virginia Tech
1954 Guy B. Johnson, University of North Carolina-Chapel Hill
1955 Morton B. King, Jr., University of Mississippi
1956 Irwin T. Sanders, University of Kentucky
1957 Homer L. Hitt, Louisiana State University
1958 C. Horace Hamilton, North Carolina State University
1959 Harold F. Kaufman, Mississippi State University
1960 E. William Noland, University of North Carolina-Chapel Hill
1961 Edgar T. Thompson, Duke University
1962 Meyer F. Nimkoff, Florida State University
1963 Alvin L. Bertrand, Louisiana State University
1964 Selz C. Mayo, North Carolina State University
1965 Bryce F. Ryan, University of Miami
1966 Joseph S. Himes, North Carolina College
1967 A. Lee Coleman, University of Kentucky
1968 Ernest Q. Campbell, Vanderbilt University
1969 John C. McKinney, Duke University
1970 John T. Doby, Emory University
1971 Alvin Boskoff, Emory University
1972 Richard L. Simpson, University of North Carolina-Chapel Hill
1973 Charles M. Grigg, Florida State University
1974 Fredrick L. Bates, University of Georgia
1975 Charles U. Smith, Florida A&M University
1976 Alan C. Kerckhoff, Duke University
1977 Thomas R. Ford, University of Kentucky
1978 Gerhard E. Lenski, University of North Carolina-Chapel Hill
1979 Clifton D. Bryant, Virginia Tech

Past Presidents, 1980-Present

1980 M. Elaine Burgess, University of North Carolina-Greensboro
1981 Irving L. Webber, University of Alabama
1982 Charles B. Nam, Florida State University
1983 Joseph H. Fichter, Loyola University-New Orleans
1984 George A. Hillery, Jr., Virginia Tech
1986 Jeffrey K. Hadden, University of Virginia
1987 Abbott L. Ferriss, Emory University
1988 Ida Harper Simpson, Duke University
1989 John Shelton Reed, University of North Carolina-Chapel Hill
1990 Lewis M. Killian, University of West Florida
1991 Joel Smith, Duke University
1992 Ronald L. Akers, University of Florida
1993 Shirley B. Laska, University of New Orleans
1994 Walter R. Gove, Vanderbilt University
1995 Thomas C. Hood, University of Tennessee
1996 John Moland, Jr., Alabama State University
1997 Karl L. Alexander, Johns Hopkins University
1998 Rebecca G. Adams, University of North Carolina-Greensboro
1999 Lynn Smith-Lovin, University of Arizona
2000 Maxine Atkinson, North Carolina State University
2001 Kenneth C. Land, Duke University
2002 Rachel A. Rosenfeld, University of North Carolina-Chapel Hill
2003 Patricia Yancey Martin, Florida State University
2004 Charles M. Tolbert II, Baylor University
2005 Michael Hughes, Virginia Tech
2006 Judith Blau, University of North Carolina-Chapel Hill
2007 Ronald W. Wimberley, North Carolina State University
2008 Larry W. Isaac, Vanderbilt University
2009 Kathleen Slevin, William & Mary
2010 Angela O'Rand, Duke University
2011 Vincent Roscigno, The Ohio State University
2012 Beth A. Rubin, University of North Carolina-Charlotte
2013 Donald Tomaskovic-Devey, UMass-Amherst
2014 Leslie Hossfeld, University of North Carolina-Wilmington
2015 David Maume, University of Cincinnati
2016 Barbara Risman, University of Chicago-Illinois
2017 Christopher G. Ellison, University of Texas at San Antonio
2018 Eduardo Bonilla-Silva, Duke University
2019 Toni Calasanti, Virginia Tech
2020 Beth Rushing, Appalachian College Association
2021 Adia Harvey Wingfield, Washington University in St. Louis
2022 Stephanie Bohon, The University of Tennessee-Knoxville
2023 Earl Wright II, Rhodes College

Previous SSS Award Recipients

Roll of Honor

2023 Lynn Smith-Lovin, Duke University
2020 Michael Hughes, Virginia Tech
2015 Robert Agnew, Emory University
2014 Walter Gove, Vanderbilt University
2014 Kenneth Land, Duke University
2013 John Shelton Reed, University of North
2012 Ronald Wimberley, North Carolina State
University
2011 Charles S. Johnson, Fisk University
2008 Clifton Bryan, Virginia Tech
2008 Patricia Yancey Martin, Florida State
University
2007 Ida Harper Simpson, Duke University
2006 Richard L. Simpson, University of North
Carolina-Chapel Hill
2002 Ronald L. Akers, University of Florida
1996 Lewis M. Killian, University of West
Florida

Distinguished Contributions to Teaching

2020 Jennifer Patrice Sims, University of
Alabama-Huntsville
2019 Jody Clay Warner, University of Georgia
2016 Department of Sociology, University of
South Florida
2015 Mindy Stompler, Georgia State
University
2013 Rebecca Bach, Duke University

Katharine Jocher-Belle Boone Beard

2018 Robin W. Simon, Wake Forest
University
2015 Holly McCammon, Vanderbilt
University
2014 David Maume, University of Cincinnati
2013 Karen Campbell, Vanderbilt University
2010 Irene Padavic, Florida State University

1995 Charles B. Nam, Florida State University
1994 Alan C. Kerckhoff, Duke University
1990 Rudolf Heberle, Louisiana State
University
1989 Kurt W. Back, Duke University
1986 Guy B. Johnson, University of North
Carolina-
1986 Joseph H. Fichter, Loyola University
1984 Joseph S. Himes, University of North
Carolina-Greensboro
1982 Vernon J. Parenton, Louisiana State
University
1979 Ernst Borinski, Tougaloo College
1977 Rupert B. Vance, University of North
Carolina- Chapel Hill
1977 T. Lynn Smith, University of Florida

2010 Edward I. Kain, Southwestern University
2006 Gregory Weiss, Roanoke College
2005 Idee Winfield, College of Charleston
2004 Maxine Atkinson, North Carolina State
University
2002 Clifton D. Bryant, Virginia Tech
2002 Department of Sociology, James
Madison University

2004 Barbara Risman, North Carolina State
University
1999 Patricia Yancey Martin, Florida State
University
1995 Rachel Rosenfeld, University of North
Carolina-Chapel Hill

Martin L. Levin Distinguished Service

2022 Shannon Davis, George Mason University
2020 Cameron Lippard, Appalachian State University
2019 David Brunsmma, Virginia Tech
2016 Dennis R. McSeveney, University of New Orleans
2014 Stephanie Bohon, University of Tennessee-Knoxville

Distinguished Lectureship

2019 Barbara Risman, University of Illinois Chicago
2015 Jon Shefner, University of Tennessee-Knoxville
2012 Shirley Laska, University of New Orleans
2011 Larry W. Isaac, Vanderbilt University
2008 Larry J. Griffin, University of North Carolina- Chapel Hill

Charles Gomillion-Joseph Sandy Himes

2020 Michael Royster, Prairie View A&M University
2019 Cynthia Neal Spence, Spelman College

SSS Junior Scholar Award

2023 William Scarborough, University of North Texas
2022 Alison Adams, University of Florida
2020 Kasey Henricks, University of Tennessee
2019 Michaela DeSoucey, North Carolina State University
2019 Victor Ray, University of Tennessee
Charles S. Johnson Award

2013 Bob Freymeyer, Presbyterian College
2010 Tom Hood, University of Tennessee
2006 Clifton Bryant, Virginia Tech
2005 Abbott L. Ferriss, Emory University
2004 Catherine Harris, Wake Forest University
2003 Martin L. Levin, Mississippi State University

2007 E.M. Beck, University of Georgia
2006 William W. Falk, University of Maryland
2005 Dolores Aldridge, Emory University
2002 John Moland, Jr., Alabama State University
1997 Charles U. Smith, Florida A&M University
1994 Daniel S. Johnson, Dillard University

2019 Charles U. Smith, Florida A&M University (posthumous)
2019 John L. Moland, Alabama State University (posthumous)

2016 Earl Wright, II University of Cincinnati
2010 Larry J. Griffin, University of Maryland
2006 William W. Falk, University of Maryland
2005 Delores P. Aldridge, Emory University
2002 John Moland, Alabama State University
1997 Charles U. Smith, Florida A&M University
1994 Charles S. Johnson, Dillard University



Departmental Members, Donors, and Sustaining Members

2024 Departmental Members

Coastal Carolina University
Davidson College
East Carolina University
Georgia State University
Louisiana State University
NC State University
St. Norbert College

University of Denver
University of Miami
University of Mississippi
University of New Orleans
University of North Carolina-Wilmington
Waldorf University
Wofford College

2024 Sustaining Members

Denise Bissler
Stephanie Bohon
Shannon N. Davis
Scott Fitzgerald
Sara Green
Leslie Hossfeld
Michael Hughes
Larry Isaac
Gayle Kaufman
Thomas Konrad

Steve McDonald
Patricia McManus
Marisela Martinez-Cola
Gretchen Peterson
Stephen Poulson
Dawn T. Robinson
Beth Rushing
Lynn Smith-Lovin
Lisa Walker
Earl Wright II

Lifetime Members

Kasey Henricks



Session Glossary

AMCRs: These “Author-Meets-Curious-Reader” Sessions are an opportunity for book authors and other experts in their field to discuss recent publications. Join these conversations to learn more about new sociological material and to hear from those likely to agree, or disagree, with the conclusions drawn.

Mini-Conference: A formal grouping of paper sessions around a central theme. The sessions provide an opportunity to learn from authors about the work they have been doing and the new sociological knowledge. These mini-conference sessions are built of 10-minute presentations and question-and-answer sessions where time allows.



Panel Sessions: These curated conversations focus on a topic and the scholars making waves within it. In viewing these sessions, you will learn from those presenting and have the opportunity to ask questions to learn more about the subject.

Paper Sessions: Paper sessions are the opportunity to learn from authors about the work they have been doing and the new sociological knowledge coming out of it. These sessions are built of 10-minute presentations and question and answer sessions where time allows.

Plenary Session: An invited formal presentation to the entire society focused on a topic that highlights the theme of the conference.

Poster Sessions: Almost paper sessions but based on posters, these sessions allow scholars to share their work with an active audience. Presenters in these sessions range from undergraduates sharing their work with the community for the first time to tenured professors continuing to share their knowledge.

Presidential Address: A formal session that serves as the keynote address of the society delivered by the president.



Roundtables: Roundtables are informal presentations focused more on conversations about the researcher’s topic. These do not include formal presentations opting instead for an informed conversational approach.

Thematic Sessions: These paper sessions and panel sessions have been selected because of their unique connection the conference theme, “Disrupting Binaries.”



Workshops: Focused on skills sociologists use such as publishing and teaching, these provide an opportunity to learn from colleagues about the inner workings of our discipline. Attend these to learn from experienced members of our network about the ways they do their work as sociologists.



Southern Sociological Society Anti-Harassment Policy

SSS is committed to providing a safe and welcoming conference environment for all participants, free from harassment based on age, race, ethnicity, national origin, religion, language, sexual orientation, gender identity or gender expression, disability, health conditions, socioeconomic status, marital status, domestic status, or parental status (hereafter, simply harassment). Harassment of colleagues, students, hotel staff or other conference participants undermines the principle of equity at the heart of these professional fora and is inconsistent with the principles of free inquiry and free expression.

Harassment of any participant is unethical behavior under the American Sociological Association Code of Ethics. Harassment consists of a single intense and severe act or of multiple persistent or pervasive acts which are demeaning, abusive, offensive, or create a hostile professional or workplace environment. Harassment may include sexual solicitation, physical advance, or verbal or non-verbal conduct that is sexual in nature; threatening, intimidating, or hostile acts; circulation of written or graphic material that denigrates or shows hostility toward an individual or group; epithets, slurs, or negative stereotyping based on group identity.

All participants at SSS meetings are expected to abide by this Anti-Harassment Policy in all meeting venues including ancillary events as well as official and unofficial social gatherings. If you witness potential harm to a conference participant, be proactive in helping to mitigate or avoid that harm. Alert conference security personnel or law enforcement if you see a situation in which someone might be in imminent physical danger.

Advocates

Advocates are volunteer members of SSS who are available to support those making a report by providing information and resources. The following Advocates will be at the annual meeting:

- Melanie Escue, Assistant Professor, University of North Carolina at Pembroke: melanie.escue@uncp.edu
- Olivia Hetzler, Associate Professor, Lincoln University: hetzlero@lincolnu.edu
- Eucharika Nkem Ozoemenam, Graduate Student, North Carolina State University: enzoeme@ncsu.edu
- Corinne Schwarz, Assistant Professor, Oklahoma State University: corinne.schwarz@okstate.edu
- Elizabeth Wroten, Graduate Student, University of Delaware: edsuofd@udel.edu

Attendees should see the SSS 2024 Mobile App and/or visit the Registration Desk on the 3rd Floor for a list of advocates and reporting processes

SSS 2024 Book Signing Schedule



Come to the Community Book Center exhibition tables at SSS 2024 to meet these authors, purchase their books, and get them signed!

Thursday, April 4, 11:05-11:30am

Isom, Deena A. 2023. *Gratuitous Angst in White America: A Theory of Whiteness and Crime*. Taylor & Francis.

Thursday, April 4, 2:05-2:30pm

Zamantakis, Alithia. 2023. *Thinking Cis: Cisgender, Heterosexual Men, and Queer Women's Roles in Anti-Trans Violence*. Rowman & Littlefield.

Friday, April 5, 11:05-11:30am

Scimecca, Joseph A. 2023. *The Not So Outrageous Idea of a Christian Sociology*. Routledge.

Friday, April 5, 2:05-2:30pm

Bartram, Robin. 2022. *Stacked Decks: Building Inspectors and the Reproduction of Urban Inequality*. University of Chicago.

Friday, April 5, 5:05-5:30pm

Miles, Corey Javon. 2023. *Vibe: The Sound and Feeling of Black Life in the American South*. University Press of Mississippi.

Saturday, April 6, 11:05-11:30am

McDonald, Maretta. 2024. *The Sociology of Cardi B: A Black Feminist Approach*. Routledge.

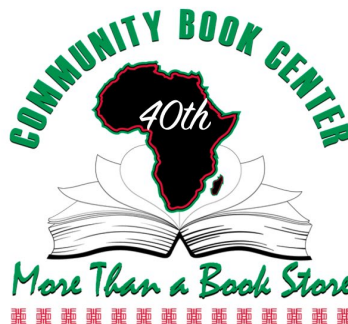

"He who does not know, can know from learning"

Community Book Center is a Black- and Woman-owned bookstore, established in 1983, in New Orleans, LA. bookshop.org/shop/readcbc

Program at a Glance

Daily Events & Space (Check daily schedule summaries for hours)

Lactation Space (Thursday-Saturday) | Poydras, 3rd Floor

Quiet Space (Thursday-Saturday) | Edgewood AB, 4th Floor

Community Space (Thursday-Saturday) | Oak Alley, 4th Floor

Collaboration Space | Crescent, 4th Floor
Committee Space | Ellendale, 4th Floor

Onsite Registration (Wednesday-Saturday) | Registration Office, 3rd Floor

PreRegistration (Wednesday-Saturday) | Napoleon Foyer, 3rd Floor

Exhibits (Thursday-Saturday) | Napoleon Foyer Exhibits Area, 3rd Floor

Committee Meetings

Executive Committee Meeting
Wednesday | 2:00 pm-6:00 pm
Friday | 8:30 am-10:30 am
Saturday | 8:30 am-10:30 am | Maurepas, 3rd Floor

Finance Committee Meeting
Thursday | 8:30 am-9:30 am | Maurepas, 3rd Floor

Sociology in Community and Small Colleges Committee Meeting
Thursday | 8:30 am-9:45 am | Ellendale, 4th Floor

Site Visit Committee Meeting
Thursday | 10:00 am-11:00 am | Maurepas, 3rd Floor

Membership Committee Meeting
Thursday | 10:00 am-11:15 am | Ellendale, 4th Floor

Status of Students Committee Meeting
Thursday | 1:00 pm-2:15 pm | Ellendale, 4th Floor

Gender and Sexuality Committee Meeting
Thursday | 2:30 pm-3:45 pm | Ellendale, 4th Floor

JEDI Committee Meeting
Thursday | 3:00 pm-4:00 pm | Maurepas, 3rd Floor

TSS Meeting
Thursday | 4:00 pm-5:15 pm | Ellendale, 4th Floor

Sociological Practice Committee Meeting
Friday | 8:30 am-9:45 am | Ellendale, 4th Floor

Local Arrangements Committee Meeting
Friday | 10:00 am-11:15 am | Ellendale, 4th Floor

Publications Committee Meeting
Friday | 1:00 pm-2:00 pm | Maurepas, 3rd Floor

2025 Honors Committee Meeting
Friday | 1:00 pm-2:15 pm | Ellendale, 4th Floor

Meeting of Social Currents Editorial Board
Friday | 2:30 pm-3:30 pm | Maurepas, 3rd Floor

Nominations Committee Meeting
Friday | 2:30 pm-3:45 pm | Ellendale, 4th Floor

2025 Program Committee Meeting
Friday | 4:00 pm-5:15 pm | Ellendale, 4th Floor

SSS Business Meeting
Saturday | 7:30 am-8:30 am | Maurepas, 3rd Floor

SWS-S Business Meeting
Saturday | 8:30 am-9:30 am | Nottoway, 4th Floor

Professions Committee Meeting
Saturday | 10:00 am-11:15 am | Ellendale, 4th Floor

Presidential Transition Meeting
Saturday | 10:30 am-11:30 am | Maurepas, 3rd Floor

Mini-Conferences

34. Diasporic Womanisms I: Diasporic Womanist Sociology: The Framework
Thursday | 1:00 pm-2:15 pm | Gallier AB, 4th Floor

53. Diasporic Womanisms II: Decolonial Womanist Methodologies
Thursday | 2:30 pm-3:45 pm | Gallier AB, 4th Floor

66. Diasporic Womanisms III: Navigating Academic Exclusions
Thursday | 4:00 pm-5:15 pm | Gallier AB, 4th Floor

84. Diasporic Womanisms IV: Womanism and Life-Death Ecologies
Friday | 8:30 am-9:45 am | Napoleon A2, 3rd Floor

97. Diasporic Womanisms V: Decolonizing Identity, Sexuality, and Self-Care
Friday | 10:00 am-11:15 am | Napoleon A2, 3rd Floor

83. Disrupting Dichotomies in the Context of Hazards/Disasters I: Community (in)Action
Friday | 8:30 am-9:45 am | Bayside B, 4th Floor

96. Disrupting Dichotomies in the Context of Hazards/Disasters II: Community (in)Action
Friday | 10:00 am-11:15 am | Bayside B, 4th Floor

113. Disrupting Dichotomies in the Context of Hazards/Disasters III: Institution and Organization (in)Actions
Friday | 1:00 pm-2:15 pm | Bayside B, 4th Floor

133. Disrupting Dichotomies in the Context of Hazards/Disasters IV: Taking Stock, Moving Forward
Friday | 2:30 pm-3:45 pm | Bayside B, 4th Floor

Receptions

Welcome Reception/Meet the Candidates
Wednesday | 5:30 pm-8:30 pm | Armstrong Ballroom, 8th Floor

First-Time Attendee Coffee with the President
Thursday | 7:30 am-8:30 am | Canal Street Corridor, 3rd Floor

Roll of Honor Session to Recognize Lynn Smith-Lovin
Thursday | 4:00 pm-5:15 pm | Napoleon C1+C2, 3rd Floor

Trivia Night!
Thursday | 6:00 pm-8:00 pm | Nottoway, 4th Floor

Student Mixer with the President @Felipe's French Quarter (301 N. Peters Street)
Thursday | 8:00 pm-10:00 pm | Offsite

SWS-S Coffee for a Cause
Friday | 4:00 pm-5:15 pm | Maurepas, 3rd Floor

Presidential and Awards Reception
Friday | 7:30 pm-9:15 pm | Armstrong Ballroom, 8th Floor

Drag Show [Reception]
Friday | 8:00 pm-9:00 pm | Armstrong Ballroom Show, 8th Floor

Numbered Sessions

Thursday, April 04

8:30 am-9:45 am

Paper Sessions

1. Social Determinants of Mental Health and Long-Term Pain | Bayside A, 4th Floor
2. Racialized Learning and Education | Bayside B, 4th Floor
3. Research on Law Enforcement and Correctional Officers | Bayside C, 4th Floor
4. Social and Institutional Change | Estherwood, 4th Floor
5. Higher Education and Social Mobility | Evergreen, 4th Floor
6. Digital Sociology I | Gallier AB, 4th Floor
7. Life Stage Transitions for Youth | Napoleon A1, 3rd Floor
8. LGBTQ+ Experiences with Religion | Napoleon A2, 3rd Floor
9. Narrative and Community in Rural America | Napoleon A3, 3rd Floor
10. Environmental Attitudes and Identities | Napoleon B1, 3rd Floor
11. Problematizing Bodies and Embodiment | Napoleon B3, 3rd Floor
12. Confronting Violent Institutions | Napoleon D3, 3rd Floor

Panels

13. Demystifying Research Grants | Borgne, 3rd Floor

14. Using Paradigms to Understand and Solve Intractable Social Problems | Napoleon D1, 3rd Floor

Workshop

15. Innovative Strategies to Enhance Experiential Learning | Southdown, 4th Floor

10:00 am-11:15 am

Paper Sessions

16. Addressing Structural Racism: A Call to Action for Medical Sociology | Bayside A, 4th Floor
17. Racialized Academy: Race, Education, and Funding | Bayside B, 4th Floor
18. Families and Stratification | Bayside C, 4th Floor
19. Transgender Health and Healthcare | Estherwood, 4th Floor
20. Gender Role Socialization, Health Disparities, and Gender-Based Criminal Outcomes | Evergreen, 4th Floor
21. Digital Sociology II | Gallier AB, 4th Floor
22. Perceptions of Rurality Across the Lifecourse | Napoleon A1, 3rd Floor
23. Sexual Violence | Napoleon A2, 3rd Floor
24. Social Movements, Labor, and Capitalism | Napoleon A3, 3rd Floor
25. Race, Gender, and Emotions | Napoleon B1, 3rd Floor
26. Climate Change | Napoleon B3, 3rd Floor

27. Disciplinary Considerations: Pushing Forward with Lessons Learned | Napoleon D1, 3rd Floor

Author-Meets-Curious-Readers

28. *Gratuitous Angst in White America: A Theory of Whiteness* and Crime by Deena A. Isom | Borgne, 3rd Floor

Panel

29. The Lavender Roar: Emerging Trans/Queer Leaders Experiences Promoting Queer Joy and Navigating Institutional Politics | Napoleon D3, 3rd Floor

Workshops

30. Professional Mentorship and CV Review | Nottoway, 4th Floor

31. GIFTS: Good Ideas for Teaching Sociology and Publishing in TRAILS | Southdown, 4th Floor

Poster Session

32. Poster Session 1 - Inequalities, Place, Environment | Bayside Foyer, 4th Floor

11:30 am-12:45 pm

33. Presidential Plenary: S.L. Crawley | Napoleon C1+C2, 3rd Floor

1:00 pm-2:15 pm

Mini-Conference

34. Diasporic Womanisms I: Diasporic Womanist Sociology: The Framework | Gallier AB, 4th Floor

Thematic Session

35. The Sociology of W. E. B. Du Bois and Black Subjugated Knowledges | Bayside A, 4th Floor

Paper Sessions

36. Organizational and Subcultural Correlates of Deviance and Social Control | Bayside B, 4th Floor

37. Race, Ethnicity, and Religion | Bayside C, 4th Floor

38. LGBTQ+ Health and Healthcare | Estherwood, 4th Floor

39. The Racialization of Asians/Asian Americans | Napoleon A1, 3rd Floor

40. Health and Sexuality in Rural America | Napoleon A2, 3rd Floor

41. Fat Studies and Body Politics, co-sponsored by SWS-South | Napoleon A3, 3rd Floor

42. Gender, Work, and Family | Napoleon B1, 3rd Floor

43. Culture and Identities Online | Napoleon B3, 3rd Floor

44. Intimacy, Pleasure, and Sex | Napoleon D3, 3rd Floor

Author-Meets-Curious-Readers

45. *Thinking Cis: Cisgender, Heterosexual Men, and Queer Women's Roles in Anti-Trans Violence* by Alithia Zamantakis | Borgne, 3rd Floor

Panels

46. Beyond "Great Man" Sociology: Innovative Approaches to Teaching Theory | Evergreen, 4th Floor

47. Teaching in Applied Sociology Courses, co-sponsored by SWS-South | Napoleon D1, 3rd Floor

Workshop

48. Workshop: Let's Talk about Writing! | Southdown, 4th Floor

Roundtables

49. Roundtable I: Crime, Law, and Deviance | Nottoway, 4th Floor (Group I)

50. Roundtable II: Work Culture | Nottoway, 4th Floor (Group II)

51. Roundtable III: College Students and Wellbeing | Nottoway, 4th Floor (Group III)

Poster Session

52. Poster Session 2 - Education and Work | Bayside Foyer, 4th Floor

2:30 pm-3:45 pm

Mini-Conference

53. Diasporic Womanisms II: Decolonial Womanist Methodologies | Gallier AB, 4th Floor

Paper Sessions

54. The Fight for Racial Justice | Bayside A, 4th Floor

55. Cyberdeviance and Victimization | Bayside B, 4th Floor

56. Racial Conceptualization and Racial Attitudes I | Bayside C, 4th Floor

57. Latino Integration and Racialization | Evergreen, 4th Floor

58. Sexual Health: Issues, Management, and Care | Napoleon A1, 3rd Floor

59. Place, Region, and Rurality | Napoleon A2, 3rd Floor

60. Addressing Reproductive Justice in Patient Care | Napoleon A3, 3rd Floor

61. Work-Family Interface | Napoleon B1, 3rd Floor

62. Environments and Economies | Napoleon B3, 3rd Floor

Thematic Session

63. Disrupting Binaries Across Contexts | Napoleon D3, 3rd Floor

Panels

64. Sister Scholars as a Source of Resistance, Strength, and Joy: Navigating Graduate School as Women of Color | Borgne, 3rd Floor

65. Teaching in Applied Sociology Programs and Projects, co-sponsored by SWS-South | Napoleon D1, 3rd Floor

4:00 pm-5:15 pm

Mini-Conference

66. Diasporic Womanisms III: Navigating Academic Exclusions | Gallier AB, 4th Floor

Paper Sessions

67. Racialized Violence and Bias | Bayside A, 4th Floor

68. Getting Campus Organized | Bayside B, 4th Floor

69. Racial Conceptualization and Racial Attitudes II | Bayside C, 4th Floor

70. Religion, Spirituality, and Health |
Estherwood, 4th Floor

71. Hegemony and Resistance Online |
Napoleon A1, 3rd Floor

72. Gender and Culture | Napoleon A3, 3rd
Floor

73. Union Formation and Dissolution |
Napoleon B1, 3rd Floor

74. (Un)Natural Disasters | Napoleon B3, 3rd
Floor

75. Bias and Discrimination in Education |
Napoleon D1, 3rd Floor

76. Unpacking the Myriad Challenges of the
Housing Crisis | Napoleon D3, 3rd Floor

Panels

77. Pedagogical Wisdom for Graduate
Students, co-sponsored by the
Committee on the Status of Students and
the Committee on Justice, Equity, and
Inclusion (JEDI) | Evergreen, 4th Floor

78. DEI On Campus, co-
sponsored by the Committee on
Justice, Equity, and Inclusion
(JEDI) and the Committee on the
Status of Students | Napoleon A2,
3rd Floor

Workshop

79. National Science Foundation: Funding
Opportunities in the Sociology Program |
Southdown, 4th Floor

Poster Session

80. Poster Session 3 - Crime, Law, and
Deviance | Bayside Foyer, 4th Floor

Special Sessions

81. SSS Antiharassment Forum | Borgne, 3rd
Floor

82. Roll of Honor Session to Recognize Lynn
Smith-Lovin | Napoleon C1+C2, 3rd Floor

Friday, April 05

8:30 am-9:45 am

Mini-Conferences

83. Disrupting Dichotomies in the Context of
Hazards/Disasters I: Community (in)Action |
Bayside B, 4th Floor

84. Diasporic Womanisms IV: Womanism
and Life-Death Ecologies | Napoleon A2, 3rd
Floor

Paper Sessions

85. Laws, Policies, and Public Attitudes
toward Punishment | Bayside A, 4th Floor

86. Racial Belonging: Placemaking,
Immigration, and Reclamation | Bayside C,
4th Floor

87. Theorizing Sex, Gender, and the Body |
Estherwood, 4th Floor

88. Sociology of Mental Health and Chronic
Illness Management | Evergreen, 4th Floor

89. Critical Evaluation and New Approaches
| Gallier AB, 4th Floor

90. Investing in Education | Napoleon A1,
3rd Floor

91. Space, Place, and LGBTQ+ Populations I:
Sponsored by SWS-South | Napoleon B1, 3rd
Floor

92. Child Safety & Legal Contexts | Napoleon D1, 3rd Floor

93. Organizations: Structure, Culture, and Behavior | Napoleon D3, 3rd Floor

94. Institutions & Their Influencers | Oakley, 4th Floor

Workshop

95. STARTS workshop, co-sponsored by the Justice, Equity, Diversity & Inclusion (JEDI) Committee | Nottoway, 4th Floor
Note. This is a working session for STARTS cohort members only.

10:00 am-11:15 am

Mini-Conferences

96. Disrupting Dichotomies in the Context of Hazards/Disasters II: Community (in)Action | Bayside B, 4th Floor

97. Diasporic Womanisms V: Decolonizing Identity, Sexuality, and Self-Care | Napoleon A2, 3rd Floor

Paper Sessions

98. Resentment Politics | Bayside A, 4th Floor

99. Race and Gender in Global Perspective | Bayside C, 4th Floor

100. Gendered Violence, Victimization, and Women's Experiences | Estherwood, 4th Floor

101. Exploring Variances and Richness in End-of-Life Journeys | Evergreen, 4th Floor

102. Impact of Covid-19 on Achievement, Emotions, and Wellbeing | Gallier AB, 4th Floor

103. Learning About Race: School, Parents, & Peer Cultures | Napoleon A1, 3rd Floor

104. Beyond Binaries: Race, Queerness, and Knowledge Production | Napoleon A3, 3rd Floor

105. Space, Place, and LGBTQ+ Populations II: Sponsored by SWS-South | Napoleon B1, 3rd Floor

106. Labor and Workplace Negotiations | Napoleon B3, 3rd Floor

107. Family, Gender, and Power | Napoleon D3, 3rd Floor

108. Genres and Representation in Popular Culture | Oakley, 4th Floor

Author-Meets-Curious-Readers

109. *The Not So Outrageous Idea of a Christian Sociology* by Joseph A. Scimecca | Borgne, 3rd Floor

Panel

110. Emerging Disciplines and the Global Impact of Student-Guided Research | Napoleon D1, 3rd Floor

Poster Session

111. Poster Session 4 - Health | Bayside Foyer, 4th Floor

11:30 am-12:45 pm

112. Presidential Plenary: Tressie McMillan Cottom | Napoleon C1+C2, 3rd Floor

1:00 pm-2:15 pm

Mini-Conference

113. Disrupting Dichotomies in the Context of Hazards/Disasters III: Institution and Organization (in)Actions | Bayside B, 4th Floor

Paper Sessions

114. Disrupting Binaries of Gender and Sexuality | Bayside A, 4th Floor

115. “Who’s Afraid of Critical Race Theory?” | Bayside C, 4th Floor

116. Feminist Transformations | Estherwood, 4th Floor

117. Divestment and Competing Interests in Urban Spaces and Places | Evergreen, 4th Floor

118. Intersectionality Research for LGBTQ+ Health Justice | Gallier AB, 4th Floor

119. Low-Income and Immigrant College Students | Napoleon A1, 3rd Floor

120. Teaching and Understanding Cultural Politics | Napoleon A2, 3rd Floor

121. Media and Pop Culture | Napoleon A3, 3rd Floor

122. Gender, Career Process, and Outcomes | Napoleon B1, 3rd Floor

123. Mental Health, Criminal Offending, and Criminal Justice Involvement | Napoleon B3, 3rd Floor

124. Parent, Child, Sibling Relationships | Napoleon D1, 3rd Floor

125. Pedagogy in Practice | Napoleon D3, 3rd Floor

126. Group Processes | Oakley, 4th Floor

Author-Meets-Curious-Readers

127. *Stacked Decks: Building Inspectors and the Reproduction of Urban Inequality* by Robin Bartram | Borgne, 3rd Floor

Panel

128. Crafting a Scholarly Research Agenda, co-sponsored by the Committee on the Status of Students | Southdown, 4th Floor

Roundtables

129. Roundtable IV: Racism, Transphobia, and Divisions in the U.S. | Nottoway, 4th Floor (Group IV)

130. Roundtable V: Religion, Politics, and Social Movements | Nottoway, 4th Floor (Group V)

131. Roundtable VI: Pedagogy | Nottoway, 4th Floor (Group VI)
Other:

132. Graduate Program Informational Session | Bayside Foyer, 4th Floor

2:30 pm-3:45 pm

Mini-Conference

133. Disrupting Dichotomies in the Context of Hazards/Disasters IV: Taking Stock, Moving Forward | Bayside B, 4th Floor

Thematic Session

134. Breaking Gender Binaries: The Category X Research Project | Bayside A, 4th Floor

Paper Sessions

135. Centering Black Voices in the Classroom: Innovations in Pedagogy Involving the History Makers' Digital Archive | Bayside C, 4th Floor

136. Us vs Them and Insider Outsiders | Estherwood, 4th Floor

137. Advancing Health Equity Among Black Communities | Evergreen, 4th Floor

138. Work, Identity, and Subjective Wellbeing | Gallier AB, 4th Floor

139. Framing: Race, Gender, and Sexuality in the Media | Napoleon A1, 3rd Floor

140. Remembering Historical Racist Violence | Napoleon A2, 3rd Floor

141. Families and Social Institutions | Napoleon A3, 3rd Floor

142. Narratives of Poverty and Inequality | Napoleon B1, 3rd Floor

143. Victimization and Victim-Offender Overlap | Napoleon B3, 3rd Floor

144. Disparities in Urban Social Capital and Belonging | Napoleon D1, 3rd Floor

145. Evaluating Opioid and Cannabis Policies and Sociolegal Responses | Napoleon D3, 3rd Floor

146. LGBT+ Identity Development & Disclosure Across the Life Course | Oakley, 4th Floor

Panels

147. Learn to Publish: A Conversation with Journal Editors | Nottoway, 4th Floor

148. Teaching and Learning in Combined Sociology and Criminology Departments | Southdown, 4th Floor
Poster Session:

149. Poster Session 5 - Sex, Gender, and Sexualities | Bayside Foyer, 4th Floor

4:00 pm-5:15 pm

Paper Sessions

150. Expanding Intersectional Identities in Community | Bayside A, 4th Floor

151. Constructing Masculinity, Femininity and Queerness in Digital Spaces | Bayside B, 4th Floor

152. Fostering Inclusivity through Research on Disability | Estherwood, 4th Floor

153. Substance Use Recovery and Health Outcomes | Evergreen, 4th Floor

154. Intersectionality and Sexual/Reproductive Health | Gallier AB, 4th Floor

155. Complicating the Disability Binary | Napoleon A1, 3rd Floor

156. Contemporary Legacies of Historical Racist Violence | Napoleon A2, 3rd Floor

157. Intersectional Masculinities | Napoleon A3, 3rd Floor

158. Guns, Lifestyles, and Gun Violence | Napoleon B1, 3rd Floor

159. Everyday Experiences of Poverty | Napoleon B3, 3rd Floor

160. Parenting Labor & Effects | Napoleon D1, 3rd Floor

161. Student Success and Well-Being |
Napoleon D3, 3rd Floor

Author-Meets-Curious-Readers

162. *Vibe: The Sound and Feeling of Black Life in the American South* by Corey J. Miles | Borgne, 3rd Floor

Panels

163. Sociologists Doing Activism, co-sponsored by the Committee on Sociological Practice | Bayside C, 4th Floor

164. Co-Constructing Student Community through Shared Investment in a Growing Sociology Program | Oakley, 4th Floor

165. Finding a Job that Matters to You | Southdown, 4th Floor

6:00 pm-7:15 pm

166. Presidential Honors and Convocation Plenary | Napoleon C1+C2, 3rd Floor

Saturday, April 06

8:30 am-9:45 am

Paper Sessions

167. Managing Race Interpersonally | Bayside A, 4th Floor

168. Disparities in Health-Related Behaviors and Healthcare | Bayside B, 4th Floor

169. Recidivism and Barriers to Reentry | Bayside C, 4th Floor

170. Teaching the Arts in Sociology | Borgne, 3rd Floor

171. Algorithms and New Online Economies | Estherwood, 4th Floor

172. Gendered Work and Labor | Evergreen, 4th Floor

173. Migration Policy and Data | Gallier AB, 4th Floor

174. State Power, Capitalism, and War | Napoleon A1, 3rd Floor

175. Overcoming Binaries in Economic Thinking | Napoleon A2, 3rd Floor

176. ACEs: New Perspectives on Adverse Experiences for Children & Youth | Napoleon A3, 3rd Floor

177. Whitespaces I: Educational Institutional Spaces | Napoleon B1, 3rd Floor

178. Exploring the Stakeholders and Gatekeepers of Urban and Community Wellbeing | Napoleon B3, 3rd Floor

179. Sociological Methodology and Pedagogy | Napoleon D1, 3rd Floor

180. Animals and Society | Napoleon D3, 3rd Floor

181. Games, Sports, and Sex: Navigating Entertainment Technologies | Oakley, 4th Floor

Panel

182. Grant-Seeking from Private Foundations: What Investigators Should Know | Southdown, 4th Floor

10:00 am-11:15 am

Paper Sessions

183. Reproductive Rights and Justice | Bayside A, 4th Floor

184. Substance Use Patterns | Bayside B, 4th Floor

185. Cybercrime and Online Hate | Bayside C, 4th Floor

186. Justice and Rights in Comparative-Historical Perspective | Estherwood, 4th Floor

187. Advancing Research Methods and Theories in Medical Sociology | Evergreen, 4th Floor

188. The Experiences of Understudied Immigrant Groups | Gallier AB, 4th Floor

189. Income and Wealth Inequalities | Napoleon A2, 3rd Floor

190. Youth Connections: Family, Peers, & Mentors | Napoleon A3, 3rd Floor

191. Whitespaces II: Discursive Spaces | Napoleon B1, 3rd Floor

192. Together Alone? Social Capital, Solitude, and Isolation | Napoleon B3, 3rd Floor

193. Life, Death, and Disease Online | Napoleon D1, 3rd Floor

Author-Meets-Curious-Readers

194. *The Sociology of Cardi B: A Black Feminist Approach* by Aaryn Green, Maretta McDonald, Veronica Newton, Candice Robinson, and Shantee Rosado | Borgne, 3rd Floor

Panels

195. Status Update: Checking in on Research and Recommendations from the ASA's Task Force on FGWC Sociologists | Napoleon A1, 3rd Floor

196. Bridges and Barriers to Participation: Supporting Sociologists at Small and Community Colleges, co-sponsored by the Committee on Sociology at Small and Community Colleges | Napoleon D3, 3rd Floor

197. Strategies for Pursuing Academic Publishing, co-sponsored by the Committee on Racial and Ethnic Minorities | Southdown, 4th Floor

11:30 am-12:45 pm

198. Presidential Plenary Panel: The Utility of Categorizing Genders | Borgne, 3rd Floor

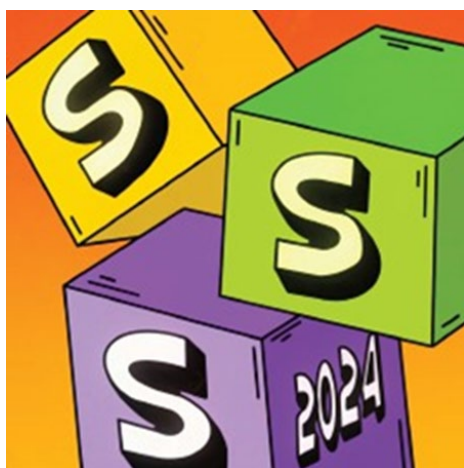

Wednesday, April 3, 2024

2:00 pm-6:00 pm

Executive Committee Meeting [Meeting]

Wednesday | 2:00 pm-6:00 pm | Maurepas, 3rd Floor

4:00 pm-6:00 pm

PreRegistration

Wednesday | 4:00 pm-6:00 pm | Napoleon Foyer, 3rd Floor

Onsite Registration

Wednesday | 4:00 pm-6:00 pm | Registration Office, 3rd Floor

5:30 pm-8:30 pm

Welcome Reception/Meet the Candidates [Reception]

Wednesday | 5:30 pm-8:30 pm | Armstrong Ballroom, 8th Floor



Welcome to the 87th Meeting of the Southern Sociological Society!

We are happy that you could join us here in New Orleans this year, and hope your time in this great city is fun, productive, and energizing.

Please visit Registration Office (for onsite registration) or Napoleon Foyer (if you preregistered) on the 3rd Floor.

We look forward to seeing you at the Welcome Reception which will be held in the Armstrong Ballroom (8th Floor) from 5:30 to 8:30pm.

Be sure to meet candidates for the upcoming SSS election there.

Thursday, April 4, 2024

7:00 am-9:00 pm

Quiet Space

Thursday | 7:00 am-9:00 pm | Edgewood AB, 4th Floor

This room is for those who need a place and time to step aside from the conference and be in a low-stimulation environment. Please be considerate of others while using this space.

Community Space

Thursday | 7:00 am-9:00 pm | Oak Alley, 4th Floor

This space is provided for members to come together, meet new members, build networks and collaborations, and socialize. Please enjoy your use of this space.

Lactation Space

Thursday | 7:00 am-9:00 pm | Poydras, 3rd Floor

This room is available during the conference for all lactation needs. Please be considerate of others' privacy in this space.

7:30 am-8:30 am

First-Time Attendee Coffee with the President

Thursday | 7:30 am-8:30 am | Canal Street Corridor, 3rd Floor

8:00 am-4:00 pm

Exhibits

Thursday | 8:00 am-4:00 pm | Napoleon Foyer Exhibits Area, 3rd Floor

PreRegistration

Thursday | 8:00 am-4:00 pm | Napoleon Foyer, 3rd Floor

Onsite Registration

Thursday | 8:00 am-4:00 pm | Registration Office, 3rd Floor

Welcome to SSS 2024!

Registration is open from 8am to 4pm. Swing by Registration Office for onsite registration, or Napoleon Foyer if you preregistered. Both are located on the 3rd Floor.

Lactation Space, Quiet Space, and Community Space are available from 7am to 9pm.

First-time attendees: Meet President Kaufman for coffee and chat. | 7:30 am-8:30 am | Canal Street Corridor, 3rd Floor

Coffee and tea are available in the Napoleon Foyer.

8:30 am-9:30 am

Finance Committee Meeting [Meeting]

Thursday | 8:30 am-9:30 am | Maurepas, 3rd Floor

8:30 am-5:15 pm

Collaboration Space

Thursday | 8:30 am-5:15 pm | Crescent, 4th Floor.

Registered attendees may sign up for use of this room in 75-minute slots to have a space to meet collaborators, establish new working relationships, and work on projects while together at our annual meeting.

8:30 am-9:45 am

1. Social Determinants of Mental Health and Long-Term Pain [Paper Session]

Thursday | 8:30 am-9:45 am | Bayside A, 4th Floor

Presenter: Madeline Brock, Mississippi State University

- *The unification of activity and disengagement theories.* John Lillis, University of North Carolina-Pembroke; Stephen Marson, University of North Carolina-Pembroke
- *Social class and informal caregiving for family members with Alzheimer's disease: The role of economic capital, cultural health capital, and social capital.* Zach Simoni, University of Tennessee at Chattanooga
- *The effectiveness of respite programs on caregivers' health.* Payton Nestor, Florida State University; Ladanya Ramirez Surmeier, Florida State University; Teresa Roach, Florida State University; Miles Taylor, Florida State University
- *Another link between physical health and fear of crime? Examining the relationship between chronic pain, feelings of physical vulnerability, and fear of crime among older persons.* Madeline Brock, Mississippi State University; Margaret Ralston, Mississippi State University; Nicole Rader, Mississippi State University

2. Racialized Learning and Education [Paper Session]

Thursday | 8:30 am-9:45 am | Bayside B, 4th Floor

Presenter: Carson Byrd, University of Michigan

- *Racial learning in a post 2020 era: How youth are making sense of race in a post George Floyd world.* Erin Oakes, University of Mississippi; Madeline Burdine, University of Mississippi; James M. Thomas, University of Mississippi
- *Examining coverage of race and racism in introductory sociology textbooks.* Sarah Friedman, Georgia State University
- *When there's not a clear before and after: Staggered implementation of affirmative action bans and its impact on student degree pathways.* Carson Byrd, University of Michigan; Katherine Leu, University of Michigan; Tabbye Chavous, University of Michigan; Timothy McKay, University of Michigan
- *Differing perceptions of diversity, equity, and inclusion (DEI) among university stakeholders.* Andrew Le, University of Southern Mississippi

3. Research on Law Enforcement and Correctional Officers [Paper Session]

Thursday | 8:30 am-9:45 am | Bayside C, 4th Floor

Presenter: Samuel Kolawole Agboola, University of Mississippi

- *Pallbearers of extinction: Policing (in) the Necrocene.* Meghan Watts, North Carolina State University
- *Identifying factors causing police response delays in Ibadan, Nigeria.* Titilayo Odedoyin, Texas Tech University
- *Predictors of stress among correctional officers in Massachusetts and Texas.* K. Brandon Lang, Commonwealth University Bloomsburg
- *Examining gender-based variations in occupational stress among police officers.* Samuel Kolawole Agboola, University of Mississippi

4. Social and Institutional Change [Paper Session]

Thursday | 8:30 am-9:45 am | Estherwood, 4th Floor

Presenter: Kendra Jason, University of North Carolina-Charlotte

- *The many meanings of social change: Understanding how organizations define success.* Lincoln Cutler, University of Tampa; David Russell Zeller, University of Tampa
- *A socio-ecological approach to identifying barriers and aids of implementation for diversity, equity, and inclusion initiatives on college campuses.* Kendra Jason, University of North Carolina-Charlotte; Tehia Starker Glass, University of North Carolina-Charlotte; Joseph Graham, University of North Carolina-Charlotte; Erika Shelton, University of North Carolina-Charlotte; Leah Bourque, University of North Carolina-Charlotte; Sayoni Ghosh, University of North Carolina-Charlotte; Brandon Wolfe, University of North Carolina-Charlotte
- *The role of impression management in virtual tech fairs.* Jessica MacDonald, Wake Technical Community College; Lisa McManus, Wake Technical Community College
- *Sentencing in a new era: Racial disparities in North Carolina.* Jacob Stewart Church, The University of Alabama

5. Higher Education and Social Mobility [Paper Session]

Thursday | 8:30 am-9:45 am | Evergreen, 4th Floor

Presenter: Evansha Andre, University of Central Florida

- *Abroad experiences steepen the ladder of inequality pre-health students have to climb.* Anna Wilkerson, St. Lawrence University; Alanna Gillis, St. Lawrence University
- *Pathways, barriers, and inequalities in STEM study abroad experiences.* Sophia Brigante, St. Lawrence University ; Alanna Gillis, St. Lawrence University
- *Food insecurity within a public university and the role of food assistance programs amid the global pandemic.* Evansha Andre, University of Central Florida

6. Digital Sociology I [Paper Session]

Thursday | 8:30 am-9:45 am | Gallier AB, 4th Floor

Organizer: Anne McNutt Patrick, Blackburn College

Presenter: Anne McNutt Patrick, Blackburn College

- *Moral relativity and framing on Reddit: How men's rights activists construct cultural norms through online engagement.* Whitney Elizabeth O'Connell, Tulane University
- *Femcels: Identity, community, and belonging in online spaces.* Madeline Bobo, Georgia State University

- *Online privacy, algorithmic literacy, and fair privacy protection.* Yu Tao, Stevens Institute of Technology
- *Following trends or principled decision making? Evaluating the influence of NLP benchmarks on digital sociology.* AJ Alvero, University of Florida; Ruohong Dong, University of Florida; Klint Kanopka, New York University; David Lang, Stanford University
- *The use of machine learning in sociological research: A comparison of ClarifAI and Kairos classifications to hand-coded images.* Crystal Peoples, Duke University; Melany Fuentes, Duke University; Paige Knudsen, Duke University

7. Life Stage Transitions for Youth [Paper Session]

Thursday | 8:30 am-9:45 am | Napoleon A1, 3rd Floor

Presenter: Joseph Adedayo Jaiyeola, University of Texas-San Antonio

- *Tracking talented Black and Latinx youth through high school and into the labor market: Who “makes it”?* Tomeka Davis, Georgia State University
- *LGBTQ youth’s experiences moving out and gaining independence.* Anna Miller, Trinity University
- *Health implication of opportunity youth status in transition to adulthood in the U.S..* Joseph Adedayo Jaiyeola, University of Texas-San Antonio
- *The lasting impact of losing a parent during adolescence: A longitudinal analysis of gender differences in relational and deviant outcomes in adulthood.* Christopher Purser, University of North Alabama; Wesley James, University of Memphis; Theresa Edwards-Capen, University of Colorado

8. LGBTQ+ Experiences with Religion [Paper Session]

Thursday | 8:30 am-9:45 am | Napoleon A2, 3rd Floor

Presenter: Courtney Heath, Mississippi State University

- *Is religion “LGBTQ+ enough”? Symbolic boundaries in the queer community.* Jayson Lee Gulick, University of North Carolina-Charlotte
- *Lost in TRANSlation: Examining queer experiences of religious spaces.* Brady McLean, Georgia Southern University; Elizabeth Rahilly, Georgia Southern University
- *I am gay and Catholic: An analysis of identity integration in LGBTQ+ members converting to Catholicism.* Maria Julian, Western Kentucky University
- *“God says for men to love women and for women to love men...”: Southern Baptist youth on God’s design for sexuality.* Courtney Heath, Mississippi State University

9. Narrative and Community in Rural America [Paper Session]

Thursday | 8:30 am-9:45 am | Napoleon A3, 3rd Floor

Presenter: Barbara Combs, Kennesaw State University

- *From the corner store to the farm: Comparative oral histories on community and belonging in North Nashville and Greene County.* Katherine Everhart, University of Virginia at Wise
- *Walking the tightrope: How white pastors pursue racial justice in southern churches.* Kelsey Mischke, North Carolina State University; Erin Johnston, Duke University; Anna Lawrence Holleman, Duke University
- *Counterstories on the riverfront: The role of the media in the Alabama riverboat brawl.* Benjamin, Vu PHAM, University of Georgia; Barbara Combs, Kennesaw State University

10. Environmental Attitudes and Identities [Paper Session]

Thursday | 8:30 am-9:45 am | Napoleon B1, 3rd Floor

President: Siti Kusujarti, Warren Wilson College

- *Do they still care? Student environmental identity long after national park travel study.* David Michael Burley, Southeastern Louisiana University
- *Cultural consensus and heterogeneity: Understanding the relationship between environmental concern, environmental efficacy, trust, and environmental sacrifice.* Joshua Franklin Doyle, Purdue University
- *Eco-reproductive decision-making across gender, sexuality, and space.* Margaux Crider Robinson, University of Kentucky; KC Vick, University of Kentucky
- *Environmental policies, perceptions, and framing.* Siti Kusujarti, Warren Wilson College; Maitreya Suchocki, Warren Wilson College

11. Problematizing Bodies and Embodiment [Paper Session]

Thursday | 8:30 am-9:45 am | Napoleon B3, 3rd Floor

President: Terence E. McDonnell, University of Notre Dame

- *"I wasn't ready for that:" The lived experience of medication abortion.* Kimberly Kelly, Mississippi State University
- *Towards a trans standpoint: Mixture, embodiment, and intersectional epistemology.* Piper Noyes Thomson, University of Virginia
- *"Who wants to see surgery scars?!" Social networks and experiences of social support among nonbinary adults.* RB Berry, University of Maryland, Baltimore County
- *Culture, cognition, and objects.* Terence E. McDonnell, University of Notre Dame

12. Confronting Violent Institutions [Paper Session]

Thursday | 8:30 am-9:45 am | Napoleon D3, 3rd Floor

President: Sarah Gaby, University of North Carolina-Wilmington

- *A hierarchy of violence tolerance: Variations in media framing of movements in China, France, and the U.S..* Yao Li, Florida State University; Marion Cassard, University of Florida; Brooke Holmes, University of Pittsburgh; Huixuan Wu, Florida State University
- *Examining support for protests (of police): A sociological vignette study.* Lily Philbrook, East Carolina University; Kirk Miller, East Carolina University
- *Legacies of racial violence and contemporary antiracist mobilization.* Firdaous Sbai, University of Toronto; Sarah Gaby, University of North Carolina-Wilmington; Tamara Cooper, University of North Carolina-Wilmington; Qurat Khan, University of North Carolina-Wilmington; Casandra Murray, University of North Carolina-Wilmington

13. Demystifying Research Grants [Panel]

Thursday | 8:30 am-9:45 am | Borgne, 3rd Floor

Organizer: Margaret Ralston, Mississippi State University

President: Margaret Ralston, Mississippi State University

Panelists:

- Stephanie Teixeira-Poit, North Carolina A&T State University
- Christina Steidl, University of Alabama in Huntsville
- John C. Kilburn, Texas A&M International University
- Shelia Cotten, Clemson University

14. Using Paradigms to Understand and Solve Intractable Social Problems [Panel]

Thursday | 8:30 am-9:45 am | Napoleon D1, 3rd Floor

Organizer: Andy Plotkin, Palm Beach State College

Presider: Andy Plotkin, Palm Beach State College

Discussant: Andy Plotkin, Palm Beach State College

Panelists:

- Charles Thorpe, UCSD
- Arnold Sherman, World Vision Solutions

15. Innovative Strategies to Enhance Experiential Learning [Workshop]

Thursday | 8:30 am-9:45 am | Southdown, 4th Floor

Organizer: Katie Morris, Pellissippi State Community College

Presider: Katie Morris, Pellissippi State Community College

Discussant: Bobby Jo Otto, University of Georgia



Sociology in Community and Small Colleges Committee Meeting [Meeting]

Thursday | 8:30 am-9:45 am | Ellendale, 4th Floor

10:00 am-11:00 am

Site Visit Committee Meeting [Meeting]

Thursday | 10:00 am-11:00 am | Maurepas, 3rd Floor

10:00 am-11:15 am

16. Addressing Structural Racism: A Call to Action for Medical Sociology [Paper Session]

Thursday | 10:00 am-11:15 am | Bayside A, 4th Floor

Presider: Stephanie Teixeira-Poit, North Carolina A&T State University

- *Race, ethnicity, and regional differences in diabetes: A critical demographic analysis.* Hayward Derrick Horton, SUNY-Albany; Samuel Ocasio, SUNY-Albany; Jacob Agwu, SUNY-Albany; Christophe Cervantes, SUNY-Albany
- *Spatial analysis of racial capitalism and COVID-19 in Louisiana.* Hyunsu Oh, Louisiana State University; Shriya Thakkar, Louisiana State University
- *Race, COVID, and the mental health paradox.* Richard Moye, Winston-Salem State University; Antonius Skipper, Georgia State University; Tangelia Towns, Winston-Salem State University; Daniel Rose, Winston-Salem State University
- *Content analysis exploring barriers to translational research among minoritized populations.* Stephanie Teixeira-Poit, North Carolina A&T State University; Anna Lee, North Carolina A&T State University; Sharon Parker, North Carolina A&T State University; Carmen Monico, North Carolina A&T State University; Sharla Kirkpatrick, North Carolina A&T State University; Keisha Joseph, North Carolina A&T State University; Ashley Gonzalez, North Carolina A&T State University

17. Racialized Academy: Race, Education, and Funding [Paper Session]

Thursday | 10:00 am-11:15 am | Bayside B, 4th Floor

President: Devon Goss, Emory University

- *"Telling a more complete story:" How universities narrativize their histories with enslavement.* Devon Goss, Emory University; Sydney Gitlitz, Emory University
- *Understanding racial concepts: Navigating predominantly white institutions as an African American student.* Jessica McCarty, University of South Alabama
- *Where NSF institutional equity transformation programs fall short: Understanding misalignments between mission and funding.* Sharon R. Bird, West Virginia University; Chardie L Baird, Kansas State University; Marta M. Maldonado, Oregon State University
- *A new equalizer? Race-ethnicity, education and visual and performing arts consumption across different broadcast media forms.* Nile DeGray Patterson, Northern Kentucky University

18. Families and Stratification [Paper Session]

Thursday | 10:00 am-11:15 am | Bayside C, 4th Floor

President: Amie Bostic, University of Texas Rio Grande Valley

- *How do kids influence adults' attitudes toward meritocracy and redistribution? A comparison of parents and childfree adults.* Joseph Merry, Furman University
- *Exploring food insecurity, race/ethnicity, and family structure in America.* Arijita Pal, Louisiana State University; Tim Slack, Louisiana State University
- *Racial/ethnic differences in single motherhood pre/post-transfer poverty in the U.S. (1994-2020) and the politics of place.* Amie Bostic, University of Texas Rio Grande Valley; Regina Baker, University of North Carolina-Chapel Hill
- *Social class and family instability: Understanding how families from different classes approach unexpected roles, relationships, and transitions.* Christopher Martin Wienke, Southern Illinois University - Carbondale

19. Transgender Health and Healthcare [Paper Session]

Thursday | 10:00 am-11:15 am | Estherwood, 4th Floor

President: Bec Stargel, North Carolina State University

- *"Medicine is not a profession for people like me": A mixed methods exploration of violence and coping strategies among transgender healthcare professionals and trainees.* Atticus Wolfe, University of South Carolina; Carl Streed, Boston University Chobanian; Michele Eliason, San Francisco State University
- *Using GIS to understand healthcare access variations among transgender and non-binary young adults in Florida.* Nino S. Franklin, University of Central Florida; Shannon K. Carter, University of Central Florida; Lindsay Taliaferro, University of Central Florida
- *Education and health: Outside the gender binary.* Brianna Leigh Patterson, University of Alabama-Birmingham
- *Pathways of survival and resistance: Navigating healthcare by doing and redoing transgender.* Bec Stargel, North Carolina State University

20. Gender Role Socialization, Health Disparities, and Gender-Based Criminal Outcomes [Paper Session]

Thursday | 10:00 am-11:15 am | Evergreen, 4th Floor

President: Ryan Talbert, University of Connecticut

- *Neonaticide: Trends, gendered sexuality scripts, and unwanted pregnancy.* Martha Smithey, Texas Tech University; Ignacio Luis Ramirez, Texas Tech University
- *Consequences of objectification and sexual aggression in public spaces: The relationship between street harassment and mental health.* Sophia Shaiman, University of South Carolina
- *The impact of stressors and social conditions on the relationship between sexual and gender-based violence and chronic health outcomes.* Megan Taylor Short, North Carolina State University
- *Gender-ethnicity, incarceration exposure, and physiological health disparities.* Ryan Talbert, University of Connecticut; Kavya Sajeev, University of Connecticut

21. Digital Sociology II [Paper Session]

Thursday | 10:00 am-11:15 am | Gallier AB, 4th Floor

Organizer: Anne McNutt Patrick, Blackburn College

President: Anne McNutt Patrick, Blackburn College

- *Digital technology and education in India: Inequitable access and outcomes.* Upali Bhattacharya, Virginia Tech
- *Digital feminism in China: Gatekeeping the feminine safe space.* Keyu Zhou, Tulane University
- *An analysis of Gumbo Slice: The internet's Uncle Remus.* John Ray Roberts, Virginia Tech; Elizabeth B. Roberts, Virginia Tech
- *"He's definitely a sobbing little bltch": Examining the protection and policing of manhood in online spaces.* Anne McNutt Patrick, Blackburn College

22. Perceptions of Rurality Across the Lifecourse [Paper Session]

Thursday | 10:00 am-11:15 am | Napoleon A1, 3rd Floor

President: Jimmy Austin Robinson, University of Kentucky

- *The middle of the road: An exploration of place and Millennial lives in the rural American South.* Jacqueline Jeneanne Crowell, University of North Carolina-Wilmington
- *In the South, at the intersections: A portrait of older, working class Black women in the rural South.* Chelsey Devonna Adams, University of Georgia
- *Students' stories and the declining significance of the rural/urban divide.* Nora Moosnick, University of Kentucky
- *Taking the rural with you: Rural artists in the city.* Jimmy Austin Robinson, University of Kentucky

23. Sexual Violence [Paper Session]

Thursday | 10:00 am-11:15 am | Napoleon A2, 3rd Floor

President: Heather A. O'Connell, Louisiana State University

- *An observable shift: A case study examining the impact of #MeToo on workplace practices and public perception in the film industry.* Courtney Bell, George Mason University
- *Comparative analysis of two quantitative methodologies for calculating rape culture.* Myrissa Eisworth, Louisiana State University

- *The effectiveness of women's security policy on sex crime reduction: A spatial analysis in Seoul Metropolitan City.* Yoon Jung Jeong, Louisiana State University; Heather A. O'Connell, Louisiana State University; Jiyoung Lee, Louisiana State University

24. Social Movements, Labor, and Capitalism [Paper Session]

Thursday | 10:00 am-11:15 am | Napoleon A3, 3rd Floor

Presider: Patrick Rafail, Tulane University

- *Follow the money: Movement alignment and congressional fundraising during the Tea Party wave.* Patrick Rafail, Tulane University; John D. McCarthy, Pennsylvania State University
- *Identifying how private certification efforts play out, and what do they actually do: A theoretical model of activists' efforts to privately regulate firms.* Andrew William Martin, Ohio State University; Marc Dixon, Dartmouth College
- *The other strike: 23 days after the Charleston Hospital strike ended.* Von Bakanic, College of Charleston
- *Young workers, climate change, and the pursuit of meaningful work.* Laura Bray, University of Oklahoma; Maria Brescia-Weiler, Labor Network for Sustainability; Matt Hessler, Independent Researcher; Oren Kadosh, Labor Network for Sustainability; Erik Kojola, Greenpeace

25. Race, Gender, and Emotions [Paper Session]

Thursday | 10:00 am-11:15 am | Napoleon B1, 3rd Floor

Presider: Rachel Douglas, Florida State College at Jacksonville

- *Why do we feel like imposters? The impact of adverse childhood experiences on the impostor phenomenon.* Matheus Bender, Berea College
- *Colorblind feeling rules in classroom settings.* Jon Gordon, Appalachian State University; Tae Hall, Appalachian State University
- *Tracing age-patterned experiences of reported race-based discrimination: Exposure and mental wellbeing.* Shania Montufar, The University of Texas at Austin
- *Exploring happiness: An examination of leisure, emotions, and community contexts.* Rachel Douglas, Florida State College at Jacksonville

26. Climate Change [Paper Session]

Thursday | 10:00 am-11:15 am | Napoleon B3, 3rd Floor

Presider: Brianna Blu Castro, Vanderbilt University

- *Sociology and the anthropocene: Theoretical implications and issues for a new epoch.* Bradley Nash, Appalachian State University
- *Disrupting the human-nature binary: Resilience-building and climate change adaptation in an unequal world.* Nicole Yvonne Zdrojewski, Virginia Tech
- *Hope, nope, or cope: Americans' perceptions of our climate change reality in the 2020s.* Brigit Suzanne Reese, Southwestern University
- *Sociology and beliefs about climate change.* Kenneth Hudson, University of South Alabama
- *Purchasing risk: Undocumented immigrant home ownership and adaptation to climate change.* Brianna Blu Castro, Vanderbilt University

27. Disciplinary Considerations: Pushing Forward with Lessons Learned [Paper Session]
Thursday | 10:00 am-11:15 am | Napoleon D1, 3rd Floor

President: Catherine Mobley, Clemson University

- *Competing demands and mixed messages: The experiences of sociology graduate students interested in careers in sociological practice.* Catherine Mobley, Clemson University; Chloe Bird, Tufts University
- *A false peace: Bringing racism and race into peace scholarship in the metropole.* Jeff Toussaint, Virginia Wesleyan University; Michael Rosino, Molloy University
- *Lack of queer representation in academic conference presentations among sociologists and criminologists.* Sarah Rogers, University of South Carolina; Sarah Franklin, University of South Carolina
- *Queer considerations in and of JHSB.* Victoria Lauraine Bechtold, Virginia Tech

28. *Gratuitous Angst in White America: A Theory of Whiteness and Crime* by Deena A. Isom [Author-Meets-Curious-Readers]

Thursday | 10:00 am-11:15 am | Borgne, 3rd Floor

Organizer: Sarah Franklin, University of South Carolina

President: Sarah Franklin, University of South Carolina

Panelists:

- Austin Ashe, Norfolk State University
- Komal Dhillon-Jamerson, Virginia Tech
- Jason Eastman, Coastal Carolina University
- David Embrick, University of Connecticut
- James M. Thomas, University of Mississippi

29. The Lavender Roar: Emerging Trans/Queer Leaders Experiences Promoting Queer Joy and Navigating Institutional Politics [Panel]

Thursday | 10:00 am-11:15 am | Napoleon D3, 3rd Floor

Organizer: Marc Settembrino, Southeastern Louisiana University

President: Marc Settembrino, Southeastern Louisiana University

Panelists:

- Matt Matthews, Southeastern Louisiana University
- Rosemary Matthews, Southeastern Louisiana University
- Autumn (Artie) Smedley, Southeastern Louisiana University
- Adrien Doucet, Southeastern Louisiana University

30. Professional Mentorship and CV Review [Workshop]

Thursday | 10:00 am-11:15 am | Nottoway, 4th Floor

Organizer: Margaret Ralston, Mississippi State University

President: Margaret Ralston, Mississippi State University

Discussants:

- Kylie Parrotta, California Polytechnic State University
- Raymond Barranco, Mississippi State University
- Corinne Schwarz, Oklahoma State University
- Daniel Morrison, University of Alabama in Huntsville
- Brent Shea, Sweet Briar College



31. GIFTS: Good Ideas for Teaching Sociology and Publishing in TRAILS [Workshop]
Thursday | 10:00 am-11:15 am | Southdown, 4th Floor

Organizers: Sarah Gaby, University of North Carolina-Wilmington; Deeb Kitchen, Marian University

President: Deeb Kitchen, Marian University



32. Poster Session 1 - Inequalities, Place, Environment [Poster Session]

Thursday | 10:00 am-11:15 am | Bayside Foyer, 4th Floor

- *The digital divide and structured inequality.* Rebecca S. Powers, East Carolina University; Michelle Livermore, Louisiana State University; Nat Sumner, Louisiana State University
- *Home in a world beyond: Housing research in the era after binary statistical significance.* Julio Richard Montanez, University of Central Florida; Amy Donley, University of Central Florida
- *College students' housing and food insecurity: the difference between on-campus and off campus-living.* Kokou Efou, Georgia State University; Armina Fani, Georgia State University; Ashley Rockwell, Georgia State University; Halley Riley, Georgia State University; Mandy Swygart-Hobaugh, Georgia State University
- *Transportation and other hurdles to food access.* Armina Fani, Georgia State University; Kokou Efou, Georgia State University; Mandy Swygart-Hobaugh, Georgia State University; Halley Riley, Georgia State University; Ashley Rockwell, Georgia State University
- *Undergraduate research scholar reflection: What I learned about how urban planning causes food swamps.* Danielle Velez, Florida State University; Ladanya Ramirez Surmeier, Florida State University; Anette Schwabe, Florida State University; Tisha Holmes, Florida State University
- *Implications of systematic government imposed barriers to African Americans civic engagement.* Rajah Lynn Thomas, Dillard University
- *Co-producing resilience: Equitable recovery dynamics in Houston's Hurricane Harvey response.* Luis Verdin-Gomez, Rice University
- *Community responses to environmental risk in the Fifth Ward cancer cluster.* Shivani Gollapudi, Rice University
- *Immigration laws and contemporary fertility trends among immigrants in the United States.* Golam Morshed Suhel, University of Memphis
- *"Triple bind": Assessing the role of intersectionality in shaping Muslim women's experiences in the U.S. asylum system.* Cayden Brooke Norman, North Carolina State University

Membership Committee Meeting [Meeting]

Thursday | 10:00 am-11:15 am | Ellendale, 4th Floor

11:30 am-12:45 pm

33. Presidential Plenary: S.L. Crawley [Presidential Plenary]

Thursday | 11:30 am-12:45 pm | Napoleon C1+C2, 3rd Floor

Presider: Shannon Carter, University of Central Florida

- *Resisting Sociology's Binaries -- and Why It Matters.* S.L. Crawley, University of South Florida

1:00 pm-2:15 pm

34. Diasporic Womanisms I: Diasporic Womanist Sociology: The Framework [Mini-Conference]

Thursday | 1:00 pm-2:15 pm | Gallier AB, 4th Floor



Organizers: Sancha Medwinter, University of Massachusetts-Amherst; Monisha Jackson, Georgia State University; Tannuja Devi Rozario, University of Massachusetts-Amherst

Presider: Sancha Medwinter, University of Massachusetts-Amherst

- *Diasporic womanist stitching: Toward a relationality of Global South diasporas.* Sancha Medwinter, University of Massachusetts-Amherst
- *A diasporic womanist method.* Tannuja Devi Rozario, University of Massachusetts-Amherst
- *Towards a diasporic womanist sociology.* Monisha Jackson, Georgia State University

35. The Sociology of W. E. B. Du Bois and Black Subjugated Knowledges [Thematic Session]

Thursday | 1:00 pm-2:15 pm | Bayside A, 4th Floor

Organizer: Earl Wright II, Rhodes College

Presider: Kalasia Shqueen Ojeh, Kean University

- *Black Sociology: The scientific/intellectual movement of social power and oppression.* Kalasia Shqueen Ojeh, Kean University
- *My brother's keeper: Two Black men navigating the tenure-track experience.* Danny Malone, Coastal Carolina University; Jesse Ford, University of North Carolina-Greensboro
- *Queer consciousness and Black resistance.* Jarvis Benson, University of North Carolina-Chapel Hill
- *Wither the double aim of research?: Toward a Du Boisian theory of social justice.* Earl Wright II, Rhodes College

Discussant: Earl Wright II, Rhodes College

Happening Now!

**Presidential Plenary:
S.L. Crawley.
University of South
Florida. "Resisting
Sociology's Binaries --
and Why It Matters."
11:30 am-12:45 pm |
Napoleon C1+C2, 3rd
Floor**



36. Organizational and Subcultural Correlates of Deviance and Social Control [Paper Session]

Thursday | 1:00 pm-2:15 pm | Bayside B, 4th Floor

Presenter: Gretchen Peterson, University of Memphis

- *Attitudes towards cheating in adult recreational softball: A comparison between 2008 and 2024.* Gretchen Peterson, University of Memphis
- *Neutralizations as symbolic power in the commission of wage theft.* Nicholas Membrez-Weiler, North Carolina State University
- *Inequality and the homicide rate in New York City.* Daryl Reed, Virginia Tech University
- *“Snitches get stitches”: An examination of informal mechanisms of social control among incarcerated men.* Abigail Kolb, University of West Georgia; Tiffany Aaron Parsons, University of West Georgia

37. Race, Ethnicity, and Religion [Paper Session]

Thursday | 1:00 pm-2:15 pm | Bayside C, 4th Floor

Presenter: Gerardo Martí, Davidson College

- *Race and religion: Current paradigms and new developments.* Simranjit Steel, University of Memphis
- *Navigating the U.S. healthcare system: The church as a site of instrumental social support in one Hispanic immigrant community.* Jaqueline Hernandez-Ramos, Wingate University; Katie Knop, Wingate University
- *Religion deserts: Congregational resource scarcity experienced by Black students at predominately undergraduate institutions (PUI).* Richard N Pitt, University of California-San Diego; Olivia Sanchez, University of California-San Diego
- *Antiracism and progressive piety: When white progressive Christians commit to confront Whiteness in their churches.* Gerardo Martí, Davidson College

38. LGBTQ+ Health and Healthcare [Paper Session]

Thursday | 1:00 pm-2:15 pm | Estherwood, 4th Floor

Presenter: Hannah M Lindl, University of Alabama-Birmingham

- *Healthcare utilization disparities: Psychological distress in LGB patients by cultural competency in diverse healthcare settings.* Hannah M Lindl, University of Alabama-Birmingham; Gabe H Miller, University of Alabama-Birmingham
- *If It hadn't been for COVID: LGBTQ+ mental health care utilization during COVID-19.* Sarah M. Groh, University of Georgia; Cerenity Collins, University of Georgia
- *A queer reluctance for medical treatment.* Victoria Lauraine Bechtold, Virginia Tech
- *Queering menstruation: Trans and non-binary adolescents' experiences with menstruation and gender identity.* Lindsay Anne Toman, Colgate University

39. The Racialization of Asians/Asian Americans [Paper Session]

Thursday | 1:00 pm-2:15 pm | Napoleon A1, 3rd Floor

Presenter: Yuki Proulx Maynor, Florida State University

- *Colorism and the whitening cream dilemma of Pakistani women.* Tarikat Khan, Louisiana State University; Heather Rackin, Louisiana State University
- *Asian/Asian American racialization through Fox News depictions of 'wet markets'.* Alex Lien Thomas, Virginia Tech

- *Members only: Asian American citizenship in the U.S.*. Yuki Proulx Maynor, Florida State University

40. Health and Sexuality in Rural America [Paper Session]

Thursday | 1:00 pm-2:15 pm | Napoleon A2, 3rd Floor

Presider: Catherine Mobley, Clemson University

- *Impact of the COVID-19 pandemic on food insecurity and food-related behaviors of rural South Carolina residents.* Ye Luo, Clemson University; Darja Beinenson, Clemson University; Catherine Mobley, Clemson University; Leslie Hossfeld, Clemson University
- *Agnology and the study of pregnancy criminalization.* Mia Rosario Milne, Georgia State University
- *Southern sexuality: A study of attitudes towards diverse sexuality in the Deep South.* Ari Michelle Attuso, University of Louisiana-Lafayette
- *"I don't want to leave... this sense of home": Local attachment and transgender experience in a small Texas city.* Kieran Turner, Rice University

41. Fat Studies and Body Politics, co-sponsored by SWS-South [Paper Session]

Thursday | 1:00 pm-2:15 pm | Napoleon A3, 3rd Floor

Organizers: Lyla Byers, Wofford College; Ariane Prohaska, University of Alabama

Presider: Lyla Byers, Wofford College

- *Confidence as embodied capital in United States pageantry.* Ariane Prohaska, University of Alabama
- *Fat hand-me-downs: Transmitting weight stigma across generations.* Lyla Byers, Wofford College; Heidi Williams, Virginia Tech
- *Fat th(i)n, fat now: Black women's embodied negotiations of moving In and out of fatness and thinness.* Brittney Miles, The University of Illinois Urbana-Champaign

Discussant: Jeannine Gailey, Texas Christian University

42. Gender, Work, and Family [Paper Session]

Thursday | 1:00 pm-2:15 pm | Napoleon B1, 3rd Floor

Presider: Jennifer Augustine, University of South Carolina

- *Workplace productivity: Gender, parenthood, and career consequences.* Jill Evelyn Yavorsky, University of North Carolina Charlotte; Yue Qian, University of British Columbia, Vancouver; Rebecca Glauber, University of New Hampshire
- *The gendered influence of relative earning levels on parenting evaluation through perceived devotion and perceived conflict.* Ziding Shen, University of Georgia
- *Women in restaurants: The divide between mothering and serving.* Kaitlyn Paige Hall, Mississippi State University
- *Gender inequality in parents' experiences working from home: A photographic investigation.* Jennifer Augustine, University of South Carolina; Morgan Koziol, University of South Carolina; Nicholas Hollis, University of South Carolina

43. Culture and Identities Online [Paper Session]

Thursday | 1:00 pm-2:15 pm | Napoleon B3, 3rd Floor

Presider: Amanda Koontz, University of Central Florida

- *Collective obsession: Redefining the meaning of "collector" in a social media age.* Amanda Koontz, University of Central Florida; Nate Chapman, Arkansas Tech University

- *Sheepdogs: Origins and social media of a neo-radical subgroup of gun owners.* Justin Lucas Sola, University of California-Irvine
- *Gender ‘cystphoria,’ dysphoria, and euphoria: The complex gendered experiences of people with polycystic ovary syndrome (PCOS).* Annie McGhee, University of Cincinnati; Ashlyn Arthur, University of Cincinnati
- *France appears exemplary: Nuclear energy and national pride in energy transition disputes.* Julie Schweitzer, Oklahoma State University; Tamara Mix, Oklahoma State University

44. Intimacy, Pleasure, and Sex [Paper Session]

Thursday | 1:00 pm-2:15 pm | Napoleon D3, 3rd Floor

President: Amie Hess, Meredith College

- *Swiping left and right: Exploring dating trends, hookup culture, and ‘situationships’ among college students.* Katie Cooper, University of Tampa; Luisa De Dea Januario, University of Tampa; Maryn Horvath, University of Tampa; Eliana Palmer, University of Tampa
- *For love, pleasure, or survival?: Queer cartageneros’ affective labors amidst the development of ‘gay tourism’.* Michael Lee Stephens, Lenoir-Rhyne University
- *How autistic sexual narratives resist and expand upon normative constructions of sex.* celeste jasmine cash, University of South Florida
- *Massage oils versus sex pills: A Foucaultian analysis of retail sales for Valentine’s Day 2023.* Fletcher Nicholas Wilson, University of Alabama in Huntsville

45. Thinking Cis: Cisgender, Heterosexual Men, and Queer Women’s Roles in Anti-Trans Violence by Alithia Zamantakis [Author-Meets-Curious-Readers]

Thursday | 1:00 pm-2:15 pm | Borgne, 3rd Floor

Organizer: Alithia Zamantakis, Northwestern University

President: Dresden Lackey, Wofford College

Panelists:

- Opal Gay, Georgia State University
- J.E. Sumerau, University of Tampa
- Sarah Rogers, University of South Carolina

46. Beyond “Great Man” Sociology: Innovative Approaches to Teaching Theory [Panel]

Thursday | 1:00 pm-2:15 pm | Evergreen, 4th Floor

Organizer: Lindsey Ibanez, Washburn University

President: Lindsey Ibanez, Washburn University

Panelists:

- Sandra Godwin, Georgia College & State University
- Timothy Gill, University of Tennessee-Knoxville
- Stephanie Baran, Nicholls State University
- Andrew Gunnoe, Maryville College
- Lindsey Ibanez, Washburn University

47. Teaching in Applied Sociology Courses, co-sponsored by SWS-South [Panel]

Thursday | 1:00 pm-2:15 pm | Napoleon D1, 3rd Floor

Organizer: Ashley Vancil-Leap, Mississippi State University

President: Ashley Vancil-Leap, Mississippi State University

- *Engaging medically underserved communities in applied sociology and evaluation projects.* Nik Lampe, University of South Florida
- *Keep calm and think about 3 career paths: Teaching the sociological career.* Marybeth Stalp, University of Northern Iowa
- *Service engagement in general education courses.* Courtney McDonald, University of South Carolina - Upstate; Tracey Woodard, University of South Carolina - Upstate
- *Students and community partners tackling food insecurity, many data points at a time.* Ashley Rockwell, Georgia State University; Halley Riley, Georgia State University; Mandy Swygart-Hobaugh, Georgia State University
- *Critical service learning around food insecurity in your community.* Lindsay Hamm, Purdue University

48. Workshop: Let's Talk about Writing! [Workshop]

Thursday | 1:00 pm-2:15 pm | Southdown, 4th Floor



Organizers: Barbara Risman, University of Illinois-Chicago; Deborah Cohan, University of South Carolina-Beaufort

President: Barbara Risman, University of Illinois-Chicago

49. Roundtable I: Crime, Law, and Deviance [Roundtable]

Thursday | 1:00 pm-2:15 pm | Nottoway, 4th Floor (Group I)

President: Joseph Michael Marchia, Davidson College

- *Towards a holistic paradigm of addiction.* Joseph Michael Marchia, Davidson College
- *(How) can peace and forgiveness be incorporated into studies of crime and punishment?* Cindy Brooks Dollar, University of North Carolina-Greensboro
- *How behavioral changes in women who have experienced sexual assault is correlated with their self-identity (victim or survivor) and their disclosure process.* Annya Forbin, Augusta University; Elizabeth Culatta, Augusta University

50. Roundtable II: Work Culture [Roundtable]

Thursday | 1:00 pm-2:15 pm | Nottoway, 4th Floor (Group II)

President: Emily Cabaniss, Sam Houston State University

- *How a commune's founding values influence their work culture and governing structures.* Sage Lalor, St. Lawrence University
- *The potential of worker-owned cooperatives to democratize the workplace, empower workers, and reduce inequalities.* Emily Cabaniss, Sam Houston State University
- *Concrete ceilings: A sociological examination of unionized labor in an urban area.* Robert K. Perkins, Norfolk State University
- *Bringing work home: Maintaining mental health and productivity.* Blane DaSilva, USC Sumter

51. Roundtable III: College Students and Wellbeing [Roundtable]

Thursday | 1:00 pm-2:15 pm | Nottoway, 4th Floor (Group III)

Presider: Amanda Patrick, Austin Peay State University

- *Discrimination and belonging of college students.* Amanda Patrick, Austin Peay State University
- *Food insecurity among college students.* Mary Wanjoya, Augusta University; Candace Griffith, Augusta University; Nicole Peritore, Augusta University
- *Food insecurity among college athletes.* Je'Bria Fullwood, Augusta University; Candace Griffith, Augusta University; Nicole Peritore, Augusta University

52. Poster Session 2 - Education and Work [Poster Session]

Thursday | 1:00 pm-2:15 pm | Bayside Foyer, 4th Floor

- *Exploring the impact between apathy towards social justice issues and prevalence of modern technologies in kids and adolescents in the digital age.* Nathan Gabriel Hernandez, University of the Incarnate Word
- *Evaluating Texas takeovers: The spillover impact of state-control on public school's disciplinary placement.* Roberto Carlos Morales Quintero, Rice University
- *Beyond recruitment: Unraveling the complex tapestry of student of color retention in higher education.* Lucia Sanchez, St. Norbert College; Erinn Brooks, St. Norbert College
- *Not in my back of the college: Student perceptions of the college's involvement in community displacement.* Jacqueline Aucoin Hansen, Wofford College; Arnise Nevaeh Wright, Wofford College; Dresden Lackey, Wofford College
- *How do Wofford students understand philanthropic fundraising?* Jordyn Arionna Ford, Wofford College; Arnise Nevaeh Wright, Wofford College; Jacqueline Aucoin Hansen, Wofford College
- *"As a parent I have let go a lot more, because I don't have a choice": Parents' experiences of their child moving away from home to attend college.* Elizabeth Wroten, University of Delaware; Sara Goldstein, University of Delaware; Kate Riera, University of Delaware; Mark Miller, University of Delaware; Victoria Figgs, University of Delaware; Gabrielle Atienza Spencer, University of Delaware; Kirsten Simperts, University of Delaware
- *More than just monetary: Wofford College students' understanding of racial reparations.* Arnise Nevaeh Wright, Wofford College; Jacqueline Aucoin Hansen, Wofford College; Dresden Lackey, Wofford College
- *Toward a role congruity theory centering race and gender: The case study of women of color faculty in STEM.* Faika Tahir Jan, Virginia Tech; Tonisha B. Lane, Virginia Tech; Helena Mariella-Walrond, Bethune Cookman University; Saundra Johnson Austin, University of South Florida; Samuel Darko, Florida Memorial University; Yolanda Michelle Bradham-Cousar, Florida International University
- *Organizational compassion climate and worker compassion fatigue and satisfaction.* Brennan James Miller, University of Kansas; Whitney Grube, University of Kansas; Erin Gulledge, University of Kansas; Shelby Clark, University of Kentucky; Vickie McArthur, University of Kansas; Becci Akin, University of Kansas
- *Unsafe work conditions at Dollar General.* Aaliyah Kristina Valdez, University of North Carolina-Pembroke; Tracy Lynn Vargas, University of North Carolina-Pembroke
- *Spirituality and its impact on job satisfaction.* Kaiyan Wang, Davidson College

Status of Students Committee Meeting [Meeting]

Thursday | 1:00 pm-2:15 pm | Ellendale, 4th Floor

2:30 pm-3:45 pm

53. Diasporic Womanisms II: Decolonial Womanist Methodologies [Mini-Conference]

Thursday | 2:30 pm-3:45 pm | Gallier AB, 4th Floor



Organizers: Sancha Medwinter, University of Massachusetts-Amherst; Monisha Jackson, Georgia State University; Tannuja Devi Rozario, University of Massachusetts-Amherst

Presider: Hollis France, College of Charleston

- *The journey of doing and becoming a Caribbean womanist ethnographer: Lessons learned from Indigenous Women's Research Project in Guyana.* Hollis France, College of Charleston
- *A labor of love: A womanist exploration of the historical and contemporary formations of Black birthing bush harbors.* Rose Elizabeth Archer, Florida State University
- *Child left behind syndrome: Imperialism's impact on transnational family dynamics.* Faith Deschamps, Ohio Wesleyan University

54. The Fight for Racial Justice [Paper Session]

Thursday | 2:30 pm-3:45 pm | Bayside A, 4th Floor

Presider: Kenneth Andrews, Washington University in St. Louis

- *Beautiful solidarity, symbolic impacts: Racial justice 2020.* Eileen O'Brien, Saint Leo University
- *Revisiting collective identity in social movements: Examining how ethnicity and sexuality shape the standpoint epistemologies of Black Christian millennials during BLM.* Shaonta' Allen, Dartmouth College; Nyima Coleman, Dartmouth College
- *"If you're wrong, people will turn away from you." How characteristics of whiteness hinder white engagement in antiracism.* Annie Pendleton Ferguson, Arizona State University
- *Protest and policy: Assessing the impact of Black Lives Matter on policing reforms.* Kenneth Andrews, Washington University in St. Louis; Neal Caren, University of North Carolina-Chapel Hill; Rashawn Ray, University of Maryland

55. Cyberdeviance and Victimization [Paper Session]

Thursday | 2:30 pm-3:45 pm | Bayside B, 4th Floor

Presider: Candace Griffith, Augusta University

- *Body and sex positivity: Identity management of a cyber-sex worker.* Maria Cullum, Texas Tech University; Martha Smithey, Texas Tech University
- *Green cybercriminology: Theory and praxis.* Robert T. Perdue, Virginia Tech
- *A quantitative exploration of academic dishonesty in GroupMe chatrooms: An examination of call and response cheating using techniques of neutralization and strain theory.* Kailyn Duncan, Southeastern Louisiana University; Micah Brown, Southeastern Louisiana University; Michael G. Bisciglia, Southeastern Louisiana University; William Chernoff, Southeastern Louisiana University; Young Ju Chae, Southeastern Louisiana University; Lisa Olson, Southeastern Louisiana University
- *Perceptions of likelihood and damage of cyber-threats among young people.* Candace Griffith, Augusta University

56. Racial Conceptualization and Racial Attitudes I [Paper Session]

Thursday | 2:30 pm-3:45 pm | Bayside C, 4th Floor

Organizer: Raj Ghoshal, Elon University

Presenter: Raj Ghoshal, Elon University

- *Who sees race as a choice? The effects of race, skin tone, and ambiguity on racial voluntarism.* Raj Ghoshal, Elon University
- *Racial resentment, racial threat, and opposition to health equity policy.* Fatima Glovena Fairfax, Duke University
- *Apples and pears: Racial sensemaking in a culturally competent community health center.* Sarah Iverson, American University
- *Threat perceptions and group empathy: An explanation of intergroup attitudes.* KayLynn Larrison, Louisiana State University

57. Latino Integration and Racialization [Paper Session]

Thursday | 2:30 pm-3:45 pm | Evergreen, 4th Floor

Presenter: Juan Salinas, University of North Florida

- *"They're not us, they're impostors": How Afro-Dominicans navigate Black denials in the U.S..* Pamela Zabala, Duke University
- *Manufacturing the Nuevo Midwest: Experiences of space, labor, and migration in a diversifying agro-industrial town.* Aaron Arredondo, Utah State University
- *Latino elites in a new destination: How ethnic leaders shape immigrant incorporation.* Gabriela Leon-Perez, Virginia Commonwealth University
- *Black and Latino community coalition building: Understanding the benefits and challenges of multiracial advocacy through minority-linked fate.* Juan Salinas, University of North Florida; Jonathan Grant, University of North Florida

58. Sexual Health: Issues, Management, and Care [Paper Session]

Thursday | 2:30 pm-3:45 pm | Napoleon A1, 3rd Floor

Presenter: Victoria Kurdyla, University of North Carolina-Pembroke

- *Testing ties: locating HIV self-testing technology.* Emma Josephine Menardi, Georgia Institute of Technology
- *Female genital mutilation: A tool of sexual impairment.* Miracle-Eunice Bolorunduro, University of Cincinnati
- *Progression or regression: A critical discourse analysis of sexual and reproductive health education curricula in the United States.* Jonzelle Marshay Bell, University of Central Florida
- *Is there a relationship between self-reported attractiveness and risky sexual behavior?* Victoria Kurdyla, University of North Carolina-Pembroke; Whitney Akers, University of North Carolina-Pembroke; Nicole Stargell, University of North Carolina-Pembroke

59. Place, Region, and Rurality [Paper Session]

Thursday | 2:30 pm-3:45 pm | Napoleon A2, 3rd Floor

Presenter: Mairead Moloney, University of Kentucky

- *Class or colony? The harms of theorizing Appalachia as an internal colony.* Amanda Marie Burroughs, Virginia Tech
- *No place like home: Place attachment and NIMBYism in small town Georgia.* Kathryn Allred Hay, Davidson College

- *The contemporary conflict between whiteness and region.* Madeline Burdine, University of Mississippi; Erin Oakes, University of Mississippi; James M. Thomas, University of Mississippi
- *“There ain’t no rest for me tonight”: A social-ecological exploration of insomnia in Appalachian women.* Mairead Moloney, University of Kentucky; Christal Badour, University of Kentucky; Daniela Moga, University of Kentucky; Nancy Schoenberg, University of Kentucky

60. Addressing Reproductive Justice in Patient Care [Paper Session]

Thursday | 2:30 pm-3:45 pm | Napoleon A3, 3rd Floor

Presider: Stephanie Teixeira-Poit, North Carolina A&T State University

- *Reproductive injustice: Abortion restrictions and maternal mortality rates.* Calinda Carolina Ayala, Virginia Tech
- *Paternal pregnancy intention and pregnancy outcomes among unmarried women by race.* Seun Ajoseh, University of Florida; John Whesu, Case Western Reserve University
- *Structural racism and maternal care: A Black feminist analysis within the Saving Black Mothers’ Lives Collaborative.* Carla D. Brailey, Texas Southern University; Maryjean Ochada, Texas Southern University; Merci Wilson, Texas Southern University
- *Exploring the binary: A systematic review considering impacts in open-bay versus single-family room neonatal intensive care unit designs.* Stephanie Teixeira-Poit, North Carolina A&T State University; Bonnie Fields, North Carolina A&T State University; Vanessa Gharbi, North Carolina A&T State University; Shalee Forney, North Carolina A&T State University; Raven Funderburk, North Carolina A&T State University; Frances Kendrick, Emory Hospital; Serena Lowe, University of Toronto; Kennedy Owens, North Carolina A&T State University

61. Work-Family Interface [Paper Session]

Thursday | 2:30 pm-3:45 pm | Napoleon B1, 3rd Floor

Presider: Trenton D. Mize, Purdue University

- *Ideal worker norms among contemporary Americans.* Jennifer Augustine, University of South Carolina; Laura Brashears, University of South Carolina-Columbia; Kirsten Hoyt, University of South Carolina
- *Reducing workplace inequalities for parents who take leave: Variation across heterosexual, gay/lesbian, and single parents.* Trenton D. Mize, Purdue University; Richard Petts, Ball State University; Gayle Kaufman, Davidson College; Reilly Kincaid, Purdue University
- *Legitimacy of family-friendly policies and stress proliferation among female employees: A cross-national analysis.* Tenshi Kawashima, University of Georgia
- *State vs. employer-sponsored childcare: Who supports mothers returning from leave most effectively?* Anne-Kathrin Kronberg, University of North Carolina-Charlotte; Anna Gerlach, Goethe University Frankfurt

62. Environments and Economies [Paper Session]

Thursday | 2:30 pm-3:45 pm | Napoleon B3, 3rd Floor

Presider: Kevin Smiley, Louisiana State University

- *“Oh yes! I earn enough”: Examining the activities that establishes agency in scrap dealing in Urban Ghana.* Teye Yevuyibor, Louisiana State University; Kevin Smiley, Louisiana State University
- *Oklahoma foragers’ pathways, practices, and interactions with local wild foods and foodscapes.* Olivia M. Fleming, Transylvania University; Tamara Mix, Oklahoma State University

- *Rural community well-being: The impact and consequences of industrial animal farming in Mississippi.* Aimee Elizabeth Imlay, Mississippi State University
- *An up-tick in Lyme: Socionatural landscapes and vector disease.* Amanda Sikirica, University of Wyoming

63. Disrupting Binaries Across Contexts [Thematic Session]

Thursday | 2:30 pm-3:45 pm | Napoleon D3, 3rd Floor



Presenter: Michelle Dietert, Texas A&M University Central Texas

- *Defining doing gender: How individuals define their gender in relation to sex.* Sophia Lily Daly, University of Louisiana-Lafayette; Emily Gwen Blosser, University of Louisiana-Lafayette
- *Disrupting gender binaries: Suggestions for pedagogical approaches and classroom engagement.* Christine Mowery, University of Richmond
- *Understanding binaries of outness and queerness through the experiences of older LGB adults.* Danny Lorraine LaVigne, Eckerd College
- *Serving with transgender service members: Conversations with cisgender veterans.* Michelle Dietert, Texas A&M University Central Texas

64. Sister Scholars as a Source of Resistance, Strength, and Joy: Navigating Graduate School as Women of Color [Panel]

Thursday | 2:30 pm-3:45 pm | Borgne, 3rd Floor

Organizer: Simone Nicole Durham, Morgan State University

Presenter: Simone Nicole Durham, Morgan State University

Panelists:

- Simone Nicole Durham, Morgan State University
- Kayland Ann Arrington, Georgia State University
- Monisha Jackson, Georgia State University
- Oluyemi Farinu, Morehouse School of Medicine
- Veronica Newton, Georgia State University

65. Teaching in Applied Sociology Programs and Projects, co-sponsored by SWS-South [Panel]

Thursday | 2:30 pm-3:45 pm | Napoleon D1, 3rd Floor

Organizer: Ashley Vancil-Leap, Mississippi State University

Presenter: Ashley Vancil-Leap, Mississippi State University

- *An overview of the WEngage program: A unique combination of service learning and domestic travel.* Katie Knop, Wingate University
- *Teaching applied sociology in a theoretical society.* J.E. Sumerau, University of Tampa
- *Data storytelling through community partnerships.* Jennifer Vanderminden, University of North Carolina-Wilmington; Julia Waity, University of North Carolina - Wilmington; Ashley Crane, University of North Carolina - Wilmington
- *Creating an applied undergraduate research program in the nation's oldest city: Student sociologists dedicated to social change in St. Augustine, Florida.* Jennifer Melvin, Flagler College

Gender and Sexuality Committee Meeting [Meeting]
Thursday | 2:30 pm-3:45 pm | Ellendale, 4th Floor

3:00 pm-4:00 pm

JEDI Committee Meeting [Meeting]
Thursday | 3:00 pm-4:00 pm | Maurepas, 3rd Floor

4:00 pm-5:15 pm

66. Diasporic Womanisms III: Navigating Academic Exclusions [Mini-Conference]
Thursday | 4:00 pm-5:15 pm | Gallier AB, 4th Floor



Organizers: Sancha Medwinter, University of Massachusetts-Amherst; Monisha Jackson, Georgia State University; Tannuja Devi Rozario, University of Massachusetts-Amherst

President: Veda Hyunjin Kim, Ohio Wesleyan University

- *When Black women enter... Towards a sociology of womanism.* Stephanie House-Niamke, West Virginia University
- *Mesearch and wesearch of a Korean boy who teaches Ida B Wells-Barnett, WEB Du Bois, Frantz Fanon, and Audre Lorde.* Veda Hyunjin Kim, Ohio Wesleyan University
- *Teaching is NOT a luxury: Creating a classroom with care.* Faith Deschamps, Ohio Wesleyan University

67. Racialized Violence and Bias [Paper Session]
Thursday | 4:00 pm-5:15 pm | Bayside A, 4th Floor

President: Deena A. Isom, University of South Carolina

- *White terrorism on trial: The 16th Street Baptist Church bombing.* Quinesha Nicole Bentley, University of Illinois, Urbana-Champaign
- *Seeing beyond Black and White to understand anti-Latino/a/x crimes of bias.* Matthew Ward, University of Southern Mississippi
- *Black or blue: Examining the role of religion in the construction of responses to anti-Black police violence.* Robert Thomson, University of Alabama in Huntsville
- *Blacks of the alt-right: A qualitative look at ideologies, perceptions of fear, and far-right conservatism in Black America.* Deena A. Isom, University of South Carolina; Toniqua Mikell, University of Massachusetts Dartmouth; Sarah Franklin, University of South Carolina; Marissa Liggins, University of South Carolina

68. Getting Campus Organized [Paper Session]
Thursday | 4:00 pm-5:15 pm | Bayside B, 4th Floor

President: Dale Wimberley, Virginia Polytechnic Institute & State University

- *Using the campus to teach environmental advocacy.* Brian Obach, SUNY New Paltz
- *Campus movement organizations within student organizational environments: The case of United Students Against Sweatshops.* Dale Wimberley, Virginia Polytechnic Institute & State University

- *Serving or saving? How students at a PWI understand their work in diverse environments.* Erinn Brooks, St. Norbert College; Frances Foote, St. Norbert College

69. Racial Conceptualization and Racial Attitudes II [Paper Session]

Thursday | 4:00 pm-5:15 pm | Bayside C, 4th Floor

Organizer: Raj Ghoshal, Elon University

Presider: Raj Ghoshal, Elon University

- *Judging rap by race: (Multi)racial identity in popular rap music.* Matthew Oware, University of Richmond
- *Arab American Muslim women: Racialized by gender and religion.* Unna Marie Yared, University of Florida
- *Everyday gendered racism: Education, microaggressions, and the moderating effects of race and gender.* Fallon Chioke Caruth, Purdue University; Kevin Stainback, Purdue University; Adia Harvey Wingfield, Washington University
- *"There is no such thing as Ottoman Greeks!": Mapping the social construction of Ottoman Greek identity through space and time.* Yiorgo Topalidis, Flagler College

70. Religion, Spirituality, and Health [Paper Session]

Thursday | 4:00 pm-5:15 pm | Estherwood, 4th Floor

Presider: Susan Bodnar Deren, Virginia Commonwealth University

- *Religiosity, diet and exercise, and body weight among Muslim immigrants to the United States.* Samira Rahman, University of Memphis; Joseph T Lariscy, University of Memphis
- *Healing with two hands: Beyond the binary of western and traditional medicine during the COVID-19 pandemic in South Africa.* Susan Bodnar Deren, Virginia Commonwealth University; Dingani Mthethwa, Virginia Commonwealth University
- *Health and religious involvement in Asian Americans: National heritage as contingency?* Xinying Zou, Louisiana State University; Samuel Stroope, Louisiana State University

71. Hegemony and Resistance Online [Paper Session]

Thursday | 4:00 pm-5:15 pm | Napoleon A1, 3rd Floor

Presider: Daulton Joseph Selke, North Carolina State University

- *Kurdish resistance and agenda setting through social media.* Ned Rinalducci, Miami Dade College; Jolene Byrne, Byrne Advocacy
- *Symbolic egalitarians and online discourse.* Chris Vidmar, Georgia Institute of Technology; Vicky Celedon-Garcia, Georgia Institute of Technology
- *Racial rearticulation and relationality in online travel writing.* Trevor Jamerson, Virginia Tech
- *The ruling ideas: The attribution of agency in media coverage of the Israeli-Palestinian conflict.* Daulton Joseph Selke, North Carolina State University; Adam Goldfarb, North Carolina State University

72. Gender and Culture [Paper Session]

Thursday | 4:00 pm-5:15 pm | Napoleon A3, 3rd Floor

Presider: Otis McCandless-Chapman, Trinity University

- *Pickup trucks and identity: The role of trucks in shaping social identities in San Antonio.* Noor Jahlul, Trinity University
- *"Swag and cheer": A sociological recap of Valentine's Day 2023.* Rebekah Woodard Faris, University of Alabama in Huntsville

- *Gender norms, heteronormativity, and markedness in four coffee houses.* Kim Tauches, Farmingdale State College
- *Are you what you eat? Food, identity, and masculinity among gay men.* Otis McCandless-Chapman, Trinity University

73. Union Formation and Dissolution [Paper Session]

Thursday | 4:00 pm-5:15 pm | Napoleon B1, 3rd Floor

Presider: Veena Kulkarni, Arkansas State University

- *Anti-marriage, pro-divorce? Attitudes toward marriage and divorce in the US.* Gayle Kaufman, Davidson College; Shuo Meng, Davidson College; Keya Zhou, Davidson College; D'Lane Compton, University of New Orleans
- *Marital partnering: Exploring educational assortative mating among legal immigrants from Mexico to the United States.* Veena Kulkarni, Arkansas State University
- *Age differences between spouses among child brides in Iran.* Zackery Butler, Fayetteville State University
- *I fell in love with a Nigerian prince: Financial fraud and relationship formation in older adults.* Bailey Hair, Texas Tech University; Emily Choi, Texas Tech University

74. (Un)Natural Disasters [Paper Session]

Thursday | 4:00 pm-5:15 pm | Napoleon B3, 3rd Floor

Presider: Edwin Grimsley, Baruch College

- *Waves: Black placemaking on and through catastrophe.* Corey Javon Miles, Tulane University
- *Experiencing disaster on higher ground: How migrants from coastal Louisiana care for their families and assist in their hometowns when disaster strikes.* Brandon Folse, University of Oregon
- *Bayou farewell? Responses to natural disaster in southeastern Louisiana.* Brandon Folse, University of Oregon; Nicholas Theis, University of Oregon; Daniel Shtob, Brooklyn College
- *Intimate relationship changes after disasters among Asian Americans in coastal Alabama.* Hosik Min, University of South Alabama; Roma Hanks, University of South Alabama
- *Structural barriers to mitigating toxic exposures in contaminated communities.* Landen Gambill Longest, North Carolina State University

75. Bias and Discrimination in Education [Paper Session]

Thursday | 4:00 pm-5:15 pm | Napoleon D1, 3rd Floor

Presider: Adam Jacob Buro, Texas Tech University

- *Community college transfer student bias and discrimination in university students.* Adam Jacob Buro, Texas Tech University
- *Diversity at international branch campuses: Whose definition of diversity matters?* H. Deborah Kwak, George Mason University, Korea; Shannon N. Davis, George Mason University Korea
- *An analytical study on the role of pedagogy on racial achievement gaps in America.* Alyson Gonzalez, University of Southern Mississippi; Karen Phelan Kozlowski, University of Southern Mississippi
- *Attitudes toward second language learning in the United States.* Liana Collins, Southwestern University

76. Unpacking the Myriad Challenges of the Housing Crisis [Paper Session]

Thursday | 4:00 pm-5:15 pm | Napoleon D3, 3rd Floor

President: David Jaffee, University of North Florida

- *The corporate landlord invasion and the rental housing crisis: The case of Jacksonville Florida.* David Jaffee, University of North Florida
- *Ownership of multifamily housing and its outcomes on tenants.* Katie Renzi, University of North Florida
- *Disrupting the binaries of food and nutrition: Promoting an ecological nutritional equity framework.* Drew Anthony Bonner, George Mason University
- *Stripping the senses: Examining Black women's experiences within gentrification.* Ashley Hollingshead, Rutgers University; Endia Hayes, Rutgers University

77. Pedagogical Wisdom for Graduate Students, co-sponsored by the Committee on the Status of Students and the Committee on Justice, Equity, and Inclusion (JEDI) [Panel]

Thursday | 4:00 pm-5:15 pm | Evergreen, 4th Floor

Organizers: Anthony Jerome Stone Jr., University of Memphis; Kierra Nicole Toney, University of Cincinnati

President: Anthony Jerome Stone Jr., University of Memphis

Panelists:

- Kendra Murphy, University of Memphis
- Stephanie McClure, Georgia College & State University
- Stephanie L Bradley, University of North Carolina-Charlotte
- William (Bill) Taylor, Chattanooga State Community College
- Edlin Veras, Swarthmore College

78. DEI On Campus, co-sponsored by the Committee on Justice, Equity, and Inclusion (JEDI) and the Committee on the Status of Students [Panel]

Thursday | 4:00 pm-5:15 pm | Napoleon A2, 3rd Floor

Presiders: Joanna Hunter, Radford University; Marni Brown, Georgia Gwinnett College

Panelists:

- Ashraf Esmail, Dillard University
- Tia Suggs, Dillard University
- Katina Whorton, Dillard University

79. National Science Foundation: Funding Opportunities in the Sociology Program [Workshop]

Thursday | 4:00 pm-5:15 pm | Southdown, 4th Floor

President: Mamadi Corra, National Science Foundation

Panelists:

- Mamadi Corra, National Science Foundation
- Antwan Jones, George Washington University
- Joseph Whitmeyer, National Science Foundation



80. Poster Session 3 - Crime, Law, and Deviance [Poster Session]

Thursday | 4:00 pm-5:15 pm | Bayside Foyer, 4th Floor

- *A new form of social control: Examining the relationship between dimensions of religion and deviant behavior.* Madison Crawford, North Carolina State University
- *Incarcerated parents' mental health and their interactions with their children.* Windsor Adcox, Louisiana State University
- *The environmental influences of violent behavior.* Zharra Armstrong, Dillard University
- *How cops are using TikTok as image management during times of public scrutiny.* Augusta R Scruggs, Appalachian State University
- *Juvenile justice from a historical and socio-legal perspective.* Leroy Miles, Bethune-Cookman University; Danielle McFarland, Bethune-Cookman University
- *Undergraduate research scholar reflection: What I learned about developmental services and programs for at risk youth.* Savannah McGregor, Florida State University; Ladanya Ramirez Surmeier, Florida State University; Helen Mahony, Florida State University; Mary Gerend, Florida State University
- *Considering the invisible population in child maltreatment.* Fadime Gokce Karaaslan, University of Central Florida; Elizabeth Ehrhardt Mustaine, University of Central Florida
- *Gender differences in egocentric social networks among people in prison-based substance use disorder treatment.* Carrie Oser, University of Kentucky; Evan Batty, University of Kentucky; Martha Tillson, University of Kentucky; Michele Staton, University of Kentucky; Peng Siyun, University of Indiana, Bloomington; Hannah Knudsen, University of Kentucky
- *The prevalence and determinants of substance use disorders among Hispanic sexual minorities in the United States.* Katheryn Olmos, University of Central Florida
- *Counter-stigma as resistance.* Opal Gay, Georgia State University

81. SSS Antiharassment Forum [Special Session]

Thursday | 4:00 pm-5:15 pm | Borgne, 3rd Floor

President: Brianna Turgeon, Jacksonville State University

SSS is in the process of forming an Anti-Harassment Committee and adopting an anti-harassment policy. This policy focuses on providing a safe and welcoming environment for everyone, free from harassment based on age, race, ethnicity, national origin, religion, language, sexual orientation, gender identity or gender expression, disability, health conditions, socioeconomic status, marital status, domestic status, or parental status and applies to members of all positions and statuses within the Society. Join members of the Anti-Harassment Taskforce at this forum to hear more about the proposed policy, the resources we are working to offer for harassment, a Q&A, and to offer comments and suggestions on the support you would like to receive from SSS.

Panelists:

- Temi Alao, Emory University
- Barbara Combs, Kennesaw State University
- Daniel Delgado, Texas A&M University at San Antonio
- Brianna Turgeon, Jacksonville State University
- Jeannette Marie Wade, University of North Carolina-Greensboro

82. Roll of Honor Session to Recognize Lynn Smith-Lovin [Special Session]

Thursday | 4:00 pm-5:15 pm | Napoleon C1+C2, 3rd Floor

Organizer: Dawn T Robinson, University of Georgia

Presenter: Dawn T Robinson, University of Georgia

Panelists:

- Lisa Slattery Walker, University of North Carolina-Charlotte
- Robert Freeland, Appalachian State University
- Kimberly Rogers, Dartmouth College
- Joseph M Quinn, University of South Carolina
- Em Maloney, Duke University

Discussant: Lynn Smith-Lovin, Duke University



TSS Meeting [Meeting]

Thursday | 4:00 pm-5:15 pm | Ellendale, 4th Floor

6:00 pm-8:00 pm

Trivia Night

Thursday | 6:00 pm-8:00 pm | Nottoway, 4th Floor

8:00 pm-10:00 pm

Student Mixer with the President @Felipe's French Quarter (301 N. Peters Street) [Off-Site Event]

Thursday | 8:00 pm-10:00 pm | Offsite



Friday, April 5, 2024

7:00 am-9:00 pm

Quiet Space

Friday | 7:00 am-9:00 pm | Edgewood AB, 4th Floor

This room is for those who need a place and time to step aside from the conference and be in a low-stimulation environment. Please be considerate of others while using this space.

Community Space

Friday | 7:00 am-9:00 pm | Oak Alley, 4th Floor

This space is provided for members to come together, meet new members, build networks and collaborations, and socialize. Please enjoy your use of this space.

Lactation Space

Friday | 7:00 am-9:00 pm | Poydras, 3rd Floor

This room is available during the conference for all lactation needs. Please be considerate of others' privacy in this space.

8:00 am-4:00 pm

PreRegistration

Friday | 8:00 am-4:00 pm | Napoleon Foyer, 3rd Floor

Exhibits

Friday | 8:00 am-4:00 pm | Napoleon Foyer Exhibits Area, 3rd Floor

Onsite Registration

Friday | 8:00 am-4:00 pm | Registration Office, 3rd Floor

8:30 am-5:15 pm

Collaboration Space

Friday | 8:30 am-5:15 pm | Crescent, 4th Floor

Registered attendees may sign up for use of this room in 75-minute slots to have a space to meet collaborators, establish new working relationships, and work on projects while together at our annual meeting.

Welcome to SSS 2024!

Registration is open from 8am to 4pm. Swing by Registration Office for onsite registration, or Napoleon Foyer if you preregistered. Both are located on the 3rd Floor.

Lactation Space, Quiet Space, and Community Space are available from 7am to 9pm.

Coffee and tea are available in the Napoleon Foyer.

8:30 am-9:45 am

83. Disrupting Dichotomies in the Context of Hazards/Disasters I: Community (in)Action [Mini-Conference]

Friday | 8:30 am-9:45 am | Bayside B, 4th Floor



Organizers: Adam Michael Straub, Rowan University; Liesel Ritchie, Virginia Tech; Kevin Smiley, Louisiana State University

President: Erin Boyle, Virginia Tech

- *I just called to say...it flooded: Flooding and governance seen through 311 calls in Baton Rouge.* Kevin Smiley, Louisiana State University; Amie Cemalovic, Louisiana State University; Stephen Faulk, Louisiana State University; Gavin Juge, Louisiana State University; Marina Mewborn, Louisiana State University; Muhammad Saiffudin, Louisiana State University; Neil Tepper, Louisiana State University; Anna Walker, Louisiana State University; Micah Williams, Louisiana State University
- *Community based organizational response after the Pearl River Flood (2022).* Erin Boyle, Virginia Tech
- *Citizen sewists?: The (unexpected) mutual aid workers of COVID-19.* Marybeth Stalp, University of Northern Iowa; Kimberly Kelly, Mississippi State University; Braden Leap, Mississippi State University
- *Engaging the community to address disaster food and nutrition insecurity.* Julia Waity, University of North Carolina - Wilmington

84. Diasporic Womanisms IV: Womanism and Life-Death Ecologies [Mini-Conference]

Friday | 8:30 am-9:45 am | Napoleon A2, 3rd Floor



Organizers: Sancha Medwinter, University of Massachusetts-Amherst; Monisha Jackson, Georgia State University; Tannuja Devi Rozario, University of Massachusetts-Amherst

President: Tamanna Rashid, University of Massachusetts-Amherst

- *Thinking life through Black feminist, decolonial and womanist experiences.* Juliana Góes, UC San Diego
- *From the trenches of Dalit insurgencies.* Swati Birla, SUNY New Paltz
- *Silenced voices: Reexamining the 1971 rape victims in Bangladesh and the unfulfilled promises of integration from a Global South feminist perspective.* Tamanna Rashid, University of Massachusetts-Amherst; Shamsul Arefin, University of Massachusetts-Amherst

85. Laws, Policies, and Public Attitudes toward Punishment [Paper Session]

Friday | 8:30 am-9:45 am | Bayside A, 4th Floor

Presenter: Ashraf Esmail, Dillard University

- *Life, liberty, and the pursuit of retribution: The relationship between homeownership and endorsing state-sponsored punishment.* Andrew Davis, North Carolina State University; Alexander Kinney, Sam Houston State University; Jessica Pfaffendorf, North Carolina State University
- *The impact of state moratoriums and abolishment of capital punishment on individual attitudes.* Katie Patton Cali, Louisiana State University
- *Quality-of-life ordinances as anti-homelessness legislation: Tracking changes in the U.S. from 2006 – 2022.* Craig Boylstein, Coastal Carolina University
- *Cooperative endeavor to review and examine the value of an equality based regulatory approach to combat human trafficking and the commercial sex trade in the City of New Orleans.* Ashraf Esmail, Dillard University; Terrel Broussard, Broussard Dispute Solutions; Tia Suggs, Dillard University; Veijah Johnson, Dillard University; Olivia Wilson, Dillard University; Asia Collins, Dillard University
- *Racialized bond hearings: An analysis of New Orleans judicial decisions.* Madison Fain McBride, Loyola University New Orleans

86. Racial Belonging: Placemaking, Immigration, and Reclamation [Paper Session]

Friday | 8:30 am-9:45 am | Bayside C, 4th Floor

Presenter: Jonathan Grant, University of North Florida

- *Racial and ethnic identities among second generation im/migrants in Central Florida.* Melanie Escue, University of North Carolina-Pembroke; Felix Sutphin, University of South Florida; Elizabeth Aranda, University of South Florida
- *Marriage, race, and ethnicity: Exploring the perception of belonging of Black African immigrants in the U.S..* Carole Ahossin, University of Florida
- *Black-White disparities in the relationship between neighborhood safety and physical activity.* Oluwatobi Abel Alawode, University of Florida
- *Black Mecca, U.S.A: An in-depth look at race, class and placemaking in Atlanta, Georgia.* Jonathan Grant, University of North Florida

87. Theorizing Sex, Gender, and the Body [Paper Session]

Friday | 8:30 am-9:45 am | Estherwood, 4th Floor

Presenter: Ethan Berger, Northern Arizona University

- *A social theory of the body.* Christopher Shane Elliott, University of North Carolina Wilmington
- *Against blondes: The Fascist aesthetics of doing sex/gender/sex.* Uday Ahuja, Davidson College
- *Developing a postcolonial episteme for sociology from a feminist perspective.* Conrad Kim, University of North Carolina-Charlotte
- *How to make functionalist arguments.* Andres Castro Araujo, Duke University
- *Navigating societal categorization: Structural dynamics, binary conundrums, and cultural evolutionary context.* Ethan Berger, Northern Arizona University

88. Sociology of Mental Health and Chronic Illness Management [Paper Session]

Friday | 8:30 am-9:45 am | Evergreen, 4th Floor

President: Shania Montufar, The University of Texas at Austin

- *Mood swinging, gun slinging? The role of mental health in predicting gun ownership during the COVID-19 pandemic.* Benjamin Dowd-Arrow, Florida State University; Amy Burdette, Florida State University; Terrence Hill, University of Texas-San Antonio; Christopher Ellison, University of Texas at San Antonio
- *Are Black women the most depressed? The long-term impact of parental incarceration on mental health.* Mikayla Herndon, Mississippi State University; Margaret Ralston, Mississippi State University; Kecia Johnson, Mississippi State University
- *Perceptions of stigma and status at the intersection of mental health and mental illness.* Greg Murray, Emory University
- *A state-level analysis of mental health in US Latinx communities.* Shania Montufar, The University of Texas at Austin

89. Critical Evaluation and New Approaches [Paper Session]

Friday | 8:30 am-9:45 am | Gallier AB, 4th Floor

President: Elizabeth East, University of Tennessee-Knoxville

- *"Black and some other race": Assessing shifts in the racial codification of Afro-Latinos in the American Community Survey.* Ricardo Henrique Lowe, University of Texas-Austin; Shania Montufar, The University of Texas at Austin; Yasmiyn Irizarry, University of Texas-Austin; Edward Vargas, Arizona State University; Nancy Lopez, University of New Mexico
- *An old pirate learning new tricks?: Moving from evaluation of programs to implementation and intervention.* Jeffrey Will, University of North Florida
- *Driving science's next generation forward: GeoBus program theory evaluation.* Elise Michelle Lorenzo, University of Central Florida
- *Engagement in the neoliberal university: Resources for social justice collaboration between faculty and community organizations.* Elizabeth East, University of Tennessee-Knoxville; Jon Shefner, University of Tennessee-Knoxville

90. Investing in Education [Paper Session]

Friday | 8:30 am-9:45 am | Napoleon A1, 3rd Floor

President: Andrea Woodward, Berea College

- *The impact of parent migration on education expenditures in rural China.* Semonti Jannat, University of Mississippi; Khadiza Tul Kubra, University of Mississippi; Ryan Parsons, University of Mississippi
- *Social class, parental expectations and involvement in schools: Seeking to quantitatively confirm Calacro and Lareau.* Andrew Frederick Baird, Christopher Newport University; Morgan Miller, Christopher Newport University
- *College currency: The process of social and cultural capital development among Pell-eligible college students and what it means for facilitating upward mobility.* Andrea Woodward, Berea College; Ethan Elliot Crofts, Berea College; Lily Barnette, Berea College; Ülvi Gitaliyev, Berea College
- *Exploring pathways: Freshmen perspectives on college decisions and readiness.* Jade Sydney Xiaoyin Stewart, High Point University

91. Space, Place, and LGBTQ+ Populations I: Sponsored by SWS-South [Paper Session]

Friday | 8:30 am-9:45 am | Napoleon B1, 3rd Floor

Organizer: Lisa Miller, Eckerd College

President: Lisa Miller, Eckerd College

- *What if we centered the queer urban south? New approaches to queer life in the U.S..* Amy L Stone, Trinity University
- *"We're just like everybody else," until we aren't: The politics of perseverance in queer Mississippi.* Madeline Burdine, University of Mississippi; K.B. Hurst, University of Mississippi; Amy McDowell, University of Mississippi
- *Gender differences in family support among LGBTQ rural adults.* Brandi Woodell, Old Dominion University
- *"How did you know about this?!": LGBTQ+ Southerner's discovery of non-heterosexuality and transgender identity during childhood.* Hailey McGee, Florida State University

Discussant: Brandi Woodell, Old Dominion University

92. Child Safety & Legal Contexts [Paper Session]

Friday | 8:30 am-9:45 am | Napoleon D1, 3rd Floor

President: Sarah Elizabeth Aadahl, Virginia Tech

- *Firsthand accounts of the effects of the foster care system.* Caroline Dalton, University of Louisiana-Lafayette; Emily Gwen Blosser, University of Louisiana-Lafayette
- *Analyzing the sociological realities of Victims of Crime Act (VOCA) funding on Court Appointed Special Advocate (CASA) programs.* Madison Markham, Georgia Southern University; April Schueths, Georgia Southern University; Julie Pickens, Child Advocacy Services, Southeast Georgia
- *Save whose children? Legalizing child labor in a time of trafficking hysteria.* Corinne Schwarz, Oklahoma State University
- *The role of pornography in the sexual abuse of children.* Sarah Elizabeth Aadahl, Virginia Tech; Jennifer Johnson, Virginia Tech; Ana Bridges, University of Arkansas; Chyng Sun, New York University; Matthew Ezzell, James Madison University

93. Organizations: Structure, Culture, and Behavior [Paper Session]

Friday | 8:30 am-9:45 am | Napoleon D3, 3rd Floor

President: Erin McDonnell, University of Notre Dame

- *"Is your money where your mouth is?": Investigating alignment between private colleges and universities' mission statements and employee salaries.* Sloan Talbot, Emory University; Michaela McMillian Jenkins, Emory University; Amber Churchwell, Emory University
- *Love or leave? The disaffiliation of United Methodist clergy over LGBTQ+ acceptance.* Joseph Charles Roso, Duke University
- *The social constraints of global nonprofits and NGOs.* Ridley Browder, Davidson College

94. Institutions & Their Influencers [Paper Session]

Friday | 8:30 am-9:45 am | Oakley, 4th Floor

President: Lisa Rodriguez, University of Central Florida

- *Racial organizations: A case study of a conservative think tank.* Annie Mae Jones, University of Central Florida
- *Retreat of democracy in an authoritarian regime: Evidence from China.* Xiaoxu Yang, Louisiana State University; Frederick Weil, Louisiana State University

- *The "sister senators" strategy: Building bipartisan coalitions to defeat extremism.* Tracy Burkett, College of Charleston
- *#PRStatus: A social media analysis of public opinion towards Puerto Rico's political status after Hurricane Maria.* Lisa Rodriguez, University of Central Florida; Angela Vergara, University of Central Florida

95. STARTS workshop, co-sponsored by the Justice, Equity, Diversity & Inclusion (JEDI) Committee [Workshop] Note. This is a working session for STARTS cohort members only
Friday | 8:30 am-9:45 am | Nottoway, 4th Floor



Organizers: Lisette Garcia, Hispanic Association on Corporate Responsibility; Kylie Parrotta, California Polytechnic State University

Sociological Practice Committee Meeting [Meeting]
Friday | 8:30 am-9:45 am | Ellendale, 4th Floor

8:30 am-10:30 am

Executive Committee Meeting [Meeting]
Friday | 8:30 am-10:30 am | Maurepas, 3rd Floor

10:00 am-11:15 am

96. Disrupting Dichotomies in the Context of Hazards/Disasters II: Community (in)Action [Mini-Conference]
Friday | 10:00 am-11:15 am | Bayside B, 4th Floor



Organizers: Adam Michael Straub, Rowan University; Kevin Smiley, Louisiana State University; Liesel Ritchie, Virginia Tech

President: Lisa Rodriguez, University of Central Florida

- *Experiences with Winter Storm Uri and perceptions of recreancy.* Kate Hamilton, Virginia Tech; Liesel Ritchie, Virginia Tech; Duane Gill, Virginia Tech
- *Beyond boundaries: An analysis of the impact of water and power outages from Winter Storm URI during COVID-19.* Maggie Leon-Corwin, University of Oklahoma; James Kendra, University of Delaware
- *Feeling the burn: A pilot study of heat wave perceptions and preparedness.* Whitney Hayes, Elevate
- *Challenging the moderate/radical dichotomy through an ecosystem of tactics model: the Mountain Valley Pipeline resistance.* Cameron Reid Baller, Virginia Tech; Shannon Bell, Virginia Tech

97. Diasporic Womanisms V: Decolonizing Identity, Sexuality, and Self-Care [Mini-Conference]

Friday | 10:00 am-11:15 am | Napoleon A2, 3rd Floor



Organizers: Sancha Medwinter, University of Massachusetts-Amherst; Monisha Jackson, Georgia State University; Tannuja Devi Rozario, University of Massachusetts-Amherst

President: Monisha Jackson, Georgia State University

- *When self care Isn't enough: Decolonizing rest and community care.* Sierra Reyes, Georgia State University
- *Coloniality of sexuality: Queer Black women's perspectives.* Monisha Jackson, Georgia State University
- *A Decolonial approach to multiraciality.* Kayland Ann Arrington, Georgia State University

98. Resentment Politics [Paper Session]

Friday | 10:00 am-11:15 am | Bayside A, 4th Floor

President: Eric Bjorklund, Arizona State University

- *Implicit resentment and the gun policy preferences of white Americans.* Benjamin Dowd-Arrow, Florida State University; Terrence Hill, University of Texas-San Antonio; Daniel Tope, None; Jeremy Uecker, Baylor University
- *Who is more likely to support conspiracy theories? Examining the connections between education, gender, and beliefs in conspiracy theory.* Carson Maxfield, Southwestern University
- *Race wars and culture wars: Explaining white Evangelical support for Donald Trump.* Melvin Thomas, North Carolina State University; Loren Henderson, University of Maryland Baltimore County; Hayward Horton, SUNY Albany
- *"The future ain't what it used to be:" Group threat, status decline, and reactionary politics amongst white working-class men.* Eric Bjorklund, Arizona State University

99. Race and Gender in Global Perspective [Paper Session]

Friday | 10:00 am-11:15 am | Bayside C, 4th Floor

President: Robert Kolbila, Mississippi State University

- *"Having a cool nationality as a white person gives you an edge": Genetic ancestry testing and white identity formation.* Whitney Erin Hunt, University of the Ozarks
- *Shades of Afro-Latinidad: Who are we observing through Afro-Latinx identification?* Shania Montufar, The University of Texas at Austin; Ricardo Henrique Lowe, University of Texas-Austin; Yasmiyn Irizarry, University of Texas-Austin; Edward Vargas, Arizona State University; Nancy Lopez, University of New Mexico
- *What does agricultural mechanization equipment in the hands of women cooperatives mean? Evidence from Ghana.* Robert Kolbila, Mississippi State University; Kathleen Ragsdale, Mississippi State University; Mary Read-Wahidi, Mississippi State University; Kerry Clark, University of Missouri
- *Apartheid in the 21st century: Racial capitalism and the struggles in Palestine..* Johnny E. Williams, Trinity College; David Embrick, University of Connecticut

100. Gendered Violence, Victimization, and Women's Experiences [Paper Session]

Friday | 10:00 am-11:15 am | Estherwood, 4th Floor

President: Marion Hughes, Towson University

- *Themes of toxic masculinity in mass shooter manifestos: A content analysis.* Rachel Rebecca Black, Texas Tech University
- *A quantitative analysis of gender inequality on efforts to reduce human trafficking.* Amelia F. Simmons, Virginia Tech
- *Exploring the role of collective guilt in shaping prosocial behavior in the context of Black and indigenous women's intersectional invisibility.* Ciara Peebles, University of Georgia; Jody Clay-Warner, University of Georgia
- *Socialization, risk interpretation, and fear of rape among women at an HBCU.* Marion Hughes, Towson University; Jennifer Langdon, Towson University; Douglas Pryor, Towson University

101. Exploring Variances and Richness in End-of-Life Journeys [Paper Session]

Friday | 10:00 am-11:15 am | Evergreen, 4th Floor

President: Deeb Kitchen, Marian University

- *Who lives, who dies, who tells your story: An interrogation of academic retirement, end-of-life, and unfinished projects.* Elizabeth Wroten, University of Delaware
- *Dying a 'good' death: The work, care, and support of end-of-life doulas.* Amy Dellinger Page, Appalachian State University; Jonelle Husain, Appalachian State University
- *The public discourse of requested death.* Deeb Kitchen, Marian University

102. Impact of Covid-19 on Achievement, Emotions, and Wellbeing [Paper Session]

Friday | 10:00 am-11:15 am | Gallier AB, 4th Floor

President: Xiaoxu Yang, Louisiana State University

- *Student alienation after COVID.* Donald Gregory, Reinhardt University; Cheryl Brown, Reinhardt University; Katrina Smith, Independent Researcher; SimonPeter Gomez, Reinhardt University
- *Examining college students' experiences in the aftermath of the Covid-19 pandemic from fall 2021-spring 2023.* Michelle McLeese, University of Southern Mississippi
- *The echo of epidemic: Long-term academic achievements post school closures.* Xiaoxu Yang, Louisiana State University
- *Identity salience, social institutions, and emotions expressed about the COVID-19 pandemic on Twitter.* Megan Suzanne Stubbs-Richardson, Mississippi State University; Lauren Brown, Mississippi State University; Etrice Earley, Mississippi State University; Sierra Nelson, Mississippi State University; Terri Hernandez, Mississippi State University

103. Learning About Race: School, Parents, & Peer Cultures [Paper Session]

Friday | 10:00 am-11:15 am | Napoleon A1, 3rd Floor

President: Alex Manning, Yale University

- *Conversations and confusions: Ethnic and racial identity exploration in an Asian culture club at a predominantly white high school.* Anqi Hu, Emory University
- *Beyond a Black-White binary: Socializing children to embrace a multiracial identity.* Katherine Johnson, North Carolina State University

- *Disagreeing with dad: Race, politics, and family socialization.* Margaret Hagerman, Mississippi State University
- *Racial learning in a youth soccer community.* Alex Manning, Yale University

104. Beyond Binaries: Race, Queerness, and Knowledge Production [Paper Session]

Friday | 10:00 am-11:15 am | Napoleon A3, 3rd Floor

President: Angelica Celeste Loblack, University of Maryland

- *The effects of household and community erasure on depression among LGBTQ+ adults: The moderating roles of race/ethnicity.* Skyler Bastow, Florida State University
- *No space is safe when you are always erased: A queer of color perspective.* Dominique Alisa Fairley, University of Florida
- *Myths of sameness & meritocracy: Individual vs collective.* Komal Dhillon-Jamerson, Virginia Tech
- *Dual auto-ethnography of multiracial family experiences: A methodological exploration.* Angelica Celeste Loblack, University of Maryland; Simone Nicole Durham, Morgan State University

105. Space, Place, and LGBTQ+ Populations II: Sponsored by SWS-South [Paper Session]

Friday | 10:00 am-11:15 am | Napoleon B1, 3rd Floor

Organizer: Lisa Miller, Eckerd College

President: Lisa Miller, Eckerd College

- *"There is evil in this world": Rhetorics of supporting and opposing anti-trans legislation in Florida.* Emily Via, University of Illinois-Chicago
- *"Every team can use a switch hitter": The intersection of baseball & queer possibilities.* J.E. Sumerau, University of Tampa
- *Bi+ people navigating monosexist exclusion in queer spaces.* Lain Mathers, Indiana State University
- *Advancing beyond deficit models: How joy is cultivated among Black transgender and nonbinary young adults in Florida.* Courtney Marcia Gardner, University of Central Florida; Shannon K. Carter, University of Central Florida; Lindsay Taliaferro, University of Central Florida

Discussant: Lisa Miller, Eckerd College

106. Labor and Workplace Negotiations [Paper Session]

Friday | 10:00 am-11:15 am | Napoleon B3, 3rd Floor

President: Robert K. Perkins, Norfolk State University

- *Challenging the individualism-vs-collectivism binary within a sociology of labor.* Natalie Marie Blaustone-Dye, Tulane University
- *Collective bargaining in major American symphony orchestras.* Jiawen Wang, Emory University
- *Being the martyr: K12 classroom teachers dismissing concerns of low pay as a part of the sacrifice of teaching.* Alicia Walker, Missouri State University; Madeline Cope, Missouri State University; Bret Cormier, Providence College; Nancy Cox, Independent Researcher
- *The influence of Black service staff on Black student graduation rates at historically white colleges in the South.* Lisa R. Gooden-Hunley, Mississippi State University
- *The sound of silence: "Quiet quitting" and the limits of workers' inquiry.* Abraham Jacob Walker, Fayetteville State University

Discussant: Robert K. Perkins, Norfolk State University

107. Family, Gender, and Power [Paper Session]

Friday | 10:00 am-11:15 am | Napoleon D3, 3rd Floor

Organizer: Dakota Dougherty, North Carolina State University

Presenter: Dakota Dougherty, North Carolina State University

- *The sociopolitical liberalization of young adults: Transforming a dominated habitus.* Gail Markle, Kennesaw State University
- *Cisnormative compliance in the families of LGBTQ youth.* Amy L Stone, Trinity University
- *Examining the passing of divorce stigma: A study of divorced women's attitudes toward and experience with divorce in the UAE.* Madalla Alibeli, United Arab Emirates University

108. Genres and Representation in Popular Culture [Paper Session]

Friday | 10:00 am-11:15 am | Oakley, 4th Floor

Presenter: Mohammad Khalilian, University of Kentucky

- *Red is hot, green is not: Gender and sexual orientation representations in Hallmark Christmas movies.* Heather Shay, South Carolina State University; Catherine Boyd, Middle Tennessee State University; Natalie Steinborn, Middle Tennessee State University
- *Revisiting open mics and participatory culture after the COVID pandemic.* Marcus David Aldredge, Iona University
- *Split it, twist it, blaze it: Situating the blunt in hip hop.* Nate Chapman, Arkansas Tech University; Anthony Kwame Harrison, Virginia Tech
- *Licensing laws, genre, and network structure in post-revolutionary Iranian music: A Bayesian analysis.* Mohammad Khalilian, University of Kentucky; Robert Krause, University of Kentucky

109. *The Not So Outrageous Idea of a Christian Sociology* by Joseph A. Scimecca [Author-Meets-Curious-Readers]

Friday | 10:00 am-11:15 am | Borgne, 3rd Floor

Organizer: Joseph A. Scimecca, George Mason University

Discussants:

- Arnold Sherman, World Vision Solutions
- Andy Plotkin, Palm Beach State College
- Matt Vos, Covenant College
- Chris Robinson, Covenant College

110. Emerging Disciplines and the Global Impact of Student-Guided Research [Panel]

Friday | 10:00 am-11:15 am | Napoleon D1, 3rd Floor

Organizer: Anita Bledsoe-Gardner, Johnson C. Smith University

Panelists:

- Anita Bledsoe-Gardner, Johnson C. Smith University
- DeMond Miller, Rowan University
- Jayla Lewis, Johnson C. Smith University
- Mariah Callahan, Johnson C. Smith University

111. Poster Session 4 - Health [Poster Session]

Friday | 10:00 am-11:15 am | Bayside Foyer, 4th Floor

- *None so lonely? Religiosity, networks, and loneliness.* Alexander Lee Smith, University of Georgia
- *Recent United States non-Hispanic white and Native American death rate trends differ by how health care is paid for.* James Gundlach, Auburn University
- *Undergraduate research scholar reflection: What I learned about the effect respite programs have on caregivers' health.* Payton Nestor, Florida State University; Ladanya Ramirez Surmeier, Florida State University; Teresa Roach, Florida State University; Miles Taylor, Florida State University
- *Sharing stories: Autoimmune disease and patient stories of eosinophilic esophagitis on YouTube.* Abigail Grace Lloyd, Kennesaw State University
- *Perception of community health resources and the management of chronic health conditions: Exploring the link and implications.* Chidimma Azubuikwe, University of Florida; Oluwatobi Abel Alawode, University of Florida
- *Racial and ethnic disparities in health service use during COVID-19.* Darja Beinenson, Clemson University; Noor Nishan, Clemson University
- *Physical and mental health: Impact on romantic relationships.* Alexandra Puckett, East Carolina University; Jordan Michelle Signorelli, East Carolina University; David Knox, East Carolina University; Lacey Ritter, Mount Mercy University
- *The correlation between national development and gender inequality.* JiaYi Wu, Davidson College
- *How does the process of immigration status and the amount of time living in the United States impact individual decisions to seek medical treatment and care as a member of the Nepali-Bhutanese refugee community residing in Harrisburg, Pennsylvania?* Kalasiddhi Thapa, Davidson College
- *To what extent does gender explain Black immigrants' mental health advantage?* Oluwaseun Temitope Emoruwa, University of Alabama-Birmingham

Local Arrangements Committee Meeting [Meeting]

Friday | 10:00 am-11:15 am | Ellendale, 4th Floor

11:30 am-12:45 pm

112. Presidential Plenary: Tressie McMillan Cottom [Presidential Plenary]

Friday | 11:30 am-12:45 pm | Napoleon C1+C2, 3rd Floor

President: Joseph Ewoodzie, Davidson College

- *Troubling the Public During Troubled Times: A Sociological Challenge.* Tressie McMillan Cottom, University of North Carolina-Chapel Hill

1:00 pm-2:00 pm

Publications Committee Meeting [Meeting]

Friday | 1:00 pm-2:00 pm | Maurepas, 3rd Floor

Happening Now!

**Presidential Plenary:
Tressie McMillan Cottom.
University of North Carolina-
Chapel Hill. "Troubling the
Public During Troubled
Times: A Sociological
Challenge." 11:30 am-12:45
pm | Napoleon C1+C2, 3rd
Floor**

1:00 pm-2:15 pm

113. Disrupting Dichotomies in the Context of Hazards/Disasters III: Institution and Organization (in)Actions [Mini-Conference]

Friday | 1:00 pm-2:15 pm | Bayside B, 4th Floor

Organizers: Adam Michael Straub, Rowan University; Kevin Smiley, Louisiana State University; Liesel Ritchie, Virginia Tech



Presenter: Adam Michael Straub, Rowan University

- *Measuring recreancy in the context of a na-tech disaster.* Michael Long, Oklahoma State University; Liesel Ritchie, Virginia Tech; Duane Gill, Virginia Tech; Kate Hamilton, Virginia Tech
- *Long-term resilience of vulnerable communities in Southeast Louisiana: An interrogation of disaster capitalism and gentrification.* Storm Wells, Tulane University
- *Disrupting “crisis”: The case of the declining Dead Sea.* Lizabeth Zack, University of South Carolina Upstate
- *A culture of recreancy: Expectations of institutional failure before, during, and after the Pearl River Flood (2022).* Adam Michael Straub, Rowan University; Liesel Ritchie, Virginia Tech; Duane Gill, Virginia Tech

114. Disrupting Binaries of Gender and Sexuality [Paper Session]

Friday | 1:00 pm-2:15 pm | Bayside A, 4th Floor

Presenter: C.L. Quebedeaux, University of New Orleans

- *Alphabet matters: Understanding the complex relationship between the communities of color and the LGBTQ community.* Markesia Howard, Bethune Cookman University; Rondrea Mathis, Bethune-Cookman University; Jahaan Chandler, Bethune-Cookman University
- *When there is no he/she: Genderless languages and attitudes towards gender equality.* Nasim S. Vaseiezadeh, Texas A&M University; Megumi Tanabe, Texas A&M University; Lily Tun, Texas A&M University; Imge Dogan, Texas A&M University
- *Transgender legislation: How politics is shaped by social discourse.* Hannah Walden, Kennesaw State University
- *Contentious publics in a neoliberal America: Analyzing the intersecting forces of moral panics, disaster capitalism, and the movement to defund public libraries.* C.L. Quebedeaux, University of New Orleans

115. “Who’s Afraid of Critical Race Theory?” [Paper Session]

Friday | 1:00 pm-2:15 pm | Bayside C, 4th Floor

Organizers: Miguel Montalva Barba, University of Massachusetts-Boston; Lauren Richter, University of Toronto

Presenter: Tiffany Chenault, Salem State University

- *Racial capitalism and settler colonialism.* Camille Petersen, University of Tennessee-Knoxville
- *Recreational running and CRT: Running through a critical race lens: Challenging inclusiveness in a non inclusive place around recreational running.* Tiffany Chenault, Salem State University
- *Disrupting whiteness in environmental sociology.* Lauren Richter, University of Toronto
- *Intersectionality and its selected embrace: Unlinking intersectionality from critical race theory.* Miguel Montalva Barba, University of Massachusetts-Boston

Discussant: Camille Petersen, University of Tennessee-Knoxville

116. Feminist Transformations [Paper Session]

Friday | 1:00 pm-2:15 pm | Estherwood, 4th Floor

President: Sarah Elizabeth Aadahl, Virginia Tech

- *Beyond the binary: Language and symbolism in the Women's March for the 50th anniversary of Roe v. Wade.* Meghan Brennan, Northern Arizona University; Reagan Eileen Warner, Northern Arizona University
- *Community and vergüenza: An examination of reproductive justice organizations in the Rio Grande Valley.* Samantha Segura, University of Texas Rio Grande Valley
- *Who is feminism for? Binary constructions of feminism in the feminist blogosphere.* Nena Sechler Craven, Harford Community College
- *Women seem wicked when you're unwanted: On masculine discrepancy and endorsement of misogyny.* Sarah Elizabeth Aadahl, Virginia Tech

117. Divestment and Competing Interests in Urban Spaces and Places [Paper Session]

Friday | 1:00 pm-2:15 pm | Evergreen, 4th Floor

President: Nick Dempsey, Eckerd College

- *Crisis effects on the cultural economy and artist spaces in New Orleans.* Meghan Rich, University of Scranton
- *Tough cities last: Revitalization and placemaking in Youngstown, Ohio.* Jill Ann Harrison, University of Oregon
- *Whose neighborhood now?: Urban gentrification and community life in disparate racial and class contexts.* AJ Golio, Tulane University
- *Arts consumption and wellbeing: Preliminary results from an ongoing survey.* Nick Dempsey, Eckerd College

118. Intersectionality Research for LGBTQ+ Health Justice [Paper Session]

Friday | 1:00 pm-2:15 pm | Gallier AB, 4th Floor

President: sal ryman, North Carolina Agricultural & Technical State University - Greensboro, NC

- *Non-institutional spaces for queer and/or trans Black, Indigenous, people of color navigating health and wellness.* Sameera V Akella, University of Florida
- *Mental health status by sexual orientation and nativity: reconsidering the immigrant health advantage.* Gabe H Miller, University of Alabama-Birmingham; Oluwaseun Temitope Emoruwa, University of Alabama-Birmingham
- *Freedom for the flesh: Intersectional stigma powers and Black bisexual men.* Opal Gay, Georgia State University; Angela Thomas, Georgia State University
- *Health care experiences of trans students attending historically Black colleges and universities.* sal ryman, North Carolina Agricultural & Technical State University - Greensboro, NC

119. Low-Income and Immigrant College Students [Paper Session]

Friday | 1:00 pm-2:15 pm | Napoleon A1, 3rd Floor

President: Patricia Sanchez Ramirez, North Carolina State University

- *Category talk: How first generation and/or low-income college alumni interpret the "1G/LI" categorization.* Sloan Talbot, Emory University
- *Second-hand illegality: Bureaucratic exclusion and resource inequality in college financial aid for U.S.-born Latina/o children of undocumented parents.* Jaqueline Mendez, Texas A&M University

- *Food insecurity among university students and the barriers to utilizing food assistance programs during and after Hurricane Ian and Nicole.* Carvis Durr, University of Central Florida; Yingru Li, University of Central Florida; Alexandria Raven McClarty, University of Central Florida
- *Examining the influence of nested contexts of reception on undocumented graduate students.* Patricia Sanchez Ramirez, North Carolina State University

120. Teaching and Understanding Cultural Politics [Paper Session]

Friday | 1:00 pm-2:15 pm | Napoleon A2, 3rd Floor

Presenter: Gaurav Pathania, Eastern Mennonite University

- *Racism, sexism and evaluations of Kamala Harris in the 2020 presidential election.* Adrienne Mathews, University of Central Florida; Jonathan Knuckey, University of Central Florida
- *Teaching about “politically dangerous” topics.* Kimberly P. Brackett, Auburn University at Montgomery; David Feltmate, Auburn University at Montgomery; Pia Knigge, Auburn University at Montgomery
- *Disrupting political binaries: Political consumerism post-2020.* Meredith Katz, Virginia Commonwealth University
- *Originalist framing in Students for Fair Admissions v. President and Fellows of Harvard College.* Adrienne Mathews, University of Central Florida; J. Scott Carter, University of Central Florida
- *An academic-activist plays his hero: The pedagogy of caste in the classroom and on a film set.* Gaurav Pathania, Eastern Mennonite University

121. Media and Pop Culture [Paper Session]

Friday | 1:00 pm-2:15 pm | Napoleon A3, 3rd Floor

Presenter: Matthew Dolliver, University of Alabama in Huntsville

- *Crimmigration, criminal labeling, and executions: The media’s portrayal of executed foreign nationals over time.* Morgan McMains-Nurisio, Rice University
- *“Popping ass” and “glutes”:* *A comparative analysis of sexualization in hip hop and country music exercise classes distributed by Peloton.* Braden Leap, Mississippi State University; Rachel Allison, Mississippi State University
- *“The-author-who-must-not-be-named”:* *Transphobic social media posts and identity change in the Harry Potter fandom.* Brianna Turgeon, Jacksonville State University; Jacob Stewart Church, The University of Alabama; Tierra James, Auburn University; Leonela Martinez, Jacksonville State University; Ariel Vicars, Jacksonville State University; Alicia Carter, Jacksonville State University
- *Cultivating a will to serve, examining the effect of consuming legal dramas on attitudes toward jury service using a national sample.* Matthew Dolliver, University of Alabama in Huntsville; Emily Pedigo, University of Alabama in Huntsville; Josie Clair Leonhardt, North Carolina State University

122. Gender, Career Process, and Outcomes [Paper Session]

Friday | 1:00 pm-2:15 pm | Napoleon B1, 3rd Floor

Presenter: Ezra Temko, Southern Illinois University Edwardsville

- *Good at math or bad at math? Gendered advice for prospective women engineers.* Emily Gwen Blosser, University of Louisiana-Lafayette
- *Gender, the aspiration-expectation gap in career mobility, and health and wellbeing.* Kevin Stainback, Purdue University; Shagun Sethi, Purdue University

- *Gendered credentialism and military service as pathways into STEM occupations.* Simon Cheng, University of Connecticut; Christina Steidl, University of Alabama in Huntsville; Regina Werum, University of Nebraska - Lincoln; Shawn Ratcliff, U.S. Census Bureau
- *"Write her a letter, too": Women legislators navigating patriarchy in the Iowa Legislature, 1963-1993.* Ezra Temko, Southern Illinois University Edwardsville

123. Mental Health, Criminal Offending, and Criminal Justice Involvement [Paper Session]

Friday | 1:00 pm-2:15 pm | Napoleon B3, 3rd Floor

Presenter: Victoria Kurdyla, University of North Carolina-Pembroke

- *Effects of differential contacts with the criminal justice system on mental health.* Elizabeth Culatta, Augusta University; Raquel Oliveira-Velez, Augusta University
- *Between two worlds: Exploring mental health service choices in deviant and non-deviant populations.* Naomi Abbe, Mercer University; Riku Kawaguchi, Mercer University
- *An analysis of the relationship between work-related stressors and criminal behavior.* Casey Fowler, Middle Tennessee State University; Ugur Orak, Middle Tennessee State University
- *The intersection of mental health and criminal justice: An analysis of behavioral health court dockets in Virginia.* Steven Tucker Keener, Christopher Newport University; Audrey Morrison, Christopher Newport University
- *How mental health impacts law enforcement calls for service.* Victoria Kurdyla, University of North Carolina-Pembroke; Rachal Davis, University of North Carolina-Pembroke; Brett Sasser, University of North Carolina-Pembroke

124. Parent, Child, Sibling Relationships [Paper Session]

Friday | 1:00 pm-2:15 pm | Napoleon D1, 3rd Floor

Presenter: Veena Kulkarni, Arkansas State University

- *"Mom, dad, I am queer": How does queerness affect parent-child relationships?* Anamaria Teodora Zgimbau, Davidson College; Lea Chen, Davidson College
- *Trailblazers, supporters, and ambivalent sibling ties: LGBTQ youth and their LGBTQ siblings.* Ryann Moos, Trinity University; Katherine Willcockson, Trinity University
- *Intergenerational transmission of adversity: Exploring the impact of parental characteristics on adult children's mental health.* Ashley Lynn Vowels, University of Kentucky
- *Navigating expectations and realities of love expression as a second generation immigrant: Preliminary results from an ongoing study.* Thuy Tram Nguyen Le, Eckerd College

125. Pedagogy in Practice [Paper Session]

Friday | 1:00 pm-2:15 pm | Napoleon D3, 3rd Floor

Presenter: Matthew John Costello, Clemson University

- *Teaching beyond binaries with writing as a tool of thinking: Sociology through film.* Tanetta Andersson, Trinity College
- *Students' perspectives on democratic service-learning classrooms: A qualitative analysis.* Stephanie Molinda Hansard, Talladega College
- *Cheating in the 21st century: ChatGPT and techno-neutralization.* Matthew John Costello, Clemson University; James Hawdon, Virginia Tech; Ashley Reichelmann, Virginia Tech

126. Group Processes [Paper Session]

Friday | 1:00 pm-2:15 pm | Oakley, 4th Floor

President: D'Lane Compton, University of New Orleans

- *Juror gender and intimate partner violence cases: When diffuse status characteristics become specific.* Kiersten Hasenour, Duke University
- *What we say in the shadows: Whisper networks among women in STEM workplaces.* Megan Lyn Routh, University of South Carolina
- *Vocal accommodation, expectations, and influence.* Joseph Dippong, University of North Carolina-Charlotte; Zara Jillani, University of Georgia
- *Culture and context in experimental design.* D'Lane Compton, University of New Orleans

Discussant: Amy Kroska, University of California-Riverside

127. *Stacked Decks: Building Inspectors and the Reproduction of Urban Inequality* by Robin Bartram [Author-Meets-Curious-Readers]

Friday | 1:00 pm-2:15 pm | Borgne, 3rd Floor

Organizer: Gretchen Purser, Syracuse University

Discussants:

- Gretchen Purser, Syracuse University
- Japonica Brown-Saracino, Boston University
- Max Besbris, UW-Madison

128. Crafting a Scholarly Research Agenda, co-sponsored by the Committee on the Status of Students [Panel]

Friday | 1:00 pm-2:15 pm | Southdown, 4th Floor

Organizers: Anthony Jerome Stone Jr., University of Memphis; Kierra Nicole Toney, University of Cincinnati

President: Anthony Jerome Stone Jr., University of Memphis

Panelists:

- James M. Thomas, University of Mississippi
- Corey Javon Miles, Tulane University
- Marni Brown, Georgia Gwinnett College
- Wesley James, University of Memphis
- Maretta McDonald, University of Wisconsin-Madison

129. Roundtable IV: Racism, Transphobia, and Divisions in the U.S. [Roundtable]

Friday | 1:00 pm-2:15 pm | Nottoway, 4th Floor (Group IV)

President: Jonniann Butterfield, Austin Peay State University

- *Implicit racial bias towards children: Extending the LAT.* Jennifer Triplett, Anderson University
- *Racial resentment and racial policy attitudes as a single dimension of racial prejudice.* Jason Micah Roos, Virginia Tech; Michael Hughes, Virginia Tech
- *Individuals sans society: Reassessing the causes of division in the American landscape.* Glenn S. Coffey, WDC Legal and Strategic Consultants
- *Politics of hostility: The effects of anti-transgender laws in the American South.* Jonniann Butterfield, Austin Peay State University

130. Roundtable V: Religion, Politics, and Social Movements [Roundtable]

Friday | 1:00 pm-2:15 pm | Nottoway, 4th Floor (Group V)

Presenter: Taline Alonso da Silva, Oklahoma State University

- *Analyzing the significance of the "Woman, Life, Freedom" slogan in the Iranian social movement.* Golasa sadat Haji mirzaei, Oklahoma State University
- *Education, war, and nonviolence: Revisiting Mahatma Gandhi's South African years and the birth of Satyagraha.* Mark Malisa, University Of West Florida
- *Interaction of religion and political ideology on belief in human-environment relation.* Kamala Shrestha, Oklahoma State University
- *From witchcraft to tarot cards: Religious individualization among Christian women.* Taline Alonso da Silva, Oklahoma State University

131. Roundtable VI: Pedagogy [Roundtable]

Friday | 1:00 pm-2:15 pm | Nottoway, 4th Floor (Group VI)

Presenter: Alexandria Lynn Almy, Oklahoma State University

- *Critical analysis of self-care imagery in mainstream media: A classroom exercise.* Kylie Parrotta, California Polytechnic State University - San Luis Obispo; Emily Cabaniss, Sam Houston State University; Shannon N. Davis, George Mason University Korea
- *Making it a mission: Incorporating a university's mental health initiative into pedagogy.* Eryn Grucza Viscarra, Georgia College & State University
- *Questioning the status quo: Ungrading dynamics/processes in higher education.* Alexandria Lynn Almy, Oklahoma State University

2025 Honors Committee Meeting [Meeting]

Friday | 1:00 pm-2:15 pm | Ellendale, 4th Floor

132. Graduate Program Informational Session

Friday | 1:00 pm-2:15 pm | Bayside Foyer, 4th Floor

2:30 pm-3:30 pm

**Meeting of Social Currents Editorial Board
[Meeting]**

Friday | 2:30 pm-3:30 pm | Maurepas, 3rd Floor

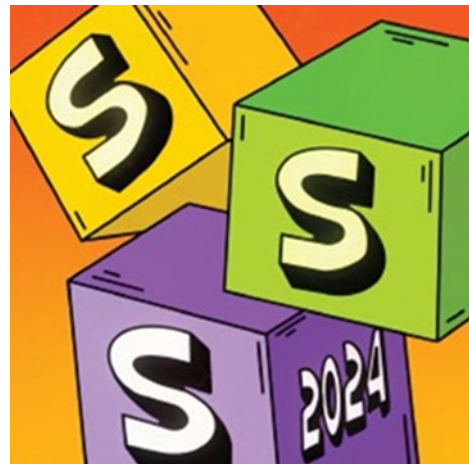

2:30 pm-3:45 pm

133. Disrupting Dichotomies in the Context of Hazards/Disasters IV: Taking Stock, Moving Forward [Mini-Conference]

Friday | 2:30 pm-3:45 pm | Bayside B, 4th Floor

Organizers: Adam Michael Straub, Rowan University; Liesel Ritchie, Virginia Tech; Kevin Smiley, Louisiana State University

President: Adam Michael Straub, Rowan University

Panelists:

- Steve Kroll-Smith, University of North Carolina-Greensboro
- Kathleen Tierney, University of Colorado-Boulder
- DeMond Miller, Rowan University
- Duane Gill, Virginia Tech
- Simone Domingue, Tulane University



134. Breaking Gender Binaries: The Category X Research Project [Thematic Session]

Friday | 2:30 pm-3:45 pm | Bayside A, 4th Floor

Organizer: Barbara Risman, University of Illinois-Chicago

President: Emily Via, University of Illinois-Chicago

- *Finding liberation: Non-binary identity construction, gender journeys, and undoing.* Mary Ann Vega, University of Illinois-Chicago; Barbara Risman, University of Illinois-Chicago
- *Confronting heterogender: Overcoming the sex-gender-heterosexual matrix.* Erielle Jones, University of Illinois-Chicago
- *Gender journeys across cultures: A comparative analysis.* Barbara Risman, University of Illinois-Chicago; Emanuela Abbatecola, University of Genoa; Arantxa Grau, University of Valencia; Lucy Nichols, Western Sydney University; Mariella Popolla, University of Genoa; Mary Ann Vega, University of Illinois-Chicago



135. Centering Black Voices in the Classroom: Innovations in Pedagogy Involving the HistoryMakers' Digital Archive [Paper Session]

Friday | 2:30 pm-3:45 pm | Bayside C, 4th Floor

Organizer: Steven Tucker Keener, Christopher Newport University

President: Steven Tucker Keener, Christopher Newport University

- *The history makers as instrument for social justice instruction in the media classroom.* George Daniels, University of Alabama-Tuscaloosa
- *Enhancing historical understanding and engagement: Exploring the integration of the HistoryMakers digital archive in a college history course.* Nafeesa Muhammad, Spelman College
- *Empowering change: Transforming STEM education with culturally relevant pedagogy for a higher pass rate and enhanced engagement.* Danielle Singh-Gray, Clark Atlanta University
- *Righting our stories with orality: Black pedagogies and the history makers.* Liseli Fitzpatrick, Wellesley College
- *Integrating the HistoryMakers digital archive into sociology and criminology courses.* Steven Tucker Keener, Christopher Newport University

136. Us vs Them and Insider Outsiders [Paper Session]

Friday | 2:30 pm-3:45 pm | Estherwood, 4th Floor

President: Nasim S. Vaseiezadeh, Texas A&M University

- *Conflicting identities at the Michigan Womyn's Music Festival: A social identity case study.* R. Lawson, Virginia Tech
- *Why inclusivity matters: Actions by authorities and coworkers enhance workplace motivation and extra-role behaviors.* Ryan Gibson, University of New Hampshire; Karen Hegtvedt, Emory University; Cathryn Johnson, Emory University; Kate Hawks, New York University
- *Aggressive women and nurturing men: The potential of martial arts practice to challenge gender norms.* Matthew Wilkinson, Coastal Carolina University; Anne Ho, University of Tennessee-Knoxville; Ina Seethaler, Coastal Carolina University
- *"Us" versus "them": A cross-national multilevel analysis of the relationship between assimilation and attitudes towards immigrants.* Nasim S. Vaseiezadeh, Texas A&M University

137. Advancing Health Equity Among Black Communities [Paper Session]

Friday | 2:30 pm-3:45 pm | Evergreen, 4th Floor

President: Myles Moody, University of Alabama-Birmingham

- *Unpacking self-rated mental and physical health: Black respondent rationale and coping strategies.* Lacey Satcher, Boston College
- *Black immigrants, social networks and upward mobility.* Karen Hofer, University of Alabama-Birmingham; Oluwaseun Temitope Emoruwa, University of Alabama-Birmingham
- *Neighborhood and health disparity among African American: Gene and environmental perspective.* Tomiwa Joshua Ayetigbo, University of Alabama-Birmingham
- *The social determinants of well-being among African-Americans.* Myles Moody, University of Alabama-Birmingham; Robert Taylor, University of Michigan; Linda Chatters, University of Michigan

138. Work, Identity, and Subjective Wellbeing [Paper Session]

Friday | 2:30 pm-3:45 pm | Gallier AB, 4th Floor

President: Ananya Sarker, Case Western Reserve University

- *Ingroup biases in cultural meanings: The case of occupational identities.* Aidan Helen Combs, Duke University
- *Economic downturns and immigrant labor market outcomes: Evidence from the Great Recession and Covid-19 pandemic.* Patricia McManus, Indiana University; Michael Thompson, Meta
- *Professional identity work among digital game workers of color.* Alison Rose Buck, Eastern Kentucky University
- *How men and women fare at health outcomes through economic rollercoasters like recessions.* Ananya Sarker, Case Western Reserve University

139. Framing: Race, Gender, and Sexuality in the Media [Paper Session]

Friday | 2:30 pm-3:45 pm | Napoleon A1, 3rd Floor

President: Michelle L Estes, Rowan University

- *Hallyu and soju: On the construction of Asian femininity for the global (white) market.* Joong Won Kim, University of Tennessee-Knoxville; Alzaina Shams, University of Tennessee-Knoxville; Allison Sullivan, Emory University

- *"It's more than just negative or positive": Black men's critical meaning making of Black masculine representations.* Anthony Jerome Stone Jr., University of Memphis
- *Homonormative objects: Queers of color as caricature on screen.* Isatou Grace Sallah, University of Illinois, Urbana-Champaign
- *Understanding newspaper messaging about wrongful convictions.* Michelle L Estes, Rowan University

140. Remembering Historical Racist Violence [Paper Session]

Friday | 2:30 pm-3:45 pm | Napoleon A2, 3rd Floor

Organizers: Heather A. O'Connell, Louisiana State University; Ashley Reichelmann, Virginia Tech

President: Heather A. O'Connell, Louisiana State University

- *The virality of racial terror in US newspapers, 1863-1921.* David Cunningham, Washington University, St Louis; Geoff Ward, Washington University in Saint Louis
- *Facing slavery as saving face: Student perceptions of universities studying slavery.* Claire Whitlinger, Furman University; Daniel Morrison, University of Alabama in Huntsville
- *Transfigurative symbolic accretions in the material cradle of the Confederacy.* Kevin Lynn, Tarleton State University
- *Can memorials influence policy positions?: The role of emotions.* Ashley Reichelmann, Virginia Tech; James Hawdon, Virginia Tech

Discussant: Heather A. O'Connell, Louisiana State University

141. Families and Social Institutions [Paper Session]

Friday | 2:30 pm-3:45 pm | Napoleon A3, 3rd Floor

President: Otis McCandless-Chapman, Trinity University

- *Making teen moms: Meaning-making institutions' role in the social construction of teenage pregnancy.* Amber Churchwell, Emory University
- *Searching for "strong families" in the family ministry space.* Kimberly P. Brackett, Auburn University at Montgomery; David Feltmate, Auburn University at Montgomery
- *Child support in the Midwest: An analysis of racial and spatial inequality.* Maretta McDonald, University of Wisconsin-Madison; Molly Costanzo, University of Wisconsin-Madison
- *Exploring the foodways of LGBT youth: Food, family adversity, and family support among LGBT youth.* Otis McCandless-Chapman, Trinity University

142. Narratives of Poverty and Inequality [Paper Session]

Friday | 2:30 pm-3:45 pm | Napoleon B1, 3rd Floor

President: Khadiza Tul Kubra, University of Mississippi

- *'Freedom of the streets' or 'barriers to success?': Factors that predict attitudes about homelessness in the United States.* Elena Clark, Southwestern University
- *What does it take to return to "normal"?: A longitudinal study of household and individual functioning during and post-COVID.* Shelley Koch, Emory & Henry College
- *SNAPshot of the city: Intersectionality of food stamps and urban planning in Tallahassee.* Danielle Velez, Florida State University; Ladanya Ramirez Surmeier, Florida State University; Anette Schwabe, Florida State University; Tisha Holmes, Florida State University
- *The role of gender non-conformity in critiquing social mobility norms: Evidence from the Hijra community of Bangladesh.* Khadiza Tul Kubra, University of Mississippi; Suraiya Akter, Hajee Mohammad Danesh Science & Technology University; Md. Abdur Rashid, Hajee Mohammad Danesh Science and Technology University; Ryan Parsons, University of Mississippi

143. Victimization and Victim-Offender Overlap [Paper Session]

Friday | 2:30 pm-3:45 pm | Napoleon B3, 3rd Floor

President: Roshan Pandian, Southern Methodist University

- *Intimate partner violence (IPV) victimization and the psychological distress of women: Exploring the mediating role of religious struggles.* Christopher Ellison, University of Texas at San Antonio; Laura Upenieks, Baylor University; Patricia Louie, University of Washington; Robert Ball, University of Texas-San Antonio; Terrence Hill, University of Texas-San Antonio
- *Who Is to blame? Examining sexually victimized women's attribution of accountability.* Kevin Weng, Meredith College
- *Sexually abused or sexual abuser? Seeing the overlap of the two.* Marcus Venable, Louisiana State University
- *Relationship instability in midlife: The long (h)arm of youth violent victimization.* Tara D Warner, University of Alabama-Birmingham; David Warner, University of Alabama-Birmingham
- *Reconsidering the relationship between educational hypogamy and intimate partner violence: evidence from India.* Roshan Pandian, Southern Methodist University

144. Disparities in Urban Social Capital and Belonging [Paper Session]

Friday | 2:30 pm-3:45 pm | Napoleon D1, 3rd Floor

President: Kierra Nicole Toney, University of Cincinnati

- *Imagining a better future: The experiences of Louisiana doulas and midwives.* Amina Mahmoud Mahfouz, Loyola University New Orleans
- *'I'm part of the Community (with a capital C)': BDSM practitioners' community participation.* Arielle Kuperberg, University of North Carolina Greensboro; Alicia Walker, Missouri State University
- *Community attachment and fracture in the Baton Rouge queer community.* Heath McNeese, Louisiana State University
- *Negotiating rivalry and stigma: Exploring the internal stigmas between two majority Black high schools.* Kierra Nicole Toney, University of Cincinnati

145. Evaluating Opioid and Cannabis Policies and Sociolegal Responses [Paper Session]

Friday | 2:30 pm-3:45 pm | Napoleon D3, 3rd Floor

President: Christopher Brent Walker, University of Central Florida

- *Understanding harm reduction measures in hospitality environments.* Alexandria Raven McClarty, University of Central Florida; Amy Donley, University of Central Florida
- *Bringing suit against Big Pharma: State and local government's response to the opioid crisis.* Paul Knudson, Methodist University
- *Achieving justice?: An exploration of consequences rendered to the major players in the opioid crisis.* Cheri Chambers, Saint Leo University; Denise Bissler, Randolph-Macon College
- *Dorms or doobies: Medical cannabis policies in on-campus residence halls at state universities.* Christopher Brent Walker, University of Central Florida

146. LGBT+ Identity Development & Disclosure Across the Life Course [Paper Session]

Friday | 2:30 pm-3:45 pm | Oakley, 4th Floor

President: Amanda Baumle, University of Houston

- *Sexual identity fluidity among adult sexual minorities: Findings from the Generations Study.* Amanda Baumle, University of Houston

- *Coming out in South Africa: What's beyond the closet?* Sophia Abigail Ludt, Davidson College
- *Cisnormativity and conditional disclosure among LGBTQ youth.* Harrison Hartman, Trinity University; Noor Jahlul, Trinity University
- *Childhood socialization of queer college students.* Amalia Ruth Wardius, St. Norbert College

147. Learn to Publish: A Conversation with Journal Editors [Panel]

Friday | 2:30 pm-3:45 pm | Nottoway, 4th Floor

Organizers: J. Scott Carter, University of Central Florida; Cameron Lippard, Appalachian State University

President: J. Scott Carter, University of Central Florida

Panelists:

- J. Scott Carter, University of Central Florida
- Cameron Lippard, Appalachian State University

148. Teaching and Learning in Combined Sociology and Criminology Departments [Panel]

Friday | 2:30 pm-3:45 pm | Southdown, 4th Floor

Organizers: Laine Briddell, Christopher Newport University; Jaime Harris, Christopher Newport University

Presiders: Jaime Harris, Christopher Newport University; Laine Briddell, Christopher Newport University

Panelists:

- Stephanie Bohon, University of Tennessee-Knoxville
- Marion Hughes, Towson University
- Hannah Liebreich, Coastal Carolina University
- Danny Malone, Coastal Carolina University
- Courtney McDonald, University of South Carolina - Upstate
- Peter Shrock, Southeastern Louisiana University
- Mike Sickels, Winthrop University

149. Poster Session 5 - Sex, Gender, and Sexualities [Poster Session]

Friday | 2:30 pm-3:45 pm | Bayside Foyer, 4th Floor

- *Condom use and STI prevention in non-traditional relationships.* Deirdre Ferguson, University of Alabama-Birmingham; Patricia Drentea, University of Alabama-Birmingham; Elizabeth Baker, University of Alabama-Birmingham
- *"I thought I was just a late bloomer!": Exploring asexual people's experiences of identity and community.* Jess Rose Walter, University of Alabama in Huntsville
- *Naming aromanticism: The developmental strategies of the online aromantic community.* Megan Paige Sweeney, Rhodes College
- *Sexual values: Impact on selecting a romantic partner.* Jordan Michelle Signorelli, East Carolina University; Alexandra Puckett, East Carolina University; Lacey Ritter, Mount Mercy University; David Knox, East Carolina University
- *Academic values and romantic relationships: A qualitative study.* Daisy Kathleen Edmondson, East Carolina University; Briana Lewis, East Carolina University; Elizabeth Perkins, Morehead State University; I Joyce Chang, University of Central Missouri; David Knox, East Carolina University

- *Romantic chemistry among undergraduates.* A-jah Monique Hill, East Carolina University; Briana Lewis, East Carolina University; I Joyce Chang, University of Central Missouri; Elizabeth Perkins, Morehead State University; Valerie Lascola, Morehead State University; David Knox, East Carolina University
- *Femme invisibility and femme-phobia in the LGBTQ+ community: A literature review.* Nat Turiczek, Eckerd College
- *By women, for women: Representations of Dobbs in conservative news.* Rutwa Shah, University of Central Florida; Uma Sriram, University of Central Florida; Saphronia Carson, Emory University; Shannon K. Carter, University of Central Florida
- *Assessing anti-abortion 'sidewalk counseling' literature as a source of abortion disinformation and stigma.* Hayley V. McMahon, Emory University
- *Extending the generalized group dominance perspective.* Jarvis Benson, University of North Carolina-Chapel Hill

Nominations Committee Meeting [Meeting]

Friday | 2:30 pm-3:45 pm | Ellendale, 4th Floor

4:00 pm-5:15 pm

150. Expanding Intersectional Identities in Community [Paper Session]

Friday | 4:00 pm-5:15 pm | Bayside A, 4th Floor

President: Lauren Nicole Aitken, University of Central Florida

- *Respectability at odds with Puertoricanness.* Stephanie A. Dhuman, Hamilton College
- *Exploring community-engaged immigration research through lived experiences and perceptions of migration.* Kamryn Danielle Warren, University of Northern Iowa; Kimberly Parker, University of Kentucky; Sam Pfeiffer, University of Kentucky; Daniela Rodriguez, University of Kentucky
- *Trans and queer voices from Louisiana's Northshore: Learning together and building community.* Marc Settembrino, Southeastern Louisiana University; Robyn Lovetro, Southeastern Louisiana University; Sarah Bise, Southeastern Louisiana University; Micah Brown, Southeastern Louisiana University; Erin Adams, Southeastern Louisiana University
- *Queer and thriving? Community as resilience in an anti-LGBTQ state.* Lauren Nicole Aitken, University of Central Florida

151. Constructing Masculinity, Femininity and Queerness in Digital Spaces [Paper Session]

Friday | 4:00 pm-5:15 pm | Bayside B, 4th Floor

President: Courtney Gold, North Carolina State University

- *Moral A-listers in a moral economy of suspicion: Promoting gender projects, re-establishing the gender order, and policing partners on online U.S. spousal reunification.* Gina Marie Longo, Virginia Commonwealth University
- *Queering play: How gender identity, gender expression, and sexuality shape goals for play in online video games.* Jeremy Brenner-Levoy, University of Cincinnati
- *"Listen to your Uncle Jimbo": 'Real' masculinity, normal people, and contested authenticity on Twitter.* Courtney Gold, North Carolina State University

152. Fostering Inclusivity through Research on Disability [Paper Session]

Friday | 4:00 pm-5:15 pm | Estherwood, 4th Floor

President: Estefany Londono, University of Central Florida

- *Emerging adults with ADHD: Disadvantages in academia.* Karen Hoefer, University of Alabama-Birmingham
- *An education for everyone: Special needs students and the need for inclusive education in public education.* Laura Summerlin, Hendrix College
- *Networks and health: How do networks influence disability identity?* Madelynn Wellons, Duke University
- *Mental health self-labeling and the role of close connections.* Gabriel Varela, Duke University
- *"We're girls and girls have a lot of feelings": Critical analysis of gendered medical dismissiveness in the diagnostic and treatment journey of PMDD.* Estefany Londono, University of Central Florida

153. Substance Use Recovery and Health Outcomes [Paper Session]

Friday | 4:00 pm-5:15 pm | Evergreen, 4th Floor

President: Beth Holden, University of Tennessee-Knoxville

- *Diminished psychedelic returns: Stigma, distress, gender, and race/ethnicity.* Matthew Vina, University of the Incarnate Word
- *Pray for me: Examining the impact of faith based group homes on women in recovery.* Rancatore Haleigh, Southeastern Louisiana University; Michael G. Bisciglia, Southeastern Louisiana University; William Chernoff, Southeastern Louisiana University; Young Ju Chae, Southeastern Louisiana University
- *Producing recovery: How Alcoholics Anonymous shapes (white) respectable drug use recoveries.* Beth Holden, University of Tennessee-Knoxville
- *Minorities' diminished psychedelic returns: Cardio-metabolic health.* Matthew Vina, University of the Incarnate Word

154. Intersectionality and Sexual/Reproductive Health [Paper Session]

Friday | 4:00 pm-5:15 pm | Gallier AB, 4th Floor

Organizers: Jeannette Marie Wade, University of North Carolina-Greensboro; Courtney Williams, Louisiana State University

President: Jeannette Marie Wade, University of North Carolina-Greensboro

- *"After they reached puberty": Vietnamese American parents and healthcare providers' discussions on the HPV vaccine.* Kim-Phuong Truong-Vu, University of Miami
- *Black women's responses to the overturning of Roe v. Wade on social media.* Zara Houser, Louisiana State University
- *Racial inequities in maternal health: A cross-sectional analysis of Black-White differences in severe maternal morbidity.* Courtney Williams, Louisiana State University
- *"It's definitely a weight that we have to carry with us:" Black women's reflections on medical racism and a legacy of trauma.* Jeannette Marie Wade, University of North Carolina-Greensboro; Sharon Parker, North Carolina A&T State University; Helyne Frederick, University of North Carolina-Chapel Hill

155. Complicating the Disability Binary [Paper Session]

Friday | 4:00 pm-5:15 pm | Napoleon A1, 3rd Floor

Organizers: Sara Green, University of South Florida; Donileen Loseke, University of South Florida

Presenter: Sara Green, University of South Florida

- *Medical and social model narratives of disability on community college disability resource office websites.* SE Jenkins, University of South Florida
- *Housing quality among people with disabilities by rural-urban location.* Alexis Swendener, University of Minnesota
- *Disabling perceptions: College students' perceptions of ableism and major field of study decisions.* Oneya Okuwobi, University of Cincinnati; Sam Riegler, University of Cincinnati; Victoria Visconti, University of Cincinnati; Kate Durso, University of Cincinnati
- *The biopolitics of the 'previvor' movement: Gender, race, class, and sexuality.* Alyson Spurgas, Trinity College; Teodora Brnovic, Trinity College

156. Contemporary Legacies of Historical Racist Violence [Paper Session]

Friday | 4:00 pm-5:15 pm | Napoleon A2, 3rd Floor

Organizers: Heather A. O'Connell, Louisiana State University; Ashley Reichelmann, Virginia Tech

Presenter: Ashley Reichelmann, Virginia Tech

- *The re-membering project: Life history interviews with descendants of the 1898 Massacre and Coup d'Etat in Wilmington, North Carolina.* Kimberly Cook, University of North Carolina-Wilmington
- *The impact of slavery on racialized environmental inequality throughout the US South.* Corrine Salter, Louisiana State University
- *Legacies of racial violence and the movement for Black lives.* Sarah Gaby, University of North Carolina-Wilmington
- *Mourning for strangers: Black women, sequelae, and the digital afterlife of police violence.* Shannon Gonzalez, University of North Carolina-Chapel Hill; Shantel Buggs, Florida State University

Discussant: Regina Baker, University of North Carolina-Chapel Hill

157. Intersectional Masculinities [Paper Session]

Friday | 4:00 pm-5:15 pm | Napoleon A3, 3rd Floor

Presenter: Derrick R. Brooms, Morehouse College

- *The "boys of fall:" Masculinity and the maintenance of white American rural identity.* Katelyn Foltz, University of Maryland-College Park
- *Black atlas: Performing blackness in higher educational spaces.* Lauren Michelle Harvey, Duke University
- *Gaming, identity threat, and masculinity.* Kylie Maria Smith, University of Georgia
- *Supporting Black men's college successes: Exploring culturally enhancing pedagogy and praxis.* Derrick R. Brooms, Morehouse College

158. Guns, Lifestyles, and Gun Violence [Paper Session]

Friday | 4:00 pm-5:15 pm | Napoleon B1, 3rd Floor

Presenter: Amy Burdette, Florida State University

- *Impact of gun laws and state policies on gun violence in the United States.* Purba Bhattacharjee, University of Memphis; Joseph T Lariscy, University of Memphis
- *Fear of crime, healthy lifestyles, or politics? Attitudes regarding gun storage practices among U.S. adults.* Christopher Ellison, University of Texas at San Antonio; Colton Daniels, St. Mary's

University; Margaret Kelley, University of Kansas; Calvin Pyatt, University of Texas-San Antonio

- *The Impact of trauma from intimate partner violence with a firearm.* Tannuja Devi Rozario, University of Massachusetts-Amherst
- *Do men and women integrate guns into risky health lifestyles in young adulthood?* Amy Burdette, Florida State University; Elizabeth Lawrence, University of Nevada Las Vegas; Terrence Hill, University of Texas-San Antonio; Miles Taylor, Florida State University; Benjamin Dowd-Arrow, Florida State University

159. Everyday Experiences of Poverty [Paper Session]

Friday | 4:00 pm-5:15 pm | Napoleon B3, 3rd Floor

Presenter: Kasey Henricks, University of Illinois-Chicago

- *Smiling under the mask: How emotional labor shapes workers' experiences during COVID.* Victoria Isabelle Thompson, Virginia Tech
- *Volatile service encounters: Tensions in the service triangle at Dollar General.* Tracy Lynn Vargas, University of North Carolina-Pembroke
- *Everyday politics of pollution and purity: A comparative analysis of caste and race.* Dhruva Das, Assumption University; Srijana Karki, Texas A&M University- Corpus Christi
- *"No more free rides": When capital profits off racial precarity.* Kasey Henricks, University of Illinois-Chicago; Ruben Ortiz, Center for Policing Equity

160. Parenting Labor & Effects [Paper Session]

Friday | 4:00 pm-5:15 pm | Napoleon D1, 3rd Floor

Presenter: Antwan Jones, George Washington University

- *Family of origin influences: Parental involvement with and potential development of children.* Shuo Meng, Davidson College
- *Parenting and school: High expectations for today's parents.* Dakota Dougherty, North Carolina State University
- *Childcare, housework, and working parents' personal care time in 2020.* Oluwafisayo Semire Ogundoro, University at Buffalo
- *Parental SES and child disability using 41 Years of cohort data.* Antwan Jones, George Washington University

161. Student Success and Well-Being [Paper Session]

Friday | 4:00 pm-5:15 pm | Napoleon D3, 3rd Floor

Presenter: Darina Lepadatu, Kennesaw State University

- *Mindfulness and intrinsic writing motivation: Decoupling contemplative education from neoliberalism.* Aarushi Bhandari, Davidson College; Uday Ahuja, Davidson College; Ameya Petsch, Davidson College
- *Happiness and hygge: Lessons from sociology (and the Danes).* Kristy Maher, Furman University; Erin Hahn, Furman University
- *Factors that impact the student success of sociology majors.* Darina Lepadatu, Kennesaw State University; William White, Kennesaw State University
- *Restorative connections through peer mentoring in education.* Michelle Bemiller, Walsh University

**162. *Vibe: The Sound and Feeling of Black Life in the American South* by Corey J. Miles
[Author-Meets-Curious-Readers]**

Friday | 4:00 pm-5:15 pm | Borgne, 3rd Floor

Organizer: Corey Javon Miles, Tulane University

Presider: Corey Javon Miles, Tulane University

Discussants:

- Demetrius Miles Murphy, University of Southern California
- Maretta McDonald, Virginia Tech
- Anthony Jerome Stone Jr., University of Memphis

**163. Sociologists Doing Activism, co-sponsored by the Committee on Sociological Practice
[Panel]**

Friday | 4:00 pm-5:15 pm | Bayside C, 4th Floor

Organizer: Dale Wimberley, Virginia Polytechnic Institute & State University

Presider: Kimberly Kelly, Mississippi State University

- *Activist students, activist scholars: Research and teaching for social change in Guatemala and the Hudson Valley.* Anne R. Roschelle, SUNY - New Paltz; Sunita Bose, SUNY - New Paltz
- *Scholar-activism is a mutualism, not a binary: My relationship to the Mountain Valley pipeline resistance as a graduate student.* Cameron Reid Baller, Virginia Tech
- *Activist public sociology informing the rental housing crisis in Jacksonville, Florida.* David Jaffee, University of North Florida
- *All abortion, all the time: Living and talking in a post-Dobbs Mississippi.* Kimberly Kelly, Mississippi State University

**164. Co-Constructing Student Community through Shared Investment in a Growing
Sociology Program [Panel]**

Friday | 4:00 pm-5:15 pm | Oakley, 4th Floor

Organizers: Christa Jane Moore, University of Virginia at Wise; Katherine Everhart, University of Virginia at Wise

Panelists:

- Christa Jane Moore, University of Virginia at Wise
- Katherine Everhart, University of Virginia at Wise
- Willa Campbell, University of Virginia at Wise
- Anngel Gallihar, University of Virginia at Wise
- Samantha Sargent, University of Virginia at Wise
- Charity Smith, University of Virginia at Wise
- Zy'Ever Wingfield, University of Virginia at Wise

165. Finding a Job that Matters to You [Panel]

Friday | 4:00 pm-5:15 pm | Southdown, 4th Floor

Organizer: Margaret Ralston, Mississippi State University

Presider: Jasmine Whiteside, University of Louisville

Panelists:

- Aimee Elizabeth Imlay, Mississippi State University
- Mike Sickels, Winthrop University

- Daniel Morrison, University of Alabama in Huntsville
- Kaitland Byrd, University of Michigan
- Dmitry Tumin, East Carolina University
- Stephanie L Bradley, University of North Carolina-Charlotte

2025 Program Committee Meeting [Meeting]

Friday | 4:00 pm-5:15 pm | Ellendale, 4th Floor

SWS-S Coffee for a Cause and Silent Auction

Friday | 4:00 pm-5:15 pm | Maurepas, 3rd Floor

6:00 pm-7:15 pm



166. Presidential Honors and Convocation Plenary [Presidential Plenary]

Friday | 6:00 pm-7:15 pm | Napoleon C1+C2, 3rd Floor

- *The future is nonbinary.* Gayle Kaufman, Davidson College

7:30 pm-9:15 pm

Presidential and Awards Reception [Reception]

Friday | 7:30 pm-9:15 pm | Armstrong Ballroom, 8th Floor

8:00 pm-9:00 pm

Drag Show, featuring Tuffy Love Andrews, Justin Betweenner, Qween Quan, and Amanda Rose Andrews [Reception]

Friday | 8:00 pm-9:00 pm | Armstrong Ballroom Show Area, 8th Floor

Happening Now!

**Presidential Plenary:
President Gayle Kaufman.
Davidson College. "The
future is nonbinary." 6:00
pm -7:15 pm | Napoleon
C1+C2, 3rd Floor**

**Presidential and Awards
Reception:
7:30 pm-9:15 pm |
Armstrong Ballroom, 8th
Floor**

**Drag Show, featuring Tuffy
Love Andrews, Justin
Betweenner, Qween Quan,
and Amanda Rose Andrews
8:00 pm-9:00 pm |
Armstrong Ballroom, 8th
Floor**

Saturday, April 6, 2024

7:00 am-12:00 pm

Quiet Space

Saturday | 7:00 am-12:00 pm | Edgewood AB, 4th Floor

This room is for those who need a place and time to step aside from the conference and be in a low-stimulation environment. Please be considerate of others while using this space.

Community Space

Saturday | 7:00 am-12:00 pm | Oak Alley, 4th Floor

This space is provided for members to come together, meet new members, build networks and collaborations, and socialize. Please enjoy your use of this space.

Lactation Space

Saturday | 7:00 am-12:00 pm | Poydras, 3rd Floor

This room is available during the conference for all lactation needs. Please be considerate of others' privacy in this space.

7:30 am-8:30 am

Business Meeting [Meeting]

Saturday | 7:30 am-8:30 am | Maurepas, 3rd Floor

8:00 am-11:30 am

Exhibits

Saturday | 8:00 am-11:30 am | Napoleon Foyer Exhibits Area, 3rd Floor

PreRegistration

Saturday | 8:00 am-11:30 am | Napoleon Foyer, 3rd Floor

8:00 am-12:00 pm

Onsite Registration

Saturday | 8:00 am-12:00 pm | Registration Office, 3rd Floor

Welcome to SSS 2024!

Registration is open from 8am to 11:30am. Swing by Registration Office for onsite registration, or Napoleon Foyer if you preregistered. Both are located on the 3rd Floor.

Lactation Space, Quiet Space, and Community Space are available from 7am to 12pm.

Coffee and tea are available in the Napoleon Foyer.

8:30 am-9:30 am

SWS-S Business Meeting [Meeting]

Saturday | 8:30 am-9:30 am | Nottoway, 4th Floor

8:30 am-11:15 am

Collaboration Space [Space]

Saturday | 8:30 am-11:15 am | Crescent, 4th Floor

Registered attendees may sign up for use of this room in 75-minute slots to have a space to meet collaborators, establish new working relationships, and work on projects while together at our annual meeting.

8:30 am-9:45 am

167. Managing Race Interpersonally [Paper Session]

Saturday | 8:30 am-9:45 am | Bayside A, 4th Floor

Presenter: Abigail Burriss Reiter, University of North Carolina-Pembroke

- *Impression management: Students navigating through social and academic spaces while managing intersecting expectations.* Abigail Burriss Reiter, University of North Carolina-Pembroke
- *“They think I think that I’m all that”:* Intra-racial skin tone discrimination and light-skinned Black women’s responses to externalized colorism. Krysten Long, University of Georgia
- *Shifting borders: Navigating Black multiracial identification and misracialization in U.S. and global contexts.* Kayland Ann Arrington, Georgia State University
- *Teaching at the intersection of race, gender, and discipline: Impression management strategies among faculty at a minority-serving institution.* Abigail Burriss Reiter, University of North Carolina-Pembroke

168. Disparities in Health-Related Behaviors and Healthcare [Paper Session]

Saturday | 8:30 am-9:45 am | Bayside B, 4th Floor

Presenter: Chidimma Azubuikwe, University of Florida

- *Health disparities between transgender and non-transgender people across the life course.* Aven N Peters, Northwestern University
- *Disparities In delayed or forgone healthcare among adults with a single chronic disease condition and multimorbidity In the United States.* Chidimma Azubuikwe, University of Florida
- *“I have to find a way to comfort her with translation:” Language brokering in medical settings.* Rosario Fernández-Romero, University of Florida
- *Political variations in pandemic lifestyles and COVID-19 vaccination by age cohort in the United States.* Benjamin Dowd-Arrow, Florida State University; Amy Burdette, Florida State University; Alyssa Smith, Florida State University

169. Recidivism and Barriers to Reentry [Paper Session]

Saturday | 8:30 am-9:45 am | Bayside C, 4th Floor

President: Rena Zito, Elon University

- *Not just a number: A qualitative analysis of the mechanisms linking prison education to reduced risk of recidivism.* Lacey Byram Moore, LaGrange College
- *Reentry and the pandemic: An examination of how the Covid-19 pandemic changed the reentry process post-incarceration.* Steven Tucker Keener, Christopher Newport University; Rachel Elizabeth Thornton, Christopher Newport University
- *The criminal justice binary in the United States: Specialty court recidivism rates in comparison to regular courts.* James Boscher, University of the Incarnate Word
- *Offense type, race, and college students' attitudes towards college applicants with criminal records.* Rena Zito, Elon University; Stacy De Coster, North Carolina State University

170. Teaching the Arts in Sociology [Paper Session]

Saturday | 8:30 am-9:45 am | Borgne, 3rd Floor

Organizer: Deborah Gambs, Borough of Manhattan Community College, CUNY

President: Deborah Gambs, Borough of Manhattan Community College, CUNY

- *Listening as institutional ethnography: Shared experience in a Sociology of Music course.* Nick Dempsey, Eckerd College
- *Making zines: Creativity and evaluation in an Art, Culture & Society course.* Deborah Gambs, Borough of Manhattan Community College, CUNY
- *Using art to teach social change.* Marci Littlefield, Borough of Manhattan Community College, CUNY
- *Art at work and in context: Doing engaged and practical sociology in a Sociology of Art course.* Colby King, University of South Carolina Upstate

171. Algorithms and New Online Economies [Paper Session]

Saturday | 8:30 am-9:45 am | Estherwood, 4th Floor

President: Maria N. Scaptura, University of Arkansas

- *Financed femininity: Sugar babies, spoiled girlfriends, and high-value women on TikTok.* Rachel E. Davis, Middle Tennessee State University
- *Online privacy, algorithmic literacy, and fair privacy protection.* Yu Tao, Stevens Institute of Technology
- *The emotional labor and costs of sugar dating: Sugar babies' experiences in the Sugar Bowl.* Maria N. Scaptura, University of Arkansas
- *It changes yet remains the same: The stigmatization of MLM participation.* Jessica Pearce, University of Louisiana-Lafayette; Kristen Kahanek, University of Louisiana-Lafayette

172. Gendered Work and Labor [Paper Session]

Saturday | 8:30 am-9:45 am | Evergreen, 4th Floor

President: Jason Eastman, Coastal Carolina University

- *Social and group influences on Black male civic engagement and participation in civic activities.* Brianne Alexandra Painia, University of Chicago
- *Caring naturally: Neoliberal femininity and the re-traditionalization of gender.* Canan Tanir, Binghamton University

- *The concept of women's empowerment in agricultural value chains: A test of validity and predictability in Zambia.* Robert Kolbila, Mississippi State University
- *Heteronormatizing truckers through song.* Jason Eastman, Coastal Carolina University; Doug Schrock, Florida State University

173. Migration Policy and Data [Paper Session]

Saturday | 8:30 am-9:45 am | Gallier AB, 4th Floor

President: Catherine Bowman, Austin College

- *Challenging the immigration policy binary: The private prison industry and the revolving immigration door.* Wenjie Liao, Rochester Institute of Technology; Kim Ebert, North Carolina State University; Emily Estrada, State University of New York at Oswego
- *The good, the bad, and the periphery: Child marriage bans and migration politics in Western Europe.* Jasmine Underwood, University of Georgia
- *Performing love for the US immigration system: A case study of 90 Day Fiancé.* Caroline Leffert, Tulane University
- *Invisible exploitation: An account of strategic mis-collection of migrant labor data.* Catherine Bowman, Austin College; Kathryn Babineau, University of Virginia

174. State Power, Capitalism, and War [Paper Session]

Saturday | 8:30 am-9:45 am | Napoleon A1, 3rd Floor

President: James Parisot, University of Texas Rio Grande Valley

- *Left and right-wing nationalist Narodniks of the Ottoman Empire: Early 20th century populism in global context.* Sahan Savas Karatasli, University of North Carolina-Greensboro; Sefika Kumral, University of North Carolina-Greensboro
- *Neo-medievalism or a New Cold War? A comparative study of world powers, paramilitaries, and the civilianization of warfare and security in the global risk society.* Cameron Taylor Graham, University of Tennessee-Knoxville
- *Domestic violent extremism in colonial capitalism's perpetual war.* Alma Hartley, University of Tennessee-Knoxville
- *Class power and the origins of the U.S. State.* James Parisot, University of Texas Rio Grande Valley

175. Overcoming Binaries in Economic Thinking [Paper Session]

Saturday | 8:30 am-9:45 am | Napoleon A2, 3rd Floor

President: Ken Kolb, Furman University

- *Disrupting the home/office binary: The case of tug boat and mooring crews.* Ken Kolb, Furman University
- *Growth, degrowth, and the financialization of environmental consumption.* Timothy Clark, Catawba College
- *Labor informality in extractive economies: An examination of African nations.* Joshua McDermott, Southeastern Louisiana University; Michael G. Bisciglia, Southeastern Louisiana University
- *Gender-sensitive budgeting as activist strategy.* Susan Pearce, East Carolina University

176. ACEs: New Perspectives on Adverse Experiences for Children & Youth [Paper Session]
Saturday | 8:30 am-9:45 am | Napoleon A3, 3rd Floor

Presenter: Noah Gibson, Duke University

- *Adverse childhood experiences and food insecurity in adulthood: Which childhood adversity patterns matter the most?* Noah Gibson, Duke University; Olivia Neff, Purdue University; Mallory Bell, Purdue University
- *Adverse childhood experiences and school outcomes.* Josalie Condon, University of Central Florida
- *An analysis of the effectiveness of developmental services and programs on cognitive development for at risk youth.* Savannah McGregor, Florida State University; Ladanya Ramirez Surmeier, Florida State University; Helen Mahony, Florida State University; Mary Gerend, Florida State University
- *Connecting adverse childhood experiences to the school-to-prison pipeline.* Alyssah Nicole Gonzalez, University of Texas-Austin

177. Whitespaces I: Educational Institutional Spaces [Paper Session]

Saturday | 8:30 am-9:45 am | Napoleon B1, 3rd Floor

Organizers: Elizabeth Roberts, Virginia Tech; David L. Brunsma, Virginia Tech

Presenter: Makenna Kelly Clark, Virginia Tech

- *Resource hoarding and the maintenance of white educational spaces in New Orleans' charter schools.* Annie McGlynn-Wright, Loyola University-New Orleans
- *Conversations and confusions: Ethnic and racial identity exploration in an Asian culture club at a predominantly white high school.* Anqi Hu, Emory University
- *Theory as embodied practice in the classroom: A feminist, decolonial approach from the margins.* Iye Ogbe, Kennesaw State University; Uddipana Goswami, Kennesaw State University

178. Exploring the Stakeholders and Gatekeepers of Urban and Community Wellbeing [Paper Session]

Saturday | 8:30 am-9:45 am | Napoleon B3, 3rd Floor

Presenter: Maximilian Cuddy, University of Chicago

- *Administrative rulemaking as a solution to discriminatory liquor license enforcement.* Angela Addae, University of Oregon
- *Black skin, white asks: The role of emergency managers in carrying out the Flint water crisis.* Aaron Christin Foote, Central Michigan University; Cedric de Leon, University of Massachusetts-Amherst
- *Uneven medicalization: The effect of county characteristics on the number of treatment courts.* Meagan Rainock, Vanderbilt University
- *Contested power relations within a new elementary school: How race and class conflicts shape the pursuit of racial equity.* Maximilian Cuddy, University of Chicago

179. Sociological Methodology and Pedagogy [Paper Session]

Saturday | 8:30 am-9:45 am | Napoleon D1, 3rd Floor

Presenter: Brett Lehman, Auburn University at Montgomery

- *The college campus as students' sociological laboratory: Researching best pedagogical practices.* Brett Lehman, Auburn University at Montgomery

- *Exploring intimacy: Collaborative learning through undergraduate research.* Amie Hess, Meredith College
- *Journaling: A lesser-known feminist method.* Dominique Alisa Fairley, University of Florida
- *Who needs sociology: Reflections of a participant observer.* Brent Shea, Sweet Briar College

180. Animals and Society [Paper Session]

Saturday | 8:30 am-9:45 am | Napoleon D3, 3rd Floor

Presenter: Nadya M Vera, University of Tennessee-Knoxville

- *The role of pet ownership in aging identity construction.* Christine Matragrano, Florida State University
- *Human/nonhuman binaries in the Anthropocene: Vitacide via chickenization.* Nadya M Vera, University of Tennessee-Knoxville
- *Disrupting species binaries: Challenging human hierarchy as a path towards environmental justice.* Peter Marina, University of Wisconsin - La Crosse
- *Soil and social science: The experience of student interns at a regenerative farm.* Michallene McDaniel, University of North Georgia; Carly Redding, University of North Georgia; Sara Mason, University of North Georgia

181. Games, Sports, and Sex: Navigating Entertainment Technologies [Paper Session]

Saturday | 8:30 am-9:45 am | Oakley, 4th Floor

Presenter: James Witte, George Mason University

- *Exploring the relationship between sports and inclusiveness.* James Witte, George Mason University; Marissa Kiss, George Mason University
- *Gaming representation: A sociological investigation.* Dallis Leno Wallace, University of Kentucky
- *Naughty Japanese babe: An analysis of racialized sex tech designs.* Kenneth R. Hanson, University of Wyoming; Chloé Locatelli, King's College London
- *Digital data and the value placed on diverse professional athletes.* James Witte, George Mason University

182. Grant-Seeking from Private Foundations: What Investigators Should Know [Panel]

Saturday | 8:30 am-9:45 am | Southdown, 4th Floor

Organizer: James Wilson, Russell Sage Foundation

Presenter: James Wilson, Russell Sage Foundation

Panelists:

- James Wilson, Russell Sage Foundation
- Sarah Gaby, University of North Carolina-Wilmington
- Angela Dixon, Emory University

Committee on Racial and Ethnic Minorities Meeting [Meeting]

Saturday | 8:30 am-9:45 am | Ellendale, 4th Floor

8:30 am-10:30 am

Executive Committee Meeting [Meeting]

Saturday | 8:30 am-10:30 am | Maurepas, 3rd Floor

10:00 am-11:15 am

183. Reproductive Rights and Justice [Paper Session]

Saturday | 10:00 am-11:15 am | Bayside A, 4th Floor

Presenter: Angela Vergara, University of Central Florida

- *Challenges to claiming reproductive rights: the right to parenthood, abolishing the nuclear family, and reproductive technologies.* Lauren Nicole Danielowski, University of Connecticut
- *The relative distribution of abortion clinics, Title X clinics, and crisis pregnancy centers in a predominantly frontier state.* Katherine Johnson, Tulane University; Al Garnsey, Montana; Jessica Liddell, University of Montana
- *Who cares? Understanding the impact of the repeal of Roe v. Wade on college students.* Carly Danielle Young, University of Texas-Austin
- *Where are we now? Donde estamos? The impact on reproductive rights and healthcare access of Latinas in the United States.* Angela Vergara, University of Central Florida

184. Substance Use Patterns [Paper Session]

Saturday | 10:00 am-11:15 am | Bayside B, 4th Floor

Presenter: Anthony Kwame Harrison, Virginia Tech

- *The relationship between the transition to high school and adolescent substance use: Variations by network position.* Cassie McMillan, Northeastern University; Brittany Nicole Freelin, Randolph-Macon College; Kaley Jones, Northeastern University
- *“Because it’s stronger”: Making sense of menthol cigarette use among low-income Black women smokers.* Juhee Woo, Appalachian State University
- *“Crack a forty-o, and then I go for mine”: Situating the forty in hip hop.* Anthony Kwame Harrison, Virginia Tech; Nate Chapman, Arkansas Tech University

185. Cybercrime and Online Hate [Paper Session]

Saturday | 10:00 am-11:15 am | Bayside C, 4th Floor

Presenter: James Hawdon, Virginia Tech

- *State dependence applicability to online victimization.* Deven Douglas, University of Georgia
- *“Proud Month”: An analysis of Proud Boys Telegram posts from June 2023.* Levi Fanuc Mitzen, Florida State University
- *Us vs. them: An examination of Islamophobia on social media.* Anisah Bagasra, Kennesaw State University
- *Online hate as a transnational social movement: A comparative analysis of exposure, targets, and framing.* James Hawdon, Virginia Tech; Pekka Räsänen, University of Turku; Markus Kaakinen, University of Helsinki

186. Justice and Rights in Comparative-Historical Perspective [Paper Session]

Saturday | 10:00 am-11:15 am | Estherwood, 4th Floor

Presenter: Roy C. Barnes, University of Michigan-Flint

- *Strategic development of insurgent practice: Transformation of the nonviolent repertoire in the long civil rights movement.* Larry Isaac, Vanderbilt University
- *System capacity and normative targets: Confidence in the legal system in comparative context.* Andrew Davis, North Carolina State University; Eucharia Ozoemenam, North Carolina State University

- *Hiding (bigamists) in plain sight: A case study of bigamy in French Colonial New Orleans.* Kathleen Guidroz, Georgetown University
- *Claiborne Avenue History Project.* Ashraf Esmail, Dillard University; Raynard Sanders, Claiborne Avenue History Project; Tia Suggs, Dillard University; Riana Bickham, Dillard University; Madisyn Hicks, Dillard University; Keymoni Coleman, Dillard University; Shaylyn Owens, Dillard University; Raven Ducre, Dillard University; Khalia Gilner, Dillard University
- *The Pujo Clubmen: Social capital and economic power at the end of the Gilded Age.* Roy C. Barnes, University of Michigan-Flint

187. Advancing Research Methods and Theories in Medical Sociology [Paper Session]

Saturday | 10:00 am-11:15 am | Evergreen, 4th Floor

President: Fatima Glovena Fairfax, Duke University

- *The relationship between privatization and the quality of patient-centered care in the United States.* Cloey Brown, Georgia College & State University; Jeff Turner, Georgia College & State University; Stephanie McClure, Georgia College & State University
- *The impact of the structural changes of SNAP during the COVID-19 pandemic.* Victoria Anyanwu, Davidson College
- *It's who you know: How network health impacts self-rated health reporting behavior.* Fatima Glovena Fairfax, Duke University

188. The Experiences of Understudied Immigrant Groups [Paper Session]

Saturday | 10:00 am-11:15 am | Gallier AB, 4th Floor

President: Sevsem Cicek-Okay, Niagara University

- *Trends in residential segregation of invisible minorities: A comparative case of South Asian and Middle Eastern and North African population.* Sevsem Cicek-Okay, Niagara University
- *African immigrants in the United States: A test of the economic inequality hypothesis.* Mamadi Corra, National Science Foundation
- *Elderly living arrangements: Exploring variations across major foreign Asian groups and native born non-Hispanic whites.* Veena Kulkarni, Arkansas State University
- *Understanding the emotional experiences of female international graduate students in the United States.* Esther Hinson, University of Memphis

189. Income and Wealth Inequalities [Paper Session]

Saturday | 10:00 am-11:15 am | Napoleon A2, 3rd Floor

President: Moshe Semyonov, University of Illinois-Chicago

- *Immigrants' characteristics and legitimation of economic discrimination: Results from a factorial survey experiment.* Moshe Semyonov, University of Illinois-Chicago; Anastasia Gorodzeisky, Tel Aviv University; Rebeca Raijman, University of Haifa; Thomas Hinz, University of Konstanz
- *Income inequality across LGBTQ+ identities.* Hannah Corey Jacobs, University of Florida
- *Do wealthy parents smooth the bumps? Early-career unemployment and parental wealth transfers.* Jarron Bowman, Kalamazoo College; Amie Bostic, University of Texas Rio Grande Valley
- *Comparing immigrant and native-born labor: Pursuing the American Dream in the U.S. job market.* Rifat Jahan Loran, University of Memphis

190. Youth Connections: Family, Peers, & Mentors [Paper Session]

Saturday | 10:00 am-11:15 am | Napoleon A3, 3rd Floor

Presider: Julia Arroyo, College of Charleston

- *Social class and the landscape of adolescent mentoring resources.* Tom Leppard, North Carolina State University; Steve McDonald, North Carolina State University
- *Exploring barriers to youth sports participation in southern states.* Emily Hope Thomson, University of Memphis
- *How does the social determinants of health impacts shared decision making among parents with a child who has a mental health condition?* Vernon T Headley, University of Central Florida

191. Whitespaces II: Discursive Spaces [Paper Session]

Saturday | 10:00 am-11:15 am | Napoleon B1, 3rd Floor

Organizers: Elizabeth Roberts, Virginia Tech; David L. Brunsma, Virginia Tech

Presider: Joong Won Kim, University of Tennessee-Knoxville

- *Searching for equity: White normativity in online skin cancer images and state public health department resources.* Ashley C. Rondini, Franklin & Marshall College; Rachel H. Kowalsky, Weill Cornell Medicine; Genab Diallo, Franklin & Marshall College; Foster Bryant, Franklin & Marshall College
- *White space, legal rhetoric in the courtroom and how race gets erased.* Charles Gallagher, La Salle University
- *Reuse and remembrance: Symbolic gentrification in an Atlanta church.* Joy Anna Dillard Appel, Georgia State University
- *Have cities abandoned their homegrown and diverse professional population for white creative outsiders?* Jennifer Simon, Georgia State University
- *Racialized fears in white spaces: The frequency with which residents worry about being perceived as suspicious in their neighborhood.* Maria R. Lowe, Southwestern University; Brigit Suzanne Reese, Southwestern University; Carson Maxfield, Southwestern University

192. Together Alone? Social Capital, Solitude, and Isolation [Paper Session]

Saturday | 10:00 am-11:15 am | Napoleon B3, 3rd Floor

Organizer: Sanem Soyarslan, North Carolina State University

Presider: Sanem Soyarslan, North Carolina State University

- *“So alone with 15,000 people around me”: Feelings of isolation in college students’ friendship networks.* Janice McCabe, Dartmouth College
- *Exploring social connections and mental health: A community-based pilot study focused on an intergenerational group of women.* Claire Reardon, University of Kentucky; Mohammad Khalilian, University of Kentucky; Anthony Bardo, University of Kentucky; Susan Thiel, University of Kentucky; Amy Kostelic, University of Kentucky
- *Intergenerational occupational transfer in US farm families.* Michael Parker Lewis, Texas Tech University
- *A conceptual analysis of solitude and loneliness.* Sanem Soyarslan, North Carolina State University

193. Life, Death, and Disease Online [Paper Session]

Saturday | 10:00 am-11:15 am | Napoleon D1, 3rd Floor

Presider: Reginald Byron, University of Denver

- *"That's crazy!": Exploring the social construction of mental illness using Google search engine results from 2012-2022.* Lauren Nicole Labuhn, University of Central Florida
- *The social construction of the end of the COVID-19 pandemic: A multiplicity of endings, a spectrum of long COVID disability.* Sarah Kington, Tulane University
- *The postmortem self: Theorizing digital life after physical death.* Julie B. Wiest, West Chester University of Pennsylvania
- *Disrupting "good" vs. "bad" person binaries by humanizing victims of urban homicide.* Reginald Byron, University of Denver; Lily Baeza, University of Denver; Ellie Barnett-Cashman, University of Denver; Malea Marxer, University of Denver

194. *The Sociology of Cardi B: A Black Feminist Approach* by Aaryn Green, Maretta McDonald, Veronica Newton, Candice Robinson, and Shantee Rosado [Author-Meets-Curious-Readers]

Saturday | 10:00 am-11:15 am | Borgne, 3rd Floor

Organizer: Maretta McDonald, University of Wisconsin-Madison

Presider: Lori Martin, Louisiana State University

Panelists:

- Corey Javon Miles, Tulane University
- Jennifer Sims, University of Alabama in Huntsville
- Lori Martin, Louisiana State University
- Jazmin Robinson-Smith, Louisiana State University
- Kayland Ann Arrington, Georgia State University

195. Status Update: Checking in on Research and Recommendations from the ASA's Task Force on FGWC Sociologists [Panel]

Saturday | 10:00 am-11:15 am | Napoleon A1, 3rd Floor

Organizer: José Muñoz, California State University - San Bernardino

Presider: José Muñoz, California State University - San Bernardino

Panelists:

- Colby King, University of South Carolina Upstate
- Vincent Roscigno, The Ohio State University
- Jasmine Whiteside, University of Louisville
- Robert Francis, Whitworth University

Discussant: José Muñoz, California State University - San Bernardino

196. Bridges and Barriers to Participation: Supporting Sociologists at Small and Community Colleges, co-sponsored by the Committee on Sociology at Small and Community Colleges [Panel]

Saturday | 10:00 am-11:15 am | Napoleon D3, 3rd Floor

Organizer: Melencia Johnson, University of South Carolina Aiken

Presider: Jenna Lemphere, Texas A&M University at Galveston

Panelists:

- Laura Atkins, Jacksonville University
- Catina Galloway, Guilford Technical Community College
- Myra Doyle, Winston-Salem State University
- Melencia Johnson, University of South Carolina Aiken
- Brent Shea, Sweet Briar College

Discussant:

- Laura Atkins, Jacksonville University

197. Strategies for Pursuing Academic Publishing, co-sponsored by the Committee on Racial and Ethnic Minorities [Panel]

Saturday | 10:00 am-11:15 am | Southdown, 4th Floor

Organizer: Derrick R. Brooms, Morehouse College

Presider: Derrick R. Brooms, Morehouse College

Panelists:

- Derrick R. Brooms, Morehouse College
- Ray Von Robertson, Florida A & M University

Professions Committee Meeting [Meeting]

Saturday | 10:00 am-11:15 am | Ellendale, 4th Floor



10:30 am-11:30 am

Presidential Transition Meeting

[Meeting]

Saturday | 10:30 am-11:30 am |

Maurepas, 3rd Floor

11:30 am-12:45 pm

198. Presidential Plenary Panel: The

Utility of Categorizing Genders

[Presidential Plenary]

Saturday | 11:30 am-12:45 pm | Borgne,

3rd Floor

President: Kristen Schilt, University of Chicago

Panelists:

- D'Lane Compton, University of New Orleans
- Michelle Johns, NORC at the University of Chicago
- Danya Lagos, University of California-Berkeley

Discussant:

- Kristen Schilt, University of Chicago

Happening Now!

Presidential Plenary Panel: The Utility of Categorizing Genders

President and Discussant: Kristen Schilt, University of Chicago

Panelists: D'Lane Compton, University of New Orleans;

Michelle Johns, NORC at the University of Chicago; Danya

Lagos, University of California-Berkeley

11:30 am-12:45 pm | Borgne, 3rd Floor



Index

- Aadahl, Sarah Elizabeth: 92, 116
Abbatecola, Emanuela: 134
Abbe, Naomi: 123
Adams, Chelsey Devonna: 22
Adams, Erin: 150
Adcox, Windsor: 80
Addae, Angela: 178
Agboola, Samuel Kolawole: 3
Agwu, Jacob: 16
Ahossin, Carole: 86
Ahuja, Uday: 87, 161
Aitken, Lauren Nicole: 150
Ajoseh, Seun: 60
Akella, Sameera V: 118
Akers, Whitney: 58
Akin, Becci: 52
Akter, Suraiya: 142
Alao, Temi: 81
Alawode, Oluwatobi Abel: 86, 111
Aldredge, Marcus David: 108
Alibeli, Madalla: 107
Allen, Shaonta': 54
Allison, Rachel: 121
Almy, Alexandria Lynn: 131
Alvero, AJ: 6
Andersson, Tanetta: 125
Andre, Evansha: 5
Andrews, Kenneth: 54
Anyanwu, Victoria: 187
Aranda, Elizabeth: 86
Archer, Rose Elizabeth: 53
Arefin, Shamsul: 84
Armstrong, Zharia: 80
Arredondo, Aaron: 57
Arrington, Kayland Ann: 64, 97, 167, 194
Arroyo, Julia: 190
Arthur, Ashlyn: 43
Ashe, Austin: 28
Atienza Spencer, Gabrielle: 52
Atkins, Laura: 196
Attuso, Ari Michelle: 40
Augustine, Jennifer: 42, 61
Ayala, Calinda Carolina: 60
Ayetigbo, Tomiwa Joshua: 137
Azubuike, Chidimma: 111, 168
Babineau, Kathryn: 173
Badour, Christal: 59
Baeza, Lily: 193
Bagasra, Anisah: 185
Baird, Andrew Frederick: 90
Baird, Chardie L: 17
Bakanic, Von: 24
Baker, Elizabeth: 149
Baker, Regina: 18, 156
Ball, Robert: 143
Baller, Cameron Reid: 96, 163
Baran, Stephanie: 46
Bardo, Anthony: 192
Barnes, Roy C.: 186
Barnett-Cashman, Ellie: 193
Barnette, Lily: 90
Barranco, Raymond: 30
Bastow, Skyler: 104
Batty, Evan: 80
Baumle, Amanda: 146
Bechtold, Victoria Lauraine: 27, 38
Beinenson, Darja: 40, 111
Bell, Courtney: 23
Bell, Jonzelle Marshay: 58
Bell, Mallory: 176
Bell, Shannon: 96
Bemiller, Michelle: 161
Bender, Matheus: 25
Benson, Jarvis: 35, 149
Bentley, Quinesha Nicole : 67
Berger, Ethan: 87
Berry, RB: 11
Besbris, Max: 127
Bhandari, Aarushi: 161
Bhattacharjee, Purba: 158
Bhattacharya, Upali: 21

Bickham, Riana: 186
 Bird, Chloe: 27
 Bird, Sharon R.: 17
 Birla, Swati: 84
 Bisciglia, Michael G. : 55, 153, 175
 Bise, Sarah: 150
 Bissler, Denise: 145
 Bjorklund, Eric: 98
 Black, Rachel Rebecca: 100
 Blaustone-Dye, Natalie Marie: 106
 Bledsoe-Gardner, Anita: 110
 Blosser, Emily Gwen : 63, 92, 122
 Bobo, Madeline: 6
 Bodnar Deren, Susan: 70
 Bohon, Stephanie: 148
 Bolorunduro, Miracle-Eunice: 58
 Bonner, Drew Anthony: 76
 Boscher, James: 169
 Bose, Sunita: 163
 Bostic, Amie: 18, 189
 Bourque, Leah: 4
 Bowman, Catherine: 173
 Bowman, Jarron: 189
 Boyd, Catherine: 108
 Boyle, Erin: 83
 Boylstein, Craig: 85
 Brackett, Kimberly P. : 120, 141
 Bradley, Stephanie L: 77, 165
 Brailey, Carla D.: 60
 Brashears, Laura: 61
 Bray, Laura: 24
 Brennan, Meghan: 116
 Brenner-Levoy, Jeremy: 151
 Brescia-Weiler, Maria: 24
 Briddell, Laine: 148
 Bridges, Ana: 92
 Brigante, Sophia : 5
 Brnovic, Teodora: 155
 Brock, Madeline: 1
 Brooks, Erinn: 52, 68
 Brooms, Derrick R.: 157, 197
 Broussard, Terrel: 85
 Browder, Ridley: 93
 Brown-Saracino, Japonica: 127
 Brown, Cheryl: 102
 Brown, Cloey: 187
 Brown, Lauren: 102
 Brown, Marni: 78, 128
 Brown, Micah: 55, 150
 Brunnsma, David L.: 177, 191
 Bryant, Foster: 191
 Buck, Alison Rose: 138
 Buggs, Shantel: 156
 Burdette, Amy: 88, 158, 168
 Burdine, Madeline: 2, 59, 91
 Burkett, Tracy: 94
 Burley, David Michael: 10
 Buro, Adam Jacob: 75
 Burroughs, Amanda Marie: 59
 Butler, Zackery: 73
 Butterfield, Jonniann: 129
 Byers, Lyla: 41
 Byrd, Carson: 2
 Byrd, Kaitland: 165
 Byrne, Jolene: 71
 Byron, Reginald: 193
 Cabaniss, Emily: 50, 131
 Cali, Katie Patton: 85
 Callahan, Mariah: 110
 Campbell, Willa: 164
 Caren, Neal: 54
 Carson, Saphronia: 149
 Carter, Alicia: 121
 Carter, J. Scott: 120, 147
 Carter, Shannon K.: 19, 33, 105, 149
 Caruth, Fallon Chioke: 69
 cash, celeste jasmine: 44
 Cassard, Marion: 12
 Castro Araujo, Andres: 87
 Castro, Brianna Blu: 26
 Celedon-Garcia, Vicky: 71
 Cemalovic, Amie: 83

Cervantes, Christophe: 16
Chae, Young Ju: 55, 153
Chambers, Cheri: 145
Chandler, Jahaan : 114
Chang, I Joyce: 149
Chapman, Nate: 43, 108, 184
Chatters, Linda: 137
Chavous, Tabby: 2
Chen, Lea: 124
Chenault, Tiffany: 115
Cheng, Simon: 122
Chernoff, William: 55, 153
Choi, Emily: 73
Church, Jacob Stewart: 4, 121
Churchwell, Amber: 93, 141
Cicek-Okay, Sevsem: 188
Clark, Elena: 142
Clark, Kerry: 99
Clark, Makenna Kelly: 177
Clark, Shelby: 52
Clark, Timothy: 175
Clay-Warner, Jody: 100
Coffey, Glenn S.: 129
Cohan, Deborah: 48
Coleman, Keymoni: 186
Coleman, Nyima: 54
Collins, Asia: 85
Collins, Cerenity: 38
Collins, Liana: 75
Combs, Aidan Helen: 138
Combs, Barbara: 9, 81
Compton, D'Lane: 73, 126, 198
Condon, Josalie: 176
Cook, Kimberly: 156
Cooper, Katie: 44
Cooper, Tamara: 12
Cope, Madeline: 106
Cormier, Bret: 106
Corra, Mamadi: 79, 188
Costanzo, Molly: 141
Costello, Matthew John: 125
Cotten, Shelia: 13
Cottom, Tressie McMillan: 112
Cox, Nancy: 106
Crane, Ashley: 65
Craven, Nena Sechler: 116
Crawford, Madison: 80
Crawley, S.L.: 33
Crider Robinson, Margaux: 10
Crofts, Ethan Elliot: 90
Crowell, Jacqueline Jeneanne: 22
Cuddy, Maximilian: 178
Culatta, Elizabeth: 49, 123
Cullum, Maria: 55
Cunningham, David: 140
Cutler, Lincoln: 4
da Silva, Taline Alonso: 130
Dalton, Caroline: 92
Daly, Sophia Lily: 63
Danielowski, Lauren Nicole: 183
Daniels, Colton: 158
Daniels, George: 135
Darko, Samuel: 52
Das, Dhruva: 159
DaSilva, Blane: 50
Davis, Andrew: 85, 186
Davis, Rachal: 123
Davis, Rachel E.: 171
Davis, Shannon N.: 75, 131
Davis, Tomeka: 7
De Coster, Stacy: 169
De Dea Januario, Luisa: 44
de Leon, Cedric: 178
Delgado, Daniel: 81
Dellinger Page, Amy: 101
Dempsey, Nick: 117, 170
Deschamps, Faith: 53, 66
Dhillon-Jamerson, Komal: 28, 104
Dhuman, Stephanie A.: 150
Diallo, Genab: 191
Dietert, Michelle: 63
Dillard Appel, Joy Anna: 191

Dippong, Joseph: 126
 Dixon, Angela: 182
 Dixon, Marc: 24
 Dogan, Imge: 114
 Dollar, Cindy Brooks : 49
 Dolliver, Matthew: 121
 Domingue, Simone: 133
 Dong, Ruohong: 6
 Donley, Amy: 32, 145
 Doucet, Adrien: 29
 Dougherty, Dakota: 107, 160
 Douglas, Deven: 185
 Douglas, Rachel: 25
 Dowd-Arrow, Benjamin: 88, 98, 158, 168
 Doyle, Joshua Franklin: 10
 Doyle, Myra: 196
 Drentea, Patricia: 149
 Ducre, Raven: 186
 Duncan, Kailyn: 55
 Durham, Simone Nicole: 64
 Durham, Simone Nicole: 64, 104
 Durr, Carvis: 119
 Durso, Kate: 155
 Earley, Etrice: 102
 East, Elizabeth: 89
 Eastman, Jason: 28, 172
 Ebert, Kim: 173
 Edmondson, Daisy Kathleen: 149
 Edwards-Capen, Theresa: 7
 Efou, Kokou: 32
 Eisworth, Myrissa: 23
 Eliason, Michele: 19
 Elliott, Christopher Shane: 87
 Ellison, Christopher: 88, 143, 158
 Embrick, David: 28, 99
 Emoruwa, Oluwaseun Temitope: 111, 118, 137
 Escue, Melanie: 86
 Esmail, Ashraf: 78, 85, 186
 Estes, Michelle L: 139
 Estrada, Emily: 173
 Everhart, Katherine: 9, 164
 Joseph Ewoodzie: 112
 Ezzell, Matthew: 92
 Fairfax, Fatima Glovena: 56, 187
 Fairley, Dominique Alisa: 104, 179
 Fani, Armina: 32
 Farinu, Oluyemi: 64
 Faris, Rebekah Woodard: 72
 Faulk, Stephen: 83
 Feltmate, David: 120, 141
 Ferguson, Annie Pendleton: 54
 Ferguson, Deirdre: 149
 Fernández-Romero, Rosario: 168
 Fields, Bonnie: 60
 Figgs, Victoria: 52
 Fitzpatrick, Liseli: 135
 Fleming, Olivia M. : 62
 Folse, Brandon: 74
 Foltz, Katelyn: 157
 Foote, Aaron Christin: 178
 Foote, Frances: 68
 Forbin, Annya: 49
 Ford, Jesse: 35
 Ford, Jordyn Arionna: 52
 Forney, Shalee: 60
 Fowler, Casey: 123
 France, Hollis: 53
 Francis, Robert: 195
 Franklin, Nino S.: 19
 Franklin, Sarah: 27, 28, 67
 Frederick, Helyne: 154
 Freeland, Robert: 82
 Freelin, Brittany Nicole: 184
 Friedman, Sarah: 2
 Fuentes, Melany: 6
 Fullwood, Je'Bria: 51
 Funderburk, Raven: 60
 Gaby, Sarah: 12, 31, 156, 182
 Gailey, Jeannine: 41
 Gallagher, Charles: 191
 Gallihar, Anngel: 164

Galloway, Catina: 196
 Gambs, Deborah: 170
 Garcia, Lisette: 95
 Gardner, Courtney Marcia: 105
 Garnsey, Al: 183
 Gay, Opal: 45, 80, 118
 Gerend, Mary: 80, 176
 Gerlach, Anna: 61
 Gharbi, Vannessa: 60
 Ghosh, Sayoni: 4
 Ghoshal, Raj: 56, 69
 Gibson, Noah: 176
 Gibson, Ryan: 136
 Gill, Duane: 96, 113, 133
 Gill, Timothy: 46
 Gillis, Alanna: 5
 Gilner, Khalia: 186
 Gitaliyev, Ülvi: 90
 Gitlitz, Sydney: 17
 Glauber, Rebecca: 42
 Godwin, Sandra: 46
 Góes, Juliana: 84
 Gold, Courtney: 151
 Goldfarb, Adam: 71
 Goldstein, Sara: 52
 Golio, AJ: 117
 Gollapudi, Shivani: 32
 Gomez, SimonPeter: 102
 Gonzalez, Alyson: 75
 Gonzalez, Alyssah Nicole: 176
 Gonzalez, Ashley: 16
 Gonzalez, Shannon: 156
 Gooden-Hunley, Lisa R.: 106
 Gordon, Jon: 25
 Gorodzeisky, Anastasia: 189
 Goss, Devon: 17
 Goswami, Uddipana: 177
 Graham, Cameron Taylor: 174
 Graham, Joseph: 4
 Grant, Jonathan: 57, 86
 Grau, Arantxa: 134
 Green, Sara: 155
 Gregory, Donald: 102
 Griffith, Candace: 51, 55
 Grimsley, Edwin: 74
 Groh, Sarah M.: 38
 Grube, Whitney: 52
 Guidroz, Kathleen: 186
 Gulick, Jayson Lee: 8
 Gullede, Erin: 52
 Gundlach, James: 111
 Gunnoe, Andrew: 46
 Hagerman, Margaret: 103
 Hahn, Erin: 161
 Hair, Bailey: 73
 Haji mirzaei, Golasa sadat: 130
 Haleigh, Rancatore: 153
 Hall, Kaitlyn Paige: 42
 Hall, Tae: 25
 Hamilton, Kate: 96, 113
 Hamm, Lindsay: 47
 Hanks, Roma: 74
 Hansard, Stephanie Molinda: 125
 Hansen, Jacqueline Aucoin: 52
 Hanson, Kenneth R.: 181
 Harris, Jaime: 148
 Harrison, Anthony Kwame: 108, 184
 Harrison, Jill Ann: 117
 Hartley, Alma: 174
 Hartman, Harrison: 146
 Harvey Wingfield, Adia: 69
 Harvey, Lauren Michelle: 157
 Hasenour, Kiersten: 126
 Hawdon, James: 125, 140, 185
 Hawks, Kate: 136
 Hay, Kathryn Allred: 59
 Hayes, Endia: 76
 Hayes, Whitney: 96
 Headley, Vernon T: 190
 Heath, Courtney: 8
 Hegtvedt, Karen: 136
 Henderson, Loren: 98

Henricks, Kasey: 159
 Hernandez-Ramos, Jaqueline: 37
 Hernandez, Nathan Gabriel: 52
 Hernandez, Terri: 102
 Herndon, Mikayla: 88
 Hess, Amie: 44, 179
 Hessler, Matt: 24
 Hicks, Madisyn: 186
 Hill, A-jah Monique: 149
 Hill, Terrence: 88, 98, 143, 158
 Hinson, Esther: 188
 Hinz, Thomas: 189
 Ho, Anne: 136
 Hoefler, Karen: 137, 152
 Holden, Beth: 153
 Holleman, Anna Lawrence: 9
 Hollingshead, Ashley: 76
 Hollis, Nicholas: 42
 Holmes, Brooke: 12
 Holmes, Tisha: 32, 142
 Horton, Hayward Derrick: 16
 Horton, Hayward: 98
 Horvath, Maryn: 44
 Hossfeld, Leslie: 40
 House-Niamke, Stephanie: 66
 Houser, Zara: 154
 Howard, Markesia: 114
 Hoyt, Kirsten: 61
 Hu, Anqi : 103, 177
 Hudson, Kenneth: 26
 Hughes, Marion: 100, 148
 Hughes, Michael: 129
 Hunt, Whitney Erin: 99
 Hunter, Joanna: 78
 Hurst, K.B.: 91
 Husain, Jonelle: 101
 Hyunjin Kim, Veda: 66
 Ibanez, Lindsey: 46
 Imlay, Aimee Elizabeth: 62, 165
 Irizarry, Yasmiyn: 89, 99
 Isaac, Larry: 186
 Isom, Deena A.: 67
 Iverson, Sarah: 56
 Jackson, Monisha: 34, 53, 64, 66, 84, 97
 Jacobs, Hannah Corey: 189
 Jaffee, David: 76, 163
 Jahlul, Noor: 72, 146
 Jaiyeola, Joseph Adedayo: 7
 Jamerson, Trevor: 71
 James, Tierra: 121
 James, Wesley: 7, 128
 Jan, Faika Tahir: 52
 Jannat, Semonti: 90
 Jason, Kendra: 4
 Jenkins, SE: 155
 Jeong, Yoon Jung: 23
 Jillani, Zara: 126
 Johns, Michelle: 198
 Johnson Austin, Sandra: 52
 Johnson, Cathryn: 136
 Johnson, Jennifer: 92
 Johnson, Katherine: 183
 Johnson, Katherine: 103
 Johnson, Kecia: 88
 Johnson, Melencia: 196
 Johnson, Veijah: 85
 Johnston, Erin: 9
 Jones, Annie Mae: 94
 Jones, Antwan: 79, 160
 Jones, Erielle: 134
 Jones, Kaley: 184
 Joseph, Keisha: 16
 Juge, Gavin: 83
 Julian, Maria: 8
 Kaakinen, Markus: 185
 Kadosh, Oren: 24
 Kahanek, Kristen: 171
 Kanopka, Klint: 6
 Karaaslan, Fadime Gokce: 80
 Karatasli, Sahan Savas: 174
 Karki, Srijana: 159
 Katz, Meredith: 120

Kaufman, Gayle: 61, 73, 112, 166
 Kawaguchi, Riku: 123
 Kawashima, Tenshi: 61
 Keener, Steven Tucker: 123, 135, 169
 Kelley, Margaret: 158
 Kelly, Kimberly: 11, 83, 163
 Kendra, James: 96
 Kendrick, Frances: 60
 Khalilian, Mohammad: 108, 192
 Khan, Qurat: 12
 Khan, Tarikat: 39
 Kilburn, John C.: 13
 Kim, Conrad: 87
 Kim, Joong Won: 139
 Kim, Joong Won: 191
 Kincaid, Reilly: 61
 King, Colby: 170, 195
 Kington, Sarah: 193
 Kinney, Alexander: 85
 Kirkpatrick, Sharla: 16
 Kiss, Marissa: 181
 Kitchen, Deeb: 31, 101
 Knigge, Pia: 120
 Knop, Katie: 37, 65
 Knox, David: 111, 149
 Knuckey, Jonathan: 120
 Knudsen, Hannah: 80
 Knudsen, Paige: 6
 Knudson, Paul: 145
 Koch, Shelley: 142
 Kojola, Erik: 24
 Kolb, Abigail: 36
 Kolb, Ken: 175
 Kolbila, Robert: 99, 172
 Koontz, Amanda: 43
 Kostelic, Amy: 192
 Kowalsky, Rachel H.: 191
 Koziol, Morgan: 42
 Kozlowski, Karen Phelan: 75
 Krause, Robert: 108
 Kroll-Smith, Steve: 133
 Kronberg, Anne-Kathrin: 61
 Kroska, Amy: 126
 Kulkarni, Veena: 73, 124, 188
 Kumral, Sefika: 174
 Kuperberg, Arielle: 144
 Kurdyla, Victoria: 58, 123
 Kusujiarti, Siti: 10
 Kwak, H. Deborah: 75
 Labuhn, Lauren Nicole: 193
 Lackey, Dresden: 45, 52
 Lagos, Danya: 198
 Lalor, Sage: 50
 Lampe, Nik: 47
 Lane, Tonisha B.: 52
 Lang, David: 6
 Lang, K. Brandon: 3
 Langdon, Jennifer: 100
 Lariscy, Joseph T: 70, 158
 Larrison, KayLynn: 56
 Lascola, Valerie: 149
 LaVigne, Danny Lorraine: 63
 Lawrence, Elizabeth: 158
 Lawson, R. : 136
 Le, Andrew: 2
 Le, Thuy Tram Nguyen: 124
 Leap, Braden: 83, 121
 Lee, Anna: 16
 Lee, Jiyoung: 23
 Leffert, Caroline: 173
 Lehman, Brett: 179
 Lemphere, Jenna: 196
 Leon-Corwin, Maggie: 96
 Leon-Perez, Gabriela: 57
 Leonhardt, Josie Clair: 121
 Lepadatu, Darina: 161
 Leppard, Tom: 190
 Leu, Katherine: 2
 Lewis, Briana: 149
 Lewis, Jayla: 110
 Lewis, Michael Parker: 192
 Li, Yao: 12

Li, Yingru: 119
 Liao, Wenjie: 173
 Liddell, Jessica: 183
 Liebreich, Hannah: 148
 Liggins, Marissa: 67
 Lillis, John: 1
 Lindl, Hannah M: 38
 Lippard, Cameron: 147
 Littlefield, Marci: 170
 Livermore, Michelle: 32
 Lloyd, Abigail Grace: 111
 Loblack, Angelica Celeste: 104
 Locatelli, Chloé: 181
 Londono, Estefany: 152
 Long, Krysten: 167
 Long, Michael: 113
 Longest, Landen Gambill: 74
 Longo, Gina Marie: 151
 Lopez, Nancy: 89, 99
 Loran, Rifat Jahan: 189
 Lorenzo, Elise Michelle: 89
 Loseke, Donileen: 155
 Louie, Patricia: 143
 Lovetro, Robyn: 150
 Lowe, Maria R.: 191
 Lowe, Ricardo Henrique: 89, 99
 Lowe, Serena: 60
 Ludt, Sophia Abigail: 146
 Luo, Ye: 40
 Lynn, Kevin: 140
 MacDonald, Jessica: 4
 Maher, Kristy: 161
 Mahfouz, Amina Mahmoud: 144
 Mahony, Helen: 80, 176
 Maldonado, Marta M.: 17
 Malisa, Mark: 130
 Malone, Danny: 35, 148
 Maloney, Em: 82
 Manning, Alex: 103
 Marchia, Joseph Michael: 49
 Mariella-Walrond, Helena: 52
 Marina, Peter: 180
 Markham, Madison: 92
 Markle, Gail: 107
 Marson, Stephen: 1
 Martí, Gerardo: 37
 Martin, Andrew William: 24
 Martin, Lori: 194
 Martinez, Leonela: 121
 Marxer, Malea: 193
 Mason, Sara: 180
 Mathers, Lain: 105
 Mathews, Adrienne: 120
 Mathis, Rondrea: 114
 Matragrano, Christine: 180
 Matthews, Matt: 29
 Matthews, Rosemary: 29
 Maxfield, Carson: 98, 191
 Maynor, Yuki Proulx: 39
 McArthur, Vickie: 52
 McBride, Madison Fain: 85
 McCabe, Janice: 192
 McCandless-Chapman, Otis: 72, 141
 McCarthy, John D.: 24
 mccarty, Jessica: 17
 McClarty, Alexandria Raven: 119, 145
 McClure, Stephanie: 77, 187
 McDaniel, Michallene: 180
 McDermott, Joshua: 175
 McDonald, Courtney: 47, 148
 McDonald, Maretta: 162
 McDonald, Maretta: 128, 141, 194
 McDonald, Steve: 190
 McDonnell, Erin: 93
 McDonnell, Terence E.: 11
 McDowell, Amy: 91
 Mcfarland, Danielle: 80
 McGee, Hailey: 91
 McGhee, Annie: 43
 McGlynn-Wright, Annie: 177
 McGregor, Savannah: 80, 176
 McKay, Timothy: 2

McLean, Brady: 8
 McLeese, Michelle: 102
 McMahan, Hayley V.: 149
 McMains-Nurisio, Morgan: 121
 McManus, Lisa: 4
 McManus, Patricia: 138
 McMillan, Cassie: 184
 McMillian Jenkins, Michaela: 93
 McNeese, Heath: 144
 Medwinter, Sancha: 34, 53, 66, 84, 97
 Melvin, Jennifer: 65
 Membrez-Weiler, Nicholas: 36
 Menardi, Emma Josephine: 58
 Mendez, Jaqueline: 119
 Meng, Shuo: 73, 160
 Merry, Joseph: 18
 Mewborn, Marina: 83
 Michelle Bradham-Cousar, Yolanda: 52
 Mikell, Toniqua: 67
 Miles, Brittney: 41
 Miles, Corey Javon: 74, 128, 162, 194
 Miles, Leroy: 80
 Miller, Anna: 7
 Miller, Brennan James: 52
 Miller, DeMond: 110, 133
 Miller, Gabe H: 38, 118
 Miller, Kirk: 12
 Miller, Lisa: 91, 105
 Miller, Mark: 52
 Miller, Morgan: 90
 Milne, Mia Rosario: 40
 Min, Hosik: 74
 Mischke, Kelsey: 9
 Mitzen, Levi Fanuc: 185
 Mix, Tamara: 43, 62
 Mize, Trenton D.: 61
 Mobley, Catherine: 27, 40
 Moeder, Jessica: 134
 Moga, Daniela: 59
 Moloney, Mairead: 59
 Monico, Carmen: 16
 Montalva Barba, Miguel : 115
 Montanez, Julio Richard: 32
 Montufar, Shania: 25, 88, 89, 99
 Moody, Myles: 137
 Moore, Christa Jane: 164
 Moore, Lacey Byram: 169
 Moos, Ryann: 124
 Moosnick, Nora: 22
 Morales Quintero, Roberto Carlos: 52
 Morris, Katie: 15
 Morrison, Audrey: 123
 Morrison, Daniel: 30, 140, 165
 Mowery, Christine: 63
 Moye, Richard: 16
 Mthethwa, Dingani: 70
 Muhammad, Nafeesa: 135
 Muñoz,, José: 195
 Murphy, Demetrius Miles: 162
 Murphy, Kendra: 77
 Murray, Casandra: 12
 Murray, Greg: 88
 Mustaine, Elizabeth Ehrhardt: 80
 Nash, Bradley: 26
 Neff, Olivia: 176
 Nelson, Sierra: 102
 Nestor, Payton: 1, 111
 Newton, Veronica: 64
 Nichols, Lucy: 134
 Nishan, Noor: 111
 Norman, Cayden Brooke: 32
 O'Brien, Eileen: 54
 O'Connell, Heather A.: 23, 140, 156
 O'Connell, Whitney Elizabeth: 6
 Oakes, Erin: 2, 59
 Obach, Brian: 68
 Ocasio, Samuel: 16
 Ochada, Maryjean: 60
 Odedoyin, Titilayo: 3
 Ogbe, Iye: 177
 Ogundoro, Oluwafisayo Semire: 160
 Oh, Hyunsu: 16

Ojeh, Kalasia Shqueen: 35
Okuwobi, Oneya: 155
Oliveira-Velez, Raquel: 123
Olmos, Katheryn: 80
Olson, Lisa: 55
Orak, Ugur: 123
Ortiz, Ruben: 159
Oser, Carrie: 80
Otto, Bobby Jo: 15
Oware, Matthew: 69
Owens, Kennedy: 60
Owens, Shaylyn: 186
Ozoemenam, Eucharia: 186
Painia, Brianne Alexandra: 172
Pal, Arijita: 18
Palmer, Eliana: 44
Pandian, Roshan: 143
Parisot, James: 174
Parker, Kimberly: 150
Parker, Sharon: 16, 154
Parrotta, Kylie: 131
Parrotta, Kylie: 30, 95
Parsons, Ryan: 90, 142
Parsons, Tiffany Aaron: 36
PATHANIA, GAURAV: 120
Patrick, Amanda: 51
Patrick, Anne McNutt: 6, 21
Patterson, Brianna Leigh: 19
Patterson, Nile DeGray: 17
Pearce, Jessica: 171
Pearce, Susan: 175
Pedigo, Emily: 121
Peebles, Ciara: 100
Peoples, Crystal: 6
Perdue, Robert T.: 55
Peritore, Nicole: 51
Perkins, Elizabeth: 149
Perkins, Robert K.: 50, 106
Peters, Aven N: 168
Petersen, Camille: 115
Peterson, Gretchen: 36
Petsch, Ameya: 161
Petts, Richard: 61
Pfaffendorf, Jessica: 85
Pfeiffer, Sam: 150
PHAM, Benjamin, Vu: 9
Philbrook, Lily: 12
Pickens, Julie: 92
Pitt, Richard N: 37
Plotkin, Andy: 14, 109
Popolla, Mariella: 134
Powers, Rebecca S.: 32
Prohaska, Ariane: 41
Pryor, Douglas: 100
Puckett, Alexandra: 111, 149
Purser, Christopher: 7
Purser, Gretchen: 127
Pyatt, Calvin: 158
Qian, Yue: 42
Quebedeaux, C.L.: 114
Quinn, Joseph M: 82
Rackin, Heather: 39
Rader, Nicole: 1
Rafail, Patrick: 24
Ragsdale, Kathleen: 99
Rahilly, Elizabeth: 8
Rahman, Samira: 70
Raijman, Rebeca: 189
Rainock, Meagan: 178
Ralston, Margaret: 1, 13, 30, 88, 165
Ramirez Surmeier, Ladanya: 1, 32, 80, 111, 142, 176
Ramirez, Ignacio Luis: 20
Räsänen, Pekka: 185
Rashid, Md. Abdur: 142
Rashid, Tamanna: 84
Ratcliff, Shawn: 122
Ray, Rashawn: 54
Read-Wahidi, Mary: 99
Reardon, Claire: 192
Redding, Carly: 180
Reed, Daryl: 36

Reese, Brigit Suzanne: 26, 191
 Reichelmann, Ashley: 125, 140, 156
 Reiter, Abigail Burris: 167
 Renzi, Katie: 76
 Reyes, Sierra: 97
 Rich, Meghan: 117
 Richter, Lauren: 115
 Riegler, Sam: 155
 Riera, Kate: 52
 Riley, Halley: 32, 47
 Rinalducci, Ned: 71
 Risman, Barbara: 48, 134
 Ritchie, Liesel: 83, 96, 113, 133
 Ritter, Lacey: 111, 149
 Roach, Teresa: 1, 111
 Roberts, Elizabeth: 177, 191
 Roberts, Elizabeth B.: 21
 Roberts, John Ray: 21
 Robertson, Ray Von: 197
 Robinson-Smith, Jazmin: 194
 Robinson, Chris: 109
 Robinson, Dawn T: 82
 Robinson, Jimmy Austin: 22
 Rockwell, Ashley: 47
 Rockwell, Ashley: 32
 Rodriguez, Daniela: 150
 Rodriguez, Lisa: 94, 96
 Rogers, Kimberly: 82
 Rogers, Sarah: 27, 45
 Rondini, Ashley C.: 191
 Roos, Jason Micah: 129
 Roschelle, Anne R.: 163
 Roscigno, Vincent: 195
 Rose, Daniel: 16
 Rosino, Michael: 27
 Roso, Joseph Charles: 93
 Routh, Megan Lyn: 126
 Rozario, Tannuja Devi: 34
 Rozario, Tannuja Devi: 34, 53, 66, 84, 97, 158
 ryman, sal: 118
 Saiffudin, Muhammad: 83
 Sajeev, Kavya: 20
 Salinas, Juan: 57
 Sallah, Isatou Grace: 139
 Salter, Corrine: 156
 Sanchez Ramirez, Patricia: 119
 Sanchez, Lucia: 52
 Sanchez, Olivia: 37
 Sanders, Raynard: 186
 Sargent, Samantha: 164
 Sarker, Ananya: 138
 Sasser, Brett: 123
 Satcher, Lacey: 137
 Sbai, Firdaous: 12
 Scaptura, Maria N.: 171
 Schilt, Kristen: 198
 Schoenberg, Nancy: 59
 Schrock, Doug: 172
 Schueths, April: 92
 Schwabe, Anette: 32, 142
 Schwarz, Corinne: 30, 92
 Schweitzer, Julie: 43
 Scimecca, Joseph A.: 109
 Scruggs, Augusta R: 80
 Seethaler, Ina: 136
 Segura, Samantha: 116
 Selke, Daulton Joseph: 71
 Semyonov, Moshe: 189
 Sethi, Shagun: 122
 Settembrino, Marc: 29, 150
 Shah, Rutwa: 149
 Shaiman, Sophia: 20
 Shams, Alzaina: 139
 Shay, Heather: 108
 Shea, Brent: 30, 179, 196
 Shefner, Jon: 89
 Shelton, Erika: 4
 Shen, Ziding: 42
 Sherman, Arnold: 14, 109
 Short, Megan Taylor: 20
 Shrestha, Kamala: 130
 Shrock, Peter: 148

Shtob, Daniel: 74
Sickels, Mike: 148, 165
Signorelli, Jordan Michelle: 111, 149
Sikirica, Amanda: 62
Simmons, Amelia F.: 100
Simon, Jennifer: 191
Simoni, Zach: 1
Simpers, Kirsten: 52
Sims, Jennifer: 194
Singh-Gray, Danielle: 135
Singh-Gray, Danielle: 135
Siyun, Peng: 80
Skipper, Antonius: 16
Slack, Tim: 18
Smedley, Autumn (Artie): 29
Smiley, Kevin: 62, 83, 96, 113, 133
Smith-Lovin, Lynn: 82
Smith, Alexander Lee: 111
Smith, Alyssa: 168
Smith, Charity: 164
Smith, Katrina: 102
Smith, Kylie Maria: 157
Smithey, Martha: 20, 55
Sola, Justin Lucas: 43
Soyarslan, Sanem: 192
Spurgas, Alyson: 155
Sriram, Uma: 149
Stainback, Kevin: 69, 122
Stalp, Marybeth: 47, 83
Stargel, Bec: 19
Stargell, Nicole: 58
Starker Glass, Tehia: 4
Staton, Michele: 80
Steel, Simranjit: 37
Steidl, Christina: 13, 122
Steinborn, Natalie: 108
Stephens, Michael Lee: 44
Stewart, Jade Sydney Xiaoyin: 90
Stone Jr., Anthony Jerome: 77, 128, 139, 162
Stone, Amy L.: 91, 107
Straub, Adam Michael: 83, 96, 113, 133
Streed, Carl: 19
Stroope, Samuel: 70
Stubbs-Richardson, Megan Suzanne: 102
Suchocki, Maitreya: 10
Suggs, Tia: 78, 85, 186
Suhel, Golam Morshed: 32
Sullivan, Allison: 139
Sumerau, J.E.: 45, 65, 105
Summerlin, Laura: 152
Sumner, Nat: 32
Sun, Chyng: 92
Sutphin, Felix: 86
Sweeney, Megan Paige: 149
Swendener, Alexis: 155
Swygart-Hobaugh, Mandy: 32, 47
Talbert, Ryan: 20
Talbot, Sloan: 93, 119
Taliaferro, Lindsay: 19, 105
Tanabe, Megumi: 114
Tanir, Canan: 172
Tao, Yu: 6, 171
Tauches, Kim: 72
Taylor, Miles: 1, 111, 158
Taylor, Robert: 137
Taylor, William (Bill): 77
Teixeira-Poit, Stephanie: 13, 16, 60
Temko, Ezra: 122
Tepper, Neil: 83
Thakkar, Shriya: 16
Thapa, Kalasiddhi: 111
Theis, Nicholas: 74
Thiel, Susan: 192
Thomas, Alex Lien: 39
Thomas, Angela: 118
Thomas, James M.: 2, 28, 59, 128
Thomas, Melvin: 98
Thomas, Rajah Lynn: 32
Thompson, Michael: 138
Thompson, Victoria Isabelle: 159
Thomson, Emily Hope: 190
Thomson, Piper Noyes: 11

Thomson, Robert: 67
 Thornton, Rachel Elizabeth: 169
 Thorpe, Charles: 14
 Tierney, Kathleen: 133
 Tillson, Martha: 80
 Toman, Lindsay Anne: 38
 Toney, Kierra Nicole: 77, 128, 144
 Topalidis, Yiorgo: 69
 Tope, Daniel: 98
 Toussaint, Jeff: 27
 Towns, Tangela: 16
 Triplett, Jennifer: 129
 Truong-Vu, Kim-Phuong: 154
 Tul Kubra, Khadiza: 90, 142
 Tumin, Dmitry: 165
 Tun, Lily: 114
 Turgeon, Brianna: 81, 121
 Turiczek, Nat: 149
 Turner, Jeff: 187
 Turner, Kieran: 40
 Uecker, Jeremy: 98
 Underwood, Jasmine: 173
 Upenieks, Laura: 143
 Valdez, Aaliyah Kristina: 52
 Vancil-Leap, Ashley: 47, 65
 Vanderminden, Jennifer: 65
 Varela, Gabriel: 152
 Vargas, Edward: 89, 99
 Vargas, Tracy Lynn: 52, 159
 Vaseiezadeh, Nasim S.: 114, 136
 Vega, Mary Ann: 134
 Velez, Danielle: 32, 142
 Venable, Marcus: 143
 Vera, Nadya M: 180
 Veras, Edlin: 77
 Verdin-Gomez, Luis: 32
 Vergara, Angela: 94, 183
 Via, Emily: 105, 134
 Vicars, Ariel: 121
 Vick, KC: 10
 Vidmar, Chris: 71
 Vina, Matthew: 153
 Viscarra, Eryn Grucza: 131
 Visconti, Victoria: 155
 Vos, Matt: 109
 Vowels, Ashley Lynn: 124
 Wade, Jeannette Marie: 81, 154
 Waity, Julia: 65, 83
 Walden, Hannah: 114
 Walker, Abraham Jacob: 106
 Walker, Alicia: 106, 144
 Walker, Anna: 83
 Walker, Christopher Brent: 145
 Walker, Lisa Slattery: 82
 Wallace, Dallis Leno: 181
 Walter, Jess Rose: 149
 Wang, Jiawen: 106
 Wang, Kaiyan: 52
 Wanjoya, Mary: 51
 Ward, Geoff: 140
 Ward, Matthew: 67
 Wardius, Amalia Ruth: 146
 Warner, David: 143
 Warner, Reagan Eileen: 116
 Warner, Tara D: 143
 Warren, Kamryn Danielle: 150
 Watts, Meghan: 3
 Weil, Frederick: 94
 Wellons, Madelynn: 152
 Wells, Storm: 113
 Weng, Kevin: 143
 Werum, Regina: 122
 Whesu, John: 60
 White, William: 161
 Whiteside, Jasmine: 165, 195
 Whitlinger, Claire: 140
 Whitmeyer, Joseph: 79
 Whorton, Katina: 78
 Wienke, Christopher Martin: 18
 Wiest, Julie B.: 193
 Wilkerson, Anna: 5
 Wilkinson, Matthew: 136

Will, Jeffrey: 89
Willcockson, Katherine: 124
Williams, Courtney: 154
Williams, Heidi: 41
Williams, Johnny E.: 99
Williams, Micah: 83
Wilson, James: 182
Wilson, Fletcher Nicholas: 44
Wilson, Merci: 60
Wilson, Olivia: 85
Wimberley, Dale: 68, 163
Wingfield, Zy'Ever: 164
Witte, James: 181
Wolfe, Atticus: 19
Wolfe, Brandon: 4
Woo, Juhee: 184
Woodard, Tracey: 47
Woodell, Brandi: 91
Woodward, Andrea: 90
Wright II, Earl: 35
Wright, Arnise Nevaeh: 52
Wroten, Elizabeth : 52, 101
Wu, Huixuan: 12
Wu, JiaYi: 111
Yang, Xiaoxu: 94, 102
Yared, Unna Marie: 69
Yavorsky, Jill Evelyn: 42
Yevuyibor, Teye: 62
Young, Carly Danielle: 183
Zabala, Pamela: 57
Zack, Lizabeth: 113
Zamantakis, Alithia: 45
Zdrojewski, Nicole Yvonne: 26
Zeller, David Russell: 4
Zgimbau, Anamaria Teodora: 124
Zhou, Keya: 73
Zhou, Keyu: 21
Zito, Rena: 169
Zou, Xinying: 70

Maps

First Floor

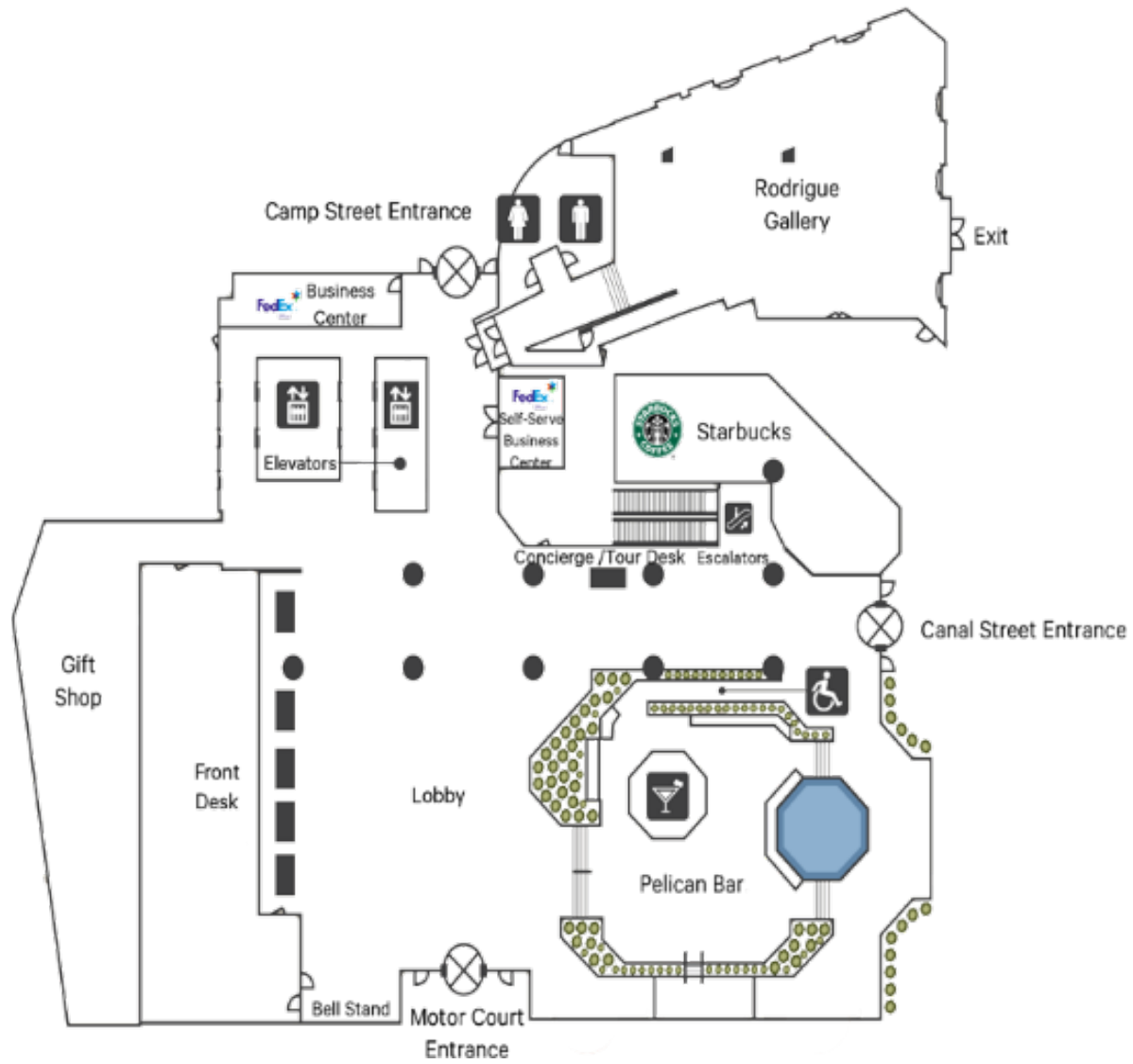

Third Floor

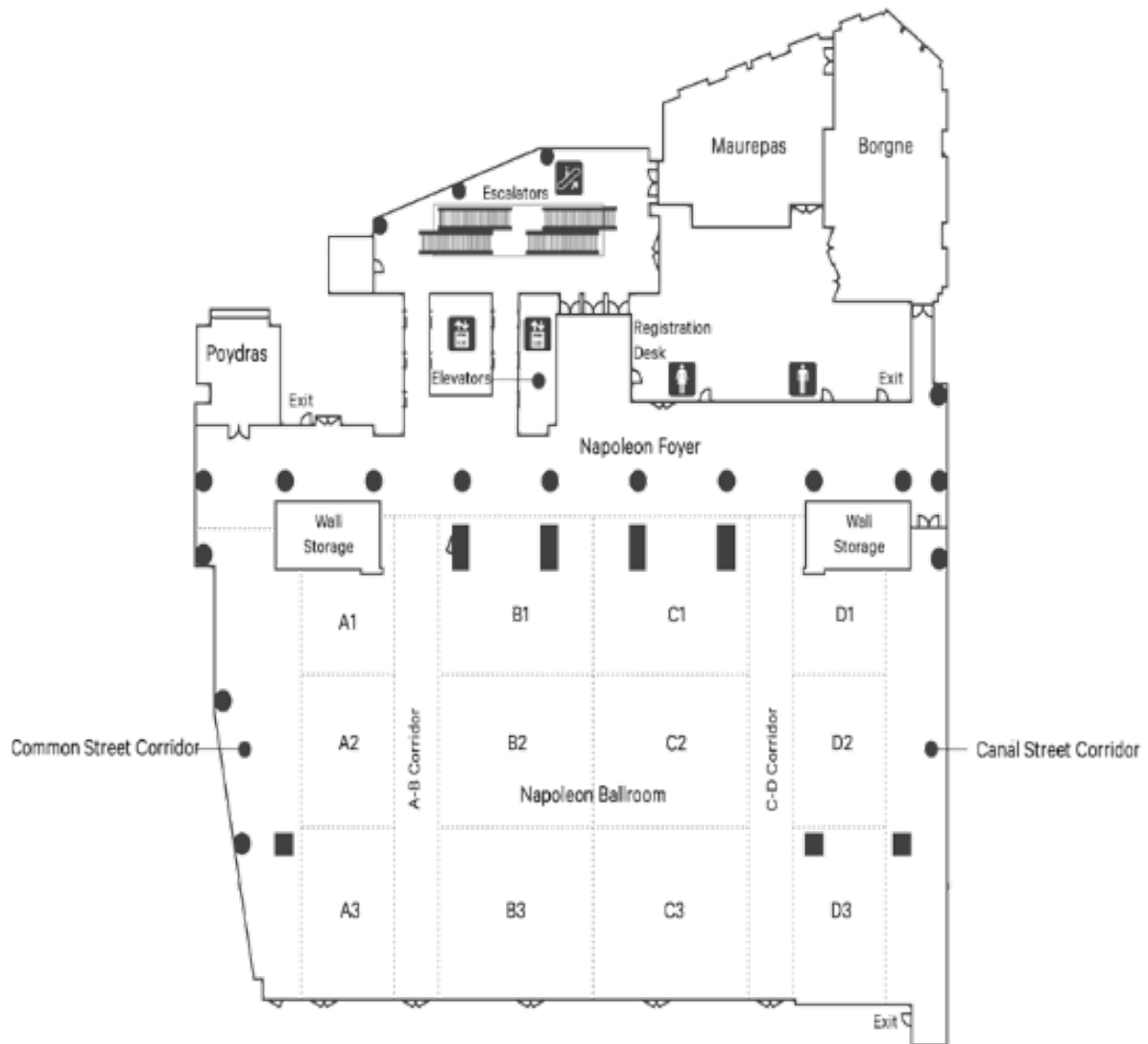

Fourth Floor

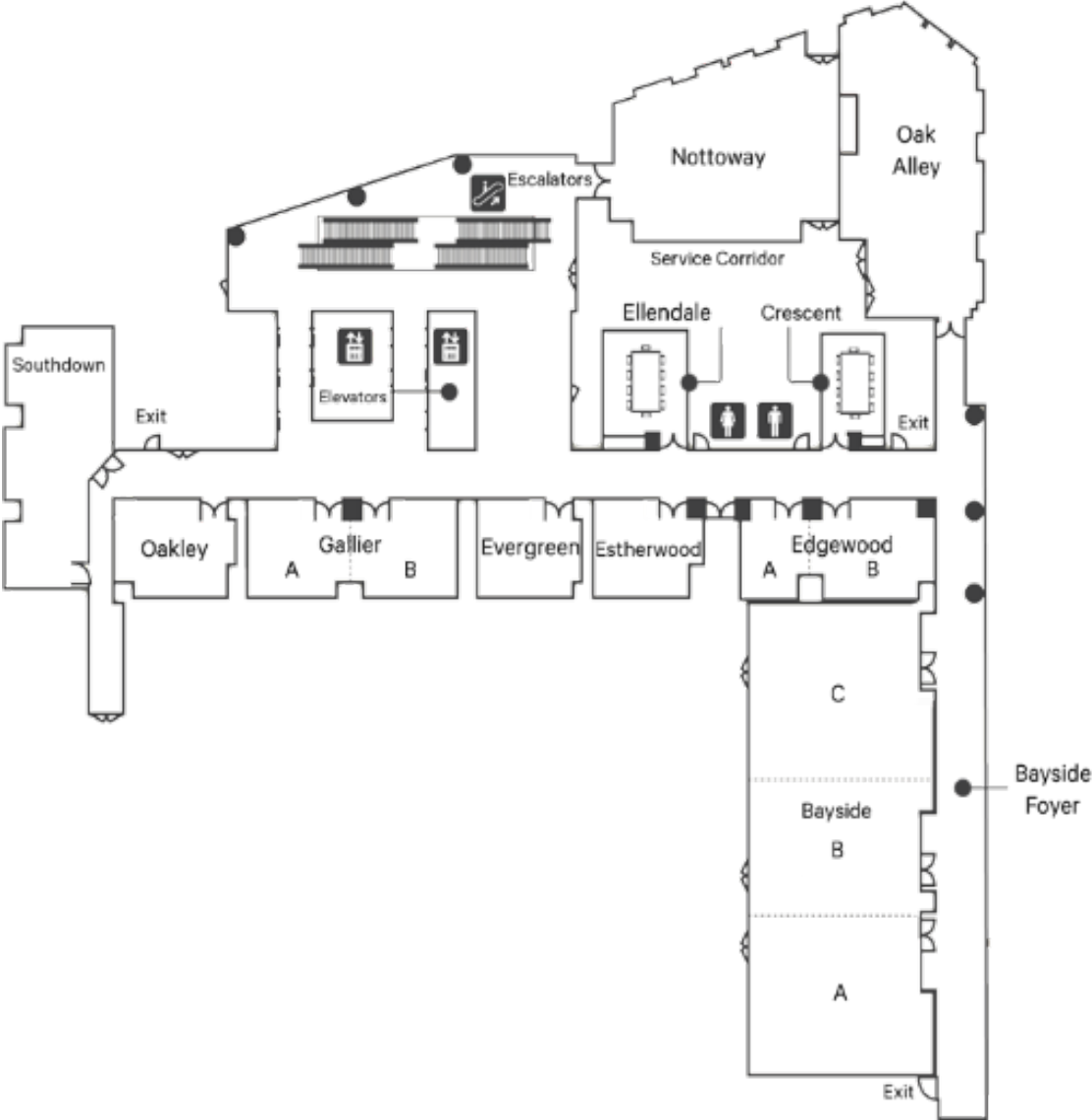

SSS 2024 Exhibit and Registration Area Layout
(3rd Floor, Napoleon Foyer, Sheraton New Orleans)

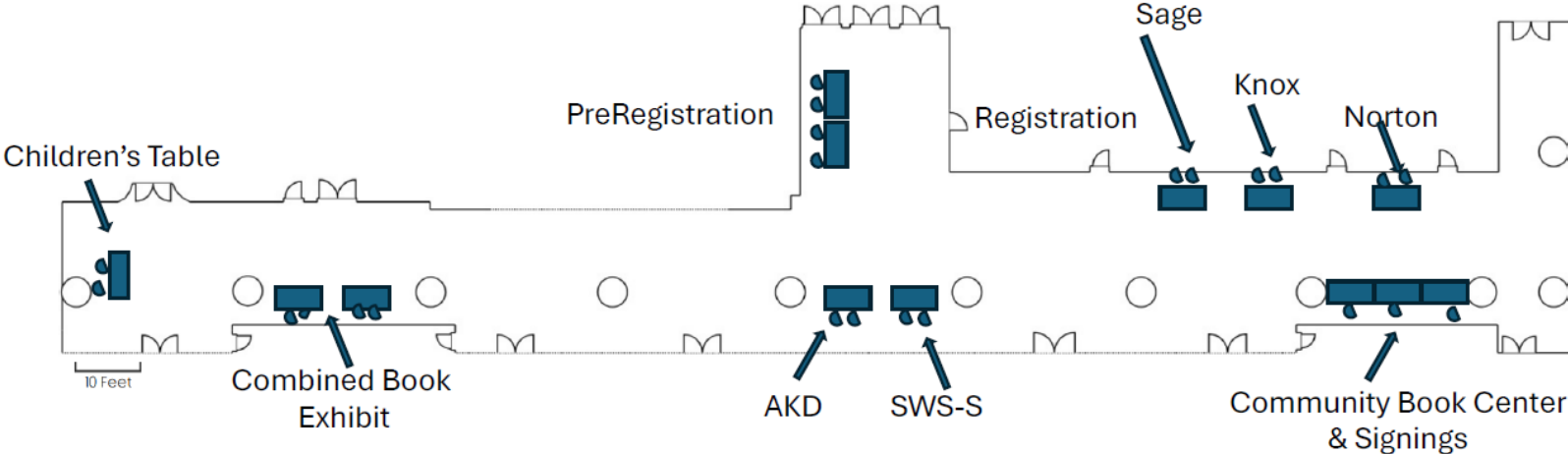

Coffee and Tea Station will also be in Napoleon Foyer!