

MilesTek

Military | Aerospace | Communications | Industrial

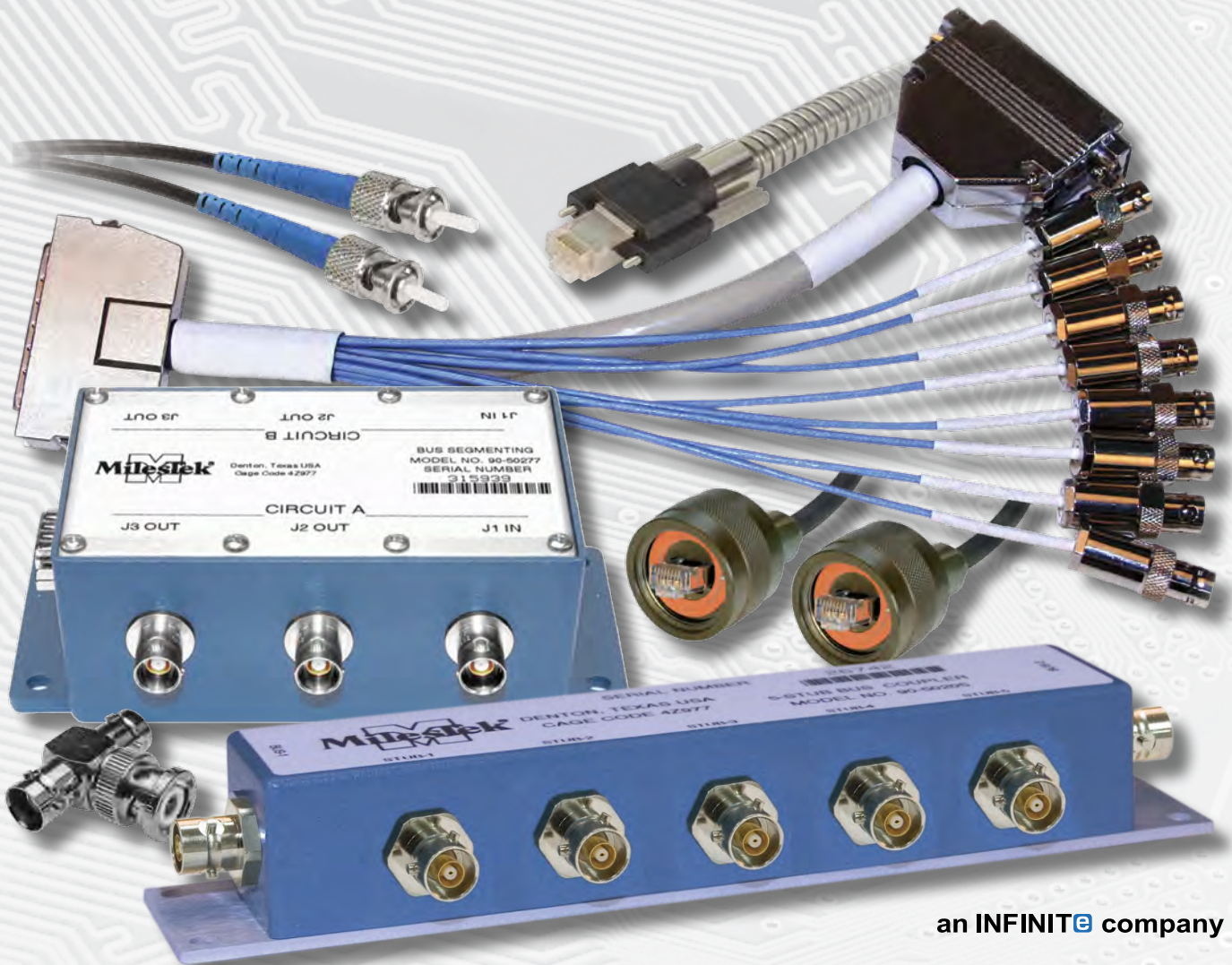

an INFINIT[®] company

Your Military & Aerospace Interconnect Specialists

Since 1981, MilesTek customers have come to expect more than just products- they expect answers & support that will help them solve all their installation or project questions.

With quick turnaround and same-day shipping for most of the high reliability products we carry, you can rely on MilesTek to help meet your project deadlines.

Markets We Serve:

- Commercial & Military Avionics
- Broadcast & DS3/Telecom
- Military and Industrial Networking
- Aerospace Communications

MilesTek Advantages:

- Large In-Stock Inventories
- Same-Day Shipping
- Prototype Development
- CAD Design Capabilities
- Multiple Testing Solutions
- Expert Technical Support
- AS9100 Certified
- ISO 9001:2008 Registered

From high-volume production, to low-volume customized products, MilesTek is your source for military, aerospace, communications and industrial interconnect solutions.



Stocking over 10,000 Products Covering a Wide Breadth of Connectivity Needs:

- Coaxial Cable Assemblies and Harnesses
- Military Avionics/ MIL-STD-1553B
- Bulk Cable by the Foot
- Custom Cable Assemblies, Panel Assemblies & Tools
- Twinaxial
- Triaxial
- LSZH Assemblies
- Data Bus Couplers
- Connectors, Adapters & Terminators
- Switching Devices
- Rugged Ethernet, USB and Fiber Assemblies



Technical Expertise • Customer Service • Unbeatable Value

For Expert Customer Service Call 866-524-1553 • MilesTek.com

TABLE OF CONTENTS

4 - 25 MIL-STD-1553B

- Data Bus Couplers - Box Style • Data Bus Couplers - Inline • Relay Devices
- Data Bus Coupler Kits • Bus/Scope Test Cable Assemblies • 78 Ohm Twinax Bulk Cable Specs • 78 Ohm Twinax Cable Assemblies • TRB Terminators & RFI Dust Caps • TRB Connectors • TRB Adapters • Crimp Tools & Cable Splicing

NEW PRODUCTS ADDED

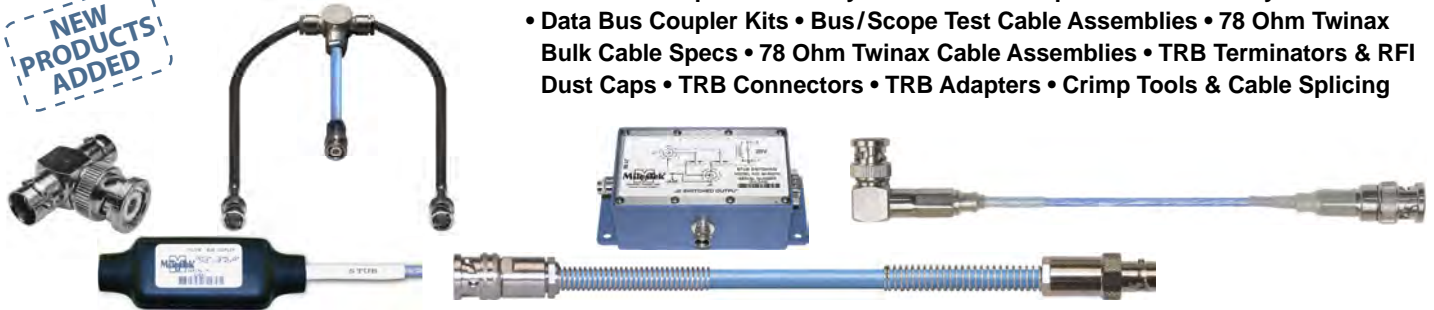

26 - 28 SUBMINIATURE

- TRS Data Bus Couplers - Box Style • TRS 78 Ohm Twinax Cable Assemblies
- TRS Subminiature Size Connectors • TRS Crimp Tools and Compatibility Information



29 - 32 TWINAXIAL

- 100 Ohm Twinax Bulk Cable Specs • 100 Ohm Twinax Cable Assemblies • 100 Ohm Bus Terminators • 100 Ohm Twinax Connectors • 124 Ohm Twinax Bulk Cable Specs • 124 Ohm Twinax Cable Assemblies • 124 Ohm Twinax Connectors

NEW PRODUCTS ADDED



34 - 38 TRIAXIAL

- Bulk Cable Specs - 50 & 75 Ohm Triax • 50 Ohm Triax Cable Assemblies
- 50 Ohm Triax Connectors • 75 Ohm Triax Cable Assemblies
- 75 Ohm Triax Connectors

NEW PRODUCTS ADDED



39 D-SUB

- Low Smoke Zero Halogen (LSZH) Cable Assemblies • DB9 - DB25 Male to Female Connectors

NEW PRODUCT OFFERING



TABLE OF CONTENTS

ETHERNET 40 - 41

- Low Smoke Zero Halogen (LSZH) Assemblies • Category Rated Keystone and Flange Mount Couplers • Industrial Ethernet M12 Assemblies • Industrial GigE Assemblies • IP67 Dual Use Outdoor Ethernet Assemblies • IP68 Ruggedized MIL RJ45 Assemblies and Components



USB 42

- 2.0 USB • 2.0 USB Waterproof Harsh Environment • 3.0 USB • 3.0 USB Industrial Harsh Environment • LSZH USB Cables • Waterproof USB



SCSI / IEEE-488 GPIB 43

- Low Smoke Zero Halogen (LSZH) Assemblies • Ultra SCSI Cable Assemblies • Premium IEEE-488 Cable Assemblies • Deluxe IEEE-488 Cable Assemblies



AUDIO/VIDEO 44 - 45

- High Speed HDMI Cable Assemblies • Premium DVI to HDMI • Mini HDMI • Deluxe DVI-D with Ferrites • LSZH Angled Cable Assemblies

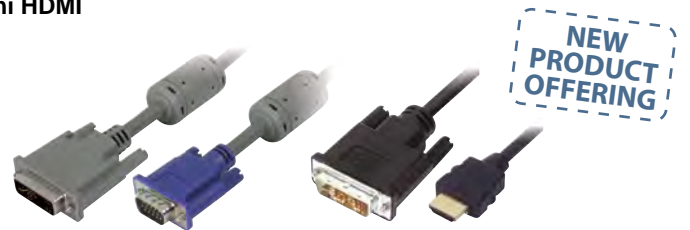

FIBER OPTIC 46 - 47

- Military Cable Assemblies • Multimode IP67 Cable Assemblies • Single mode IP67 Cable Assemblies • IP67 Connectors • Ruggedized IP68 Connectors and Receptacles



PATCH PANELS 48 - 55

- Ethernet, USB, D-Sub, HDMI, Fiber Optic Rack Panels • Universal Master Rack Panels • Universal Sub-Panels • Power Cords

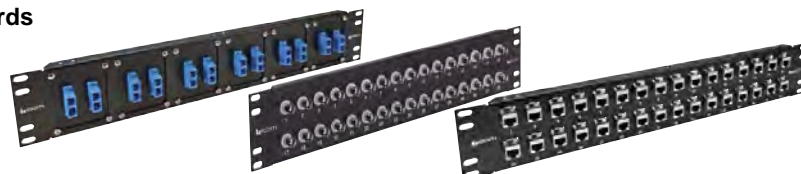

1-Stub Data Bus Couplers



90-50201

Part #	1 Piece Price
90-50201	\$183.34
Feature	Specification
bus & stub jacks	TRB 3-lug jacks
tech note	non-terminated
bus termination	none



90-50211

Part #	1 Piece Price
90-50211	\$201.60
Feature	Specification
bus & stub jacks	TRB 3-lug jacks
tech note	single-terminated
bus termination	none



90-51211

Part #	1 Piece Price
90-51211	\$219.45
Feature	Specification
bus & stub jacks	TRB 3-lug jacks
tech note	single-terminated
bus termination	one 78.7 ohm resistor



90-52211

Part #	1 Piece Price
90-52211	\$220.50
Feature	Specification
bus & stub jacks	TRB 3-lug jacks
tech note	single-terminated
bus termination	one 78.7 ohm resistor



90-50231

Part #	1 Piece Price
90-50231	\$225.68
Feature	Specification
bus & stub jacks	TRB 3-lug jacks
tech note	single-terminated
bus termination	one 78.7 ohm resistors

2-Stub Data Bus Couplers



90-50202

Part #	1 Piece Price
90-50202	\$298.70
Feature	Specification
bus & stub jacks	TRB 3-lug jacks
tech note	non-terminated
bus termination	none



90-50212

Part #	1 Piece Price
90-50212	\$311.06
Feature	Specification
bus & stub jacks	TRB 3-lug jacks
tech note	single-terminated
bus termination	one 78.7 ohm resistor



90-51212

Part #	1 Piece Price
90-51212	\$341.96
Feature	Specification
bus & stub jacks	TRB 3-lug jacks
tech note	single-terminated
bus termination	one 78.7 ohm resistor



90-52212

Part #	1 Piece Price
90-52212	\$341.96
Feature	Specification
bus & stub jacks	TRB 3-lug jacks
tech note	single-terminated
bus termination	one 78.7 ohm resistor



90-50222

Part #	1 Piece Price
90-50222	\$408.91
Feature	Specification
bus & stub jacks	TRB 3-lug jacks
tech note	dual-terminated
bus termination	two 78.7 ohm resistors

Custom connectorization and configuration options available.

Plenum Cable Assemblies

Item #	Description	1 Pc. Price
MSA00096-12N	Plenum Cable Assembly TRB 3-Slot Plug to Plug MIL-STD-1553 .242" O.D. +125C 78 Ohm Twinaxial Shielded Twisted Pair 1'	\$99.71
MSA00097-12N	Plenum Cable Assembly TRB 3-Slot Plug to Blunt MIL-STD-1553 .242" O.D. +125C 78 Ohm Twinaxial Shielded Twisted Pair 1'	\$88.25
MSA00098-12N	Plenum Cable Assembly TRB 3-Slot Plug to 3-Lug Cable Jack MIL-STD-1553 .242" O.D. +125C 78 Ohm Twinaxial Shielded Twisted Pair 1'	\$104.92
MSA00099-12N	Plenum Cable Assembly TRB 3-Slot Plug to Non-Insulated Bulk Head 3-Lug Cable Jack MIL-STD-1553 .242" O.D. +125C 78 Ohm Twinaxial Shielded Twisted Pair 1'	\$106.33
MSA00100-12N	Plenum Cable Assembly TRB 3-Slot Plug to Insulated Bulk Head 3-Lug Cable Jack MIL-STD-1553 .242" O.D. +125C 78 Ohm Twinaxial Shielded Twisted Pair 1'	\$111.85
MSA00101-12N	Plenum Cable Assembly TRB 3-Slot Plug to Plug with Bend Reliefs MIL-STD-1553 .242" O.D. +125C 78 Ohm Twinaxial Shielded Twisted Pair 1'	\$108.83
MSA00102-12N	Plenum Cable Assembly TRB 3-Slot Plug with Bend Relief to Blunt MIL-STD-1553 .242" O.D. +125C 78 Ohm Twinaxial Shielded Twisted Pair 1'	\$92.78
MSA00103-12N	Plenum Cable Assembly TRB 3-Slot Plug to 3-Lug Cable Jack with Bend Reliefs MIL-STD-1553 .242" O.D. +125C 78 Ohm Twinaxial Shielded Twisted Pair 1'	\$112.32
MSA00104-12N	Plenum Cable Assembly TRB 3-Slot Plug to Non-Insulated Bulk Head 3-Lug Cable Jack with Bend Reliefs MIL-STD-1553 .242" O.D. +125C 78 Ohm Twinaxial Shielded Twisted Pair 1'	\$113.73
MSA00105-12N	Plenum Cable Assembly TRB 3-Slot Plug to Insulated Bulk Head 3-Lug Cable Jack with Bend Reliefs MIL-STD-1553 .242" O.D. +125C 78 Ohm Twinaxial Shielded Twisted Pair 1'	\$119.25
MSA00106-12N	Plenum Cable Assembly TRB 3-Lug Cable Jack to Jack MIL-STD-1553 .242" O.D. +125C 78 Ohm Twinaxial Shielded Twisted Pair 1'	\$108.83
MSA00107-12N	Plenum Cable Assembly TRB Non-Insulated Bulk Head 3-Lug Cable Jack to Jack MIL-STD-1553 .242" O.D. +125C 78 Ohm Twinaxial Shielded Twisted Pair 1'	\$112.95
MSA00108-12N	Plenum Cable Assembly TRB Insulated Bulk Head Jack 3-Lug Cable Jack to Jack MIL-STD-1553 .242" O.D. +125C 78 Ohm Twinaxial Shielded Twisted Pair 1'	\$124.04
MSA00109-12N	Plenum Cable Assembly TRB 3-Lug Cable Jack to Jack with Bend Reliefs MIL-STD-1553 .242" O.D. +125C 78 Ohm Twinaxial Shielded Twisted Pair 1'	\$115.81
MSA00110-12N	Plenum Cable Assembly TRB Non-Insulated Bulk Head 3-Lug Cable Jack to Jack with Bend Reliefs MIL-STD-1553 .242" O.D. +125C 78 Ohm Twinaxial Shielded Twisted Pair 1'	\$113.73
MSA00111-12N	Plenum Cable Assembly TRB Insulated Bulk Head 3-Lug Cable Jack to Jack with Bend Relief MIL-STD-1553 .242" O.D. +125C 78 Ohm Twinaxial Shielded Twisted Pair 1'	\$113.73

Assembly prices shown for 12" length. See our website for additional lengths.

See our website, MilesTek.com to view all of our products.



MIL-STD-1553B | 3-Stub Data Bus Couplers



Part #	1 Piece Price	Feature	Specification
90-50203	\$369.24	bus & stub jacks	TRB 3-lug jacks
		tech note	non-terminated
		bus termination	none



Part #	1 Piece Price	Feature	Specification
90-50213	\$390.37	bus & stub jacks	TRB 3-lug jacks
		tech note	single-terminated
		bus termination	one 78.7 ohm resistor



Part #	1 Piece Price	Feature	Specification
90-51213	\$422.30	bus & stub jacks	TRB 3-lug jacks
		tech note	single-terminated
		bus termination	one 78.7 ohm resistor



Part #	1 Piece Price	Feature	Specification
90-52213	\$426.40	bus & stub jacks	TRB 3-lug jacks
		tech note	single-terminated
		bus termination	one 78.7 ohm resistor



Part #	1 Piece Price	Feature	Specification
90-50223	\$465.56	bus & stub jacks	TRB 3-lug jacks
		tech note	dual-terminated
		bus termination	two 78.7 ohm resistors

Halogen Free Cable Assemblies

Item #	Description	1 Pc. Price
MSA00224-12N	Halogen Free Cable Assembly TRB 3-Slot Plug to Plug MIL-STD-1553 .242" O.D. -30C +80C 78 Ohm Twinaxial Shielded Twisted Pair 1'	\$93.68
MSA00225-12N	Halogen Free Cable Assembly TRB 3-Slot Plug to Blunt MIL-STD-1553 .242" O.D. -30C +80C 78 Ohm Twinaxial Shielded Twisted Pair 1'	\$82.22
MSA00226-12N	Halogen Free Cable Assembly TRB 3-Slot Plug to 3-Lug Cable Jack MIL-STD-1553 .242" O.D. -30C +80C 78 Ohm Twinaxial Shielded Twisted Pair 1'	\$98.89
MSA00227-12N	Halogen Free Cable Assembly TRB 3-Slot Plug to Non-Insulated Bulk Head 3-Lug Cable Jack MIL-STD-1553 .242" O.D. -30C +80C 78 Ohm Twinaxial Shielded Twisted Pair 1'	\$100.30

Assembly prices shown for 12" length. See our website for additional lengths.



Custom connectorization and configuration options available.

4-Stub Data Bus Couplers | MIL-STD-1553B

Part #	1 Piece Price	Feature	Specification
90-50204	\$447.78	bus & stub jacks	TRB 3-lug jacks
		tech note	non-terminated
		bus termination	none



90-50204

Part #	1 Piece Price	Feature	Specification
90-50214	\$473.20	bus & stub jacks	TRB 3-lug jacks
		tech note	single-terminated
		bus termination	one 78.7 ohm resistor



90-50214

Part #	1 Piece Price	Feature	Specification
90-51214	\$502.32	bus & stub jacks	TRB 3-lug jacks
		tech note	single-terminated
		bus termination	one 78.7 ohm resistor



90-51214

Part #	1 Piece Price	Feature	Specification
90-52214	\$502.32	bus & stub jacks	TRB 3-lug jacks
		tech note	single-terminated
		bus termination	one 78.7 ohm resistor



90-52214

Part #	1 Piece Price	Feature	Specification
90-50224	\$554.14	bus & stub jacks	TRB 3-lug jacks
		tech note	dual-terminated
		bus termination	two 78.7 ohm resistors



90-50224

Halogen Free Cable Assemblies

Item #	Description	1 Pc. Price
MSA00228-12N	Halogen Free Cable Assembly TRB 3-Slot Plug to Insulated Bulk Head 3-Lug Cable Jack MIL-STD-1553 .242" O.D. -30C +80C 78 Ohm Twinaxial Shielded Twisted Pair 1'	\$105.92
MSA00234-12N	Halogen Free Cable Assembly TRB 3-Lug Cable Jack to Jack MIL-STD-1553 .242" O.D. -30C +80C 78 Ohm Twinaxial Shielded Twisted Pair 1'	\$104.10
MSA00229-12N	Halogen Free Cable Assembly TRB 3-Slot Plug to Plug with Bend Reliefs MIL-STD-1553 .242" O.D. -30C +80C 78 Ohm Twinaxial Shielded Twisted Pair 1'	\$102.80
MSA00230-12N	Halogen Free Cable Assembly TRB 3-Slot Plug with Bend Relief to Blunt MIL-STD-1553 .242" O.D. -30C +80C 78 Ohm Twinaxial Shielded Twisted Pair 1'	\$86.91

Assembly prices shown for 12" length. See our website for additional lengths.



Custom connectorization and configuration options available.

MIL-STD-1553B | 5-Stub Data Bus Couplers



90-50205

Part #	1 Piece Price	Feature	Specification
90-50205	\$531.42	bus & stub jacks	TRB 3-lug jacks
		tech note	non-terminated
		bus termination	none



90-50215

Part #	1 Piece Price	Feature	Specification
90-50215	\$566.80	bus & stub jacks	TRB 3-lug jacks
		tech note	single-terminated
		bus termination	one 78.7 ohm resistor



90-51215

Part #	1 Piece Price	Feature	Specification
90-51215	\$593.84	bus & stub jacks	TRB 3-lug jacks
		tech note	single-terminated
		bus termination	one 78.7 ohm resistor



90-52215

Part #	1 Piece Price	Feature	Specification
90-52215	\$587.10	bus & stub jacks	TRB 3-lug jacks
		tech note	single-terminated
		bus termination	one 78.7 ohm resistor



90-50225

Part #	1 Piece Price	Feature	Specification
90-50225	\$636.54	bus & stub jacks	TRB 3-lug jacks
		tech note	dual-terminated
		bus termination	two 78.7 ohm resistors

Halogen Free Cable Assemblies

Item #	Description	1 Pc. Price
MSA00231-12N	Halogen Free Cable Assembly TRB 3-Slot Plug to 3-Lug Cable Jack with Bend Reliefs MIL-STD-1553 .242" O.D. -30C +80C 78 Ohm Twinaxial Shielded twisted pair 1'	\$103.84
MSA00232-12N	Halogen Free Cable Assembly TRB 3-Slot Plug to Non-Insulated Bulk Head 3-Lug Cable Jack with Bend Reliefs MIL-STD-1553 .242" O.D. -30C +80C 78 Ohm Twinaxial Shielded twisted pair 1'	\$107.70
MSA00233-12N	Halogen Free Cable Assembly TRB 3-Slot Plug to Insulated Bulk Head 3-Lug Cable Jack with Bend Reliefs MIL-STD-1553 .242" O.D. -30C +80C 78 Ohm Twinaxial Shielded twisted pair 1'	\$98.27
MSA00235-12N	Halogen Free Cable Assembly TRB Non-Insulated Bulk Head 3-Lug Cable Jack to Jack MIL-STD-1553 .242" O.D. -30C +80C 78 Ohm Twinaxial Shielded twisted pair 1'	\$106.97

Assembly prices shown for 12" length. See our website for additional lengths.



Custom connectorization and configuration options available.

6-Stub Data Bus Couplers | MIL-STD-1553B

Part #	1 Piece Price	Feature	Specification
90-50206	\$643.62	bus & stub jacks	TRB 3-lug jacks
		tech note	non-terminated
		bus termination	none



90-50206

Part #	1 Piece Price	Feature	Specification
90-50216	\$689.07	bus & stub jacks	TRB 3-lug jacks
		tech note	single-terminated
		bus termination	one 78.7 ohm resistor



90-50216

Part #	1 Piece Price	Feature	Specification
90-51216	\$667.44	bus & stub jacks	TRB 3-lug jacks
		tech note	single-terminated
		bus termination	one 78.7 ohm resistor



90-51216

Part #	1 Piece Price	Feature	Specification
90-52216	\$708.24	bus & stub jacks	TRB 3-lug jacks
		tech note	single-terminated
		bus termination	one 78.7 ohm resistor



90-52216

Part #	1 Piece Price	Feature	Specification
90-50226	\$751.90	bus & stub jacks	TRB 3-lug jacks
		tech note	dual-terminated
		bus termination	two 78.7 ohm resistors



90-50226

Halogen Free Cable Assemblies

Item #	Description	1 Pc. Price
MSA00236-12N	Halogen Free Cable Assembly TRB Insulated Bulk Head Jack 3-Lug Cable Jack to Jack MIL-STD-1553 .242" O.D. -30C +80C 78 Ohm Twinaxial Shielded twisted pair 1'	\$118.01
MSA00237-12N	Halogen Free Cable Assembly TRB 3-Lug Cable Jack to Jack with Bend Reliefs MIL-STD-1553 .242" O.D. -30C +80C 78 Ohm Twinaxial Shielded twisted pair 1'	\$109.83
MSA00238-12N	Halogen Free Cable Assembly TRB Non-Insulated Bulk Head 3-Lug Cable Jack to Jack with Bend Reliefs MIL-STD-1553 .242" O.D. -30C +80C 78 Ohm Twinaxial Shielded twisted pair 1'	\$110.09
MSA00239-12N	Halogen Free Cable Assembly TRB Insulated Bulk Head 3-Lug Cable Jack to Jack with Bend Relief MIL-STD-1553 .242" O.D. -30C +80C 78 Ohm Twinaxial Shielded twisted pair 1'	\$123.69

Assembly prices shown for 12" length. See our website for additional lengths.



Custom connectorization and configuration options available.

MIL-STD-1553B | 7-Stub Data Bus Couplers



90-50207

Part #	1 Piece Price	Feature	Specification
90-50207	\$754.00	bus & stub jacks	TRB 3-lug jacks
		tech note	non-terminated
		bus termination	none



90-50217

Part #	1 Piece Price	Feature	Specification
90-50217	\$719.00	bus & stub jacks	TRB 3-lug jacks
		tech note	single-terminated
		bus termination	one 78.7 ohm resistor



90-51217

Part #	1 Piece Price	Feature	Specification
90-51217	\$755.04	bus & stub jacks	TRB 3-lug jacks
		tech note	single-terminated
		bus termination	one 78.7 ohm resistor



90-52217

Part #	1 Piece Price	Feature	Specification
90-52217	\$755.04	bus & stub jacks	TRB 3-lug jacks
		tech note	single-terminated
		bus termination	one 78.7 ohm resistor



90-50227

Part #	1 Piece Price	Feature	Specification
90-50227	\$808.08	bus & stub jacks	TRB 3-lug jacks
		tech note	dual-terminated
		bus termination	two 78.7 ohm resistors

TRB Bus & Stub Terminators - Without Chain

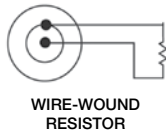

Terminator	Description	Resistor Value	1 Pc. Price
10-06403-025	bus terminator, without chain	78 ohm	\$61.77
10-06403-033	stub terminator, without chain	1000 ohm	\$85.05
10-06403-044	stub terminator, without chain	2000 ohm	\$86.16
10-06403-024	stub terminator, without chain	3000 ohm	\$86.16

TRB Bus & Stub Terminators - With 3 Inch Stainless Steel Chain



Terminator	Description	Resistor Value	1 Pc. Price
10-06403-060	bus terminator, 3" chain	78 ohm	\$67.38
10-06403-066	stub terminator, 3" chain	1000 ohm	\$78.15
10-06403-065	stub terminator, 3" chain	2000 ohm	\$81.28
10-06403-064	stub terminator, 3" chain	3000 ohm	\$82.84

Custom connectorization and configuration options available.

8-Stub Data Bus Couplers | MIL-STD-1553B

Part #	1 Piece Price	Feature	Specification
90-50208	\$844.56	bus & stub jacks	TRB 3-lug jacks
		tech note	non-terminated
		bus termination	none



90-50208

Part #	1 Piece Price	Feature	Specification
90-50218	\$915.20	bus & stub jacks	TRB 3-lug jacks
		tech note	single-terminated
		bus termination	one 78.7 ohm resistor



90-50218

Part #	1 Piece Price	Feature	Specification
90-51218	\$927.68	bus & stub jacks	TRB 3-lug jacks
		tech note	single-terminated
		bus termination	one 78.7 ohm resistor



90-51218

Part #	1 Piece Price	Feature	Specification
90-52218	\$926.64	bus & stub jacks	TRB 3-lug jacks
		tech note	single-terminated
		bus termination	one 78.7 ohm resistor



90-52218

Part #	1 Piece Price	Feature	Specification
90-50228	\$977.60	bus & stub jacks	TRB 3-lug jacks
		tech note	dual-terminated
		bus termination	two 78.7 ohm resistors



90-50228

TRB Bus & Stub Terminators - With 6 Inch Stainless Steel Chain

Terminator	Description	Resistor Value	1 Pc. Price
10-06403-026	bus terminator, 6" chain	78 ohm	\$64.56
10-06403-034	stub terminator, 6" chain	1000 ohm	\$86.16
10-06403-042	stub terminator, 6" chain	2000 ohm	\$86.16
10-06403-038	stub terminator, 6" chain	3000 ohm	\$86.16



WIRE-WOUND RESISTOR

TRB RFI Dust Protection Caps - Stainless Steel Chain Options

RFI Cap	Description	1 Pc. Price
10-06300	RFI dust cap, without chain	\$14.36
10-06304	RFI dust cap, 3" chain	\$15.47
10-06303	RFI dust cap, 6" chain	\$15.47



10-06300



10-06304



10-06303

Custom connectorization and configuration options available.

1-Stub Inline Bus Couplers



90-50251-12

Part #	1 Piece Price
90-50251-12	\$310.96
Feature	Specification
bus & stub jacks	12" M17/176-00002 blunt ends
tech note	non-terminated
bus termination	none
nominal unit weight	1.50 oz (42.52 g)



90-50261-12

Part #	1 Piece Price
90-50261-12	\$325.48
Feature	Specification
bus & stub jacks	12" M17/176-00002 blunt ends
tech note	single-terminated
bus termination	one 78.7 ohm resistor
nominal unit weight	1.10 oz (31.18 g)



90-50361-12

Part #	1 Piece Price
90-50361-12	\$316.00
Feature	Specification
bus & stub jacks	12" M17/176-00002 blunt ends
tech note	single-terminated
bus termination	one 78.7 ohm resistor
nominal unit weight	1.10 oz (31.18 g)



90-50461-12

Part #	1 Piece Price
90-50461-12	\$311.00
Feature	Specification
bus & stub jacks	12" M17/176-00002 blunt ends
tech note	dual-terminated
bus termination	two 78.7 ohm resistor
nominal unit weight	0.70 oz (19.74 g)

2-Stub Inline Bus Couplers



90-50252-12

Part #	1 Piece Price
90-50252-12	\$425.36
Feature	Specification
bus & stub jacks	12" M17/176-00002 blunt ends
tech note	non-terminated
bus termination	none
nominal unit weight	1.90 oz (53.86 g)



90-50262-12

Part #	1 Piece Price
90-50262-12	\$459.38
Feature	Specification
bus & stub jacks	12" M17/176-00002 blunt ends
tech note	single-terminated
bus termination	one 78.7 ohm resistor
nominal unit weight	1.50 oz (42.52 g)



90-50362-12

Part #	1 Piece Price
90-50362-12	\$463.84
Feature	Specification
bus & stub jacks	12" M17/176-00002 blunt ends
tech note	single-terminated
bus termination	one 78.7 ohm resistor
nominal unit weight	1.50 oz (42.52 g)



90-50462-12

Part #	1 Piece Price
90-50462-12	\$486.16
Feature	Specification
bus & stub jacks	12" M17/176-00002 blunt ends
tech note	dual-terminated
bus termination	two 78.7 ohm resistor
nominal unit weight	1.10 oz (31.18 g)



90-50562-12

Part #	1 Piece Price
90-50562-12	\$501.28
Feature	Specification
bus & stub jacks	12" M17/176-00002 blunt ends
tech note	dual-terminated
bus termination	two 78.7 ohm resistor
nominal unit weight	1.10 oz (31.18 g)

Custom lengths and connectorization options are available.

3-Stub Inline Bus Couplers

Part #	1 Piece Price
90-50253-12	\$501.28
Feature	Specification
bus & stub jacks	12" M17/176-00002 blunt ends
tech note	non-terminated
bus termination	none
nominal unit weight	2.70 oz (76.54 g)

Part #	1 Piece Price
90-50363-12	\$526.24
Feature	Specification
bus & stub jacks	12" M17/176-00002 blunt ends
tech note	single-terminated
bus termination	one 78.7 ohm resistor
nominal unit weight	2.30 oz (65.20 g)

Part #	1 Piece Price
90-50563-12	\$570.00
Feature	Specification
bus & stub jacks	12" M17/176-00002 blunt ends
tech note	dual-terminated
bus termination	two 78.7 ohm resistor
nominal unit weight	1.90 oz (53.86 g)

Part #	1 Piece Price
90-50263-12	\$554.32
Feature	Specification
bus & stub jacks	12" M17/176-00002 blunt ends
tech note	single-terminated
bus termination	one 78.7 ohm resistor
nominal unit weight	2.30 oz (65.20 g)

Part #	1 Piece Price
90-50463-12	\$526.24
Feature	Specification
bus & stub jacks	12" M17/176-00002 blunt ends
tech note	single-terminated
bus termination	one 78.7 ohm resistor
nominal unit weight	2.30 oz (65.20 g)

Part #	1 Piece Price
90-50663-12	\$563.68
Feature	Specification
bus & stub jacks	12" M17/176-00002 blunt ends
tech note	dual-terminated
bus termination	two 78.7 ohm resistor
nominal unit weight	1.90 oz (53.86 g)



90-50253-12



90-50263-12

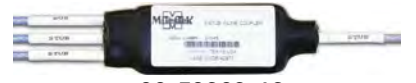

90-50363-12



90-50463-12



90-50563-12



90-50663-12

4-Stub Inline Bus Couplers

Part #	1 Piece Price
90-50254-12	\$662.29
Feature	Specification
bus & stub jacks	12" M17/176-00002 blunt ends
tech note	non-terminated
bus termination	none
nominal unit weight	3.10 oz (87.88 g)

Part #	1 Piece Price
90-50364-12	\$694.72
Feature	Specification
bus & stub jacks	12" M17/176-00002 blunt ends
tech note	single-terminated
bus termination	one 78.7 ohm resistor
nominal unit weight	2.70 oz (76.54 g)

Part #	1 Piece Price
90-50264-12	\$695.76
Feature	Specification
bus & stub jacks	12" M17/176-00002 blunt ends
tech note	single-terminated
bus termination	one 78.7 ohm resistor
nominal unit weight	2.70 oz (76.54 g)

Part #	1 Piece Price
90-50464-12	\$661.00
Feature	Specification
bus & stub jacks	12" M17/176-00002 blunt ends
tech note	dual-terminated
bus termination	one 78.7 ohm resistor
nominal unit weight	2.30 oz (65.20 g)

Part #	1 Piece Price
90-50564-12	\$661.00
Feature	Specification
bus & stub jacks	12" M17/176-00002 blunt ends
tech note	dual-terminated
bus termination	two 78.7 ohm resistor
nominal unit weight	2.30 oz (65.20 g)



90-50254-12



90-50264-12



90-50364-12



90-50464-12



90-50564-12

Custom lengths and connectorization options are available.



90-50270
90-50271

Stub Switching Relays

Part #	1 Piece Price
90-50270	\$326.19
Feature	Specification
nominal coil voltage	28V
bus input jack	one TRB 3-lug jack
bus output jack	one TRB 3-lug jack
interface connector	DB9 male

Part #	1 Piece Price
90-50271	\$326.19
Feature	Specification
nominal coil voltage	5V
bus input jack	one TRB 3-lug jack
bus output jack	one TRB 3-lug jack
interface connector	DB9 male

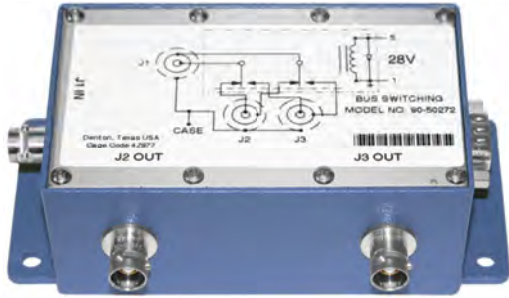

90-50272
90-50273

Bus Switching Relays

Part #	1 Piece Price
90-50272	\$403.13
Feature	Specification
nominal coil voltage	28V
bus input jack	one TRB 3-lug jack
bus output jack	two TRB 3-lug jack
interface connector	DB9 male

Part #	1 Piece Price
90-50273	\$403.13
Feature	Specification
nominal coil voltage	5V
bus input jack	one TRB 3-lug jack
bus output jack	two TRB 3-lug jack
interface connector	DB9 male



90-50274
90-50275

Bus Segmenting Relays

Part #	1 Piece Price
90-50274	\$495.25
Feature	Specification
nominal coil voltage	28V
bus input jack	two TRB 3-lug jack
bus output jack	one TRB 3-lug jack
interface connector	DB9 male

Part #	1 Piece Price
90-50275	\$495.25
Feature	Specification
nominal coil voltage	5V
bus input jack	two TRB 3-lug jack
bus output jack	one TRB 3-lug jack
interface connector	DB9 male



90-50277
90-50278

Dual Bus Switching

Part #	1 Piece Price
90-50277	\$817.10
Feature	Specification
nominal coil voltage	28V
bus input jack	two TRB 3-lug jack
bus output jack	four TRB 3-lug jack
interface connector	DB9 male

Part #	1 Piece Price
90-50278	\$817.10
Feature	Specification
nominal coil voltage	5V
bus input jack	two TRB 3-lug jack
bus output jack	four TRB 3-lug jack
interface connector	DB9 male

Custom lengths and connectorization options are available.

Data Bus Coupler Kits - 2 Terminal & 4 Terminal



Part #	1 Piece Price	
TK-1037	\$764.00	
Quantity	Component	Part Number
2 each	1-stub bus couplers	90-50201
2 each	bus terminators	10-06403-025
1 each	bus cable assembly	CA-2009-72
2 each	stub cable assemblies	CA-2009-48



Part #	1 Piece Price	
TK-1038	\$1168.79	
Quantity	Component	Part Number
2 each	2-stub bus couplers	90-50202
2 each	bus terminators	10-06403-025
1 each	bus cable assembly	CA-2009-72
2 each	stub cable assemblies	CA-2009-48

Bus/Scope Test Cables



Part #	1 Piece Price
CA-5111	\$354.37
Feature	Specification
coaxial cable	75 ohm, 6.00 inches, BNC plugs
twinaxial cable	78 ohm, 60.00 inches, TRB plug



Part #	1 Piece Price
CA-5112	\$354.37
Feature	Specification
coaxial cable	75 ohm, 60.00 inches, BNC plugs
twinaxial cable	78 ohm, 10.00 inches, TRB plug

Custom Bus Kits

MilesTek data bus coupler kits offer a complete solution to laboratory application requirements. Pre-assembled kits guarantee compatibility between various MIL-STD-1553B components. Custom data bus coupler kits are available.

Bus/Scope Application

See application chart (right). Bus/scope test cables are typically used in laboratory testing environments. Bus/scope test cables are used with an oscilloscope to split and analyze individual signals on a bus.

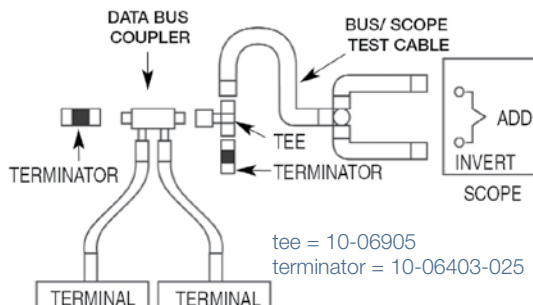

Vacuum Rated TVAC Twinaxial Cable Assemblies

Item #	Description	1 Pc. Price
MSA00001-12N	Vacuum Rated TVAC Twinaxial High Temp PFA Jacket 78 Ohm TRB 3 Slot Crimp Plug to TRB 3 Slot Crimp Plug .129" O.D. Cable Assembly -55C to +200C	\$573.10
MSA00002-12N	Vacuum Rated TVAC Twinaxial High Temp PFA Jacket 78 Ohm TRB 3 Slot Crimp Plug to Blunt .129" O.D. Cable Assembly -55C to +200C	\$338.65
MSA00003-12N	Vacuum Rated TVAC Twinaxial High Temp PFA Jacket 78 Ohm TRB 3 Slot Crimp Plug to TRS 3 Slot Crimp Plug .129" O.D. Cable Assembly -55C to +200C	\$573.10
MSA00004-12N	Vacuum Rated TVAC Twinaxial High Temp PFA Jacket 78 Ohm TRB 3 Slot Crimp Plug to TTM Threaded Crimp Plug .129" O.D. Cable Assembly -55C to +200C	\$573.10
MSA00005-12N	Vacuum Rated TVAC Twinaxial High Temp PFA Jacket 78 Ohm TRS 3 Slot Crimp Plug to TRS 3 Slot Crimp Plug .129" O.D. Cable Assembly -55C to +200C	\$573.10
MSA00006-12N	Vacuum Rated TVAC Twinaxial High Temp PFA Jacket 78 Ohm TRS 3 Slot Crimp Plug to Blunt .129" O.D. Cable Assembly -55C to +200C	\$338.65
MSA00007-12N	Vacuum Rated TVAC Twinaxial High Temp PFA Jacket 78 Ohm TRS 3 Slot Crimp Plug to TTM Threaded Crimp Plug .129" O.D. Cable Assembly -55C to +200C	\$573.10
MSA00008-12N	Vacuum Rated TVAC Twinaxial High Temp PFA Jacket 78 Ohm TTM Threaded Crimp Plug to TTM Threaded Crimp Plug .129" O.D. Cable Assembly -55C to +200C	\$573.10
MSA00009-12N	Vacuum Rated TVAC Twinaxial High Temp PFA Jacket 78 Ohm TTM Threaded Crimp Plug to Blunt .129" O.D. Cable Assembly -55C to +200C	\$338.65
MSA00010-12N	Vacuum Rated TVAC Twinaxial High Temp PFA Jacket 78 Ohm TCS Threaded Crimp Plug Pin to TCS Threaded Crimp Plug Pin .129" O.D. Cable Assembly -55C to +200C	\$677.30
MSA00011-12N	Vacuum Rated TVAC Twinaxial High Temp PFA Jacket 78 Ohm TCS Threaded Crimp Plug Pin to Blunt .129" O.D. Cable Assembly -55C to +200C	\$442.85
MSA00012-12N	Vacuum Rated TVAC Twinaxial High Temp PFA Jacket 78 Ohm TCS Threaded Crimp Plug Skt to TCS Threaded Crimp Plug Skt .129" O.D. Cable Assembly -55C to +200C	\$677.30
MSA00013-12N	Vacuum Rated TVAC Twinaxial High Temp PFA Jacket 78 Ohm TCS Threaded Crimp Plug Socket to Blunt .129" O.D. Cable Assembly -55C to +200C	\$442.85
MSA00014-12N	Vacuum Rated TVAC Twinaxial High Temp PFA Jacket 78 Ohm TRB 3 Slot Crimp Plug to TCS Threaded Crimp Plug Pin .129" O.D. Cable Assembly -55C to +200C	\$625.20
MSA00015-12N	Vacuum Rated TVAC Twinaxial High Temp PFA Jacket 78 Ohm TRB 3 Slot Crimp Plug to TCS Threaded Crimp Plug Socket .129" O.D. Cable Assembly -55C to +200C	\$625.20

Assembly prices shown for 12" length. See our website for additional lengths.

See our website, MilesTek.com to view all of our products.

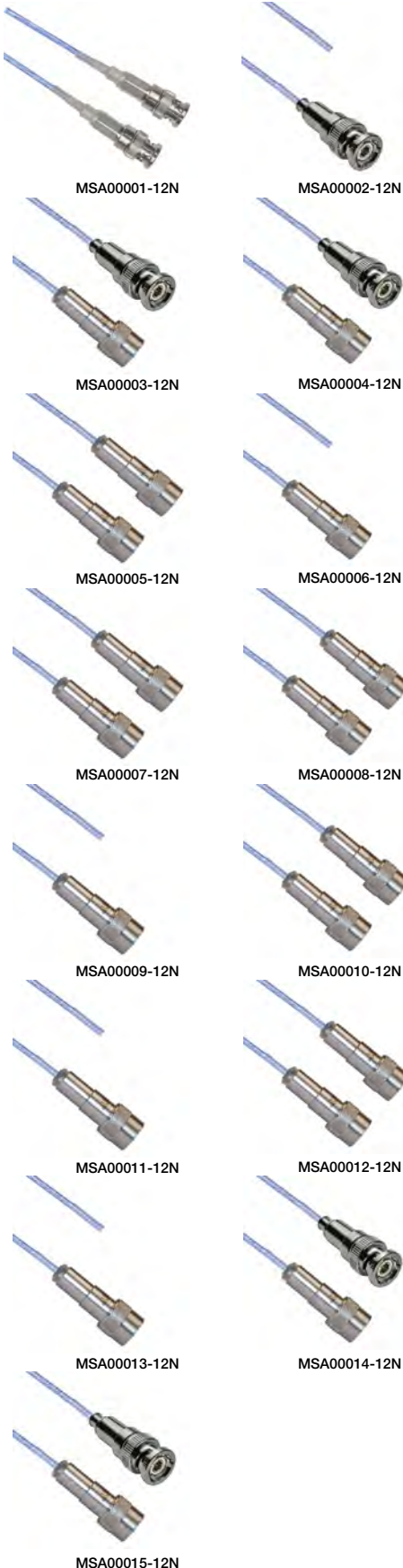

TRB Plenum Cable Assemblies

Item #	Description	1 Pc. Price
MSA00032-12N	Plenum Cable Assembly TRB 3-Slot Plug to Plug MIL-STD-1553 .150" O.D. +125C 78 Ohm Twinaxial Shielded Twisted Pair 1'	\$97.16
MSA00033-12N	Plenum Cable Assembly TRB 3-Slot Plug to Blunt MIL-STD-1553 .150" O.D. +125C 78 Ohm Twinaxial Shielded Twisted Pair 1'	\$85.70
MSA00034-12N	Plenum Cable Assembly TRB 3-Slot Plug to 3-Lug Cable Jack MIL-STD-1553 .150" O.D. +125C 78 Ohm Twinaxial Shielded Twisted Pair 1'	\$102.68
MSA00035-12N	Plenum Cable Assembly TRB 3-Slot Plug to Non-Insulated Bulk Head 3-Lug Cable Jack MIL-STD-1553 .150" O.D. +125C 78 Ohm Twinaxial Shielded Twisted Pair 1'	\$105.60
MSA00036-12N	Plenum Cable Assembly TRB 3-Slot Plug to Insulated Bulk Head 3-Lug Cable Jack MIL-STD-1553 .150" O.D. +125C 78 Ohm Twinaxial Shielded Twisted Pair 1'	\$109.30
MSA00037-12N	Plenum Cable Assembly TRB 3-Slot Plug to Plug with Bend Reliefs MIL-STD-1553 .150" O.D. +125C 78 Ohm Twinaxial Shielded Twisted Pair 1'	\$118.94
MSA00038-12N	Plenum Cable Assembly TRB 3-Slot Plug with Bend Relief to Blunt MIL-STD-1553 .150" O.D. +125C 78 Ohm Twinaxial Shielded Twisted Pair 1'	\$95.91
MSA00039-12N	Plenum Cable Assembly TRB 3-Slot Plug to 3-Lug Cable Jack with Bend Reliefs MIL-STD-1553 .150" O.D. +125C 78 Ohm Twinaxial Shielded Twisted Pair 1'	\$114.35
MSA00040-12N	Plenum Cable Assembly TRB 3-Slot Plug to Non-Insulated Bulk Head 3-Lug Cable Jack with Bend Reliefs MIL-STD-1553 .150" O.D.+125C 78 Ohm Twinaxial Shielded Twisted Pair 1'	\$114.46
MSA00041-12N	Plenum Cable Assembly TRB 3-Slot Plug to Insulated Bulk Head 3-Lug Cable Jack with Bend Reliefs MIL-STD-1553 .150" O.D. +125C 78 Ohm Twinaxial Shielded Twisted Pair 1'	\$119.98
MSA00042-12N	Plenum Cable Assembly TRB 3-Lug Cable Jack to Jack MIL-STD-1553 .150" O.D. +125C 78 Ohm Twinaxial Shielded Twisted Pair 1'	\$108.00
MSA00043-12N	Plenum Cable Assembly TRB Non-Insulated Bulk Head 3-Lug Cable Jack to Jack MIL-STD-1553 .150" O.D. +125C 78 Ohm Twinaxial Shielded Twisted Pair 1'	\$110.81
MSA00044-12N	Plenum Cable Assembly TRB Insulated Bulk Head Jack 3-Lug Cable Jack to Jack MIL-STD-1553 .150" O.D. +125C 78 Ohm Twinaxial Shielded Twisted Pair 1'	\$121.91
MSA00045-12N	Plenum Cable Assembly TRB 3-Lug Cable Jack to Jack with Bend Reliefs MIL-STD-1553 .150" O.D. +125C 78 Ohm Twinaxial Shielded Twisted Pair 1'	\$113.73
MSA00046-12N	Plenum Cable Assembly TRB Non-Insulated Bulk Head 3-Lug Cable Jack to Jack with Bend Reliefs MIL-STD-1553 .150" O.D. +125C 78 Ohm Twinaxial Shielded Twisted Pair 1'	\$113.52
MSA00047-12N	Plenum Cable Assembly TRB Insulated Bulk Head 3-Lug Cable Jack to Jack with Bend Relief MIL-STD-1553 .150" O.D. +125C 78 Ohm Twinaxial Shielded Twisted Pair 1'	\$127.64

Assembly prices shown for 12" length. See our website for additional lengths.

See our website, MilesTek.com to view all of our products.



MIL-STD-1553B | Lab Twinax Assemblies

30-02001 Cable - Lab-Rated Pvc, 0.242 Inch Overall Diameter

xxx = cable length in inches
CA-2009-72 = 6 ft. (72 in.) CA-2009-xxx assembly

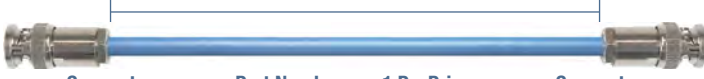

Connector	Part Number	1 Pc. Price	Connector
10-06030-210 straight 3-slot solder/clamp plug	CA-2009-xxx	\$98.07	10-06030-210 straight 3-slot solder/clamp plug

Prices shown for 12" length



Connector	Part Number	1 Pc. Price	Connector
10-06030-210 straight 3-slot solder/clamp plug	CA-2219-xxx	\$62.52	blunt - no connector

Prices shown for 12" length



Connector	Part Number	1 Pc. Price	Connector
10-06030-210 straight 3-slot solder/clamp plug	CA-2171-xxx	\$106.46	10-06031-210 straight 3-slot solder/clamp plug

Prices shown for 12" length



Connector	Part Number	1 Pc. Price	Connector
10-06030-210 straight 3-slot solder/clamp plug	MP-2177-xxx	\$97.95	10-06575-210 straight 3-lug solder/clamp jack

Prices shown for 12" length



Connector	Part Number	1 Pc. Price	Connector
10-06030-210 straight 3-slot solder/clamp plug	MP-2268-xxx	\$104.20	10-06577-210 non-isolated 3-lug bulkhead jack

Prices shown for 12" length



Connector	Part Number	1 Pc. Price	Connector
10-06030-210 straight 3-slot solder/clamp plug	MP-2192-xxx	\$104.20	10-06573-210 isolated 3-lug bulkhead jack

Prices shown for 12" length



Connector	Part Number	1 Pc. Price	Connector
10-06575-210 straight 3-lug solder/clamp jack	MP-2218-xxx	\$104.20	10-06575-210 straight 3-lug solder/clamp jack

Prices shown for 12" length



Connector	Part Number	1 Pc. Price	Connector
10-06575-210 straight 3-lug solder/clamp jack	MP-2275-xxx	\$87.53	blunt - no connector

Prices shown for 12" length

xxx = cable length in inches
MP-2151-120 = 10 ft. (120 in.) MP-2151-xxx assembly

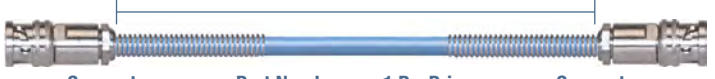

Connector	Part Number	1 Pc. Price	Connector
10-06033-210 bend relief, straight 3-slot solder/clamp plug	MP-2151-xxx	\$106.46	10-06033-210 bend relief, straight 3-slot solder/clamp plug

Prices shown for 12" length



Connector	Part Number	1 Pc. Price	Connector
10-06033-210 bend relief, straight 3-slot solder/clamp plug	MP-2156-xxx	\$83.36	blunt - no connector

Prices shown for 12" length



Connector	Part Number	1 Pc. Price	Connector
10-06031-210 straight 3-slot full crimp plug	MP-2357-xxx	\$87.53	blunt - no connector

Prices shown for 12" length



Connector	Part Number	1 Pc. Price	Connector
10-06033-210 bend relief, straight 3-slot solder/clamp plug	MP-2396-xxx	\$104.20	10-06570-210 bend relief, straight 3-lug solder/clamp jack

Prices shown for 12" length



Connector	Part Number	1 Pc. Price	Connector
10-06033-210 bend relief, straight 3-slot solder/clamp plug	MP-2624-xxx	\$83.36	10-06579-210 non-isolated, bend relief 3-lug bulkhead jack

Prices shown for 12" length



Connector	Part Number	1 Pc. Price	Connector
10-06033-210 bend relief, straight 3-slot solder/clamp plug	MP-2414-xxx	\$117.75	10-06574-210 isolated, bend relief 3-lug bulkhead jack

Prices shown for 12" length



Connector	Part Number	1 Pc. Price	Connector
10-06570-210 bend relief, straight 3-lug solder/clamp jack	MP-2540-xxx	\$107.33	10-06570-210 bend relief, straight 3-lug solder/clamp jack

Prices shown for 12" length



Connector	Part Number	1 Pc. Price	Connector
10-06030-210 straight 3-slot solder/clamp plug	CA-2253-xxx	\$93.78	10-09030-210 straight threaded plug

Prices shown for 12" length

30-02003 Cable - Lab-Rated Pvc, 0.150 Inch Overall Diameter

xxx = cable length in inches
CA-2014-72 = 6 ft. (72 in.) CA-2014-xxx assembly



Connector	Part Number	1 Pc. Price	Connector
10-06030-231 straight 3-slot solder/clamp plug	CA-2014-xxx	\$100.32	10-06030-231 straight 3-slot solder/clamp plug

Prices shown for 12" length



Connector	Part Number	1 Pc. Price	Connector
10-06030-231 straight 3-slot solder/clamp plug	MP-2017-xxx	\$76.07	blunt - no connector

Prices shown for 12" length



Connector	Part Number	1 Pc. Price	Connector
10-06031-231 straight 3-slot full crimp plug	MP-2352-xxx	\$132.34	10-06031-231 straight 3-slot full crimp plug

Prices shown for 12" length



Connector	Part Number	1 Pc. Price	Connector
10-06030-231 straight 3-slot solder/clamp plug	CA-2257-xxx	\$93.78	10-06575-231 straight 3-lug solder/clamp jack

Prices shown for 12" length



Connector	Part Number	1 Pc. Price	Connector
10-06030-231 straight 3-slot solder/clamp plug	MP-2224-xxx	\$93.78	10-06577-231 non-isolated 3-lug bulkhead jack

Prices shown for 12" length



Connector	Part Number	1 Pc. Price	Connector
10-06030-231 straight 3-slot solder/clamp plug	MP-2310-xxx	\$93.78	10-06573-231 isolated 3-lug bulkhead jack

Prices shown for 12" length



Connector	Part Number	1 Pc. Price	Connector
10-06575-231 straight 3-lug solder/clamp jack	MP-2542-xxx	\$97.95	10-06575-231 straight 3-lug solder/clamp jack

Prices shown for 12" length



Connector	Part Number	1 Pc. Price	Connector
10-06575-231 straight 3-lug solder/clamp jack	MP-2442-xxx	\$83.36	blunt - no connector

Prices shown for 12" length

xxx = cable length in inches
MP-2164-120 = 10 ft. (120 in.) MP-2164-xxx assembly



Connector	Part Number	1 Pc. Price	Connector
10-06033-231 bend relief, straight 3-slot solder/clamp plug	MP-2164-xxx	\$124.00	10-06033-231 bend relief, straight 3-slot solder/clamp plug

Prices shown for 12" length



Connector	Part Number	1 Pc. Price	Connector
10-06033-231 bend relief, straight 3-slot solder/clamp plug	MP-2347-xxx	\$80.24	blunt - no connector

Prices shown for 12" length



Connector	Part Number	1 Pc. Price	Connector
10-06031-231 straight 3-slot full crimp plug	MP-2358-xxx	\$83.36	blunt - no connector

Prices shown for 12" length



Connector	Part Number	1 Pc. Price	Connector
10-06033-231 bend relief, straight 3-slot solder/clamp plug	MP-2397-xxx	\$108.37	10-06570-231 bend relief, straight 3-lug solder/clamp jack

Prices shown for 12" length



Connector	Part Number	1 Pc. Price	Connector
10-06033-231 bend relief, straight 3-slot solder/clamp plug	MP-2625-xxx	\$104.20	10-06579-231 non-isolated, bend relief 3-lug bulkhead jack

Prices shown for 12" length



Connector	Part Number	1 Pc. Price	Connector
10-06033-231 bend relief, straight 3-slot solder/clamp plug	MP-2415-xxx	\$114.62	10-06574-231 isolated, bend relief 3-lug bulkhead jack

Prices shown for 12" length



Connector	Part Number	1 Pc. Price	Connector
10-06570-231 bend relief 3-lug solder/clamp jack	MP-2543-xxx	\$108.37	10-06570-231 bend relief, straight 3-lug solder/clamp jack

Prices shown for 12" length



Connector	Part Number	1 Pc. Price	Connector
10-06570-231 bend relief, straight 3-lug solder/clamp jack	MP-2544-xxx	\$87.53	blunt - no connector

Prices shown for 12" length

MIL-STD-1553B | Vehicle Twinax Assemblies

M17/176-00002 Cable - Vehicle High-Temp, 0.129 Inch Overall Diameter

xxx = cable length in inches
CA-2008-72 = 6 ft. (72 in.) CA-2008-xxx assembly



Connector	Part Number	1 Pc. Price	Connector
10-06030-206 straight 3-slot solder/clamp plug	CA-2008-xxx	\$113.36	10-06030-206 straight 3-slot solder/clamp plug

Prices shown for 12" length



Connector	Part Number	1 Pc. Price	Connector
10-06030-206 straight 3-slot solder/clamp plug	CA-2430-xxx	\$62.52	blunt - no connector

Prices shown for 12" length



Connector	Part Number	1 Pc. Price	Connector
10-06031-206 straight 3-slot full crimp plug	CA-2001-xxx	\$135.21	10-06031-206 straight 3-slot full crimp plug

Prices shown for 12" length



Connector	Part Number	1 Pc. Price	Connector
10-06032-206 right angle 3-slot full crimp plug	MP-2166-xxx	\$139.84	10-06031-206 straight 3-slot full crimp plug

Prices shown for 12" length

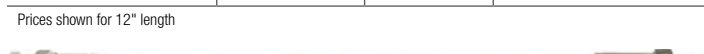

Connector	Part Number	1 Pc. Price	Connector
10-06030-206 straight 3-slot solder/clamp plug	MP-2059-xxx	\$93.78	10-06575-206 straight 3-lug solder/clamp jack

Prices shown for 12" length



Connector	Part Number	1 Pc. Price	Connector
10-06030-206 straight 3-slot solder/clamp plug	MP-2252-xxx	\$97.95	10-06577-206 non-isolated 3-lug bulkhead jack

Prices shown for 12" length



Connector	Part Number	1 Pc. Price	Connector
10-06030-206 straight 3-slot solder/clamp plug	MP-2209-xxx	\$114.62	10-06573-206 isolated 3-lug bulkhead jack

Prices shown for 12" length



Connector	Part Number	1 Pc. Price	Connector
10-06030-206 straight 3-slot solder/clamp plug	CA-2416-xxx	\$113.36	10-07030-206 straight 4-slot solder/clamp plug

Prices shown for 12" length

xxx = cable length in inches
MP-2165-120 = 10 ft. (120 in.) MP-2165-xxx assembly



Connector	Part Number	1 Pc. Price	Connector
10-06030-206 straight 3-slot solder/clamp plug	MP-2165-xxx	\$129.42	10-06033-206 bend relief, straight 3-slot solder/clamp plug

Prices shown for 12" length



Connector	Part Number	1 Pc. Price	Connector
10-06033-206 bend relief, straight 3-slot solder/clamp plug	CA-2342-xxx	\$83.36	blunt - no connector

Prices shown for 12" length



Connector	Part Number	1 Pc. Price	Connector
10-06031-206 straight 3-slot full crimp plug	MP-2359-xxx	\$69.82	blunt - no connector

Prices shown for 12" length



Connector	Part Number	1 Pc. Price	Connector
10-06032-206 right angle 3-slot full crimp plug	MP-2167-xxx	\$171.10	10-06032-206 right angle 3-slot full crimp plug

Prices shown for 12" length

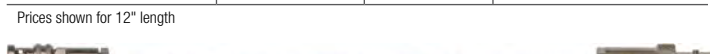

Connector	Part Number	1 Pc. Price	Connector
10-06033-206 bend relief, straight 3-slot solder/clamp plug	MP-2398-xxx	\$117.75	10-06570-206 bend relief, straight 3-lug solder/clamp jack

Prices shown for 12" length



Connector	Part Number	1 Pc. Price	Connector
10-06033-206 bend relief, straight 3-slot solder/clamp plug	MP-2411-xxx	\$104.20	10-06579-206 non-isolated, bend relief 3-lug bulkhead jack

Prices shown for 12" length



Connector	Part Number	1 Pc. Price	Connector
10-06575-206 straight 3-lug solder/clamp jack	MP-2041-xxx	\$101.08	10-06575-206 straight 3-lug solder/clamp jack

Prices shown for 12" length



Connector	Part Number	1 Pc. Price	Connector
10-06030-206 straight 3-slot solder/clamp plug	MP-2377-xxx	\$90.66	10-08030-206 straight 2-slot solder/clamp plug

Prices shown for 12" length

Vehicle Twinax Assemblies | MIL-STD-1553B

30-02002 Cable - Vehicle High-Temp, 0.095 Inch Overall Diameter

xxx = cable length in inches
MP-2168-72 = 6 ft. (72 in.) MP-2168-xxx assembly

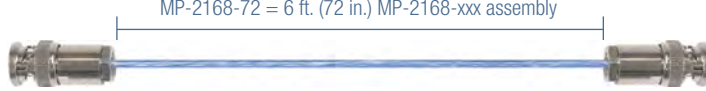

Connector	Part Number	1 Pc. Price	Connector
10-06030-242 straight 3-slot solder/clamp plug	MP-2168-xxx	\$101.76	10-06030-242 straight 3-slot solder/clamp plug

Prices shown for 12" length



Connector	Part Number	1 Pc. Price	Connector
10-06030-242 straight 3-slot solder/clamp plug	MP-2364-xxx	\$79.20	blunt - no connector

Prices shown for 12" length



Connector	Part Number	1 Pc. Price	Connector
10-06030-242 straight 3-slot solder/clamp plug	MP-2395-xxx	\$93.78	10-06575-242 straight 3-lug solder/clamp jack

Prices shown for 12" length



Connector	Part Number	1 Pc. Price	Connector
10-06030-242 straight 3-slot solder/clamp plug	MP-2623-xxx	\$97.95	10-06577-242 non-isolated 3-lug bulkhead jack

Prices shown for 12" length



Connector	Part Number	1 Pc. Price	Connector
10-06030-242 straight 3-slot solder/clamp plug	MP-2413-xxx	\$139.84	10-06573-242 isolated 3-lug bulkhead jack

Prices shown for 12" length



Connector	Part Number	1 Pc. Price	Connector
10-06575-242 straight 3-lug solder/clamp jack	MP-2545-xxx	\$100.04	10-06575-242 straight 3-lug solder/clamp jack

Prices shown for 12" length



Connector	Part Number	1 Pc. Price	Connector
10-06575-242 straight 3-lug solder/clamp jack	MP-2443-xxx	\$158.84	blunt - no connector

Prices shown for 12" length

xxx = cable length in inches
MP-2360-120 = 10 ft. (120 in.) MP-2360-xxx assembly

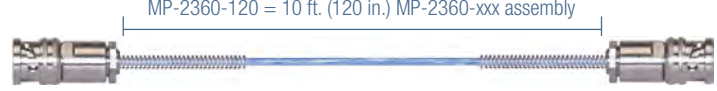

Connector	Part Number	1 Pc. Price	Connector
10-06033-242 bend relief, straight 3-slot solder/clamp plug	MP-2360-xxx	\$132.34	10-06033-242 bend relief, straight 3-slot solder/clamp plug

Prices shown for 12" length



Connector	Part Number	1 Pc. Price	Connector
10-06033-242 bend relief, straight 3-slot solder/clamp plug	MP-2365-xxx	\$87.53	blunt - no connector

Prices shown for 12" length



Connector	Part Number	1 Pc. Price	Connector
10-06033-242 bend relief, straight 3-slot solder/clamp plug	MP-2399-xxx	\$108.37	10-06570-242 bend relief, straight 3-lug solder/clamp jack

Prices shown for 12" length



Connector	Part Number	1 Pc. Price	Connector
10-06033-242 bend relief, straight 3-slot solder/clamp plug	MP-2412-xxx	\$104.20	10-06579-242 non-isolated, bend relief 3-lug bulkhead jack

Prices shown for 12" length



Connector	Part Number	1 Pc. Price	Connector
10-06033-242 bend relief, straight 3-slot solder/clamp plug	MP-2417-xxx	\$160.68	10-06574-242 isolated, bend relief 3-lug bulkhead jack

Prices shown for 12" length



Connector	Part Number	1 Pc. Price	Connector
10-06570-242 bend relief, straight 3-lug solder/clamp jack	MP-2546-xxx	\$132.34	10-06570-242 bend relief, straight 3-lug solder/clamp jack

Prices shown for 12" length



Connector	Part Number	1 Pc. Price	Connector
10-06570-242 bend relief, straight 3-lug solder/clamp jack	MP-2547-xxx	\$87.53	blunt - no connector

Prices shown for 12" length



Crimp Tools & Positioners

page 28



Bus Couplers

pages 6-11



RFI Caps

page 11



Adapters

page 24

MIL-STD-1553B | 78 Ohm Twinax Cable



30-02001
assemblies page 18



30-02003
assemblies pages 19, 27



M17/176-00002
assemblies pages 20, 26



30-02002
assemblies page 21

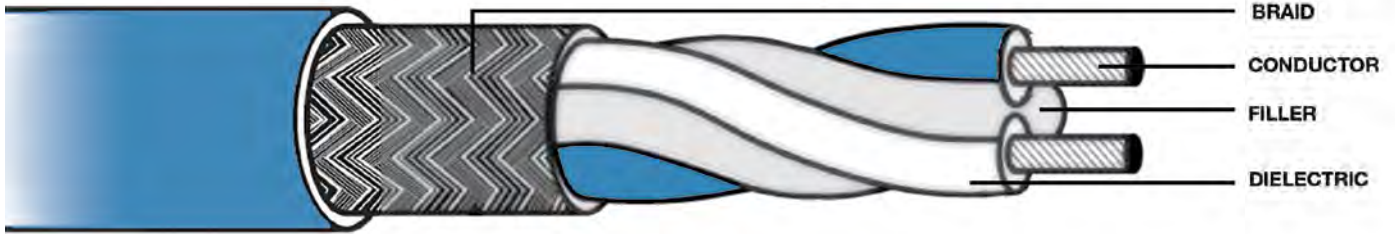

MilesTek	Lab-Rated Twinaxial Cable		Vehicle-Rated High-Temp Twinaxial Cable	
Cable Type Part Number	30-02001	30-02003	M17/176-00002	30-02002
Price Per Foot	\$2.19	\$2.14	\$4.34	\$5.53
uses MilesTek connector	-210	-231	-206	-242
Specifications				
nominal impedance (ohms)	78 ± 3	78 ± 3	77 ± 7	77 ± 7
nominal outer diameter (inches)	0.242	0.15	0.129	0.095
conductor diameter (inches)	0.037	0.022	0.024	0.0149
operating temperature range	-20°C to +75°C	-20°C to +75°C	-55°C to +200°C	-55°C to +200°C
minimum bend radius (inches)	2.42	1.5	1.5	1.25
nominal capacitance (pF/ft.)	19.7	20.3	24	23
outer jacket material	PVC	PVC	Teflon® FEP	PFA
insulation material	PVC	PVC	Teflon® FEP	FEP
shield coverage	0.93	0.93	0.93	0.9
Attenuation (Db/100 Ft.)				
1 MHz	0.6	2	1.4	2
3 MHz		3	2.1	
10 MHz	2.1	5.3	4.500 (max.)	6.5
20 MHz		7.5		
30 MHz		9.2		
40 MHz		10.6		
50 MHz	5	11.9		
100 MHz	7.5	16.8		
200 MHz	11	23.7		
400 MHz	16	--		
500 MHz		37.5		
700 MHz		44.3		
1000 MHz		53		

Alternate Cable Options

Plenum, low smoke, high-temperature, and halogen-free bulk cable is also available. For any other bulk cable needs or requests, please contact MilesTek.

TRB & TRS Bushing/Shield Crimp Tools - Compatible Set

Crimp Tool Description	Part Number	1 Pc. Price
bushing/shield crimp handle	M22520/5-01	\$364.70
TRB crimp die set	CD5-8 (Y778)	\$590.77
TRS crimp die set	CD5-9 (Y687)	\$751.34



M22520/5-01



CD5-8 (Y778)



CD5-9 (Y687)

TRB Center Contact Crimp Tools - Compatible Set

Crimp Tool Description	Part Number	1 Pc. Price
center contact crimp handle	M22520/1-01	\$328.23
TRB center pin positioner	010-0044 (TP837)	\$220.79
TRB center socket positioner	010-0045 (TP838)	\$220.03



M22520/1-01



010-0044 (TP837)



010-0045 (TP838)

TRS Submin Center Contact Crimp Tools - Compatible Set

Crimp Tool Description	Part Number	1 Pc. Price
center contact crimp handle	M22520/2-01	\$513.71
TRS center pin positioner	010-0041 (K815-S)	\$194.86



M22520/2-01



010-0041 (K815-S)

M17/176-00002 Cable Splicing Tools - Compatible Set

Splicing Tool Description	Part Number	1 Pc. Price
splice crimp tool	AD-1377	\$403.83
eight-piece splicing kit	10-06950	\$82.57

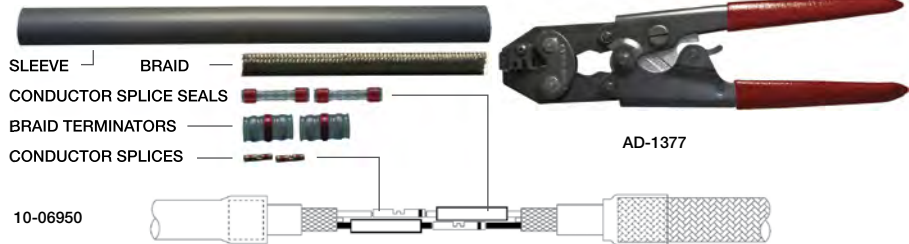

10-06950

AD-1377

Crimp Tool Compatibility Guide

Full Crimp Connector Series	Cable Group	Cable Part Number	Bushing/Shield Crimp Handle	Bushing/Shield Crimp Die Set	Center Contact Crimp Handle	Center Contact Positioner
TRB Standard (full crimp - page 32)	-210	30-02001 TWC-78-2 TWC-124-2	M22520/5-01	CD5-8 (Y778)	M22520/1-01	010-0044 (TP837) use for pin contacts (plugs)
	-231	30-02003 TWC-78-1 TWC-124-1A				010-0045 (TP838) use for socket contacts (jacks)
	-206	M17/176-00002				
	-242	30-02002				
TRS Subminiature (full crimp - page 40)	-231	30-02003 TWC-78-1 TWC-124-1A	M22520/5-01	CD5-9 (Y687)	M22520/2-01	010-0041 (K815-S) use for pin (plugs) & socket (jacks) contacts
	-206	M17/176-00002				
	-242	30-02002				

MIL-STD-1553B | TRB Connectors & Adapters

TRB Cable Plug 3-Slot, Full Crimp



Compatible Twinax Cable Type	Straight	1 Pc. Price	Right Angle	1 Pc. Price
30-02001, TWC-78-2, TWC-124-2	10-06031-210	\$18.76	-	
30-02003, TWC-78-1, TWC-124-1A	10-06031-231	\$20.01	-	
M17/176-00002	10-06031-206	\$19.70	10-06032-206	\$102.95
Specifications - Dimensions		Straight	Right Angle	
overall body width - inches (mm)	0.57" (14.50)		-	
overall body length - inches (mm)	1.70" (43.18)		-	
overall body height - inches (mm)	-		1.13" (28.70)	

TRB Bulkhead Jack To Solder Pot (Non-Isolated) Mating Options



Mating Interface	Front Mount	1 Pc. Price	Rear Mount	1 Pc. Price
3-lug female jack	10-06569	\$27.62	10-06570	\$27.62
Specifications - Dimensions		Front Mount	Rear Mount	
mounting hole size - see chart below	D2.125		D3.218	
overall body width - inches (mm)	0.56" (14.27)		0.69" (17.45)	
overall body length - inches (mm)	1.12" (28.50)		1.31" (33.32)	

TRB Bulkhead Jack To Solder Pot (Isolated) Mating Options



Mating Interface	Front Mount	1 Pc. Price	Rear Mount	1 Pc. Price
3-lug female jack	10-06571	\$33.14	10-06572	\$32.83
Specifications - Dimensions		Front Mount	Rear Mount	
mounting hole size - see chart below	D2.140		D2.140	
overall body width - inches (mm)	0.87" (22.04)		0.87" (22.04)	
overall body length - inches (mm)	1.37" (34.80)		1.37" (34.80)	

TRB Bulkhead Jack Feedthru (Isolated & Non-Isolated) Mating Options



Mating interface	Isolated	1 Pc. Price	Non-isolated	1 Pc. Price
3-lug female jack feedthru	10-06568	\$40.10	10-06567	\$37.20
Specifications - Dimensions		Isolated	Non-Isolated	
mounting hole size - see chart below	D2.140		D3.187	
overall body width - inches (mm)	0.80" (20.32)		0.73" (18.60)	
overall body length - inches (mm)	1.29" (32.77)		1.29" (32.77)	

TRB Standard Within-Series Adapters



Description	Mating Interface	Adapter	1 Pc. Price
TRB 3-lug jack to TRB 3-lug jack	feedthru female to female	10-06901	\$27.62
TRB 3-slot plug to two TRB 3-lug jacks	tee female-male-female	10-06905	\$97.67
TRB 3-slot plug to TRB 3-lug jack	right angle male to female	10-06909	\$95.37

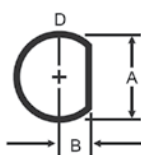

Mounting Hole Sizes

D1 = (A) 0.755-0.760" (B) 0.343-0.346"
D2 = (A) 0.630-0.635" (B) 0.281-0.284"
D3 = (A) 0.505-0.510" (B) 0.218-0.221"
D4 = (A) 0.439-0.443" (B) 0.187-0.190"

D2.140
 maximum panel thickness in inches

D5 = (A) 0.380-0.384" (B) 0.156-0.159"
D6 = (A) 0.317-0.321" (B) 0.128-0.131"
D7 = (A) 0.281-0.285" (B) 0.125-0.128"
D8 = (A) 0.439-0.443" (B) 0.187-0.190"
D9 = (A) 0.567-0.572" (B) 0.257-0.260"

D7.250
 maximum panel thickness in inches

Plug	1 Pc. Price	Plug + Spring	1 Pc. Price	Compatible Twinax Cable Type
10-06030-210	\$18.60	10-06033-210	\$24.30	30-02001, TWC-78-2, TWC-124-2
10-06030-231	\$18.60	10-06033-231	\$24.30	30-02003, TWC-78-1, TWC-124-1A
10-06030-206	\$18.60	10-06033-206	\$24.30	M17/176-00002
10-06030-242	\$18.78	10-06033-242	\$24.30	30-02002, TWAC-78-1F2
10-06030-227	\$18.78	10-06033-227	\$24.30	0024A0024-9X
Plug	Plug + Spring		Specifications - Dimensions	
0.57" (14.50)	0.57" (14.50)		overall body width - inches (mm)	
1.12" (28.50)	1.12" (28.50)		overall body length - inches (mm)	
-	1.85" (46.88)		spring length - inches (mm)	

TRB Cable Plug - 3-Slot, Solder/Clamp



Jack	1 Pc. Price	Jack + Spring	1 Pc. Price	Compatible Twinax Cable Type
10-06575-210	\$27.62	10-06570-210	\$35.43	30-02001, TWC-78-2, TWC-124-2
10-06575-231	\$27.62	10-06570-231	\$35.43	30-02003, TWC-78-1, TWC-124-1A
10-06575-206	\$27.62	10-06570-206	\$35.43	M17/176-00002
10-06575-242	\$27.62	10-06570-242	\$35.43	30-02002, TWAC-78-1F2
Jack	Jack + Spring		Specifications - Dimensions	
0.57" (14.50)	0.57" (14.50)		overall body width - inches (mm)	
1.31" (33.40)	1.31" (33.40)		overall body length - inches (mm)	
-	1.85" (46.88)		spring length - inches (mm)	

TRB Cable Jack - 3-Lug, Solder/Clamp



Jack	1 Pc. Price	Jack + Spring	1 Pc. Price	Compatible Twinax Cable Type
10-06577-210	\$30.93	10-06579-210	\$37.52	30-02001, TWC-78-2, TWC-124-2
10-06577-231	\$30.93	10-06579-231	\$37.52	30-02003, TWC-78-1, TWC-124-1A
10-06577-206	\$30.93	10-06579-206	\$37.52	M17/176-00002
10-06577-242	\$30.93	10-06579-242	\$37.52	30-02002, TWAC-78-1F2
Jack	Jack + Spring		Specifications - Dimensions	
D3.157	D3.157		mounting hole size - see chart pg 24	
0.69" (17.50)	0.69" (17.50)		overall body width - inches (mm)	
1.41" (35.81)	1.41" (35.81)		overall body length - inches (mm)	
-	1.85" (46.88)		spring length - inches (mm)	

TRB Bulkhead Cable Jack - 3-Lug, Solder/Clamp (Non-Isolated)



Jack	1 Pc. Price	Jack + Spring	1 Pc. Price	Compatible Twinax Cable Type
10-06573-210	\$32.45	10-06574-210	\$46.89	30-02001, TWC-78-2, TWC-124-2
10-06573-231	\$32.45	10-06574-231	\$46.89	30-02003, TWC-78-1, TWC-124-1A
10-06573-206	\$32.45	10-06574-206	\$46.89	M17/176-00002
10-06573-242	\$32.45	10-06574-242	\$46.89	30-02002, TWAC-78-1F2
Jack	Jack + Spring		Specifications - Dimensions	
D2.157	D2.157		mounting hole size - see chart pg 24	
0.87" (22.04)	0.87" (22.04)		overall body width - inches (mm)	
1.41" (35.81)	1.41" (35.81)		overall body length - inches (mm)	
-	1.85" (46.88)		spring length - inches (mm)	

TRB Bulkhead Cable Jack - 3-Lug, Solder/Clamp (Isolated)



SUBMINIATURE | Vehicle Twinax Assemblies

M17/176-00002 Cable - Vehicle High-Temp, 0.129 Inch Overall Diameter

xxx = cable length in inches
CA-2414-72 = 6 ft. (72 in.) CA-2414-xxx assembly



Connector	Part Number	1 Pc. Price	Connector
10-10030-206 subminiature, straight 3-slot solder/clamp plug	CA-2414-xxx	\$98.16	10-06030-206 straight 3-slot solder/clamp plug

Prices shown for 12" length



Connector	Part Number	1 Pc. Price	Connector
10-10030-206 subminiature, straight 3-slot solder/clamp plug	MP-3006-xxx	\$97.95	10-06575-206 straight 3-lug solder/clamp jack

Prices shown for 12" length



Connector	Part Number	1 Pc. Price	Connector
10-10031-206 subminiature, straight 3-slot full crimp plug	MP-2079-xxx	\$121.92	10-06031-206 straight 3-slot full crimp plug

Prices shown for 12" length



Connector	Part Number	1 Pc. Price	Connector
10-10031-206 subminiature, straight 3-slot full crimp plug	MP-2186-xxx	\$120.88	blunt - no connector

Prices shown for 12" length



Connector	Part Number	1 Pc. Price	Connector
10-12030-206 subminiature, straight threaded plug	MP-2006-xxx	\$135.46	10-10030-206 subminiature, straight 3-slot solder/clamp plug

Prices shown for 12" length



Connector	Part Number	1 Pc. Price	Connector
10-12030-206 subminiature, straight threaded plug	MP-5259-xxx	\$121.92	blunt - no connector

Prices shown for 12" length



Connector	Part Number	1 Pc. Price	Connector
10-12031-206 subminiature, straight threaded full crimp plug	MP-2485-xxx	\$163.81	10-06031-206 straight 3-slot full crimp plug

Prices shown for 12" length

xxx = cable length in inches
MP-2134-120 = 10 ft. (120 in.) MP-2134-xxx assembly



Connector	Part Number	1 Pc. Price	Connector
10-10030-206 subminiature, straight 3-slot solder/clamp plug	MP-2134-xxx	\$93.78	10-10030-206 subminiature, straight 3-slot solder/clamp plug

Prices shown for 12" length



Connector	Part Number	1 Pc. Price	Connector
10-10030-206 subminiature, straight 3-slot solder/clamp plug	MP-2341-xxx	\$77.11	blunt - no connector

Prices shown for 12" length



Connector	Part Number	1 Pc. Price	Connector
10-10031-206 subminiature, straight 3-slot full crimp plug	CA-2095-xxx	\$152.35	10-10031-206 subminiature, straight 3-slot full crimp plug

Prices shown for 12" length



Connector	Part Number	1 Pc. Price	Connector
10-12030-206 subminiature, straight threaded plug	MP-2277-xxx	\$145.88	10-12030-206 subminiature, straight threaded plug

Prices shown for 12" length



Connector	Part Number	1 Pc. Price	Connector
10-12030-206 subminiature, straight threaded plug	MP-2004-xxx	\$135.46	10-06030-206 straight 3-slot solder/clamp plug

Prices shown for 12" length



Connector	Part Number	1 Pc. Price	Connector
10-12031-206 subminiature, straight threaded full crimp plug	MP-2096-xxx	\$163.81	10-12031-206 subminiature, straight threaded full crimp plug

Prices shown for 12" length



Connector	Part Number	1 Pc. Price	Connector
10-12031-206 subminiature, straight threaded full crimp plug	MP-2305-xxx	\$142.76	blunt - no connector

Prices shown for 12" length

TRS Submin Cable Plug - 3-Slot, Solder/Clamp



10-10030-xxx

Compatible Twinax Cable Type	Plug	1 Pc. Price
30-02003, TWC-78-1, TWC-124-1A	10-10030-231	\$28.72
M17/176-00002	10-10030-206	\$28.72
Specifications - Dimensions		Plug
overall body width - inches (mm)	0.46" (11.68)	
overall body length - inches (mm)	0.83" (21.08)	

30-02003 Cable - Lab-Rated Pvc, 0.150 Inch Overall Diameter

Assembly #	Cable Type	Application	1 Pc. Price
CA-2005-xxx	30-02003	laboratory	\$93.78

Prices shown for 12" length

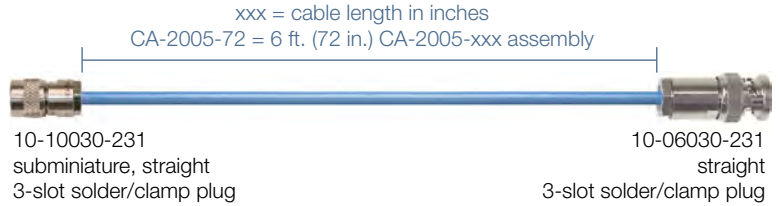

Assembly #	Cable Type	Application	1 Pc. Price
CA-2375-xxx	30-02003	laboratory	\$82.32

Prices shown for 12" length

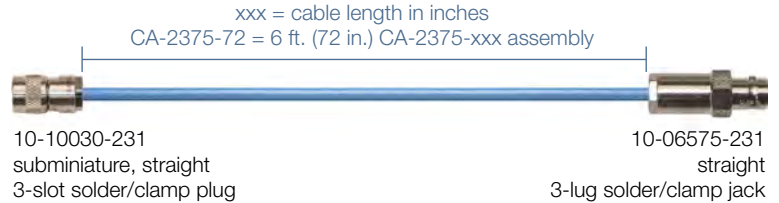

Assembly #	Cable Type	Application	1 Pc. Price
MP-2474-xxx	30-02003	laboratory	\$111.67

Prices shown for 12" length

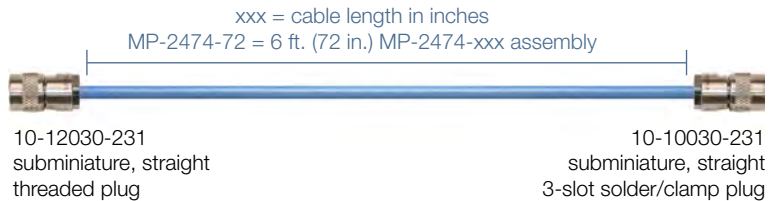

Assembly #	Cable Type	Application	1 Pc. Price
MP-2478-xxx	30-02003	laboratory	\$111.50

Prices shown for 12" length

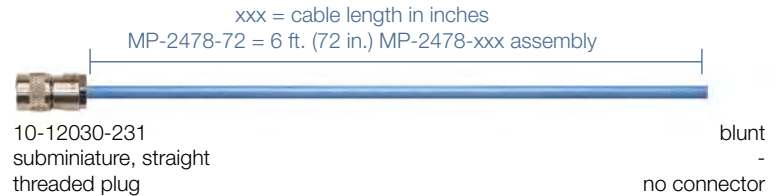

Assembly #	Cable Type	Application	1 Pc. Price
MP-2018-xxx	30-02003	laboratory	\$93.78

Prices shown for 12" length

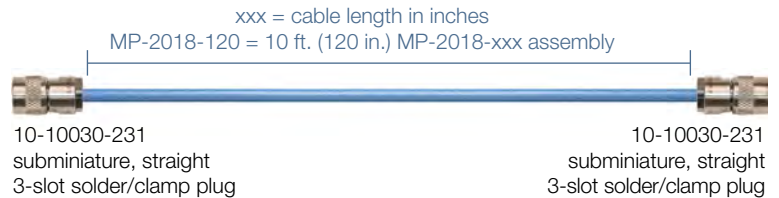

Assembly #	Cable Type	Application	1 Pc. Price
MP-2456-xxx	30-02003	laboratory	\$93.78

Prices shown for 12" length

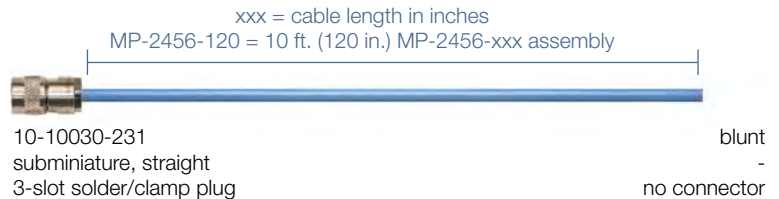

Assembly #	Cable Type	Application	1 Pc. Price
MP-2098-xxx	30-02003	laboratory	\$164.00

Prices shown for 12" length

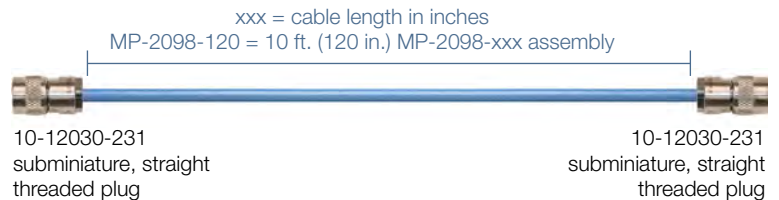

Assembly #	Cable Type	Application	1 Pc. Price
MP-2229-xxx	30-02003	laboratory	\$132.34

Prices shown for 12" length

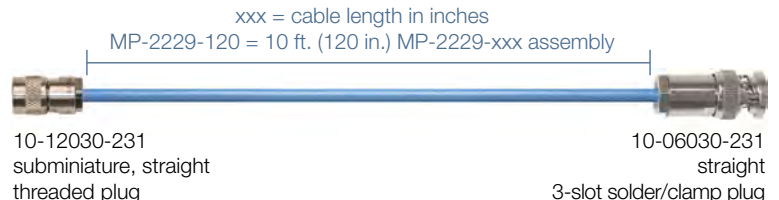

SUBMINIATURE | TRS Crimp Tools, TRB v TRS



3-slot, 3-lug



2-slot, 2-lug



4-slot, 4-lug



threaded

Mating Interfaces

Standard MilesTek TRB 3-slot plugs and TRB 3-lug jacks are the most common mating interfaces. MilesTek also offers connectors in 2-slot/lug, 4-slot/lug, and threaded mating interfaces. Call to request these alternate mating solutions.

TRS Submin Center Contact Crimp Tools - Compatible Set



M22520/2-01



010-0041 (K815-S)

Crimp Tool Description	Part Number	1 Pc. Price
center contact crimp handle	M22520/2-01	\$513.71
TRS center pin positioner	010-0041 (K815-S)	\$194.86

TRS Submin Crimp Tool Compatibility Guide

full crimp connector series	cable group	cable part number	bushing/shield crimp handle	bushing/shield crimp die set	center contact crimp handle	center contact positioner
TRS subminiature full crimp 10-10031-xxx 10-10032-xxx	-231	30-02003 TWC-78-1 TWC-124-1A	M22520/5-01	CD5-9 (Y687)	M22520/2-01	010-0041 (K815-S) use for pin (plugs) & socket (jacks) contacts
	-206	M17/176-00002				
	-242	30-02002				

TRB Standard v. TRS Subminiature

TRB Standard Connectors

Standard (TRB) connectors are designed for extreme durability and heavy-use applications. TRB connectors are the most common interface size (same size as BNC/TNC series). This connector series is not recommended for weight-sensitive applications. The maximum outer cable diameter is 0.475 inches (large-body versions are available for larger cables).

TRS Subminiature Connectors

Subminiature (TRS) connectors are preferred in applications that require weight reduction, high packing density, and noise-free guarded circuits. TRS connectors can increase packing density to more than 240% compared to TRB standard connectors. The reduced size limits the maximum outer cable diameter to 0.250 inches.



10-06030-xxx



**3-SLOT
TRB PLUG**



**3-SLOT
TRS PLUG**



10-10030-xxx



0024A0024-9X
assembly & components below

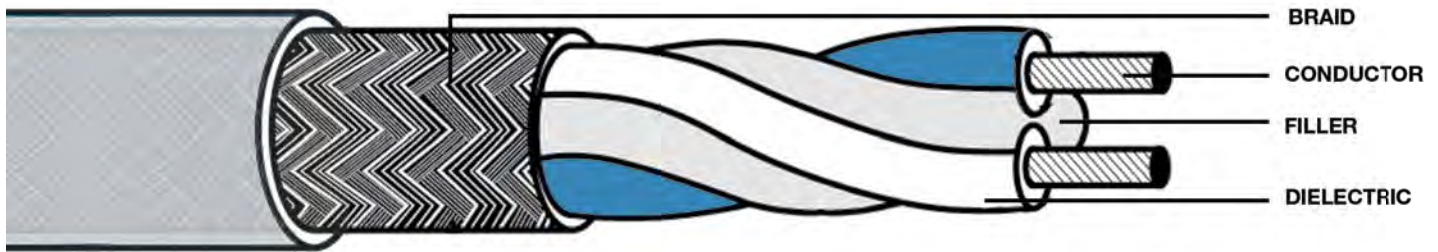

MilesTek 100 Ohm Twinaxial Cable

cable type part number	0024A0024-9X
Price Per Foot	\$11.00
uses MilesTek connector	-227

Specifications

nominal impedance (ohms)	100 ± 7
nominal outer diameter (inches)	0.149
conductor diameter (inches)	0.025
max. operating VDC	1000 V _{RMS}
max. operating VAC (RMS)	1.0 kV
minimum bend radius (inches)	1.788
max. capacitance (pF/ft.)	13.5 (mutual)
outer jacket material	Modified FEP
insulation material	Rayfoam® H
shield coverage	90%

Attenuation (dB/100 ft.)

1 MHz	0.300
3 MHz	
10 MHz	1.200
20 MHz	
30 MHz	
40 MHz	
50 MHz	2.800
100 MHz	4.100
200 MHz	6.400
400 MHz	10.200

100 Ohm TRB Plug To Plug Cable Assembly

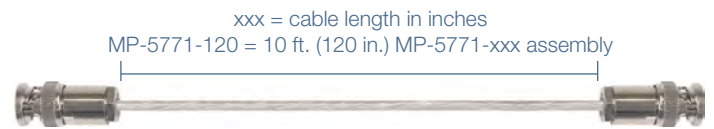

Connector	Part Number	1 Pc. Price	Connector
10-06030-227 straight 3-slot solder/clamp plug	MP-5771-xxx	\$163.60	10-06030-227 straight 3-slot solder/clamp plug

Prices shown for 12" length

100 Ohm TRB Cable Plug - 3-Slot, Solder/Clamp



Compatible Twinax Cable Type	Plug	1 Pc. Price
0024A0024-9X	10-06030-227	\$18.78

Specifications - Dimensions

	Plug
overall body width - inches (mm)	0.57" (14.50)
overall body length - inches (mm)	1.12" (28.50)

100 Ohm TRB Bus Terminator - Chain Options



Description	Terminator	1 Pc. Price
bus terminator, w/out chain	10-06403-044	\$86.16
bus terminator, 3" chain	10-06403-072	\$92.74
bus terminator, 6" chain	10-06403-071	\$92.74

TWINAXIAL | 124 Ohm Twinax Cable



TWC-124-2
assemblies page 31



TWC-124-1A
assemblies page 31

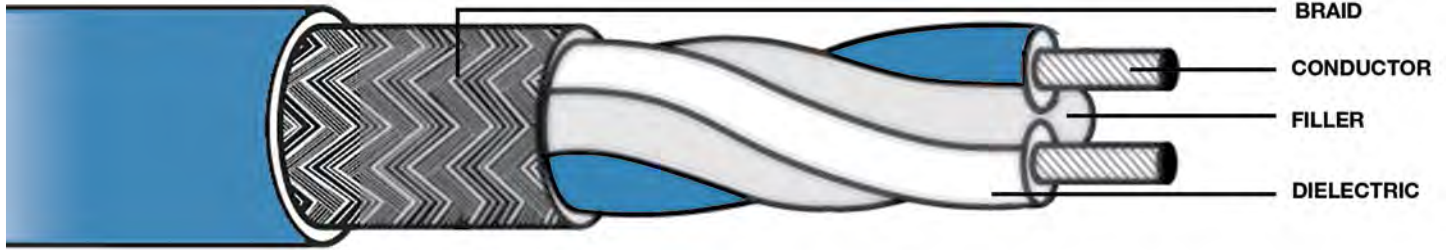

MilesTek 124 Ohm Twinaxial Cable

Cable Type Part Number	TWC-124-2	TWC-124-1A
Price Per Foot	\$2.21	\$2.21
uses MilesTek connector	-210	-231

Specifications

nominal impedance (ohms)	124 ± 4	124 ± 5
nominal outer diameter (inches)	0.245	0.150
conductor diameter (inches)	0.022	0.012
max. operating VDC	2.0 kV	0.6kV
max. operating VAC (RMS)	1.0 kV	0.3 kV
minimum bend radius (inches)	1.25	1.50
max. capacitance (pF/ft.)	12.30	12.40
outer jacket material	PVC	PVC
insulation material	PVC	PVC
shield coverage	93%	93%

Attenuation (dB/100 ft.)

1 MHz	0.540	3.250
3 MHz	0.920	4.400
10 MHz	1.650	5.900
20 MHz	2.300	8.300
30 MHz	2.800	10.200
40 MHz	3.200	11.800
50 MHz	3.600	13.200
100 MHz	5.100	18.700
200 MHz	7.200	26.400
400 MHz	-	-
500 MHz	11.400	41.700
700 MHz	13.500	49.400

Alternate Cable Options

Plenum, low smoke, high-temperature, and halogen-free bulk cable is also available upon request. For any other bulk cable needs or requests, please contact MilesTek.

TWC-124-2 cable PVC, 0.245 Inch Overall Diameter

xxx = cable length in inches
MP-2205-72 = 6 ft. (72 in.) MP-2205-xxx assembly



Connector	Part Number	1 Pc. Price	Connector
10-06030-210 straight 3-slot solder/clamp plug	MP-2205-xxx	\$93.78	10-06030-210 straight 3-slot solder/clamp plug

Prices shown for 12" length



Connector	Part Number	1 Pc. Price	Connector
10-06030-210 straight 3-slot solder/clamp plug	MP-2302-xxx	\$51.06	blunt - no connector

Prices shown for 12" length



Connector	Part Number	1 Pc. Price	Connector
10-06033-210 bend relief, straight 3-slot solder/clamp plug	MP-2152-xxx	\$100.04	10-06033-210 bend relief, straight 3-slot solder/clamp plug

Prices shown for 12" length



Connector	Part Number	1 Pc. Price	Connector
10-06030-210 straight 3-slot solder/clamp plug	MP-2600-xxx	\$83.36	10-06575-210 straight 3-lug solder/clamp jack

Prices shown for 12" length



Connector	Part Number	1 Pc. Price	Connector
10-06575-210 straight 3-lug solder/clamp jack	MP-2601-xxx	\$83.36	10-06575-210 straight 3-lug solder/clamp jack

Prices shown for 12" length

TWC-124-1A cable PVC, 0.150 Inch Overall Diameter

xxx = cable length in inches
MP-2292-120 = 10 ft. (120 in.) MP-2292-xxx assembly



Connector	Part Number	1 Pc. Price	Connector
10-06030-231 straight 3-slot solder/clamp plug	MP-2292-xxx	\$124.42	10-06030-231 straight 3-slot solder/clamp plug

Prices shown for 12" length



Connector	Part Number	1 Pc. Price	Connector
10-06030-231 straight 3-slot solder/clamp plug	MP-2602-xxx	\$56.27	blunt - no connector

Prices shown for 12" length



Connector	Part Number	1 Pc. Price	Connector
10-06033-231 bend relief, straight 3-slot solder/clamp plug	MP-2487-xxx	\$104.20	10-06033-231 bend relief, straight 3-lug solder/clamp jack

Prices shown for 12" length



Connector	Part Number	1 Pc. Price	Connector
10-10030-231 subminiature, straight 3-slot solder/clamp plug	MP-2603-xxx	\$93.78	10-10030-231 subminiature, straight 3-slot solder/clamp plug

Prices shown for 12" length



Connector	Part Number	1 Pc. Price	Connector
10-10030-231 subminiature, straight 3-slot solder/clamp plug	MP-2344-xxx	\$88.57	10-06030-231 straight 3-slot solder/clamp plug

Prices shown for 12" length

TRB Cable Plug - 3-Slot, Solder/Clamp

Compatible Twinax Cable Type	Plug	1 Pc. Price
TWC-124-2	10-06030-210	\$18.60
TWC-124-1A	10-06030-231	\$18.60

Specifications - Dimensions	Plug
overall body width - inches (mm)	0.57" (14.50)
overall body length - inches (mm)	1.12" (28.50)



TRB Cable Plug - 3-Slot, Bend Relief

Compatible Twinax Cable Type	Plug + Spring	1 Pc. Price
TWC-124-2	10-06033-210	\$24.30
TWC-124-1A	10-06033-231	\$24.30

Specifications - Dimensions	Jack + Spring
overall body width - inches (mm)	0.57" (14.50)
overall body length - inches (mm)	1.12" (28.50)
spring length - inches (mm)	1.85" (46.88)



TRB Cable Jack - 3-Lug, Solder/Clamp

Compatible Twinax Cable Type	Jack	1 Pc. Price
TWC-124-2	10-06575-210	\$27.62
TWC-124-1A	10-06575-231	\$27.62

Specifications - Dimensions	Jack
overall body width - inches (mm)	0.57" (14.50)
overall body length - inches (mm)	1.31" (33.40)



TRS Submin Plug - 3-Slot, Solder/Clamp

Compatible Twinax Cable Type	Plug	1 Pc. Price
TWC-124-1A	10-10030-231	\$28.72

Specifications - Dimensions	Plug
overall body width - inches (mm)	0.46" (11.68)
overall body length - inches (mm)	0.83" (21.08)





Plenum Cable Assemblies

Item #	Description	1 Pc. Price
MSA00160-12N	Plenum Cable Assembly TRB 3-Slot Plug to Plug .242" O.D. +125C 124 Ohm Twinaxial Shielded Twisted Pair 1'	\$97.21
MSA00161-12N	Plenum Cable Assembly TRB 3-Slot Plug to Blunt .242" O.D. +125C 124 Ohm Twinaxial Shielded Twisted Pair 1'	\$88.25
MSA00162-12N	Plenum Cable Assembly TRB 3-Slot Plug to 3-Lug Cable Jack .242" O.D. +125C 124 Ohm Twinaxial Shielded Twisted Pair 1'	\$104.92
MSA00163-12N	Plenum Cable Assembly TRB 3-Slot Plug to Non-Insulated Bulk Head 3-Lug Cable Jack .242" O.D. +125C 124 Ohm Twinaxial Shielded Twisted Pair 1'	\$106.33
MSA00164-12N	Plenum Cable Assembly TRB 3-Slot Plug to Insulated Bulk Head 3-Lug Cable Jack .242" O.D. +125C 124 Ohm Twinaxial Shielded Twisted Pair 1'	\$111.85
MSA00165-12N	Plenum Cable Assembly TRB 3-Slot Plug to Plug with Bend Reliefs .242" O.D. +125C 124 Ohm Twinaxial Shielded Twisted Pair 1'	\$99.71
MSA00166-12N	Plenum Cable Assembly TRB 3-Slot Plug with Bend Relief to Blunt .242" O.D. +125C 124 Ohm Twinaxial Shielded Twisted Pair 1'	\$92.78
MSA00167-12N	Plenum Cable Assembly TRB 3-Slot Plug to 3-Lug Cable Jack with Bend Reliefs .242" O.D. +125C 124 Ohm Twinaxial Shielded Twisted Pair 1'	\$112.32
MSA00168-12N	Plenum Cable Assembly TRB 3-Slot Plug to Non-Insulated Bulk Head 3-Lug Cable Jack with Bend Reliefs .242" O.D. +125C 124 Ohm Twinaxial Shielded Twisted Pair 1'	\$112.32
MSA00169-12N	Plenum Cable Assembly TRB 3-Slot Plug to Insulated Bulk Head 3-Lug Cable Jack with Bend Reliefs .242" O.D. +125C 124 Ohm Twinaxial Shielded Twisted Pair 1'	\$113.73
MSA00170-12N	Plenum Cable Assembly TRB 3-Lug Cable Jack to Jack .242" O.D. +125C 124 Ohm Twinaxial Shielded Twisted Pair 1'	\$108.83
MSA00171-12N	Plenum Cable Assembly TRB Non-Insulated Bulk Head 3-Lug Cable Jack to Jack .242" O.D. +125C 124 Ohm Twinaxial Shielded Twisted Pair 1'	\$112.95
MSA00172-12N	Plenum Cable Assembly TRB Insulated Bulk Head Jack 3-Lug Cable Jack to Jack .242" O.D. +125C 124 Ohm Twinaxial Shielded Twisted Pair 1'	\$124.04
MSA00173-12N	Plenum Cable Assembly TRB 3-Lug Cable Jack to Jack with Bend Reliefs .242" O.D. +125C 124 Ohm Twinaxial Shielded Twisted Pair 1'	\$115.81
MSA00174-12N	Plenum Cable Assembly TRB Non-Insulated Bulk Head 3-Lug Cable Jack to Jack with Bend Reliefs .242" O.D. +125C 124 Ohm Twinaxial Shielded Twisted Pair 1'	\$115.81
MSA00175-12N	Plenum Cable Assembly TRB Insulated Bulk Head 3-Lug Cable Jack to Jack with Bend Relief .242" O.D. +125C 124 Ohm Twinaxial Shielded Twisted Pair 1'	\$129.72

Assembly prices shown for 12" length. See our website for additional lengths.

See our website, MilesTek.com to view all of our products.

Twinaxial Cable



Description

Twinax cable is a two-conductor, twisted, balanced wire line with a specific impedance and a shielding braid around both wires.

Technical Information

The twisting of the two balanced signal-carrying conductor wires cancels any random induced noise voltage pickup, giving protection against any low-frequency magnetic noise passing through the copper braid. Twinax cable is shielded, insulated from the twisted signal carrying conductors.

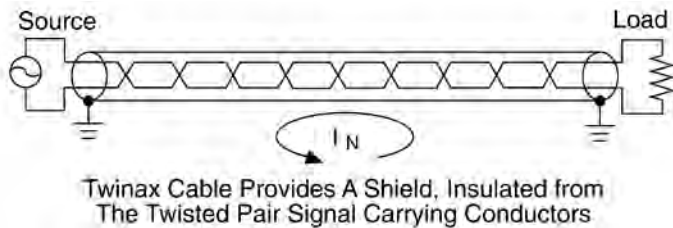

MilesTek's twinax cable design lowers cable losses by adding two dielectric fillers under the braid (separating the braid away from the signal pair), thereby lowering the leakage capacitance to ground. The coverage is improved to up to 93% by using more copper wire in the braid and weaving it tighter. This design also provides protection against ground loops and capacitive fields.

Applications

Twinax cables are a cost-efficient and effective option for short-range, high-speed, differential signaling applications. For this reason, twinax is best suited for low-frequency digital and video distribution systems, like connecting MIL-STD-1553 bus and stub devices. Twinax cable is most effective up to approximately 15 MHz, since it has higher transmission losses above this frequency.



Triaxial Cable

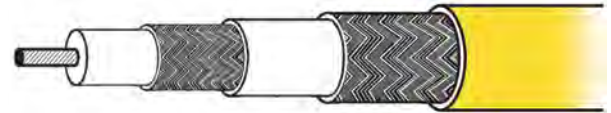

Description

Triax cable is coax cable with an additional outer copper braid (insulated from the signal carrying conductors) which acts as a shield protecting the enclosed coax conductors.

Technical Information

The outer braid is grounded and passes both ground loop and capacitive field noise currents away from the signal-carrying coax. This greatly improves the "signal-to-noise" ratio when compared to standard coax cable. In essence, triax cable provides additional shielding, insulated from the signal carrying coax.

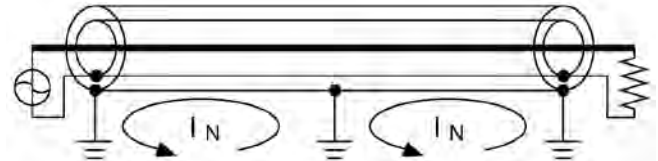

Driven Shield

Triax cable is also used in "Driven Shield" (see diagram below) applications, where the inner conductor and the inner braid are driven in parallel at the transmitting end, and work against the outer braid which is insulated above ground. The inner braid creates a "Faraday" shield between the inner conductor and outer braid, as it is floating at the receiving end. Thus, the cable's distributed capacitance, cable losses and loading are greatly reduced.

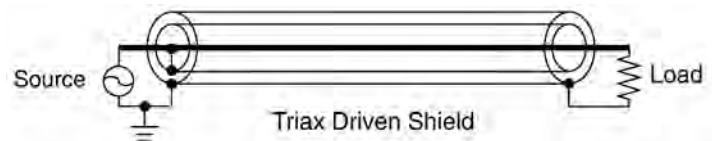

Applications

Triax cables are effective for a broad range of applications, including high-frequency transducer data systems (where the distributed capacity in coax cable limits the data accuracy) and precision low-current measurements. Also, the two braids are useful as a low-impedance transmission line (approximately 12 ohms) to carry high-current pulses to low-impedance laser lamps or exploding bridge wire (EBW) ordinance systems.

TRIAXIAL | 50 & 75 Ohm Triax Cable



TRC-50-2
assemblies page 35



TRC-50-1
assemblies page 35



TRC-75-2
assemblies page 38



TRC-75-1
assemblies page 38

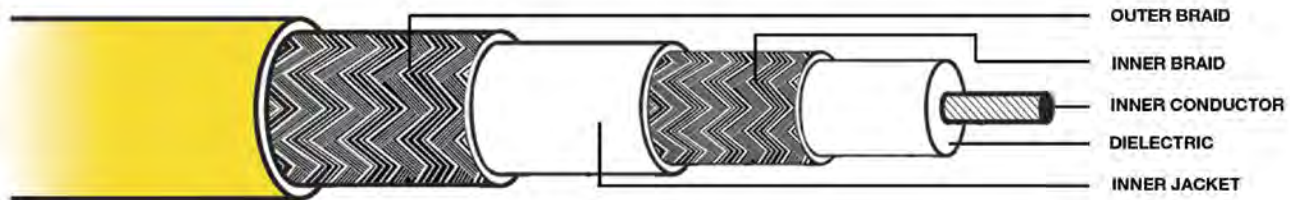

MilesTek	50 Ohm Triaxial Cable		75 Ohm Triaxial Cable	
----------	-----------------------	--	-----------------------	--

Cable Type Part Number	TRC-50-2	TRC-50-1	TRC-75-2	TRC-75-1
Price Per Foot	\$3.32	\$3.32	\$3.32	\$3.43
uses MilesTek connector	-310	-370	-310	-350

Specifications				
----------------	--	--	--	--

nominal impedance (ohms)	50 ± 2	50 ± 2	75 ± 5	75 ± 5
nominal outer diameter (inches)	0.242	0.156	0.245	0.189
conductor diameter (inches)	0.037	0.015	0.185	0.012
max. operating VDC	6.0 kV	2.0 kV	6.0 kV	2.0 kV
max. operating VAC (RMS)	2.0 kV	1.0 kV	2.0 kV	1.0 kV
minimum bend radius (inches)	1.25	0.75	1.25	1.00
nominal capacitance (pF/ft.)	32.00	29.50	20.50	20.00
outer jacket material	PVC	PVC	PVC	PVC
insulation material	PVC	PVC	PVC	PVC
shield coverage	93%	93%	93%	93%

Attenuation (dB/100 ft.)				
--------------------------	--	--	--	--

1 MHz	0.500	2.800	0.480	0.900
3 MHz	0.800	3.100	0.880	1.300
10 MHz	1.500	4.100	1.500	2.400
20 MHz	2.300	5.500	2.300	3.600
30 MHz	2.900	7.000	2.900	4.500
40 MHz	3.400	7.500	3.300	5.400
50 MHz	3.900	9.100	3.600	6.100
100 MHz	5.800	14.000	5.200	9.700
200 MHz	8.800	22.000	7.600	16.500
400 MHz	-	-	-	-
500 MHz	15.300	40.000	10.800	28.500
700 MHz	18.000	50.000	14.700	36.000

TRC-50-2 Cable PVC, 0.242 Inch Overall Diameter

xxx = cable length in inches
CA-3017-72 = 6 ft. (72 in.) CA-3017-xxx assembly



Connector	Part Number	1 Pc. Price	Connector
10-06030-310 straight 3-slot solder/clamp plug	CA-3017-xxx	\$108.37	10-06030-310 straight 3-slot solder/clamp plug

Prices shown for 12" length



Connector	Part Number	1 Pc. Price	Connector
10-06030-310 straight 3-slot solder/clamp plug	MP-2604-xxx	\$70.86	blunt - no connector

Prices shown for 12" length



Connector	Part Number	1 Pc. Price	Connector
10-06033-310 bend relief, straight 3-slot solder/clamp plug	MP-2605-xxx	\$130.25	10-06033-310 bend relief, straight 3-slot solder/clamp plug

Prices shown for 12" length



Connector	Part Number	1 Pc. Price	Connector
10-06030-310 straight 3-slot solder/clamp plug	MP-2606-xxx	\$165.86	10-06575-310 straight 3-lug solder/clamp jack

Prices shown for 12" length



Connector	Part Number	1 Pc. Price	Connector
10-06575-310 straight 3-lug solder/clamp jack	MP-2607-xxx	\$162.56	10-06575-310 straight 3-lug solder/clamp jack

Prices shown for 12" length

TRC-50-1 Cable PVC, 0.156 Inch Overall Diameter

xxx = cable length in inches
MP-2346-120 = 10 ft. (120 in.) MP-2346-xxx assembly



Connector	Part Number	1 Pc. Price	Connector
10-06030-370 straight 3-slot solder/clamp plug	MP-2346-xxx	\$132.21	10-06030-370 straight 3-slot solder/clamp plug

Prices shown for 12" length



Connector	Part Number	1 Pc. Price	Connector
10-06030-370 straight 3-slot solder/clamp plug	MP-2608-xxx	\$84.41	blunt - no connector

Prices shown for 12" length



Connector	Part Number	1 Pc. Price	Connector
10-06030-370 straight 3-slot solder/clamp plug	MP-2609-xxx	\$140.67	10-06575-370 straight 3-lug solder/clamp jack

Prices shown for 12" length



Connector	Part Number	1 Pc. Price	Connector
10-10030-370 subminiature, straight 3-slot solder/clamp plug	MP-2610-xxx	\$140.67	10-10030-370 subminiature, straight 3-slot solder/clamp plug

Prices shown for 12" length



Connector	Part Number	1 Pc. Price	Connector
10-10030-370 subminiature, straight 3-slot solder/clamp plug	MP-2611-xxx	\$155.85	10-06030-370 straight 3-slot solder/clamp plug

Prices shown for 12" length

TRB Cable Plug - 3-Slot, Solder/Clamp

Compatible Triax Cable Type	Plug	1 Pc. Price
TRC-50-2	10-06030-310	\$18.78
TRC-50-1	10-06030-370	\$18.78
Specifications - Dimensions	Plug	
overall body width - inches (mm)	0.57" (14.50)	
overall body length - inches (mm)	1.12" (28.50)	



TRS Submin Plug - 3-Slot, Solder/Clamp

Compatible Triax Cable Type	Plug	1 Pc. Price
TRC-50-1	10-10030-370	\$28.72
Specifications - Dimensions	Plug	
overall body width - inches (mm)	0.46" (11.68)	
overall body length - inches (mm)	0.83" (21.08)	



TRIAxIAL | 50 Ohm Triax Assemblies



Halogen Free Cable Assemblies

Item #	Description	1 Pc. Price
MSA00288-12N	Halogen Free Cable Assembly with TRB 3-Slot Plug to Plug .245" O.D. -30C +80C 50 Ohm Triaxial Yellow 1'	\$128.59
MSA00289-12N	Halogen Free Cable Assembly TRB 3-Slot Plug to Blunt .245" O.D. -30C +80C 50 Ohm Triaxial Yellow 1'	\$117.13
MSA00290-12N	Halogen Free Cable Assembly TRB 3-Slot Plug to 3-Lug Cable Jack .245" O.D. -30C +80C 50 Ohm Triaxial Yellow 1'	\$145.26
MSA00291-12N	Halogen Free Cable Assembly TRB 3-Slot Plug to Non-Insulated Bulk Head 3-Lug Cable Jack .245" O.D. -30C +80C 50 Ohm Triaxial Yellow 1'	\$146.67
MSA00292-12N	Halogen Free Cable Assembly TRB 3-Slot Plug to Insulated Bulk Head 3-Lug Cable Jack .245" O.D. -30C +80C 50 Ohm Triaxial Yellow 1'	\$152.24
MSA00293-12N	Halogen Free Cable Assembly TRB 3-Slot Plug to Plug with Bend Reliefs .245" O.D. -30C +80C 50 Ohm Triaxial Yellow 1'	\$134.27
MSA00294-12N	Halogen Free Cable Assembly TRB 3-Slot Plug with Bend Relief to Blunt .245" O.D. -30C +80C 50 Ohm Triaxial Yellow 1'	\$119.99
MSA00295-12N	Halogen Free Cable Assembly TRB 3-Slot Plug to 3-Lug Cable Jack with Bend Reliefs .245" O.D. -30C +80C 50 Ohm Triaxial Yellow 1'	\$150.94
MSA00296-12N	Halogen Free Cable Assembly TRB 3-Slot Plug to Non-Insulated Bulk Head 3-Lug Cable Jack with Bend Reliefs .245" O.D. -30C +80C 50 Ohm Triaxial Yellow 1'	\$150.99
MSA00297-12N	Halogen Free Cable Assembly TRB 3-Slot Plug to Insulated Bulk Head 3-Lug Cable Jack with Bend Reliefs .245" O.D. -30C +80C 50 Ohm Triaxial Yellow 1'	\$157.92
MSA00298-12N	Halogen Free Cable Assembly TRB 3-Lug Cable Jack to Jack .245" O.D. -30C +80C 50 Ohm Triaxial Yellow 1'	\$161.93
MSA00299-12N	Halogen Free Cable Assembly TRB Non-Insulated Bulk Head 3-Lug Cable Jack to Jack .245" O.D. -30C +80C 50 Ohm Triaxial Yellow 1'	\$162.24
MSA00300-12N	Halogen Free Cable Assembly TRB Insulated Bulk Head Jack 3-Lug Cable Jack to Jack .245" O.D. -30C +80C 50 Ohm Triaxial Yellow 1'	\$142.08
MSA00301-12N	Halogen Free Cable Assembly TRB 3-Lug Cable Jack to Jack with Bend Reliefs .245" O.D. -30C +80C 50 Ohm Triaxial Yellow 1'	\$136.35
MSA00302-12N	Halogen Free Cable Assembly TRB Non-Insulated Bulk Head 3-Lug Cable Jack to Jack with Bend Reliefs .245" O.D. -30C +80C 50 Ohm Triaxial Yellow 1'	\$136.66
MSA00303-12N	Halogen Free Cable Assembly TRB Insulated Bulk Head 3-Lug Cable Jack to Jack with Bend Relief .245" O.D. -30C +80C 50 Ohm Triaxial Yellow 1'	\$147.76

Assembly prices shown for 12" length. See our website for additional lengths.

See our website, MilesTek.com to view all of our products.

Teflon Jacket Cable Assemblies

Item #	Description	1 Pc. Price
MSA00352-12N	Teflon Jacket Cable Assembly with TRB 3-Slot Plug to Plug .236" O.D. -55C +200C 50 Ohm Triaxial 1'	\$156.51
MSA00353-12N	Teflon Jacket Cable Assembly TRB 3-Slot Plug to Blunt .236" O.D. -55C +200C 50 Ohm Triaxial 1'	\$129.42
MSA00354-12N	Teflon Jacket Cable Assembly TRB 3-Slot Plug to 3-Lug Cable Jack .236" O.D. -55C +200C 50 Ohm Triaxial 1'	\$173.19
MSA00355-12N	Teflon Jacket Cable Assembly TRB 3-Slot Plug to Non-Insulated Bulk Head 3-Lug Cable Jack .236" O.D. -55C +200C 50 Ohm Triaxial 1'	\$174.59
MSA00356-12N	Teflon Jacket Cable Assembly TRB 3-Slot Plug to Insulated Bulk Head 3-Lug Cable Jack .236" O.D. -55C +200C 50 Ohm Triaxial 1'	\$173.91
MSA00357-12N	Teflon Jacket Cable Assembly TRB 3-Slot Plug to Plug with Bend Reliefs .236" O.D. -55C +200C 50 Ohm Triaxial 1'	\$131.14
MSA00358-12N	Teflon Jacket Cable Assembly TRB 3-Slot Plug with Bend Relief to Blunt .236" O.D. -55C +200C 50 Ohm Triaxial 1'	\$147.92
MSA00359-12N	Teflon Jacket Cable Assembly TRB 3-Slot Plug to 3-Lug Cable Jack with Bend Reliefs .236" O.D. -55C +200C 50 Ohm Triaxial 1'	\$178.86
MSA00360-12N	Teflon Jacket Cable Assembly TRB 3-Slot Plug to Non-Insulated Bulk Head 3-Lug Cable Jack with Bend Reliefs .236" O.D. -55C +200C 50 Ohm Triaxial 1'	\$180.27
MSA00361-12N	Teflon Jacket Cable Assembly TRB 3-Slot Plug to Insulated Bulk Head 3-Lug Cable Jack with Bend Reliefs .236" O.D. -55C +200C 50 Ohm Triaxial 1'	\$182.98
MSA00362-12N	Teflon Jacket Cable Assembly TRB 3-Lug Cable Jack to Jack .236" O.D. -55C +200C 50 Ohm Triaxial 1'	\$189.86
MSA00363-12N	Teflon Jacket Cable Assembly TRB Non-Insulated Bulk Head 3-Lug Cable Jack to Jack .236" O.D. -55C +200C 50 Ohm Triaxial 1'	\$192.88
MSA00364-12N	Teflon Jacket Cable Assembly TRB Insulated Bulk Head Jack 3-Lug Cable Jack to Jack .236" O.D. -55C +200C 50 Ohm Triaxial 1'	\$203.77
MSA00365-12N	Teflon Jacket Cable Assembly TRB 3-Lug Cable Jack to Jack with Bend Reliefs .236" O.D. -55C +200C 50 Ohm Triaxial 1'	\$195.54
MSA00366-12N	Teflon Jacket Cable Assembly TRB Non-Insulated Bulk Head 3-Lug Cable Jack to Jack with Bend Reliefs .236" O.D. -55C +200C 50 Ohm Triaxial 1'	\$198.35
MSA00367-12N	Teflon Jacket Cable Assembly TRB Insulated Bulk Head 3-Lug Cable Jack to Jack with Bend Relief .236" O.D. 55C +200C 50 Ohm Triaxial 1'	\$209.45

Assembly prices shown for 12" length. See our website for additional lengths.

See our website, MilesTek.com to view all of our products.



TRIAXIAL | 75 Ohm Triax Assemblies

TRC-75-2 Cable Pvc, 0.245 Inch Overall Diameter

xxx = cable length in inches

CA-3013-72 = 6 ft. (72 in.) CA-3013-xxx assembly



Connector	Part Number	1 Pc. Price	Connector
10-06030-310 straight 3-slot solder/ clamp plug	CA-3013-xxx	\$108.37	10-06030-310 straight 3-slot solder/clamp plug

Prices shown for 12" length



Connector	Part Number	1 Pc. Price	Connector
10-06030-310 straight 3-slot solder/clamp plug	MP-2612-xxx	\$92.74	blunt - no connector

Prices shown for 12" length



Connector	Part Number	1 Pc. Price	Connector
10-06030-310 bend relief, straight 3-slot solder/clamp plug	MP-2613-xxx	\$140.67	10-06030-310 bend relief, straight 3-slot solder/clamp plug

Prices shown for 12" length



Connector	Part Number	1 Pc. Price	Connector
10-06030-310 straight 3-slot solder/clamp plug	MP-2614-xxx	\$118.79	10-06575-310 straight 3-slot solder/clamp jack

Prices shown for 12" length



Connector	Part Number	1 Pc. Price	Connector
10-06575-310 straight 3-lug solder/clamp jack	MP-2615-xxx	\$130.25	10-06575-310 straight 3-lug solder/clamp jack

Prices shown for 12" length

TRC-75-1 Cable Pvc, 0.189 Inch Overall Diameter

xxx = cable length in inches

MP-3000-120 = 10 ft. (120 in.) MP-3000-xxx assembly



Connector	Part Number	1 Pc. Price	Connector
10-06030-350 straight 3-slot solder/clamp plug	MP-3000-xxx	\$140.67	10-06030-350 straight 3-slot solder/clamp plug

Prices shown for 12" length



Connector	Part Number	1 Pc. Price	Connector
10-06030-350 straight 3-slot solder/clamp plug	MP-2616-xxx	\$104.08	blunt - no connector

Prices shown for 12" length



Connector	Part Number	1 Pc. Price	Connector
10-06030-350 straight 3-slot solder/clamp plug	MP-2617-xxx	\$185.11	10-06575-350 straight 3-slot solder/clamp jack

Prices shown for 12" length



Connector	Part Number	1 Pc. Price	Connector
10-10030-350 subminiature, straight 3-slot solder/clamp plug	MP-2618-xxx	\$145.88	10-10030-350 subminiature 3-slot solder/clamp plug

Prices shown for 12" length



Connector	Part Number	1 Pc. Price	Connector
10-10030-350 subminiature, straight 3-slot solder/clamp plug	MP-2619-xxx	\$140.67	10-06030-350 straight 3-slot solder/clamp plug

Prices shown for 12" length

TRB cable plug - 3-slot, solder/clamp

Compatible Triax Cable Type	Plug	1 Pc. Price
TRC-75-2	10-06030-310	\$18.78
TRC-75-1	10-06030-350	\$18.78
Specifications - Dimensions	Plug	
overall body width - inches (mm)	0.57" (14.50)	
overall body length - inches (mm)	1.12" (28.50)	



TRS Submin Plug - 3-Slot, Solder/Clamp

Compatible Triax Cable Type	Plug	1 Pc. Price
TRC-75-1	10-10030-350	\$28.72
Specifications - Dimensions	Plug	
overall body width - inches (mm)	0.46" (11.68)	
overall body length - inches (mm)	0.83" (21.08)	



LSZH Cable Assemblies

Item #	Description	1 Pc. Price
DSA00001-1F	LSZH D-Sub Cable, DB9 Male / DB9 Male	\$33.09
DSA00001-205F	LSZH D-Sub Cable, DB9 Male / DB9 Male	\$35.54
DSA00001-5F	LSZH D-Sub Cable, DB9 Male / DB9 Male	\$39.55
DSA00001-10F	LSZH D-Sub Cable, DB9 Male / DB9 Male	\$47.68
DSA00001-15F	LSZH D-Sub Cable, DB9 Male / DB9 Male	\$55.75
DSA00001-25F	LSZH D-Sub Cable, DB9 Male / DB9 Male	\$63.88
DSA00001-50F	LSZH D-Sub Cable, DB9 Male / DB9 Male	\$104.36
DSA00001-125F	LSZH D-Sub Cable, DB9 Male / DB9 Male	\$225.81
DSA00002-1F	LSZH D-Sub Cable, DB9 Male / DB9 Female	\$33.09
DSA00002-205F	LSZH D-Sub Cable, DB9 Male / DB9 Female	\$35.54
DSA00002-5F	LSZH D-Sub Cable, DB9 Male / DB9 Female	\$39.55
DSA00002-10F	LSZH D-Sub Cable, DB9 Male / DB9 Female	\$47.68
DSA00002-15F	LSZH D-Sub Cable, DB9 Male / DB9 Female	\$55.75
DSA00002-25F	LSZH D-Sub Cable, DB9 Male / DB9 Female	\$63.88
DSA00002-50F	LSZH D-Sub Cable, DB9 Male / DB9 Female	\$104.36
DSA00002-125F	LSZH D-Sub Cable, DB9 Male / DB9 Female	\$225.81
DSA00004-1F	LSZH D-Sub Cable, DB15 Male / DB15 Male	\$34.96
DSA00004-205F	LSZH D-Sub Cable, DB15 Male / DB15 Male	\$38.19
DSA00004-5F	LSZH D-Sub Cable, DB15 Male / DB15 Male	\$43.61
DSA00004-10F	LSZH D-Sub Cable, DB15 Male / DB15 Male	\$54.40
DSA00004-15F	LSZH D-Sub Cable, DB15 Male / DB15 Male	\$65.23
DSA00004-25F	LSZH D-Sub Cable, DB15 Male / DB15 Male	\$74.40
DSA00004-50F	LSZH D-Sub Cable, DB15 Male / DB15 Male	\$128.38
DSA00004-125F	LSZH D-Sub Cable, DB15 Male / DB15 Male	\$290.31
DSA00005-1F	LSZH D-Sub Cable, DB15 Male / DB15 Female	\$34.96
DSA00005-205F	LSZH D-Sub Cable, DB15 Male / DB15 Female	\$38.19
DSA00005-5F	LSZH D-Sub Cable, DB15 Male / DB15 Female	\$43.61
DSA00005-10F	LSZH D-Sub Cable, DB15 Male / DB15 Female	\$54.40
DSA00005-15F	LSZH D-Sub Cable, DB15 Male / DB15 Female	\$65.23
DSA00005-25F	LSZH D-Sub Cable, DB15 Male / DB15 Female	\$74.40
DSA00005-50F	LSZH D-Sub Cable, DB15 Male / DB15 Female	\$128.38
DSA00005-125F	LSZH D-Sub Cable, DB15 Male / DB15 Female	\$290.31
DSA00006-1F	LSZH D-Sub Cable, DB25 Male / DB25 Male	\$38.77
DSA00006-205F	LSZH D-Sub Cable, DB25 Male / DB25 Male	\$43.61
DSA00006-5F	LSZH D-Sub Cable, DB25 Male / DB25 Male	\$51.69
DSA00006-10F	LSZH D-Sub Cable, DB25 Male / DB25 Male	\$67.89
DSA00006-15F	LSZH D-Sub Cable, DB25 Male / DB25 Male	\$84.09
DSA00006-25F	LSZH D-Sub Cable, DB25 Male / DB25 Male	\$100.30
DSA00006-50F	LSZH D-Sub Cable, DB25 Male / DB25 Male	\$181.26
DSA00006-125F	LSZH D-Sub Cable, DB25 Male / DB25 Male	\$424.20
DSA00007-1F	LSZH D-Sub Cable, DB25 Male / DB25 Female	\$38.77
DSA00007-205F	LSZH D-Sub Cable, DB25 Male / DB25 Female	\$43.61
DSA00007-5F	LSZH D-Sub Cable, DB25 Male / DB25 Female	\$51.69
DSA00007-10F	LSZH D-Sub Cable, DB25 Male / DB25 Female	\$67.89
DSA00007-15F	LSZH D-Sub Cable, DB25 Male / DB25 Female	\$84.09
DSA00007-25F	LSZH D-Sub Cable, DB25 Male / DB25 Female	\$100.30
DSA00007-50F	LSZH D-Sub Cable, DB25 Male / DB25 Female	\$181.26
DSA00007-125F	LSZH D-Sub Cable, DB25 Male / DB25 Female	\$424.20



See our website, MilesTek.com to view all of our products.

ETHERNET | Category 5e, 6, 6a Cable Assemblies

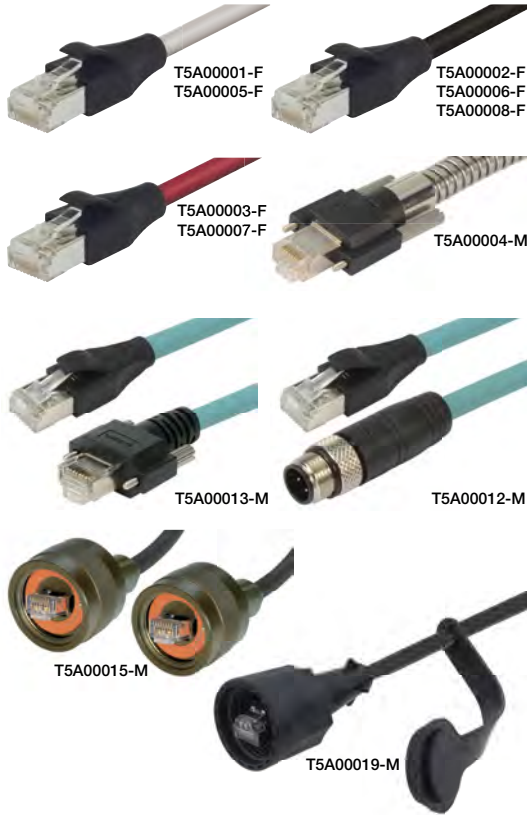

T5A - Category 5e Cables

Item #	Description	1 Pc. Price
T5A00001-1F	Double Shielded 24 AWG Solid Category 5e LSZH Patch Cord, Gray	\$17.51
T5A00002-1F	Double Shielded 24 AWG Solid Category 5e LSZH Patch Cord, Black	\$17.51
T5A00003-1F	Double Shielded 24 AWG Solid Category 5e LSZH Patch Cord, Red	\$17.51
T5A00004-1M	Category 5e GigE Double Shielded Armored Ethernet Cable, GigE / GigE	\$45.28
T5A00005-1F	Double Shielded 26 AWG Stranded Category 5e LSZH Patch Cord, Gray	\$15.53
T5A00006-1F	Double Shielded 26 AWG Stranded Category 5e LSZH Patch Cord, Black	\$15.53
T5A00007-1F	Double Shielded 26 AWG Stranded Category 5e LSZH Patch Cord, Red	\$15.53
T5A00008-1F	Shielded Category 5e Low Smoke Zero Halogen Cable, RJ45 M / M, Black	\$14.91
T5A00009-1M	Category 5e M12 4 Position D Code Double Shielded Industrial Cable, M12 M / M12 M	\$37.99
T5A00010-1F	Shielded Category 5e Extreme High Flex Ethernet Cable, RJ45 / RJ45, Teal	\$46.63
T5A00011-1M	Category 5e M12 4 Position D code Double Shielded Industrial Cable, M12 M / M12 F	\$39.03
T5A00012-1M	Category 5e M12 4 Position D code Double Shielded Industrial Cable, M12 M / RJ45	\$30.69
T5A00013-1M	Category 5e GigE Double Shielded High Flex Ethernet Cable, GigE / RJ45	\$21.52
T5A00014-1M	Category 5e M12 4 Position D code Double Shielded Industrial Cable, M12 F / RJ45	\$31.73
T5A00015-1M	IP68 Cat5e Cable, Rugged RJ45, Plug to Plug, ZnNi Finish w/ FR-TPE Cable & Dust Caps	\$392.21
T5A00016-1M	Category 5e GigE Double Shielded High Flex Ethernet Cable, GigE / GigE	\$22.88
T5A00019-1M	Category 5e RJ45 IP67 Rated Dual Use Outdoor Cable, Black	\$22.95

Assembly prices shown for 1.0m length. See our website for additional lengths.

T6A - Category 6 Cables



Item #	Description	1 Pc. Price
T6A00001-1F	Double Shielded LSZH 26 AWG Stranded Cat 6 RJ45 / RJ45 Patch Cord, Black	\$17.04
T6A00002-1F	Double Shielded LSZH 26 AWG Stranded Cat 6 RJ45 / RJ45 Patch Cord, Gray	\$17.04
T6A00003-1F	Double Shielded LSZH 26 AWG Stranded Cat 6 RJ45 / RJ45 Patch Cord, Red	\$17.04
T6A00004-1F	Shielded Category 6 Cable, RJ45 / RJ45 LSZH Jacket, Gray	\$12.72
T6A00005-1F	Shielded Category 6 Cable, RJ45 / RJ45 LSZH Jacket, Black	\$12.56
T6A00006-1F	Shielded Category 6 Cable, RJ45 / RJ45 LSZH Jacket, Red	\$12.56
T6A00008-1F	Category 6 RJ45 IP67 Rated Dual Use Outdoor Cable, Black	\$25.95

Assembly prices shown for 1.0m length. See our website for additional lengths.

TAA - Category 6a Cables



Item #	Description	1 Pc. Price
TAA00001-1M	Category 6a GigE Double Shielded High Flex Ethernet Cable, GigE / GigE	\$26.52
TAA00002-1M	Category 6a GigE Double Shielded High Flex Ethernet Cable, GigE / RJ45	\$24.86
TAA00003-1F	Category 6a Shielded LSZH Ethernet Cable RJ45 / RJ45, Red	\$36.43
TAA00004-1F	Category 6a Shielded LSZH Ethernet Cable RJ45 / RJ45, Black	\$36.43
TAA00005-1F	Category 6a Shielded LSZH Ethernet Cable RJ45 / RJ45, Blue	\$36.43

Assembly prices shown for 1.0m length. See our website for additional lengths.

Miscellaneous Hardware



Item #	Description	1 Pc. Price
TMK00001	Dust Cap plus Collared Lanyard for Ruggedized Jam-Nuts, Zinc-Nickel Finish	\$35.49
TMK00003	Dust Cap plus Eyelet Lanyard for Ruggedized Flange Mounts, Zinc-Nickel Finish	\$25.74

See our website, MilesTek.com to view all of our products.

Category 5e Adapters and Couplers

Item #	Description	1 Pc. Price
T5C00001	Category 5e RJ45 Coupler Unshielded (8x8) Panel Mount Style	\$11.15
T5C00002	Category 5e RJ45 Coupler Shielded (8x8) Panel Mount Style	\$13.86
T5C00003	Category 5e RJ45 Mini Coupler Unshielded RJ45 (8x8) Panel Mount Style	\$12.25
T5C00004	Category 5e RJ45 Mini Coupler Shielded RJ45 (8x8) Panel Mount Style	\$14.96
T5C00005	Ruggedized Flange Mount, Zinc-Nickel Finish with Grounding Shield	\$59.82
T5C00006	Ruggedized Flange Mount, Anodized Finish	\$45.02
T5C00007	Ruggedized Flange Mount, Zinc-Nickel Finish	\$51.79
T5C00008	Ruggedized Flange Mount, Zinc-Nickel Finish with Grounding Shield and Dust Cap	\$82.48
T5C00009	Ruggedized Flange Mount, Anodized Finish with Dust Cap	\$67.68
T5C00010	Ruggedized Flange Mount, Zinc-Nickel Finish with Dust Cap	\$75.65
T5C00011	Ruggedized Flange Mount, Zinc-Nickel Finish w/ Grounding Shield and Mounting Hardware	\$68.88
T5C00012	Ruggedized Flange Mount, Anodized Finish with Mounting Hardware	\$55.28
T5C00013	Ruggedized Flange Mount, Zinc-Nickel Finish with Mounting Hardware	\$62.06
T5C00014	Ruggedized Flange Mount, Zinc-Nickel Finish w/ Grounding Shield, Mounting Hardware and Dust Cap	\$93.84
T5C00015	Ruggedized Flange Mount, Anodized Finish with Mounting Hardware and Dust Cap	\$80.19
T5C00016	Ruggedized Flange Mount, Zinc-Nickel Finish w/ Mounting Hardware and Dust Cap	\$88.11
T5C00017	Ruggedized D38999 Jam-nut, Zinc-Nickel Finish	\$68.88
T5C00018	Ruggedized D38999 Jam-nut, Zinc-Nickel Finish w/ Grounding Shield and Dust Cap	\$129.42
T5C00019	Ruggedized Jam-nut, Anodized Finish	\$51.79
T5C00020	Ruggedized Jam-nut, Zinc-Nickel Finish	\$58.62
T5C00021	Category 5e, Ruggedized Jam-nut, Zinc-Nickel Finish	\$58.62
T5C00022	Ruggedized Jam-nut, Zinc-nickel Finish with Grounding Shield and Dust Cap	\$103.94
T5C00023	Ruggedized Jam-nut, Anodized Finish with Dust Cap	\$82.48
T5C00024	Category 5e, Ruggedized Jam-nut, Anodized Finish with Dust Cap	\$82.48
T5C00025	Ruggedized Jam-nut, Zinc-Nickel Finish with Dust Cap	\$92.64
T5C00026	Ruggedized Jam-nut, Zinc-Nickel Finish with Grounding Shield	\$68.88
T5C00027	Cat5e IP67 RJ45 Bulkhead Panel Mount Coupler, Shielded, Feed-Thru w/ Dust Cap	\$17.95
T5C00028	Cat5e IP67 RJ45 to 110 Bulkhead Panel Mount Coupler, Shielded, Feed-Thru, PoE+ w/ Dust Cap	\$17.95



Category 6 Adapters and Couplers

Item #	Description	1 Pc. Price
T6C00001	Category 6 RJ45 Coupler Unshielded (8x8) Panel Mount Style	\$12.25
T6C00002	Category 6 RJ45 Coupler Shielded (8x8) Panel Mount Style	\$14.38
T6C00003	Category 6 RJ45 Mini Coupler Unshielded RJ45 (8x8) Panel Mount Style	\$13.34
T6C00004	Category 6 RJ45 Mini Coupler Shielded RJ45 (8x8) Panel Mount Style	\$15.48
T6C00005	Cat6 IP67 RJ45 Bulkhead Panel Mount Coupler, Shielded, Feed-Thru with Dust Cap	\$19.95
T6C00006	Cat6 IP67 RJ45 to 110 Bulkhead Panel Mount Coupler, Shielded, Feed-Thru, PoE+ w/ Dust Cap	\$19.95



Category 6a Adapters and Couplers

Item #	Description	1 Pc. Price
TAC00001	Category 6a RJ45 Coupler Unshielded (8x8) Panel Mount Style	\$17.09
TAC00002	Category 6a RJ45 Coupler Shielded (8x8) Panel Mount Style	\$20.32



Miscellaneous Adapters and Couplers

Item #	Description	1 Pc. Price
TMC00001	Category 3 RJ45 Coupler Unshielded (8x8) Panel Mount Style	\$8.45
TMC00002	Category 3 RJ45 Coupler Shielded (8x8) Panel Mount Style	\$11.15



MUS2A00018-M



MUS2A00001-M



MUS2A00002-2M



MUS2A00003-05M



MUS2A00004-05M



MUS2A00005-2M



MUS2A00012-05M



MUS2A00013-05M



MUS3A00019-03M



MUS3A00020-03M



MUS3A00021-03M



MUS3A00022-03M



MUS3A00023-03M



MUS3A00025-03M



MUS2A00006

MUS2A00007



MUS2B00008

MUS2B00009



MUS2B00014

MUS2B00015

USB 2.0 Latching LSZH Cable Assemblies

Item #	Description	1 Pc. Price
MUS2A00017-03M	LSZH USB Cable Assembly, Latching A / Latching A	\$19.96
MUS2A00017-5M	LSZH USB Cable Assembly, Latching A / Latching A	\$34.65
MUS2A00018-03M	LSZH USB Cable Assembly, Latching A / Standard B	\$18.14
MUS2A00018-5M	LSZH USB Cable Assembly, Latching A / Standard B	\$32.83

See our website MilesTek.com for additional lengths.

USB 2.0 Waterproof Cable Assemblies

Item #	Description	1 Pc. Price
MUS2A00001-2M	USB Cable, Waterproof Type A Male - Standard Type B Male	\$25.53
MUS2A00001-5M	USB Cable, Waterproof Type A Male - Standard Type B Male	\$30.01
MUS2A00002-2M	USB Cable, Waterproof Type B Male - Standard Type B Male	\$26.37
MUS2A00002-5M	USB Cable, Waterproof Type B Male - Standard Type B Male	\$30.01
MUS2A00003-05M	USB Cable, Waterproof Panel Mount Type A Female - Standard Type A Male	\$22.88
MUS2A00003-5M	USB Cable, Waterproof Panel Mount Type A Female - Standard Type A Male	\$28.82
MUS2A00004-05M	USB Cable, Waterproof Type B Female - Standard Type A Male	\$22.88
MUS2A00004-5M	USB Cable, Waterproof Type B Female - Standard Type A Male	\$28.82
MUS2A00005-2M	USB Cable, Waterproof Mini B 5 Female / Mini B 5 Male	\$27.62
MUS2A00012-05M	Shielded Waterproof Panel Mount Type A Female - Standard Type A Male	\$41.42
MUS2A00012-5M	Shielded Waterproof Panel Mount Type A Female - Standard Type A Male	\$48.09
MUS2A00013-05M	Shielded Waterproof Type A Male - Standard Type B Male	\$37.00
MUS2A00013-5M	Shielded Waterproof Type A Male - Standard Type B Male	\$42.26

See our website MilesTek.com for additional lengths.

USB 3.0 Cable Assemblies

Item #	Description	1 Pc. Price
MUS3A00019-03M	USB 3.0 Cable, Type A / A with Thumbscrew Hardware	\$19.44
MUS3A00019-5M	USB 3.0 Cable, Type A / A with Thumbscrew Hardware	\$29.60
MUS3A00020-03M	USB 3.0 Cable, Type B / A with Thumbscrew Hardware	\$20.53
MUS3A00020-5M	USB 3.0 Cable, Type B / A with Thumbscrew Hardware	\$30.64
MUS3A00021-03M	USB 3.0 Cable, Type Micro B / A with Thumbscrew Hardware	\$21.57
MUS3A00021-5M	USB 3.0 Cable, Type Micro B / A with Thumbscrew Hardware	\$31.73
MUS3A00022-03M	USB 3.0 Cable, Type A / B with Thumbscrew Hardware	\$24.80
MUS3A00022-5M	USB 3.0 Cable, Type A / B with Thumbscrew Hardware	\$34.96
MUS3A00023-03M	USB 3.0 Cable, Type A / Micro B with Thumbscrew Hardware	\$25.90
MUS3A00023-5M	USB 3.0 Cable, Type A / Micro B with Thumbscrew Hardware	\$36.06
MUS3A00025-03M	USB 3.0 Machine Vision Panel Mount Cable Assembly	\$22.82
MUS3A00025-2M	USB 3.0 Machine Vision Panel Mount Cable Assembly	\$27.36

See our website MilesTek.com for additional lengths.

Jacks, Covers, Connectors and Hardware

Item #	Description	1 Pc. Price
MUS2A00006	Waterproof USB Type A Jack with 10" Wire Leads	\$20.84
MUS2A00007	Waterproof USB Type B Jack with 10" Wire Leads	\$20.84
MUS2B00008	Waterproof USB Cover	\$5.32
MUS2B00009	Waterproof Cap for USB + IEEE-1394 (Firewire)	\$8.45
MUS2K00010	Nylon Nut for Housing Size 13/16-28	\$7.81
MUS2K00011	EPDM Rubber Gasket for Housing Size 13/16	\$4.04
MUS2B00014	Shielded Waterproof Cap for USB IP67 Cables	\$11.10
MUS2B00015	USB Type A Waterproof Field Installable Connector	\$17.20
MUS2B00016	USB Type B Waterproof Field Installable Connector	\$17.20

See our website, MilesTek.com to view all of our products.

LSZH SCSI-3 Cable Assemblies

Item #	Description	1 Pc. Price
SZA00001-1M	LSZH SCSI-3 Cable, HPDB68 Male / HPDB68 Male	\$124.99
SZA00001-3M	LSZH SCSI-3 Cable, HPDB68 Male / HPDB68 Male	\$168.08

See our website MilesTek.com for additional lengths.



Ultra SCSI Cable Assemblies

Item #	Description	1 Pc. Price
SZA00002-05M	Ultra SCSI Cable, .8mm Male / HPDB68 Male	\$85.03
SZA00002-3M	Ultra SCSI Cable, .8mm Male / HPDB68 Male	\$112.33
SZA00003-05M	Ultra SCSI Cable, .8mm Male / HPDB50 Male	\$85.03
SZA00003-3M	Ultra SCSI Cable, .8mm Male / HPDB50 Male	\$96.18
SZA00004-05M	Ultra SCSI Cable, .8mm Male / Male	\$93.51
SZA00004-3M	Ultra SCSI Cable, .8mm Male / Male	\$120.12

See our website MilesTek.com for additional lengths.



Premium IEEE-488 Cable Assemblies

Item #	Description	1 Pc. Price
MGPA00001-03M	Premium IEEE-488 Cable, Normal / Normal	\$119.00
MGPA00001-18M	Premium IEEE-488 Cable, Normal / Normal	\$398.99
MGPA00002-05M	Premium IEEE-488 Cable, Normal / Inline	\$114.10
MGPA00002-1M	Premium IEEE-488 Cable, Normal / Inline	\$119.89
MGPA00002-8M	Premium IEEE-488 Cable, Normal / Inline	\$201.63
MGPA00003-05M	Premium IEEE-488 Cable, Inline / Inline	\$108.22
MGPA00003-8M	Premium IEEE-488 Cable, Inline / Inline	\$195.85
MGPA00004-1M	Premium IEEE-488 Extension Cable	\$114.10
MGPA00004-3M	Premium IEEE-488 Extension Cable	\$137.44

See our website MilesTek.com for additional lengths.



Deluxe IEEE-488 Cable Assemblies

Item #	Description	1 Pc. Price
MGPA00005-03M	Deluxe IEEE-488 Cable	\$111.39
MGPA00005-8M	Deluxe IEEE-488 Cable	\$195.85

See our website MilesTek.com for additional lengths.

Molded IEEE-488 Cable Assemblies

Item #	Description	1 Pc. Price
MGPA00006-05M	Molded IEEE-488 Cable, Normal / Normal	\$79.77
MGPA00006-8M	Molded IEEE-488 Cable, Normal / Normal	\$148.44
MGPA00007-05M	Molded IEEE-488 Cable, Reverse / Reverse	\$83.26
MGPA00007-8M	Molded IEEE-488 Cable, Reverse / Reverse	\$155.16
MGPA00008-03M	Molded IEEE-488 Cable, Normal / Reverse	\$81.33
MGPA00008-1M	Molded IEEE-488 Cable, Normal / Reverse	\$88.05
MGPA00009-05M	Molded IEEE-488 Cable, Normal / Inline	\$69.30
MGPA00009-10M	Molded IEEE-488 Cable, Normal / Inline	\$149.79
MGPA00011-05M	Molded IEEE-488 Cable, Inline / Inline	\$49.03
MGPA00011-10M	Molded IEEE-488 Cable, Inline / Inline	\$146.87

See our website MilesTek.com for additional lengths.



GPIB Adapter/Extension Cable

Item #	Description	1 Pc. Price
MGPA00010-1M	GPIB Adapter / Extension Cable	\$63.15

DVI-D Single & Dual Link Angled Cable Assemblies

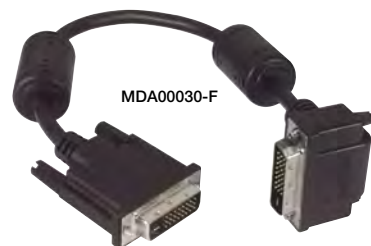

Item #	Description	1 Pc. Price
MDA00022-1F	DVI-D Single Link DVI Cable Male / Male Right Angle, Bottom	\$23.35
MDA00022-3F	DVI-D Single Link DVI Cable Male / Male Right Angle, Bottom	\$25.27
MDA00023-05M	DVI-D Single Link DVI Cable Male / Male Right Angle, Bottom	\$18.76
MDA00023-1M	DVI-D Single Link DVI Cable Male / Male Right Angle, Bottom	\$25.53
MDA00024-1F	DVI-D Single Link DVI Cable Male / Male Right Angle, Top	\$23.35
MDA00024-3F	DVI-D Single Link DVI Cable Male / Male Right Angle, Top	\$25.27
MDA00025-05M	DVI-D Single Link DVI Cable Male / Male Right Angle	\$18.76
MDA00025-1M	DVI-D Single Link DVI Cable Male / Male Right Angle	\$25.53
MDA00026-1F	DVI-D Single Link DVI Cable Male / Male Right Angle, Left	\$23.35
MDA00026-3F	DVI-D Single Link DVI Cable Male / Male Right Angle, Left	\$25.27
MDA00027-1F	DVI-D Single Link DVI Cable Male / Male Right Angle, Right	\$23.35
MDA00027-3F	DVI-D Single Link DVI Cable Male / Male Right Angle, Right	\$25.27
MDA00028-1F	DVI-D Dual Link DVI Cable Male / Male Right Angle, Bottom	\$28.24
MDA00028-3F	DVI-D Dual Link DVI Cable Male / Male Right Angle, Bottom	\$31.21
MDA00029-05M	DVI-D Dual Link DVI Cable Male / Male Right Angle, Bottom	\$29.29
MDA00029-1M	DVI-D Dual Link DVI Cable Male / Male Right Angle, Bottom	\$31.47
MDA00030-1F	DVI-D Dual Link DVI Cable Male / Male Right Angle, Top	\$28.24
MDA00030-3F	DVI-D Dual Link DVI Cable Male / Male Right Angle, Top	\$31.21
MDA00031-05M	DVI-D Dual Link DVI Cable Male / Male Right Angle, Top	\$29.29
MDA00031-1M	DVI-D Dual Link DVI Cable Male / Male Right Angle, Top	\$31.47
MDA00032-1F	DVI-D Dual Link DVI Cable Male / Male Right Angle, Left	\$28.24
MDA00032-3F	DVI-D Dual Link DVI Cable Male / Male Right Angle, Left	\$31.21
MDA00033-1F	DVI-D Dual Link DVI Cable Male / Male Right Angle, Right	\$28.24
MDA00033-3F	DVI-D Dual Link DVI Cable Male / Male Right Angle, Right	\$41.63

See our website MilesTek.com for additional lengths.

DVI-D Single & Dual Link LSZH Angled Cable Assemblies

Item #	Description	1 Pc. Price
MDA00039-1F	DVI-D Single Link LSZH DVI Cable Male / Male Right Angle, Bottom	\$26.32
MDA00039-15F	DVI-D Single Link LSZH DVI Cable Male / Male Right Angle, Bottom	\$41.48
MDA00040-1F	DVI-D Single Link LSZH DVI Cable Male / Male Right Angle, Top	\$26.32
MDA00040-15F	DVI-D Single Link LSZH DVI Cable Male / Male Right Angle, Top	\$41.48
MDA00041-1F	DVI-D Single Link LSZH DVI Cable Male / Male Right Angle, Left	\$26.32
MDA00041-15F	DVI-D Single Link LSZH DVI Cable Male / Male Right Angle, Left	\$41.48
MDA00042-1F	DVI-D Single Link LSZH DVI Cable Male / Male Right Angle, Right	\$26.32
MDA00042-15F	DVI-D Single Link LSZH DVI Cable Male / Male Right Angle, Right	\$41.48
MDA00043-1F	DVI-D Dual Link LSZH DVI Cable Male / Male Right Angle, Bottom	\$31.73
MDA00043-15F	DVI-D Dual Link LSZH DVI Cable Male / Male Right Angle, Bottom	\$58.20
MDA00044-1F	DVI-D Dual Link LSZH DVI Cable Male / Male Right Angle, Top	\$31.73
MDA00044-15F	DVI-D Dual Link LSZH DVI Cable Male / Male Right Angle, Top	\$58.20
MDA00045-1F	DVI-D Dual Link LSZH DVI Cable Male / Male Right Angle, Left	\$31.73
MDA00045-15F	DVI-D Dual Link LSZH DVI Cable Male / Male Right Angle, Left	\$58.20
MDA00046-1F	DVI-D Dual Link LSZH DVI Cable Male / Male Right Angle, Right	\$31.73
MDA00046-15F	DVI-D Dual Link LSZH DVI Cable Male / Male Right Angle, Right	\$58.20

See our website MilesTek.com for additional lengths.

Premium DVI to HDMI Cable Assembly

Item #	Description	1 Pc. Price
MDA00049-1M	Premium DVI to HDMI Cable Assembly, HDMI-M / DVI-D Single Link-M	\$23.61

Assembly prices shown for shortest length in the series. See our website for additional lengths.

DisplayPort LSZH Cable Assembly & Panel Mount Adapter

Item #	Description	1 Pc. Price
MPDA00001-05M	LSZH DisplayPort Cable Male-Male	\$30.64
MDC00010	DisplayPort Panel Mount Adapter Female DP / Female DP	\$19.33

Assembly prices shown for shortest length in the series. See our website for additional lengths.

Premium DVI-D Cable Assemblies with Ferrites

Item #	Description	1 Pc. Price
MDA00011-3F	Premium DVI-D Single Link DVI Cable Male / Male with Ferrites	\$25.74
MDA00011-5F	Premium DVI-D Single Link DVI Cable Male / Male with Ferrites	\$27.93
MDA00012-1F	Deluxe DVI-D Single Link DVI Cable Male / Male with Ferrites	\$14.96
MDA00012-3F	Deluxe DVI-D Single Link DVI Cable Male / Male with Ferrites	\$17.09
MDA00013-3F	Premium DVI-D Dual Link DVI Cable Male / Male with Ferrites	\$34.39
MDA00013-5F	Premium DVI-D Dual Link DVI Cable Male / Male with Ferrites	\$36.53
MDA00014-1F	Deluxe DVI-D Dual Link DVI Cable, Male / Male with Ferrites	\$20.32
MDA00014-3F	Deluxe DVI-D Dual Link DVI Cable, Male / Male with Ferrites	\$22.51
MDA00015-3F	DVI-D Single Link LSZH Cable Male / Male with Ferrites	\$20.32
MDA00015-5F	DVI-D Single Link LSZH Cable Male / Male with Ferrites	\$22.51
MDA00016-3F	DVI-D Dual Link LSZH Cable Male / Male with Ferrites	\$27.93
MDA00016-5F	DVI-D Dual Link LSZH Cable Male / Male with Ferrites	\$32.20
MDA00017-3F	Premium DVI-I Single Link DVI Cable Male / Male with Ferrites	\$37.62
MDA00017-5F	Premium DVI-I Single Link DVI Cable Male / Male with Ferrites	\$40.85
MDA00018-3F	Premium DVI-I Dual Link DVI Cable Male / Male with Ferrites	\$39.76
MDA00018-5F	Premium DVI-I Dual Link DVI Cable Male / Male with Ferrites	\$43.04
MDA00019-1F	Deluxe DVI-I Dual Link DVI Cable Male / Male with Ferrites	\$21.94
MDA00019-3F	Deluxe DVI-I Dual Link DVI Cable Male / Male with Ferrites	\$23.03
MDA00020-3F	Premium DVI-A Male DVI Cable / HD15 Male with Ferrites	\$24.65
MDA00020-5F	Premium DVI-A Male DVI Cable / HD15 Male with Ferrites	\$27.93

See our website MilesTek.com for additional lengths.

DVI-D 45 Degree Cable Assemblies

Item #	Description	1 Pc. Price
MDA00034-1F	DVI-D Single Link DVI Cable Male / Male 45 Degree Left	\$23.35
MDA00034-15F	DVI-D Single Link DVI Cable Male / Male 45 Degree Left	\$35.54
MDA00035-1M	DVI-D Single Link DVI Cable Male / Male 45 Degree Left	\$25.53
MDA00035-5M	DVI-D Single Link DVI Cable Male / Male 45 Degree Left	\$37.15
MDA00036-1F	DVI-D Dual Link DVI Cable Male / Male 45 Degree Left	\$28.24
MDA00036-15F	DVI-D Dual Link DVI Cable Male / Male 45 Degree Left	\$49.29
MDA00037-1F	DVI-D Single Link LSZH DVI Cable Male / Male 45 Degree Left	\$25.53
MDA00037-15F	DVI-D Single Link LSZH DVI Cable Male / Male 45 Degree Left	\$51.69
MDA00037-2M	DVI-D Single Link LSZH DVI Cable Male / Male 45 Degree Left	\$37.15
MDA00037-5M	DVI-D Single Link LSZH DVI Cable Male / Male 45 Degree Left	\$52.78
MDA00038-5F	DVI-D Dual Link LSZH DVI Cable Male / Male 45 Degree Left	\$39.55
MDA00038-15F	DVI-D Dual Link LSZH DVI Cable Male / Male 45 Degree Left	\$65.49

See our website MilesTek.com for additional lengths.

DVI Panel Mount Cable Assemblies

Item #	Description	1 Pc. Price
MDA00047-1F	Premium Panel Mount DVI-D Single Link Male / Female Cable Assembly	\$23.92
MDA00048-1F	Premium Panel Mount DVI-D Dual Link Male / Female Cable Assembly	\$32.25
MMIA00001-05M	High Speed HDMI Cable with Ethernet, Male / Panel Mount Female	\$24.60

Assembly prices shown for shortest length in the series. See our website for additional lengths.

Audio/Video Adapters

Item #	Description	1 Pc. Price
MDC00001	DVI Adapter, DVI-A Male / HD15 Female	\$13.19
MDC00002	DVI Adapter, DVI-A Female / HD15 Male	\$13.92
MDC00004	DVI Adapter, DVI-I Female / HDMI Male	\$13.45
MDC00005	DVI Adapter, DVI-I Female / HDMI Female	\$13.45
MDC00006	DVI Adapter, DVI-D Male / HDMI Male	\$13.45
MDC00008	DVI Bulkhead Adapter Female / Female	\$19.54
MDC00009	HDMI Panel Mount Adapter, Female / Female	\$15.22

See our website MilesTek.com for all of our Audio/Video adapters.

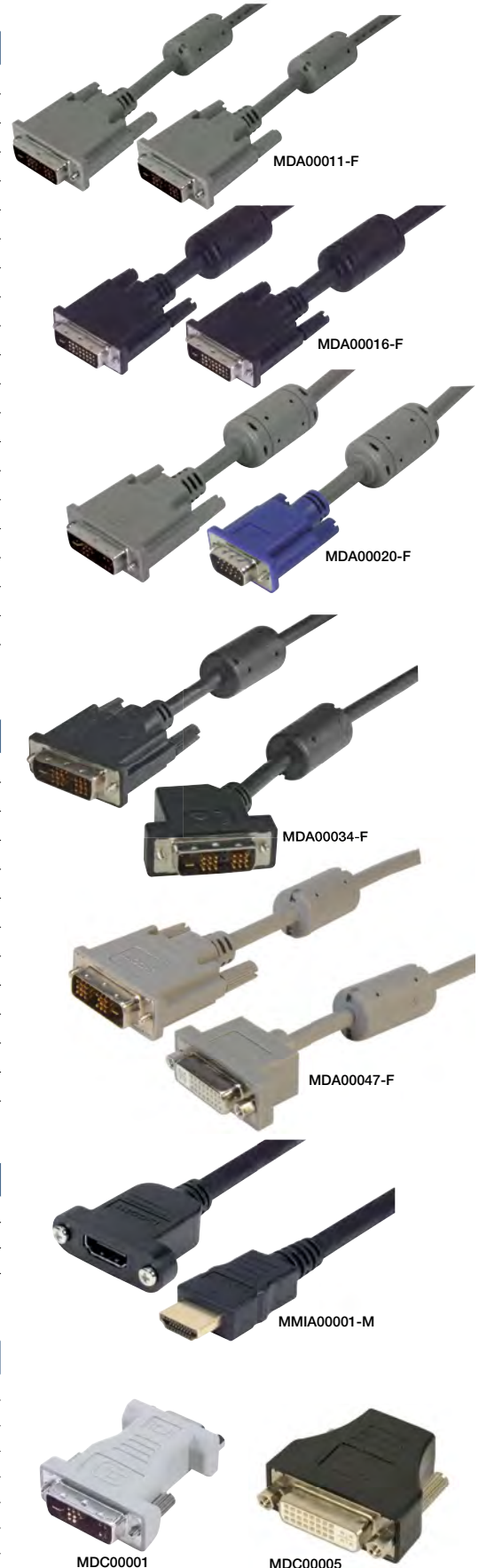



F1A00001-M
F2A00001-M
F3A00001-M



F1A00002-M
F2A00002-M
F3A00002-M



F1A00003-M
F2A00003-M
F3A00003-M

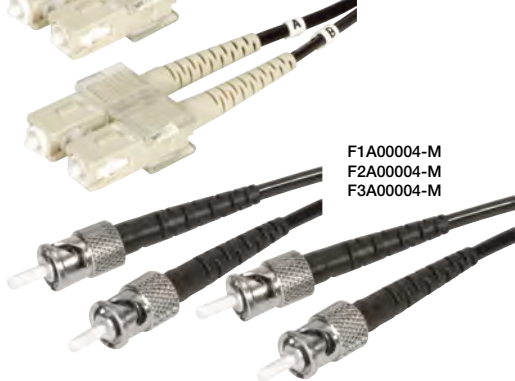

F1A00004-M
F2A00004-M
F3A00004-M



FSA00002-M



FSA00003-M



FSA00004-M

F1A - OM1 Assemblies

Item #	Description	1 Pc. Price
F1A00001-1M	OM1 IP67 Fiber Cable, Dual LC / Dual LC	\$191.13
F1A00002-1M	OM1 62.5/125, Military Fiber Cable, Dual LC / Dual LC	\$54.20
F1A00003-1M	OM1 62.5/125, Military Fiber Cable, Dual SC / Dual SC	\$45.06
F1A00004-1M	OM1 62.5/125, Military Fiber Cable, Dual ST / Dual ST	\$91.56

Assembly prices shown for 1.0m length. Also available 3.0m, 5.0m and 10.0m lengths.

F2A - OM2 Assemblies

Item #	Description	1 Pc. Price
F2A00001-1M	OM2 50/125, IP67 Multimode Fiber Cable, Dual LC / Dual LC	\$209.27
F2A00002-1M	OM2 50/125, Military Fiber Cable, Dual LC / Dual LC	\$56.53
F2A00003-1M	OM2 50/125, Military Fiber Cable, Dual SC / Dual SC	\$45.07
F2A00004-1M	OM2 50/125, Military Fiber Cable, Dual ST / Dual ST	\$90.03

Assembly prices shown for 1.0m length. Also available 3.0m, 5.0m and 10.0m lengths.

F3A - OM3 Assemblies

Item #	Description	1 Pc. Price
F3A00001-1M	OM3 50/125, 10 Gig, IP67 Multimode Fiber Cable, Dual LC / Dual LC	\$214.67
F3A00002-1M	OM3 50/125 10 Gig, Military Fiber Cable, Dual LC / Dual LC	\$61.48
F3A00003-1M	OM2 50/125, 10 Gig, Military Fiber Cable, Dual SC / Dual SC	\$50.33
F3A00004-1M	OM3 50/125 10 Gig, Military Fiber Cable, Dual ST / Dual ST	\$95.04

Assembly prices shown for 1.0m length. Also available 3.0m, 5.0m and 10.0m lengths.

FSA - Singlemode Assemblies

Item #	Description	1 Pc. Price
FSA00001-1M	Single mode IP67 Fiber Cable, Dual LC / Dual LC	\$202.47
FSA00002-1M	9/125 Single mode, Military Fiber Cable, Dual LC / Dual LC	\$61.48
FSA00003-1M	9/125 Single mode, Military Fiber Cable, Dual SC / Dual SC	\$46.58
FSA00004-1M	9/125 Single mode, Military Fiber Cable, Dual ST / Dual ST	\$185.65

Assembly prices shown for 1.0m length. Also available 3.0m, 5.0m and 10.0m lengths.

Custom connectorization and configuration options available.

FYB - Connectors

Item #	Description	1 Pc. Price
FYB00001	MIL M83522 ST Connector, Multimode Locking Nickel Plated Brass for 2mm Fiber	\$34.86
FYB00002	MIL M83522 ST Connector, Single mode Locking Nickel Plated Brass for 2mm Fiber	\$36.63
FYB00003	MIL M83522 ST Connector, Multimode Non-Locking Nickel Plated Brass for 2mm Fiber	\$18.34
FYB00004	MIL M83522 ST Connector, Multimode Non-Locking Stainless Steel for 2mm Fiber	\$26.32
FYB00005	MIL M83522 ST Connector, Multimode Non-Locking Stainless Steel for 2mm Fiber	\$18.40
FYB00006	MIL M83522 ST Connector, Single mode Non-Locking Stainless Steel for 2mm Fiber	\$26.42
FYB00007	Duplex Multimode LC IP67 Connector	\$76.26
FYB00008	Duplex Single mode LC IP67 Connector	\$94.88
FYB00009	Ruggedized LC IP68 Plug, Duplex, Multimode with Dust Cap	\$148.97
FYB00010	Ruggedized LC IP68 Plug, Duplex, Single mode with Dust Cap	\$148.45
FYB00011	Ruggedized LC IP68 Plug, Duplex, Single mode APC Polish with Dust Cap	\$155.20
FYB00012	Ruggedized LC IP68 In-Line Receptacle, Duplex, Multimode with Dust Cap	\$185.86
FYB00013	Ruggedized LC IP68 In-Line Receptacle, Duplex, Single mode with Dust Cap	\$190.80
FYB00014	Rugged LC IP68 In-Line Receptacle, Duplex, Single mode APC Polish with Dust Cap	\$206.32



FYC - Adapters

Item #	Description	1 Pc. Price
FYC00001	MIL M83522 ST Coupler, Multimode & Single mode Nickel Plated Brass	\$20.32
FYC00002	MIL M83522 ST Coupler, Multimode & Single mode Stainless Steel	\$40.33
FYC00004	MIL M83522 ST Coupler, Multimode & Single mode Stainless Steel	\$41.06
FYC00005	Multimode IP67 Duplex LC Bulkhead Adapter	\$53.64
FYC00006	Single mode IP67 Duplex LC Bulkhead Adapter	\$64.54
FYC00009	Ruggedized LC IP68 Flange Mount Receptacle, Duplex, Multimode w/ Dust Cap	\$75.07
FYC00010	Ruggedized LC IP68 Flange Mount Receptacle, Duplex, Single Mode w/ Dust Cap	\$74.42
FYC00011	Ruggedized LC IP68 Flange Mount Receptacle, Duplex, Single Mode APC Polish w/ Dust Cap	\$76.13
FYC00012	Ruggedized LC IP68 Jam Nut Receptacle, Duplex, Multimode w/ Dust Cap	\$85.41
FYC00013	Ruggedized LC IP68 Jam Nut Receptacle, Duplex, Single Mode w/ Dust Cap	\$74.99
FYC00014	Rugged LC IP68 Jam Nut Receptacle, Duplex, Single Mode APC Polish w/ Dust Cap	\$85.41
FYC00015	Ruggedized LC IP68 D38999 Jam Nut Receptacle, Duplex, Multimode w/ Dust Cap	\$96.41
FYC00016	Rugged LC IP68 D38999 Jam Nut Receptacle, Duplex, Single Mode w/ Dust Cap	\$96.41
FYC00017	Ruggedized LC IP68 D38999 Jam Nut Receptacle, Duplex, Single Mode APC Polish w/ Dust Cap	\$96.41
FYC00018	Ruggedized LC IP68 Daisy Chain Receptacle, Duplex, Multimode w/ Dust Cap	\$68.30
FYC00019	Ruggedized LC IP68 Daisy Chain Receptacle, Duplex, Single Mode w/ Dust Cap	\$68.13
FYC00020	Ruggedized LC IP68 Daisy Chain Receptacle, Duplex, Single Mode APC Polish w/ Dust Cap	\$68.46



FYK - Hardware

Item #	Description	1 Pc. Price
FYK00001	IP67 Duplex LC Cap with Chain for Bulkhead Receptacle	\$15.96
FYK00004	IP67 Duplex LC Cap with Chain for Industrial Plugs	\$21.29
FYK00005	ST Dust Cap for MIL & Ruggedized COTS Couplers, Nickel Plated Brass w/ Lanyard	\$23.71
FYK00006	ST Dust Cap for MIL & Ruggedized COTS Couplers, Stainless Steel with Lanyard	\$26.47
FYK00007	ST Dust Cap for MIL & Rugged COTS Connectors, Nickel Plated Brass with Lanyard	\$27.51
FYK00008	ST Dust Cap for MIL & Ruggedized COTS Connectors, Stainless Steel with Lanyard	\$30.38
FYK00009	MIL M83522 ST Crimp Ferrule for use with 2.5 & 3mm Fiber	\$5.74



See our website to view all of our products.

PATCH PANELS | Universal Rack & Sub-Panels

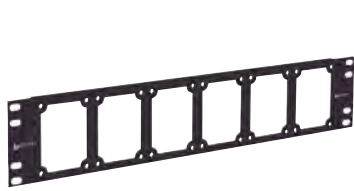

Part #	1 Piece Price
REF00001	\$31.77
Description	
3.5" x 19" Universal Master Rack Panel	



Part #	1 Piece Price
REF00002	\$5.75
Description	
Universal Sub-Panel, Steel 3.5" x 19" Universal Master Rack Panel	



Part #	1 Piece Price
REF00003	\$45.23
Description	
Universal Sub-Panel, IEEE-488 (GPIB) Bulkhead Adapter, Normal Entry	



Part #	1 Piece Price
REF00004	\$45.23
Description	
Universal Sub-Panel, IEEE-488 (GPIB) Bulkhead Adapter, Reverse Entry	



Part #	1 Piece Price
REF00005	\$113.09
Description	
3 Way IEEE-488 (GPIB) Switch Box, Off-A-B	



Part #	1 Piece Price
REF00006	\$11.56
Description	
Universal Sub-Panel with Binding Post Pair	



Part #	1 Piece Price
REF00007	\$22.68
Description	
Universal Sub-Panel, Two USB Type A/B Flange Style Mount Couplers	



Part #	1 Piece Price
REF00008	\$24.95
Description	
Universal Sub-Panel, Two Shielded USB Type A/B Flange Style Mount-Couplers	



Part #	1 Piece Price
REF00009	\$30.63
Description	
Universal Sub-Panel, Two IEEE-1394 (FireWire) Type 1/Type1 Flange Style Mount Couplers	



Part #	1 Piece Price
REF00010	\$7.90
Description	
Universal Sub-Panel with Two Flange Style Mount Coupler Holes	



Part #	1 Piece Price
REF00011	\$28.36
Description	
Universal Sub-Panel, 2 Shielded Category 6 Couplers, RJ45 Straight Thru	



Part #	1 Piece Price
REF00012	\$16.66
Description	
Universal Sub-Panel, 4 Shielded Category 6 Couplers, RJ45 Straight Thru	



Part #	1 Piece Price
REF00013	\$7.90
Description	
Universal Steel Sub-Panel with Two Keystone Openings	



Part #	1 Piece Price
REF00014	\$7.90
Description	
Universal Steel Sub-Panel with Four Keystone Openings	



Part #	1 Piece Price
REF00015	\$6.76
Description	
Universal Steel Sub-Panel with One 0.5" D-Hole	



Part #	1 Piece Price
REF00016	\$6.76
Description	
Universal Steel Sub-Panel with Two 0.5" D-Holes	

Universal Sub-Panels | PATCH PANELS



Part #	1 Piece Price
REF00017	\$6.76
Description	
Universal Steel Sub-Panel with Three 0.5" D-Holes	

Part #	1 Piece Price
REF00018	\$6.76
Description	
Universal Steel Sub-Panel with Four 0.5" D-Holes	

Part #	1 Piece Price
REF00019	\$18.51
Description	
Universal Sub-Panel, 2 BNC Feed-Thru Adapters	

Part #	1 Piece Price
REF00020	\$28.36
Description	
Universal Sub-Panel, 4 BNC Feed-Thru Adapters	



Part #	1 Piece Price
REF00021	\$7.30
Description	
Universal Sub-Panel, 2 Insulated BNC Feed-Thru Adapters	

Part #	1 Piece Price
REF00022	\$31.77
Description	
Universal Sub-Panel, 4 Insulated BNC Feed-Thru Adapters	

Part #	1 Piece Price
REF00023	\$5.03
Description	
Universal Sub-Panel, One N Type Feed-Thru Bulkhead Adapter	

Part #	1 Piece Price
REF00024	\$19.26
Description	
Universal Sub-Panel, 2 TNC Feed-Thru Adapters, Grounded	



Part #	1 Piece Price
REF00025	\$21.53
Description	
Universal Sub-Panel, 2 TNC Feed-Thru Adapters, Insulated	

Part #	1 Piece Price
REF00026	\$7.90
Description	
Universal Steel Sub-Panel with Two DB9/HD15 holes	

Part #	1 Piece Price
REF00027	\$7.90
Description	
Universal Steel Sub-Panel with Two DB15/HD26 holes	

Part #	1 Piece Price
REF00028	\$7.90
Description	
Universal Steel Sub-Panel with Two DB25/HD44 holes	



Part #	1 Piece Price
REF00029	\$7.90
Description	
Universal Steel Sub-Panel with One DB37/HD62 hole	

Part #	1 Piece Price
REF00030	\$20.40
Description	
Universal Sub-Panel, 2 DB9 Feed-Thru Adapters	

Part #	1 Piece Price
REF00031	\$26.64
Description	
Universal Sub-Panel, 2 HD15 Feed-Thru Adapters	

Part #	1 Piece Price
REF00032	\$22.68
Description	
Universal Sub-Panel, 2 HD15 Feed-Thru Adapters	

See our website to view all of our products.

PATCH PANELS | Universal Rack & Sub-Panels



Part #	1 Piece Price
REF00033	\$29.48
Description	
Universal Sub-Panel, 2 HD26 Feed-Thru Adapters	



Part #	1 Piece Price
REF00034	\$24.95
Description	
Universal Sub-Panel, 2 DB25 Feed-Thru Adapters	



Part #	1 Piece Price
REF00035	\$32.90
Description	
Universal Sub-Panel, 2 HD44 Feed-Thru Adapters	



Part #	1 Piece Price
REF00036	\$23.17
Description	
Universal Sub-Panel, One DB9 and One DB25 Feed-Thru	



Part #	1 Piece Price
REF00037	\$18.13
Description	
Universal Sub-Panel, One DB37 Feed-Thru Adapter	



Part #	1 Piece Price
REF00038	\$34.04
Description	
Universal Sub-Panel, Dual HDMI Couplers	



Part #	1 Piece Price
REF00039	\$45.40
Description	
Universal Sub-Panel, Dual DVI Couplers	



Part #	1 Piece Price
REF00040	\$17.00
Description	
Universal Sub-Panel, Dual XLR 3 Pin Male Couplers	



Part #	1 Piece Price
REF00041	\$17.08
Description	
Universal Sub-Panel, Dual XLR 3 Pin Female Couplers	



Part #	1 Piece Price
REF00042	\$17.00
Description	
Universal Sub-Panel, Dual XLR 3 Pin Couplers 1-M 1-F	



Part #	1 Piece Price
REF00043	\$26.09
Description	
Universal Sub-Panel, Dual 3.5mm Stereo Audio Female Couplers	



Part #	1 Piece Price
REF00044	\$17.22
Description	
Universal Sub-Panel, Quad 3.5mm Stereo Audio Female Couplers	



Part #	1 Piece Price
REF00045	\$55.64
Description	
1.75" Cable Management Bracket Kit for 19" Panels	



Part #	1 Piece Price
REF00046	\$59.12
Description	
Universal Rack Panel Kit with 6 Steel Sub-Panels	



Part #	1 Piece Price
REF00047	\$5.75
Description	
Universal Plastic Blank Sub-Panel	



Part #	1 Piece Price
REF00048	\$5.75
Description	
Universal Aluminum Blank Sub-Panel	

Universal Sub-Panels & Power Cords | PATCH PANELS



Part #	1 Piece Price
REF00049	\$23.40
Description	
Universal Sub-Panel and 6" Drawer Combination	

Part #	1 Piece Price
REF00050	\$21.53
Description	
Universal Sub-Panel, Cable Minder Kit	

Part #	1 Piece Price
REF00051	\$19.26
Description	
Universal Sub-Panel, 2 Simplex ST Couplers	

Part #	1 Piece Price
REF00052	\$24.95
Description	
Universal Sub-Panel, 4 Simplex ST Couplers	



Part #	1 Piece Price
REF00053	\$21.53
Description	
Universal Sub-Panel, 1 Singlemode or Multimode Duplex LC Coupler	

Part #	1 Piece Price
REF00054	\$31.77
Description	
Universal Sub-Panel, 2 Multimode Quad LC Couplers	

Part #	1 Piece Price
REF00055	\$34.04
Description	
Universal Sub-Panel, 2 Simplex APC FC Couplers	

Part #	1 Piece Price
REF00056	\$54.49
Description	
Universal Sub-Panel, 4 Simplex APC FC Couplers	



Part #	1 Piece Price
REF00057	\$30.63
Description	
Universal Sub-Panel, 1 Duplex APC SC Coupler	

Part #	1 Piece Price
REF00058	\$32.90
Description	
Universal Sub-Panel, 2 Duplex APC SC Couplers	

Part #	1 Piece Price
REF00061	\$24.73
Description	
N5-15 to C13 LSZH Power Cords 14AWG 2 Meters	

Part #	1 Piece Price
REF00143	\$28.14
Description	
N5-15 to C13 LSZH Power Cords 14AWG 3 Meters	



Part #	1 Piece Price
REF00060	\$18.55
Description	
N5-15 to C13 LSZH Power Cords 16AWG 2 Meters	

Part #	1 Piece Price
REF00144	\$20.59
Description	
N5-15 to C13 LSZH Power Cords 16AWG 3 Meters	

Part #	1 Piece Price
REF00145	\$15.74
Description	
N5-15 to C13 LSZH Power Cords 18AWG 2 Meters	

Part #	1 Piece Price
REF00146	\$19.55
Description	
N5-15 to C13 LSZH Power Cords 18AWG 3 Meters	

See our website to view all of our products.

PATCH PANELS | Fiber Optic Rack Panels

Our Patch Panels are designed for Military applications. Fiber Optic and Coaxial versions are suited for rugged environments and are available in many different configurations to meet all applications and forms of connectivity. Custom panel identifiers and connector options are also available with quick turn.



Part #	1 Piece Price
REF00059	\$174.98
Description	
Universal Rack Panel with 6 Type N Couplers, 50 Ohm	



Part #	1 Piece Price
REF00068	\$142.01
Description	
Universal Rack Panel with 12 Simplex ST Couplers	



Part #	1 Piece Price
REF00069	\$187.48
Description	
Universal Rack Panel with 24 Simplex ST Couplers	



Part #	1 Piece Price
REF00065	\$236.34
Description	
3.50" Panel, 32 ST Bronze Couplers with Cable Minder	



Part #	1 Piece Price
REF00067	\$298.85
Description	
3.50" Panel, 32 ST Ceramic Couplers with Cable Minder	



Part #	1 Piece Price
REF00064	\$162.47
Description	
1.75" Panel, 16 ST Bronze Couplers with Cable Minder	



Part #	1 Piece Price
REF00070	\$249.99
Description	
1.75" Panel, 16 FC Bronze Couplers with Cable Minder	



Part #	1 Piece Price
REF00074	\$335.23
Description	
1.75" Panel, 16 FC APC Ceramic Couplers with Cable Minder	



Part #	1 Piece Price
REF00072	\$274.98
Description	
1.75" Panel, 16 FC Ceramic Couplers with Cable Minder	



Part #	1 Piece Price
REF00066	\$199.13
Description	
1.75" Panel, 16 ST Ceramic Couplers with Cable Minder	



Part #	1 Piece Price
REF00071	\$417.06
Description	
3.50" Panel, 32 FC Bronze Couplers with Cable Minder	



Part #	1 Piece Price
REF00073	\$442.06
Description	
3.50" Panel, 32 FC Ceramic Couplers with Cable Minder	



Part #	1 Piece Price
REF00075	\$335.23
Description	
3.50" Panel, 32 Duplex SC Couplers Multimode	



Part #	1 Piece Price
REF00076	\$397.73
Description	
3.50" Panel, 32 Duplex SC Couplers Single Mode	



Part #	1 Piece Price
REF00077	\$162.47
Description	
Universal Rack Panel with 6 Duplex SC Couplers	



Part #	1 Piece Price
REF00078	\$187.48
Description	
Universal Rack Panel with 12 Duplex SC Couplers	



Part #	1 Piece Price
REF00079	\$223.84
Description	
1.75" x 19" Patch Panel, with 16 LC Singlemode Couplers	



Part #	1 Piece Price
REF00080	\$131.78
Description	
1.75" x 19" Patch Panel, with 16 LC Multimode Couplers	

Fiber Optic & Coaxial Panels | PATCH PANELS



Part #	1 Piece Price
REF00081	\$323.86
Description	
Rack Panel, 96 LC Couplers Multimode-Bronze Sleeves	

Part #	1 Piece Price
REF00082	\$611.41
Description	
Rack Panel, 96 LC Couplers Single mode-Ceramic Sleeves	

Part #	1 Piece Price
REF00083	\$254.20
Description	
1.75" x 19" Patch Panel, with 24 LC Multimode Couplers	

Part #	1 Piece Price
REF00084	\$415.58
Description	
1.75" x 19" Patch Panel with 24 LC Singlemode Couplers	



Coaxial Rack Panels



Part #	1 Piece Price
REF00085	\$248.85
Description	
19" Rack Panel with 16 MPO Fiber Optic Couplers - 1U High	

Part #	1 Piece Price
REF00087	\$32.87
Description	
1.75" Panel, 16 0.5" D-Holes	

Part #	1 Piece Price
REF00088	\$47.68
Description	
1.75" Panel, 16 0.5" D-Holes with Cable Minder	



Part #	1 Piece Price
REF00089	\$37.45
Description	
3.50" Panel, 32 0.5" D-Holes	

Part #	1 Piece Price
REF00090	\$62.45
Description	
3.50" Panel, 32 0.5" D-Holes with Cable Minder	

Part #	1 Piece Price
REF00095	\$137.47
Description	
1.75" Panel, 16 75 Ohm BNC Adapters Insulated	

Part #	1 Piece Price
REF00091	\$124.97
Description	
1.75" Panel, 16 BNC Adapters Insulated	



Part #	1 Piece Price
REF00092	\$224.98
Description	
3.50" Panel, 32 BNC Adapters Insulated	

Part #	1 Piece Price
REF00093	\$149.97
Description	
1.75" Panel, 16 BNC Adapters Insulated with Rear Cable Minder	

Part #	1 Piece Price
REF00094	\$249.99
Description	
3.50" Panel, 32 BNC Adapters Insulated with Rear Cable Minder	

Part #	1 Piece Price
REF00096	\$262.50
Description	
3.50" Panel, 32 75 Ohm BNC Adapters Insulated	



Part #	1 Piece Price
REF00097	\$248.85
Description	
1.75" x 19" HDMI Patch Panel, 16 HDMI Female / Female Couplers	

Part #	1 Piece Price
REF00098	\$373.31
Description	
3.50" x 19" HDMI Patch Panel, 32 HDMI Female / Female Couplers	

Part #	1 Piece Price
REF00099	\$198.84
Description	
3.50" x 19" Panel, 16 DVI Female / Female Couplers	

See our website to view all of our products.

PATCH PANELS | USB, D-Sub & HDMI® Rack Panels

Our Patch Panels are designed for Military applications. USB, D-Sub, HDMI® and Ethernet versions are suited for rugged environments and are available in many different configurations to meet all applications and forms of connectivity.

Custom panel identifiers and connector options are also available with quick turn.



Part #	1 Piece Price
REF00103	\$67.00
Description	
1.75" X 19" Blank Panel with 16 Universal DB9 / HD15 / HDMI Cutouts	

Part #	1 Piece Price
REF00104	\$70.41
Description	
3.5" X 19" Blank Panel with 32 Universal DB9 / HD15 / HDMI Cutouts	



Part #	1 Piece Price
REF00105	\$37.45
Description	
3.5" X 19" Blank Panel with 16 Universal DB15 / HD26 / DVI DisplayPort Cutouts	

Part #	1 Piece Price
REF00106	\$35.58
Description	
3.5" X 19" Blank Panel with 16 Universal DB25 / HD44 Cutouts	

Part #	1 Piece Price
REF00107	\$74.96
Description	
3.5" X 19" Blank Panel with 16 Universal DB37 / HD62 Cutouts	

Part #	1 Piece Price
REF00140	\$59.04
Description	
Universal Rack Panel Kit with 6 Aluminum Sub-Panels	



Part #	1 Piece Price
REF00101	\$162.47
Description	
1.75" 16 Port Panel USB A/B Flanged Coupler, Shielded	

Part #	1 Piece Price
REF00102	\$287.48
Description	
3.50" 32 Port Panel USB A/B Flanged Coupler, Shielded	

Part #	1 Piece Price
REF00100	\$149.97
Description	
1.75" 16 Port Panel USB A/B Flanged Coupler	

Part #	1 Piece Price
REF00108	\$144.28
Description	
1.75" x 19" Panels with 16 DB9 Female / Female Couplers	



Part #	1 Piece Price
REF00109	\$223.84
Description	
3.5" x 19" Panels with 32 DB9 Female / Female Couplers	

Part #	1 Piece Price
REF00110	\$149.97
Description	
Universal Rack Panel with 12 DB9 Female / Female	

Part #	1 Piece Price
REF00111	\$156.78
Description	
1.75" x 19" Panel, 16 HD15 Female / Female SVGA Couplers	

Part #	1 Piece Price
REF00112	\$244.30
Description	
3.50" x 19" Panel, 32 HD15 Female / Female SVGA Couplers	



Part #	1 Piece Price
REF00113	\$156.78
Description	
3.50" x 19" Panel, 16 DB15 Female / Female Couplers	

Part #	1 Piece Price
REF00114	\$174.98
Description	
3.50" x 19" Panel, 16 DB25 Female / Female Couplers	

Part #	1 Piece Price
REF00115	\$215.89
Description	
3.50" x 19" Panel, 16 DB37 Female / Female Couplers	

See our website to view all of our products.

Ethernet Rack Panels | PATCH PANELS



Part #	1 Piece Price
REF00126	\$49.96
Description	1.75" Blank Rack Panel Accepts 16 Flange Style Couplers



Part #	1 Piece Price
REF00138	\$37.45
Description	1.75" Blank Panel Accepts 16 Keystone Couplers



Part #	1 Piece Price
REF00127	\$63.60
Description	3.50" Blank Rack Panel Accepts 32 Couplers



Part #	1 Piece Price
REF00139	\$49.96
Description	3.50" Blank Panel Accepts 32 Keystone Couplers



Part #	1 Piece Price
REF00118	\$211.73
Description	1.75" 16 Port Flange Style Mounted Category 5e Feed-Thru Panel, Unshielded



Part #	1 Piece Price
REF00119	\$287.48
Description	1.75" 16 Port Flange Style Mounted Category 5e Feed-Thru Panel, Shielded



Part #	1 Piece Price
REF00120	\$249.99
Description	1.75" 16 Port Flange Style Mounted Category 6 Feed-Thru Panel, Unshielded



Part #	1 Piece Price
REF00121	\$317.98
Description	1.75" 16 Port Flange Style Mounted Category 6 Feed-Thru Panel, Shielded



Part #	1 Piece Price
REF00130	\$232.93
Description	Universal Sub-Panel, Steel 3.5" x 19" Universal Master Rack Panel



Part #	1 Piece Price
REF00131	\$278.40
Description	1.75" 16 Port Low Profile Offset Category 5e Feed-Thru Panel, Shielded



Part #	1 Piece Price
REF00122	\$400.01
Description	3.50" 32 Port Flange Style Mounted Category 5e Feed-Thru Panel, Unshielded



Part #	1 Piece Price
REF00123	\$500.02
Description	3.50" 32 Port Flange Style Mounted Category 5e Feed-Thru Panel, Shielded



Part #	1 Piece Price
REF00124	\$437.51
Description	3.50" 32 Port Flange Style Mounted Category 6 Feed-Thru Panel, Unshielded



Part #	1 Piece Price
REF00125	\$537.53
Description	3.50" 32 Port Flange Style Mounted Category 6 Feed-Thru Panel, Shielded



Part #	1 Piece Price
REF00134	\$237.49
Description	1.75" 16 Port Low Profile Category 6 Feed-Thru Panel, Unshielded



Part #	1 Piece Price
REF00135	\$299.99
Description	1.75" 16 Port Low Profile Category 6 Feed-Thru Panel, Shielded



Part #	1 Piece Price
REF00132	\$392.05
Description	3.50" 32 Port Low Profile Offset Category 5e Feed-Thru Panel, Unshielded



Part #	1 Piece Price
REF00133	\$454.56
Description	3.50" 32 Port Low Profile Offset Category 5e Feed-Thru Panel, Shielded



Part #	1 Piece Price
REF00137	\$462.52
Description	3.50" 32 Port Low Profile Category 6 Feed-Thru Panel, Shielded



Part #	1 Piece Price
REF00136	\$400.01
Description	3.50" 32 Port Low Profile Category 6 Feed-Thru Panel, Unshielded

REFERENCE | Terms & Conditions

1. SCOPE; CHANGES

The terms and conditions stated herein (this "Agreement") govern all sales of products or services ("products") by Infinite Electronics, Inc. (collectively, "we," "us," "our," or "seller") to you or the entity you represent ("you" or "buyer"). You represent to us that you are lawfully able to enter into contracts (e.g., you are not a minor) and that if you are entering into this Agreement for an entity, such as the company you work for, you represent to us that you have the legal authority to bind that entity. Unless otherwise agreed to in writing by seller's authorized agent, any terms and conditions contained in buyer's purchase order or any other document that are different from or in addition to these terms and conditions are objected to, are rejected, and will not be binding on us. By placing an order for products from us, or by accepting delivery of the products described on the applicable packing slip, bill of lading and/or invoice received with the products, you agree to be bound by and accept these terms and conditions of sale.

We may change the terms and conditions of this Agreement in our sole discretion by posting an updated version of these terms and conditions at this location; provided, however, that the terms and condition of this Agreement in effect as of the date of an applicable order shall continue to govern such order and the products purchased thereunder.

2. ORDER ACCEPTANCE

- a) Your receipt of an email or other form of order confirmation does not constitute our acceptance of your order or a confirmation of an offer to sell.
- b) We reserve the right, without prior notification, to limit the order quantity on any item and/or refuse service to anyone.
- c) All orders are subject to review and acceptance by us. You agree to provide complete and accurate contact information in connection with any order submitted to us. Verification of information may be required prior to the acceptance of any order.
- d) In the case of pre-stocked finished goods, order acceptance is designated by fulfilling the order. In the case of products requiring post-order processing (including but not limited to design, material purchase, manufacturing or test), order acceptance is designated by performing activities unique to the order.

3. ORDER CANCELLATION

- a) Orders fully or partially processed by seller may not be cancelled by buyer.
- b) Products not previously stocked as finished goods are both Non-Cancelable and Non-Refundable ("NC/NR"). NC/NR products include cable assemblies, special orders, custom orders, orders for non-standard products, products not customarily in stock, scheduled orders requiring special procurements, or orders for products requiring assembly or manufacturing activities prior to shipping (not stored in completed state) as well as purchased services such as special testing or product modifications.
- c) In the event of cancellation or other withdrawal of an order for any reason and without limiting any other remedy as a result of such cancellation or other withdrawal, reasonable cancellation or restocking charges, which shall include all expenses then incurred and commitments made by seller, shall be paid by buyer. Buyer's requests to reschedule are subject to acceptance by seller in its sole discretion. Orders may not be rescheduled after the order has been submitted by seller to the shipment carrier.

4. PRICES

- a) Orders are billed at the prices (in US dollars) in effect at the time of shipment.
- b) Prices will be as specified within seller's website or as stated in seller's quote / proposal. If no period is specified, quoted prices will be applicable for thirty (30) days.
- c) For catalog products, the website contains the most current catalog pricing and is the price reference for such orders. Pricing included in the catalog is for reference only and final pricing is determined by the published website price.
- d) For non-catalog products and services, prices cited are based on current costs and are subject to reasonable adjustment on or after the date of acceptance of any purchase order to meet a rise or fall in such costs, as computed on the date of delivery.
- e) Prices are subject to change without notice.
- f) Prices are exclusive of taxes, impositions and other charges, including: sales, use, excise, value added and similar taxes or charges imposed by any government authority, international shipping charges, forwarding agent's and broker's fees, bank fees, consular fees, document fees and import duties.

5. TERMS OF PAYMENT

- a) All payments must be in US Dollars, or will be converted to US Dollars using seller's standard exchange rate at the time of purchase.
- b) MasterCard, VISA and American Express credit cards, purchase cards and major bank debit cards are accepted. Payment via net thirty (30) days is available to businesses, schools and agencies or as otherwise specified by seller subject to credit approval.
- c) For International Orders, MasterCard, VISA, and American Express credit cards are accepted. Payment via open credit account with Net thirty (30) days may be established for companies having three U.S. references accepted to seller. Prepaid Wire Transfer: You can wire the funds to our bank. We will contact you with the total amount, which will include shipping charges and a \$40 wire transfer fee. Orders will not be accepted until funds have been received in full and

the Purchase Order (PO) has been received. Notwithstanding anything to the contrary in this Agreement, seller may add or remove payment options in seller's sole discretion.

d) Buyer acknowledges that seller has the right to reassess buyer's creditworthiness from time to time. To the extent such is in accordance with law, in the event there is a decline in buyer's creditworthiness, seller may, upon thirty (30) days written notice, revise the payment terms between the parties. Upon request, buyer shall provide financial data evidencing the buyer's worth in order for seller to determine the creditworthiness of buyer. Such information shall include, but not be limited to, annual reports, balance sheets, and bank records.

e) If buyer is delinquent in its payment obligations, without prejudice to any other remedies available to it by law or in equity, seller may demand immediate payment and at seller's option.

(i) suspend all further deliveries to be made under the purchase order or any further performance under any other contract with buyer or buyer's affiliates, in which event buyer shall not be released in any respect from its obligations to seller under the purchase order; (ii) recover all costs of collection including but not limited to reasonable attorneys' fees; (iii) repossess the product for which payment has not been made; (vi) charge interest at 1.5% per month on the past due amount, not to exceed the interest percentage allowed by law; and (vii) reassess the credit worthiness of buyer and change any current payment terms. Any discount from seller's rates, if any, shall cease to apply to the delinquent invoice, buyer shall be invoiced for such differences in cost, and shall immediately pay the resulting invoice.

6. TAXES AND DUTIES

- a) Any taxes related to the products purchased are the responsibility of buyer (excluding taxes based on seller's net income), unless buyer presents an exemption certificate acceptable to seller and the applicable taxing authorities. If any exemption certificate presented by buyer is held to be invalid, then buyer will pay seller the amount of the tax and any penalties and interest related thereto.
- b) If possible, seller will bill taxes as a separate item on the invoice presented to buyer.
- c) Sales tax will be charged on product cost and shipping & handling where applicable and required by law. Any sales tax due that is not collected by the seller is the responsibility of the buyer.
- d) International orders may be subject to various taxes and duties in the country of destination, all of which are the responsibility of the buyer. This includes sales, use, excise, value added and similar taxes or charges imposed by any government authority, international shipping charges, forwarding agent's and broker's fees, bank fees, consular fees, document fees and import duties.

7. SHIPPING COSTS

Shipping or freight charges and insurance will be paid by the buyer and added to the invoice or billed collect unless specifically stated in the quote or order confirmation based on seller practices or promotions.

8. DELIVERY AND TITLE

- a) Unless otherwise agreed to in writing, all products are shipped Incoterms 2010 - FCA Shipping Point. Subject to seller's right of stoppage in transit, delivery of the products to the carrier will constitute delivery to buyer and title and risk of loss will pass to buyer.
- b) Seller will make reasonable efforts to initiate shipment and schedule delivery as close as possible to buyer's requested delivery date(s). Buyer acknowledges that delivery dates provided by seller are estimates only and that seller will not be liable for failure to deliver on such dates.
- c) Selection of the carrier and delivery route will be made by seller unless specifically designated by buyer.
- d) Seller reserves the right to make deliveries in installments. Delay in delivery of one installment will not entitle buyer to cancel any other installment(s). Delivery of any installment of products within thirty (30) days after the date requested will constitute a timely delivery. Delivery of a quantity that varies from the quantity specified shall not relieve buyer of the obligation to accept delivery and pay for the products delivered.
- e) Deliveries shall be made during normal business hours Monday through Friday. One attempt to deliver will be made. Should delivery need to be rescheduled, any additional costs incurred for redelivery and/or storage fees will be charged to the buyer. Seller shall use reasonable efforts to make timely delivery but shall be excused from any delays arising out of causes beyond its reasonable control. Any specific delivery dates that may be stated are approximate.
- f) If completion of delivery is prevented through no fault of seller, seller may specify a reasonable alternative place of delivery. Buyer agrees that all costs of storage and transport incurred following an initial attempt at delivery are hereby allocated to and imposed upon buyer, and shall be added by seller to the sale price. Delivery may at any time be withheld by seller pending payment of any sum due from the buyer to seller. Seller will return Product via the incoming method unless an alternative method has been indicated on the purchase order or a change authorized by the buyer representative.
- g) Deliveries made outside the 48 contiguous States may be subject to modified terms and conditions as stated within the order quote.

Please visit [MilesTek.com](https://www.milestek.com) for the full listing of MilesTek's terms and conditions.

MilesTek, an Infinite Electronics company

Infinite Electronics: A Portfolio of Companies Dedicated to Serving the Engineers' Urgent Needs

Each Infinite company is a specialist within their respective product set, offering broad inventories of engineering-grade product, paired with expert technical support and short lead times.

Brands



Products

Radio Frequency

Comprehensive and continuously expanding portfolio of radio frequency, microwave and millimeter products including interconnects, passives components and active components.

Wireless Connectivity

Full suite of passive WiFi and RFID products primarily used for wireless communications that include antennas, radios, surge protectors, cellular amplifiers and more.

Wired Connectivity

Diverse offering of standard, unique and custom products across the spectrum of connectors, cable assemblies, adapters and contact insertion/removal tools.

Industrial Networking

Network equipment, conversion equipment, power products and test related products with a focus on harsh environments and factory automation.

Applications

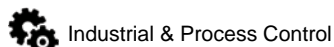
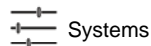
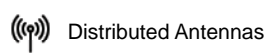
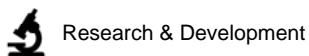

Markets

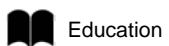
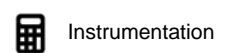
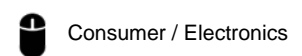
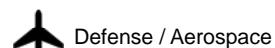

MilesTek

301 Leora Ln., Suite 100
Lewisville, TX 75056

If undeliverable to addressee, please route to
Engineering or Purchasing Department.

PRSR STD
U.S. POSTAGE
PAID
L-com

CONTACT ID: 

Our Experts Are Here to Help.



Same-day shipping

On orders placed by 5:00 pm CT



Secure online ordering

MilesTek.com

sales@MilesTek.com



Toll Free (866) 524-1553

Phone (940) 484-9400



Fax 1-972-394-7913



ISO 9001:2008