

7-7R



United States
Department of
Agriculture

Forest Service

Southern Forest
Experiment Station

New Orleans,
Louisiana

General Technical Report
S0-56
August 1985



Integrated Pest Management Research Symposium: The Proceedings



ACKNOWLEDGMENTS

The editors of this volume wish to thank the following for their invaluable assistance in its preparation: Robert C. Biesterfeldt and Marilyn Meeker, Southeastern Forest Experiment Station, for editing and preparation of individual papers; Howard W. Mobley and Carol A. Lowe, Southern Forest Experiment Station, for editing and preparation of individual papers; David M. Webb, Southern Region, for editing and preparation of individual papers; Marlene Hanna, Southern Forest Experiment Station, for design and printing services; and Julia G. Wilson, Southern Forest Experiment Station, for word processing services.

Integrated Pest Management Research Symposium: The Proceedings

Edited by Susan J. Branham and Robert C. Thatcher

Asheville, NC
April 15–18, 1985

Sponsored by:

Southeastern Forest Experiment Station
Southern Forest Experiment Station
Southern Region, State and Private Forestry
USDA Cooperative State Research Service

Cooperating Organizations:

Southern Region, National Association of Professional Forestry Schools
and Colleges
Southern Industrial Forestry Research Council
Southern State Agriculture Experiment Stations
Association of Consulting Foresters
Southern Regional Planning Group 2.0

CONTENTS

PREFACE	v
INTRODUCTORY REMARKS	1
Integrated Pest Management Research Symposium A. C. Mace, Jr.	1
Integrated Pest Management in the South K. R. Shea	3
SESSION I — SAMPLING AND IMPACT ASSESSMENT	5
Sampling Pest Populations	
Procedures for sampling six-spined <i>Ips</i> populations in slash pine J. L. Foltz, J. A. Corneil, and R. M. Reich	6
Line intersect sampling technique for estimating <i>Ips</i> populations in logging residue C. W. Berisford, R. F. Mizell, III, and L. H. Kudon	13
Turpentine-baited traps capture black turpentine beetles and other forest Coleoptera but do not prevent attacks on pines C. W. Fatzinger	26
Estimating Areawide Pest Population Change/Timber Loss	
Estimating southern pine beetle-caused timber losses over extensive areas J. D. Ward, C. W. Dull, G. W. Ryan, and M. C. Remion	34
Objective prediction of climate-related changes in the distribution of southern pine beetle P. J. Michaels, D. E. Sappington, and P. J. Stenger	41
The large-scale prediction of southern pine beetle populations W. D. Mawby and F. P. Hain	53
Methods for estimating annosus root rot in loblolly pine stands S. A. Alexander, R. H. Hokans, E. S. Fanelli, and T. M. Kurdyla	56
Growth following thinning model for loblolly pine plantations infected by annosus root rot R. H. Hokans, E. S. Fanelli, and S. A. Alexander	59
Predicting survival and yield of unthinned slash and loblolly pine plantations with different levels of fusiform rust W. L. Nance, E. Shoulders, and T. R. Dell	62
SESSION II — PESTS AND HOST/PEST INTERACTIONS	73
Pests and Associated Organisms	
Host preference behavior of insect parasites in the presence of southern pine beetle and one or more <i>Ips</i> species L. H. Kudon and C. W. Berisford	74
Strategies for cohabitation among the southern pine bark beetle species: comparisons for life process biologies T. L. Wagner, R. O. Flamm, and R. N. Coulson	87
Effects of temperature and slash pine phloem thickness on <i>Ips calligraphus</i> life processes R. A. Haack, J. L. Foltz, and R. C. Wilkinson	102
Interactions of the southern pine beetle with competitor species and meteorological factors F. P. Hain and A. Ben Alya	114
Relationship of symbiotic fungi to southern pine beetle population trends J. R. Bridges	127
Population dynamics of initiation and growth of southern pine beetle infestations R. N. Coulson, R. O. Flamm, T. L. Wagner, E. J. Rykiel, P. J. H. Sharpe, T. L. Payne, and S. K. Lin	136
Host/Pest Interactions	
Factors contributing to southern pine beetle host resistance F. P. Hain, S. P. Cook, P. A. Matson, and K. G. Wilson	154
Host/beetle interactions: influence of associated microorganisms, tree disturbance, and host vigor J. D. Hodges, T. E. Nebeker, J. D. DeAngelis, and C. A. Blanche	161
Induced defenses against <i>Dendroctonus frontalis</i> and associated fungi: variation in loblolly pine resistance T. D. Paine, F. M. Stephen, and R. G. Cates	169
Variation in the chemistry of loblolly pine in relation to infection by the blue-stain fungus H. A. Gambliel, R. G. Cates, M. Caffey-Moquin, and T. D. Paine	177

Descriptive and Predictive Models

A <i>Dendroctonus frontalis</i> infestation growth model: organization, refinement, and utilization F. M. Stephen and M. Lih	186
A methodology for biophysical modeling using TAMBEETLE as an example R. M. Feldman, T. L. Wagner, G. L. Curry, R. N. Coulson, and P. J. H. Sharpe	195
Evaluation and application of the TAMBEETLE and Arkansas southern pine beetle spot growth models in the Gulf Coastal Plain W. A. Nettleton and M. D. Connor	202
Energetics of pine defense systems to bark beetle attack P. J. H. Sharpe, H. Wu, R. G. Cates, and J. D. Goesch	206

SESSION III — MANAGEMENT APPROACHES AND IPM SYSTEMS

225

Hazard-Rating Systems

Development, implementation, and validation of a large area hazard- and risk-rating system for southern pine beetle R. F. Billings, C. M. Bryant, and K. H. Wilson	226
Predicting susceptibility to southern pine beetle attack in the Coastal Plain, Piedmont, and southern Appalachians R. L. Hedden and R. P. Belanger	233
Potential use of soil maps to estimate southern pine beetle risk P. L. Lorio, Jr., and R. A. Sommers	239
Adaptation of littleleaf disease hazard rating for use in forest management in South Carolina National Forests S. W. Oak	246

Management Tactics

Fusiform rust: guidelines for selective cutting of rust-infected trees in merchantable slash pine plantations R. P. Belanger, T. Miller, and J. F. Godbee	254
Pest assessments after sanitation-salvage cutting in fusiform rust-infected slash pine plantations T. Miller, R. P. Belanger, R. S. Webb, and J. F. Godbee	258
Thinning and harvesting practices to minimize site and stand disturbance and susceptibility to bark beetle and disease attacks T. E. Nebeker and J. D. Hodges	263
Field tests of insecticides for control of black turpentine beetle J. C. Nord, A. S. Jones, and F. L. Hastings	272
Effects of frontalure in suppressing southern pine beetle spot growth under endemic and epidemic population levels T. L. Payne, L. H. Kudon, C. W. Berisford, B. F. O'Donnell, and D. K. Walsh ..	281

IPM Systems

Simulation of southern pine beetle-associated timber loss using CLEMBEETLE R. L. Hedden	288
SPB-MICROBEETLES: A simulation system for evaluating economic performance of management alternatives for stands attacked by southern pine beetle W. A. Thompson	292
ITEMS: an integrated method to project southern pine stand development J. M. Vasievich and W. A. Thompson	300
Risk assessment of investments in loblolly pine plantations threatened by bark beetles W. C. Anderson, R. W. Guldin, and J. M. Vasievich	328
Development and implementation of the southern pine beetle decision support system M. C. Saunders, D. K. Loh, R. N. Coulson, R. J. Rykiel, T. L. Payne, P. E. Pulley, and L. C. Hu	335

OVERVIEW

364

Integrated Pest Management in the South: An Overview R. C. Thatcher, G. N. Mason, and G. D. Hertel	364
---	-----

PREFACE

The Integrated Pest Management Research, Development, and Applications Program for Bark Beetles of Southern Pines held a final Research Symposium at the Grove Park Inn in Asheville, NC, on April 15–18, 1985. The purpose of the meeting was to summarize findings from research and development work conducted in the South during the 5 years (1980–85) of the Program's existence. Results were presented in several subject areas, including sampling and impact assessment; bark beetle biology and ecology; pest, associated organism and host/pest interactions; hazard rating for bark beetles and diseases; management tactics, and integrated pest management systems. The texts for these presentations are included in these proceedings along with an overview of the Program's mission and accomplishments.

The steering committee for the symposium was composed of Dr. Stanley J. Barras (USDA Forest Service), Dr. Arnett C. Mace, Jr., (University of Florida), Dr. Jerry A. SESCO (USDA Forest Ser-

vice), Dr. John C. Meadows (Cooperative State Research Service), and Dr. Harvey V. Toko (USDA Forest Service). Moderators included James E. Neal (Cooperative Extension Service), Dr. Boyd W. Post (Cooperative State Research Service), Dr. Garland N. Mason (USDA Forest Service), Dr. Jerry A. SESCO (USDA Forest Service), Dr. Stanley J. Barras (USDA Forest Service), Dr. Gerard D. Hertel (USDA Forest Service), Dr. LeRoÿ Jones (USDA Forest Service), Dr. Barry F. Malac (Union Camp Corporation), Dr. Max W. McFadden (USDA Forest Service), and Dr. Robert C. Thatcher (USDA Forest Service). Dr. Thomas H. Ellis, Director, Southern Forest Experiment Station, introduced the guest speakers, Dr. Arnett C. Mace, Jr., University of Florida, and Dr. Keith R. Shea (USDA Forest Service).

The IPM Program management team is grateful to the many Federal, State, university, and industrial persons who contributed to the symposium and to the management of the Grove Park Inn for facilitating its planning and execution.

INTRODUCTORY REMARKS

Integrated Pest Management Research Symposium

Introductory Comments by Arnett C. Mace, Jr.¹

The program for this Symposium indicates its purpose is to summarize the findings from research and development work conducted as part of the Integrated Pest Management Research, Development and Applications Program for Bark Beetles of Southern Pines.

My comments will relate primarily to addressing the development of this program, its organization, some outputs, and personal biases for the future.

In addition, I shall attempt to avoid preemptions of my associate commentator—Keith Shea.

The IPM RD&A Program evolved from the ESPBRAP beginning in 1980 for the purpose of conducting research and technology transfer programs to provide information and methods for assessing and suppressing pest impacts on multiple forest resources. The specific *objectives* of the program were to:

1. Develop methods for measuring and predicting biological, economic and environmental impacts of pine bark beetle infestations on forest resources.
2. Develop methods for measuring and evaluating benefit/costs or cost effectiveness of alternative tactics and strategies for use in control decisionmaking.
3. Develop and/or test techniques for relating beetle activity, stand disturbance, and site/stand factors to forest damage.
4. Develop guidelines for increasing the utilization of beetle-killed timber.
5. Develop methods for sampling beetle populations, describing the interactions between bark beetle species, and determining the roles of natural control agents in regulating beetle populations.
6. Develop methods for measuring and predicting host susceptibility to beetle attack in natural and planted stands.

7. Evaluate thinning and harvesting practices affecting beetle-caused losses and procedures for preventing or reducing such losses.
8. Evaluate behavioral chemical formulations and deployment strategies for detecting and/or suppressing bark beetle infestation incidence and spot growth.

9. Extend the registrations of Dursban® and/or Sumithion® to include control of *Ips* spp. and/or black turpentine beetle and determine the efficacy and safety of an additional toxicant, if needed.
10. Integrate program results and encourage the incorporation of pest management approaches in forest management systems.

These objectives were established through a planning team composed of scientists, forest managers, and program leaders from the U.S. Forest Service, universities, and industry in 1978-79. This group worked under the auspices of the southern ASCUFRO (NAPFSC) and the Forest Service.

Of course, the rationale was the importance of forestry in the South, the continuing severity of bark beetle outbreaks in five southern States, the need to continue unfinished aspects of ESPBRAP and aggressively transfer new or improved technology to users.

An important point is the coordination of planning and execution of this program. ESPBRAP funds were obtained through a combined effort of the U.S. Forest Service, industries, and universities. The new program was similar; but even more coordinated as evidenced by the organizational structure. Funding was through the Forest Service and CSRS and oversight was provided by RPG 2.0 and an Oversight and Guidance Committee composed of diverse interests from among industry, State forestry organizations, State and Private Forestry, National Forest Administration, universities, consultants, etc.

Functions of the Oversight and Guidance Committee included:

1. Reviewing and recommending a 5-year schedule of activities for the Program.
2. Reviewing annual plans of work and budget.
3. Reviewing and assessing overall accomplishments.

¹ Director, School of Forest Resources and Conservation, University of Florida, Gainesville, FL. Remarks to the Integrated Pest Management Research Symposium, Asheville, NC, April 16, 1985.

4. Recommending changes in Program priorities and direction.
5. Exposing program management to a wide range of administrative perspectives and changing needs.

The need for basic and applied studies was recognized. A planned technology transfer effort was undertaken to assure that better tools were provided to practitioners and that research results were validated and applied over a wide range of management situations. A peer review process was also involved for the purposes of maintaining credibility, monitoring, and evaluation.

The planned coordinated technology transfer program resulted in continuous interaction with various user groups, demonstration of new and/or improved technologies, and packaging and transfer of a wide variety of written and visual materials. This information has been used by various segments of private forestry, State forestry organizations, Cooperative Extension, National Forest Administration, and others. This effort has included:

1. The development and use of sampling techniques and/or models for determining the impacts of annosus root rot and fusiform rust.
2. The development and use of simulation techniques for projecting the effects of stand management practices and the economic returns from such practices in single or multiple stands in the presence or absence of southern pine beetle over a rotation.
3. The development and use of spot growth models for predicting timber and economic losses over the next 30-90 days.
4. The development and use of sawmill guidelines for determining the profitability of processing logs of different sizes and stages of deterioration for lumber from green and beetle-killed timber.
5. Validation and implementation of stand hazard-rating systems for southern pine beetle, annosus root rot, and littleleaf disease.
6. The development of salvage cutting guidelines for reducing fusiform rust-caused losses in slash and loblolly pine plantations.

7. The development of guidelines for thinning to prevent or reduce pest-caused losses.
8. Use of an attractant to suppress southern pine beetle spot growth in special management situations.
9. Development and use of alternative insecticides for preventive or remedial control of bark beetles in standing or felled trees, respectively.
10. Development of a pest management system for the southern pine beetle.
11. Demonstration and/or incorporation of new methods into management plans and operations.

These achievements and others could not have been accomplished without the cooperative efforts of many people representing various organizations. The acquisition of funding, program development and execution, transfer and utilization of information in management practices resulted because *we worked together*. We put organizational and personal goals and objectives aside to accomplish a difficult and complex task.

But our work is not finished because a significant amount still remains to be accomplished. This includes continuing transfer of information obtained and new research to be conducted on new and old pests that still significantly reduce the growth and/or survival of southern forests.

Have we missed an opportunity to continue high priority parts of this program, to change the emphasis to other priorities, and to cooperate as we have in the past? Each of us and our organizations have to respond to this question.

However, from my limited and biased perspective, reduced budgets at the Federal, State, and industry levels have caused us to look more inwardly and to abandon an extremely valuable model for focusing on complex regional forestry problems. Let's hope we do not regret our decisions of yesterday and today, for pest management is still a significant problem for most forest resource managers in the South.

In concluding, on behalf of the Oversight and Guidance Committee and many others, I wish to extend our appreciation to Bob Thatcher, Garland Mason, and Gerry Hertel and their staff people for a job well done.

Integrated Forest Pest Management in the South

Introductory Comments by Keith R. Shea¹

Historical background—Intensive, cooperative research on the southern pine beetle had its beginning in the fall of 1974 (fiscal year 1975), when the Congress appropriated funds for three major forest insect programs—southern pine beetle, gypsy moth, and Douglas fir tussock moth. I had the honor of leading the early planning effort in the winter of 1973–74, obtaining approval of the U.S. Department of Agriculture (USDA) and the Office of Management and Budget, testifying before the Congress, and ultimately serving as staff officer in the Office of the Secretary, USDA. In addition to the Forest Service (FS), the Cooperative State Research Service (CSRS), the Agriculture Research Service (ARS), and the Animal and Plant Health Inspection Service (APHIS) were heavily involved. Over \$6 million was appropriated for this new and novel effort in addition to funds already available to the agencies. Ultimately, over 30 universities, 9 State organizations, and several industries participated in the programs with a total Federal budget of about \$9.5 million. The Expanded Southern Pine Beetle Research and Application Program (ESPBRAP) received over \$2 million annually which was allocated through the FS and CSRS.

As you all know, Bob Thatcher was selected to be Program Manager for ESPBRAP. Bob assumed this position with essentially no guidelines or direction as to how to organize and manage such an interagency, multidisciplinary effort. It never had been done before. There were many skeptics. Bob, the other two Program Managers, and I spent many long hours agonizing over organization, structures, recruitment of Research and Application Coordinators, planning, budgeting, and processes for funding participants. Each of the three programs evolved along slightly different paths. Each was highly successful in achieving the original objectives. The Gypsy Moth and Douglas Fir Tussock Moth Programs were re-directed into the Canada/United States Spruce

Budworms Program (known as CANUSA) which now is winding down.

ESPBRAP and IPM—Having been involved, either directly or indirectly, in accelerated insect research and development programs for over a decade, I would like to share some thoughts with you with special emphasis on ESPBRAP and its successor IPM Program.

First of all, such interagency, cooperative programs require a tremendous amount of executive energy from all participating organizations. This is not business as usual. Commitment of top level administrators to the program is essential. We were fortunate to have Assistant Secretary Bob Long fully committed to ESPBRAP as were the Administrators of the four Federal agencies. Many of the organizational problems we encountered would have defeated our efforts had it not been for this commitment at high levels.

Our experiences have shown there are many benefits from advanced planning, including definition of targets and outputs as end products within given time frames; involvement of the forestry community in planning and review prior to and during the program; coordination of work within and among disciplines, organizations, and the research and action communities; continuous monitoring and evaluation of ongoing work; and early (even informal) release of results to various audiences.

Having a plan of work, budget, and a Program Manager doesn't assure success. Cooperation and/or support from many organizations are essential to accomplishing meaningful work, gaining early acceptance of results and applying those results to field operation. Such cooperation and support doesn't just happen. It is achieved only by highly personal interactions among all concerned parties. Here in the South, Bob Thatcher exemplifies the kind of leadership essential for success. His leadership is widely acknowledged both here and in the Department of Agriculture which recognized him in 1982 with a Superior Service Award for his work in the ESPBRAP.

Following up on the success of ESPBRAP, the 5-year Integrated Pest Management Program (IPM) for Bark Beetles of Southern Pines was started in 1980. This program will be concluded in September

¹ Associate Deputy Chief for Research, U.S. Department of Agriculture, Forest Service, Washington, DC. Remarks to the Integrated Pest Management Research Symposium, Asheville, NC, April 16, 1985.

1985 having within its allocated time frame achieved its mission of (1) completing and transferring the technology from ESPBRAP, (2) beginning the development of integrated forest pest management systems for the bark beetle and disease complex of southern pines, and (3) promoting the use of pest management as a part of total resource management on all forest lands. As you know, the IPM Program has emphasized the southern pine beetle, as it influences or is influenced by the three southern *Ips* engraver beetles, the black turpentine beetle, and three major diseases of southern pines—fusiform rust, annosus root rot, and littleleaf disease.

Much has been accomplished. There is, however, a continuing need for analyses, reporting, and transfer of technology in order to benefit fully from the information generated from 11 years of research and development and the over \$22 million in expenditures. Research also must continue with emphasis on (1) host dynamics and host/pest interactions, (2) southern pine beetle spot growth and population dynamics models, and (3) diseases of southern pines. Technology transfer must be strengthened and continued.

Achievement of these tasks will require continued, coordinated work by the southern forestry community. The partnership among the Forest Service, universities, State organizations, and forest industries should be maintained to the extent that resources permit. But new and innovative ways must be found to fund some of this work.

Due to the technological advances that have been

made in improved management guidelines, tactics, and strategies, field or pilot tests must be conducted to verify and expand the applicability of the results over a wide range of situations. This will require close collaboration among researchers, pest control specialists, and forest practitioners in the planning and execution phases. It will also require a commitment to technology transfer. The whole process should involve and utilize existing organizations, experienced people, and proven communication methods.

Conclusions—In conclusion, the ESPBRAP and the successor IPM RD&A Program are milestones of great significance. Their accomplishments have surpassed expectations, and the cooperative working relations established during the last decade will, I am sure, continue for many years in the future.

You all should be proud of what you have achieved together. You have combined the best talent of all concerned organizations—Federal, State, universities, and private industry—to address major pest problems limiting productivity of the southern pine resource. You have excelled in technology transfer. Such cooperation will need to continue as you address future needs and incorporate new knowledge into forest management practices. It has been personally rewarding to have been involved in a minor way during the 11 years of concentrated research and development. The southern pine beetle problem is still with us, but this Program has provided many of the tools forest managers need to cope with it. Congratulations and well done!

SESSION I—SAMPLING AND IMPACT ASSESSMENT

Sampling Pest Populations

Procedures for Sampling Six-Spined *Ips* Populations in Slash Pine

John L. Foltz, Jeffrey A. Corneil, and Robin M. Reich¹

Abstract—The precision of gallery length estimates for *Ips calligraphus* (*Ic*), the primary bark beetle infesting Florida slash pine, is markedly affected by both shape and size of bark samples. Because egg galleries extend vertically in the trees, rectangular samples with the long axis oriented horizontally intersect more galleries and are less variable than squares or vertically oriented rectangles of equal area. For estimating adult densities, sample unit size (but not shape) is an important consideration. Regression equations of sample unit variance as a function of population density can be used to calculate the number of sample units needed to estimate gallery length and brood densities at specified error and confidence levels.

Data collected from 10 infested trees showed that the *Ic* population on a tree typically consisted of multiple cohorts rather than a single, even-aged cohort. *Ic* broods frequently emerged from the midbole region before the extremes were colonized. The magnitude and causes of brood mortality often appeared different at different heights and times. Attack density tended to be lowest in the midbole region, increased slightly toward the base, and was greatest in the upper bole up to the height where interspecific competition occurred. Egg density was least in the lower bole and tended to increase with height. Brood emergence was least at 4 m, increased to peaks at 2 and 8 m, then diminished toward the extremes of the *Ic*-infested bole.

Additional keywords: Bark beetle, Scolytidae, *Ips calligraphus*, *Ips avulsus*, *Ips grandicollis*, *Dendroctonus terebrans*, *Pinus elliottii*.

INTRODUCTION

Slash pine, *Pinus elliottii* Englem. var. *elliottii*, is one of the most important pines in the southeastern United States and one of the two southern pines worked for naval stores (Koch 1972). The natural range of slash pine extends from South Carolina to Louisiana, but has been extended into other adjacent States by planting, as in East Texas (Fowells 1965). Nearly 12 million acres are occupied by slash pine east of the Mississippi River, where the slash pine ecosystem is capable of producing an estimated 1 bil-

lion cu. ft. of net annual growth per year if carefully managed in well-stocked natural stands and plantations (Boyce et al. 1975).

In Florida, over 5 million acres have been planted to slash pine since World War II. An equal area of land is occupied by natural pine stands, with slash pine occurring as the predominant species in many of them. Annual aerial surveys indicate that pine mortality increased four- to fivefold between 1959 and 1979, and the monetary value of killed standing timber increased from a total of \$8.7 million during the decade 1959–68 to \$39 million during the decade 1969–79 (Chellman 1980). Three *Ips* species, *I. avulsus* (Eichh.), *I. grandicollis* (Eichh.), and *I. calligraphus* (Germar), and the black turpentine beetle, *Dendroctonus terebrans* (Olivier), have been associated with this increased mortality, but relatively little is known about the population dynamics of these beetles (Wilkinson and Foltz 1980, Foltz et al. 1984). The objectives of the research project initiated in 1981 at the University of Florida were to develop sampling procedures for the primary pests in slash pine plantations and to investigate their population dynamics. The information on sampling procedures is presented in this paper. Information about host tree effects on *Ips calligraphus* reproduction and survivorship is presented separately in Haack et al. (1985).

METHODS AND MATERIALS

The specific study objectives for the first year (1981) were to determine the spatial and temporal patterns of colonization of slash pine by bark beetles and how the size and configuration of bark samples interact to affect the confidence intervals for population estimates. To accomplish these objectives, x-ray maps were made of 60- to 90-cm long sections of infested stems from 15 slash pines, the procedures generally following those described by Stephen and Taha (1976) and Coulson et al. (1975, 1979). For each 2.5-cm square in these maps, data were recorded on nuptial chambers, the amount of egg gallery, and the number of each life stage for each beetle species. Altogether, 99 sections were mapped with surface areas ranging from 300 to 6181 cm². Comparisons of insect age distributions gave us information on where a given tree was first colonized and how rapidly colonization progressed to other portions. Specially written computer programs were then used to sim-

¹ Respectively, Associate Professor, Research Associate, and Research Assistant, Department of Entomology and Nematology, University of Florida, Gainesville, FL, when this paper was prepared.

ulate sampling of 21 selected maps with sample units of various sizes from 6.25 cm² to 200 cm² and shapes from 2.5 to 20 cm in height and/or width.

During 1982, the second summer field season, 10 standing trees were sampled at 1 meter at weekly intervals with the objective of comparing insect density at one time and height with densities at other times and heights. Based on preliminary analyses of the 1981 data, data gathering was limited to that portion of the tree infested by *Ips calligraphus*. The sample unit used was a bark rectangle 5 cm high and 20 cm wide. Emerging brood were collected in 10 x 10 cm emergence traps (McClelland et al. 1978). The bark samples were dissected in the laboratory where gallery length, egg niches, and numbers of each *Ic* life stage were recorded. Densities and total numbers for each 1-meter frustum were calculated from the weighted mean of the top and bottom samples (Pulley et al. 1977). Data management and analyses were accomplished using the Statistical Analysis System (SAS).

RESULTS

Colonization sequence and importance of four bark beetles in slash pine.—Data from 396 30-cm bolts from the main stems and branches of 15 trees in 1981 show that *Ips calligraphus* (*Ic*) is the most abundant of the bark beetles typically infesting slash pine. *Ic* was found in all 15 trees, mostly in the main stem below the crown. *Ips avulsus* (*Ia*) was found in 13 trees, mostly in the main stem above the base of the live crown and in the branches. *Ips grandicollis* (*Ig*) occurred in seven trees, mostly in the lower crown. *Dendroctonus terebrans* (*Dt*) was found near the ground in nine pines.

Comparison of the distributions of the life stages within and among trees indicates that *Ic* was the first species to colonize 14 of the 15 trees, and that initial colonization took place a few meters below the live crown. *Ia* apparently colonized the trees shortly after *Ic* and at a point near the middle of the live crown. *Ig*, when present, was mixed with *Ic* and *Ia* in the lower crown and came in after *Ic*. *Dt* started its colonization of the trees at the ground line and in one instance apparently preceded *Ic*.

Directional preference.—Analysis of data from five trees produced no evidence of any directional preference by *Dendroctonus terebrans* or the three *Ips* species. This is the expected result for standing trees infested during the summer; felled trees and winter-infested trees might be different due to solar radiation making one side more or less hospitable to the beetles. Given the consistency of the results from the five trees, we did not analyze the data from the remaining trees.

Spatial attack patterns.—Analyses using Morisita's I-delta and the Clark and Evans statistics showed that *Ips calligraphus* (*Ic*) attacks on a tree tend to be regularly spaced. For Morisita's index, the I-delta value is zero for a 2-cm quadrat. It is possible that *Ic* males use a sequential combination of pheromones, bark topography, and sonic signals to space themselves regularly on a given host.

Sample unit size, shape, and number.—The felling and dissection of the 15 trees in 1981 yielded 99 maps of the insects infesting stem sections 60- to 96-cm long (areas of 300 to 6181 cm²). The simulated sampling of these maps shows that bark sample size has a marked effect on the variability among sample observations of *Ic* brood density, but that the shape of the sample unit has little effect (fig. 1, table 1). Sample units of 50 cm² have about the same standard deviations whether shaped 10x5 or 5x10 cm (height x width). Increasing the sample unit to 200 cm² reduces the standard deviation to ca. one-half the 50-cm² value.

Sample unit shape, as well as size, is an important factor to consider when sampling *Ic* egg galleries (fig. 2, table 2). The 5 x 20 cm samples have ca. half the standard deviation as 20x5 cm samples while the 10x10 cm samples fall in between. The 2.5x10 cm (25 cm²) sample unit is just as good as the 20x5 cm (100 cm²) sample unit even though the latter has four times the bark area. The orientation of the 2.5x10 cm sample so that it cuts across more of the vertical egg gallery systems reduces the number of zero counts and the standard deviation. Size of the sample unit still has an effect, but only when compared between samples of similar shape.

Regression equations of sample variance versus mean density can be used to calculate the number of samples needed to estimate *Ic* population densities at any desired precision and confidence level. The equation for calculating sample size *n* is:

$$n = \frac{s^2 t^2}{D^2}$$

where *s* is the standard deviation of the sample observations, *t* is Student's *t* for the desired probability level, and *D* is the allowable error expressed as the difference between sample mean and the true mean. (e.g., *D* = ±5.0 brood/dm² for a 20 percent error about a true mean of 25 brood/dm²). Figure 3 illustrates the sample sizes calculated for estimating *Ic* brood and gallery length densities with ± 20 percent at the 90 percent confidence level (*t*_{10, sdr} = 2.015) and using the 5 x 20 cm bark sample.

Our experience has demonstrated that radiography of bark samples is unnecessary for sampling populations of *I. calligraphus* in slash pine unless a perma-

Table 1. — Sample standard deviations for estimates of *Ips calligraphus* brood density (brood/dm²) using bark samples of several sizes and shapes. Regression model is $Y = A + BX$ where Y is the standard deviation and X is the population mean. Data from 21 maps in 15 *Pinus elliottii* (Alachua Co., FL, 1981)

Sample unit dimensions			Standard deviations (brood/dm ²)			Regression equation	R ² (%)
Size cm ²	Height cm	Width cm	Average	Minimum	Maximum		
6.25	2.5	2.5	24.8	6.4	44.8	$Y = 9.52 + 0.83X$	74
25	5	5	14.6	3.5	30.7	$Y = 5.37 + 0.50X$	66
	2.5	10	13.5	3.3	29.5	$Y = 4.65 + 0.48X$	70
50	5	10	10.7	2.5	23.4	$Y = 4.17 + 0.35X$	57
	2.5	20	10.2	2.2	25.2	$Y = 3.09 + 0.39X$	70
100	20	5	8.7	1.8	18.3	$Y = 3.97 + 0.25X$	46
	10	10	8.3	1.8	16.3	$Y = 3.86 + 0.24X$	45
	5	20	8.0	1.6	19.9	$Y = 2.82 + 0.28X$	59
200	10	20	6.1	1.1	12.6	$Y = 2.67 + 0.19X$	48

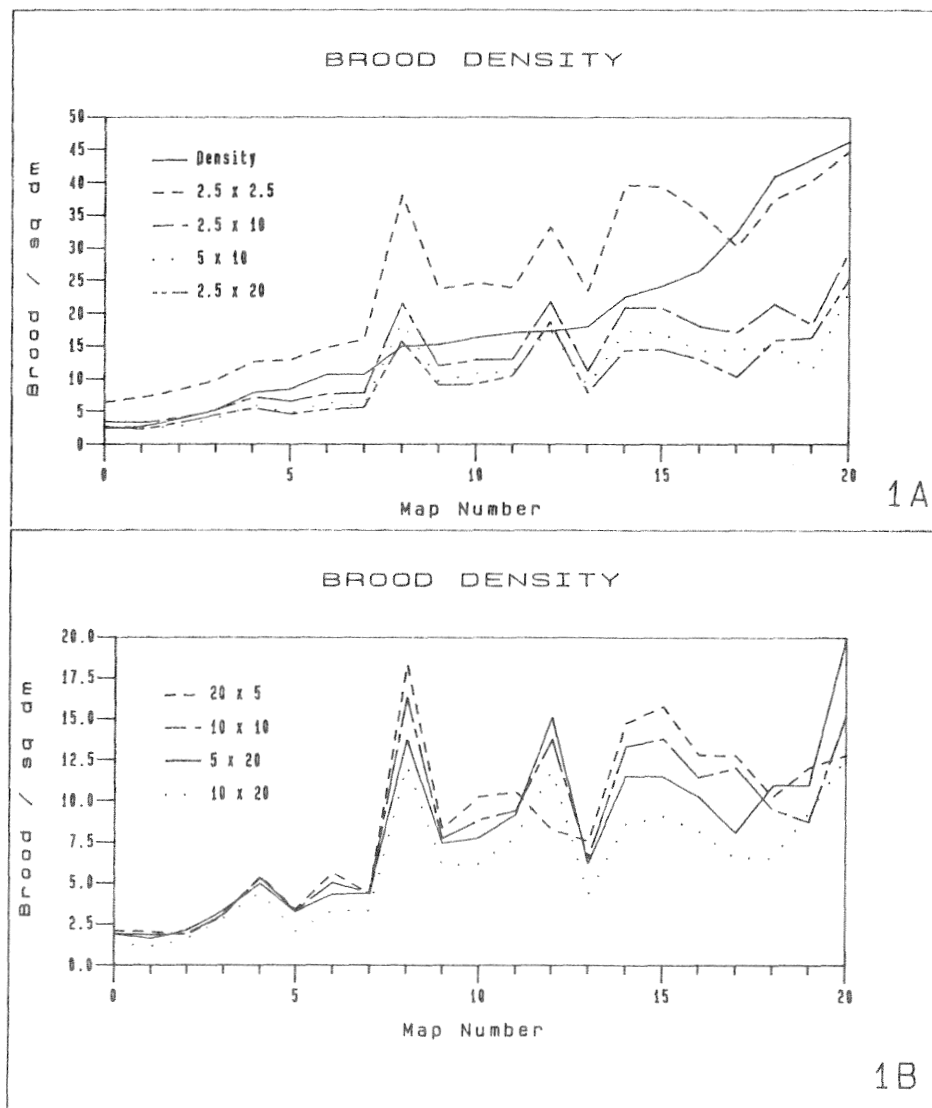

Figure 1.—Standard deviations for observations of *Ips calligraphus* brood density (no./dm²) using bark samples of various heights and widths (cm²). (A) Mean density and variability for sample units of 6.25, 25, and 50 cm². (B) Sample unit variability for samples of 100 and 200 cm².

Table 2. — Variability of *Ips calligraphus* gallery length estimates (cm/dm²) in bark samples of several sizes and shapes. Regression model is $Y = A + BX$ where Y is the standard deviation and X is the population mean. Data from 21 maps in 15 *Pinus elliottii* (Alachua Co., FL, 1981)

Size cm ²	Sample unit dimensions		Standard deviations (cm/dm ²)			Regression equation	R ² (%)
	Height cm	Width cm	Average	Minimum	Maximum		
6.25	2.5	2.5	33.8	24.7	42.9	$Y = 21.68 + 0.40X$	64
25	5	5	21.5	15.3	29.8	$Y = 14.38 + 0.23X$	40
	2.5	10	15.3	11.2	22.2	$Y = 10.06 + 0.17X$	36
50	5	10	13.8	9.7	20.5	$Y = 9.45 + 0.14X$	26
	2.5	20	10.8	6.8	16.2	$Y = 6.45 + 0.14X$	29
100	20	5	15.9	9.6	22.4	$Y = 11.25 + 0.15X$	17
	10	10	12.0	8.4	18.1	$Y = 8.57 + 0.11X$	16
	5	20	9.6	5.8	14.7	$Y = 6.25 + 0.11X$	18
200	10	20	8.2	3.7	13.0	$Y = 5.71 + 0.08X$	11

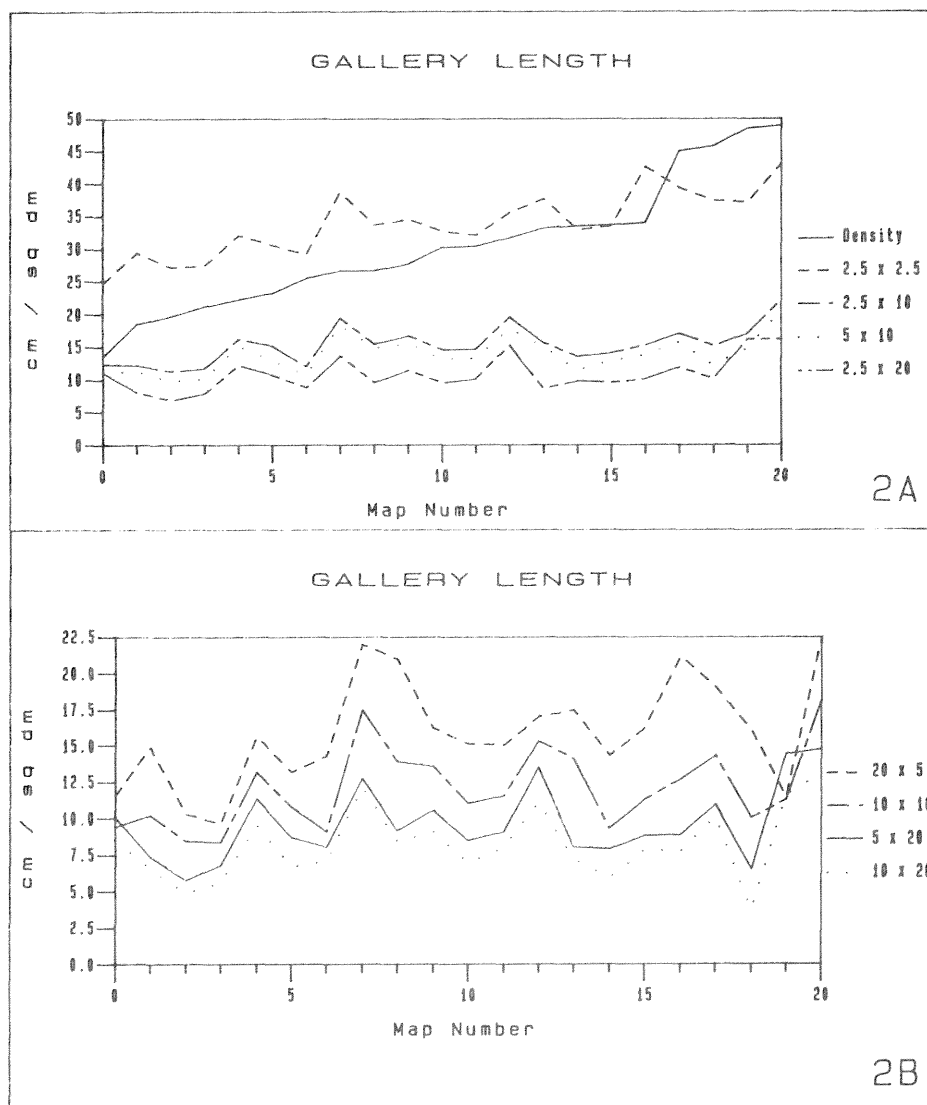

Figure 2.—Standard deviations for observations of *Ips calligraphus* egg gallery density (cm/dm²) using bark samples of various heights and widths (cm). (A) Mean density and variability for sample units of 6.25, 25, and 50 cm². (B) Sample unit variability for samples of 100 and 200 cm².

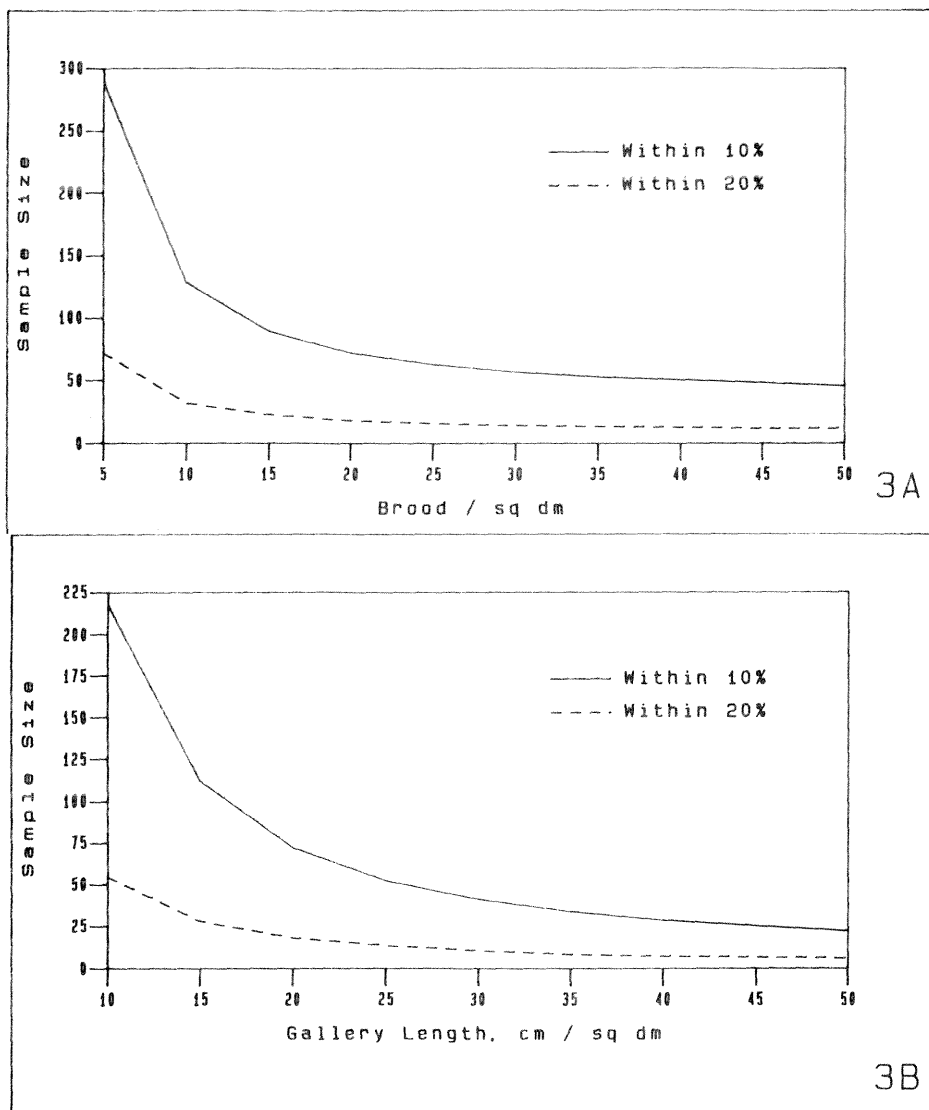

Figure 3.—Sample sizes required for estimating *Ips calligraphus* densities within 10 and 25 percent of true values at 90 percent confidence. Sample unit is 5 cm high and 20 cm wide. (A) Brood density. (B) Gallery length density.

nent record is desired. The destructive examination of samples under a stereo microscope is faster, less expensive in labor and supplies, and provides immediate identification of species and instars. Furthermore, because of the many factors affecting eggs/cm, this quantity should be determined by dissection and direct observation of egg niches whenever initial brood number is a sampling objective.

Populations in trees.—Data collected at 1 meter and 1 week intervals from 10 infested trees demonstrate that the *Ic* population on a tree consists of multiple cohorts rather than a single, even-aged cohort as is assumed for the southern pine beetle (SPB), *Dendroctonus frontalis*, during outbreaks (Coulson et al. 1976). Frequently, *Ic* broods emerge from the midbole before the extremes are colonized.

The magnitude and causes of brood mortality often appear different at different heights and times. Thus, it appears improbable that an SPB-like proportional density function (PDF) would provide reasonable precision as part of a within-tree sampling procedure.

The numbers of *Ic* adults attacking the 10 trees in the study ranged from 372 to 720 ($\bar{x} = 455$). These adults produced from 8,500 to 32,000 eggs/tree ($\bar{x} = 20,000$) and from 780 to 5,600 brood adults ($\bar{x} = 1,860$). On a square decimeter (100 cm²) basis, mean parent adult densities on the trees ranged from 0.26 to 1.24 adults/dm² and averaged 0.78 adults/dm². The maximum observed in a single 5×20 cm bark sample was seven parent adults. The egg density averaged 36.7 eggs/dm² (minimum = 17.2, maximum = 54.6), and the greatest number observed in one

bark sample was 181. The emergence traps captured an average of 3.18 brood adults/dm² (minimum = 0.93 and maximum = 4.33), and the greatest number in one trap was 25.

One objective in collecting these data was to compare the densities at various heights with the average density on the tree. Therefore, relative density (RD) was defined as the density on a 1-m frustum divided by the tree density. Averaging across trees and plotting by sample height (fig. 4) showed that parent adult density tended to be lowest in the midbole region (RD = 0.60 at 6 m), increased slightly toward the base, and was greatest in the upper bole (RD = 1.69 at 10 m). The data were sparse and highly variable above 12 meters; interspecific competition was undoubtedly a factor affecting *Ic* densities at both the upper and lower extremes. *Ic* egg density was least in the lower bole (RD = 0.61 at 3 m) and increased steadily with increasing height (RD = 1.51 at 11 m). Brood emergence, in contrast, was least at 4 m (RD = 0.65), increased to peaks at 2 and 8 m, then diminished toward the extremes of the *Ic*-infested bole.

DISCUSSIONS AND CONCLUSIONS

The data collected during this investigation are in agreement with published and unpublished reports regarding the relative importance of the various bark beetles that infest slash pines in Florida. The two "primary" species are *Dendroctonus terebrans* and *Ips calligraphus*. *Ips avulsus* and *Ips grandicollis* are "secondary" pests, generally infesting only logging

residues and severely weakened trees. *Dendroctonus frontalis* is not a problem in slash pine plantations established on good sites within the tree's natural range.

The procedures developed and used during 1982 were generally satisfactory for estimating *Ic* population density in trees. The two 5 × 20 cm bark samples collected at 1 meter and 1 week intervals were a reasonable compromise between a number of physical and statistical constraints. It takes approximately 15 minutes to extract the two samples at one sample height, and there is enough bark area to permit the collection of three pairs of samples. Samples collected when the broods are just beginning to pupate are satisfactory for measuring egg gallery length and egg niches provided sawyer larvae have not foraged the area; samples collected after the callow adults have started their maturation feeding are no longer suitable for determining initial populations. Thus, collecting samples at the beginning of the pupal stage and then attaching emergence traps is the minimum sampling required to estimate initial egg density and final brood emergence for life tables and other population studies. Sampling at weekly intervals is not frequent enough for identifying and quantifying all the mortality agents affecting a rapidly developing cohort.

LITERATURE CITED

Boyce, S. G.; McClure, J. P.; Sternitze, H. S. Biological potential for the slash pine ecosystem. Res.

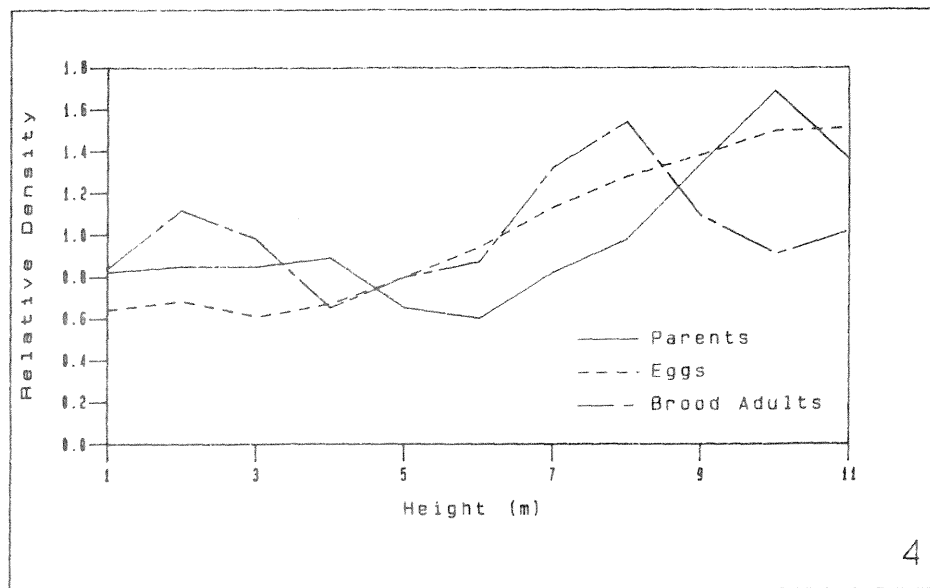

Figure 4.—Densities of *Ips calligraphus* at the sample heights relative to whole-tree densities. Data for 10 slash pines (Alachua Co., FL, 1982).

- Pap. SE-141. Asheville, NC; U. S. Department of Agriculture, Forest Service, Southeastern Forest Experiment Station; 1975. 29 p.
- Chellman, C. W. Tree mortality (pest) surveys in Florida from 1959 thru 1979. In: Forest pest management symposium: proceedings of the Florida section of SAF; 1980 June 3-4; Gainesville, FL. Gainesville: School of Forest Resources and Conservation, University of Florida; 1980: 8-12.
- Coulson, R. N.; Hain, F. P.; Foltz, J. L. [and others]. Techniques for sampling the dynamics of southern pine beetle populations. Texas Agric. Exp. Sta. Misc. Pub. 1185. College Station, TX: Texas A&M University; 1975. 18 p.
- Coulson, R. N.; Pulley, P. E.; Foltz, J. L. [and others]. Procedural guide for quantitatively sampling within-tree populations of *Dendroctonus frontalis*. Texas Agric. Exp. Sta. Misc. Pub. 1267. College Station, TX: Texas A&M University; 1976. 26 p.
- Coulson, R. N.; Fargo, W. S.; Edson, L. J. [and others]. Procedural guide for conducting field investigations on the population dynamics of the southern pine beetle. Texas Agric. Exp. Sta. Misc. Pub. 1427. College Station, TX: Texas A&M University; 1979. 19 p.
- Foltz, J. L.; Merkel, E. P.; Wilkinson, R. C. Annotated bibliography of *Dendroctonus terebrans* (Olivier), *Ips avulsus* (Eichhoff), *Ips grandicollis* (Eichhoff), and *Ips calligraphus* (Germar) in the Southeastern U.S.A. Monograph No. 12. Gainesville, FL: University of Florida, Institute of Food and Agricultural Sciences, Agricultural Experiment Station; 1984. 47 p.
- Fowells, H. A. Silvics of forest trees of the United States. Agric. Handb. 271. Washington, DC: U.S. Department of Agriculture; 1965. 762 p.
- Haack, R. H.; Foltz, J. L.; Wilkinson, R. C. Effects of temperature and slash pine phloem thickness on *Ips calligraphus* life processes. In: Proceedings, integrated pest management research symposium; 1985 April 15-18; Asheville, NC. Gen Tech. Rep. SO-56. New Orleans, LA: U.S. Department of Agriculture, Forest Service, Southern Forest Experiment Station; 1985: 102-113.
- Koch, P. Utilization of the southern pines. Vol. 1. The raw material. Agric. Handb. 420. Washington, DC: U.S. Department of Agriculture; 1972. 734 p.
- McClelland, W. T.; Hain, F. P.; DeMars, C. J. [and others]. Sampling bark beetle emergence: a review of methodologies, a proposal for standardization, and a new trap design. Bull. Entomol. Soc. America 24(2): 137-140; 1978.
- Pulley, P. E.; Foltz, J. L.; Mayyasi, A. M. [and others]. Sampling procedures for within-tree attacking adult populations of the southern pine beetle, *Dendroctonus frontalis* (Coleoptera: Scolytidae). Can. Entomol. 109: 39-48; 1977.

Line Intersect Sampling Technique for Estimating *Ips* Populations in Logging Residue

C. Wayne Berisford, Russell F. Mizell, III, Louis H. Kudon, and Kenneth D. Ware¹

Abstract.—A multistage line intersect sampling (LIS) technique was developed and tested for estimating population of *Ips* spp. bark beetles in logging slash. The technique utilized a series of grid points through which randomly directed sample lines 50 m long were established. Slash exceeding 2 cm in diameter that was intersected by the line was measured and samples of every sixth infested piece were taken for dissection and beetle rearing. Estimates were calculated for slash volumes, bark surface areas, and numbers of beetles produced on 30 different sites.

Estimates of beetle populations were highly variable among sites, ranging from zero to 880,000 beetles per hectare, with an average density of ca. 180,000 beetles/ha. Production of beetles relative to bark surface area was low, averaging only ca. 210 beetles/m² of bark surface.

This technique may be used to evaluate the potential threat of beetle populations in logging residue to residual or nearby stands. This information might also be incorporated into existing stand hazard-rating systems or bark beetle infestation dynamics models. **Additional keywords:** *Dendroctonus frontalis* Zimmermann, *Ips grandicollis* (Eichhoff), insect associates, population dynamics, prediction.

INTRODUCTION

During the last decade, intensive research on bark beetles attacking southern pines has led to a better understanding of these pests and provided a foundation for developing more effective management practices. Most research has concentrated on the southern pine beetle, *Dendroctonus frontalis* Zimmermann (SPB). However, research sponsored by the Integrated Pest Management R, D & A Program for Bark Beetles of Southern Pines was broadened to include other important bark beetle species. This effort recognized the biological reality that these insects, which include five major pest species and two genera, must be studied as a complex rather than independently.

The population dynamics of bark beetle species that coinhabit the same trees is closely linked. For instance, trees attacked by the SPB are also usually invaded by one to three species of *Ips* and/or the black turpentine beetle, *Dendroctonus terebrans* Olivier (BTB). In some cases, the population of *Ips* spp. forms a significant portion of the total bark beetle population within a spot (Hain and McClelland 1979). *Ips* spp. and SPB may attack standing trees simultaneously, and they effectively partition the resource until all habitable portions of the bole and limbs are occupied (Birch et al. 1980). As SPB populations decline, *Ips* spp. occupy a higher percentage of infested tree boles. *Ips* spp. beetles are probably a significant factor in the maintenance of endemic SPB populations by initiating attacks and helping to overcome the resistance to attack (Hain and McClelland 1979). Since *Ips* spp. may augment SPB attacks, help maintain endemic SPB populations, and/or initiate infestations on their own, it is important to identify and quantify sources of large *Ips* spp. populations. While both the SPB and *Ips* spp. attack standing trees, *Ips* also attack fallen trees, limbs, and logging slash. *Ips* spp. are quickly attracted to logging slash or felled trees (Mason 1969, 1970; Berisford and Franklin 1971) or other damaged material (Hodges and Pickard 1971). *Ips* spp. populations may increase dramatically following severe weather such as hurricanes, tornadoes or ice storms (Speers 1971). In Australia, high populations of *Ips grandicollis* (Eichhoff) from high volumes of logging slash often cause substantial mortality in nearby stands, including saplings only 2-3 years old (Morgan 1967, and others²).

Logging slash generates the highest volumes of host material and the most consistent production of *Ips* spp. High beetle populations resulting from various types of logging operations may be an important factor in the occurrence and/or severity of bark beetle attacks in nearby stands. Large beetle populations produced in logging slash could increase the risk of initial infestation and also the potential for spot expansion once infestations occur by augmenting attacking SPB and *Ips* populations. Nebeker and Hodges (1983) and Nebeker (1985) showed that residual tree mortality following thinning operations was correlated with the volume and distribution of the slash.

¹ Respectively, Professor, Department of Entomology, University of Georgia, Athens, GA; Assistant Professor, University of Florida, Agricultural Research Center, Monticello, FL; Research Associate, Department of Entomology, University of Georgia, Athens, GA; and Mensurationist, U.S. Forest Service, Southeastern Forest Experiment Station, Athens, GA. (The authors are grateful to William Harris, Pritch Morgan, and Robert Watson for technical assistance and to Ray Souter for assistance with statistical analyses.)

² Berisford, unpublished data.

The potential hazard imposed by sporadic and often large *Ips* populations generated in logging slash should perhaps be integrated into hazard-rating systems for bark beetles (Belanger et al. 1981, Hicks et al. 1980, Ku et al. 1980, Lorio and Sommers 1981) and SPB spot growth models (Hines et al. 1980; Feldman et al. 1981a, 1981b). With the exception of data acknowledging already established infestations or stand disturbances as factors in high-hazard stands, no data on the presence of *Ips* spp. in logging slash are included in current bark beetle risk-rating systems. There are several reasons for this, but it is primarily because beetle populations in slash are transitory, as slash is habitable for only a short time. No data are available on beetle numbers that might constitute a significant threat to stands in specific hazard categories, and until now, there were no techniques for estimating populations of *Ips* produced in logging slash. A reliable method based on line intersect sampling is presented here for making estimates of *Ips* spp. populations in logging slash. The method is easy to use by field personnel; i.e., the procedure is simple and requires no highly specialized equipment, and it yields population estimates with a reasonable investment of time.

MATERIALS AND METHODS

Selection of Sites

The minimum criteria in this study for a site to be selected were that logging operations had been recently completed or were in progress and that at least 10 acres of logged area was available for sampling. Sampling was initiated if preliminary checks showed that the slash contained late instar larvae and/or pupae of one or more *Ips* spp. Sites with different types of logging operations were selected, including thinnings, clearcuts (with or without tree-length skidding and limbing gates) and clearcut areas with log skidding only. Sites in both the Coastal Plain and Piedmont were sampled.

Sampling Procedures

Once a site was deemed suitable for sampling, a baseline was set up that was roughly parallel to one side of the area to be sampled. A field map of each site was constructed that included the location of the baseline and its compass orientation, logging decks, limbing gates, bark beetle infestations in residual trees, hardwood inclusions, etc. Figure 1 shows how a typical site was gridded and how sample lines were established. With the baseline as a reference, the site was marked off in 50 m grids. The intersections of grid lines were designated as "grid points" from which sample 50 m lines were drawn. Each

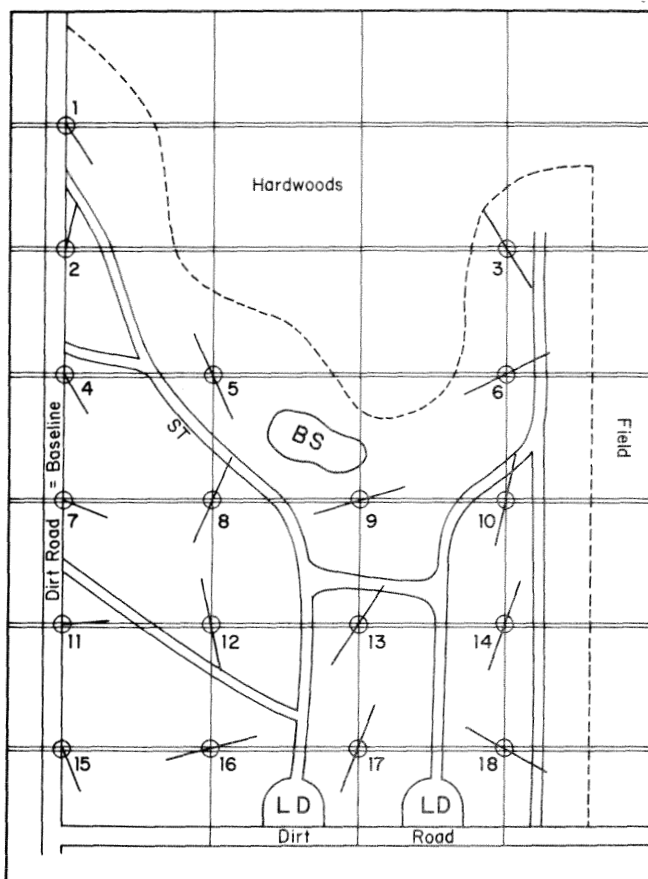

Figure 1.—Site map showing layout of baseline, 50 m grids and sampling lines. BS = beetle spot, LD = log deck, ST = skid trail.

sample line extended in a randomly selected direction bisected by the grid point unless site boundaries or other constraints prevented sampling the full 50 m. A 50 m line marked off in 1 m intervals was laid out across the gridpoint and tied in place for sampling the slash. Each piece of slash exceeding 2 cm that intersected the line was measured. Diameter at the intersect was measured with calipers and the total length of that part of each piece exceeding 2 cm in diameter was recorded. Every piece of slash measured was recorded as infested or uninfested by *Ips* spp. beetles. The percentage of bark remaining on the piece at the intersect point was visually estimated.

Samples were cut from each sixth piece. If infested, they were taken to the lab for dissection and rearing. The length of each sample taken was based on the diameter at the intersect point so that each sample had 800 cm² (or 20 percent) of the total bark surface area of the piece, whichever was larger. Samples brought into the laboratory were identified by site, grid point, and point on line. Each sample was cut in half and, in 1983 only, half was placed in ventilated rearing containers similar to those described by Berisford et al. (1971). Emergent *Ips* spp. beetles were

counted and identified by species on alternate days for 3 weeks. The remaining half of each sample was dissected and numbers of *Ips* spp. nuptial chambers, length of egg galleries, and numbers of different *Ips* life stages (larvae, pupae, parent and/or callow adults) were recorded (1982 and 1983).

Estimation Procedures

The basic sampling procedures and appropriate theory are all based on extensions of multistage line intersect sampling. Line intersect sampling (LIS) has been studied by DeVries (1973, 1974), Van Wagner (1968), and others (Warren and Olsen, 1964, Hazard and Pickford 1983), and there is substantial literature about the use of it for estimating forest residues.

The sample selection procedures previously described are a three-stage line intersect sample with stratification and with multiple lines. The first stage selects primary units, which are pieces of slash (above 2 cm diameter) with probability proportional to length of the piece. On these selected pieces, the diameters at the point of intersection, d , and the length, l , are observed and recorded. The pieces are stratified into small and large diameter classes. From each stratum, a second-stage subsample of bolts is drawn with equal probability for dissection and rearing as described previously. Each second-stage subsample is further subsampled with equal probability, yielding third-stage elements that are bark surface areas on which the dissection counts and rearing counts are made in the laboratory.

The sample selection and observation procedures are relatively easy to describe. The estimation procedures are, however, necessarily complex and involve relatively complicated formulae. In future applications, these algebraic formulae will be written into a standard computer language and automated software so that users of the technique can have the estimates easily and directly produced. It is necessary, however, to document the estimators in standard statistical sampling terminology and symbology.

For this purpose, we designate the observed sample quantities as follows:

L_h = length of sample line for line h ; $h = 1, 2, \dots, k$

d_{ihs} = observed diameter of i -th piece of slash on h -th line belonging to the "small" (s) diameter class

d_{ihL} = as above, for "large" diameter class

n_{hs} = number of pieces of "small" slash measured for diameter and length on line h

n_{hL} = number of pieces of "large" slash measured for diameter and length on line h

l_{ihs} = length as above for d_{ihs}

l_{ihL} = length as above for d_{ihL}

f_s = sampling fraction for selecting pieces of slash to be measured in the "small" class (usually 1/3)

f_L = analogous sampling fraction for "large" class (usually 1 of each 1; all)

D_B = diameter of slash at stratum boundary between "small" and "large" (usually 5 cm)

D_m = minimum diameter of slash in small stratum (for small plots $D_m = 1$ cm, for others, $D_m = 2$ cm)

n'_{hs} = number of "small" pieces of slash selected for dissection on the h -th line from the n_{hs} measured for diameter and length

n'_{hL} = number of pieces of "large" slash selected for dissection from the n_{hL} measured on line h

M_{ihs} = number of sub-elements (bark samples for dissection) in the i -th piece of slash on h -th line in the "small" diameter class

M_{ihL} = analogous to M_{ihs} but for "large" slash (numbered $j = 1, 2, \dots, M_i$)

m_{ihs} = number of sub-elements selected for dissection from i -th piece, h -th line and small diameter class (numbered $j = 1, 2, \dots, m_i$)

m_{ihL} = analogous number, large class

B_{ihs} = bark surface area of i -th piece of slash, h -th line, small diameter class

$B_{ihL} = (\pi) (d_{ihs}) (l_{ihs})$

b_{ijjs} = bark area of j -th subsample dissected from "small" class i -th piece of slash, h -th line

b_{ihjL} = analogous area, large class

$M_{ihs} = B_{ihs}/b_{ihs}$

Now, if there is one line of length L and no subsampling and we observe a characteristic of interest, X_i , and length, l_i , of each element selected by LIS, the mean quantity of X per unit area is estimated by:

$$\hat{X} = \frac{\pi}{2L} \sum_{i=1}^n X_i/l_i \quad (1)$$

Consequently, for all characteristics of the slash we have for line h :

$$\hat{X}_h = \frac{\pi}{2L} \sum_{i=1}^{n_h} X_{ih}/l_{ih} \quad (2)$$

Since for volume:

$$V = \pi \left(\frac{d}{2} \right)^2 l \quad (3)$$

we have for line h the estimate of volume in m^3/m^2 :

$$\hat{V}_h = \frac{\pi^2}{8 L_h} \sum_{i=1}^{n_h} d_{ih} \quad (4)$$

For k lines, the overall estimate is:

For two size classes (strata) by diameter, designated by subscript s for small and L for large:

$$\hat{V} = \frac{\pi^2}{8} \frac{\sum_{h=1}^k \sum_{i=1}^{n_h} d_{ih}^2}{\sum_{h=1}^k L_h} \quad (5)$$

For two size classes (strata) by diameter:

$$\hat{V} = \frac{\pi^2}{8} \sum_{h=1}^k L_h \left\{ \frac{1}{f_s} \sum_{h=1}^k \sum_{i=1}^{n_s} d_{ihs} + \frac{1}{f_L} \sum_{h=1}^k \sum_{i=1}^{n_L} d_{ihL} \right\} \quad (6)$$

For total bark surface area/ m^2 (in m^2/m^2), analogously:

$$\hat{X}_A = \frac{\pi^2}{2} \sum_{h=1}^k L_h \left\{ \frac{1}{f_s} \sum_{h=1}^k \sum_{i=1}^{n_s} d_{ihs} + \frac{1}{f_L} \sum_{h=1}^k \sum_{i=1}^{n_L} d_{ihL} \right\} \quad (7)$$

For total of mid-diameters of slash / m^2 (in m/m^2), analogously:

$$\hat{X}_D = \frac{\pi}{2} \sum_{h=1}^k L_h \left\{ \frac{1}{f_s} \sum_{h=1}^k \sum_{i=1}^{n_s} \frac{d_{ihs}}{l_{ihs}} + \frac{1}{f_L} \sum_{h=1}^k \sum_{i=1}^{n_L} \frac{d_{ihL}}{l_{ihL}} \right\} \quad (8)$$

For number of pieces of slash / m^2 (using as counter $X = 1$ when slash is intersected):

$$\hat{X}_C = \frac{\pi}{2} \sum_{h=1}^k L_h \left\{ \frac{1}{f_s} \sum_{h=1}^k \sum_{i=1}^{n_s} \frac{1}{l_{ihs}} + \frac{1}{f_L} \sum_{h=1}^k \sum_{i=1}^{n_L} \frac{1}{l_{ihL}} \right\} \quad (9)$$

Hence, for the average (over the whole plot) per piece of any characteristic of individual pieces of slash, we use the ratio of the amount of the characteristic per m^2 to the number of pieces per m^2 . For example, for diameter:

$$\text{average per piece} = \frac{\hat{X}_D}{\hat{X}_C} \quad (10)$$

the total over the whole plot is estimated from the average per m^2 and the plot area via:

$$\hat{X}_{-T} = (\text{plot area in } m^2) (\hat{X}_{-}) \quad (11)$$

where the $(-)$ in the subscript denotes "blank" for any characteristic of interest.

For estimating numbers of beetles per unit area; i.e., count/ m^2 , denote by x_{ihjs} the number of beetles counted (or other variable observed) in the j-th subsample dissected from the i-th piece of slash, h-th line and the "small" class of slash:

x_{ihjL} = analogous for large slash

Similarly, denote by:

z_{ihjs} = the number of beetles counted in j-th bark subsample reared from i-th piece of slash,

h-th line and small class of slash

z_{ijL} = analogous, for large slash

For 1 sample (one line of length L_h):

$$\hat{X}_h = \frac{\pi (n_h)}{2 L_h (n^1)} \sum_{i=1}^{n'} M_i \bar{x}_{ih} \quad (12)$$

$$\text{in which } \bar{x}_i = \sum_{j=1}^{m_i} x_{ij}/m_i$$

so that for one stratum, say "large":

$$\hat{X}_{hL} = \frac{\pi (n_h)}{2 L_h (n^1)} \sum_{i=1}^{n'} \frac{M_{ih}}{l_{ih}} \sum_{j=1}^{m_i} x_{ijh}/m_i \quad (13)$$

For two strata (small slash and large slash), we have for the h-th line then.

$$\hat{X}_h = \frac{\pi}{2 L_h} \left\{ \frac{1}{f_s} \left(\frac{n_{hs}}{n'^{hs}} \right) \sum_{i=1}^{n'_{hs}} \frac{M_{ijhs}}{l_{ihs}} \sum_{j=1}^{m_i} \frac{m_i}{x_{ijh}} \right. \\ \left. + \frac{1}{f_L} \sum_{i=1}^{n'_{hL}} \frac{M_{ijhL}}{l_{ihL}} \sum_{j=1}^{m_i} \frac{x_{ijh}}{m_i} \right\} \quad (14)$$

For 1981 data (plots 1 to 12), $m_i = 1$ bark sample for dissection per piece of slash. However, the size of bark sample was calculated to yield 10 percent of the bark of the piece of slash or 400 cm², whichever is larger. Hence:

$$M_{ijhs} = B_{ihs}/b_{ihs} = \pi d_{ihs} l_{ihs}/(\text{"Sample Size"}) \quad (15)$$

For 1982 data (plots 15 to 30), two bark samples of this size were taken from each piece.

The estimator for the variance of any estimate \hat{X}_h for the h-th line is the sum of the variances for the "small" and the "large" strata. Taking the large stratum as the example:

$$\text{var}(\hat{X}_{hL}) = \left(\frac{\pi}{2 L_h} \right)^2 \left(\frac{n_{hL}}{n'^{hL}} \right) \left\{ (n_{hL} - n'^{hL}) s^2_h \right. \\ \left. + \sum_{i=1}^{n'_{hL}} \left[\frac{M_{ihL}}{l_{ihL}} \sum_{j=1}^m \frac{x_{ijh}}{m_i} \right]^2 \right\} \quad (16)$$

in which

$$s^2_h = \frac{1}{(n'^{hL}-1)} \left\{ \sum \left[\frac{M_{ihL}}{l_{ihL}} \sum_{j=1}^{m_i} \frac{m_i}{x_{ijh}} \right]^2 \right. \\ \left. - \left[\sum_{i=1}^{n'_{hL}} \frac{M_{ihL}}{l_{ihL}} \sum_{j=1}^{m_i} \frac{x_{ijh}}{m_i} \right]^2 / n'^{hL} \right\} \quad (17)$$

Now for the two strata:

$$\text{var}(\hat{X}_h) = \text{var}(\hat{X}_{hL}) + \text{var}(\hat{X}_{hs}) \quad (18)$$

Consequently, using inverse variance weights, $w_h = 1/\text{var}(\hat{X}_h)$, we have for k independent lines ($h = 1, 2, \dots, k$) the estimator for number of beetles (or other characteristic observed on the bark subsample) per unit area (m^2):

$$\hat{X}_w = \frac{\sum_{h=1}^k w_h \hat{X}_h}{\sum_{h=1}^k w_h} \quad (19)$$

$$= \frac{\sum_{h=1}^k \frac{\hat{X}_h}{\text{var}(\hat{X}_h)}}{\sum_{h=1}^k \frac{1}{\text{var}(\hat{X}_h)}} \quad (20)$$

This has the estimated variance:

$$\text{var}(\hat{X}_w) = \left\{ \frac{1}{\sum_{h=1}^k w_h} \right\} \sum_{h=1}^k w_h (\hat{X}_h - \hat{X}_w)^2 / (k-1) \quad (21)$$

Where there are no samples selected on a line (no slash intersected) or where there are zero beetle counts, no variance can be calculated for the estimate for the line. The literature does not mention this difficulty and, therefore, no solution is recommended for it. However, it seems intuitively best to form two strata of lines (those with zero observations, designated by subscript h.0 and those with variance estimates, subscripted by h.v) and combine these, using the line lengths within each stratum as weights.

This intuitive estimator (call it "combined" and designate subscript c):

$$\hat{X}_c = \frac{\left(\sum L_{h.0} \right) \hat{X}_{w.0} + \left(\sum L_{h.v} \right) \hat{X}_{w.v}}{\sum_{h=1}^k L_h} \quad (22)$$

where $\Sigma L_{n,o}$ = sum of line lengths of all lines containing zero observations for which no variance can be calculated, etc.,

so:

$$\Sigma L_n = \Sigma L_{n,o} + \Sigma L_{n,v} \quad (23)$$

= sum of lengths of all lines over both strata.

We have made estimates based on two approaches: the one described, and another that is analogous in all respects except that we aggregated the observations (lines) where possible until the counts were 2 or larger. Where this was not possible, the observations still went into the "zero" stratum.

This summarizes the procedure for direct estimation; that is, estimation for characteristics directly observed in the sampling. Direct estimation would always be done for attributes of the slash itself, such as volume and surface area, which are based on observed dimensions. Analogously, for the subsample units, any characteristic actually observed can be directly estimated, including the counts of nuptial chambers, beetles by life stages from dissection or from rearing, gallery length, etc.

However, because the laboratory phase of counting beetles from the dissection subsamples or of actually rearing from the samples is extremely costly, approaches must be considered that are based on estimating indirectly by regression from observations of the easier-to-observe characteristics such as count of nuptial chambers and measure of piece size such as surface area. For this purpose, appropriate regressions have been investigated from our extensive data and reported for possible use by others in the indirect approach.

For each of these plots, we have also estimated beetle count (dissection) by approaches involving three estimators each applied to unaggregated lines (hence six estimates):

For unaggregated, then repeat for aggregated:

- 1) Use our standard LIS estimator for the directly observed dissection count from subsampling (i.e., equation carrying through and combining the estimates from "zero" lines and "non-zero" lines):

$$\hat{X}_c = \left(\frac{1}{\Sigma L_n} \right) \left(\Sigma L_{n,o} \left[\hat{X}_{w,o} \right] + \Sigma L_{n,v} \hat{X}_{w,v} \right)$$

- 2) Use observed nuptial count, X_2 , and surface area of the slash, X_1 , in the regression relating dissection count to these variables, i.e., in:

$$\hat{Y}_{bolt} = B_0 + B_1 X_1 + B_2 X_2 + B_3 X_1 X_2$$

to estimate the dissection count for each bolt. Now use this estimate rather than the observed dissection count in the same estimators as used in approach 1, above.

- 3) Estimate the average for the plot of total surface area of slash /m² and, similarly, of nuptial count/m². Then estimate these quantities on a "per piece of slash" basis, yielding average values of the X_1 and X_2 defined in 2) above. Now, use the same regression used in 2) to estimate average dissection count on a "per piece of slash" basis. On the basis of that, estimate the dissection count/m². The steps are:

- a) Estimate bark surface area/m² for plot
- b) Estimate number of pieces of slash per m² using equation with count variable of $X_{1,1h} = 1$ for each piece of slash intersected, no subsampling
- c) Divide a) by b) to estimate bark surface area per piece of slash; convert to per bolt basis to get x_1 for the regression
- d) Estimate nuptial count/m² for plot
- e) Divide d) by b) to estimate nuptial count per piece of slash; convert to bolt basis to get \bar{X}_2 for the regression

- f) Use regression from 2) above, with $X_1 = \bar{X}_2$, $\bar{X}_2 = \bar{X}_2$ from (c) and (e) as independent variables to estimate dissection count on per bolt basis, Y_b

- g) Estimate dissection count/m² for plot from:
 Y_b (number pieces per unit area)
 (average number bolts per piece)

where Y_b is from (f), number of pieces is from (b), and average number of bolts per piece is from $\Sigma B_{1hs} / \Sigma b_{1hs}$, for small, for example.

RESULTS AND DISCUSSION

Estimates Produced

Measures of habitable residue.—The amount of residue habitable by beetles may be measured in several ways, each possibly useful for different purposes. The most obvious measure of forestry interest is the volume of slash left on the site, and much has been written about this. From the viewpoint of

habitat for bark beetles, however, the most relevant measure is surface area of the bark of the slash. Other indices that may be useful, especially as "rule of thumb" indicators, are the average size (diameter, length) of the pieces and the number of pieces of slash on the site.

When diameter and length of intersected pieces are observed, the LIS procedure readily provides estimates of all these measures, on a per unit area basis. We have (via equations 9, 8, 10, 7 and 6) estimated, respectively, the number of pieces, the total of midsection diameters, the average diameter of pieces of slash, the surface area of bark, and the volume of the slash (refer to table 7).

Perhaps most remarkable is how little slash was actually present on any of the sites and how relatively small were the differences between averages for tracts harvested in different ways.

Relationships among measures of beetle presence.—Recall that data are available for reared beetle counts only for plots 15–30. (For plots 1–12, all other data are available.) It is informative to consider the average relationships among the measures of beetle presence (beetle counts from dissection, beetle counts from rearing, counts of nuptial chambers from dissection, and measurements of length of galleries) based on all the observations (plots 15–30).

We began with the assumption that there should be a relatively stable ratio of reared count to dissected count. However, zero counts were so often found either for dissection or reared that ratios were undefined or otherwise ill-behaved. To overcome this problem, 1 was added to all counts, both dissected and reared, and then the ratio of these adjusted counts was calculated for each sample bolt. These proved to be extremely variable. Counts were then plotted over diameter by size stratum and plot in an attempt to find a basis that would yield ratios stable enough for use in indirect estimation or in some way indicative of underlying relationships. None of these attempts were successful; hence, it was necessary to determine whether more complex relationships involving univariate—or, ultimately, multivariate—regressions might be informative and useful for estimation.

We fitted ordinary univariate linear regressions of the form:

$$Y = B_0 + B_1X.$$

Two dependent variables were considered: Y, which were reared counts ("reared") or dissection counts ("dissected") and the independent variables either nuptial chamber count ("nuptials") or galleries length ("galleries"). The relationship of "galleries" (Y) to "nuptials" (X) and "reared" (Y) to "dissected" (X) were also examined.

The measure of linear association for which most have an intuitive appreciation is the coefficient of determination, R^2 , which is the proportion of the total variation of Y that is accounted for by the linear relationship with the independent variable, X. Although all the relationships are statistically significant, there is no case where more than half of the variation in either reared count or dissected count is accounted for by the regression (table 1). The relationships to dissected counts are always substantially stronger (two to three times as measured by R^2) than for reared counts. There is a strong association ($R^2 = .96$, table 1) between gallery length, and nuptials.

From the viewpoint of estimation, which is our ultimate objective here, the more relevant statistics are those that may be used to measure precision of estimates from the relationship. Hence, several relevant summary statistics are presented in table 1):

\bar{Y} = arithmetic mean of the dependent variable

MSE = $s_{y,x}$ = square root of the mean square error from error row of ANOVA of linear regression

\hat{B}_0, \hat{B}_1 = estimates of regression coefficients

std. error of B_0, B_1 = square root of the estimated variance of each regression coefficient

These results make it evident that for estimation purposes the relationship of dissection to nuptials is most promising. The nuptial chamber count is much less time-consuming and can be more objectively observed than can gallery length.

Relationships of measure of beetle presence to size of slash.—We hypothesized *a priori* that the size of the slash would be related to the level of beetle populations. However, it was not known just what measures of size of slash would be most useful or how strong this relationship might be in the presence of other influencing factors.

In the explorations of relationships to size of slash, linear regressions were fitted of each of the four measures of beetle presence (nuptials, galleries, dissected, and reared) upon both diameter and surface area of the slash samples. The regressions were all statistically significant. However, their predictive power was disappointing (table 1); in no case was more than 40 percent of the variation in measures of beetle presence accounted for by the relationship to slash diameter or surface area.

Nuptial chamber counts and length of galleries are highly correlated ($R^2 = .96$, table 1), and the relationships of both these measures to surface area are almost equivalent (table 1). The relationship of dissected counts to surface area is best in terms of relative mean square error (table 1), and (recall the previous discussion) the relationship of dissected to

Table 1. — Summary statistics for univariate regressions of measures of beetle presence and size of slash, plots 15-30

Dep. var., Y	Indep. var., X	R ²	√MSE	Ȳ	∧ B ₀	Std. error of B ₀	∧ B ₁	Std. error of B ₁
nuptial	diameter	.21	12.68	5.06	-10.45	1.93	.244	.0279
galleries	diameter	.21	29.13	10.29	-24.72	4.44	.551	.0642
dissected	diameter	.18	10.30	6.11	-5.07	1.57	.176	.0227
reared	diameter	.22	58.91	20.67	-50.83	8.97	1.13	.130
nuptial	surf. area	.39	11.17	5.06	-1.23	.821	.0137	.00103
galleries	surf. area	.39	25.55	10.29	-4.12	1.88	.0314	.00236
dissected	surf. area	.28	9.67	6.11	1.91	.711	.00916	.00089
reared	surf. area	.19	59.69	20.67	.136	4.39	.0448	.00551
dissected	galleries	.43	8.62	6.11	3.78	.544	.226	.0159
reared	galleries	.12	62.29	20.67	13.36	3.93	.711	.115
galleries	nuptial	.96	6.54	10.29	-1.07	.418	2.24	.0276
dissected	nuptial	.48	8.20	6.11	3.32	.524	.550	.0345
reared	nuptial	.16	61.10	20.67	11.39	3.90	1.83	.257
reared	dissected	.21	59.19	20.67	4.39	4.05	2.67	.314

nuptials showed promise. Hence, indications are that for estimation, a useful multivariate regression can be derived involving logical relationships of dissection count to nuptials and surface area.

Differences among sample locations, harvest types, etc.—Since our goal in sample surveys is estimation rather than hypothesis testing, the decision on whether to “pool” data from subpopulations of the whole universe depends on the effect of pooling on the precision obtained when the relationship is applied in making the estimates and whether separate estimates are sought for subpopulations. For our studies, we are not only interested in the estimates themselves and how they differ among plots, but in determining what is best for future applications. The plots were selected to represent a variety of conditions and harvest methods, as described earlier, and one would like to reach some conclusion about differences among infestations under these different conditions as well as to determine the most overall effective system of sampling and estimation.

Here, the evidence is inconclusive about whether plot 15, thinned in mid-June for shortwood by chainsaw, should be considered to belong to a different population, and, if so, how to identify the relevant populations to which relationships based on it are applicable in the future. For plot 15, the sample contained only eight bolts (four pairs). Of these, one pair had exceptionally large diameter and length. The counts of beetles or beetle indications (number reared, number dissected, nuptials, and galleries) for these two samples were from 11 to 61 times as large as those for the average of all other plots. The effect upon the regression of the extreme values for the pair of observations is quite striking. So, regression fittings were carried out for plot 15

separately, for all other plots combined as a group excluding it, and for all plots combined including it. Observations with values this far from the means of y and x have a profound effect on the coefficient of determination, R², producing some very near 1.0 for this plot taken alone (compare corresponding rows in tables 1 and 2). For galleries vs. nuptials, R² = .999, and for reared vs. dissected, R² = .997. Only in these two cases, however, is the mean square error from regression smaller for this sample plot alone than for the same variables when fitted to combined data from all plots (tables 1 and 2).

When regressions are based on all the data except those from plot 15, the values are generally dramatically decreased (in some cases, R² was only a fourth as large) considering the few observations involved. In only two cases, dissected vs. galleries and dissected vs. nuptial, are the R² values large when plot 15 is excluded. The mean square errors, however, are always smaller when the fitting is based on excluding plot 15.

Since plot 15 is one of the plots that was thinned rather than clearcut, it would be reasonable to hypothesize that as the basis of the difference. The relationships fitted separately to the clearcut plots and to the thinned plots were examined. For this analysis, attention focused on only the two ultimate dependent variables, the counts from rearing and the counts from dissection, and only three independent variables, surface area of bark, gallery length, and nuptial chambers count, and combinations of these.

We considered multivariate regression equations of the form:

$$Y_i = B_0 + B_1 X_1 + B_2 X_2 + B_3 X_1 X_2$$

for $i = 1, 2, j = 2, 3$, where:

Table 2. — Summary statistics for univariate regressions, plot 15

Dep. var., Y	Indep. var., X	R ²	√MSE	Ȳ	∧ B ₀	Std. error of ∧ B ₀	∧ B ₁	Std. error of ∧ B ₁
nuptial	diameter	.77	39.3	39.0	-55.2	NS	.949	.213
galleries	diameter	.79	86.9	92.4	-129.3	NS	2.23	.470
dissected	diameter	.87	16.3	24.2	-30.4	10.5	.551	.088
reared	diameter	.87	62.1	85.0	-129.2	39.9	2.16	.336
dissected	galleries	.56	29.5	24.2	7.91	NS	.177	.063
reared	galleries	.55	116.7	85.0	21.9	NS	.683	.251
galleries	nuptial	.999	5.44	92.4	1.90	NS	2.32	.027
dissected	nuptial	.54	30.4	24.2	8.64	NS	.400	.152
reared	nuptial	.52	120.3	85.0	24.8	NS	1.54	.601
reared	dissected	.997	9.08	85.0	-9.48	3.79	3.90	.083

Table 3. — Summary statistics for univariate regressions, plots 16-30 combined (all except plot 15)

Dep. var., Y	Indep. var., X	R ²	√MSE	Ȳ	∧ B ₀	Std. error of ∧ B ₀	∧ B ₁	Std. error of ∧ B ₁
nuptial	diameter	.06	4.92	4.05	.98	NS	.0491	.0123
galleries	diameter	.04	9.24	2.84	7.78	NS	.0809	.0230
dissected	diameter	.04	8.64	5.57	.887	NS	.0750	.0215
reared	diameter	.12	57.4	18.7	-35.2	9.58	.863	.143
dissected	galleries	.53	6.01	5.57	.194	NS	.686	.0390
reared	galleries	.02	60.7	18.7	12.5	4.82	.796	.394
galleries	nuptial	.68	5.36	7.84	1.60	.419	1.53	.0648
dissected	nuptial	.69	4.93	5.57	-.302	NS	1.45	.0596
reared	nuptial	.08	58.7	18.7	4.82	NS	3.44	.710
reared	dissected	.07	59.0	18.7	8.49	4.26	1.84	.409

- Y₁ = dissection count
- Y₂ = reared count
- X₁ = surface area of bark on sample bolt
- X₂ = galleries count
- X₃ = nuptials count

We also considered selected univariate models of the form:

$$Y_i = B_0 + B_1X_j$$

These univariate and multivariate model forms were then fitted separately to the data from the thinned plots (#15, 18, 21 23), the clearcut plots, and all plots combined.

There were several differences between the univariate relationships for plots that were thinned and those clearcut (table 4). For thinned plots, the surface area of bark is more consistently related both to the dissected count and the reared count for the clearcut plots. The reared count especially is not only more highly correlated with surface area for thinned plots (R² = .54 vs. R² = .18, table 4), but it has a smaller root mean square error (40 vs. 63) with nearly the same average reared count.

The relationship of dissected count to surface area is also more evident for thinned plots (R² = .39 vs. R² = .06, table 4); the average dissected count and the root mean square error are both approximately twice as large for the thinned plots as for those clearcut.

The relationship of reared counts to galleries and nuptial chambers are also quite strong for thinned plots and either nonsignificant or very weak for clearcut plots (table 4). The R² = .004 for reared count vs. galleries on clearcut plots, based on 202 observations, is most convincing evidence of lack of association in the clearcut situation.

For the multivariate relationships that involve not only surface area but either gallery length or nuptial chamber counts as well, the fits are better for thinned plots and the means and parameter estimates (regression coefficients) different (table 4) from those for the clearcut plots. The reared counts can be considerably more precisely predicted from the multiple regressions for thinned plots than for the clearcut plots. Although average reared counts

Table 4. — Summary statistics of univariate regressions by harvest method and for all plots combined

X_i	Harvest method	Dep. var. Y_i	R^2	\sqrt{MSE}	\bar{Y}	\hat{B}_0	Std. error of \hat{B}_0	\hat{B}_1	Std. error of \hat{B}_1
Surface area	Thin	Dissected	.39	13.53	9.34	3.07 ^{ns}	1.83	.0092	1.36×10^{-3}
	Clearcut	Dissected	.06	7.82	4.92	2.25	.96	.0071	2.08×10^{-3}
	All	Dissected	.28	9.67	6.11	1.92	.711	.0092	$.89 \times 10^{-3}$
	Thin	Reared	.54	39.95	21.65	-4.01 ^{ns}	5.4	.0376	4.0×10^{-3}
	Clearcut	Reared	.18	62.76	20.31	-21.02	7.7	.1100	16.7×10^{-3}
	All	Reared	.19	59.68	20.67	.13 ^{ns}	4.4	.0448	5.5×10^{-3}

are just slightly larger on thinned plots, the root mean square errors are only approximately half as large (33 vs. 63 for surface area and galleries, and 34 vs. 61 for surface area and nuptials, table 5). Also, for the thinned plots, the gallery and nuptial counts were effective in improving the relationships over those with surface area as the only independent variable. For the clearcut plots, however, these variables generally did not significantly reduce residual variation when they were added to equations containing the surface area as the independent variable.

For estimating dissection count, the predictive power of both nuptial count and gallery count, along with surface area, is stronger for the clearcut plots, measured by the root mean square error; both root mean square error and mean dissected count for clearcut plots being about half those for thinned plots (table 5).

With this view to determining whether stratification by size would be effective in improving indirect estimation by regression (as well as to determine whether relationships were different for small slash than for large slash), we fitted the same multivariate models separately to the two size strata.

The relationship of reared counts to both galleries and nuptials is significant, but the other variables involving surface area were not important for small slash (stratum 1), while for large slash (stratum 2), all variables including those involving surface area are significant (table 6).

Choosing among the alternative estimation procedures.—In the earlier section on estimation procedures, not only was the basic LIS procedure described for direct estimation but also several variants that are our extensions to accommodate indirect estimation via regression, to accommodate zero counts, etc.

Our modifications of the basic technique include stratification of slash into two size classes, aggregation of lines until there are two or more nonzero observations, and indirect estimation involving different multivariate regressions for thinned plots and

clearcut plots. Following is an examination of each of these aspects individually.

The stratification of slash into two size classes ($2\text{cm} < \text{diameter} < 5\text{cm}$) is aimed at improving cost effectiveness in the subsampling. Although the boundary between strata (5cm) is arbitrary, it was set on the basis of a field pilot study as the approximate threshold size for substantial beetle infestation. Also, there is a high frequency of the small diameter slash that is poor beetle habitat and a low frequency of larger slash; hence, it is desirable to use subsampling rates that are higher for the large slash.

The decision to aggregate observations until non-zero counts are obtained is to alleviate some of the difficulty caused for efficient estimation by the "zero" observations. The best estimates are obtained when the estimates from individual lines are combined by inverse variance weighting. However, for a line on which no slash is intersected (hence a "zero" count of slash), the variance cannot be estimated; analogously, at each subsampling stage a "zero" observation leads to unestimable variances. Hence, the estimation procedure of DeVries (1974) that involves inverse variance weights cannot be applied for such lines. This problem has a high rate of occurrence in this application and leads to practical and theoretical difficulties. Our rule for aggregating the observations and forming two estimates for each plot is an intuitive (rather than theoretically deductive) approach to handling this difficulty.

Because of the extremely high cost of directly observing beetle counts by dissection or rearing, we are led to consider indirect estimation by ratio or regression estimators, using relationships derived from our research studies as the indirect estimators.

The simplest form of indirect estimator would be the ratio estimator of beetle count to some easily observed variable such as size of slash or count of nuptial chambers. Our investigations revealed highly unstable behavior in the ratios, so it was concluded that more complex univariate or multivariate regressions must be sought.

Table 5. — Summary statistics of multivariate regressions by harvest method (model form $Y = B_0 + B_1X_1 + B_2X_2 + B_3X_1X_2$), and for all plots combined

Harvest method	R ²	√MSE	Ȳ	ĤB ₀	ĤB ₁	ĤB ₂	ĤB ₃
Y ₁ = dissected, X ₁ = surface area, X ₂ = galleries							
Thin	.71	9.51	9.34	-1.61 ^{ns}	.537 × 10 ⁻²	.790	.121 × 10 ⁻³
Clearcut	.45	6.01	4.93	.08 ^{ns}	.120 × 10 ^{-2ns}	.383	.498 × 10 ⁻³
All	.61	7.15	6.11	-1.54	.526 × 10 ⁻²	.688	-.102 × 10 ³
Y ₂ = reared, X ₁ = surface area, X ₂ = galleries							
Thin	.69	33.35	21.6	-712 ^{ns}	2.28 × 10 ⁻²	1.13	-1.26 × 10 ⁻³
Clearcut	.18	63.07	20.3	-22.04	11.30 × 10 ⁻²	.199 ^{ns}	-.512 × 10 ^{-3ns}
All	.21	59.48	20.7	-1.80 ^{ns}	3.84 × 10 ⁻²	.601 ^{ns}	-0.71 ^{ns} × 10 ⁻³
Y ₁ = dissected, X ₁ = surface area, X ₃ = nuptials							
Thin	.70	9.66	9.34	-2.18 ^{ns}	.543 × 10 ⁻²	1.87	-.289 × 10 ⁻³
Clearcut	.68	4.57	4.93	-.101 ^{ns}	-.0001 × 10 ⁻²	1.16	.232 × 10 ^{-3ns}
All	.68	6.46	6.11	-1.91	.482 × 10 ⁻²	1.49	-.216 × 10 ⁻³
Y ₂ = reared, X ₁ = surface area, X ₃ = nuptials							
Thin	.68	34.2	21.6	-7.70 ^{ns}	2.36 × 10 ⁻²	2.54	-.285 × 10 ^{-3ns}
Clearcut	.23	60.9	20.3	-11.0 ^{ns}	6.92 × 10 ⁻²	-2.17 ^{ns}	7.64 × 10 ⁻³
All	.24	58.12	20.7	-8.06 ^{ns}	3.69 × 10 ⁻²	3.06	-.457 × 10 ⁻³

Table 6. — Multivariate regressions by size class of slash

	R ²	√MSE	Ȳ	ĤB ₀	ĤB ₁ × 10 ⁻²	ĤB ₂	ĤB ₃ × 10 ⁻³
Y ₂ = reared count, X ₁ = surface area, X ₂ = galleries							
Small stratum	.42	5.91	4.27	.639 ^{ns}	-.068 ^{ns}	.459	.500 ^{ns}
Large stratum	.19	72.3	28.6	2.59 ^{ns}	3.63	.583 ^{ns}	-.065 ^{ns}
Overall	.21	59.5	20.7	-1.80 ^{ns}	3.84	.601	-.071 ^{ns}
Y ₂ = reared count, X ₁ = surface area, X ₃ = nuptials							
Small stratum	.39	6.06	4.27	1.85 ^{ns}	-.969 ^{ns}	1.34	-.190 ^{ns}
Large stratum	.23	70.6	28.6	-6.10 ^{ns}	3.59	3.35	-.504
Overall	.24	58.1	20.7	-8.06 ^{ns}	3.69	3.06	-.457
Y ₁ = dissected count, X ₁ = surface area, X ₂ = galleries							
Small stratum	.47	4.03	3.59	1.38 ^{ns}	-.354 ^{ns}	.366	.413 ^{ns}
Large stratum	.61	8.22	7.33	-1.83 ^{ns}	.532	.736	-.111
Overall	.61	7.15	6.11	-1.54	.526	.688	-.102
Y ₁ = dissected count, X ₁ = surface area, X ₃ = nuptials							
Small stratum	.53	3.81	3.59	2.50 ^{ns}	-.930 ^{ns}	.638	1.55
Large stratum	.69	7.37	7.33	-2.26	.494	1.56	-.228
Overall	.68	6.46	6.11	-1.91	.482	1.49	-.216

The univariate regressions of the measure of beetle presence to potential independent variables were in some cases reasonably promising (tables 1, 2, 3, 4), but most were inadequate for use as estimators. We, therefore, investigated an array of possible dependent and independent variables in several multivariate model forms based on the simplest and most economical combinations that showed promise from the univariate models. The results indicated that the overall best models from the standpoint both of precision and cost-effectiveness involved dissection count as the measure of beetle presence (dependent variable) and surface area of slash and nuptial chamber count as the independent variables to be observed in the field (tables 5, 6). These are not only relatively effective predictor variables, but

they also are far less costly to observe in the field than are either direct observation of beetle measures or the alternatives.

It is evident that the relationships of measure of beetle presence to surface area and nuptial chambers count vary with harvest method and other site characteristics. However, the only site characteristic that shows obvious differences that could be readily distinguished in future application is whether the stand is thinned or clearcut. The relationships for thinned sites (plots 15, 18, 21, 23) are substantially different from those for the clearcut sites in means, regression parameter estimates, and root mean square residual (table 5); hence, separate regressions have been derived for the two types.

Table 7. — *Estimates of slash diameters, number of pieces, volume of slash, bark surface area, nuptial chambers, numbers of dissected beetles, numbers of reared beetles, and ratios of rearing to dissected beetles and dissected beetles to nuptial chambers, based on aggregating lines*

Plot no.	Avg. diameter	No. pieces of slash/m ²	Volume m ³ /m ²	Surface area m ² /m ²	Nuptial chambers no./m ²	Diss. no./m ²	Rearing no./m ²	Rear./diss.	Diss./nuptial
	cm								
	× 10 ⁻¹		× 10 ⁻²						
1	.25	.59	.100	.086	0	0			...
2	.23	1.30	.126	.135	0	28.2			...
3	.20	.87	.078	.088	0	36.2			...
5	.26	1.22	.236	.185	0	39.5			...
6	.23	.64	.099	.090	5.8	20.2			3.5
7	.30	.40	.060	.062	2.5	5.7			2.3
8	.33	.53	.081	.082	1.5	10.4			6.9
9	.29	.47	.084	.070	7.9	88.0			11.1
10	.37	.66	.217	.167	3.7	31.3			8.5
11	.30	.36	.026	.023	1.1	9.4			8.5
12	.41	.36	.159	.106	8.5	65.6			7.7
15	.56	.30	.255	.109	17.7	14.0	33.8	2.4	.8
16	.46	.55	.240	.171	20.8	41.8	98.6	2.4	2.0
17	.44	.38	.149	.100	16.5	18.6	30.4	1.9	1.1
18	.46	.21	.142	.074	6.0	5.9	8.0	1.4	1.0
19	.39	.48	.136	.118	19.5	27.5	20.2	.7	1.4
20	.47	.38	.158	.111	1.4	1.7	4.0	2.4	1.2
21	.41	.07	.055	.031	4.2	9.5	14.0	1.5	2.3
22	.41	.28	.151	.055	3.9	2.1	4.0	1.9	.5
23	.44	.20	.157	.088	5.1	5.9	9.3	1.6	1.1
24	.39	.43	.204	.122	17.1	20.7	31.5	1.5	1.2
25	.37	.40	.146	.097	2.7	7.4	60.4	8.2	2.7
26	.35	.33	.162	.085	9.2	10.7	28.9	2.7	1.2
27	.40	.25	.124	.073	11.2	6.5	6.8	1.0	.6
28	.42	.31	.151	.083	0.7	0.1	0.3	3.0	.1
29	.38	.45	.211	.140	4.4	0.9	6.1	6.8	.2
30	.38	.24	.066	.056	1.0	0.7	0.7	1.0	.7

LITERATURE CITED

- Belanger, R. P.; Porterfield, R. L.; Rowell, C. E. Development and validation of systems for rating the susceptibility of natural stands in the piedmont of Georgia to attack by the southern pine beetle. In: Hedden, R. L.; Barras, S. J.; Coster, J. E., eds. Hazard-rating systems in forest pest management: symposium proceedings; 1981 July 31–August 1; Athens, GA. Gen. Tech. Rep. WO-27. Washington, D. C.: U.S. Department of Agriculture, Forest Service; 1981: 79–86.
- Berisford, C. W.; Kulman, H. M.; Pienkowski, R. L.; Heikkinen, H. J. Factors affecting distribution and abundance of hymenopterous parasites of *Ips* spp. bark beetles in Virginia (Coleoptera: Scolytidae). *Canad. Entomol.* 103: 235–239; 1971.
- Berisford C. W.; Franklin, R. T. Attack patterns of *Ips avulsus* and *I. grandicollis* (Coleoptera: Scolytidae) on four species of southern pines. *Ann. Entomol. Soc. Am.* 64: 894–897; 1971.
- Birch, M. C.; Svihra, P.; Paine, T. D.; Miller, J. C. Influence of chemically mediated behavior on host tree colonization by four species of bark beetles. *J. Chem. Ecol.* 6: 395–414; 1980.
- DeVries, P. G. A general theory on line intersect sampling. *Bulletin* 73-11. Wageningen, Netherlands: Mededelingen Landouw Hogeschool; 1973. 23 p.
- DeVries, P. G. Multi-stage line intersect sampling. *For. Sci.* 20: 129–133; 1974.
- DeVries, P. G. Line intersect sampling—statistical theory, applications and suggestions for extended use in ecological inventory. In: Cormack, R. M.; Patis, G. P.; Robson, D. S., eds. *Statistical ecology 6: sampling biological populations*. Burtonsville, MD: International Co-operator Publishing House; 1979: 1–70.
- Feldman, R. M.; Wagner, T. L.; Sharpe, P. J. H.; Gagne, J. A.; Coulson, R. N. Within-tree life process models of the southern pine beetle, *Dendroctonus frontalis*. *Ecol. Model.* 13: 247–259; 1981a.
- Feldman, R. M.; Curry, G. L.; Coulson, R. N. A mathematical model of field population dynamics of the southern pine beetle, *Dendroctonus frontalis*. *Ecol. Model.* 13: 261–281; 1981b.
- Hain, F. P.; McClland, W. T. Studies of declining and low level populations of the southern pine beetle in North Carolina. In: Hain, F. P., ed. *Work conference on population dynamics of forest insects*, 1979 August 9–10; North Carolina State University, Raleigh, NC; 1979: 9–26.
- Hazard, J. W.; Pickford, S. G. Cost functions for the line intersect method of sampling forest residue in the Pacific Northwest. *Canad. J. For. Res.* 14: 57–62; 1984.
- Hicks, R. R., Jr.; Howard, J. E.; Watterson, K. G.; Coster, J. E. Rating forest stand susceptibility to southern pine beetle in east Texas. *For. Ecol. Manage.* 2: 269–283; 1980.
- Hines, G. S.; Taha, H. A.; Stephen, F. M. Model for predicting southern pine beetle population growth and tree mortality. In: Stephen, F. M.; Searcy, J. L.; Hertel, G. D., eds. *Modeling southern pine beetle populations: symposium proceedings*; 1980 February 20–22; Asheville, NC. *Tech. Bull. No. 1630*, Washington, DC: U.S. Department of Agriculture; 1980: 4–12.
- Hodges, J. D.; Pickard, L. S. Lightning in the ecology of the southern pine beetle, *Dendroctonus frontalis* (Coleoptera: Scolytidae). *Canad. Entomol.* 103: 44–51; 1971.
- Ku, T. T.; Sweeney, J. M.; Shelburne, V. B. Site and stand conditions associated with southern pine beetle outbreaks in Arkansas—a hazard rating system. *South. J. Applied For.* 4: 103–106; 1980.
- Lorio, P. L.; Sommers, R. A. Use of available resource data to rate stands for southern pine beetle risk. In: Hedden, R. L.; Barras, S. J.; Coster, J. E., eds. *Hazard-rating systems in forest pest management: symposium proceedings*, 1981 July 31–August 1; Athens, GA. Gen. Tech. Rep. WO-27. Washington, D.C.: U.S. Department of Agriculture, Forest Service; 1981: 75–86.
- Morgan, R. R. Behavior of *Ips* populations after summer thinning in a loblolly pine plantation. *For. Sci.* 15: 390–398; 1969.
- Morgan, R. R. Comparison of flight aggregation in two species of southern *Ips* (Coleoptera: Scolytidae). *Canad. Entomol.* 102: 1036–1041; 1970.
- Morgan, F. D. *Ips grandicollis* in South Australia. *Australian Forestry* 31: 137–155; 1967.
- Nebeker, T. E. Forestry practices and bark beetles, a perspective. In: *Insects and diseases of southern forests: proceedings, 34th Annual LSU Forestry Symposium*. 1985 March 26–27; Baton Rouge, LA; 1985. (In press.)
- Nebeker, T. E.; Hodges, J. D. Influence of forestry practices on host susceptibility to bark beetles. *Zeit. angew. Entomol.* 96: 194–208; 1983.
- Speers, C. F. *Ips* bark beetles in the South. *For. Pest Leaflet* 129. Washington, DC: U.S. Department of Agriculture, Forest Service; 1971.
- Van Wagner, C. E. The line intersect method in forest fuel sampling. *For. Sci.* 14: 20–26; 1968.
- Warren, W. G.; Olsen, P. F. A line intersect technique for assessing logging waste. *For. Sci.* 10: 267–276; 1964.

Turpentine-Baited Traps Capture Black Turpentine Beetles and Other Forest Coleoptera but do not Prevent Attacks on Pines

Carl W. Fatzinger¹

Abstract.—Turpentine-baited traps captured several species of forest Coleoptera and were particularly effective for monitoring black turpentine beetles, pales weevils, pitch-eating weevils, southern pine sawyers, and Carolina pine sawyers. The traps were not effective for preventing attacks by black turpentine beetles on 1.7 ha plots containing slash pines artificially stressed with either a bark wound or a bark wound treated with paraquat, or on check plots with unwounded trees. Captures of black turpentine beetles were increased 59 percent by the addition of ethanol to the turpentine bait, but the improved bait has not been evaluated for preventive control.

Additional keywords: *Pinus elliottii* var. *elliottii*, host attraction, *Dendroctonus terebrans*, paraquat-treated trees.

INTRODUCTION

The black turpentine beetle (BTB) (*Dendroctonus terebrans* (Olivier)) usually causes only minor damage in southern forests, but during sporadic major outbreaks its damage is quite serious. The insect shows a preference for bark of freshly cut stems or the bases and roots of living and dying trees (Smith and Kowal 1968). It is attracted to trees disturbed by logging, naval stores operations, lightning, or drought (Smith and Lee 1957). During the early 1950's, the BTB virtually forced many turpentine farmers out of business (Merkel 1981) and destroyed an estimated 37 million board feet of timber in the southeastern United States. The BTB again became a serious problem during the late 1970's, attacking up to 50 percent of the faced trees in gum naval stores stands in Georgia and Florida and damaging ornamental pines in urban and forested recreational areas.

Preventative and remedial controls for the BTB are currently limited to spraying the bark of trees

with lindane or chlorpyrifos insecticides. A trapping technique could be useful for monitoring field populations of the insect to predict needs for preventive control during sporadic outbreaks. Traps might also be useful for preventing BTB attacks in small stands of susceptible pines or for reducing attacks on ornamental trees in residential areas.

Hopkins (1909) observed swarms of BTB near freshly painted buildings where there was a strong odor of turpentine; he also reported the species' habit of flying into, and bouncing from windows and doors. Hughes (1975) reported trapping BTB adults in field olfactometers baited with resin of loblolly pine (*Pinus taeda* L.), and Clements and Williams (1981) captured numerous BTB in stove pipe traps baited with turpentine freshly distilled from the oleoresin of slash (*P. elliottii* Engelm. var. *elliottii*) and longleaf pines (*P. palustris* Mill.).

The study described here was initiated in 1980 to: (1) evaluate different techniques for trapping the BTB; (2) determine optimal periods for trapping by investigating peak seasonal and daily times of BTB flight activities, and the influence of weather on daily flight periods; and (3) evaluate the use of BTB traps for preventing attacks on pines in small tracts such as naval stores or lightwood production areas.

METHODS

Several trap designs, bait dispensers, and trap colors were evaluated for capturing BTB. A modification of the stove pipe trap designed by Clements and Williams (1981) baited with freshly distilled turpentine² was selected as a standard trap for experiments (fig. 1). Details of studies on the designs of traps and bait dispensers, improvements of the turpentine bait, daily and seasonal periods of peak trap captures, and the effects of local weather conditions on BTB flight activity are described in a paper submitted elsewhere for publication.

Four studies were installed in north Florida between June 1980 and March 1982 to evaluate the use

¹ Research Entomologist, U.S. Department of Agriculture Forest Service, Southeastern Forest Experiment Station, Olustee, FL. (This work was partially funded by the Integrated Pest Management Program, U.S. Department of Agriculture, Forest Service, Southern Forest Experiment Station, and the Georgia Forestry Commission. Appreciation is expressed to David Muse, U.S. Department of Agriculture, Forest Service, Southeastern Forest Experiment Station, for help in analyzing the study results.)

² Turpentine distilled from the oleoresin of slash and longleaf pines was obtained from the Shelton Naval Stores Processing Company, Valdosta, GA.

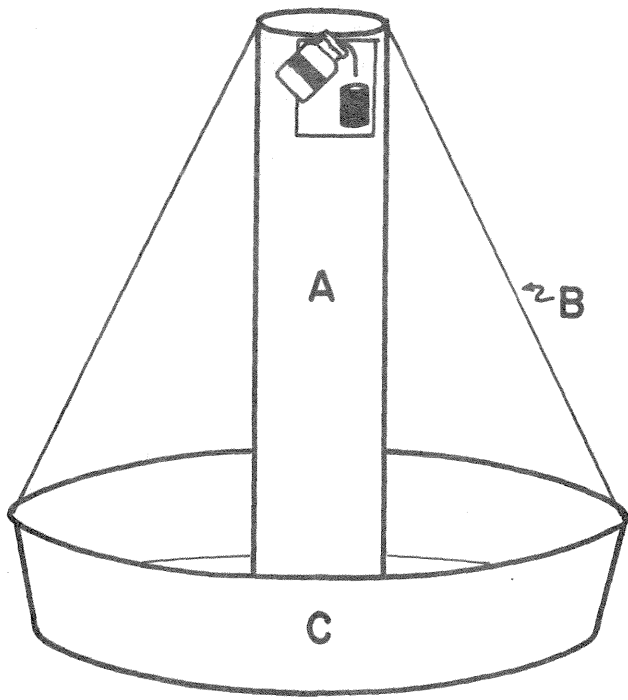

Figure 1.—Standard BTB trap consisted of a black cylindrical bounce column (23 cm diam. by 1.2 m long [9 in diam. by 4 ft long]) (A) vertically supported by three guy wires (B) in the center of a juvenile wading pool (1.2 m diam. by 23 cm deep [4 ft diam. by 9 in deep]) $\frac{2}{3}$ full of soapy water (C). A 500 ml bait dispenser (D) with a cotton wick and a cup to prevent turpentine from dripping into the pool was attached to the top of the trap.

of the standard traps baited with turpentine for preventing attacks on small stands of pines. Trees within each stand were observed once a month for signs of insect attack, and the numbers of BTB captured by traps were recorded at weekly or biweekly intervals. The first two exploratory studies were installed in experimental naval stores stands near Olustee, FL, in June 1980. Traps were deployed around the borders of each stand for 391 days. Naval stores treatments included chipping trees and applying sulphuric acid paste at 3-week intervals from April through October. In one study, six traps were placed around the border of a 1.2 ha (3.0 acre) stand of 75 longleaf pines treated for naval stores. Three of the trees had been attacked by BTB and were sprayed with a 1-percent aqueous solution of lindane just prior to installation of the traps. In the second exploratory study, 15 traps were placed around the border of a 6.2 ha (15 acre) stand of slash pine in which 150 trees were treated for naval stores. Additional naval stores stands were not available for use as check plots in the Olustee area because operators had begun routine applications of lindane for control of the BTB during the spring of 1980.

The third study (study "A") was conducted 11 km (7 miles) south of Olustee from May 1981 to November 1982 to evaluate four methods of deploying traps on 1.7 ha (4.1 acre) plots containing about 2,500 trees per plot. Sample trees within each plot were artificially stressed to induce attack just prior to expected periods of peak BTB flights. A 4-percent paraquat solution was applied to a 2.5 cm (1 inch) wide wound made through the bark of sample trees with a power chipper described by Clements and McReynolds (1977). Each wound extended around one third the circumference of the tree bole at a height of 1 m (3 feet). Twenty trees spaced as evenly as possible throughout each of 15 plots were selected during May 1981 for paraquat treatments. An additional 20 trees per plot were again treated with paraquat during August 1981 and 20 more trees per plot were stressed only with a wound during May 1982. The number of trees stressed during each treatment ranged from 16 to 20 per plot because occasional high water levels at swamp margins precluded the safe application of paraquat. The rectangular plots (91.4 by 182.8 m [300 by 600 feet]) were at least 61.0 m (200 feet) apart with their longest sides oriented north and south. Four methods of deploying traps spaced at intervals of 91.4 m (300 feet) were evaluated: three traps per plot through (1) the center of plots, (2) along the east edges of plots, (3) along the west edges of plots; and (4) six traps around the boundaries of plots. Each trap deployment pattern was installed on three randomly selected plots. Three plots without traps served as checks.

The fourth study (study "B") was installed on the Osceola National Forest near Lake City, FL, during 1982. Three different levels of tree susceptibility to BTB attacks were simulated on six replicated plots per level: (1) tree wounds treated with paraquat as described above to simulate a lightwood production treatment (= highly susceptible trees), (2) the same tree wounds without paraquat to simulate a naval stores treatment (= moderately susceptible trees), and (3) no wounded trees within check plots (= low tree susceptibility). Twenty trees per plot were treated in early March and 20 more trees per plot were treated in June to provide susceptible trees during the spring and summer flight periods of the BTB. This study included 18 rectangular plots (91.4 by 182.8 m [300 by 600 feet]) oriented in a north-south direction that contained about 1,500 trees per plot. Six traps were deployed at 91.4 m (300 feet) intervals around the borders of half of the plots within each tree stress treatment. Prior to the tree stress treatments, the traps were placed in small openings at least 15.2 m (50 feet) from adjacent trees.

In studies "A" and "B", new BTB attacks were

identified with colored map pins inserted into the bark of sample trees. Trees attacked by four or more BTB were sprayed to a height of 2.4 m (8 feet) with 1-percent lindane in water at monthly intervals until new BTB attacks ceased to occur on individual trees.

The distance and direction of trap locations and of trees attacked by BTB were measured from one flagged tree near the center of each plot. These measurements were used to calculate the distances and directions of newly attacked trees from the nearest traps and from the nearest previously attacked trees within plots. Monthly results were compared by analysis of variance to determine whether new attacks occurred on trees in close proximity to either traps or previously attacked trees. The effectiveness of the different trap deployment methods also was evaluated by an analysis of variance to determine the significance of differences between the proportions of artificially stressed trees attacked and total attacks per tree within plots that received different trap treatments.

RESULTS AND DISCUSSION

The standard trap with a black bounce column and a wick-type bait dispenser was the best design tested for capturing BTB and other species of forest Coleoptera. Traps equipped with a wick-type dispenser (fig. 1) consistently captured more insects than traps with dispensers that released smaller amounts of turpentine. During 1983, ethanol was found to have a synergistic effect when mixed with the turpentine bait;

it increased trap captures by 59 percent. Peak captures of BTB occurred about three times a year in March, July, and October. Maximum daily trap captures occurred on heavily overcast days shortly after sunset. BTB tended to fly upwind to traps when windspeeds were less than 1.6 km/h (1 mph) and most of them were captured at average temperatures of 32°C and relative humidities of 77 percent. The greatest numbers of BTB were captured during periods of a new moon, when the moon was in its last quarter, and when the moon was either below the horizon or setting in the west.

The traps also captured large numbers of *Ips* spp., pales weevils (*Hylobius pales* (Herbst)), pitch-eating weevils (*Pachylobius picivorus* Germar), deodar weevils (*Pissodes nemorensis* Germar), southern pine ambrosia beetles (*Platypus flavicornis* (F.)), and several species of round-headed woodboring beetles including the Carolina pine sawyer (*Monochamus carolinensis* (Olivier)) and the southern pine sawyer (*M. titillator* (Fabricius)).

The majority of BTB attacks on artificially stressed trees occurred from mid-July to mid-August. Trap captures of BTB tended to increase and decrease with the percentage of total trees attacked during 1982, but there was a time lag of about 2 weeks between peak trap captures and peak attacks during the fall of 1981 (fig. 2). The relationship between trap captures and attacks during 1981 was somewhat obscured because observations were not begun until May.

Both of the experimental naval stores stands remained free from BTB attacks for 1 year even though

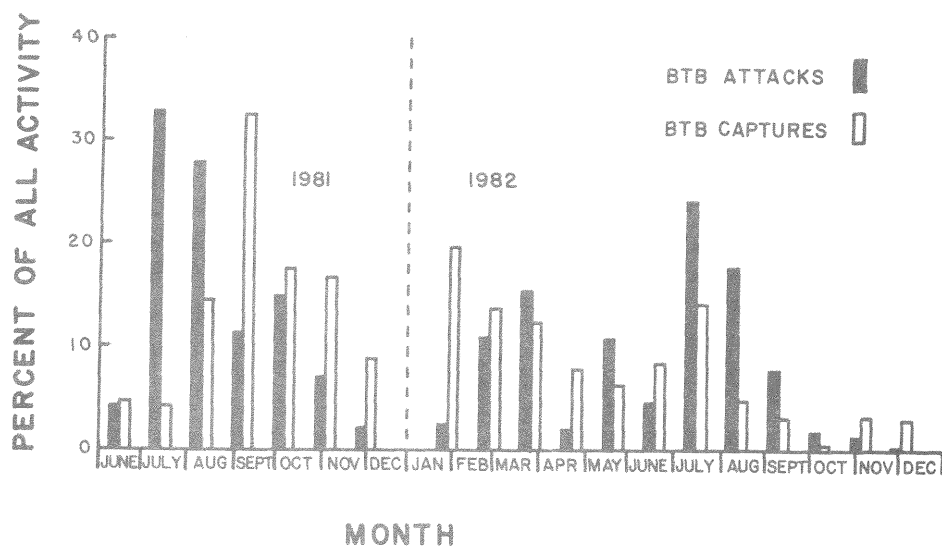

Figure 2.—Proportions of total trap captures of BTB and proportions of total artificially stressed trees attacked by BTB at 4-week intervals from June 1981 to December 1982.

the turpentine baited traps deployed around their boundaries captured ca. 14,000 BTB and 2,700 *Ips* spp. (table 1). The trees apparently remained susceptible to insect attack throughout the study as seven of the longleaf pines were attacked by southern pine coneworms (*Dioryctria amatella* (Hulst)) near the naval stores faces (Fatzinger and DeBarr 1969). The lack of BTB attacks in both naval stores stands could only be indirectly related to the presence of traps because check plots without traps were not available during the exploratory tests. About 10 percent of the trees in other naval stores stands in north Florida and south Georgia, however, continued to be attacked by the BTB despite preventive applications of lindane³.

The 45 traps deployed in study "A" captured 18,928 BTB in 18 months (table 2). BTB initially began attacking trees that had been accidentally wounded by a mower, but these attacks decreased abruptly after the traps were installed. Attacks continued throughout the study on trees attacked prior to operation of the traps and on trees artificially stressed with paraquat. A total of 39 percent (330 trees) of the 846 artificially stressed trees and about 1 percent (244 trees) of the unwounded and mower wounded trees were eventually attacked.

Plots with six traps captured more BTB than plots with three traps, and the fewest BTB were captured by traps deployed along the west edge of plots. There were no significant differences ($P=0.05$) in the percentages of newly attacked trees per plot between trap deployment methods (table 2). Likewise, the number of BTB attacks per tree during each observation period did not differ significantly by trapping methods.

A total of 6,270 BTB were captured in 7 months in the 54 traps deployed in study "B" (table 3). BTB attacked 21 percent (101 trees) of the 477 artificially stressed trees and 7 unwounded trees on the 18 plots. The numbers of trees attacked increased with the level of artificial stress imposed. Thus, 86.5 percent of the attacked trees were treated with a wound plus paraquat, 9.9 percent were stressed only by a wound, and the remaining 3.6 percent were on the check plots. The percentages of sample trees attacked were significantly higher on the paraquat treated plots, but there were no significant differences in attack rates between plots with the wound only treatments and unwounded check plots. As in study "A", the presence of traps did not significantly reduce the average number of BTB attacks per tree. Paraquat treated trees, however, received significantly more

Table 1. — Total number of insects captured by traps during exploratory studies in each of two experimental naval stores areas near Olustee, FL (July 1980–July 1981)

Pine species	Acres	BTB	<i>Ips</i> spp.	Pales and pitch-eating weevils	Pine sawyers
Longleaf	2.5	4746	1824	3845	779
Slash	13.0	9239	967	7800	939
Total	15.5	13985	2791	11645	1718

Table 2. — Captures of BTB and attack rates on artificially stressed trees in plots with either three traps deployed on the east (3E) or west (3W) boundaries, three deployed through the center (3C), six positioned around the borders (6B), or on check plots (CK) without traps (Study "A", May 1981–November 1982)

Year	Month obs.	Total BTB captured				Proportions ¹ of stressed trees newly attacked by BTB per plot				
		3E	3C	3W	6B	3E	3C	3W	6B	CK
		Number				Percent				
1981	June	40	57	17	19	12	14	10	6	5
	July	201	214	153	294	20	12	12	12	12
	Sept.	446	374	300	784	14	17	19	21	8
	Oct.	275	177	185	465	20	12	12	12	10
	Dec.	74	119	56	156	7	1	2	17	1
1982	Feb.	940	1727	839	1248	18	9	4	7	6
	Mar.	449	574	200	824	22	11	5	15	8
	Apr.	335	438	306	694	12	7	11	12	7
	June	136	364	70	81	4	1	0	5	2
	July	1055	603	621	1158	4	2	4	4	4
	Aug.	159	110	119	260	0	0	0	0	2
	Oct.	7	19	15	10	0	2	0	3	2
	Nov.	102	83	40	166	0	2	0	2	0
	Total	4239	5609	2921	6159					

¹The average number of artificially stressed trees per plot increased from 20 after June to 40 after September 1981, and to 60 after June 1982. Means were not significantly different ($P=0.05$) between trap deployment treatments during any of the observation periods.

attacks per tree during each observation period (range from 4.2 to 28.9) than did attacked trees on other plots (range from 0 to 5.0). There were no significant differences in the average number of attacks per tree between check plots and plots receiving the wound only treatment. The level of artificial stress imposed on sample trees appeared to have little effect on the number of BTB captured in traps surrounding the plots (table 3).

In some of the plots in studies "A" and "B", newly attacked trees appeared to be somewhat clustered about traps or about trees previously attacked by

³H. Grady Williams, personal communication.

Table 3. — *BTB captured by traps and attack rates on artificially stressed trees on plots with six traps (T) deployed around the borders of each of three plots per tree stress treatment: paraquat (P), wound (W), and untreated check (CK) (study "B", May to October, 1982)*

Month obs.	Total BTB captured per tree stress treatment			Proportions ¹ of stressed trees newly attacked by BTB per plot					
	P	W	CK	P	P(T)	W	W(T)	CK	CK(T)
	----- Number -----			----- Percent -----					
May	576	658	472	4	4	3	4	2	5
June	449	631	463	16	26	2	0	0	0
Aug.	496	386	355	17	16	0	0	0	0
Sept.	215	307	182	3	1	0	0	0	0
Oct.	438	268	374	1	2	0	0	0	0
Total	2174	2250	1846						

¹The average number of stressed trees per plot increased from 20 after March to 40 after June. Means were not significantly different ($P=0.05$) between plots with and without traps within a given tree stress treatment.

Table 4. — *Survival and continued susceptibility to BTB attack of trees treated with 1.0 percent lindane in water for remedial control during studies "A" and "B"*¹

Lindane treatment	Total trees	Tree survival	Attacks per tree		Surviving trees re-attacked
			Surviving trees	Dead trees	
	----- Number -----	Percent	----- Number -----		Percent
1	445	74	11.1	9.1	50.6
2	167	65	11.8	14.9	31.5
3	34	65	13.4	12.7	9.1
4	2	100	10.0	...	0

¹Data include only those trees with more than four BTB attacks that were sprayed at least once with lindane.

BTB. An analysis of the distances and directions of newly attacked trees from the nearest traps or nearest trees attacked during the previous month, however, indicated a uniform distribution of attacked trees throughout the plots.

About half of the attacked trees that were treated with a 1-percent solution of lindane were attacked a second time (table 4). The attack rates on previously attacked trees decreased with the number of lindane applications, and no further attacks occurred after the fourth applications. Tree mortality ranged from 25 percent following the first lindane application to 35 percent following the second and third applications. The average numbers of BTB attacks per tree were about equal between trees that survived and trees that eventually died after the lindane applications. Tree mortality was probably influenced by

unmeasured factors such as differences in bark thickness or texture and related rates of lindane penetration through the bark.

CONCLUSIONS

The differences between attack rates as high as 10 percent on lindane treated trees in commercial naval stores operations throughout Florida and Georgia and no BTB attacks on unsprayed trees in the two exploratory study areas protected with traps suggested that the traps might be effective in preventing BTB attacks. The presence of traps, however, did not decrease attack rates on plots with untreated trees or trees treated with either a wound plus paraquat or only a wound during studies "A" or "B". The traps also appeared to be ineffective for preventing

attacks on previously attacked trees. In study "A", for example, wounded trees that had been attacked prior to the installation of traps continued to be attacked after the traps were present. First attacks on mower-wounded trees, however, decreased abruptly after the traps were installed. The turpentine bait may have been more attractive to the BTB than the oleoresin that exuded from recently wounded trees, because turpentine had a higher concentration of volatile monoterpenes. The paraquat-treated trees, however, appeared to be more attractive than the turpentine bait to BTB. Additional attractants may be produced by paraquat-treated trees or pheromones may be produced by attacking BTB in combination with the oleoresin produced at the wound site.

Naval stores trees attacked by the BTB are known to be twelve times more prone to attack than similarly treated trees that have not been attacked (Smith 1958). Both male and female BTB are believed to produce secondary attractants (Godbee and Franklin 1976), and the insect is capable of producing the aggregation pheromone *trans-verbenol* (Hughes 1975). Seigfried (1984) found that *trans-verbenol* increased captures of BTB by 38 percent when released from turpentine baited traps. Additional research is needed to evaluate the use of *trans-verbenol* with a mixture of turpentine and ethanol as bait for trapping the BTB.

The traps have potential value for monitoring field populations of BTB as well as other destructive forest insects including pales and pitch-eating weevils, deodar weevils, Carolina and southern pine sawyers, and southern pine ambrosia beetles. A trapping system might be developed for predicting tree mortality rates and planning control measures, because trap captures tended to reflect BTB attack rates on trees. Traps with improved baits also might be useful for preventing BTB attacks on ornamental pines and for reducing attacks in naval stores or lightwood production operations. In view of the observed tendency for some attacks to occur near traps, it is suggested that traps be located in small openings away from trees, or that trees in close proximity to traps be sprayed with lindane. Maximum trap captures should occur three times a year in early spring, early summer, and early fall. Daily captures should be maximum near sunset on heavily overcast days when the windspeed is less than 1.6 km/h (1 mph).

LITERATURE CITED

- Clements, R. W.; McReynolds, R.D. A motorized, rotary chipping tool for the gum naval stores industry. Res. Note SE-250. Asheville, NC: U.S. Department of Agriculture, Forest Service, Southeastern Forest Experiment Station; 1977. 4 p.
- Clements, Ralph W.; Williams, Grady H. Attractants, techniques, and devices for trapping bark beetles. Res. Note SE-309. Asheville, NC: U.S. Department of Agriculture, Forest Service, Southeastern Forest Experiment Station; 1981. 3 p.
- Fatzinger, C. W.; DeBarr, G. L. How to distinguish attacks by the black turpentine beetle and *Dioryctria amatella* on southern pines. Res. Note SE-101. Asheville, NC: U.S. Department of Agriculture, Forest Service, Southeastern Forest Experiment Station; 1969. 4 p.
- Godbee, J. F.; Franklin, R. T. Attraction, attack patterns and seasonal activity of the black turpentine beetle. *Ann. Entomol. Soc. Am.* 69:653-655; 1976.
- Hopkins, A. D. Practical information on the scolytid beetles of North American forests—1. Bark beetles of the genus *Dendroctonus*. Bull. 83. Washington, DC: U.S. Department of Agriculture, Bureau of Entomology; 1909: p. 146-153.
- Hughes, Patrick R. Pheromones of *Dendroctonus*: origin of *alpha*-pinene oxidation products present in emergent adults. *J. Insect Physiol.* 21:687-691; 1975.
- Merkel, E. P. Control of the black turpentine beetle. Res. Pap. 15. Macon, GA: Georgia Forestry Commission; 1981. 6 p.
- Siegfried, B. D. Attraction of the black turpentine beetle, *Dendroctonus terebrans*, to host- and insect-produced volatiles. Gainesville, FL: University of Florida; 1984. 59 p. [Dissertation].
- Smith, R. H. Control of the turpentine beetle in naval stores stands by spraying attacked trees with benzene hexachloride. *J. For.* 56:190-194; 1958.
- Smith, R. H.; Kowal, R. J. Attack of the black turpentine beetle on roots of slash pine. *J. Econ. Entomol.* 61:1430-1432; 1968.
- Smith, R.H.; Lee, R. E. Black turpentine beetle. For. Pest Leaflet 12. Washington, DC: U.S. Department of Agriculture, Forest Service; 1957. 7 p.

SESSION I—SAMPLING AND IMPACT ASSESSMENT

Estimating Areawide Pest Population Change/Timber Loss

Estimating Southern Pine Beetle Caused Timber Losses Over Extensive Areas

J. D. Ward, C. W. Dull, George W. Ryan and M. C. Remion¹

Abstract.—A aerial photographic sampling method for assessing timber losses caused by the southern pine beetle *Dendroctonus frontalis* Zimm. was developed in Mississippi in 1979–80 and pilot tested on 9 million acres in western South Carolina in 1981–82. A combination of aerial photographic sampling and timber volume estimates derived from Renewable Resources Evaluation Survey data can be used to obtain statistically reliable estimates of losses for extensive areas anywhere in the South, at a reasonable cost.

Additional keywords: Damage appraisal, survey, aerial photographic sampling.

INTRODUCTION

Pest damage appraisal surveys are needed at all levels of forest management to provide economic information for making management decisions and evaluating control tactics. In the past, there have been few attempts to assess the timber volume killed by the southern pine beetle over extensive areas, primarily because of the lack of a statistically reliable method to acquire the information. In 1978, under the Expanded Southern Pine Beetle Research and Applications Program, an evaluation of aerial photographic sampling was initiated to assess the damage of a southern pine beetle outbreak in central Mississippi. Aerial photographic methods have been used since 1967 for southern pine beetle biological evaluations (Ciesla et al. 1967). Aerial photo sampling was considered a potentially good method for assessing the number of trees killed by southern pine beetles on 3 million acres in Mississippi because it was (1) a rapid way to collect data over a large area and (2) the aerial photographs provided a permanent record from which to locate and quantify tree mortality (Clerke and Ward 1979).

The evaluation in Mississippi utilized a modified random sampling plan with 45 sampling points randomly selected in seven counties. Plots were variable in size, but each contained at least 500 acres of host type. The plots began at the preselected sampling point and continued until 500 acres of host type were

photographed for each plot.

Two coverages were used to get a periodic estimate of the damage occurring in the area. The initial coverage established the baseline mortality and the final coverage established the damage occurring on the same plot at the end of the evaluation.

The initial sampling showed $703,105 \pm 72,776$ cubic feet (68 percent confidence level) of timber killed by the southern pine beetle in the spring of 1978, and $3,135,640 \pm 203,284$ cubic feet of timber during the winter of 1979–1980. By subtracting the initial survey estimate from the final survey, a loss of 2,432,535 cubic feet of timber occurred. No adjustment was made for the timber salvaged to determine the actual loss. The actual loss could have been estimated with a minimum of ground checking or provided through State salvage records.

This evaluation method provided a statistically acceptable estimate. It also was the first successful test of an airborne Loran-C navigation system which was the real key to completing this type of survey (Dull 1980). The Loran-C navigation system provided a means of locating loss assessment plots without visual prominent landmarks. The system also guided the aircraft back to the same plots for the resample. Another contribution from the Mississippi project was the development of an aerial photo volume for trees killed by southern pine beetles in central Mississippi (Mead and Smith 1979).

Although the method was satisfactory for sampling losses, it still required a considerable amount of ground checking. Also, the method required aerial photo volume tables, which were nonexistent for most of the South. Volume tables can be constructed from the aerial photos and ground sampling, but this process is extremely time consuming. Therefore, this method could not be very useful on an operational basis without some modification (Ghent and Ward 1980).

In 1981, the IPM program funded a pilot test of the sampling method developed in Mississippi (Dull 1980). This project was conducted over 21 counties (8,154,827 acres) in South Carolina in cooperation with the Pest Control Branch of the South Carolina Commission of Forestry. The objective of the project was to determine the operational feasibility of the aerial photographic sampling procedure developed in Mississippi with some modifications in the volume determination.

¹ Respectively, Entomologists and Statistician, USDA Forest Service, Southern Region, Doraville and Atlanta, GA, respectively, and Entomologist, South Carolina Forestry Commission, Columbia, SC.

MATERIALS AND METHOD

Description of Study Area

The western 21 counties of South Carolina covering 8,154,827 acres, were selected for the pilot project area. This area was the only one in the South considered to be in a southern pine beetle outbreak status as of November 1980. This area included National Forests, industrial, State and small, private ownerships. An 18-county area within the 21-county study site is considered one of the three survey units in South Carolina by the Forest Inventory Analysis-Southeastern Forest Experiment Station, formerly Renewable Resources Evaluation Group (Snyder 1978). Within this Piedmont area of South Carolina, a considerable variation in forest composition occurs. Hardwood, mixed pine/hardwood, pure pine stands with loblolly, *Pinus taeda*, and shortleaf pines, *P. echinata*, are present. The western edge of the study area contains mountainous terrain with elevations of up to 3,500 feet, while the eastern edge of the area is gently rolling terrain with elevations around 500 feet above sea level.

Acquisition of Aerial Photography

Color infrared aerial photography (film type 2443) was acquired by the Forest Pest Management Aerial Survey Team, Doraville, GA. Initial (baseline data) coverage was acquired in stereo for the entire 21-county area at a scale of 1:24000 (fig. 1). The team flew 6,000 linear flight-line miles with two Aero Commander 500B aircraft, each equipped with an RC-10 aerial mapping camera and a Loran-C navigation system. This system provided flight line navigation (Dull and Clerke 1980, 1983). Geographic coordinate centered flight lines were flown. Plot boundaries were also defined in terms of geographic coordinates.

Complete coverage of the study area began May 4 and ended May 15, requiring only 8 days or 58.6 hours flight time to cover the 8-million-acre area.

Aerial photographic resampling within the 21-county area began on September 16, 1982, and continued through September 29. A total of 83 plots were photographed at a scale of 1:12000.

Sample Design

Before we selected the photo plots, the South Carolina State Commission of Forestry sketch-mapped the 21-county area in April 1981, and estimated the level of outbreak intensity in each county as low, moderate or high. Trees killed by southern

pine beetles were distributed mainly in the extreme western portion of the survey area.

The entire (100 percent) area coverage provided data on the whole population (tree mortality) so that any estimates from sampling could be compared to the actual population total. Although the State aerial survey data was available, it was not used to stratify before the initial coverage in contrast to a normal operational situation. This data was not needed because we obtained 100 percent coverage. As it turned out, because of the drastic change in the southern pine beetle population, had the plots been selected on a normal basis they would have been useless for the resample.

Before resampling the area was stratified by (1) using the locations and volume killed by southern pine beetle as shown on the 100-percent coverage and (2) the acres of host type per county as indicated by RRE survey reports. Fifty plots were selected for each method (fig. 2 and 3). Because some of the plots could be used for either method only 83 had to be photographed.

A stratified random-sampling plan and analysis, using ratio estimation, was employed for both methods (Cochran 1977).

Photo Interpretation

To facilitate the photo interpretation process on such a massive number of frames, initial monoscopic viewing to determine the location and number of southern pine beetle spots was done on a Houston Instruments variscan film viewer. The viewer allowed the 1:2400 scale film to be magnified and viewed at a 1:4000 scale. After the 100-percent coverage had been interpreted to locate spots, the transparencies were viewed with a Bausch & Lomb 240 Model zoom stereoscope mounted on a Richards MIM-4 motorized light table. Each spot was categorized by the number of red and fading trees within the spot as follows:

Category 1	10-25 trees
Category 2	26-50 trees
Category 3	51-100 trees
Category 4	100+ trees

Actual counts of the number of red and fading trees were made on the photography. Crown diameter was measured using a fine scale with increments of .002 inches. Photography at a scale of 1:24000 enabled a minimum resolution with the .002 inch scale of 4 feet. Stand height was estimated with a representative sample of stands actually measured to allow for more accurate stand height estimates. The acreage of red and fading trees, black top trees, and total spot size was measured using a 1 mm square

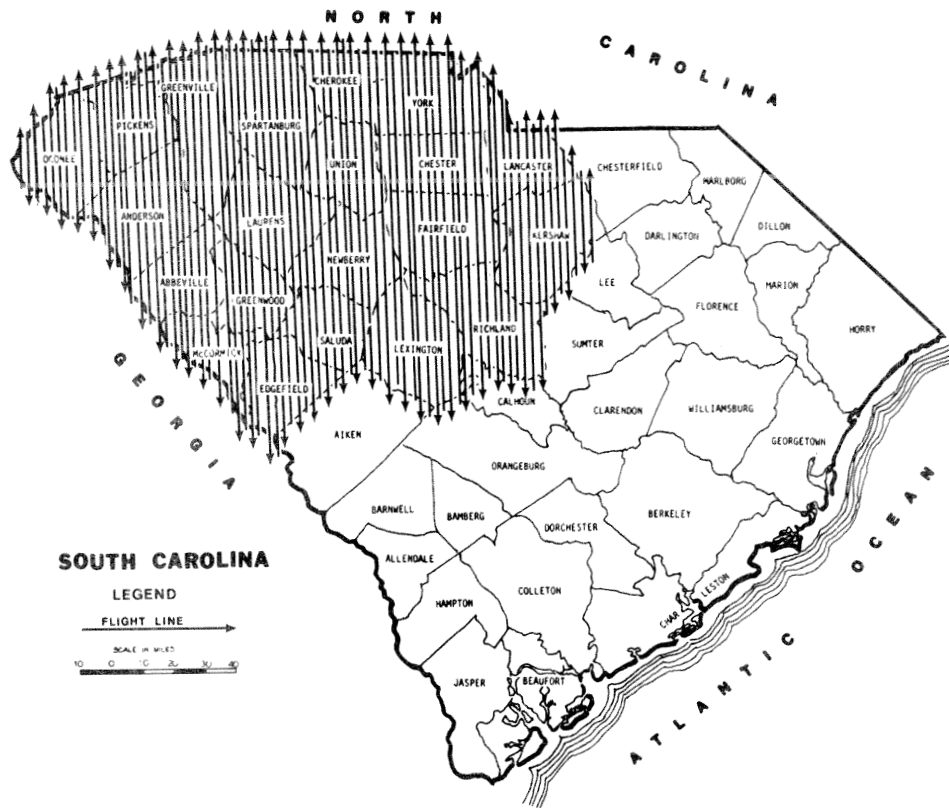

Figure 1.—Location of aerial flight lines to obtain aerial photographic coverage of the 21-county area.

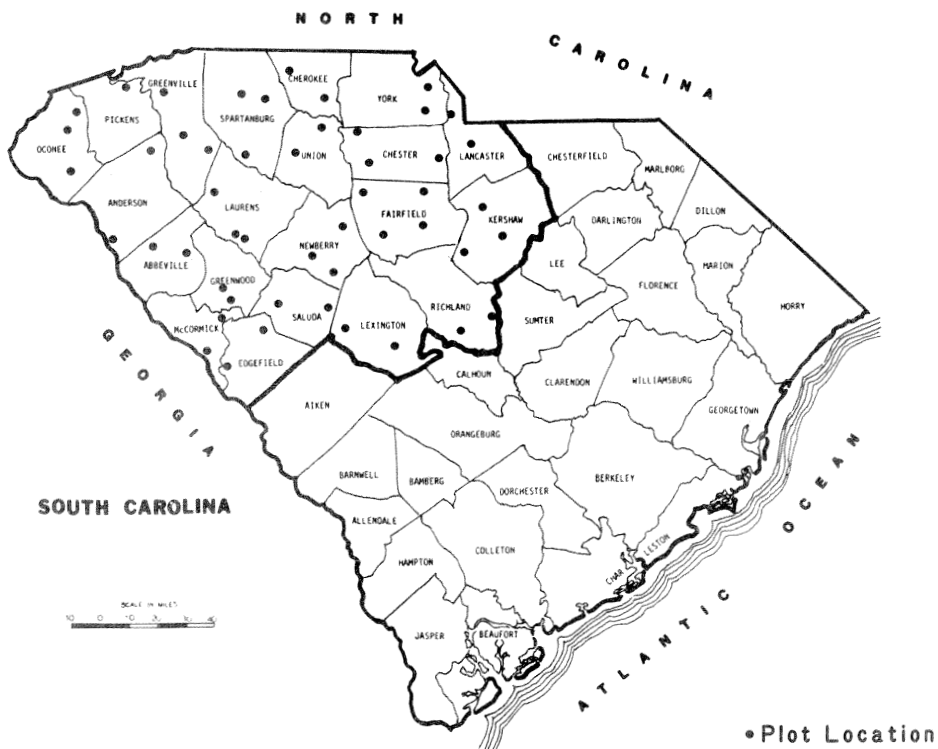

Figure 2.—Sample plot locations stratified by amount of host type per county.

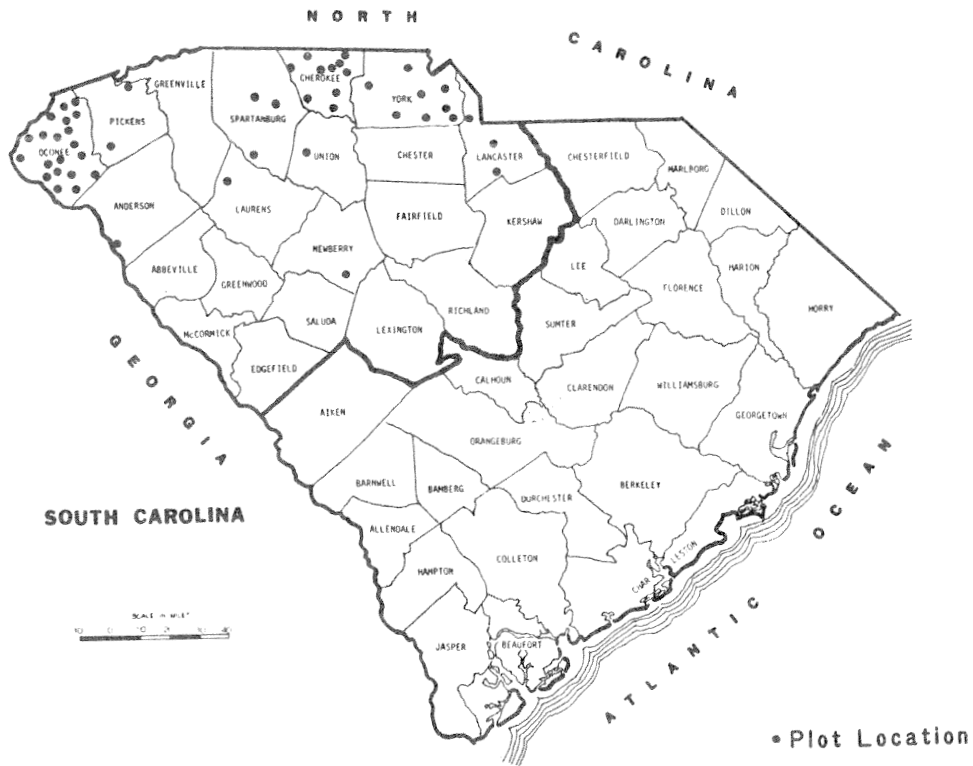

Figure 3.—Sample plot locations stratified by volume of previously detected southern pine beetle caused mortality.

finescale grid. Each grid equaled 6,400 square feet or .147 acres. The number of trees per acre were also counted using a 8-acre cell grid overlaid on the photography. All cells with 25 percent or more of the pine host type within that cell were considered as host type. The total number of cells counted within the stereo coverage area was expanded to determine the amount of host type within a plot, to determine density.

Stochastic Sampling Procedure

In the past, volume has been estimated using either available aerial tree volume tables or by regression analysis of aerial tree counts and ground measured volumes. During the Mississippi project local aerial volume tables were constructed from data collected in the beetle-killed spots.

No local aerial volume tables were available in this study area. However, the pilot test area was also the same as the Piedmont Survey Unit of the Renewable Resources Evaluation Group, Southeastern Forest Experiment Station, Asheville, NC. Equations de-

rived from data in the station's survey plots were used to estimate volume for two size classes of pines. Cubic foot volume was calculated using the following equations:

$$PV = NTPA (-.830 + .002137 (D^2H))$$

$$SV = NTPA (-.645 + .002099 (D^2H))$$

Where:

NTPA = number of trees per acre

PV = poletimber volume (5.0 to 8.9 inches d.b.h.)

SV = sawtimber volume (>9 inches d.b.h.)

H = height of stand

D = diameter at breast height

Constants in these equations were based on data from 2,086 inventory plots in the survey unit.

The Southeastern Station also provided information to derive tree diameter classes from crown diameter needed in the volume equations. The following equation was provided by the RRE Group to determine d.b.h. class from crown diameter:

$$\text{d.b.h. (inches)} = 2.661716928 + .462203926 (\text{crown diameter in feet})$$

This equation was based on 6,629 sample plots within the Piedmont Survey Unit in western South Carolina.

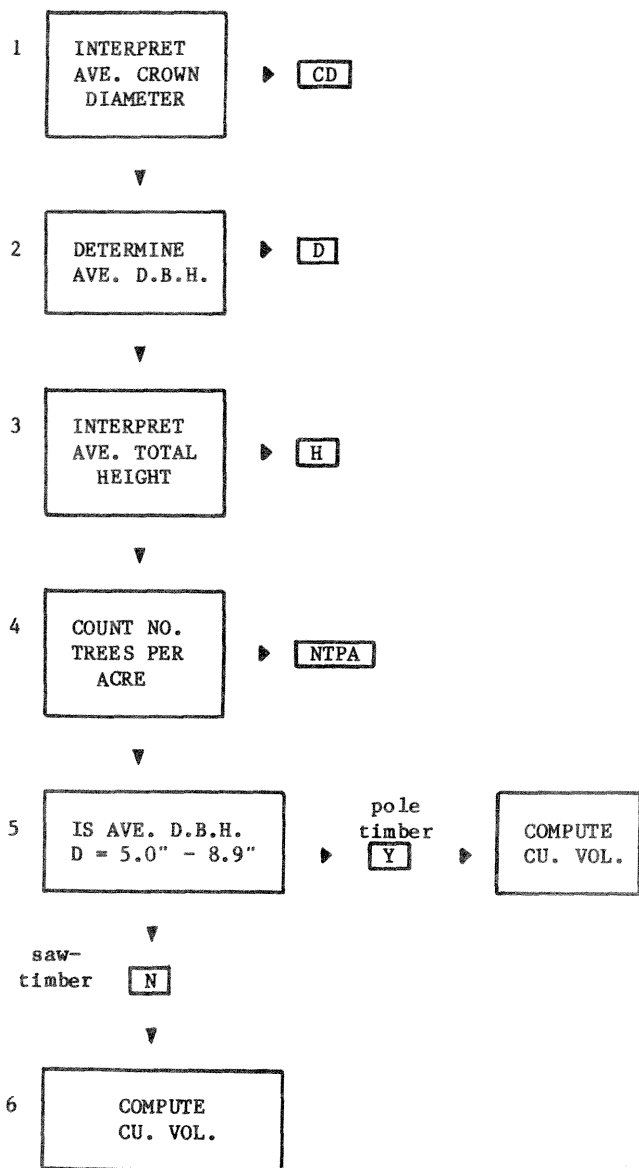

Figure 4.—Steps involved to compute merchantable cubic foot volume for the photographic interpretation estimate using RRE regression equations.

Readers should be aware that this procedure cannot be used to determine individual tree spot volumes. The procedure is intended only for calculating volumes over extensive areas. Figure 4 shows a flow chart of the steps for computing tree volume for the loss assessment survey.

Data Analysis

A stratified random sampling scheme using a ratio estimator within each stratum was employed on 83 variable-sized photo plots to determine the timber volume loss from southern pine beetles over the entire 9 million acres.

To calculate estimates of timber loss over these variable-size plots, the ratio of volume loss:acreage

was computed for each plot within each stratum. The use of ratio estimators is well documented and justified in the statistical literature (Cochran 1977). A significant decrease in the variance of estimators can be accomplished through the use of ratio estimators compared to "mean per unit" estimators (i.e., constant-size plots).

Ground Truth

Forty of the 67 spots detected on the initial photographic coverage (100 percent) were ground checked to determine the causal agent. Volume estimates of mortality were obtained in 20 of the spots on the initial set of photography and compared with aerial photographic estimates. On the resample in 1982, the same comparison was made in 30 additional spots.

RESULTS AND DISCUSSION

Photo interpretation for the presence of trees killed by southern pine beetles at the time of the initial photo coverage revealed 67 spots within the 21-county area (fig. 3). These 67 spots covered 41.59 acres or only 0.001 percent of the entire area of pine host type within the 21 counties, or only .0005 percent of the total acres within the study area. Although trees in the western portion of South Carolina were attacked by southern pine beetles before the survey, during the spring of 1981, the outbreak collapsed and beetle spots occurred rarely. Total merchantable cubic foot volume mortality caused by the southern pine beetle on the initial coverage was estimated to be 84,104 cubic feet. Forty of the 67 spots detected on the photographs were ground checked to determine if southern pine beetles indeed killed the pines. Thirty-seven of the 40 spots were determined to be caused by southern pine beetles. This check produced only a 7.5 percent error of commission in the photographic interpretation of the 1:24000 scale aerial photographs.

The 1982 aerial photographic resample for the 50 plots stratified by 1981 volume mortality showed a merchantable loss of 1,622,947 cubic feet \pm 140,260 cubic feet (68 percent confidence level). A total of 1,018,299 merchantable cubic feet \pm 140,260 cubic feet (68 percent confidence level) were lost based on stratification by acres of host type. The statistical efficiency for the host type stratification method was 1.64, i.e., the host type stratification method is 64 percent more precise statistically or 64 percent more sampling would be required if the volume stratification method were used. The ratio of standard er-

ror/mean (SE/mean) equals .18 for volume stratification whereas the SE/mean ratio equals .14 for the host type stratification method. The total number of samples used in this sampling design was more than adequate to conduct these analyses.

The volume stratification was based on the initial 100-percent photo coverage made in 1981, 16 months before the resample. The decrease in precision is related to the change in the location of beetle activity, which was different for the resample. This change illustrates the need to accurately estimate population activity immediately before the stratified sample is obtained to more accurately estimate the volume loss and reduce survey costs. The southern pine beetle is so dynamic that during periods of outbreaks the length of time to determine the stratification based on volume may be long enough for the population to change drastically and alter the validity of the survey results. The analysis also indicates that more intensive sampling would be needed during periods of low population activity to obtain a statistically reliable volume loss estimate.

The disadvantage to stratifying by southern pine beetle outbreak intensity (volume killed) is that the amount of effort required to stratify is much greater than that required to stratify by distribution of acres of host type. Moreover, a preliminary survey is needed to obtain the information on the location of beetle infestations. Another disadvantage of using outbreak intensity is that outbreak levels may change between two surveys. If the information on outbreak intensity is available and a one-point-in-time evaluation of losses is being conducted or the interval between surveys is less than 1 year, stratify by outbreak intensity. If the outbreak intensity information is not available or the interval between surveys is greater than 1 year then stratify the distribution of acres by host type.

The comparison between the photo-interpreted volume loss versus the ground-determined volume in the 30 spots checked showed an underestimate of 26 percent for the photo method. The comparison between photo-determined volume loss and ground-detection volume loss on 20 spots on the 1982 resample showed again that the aerial photographic estimate gave a lower estimate than did the ground truth inventory. The total percent error was -24.7 percent, i.e., the aerial photographic volume estimation was 24.7 percent less than the ground inventory volume estimations.

The underestimation of 26.1 percent and 24.7 percent, 1981 and 1982 respectively, for photographic volume estimation compared to the ground truth inventory can be explained after review of the data obtained from photographic measurements. Aerial

photographic estimates of crown diameter were consistently underestimated. The crown diameter measurements were used as a variable in a regression equation to compute dbh which, in turn, was used in a regression equation to compute volume. Although a close correlation can be determined between crown diameter and dbh, small scale aerial photography allows the photo-interpreter to only view, in many cases a very closed canopy, the very top portion of the crown. The underestimation of crown diameter and observed crowns of some codominant trees probably accounts for the difference in the volume estimates.

The periodic timber volume loss was computed by subtracting the volume estimate for the 100-percent aerial photographic coverage obtained in the spring of 1981 from the volume estimate obtained by the more statistically reliable host acre stratification sample obtained in the fall of 1982. During this 16-month period a total of 934,195 merchantable cubic feet were lost as a result of southern pine beetles.

The 100-percent aerial photographic coverage for the entire 21-county area cost \$0.0032 cents per acre. The cost of acquiring the volume estimate of timber mortality over the 8,154,827 acres using the stratified random sampling design using 50 sample plots costs \$0.0007 cents per acre. This figure includes the costs of acquiring the imagery, as well as labor involved in the photointerpretation.

LITERATURE CITED

- Ciesla, W. M.; Bell, J. C., Jr.; Curlin, J. W. Color photos and the southern pine beetle. *Photogrammetric Engineering*. 33:883-888; 1967.
- Clerke, W. H.; Ward, J. D. Estimating tree mortality over extensive areas. In: *Symposium proceedings: evaluating control tactics for the southern pine beetle*. 1979 January 30-February 1; Many, LA. *Tech. Bull.* 1613. Washington, DC: U.S. Department of Agriculture; 1979: 75-85.
- Cochran, W. *Sampling techniques*, 3d ed. New York: John Wiley and Sons, Inc.; 1977. 413 p.
- Draper, N. R.; Smith, H. *Applied regression analysis*. New York: John Wiley and Sons, Inc.; 1966. 407 p.
- Dull, C. W. Pilot test of a sampling method to measure timber mortality caused by the southern pine beetle in South Carolina. Atlanta, GA: U. S. Department of Agriculture, Forest Service, Southeastern Area State and Private Forestry; 1980. 73 p.
- Dull, C. W.; Clerke, W. H. Loran-C navigation systems as an aid to southern pine beetle surveys. *Agric. Handb.* 567. Washington, DC.: U. S. Department of Agriculture; 1980. 15 p.

- Dull, C. W.; Clerke, W. H. Loran-C navigation as an aid to aerial photographic operations. *Photogrammetric Engineering and Remote Sensing* 49(11): 1577-1584; 1983.
- Ghent, J. H.; Ward, J. D. Determination of annual timber mortality: impact of the southern pine beetle. Final report to the Expanded Southern Pine Beetle Research and Applications Program. Pineville, LA: U. S. Department of Agriculture, Southern Forest Experiment Station; 1980. 39 p. [Unpublished report.]
- Mead, Roy A.; Smith, James L. Development of an aerial photo volume table for trees infested with southern pine beetles. Final Report No. 80-1. Atlanta, GA: U. S. Department of Agriculture, Forest Service, Southeastern Area State and Private Forestry; 1979. 33 p. [Unpublished report.]
- Snyder, Nolan L. Forest statistics for the piedmont of South Carolina 1977. Resource Bulletin SE-45. Asheville, NC: U. S. Department of Agriculture, Forest Service, Southeastern Forest Experiment Station; 1978. 33 p.

Objective Prediction of Climate-Related Changes in the Distribution of Southern Pine Beetle

Patrick J. Michaels, David E. Sappington, and Philip J. Stenger¹

Abstract.—A statistical model has been developed to relate changes in areal coverage of the southern pine beetle (*Dendroctonus frontalis* Zimm.) to a multivariate combination of temperature and moisture status indices. It is applicable over the entire range of epidemic outbreaks during the last quarter-century. The model properly hindcast the signs of major coverage changes during that period in a highly significant fashion, based upon an independent data set.

The study results have been adopted into an interactive computer program named SPBCMP. It requires only easily-accessed climatic data and a mini-computer. The program is particularly amenable for management decisions based upon "what if?" scenarios of future weather.

Additional keywords: *Dendroctonus frontalis*, large-area modeling, pine beetle/host relationships.

INTRODUCTION

The southern pine beetle (*Dendroctonus frontalis* Zimm.) is one of the most economically important forest pests in the United States. Several major outbreaks during the 20th century have damaged extensive stands of southern pine species, resulting in multimillion dollar losses and also in substantial alteration of both natural and managed stands.

The study detailed here describes a series of computer models that qualify our knowledge of the relationships between southern pine beetle ("SPB") and its gross environmental determinants—monthly mean temperatures, total precipitation, and long- and short-term moisture stress indices.

Objectives included:

1) Determination of the relationship between cli-

matic variability and changes in SPB coverage over its entire epidemic range, and

2) Development of a management-oriented computer package to use those findings for predictive purposes.

BACKGROUND RESEARCH

The early literature on the southern pine beetle suggested that the prime determinant of change in infestation level is the moisture status of the host trees (Craighead 1925, Beal 1933). The literature also suggested that winter temperatures strongly influence the infestation levels in succeeding years.

Quantitative investigations of the influence of climatic fluctuation on large-area changes in SPB levels began with the multiple regression models of Kroll and Reeves (1978) and Campbell and Smith (1980). These two statistical models, based upon rather simple temperature and rainfall data, fit historical records of SPB quite well, but do not exhibit predictive capability when tested on independent data.

Multiple regression models often become unstable in the predictive mode because an inappropriate number of residual degrees of freedom is consumed in the fitting mode. Recognizing this, Kalkstein (1981) first filtered the temperature and precipitation data with a principal component analysis (PCA) before using them as predictors for SPB changes. That work was more stable in the predictive mode than earlier attempts, but still suffered from an inability to produce statistically significant results over an aggregate of independent data.

Michaels (1984) also performed a prior PCA on temperature and precipitation data. Predictive capability was maintained in the test mode by substantially increasing the number of residual degrees of freedom through use of multiple climatic districts (CD's) within an overall geographic model. That work, applicable to coastal and Piedmont Virginia and the Carolinas, was not successfully extended to surrounding regions.

The CD appears to be an appropriate unit for both the aggregation of climatic data and determination of pest response. CD's were chosen to delineate relatively uniform climatic regions, based both upon hydrography and geography. The associated tree species (which respond to both) thus tend to aggre-

¹ Virginia State Climatologist, and Research Assistants, Climate/Ecosystems Dynamics Group, Department of Environmental Sciences, University of Virginia, Charlottesville, VA. (This work was primarily supported by Cooperative Agreement #59-2513-1-3-006-0 with the United States Department of Agriculture, Forest Service. Additional support was provided by the Virginia State Climatology Office and the University of Virginia Academic Computing Center. The authors appreciate the technical assistance of Martha J. Buffum, John R. Scala, and John K. Hoover of the Department of Environmental Sciences, University of Virginia.)

gate into community distributions along similar geographic lines.

The work presented here extends Michaels' (1984) results over the entire endemic range of the SPB. Increased geographic coverage was gained by including a multivariate analysis of two objective soil moisture indicators, the Palmer Drought Severity Index (PDSI), and the Crop Moisture Index (CMI).

Our research was then integrated into an interactive microcomputer-applicable program, designated SPBCMP (SPB CoMPutation). This program was designed to meet the objectives described earlier and can thus serve as a useful tool for determination of management decisions related to the large-area spread of SPB.

METHODOLOGY

The principal components of the combined fields of temperature, rainfall, and two moisture status indices were first calculated, then used as predictors of the change in areal coverage from one year to the next. For the illustrative example used to describe our models, the climatic input begins in July previous to the outbreak year, and continues through June of the outbreak year; for application purposes, three different models were constructed that end at different times during the year.

Database—temperature and precipitation.—Our temperature and precipitation database consisted of the 53-year (1931-83) record of Climatic District (CD) monthly mean temperatures and total precipitation from NOAA's National Climatic Data Center (NCDC) in Asheville, NC. The substantial reliability of these data was detailed in the earlier report (Michaels 1984). This and the subsequently described climatic databases apply to the 38 CD's over the epidemic range of SPB (fig. 1).

Palmer drought severity index (PDSI). — Data from 1931-83 were also provided by NCDC for each CD; 1982-83 data were from the National Oceanic and Atmospheric Administration's Climate Analysis Center (NOAA-CAC). The PDSI is a long-term indicator of moisture status. (See Palmer (1948) for a detailed description.) Briefly, the PDSI is a hydrologic-balance measure, based upon temperature, precipitation, runoff, and storage terms. The storage terms are designed so that time constants for both the development and the cessation of drought are quite large. Over most of our study area, a substantial number of below-normal monthly rainfall totals is required to change the index from "normal" values (PDSI between ± 2.00) to those indicating unusual moisture excess or deficit (greater or less than ± 2.00).

The PDSI also suffers from the fact that it is normalized to a value of ± 2.00 for each CD, based upon a mean of zero and its raw standard deviation. Thus,

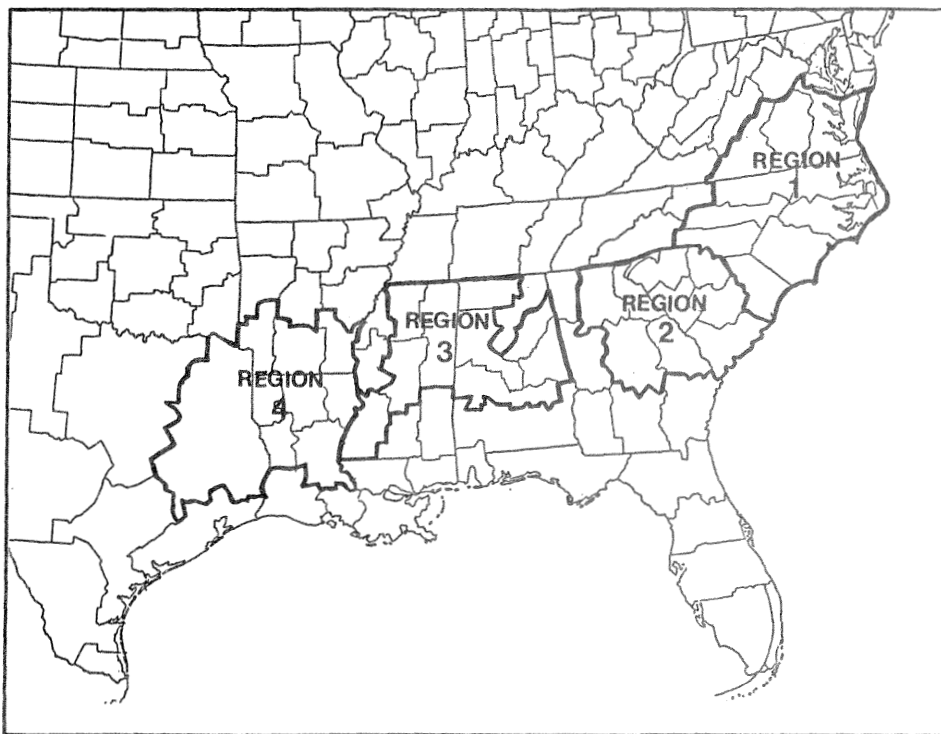

Figure 1.—The four regions used in this study.

it can be expected in 1 or 3 years, in each CD, that the PDSI will show excessive moisture surplus or shortfall. The underlying assumption is that agricultural economies are negatively impacted in the 1-in-6 years in which it falls below -2.00 over each CD.

Another problem with the PDSI concerns the time constants — agricultural droughts are known to develop before the index reaches excessively negative values—presumably because topsoil and crop root depth levels dry out before the index does. The midwestern and mideastern agricultural droughts of 1980 and 1983, which occurred before the index registered very low values, bear testimony to the PDSI's shortcomings.

It is perhaps most useful to consider the PDSI as a measure of deep-soil moisture. A modified index, called the Crop Moisture Index (CMI), is more reflective of shallow-soil moisture status and is the remaining variable used in our model of SPB coverage change.

Crop moisture index (CMI).—The CMI is a modified version of the PDSI, based primarily on non-linear changes in the storage terms. Up to the time of this study, there was no long-term record of the CMI that could be used for modeling purposes. The joint USDA/NOAA Agricultural Weather Facility supplied us with the program that calculates the PDSI and CMI. We modified it, inputting CD temperature and precipitation values from NCDC, and calculated a 51-year (1930-80) record of the CMI. Data for 1981-83 were obtained from NOAA-CAC.

The CMI is a weekly-based index, while PDSI is monthly. We generated surrogate weekly PDSI values by fitting a smooth curve through the monthly time series. We then calculated weekly values of the intermediate terms used in the PDSI formulation—including storage terms, hydrological factors, and modifications to normalize the data, as described above. The weekly CMI values were then converted into monthly ones with simple averaging.

To our knowledge, this represents the most comprehensive CMI file currently available and thus should be useful to both forestry and agricultural researchers. Copies can be obtained either from the authors or through the USDA Forest Service's Southern Forest Experiment Station, New Orleans, LA.

SPB coverage data.—Our dependent variable, SPB coverage, was calculated from the southwide county-presence data of Price and Doggett (1978) and Swain (1980). The period of record is the 24 years extending from 1960 through 1983.² As noted earlier (Michaels 1984), the data only indicate the presence

of spots in a county, and do not directly represent the density or severity of an outbreak.

First, the area of each county was expressed as a percentage of the total area circumscribed by each CD. The annual record of county presence was then entered. SPB infestation intensity was then recorded as the percentage of CD area in which spots were reported, based upon county presence or absence.

Not all of the land within a CD contains the community composition that can support SPB. Initially, the total area of each CD was adjusted for the amount of colonizable land, as determined by USDA forest inventory statistics. Subsequent results indicated no significant model improvement when this database modification was made. In fact, the final regression often indicated that more than 100 percent of the apparently colonizable land could be covered by SPB spots when referenced to the county data. Therefore, we chose to use our earlier, simple formulation in the subsequent models.

Input Data Analyses

The time series of temperature, precipitation, PDSI, and the CMI displays considerable temporal and spatial correlation. Thus, a principal component analysis (PCA) was performed on the monthly variables in an attempt to combine them into groups of uncorrelated predictors. This technique resulted in a series of linear combinations of the data that efficiently explained most of the variance within and between original input variables.

While applications of this technique are relatively recent in the forestry literature (Michaels 1984, Newcomer and Meyers 1984, Kalkstein 1981), principal components, or some variant of them, are often used in the climatological and meteorological literature (see Michaels and Gerzoff 1984, Cohen 1983, Hayden and Smith 1982, for typical recent examples). Over 60 recent articles in referred atmospheric science journals used this type of analysis (Richman 1983).

We subdivided the southeastern endemic SPB area into four distinct regions (fig. 1). They are 1) the same coastal and Piedmont regions of Virginia and the Carolinas used in our earlier work (Michaels 1984), 2) upland and Piedmont Georgia and South Carolina, 3) Piedmont Mississippi and Alabama, and 4) southern Arkansas, northern and central Louisiana, and a large area in east Texas. These regions were chosen to minimize the number of CD's that would enter into a predictive model. Larger areas lost predictability in part because of seasonality changes through a southwestward transit of the region. As an example, the onset of spring is over a

² Data for 1981-83 were supplied by personal communication.

month earlier in Louisiana than in Virginia. The design of our statistical models, described below, makes them unable to compensate for this natural phenomenon.

The principal components of the climatic data were of the form:

$$PC_n = \sum_{i=1}^{12} \alpha_i T_i + \sum_{i=1}^{12} \beta_i P_i + \sum_{i=1}^{12} \lambda_i D_i + \sum_{i=1}^{12} \phi_i M_i \quad (1)$$

where n refers to the order (first, second, etc. . . .). Each linear combination of the raw data is uncorrelated with each of the others, and successively explains less of the variance-covariance structure of the input data.

The summation ($i=1$ to 12) is over the 12 months including and prior to midsummer when SPB becomes economically important; note that we have developed applications models ending at other times, as detailed below. In the example here, the data extend from July of the previous year through June of the current one. T_i and P_i refer to mean monthly temperature and total precipitation. D_i and M_i are monthly average drought and moisture index values. The Greek letters are individual monthly coefficients (sometimes called "weightings") for each of the climatic terms.

The absolute values of the weightings within each component determine the importance of the climatic variables. Variables that have the most spatial and temporal correlation will tend to be the highest weighted on the lower order (first, second, etc. . . .) components. Thus the PDSI values, which have a long time constant, display month-to-month correlations that are accounted for in the components statistically most important.

Table 1 details, in abbreviated form, the relative weightings for each group of climatic terms in the first five principal components for Region 1 (see regional breakdown above). The highest values in the first component are uniformly distributed through the PDSI variables. They are approximately the same for the 8 months not listed in the table. Thus, the most common pattern of fluctuation in the climatic data is for the PDSI to be either uniformly above or below normal for the entire year. The same applies to temperature in the second principal component. In higher order components, expected climatic anomalies tend to become more seasonal in nature; by component #6, they tend to be monthly.

The statistical test of Overland and Preisendorfer (1982) can be used to determine whether or not an individual high order component is primarily dependent only upon the variance of one variable. The null

Table 1. — *Weighting factors for the climatic data for the first five principal components¹*

Variable	Comp #1 Weight	Comp #2 Weight	Comp #3 Weight	Comp #4 Weight	Comp #5 Weight
TJUL	-.0187	.1070	.0763	-.0628	.0693
TOCT	-.0158	.1154	.0206	.0403	.0100
TJAN	-.0042	.1111	.0275	-.0008	.0333
TAPR	-.0152	.1000	.0072	-.0676	.0834
PJUL	.0147	.0820	-.0516	.0629	-.0937
POCT	.0247	-.0190	-.0152	-.0021	.1336
PJAN	.0339	-.0138	.0875	-.0101	-.0052
PAPR	.0349	-.0268	.0926	-.0208	-.0099
CMIJUL	.0251	.0457	-.0766	.0585	-.1417
CMIOCT	.0534	.0112	-.0919	-.0241	.0309
CMIJAN	.0561	-.0274	.0674	-.0713	.0315
CMIAPR	.0395	-.0376	.1127	-.0025	-.0830
PDSIJUL	.0529	.0384	-.0776	.0445	-.0964
PDSIOCT	.0732	.0146	-.0828	-.0290	.0371
PDSIJAN	.0826	.0062	.0185	-.0606	.0416
PDSIAPR	.0764	-.0113	.0925	.0063	-.0452

¹Includes only data for July, October, and January because of space limitations.

hypothesis used with this test is that the data are spatially uncorrelated.

The Overland and Preisendorfer (1982) test is based upon an extensive Monte Carlo analysis. The published table, which only applies to the .05 level, gives the expected value of explained variance as a function of the number of raw variables, the number of observations, and principal component number. It also extends only through the fifth principal component: it was extended with a regression-based logarithmic extrapolation. Table 2 details some of the results of this test.

Cohen (1983) used another significance criterion, called the Scree Test, in which components whose eigenvalue is less than 1.0 are considered insignificant. In that case, the principal component explains less variance than does an average raw input variable prior to the initiation of the PCA. While this may seem an appropriate ending point for the analysis, Jolliffe (1982) argues that higher order components that do not pass the Scree Test may still be important predictors of some response variable.

Southwide Models for SPB and Climate

After the raw data were filtered to determine their most significant modes of variation with the principal component analysis, the derived variables were subjected to a multiple regression analysis to determine their relation to SPB coverage. The basic prediction model, for each of the four regions, was of the form.

$$\Delta SPB = K + \sum_{i=1}^n \beta_i (PC_i) \quad (2)$$

Table 2. — Summary of principal components analyses of the climatic data for the four regions

Comp. #	Region 1		Region 2		Region 3		Region 4	
	Percent var. expl.	Cum. percent var.	Percent var. expl.	Cum. percent var.	Percent var. expl.	Cum. percent var.	Percent var. expl.	Cum. percent var.
1	22.2*	22.2	29.0*	29.0	27.2*	27.2	24.7*	24.7
2	12.7*	34.9	14.3*	43.3	10.8*	38.0	13.6*	38.3
3	10.3*	45.2	8.7*	52.0	8.1*	46.1	8.7*	47.0
4	6.9*	52.1	6.1*	58.1	6.3*	52.4	5.4*	52.4
5	6.7*	58.8	5.1*	63.2	5.4*	57.8	5.0*	57.4
6	4.2*	63.0	3.9*	67.1	5.3*	63.1	4.3*	61.7
7	4.1*	67.1	3.5*	70.6	4.2*	67.3	4.1*	65.8
8	3.3*	70.4	3.2*	73.8	3.6*	70.9	3.6*	69.4
9	3.1*	73.5	2.9*	76.7	3.2*	74.1	3.3*	72.7
10	2.9*	76.4	2.8*	79.5	2.7	76.8	3.2*	75.9
11	2.6*	79.1	2.6	82.1	2.4	79.2	2.7*	78.6
12	2.6*	81.7	2.1	84.2	2.2	81.4	2.4	81.0
13	2.3	84.0	2.0	86.2	2.0	83.4	2.2	83.2

*Significant at the .05 level, according to the Overland and Preisendorfer (1982) Monte Carlo simulation. (See text for details.)

$$SPB_i = \hat{SPB}_i + e_i \quad (3)$$

The regression model is based upon 1960-83 beetle and climate data. \hat{SPB}_i is the regression-fit change in percent CD coverage, subject to the restrictions described in the Input Data Analysis section. It is expressed as the best-fitting linear combination of the variables on the righthand side of the equation.

K is the regression constant for each of the four regions. The $(PC)_i$ are the amplitudes for each component selected as a significant predictor. The β_i are coefficients for each of the components calculated with least squares regression. Components were selected in an iterative fashion, with the lowest order ones entered first and tested for significance. No order higher than 18 was entered, as it is in that range that eigenvalues begin to fall below 1.0. The observed value, SPB_i , is the sum of the predicted value (\hat{SPB}_i) and the residual, e_i .

Each of the components was included in a stepwise fashion, and only those that were significant with a partial F-value of 4.00, corresponding to the 6 percent significance level, were retained in the final prediction equations for each region. Statistical summaries of each regional model are presented in tables 3a-d. The equations governing each model can be deduced from the tables by expressing them as the regression constant plus the algebraic sum of the regression coefficients multiplied by each principal component.

The analyses of variance included in tables 3a-d show that, in general, more spatial and temporal variance was explained in each region than in our earlier work for the Atlantic Coastal and Piedmont region.

In that region, percent variation explained increased substantially: from 25 to 38 percent.

Figure 2 details the percentage of occurrences in which the regression model successfully diagnosed the sign of a coverage change greater than 25 percent.

Model Testing

Each input year was then sequentially withheld from each regional model and new regression equations calculated. This changes the models from "fitting" to "test" mode, mimicking the situation in which planners would use models that were updated with new data every year. The results of this test, for the major population change years, are shown in figure 3. Figures 4a and 4b display the observed, regression-fit, and test-calculated values of SPB coverage change during each of the major population change years in regions 1 and 4.

Also tested was whether the percent of correct estimates of the sign of coverage change during the most important years differed significantly from chance, with the binomial probability distribution as the null hypothesis. The figures shown in table 4 refer to the "test" mode that mimics operational use.

Our results indicate that the regression equations used to estimate SPB coverage change are robust enough for operational use, on an interactive micro-computer program designed for field application.

PREDICTION MODEL SPBCMP

The principal components of the climatic data and the regional regression equations were input into an interactive computer program for field use, des-

Table 3a. — *Statistical summary of the region 1 model (July-June)*

Variable	Reg. coeff.	F/significance
Component #6	10.22	48.24/.000
Component #13	-8.76	37.41/.000
Component #18	-6.39	24.70/.000
Component #4	4.68	15.66/.000
Component #15	-4.33	9.33/.002
Component #12	2.66	4.06/.045
Component #3	2.33	3.14/.078
Regression constant	2.24	2.57/.110
Summary statistics		
Standard error of individual estimates		19.27
Multiple correlation coefficient		.6199
Percent variation explained		38.43
Overall F-ratio/significance		19.79/.0000

Table 3b. — *Statistical summary of the region 2 model (July-June)*

Variable	Reg. coeff.	F/significance
Component #6	-11.15	29.97/.000
Component #13	7.82	14.94/.000
Component #3	6.76	10.42/.001
Component #4	5.49	7.58/.006
Component #2	-5.38	7.02/.009
Regression constant	2.37	2.12/.266
Summary statistics		
Standard error of individual estimates		31.24
Multiple correlation coefficient		.5062
Percent variation explained		25.63
Overall F-ratio/significance		15.43/.000

Table 3c. — *Statistical summary of the region 3 model (July-June)*

Variable	Reg. coeff.	F/significance
Component #2	7.24	15.78/.000
Component #5	-6.55	12.94/.000
Component #14	6.54	12.36/.001
Component #3	5.85	11.42/.001
Component #6	-4.26	6.05/.015
Regression constant	2.74	2.30/.131
Summary statistics		
Standard error of individual estimates		24.85
Multiple correlation coefficient		.5476
Percent variation explained		29.99
Overall F-ratio/significance		19.18/.000

Table 3d. — *Statistical summary of the region 4 model (July-June)*

Variable	Reg. coeff.	F/significance
Component #12	-9.64	31.95/.000
Component #11	5.89	18.46/.000
Component #14	5.18	11.18/.001
Component #7	3.78	6.87/.009
Component #13	-3.68	4.34/.039
Component #18	2.64	3.66/.057
Regression constant	0.21	0.18/.892
Summary statistics		
Standard error of individual estimates		.20.51
Multiple correlation coefficient		.5068
Percent variation explained		25.69
Overall F-ratio/significance		11.51/.000

Table 4. — *Summary of predictive test when the coverage change in a CD was more than 25*

Region #	N correct/nobs	Percent correct	Due chance
1	36/42	85.7%	.0000
2	51/80	63.8%	.0092
3	37/60	61.7%	.0462
4	30/37	81.1%	.0001
Total	154/219	70.3%	.0000

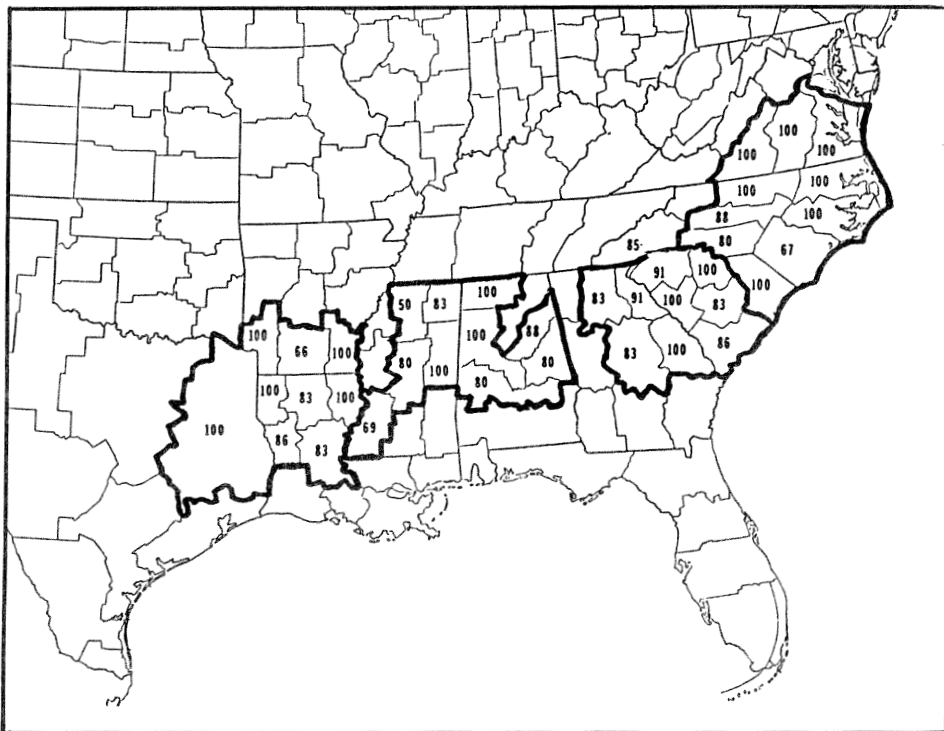

Figure 2.—*Percent of occurrences that the sign of a major (25 percent) coverage change was correctly fit by the regression (July-June model).*

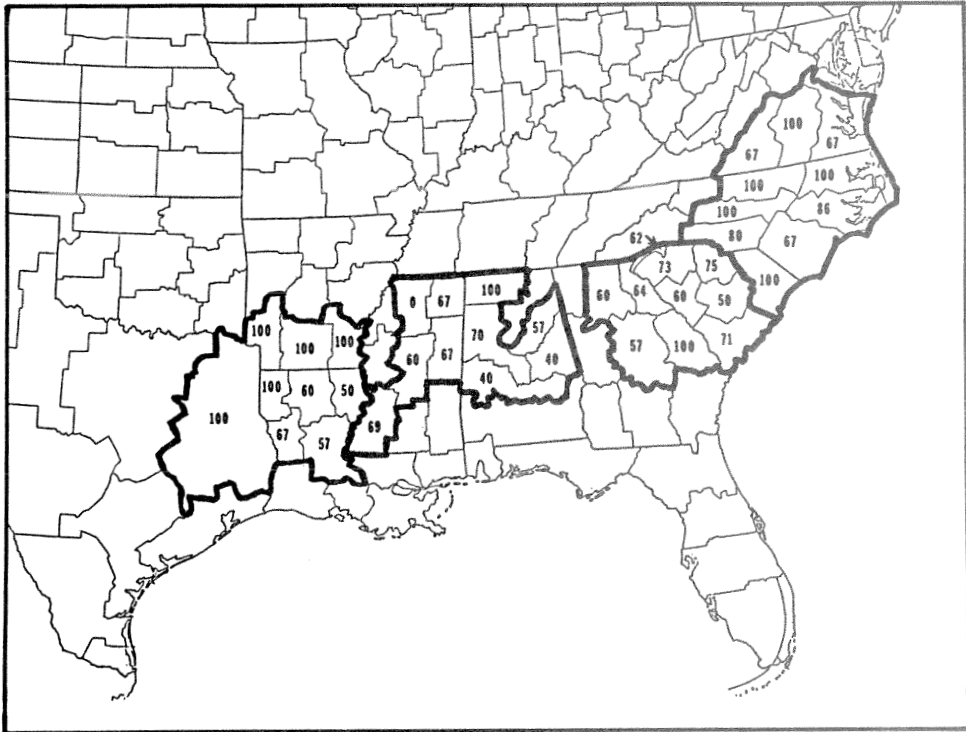

Figure 3.—Percent of occurrences that the sign of a major (25 percent) coverage change was properly forecast by the model using independent data (June-July model).

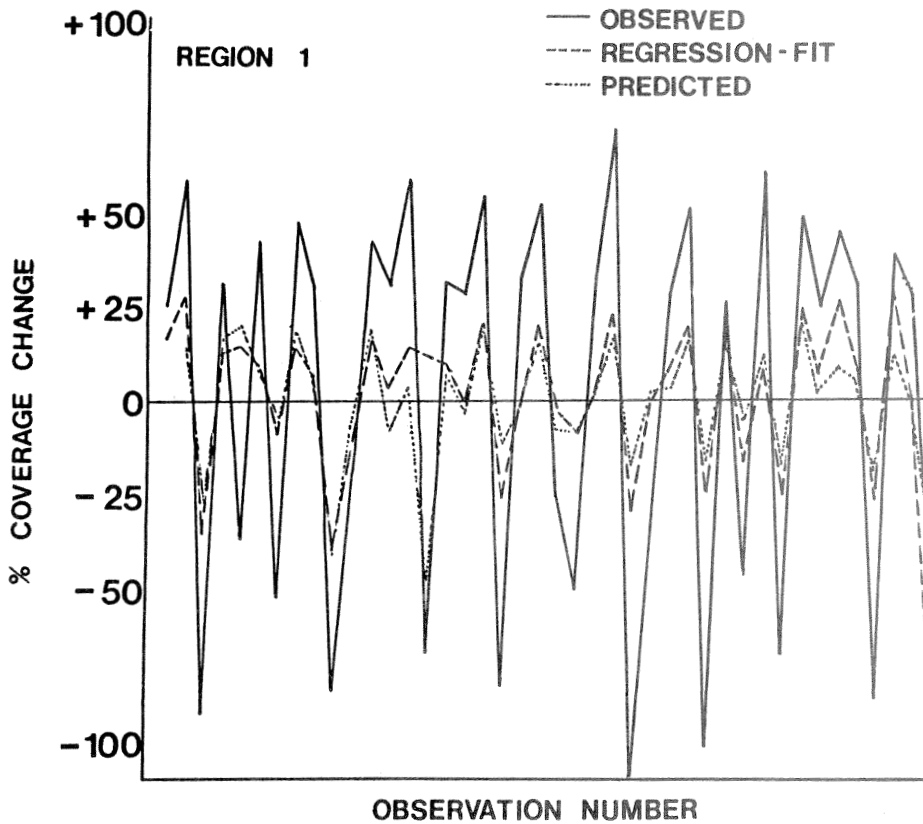

Figure 4a.—Observed, fit, and predicted SPB coverage changes for the most important years in Region 1 (July-June model).

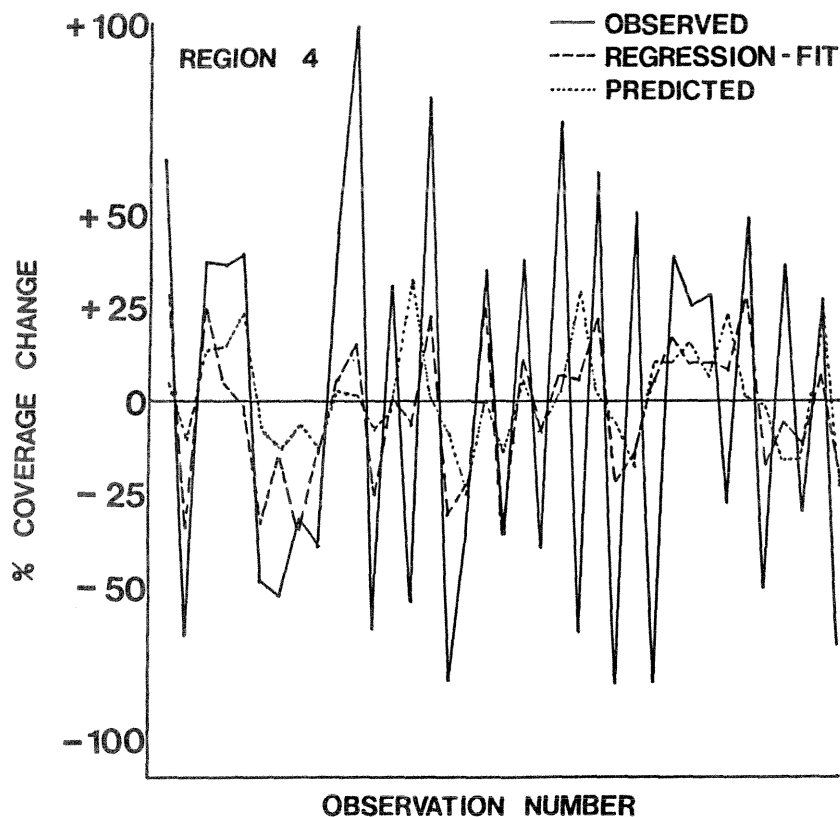

Figure 4b.—Observed, fit, and predicted SPB coverage changes for the most important years in Region 4 (July–June model).

ignated SPBCMP (SPB CoMputation). SPBCMP is completely menu-driven, and requires no outside documentation for general operation. However, a step-by-step manual is currently in preparation for distribution.

SPBCMP is available in three versions. Version 1 uses climatological data from April of the previous year through March of the current year. Version 2 uses climatological data from January through December of the previous year and is thus designed for longer range predictions than version 1. The third version uses climatological data from July of the previous year through June of the current (outbreak) year. It is most suitable for application in the late spring, when “what if?” statements concerning May and June weather might yield useful information for planning purposes.

Each version has been written in BASIC language and can be operated on almost any microcomputer with BASIC and at least 64K of random access memory. All three versions of SPBCMP for one region can be contained on one standard 5.25-inch floppy diskette. The typical user would, therefore, require a diskette for each region desired. Diskettes containing SPBCMP are currently available in a number of formats for many common microcomputers. Copies

of the diskettes, as well as paper copy of the BASIC source code, are available either from the authors, or from the Forest Service. Additionally, any of the SPBCMP version/region combination desired can be downloaded by any user with a modem by accessing the University of Virginia Academic Computing Center. Downloading of the program in this fashion circumvents formatting problems associated with the direct distribution of diskettes. It also allows users to obtain new copies or improved versions of SPBCMP.

The flowchart for SPBCMP is detailed in figure 5. After the user loads and initiates the running of SPBCMP in BASIC, the program presents an introduction, which identifies both the version and region in use and the authors, gives a brief description of the program, and explains to the user what data will need to be entered into the program. In version 1, for instance, the required data are monthly temperature, precipitation, PDSI, and CMI for May of the previous year through April of the current year. If the user does not have this information available, the latest data may be obtained by accessing the supporting program SPBCLI at the University of Virginia Academic Computing Center or by contacting the authors directly. SPBCLI provides a climatic data

listing for the most recent 24 months. It is updated with the previous month's data as soon after the end of the month as possible.

SPBCMP then displays the climate districts in the appropriate operational region. After the desired CD is selected, the program prompts the user for all of the necessary climatic data. By entering "99" in response to a prompt, the user directs the program to insert the mean value for the last 50 years for that parameter. When the climatic data have been entered, SPBCMP then calculates the percentage of coverage change expected within the CD and the confidence that the system has in its ability to diagnose the *sign* of the change for that year. Note that no confidence figure is calculated for the absolute magnitude.

After the initial calculations are made, SPBCMP also allows for the input of various forecasts and scenarios of future weather. This is accomplished by a simple editing feature contained within the program. For example, a user desiring a calculation during the spring prior to outbreak can input the observed data through late winter, and add forecast or hypothesized values for the spring and early summer. Thus he can calculate the effect of unusual future weather acting in concert with that which has been observed during the previous 9 months. An analogous example is given in figure 6. An additional advantage of this "what if?" feature is that it allows the user to determine those climatic variables to which SPB coverage is most sensitive, given a particular area/time combination.

DISCUSSION AND CONCLUSION

A statistically significant fit of 24 years of Climate District-based SPB coverage figures was achieved with combined temperature and moisture indices generated by principal components analysis. The results only detail multiple correlation, rather than causation. However, the regression models perform adequately under field test conditions.

We feel that this work probably exhausts the readily available climatic data that can be used to predict

SPB coverage changes. However, some additional improvement might be afforded by the inclusion of more arcane climatic data, such as thunderstorm and lightning frequency.

Our models were sufficiently robust to warrant the development of a series of interactive computer programs, designated SPBCMP, that allows for the calculation of coverage change with the input of the CD location, temperature, precipitation, and moisture index values. Those programs are briefly described here. Also being completed is an overall reference manual that will be available either from the authors or from the USDA Forest Service.

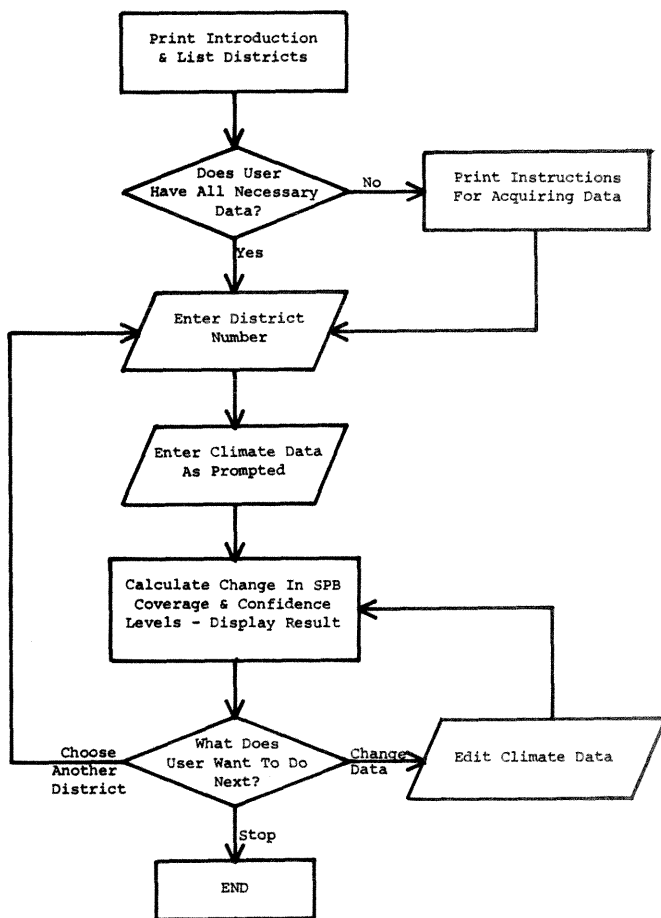

Figure 5.—Flowchart for SPBCMP.

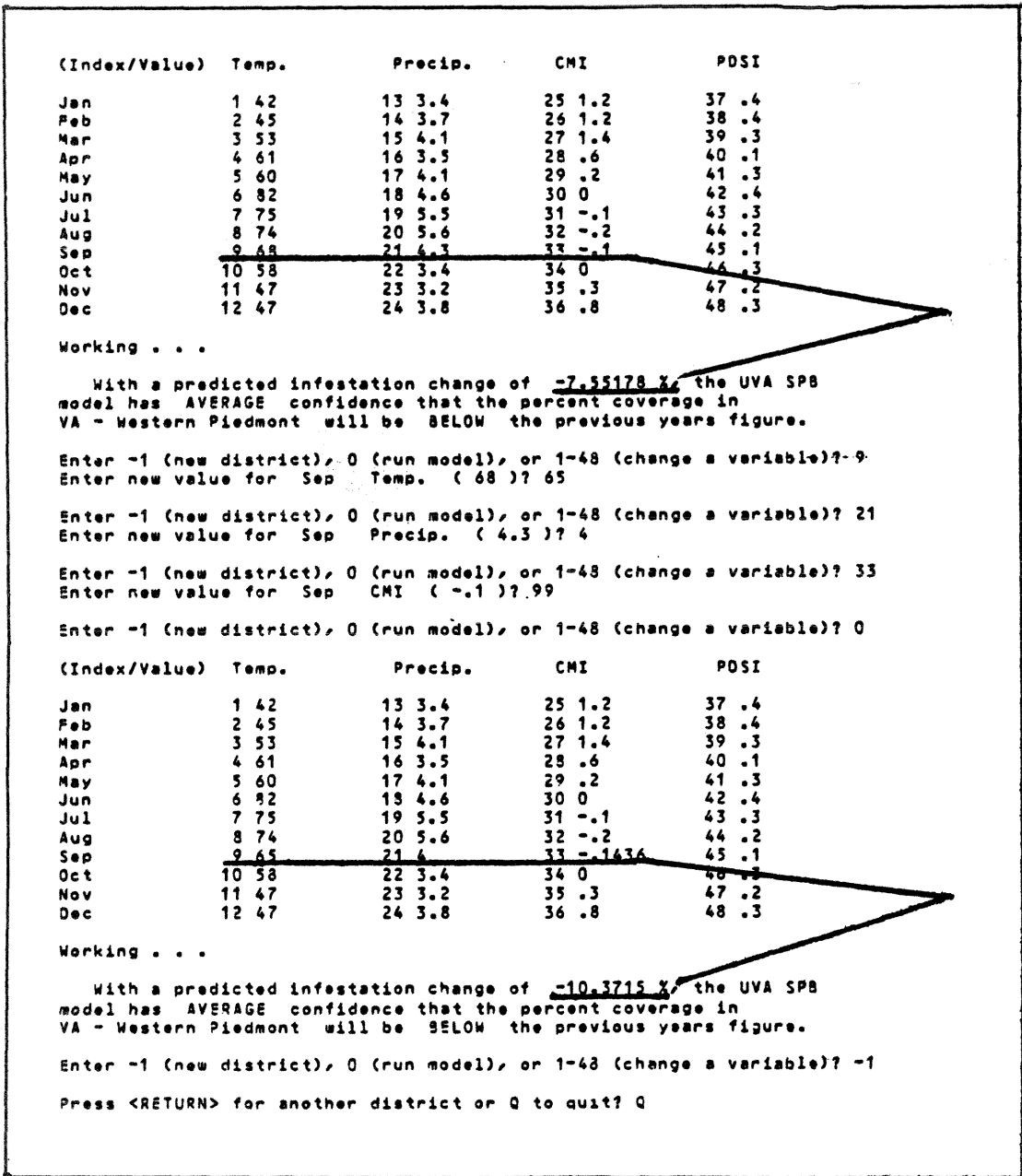

Figure 6.—In this “what if” example, the user has slightly changed September temperature and rainfall, resulting in a small decline in predicted SPB coverage the next year.

LITERATURE CITED

- Beal, J. A. Temperature extremes as a factor in the ecology of the southern pine beetle. *J. For.* 31: 329-336; 1933.
- Campbell, J. B.; Smith, K. E. Climatological forecasts of southern pine beetle infestations. *South-east. Geog.* 20: 16-30; 1980.
- Cohen, S. J. Classification of 500mb height anomalies using obliquely rotated principal components. *J. Clim. and Appl. Meteor.* 22: 1975-1990; 1983.
- Craighead, F. C. Bark beetle epidemics and rainfall deficiency. *J. Econ. Entomol.* 18: 557-586; 1925.
- Hayden, B. P.; Smith, W. L. Season-to-season cyclone frequency prediction. *Mon. Wea. Rev.* 10: 239-253; 1982.
- Joliffe, I. T. A note on the use of Principal Components in regression. *Appl. Stat.* 31: 300-308; 1982.
- Kalkstein, L. S. An improved technique to evaluate climate-southern pine beetle relationships. *For. Sci.* 27: 579-589; 1981.
- Kroll, J. C.; Reeves, H. C. A simple model for predicting annual numbers of southern pine beetle infestations in East Texas. *South. J. Appl. For.* 2: 62-64; 1978.
- Michaels, P. J. Climate and the southern pine beetle in Atlantic Coastal and Piedmont regions. *For. Sci.* 30: 143-156; 1984.
- Michaels, P. J.; Gerzoff, R. B. Statistical relations between summer thunderstorm patterns and continental midtropospheric heights. *Mon. Wea. Rev.* 112: 778-789; 1984.
- Newcomer, J. A.; Meyers, W. L. Principal components analysis of total tree form in seven central Pennsylvania hardwood forests. *For. Sci.* 30: 64-70; 1984.
- Overland, J. E.; Preisendofer, R. W. A significance test for principal components applied to a cyclone climatology. *Mon. Wea. Rev.* 110: 1-4; 1982.
- Palmer, W. E. Meteorological drought. U. S. Weather Bureau Research Paper #48. Washington, DC: U.S. Department of Commerce; 1948. 58 p.
- Price, T. S.; Doggett, C. A history of southern pine beetle outbreaks in the southeastern United States. Athens, GA: Georgia Forestry Commission; 1978. 31 p.
- Richman, M. B. Rotation of principal components in climatological research. Part I: Theoretical considerations, suitable applications and advantages over unrotated solutions. In: *Proceedings of the 8th Conf. on Prob. and Stats., American Meteorological Society, Boston, MA; 1983.*
- Swain, K. M. Forest insect and disease conditions in the South. *For. Serv. Rep. SA-FR 4.* Atlanta, GA: U.S. Department of Agriculture, Forest Service, Southern Region State and Private Forestry; 1980. 25 p.

The Large-Scale Prediction of Southern Pine Beetle Populations

William D. Mawby and Fred P. Hain¹

Abstract.—The prediction of southern pine beetle population levels from one year to the next is approached through a five-level hierarchical model. Exploratory time-space series and principal components analyses to each level indicate that population level is the dominant factor, with weather and host susceptibility levels playing important secondary roles. Two methods of prediction are created and tested for their percentage of correct population forecasts in: direction of change, relative size of change, both direction and size of change, and large increases. Suggestions can then be made for improvement of the predictions through the addition of weather and host information.

Additional keywords: Prediction, population dynamics.

INTRODUCTION

Substantial improvement in predicting future southern pine beetle levels has now been achieved. This report catalogues the various prediction methods available, examines their assumptions, tests their abilities to predict correctly, and illustrates some potential improvements. In all cases, applicability of the methods to current pest management problems has been the primary objective of the research.

One way to overcome the complexity of the southern pine beetle problem is to partition it into five levels arranged hierarchically (fig. 1). Based on Gold, Mawby and Hain (1980) and Mawby (1980), these five levels correspond to individual trees, spots, counties, States and the southwestern United States. Mawby and Gold (1985) discussed the results of applying sophisticated statistical analyses to the uppermost level, while Mawby and Hain (1985) and Mawby (1985) discussed the results of similar analyses at the State level for North Carolina and Georgia, respectively. Similar (unreported) studies have been undertaken by the authors for the county, spot, and tree levels as well. A summary of these results (fig. 2) indicates that population level is the dominant factor in determining future levels of southern pine beetle.

SOUTHERN PINE BEETLE HIERARCHY

SOUTHWIDE (REGION)	13 STATES
↑ ↓	
STATES (SUBREGIONS)	APPROX. 1100 COUNTIES
↑ ↓	
COUNTIES (PATCHES)	APPROX. 100,000 SPOTS
↑ ↓	
SPOTS	APPROX. 10,000,000 TREES
↑ ↓	
TREES	APPROX. 10,000,000,000 BEETLES

Figure 1.—The southern pine beetle hierarchy of five levels.

SOUTHWIDE

SHORT ENDEMIC SPATIAL INFLUENCE
 STRONG TREND IN TIME, WITH 3 YEAR LAG UNDERLYING PROCESS
 STRONG EPIDEMIC SPATIAL INFLUENCE
 STRONG FIRST PRINCIPAL COMPONENT
 RISK-RATING, SURVEILLANCE, AND PREDICTION SYSTEMS
 ESTIMATION OF EQUILIBRIUM POINTS INCLUDING THRESHOLD

STATES

SHORT ENDEMIC SPATIAL INFLUENCE IN NORTH CAROLINA
 STRONG TREND IN TIME IN NORTH CAROLINA, WITH 3 YEAR LAG
 STRONG EPIDEMIC SPATIAL INFLUENCE
 STRONG FIRST COMPONENTS IN TEXAS, GEORGIA, AND NORTH CAROLINA
 RISK-RATING, SURVEILLANCE, AND PREDICTION SYSTEMS IN ALL
 3 STATES
 ESTIMATION OF EQUILIBRIUM POINTS FOR VARIOUS STATES
 EFFECTS OF PATCHINESS OR EPIDEMIC DURATION

COUNTIES

STRONG TREND IN TIME
 RISK-RATING, SURVEILLANCE, AND PREDICTION SYSTEMS
 WINTER TEMPERATURE EXTREMES AND LONG-TERM TRENDS
 ARE IMPORTANT
 CONTAGIOUS/ANTI-CONTAGIOUS SPOT PROLIFERATION
 BEHAVIOR
 ESTIMATION OF EQUILIBRIUM POINTS FOR VARIOUS AREAS

Figure 2.—Summary of results from various studies at three levels of southern pine beetle populations.

¹ Respectively, former Research Consultant (currently in Greenville, SC), and Entomologist, Department of Entomology, North Carolina State University, Raleigh, NC.

Based upon the results of the individual level analyses, two types of prediction methods can be constructed. The *naive* method assumes no underlying biological knowledge and seeks merely to statistically predict the levels. For example, the number of spots in a State is often counted on a per county basis. One naive method presented here can predict next year's statewide spot total based upon knowledge of the current year's spot totals in just four selected counties. The *two-phase* method assumes that southern pine beetle populations display a particular set of behaviors (Berryman 1979). Two population phases, high and low, are presumed to exist at each level. If the change in beetle population size from year to year is compared, there are four possibilities. First, the level is so low that it decreases to extinction. Second, the level fluctuates around a low level, or enzootic, maximum. Third, the level explodes to a high level, or epizootic, maximum. Fourth, the level collapses to a low level after such an epizootic explosion. The population level at which the explosion to an epizootic condition occurs is the threshold, and it is extremely important to successful pest management (Mawby and Gold 1985). For example, a method has been developed for Iredell County, NC, to predict next year's spots from the current year's count. This method assumes that historical spot levels in the county follow the two-phase system described above.

The prediction methods that deserve consideration should be able to correctly predict four properties of population change a large percentage of the time. The four properties are: the direction of population change, the relative size of the change (greater or less than 0 percent, both direction and size, and the imminence of a large increase; i.e., an epizootic. Such measurements of prediction ability are considered the best for pest management applications. Tables 1 and 2 display the percentages of correct predictions for the four properties for the naive and two-phase methods, respectively. As an example, the two-phase prediction of the next year's kilocords of damage is correct 83 percent of the time in direction, 83 percent of the time in relative size, 75 percent of the time in both size and direction, and 100 percent of the time in epizootic explosions. These percentages are based upon historical data in each case.

DISCUSSION

The methods detailed in this report do significantly improve the prediction of future southern pine beetle population levels. They are not perfect, however. Most of the errors in the two-phase prediction method's forecasts occur around the enzootic-to-epizootic threshold or in the collapse of a large outbreak. In the former case, the method requires addi-

Table 1. — Percentage of correct predictions from a set of naive methods for several levels of hierarchy

Area	Unit	B ²	PR > F	Percent correct			
				Direction	Size	Both	Epidemic
Southeast	Counties	.71	.002	72	100	72	100
Southeast	MBF	.42	.066	70	75	65	76
Southeast	Kilocords	.65	.079	83	83	75	100
North Carolina Region	Counties	.78	.001	81	50	50	50
North Carolina Region	Kilocords	.66	.002	70	75	50	80
Texas Region	Kilocords	.41	.075	75	80	65	70
AL + MS	Kilocords	.98	.006	100	63	63	100
AK + MS + GA	Kilocords	.74	.001	60	70	40	60
GA + SC + NC	Counties	.75	.001	70	80	65	100
GA + SC + NC	Kilocords	.82	.001	76	53	47	83
North Carolina	Kilocords	.64	.040	79	79	64	100
North Carolina	Counties	.48	.034	65	70	50	60
Texas	Kilocords	.60	.018	82	76	65	83
Georgia	Counties	.79	.001	73	67	40	100
South Carolina	Counties	.83	.040	90	80	70	50
Tennessee	Counties	.52	.067	69	75	44	100
North Carolina							
Central Piedmont	Spots	.61	.035	69	75	44	100

Table 2. — Percentage of correct predictions from a set of two-phase methods for several levels of the hierarchy

Area	Subarea	Unit	R ²	PR > F	Percent correct			
					Direction	Size	Both	Epidemic
Surveillance								
Southeast	States	Infested counties	.780	.001	85	80	65	100
Southeast	Blocks	Infested area	.836	.001	75	88	69	67
North Carolina	One county	Spots	.738	.001	70	60	60	100
North Carolina	Four counties	Spots	.934	.001	80	70	60	100
Georgia	Four counties	Spots	.974	.002	100	75	75	100
North Carolina								
Central Piedmont	One county	Spots/Kacre host	.820	.001	71	93	64	100
Prediction								
Southeast	Blocks	Infested area	.713	.001	75	88	69	100
	States	Infested counties	.860	.001	85	75	65	75
North Carolina	Counties	Spots/Kacre host	.662	.004	80	70	60	75
Georgia	Counties	Spots/Kacre host	.513	.046	88	63	63	100
North Carolina								
Central Piedmont	Counties	Spots/Kacre host	.504	.004	75	83	58	100

tional information to improve the forecast. (For example, a predicted epizootic may not occur due to very harsh winter weather. It is likely that weather factors could be introduced to help predictions in those sensitive conditions.) In the latter case, the method does not explicitly allow high level populations to collapse. One way of improving the predictions under these conditions would be to track the depletion of susceptible host material. A beetle population collapse is inevitable if food resources drop drastically.

Another type of improvement which can be made in this prediction technology is combining several predictions into a single, more reliable forecast. For example, two independent predictions of population direction change may be available for the State of North Carolina. If prediction A is wrong 20 percent of the time and prediction B is wrong 15 percent of the time, then both methods are wrong together only 3 percent of the time; i.e., the joint prediction is correct 97 percent of the time. Similarly, if a prediction is made for the number of spots in North Carolina to increase next year, then some counties have to have an increase in their individual spot levels. Thus, the original 80 percent correct prediction of an increase in Iredell County (for example) could be 90 percent correct when the prediction for the State as a whole is considered.

LITERATURE CITED

- Berryman, A. A. Dynamics of bark beetle populations: analysis of dispersal and redistribution. *Bull. Swiss. Entomol. Soc.* 227-234; 1979.
- Gold, H. J.; Mawby, W. D.; Hain, F. P. A modeling hierarchy for the southern pine beetle. In: Stephen, F.; Searcy, J.; Hertel, G., eds. *Modeling southern pine beetle populations: symposium proceedings.* Tech. Bull. 1630. Washington, DC: U.S. Department of Agriculture; 1980. 174 p.
- Mawby, W. D. Development of an upper echelon sub-model for the southern pine beetle hierarchy. Institute of Statistics Mimeo Series No. 1314. Raleigh, NC: North Carolina State University; 1980. [Ph.D. Thesis].
- Mawby, W. D. A principal components analysis of statewide southern pine beetle (*Dendroctonus frontalis* Zimmermann) in Georgia during 1972-1980; 1985. [In preparation].
- Mawby, D. D.; Gold, H. J. A reference curve and space-time series analysis of the regional population dynamics of the southern pine beetle (*Dendroctonus frontalis* Zimmermann). *Res. Popul. Ecol.* 26:261-274; 1985.
- Mawby, W. D.; Hain, F. P. A time-space series and principal components analysis of North Carolina southern pine beetle spot data during 1967-1977; 1985. [In preparation].

Methods for Estimating Annosus Root Rot in Loblolly Pine Stands

S. A. Alexander, R. H. Hokans, E. S. Fanelli, and T. M. Kurdyla¹

Abstract.—An Annosus Sampling Procedure (ASP) was developed for estimating the severity of annosus root rot in thinned loblolly pine stands. The ASP is based on the systematic establishment of 20 plots with root samples collected at each plot evaluated for symptoms of annosus root rot. ASP is accurate to approximately 10 percent of the baseline annosus root rot severity. Two annosus prediction models have also been developed using regression techniques. These models were based primarily on above-ground measurements; i.e., site index, basal area, diameter breast height, radial growth, etc. The number of plots for the prediction models varies depending on the level of accuracy required. The percent annosus severity obtained from the ASP and prediction models may be used for the GY-ANNOSUS growth and yield model.

Additional keywords: *Heterobasidion annosum*, *Fomes annosus*, *Pinus taeda*, disease severity, root rot, disease sampling.

INTRODUCTION

Annosus root rot is a major disease of loblolly pine (*Pinus taeda* L.) and other southern pines in the southeastern United States. The disease is most severe in thinned plantations and stands because thinning creates stump surfaces and root wounds that act as points of entry for *Heterobasidion annosum* (Fr.) Bref., the cause of annosus root rot. Severely affected trees grow at a slower rate and are more susceptible to bark beetle infestation. Tree mortality tends to occur in pockets, although it may occur uniformly in severely affected stands. Annosus root rot tends to be more severe on well-drained soils with a sandy to sandy loam texture, 12 inches or more in depth, and with a low seasonal water table. Thus, these soil types are generally referred to as high-hazard soils.

Evaluating the presence and impact of annosus root rot has been difficult due to the lack of effective methods for estimating the severity of the disease. It was the objective of this project to develop practical and effective methods for estimating annosus root rot in loblolly pine stands.

STUDY METHODS AND RESULTS

Forty-eight plots in 24 thinned loblolly pine plantations in Virginia, Alabama, and Mississippi were used to develop the Annosus Sampling Procedure and annosus prediction models. Above-ground data collected included: crown class, diameter at breast height (d.b.h.), height, height to live crown, basal area, and site index. Stand history factors like age, thinning dates, and tree spacing were also recorded. Annual incremental growth of cores removed at d.b.h. was measured using an Addo-X dendrochronograph. Baseline levels of annosus root rot were determined by excavating all trees in systematically placed twentieth-acre plots, and evaluating their root systems for annosus root rot.

Annosus Sampling Procedure

The Annosus Sampling Procedure (ASP) provides a means of estimating annosus root rot severity in a stand. Twenty sample plots are systematically distributed through the stand to be sampled. Once a plot center has been located, the actual sampling point is moved to a position that maximizes the number of tree root systems sampled. Sampling begins with the removal of the duff layer over an area 1-foot-square. A 1-cubic-foot sample of soil is removed with a shovel and all pine root segments removed for evaluation. All pine root segments $\frac{1}{8}$ inch in diameter or larger are separated, counted, and examined for typical annosus symptoms, resin-soaking and stringy, white rot. Roots with other symptoms (or symptomless) are classified as noninfected. The sampling process is repeated at each of the 20 plots, and the results averaged to provide an estimate of the severity of annosus root rot in the stand. Data collected from Virginia, Alabama, and Mississippi were used in developing the procedure. Baseline levels of annosus root rot severity were obtained from root system excavations and used for determining the accuracy of the ASP. The ASP can estimate severity to within 10 percent of the baseline at $P=0.05$.

Annosus Root Rot Prediction Models

Tree and stand data were collected from loblolly pine stands in Virginia, Alabama, and Mississippi. The data were analyzed and a prediction model selected based on biological and statistical inferences. The models are described below.

¹ Respectively, Associate Professor, Assistant Professor, and Graduate Research Assistants, Virginia Polytechnic Institute and State University, Blacksburg, VA.

The Virginia annosus prediction model consisted of the following variables:

MGR5=mean radial growth over the past 5 years in inches

SI=site index in feet at base age 25

BA=basal area in square feet per acre

YST=years since first thinning

Age

Tan (MDBH)=tangent of mean d.b.h. in inches

QMDBH=quadratic mean d.b.h. in inches

Cos (BA)=cosine of basal area

MARRS=mean annosus root rot severity

The Virginia model is as follows:

$$\begin{aligned} \text{MARRS (\%)} = & 108.09 - 112.07 (\text{MGR5}) - 1.16 \\ & (\text{SI}) \\ & + 0.21 (\text{BA}) - 2.70 [\text{Tan} \\ & (\text{MDBH})] \\ & + 4.67 (\text{YST}) - 4.93 (\text{Age}) \\ & + 11.25 (\text{QMDBH}) + 9.69 [\text{Cos} \\ & (\text{BA})]. \end{aligned}$$

The Virginia model had an regression R square value of 0.99, and a p value of 0.0001.

The Alabama annosus prediction model consists of the following variables:

RSP=percent roots symptomatic for *H. annosum* in 1-cu-ft soil sample

SI=site index in feet at base age 25 yrs

MDBH=mean d.b.h. in inches

Tan (MDBH)=tangent of MDBH

YST=years since first thinning

QMDBH=quadratic of MDBH

BA/LC=basal area/percent live crown

MARRS=mean annosus root rot severity

The Alabama prediction model is as follows:

$$\begin{aligned} \text{MARRS (\%)} = & 108.05 + 0.54 (\text{RSP}) - 2.18 (\text{SI}) \\ & - 53.24 (\text{MDBH}) - 1.54 [\text{Tan} \\ & (\text{MDBH})] \\ & - 6.56 (\text{YST}) + 52.36 \\ & (\text{QMDBH}) + 15.34 (\text{BA/LC}). \end{aligned}$$

The Alabama prediction model had a regression R square value of 0.96, and a p value of 0.0001.

SUMMARY

Root diseases such as annosus root rot are particularly difficult to evaluate because they do not always reveal their presence with above-ground symptoms even when growth is impacted. The Annosus Sampling Procedure and the Virginia and Alabama prediction models developed during this project effectively address two important aspects of annosus root rot management: (1) How to practically sample for annosus root rot in the field; and (2) how to accurately estimate the severity of the disease in the stand. Annosus root rot severity, along

with other information derived from the ASP and prediction models, can be used to obtain estimates from the GY-ANNOSUS growth and yield model. Estimates of mortality and growth loss will provide the forest manager with the information necessary for making more effective decisions concerning annosus root rot.

SELECTED REFERENCES

- Alexander, S.A.; Skelly, J.M. A comparison of isolation methods for determining the incidence of *Fomes annosus* in living loblolly pine. *European Journal Forest Pathology* 4:33-38; 1974.
- Alexander, S.A.; Skelly, J.M. The effect of *Fomes annosus* infection on diameter growth of *Pinus taeda*: an initial report. In Kuhlman, E.G., ed. *Proceedings, fourth international conference on Fomes annosus*. Asheville, NC: U.S. Department of Agriculture, Forest Service, Southeastern Forest Experiment Station; 1974: 30-34.
- Alexander, S.A.; Skelly, J.M.; Morris, C.L. Edaphic factors associated with the incidence and severity of disease caused by *Fomes annosus* in loblolly pine plantations in Virginia. *Phytopathology* 65:585-591; 1975.
- Alexander, S.A.; Skelly, J.M.; Webb, R.S. (and others). Association of *Heterobasidion annosum* and the southern pine beetle on loblolly pine. *Phytopathology* 70:510-513; 1980.
- Alexander, S.A.; Skelly, J.M.; Webb, R.S. Effects of *Heterobasidion annosum* on radial growth in southern pine beetle-infested loblolly pine. *Phytopathology* 71:479-481; 1981.
- Alexander, S.A.; Anderson, R.L. How to identify and control annosus root rot in the southeast. *Forestry Bulletin SA-FB/P 4*. Atlanta, GA: U.S. Department of Agriculture, Forest Service, Southeastern Forest Experiment Station; 1982. 2 p.
- Bradford, B.; Alexander, S.A.; Skelly, J.M. Determination of growth loss of *Pinus taeda* L. caused by *Heterobasidion annosus* (Fr.) Bref. *European Journal of Forest Pathology* 8:129-134; 1978.
- Bradford, B.; Skelly, J.M.; Alexander, S.A. Incidence and severity of annosus root rot in loblolly pine plantations in Virginia. *European Journal of Forest Pathology* 8:135-144; 1978.
- Froelich, R.C.; Cowling, E.B.; Collicot, L.V.; Del, T.R. *Fomes annosus* reduces height and diameter growth of planted slash pine. *Forest Science* 23:299-306; 1977.
- Hodges, C.S., Jr. Modes of infection and spread of *Fomes annosus*. *Annual Review of Phytopathology* 7:247-266; 1969.

- Hodges, C.S., Jr.; Kuhlman, E.G. Spread of *Fomes annosus* in roots of red cedar and loblolly pine. *Plant Disease Reporter* 58:282-284; 1974.
- Kuhlman, E.G. Variation in infection of loblolly pine roots on high and low hazard sites in the southeastern United States. In Kuhlman, E.G., ed. *Proceedings, fourth international conference on Fomes annosus*. Asheville, NC: U.S. Department of Agriculture, Forest Service, Southeastern Forest Experiment Station; 1974: 179-183.
- Morris, C.L.; Frazier, D.H. Development of a hazard rating for *Fomes annosus* in Virginia. *Plant Disease Reporter* 50:510-512; 1966.
- Webb, R.S.; Alexander, S.A.; Skelly, J.M. Incidence, severity and growth effects of *Heterobasidion annosum* in unthinned loblolly pine plantations. *Phytopathology* 71:661-662; 1981.

Growth Following Thinning Model for Loblolly Pine Plantations Infected by Annosus Root Rot

Rickard H. Hokans, Eric S. Fanelli, and Samuel A. Alexander¹

Abstract.—Thinning loblolly pine plantations exposes the residual stand to infection by annosus root rot. Thinned stand growth and yield models have been developed to account for reduced radial growth following the initial mortality resulting from annosus root rot infection. Financial evaluation of growth impacts indicates that the cost of stump protection is fully justified to insure value-growth of the stand. **Additional keywords:** Basal area growth, volume yield, *Pinus taeda*, *Heterobasidion annosum*, *Fomes annosus*.

Dr. Samuel Alexander and other forest pathologists at Virginia Polytechnic Institute and State University have been collecting stand data on diseased pine plantations for many years. This study was undertaken to determine whether growth models might be fitted to these data. While extensive data were not available in the normal growth and yield modeling sense, a remarkably good model was devised. This model is specifically intended for use on loblolly pine (*Pinus taeda*) plantations on high annosus hazard sites.

DATA

Fifteen plots were located in the Atlantic Coastal Plain of Virginia and eighteen were from the Gulf Coastal Plain of Alabama. All were temporary 0.05-acre plots located in thinned loblolly pine plantations on moderate- to high-annosus-hazard sites. Above ground measurements included d.b.h., total height, height-to-live crown, and radial growth increment. Site index (base age 25) was calculated using two trees and Devan's (1979) equation. The two trees were selected on the basis of total height, crown ratio, and the absence of annosus infection. Burkhart's (1977) volume ratio was used to compute outside bark cubic-foot volumes to a 4-inch top outside bark for all trees greater than 4.5 inches d.b.h. After these measurements were taken, the root systems of all trees on the plot were excavated with bulldozers, and the percentage of roots infected was determined for each tree. Selected roots were isolated and later cultured in the laboratory.

¹ Respectively, Assistant Professor, former Graduate Assistant, and Associate Professor, Virginia Polytechnic Institute and State University, Blacksburg, VA.

In the absence of remeasurement data, basal area growth data were approximated by using the radial growth data. Each tree's diameter was reduced by twice its radial growth over a given time period. Period lengths were varied between plots to represent different areas in the growth curve. This assumed that trees present on the plots at sampling time were the only ones present at the beginning of the growth period (2 to 6 years prior to sampling). In essence, this amounted to the assumption of no mortality during that period. While this may be inappropriate, Morris (1970) and others have shown the major wave of mortality to occur within the first 7 to 9 years subsequent to thinning.

The 33 sample plots averaged 29.6 years of age, site index 56.9 (base age 25), 113 sq. ft./acre basal area, and 10 years since thinning. The Alabama plots had suffered significant mortality, whereas mortality had been minimal in Virginia. For full life cycle modeling of the stand growth from the time of thinning, an appropriate mortality model is required. In the absence of such a model, the growth prediction equations developed are intended for post-mortality use only.

VOLUME AND BASAL AREA GROWTH MODELS

Model forms presented by Sullivan and Clutter (1972) were used as a basis for the models. A term to include mean annosus root rot severity level (MARRS) was added with the quantity $(1-A_1/A_2)$ to insure that the modifying term would equal zero when no projection was involved. MARRS would be determined by the methods described by Alexander elsewhere in these proceedings. The final model forms are:

$$\ln Y = b_0 + b_1 S + b_2 (1/A_2) + b_3 (A_1/A_2) \ln B_1 \quad (1) \\ + b_4 (1-A_1/A_2) + b_5 S (1-A_1/A_2) \\ + b_6 \text{MARRS} (1-A_1/A_2)$$

$$\ln B_2 = (A_1/A_2) \ln B_1 + a_1 (1-A_1/A_2) + a_2 S (1-A_1/A_2) \quad (2) \\ + a_3 \text{MARRS} (1-A_1/A_2)$$

Where:

Y = cubic-foot volume o.b. to a 4" top o.b. in the 5" d.b.h. class and above at projection age, A_2 years.

B_2 = basal area (sq. ft./acre) at projection

S = site index in feet (base age 25 years).

B₁ = initial basal area (sq. ft./acre).

A₁ = initial age (years)

ln = natural logarithm.

While individual models for Virginia and Alabama were explored, a single model based on the combined data performed well. Model forms (1) and (2) were simultaneously fitted using a procedure developed by David Reed and presented by Burkhart and Sprinz (1984). The r-square statistic, similar to the R² used in ordinary least squares, was .98 for the combined data. The resulting coefficients are presented in table 1.

These coefficients have been implemented in the microcomputer program called GY-ANNOSUS. This program is a complete yield simulator with the following characteristics:

OUTPUTS:

- 1) Site index (base age 25)
- 2) Current age (years)
- 3) Current basal area (square feet)
- 4) Annosus severity level
- 5) Ages for thinning and harvest
- 6) Residual basal area for thinning

OUTPUTS:

- 1) Cubic foot yields and basal area of infected stand
- 2) Cubic foot yields and basal area of comparable healthy stand
- 3) Percent difference between infected and healthy stands

While the program stands alone as a yield simulator, the authors suggest that it be used as a percent reduction estimate for a diameter distribution model such as PCWTHIN by Thomas Burk (1984). GY-ANNOSUS is written in BASIC language and implemented on the Apple II series microcomputer with 48K RAM, one disk drive, a monochrome display, and an optional 80-column printer. A program disk with complete documentation and source code is available from the authors² at a distribution charge of \$20.

IMPLICATIONS OF THE MODEL

The intensive management of loblolly pine in the southeastern U.S. involves cultural and financial decisions based on yield projections using any of several models. While the data used to build these models generally exclude areas of high annosus-induced

Table 1. — Coefficients of cubic-foot volume and basal area projection models

Cubic-foot volume equation	Basal area equation
b ₀ = 2.41906	a ₁ = 4.46380
b ₁ = 0.00997	a ₂ = 0.01901
b ₂ = -22.90911	a ₃ = -0.00629
b ₃ = 1.20439	
b ₄ = 5.37615	
b ₅ = 0.02289	
b ₆ = -0.00758	

mortality, most data sets from Coastal Plain sites will contain some annosus infected stands. The significance of the mean infection level term in the above model implies that some of the variation in the standard growth models can be explained by an annosus growth effect. Further, the standard yield prediction models will be overly optimistic for stands where extensive annosus infection has been identified. The optimism can result in serious errors in analysis of thinning alternatives where treatment to prevent annosus infection is not done.

ILLUSTRATION OF POTENTIAL IMPACT ON FORESTRY INVESTMENT ANALYSIS

Consider a loblolly pine plantation on a high annosus hazard site with site index 60 and an original planting density of 1,000 trees per acre. A rotation age of 35 will be used. The forester wishes to evaluate the financial returns from a thinning at age 21 to 75 sq. ft. of basal area. Analyses for annosus-free and infected stands are compared in the following:

Financial assumptions:

Discount rate = 6 percent (after tax)

Ordinary tax rate = 40 percent

Capital gains tax rate = 16 percent

Inflation = 3 percent

Reforestation/planting costs = \$125/acre

Annual management fee = \$5 per acre per year

Pulp stumpage = \$10/cord

Sawtimber stumpage = \$100/MBF

Borax treatment = \$.29/cord

The following table (table 2) is the result of an investment analysis using the above assumptions, yields from PCWTHIN (Burk 1984), yield impacts from GY-ANNOSUS, and financial evaluation with QUICK-SILVER 2.OPC (Vasievich 1984). A low mortality Virginia situation is assumed.

² Contact Dr. S. A. Alexander, Associate Professor, Department of Plant Pathology and Physiology, Virginia Polytechnic Institute and State University, Blacksburg, VA 24061.

Table 2. — Comparison of internal rates of return (IRR) for thinned and unthinned loblolly pine stands, with and without annosus infection

Regime	Pulpwood yields (cd)	Sawtimber yields (MBF)	IRR percent	Comments
No thin	29.0	11.8	12.15	
Thin (assume no infection)	18.9	12.4	12.37	Appears to be the preferred regime.
Thin (40 percent infection)	19.2	8.9	11.84	An 11.4 percent growth loss makes this less desirable than no-thin.
Thin & borax treatment	19.0	12.4	12.36	Treatment pays!
Worst scenario: 40 percent infection + 20 percent mortality	15.9	8.9	11.67	The manager risks significant losses \$185/acre present net worth.

SUMMARY

Potential losses to annosus root rot include both the obvious mortality and the more insidious growth loss. Present management decisionmaking risks serious errors by not treating high-hazard site thinnings to prevent the disease. Costs of prevention are offset by insured growth as well as the prevention of mortality. The financial analysis illustrated could also be utilized by managers who have not treated stumps, have estimated a serious annosus severity level, and wish to decide whether or not to liquidate the stand. The utilization of microcomputer software facilitates the analysis by field-level forest managers and consultants, allowing each situation to be evaluated for financial and biological assumptions. Given that commercial forest management is the objective of the landowner, there are thousands of different combinations of assumptions that can affect the outcome of this analysis, making broad policy statements questionable.

LITERATURE CITED

- Blacksburg, VA: Forestry Department, Virginia Polytechnic Institute and State University; 1985. 23 p. [Computer program].
- Burkhart, H.E. Cubic foot volume of loblolly pine to any merchantable top limit. *South. J. Appl. For.* 1(2): 7-9; 1977.
- Burkhart, H.E.; Sprinz, P.T. Compatible cubic foot volume and basal area projection equations for thinned old-field loblolly pine plantations. *For. Sci.* 30: 86-93; 1984.
- Devan, J.S. Base-age invariant polymorphic site index curves for loblolly pine. Blacksburg, VA: Virginia Polytechnic Institute and State University; 1979. 83 p. [Thesis].
- Morris, C.L.; Frazier, D.H. Development of a hazard rating system for *Fomes annosus* in Virginia. *Plant Dis. Rep.* 50: 510-512; 1966.
- Sullivan, A.D.; Clutter, J.L. A simultaneous growth and yield model for loblolly pine plantations in loessial soil areas. *Bull.* 86. Starkville, MS: Mississippi Agricultural Experiment Station; 1972; 16 p.
- Vasievich, M.; QUICK-SILVER 2.OPC: forestry investment analysis program. Research Triangle Park, NC: Southeastern Center for Forest Economics Research, U.S. Department of Agriculture, Forest Service, Southeastern Forest Experiment Station; 1984. [Computer program].
- Burk, T.E. PCWTHIN 2.0: growth and yield prediction for thinned old-field loblolly pine stands.

Predicting Survival and Yield of Unthinned Slash and Loblolly Pine Plantations With Different Levels of Fusiform Rust

W. L. Nance, E. Shoulders, and T. R. Dell¹

Abstract.—Modification of an existing slash pine growth and yield system to incorporate a rust-level parameter gave predictions that agree closely with observed data from rust-infected plantations planted in a variety of situations throughout the South. A major revision of a loblolly pine model has been initiated to correct basic deficiencies in the original growth and yield model, which, when applied to high density stands, had prevented the incorporation of a rust-level parameter.

Additional keywords: Disease impact, rust management strategies, growth simulation.

INTRODUCTION

Fusiform rust (*Cronartium quercum* Berk Miyabe ex Shirai f. sp *fusiforme*) is the most serious destructive agent yet encountered in the management of slash pine (*Pinus elliottii* Engelm. var *elliottii*) and loblolly pine (*Pinus taeda* L.) plantations. In young stands, the dominant influence of the disease is the death of trees, which can result in departure from desired stocking regimes. Effective application of control measures and the development of management strategies to minimize economic impacts are dependent on yield predictions that consider levels of the disease.

Basic concepts of disease loss assessment for killing diseases in young forest stands were presented by Meinecke (1928). He emphasized consideration of stand dynamics and made a careful distinction between disease effects on individual trees and those on stand developments. His formulation was essentially a call for what would today be designated a growth and yield modeling approach. Specifically, the caution was made that disease incidence, or even the death of an individual tree, may not necessarily constitute economic loss. Unfortunately, this guidance has been ignored. Holley and Veal (1977) concluded that reliable estimates of rust impact for man-

agement of a given stand or for large area planning purposes were not available. They concluded that the limiting factor was quantitative information on how alternative levels of rust affect growth and yield.

One approach to provide this quantitative information was presented by Nance et al. (1982). In that work and in an earlier paper (Nance et al. 1981), efforts were described in detail to: (1) Modify an existing unthinned slash pine plantation yield system that had been developed by Dell et al. (1979) to forecast yields under different levels of rust, (2) validate the new system by comparing corresponding predicted and witnessed yields for plots under a wide range of situations throughout the South, and (3) involve potential users of the system by letting them provide feedback for further enhancement to the system.

The main purpose of this paper is to describe how the slash pine system was developed and to report on its reliability, with a discussion of how the slash pine system may be used to solve selected problems of the forest manager. The status of similar efforts to develop a loblolly pine model is also discussed.

MODELING BACKGROUND

The original form of the plantation yield system was described in Dell et al. (1979) and Feduccia et al. 1979). This modeling work, which involved both slash and loblolly pine growing in plantations essentially free of fusiform rust, was implemented in a computer program called USLYCOWG (Unthinned Slash and Loblolly Yields for Cutover Sites in the Western Gulf).

The USLYCOWG prediction system can be briefly described in functional form as follows. For an unthinned plantation (slash or loblolly pine), it is assumed that predictions of current yield (Y) can be generated using only three parameters: the age of the plantation in years (Ap), the number of living trees at that age (T_L), and the mean height of dominant and codominant trees in the plantation at that age (H_D). In functional form, this appears as:

$$\hat{Y} = f(H_D, T_L, AP) \quad (1)$$

This form is concerned with predicting current yields not with forecasting future yields since both H_D and T_L must be known at the age of interest, Ap .

¹ Respectively, Principal Plant Geneticist (Gulfport, MS), Principal Silviculturist (Pineville, LA), Mathematical Statistician (New Orleans, LA), U.S. Department of Agriculture, Forest Service, Southern Forest Experiment Station. (Current developments are being supported by a grant from the Integrated Pest Management Program, U.S. Department of Agriculture, Forest Service, Pineville, LA.)

However, if predicted values for H_D and T_L (symbolized by \hat{H}_D and \hat{T}_L) at age A_p are substituted in place of the known values, the resulting form:

$$\hat{Y} = f(\hat{H}_D, \hat{T}_L, A_p) \quad (2)$$

can be used to forecast yields.

In the case of H_D , predicted heights can be generated if one has an estimate of the site index (S_i) of the planting site—obtained either from soil-site relationships or the performance of prior or nearby stands. The predicted mean dominant-codominant height for this case appears as:

$$\hat{H}_D = f(S_i, A_p) \quad (3)$$

In the case of survival, predicted values can be generated using a survival function that requires one to know site index (S_i), the number of trees initially planted on the site (T_P), and the plantation age (A_p):

$$\hat{T}_L = f(S_i, T_P, A_p) \quad (4)$$

Hence, in the forecasting mode, the USLYCOWG system simply replaces known values of H_D and T_L with predicted values generated by appropriate prediction equations, and the resulting functional form for forecasting yields appears as:

$$\hat{Y} = f(S_i, T_P, A_p) \quad (5)$$

SLASH PINE MODEL MODIFICATIONS REQUIRED FOR FUSIFORM RUST

The basic approach in incorporating fusiform rust into the USLYCOWG slash pine model was to: (1) Acquire a large data base generated by long-term growth and yield type studies in which fusiform rust infection had been closely monitored, (2) determine which components of the original slash pine model required modification for fusiform rust, (3) accomplish the required modifications, (4) integrate the new components into the USLYCOWG system, and (5) provide an enhanced user interface to the new system.

The Slash Pine Data Base

Two large, long-term experiments generated the data used in this modeling work. The first experiment, designated as set A, was originally designed to compare the growth and yield of loblolly, slash, and longleaf pines on diverse sites (Shoulders 1976, Shoulders and Walker 1979, Nance et al. 1981). This study was measured periodically for rust infection and growth for 20 years. The slash pine data from this study involved 100 plots from Mississippi and 87 from Louisiana. There were 64 planted trees

in the interior of each Mississippi plot and 49 in each of the Louisiana plots. Site indexes at base age 25 (estimated from an equation presented by Dell et al. 1979), ranged from 25 to 80 feet, with a mean of 62 feet. Planting density (number of trees planted per acre) was 1,210 for all plots, with the number of trees surviving at plantation age 5 (T_5) ranging from 600 to 1,210 trees per acre, with a mean of 996. The percentage of living trees with a stem canker at age 5 (S_5) ranged from 0 to 32, with a mean of 4, and the cumulative percentage of trees that died with a stem canker by age 20 ranged from 0 to 44, with a mean of 14.

The second experiment, designated as set B, was installed by a large industrial forestry firm to compare the growth and yield of slash and loblolly pine planted on a wide array of sites. This study was measured periodically for rust infection and growth for 17 years. The slash pine data from this experiment involved 281 plots from Alabama, Georgia, Florida, and South Carolina. There were 25 measured trees in each plot, with site indexes at base age 25 (estimated as in set A) ranging from 25 to 78 feet, with a mean of 54 feet. Planting density ranged from 100 to 1,100 and establishment densities (T_5) from 80 to 1,000 trees per acre, with a mean of 406. The percentage of living trees with a stem canker at age 5 (S_5) ranged from 0 to 76, with a mean of 18. The cumulative percentage of trees that died with a stem canker present by age 17 ranged from 0 to 78, with a mean of 21.

Modifications Required for Fusiform Rust

Previous work by Nance et al. (1981) detailed some of the effects of fusiform rust on the growth and development of slash pine plantations derived from the slash pine data base. Briefly, slash pines that developed fusiform rust stem cankers by age 5 were found to have a much higher probability of death in later years than their rust-free neighbors. Surprisingly, however, trees that survived with stem cankers to later ages appeared to compete and grow as well over time as their noninfected neighbors.

These observations on individual-tree growth and survival were reinforced and confirmed by two fundamental modeling results (Nance et al. 1982). The first was that the basic assumption underlying the USLYCOWG system—that current yield in an unthinned slash pine stand is simply a function of T_L and H_D —was also valid for rust-infected stands that had undergone natural thinning from fusiform rust. Table 1 compares volumes and quadratic mean diameters in data sets A and B with those predicted by the original USLYCOWG system when used with the

Table 1. — Comparison of observed and predicted volumes and quadratic mean diameters for two data sets using H_D and T_L values at age 17 or 209 as input to USLYCOWG

Data base	Age	No. plots	Variable predicted	r^1	BIAS ²
	<i>Yrs</i>				<i>Percent</i>
Set A	20	187	Volume ³	0.91	2.18
	20	187	QMDBH ⁴	0.90	1.33
Set B	17	281	Volume	0.98	4.12
	17	281	QMDBH	0.91	4.45

¹ r denotes the simple correlation between observed and predicted values of the response variable.

² BIAS percent = ((predicted - observed)/observed) × 100

³ Volume = 0.0339 + 0.0026 (d.b.h.² × HEIGHT) for all trees (Moehring et al. 1973)

⁴ QMDBH = quadratic mean d.b.h., or the d.b.h. of the tree with average basal area.

observed H_D and T_L values for these rust-infected plots.

The second result was that future survival for both infected and noninfected stands could be predicted if a rust level variable were incorporated into the survival function. The specific form of the survival function developed as a replacement for (4) was:

$$\hat{T}_L = [T_5 \quad] [(1-S_5) \quad] \quad (6)$$

where T_5 is the observed number of surviving trees in the plantation at age 5, and S_5 is the observed proportion of living trees at age 5 with a fusiform rust stem canker. Note that this form does not require S_1 , which is partly a consequence of using T_5 instead of T_P as the primary density variable. Mortality before plantation age 5 is often strongly related to site quality, while mortality after age 5 shows a much weaker relationship to site quality. Table 2 compares the observed and predicted survivals for data sets A and B using this survival function.

Integration of the Modified Survival Model

Because the survival function was the only component of the original USLYCOWG slash pine model that required modification, it was a relatively simple task to delete the old survival subroutine and insert a new one in its place. Functionally, this replacement produces the final form:

$$\hat{Y} = f(S_1, T_5, S_5, Ap) \quad (7)$$

which allows the forecasting of yields for infected plantations with known rust level (S_5), establishment density (T_5) and site index (S_1).

Development of an Enhanced User Interface

It was felt that the original USLYCOWG system was not particularly easy to use nor easily accessible to most potential users. The program was not interactive, was not accessible via dial-up facilities, and could not be executed on microcomputers. In order to correct these deficiencies in the rust version, the program was rewritten.

Once this was accomplished, it was possible to allow a large number of users to access the new model via dial-up telephone lines, run the system interactively, and provide feedback regarding improvements that could be made to the system. This feedback mechanism provided many valuable suggestions, all of which were eventually incorporated into the rust model, which has been converted to the FORTRAN 77 language and is compatible with most computer systems (including microcomputers).

LOBLOLLY PINE MODEL MODIFICATIONS REQUIRED FOR FUSIFORM RUST

With work completed on the slash pine rust model, the problem of modifying the loblolly pine USLYCOWG system for fusiform rust was addressed using essentially the same approach as that used for slash pine. Two large data bases—the counterparts of sets A and B described above—were acquired, and essentially the same analyses were applied.

The analyses of the effects of fusiform rust on individual-tree growth and survival gave results very similar to those obtained for slash pine. Like slash pine, loblolly pine trees that developed fusiform rust stem cankers by age 5 had a much higher probability of death in later years than those that were rust-free, although the probability of death was somewhat lower than for slash pine. Likewise, trees that survived with stem cankers appeared to compete and grow as well over time as their noninfected neighbors. Based on these results, one might assume that the incorporation of fusiform rust into the loblolly pine model would pose no particular problems.

Unfortunately, when observed T_L and H_D values were input from the rust infected loblolly pine plots into the USLYCOWG system, the predicted volumes deviated widely from the observed volumes on these plots—thus violating the fundamental assumption

Table 2. — Comparison of observed and predicted survival using S_5 for all measurement ages

Model	Data base	Observations ¹	B_1	B_2	r^2	Bias ³	Std. error ⁴
		No.				Percent	
S_5^5	A	561	0.0031113	-0.1038100	0.71	-0.10	125
	B	1124	0.0010951	-0.0841180	0.99	-2.60	38
	A + B	1685	0.0025306	-0.0712972	0.96	-0.50	84

¹ For set A, based on measurements at ages 10, 15, and 20 for 187 plots, and for set B based on ages 8, 11, 14, and 17 for 281 plots.

² r denotes simple correlation between observed and predicted number of surviving trees per acres.

$$^3 \text{ Bias} = \frac{(\text{predicted survival} - \text{observed survival})}{\text{observed survival}} \times 100$$

⁴ Std. error = standard deviation of (observed - predicted) survival in trees per acre (T/A) units.

⁵ S_5 = the proportion of trees living at age 5 with a stem canker.

underlying the USLYCOWG system. An analysis of these deviations showed that the problem was primarily related to high density (above 800 trees per acre) and not to fusiform rust. Apparently, the data base used to construct the loblolly pine version of USLYCOWG contained only a few high density plots, and, as a result, the model cannot be used with confidence at these high densities.

We attribute this problem to the dramatic difference in the response of the two species to high stand density. Our data suggest that slash pine plantations growing under intense density stress—such as that encountered in a plantation established at 1,210 trees per acre and left unthinned for 20 years—tend to respond to this stress by a decrease in growth rate that is quite uniformly exhibited by the individual trees within the stand. This type of stagnation may eventually result in high (perhaps catastrophic) levels of mortality at advanced ages, but for the most part, mortality rates are relatively low through age 20 for the densities and sites encountered in our data.

Loblolly pine appears to respond to high stand density in a much different way. Rather than a uniform decrease in growth rate, there is much more diversity, with some individual trees rapidly declining in vigor and often succumbing rather quickly, while others continued rather rapid growth rates. This response tends to produce higher and more regular rates of mortality over time in dense stands than is observed in slash pine stands, with a marked effect on stand structure.

Currently, we are refitting the basic components of the loblolly USLYCOWG system using high as

well as low density data. The preliminary results are encouraging, and we expect to release a new system that can be used with confidence for a wide range of densities with varying levels of fusiform rust infection.

A CLOSER LOOK AT THE SLASH PINE RUST MODEL

The enhanced rust model for slash pine is essentially complete and is serving as a template for the loblolly pine model currently being developed. The current version of the slash pine system is primarily designed to accept inputs that describe a newly established slash pine plantation, then project future yields for that plantation for any age up to age 20. The four basic input variables accepted are: (T_5) the number of trees living at age 5, (S_5) the proportion of living trees at age 5 that have a fusiform rust stem canker, (S_r) the site index of the planting site, and (Ap) the plantation age for which a stand table projection is desired.

Given the basic input variables, the model projects survival and yield by diameter class to any user-specified projection age up to age 20, assuming no thinnings. Additional user input is allowed for specification of merchantability limits such as stump height, limiting top diameter, and minimum acceptable diameter at breast height (d.b.h.).

Figure 1 shows the menu displayed by the program. The top half of the menu, labeled "RANGE OF APPLICATION", shows the basic input variables

that control the number and type of stand tables subsequently generated by the program. The column labeled "KEY" contains a two-letter abbreviation for each variable in the menu, and in the following discussion the key, rather than the full description, will be used to refer to input variables.

Because most users want to generate an array of stand tables rather than a single table, the four input variables under the heading "PRIMARY VARIABLES" are assigned a range of values rather than a single value. The range is controlled by the FIRST, LAST, and STEP values assigned by the user for each of the primary variables SI, T5, S5, and PA. The program will begin execution with the primary variable equal to FIRST, then increment the variable to a new value equal to FIRST + STEP, and continue this process until the variable exceeds LAST. By default, the primary variables are loaded with typical FIRST values, LAST is set equal to FIRST, and STEP is set equal to one. This simply defines a range of one value for each of the primary variables.

If, using SI for example, the user sets FIRST, LAST, and STEP values equal to 50, 70, and 10, respectively, then upon execution the program will generate stand tables for site indices of 50, 60, and

70. The values for the other three primary variables could also take on many different values at the same time, multiplying the total number of stands that would be generated. For example, if the user changed the input menu to appear as follows:

KEY	FIRST	LAST	STEP
SI	50	70	10
T5	800	1000	100
S5	10	50	10
PA	15	20	5

the program would generate 90 stand tables (3 x 3 x 5 x 2), with the first projected at age 15 for a plantation established on a site with a site index of 50 (index age 25) with 800 trees per acre living at age 5 with 10 percent of those trees infected with stem cankers.

The two remaining variables listed under "RANGE OF APPLICATION", IA and C5, can only take on a single value and hence do not actually affect the number of stand tables generated. The first, IA, simply allows the user to define an index age for site index. Slash pine site indexes are normally based on plantation age 25, which is the default value assigned to IA in the initial menu. The variable C5 allows the user to specify a comparison level for percent stem

=====

YIELDS BY DIAMETER CLASSES FOR UNTHINNED SLASH PINE PLANTATIONS INFECTED
WITH FUSIFORM RUST STEM CANKERS AT AGE 5

```

*****RANGE OF APPLICATION*****
-----PRIMARY VARIABLES-----
SITE INDEX                KEY    FIRST  LAST  STEP
TREES ESTABLISHED (AGE 5) T5     800    800   100
PERCENT STEMS RUST INFECTED (AGE 5) S5     60     60    10
PROJECTED PLANTATION AGE (YEARS) PA     20     20     5
-----ADDITIONAL VARIABLES-----
INDEX AGE FOR SITE INDEX  IA     25
S5 FOR COMPARISON        C5     0

*****VOLUME SPECIFICATION*****
      FROM STEM PROFILE          *      FROM DSQH EQUATION
      ITEM                      KEY  VALUE *      ITEM                      KEY  VALUE
-----
MIN DBH CLASS                MD    4    * MIN DBH CLASS                MC    0
TOP LIMIT DIAMETER (INCHES) TD    3    * INTERCEPT                  BZ   0.033900
TD OUTSIDE OR INSIDE BARK?  OI   OB  * LINEAR                        B1   0.002646
STUMP HEIGHT (FEET)         SH   0.5 * QUADRATIC                     B2   0.000000
*****
*** Available commands are HELP, DISPLAY, FULL, BRIEF, RUN, and STOP ***
*** Type HELP INPUT for help on changing values in this input menu ***
COMMAND?

```

Figure 1.—Default menu for slash pine rust model.

infection. For each set of SI, T5, S5, and PA values, the program automatically generates a comparison stand with the same SI, T5, and PA, but uses C5 instead of S5 for the rust variable. The two stand tables are then compared automatically and the results printed along with the stand table. The process is repeated for all combinations of SI, T5, S5, and PA values defined by the menu. Initially, a default value of zero is assigned to C5 to provide comparisons with rust-free stands.

The bottom half of figure 1, labeled "VOLUME SPECIFICATION", allows the user strict control of volume computations for each stand table. The left half of the volume specification menu controls volumes that are computed by stem profile equations, and the right half controls volumes computed by equations based on the square of d.b.h. multiplied by total height (DSQH). The program computes merchantable volumes by diameter class using the stem profile model defined by Dell and others (1979).

The DSQH variables include MC, BZ, B1, and B2. The variable MC is equivalent to the stem profile variable MD, and simply defines the minimum acceptable d.b.h. The variables BZ, B1, and B2 define the coefficients to be used in the following quadratic equation:

$$V = BZ + B1(DSQH) + B2(DSQH*DSQH)$$

where

V = volume (or perhaps dry weight),

BZ = intercept term,

B1 = linear coefficient of DSQH,

B2 = quadratic coefficient of DSQH,

DSQH = d.b.h. \times d.b.h. \times total height.

By setting B2 equal to zero, the user can force a simple linear regression model for volume equations based on DSQH. Typical default values for slash pine are initialized in the menu, but most users prefer to use their own local values instead.

The value for any variable in the menu can be changed easily by the user. In response to the "COMMAND?" prompt, the user types the key letters and the new values:

$$SI = 50,70,10$$

This statement redefines FIRST, LAST, and STEP values for site index to 50, 70, and 10 respectively. Typing "DISPLAY" in response to the COMMAND prompt will display (or print, if the terminal is a hardcopy device) a new menu containing the current values for all input variables. When no more changes to the input menu are desired, typing "RUN" causes the program to generate stand tables prescribed by the menu. Typing "FULL" before typing "RUN" directs the program to print the full stand table. If full output is not desired, typing "BRIEF" before "RUN" causes another menu to appear, from which the user can select the particular

stand summary information to be printed. BRIEF output is much more compact than FULL and is preferable when generating more than a few stand tables. The program also allows a HELP command that provides information regarding the operation of the program.

Figure 2 is a copy of the FULL printout generated by the menu shown in figure 1. Most of the output is self explanatory, but the following cryptic abbreviations may not be obvious:

Abbreviation	Meaning
AV. D+C HT.	average height of dominant and codominant trees
CR	average crown ratio
AV HT.	average height of all trees
O.B.	outside bark
I.B.	inside bark
AP	plantation age, same as PA
D2H	d.b.h. \times d.b.h. \times total height, same as DSQH
A, B, C	the shape, scale, and location parameters of the Weibull distribution function used to represent the diameter distribution of the current stand table

The top section, labeled "STAND TABLE", contains predicted values for each 1-inch diameter class. The lower half, labeled "MORE DETAILS ON RUST COMPARISON", contains several stand summary statistics, which are compared for the two stands with rust levels equal to S5 and C5. The comparison between C5 and S5 is highlighted throughout the output.

APPLICATION OF THE SLASH PINE MODEL

The three primary variables (T5, S5, and SI) must be specified in order to generate predicted yields. For any plantation that can be observed at age 5, a suitable sampling scheme can be utilized to obtain estimates of the number of living trees per acre (T5) as well as the proportion of those trees with stem galls (S5). However, the site index (SI) of the established site is more difficult to estimate. Experience has shown that tree height at age 5 is a poor predictor of mean dominant-codominant height in future years, so it is recommended that estimates of site index be based on concomitant information, such as soil-site predictors or perhaps site index estimates for either prior or nearby slash pine stands. Once estimates of T5, S5, and SI are obtained, the program can be used to generate expected yields at any future

YIELDS BY DIAMETER CLASSES FOR AN UNTHINNED SLASH PINE PLANTATION OF GIVEN AGE (AP), SITE INDEX (SI), TREES LIVING AT AGE 5 (T5), AND PERCENT OF LIVING TREES INFECTED WITH FUSIFORM RUST STEM CANKERS AT AGE 5 (S5)

*****STAND TABLE*****
 INCLUDES COMPARISONS TO A REFERENCE PLANTATION WITH A DIFFERENT RUST LEVEL (S5) BUT THE SAME VALUES FOR AP, SI, AND T5

SITE INDEX 70 (BASE AGE 25)

AGE						-----CUBIC FOOT VOLUME-----				
						MERCHANTABLE TREES				
GROWING SEASONS IN FIELD	AV. D+C HT.	DBH CLASS	TREES PER ACRE	BASAL AREA/ACRE	CR	AV. HT.	ALL TREES GROUND TO TIP	>= 4 IN. DBH CLASS FROM 0.5 FT. STUMP TO 3.0 IN. OB TOP		
*****	***	***	*****	*****	**	***	O.B.	I.B.	O.B.	I.B.
20	60	4	2	0.2	34	33	4	2	3	2
		5	8	1.1	37	41	25	16	21	14
		6	21	4.1	40	47	108	73	97	67
		7	41	11.0	42	52	315	221	293	208
		8	60	20.9	44	56	645	462	607	439
		9	57	25.2	46	60	825	600	783	575
		10	33	18.0	47	63	615	453	587	436
		11	10	6.6	49	65	231	172	221	166
		12	1	0.8	50	67	28	21	27	20
-----TOTALS-----			-----	-----	-----	-----	-----	-----	-----	-----
FOR S5	=	60%	233	87.9			2796	2020	2639	1927
IF S5	=	0%	621	158.1			4933	3488	4561	3268
DIFFERENCE			-388	-70.2			-2137	-1468	-1922	-1341
% DIFFERENCE				-43			-42	-41	-41	-40

***** MORE DETAILS ON RUST COMPARISON *****

	S5 = 60%	S5 = 0%	% DIFFERENCE
*****	*****	*****	*****
SURVIVAL AND RUST			
NUMBER OF LIVING TREES AT AGE 5 (T5) ---	800	800	
PERCENT STEMS RUST INFECTED AT AGE 5 (S5)	60	0	
PERCENT SURVIVAL AT AP = 20 -----	29	78	-49
DBH AND CROWN RATIO			
MEAN CROWN RATIO (ALL TREES) -----	44	34	10
ARITH. MEAN DBH -----	8.2	6.6	23
QUADRATIC MEAN DBH -----	8.3	6.8	22
DSQH VOLUME PER ACRE (DBH CLASSES >= 0)			
SUM OF DSQUARED H -----	937514.	1686294.	-43
VOLUME: USING 0.033900 + 0.002646 * D2H + 0.000000 * D2H * D2H -----	2489.	4483.	-43
WEIBULL PARAMETERS			
A -----	1.55	1.08	44
B -----	7.21	6.14	17
C -----	5.10	4.06	26

Figure 2.—Stand table output generated by slash pine rust model with default input values.

age up to 20, assuming no thinnings. The predicted yields could then be combined with economic data to help the manager make decisions regarding the management of that particular plantation.

Although the model can be used in the manner described above, it is perhaps more valuable to the manager when used to simulate yields. In this way, the user assigns a range of values to T5, S5, and SI; generates the predicted yields for these values; and then combines the yield information with economic data to help him make decisions regarding the establishment and management of new slash pine plantations in his particular operation.

A HYPOTHETICAL SLASH PINE MANAGEMENT PROBLEM

A simplified example is offered to illustrate one way in which the slash pine model yield simulations might be used to aid in preplanting decisions. In this example, total cubic foot volume will be the only production unit considered; economic data on costs and returns will not be considered, and the range of alternatives to be considered will be severely restricted.

The Problem

A manager has to plant 3,000 acres with slash pine seedlings. Half the land is of good quality, having a site index of 70, and the other half is of much poorer quality, having a site index of 50. Sites of both good and poorer quality are evenly distributed throughout the 3,000 acres. Fusiform rust presents a high hazard (S5 = 70 percent to 1,000 acres, a medium hazard (S5 = 30 percent) to 1,000 acres, and a low hazard (S5 = 10 percent) to 1,000 acres. The distribution of sites is:

Site category	SI	S5	Acreage
1	70	50	500
2	70	30	500
3	70	10	500
4	50	50	500
5	50	30	500
6	50	10	500

The manager normally plants 750 trees per acre and achieves, on the average, an establishment density of 500 trees per acre. Non-improved planting stock is typically used. The manager generally waits until about age 15 before considering thinning and other management options. The manager wants to know: (1) The expected volume losses (relative to when S₅ = 0) due to fusiform rust if he establishes the planting sites in the normal way, (2) the alternatives available to reduce the volume losses, and (3) the amount of the volume loss.

Available Alternatives

Many alternatives could be considered with the current model, but only three will be examined in this case. Alternative A would establish the plantations in the normal way using nonimproved planting stock and a planting density of 750 trees per acre. Alternative B would increase the planting density with nonimproved stock to compensate for the increased mortality due to fusiform rust. Alternative C would use resistant planting stock (the planting density could be changed at the same time).

Assessment of Alternative A

Table 3 summarizes the expected total volume per acre for the six site categories and the expected volume loss due to fusiform rust under this manage-

Table 3. — *Expected total volumes (per acre, outside bark) and volume losses due to fusiform rust at age 15 for management option A*

Site category	Assumed values			Expected volume	Assumed values			Expected volume	Expected loss due to rust	
	SI	S5	T5		SI	S5	T5		Loss	
----- With fusiform rust -----				----- Without fusiform rust -----						
	ft	%	t/a	ft ³	ft	%	t/a	ft ³	ft ³	%
1	70	50	500	2030	70	0	500	2735	705	25
2	70	30	500	2372	70	0	500	2735	363	12
3	70	10	500	2631	70	0	500	2735	104	3
4	50	50	500	988	50	0	500	1234	246	19
5	40	30	500	1109	50	0	500	1234	125	9
6	50	10	500	1187	50	0	500	1234	47	3
Mean per acre				1720				1984	265	13

ment option. About half of the expected volume losses are confined to sites of index 70, with S5 equal to 50 percent, and almost three-fourths of the expected volume losses occur on sites where the site index is 70. Considering the total acreage, this alternative has an expected volume at age 15 of about 5,158,500 cubic feet, and 795,000 cubic feet are expected to be lost due to fusiform rust.

Assessment of Alternative B

Two simple variations of this alternative were considered. The first, option 1, is simply to choose a uniformly higher planting density for all site categories in order to lower the overall expected volume losses and achieve some target goal. Option 2 is to allow different planting densities for each site category in an attempt to reach the same target goal. In both options, the target goal for this example will be to produce 5,953,500 cubic feet total volume for the 3,000 acres—the expected volume under management alternative A in the absence of rust.

To find a uniform planting density for all site categories that will produce the required volume, the program can simply be applied repeatedly for a range of T5 values until one is found that produces the desired volumes. The following input values for the primary variable in the input menu was used to accomplish the task:

KEY	FIRST	LAST	STEP
SI	50	70	20
T5	500	700	10
S5	10	50	20
PA	15	15	1

The values for SI and S5 define the range of site indexes and rust levels for the six site categories of interest, and the values for T5 define a range of 20 establishment densities to simulate for each cate-

gory. The program output reveals that when T5 equals 660 trees per acre, the total volume over all six site categories is 5,943,500 cubic feet, which is within 10,000 cubic feet of the target volume. Table 4 contains a summary of the increase in volume by category for option 1. Assuming the same planting mortality rate as before (33 percent), an establishment density of 660 trees per acre translates to a required planting density of 990 trees per acre, or an increase of 240 trees per acre (or 720,000 trees for the 3,000 acres) in planting density compared to alternative A.

Unfortunately, the regained volume under this strategy is not ideally distributed throughout the six site categories. For example, only about half of the expected losses in categories 1 and 4 (high hazard) would be regained with this option, while net increases over and above expected losses for categories 3 and 6 (low hazard) make up the difference. Only categories 2 and 5 (medium hazard) appear to be correctly adjusted by this approach.

The second option is perhaps more realistic, since it allows one to vary T5 for the different site categories in order to achieve the same goal. Repeated application of the program, category by category, results in the required T5 values for each category shown in table 5. As expected, the required adjustment in T5 ranges from a small increase of only 40 established trees per acre (or 60 planted trees per acre) for categories 3 and 6, to a large increase of 230 established trees per acre (or 345 planted trees per acre) for categories 1 and 4. Categories 2 and 5, as expected, were only slightly changed from the densities required in option 1.

Assessment of Alternative C

The use of genetically resistant planting stock is currently the primary control measure for fusi-

Table 4.—Expected gains from uniformly increasing establishment density under management option B

Site category	Assumed values			Expected volume	Assumed values			Expected volume	Expected gain from higher T5		
	SI	S5	T5		SI	S5	T5		Gain		
	----- With lower T5 -----				----- With higher T5 -----				----- Gain -----		
	ft	%	t/a	ft ³	ft	%	t/a	ft ³	ft ³	%	
1	70	50	500	2030	70	50	660	2418	388	25	
2	70	30	500	2372	70	30	660	2761	389	12	
3	70	10	500	2631	70	10	660	3015	384	3	
4	50	50	500	988	50	50	660	1130	142	19	
5	50	30	500	1109	50	30	660	1237	128	9	
6	50	10	500	1187	50	10	660	1326	139	3	
Mean per acre				1720				1981	262	13	

form rust. In addition to lowering infection levels, improved stock offers the possible advantage of increased growth potential as well.

Two different types of improved stock are simulated in this alternative. The first type (type 1 stock) offers resistance without increased growth potential when compared to the nonimproved stock assumed in management alternative A. The use of this stock would simply result in a 50 percent reduction in S5 values. The second type of stock (type 2 stock) will be assumed to offer both resistance and increased growth potential. This stock has the same resistance as type 1 stock (lowering S5 by 50 percent), but at the same time increases the growth potential of the site (expressed as site index) by 6 percent when compared to nonimproved stock.

Table 6 shows the effect of using type 1 stock. About half of the expected losses under management alternative A would be regained under this option. As expected, the volume gains are not distributed equally over the six site categories—high-hazard

sites benefit much more from the use of the resistant stock than the other site categories.

Table 7 shows the additional effect of using type 2 stock, where the combination of resistance and growth rate resulted in an expected overall gain of 1,261,000 cubic feet over the 3,000 acres—surpassing the amount needed to regain the expected volume loss under management alternative A for all six site categories. The total increase in expected volume for the 3,000 acres amounted to 466,000 cubic feet (or 155 cubic feet per acre).

Many more options could be addressed in a similar way. The normally limited supply of improved seed, especially from the better families, suggests that alternatives seeking a more refined allocation of improved seedlings should be investigated. This might involve variable planting densities by site and family as well as numerous deployment options, such as mixing of different families or even the mixing of nonimproved and improved seedlings in various proportions.

Table 5. — *Expected gains from variable increases in establishment density under management option B*

Site category	Assumed values			Expected volume	Assumed values			Expected volume	Expected loss from higher T5	
	SI	S5	T5		SI	S5	T5		Gain	
----- With lower T5 -----				----- With higher T5 -----				----- Gain -----		
	<i>ft</i>	<i>%</i>	<i>t/a</i>	<i>ft³</i>	<i>ft</i>	<i>%</i>	<i>t/a</i>	<i>ft³</i>	<i>ft³</i>	<i>%</i>
1	70	50	500	2030	70	50	830	2735	704	35
2	70	30	500	2372	70	30	650	2742	370	16
3	70	10	500	2631	70	10	540	2735	104	4
4	50	50	500	988	50	50	830	1234	246	25
5	50	30	500	1109	50	30	650	1231	122	11
6	50	10	500	1187	50	10	540	1234	47	4
Mean per acre				1720				1985	266	15

Table 6. — *Expected gains from uniformly decreasing rust levels under management option C using resistant planting stock*

Site category	Assumed values			Expected volume	Assumed values			Expected volume	Expected gain from lower S5	
	SI	S5	T5		SI	S5	T5		Gain	
----- With higher S5 -----				----- With lower S5 -----				----- Gain -----		
	<i>ft</i>	<i>%</i>	<i>t/a</i>	<i>ft³</i>	<i>ft</i>	<i>%</i>	<i>t/a</i>	<i>ft³</i>	<i>ft³</i>	<i>%</i>
1	70	50	500	2030	70	25	500	2441	411	20
2	70	30	500	2372	70	15	500	2572	200	8
3	70	10	500	2631	70	5	500	2689	58	2
4	50	50	500	988	50	25	500	1133	145	15
5	50	30	500	1109	50	15	500	1178	69	6
6	50	10	500	1187	50	5	500	1208	21	2
Mean per acre				1720				1870	151	9

Table 7. — *Expected gains from uniformly decreasing rust levels and increasing site index under management option C using resistant planting stock with increased growth potential*

Site category	Assumed values			Expected volume	Assumed values			Expected volume	Expected gain higher T5, SI	
	SI	S5	T5		SI	S5	T5		ft ³	%
	-----With higher S5, lower SI-----				-----With lower S5, higher SI-----				-----Gain-----	
	ft	%	t/a	ft ³	ft	%	t/a	ft ³	ft ³	%
1	70	50	500	2030	74	25	500	2794	764	38
2	70	30	500	2372	74	15	500	2726	554	23
3	70	10	500	2631	74	5	500	3051	420	16
4	50	50	500	988	53	25	500	1304	316	32
5	50	30	500	1109	53	15	500	1359	250	23
6	50	10	500	1187	53	5	500	1405	218	18
Mean per acre				1720				2140	420	24

CONCLUSIONS

Our experience in attempting to incorporate a fusiform rust level parameter into an existing growth and yield prediction system suggests that the approach is fundamentally sound. A model for predicting the growth and yield of rust-infected slash pine plantations has been completed and is available from the authors in a variety of machine readable formats.

Further research is needed to incorporate other management options into the models (such as thinning, site preparation, and various deployment options such as mixing) as well as economic assessment routines to allow managers to study a wider array of economic strategies designed to minimize the impact of this important disease on their operations.

LITERATURE CITED

Dell, T. R.; Feduccia, D. P.; Campbell, T. E.; Mann, W. F., Jr.; Polmer, B. H. Yields of unthinned slash pine plantations on cutover sites in the west Gulf region. Res. Pap. SO-147. New Orleans, LA: U.S. Department of Agriculture, Forest Service, Southern Forest Experiment Station; 1979. 84 p.

Feduccia, D. P.; Dell, T. R.; Mann, W. F., Jr.; Campbell, T. E.; Polmer, B. H. Yields of unthinned loblolly pine plantations on cutover sites in the west Gulf region. Res. Pap. SO-148. New Orleans, LA: U.S. Department of Agriculture, Forest Service, Southern Forest Experiment Station; 1979. 88 p.

Holley, D. L.; Veal, M. A. Economic impact of fusiform rust. In: Dinus, R. J.; Schmidt, R. A., eds.

Management of fusiform rust in southern pines. Proceedings of a symposium; Gainesville FL; 1977: 39-50.

Meinecke, E. P. The evaluation of loss from killing diseases in the young forest. J. For. 26: 283-298; 1928.

Moehring, D. M.; Holmes, M. R.; Merrifield, R. G. Tables for estimating cubic foot volume and fresh weight of planted slash pine. MP-1079. College Station, TX: Texas A&M University; 1973.

Nance, W. L.; Froelich, R. C.; Shoulders, E. Effects of fusiform rust on survival and structure of Mississippi and Louisiana slash pine plantations. Res. Pap. SO-172. New Orleans, LA: U.S. Department of Agriculture, Forest Service, Southern Forest Experiment Station; 1981. 11 p.

Nance, W. L.; Froelich, R. C.; Dell, T. R.; Shoulders, E. A growth and yield model for unthinned slash pine plantations infected with fusiform rust. In: Jones, Earle P., Jr., ed. Proceedings of the second biennial southern silvicultural research conference; 1982 November 4-5; Atlanta GA. Gen. Tech. Rep. SE-24. Asheville, NC: U.S. Department of Agriculture, Forest Service, Southeastern Forest Experiment Station; 1982: 275-282.

Shoulders, E. Site characteristics influence relative performance of loblolly and slash pine. Res. Pap. SO-115. New Orleans, LA: U.S. Department of Agriculture, Forest Service, Southern Forest Experiment Station; 1976. 115 p.

Shoulders, E.; Walker, F. V. Soil, slope, and rainfall affect height and yield in 15-year-old southern pine plantations. Res. Pap. SO-153. New Orleans, LA: U.S. Department of Agriculture, Forest Service, Southern Forest Experiment Station; 1979. 52 p.

SESSION II—PESTS AND HOST/PEST INTERACTIONS

Pests and Associated Organisms

Host Preference Behavior of Insect Parasites in the Presence of Southern Pine Beetle and One or More *Ips* Species

L. H. Kudon and C. W. Berisford¹

Abstract.—Gas liquid chromatography analysis of parasite lipid profiles was utilized to determine host origin of parasites infesting southern pine beetles (SPB) and *Ips* spp. in rapidly collapsing, transient stable, and expanding infestations. SPB population estimates and emergence and sticky trap catches of most SPB associates were also used in the study sites.

In two adjacent concurrent infestations, SPB origin parasites tended to disperse rather than attack *Ips* spp. when SPB became scarce in the infestation. There were indications of parasite dispersal from the rapidly collapsing infestation as *Ips* spp. became more abundant than SPB. A time lag between the parasites switching from host of origin to alternate hosts was attributed to parasite host preference and tenacity.

Additional keywords: *Dendroctonus frontalis* Zimmermann, natural enemies, population dynamics, sampling.

INTRODUCTION

The southern pine beetle, *Dendroctonus frontalis* Zimmermann (SPB), is the most serious pest of southern pines and one of the most damaging of all eastern forest insects.

In 1982, an endemic year for the southern pine beetle in Georgia, combined losses for SPB and other pine bark beetles (*Ips* spp.) exceeded \$800,000 (Suber et. al. 1984). From 1961–76, over 25 million dollars in damage was directly attributable to the SPB in Georgia. The loss during the same period for the 12-State southern region exceeded \$190 million. (Price and Doggett 1978).

The southern pine beetle has a large number of natural enemies. Predators, parasites, and competitors may reduce SPB numbers or help prevent or delay population explosions. Natural enemies make up a significant portion of the diverse arthropod community in a tree infested with SPB (Dixon and Payne 1979).

Most of the Hymenopterous parasites attacking the southern pine beetle are not host specific. Several *Ips* spp. and other bark beetle associates of SPB as well as bark beetles infesting nonpine hosts are attacked by many of these parasites (Dixon and Osgood 1961). The impact of nonhost-specific parasites on SPB population dynamics is largely dependent on the nature of the interaction of parasites in selecting between SPB and non-SPB hosts. Kudon and Berisford (1980) demonstrated the existence of host preferences of some of these parasites. A conceptual model was proposed for the interaction of the parasites with SPB and *Ips* spp. (Berisford 1980). This model raises the possibility that endemic *Ips* spp. populations may not function solely as a reservoir for SPB parasites between epidemics, but may be competing hosts; i.e., parasites may switch to the relatively abundant *Ips* spp. at endemic SPB population levels thereby reducing SPB mortality.

This conceptual model also attempted to characterize the relationship between host preferences of parasites for endemic, epidemic, and intermediate SPB populations.

Both the validity of the proposed conceptual model and the relationship of parasite host preference to beetle population trends are vital to defining the collective role of natural enemies on *Ips* spp. and SPB populations. This study attempts to provide a factual basis for evaluation of the model and to further elucidate host-parasite interaction for southern pine bark beetles.

METHODS

Several southern pine beetle infestations having differing degrees of activity were selected. Sites were chosen with 15 to 50 active trees and with expansion potential relative to tree host availability and beetle brood. SPB population estimates were made in each site utilizing a sampling and estimation procedure based on Coulson et. al. (1976) and Pulley et. al. (1977). All trees with d.b.h. of at least 17 cm and containing brood were sampled. Bark discs 10 cm in diameter were removed from each sampled tree at two heights: 3 and 6 meters. Autoradiographs and dissection of these samples were used to determine beetle density, presence of parasites, stage of development of infesting beetles, and primary beetle species infesting the tree. On all trees past mass beetle attack emergence traps were attached at the

¹ Respectively, Research Associate and Professor, Department of Entomology, University of Georgia, Athens, GA. (Joseph S. Hamilton and Thomas A. Coffey both provided invaluable technical assistance toward the completion of this study. We are grateful to Drs. Gary L. DeBarr and Gerold Morrison for reviewing the manuscript).

same heights as those at which the bark discs were removed. These traps were checked three times per week. Numbers and species of beetles and parasites trapped were recorded. Sticky traps of 1000 cm² were placed on infested trees at locations infested primarily with 3rd and 4th instar beetle larvae of primarily one host. Traps were also checked every 3 days and all parasites and beetles were removed, counted, and identified.

Parasites ovipositing on trees or parts of trees infested uniformly with either SPB or *Ips* spp. were collected and analyzed for lipid profile (Kudon and Berisford 1981). These lipid profiles were matched with SPB and *Ips* profiles to determine host of origin of the parasites.

Each selected SPB infestation was monitored for expansion during the study. Data collected were characterized according to whether the SPB infestation was expanding, rapidly collapsing, or transient stable. Since data were collected every 3 days, this period is referred to in this paper as 1 sampling day. Each site was observed for 21 sampling days, which equalled approximately 7 weeks.

RESULTS AND DISCUSSION

Seven southern pine beetle infestations were sampled over a 2-year period. The sampled sites were classified for purposes of this study into four categories based on the behavior of the SPB populations. These categories were: 1) Adjacent concurrent infestations, 2) expanding infestations, 3) rapidly collapsing infestations, and 4) transient stable infestations. Transient stable infestations were sites that had relatively stable populations during the 7 week study period but died out by the end of that time and (refer to fig. 2a). The rapidly collapsing infestation (see fig. 5a) started with a moderate population and steadily declined until only halfway through the study period no active SPB's were left in the site. Both expanding infestations actually decreased in population over the study period, but due to late expansion ended with substantial potential for continued spot growth (see figs. 4a and 7a). The adjacent concurrent infestation involved a rapidly collapsing infestation that developed a concurrent satellite infestation nearby.

Over 1,800 individual live parasites were collected for lipid analysis. These were: *Heydenia unica* Cook and Davis (Pteromalidae), *Coeloides pissodes* (Ashmead) (Braconidae), *Dendrosoter sulcatus* Muesebeck (Braconidae), *Roptrocercus xylophagorum* (Ratzeburg) (Torymidae) and *Spathius* sp. (Braconidae). Parasites were also collected in emergence traps and from sticky traps yielding the following genera: *Spathius* (Braconidae), *Dinotiscus* (Ptero-

malidae), *Heydenia* (Pteromalidae), *Coeloides* (Braconidae), *Roptrocercus* (Torymidae), *Eurytoma* (Eurytomidae), *Platygaster* (Platygastridae), *Meteorus* (Braconidae) and *Dendrosoter* (Braconidae).

Primary bark beetle hosts trapped in emergence and sticky devices were *Dendroctonus frontalis*, *Ips avulsus* (Eichhoff), *Ips calligraphus* (Germar), *Ips grandicollis* (Eichhoff). The numbers and trap dates of the following SPB associates were also logged: *Atanycolus* (Braconidae), *Cenocoelius* (Braconidae), *Cossonus* (Curculionidae), *Crypturgus* (Scolytidae), *Gnathotrichus* (Scolytidae), *Hylastes* (Curculionidae), *Lasconotus* (Colydiidae), *Leptacinus* (Staphylinidae), *Leptacis* (Platygastridae), *Lonchaea* (Lonchaeidae), *Medetera* (Dolichopodidae), *Pityophthorus* (Scolytidae), *Platysoma* (Histeridae), *Plegaderus* (Histeridae), *Temnochila* (Trogositidae), *Tenebroides* (Trogositidae), *Thanasimus* (Cleridae) and *Xyleborus* (Scolytidae).

Adjacent Concurrent Infestations

The original infestation was located about 300 feet from the western edge of a 10-acre loblolly plantation. At the onset, there were five green infested trees and seven redtops, most of which were infested with late stage larvae or pupae. The spot rapidly declined with almost all activity ceasing by the end of the second week of the study period. At the beginning of the third week of monitoring, another infestation was established south of the initial one. This infestation was located about 1000 feet from the original and was bordered on the east by a cutover and on the south by a deep draw. This satellite infestation consisted of 15 trees that were infested with larvae and pupae when located. Because of expansion barriers (cutover, draw) and a predominance of surrounding hardwoods, the site had little opportunity for expansion. There were no new infested trees, and as all the other infested trees at this site were infested with SPB of the same approximate life stage, the spot remained static until decline.

Initially, in the original infestation, bark disc sampling showed a relatively large population of late stage SPB (over 70,000 beetles) and concomitant *Ips* spp. (fig. 1a). Emergence trap catch for SPB peaked on sampling day 5 and thereafter rapidly diminished so that at the next sampling day emergence was negligible. Site SPB population estimates also dropped to zero around sampling day 5 (fig. 1a). This is indicative of SPB dispersal from the original site and/or beetle mortality. There were no newly infested trees and sticky trap catches of both *Ips* spp. and SPB were minimal. Site evaluation on sampling days 5-7 showed little *Ips* spp. activity. Site two was initiated through the simultaneous infestation of 15 trees. Emergence trap data (60

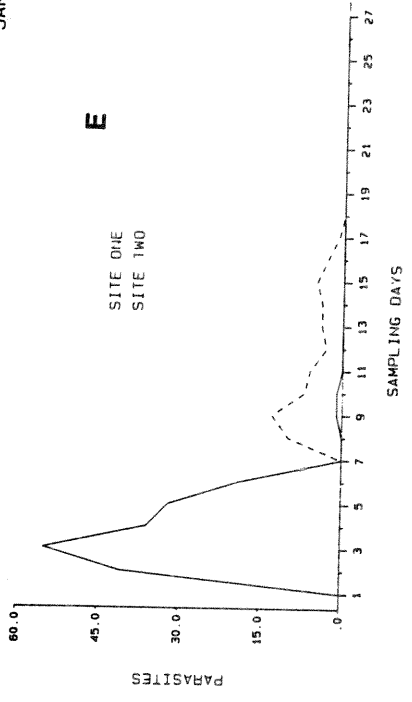
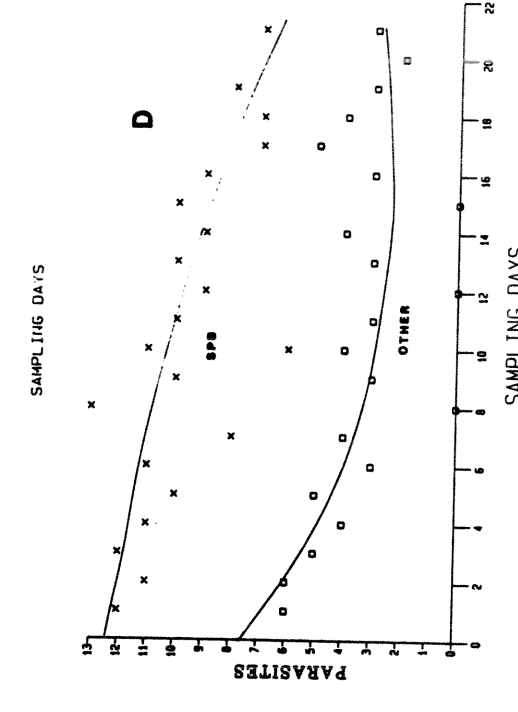
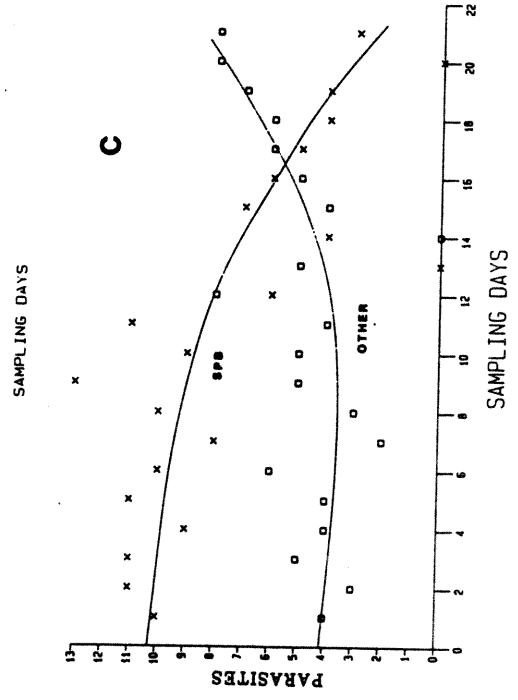
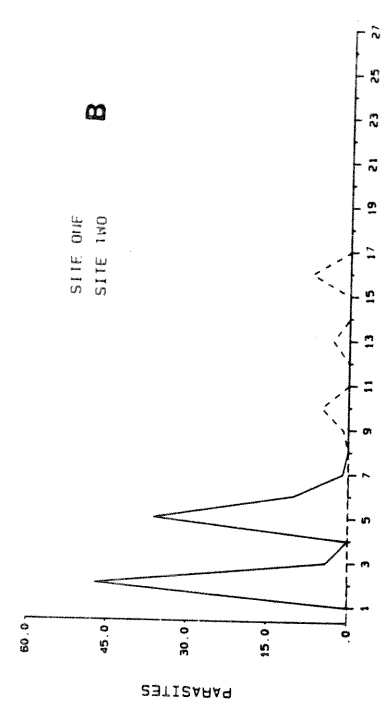
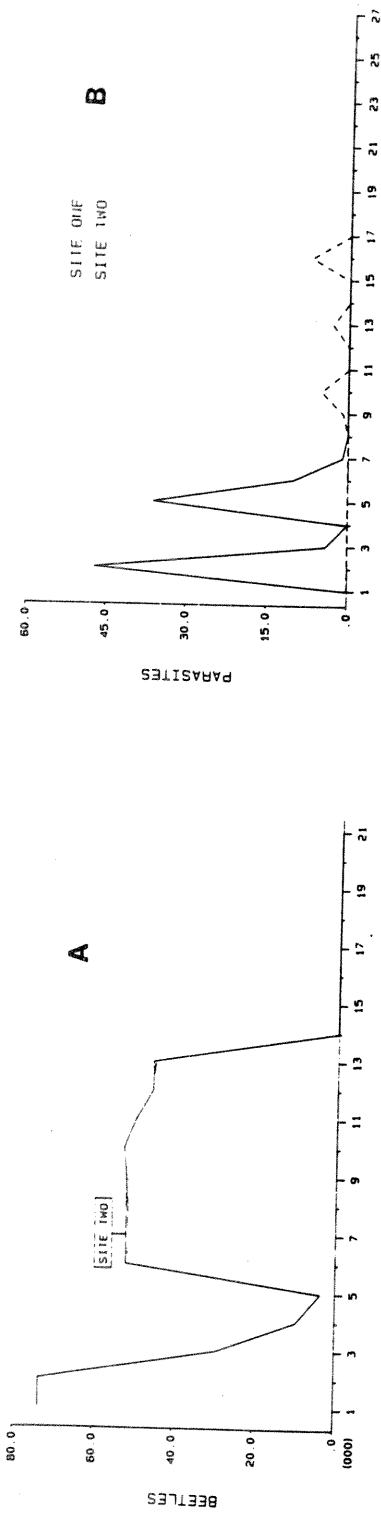

Figure 1.—Site 1 and 2 sampling results: (a) SPB population estimates; (b) parasite emergence trap catch; (c) site 1 host of origin for parasites based on lipid analysis; (d) site 2 host of origin for parasites based on lipid analysis (SPB = southern pine beetle, OTHER = other beetle hosts including Ips, Phloeosinus, etc.); (e) parasite sticky trap catch.

percent) of all SPB emergence occurring in 3 days) coupled with life stage data (all trees infested with mixed 4th instar and pupae) bear this out. Estimates showed stable populations at life two for 8 sampling days, with a precipitous dropoff on sampling 13 (fig. 1a), which is expected for a synchronous infestation. *Ips avulsus* emergence was fairly constant from sampling day 7 to 13 (averaging six per day) and further catches (seven beetles) were recorded as late as sampling day 26 in site two. Peak sticky trap catches for *Ips avulsus* trailed peak emergence trap catches typically by a single sampling day. Thus, it is probable that some reinfestation accounts for the *Ips avulsus* emergence patterns.

Parasite emergence (*Heydenia*, *Coeloides* and *Roptrocerus*) and sticky trap catch for site one (fig. 1b,e) was high on sampling days 2–6 (collectively over 90 trapped individual parasites) but was very low thereafter. When each parasite species was considered separately, emergence trap catches closely preceded sticky trap catches. All parasites for which there were adequate data (*Coeloides*, *Roptrocerus*, *Eurytoma* and *Heydenia*) had late emergence trap catches (sampling days 6–7) not followed by sticky trap catches in site one. There were early sticky trap catches (sampling days 8 and 9) of these parasites in site two. The first emergence trap catches of parasites did not occur until the following sampling day (fig. 1b,e). Thus, these early sticky trap catches most likely represent migration of parasites from the original site to the satellite infestation.

Initially, in site one, a high percentage of parasites had SPB host origin (over 60 percent) (fig. 1c). The numbers of SPB-origin parasites declined steadily over the study period with a collateral rise in the number of *Ips* spp.-origin parasites. There was an intersection of the two curves around the seventeenth sampling day. The first parasites analyzed for lipids in site two (sampling day 7) were all of SPB host origin. Throughout the study period, overall numbers of both SPB host origin parasites and *Ips*-origin parasites decreased, with the average percentage of *Ips* spp. parasites slowly decreasing from the fourteenth sampling day on.

The host origin curves follow the general trend of beetle populations. This cannot be easily explained by migration of new parasites into the infestation because of temporal considerations. Searching-related mortality and dispersal engendered by falling SPB populations could account for the switch in parasite host origin. Parasite populations in site one tended to attack hosts in nearby trees (fig. 1c,e) for a period ending about the fifth sampling day. At this juncture, sticky trap and emergence trap data suggest an increasing amount of dispersal or mortality of both *Ips* spp. and SPB parasites. There were fewer

SPB parasites in site one reattacking beetle hosts as can be seen from host origin and parasite emergence/reinfestation data. In site two, the original predominance of SPB host-origin parasites strongly suggests that this satellite infestation received SPB-origin parasites dispersing from site one. Emergence/attack data for parasites derived from emergence traps and sticky traps tend to support this assumption. Most of the parasites that dispersed from site one had SPB host origin and thus SPB host preference. As site one declined and the proportion of *Ips* spp. to SPB increased, parasites with SPB host preference dispersed to site two or elsewhere, where SPB still prevalent, and site one became dominated by *Ips* spp. parasites. This would account for an unusually high parasite impact on the newly founded SPB population in site two. These unbalanced parasite-to-beetle populations in both sites may explain the rapid demise of site two and the inability of *Ips* spp. to capitalize on site one resources. Although numbers of parasites trapped at site two were lower overall than those trapped at site one, (>50 vs >200), such is not necessarily indicative of dispersal success, as many other factors including sampling efficiency could account for it. The fortuitous occurrence of this satellite infestation supports the concept that parasite host origin and preference can initiate wholesale switching to more preferred hosts invariably influencing parasite dispersal and host mortality and dynamics.

Transient Stable Infestations

Two transient stable infestations were studied. Both these sites were consynchronous but separated by a distance of ca. 16 kilometers. The first site, designated as site three, was part of a large Virginia pine/loblolly plantation. The center of the infestation was approximately 30 meters from a pasture bordering the edge of the plantation. When sampling was initiated, this site had 18 redtop trees and 9 green infested trees. The average d.b.h. was 23 cm. and the predominant SPB life stage was parent adult. All infested trees were Virginia pine.

Six new trees were infested during the first 2 weeks of the study, but further expansion did not occur. This may be partly attributable to cool temperatures; as temperatures averaged 24.7°C over the first 15 sampling days, only 21.2°C for the whole study period, and 17.5°C for the last 15 days (October).

The second transient stable infestation (site four) was located in a 20-acre loblolly pine plantation adjacent to a residential area. The site was expanding to both the west and south and was bordered by expansion barriers to the north (road) and east (residence).

The 31 infested trees yielded mostly late larvae and brood adults with 6 trees being primarily infested with parent-adults. The spot was fairly static in growth; a satellite infestation was discovered over 400 meters distant from the original infestation. This outbreak had nine trees that were heavily infested with SPB; but due to the small number of trees and the considerable distance from the assumed parent infestation, this site was not sampled. In sharp contrast, the parent infestation had very low brood density (10/100 cm² vs 80/100 cm²).

The SPB populations in these two sites remained very high and stable for most of the study period (38,000–48,000 beetles for 17 sampling days in site three and 13,000–7,000 beetles for 17 sampling days in site four) (fig. 2a,3a). Populations at both sites leveled off after an initial decline before resuming the decreasing trend around the sixteenth sampling day. The drop in SPB population was conspicuous at site three, and this was not unexpected considering the uniform infestation by parent-adults and the moderating temperatures, which produced a prolonged development period and static populations. Since there were plenty of colonizable pines adjacent to the infestation, low temperatures may have stopped spot expansion, even though relatively high beetle populations were present. Brood density in the sampled discs averaged 20 larvae with counts as high as 36 per 100 cm². *Ips* spp. populations were prevalent in site three, being in most SPB-infested trees, but there were no trees wholly infested by *Ips* spp. Site four showed little evidence of *Ips* spp. in infested trees.

SPB emergence trap catches for site three were initially high (40 beetles on sampling day 5) but declined thereafter and were sporadic for the duration of the study period. *Ips* spp. emergence trap catch in this site declined almost linearly from sampling day 1 (15 beetles); reaching zero on sampling day 11. Site four had low emergence trap catch for both SPB and *Ips* spp. The SPB trap catch declined steadily from sampling day 1 (16 beetles); reaching zero on sampling day 7. *Ips* spp. trap catch was too low to warrant inclusion.

Except for a period of unusually cold weather from sampling day 11 to 12, parasite emergence and reattack as shown by emergence and sticky trap data (fig. 2b,d) were continuous throughout the study period, although sporadic. Parasite emergence trap catch in site four was low (28 parasites total) with peak catch occurring around sampling days 3 and 4 (14 parasites) and then falling rapidly for the rest of the study period (fig. 3b). Sticky trap catch on sampling days 2 and 3 exceeded 125 parasites, but declined over time similar to the emergence trap catch (fig. 3d).

Host origin curves for both sites were similar, differing primarily in the magnitude. At sampling day 6 or 7, the number of parasites with SPB host origin fell below the number coming from other hosts. As the study progressed, numbers of parasites available for analysis in both sites declined (from 25 to as low as 10); however, a tendency for the numbers of SPB-origin parasites and the numbers of *Ips*-origin parasites to converge was evident at both sites three and four.

Host origin data show larger numbers of SPB-origin parasites earlier in the site than *Ips*-origin parasites. Given the probable history of these infestations, the opposite might be expected. Parasites from endemic levels of *Ips* spp. were most likely flooded initially by dispersal from other SPB infestations (SPB activity in the area was high). As SPB populations increased and numbers of SPB hosts greatly exceeded numbers of *Ips* spp. present, more *Ips*-origin parasites tended to switch to SPB. The reason numbers of SPB-origin parasites fell more rapidly than *Ips*-origin parasites is not clear; but mild temperatures at the time may have delayed SPB parasite emergence. In this site, parasite emergence was staggered whereas *Ips* spp. are usually present in all stages, and emergence of parasites can be looked on as almost continuous.

Initially, parasite emergence trap catch matched sticky trap catch. This is most likely due to reinfestation of the spot by emerging parasites. The secondary peak of parasite emergence is not matched by a similar peak in sticky trap catch. Apparently, parasites emerging at that time (sampling days 6-10) dispersed; i.e., to a satellite infestation. This would also be reflected in the numbers of parasites with host origins other than SPB increasing beyond numbers of parasites with SPB host origin; this occurred from sampling day 6 onward.

Since most of the bark beetles in the site were SPB, it is logical to expect that the majority of parasites would be of SPB origin. These parasites would then disperse to find their preferred host (SPB) in other infestations or elsewhere, leaving a majority of *Ips* spp. parasites behind.

Expanding Infestations

Two sites still had considerable potential for expansion at the end of the study period. These sites, designated sites five and seven, were not adjacent in time or place; site five starting July 7 and site seven starting August 18. Locations were 90 kilometers apart. Site five was discovered in a large loblolly pine plantation and was bordered on all sides by pines. A recent clearcut was located around 900 meters to the east. At study initiation, there were 13

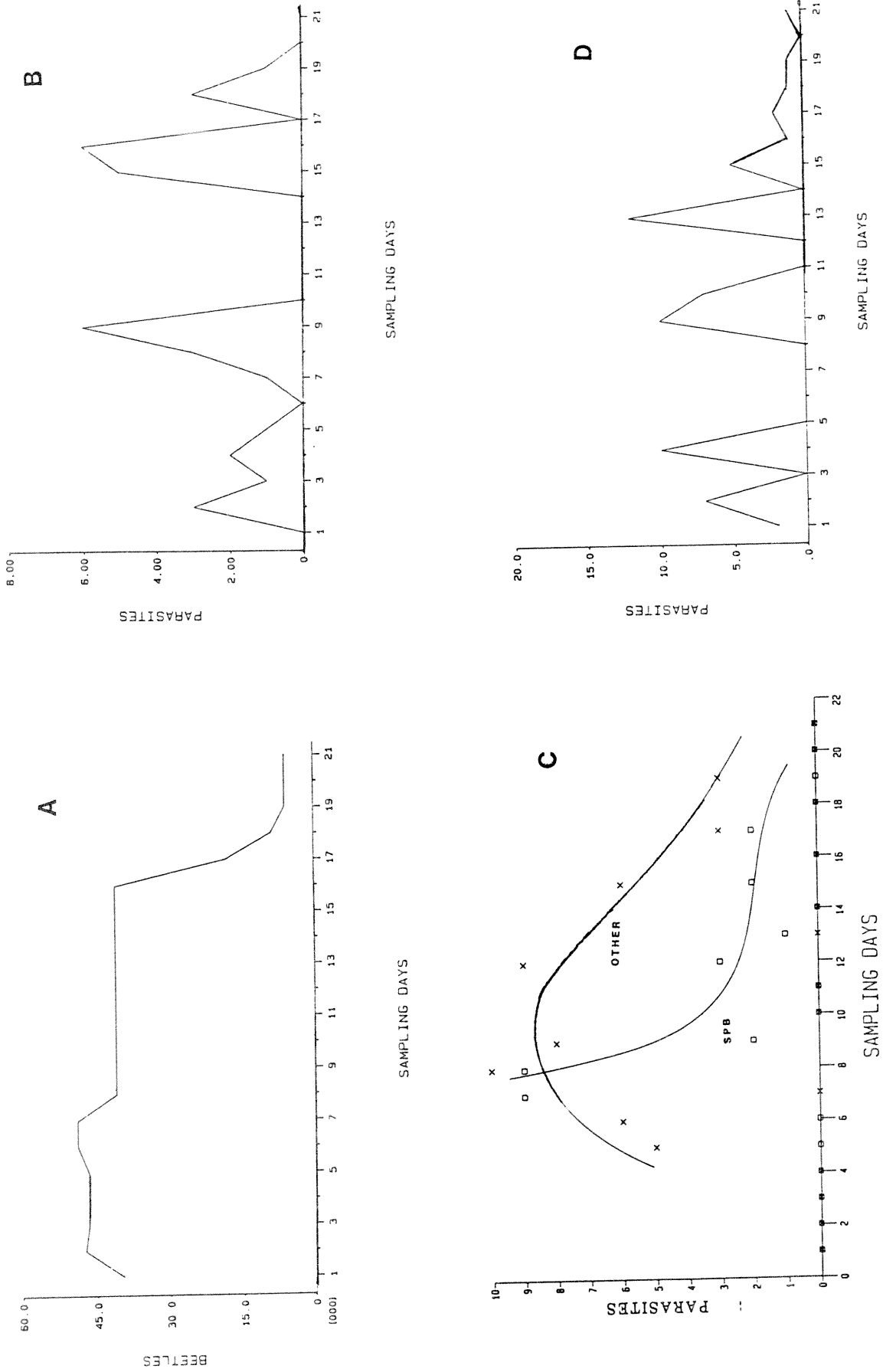

Figure 2.—Site 3 sampling results: (a) SPB population estimate; (b) parasite emergence trap catch; (c) host of origin for parasites based on lipid analysis (SPB = southern pine beetle, OTHER = other beetle hosts including Ips, Phloeosinus, etc.); (d) parasite sticky trap catch.

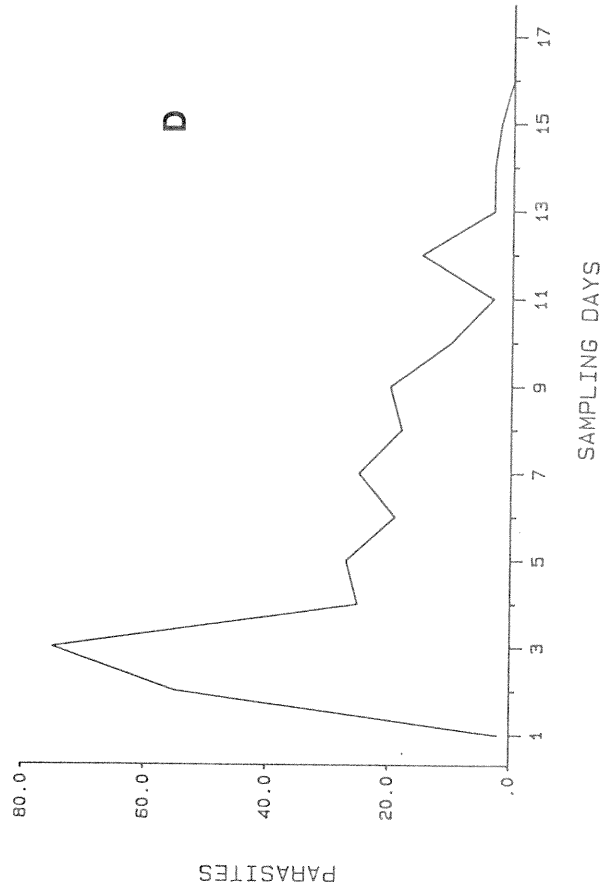
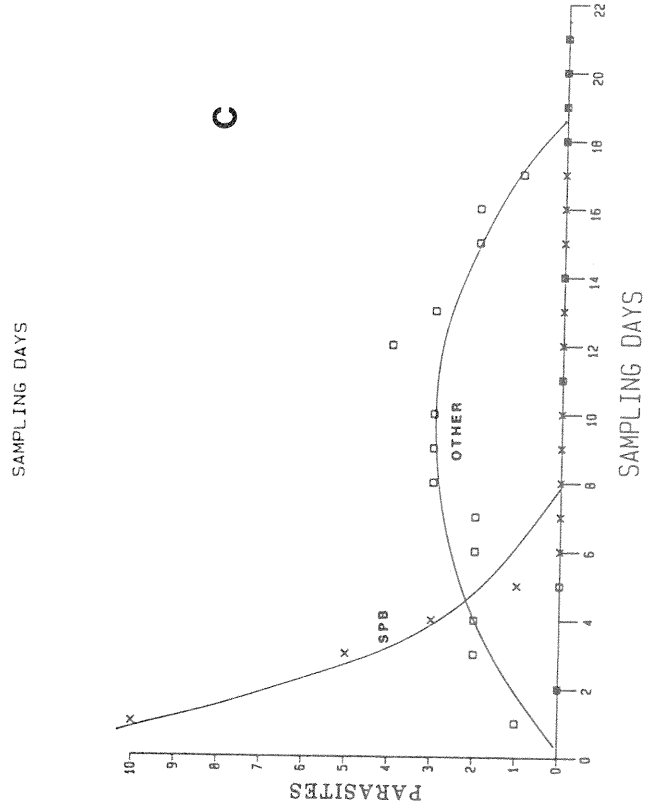
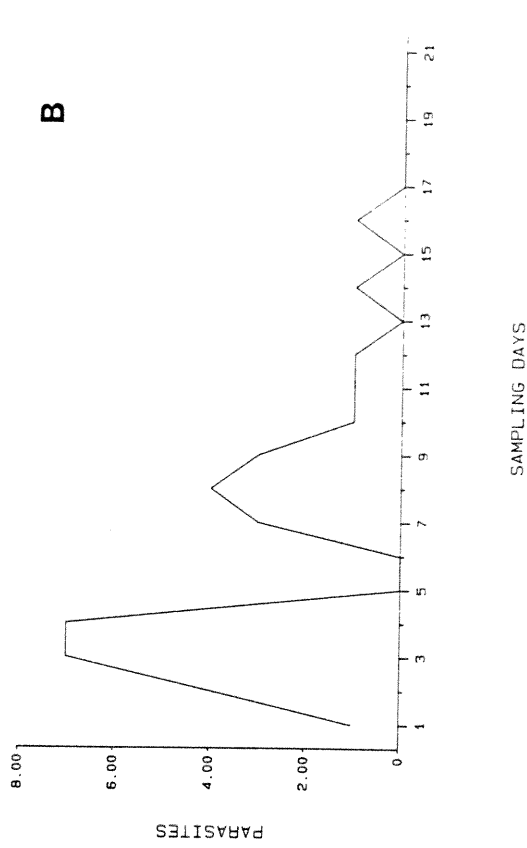
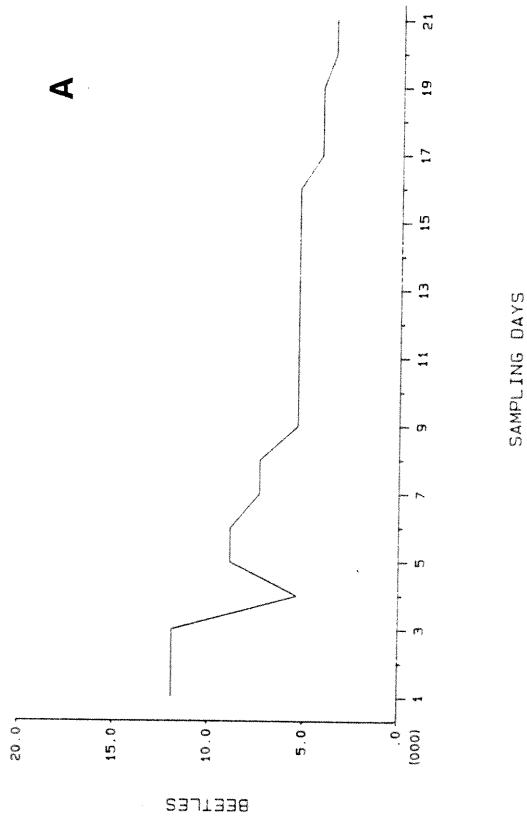

Figure 3.—Site 4 sampling results: (a) SPB population estimate; (b) parasite emergence trap catch; (c) host of origin for parasites based on lipid analysis (SPB = southern pine beetle, OTHER = other beetle hosts including Ips, Phloeosinus, etc.); (d) parasite sticky trap catch.

green infested trees, 17 faders, and 14 redtops. At termination, there were over 73 actively infested trees. All stages of SPB were present in this site. Site seven was located in a 20-acre natural pine stand situated at the bottom of a clearcut slope and bordered on the north by a hardwood swamp and on the west by a hardwood ridge. The pines extended east for a considerable distance. At the outset, there were 14 green infested trees, 8 faders, and no redtops. There were 35 newly infested trees while the site was being studied. At the end of the study period, enough green infested trees (>13) remained to insure spot growth (in the absence of cool weather interference).

The SPB population at site five was very high (>300,000 beetles) (fig. 4a), and brood density averaged 50 SPB/100 cm². There was sufficient activity in this site at the end of the study period to make further spot expansion likely. Emergence trap catch of SPB in this site at outset averaged about 30 beetles with as many as 90 being trapped on sampling day 8. Catch decreased over time and then finally ended with a spurt of emergence (>100 beetles over the last 3 sampling days), reflecting high terminal activity. *Ips* spp. were fairly prevalent in site five, with three trees being infested primarily with *Ips* spp. plus at least some brood present in most other trees.

In contrast, very little *Ips* spp. brood were encountered in site seven. This site had such rapidly expanding SPB populations that *Ips* spp. populations had little chance to be established. SPB populations were even higher at site seven (up to 600,000 beetles) than at site five but still comparable (fig. 6a). Brood density in sampled trees was about the same as in site five. Patterns of population increase and decrease were similar in both sites with a noticeable decline in active beetles centered around sampling days 15 to 20 (from 300,000 down to 20,000). At the termination of the study period, SPB populations in the site had begun to expand rapidly again. Emergence trap catch of SPB gradually increased from a sampling day 1 total of about 50 beetles to 600 on sampling day 8. The catch then fell rapidly to zero by sampling day 15. Expansion of this site occurred in three waves, the final involving 13 trees. This type of expansion results in brood development being synchronous and emergence data will typically be represented by peaks. The peak on sampling day 8 was the result of the second wave; development times precluded observation of emergence from the last expansion pulse. Sticky trap catch for beetles in this site was very low due to the rapid expansion of the site and resulting physical difficulty of keeping traps on trees under attack.

Parasite emergence and sticky trap catch in site

five followed a pattern similar to the SPB population. Initially, large numbers of parasites were trapped (>400 parasites combined catch in the first 5 sampling days) followed by a period of low catches lasting from sampling day 7 to sampling day 16 (averaging less than nine parasites per sampling day). At this point, trap catch began to increase. As in the SPB population, two major peaks of activity can be distinguished, separated by about 9 sampling days. Peak emergence preceded peak sticky trap catch by 1 to 2 days. Again, this is evidence of reinfestation of the site by parasites.

In site seven, a different pattern of parasite activity was apparent: Trap catch curves were convex instead of concave, but still matched the SPB population curve fairly closely. The only discrepancy was the lack of any parasite trap catch after sampling day 15. Parasite emergence and sticky trap catch synchronized fairly closely in this site, indicating parasite reinfestation. The lack of trap catch after sampling day 15 prevented a comparison of parasite trends with the terminal SPB population increase. The onset of cooler weather could have been a factor in the cessation of trap catch, but enough parasites were in the site to permit capture for lipid analyses. The parasites collected for lipid studies could have been the result of dispersal into the site, and thus were not reflected in trap catch. A few parasites were caught in sticky traps on sampling day 20.

The parasite trap catch reflects the wave nature of the infestation. Emergence of parasites and reinfestation would not occur until slightly after onset of SPB expansion; this expansion manifested itself at the termination of the study. These expected peaks of parasite activity were missed due to cessation of sampling.

During most of the study period, the ratio of the numbers of parasites with host origin other than SPB to the numbers of parasites from SPB stayed fairly constant (ca. 1 to 2). Only around sampling day 19 was there any variation in this trend. The same trend can be seen in site seven with the exception of a sharp fall in the overall number of parasites collected (from 25 down to 10). There was an increase in the number of parasites with host origins other than SPB relative to those with SPB host origins from sampling days 19 to 21 (36 percent to 58 percent). This change in ratio is undoubtedly due in part to clumping of points because of the low number of parasites collected (15), but it probably also reflects an actual change in the overall host origin of the parasites.

In both sites, high parasite populations showed a constant ratio between SPB host-origin parasites and those with host origin other than SPB. At the

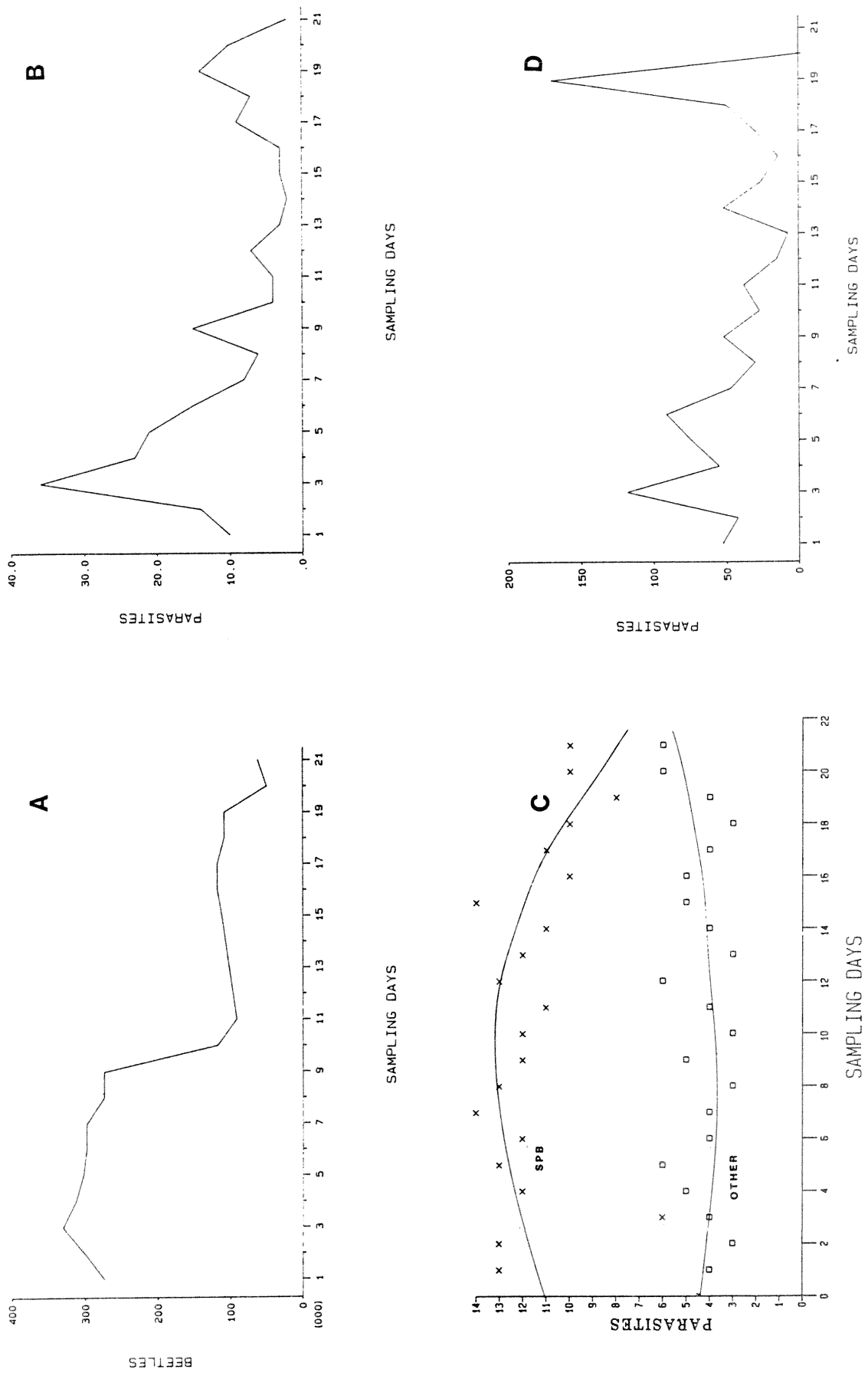

Figure 4—Site 5 sampling results: (a) SPB population estimate; (b) parasite emergence trap catch; (c) host of origin for parasites based on lipid analysis (SPB = southern pine beetle, OTHER = other beetle hosts including Ips, Phloeosinus, etc.) (d) parasite sticky trap catch.

same time, the numbers of SPB were fairly constant. Host-origin curves for both sites show a rather constant level of *Ips*-host origin parasites for most of the study period. This is easily attributed to a steady influx of parasites from nearly *Ips* spp. infestations: the clearcut in site five and endemic populations near site seven. When parasite populations dropped in site seven, higher numbers of parasites with host origins other than SPB were collected. These parasites had to originate primarily outside the infestation and thus came from other than SPB hosts.

Rapidly Collapsing Infestation

Site six was located in a ca. 30-acre mixed loblolly-shortleaf plantation. The infestation was bordered on all sides by pines. There were no edaphic or other barriers, and the nearest highway was situated about 220 meters to the east of the site. At the onset of the study, there were 16 green infested trees and 28 redtops. Eight of the infested trees were shortleaf pine. The spot showed no expansion during the study period, and all SPB activity had ceased in the spot by sampling day 15.

Estimated initial populations of SPB were high (32,000 beetles), but by sampling day 3, they had begun to fall rapidly (fig. 5a). The population leveled off from sampling day 5 to sampling day 11 at less than 20 percent of the initial estimated population. On sampling day 12, SPB populations reached zero and no activity was recorded for SPB from sampling day 15 on. *Ips* spp. occupied the upper crowns of most infested trees, plus there were three trees infested only by *Ips*.

Maximum SPB emergence occurred between sampling days 1 and 3 (59 beetles). Emergence subsequently dropped off, falling to zero by sampling day 9. There was a very small recurrence of emergence after this period (10 beetles), but all emergence had ceased by sampling day 15. Sticky trap catch of SPB in this site was insignificant, but trap catch for all three *Ips* species was constant throughout the period of activity.

Parasite emergence and sticky trap catches both started out relatively high (6 and 52 parasites, respectively) (fig. 5b,d), suggestive of some initial re-infestation of the site by parasites. Every emergence peak was matched or followed by a sticky trap catch until sampling day 11. At that time, two major emergence peaks occurred (sampling day 11 and sampling day 14), and no corresponding sticky trap catch peak was noted. This implies parasite dispersal from the site.

The initial lipid analyses for site six consisted mostly of SPB lipid patterns. Between sampling days

1 and 3, 85 percent of all analyzed parasites were of SPB host origin (fig. 5c). Thereafter, the numbers of parasites of SPB host origin fell rapidly while those of *Ips*-origin parasites increased, intersecting at about sampling day 14.

As numbers of SPB in the site dropped, the percentage of parasites from host origins other than SPB increased. The predominant hosts in the site were becoming non-SPB hosts, and parasites were dispersing from endemic hosts into the site to parasitize the remaining SPB and the *Ips* spp. present. There is an 8 to 10 day lag between the drop in SPB population and the preponderance of the switch in hosts.

Summary

The exchange of parasites between *Ips* spp. and SPB according to the conceptual model was discussed by Berisford (1980). The conceptual model deals with four population levels of bark beetles: endemic, expanding, epidemic, and declining. This study examined specific examples of epidemic (transient stable infestations), declining (rapidly collapsing infestations) and late expanding populations. Ideally, it would be best to study an infestation from its inception through rapid expansion; but it is impossible (or at least extremely difficult) to determine where such spots will occur. In practicality, spots can only be located after they are already well established. Sampling endemic populations is also very difficult; because of their nature, they are dispersed and relatively scarce, causing sampling procedures to be so rigorous as to be impractical.

A compilation of parasite exchange as represented by host origin data for this study is shown in figure 7a. This figure can be divided into three sections representing the types of infestations examined. From point A to B is typical of the expanding infestations; from point B to C is typical of stable transient infestations, and finally from point C onward is typical of rapidly declining infestations. Unlike the conceptual model, these curves consider all other acceptable hosts not just *Ips* spp., although *Ips* spp. are certainly the major alternate host involved. At point A, most parasites are switching to SPB and thus the curve for hosts other than SPB is beginning to decrease (fig. 7a). This corresponds well with the rapidly expanding sites (fig. 4c,6c). At point B, SPB populations have stabilized at a high epidemic level and *Ips* spp. populations are low relative to the SPB. Both curves have stabilized because the numbers of SPB parasites are so much higher than those of *Ips* spp. that switching between hosts (although one way) is insignificant. Finally, at point C, the other-hosts curve begins to increase

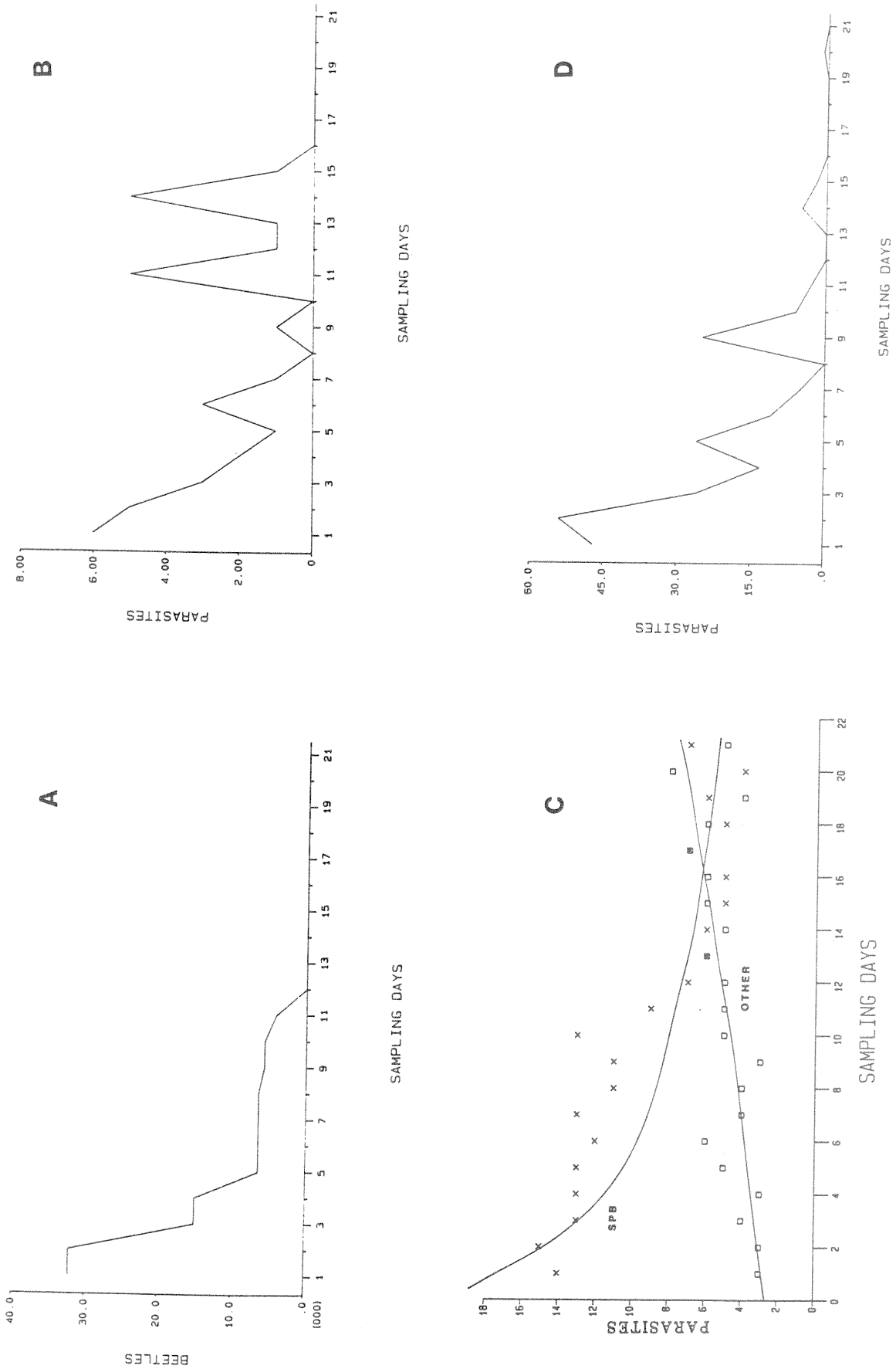

Figure 5.—Site 6 sampling results: (a) SPB population estimate; (b) parasite emergence trap catch; (c) host of origin for parasites based on lipid analysis (SPB = southern pine beetle, OTHER = other beetle hosts including Ips, Phloeosinus, etc.) (d) parasite sticky trap catch.

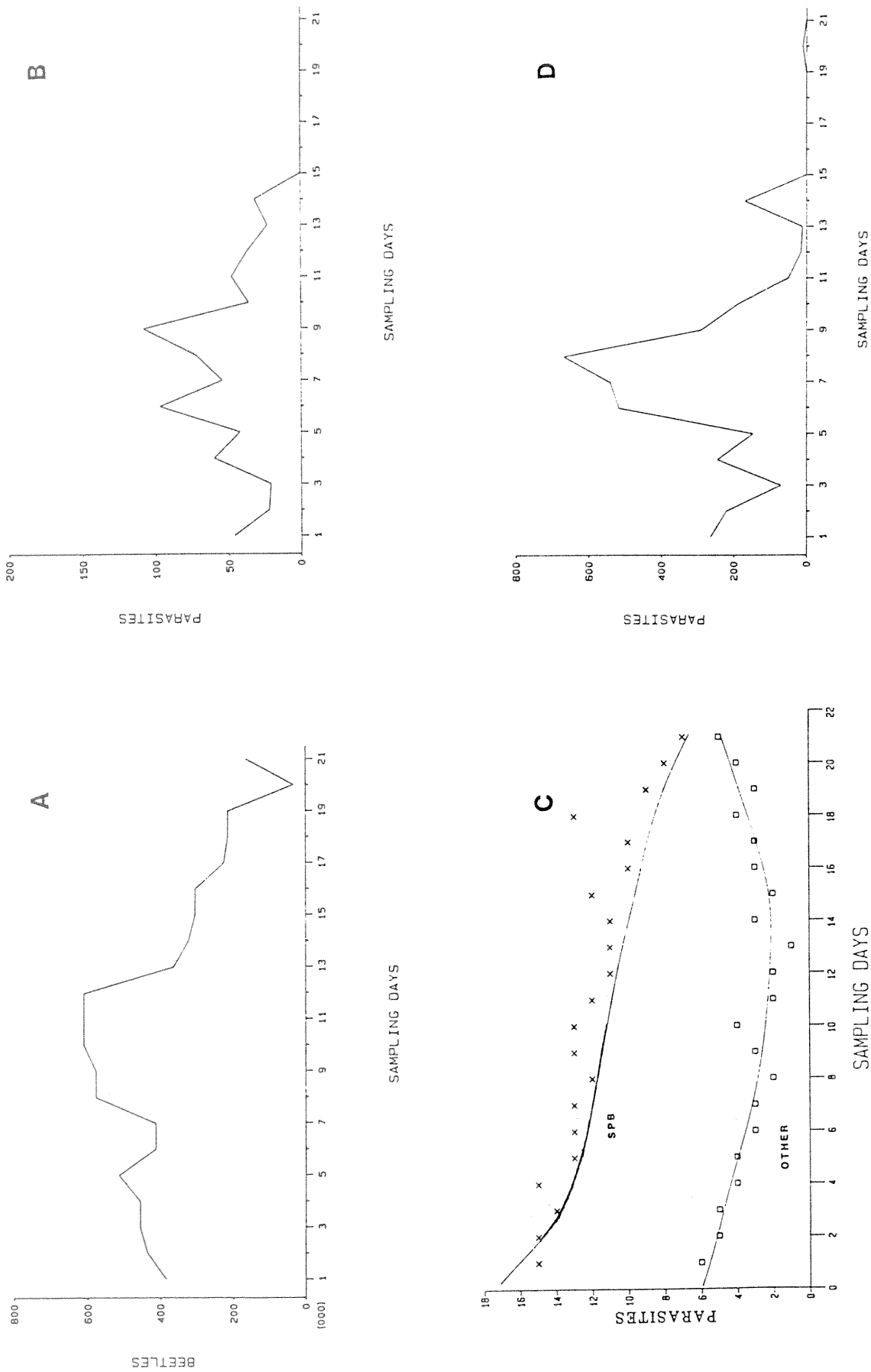

Figure 6.—Site 7 sampling results: (a) SPB population estimate; (b) parasite emergence trap catch; (c) host of origin for parasites based on lipid analysis (SPB = southern pine beetle, OTHER = other beetle hosts including Ips, Phloeosinus, etc.); (d) parasite sticky trap catch.

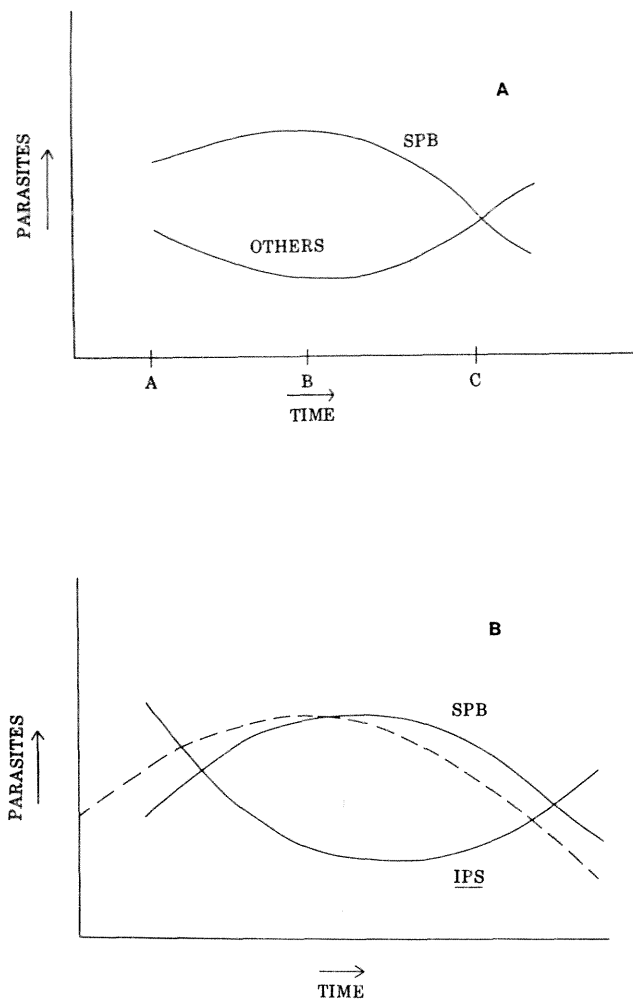

Figure 7.—Composite host of origin curves for parasites in SPB infestations: (a) Host of origin curves based on data from this study; (b) host of origin curves based on data and conceptual model.

rapidly as parasites start to switch back to the now relatively abundant *Ips* spp. This point corresponds well to transient stable populations (fig. 2c,3c). After point C, *Ips*-origin parasites begin to dominate as SPBs and their parasites become relatively scarce. This is seen in the rapidly declining infestation (fig. 5c). An extrapolated curve (fig. 7b) represents a combination of data and the conceptual model. The dotted line represents changes in SPB population (based on site estimates from this study).

CONCLUSION

In most SPB infestations, the emergence and re-attack of beetle hosts are continuous processes over the course of the infestation. The host origin of parasites should thus closely approximate changes in beetle host populations. A lag between parasite host preference switching and beetle populations occurs. In our study, this lag was as long as 2 weeks

but averaged closer to 1 week. This lag suggests a tendency for parasites to resist host change (parasite tenacity) when a previously relatively rare host becomes readily available. Data from the adjacent concurrent sites indicate a strong tendency for parasites to disperse in locating preferred hosts rather than attacking available alternate hosts. Some level of parasite acceptance of alternate hosts does exist. The thresholds (searching time, energy levels, number of contacts with alternate hosts etc.) by the parasites has not been established.

LITERATURE CITED

- Berisford, C.W. Natural enemies and associated organisms. In: Thatcher, R.C.; Searcy, J.L.; Coster, J.A.; Hertel, G.D., eds. The southern pine beetle. Tech. Bull. 1631. Washington, DC: U.S. Department of Agriculture; 1980: 31-52.
- Coulson, R.W.; Pulley, P.E.; Foltz, J.L.; Martin, W.C. Procedural guide for quantitatively sampling within-tree populations of *Dendroctonus frontalis*. Tex. Agric. Exp. Sta. Misc. Publ. 1267. College Station, TX: Texas Agricultural Experiment Station; 1976. 27 p.
- Dixon, J.C.; Osgood, E.A. Southern pine beetle: review of present knowledge. Res. Pap. SE-128. Asheville, NC: U.S. Department of Agriculture, Forest Service, Southeastern Forest Experiment Station; 1961. 34 p.
- Dixon, W.N.; Payne, T.L. Sequence of arrival and spatial distribution of entomophagous and associated insects on southern pine beetle infested trees. Tex. Agric. Exp. Sta. Bull. MP-1432. College Station, TX: Texas Agricultural Experiment Station; 1979. 27 p.
- Kudon, L.H.; Berisford, C.W. Influence of brood hosts on host preferences of bark beetle parasites. Nature 283: 288-290; 1980.
- Kudon, L.H.; Berisford, C.W. Identification of host origin of parasites of bark beetles (Coleoptera: Scolytidae) by fatty acid composition. Can. Entomol. 113: 205-212; 1981.
- Price, T.S.; Doggett C. A history of southern pine beetle outbreaks in the Southeastern United States. Macon, GA: Georgia Forestry Commission; 1978. 31 p.
- Pulley, P.E.; Foltz, J.L.; Mayyasi, A.M.; Coulson, R.N.; Martin, W.C. Sampling procedures for within-tree attacking adult populations of the southern pine beetle, *Dendroctonus frontalis* (Coleoptera:Scolytidae). Can. Entomol. 109:39-48; 1977.
- Suber, E.F.; Sheppard, D.C.; Gardner, W.A. Summary of losses from insect damage and costs of control in Georgia. Agric. Exp. Sta. Spec. Publ. 27. Athens, GA: University of Georgia; 1984. 41 p.

Strategies for Cohabitation Among the Southern Pine Bark Beetle Species: Comparisons of Life-Process Biologies

Terence L. Wagner, R. O. Flamm, and R. N. Coulson¹

Abstract.—*Dendroctonus frontalis* Zimmermann, *D. terebrans* (Olivier), *Ips avulsus* (Eichhoff), *I. grandicollis* (Eichhoff), and *I. calligraphus* (Germar) often inhabit the same southern pine trees, *Pinus* spp. Their spatial arrangement on these trees frequently overlaps as arriving insects select breeding sites suitable for brood development. This material must be fresh (living or recently killed trees at the time of attack), and for all species, the host must die for the insects to complete development. These species are believed to increase their breeding opportunities through association, although this factor and their similar niche requirements increase the potential for competitive interactions. The nature of competition among the southern pine bark beetle species and the different structural, behavioral, and physiological characteristics that reflect adaptive strategies for cohabitation are examined. The conclusion is that the beneficial effects of additional resource made available to each species through association outweigh the negative effects of competition brought on by the association. The adaptive strategies of each species reduce competition at all population densities, and evidence of severe exploitative competition among the species is minimal.

Additional keywords: *Dendroctonus frontalis* Zimmermann, *Ips* species, species competition, pest interactions, *Dendroctonus terebrans* (Olivier), insect associates

INTRODUCTION

The major bark beetle species attacking southern pines (*Pinus* spp.) can be considered guild members. These species are: *Dendroctonus fron-*

talis Zimmermann, *D. terebrans* (Olivier), *Ips avulsus* (Eichhoff), *I. grandicollis* (Eichhoff), and *I. calligraphus* (Germar). A guild is a group of species (regardless of taxonomic relationship) that exploits the same resource in a similar way (Root 1967). According to the concept, the niche requirements of the species must overlap significantly for them to be guild members. This criterion is certainly met by the southern pine bark beetle species. These insects are often found together in trees, and all require fresh phloem tissue for their development.

The potential for competition naturally exists among guild members because of their similar habitat requirements and close association. Yet, it is obvious that interspecific competition is deleterious, and that natural selection would tend to favor divergence among species leading to a reduction in the level of competition (Root 1967). Otherwise, the outcome of intense competition between species would be displacement or elimination of the weaker competitor from the habitat (competitive exclusion principle) (Hardin 1960). Although displacement could be an ongoing process with regard to some of the southern pine bark beetle species, all remain members of the guild. Therefore, adaptive strategies must exist that reduce competitive interactions among them.

This paper examines the nature of competitive interactions among southern pine bark beetle species and some of the physical, behavioral, and physiological adaptations for reducing the intensity of these interactions. This is not an all-inclusive treatise on the subject, for there is much not known about individual species and their interactions. Knowledge is especially deficient on *D. terebrans* and *I. grandicollis*; however, enough information is available to provide insight into the ecological diversity among the species. This ecological perspective is necessary to the management of the bark beetle complex as a whole.

The reader is cautioned on two points: *First*, this is not a literature review although pertinent citations are given. Information is drawn from a variety of sources, but relies most heavily on original research. Although some of this research is unpublished, in most cases, manuscripts are in some stage of preparation and are footnoted in the text. *Second*, the hypotheses formulated throughout the paper are based on the best available information. Alternative hypotheses may be possible.

¹ Respectively, Assistant Research Scientist, Graduate Assistant, and Professor, Department of Entomology, Texas A&M University, College Station, TX. (We wish to thank our colleagues at Texas A&M University who have contributed knowledge over the years to this work, especially K. W. Brown, A. M. Bunting, S. P. Cook, P. S. Doraiswamy, W. S. Fargo, R. M. Feldman, J. A. Gagne, P. B. Hennier, L. L. Keeley, P. J. H. Sharpe, T. L. Payne, P. E. Pulley, and H. Wu. Special thanks are extended to D. Watkins and L. Gattis for technical and clerical assistance.) Texas Agricultural Experiment Station Paper Number TA20551.

STUDY DISCUSSION

All southern pine bark beetle species have similar life histories that can be broadly categorized into processes of attack, reproduction, development, re-emergence, and emergence. Information exists in each of these areas for comparing species adaptations to their environment. These comparisons enhance our understanding of species interactions.

Attack Patterns

Competitive interactions cannot exist among species unless their niche requirements overlap. The niche requirements of species are understood and examined most easily in terms of a single resource dimension. A foundation can be established for interactions among the bark beetle species through examination of their spatial arrangement in trees.

Spatial arrangement.—Several investigators have studied the spatial arrangement in trees of attacking bark beetles, but only two studies provide quantitative information on several species combined (Paine et al. 1981, Flamm et al. 1985²). A general pattern emerges from these and other reports (fig. 1). *D. terebrans* occupies the roots, root collar, and lower tree bole. Occasionally, this species is found in the

mid-bole region but not in association with other bark beetle species. The highest attack densities of *D. frontalis* are found in the mid- to lower bole, with declining densities toward the bole extremes. *I. avulsus* occurs in the mid- to upper bole and tree crown but occasionally is found in the lower bole. Attack of *I. calligraphus* occurs over the entire tree bole, but areas of highest density vary from tree to tree. *I. grandicollis* occurs similarly over the entire bole, but frequently is found primarily in the lower crown. These spatial attack patterns are by no means fixed. The ability of a species to colonize an area depends on various interrelated factors, including species composition on the tree, density of the attacking populations, sequence of arrivals at the host, how well the species are adapted to remaining resources between species, and the season of the year.

Species composition.—Paine et al. (1981) documented the importance of species composition on attack distribution in a study on niche breadth and resource partitioning of *D. frontalis* and the three *Ips* species. Their study found that *D. frontalis*, *I. avulsus*, and *I. grandicollis* colonize less area in the presence of other species than is expected without interspecific contact. Thus, the realized niche of a species occupied in the presence of other species is different from the fundamental niche occupied in their absence (Miller 1967, Pianka 1981). *I. calligraphus* was the least influenced by species interactions. The area colonized by this species was reduced only when three species were found in the same area, but rarely were three found together, and all four species studied by Paine et al. (1981) never occupied the same area. The mechanisms behind this partitioning are not well understood, but surely they involve beetle size and beetle communication.

It is generally recognized that two species cannot form steady-state populations in the same area at the same time. Consequently, for species to coexist, they must be different (Pianka 1981). One obvious way the southern pine bark beetle species have specialized is through body size. From largest to smallest, the species are: *D. terebrans* (5.0 to 10.0 mm in length), *I. calligraphus* (4.0 to 6.0 mm in length by 1.5 to 2.1 mm in width), *I. grandicollis* (3.1 to 4.3 mm by 1.3 to 1.5 mm), *D. frontalis* (2.2 to 4.2 mm by 1.0 to 1.3 mm), and *I. avulsus* (2.1 to 2.6 mm by 0.8 to 1.0 mm). A species can be excluded from a particular microhabitat depending on its body size relative to the thickness of the phloem. From this standpoint alone, it is more beneficial to be small. For example, *I. avulsus* potentially can colonize a wide range of bark thicknesses because of its small size, but the larger-bodied *D. terebrans* or *I. calligraphus* generally are restricted to areas of

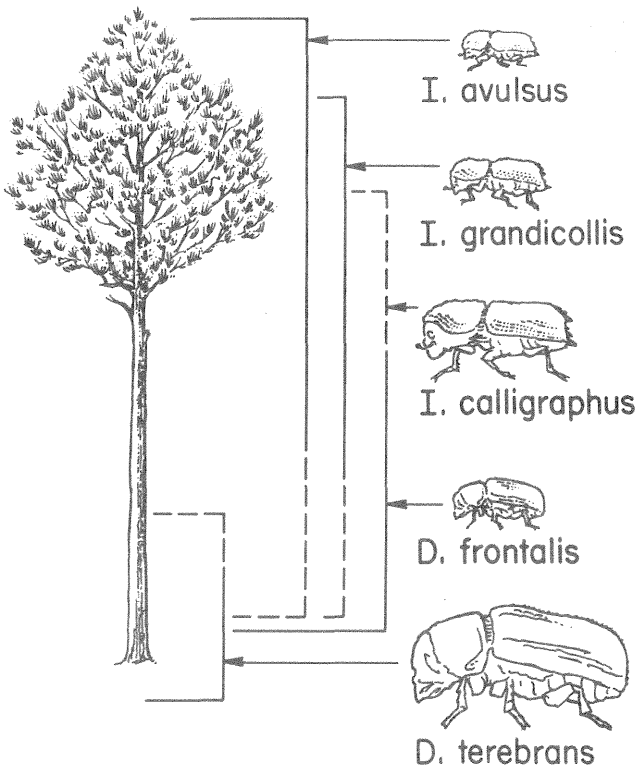

Figure 1.—Typical spatial arrangement of *Dendroctonus* and *Ips* bark beetle species on a southern pine tree (likelihood of species occurrence decreases in areas adjacent to the broken line).

thicker phloem. With its ability to use small microhabitats (e.g., limbs of ca. 2.5 mm diameter), *I. avulsus* is capable of minimizing competition from the larger species. Given the opportunity, however, it also has the ability to inhabit areas that are well-suited to the larger species. Thus, body size can directly affect the competitive interactions among species, and small size may provide increased niche breadth as seen in *I. avulsus* (Paine et al. 1981).

Regardless of these apparent advantages, small body size is not exclusively beneficial. Larger-bodied species are often more competitive than their cohabitants (Price 1975), and this association is at least partly true for the complex of southern pine bark beetle species. For example, Paine et al. (1981) found that *D. frontalis* and *I. avulsus* colonize less area in the presence of *I. calligraphus*, but the area inhabited by *I. calligraphus* is unaffected by either of these species alone. Furthermore, the benefits of small body size are not mutually exclusive. Body size varies within a population, and some individuals of the larger-bodied species may be able to occupy small microhabitats. For example, *I. grandicollis* is the third largest species in the guild, but it often occupies the larger branches (Paine et al. 1981). Nevertheless, large species that occupy small habitats have shortened adult lifespan and reduced reproductive potential because they consume greater quantities of outer bark and wood relative to the amount of nutrient-rich phloem (Haack et al. 1984a, 1984b). The brood of these adults probably exhibit lengthened development time, reduced adult body size, and lower fecundity. Thus, each species has an optimal habitat based partly on body size and the tree's physical characteristics. In other words, body size can affect the competitive interactions among species indirectly as well as directly. Obviously, body size alone does not control the spatial attack patterns among species, and, as pointed out by Birch et al. (1980), any mechanism regulating the attack distribution would be intrinsically more efficient if active *before* the insect has reached the phloem. Beetle senses play an important role in this regard.

Vision aids the beetle in selecting a host at close range. For example, *D. frontalis* only orients to vertical objects (e.g., standing tree boles), whereas the searching behavior of *Ips* species apparently is unaffected by the spatial orientation of the host. Once attack has begun, stridulation may be important in species recognition, sex recognition, or in courtship behavior (Wilkinson et al. 1967). Stridulation also stimulates the production of inhibitory chemicals in some *Dendroctonus* species, which may serve as a spacing mechanism near the attack hole (see Birch 1978). A similar phenomenon may occur

in *D. frontalis*, except in this case the inhibitory chemical verbenone stimulates rivalry chirps in the male (Rudinsky 1973).

Of all the senses, olfaction is the most important in delineating breeding sites on the tree and in influencing the attack sequence among species. Olfaction acts to attract mates, aggregate the sexes, discontinue attack within a species, or inhibit attack by other species. Changes in the chemical constituents among species, the combinations of these constituents, and the context in which they are used can give different biological signals as judged by the behaviors of the responding insects (Birch 1978). Studies by Vité et al. (1964) and Birch et al. (1980) describe the interrelationships among cohabiting species. These relationships will be discussed later in this report.

Sequence of arrival.—How do arrival times at the host influence spatial distribution of these species? Of all the species, *D. frontalis* is the best studied (Coulson 1979). The ability to quickly assemble large numbers of attacking adults enables this species to overwhelm the defense mechanisms of living trees. In actively expanding infestations, the entire attack process normally is completed in less than 2 weeks, with peak attack density occurring 4 to 5 days from the onset of mass attack (Coster et al. 1977, Fargo et al. 1978). Attack is initiated at the mid-bole (3 to 5 m) and spreads vertically over the entire bole. The system of population growth that makes this species successful ecologically is dependent upon its ability to attack and kill living trees. This ability provides *D. frontalis* with breeding material otherwise not available, and as a result, breeding opportunities are also extended to the other beetle species. Thus, in providing for itself, *D. frontalis* establishes the conditions necessary for species interactions.

Aggregation of *I. avulsus* resembles that of *D. frontalis*. Attacking adults accumulate rapidly and in large numbers. Peak attack density occurs in 5 to 7 days (Berisford and Franklin 1971, Flamm et al. 1985²). Aggregation of *I. calligraphus* and *I. grandicollis* is more extended, lasting up to 50 days, and is much less intense in numbers of attacking adults (Wood and Stark 1968, Mason 1970, Berisford and Franklin 1971, Flamm et al. 1985²). (See text footnotes at the end of the paper.) Despite these differences among species, the sequence of arrival at trees is often indistinguishable (Dixon and Payne 1979, Svihra et al. 1980, Flamm et al. 1985²). The near synchronous arrival times (rapid response to trees under attack) help to ensure breeding sites for all species, but not without competition for the best sites (e.g., sites with optimal phloem thickness for a species).

The ability of *D. frontalis* and *I. avulsus* to aggregate quickly and in large numbers allows these species to secure fresh breeding material, including living trees. One could hypothesize that this ability enables these species to acquire more of the best sites when several species attack simultaneously. Chemically-mediated behavior strengthens this hypothesis since attack by *D. frontalis* apparently is not influenced by other species already in the tree (with the exception of inhibition to *I. grandicollis* at close range). *I. avulsus* is attracted to all species either individually or in combination. On the other hand, the inability of *I. calligraphus* and *I. grandicollis* to rapidly concentrate large numbers of attacking adults may affect both species' ability to secure optimal breeding sites. This potential problem may be greater for *I. grandicollis*, as this species is attracted to trees containing *I. avulsus*, *I. calligraphus*, or *D. frontalis*, but it is inhibited at close range in areas containing either of the latter two species. Slow attack and chemically-induced inhibition may limit *I. grandicollis* to suboptimal sites (e.g., branches) when multiple species attack the tree. The ability of *D. frontalis* or *I. calligraphus* to interfere with colonization of *I. grandicollis* may represent competitive displacement through reduced reproductive potential of the latter species. Attack of *I. calligraphus* is also inhibited in areas containing high densities of *I. avulsus* (Birch et al. 1980); but when these species attack simultaneously at low densities, inhibition of *I. calligraphus* apparently does not occur and cohabitation results (Paine et al. 1981, Flamm et al. 1985²).

Influence of season.—It must be noted that attack densities and arrival times vary greatly in all the beetle species. This is even true for *D. frontalis*, whose population system is dependent upon the ability to overcome living trees rapidly. Season strongly influences population abundance and thus the availability of beetles for attack. For example, during the hottest times of the year, *D. frontalis* suffers reduced reproductive potential, longer development time, and greater brood mortality (Wagner et al. 1981a, 1984a). The loss of beetle numbers in active infestations threatens the insect's system of population growth centered around living trees. With fewer beetles available for attack, it becomes more difficult to overwhelm host defenses. Attack duration is extended over considerable periods, and the final area colonized is reduced in both vertical directions (Wagner et al. 1979, Flamm et al. 1985²). Hotter temperatures have less impact on the *Ips* species (Wagner et al. 1985a–1985e³), and one would expect them to take advantage of the resource unused by *D. frontalis*. This interaction among species is advantageous to all (discussed in greater detail later).

Reproduction

Attack is normally initiated by a single sex. The attacking sex is responsible for selecting a suitable host as well as a suitable location on that host from which to begin ovipositing. Host and site selection of the adults impact their brood through resource quality and quantity. In the monogynous *D. frontalis*, females initiate attack and thus select the attack site. Males initiate attack in the *Ips* species, although an exception was described by All and Anderson (1972) in which female *I. grandicollis* attack without the aid of a male and even produce brood if predated. In either case, females ultimately are responsible for selecting oviposition sites, although in the case of the *Ips* species, the female initially selects the site through the male. After mating, females of all species (except *D. terebrans*) deposit eggs individually in niches cut along the gallery. Notwithstanding this similarity, some interesting and contrasting behaviors delineate reproduction among the species. These behaviors help to optimize survival among conspecific and interspecific brood.

Reproductive behavior.—Eggs of *D. frontalis* are distributed more or less uniformly in the phloem (Foltz et al. 1976). This distribution pattern results from several behaviors involving gallery construction and oviposition. During gallery excavation, *D. frontalis* avoids contact with pre-existing conspecific or interspecific egg galleries (Wagner et al. 1981a). Other unsuitable areas of phloem are also avoided, e.g., wounds, knots, and areas contaminated with blue-stain fungus (Franklin 1970a). Female avoidance behavior results in meandering egg galleries (fig. 2A), but as unused phloem becomes scarce, avoidance becomes difficult and galleries sometimes intersect. This behavior optimizes the resource for oviposition regardless of attack density due to a compensatory feedback mechanism that controls the termination of oviposition in individual females (to be discussed in more detail later).

Other behaviors influence the distribution of *D. frontalis* eggs in the host, including the alternate placement of eggs on opposite sides of the gallery and a uniform egg spacing throughout a female's oviposition period (fig. 2A). Distances between eggs in this and the other species probably are regulated by rates of phloem consumption and nutrient conversion to yolk during egg production (Wagner et al. 1981a; Haack et al. 1984a, 1984b). These rates change with environment and host conditions

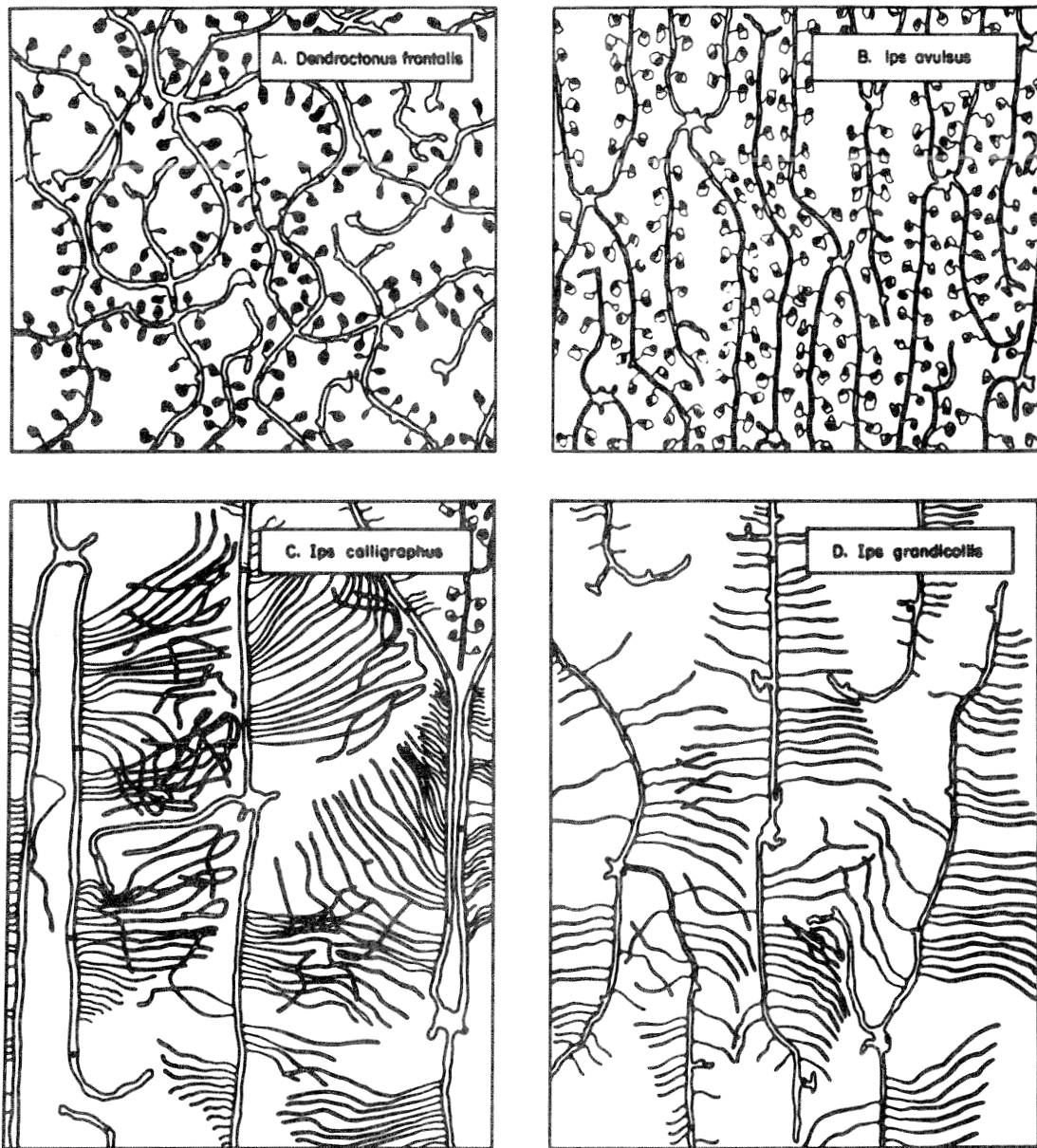

Figure 2.—Typical gallery patterns made by attacking adults and larvae of (A) *Dendroctonus frontalis*, (B) *Ips avulsus*, (C) *I. calligraphus*, and (D) *I. grandicollis*.

(thus egg spacing may also change), but egg spacing remains quite constant within the oviposition period of a given female, suggesting that most oviposition is completed prior to significant host deterioration. *D. frontalis* normally deposits eggs about 2 to 5 mm apart, but the alternate placement of eggs at uniform distances along meandering galleries optimizes phloem resource for developing brood.

Of the three *Ips* species, reproduction of *I. avulsus* is the most similar to that of *D. frontalis*, and of all the species in the guild, *I. avulsus* often displays the most flexible (plastic) reproductive behaviors. Based on early reports, this species was considered polygynous, but recent studies indicate that *I. avul-*

sus modifies its mate selection behavior to fit the sex ratio of attacking adults (Cook et al. 1983). With a 1:1 sex ratio on attack (probably typical), multiple males and females often use the same nuptial chamber. These beetles form mating pairs that remain together in much the same way as *D. frontalis*. If the sex ratio during attack favors the female, however, more multiple matings by males result. In either case, multiple egg galleries usually radiate from a single nuptial chamber. As with the other *Ips* species, egg galleries of *I. avulsus* tend to follow the grain of the wood, but the basal and distal (egg-free) portions of gallery often do not (fig. 2B). Parallel galleries from the same or

different conspecific nuptial chamber(s) typically are spaced more or less equidistant, and eggs are deposited alternately on opposite sides of the gallery. If parallel egg galleries lie close together, oviposition may be concentrated on the opposite sides of the respective galleries. Distances between eggs are large (about 3 to 6 mm) compared to the other *Ips* species.

I. calligraphus and *I. grandicollis* share similar reproductive behavior. The sex ratios of arriving and attacking adults favor the female by about 2 or 3 to 1, thus each species exhibits harem polygynous behavior (Berisford and Franklin 1971, Cook et al. 1983). As previously stated, *I. grandicollis* females are also capable of initiating attack independently of the male. Gallery construction and oviposition of these species differ primarily in scale, with slightly larger and longer egg galleries and more eggs reported in *I. calligraphus*. Other subtle but important differences also exist (fig. 2C and 2D). For example, paired egg galleries originating from the same nuptial chamber generally are spaced closer together by *I. calligraphus* than *I. grandicollis*. *I. calligraphus* oviposits large numbers of eggs on one side of the gallery, with an occasional egg or two placed on the opposite side interrupting the series. On the other hand, *I. grandicollis* often uses both sides of the gallery for oviposition, alternating eggs or small series of eggs between sides depending upon the amount of crowding adjacent to the gallery. Finally, eggs are spaced closer together by *I. calligraphus* than *I. grandicollis* (about 1 to 3 mm apart versus 1 to 5 mm). From these observations, the gallery construction and oviposition behavior of *I. grandicollis* can be described as intermediate between *I. avulsus* and *I. calligraphus*.

Factors affecting reproduction.—Numerous factors affect gallery construction and oviposition in individual beetles. These factors include: (1) The quantity of resource available to the insect as influenced by the relative attack times, attack density, and beetle location on the host; (2) the quality of resource as influenced by season, microorganism, time of attack, and host status; (3) environmental temperature; (4) female body size; (5) female reproductive history, and possibly (6) beetle population quality (Coulson et al. 1976; Wagner et al. 1979, 1981a, 1981b, 1982; Haack et al. 1984a, 1984b). Each of several factors can affect reproduction significantly. Furthermore, these factors can interact in such a way that the effects of one cannot be accurately described independently of the others (Wagner et al. 1981a). These considerations make it very difficult to model reproduction and to compare empirical results from several sources. Nevertheless, through examination of data

Good information exists on *D. frontalis*, where temperature effects and other independent variables have been modeled (Wagner et al. 1981a). In terms trends instead of numbers *per se*, experimental results can be compared and conclusions regarding species adaptations can be formulated.

Of all the factors influencing reproduction, temperature is one of the most important. It is also one of the best studied, with data on several species. of total gallery and egg production per female, this

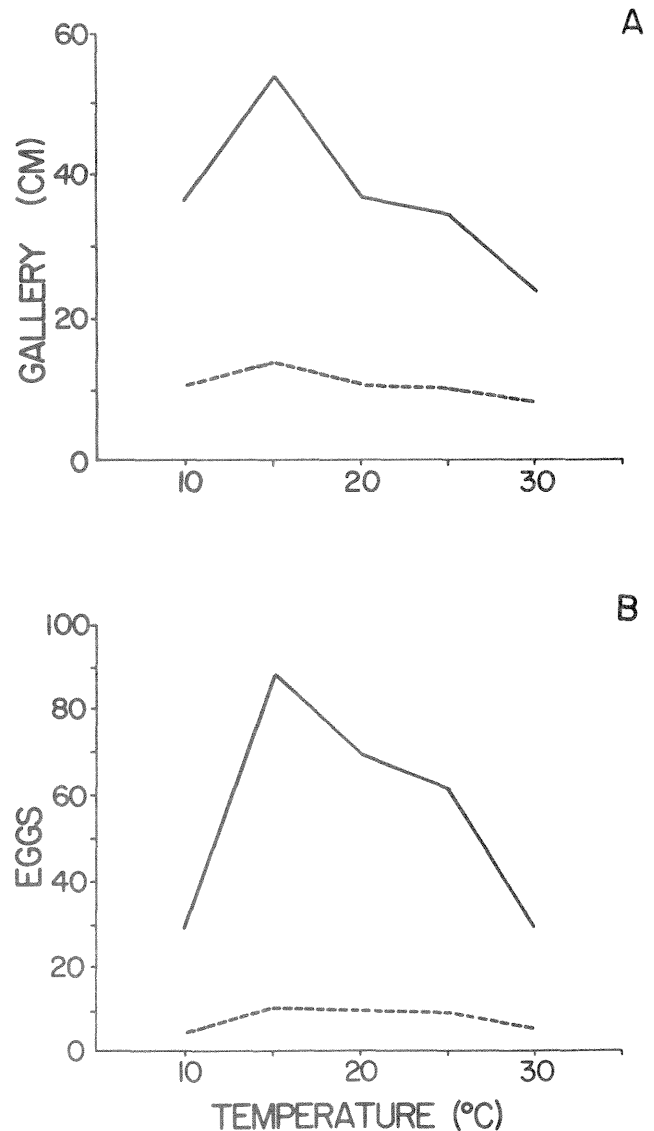

Figure 3.—Model predictions of total *Dendroctonus frontalis* (A) gallery and (B) eggs per mating pair at different constant temperatures. The solid and broken lines illustrate the effects of two contrasting attack densities, female sizes and types (season) on reproductive potential (Figure taken from Wagner et al. 1981a).

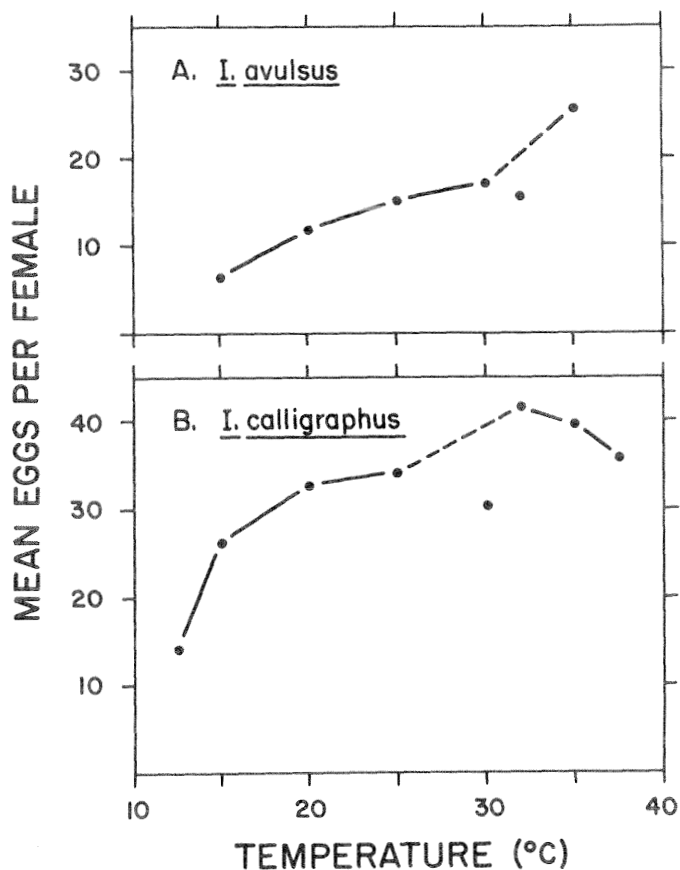

Figure 4.—Mean eggs per female for (A) *Ips avulsus* and (B) *I. calligraphus* at different constant temperatures.

species is well adapted to the cool and intermediate temperatures (e.g., from about 13 to 25°C) (fig. 3). In contrast, the *Ips* species are better adapted to the intermediate and high temperatures (e.g., from about 25 to 37.5°C) (fig. 4).

Development and Mortality

Just as adults compete for breeding and oviposition sites, their brood compete for feeding sites. All beetle species in the guild use phloem as the primary source of nutrition; therefore, successful development of cohabiting species may reflect differences in exploitation of this resource. Several differences in feeding behavior are noteworthy.

Feeding behavior.—*D. frontalis* and *I. avulsus* show similar feeding behavior. These species excavate elongated galleries during the first two larval stages but broad feeding "cells" during the third stage (fig. 2A and 2B). Larval galleries orient obliquely or perpendicular to the parent gallery and extend about 5 to 10 mm from their origin in *D. frontalis* and 4 to 8 mm in *I. avulsus*. *D. frontalis* has an additional larval stage found in the outer

bark where it pupates. Pupation of *I. avulsus* occurs in the phloem.

Feeding behavior is also similar in *I. calligraphus* and *I. grandicollis*. These species have three larval stages that form elongated galleries oriented at near right angles to the parent gallery (fig. 2C and D). Typical gallery lengths are about 100 to 120 mm in *I. calligraphus* and 50 to 70 mm in *I. grandicollis*. This feeding strategy requires large areas of phloem for successful development.

Species requiring large feeding areas can pack fewer individuals into an area than those requiring smaller areas. Based on this information alone, *D. frontalis* and *I. avulsus* will have greater capacities for population growth than the larger *Ips* species. Why then do *I. calligraphus* and *I. grandicollis* employ a feeding strategy that limits their numerical growth? We believe these species generally are too large relative to the thickness of the phloem to employ a more efficient strategy. As long as the size of the insect (head capsule?) is small relative to the thickness of the phloem, the insect feeds in three-dimensional space. Under these conditions, the economy of size favors feeding in cells. In contrast, when the size of the insect is large relative to phloem thickness, the insect feeds in two-dimensional space and benefits from feeding in elongated galleries. Because the phloem varies in thickness inversely with tree height, some areas of the tree may allow feeding in cells; however, such a strategy in the larger *Ips* species probably would restrict their feeding niche on the tree. Feeding in elongated galleries reduces numerical growth of these species on a unit area basis, but probably broadens their spatial niche on the tree into areas of thinner phloem.

The consequences of these alternative feeding strategies are not limited to the spatial dynamics affecting population growth. Elongated galleries increase the change of contact between conspecific brood, which inevitably results in increased cannibalism or starvation when larval densities are high (Wagner et al. 1985a³). In fact, these negative outcomes are increased because *I. calligraphus* larvae do not cross egg galleries as they feed (fig. 2C). Thus, larvae are confined to "islands" of phloem between egg galleries. Larvae of *D. frontalis* and *I. avulsus* rarely interfere with one another, although their restricted feeding in cells makes them more vulnerable to carnivory by the larger *Ips* species.

Resource allocation.—In spite of these observations, we believe that all four beetle species optimize the number of individuals in an area by spatially allocating gallery and eggs in a way that minimizes competition among developing brood. In other words, gallery construction and oviposition behaviors of

the adult are compatible with larval feeding behavior. Packing more individuals into an area than that area can support results in high cannibalism, carnivory, or starvation. This hypothesis is developed in the discussion that follows.

On the one hand, *I. calligraphus* requires large feeding areas for successful development. Brood survival in this species is optimized by tightly packing eggs into elongated elliptical areas centered around attack sites (fig. 2C). This strategy involves well-spaced attack sites, each with four or fewer females that construct egg galleries running with the grain of the wood, closely-spaced pairs of egg galleries originating from the same nuptial chamber, and tightly-packed eggs deposited along opposing sides of the parallel galleries. Because foraging larvae do not cross egg galleries, the area between paired galleries generally is not large enough to accommodate many brood without high mortality. Although egg gallery orientation generally follows the grain of the wood, *I. calligraphus* can alter the direction it travels. Instead of avoiding adjacent egg galleries, ovipositing females optimize the amount of phloem available to the brood by minimizing the distance between adjacent galleries and by placing all (or most) eggs on the resource-rich side. Parallel egg galleries originating from the same nuptial chamber often are found within 15 mm of each other, and it is not uncommon for these galleries to virtually touch. This strategy of resource utilization tightly packs galleries and eggs into elongated areas thereby leaving more phloem between conspecific breeding sites. Thus, avoidance of conspecific egg galleries normally is absent in ovipositing *I. calligraphus*, and in fact, this species may be weakly attracted to its own galleries. Attraction to the galleries of other species does not appear to be the case, as we have observed *I. calligraphus* egg galleries avoiding the galleries of *D. frontalis* and *I. avulsus* (e.g., see figure 2C, upper right).

In contrast, ovipositing *D. frontalis* normally avoid conspecific and interspecific egg galleries, and any other obstruction they encounter. Eggs are widely spaced along the gallery and alternated side-to-side. These combined behaviors distribute gallery and eggs uniformly in the phloem, as opposed to the clumped distributions of *I. calligraphus*. Uniform egg spacing in *D. frontalis* improves brood survival because the area required by foraging larvae is relatively small.

The reproductive and development strategies of *I. avulsus* are similar to those of *D. frontalis*. *I. avulsus* excavates egg galleries running parallel to the grain of the wood, but these are spaced more or less equidistant, often within 10 to 15 mm of each other. The distance between egg galleries decreases with

increasing attack density. This strategy suggests avoidance of conspecific egg galleries to distribute eggs uniformly. Eggs are widely spaced and alternated side-to-side, and larvae require little area for development.

It should be evident from the preceding discussion that resource allocation within the host is controlled by the female through gallery construction and oviposition. Proper placement of gallery and eggs, including their controlled termination, optimizes available resource to developing brood and thus creates optimum conditions for brood survival. Observations of reproductive biology, supplemented with information from the literature, provide insight into the mechanism controlling resource allocation and the termination of oviposition among these species. (Wagner et al. (1982) presents initial thoughts on this subject.)

We believe chemicals strongly influence the efficient placement of gallery and eggs in the host in a manner not unlike the chemically-mediated behavior used to obtain breeding sites and mates. Chemical markers are commonly used to establish territories among animal species (Miller 1967), and considering the cryptic habitat of the beetle species, chemicals can be a reliable means of communicating resource availability (or use) for several reasons. Unlike auditory signals that change rapidly in time and space, chemicals are temporally constant, durable, and spatially precise. We believe chemicals originating from the beetle galleries disperse rapidly into the phloem, thereby establishing a concentration gradient adjacent to the galleries. These chemicals are perceived by ovipositing females (via contact chemoreceptors) prior to encountering pre-existing galleries; thus they provide time for the insect to take evasive action. Furthermore, the concentration gradient can be used by the *Ips* species to determine egg placement. The rapid dispersal of chemicals through the phloem opposes the slower physical changes accompanying gallery construction that also could elicit behavioral responses through tactile means.

The complexity of behaviors exhibited by all species suggests that the chemicals involved are beetle-derived compounds concentrated in the frass, but that chemicals from other sources (e.g., symbiotic microorganisms or the host plant) may interact with beetle compounds to elicit specific insect responses. Unlike chemicals from other sources, beetle-derived compounds transmit and elicit species-specific messages and behaviors. As egg galleries fill the resource space (resulting in more gallery intersections), the frequency of contact with inhibitory chemicals increases. Eventually, a threshold is surpassed and neuro-physiological changes

terminate reproduction in the female, which initiates reemergence. Thus, chemical compounds constitute an efficient means of interfering with a competitor's access to needed resource. Through termination of oviposition, these chemicals also help assure possession of minimum space for brood development; i.e., they help prevent overcrowding.

Reemergence and Emergence

Reemergence occurs when an adult exits the host after reproducing, usually for the purpose of seeking out new breeding material. This behavior occurs in all southern pine bark beetle species (Franklin 1970b, All and Anderson 1972, Gouger et al. 1975, Cook et al. 1983), but until recently, little quantitative information on it was available for any species except *D. frontalis* (Coulson et al. 1978, 1979; Schowalter et al. 1981). In this species, the redistribution of adults through reemergence influence populations in some important ways. For example, reemerging beetles help to maintain a continuous supply of adults for attack, which in turn provides new centers of attraction at the active front of the infestation. Reemerging *D. frontalis* also 1) aid in overcoming host resistance, 2) secure new mates, thereby mixing the gene pool, and 3) produce additional brood populations. The importance of reemergence to *Ips* populations has not been determined, but certainly some of the factors mentioned above also pertain to these species.

For example, the process by which beetles become available for attack involves reemergence of parent adults and emergence of brood adults. The blending of these populations—called allocation by Coulson (1979)—is important because it influences a species' ability to assemble adults to new hosts. Understanding the intensity and duration of these population events, as well as the degree of temporal overlap between them, will provide insight into the dynamics of attack among species.

Differences among species were analyzed using validated simulation models of reemergence and emergence (Feldman et al. 1981, Wagner et al. 1984a, 1985b–e³). These models integrate a temperature-dependent rate function with a temperature-independent distribution function (Wagner et al. 1984b, 1984c; Wagner 1985f⁴). The rate function determines the "speed" at which a population reemerges or emerges as a function of changing temperature, whereas the distribution function determines the cumulative fraction of the population reemerging or emerging through time as a function of accumulating rates. These analyses reveal some interesting aspects of beetle biology.

Variability in times.—The distribution function

alone can be used to evaluate the relative variability in reemergence and emergence times among individuals in a population. Figures 5A and 5B illustrate the cumulative distributions of normalized reemergence and emergence times for *D. frontalis*, *I. avulsus*, and *I. calligraphus*. By normalizing the time scale (X-axis), we are able to examine these processes independent of temperature effects (the normalization process represents chronological time in days divided by the mean or median time of the original temperature-dependent distributions). Note the dissimilar reemergence curves (i.e., their contrasting steepness) and the similar emergence curves. For all species, especially *I. calligraphus*, apparently there is greater variability in reproductive activities influencing reemergence times than in development influencing emergence times. Given an identical attack time among individuals in a population, *D. frontalis* and *I. avulsus* reemerge over shorter periods than *I. calligraphus*. The greater synchrony in reemergence times among individuals of the former two species may aid them in rapidly assembling large numbers of beetles for attack. The protracted reemergence times of *I. calligraphus* suggest a different strategy by which adults become available for attack. Because this species normally does not attack living hosts (unless accompanied by other species), the need to rapidly assemble large numbers of adults does not exist. Thus, for this scavenging species, it may be more efficient to have a few beetles available for attack most of the time, instead of many available some of the time. The constant availability of a few "pioneer" beetles may allow *I. calligraphus* to rapidly respond to trees coming under mass attack by *D. frontalis* and *I. avulsus* (which might explain the near synchronous attack often observed among the beetle species).

Effects of temperature.—The rate function can be used to evaluate the effects of temperature on reemergence and emergence as illustrated in figures 6A and 6B. These response curves indicate different temperature adaptations among the three beetle species, with the *Ips* species better suited to intermediate and high temperatures between 22 to 37°C and *D. frontalis* better suited to cool and intermediate temperatures between 10 to 22°C. These observations are based on the relative differences in rates at various temperatures along the curves, as well as differences in the optimum temperatures for the three species. For example, note that the shortest residence times occurred at 31 to 32°C for the *Ips* species, but at 26° for *D. frontalis* (fig. 6A). Recall that the *Ips* species also oviposited more eggs per female at 32 to 35°C (fig. 4), indicating that the greatest oviposition rate per day occurs at these high temperatures. *D. frontalis* oviposited

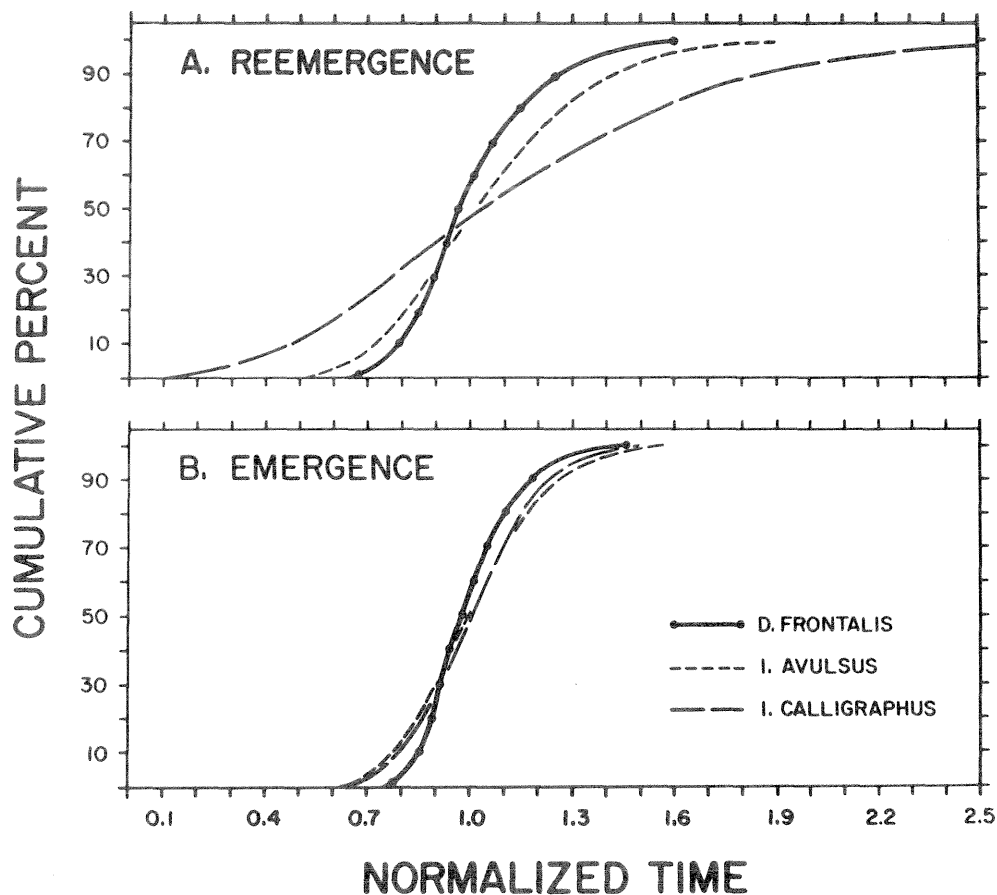

Figure 5.—Model predictions of cumulative percent (A) reemergence and (B) emergence versus normalized time for *Dendroctonus frontalis*, *Ips avulsus*, and *I. calligraphus*. A discrete distribution (11 values) is used for *D. frontalis*, whereas a three-parameter Weibull function is used for the *Ips* species (see the text for reference citations).

more eggs per female at 15°C (fig 3B), but with the shortest residence time at 26°C, the greatest oviposition rate per day occurs at about 25°C.

The optimum temperatures for development were not unlike those for oviposition and reemergence (fig. 6B). Development from eggs to adult emergence occurred most rapidly at 37°C for *I. calligraphus*, 34°C for *I. avulsus*, and 30°C for *D. frontalis*.

Seasonal dynamics.—To better understand the dynamics of the rate and distribution functions, we incorporated these functions into a larger simulation model and ran a series of simulation experiments comparing the residence (or reemergence) times of the three beetle species at different times of the year. Similar simulation experiments were conducted for development (emergence). These simulations provide greater insight into the seasonal dynamics of each species, as well as how these species interact as members of a cohabiting group. Normally, a distribution of attacking adults

is used to initiate the starting times of a multiple-cohort simulation of reemergence (Wagner et al. 1985f¹). An oviposition distribution is used to initiate a similar simulation of emergence. For simplicity, single-cohort simulations were conducted for each process. The simulations were initiated simultaneously on the first day of spring, the first day of summer, and the first day of fall. Thirty-year average temperatures from Lufkin, TX, were used to drive the reemergence and emergence models. The results of the simulations are shown in figure 7, and clearly illustrate the different temperature adaptations among beetle species.

During the early spring, *D. frontalis* generally has the shortest residence and development times compared to the *Ips* species (fig. 7, top). The *Ips* species are not as well adapted to cool temperatures as *D. frontalis*, and this fact is evident again during the fall simulations (fig. 7, bottom). Fall temperatures are initially warm, and the *Ips* species begin

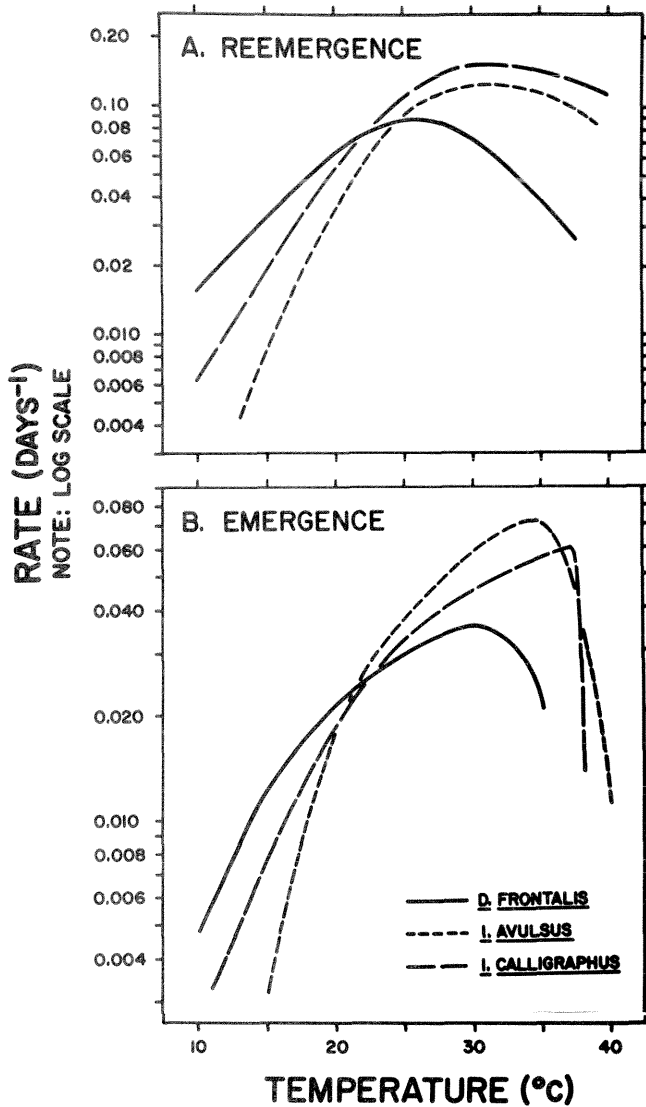

Figure 6.—Model predictions of (A) reemergence and (B) emergence rates versus constant temperatures for *Dendroctonus frontalis*, *Ips avulsus*, and *I. calligraphus* (see the text for reference citations).

to reemerge and emerge first since they are better suited to warm temperatures of early fall. As time proceeds and temperatures cool, both reemergence and emergence slow in the *Ips* species at a rate disproportionate to *D. frontalis*. As a result, *D. frontalis* completes both processes prior to the *Ips* populations. In contrast to the cooler times of the year, the high summer temperatures favor the *Ips* species over *D. frontalis* (fig. 7, middle). Populations of both *Ips* species reemerge and emerge prior to *D. frontalis*.

These simulations also provide information on the seasonal dynamics of allocation, the process by which adults become available for attack through

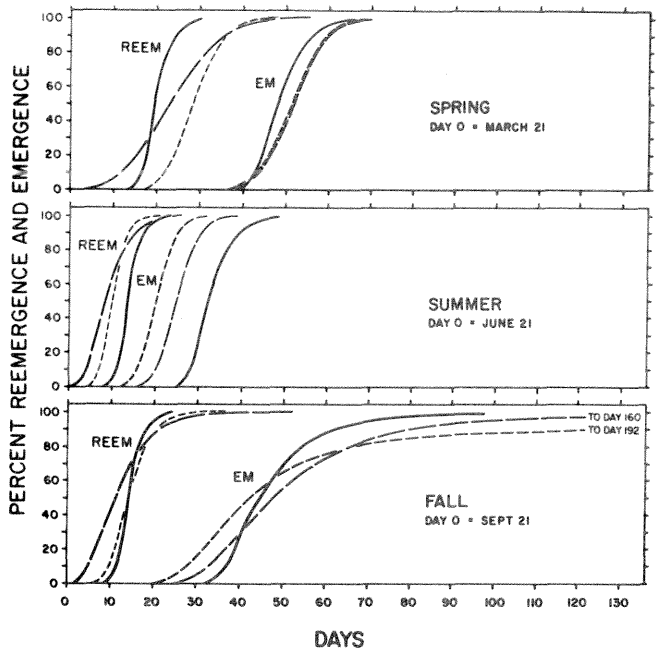

Figure 7.—Model simulations of percent reemergence (REEM) and emergence (EM) through time for *Dendroctonus frontalis* (—), *Ips avulsus* (---), and *I. calligraphus* (-.-.-), Simulations were initiated on the first day of spring, the first day of summer, and the first day of fall (see the text for reference citations).

the combined events of reemergence and emergence (Pope et al. 1980). Of particular interest is the relationship of reemergence and emergence through time. First, compare these processes for *D. frontalis* (fig. 7). In springtime, about 10 days separated last reemergence and first emergence; 3 days separated these events in the summer; and 8 days in the fall. It is important to realize that, for simplicity, these results are based on single-cohort simulations. More realistic multiple-cohort simulations would probably reveal overlapping reemergence and emergence curves, especially in the summer. As reemergence and emergence converge in time, increased mixing of the adult populations will occur and greater numbers of beetles will become available for attack. The ability to assemble large numbers of beetles quickly allows *D. frontalis* to overcome the defense mechanisms of living trees. These simulations indicate optimal conditions for mass attack during the warmer months, e.g., in late spring, summer, and early fall. At these times, the duration of reemergence and emergence is shortest (note the steepness of the curves), and the processes are least separated in time.

In contrast to the pattern in *D. frontalis*, reemergence and emergence overlapped throughout the year in both the *Ips* species (fig. 7). These processes

overlapped for longer periods in the spring and fall simulations compared to the summer. For example, the overlap for *I. avulsus* was about 9 days in the spring, 12 in the fall, and 8 in the summer; whereas for *I. calligraphus* the overlap was about 15 days in the spring, 25 in the fall, and 10 in the summer. More importantly, however, a greater percentage of the reemerging population was present during emergence in the summer compared to the spring and fall. This result was especially true for *I. avulsus*, where about 25 percent of the parent adults reemerged with brood adults in the summer, but this value was only about 10 percent in the spring and fall. The higher percentage in the summer probably provides more beetles for attack in shorter periods of time. This prescription is ideal for supporting the dwindling numbers of *D. frontalis* and their efforts to overcome host resistance of living trees.

CONCLUSIONS

The potential for intense exploitative competition exists among the southern pine bark beetle species because these species often share a limited resource. This type of competition is not widespread, however. Several factors reduce niche overlap, and thus exploitative competition among the species. Different body sizes among the species help regulate their spatial distributions on trees. Size can affect competitive interactions directly by preventing large beetles from colonizing small microhabitats, or it can indirectly affect interactions by shortening adult life span, reducing reproductive potential, lengthening development time, and increasing brood mortality when large beetles colonize areas of thin phloem. The latter instance influences adults as well their offspring.

The spatial arrangement of beetle species on trees is also regulated by an elaborate system of beetle communications. Pheromones draw insects to a tree and aggregate them to specific areas on the host. These chemicals often attract other species to the tree, acting as allomones at a distance. At close range, however, the chemicals may inhibit attack of the responding species. In this way, the tree is partitioned into areas dominated by one species, but several species attack, bringing about a more rapid decline and death to the host. The location of each species on the tree and the amount of area it occupies depend on the intensity and duration of attack as well as the timing of attack relative to that by other species.

Chemically-mediated attraction, cross-attraction, and interspecific inhibition reduce niche overlap on

trees. Interspecific territories are established through interference competition when one species is denied access to a required resource. For example, interference occurs at the macrosite level when *I. grandicollis* attempts to acquire breeding sites in areas of the bole occupied by *D. frontalis* or *I. calligraphus*. In this case, *I. grandicollis* is denied access to prime breeding sites characterized by thick phloem. Thus, it often becomes established in the crown where the phloem is thinner. Interference competition also occurs at the macrosite level when one species attempts to acquire oviposition sites in the phloem containing galleries of other species. In this case, ovipositing females avoid galleries by detecting chemicals (or other stimuli) associated with these galleries.

Chemical communications inside and outside the host help to partition the resource among beetle species and reduce exploitative competition. However, communication systems alone do not prevent species overlap, nor must they. Although niche overlap is required for exploitative competition, overlap does not necessarily lead to competition unless resources are in short supply (Pianka 1981). Other reproductive and developmental strategies reduce competitive interactions among species. For example, *D. frontalis* and *I. avulsus* are often found together, but compatible lifestyles usually prevent overuse of the phloem and exploitative competition. In addition to avoiding each other's galleries during oviposition, these species alternate eggs on opposite sides of the gallery and space eggs widely apart. Larval galleries are short and terminate in feeding cells. *D. frontalis* also moves from the phloem to the outer bark to complete larval and pupal development. These behaviors, combined with a density-dependent mechanism that influences the termination of oviposition, enable *D. frontalis* and *I. avulsus* to coexist with little exploitation.

In contrast, *I. calligraphus* packs eggs tightly along one side of the gallery, and larvae excavate elongated mines that extend considerable distances often in unison. This species commonly is found with *D. frontalis* and *I. avulsus*, but *I. calligraphus* is a stronger competitor because of its size and aggressive feeding behavior. Nevertheless, when *D. frontalis* and *I. avulsus* population densities are high, these species may reduce or displace *I. calligraphus* by rapidly accumulating adults and gallery in the tree. Under these conditions, competitive mutualism (Pianka 1981) may result between *D. frontalis* and *I. avulsus*. Although high densities of *D. frontalis* and *I. avulsus* may result in greater overlap between these species, the increased negative effects between these weak competitors are offset by decreased contact with their stronger competitor, *I. calligraphus*.

Stated differently, *D. frontalis* and *I. avulsus* have a beneficial net effect on one another (e.g., they actually act to increase one another's densities), even though their direct pairwise interaction is somewhat detrimental.

Given a multidimensional perspective of resource use, competitive mutualism may not be limited to *D. frontalis* and *I. avulsus*. Associations among the five bark beetle species vary widely. The number of species attacking a tree is not fixed, nor are the spatial and temporal attack patterns or the final attack densities. Furthermore, the species response to environmental variables differs. For example, the *Ips* species are better adapted to high temperatures, and *D. frontalis* is better adapted to cool temperatures. These differences may influence the seasonal dynamics of populations. In late winter/early spring, the *Ips* species and *D. terebrans* may support enlarging populations of *D. frontalis* (Coulson et al. 1985⁵). This support may be more prominent in the summer, when populations of *D. frontalis* are declining. In both situations, all species act mutually to overcome host resistance by increasing the total number of beetles attacking the tree. Pairs of species with the potential for high niche overlap and strong competitive interactions (e.g., *D. frontalis* and *I. calligraphus*) may interact only weakly because of the reduced population densities. We hypothesize that increased resource is made available to each species through their association, and that this beneficial effect outweighs the negative effects of resulting competition.

A similar situation may also exist when beetle populations are at endemic levels. At these times, cooperation among the beetle species probably increases their ability to secure breeding and oviposition sites suitable for brood development. Cooperation among species when densities are low may be especially important to *D. frontalis*, a species that normally kills trees by rapidly assembling large numbers of beetles at the host. This mass attack phenomenon has prescribed effects on the tree (Wagner et al. 1979) that conditions it for successful brood development. The condition of the host is particularly critical during the early larval stages when development is most vulnerable (Wagner et al. 1979). Late-stage larvae apparently can tolerate a wider range of host conditions, as can the larvae of the *Ips* species (based on our ability to rear late-stage *D. frontalis* and *Ips* species in the laboratory, and our inability to rear early-stage *D. frontalis* larvae). *D. frontalis* cannot overcome living trees at low population densities, and given its narrow tolerance of host conditions during larval development, suitable habitats may be more limiting to *D. frontalis* than to the *Ips* species. Association with the *Ips*

species may enable *D. frontalis* to secure host material suitable for development. The obvious benefits of this association are probably extended to all species, since competition would be minimal given the low beetle densities.

Finally, it is apparent that many of the structural, behavioral, and physiological differences among the southern pine bark beetle species reflect adaptive strategies for cohabitation. These differences enable the five species to reduce the intensity of competition at all population density levels and to cooperate in the exploitation of living southern pine trees.

LITERATURE CITED

- All, J.N.; Anderson, R.F. Initial attack and brood production by females of *Ips grandicollis* (Coleoptera:Scolytidae). *Ann. Entomol. Soc. Am.* 65: 1293-1296; 1972.
- Berisford, C.W.; Franklin, R.T. Attack patterns of *Ips avulsus* and *I. grandicollis* (Coleoptera:Scolytidae) on four species of southern pines. *Ann. Entomol. Soc. Am.* 64: 894-897; 1971.
- Birch, M.C. Chemical communication in pine bark beetles. *Am. Sci.* 66: 409-419; 1978.
- Birch, M.C.; Svihra, P.; Paine, T.D.; Miller, J.C. Influence of chemically mediated behavior on host tree colonization by four cohabiting species of bark beetles. *J. Chem. Ecol.* 6: 395-414; 1980.
- Cook, S.P.; Wagner, T.L.; Flamm, R.O.; Dickens, J.C.; Coulson, R.N. Examination of sex ratios and mating habits of *Ips avulsus* and *I. calligraphus* (Coleoptera:Scolytidae). *Ann. Entomol. Soc. Am.* 76: 56-60; 1983.
- Coster, J.E.; Payne, T.L.; Hart, E.R.; Edson, L.J. Aggregation of the southern pine beetle in response to attractive host trees. *Environ. Entomol.* 6: 725-731; 1977.
- Coulson, R.N. Population dynamics of bark beetles. *Ann. Rev. Entomol.* 24: 417-447; 1979.
- Coulson, R.N.; Mayyasi, A.M.; Foltz, J.L.; Hain, F.P.; Martin, W.C. Resource utilization by the southern pine beetle, *Dendroctonus frontalis*. *Can. Entomol.* 108: 353-362; 1976.
- Coulson, R.N.; Fargo, W.S.; Pulley, P.E.; Foltz, J.L.; Pope, D.N.; Richerson, J.V.; Payne, T.L. Evaluation of the re-emergence process of parent adult *Dendroctonus frontalis* (Coleoptera:Scolytidae). *Can. Entomol.* 110: 475-486; 1978.
- Coulson, R.N.; Fargo, W.S.; Pulley, P.E.; Pope, D.N.; Foltz, J.L.; Bunting, A.M. Spatial and temporal patterns of emergence for within-tree populations of *Dendroctonus frontalis*. *Can. Entomol.* 111: 273-287; 1979.
- Dixon, W.N.; Payne, T.L. Sequence of arrival and spatial distribution of entomophagous and asso-

- ciated insects on southern pine beetle-infested trees. *Tex. Agric. Exp. Sta. Bull.* MP-1432. College Station, TX: Texas A&M University; 1979. 27 p.
- Fargo, W.S.; Coulson, R.N.; Pulley, P.E.; Pope, D.N.; Kelley, C.L. Spatial and temporal patterns of within-tree colonization by *Dendroctonus frontalis* (Coleoptera:Scolytidae). *Can. Entomol.* 110: 1213-1232; 1978.
- Feldman, R.M.; Wagner, T.L.; Sharpe, P.J.H.; Gagne, J.A.; Coulson, R.N. Within-tree life process models of the southern pine beetle, *Dendroctonus frontalis*. *Ecol. Modelling* 13: 247-260; 1981.
- Foltz, J.L.; Mayyasi, A.M.; Hain, F.P.; Coulson, R.N.; Martin, W.C. Egg-gallery length relationships and within-tree analyses for the southern pine beetle, *Dendroctonus frontalis*. *Can. Entomol.* 108: 341-352; 1976.
- Franklin, R.T. Observations on the blue stain-southern pine beetle relationship. *J. Ga. Entomol. Soc.* 5: 53-57; 1970a.
- Franklin, R.T. Southern pine beetle population behavior. *J. Ga. Entomol. Soc.* 5: 175-182; 1970b.
- Gouger, R.J.; Yearian, W.C.; Wilkinson, R.C. Feeding and reproductive behavior of *Ips avulsus*. *Fla. Entomol.* 58: 221-229; 1975.
- Haack, R.A.; Wilkinson, R.C.; Foltz, J.L.; Corneil, J.A. Gallery construction and oviposition by *Ips calligraphus* (Coleoptera:Scolytidae) in relation to slash pine phloem thickness and temperature. *Can. Entomol.* 116: 625-632; 1984a.
- Haack, R.A.; Foltz, J.L.; Wilkinson, R.C. Longevity and fecundity of *Ips calligraphus* (Coleoptera:Scolytidae) in relation to slash pine phloem thickness. *Ann. Entomol. Soc. Am.* 77: 657-662; 1984b.
- Hardin, G. The competitive exclusion principle. *Science* 131: 1292-1297; 1960.
- Mason, R.R. Comparison of flight aggregation in two species of southern *Ips* (Coleoptera:Scolytidae). *Can. Entomol.* 102: 1036-1041; 1970.
- Miller, R.S. Pattern and process in competition: In: Cragg, J.B., ed. *Advances in ecological research*, Vol. 4. New York: Academic Press; 1967: 1-74.
- Paine, T.D.; Birch, M.C.; Svihra, P. Niche breadth and resource partitioning by four sympatric species of bark beetles (Coleoptera:Scolytidae). *Oecol.* 48: 1-6; 1981.
- Pianka, E.R. Competition and niche theory. In: May, R.M., ed. *Theoretical ecology, principles and applications*, 2nd Edition. Sunderland, MA: Sinauer Associates, Inc. 1981: 167-196.
- Pope, D.N.; Coulson, R.N.; Fargo, W.S.; Gagne, J.A.; Kelley, C.L. The allocation process and between-tree survival probabilities in *Dendroctonus frontalis* infestations. *Res. Pop. Ecol.* 22: 197-210; 1980.
- Price, P.W. *Insect ecology*. New York: John Wiley and Sons; 1975.
- Root, R.B. The niche exploitation pattern of the blue-gray gnatcatcher. *Ecol. Monogr.* 37: 317-349; 1967.
- Rudinsky, J.A. Multiple function of the southern pine beetle pheromone verbenone. *Environ. Entomol.* 2: 511-514; 1973.
- Schowalter, T.P.; Pope, D.N.; Coulson, R.N.; Fargo, W.S. Patterns of southern pine beetle (*Dendroctonus frontalis* Zimm.) infestation enlargement. *For. Sci.* 27: 837-849; 1981.
- Svihra, P.; Paine, T.D.; Birch, M.C. Interspecific olfactory communications in southern pine beetles. *Naturwiss.* 67: 518-519; 1980.
- Vité, J.P.; Gara, R.I.; von Scheller, H.D. Field observations on the response to attractants of bark beetles infesting southern pines. *Contr. Boyce Thompson Inst. Pl. Res.* 22: 461-470; 1964.
- Wagner, T.L.; Gagne, J.A.; Doraiswamy, P.C.; Coulson, R.N.; Brown, K.W. Development time and mortality of *Dendroctonus frontalis* in relation to changes in tree moisture and xylem water potential. *Environ. Entomol.* 8: 1129-1139; 1979.
- Wagner, T.L.; Feldman, R.M.; Gagne, J.A.; Cover, J.D.; Coulson, R.N.; Schoolfield, R.M. Factors affecting gallery construction, oviposition, and reemergence by *Dendroctonus frontalis* in the laboratory. *Ann. Entomol. Soc. Am.* 74: 255-273; 1981a.
- Wagner, T.L.; Gagne, J.A.; Cover, J.D.; Coulson, R.N.; Pulley, P.E. Comparison of gallery construction, oviposition, and reemergence by *Dendroctonus frontalis* females producing first and second broods. *Am. Entomol. Soc. Am.* 74: 570-575; 1981b.
- Wagner, T.L.; Fargo, W.S.; Keeley, L.L.; Coulson, R.N.; Cover, J.D. Effects of sequential attack on gallery construction, oviposition, and reemergence by *Dendroctonus frontalis* (Coleoptera:Scolytidae). *Can. Entomol.* 114: 491-502; 1982.
- Wagner, T.L.; Gagne, J.A.; Sharpe, P.J.H.; Coulson, R.N. A biophysical model of southern pine beetle, *Dendroctonus frontalis* Zimmermann (Coleoptera:Scolytidae), development. *Ecol. Modelling* 21: 125-147; 1984a.
- Wagner, T.L.; Wu, H.; Sharpe, P.J.H.; Schoolfield, R.M.; Coulson, R.N. Modeling insect development rates: a literature review and application of a biophysical model. *Ann. Entomol. Soc. Am.* 77: 208-225; 1984b.
- Wagner, T.L.; Wu, H.; Sharpe, P.J.H.; Coulson, R.N. Modeling distributions of insect development time: a literature review and application of

the Weibull function. *Ann. Entomol. Soc. Am.* 77: 475-487; 1984c.

Wilkinson, R.C.; McClelland, W.T.; Murillo, R.M.; Ostmark, E.O. Stridulation and behavior in two southeastern *Ips* bark beetles (Coleoptera:Scolytidae). *Fla. Entomol.* 50: 185-195; 1967.

Wood, D.L.; Stark, R.W. The life history of *Ips calligraphus* (Coleoptera:Scolytidae) with notes on its biology in California. *Can. Entomol.* 100: 145-151; 1968.

TEXT FOOTNOTES

² Flamm, R. O.; Wagner, T. L.; Cook, S. P.; Pulley, P.E.; Coulson, R. N.; McArdle, T. Host colonization by cohabiting *Dendroctonus frontalis*, *Ips avulsus*, and *I. calligraphus* (Coleoptera:Scolytidae); 1985. (In review).

³ Wagner, T. L.; Fargo, W. S.; Flamm, R. O.; Coulson, R. N.; Pulley, P. E. Aspects of development and mortality of *Ips calligraphus* (Coleoptera: Scolytidae) at constant tempera-

tures; 1985a. (In review).

Wagner, T. L.; R. O. Flamm; Wu, H.; Fargo, W. S.; Coulson, R. N. A temperature-dependent model of life cycle development of *Ips calligraphus* (Coleoptera:Scolytidae); 1985b. (In review).

Wagner, T. L.; Flamm, R. O.; Coulson, R. N. A temperature-dependent model of reemergence of *Ips calligraphus* (Coleoptera:Scolytidae); 1985c. (In review).

Wagner, T. L.; Hennier, P. B.; Flamm, R. O.; Coulson, R. N. Aspects of development and mortality of *Ips avulsus* (Coleoptera:Scolytidae) at constant temperatures; 1985d. (In review).

Wagner, T. L.; Flamm, R. O.; Hennier, P. B.; Coulson, R. N. A temperature dependent model of reemergence of *Ips avulsus* (Coleoptera:Scolytidae); 1985e. (In preparation).

⁴Wagner, T. L.; Hu, W.; Feldman, R. M.; Sharpe, P. J. H.; Coulson, R. N. A multiple-cohort approach for simulating development of insect populations under variable temperatures. *Ann. Entomol. Soc. Am.*; 1985f. (In press).

⁵Coulson, R. N.; Flamm, R. O.; Pulley, P. E.; Payne, T. L.; Rykiel, E. J.; Wagner, T. L. Response of the southern pine beetle guild to host disturbance; 1985. (In review).

Effects of Temperature and Slash Pine Phloem Thickness on *Ips calligraphus* Life Processes

Robert A. Haack, John L. Foltz, and Robert C. Wilkinson¹

Abstract.—Reproductive performance and larval development of *Ips calligraphus* (Germar) in slash pine bolts and slabs with phloem thicknesses ranging from 0.5 to 4.0 mm were studied at 20°, 25°, and 30°C in the laboratory. Oviposition rate and egg density were positively correlated with temperature and phloem thickness. Longevity and fecundity of *I. calligraphus* reared at 30°C were significantly greater for females in thick (>female pronotal width) versus thin (<female pronotal width) phloem; females switched between thick and thin phloem at 3-day intervals had intermediate values. Rate of larval development and progeny adult production per parent female increased with increasing temperature and phloem thickness. Progeny adults from thin phloem were smaller in body size and had a female-biased sex ratio (1 male: 2 females). When progeny adults from thin phloem were allowed to mate among themselves and reproduce in thick phloem, their progeny (F₂) were similar in body size and sex ratio to offspring of thick-phloem-reared adults that also had developed in thick phloem. Nutritional and physical characteristics of phloem, xylem, and outer bark are significant in relation to *I. calligraphus* reproduction and development.

Additional keywords: Bark beetle, gallery construction, reemergence, brood emergence, pronotal width, plant-insect interaction.

INTRODUCTION

The six-spined ips, *Ips calligraphus* (Germar) (Coleoptera: Scolytidae) is the most aggressive and destructive of the bark beetle species infesting slash pine (*Pinus elliottii* Engelm. var. *elliottii*), one of the four major southern pines (Fatzinger et al. 1983). In Florida, slash pine is the principal commercial

forest tree species, accounting for nearly 5 million acres of managed plantations. Losses of about 1 cord per acre per 20-year rotation period occur in Florida's slash pine plantations, with the six-spined ips being associated with many of those losses (Chellman 1980).

Like many other bark beetles, *I. calligraphus* lives primarily within the inner bark (phloem) of its host. However, when phloem thickness is less than average beetle pronotal width (ca. 1.8 mm; Haack 1984), adults as well as late-instar larvae must etch deeper into outer bark and sapwood (xylem). When phloem thickness is greater than beetle width, they tunnel primarily into the phloem and only slightly score the sapwood (Haack et al. 1984b). Figure 1 contrasts the differences in the host tissues encountered when *Ips* construct a 2-mm wide gallery in 3- and 1-mm thick phloem. Because phloem thickness commonly ranges from 0.5 to 4.0 mm (Haack et al. 1984b) and is generally consistent along the trunk of individual slash pine trees (fig. 2), *I. calligraphus* adults and their progeny will encounter dramatically different host environments depending on the tree colonized.

In thick phloem (i.e., thicker than adult pronotal width), nutrients probably are derived almost entirely from the soft and nutrient-rich phloem. However, more outer bark and more xylem (both nutritionally inferior and physically denser than phloem) (Haack and Slansky, in press), must be

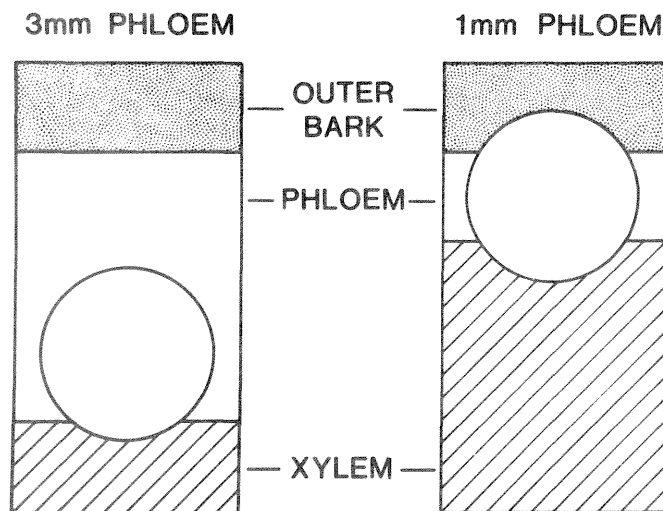

Figure 1.—Cross-sectional view of 2-mm wide *Ips calligraphus* egg galleries in 3-mm and 1-mm thick phloem.

¹ Respectively, Research Associate, Department of Entomology, Michigan State University, East Lansing, MI, and Associate Professor and Professor, Department of Entomology and Nematology, University of Florida, Gainesville, FL. (We thank Owens-Illinois Paper Company for use of their plantations and the U. S. Department of Agriculture for partial funding of this research under the program entitled "The Integrated Pest Management RD&A Program for Bark Beetles of Southern Pines", Southern Forest Experiment Station Cooperative Agreement 19-81-8 with the University of Florida.)

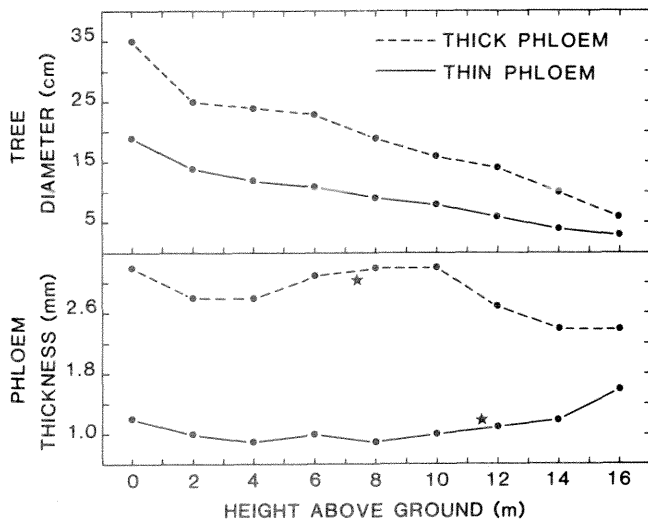

Figure 2.—Average diameter and phloem thickness at 2-m intervals along the trunks of five slash pine trees with thick phloem (2.5–3.5 mm) and five trees with thin phloem (0.5–1.5 mm) at breast height (1.4 m) (Stars signify average height at which the live crown began).

chewed when in thin phloem (<adult pronotal width). Because phloem thickness in slash pine ranges from much less to much more than the average width of *I. calligraphus* adults, we wondered how certain life processes of this bark beetle would vary in relation to phloem thickness and how these relationships would vary with temperature. If phloem thickness proved to be a significant factor, it was our hope that this host characteristic would be incorporated in future sampling and risk-rating systems for *I. calligraphus* in the slash pine ecosystem. Summarized here are highlights of our research (Haack 1984; Haack et al. 1984a, 1984b) on *I. calligraphus* reproductive performance and larval development in relation to temperature and slash pine phloem thickness.

METHODS AND MATERIALS

Temperature and Phloem Thickness Effects on Gallery Construction and Oviposition (First Experiment)

Bark and slab preparation.—Gallery construction and oviposition by *I. calligraphus* were monitored in slash pine bark slabs by means of radiography and slab dissection as described in Haack et al. (1984b). Dominant and codominant slash pine trees were used from a 20- to 21-year-old plantation (site index of

58 ft (17.6 m) at 25 years) near Orange Heights, Alachua County, FL. Five trees were felled in the fall of 1981 and four during the summer of 1982. The selected trees had phloem thicknesses ranging from 0.5 to 4.0 mm. Bolts (30–35 cm long) were cut from the trunk of each felled tree, the ends dipped in a 1-percent benomyl fungicide solution, and dried for 3–4 days. Following drying, longitudinal grooves were cut along the length of each bolt with a table saw, and then bark slabs (29–33 cm long, 10–14 cm wide, 2–4 cm thick) were split away with an ax and hammer. Slabs were coated with paraffin on all cut surfaces to inhibit desiccation.

Collection and introduction of beetles into bark slabs.—The beetles used as parent adults were reared from naturally infested, thick-phloem slash pines. When most of the developing brood reached the pupal stage, infested trunk sections were taken to the laboratory and stored in outdoor emergence cages. Emerging brood adults were collected several times daily, sexed according to the form of the third elytral tooth (Hopping 1963), and stored in containers with moist, unbleached paper towels at 20°C until used. Only mature, non-injured beetles that had been collected within 48 hours prior to the time of introduction were used as parent adults.

Based on the methods of Wilkinson (1964), a “starter hole” was made through the outer bark in the center of each slab. A single male (the colonizing sex in *Ips* beetles) was placed into the long half of a gelatin capsule that was pierced on the end for ventilation and had a ring of paper for footing. The capsule was held over the hole with a ring of the sealing compound Duxseal®. Males were allowed 24 hours to construct their nuptial chambers at 25°C, after which three females were introduced into each chamber at 30–45 minute intervals. The infested slabs were assigned randomly to one of three temperature treatments (20°, 25°, 30° C) and stored in ventilated rearing cans (photoperiod 12L:12D, 55–70 percent RH). These temperatures reflect summer readings that can average near 30°C and spring and fall readings that average near 20°C in Alachua County, FL (Dohrenwend 1978).

Data collection.—*Ips calligraphus* gallery construction and oviposition were monitored using a Faxitron® X-ray unit and Kodak® AA 11m. All slabs were radiographed following female introduction and daily thereafter until most females had tunneled to the slab ends; mated females tend to follow the woodgrain when constructing egg galleries (Wilkinson et al. 1967). After the last day of radiography, the slabs were frozen and later dissected to recover the parent adults and to map the gallery system on acetate. The daily pattern of gallery construction and oviposition were recorded for each female along

with the average phloem thickness through which she tunneled and the average depth to which she etched the xylem.

Analyses.—Data analyses followed the general linear models procedures of the Statistical Analysis System (SAS), and were based on the first 8 days of gallery construction at 20°C, first 6 days at 25°C, and first 4 days at 30°C. Regression of oviposition rate (eggs/day), length of initial egg-free gallery (mm), egg density (egg/cm of gallery starting at the first egg), and depth of xylem-etching (mm) were each performed over the entire data set, using phloem thickness as the independent variable and season and temperature as class variables. Because of the curvilinear relation between egg density and phloem thickness, these two variables were log-transformed prior to linear regression (Steel and Torrie 1980).

Phloem Thickness Effects on Female Longevity and Fecundity (Second Experiment)

Longevity and fecundity of *I. calligraphus* were studied in relation to phloem thickness using slash pine bolts at 30°C as described in Haack et al. (1984a). This temperature was selected because reproductive performance of *I. calligraphus* had varied the most between thick and thin phloem at 30°C in the previous study (Haack et al. 1984b). We were interested in learning whether or not greater reproductive rates in thick phloem eventually would lead to earlier female death in such phloem, in comparison with longevity in thin phloem.

Bolt preparation.—Bolts (35 cm long) were obtained from 15 slash pine trees felled in the Orange Heights plantation between April and June 1982; phloem thickness was thin (1.0–1.5 mm) on 7 trees and thick (2.5–3.5 mm) on 8. The bolts were dried and disinfected as before, after which the loose flakes of outer bark were removed and the bolt ends pared back to unstained phloem and covered with paraffin.

Collection, introduction, and transfer of beetles.—Beetles for this study were collected, sexed, and stored as described above. Only females collected within 24 hours, and males within 48 hours prior to the time of beetle introduction were used. From two to six starter holes were made around the midline of each bolt with no two holes closer than 10 cm. Males were introduced as described above and given 24 hours to construct their nuptial chambers at 30°C, after which one female was introduced into each. Infested bolts were placed in ventilated rearing cans and maintained at 30°C, 60–70 percent RH, and a photoperiod of 12L:12D.

After 3 days, the time when females were nearing

the bolt ends, each gallery was carefully dissected with the female being removed and immediately introduced into another (then 24 hours old) nuptial chamber on a different bolt. Similarly, 40 females were transferred again and again every 3 days until their death. There were four treatments (N=10 females each) with respect to how the females were transferred: (1) KK, from thick phloem to thick phloem only; (2) KN, alternating between thick and thin phloem, beginning on thick; (3) NK, alternating between thick and thin phloem, beginning on thin; and (4) NN, from thin phloem to thin phloem only.

Data collection.—The ovipositional history of each female was recorded by making tracings on acetate of all her egg galleries, including the nuptial chamber, gallery, and egg niches. For each female, total number of eggs, total gallery length (measured beginning at the first egg in each gallery), and longevity in days were recorded. From those values, gallery construction rate (mm/day), oviposition rate (eggs/day), and egg density (eggs/cm) were calculated over each female's lifetime. For those females switched between thick and thin phloem, numbers of eggs laid in the first 2 cm (beginning at the first egg) and last 2 cm of each gallery were recorded. Additionally, average water content of the phloem through which each female tunneled was estimated (see Haack et al. 1984a).

Analyses.—Data analyses followed the SAS procedures. Mean female longevity, total gallery length (cm), gallery construction rate, fecundity (eggs), oviposition rate, and egg density were compared among treatments with Duncan's multiple range test. For females switched between thick and thin phloem (KN & NK), *t* tests were used to compare (1) overall gallery construction rate, oviposition rate, and egg density while in thick phloem to that in thin phloem, and (2) egg density over the first 2 cm of gallery to that over the last 2 cm of gallery within each phloem thickness class. In the latter analyses (KN & NK), only those data from the 2nd-7th galleries (days 4–21) were used. Phloem water content was compared between phloem thickness classes with the *t* test.

Temperature and Phloem Thickness Effects on Reemergence and Brood Development (Third Experiment)

Bolt and bark slab preparation.—*Ips calligraphus* parent adult reemergence and brood development were studied using bolts and bark slabs of slash pine as described in Haack (1984). Rearing materials were obtained from 16 slash pine trees felled in the Orange Heights plantation between April and Sep-

tember 1981; phloem thickness was thin (0.5–1.5 mm) on 7 trees and thick (2.5–3.5 mm) on 9. The bolts and slabs (30–35 cm long) were prepared as described above.

Collection and introduction of beetles.—Beetles were collected from naturally infested slash pines, sexed, and stored as reported above. Only mature, non-injured beetles collected within 48 hours prior to the time of introduction were used as parent adults. Bolts were infested with two males each by introducing them into starter holes made along the bolt midline on opposite sides; one male was introduced into the center of each slab. Males were allowed 24 hours to construct their nuptial chambers at 30°C before three females were introduced into each chamber. The infested bolts and slabs were assigned randomly to one of three temperature treatments (20°, 25°, 30°C).

After seeing that progeny adults (F_1) from thin phloem were smaller and had a female-biased sex ratio, we were interested in testing whether these changes would continue or not in the subsequent F_2 generation when allowed to reproduce in thick phloem (F_1 - F_2 study). To do this, several thin- and thick-phloem-reared F_1 progeny adults from the 30°C treatment were introduced into thick-phloem bolts within 24 hours of their emergence and maintained at 30°C. All matings occurred between beetles reared from the same phloem thickness class; three females were introduced into each nuptial chamber as before.

Data collection.—Parent adult reemergence from both bolts and slabs was tallied daily. Brood development in bark slabs was monitored at regular intervals using radiography as described above. The larvae, pupae, and young progeny adults were counted on each radiograph, and the numbers were recorded on a per-slab and a per-female basis. Several slabs were frozen following the last day of radiography, while the others were left for emergence of progeny adults. The frozen slabs were later dissected and egg niches counted to determine initial oviposition. Emergence of progeny adults was tallied daily (both sexes combined) and recorded as days elapsed after parent female introduction; mean time to 50 percent progeny adult emergence was calculated on a per-bolt or per-slab basis. Production of progeny adults per parent female was recorded from both bolts and slabs. All progeny adults were sexed, and from a sample of these adults, pronotal width was measured using a microscope with ocular micrometer.

In the F_1 - F_2 study, all bolts were debarked when most of the F_2 progeny were teneral adults. Pronotal width and sex of the F_2 progeny adults were determined from samples representing each bolt.

Analyses.—Data analyses were conducted using the *t*-test and the SAS procedures. Where applicable, reemergence, brood development, progeny adult production per parent female, pronotal width, and sex ratio were compared between sexes, phloem thickness classes, generations, and among temperature treatments. Regression analyses of parent adult reemergence and progeny adult emergence with temperature were performed. Percentage values were analyzed without transformation.

RESULTS

First Experiment

Preliminary analyses showed that size of parent females did not vary ($P > 0.05$) between studies nor among temperature treatments, and therefore was not a factor contributing to the treatment differences noted below.

Oviposition rate.—Females laid more eggs per day as temperature and phloem thickness increased (fig. 3); for a given temperature and phloem thickness, oviposition rate was generally greater in the summer than in the fall study. Temperature and phloem thickness were the principal factors influencing oviposition rate (table 1).

Gallery construction rate.—The rate at which females constructed galleries was influenced most by temperature and to a much smaller degree by season and phloem thickness (table 1). After pooling the data with respect to season and phloem thickness,

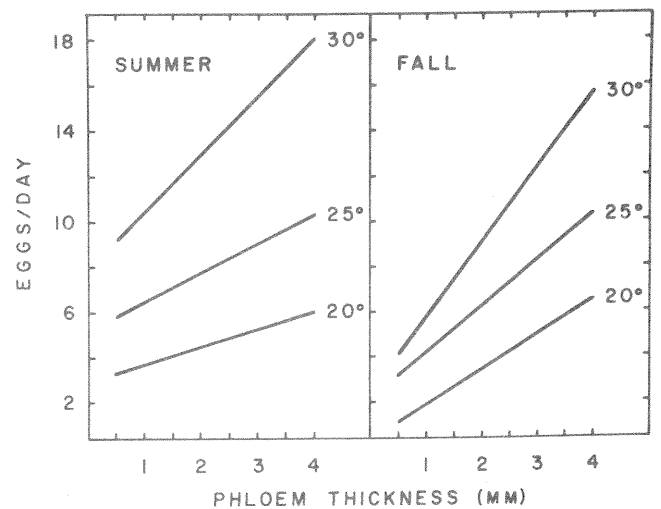

Figure 3.—*Ips calligraphus* oviposition rate (eggs/day) at three temperatures in bark slabs from slash pines cut in the fall of 1981 and the summer of 1982 with varying phloem thicknesses (equations given in Haack et al. 1984b).

Table 1. — Significance of variables affecting *Ips calligraphus* life processes at 20°, 25°, and 30°C. in slash pine bark slabs

Model variable	Oviposition and gallery construction parameters ¹				
	OR	GCR	EFG	ED ²	DXE
Season	0.090 ^{3**}	0.007*	0.050**	0.179**	0.011**
Temperature	0.536**	0.631**	0.212**	0.152**	0.031**
Phloem thickness	0.179**	0.014**	0.017**	0.397**	0.622**
Overall	0.805**	0.652**	0.279**	0.728**	0.664**
N	309	309	309	309	309

¹ OR = oviposition rate; GCR = gallery construction rate; EFG = initial egg-free gallery; ED = egg density; DXE = depth of xylem etching.

² Linear regression of ED with phloem thickness was performed after log transformation of both variables.

³ Significance: * = P < 0.05, ** = P < 0.01. (Source: Haack et al. 1984b.)

Table 2. — Average length (mm) of *Ips calligraphus* initial egg-free gallery in bark slabs from slash pines cut in fall 1981 and summer 1982 with phloem thickness ranging from 0.5 to 4.0 mm at 20°, 25°, or 30°C¹

Season	Temperature (°C)		
	20°	25°	30°
	$\bar{X} \pm SD$ (N, range)	$\bar{X} \pm SD$ (N, range)	$\bar{X} \pm SD$ (N, range)
	-----mm.-----		
Fall	24.2 ± 7.7 a1 ² (43, 9-44)	21.4 ± 7.3 a1 (49, 10-57)	17.7 ± 6.1 a2 (46, 6-39)
Summer	23.3 ± 7.6 a1 (53, 11-49)	17.1 ± 5.0 b2 (59, 8-28)	13.5 ± 3.4 b3 (59, 7-20)

¹ Initial egg-free gallery was measured from the point where each female began tunneling to her first egg. The data were pooled over all phloem thicknesses.

² Means followed by the same letter (within columns) or number (within rows) are not significantly different at the P < 0.05 level (Duncan's multiple-range test). (Source: Haack et al. 1984b.)

mean ($\bar{X} \pm SE$) gallery construction rate in cm/day was 1.7 ± 0.04 at 20° (N = 96), 2.4 ± 0.04 at 25° (N = 108), and 3.3 ± 0.07 at 30°C (N = 105), for both studies combined. When the two studies were analyzed separately, gallery construction rate was significantly and positively correlated with phloem thickness in the fall study only.

Initial egg-free gallery.—The distance that females tunneled before laying their first eggs depended mostly on temperature, with season and phloem thickness being of minor importance (table 1). After the data were pooled with respect to phloem thickness, mean distance to the first egg was shorter in

the summer study than in the fall study at 25° and 30°C but not at 20°C (table 2). Again, when the studies were analyzed separately, initial egg-free gallery was significantly related to phloem thickness in the fall study only.

Egg density.—Females laid more eggs in each unit of gallery as temperature and phloem thickness increased, and for a given temperature and phloem thickness, egg density was greater in the summer than in the fall study (fig. 4). Phloem thickness was the principal factor influencing egg density (table 1).

Depth of xylem-etching.—The depth to which females etched into xylem was most strongly correlated with phloem thickness, and only slightly correlated with season and temperature (table 1). After the data with respect to season and temperature were pooled, the overall regression equation for depth of xylem-etching (DXE, mm) with phloem thickness (PT, mm) was: $DXE = 0.503 - 0.119 PT$ ($r^2 = 0.66$, N = 309).

Second Experiment

Preliminary analyses indicated that female size did not vary significantly ($P > 0.10$) among treatments and thus was not a significant factor in treatment responses noted below. Similarly, no significant ($P > 0.10$) differences occurred between KN and NK for several measured parameters, and thus these data were pooled.

Female longevity.—Females lived 66 percent longer on KK and 31 percent longer on KN+NK compared with NN (table 3). Most females (38 of 40) died at the end of the gallery they were con-

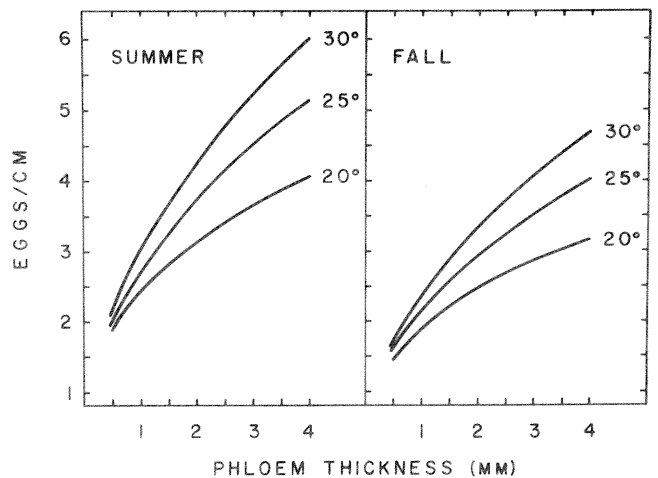

Figure 4.—*Ips calligraphus* egg density (eggs/cm) at three temperatures in bark slabs from slash pines cut in the fall of 1981 and the summer of 1982 with varying phloem thicknesses (equations given in Haack et al. 1984b).

Table 3.—*Longevity, total gallery length (TGL), gallery construction rate (GCR), fecundity, oviposition rate (OR), and egg density of Ips calligraphus females maintained in slash pine bolts at 30°C by treatment*

Parameter	Treatment ¹		
	KK	KN + NK	NN
	$\bar{X} \pm SD$ (Range)	$\bar{X} \pm SD$ (Range)	$\bar{X} \pm SD$ (Range)
Longevity, days	29 ± 12 a (14 - 54)	23 ± 14 a (9 - 54)	17 ± 8 b (9 - 30)
TGL, cm	76 ± 20 a (44 - 113)	74 ± 33 a (32 - 149)	56 ± 25 a (24 - 101)
GCR, mm/day	28 ± 6 b (21 - 40)	35 ± 6 a (24 - 44)	32 ± 5 a (24 - 41)
Fecundity, eggs	326 ± 104 a (156 - 464)	263 ± 120 a (80 - 572)	160 ± 70 b (58 - 280)
OR, eggs/day	12 ± 3 a (9 - 17)	12 ± 3 a (8 - 17)	9 ± 2 b (6 - 11)
ED, eggs/dm	43 ± 8 a (35 - 59)	36 ± 5 b (25 - 48)	29 ± 3 c (23 - 32)

¹ KK = 10 females maintained on thick (K, 2.5–3.5 mm) phloem, KN + NK = 20 females switched between thick and thin (N, 1.0–1.5) phloem at 3-day intervals, and NN = 10 females maintained on thin phloem only. Means followed by the same letter (within rows) are not significantly different at the $P < 0.05$ level ($P < 0.01$ for ED) (Duncan's multiple-range test). (Source: Haack et al. 1984a.)

structing, often next to a partially constructed egg niche.

Total gallery length and gallery construction rate.—Total gallery length did not vary significantly among treatments (table 3). However, with respect to gallery construction rate, females constructed 24 percent more gallery per day on KN+NK than KK (table 3). For females switched between thick and thin phloem, mean rate of gallery construction while in thick phloem did not differ ($P > 0.10$) from that when in thin phloem; mean values were 30.6 mm/day (± 1.3 S.E.) and 33.8 (± 1.4), respectively.

Realized fecundity and oviposition rate.—Females laid 104 percent more eggs per lifetime on KK and 64 percent more on KN+NK than did females on NN (table 3). Most females (34 of 40) laid eggs until the last day of their lives.

Females laid 27 percent more eggs per day on KK than on NN (table 3). For females on the KN+NK treatment, oviposition rate was significantly greater ($P < 0.01$) when in thick versus thin phloem; mean values were 13.2 eggs/day (± 0.6) and 10.0 (± 0.6), respectively.

Egg density.—Females laid 49 percent more eggs

per unit length of gallery on KK and 25 percent more on KN+NK than did females on NN (table 3). The density of eggs laid by females in the KN+NK treatment generally increased while on thick phloem and decreased while on thin phloem (fig. 5). Average egg density was 4.3 eggs/cm (± 0.1) in thick phloem and 2.88 (± 0.1) in thin phloem. More specifically, mean egg density changed ($P < 0.01$) between the beginning and the end of individual galleries after females were switched to a new phloem thickness class. Females switched from thin into thick phloem laid 3.8 (± 0.2) eggs/cm in the first 2 cm and 5.0 (± 0.2) in the last 2 cm, whereas those switched from thick into thin phloem laid 3.5 (± 0.2) eggs/cm initially and then 2.4 (± 0.2) at the end.

Third Experiment

Preliminary analyses indicated no significant differences ($P > 0.10$) between bolts and slabs of similar phloem thickness for several adult and brood parameters, and therefore the data were pooled.

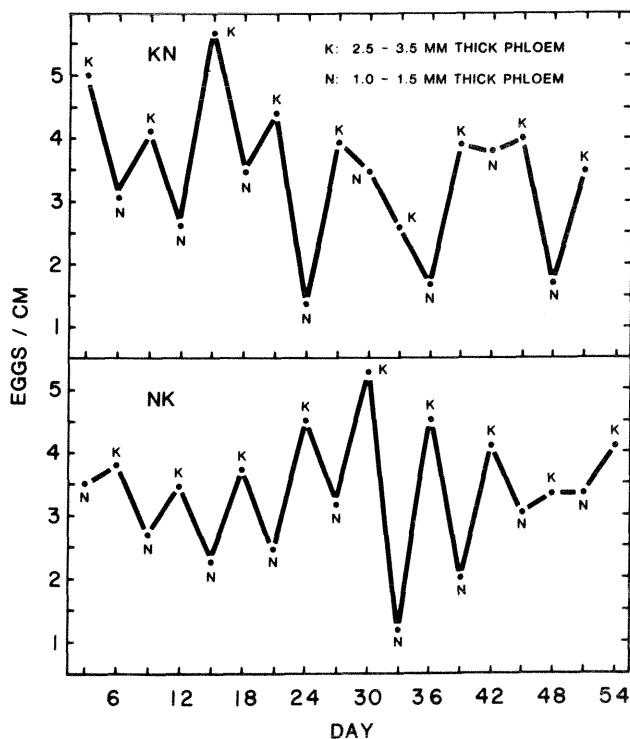

Figure 5.—*Egg density (eggs/cm) averaged over 3-day periods throughout the lives of Ips calligraphus females switched between thick (K) and thin (N) phloem every 3 days at 30°. KN = 10 females switched between thick and thin phloem beginning on thick; NK = 10 females switched between thick and thin phloem beginning on thin (from Haack et al. 1984a).*

Table 4. — Average number of days to 50 percent reemergence of *Ips calligraphus* male and female parent adults (starting from introduction) in slash pine bolts and slabs with thick or thin¹ phloem at 20°, 25°, or 30°C²

Sex	Temperature (°C)		
	20°	25°	30°
	$\bar{X} \pm SD$ (N, range)	$\bar{X} \pm SD$ (N, range)	$\bar{X} \pm SD$ (N, range)
Male	24.3 ± 5.4 a1 ³ (28, 16-35)	14.1 ± 3.6 b2 (30, 8-20)	8.6 ± 2.4 b3 (29, 6-15)
Female	25.9 ± 5.5 a1 (68, 18-37)	15.7 ± 3.0 a2 (57, 10-20)	10.9 ± 2.4 a3 (72, 6-15)

¹ 2.5-3.5 mm and 0.5-1.5 mm, respectively.

² Data from both the thick- and thin-phloem treatments were combined.

³ Means followed by the same letter (within columns) or number (within rows) are not significantly different at the P < 0.05 level (Duncan's multiple-range test). (Source: Haack 1984.)

Reemergence.—Analyses indicated that reemergence was not affected ($P > 0.10$) by phloem thickness, and therefore the data were pooled. Males tended to reemerge 1-2 days earlier than females at each temperature tested (table 4). Overall, 90-100 percent of the males and 89-100 percent of the females reemerged in the various studies. Descriptive regression equations for mean time to 50 percent reemergence (RE, days) with temperature (C, °C) were: $RE = 54.7 - 1.6C$ for males ($r^2 = 0.71$, $N = 87$ parent males), and $RE = 55.2 - 1.5C$ for females ($r^2 = 0.71$, $N = 197$ parent females).

Brood development and progeny production per parent female.—Brood developed faster in thicker phloem at each of the temperatures tested as evidenced by the greater proportion of advanced life stages in thick versus thin phloem on a given day (fig. 6). Additionally, the number of progeny adults that emerged per parent female increased with increasing temperature and phloem thickness; progeny production was greatest in thick phloem at 30°C and least in thin phloem at 20°C (fig. 7).

Progeny adult emergence.—Progeny adults emerged sooner with increasing temperature and phloem thickness (fig. 7). Regression equations describing mean time to 50 percent progeny adult emergence (E, days) with temperature (C, °C) were: $E = 108.0 - 2.8C$ in thick phloem ($r^2 = 0.82$, $N = 3090$ progeny adults), and $E = 110.6 - 2.7C$ in thin phloem ($r^2 = 0.83$, $N = 1006$).

Pronotal width of progeny adults.—Males and females reared from thick phloem were, respectively, 8 percent and 5 percent wider than those from thin phloem (table 5). When development occurred in thick phloem, males were 5 percent wider than fe-

males ($P < 0.01$), whereas in thin phloem, the sexes were of similar size ($P > 0.49$). With respect to the F_2 progeny adults, which all developed in thick phloem, progeny of the thin-phloem-reared F_1 adults were as large as progeny of thick-phloem-reared F_1 adults.

Progeny adult sex ratio.—The sex ratio of the F_1 progeny adults was approximately 1:1 (males:females) for those reared in thick phloem, and nearly 1:2 for those reared in thin phloem (table 5). In the F_2 generation, where all development occurred in thick phloem, the sex ratio was 1:1 for the progeny

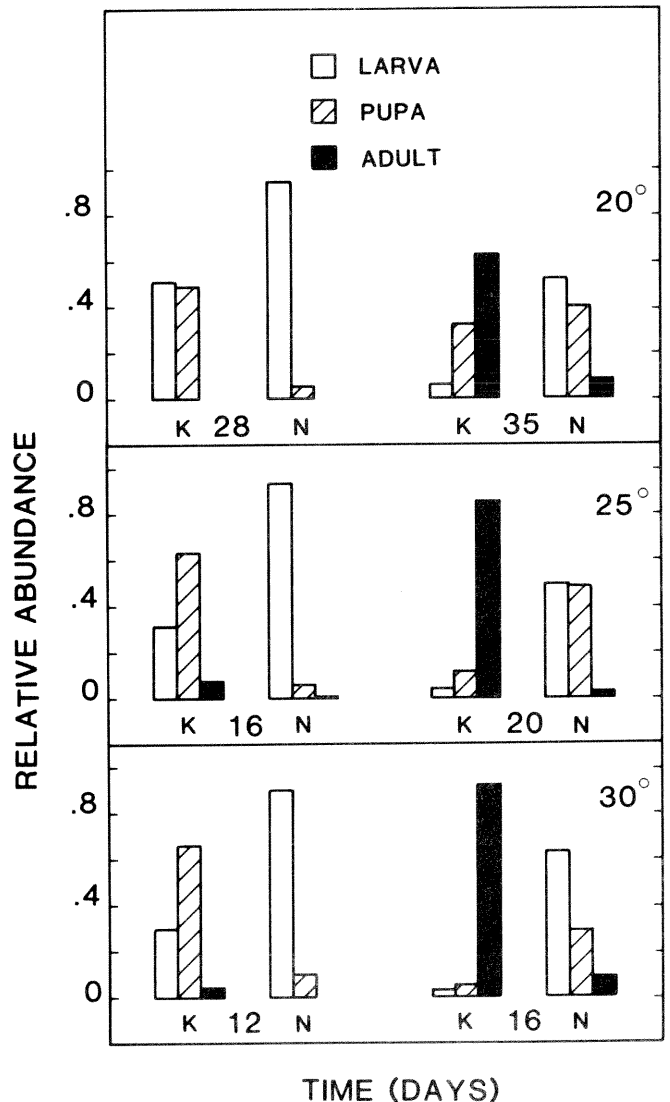

Figure 6.—Percentage of *Ips calligraphus* brood individuals found in larval, pupal, and adult stages in slash pine slabs with thick (K; 2.5-3.5 mm) or thin (N; 0.5-1.5 mm) phloem when radiographed on specified days throughout the developmental period at three temperatures. Numbers counted were 158(K) and 116(N) on day 28 at 20°; 854(K) and 189(N) on day 16 at 25°; and 1035(K) and 194(N) on day 12 at 30° C (from Haack 1984).

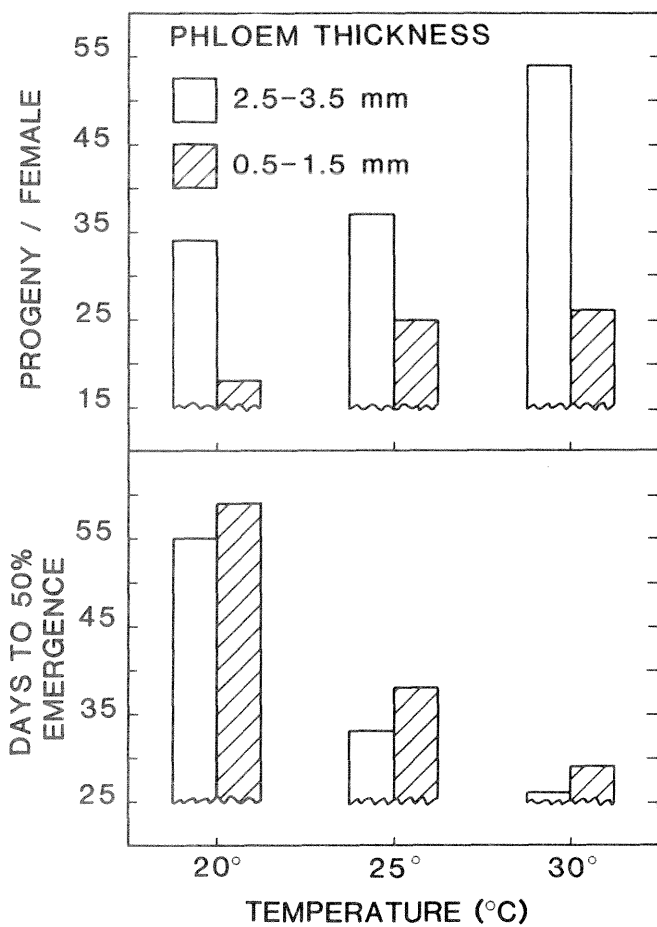

Figure 7.—Average number of progeny adults produced per parent female and average number of days from introduction to 50 percent emergence of progeny adults for *Ips calligraphus* in slash pine bolts and slabs with thick or thin phloem at 3 temperatures. (Mean values were significantly different ($P < 0.05$; t test) between thick and thin phloem for each of the six pairs (from Haack 1984).

of both thick- and thin-phloem-reared F_1 adults.

DISCUSSION

Phloem Thickness and Reproduction

Almost every life process of *I. calligraphus* is enhanced in thick phloem. We feel that host-quality differences (i.e., nutritional and physical differences among phloem, xylem, and outer bark) best explain how phloem thickness influences beetle performance. Viewed simply, phloem is better than either xylem or outer bark as a medium for bark beetle reproduction because it is much more nutritious and much less dense: nitrogen, sugar, mineral, and water content are highest in phloem, lower in sapwood xylem, and lower still in outer bark (Haack and Slansky,

Table 5.—Male and female pronotal width and proportion of *Ips calligraphus* male progeny adults reared at 30°C in slash pine bolts having either thick (TK) or thin (TN) phloem

Phloem	F_1 Brood adults	F_1 to F_2 change in phloem	F_2 Brood adults
Male pronotal width (mm)			
TK	1.84 ± 0.09 ² a2 ³ (50, 1.7-2.1)	TK to TK	1.90 ± 0.09 a1 (50, 1.7-2.1)
TN	1.70 ± 0.14 b2 (50, 1.4-2.0)	TN to TK	1.89 ± 0.09 a1 (50, 1.7-2.1)
Female pronotal width (mm)			
TK	1.77 ± 0.08 a2 (50, 1.6-1.9)	TK to TK	1.81 ± 0.08 a1 (50, 1.7-2.0)
TN	1.69 ± 0.08 b2 (50, 1.5-1.8)	TN ± TK	1.78 ± 0.08 a1 (50, 1.5-1.9)
Percent males (%)			
TK	49.9 ± 4.2 a1 (1223, 42-59)	TK to TK	49.2 ± 3.1 a1 (1005, 45-54)
TN	33.7 ± 5.5 b2 (280, 29-41)	TN to TK	50.3 ± 3.4 a1 (764, 46-56)

¹ TK = 2.5-3.5 mm and TN = 0.5-1.5 mm, respectively.

² Values are: mean ± SD (N, range).

³ For each of the above parameters, means followed by the same letter (within columns) or number (within rows) are not significantly different at the $P < 0.05$ level (t -test). (Source: Haack 1984).

in press). Typically, cell walls are thick and heavily lignified in xylem; they are heavily suberized in outer bark; but mostly thin, unligified, and unsuberized in phloem (Howard 1971, Kramer and Kozlowski 1979). Water content (fresh weight) averages 69 percent in phloem (Martin 1969), 47 percent in xylem (Miller 1959), and 20 percent in outer bark (Martin 1969) of slash pine. Similar values have been reported for loblolly pine, *Pinus taeda* L. (Wagner et al. 1979).

Considering the above tissue characteristics and that *Ips* beetles derive most of their nourishment from the cell contents of their food (host tissues are compressed in the buccal cavity and then expelled; Gouger et al. 1975), it seems probable that fewer nutrients would be obtained (and concomitantly that more energy would be expended) per unit-length of gallery constructed in thin versus thick phloem. Such a scenario would explain the decline in oviposition rate and egg density in thin phloem because nutrients (1) activate and maintain corpora allata secretion of juvenile hormone which influences vitellogenesis, and (2) serve as raw materials and energy sources in egg production (Engelmann 1970). Oviposition is influenced rapidly by changes in host

environment as evidenced by the fluctuations in egg density as the same females were switched between thick and thin phloem.

Reid (1962) reported that oviposition by *Dendroctonus ponderosae* Hopkins declined with a decrease in phloem water content and ceased when water content fell below ca. 51 percent (fresh weight). Reproductive performance of *D. ponderosae* is also influenced by phloem thickness as evidenced by a higher oviposition rate and egg density in thicker phloem (Amman 1972). Because females of both *D. ponderosae* and *I. calligraphus* must chew more xylem and outer bark when tunneling in thin phloem, their diet would contain less water than that of females in thick phloem who tunnel almost exclusively within phloem.

Similarly, the enhanced reproductive performance of *I. calligraphus* evidenced during the summer compared with the fall for a specified phloem thickness and temperature can be explained, in part, by seasonal variations that occur in xylem. During the summer study, the outermost xylem consisted of thin-walled cells (earlywood), whereas thick-walled cells (latewood) were outermost in the current annual ring of xylem during the fall study. Latewood is two to two and a half times denser than earlywood in slash pine (Paul 1939, Ifju 1969), and therefore, latewood should have less water than earlywood. Nitrogen content of earlywood is greater than that of latewood in the sapwood of conifers (Merrill and Cowling 1966); a similar relationship probably exists for sugars, lipids, and minerals.

The fact that, for a given thickness of phloem, females lay more eggs per unit length of gallery as temperature increases suggests that females are more efficient at converting and assimilating ingested food into eggs at higher temperatures (Scriber and Slansky 1981). In contrast, Sahota and Thomson (1979) reported that egg density was independent of temperature in *Dendroctonus rufipennis* (Kirby). However, this lack of relationship may have occurred because variation in phloem thickness was not considered in their study.

A factor not addressed in our research is the nutritional quality of thin versus thick phloem. Because thick-phloem trees tend to be the edge or dominant trees in a stand and thin-phloem trees tend to be the codominant or suppressed trees, it seems plausible that thicker phloem also could be richer in nutrients per unit of dry weight. In our studies, water and lipid content were independent of phloem thickness; average water and lipid content were 68.5 percent (fresh weight; Haack et al. 1984a)

and 2.2 percent (dry weight)². With respect to xylem, however, water and lipid content in the current annual ring of xylem was greater in slash pines with thick versus thin phloem³. This probably occurs in thin-phloem trees. Additional studies should be conducted to measure the nitrogen, sugar, and mineral content in phloem and outer sapwood of slash pines with different phloem thicknesses.

The inverse relationship found between *I. calligraphus* initial egg-free gallery and temperature is similar to that reported for *Dendroctonus frontalis* Zimmermann (Wagner et al. 1981) and *D. rufipennis* (Sahota and Thomson 1979). This relationship probably reflects temperature-dependent processes that act on the flight muscle, fat body, reproductive organs, and corpora allata prior to first oviposition (Reid 19588, Sahota and Thomson 1979). Longer distances to first oviposition at 25°C and 30°C reported in the fall study compared with the summer one may reflect the density, moisture, and nutrient differences between latewood and earlywood. Similarly, physical and nutritional differences between latewood and earlywood may explain why initial egg-free gallery was significantly correlated with phloem thickness in the fall study but not in the summer study.

Phloem Thickness and Rate of Egg-Gallery Construction

The fact that gallery construction rate is independent of phloem thickness may be explained in terms of how time is allocated between tunneling and oviposition as phloem thickness varies. Reproductive behavior by *Ips* bark beetles is illustrated in Schmitz (1972) and Gouger et al. (1975). For example, females in thick phloem probably spend much of their time constructing egg niches and ovipositing and little constructing gallery; whereas females in thin phloem probably spend little time constructing egg niches and ovipositing, but a great deal of it constructing egg gallery. As a result, females construct similar lengths of gallery per unit of time over a range of phloem thicknesses.

Phloem Thickness and Brood Development

Thick phloem is more favorable than thin phloem for *I. calligraphus* brood development as shown by faster larval development, earlier progeny adult

² Unpublished data.

³ Ibid.

curred because the current increment of xylem in thick-phloem trees was wider and had a greater proportion of earlywood to latewood than that in emergence, greater body size, and a 1 to 1 sex ratio. The same physical and nutritional advantages described above for *I. calligraphus* adults reproducing in thick phloem can be proposed as the principal factors for enhanced brood development in thick phloem. The fact that average time to 50 percent emergence and pronotal width of *I. calligraphus* brood adults in Dale's study (1967) were ca. 45 days and 1.7 mm at 25°C and 29 days and 1.6 mm at 30°C, respectively, suggests that host material with thin phloem was used.

Food quality is known to influence rate of larval development (Becker 1977) and adult body size (Anderson and Nilssen 1983) in many other species of bark- and woodboring Coleoptera. For *D. ponderosae* developing in relatively thin phloem, larvae develop slower, progeny adults emerge later and are smaller in body size, and the sex ratio is female-biased (Amman and Pace 1976; Amman and Cole 1983).

The physical and nutritional constraints of the thin-phloem environment should most affect the last (third) larval instar of *I. calligraphus*, simply because of its size; head capsule width averages ca. 1 mm in third instars (Wilkinson 1963). However, earlier larval instars of *I. calligraphus* apparently detect differences as evidenced by longer larval mines in thin versus thick phloem (Haack 1984). Early larval instars of *D. ponderosae* mined faster in thin compared to thick phloem (Amman and Cole 1983).

Given that *I. calligraphus* egg density increases with both increasing phloem thickness and temperature (Haack et al. 1984b), the observed greater brood production in thick phloem probably is best explained in terms of greater original egg density rather than greater brood survival in thicker phloem. In fact, brood mortality was similar between phloem thickness classes, being ca. 35–50 percent in bolts (Haack 1984). This observation demonstrates the importance of reproductive performance being in part host-regulated; i.e., females seem to lay the optimum number of eggs that can be supported by the host. Such behavior would allow females to maximize their fitness by laying an optimum number of eggs in each host they colonize.

Phloem Thickness and Other Southeastern Bark Beetles

In the southeastern U.S., four other major bark beetle species infest pines: *Dendroctonus terebrans* (Olivier), *D. frontalis*, *Ips avulsus* (Eichhoff), and

Ips grandicollis (Eichhoff) (Wilkinson and Foltz 1980). Figure 8 contrasts the relative size of all five southeastern species (values estimated from data in Wood 1982) with 1.5-mm thick phloem, which is the average thickness found in most species of southern pines (Howard 1971). Only one other large species (*D. terebrans*) would appear to be constrained by the relatively thin phloem of most southern pines. In fact, no correlation was found between *D. frontalis* reproduction and loblolly pine (*Pinus taeda* L.) phloem thickness in the study by Wagner et al. (1981). Although smaller adult size may allow for greater host choice, it also may allow for easier expulsion of such adults from resinous trees like slash and longleaf pine (*Pinus palustris* Mill.) (Hodges et al. 1979).

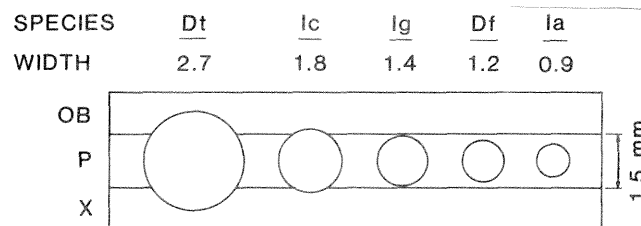

Figure 8.—Relative adult male size based on pronotal width estimates (from data in Wood 1982) of *Dendroctonus terebrans* (*Dt*), *Ips calligraphus* (*Ic*), *Ips grandicollis* (*Ig*), *Dendroctonus frontalis* (*Df*), and *Ips avulsus* (*Ia*) with respect to typical host environment in southern pines (1.5-mm thick phloem) (Howard 1971). OB = outer bark, P = phloem, X = xylem.

SUMMARY

The three laboratory experiments reported in this paper demonstrate that phloem thickness is an important variable in the biology of *I. calligraphus*. Therefore, it should be considered in sampling and population dynamics studies of this beetle in the slash pine ecosystem, especially in summer when warmer temperatures accentuate phloem thickness effects on the beetle's life processes. Future research is needed to identify: (1) Why phloem thickness is correlated with longevity, egg production, and larval development; (2) what physical and chemical factors cause the observed effects; and (3) what other life processes might be correlated with phloem thickness.

LITERATURE CITED

Amman, Gene D. Some factors affecting oviposition behavior of the mountain pine beetle. *Environ. Entomol.* 1(6): 691–695; 1972.

- Amman, Gene D.; Cole, Walter E. Mountain pine beetle dynamics in lodgepole pine forest. Part II. Population dynamics. Gen. Tech. Rep. INT-145. Ogden, UT: U.S. Department of Agriculture, Forest Service, Intermountain Forest and Range Experiment Station; 1983. 59 p.
- Amman, Gene D.; Pace, Vincent E. Optimum egg gallery densities for the mountain pine beetle in relation to lodgepole pine phloem thickness. Res. Note INT-209. Ogden, UT: U.S. Department of Agriculture, Forest Service, Intermountain Forest and Range Experiment Station; 1976. 8 p.
- Anderson, Johan; Nilssen, Arne C. Intrapopulation size variation of free-living and tree-boring Coleoptera. *Can. Entomol.* 115(11): 1453-1464; 1983.
- Becker, Gunther. Ecology and physiology of wood destroying Coleoptera in structural timber. *Mater. Org.* 12(2): 141-160; 1977.
- Chellman, C. W. Tree mortality (pest) surveys in Florida from 1959 thru 1979. In: Forest pest management symposium. 1980 June 3-4; Gainesville, FL. Res. Rep. 7. Gainesville, FL: School of Forest Resources and Conservation, University of Florida; 1980; 8-12.
- Dale, John W. The influence of temperature on the population growth of three species of southern pine engravers. Durham, NC: Duke University, School of Forestry; 1967. 137 p. [Thesis.]
- Dohrenwend, R. E. The climate of Alachua County, Florida. *Fla. Agric. Exp. Sta. Bull.* 796. Gainesville, FL: Florida Agricultural Experiment Station; 1978. 25 p.
- Englemann, Franz. The physiology of insect reproduction. Oxford: Pergamon Press; 1970. 307 p.
- Fatzinger, C. W.; Wilkinson, R. C.; Berisford, C. W. Insects affecting the managed slash pine ecosystem. In: The managed slash pine ecosystem: proceedings of the symposium; 1981 June 9-11; Gainesville, FL. Gainesville: School of Forest Resources and Conservation, University of Florida; 1983: 228-256.
- Gouger, R. J.; Yearian, W. C.; Wilkinson, R. C. Feeding and reproductive behavior of *Ips avulsus*. *Fla. Entomol.* 58(4): 221-229; 1975.
- Haack, Robert A. Attack, reproduction, and development of *Ips calligraphus* (Coleoptera: Scolytidae) in relation to temperature and slash pine phloem thickness. Gainesville: University of Florida; 1984. 178p. [Dissertation.]
- Haack, Robert A.; Foltz, John L.; Wilkinson, Robert C. Longevity and fecundity of *Ips calligraphus* (Coleoptera: Scolytidae) in relation to slash pine phloem thickness. *Ann. Entomol. Soc. Am.* 77(6): 657-662; 1984a.
- Haack, Robert A.; Wilkinson, Robert C.; Foltz, John L.; Corneil, Jeffrey A. Gallery construction and oviposition by *Ips calligraphus* (Coleoptera: Scolytidae) in relation to slash pine phloem thickness and temperature. *Can. Entomol.* 116(4): 625-632; 1984b.
- Haack, Robert A.; Slansky, F., Jr. Nutritional ecology of wood-feeding Coleoptera, Lepidoptera, and Hymenoptera. In: Slansky, F., Jr.; Rodriguez, J. G.; eds. Nutritional ecology of insects, mites, and spiders. New York: John Wiley and Sons. [In press.]
- Hodges, John D.; Elam, William W.; Watson, William F.; Nebeker, T. Evan. Oleoresin characteristics and susceptibility of four southern pines to southern pine beetle (Coleoptera: Scolytidae) attacks. *Can. Entomol.* 11(8): 889-896; 1979.
- Hopping, G. R. The natural groups of species in the genus *Ips* DeGeer (Coleoptera: Scolytidae) in North America. *Can. Entomol.* 95(5): 508-516; 1963.
- Howard, Elaine T. Bark structure of the southern pines. *Wood Sci.* 3(3): 134-148; 1971.
- Ifju, Geza. Within-growth-ring variation in some physical properties of southern pine wood. *Wood Sci.* 2(1): 11-19. 1969.
- Kramer, Paul J.; Kozlowski, Theodore T. Physiology of woody plants. New York: Academic Press; 1979. 811 p.
- Martin, Robert E. Characterization of southern pine barks. *For. Prod. J.* 19(8): 23-30; 1969.
- Merrill, William; Cowling, Ellis B. Role of nitrogen in wood deterioration: amounts and distribution of nitrogen in tree stems. *Can. J. Bot.* 44(11): 1555-1580; 1966.
- Miller, Sharon R., Jr. Variation in inherent wood characteristics in slash pine. In: Forest tree improvement: proceedings of the 5th southern conference; 1959 June 11-12; Raleigh, NC. Raleigh: School of Forestry, North Carolina State University; 1959: 97-106.
- Paul, Benson H. Variation in the specific gravity of the springwood and summerwood of four species of southern pines. *J. For.* 37(6): 478-482; 1939.
- Reid, R. W. Internal changes in the female mountain pine beetle, *Dendroctonus monticolae* Hopk., associated with egg laying and flight. *Can. Entomol.* 90(8): 464-468; 1958.
- Reid, R. W. Biology of the mountain pine beetle, *Dendroctonus monticolae* Hopkins, in the East Kootenay region of British Columbia. II. Behavior in the host, fecundity, and internal changes in the female. *Can. Entomol.* 94(6): 605-613; 1962.

- Sahota, T. S.; Thomson, A. J. Temperature induced variation in the rates of reproductive processes in *Dendroctonus rufipennis* (Coleoptera: Scolytidae): a new approach to detecting changes in population quality. *Can. Entomol.* 111(9): 1069-1078; 1979.
- Schmitz, Richard F. Behavior of *Ips pini* during mating, oviposition, and larval development (Coleoptera: Scolytidae). *Can. Entomol.* 104(11): 1723-1728; 1972.
- Scriber, J. M.; Slansky, F., Jr. The nutritional ecology of immature insects. *Ann. Rev. Entomol.* 26: 183-211; 1981.
- Steel, Roger G. D.; Torrie, James H. Principles and procedures of statistics. 2nd ed. New York: McGraw-Hill Book Co.; 1980. 633 p.
- Wagner, Terence L.; Gagne, James A.; Doraiswamy, Paul C.; Coulson, Robert N.; Brown, Kirk W. Development time and mortality of *Dendroctonus frontalis* in relation to changes in tree moisture and xylem water potential. *Environ. Entomol.* 8(6): 1129-1138; 1979.
- Wagner, T. L.; Feldman, R. M.; Gagne, J. A.; Cover, J. D.; Coulson, R. N.; Schoolfield, R. M. Factors affecting gallery construction, oviposition, and reemergence of *Dendroctonus frontalis* in the laboratory. *Ann. Entomol. Soc. Am.* 74(3): 255-273; 1981.
- Wilkinson, R. C. Larval instars and head capsule morphology in three southeastern *Ips* bark beetles. *Fla. Entomol.* 46(1): 19-22; 1963.
- Wilkinson, R. C. Attraction and development of *Ips* bark beetle populations in artificially infested pine bolts exposed on firetowers and turntables in Florida. *Fla. Entomol.* 47(1): 57-64; 1964.
- Wilkinson, R. C.; Foltz, J. L. A selected bibliography (1959-1979) of three southeastern species of *Ips* engraver beetles. *Bull. Entomol. Soc. Am.* 26(3): 375-380; 1980.
- Wilkinson, R. C.; McClelland, W. T.; Murillo, Ruth M.; Ostmark, E. O. Stridulation and behavior in two southeastern *Ips* bark beetles (Coleoptera: Scolytidae). *Fla. Entomol.* 50(3): 185-195; 1967.
- Wood, Stephen L. The bark and ambrosia beetles of North and Central America (Coleoptera: Scolytidae), a taxonomic monograph. *Great Basin Nat. Mem.* 6; 1982. 1359 p.

Interactions of the Southern Pine Beetle With Competitor Species and Meteorological Factors

Fred P. Hain and Abelmajid Ben Alya¹

Abstract.—Evidence suggests that weather conditions (especially winter temperatures) and competition with other insect species, especially *Ips* and *Monochamus* species, contribute to the patterns of SPB activity in North Carolina. Monitoring of overwintering emergence during an average North Carolina winter showed that most emergence occurred in late April and early May. Very little occurred earlier. However, no additional trees were attacked within the spot infestations. Super cooling tests suggest that larvae are the most susceptible life stage to the lethal effects of cold temperatures. The mean freezing point for larvae was $-13.10^{\circ} \pm 1.8^{\circ}\text{C}$, while the pupal mean was $-16.35^{\circ} \pm 2.2^{\circ}\text{C}$. Preconditioning to colder temperatures improved the survival of laboratory-reared pupae. The adult flight period of *Monochamus carolinensis* and *M. titillator* extended over a period of approximately 4 months, from late May to mid-October. Brood development within infested logs required approximately 12 months; however, some individuals that infested a log by June completed development within 4 months. Cumulative mortalities from larvae establishment to adult emergence were 85.0 percent and 85.6 percent for *M. carolinensis* and *M. titillator*, respectively. Phloem moisture content of trees infested by *Ips* bark beetles or black turpentine beetles showed great fluctuation. However, it appears that *Ips* infested trees can support SPB populations for up to 8 weeks after crown fade, but only at low population levels. When SPB and *I. calligraphus* are infesting the same cut bolt, *I. calligraphus* survival from eggs to adults is comparable to or better than SPB survival. In a wind tunnel, SPB adults show no strong response to *I. calligraphus* males infesting loblolly pine bolts.

Additional keywords: *Ips avulsus*, *I. grandicollis*, *I. calligraphus*, *Dendroctonus frontalis*, *D. terebrans*, *Monochamus titillator*, *M. carolinensis*, loblolly pine,

Pinus taeda, wind tunnel, super cooling, overwintering, pheromone response, phloem decomposition.

INTRODUCTION

Periodic outbreaks of southern pine beetle (SPB), *Dendroctonus frontalis* Zimm., have been documented in North Carolina since 1960 (Price and Doggett 1982). However, from 1973 through 1976, an unprecedented epidemic destroyed an estimated 996,000 cords and 420,000 MBF of timber. At least 2½ times as much timber in cords and at least 3.9 times more MBF were lost than during any other 4-year period before or since. During the winter of 1974–75 and the summer of 1975, respectively² 22,000 and 20,000 SPB infestations were recorded by the North Carolina Forest Service.

An examination of the SPB survey maps (Price and Doggett 1982) suggests that the North Carolina-Virginia border is the northern limit of the SPB continuous range. However, sporadic activity in Virginia, especially during large outbreaks, does occur. A climate with a hard winter freeze may limit the northern extension of the SPB range and may contribute to the outbreak patterns in North Carolina. For example, during the 1973–76 epidemic, North Carolina was experiencing an unprecedented series of warm winters (fig. 1), beginning during the winter of 1970–71 and culminating during the winter of 1976–77 (the coldest winter recorded since 1959–69). Figure 2 shows the average temperatures of the coldest winter month (either December, January or February) and confirms that the winters of 1970–71 through 1975–76 were unusually warm while 1976–77 was extremely cold.

During periods of low SPB activity in North Carolina, Hain and McClelland (1979) reported that SPB were most frequently infesting trees in association with *Ips* bark beetles. It appeared that *Ips avulsus* (Eichoff) infesting the tree crown were frequently the primary attacking bark beetle and that SPB and

¹ Respectively, Professor and Research Assistant, Department of Entomology, North Carolina State University, Raleigh, NC. (We gratefully acknowledge W. Hobbs and E. Younan for technical assistance with experimental procedures. This work was supported in part by the USDA-sponsored IPM bark beetle program.)

² Doggett, personal communication.

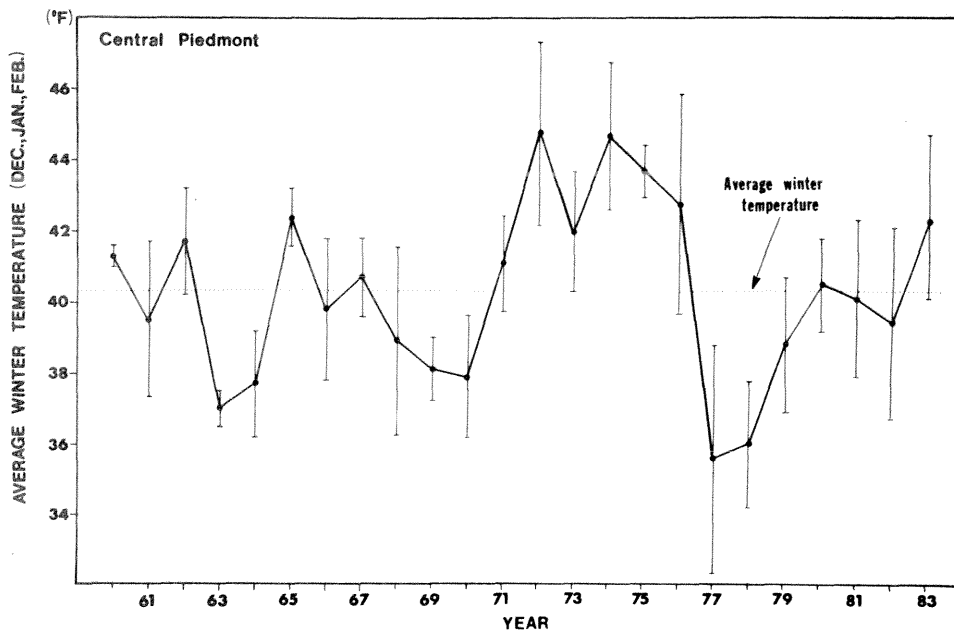

Figure 1.—Average winter (December, January, February) temperature for the central Piedmont of North Carolina.

Ips calligraphus (Germar) were occupying the tree bole as secondary invaders. SPB oviposition was reduced in these trees, probably as a result of resource competition with the other insect species.

During the 1981 field season, SPB activity was extremely low in North Carolina. Of the 12 small spots with active SPB brood that were located, all but one were overtaken by cerambycid foraging, and little SPB brood adult emergence occurred. Coulson et al. (1976) had demonstrated that cerambycids are a strong SPB competitor, and our observations suggested that under low level conditions cerambycids can totally displace within-tree SPB populations.

The purpose of our research was to test the following hypothesis: low level SPB activity in North Carolina is primarily controlled by: 1) Weather conditions, especially winter temperatures; 2) competition with other insect species, especially other bark inhabiting species such as *Ips* and cerambycids, and 3) the spatial and temporal distribution of susceptible host trees as determined by physiological parameters. The latter factor became the primary focus of our research and is reported elsewhere. This paper reports on some tests conducted to clarify our understanding of the influence of winter temperatures, and competition with *Ips* and cerambycids on SPB survival.

Specific objectives were to: 1) Observe the overwintering emergence patterns of SPB adults during a typical North Carolina winter; 2) determine the

cold hardiness of various SPB life stages; 3) establish the life history of the most common cerambycids in the North Carolina Piedmont; 4) observe the phloem decomposition, in terms of phloem moisture content, in the bole of trees with a crown infestation of *I. avulsus*; 5) evaluate the competitive interaction of *Ips* and SPB infesting the same host material under various temperature regimes; 6) observe the wind tunnel response of low-level SPB populations to various pheromone sources, especially that produced by *Ips* bark beetles.

METHODS

Overwintering

Emergence.—During the winter of 1979–80, 16 infested trees located in the central Piedmont (7 from Chatam Co., 2 from Durham Co., 7 from Orange Co.) were observed for emergence every 2 weeks. Emergence was determined by the on-tree emergence trap technique (McClelland et al. 1978). Twenty traps were placed on each tree (10 on opposite sides), and monitoring occurred from December 4, 1979 through June 6, 1980.

Super cooling.—Super cooling experiments were conducted to evaluate the cold hardiness of SPB (some *I. calligraphus* were also tested). The freezing of field, laboratory-reared, and preconditioned SPB

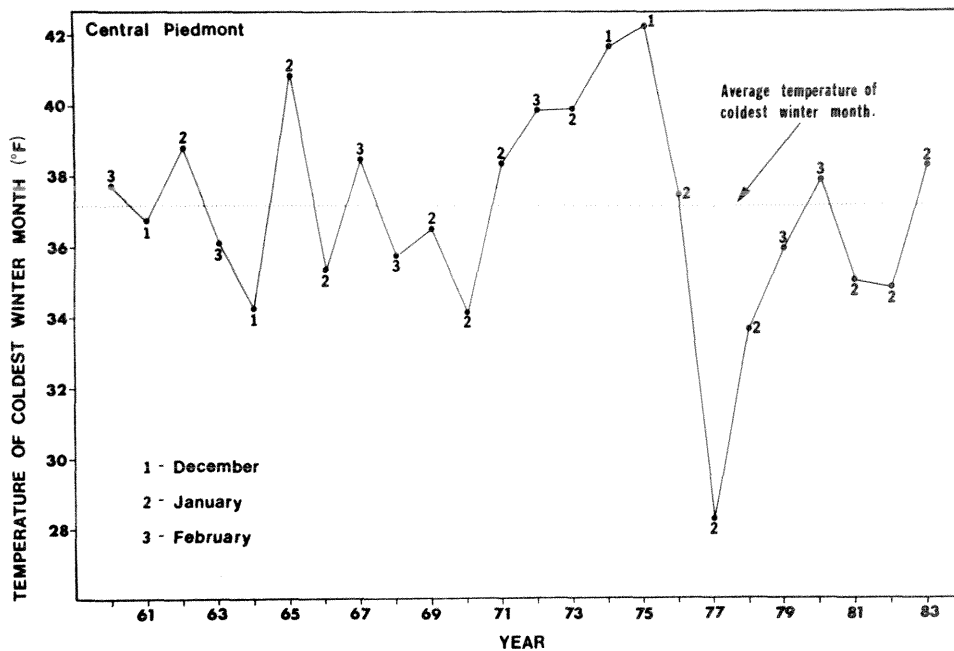

Figure 2.—Average temperature of coldest winter month (December, January, February) for the central Piedmont of North Carolina.

(late larvae and pupae) was performed every other week between December 12, 1982 and April 12, 1983. The three treatments consisted of: 1) Field populations of SPB collected from an infestation in Jones Co., NC; 2) laboratory reared beetles kept at a constant temperature of ca. 26°C; and 3) preconditioned laboratory-reared SPB kept at 3°C for 2 days, -4°C for 4 days, and -10°C for 1 day. Preconditioning was changed for the last three dates by adding another day at -10°C and 1 day at room temperature.

Beetles removed from the bark were placed in 1.5 cm long bar straws with one end sealed. A Bailey (Model Bat-12) thermocouple thermometer with a 1 cm hypodermic needle microprobe was used to determine the heat of fusion point. The microprobe was placed in the bar straw so that the probe was gently resting on the insect. The probe, straw, and beetle were placed in a cooler containing dry ice so that the temperature would drop at a slow constant rate. The point at which the temperature rose (heat of fusion) was recorded for each of the two stages.

SPB Competitors

Cerambycids.—Studies of the seasonal history of two common cerambycids in the Piedmont of North Carolina, *Monochamus titillator* (Fab.) and *M. carolinensis* (Olivier), were conducted during the summers of 1982 and 1983. The information was gathered from three main sources: flight traps, rearing in field cages, and field observations of felled trees.

Six baffled traps (Younan and Hain 1982) were baited with α -pinene and frontalin in a 2:1 ratio and placed in a lumberyard and the Schenk Forest (near Raleigh) during each summer. Each species was counted and collected daily, sexed, paired, and then released into a separate field cage throughout the summer, beginning in early June and ending when no more beetles were trapped. The caged insects were provided with freshly cut pine logs and small branches for oviposition and feeding, respectively. Adult feeding, shape of egg niches, egg arrangement, number of eggs/niche, and the larvae galleries were observed for both species.

To determine the duration of a log's attractiveness for oviposition, three loblolly pine trees were felled and cut on June 25, 1982. The logs were left in the stand for natural colonization and the number of egg niches was counted after 1 week and at 3-day intervals thereafter.

The seasonal period of oviposition was monitored weekly for new egg niches by cutting two loblolly pine trees at the end of each month from May to September 1983. Three logs selected in late June 1983 were used to assess the incubation period. The logs were examined daily for new egg niches, and allowed to incubate for 5, 7, and 9 days, respectively. Then the bark was dissected to examine for egg hatch.

We estimated population loss during sawyer development by assessing the population density of 28 field-infested logs and 12 cage-infested logs. All logs were placed in a field cage to trap emerging adults. After emergence, the density of each life stage

was estimated. Since the second instar larvae score the bark and the wood, we made density estimates of this stage by counting the number of scored areas. The number of third instar larvae was estimated by a count of the xylem entrance holes. The exit holes gave an accurate measure of the population reaching maturity.

Phloem moisture content.—Since low-level SPB populations frequently attack trees infested with *Ips* bark beetles, we were interested in evaluating phloem decomposition (as measured by phloem moisture content) caused by an initial *Ips* attack. The boles of six trees with a crown infestation of *I. avulsus* were tented with saran screen to prevent further bark beetle attack. Four of these trees were infested with *D. terebrans* (Olivier) at the tree base. Two other trees had *I. calligraphus* in the bole. Moisture content was monitored weekly for a 6-8-week period through phloem samples taken from the upper, middle, and lower bole.

Within-bolt competition.—Direct competition between SPB and *I. calligraphus*, two species that occupy very similar niches (Paine et al. 1981), was evaluated by force attacking (placing beetles in a gelatin capsule covering a bark puncture) ca. 25 pairs of SPB and 25 pairs of *I. calligraphus* on a 4-foot bolt. Control bolts contained 25 pairs of only one species. The bolts were placed in constant temperature cabinets with temperatures selected to optimize development of one or the other species. Other bolts were placed under a constant temperature that was suboptimal for both species. After development and emergence were complete, total eggs per female, total egg hatch per female, total pupae per gallery, and gallery length per mating pair were measured.

Wind tunnel responses.—The response of SPB to various odors such as *Ips*-infested bolts was measured by placing ca. 50 adult SPB in a wind tunnel (fig. 3) with an upwind odor source. The SPB were placed on the elevated release arena and collected from either end of the tunnel at 2-hour intervals or after an overnight test. The flying beetles that reached either end of the tunnel would strike the screen barrier and fall into a collecting trough filled with water. Walking beetles were collected by hand. Fan speed was adjusted for a setting that allowed a majority of SPB to fly into the wind when synthetic pheromone (frontalure) had been tested. The resulting wind speed was less than 0.5 mph.

RESULTS AND DISCUSSION

Overwintering

McClelland and Hain (1979) studied declining infestations of SPB during a severe (1976-77) and a

mild (1975-76) winter. During the severe winter, nearly 100 percent within-tree brood mortality occurred following a period of subfreezing temperatures. During the mild winter, survival was dependent on brood stage and location within the tree. It appeared that larvae in the upper bole were most susceptible to lethal low temperatures. Brood survival percentages during the mild winter were similar to the percentage of brood survival that had occurred the previous late summer and autumn in nearby infestations. While brood survival differed dramatically between the two winters, the net effect on population trends was the same. Infestations in the study areas neither survived nor proliferated during the following spring and summer. Periodic emergence during mild winter weather, a tendency to disperse because of the absence of a pheromone source, and high dispersal losses were believed to be the major factors contributing to spot collapse the following spring.

Emergence.—The winter of 1979-80 was slightly warmer than average in North Carolina (figs. 1 and 2) and provided ideal conditions for observing overwintering emergence patterns. Figures 4 and 5 show that some emergence occurred during the late fall (JD³ 335; December 1) and sporadic emergence occurred during the winter (between JD 355 of 1979 and 110 of 1980; December 21-April 20). Most of this was probably reemerging adults. A mass emergence occurred between JD 110 and 130 (April 20-May 10) as temperatures continued to warm (fig. 6). However, no additional trees were attacked, and once again, the spots collapsed. It appears that the main reason for overwintering spot collapse in North Carolina is the lack of a pheromone source for the beetles to concentrate toward, and the subsequent losses due to dispersal.

Super cooling.—A t-test between the mean freezing points of 622 larvae and 556 pupae resulted in a highly significant difference. The mean freezing point for the larvae was $-13.10^{\circ} \pm 1.8^{\circ}\text{C}$ (\pm standard deviation), while the pupal mean was $-16.35^{\circ} \pm 2.2^{\circ}\text{C}$. Thus, the larval stage is more susceptible to cold temperatures and confirms our field observations (McClelland and Hain 1979).

Freezing points of field populations of SPB larvae and pupae varied significantly over time (fig. 7). However, laboratory-reared beetles kept at a relatively constant temperature did not change significantly over time (fig. 8). The same was true of preconditioned larvae and pupae until the preconditioning treatments were changed (fig. 9). Changes in the preconditioning treatment resulted in significant dif-

³ Julian date.

TOP VIEW OF BARK BEETLE WIND TUNNEL

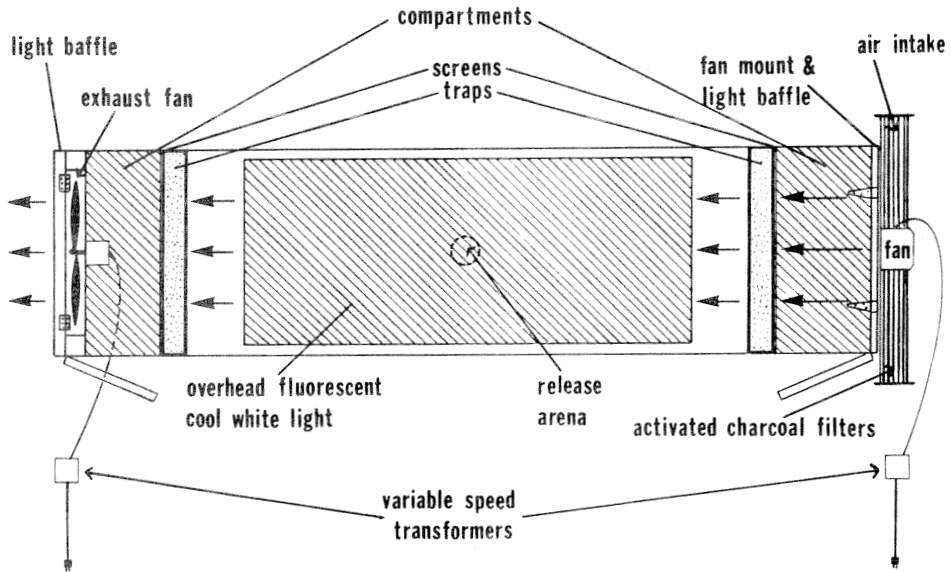

dimensions 2'x2'x8'

Figure 3.—Wind tunnel used for testing response of SPB to attraction sources placed in the upwind compartment.

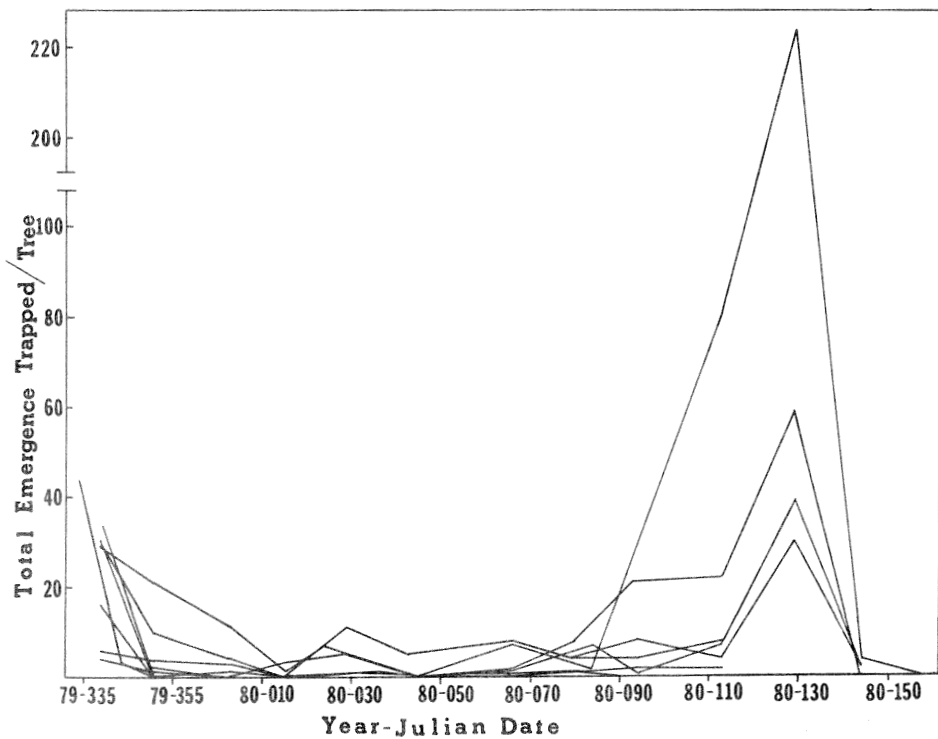

Figure 4.—Overwintering emergence of eight trees during the winter of 1979-80.

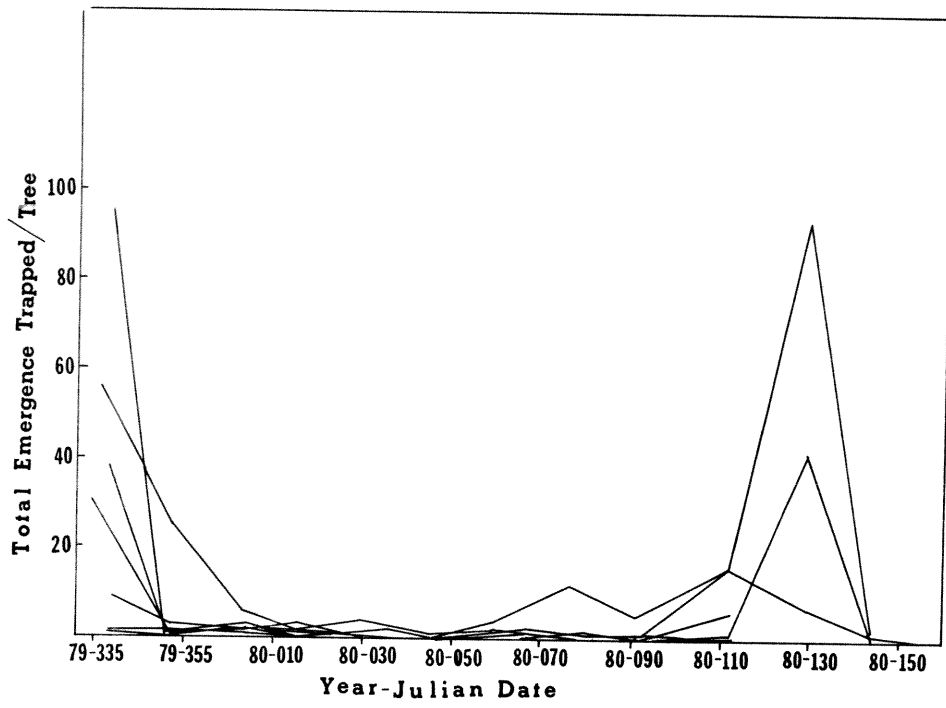

Figure 5.—Overwintering emergence of eight trees during the winter of 1979–80.

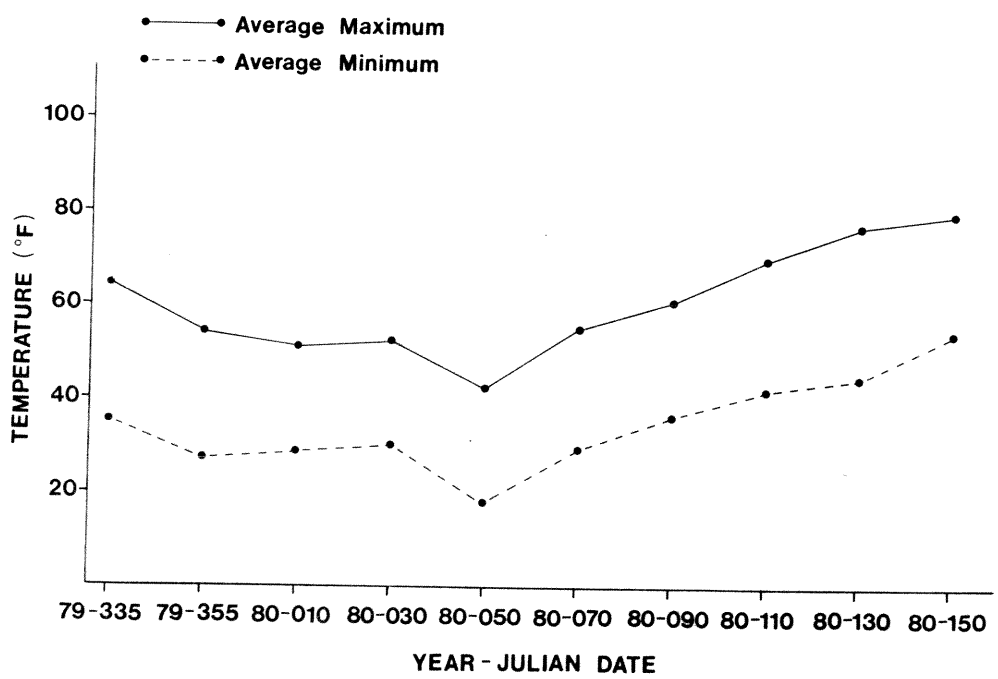

Figure 6.—Average maximum and minimum temperatures during the winter of 1978–80.

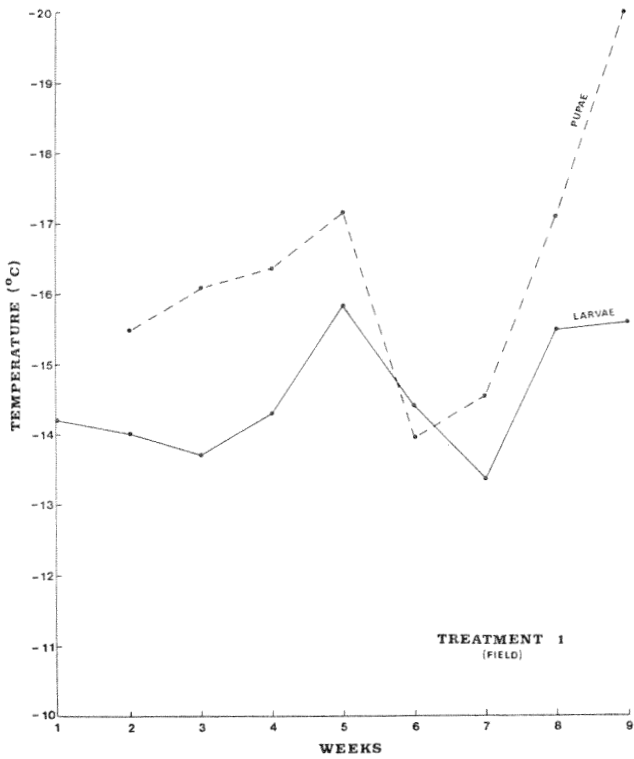

Figure 7.—Freezing points of SPB field populations collected during the winter of 1982–83.

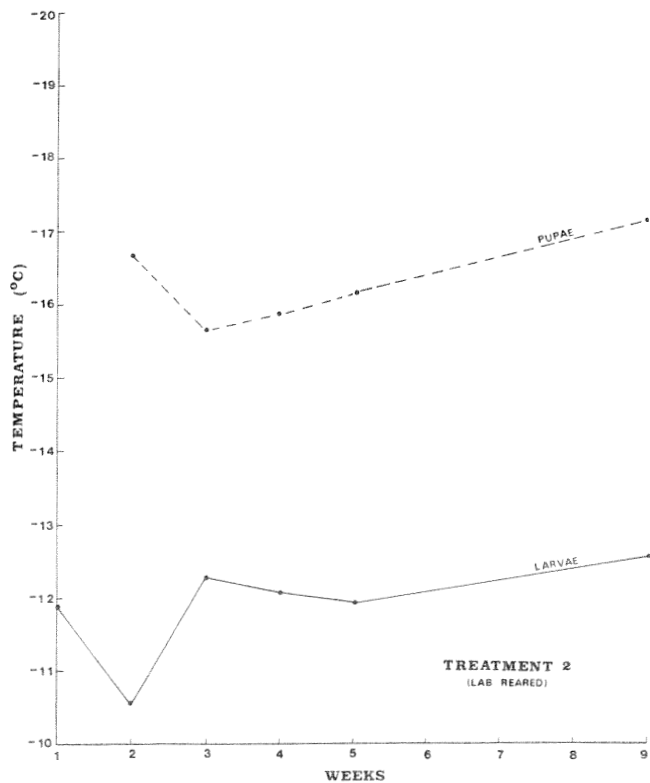

Figure 8.—Freezing points of laboratory-reared SPB collected during the winter of 1982–83.

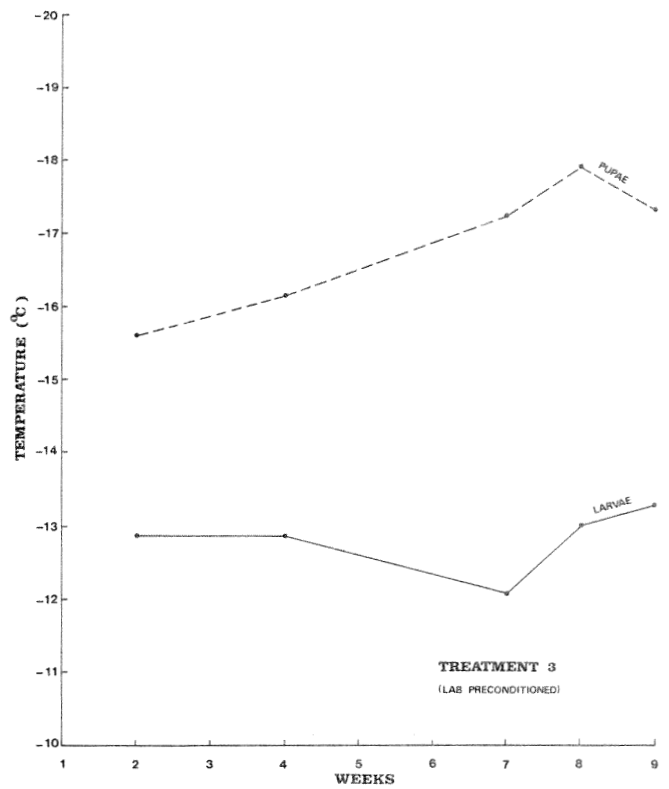

Figure 9.—Freezing points of laboratory preconditioned SPB collected during the winter of 1982–83. On the first two dates, SPB were kept at 3°C for 2 days, -4°C for 4 days, and -10°C for 1 day. On the last three dates, another day at -10°C was added and 1 day at room temperature.

ferences in the freezing points of the pupae but not in the larvae. Pupae held for 2 days at -10°C froze at significantly lower temperatures than pupae held at -10°C for 1 day (fig. 9). Freezing points of field populations of SPB larvae were significantly lower than those of preconditioned larvae, which were significantly lower than those of laboratory-reared larvae (fig. 10). There were no significant differences between the pupal treatments (fig. 11).

Also tested were 138 *I. calligraphus* (46 adults, 20 second instar larvae, 21 third instar larvae, 24 pupae and 27 callow adults). The results (fig. 12) are similar to those of SPB, with the pupal stage being the most tolerant of cold temperatures.

It appears that the ability of SPB to survive periods of cold temperature is partially dependent upon the preconditioning environment experienced. A sudden cold spell may be more lethal than a gradual and prolonged cold period. *I. calligraphus* does not seem to have a competitive advantage in surviving periods of cold temperature, although further testing is necessary.

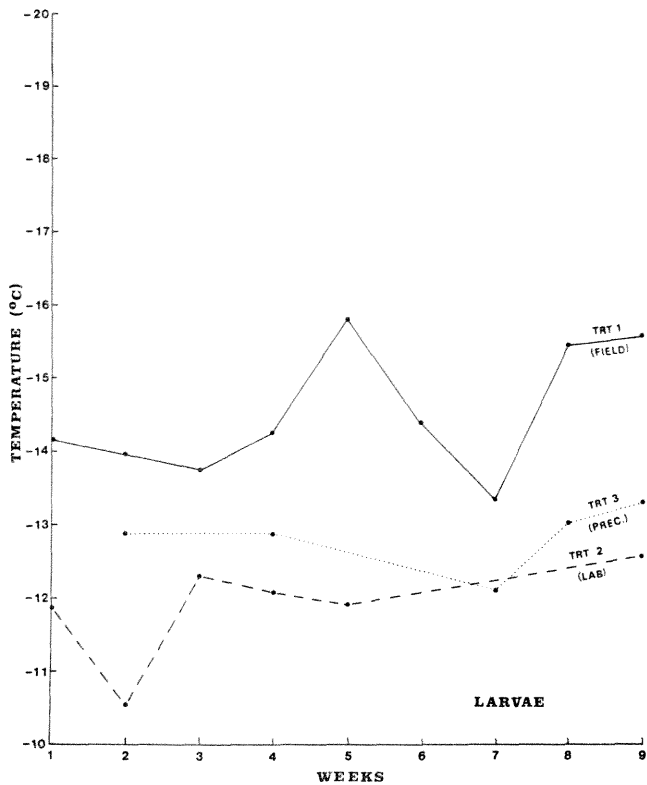

Figure 10.—Freezing point temperatures of field-collected, laboratory-reared and preconditioned larvae collected during the winter of 1982–83.

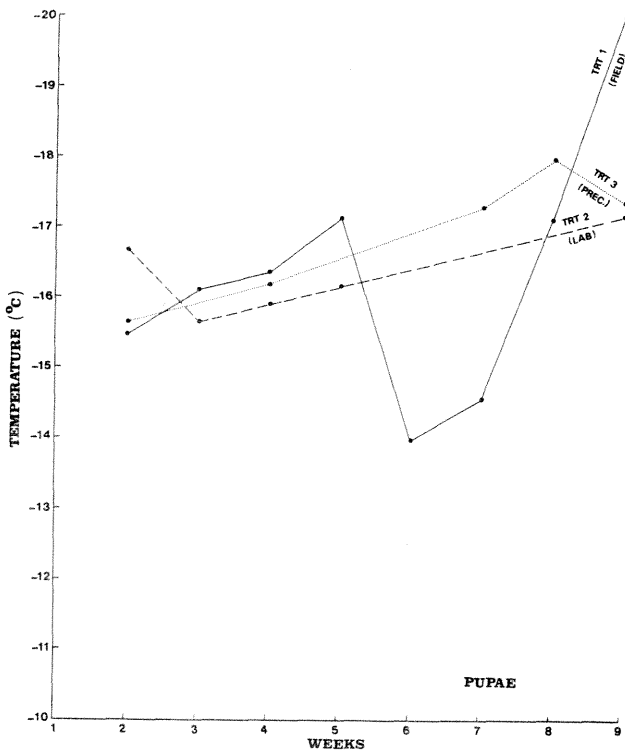

Figure 11.—Freezing point temperatures of field-collected, laboratory-reared, and preconditioned pupae collected during the winter of 1982–83.

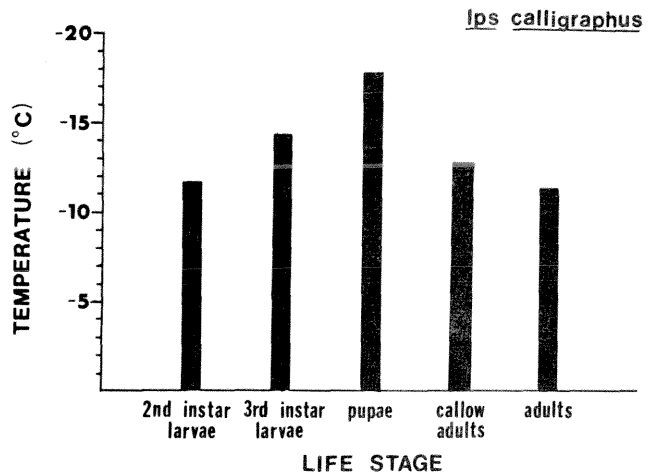

Figure 12.—Freezing points of *Ips calligraphus* adults, larvae, and pupae.

SPB Competitors

Cerambycids.—The adult flight period of *M. carolinensis* and *M. titillator* extended over approximately 4 months, beginning in late May and ending in mid-October of 1983 (Alya 1984). The seasonal trend for both species appears to be quite similar, and reached a peak by the middle of June. It remained at a steady level until early September when it rose again briefly. This second peak may represent a partial generation emergence. However, logs cut in late September to monitor oviposition were not infested.

Webb (1909) reported a 5-day egg incubation period; however, in our study, 7 to 9 days were required. Length of time required for passing from the egg to the adult stage varies greatly. The caged logs infested in June 1982 had their first emergence during the first week of September (Alya 1984). Thus, less than 4 months were required for the insects to develop from egg to adult. Other individuals in the same logs did not start to emerge until May 1983, reached a peak by mid-June, and terminated by the third week of July (Alya 1984). Only a few adults emerged in the fall. About 85 percent of the population overwintered as larvae and pupated late in the spring.

The newly emerged adults that were caged and provided with freshly cut branches and logs fed exclusively on the tender bark of small shoots and branches for about 3 weeks. No eggs were laid during this period. Later, the insects began to feed on the thicker bark of the logs and large branches. It was assumed that the first feeding period on the tender bark was a maturation feeding and the later one a subsistence feeding. Adults were observed feeding even after they

began to oviposit (Alya 1984).

Felled trees were attacked by ovipositing females within 7 days. The number of eggs per niche varied from three to six for *M. titillator* and from one to three for *M. carolinensis* (Alya 1984). The logs felled during late June remained attractive to ovipositing females for 42 days. Peak colonization occurred after 2 weeks and declined thereafter.

The percent mortality for both species during different periods of larval development in the field infested logs was 80.5 percent for larvae feeding in the phloem tissue, 28.6 percent for larvae feeding in the xylem, and 10.7 percent for pupae and adults. The total mortality from larval establishment to adult emergence of both sawyer species was 86.7 percent. Percent mortality for *M. carolinensis* and *M. titillator* determined separately from logs infested in the cages was 82.5 percent and 91.2 percent for larvae feeding in phloem tissue, 40.4 percent and 42.4 percent for larvae feeding in the xylem, and 12.4 and 13.1 percent for pupae and adults, respectively. Cumulative mortalities were 85.0 percent and 85.6 percent

for *M. carolinensis* and *M. titillator*, respectively (Alya 1984).

Phloem moisture content.—Figures 13–18 show the fluctuations of phloem moisture content of six trees infested with *Ips*. Figures 13–16 are of trees (observed in 1981) that had no *Ips* or SPB infesting the main bole, only *I. avulsus* in the crown and upper bole and *D. terebrans* at the base. Figures 17 and 18 show trees (observed in 1982) with *I. calligraphus* infesting the main bole as well as *I. avulsus* in the crown. Although the graphs show great fluctuations in moisture levels, the readings are generally within the range reported by Webb and Franklin (1978) and Wagner et al. (1979). Webb and Franklin (1978) reported that the phloem of trees attacked by SPB exhibited a characteristic drying followed by rehydration. They also indicated that SPB survival was poorest in trees with the highest phloem moisture levels. Wagner et al. (1979) reported that the second and third instar larvae are the most susceptible stage to phloem moisture changes. Larval development time remained fairly constant between 80

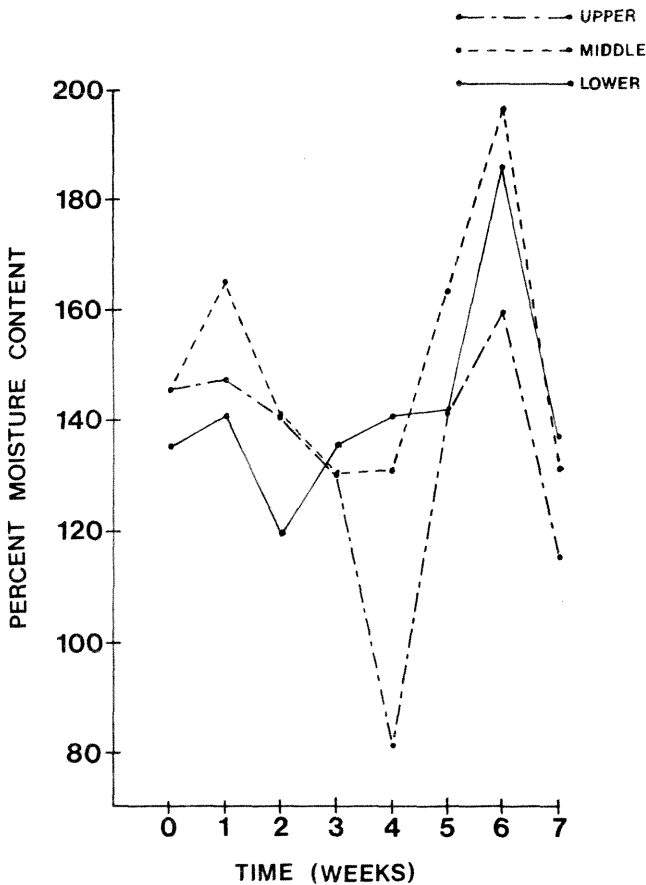

Figure 13.—Phloem moisture content of a tree with a crown infestation of *Ips avulsus* and a trunk infestation of *Dendroctonus terebrans*; no infestation in the central bole.

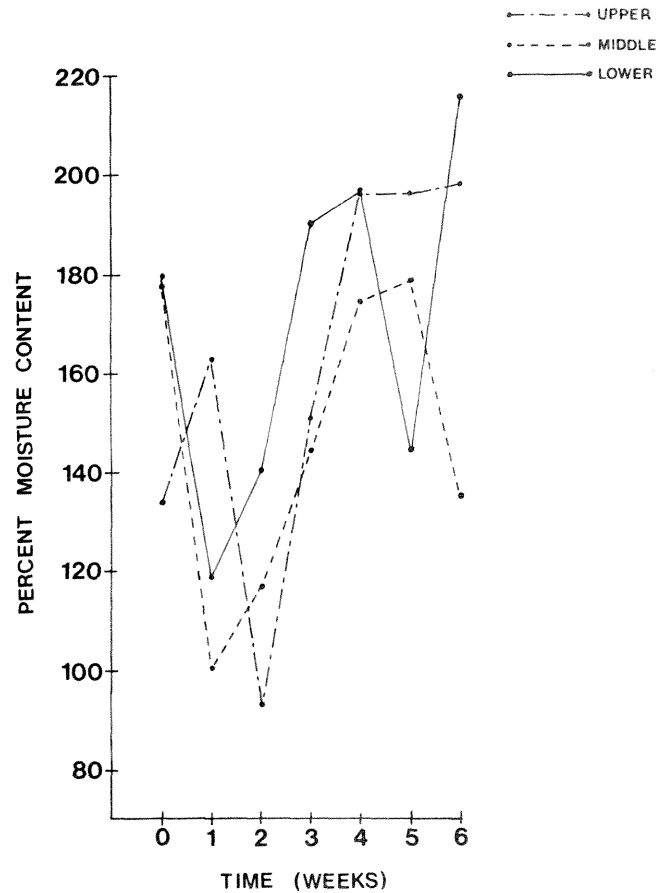

Figure 14.—Phloem moisture content of a tree with a crown infestation of *Ips avulsus* and a trunk infestation of *Dendroctonus terebrans*; no infestation in the central bole.

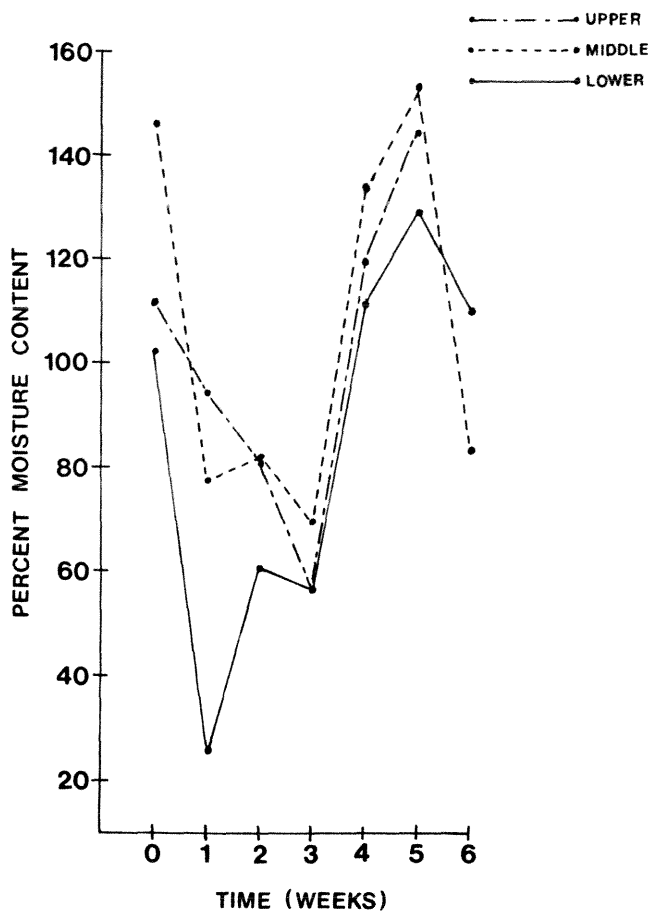

Figure 15.—Phloem moisture content of a tree with a crown infestation of *Ips avulsus* and a trunk infestation of *Dendroctonus terebrans*; no infestation in the central bole.

percent and 170 percent, but decreased dramatically above 170 percent. Their study also noted that larval development time was decreased in trees exhibiting large decreases in phloem moisture content during the second and third instar.

Our observations tend to indicate that, in terms of phloem moisture content, *Ips*-infested trees can support SPB populations for up to 8 weeks after crown fade. However, moisture levels will not be optimal and will exhibit significant fluctuations so that the SPB generation increase will not be great. Thus, the SPB populations can survive in *Ips*-infested trees but will be maintained at low levels.

Within-bolt competition.—To date, 39 bolts have been infested with either *I. calligraphus*, SPB, or *I. calligraphus* and SPB. Our preliminary results (fig. 19) suggest that under our experimental conditions, the survival of *I. calligraphus* from eggs to adults is comparable to or better than SPB survival, especially when the two species are infesting the same bolt. However, this apparent competitive edge may

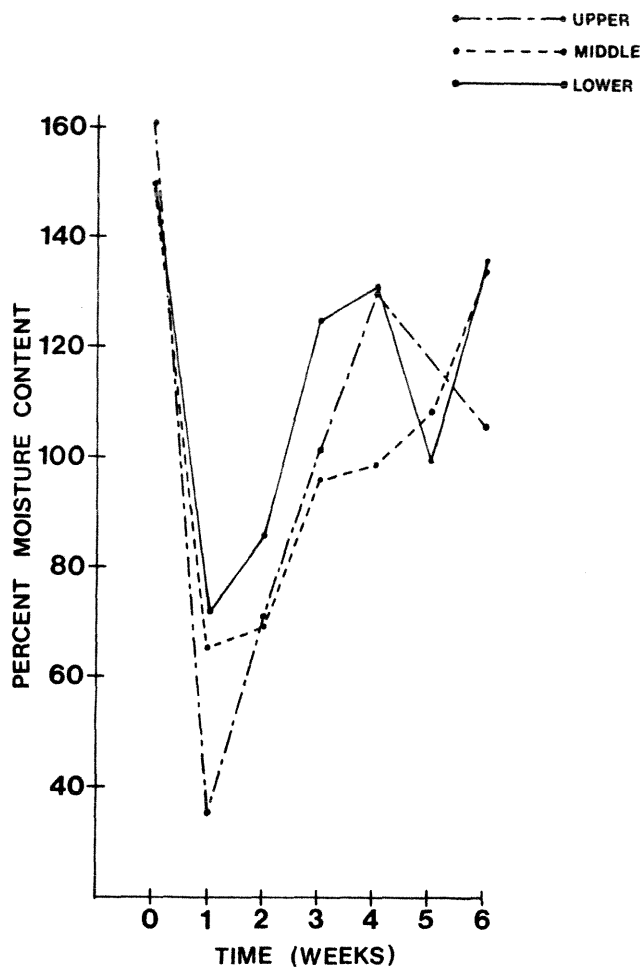

Figure 16.—Phloem moisture content of a tree with a crown infestation of *Ips avulsus* and a trunk infestation of *Dendroctonus terebrans*; no infestation in the central bole.

be negated when they are attacking living trees.

Wind tunnel responses.—We have tested ca. 6,000 SPB in the wind tunnel to date. Figure 20 shows that the wind tunnel *per se* produces unbiased results. The flying and walking beetles showed no directional bias in an empty wind tunnel or in an empty wind tunnel with a slow fan speed. But as the fan speed increased (fan 75), more flights occurred with the wind. Uninfested loblolly bolts and synthetic frontalure placed outside the wind tunnels, but near the air filters, did not produce a significant response. Only synthetic frontalure inside the wind tunnel resulted in a clear response (fig. 21), but when the fan speed was increased, the beetles were pushed away from the pheromone source. Surprisingly, there was no strong response to SPB females infesting loblolly pine bolts. Perhaps our laboratory SPB colony is not capable of producing a strong pheromone, or the cut-bolt technique prevents the production of a strong pheromone.

Of the other bark beetle species, the SPB clearly shows no strong response to *I. calligraphus* males infesting loblolly pine bolts. However, there may be some response to *I. avulsus*, *I. grandicollis*, and *D. terebrans* (BTB). This remains an open question and deserves further testing. Paine et al. (1981) found SPB to have the greatest niche overlap with *I. calligraphus*. Thus, SPB does not appear to respond to the pheromone of the species that most vigorously competes with it for the same resource. Birch et al. (1980) found no significant SPB attraction for the pheromone of any of the *Ips* species. However, low level populations of SPB may show some response, as suggested by our results.

CONCLUSIONS

The findings reported herein have led us to further elaborate on the hypothesis stated in the Introduction. Winter temperatures do affect SPB activity in North Carolina by terminating the growth of spot

infestations and necessitating spring dispersal flights, probably as a result of the absence of a pheromone source. Although normal winters do not appear to cause a significant increase in brood mortality, cold North Carolina winters with sudden freezes can cause nearly total brood mortality and may contribute to the termination of an epidemic.

Under low level conditions, SPB is a poor competitor with other bark-inhabiting insects, especially *Monochamus* and *Ips* species. However, SPB can survive in direct competition with these species and, in fact, may show some response to their pheromones. This may provide a mechanism for survival during low-level phases. The "tree-killing" characteristics of epidemic SPB may have evolved as an avoidance response to competition with other species. Thus, the "boom and bust" cycle of SPB. During epidemics, direct competition has been minimized, but overcoming host resistance is the tradeoff. During epidemic periods, the extent and distribution of susceptible host type will determine the extent and severity of the epidemic.

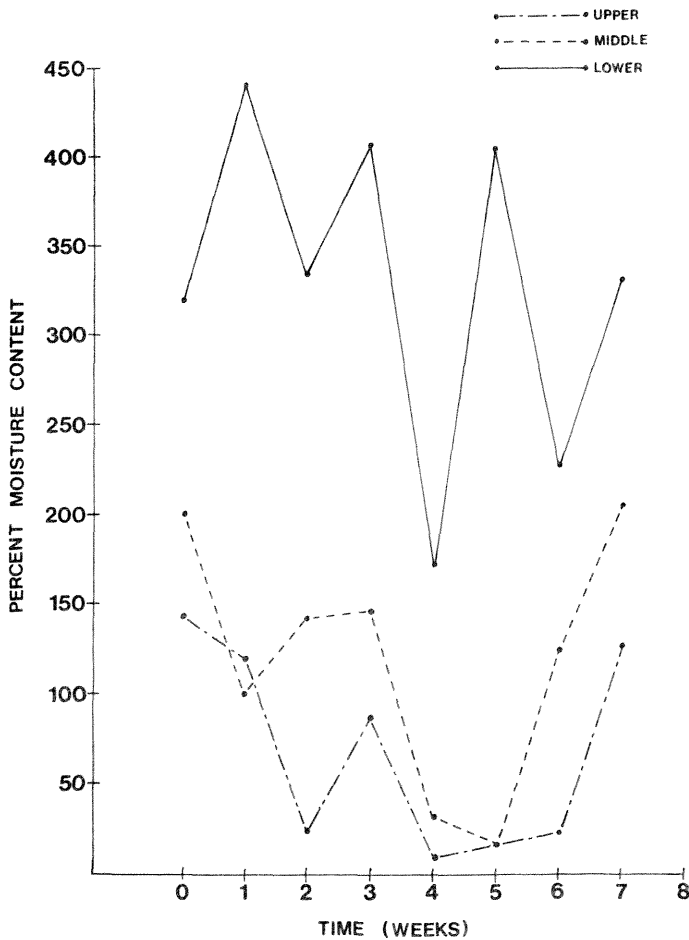

Figure 17.—Phloem moisture content of a tree with a crown infestation of *Ips avulsus* and a trunk infestation of *I. calligraphus*.

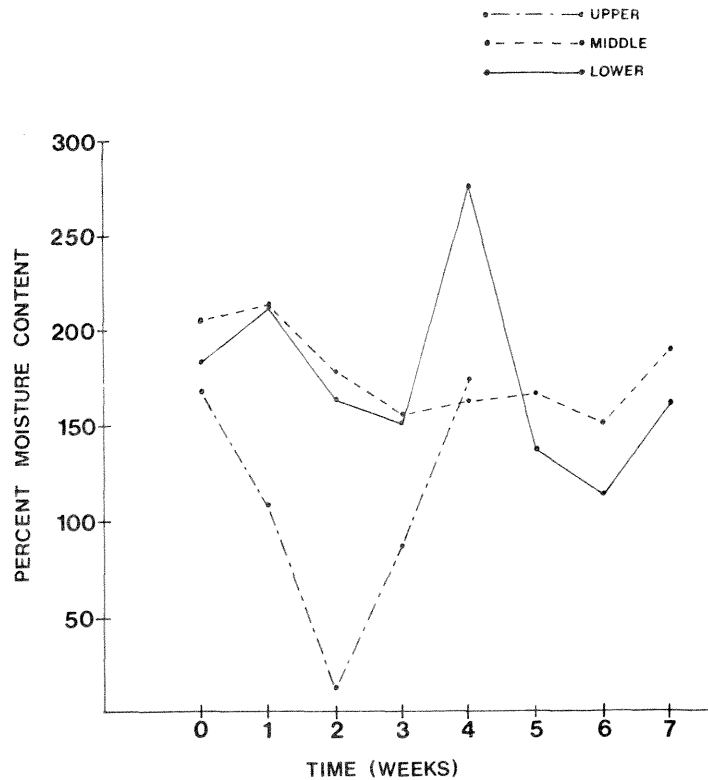

Figure 18.—Phloem moisture content of a tree with a crown infestation of *Ips avulsus* and a trunk infestation of *I. calligraphus*.

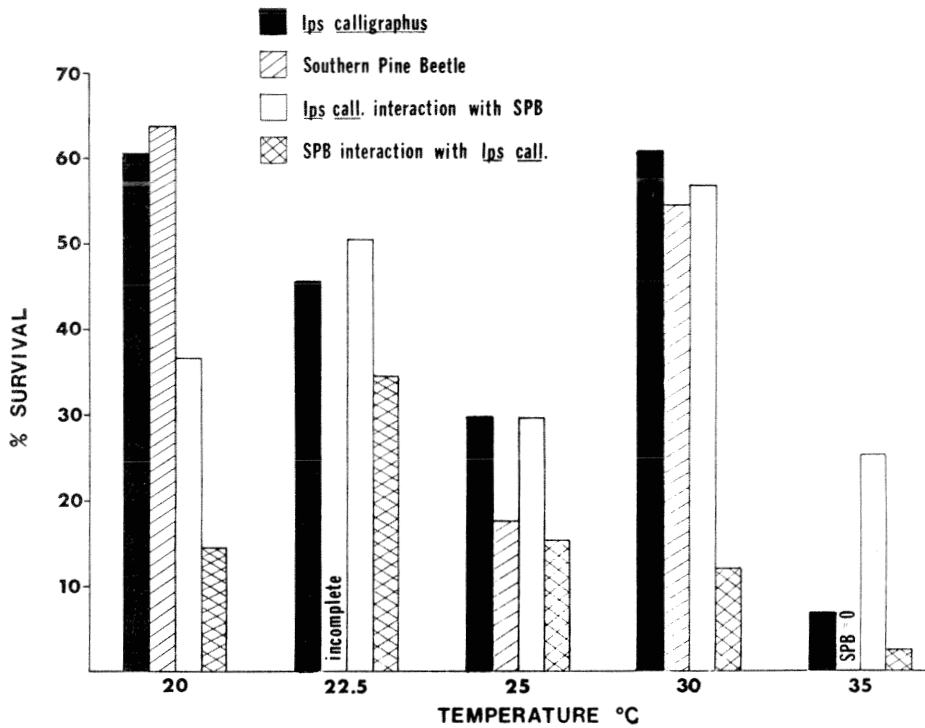

Figure 19.—Within-bolt competition between SPB and *Ips calligraphus* at various temperatures.

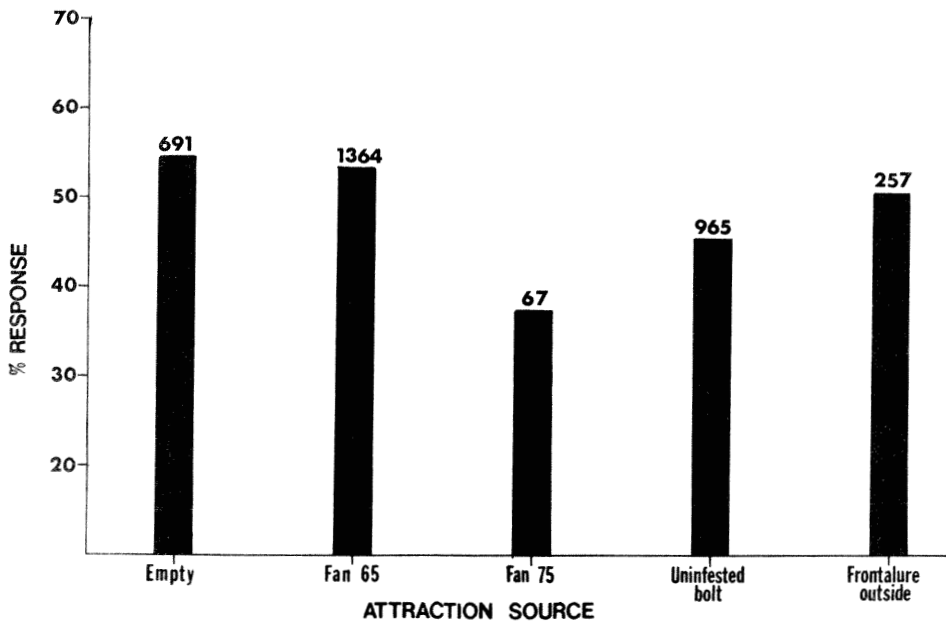

Figure 20.—Wind tunnel responses in an empty tunnel with no wind, at a slow fan speed (fan 65), a slightly faster fan speed (fan 75), with an uninfested bolt in the upwind compartment and with frontalure outside the wind tunnel next to the air filters. (Numbers are total numbers of beetles tested.)

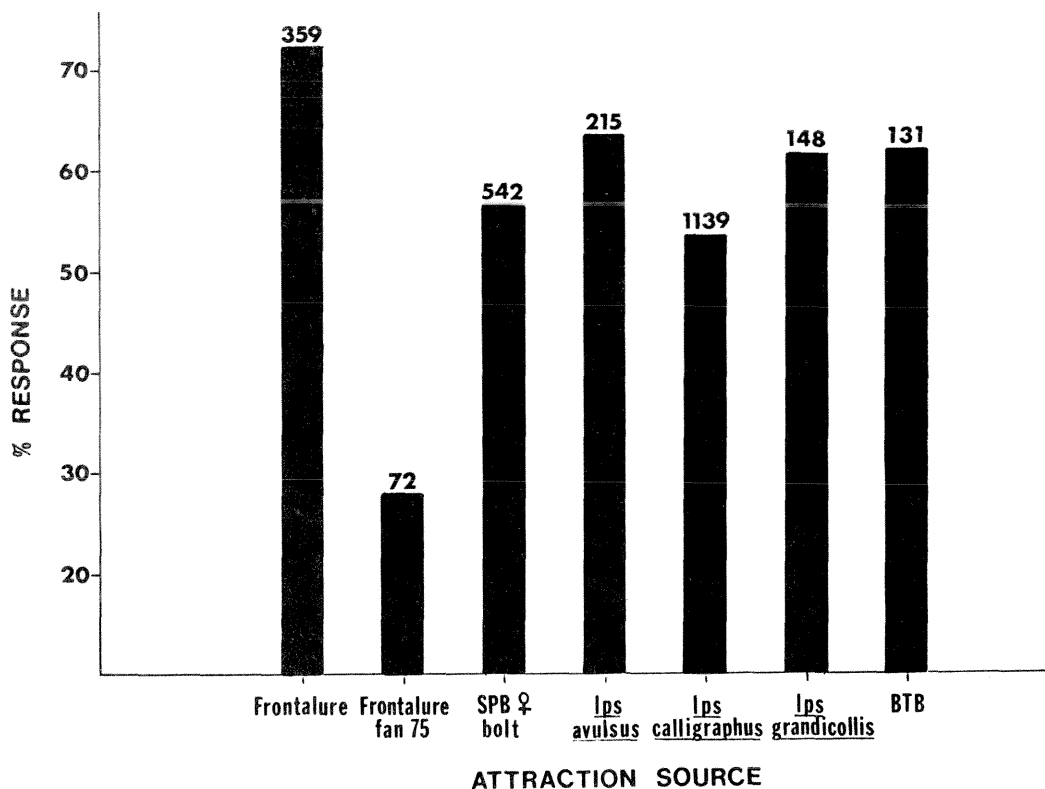

Figure 21.—Wind tunnel responses with frontalure, bolts infested with female SPB, male *Ips avulsus*, *I. calligraphus* or *I. grandicollis*, or field collected bolts infested with *Dendroctonus terebrans* (BTB) placed in the upwind compartment. (Fan 75 indicates increased wind speed. Numbers are total of beetles tested.)

LITERATURE CITED

- Alya, A. B. Laboratory and field studies of *Monochamus carolinensis* and *M. titillator* (Coleoptera: Cerambycidae) in the Piedmont of North Carolina. Raleigh, NC: North Carolina State University; 1984. 48 p. [Thesis].
- Birch, M. C.; Svikra, P.; Paine, T. D.; Miller, J. C. Influence of chemically mediated behavior on host tree colonization by four cohabiting species of bark beetles. *J. Chem. Ecol.* 6: 395–414; 1980.
- Coulson, R. N.; Mayyasi, A. M.; Foltz, J. L.; Hain, F. P. Interspecific competition between *Monochamus titillator* and *Dendroctonus frontalis*. *Environ. Entomol.* 5:235–247; 1976.
- Hain, F. P.; McClelland, W. T. Studies of declining and low level populations of the southern pine beetle in North Carolina. In: Hain, F. P., ed. Population dynamics of forest insects at low levels. Work Conf. Proc., Raleigh, NC; 1979, 32 p.
- McClelland, W. T.; Hain, F. P.; DeMars, C. J.; Fargo, W. S.; Coulson, R. N.; Nebeker, T. E. Sampling bark beetle emergence: a review of methodologies, a proposal for standardization, and a new trap design. *ESA Bull.* 24:137–140; 1978.
- McClelland, W. T.; Hain, F. P. Survival of declining *Dendroctonus frontalis* populations during a severe and non-severe winter. *Environ. Entomol.* 8:231–235; 1979.
- Paine, T. D.; Birch, M. C.; Svikra, P. Niche breadth and resource partitioning by four sympatric species of bark beetles (Coleoptera: Scolytidae). *Oecologia* 48: 1–6; 1981.
- Price, T. S.; Doggett, C., eds. A history of southern pine beetle outbreaks in the southeastern United States. Macon, GA: Georgia Forestry Commission; 1982. 35 p.
- Wagner, T. L.; Gagne, W. A.; Doraiswamy, P. C.; Coulson, R. N.; Brown, K. W. Development time and mortality of *Dendroctonus frontalis* in relation to changes in tree moisture and xylem water potential. *Environ. Entomol.* 8:1129–1138; 1979.
- Webb, J. L. The southern pine sawyer. *Bull.* 58. Washington, DC: U.S. Department of Agriculture, Bureau of Entomology; 1909: 41–56.
- Webb, J. W.; Franklin, R. T. Influence of phloem moisture on brood development of the southern pine beetle (Coleoptera: Scolytidae). *Environ. Entomol.* 7:405–410; 1978.
- Younan, E. G.; Hain, F. P. Evaluation of five trap designs for sampling insects associated with severed pines. *Can. Entomol.* 114: 789–796; 1982.

Relationship of Symbiotic Fungi to Southern Pine Beetle Population Trends

J. Robert Bridges¹

Abstract.—The symbiotic fungi associated with the southern pine beetle (*Dendroctonus frontalis* Zimmermann) vary widely among beetle infestations. Two mycangial fungi significantly affected beetle survival, brood production, and infestation growth, but each affected the beetle in different ways. Understanding complex symbiotic interrelationships may be the key to understanding beetle population dynamics. **Additional keywords:** *Dendroctonus frontalis*, *Ceratocystis minor*, *Sporothrix*, bark beetle, symbiosis, blue-stain fungus.

INTRODUCTION

The evolutionary success of bark beetles can be attributed in part to symbiotic relationships with fungi (Berryman 1982). Although fungi are thought to be the major pathogens of beetle-infested trees, they may also be important in larvae nutrition, affecting the survival and development of beetle broods. Knowledge of this symbiosis is a key element in understanding the population dynamics of these insects (Berryman 1982).

The association of *Dendroctonus frontalis* Zimmermann (SPB) and fungi is an example of a highly evolved symbiosis. The adult female SPB has a highly developed mycangium, which is a cuticular pouch on the prothorax containing specialized gland cells (Happ et al. 1971, Barras and Perry 1972). This structure assures the transmission of fungi from tree to tree.

The SPB carries two species of fungi in its mycangium. One of the fungi is an unidentified basidiomycete. The other fungus is a *Sporothrix* sp. (Barras and Perry 1971). This nonstaining ascomycete is a variety of the blue-staining fungus, *Ceratocystis minor* Hedgcock (Hunt), also associated with SPB (Barras and Taylor 1973). The blue-staining form is not carried in the mycangium but is carried externally on SPB by phoretic mites (Bridges and Moser 1983).

This research examined the fungi associated with several SPB populations over a 2-year period. The purpose was to determine the frequency of occurrence of the two mycangial fungi and the blue-staining fungus, *C. minor*, in beetle infestations and to relate variations in fungal populations to SPB population changes.

METHODS

Study Locations

In 1983, SPB infestations were sampled in Texas, Louisiana, Mississippi, Alabama, and Georgia. Plots were located in seven geographic areas that included the Sam Houston National Forest in Texas, the Sabine, Davy Crockett, and Angelina National Forests in east Texas, the Kisatchie National Forest in central Louisiana, Calcasieu Parish in southwest Louisiana, the Homochitto National Forest in Mississippi, Pickens and Lamar Counties in Alabama, and the Fort Benning Military Reservation in Georgia. In 1984, SPB infestations were sampled on the Sam Houston and Sabine National Forests in Texas and on the Kisatchie National Forest in Louisiana.

Data Collection Procedures

1983.—In most infestations (spots), five trees were sampled. Trees were selected in which SPB pupal/callow adult stages were predominant. In each tree, four 100-cm² bark disk samples were removed at each of three heights (1.5, 3.5, and 6.5 m). After each bark sample had been removed, the wood beneath the sample was examined. If the blue-stain present was characteristic of that produced by *C. minor*, the area of stained wood was recorded by tracing the stain onto a piece of mylar (Bridges et al. 1985).

Bark samples were taken to the laboratory and placed in individual rearing containers. The number of attack sites was determined by examining the bark samples (Linit and Stephen 1978). Measurement of the length of gallery constructed by SPB considered only the parts of the sample not destroyed by sawyer beetle foraging (Coulson et al. 1976). Emerging brood adult beetles were collected daily, except for weekends. Live female beetles without missing parts were weighed using a Cahn electrobalance, then frozen until their mycangia could be examined. For identification of the fungi, the mycangium of each female was removed and mounted in lactophenol/cotton blue on a microscope slide (Bridges 1983).

Data were obtained on total emergence of brood adults (EMER) and the number of eggs laid (EGG). (See table 1 for definitions of abbreviations.) EGG was estimated as $1.59 \times \text{GLEN}$ (Foltz et al. 1976). Population trend indexes included survival

¹ Research Entomologist, U.S. Department of Agriculture, Forest Service, Southern Forest Experiment Station, Pineville, LA.

(SURV) = EMER/EGG and ratio of increase (RI) = EMER/(2 × ATK) (Thatcher and Pickard 1964). Each sample tree was measured to determine diameter at breast height (DBH), total height (HGT), crown ratio (CR), and radial growth in the last 5 and 10 years (G5 and G10).

Most of the spots were examined 2 weeks after the initial sampling to assess infestation enlargement. At each visit, the predominant brood stage in each infested tree was recorded. Pine and hardwood basal areas of the stand were measured at the advancing head of each spot.

1984.—In 1984, sampling procedures were similar to those used in 1983. Three trees were sampled in most spots. Beetle collection procedures were the same as in 1983, except that beetles were not weighed.

Additional trees in each spot were examined by removing a strip of bark approximately 30 cm wide from around each tree at 1.5 m and observing the wood for characteristic patches of *C. minor* stain. Only trees with SPB brood in late larva to adult stages were used for these blue-stain observations. Blue-stain in trees with brood in earlier stages may not be fully developed or recognizable.

Data Analyses

For analysis of the relationship of female weight and mycangial fungi, beetles were grouped according to whether they carried the basidiomycete alone, *Sporothrix* alone, both fungi, or no fungi. Mean weights of beetles in these groups were compared using a one-way analysis of variance.

Stepwise regression analyses were run to examine the relationship of symbiotic fungi to beetle population trend indexes. Regression analyses were run using BMDP² computer programs. Dependent variables were SURV and RI (table 1). Independent variables included measurements of sample tree characteristics, variables describing the frequency of occurrence of mycangial fungi, and blue-stain variables (table 1). Data were pooled for each tree. Data on 206 trees from both years were included in the analyses.

Stepwise regression analyses were also used to evaluate relationships between spot growth parameters and other infestation parameters. Data were pooled for each plot, and data from both years were included in the analyses. The dependent variable was the number of dead trees in the spot at the second visit (T2). Independent variables included the number of dead trees in the spot at the initial visit (T1), mycangial fungus variables, blue stain vari-

ables, EMER, SURV, RI, proportion of trees with SPB in each brood stage, proportion of infested trees of each species, mean d.b.h. of infested trees, sample tree characteristics, and basal area measurements.

Table 1. — List of abbreviations of variables measured for each tree sampled

Variable	Definition
ATK	Number of attack sites per sample
B	Percent of females with the basidiomycete
BA	Percent of females with the basidiomycete alone
BOTH	Percent of females with both fungi
BSA	Percent of each sample stained by <i>C. minor</i>
BSZ	Percent blue stain-free samples in a tree
CR	Crown ratio
DBH	Diameter at breast height of sample tree
EGG	Eggs = GLEN × 1.59
EMER	Total number of brood emerged per sample
FUNGUS	Percent of females with either fungus
G5	Radial growth in last 5 years
G10	Radial growth in last 10 years
GLEN	Length of SPB gallery per sample
HGT	Tree height
RI	Ratio of increase = EMER/(2 × ATK)
S	Percent of females with <i>Sporothrix</i>
SA	Percent of females with <i>Sporothrix</i> alone
SURV	Brood survival = EMER/EGG

RESULTS

Examination of emerging beetles for the presence of mycangial fungi revealed that the basidiomycete was the predominant fungus in most SPB populations. In 1983, *Sporothrix* occurred more frequently than the basidiomycete in only three spots (table 2). In 1984, the *Sporothrix* occurred more frequently than the basidiomycete in four spots (table 3). Although emerging beetles almost always carried one or both fungi, a small proportion of the population in each spot emerged with empty mycangia. In 1983, the proportion of beetles that carried no mycangial fungi ranged from 0.6 percent to 8.6 percent (table 2); in 1984, the values were 0.4 percent to 7.0 percent (table 3).

Beetles often emerged carrying both fungi (tables 2 and 3). The two fungi were seldom intermixed in the mycangium. When a beetle carried both fungi, they were usually found on opposite sides of the mycangium. Of 14,215 beetles examined in 1983, only 0.3 percent of the time were the two fungi intermixed. In 1984, 1.8 percent of 9,914 beetles had intermixed fungi. In earlier studies, 0.3 percent of SPB mycangia were found to contain intermixed fungi (Bridges 1983).

² Produced by Software Development Inc., P.O. Box 675, Middlebury, VT 05753.

Table 2. — Proportion of beetles in each plot in 1983 that carried the basidiomycete alone (BA), Sporothrix alone (SA), both fungi, or neither fungus

Spot no.	Location code ¹	Beetles examined <i>Number</i>	Beetles with or without fungi			
			BA	SA	Both	Neither
			----- Percent -----			
1	2	848	44.7	30.3	24.4	0.6
2	5	360	43.1	31.7	24.7	0.6
3	1	946	55.6	31.1	10.9	2.4
4	1	922	69.3	20.3	9.1	1.3
5	5	612	44.0	34.5	19.6	2.0
6	3	361	26.0	49.9	22.2	1.9
7	3	683	34.1	40.4	22.7	2.8
8	5	174	36.8	40.8	20.7	1.7
9	4	576	52.3	32.3	12.7	2.8
10	5	251	51.0	34.3	11.6	3.2
11	6	105	52.4	32.4	6.7	8.6
12	4	382	56.0	28.3	12.0	3.7
13	6	51	60.8	17.6	19.6	2.0
14	5	600	46.7	36.8	15.5	1.0
15	1	496	55.0	22.8	20.4	1.8
16	2	389	50.1	33.4	12.9	3.6
17	1	331	58.6	21.1	13.6	6.6
18	2	355	54.4	27.0	16.6	2.0
19	4	540	48.3	29.3	16.7	5.7
20	1	397	41.3	41.3	14.4	3.0
21	2	915	55.8	25.2	16.6	2.3
22	2	576	39.9	38.9	16.1	5.0
23	5	395	38.0	35.7	24.8	1.5
24	5	455	43.1	39.1	16.0	1.8
25	2	479	49.7	31.7	14.6	4.0
26	2	488	63.5	17.0	13.3	6.1
27	5	397	56.7	24.4	14.6	4.3
28	5	418	55.8	26.3	16.8	1.2
72	7	165	40.0	38.2	17.6	4.2
75	7	216	50.5	32.4	15.3	1.9
86	7	232	41.4	38.8	16.4	3.4
Weighted means			49.7	31.2	16.4	2.7

¹ 1 = Sam Houston National Forest; 2 = Sabine, Davy Crockett and Angelina National Forests; 3 = Calcasieu Parish, LA; 4 = Kisatchie National Forest; 5 = Homochitto National Forest; 6 = Alabama; 7 = Georgia.

The weighted means across all spots were similar between the 2 years (tables 2 and 3). However, there were large variations in both 1983 and 1984 in the frequency of occurrence of mycangial fungi among infestations. For example, the percentage of beetles carrying the basidiomycete alone ranged from 26.0 percent to 69.3 percent in 1983 and from 34.4 percent to 60.2 percent in 1984.

Fungi in SPB populations are compared among various geographic locations in tables 4 and 5. Percentages of each fungus present in these populations were calculated using pooled data. The most striking difference among the areas was that the basidiomycete predominated in all areas except the two spots in southwest Louisiana (table 4).

Distinct differences in the occurrence of blue stain were observed among SPB infestations during both

years. In 1983, six spots were observed with no *C. minor*-caused stain in any of the sampled trees. These blue stain-free infestations were on the Sam Houston National Forest in Texas and in southwest Louisiana, and have been described by Bridges et al. (1985). Most of the samples from the other areas contained blue stain (table 6).

Unlike 1983, blue stain caused by *C. minor* was found in all spots examined in 1984, but there was less blue stain in trees sampled in spots on the Sam Houston National Forest than in other areas (table 7). In the trees on the Sam Houston National Forest with late-stage SPB brood, only 57.4 percent had *C. minor*-caused blue stain at breast height (table 8). Most of the trees on the Sabine and Kisatchie National Forests had blue stain.

The presence or absence of mycangial fungi had

Table 3. — Proportion of beetles in each plot in 1984 that carried the basidiomycete alone (BA), *Sporothrix* alone (SA), both fungi, or neither fungus

Spot no.	Location code ¹	Beetles examined	Beetles with or without fungi			
			BA	SA	Both	Neither
		Number	Percent			
2	3	244	34.4	37.7	27.5	0.4
3	3	487	46.6	29.4	21.1	2.9
4	3	244	60.2	15.2	23.4	1.2
6	3	197	50.8	22.3	22.3	4.6
10	1	399	39.6	37.1	22.3	1.0
11	1	248	44.8	32.3	16.9	6.0
12	1	402	36.1	39.1	23.4	1.5
13	1	346	53.5	31.2	13.9	1.4
14	1	398	51.5	29.9	17.1	1.5
15	1	690	37.1	44.2	17.4	1.3
16	1	332	47.0	32.8	16.9	3.3
17	1	644	40.7	39.0	19.3	1.1
18	1	389	44.5	35.2	18.8	1.5
19	3	175	55.4	21.7	20.6	2.3
20	1	201	51.2	24.4	17.4	7.0
21	1	205	38.5	33.2	25.9	2.4
22	3	207	47.8	37.2	14.0	1.0
23	1	411	49.9	33.6	15.6	1.0
24	1	314	39.2	39.8	19.1	1.9
25	3	456	57.0	25.2	17.1	0.7
26	2	284	46.1	31.3	19.0	3.5
27	2	316	45.9	32.6	19.3	2.2
28	3	397	47.1	27.5	23.9	1.5
29	2	430	46.7	34.9	16.3	2.1
30	2	434	42.2	33.6	19.6	4.6
31	3	680	48.5	29.7	20.0	1.8
32	3	384	57.3	23.6	16.1	2.9
Weighted means			46.1	32.6	19.2	2.1

¹ 1 = Sam Houston National Forest; 2 = Sabine National Forest; 3 = Kisatchie National Forest.

significant effects on female SPB weight. Beetles carrying only the basidiomycete in the mycangium were significantly heavier than beetles that carried both fungi (table 9). Beetles that carried both fungi were heavier than beetles that carried only *Sporothrix*. Beetles without fungi were significantly lighter than beetles with fungi. These results are comparable to earlier results (Bridges 1983). Average weight of beetles in this study was less than in the earlier study, but the relationship of weight to the presence or absence of mycangial fungi was the same.

Stepwise regression analysis showed that mycangial fungi were significantly related to SURV (table (10) and RI (table 11). The models were similar in both cases. Although the overall models were significant ($P < 0.005$ for both models), the models explained only 14 percent and 22 percent of the variation in SURV and RI, respectively. For SURV, the four variables in the model were FUNGUS, DBH, G5, and SA. FUNGUS and DBH were positively correlated with both SURV and RI, whereas G5 and

SA were negatively correlated. For RI, BSF was also included in the model as a positive correlate. BSF is an indication of the amount of blue stain in the tree. It was a significant variable in the model, probably because blue-stained phloem is inhibitory to SPB larvae (Barras 1970, Franklin 1970). The fact that G5 was negatively correlated with both SURV and RI indicates that faster growing trees may be less suitable for SPB development. The finding that FUNGUS and SA were correlated with SURV and RI confirms earlier results (Bridges 1983). In that study, the presence of the basidiomycete was positively correlated with SURV and RI, whereas the presence of *Sporothrix* was negatively correlated with these variables.

The results of stepwise regression analysis of spot growth are presented in table 12. The objective of this analysis was to find which variable in the data set seemed to influence the number of trees killed in a spot (T2). As expected, the most important variable in the model was the total number of trees in the

Table 4. — Frequency of occurrence of mycangial fungi among geographic locations in 1983

Location	Spots	Beetles examined	Fungus ¹			
			BA	SA	Both	None
		----- Number -----	----- Percent -----			
Sam Houston NF ² , TX	5	3092	58.1	26.8	12.6	2.5
Sabine, Davy Crockett, and Angelina NF, TX	7	4050	50.8	29.0	17.2	3.1
Southwest LA	2	1044	31.3	43.7	22.5	2.5
Kisatchie NF, LA	3	1498	51.8	30.2	14.0	4.1
Homochitto NF, MS	9	3762	46.7	33.4	18.2	1.8
Alabama	2	156	55.1	27.6	10.9	6.4
Georgia	3	613	44.2	36.4	16.3	3.1

¹ Percent of beetles with basidiomycete alone (BA), *Sporothrix* alone (SA), both fungi, or neither fungus (none).

² NF = National Forest

Table 5. — Frequency of occurrence of mycangial fungi among geographic locations in 1984

Location	Spots	Beetles examined	Fungus ¹			
			BA	SA	Both	None
		----- Number -----	----- Percent -----			
Sam Houston NF ² , TX	13	4979	43.4	36.0	18.6	2.0
Sabine NF, TX	4	1464	45.1	33.3	18.4	3.1
Kisatchie NF, LA	10	3471	50.4	27.3	20.4	1.9

¹ Percent of beetles with basidiomycete alone (BA), *Sporothrix* alone (SA), both fungi, or neither fungus (none).

² NF = National Forest

spot on the first visit (T1). The proportion of trees under attack at the first visit (AT) was included in the model. FUNGUS was positively correlated with spot growth. This variable may be an indicator of beetle vigor. Beetles carrying fungus are more vigorous and therefore better able to attack new trees.

DISCUSSION

This study examined the relationship of mycangial fungi to SPB weight, population trend indicators, and infestation enlargement. Determination of mycangial fungi associated with SPB populations was done by observing which of two fungi were present in emerging beetles. For the purposes of this discussion, it is assumed that the fungi in the mycangium of emerging beetles reflect the fungi present in the gallery during the development of the larvae. Thus, beetles emerging without fungi in the mycangium would have developed without fungi. An alternative hypothesis is that beetles emerging with empty mycangia may have developed in the presence of fungi, but failed to pick up the fungi in the mycangium.

Results of the present study also show that the relationship between mycangial fungi and SPB is a quantitative symbiosis. Survival rates and ratio of increase were positively correlated with the occurrence of fungi in beetle populations (tables 10 and 11), and weights of individual beetles varied with the presence or absence of the two mycangial fungi. The assumption that beetles emerging with empty mycangia developed without fungi indicates that the presence of fungi is not obligatory for the development of individual larvae. In laboratory experiments, Barras (1970) showed that beetles could develop without fungi, but the developmental time was much longer, and mortality was high.

Weight of emerging SPB varied significantly depending on which of the two fungi were carried in the mycangium of emerging beetles. This study confirms the results of an earlier study but uses a much larger data base (Bridges 1983). Adult female beetles carrying only the basidiomycete were heavier than those carrying *Sporothrix* or those lacking both fungi (table 9). Although there is no direct evidence that larvae feed on this fungus, it is possible that the basidiomycete functions as a source of nutrition for

Table 6. — Mean percent of sample area stained by *C. minor* (BSA) and mean proportion of samples without blue stain (BSF) grouped by geographic location for 1983

Location	Trees		BSA		BSF	
	Number	Percent	Number	Percent	Number	Percent
Sam Houston NF ¹ , TX	22	264	0.2	95.8		
Southwest LA	10	120	0.0	100.0		
Kisatchie NF, LA	15	178	6.7	6.7		
Homochitto NF, MS	40	468	12.7	12.8		
Sabine, Davy Crockett, and Angelina NF, TX	36	419	14.5	6.2		
Georgia	12	142	18.4	0.0		

¹ NF = National Forest

the developing larvae. A role in bark beetle nutrition for symbiotic fungi has been suggested (Barras and Perry 1972, Whitney 1982, Bridges et al. 1984). That survival rates were positively correlated with the presence of the basidiomycete is also consistent with a role in nutrition. Assuming that the basidiomycete is important for larval nutrition, then development rates would probably be faster when the basidiomycete is present. In laboratory studies, beetles carrying fungi had faster developmental times (Barras 1970). Because the rate of beetle production is an important component of beetle population systems (Berryman 1982), the nutritional effect of fungi on developmental processes helps to explain their role in beetle population dynamics.

The influence of mycangial fungi on beetle weight probably affects the population dynamics of SPB. Beetle size is related to fecundity (Reid 1962, Aman 1972, Clarke et al. 1979) and may be an index of beetle vigor. Adult beetle mortality is a key process regulating infestation growth (Hines et al. 1980), and heavier beetles are probably more successful at locating and attacking new hosts. Although there is no direct evidence from this study of an effect of fungi on between-tree mortality, fungi probably play an important role, at least indirectly. The principal role ascribed to fungi is usually that of blue-staining fungi in tree mortality (Berryman 1972). The hypothesis that fungi are required to kill bark beetle-attacked trees is based on several findings. Bark beetles are almost always associated with blue-staining fungi of the genus *Ceratocystis* (Whitney 1982). These fungi have been shown to be pathogenic, causing classical wilt symptoms of pines (Basham 1970, Mathre 1964a, 1964b). The girdling action of beetles is not thought to be sufficient to explain the rapid death of SPB-attacked trees (Craighead 1928, Bramble and Holst 1940, Nelson and Beal 1929, Miller and Keen 1960). Inoculation with fungi re-

Table 7. — Mean percent of sample area stained by *C. minor* (BSA) and mean proportion of samples without blue stain (BSF) grouped by geographic location for 1984

Location	Trees		BSA		BSF	
	Number	Percent	Number	Percent	Number	Percent
Sam Houston NF ¹ , TX	39	468	3.5	57.7		
Sabine NF, TX	12	144	13.9	5.6		
Kisatchie NF, LA	31	372	14.7	4.0		

¹ NF = National Forest

Table 8. — Percent of trees with late stage SPB with blue stain at breast height

Location	Trees examined		With blue stain	
	Number	Percent	Number	Percent
Sam Houston NF ¹ , TX	176	57.4		
Sabine NF, TX	44	86.4		
Kisatchie NF, LA	88	100.0		

¹ NF = National Forest

Table 9. — Relationship of the presence of fungus in the mycangium of emerging SPB females to beetle weight

Fungus	No. beetles	Weight (mg) ¹
Basidiomycete alone	5325	2.02 a
Both fungi	1730	1.87 b
<i>Sporothrix</i> alone	3156	1.73 c
Neither fungus	246	1.35 d

¹ Means not followed by the same letter are significantly different ($P < 0.05$) by Duncan's multiple range test.

Table 10. — Results of stepwise regression of tree and fungus variables on brood survival¹

Dependent variable	Independent variable ²	Regression coefficient	F	P
SURV ³	FUNGUS	0.6831	14.16	< 0.005
	DBH	0.0040	8.69	< 0.005
	G5	-0.0019	4.51	< 0.05
	SA	-0.1027	4.97	< 0.05

¹ R² = 0.14; Std. error = 0.0678

² Independent variables included in the analysis were: BA, B, SA, S, BOTH, FUNGUS, BSA, BSF, ATK, DBH, HGT, CR, AGE, G5, AND G10.

³ See Table 1 for definitions of abbreviations.

Table 11. — Results of stepwise regression of tree and fungus variables on ratio of increase

Dependent variable	Independent variable ²	Regression coefficient	F	P
RI ³	DBH	0.0967	20.57	< 0.005
	FUNGUS	11.4685	10.36	< 0.005
	G5	-0.0436	8.99	< 0.005
	SA	-2.2432	6.60	< 0.025
	BSF	0.4802	5.82	< 0.025

¹ R² = 0.22; Std. error = 1.129

² Independent variables were the same as in Table 10 (except ATK was not included).

³ See Table 1 for definitions of abbreviations.

Table 12. — Results of stepwise regression of spot parameters on number of dead trees in a spot 2 weeks after first visit

Dependent variable	Independent variable ²	Regression coefficient	F	P
T2	T1	1.075	483.36	< 0.005
	FUNGUS	480.791	5.21	< 0.05
	AT	72.310	5.08	< 0.05

¹ R² = 0.94; Std. error = 17.27

² T2 = Total number of dead trees in spot 2 weeks after initial visit.

T1 = Total number of dead trees in spot at initial visit.

FUNGUS = Percent of beetles with mycangial fungi.

AT = Proportion of trees in spots under attack at the initial visit.

duces the moisture content of trees (Mathre 1964b), and this is thought to be related to improved SPB development (Webb and Franklin 1978).

The question of whether fungi kill SPB-attacked trees has not been unequivocally answered. As pointed out by Whitney (1982), trees are not likely to be killed by the fungus or the beetle exclusively. The organisms probably work in concert to bring about the death of the tree. The girdling action of winding SPB galleries undoubtedly initiates drying of the tree by exposing the sapwood to the air. The winding *D. brevicomis* galleries, which are similar to SPB galleries, expose as much as 14 percent of the sapwood (Miller and Keen 1960). There seems to be little doubt that beetle gallery construction activity enhances the establishment of fungi in the phloem.

CONCLUSIONS

It can now be concluded that *C. minor* is not always the major tree-killing agent associated with SPB. Observations of SPB infestations without any evidence of *C. minor* support this conclusion (Bridges et al. 1985, Hetrick 1949). Although *C. minor* is not a prerequisite for SPB attack success, the involvement of other fungi cannot be excluded. Except for the mycangial fungi, other fungi associated with SPB have been largely ignored as components of the SPB attack process. There have been few studies to describe the other fungi associated with SPB galleries.

A number of undescribed fungi were observed consistently in SPB galleries, even in trees without *C. minor*. All of the SPB-infested trees examined had evidence of fungi that penetrated the sapwood. Therefore, other fungi, especially nonstaining or lightly staining ones, may be more important in contributing to tree mortality than *C. minor*. Whitney and Cobb (1972) concluded that *C. minor* was probably not responsible for the disruption of the conducting system of *D. brevicomis*-killed trees. They found that nonstaining fungi were more widespread in beetle-killed trees than *C. minor*.

Although the basidiomycete appears to function in SPB nutrition, the role of *Sporothrix* is still not known. The presence of *Sporothrix* is negatively correlated with survival and brood production. Beetles emerging with the *Sporothrix* alone are significantly smaller than beetles with the basidiomycete. However, beetles carrying *Sporothrix* are significantly heavier than beetles with empty mycangia. Perhaps *Sporothrix* is involved in tree pathology. The role of a fungus that causes pathological changes or affects the water status of the tree can be thought of in

terms of a fungus-tree interaction. Although pathological changes might alter the nutritional quality of the tree, the effect would be more or less the same for all beetles in a tree. On the other hand, the role of the basidiomycete can be thought of in terms of a fungus-beetle interaction—an effect at the gallery level. Its presence or absence could affect each larva or small groups of larvae.

During the course of this study, the level of SPB activity increased in some areas over previous years. The activity was most apparent on the Sam Houston National Forest. Most noteworthy was the Four Notch area of this Forest, where about 2,000 acres were destroyed by SPB in 1983. Trees in this area and in southwest Louisiana showed little or no blue-stain in 1983. Of all the areas sampled in 1983, these two locations had higher SPB infestation densities (Bridges et al. 1985). In 1984, there were also lesser amounts of blue stain in SPB-infested trees on the Sam Houston National Forest. These results suggest that the amount of blue stain and SPB population levels in an area may be related. It is possible that the absence of blue stain can be an indicator of SPB outbreaks (Bridges et al. 1985).

LITERATURE CITED

- Amman, G. D. Some factors affecting oviposition behavior of the mountain pine beetle. *Environ. Entomol.* 1:691–695; 1972.
- Barras, S. J. Antagonism between *Dendroctonus frontalis* and the fungus *Ceratocystis minor*. *Ann. Entomol. Soc. Amer.* 63: 1187–1190; 1970.
- Barras, S. J.; Perry, T. Fungal symbionts in the prothoracic mycangium of *Dendroctonus frontalis* (Coleopt.: Scolytidae). *Zeit. angew. Entomol.* 71: 95–104; 1972.
- Barras, S. J.; Perry, T. Gland cells and fungi associated with prothoracic mycangium of *Dendroctonus adjunctus* (Coleoptera: Scolytidae). *Ann. Entomol. Soc. Amer.* 64: 123–126; 1971.
- Barras, S. J.; Taylor, J. J. Varietal *Ceratocystis minor* identified from mycangium of *Dendroctonus frontalis*. *Mycopathol. Mycol. Appl.* 50: 293–305; 1973.
- Basham, H. G. Wilt of loblolly pine inoculated with blue-stain fungi of the genus *Ceratocystis*. *Phytopath.* 60: 750–754; 1970.
- Berryman, A. A. Population dynamics of bark beetles. In: Mitton, J. B.; Sturgeon, K. B., eds. *Bark beetles in North American conifers: a system for the study of evolutionary biology*. Austin, TX: University of Texas Press; 1982: 264–314.
- Berryman, A. A. Resistance of conifers to invasion by bark beetle-fungus associations. *Bioscience* 22: 598–602; 1972.
- Bramble, W. C.; Holst, E. C. Fungi associated with *Dendroctonus frontalis* in killing shortleaf pines and their effect on conduction. *Phytopath.* 30:881–899; 1940.
- Bridges, J. R. Mycangial fungi of *Dendroctonus frontalis* (Coleoptera: Scolytidae) and their relationship to beetle population trends. *Environ. Entomol.* 12:858–861; 1983.
- Bridges, J. R.; Marler, J. E.; McSparrin, B. H. A quantitative study of the yeasts and bacteria associated with laboratory-reared *Dendroctonus frontalis* Zimm. (Coleoptera: Scolytidae). *Zeit. angew. Entomol.* 97:261–267; 1984.
- Bridges, J. R.; Moser, J. C. Role of two phoretic mites in transmission of blue-stain fungus, *Ceratocystis minor*. *Ecol. Entomol.* 8: 9–12; 1983.
- Bridges, J. R.; Nettleton, W. A.; Connor, M. D. Southern pine beetle (Coleoptera: Scolytidae) infestations without the blue-stain fungus, *Ceratocystis minor*. *J. Econ. Entomol.* 78:325–327; 1985.
- Clarke, A. L.; Webb, J. W.; Franklin, R. T. Fecundity of the southern pine beetle in laboratory pine bolts. *Ann. Entomol. Soc. Am.* 72: 229–231; 1979.
- Coulson, R. N.; Mayyasi, A. M.; Foltz, J. L.; Hain, F. P. Interspecific competition between *Monochamus titillator* and *Dendroctonus frontalis*. *Environ. Entomol.* 5:235–247; 1976.
- Craighead, C. F. Interrelation of tree-killing bark beetles (*Dendroctonus*) and blue stains. *J. For.* 26: 886–887; 1928.
- Foltz, J. L.; Mayyasi, A. M.; Hain, F. P. (and others). Egg-gallery length relationship and within-tree analyses for the southern pine beetle, *Dendroctonus frontalis* (Coleoptera: Scolytidae). *Can. Entomol.* 108: 341–352; 1976.
- Franklin, R. T. Observations on the blue stain-southern pine beetle relationship. *J. Ga. Entomol. Soc.* 5: 53–57; 1970.
- Happ, G. M.; Happ, C. M.; Barras, S. J. Fine structure of the prothoracic mycangium, a chamber for the culture of symbiotic fungi, in the southern pine beetle, *Dendroctonus frontalis*. *Tissue and Cell* 3: 295–308; 1971.
- Hetrick, L. A. Some overlooked relationships of southern pine beetle. *J. Econ. Entomol.* 42: 466–469; 1949.
- Hines, G. S.; Taha, H. A.; Stephen, F. M. Model for predicting southern pine beetle population growth and tree mortality. In: *Proceedings, symposium on modeling southern pine beetle populations; 1980 February 20–22; Asheville, NC. Tech. Bull.*

1630. Washington, DC: U.S. Department of Agriculture; 1980: 4-12.
- Linit, M. J.; Stephen, F. M. Comparison of methods for estimation of attacking adult populations of *Dendroctonus frontalis*. *J. Econ. Entomol.* 71: 732-735; 1978.
- Mathre, D. E. Survey of *Ceratocystis* spp. associated with bark beetles in California. *Contrib. Boyce Thompson Inst.* 22: 353-362; 1964a.
- Mathre, D. E. Pathogenicity of *Ceratocystis ips* and *Ceratocystis minor* to *Pinus ponderosa*. *Contrib. Boyce Thompson Inst.* 22: 363-388; 1964b.
- Miller, J. M.; Keen, F. P. Biology and control of the western pine beetle. *Misc. Publ.* 800. Washington, DC: U.S. Department of Agriculture; 1960. 381 p.
- Nelson, R. M.; Beal, J. A. Experiments with blue-stain fungi in southern pines. *Phytopath.* 19: 1101-1106; 1929.
- Reid, R. W. Biology of the mountain pine beetle, *Dendroctonus monticolae* Hopkins, in the east Kootenay Region of British Columbia. II. Behaviour in the host, fecundity and internal changes in the female. *Can. Entomol.* 94: 605-613; 1962.
- Thatcher, R. C.; Pickard, L. S. Seasonal variations in the activity of the SPB in east Texas. *J. Econ. Entomol.* 57: 840-842; 1964.
- Webb, J. W.; Franklin, R. T. Influence of phloem moisture on brood development of the southern pine beetle (Coleoptera: Scolytidae). *Environ. Entomol.* 7:405-409; 1978.
- Whitney, H. S. Relationships between bark beetles and symbiotic organisms. In: Mitton, J. B.; Sturgeon, K. B., eds. *Bark beetles in North American conifers: a system for the study of evolutionary biology*. Austin, TX: University of Texas Press; 1982: 183-211.
- Whitney, H. S.; Cobb, F. W., Jr. Non-staining fungi associated with the bark beetle *Dendroctonus brevicornis* (Coleoptera: Scolytidae) on *Pinus ponderosa*. *Can. J. Bot.* 50: 1943-1945; 1972.

Population Dynamics of Initiation and Growth of Southern Pine Beetle Infestations

R. N. Coulson, R. O. Flamm, T. L. Wagner, E. J. Rykiel,
P. J. H. Sharpe, T. L. Payne, and S. K. Lin¹

Abstract.—Population dynamics of the southern pine beetle, *Dendroctonus frontalis* Zimmermann, has been studied extensively during the last decade. Most of the research has been directed to events associated with growth of established infestations. Factors governing the initiation process have not been addressed conceptually or experimentally until recently. A review of current knowledge of the processes of initiation and subsequent growth of infestations is necessary to further study. Major emphasis has been placed on the process of initiation. The role of natural disturbances in this process has been addressed by two studies at Texas A&M. The first study deals with response of the southern pine bark beetle guild to host disturbance. Variables considered include: colonization of disturbed hosts, temporal response of the bark beetle guild, and structure of the populations responding to the disturbance. The second study examines the characteristics of the lightning disturbance regime. Frequency, spatial distribution, and temporal distribution of cloud-to-ground lightning strikes were evaluated for east Texas during a 5-year period. These two studies provide a test of the basic tenets of the hypothesis that lightning-struck trees play a fundamental role in the natural history and epidemiology of the southern pine bark beetle guild (Coulson et al. 1983, 1985a).

Additional keywords: Disturbance theory, population ecology, lightning strikes, *Dendroctonus frontalis* Zimmermann.

¹ Respectively, Professor, Graduate Assistant, and Research Associate, Department of Entomology; Assistant Professor, Department of Range Science; Professor, Industrial Engineering Department; Professor, Department of Entomology; and Graduate Research Assistant, Industrial Engineering Department, all Texas A&M University, College Station, TX (We acknowledge and thank A.M. Bunting, D. Watkins, and L. Gattis for technical assistance in the preparation of this manuscript. This work was supported by the USDA Forest Service, Integrated Pest Management Program for Bark Beetles of Southern Pines (TEX 6523) and by the Texas Agricultural Experiment Station (MS 6009). The findings expressed herein are those of the authors. This is Texas Agric. Exp. Sta. Pap. No. 20711.

INTRODUCTION

The southern pine bark beetle guild consists of *Dendroctonus frontalis* Zimmermann, *D. terebrans* (Olivier), *Ips calligraphus* (Germar), *I. grandicollis* (Eichhoff), and *I. avulsus* (Eichhoff) (Coleoptera: Scolytidae). An infestation (spot) is a group of host pines that has been colonized by *D. frontalis* and the other members of the guild. It is the basic study unit used in research on most aspects of population dynamics of *D. frontalis*. The infestation is also the unit used in surveying the distribution and abundance of the insect over broad geographic areas, the focus of tree mortality resulting from the activities of the insect, and the target for remedial treatment tactics aimed at suppression of populations. Therefore, population events associated with infestations are of concern to the scientist, forester, and pest management specialist. The fundamental questions of interest to all three groups are (1) how many infestations will occur annually in a given area, (2) where will the infestations be located, and (3) how large in size will the infestations become. The first two questions deal with factors associated with initiation of infestations and the third with growth of infestations.

Our objectives in this paper are to (1) review current concepts dealing with initiation and growth of *D. frontalis* infestations, (2) examine the process of initiation of infestations in response to host disturbance, and (3) illustrate the association between natural disturbance and bark beetle infestations. Emphasis is placed on *D. frontalis* infestations, but all members of the guild are involved. Focus is directed to results of research dealing with these subjects and not on details of methodology.

CURRENT CONCEPTS ON INITIATION AND GROWTH OF INFESTATIONS

Dendroctonus frontalis has been the focus of intensive research during the last 12 years, principally because of its role as a mortality agent of mature pines, *Pinus* spp., throughout the southern United

States. In this role, the insect alters forest ecosystem structure and function by influencing nutrient cycling, energy flow, information control, and assembly processes (Schowalter et al. 1981). The net result of herbivory by *D. frontalis* is an impact on all values for which southern forests are managed; i.e., timber production, hydrology, fish and wildlife, recreation, and grazing. The extent of the impact and the rate at which it occurs are determined by changes in the distribution and abundance of *D. frontalis* through space and time (Coulson and Witter 1984).

Because of the relationships among herbivory, forest ecosystem structure and function, and impact on resource values, considerable emphasis in research has been placed on studies of population dynamics of *D. frontalis*. Coulson (1984) reviewed the history, current status, and future research needs on population dynamics of the insect. Literature on the subject includes studies of both the structure and function of the population system. *Structure*, which was identified by Coulson (1979, 1980), deals with components of the system and their interrelationships. *Function* deals with the operation of the system in forest ecosystems. Two aspects of function are of particular importance. The first includes the factors involved in the distribution and abundance of infestation centers through space and time; i.e., the *initiation* of infestations. The second includes the factors involved in *growth* of infestations once they have become established. The general components involved in these two processes are illustrated in figure 1.

Initiation of Infestations

The process of initiation of *D. frontalis* infestations is poorly understood but thought to occur as a result of colonization of a single tree that has diminished capacity for defense. Adjacent trees may subsequently be attacked by beetles that colonized the original host, brood adults produced in the original host, or immigrant beetles. Depending on forest stand structure, landscape structure, meteorological conditions, and beetle population size, the infestation may grow in size by the accumulation of additional trees. That growth rate is governed by the degree of host susceptibility, which is a function of inherent characteristics of the trees mediated through the four composite variables enumerated above. This general scheme is illustrated in figure 2.

Until recently (Coulson et al. 1983, 1985a, 1985b; Payne and Coulson 1985), the issue of initiation of infestation centers had not been addressed conceptually or experimentally. It is an extremely important aspect of population dynamics of *D. frontalis*. Historical records from Texas Forest Service aerial surveys indicate that the number of new infestations annually ranges from several hundred to several thousand per year for east Texas. At present, there is no way to predict the distribution and abundance of these infestation centers. A conceptual model of the initiation phase of infestation establishment has been developed (Coulson et al. 1985a). However, a mechanistic model of the process is needed.

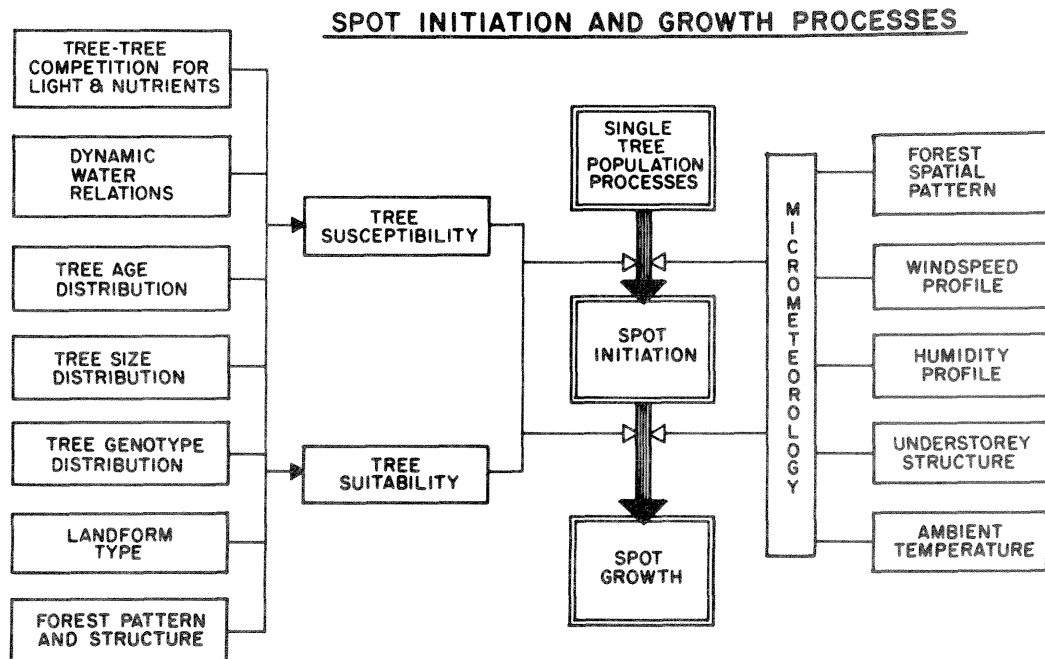

Figure 1.—General scheme of the components involved in the initiation and growth of *Dendroctonus frontalis* infestations.

SINGLE TREE POPULATION PROCESSES

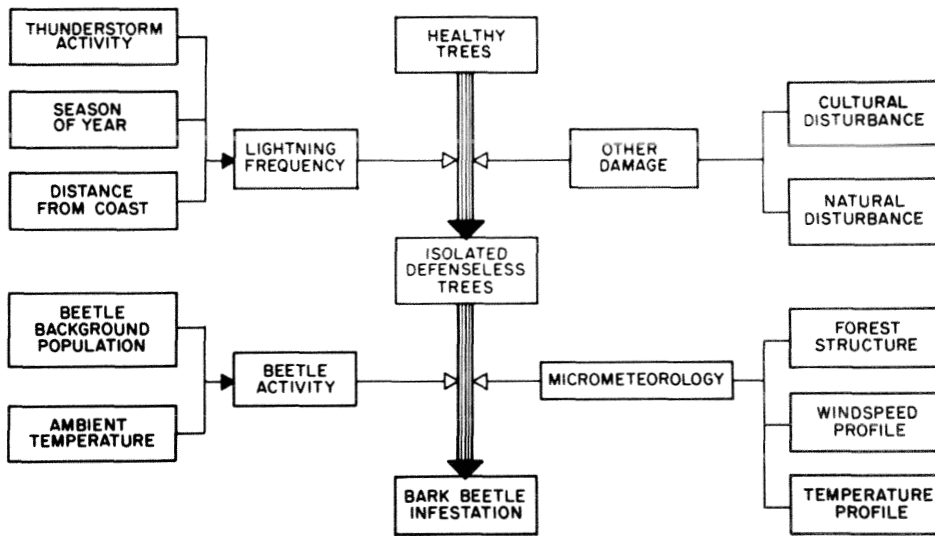

Figure 2.—General scheme of the components involved in the initiation of *Dendroctonus frontalis* infestations.

Growth of Infestations

Knowledge of the factors involved in growth of established infestations is advanced. By far, the greatest emphasis in research on population dynamics has been directed to this subject. TAM-BEETLE (Feldman et al. 1981a, 1981b), which is a mechanistic model, abstracts contemporary knowledge on growth of *D. frontalis* infestations (fig. 3). The most important weakness in our understanding of infestation growth centers on the process of host susceptibility. This dynamic process, which involves the interaction of beetle populations with host defense systems (Cates and Alexander 1982), is currently the subject of considerable research in North America and Europe (Safranyik and Berryman 1985, Vité 1983). Sharpe and Wu (1985a, 1985b) have developed a conceptual model, based on mechanistic principles, that is a synthesis of contemporary knowledge on the subject.

Growth of *D. frontalis* infestations is unique, relative to other bark beetle species, in that there is generally an active front where new trees are being colonized, development is directional (usually following the path of highest tree density, Schowalter et al. 1981), and the rate of development can be rapid. The current TAMBEETLE model can mimic the pattern of infestation growth, but is often inaccurate in tracking rate of spread and time of extinction.

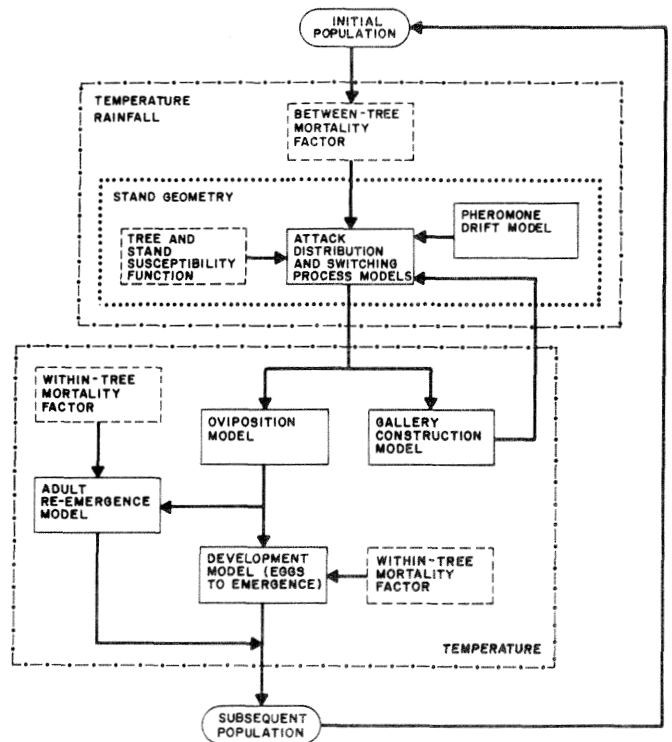

Figure 3.—General structure of the components of the TAM-BEETLE model of population dynamics of *Dendroctonus frontalis*.

In our view, accurate prediction of population dynamics is contingent upon an understanding of both the processes of initiation and growth of infestations. The initiation process is poorly understood and research pertinent to the subject has been organized but not interpreted. Understanding of the process of growth of infestations is advanced. However, the dynamic component of host susceptibility has not been adequately addressed. Mechanistic models of these processes provide a means of efficiently abstracting knowledge of the systems. The addition of these two components to TAMBEETLE would provide a holistic description of bark beetle/infestation dynamics. Using TAMBEETLE as a repository for all available scientific information regarding the bark beetle infestation process would provide a useful predictive tool as well as a synthesis that reflects basic knowledge and understanding of biological phenomena involved.

INITIATION OF INFESTATIONS IN RESPONSE TO HOST DISTURBANCE

Historical records on the incidence of *D. frontalis* indicate a remarkable variation in the number of infestations detected on an annual basis within a particular geographic location. A number of studies have been designed to correlate incidence of infestations with weather variables (e.g., Gagne et al. 1980, Kalkstein 1976, King 1972). These studies did not demonstrate how weather-related variables affect *D. frontalis* distribution and abundance and, indeed, produced conflicting interpretations. For example, it has not been possible to predict with any consistency the number of new infestations that will occur in a year or their location using weather data from the preceding year. Also, historical information on past levels of infestation does not correlate well with future population trends.

Coulson et al. (1983) hypothesized that initiation of *D. frontalis* infestations was a function of beetle response to host disturbance. Furthermore, we suggested that the lightning disturbance regime, because of its frequency and reliability in space and time, was the focus for initiation of infestation. In this section, the basic tenets of this hypothesis are reviewed, a conceptual model of the process illustrated, and experimental testing of the hypothesis reviewed briefly.

Association of Lightning and *D. frontalis* Infestations

Coulson et al. (1983) advanced the hypothesis that a fundamental relationship exists between the initiation of *D. frontalis* infestations and the pattern

of lightning strikes (e.g., frequency, spatial distribution, and temporal distribution) occurring in pine ecosystems in the southern United States. Evidence to support the hypothesis was based on an examination of literature documenting (1) the commonly observed association of bark beetles with lightning-struck pines (Blanche et al. 1983); (2) the effects produced by lightning striking a pine relative to colonization and brood development of *D. frontalis* (Hodges and Pickard 1971); and (3) the relationship of thunderstorms, incidence of lightning, and cloud-to-ground lightning strikes. The empirical evidence on these three subjects was interpreted in the context of theory on (1) foraging strategies of bark beetles in relation to defense strategies of host trees, (2) climatic release of insect populations, and (3) ecological disturbances. Among the conclusions reached, the following are of particular importance:

1. Lightning-struck pines are identified by adult bark beetles and are by far the most frequent disturbance associated with the initiation of infestations (Hicks 1980, Bryant 1983, Payne and Coulson 1985) (table 1).

2. Lightning striking a pine substantially diminished the function of the primary and hypersensitive defense systems of the tree (Cates and Alexander 1982), which greatly enhances colonization by *D. frontalis* and other members of the bark beetle guild. Consequently, it is likely that in contrast to non-lightning-struck trees: (1) Fewer beetles are required to kill the host, (2) beetle mortality resulting from the tree defense systems is less, and (3) the relatively benign *Ips* spp. are capable of colonizing the host as easily as *D. frontalis* (Hodges and Pickard 1971, Blanche et al. 1983).

3. Lightning-struck pines provide particularly suitable habitat for brood development for all members of the bark beetle guild. Typical patterns of resource partitioning by members of the complex are not as apparent in lightning-struck trees.

4. The general climatic regime of an area establishes the characteristic thunderstorm pattern and hence determines the spatial and temporal distribution and frequency of lightning strikes. The lightning disturbance regime for east Texas is discussed in the last section of this paper.

5. The strategies used by *D. frontalis* for dispersal clearly have bearing on the ability of the insects to utilize lightning-struck trees for colonization and subsequent brood development. Although poorly documented in the literature, it is likely that dispersal is accomplished by both active and passive means and that lightning-struck trees are important in the insect persistence in both cases. Most of the literature on dispersal deals with *D. frontalis* and suggests that active dispersal, requiring use of meta-

Table 1. — Summary of weather-related stand disturbances in infested (attacked) and baseline (nonattacked) study plots in the Gulf Coastal Plain¹

Disturbance	Arkansas		Louisiana		Texas		Georgia	
	Attacked	Non-attacked	Attacked	Non-attacked	Attacked	Non-attacked	Attacked	Non-attacked
Severe ice or hail > 50 percent stems affected)	4.0	4.0	0.0	...	0.0	0.0	1.0	0.0
Light ice or hail < 50 percent stems affected)	20.0	20.0	0.0	...	0.2	0.7	5.0	4.0
Lightning	39.0	0.4	10.2	...	31.6	0.9	23.0	1.0
Wind	1.0	0.4	4.0	...	4.6	0.0	2.0	1.0

¹ Source: Hicks (1980)

holic energy, is a short-distance phenomenon. The dispersal distance is probably less than two sq kilometers (Pope et al. 1980; Coulson et al. 1979; Schowalter et al. 1981; Coster and Johnson 1979a, 1979b; Johnson and Coster 1978). For lightning-struck trees to be utilized as refuges by bark beetles, they must be within the dispersal range of the insect and be available at the time(s) when dispersal takes place. Estimates of lightning-strike frequency and the seasonal pattern of lightning occurrence (Coulson et al. 1983) satisfy these conditions. The significant points of this discussion are that (1) persistence of a population, particularly at an enzootic level, is greatly enhanced through utilization of lightning-struck pines, which have diminished defense capabilities, and (2) these defenseless hosts (lightning-struck trees) occur within the dispersal range of the insect.

6. Numerous types of disturbances occur in forests of the southern United States that increase susceptibility of pines to bark beetle colonization. These trees are certainly utilized when discovered. Lightning is unique in that it is a locally random process, is spatially and temporally reliable, and occurs with sufficient frequency to be incorporated as a dimension of the natural history of *D. frontalis*.

7. The degree of utilization of lightning-struck trees by *D. frontalis* is related to the background population levels and local weather conditions.

Conceptual Model of Lightning's Role in the Epidemiology of *D. frontalis*

Based on the concepts presented in the preceding section, Coulson et al. (1985a) developed a conceptual model of the role of lightning in the epidemiology of *D. frontalis*. The model contains four basic components: meteorological conditions, forest stand structure, landscape structure, and bark beetle populations (fig. 4). These components are related in the following way. *First*, the potential rate of initiation of new infestations in a particular forested area is related to meteorological conditions that influence incidence of thunderstorms and associated lightning strikes on host trees. *Second*, the potential number of new sites (lightning-struck trees) utilized is a function of the size of bark beetle populations residing in refuge trees. The background population includes all species of the bark beetle guild. *Third*, variables associated with landscape and forest structure establish the potential for epizootic population growth. *Fourth*, the actual meteorological conditions prevailing at a particular time allow or prevent population release.

The variables associated with each of the four components are identified in figure 5 and the inter-

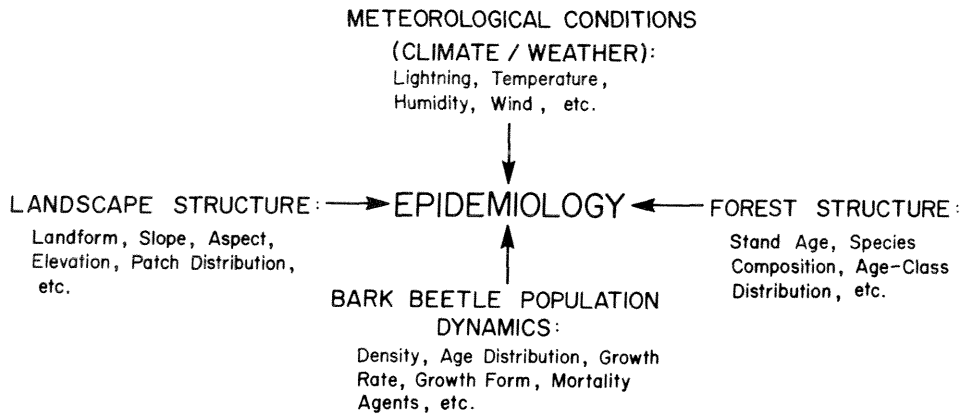

Figure 4.—Prominent components involved in the epidemiology of *Dendroctonus frontalis* (from Coulson et al. 1985a).

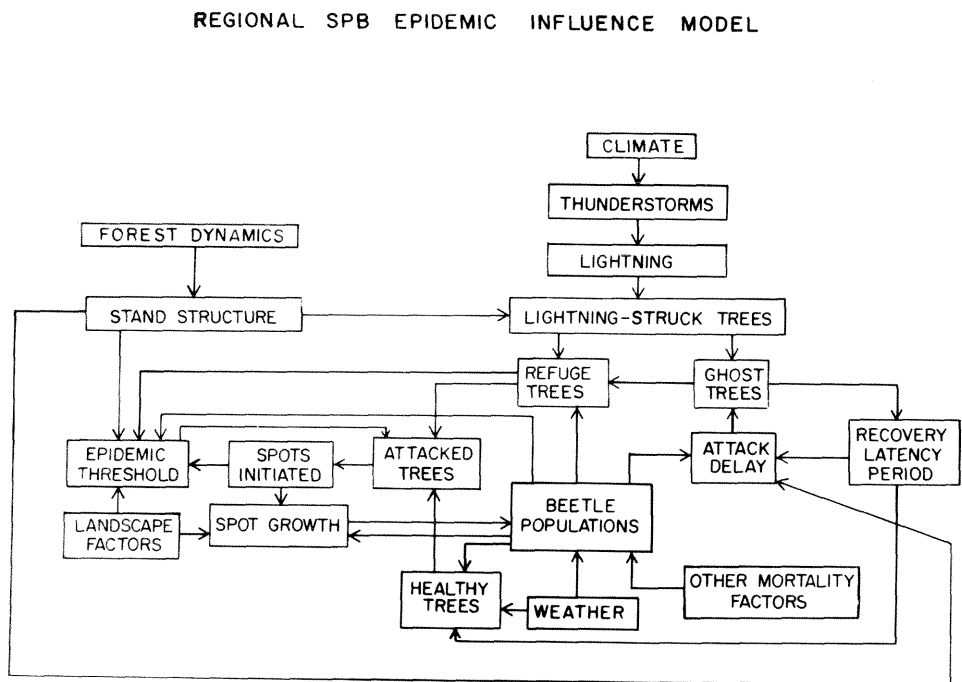

Figure 5.—Influence diagram of the major variables associated with epidemiology of *Dendroctonus frontalis* (from Coulson et al. 1985a).

relationships defined. This “influence diagram” illustrates the relationships between variables involved in the initiation and subsequent growth of infestations.

Experimental Evidence of the Role of Host Disturbance in Initiation of Infestations

The alleged role of host disturbance in the natural history of *D. frontalis* (and other bark beetles) and the conceptual model of epidemiology are based entirely on the literature. If the basic tenets presented in Coulson et al. (1983, 1985a) are correct,

it should be possible to simulate the process of initiation and subsequent growth of infestations by creating a disturbance of sufficient magnitude to severely stress host trees and measure the response of the bark beetle guild. Accordingly, as part of the USDA Forest Service program, a study was conducted to measure response of the bark beetle guild to severely stressed host trees (Coulson et al. 1985b).

The study was replicated four times in southeast Texas during 1983 at periods that roughly coincided with the winter, spring, summer, and fall seasons. Each replicate contained five plots with two

treatment trees and one control tree each. The treatment trees were severely stressed. Detonator chord (PENT, pentaerythritol tetranitrate) was attached to the 40 treatment trees and ignited using a blasting cap (fig. 6). The procedure is described in detail by Miller (1983) and Coulson et al. (1985b). Beetle populations responding to treatment trees were measured using relative estimation procedures. The general results of the experiment are summarized below in terms of (1) tree mortality resulting from bark beetle colonization in response to the disturbance, (2) temporal response of the bark beetle guild to host disturbance, and (3) structure of the bark beetle populations responding to the disturbed host. This study is described in detail by Coulson et al. (1985b).

Tree mortality resulting from bark beetle colonization in response to disturbance.—All 40 treatment trees in the four replicate experiments were dis-



Figure 6.—Illustration of the procedure used to disturb the treatment trees. Detonator chord was wrapped around the host trees, secured at the base and top of the tree, and ignited with a blasting cap. Photograph courtesy Dr. R. F. Billings, Texas Forest Service (from Coulson et al. 1985b).

covered and successfully colonized by the bark beetle guild. In all cases, initial colonization was focused on treatment trees. None of the control trees were colonized. Response of the bark beetle guild to the treatment trees is equivalent in effect to the initiation phase of infestation establishment.

After initial response of the bark beetle guild to the treatment trees, in 10 of the 20 plots, hosts adjacent to the disturbed trees were successfully colonized (fig. 7). In two plots, only one additional tree was colonized. The remaining eight plots developed into multiple tree infestations (table 2). Colonization of hosts adjacent to disturbed trees is equivalent in effect to growth of infestations under natural conditions (Schowalter et al. 1981).

Both the response to the disturbed host (initiation of infestations) and subsequent colonization of adjacent trees (growth of infestations) were predicted as part of the hypothesis on the role of host disturbance in the epidemiology of *D. frontalis* (Coulson et al. 1985b). It is noteworthy that all treated trees were colonized regardless of season of the year and local stand conditions.

Temporal response of the bark beetle guild to host disturbance.—The time interval between initiation of the treatment and mass colonization by the bark beetle guild varied in the four seasonal treatments (fig. 7). In the winter, replicate mass colonization occurred ca 150–180 days following treatment. In the other three replicates, colonization occurred directly following treatment.

The numerical response of the bark beetle guild to the disturbed trees is illustrated in figure 8. In all four replicates, the disturbed trees were discovered immediately following treatment. However, in the winter replicate, mass colonization occurred ca 150–180 days after treatment. Once the disturbed trees were discovered and weather conditions were suitable for dispersal, bark beetle response was rapid. The response curves observed in the study were characteristic of the pattern for reaction of bark beetles to semiochemicals.

From figures 7 and 8, it is obvious that the trees disturbed by the treatment persist as epicenters for colonization by the bark beetle guild for a considerable period of time; i.e., 150 to 180 days. This observation is particularly important in the hypothesis that host disturbance is an integral component of the natural history of the bark beetle guild. The time scale for the life cycles of the bark beetles does not have to be coincidental with the disturbance event, because of the persistence of the disturbed hosts in space and time. Trees disturbed by winter storms or during periods of beetle inactivity (i.e., during late summer months) remain available for colonization when conditions for beetle dispersal are

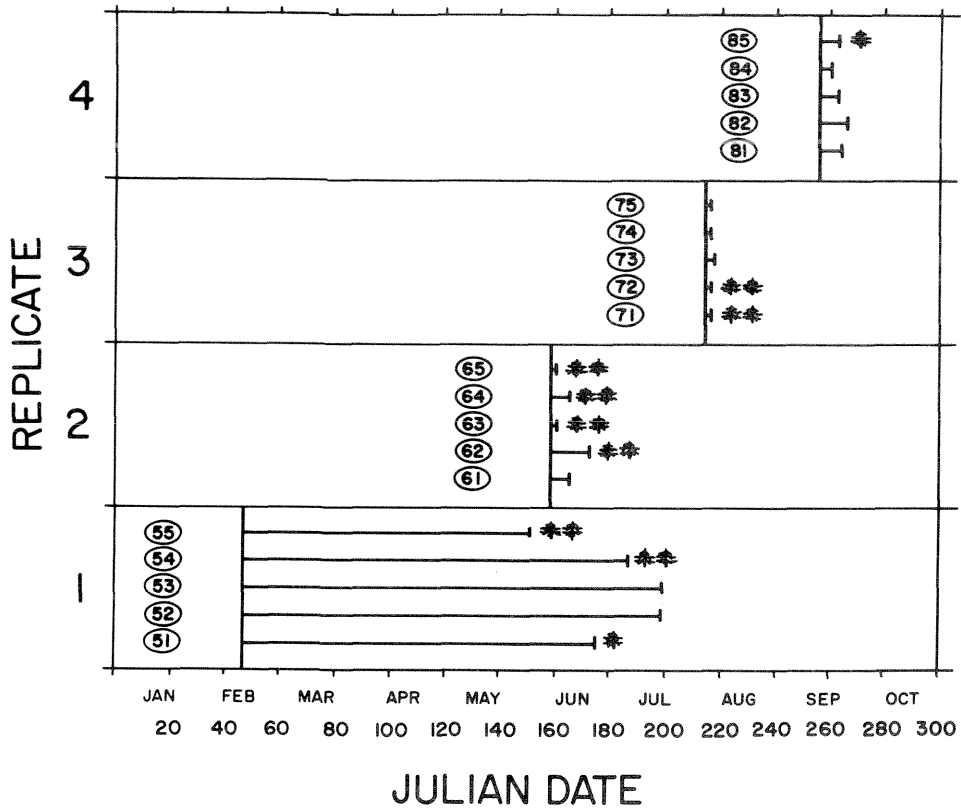

(51) PLOT NUMBER
 一 NON-TREATED TREE ATTACKED BY BEETLES
 一 一 一 > 1 NON-TREATED TREE ATTACKED BY BEETLES

Figure 7.—Response of the bark beetle guild to the 20 plots (numbers enclosed in circles) in the four replicate experiments. The length of the horizontal lines represents the time between treatment of the trees and mass colonization by the bark beetle guild. The “tree” symbol indicates plots that developed into multiple-tree infestations (from Coulson et al. 1985b).

Table 2. — Average (standard deviation) tree and stand characteristics for each replicate experiment

Replicate		N	D.b.h.	Tree height	Age	Basal Area ¹	Number of plots with non-treated trees attacked	
							1 tree	> 1 tree
			cm	m	years	m ² /ha		
1	treatments	10	32.1 (4.31)	24.9 (2.12)	51.0 (16.1)	42.7 (9.08)	1	2
	controls	5	38.8 (4.23)	43.8 (12.1)
2	treatments	10	33.8 (25.4)	24.6 (1.22)	47.6 (4.53)	32.9 (6.86)	0	4
	controls	5	38.0 (5.31)	45.0 (10.0)
3	treatments	10	35.5 (2.32)	24.8 (3.01)	47.8 (13.0)	40.5 (9.42)	0	2
	controls	5	35.7 (3.13)	45.0 (14.4)
4	treatments	10	32.4 (2.04)	22.1 (2.14)	45.4 (3.84)	36.6 (7.04)	1	0
	controls	5	35.8 (1.14)	38.2 (5.54)

¹ Four basal area measurements were taken around each treatment tree. The largest measurement was used to calculate mean basal area.

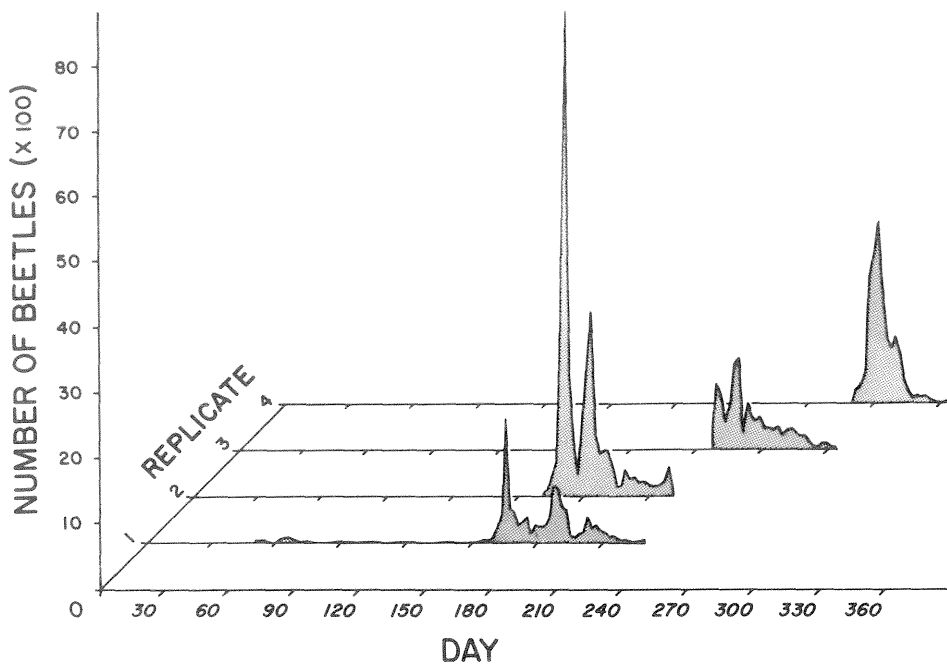

Figure 8.—Numerical response of the bark beetle guild to the disturbed trees in each of four replicates from the time of initial treatment to mass colonization. Response is summarized for all treatment trees within a replicate, expressed as number of beetles, and plotted on a 6-day interval (from Coulson et al. 1985b).

favorable. We indicated earlier that the disturbed trees serve as centers for the initiation and subsequent growth of infestations.

Structure of bark beetle populations responding to disturbed hosts.—Although all 40 trees in the four replicate experiments were successfully colonized, the structure of the populations responding to the disturbed hosts was quite different for each replicate (figs. 9a–d). All five species in the guild were present in each replicate, but the relative proportions changed dramatically throughout the course of the study. Figure 9 illustrates that establishment of infestations can be accompanied by very different blends in the guild. We indicated earlier (table 1) that multiple tree infestations developed in each of the replicate experiments.

It is noteworthy that the *Ips* spp. was the predominant component of the population structure in the first two replicates and *D. frontalis* dominated the second two. Although the *Ips* spp. are commonly found in association with *D. frontalis*, their role in initiation and perpetuation of infestations is poorly understood. Berisford et al. (1985) discuss this point in further detail. It is very likely that the *Ips* spp. play a prominent role in the initiation of infestations and in creating habitats suitable for enzootic population levels of *D. frontalis*.

Conclusions From the Study of Host Disturbance

From this study, a number of fundamental issues relative to host disturbance and bark beetle population dynamics have been clarified. Following are the most significant: *First*, severely disturbed host trees are discovered and colonized by the bark beetle guild. *Second*, multiple-tree infestations develop from the disturbance centers, if weather, landscape, and forest stand conditions are favorable. Disturbed hosts mass-colonized in the spring and fall most often developed into multiple tree infestations. However, the actual disturbance event may have occurred during the winter or summer. *Third*, disturbed trees persist as attractive centers in the environment for extended periods of time. Therefore, the time scale for the life cycles of the bark beetles does not have to be coincidental with the disturbance regime. *Fourth*, disturbed trees are discovered and colonized at all seasons of the year. Diminished defense capabilities resulting from the disturbance and the production of host- and beetle-produced attractants enhance the process of mass colonization. *Fifth*, all five species of the bark beetle guild respond to the disturbed hosts and are involved in colonization. *Sixth*, the relative proportions of the different species of the guild change seasonally, although it is not

PROPORTION

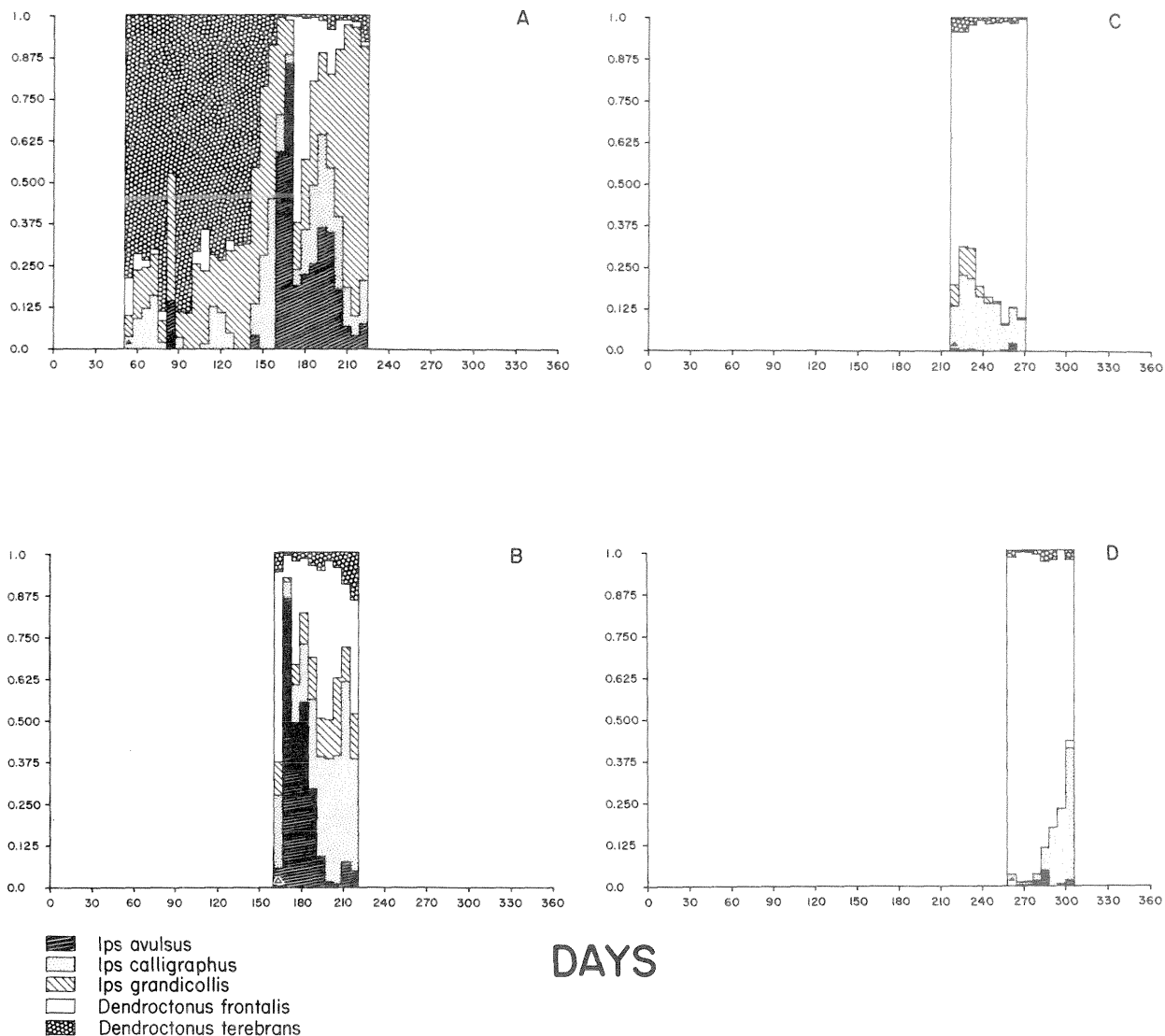

DAYS

Figure 9a-d.—The relative proportions of *I. avulsus*, *I. calligraphus*, *I. grandicollis*, *D. terebrans*, and *D. frontalis* responding to the disturbed trees in plots of replicate one (a), two (b), three (c), and four (d) from the initiation of treatment until mass colonization, plotted on a 6-day interval (from Coulson et al. 1985b).

known if this circumstance is simply a reflection of beetle species present in a local area or a consistent pattern in the natural history of the guild.

NATURAL DISTURBANCES AND BARK BEETLE INFESTATIONS

Natural and cultural disturbances to host pines commonly occur in forest ecosystems of the south-eastern United States and often result in the creation of habitats that are exploited by the bark beetle guild. Coulson et al. (1983) hypothesized that the lightning disturbance regime was an integral component of the natural history of the bark beetle guild, because of its frequency and reliability in

space and time. As with the evidence on bark beetle response to lightning-struck trees, information on characteristics of the lightning disturbance regime (used in development of the hypothesis) was taken from the published literature (Coulson et al. 1983). Therefore, a study was initiated to define the frequency, spatial distribution, and temporal distribution of cloud-to-ground lightning strikes using empirical evidence. The study was restricted primarily to east Texas where information on the distribution and abundance of *D. frontalis* was also available.

This section provides a brief overview of partial results of the study, which is continuing at present. Specific topics discussed are general methodology used and frequency, temporal distribution, and spatial distribution of cloud-to-ground lightning strikes.

General Procedures

About 70 percent of the land mass of the United States is covered by a lightning detection and tracking system. Southeastern Texas is not included, and we thus utilized meteorological data from radar summary charts. These charts provide the following information: (1) Echo patterns and associated types of precipitation, (2) location of thunderstorm centers, (3) cloud echo heights, (4) velocity of cloud movement, and (5) echo intensity isocontours. Information contained on the radar summary charts was used to estimate frequency and spatial and temporal distribution of cloud-to-ground lightning strikes. The 50,240 km² study area for east Texas is illustrated in figure 10. This area has had outbreaks of *D. frontalis* for many years, and the Texas Forest Service has maintained survey records on the distribution and abundance of infestations. Figure 11 illustrates the pattern of infestation for the years of the study, 1975 through 1977 and 1982 to 1983. The level of resolution used in the study was the 5'×5' grid block (ca 64 km²) on a standard quadrangle map.

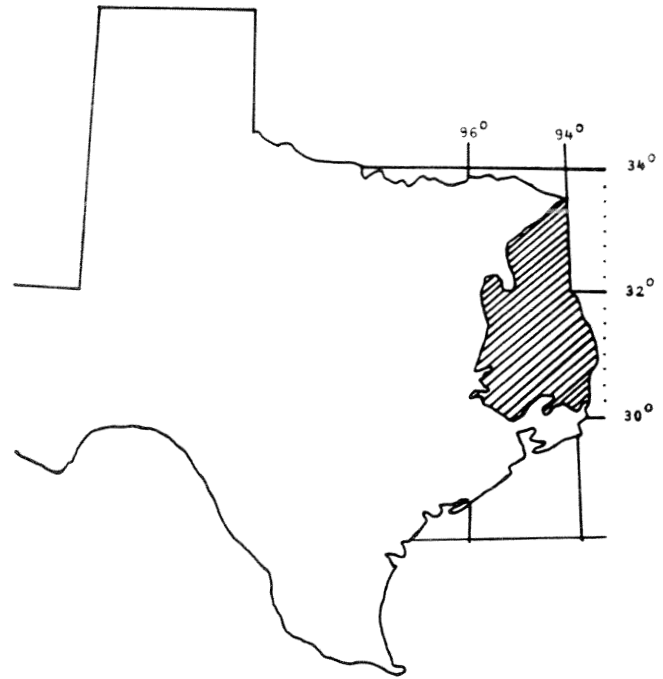

Figure 10.—Boundaries of the region of east Texas used in the study of the lightning disturbance regime.

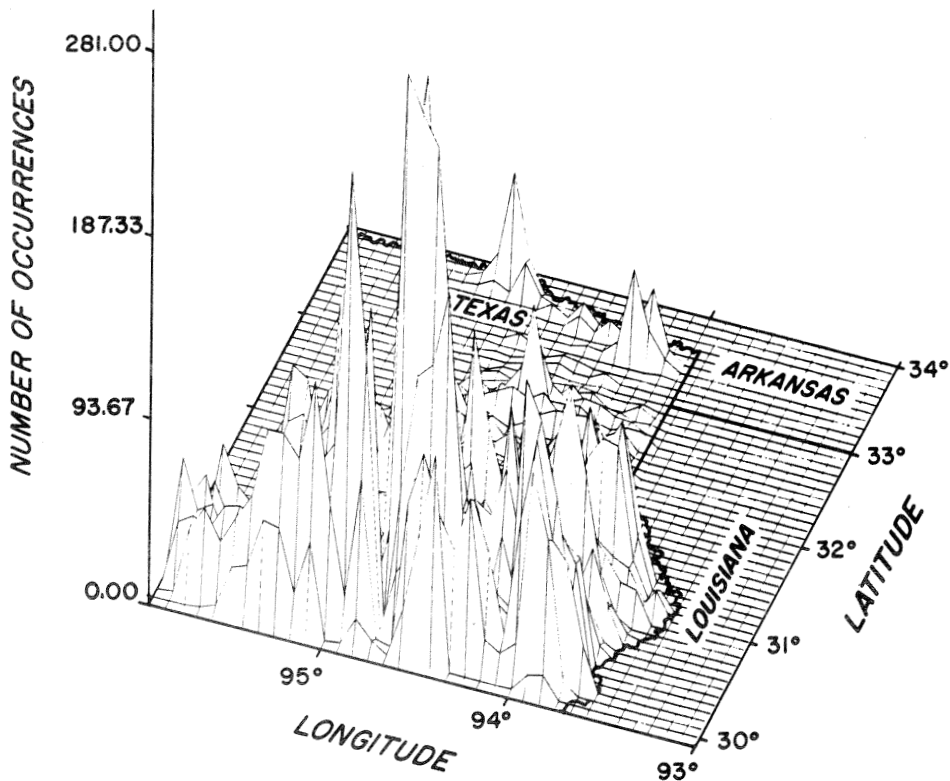

Figure 11.—Three dimensional spatial distribution of southern pine beetle infestations occurring in east Texas during 1975 through 1977, and 1982 to 1983. The vertical axis represents the number of spots recorded for each grid block during the study years. Most of the infestations are distributed in the southern portion of the study area (data courtesy of the Texas Forest Service).

Frequency of Cloud-to-Ground Lightning Strikes

Since east Texas is not included in the area serviced by a lightning detection and tracking system, two models were used to estimate cloud-to-ground lightning density (lightning strikes/km²/month or year). The first model (Pierce 1968) describes the empirical relationship between monthly thunderstorm days and cloud-to-ground lightning strike densities. The second model describes the empirical relationship between cloud-to-ground lightning strikes and thunderstorm echo heights (Holle and Maier 1981).

Figure 12 illustrates the range in cloud-to-ground lightning strikes for the study area using the first model. Lightning density varied from ca 2–9 flashes/km²/year. The average for east Texas was 7.72. The general pattern of cloud-to-ground lightning density for the United States, calculated using the same procedure, is illustrated in figure 13. The range for the southern region is ca 8 to 50 flashes/km²/yr.

The second model, which likely produces a more reliable and accurate estimate, resulted in a similar pattern of lightning occurrence, but the density/km²/yr was ca half that obtained with the first model. In subsequent analyses, the second model was used.

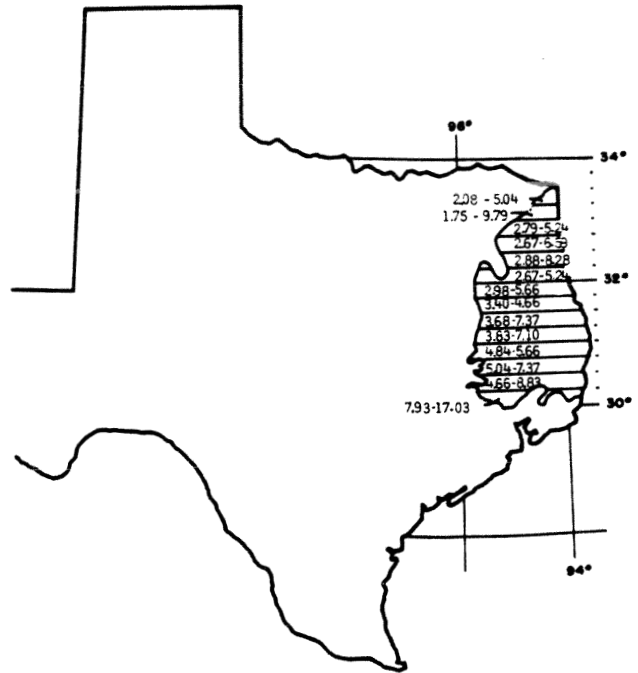

Figure 12.—The lower and upper bounds of annual cloud-to-ground lightning densities in east Texas. The lightning density for region between 30° and 31° N is about 7.72 flashes/km²/yr (from Coulson, unpublished).

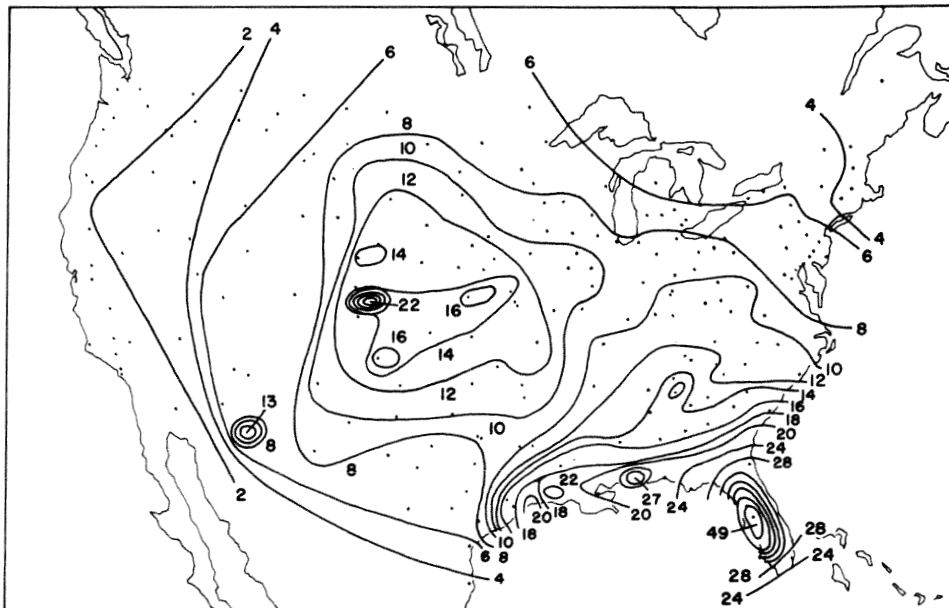

Figure 13.—Isocontours of annual average cloud-to-ground lightning densities in the United States. (Figure provided by Dr. A. Few, Space Physics, Rice University).

The significant point of the analysis is that the density of cloud-to-ground lightning in the study area and throughout the range of *D. frontalis* in the southern region is quite high. Therefore, there are numerous refuges available where the bark beetle guild can initiate infestations.

Spatial and Temporal Distribution of Cloud-to-Ground Lightning Strikes

The spatial and temporal distribution of cloud-to-ground lightning strikes for east Texas is illustrated in figures 14 and 15. As expected, these distributions follow the annual pattern of thunderstorm activity throughout the region (fig. 16)

As indicated in the previous section, disturbed hosts can persist for periods of 150 to 180 days and still function as epicenters for colonization by bark beetles. Therefore, trees struck by lightning during winter months or periods of beetle inactivity accumulate and are available for colonization during periods favorable for insect dispersal. That is, the

disturbance event and the seasonal life cycles of the bark beetles do not have to occur coincidentally. Furthermore, because of the spatial pattern, illustrated in figures 14 and 15, it is probable that many of the lightning strikes occur in high-hazard stands where the potential for infestation growth, following colonization of disturbed hosts, is high.

Conclusions From the Preliminary Study of Lightning Disturbance

Although the association of the bark beetle guild and lightning-struck trees has been recognized for many years, its fundamental importance in the insects' natural history has not previously been examined in detail. For lightning-struck trees to be considered as components of the bark beetle guild's natural history, several conditions must prevail. *First*, the lightning-struck trees must occur within the foraging range of the insect. *Second*, the event must be reliable on a seasonal basis. *Third*, the event must occur frequently. Our examination of the

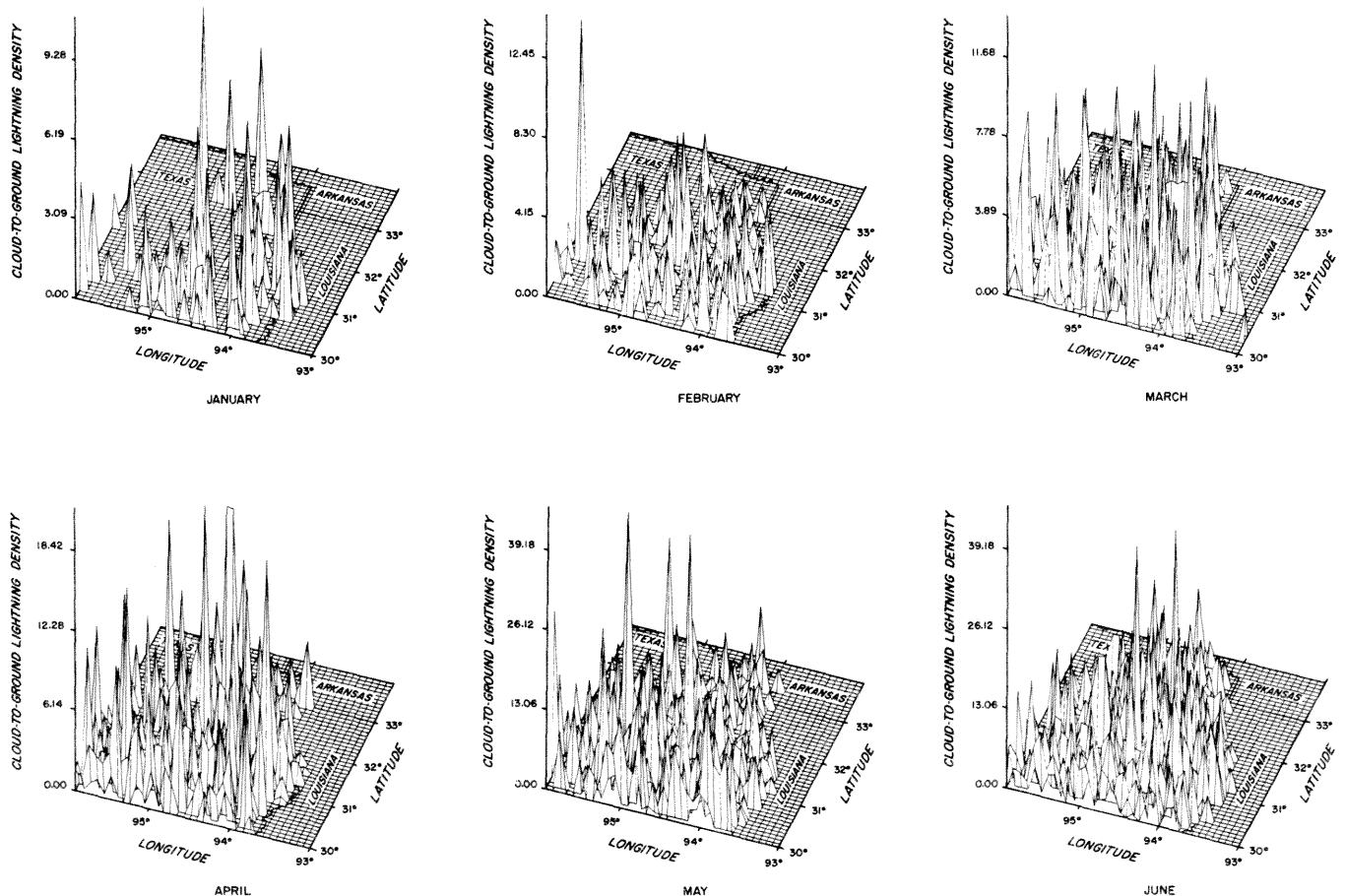

Figure 14.—Three dimensional spatial distributions of monthly cloud-to-ground lightning densities for January–June. The lightning density is a function of thundercloud echo height and is expressed as the total ground flashes on a 5-min by 5-min area of longitude and latitude, about 64 km² in actual size (from Coulson, unpublished).

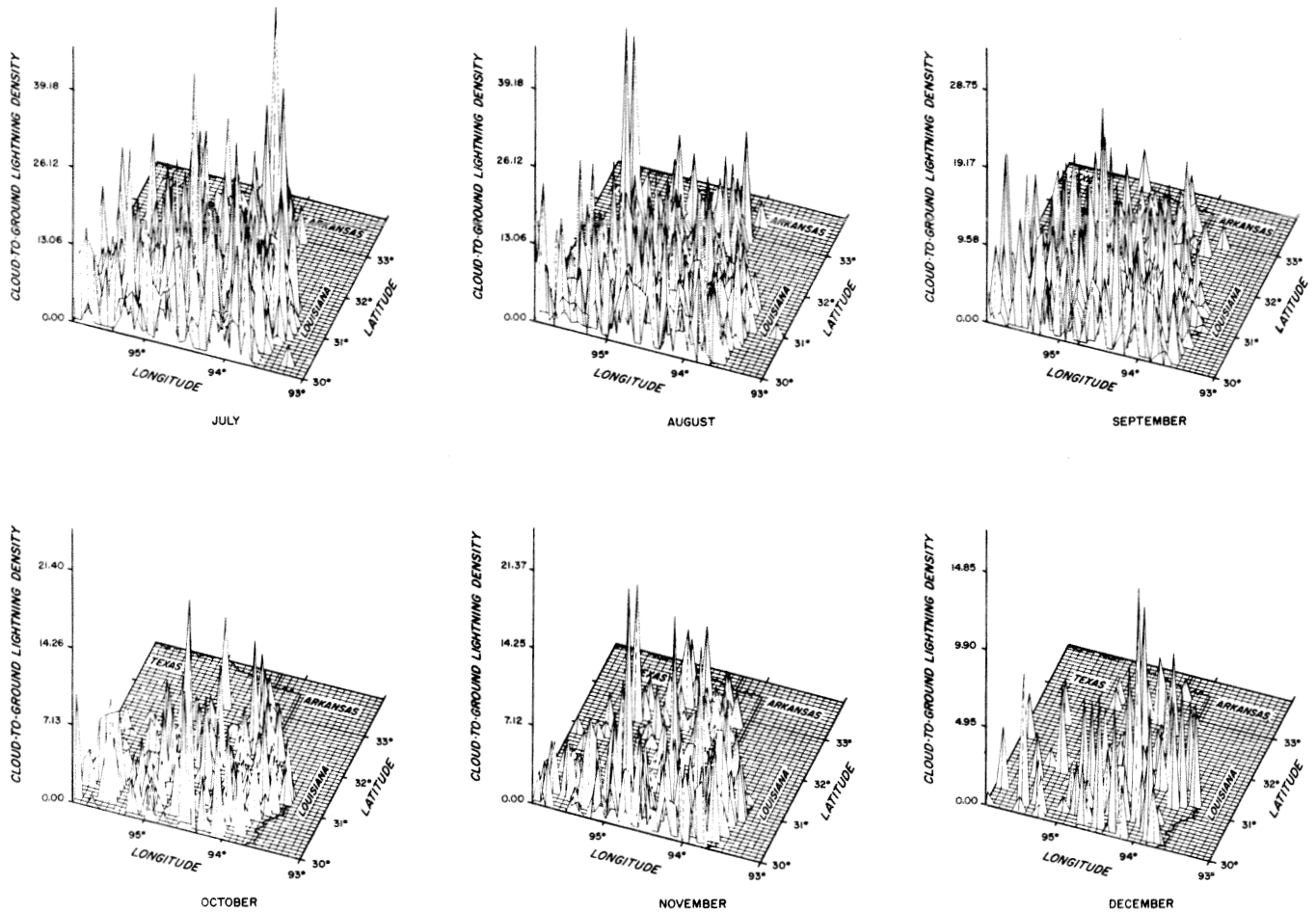

Figure 15.—Three dimensional spatial distributions of monthly cloud-to-ground lightning densities for July–December. The lightning density is a function of thundercloud echo height and is expressed as the total ground flashes on a 5-min by 5-min area of longitude and latitude, about 64 km² in actual size (from Coulson, unpublished).

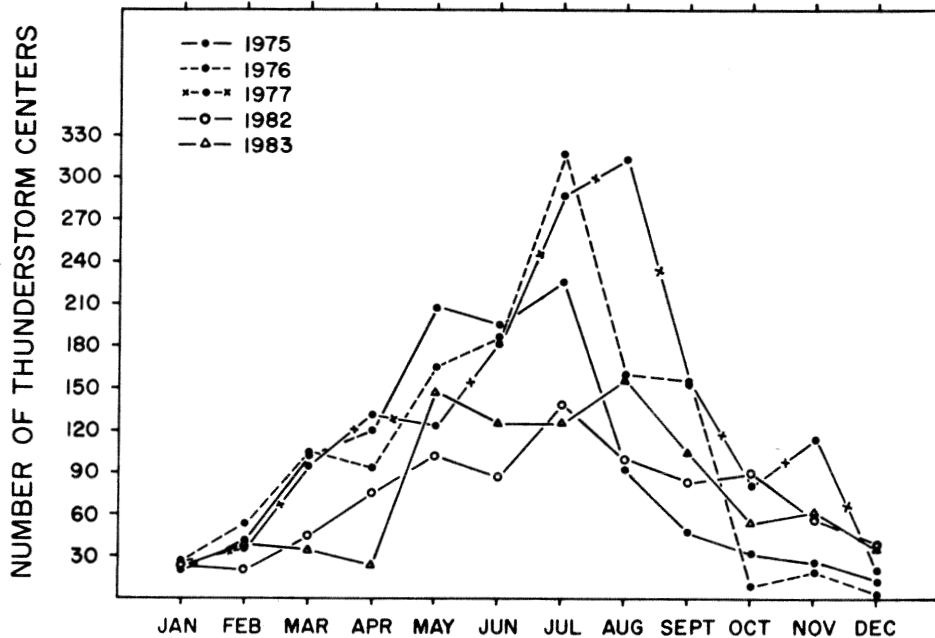

Figure 16.—The frequency distribution of annual thunderstorm centers of the study area during 1975 through 1977, and 1982 to 1983. About 46.7 percent of all recorded thunderstorm centers occurred in summer months. July was the month having the most thundershowers (from Coulson, unpublished).

characteristics of the lightning disturbance regime indicates that these conditions are met. This analysis, together with the study on response of the bark beetle guild to host disturbance, strongly supports the basic tenets of the hypothesized role of lightning in the epidemiology of the bark beetle guild (Coulson et al. 1983).

SUMMARY

Most of the research conducted on population dynamics of *D. frontalis* and the other members of the bark beetle guild has centered on issues relating to growth of established infestations, e.g., the TAM-BEETLE model of population dynamics. Continued research on the initiation phase of infestation establishment will eventually permit the development of a model that combines both components; i.e., initiation and subsequent growth of infestations.

LITERATURE CITED

- Berisford, C.W.; Mizell, R.F.; Kudon, L.H.; Ware, K.D. Line intersect sampling technique for estimating *Ips* populations in logging residue. In: Branham, Susan J.; Thatcher, Robert C.; eds. Proceedings, integrated pest management research symposium; 1985 April 15-18; Asheville, NC. Gen. Tech. Rep. SO-56. New Orleans, LA: U.S. Department of Agriculture, Forest Service, Southern Forest Experiment Station; 1985: 13-25.
- Blanche, C.A.; Hodges, J.D.; Nebeker, T.E.; Moehring, D.M. Southern pine beetle: the host dimension. Miss. Agric. and For. Exp. Sta. Publ. 917. Mississippi State, MI: Mississippi State University; 1983: 1-29.
- Bryant, C.M. Pine engraver and black turpentine beetles associated with endemic populations of southern pine beetles in east Texas. Nacogdoches, TX: Stephen F. Austin State University; 1983. 81 p. [M.S. Thesis].
- Cates, R.G.; Alexander, H. Host resistance and susceptibility. In: Mitton, J.B.; Sturgeon, K.B., eds. Bark beetles in North American conifers. Austin: University of Texas Press; 1982: 212-263.
- Coster, J.E.; Johnson, P.C. Dispersion patterns of *Dendroctonus frontalis* and its predator *Thanasimus dubius*: influence of behavioral chemicals. Mitt. Schweiz. Entomol. Gesellsch. 52: 309-322; 1979a.
- Coster, J.E.; Johnson, P.C. Characterizing flight aggregation of the southern pine beetle. Environ. Entomol. 8: 381-387; 1979b.
- Coulson, R.N. Population dynamics of bark beetles. Ann Rev. Entomol. 24: 417-447; 1979.
- Coulson, R.N. Population dynamics of the southern pine beetle. In: Thatcher, R.C.; Searcy, J.L.; Coster, J.E.; Hertel, G.D., eds. The southern pine beetle. Tech. Bull. 1631. Washington, DC: U.S. Department of Agriculture; 1980: 71-105.
- Coulson, R.N. History, status, and future needs for research on population dynamics of the southern pine beetle. In: Payne, T.L.; Billings, R.F.; Coulson, R.N.; Kulhavy, D.L., eds. History, status, and future needs for research in southern forest entomology. Texas Agric. Exp. Sta. Misc. Publ. 1553. College Station, TX: Texas A&M University; 1984: 30-35.
- Coulson, R.N.; Witter, J.A. Forest entomology: ecology and management. New York: John Wiley and Sons; 1984. 669 p.
- Coulson, R.N.; Pulley, P.E.; Pope, D.N.; Fargo, W.S.; Gagne, J.A.; Kelley, C.L. Estimation of survival and allocation of adult southern pine beetles between trees during the development of an infestation. In: Berryman, A.A.; Safranyik, L., eds. Dispersal of forest insects: evaluation, theory, and management implications. Proceedings, IUFRO Symposium; Sandpoint, ID; 1979.
- Coulson, R.N.; Hennier, P.B.; Flamm, R.O.; Rykiel, E.J.; Hu, L.C.; Payne, T.L. The role of lightning in the epidemiology of the southern pine beetle. Ziet. angew. Entomol. 96: 182-193; 1983.
- Coulson, R.N.; Rykiel, E.J.; Saunders, M.C.; Payne, T.L.; Flamm, R.O.; Wagner, T.L.; Hennier, P.B. A conceptual model of the role of lightning in the epidemiology of the southern pine beetle. In: Safranyik, L.; Berryman, A.A., eds. Insect-host interaction. Proceedings, IUFRO Symposium, Banff, Alberta, Canada; 1985a. [In press].
- Coulson, R.N.; Flamm, R.O.; Pulley, P.E.; Payne, T.L.; Rykiel, E.J.; Wagner, T.L. Response of the southern pine bark beetle guild to host disturbance. 1985b. [In preparation].
- Feldman, R.M.; Wagner, T.L.; Sharpe, P.J.H.; Gagne, J.A.; Coulson, R.N. Within-tree life process models of the southern pine beetle, *Dendroctonus frontalis*. Ecol. Model. 13: 247-259; 1981a.
- Feldman, R.M.; Curry, G.L.; Coulson, R.N. A mathematical model of field population dynamics of the southern pine beetle, *Dendroctonus frontalis*. Ecol. Model. 13: 261-281; 1981b.
- Gagne, J.A.; Coulson, R.N.; Foltz, J.L.; Wagner, T.L.; Edson, L.J. Attack and survival of *Dendroctonus frontalis* in relation to weather during 3 years in east Texas. Environ. Entomol. 9: 222-229; 1980.
- Hicks, R.R., Jr. Climate, site, and stand factors. In: Thatcher, R.C.; Searcy, J.L.; Coster, J.E.; Hertel, G.D., eds. The southern pine beetle. Tech. Bull.

1631. Washington, DC: U.S. Department of Agriculture; 1980: 55-68.
- Hodges, J.D.; Pickard, L.S. Lightning in the ecology of the southern pine beetle, *Dendroctonus frontalis* (Coleoptera: Scolytidae). *Can. Entomol.* 103: 44-51; 1971.
- Holle, R.L.; Maier, M.W. Radar echo height related to cloud-to-ground lightning in South Florida. Preprints, 12th Severe Local Storms Conference; 1981 January 11-15; San Antonio, TX; 1981.
- Johnson, P.E.; Coster, J.E. Probability of attack by southern pine beetle in relation to distance from an attractive host tree. *For. Sci.* 24: 574-580; 1978.
- Kalkstein, L.S. Effects of climatic stress upon outbreaks of the southern pine beetle. *Environ. Entomol.* 5: 653-658; 1976.
- King, E.W. Rainfall and epidemics of the southern pine beetle. *Environ. Entomol.* 1: 279-285; 1972.
- Miller, M.C. Lightning strike simulation for studying southern pine bark and engraved beetle attacks. Res. Pap. SO-296. New Orleans, LA: U.S. Department of Agriculture, Forest Service, Southern Forest Experiment Station; 1983. 4 p.
- Payne, T.L.; Coulson, R.N. Role of visual and olfactory stimuli in host selection and aggregation behavior by *Dendroctonus frontalis*. In: Safranyik, L.; Berryman, A.A., eds. Insect-host interactions. Proceedings, IUFRO Symposium; Banff, Alberta, Canada; 1985. [In press].
- Pierce, E.T. A relationship between thunderstorm days and lightning flash density. *Trans. Am. Geophys. Un.* 686; 1968.
- Pope, D.N.; Coulson, R.N.; Fargo, W.S.; Gagne, J.A.; Kelly, C.L. The allocation process and between-tree survival probabilities in *Dendroctonus frontalis* infestations. *Res. Pop. Ecol.* 22: 197-210; 1980.
- Safranyik, L.; Berryman, A.A., eds. Insect-host interaction. Proceedings, IUFRO Symposium; Banff, Alberta, Canada; 1985. [In press].
- Schowalter, T.D.; Pope, D.N.; Coulson, R.N.; Fargo, W.S. Patterns of southern pine beetle (*Dendroctonus frontalis* Zimm.) infestation enlargement. *For. Sci.* 27: 837-849; 1981.
- Sharpe, P.J.H.; Wu, H. A preliminary model of host susceptibility to bark beetle attack. In: Safranyik, L.; Berryman, A.A., eds. Insect-host interactions. Proceedings, IUFRO Symposium, Banff, Canada; 1985a. [In press].
- Sharpe, P.J.H.; Wu, H. A preliminary model of host susceptibility to bark beetle attack. In: Branham, Susan J.; Thatcher, Robert C., eds. Proceedings, integrated pest management research symposium; 1985 April 16-18; Asheville, NC. Gen. Tech. Rep. SO-56. New Orleans, LA: U.S. Department of Agriculture, Forest Service, Southern Forest Experiment Station; 1985b: 206-224.
- Vité, J.P., ed. Insect and host tree interactions. Symposium proceedings, Institute Forest Zoology, University of Freiburg, West Germany. *Zeit. angew. Entomol.* 96: 105-265; 1983.

SESSION II—PESTS AND HOST/PEST INTERACTIONS

Host/Pest Interactions

Factors Contributing to Southern Pine Beetle Host Resistance

Fred P. Hain, Stephen P. Cook, Pamela A. Matson and Karen G. Wilson¹

Abstract.—The wound-cleansing response of the preformed resin system and the containment of the infection by the hypersensitive reaction produced were studied in loblolly, *Pinus taeda* L., and shortleaf, *P. echinata* Mill., pines responding to attacks by southern pine beetles (SPB), *Dendroctonus frontalis* Zimm., and their associated *Ceratocystis* fungi. The lesion length varied with the virulence of the attacking fungus and the season of the year. However, the monoterpene composition showed no difference based upon the virulence of the attacker. There was a significant difference in monoterpene composition and content between the hypersensitive reaction zone and unwounded tissue. Soluble sugar content decreased in the hypersensitive reaction and appeared to decrease more rapidly in loblolly pine. Comparison of loblolly and shortleaf pines showed no significant differences in the length of the hypersensitive reaction or the total decrease in its soluble sugar content. Although the total preformed monoterpenes were in higher concentrations in loblolly, the induced response of shortleaf produced higher concentrations of β -pinene and β -phelandrene. Bark thickness was significantly greater in the loblolly pines. Of the 22 loblolly and 16 shortleaf pines exposed to an attack of 2,000 or more SPB, 76 percent would have been correctly classified as resisting or succumbing to the attack based upon a threshold resin flow rate of 0.20 ml/hr. While resin flow appears to be of primary importance in evaluating a tree's resistance properties, other factors are of some importance such as bark thickness, quantity and quality of the induced monoterpenes within the hypersensitive response, and the withdrawal of essential nutrients from the wound tissue. The defensive strategies of loblolly and shortleaf pine are discussed. SPB brood survival within shortleaf or loblolly pine bolts was not significantly different under laboratory conditions. The between-tree variation in defensive characteristics represents a wide arsenal for SPB to overcome when establishing outbreak conditions. **Additional keywords:** Resin flow, hypersensitive reaction, soluble sugars, bark thickness, preformed

monoterpenes, induced monoterpenes, lesion length, α -pinene, β -pinene, camphene, limonene, myrcene, β -phelandrene, *Pinus taeda*, *P. echinata*, *Dendroctonus frontalis*, *Ceratocystis minor*, *C. minor* var. *barrassi*.

INTRODUCTION

In 1972, Berryman hypothesized that the response of a conifer to an invading organism, such as *Dendroctonus* bark beetles and their associated fungi, is generalized and consists of three components: 1) The wound-cleansing response of the preformed resin system, 2) the containment of the infection by the hypersensitive reaction, and 3) wound healing by wound periderm formation.

Wound-cleansing by preformed resin is the first line of defense (Berryman 1972). Hodges et al. (1979) studied the physical properties of oleoresin and its composition in terms of preformed monoterpenes and resin acids for the four major southern pine species. Of course, loblolly (*Pinus taeda* L.) and shortleaf (*P. echinata* Mill.) pines are considered more susceptible to successful southern pine beetle (SPB), *Dendroctonus frontalis* Zimm., attack than slash pine (*P. elliotti* Engelm.) and longleaf (*P. palustris* Mill.). Their study concluded that the best characteristics for classifying a tree's resistance were physical properties (total flow, flow rate, viscosity, and time to crystallization), but not the composition of the preformed resin.

However, some work has indicated that resin composition may have some importance in resisting SPB attacks. In laboratory bioassays of monoterpenes found in shortleaf and loblolly pines, Coyne and Lott (1976) found that limonene was usually the substance most toxic to SPB. In fact, Smith (1965 and 1966) arrived at the same conclusion for western pine beetle (WPB), *Dendroctonus brevicomis* LeConte. Smith (1975) presented a formula for describing the effect of insect and host tree factors on resistance to WPB. It infers that the favorable effect of resin quality may be negated by poor quantity and, likewise, poor quality may be offset by good quantity.

The hypersensitive reaction is the second line of defense (Berryman 1972). It is an active metabolic process involving the degeneration of cells surrounding the attack site and the induced release of terpenes, polyphenols, and perhaps other toxic or inhibitory compounds. Thus, the beetle and associated

¹ Respectively, Professor, Research Assistant, and Research Associates, North Carolina State University, Raleigh, NC. (We gratefully acknowledge W. Hobbs, P. Nappen, and E. Younan for technical assistance with experimental procedures. We also thank J. R. Bridges, who furnished the fungal cultures used in this study, and F. L. Hastings for the use of a colorimeter and gas chromatograph. This work was supported by the USDA-sponsored bark beetle IPM Program).

fungi become surrounded by a lesion of dead, resin-impregnated tissue. Berryman (1972) suggested that the intense metabolism in parenchyma cells surrounding the infection site and/or the synthesis of toxic compounds result in cell death and the release of these compounds into the necrotic area. Thus, nutrients essential to the pathogen are converted to toxic or inhibitory compounds and/or materials that cannot be metabolized by the pathogens (Wong and Berryman 1977). The intensity and extent of the reaction are probably functions of the sensitivity of the host cells, physiological condition of the host, and virulence of the pathogen. Russell and Berryman (1976) concluded that lesion formation and terpene synthesis are two independent activities during wound response. Necrosis proceeds more rapidly than does terpene synthesis. Thus, the fungus is first confined by removal of essential nutrients, and secondly, by resinosis.

Russell and Berryman (1976) investigated the interaction of *Scolytus ventralis* LeConte, a species that normally attacks only weakened trees, and grand fir (*Abies grandis* (Dougl.)). They found that the preformed and induced monoterpenes differed both quantitatively and qualitatively. This suggests that grand fir responds to a fungus infection by producing monoterpenes that are more toxic, repellent, or inhibitory to bark beetles and their associated fungi at the expense of attractive or less biologically active compounds. On the other hand, Raffa and Berryman (1982) evaluated the traits of lodgepole pine, *P. contorta* var. *latifolia* Engelm., for resistance to mountain pine beetle (MPB), *D. ponderosae*. Although they found quantitative differences in induced monoterpene production between resistant and susceptible trees, only slight qualitative differences were observed between the preformed and induced monoterpenes. In this case, the induced response appears to simply supplement the preformed monoterpenes. It is interesting to note that MPB is capable of periodic outbreaks that infest apparently healthy trees.

Matson and Hain (1985) hypothesized that the relative importance of wound-cleansing by preformed resin and containment of the infection by the hypersensitive response can be related to differences in insect pressure (as well as other invading organisms). Pines, such as southern yellow pines, which are subject to many asynchronous beetle generations annually may rely more heavily on the preformed resin system as a first line of defense. On the other hand, species such as lodgepole pine that defend against few and synchronous beetle generations each year may rely more on an inducible and localized hypersensitive response. The maintenance of a large reservoir of preformed resin, while energetically expensive, is less

costly than the hypersensitive response would be, if continuously induced. In other words, southern yellow pines may rely on the preformed resin system to physically resist beetle attack and "buy time" for the hypersensitive response to withdraw essential nutrients from the attack zone and produce chemicals that repel, inhibit, or poison the invading organism. If attacking populations are low, the first line of defense may be all that is necessary.

In order to test the above hypothesis on loblolly and shortleaf pines, the following questions were investigated:

- 1) Does the hypersensitive reaction described for the western conifers occur in loblolly pine?
- 2) Is there a change over time in monoterpene and soluble sugar content of phloem tissue in the hypersensitive reaction zone compared with tissue outside the zone?
- 3) Are there differences in the intensity of the active response (measured by lesion length) between treatments involving simple mechanical wounding and those with wounding plus fungal inoculation?
- 4) Are there quantitative differences in resin flow and the hypersensitive reaction of loblolly and shortleaf pine located on a single study site in the North Carolina Piedmont?
- 5) Do the loblolly and shortleaf pines differ in their relative abilities to resist attacking SPB?
- 6) What are the within-species characteristics of shortleaf pine that distinguish those trees that successfully resisted an SPB attack from those that succumbed?
- 7) What are the within-species characteristics of loblolly pine located on a single study site in the Virginia Coastal Plain that distinguish those trees that successfully resisted an SPB attack from those that succumbed?
- 8) Are there differences in brood development between SPB reared on loblolly or shortleaf pine bolts?

METHODS

All the experimental work was conducted at one of three study sites: 1) A loblolly pine stand near West Point, VA (Coastal Plain) that had been subjected to four silvicultural treatments in 1978 (plots were either thinned, fertilized, fertilized and thinned, or untreated controls); 2) adjacent loblolly and shortleaf pine stands in the Hill Forest (Piedmont) near Durham, NC; and 3) a loblolly pine stand overlooking Jordan Lake Reservoir, NC (on the Coastal Plain side of the fall line dividing Piedmont and Coastal Plain).

Resin flow was measured 4-5 hours after a resin flow tube 19 mm was inserted into a tree at d.b.h.

The measurement was then converted to ml/hr. The hypersensitive response was measured by wounding a tree to the xylem with a #9 cork borer (13 mm diameter) and soaking exposed tissue with a 1 ml fungal solution. Usually, the fungus was *Ceratocystis minor* (Hedgecock) Hunt (Rumbold 1931), but we also tested *C. minor* var. *barrassi* Taylor (Barras and Taylor 1973). Samples of the hypersensitive reaction zone were removed from 1 day to 2 weeks later. Measurements included zone length and width, soluble sugar content, and monoterpene content. The samples were placed in a vial of pentane and frozen for GC analysis using ρ -cymene as an internal standard. Monoterpene concentrations are reported in ρ -cymene equivalents. A before-wounding sample was also taken. Soluble sugar content was analyzed according to an Anthrone Colorimetric technique.

In order to test a tree's ability to resist an SPB attack, a field bioassay was developed. The boles of selected trees were tented with saran screening, and infested bolts with ready-to-emerge SPB were introduced underneath the tent. Emergence was estimated by two methods: first, by bark subsampling to roughly control the number of beetles within each tent; and secondly, by counting emergence and ventilation holes before and after mass emergence. The difference gave a more precise estimate of actual emergence. We took numerous measurements on all trees tented; the most important of which were primary resin flow, length and area of the hypersensitive zone; soluble sugar content; and preformed and induced monoterpene content.

Beetles for the bioassay were laboratory-reared according to the technique of Bridges and Moser (1984). A modification of that technique was used to compare the suitability of loblolly or shortleaf pine bolts for brood development. After a bolt was punctured with a #4 cork borer, a gelatin capsule containing one female SPB was placed over each puncture. After the female had begun boring into the log, a male was placed underneath the capsule. When a brood was established, the logs were maintained under similar environmental conditions for 21 to 29 days. Thereafter, brood emergence was monitored daily and when it ceased, the bolts were dissected. The following measurements were made: total egg gallery length, distance between egg niches, total number of egg niches per gallery, total egg hatch, and total number of larvae that migrated to the outer bark.

RESULTS AND DISCUSSION

Length of the Hypersensitive Reaction in Loblolly Pine

Of 20 loblolly pines that were either wounded, wounded and inoculated with *C. minor*, wounded

and inoculated with *C. minor* var. *barrassi*, a hypersensitive reaction was produced by all wounds (Cook and Hain 1985a). The lesion length was longest when wounding was accompanied by an inoculation of *C. minor* and shortest when the wound was not accompanied by a fungal inoculation (Cook and Hain 1985a). The differentiation in reaction size based upon the virulence of the attacker suggests that the tree expends less energy in defending itself upon infection by a less virulent attacker.

The reaction length increases during the season, reaching a peak in late summer and early fall according to Cook and Hain (1985a) and other studies². This is probably a reflection of temperature; cold temperatures may slow the trees' active response as well as slow the invasion of the fungus.

Monoterpene Content of the Hypersensitive Reaction in Loblolly Pine

The percent monoterpene content between preformed and induced monoterpenes differed significantly (Cook and Hain 1985a). However, there were no significant differences between the *C. minor* treatment and the *C. minor* var. *barrassi* treatment (Cook and Hain 1985a). Thus, the monoterpene composition, unlike the reaction length, showed no difference based upon the virulence of the attacker.

There was an increase in the percentage of camphene, β -pinene, myrcene, and limonene in the hypersensitive reaction zone of wounded tissue compared with unwounded tissue (Cook and Hain 1985a). Coyne and Lott (1976) reported that limonene, α -pinene, β -pinene, and myrcene are toxic to SPB in that order.

Soluble Sugar Content of the Hypersensitive Reaction in Loblolly Pine

The percentage of total dry weight of phloem composed of soluble sugars was significantly greater in uninfected phloem in comparisons with the reaction zones of either fungal inoculations, but there was no difference between the fungal treatments (Cook and Hain 1985a). As with monoterpene composition, there was no difference in the extent of the active response of the tree based upon the virulence of the invading organism. Thus, the trees appear to be decreasing the potential food available to the invading organism while increasing the amounts of toxic material present near the wound/infection site.

Comparisons of Loblolly and Shortleaf Pine

Resin flow.—The resin flow measurements were not significantly different between the 36 loblolly

² Hain, unpublished data.

pinus and 35 shortleaf pines examined during this study (Cook 1985). However, the within-species variable in resin flow rate (the range of from 0.00 to 1.11 ml/hr in loblolly and from 0.00 to 1.00 ml/hr in shortleaf) suggests that this factor may be important in determining an individual tree's susceptibility to SPB.

Length of the hypersensitive reaction.—Although the loblolly pines produced a longer average hypersensitive lesion than did the shortleaf during each of three sample periods (June, July, and August), the difference was not statistically significant (Cook 1985).

Soluble sugar content.—The hypersensitive tissue soluble sugar content decreased throughout the 1984 summer in both tree species. Also, there was a significant decrease in inner bark soluble sugar content between unwounded tissue and tissue from the 2-week hypersensitive lesion in loblolly and shortleaf pine. But there was no significant difference in the average decrease in inner bark soluble sugar content between the two species (Cook 1985). In a separate study of 10 loblolly and 10 shortleaf pines, soluble sugars in the hypersensitive reaction were analyzed 1, 2, 7, and 14 days after inoculation. In this case, the loblolly pines showed a greater reduction in soluble sugars after 1 day, and the difference persisted during the 14-day study (Cook 1985). The differing results of these tests suggest, once again, that tree-to-tree variation may render individual trees susceptible or resistant to the SPB attack. The rapid withdrawal of essential nutrients may be critical in resisting attack.

Monoterpene content ($\mu\text{l/g}$).—The average induced monoterpene content in the 2-week hypersensitive reaction was significantly greater than the preformed monoterpene content of unwounded phloem for both tree species (Cook 1985). The amount of every monoterpene increased in the hypersensitive lesion. Although the total preformed monoterpenes were in higher concentration in loblolly pine, the induced response of shortleaf produced higher concentrations of β -pinene and β -phelandrene. There was a significant difference in the change in monoterpene content between the two host species (Cook 1985). The large range in monoterpene concentrations in both loblolly and shortleaf pines may be important in determining which individuals within a species are most susceptible to SPB.

Monoterpene composition (percentage).—The preformed monoterpene composition was similar between the two species. However, the percentage of α -pinene in the induced response of loblolly pine increased and the β -pinene percentage decreased, while the opposite pattern occurred in the shortleaf pines. Also, loblolly produced a much larger percent-

age of myrcene in the induced response than did shortleaf, and the induced response of shortleaf contained β -phelandrene, which was not detected in the preformed resin (Cook 1985). Again, there was a large range in monoterpene composition in both species that may be important to individual trees in resisting SPB attack.

Of the other characteristics measured between the two host species, bark thickness was significantly greater in the loblolly pines ($2.24 \text{ mm} \pm 0.55$) compared to the shortleaf pines ($1.23 \text{ mm} \pm 0.29$).

Comparisons of Successfully and Unsuccessfully Attacked Loblolly Pine

The goal of our field bioassay was to expose trees to the minimum number of beetles required to successfully infest a susceptible tree. By performing at or near this "threshold" value, a relatively resistant tree would not be overwhelmed by a large population of attacking beetles.

Resin flow.—The results from the Virginia study indicate that preformed resin flow rate of 0.2 ml/hr (table 1) was a threshold between successful and unsuccessful attack for 7 of the 10 trees. However, of the three trees exposed to 3,000 or more beetles (highest exposure rate), one had no measurable flow and was unsuccessfully attacked; the other two had very good flow, and one was successfully attacked, the other not.

Monoterpene content ($\mu\text{l/g}$).—The means of total preformed monoterpenes were low relative to the means of the total induced monoterpenes (table 2), with the infested trees showing the greatest change. Most of that change was due to an increase in production of α -pinene (table 3). But both infested and uninfested trees responded to wounding by producing increased quantities of β -pinene, myrcene, and limonene as well (β -phelandrene and camphene were not analyzed). Comparing the two groups, the infested trees produced slightly more α -pinene, the uninfested slightly more β -pinene.

Table 1. — Comparison of resin flow rate and success of SPB attack in loblolly pine in the coastal plain of Virginia, 1983.

Approx. no. beetles	Flow rate ml/hr	Successful attack
3000	0.00	no
2500	0.02	yes
2200	0.05	yes
2000	0.08	yes
2000	0.24	no
2400	0.26	yes
2300	0.30	no
3000	0.32	yes
3100	0.48	no
2300	0.54	no

Table 2. — Comparison of total monoterpenes between loblolly pines successfully and unsuccessfully attacked by SPB

Successful attack	Total monoterpenes μg	
	Preformed	Induced
yes	4 \pm 1*	345 \pm 87
no	12 \pm 13	297 \pm 110

*Standard deviation.

Monoterpene composition (percentage).—Table 4 shows an expanded data set of 23 loblolly pines taken from the Virginia site. Since α -pinene is the primary monoterpene constituent, table 4 compares the proportional change in composition of α -pinene between induced and preformed monoterpenes. Some trees (numbers 3224, 2310, and 4427) showed dramatic proportional differences between preformed and induced monoterpenes, whereas others (numbers 314, 4122 and 342) showed few differences. Most trees produced an increased percentage of the "minor" monoterpenes (β -pinene + myrcene + limonene) in the induced response.

Table 5 shows the results of the 10 loblolly pines at the Virginia Coastal Plain study that were exposed to an attack of 2000 or more beetle (avg. = 2480). Five trees were successfully attacked: three of these had very low resin flow rates (less than 0.20 ml/hr). Of the five trees resisting attack, four had flow rates greater than 0.20 ml/hr. Trees numbered 2217 and 2402 both had flow rates greater than 0.20 ml/hr but were successfully attacked. Tree 2402 was attacked by 3000 beetles and the composition of the induced response was 97 percent α -pinene. Tree 2217 was attacked by 2,400 beetles and the composition of the induced responses was 75 percent α -pinene. Tree 2113 had no measurable flow rate, and yet it resisted an attack of 3,000 beetles; its induced response consisted of only 60 percent α -pinene.

Table 6 shows the results of the exposure of 12 loblolly pines from the NC Piedmont study to 2,000 \pm 200 SPB attacks. All the trees successfully resisted attack, and nine had a flow rate close to or greater than 0.20 ml/hr. The monoterpene concentration (μg) of the induced response for all of the trees was considerably higher (avg. = 1045 μg ; range = 498-3636 μg) than for the loblolly pine in the Virginia study (avg. = 321 μg ; range = 140-426 μg). The percent of α pinene in the induced response was similar for the two areas averaging 81 percent (range = 60-91 percent) in Virginia and 78 percent (range 67-88 percent) in North Carolina.

Comparisons of Successfully and Unsuccessfully Attacked Shortleaf Pine

Table 7 shows the results of exposure of the shortleaf pines in the NC Piedmont study to 2,000 \pm 200

SPB attacks. Four trees were successfully attacked, all of which had flow rates considerably below 0.20 ml/hr. Of the 12 trees resisting attack, all but 3 had flow rates above 0.20 ml/hr. The monoterpene concentration of the induced response was lower for the shortleaf pine (avg. = 709; range = 169-1735 μg) than for the loblolly located in the adjacent stand. But the percent of α -pinene in the induced response was also lower, averaging just 58 percent (range = 38-89 percent). Further, the successfully attacked shortleaf pines produced a significantly longer hypersensitive lesion than did the unsuccessfully attacked trees (Cook 1985).

Table 3. — Comparison of monoterpenes between loblolly pines successfully and unsuccessfully attacked by SPB

Successful attack	μg							
	α -Pinene		β -Pinene		Myrcene		Limonene	
	P ¹	I ²	P ¹	I ²	P ¹	I ²	P ¹	I ²
yes	4	290	0	46	0	5	0	5
no	11	217	1	74	0	4	0	2

¹Preformed.

²Induced.

Table 4. — Differences in the proportions of α -pinene in preformed and induced monoterpene production of 23 loblolly pines

Tree no.	Treatment	Difference
314	Control (-.053) ³	-0.025
3120		-0.111
3129		-0.169
4114		-0.037
4122		-0.018
5125		0.032
5126		-0.041
3224	Thinned (-.182)	-0.260
4226		-0.163
5224		-0.122
2310	Fertilized (-.062)	-0.254
2313		0.042
2325		-0.034
3328		-0.182
434		0.027
4311		-0.147
5322		0.114
342	Fertilized + Thinned (-.072)	0.007
3417		-0.168
3427		0.060
4427		-0.213
541		-0.078
5427		-0.041

¹Difference = proportion of α -pinene in induced monoterpenes - proportion of α -pinene in preformed monoterpenes.

²A minus sign indicates that the induced response produced a smaller proportion of α -pinene.

³Number in parenthesis is the average for the treatment.

SPB Survival in Loblolly and Shortleaf Pine Bolts in the Laboratory

Cook and Hain (1985b) reported on a laboratory study comparing the survivorship of SPB reared in loblolly (average bark thickness = 12.1 mm) and shortleaf (average bark thickness = 7.6 mm) pine bolts. The average distance between egg niches was similar in both species; the average parent gallery was almost 90 mm longer in the shortleaf bolts. However, the 4 percent higher pupal survival in loblolly bolts, although not significant, did negate the longer gallery length in the shortleaf pines, and there was no significant difference in brood adult emergence. In fact, the loblolly bolts consistently produced more brood adults.

CONCLUSIONS

Of the 22 loblolly pines and 16 shortleaf pines that were exposed to an attack of 2,000 or more SPB, 76 percent would have been correctly classified as resisting or succumbing to the attack based upon a threshold resin flow rate of 0.20 ml/hr. Only 2 of the 22 loblolly pines with flow rates greater than the threshold were successfully attacked, whereas four loblolly pines with flow rates significantly lower than the threshold resisted attack. None of the shortleaf pines with flow rates above 0.20 ml/hr succumbed to attack, and three shortleaf with flow rates below the threshold resisted attack.

While resin flow appears to be of primary importance in evaluating a tree's resistance properties, other factors such as bark thickness, quantity and quality of the induced monoterpenes within the hypersensitive response, and the withdrawal of essential nutrients from the wound tissue also seem to be of some importance.

Shortleaf and loblolly pines seem to have evolved slightly different defensive strategies that represent various tradeoffs. For example, the thicker bark of loblolly pine presents a more formidable physical barrier to the beetle and more hiding places for predators (Franklin and Green 1965), but may also provide a better rearing media for brood development and greater protection from bark-piercing parasites (Goyer and Finger 1980). The induced hypersensitive response of loblolly seems to be more of a quantitative response when compared to that of shortleaf. Although, there are large tree-to-tree variations, the general loblolly response resulted in a high concentration of the induced monoterpenes within the hypersensitive tissue, and a high percentage of α -pinene. This may complement the primary resin flow in physically resisting attack, but the high α -pinene

Table 5. — Comparison of resin flow rate, proportion of induced α -pinene and success of SPB attack in loblolly pine

Tree no.	Approx. no. beetles	Flow rate ml/hr	Proportion of α -pinene ¹	Successful attack
2310	2500	0.02	0.75 (426)	yes
4309	2200	0.05	0.98 (260)	yes
2327	2000	0.08	...	yes
2217	2400	0.26	0.76 (414)	yes
2402	3000	0.32	0.97 (279)	yes
2113	3000	0.00	0.60 (310)	no
2215	2000	0.24	0.86 (393)	no
2313	2300	0.30	0.94 (140)	no
2401	3100	0.48	0.62 (344)	no
4329	2300	0.54	...	no

¹Numbers in parentheses are total monoterpenes ul/g.

Table 6. — Comparison of resin flow, proportion of induced α -pinene and success of 2000±200 SPB attacks in loblolly pine located on one site in the North Carolina Piedmont

Tree no.	Flow rate ml/hr	Proportion of α -pinene ¹	Successful attack
57	0.02	.86 (951)	no
40	0.08	.72 (568)	no
41	0.13	.74 (601)	no
39	0.19	.78 (3636)	no
42	0.21	.76 (750)	no
45	0.23	.73 (1077)	no
55	0.23	.78 (833)	no
60	0.23	.67 (1104)	no
44	0.36	.87 (782)	no
43	0.38	.79 (498)	no
46	0.38	.83 (840)	no
62	0.52	.88 (910)	no

¹Numbers in parentheses are total monoterpenes ul/g.

Table 7. — Comparison of resin flow, proportion of induced α -pinene and success of 2000±200 SPB attacks in shortleaf pine located on one site in the North Carolina Piedmont

Tree no.	Flow rate ml/hr	Proportion of α -pinene ¹	Successful attack
32	0.00	.38 (569)	yes
35	0.04	.69 (1240)	yes
54	0.06	.89 (304)	yes
48	0.11	...	yes
51	0.09	.59 (1129)	no
53	0.12	.49 (169)	no
49	0.16	.61 (379)	no
47	0.20	...	no
36	0.21	.53 (798)	no
37	0.21	.57 (696)	no
50	0.22	.50 (1735)	no
52	0.27	.50 (354)	no
33	0.29	.64 (462)	no
34	0.35	.51 (665)	no
38	0.52	...	no
31	0.68	.61 (723)	no

¹Numbers in parentheses are total monoterpenes ul/g.

component may also contribute to the pheromone system of the bark beetle.

One study also suggested that loblolly may withdraw essential nutrients required for fungal development more rapidly from the infection zone.

On the other hand, the thin bark of shortleaf pine provides less of a physical barrier and fewer hiding places for SPB predators (Franklin and Green 1965). But the quality of the shortleaf rearing media may reduce brood survival, and the thin bark may result in higher parasitism rates (Goyer and Finger 1980). The induced hypersensitive response of shortleaf pine also showed large tree-to-tree variations, but the general response resulted in a smaller concentration of induced monoterpenes than generally occurred in loblolly, and a lower percentage of α -pinene. Thus, the hypersensitive response of shortleaf may be more qualitative in that the attractant α -pinene comprises a much smaller component of the total induced monoterpenes. The other monoterpenes (camphene, β -pinene, myrcene, limonene and β -phelandrene) may be toxic, inhibitory, repellent, or non-attractive to SPB.

The tree-to-tree variations in both species resulted in numerous combinations of the above resistance characteristics. Perhaps, the most resistant individual trees would possess high resin flow rates, the thick bark, the rapid withdrawal of essential nutrients, and the high concentration of induced monoterpenes generally found in loblolly pines and the lower percentage of induced α -pinene more characteristic of shortleaf.

LITERATURE CITED

- Barras, S. J.; Taylor, J. J. Varietal *Ceratocystis minor* identified from mycelium of *Dendroctonus frontalis*. Mycopathol. Mycol. Appl. 50: 293-305; 1973.
- Berryman, A. A. Resistance of conifers to invasion by bark beetle fungus associations. BioSci. 22: 598-602; 1972.
- Bridges, J. R.; Moser, J. C. A continuous mass-rearing technique for the southern pine beetle (Coleoptera: Scolytidae). J. Ga. Entomol. Soc. 19: 480-482; 1984.
- Cook, S. P. Relative susceptibility and suitability of loblolly and shortleaf pine to the southern pine beetle, *Dendroctonus frontalis* Zimm. Raleigh, NC: North Carolina State University; 1985. [Dissertation]
- Cook, S. P.; Hain, F. P. Qualitative examination of the hypersensitive response of loblolly pine, *Pinus taeda* L., inoculated with two fungal associates of the southern pine beetle, *Dendroctonus frontalis* Zimm. (Coleoptera: Scolytidae). Environ. Entomol.; 1985a. [In press]
- Cook, S. P.; Hain, F. P. Comparison of loblolly and shortleaf pine bolts as hosts of the southern pine beetle, *Dendroctonus frontalis* Zimm., (Coleoptera: Scolytidae). Environ. Entomol. 14: 332-335; 1985b.
- Coyne, J. F.; Lott, L. H. Toxicity of substances in pine oleoresin to southern pine beetles. J. Ga. Entomol. Soc. 11: 297-301; 1976.
- Franklin, R. T.; Green, H. J. Observations on clerid predation of southern pine beetles. J. Kans. Entomol. Soc. 38: 202-203; 1965.
- Goyer, R. A.; Finger, C. K. Relative abundance and seasonal distribution of the major hymenopterous parasites of the southern pine beetle, *Dendroctonus frontalis* Zimm., on loblolly pine. Environ. Entomol. 9: 97-100; 1980.
- Hodges, J. D.; Elam, W. W.; Watson, W. F.; Nebeker, T. E. Oleoresin characteristics and susceptibility of four southern pines to southern pine beetle (Coleoptera: Scolytidae) attacks. Can. Entomol. 111: 889-896; 1979.
- Matson, P. A.; Hain, F. P. Host conifer defense strategies: A hypothesis. In: Safranyik, L., ed. The role of the host in the population dynamics of forest insects. Proceedings, IUFRO symposium; Banff, Alberta, Canada; 1985. Victoria, BC: Canadian Forestry Service and U.S. Department of Agriculture, Forest Service; 1985: 33-42.
- Raffa, K. F.; Berryman, A. A. Physiological differences between lodgepole pines resistant and susceptible to the mountain pine beetle and associated microorganisms. Environ. Entomol. 11: 486-492; 1982.
- Rumbold, C. T. Two blue-staining fungi associated with bark-beetle infestation of pines. J. Agric. Res. 43: 847-873; 1931.
- Russell, C. E.; Berryman, A. A. Host resistance to the fir engraver beetle. 1. Monoterpene composition of *Abies grandis* pitch blisters and fungus-infected wounds. Can. J. Bot. 54: 14-18; 1976.
- Smith, R. H. Effect of monoterpene vapors on the western pine beetle. J. Econ. Entomol. 58: 509-510; 1965.
- Smith, R. H. Forcing attacks of western pine beetles due to test resistance of pines. Res. Note PSW-119. Berkeley, CA: U. S. Department of Agriculture, Forest Service, Pacific Southwest Forest and Range Experiment Station; 1966. 12 p.
- Smith, R. H. Formula for describing effect of insect and host tree factors on resistance to western pine beetle attack. J. Econ. Entomol. 68: 841-844; 1975.
- Wong, B. L.; Berryman, A. A. Host resistance to the fir engraver. 3. Lesion development and containment of infection by resistant *Abies grandis* inoculated with *Trichosporium symbioticum*. Can. J. Bot. 55: 2358-2365; 1977.

Host/Beetle Interactions: Influence of Associated Microorganisms, Tree Disturbance, and Host Vigor

J. D. Hodges, T. E. Nebeker, J. D. DeAngelis, and C. A. Blanche¹

Abstract.—Results of three separate but related investigations have shown that a number of factors influence host resistance to southern pine beetle. In one study, phenolic metabolites of *C. minor* stimulated transpiration in loblolly pine seedlings when administered through the cut stem. Rates of water loss were doubled within 24 hours after treatment with isocoumarin solutions. A second study showed that physical and chemical properties of the oleoresin system may be altered due to wounding of the stem and root system such as may occur during a thinning operation. A third set of investigations resulted in development of techniques for distinguishing between sapwood and heartwood of loblolly pine and disclosed that stem electrical resistance (SER) can be used to rate the vigor of individual trees within a stand. Other indicators of tree vigor in loblolly pine were: (1) Grams of stemwood produced per sq. m of leaf surface, and (2) last year increment as a percentage of total cross-sectional sapwood area.

Additional keywords: Transpiration, fungal toxins, sapwood area, electrical resistance.

INTRODUCTION

Mississippi State's cooperative work under the Integrated Pest Management Program has dealt primarily with host/pest interactions. We have been most interested in the host and factors that might influence its resistance to the southern pine beetle (SPB). Specifically, we have looked at: (1) The role of microorganisms associated with the beetle in overcoming tree resistance; (2) the influence of tree disturbances, such as those caused by logging operations, on tree resistance, and (3) host vigor and methods for evaluating it.

From the earliest work on the SPB, it was assumed that the oleoresin system of the southern pines was responsible for differences in tree resistance (Thatcher 1960). Resistance was hypothesized to be related to the chemical composition of the oleoresin (Coyne 1973; Hodges and Lorio 1973, 1975; Coyne

and Lott 1976) or to physical properties of the system such as flow rate and viscosity (Anderson and Anderson 1968; Hodges and Lorio 1968; Lorio and Hodges 1968a, 1968b, 1974, 1977; Mason 1971). Recent work (Hodges et al. 1977, 1979) has definitely established that there is a very strong relationship between physical properties of the oleoresin system, such as total flow of oleoresin, and the success of SPB attacks. More beetles are needed to overcome a tree with a copious resin flow than one with a low flow; i.e., the one with copious flow is more attack resistant.

Even though the importance of the oleoresin system in tree resistance is now well established, the mechanism(s) whereby high oleoresin flow can impart greater resistance to the tree are not entirely understood nor are the ways that beetles may eventually be able to overcome tree resistance and kill the tree. In a recent article, Hodges et al. (1985) speculated that the function of oleoresin in tree resistance is to prevent inoculation of the tree with microorganisms associated with the SPB. The hypothesis was: "The success of beetle attack, and thus the death of the tree, is directly related to the complete circumferential introduction of fungal inoculum into the living tree, and the subsequent production of toxic substances which in turn alter physiological processes (e.g., water relations) in the tree, and thus make the tree far more susceptible to subsequent attacks. Relative resistance is therefore a function of the ease with which inoculum can be introduced and successfully established."

One phase of this research has dealt with the role of microorganisms associated with the SPB in overcoming tree resistance to beetle attack. Specifically, we have examined the influence of compounds produced by *Ceratocystis minor* (Hedgcock) on tree water relations. Results of this work have provided a plausible explanation of the sequence of events in attacked trees leading to a rapid reduction in oleoresin flow, successful beetle attack, and tree death.

A second phase of the work examined the influence of tree disturbances (simulated thinning injuries) on tree vigor and properties of the oleoresin system. The intent was to determine changes caused by injuries that could increase susceptibility to beetle attack. A third part of the research was concerned with host vigor and the development of a vigor indexing system for loblolly pine.

A description of the study on host/pest interac-

¹ Respectively, Professor, Department of Forestry; and Professor and Assistant Entomologists, Department of Entomology, Mississippi State University, Mississippi State, MS. (This paper is Contribution No. 6083 of the Mississippi Agricultural and Forestry Experiment Station.)

tions and its results are presented in the following three sections, each of which deals with one phase of the research mentioned above. Some of the results are published in more detail elsewhere.

INFLUENCE OF METABOLITES OF *C. MINOR* ON HOST TREE PHYSIOLOGY

The ascomycete fungus *Ceratocystis minor* (Hedgcock) is introduced into phloem and xylem tissues of loblolly pine (*Pinus toeda* L.) by the southern pine beetle, *Dendroctonus frontalis* Zimmermann. *C. minor* is the principal blue-stain fungus of loblolly pine. Infection by *C. minor* is likely to contribute to predisposing the host tree to a successful bark beetle attack, to ensuring subsequent bark beetle brood development, and to eventual death of the host tree.

Several mechanisms have been proposed to account for the observed effects characteristic of *C. minor* infection in loblolly pine, including the possible involvement of toxin(s) (Anderson 1960). The most noticeable effect in loblolly pine is disruption of normal plant water relations leading to rapid development of severe water stress. Secondary symptoms that result from water stress include: (1) Rapid drop in turgor pressure in living cells throughout the bole as evidenced by reduction in oleoresin exudation pressure shortly after successful beetle invasion; (2) blockage or aspiration of tracheids and concomitant reduction in the volume of water transported to the crown; (3) crown fading (premature needle chlorosis and death); and (4) drying of the outer bole tissues as water is withheld from below and within. Cause and effect relationships have not yet been elucidated. Symptoms may result from blockage of xylem tracheids by fungal hyphae, by toxic fungal metabolites, or by aspiration of individual tracheids when tracheid walls are penetrated by growing hyphae. Basham (1970) reported that four *Ceratocystis* species, including *C. minor*, produced a deeply penetrating blue stain of the sapwood of loblolly pine and eventually killed the trees. The primary disease symptom was blockage of xylary water conduction near the blue stain.

Study Methods

Recent attention has focused on involvement of toxic phenolic dihydro-isocoumarin acids in the development of disease symptoms. Isocoumarins are known for their biological activity toward plant growth (Kameda et al. 1973), and for their effects on biological membrane structure (Glass and Dunlop

1974). Hemingway et al. (1977) isolated three phenolic acids from liquid cultures of *C. minor* and from infected tissues of loblolly pine. The most abundant compound was 6,8-dihydroxy-3-hydroxymethyl isocoumarin (fig. 1), a previously unknown fungal metabolite. Isolated also was 6,8-dihydroxy-3-methyl isocoumarin, but in much smaller amounts (fig. 1). A third compound, 3,6,8-trihydroxy- α -tetralone, was isolated from liquid culture, but was not detected in extracts from infected tissues.

Fungal isolates of *C. minor*, obtained from Dr. J. R. Bridges, of the U.S. Forest Service's Southern Forest Experiment Station at Pineville, LA. were grown in liquid shake culture on 2.5 percent malt extract broth. After 21 days at room temperature, cultures were saturated with NaCl (35g/100ml) and filtered through rayon or cotton balls to remove large particulate matter and hyphae. These filtrates ranged in pH between 3.5 and 4.0. Filtrates were then neutralized with 0.1M sodium bicarbonate and extracted twice with chloroform, then acidified (pH 2) with 17 percent HCL and extracted five times with reagent grade ethyl acetate (1/2 v/v). Two fractions were present in the ethyl acetate: a yellow to reddish-brown, soluble component and a dark brown, insoluble resinous material. The resinous material was collected and washed repeatedly with ethyl acetate to recover completely the soluble component. Ethyl acetate extracts were concentrated under reduced pressure at 60 degrees C in a water bath. After evaporation of the ethyl acetate, the remaining reddish-brown, water-soluble residue was dissolved in a minimum volume of distilled water and stored at 5 degrees C.

Thin-layer chromatography (TLC) and solid-probe mass spectrophotometry (MS) were used to determine the number of compounds present in the final extract, and their identity based on work by

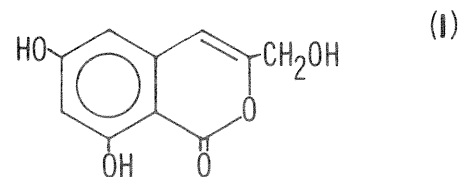

6,8-Dihydroxy-3-hydroxymethyl isocoumarin

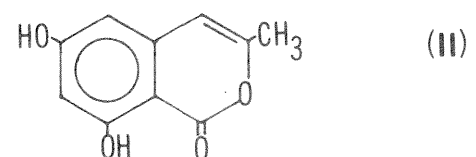

6,8-Dihydroxy-3-methyl isocoumarin

Figure 1.—Major phenolic metabolites isolated from liquid shake cultures of *C. minor*.

Hemingway et al. (1977) and McGraw and Hemingway (1977). The major phenolic metabolite recovered from shake culture under our conditions was 6,8-dihydroxy-3-hydroxymethyl isocoumarin (compound I). This compound was crystallized from water by chilling the solution, and subjected to solid-probe MS to confirm its identity. Lesser amounts of 6,8-dihydroxy-3-isocoumarin were recovered and tentatively identified by TLC.

Terminal branches were cut from greenhouse-grown 1-2-year-old loblolly pine seedlings that had been brought into the lab and held for 24 hours under constant light. Terminals were then weighed and recut under water and placed in 125 ml plastic Ehrlenmeyer flasks that had the tops sealed with Parafilm around the stem of the terminal. Flasks and terminals were weighed at intervals using a top-loading analytical balance, and water loss calculated as the difference in weights between successive periods. Flasks were kept full of solution by adding half strength Hoagland's nutrient solution as necessary. Transpiration rates were expressed as grams of water loss per hour per gram fresh weight of terminals. All experiments were conducted in a controlled-environment chamber at 26-28° C under constant light. All seedlings and terminals were randomly assigned to treatments.

Solutions of partially purified isocoumarins were added to flasks containing the terminals. Since not enough crystallized compound I could be obtained to serve as an authentic standard on which to base a quantitative assay, applied dose is presented in terms of absorbance (in water) at 329 nm of the final solution.

Findings

Solutions of isocoumarins produced striking effects on transpiration (fig. 2). Within 15-30 hours after treatment, the transpiration rate (mg/h/gfw) was nearly doubled in treated terminals compared to untreated controls. After the early peak in transpiration, treated terminals exhibited a rapid decline in transpiration to levels below those of controls (fig. 2).

Wilt-causing toxins operate through disruption of membranes, interference with stomatal regulation of transpiration and reduction in waterflow through the stem by vascular plugging or increased sap viscosity (Van Alfen and Turner 1975). It has been demonstrated that later stages of *Ceratocystis* infection in pines are characterized by xylem blockage probably resulting from aspiration of tracheids (e.g., Nelson 1934; Paine 1984). Early stages of infection (within a few days after successful beetle attack) now appear to be characterized by symptoms brought about by

fungal toxins. The dominant effect of these compounds may be to induce temporary tree water deficits and thereby lower the tree's defensive capacity by reducing oleoresin exudation at the time of greatest beetle activity.

Data presented by Lorio and Hodges (1968) show that oleoresin exudation pressure (OEP) varies diurnally with vapor pressure deficit (VPD), and while VPD was not directly related to plant water status, an assumption can be made for a correlation between VPD and water potential when soil water is limited. Rapid and short-term water stress was related to reduction in OEP and the tree's overall defensive capacity.

Stomata regulate exchange of carbon dioxide and water vapor between leaf mesophyll cells and the bulk air surrounding the leaf. Epidermal cells surrounding guard cells have a mechanical advantage over guard cells that is proportional to the area of contact between the two cell types, and thus regulate movement by supplying a counterforce to opening. Because of this mechanical advantage of epidermal cells over adjacent guard cells, stomata would be expected to close while guard cell pressure still exceeds that of epidermal cells (DeMichele and Sharpe 1973). Epidermal cell osmotic potential determines the leaf water potential at which stomata open. Epidermal turgor is responsible for positive hydropassive feedback in this regulatory scheme. Total volume of epidermal cells is at least 30 times

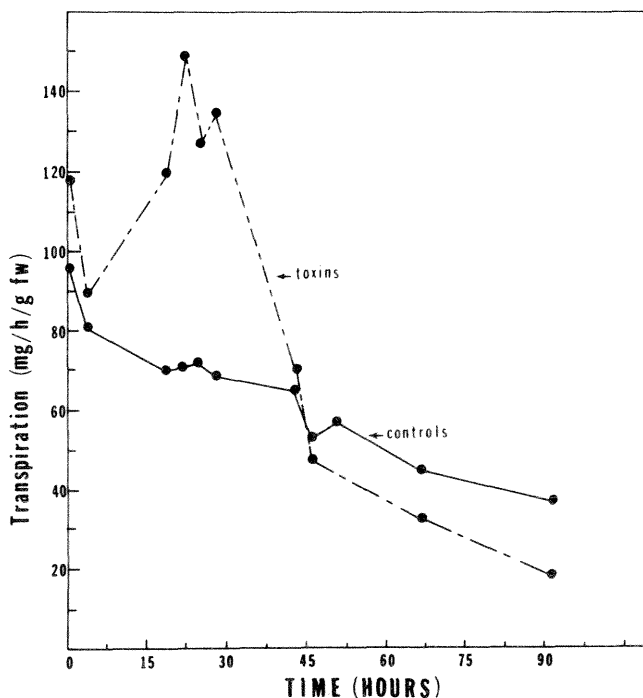

Figure 2.—Effects of isocoumarin solutions on transpiration in loblolly pine. Means of three terminals are plotted. Dose: absorbance (329 nm) = 1.94.

greater than that of guard cells. Turgor pressure is produced in guard and epidermal cells by osmotic pressure exerted by imported potassium ions in association with intracellular organic anions and imported chloride ions (Raschke 1975).

This study proposes that isocoumarins produced during the early phase of beetle attack and fungal inoculation are transported to needles in the transpiration stream and affect ion leakage principally in epidermal cells (DeAngelis et al. 1985). This leakage would lower turgor in the epidermal cells surrounding the guard cells and allow stomata to open because of reduced counterforce. Disruption of stomatal function in this fashion would adversely affect the tree's defensive posture by lowering water content through the bole and affecting lowered OEP.

INFLUENCE OF DISTURBANCES ON TREE RESISTANCE

Thinning-related injuries have been suspected of predisposing injured residual trees to bark beetle attack. To substantiate this, we initiated investigations in two loblolly pine stands representing two distinct sites (bottomland and upland). These stands were manually thinned to basal areas of 90 square feet. Simulated thinning damage in the form of bole wounding, two levels of root injury, and their combinations was applied to residual trees. Bole wounding was inflicted using hand knives, and root injury with a Ditch Witch. The following data were recorded before and after wounding: total resin flow for 8 hours, initial flow rate, relative resin viscosity, oleoresin exudation pressure, levels of total and individual monoterpenes, and stem electrical resistance. The monoterpene fraction was analyzed chromatographically by flame ionization detection (Blanche et al. 1985a). Measurements of resin physical properties were described in detail earlier (Nebeker et al. 1983).

Results (Nebeker et al. 1983; Nebeker and Hodges 1983) showed that resin flow and viscosity were significantly affected by the treatments. Basal wounding alone and in combination with root pruning caused an increase in total resin flow for the first 2 months after being applied. This suggests that, at least initially, basally wounded trees may have an enhanced resistance to beetle attack. Total monoterpene level was unaffected by the treatments.

In a replicated study, Blanche et al. (1985a) sought to determine whether the same patterns of change in host conditions are repeatable when treatments are imposed during the fall rather than in spring. It was shown that root pruning on two sides initially reduced total amount of resin flow, whereas basal wounding stimulated it. These effects, however, dis-

appeared after 7 months. Basal wounding alone and together with root pruning induced lower initial resin flow rates than occurred in control and root-pruned trees. Total monoterpene levels and alpha-pinene increased in response to thinning injury. This response is similar to the effect on loblolly pine xylem monoterpene caused by moisture stress reported by Hodges and Lorio (1975). Results also indicate that the more viscous the resin, the less the total resin flow and the lower the total monoterpene content. Basal wounding alone caused a decline in stem electrical resistance, whereas root pruning on two sides caused an increase. These observations indicate that root damage may increase susceptibility to bark beetle attack, whereas bole scarring may temporarily reduce it. Moreover, based on these studies, it seems that trees injured during the spring recover much faster than those injured during the fall.

In the course of these investigations, a lightning strike on an experimental plot on April 29, 1982, provided an opportunity to investigate changes in host characteristics that might explain the observed preference by bark beetles for lightning-struck pines. We found that xylem resin flow was too low to be measured for the first few days after the strike, but flow was restored after 3 weeks. The content of known beetle-attractive monoterpenes (alpha-pinene, camphene, and myrcene) in the oleoresin increased 3 weeks after the strike, whereas the level of beta-pinene showed a dramatic decline. Limonene and beta-phellandrene also decreased. Based on these and other observations, it appears that lightning-struck trees serve as major focal points of bark beetle infestations for one or all of the following reasons: (a) Increased susceptibility due to a reduction in xylem resin flow immediately after the strike (Blanche et al. 1985b); (b) increased attractiveness to SPB as a result of quantitative changes in the monoterpene fractions (Blanche et al. 1985b); and (c) increased suitability due to an alteration in carbohydrate levels and a reduction in relative water content of the bark (Hodges and Pickard 1971).

HOST VIGOR AND METHODS OF EVALUATION

Host vigor considerations are essential to better pest management decisionmaking. Although the concept of vigor is somewhat nebulous, we earlier defined it as the overall state of the host as reflected in the different degrees of metabolic activities (synthetic vs degradative processes) (Blanche et al. 1983). We also indicated that radial growth is one manifestation of the net effect of these metabolic activities.

During 1982, we initiated several studies aimed at providing basic information for the development of

a vigor indexing system for loblolly pine. These investigations took two major directions, one using standardized growth and the other using stem electrical resistance (SER). The former involves growth variables such as basal area increment, sapwood area, and stemwood produced per unit of leaf area. The major objection to this technique is that it indicates past performance (vigor history) rather than current vigor. Thus, SER was also tested since it should more closely reflect the current physiological status of the tree.

Study Methods

Because of the lack of a distinct boundary between sapwood and heartwood of living loblolly pines, we first had to develop an effective technique for differentiating between them. This was accomplished by screening 20 different solutions known to stain different wood constituents. Three of the solutions (diazotized benzidine dihydrochloride, 2-methoxyaniline and fast blue) effectively distinguished the sapwood-heartwood boundary (Blanche et al. 1984). The basis for the differentiation is the higher concentration of phenolic compounds in the heartwood. Because phenolic compounds fluoresce, it is also possible to differentiate between heartwood and sapwood using an ultraviolet light source, and the results are identical to those obtained with the three stains.

It was found that sapwood thickness was not constant but was linearly related to d.b.h. as follows:

$$Y = 0.36X + 0.244 \quad (r = 0.964)$$

where,

Y = sapwood thickness in cm

X = outside bark diameter at breast height in cm.

It was concluded that for a single-aged stand, sapwood thickness can be a reliable indicator of tree vigor in loblolly pines.

Once we could effectively distinguish between sapwood and heartwood, the following questions were addressed as they related to vigor assessment:

(a) How does stem cross-sectional sapwood area relate to leaf area?

(b) Does time of foliage sampling affect the sapwood area-leaf area relationship? and

(c) How do specific leaf area (SLA) and leaf area-sapwood area ratios vary among individual trees?

To answer these questions, we destructively sampled 45 loblolly pine trees from 14 natural stands in East Central Mississippi ranging in age from 17 to 80 years and in diameter from 14 to 58 cm. Sampling was done in May and again in late summer (mid-August through mid-September) with the following information recorded for each tree: total height; height to first live limb; bark thickness; radial increments (current year, last year, and last 5 years);

total cross-sectional sapwood area at breast height, midbole, and base of crown; total fresh weight of the needles, and specific leaf areas of needles subsampled throughout the crown length. Stemwood production was calculated from stem analysis by converting volume increment to weight increment using a constant specific gravity of 0.48 (U. S. Forest Service 1974), and then eventually expressed as grams of stemwood produced per square meter of foliage area.

Results

Sapwood cross-sectional area was found to be linearly related to leaf area, with the best correlation obtained using sapwood area taken at the base of the live crown (Blanche et al. 1985c). Correlation was further improved when the variables were sampled at time of maximum needle biomass (mid-August through mid-September).

Specific leaf area (area in sq. cm/g dry weight) was variable, but the mean of 95.32 is comparable to reported values for loblolly pine and other pine species. The leaf area/sapwood area ratio (sq. m/sq. cm) at breast height varies slightly among individual trees so that a mean ratio of $0.29\text{m}^2 + 0.029\text{m}^2/\text{cm}^2$ may be utilized to predict leaf area. Tree vigor values (gram stemwood produced per sq. m of leaf area) varied greatly (21-180 g/sq. m foliage) suggesting the possibility of developing vigor classes that are more meaningful than the traditional crown class distinctions. The absence of validating data from infested and noninfested trees or stands prevented us from defining discrete vigor classes in relation to bark beetle susceptibility. However, Mitchell et al. (1983) found that unthinned and lightly thinned lodgepole pine stands with current stemwood production of less than 80 g/sq. m of foliage suffered significant beetle mortality; while heavily thinned stands with a mean vigor rating of greater than 120 did not have beetle-caused mortality. Since this method of vigor expression is based on standardized growth, it allows comparisons of vigor for trees from different sites and stages of development.

During the summer of 1984, an extensive sampling of SPB infestations was undertaken in Alabama, Mississippi, Louisiana, and Texas with the objective of validating data for the tree vigor indexing system (g stemwood produced per sq. m of leaf area). Successfully attacked trees and those that resisted attacks were destructively sampled and the following information recorded: total height; height to the lowest live limb; total needle biomass; cross-sectional sapwood areas at breast height, midbole, and base of crown; bark thickness, diameter; radial increment (current year and last year); tree age, and SPB

attack density (number of attacks per sq. m of bark surface).

Unfortunately, vigor could not be evaluated on the basis of stemwood produced per sq. m of leaf area because a lot of foliage on the successfully attacked trees was lost before or at the time of sampling. Therefore, we utilized last year area increment as a percent of total cross-sectional sapwood area as a measure of tree vigor. Results revealed that most of the successfully attacked trees had a vigor rating of less than 5 percent, whereas most of those that resisted attacks had a vigor rating of 9 percent or more (Blanche et al. 1985c). An attack density threshold function that distinguished trees that resisted attack from those that succumbed was defined by the equation:

$$Y = 15 + 25 X \text{ (with an upper limit at } Y = 500)$$

where,

Y = attack density (# of attacks/sq. m of bark surface)

X = host vigor as ($[\text{last year's area increment/sapwood area}] \times 100$).

These results indicate that at least 140 beetle attacks are required to kill a loblolly pine with a vigor rating of 5 percent. The threshold function is valid for all values of Y less than 500. At a beetle attack density of 500 or more, there apparently is no such thing as a resistant loblolly pine.

Further analysis of our data demonstrated that vigor decreases with age (fig. 3) as described by the regression equation:

$$Y = 23.98 - 0.79X + 0.0072X^2 \text{ (} r^2 = 0.64)$$

where,

X = host vigor

Y = tree age.

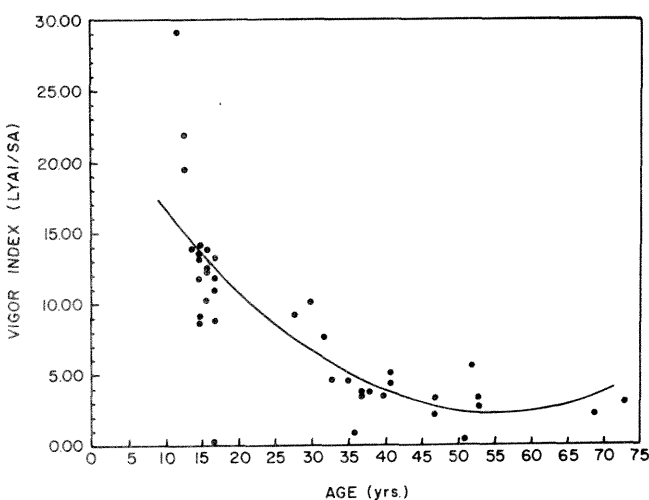

Figure 3.—*Loblolly pine tree vigor (%) as a function of age.* (LYAI = last year xylem area increment in sq. cm; SA = sapwood cross-sectional area in sq. cm.)

This suggests that older trees are more susceptible to beetle attacks than are younger ones.

SER was also tested as an indicator of tree vigor since it supposedly reflects the current physiological state of the tree. SER is measured in K ohms using a field ohmmeter (Osmose Shigometer Model OZ-67). In theory, the lower the resistance reading, the higher the vigor of the tree. We performed a series of investigations to: (a) Determine whether site index influences SER; (b) test whether crown classes can be effectively differentiated by SER; (c) determine how SER is related to xylem area growth, air and soil temperature, and soil moisture, and (d) describe the seasonal variation in SER.

We resolved objectives (a) and (b) by examining 28 loblolly pine plantations in East Central Mississippi and West Central Alabama. These stands ranged in age from 21 to 26 years with average d.b.h. of 15.5 to 28.7 cm and average stand density of 1,284 trees per hectare. Site indices in meters at age 25 ranged from 14 to 28. Results (Blanche et al. 1985d) indicated that SER of loblolly pine trees in plantations is independent of site index. SER effectively differentiated between trees in the dominant, intermediate, and overtopped crown classes. This may correspond to a separation into high, medium, and low vigor classes, respectively, but it is also possible to separate trees into more than three classes.

Monthly measurements of SER on dominant trees from six plots with varying site indices revealed a definite seasonal pattern (fig. 4). SER was lowest in June, July, and August, coinciding with the period of most active growth, and highest during the dormant period (winter). This suggests the time of sampling should be taken into consideration when comparing vigor of different stands.

In an attempt to clarify some of the factors complicating SER, we monitored the SER of 30 trees in a 25-year-old stand on a bottomland site and another 30 trees in a comparable stand on an upland site from May to October. Data were also obtained on air and soil temperature and soil moisture. Xylem area growth, sapwood area, and d.b.h. were measured at the end of the growing season. SER was found to be inversely related to all the above variables except soil moisture, which was positively correlated with SER of trees on the bottomland site but negatively correlated with SER of trees on the upland site. This observation suggests that trees on the bottomland site were stressed by the occasional flooding, thus likely rendering them more vulnerable to beetle attack. Of all the variables, air temperature was the most closely correlated ($r = -0.98$) with SER, which may explain the significance of seasonality in SER.

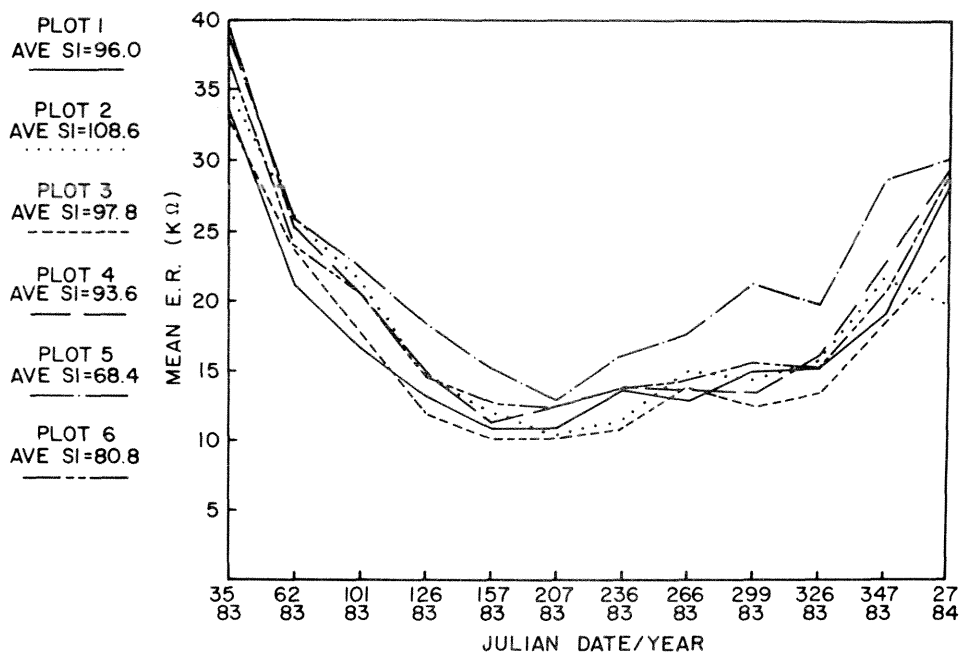

Figure 4.—Monthly stem electrical resistance readings on loblolly pine trees from stands of varying site indices.

CONCLUSIONS

The study demonstrated that SER can be used to rate the vigor of individual trees in a given stand. Trees can be classified into low or high vigor classes using the SER mean as the dividing line or into several classes delineated by dividing the range of SER values into the desired number of classes.

LITERATURE CITED

- Anderson, N.H.; Anderson, D.B. *Ips* bark beetle attacks and broad development on a lightning-struck pine in relation to its physiological decline. *Florida Entomologist* 51(1): 23–30; 1968.
- Anderson, R.F. *Forest and shade tree entomology*. New York: John Wiley and Sons; 1960. 428 p.
- Basham, H.G. Wilt of loblolly pine inoculated with blue-stain fungi of the genus *Ceratocystis*. *Phytopathology* 60: 750–754; 1970.
- Blanche, C.A.; Hodges, J.D.; Nebeker, T.E.; Moehring, D.M. Southern pine beetle: the host dimension. *Miss. Agric. For. Exp. Sta. Bull.* 917. Mississippi State, MS: Mississippi State University; 1983. 29 p.
- Blanche, C.A.; Nebeker, T.E.; Schmitt, J.J.; Hodges, J.D. Techniques for distinguishing the sapwood-heartwood boundary in living loblolly pine (*Pinus taeda* L.). *Forest Science* 30(3): 756–760; 1984.
- Blanche, C.A.; Nebeker, T.E.; Hodges, J.D.; Karr, B.L.; Schmitt, J.J. Effect of thinning damage on bark beetle susceptibility indicators in loblolly pine. In: Shoulders, E., ed. *Proceedings, third biennial southern silvicultural research conference*; 1984 November 7–8; Atlanta, GA. Gen. Tech. Rep. SO-54. New Orleans, LA: U.S. Department of Agriculture, Forest Service, Southern Forest Experiment Station; 1985a: 471–479.
- Blanche, C.A.; Hodges, J.D.; Nebeker, T.E. Changes in bark beetle susceptibility indicators in a lightning-struck loblolly pine. *Canadian Journal of Forest Research* 15: 1985b. [In press].
- Blanche, C.A.; Hodges, J.D.; Nebeker, T.E. A leaf area/sapwood area ratio developed to rate loblolly pine tree vigor. *Canadian Journal of Forest Research*. 1985c. [In press].
- Blanche, C.A.; Schmitt, J.J.; Nebeker, T.E.; Hodges, J.D.; Honea, C.R. The applicability of stem electrical resistance in rating loblolly pine tree vigor; 1985d. [Unnumbered report].
- Blanche, C.A.; Nebeker, T.E.; Hodges, J.D.; Honea, C.R. Threshold southern pine beetle attack densities required to overcome varying host resistance. 1985e. [Manuscript in preparation].
- Coyne, J.F. Chemical mechanisms of resistance. In: *Proceedings, 18th southern forest insect work conference, 1973 August 14–16; Jackson, MS; 1973*.
- Coyne, J.F.; Lott, L.H. Toxicity of substances in pine oleoresin to southern pine beetles. *Journal of the Georgia Entomological Society* 11(4): 297–301; 1976.
- DeAngelis, J.D.; Hodges, J.D.; Nebeker, T.E. Phenolic metabolites of *Ceratocystis minor* (Hedcock) from laboratory cultures and their effects on transpiration in loblolly pine seedlings. *Canadian Journal of Botany*; 1985. [In press].

- DeMichele, D.W.; Sharpe, P.J.H. A parametric analysis of the anatomy and physiology of the stomata. *Agricultural Meteorology* 14: 229-241; 1974.
- Glass, A.D.M.; Dunlop, J. Influence of phenolic acids on ion uptake. Part 4. Depolarization of membrane potentials. *Plant Physiology* 54(6): 855-858; 1974.
- Hemingway, R.W.; McGraw, G.W.; Barras, S. Polyphenols in *Ceratocystis minor*-infected *Pinus taeda*: fungal metabolites, phloem and xylem phenols. *Agriculture Food Chemistry* 25(4): 717-722; 1977.
- Hodges, J.D.; Nebeker, T.E.; DeAngelis, J.D.; Karr, B.L.; Blanche, C.A. Host resistance and mortality: an hypothesis based on the southern pine beetle-microorganism-host interaction. *Bulletin of the Entomological Society of America*; 1985. [In press].
- Hodges, J.D.; Elam, W.W.; Watson, W.F.; Nebeker, T.E. Oleoresin characteristics and susceptibility of four southern pines to southern pine beetle (Coleoptera: Scolytidae) attacks. *Canadian Entomology* 111: 889-896; 1979.
- Hodges, J.D.; Elam, W.W.; Watson, W.F. Physical properties of the oleoresin system of the four major southern pines. *Canadian Journal of Forest Research*. 7: 520-525; 1977.
- Hodges, J.D.; Lorio, P.L., Jr. Moisture stress and composition of xylem oleoresin in loblolly pine. *Forest Science* 21: 283-290; 1975.
- Hodges, J.D.; Lorio, P.L., Jr. Comparison of oleoresin composition in declining and healthy loblolly pines. Res. Note SO-158. New Orleans, LA: U.S. Department of Agriculture, Forest Service, Southern Forest Experiment Station; 1973. 4 p.
- Hodges, J.D.; Lorio, P.L., Jr. Measurement of oleoresin exudation pressure in loblolly pine. *Forest Science* 14(1): 75-76; 1968.
- Hodges, J.D.; Pickard, L.S. Lightning in the ecology of the southern pine beetle, *Dendroctonus frontalis* (Coleoptera: Scolytidae). *Canadian Entomology* 103: 44-51; 1971.
- Kameda, K.; Tanaka, H.; Namiki, M. Studies on metabolites of *Alternaria kikuchiana* Tanaka, a phytopathogenic fungus of Japanese pear. *Agricultural and Biological Chemistry* 37(9): 2137-2146; 1973.
- Lorio, P.L., Jr.; Hodges, J.D. Tree water status affects induced southern pine beetle attack and brood production. Res. Pap. SO-135. New Orleans, LA: U.S. Department of Agriculture, Forest Service, Southern Forest Experiment Station; 1977. 7 p.
- Lorio, P.L., Jr.; Hodges, J.D. Host and site factors in southern pine beetle infestations. In: Payne, T.L.; Coulson, R.W.; Thatcher, R.C., eds. Proceedings, southern pine beetle symposium. College Station, TX: Texas Agriculture Experiment Station and U.S. Department of Agriculture, Forest Service; 1974: 32-34.
- Lorio, P.L., Jr.; Hodges, J.D. Oleoresin exudation pressure and relative water content of inner bark as indicators of moisture stress in loblolly pines. *Forest Science* 14(4): 392-398; 1968a.
- Lorio, P.L., Jr.; Hodges, J.D. Microsite effects on oleoresin exudation pressure of large loblolly pines. *Ecology* 49(6): 1207-1210; 1968b.
- Mason, R.R. Soil moisture and stand density affect oleoresin exudation flow in a loblolly pine plantation. *Forest Science* 17(2): 170-177; 1971.
- McGraw, G.W.; Hemingway, R.W. 6,8-Dihydroxy-3-hydroxymethylisocoumarin, and other phenolic metabolites of *Ceratocystis minor*. *Phytochemistry* 16: 1315-1316; 1977.
- Mitchell, R.G.; Waring, R.H.; Pitman, G.B. Thinning lodgepole pine increases tree vigor and resistance to mountain pine beetle. *Forest Science* 27(1): 204-211; 1983.
- Nebeker, T.E.; Hodges, J.D. Influence of forestry practices on host susceptibility to bark beetles. *Zeitschrift fur Angewandte Entomologie* 96(2): 194-208; 1983.
- Nebeker, T.E.; Moehring, D.M.; Hodges, J.D.; Brown, M.W.; Blanche, C.A. Impact of thinning on host susceptibility. In: Jones, E.P., Jr., ed. Proceedings, second biennial southern silvicultural research conference; 1982 November 4-5; Atlanta, GA. Gen. Tech. Rep. SE-24. Asheville, NC: U.S. Department of Agriculture, Forest Service, Southeastern Forest Experiment Station; 1983: 376-381.
- Nelson, T.C. Effect of blue-stain fungi on southern pine attacked by bark beetles. *Phytopathology Zeitschrift Bd. 7 Hft 4*: 327-353; 1934.
- Paine, T.D. Influence of the mycangial fungi of the western pine beetle on water conduction through ponderosa pine seedlings. *Canadian Journal of Botany* 62(3): 556-563; 1984.
- Raschke, K. Stomatal action. *Annual Review of Plant Physiology* 26: 309-340; 1975.
- Thatcher, R.C. Bark beetles affecting southern pines: a review of current knowledge. Occasional Paper 180. New Orleans, LA: U.S. Department of Agriculture, Forest Service, Southern Forest Experiment Station; 1960. 25 p.
- U.S. Forest Service, Forest Products Laboratory. Wood handbook: wood as an engineering material. Agric. Handb. 72. Washington, DC: U.S. Department of Agriculture; 1974: 1-15.
- Van Alfen, N.K.; Turner, N.C. Influence of a *Ceratocystis ulmi* toxin on water relations of elm (*Ulmus americana*). *Plant Physiology* 55: 312-336; 1975.

Induced Defenses Against *Dendroctonus Frontalis* and Associated Fungi: Variation in Loblolly Pine Resistance

T. D. Paine, F. M. Stephen, and R. G. Cates¹

Abstract.—The impact of the host tree resistance on southern pine beetle population dynamics has been identified as a critical element needed to improve the predictions of spot growth simulation models. Host resistance, as determined by the size of the induced hypersensitive response, varies both in total size and rate of formation during the year. Trees produce larger lesions in response to infection by the blue-staining form of *C. minor* than to infection by either mycangial fungus or sterile wounding, and there were no differences in the size of the response to either of the mycangial fungi or sterile controls. Smaller lesions are produced by more highly stressed trees than in less stressed trees. This suggests that trees with differing levels of vigor or stress have differing levels of resistance and as a result may influence colonizing beetles differently. Individual tree death and the risk of spot growth can be described by two conceptual models that incorporate tree condition and changes in tree defense through the year with southern pine beetle population parameters that include population size, attack rate, and attack density.

Additional keywords: Host resistance, plant stress, hypersensitive response, mycangial fungi, tree susceptibility.

INTRODUCTION

Substantial research effort has been directed toward the development of southern pine beetle population dynamics models during the last 10 years (Hines et al. 1980; Taha and Stephen 1984; Stephen and Lih 1985; Feldman et al. 1981, 1985). The Arkansas model (Stephen and Lih 1985) has been

successful in simulating the dynamics of infestations originating in stands similar to those used originally in the development of the model. However, such models are not as successful in predicting infestation growth in stands of greatly different characteristics or at all times of the year. We postulate that part of the reason for this is a lack of information on how tree susceptibility and/or suitability changed throughout the year and how tree resistance mechanisms influenced the population dynamics of colonizing beetles.

Stands of southern pines vary in their susceptibility to infestation by the southern pine beetle. Resistant trees can be functionally defined as those having the capacity to absorb more beetles before dying than do susceptible ones. The resistance characteristic spans a continuum from highly resistant to highly susceptible, with the resistant trees having quantitatively or qualitatively more physiological attributes conferring resistance than more susceptible trees.

There are two recognized defense systems in conifers, a preformed resin system and an induced hypersensitive response (Berryman 1972), and these are particularly well developed in loblolly pines (*Pinus taeda* L.) Conifer defenses are generally thought to be effective against bark beetles and associated fungal pathogens. However, the defense mechanisms may have evolved as general defenses against stem invasion rather than against bark beetles in particular. The expression of these resistance mechanisms may be used as a measure of tree vigor in repelling stem invasion.

The primary form of conifer defense is the preformed resin system. The resin system has a number of characteristics that have been associated with resistance, including resin flow rate, total flow, viscosity, crystallization rate (Hodges et al. 1979), resin pressure (Vité and Wood 1961, Lorio and Hodges 1977), and resin composition (Coyne and Lott 1976, Smith 1966). Resin ducts are initiated at the cambial initials, and the number of ducts is a function of time of year and plant stress (Werker and Fahn 1969). Sapwood resin is secreted into both vertical and radial resin ducts by thin-walled epithelial cells. The cells lining the ducts can swell under turgor pressure which, in turn, exerts pressure on the resin within the central cavity. When the ducts are disrupted, resin flows under pressure from both ends of the disrupted duct and from vertical ducts connected in

¹ Respectively, Research Associate and Professor, Department of Entomology, University of Arkansas, Fayetteville, AR; and Associate Professor, Chemical Ecology Laboratory, University of New Mexico, Albuquerque, NM. (This contribution is published with the approval of the Director, Arkansas Agricultural Experiment Station. We appreciate greatly the cooperative effort in both the field and open detailed discussions with T. E. Nebeker, J. R. Bridges, P. J. H. Sharpe, P. L. Lorio, and J. D. DeAngelis. The cooperation has benefited all the projects aimed at determining host tree impact of the southern pine beetle. We also thank the IPM Program management, particularly R. C. Thatcher, for their continued support.)

a radial plane via a horizontal duct. A tree under stress may have fewer ducts, consequently produce less total resin, and resin may be under less pressure (Fahn 1970).

Individual resin constituents may be toxic to non-adapted bark beetles and to invading fungi (Smith 1963). However, the flow of resin under pressure acts to flush invading beetles and their associated fungi (the mycangial fungi *Ceratocystis minor* var. *barrasii* and an unidentified basidiomycete, plus the nonmycangial blue-staining form of *C. minor*) out of the tree (Hodges et al. 1985). Low rates of flow and low oleoresin pressure have thus been associated with susceptibility to southern pine beetle (Mason 1971, Lorio and Hodges 1977).

The potential physical action of resin flow from disrupted resin ducts and the potential toxicity of resin composition exist *in situ* prior to insect colonization. The resin system may also be a form of carbon storage since there is a continual turnover of monoterpenes. However, the hypersensitive reaction is initiated only following invasion by the insect or fungi (Berryman 1972). This system is energy-demanding and is initiated only at the sites of infection rather than as a systemic response (Raffa and Berryman 1983, Paine 1984). Thus, it is a conservative defense system.

The infected areas in loblolly pines are initially soaked with resin (Stephen et al. 1983). Resin constituents of the hypersensitive response of lodgepole pine to *D. ponderosae* colonization have been demonstrated to be fungistatic (Shrimpton 1973; Shrimpton and Whitney 1979). The invaded tissue is surrounded by callus cells originating from the cambium (Wong and Berryman 1977). Subsequently, this resin-soaked zone dies and is surrounded by newly formed periderm (Shrimpton 1978). The hypersensitive reaction has been observed in response to both colonizing beetles and inoculated fungi (Reid et al. 1967, Shrimpton 1978, Paine 1981, Stephen et al. 1983).

SOURCES OF VARIATION IN RESISTANCE

Characterization of the types of resistance mechanisms found in loblolly pine was insufficient to evaluate the impact of host vigor on population dynamics and improve model predictions. The objectives of the research proposed under the Integrated Pest Management Program were to: 1) Evaluate tree resistance to southern pine beetle and to develop a resistance profile for stands of trees; 2) establish a functional relationship between tree and stand resistance and

SPB population dynamics; and 3) integrate stand resistance with population and damage prediction models. While much of the research at the University of Arkansas to satisfy these objectives has concentrated on characterizing the inducible or hypersensitive mechanism of loblolly pine resistance to stem invasion (Stephen et al. 1985), research elsewhere has focused on the preformed defense system (Hain and Perry 1985, Hodges and Nebeker 1985, Lorio 1985). Integrating the results from these cooperative efforts will result in a more complete understanding of host defenses.

New beetle infestations are frequently initiated in the spring of the year and decline during the winter. This pattern can be partially related to the effects of temperature on insect development, and to the availability of susceptible hosts resulting from lightning strikes (Coulson et al. 1983). Lorio and Hodges (1985) hypothesized that the balance of available energy allocated to cellular growth and differentiation (particularly relating to resin duct formation in late-versus earlywood) may play a key role in bark beetle infestation patterns. We have established that healthy trees show a seasonal pattern in the expression of their induced defenses (Stephen and Paine 1985). Except during the coldest months of the year, trees growing on the same site respond to monthly fungal infection by producing lesions that are the same length (fig. 1). During the months of November, December, and January, these lesions are significantly smaller than during the rest of the year, and during September, significantly longer.

The ultimate size of the response, however, may not be as critical to successful defense as the rate of lesion formation. Trees respond with the same size lesions during both the spring and summer, but the rate of response differs significantly (fig. 2). During the summer months, maximum lesion size is achieved during the first week following inoculations. In the spring, however, lesions are not fully developed until 3 weeks after inoculation (Stephen and Paine 1985). This suggests that the tree may be more vulnerable to prolonged attacks during the spring, and conversely implies that beetles attacking at a similar rate during the summer would induce a quick response from the tree and would more likely be killed. However, a rapid rate of colonization may still result in tree death.

An additional study was conducted to examine the rate of the induced response on a much finer scale. Trees inoculated in June showed little response to infection with any combination of fungi during the first 60 hours, but then responded rapidly during the following 60 hours, achieving almost maximum lesion size during that time interval. This indicates that a

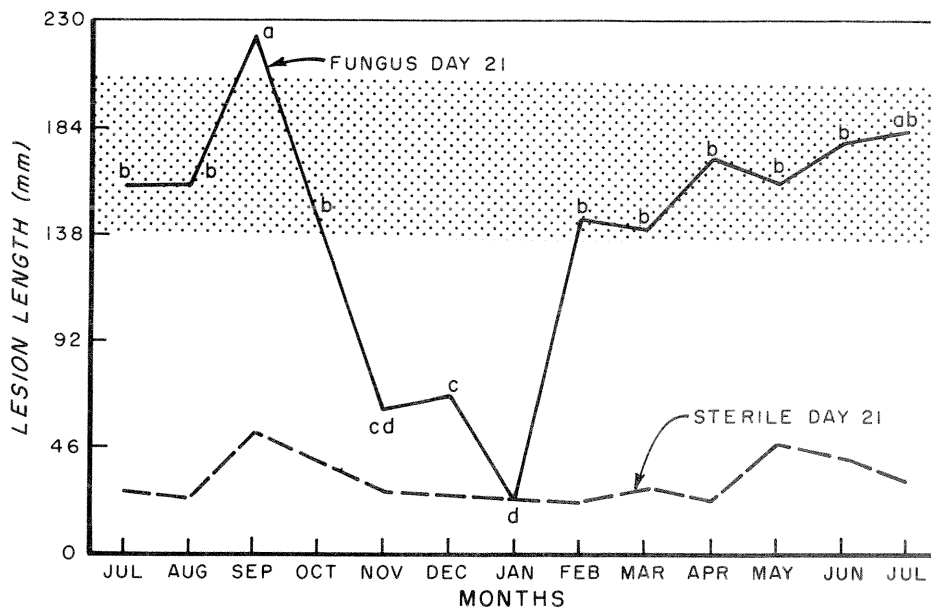

Figure 1.—Mean length of hypersensitive lesion produced in loblolly pines 21 days after inoculation with *C. minor* or sterile control. Shaded band represents most common lesion size, resulting from *C. minor* inoculation throughout the year (Stephen and Paine 1985).

rapid colonization phase by the beetle will overcome the tree before the induced system can be fully initiated. However, females attacking at a low density, over a prolonged period must deal with the induced system that responds rapidly after an initial lag period.

Other insights were obtained from these phenology studies. The most important resulted from comparison of the trees' response to combinations of the three fungi associated with the southern pine beetle. Preliminary studies suggest that trees respond very differently to the fungi. Although the rate of lesion formation is very similar for all fungi (Stephen and Paine 1985), the sizes of the responses are significantly different. In fact, lesions produced in response to either mycangial fungus were not significantly different from those seen following sterile wounding, but the response to the nonmycangial form of *C. minor* was significantly larger (Paine and Stephen 1985a). If the mycangial fungi do not stimulate the inducible defenses of the tree, this may provide an advantage to beetles that colonize trees while carrying these fungi but lacking *C. minor*, supporting the findings of Bridges (1985). This also suggests that the mycangial fungi may be more highly adapted as pathogens than the blue-staining type that has consistently been designated as the fungus responsible for tree death. Growth rates are not yet available for the two mycangial fungi, but the staining form of *C. minor* grows as much as 3 cm from the point of infection in the first

48 hours following inoculation and up to 5 cm within 6 days. However, the fungus is confined completely within the fully formed lesion after 3 weeks (Paine and Stephen 1985a).

The induced system, as one aspect of host tree defenses, has been used to characterize host vigor in other parts of North America (Safranyik et al. 1975, Peterman 1977). If the induced system is to be used as a vigor index for loblolly pine, it is important to determine whether the response is graded and related to the amount of inoculum, or whether the size is a characteristic of the tree. That is, will only a single size lesion be produced for a tree with a particular set of vigor characteristics? The size of the response does not seem to be dosage dependent. The same size responses were produced following inoculation with doses of fungi varying by a factor of eight, even if the size of the wound was not constant. Fungal infections induced significantly longer lesions than did sterile wounding or killed fungi at all but one dosage level (Paine and Stephen 1985b). In another experiment, there were no differences in the size of a control response in an inoculation pattern varying in density from 1 to 32 inoculation points per 10 square dm (Paine and Stephen 1985a). Equal dosages of fungi produced significantly different lesion sizes in trees of various diameter classes growing on the same site. These results suggest that a tree responds to infection independently of the amount of inoculum, but rather tree response may be a function of initial tree vigor.

RATE OF LESION GROWTH

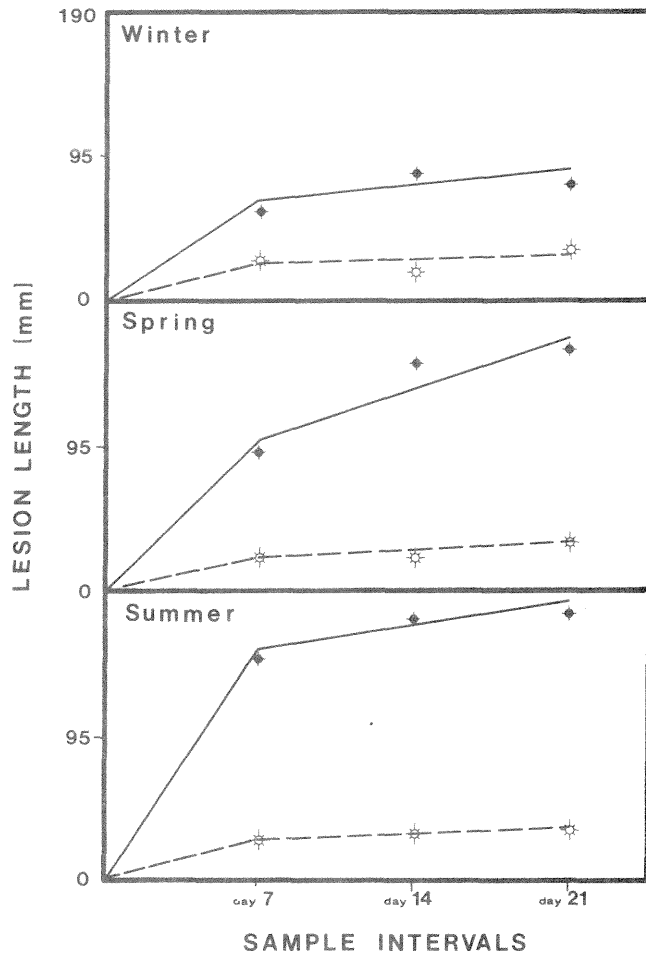

Figure 2.—Mean length of hypersensitive lesion produced in loblolly pines 7, 14, and 21 days after inoculation with *C. minor* or sterile control, grouped by season of the year (Stephen and Paine 1985).

It follows that inoculations of trees within a stand can be compared, and that the technique may be suitable to establish a vigor index.

The inoculation of *C. minor* could be used to distinguish among levels of tree stress. In an even-age stand, smaller trees, assumed to be stressed by competition, produced smaller lesions in response to infection than did dominant or codominant trees (Paine and Stephen 1985c). Also, trees growing on a poorly drained site (bottom plot) produced smaller lesions than did the same diameter trees growing on a ridge plot with better drainage (Paine and Stephen 1985d). The size of the response did not vary with the height of the inoculation, suggesting that the site of initial infestation by the beetle is probably not a function of variation in host defenses up the bole (Paine and Stephen 1985d). There were also no differences in the size of response between trees that had been inoculated previously compared to those initially inocu-

lated at the same time of year (Paine et al. 1985; Paine and Stephen 1985d). This suggests that the induced defense system is not sensitized by previous infection or beetle activity.

In addition to analyzing for differences in lesion size among trees of different stress levels and between plots, work done in conjunction with Dr. T. E. Nebeker at Mississippi State University has indicated differences in chemical composition of the lesion. Lesions from trees growing on the ridge plot had significantly lower composition (by percent) in myrcene and three unknown monoterpenes. However, lesions produced by trees growing on the ridge had significantly higher levels of β -phelandrene compared to those sampled on the less well-drained bottom site. There were also significant differences between the composition of liquid resin and the resin found within lesions for six of the nine monoterpenes common to both, as well as two compounds found in the lesions and not found in the preformed liquid resin (Nebeker et al. 1985).

Trees that are growing vigorously produce larger lesions than do more stressed trees. However, whether the induced system of tree defense has an impact on colonizing adults and their subsequent reproductive success is unclear. Field observations support the assumption that the tree responds to attacking females in the same manner as to the artificial inoculation, and that as a result, attacking adults can be killed. Laboratory studies also demonstrate the impact of these defenses. A higher degree of initial mortality was observed in adults forced to bore in the hypersensitive reaction tissue of trees that had been inoculated with *C. minor* 6 weeks prior to beetle introduction when compared with uninfected control log tissue. The test trees had completed the reactions to fungal inoculations before then and were felled and returned to the laboratory for insect colonization. This was probably due to the deposition of resins within the reaction zones and subsequent flow of those resins into the galleries. This experiment was designed to simulate a gradual attack process, where attacking adults may encounter developing lesions. Similarly, the number of progeny emerging from logs where adults constructed galleries in hypersensitive tissue was only 44 percent of the number emerging from the control tissue. These results are preliminary, and analyses are underway to determine whether fewer eggs were laid per adult female, or whether the developing progeny suffered a higher rate of mortality. Studies using wild populations of beetles in natural stands are also being analyzed, but in the highly controlled (yet somewhat artificial) laboratory studies, the induced system appears to have a strong influence on attacking and reproductive success.

RELATION OF DEFENSE AND BEETLE INFESTATIONS

Study results generated over the last 3 years suggest that trees varying in vigor also vary in the expression of resistance to stem invasion and that the level of resistance varies throughout the year. There is also an indication that the impact of resistance can extend temporally beyond the colonizing parent beetles and influence their reproductive rates. The potential effect of tree vigor on colonizing beetles has been incorporated indirectly into hazard-rating systems (Smith et al. 1981, Nebeker and Hodges 1983). Paine et al. (1984) have defined stand risk as the probability of an infestation starting and growing and have proposed a conceptual model that integrates stand condition (hazard) and bark beetle population levels (fig. 3). This model provides a mechanism for simulation models developed under one set of conditions to be applied broadly to other site and stand parameters. That is, by incorporating impact of host resistance of trees growing under a specific set of conditions and with a measurable vigor level on a colonizing beetle population of a certain size, the prediction capability of the simulation models can be refined.

The results from this and other research concerned

with host resistance of southern yellow pines have implications that are both biologically fascinating and important for forest management. The induced system shows a pattern of seasonal variation very similar to the pattern of resin synthesis and resin duct formation described by Lorio and Hodges (1985). The rate of lesion formation is much slower in the spring, the same time of year when resin synthesis is low and few resin ducts are formed in the sapwood. While conifer defenses have previously been thought of as two distinct systems, preformed and induced, it may be more realistic to think of them as an integrated system. Resin, initially at extremely low levels in (or absent from) inner bark (Cates et al. 1985), appears in the developing induced response too quickly to be produced solely from *de novo* synthesis. This resin may, in fact, be sapwood resin moving from xylem resin ducts through radial ducts into the phloem ducts. The concept of seasonal variation in overall tree defense, rather than an emphasis on one system or the other, may be critical to developing a better understanding of bark beetle outbreaks throughout the year (Sharpe et al. 1985).

Host defenses may not play a major role in protecting trees in an expanding infestation. Beetles colonizing rapidly and in large numbers over the surface of the tree bole can quickly kill most—if not all—

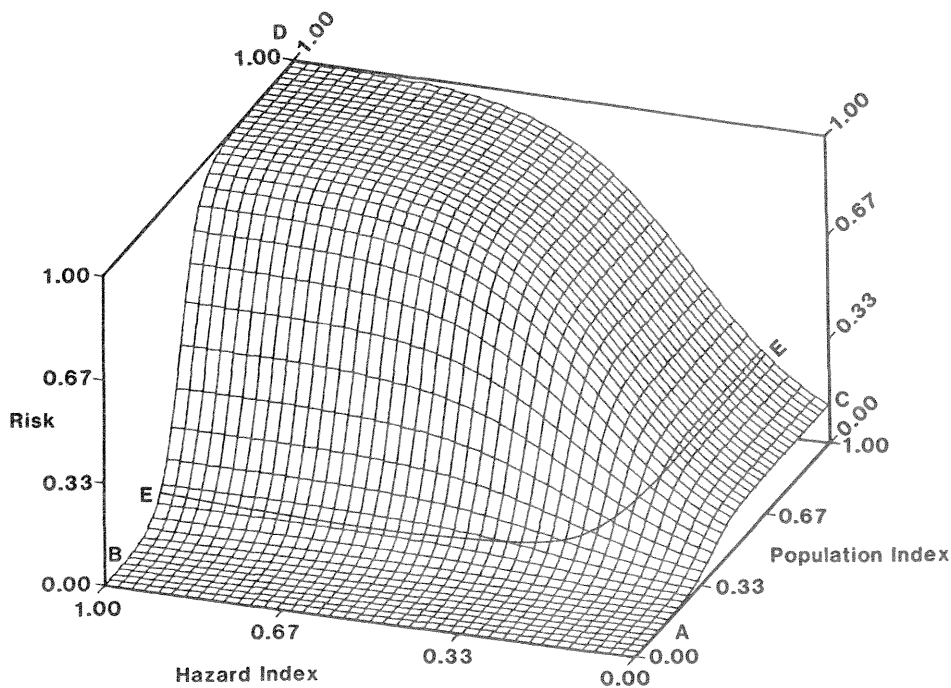

Figure 3.—Surface produced from conceptual model which describes the probability (risk) of a bark beetle infestation starting and growing in terms of hazard (a function of host tree, site, and stand conditions) and bark beetle population levels (Paine et al. 1984).

trees. However, the defenses may have a more subtle impact on bark beetle population dynamics. If beetle reproduction is influenced by lengthening generation time, affecting numbers of eggs laid, or larval survival, then overall population growth will be affected even if trees are killed.

Both defense systems may have greatest impact on colonizing beetles when populations are low or attack rates are slow. The induced system may have little impact if colonization is completed within 60 hours. However, if the attack is at low densities over a prolonged period, then the induced system may be very effective at directly influencing the beetle population dynamics. The critical colonization rate and threshold attack density for overcoming host defenses are functions of tree vigor. However, rapid colonization mediated by pheromones renders virtually any tree highly susceptible to infestation and death (fig. 4).

The impact of host defenses on invading insects and infectious pathogens is highly related to plant nutritional status, water relations, physiological condition, and competition. Overall site and stand conditions and time of year directly influence stand

hazard, which can be dynamic. Stand risk and the probability of an infestation starting and growing can thus be dynamic, changing with the time of year (i.e., seasonal phenology), as well as changing as a result of different insect population levels. This also implies that a given stand of trees may be capable of producing more beetles if colonized during one particular time of year (e.g., spring) when trees may be less resistant, than if colonized later when they are more resistant. Beetle attack rate and density, the type of associated fungi, their contribution to tree death, and their different capabilities to stimulate the inducible defense system may also be critical to the effectiveness of host resistance mechanisms involved in successfully defending the tree against infestation pressures. These differences may be important considerations to be incorporated into simulation models of SPB population dynamics.

CONCLUSIONS

It will be important in the future to understand the direct impact of host resistance, as one unified

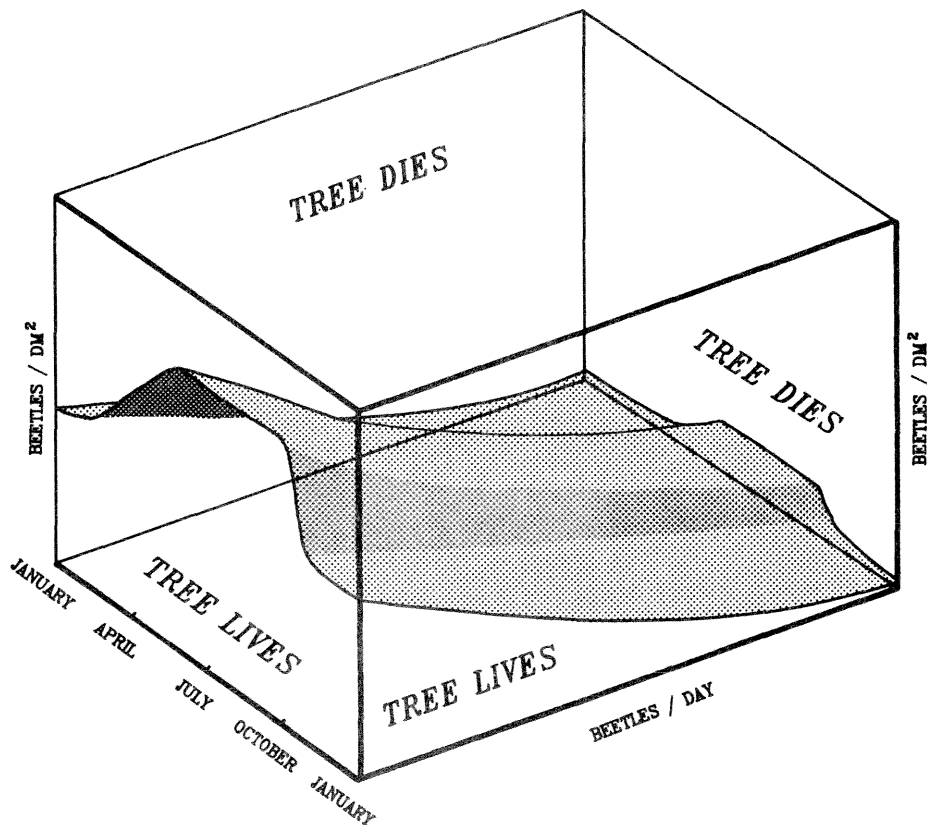

Figure 4.—Surface describing the hypothetical relationships of beetle attack rate, beetle attack density, and seasonal changes in individual tree resistance to determine if an attacked tree will live or die.

system, on bark beetle population dynamics. The current work has necessarily been conceptual in nature and represents small-scale studies in the laboratory and the field. Beetle population dynamics must be investigated in trees that have been characterized as resistant or susceptible based on their resistance mechanisms and chemical constituents. The role of the various specific components of resistance in both attack and reproductive success must be determined. Results of these studies on host resistance and suitability to southern pine beetle population processes must then be incorporated into the simulation models for predicting infestation growth and tree mortality. Such studies will provide a deeper basic understanding of insect/host plant systems and also improve the available tools for managing forest stands against beetle activity and tree mortality.

LITERATURE CITED

- Berryman, A. A. Resistance of conifers to invasion by bark beetle-fungus associations. *BioScience* 22: 589-602; 1972.
- Coulson, R. N.; Hennier, P. B.; Flamm, R. O. [and others]. The role of lightning in the epidemiology of the southern pine beetle. *Zeit angew. Entomol.* 96:182-193; 1983.
- Coyne, J. F.; Lott, L. H. Toxicity of substances in pine oleoresin to southern pine beetle. *J. Ga. Entomol. Soc.* 11:297-301; 1976.
- Fahn, A. Morphological and anatomical changes related to resin stimulation. Olustee, FL: U.S. Department of Agriculture, Forest Service, Southeastern Forest Experiment Station; 1970. [Unpub. report]
- Feldman, R. M.; Wagner, T. L.; Gagne, J. A. [and others]. Within-tree life process models of the southern pine beetle, *Dendroctonus frontalis*. *Ecol. Modelling* 13:246-260; 1981.
- Hines, G. S.; Taha, H. A.; Stephen, F. M. Model for predicting southern pine beetle population growth and tree mortality; 1980. In: Stephen, F. M.; Searcy, J. L.; Hertel, G. D., eds. Modeling southern pine beetle populations: symposium proceedings; 1980 Feb. 20-22; Asheville, NC. *Tech. Bull.* 1630. Washington, DC: U.S. Department of Agriculture; 1980:4-12.
- Hodges, J. D.; Elam, W. W.; Watson, W. F. [and others]. Oleoresin characteristics and susceptibility of four southern pines to southern pine beetle (Coleoptera: Scolytidae) attacks. *Can. Entomol.* 111: 889-896; 1979.
- Hodges, J. D.; Nebeker, T. E.; DeAngelis, J. D. [and others]. Host resistance and mortality: A hypothesis based on the southern pine beetle-microorganism-host interaction. *Bull. Entomol. Soc. Amer.*; 1985. (In press.)
- Lorio, P. L., Jr.; Hodges, J. D. Tree water status affects induced southern pine beetle attack and brood production. Res. Paper SO-135. New Orleans, LA: U.S. Department of Agriculture, Forest Service, Southern Forest Experiment Station; 1977. 7 p.
- Lorio, P. L., Jr.; Hodges, J. D. Theories of interactions among bark beetles, associated microorganisms, and host trees. In: E. Shoulders, ed. Proceedings, third biennial southern silviculture research conference. Gen. Tech. Rep. SO-54. New Orleans, LA: U.S. Department of Agriculture, Forest Service, Southern Forest Experiment Station; 1985: 485-492.
- Mason, R. R. Soil moisture and stand density affect oleoresin exudation flow in a loblolly pine plantation. *For. Sci.* 17:170-177; 1971.
- Nebeker, T. E.; Blanche, C. A.; Paine, T. D. [and others]. Composition of loblolly pine resin defenses: comparison of lesion and sapwood resins. 1985. (In preparation.)
- Nebeker, T. E.; Hodges, J. D. Influence of forestry practices on host-susceptibility to bark beetles. *Zeit. angew. Entomol.* 96:194-208; 1983.
- Paine, T. D. Aspects of the physiological and ecological relationships between the western pine beetle, *Dendroctonus brevicomis*, and associated fungi. Davis, CA: University of California; 1981. [Ph.D. dissertation]
- Paine, T. D. Seasonal response of ponderosa pine to inoculation of the mycangial fungi from the western pine beetle. *Can. J. Bot.* 62: 551-555; 1984.
- Paine, T. D.; Stephen, F. M. Fungi associated with the southern pine beetle: avoidance of the induced defense response in pine hosts; 1985a. [In preparation.]
- Paine, T. D.; Stephen, F. M. Response of loblolly pine to different inoculum doses of fungi associated with *Dendroctonus frontalis* Zimm.; 1985b. [In preparation.]
- Paine, T. D.; Stephen, F. M. The relationship of tree height and plant stress to the induced plant defense of loblolly pine; 1985c. [In preparation.]
- Paine, T. D.; Stephen, F. M. Influence of tree stress and site quality on the induced defense system of loblolly pine; 1985d. [In preparation.]
- Paine, T. D.; Stephen, F. M.; Taha, H. A. A conceptual model to integrate bark beetle abundance and host tree susceptibility with probability of loss. *Environ. Entomol.* 13:619-624; 1984.
- Paine, T. D.; Stephen, F. M.; Wallis, G. W. [and others]. The seasonal variation in a host tree defense to the southern pine beetle and its fungal as-

- sociates. *Ark. Farm Res.* 34:5; 1985.
- Peterman, R. M. An evaluation of the fungal inoculation method of determining the resistance of lodgepole pine to mountain pine beetle (Coleoptera: Scolytidae) attacks. *Can. Entomol.* 109:443-448; 1977.
- Raffa, K. F.; Berryman, A. A. The role of host plant resistance in the colonization behavior and ecology of bark beetles (Coleoptera: Scolytidae). *Ecol. Monographs.* 53:27-49; 1983.
- Reid, R. W.; Whitney, H. S.; Watson, J. A. Reactions of lodgepole pine to attack by *Dendroctonus ponderosae* Hopkins and blue-stain fungi. *Can. J. Bot.* 45:1115-1126; 1967.
- Safranyik, L.; Shrimpton, D. M.; Whitney, H. S. An interpretation of the interaction between lodgepole pine, the mountain pine beetle and its associated blue-stain fungi in Western Canada. In: Baumgartner, D. M., ed. *Management of lodgepole pine ecosystems.* Pullman, WA: Washington State University, Cooperative Extension Service; 1975: 406-428.
- Shrimpton, D. M. Extractions associated with wound response of lodgepole pine attacked by the mountain pine beetle and associate microorganisms. *Can. J. Bot.* 51:527-534; 1973.
- Shrimpton, D. M. Resistance of lodgepole pine to mountain pine beetle infestation. In: Berryman, A. A.; Amman, G. D.; Stark, R. W. [and others], eds., *Theory and practice of mountain pine beetle management in lodgepole pine forests.* Moscow, ID: University of Idaho Press; 1978: 64-76.
- Shrimpton, D. M.; Whitney, H. S. *In vitro* growth of two blue-stain fungi into resinous compounds produced during wound response of lodgepole pine. *Bi-monthly Res. Notes.* 35:27-28; 1979.
- Smith, R. H. Toxicity of pine resin vapors to three species of *Dendroctonus* bark beetles. *J. Econ. Entomol.* 56:327-331; 1963.
- Smith, R. H. Resin quality as a factor in the resistance of pines to bark beetles. In: Gerhold, H. D.; McDermott, R. E.; Schreiner, E. J. [and others], eds. *Breeding pest-resistant trees.* Oxford: Pergamon Press; 1966: 189-196.
- Smith, R. H.; Wickman, B. E.; Hall, R. C. [and others]. The California pine risk rating system: its development, use, and relationships to other systems. In: Hedden, R. L.; Barras, S. J.; Coster, J.E., eds. *Hazard-rating systems in forest insect pest management.* Gen. Tech. Rep. WO-27. Washington, DC: U.S. Department of Agriculture, Forest Service; 1981: 53-69.
- Stephen, F. M.; Paine, T. D. Seasonal patterns of host tree resistance to fungal associates of the southern pine beetle. *Zeit. angew. Entomol.*; 1985. [In press.]
- Stephen, F. M.; Paine, T. D.; Lih, M. P. Understanding bark beetle/host interactions: a means for improving decision strategies. *Zeit. angew. Entomol.* 96:257-265; 1983.
- Stephen, F. M.; Paine, T. D.; Lih, M.P. Mechanisms of tree resistance to bark beetles: synthesis and application. In: Goyer, R. A.; Jones, J. P.; eds. *Insects and diseases of southern forests.* Proceedings, Louisiana State University forestry symposium; 1985 March 27-28; Baton Rouge, LA. Baton Rouge: Louisiana State University; 1985. [In press.]
- Stephen, F. M.; Taha, H. A. Validation, testing and implementation of a southern pine beetle damage and population prediction model. Pineville, LA: U.S. Department of Agriculture, Forest Service, Southern Forest Experiment Station; 1981. 13 p. [Unprinted progress report to the IPM RD&A Program].
- Taha, H. A.; Stephen, F. M. Modeling with imperfect data: A case study simulating a biological system. *Simulation* 42:109-115; 1984.
- Vité, J. P.; Wood, D. L. A study of the applicability of the measurement of oleoresin exudation pressure in determining susceptibility of second growth ponderosa pine to bark beetle infestation. *Contrib. Boyce Thompson Inst.* 21:67-76; 1981.
- Werker, E.; Fahn, A. Resin ducts of *Pinus halepensis* Mill.—their structure, development, and pattern of arrangement. *Bot. J. Lin. Soc.* 62:379-411; 1969.
- Wong, B. L.; Berryman, A. A. Host resistance to the fir engraver beetle. (3). Lesion development and containment of infection by resistant *Abies grandis* inoculated with *Trichosporium symbioticum*. *Can. J. Bot.* 55:2358-2365; 1977.

Variation in the Chemistry of Loblolly Pine in Relation to Infection by the Blue-Stain Fungus

Herve A. Gambliel, Rex G. Cates, Margaret K. Caffey-Moquin, and T. D. Paine¹

Abstract.—Loblolly pine phloem responds to infection by the blue-stain fungus with the accumulation of monoterpene olefins, 4-allyl anisole, and various resin acids at the site of injury. The chemical response is due primarily to the presence of the fungus, and differs quantitatively but not qualitatively within each tree. This response, with regard to monoterpenes and resin acids, appears to be an extension of the sapwood oleoresin system due to traumatic duct activation rather than synthesis of compounds in the phloem resulting from wounding or infection. Components of the oleoresin chemistry of the phloem lesions varied within and among trees, but the relative distribution of monoterpene olefins and their enantiomers was specific to each of three trees tested. Infected phloem was less astringent than control phloem. Two novel methods were also developed for loblolly pine. One facilitates the simultaneous measurement of individual monoterpenes and resin acids, and the other allows concurrent micro-determination of specific rotation of alpha-pinene, beta-pinene, and limonene.

Additional keywords: Monoterpenes, resin acids, enantiomers, astringency, hypersensitive reaction, chemical response, phloem, *Pinus taeda* L., *Ceratocystis minor* Hedg.

INTRODUCTION

Over the past decade, a considerable research effort has focused on the population dynamics and economic impact of the southern pine beetle (*Dendroctonus frontalis* Zimm.). Recently, the importance of the interaction between southern pine beetle (SPB), its associated fungi, and host tree chemistry has been recognized as an area where knowledge is insufficient. The available information concerning the physical properties and chemical composition of the oleoresin is summarized by Blanche et al. (1983).

However, it is recognized that more information is needed about the qualitative and quantitative chemical attributes of the wound or hypersensitive response, as well as the variability in this response within and among southern pine trees.

Our overall objective in a more encompassing study is to determine the chemistry involved in the wound response or hypersensitive reaction of loblolly pine (*Pinus taeda* L.) that may be conferring resistance and reducing the host suitability to the bark beetle-fungal complex. This particular paper reports on a novel practical method for simultaneous chemical quantification of monoterpenes and resin acids of loblolly pine and a new method for determination of the specific rotation of monoterpene olefin enantiomers using microgram quantities of sample. Also reported are some chemical attributes of the wound response to the blue-stain fungus, *Ceratocystis minor*, including the monoterpenes, resin acids, and protein-complexing capacity of injured and uninjured phloem tissue. In addition, aspects of the variation within and among trees in the secondary chemistry of wound lesions are investigated.

STUDY METHODS

Site Description and Sample Collection

In May, 1984, 30 loblolly pine trees were chosen in a uniform stand located in the Kisatchie National Forest, Rapides Parish, LA, as part of a study to determine the within- and among-tree variation in preformed and wound response chemistry. In the study reported here, six rings, equally spaced above and below breast height, were subdivided into three sectors in 10 of the 30 trees studied. Four treatments were established within each sector. These were: (1) A plug of phloem about 1.2 cm in diameter was removed from the tree to serve as a control immediately prior to fungal inoculation; (2) a plug of bark was removed from an adjacent site, and then a phloem disc, previously inoculated with *C. minor* following the methods of Paine et al. (1985) was placed against the exposed inner bark and the original bark was replaced; (3) a sterile wound inoculation was performed in the same fashion, but without the inoculum disc, then placed next to the fungal inoculation treatment; and (4) a plug of un-

¹ Respectively, Research Associate, Associate Professor, and Technician, Chemical Ecology Laboratory, University of New Mexico, Albuquerque, NM; and Research Associate, Department of Entomology, University of Arkansas, Fayetteville, AR. (We thank John Horner for reviewing the manuscript, and IPM Program management, particularly Bob Thatcher, for their support. Support for this research was provided through the Integrated Pest Management Research, Development, and Applications Program).

infected phloem was removed 3 weeks after the initial phloem sample was collected. The lesions from treatments (2) and (3) were allowed to develop for 3 weeks; then they were collected, measured, and stored at -60°C until analyzed. Samples from 3 of the 10 trees were analyzed for monoterpenes, monoterpene enantiomers, resin acids, and protein-complexing capacity. Chemical analyses from three of the four treatments (1, 2, and 3) are discussed here.

Materials and Equipment²

All reference monoterpene standards, which included: (*l*)- and (*d*)-alpha-pinene ($[\alpha] = -45^{\circ}$, neat, $[\alpha] = +50.7^{\circ}$, neat, respectively), (*l*)-beta-pinene ($[\alpha] = -21^{\circ}$, neat), (*l*)- and (*d*)-limonene ($[\alpha] = -100^{\circ}$, $c = 10$, ethanol, $[\alpha] = +106^{\circ}$, $c = 1$, methanol), as well as all other monoterpenes and 4-allyl anisole, were of greater than 95 percent chemical purity.³ Resin acid standards were obtained through USDA Forest Service's Forest Products Laboratory, Madison, WI.⁴ Bovine hemoglobin Type II was used.⁵ Gas-liquid chromatography (GLC) was performed on a Perkin-Elmer 3920B instrument modified for on-column capillary injection (J.W. Scientific). High pressure liquid chromatography (HPLC) was performed on a Waters Associates dual pump system (Model 6000) fitted with a Rheodyne Model 7125 injector and equipped with a 20 μl loop. The column, 7 percent silver nitrate on 7.5 Nucleosil (Macherey-Nagel), was custom-packed.⁶ A Perkin-Elmer model 340 LC polarimeter was used for detection. Analytical quantification was performed by a Hewlett-Packard 3390A digital recorder/integrator. Gas liquid chromatography/mass spectrometry was carried out on a Finnigan instrument.

Extraction of Loblolly Pine Phloem

After being weighed, each sample was ground with a pestle in liquid nitrogen, extracted serially and exhaustively four times with pentane, ether, methanol, and methanol/distilled water (6:4) in a porcelain mortar. The extracts were then filtered

² Trade names used herein are for the information of the reader. Such use does not imply endorsement or approval by the Federal government to the exclusion of other products or services that may be suitable.

³ Obtained from Aldrich Chemical Co., Inc., Milwaukee, WI.

⁴ Courtesy of Dr. D. Zinkel.

⁵ Obtained from Sigma Chemical Company, St. Louis, MO.

⁶ By AllTech Associates, Deerfield, IL.

through glass wool and adjusted to 30 ml with the appropriate solvent. The pentane extract was used for the analysis of the enantiomers. Aliquots of the pentane, ether, and methanol extracts were recombined and analyzed for monoterpene content and resin acid methyl esters. Aliquots of the methanol and methanol/water extracts were used for the protein-complexing capacity assay. These extraction procedures yielded greater than 95 percent of the extractable activity for each assay.

Monoterpenes and Resin Acid Methyl Esters

An aliquot of the recombined pentane/ether/methanol extracts was taken into 3 ml ether/methanol (9:1). Gamma-terpene, eugenol, and oleic acid (120 μg each) were then added as internal standards. An excess of diazomethane generated according to the supplier's directions (Aldrich Chemical Company 1982) was added until the characteristic yellow color persisted to generate the resin acid methyl esters. The reaction was allowed to proceed for 5 minutes at room temperature, then the excess of diazomethane was removed under a stream of nitrogen. Analysis was by fused silica capillary GLC using a 25 m x 0.25 mm ID bonded OV-101 column (Perkin-Elmer). A modified cool on-column injection system (J. W. Scientific) was used and found to be a significant improvement in the stability and quantification of resin acid methyl esters, a few of which are known to be thermally labile (Foster and Zinkel 1983). The conditions were: flow rate, 0.5 cc/minute; helium detector temperature, 210°C ; injection, room temperature; temperature programming, 4 minutes at 50°C , followed by a $16^{\circ}\text{C}/\text{minute}$ increase to 245°C ; hold time, 16 minutes.

Diazomethane treatment did not significantly affect the quantification of any of the monoterpene hydrocarbons or of 4-allyl anisole in loblolly pine under the above conditions. The inclusion of three internal standards was necessary. Gamma-terpinene was used to measure all monoterpene hydrocarbons. Eugenol and oleic acid were used to quantify 4-allyl anisole and resin acids, respectively. Chemical identifications were made by co-elution of loblolly pine components with authentic standards on two columns of widely differing polarities and by GLC/MS. Each spectrum was matched by the computer to the library of spectra of the National Bureau of Standards.

Monoterpene Enantiomers

An aliquot of pentane extract (8–16 ml on a sliding scale depending on sample weight) was eluted through a small column of silica gel G

(5 cm × 1 cm) to remove oxygenated compounds that interfere with efficient subsequent chromatography of the monoterpene olefins. The eluate was adjusted to standard volume and 20 μ l used for the determination of optical rotations. In order to determine the amount of monoterpene olefins in the above aliquot, another 20 μ l aliquot was diluted in ether to a known volume, with 212 μ g of gamma-terpinene added as an internal standard, and analyzed by GLC using an isocratic system at 75°C (other conditions being the same as above). The amounts of alpha-pinene, beta-pinene, and limonene used in the determination of optical rotation were calculated from this analysis.

Specific optical rotations were determined by on-line HPLC/polarimetry and argentation chromatography using a silica column containing 7 percent silver nitrate on 7.5 μ Nucleosil. The eluent was hexane/acetonitrile/acetic acid (100:0.11:0.04) flowing at 1 ml/minute. This system achieves baseline resolution of alpha-pinene, beta-pinene, and limonene (fig. 1). Optical measurements were made at the Hg, 302 line with a polarimetric micro-flow cell that had a nominal volume of 30 μ l and a pathlength of 10 cm (Perkin-Elmer).

Detection limits were 80 μ g for alpha-pinene and 20 μ g for limonene of 75 percent optical purity. This is at least tenfold more sensitive than standard procedures and provides a quick and efficient way to measure enantiomeric ratios on several components simultaneously without prior purification. The observed rotation of each component was determined from integration of the positive or negative signals detected by the reporter/integrator interfaced with the polarimeter. The specific rotation of each component was then obtained from the equation:

$$[\alpha]_{23^\circ} = \alpha/c$$

Hg, 302

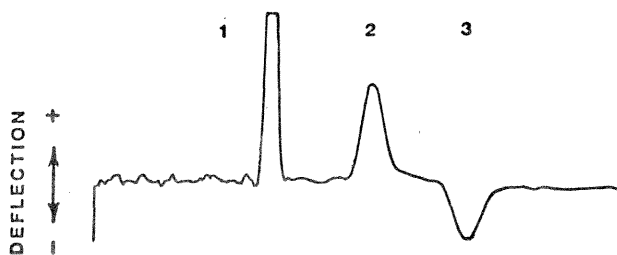

Figure 1.—Polarimetric deflection of the monoterpene olefins of a fungal lesion of loblolly pine after resolution by HPLC. (1) alpha-pinene (321 μ g); (2) beta-pinene (207 μ g); (3) limonene (57 μ g). Optical rotations were measured at the Hg, 302 line. (Note that at this wavelength (α)-alpha-pinene and (β)-beta-pinene read positive, while (ψ)-limonene reads negative.)

where α = observed rotation, l = pathlength (1 dm), and c = amount as determined in the GLC part of this assay. The enantiomeric ratios were then obtained from standard curves generated from components of known enantiomeric composition. To facilitate comparisons with other published data, these ratios were then converted and reported as their degree equivalents at the Na D line. It was noted that the signs of the rotation for (ψ)-beta-pinene and (d)-alpha-pinene were positive at the Hg, 302 line, whereas both (ψ)-alpha-pinene and (ψ)-limonene displayed negative deflections at that wavelength.

Protein-Complexing Capacity of Phloem

The astringency, or protein-complexing capacity, of phloem tissue was assayed for its ability to precipitate hemoglobin from recombined aliquots of the pooled methanol and methanol/water extracts. The method is based on modification of the assay of Martin and Martin (1983). The methanol was evaporated under a stream of nitrogen at 60°C to prevent oxidation. The remaining aqueous solution was diluted to 10 ml with 0.1 M sodium phosphate buffer (pH 6.5), and then filtered through 0.45 μ nylon 66 filters. A 1.0 ml aliquot was then added to a 1.0 ml solution of hemoglobin (2.2 mg/ml) and mixed. Although the precipitation reaction is instantaneous, the mixture was allowed to stand at room temperature for 15 minutes to achieve equilibrium, then centrifuged at 3,000 rpm for another 15 minutes. The supernatant was then eluted through a small column of Sephadex G-25 (2.5 cm × 1 cm) to remove absorbing material that interferes with the spectrophotometric determination of protein. The collected eluate was adjusted to 5.0 ml, and a 0.5 ml aliquot was assayed for protein content by the method commercially available from Bio-Rad (Bradford 1976). The milligram equivalents of quebracho tannin per milligram fresh weight tissue were then determined from a standard curve generated with a dilution series from 0 to 2.0 mg quebracho tannin.

RESULTS

Chemistry of Loblolly Pine Phloem Infected with *C. minor*

Analysis of *C. minor*-inoculated phloem by GLC indicated that the monoterpene olefins alpha-pinene, beta-pinene and limonene were the major components (fig. 2). Tricyclene, camphene, myrcene, terpinolene, 3-carene, and beta-phellandrene also were present in small quantities. In addition, 4-allyl anisole, a phenylpropanoid previously unreported

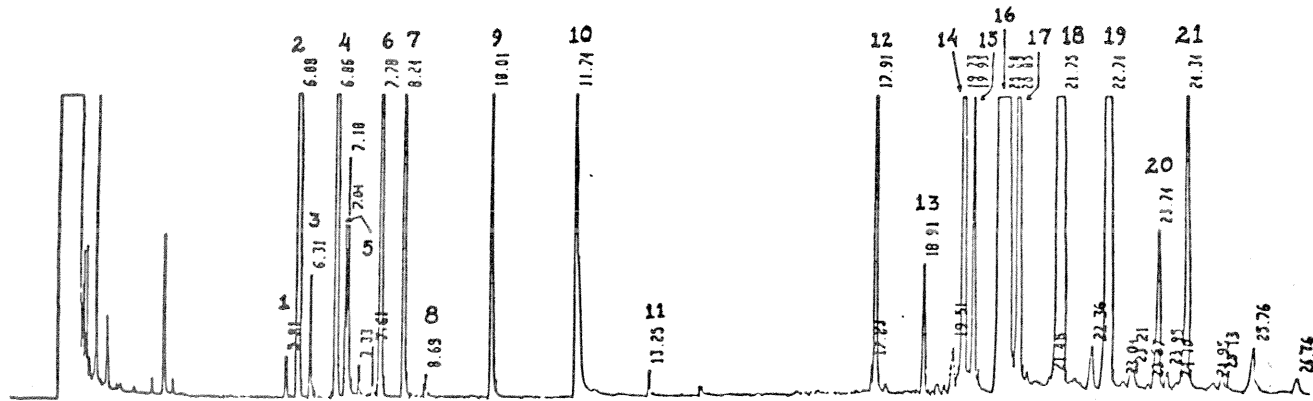

Figure 2.—Capillary GLC of an extract of loblolly pine phloem collected 3 weeks after inoculation with *C. minor*. Individual components are: (1) Tricyclene; (2) α -pinene; (3) camphene; (4) β -pinene; (5) myrcene; (6) limonene; (7) γ -terpinene (internal standard); (8) terpinolene; (9) 4-allyl anisole; (10) eugenol (internal standard); (11) contaminant; (12) methyl oleate (internal standard); (13) unknown; (14) methyl pimarate; (15) methyl sandaracopimarate; (16) methyl levopimarate + methyl palustrate + methyl isopimarate; (17) unknown; (18) methyl abietate; (19) methyl neoabietate; (20) unknown; (21) contaminant. Retention times are in minutes (Conditions are described under the section on Study Methods).

in loblolly pine, was found in significant amounts. The following resin acids were detected: pimaric acid, sandaracopimaric acid, iso- and levopimaric acid, palustric acid, abietic acid, neoabietic acid, and two undescribed components.

Investigation of the enantiomeric composition of the monoterpene olefins by on-line HPLC/polarimetry revealed that α -pinene consisted predominantly of the dextrorotatory antipode (fig. 1). As expected, β -pinene, which is almost ubiquitously found in the laevorotatory form in nature (Gambiel and Croteau 1984), was present in the nearly pure (*l*)-form. Limonene was predominantly laevorotatory.

Comparison of Control, Sterile- and Fungal-Inoculated Phloem

Chemical analysis of control phloem and of sterile and fungal inoculations revealed the importance of monoterpenes and resin acids in the wound response of loblolly pine (table 1). Thirty percent of the total number of control phloem samples ($n = 36$) lacked detectable monoterpenes and resin acids, while the rest contained small quantities of these compounds. It is possible that the opening of phloem resin canals because of bark stripping resulted in a traumatic accumulation of oleoresin in some samples. Such radial resin ducts exist in the phloem in a collapsed state⁷. Furthermore, we have observed discrete resin beading on the surface of exposed phloem within minutes after bark removal. Thus, the presence of

monoterpenes and resin acids in uninjured phloem of loblolly pine is probably artifactual. This is in contrast to lodgepole pine, in which significant amounts of resin were found in the phloem (Raffa and Berryman 1983).

Both sterile and fungal inoculations resulted in the accumulation of monoterpenes and resin acids at the wounding site. (table 1). Moreover, no new terpenes or resin acids were found in the fungal-inoculated samples that were not already present in the sterile controls. The fungal inoculations, however, resulted in greater than a fortyfold increase in the accumulation of monoterpenes and a twenty-fivefold increase in resin acids over the levels found in the sterile inoculations.

Interestingly, the protein-complexing capacity of inoculated phloem, a measure of condensed tannins in loblolly pine, decreased slightly in comparison with that of control phloem (table 2).

Variation in the Chemical Composition of Phloem Fungal Lesions

Analysis of 18 lesions from each of the three trees shows a wide range of variation in the number of samples needed to characterize each tree (table 3).

In order to encompass 90 percent of that variation in at least the main monoterpene components, 3 to 23 samples per tree may be required. In the case of resin acids, between 3 and 25 may be necessary, depending on the tree and the component of interest. The relatively wide range in the sizes of both mechanically induced or fungally induced lesions (see table 3) may have been a contributing factor to this variation. Clear qualitative and quantitative

⁷ De Angelis, personal communication.

Table 1. — *Monoterpene and resin acid content of loblolly pine phloem before and after mechanical or fungal injury (in mg/g fresh weight)*

Tree	Total monoterpenes			Total resin acids		
	Control ² (N = 12)	Sterile ² (N = 4)	Fungal (N = 12)	Control ² (N = 12)	Sterile ² (N = 4)	Fungal (N = 12)
105	0.9	3 ± 2.8	132 ± 24	7	11 ± 8	322 ± 73
106	0.8	2 ± 2.1	108 ± 45	8	11 ± 9	287 ± 115
110	2.0	1 ± 0.4	110 ± 23	0.1	4 ± 3	279 ± 58

¹Because 30 percent of the control phloem samples contained no detectable monoterpenes, standard deviations are not reported for this group.

²N = 12 per tree.

Table 2. — *Protein-complexing capacity of loblolly pine phloem before and after injury with C. minor (values expressed as mg equivalent quebracho/g fresh weight)*

Tree	N	Treatment (X ± SD)		Significance level
		Control	Fungal inoculation	
105	11	33.8 ± 16.4	21.2 ± 4.3	.005 < p < .015
106	11	21.4 ± 6.6	13.0 ± 3.5	.01 < p < .02
110	10	35.2 ± 8.3	27.0 ± 4.6	.02 < p < .05

¹The two-tailed paired-sample t test measures the level of significance above which the null hypothesis that equivalent astringency levels are associated with tissue from both treatments is rejected.

Table 3. — *Variation in the secondary chemistry of loblolly pine phloem after inoculation with C. minor¹*

Component	Tree 105			Tree 106			Tree 110		
	Mean	S.D.	Nmin	Mean	S.D.	Nmin	Mean	S.D.	Nmin
Monoterpenes and resin acids: ^{2,3}									
alpha-pinene	77.3	12.5	3	46.4	16.7	13	63.3	13.4	5
beta-pinene	49.1	11.6	6	42.9	20.6	23	36.0	9.7	7
limonene	5.5	1.8	11	18.8	8.8	22	10.8	2.6	6
4-allyl anisole	5.3	3.4	41	6.6	3.0	20	5.6	1.6	8
pimaric acid	29.1	7.9	7	24.2	9.9	17	20.2	4.5	5
sandaraco-									
pimaric acid	6.1	1.3	4	6.2	2.6	17	5.3	0.9	3
levopimaric +	205.0	48.0	6	176.0	70.6	16	154.0	32.4	4
abietic acid	51.6	26.0	25	45.4	21.1	21	54.9	20.2	13
neobietic acid	30.7	7.1	5	34.8	14.0	16	38.3	11.3	9
Tannin capacity ^{4,5}	19.5	4.8	6	12.6	3.5	8	27.0	4.6	3
Lesion weight ^{4,6}	2.5	1.2	24	3.1	2.0	55	1.7	0.7	19

¹Minimum number of samples needed to characterize a given tree calculated at the 90 percent confidence level using the formula $N_{min} = (S.D./0.1 X)^2$.

²N = 18 per tree.

³Expressed as mg/g fresh weight.

⁴N = 12 per tree.

⁵In mg equivalent quebracho tannin/g fresh weight.

⁶In grams.

differences also existed among the three trees. The lesions in tree 105 had higher content of total monoterpenes on a per gram fresh weight basis than either tree 110 or tree 106 ($p < 0.05$), which did not differ significantly from each other in this respect. Additionally, tree 105 accumulated higher levels of total resin acids ($p < 0.05$) at the sites of injury (see tables 1 and 3) than either of the other two trees.

The relative distribution of monoterpenes, expressed by the ratios of the biosynthetically related olefins alpha-pinene, beta-pinene, and limonene, was unique to each of the three trees analyzed (fig. 3). Tree 106, for instance, was relatively high in limonene and low in alpha-pinene compared to trees 105 and 110.

Small but significant differences ($p < 0.05$) existed in the enantiomeric composition of alpha-pinene among trees (table 4). Thus, alpha-pinene from tree 110 was more dextrorotatory ($[\alpha] = +34^\circ$, or 81 percent (d)-) than alpha-pinene from tree 106 ($[\alpha] = +16^\circ$, or 65 percent (d)-). As expected, beta-pinene, which is almost ubiquitously found in the laevorotatory form in nature (Gambliel and Croteau 1984) was present in nearly pure (l)-form in all three trees. Limonene also was predominantly laevorotatory, and tree 106 was significantly higher in (l)-limonene compared to tree 110 ($p < 0.05$). Within-tree variation in the enantiomeric composi-

tion of all three terpenes was low (in all cases, two samples or fewer describe the variation at the 90 percent confidence level).

DISCUSSION

It is clear that within- and among-tree differences exist in the wound response of loblolly pine. The relatively large variation observed in lesion sizes (table 3) suggests that different spatial arrangements of phloem traumatic ducts may affect the extent of the response. This could be mediated by the opening of the closed radial phloem resin ducts mentioned by De Angelis et al.⁸ We also have observed that contact between phloem and sapwood is required for initiation of resin flow in the phloem. The additional fact that little or no preformed oleoresin was found in untreated phloem suggests that the response to mechanical injury and/or fungal infection originates from preformed chemistry in the sapwood rather than from *de novo* synthesis of resin components, at least in the initial stages. The chemical variation in sterile and fungal responses also

⁸ Personal communication.

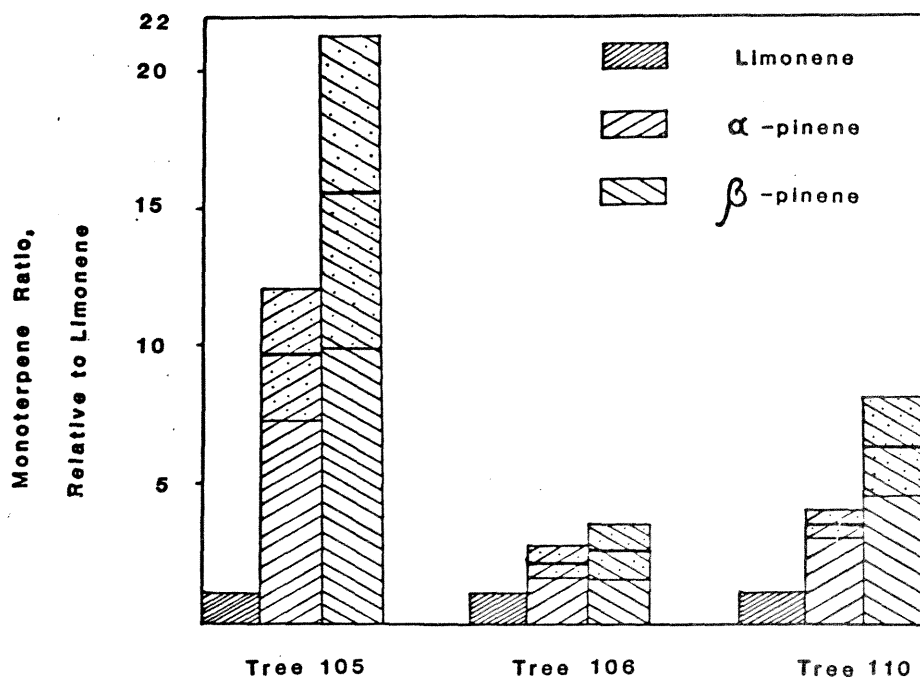

Figure 3.—Among-tree differences in the relative monoterpene olefin composition of the wound response of loblolly pine to *C. minor*. The data are expressed as the ratio of alpha- or beta-pinene to limonene, where limonene = 1. Means and standard deviations are indicated graphically.

Table 4. — Variation in the enantiomeric composition of the monoterpene olefins of loblolly pine lesions resulting from inoculation with *C. minor* ($N = 12$ samples per tree)ⁱ

Tree	Mean $[\alpha]_D^{23^\circ}$ equivalent \pm S.D.					
	α -pinene		β -pinene		Limonene	
	$[\alpha]_D^{23^\circ} \pm$ SD	% \pm SD	$[\alpha]_D^{23^\circ} \pm$ SD	% \pm SD	$[\alpha]_D^{23^\circ} \pm$ SD	% \pm SD
105	+28 \pm 4	75 \pm 4	-22 \pm 1	97 \pm 3	-82 \pm 21	83 \pm 9
106	+16 \pm 4	65 \pm 4	-20 \pm 2	93 \pm 6	-93 \pm 12	88 \pm 5
110	+34 \pm 3	81 \pm 3	-20 \pm 2	94 \pm 4	-78 \pm 12	82 \pm 5

ⁱSpecific rotations are given along with their standard deviations in degree equivalents at the Na D line to facilitate comparisons with published data. Percentages reflect the relative abundance of the predominating antipode.

could to a small extent reflect variation in the mechanical component of the injury.

Specific qualitative chemical patterns in the fungal lesions are characteristic of individual trees. With respect to monoterpenes, the most interesting observation is that fungal wound responses are best characterized by their relative ratio of monoterpene olefins (fig. 3). This is potentially very important, since bark beetles are thought to respond, not to any one, but rather, to a complex of host monoterpenes (Borden 1982). In loblolly pine, (d)-alpha-pinene, (l)-beta-pinene, and myrcene function either as pheromone precursors or as synergists in the southern pine beetle-fungal complex (Renwick et al. 1976; Borden 1982). Limonene, another characteristic component, has been implicated as an index of resistance in ponderosa pine (Smith 1977; Sturgeon 1979). Little within-tree variation was observed in the enantiomeric composition of these olefins in the portion of the tree initially colonized by bark beetles. However, it should be noted that differences were found in the enantiomeric ratios of alpha-pinene among the trees tested. This is expected to significantly affect the relative production of the bark beetle pheromones (d)-*cis*-verbenol and (l)-*trans*-verbenol (Renwick et al. 1976) and thus alter beetle colonization behavior. The presence of 4-allyl anisole, a phenylpropanoid component, is interesting since it requires a different biosynthetic route from that of the terpenoid components of the oleoresin. On the other hand, alpha-pinene, beta-pinene, camphene, myrcene, and limonene are all made by just two cyclases with multiple activities and opposite enantiomeric specificity (Gambliel and Croteau 1984).

The data we present do not support a defensive role against *C. minor* for condensed tannins in the wound response of loblolly pine. In fact, a post-infection decrease in the overall astringency of the lesions suggests possible detoxification by the fungus, which

may possess phenyl oxydases⁹. It must be recognized, however, that the astringency assay that detects complexing capacity with respect to hemoglobin is not necessarily sensitive to the specificity that loblolly pine tannins may have toward other proteins and/or carbohydrates.

Despite the decrease in astringency in the fungal-inoculated lesions, the survival of attacking beetle adults, and their reproduction, is lower when colonization is forced into fungus-infected lesions¹⁰. This may be due to the accumulation of oleoresin and/or stilbenes (e.g., pinosylvin, pinosylvin methyl ether) that have also been implicated in the fungal wound response of loblolly pine (Hemingway et al. 1977). These, as well as other phenolic components, will be the subject of another report.

CONCLUSION

It appears, therefore, that tree-specific monoterpene olefin complements and enantiomeric ratios merit detailed consideration in future studies. Our findings underscore the need for further assessment of the among-tree variation in the secondary chemistry described in this report and for a careful determination of the relationship between secondary chemistry and the population dynamics of the bark beetle-fungal complex.

LITERATURE CITED

- Aldrich Chemical Company, Inc. Mini Diazald apparatus. Technical Information Bulletin Number AL-121. Milwaukee, WI: Aldrich Chemical Co.; 1982.
- Blanche, C.A.; Hodges, J.D.; Nebeker, T.E. [and others]. Southern pine beetle: the host dimension. Miss. Agr. and For. Exp. Sta. Bull. 917. Mississippi State, MS: Mississippi State University; 1983. 29 p.

⁹ Hemingway, personal communication.

¹⁰ Paine and Stephen, unpublished information.

- Borden, J.H. Aggregation pheromones. In: Mitton, J.B.; Sturgeon, K.B., eds. Bark beetles in North American conifers. Austin: University of Texas Press; 1982:109.
- Bradford, M.M. A rapid and sensitive method for the quantitation of microgram quantities of protein utilizing the principle of protein-dye binding. *Anal. Biochem.* 72:248-250; 1976.
- Foster, D.O.; Zinkel, D.F. Qualitative and quantitative analysis of diterpene resin acids by glass capillary gas-liquid chromatography. *J. Chromatogr.* 242:89-98; 1982.
- Gambliel, H.; Croteau, R. Pinene cyclases I and II: two enzymes from sage (*Salvia officinalis*) which catalyze stereospecific cyclizations of geranyl pyrophosphate to monoterpene olefins of opposite configuration. *J. Biol. Chem.* 259(2):740-748; 1984.
- Hemingway, R.W.; McGraw, G.W.; Barras, S.J. Polyphenols in *Ceratocystis minor*-infected *Pinus taeda*: fungal metabolites, phloem and xylem phenols. *J. Agric. Food Chem.* 25(4):717-722; 1977.
- Martin, J.; Martin, M. Tannin assays in ecological studies; lack of correlation between phenolics, proanthocyanidins, and protein-precipitating constituents in mature foliage of six oak species. *Oecologia* 54: 205-211; 1983.
- Paine, T.D.; Stephen, F.M.; Cates, R.G. Induced defenses against *Dendroctonus frontalis* and associated fungi: variation in loblolly pine resistance. In: Branham, Susan J.; Thatcher, Robert C., eds. Proceedings, integrated pest management research symposium; 1985 April 15-18; Asheville, NC. Gen. Tech. Rep. SO-56. New Orleans, LA: U.S. Department of Agriculture, Forest Service, Southern Forest Experiment Station; 1985:169-176.
- Raffa, K.F.; Berryman, A.A. The role of host plant resistance in the colonization behavior and ecology of bark beetles. *Ecol. Monograph* 53:27-49; 1983.
- Renwick, J.A.A.; Hughes, P.R.; Krull, I.S. Selective production of *vis-* and *trans-*verbenol from (-)- and (+)-alpha-pinene by a bark beetle. *Science* 191:199-201; 1976.
- Smith, R.H. Monoterpenes of ponderosa pine xylem resin in western United States. *Tech. Bull.* 1532. Washington, DC: U.S. Department of Agriculture; 1977. 48 p.
- Sturgeon, K.B. Monoterpene variation in ponderosa pine xylem resin related to western pine beetle predation. *Evolution* 33:803-814; 1979.
- Wood, D.L.; Browne, L.E.; Ewing, B. [and others]. Western pine beetle: specificity among enantiomers of male and female components of an attractant pheromone. *Science* 192:896-898; 1976.

SESSION II—PESTS AND HOST/PEST INTERACTIONS

Descriptive and Predictive Models

***A Dendroctonus Frontalis* Infestation Growth Model: Organization, Refinement, and Utilization**

F. M. Stephen and M. P. Lih¹

Abstract—The southern pine beetle integrated modeling system at the University of Arkansas, Fayetteville, is a user-oriented computer simulation model that provides short-term predictions of potential tree mortality and corresponding monetary loss in currently infested stands. Model design follows a life table format, with beetle development rates regulated by ambient temperature. Stage-specific southern pine beetle mortality is affected by tree and stand conditions, natural enemies, and time of year. Minimal input data are required to initialize the model. Performance of the model was considerably improved by recent refinements that made it more responsive to tree and stand conditions. The structure of the model and the extensive population data base available provide a useful means of testing ecological and management hypotheses. The model has been used to explore the impact of parasites and predators on southern pine beetle population expansion.

Additional keywords: Southern pine beetle, modeling, population dynamics, natural enemies, pest management.

INTRODUCTION

Prediction of the rate at which southern pine beetle (SPB) populations grow and the amount of timber loss associated with varying levels of infestation was a research target during the USDA Science and Education Administration-sponsored Expanded Southern Pine Beetle Research and Applications Program (ESPBRAP). A goal of the subsequent Integrated Pest Management Pine Bark Beetle Program has been the validation, refinement, and implementation of those models developed during ESPBRAP. Our research objectives at the University of Arkansas have been directed toward develop-

ment of a computer-based model to provide short-term predictions of the rate and extent of SPB population growth and the corresponding amount of timber loss that is likely to occur in an existing infestation. Development of this model was a natural extension of earlier research that established a population data base and life tables for the southern pine beetle in south Arkansas.

To successfully build the model, it was essential to pool available knowledge on population dynamics of the southern pine beetle and its complex interactions with natural enemies, associated fungi, host trees, the surrounding forest stand, and areawide beetle population levels. This process provided insight into SPB ecology, and served to focus upon several additional research areas in need of study. For example, as a result of our model validation and sensitivity analyses (Taha et al. 1980), the need was established to place additional emphasis on understanding host tree resistance and the impact of the preformed and induced defense mechanisms of loblolly pine on SPB population dynamics (Paine et al. 1985). With this information, model performance can be improved and a more useful pest management tool made available (Stephen et al. 1983).

The Arkansas model was designed primarily to function as a decisionmaking aid for forest pest managers who must determine whether to initiate control measures in an existing infestation or to develop a priority schedule for control of a number of infestations. Accurate predictions of anticipated spot growth can serve foresters as a support tool in this process. Essential to the development of the model has been the need to keep the amount and complexity of information required as model input to a minimum, thus facilitating its acceptance by the user community.

Besides having practical application for the forest pest management specialist and providing assistance in setting priorities for future research efforts, the model's design permits it to be used as a research tool and a mechanism for testing both ecological and management hypotheses. This paper describes the design, development, and refinement of our SPB simulation model, and then explores a theoretical question with it: Are naturally occurring parasites and predators an important influence on SPB infestation growth?

¹Respectively, Professor and Research Assistant, Department of Entomology, University of Arkansas, Fayetteville, AR. (The authors gratefully acknowledge the contributions of H. A. Taha, G. S. Hines, J. Ghosh, M. Motamedi, G. W. Wallis, T. D. Paine, and R. C. Sanger. We also thank the IPM Program management, particularly R. C. Thatcher, for continued support. Published with the approval of the Director, Arkansas Agricultural Experiment Station.)

MODEL DESIGN

The design and structure of the model (Hines et al. 1980) are based on our knowledge of the life history of the southern pine beetle within existing infestations. Beetles mass attack living trees, and if successful in overcoming host defenses and killing the tree, colonize, mate and deposit eggs, with the subsequent larvae developing within the phloem and inner bark tissues. New adults emerge and fly to colonize other trees. These developmental processes are regulated by the ambient temperature and the influence of host tree resistance mechanisms, host suitability, natural enemies, pheromones, and many other physical and biotic factors in the forest environment.

The paths through which beetle life forms develop in the model are graphically illustrated in figure 1. The rectangles represent developmental levels containing numbers of southern pine beetles in specific life stages. The solid lines represent the transformation from one life stage (level) to the next.

In its present form (fig. 1), the model is a closed system that deals only with currently existing infestations and does not allow immigration or emigra-

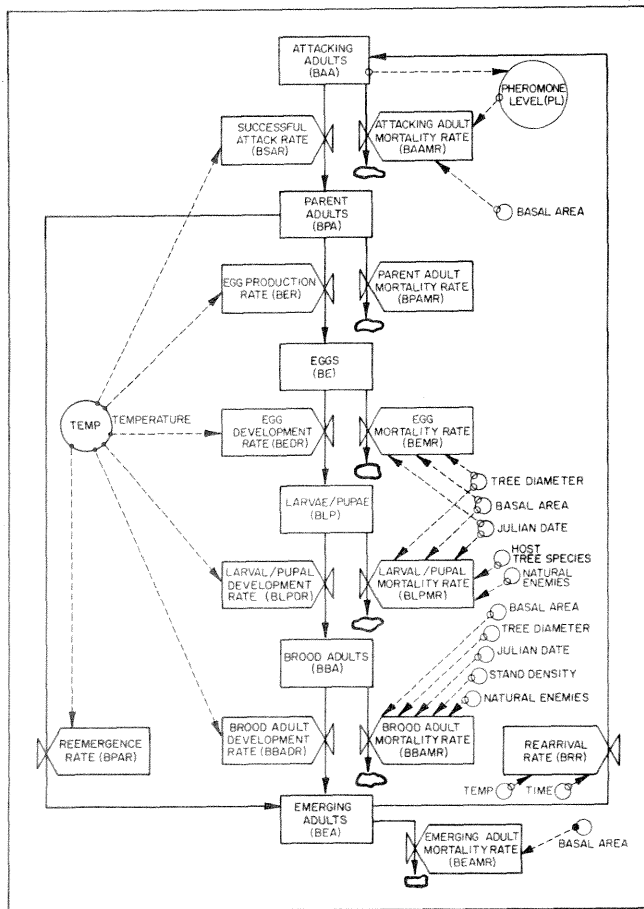

Figure 1.—Graphical representation of the southern pine beetle simulation model.

tion of adult beetles. Thus, the population of attacking adults (BAA) is composed of those emerging and reemerging adult beetles within one infested spot. As trees are mass attacked and successfully colonized, the attacking adults become parent adults (BPA), and initiate the next generation by constructing galleries and depositing eggs within them (BE). Parent adults are then able to reemerge, at which time they join the pool of emerging adults (BEA). Eggs hatch and develop into larvae-pupae (BLP) and brood adults (BBA), which subsequently contribute to the emerging adult population (BEA).

A series of variables and rates influences SPB development (fig. 1). Mortality rates—such as BAAMR (beetle attacking adult mortality rate), production rates and development rates—for example, BER (beetle egg production rate)—are graphically represented by bottlenecks. These rates control the magnitude of changes in each level through time, by regulating mortality of existing beetles and the production and development of eggs and subsequent life stages. Variables (represented by circles) such as temperature, Julian date, stand basal area, and tree species composition affect the values of the development and mortality rates. The broken lines represent information affecting the values of rates and levels. The irregular closed curves represent population sinks that are external to the SPB life system.

Parameter values for the within-tree rates and variables, illustrated in figure 1, are based on extensive population data, representing varied population levels and stand conditions, collected over 7 years in 22 infested plots located in four southern States (Arkansas, Georgia, Louisiana and Mississippi). A total of 312 trees was sampled at either three or five heights along the infested bole. The available data include measurements of attacking adult density, egg density, larval/pupal density, emerging brood adult counts, immature and adult parasite and predator densities, and mortality affecting eggs, larvae and pupae, and brood adults. In addition to population variables, tree and stand variables and spot growth data were also collected for most of the sampled spots. Mortality of beetles in flight between trees and mortality of attacking adult beetles were estimated using an input-output procedure described by Taha and Stephen (1984).

Temperature plays a critical role in the maturation and reproduction of insects and is of paramount importance in our model. The development rates of the beetle life stages are temperature-dependent, based on a series of extensive studies at Texas A. & M. University (Wagner et al. 1984). The model possesses a subsystem that simulates ambient temperature based on average daily maximum and minimum temperatures.

MODEL DEVELOPMENT AND USER ORIENTATION

The model has been user-oriented since its inception, and thus, minimizing input requirements without sacrificing predictive accuracy has been a persistent concern. Input data, as required in 1979 and 1985, are compared in table 1, and it is evident that necessary input has been substantially reduced. Longitude and latitude estimates for the infested site have been changed to the name of the State where the infested spot is located. Radial growth and tree age measurements are now optional input data. A count of previously infested and currently infested trees is required, but determination of the predominant beetle life stage present at breast height in infested trees is now optional (though still highly recommended). The diameter at breast height (d.b.h.) distribution of all infested trees in the stand and the current stumpage prices for salvaged sawtimber and pulpwood are required only if estimates of volume and monetary loss are requested. The mean heights at top and base of the infested portion of the tree and mean circumference at the top of the infestation are no longer requested. All data may now be recorded in English or metric units. A practitioner's manual has been prepared that includes sample field forms and assists the user in the collection of necessary input data (Lih and Stephen 1985a).

The model has been incorporated into an integrated structure that allows the input, editing, and storage of data from infested spots, as well as execution of simulation runs. A user's guide to the model (Lih and Stephen 1985b) aids in summarization of

field-collected data for input to the model and provides an example of an interactive session on the computer.

Once the user has accessed the integrated modeling system (with the help of the user's guide), a "help" facility and optional instructions are available to assist with data entry and model execution. Users may specify length of time for the simulation to be conducted. The model can easily be made highly site-specific in regard to local temperature conditions, and whether estimates of volume and monetary loss are needed can be stipulated. Repeated runs can be made on a single infested spot, if, for instance, the user wants to evaluate the effects of unusually hot weather or an intended control treatment on predicted spot growth.

In 1979, model output was expressed as a weekly prediction of the number of infested trees in each beetle life stage level, and the total numbers of infested and dead trees. Currently, model predictions are output on a user-determined daily or weekly basis. Projected spot growth is expressed as confidence intervals around the predicted numbers of infested and dead trees over time. The confidence intervals provide the user with the predicted trend of spot growth, while both compensating for the uncertainty in estimating specific model parameters (Taha and Stephen 1984) and also helping to account for individual differences associated with each infestation.

MODEL REFINEMENT

User needs have largely defined the current model input requirements, model output format, and structure of the user-friendly integrated modeling system. Internal refinements have also been made to help users. For instance, height and circumference at the top of the infested tree bole were required input variables until a regression equation was developed that used mean d.b.h. to predict the average amount of infested bark area per tree (Stephen and Taha 1979). Southern pine beetle brood stage distribution at breast height for the infested trees is a recommended (but not required) input variable. The default brood stage distribution assigned to infested trees when the actual distribution is unknown is the result of additional research to make the model more user-oriented.

Pilot testing of the model was conducted with SPB infestation data collected by U. S. Forest Service, State and Private Forestry crews and University of Arkansas crews in several geographic regions across the South that represent different forest site and stand conditions and different areawide levels of bark beetle populations. Model predictions were ac-

Table 1. — *Data required for model initialization: comparison of input requirements in 1979 versus 1985*

1979	1985	Input requirements
R	R	— Date of ground survey
R	R	— Number of days of simulation
R		— Longitude and latitude of infestation
	R	— State in which infestation is located
R	R	— Mean pine and hardwood basal areas
R	R	— Host species composition
R	R	— Mean d.b.h. of infested trees
R	R	— Number currently infested trees
R	R	— Number previously infested trees
R	O	— Mean 5-year radial growth
R	O	— Mean stand age
R	O ⁺	— SPB life stage estim. in infested trees
R		— Mean ht: top and base of infested trees
R		— Mean circumference at top infestation
R	V	— D.b.h. distribution of surveyed trees
R	V	— Current stumpage prices

R = Required

O = Optional

O = Optional — highly recommended for accurate prediction

V = Required for volume and monetary loss estimation

ceptable in circumstances where overall population levels were high, and stand conditions were similar to those sites in south Arkansas where data were collected for model construction. However, model predictions were not reliable under highly different stand conditions and in situations where areawide SPB populations were at a low level. The observed inconsistencies in spot growth rate and the model's inability to account for the factors causing these inconsistencies suggested that the model had not captured the essential nature of how differences in tree and stand conditions and areawide population levels influence SPB population dynamics.

Model behavior is under continual scrutiny. When output deviates substantially from that expected or observed in the field, refinements may be required. One such instance resulted in the restructuring of the attacking adult subroutine to accommodate new data, and to produce a more realistic pattern of spot growth.

Sensitivity analysis was conducted on several of the model's input variables, parameters, and rates (Taha et al. 1980). This established the relative degree of influence that each parameter has on model output; i.e., the number of dead trees. Additional model refinement efforts could then be concentrated on finding reliable means for determining those parameters that have the greatest effect on model behavior. The analysis indicated that within-tree beetle mortality rates (egg, larval-pupal, and brood adult mortalities) and the densities of attacking adults and eggs are relatively sensitive parameters.

Although tree and stand conditions did play a role in the setting of beetle mortality rates in the early model versions, their impact was inferred by our intuitive understanding of the interactions between stand variables and specific beetle population parameters. Research was conducted to determine whether a functional relationship could be established between tree and stand conditions, and these five most sensitive population parameters (Lih and Stephen 1985c). Regression equations were developed for each, and these predictive equations were incorporated into the "new" or "refined" version of the simulation model.

Test runs were then made on 70 infestations from which data were available. The differences between observed and predicted numbers of infested and dead trees were calculated for each spot. These residual values were adjusted for spot size, providing a percent error term, and then plotted. Both the original and refined models have less error in predicted dead trees than in predicted infested trees. It can be seen from the graphs showing numbers of dead trees that the predictions made by the refined model have much smaller percent residual values than do those made

by the original model (figs. 2 and 3), particularly as the simulation progresses through time. The predicted and observed numbers of infested and dead trees were then compared graphically. The original model had a strong tendency to overestimate numbers of dead trees (fig. 4). Although the refined model is less erratic in its predictions, it has a nearly equal tendency to over- and underpredict (fig. 5). The new model's predictions are, on the average, substantially closer to actual infestation growth data than were those of the early version.

The predicted mortality rates from the refined model were compared to those obtained through population sampling. Predicted values of brood adult mortality rate were less accurate than egg and larval-pupal mortality rate predictions, but overall the predicted rates closely corresponded with observed values.

Work is now underway to write a complete version of the model that will run on many of the microcomputers currently being used by universities, industry, and State or Federal Forest Service organizations. In addition, the integrated modeling system has been provided to Texas A&M University for incorporation into the Southern Pine Beetle Decision Support System (Saunders et al. 1985).

NATURAL ENEMY SIMULATIONS

Methods

The data base on stage-specific density and mortality of within-tree populations of southern pine beetle was used to assess the impact of natural enemies on beetle population dynamics. The population data were summarized and organized in life tables. Each life table corresponds to the mean values from the population samples collected in a single infested spot during a single sampling period (about 4 days). The life tables include information on the within-tree beetle population parameters depicted in the flow diagram of the model (fig. 1); i.e., the densities of the within-tree beetle life stages and the mortality rates affecting each immature developmental stage are included as variables in the life tables. The life tables also indicate the numbers of immature parasites, and both immature and adult predators that are present in the bark samples with the late larval and pupal stages of the beetle. These natural enemy counts are taken from radiographs of infested bark.

The number of life tables available for a single infested spot depends on the number of times the spot was sampled for SPB population data. Four infested spots that were sampled at least three times each and that also had measurements of all the stand

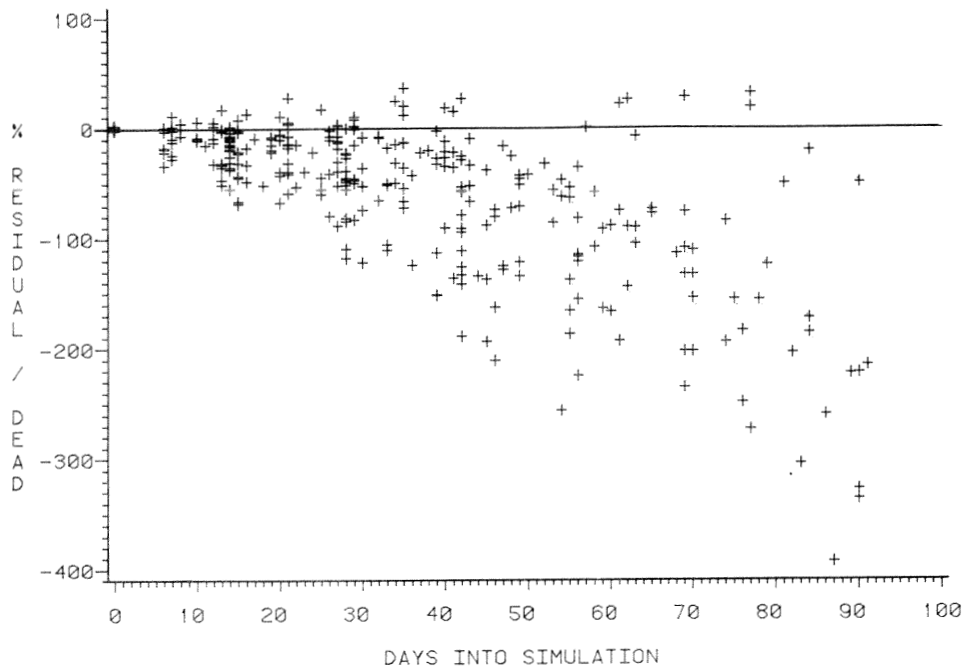

Figure 2.—Deviation of simulated infestations from actual data (original model).
Expressed as percent residual: $100 \times (\text{actual} - \text{predicted})/\text{actual}$.

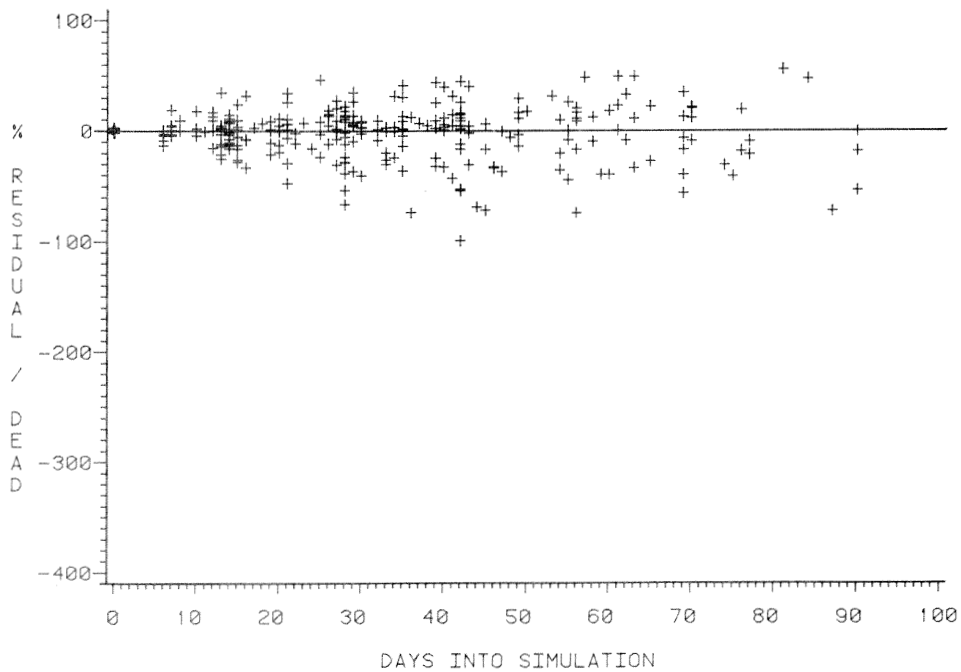

Figure 3.—Deviation of simulated infestations from actual data (refined model).
Expressed as percent residual: $100 \times (\text{actual} - \text{predicted})/\text{actual}$.

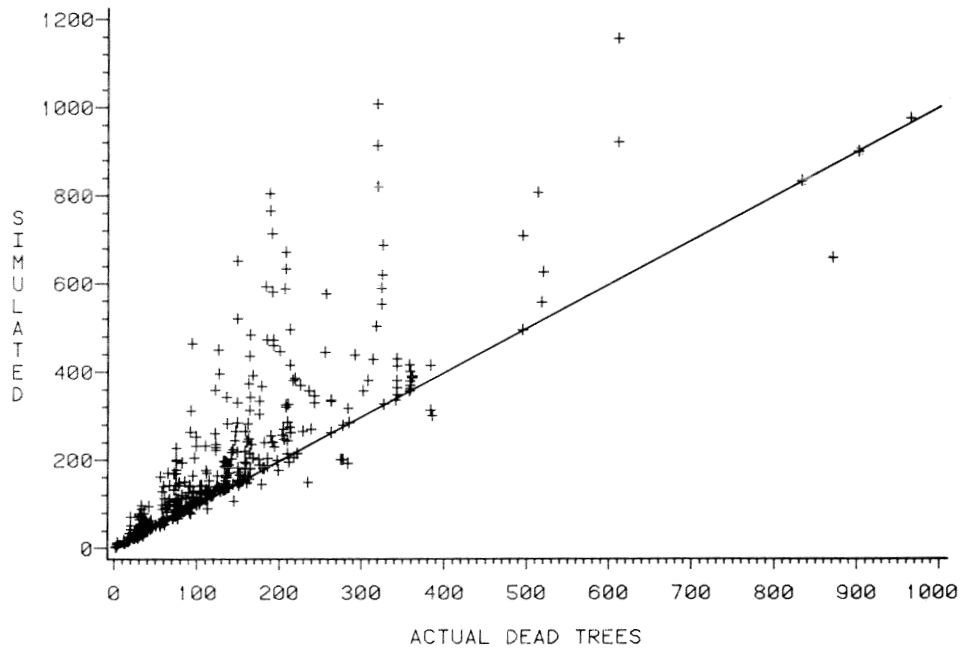

Figure 4.—Comparison of numbers of simulated and actual dead trees (original model).

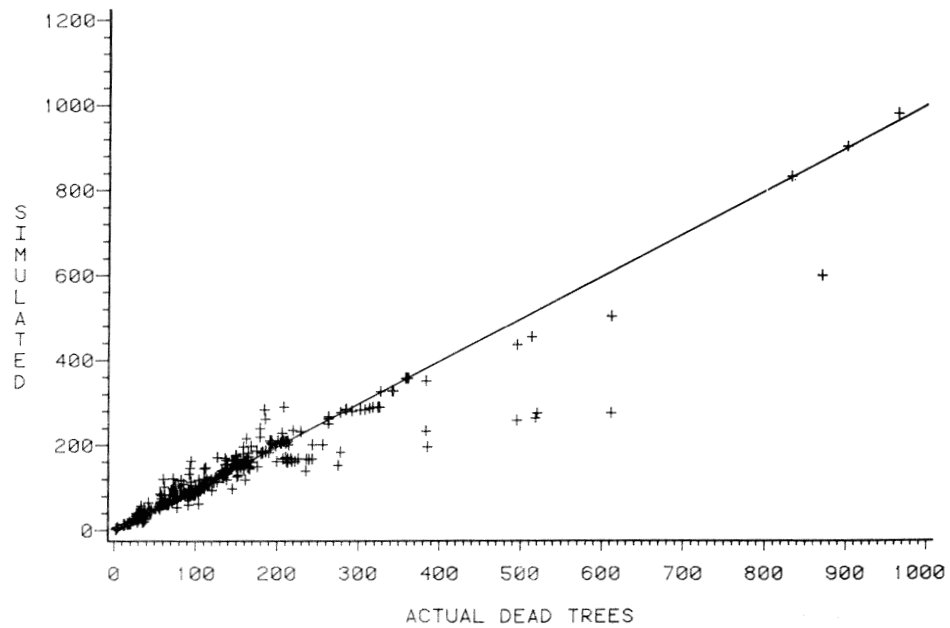

Figure 5.—Comparison of numbers of simulated and actual dead trees (refined model).

and spot growth variables required to make a validation simulation run were chosen for use in this study. These four infestations occurred in 4 different years in three States: Arkansas (1976, 1978), Mississippi (1982), and Louisiana (1983).

The values from the life tables for each of the following parameters were arranged chronologically in a table for each of the four infested spots: attacking adult density, egg density, egg mortality rate, larval-pupal mortality rate, and brood adult mortality rate. These tables were placed in the model, and linear interpolation was used to determine a value for the parameters for each Julian date covered by the simulation run. Thus, the within-tree parameters in the model were tailored for a particular spot based on population data specific to the spot. A model run was made for each infestation using the appropriate population and input data.

The amount of beetle mortality due to the parasites and predators present in the tree was then calculated for each life table. Since the parasite and predator counts represent numbers of natural enemies present with the late larval stages of the beetle, the following assumptions were made for determining the natural enemy-caused mortality. First, each parasite has removed one SPB larva from the system and second, each predator has already removed one larva from the system, and will remove one more pupa or brood adult from the system. These are conservative estimates of predation, both because predators may consume more than two prey and because some predators were probably overlooked in the examination of the radiographs of the infested bark. Linear interpolation was again used to determine values for parasite- and predator-caused mortality for each Julian date. The larval-pupal and brood adult mortality rates from the life tables were then adjusted to eliminate the effects of the natural enemies on the system, and simulation runs were made for each spot.

Results

The model's predictions of spot growth for each of the four spots using the parameter values taken from the life tables and the parameter values after adjustment to exclude the effects of natural enemies are presented in figures 6-9. The exclusion of natural enemies resulted in a dramatic increase in the predicted spot growth for each spot. Plots 2 and 9 showed smaller rates of increase between the two model runs than did the other plots, with 201 percent and 260 percent increases, respectively, in the predicted number of dead trees on day 92 (figs. 8 and 9). Infested trees for plot 2 increased by 345 percent when natural enemies were excluded, and

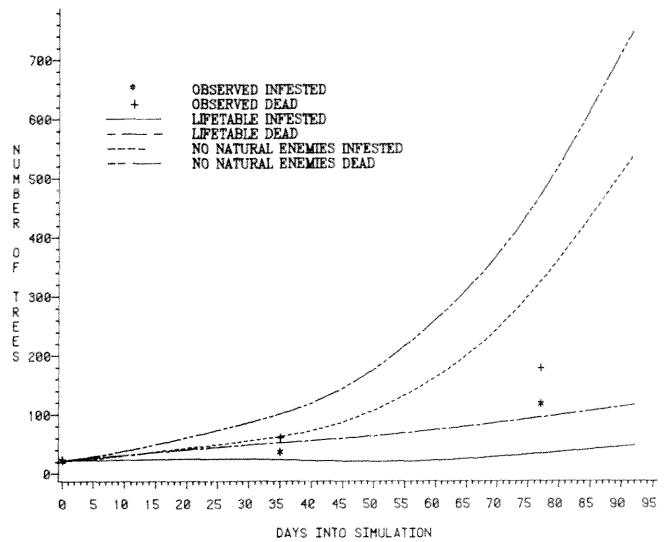

Figure 6.—Predicted and observed numbers of dead and infested trees, with and without natural enemies present. (Plot 8, Gum Flats, AR, July 12, 1976.)

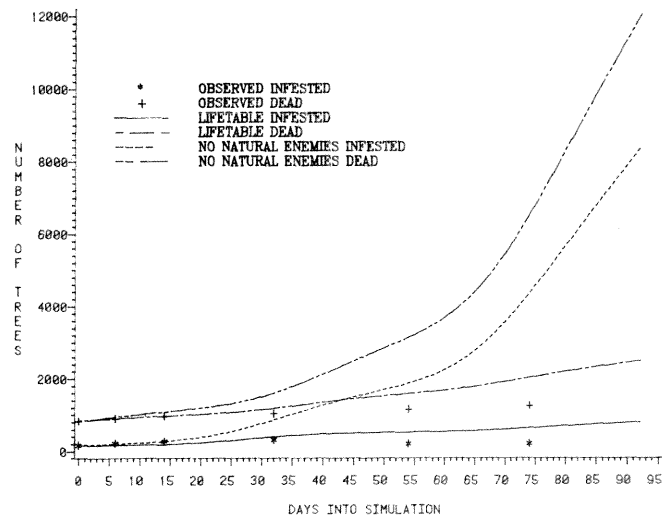

Figure 7.—Predicted and observed numbers of dead and infested trees, with and without natural enemies present. (Plot 8), Gum Flats, AR, July 12, 1976.)

plot 9 showed a 423 percent increase. The Arkansas spots had the most dramatic increases in spot growth. Figures 6 and 7 demonstrate the exponential rate of spot growth occurring after day 60 in plots 8 and 3 as a result of natural enemy exclusion. Predicted dead trees on day 92 for these spots increased by 651 percent and 481 percent, respectively. Infested trees increased by 1154 percent and 1048 percent.

The observed numbers of infested and dead trees are also included in figures 6-9. The model using life table data underpredicts spot growth in three of the four spots: plots 8, 2 and 9. The model overpredicts spot growth for plot 3.

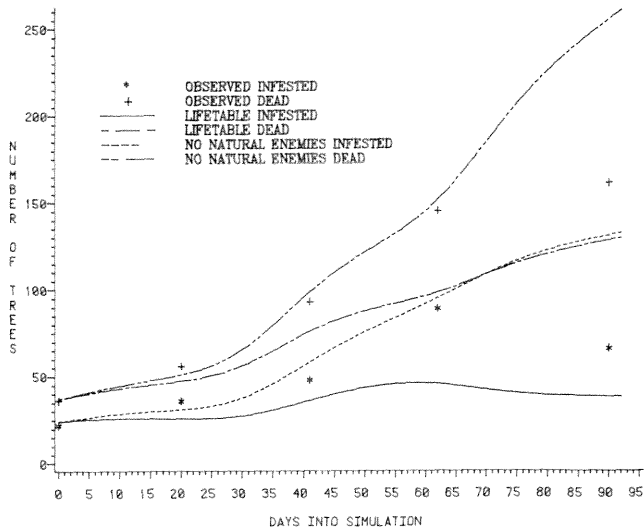

Figure 8.—Predicted and observed numbers of dead and infested trees, with and without natural enemies present. (Plot 2, Homochitto National Forest, MS, July 21, 1982.)

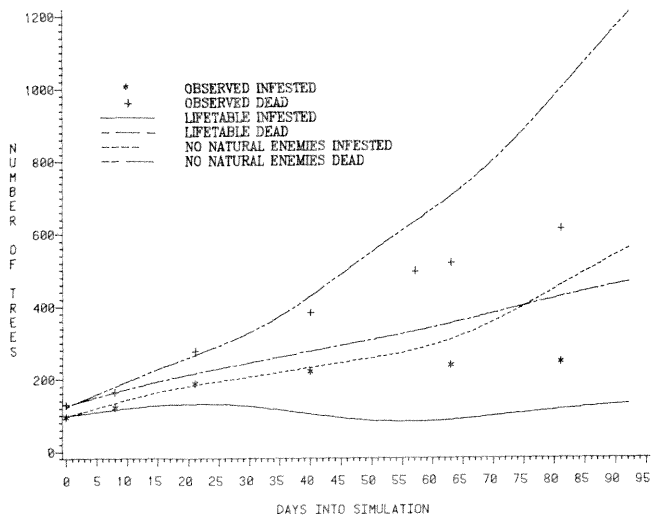

Figure 9.—Predicted and observed numbers of dead and infested trees, with and without natural enemies present. (Plot 9, Catahoula Ranger District, LA, July 28, 1983.)

Discussion

This method of comparing spot growth with and without natural enemies present assumes that there would be no other mortality agents compensating for some or all of the natural enemy-caused mortality if the natural enemies were excluded. In all likelihood, some compensatory mortality would be occurring due to increased intraspecific competition, declining habitat quality, and other factors. However,

the estimates of predation (two prey per predator) used in this study were probably conservative (Linit and Stephen (1983) estimated 4.79 southern pine beetle immatures destroyed by each predator), and the numbers of parasites and predators counted in the radiographs most likely under-represent the actual population of natural enemies present in the spot. Therefore, predictions of spot growth with natural enemies excluded from the spot are considered to be reasonable estimates of what might actually occur in these circumstances. Thus natural enemies seem to play a crucial role in governing SPB population expansion.

Although the current model, when tailored for individual spots, underestimated observed spot growth in three of four spots, the pattern of the predicted growth generally follows that of observed spot growth. The predictions are quite good for each of the Arkansas spots early in the prediction period. However, the predictions are less accurate after about day 35. In the Mississippi and Louisiana spots, the predictions with natural enemies excluded are more accurate early in the prediction period than the predictions using life table data. These spots were not used in the estimation of unknown parameters in the simulation model; however, the Arkansas data were used in estimating values for between-tree in-flight mortality and attacking adult mortality (Taha and Stephen 1984). These results suggest that there may be less between-tree mortality or attacking adult mortality in the Mississippi and Louisiana spots than occurred in the Arkansas spots. Alternatively, there could be immigration of beetles occurring in plots 2 and 9, though there is no reason to expect that immigration would be more prevalent in these spots than in the Arkansas spots. A third explanation may be that development is more rapid in these areas, and adjustment of the temperature profile would be beneficial for these model runs. Current research on host plant resistance and its effects on SPB population dynamics may provide insight in this area.

CONCLUSION

The processes of model testing, model validation, model updating, and model refinement are by necessity concurrent events in the construction of a simulation model that strives to mimic a system as complex as the ecosystem of the southern pine beetle (Taha and Stephen 1984). Our model has recently undergone extensive revision, resulting in an increased responsiveness to varying site and stand conditions. The revised model was tested using infested spot data from 70 infested spots and performed very well, averaging 13.3 percent error in its

prediction of numbers of dead trees over the 92-day prediction period (Lih and Stephen 1985c). An evaluation of the model in the Gulf Coastal Plain, which was conducted by U. S. Forest Service, State and Private Forestry, is presented elsewhere in these proceedings (Nettleton and Connor 1985). The current study comprises part of a validation phase for the model, wherein spots are matched with spot-specific population data to determine whether additional updating of other population parameters is appropriate at this time. Model validation also helps to determine which model parameters are in need of adjustment. New data may result in additional refinements, which initiate the cycle anew.

The model is structured to represent the life cycle of the southern pine beetle, and as such, provides a tool for exploration of this intricate ecosystem. The model has been used to demonstrate the restraining influence that natural enemies have on SPB population growth.

LITERATURE CITED

- Hines, G. S.; Taha, H. A.; Stephen, F. M. Model for predicting southern pine beetle population growth and tree mortality. In: Stephen, F. M.; Searcy, J. L.; Hertel, G. D., eds. Modeling southern pine beetle populations: symposium proceedings; 1980 Feb. 20-22; Asheville, NC. Tech. Bull. 1630. Washington, DC: U.S. Department of Agriculture; 1980: 4-12.
- Lih, M. P.; Stephen, F. M. Data requirements and collection procedures for using the SPB predictive model: a practitioner's manual. Fayetteville, AR: Arkansas Agricultural Experiment Station; 1985a. [In press].
- Lih, M. P.; Stephen, F. M. The southern pine beetle integrated modeling system at the University of Arkansas: a user's guide. Fayetteville, AR: Arkansas Agricultural Experiment Station; 1985b. [In press.]
- Lih, M. P.; Stephen, F. M. Refinement of a southern pine beetle infestation prediction model by incorporation of tree and stand characteristics. Ecol. Modelling; 1985c. [In preparation.]
- Linit, M. J.; Stephen, F. M. Parasite and predator component of within-tree southern pine beetle (Coleoptera: Scolytidae) mortality. Can. Ent. 115: 679-688; 1983.
- Nettleton, W. A.; Connor, M. D. Evaluation and application of the TAMBEETLE and Arkansas spot growth models in the Gulf Coastal Plain. In: Branham, S. J.; Thatcher, R. C., eds. Proceedings, integrated pest management research symposium; 1985 April 15-18; Asheville, NC. Gen. Tech. Rep. SO-56. New Orleans, LA: U.S. Department of Agriculture, Forest Service, Southern Forest Experiment Station; 1985: 202-205.
- Paine, T. D.; Stephen, F. M.; Cates, R. G. Induced defenses against *Dendroctonus frontalis* and associated fungi: variation in loblolly pine resistance. In: Branham, S. J.; Thatcher, R. C., eds. Proceedings, integrated pest management research symposium; 1985 April 15-18; Asheville, NC. Gen. Tech. Rep. SO-56. New Orleans, LA: U.S. Department of Agriculture, Forest Service, Southern Forest Experiment Station; 1985: 169-176.
- Saunders, M. C. [and others]. The southern pine beetle decision support system. In: Branham, Susan J.; Thatcher, Robert C., eds. Proceedings, integrated pest management research symposium; 1985 April 15-18; Asheville, NC. Gen. Tech. Rep. SO-56. New Orleans, LA: U.S. Department of Agriculture, Forest Service, Southern Forest Experiment Station; 1985: 335-363.
- Stephen, F. M.; Taha, H. A. Tree mortality, infested bark area, and beetle population measurements as components of treatment evaluation procedures on discrete forest management units. In: Coster, J. E.; Searcy, J. L., eds. Evaluating control tactics for the southern pine beetle: symposium proceedings; 1979 Jan. 30-Feb. 1; Many, LA. Tech. Bull. 1613. Washington, DC: U.S. Department of Agriculture; 1979: 45-53.
- Stephen, F. M.; Paine, T. D.; Lih, M. P. Understanding bark beetle/host interactions: a means for improving decision strategies. Zeit. angew. Entomol. 96(3): 256-265; 1983.
- Taha, H. A.; Stephen, F. M.; Motamedi, M. Sensitivity analysis and uncertainty in estimation of rates for a southern pine beetle model. In: Stephen, F. M.; Searcy, J. L.; Hertel, G. D., eds. Modeling southern pine beetle populations: symposium proceedings; 1980 Feb. 20-22; Asheville, NC. Tech. Bull. 1630. Washington, DC: U.S. Department of Agriculture; 1980: 13-19.
- Taha, H. A.; Stephen, F. M. Modeling with imperfect data: a case study simulating a biological system. Simulation 42(3): 109-115; 1984.
- Wagner, T. L.; Gagne, J. A.; Sharpe, P. J. H.; Coulson, R. N. A biophysical model of southern pine beetle, *Dendroctonus frontalis* Zimmermann (Coleoptera: Scolytidae) development. Ecol. Modelling 21: 125-147; 1984.

A Methodology for Biophysical Modeling Using TAMBEETLE as an Example

Richard M. Feldman, Terence L. Wagner, Guy L. Curry, Robert N. Coulson,
and Peter J. H. Sharpe¹

Abstract.—The steps and considerations involved in building a mechanistic model can be illustrated using the TAMBEETLE model as an example. The developmental process of TAMBEETLE, including its strengths and weaknesses, can serve as a basis for future research models for other insect/host systems. A description of model components and references to publications containing more extensive details enhance our understanding of the modeling approach.

Additional keywords: Population dynamics, mathematical modeling, iterative cohort methodology.

INTRODUCTION

The southern pine beetle, *Dendroctonus frontalis* Zimmermann (Coleoptera: Scolytidae), has been the subject of intensive research for more than a decade, principally because of its role in pine (*Pinus* spp.) mortality throughout the southern region of the United States. One of the primary goals of such research has been the development of an integrated management system. Obviously, an effective management system depends upon a thorough understanding of population dynamics of *D. frontalis*. Much of the focus of the southern pine beetle research was, therefore, directed at issues relating to population dynamics. As various research projects accumulated information on the insect, it became necessary to synthesize and integrate the many diverse aspects of population dynamics. To accomplish the “warehousing” and coordination of the accumulating biological information, a mechanistic model of the *D. frontalis* population dynamics was developed. This model, referred to as TAMBEETLE, was developed by the Biosystems Research Group (Department of Industrial Engineering) and the Department of Entomology at Texas A&M University.

The general reasons for building a model are (1)

exploration, (2) explanation, (3) projection, and (4) prediction. (Rykiel 1984). As the sole model-building objective, prediction leads to poor experimental design, little scientific understanding or learning, and the development of inadequate and inflexible models. By contrast, formulation of mechanistic models provides a means for emphasizing and accomplishing the four goals of model building.

The purpose of this paper is to summarize the steps and considerations involved in building a mechanistic model, using TAMBEETLE as an example. The strengths and weaknesses of TAMBEETLE will be pointed out along with the general overview. The reasons for detailing developmental steps are twofold: (1) It provides an understanding of the model itself, and (2) it serves as a basis for future research directed at building mechanistic models for other insect/host systems.

SYSTEMS ANALYSIS

Systems analysis involves activities of description, explanation, and control of a system's behavior over time. In general, a system refers to any collection of components along with the relationships between them.

In a modeling context, it is often convenient to make a distinction between the system and its environment. All components to be described or modeled are included as part of the system. The environment consists of those factors that drive the system (modeled components), but are not themselves modeled. Instead, the environmental factors must usually be monitored. Thus, system behavior is guided or influenced by its environment. For example, a typical population process treats the insects and host plants as system components and temperature as an environmental factor. The modeling effort is directed at describing the insect/plant dynamics treating temperature as the “driving force”.

As another example, consider a field population of insects. The population growth of insects is certainly influenced by immigrating and emigrating populations. When a global context is of interest, the system includes the in-field, immigrating, and emigrating components. However, when focusing on a single

¹ Respectively, Professor, Industrial Engineering Department; Research Associate, Department of Entomology; Professor, Industrial Engineering Department; Professor, Department of Entomology; and Professor, Industrial Engineering Department, all Texas A&M University, College Station, TX.

field, we may choose to measure the immigrating and emigrating populations instead of modeling them. Thus, these migrating populations would be considered environmental instead of system components.

Selection of the system boundaries, segmentation of the environment and the system into components, and descriptive modeling of system components involve both science and art. There are no absolute rules, and the experience gained in the development of TAMBEETLE offers a guide to other modeling efforts.

Descriptive Aspects

Once the system has been defined and the environmental and system components compartmentalized, system modeling can commence. The descriptive aspect of systems analysis (i.e., development of the model) is the critical activity in the analytical procedure. Because the model will be used to explain the biological system and/or as a tool for decision-making in regard to system management, the degree of reality it contains is of paramount importance. Rarely will quality predictions or decisions result from a subquality model. It should be realized that a model is merely an abstraction of the real system. Hence, every model has its limitations and validity range.

The level of detail or descriptive depth needed in a model depends on its intended use. For example, plane geometry is a collection of geometrical relationships that have great utility and mathematical validity within the context of their environment. However, a basic assumption like "parallel lines never intersect" is not adequate in the context of global travel where spherical geometry must be utilized. Thus, plane geometry might be suitable to describe short range travel, but the additional complexity of spherical geometry would be needed to describe long-distance travel. In a similar manner, modeling "tradeoff" decisions for biological systems must constantly be made where realism and tractability are in conflict.

As with the analysis of any problem, the domain of concern should first be decided. This domain determines the approach for analysis, the components of the system that must be considered, and possibly the level of detail applicable in the study. This domain includes both the time aspect and the physical region of interest. If we are attempting to model a statewide *D. frontalis* epidemic, then migration between spots and spot initiation are important and must be modeled. Whereas, if our goal is to model a single infestation (as in TAMBEETLE), then spot

initiation is an initial condition and can be considered as part of the environment.

A similar analysis is applicable for the time aspect and its impact on the general level and detail needed for modeling purposes. If long-term studies are of interest for a pest population, then the surviving fraction of the overwintering population must be included in the model since it is a major force in long-term population behavior. However, if one is interested in a short-term population response, then the overwintering population does not need to be part of the system. Instead, it could be treated as an environmental component that is measured (sampled) at the start of the season and then used to initiate the model. From this initiation, it may be possible to model adequately the dynamics of the population throughout the period of concern.

System Components

Our approach to modeling population dynamics is to segregate the general process into component parts. These system components for TAMBEETLE included development, reproduction (gallery construction and oviposition), reemergence, aggregation, tree susceptibility, and tree suitability. Individual components can be measured and analyzed more easily in isolation; however, by isolating components, experiments often induce an artificial aspect into the measurements taken. The isolated components are analyzed and modeled based on the environmental factors affecting their behavior. These component models are then validated/calibrated individually. Finally, the components are integrated into a general population model. This synthesis requires validation checks and composite response verification on individual components. The resultant component models may need to be recalibrated using data from general population studies.

Model Validation

Field validation of biological models is a difficult task. *Model validation* implies that the model accurately describes the entire physical system and system responses to the environment. In a strict sense, total model validation is not possible since a model by definition is an abstraction of a real world process. We use validation to mean that the abstraction (i.e., the model) captures the pertinent behavior of the real system. Computer models are often validated in another sense in that they are certified as accurate translations of the mathematical abstraction into a computer program. This type of validation merely

establishes that the computer code is functioning properly, but does not validate the proper behavior of the model itself.

If population numbers over time are modeled, then several independent populations must be sampled throughout the period of concern in order to perform a statistical validation. Under field conditions, intensive sampling of even a single population through time is expensive. Thus, monitoring several independent populations becomes difficult and costly. However, the major difficulty for biological systems is obtaining different sample populations that have identical conditions. Repeated sampling from a single population at a given point in time reduces the sampling error, but does not estimate the inherent biological variation. It should be noted that variation due to measurement errors associated with sampling generates confidence limits. However, these confidence intervals do not describe the variability of the population being studied. Consequently, inferences concerning model validity should not be based on confidence intervals obtained from measurement error.

Although the above statements seem obvious, it is easy to fall into this trap. When model results are reported with data, it is impressive to present a graph of the model together with the data and the error bounds for the data. The major problem is that the error bounds are usually those associated with sampling variability and not biological variation. It is easy to see that the use of these (measurement error) confidence intervals is an improper procedure by considering the logical conclusion when carried to an extreme. Such an approach could lead one to erroneously conclude that bad sampling methods (large sampling error range) produce good models since the model would be validated more frequently with large sampling error ranges. On the other hand, if sampling were performed without error, the model would almost never be valid since it is unlikely that it would predict each sample mean exactly.

The underlying problem of validation concerns whether the model reasonably reproduces the growth or decline of the actual population. Under identical conditions, the population could take many different trajectories, only one of which we generally have sampled. (A *population trajectory* refers to the entire sequence of population sizes over time.) If we knew the distribution of all possible population trajectories (instead of just the mean values), then we could perform a comparison procedure for validating the model. To obtain an estimate of the distribution of the population trajectories, several independent populations must be sampled under identical conditions or the model must predict variances and covari-

ances as well as means (Feldman et al. 1984). Unfortunately, very few models predict other than mean trajectories. The authors are not aware of methods other than mean-valued predictors for population modeling with enough realistic structure to be of practical use in integrated pest management.

Even when a statistical approach can be properly applied, there is no absolute guarantee that the model is valid. Statistical tests are devised so as to have a high (known) probability of rejecting a false hypothesis and a relatively low probability of rejecting a valid one. When a statistical hypothesis is rejected, there is a known probability of making an error (called a Type I error). When a statistical hypothesis is not rejected, the probability of error is usually unknown with a maximum possible value of one minus the probability of a Type I error. Thus, the error bound for statistically accepting the hypothesis that the model is predicting accurately is large. However, statistical tests are the best objective method for model validation.

Finally, the testing of model behavior is usually done with insufficient data to properly assess the model's validity as a surrogate for the true population. Often, models validated for a given location fail miserably in another geographical region. Frequently in these situations, a readjustment of some parameter values will result in acceptable model behavior for the new region. This parameter adjustment procedure for each general region is called *model calibration*. It is not surprising that even a "good" model must be recalibrated for different situations. In general, models lack the structure to set the parameters automatically. Extending the model to cover the missing aspects may not even be possible with the current knowledge base. In general, there is a tradeoff between the utility of a more detailed model and the expense of further refinement. Therefore, calibration to acclimate the model to various site conditions should be an accepted and routine procedure.

THE COMPONENTS

Development and Emergence

The temperature description of poikilotherm responses for all components warrants discussion. These responses usually have characteristics that are consistent but difficult to discern under naturally varying environmental regimes. The concept of a temperature-dependent rate function has been utilized with considerable success since the late 1800's. One popular specialization of this concept is the

degree-day concept. The common usage is to associate a fixed number of degree-day units with the completion of the process; however, a more accurate approach is to utilize a distribution of completion times on the degree-day scale. This latter approach results in the completion time being distributed for a cohort of individuals, which is a more common phenomenon.

Although the degree-day concept is used for many applications, it has been shown to be applicable only over a narrow temperature range. This method assumes that the rate of development increases linearly with temperature. Another method, the *rate summation method*, can be used for more general developmental functions. It is based on the concept that developmental rates are additive for changing temperatures and not restricted to a linear temperature response. Curry et al. (1978) gave the theoretical foundation for the rate function; Feldman et al. (1981b) gave the application to *D. frontalis*; and Wagner et al. (1984) gave a methodological discussion of the practical use of rate summation in a general situation.

Reemergence

Reemergence of parent adults was modeled the same way as the development of the immatures. That is, the rate summation method was used to describe reemergence of the beetle. Although the timing of gallery construction and oviposition was strongly density-dependent, reemergence was not, and thus, the temperature-driven rate summation was suitable. The particular formulation and parameter values, together with a validation, are given in Feldman et al. (1981b).

Reproduction

Reproduction is a more complex process and thus more difficult to model. The great diversity in reproductive behavior implies a need for diversity in reproductive models. The experimental evidence of Wagner et al. (1981) indicates that much more is involved in controlling reproduction than temperature. Specifically, attacking-adult density, female size, and season of adult emergence affected reproductive rates. However, field data were usually collected between May and September, and thus the independent variable representing season of adult emergence was not incorporated in our model. Also, because female sizes were not measured in the field, the size parameter could not be established. Therefore, the *D. frontalis* reproductive model only in-

cludes temperature and density as independent variables.

Models of reproduction generally take the form of rates describing the population increase in differential equation systems. Unfortunately, such models do not include age dependencies. The model of reproduction used in our component-based biophysical model consists of two components: (1) An age-dependent reproductive profile describing the proportion of the total reproductive potential that elapses during each time period and (2) a temperature-dependent function that gives the expected total reproduction. Typically, reproduction varies from low numbers at both the high and low temperature extremes to relatively high numbers in the midrange of the organism's viable temperature region.

For *D. frontalis*, the reproduction profile depends on a temperature-and-density normalized time. That is, both temperature-dependent and density-dependent rate functions are used with the rate summation method to define normalized time. Once normalized time is obtained, the reproductive profile is a function of normalized time alone. The total reproductive potential function is dependent on both density and temperature. A discussion of the reproductive modeling approach and its justifications are given in Curry et al. (1978b) and the application to *D. frontalis* is in Feldman et al. (1981b) and Wagner et al. (1981).

Aggregation

Aggregation is a critical population component of many bark beetles and leads to successful colonization of the host tree and propagation of the species. Through aggregation behavior, beetles attack a host tree *en masse*, overcoming its defense mechanism (*resinosis*) and subsequently rendering the tree a suitable environment (moisture level and fungal composition) for development of the next generation of beetles. Although aggregation is critical, it is extremely difficult to model and validate. For purposes of model description, trees are divided into two categories: (1) Trees undergoing mass attack due to pheromone production (active trees) and (2) those undergoing random attacks due to their proximity to active trees (neighboring trees).

Attacks on active trees.—The dynamics of the attack process on active trees is controlled by the number of beetles available for attack, the production of pheromone from the attacking beetles, and the release of tree volatiles from the attacked host. The attack process lasts for several days. As the amount of gallery within the tree increases, the proportion of beetles attacking it decreases. Residual beetles drawn to the active tree go on to attack neighboring

trees. Within an infestation, the proportion of beetles attracted to a given active tree is a function of the strength of the attractant emanating from that tree relative to all other competing sources of attraction. Thus, to model aggregation, an expression is obtained that represents the attractiveness of each tree. Allocation of the available beetles is then made on the basis of the weighted average of the various attractiveness factors from all active trees.

Attacks on neighboring trees.—After beetles are allocated to an active tree, a second criterion is used to determine how many of these beetles are redirected to neighboring trees. As attacks on active trees progress, an increasing number of beetles “switch” their attacks from active to neighboring (inactive) trees. In this fashion, the infestation spreads as beetles overcome the resistance of new trees. Attacks on neighboring trees normally do not occur at distances greater than 6 to 7 meters from the active trees (Johnson and Coster 1978). However, the dynamics of attacks on neighboring trees involves many factors, and the critical distance of 6 to 7 meters is not constant but varies depending on local temperature and wind conditions (Schowalter et al. 1981).

To model this switching phenomenon, an area of attractiveness around each active tree was defined. Beetles redirecting their attack could potentially attack any neighboring tree within this area of attractiveness. At very high temperatures, a reduction (empirically determined) in the attractiveness region was made; that is, for each degree above 33°C, all dimensions of the attractiveness region were reduced 20 percent. There was also a high and low temperature flight inhibitor based on results of White and Franklin (1976) that was used to reduce flight at temperatures not conducive to beetle activity. Once the area of attractiveness was established, the likelihood of attacks on neighboring trees within that area increased in proportion to the cross-sectional area of the tree and decreased with the square root of the distance from the active tree for all trees beyond 3 meters. The 3-meter threshold and the use of the square root decrease were determined empirically by comparing the times of attacks in field plots with model predictions. The specific mathematical formulation for the switching model is given in Feldman et al. (1981a).

Tree Susceptibility

If enough beetles attack a neighboring tree to overcome its defense mechanisms, that tree will become attractive. We define susceptibility in terms of the number of attacks necessary to cause a tree to become active (an aggregator). Many factors influ-

ence susceptibility, and these are incorporated in a preliminary biophysical model (Sharpe and Wu 1985). This model has not yet been incorporated into TAMBEETLE. The present susceptibility model used in TAMBEETLE is an empirical function using landform, average d.b.h., and pine basal area. This function is based on data supplied by the U.S. Forest Service (Nettleton et al. 1985). Although susceptibility should vary among trees, only an average value for the infestation is currently used. The susceptibility model is clearly an integral part of the aggregation model; therefore, because the susceptibility component is currently not a biophysical model, the allocation procedure of TAMBEETLE is its weakest component.

Tree Suitability

Tree suitability is similar to tree susceptibility. Susceptibility has to do with the ability of the beetles to overcome the initial tree defenses; whereas, suitability has to do with developmental processes of the beetle within the tree. It is logical to assume that development rates and immature mortality would depend partly on tree factors, but currently there are few biological data to establish clear relationships.

THE POPULATION MODEL

The dynamics of population growth and decline is influenced by the individual components and their interactions. Both the components and component interactions must be approximated in the mathematical model. One procedure for integrating model components is called the *iterative cohort method* (Curry et al. 1978b). The general approach is to approximate time as a discrete parameter and view the population as a collection of cohorts. (A *cohort* is a group of organisms within a developmental stage that begins the stage at the same time and is under the influence of identical environmental factors.) The methodology is conceptually an “accounting” procedure that maintains a record of the active cohorts making up the population. The process is initiated by an initial group of cohorts. A time increment equaling 1 day is used to iteratively compute the population over time.

There are three types of cohorts: an immature insect cohort, an adult insect cohort, and a tree cohort. The immature insect cohort represents the developing immatures from oviposition to brood emergence. The adult insect cohort represents the parent adults from first attack to reemergence. Thus, the beetles available for allocation to active and neighboring

trees are obtained from these two cohorts.

For modeling purposes, the insect cohorts are represented by a two-dimensional vector. The first number within the vector gives the current number of insects remaining alive within the cohort, and the second number gives the current normalized time (i.e., physiological age) of the cohort, indicating its developmental status. At the end of each day (time increment), all newly deposited eggs within all trees during the day are accumulated to form a new immature insect cohort. Similarly, all adults that attacked trees during the day are accumulated to begin a new adult insect cohort. Based on the rates for emergence and reemergence, the emerging and re-emerging beetles are determined at the start of each day by incrementing the normalized time of the cohorts. If a tree suitability component model becomes available, then it will be necessary to have more than one immature cohort and one adult cohort formed each day. If tree characteristics affect emergence and reemergence times, then different cohorts would be formed to represent the various tree characteristics present within an infestation.

Cohorts of trees are used to maintain the relevant information regarding active trees. Because many factors influence the status of active trees, the tree cohorts are much more complex. The information for each tree is: the day the tree became active, number of beetles within the tree, number of eggs within the tree, amount of gallery within the tree, distribution of insect density within the tree, and the tree attractiveness factor. With this information, the allocation of beetles and the status of the trees can be determined each day.

CONCLUSIONS

The TAMBEETLE model represents a synthesis of more than a decade of research directed specifically at population dynamics of *D. frontalis*. The goal of the modeling approach at the onset of the research was to organize knowledge on *D. frontalis* population dynamics for the following purposes: exploration, explanation, projection, and prediction. To varying degrees, each of these purposes was accomplished. TAMBEETLE is currently an element in the Southern Pine Beetle Decision Support System (Rykiel et al. 1984), and serves as a valuable aid in integrated pest management decisionmaking.

It is important to recognize that no aspect of the research on population dynamics of *D. frontalis* is so well understood that additional research would be unwarranted. In our view, more research is critically needed on host susceptibility, stand-growth model-

ing, beetle species interactions, and dynamics of within-tree mortality.

Sensitivity analyses conducted on TAMBEETLE indicate that performance of the model is greatly affected by variation in host susceptibility. The current version of TAMBEETLE uses an empirical function for host susceptibility that is clearly inadequate. Sharpe and Wu (1985) have developed a conceptual model of host susceptibility, which is based on fundamental theory of plant physiology. This model eventually will be incorporated into TAMBEETLE.

Numerous stand growth and yield models are available for southern pines. These models were developed using regression techniques. There has not been a concerted effort to develop a mechanistic model that abstracts basic knowledge of plant physiology. This type of model has been developed for a number of different crop plants and is needed for understanding and predicting interaction of plants (trees) with biotic and abiotic components of the environment.

Although *D. frontalis* is often the most prominent insect species within a spot, several other insects can influence the growth and decline of an active infestation. Wagner et al. (1985) reported prominent interactions among the five southern pine beetle species. In order for TAMBEETLE to be an accurate model of an infestation, an *Ips* component must be added. We are in the process of integrating the *Ips* components into a population model that can then be integrated into TAMBEETLE.

The factors involved in the dynamics of within-tree mortality are poorly understood. We know that about 80 to 90 percent of the within-tree population will perish. Certainly, natural enemies contribute to the observed mortality, but other factors are clearly involved. Describing or modeling within-tree mortality is a difficult problem that has not adequately been addressed.

Most of the individual components of TAMBEETLE have been calibrated for east Texas. The components of emergence, reemergence, and reproduction have been validated to a reasonable degree. However, as mentioned above, the tree susceptibility, and thus the allocation procedure, need additional work. Through the efforts of Nettleton and Connor of the USDA Forest Service, a large data set has been made available for the testing of the model. Based on their data, the parameter values for the susceptibility model were adjusted; however, the model still did not perform adequately in many of the spots. This emphasizes the need to have a susceptibility index with a biophysical base and with the ability to vary among trees.

LITERATURE CITED

- Curry, G. L.; Feldman, R. M.; Sharpe, P. J. H. Foundations of stochastic development. *J. Theor. Biol.* 74: 397-410; 1978a.
- Curry, G. L.; Feldman, R.M.; Smith, K.C. A stochastic model of a temperature dependent population. *Theor. Popul. Biol.* 13:197-213; 1978b.
- Feldman, R. M.; Curry, G. L.; Coulson, R. N. A mathematical model of field population dynamics of the southern pine beetle. *Ecological Modelling* 13: 261-281; 1981a.
- Feldman, R. M.; Curry, G. L.; Wehrly, T. E. A statistical procedure for a simple population model. *Environ. Entomol.* 13: 1446-1451; 1984.
- Feldman, R. M.; Wagner, T. L.; Sharpe, P. J. H.; Gagne, J. A.; Coulson, R. N. Within-tree life process models of the southern pine beetle. *Ecological Modelling* 13: 247-260; 1981b.
- Johnson, P. E.; Coster, J. E. Probability of attack by southern pine beetle in relation to distance from an attractive host tree. *For. Sci.* 24: 574-580.
- Nettleton, W. A.; Connor, M. D.; Ryan, G. W. Evaluation and application of the TAMBEETLE and Arkansas southern pine beetle spot growth models in the Gulf Coastal Plains. In: Branham, S. J.; Thatcher, R. C., eds. Proceedings, integrated pest management research symposium; 1985 April 15-18; Asheville, NC. Gen. Tech. Rep. SO-56. New Orleans, LA: U.S. Department of Agriculture, Forest Service, Southern Forest Experiment Station; 1985: 202-205.
- Rykiel, E. J., Jr. Modeling agroecosystems: lessons from ecology. In: Stinner, B.; Lawrance, R.; House, G., eds. *Agricultural ecosystems: unifying concepts*. New York: John Wiley and Sons; 1984: 157-178.
- Rykiel, E. J., Jr.; Saunders, M. C.; Wagner, T. L.; Loh, D. K.; Turnbow, R. H.; Hu, L. C.; Pulley, P. E.; Coulson, R. N. Computer-aided decision-making and information accessing in pest management systems, with emphasis on the southern pine beetle. *J. Econ. Entomol.* 77: 1073-1082; 1984.
- Schowalter, T. D.; Pope, D. N.; Coulson, R. N.; Fargo, W. S. Patterns of southern pine beetle (*Dendroctonus frontalis* Zimm.) infestation enlargements. *For. Sci.* 27: 837-849; 1981.
- Sharpe, P. J. H.; Wu, H. A preliminary model of host susceptibility to bark beetle attack. In Safranyik, L.; Berryman, A. A., eds. *Insect/host interactions*. Proceedings, IUFRO Symposium; Banff, Alberta, Canada; 1985. [In press.]
- Wagner, T. L.; Wu, H.; Sharpe, P. J. H.; Schoolfield, R. M.; Coulson, R. N. Modeling insect development rates: a literature review and application of a biophysical model. *Ann. Entomol. Soc. Am.* 13:1125-1130; 1984.
- Wagner, T. L.; Flamm, R. O.; Coulson, R. N. Strategies for cohabitation among the southern pine bark beetle species: comparisons of life process biologies. In: Branham, S. J.; Thatcher, R. C., eds. Proceedings, integrated pest management research symposium; 1985 April 15-18; Asheville, NC. Gen. Tech. Rep. SO-56. New Orleans, LA: U.S. Department of Agriculture, Forest Service, Southern Forest Experiment Station; 1985.
- White, R. A.; Franklin, R. T. Activity of the southern pine beetle in response to temperature. *J. Georgia Entomol. Soc.* 11:370-372; 1976.

Evaluation and Application of the TAMBEETLE and Arkansas Southern Pine Beetle Spot Growth Models in the Gulf Coastal Plain

Wesley A. Nettleton, Michael D. Connor, and George W. Ryan¹

Abstract.—In 1983, the TAMBEETLE and Arkansas computer-based southern pine beetle (SPB) spot growth models were pilot tested across the Gulf Coastal Plain. Twenty-seven SPB spots were sampled and evaluated for 30 days for comparison of model predictions to actual spot growth. The TAMBEETLE model tended to underpredict and the Arkansas model overpredict spot growth. Both models have been updated as a result of this study.

Additional keywords: *Dendroctonus frontalis*, prediction.

INTRODUCTION

Managing outbreaks of the southern pine beetle (SPB), *Dendroctonus frontalis* Zimmermann, depends on a thorough understanding of the dynamics of infestation growth and decline. SPB integrated pest management should consist of more than direct control activities, salvaging one spot after the next with little regard for control priorities. Rather, SPB integrated pest management should be based on a systems approach that considers insect population dynamics, host population dynamics, the impact on resource values and management objectives, and treatment strategies (Coster 1980).

Because of the complexities involved with SPB/host/site interactions, computer simulation models are needed to combine available data with the latest technology, to provide the pest management specialist/forester with spot growth predictions. Input and output for these models have purposely been made flexible enough to allow different levels of accuracy. Thus, models can accept precise estimates of initial beetle numbers within a spot, and produce estimates of how these numbers will change as the spot grows and declines. Predictions can also be made with less

precise information, e.g., number of infested trees and stand conditions associated with the particular spot. However, the accuracy of these predictions will be reduced (Hertel 1980).

Computerized SPB spot growth models have been developed at Texas A&M University (TAMBEETLE Model: Turnbow et al. 1982) and the University of Arkansas (Arkansas Model: Lih and Stephen 1983). Both models provide short term predictions (i.e., 1 to 3 months) of tree mortality. TAMBEETLE and the Arkansas Model have been developed for use in pine stands in Texas and Arkansas, respectively. These models could also be of value if adapted for the regular SPB program of pest management specialists. The models could be used to predict spot growth, to select prevention tactics and to determine economic losses. However, before implementing the models, we determined the accuracy of the predictions over the Gulf Coastal Plain, covering a range of stand conditions and SPB population levels. This paper summarizes the results of an evaluation of the performance of the two models and examines the use of these models for both the pest management specialist and resource manager.

METHODS

From June to October 1983, prospective SPB spots were located by National Forest ranger district personnel and State pest management specialists. The spots were ground checked to determine their suitability before sampling. We gave priority to spots with fewer than 50 active trees, which included freshly attacked trees. All the tree, insect, and environmental data needed to initialize and evaluate the TAMBEETLE and Arkansas models were collected on selected infestations in Texas, Louisiana, Mississippi and Alabama.

On the first visit to a spot, we recorded the number of vacated trees, the number of infested trees, the pine basal area, and the total basal area at the active head(s) of the infestation. For infested trees, the following information was also collected: d.b.h., tree species, brood stage, and crown color. From a subsample of the infested trees, averages were determined for the height to the bottom of the live crown, total height of the tree, stand age and radial growth in the last 5 years.

¹ Respectively, Entomologists, U.S. Department of Agriculture, Forest Service, Southern Region, Forest Pest Management, Pineville, LA, and Statistician, Forest Service, Southern Region, Forest Pest Management, Atlanta, GA. (The authors thank Phillip Schwolert, Laura Mitchell, and Donald Lewis for their valuable assistance in collection and analysis of the field data. They also thank Nona Huckabee, computer assistant, for calculations and printouts for the table.)

Ten trees were intensively sampled in each infestation. These trees were chosen to proportionately represent the brood stages in the spot. Four 100-cm² bark disk samples were taken at each of two heights, 3.5 m and 6.5 m. The disk samples were brought back to the lab and x-rayed. SPB life stage counts (the numbers of attacking adults, parent gallery length, larvae, pupae, and callow adults/100 cm²) were obtained by x-ray interpretation. These data gave the model developers an indication of initial SPB population numbers and a better understanding of why model predictions were, or were not, accurate.

All required data were used to initialize the models and obtain predictions of infestation growth or decline. Local weather records for each spot were entered when running the TAMBEETLE simulations. Subsequent visits to each SPB spot were conducted at approximately 2-week intervals. On these visits, the brood stage of previously infested trees, the number of newly attacked trees, and the pine and hardwood basal areas at the head of the spot were recorded. These data were then used to compare the predicted number of dead and infested trees from the models with the actual numbers of trees that were present in the infestations.

Before implementing the models, the authors established the criteria that the spot growth models should predict with less than 30 percent error 70 percent of the time. Although the majority of the infestations were sampled for a longer period, 30 days was the point in time that was used to determine the accuracy of the models' predictions. From a practical standpoint, that is the approximate time it would take resource managers to control a typical SPB spot.

RESULTS

A total of 27 SPB infestations was sampled and evaluated. Eleven were located in Texas, 5 in Louisiana, 9 in Mississippi, and 2 in Alabama. On the day of the first visit, the spots ranged in size from 12 to 156 actively infested trees. Overall, the average spot size after 30 days was 110 trees. Only 1 spot (spot 8) did not have any additional trees attacked.

Comparisons of the predicted and actual SPB spot growth (cumulative numbers of attacked trees) for the TAMBEETLE and Arkansas Models are presented in table 1. The data demonstrated that when analyzed on a spot-by-spot basis both models failed to perform at the level first established. The actual

Table 1. — Comparison of actual and predicted southern pine beetle spot growth for 30 days by the TAMBEETLE and Arkansas Models (cumulative number of attacked trees)

Spot no.	Day no.	TAMBEETLE				Actual	Arkansas model			
		Low	Median	High	Percent error		Pred. min.	Pred. max.	Mean	Percent error
1	29	280	317	356	8.6	292	414	480	447	53.1
2	28	94	94	94	-28.8	132	187	217	202	53.0
3	28	71	100	101	-27.5	138	162	188	174	26.8
4	26	90	128	171	-39.0	210	211	243	227	8.1
5	30	23	25	27	-21.9	32	46	54	50	56.3
6	29	71	72	88	-28.0	100	110	128	119	19.0
7	28	30	30	30	- 3.2	31	60	70	65	109.7
8	21	27	27	27	0.0	27	40	46	43	59.3
9	29	87	94	119	-41.6	161	137	159	148	-8.1
10	25	16	18	23	-48.6	35	27	33	30	-14.3
11	28	141	155	160	29.2	120	113	131	122	1.7
12	29	90	94	103	-40.9	159	150	174	162	1.9
13	27	59	62	71	37.8	45	58	68	63	40.0
14	29	34	34	34	-62.6	91	77	89	83	-8.8
15	29	82	88	137	-43.2	155	142	164	153	-1.3
16	27	19	19	19	-36.7	30	28	34	31	3.3
17	28	32	36	42	-2.7	37	52	60	56	51.4
18	27	38	38	38	-50.6	77	71	83	77	0.0
19	22	40	42	48	-27.6	58	84	96	90	55.2
20	28	38	38	38	-51.3	78	91	105	98	25.6
21	26	102	104	114	-36.7	166	219	253	236	42.2
22	NO DATA AVAILABLE									
23	26	104	116	134	-34.1	176	177	205	191	8.5
24	25	74	741	74	-18.7	91	133	153	143	57.1
25	29	55	79	105	9.7	72	124	144	134	86.1
26	28	193	207	230	-0.5	208	303	349	326	56.7
27	28	168	185	201	17.1	158	205	237	221	39.9
28	19	94	95	106	1.1	94	108	124	116	23.4

value was within 30 percent of the predicted value on 13 (48 percent) and 15 (55 percent) of the 27 spots for the Arkansas and TAMBEETLE Models, respectively. The Arkansas Model tended to overpredict and TAMBEETLE underpredict. A statistical, paired t-test based on percent error showed a significant difference between the models, $t = 9.49$ ($p = .01$). The average percent error for all 27 spots was -20.3 percent with a standard error of the mean of 5.07 percent for the TAMBEETLE Model while the Arkansas Model had a $+31.33$ percent error with a standard error of the mean of 5.99 percent. Figures 1 and 2 illustrate actual spot growth at approximately 30 days compared to the predicted

maximum and minimum number of attacked trees for the Arkansas Model and high and low cumulative number of attacked trees predicted by TAMBEETLE. The Arkansas Model predicted more accurately during July and August (spots 9 to 18). There were no significant differences in the model predictions between States.

In addition, the models were analyzed using a categorical approach. We based this analysis on whether or not the SPB infestation would have been controlled. These decisions were compared with the standard control priority guidelines used by entomologists from the USDA Forest Service on infestations located on National Forest ranger districts

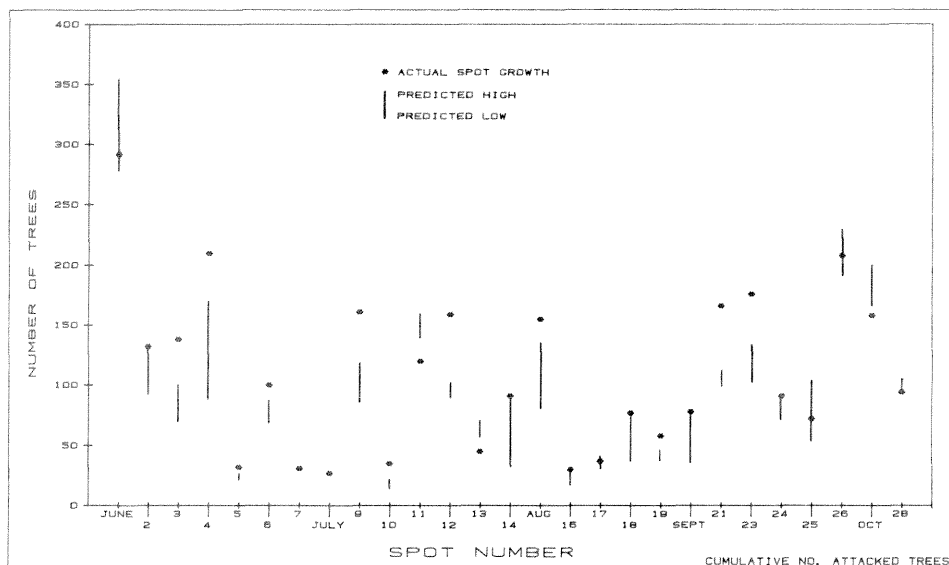

Figure 1.—Comparison of actual SPB spot growth to the predicted range of spot growth by the TAMBEETLE model.

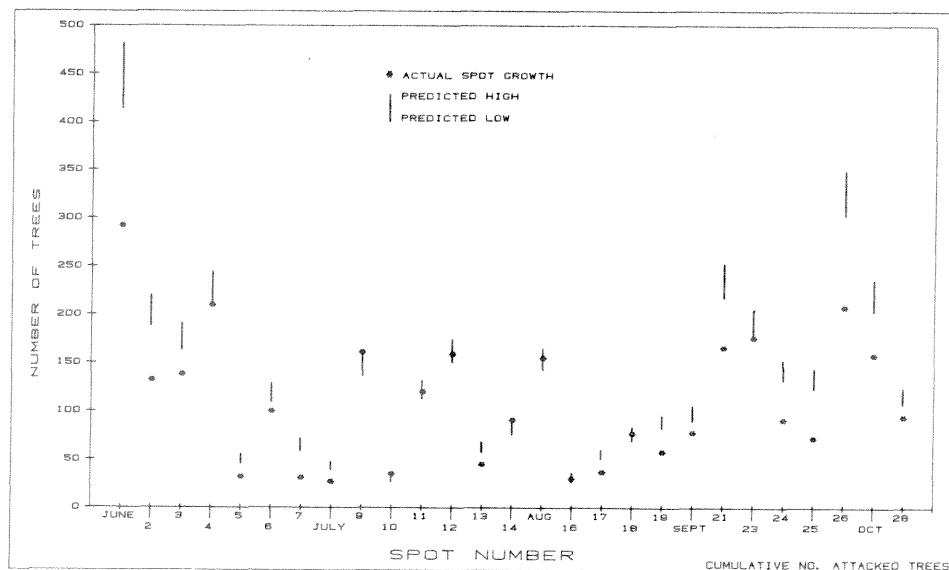

Figure 2.—Comparison of actual SPB spot growth to the predicted range of spot growth by the Arkansas model.

(Billings and Pase 1979). Figure 3 shows the results of this comparison. Twenty of the 27 infestations exhibited spot growth greater than five trees in 30 days. A type-I error was considered to be a "no control" decision on a spot that did significantly expand (more than five trees in 30 days). A type-II error is a decision to control a spot that did not grow. From a practical standpoint, this error is the less serious of the two. Based on these results, both the FPM guidelines and the Arkansas Model tended to overpredict spot growth and met control criteria several times when infestations collapsed. The TAMBEETLE Model was more conservative and 13 times recommended no control when the spot did grow. In the interim between 1983 and 1985, both models have been updated. The results of the revised predictions are summarized in figure 4.

The revised simulations show significant improvement. Both models seem to be more sensitive to the spot growth trends. The actual value was within 30 percent of the predicted value on 21 (78 percent) and 23 (85 percent) of the 27 spots for the Arkansas and TAMBEETLE Models, respectively. The revised Arkansas Model now meets the criteria initially established by the authors. However, because some of the data used to revise the TAMBEETLE Model were from this study, no further conclusions regarding its validity will be made until an independent data set can be obtained.

Steps have been taken by the model developers to incorporate changes in both the input procedures and the output to make the models more understandable and easier to use. Both models could be incorporated for use by pest management specialists. They would

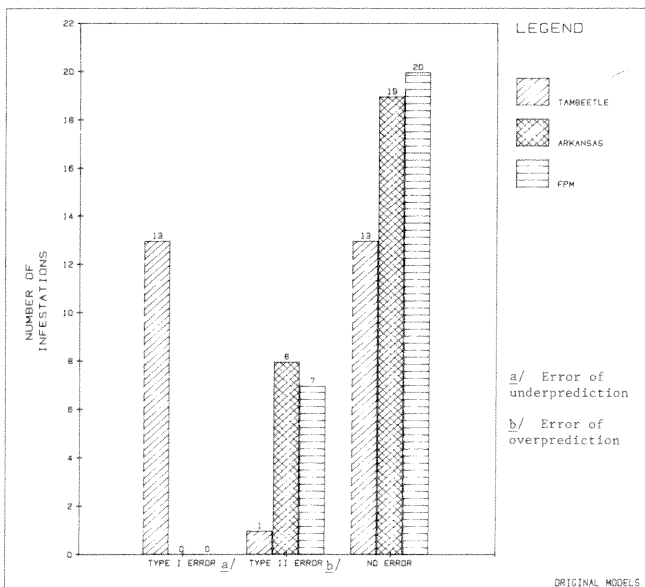

Figure 3.—Comparison of the original TAMBEETLE, Arkansas model, and standard FPM guidelines in making control/no control decisions versus actual SPB spot growth.

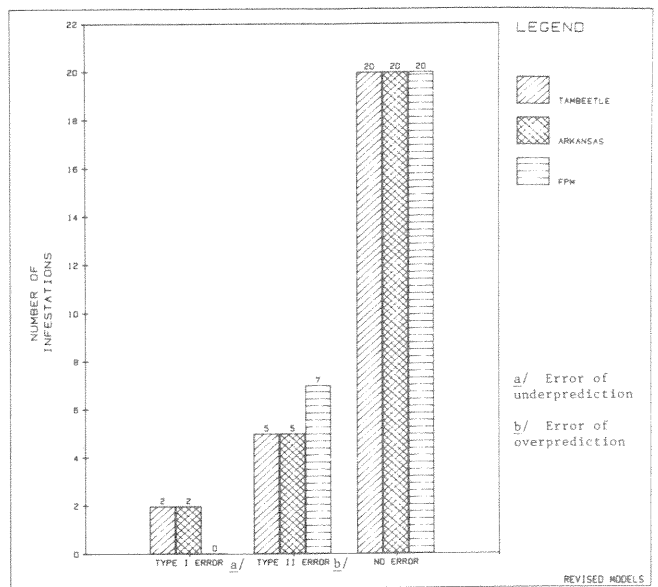

Figure 4.—Comparison of the revised TAMBEETLE, Arkansas model, and standard FPM guidelines in making control/no control decisions versus actual SPB spot growth.

be particularly appropriate when preparing SPB biological evaluations especially in wilderness and special administrative areas. This type of information will enable the resource manager to make better-informed decisions.

LITERATURE CITED

- Billings, Ronald F.; Pase, Herbert A., III. Southern pine beetle handbook: a guide for ground checking southern pine beetle spots. Agric. Handb. 558 Washington, DC: U.S. Department of Agriculture; 1979. 19 p.
- Coster, Jack E. Developing integrated pest management strategies. In: The southern pine beetle. Tech. Bull. 1631. Washington, DC: U.S. Department of Agriculture; 1980: 195–203.
- Hertel, Gerard D. Recommendations for further work. In: The southern pine beetle. Tech. Bull. 1631. Washington, DC: U.S. Department of Agriculture; 1980: 205–213.
- Lih, M. P.; Stephen, F. M. Southern pine beetle fact sheet number 26: Use of computer simulation models to predict expected tree mortality and monetary loss from southern pine beetle spots—a research update. Forestry Bulletin R8-FB/P 1. Atlanta, GA: U.S. Department of Agriculture, Forest Service, Southern Region; 1983. 2 p.
- Turnbow, R. H.; Coulson, R. N.; Hu, L.; Billings, R. F. Procedural guide for using the interactive version of the TAMBEETLE model of southern pine beetle population and spot dynamics. Miscellaneous Publication 1518. College Station, TX: Texas Agricultural Experiment Station; 1982. 24 p.

Energetics of Pine Defense Systems to Bark Beetle Attack

Peter J. H. Sharpe, Hsin-i Wu, R. G. Cates, and J. D. Goeschl¹

Abstract.—A conceptual mathematical model has been developed to consolidate and clarify tree susceptibility hypotheses previously published. A systems model provides a framework for linking these hypotheses and explaining system behavior. The primary focus of this study was the influence of short-term water stress regimes on tree defense energetics. Water stress has two somewhat counteractive effects upon plant metabolism: 1) It increases soluble carbohydrate and amino acids, thereby increasing suitability of the tree for bark beetle colonization, reproduction, brood development, and survival; 2) it increases the substrate reservoir for synthesis of carbon allelochemicals for anti-herbivore defense. Increased food value (as opposed to increased chemical defense) as a result of short-term stress was found to be relatively important.

The secondary focus of the study was modeling the interrelationship between the resin duct defense system and the wound response, two defense systems previously studied apart from each other. The model has been extended to link these two defense systems and the linked model shown to be consistent with the observed behavior of the seasonal dynamics of the wound response.

Additional keywords: Tree physiology, tree stress, chemical response, wound response, host/pest interaction, *Dendroctonus frontalis* Zimmermann, mechanistic modeling.

INTRODUCTION

Pine trees acquire light, water, and nutrients for a variety of physiological functions, including respiratory metabolism, growth, reproduction, and defense.

¹ Respectively, Professor, Associate Professor and Senior Research Scientist, Biosystems Research Group, Department of Industrial Engineering and Department of Soil Crop Sciences, Texas A&M University, College Station, TX; and Associate Professors, Chemical Ecology Laboratory, Department of Biology, University of New Mexico, Albuquerque, NM. (Technical discussions leading to model formulations were held with Peter Lorio, Robert Sommers, Karel Sztozek, Gary Pitman, Evan Nebeker, Pamela Matson, Alan Berryman, C. A. Blanche, Jack DeAngelis, John Hodges, Fred Stephen, Tim Paine, Robert Coulson, and Tom Payne. This study was jointly funded through National Science Foundation Grant BSR-84-06136 and the Integrated Pest Management RD&A Program for Bark Beetles of Southern Pines, USDA Forest Service Grant Number FS-30-82-4.)

Energy and nutrients allocated to one function are unavailable for others. Some ecological energetics studies such as Townsend and Calow (1981) are based on the premise that a direct relationship exists between resource assimilation/allocation and fitness; that resources are limited; and that their optimum allocation is essential. Wiens (1984) notes that this latter assumption is not necessarily supported by empirical studies.

Resource limitation can operate at two distinct levels: individual and population. In the resource allocation context, limitation affects individuals, potentially altering their metabolic performance, growth, defense capabilities, or reproduction. These effects may or may not be expressed as a resource limitation for the population or be recognized as causing variations in population size or age structure. Some circumstances, such as those reported by Whitham (1981), show that resource limitation can be assessed at both levels, but this is rare and often not possible. A major limitation is that the specifics of system dynamics are unknown, particularly the influence of resource interactions on availability.

Attributes such as chemical composition affect resource availability in a variety of ways (Wiens 1984). Variations in allelochemical concentrations in plant tissues have an effect on dietary suitability to phytophagous insects and large herbivores (Atsatt and O'Dowd 1976; Feeny 1976; Rhoades and Cates 1976; Rhoades 1979; Rosenthal and Janzen 1979; Bryant and Kuropat 1980; Cates et al. 1983).

A demonstration of such effects is provided by Whitham (1978, 1980, 1981) in studies of aphids colonizing cottonwood leaves. Availability and suitability to aphids vary based on size and shoot position at budbreak. Various portions of an individual leaf also vary in suitability. Zucher (1982) has shown that these patterns are associated with variations in concentrations of phenolic compounds. Whitham (1981) suggests that this intraplant variation is an adaptive response to herbivory. Similarly, availability and suitability of Douglas-fir to the western spruce budworm are not only functions of shoot size but also of the composition and quantity of terpenes and possibly other compounds (such as phenolics) in shoots of different sizes (Cates et al. 1983, Redak and Cates 1984, Gambliel and Cates.²)

² Unpublished data.

A large gap in the literature that is becoming an area of increased research effort is the relationship between various plant physiological processes and anti-herbivore response as defined by defensive chemistry. A hypothesis proposed for defoliators by Tuomi et al. (1984) suggests that changes in carbon-based allelochemicals may result from shifts in the plant's carbon/nutrient balance rather than from active defensive responses by the host plant to herbivory. These changes appear to be consistent with observed increases in carbon-based allelochemicals at times of the year and under environmental conditions when there is a carbon surplus that cannot be used for maintenance and growth (Bryant et al. 1983). As a result of nutrient or other types of stress, carbon that cannot be invested in growth is diverted to secondary (allelochemical) metabolite production (Chew and Rodman 1979). Fertilization, however, diverts carbon to growth and tends to reduce excess carbon available for the production of allelochemicals (Bryant et al. 1983). An alternative hypothesis is that a shift in carbon/nitrogen ratios resulting from defoliation may be a local stimulus resulting in the shift to more defensive allelochemicals. This shift in turn may increase the fitness of the plant, particularly the foliage. It would also be valuable to know if the chemicals included in this increase are primarily those that may be toxic or detrimental to the herbivore (or pathogens, should they elicit the same response). Furthermore, abiotic stresses such as water, nutrients, or light may not result in the changes described by Tuomi et al. (1984).

SOUTHERN PINE DEFENSE SYSTEMS

The southern pine bark beetle (SPB) has been extensively studied for the past 12 years, yet very little is known about the dynamics of the pine host defense system and its interaction with the attacking beetle. Dynamic changes in host defense occur through shifts in the tree's metabolism that result in differing levels of allelochemicals, principally resin acids and monoterpenes. Changes in relative concentrations of these chemicals provide opportunities for bark beetle colonization.

Host defenses against bark beetle attack are complex phenomena involving numerous physiological processes and environmental regulators. Because of its complexity, host defense dynamics can best be described by a mathematical model using the computer to integrate interdependent processes. Of particular interest are the interactions between host

stress factors on the primary defense and the wound response defense systems of southern pines.

The oleoresin production system in pines is the primary defense mechanism against bark beetle attack (Rudinsky 1966a, 1966b; Reid et al. 1967; Anderson and Anderson 1968; Mason 1971; Berryman 1972; Smith 1975; Hodges et al. 1979; Blanche et al. 1983). Hodges et al. (1979) suggest that southern pines can be classified by bark beetle resistance or susceptibility using physical properties of oleoresin such as total flow, flow rate, viscosity, and time to crystallization. In addition, low oleoresin exudation pressure (OEP) resulting from flooding or drought is generally correlated with successful bark beetle attack (Thatcher 1960; Vité 1961; Vité and Wood 1961; Lorio and Hodges 1968, 1977; Goeschl 1979).

The primary resin duct defense system has received the most research attention. Berryman (1972), Shrimpton (1978), Cates and Alexander (1982), and Hain et al. (1985) suggest that, in the most resistant trees, a combination of the primary resin response and a wound response is required to explain tree resistance or susceptibility. The wound response is also important in conifer species that do not have a primary resin system, or in those trees where beetles survive the primary resin response (Berryman 1972). The response characteristics of both systems have been considered in formulating this host resistance model.

A tree's susceptibility and resistance levels determine the probability of its being colonized by bark beetles. Susceptibility is clearly the opposite of resistance, depending on site characteristics and stand dynamics (stocking levels, stand composition, vigor, structure, tree and stand maturity; see Wulf and Cates 1985). In addition, resistance is greatly modified by insect population dynamics; few resistant trees are likely if the attacking insect population is sufficiently large. Bark beetle population dynamics and stand mortality, especially as influenced by seasonal and weather phenomena, have been included in an SPB spot growth model (Feldman et al. 1981a, 1981b; 1985).

HOST STRESS PHYSIOLOGY

A recent focus of attention, which is of major importance to host-insect interactions, is the effect of stress on ecosystem processes. Terms such as *stress*, *stressful environments*, *environmentally-stressed* individuals and *biological stress*, however, have been used in several different ways in the plant-herbivore,

plant physiology, and ecosystem process literature. For example, little is known about the effect of the duration of stress, type of stress or seasonality and magnitude of stress on the production of allelochemicals. Stress has many effects on various physiological processes, above- and below-ground herbivory, nutrient and secondary metabolite allocation among tissues, decomposition and nutrient cycling (Cates, Horner, and Gosz).³ A comprehensive set of data, however, suggests that host tissue quality is usually improved as a food resource when hosts are experiencing stress (Hodges and Lorio 1969, Goeschl 1979, Rhoades 1979, Cates et al. 1983).

In general, it is important to note that stress is considered in the context of long-term, adverse abiotic conditions, particularly when ecosystem processes are discussed. On the other hand, in plant defense theory, stress is usually considered in the short term, and is somewhat unpredictable in time and space.

Long-term stress usually refers to such conditions as soils unfavorable for plant growth due to adverse combinations of temperature, moisture, structure, mineralogy, texture, and pH. The distinction between periodic short-term stress and long-term conditions unfavorable for growth has led to considerable confusion in predicting production and turnover of natural product chemistry in plants. From the chemistry viewpoint, plants that have evolved under long-term stress have high levels of polyphenols and organic acids (Gosz 1981, Cates, Horner and Gosz⁴).

It has been suggested that short-term stress increases qualitative or toxin defenses and decreases the higher molecular weight tannin and resin acid defenses. Even though few rigorous studies are available, the considerations and models developed in this paper deal primarily with short-term stress.

Kinds of Stresses

In formulating models of host stress physiology, it is important to distinguish clearly between the functional differences among various kinds of stresses. For example, while the literature suggests that toxins increase and tannins decrease under water stress (Rhoades 1979, Cates et al. 1983), both the low molecular weight phenolics and tannins were demonstrated to decrease under reduced light stress (Cates, Van Horne and Hanley).⁵ Light stress (shade) results from decreasing photosynthate

caused by competition for light among neighboring trees. Light stress and nutrient stress reduce the concentration of photosynthetic enzymes (Farquhar and von Caemmerer 1982). Moderate water stress has a greater influence on photosynthate demand than on supply (Wadleigh et al. 1946). Heavy to severe water stress affects all physiological processes.

The importance of light stress as a factor in host defense has been well documented. Clements (1974) found that the volume of oleoresin produced from southern pines is directly related to crown size. Waring and Pitman (1980) relate leaf area, sapwood growth, and host resistance to host vigor. In southern forests, Ku et al. (1976, 1980) found that pines attacked by SPB were generally associated with poor growth, smaller size, smaller crown, and thinner bark relative to healthy trees. In selecting susceptible trees for attack during field experimentation, Hodges and Lorio (1973) chose morphological features such as short yellowish needles, small cones, and sparse crowns, all characteristic of reduced-light stress.

Water stress is more complex than light stress because plant responses differ markedly according to the type of water stress (i.e., drought or waterlogging) and its duration. Low or negligible water stress favors growth, or at least does not impede it. Moderate water stress limits growth but not photosynthesis. Photosynthate products are diverted from growth to the formation of differentiation products such as rubber, essential oils, and oleoresin (Black 1957). Wadleigh et al. (1946) showed interaction between water stress, growth and rubber synthesis in guayule; growth decreased with increasing water stress, while rubber yield percentage initially increased with water stress and then declined. These and similar studies suggest that osmoregulation resulting from mild water stress favors synthesis of differentiation products. Under severe water stress, all synthesis processes are reduced.

Tree Growth and Susceptibility

Growth has also been used as an indicator of vigor and, therefore, of susceptibility (Lorio 1973, Lorio and Hodges 1974, Hicks et al. 1978, Hicks 1980). Because growth varies with site, age, soil moisture, basal area, and other factors, Blanche et al. (1983) and Cates et al. (1983) suggest that the relationship between growth and susceptibility may be difficult to measure under field conditions. This theoretical analysis, in which hypotheses of interactions between processes are proposed, provides a method by which the underlying complexity can be explored, and possibly explained.

³ Unpublished data.

⁴ *Ibid.*

⁵ Unpublished data.

MODELING APPROACH

Host defense energetics involves the allocation processes of plant carbon metabolism. Photosynthesis, respiration, growth, allelochemical synthesis, and wound response following beetle attack are the essential elements of an energetics model. The problem lies in combining these processes into a relatively simple mathematical model. The traditional modeling approach, which builds and then combines individual process models, has several drawbacks: 1) Interaction between processes must be imposed externally, 2) the computer code is long and tedious and 3) the number of parameters to be determined is usually large. A recently developed alternative is the continuous time Markov (CTM) approach. CTM has a number of advantages because it represents physiological processes in terms of states and transitions, treats resources as an interacting group, and provides an approach whereby pathways for synthesizing defensive chemicals can be coupled with other competing synthesis pathways as well as phloem transport, photosynthesis, respiration and uptake of soil oxygen, water, light, and nutrients. The critical CTM feature (and one that greatly assists the development of this type of model) is the provision of a means whereby physiological interactions can be made state-dependent and thereby coupled with both resource availability and other competing processes.

Earlier Model Development

Photosynthesis and respiration were represented within a CTM context in the model by Sharpe (1983), which was based upon DeMichele et al. (1978). In both these models, carbon metabolism was described as three processes: photosynthetic light reaction, carbon reduction, and dark respiration. As presented, the model's major drawback was that the coupling of light and carbon reduction reactions required an iterative solution technique (DeMichele et al. 1978), which made parameter estimation tedious. The other drawback was that the model derivation was not set within the context of established mathematical theory. Olson et al. (1985) outlined an abstract CTM approach for describing plant growth as a function of water, light, and nutrients, emphasizing four assumptions underlying CTM methodology as well as the abstract nature of the states. The states of the growth model, however, while abstract, are not arbitrary, and a physiological interpretation of system states and transitions is necessary if the approach is to be of practical use in describing the energetics of host defense.

A physiological interpretation of states and transi-

tions associated with plant growth in a CTM model has been outlined by Sharpe et al. (1985). In the present model, physiological interpretations presented in that study are modified and adapted to describe the energetics of southern pine defense against bark beetles.

The SPB Defense Model

The states and transitions of the SPB defense model are shown in figure 1. There are five states in this diagram with transitions between states shown by large arrows. The probability transitions between states are abstract in that no material or energy flows are represented. Similarly, the states are abstract because they do not represent material pools or compartments. The power of the CTM approach is its ability to combine processes that use different material and energy inputs. Transitions between states can be identified with, and states interpreted in terms of the probabilities of, completing specific physiological processes.

Sequential arrangement of transitions between states is organized to satisfy the need for combining water, light, and nutrients as resource inputs leading to the competing processes of growth, synthesis of resin acids, synthesis of monoterpenes and, in the event of beetle attack, formation of a lesion. The preformed chemical defense system has been broken down into resin acids and monoterpenes for the following reasons: 1) Resin acids have higher molecular weight and are more costly to synthesize and monoterpenes; 2) resin acids apparently confer a greater protection against herbivory than do monoterpenes, 3) Lawrence's (1971) study with southern pines shows that monoterpenes are readily remetabolized, whereas resin acids represent metabolic end products; 4) water stress effects upon southern pines change the relative composition of oleoresin. Hodges and Lorio (1975) found that, as southern pines became water-stressed, the relative resin acid concentration decreased while the monoterpene concentration increased. Similar effects were observed by Cates et al. (1983) in Douglas-fir where, under water stress as measured by xylem pressure potentials, some terpene concentrations increased, others decreased, and tannins decreased.

The wound response is included in the model for completeness, although the chemical mechanisms underlying it are not completely understood. Recently, doubt has been expressed as to whether the wound response in southern pines represents *in situ* synthesis of chemical compounds (Gambliel et al. 1985). The chemical composition of the wound response is identical to the preformed oleoresin system in mono-

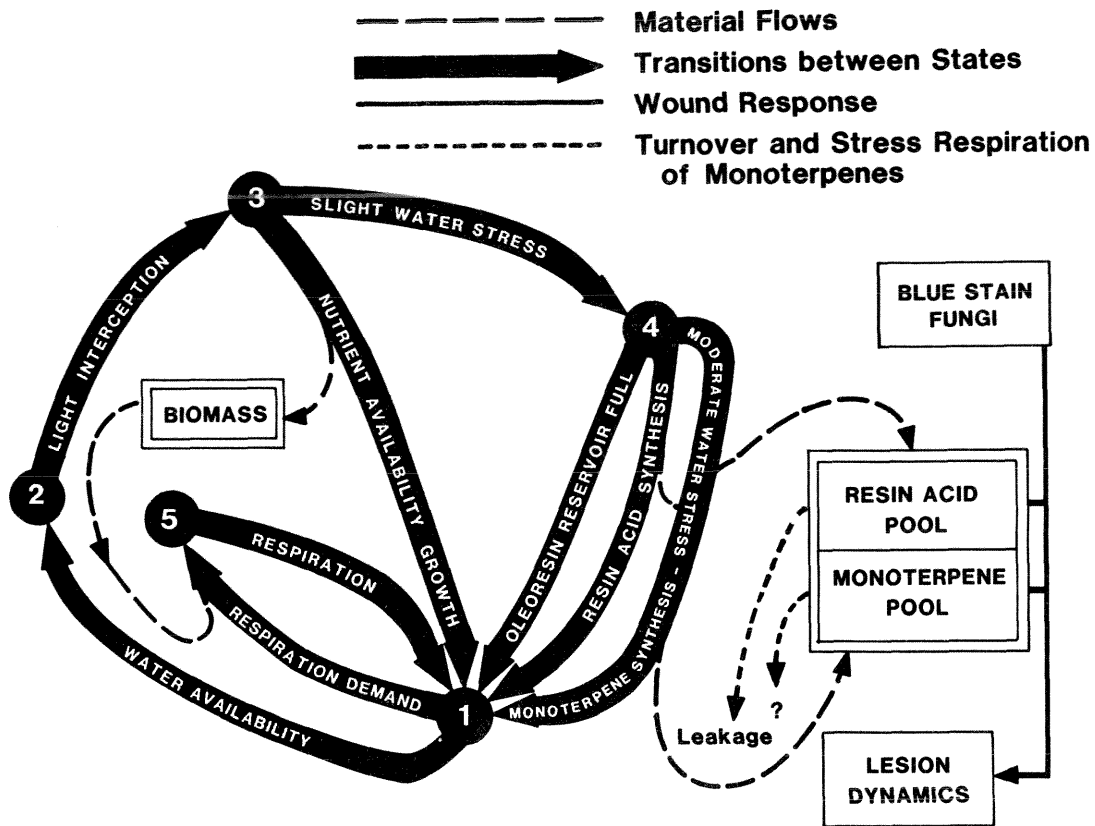

Figure 1.—Transition diagram for pine tree growth and defense processes. Black arrows represent physiological processes, black circles represent states, and boxes represent metabolic pools outside the CTM model.

terpenes, resin acids, and 4-allyl anisole (a phenylpropanoid) (Gambliel et al. 1985). It may represent, therefore, a region of accumulated preformed resin compounds due to the activation of traumatic ducts in the phloem following beetle attack. There will be, however, a cost associated with wound production, and the growth rate and the ultimate size of the wound response will be determined by tree energetics at the time of beetle attack.

PHYSIOLOGICAL INTERPRETATION OF TRANSITIONS AND STATES

Plant biophysical processes have been greatly simplified to facilitate derivation of a unified mathematical equation that includes all the processes shown in figure 1. The order of the processes reflects the sequence of steps involved in water uptake by the roots, reduction of carbon in the needles, and synthesis of complex molecules at the tree's growth or differentiation sinks. Growth, resin acid, and monoterpene synthesis compete for available reduced carbon fixed during photosynthesis. The bio-

mass, resin acid, and monoterpene pools are external to the CTM model and therefore have been connected to the transition diagram by dotted lines. Because these pools are not states, they do not need to satisfy the four Markov assumptions outlined by Olson et al. (1985). Thus, the model combines the forgetfulness characteristics of Markov processes with the memory features (accumulation of material) of metabolic pools. This feature is discussed by Sharpe et al. (1985).

Resource Availability

The uptake of soil water by roots leading to transpiration, CO₂ uptake, and assimilation has been chosen as the first transition. This process is represented by the transition from state 1 to state 2. Its mean transition rate λ_{12} is assumed to be proportional to available soil water H (i.e., $\lambda_{12} = \alpha_1 H$, where α is a proportionality constant between the mean transition rate λ_{12} and resource availability H). Subsequent transitions will also be represented with similar proportionality relationships.

The transition from state 2 to state 3 represents

light absorption in the photosynthesis light reaction. This process provides energy for carbon reduction and other synthesis processes. The mean transition rate λ_{23} is assumed to be proportional to available light energy I ($\lambda_{23} = \alpha_2 I$). In this application, ambient temperature is assumed to be constant.

Growth, including intermediary metabolism, allelochemical synthesis, cell differentiation and expansion, requires a balanced uptake of plant nutrients. In this model, nutrients are treated as a group in which the metabolically limiting nutrient predominates. This aspect of the model can be expanded in future applications. In the current application, the mean transition rate λ_{31} is assumed to be equal to $\alpha_3 N$, where N is any limiting nutrient.

Resource levels are defined in terms of availability to the plant. In the case of water, zero water availability occurs at the soil water potential where the plant can no longer take up water. A value of 1 occurs at a soil water content or potential at which additional soil water content is not reflected by increased plant growth. Water availability limits are also influenced by the interaction between ambient saturation deficit and soil water potential.

Theoretical analysis and experimental studies (Fischer and Turner 1978) indicate that water use efficiency for plant growth is affected primarily by two factors: average leaf-to-air concentration differences in water vapor and average concentration of photosynthetic carboxylating enzymes in leaves. Carboxylation enzyme concentration is a function of average foliage nitrogen concentration (Farquhar and von Caemmerer 1982), which is, in general, proportional to available limiting nutrient. This aspect of the water-use efficiency component is embodied in mean transition rate λ_{31} (Sharpe et al. 1985). Nutrient availability is also defined in terms of the plant. For example, nutrient imbalance can reduce the availability of nutrients that exist in reasonable concentrations and would otherwise be expected to be readily available (Wu et al. 1985).

Physiological Changes Related to Water Stress

The water stress-dependent physiological processes involve six transitions that begin with state 3. These transitions represent changes in growth energetics and defense capability with water stress. The relative mean rates of the transition λ_{31} and three parallel transitions λ_{41} , have been formulated in terms of sink substrate availability as determined by phloem transport dynamics.

The important feature of the phloem translocation system is that it modulates energy allocation within the tree. It also establishes the sink substrate con-

centration for synthesis pathways in the stem. Extensive experimental and theoretical studies of phloem translocation (Goeschl et al. 1976, 1984; DeMichele et al. 1978; Fares et al. 1984) have established that phloem substrate concentrations of carbohydrate increase under water stress. This phenomenon is the first step in osmoregulation and has three effects: 1) It raises the energy cost of transporting materials because loading processes must operate against a higher phloem concentration; 2) it increases substrate concentration in the epithelial cells of the resin ducts, thereby maintaining oleoresin pressure and favoring synthesis of oleoresin compounds, and 3) it provides a higher concentration of carbohydrates and amino acids in inner bark and xylem rays (Hodges and Lorio 1969) for colonizing bark beetles and associated fungi. It should be noted that these responses may have counteracting effects on susceptibility and suitability for brood development because the food value of phloem is increasing concomitant with increased development of defense mechanisms. Synthesis of defensive chemicals would partially counteract the effects of reduced xylem water potential on oleoresin exudation pressure (Goeschl 1979).

Osmoregulation is necessary for plants to maintain function under water stress, otherwise, the transport of photosynthate would cease. The necessity for phloem osmoregulation was originally pointed out in theoretical studies by DeMichele et al. (1978), and has been recently confirmed in Carbon-11 tracer studies by Fares et al. (1984) and Goeschl et al. (1984). The theoretical and experimental analyses of phloem translocation dynamics under increasing water stress are complex. Insights gained from these studies are used to formulate simpler relationships that describe the effects of osmoregulation upon growth and defense.

OSMOREGULATION RELATIONSHIPS

DeMichele et al. (1978) pointed out that the metabolic energy cost for translocation is lowest when solutes are transported at a low concentration and high velocity. This condition cannot be maintained under water stress because negative pressures develop first at the terminal end of the sieve tubes, probably at the root tips. Unlike xylem vessels and tracheids (through which water is conducted under very great tensions, e.g., -1 to -5 MPa), the sieve tubes are mechanically delicate. If low or negative pressures develop, the sieve tubes would likely plasmolyze or be constricted by the balloonlike expansion of the surrounding parenchyma cells. These paren-

chyma cells are likely to maintain high positive pressures in the unloading regions near the resin duct epithelial cells and constrict sieve tubes if they are not also maintaining positive turgor pressure.

Although functioning sieve tubes are always in a state of osmotic disequilibrium, their mean pressure is essentially based on the combination of their mean osmotic concentration and the water potential of the nearest xylem tissue. Transport of solutes under water stress can be maintained by two mechanisms: 1) Reduction in the phloem unloading conductance in the sink regions, especially in growing meristems and ray parenchyma near resin ducts, and 2) increase in the phloem loading rate. These processes are interdependent, with mechanism 1) leading to 2) as water stress increases for the following reasons:

- To overcome the problem created by negative pressures in the sieve tubes, a decrease in the phloem unloading conductance causes the solute concentration in the phloem to increase and the mass flow velocity to decrease (Goeschl 1979).
- The resulting high concentration of solutes inhibits loading and thus solute flux.
- Active solute loading, particularly of sucrose, occurs, but only to the point where high sucrose concentration causes problems with excessive phloem sap viscosity that impedes translocation (DeMichele et al. 1978).
- Many plants adapt to water stress by establishing a relatively high concentration of solutes such as malate, proline, soluble amino acids, and mineral salts in their living cells. It is likely that these osmotic solutes are recycled in the phloem-xylem system.

Energetically, the above system can be reviewed as two supplemental loading systems: a sucrose remobilization and loading process (mechanism I), and a small molecule osmotic solute recycling process (mechanism II). The second of these is the most costly because 1) the metabolic cost of loading is nearly the same for large or small molecules, thus the per-carbon atom cost of a three-carbon organic acid would be four times that of sucrose, 2) these molecules require additional cost for balancing ionic and pH effects, and 3) many of these molecules are recycled, and thus do not contribute to synthesis of cellular components in the sink tissues. Because mechanism I is the least costly, it is assumed that it has a lower water-stress threshold for activation.

Mathematically, mechanism I has been assumed to be a negative exponential function f_1 of soil water content W_0 :

$$f_1 = e^{-\beta_1 W_0}, \quad (1)$$

where β_1 is the sucrose remobilization constant. Similarly, mechanism II has been assumed to be a Gaussian function f_2 of soil water content W_0 :

$$f_2 = e^{-\beta_2 W_0^2} \quad (2)$$

where β_2 is the osmotic solute recycling constant.

CHEMICAL DEFENSE TRANSITIONS

The wound response is considered to be an extension of the preformed oleoresin system of the sapwood to the phloem through activation of traumatic ducts (Gambliel et al. 1985). Necrosis surrounding invasion sites of bark beetles and associated mycangial and nonmycangial fungi follows activation of traumatic ducts (Paine et al. 1985). Other fungi introduced by southern pine beetles apparently do not induce the wound response. Although the frequency and intensity of the wound response may depend upon the density of attacking bark beetles, the preliminary model assumes that the response is independent, although it may be a function of attack rate.⁶

Mean transition rates for chemical defense and growth can be defined as described below. The mean growth transitions λ_{31} can be written:

$$\lambda_{31} = \lambda_3 (1 - f_1), \quad (3)$$

where λ_3 is the total mean transition rate from state 3 to states 1 and 4. Growth predominates when f_1 is small. As f_1 increases with water stress, growth transitions decrease, while transitions to state 4 (which lead to oleoresin synthesis) increase.

Transitions from state 4 include synthesis of resin acids and monoterpenes. Studies by Hodges and Lorio (1975) show that resin acids decrease and monoterpenes increase under moderate water stress. In Douglas-fir foliage, water stress resulted in a change in terpene composition (Cates et al. 1983). In a review of the literature, Rhoades (1979) found that toxins or low molecular weight compounds increased due to a variety of stresses, whereas the high molecular weight resin acids and tannins decreased.

This is set up in the model by assigning λ_4 to the total mean transition rate between state 4 and 1. The mean transition rate for synthesis of resin acid λ_{4x} is given by the relationship:

$$\lambda_{4x} = (1 - f_2) \lambda_4, \quad (4)$$

⁶ Paine, personal communication.

and that for synthesis of monoterpene λ_{4y} is:

$$\lambda_{4y} = f_2 \lambda_4. \quad (5)$$

Synthesis of oleoresin ($x+y$) is ultimately dependent upon the storage capacity of the resin duct system. When this capacity is exceeded, synthesis of monoterpenes or resin acids ceases. The extra transition from state 4 to state 1 (fig. 1) occurs when resin duct reservoirs are full. The physiology of this end product inhibition process is not well understood.

RESPIRATION TRANSITIONS

Dark Respiration

In the presence or absence of photosynthate production (λ_{23}), maintenance respiration must proceed. Therefore, it must be considered as a separate pathway in the transition diagram. The respiration rate increases with plant biomass due to the increasing need for cell maintenance, phloem translocation over increasing distances, and enzyme resynthesis. Plant growth models commonly assume that dark respiration is proportional to biomass. Therefore, the mean transition rate λ_{15} is assumed proportional to plant biomass m , ($\lambda_{15} = \gamma_1 m$). The mean transition rates λ_{15} and λ_{12} compete in the model. The higher the relative value of λ_{15} , the lower the relative mean transition rate λ_{12} . In other words, as m increases, more respiration transitions occur.

To simulate material loss associated with respiration, material is withdrawn from the biomass pool in proportion to λ_{15} . This represents another interface between the CTM model and the biomass that lies outside the model. As biomass increases, a larger amount of material is withdrawn until a biomass is reached at which growth and respiration are equal, and therefore biomass reaches a maximum. The transition from state 5 to state 1 uses stored carbohydrates, nonstructural carbohydrate, lipid and protein biomass to complete the respiratory cycle of transitions. Physiologically, λ_{51} represents the mean transition rate of carbon dioxide evolution associated with dark respiration.

Oleoresin Metabolism

Another aspect of respiration that is not well understood is oleoresin metabolism in pines. Studies were undertaken by Sukhov (1958) and Tinus (1966) that resulted in contradictory conclusions. Sukhov (1958) determined that monoterpenes and resin acids have a turnover time of about 10 days. Tinus (1966) concluded that oleoresin metabolic turnover time is 0.5 to 20 years. Lawrence (1971)

carried out a series of experiments to resolve this conflict, and found that monoterpenes in southern pines can be readily remetabolized, although resin acids cannot be catabolized. The abundance of preferred substrates for use as reserve foods might prevent synthesis of enzymes responsible for resin acid catabolism.

Until studies show otherwise, resin acids are assumed not to be catabolized in southern pines, but can be lost by leakage from resin duct reservoirs (Sharpe and Wu 1985). Based upon the findings of Lawrence (1971), monoterpenes can be assumed to be readily catabolized. Where and how they are used is unfortunately not understood at present. Monoterpene remetabolism is, therefore, not included in the present model although it should be considered in refinements of tree susceptibility models in the future.

Water Stress Effects on Respiration

Indirect evidence for water stress-related mechanisms involving osmoregulation (i.e., mechanisms I and II discussed earlier), can be found in the experimental studies presented by Brix (1962) that compared water stress effect on photosynthesis and respiration rates in tomato plants and loblolly pine

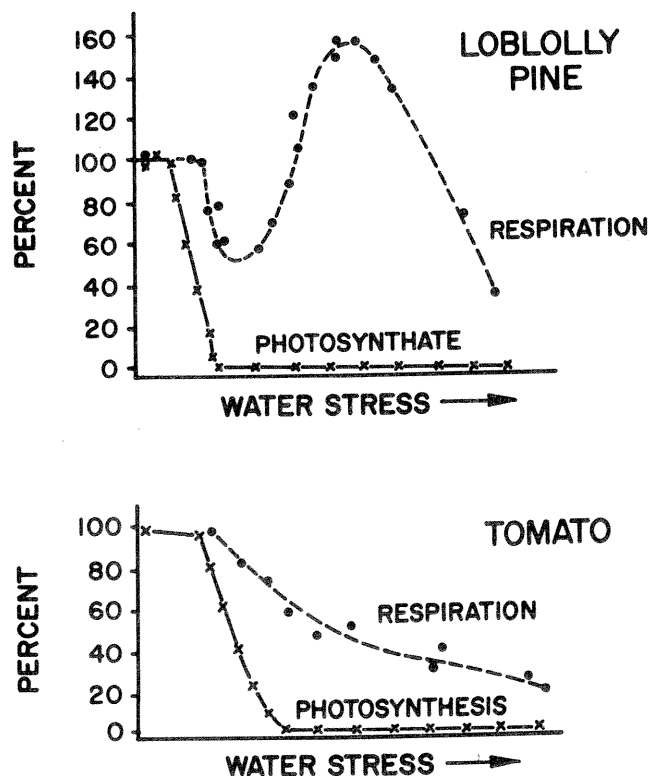

Figure 2.—Effect of water stress on rate of photosynthesis and respiration. (Upper graph) loblolly pine seedlings; (lower graph) tomato plants.

seedlings. The tomato respiration curve declined steadily with water stress, whereas the loblolly pine respiration demonstrated three phases of behavior. Brix (1962) studied the Q_{10} and respiratory quotient (RQ) to find an explanation. The Q_{10} results indicated that respiration was limited by a biochemical process, rather than by the diffusion of oxygen in the range of water stress studied. The respiration rate curve shown in figure 2 indicates four phases that are termed low stress (0 to 10 DPD atm), slight stress (10 to 18 DPD atm), moderate stress (20 to 40 DPD atm), and severe stress (> 40 DPD atm). The RQ remained close to 1 except during the severe stress phase when it became inconsistent, ranging from 1.0 to 2.6. Although the RQ is not a certain indicator of the type of respiratory substrates used, it does suggest that, as water stress increases, respiratory substrates change from carbohydrates to other secondary compounds, possibly monoterpenes. These experiments need to be repeated.

BIOMASS DYNAMICS

Transitions between states are solved for quasi-steady state conditions with W_0 , I , N , and m constant. Changes in these values are handled by assuming that a piecewise stationary condition can be satisfied. This condition allows calculation of steady state probabilities, which are used to define quasi-static synthesis and tree growth rates.

The derivation and solution of the CTM model will be detailed in supplemental publications. The iterative equation for biomass growth increment Δm is:

$$m_{i+1} = m_i \left[1 + \frac{(1-f_1)N - \rho_1 m_i/H}{D} \right], \quad (6)$$

where i represents value at current time, and

$$D = G \left[\kappa_0 + \frac{\kappa_1}{H} + \frac{\kappa_2}{L} + \kappa_3 f_1 + \kappa_4 \rho_1 m_i/H \right] \quad (7)$$

with $\rho_1 = \gamma_1/\alpha_1$, $G\kappa_0 = 1/\lambda_3$, $G\kappa_1 = 1/\alpha_1$, $G\kappa_2 = 1/\lambda_2$,

$G\kappa_3 = 1/\lambda_4$ and $G\kappa_4 = 1/\lambda_{51}$. The parameter G represents a genotype parameter that changes with seasonal temperature T ; i.e., $G = G(T)$.

The respiration rate R_D is given by the equation:

$$R_D = \frac{\rho_1 m_i^2}{DH}. \quad (8)$$

It should be noted that respiration rate is proportional to the square of the biomass in this model.

Decreases in soil water availability during dry periods are simulated using the function:

$$H = \frac{1}{1 + e^{\beta_0(W_{th} - W_0)}}, \quad (9)$$

where W_{th} is the threshold soil water content at which water availability decreases below 1 and β_0 is the soil water availability coefficient.

RESIN ACID DYNAMICS

Model formulation is focused on estimating the quantity of resin acids in the resin duct reservoir. Changes in oleoresin exudation pressure have been ignored because they are transient phenomena that vary with such factors as cloud cover and time of day. The amount of resin acid in the resin duct reservoirs is assumed to be depleted by leakage because no other forms of loss can be identified from the literature. In the absence of production and bark beetle attack, the rate of resin loss has been assumed to be proportional to the amount in the reservoir x . Thus, the loss Δx during time Δt is given by:

$$\Delta x = -\eta x \Delta t, \quad (10)$$

where η is the loss coefficient, which increases with tree age.

Resin acid loss also occurs when bark beetles attack, causing the activation of traumatic ducts in the phloem (Gambliel et al. 1985). Resin acid loss Δx_b by traumatic ducts following bark beetle attack is given by:

$$\Delta x_b = -\eta_b \delta_b x \Delta t, \quad (11)$$

where η_b is traumatic duct conductivity and δ_b is equal to 1 for bark beetle attack and 0 for no attack. If bark beetle attack density is shown to be important, then δ_b can take values between 0 and 1, depending on attack density.

When loss and production terms are combined, the resin acid content x is given by:

$$x_{i+1} = x_i e^{-\frac{(\eta + \eta_b \delta_b) \Delta t}{D}} + \frac{f_1(1-f_2)\delta_{<1}}{D}, \quad (12)$$

where $\delta_{<1}$ is a check for determining whether the oleoresin (resin acid and monoterpene) reservoir is full. If the reservoir is full, then $\delta_{<1} = 0$, otherwise $\delta_{<1} = 1$.

MONOTERPENE DYNAMICS

The amount of monoterpene y in the resin ducts is determined by production and loss rates. In most

unattacked trees, monoterpene content is depleted by remetabolism, leakage, and volatilization. In this model, these system components have been ignored, and emphasis has been given to monoterpene movement along traumatic ducts into lesions following bark beetle attack. This flow is given by the equation:

$$\Delta y_b = -\eta_b \delta_b^y \Delta t. \quad (13)$$

When production and loss terms are combined, the equation for change in monoterpene Δy is:

$$y_{i+1} = y_i e^{-\eta_b \delta_b \Delta t} + \frac{f_1 f_2 \delta_{<1}}{D} \quad (14)$$

LESION DYNAMICS

In contrast to Sharpe and Wu's (1985) previous model, this model includes the wound response as an integral component. The wound response is measured as the area of the lesion Z in cm^2 . The lesion is assumed to grow in diameter as activation of traumatic ducts proceed in the phloem. After traumatic ducts are activated, resin acid and monoterpene flow into the lesion region. The lesion is assumed to grow until the oleoresin reservoir is drained. Further lesion growth is dependent upon synthesis of additional resin acid and monoterpenes. The lesion growth rate thus depends upon the amount of oleoresin ($x+y$) in the primary resin ducts as well as the conductivity of the traumatic resin ducts η_b :

$$Z_{i+1} = Z_i \left\{ 1 + k(x_i + y_i) e^{-\eta_b \delta_b \Delta t} \right\}, \quad (15)$$

where k is the proportionality constant between oleoresin concentration and lesion area.

Lesions are typically long, narrow ellipses, with long axis L_i and short axis l_i . Lesion length L_i can be calculated from lesion area Z_i from the relationship:

$$L_i = \left(\frac{1}{1-\epsilon^2} \right)^{1/4} \left(\frac{Z_i}{\pi} \right)^{1/2} \quad (16)$$

where ϵ is the eccentricity of the lesion ellipse defined as:

$$\epsilon = \left(\frac{L_i^2 - l_i^2}{L_i^2} \right)^{1/2} \quad (17)$$

and which is assumed to be constant during lesion growth.

MODEL PARAMETERIZATION

For simplicity, growth rate, wound response, resin

acid and monoterpene synthesis are assumed to be equally sensitive to changes in soil water availability, limiting nutrient status, and light interception. If each of these variables is scaled from 0 to 1, the value of the parameters κ_0 , κ_1 , κ_2 , κ_3 and κ_4 can be set to 1.

The value of β_1 determines the relative amount of photosynthate used for oleoresin synthesis and the amount used for growth. This allocation depends upon the soil water content W_0 . We set $\beta = 1.386$, which means that for high soil water contents $W_0 = 1$ (i.e., no stress), 75 percent of available photosynthate is allocated to growth and 25 percent to oleoresin synthesis. At $W_0 = 0.5$, 50 percent is allocated to growth and 50 percent to oleoresin. The partitioning of photosynthate for resin acid and monoterpene synthesis is controlled by β_2 . We set $\beta_2 = 5.5$, which allocates photosynthate primarily to resin acid under low water stress. As water stress increases, photosynthate is preferentially allocated to synthesis of monoterpene.

The method for handling changes in light interception, nutrient availability, and soil oxygen availability has been described previously by Sharpe and Wu (1985).

SIMULATION RESULTS

Lack of data on long-term trends in monoterpene and resin acid contents of trees makes it difficult to build, and subsequently validate, models of this type. Data for interpreting the dynamics of host defense against bark beetles come primarily from two sources. Hodges and Lorio (1975) described changes in composition of xylem oleoresin in loblolly pine as a result of moisture stress extending over a 100-day period. Moisture stress was imposed by trenching around individual trees and constructing rain shelters to prevent recharge of soil moisture. Paine et al. (1985) found that in nonstressed, healthy trees, the pattern of the lesion varied seasonally. During the winter, lesion size is significantly smaller than during the rest of the year. Trees respond with similar size lesions during both spring and summer, but the rate of the response is significantly different.

In the series of simulations that follows, the response of this model is compared with these two experimental studies, with the goal, not of reproducing the experimental data, but rather of determining whether the assumptions of the model cause it to exhibit behavior consistent with these studies. Model calibration can be undertaken when it is established that the conceptual foundation is appropriate.

The first series of simulations describes changes in growth rate, respiration, resin acid, and monoterpene

concentration when trees are subjected to a 100-day drought. Simulations are presented for winter, spring, and summer temperature regimes. Seasonal aspects of the model are introduced by initial amounts of preformed resin acid and monoterpenes and different values of *G* for winter (high), spring (medium), and summer (low) corresponding to their average temperature. Growth in winter is assumed to be about 30 percent of that in summer, with spring rates intermediate. The initial composition of oleoresin was set to the same value for all seasons: 67 percent resin acid and 33 percent monoterpene. These are approximate values for the initial composition of oleoresin determined by Hodges and Lorio (1975).

Simulation of a winter drought sequence is shown in figure 3. Growth rate decreases with water stress until it becomes slightly negative, indicating net leaf and fine root loss. Respiration remains relatively constant and then increases during the middle period of the water stress sequence, reaching a plateau after 60 days. Monoterpene increases during this water stress, whereas resin acid content decreases. A similar pattern occurs during the spring (fig. 4), although the magnitude of the responses to water stress is greater due to higher initial values and rates as determined by higher temperatures.

A drought stress sequence in the summer (fig. 5) has an even greater amplitude of response. The most interesting aspect is that the respiration response is qualitatively similar to that of loblolly pine (fig. 2). Respiration, which is initially constant, decreases for slight water stress, then rises steeply with the onset of moderate water stress, finally reaching a plateau for high water stress.

The next series of simulations describes the lesion response following bark beetle attack in winter, spring, or summer. To avoid confusion between factors, lesion dynamics are simulated during periods with adequate soil water availability. In each of these simulations, the quantity of resin acid and monoterpene in the oleoresin reservoir is described, together with the increase in the length of the wound lesion. Figures 6, 7, and 8 show the daily change in lesion length for winter, spring, and summer. The data points for each simulation are the observed values from Paine et al. (1985). These comparisons show that the results of the conceptual model are consistent with observation, although they do not necessarily validate its assumptions.

DISCUSSION AND CONCLUSIONS

The role of model building in this study has been to clarify tree susceptibility hypotheses previously presented in the literature. A systems model provides a framework for linking hypotheses and explaining system behavior. It can be used to explore consequences of alterations in resource availabilities upon tree defense and growth. Physiologically-based models provide rational explanations for interpreting alterations in chemical defense synthesis, especially those related to changes in plant energetics caused by water stress.

The primary focus of this study has been the modeling of water stress effects on tree defense energetics. Water stress has three counteractive effects upon plant metabolism as represented in the model: 1) It reduces growth and promotes synthesis

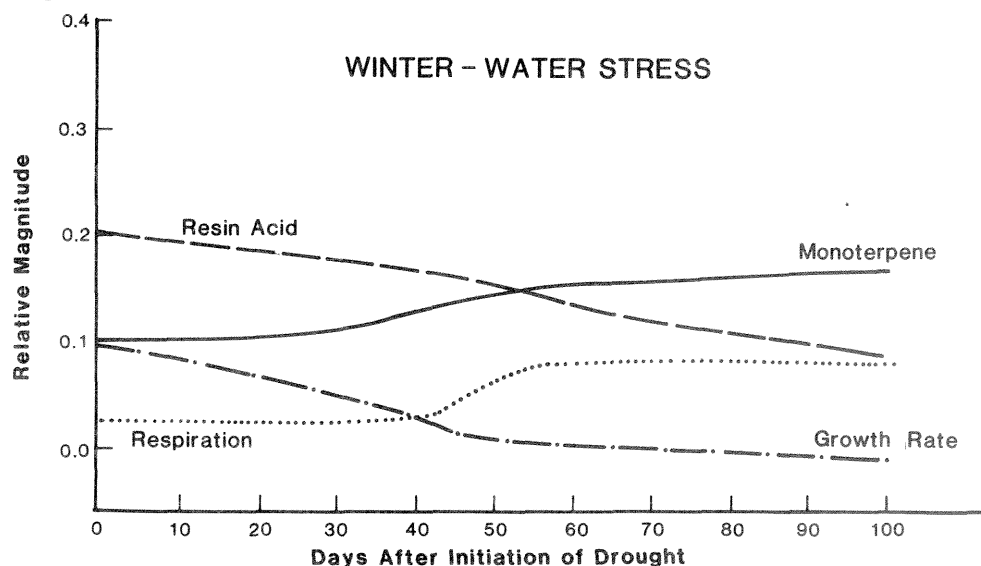

Figure 3.—Simulation of increasing daily water stress on growth rate, respiration, resin acid, and monoterpene pools during mild winter conditions in southern regions of the United States.

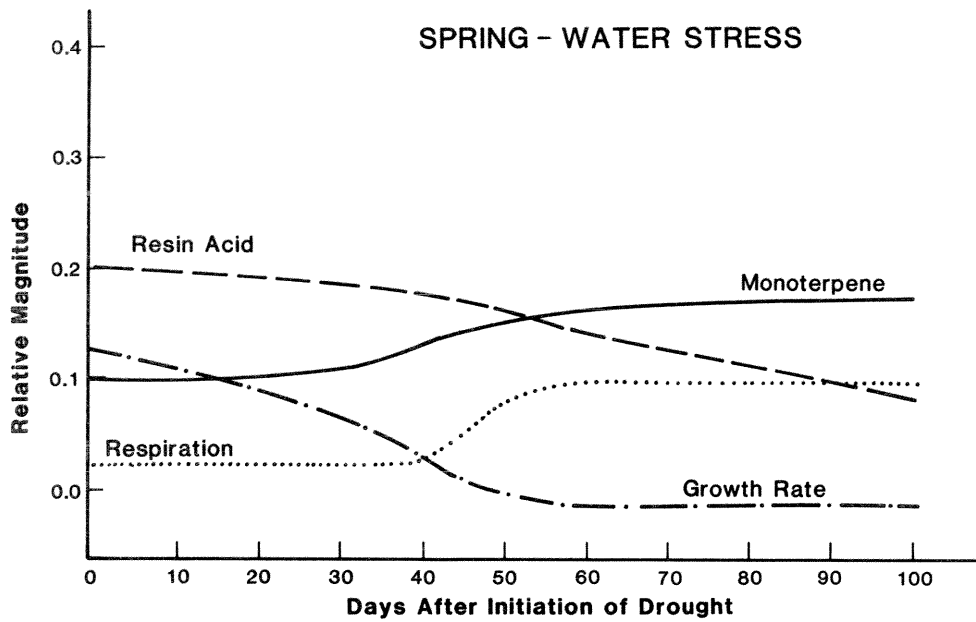

Figure 4.—Simulation of increasing daily water stress on growth, respiration, and defensive chemical pools during spring conditions.

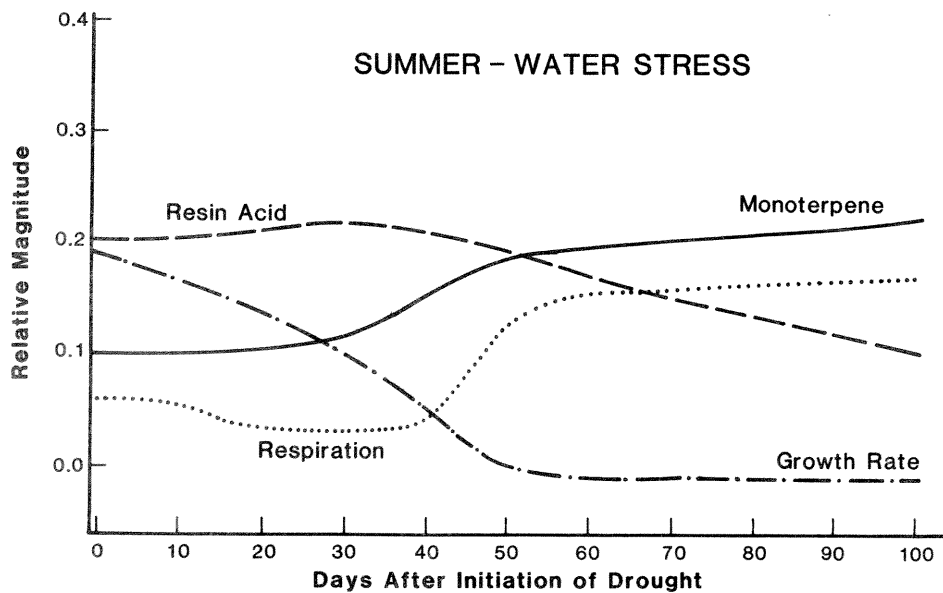

Figure 5.—Simulation of increasing daily water stress on growth, respiration, and defensive chemical pools during summer conditions.

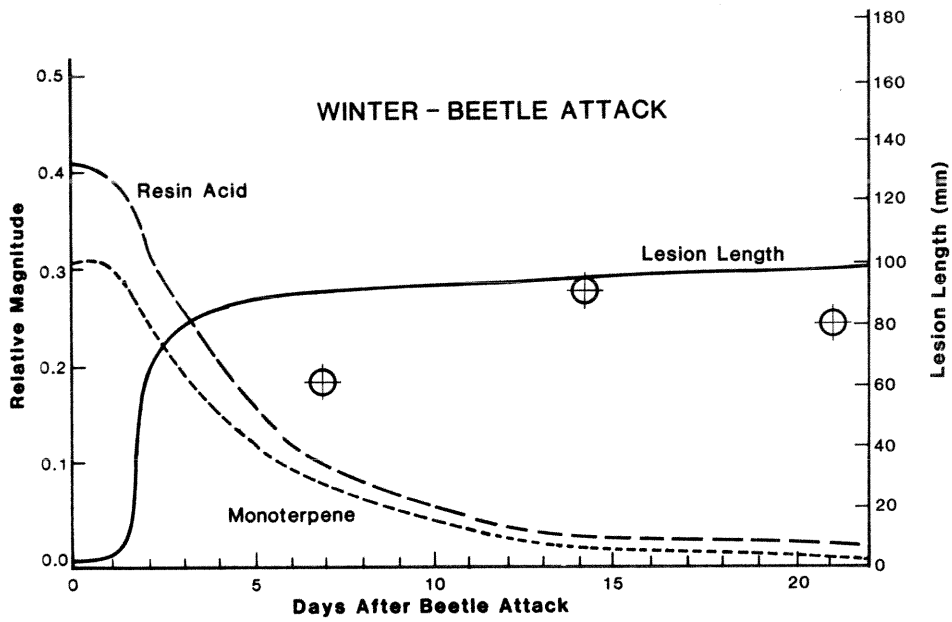

Figure 6.—Simulation of lesion length increase and reduction in resin acid and monoterpene oleoresin pools during the winter (with adequate soil water availability).

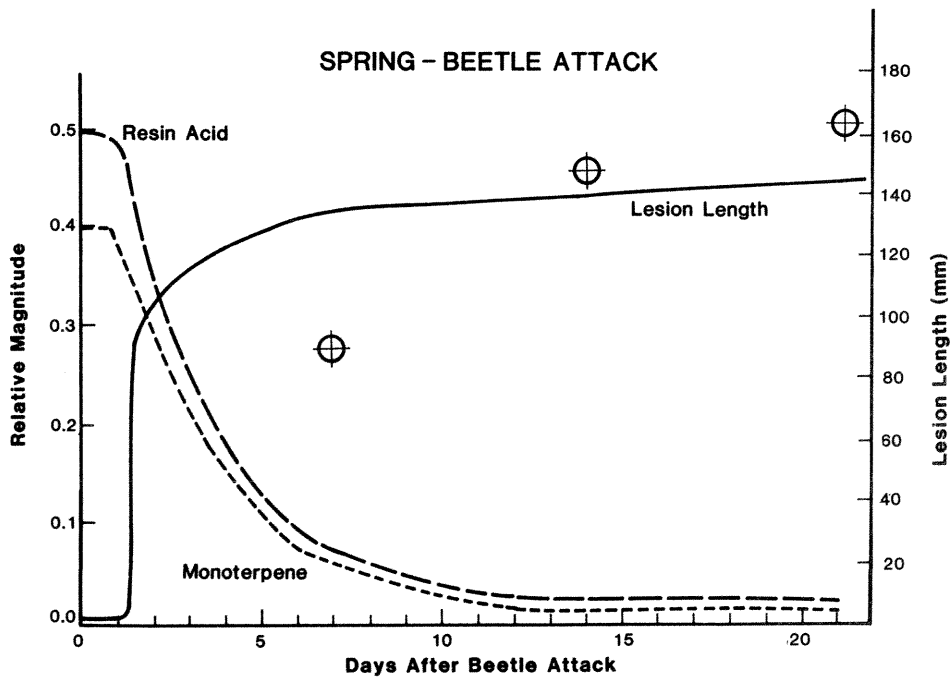

Figure 7.—Simulation of lesion dynamics during the spring.

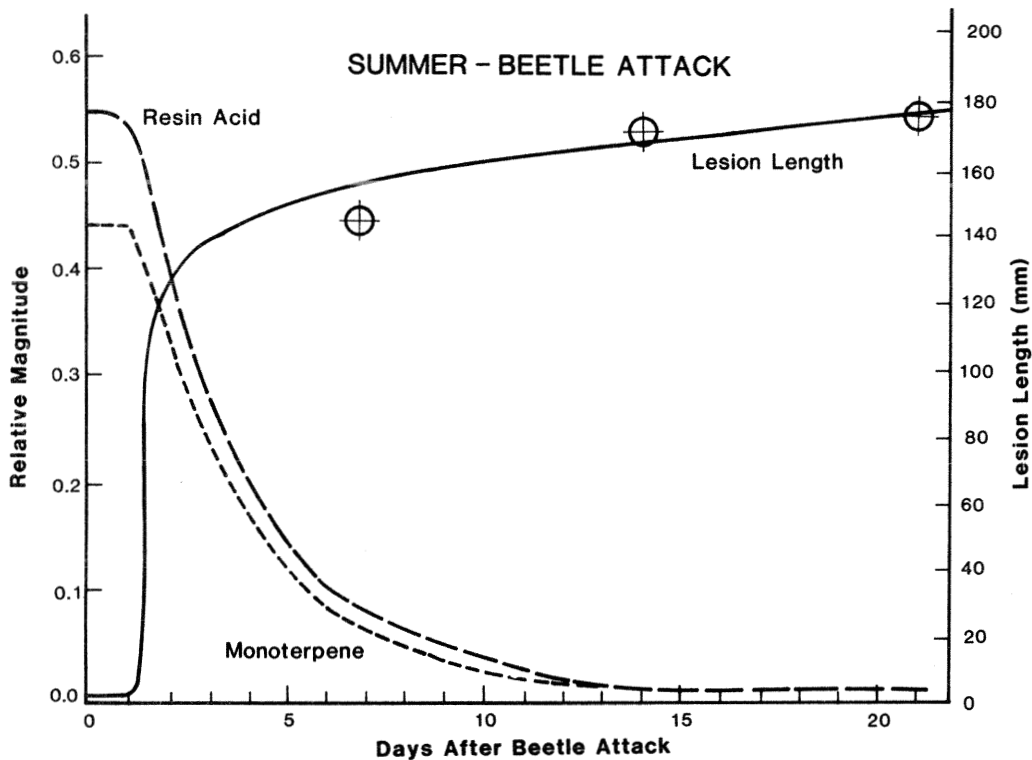

Figure 8.—Simulation of lesion dynamics during the summer.

of allelochemical compounds (Lorio and Hodges 1985), 2) it increases soluble carbohydrate and amino acids (Hodges and Lorio 1975; White 1969, 1974, 1984), and 3) it reduces the concentration of high molecular weight digestibility reducing compounds and increases the concentration of low molecular weight, presumably toxic carbon allelochemicals for anti-herbivore defense (Hodges and Lorio 1975, Gambliel et al. 1985). Increased soluble carbohydrates and amino acids raise the food value of the tissue for herbivores, thereby increasing the tissue's *suitability* for colonization, reproduction, brood development, and survival (Goeschl 1979). The relative importance of increased food value and increased chemical defense compounds probably depends on the tree's genotype, history, and current environmental conditions. For example, in the early stages of modest stress, increased food availability may be expected to predominate. With longer periods of modest stress, or in trees subject to long periods of less than optimal growth, the capacity to synthesize defensive chemicals may be more important. The important point is that water status alone would not be adequate to explain susceptibility or suitability to beetle infestation.

Energetically, the changes that occur can be explained in terms of the underlying mechanisms controlling phloem loading and unloading. It can be

hypothesized that the phloem unloading conductance at growth sinks is higher than that for secondary carbohydrate storage sites in the stem. When water stress slows the phloem-unloading conductance at the growth sites, it raises the solute concentration in the phloem and makes the secondary unloading sites more competitive for photosynthate. As a result, solute unloading at secondary carbohydrate storage sites increases significantly, raising the food and nutritive value of these tissues. At the same time, unloading provides increased substrate, and therefore, an increased driving force for the synthesis of carbon allelochemicals for tissue defense. Thus, stress causes an increase in tissue suitability for colonization, while at the same time, increasing the concentration of defensive compounds. A judgment with respect to the optimization of this defensive strategy is left to subsequent analyses.

The secondary focus of the study has been the interrelationship between the resin duct defense system and the wound response. This study represents the first time that a model linking these two processes has been formulated. These two defense systems have heretofore been studied separately. If they are part of the same system, then studies need to be initiated to study them together. A major data gap exists regarding the mechanisms of monoterpene and resin acid loss from the tree during periods

without bark beetle attack. Likely sinks for these materials include accumulation in the xylem heartwood, volatilization, and remetabolism. The dynamics of these processes must be understood in greater detail before a predictive model of tree susceptibility can be formulated.

LITERATURE CITED

- Anderson, N.H.; Anderson, B. *Ips* bark beetle attacks and brood development on a lightning-struck pine in relation to its physiological decline. *Fla. Entomol.* 51(1): 23–30; 1968.
- Atsatt, P.R.; O'Dowd, D.J. Plant defense guilds. *Science* 193: 24–29; 1976.
- Berryman, A.A. Resistance of conifers to invasion by bark beetle-fungus associations. *Bio.Sci.* 22: 598–602; 1972.
- Black, C. A. Soil plant relationships. New York: John Wiley and Sons; 1957: 116–152.
- Blanche, C.A.; Hodges, J.D.; Nebeker, T.E.; Moehring, D.M. Southern pine beetle: the host dimension. Bull. 917. Mississippi State, MS: Mississippi Agricultural and Forestry Experiment Station; 1983. 29 p.
- Brix, H. The effect of water stress on the rates of photosynthesis and respiration in tomato plants and loblolly pine seedlings. *Physiol. Plantarum* 15: 10–20; 1962.
- Bryant, J.P.; Kuropat, P.J. Selection of winter forage by subarctic browsing vertebrates: the role of plant chemistry. *Ann. Rev. Ecol. Syst.* 11: 161–185; 1980.
- Bryant, J.P.; Chapin, F.S., III; Klein, D.R. Carbon/nutrient balance of boreal plants in relation to vertebrate herbivory. *Oikos* 40: 357–368; 1983.
- Cates, R.G.; Alexander, H.J. Host resistance and susceptibility. In: Mitton, J.B.; Sturgeon, K.B., eds. *Bark beetles in North American conifers: evolution and ecology*. Austin, TX: University of Texas Press; 1982: 212–263.
- Cates, R.G.; Redak, R.A.; Henderson, C.B. Patterns in defensive natural product chemistry: Douglas-fir and western spruce budworm interactions. In: Heden, Paul, ed. *Plant resistance to insects*. Washington, DC: American Chemical Society; 1983: 3–19.
- Cates, R.G.; Redak, R.A. Douglas-fir-spruce budworm interactions: the effect of nutrition, chemical defenses, tissue phenology, and tree physical parameters on budworm success. *Oecologia* 62: 61–67; 1984.
- Chew, F.S.; Rodman, J.B. Plant resources for chemical dense. In: Rosenthal, G.A.; Janzen, D.H., eds. *Herbivores: their interaction with secondary plant metabolites*. New York: Academic Press; 1979: 271–303.
- Clements, R.W. *Modern gum naval stores methods*. Gen. Tech. Rep. SE-7. Asheville, NC: U.S. Department of Agriculture, Forest Service, Southeastern Forest Experiment Station; 1974. 20 p.
- DeMichele, D.W.; Sharpe, P.J.H.; Goeschl, J.D. Towards the engineering of photosynthetic productivity. *Critical Reviews in Bio-engineering* 3: 29–91; West Palm Beach, FL: CRC Press; 1978.
- Fares, Y.; Magnuson, C.E.; Goeschl, J.D. Maintenance of phloem turgor in water stressed plants: experimental tests using $^{14}\text{CO}_2$ extended square wave tracer kinetics. Abstract, symposium on carbon transport under water stress. Annual meeting, American Society of Agronomy. 1984 November 26–29; Las Vegas, NV; 1984.
- Farquhar, G.D.; von Caemmerer, S. Modelling of photosynthetic response to environmental conditions: In: Lange, O.L.; Nobel, P.S.; Osmond, C.B.; Zeigler, H., eds. *Water relations and carbon assimilation. Physiological Plant Ecology II (Encyclopedia of Plant Physiology; new ser., Vol. 12B)*. Berlin-Heidelberg-New York: Springer-Verlag; 1982: 549–587.
- Feeny, P. Plant apparency and chemical defense. *Recent Adv. Phytochem* 10:1–40; 1976.
- Feldman, R.M.; Curry, G.L.; Coulson R.N. A mathematical model of field population dynamics of the southern pine beetle, *Dendroctonus frontalis*. *Ecol. Modelling* 13: 261–281; 1981a.
- Feldman, R.M.; Wagner, R.L.; Sharpe, P.J.H.; Gagne, J.A.; Coulson, R.N. Within-tree life process models of the southern pine beetle, *Dendroctonus frontalis*. *Ecol. Modelling* 13: 247–259; 1981b.
- Feldman, R.M.; Wagner, T.L.; Curry, G.L.; Coulson, R.N.; Sharpe, P.J.H. A methodology for biophysical modeling using TAMBEETLE as an example. In: Branham, Susan J.; Thatcher, Robert C., eds. *Proceedings, integrated pest management research symposium*; 1985 April 15–18; Asheville, NC. Gen. Tech. Rep. SO-56. New Orleans, LA: U.S. Department of Agriculture, Forest Service, Southern Forest Experiment Station; 1985: 195–201.
- Gambliel, H.A.; Cates, R.G.; Caffey-Moquin, M.K.; Paine, T.D. Variation in the chemistry of loblolly pine in relation to infection by the blue-stain fungus. In: Branham, S.J.; Thatcher, R.C., eds. *Proceedings, integrated pest management research symposium*; 1985 April 15–18; Asheville, NC. Gen. Tech. Rep. SO-56. New Orleans, LA: U.S. Department of Agriculture, Forest Service, Southern Forest Experiment Station; 1985: 177–184.

- Goeschl, J.D. Hypothesis to explain the moderate level of correlation among water stress, oleoresin pressure and success of colonizing pine beetles. Proceedings, 13th annual western forest insect work conference; 1979 March 6-8; Boise, ID; 1979: 110-111.
- Goeschl, J.D.; Magnuson, C.E.; DeMichele, D.W.; Sharpe, P.J.H. Concentration dependent unloading as a necessary assumption for a closed form mathematical model of osmotically driven pressure flow in phloem. *Plant Physiol.* 58: 556-562; 1976.
- Goeschl, J.D.; Magnuson, C.E.; Fares, Y.; Sharpe, P.J.H. Maintenance of phloem turgor in plants under water stress: a theoretical basis for reduced photosynthetic productivity. Abstract from symposium on carbon transport under water stress. Annual meeting, American Society of Agronomy; 1984 November 26-29; Las Vegas, NV; 1984.
- Gosz, J. Nitrogen cycling in coniferous ecosystems. In: Clark, F.; Roswall, T., eds. Nitrogen cycling in terrestrial ecosystems: processes, ecosystem strategies, and management impacts. *Ecological Bulletins (Stockholm)* 33: 405-426; 1981.
- Hain, F.P.; Cook, S.P.; Matson, P.A.; Wilson, K.G. Factors contributing to southern pine beetle host resistance. In: Branham, Susan J.; Thatcher, Robert C., eds. Proceedings, integrated pest management research symposium; 1985 April 15-18; Asheville, NC. Gen. Tech. Rep. SO-56. New Orleans, LA: U.S. Department of Agriculture, Forest Service, Southern Forest Experiment Station; 1985: 154-160.
- Hicks, R.R., Jr. Climate, site, and stand factors. In: Thatcher, R.C.; Searcy, J.L.; Coster, J.E.; Hertel, G.D., eds. The southern pine beetle. *Tech. Bull.* 1631. U.S. Department of Agriculture; 1980: 55-68.
- Hicks, R.R., Jr.; Howard, J.E.; Coster, J.E.; Watterson, K.G. The role of tree vigor in susceptibility of loblolly pine to southern pine beetle. In: Hollis, C.A.; Squillante, A.E., eds. Proceedings, fifth North American forest biology workshop. Gainesville, FL: University of Florida, School of Forest Resources; 1978: 177-181.
- Hodges, J.D.; Lorio, P.L., Jr. Carbohydrate and nitrogen fractions of the inner bark of loblolly pines under moisture stress. *Can. J. Bot.* 47: 1652-1657; 1969.
- Hodges, J.D.; Lorio, P.L., Jr. Comparison of oleoresin composition in declining and healthy loblolly pines. Res. Note SO-158. New Orleans, LA: U.S. Department of Agriculture, Forest Service, Southern Forest Experiment Station; 1973. 4 p.
- Hodges, J.D.; Lorio, P.L., Jr. Moisture stress and composition of xylem oleoresin in loblolly pine. *For. Sci.* 22: 283-290; 1975.
- Hodges, J.D.; Elam, W.W.; Watson, N.R.; Nebeker, T.E. Oleoresin characteristics and susceptibility of four southern pines to southern pine beetle (Coleoptera: Scolytidae) attacks. *Can. Entomol.* 111: 889-896; 1979.
- Ku, T.T.; Sweeney, J.M.; Shelburne, V.B. Preliminary evaluation of site and stand characteristics associated with southern pine beetle infestations in Arkansas. *Ark. Farm. Res.* 25(2): 2; 1976.
- Ku, T.M.; Sweeney, J.M.; Shelburne, V.B. Site and stand conditions associated with southern pine beetle outbreaks in Arkansas - a hazard-rating system. *South. J. Appl. For.* 4(2): 103-106; 1980.
- Lawrence, R.H. Biosynthesis and metabolism of terpenoids in *Pinus elliottii* Engelm. and *Pinus palustris* Mill. Athens, GA: University of Georgia, School of Forest Resources; 1971. 117 p. [PhD. Dissertation]
- Lorio, P.L., Jr. Declining pines associated with bark beetle activity in Allen Parish, LA. Res. Note SO-163. New Orleans, LA: U.S. Department of Agriculture, Forest Service, Southern Forest Experiment Station; 1973. 3 p.
- Lorio, P.L., Jr.; Hodges, J.D. Microsite effects of oleoresin exudation pressure of large loblolly pines. *Ecol.* 49: 1207-1210; 1968.
- Lorio, P.L., Jr.; Hodges, J.D. Host and site factors in southern pine beetle infestations. In: Payne, T.L.; Coulson, R.N.; Thatcher, R.C., eds. Proceedings, southern pine beetle symposium; College Station, TX. College Station: Texas Agricultural Experiment Station and U.S. Department of Agriculture, Forest Service; 1974: 32-34.
- Lorio, P.L., Jr.; Hodges, J.D. Tree water status affects induced southern pine beetle attack and brood production. Res. Pap. SO-135. New Orleans, LA: U.S. Department of Agriculture, Forest Service, Southern Forest Experiment Station; 1977. 7 p.
- Lorio, P.L., Jr.; Hodges, J.D. Theories of interactions among bark beetles, associated microorganisms, and host trees. In: Shoulders, E., ed. Proceedings, third biennial southern silvicultural research conference; 1984 November 7-8; Atlanta, GA. Gen. Tech. Rep. SO-54. New Orleans, LA: U.S. Department of Agriculture, Forest Service, Southern Forest Experiment Station; 1985: 485-492.
- Mason, R.R. Soil moisture and stand density affect oleoresin exudation flow in a loblolly pine plantation. *For. Sci.* 17: 170-177; 1971.
- Olson, R.L., Jr.; Sharpe, P.J.H.; Wu, H. Whole plant modelling: a continuous time Markov (CTM approach). *Ecol. Modelling* 1985. [In press].

- Paine, T.D.; Stephen, F.M.; Cates, R.G. Induced defenses against *Dendroctonus frontalis* and associated fungi: variation in loblolly pine resistance. In: Branham, Susan J.; Thatcher, Robert C., eds. Proceedings, integrated pest management research symposium, 1985 April 15–18; Asheville, NC. Gen. Tech. Rep. SO-56. New Orleans, LA: U.S. Department of Agriculture, Forest Service, Southern Forest Experiment Station; 1985: 169–176.
- Reid, R.W.; Whitney, H.S.; Watson, J.A. Reactions of lodgepole pine to attack by *Dendroctonus ponderosa* Hopkins and blue-stain fungi. *Can. J. Bot.* 45: 1115–1126; 1967.
- Rhoades, D.F. Evolution of plant chemical defense against herbivores. In: Rosenthal, G.A.; Janzen, D.H., eds. *Herbivores: their interaction with secondary plant metabolites*. New York: Academic Press; 1979: 3–54.
- Rhoades, D.F.; Cates, R.G. A general theory of plant antiherbivore chemistry. In: Wallace, J.W.; Mansell, R.L., eds. *Biochemical interaction between plants and insects. Recent Advances in Phytochemistry* (Vol. 10). New York: Plenum Press; 1976: 168–213.
- Rosenthal, G.A.; Janzen, D.H., eds. *Herbivores: their interaction with secondary plant metabolites*. New York: Academic Press; 1979.
- Rudinsky, J.A. Scolytidae beetles associated with Douglas-fir: responses to terpenes. *Sci.* 152: 218–219; 1966a.
- Rudinsky, J.A. Host selection and invasion by the Douglas-fir beetle, *Dendroctonus pseudotsugae* Hopkins, in coastal Douglas-fir forests. *Can. Entomol.* 98: 98–111; 1966b.
- Sharpe, P.J.H. Photosynthetic and dark respiration response to temperature. *Ann. Bot.* 52: 325–343; 1983.
- Sharpe, P.J.H.; Walker, J.; Penridge, L.K.; Wu, H. A physiologically based continuous time Markov approach to plant growth modelling in semi-arid woodlands. *Ecol. Modelling*; 1985. [In press].
- Sharpe, P.J.H.; Wu, H. A preliminary model of host susceptibility to bark beetle attack. Proceedings: international union of forest research organizations, host insect work group; 1983 September; Banff, Alberta, Canada. Victoria, B.C.: Canadian Forestry Service; 1985: 108–127.
- Shrimpton, D.M. Extracts associated with wound response of lodgepole pine attacked by the mountain pine beetle and associated micro-organisms. *Can. J. Bot.* 51: 527–534; 1973.
- Smith, R.H. Formula for describing the effect of insect and host tree factors on resistance to western pine beetle attack. *J. Econ. Entomol.* 68: 841–844; 1975.
- Sukhov, G.V. The use of radiocarbon in the study of biosynthesis of terpenes. In: Extermann, R.C., ed. *Radioisotopes in scientific research. Vol. IV. Research with radioisotopes in plant biology and some general problems*. New York: Pergamon Press; 1958: 535–547.
- Thatcher, R.C. Bark beetles affecting southern pines: a review of current knowledge. *Occas. Pap.* 180. New Orleans, LA: U.S. Department of Agriculture, Forest Service, Southern Forest Experiment Station; 1960; 25 p.
- Tinus, R.W. The role of oleoresin in the metabolism of *Pinus ponderosa* Laws. Berkeley, CA: University of California; 1966. [PhD. Dissertation].
- Townsend, C.R.; Calow, P., eds. *Physiological ecology; an evolutionary approach to resource use*. Sunderland, MA: Sinauer; 1981.
- Tuomi, J.; Niemela, P.; Haukioja, E.; Siren, S.; Neuvonen, S. Nutrient stress: an explanation for plant anti-herbivore responses to defoliation. *Oecologia* (Berlin) 61: 208–210; 1984.
- Vité, J.P. The influence of water supply on oleoresin exudation pressure and resistance to bark beetle attack in *Pinus ponderosa*. *Contrib. Boyce Thompson Inst.* 21: 37–66; 1961.
- Vité, J.P.; Wood, D.L. A study of the applicability of the measurement of oleoresin exudation pressure in determining susceptibility of second growth ponderosa pine to bark beetle infestation. *Contrib. Boyce Thompson Inst.* 21: 67–76; 1961.
- Wadleigh, C.H.; Gauch, H.G.; Magistad, O.C. Growth and rubber accumulation in guayule as conditioned by soil salinity and irrigation regime. *Tech. Bull.* 925. Washington, DC: U.S. Department of Agriculture; 1946.
- Waring, R.H.; Pitman, G.B. A simple model of host resistance to bark beetles. *Res. Note* 65. Corvallis, OR: Oregon State University, Forest Research Laboratory; 1980. 2 p.
- Weins, J.A. Resource systems, populations, and communities. In: Price, P.W.; Slobodchikoff, C.N.; Gaud, W.S., eds. *A new ecology: novel approaches to interactive systems*. New York: John Wiley and Sons; 1984: 397–436.
- White, T.C.R. An index to measure weather related induced stress of trees associated with outbreaks of Psyllids in Australia. *Ecology* 50: 905–909; 1969.
- White, T.C.R. A hypothesis to explain outbreaks of looper caterpillars, with special reference to populations of *Selidosema suavis* in a population of *Pinus radiata* in New Zealand. *Oecologia* (Berlin) 16: 279–301; 1974.
- White, T.C.R. The abundance of invertebrate herbivores in relation to the availability of nitrogen in

- stressed food plants. *Oecologia* (Berlin) 63: 90–105; 1984.
- Whitham, T.G. Habitat selection by *Pemphigus* aphids in response to resource limitation and competition. *Ecology* 59: 1164–1176; 1978.
- Whitham, T.G. The theory of habitat selection: examined and extended using *Pemphigus* aphids. *Am. Nat.* 115: 449–466; 1980.
- Whitham, T.G. Individual trees as heterogeneous environments: adaptation to herbivory or epigenetic noise? In: Denno, R.F.; Dingle, H., eds. *Insect life history patterns: habitat and geographic variation*. New York: Springer-Verlag; 1981: 9–27.
- Wu, H.; Sharpe, P.J.H.; Walker, J.; Penridge, L.K. Ecological field theory: a spatial analysis of resource interference among plants. *Ecol. Modelling*; 1985. [In press].
- Wulf, N.W.; Cates, R.G. Site and stand characteristics. In: Brookes, M.H.; Campbell, R.W.; Colbert, J.; Mitchell, R.G.; Stark, R.W., eds. *Western spruce budworm*. Tech. Bull. 1694. Washington, DC: U.S. Department of Agriculture; 1985. [In press].
- Zucher, W.V. How aphids choose leaves: the role of phenolics in host selection by a galling aphid. *Ecology* 63: 972–981; 1982.

SESSION III—MANAGEMENT APPROACHES AND IPM SYSTEMS

Hazard-Rating Systems

Development, Implementation, and Validation of a Large Area Hazard- and Risk-Rating System for Southern Pine Beetle

R. F. Billings, C. M. Bryant, and K. H. Wilson¹

Abstract.—A practical system for mapping the abundance and distribution of suitable habitat for the southern pine beetle (SPB), *Dendroctonus frontalis* Zimmermann, was devised and applied to 11.8 million acres in east Texas in 1983. A wide area hazard-rating procedure was developed from a step-wise discriminant analysis of 1974 color infrared aerial photography (scale = 1:120,000) and computerized SPB infestation records for 1973-77. This procedure was then used to classify 656 grid blocks (18,000-acre units) as low, moderate, or high hazard for SPB outbreaks, based on site/stand information sampled from current photography. A further refinement assigned a risk classification to each grid block (very low, low, moderate, high, and extreme) by systematically combining the grid block's hazard class with numbers of recent beetle infestations detected in the same grid block. To validate the system, actual numbers of beetle infestations (≥ 10 trees) recorded from 1982-84 operational records within 502 grid blocks were correlated with predetermined hazard and risk classifications. Grid blocks rated as high, moderate, and low hazard based on habitat conditions alone supported an average of 63.3, 20.6, and 6.8 infestations per grid block, respectively. In 1984, infestations averaged 89.2 in those grid blocks anticipated to be extreme risk. Levels decreased correspondingly by risk class to an average of only 3.6 infestations in grid blocks rated as very low risk. This system provides a means of monitoring temporal and spatial changes in SPB habitat conditions over wide areas—information essential for forecasting associated shifts in beetle infestation levels.

Additional keywords: *Dendroctonus frontalis*, habitat mapping, aerial photography.

INTRODUCTION

To more effectively manage populations of the southern pine beetle (SPB), *Dendroctonus frontalis* Zimmermann, forest managers need a reliable means of predicting where infestations are most likely to occur. Once this capability is developed, beetle-

caused timber losses can be avoided or minimized through long-range forest management planning (Peterson 1984), silvicultural manipulations (Belanger and Malac 1980), and/or more responsive direct control tactics (Billings 1980).

The susceptibility of single pine trees and forest stands to the SPB has received considerable attention in recent years (Blanche et al. 1983, Hicks 1980). These research efforts have led to practical systems for hazard rating individual pine stands for susceptibility to beetle infestations (Lorio 1980). Less is known about factors influencing the spatial distribution and abundance of SPB outbreaks over wide areas.

Computerized historical records of SPB infestations (spots) maintained by the Texas Forest Service since 1973 (Pase and Fagala 1980) provide a valuable source of information for analyzing spatial and temporal distributions of beetle populations in east Texas. Each infestation (≥ 10 trees) detected throughout the 12 million acres of commercial pine forests is recorded by its specific location within unit tracts known as grid blocks. Grid blocks are rectangular mapping units delineated by 5-minute intervals of longitude and latitude on U.S. Geological Survey maps. A grid block measures ca 5.74 miles (9.2 km) north/south by ca 4.87 miles (7.8 km) east/west and covers ca 18,000 acres (7,300 ha).

The objective of the study undertaken by the Pest Control Section of the Texas Forest Service was to develop, implement, and validate a system for identifying grid blocks capable of supporting high infestation levels of southern pine beetle, based on resource information available from aerial photography. Once identified, "high-hazard" grid blocks could receive priority in detection and control programs and be targeted for silvicultural treatments designed to reduce the potential for future beetle outbreaks. In a further application, the hazard-rating system was modified with input from recent beetle infestation records to generate an up-to-date risk-rating scheme to identify areas where beetle outbreaks are most likely to occur during the coming year. Hazard in this context refers to the relative susceptibility of an area to beetle infestation, based solely on site/stand factors and host abundance. Risk is defined as the probability of a bark beetle infestation becoming established within a given time span, and results from the interaction of hazard and existing beetle population levels (Paine et al. 1984).

¹ Respectively, Principal Entomologist, former Project Forester, and Project Technician, Forest Pest Control Section, Texas Forest Service, Lufkin, TX.

METHODS

By means of discriminant analysis (Nie et al. 1975), an equation to identify 18,000-acre grid blocks capable of supporting high populations of SPB was generated. The analysis involved correlating historical infestation records from 1973-77 for 90 randomly selected grid blocks in east Texas with prevailing site/stand information, the latter sampled from 1974 small scale (1:120,000) color infrared aerial photography (Billings and Bryant 1983). Briefly, the sample grid blocks were divided into two groups for analysis, those with more than 80 SPB infestations (≥ 10 trees) over the 5-year outbreak period and those with fewer than 80 infestations. Independent variables were sampled from the aerial photography by use of an acetate template equal in size to a single grid block and having 20 circular photo plots systematically arranged in five rows and four columns. The 20 photo plots, each covering ca 10 acres, provide a 3 percent sample of host conditions within each grid block.

Within a given grid block, each of the 20 circular plots was classified as follows:

Host type

- Nonhost (hardwoods, water, open fields, etc.)
- Young pine (less than 15 years)
- Pine host (15 years or more)

For each circular plot classified as pine host type, the following additional information was collected:

<i>Factor</i>	<i>Category</i>
Percent pine coverage	15-69%
	≥ 70
Percent pine crown closure	$< 80\%$
	$\geq 80\%$
Landform	upland, ridge, or sideslope bottomland

The equation used to identify grid blocks with high potential for southern pine beetle infestation is:

$$\text{DS: } -1.35 - 0.108(\text{A}) + 0.135(\text{D}) + 0.330(\text{E}) + 0.404(\text{F}) + 0.305(\text{I}) + 0.271(\text{J})$$

where:

D.S. = Discriminant score

A = number of photo plots in grid block classified as non-host

D = number classified as pine host, $<70\%$ pine coverage, $<80\%$ pine crown closure, bottomland

E = number classified as pine host, $<70\%$ pine coverage, $>80\%$ pine crown coverage, other terrain

F = number classified as pine host, $<70\%$ pine coverage, $>80\%$ pine crown closure, bottomland

I = number classified as pine host, $>70\%$ pine coverage, $>80\%$ pine crown closure, other terrain

J = number classified as pine host, $>70\%$ pine coverage, $>80\%$ pine crown closure, bottomland

The numerical discriminant score is used to ascertain the grid block classification, based on a 95 percent confidence interval (Bryant 1985), as follows:

<i>Discriminant score</i>	<i>Hazard classification</i>
< 0.42	Low
0.42 to 1.11	Moderate
> 1.11	High

As part of model development, 50 additional grid blocks not used in development of the hazard-rating discriminant equation were rated for hazard based on 1974 aerial photography input data. The hazard group to which each grid block was assigned was compared to the actual group to which it belonged based on historical infestation records for the period 1973-77. The discriminant function correctly classified 96 percent of the grid blocks used for validation (Billings and Bryant 1983).

Following development and initial validation of the discriminant equation based on 1973-77 data, the same hazard rating procedure was then applied to 1980-83 color infrared aerial photography (scale = 1:120,000). To date, 656 grid blocks covering over 11.8 million acres in east Texas have been hazard rated. The final product, produced in cooperation with the Texas Natural Resources Information Service in Austin, TX, is an areawide hazard map with color-coded hazard indices.

Final validation of the current east Texas hazard map was accomplished by correlating new infestations detected per grid block within 502 grid blocks (covering 20 infested counties) in 1982-84 with the corresponding grid block hazard classification. All infestations on Federal, State, industrial, and private lands were included in this validation if they had been verified as SPB spots on the ground and contained 10 or more affected trees. The total numbers of spots used for validation were 256 in 1982, 1,151 in 1983, and 4,802 in 1984.

The hazard classification was carried an additional step by combining hazard class with recent SPB infestation records for a given grid block to generate a risk classification for each grid block (table 1). For this purpose, low-, moderate- and high-hazard grid blocks were assigned weights of 0, 1, and 3 points, respectively. Similarly, additional points were assigned each grid block according to the number of documented SPB infestations reported during the previous 1 or 2 years. To generate the 1984 risk rating, for example, grid blocks with 0, 1-10, 11-30

Table 1. — Procedure used to assign 1984 risk classes to TFS grid blocks, based on hazard class and recent beetle infestation level

Grid block hazard	SPB infestation index (spots/grid block in 1982 and 1983)			
	0 (0)**	1-10(1)	11-30(2)	>30(3)
High hazard (3)*	Moderate	High	High	Extreme
Moderate hazard (1)	Low	Moderate	Moderate	High
Low hazard (0)	Very low	Low	Moderate	Moderate

Risk rating points = hazard points + population index points + proximity points***

Where 6 or 7 = Extreme risk of SPB infestations in 1984

4 or 5 = High risk

2 or 3 = Moderate risk

1 = Low risk

0 = Very low risk

*Hazard points

**Population index points

***If grid block is located adjacent to a high-hazard grid block having >30 spots = 1 point.

or >30 infestations during 1982-83 were assigned 0, 1, 2, or 3 points, respectively. Finally, one additional rating point was given to each grid block situated immediately adjacent to a high-hazard grid block having more than 30 spots in an attempt to account for beetle immigration. Each grid block was rated as extreme, high, moderate, low, or very low risk based on its cumulative risk points, as shown in table 1.

With this risk rating system, all grid blocks that had previously been hazard rated in east Texas were assigned a risk class prior to the 1984 beetle season. The distribution of grid blocks by risk class for 1984 consisted of 10 rated as extreme risk, 16 high risk, 60 moderate risk, 102 low risk, and the remainder (314) very low risk. The list of risk-rated grid blocks was distributed to all forest industrial, State and Federal field and administrative offices during the spring of 1984 to notify forest managers of where to expect southern pine beetle problems during the coming season. At the end of the year, computerized infestation records from private, State, and Federal forest lands in Texas were used to evaluate how well the hazard- and risk-rating system performed under operational conditions.

RESULTS

Frequency and Geological Distribution of High-Hazard Grid Blocks

Of the 656 grid blocks evaluated for southern pine beetle hazard in east Texas from 1981-83 aerial photography, 33 (5 percent), 72 (11 percent) and 551 (84 percent) were classified as high, moderate, and low hazard, respectively. This represents a substantial reduction in the abundance of high-hazard grid blocks in Texas during the last decade; 17 percent of the grid blocks ranked as high hazard in 1974. Furthermore, most high-hazard grid blocks are now located in central east Texas (30 percent) and on the western fringe of the pine zone (59 percent), as shown in figure 1A. Of the 33 grid blocks rated as high hazard, 27 (82 percent) contain more than 10 percent National Forest land. The reduction of high-hazard grid blocks on industrial and privately-owned lands in southeast Texas since 1974 is attributed to the accelerated harvest of mature pine forests and their subsequent conversion to young pine plantations in recent years. Also, the severe SPB outbreak of 1973-77 was centered in these counties and tem-

porarily eliminated much of the susceptible host type.

Correlated with the geographical shift in high-hazard grid blocks in east Texas has been a similar shift in beetle infestation patterns in recent years. A majority (56 percent) of the confirmed SPB infestation for the period 1982–84 occurred in western fringe counties, rather than in the Southeast, where beetle population were concentrated in the 1970's (fig. 1B). Furthermore, 48 percent of these infestations developed on the National Forests, even though these lands represent only ca 7 percent of the total acreage of commercial pine forests in Texas.

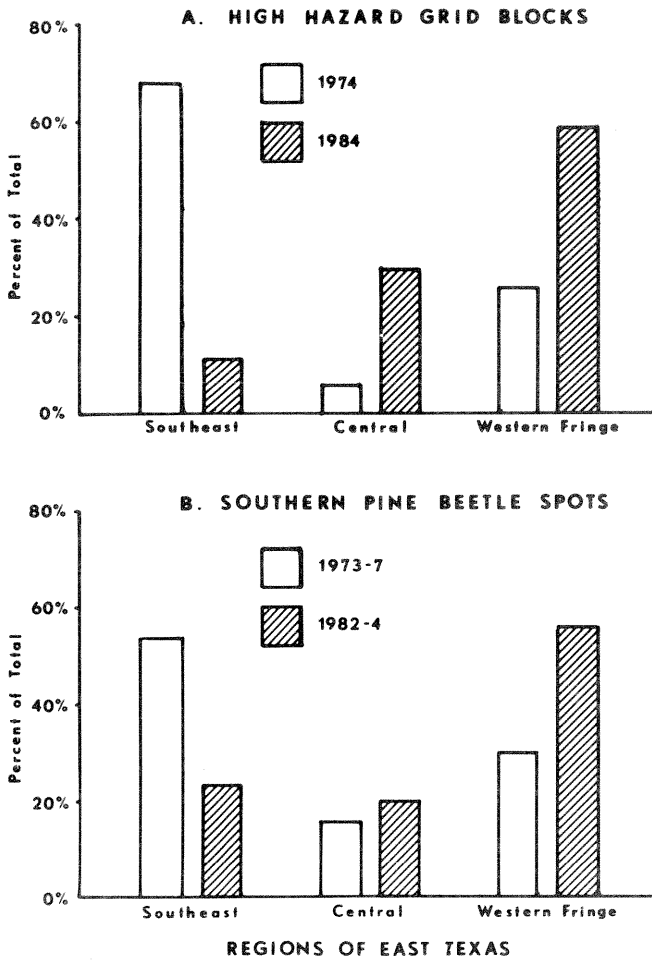

Figure 1.—(A) Shifts in the distribution and abundance of high-hazard grid blocks within three geographical regions of east Texas between 1974 (total of 87 high-hazard grid blocks) and 1984 (total of 33 high-hazard grid blocks). (B) Corresponding shifts in southern pine beetle infestation levels among the three geographical regions of east Texas between 1973–77 (total of 25,109 spots) and 1982–84 (total of 6,210 spots). Southeast = Polk, Tyler, Jasper, Newton, Orange, Jefferson, Chambers, Hardin, and Liberty counties; Central = Sabine, San Augustine, Shelby, Nacogdoches, Angelina, and southern Cherokee counties; Western fringe = Houston, Trinity, San Jacinto, Walker, Montgomery, and Harris counties.

Validation of Grid Block Hazard Ratings

The average numbers of spots per grid block in each hazard class provided a post-season measure of how well the grid block hazard-rating system performed in 1982–83 and in 1984. During 1982–83, grid blocks rated as high hazard based on prevailing habitat conditions alone supported an average of 16.9 spots, whereas those rated as moderate hazard had 5.1 spots, and low-hazard grid blocks had only 1.1 spots. Southern pine beetle populations increased dramatically the following year; accordingly, the corresponding average numbers of spots per grid block were 46.4 in high-hazard, 15.2 in moderate-hazard, and 5.6 in low-hazard grid blocks in 1984. Combined data for the three-year period 1982–84 reveal that, on the average, high-hazard grid blocks supported three times as many spots (63.3 ± 79.21) as moderate-hazard grid blocks (20.6 ± 32.68) and nine times as many as low-hazard grid blocks (6.8 ± 13.27).

Validation of Grid Block Risk Ratings

The risk-rating scheme developed for distribution in 1984 performed as expected; mean numbers of 1984 spots per risk class increased consistently in direct proportion to increasing severity of risk (table 2). Mean numbers of spots per risk class increased from 3.6 spots in very low risk grid blocks to 89.2 spots in the 2 percent of grid blocks listed as extreme risk.

Variation in numbers of 1984 spots per grid block in each risk class was considerable (table 2), reflecting in large part the uneven geographical distribution of beetle populations. Fifty-eight percent of all infestations in 1984 occurred in San Jacinto, Walker, and Montgomery counties. Accordingly, within the western fringe zone which includes these counties, extreme-risk grid blocks contained an average of 159.8 infestations each, compared to an average of 18.6 in grid blocks rated as extreme risk in the central zone of east Texas (table 3). The high beetle population in San Jacinto, Walker, and Montgomery counties is largely attributed to Hurricane Alicia which passed through them in August, 1983, damaging forest stands and providing foci for many SPB infestations in 1984. Infestation levels were particularly severe on the Sam Houston National Forest, where a massive population of SPB developed in a proposed wilderness area in 1983 (Texas Forest Service 1984).

Among the three geographical areas in east Texas, the correlation of 1984 spots with risk class (table 3) was poorest in southeastern counties (Polk, Tyler, Jasper, Newton, Orange, Hardin, and Liberty),

Table 2. — Summary of mean number of 1984 southern pine beetle spots per grid block (\pm standard error) by projected risk class for Texas Forest Service Area III-V

Risk class	No. of grid blocks	Percent of total	No. of spots*	Percent of total	Mean spots per grid block
Very low	314	62.5%	1125	23.4%	3.6 \pm 8.26
Low	102	20.3%	1127	23.5%	11.1 \pm 19.09
Moderate	60	12.0%	1017	21.2%	16.9 \pm 29.26
High	16	3.2%	641	13.3%	40.1 \pm 48.00
Extreme	10	2.0%	892	18.6%	89.2 \pm 92.20
Total	502	100.0%	4802	100.0%	

*Excludes spots with less than 10 trees at detection and those never ground checked.

Table 3. — Summary of mean number of 1984 southern pine beetle spots per grid block (\pm standard error) by projected risk class for three geographical regions of east Texas

Risk class	Southeast ¹		Central ²		Western fringe ³	
	No. of grid blocks	Spots per grid block	No. of grid blocks	Spots per grid block	No. of grid blocks	Spots per grid block
Very low	141	3.3 \pm 8.29	86	0.7 \pm 1.93	87	6.8 \pm 10.68
Low	62	8.0 \pm 8.98	25	7.7 \pm 12.04	15	29.3 \pm 40.15
Moderate	23	6.4 \pm 7.55	18	10.6 \pm 11.46	19	35.8 \pm 45.30
High	0	...	6	18.5 \pm 13.72	10	53.0 \pm 56.91
Extreme	0	...	5	18.6 \pm 9.57	5	159.8 \pm 81.09

¹Polk, Tyler, Jasper, Newton, Orange, Jefferson, Chambers, Hardin and Liberty counties.

²Sabine, San Augustine, Shelby, Nacogdoches, Angelina, Southern Cherokee counties.

³Houston, Trinity, San Jacinto, Walker, Montgomery, Harris counties.

for reasons that remain unclear. Although recent aerial photographs suggest that these counties have less susceptible host type at present, they have historically supported high beetle populations. In these areas, SPB infestations were observed in certain plantations less than 15 years of age or in pine pockets located in primarily hardwood stands of the Big Thicket National Preserve. Perhaps more consideration should be given to the poorly drained bottomland sites and young pine plantations that prevail in these areas in assigning future hazard ratings.

A post-season evaluation of 1984 ground check information from the outbreak area of Sabine, Walker, San Jacinto, and Houston counties was conducted to compare the spot size distribution for all grid blocks rated as high and extreme risk with that for interspersed grid blocks rated low and very low risk. Results (fig. 2) reveal that only 15 percent of all spots in extreme- and high-risk grid blocks were inactive (vacated by beetles) at the time of ground check, while 18 percent were larger than 50 active (currently infested) trees. In contrast, 38 percent of spots in grid blocks rated as low or very low risk in the same counties were reported to be inactive at ground check and only 10 percent exceeded 50 trees in size.

The distribution of spots per spot size category proved to be significantly different by Chi square analysis ($\chi^2 = 146.4$, $P < 0.01$) between the two risk categories. Clearly, then, both the frequency of occurrence and severity of beetle infestations were found to be greatest in those grid blocks singled out as extreme or high risk prior to the 1984 beetle season.

DISCUSSION

The hazard- and risk-rating system described herein represented the first successful attempt to monitor changes in SPB habitat conditions over wide areas and to predict corresponding shifts in beetle infestation patterns. The close correlation between host abundance and outbreak populations of southern pine beetle emphasizes the importance of the host factor in beetle population dynamics (Blanche et al. 1983) Although individual forest stands can be rated for hazard based on existing site/stand conditions (Belanger et al. 1981, Mason et al. 1983), the actual risk of beetle infestation in any given year will be influenced by many additional factors (Paine et

al. 1984). These include: 1) Beetle populations in the area, 2) the abundance of suitable habitat for beetles on an area basis, and 3) exogenous stress factors such as lightning, windstorms, drought, and flooding. The current risk-rating system takes into account all but the latter factor. Until accurate weather predictions can be made and the frequency of climatic disturbances monitored, the current system may be unable to adequately account for all observed variation in beetle population levels among different areas of east Texas.

Nevertheless, the capability to hazard and risk rate large areas are of value to pest control specialists and forest managers. High-hazard grid blocks warrant priority for long-range forest management planning. Individual stands in these areas should be hazard rated and treated silviculturally to reduce susceptibility to SPB (Belanger and Malac 1980, Lorio 1980). Grid blocks identified as high or extreme risk provide land managers with insight into where beetle problems are most likely to occur in the near future. Increased detection flights and priority for prompt control (Billings 1980) are essential in these areas to minimize timber losses until hazardous stand conditions can be modified.

Following successful implementation in 1984, the SPB risk rating system is to be updated annually, based on the most recent infestation records, and redistributed to forest managers throughout the

State in preparation for each new beetle season. To account for changes in forest composition and structure that result from ongoing harvest and thinning operations and tree growth, the grid block hazard classifications are to be revised at 5- or 6-year intervals, depending on the availability of suitable aerial photography.

CONCLUSIONS

In summary, the Texas grid block hazard-rating system provides a practical and reliable means for monitoring spatial and temporal changes in SPB host abundance. The abundance of susceptible host, in turn, appears to largely govern regional shifts in beetle infestation levels and the severity of areawide outbreaks. Such information is essential for anticipating potential bark beetle problems.

LITERATURE CITED

- Belanger, R. P.; Malac, B. F. Silviculture can reduce losses from the southern pine beetle. *Agric. Handb.* 576. Washington, DC: U.S. Department of Agriculture; 1980. 17 p.
- Belanger, R. P.; Porterfield, R. L.; Rowell, C. E. Development and validation of systems for rating

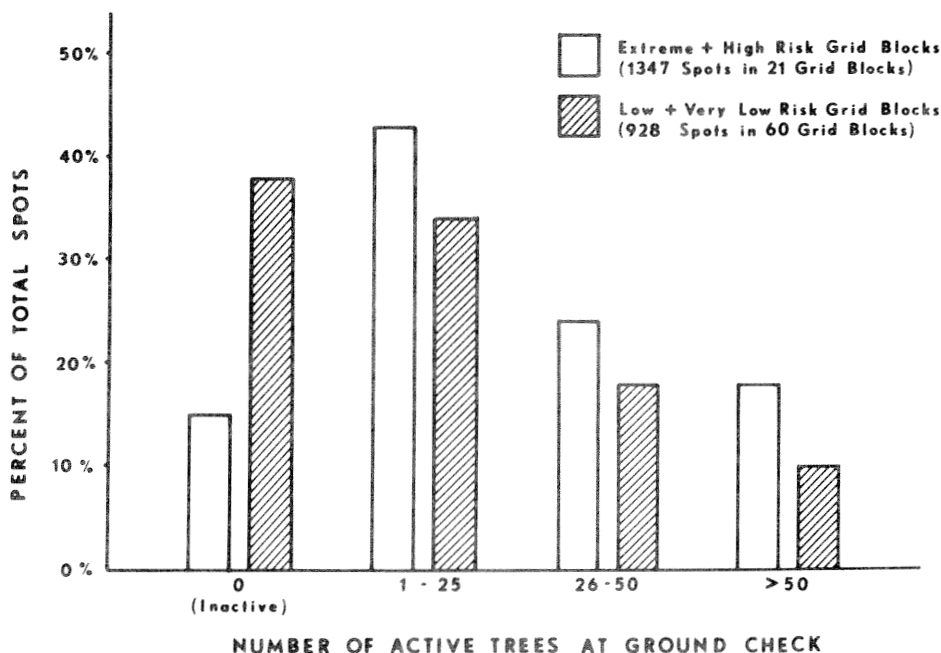

Figure 2.—Comparison of spot size distributions at first ground check between grid blocks rated as extreme or high risk to southern pine beetle and those rated as low or very low risk in Sabine, Walker, San Jacinto, and Houston counties in 1984.

- the susceptibility of natural stands in the Piedmont of Georgia to attack by the southern pine beetle. In: Hedden, R. L.; Barras, S. J.; Coster, J. E., tech. coords. Hazard-rating systems in forest pest management: symposium proceedings; 1980 July 31–August 1; Athens, GA. Gen. Tech. Rep. WO-27. Washington, DC: U.S. Department of Agriculture, Forest Service; 1981: 79-86.
- Billings, R. F. Direct control. In: Thatcher, R. C.; Searcy, J. C.; Coster, J. E.; Hertel, G. D., eds. The southern pine beetle. Tech. Bull. 1631. Washington, DC: U.S. Department of Agriculture; 1980: 179–192.
- Billings, R. F.; Bryant, C.M. Developing a system for mapping the abundance and distribution of southern pine beetle habitats in east Texas. *Zeitschrift für Angewandte Entomologie* 96:208–216; 1983.
- Blanche, C. A.; Hodges, J. D.; Nebeker, T. E.; Moehring, D. M. Southern pine beetle: the host dimension. Bulletin 197. Mississippi State, MS: Mississippi Agricultural and Forestry Experiment Station, Mississippi State University; 1983. 29 p.
- Bryant, C. M. Hazard rating systems and southern pine beetle prevention in Texas. In: Shoulders, E., ed. Proceedings, third biennial southern silvicultural research conference; 1984 November 7–8; Atlanta, GA. Gen. Tech. Rep. SO-54. New Orleans, LA: U.S. Department of Agriculture, Forest Service, Southern Forest Experiment Station; 1985; 480–484.
- Hicks, R. R., Jr. Climatic, site, and stand factors. In: Thatcher, R. C.; Searcy, J. L.; Coster, J. E.; Hertel, G. D., eds. The southern pine beetle. Tech. Bull. 1631. Washington, DC: U.S. Department of Agriculture; 1980: 55–68.
- Lorio, P. L., Jr. Rating stands for susceptibility to SPB. In: Thatcher, R. C.; Searcy, J. L.; Coster, J. E.; Hertel, G. D., eds. The southern pine beetle. Tech. Bull. 1631. Washington, DC: U.S. Department of Agriculture; 1980: 153–163.
- Mason, G. D., Hertel, G. D.; Thatcher, R. C. Southern pine beetle hazard ratings—uses, implementation, and evaluation. In: Jones, E. P., Jr., ed. Proceedings, second biennial southern silvicultural research conference; 1982 November 4–5; Atlanta, GA. Gen. Tech. Rep. SE-24. Asheville, NC: U.S. Department of Agriculture, Forest Service, Southeastern Forest Experiment Station; 1983: 365–370.
- Nie, N. H.; Hull, C. H.; Jenkins, J. G.; Steinbrenner, K.; Bent, D. H. SPSS: statistical package for the social sciences. New York: McGraw-Hill, Inc.; 1975. 675 p.
- Paine, T. D.; Stephen, F. M.; Taha, H. A. Conceptual model of infestation probability based on bark beetle abundance and host tree susceptibility. *Environmental Entomology* 13: 619–624; 1984.
- Pase, H. A.; Fagala, E. P. A computer-based informational system to aid southern pine beetle control operations. Texas Forest Service Publ. 120. Lufkin, TX: Texas Forest Service; 1979. 21 p.
- Peterson, R. M. The role of integrated pest management in forest planning and management. In: Branham, S. J.; Hertel, G. D., eds. Proceedings, integrated forest pest management symposium; 1984 June 19–21; Athens, GA. Athens: School for Continuing Education, The University of Georgia; 1984: 2-7.
- Texas Forest Service. Texas forest pest report 1982–83. Texas Forest Service Publ. 136. Lufkin, TX: Texas Forest Service; 1984. 31 p.

Predicting Susceptibility to Southern Pine Beetle Attack in the Coastal Plain, Piedmont, and Southern Appalachians

Roy L. Hedden and Roger P. Belanger¹

Abstract.—Logistic regression equations were developed for predicting the probability of southern pine beetle infestation (risk) in the Gulf Coastal Plain, Southern Piedmont, and Southern Appalachians. These models are applicable to undisturbed and disturbed natural and planted pine stands. The models, modified to accommodate varying levels of SPB population, are used to generate the probability of infestation per acre in the CLEMBEETLE simulation program. In addition, these models can be used in combination with some measure of spot growth (hazard) to provide estimates of expected timber loss from southern pine beetle attack. This composite measure of expected loss furnishes more information to decisionmakers than either risk or hazard rating alone.

Additional keywords: Risk rating, hazard rating, *Dendroctonus frontalis* Zimm.

INTRODUCTION

The key to preventing forest pest problems is understanding the closely associated pest, tree, and site factors that make a stand susceptible to attack. In recent years, systems have been developed using this relationship which easily and reliably determine where pest attacks are most likely to occur (Hedden et al. 1981). These systems are commonly known as risk- and/or hazard-rating systems.

Although the terms risk or hazard are often used interchangeably, they have distinct meanings. Risk can be defined as the probability of pest occurrence per unit area (acre, hectare, etc.). Risk is synonymous with susceptibility. Hazard, on the other hand, is the degree to which damage is likely to occur once a pest becomes established. Hazard is also known as vulnerability. In this paper, we will primarily be concerned with susceptibility or risk.

Numerous methods for predicting susceptibility have been developed for the southern pine beetle (SPB), *Dendroctonus frontalis* Zimmermann (Billings and Bryant 1982, Daniels et al. 1979, Hicks et al. 1980, Mason et al. 1981, Kushmaul et al. 1979, Lorio and Sommers 1980). Most of these systems deal with undisturbed natural stands in a fairly

restricted geographical area such as a State. The single exception is the model developed by Kushmaul et al. (1979) for undisturbed natural stands in east Texas, Louisiana, and Mississippi. The models presented in this paper are applicable to disturbed and undisturbed natural and planted stands for the broad geographical regions of the Gulf Coastal Plain, Southern Piedmont, and Southern Appalachians.

PROCEDURES

Data

Data for the development of the models came from the Coordinated Site/Stand Project of the Expanded Southern Pine Beetle Research and Applications Program (ESPBRAP) (Coster and Searcy 1981). Information for the Gulf Coastal Plain was obtained from plots in Arkansas, Texas, Louisiana, and Mississippi. The Piedmont data were obtained from Georgia, South Carolina, and North Carolina. The data for the Southern Appalachians were collected in Rabun County, GA, primarily in the Chattahoochee National Forest. Detailed data were collected on soil, site, and stand conditions on both SPB infested and baseline plots. A complete description of the variables measured on each plot can be found in Coster and Searcy (1981). Infested plots were randomly selected from aerial or ground surveys. The center of each plot was established at or near the point where the SPB infestation began. Most infestations sampled were less than 3 months old, and no plots were established in infestations older than 1 year. Baseline plots were established either randomly or on a systematic grid in uninfested stands.

Preliminary Analysis

The first part of the analysis determined which stand disturbance and landform variables were significantly related to SPB occurrence. This step was accomplished by comparing the frequency of infested and baseline plots for each disturbance category with the frequency of infested and baseline plots that had no known disturbances. The hypothesis tested was that stands in which disturbances occurred had different frequencies of baseline and infested plots than those in which disturbances did not occur. A statistical procedure suggested by Brunden (1972) as illustrated by Everitt (1977) was used. Also, since hazard-rating systems presently in use in the Coastal Plain (Mason et al. 1981) classify landform as

¹ Respectively, Professor, Department of Forestry, Clemson University, Clemson, SC; and Principal Silviculturist, USDA Forest Service, Southeastern Forest Experiment Station, Athens, GA.

ridge (upland flat or ridge), bottom (flood plain, stream terrace, bay, or lower slope), or other (side-slope or steep sideslope), the adequacy of this system of classification was tested.

Logistic Regression

The models for predicting the probability of SPB infestation for each subregion were fitted using stepwise logistic regression (Afifi and Clark 1984). The computer program LOGIST was used in the analysis (Harrel 1980). Model coefficients were estimated using the method of maximum likelihood. Variables were selected for entry in the model based upon the criteria of a significant ($P < .05$) increase in the likelihood ratio statistic. Criteria for evaluating the adequacy of the models were the percentages of correct plot classification by infestation status (attacked or baseline).

The southwide data were stratified by geographical subregion with separate models being developed for the Piedmont, Coastal Plain, and Southern Appalachians. Natural and planted stands as well as disturbed and undisturbed plots were combined for analysis. Interaction terms between independent variable were included where appropriate.

The unmodified logistic regression equations resulting from the analyses are of the form:

$$\hat{p} = 1 / (1 + \text{EXP} [B_0 + B_i X_i]) \quad (1)$$

where \hat{p} = the estimated probability of infestation

B_0 = the constant

B_i = the estimated regression coefficients

X_i = the independent variables

EXP = the exponential e

The constant, B_0 , can be modified to remove the effect of separate sampling of the baseline and infested plot data (Reed et al. 1982). This modified constant can then be adjusted for different beetle population levels (Appendix).

RESULTS AND DISCUSSION

Gulf Coastal Plain

The preliminary analysis showed that the disturbance categories for which the frequency of baseline and infested plots was significantly different were logging activity within the previous year, severe ice and/or hail damage with over half of the stems affected, evident lightning strike, wind damage, and a miscellaneous category of all other disturbances (table 1). Plots with these occurrences were considered *disturbed* in the development of the logistic regression model.

In addition to disturbance, SPB infestation pattern as related to landforms was also determined. The results (table 2) show that there is no significant difference between the ridge and bottom categories, but that the sideslope category is significantly different from the other two. This result may partially explain the differences in the results between the risk-rating system developed for Arkansas (Ku et al. 1980), which indicated that infested plots were more likely to occur on dry sites than were baseline plots, and for the lower Coastal Plain, which showed that infestations occur more often on wet, low-lying sites (Mason et al. 1980). However, in order to maintain consistency with other risk-rating systems (Mason et al. 1980, Billings and Bryant 1982), the three broad landform characteristics were used in developing the logistic probability models.

The adjusted logistic regression model used for estimating the per acre probability of infestation is:

$$\hat{p} = 1 - (1 / [1 + \text{EXP} (\ln (S / [1000 - S]) - 3.30534 + .01336 \text{ TBA} + .83870 \text{ LAND1} + 1.09323 \text{ LAND2} - 12.01177 / \text{AGE} + 2.50895 \text{ PP} - 1.23183 \text{ DIST} + .00225 \text{ TBA} * \text{DIST}])$$

where \hat{p} = the estimated probability of infestation per acre

S = the number of SPB infestations per 1,000 acres of susceptible host type

Table 1. — Frequency of baseline and infested plots for the different disturbance categories (note that a plot may have more than one disturbance)

Disturbance category	Baseline		Baseline	
	No. ¹	percent ²	No. ¹	percent ²
No known disturbance	730	47	837	53
Logging activity within the previous year ³	120	32	260	68
Logging activity more than 1 year ago	297	51	282	49
Severe ice and/or hail damage with over half the stems affected ³	8	21	30	79
Ice and/or hail damage with less than half the stems affected	134	46	160	54
Fire within the previous year	22	39	34	61
Fire more than a year ago	100	56	78	44
Evidence of lightning strike ³	22	4	539	96
Chemical brush control within the previous year	11	32	23	68
Wind damage ³	17	23	58	77
Other ³	22	18	104	82

¹The number of occurrences.

²Percentage of total plots in the category that are attacked or baseline.

³Disturbances for which the frequency of attacked and baseline plots was significantly different ($P < .05$) from the frequency for the "no known disturbance" category.

Table 2. — Frequency of baseline and attacked plots for the different landform categories

Landform category	Attacked		Baseline	
	No. ¹	Percent ²	No. ¹	Percent ²
Ridge	1167	63	672	37
Bottom	358	65	189	35
Other	298	42	418	58

¹The number of occurrences.

²Percentage of total plots in the category that are attacked or baseline.

- TBA = total basal area per acre in square feet
 LAND1 = 1 if the landform is a ridge, 0 otherwise
 LAND2 = 1 if the landform is a bottom, 0 otherwise
 AGE = stand age in years
 PP = proportion of pine in the stand as a ratio of pine basal area to total basal area
 DIST = 1 if the stand is disturbed, 0 otherwise

This equation was derived from 1,363 baseline plots and 1,968 attacked plots. The unmodified constant, Bo, was -2.93801 (Appendix). The equation classified all plots as infested or baseline at a rate of 74 percent. Baseline plots were classified correctly 65 percent of the time, whereas the percentage of correct classification for all attacked plots was 82 percent. This difference in correct classification rate between attacked and baseline plots is understandable since some of the baseline (uninfested) plots should have characteristics associated with stands with high infestation probability. This trend of higher correct classification rate for infested plots was observed for all data combinations (table 3). In general, disturbed plots were correctly classified more often than undisturbed ones. Also, natural stands had a higher correct classification rate than did planted stands (table 3). Given the geographical range of the

data, and the number of individual investigators involved in data collection, the overall performance of this model is excellent.

On the Coastal Plain, the probability of infestation (P) increases as basal area (TBA), age, and percent pine increases (PP). P is higher for disturbed than undisturbed stands, and higher on ridges or bottoms than on sideslopes. The most interesting characteristic of the model is the interaction between disturbance and total basal area. For values of TBA around 200 square feet per acre, P is the same for both disturbed and undisturbed stands. This interaction suggests that overstocked stands may be suffering stresses equal to those present in a stand when a disturbance occurs. The implications of this phenomenon are that high-density, severely overstocked pine stands may be very susceptible to beetle attack, even during periods of very low populations. Furthermore, since the attack probability for disturbed and severely overstocked stands is nearly equal, these overdense stands may be reservoirs for beetles similar to lightning-struck trees.

Piedmont

The method of classifying plots as undisturbed or disturbed used for the Coastal Plain was also used for the Piedmont plots. However, a different landform classification system was used: essentially, plots that occurred on steep sideslopes were identified separately from all other plots. In general, plots on steep sideslopes had a much higher frequency of infestation than did those on other landforms (Coster and Searcy 1981). In addition, attacked plots occurred on sites with higher than average clay contents in the surface soil (0-15 cm of the soil surface) (Coster and Searcy 1981). Also, shortleaf pine was more susceptible to attack than loblolly or Virginia pine. Based on these characteristics, the following model was developed for natural and planted stands

Table 3. — Percent correct classifications for various groupings of the infested and baseline plots for the Gulf Coastal Plain

Plot combinations	Number of plots	Percent baseline	Correct classification	
			Attacked	All plots
All plots	3332	65	82	74
All undisturbed	2288	65	75	69
All disturbed	1044	63	86	85
All natural stands	3097	66	82	74
All plantations	229	57	74	69
Undisturbed natural	2114	66	77	69
Disturbed natural	983	64	86	85
Undisturbed plantations	169	56	65	62
Disturbed plantations	60	¹	88	87

¹There were no disturbed baseline plots.

in the Piedmont:

$$\hat{p} = 1 - (1 / [1 + \text{EXP} (\ln [S / (1000 - S)] + 2.00767 - .44092 \text{ PTYPE} - .42045 \text{ LAND} + .69601 \text{ STYPE} + .59000 \text{ DIST} - .08931 \text{ NRG} + .00669 \text{ PSI})])$$

where \hat{p} = the estimated probability of infestation per acre

S = the number of SPB infestations per 1,000 acres of susceptible host type

PTYPE = -1 if shortleaf pine, 1 otherwise

LAND = -1 if the landform is steep sideslope, 1 otherwise

STYPE = 1 if the clay content of the surface soil is ≥ 28 percent, -1 otherwise

DIST = 1 if the stand is disturbed, -1 otherwise

NRG = for natural stands, the radial growth during the last 5 years in mm, for planted stands NRG = 0

PSI = for planted stands, the site index in feet for base age of 50 years, for natural stands PSI = 0.

This equation was derived from 193 baseline plots and 161 attacked plots. The unmodified constant, B_0 , was 1.82638 (Appendix).

For the purposes of this model, NRG can be predicted from the following equation:

$$\text{NRG} = 13.10012 + 2.41042 \text{ PTYPE} - 0.01730 \text{ TBA} + 169.833 / \text{AGE} - 0.05094 \text{ DBH}$$

where NRG = the radial growth in mm during the last 5 years for a natural stand

PTYPE = -1 if shortleaf pine, 1 otherwise

TBA = the total basal area per acre in square feet

AGE = the stand age in years

DBH = the average diameter at breast height in inches

This equation has a coefficient of determination (R^2) of 0.48 and a standard error of estimate ($s_{y,x}$) of 3.85.

The site index equation for the planted stands (PSI) is from Schumacher and Coile (1960):

$$\text{LOG} (\text{SI}) = \text{LOG} (\text{HT}) + 6.528 ([1/A] - [1/50])$$

where SI = the site index at age 50

HT = the average height in feet of the dominant and codominant trees in the stand

A = the current age of the stand in years

LOG = the base 10 logarithm

The logistic regression model classified all plots as infested or baseline at a rate of 73 percent. Baseline

plots were correctly classified 75 percent of the time, whereas the percentage of correct classifications for all attacked plots was 70 percent. The results are somewhat similar to those obtained for the Coastal Plain with natural stands having a higher correct classification rate than planted ones, and disturbed plots having a higher correct classification rate than undisturbed plots. The overall performance of this model is good; however, it's developed on a much smaller and geographically restricted data base than the Coastal Plain logistic regression model (354 versus 3,332 plots).

In contrast, the case for the Coastal Plain, the probability of infestation (P) in the Piedmont is much more closely related to site factors than stand characteristics such as stocking level and stand composition. Shortleaf pine growing in soils with high clay content on steep sideslopes is most susceptible to attack. This combination of species and site is also very conducive to the development of littleleaf disease of pine. The frequency of disturbance in the Piedmont appears to be lower than in the Coastal Plain; however, disturbed stands have a higher probability of infestation than undisturbed stands.

Southern Appalachians

Preliminary analysis of the data indicated that diameter at breast height, bark thickness, radial growth, percent pine, and species of pine were potential variables for the development of models. The final model is applicable to shortleaf, Virginia, and pitch pine. White pine stands have a very low probability of infestation and they are normally only attacked when in mixture with one of the more susceptible pine species.

The adjusted probability model for estimating the per acre probability of infestation is:

$$\hat{p} = 1 - (1 / [1 + \text{EXP} (\ln (S / [1000 - S]) - 5.90 - 3.97 \text{ PPS} + 2.14 \text{ LRG})])$$

where \hat{p} = the estimated probability per acre

S = the number of SPB infestation per 1000 acres of susceptible host type

PPS = the proportion of pine

LRG = \ln (radial growth in the last year's (mm) + .5

This equation was derived from 47 infested and 40 baseline plots. The unmodified constant, B_0 , is -5.74 (Appendix). The equation had an overall correct classification rate of 75 percent. Baseline plots were correctly classified 70 percent of the time while the rate for infested plots was 79 percent. The probability of infestation decreases as radial growth increases and increases as the proportion of pine in the stand increases.

Using the Models

These models were originally developed for use in the CLEMBEETLE (Hedden 1985) simulation program. CLEMBEETLE requires the probability of an infestation per acre in order to generate the expected proportion of the stand killed in a given year. The logistic functions, modified to accommodate varying levels of SPB populations, are ideally suited for this use.

The models can be used like other risk- or hazard-rating systems to allocate stands to risk classes such as low, medium, or high. Risk classes are defined in a manner analogous to that for discriminant models. Indeed, both systems have been modified for this purpose (Hedden and Karpinski 1983; Karpinski et al. 1984, 1985; Karpinski and Hedden 1984). The Piedmont version of the model has been extensively tested and is now being operationally used by the States of South Carolina and Georgia, and by the USDA Forest Service. These modified systems combine the probability of spot occurrence (risk) with the potential for spot spread (hazard) to determine the potential for loss. The potential loss value is used to assign priorities for cultural treatments such as thinning, harvesting and the like.

Advantages of Logistic Models

The fundamental assumption in logistic regression analysis is that $\ln[p/(1-p)]$ is linearly related to the independent variables. No assumptions are made regarding the distribution of the X variables. In fact, one of the major advantages of this function is that the X variables may either be continuous or discrete (Afifi and Clark 1984). In contrast, linear discriminant analysis assumes that the populations of interest have a multivariate normal distribution and that the covariance matrix is the same for both populations.

However, for risk rating forest stands, the major advantage of the logistic model is the continuous probability scale. This allows stands to be ranked from lowest to highest in order of infestation probability. This ranking provides more information to the decisionmaker than does a classification of stands into a discrete number of risk or hazard classes. In addition, when the decisionmaker has an estimate of spot growth (hazard); i.e., the number of trees or volume of timber killed by the SPB in a stand over a specified period of time, then the product of the infestation probability and the loss from spot growth expresses the expected loss (Hedden and Billings 1979, Reed et al. 1981). For example, assume that the probability of a pine stand being infested by the SPB in an outbreak year is .1, and that if a spot becomes established the estimated loss is 200

trees, then the expected loss per acre would be $.1 \times 200 = 20$ trees/acre. This figure is the average expected loss for the stand. In other words, 9 out of 10 stands with similar conditions would have 0 loss, whereas one stand would have 200 trees killed for an average loss of 200 trees per stand (200 trees/10 stands).

CONCLUSIONS

The combination of risk (susceptibility) and hazard (vulnerability) is a better measure of expected loss to SPB than either factor by itself. Stands can be low risk/high hazard, high risk/low hazard, or both low or high risk/hazard. Combinations of low or high risk and low or high hazard are especially common in the Piedmont where the infestation is related primarily to the site factors and spot growth is related to stand density. In this region, a combination of risk and hazard rating to express expected loss provides more useful information to decision-makers in the long run than either factor alone.

LITERATURE CITED

- Afifi, A. A.; Clark, V. Computer-aided multivariate analysis. Belmont, CA: Lifetime Learning Publications; 1984. 458 p.
- Belanger, P.; Porterfield, R. L.; Roswell, C. E. Development and validation of systems for rating the susceptibility of natural stands in the Piedmont of Georgia to attack by the southern pine beetle. In: Hedden, R. L.; Barras, S. J.; Coster, J. E., coords. Hazard-rating systems in forest insect pest management: symposium proceedings. 1980 July 31-August 1; Athens, GA. Gen. Tech. Rep. WO-27. Washington, DC: U.S. Department of Agriculture, Forest Service; 1981: 79-86.
- Billings, R. F.; Bryant, C. M. Southern pine beetle field guide for hazard rating, prevention, and control. Tex. For. Serv. Circ. 259. Lufkin, TX: Texas Forest Service; 1982. 24 p.
- Brunden, M. N. The analysis of non-independent 2×2 tables using rank sums. *Biometrics* 28:603-607; 1972.
- Coster, J. E.; Searcy, J. L., eds. Site, stand and host characteristics of southern pine beetle infestations. Tech. Bull. 1612. Washington, DC: U.S. Department of Agriculture; 1981. 115 p.
- Daniels, R. F.; Leuschner, W. A.; Zarnoch, S. J.; Burkhart, H. E.; Hicks, R. R. A method of estimating the probability of southern pine beetle outbreaks. *For. Sci.* 25:265-269; 1979.
- Everitt, B. S. The analysis of contingency tables. London: Chapman and Hall; 1977. 128 p.

- Harrell, F. The LOGIST procedure. In: Reinhardt, P. S., ed. SAS supplemental library user's guide. Cary, NC: SAS Institute, Inc.; 1980; 83-102.
- Hedden, R. L. Simulation of southern pine beetle associated timber loss using CLEMBEETLE. In: Branham, S. J.; Thatcher, R. C., eds. Proceedings, integrated pest management research symposium; 1985 April 15-18; Asheville, NC. Gen. Tech. Rep. SO-56. New Orleans, LA: U.S. Department of Agriculture, Forest Service, Southern Forest Experiment Station; 1985: 288-291.
- Hedden, R. L.; Billings, R. F. Southern pine beetle: factors affecting the growth and decline of summer infestations in east Texas. *For. Sci.* 25:547-556; 1979.
- Hedden, R. L.; Karpinski, C. Estimating potential loss from the southern pine beetle. *For. Pest Leaflet*. No. 8. Clemson, SC: Clemson University, Department of Forestry and Cooperative Extension Service; 1983.
- Hedden, R. L.; Barras, S. J.; Coster, J. C., eds. Hazard-rating systems in forest insect pest management: symposium proceedings. 1980 July 31-August 1; Athens, GA. Gen. Tech. Rep. WO-27. Washington, DC: U.S. Department of Agriculture, Forest Service; 1981. 169 p.
- Hicks, R. R., Jr.; Watterston, K. G.; Coster, J. E. Rating east Texas stands for susceptibility to southern pine beetle attack. *South. J. Appl. For.* 5:7-10; 1980.
- Karpinski, C.; Ham, D. L.; Hedden, R. L. Predicting potential loss to southern pine beetle in natural stands in the Piedmont. *For. Pest Leaflet*. No. 11. Clemson, SC: Clemson University, Department of Forestry and Cooperative Extension Service; 1984.
- Karpinski, C., Jr.; Hedden, R. L.; Belanger, R. P.; Price, T. S. Guidelines for managing pine bark beetles in Georgia. Georgia For. Comm. Pub. 235-1, Macon, GA: Georgia Forestry Commission; 1984. 61 p.
- Ku, T. T.; Sweeney, J. M.; Shelbourne, V. B. Site and stand conditions associated with southern pine beetle outbreaks in Arkansas—a hazard-rating system. *South. J. Appl. For.* 4:103-106; 1980.
- Kushmaul, R. J.; Cain, M. D.; Rowell, C. E.; Porterfield, R. L. Stand and site conditions related to southern pine susceptibility. *For. Sci.* 25:656-664; 1979.
- Lorio, P. L., Jr.; Sommers, R. A. Use of available resource data to rate stands for southern pine beetle risk. In: Hedden, R. L.; Barras, S. J.; Coster, J. E., eds. Hazard-rating systems in forest insect pest management: symposium proceedings; 1980 July 31-August 1; Athens, GA. Gen. Tech. Rep. WO-27. Washington, DC: U.S. Department of Agriculture, Forest Service; 1981.
- Mason, G. N.; Hicks, R. R.; Bryant, C. M., V.; Mathews, M. L.; Kulhavy, D. L.; Howard, J. E. Rating southern pine beetle hazard by aerial photography. In: Hedden, R. L.; Barras, S. J.; Coster, J. C., eds. Hazard-rating systems in forest insect pest management: symposium proceedings; 1980 July 31-August 1; Athens, GA. Gen. Tech. Rep. WO-27. Washington, DC: U.S. Department of Agriculture, Forest Service; 1981.
- Reed, D. D.; Hedden, R. L.; Daniels, R. F. Estimating the annual probability of southern pine beetle outbreak. *For. Sci.* 28:202-206; 1982.
- Reed, D. D.; Burkhart, H.; Leuschner, W. A.; Hedden, R. L. A severity model for southern pine beetle infestations. *For. Sci.* 27:290-296; 1981.
- Sader, S. A.; Miller, W. F. Development of a risk rating system for southern pine beetle infestation in Copiah County, MS. In: Shamrohki, F., ed. Proceedings, remote sensing of earth resources. Talahoma, TN: University of Tennessee; 1976: 277-294.

APPENDIX

The unmodified logistic regression equations resulting from the analyses are of the form:

$$p = 1 / (1 + \text{EXP} [B_0 + B_i X_i]) \quad (1)$$

where p = the estimated probability of infestation

B_0 = the constant

B_i = the estimated regression coefficients

X_i = the independent variables

EXP = the exponential e.

The constant, B_0 , is modified to removed the effects of the separate sampling procedure used in collecting baseline and infested plot data (Reed et al. 1982):

$$B_m = B_0 - \ln (n_1/n_2) \quad (2)$$

where B_m = the modified constant

n_1 = the number of attacked plots used in developing the model

n_2 = the number of baseline plots used in developing the model

\ln = the natural logarithm

B_m can then be adjusted for different beetle population levels or stand conditions:

$$B_a = B_m + \ln (N_1/N_2) \quad (3)$$

where B_a = the adjusted constant

B_m = the modified constant

N_2 = the number of uninfested stands or acreage in the population of interest

N_1 = the total number of beetle infestations or infested acreage in the population of N stands.

The adjusted constant, B_a , is substituted for B_0 in equation (1). The resulting probabilities will be absolute in the sense that they represent the specified beetle population levels and stand conditions.

Potential Use of Soil Maps to Estimate Southern Pine Beetle Risk

Peter L. Lorio, Jr., and Robert A. Sommers¹

Abstract.—Moist productive soils, supporting loblolly pine, shortleaf pine, and pine-hardwood pole-timber and sawtimber stands, were closely associated with southern pine beetle (SPB) (*Dendroctonus frontalis* Zimmermann) infestations on the Catahoula and South Winn Ranger Districts of the Kisatchie National Forest in central Louisiana. Relationships on the Kisatchie Ranger District (an area unique in terms of landscape, soils, and vegetation) did not follow trends on the other two districts. However, it appears that soil mapping units grouped into landform, texture, and water regime classes could be used effectively in estimating potential timber losses to the southern pine beetle. Growth and differentiation balance relationships provide a basis for explaining the commonly observed correlation between moist, productive sites and SPB infestation incidence.

Additional keywords: *Pinus taeda*, *P. echinata*, growth, defensive chemicals, oleoresin, susceptibility, resistance.

INTRODUCTION

Previous study of soil and stand conditions associated with southern pine beetle (SPB), *Dendroctonus frontalis* Zimm., on the Kisatchie National Forest indicated that soil mapping information might be useful in estimating potential losses to the SPB (Lorio and Sommers 1981). Until recently, lack of generally available soil mapping information on the National Forest made it impossible to study the degree of association between infestations and soils. Completion of order 2 soil surveys² on large portions of the Kisatchie National Forest in the last several years made this study possible on three ranger districts.

Approximately 271,000 acres on the Catahoula, South Winn, and Kisatchie Ranger Districts com-

prised the study area (fig. 1). Infestations were plotted on overlays of base, soil, and stand maps to determine relationships between soil mapping units (SMU's) and SPB infestations. Soils and infestation data were put on a per-unit-area basis, and comparisons were made of expected and observed frequency distributions of infestations.

Silvicultural prescriptionists are currently using soil maps in making a variety of forest management decisions. Results of this study indicate the further potential application of soils information for estimating future loss of resources to the SPB.

METHODS

Maps were prepared for each compartment of the three ranger districts included in the study area. Base maps were prepared first from U.S. Geological Survey quadrangle maps that provided a uniform scale on which to transfer stand, soil, and SPB infestation information. A total of 209 compartment maps was developed in the process. Compartments ranged in size from approximately 500 to 2,600 acres. Stands delineated within compartments on the basis of forest type and stand condition class are basic units for management. Criteria for forest type are those adopted by the Society of American Foresters. The primary factors in stand condition class are damage, quality, density, and age.³

Compartment maps were drawn showing forest types, stand condition classes, and SMU boundaries, and the number of acres occupied by every combination of mapping units was determined. The study was limited initially to the Catahoula and South Winn districts (contiguous forested areas) to determine the level of relationships between soils and SPB infestations; and subsequently, the relationships found there were evaluated for the Kisatchie district, an area recognized as differing considerably in geology, soils, and forest composition. A total of 2,174 infestations, observed from April 1975 through September

¹Respectively, Project Leader and Forestry Technician, U.S. Department of Agriculture, Forest Service, Southern Forest Experiment Station, Pineville, LA. (Special thanks are due John Bellemore, Soil Scientist, Kisatchie National Forest, members of the KNF Supervisor's staff, and district rangers and staff of the Catahoula, Winn, and Kisatchie Ranger Districts.)

²Surveys suitable for making silvicultural prescriptions and other detailed functional plans.

³Definitions are given in the Silvicultural Practices Handbook (U.S. Department of Agriculture, Forest Service, 1974).

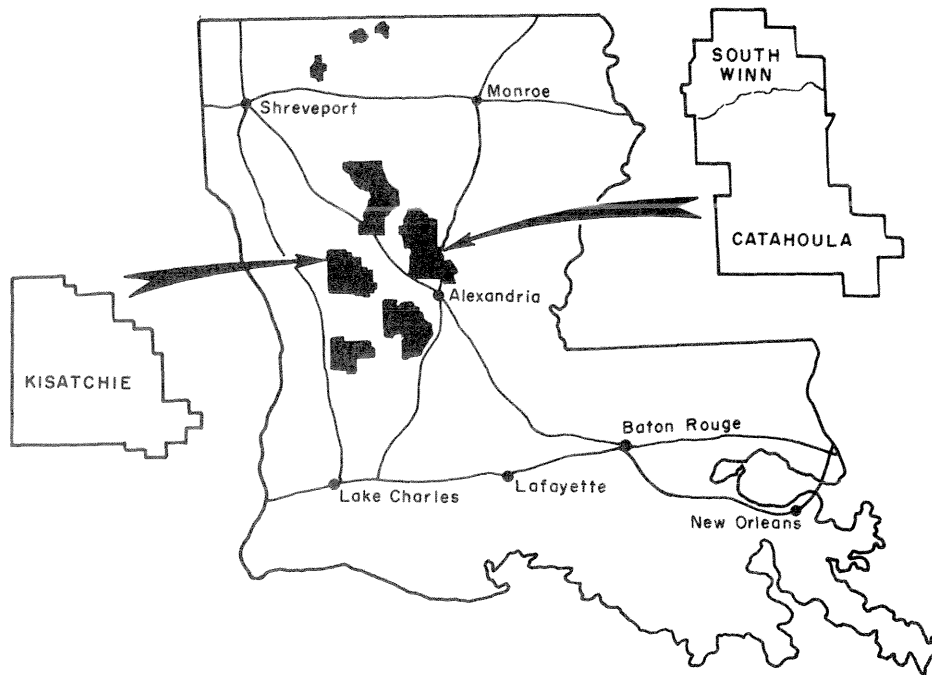

Figure 1.—Kisatchie National Forest, showing location of study areas: Catahoula, South Winn and Kisatchie Ranger Districts, approximately 271,000 acres.

1982, was plotted to determine relationships between infestation frequency and combinations of SMU/forest type/stand condition classes.

National Forest soil scientists place individual SMU's into ecological management units (EMU's) to facilitate the use of soils information in the development of stand prescriptions and for other management purposes (USDA Forest Service 1972). Each SMU is given a five-digit code according to the landform, texture, water regime, accessory characteristics, and modifiers considered by soil scientists to best describe the nature of the soils. For our purposes, we used the first three categories of the five-digit code to evaluate relationships of SPB infestations with soils on various landforms and with various textures and water regimes.

In a preliminary study, logistic regression analysis was used to select site and stand variables useful in predicting SPB infestation probability in natural loblolly (*Pinus taeda* L.) and shortleaf (*P. echinata* Mill.) pine stands (Zarnoch et al. 1984). The analysis was based on a limited sample of data from the Catahoula and South Winn Districts (304 infested and 304 noninfested substands).

Chi-square analyses were employed with the complete data set for the study area to test for significant differences between expected and observed frequency distributions of infestations.

RESULTS

Catahoula and South Winn Ranger Districts

Loblolly and shortleaf pine types and pine-hardwood types constituted the primary SPB host species on the Kisatchie National Forest. Poletimber (5.0 to 10.9 inches d.b.h.) and sawtimber (≥ 11.0 inches d.b.h.) constitute the stand condition classes most commonly affected by infestations. For the combined area of the Catahoula and South Winn, these types and condition classes made up 95,871 acres (about 63 percent of the total area) and sustained 1,336 infestations (about 80 percent of the total number of infestations).

In the preliminary study already referred to (Zarnoch et al. 1984), model variables were stand age, stand size, and soil texture. Although soil texture was found to be a significant variable in predicting SPB infestation, the authors indicated that texture should not be considered as a causal factor. In the data set employed in model development, silty- and medium-textured soils grouped together were strongly associated with SPB infestations.

Chi-square analysis of expected and observed infestation frequency distributions in loblolly, shortleaf, and pine-hardwood poletimber and sawtimber stands indicated that those on soils grouped by landform classes were not infested proportionately to areas occupied by the various landforms. Stands on stream terraces and upland flats had disproportion-

Table 1. — *Expected and observed frequency of SPB infestations (by landform classes) for soils stocked with poletimber and sawtimber stands of loblolly, shortleaf, and pine-hardwood forest types on the Catahoula and South Winn Ranger Districts (April 1975 through September 1982)*

Landform	Acres	Infestations ¹	
		Expected	Observed
Flood plain	6,673	93	81
Stream terrace	10,740	150	162
Upland flat	18,742	261	334
Sideslope	14,601	203	133
Steep sideslope	434	6	6
Ridge	44,681	623	620
Totals	95,871	1,336	1,336

¹Chi-square = 47.1, df = 5, P = 0.0000

Table 2. — *Expected and observed frequency of SPB infestations (by texture classes) for soils stocked with poletimber and sawtimber stands of loblolly, shortleaf, and pine-hardwood forest types on the Catahoula and South Winn Ranger districts (April 1975 through September 1982)*

Texture	Acres	Infestations ¹	
		Expected	Observed
Sandy	2,685	37	27
Silty	29,670	413	480
Medium	34,414	480	418
Fine	29,098	406	411
Clay to surface	4	<1	0
Totals	95,871	1,336	1,336

¹Chi-square = 21.6, df = 4, P = 0.0002

Table 3. — *Expected and observed frequency of SPB infestations (by water regime classes) for soils stocked with poletimber and sawtimber stands of loblolly, shortleaf, and pine-hardwood forest types on the Catahoula and South Winn Ranger Districts (April 1975 through September 1982)*

Water regime	Acres	Infestations ¹	
		Expected	Observed
Wet	4,929	69	58
Moist	33,618	468	548
Dry	55,740	777	715
Droughty	1,584	22	15
Totals	95,871	1,336	1,336

¹Chi-square = 22.6, df = 3, P = 0.0000

ately high numbers of infestations relative to the area occupied by soils on those landforms (table 1). Similarly, stands on silty soils and on soils with moist water regimes were infested at a higher rate than expected (tables 2 and 3). The texture most closely associated with SPB infestations for the complete data set was observed to be somewhat different than that found by Zarnoch et al. (1984). This result is not surprising when it is considered that the larger data base brings into analysis a much wider range of sites than the sample data set. Further, it should be recognized that landform, texture, and water regime are confounded to some degree. Certain soils are found only on certain landforms, and the independent relationships of any one category with SPB infestations cannot be determined.

Although soils that fall in dry water regimes as a group are not closely associated with SPB infestation, examination of the SMU's that make up the group revealed that three soil series—Malbis, Cadeville, and Gore—had disproportionately high infestation frequencies (table 4). The Susquehanna series had only slightly higher than expected infestation frequency. All of these soil series have some wetness characteristics. Cadeville and Gore occupy relatively small areas on the two ranger districts studied; however, Malbis is much more widely distributed and is a common soil on ridges. In apparent conflict with its placement in soils with dry water regimes, Malbis has a site index for loblolly pine of 90 (height in feet at base age 50); its permeability is moderately slow in the B_{23t} horizon and moderate in upper B_{2t} horizons; and horizons with plinthite perch water at depths of 30 to 50 inches during fall and winter (National Cooperative Soil Survey 1974).

Table 4. — *Expected and observed frequency of SPB infestations (by soil series classed as having dry water regimes) on soils stocked with poletimber and sawtimber stands of loblolly, shortleaf, and pine-hardwood forest types on the Catahoula and South Winn Ranger Districts (April 1975 through September 1982)*

Soil series	Acres	Infestations ¹	
		Expected	Observed
Susquehanna	17,513	225	228
Ruston	13,291	170	158
Smithdale	11,832	152	99
Malbis	9,031	116	155
Cadeville	1,397	18	24
Gore	1,336	17	41
Shubuta	961	12	5
Briley	242	3	5
Bienville	137	2	0
Totals	55,740	715	715

¹Chi-square = 75.8, df = 8, P = 0.0000

Caddo, Glenmora, Beauregard, Metcalf, Mayhew, and Keithville soil series are the principal soils that make up the group with moist water regimes (table 3). These, along with Malbis on ridges (which also has some wetness characteristics), could serve to indicate areas of potential SPB problems when occupied by loblolly, shortleaf, or pine-hardwood poletimber and sawtimber stands. These relationships may or may not hold for other ranger districts on the Kisatchie National Forest, depending on the array of soils that comprises the districts, extent and distribution, and the nature of the forests that occupy the sites.

Kisatchie Ranger District

The Kisatchie Ranger District differs considerably from the Catahoula and South Winn and other districts of the Kisatchie National Forest in landscape and composition of the forest. The landscape is characterized by steep slopes and relatively narrow ridges, with outcroppings of sandstone common. Loblolly, shortleaf, and pine-hardwood forest types make up only 47 percent of the area, whereas they make up 75 percent of the area in the Catahoula and South Winn Districts. Further indication of the uniqueness of this part of the Kisatchie is the fact that approximately 8,500 acres have been set aside as a wilderness area. A large part of the wilderness area is occupied by mature loblolly pine sawtimber on small stream flood plains.

Analysis of relationships on the Kisatchie Ranger District was performed with 247 infestations on 68,664 acres of loblolly, shortleaf, pine-hardwood poletimber and sawtimber. Data were collected between April 1975 and September 1980. The relatively small number of infestations available for analysis limits

Table 5. — *Expected and observed frequency of SPB infestations (by landform classes) for soils stocked with poletimber and sawtimber stands of loblolly, shortleaf, and pine-hardwood forest types on the Kisatchie Ranger District (April 1975 through September 1980)*

Landform	Acres	Infestations ¹	
		Expected	Observed
Flood plain	9,866	36	73
Stream terrace	987	4	2
Upland flat	9	<1	0
Sideslope	32,579	117	26
Steep sideslope	7,991	29	47
Ridge	17,232	62	99
Totals	68,664	247	247

¹Chi-square = 143.1, df = 5, P = 0.0000

Table 6. — *Expected and observed frequency of SPB infestations (by texture classes) for soils stocked with poletimber and sawtimber stands of loblolly, shortleaf, and pine-hardwood forest types on the Kisatchie Ranger District (April 1975 through September 1980)*

Texture	Acres	Infestations ¹	
		Expected	Observed
Sandy	32,047	115	31
Silty	9,439	34	65
Medium	6,664	24	44
Fine	20,478	74	107
Clay to surface	36	<1	0
Totals	68,664	247	247

¹Chi-square = 121.1, df = 4, P = 0.0000

Table 7. — *Expected and observed frequency of SPB infestations (by water regime classes) for soils stocked with poletimber and sawtimber stands of loblolly, shortleaf, and pine-hardwood forest types on the Kisatchie Ranger District (April 1975 through September 1980)*

Water regime	Acres	Infestations ¹	
		Expected	Observed
Wet	9,318	33	65
Moist	1,622	6	10
Dry	11,051	40	67
Droughty	46,673	168	105
Totals	68,664	247	247

¹Chi-square = 75.5, df = 3, P = 0.0000

interpretations.

As with analyses done for the Catahoula and South Winn Ranger Districts, Chi-square values for the Kisatchie Ranger District indicated some significant differences among soils grouped by landform, texture, and water regime (table 5, 6, and 7). However, the relationships were considerably weaker. The strongest relationship appeared to be between soils on flood plains and infestation frequency. One soil mapping unit comprises 94 percent of the area in flood plains (Guyton, frequently flooded). Steep sideslopes and ridges were also disproportionately associated with infestations, the Kisatchie series being primary on steep sideslopes, and the Anacoco on ridges.

The Kisatchie series is an unproductive soil with a site index (base age 50 years) of less than 65 for loblolly pine. Such poor sites are managed to maintain existing forest cover to protect the soils, and the potential loss of valuable timber is minimal. The Anacoco series is somewhat more productive than the Kisatchie series, with a site index of 70 for loblolly pine; and, although it is said to have a droughty water regime, it has slow internal drainage

and perches water from December through April.

Relationships with soil textural groups are so broad as to be of little interpretive value; the same is true for water regime groups, where both wet and dry water regimes appear to be disproportionately associated with infestations.

In recent months, large infestations developed on flood plain areas in the Kisatchie Hills Wilderness Area of the Kisatchie Ranger District where the Guyton (frequently flooded) SMU prevails. Several hundred acres of mature and maturing loblolly stands were infested and, over time, infestations developed on slopes and ridges surrounding the flood plains.

DISCUSSION

The results of this study of the relationships of soil mapping units with SPB incidence indicate the potential application of such soils information in developing risk or hazard estimates of future SPB infestation. Further, they again emphasize relationships between site characteristics and SPB infestations frequently reported for the West Gulf Coastal Plain (Lorio 1968, 1978, 1980; Lorio and Bennett 1974; Lorio and Sommers 1981; Kushmaul and Cain 1981), which indicate that moist or wet productive sites are commonly associated with SPB infestations. Studies by Hicks et al. (1981) in eastern Texas and Ku et al. (1981) in southern Arkansas, which were conducted during outbreaks, indicate a somewhat lower site quality associated with SPB infestations. However, if one accepts that a relationship does exist between site productivity and the potential development of SPB infestations, a question remains as to its nature or possible cause.

We would like to offer a proposed explanation here for a close relationship between moist, productive sites and SPB infestations based on the concept of growth-differentiation balance (Loomis 1932, 1953; Lorio and Hodges 1985). Photosynthates are partitioned among growth and differentiation processes at least partly in response to environmental influences, and Loomis and Croteau (1980) suggest that the synthesis, storage, and catabolism of monoterpenes are controlled by growth-differentiation balance.

A study by Lorio and Hodges (1971) indicates how growth and differentiation balance relationships probably are related to SPB infestation incidence and site characteristics in the West Gulf Coastal Plain. For example, fast-growing loblolly pines on a wet, productive site in southwest Louisi-

ana experienced intermittent severe water deficits during two growing seasons, and relatively slow-growing pines on slightly elevated, drier, better drained mounds were less affected. In this example, stem diameter growth on the intermound site continued at a very fast rate up to 2 months longer than on the mound. Under these conditions, the supply of carbohydrates available to produce defensive chemicals such as oleoresins (monoterpenes and resin acids) would be limited because of the demand by the growth process. In effect, the prolonged period of fast growth on intermound sites provided an extended length of time during which such trees would be relatively less resistant to SPB attack than their neighbors on mounds. Further, pines on these sites demonstrated strong growth responses to intermittent rainfall in the mid- to late summer and tended to produce false rings within annual rings. Severe effects of water deficits in mid- to late summer were evident in terms of reduced oleoresin exudation pressure, cessation of diameter growth, and even shrinkage (Lorio and Hodges 1968, 1971). These responses were consistent with the nature of the root systems that developed on such sites (Lorio et al. 1972).

Observations reported by Lorio (1968) and Thatcher (1971) indicate that SPB infestations tend to start on intermound areas in forest conditions in southeast Texas and central Louisiana similar to those described by Lorio and Hodges (1971), and Lorio et al. (1972). Pines on mounds either escape attack entirely, or are attacked later as infestations enlarge. Apart from excessive competition related to stocking, old age and root disease effects, and various disturbances like lightning strikes, growth and differentiation balance relationships provide a physiologically and biologically rational explanation for commonly observed SPB infestation tendencies. Particularly important to the initiation of new infestations in the spring (March through May) is the prolonged period of rapid growth that would make the general tree population on sites similar to those described especially susceptible to SPB attack. Such conditions favor the potential success of attacking SPB populations that are said to disperse widely from fall-and-winter-initiated infestations (Thatcher 1971, 1974; Hedden and Billings 1977; Billings and Kibbe 1978; Billings 1979; Payne 1980).

CONCLUSIONS

In a particular area, it appears quite feasible to develop relationships between soil mapping units

and SPB infestations and then use these relationships to identify potential future problem areas. This effort would require the further division of stands occupying several soil mapping units into substands occupying soils with common characteristics, such as landform, texture, and water regime. Clearly, however, the results for the Kisatchie Ranger District in Louisiana do not parallel those for the Catahoula and South Winn Districts, and illustrate the potential difficulties of applying relationships in one forest area to other, apparently similar, areas without further evaluations.

In forests having landscapes and soils like those of the Catahoula and South Winn Districts (with similar forest types and stand conditions), the potential risk of losses to SPB should be high in stands on stream terraces and upland flats that have silty-textured soils and moist water regimes. Wherever flood plains (such as occur on the Kisatchie) are occupied by maturing loblolly and shortleaf pine, the potential risk of loss to the SPB will be high. However, application of these relationships to other forest areas should be preceded by specific evaluations for the areas of interest.

Relationships between soils and SPB infestation incidence observed in this study and other studies in the West Gulf Coastal Plain can be explained on the basis of growth and differentiation balance relationships. Prolonged rapid growth on moist, productive sites extends the period of high demand for photosynthates for growth processes and limits the potential synthesis of protective chemicals at a time when SPB activity is high and many new infestations are being initiated.

LITERATURE CITED

- Billings, R.F. Detecting and aerielly evaluating southern pine beetle outbreaks. *South. J. Appl. For.* 3: 50-54; 1979.
- Billings, R.F.; Kibbe, A. Seasonal relationships between southern pine beetle brood development and loblolly pine foliage color in east Texas. *Southwestern Entomol.* 3(2): 89-95; 1978.
- Hedden, R.L.; Billings, R.F. Seasonal variations in fat content and size of the southern pine beetle in east Texas. *Annals Entomol. Soc. Am.* 70: 876-880; 1977.
- Hicks, R.R., Jr.; Watterston, K.G.; Coster, J.E.; and others. Gulf Coastal Plain/eastern Texas. In: Coster, J.E.; Searcy, J.L., eds. Site, stand, and host characteristics of southern pine beetle infestations. *Tech. Bull.* 1612. Washington, DC: U.S. Department of Agriculture; 1981: 8-15.
- Ku, T.T.; Sweeney, J.M.; Shelburne, V.B. Gulf Coastal Plain/southern Arkansas. In: Coster, J.E.; Searcy, J.L., eds. Site, stand, and host characteristics of southern pine beetle infestations. *Tech. Bull.* 1612. Washington, DC: U.S. Department of Agriculture; 1981: 16-22.
- Kushmaul, R.J.; Cain, M.D. Gulf Coastal Plain/southern Mississippi, Louisiana, and eastern Texas. In: Coster, J.E.; Searcy, J.L., eds. Site, stand, and host characteristics of southern pine beetle infestations. *Tech. Bull.* 1612. Washington, DC: U.S. Department of Agriculture; 1981: 40-49.
- Loomis, W.D.; Croteau, R. Biochemistry of terpenoids. In: Stumpf, P.K.; Conn, E.E., eds. *The biochemistry of plants* (Vol. 4). New York: Academic Press; 1980: 364-418.
- Loomis, W.E. Growth-differentiation balance vs. carbohydrate-nitrogen ratio. *Proc. Am. Soc. Hort. Sci.* 19: 240-245; 1932.
- Loomis, W.E. Growth correlation. In: Loomis, W.E., ed. *Growth and differentiation in plants*. Ames, IA: Iowa State University Press; 1953: 197-217.
- Lorio, P.L., Jr. Soil and stand conditions related to southern pine beetle activity in Hardin County, Texas. *J. Econ. Entomol.* 61: 565-566; 1968.
- Lorio, P.L., Jr. Developing stand risk classes for the southern pine beetle. *Res. Pap.* SO-144. New Orleans, LA: U.S. Department of Agriculture, Forest Service, Southern Forest Experiment Station; 1978. 9p.
- Lorio, P.L., Jr. Loblolly pine stocking levels affect potential for southern pine beetle infestation. *South. J. Appl. For.* 4(4): 162-165; 1980.
- Lorio, P.L., Jr.; Bennett, W.H. Recurring southern pine beetle infestations near Oakdale, Louisiana. *Res. Pap.* SO-95. New Orleans, LA: U.S. Department of Agriculture, Forest Service, Southern Forest Experiment Station; 1974: 6 p.
- Lorio, P.L., Jr.; Hodges, J.D. Microsite effects on oleoresin exudation pressure of large loblolly pines. *Ecology* 49(6): 1207-1210; 1968.
- Lorio, P.L., Jr.; Hodges, J.D. Microrelief, soil water regime, and loblolly pine growth on a wet, mounded site. *Soil Sci. Soc. Am. Proc.* 35: 795-800; 1971.
- Lorio, P.L., Jr.; Hodges, J.D. Theories of interactions among bark beetles, associated microorganisms, and host trees. In: Shoulders, E., ed. *Proceedings, third biennial southern silvicultural research conference*; 1984 November 7-8; Atlanta, GA. *Gen. Tech. Rep.* SO-54. New Orleans, LA: U.S. Department of Agriculture, Forest Service, Southern Forest Experiment Station; 1985: 485-492.

- Lorio, P.L., Jr.; Howe, V.K.; Martin, C.N. Loblolly pine rooting varies with microrelief on wet sites. *Ecology* 53: 1134-1140; 1972.
- Lorio, P.L., Jr.; Sommers, R.A. Gulf Coastal Plain/central Louisiana. In: Coster, J.E.; Searcy, J.L., eds. Site, stand, and host characteristics of southern pine beetle infestations. Tech. Bull. 1612, Washington, DC: U.S. Department of Agriculture; 1981: 23-39.
- Payne, T.L. Life history and habits. In: Thatcher, R.C.; and others, eds. The southern pine beetle. Tech. Bull. 1631. Washington, DC: U.S. Department of Agriculture; 1980: 7-28.
- Thatcher, R. C. Seasonal behavior of the southern pine beetle in central Louisiana. Auburn, AL: Auburn University; 1971. 102 p. [M.S. Thesis].
- Thatcher, R.C. Past and present approaches to southern pine beetle research—an overview. In: Payne, T.L.; and others, eds. Southern pine beetle symposium; 1974 March 7-8; College Station, TX. College Station: Texas A&M University; 1974: 8-11.
- U.S. Department of Agriculture, Forest Service, Forest Service handbook. Sec. 2471.1, R-8 (Silvicultural practices handbook). Washington, DC: U.S. Department of Agriculture, Forest Service; 1974.
- U.S. Department of Agriculture, Forest Service. Soils resource guide—southern region. Atlanta, GA: U.S. Department of Agriculture, Forest Service, Southern Region; 1972. 48 p.
- Zarnoch, S.J.; Lorio, P.L., Jr.; Sommers, R.A. A logistic model for southern pine beetle stand risk rating in central Louisiana. *J. Georgia Entomol. Soc.* 19(2): 168-175; 1984.

Adaptation of Littleleaf Disease Hazard Rating for Use in Forest Management in South Carolina National Forests

Steven W. Oak¹

Abstract.—Forest stands on the Enoree Division of the Sumter National Forest, SC, were rated for potential damage from littleleaf disease (LLD) of shortleaf (*Pinus echinata* Mill.) and loblolly (*Pinus taeda* L.) pines. The purpose was to reduce losses caused by the disease by locating potential trouble spots in an area where LLD has historically been severe. The hazard rating was based on soil series and the presence of susceptible pines. Computer-generated hazard maps were produced to aid in locating stands with various priorities of need for preventive or therapeutic silvicultural treatments. **Additional keywords:** Computerized mapping, soils classification, *Phytophthora cinnamomi*.

INTRODUCTION

Littleleaf disease (LLD) is the most important management consideration in shortleaf pine forests on the Piedmont Plateau of the southeastern United States. Forest management has been seriously affected by LLD on about 5 million acres, and an additional 10 million acres have had more dispersed but locally heavy disease incidence (Campbell and Copeland 1954). On affected sites, tree mortality and slow stand growth after age 30 limit economic forest management to short pulpwood rotations. Additional losses accrue from southern pine beetles, which preferentially attack LLD-affected stands. Favoring immune hardwoods is suggested, but it is often economically unattractive. Loblolly pine has replaced shortleaf in many LLD areas under active management. It is considered less susceptible, but forest managers tell of severe losses for this species in some locations². Practical methods for predicting damage are the first steps toward managing losses. A predictive system has existed for many years, but has not been widely applied by forest managers.

Littleleaf disease is especially common on the Piedmont Plateau ranger districts of the Sumter National Forest (fig. 1). About 100,000 acres of shortleaf and loblolly pine stands on the Enoree Division (Tyger and Enoree Ranger Districts) alone are

showing damage or are at risk, in part because of National Forest policy favoring long sawtimber rotations. Where the hazard is high, shorter rotations have to be considered. An understanding of disease biology is necessary before the system is presented.

DISEASE BIOLOGY

No single cause of LLD can be assigned, but two primary features of damaged stands are evident. They are shallow, eroded clay soils with poor internal drainage and feeder root damage caused by *Phytophthora cinnamomi* Rands. These soils provide the intermittently waterlogged conditions that are ideal for fungus-spore dispersal and root infection, and they

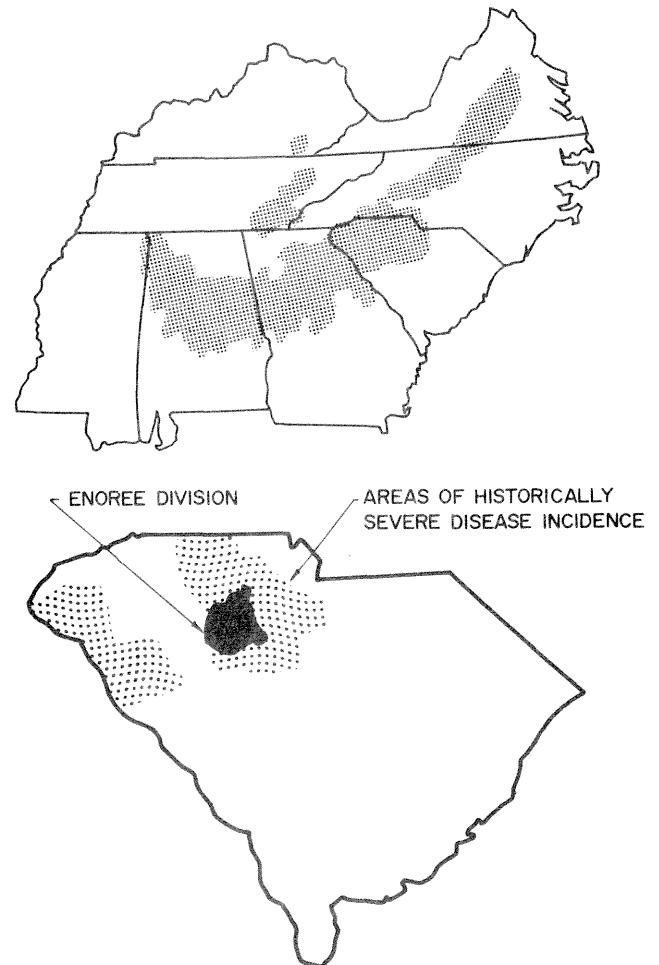

Figure 1.—Distribution of littleleaf disease in the Southeast (top). Areas of historically severe littleleaf disease encompass nearly all of the Enoree Division, Sumter National Forests, in South Carolina (bottom).

¹ Plant Pathologist, U.S. Department of Agriculture Forest Service, Southern Region, Forest Pest Management, Asheville, NC.

² H. E. Johnson, Tyger District Ranger, personal communication.

do not permit sufficient root regeneration. As a result, the capacity for nutrient and water absorption by pine root systems is reduced. Height and diameter growth is slowed, and foliage becomes dwarfed, tufted, and yellow. In advanced stages, branches die back, and the distressed trees produce heavy crops of undersized cones. Trees die outright from the disease or succumb to bark beetle attack. The disease acts slowly, and trees younger than 30 years seldom develop aboveground evidences of LLD, though growth may be below expectations.

The fungus is widely distributed and present under diseased and healthy stands alike. It is, therefore, the soil properties that provide the basis for predicting LLD damage.

PREDICTING LLD DAMAGE— HAZARD RATING

Campbell and Copeland (1954) showed that erosion class and internal soil drainage are the critical factors controlling the occurrence and severity of LLD. They further defined internal drainage in terms of subsoil consistence, depth to a zone of greatly reduced permeability, and the presence of subsoil mottling, in decreasing order of relative importance. They then devised a 100-point rating system, which required onsite inspections of individual

Table 1. — *Soil rating scale¹ for littleleaf disease hazard rating (100-point system). The higher the scale, the lower the hazard. Severe hazard < 50; light to moderate hazard 49-75; low hazard > 75*

Soil characteristic and class	Value
Erosion:	
Slight	40
Moderate	30
Severe	20
Rough gullied	10
Subsoil consistence (when moist):	
Very friable	32
Friable	24
Firm	16
Very firm	16
Extremely firm	0
Depth to zone of greatly reduced permeability:	
24 to 36 inches	15
18 to 23 inches	12
12 to 17 inches	9
6 to 11 inches	6
0 to 5 inches	3
Subsoil mottling:	
None	13
Slight	9
Moderate	5
Strong	1

¹In: Campbell and Copeland 1954.

stands (table 1).

In these inspections, erosion class had to be estimated and soils had to be sampled to determine internal drainage characteristics. The resultant LLD hazard classifications were accurate, but these procedures prove impractical when large acreages and many stands are involved.

A more extensive, and necessarily less precise, system was needed to predict hazard for the 150,000 acres of forest stands in the Enoree Division. Its adaptation and use are described here. It was built upon the same survey work used to develop the 100-point rating system. Consistent relationships exist between internal drainage characteristics and LLD damage, and soil series are identified, in part, on the basis of these same characteristics. Therefore, soils sharing similar internal drainage characteristics also share similar risks for LLD. This relationship was exploited to erect broad hazard classes—low, intermediate, and high—for soil series sampled in the early survey work (Campbell and Copeland 1954, table 2). By examining the drainage characteristics of these soils, it was possible to extend the rating system to soils that had not been rated in the past.

Adapting the Soil Series Hazard-Rating System

Detailed descriptions of soil series and data pertaining to their drainage characteristics were obtained from the Soil Conservation Service (SCS) County Survey Reports. Tabulating the pertinent features of each hazard class confirmed similarities indicated by early researchers. Of the 20 soil series included in the original groupings, 16 were found in the four-county area encompassing the Enoree Division. An additional 26 soil series were rated for the first time using the original criteria (table 3).

COMPARTMENT MAPPING

Because our goal was to ensure that field foresters would capitalize on the rating information, we packaged it in a form that could be easily assimilated into existing management procedures.

Individual stands and compartments are the basic management units on National Forest ranger districts. Integration of the hazard ratings into management, therefore, required presentation of the ratings for stands and compartments. Ranger districts have compartment maps on which the individual stands are delineated and the forest type of each is indicated.

In hazard rating, forest type is obviously a key variable. There is no current LLD hazard in a hardwood stand, and the hazard is somewhat lower in a loblolly than in a shortleaf pine stand. These factors had to be integrated with the information on soil series shown on SCS maps. We adjusted the 1:20,000

Table 2. — *Soil series grouped according to littleleaf disease damage level (hazard class) and relative internal drainage*¹

Hazard class and soil series	Mean percent littleleaf incidence	Relative internal drainage
High		
Wilkes, Vance, Orange, Cataula, Mecklenburg, Herndon, Tatum, Manteo	25.5	Poor
Intermediate		
Louisa, Madison, Appling, Helena	12.1	Good to poor
Low		
Lloyd, Nason, Durham, Lockhart, Cecil, Georgeville, Davidson, Alamance	3.9	Excellent to good

¹In: Campbell and Copeland 1954.

Table 3. — *Internal drainage characteristics of soil series with known relationships to littleleaf damage class (hazard class) and previously unclassified soils from the Tyger and Enoree Ranger Districts, Sumter National Forest, SC, sharing those characteristics*

Damage class ² (hazard)	Internal drainage characteristics ¹			Previously unclassified soils
	Subsoil	Permeability	Mottles	
High	mostly clay	slow to moderately slow with marked reduction at 12" or less. <u>exception:</u> Herndon	present within 18-24"	Winnsboro, Iredell, Goldston, Efland, Enon
Intermediate	mostly clay	moderate to moderately slow without marked change <u>exception:</u> Helena	usually greater than 24"	Vaughn, Colfax
Low	loamy clay or coarser	moderate without marked change	usually greater than 36"	Tirzah, Rion, Pacolet, Louisburg, Hiwassee, Congaree, Worsham, Wickham, Wehadkee, Wateree-Rion, Toccoa, Enoree, Molena variant, Buncombe, Armenia, Chewacla, Blanton, Altavista, Cartecay-Toccoa

¹In: Camp et al. 1975; Camp et al. 1960; Hardee 1982.

²Association of soil series with damage class. In: Campbell and Copeland 1954.

scale of the SCS maps to the standard compartment scale of 1:24,000 by photo reduction. Common landmarks were then identified, the maps were overlain, and soil hazard within stands was delineated. In this work, shortleaf pine stands were assigned the rating indicated by the soil series. Loblolly pine stands were assigned lower hazard ratings. Stands of this species more than 30 years old were assigned a rating one step below that indicated by the soil series. All younger loblolly pine stands were placed in the low-risk category. Ranger district foresters quickly became familiar with this system and had no difficulty in assigning hazard classes.

The system was refined further by computerizing the mapping and recordkeeping. The computer programs, called PEST, were adapted from a Geographic Information System developed by Beveridge and Knapp (1984). As adapted, this system maps compartments, stands, and soil types, and indicates appropriate hazard ratings for the stands by summarizing stand acreages by hazard class for each compartment (fig. 2). Scale conversions are made electronically, and maps can be printed at any desired scale.

The advantages over manual methods are obvious: easy, long-term storage, reproduction speed, and

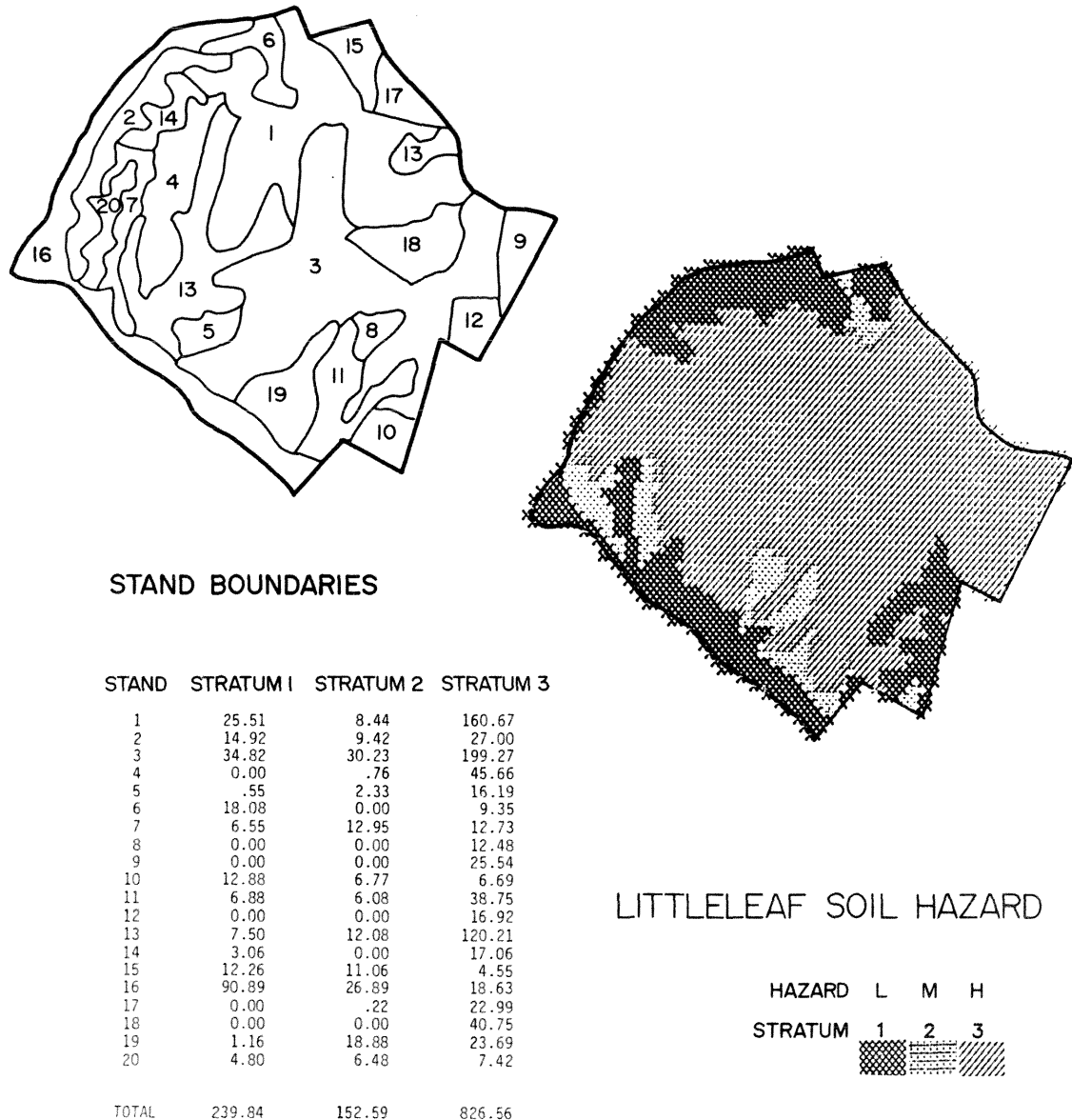

Figure 2.—Maps of stand boundaries and littleleaf disease soil hazard for compartment 101, Enoree Ranger District, Sumter National Forest. Tabular summary results from an electronic overlay of stand boundaries and littleleaf soil hazard. Hazard L = low; M = moderate; H = high. Maps and table plotted via PEST Geographic Information System (Beveridge and Knapp 1984).

reproduction accuracy. When stand boundaries are changed through silvicultural prescription, modifications are easily made. Similarly, resorting of soils or stand information using criteria of importance to other pest hazard-rating systems or other forest management practices is possible if desired.

USES AND LIMITATIONS

Silvicultural prescriptions for National Forest compartments are reformulated about every 10 years, and hazard maps are important to the process. Stands with a high priority for preventive or therapeutic treatments can be easily identified. Such treatments include salvage harvesting, presalvage thinnings, timber stand improvement cuts, and forest fertilization. Pine stands rated high hazard for LLD losses can be identified for possible conversion to hardwood types, and regeneration planning is aided. Conversely, hardwood types on high-hazard soils can be identified and retained. Because LLD-damaged stands are bark beetle targets, hazard maps can be useful for prioritizing reconnaissance and salvage activities before and during southern pine beetle outbreaks.

One limitation of the hazard-rating system is that it is based on soil series and is less precise than the 100-point system based on direct observation. Soils maps that are often less than perfect add some error. SCS surveys are designed to provide 80 percent accuracy, but in practice are sometimes less accurate. Soil map errors are corrected when recent Forest Service soil surveys have been conducted, but not all lands have been resurveyed. Because the disease does not occur with equal intensity or regularity on the same soil series, and considering the more general nature of soil series hazard rating, hazard maps are best used as guides rather than as rigid predictors.

Recent surveys of LLD damage on loblolly pine stands on the Tyger Ranger District confirm hazard ratings as useful general guides. Ultimately, the value of the maps will depend on the ways in which forest managers apply them. Forest managers must be committed to reducing LLD losses before hazard maps become useful. We have maximized the chances of implementation by providing maps in a format compatible with foresters' current procedures. By targeting our efforts at the compartment prescription process, hazard rating can have an impact on National Forest management for at least 10 years.

CONCLUSIONS

Hazard rating can easily be expanded to other areas of the Piedmont Plateau where LLD has caused damage in the past by categorizing soil series accord-

ing to internal drainage features. While it is true that the acreage of the most sensitive host, shortleaf pine, has been declining steadily in the South, it is being replaced by loblolly pine. Loblolly stands in formerly severe LLD areas, especially in Georgia, Alabama, and South Carolina, are now entering the age class when LLD begins to cause damage. A recent survey shows damage is already occurring with impacted trees having half the volume of healthy trees on the same site. Foresters can benefit from hazard rating in determining management objectives. Hazard rating is most useful when long rotations are desired.

Computerized mapping methods have the benefit of manipulating data rapidly and accurately for different uses. For example, soils data can be sorted to determine LLD hazard and then resorted to provide one component needed to determine southern pine beetle hazard (fig. 3). Other management activities also benefit, such as analyses of site productivity as it relates to soil series.

The large initial time investment needed to get soils information into a digital format seems small in comparison to the potential benefits. When the SCS begins storing soils maps electronically and makes them available to land managers with access to Geographic Information Systems, even this drawback will be removed.

LITERATURE CITED

- Beveridge, R. L.; Knapp K. A. Detection and dissemination of forest pest data utilizing aerial detection surveys and the Region 4 computer automated mapping system. Rep. No. 84-8. Boise, ID: U.S. Department of Agriculture, Forest Service, Intermountain Region, Forest Pest Management; 1984. 12 p.
- Camp, W. J.; Jones, W. E.; Milford, P. R.; Hearn, S. H.; Aull, L. E. Soil survey of Newberry County, South Carolina. Washington, DC: U.S. Department of Agriculture, Soil Conservation Service; 1960. 62 p.
- Camp, W. J.; Meetze, J. C.; Fleming, W. H.; Andrew, L. E. Soil survey of Laurens and Union Counties, South Carolina. Washington, DC: U.S. Department of Agriculture, Soil Conservation Service; 1975. 65 p.
- Campbell, W. A.; Copeland, O. L. Littleleaf disease of shortleaf and loblolly pines. Circular No. 940. Washington, DC: U.S. Department of Agriculture, Forest Service; 1954. 41 p.
- Hardee, G. E. Soil survey of Chester and Fairfield Counties, South Carolina. Washington, DC: Department of Agriculture, Soil Conservation Service; 1982. 110 p.

Figure 3.—Maps of stand boundaries and southern pine beetle (SPB) soil hazard for compartment 101, Enoree Ranger District, Sumter National Forest. Soils data used in plotting littleleaf disease hazard (ref. fig. 2) are resorted using different criteria to produce SPB soil hazard. Tabular summary results from an electronic overlay of stand boundaries and SPB soil hazard. Hazard L = low; M = moderate; H = high. Maps and table plotted via PEST Geographic Information System (Beveridge and Knapp 1984).

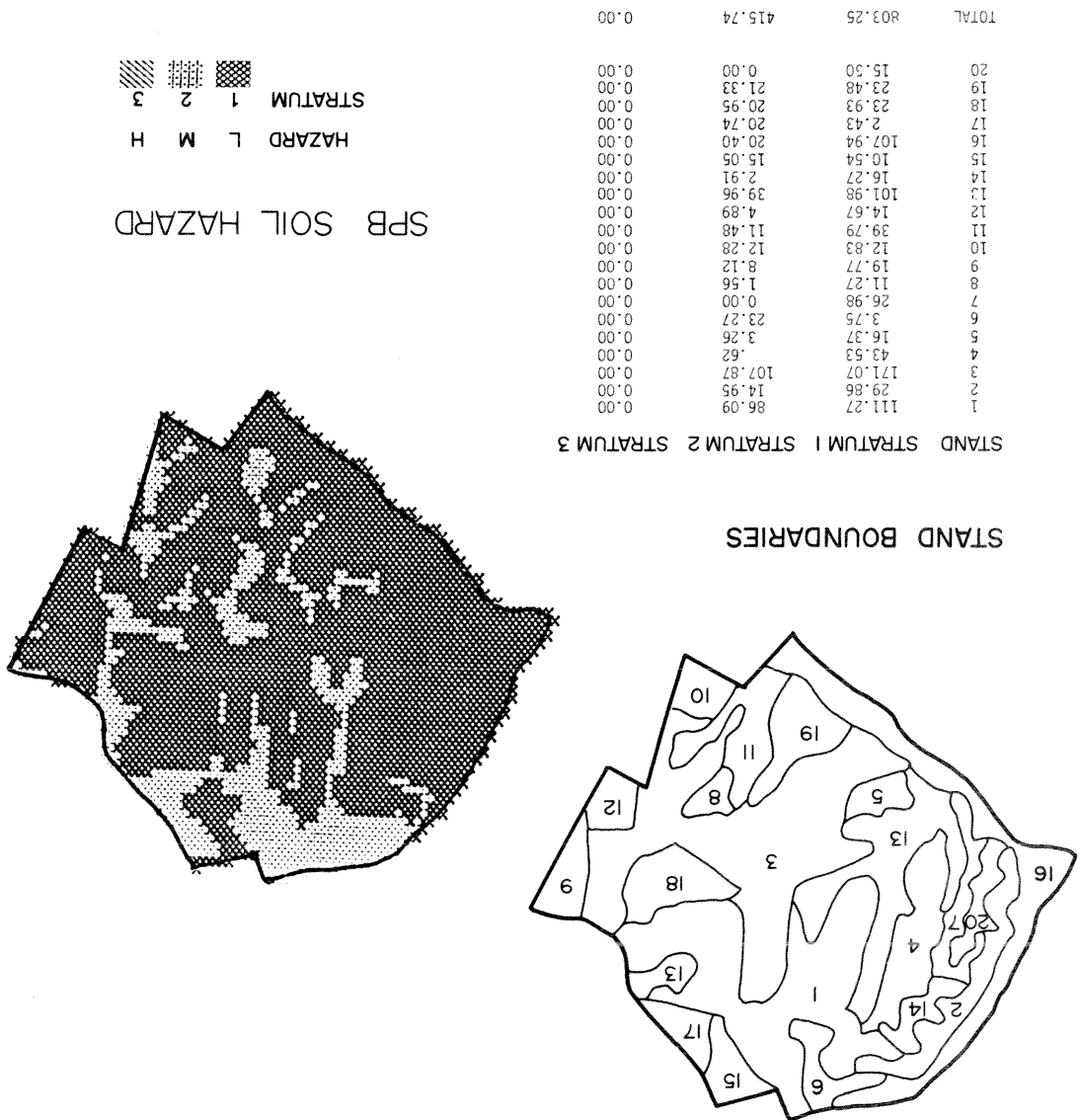

SESSION III—MANAGEMENT APPROACHES AND IPM SYSTEMS

Management Tactics

Fusiform Rust: Guidelines for Selective Cutting of Rust-Infected Trees in Merchantable Slash Pine Plantations

R. P. Belanger, T. Miller, and J. F. Godbee¹

Abstract.—Selective cutting of trees severely infected with fusiform rust has been proposed to salvage potential mortality and improve stand quality. Stand structure and rust characteristics of residual trees after removal of rust-infected trees from merchantable slash pine plantations were studied to establish the efficacy of selective cutting. Stands contained an average of 213 trees/acre with stem infections prior to treatment. Selections for removal were based on potential mortality: 85 percent of the trees removed were from high- and moderate-risk classes. Residual stands contained an average of 238 low-risk trees/acre. Quality of the treated stands was improved significantly. Residual stem galls were small and had little cankering. Salvage cutting is a viable option for improving stand quality in slash pine plantations being managed under long rotations. **Additional keywords:** Pest management, salvage, thinning, *Pinus elliottii* var. *elliottii*.

INTRODUCTION

Fusiform rust, caused by *Cronartium quercuum* (Berk.) Miyabe ex Shirai f. sp. *fusiforme*, is the most widespread and destructive forest tree disease in the southern United States. In 1974, surveys showed more than 800 million slash (*Pinus elliottii* Engelm. var. *elliottii*) and loblolly (*Pinus taeda* L.) pine trees in South Carolina, Georgia, and Florida had potentially lethal stem infections (Powers et al. 1975.) The disease is equally severe in other parts of the South. Other estimates made in 1974 indicated an annual stumpage loss to fusiform rust of \$30 million and a finished wood products loss of \$150 million (Phelps 1974). In addition, infection rates are estimated to be increasing by 2 to 3 percent each year (Schmidt et al. 1974). Losses to rust occur from mortality, stem defects, and wind breakage. These problems are

often increased markedly by the intensive management of pine plantations (Dinus 1974, Dinus and Schmidt 1977).

Management strategies have been proposed for reducing losses from fusiform rust in planted pine stands (Dinus and Schmidt 1977, Powers et al. 1981, Schmidt and Klapproth 1982). Major (and deserved) emphasis is on preventing and managing rust during the early life of the stand, when trees are most susceptible to infection and associated mortality. Also of economic concern are losses occurring from rust mortality and stem degrade in merchantable stands. Salvage cutting has been proposed as a means of reducing these losses (Powers et al. 1974, Belcher et al. 1977, Schmidt and Klapproth 1982), but guidelines are needed for selecting high-risk stands and implementing treatments. A cooperative study is being conducted in Alabama, Georgia, Florida, and South Carolina to develop such guidelines. This paper (1) characterizes the stand structure of merchantable slash pine plantations following the selective cutting of rust-infected trees, (2) describes the quality of residual stands, and (3) discusses management options for stands with varying levels of rust infections.

MATERIALS AND METHODS

Study Plantations

Ten slash pine study plantations were located in the coastal plain of South Carolina and Georgia. They were selected to include a wide range of stand and rust conditions (table 1). Age of the study plantations ranged from 13 to 21 years and averaged 16 years. Individual trees and total volumes in plantations younger than 13 years are usually too small for

Table 1. — Average stand characteristics and fusiform-rust incidence of 10 slash pine study plantations

Variable	Unit	Mean	Minimum	Maximum
Age	years	16	13	21
Height	feet	47	34	61
Site quality	ht/25 yr.	62	54	69
D.b.h.	inches	6.2	5.2	7.3
Live trees	no./acre	420	323	507
Basal area	ft ² /acre	96	63	116
Volume	ft ³ /acre	2,393	1,08	
			87	3,596
Rust incidence	% of stems	49	35	70

¹ Respectively, Silviculturist, U.S. Department of Agriculture, Forest Service, Southeastern Forest Experiment Station, Athens, GA; Plant Pathologist, Southeastern Forest Experiment Station, Gainesville, FL; and Pest Management Specialist, Union Camp Corporation, Rincon, GA. (This research was funded in part by a U.S. Department of Agriculture-sponsored program entitled "The Integrated Pest Management RD&A Program for Bark Beetles of Southern Pines.")

commercial cuttings; trees in stands older than the study plantations often have poor live crown depths and do not respond favorably to thinning (Fisher 1983).

Average diameter at breast height (d.b.h. at 4.5 feet above ground) was 6.2 inches. Approximately 9 percent of the stems were sawtimber-size trees (d.b.h. \geq 9.0 inches). Fusiform rust can significantly reduce utilizable volume in these high-value trees (Webb and Patterson 1984).

Volumes ranged from 1,087 to 3,596 ft³/acre prior to treatment; number of live trees ranged from 323 to 507 stems/acre. Management assessments indicated that (1) at least 400 ft³/acre be removed to satisfy the production requirements of harvesting, and (2) a minimum of 200 trees/acre be left to stock the residual stand.

Incidence of stem galls was the most obvious and important consideration in the selection of study plantations. Incidence of stem infections ranged from 35 to 70 percent. Plantations with less than 35 percent of the stems infected contain too few damaged trees for profitable harvest; plantations with more than 70 percent of the stems infected are usually clearcut and regenerated. Detailed rust information related to the study is discussed by Miller et al. (1985) elsewhere in these proceedings.

Areas of study plantations ranged from approximately 75 to 200 acres. Portions of each plantation were selected for salvage cutting and the remaining portions were left as controls. Four 1/4-acre permanent plots were established in the treated and untreated areas of each plantation to assess the management advantages and disadvantages of removing trees with severe fusiform rust infections. All stems were tagged to maintain their identities throughout the study. Trees were cut and removed during all seasons of the year. Scheduling was strongly dependent on the availability of logging crews, weather, and local markets.

Marking Guidelines

The success of salvage cutting in rust-infected plantations is based on anticipating mortality. The following risk classes were the preliminary basis for marking and removal (table 2).

Low risk.—Trees likely to survive through rotation (22-25 years); either rust-free or with galls of a size and condition unlikely to affect survival.

Moderate risk.—Trees with one or more galls and a size and condition making survival to rotation age questionable.

High risk.—Trees likely to die before rotation; one or more galls generally encircling $>$ 50 percent of the circumference of the main stem; severe stem cankering common.

All high-risk trees were marked; low-risk trees were not marked. Moderate-risk trees provided flexibility in the selection process—removals were based on the potential value of trees, an assessment of production requirements, and spacing. Several field foresters were trained to use these guidelines. They were able to identify the three classes quickly and accurately.

RESULTS

Stand Structure

The selective cutting of rust-infected stems removed an average volume of 732 ft³/acre (table 3). Basal area was reduced from an average of 96 to 67 ft²/acre (table 4). Residual stocking in the treated stands averaged 296 live stems/acre (table 5). Most of the trees removed were from the moderate- and high-risk classes. Treated stands contained an average of 238 low-risk trees/acre. Volume harvested and residual stand stocking satisfied all the production requirements specified by management.

Salvage cutting removed 77 percent of the high-risk trees. This potential mortality represented ap-

Table 2. — Average tree size and rust condition of infected stems by risk class based on a subsample of trees in 10 slash pine plantations

Variable	Unit	Risk class		
		Low	Moderate	High
D.b.h.	inches	6.8	6.6	5.7
Stem girdled	percent	39	56	72
Stem cankered	percent	21	28	39
Stem infections	no./tree	1.3	1.6	2.1

Table 3. — Salvage cutting-affected average volume distribution in fusiform-rust risk classes in 10 slash pine plantations

Risk class	Volume		
	Pretreatment	Salvaged	Residual
	----- Ft ³ /acre -----		
Low	1,590	122	1,468
Moderate	419	276	143
High	384	334	50
Total	2,393	732	1,611

Table 4. — *Salvage cutting-affected average basal area distribution in fusiform-rust risk classes in 10 slash pine plantations*

Risk class	Basal area		
	Pretreatment	Salvaged	Residual
	-----Ft ² /acre-----		
Low	63.1	4.8	58.3
Moderate	16.9	10.9	6.0
High	16.2	13.9	2.3
Total	96.2	29.6	66.6

Table 5. — *Salvage cutting-affected number of stems/acre in fusiform rust risk classes in 10 slash pine plantations*

Risk class	Live stems/acre		
	Pretreatment	Salvaged	Residual
	-----Number-----		
Low	259	21	238
Moderate	82	46	36
High	96	74	22
Total	437	141	296

Table 6. — *Salvage cutting-affected average diameter of trees in fusiform rust risk classes in 10 slash pine plantations*

Risk class	D.b.h.		
	Pretreatment	Salvaged	Residual
	-----Inches-----		
Low	6.5	6.3	6.5
Moderate	5.9	6.4	5.2
High	5.3	5.7	4.1

Table 7. — *Salvage cutting-affected average height of trees in fusiform rust risk classes in 10 slash pine plantations*

Risk class	Total height		
	Pretreatment	Salvaged	Residual
	-----Feet-----		
Low	49.7	50.0	49.7
Moderate	46.5	48.2	44.1
High	42.1	44.2	34.4

proximately 46 percent of the total volume harvested. The high-risk trees that were not cut were generally too small for the harvesting crews to handle efficiently (tables 6 and 7).

The average diameter and total height of the residual low-risk trees were not affected by treatment. Approximately 21 low-risk trees/acre were removed to provide access through the stand by harvesting equipment. These trees were selected without regard to rust conditions.

Salvage cutting significantly reduced the average diameter and height of moderate- and high-risk trees. Marking crews were instructed to emphasize the selection of merchantable-size trees for removal. Consequently, a large proportion of small intermediate and suppressed trees was left in these two risk categories. However, total volume represented by moderate- and high-risk trees was only 12 percent of the residual stand.

Control and treated portions of all study plantations will be remeasured at 5-year intervals to evaluate growth and stand structure over time.

Stand Improvement

Salvage cutting clearly reduced the number of infested stems in the plantations (table 8). Incidence of stem infections was lowered from 49 to 27 percent, and the total number of stem infections was reduced by two-thirds. Residual stem galls were small and had little cankering. Quality of the residual trees was excellent—an important attribute in plantations on long rotations.

Approximately 57 percent of the total stem infections in the study plantation occurred within the first 10 feet of the lower bole (Miller et al. 1985). The greatest average percentage volume loss to fusiform rust occurs within the first 8 feet of the butt log (Webb and Patterson 1984). Reduction of utilizable wood is obviously compounded by multiple stem galls. Preliminary results also indicate that mortality is greatest for trees with multiple stem galls.

Removing trees with:

- large basal galls (> 50 percent stem circumference infected)
- severely cankered galls (> 30 percent stem circumference infected)
- multiple stem galls

will improve the quality of the stand and salvage much of the mortality caused by fusiform rust.

CONCLUSIONS

The selective cutting of trees severely infected with fusiform rust appears to be a viable manage-

Table 8. — Average rust characteristics following the salvage removal of rust-infected stems from 10 slash pine plantations

Variable	Unit	Pretreatment	Salvaged	Residual
Stem infections				
Infected stems	no./acre	213	132	81
Incidence	percent	49	94	27
Total galls	no./acre	372	258	114
Gall characteristics				
Circumference	% stem	61	67	50
Cankering	% stem	31	33	24

ment option for improving the stand quality of slash pine plantations. Benefits will be greatest in stands being managed under long rotations. Results and guidelines presented in this paper are preliminary. More time will be required to fully assess treatment effects on growth, yield, and mortality of utilizable wood.

LITERATURE CITED

- Belcher, H. J.; Crafts, W. J., Jr.; Erickson, W. D. [and others]. Plantation management. In: Dinus, Ronald J.; Schmidt, Robert A., eds. Management of fusiform rust in southern pines. Gainesville, FL: University of Florida; 1977: 158–163.
- Dinus, R. J. Knowledge about natural ecosystems as a guide to disease control in managed forests. In: Proceedings, American Phytopathological Society; 1974 August 12; Vancouver, B.C.. St. Paul, MN: American Phytopathological Society, Inc.; 1974: 184–190.
- Dinus, R. J.; Schmidt, R. A., eds. Management of fusiform rust in southern pines. Gainesville, FL: University of Florida; 1977. 163 p.
- Fisher, R. F. Silvical characteristics. In: Stone, E. L., ed. The managed slash pine ecosystem. 1981 June 9-11; Gainesville, FL. Gainesville, FL: School of Forest Resources and Conservation, University of Florida; 1983; 48–45.
- Miller, T.; Belanger, R. P.; Webb, R. S.; Godbee, J. F. Pest assessments after sanitation-salvage cutting in fusiform rust-infected slash pine plantations. In: Branham, Susan J.; Thatcher, Robert C. Proceedings, integrated pest management research symposium; 1985 April 15–18; Asheville, NC. Gen. Tech. Rep. SO-56. New Orleans, LA: U.S. Department of Agriculture, Forest Service, Southern Forest Experiment Station; 1985.
- Phelps, W. R. Evaluation of fusiform rust incidence on loblolly and slash pine in the south. Plant Dis. Rep. 58: 1137–1141; 1974.
- Powers, H. R., Jr.; McClure, J. P.; Knight, H. A. [and others]. Fusiform rust. Res. Pap. SE-127. Asheville, NC: U.S. Department of Agriculture, Forest Service, Southeastern Forest Experiment Station; 1975. 16 p.
- Powers, H. R., Jr.; Matthews, F. R.; Hawes, R. B. Volume loss resulting from fusiform rust in young plantations of slash pine. Res. Note SE-200. Asheville, NC: U.S. Department of Agriculture, Forest Service, Southeastern Forest Experiment Station; 1974. 8 p.
- Powers, H. R., Jr.; Schmidt, R. A.; Snow, G. A. Current status and management of fusiform rust on southern pines. Annual Review of Phytopathology Society 19: 353–371; 1981.
- Schmidt, R. A.; Goddard, R. E.; Hollis, C. A. Incidence and distribution of fusiform rust in slash pine plantations. Tech. Bull. 763. Tallahassee, FL: Florida Agricultural Experiment Station; 1974. 21 p.
- Schmidt, R. A.; Klapproth, M. C. Delineation of fusiform rust hazard based on estimated volume loss as a guide to rust management decisions in slash pine plantations. South. Jour. App. For. 6: 59–63; 1982.
- Webb, R. S.; Patterson, H. D. Effect of stem location of fusiform rust symptoms on volume yields of loblolly and slash pine sawtimber. Phytopathol. 78: 980–983; 1984.

Pest Assessments After Sanitation-Salvage Cutting in Fusiform Rust-Infected Slash Pine Plantations

Thomas Miller, Roger P. Belanger, Roger S. Webb, and John F. Godbee¹

Abstract.—Ten slash pine plantations infected with fusiform rust were selected to evaluate sanitation-salvage harvests for reducing losses to fusiform rust without increasing activity of other potentially damaging forest pests. Pretreatment samples described the incidence and severity of fusiform rust and provided the data for proposing marking guidelines for salvage harvests. Root rots and bark beetle activity were also assessed before treatment. Fusiform rust stem gall incidence averaged 49 percent (1.8 stem galls/tree), root rot incidence < 1 percent, and no active bark beetle infestations were detected. Evaluations of pest incidence and tree mortality in six plantations for 4 years after treatment have shown: (1) Greater volume loss in both total mortality (177 cu ft/acre) and rust-associated mortality (147 cu ft/acre) in untreated areas compared to 69 cu ft/acre and 28 cu ft/acre in treated areas; (2) minimal losses due to insect activity (6.4 cu ft/acre), largely associated with logging activities; and (3) no additional root rot. Preliminary analysis suggests that sanitation-salvage harvests are of questionable economic value in stands managed on short rotations, but that they would be a viable option for longer rotations. **Additional keywords:** Slash pine, fusiform rust, forest insects, root rot, tree mortality.

INTRODUCTION

Sanitation-salvage operations in merchantable fusiform rust-infected plantations are meant to utilize the wood that might otherwise be lost due to mortality and to leave an adequately stocked, residual stand of healthy or low-risk trees that are expected to survive to rotation at an increased rate of growth. Also, the operation should be accomplished in a

manner that minimizes potential insect and root rot problems.

The impact of fusiform rust varies with the age of the affected stand. Mortality usually is greatest during the first 5 years. Rust-associated mortality in older stands (10+ years) occurs over an extended period, resulting from wind-or ice-breakage at a gall (Wenger 1950, Cool et al. 1971, Van Lear and Saucier 1973) or from a variety of fungi and insects that frequently attack and colonize fusiform rust galls. Whether the fusiform rust fungus is directly responsible for the death of trees above a certain age or size remains a moot question. Cankering, which may affect a significant portion of the gall surface, is the most common symptom of activity by secondary organisms, especially the wood-rotting fungi. It contributes to the susceptibility to breakage and possibly to reduced tree vigor in extreme cases.

The principal objectives of this research were to develop guidelines for selecting trees to be harvested in a sanitation-salvage operation, to determine the wood volume losses caused by rust-associated mortality and other agents in treated and untreated portions of slash pine plantations, to determine the pre- and post-harvest incidence of annosum root rot, and to identify stand disturbances and pest problems associated with the operation over time.

MATERIALS AND METHODS

The criteria for plantation selection, and the details of plot installation and general data collection have been described previously (Belanger et al. 1985). Means and ranges in stand characteristics are shown in table 1. Data were collected from four ¼-acre plots established in the portions of each of the 10 plantations to be salvaged (treated) and in the portions left as control areas (untreated), for a total of 40 plots (10 acres) each in treated and untreated areas. The initial data collected on sample trees with fusiform rust galls included:

1. Number and location of all stems galls. (Heights were from ground level to the gall midpoint; heights > 6 feet were estimated or determined with a hypsometer.)
2. The estimated percentage of stem circumfer-

¹Respectively, Plant Pathologist, U.S. Department of Agriculture, Forest Service, Southeastern Forest Experiment Station, Gainesville, FL; Silviculturist, Southeastern Forest Experiment Station, Athens, GA; Assistant Professor, School of Forest Resources and Conservation, University of Florida, Gainesville, FL; and Pest Management Specialist, Union Camp Corp., Rincon, GA. (Research funded in part by a U.S. Department of Agriculture-sponsored program entitled "The Integrated Pest Management RD&A Program for Bark Beetles of Southern Pines.")

Table 1. — Stand and fusiform rust characteristics of 10 slash pine plantations in Georgia and South Carolina prior to a sanitation-salvage operation

Stand characteristic and unit of measure	Mean	Minimum	Maximum
Age (yr)	16	13	21
Site index (25 yr)	62	54	69
Live stems/acre (mean)	420	323	507
Fusiform rust characteristics	Mean	Minimum	Maximum
Stem galls			
Trees/acre	204	156	291
Incidence (percent)	49	35	70
Infections/acre	362	219	646
Infections/tree	1.8	1.4	2.3
Stem circumference galled (percent)	62	57	73
Stem galls cankered (percent)	61		
Stem circumference cankered (percent)	35	26	42
Total galls			
Trees/acre	234	186	311
Incidence (percent)	56	34	70
Infections/acre	512	287	941
Infections/tree	2.2		

ence galled.

3. The estimated percentage of stem circumference cankered.
4. Number of living branch galls.
5. Prediction of the probability of infected trees surviving for at least 5 years.

Mortality in the treated and control plots has been recorded yearly since salvage operations were completed. All experimental plantations have been surveyed aerially or on the ground for any indication of bark beetle or other damaging insect activity.

The pretreatment incidence of root rot was determined in two 1/10-acre plots established in the treated portion of each plantation. The root systems of half the trees in each of these plots were excavated with a bulldozer and inspected for resin soaking or stringy decay, which are symptoms of root disease. Lengths of resinous and/or decayed roots, as well as healthy roots, were recorded to determine disease severity. Samples of symptomatic roots were cultured on: (1) *Ortho*-phenylphenol medium for the presence of the asexual stage of *Heterobasidion anomum* and (2) a general medium (2 percent malt extract agar) for other basidiomycetes possibly associated with root disease, e.g., *Polyporus tomentosus*. The root systems of the remaining half of the trees in each plot were left for future observations.

RESULTS

In the 10 plantations, an average of 49 percent of the living trees had at least one stem gall and the

mean number of stem galls per tree was 1.8 (table 1). The average stem gall encircled 62 percent of stem circumference. Sixty-one percent of the stem galls were cankered with an average of 35 percent of the stem circumference necrotic. An average of 7 percent of the trees in the 10 plantations had branch galls only.

Numbers of branch galls averaged 149 per acre or 1.7 branch galls per tree. Numbers of trees with stem or branch galls averaged 234 per acre (mean incidence 56 percent), and there were 512 infections per acre and 2.2 galls per tree.

In the three fusiform rust risk classes (low, moderate, and high), the percentage of stem circumference encircled by galls and cankered and the number of galls per tree increased from low risk to high risk (table 2). In all three characteristics used to rate risk for infected stems, the trees rated as low risk were less severely affected by the disease than those rated moderate or high.

The vertical distribution and severity of stem galls by 5-foot intervals are shown in table 3. Seventy-one percent of all stem galls occurred in the first 15 feet, 24 percent between 16 to 30 feet, and the remaining 5 percent at heights above 30 feet. Galls at less than 15 feet had encircled an average of about 65 percent of stem circumference, while those above 15 feet had encircled about 50 percent of stem circumference. The proportion of stem circumference cankered was about 30 percent for all cankered galls below 35 feet.

After the sanitation harvest in the treated portions of six plantations, the percentage of galls in

Table 2. — Characteristics of infected stems in low, moderate, and high-risk classes in 10 slash pine plantations in Georgia and South Carolina

Stem characteristic and unit of measure	Risk classes		
	Low	Moderate	High
Stem circumference galled (percent)	39	56	72
Stem circumference cankered (percent)	21	28	39
Stem infections per tree (number)	1.3	1.6	2.1

Table 3. — Vertical distribution and severity of stem galls in 10 slash pine plantations in Georgia and South Carolina prior to sanitation-salvage

Portion of stem (ft)	Stem galls		Stem circumference (%)	
			Galled	Cankered
	Number	Percent	-----Percent-----	
0-5	553	35	67	33
6-10	340	22	65	38
11-15	225	14	63	37
16-20	138	9	51	27
21-25	136	9	56	34
26-30	89	6	52	32
31-35	46	3	50	30
36-40	21	1	48	16
42-45	22	1	46	10

Table 4. — Vertical distribution of fusiform rust galls in the treated portion of six slash pine plantations after sanitation-salvage harvest

Portion of stem (ft)	Stem galls	
	Before treatment	After treatment
0-15	69	59
16-30	24	27
31-45	7	14

the 0-15 foot segment of the infected residual trees was decreased while the proportion in the 16-30 and 31-45 foot segments were increased slightly (table 4).

An analysis of diameter distributions between rust infected and noninfected trees failed to indicate any difference in diameter growth between galled and non-galled trees (fig. 1).

Table 5 shows the total and rust-associated mortality in the control and treated portions of six slash pine plantations 1, 3, and 4 years after treatment. Total 4-year mortality in the unthinned areas was 177 cu. ft./acre (range 62-330 cu. ft./acre)

compared to 69 cu. ft./acre (range 17-125 cu. ft./acre) in the treated areas, a difference of over 150 percent. The net average total loss per acre per year has been 26.9 cu. ft. Rust-associated mortality in the unthinned areas accounted for 84 percent of total mortality (147 cu. ft./acre) (range 48-317 cu. ft./acre) and 41 percent (28 cu. ft./acre) (range 1-60 cu. ft./acre) in the treated areas, a difference of more than 400 percent. Of the rust-associated tree mortality, 86 percent was from high-risk trees. The percentages from the moderate and low risk classes were 10 and 4 percent, respectively. The proportions of trees in the three classes that have died over 4 years were: low risk 0.06 percent, medium risk 5 percent, and high risk 25 percent. Stem breakage at galls accounted for 31 percent of rust-associated mortality (range 21-46 percent).

Mortality attributable to insects has been minimal, averaging 6.4 cu. ft./acre in the treated areas and 2.1 cu. ft./acre in the control areas. The greatest losses from bark beetles occurred in areas where felled trees were not removed promptly. Some residual trees damaged during logging were attacked by insects but not killed.

A total of 930 trees were excavated in the plantations to assess the incidence of root diseases. Only 35 trees (4 percent) exhibited possible symptoms of root disease. Laboratory culture confirmed the presence of *H. annosum* in only one root system (0.1 percent) and *P. tomentosus* in three root systems (0.3 percent).

Observations of pine stump surfaces in these treatment areas 1 to 3 years after cutting have revealed no basidiocarps of *H. annosum*. Further work is scheduled to excavate stump root systems for intensive cultural isolation to determine post-harvest infection levels by *H. annosum*, *P. tomentosus*, *Inonotus circinatus*, and *Phaeolus schweinitzii*.

DISCUSSION

In this research, we proposed and evaluated guidelines for practical sanitation-salvage harvests

Table 5. — Total and rust-associated mortality (RAM) in treated and untreated portions of six slash pine plantations 1, 3, and 4 years after a sanitation salvage operation

Years after treatment	Total mortality		RAM	
	Treated	Control	Treated	Control
1	10.3	21.8	2.7	17.0
3	30.5	51.0	10.3	40.2
4	28.2	103.7	15.2	90.2
Total	69.0	176.5	28.2	147.4

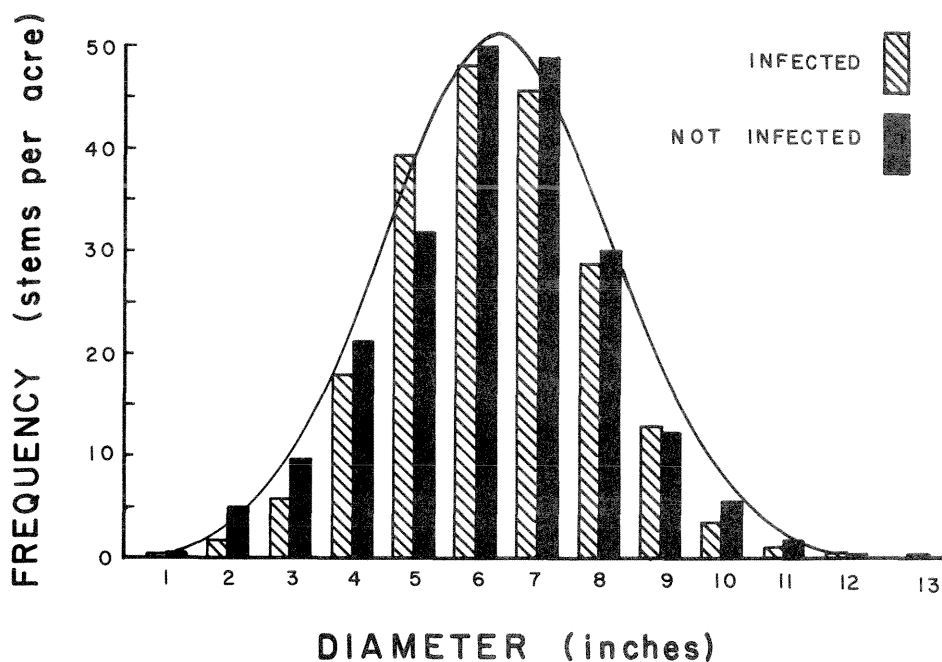

Figure 1.—Diameter distribution of rust-infected and noninfected slash pines in 10 plantations in Georgia and South Carolina.

in slash pine plantations with moderate to moderately severe fusiform rust infection. In accomplishing this major objective, a great deal of basic information was accumulated on the number, condition, severity, and distribution of fusiform rust galls in the stands. The marking guidelines proposed and utilized were based on the number of galls per tree, the height of the galls, the proportion of the stem galled, and the extent of cankering. The three risk classes (low, moderate, and high) were based on the likelihood of an individual infected tree surviving for 5 years. These risk classes were designed to provide a rapid means of characterizing each infected tree. The data summarized in table 2 indicate the relative accuracy of the system in placing infected trees in the three classes. The trees classified as low risk had smaller galls, less cankering, and fewer galls/tree than trees in the moderate and high risk classes.

Over 50 percent of stem galls occurred within 10 feet of the ground and 70 percent within 15 feet. Therefore, risk can be determined, in most cases, by observing only the lower portion of the stem, which can be done rapidly.

The effects of fusiform rust on the diameter growth of infected trees has been the subject of some differences of opinion in the literature (Belcher et al. 1977, Dell and Driver 1963, Holley and Veal 1977, Jones 1972, Powers et al. 1974, and Sluder 1977). Our data from the 10 slash pine plantations indi-

cate no difference in diameter distributions between infected and noninfected trees prior to thinning. Treatment had no major effect on the diameter distribution of the low-risk trees in the residual stands.

The low mortality in treated areas and high mortality in untreated portions show that sanitation-salvage harvests can work. Wood that would otherwise be lost can be salvaged. While most of the rust-associated mortality has occurred among the high-risk trees (86 percent), three-quarters of these trees survived. Thus our system of risk rating may require some refinement to more accurately identify rust infected trees that are likely to die before scheduled rotation. In the treated areas, rust accounted for only 41 percent of the losses, while in the untreated areas rust accounted for 84 percent of the losses. Since the majority of the high-risk trees were removed from the treated areas, at least a portion of the non-rust-associated losses in the treated areas must be attributed to stand disturbances caused by salvage operations.

When we planned the study, we were concerned that the treatment would increase the potential hazard of insect infestations, especially by bark beetles. Through 4 years, however, insect attacks have been remarkably low. The attacks that occurred were consistently associated with residual trees that were damaged during the operations and did not spread to adjacent trees.

The incidence and severity of root decay fungi

as supported by cultural determination of symptomatic roots were negligible in the plantations. Post-thinning disease levels in treatment areas appear to be similarly low, but future excavation work is planned to substantiate this conclusion with cultural isolations.

Although annosum root rot was found in only one tree in 10 plantations, thinning is the major management procedure that favors development of root disease fungi, especially *H. annosum*, in southern pine stands. Sanitation/salvage in fusiform-rust-infected southern pine stands, therefore, should include allowance for stump treatment with borax in areas with proven incidence of *H. annosum*. Where *H. annosum* signs are absent, borax stump treatment is needed only where the chances of entry of *H. annosum* into the residual stand after thinning are high.

CONCLUSIONS

1. Preliminary analysis of accumulated average net losses (cu ft./acre/year) due to fusiform rust in six slash pine plantations over 4 years suggests that sanitation-salvage harvests in stands managed on short rotations are economically questionable. However, as concluded by Belanger et al. 1985, such treatments seem to be viable options for longer rotations.

2. Southern pine bark beetles or other insect pests were not a serious problem. The minor losses to bark beetles were associated with tree damage during logging and failure to remove felled stems from the stands promptly.

3. Annosum root rot was detected on the root system of only a single tree in the 10 plantations. Any recommendations about treating stump tops with borax in sanitation-salvage operations must await the results of observations and isolations from residual stumps over the next several years.

LITERATURE CITED

- Belanger, R. P.; Miller, T.; Godbee, J. F. Fusiform rust; guidelines for selective cutting of rust-infected trees in merchantable slash pine plantations. In: Branham, S. J.; Thatcher, R. C., eds. Proceedings, integrated pest management research symposium; 1985 April 15-18; Asheville, NC. Gen. Tech. Rep. SO-56. New Orleans, LA: U.S. Department of Agriculture, Forest Service, Southern Forest Experiment Station; 1985: 254-257.
- Belcher, H. J.; Craft, W. J. Jr.; Erickson, W. D.; Ward, R. H. Fusiform rust management strategies in practice: plantation management. In: Dinus, R. J.; Schmidt, R. A. eds. Proceedings, management of fusiform rust in southern pines symposium, 1976 December 7-8; Gainesville, FL. Gainesville: University of Florida; 1977: 158-161. (Available from School of Forest Resources and Conservation, University of Florida, Gainesville, FL)
- Cool, B. M.; Goebel, N. B.; Wooten, T. E.; Loadholt, C. B. Glaze damage to pine trees in the sandhills area of South Carolina. Forest Research Series No. 21. Clemson, SC: Clemson University, Department of Forestry; 1971. 13 p.
- Dell, T. R.; Driver C. H. The relationship of D.B.H. to fusiform stem cankering in old field slash pine plantations. Journal of Forestry 61: 872; 1963.
- Holley, D. L.; Veal, M. A. Economic impact of fusiform rust. In: Dinus, R. J.; Schmidt, R. A., eds. Proceedings, management of fusiform rust in southern pines symposium; 1976 December 7-8; Gainesville, FL. Gainesville: University of Florida; 1977: 39-50. (Available from School of Forest Resources and Conservation, University of Florida, Gainesville, FL)
- Jones, E. P. Jr. Fusiform rust affects planted slash pine. Journal of Forestry 70: 350-352; 1972.
- Powers, H. R., Jr.; McClure, J. P.; Knight, H. A.; Dutrow, G. F. Incidence and financial impact of fusiform rust in the south. Journal of Forestry 72: 398-401; 1974.
- Sluder, E. R. Fusiform rust in loblolly and slash pine plantations on high-hazard sites in Georgia. Research Paper SE-160. Asheville, NC: U.S. Department of Agriculture, Forest Service, Southeastern Forest Experiment Station; 1977. 10 p.
- Van Lear, D. H.; Saucier, J. R. Comparative glaze damage in adjacent stands of slash and longleaf pine. Forest Research Series No. 27. Clemson, SC: Clemson University, Department of Forestry; 1973. 7 p.
- Wenger, C. F. The mechanical effect of fusiform rust cankers on stems of loblolly pine. Journal of Forestry 48: 331-333; 1950.

Thinning and Harvesting Practices to Minimize Site and Stand Disturbance and Susceptibility to Bark Beetle and Disease Attacks

T. Evan Nebeker and John D. Hodges¹

Abstract.—Site and stand conditions in southern pine stands can be modified to reduce the impact of insects and diseases. The selection of a thinning strategy depends on a number of factors that are influenced by economics. However, there are biological factors that need to be considered, which are the primary focus of this study undertaken to assess the effects of thinning-related disturbances on stands. Different types of thinning operations were evaluated along with their potential impact on the sites, stand, pest populations, and recommendations developed.

Additional keywords: Silvicultural treatment, management strategies, growth impact, tree damage, *Dendroctonus frontalis* Zimmermann, tree pathogens.

INTRODUCTION

Demands on our forest resources are growing. To meet these needs, plantations are of increasing importance as a source of fiber in all geographic subregions of the South. Currently, vast acreages of southern pine plantations are in need for silvicultural treatment to maintain their productivity. One recommended treatment for ensuring production goals and reducing losses from various mortality agents is thinning. Of some concern are possible additional losses from pest problems as well as growth losses associated with disturbances caused by intervention such as soil rutting and compaction, root breakage, bole wounding of the residual stems, and crown damage due to felling techniques. Wounded areas on residuals may serve as infection courts for various pathogens or as sources of attractants and subsequent sites for insect invasion.

In general, southern pine beetle (*Dendroctonus frontalis* Zimmermann) infestations occur in slow-growing, overstocked pine stands where individual tree vigor and resistance to attack are low. Factors such as landform, water regime, soil texture, soil chemical properties, site index, soil depth, pH, stand density, radial growth, species composition, average stand age, height, diameter, live crown ratio, etc.,

have been utilized in describing hazardous conditions associated with both insects and diseases. We and others (Belanger and Malac 1980, Hedden 1978) have been recommending that pine stands be thinned to reduce susceptibility to bark beetle attack, particularly to the southern pine beetle. The rationale for this is that thinning will decrease competition and stress within the stand, thus increasing vigor and resistance of individual trees (Nebeker et al. 1983). Treatments that are not cautiously applied may create conditions conducive to pest colonization or alter environmental factors that may offset any benefits from thinning (Belanger et al. 1979). Some of the post-thinning potential problems in southern pine stands (Nebeker et al. 1983, Nebeker and Hedden 1984) include *Ips* spp. (engraver beetles), *D. terebrans* (Oliv.) (black turpentine beetle), *Heterobasidion annosum* (Fr.) Bref. (= *Fomes annosus* (Fr.) Cke.), other root and stem diseases, root breakage, and soil compaction. In addition, conditions created by thinning might influence population buildups of such species as pales weevil (*Hylobius pales* (Herbst)), a problem in regeneration areas, along with insect species capable of transmitting the pine wood nematode (*Bursaphelenchus xylophilus* (Steiner & Buhner) Nickle), the causal organism of pine wilt. Growth or production losses resulting from these problems have not been quantified for the South, but in other forest regions, losses exceeding 10 percent have been attributed to thinning-caused stand and site damage (Froehlich 1976).

The authors have been involved with studies that were designed to evaluate the impact(s) of thinning-related disturbances over a variety of site conditions when thinnings were done during wet- and dry-soil moisture conditions (Nebeker and Hodges 1983, Nebeker et al. 1983; Nebeker 1985, Nebeker et al. 1985). We have also been interested in the resultant insect/microorganism/host interactions, which are discussed in more detail by Hodges et al. (1985) elsewhere in these proceedings.

Studies were conducted to 1) quantify the growth impact of soil and tree damage associated with thinning plantations on selected soils with different moisture conditions and 2) determine the incidence, sequence, and severity of bark beetle attacks and possible diseases in loblolly pine (*Pinus taeda* L.) plantations following thinning. The intent of this

¹ Respectively, Professor, Department of Entomology, and Professor, Department of Forestry, Mississippi State University, Mississippi State, MS.

paper is to draw together the results of these studies and related ones in order to provide general recommendations that will minimize site and stand disturbance and bark beetle/disease susceptibility.

THINNING AS A PRESCRIPTION

Benefits of Thinning

Before prescribing thinning, forest managers must take numerous factors into consideration. The decision to thin or not is based primarily on the product objective. For example, if pulpwood is the major objective, then the value of thinning is questionable. Most studies (Nebeker et al. 1985) suggest that, for pulpwood rotations, thinning of normal intensity will have no influence on cubic volume yield or, more commonly, will reduce the total yield. An exception would be extremely dense young stands where pre-commercial thinning may be necessary to prevent near stagnation of the stand or much reduced volume growth. Thinning in immature stands is primarily for the purpose of increasing the economic value of the residual trees. However, as our understanding of site and stand conditions associated with various pest problems has increased, it has become apparent that thinning might also benefit the stand in other ways, such as reducing its susceptibility to insect infestation and other biotic and abiotic factors (Nebeker and Hodges 1983).

Where sawlogs or multiple products are desired, thinnings should be an integral part of southern pine stand management (Bennett 1963). Under such circumstances, the issues that must be addressed include: 1) The relationship between initial spacing and the need for thinnings, 2) time to thin (age) and time of year, 3) intensity and frequency of thinnings, and 4) the most appropriate method of thinning (Nebeker et al. 1985). These points will be covered in this paper directly or indirectly as they relate to an increase or decrease in susceptibility to bark beetle attack or infection rates of various pathogens.

Initial Spacing and Timing

With respect to 1) and 2) above, initial spacing may be dictated by the type of equipment to be used in future thinning operations. That is, it may be necessary to insure that the rows will be wide enough to allow specific types of equipment access to the stands without undue damage to the residual stems. The timing of the thinning operation is also important to consider. If growth is used as an indicator of vigor, it is suggested that if thinning takes

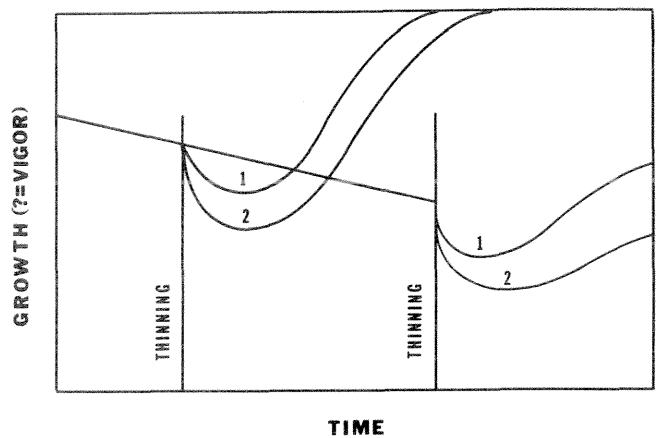

Figure 1.—Conceptual view of decreasing growth as a function of time and degree of disturbance (1 and 2) associated with thinning (after Nebeker et al. 1983).

place shortly after tree growth rates have begun to decrease, growth rates will return to near the maximum observed prior to the time when they had begun to decrease. The rate at which they return is dependent on the amount of disturbance, such as soil compaction, root breakage, bole wounding, etc., that takes place at a given point in time. This concept is presented in figure 1. If, however, thinning is delayed and similar intensity of site and stand disturbances occurs at the time of thinning, the growth responses are much slower (reduced even more and for a greater duration).

Conceptually, even though growth rates do not return to maximum levels, the alteration in host and environmental conditions following thinning ultimately increases resistance to pest attack, primarily bark beetles (Nebeker et al. 1983, Blanche et al. 1985) (fig. 2). As the stand basal area is decreased following thinning, the number of beetles required to successfully colonize a tree increases. The inherent state (relative resistance) of the trees also has to be taken into consideration. We know that environmental modifications through thinning influence the behavior and success of beetles within a stand. However, the component that has been overlooked is the inherent resistance of the tree(s) that make up the stand. This is the third dimension presented in figure 2. Depending on the inherent resistance level, the number of beetles required to successfully colonize a tree changes. The inherent resistance characteristics that may be involved include such factors as total resin flow (for a specified time period), rate of flow, viscosity, chemical composition, and rate of crystallization to mention a few that have been suggested as either under complete or at least partial genetic control (Hodges et al. 1979).

HARVESTING AND SILVICULTURAL PRACTICES

In response to insect and disease problems and potential problems, numerous strategies and tactics can be considered. The major problem is which course of action to take. That, of course, is dependent on the management objectives in relation to pest problems. Basically, there are two approaches. The first is the *reactive* approach where nothing is done until mortality from pest invasion has been noted. The second is the *proactive* approach where preventive measures are taken prior to potential pest invasion in hopes of preventing it or lessening the impact should an invasion occur.

Pest populations fluctuate through time and periodically pose a threat to forest resources, resulting in a loss of revenue. Pathogenic organisms appear to be a more continuous pressure without the radical fluctuations observed in organisms like bark beetles, in particular, the southern pine beetle. A number of harvesting or silvicultural tactics is available to reduce the impact of a given pest or pest complex. The primary goals should be, in any case, (Nebeker et al. 1984) to: (1) Reduce the pest population or tree mortality to a level below some previously established infection or infestation threshold, based on economic, sociopolitical or esthetic criteria; (2) decrease the amplitude of the fluctuation (outbreak); (3) increase the time between outbreaks (major population fluctuations and subsequent tree mortality); (4) decrease the duration of the outbreak; and (5) maintain the pest population or mortality

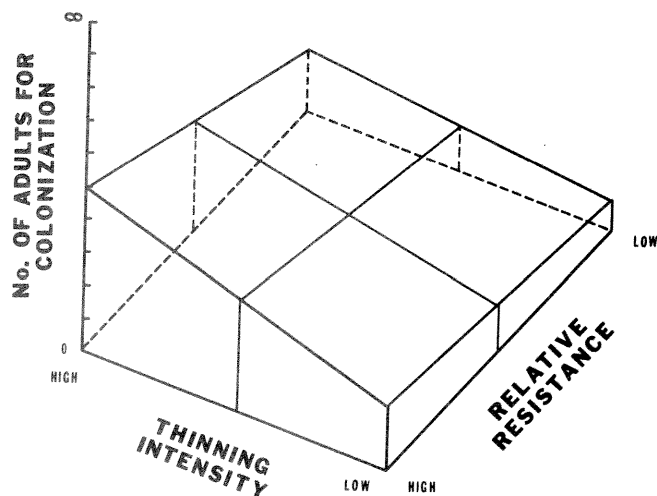

Figure 2.—Conceptual relationship between thinning intensity (very little or none to high-basal area reductions by half or more), relative resistance of the residual stems, and the number of beetles required to successfully colonize an individual tree.

at an acceptable lower level of equilibrium.

Even in light of these goals, one possible tactic would be to do nothing. In that case, one would expect to experience similar losses as in the past and proportional to the changing host availability. As host availability increases, greater losses over larger areas would be expected. Two additional approaches may also be taken, depending on whether the reactive or proactive mode of operation is used. If the reactive mode is used, direct intervention such as salvage, cut-and-leave, pesticide application(s), pile-and-burn, or other disruptive tactics could be utilized. Basically, clearcutting operations would be undertaken and the specific tactic dictated by the economics of the operation. If the proactive mode is used, stand modification tactics would be employed.

Spot Clearcutting

All trees are felled within a given area and removed for sale or left. If left, they may be treated or untreated (i.e., piled and burned or felled in such a way as to increase direct exposure of the infested boles to solar radiation). In areas where root rots are important, then treatment of the stumps (infection courts) along the margin of the clearcut may be considered to prevent further losses. Slash distribution and timing of the subsequent plantings are critical in areas where other pest species such as the pales weevil are a problem (Hedden and Nebeker 1984, and others²). The principal recommendation is the removal or distribution of the residual material in such a way that it is not suitable for various pest species to reproduce in.

Thinning Practices

Studies have shown that silvicultural techniques such as thinning offer the most promising and long-lasting means of preventing losses due to insects and, if properly applied, even to diseases. In principle, we are referring in the latter case to the sanitation type thinnings prescribed for fusiform rust-infected areas³. We also know that above- and below-ground injuries caused by harvesting and thinning operations serve as infection courts for disease organisms causing decay and deterioration. In fact, thinning can increase the incidence of annosus root rot. Wounded trees have traditionally been considered more susceptible to insect infestation. However, recent observations (Nebeker et al. 1983), as discussed below, do

² Berisford and Mizell, personal communications, 1985.

³ Belanger and Godbee, personal communications, 1983.

not support this conclusion.

Timing of the first thinning, as we have seen, is also of concern. Precommercial thinning is deemed unnecessary by many foresters, especially with the spacings now commonly used in the South. There may be a need for such thinnings in dense, natural stands and in plantations established by direct seeding or supplemented with natural regeneration from surrounding stands. Precommercial thinning is probably justified if there are 1500 or more well-spaced seedlings per acre (Balmer and Williston 1973). Thinning is best performed as soon as seedlings are well established, usually between ages 2-5, and possibly as late as age 7, but before they have experienced severe intraspecific competition and are still small enough to be thinned with relatively light equipment or by hand. A problem that has been noted in such thinnings relates to time (i.e., season). In thinnings completed before May, considerable mortality has been observed due to *Ips* invasion. Later thinnings in these plantations did not result in such mortality. The frequency of this occurrence was low and limited in scale. In fact, this may be an extremely rare event. However, where considerable precommercial thinning is planned and the p-size is fairly large, one might expect to see an increase in mortality due to the buildup of *Ips* populations in the slash material left in conjunction with the operation. In many cases, the basal area and stand density are reduced by half by such thinnings. Hence, an increase in the preferred host material is provided and a correlating increase in mortality can be expected if the timing of the operation is not taken into consideration.

Pine stands can be thinned by several methods. These include: (1) Selective thinning (low, crown, selection), (2) row thinnings (e.g., 1 in 3, 1 in 5), (3) row, or corridor, plus selective thinning in leave rows, and (4) leave tree thinning in which the best tree in an area of a given size is marked to be left and all other trees are cut. All of these methods are used with the southern pines, and the choice depends on such things as stand age and density as well as the type of equipment available to do the job. It is not the intent of this paper to review all the different types of equipment on the market, but rather to examine the impact of equipment used on the site.

IMPACT OF THINNING

Tree Growth

Observations indicate that thinning can have both positive and negative effects on the residual stems

and stand. The degree of impact is dependent on how, where, and when the thinning is conducted. That is, the amount of damage is related to the method of felling, equipment used and its configuration, species being thinned, initial density, age, time of year, and soil moisture conditions. There are many additional factors, but these are the principal ones. The type of damage generally observed is bole wounding, limb breakage, and root exposure and breakage.

The impact of thinning and subsequent disturbances on growth have been generalized in figure 1. In studies conducted over a 5-year period (Nebeker and Hodges 1983), it was found that diameter growth at breast height and at various heights on the stem is inversely proportional to the residual basal area after thinning. Even though thinnings, when conducted at the proper time and intensity, generally result in a growth increase on most of the residual stems, there may be decreases in growth rate on some trees near skid lanes.

The percentage of volume growth loss of loblolly pine in relation to depth of skid rut and distance from skid rut 3 years after rutting is presented in figure 3. This information was obtained by Joe Hughs of the Weyerhaeuser Company,⁴ from thinning plots which we established during the winter of

⁴ Personal communication, 1981.

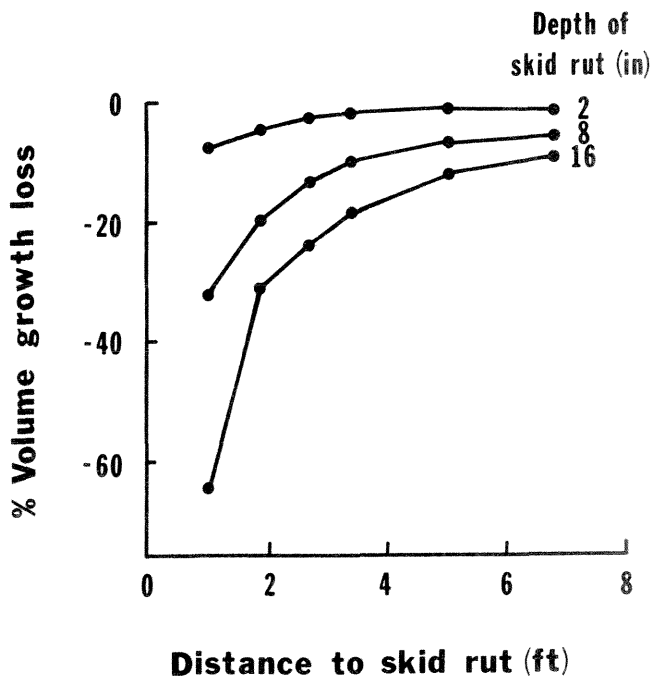

Figure 3.—Growth loss in relation to skidding-caused soil damage.

1977 and early 1978. No skid trails were permitted on the experimental plots; the trails near the plot borders were used repeatedly and some rather deep and extensive ruts were created. Hughs used trees near these skid lanes to describe the amount of growth loss as a function of distance from a rut and depth of rut. From this information, we have presented (Nebeker and Hodges 1983) the percent volume growth loss (fig. 3) for three different rut depths. The amount and duration of decreased growth are functions of many factors. Some of the factors are amount of soil compaction, root breakage, bole wounding, and rainfall distribution patterns. The principal factors are related to the amount and intensity of site and stand disturbances caused by the thinning operations.

In a subsequent study by Nebeker and Hodges (1983) and based on work by Nickolich (1983), mixed results were obtained in that neither a positive nor negative impact, as measured by growth, was observed in relation to soil rutting 1 year after treatment. In one case, there was a slight positive correlation between growth and soil rutting, especially when the depth of rutting is considered. There are several reasons why the damage variables (distance to the nearest rut, depth of the nearest rut, and aerial extent of rutting) had mixed influences during the first year. First, a 1-year response period might not be sufficiently long for the negative effects of soil rutting to become apparent. Since much of a tree's early growth in a given season is governed by conditions in the preceding growing season, it follows that the greatest growth losses from rutting should occur after the first growing season following thinning. Second, rainfall distribution patterns need to be considered. Rainfall was well distributed and plentiful throughout the spring and early summer, when most of the growth was taking place. Under the opposite conditions, the trees might have experienced some moisture stress. Had this been the case, those with large portions of their root systems severed from rutting would possibly have been at a disadvantage. In any event, comparisons of radial growth rates after thinning with the previous 5 years growth indicate a positive response to release by thinning. Such a response might have overshadowed any negative effects from thinning damage.

Spot Growth

A question often asked is: "What will happen if southern pine beetle infestations become established in recently thinned stands and unthinned stands?" A study was established on the John Starr Memorial Forest in Mississippi during 1977 to address

this question with followup studies to be done on the same forest and on lands provided by Weyerhaeuser Company. The basic experimental design and procedures were outlined by Nebeker (1980), Nebeker et al. (1983), and Nebeker and Hodges (1983). The procedure was to create southern pine beetle infestations of different initial spot sizes (single tree and five tree) in loblolly pine stands following thinnings to prescribed basal areas. After the initial spot size was established, the infestations were followed for spot growth for a period up to 4 months after introduction. The generalized results are presented in figure 4. These results suggest that if the basal areas are reduced to approximately 70 ft², the probability of additional mortality beyond the one to five trees being killed is very very low. As the basal area increases, then the expected number of trees killed will increase at an exponential rate as depicted in figure 4. The upper limit of initial spot size where spot growth will occur when the stand has been thinned back to around 70 ft² has not been observed within the past 5 years.

Incidence, Sequence, and Severity of Pest Populations

The most damaging insects in thinned stands include the black turpentine beetle and the three *Ips* engraver beetles. The relationship between thinnings and pest populations has been explored in a general way, with few specific evaluations. Mason (1969) investigated the behavior of *Ips* species that had infested the residual slash following a summer thinning in a loblolly pine plantation and observed that

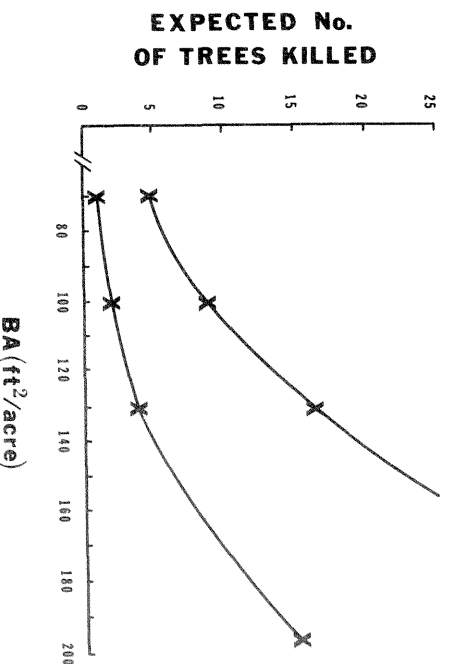

Figure 4.—Initial spot size and expected mortality in relation to basal area following thinning. Lower line for single tree and the upper line for infestations with 5 trees being attacked initially.

the beetles did not attack residual trees but dispersed. It was concluded that, in pulpwood stands in the mid-South, *Ips* rarely pose a problem to residual trees following summer thinning. A similar conclusion was arrived at following our thinnings of loblolly pine plantations by hand on the John Starr Memorial Forest during the winter and spring of 1977-78. Large numbers of *Ips* spp. were attracted to the slash and freshly felled trees, and little residual stem mortality occurred. However, during 1981 and 1982, mortality of residual stems did occur when slash was left piled around the base of residual trees.

Engraver beetle populations are usually absorbed into the slash and infrequently infest residual trees unless the slash is clumped. This concept was presented by Nebeker et al. (1983) and is depicted in figure 5. As a thinning operation begins, the preferred resource (i.e., slash or down material) increases and the *Ips* spp. colonize it. As long as this material is available, the beetle population is absorbed into it and the population may increase. As the thinning operation is concluded and the preferred resources are no longer available, standing trees are attacked. This occurrence is very similar to what happens in Australia⁵ where large *Ips* populations build up in the slash, and when the harvesting operation is completed and the available resources run out, the residual stems are attacked. However, in this country, attacks on residual trees are not as severe, probably because of the presence here (but not in Australia) of natural enemies that follow the beetle populations.

Additional mortality from sources other than bark beetles has been observed in pine stands following thinning. For example, mortality due to pine wilt disease has been observed and is the only disease-related mortality that might be directly associated with the slash left after the thinning operation. Longhorned beetles, the insects that have been implicated in the transmission of pine wood nematode responsible for pine wilt disease, have been found developing in the larger diameter slash material.

Trees that are basally wounded in thinning operations are often attacked by the black turpentine beetle. However, observations of these wounded trees over a 2-to 3-year period show minimal, if any, brood development and no mortality. These trees may prove to be more of a sink than a source for beetle populations, such as the black turpentine beetle, to build up in. A final problem one should be aware of is the attraction of pales weevil to the freshly cut stumps in the thinning area. If a recently regenerated stand is nearby or next to one being thinned, mortality due to the pales weevil may be

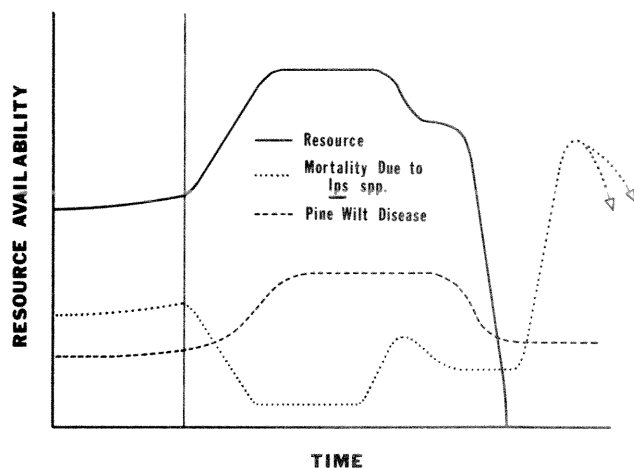

Figure 5.—Conceptual relationship between resource availability and subsequent mortality to the residual stand following thinning.

observed, primarily in the rows adjacent to the thinned stand.

MANAGEMENT RECOMMENDATIONS

Any thinning strategy must consider the potential hazards associated with intensive silvicultural practices. The following management approaches are recommended to minimize the impact of damaging organisms and environmental factors on pine stands (Nebeker et al. 1985).

Southern Pine Beetle

Southern pine beetle infestations are often associated with poor tree vigor. Since tree vigor is basically related to site, tree, stand, and environmental conditions, SPB outbreaks are strongly influenced by these conditions. Though vigor is difficult to quantify, radial growth rate can serve as a strong indicator of tree condition or vigor. Other factors that affect vigor include: age, stand density, species composition, soil texture and type, drainage patterns, and stand disturbances associated with cultural practices.

Poor tree vigor is usually associated with densely stocked stands and declining or slow radial growth, conditions readily alleviated by thinnings, especially those that remove the lower crown classes. These types of thinnings eliminate the less vigorous or weakened individuals that are the prime targets of SPB. Reduced competition pressure enhances the vigor of the residual trees. Thinning stands back to 70-100 ft²/acre basal area reduces the risk of SPB

⁵ Berisford, *op. cit.*

attacks and may also help slow spot growth if an attack does occur. For greater effectiveness, thinning can be done in winter when the beetles are less active. Thinning to reduce the hazard is recommended when basal area approaches 120 ft²/acre, or when live crown ratios drop to about 40 percent. A properly conducted thinning will stimulate radial growth, reduce evapotranspiration, and increase rain throughfall. The reduction in evapotranspiration slows down the depletion of groundwater and favors continued diameter growth. The prevention of severe water stress results in lower monoterpene concentration and higher levels of resin acids, which could be involved in making the stand less attractive to beetles (Hodges and Lorio 1975).

Pine stands in low-lying areas are frequently subjected to flooding and become attractive to SPB. Thinning alone may not correct the problem in these areas. Additional management actions (such as drainage) to divert excess water may be needed.

Any thinning strategy to reduce southern pine beetle risks should be compatible with management goals and consider such things as site and stand factors, equipment, seasonality, and product objective. Consideration of other potential hazards (e.g., annosus root rot, *Ips* spp., and black turpentine beetle) that might conflict with SPB recommendations must also enter into the decisionmaking process.

Annosus Root Rot

Thinning is the single most important factor contributing to annosus root rot in pine stands since cutting exposes stump surfaces to infection. Damage due to the fungus increases with time after thinning up to about 8 years, after which the damage level stabilizes. Since annosus spore production is at its highest level in January and February, thinning during the winter increases the likelihood of infection. In addition to thinning, species susceptibility, virulence of the disease, deep sandy soils, low soil organic matter, air temperature below 70°F, duration of stump susceptibility, and pruning contribute to and/or facilitate infection.

A comprehensive survey of annosus root rot damage throughout the South revealed that 2.8 and .07 percent, respectively, of trees in plantations and natural stands were infected. In scattered high-hazard areas, 5-year volume loss following thinning was estimated to be 20 percent of the stand (9 of 46 cords per acre). In general, volume loss following thinning ranges from 0.1 to 0.5 cords/acre/year (Alexander et al. 1981).

For high-hazard sites, the following measures are recommended for minimizing losses to annosus root

rot (Kuhlman et al. 1976):

- (1) Delay thinning or reduce the number of thinnings to reduce the risk of loss. Wider spacing and reduced thinning are beneficial practices.
- (2) Use borax on cut stumps for the most positive control. Borax is not effective for a second thinning if not used for the first.
- (3) Thin from April to August south of 34°N latitude to provide control because of high air and stump temperatures (which are lethal to disease spores) and low spore numbers.
- (4) Don't take any special precautions when replanting previously infected sites. The disease does not persist in the soil.
- (5) Plant more resistant species on high-hazard sites (e.g., longleaf is more resistant than loblolly).

There is some evidence that prescribed burning will reduce the severity of annosus root rot in thinned plantations (Froelich et al. 1978). On low-hazard sites, chemical treatment of the stumps is of doubtful value (Hodges 1974). It is generally believed that on sites rated low hazard for annosus root rot, no restrictions on thinning are necessary. While the best strategy for reducing the disease on high-hazard sites may be to delay or do no thinning, stands on low-hazard sites may be thinned based on normal silvicultural prescriptions dictated by product objectives, biological constraints, and desired capital recovery. As recommended here, stumps on high-hazard sites should be treated with borax, and, in stands with confirmed root rot, *Peniophora gigantia* (Fr.) Masee, a saprophytic fungus. In addition, thinning should be done when possible during the hottest months of the year (May–August) to take advantage of high temperatures and low spore production/survival conditions. Prescribed burning may be done before and after thinning to further insure the protection of residual stands from infection.

If spacing is wider than 8 × 8 feet, and the product objective is pulpwood, thinning may be foregone, particularly on high-hazard sites. Chemical thinnings should be done for precommercial thinning on high-hazard sites.

Since thinning to reduce the hazard of southern pine beetle incidence conflicts with management recommendations for annosus root rot, foresters should be aware of the tradeoffs in areas where both pests are likely to occur. Benefits must be weighed against potential losses for any chosen thinning strategy. In most cases, thinning should be done in the winter to reduce the SPB hazard and the stumps treated with borax to prevent annosus infection.

Fusiform Rust

Losses to fusiform rust have been estimated to exceed \$25 million annually in value, making it the most economically damaging disease of southern pines. Slash and loblolly pines are the preferred hosts, slash being the more seriously affected. The disease is more severe in plantations than in natural stands with mortality occurring primarily in the seedling stage.

Interestingly enough, cultural practices that favor fast stand growth increase the incidence of fusiform rust. However, to prescribe against cultural practices that improve growth is neither silviculturally nor economically sound. It has been claimed that even a 50 percent rust infection rate in a stand can be offset by an increase in volume resulting from such intensive cultural practices as site preparation and fertilization.

Thinning has little or no practical value in reducing fusiform rust incidence because infection occurs at the early stages of stand development. It must, therefore, be practiced for a different purpose—to minimize losses due to rust; i.e., salvage. The first 5 years after planting are the critical period. Precommercial thinning may not be justified and may aggravate the problem by increasing the surface area for infection and by preventing natural pruning. This implication is supported by the finding that close spacing reduces fusiform rust incidence. Heavy thinning may also have an adverse effect by favoring the growth of alternate hosts (oaks), thereby enhancing rust incidence. Thinning of heavily infected stands, on the other hand, can profoundly affect total wood production if heavily infected trees certain to die before final harvest are removed. If rust incidence is less than 25 percent, the first thinning should remove most of the diseased trees. Opening up the stand too much can have unfavorable consequences on the residual stand in terms of growing and damage from ice and wind. Other factors such as wind/windthrow, ice, etc. are considered in detail by Nebeker et al. (1985).

LITERATURE CITED

- Alexander, S.A.; Skelly, J.M.; Webb, R.S. Effects of *Heterobasidion annosum* on radial growth in southern pine beetle-infested loblolly pine. *Phytopathology* 71:479–481; 1981.
- Balmer, W.E.; Williston, H.L. The need for precommercial thinning. *For. Manage. Bull. Atlanta, GA*: U.S. Department of Agriculture, Forest Service, Southeastern Area State and Private Forestry; 1973. 6 p.
- Belanger, R.P.; Malac, B.F. Silviculture can reduce losses from the southern pine beetle. *Agric. Handb.* 576. Washington, DC: U.S. Department of Agriculture; 1980. 17 p.
- Belanger, R.P.; Osgood, E.A.; Hatchell, G.E. Stand, soil and site characteristics associated with southern pine beetle infestations in the southern Appalachians. *Res. Pap. SE-198*. Asheville, NC: U.S. Department of Agriculture, Forest Service, Southeastern Forest Experiment Station; 1979. 7 p.
- Bennett, F.A. Growth and yield of slash pine plantations. *Res. Pap. SE-1*. Asheville, NC: U.S. Department of Agriculture, Forest Service, Southeastern Forest Experiment Station; 1963. 23 p.
- Blanche, C.A.; Nebeker, T.E.; Hodges, J.D.; Karr, B.L.; Schmitt, J.J. Effect of thinning damage on bark beetle susceptibility indicators in loblolly pine. In: Shoulders, E., ed. *Proceedings, third biennial southern silvicultural research conference*; 1984 November 7–8; Atlanta, GA. *Gen. Tech. Rep. SO-54*. New Orleans, LA: U.S. Department of Agriculture, Forest Service, Southern Forest Experiment Station; 1985a: 471–479.
- Froehlich, H.A. The influence of different thinning systems on damage to soil and trees. *Proc. XVI IUFRO World Congress, Div. IV, Oslo, Norway*; 1976.
- Froelich, R.C.; Hodges, C.S., Jr.; Sackett, S.S. Prescribed burning reduces severity of annosus root rot in the South. *Forest Science* 24(1):93–100; 1978.
- Hedden, R.L. The need for intensive forest management to reduce southern pine beetle activity in east Texas. *South. Jour. Applied For.* 1:19–22; 1978.
- Hedden, R.L.; Nebeker, T.E. Integrated forest pest management in pine stands (0-6 yrs.)-insects. In: Branham, S.J.; Hertel, G.D., eds. *Proceedings, integrated forest pest management symposium*; 1984 June 19–21; Athens, GA. Athens: University of Georgia; 1984: 39–53.
- Hodges, C.S. Symptomatology and spread of *Fomes annosus* in southern pine plantations. *Res. Pap. SE-114*. Asheville, NC: U.S. Department of Agriculture, Forest Service, Southeastern Forest Experiment Station; 1974. 10 p.
- Hodges, J.D.; Lorio, P.L., Jr. Moisture stress and composition of xylem oleoresin in loblolly pine. *Forest Science* 21:283–290; 1975.
- Hodges, J.D.; Elam, W.W.; Watson, W.F.; Nebeker, T.E. Oleoresin characteristics and susceptibility of four southern pines to southern pine beetle (Coleoptera: Scolytidae) attacks. *Canadian Entomology* 111: 889–896; 1979.
- Hodges, J.D.; Nebeker, T.E.; DeAngelis, J.D.; Blanche, C.A. Host/beetle interactions: Influence of associated microorganisms, tree disturbance, and

- host vigor. In: Branham, S.J.; Thatcher, R.C., eds. Proceedings, integrated pest management research symposium; 1985 April 15–18; Asheville, NC. Gen. Tech. Rep. SO-56. New Orleans, LA: U.S. Department of Agriculture, Forest Service, Southern Forest Experiment Station; 1985: 161–168.
- Kuhlman, E.G.; Hodges, C.S., Jr.; Froelich, R.C. Minimizing losses to *Fomes annosus* in the southern United States. Res. Pap. SE-151. Asheville, NC: U.S. Department of Agriculture, Forest Service, Southeastern Forest Experiment Station; 1976. 16 p.
- Mason, R.R. Behavior of *Ips* populations after summer thinning in a loblolly pine plantation. *Forest Science* 15(4):390–398; 1969.
- Nebeker, T.E. Manipulation of stand density for prevention of southern pine beetle infestations in loblolly pine plantations; 1980. [Final Tech. Rep. to Expanded Southern Pine Beetle Research and Application Program—unpublished paper.]
- Nebeker, T.E. Influence of forestry practices on bark beetle populations: a perspective. In: Proceedings, Louisiana State University forestry symposium; 1985 March 26–27; Baton Rouge, LA. Baton Rouge: Louisiana State University; 1985. [In press].
- Nebeker, T.E.; Hedden, R.L. Integrated pest management in pine stands (6+ yrs.)—insects. In: Branham, S.J.; Hertel, G.D., eds. Proceedings, integrated forest pest management symposium; 1984 June 19–21; Athens, GA. Athens: University of Georgia; 1984: 116–125.
- Nebeker, T.E.; Hodges, J.D. Influence of forestry practices on host susceptibility to bark beetles. *Zeitschrift fur Angewandte Entomologie* 96(2): 194–208; 1983.
- Nebeker, T.E.; Moehring, D.M.; Hodges, J.D.; Brown, M.W.; Blanche, C.A. Impact of thinning on host susceptibility. In: Jones, E. P., Jr., ed. Proceedings, second biennial southern silvicultural research conference; 1982 November 4–5; Atlanta, GA. Gen. Tech. Rep. SE-24. Asheville, NC: U.S. Department of Agriculture, Forest Service, Southeastern Forest Experiment Station; 1983: 376–381.
- Nebeker, T.E.; Mizell, R.F., III; Bedwell, N.J. Management of bark beetle populations: impact of manipulating predator cues and other control tactics. In: Garner, W.Y.; Harvey, J. Jr., eds. Chemical and biological controls in forestry. ACS Symposium Ser. 238: 25–33; 1984.
- Nebeker, T.E.; Hodges, J.D.; Karr, B.L.; Moehring, D.M. Thinning practices in the southern pines—with pest management recommendations. *Tech. Bull.* 1703. Washington, DC: U.S. Department of Agriculture; 1985. [In press].
- Nickolich, M.B. The effect of soil rutting on the growth of residual loblolly pine trees following thinning operations. Mississippi State, MS: Mississippi State University; 1983. [M.S. Thesis].

Field Tests of Insecticides for Control of Black Turpentine Beetle

John C. Nord, Alice S. Jones, and Felton L. Hastings¹

Abstract.—Three pyrethroids, Ambush®, Pydrin®, and Cymbush®, were field tested at three rates for preventive control of black turpentine beetle on loblolly and slash pine in North Carolina and Florida in 1984. In addition, Dursban® and Sumithion® were tested at three rates in Florida. Of the pyrethroids, the high rate of Ambush (0.6 percent) and Cymbush (0.3 percent) appeared to be approaching the minimum effective rates for 2- to 3-month control, whereas the high rate of Pydrin (0.6 percent) did not. The high rate of Dursban and Sumithion (2.0 percent) appears to be effective. The results suggest that all insecticides except Pydrin should be tested further at slightly higher rates. Pydrin rates should be elevated substantially in any future tests. There was an indication that lower rates of Pydrin and Cymbush in some way caused a significant increase in attacks over the controls. This might have been caused by an effect of the pyrethroids on adult behavior of the beetle.

Additional keywords: *Dendroctonus terebrans* (Olivier), cypermethrin, fenitrothion, permethrin, fenvalerate, chlorpyrifos, lindane.

INTRODUCTION

Although lindane has been used for many years as an effective preventive control of black turpentine beetle (BTB) *Dendroctonus terebrans* (Olivier) (Smith 1954, 1958), there was a need to test alternative insecticides that might be safer and more effective than lindane. The insecticides of interest are some of the pyrethroids, only one of which has been tested on BTB (Williams 1979), and Dursban and Sumithion because they have been shown to be effective against southern pine beetle (*Dendroctonus frontalis* Zimmermann) (Hastings and Coster 1981), and they have also shown promise for controlling BTB (Moore 1977, Merkel 1979, Merkel and Clark 1981).

¹ Research Entomologist, Research Microbiologist, and Principal Research Entomologist, respectively, U.S. Department of Agriculture, Forest Service, Southeastern Forest Experiment Station, Forestry Sciences Laboratory, Research Triangle Park, NC. (The authors wish to acknowledge the following: Federal Paper Board Company, Inc., who provided the North Carolina research areas and Union Camp Corporation, who provided the Florida site, and the Integrated Pest Management Research, Development and Applications Program for Bark Beetles of Southern Pines, who funded the research.)

Contact toxicity tests of eight insecticides were conducted at our laboratory in Research Triangle Park, NC, in the spring of 1983² to determine relative toxicity. In those tests, a 0.62 μ l droplet of acetone varying in concentration of toxicant was applied to the ventral thorax of adult beetles after which the beetles were held at ambient temperature in ventilated cups of ground pine phloem for 48 hours. Mortality counts were then made, and LD₅₀ and LD₉₀ dosages were calculated with POLO2 (Robertson et al. 1981). Table 1 shows the results of those tests. All insecticides were 3 to 66 times as toxic as lindane. Deltamethrin, cypermethrin, and fenitrothion were particularly toxic to BTB relative to lindane. Because deltamethrin was not likely to be available commercially, we selected the other pyrethroids, Pydrin, Ambush, and Cymbush (=cypermethrin) to field test along with Dursban and Sumithion (=fenitrothion).

METHODS

Three field tests of insecticides were established in June of 1984: two in North Carolina, one near Laurinburg and the other near Aberdeen, one in north Florida near Palatka. Each test was established in a loblolly pine (*Pinus taeda* L.) or slash pine (*P. elliottii* Engelm.) plantation immediately adjacent to a fresh pine clearcut or thinning. Table 2 gives details of the test stands.

Experimental Design

The experimental design was a randomized complete block design with three blocks, and all treatments were randomly assigned to 3–5 trees/block/month combination for a total of 9–15 trees/treatment \times month in the experiment.

The experiment was blocked by distance from the probable BTB source (stumps and root systems in adjacent cutting area) (fig. 1). The blocks were rectangular, approximately the same size for each test, and all oriented with the long side parallel to the edge of the clearcut.

Treatments

All trees in each test were sprayed at one time (table 3). Three pyrethroids, Pydrin, Ambush, and

² Nord et al, unpublished.

Table 1. — Toxicity of insecticides topically applied to black turpentine beetle adults.^{1, 2}

Insecticide (trade name)	Sex	No. insects	Slope (SE)	LD ₉₀ (95% CL) ³	TI ₉₀ (females)
Deltamethrin	F	576	3.16 (0.32)	0.057 (0.048–0.071)	66.0
	M	649	2.10 (0.19)	0.051 (0.042–0.065)	
Cypermethrin (Cymbush®)	F	472	2.45 (0.26)	0.30 (0.25–0.40)	12.5
	M	598	3.23 (0.25)	0.25 (0.22–0.29)	
Fenitrothion (Sumithion®)	F	798	3.62 (0.35)	0.32 (0.29–0.38)	11.8
	M	778	3.60 (0.39)	0.35 (0.30–0.41)	
Permethrin (Ambush®)	F	637	3.37 (0.37)	0.66 (0.58–0.80)	5.7
	M	636	1.74 (0.36)	0.82 (0.63–1.39)	
Phosmet (Imidan®)	F	639	3.00 (0.31)	0.72 (0.62–0.88)	5.2
	M	680	2.59 (0.25)	0.79 (0.67–0.98)	
Fenvalerate (Pydrin®)	F	616	2.48 (0.23)	1.02 (0.83–1.36)	3.7
	M	614	2.86 (0.28)	0.60 (0.52–0.73)	
Chlorpyrifos (Dursban®)	F	819	3.41 (0.38)	1.12 (0.99–1.34)	3.4
	M	760	4.10 (0.37)	0.90 (0.82–1.03)	
Lindane	F	617	4.37 (0.40)	3.76 (3.44–4.19)	1.0
	M	618	3.93 (0.41)	3.11 (2.81–3.50)	

¹Insects from laboratory colony in Research Triangle Park, NC.

²Column headings are slope (SE), calculated slope and its standard error; LD₉₀ (95 percent CL), dosage necessary for 90 percent lethal effects and their respective confidence limits; TI₉₀ (females), toxicity index for females, i.e., toxicity relative to lindane $TI_{90} = LD_{90} \text{ lindane} \div LD_{90} \text{ candidate insecticide}$.

³Dosage expressed in $\mu\text{g}/\text{insect}$.

Cymbush, and two organophosphates, Dursban and Sumithion, were tested at three rates (tables 4, 10) and they were compared with the standard treatment, lindane 1.0 percent active ingredient (AI), and an unsprayed control. Trees were treated with aqueous emulsions applied to the point of runoff to the lower bole from the ground up to a height of 1.1 m. A 9.5 L compressed-air sprayer was used. At 4, 8, and 12 weeks postspray, one-third of the trees were wounded and treated with a paraquat herbicide to induce BTB attack (fig. 2). The trees were partially girdled with a special chainsaw. The girdle was 2.5 cm wide extending down into the outer xylem and extending one-third of the circumference of the tree on a convenient side at 30.5 cm above and parallel to the ground. The wound was immediately sprayed to wetness with 4 percent (weight/weight) aqueous solution of paraquat with a 1 L compressed-air sprayer. Thus, a condition of physiological stress was established at 4, 8, and 12 weeks after insecticide was applied in three sets of trees, which induced BTB attack.

Evaluation

Four weeks after paraquat application (end of attack period 1), all BTB attacks were marked from the ground up to 1 m with color-coded map tacks and the number was recorded (table 3). In

addition in the Palatka test, attacks on the same trees were similarly marked at the end of 8 weeks (end of attack period 2) (fig. 2). Thus, in the North Carolina tests, attacks were made on trees containing insecticide deposits 1-2 months old, 2-3 months old, and 3-4 months old. In Florida, we have these data and additional data on attacks made on 2- to 3-month-old deposits and 3- to 4-month-old deposits (attack period 2). These latter data were analyzed separately because the two sets of attacked trees were under different conditions immediately before attack counts. The trees, where attack period 2 data were taken, had been paraquat-treated and most were under attack for 1 month before the beginning of that attack period; whereas, the other groups of trees with 2- to 3- and 3- to 4-month-old

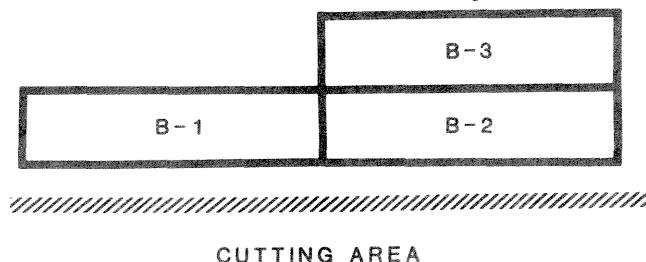

Figure 1.—Layout of field test of insecticides for black turpentine beetle preventive control. North Carolina and Florida, 1984.

Table 2. — Location and description of test stands where field tests of insecticides were conducted in North Carolina and Florida, 1984

Study	Location	Pine spp.	Age (yr)	Ave. d.b.h. (cm)	No. test trees	No. trees/treat x mo/block	Block size (m)	Size of adjacent pine cutting (ha)
Laurinburg	Scotland Co., NC	Loblolly	27	28.9	421	5	140 x 40	10 ¹
Aberdeen	Moore Co., NC	Slash	26	18.3	437	5	57 x 39	142 ²
Palatka	Pulnam Co., FL	Slash	27	21.6	438	3	148 x 39	24 ²

¹Thinning.

²Clearcut.

Table 3. — Dates of insecticide and paraquat treatments, and dates of black turpentine beetle attacks recorded in field tests of insecticides — North Carolina and Florida, 1984

Study	Spray date	Paraquat treatment		Attacks marked in . . .						
				Attack period 1			Attack period 2			
Laurinburg	6/12	7/11	8/6	9/5	8/6	9/4	10/2
Aberdeen	6/21	7/16	8/13	9/11	8/13	9/11	10/9
Palatka	6/28	7/24	8/21	9/18	8/21	9/18	10/16	9/18	10/16	11/14

deposits were not under attack before paraquat application, and they were girdled immediately before the attack period.

An estimate of the proportion of successful attack was made possible by dissecting some of the attacks about 4 weeks after they were tagged and noting the status of parents and brood. The sampling area was the lower bole opposite the one-third-circumference girdle from the level of the girdle (30.5 cm) up to a height of 1 m above ground. The edges of the sample area were imaginary vertical lines passing through the ends of the girdle so that no attacks above or below the girdle were sampled. All attacks in the sample area were numbered from 1 to n, and a random sample equal to a minimum of three per tree or 10 percent of the total number on the tree (whichever was greater) was dissected. Most of the attacks occurred in the sample zone. There were usually no attacks above the girdle up to a height of 1 m probably because of the cortical and sub-cortical necrosis caused by the paraquat. There were usually some attacks below the girdle, but these and others below 30.5 cm on the opposite side were not dissected because of the difficulty in sampling galleries that extended below the soil level.

The only deviation from the sample size was at Aberdeen during the sampling of attacks on trees

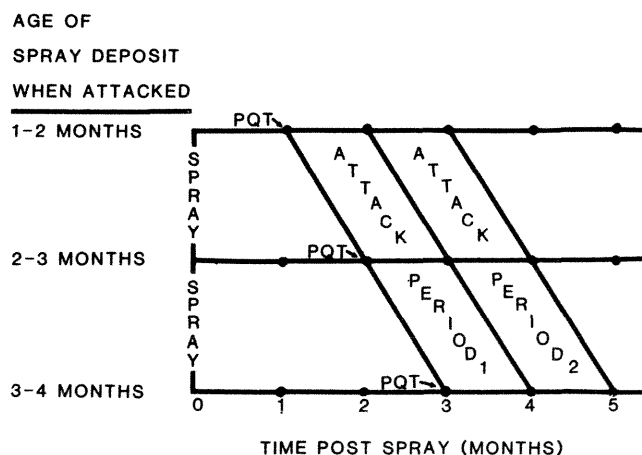

Figure 2.—Timing of insecticide treatment and induction of black turpentine beetle attack in field tests of insecticides—North Carolina and Florida, 1984. All trees sprayed at time 0 and treated with paraquat (PQT) at either 1, 2, or 3 months after spray.

treated with paraquat 1 month after spray. A minimum of one attack per tree or 10 percent of the total, whichever was greater, was sampled. In the Aberdeen and Laurinburg tests, also in trees that received paraquat at 1 month, attacks were counted at 4 weeks after paraquat treatment according to plan, but they were not marked for dissection until 2 weeks later at Aberdeen and 3 weeks later at Laurinburg. On these trees, only 15 attacks distributed over the sampling zone were marked. Attacks dissected were numbered and randomly chosen from these 15 attacks.

Dissected attacks were classified as (1) unsuccessful (i.e., with no egg gallery, or short egg gallery with no adults, or moribund adults and no eggs), (2) successful, with adults (long egg gallery ≥ 5 cm with two live, healthy looking adults and no immature BTB), (3) successful, with eggs (same as 2 with eggs present), (4) successful, with larvae (same as 2 with larvae present). When a dissected gallery coalesced with another so that it was impossible to tell whether the sample attack was successful or not, another attack was randomly chosen for dissection. There were 46 BTB-girdled trees at Aberdeen and 4 at Laurinburg where practically no gallery success data were available due to coalescing galleries. In order for these girdled trees to be used in calculating the proportion of successful attack, this proportion was set at the same average as that of the other trees from which data were available for that treatment \times month combination. This estimate was considered conservative because the girdled trees had many larvae present under the bark.

All attacks in classes 2-4 were considered successful for this study. A proportion of successful attack was computed for each treatment \times month combination in each study. Attacks/m² bark surface in each tree were multiplied by the proportion successful for that treatment \times month combination to obtain number of successful attacks/m² for the tree.

There were usually successful attack data from 5 to 10 trees for each treatment \times month combination. In some of the more effective treatments, such as lindane and the high Ambush treatment, there were no trees or only one tree available for the proportion of successful attack estimate. In these cases, the proportion could not be estimated with any degree of accuracy so it was set at the maximum, or 1.0, to facilitate analysis of the data. Since attacks/m² were usually < 2 in these cases, the maximum successful attacks/m² were also < 2 . The actual number of successful attacks/m² is less than the maximum number but close to it. Since the actual proportion of successful attack is slightly below the maximum, the resulting Duncan test of mean differences is conservative.

Data were analyzed by analysis of variance and Duncan's new multiple range test, with the General Linear Models procedure of Statistical Analysis Systems program (Anonymous 1982).

RESULTS

BTB attack density (attacks/m² bark surface) was highest in all three tests on trees treated with paraquat 1 month after spray. It was particularly high in the North Carolina plots. Attack decreased markedly on trees receiving paraquat at 2- and 3-months after spray. Because the number of trees attacked was so low in the 3-month group, due either to a declining BTB adult population in the aging adjacent cutting area or to the lateness of the season, these data were not analyzed.

On a month-by-month basis, the data indicate that there are few consistent significant differences between treatments and the control, treatments and lindane, and between insecticides. Considering the significant differences that were detected and the trends between insecticide rates, some reasonable statements can be made about the relative effectiveness of insecticides and rates tested. Pyrethroids will be discussed separately because they were tested in all three areas.

Pyrethroids

One- to two-month-old spray deposits.— In all three tests of 1- to 2-month old spray deposits, the high rate of Ambush was 31-39 percent as high as the control in mean attack density (attacks/m²) and the high Cymbush was 34-71 percent as high as the control (table 4.) Only one of these differences was significant, however. Likewise, successful attack densities in the high Ambush and high Cymbush treatments were usually well below those in the controls, but only two of these differences were significant (table 5). In the case of Ambush, the high rate was usually significantly lower in attacks/m² and successful attacks/m² than the low rate, whereas, with Cymbush in all three tests, the high rate was significantly lower in attack density and successful attack density than the middle and low rates. In two of three tests, Ambush at 0.6 percent was significantly lower in attack density than Pydrin at the same rate; and although successful attack density was lower in the high Ambush treatment than in the high Pydrin, it was significantly lower only at Palatka. Cymbush at 0.3 percent was not different from Pydrin at 0.6 percent in the two North Carolina tests and significantly lower in attack and successful attack density at Palatka.

Table 4. — *Black turpentine beetle attacks/meter² bark surface¹ on 1- to 2-month-old pyrethroid spray deposits in field tests of insecticides — North Carolina and Florida, 1984*

Treatment	(% AI)	Laurinburg ²	Aberdeen ²	Palatka ²
Pydrin	(0.6)	12.6 bc	67.3 c	16.7 bc
	(0.3)	24.5 b	95.4 a	15.5 bc
	(0.1)	52.4 a	89.7 ab	13.6 bcd
Ambush	(0.6)	8.4 bc	28.3 d	2.2 e
	(0.3)	10.5 bc	31.3 d	6.8 cde
	(0.1)	20.1 bc	72.0 bc	16.4 bc
Cymbush	(0.3)	13.9 bc	51.9 c	2.4 e
	(0.1)	47.0 a	90.5 ab	30.6 a
	(0.05)	51.8 a	95.7 a	21.2 b
Lindane	(1.0)	0.1 c	1.5 e	0.6 e
Control		24.3 b	72.7 bc	7.1 cde

¹ Attacks marked 8 weeks after insecticide spray (attack period 1, fig. 2).

² For each location, means within each column followed by the same letter are not significantly different ($P = 0.05$) according to Duncan's new multiple range test.

Table 6 shows the percentage of trees in each treatment that sustained five or more BTB attacks in the lower 1 meter of the bole. In the Palatka test, only 13 and 11 percent of the trees had five or more attacks in the high Ambush and high Cymbush treatments, respectively, versus 38 percent in the control. These differences were not as marked in the North Carolina tests where attack densities were much higher. Due to the nature of these data (i.e., there is only one estimate of percentage infested for each treatment \times month combination), they could not be subjected to analysis of variance and Duncan's test.

With two of the three pyrethroids, Pydrin and Cymbush, there usually was an increase in attack density and successful attack density with a decrease in rate to an extent that—surprisingly—several of the lower and middle rates had significantly greater attack and successful attack densities than the control (tables 4, 5). The lower rates of Pydrin and Cymbush also had more heavily attacked trees than did the control (table 6).

Two- to three-month-old spray deposits.—In tests of 2- to 3-month old spray deposits, the high rates of Ambush and Cymbush were 18–43 percent and 23–88 percent of the controls in attack density (table 7), but these differences were not significant. Likewise, successful attack densities in the high Ambush and high Cymbush treatments were, with one exception, below the control (26–67 percent of the control), but only one difference is significant (table 8).

The high Ambush was lower in attack density and successful attack density than the high Pydrin but significantly lower only in the Palatka test during

both attack periods (tables 7, 8). Attack density for Cymbush at 0.3 percent is not significantly different from Pydrin at 0.6 percent in the three sets of attack period 1 data and significantly lower than the high Pydrin in the attack period 2 data (table 7). In successful attack density, Cymbush at 0.3 is significantly lower than Pydrin at 0.6 percent in Florida and not different from the high Pydrin in the North Carolina tests (table 8).

Table 9 shows the percentage of trees with 2- to 3-month-old spray deposits that have five or more BTB attacks. The high Ambush and Cymbush treatments show the lowest percentages among the pyrethroid treatments, usually well below the control.

As in trees with 1- to 2-month-old spray deposits, there was a tendency for middle and lower rates of Pydrin and Cymbush on trees with 2- to 3-month-old deposits to have higher attack and successful attack densities than the control (tables 7, 8). There were fewer significant treatment differences in this spray deposit age, however. There were usually more heavily attacked trees at the middle and low rates of Pydrin and Cymbush than in the controls (table 9).

Dursban and Sumithion

There were no significant differences in attack density or successful attack density between the middle and high Dursban and Sumithion treatments

Table 5. — *Successful black turpentine beetle attacks/meter² bark surface¹ on 1- to 2-month-old pyrethroid spray deposits in field tests of insecticides — North Carolina and Florida, 1984*

Treatment (% AI)	Laurinburg ²	Aberdeen ²	Palatka ²
Pydrin (0.6)	7.0 cd	34.5 cd	10.7 bcd
	(0.3)	12.5 bc	9.7 bcd
	(0.1)	20.0 b	10.7 bcd
Ambush (0.6)	3.0 cd	22.0 d	(2.2) e
	(0.3)	3.9 cd	(6.8) bcde
	(0.1)	10.4 bcd	13.1 b
Cymbush (0.3)	6.7 cd	44.5 c	0.6 e
	(0.1)	20.3 b	25.2 a
	(0.05)	37.6 a	12.1 bc
Lindane (1.0)	(0.1) d	0.8 e	(0.6) e
Control	6.8 cd	62.9 b	5.5 cde

¹ Attacks marked 8 weeks after insecticide spray (attack period 1, fig. 2).

² For each location, means within each column followed by the same letter are not significantly different ($P = 0.05$) according to Duncan's new multiple range test. Values in parentheses indicate treatments with little data for proportion of successful attack given a proportion successful of 1.0; see Methods.

Table 6. — Percentages of trees with 1- to 2-month-old pyrethroid-spray deposits, having five or more black turpentine beetle attacks¹ on the lower 1 meter of the bole — North Carolina and Florida field tests, 1984

Treatment	(% AI)	Laurinburg	Aberdeen	Palatka
Pydrin	(0.6)	54	92	100
	(0.3)	77	100	63
	(0.1)	93	100	50
Ambush	(0.6)	46	80	13
	(0.3)	45	93	38
	(0.1)	69	100	88
Cymbush	(0.3)	54	100	11
	(0.1)	71	100	89
	(0.05)	85	100	89
Lindane	(1.0)	0	7	0
Control		69	100	38

¹ Attacks marked 8 weeks after insecticide spray (attack period 1, fig. 2).

Table 7. — Black turpentine beetle attacks/meter² bark surface on 2- to 3-month-old pyrethroid spray deposits in field tests of insecticides — North Carolina and Florida, 1984

Treatment	(% AI)	Laurinburg ¹	Aberdeen ¹	Palatka ¹	Palatka ²
Pydrin	(0.6)	5.3 abc ³	10.3 cde	9.5 b	11.9 ab
	(0.3)	13.4 a	23.1 ab	5.4 bcd	16.8 a
	(0.1)	5.7 abc	19.8 abc	3.9 bcd	11.1 abc
Ambush	(0.6)	2.1 bc	6.2 de	1.7 d	1.4 ef
	(0.3)	5.9 abc	14.0 bcd	2.4 bcd	6.5 bcdef
	(0.1)	6.8 abc	19.5 abc	4.3 bcd	12.0 ab
Cymbush	(0.3)	1.2 c	12.6 cd	2.8 bcd	4.4 cdef
	(0.1)	10.5 ab	25.5 a	22.8 a	10.1 bc
	(0.05)	10.2 ab	16.6 abc	9.1 bc	11.9 ab
Lindane	(1.0)	0.5 c	0.8 e	0 d	0 f
Control		5.3 abc	14.4 bcd	4.6 bcd	7.9 bcde

¹ Attacks marked 12 weeks after insecticide spray (attack period 1, fig. 2).

² Attacks marked 12 weeks after insecticide spray (attack period 2, fig. 2)

³ For each location, means within each column followed by the same letter are not significantly different ($P = 0.05$) according to Duncan's new multiple range test.

Table 8. — Successful black turpentine beetle attacks/meter² bark surface on 2- to 3-month old pyrethroid spray deposits in field test of insecticides — North Carolina and Florida, 1984

Treatment (% AI)	Laurinburg ¹	Aberdeen ¹	Palatka ¹	Palatka ²
Pydrin (0.6)	1.1 b ³	3.1 ef	7.5 b	9.3 abc
	(0.3)	3.8 a	18.2 a	1.2 d
	(0.1)	0.4 b	14.2 abc	3.1 cd
Ambush (0.6)	1.4 b	2.8 ef	(1.7) d	(1.4) ghi
	(0.3)	0.9 b	9.8 bcd	(2.4) cd
	(0.1)	2.0 ab	10.1 bcd	0.7 d
Cymbush (0.3)	0.6 b	6.6 def	1.7 d	1.2 ghi
	(0.1)	3.8 a	14.8 ab	14.1 a
	(0.05)	0.8 b	8.0 cde	6.4 bc
Lindane (1.0)	(0.5) b	(0.8) f	(0) d	(0) i
Control	0.9 b	9.9 bcd	2.6 cd	4.7 defgh

¹ Attacks marked 12 weeks after insecticide spray (attack period 1, fig. 2).

² Attacks marked 12 weeks after insecticide spray (attack period 2, fig. 2).

³ For each location, means within each column followed by the same letter are not significantly different ($P = 0.05$) according to Duncan's new multiple range test. Values in parentheses indicate treatment with little data for proportion of successful attack given a proportion successful of 1.0; see Methods.

Table 9. — Percentages of trees with 2- to 3-month-old pyrethroid spray deposits having five or more black turpentine beetle attacks on the lower 1 meter of the bole — North Carolina and Florida field tests, 1984

Treatment (% AI)	Laurinburg ¹	Aberdeen ¹	Palatka ¹	Palatka ²
Pydrin (0.6)	43	57	63	100
(0.3)	71	77	44	88
(0.1)	40	83	33	75
Ambush (0.6)	14	38	11	0
(0.3)	46	75	0	38
(0.1)	43	80	22	88
Cymbush (0.3)	10	57	11	22
(0.1)	50	71	89	67
(0.05)	33	83	44	89
Lindane (1.0)	0	0	0	0
Control	50	64	22	38

¹ Attacks marked 12 weeks after insecticide spray (attack period 1, fig. 2).

² Attacks marked 12 weeks after insecticide spray (attack period 2, fig. 2).

and the control or lindane for either age of deposit (table 10). There were also no significant differences between the middle and high Dursban and Sumithion rates and the high Ambush or high Cymbush treatments. In terms of number of trees affected (i.e., trees with five or more BTB attacks), the 2 percent rates of these insecticides are similar to those found in the high Ambush and high Cymbush treatments (tables 6, 9, 11).

Lindane

Lindane had the lowest mean attack and successful attack density of any treatment. The values for these variables in all three tests for both deposit ages were almost always below 1. The differences in attack density and successful attack density between lindane and the control were significant at Aberdeen for both 1- to 2- and 2- to 3-month-old spray deposits (tables 4, 5, 7, 8) and in Palatka on 2- to 3-month-old deposits in attack period 2. There was one other significant difference between lindane and the control and that was in the attack density on 1- to 2-month-old deposits at Laurinburg (table 4); all other differences between lindane and the controls were not significant. There was only one lindane-treated tree in all three tests that had 5 or more attacks in the lower 1 meter of the bole—it had 10 attacks. This occurred at Aberdeen after the first paraquat treatment when beetle pressure was extremely high. During this time, 80 to 100 percent of the trees in the other treatments and control had five or more attacks (table 6).

DISCUSSION

Pyrethroids

There were not many significant differences in attack and successful attack density between the best pyrethroid treatments and the control. Nevertheless, in two of the three tests, Laurinburg and Palatka, the mean attacks/m² and successful attacks/m² compared with the control and the trends of the two attack variables related to decreasing AI rates indicate that the high rate of Ambush and Cymbush approaches a minimum effective rate for 2- to 3-month protection from BTB. However, at Aberdeen, especially in the test of 1- to 2-month-old spray deposits, none of the treatments except lindane was effective in reducing BTB attacks (tables 4, 5, 6). Attack density and successful attack density were relatively higher at Aberdeen than in the other areas partially because of smaller diameter trees. However, the percentage of trees attacked and attack density were high in this test. Attacks were common on yet-to-be-girdled test trees and other trees that were not part of the test. Thirty test trees were attacked before girdling, and they had to be thrown out of the test. It is possible that the trees at Aberdeen were unusually attractive to BTB because they were under water stress due to the poor Sandhills site. Also, the large size of the adjacent clearcut (beetle source), as well as the greater density of girdled trees due to the relatively smaller size of the block at Aberdeen, might have contributed to the infestation level (table 2). If Aberdeen is an unusual case and we can attach

Table 10. — *Black turpentine beetle attacks/meter² and successful attacks/meter² bark surface on 1- to 2- and 2- to 3-month-old spray deposits of Dursban and Sumithion — Florida field test, 1984*

Treatment (% AI)	Age of spray deposits (months)					
	1 to 2 ¹		2 to 3 ¹		2 to 3 ²	
	Attacks/m ²	Successful attacks/m ² ³	Attacks/m ²	Successful attacks/m ² ³	Attacks/m ²	Successful attacks/m ² ³
Dursban (2.0)	3.3 de ⁴	(3.3) de	2.2 cd	1.1 d	1.9 def	(1.9) fghi
(1.0)	4.4 de	2.0 e	1.3 d	0.7 d	4.3 cdef	0.7 hi
(0.5)	7.0 cde	4.7 de	4.1 bcd	1.2 d	8.3 bcd	5.9 bcdef
Sumithion (2.0)	3.8 de	(3.8) de	3.0 bcd	1.8 d	5.9 bcdef	3.6 defghi
(1.0)	8.4 cde	5.0 cde	4.6 bcd	0 d	5.6 bcdef	3.8 defghi
(0.5)	8.4 cde	6.0 cde	5.7 bcd	2.4 cd	7.2 bcde	5.4 cdefg
Lindane (1.0)	0.6 e	(0.6) e	0 d	(0) d	0 f	(0) i
Control	7.1 cde	5.5 cde	4.6 bcd	2.6 cd	7.9 bcde	4.7 defgh

¹ Attacks marked 12 weeks after insecticide spray (attack period 1, fig. 2).

² Attacks marked 12 weeks after insecticide spray (attack period 2, fig. 2).

³ Values in parentheses indicate treatment with little data for proportion of successful attack given a proportion successful of 1.0, see Methods.

⁴ For each location means within each column followed by the same letter are not significantly different (P = 0.05) according to Duncan's new multiple range test.

less importance to it, then high Ambush and high Cymbush treatments are truly approaching minimum effective rates; future research should test 0.4, 0.7, and 1.0 percent rates for Ambush and 0.2, 0.5, and 0.8 percent for Cymbush. If not, we may need to raise the rates considerably in future tests.

The high rate of Pydrin (0.6 percent) did not appear very close to the minimum effective rate. Therefore, Pydrin could be dropped from future testing, or it should be tested at rates of 0.6, 0.9, and 1.2 percent.

The tendency for lower rates of Pydrin and Cymbush to have significantly greater attack densities than the control is difficult to explain. There is a possibility that sublethal amounts of these insecticides are causing a behavioral effect that enhances attraction of the natural sex and/or aggregation pheromone, which results in greater attraction of beetles to Pydrin- and Cymbush-treated trees. In previously mentioned contact toxicity tests, all the pyrethroids were associated with hyperactivity and loss of tarsi, tibiae, and femora without causing mortality. The loss of legs occurred even when beetles were isolated in holding containers (the standard holding method for pyrethroids) to eliminate biting by other individuals. In fact, the loss of leg segments on more than one leg was considered a symptom of toxicity tests of pyrethroids because it was assumed to be a serious disadvantage, possibly causing a reduction of mating success and/or reduced survival of the adults and possibly that of the brood also.

Table 11. — *Percentages of trees with 1- to 2- and 2- to 3-month-old Dursban and Sumithion spray deposits having five or more black turpentine beetle attacks in the lower 1 meter of the bole — Florida field test, 1984*

Treatment (% AI)	Age of spray deposits (months)		
	1 to 2	2 to 3	
	Attack period 1 ¹	Attack period 1 ¹	Attack period 2 ¹
Dursban (2.0)	11	13	11
(1.0)	33	0	33
(0.5)	33	13	56
Sumithion (2.0)	13	22	38
(1.0)	63	25	38
(0.5)	56	38	56
Lindane (1.0)	0	0	0
Control	38	22	38

¹ Fig. 2.

Dursban and Sumithion

Although there were not any significant differences between the middle and upper rates of Dursban and Sumithion and the controls and lindane, the sizes of means and trend of attack and successful attack density between rates indicate that slightly higher rates of the insecticides should be tested in the future. Rates for a future test should be 1.5, 2.0, and 2.5 percent AI.

In these tests, the number of trees/treatment \times month combination was approximately 15 in North Carolina and 9 in Florida. The number of trees in the Florida test was perhaps too low for detecting important differences between means. In order to detect smaller differences between means, more trees/treatment \times month combinations are needed—at least 15–20 trees. This would probably necessitate a reduction of the number of treatments tested. The experiment should be blocked by distance from the beetle source as these tests were. The test site at Aberdeen was a poor sandy site. The trees were probably already in a weakened condition when they were treated with paraquat, which may have intensified BTB attack above normal levels. Better sites should be chosen for future tests. The use of paraquat for inducing BTB attack in pine near fresh clearcuts appears to be a dependable method of assuring moderate to high levels of BTB attack on treated trees. There were almost no attacks by other bark beetles, such as *Ips* spp., in the lower boles of the test trees.

CONCLUSIONS

Although the results are inconclusive, the significant differences found between treatments and between treatments and controls, as well as the trends in attack density, successful attack density, and percentage of trees having five or more BTB attacks were used to arrive at a few general statements:

1. The high rates of Ambush (0.6 percent) and Cymbush (0.3 percent) tested appear to approach the minimum effective rates for preventive control of BTB for 2–3 months. More testing at slightly higher rates is recommended: Ambush at 0.4, 0.7, and 1.0 percent AI; Cymbush at 0.2, 0.5, and 0.8 percent AI.

2. Pydrin was not effective at any of the rates tested and should be dropped from testing or tested at higher rates: 0.6, 0.9, and 1.2 percent AI.

3. There were no significant differences between any of the rates of Sumithion and Dursban tested and that of the controls. Slightly higher rates should be tested in the future: 1.5, 2.0 and 2.5 percent AI.

- Anonymous. SAS users' guide: statistics. Cary, NC: SAS Institute, Inc.; 1982. 584 p.
- Hastings, F. L.; Coster, J. E., eds. Field and laboratory evaluations of insecticides for southern pine beetle control. Gen. Tech. Rep. SE-21. Asheville, NC: U.S. Department of Agriculture, Forest Service, Southeastern Forest Experiment Station; 1981. 40 p.
- Merkel, E. P. Field trial of lindane, phosmet, and fenitrothion to prevent insect-caused mortality of paraquat-treated slash pines. Res. Note SE-278. Asheville, NC: U.S. Department of Agriculture, Forest Service, Southeastern Forest Experiment Station; 1979. 4 p.
- Merkel, E. P.; Clark, E. W. Insecticides for preventing insect-caused mortality of paraquat-treated slash pines. Res. Pap. SE-219. Asheville, NC: U.S. Department of Agriculture, Forest Service, Southeastern Forest Experiment Station; 1981. 7 p.
- Moore, G. E. BHC, Dowco 214, and Dursban protect paraquat-treated trees from bark beetles. In: Lightwood research coordinating council proceedings; 1977 January 18–19; Atlantic Beach, FL; 1979: 20–24. [Available from Southeastern Forest Experiment Station, Asheville, NC]
- Robertson, J. L.; Russell, R. M.; Savin, N. E. POLO2: a computer program for multiple probit or logit analysis. Bull. Entomol. Soc. Am. 27(3): 210–211; 1981.
- Smith, R. H. Benzene hexachloride controls black turpentine beetle. South. Lumberman 189(2369): 155–157; 1954.
- Smith, R. H. Control of the turpentine beetle in naval stores stands by spraying attacked trees with benzene hexachloride. J. For. 56: 190–194; 1958.
- Williams, I. L., Jr. Insecticide control in Florida: a progress report. In: Sixth annual lightwood research conference proceedings; 1979 January 17–18; Atlanta, GA; 1979: 41–47. [Available from Southeastern Forest Experiment Station, Asheville, NC]

Effects of Frontalure in Suppressing Southern Pine Beetle Spot Growth Under Endemic and Epidemic Population Levels

T. L. Payne, L. H. Kudon, C. W. Berisford, B. P. O'Donnell, and D. K. Walsh¹

Abstract.—The application of frontalure has potential for use in suppressing infestations of the southern pine beetle under endemic infestation densities to prevent population buildup. Under epidemic conditions, the tactic appears to be less effective in suppressing infestations. Formulated as an acrylic polymer microencapsulant spray, frontalure application can be labor-saving at an operational level for use during routine ground checks.

Additional keywords: *Dendroctonus*, attractant, infestation microencapsulant, behavioral chemicals.

INTRODUCTION

Research and development efforts aimed at suppressing infestations of the southern pine beetle (*Dendroctonus frontalis* Zimmermann) have been limited and fragmented since A. D. Hopkins first reported the pest in the southeastern United States in the late 1800's. Historically, efforts to control the beetle have been remedial in nature and primarily included the use of insecticides and salvage. Salvage is still practiced, but in the last decade, high costs and environmental restrictions have all but eliminated the operational use of insecticides in the forest. As a result, the forest manager is greatly limited in the choice of direct control methods with which to attempt to deal with the beetle.

In recent years, efforts have been underway to develop additional and alternate means for suppressing southern pine beetle infestations (Coster 1977, Leuschner et al. 1977). Through the Expanded Southern Pine Beetle Research and Application Program, and subsequently through the IPM Bark

Beetle Program, some emphasis has been placed on behavioral chemicals because of the potential they offer for managing beetle populations.

USING BEHAVIORAL CHEMICALS

Several behavioral chemicals have been found to play a role in the landing and attack behavior of the southern pine beetle (Borden 1974, Vité and Francke 1976, Payne et al. 1978). Some of the chemicals have an attractant effect on beetle response.

In nature, attractants function to orient flying beetles to a common host tree so that they arrive in sufficient numbers over a relatively short period of time to overcome the resistance of the tree and successfully colonize it. Frontalin (1,5-dimethyl-6,8-dioxabicyclo [3.2.1] octane (Kinzer et al. 1969), produced by the female and believed to be released when she makes contact with a suitable host tree (Renwick and Vité 1969), is considered the primary aggregation pheromone of the southern pine beetle (Kinzer et al. 1969, Payne et al. 1978). By itself, frontalin attracts flying beetles of both sexes, but in the presence of host odor, such as *alpha*-pinene, its effect can be greatly enhanced (Kinzer et al. 1969, Payne et al. 1978). *Alpha*-pinene supposedly functions as an arrestant in combination with frontalin (Renwick 1970); that is, the pheromone attracts beetles to the tree and the host odor arrests their flight so that they land.

These compounds have potential for managing southern pine beetle through baited traps, trap trees, and/or the disruption of the beetle's natural aggregation behavior. The attractant mixture frontalure (frontalin plus *alpha*-pinene) was evaluated in a trap-tree application with the herbicide cacodylic acid (Vité 1970). The technique was influenced by several variables and met with limited success (Coulson et al. 1973a, 1973b, 1975). Frontalure was evaluated in an infestation-wide, aerial application to determine its effectiveness in disrupting the aggregation behavior of the southern pine beetle and the ability of the beetle to attack and colonize host trees (Vité et al. 1976). The application was not successful in halting activity in the infestation, since it resulted in increased attack on host trees. How-

¹ Respectively, Professor, Department of Entomology, Texas A&M University, College Station, TX; Research Associate and Professor, Department of Entomology, University of Georgia, Athens, GA; and Technicians, Texas A&M University, College Station, TX. (This is Texas Agriculture Experiment Station Paper No. 20516. The work was funded in part by McIntire-Stennis project 1525, the USDA-Forest Service, RD&A Program for Bark Beetles of Southern Pines, and funds allocated to the Georgia Agricultural Experiment Stations. We thank R. Billings, C. Bryant, T. Coffey, M. Dalusky, J. Delorme, C. Russell, D. Ivans, J. Morrissey, and T. Potter for assistance in the field research.)

ever, the attractant mixture does have implication for use in aggregating beetles within an infestation to be salvaged.

Frontalure's aggregating effect on southern pine beetles suggested the mixture might have application in halting infestation growth when applied selectively within an infestation, rather than areawide.

In an attempt to determine the effects of frontalure on southern pine beetle infestations in a combination of interruption and bait-tree methods, Richerson et al. (1980) conducted a series of field tests in two active infestations, each of ca. 75 loblolly pines (*Pinus taeda* L.), in Montgomery County, TX.

The number of newly-attacked trees was monitored during a pretreatment period, a treatment period, and a post-treatment period after the attractant had been removed from the infestation. All host trees containing either emerging brood adults, callow adults, pupae, or 1st to 4th instar larvae, and all nonhost trees in the area of those infested host trees were baited. The synthetic attractant was not placed adjacent to naturally attractive sources at the front of the infestation.

All tests showed that no previously uninfested trees came under successful mass attack during the frontalure treatment periods as opposed to during the pre- and post-treatment periods when southern pine beetles were successfully attacking host trees.

This study concluded that the placement of frontalure within the infestation interrupted the spot growth phenomenon of beetle activity by containing emerging broods and randomly redistributing beetle numbers throughout the infestation. Consequently, insufficient numbers of beetles were present at the active front to successfully overcome host resistance. Beetle activity outside the treated area did not occur. The normal infestation spot growth/beetle attack behavior was reestablished after the frontalure treatment was removed.

Results indicated the feasibility of attractant use in southern pine beetle control. Keeping beetles in an area of the infestation not conducive to population growth may disrupt spot dynamics to the extent that expansion is slowed greatly or stopped altogether. Hypothetically, if beetles are kept from aggregating on suitable hosts, they will succumb to the influence of abiotic and biotic factors.

In their tests, Richerson et al. (1980) did not consider the duration over which infestation growth could be suppressed in the presence of artificial attractants. Our study initiated field tests in Texas and Georgia to obtain that information and to determine the potential for using frontalure as a tactic to suppress infestations of the southern pine beetle under both epidemic and endemic population levels.

Infestations

Candidate southern pine beetle infestations for test sites were categorized by the following parameters to aid in determining the likelihood an infestation would expand if left untreated: (1) Number of active trees, (2) predominant life stage in active trees, (3) tree species composition, (4) stand density, (5) edaphic barriers, and (6) available uninfested host type. All currently infested trees were marked. A pretreatment evaluation period of at least 1 week was generally used to select infestations that were actively growing. Candidate infestations were visited weekly to monitor for the presence of newly attacked trees. Only infestations with a high likelihood of growth were selected for use in the test. In most cases, test infestations were limited to those in the 20–50 infested tree range due to the fact that, with the availability of host type, infestations in that size range have a high probability for growth (Hedden and Billings 1979).

Because of the extensive variability that can occur between paired infestations selected as controls and treatments, pretreatment evaluation periods of each potential test infestation were used to provide control data. That is, a given infestation was not treated unless the rate of growth during the pretreatment period indicated the infestation would expand if left untreated.

In Texas, southern pine beetle infestation density was at epidemic proportions in many areas. As a result, the infestations treated in Texas were, in general, within close proximity of other active infestations. In Georgia, southern pine beetle activity was at endemic levels, and treated infestations were isolated.

Treatments

Frontalure was eluted from four different elution devices: 1. Screw cap vials and filters (Billings et al. 1980), 2. prototype polyethylene bubblecaps (Phero Tech Inc.)², 3. a prototype pest striplike device in which frontalure and *alpha*-pinene were contained separately in two elution bubbles on its surface (Bend Research Inc.)³, and 4. an acrylic polymer microencapsulant spray formulation. All devices were intended to elute at a rate of 75–80 mg/tree, and contained enough attractant for an estimated

² Phero Tech Inc., Vancouver, B.C., Canada.

³ Bend Research Inc., Bend, OR, U.S.A.

elution period of 50 days. However, during the course of the field season, it became evident that the attractant was being eluted faster from the vials, prototype bubblecaps, and pheromone-strips than had been anticipated. As a result, it was necessary to retreat with attractant 1-3 weeks after the initial treatment in infestations where these devices were used.

Eleven southern pine beetle infestations were treated in Georgia (table 1); 10 (1-10) with screw cap vials and 1 (11) with the microencapsulant formulation. In Texas, 25 infestations were baited (table 2); 18 with screw cap vials (1-18), 3 with bubblecaps (21-23), 2 with pheromone-strips (19, 20), and 2 with the microencapsulant formulation (24,25).

Elution devices (vials, bubblecaps, and pheromone-strips) were placed at 3 m on selected host and non-host trees. The microencapsulant formulation was prepared by mixing frontalure and acrylic polymer at a ratio of 1:50. With a handheld garden sprayer, 200 ml of the formulation was applied to a 30 cm² area at d.b.h. on the bark of selected host and non-host trees. All host trees containing either emerging brood adults, callow adults, pupae, or first to late instar larvae were baited (fig. 1). Host trees that contained predominantly parent adults at 2 m (new attacks) were not baited. The attractant was not placed adjacent to the most recently attacked trees located at the head of infestation, since it would likely have attracted beetles to nearby uninfested trees and promoted infestation growth.

Monitoring

In all infestations selected for treatment, trees containing beetles were flagged, dated, and categorized as to predominant life stage. Infestations were cruised weekly. All newly attacked trees were flagged, dated, and categorized as to life stage. Treatment

effect was measured by the number of newly attacked trees.

Infestations were baited with pheromone in June through October 1983 and May through November 1984 in Texas and July through September 1983 in Georgia.

RESULTS AND DISCUSSION

The attractant greatly suppressed or stopped infestation growth under the endemic infestation density levels in Georgia (fig. 2A, table 1). Six of the 11 infestations treated (5, 7-11) had completely stopped growing by the end of the monitoring periods, ca. 40-60 days. The growth that did occur was reduced from 30 to 100 percent from that which occurred before treatment. Although the remaining five infestations (1-4, 6) were not stopped by the treatment, the rate of growth was reduced 34-96 percent from that which occurred before treatment.

The effect of treatment was less pronounced under epidemic infestation density levels in Texas. Five infestations (13, 19, 20, 23, 25) showed no growth by the end of the monitoring period. In infestation "13", all newly attacked trees had been felled immediately prior to treatment of the infestation with attractant. Seven additional infestations (8, 11, 12, 14, 15, 16, 24) did show some level of reduction in growth (8-80 percent) after treatment (fig. 2B, table 2). However, of the 25 infestations treated, over half showed no reduction in growth rate after treatment.

A review of aerial survey maps revealed as many as 10 infestations per 2.6 km² in the area of the infestations treated in Texas. By comparison, there was an average of less than one infestation per 2.6 km² area in Georgia. The findings suggest that frontalure application has potential use in suppressing southern pine beetle infestations under endemic infestation densities to prevent population buildups.

Table 1. — Number of infested trees and growth rates of infestations under endemic population conditions before and after treatment with frontalure in Georgia, 1984

Infestation	Infested trees pretreatment	Growth rate (trees/day)	Newly infested trees, post-treatment (days)	Growth rate (trees/day) post-treatment	% Growth rate change (+ or -) pre- vs post-treatment
1	18	0.6	13 (67)	0.2	- 96
2	55	2.5	17 (22)	0.8	- 69
3	51	1.1	53 (72)	0.7	- 34
4	63	3.4	45 (73)	0.6	- 82
5	81	1.8	10 (51)	0.2	- 89
6	46	1.8	35 (57)	0.6	- 66
7	61	0.9	1 (60)	0.01	- 98
8	25	0.1	2 (40)	0.1	- 30
9	32	0.4	0 (62)	0	-100
10	32	0.7	2 (61)	0.03	- 95
11	58	0.9	1 (60)	0.02	- 98

Table 2. — Number of infested trees and growth rates of infestations under endemic population conditions before and after treatment with frontalure in Texas, 1984

Infestation	Infested trees pretreatment	Growth rate (trees/day)	Newly infested trees, post-treatment (days)	Growth rate (trees/day) post-treatment	% Growth rate change (+ or -) pre- vs post-treatment
1	85	4.0	98 (19)	5.2	+ 30
2	87	2.1	54 (24)	2.3	+ 5
3	74	0.6	41 (14)	2.9	+433
4	76	2.6	93 (35)	2.7	+ 4
5	58	1.0	58 (34)	1.7	+ 70
6	49	2.0	16 (8)	2.0	0
7	50	1.3	43 (22)	1.9	+ 51
8	56	2.6	22 (21)	1.0	- 60
9	41	0.7	49 (28)	1.7	+162
10	52	1.7	60 (29)	2.1	+ 20
11	41	1.0	36 (42)	0.9	- 14
12	39	2.0	90 (49)	1.8	- 8
13	37	1.0	0 (24)	0	-100
14	29	1.7	14 (43)	0.3	- 80
15	44	1.9	60 (41)	1.5	- 23
16	50	3.0	32 (33)	1.0	- 67
17	36	0.8	60 (34)	1.8	+125
18	34	0.8	73 (34)	2.2	+175
19	21	0.3	38 (238)	0.2	- 33
20	23	1.3	36 (238)	0.2	- 85
21	51	0.7	19 (14)	1.4	+100
22	76	2.3	31 (13)	2.4	+ 4
23	28	0.2	30 (142)	0.2	0
24	45	1.2	36 (36)	1.0	- 17
25	33	0.4	44 (197)	0.2	- 50

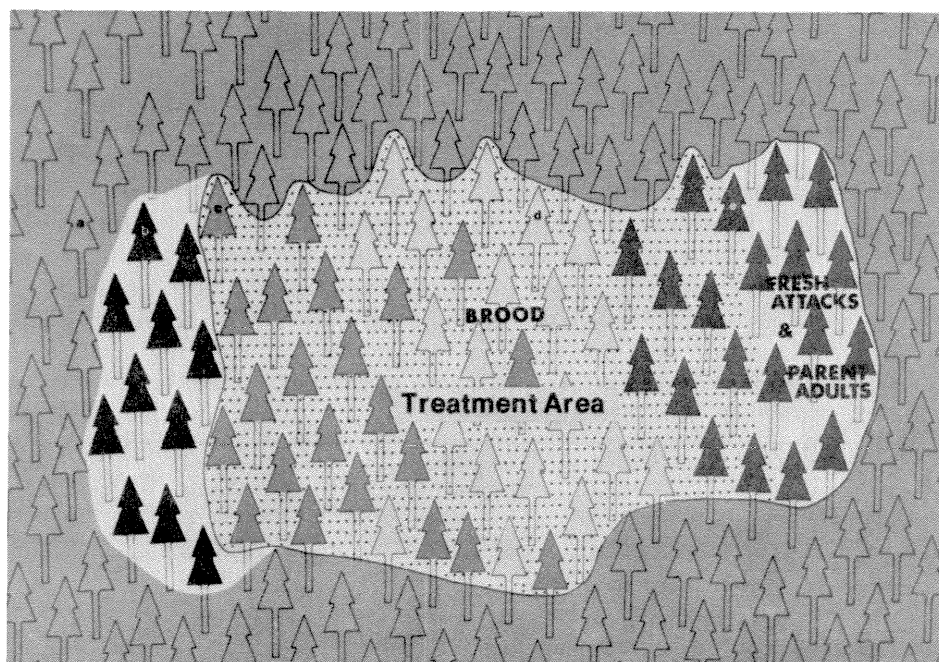

Figure 1.—Schematic of the attractant-treated (frontalure) area within an active southern pine beetle infestation. The clear area represents the infestation. The stippled area represents the treated trees and developing brood. (a) Treated trees; (b) old attacked trees, beetles no longer present; (c) primarily pupae, callow adult, and brood adult trees; (d) primarily late egg, larval brood trees (Payne 1981).

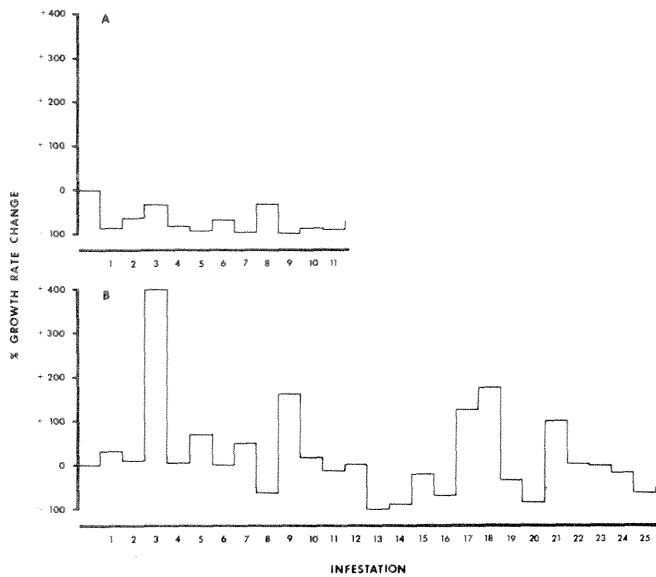

Figure 2.—Percent increase (+) or decrease (—) in the growth rate of infestations after treatment with frontalure under (A) endemic and (B) epidemic infestation conditions.

Under epidemic conditions, the tactic appears to be less effective in suppressing infestations. As a result, it is proposed for use in suppressing small spots of less than 50 trees to prevent population buildup to epidemic levels and to delay or stop spot growth. This would enable the timely application of salvage efforts. Use of the microencapsulant formulation can facilitate quick and easy application of the procedure during groundcheck operations.

The attractant tactic will be pilot-tested for operational use during the summer of 1985, in cooperation with the U. S. Forest Service, State and Private Forestry. A procedural guide will be developed for use of the tactic and will include sections on the following: (1) Infestation parameters, (2) application of the tactic, (3) post-treatment evaluation.

LITERATURE CITED

- Billings, P. D.; Roberts, E. A.; Payne, T. L. Controlled release device for southern pine beetle behavioral chemicals. *J. Ga. Entomol. Soc.* 16(2): 181–185; 1980.
- Borden, J. H. Aggression pheromone in the Scolytidae. In: Birch, M.C., ed. *Pheromones*. Amsterdam: North Holland Publishing Co.; 1974: 135–160.
- Coster, J. E. Towards integrated protection from the southern pine beetle. *J. For.* 75(8): 481–484; 1977.
- Coulson, R. N.; Oliveria, F. L.; Payne, T. L.; Houseweart, M. W. Variables associated with use of frontalure and cacodylic acid in suppression of the southern pine beetle. 1. Factors influencing manipulation to prescribed trap trees. *J. Econ. Entomol.* 66(4): 893–896; 1973a.
- Coulson, R. N.; Oliveria, F. L.; Payne, T. L.; Houseweart, M. W. Variables associated with use of frontalure and cacodylic acid in suppression of the southern pine beetle. 2. Brood reduction in trees treated with cacodylic acid. *J. Econ. Entomol.* 66(4): 897–899; 1973b.
- Coulson, R. N.; Foltz, J. L.; Mayyasi, A. M.; Hain, F. P. Quantitative evaluation of frontalure and cacodylic acid treatment effects on within-tree populations of the southern pine beetle, *Dendroctonus frontalis* Zimmermann. *J. Econ. Entomol.* 68(5): 671–678; 1975.
- Hedden, R. L.; Billings, R. F. Southern pine beetle: factors influencing the growth and decline of summer infestations in East Texas. *Forest Sci.* 25(4): 547–556; 1979.
- Kinzer, G. W.; Fentiman, A. F.; Page, T. F.; Foltz, J. L.; Vité, J. P.; Pitman, G. B. Bark beetle attractants: identification, synthesis and field bioassay of a new compound isolated from *Dendroctonus*. *Nature* 221(5179): 477–478; 1969.
- Leuschner, W. A.; Thatcher, R. C.; Payne, T. L.; Buffam, P. E. ESPBRAP—an integrated research and applications program. *J. For.* 75(8): 748–780; 1977.
- Payne, T. L. Disruption of southern pine beetle infestations with attractants and inhibitors. In: Mitchell, E. R., ed. *Management of insect pests with semiochemicals*. New York: Plenum Publishing Corp.; 1981: 365–383.
- Payne, T. L.; Coster, J. E.; Richerson, J. V.; Edson, L. J.; Hart, E. R. Field response of the southern pine beetle to behavioral chemicals. *Environ. Entomol.* 7(4): 578–582; 1978.
- Renwick, J. A. A. Chemical aspects of bark beetle aggregation. In: *Symposium on population attractants*. *Contri. Boyce Thompson Inst.* 24(13): 337–343; 1970.
- Renwick, J. A. A.; Vité, J. P. Bark beetle attractants: mechanism of colonization by *Dendroctonus frontalis*. *Nature* 224: 1222; 1969.
- Richerson, J. V.; McCarty, F. A.; Payne, T. L. Disruption of southern pine beetle infestations with frontalure. *Environ. Entomol.* 9(1): 90–93; 1980.
- Vité, J. P. Pest management systems using synthetic pheromones. In: *Symposium on population attractants*. *Contri. Boyce Thompson Inst.* 24(13): 343–350; 1970.
- Vité, J. P.; Francke, W. The aggregation pheromones of bark beetles: progress and problems. *Naturwiss.* 63(43): 550–555; 1976.
- Vité, J. P.; Hughes, P. R.; Renwick, J. A. A. Southern pine beetle: effect of aerial pheromone saturation on orientation. *Naturwiss.* 63(1): 44; 1976.

SESSION III—MANAGEMENT APPROACHES AND IPM SYSTEMS

IPM Systems

Simulation of Southern Pine Beetle-Associated Timber Loss Using CLEMBEETLE

Roy L. Hedden¹

Abstract.—CLEMBEETLE is a simulation model for the southern pine beetle (SPB) with the capability to project beetle-caused damage on a stand basis. Stand level losses can be aggregated to obtain multicounty and regional estimates of loss. The type of loss considered is the expected proportion of the stand killed. This value can be used to estimate the volume killed due to beetle attack.

Additional keywords: *Dendroctonus frontalis* Zimm., infestation probability, spot growth, southern pine.

SIMULATION PROCEDURE

The CLEMBEETLE damage projection system considers the damage occurring in many potential spots. This requires that the probability of an infestation occurring and the eventual size of the individual spot be determined. These components of loss are simulated for each year as follows:

1. Calculate the probability of an infestation occurring per acre (P), and test to see if the spot occurs by comparing P with a uniform random number (R) on the interval from 0–1. If a spot does not occur ($P < R$), generate another P .

2. If a spot is created ($P \geq R$), then generate the number of active trees (AT).

3. Calculate the probability of spot being inactive (PI), and test to see if the spot is active by comparing PI with a uniform random number (R) on the interval 0–1.

4. If the spot is inactive ($PI \geq R$), then generate the number of dead trees in an inactive spot. ($DEADI$).

5. If a spot is active ($PI < R$), then generate the number of trees killed per day (TK), and the number of days a spot is active ($DAYS$).

6. Calculate the number of trees killed in the active spot: $DEADACT = (TK * DAYS) + AT$.

7. Repeat this procedure 200 times accumulating $DEADI$ and $DEADACT$: $TOTKILL = \sum DEADI + \sum DEADACT$.

8. Calculate the expected number of trees killed: $ELOSS = TOTKILL / 200$.

9. Calculate the proportion of the stand killed ($PKILL$) by dividing $ELOSS$ by the number of pine trees per acre (PPA): $PKILL = ELOSS / PPA$.

10. Multiply the proportion of the stand killed by the proportion of the total region in an outbreak condition to obtain a weighted proportion of the stand killed. Then use this proportion to obtain the expected volume killed.

MODEL INPUT

The input necessary to run the CLEMBEETLE simulation program is mean diameter at breast height, total and pine basal area per acre, proportion of pine in the stand, number of pine stems per acre, and the predominant pine species (loblolly or shortleaf) in the stand. Additional data needed to run the model for the Piedmont are the clay content of the surface soil, percent slope, and stand origin (planted or natural). Additional input needed for the Coastal Plain is landform (bottom, ridge, and sideslope).

SYSTEM COMPONENTS

The Probability of Infestation

The data set generated by the Coordinated Site/Stand Regional Project of the Expanded Southern Pine Beetle Research and Applications Program (ESPBRAP) (Coster and Searcy 1981) was used to develop logistic models for predicting the probability of SPB infestation.

The data set was stratified by geographical sub-region with separate models being developed for the Piedmont and Coastal Plain regions. Natural and planted stands, as well as disturbed and undisturbed plots, were combined for the analysis. Interaction terms between independent variables were included when appropriate. A complete description of these models can be found in Hedden and Belanger (1985).

Spot Growth and Inactivity

The spot growth equations developed by Reed et al. (1981) are used to estimate the number of

¹ Professor, Department of Forestry, Clemson University, Clemson, SC.

trees killed per day. The equation requires as input the number of initial active trees, SPB population level expressed as the number of spots per 1,000 acres of susceptible host type, diameter at breast height, and total basal area per acre.

The number of initial active trees (AT) is the number of active trees at ground check. This number is generated as a random exponential variate with an expected value (EX) of active trees specified by the user ($AT = -EX \ln r$, where r is a uniform random variate from 0-1 and \ln is the natural logarithm). The default value for EX is .15 times the number of trees per acre.

The user also has the option of specifying the SPB population level for simulation purposes. The default value of population level is two spots per 1,000 acres of host type.

The probability of a spot being inactive within 30 days of detection is determined using the equation developed by Hedden and Reed (1980). If the spot is predicted to be inactive, then the number of dead trees (DEADI) is generated as a random exponential variate with an expected value (EX) specified by the user ($DEADI = -EX \ln r$). The default value for EX is 11 dead trees.

The number of trees dead (DEADACT) in an active spot is the product of the number of trees killed per day (TKD) and the number of days the spot is active (DAYS), plus the number of initial active trees ($DEADACT = [TKD * DAYS] + AT$). The number of days a spot remains active is generated as a random exponential variate with an expected value (EX) specified by the user ($DAYS = -EX \ln r$). The default value of EX is 45 days.

MODEL VALIDATION

Methods

The ability of CLEMBEETLE to predict region-wide losses was tested using forest survey data for the region encompassed by the Southern and Southeastern Forest Experiment Stations of the USDA Forest Service.

Loss simulation was accomplished by the following steps:

- (1) Calculate the probability of an infestation occurring per acre (PROB).
- (2) Generate the number of active trees (AT).
- (3) Calculate the probability of spot being inactive at detection (PROBI).
- (4) Test to see if the spot is inactive.
- (5) If the spot is inactive at ground check, calculate the number of dead trees (DEADI).
- (6) If the spot is not inactive, calculate the number of trees killed per day (TKD).

(7) Calculate the number of trees killed in an active spot: $DEADACT = (TKD * DAYS) + AT$.

(8) Calculate the expected number of trees killed (ELOSS):

(a) inactive spots: $ELOSS = PROB * DEADI$, and

(b) active spots: $ELOSS = PROB * DEADACT$.

For each State, these steps were repeated 150 times for each forest survey plot that contained forest types susceptible to SPB. The sum of the ELOSS's was divided by 150 to obtain the average expected numbers of trees killed.

The expected volume per acre killed by the SPB was obtained by multiplying ELOSS by the average pine volume per tree for each survey plot. The average pine volume per tree was derived from the total pine volume per plot and the number of growing stock trees per plot. For the area covered by the Southeastern Forest Experiment Station, the number of growing stock trees per acre was derived from the total number of live stems per acre, age, and basal area per acre. Survey data for the Southern Forest Experiment Station did not include the number of live stems per acre; therefore, trees per acre were estimated using forest type, age, and observed basal area per acre.

The expected volume killed per survey plot was multiplied by the volume expansion factor for that plot. The expanded volume killed was then totaled for the survey unit.

In order to determine the reliability of the results of the simulation procedure, actual published data on the volume killed by the SPB (Price and Doggett 1982) were compared to the simulated losses for the southern region. Data for the decade 1971 to 1980 were used in the analysis. For each survey unit, predicted losses for the moderate SPB population level (two spots/1,000 acres) were multiplied by the proportion of the unit area in an outbreak condition in each year. These adjusted loss estimates were added to obtain total decade losses by survey unit. The unitwide losses were then aggregated to obtain State and regional totals.

In order to obtain the loss projections, an estimate of the average number of days a spot is allowed to grow was needed. During outbreak periods, most States make three to four detection flights a year. Assuming the flights were optimally timed, and that the spots were either controlled or inactive within 30 days of detection, the average interval of spot growth (De Steiguer and Hedden)² is:

² Unpublished data.

Number of flights	Days of spot growth:	
	Piedmont	Coastal Plain
3	71	76
4	65	70

When these periods of spot growth were used to generate expected losses, the results in table 1 were obtained.

Results

The results indicate a positive bias in the predictions. An average period of 65 days between spot occurrence and control is probably optimistic. Reported periods between detection and control in East Texas for 1974 and 1975 were 53 and 35 days, respectively (Texas Forest Service 1976). During this period, the Texas Forest Service was flying seven or more detection flights a year, which means that the average period of spot growth was between 65 and 83 days. If the average period a spot grows is assumed to be 75 days, then the results in table 2 are obtained for each of the States.

On a statewide basis, the poorest predictions were for Arkansas and Tennessee, States that are on the extreme northern range of the SPB. Even including these States, the rank correlation between the observed and predicted volumes killed is 0.8 (Spearman's rank correlation, statistically significant at 99.5 percent level).

Table 1. — Predicted average annual cubic feet of volume killed by the southern pine beetle in 10 southern States

Days of spot growth	Predicted volume killed ¹	Difference between predicted and observed ²	Percent error ³
	<i>cubic feet × 10⁶</i>		
65	131.235	3.359	2.56
70	137.619	9.743	7.08
71	138.895	11.019	7.93
76	145.279	17.403	11.98

¹ Predicted volume killed includes an average buffer strip volume of 30 percent for all salvaged spots.

² Observed average volume killed including buffer strip trees (Price and Doggett 1982) for 1971 to 1980 are 12.788×10^6 cubic feet; cords and MBF were converted to cubic feet using factors of 70 cu. ft./cord and 210 cu. ft./MBF.

³ Percent error = (predicted - observed)/predicted.

There were many potential sources of error in this comparison of predicted and observed volumes killed by the SPB. The data on the observed volume killed were those reported by each State. The degree of emphasis given to pest control activities, the level of the personnel involved, and the methods of reporting volume killed vary greatly from State to State. The data are adequate for internal use by the States, but may be less than satisfactory for model validation purposes. This is especially true for the volume killed but not salvaged. Furthermore, the conversion factors used to obtain cubic foot volume from cords and MBF can also be a source of bias.

There was also potential error associated with the method of determining the buffer strip volume from the simulation results. It was assumed that, of the total volume salvaged, an average of 30 percent consisted of buffer strip trees. This value, expressed as a proportion, was multiplied by the reported average proportion of the total volume killed that was salvaged and by the total predicted volume killed in each State to obtain the predicted volume of buffer strip trees. This volume was added to the predicted volume killed to obtain the combined volume lost to SPB.

The forest survey was also a source of potential error. Data were collected at a single point in time and were used to generate predicted losses, which were compared to average observed losses over a decade. However, forest conditions were dynamically

Table 2. — Predicted and observed average annual cubic feet of volume killed by the southern pine beetle if the average infestation grows for 75 days

State	Predicted volume killed	Observed volume killed ²	Percent error ³
	<i>----- cubic feet × 10⁶ -----</i>		
Alabama	21.250	34.374	- 61.76
Arkansas	8.892	1.560	82.44
Georgia	17.612	20.541	- 16.63
Louisiana	14.215	4.434	68.81
Mississippi	12.794	7.050	44.90
North Carolina	26.930	21.272	21.01
South Carolina	13.780	14.862	- 7.85
Tennessee	2.285	6.436	181.66
Texas	21.011	14.137	32.72
Virginia	5.143	3.211	37.56

¹ Predicted volume killed includes an average buffer strip volume of 30 percent for all salvaged spots.

² Observed average volume killed including buffer strip trees for 1971 to 1980 (Price and Doggett 1982); cords and MBF were converted to cubic feet using factors of 70 cu. ft./cord and 210 cu. ft./MBF.

³ Percent error = (predicted - observed)/predicted.

changing; thus, the overall susceptibility and vulnerability of the forest to SPB attack were changing from year to year. Furthermore, some modification of the simulation program was necessary to accommodate the forest survey data. These modifications resulted in the use of some submodels with reduced predictive ability.

Finally, the survey data obtained from the Southern Forest Experiment Station included age expressed in 10-year increments and did not include information on the number of trees per acre; therefore, number of trees had to be generated from other survey plot variables, one of which was age. This procedure was less than satisfactory, and it is reflected in the simulation results where the average error associated with States in the Southern region is much greater than in the Southeastern region.

Forest experiment station	Predicted volume killed (<i>cu. ft. × 10⁶</i>) ³	Observed volume killed (<i>cu. ft. × 10⁶</i>)	Percent error ⁴
Southern ¹	80,437	67,991	15.47
Southeastern ²	63,465	59,886	5.64

¹ Alabama, Arkansas, Louisiana, Mississippi, Tennessee, and Texas.

² Georgia, North Carolina, South Carolina, and Virginia.

³ Based upon an average period of spot growth of 75 days.

⁴ Percent error = (predicted - observed)/predicted.

In summary, the simulation program seems to slightly overpredict volume killed by the southern pine beetle on a regional basis. Overprediction appears to be greater for the States in the forest survey region of the Southern Forest Experiment Station. The predictions for the States covered by the Southeastern Station survey (Georgia, North Carolina, South Carolina, and Virginia) are close to the observed volumes killed when all the sources of potential error are considered.

MODEL LINKAGES

CLEMBEETLE can be linked to a growth and yield model to provide estimates of pine volume killed in the presence of the southern pine beetle. The pine volume killed can be subtracted from the unadjusted volume to obtain the expected volume per acre in the presence of beetles. These modified yields

can then be used as input to a financial model to analyze the expected economic impact of SPB under varying management scenarios.

SUMMARY

CLEMBEETLE is a flexible damage projection system used to simulate representative losses caused by the southern pine beetle in pine stands. The model uses easily obtainable growth and yield data as input. The simulation output is the proportion of the stand killed by the southern pine beetle. This damage estimate is used to adjust pine yield for SPB-caused losses. The modified yield is used as input for a financial model to obtain an estimate of the economic impact of SPB-caused damage in a pine stand. Alternative forest management and SPB control scenarios can be evaluated through modification of the model parameters and input to provide guidelines to forest managers and pest control specialists for management of pine forests to reduce losses from the southern pine beetle.

LITERATURE CITED

- Hedden, R. L.; Belanger, R. P. Predicting susceptibility to southern pine beetle attack in the Coastal Plain, Piedmont, and Southern Appalachians. In: Branham, Susan J.; Thatcher, Robert C., eds. Proceedings, integrated pest management research symposium; 1985 April 15-18; Asheville, NC. Gen. Tech. Rep. SO-56. New Orleans, LA: U.S. Department of Agriculture, Forest Service, Southern Forest Experiment Station; 1985.
- Hedden, R. L.; Reed, D. D. Southern pine beetle: Factors influencing the growth and decline of summer infestations. In: Stephen, F. M.; Searcy, J. L.; Hertel, G. D., eds. Modelling southern pine beetle populations: symposium proceedings; 1980 February; Raleigh, NC. Tech. Bull. 1630. Washington, DC: U.S. Department of Agriculture; 1980: 145-151.
- Price, T. S.; Doggett, Coleman. A history of southern pine beetle outbreak in the southeastern United States. Macon, GA: Georgia Forestry Commission; 1982. 35 p.
- Reed, D. D.; Burkhart, H. E.; Leuschner, W. E.; Hedden, R. L. A severity model for southern pine beetle infestations. For. Sci. 27: 290-296; 1981.
- Texas Forest Service. Texas forest pest activity 1974-1975 and forest pest control section biennial report. TFS Circ. 226. College Station, TX: Texas Forest Service; 1976. 19 p.

SPB-MICROBEETLES: A Simulation System for Evaluating Economic Performance of Management Alternatives for Stands Attacked by Southern Pine Beetles

William A. Thompson¹

Abstract.—SPB-MICROBEETLES is a management tool for foresters managing southern pines that are subject to losses from southern pine beetles. Using basic stand inventory data, historic SPB infestation levels, and price and cost data, the system projects economic returns for a variety of user-selected management scenarios. The results provide the manager with a good comparative basis for planning thinning and SPB control of loblolly and slash pine stands over one rotation.

Additional keywords: Stand growth, loblolly pine, financial analysis, insect impacts, management strategies.

INTRODUCTION

SPB-MICROBEETLES is a simulation forecasting tool for projecting stand yield and economic return from southern pines subject to attack by southern pine beetles (SPB). Its primary purpose is to provide forest managers with a means of comparing the economic tradeoffs of various SPB management strategies, including both thinning and direct SPB control treatments. The model combines stand growth and yield projection with management simulation. The costs and revenues generated are provided to the user in a number of reports. The system's modest input requirements (standard forestry inventory data) and implementation on a popular microcomputer (Apple II®, II®+, IIe®, and IIc®) make it a readily accessible and practical tool for the practicing forest manager.

¹ Assistant Professor, Appalachian Environmental Laboratory, University of Maryland, Frostburg, MD (and CSIRO, Division of Forest Research, Banks Street, Yarralumla, ACT 2600, Australia). (This research was supported by the IPM Program for Bark Beetles of Southern Pines, USDA Forest Service, Pineville, LA. The conceptual framework and many of the components of this model were derived from ITEMS, a mainframe computer model developed in conjunction with J. M. Vasievich of the U.S. Forest Service's Southeastern Forest Experiment Station, Research Triangle Park, NC.)

METHODS

SPB-MICROBEETLES combines a number of models: stand growth and yield; product mix; SPB infestation and timber loss; low thinning; and SPB control treatments. Associated with each management treatment are stand response, SPB response, and cash flow (cost or revenue). Standard accounting methods are used for calculating the net present value of the time stream of cash flows for the simulated period through to final harvest.

Stand Growth and Yield

The user provides initial data on stand conditions. From this, stand growth and yield are calculated using Schumacher and Coile's (1960) equations for natural stands of loblolly or slash pine. For both forest types, stand growth is projected in yearly increments from height growth, stocking/basal area, and mortality equations. Inputs required by the model are site index, stand age, height, basal area and density.

1. Height

$$H_{t+1} = H_t \exp[h_1 \ln(10) + h_2 \ln(SI_{50})] / A_t / A_{t+1}$$

2. Stocking/Basal Area

$$S_t = B_t R_t$$

$$R_t = b_1 - b_2 H_t + (b_3 - b_3 H_t) / A_t$$

$$S_{t+1} = 100 \exp[(A_t / A_{t+1}) \ln(S_t / 100)]$$

$$B_{t+1} = S_{t+1} / R_{t+1}$$

3. Mortality

$$T_{t+1} = T_t \exp[m_1 \ln(10) / A_t / A_{t+1} + m_2 \ln(H_{t+1} / H_t) + m_3 \ln(B_{t+1} / B_t)]$$

where

H_t = stand height in year t

SI_{50} = site index at age 50

A_t = stand age in year t

h_1, h_2 = height growth parameters

S_t = stocking (percent) in year t

B_t = stand basal area in year t

b_1, \dots, b_4 = stocking/basal area parameters

T_t = stand density in year t

m_1, \dots, m_3 = mortality parameters

\ln = natural logarithm

Parameter values for this set of stand growth equations are given in table 1.

Stand yield is computed for the following volume equation:

$$V_t = v_1 T_t \exp[v_2 \ln(D_t) + v_3 \ln(H_t)]$$

where V_t = stand volume in year t
 D_t = quadratic mean diameter (at breast height)
 v_1, \dots, v_3 = volume parameters

Parameter values for the volume equation are also given in table 1.

Product Mix

The product mix (pulpwood/sawtimber) model determines the separation of timber volume into the two products, pulpwood and sawtimber. Model inputs required are basal area (in square feet/acre) and quadratic mean d.b.h. (in inches).

Model calculations are performed in three steps. First, a diameter distribution for the timber under consideration is calculated. This is done by assuming that the true diameter distribution can be fitted with a three-parameter Weibull distribution. The Weibull in turn can be approximated adequately by a multinomial distribution with six diameter classes. The six classes are centered on 0.5, 0.7, 0.9, 1.1, 1.3, and 1.5 times the quadratic mean d.b.h., with respective frequencies of 2 percent, 14 percent, 36 percent, 36 percent, 11 percent, and 1 percent.

In the second step, the model computes for each diameter class the portions of the volume that are pulpwood and sawtimber. The bole is approximated as the frustum of a cone, with base diameter given by the diameter class and top diameter of 1 inch. That portion of the bole with diameter greater than a user specified minimum (typically 6-8 inches) is taken to be sawtimber; the remainder is pulpwood. With the diameter class= D and the minimum saw-

timber diameter= M , the formula is:

$$\begin{aligned} \text{percent sawtimber} &= (D^3 - M^3)/(D^3 - 1) \times 100\% \\ &\quad \text{for } D > M \\ &= 0\% \\ &\quad \text{for } D < M \end{aligned}$$

One virtue of this formula is the simplicity with which it can accommodate different milling requirements through alternative minimum diameters for sawtimber. In more general terms, the formula is:

$$\begin{aligned} \text{percent sawtimber} &= \\ &= \frac{(\text{basal diam})^3 - (\text{min saw diam})^3}{(\text{basal diam})^3 - (\text{top diam})^3} \\ &\quad \times 100 \text{ percent} \end{aligned}$$

Finally, in the third step, the model takes the total volume for the stand (see above) and apportion it to the diameter classes according to their fractional volumes. Then, for each diameter class, the volume of sawtimber is computed and these volumes are added to give the volume of sawtimber for the stand. Pulpwood volume is the remainder. When the timber comes from a low thinning, a further calculation is made to check that the sawtimber in the residual stand plus that removed adds up to the sawtimber volume of the stand prior to thinning. If it does not, the calculated volume of sawtimber removed is adjusted to eliminate the discrepancy.

SPB Infestation

The SPB infestation and timber damage data were developed from DAMBUGS (Reed 1979, Daniels et al. 1979) and R. Hedden.² In each year, the model projects the number of SPB spots and their month of and size at detection. Then, on a monthly basis, the model projects the rate of spot growth/decline, spot inactivity, and number of trees killed. All spots become inactive during the winter. Model inputs required are the number of acres of timber, the long-term yearly average number of SPB spots/1,000 acres locally, and a random number seed. The model includes stochastic sections in which it computes the probability of an event (e.g., a spot becoming inactive in the current month), and then it draws a random number to determine whether the event takes place. Methods for generation of random numbers on a microcomputer were taken from Sparks (1983) and Law and Kelton (1979).

The spot incidence submodel begins by drawing a random number N_t , the regional mean level of SPB infestation in the current year, from an exponential distribution. The mean value of that distribution is the long-term average number of spots per 1,000

Table 1. — *Parameter values for height/growth, stocking/basal area growth, mortality, and volume equations used in SPB-MICROBETLES*

Parameter	Loblolly	Slash
h_1	6.528	23.907
h_2	0.0	- 9.7172
b_1	0.8407	1.3079
b_2	0.001707	0.006989
b_3	10.62	0.0
b_4	0.1408	0.0
m_1	- 2.6843	- 3.6047
m_2	- 1.7313	- 1.8199
m_3	0.6343	0.5154
v_1	0.0004055	0.0009441
v_2	1.3321	1.6700
v_3	1.7411	1.3475

² Personal communication.

acres locally. An implicit assumption here is that year-to-year infestation levels are largely independent. While this assumption of independence is unlikely to be true for many regions, it introduces no significant errors for simulations covering a few years or more. Next, the number of spots in the stand is obtained by drawing a random number from a Poisson distribution with mean value Q_t , which is calculated as:

$$Q_t = SA / [1 + \exp(C_t + q_1 SI_{50} - q_2 A_t - q_3 b_t / A_t)]$$

$$C_t = \ln(1000/M_t - 1) - q_4$$

where Q_t = mean number of spots/acre in the region for the given stand conditions in year t

SA = stand area in pine

M_t = regional mean spots/1000 acres in year t

$$q_1, \dots, q_4 = 0.0106, 0.0, 0.08400, 0.5107 \text{ for loblolly} \\ = 0.0, 0.00714, 0.00162, 1.0903 \text{ for slash}$$

Each spot thus created is given an initial size and month of detection. Spot size at time of detection is drawn randomly from an exponential distribution with mean number of active trees equal 25. Number of already dead trees is set to 60 percent of the number of active ones. Finally, month of detection is drawn with equal probabilities for each month from February through October.

In each month, once detected, a spot may go inactive with probability I , where

$$I = 1 / [1 + \exp(-1.04 + 0.06J)]$$

and

J = current number of active trees.

If a spot goes inactive, all the currently active trees die. Otherwise, half the currently active trees die. Thus, the average brood tree dies within 2 months of initial attack. In addition, new trees are successfully attacked. The number of newly attacked trees, K , is computed as

$$K = 30 \exp[0.781 + 0.0169B_t + 0.558M_t - 0.788B_t/D_t^2 + 0.965 \ln(J) - 2.847 \ln(D_t)]$$

Finally, the dead trees in a spot are separated into four groups according to how long they've been dead: 0-1, 1-2, 2-3 months, and longer than 3 months. This information is used in estimating salvage value.

Low Thinning

A low thinning removes trees from the lower crown classes of a stand (Smith 1962). The model assumes that these trees are largely in the lower diameter classes (mainly due to suppression), with the remainder being larger diameter trees of poor health, form, or spacing. Figure 1 depicts such a re-

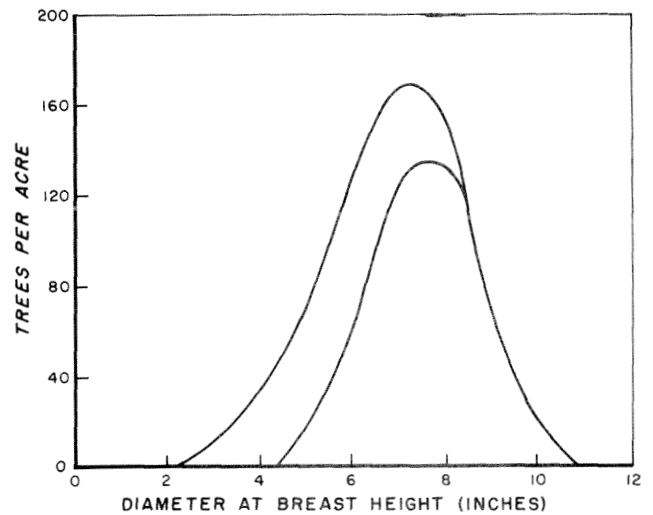

Figure 1.—Idealized diameter distributions of a stand before thinning (Curve A) and after (Curve B).

moval pattern. Thus, for calculating the number of stems removed to achieved a prescribed residual basal area, some assumptions about stand diameter distribution are required. The approach adopted was similar to but more general than the one taken for estimating product mix. In the idealized thinning of figure 1, it is evident that the shapes of the pre- and post-thinning diameter distributions are substantially the same. The key change is in the mean diameter.

A large number of hypothetical stands was generated using the three-parameter Weibull distribution (Matney and Sullivan 1982, Bailey and Dell 1973, Cao et al. 1982). Simulated low thinnings were applied by both removing all stems below some minimum diameter (Min) and removing a linearly declining fraction of the stems from Min to some maximum diameter (Max). The simulated thinnings removed from 10 percent to 60 percent of the basal area. These simulated thinnings were then treated as the data to which a nonlinear regression model was fitted.

$$SR = BR F(BR)$$

where SR = the ratio of residual stems to initial stems

BR = the ratio of residual basal area to initial basal area

$$0 < F(BR) < BR \text{ for } 0$$

$$< BR < 1$$

$$F(1) = 1$$

A variety of functions was tested for $F(BR)$ and fitted using the SAS nonlinear regression package NLIN (SAS Institute 1982). The most successful ($R^2 = 0.94$) was:

$$F(BR) = BR^{BR}$$

The relationship between SR and BR is shown in figure 2.

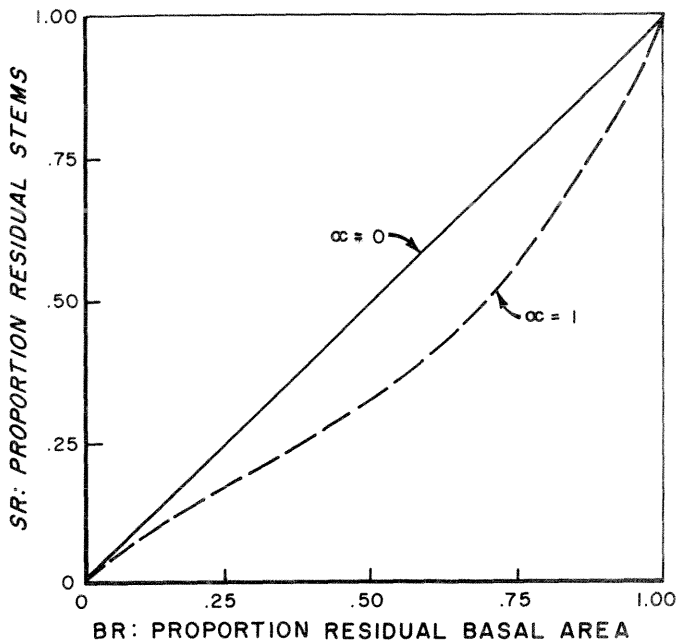

Figure 2.—Relationship for a low thinning between the fraction of basal area that remains and the fraction of stems that remains (labeled $\alpha = 1$). For comparison, a straight line relationship is shown (labeled $\alpha = 0$).

SPB Control

Three methods of SPB control are simulated: salvage, cut-and-leave, and cut-and-spray. The model assumes that each treatment is properly applied, and thus 100 percent effective.

Salvage is one of the most widely used SPB control methods. Its purpose is to utilize the already infested timber while eliminating a beetle spot. In general, salvage is used on infested timber spots that are merchantable and accessible for logging. All merchantable infested and dead timber is removed, with nonmerchantable infested timber being cut-and-left or cut-and-sprayed. In addition, a horseshoe-shaped buffer strip is also cut. This serves to prevent reinfestation and also provide some green timber to make the operation cost effective. A salvage cut is not normally done unless sale value of the material involved covers operational costs (Smith 1960). Since stumpage prices for beetle-killed and infested timber are usually well below those for green timber, some green timber is needed to make the salvage cut profitable.

In the model, the user specifies the conditions under which salvage should be undertaken. He also enters a minimum width for the buffer strip, stumpage price depressions for SPB-killed pulpwood and sawtimber, and a minimum percentage of cut volume that must be green timber in order to make a sale. The model adds additional green timber if necessary

to meet the no-cost criterion, and the buffer is cut wider if the dominant tree height exceeds the minimum buffer width.

Cut-and-leave is an SPB control tactic that has come into extensive use during the past decade since its reintroduction in Texas. It is generally used on small to medium spots to eliminate them or slow their growth until a salvage operation can be done. It is a recommended primary control method on unmerchantable stands. Infested trees are felled toward the center of the spot and a horseshoe-shaped buffer strip cut around the recently attacked trees. The effects of bole drying and heating reduce the size of beetle broods (Coster 1977).

In the simulation model, the user specifies the conditions for application of cut-and-leave. In addition, he must estimate a fixed cost and a variable cost (either per acre or per tree treated) for the operation and a minimum width for the buffer strip. The buffer is cut to the height of the dominant trees if their height exceeds the minimum buffer width.

Cut-and-spray has been declining in popularity as an SPB control treatment. It is generally restricted to high value stands where salvage is considered inappropriate or unfeasible. Only infested trees are treated, as no buffer strip is cut. The infested trees are felled, limbed, and bucked into workable lengths. Then they are sprayed with one of several insecticides to kill the beetles either below the bark or as they emerge. Cut-and-spray is considerably more expensive and labor intensive than cut-and-leave.

In the simulation model, the user supplies cost figures (including chemicals) as for cut-and-leave.

The simulation is continued until the user-specified conditions for the final harvest are met (generally rotation length). At this point, a summary of the simulated results is provided and various options given for providing more detailed results or conducting additional economic analyses.

INPUTS

SPB-MICROBEETLES requires 22 inputs to make a forecast. These inputs and example values are given in table 2. Initial values for these inputs are provided with the program, so that the user only needs to change them to match his site conditions. A menu driven input system makes data entry simple, and values entered are cross checked to catch most typing errors. In addition, a readily available "help" facility allows the user to interrupt data entry to look up procedures for entering data, variable definitions, etc. Where inputs are numeri-

Table 2. — *Input summary and example values for SPB-MICROBEETLES*

Input summary	Example stand
Title of run	
First year	1985
# years to run	12
Random # seed	12345
Stand type	LOBLOLLY
Area (acres)	1000
% area in pine	100
Site index age 25	70
Site index age 50	94
Stand age (yrs)	12
Height (ft)	36
Trees/acre	500
BA (soft/acre)	90
D.b.h. (in)	5.7
Spots/1000 acres	2.0
Pulp (\$\$/cord)	15.00
Saw (\$\$/MBF)	120.00
P-\$\$ Inc. (%/yr)	0
S-\$\$ Inc. (%/yr)	0
Cu ft/cord	82
Cu ft/MBF	180
Min. saw. diam.	8.0

cally dependent, changing one will automatically change the others. For example, changing basal area will automatically adjust stand density (and leave d.b.h. unchanged). Besides these basic stand, SPB, economic, and physical inputs, the user may also specify conditions for final harvest, low thinning, and/or SPB control treatments. In this case, additional inputs are required (see above).

OUTPUTS

SPB-MICROBEETLES keeps a yearly record of stand conditions, SPB spots, timber lost to SPB or SPB control, management treatments and cash flows. Most of this information is made available to the user in the output module of the program. The small size of the "standard" Apple microcomputer, 48K bytes, placed a limitation on the number and variety of output reports and analyses.

The basic output report is shown as table 3. It summarizes stand growth, SPB damages, and cumulative costs and revenues. In addition, it computes the net present value of the timber crop at three discount rates, 0 percent (i.e., net revenue), 4 percent, and 10 percent. All the economic calculations are done in current dollars. That is, inflation rate has been removed from the figures. Thus, these discount rates represent "real" interest rates. Net present value is calculated as:

$$NPV = \sum_{t=1}^{FH} CF_t / [1 + d/100]^t$$

Table 3. — *Output summary and example values for SPB-MICROBEETLES*

Output summary			
Title: Example stand		1000 acres	
Type: Loblolly		30 spots	
Simulation from			
Age 12 to Age 24		Initial	Final
Height (ft)		36	67
BA (sq ft/acre)		90	137
Trees/acre		500	170
D.b.h. (in)		5.7	12.1
Acres lost		0	1.4
Revenues: Final harvest			1427 \$/acre
0 Thinnings (S)			0 \$/acre
0 Salvage (S)			0 \$/acre
Costs: 0 SPB control (S)			0 \$/acre
Net present			
value	0%	4%	10%
(\$\$/acre)	1427	891	455

where FH = number of years simulated (= final stand age — initial age)
 DF_t = net cash flow in year t
d = discount rate as a percent

More detailed reports of final yield and other management treatments are also available (for example, table 4).

A module to perform sensitivity analysis on prices is in the program (see table 5). It is particularly instructive to note the great effect of small changes in the rate of stumpage price increase (or decrease) compared with inflation for sawtimber and/or pulpwood. For example, over 12 years, a 1 percent increase for sawtimber above inflation and 0.5 percent increase for pulpwood resulted in an 11 percent increase in net revenue at final harvest for the example loblolly stand (as given in table 2). This high degree of sensitivity to price shifts shows the need for restraint in using this or any other program for making absolute economic forecasts. Fortunately, this sensitivity in absolute dollars rarely affects the relative worth of one management plan in comparison with another.

SPB-MICROBEETLES can also be used to estimate *soil rent*; that is, the net present value of the cleared land following timber harvest. This estimate is done in either of two ways. The first is to input a site preparation and planting cost. The model assumes that this cost applies to each future timber crop and that all future crops will be identical in yield to the one just simulated. Then the Faustmann formula (cf., Clark 1976) is applied to obtain the net present value of the current plus all future crops (table 6). This can only be done for positive discount rates, so only the 4 percent and 10 percent

Table 4. — *Example harvest results available from SPB-MICROBEETLES*

Harvest guidelines	
Age \geq 24.00	
Harvest	
Total acreage 1000	
Age	24
Year	1997
Acres cut	998.6
Volume cut	2927 cu ft/acre
Sawtimber	10.3 MBF/acre
Pulpwood	13.2 cords/acre
\$/acre	1427
Total \$\$	1,427,047

Table 5. — *Sensitivity analysis data in the SPB-MICROBEETLES program*

Vary economic parameters			
Parameter	Current value		
>Saw timber	\$/MBF		120
>Pulpwood	\$/cord		15
>Saw — yrly % value inc.			1
>Pulp — yrly % value inc.			.5
>SPB — killed saw price dep. %			50
>SPB — killed pulp price dep. %			65
>Recalculate results			
>Finished			
Net present value	0%	4%	10%
(\$\$/acre)	1580	987	504

Table 6. — *Estimate of soil rent (net present value of cleared land following timber harvest) generated by SPB-MICROBEETLES*

Net present value		
Current crop + soil rent		
Multiple rotations (of 24 yrs)		
Site prep + planting costs 150\$/acre		
Values (\$/acre)	4%	10%
Npv 1st crop	891	455
All crops	1308	453
Elv	667	-6

rates are computed. Note that this figure is likely to be an underestimate since future crops can be expected to be more productive per dollar invested through such things as genetically improved seedlings, better seedling survival and stand establishment, and higher stand growth rate.

The second method of estimating soil rent is simply to input a land sale value for the year of final harvest. This value, discounted to the initial year, is the soil rent. Using either method, the model also calculates an "equivalent" land value or site preparation and planting cost. This figure can be used as a guide to whether continued commercial forestry is the economically optimal land use.

RESULTS

The following results are illustrative of the use of the program and indicate general trends. Particular sites and stands should be analyzed on an individual basis. Tables 2-6 show the analysis of a typical loblolly stand. The example stand (table 2) is 1,000 acres of 12-year-old loblolly pine on site index 70 (age 25) land. Basal area is 90 sq. ft./acre, stand density is 500 stems/acre, and the long-term yearly SPB infestation level in the region is 2 spots/1,000 acres. The only management treatment is the final harvest after 12 years, that is, age 24. Table 3 shows that 30 SPB spots occurred in the 12 years, destroying 1.4 acres of timber. This is really a minor loss, just 0.14 percent over the rotation. If no beetles were present for the same period, then the projected net revenue at harvest would have been \$1,429. Table 4 gives more details of the harvest. Table 5 shows the effect of a 1 percent price increase per year (above inflation) in sawtimber and 0.5 percent in pulpwood. The final effect is an 11 percent increase in net present value, regardless of the discount rate. This illustrates the high sensitivity of the economic forecast to uncertainties in economic values. Finally, table 6 shows the net present value for multiple rotations. Soil rent is the difference between lines 2 and 1. The third line gives the "equivalent" land value. Thus, at 4 percent discount rate and \$150 stand establishment costs, the site should be kept in timber production until the land value exceeds \$667. But at 10 percent discount rate, it is better to sell the land at any price after harvest. Naturally, these figures are very rough since they ignore tax considerations.

In addition to its use in management planning for individual stands, SPB-MICROBEETLES can be used to examine more general patterns in southern pine management. Figure 3 shows the influence of harvest age on net present value and cumulative

timber losses. Final harvest revenue increases with rotation length. But net present value peaks for the example stand at a rotation length of about 28 years at 4 percent discount rate and about 20 years at 10 percent. Thereafter, the value declines. This is because the annual increment in value exceeds the discount rate for some years, but eventually declines below the discount rate. And the higher the discount rate, the sooner the net present value of a timber crop starts to decline with increased rotation length. A second example (fig. 4) shows that the age at which a low thinning is done can have a marked effect upon the net present value of a timber stand. While the economically optimal time to thin depends upon the discount rate, a general pattern holds true. Either thin very early, removing little timber but improving the value of the final crop, or delay thinning until past the time when the stand first has trees of sawlog dimensions. The reason for this is that the annual increment in value suddenly accelerates when the stand first begins to yield sawtimber.

Repeated uses of the model have shown several general patterns. Low thinning is almost always profitable, especially at a high (10 percent) discount rate, largely because a portion of the timber is converted into cash early and can earn interest at a faster rate than the timber growth rate (fig. 5). Although the total harvest, final plus thinning, is generally of lower volume than would be obtained without thin-

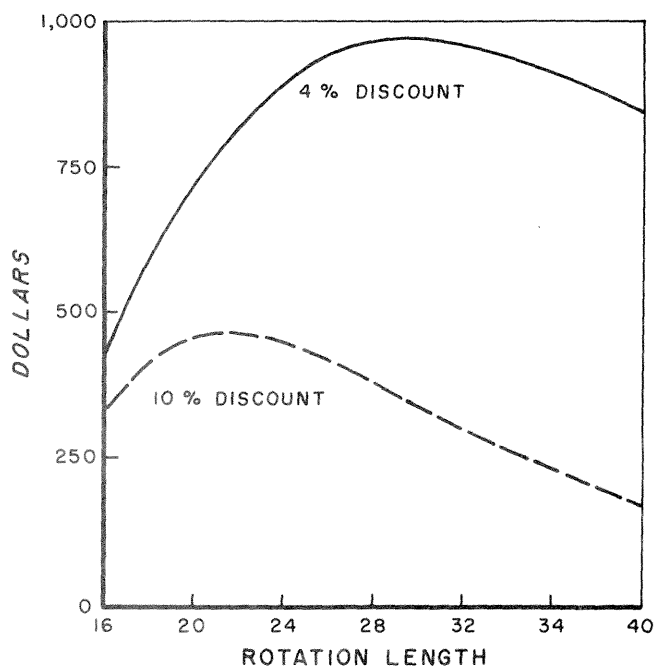

Figure 3.—Net present value of a timber crop at two discount rates, shown as a function of stand age at harvest.

ning, the increased sawtimber portion in the final harvest of the thinned stand makes up in value for the reduced yield. An additional, smaller payoff for thinning comes from harvesting trees that would otherwise have been killed by SPB before the final harvest. The model is very conservative here in that it does not explicitly assume any significant mortality reduction from commercial low thinning, whether through reduced competition or through reduced SPB hazard. This represents an area where changes to the model will be needed if and when such mortality reductions are firmly established.

As noted above, timing can have a major effect on the economic value of a low thinning. During the development of a stand, the discounted value of the standing timber increases quite rapidly for the first few years. Thereafter, the annual increment in discounted value declines steadily until the first trees in the stand reach sawlog sizes. At that time, the discounted value rises at an accelerating rate for a few years, before slowing down again. It is during this phase that thinning is best postponed. The growth model in SPB-MICROBEETLES gives this range of ages as roughly 16 to 20 years, though the exact range depends upon stand and site conditions, stumpage prices, SPB infestation levels, and discount rate.

A third generalization is that SPB control practices, even when 100 percent effective, usually do not

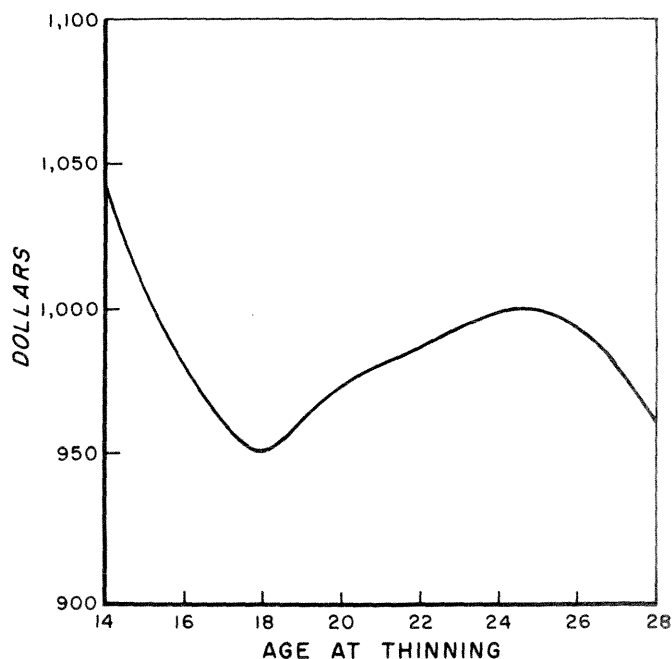

Figure 4.—Net present value of timber at 4 percent discount rate, shown as a function of stand age at the time of thinning. Each point represents a simulation with one low thinning to 80 sq. ft./acre at the given age, and final harvest at age 28.

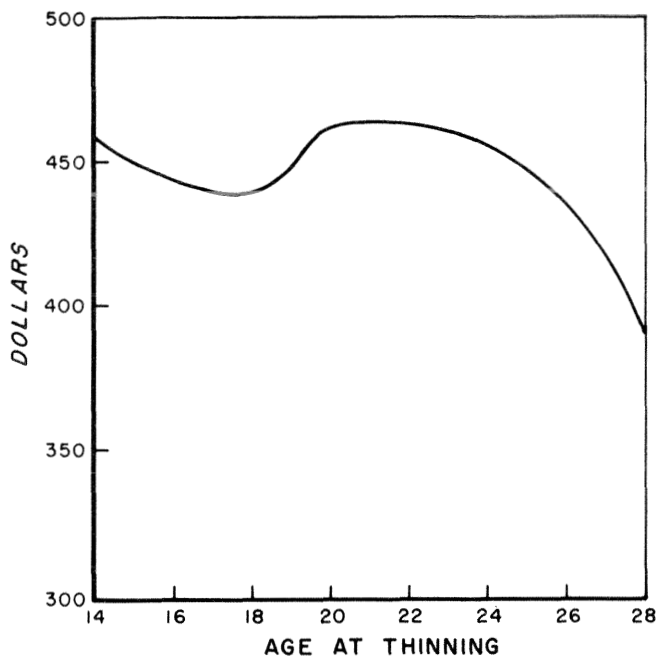

Figure 5.—Net present value of timber at 10 percent discount rate, shown as a function of stand age at the time of thinning. Each point represents a simulation with one low thinning to 80 sq. ft./acre at the given age, and final harvest at age 28.

significantly affect timber value. This is simply because over a full timber rotation of 40 years or less, SPB infestations do not usually cause substantial timber loss. However, in old, dense stands, over very long rotations, on some other high-hazard stands, and for extremely large spots, SPB control measures can have an important economic impact.

CONCLUSIONS

SPB-MICROBEETLES is a simple and practical tool to use for management planning of pine stands, particularly where southern pine beetles are a widespread hazard. As described here, this system can perform useful projections of economic returns and a number of economic analyses. But it does have some major limitations that must be noted.

First, it is not useful as a short-term (few months) management tool. In particular, it cannot give worthwhile information on whether a specific SPB spot will grow or decline; or on how a particular SPB spot will respond to a specific SPB control treatment. *Second*, the absolute dollar values of the economic projections are severely limited by economic uncertainties in future costs and prices and by projections being restricted to pretax dollars. Nonetheless, the relative economic returns of alternative management plans are not usually sensitive to economic uncer-

tainties. That is, a price decline will affect most management plans in about the same way. Furthermore, the individual user can often make suitable adjustments to the projected returns for taxes. *Third*, the yield and/or loss estimates may be inaccurate due to regional bias in the models. As with economic uncertainties, this potential problem will usually have little effect upon the relative merits of management alternatives. Finally, the growth and yield model and the spot incidence, growth, and decline models are not adequate for old stands past 60 years, or for extreme beetle infestation levels (over 12 spots per 1,000 acres per year).

Overall, the model supports the premise that the economic returns available from proper thinning far outweigh the returns available from SPB protection and control measures for short to medium rotation commercial forestry in the South and Southeast.

LITERATURE CITED

- Bailey, R. L.; Dell, T. R. Quantifying diameter distributions with the Weibull function. *For. Sci.* 19: 97-104; 1973.
- Cao, Q. V.; Burkhart, H. E.; Lewin, R. C. Diameter distributions and yields of thinned loblolly pine plantations. Pub. No. FWS-1-82. Blacksburg, VA: School of Forestry and Wildlife Resources, Virginia Polytechnic Institute and State University; 1982.
- Clark, C. C. *Mathematical bioeconomics*. New York: John Wiley and Sons; 1976.
- Coster, J. E. Towards integrated protection from the southern pine beetle. *J. For.* 75(8): 481-484; 1977.
- Daniels, R. F.; Leuschner, W. A.; Zarnoch, S. J.; Burkhart, H. E.; Hicks, R. R. A method for estimating the probability of SPB outbreaks. *For. Sci.* 25: 265-269; 1979.
- Law, A. M.; Kelton, W. D. *Simulation modeling and analysis*. New York: McGraw Hill; 1982.
- Matney, T. G.; Sullivan, A. D. Compatible stand and stock tables for thinned and unthinned loblolly pine stands. *For. Sci.* 28: 161-171; 1982.
- Reed, D. D. Estimating region-wide damages by the southern pine beetle. Blacksburg, VA: Virginia Polytechnic Institute and State University; 1979. 90 p. [M.S. thesis].
- SAS Institute. *SAS user's guide: statistics*. Cary, NC: SAS Institute; 1982.
- Schumacher F. X.; Coile, T. S. Growth and yield of natural stands of southern pines. Durham, NC: T. S. Coile, Inc.; 1960. 115 p.
- Smith, D. M. *The practice of silviculture*. New York: John Wiley and Sons; 1962.
- Sparks, D. RND is fatally flawed. *Call A.P.P.L.E.* 6:29-32; 1983.

I-T-E-M-S: An Integrated Method to Project Southern Pine Stand Development

J. Michael Vasievich and William A. Thompson¹

Abstract.—The Integrated Timber Economic Management Simulator (ITEMS) is a computerized system for assessing the silvicultural and financial development of southern pine timber stands subject to infestations of southern pine beetles. The system consists of three components: an input generator, a simulation processor, and a report generator. ITEMS was designed to project individual timber stands for up to 40 years under specified conditions of treatment costs, market prices, beetle populations, and management strategies. ITEMS is a stochastic model that can test the effect of random variation in timber stand growth, timber management costs and prices, and beetle dynamics. The primary purpose of the model is to study the integrated effects of different management strategies on the economic performance of southern pine timber production. **Additional keywords:** Stand growth, financial analysis, pest impacts, southern pine, management strategies.

INTRODUCTION

The southern pine beetle, *Dendroctonus frontalis*, Zimm., is one of the most destructive pests of southern pine forests. Periodic outbreaks in some areas cause tree mortality and economic losses. Little can be done to prevent beetle population explosions, but the chances of heavy damage in individual stands can be limited and some can be salvaged. Treatments such as decreasing planting densities, early harvests, and thinning reduce pine stocking and are thought to reduce the chances of severe beetle infestations, but they also reduce potential product yields. Beetle spot control activities such as cut-and-leave or cut-and-spray can limit spot spread, but they are costly. Prompt salvage can control spots and generate some revenue, but it also has some cost. The multiple man-

agement options and uncertain beetle impacts in developing forests produce complex situations that defy rule-of-thumb analyses. If forests are to be managed for maximum profits, then forest managers need to determine how possible management strategies affect timber yields, beetle losses, cash flow, and profits. ITEMS, the Integrated Timber Management Simulator, provides a method to determine the integrated effects of many of these factors.

MODEL OVERVIEW

Purpose and Description

The Integrated Timber Economic Management Simulator (ITEMS) displays the silvicultural and economic performance of southern pine forests affected by southern pine beetle infestations. Four processes associated with production of even-aged southern pine forests are modeled—timber growth and yield, cultural treatments, southern pine beetle attack and control, and economic analysis. The model allows stochastic variation in treatment costs, timber revenues, growth processes, and insect infestations.

The primary application of ITEMS is to test the economic effects of silvicultural and management activities in combination with beetle infestations. The model projects the development of one or more stands for 10 to 40 years. Cost and price trends, stand growth, and beetle spot development are projected; management practices are applied; and routine accounting functions are performed.

In its 5-year evolution, ITEMS has been improved as deficiencies have been identified. The current model produces reliable results, but efforts continue to improve accuracy, reduce computation time, add new features, improve the ease of use, reformat reports, and replace obsolete program components. The authors continue to strive for a model that more closely meets the original goals.

Goals

ITEMS was developed to study the economics of timber stand development, but the emphasis was on practical application. ITEMS had to be capable

¹ Respectively, Research Forest Economist, U.S. Department of Agriculture, Forest Service, Southeastern Forest Experiment Station, Research Triangle Park, NC, and Assistant Professor, Appalachian Environmental Lab, University of Maryland, Frostburg, MD. (The authors would like to acknowledge the former graduate students at Duke University who assisted in the development of ITEMS: namely, David Wear, Robin Wildermuth, Sallie Roper, Larry Ticknor, David Ellenbogen, and Lynn Luderer. Thanks also go to Dr. Roy Hedden of Clemson University, who provided valuable information to aid in the development of ITEMS.)

of answering questions on the financial consequences of timber stand management alternatives easily and accurately. Development standards were applied in three main areas: the user interface, technical aspects of the simulation, and computer code:

User Interface

- Easy to comprehend and use.
- No extraordinary data as input.
- Error checking to avoid runtime failures.
- Clear and concise printed output.
- Flexibility to address a broad sets of problems.
- Be able to model a wide array of management strategies.

Technical Aspects Of The Simulation

- Realistic simulation results.
- The capability for stochastic variation of process variables.
- Use of existing model technologies for stand and beetle dynamics.

Computer Code

- Use of standard computer language syntax, without extensions.
- Use of separate modules to facilitate improvements.
- Transportability to many mainframe computers.
- Extensive documentation within the computer code.

ITEMS does not identify optimum treatment schedules directly. It contains no linear or other optimization routines. It can only identify superior management strategies through multiple trials of options recommended by the user. ITEMS was developed to allow managers to test their recommended treatments rather than to provide optimal treatment schedules for managers to consider.

Structure of the System

The ITEMS system consists of three major program components written in ANSI FORTRAN 66. Inputs are entered with a user-friendly, interactive input generator. This program simplifies data entry with prompts, error checking, and editing capabilities. The simulation processor reads input data files, projects forest development, and writes output data files. A report generator reads these files, computes financial analyses, and prints summary reports. These three program components are executed in sequence and are linked through the operating system and data files.

The ITEMS model was originally developed for use on large mainframe computers. Inputs are entered at a CRT terminal and reports are printed on a high-speed printer. Although the complete ITEMS

system is not operational on microcomputers, work is underway to adapt the full model to microcomputers with sufficient memory and computational speed. A modified version of the model, called SPB-MICROBEETLES is available for APPLE II series computers and compatibles (Thompson 1985).

Simulations With ITEMS

Simulations can be conducted with ITEMS on actual or hypothetical forest stands. The model can project future stand development for existing forests after current inventory data and recommended treatments are entered. For experimental purposes, particular stand conditions can be used as starting points. Multiple replications of identical stands can be tested with random variations in timber, beetle, and economic processes.

One of the most powerful features of ITEMS is the ability to test different management strategies. Management strategies consist of a list of forest treatments and the specific timber stand conditions under which they are to be applied. ITEMS allows the user wide latitude in specifying when and how different treatments are to be used. Users can specify that one group of stands be managed with one treatment list and another group of stands with a different list.

Another feature of ITEMS is the ability to run simulations with or without implementing some major system features. For example, stands can be projected without implementing the pine beetle dynamics components of the model. Also, simulations can be made deterministically or by invoking stochastic variability for timber growth, management costs, or timber prices. These capabilities make ITEMS particularly suitable for Monte Carlo simulations to develop probability distributions of outcome for prespecified starting conditions. For example, ITEMS can be run on 50 identical stands to test the effect of random variations in timber growth on expected volume production and rates of return.

SYSTEM COMPONENTS

Interactive Data Entry

Many complicated models require carefully formatted input on cards or data files for operation. Input for ITEMS is entered interactively from a computer terminal. The input generator assists in the process by prompting the user for data, checking for valid entries, allowing data files to be saved and

 INTEGRATED TIMBER ECONOMIC MANAGEMENT SIMULATOR
 INPUT GENERATOR VERSION 1.3

MAIN MENU OPTIONS	USER OPTIONS	PROGRAM ACTIONS
OPEN EXISTING FILE ----- Read existing file for editing	Not allowed if a file is open for data entry. User must SAVE or KILL open file first.	Save backup copy of input file, then open and read data file.
CREATE NEW FILE ----- Open a new file for entry of completely new data	Not allowed if a file is open for data entry. User must SAVE or KILL open file first.	Save backup copy of data file. Clear all data in preparation for entry of new data.
ENTER/EDIT DATA ----- Enter new data records or modify existing data for three groups > Stand inventory > Management guidelines > Simulation parameters	1) Select data group 2) Add new records Delete records Edit/change records Find selected records Copy data from record List selected records List record identifiers	Open selected data group and display records. Prompt user for input Display valid data codes Check range of entries Display completed records
PRINT DATA SECTION ----- Generate a printed record of current data file	User must confirm option	Output data from open file to print file in tabular format.
SAVE THE DATA FILE ----- Save the open data file to disk	No other user options	Save data from open file to disk and return for additional editing.
KILL FILE - START OVER ----- Erase all data and begin with an empty file	User must confirm option	Clear all data files in preparation for entry of new data.
HELP INFORMATION ----- Print information to explain input procedures	Select help session for display on screen	Display selected help information on screen.
QUIT INPUT PROCESSOR ----- Exit input processor with or without saving file	User must confirm option	Exits input processor. Notifies user if data file has not been saved and will be lost.

Figure 1.—Structure of ITEMS Input Generator with user options.

then changed, and providing online help information to guide the user through the data entry process. The input generator greatly reduces the time and cost of setting up simulation runs. Some of the features and capabilities of the input generator are shown in figure 1.

Simulation Processor

The simulation processor is the most important component of the ITEMS system. This program reads in the input data files, projects forest development annually for 10 to 40 years, and writes output files for the report generator.

The simulation processor applies four processes for each of the simulation in the following order: (1) Timber price trends, (2) timber stand growth, (3) management treatment, and (4) southern pine beetle activities. These submodels are applied sequentially rather than simultaneously or continuously. Therefore, all timber growth activities are applied before any management activities are done and before any simulated beetle population activity takes place. This procedure has the effect of causing timber stands to accumulate an entire year's growth and mortality instantaneously and in isolation, rather than continuously or in small increments over an entire year. The structure of the simulation processor is shown in figure 2.

The simulation processor also generates periodic costs and revenues and maintenance of a financial ledger. Costs or revenues are produced by management activities such as stand treatments, timber sales, or pest control.

Report Generator

The report generator reads output data files created by the simulation processor, applies financial analysis procedures, and produces formatted reports of simulation results. Two reports show aggregate results for a forest composed of all simulated stands. Three reports are produced for each stand: (1) A summary of stand inventory characteristics; (2) a log of all management activities, including costs and revenues; and (3) a financial analysis of the stand. Sample reports are presented in the Appendix along with descriptive information for each report.

SYSTEM INPUTS

Three groups of inputs are needed for the ITEMS model—stand inventory records, specification of management activities, and simulation parameters.

These data groups are entered through the INPUT GENERATOR. Four different types of data are requested. Data items that require entry of text such as a stand name or run title are termed ALPHA entries. These entries are for identification purposes only and text string is allowed. NUMERIC entries, the second type, call for a number. The input generator will automatically assign a default value if the entry is passed over by the user. Also, entries are automatically checked for a valid range. For the third data type, CODED, the user is presented with a list of available option codes and must choose one. A default is assigned if the data entry is bypassed. The fourth data type is the YES/NO type. Here, the user must answer a question with a yes or no.

The sections below briefly describe each data group and indicate the data types and default values for each entry.

Inventory Records

The first data group is stand inventory data. This group specifies the starting conditions for each stand including: stand identification, acres, forest type, site index, stand age, stocking, percent pine composition, and timber quality indexes. Admissible variables are shown in table 1. Inventory data may be entered for up to 50 stands to be simulated in a single ITEMS run.

Management Activity Specifications

The second input group, shown in table 2, is a description of management activities to be applied to the simulated forest. Typical activities include: site preparation, planting, stocking control, thinning, final harvest, and beetle control activities (cut-and-spray, cut-and-leave, and spot salvage). Treatment cost, variation in costs, and silvicultural consequences of each treatment are specified as parameters. Up to 50 management activities may be entered.

Stand conditions that trigger application of each treatment are defined by this data group. Up to five application conditions formatted as equations or inequalities can be specified. These conditions are based on current forest response variables or other simulation parameters. To specify a treatment condition, the user first selects a forest response variable from a list of 25 codes shown in table 3. Then, one of five relationships is selected from (1) less than; (2) less than or equal to; (3) equal to; (4) greater than or equal to; or (5) greater than. Finally, a numeric constant is used to complete the condition.

If no conditions are specified for a management

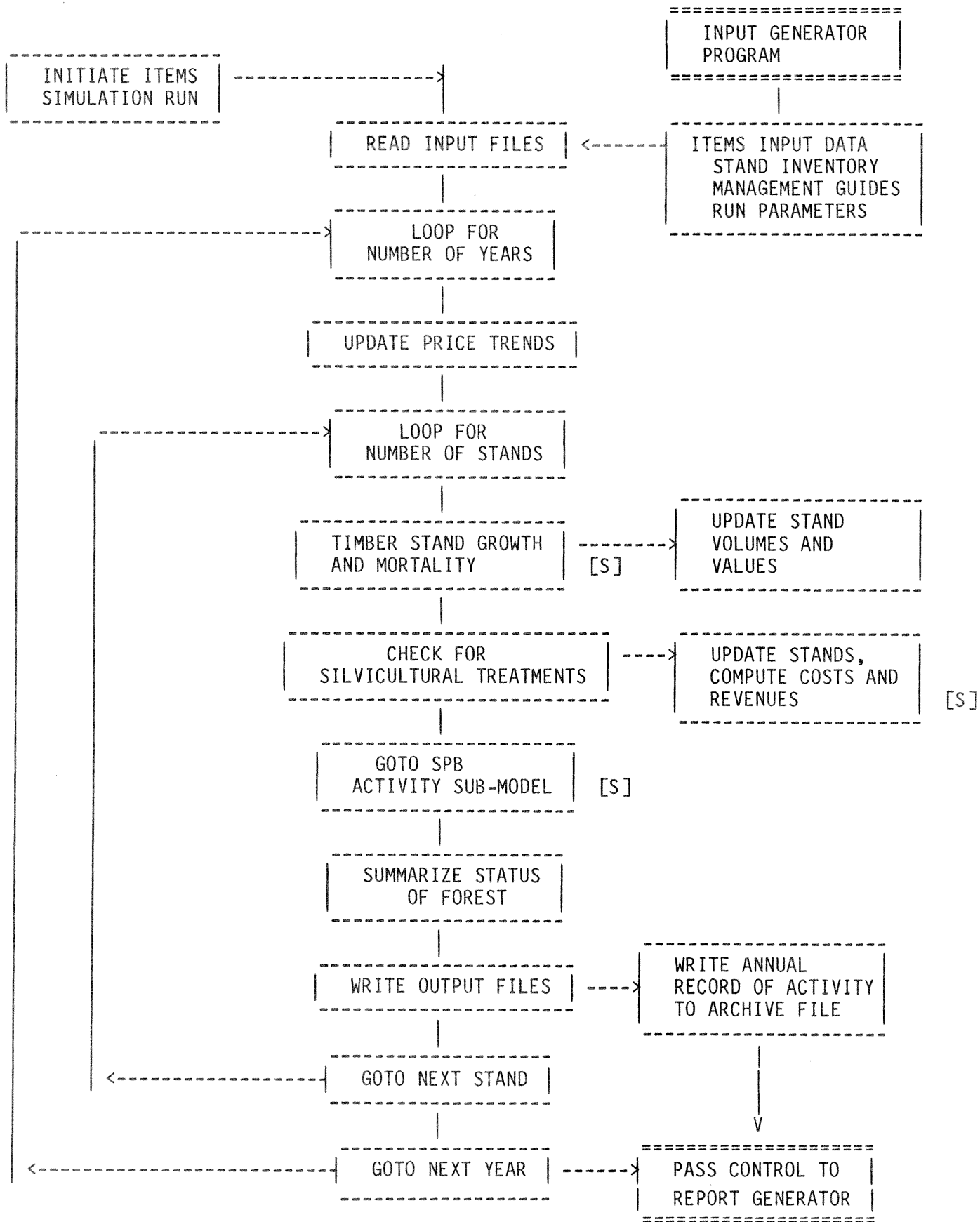

Figure 2.—Flowchart of ITEMS Simulation Processor with stochastic components marked with [S].

Table 1. — Inventory variables required to describe each stand for ITEMS simulations

Variable description	Typical range	Default value	Data type
Stand descriptors			
* Name of stand for identification	(12 char.)	blank	(Alpha)
Stand identification number	0-9999	1	(Numeric)
Stand group number	0-9999	1	(Numeric)
* Tract size, productive acres	0-9999	1	(Numeric)
Forest type			(Coded)
* Site index (base age 25)	30-80	50	(Numeric)
Age of stand in years	0-50	0	(Numeric)
Basal area, square feet/acre, for all trees	0-180	0	(Numeric)
Number of trees per acre (> 4.5 inch d.b.h., all species)	0-20000	0	(Numeric)
Percent pine basal area	70-100	100	(Numeric)
Number of years since last thinning	0+	0	(Numeric)
Timber quality price multipliers			
Quality index — pine pulpwood	0.5-1.5	1.0	(Numeric)
Quality index — pine sawtimber	0.5-1.5	1.0	(Numeric)
Quality index — hardwood pulpwood	0.5-1.5	1.0	(Numeric)
Quality index — hardwood sawtimber	0.5-1.5	1.0	(Numeric)
Stand establishment conditions			
Trees planted per acre, if less than 5 years old	300-1000	0	(Numeric)

* Minimum data required for nonstocked land.

Table 2. — Variables required to describe each management activity for ITEMS simulations. No defaults are assigned for these variables

Variable description	Typical range	Data type
Descriptive parameters		
Short name of practice	(12 char.)	(Alpha)
Practice type codes		(Coded)
Application conditions		
First variable code for this practice		(Coded)
First relation for this practice		(Coded)
First constant for this practice		(Numeric)
Second variable code, relation, constant		Same as above
Third variable code, relation, constant		
Fourth variable code, relation, constant		
Fifth variable code, relation, constant		
Treatment costs		
Current average cost per acre for this practice	varies	(Numeric)
Cost coefficient of variation (% of mean)	0-20	(Numeric)
Fee/overhead (% of total cost or revenue)	0-12	(Numeric)
Annual rate of real change in cost (percent)	0-5	(Numeric)
Application parameters		
Site preparation code	0-5	(Coded)
Trees planted per acre (number)	500-1000	(Numeric)
Residual trees for stocking control (trees/acre)	400-1000	(Numeric)
Residual stocking for stocking control (sf/ac)	70-120	(Numeric)
Forest type established		(Coded)
Pulpwood price multiplier for salvage	0-1	(Numeric)
Sawtimber price multiplier for salvage	0-1	(Numeric)
Fixed cost for SPB spot treatment (\$/spot)	5.00-100.00	(Numeric)
Cost per tree for SPB treatment (\$/tree)	1.00-5.00	(Numeric)
Minimum buffer strip (feet) for SPB control	20-100	(Numeric)
Maximum acceptable SPB treatment cost (\$/spot)	0-9999	(Numeric)
Minimum spot size to treat (number of trees)	10-50	(Numeric)

Table 3. — List of forest response variables for screening management activities

Code	Forest response variable	Units of measurement
AFOR	Total forest area	Acres in entire forest
AGE	Stand age	Years
AREA	Area of stand	Acres in stand
BA	Basal area of stand	Square feet/acre
DBH	Diameter breast height	Inches
HT	Height of dominants	Feet
LCUT	Number of years since last cut	Years
NSPT	Number of beetle spots in stand	Number
PREP	Site preparation code	Code, 0 (none)-5 (intense)
RAND	Uniform random variate (0-1)	Number in range 0-1
SGRP	Stand group number	Number in range 0-9999
RGRO	Radial growth rate	Inches/year
SI25	Site index, base age 25	Feet at age 25
SI50	Site index, base age 50	Feet at age 50
SVOL	Salvage volume	Cubic feet
SNUM	Stand number	Number
TRES	Trees per acre	Number
VALU	Value of merchantable timber	Dollars per acre
VGPA	Current volume growth rate	Cubic feet/acre/year
VOL	Current volume per acre	Cubic foot inventory
VRAT	Current value growth rate	Dollars per acre per year
TVAL	Total value of forest	Dollars, all stands
TVOL	Total volume of forest	Cubic feet, all stands
YEAR	Year	Calendar year

activity, then each stand is treated with that activity in each year. If one equation or inequality is entered for a management activity, then any stand meeting that condition is treated. If the stand continues to meet the condition in subsequent years, then the treatment is repeated. If more than one condition is entered, then the stand is treated only if all conditions are met. Some valid application conditions are:

Stand age greater than 20

Volume growth per acre less than 30 cubic feet per acre

Stand number equal to 22

A generated uniform random number is less than .15

Site index (base age 25) is greater than 70

Value growth rate is less than 6 percent.

System Parameters

The third data group controls the simulation. Inputs include a random number seed, number of years to simulate, base timber prices, price trends, average beetle population level, and a description of the simulation run. This data group also includes several program options that turn stochastic features of the model on or off. Table 4 shows the list of required simulation parameter inputs.

SYSTEM OUTPUTS

Results of ITEM simulations are printed as formatted reports. These are described briefly here.

Samples of actual simulation printouts are contained in the Appendix.

Summary Reports

Two management summary reports describe the status of the entire forest for each year. Forest Management Report 1 includes: productive area, total cubic-foot volume, pine and hardwood volumes; value of merchantable timber, costs, and revenues. Report 2 includes: trend prices for pine and hardwood; acres clearcut, thinned, regenerated, and non-merchantable; and average volume and value per acre for all stands combined. Two management reports are produced for each simulation run.

Stand Reports

Three output tables are produced for each stand. The first shows stand inventory and value for each year. Data included in the stand report are: productive acres, age, basal area, trees per acre, mean d.b.h., mean height, cubic-foot volume per acre, pine and hardwood Mbf and cords, value per acre, cubic-foot growth (current increment), value growth in dollars, value growth in percent of inventory, and number of beetle spots.

The second table lists all management activities carried out on the stand. Data in this table include year done, treatment, acres treated, cubic-foot volume cut, total costs and revenues, average cost per acre, and net revenue per acre. Also, occurrences of treated beetle spots are reported.

Table 4. — *Parameter variables required for ITEMS simulations*

Variable description	Typical range	Default value	Data type
Descriptive parameters			
Descriptive title for simulation run	(72 char.)	1	(Alpha)
Run identification number	0-9999	1	(Numeric)
Year to start the simulation	1985	1985	(Numeric)
Number of years to run	10-40	10	(Numeric)
Random number seed (odd, 5 digits)	1-99999	12345	(Numeric)
Price parameters			
Current pine pulpwood price, (\$/cord)	5-50	10	(Numeric)
Real price change rate, pine pulpwood, (%/yr)	- 2-3	0	(Numeric)
Current pine sawtimber price, (\$/MBF INT)	90-250	150	(Numeric)
Real price change rate, pine sawtimber (%/yr)	- 2-3	0	(Numeric)
Current hardwood pulpwood price, (\$/cord)	3-15	5	(Numeric)
Real price change rate, hardwood pulpwood, (%/yr)	- 3-2	0	(Numeric)
Current hardwood sawtimber price, (\$/MBF)	50-150	75	(Numeric)
Real price change rate, hardwood sawtimber, (%/yr)	- 2-3	0	(Numeric)
Annual rate of inflation, (%)	0-8	0	(Numeric)
Pine beetle parameters			
Average pine beetle infestation level (spots per 1000 acres of pine host type)	0.1-4.0	1.0	(Numeric)
Program options			
Simulate SPB attacks?		YES	(Yes/No)
Simulate timber growth variation?		YES	(Yes/No)
Simulate cost variation?		YES	(Yes/No)
Simulate price variation?		YES	(Yes/No)

The third table generated for each stand is a financial analysis of all costs and revenues. It shows the internal rate of return (IRR) and present net worth (PNW) at five discount rates (0, 2, 4, 7, and 10 percent). IRR and PNW are computed for each simulated year. These figures are based on costs and revenues that would be generated, if the stand was liquidated in that year. Optimum rotation age and maximum rate of return can be found with this table.

STAND MANAGEMENT ACTIVITIES

ITEMS compares each stand with a user-specified list of silvicultural management activities each year to determine if treatments should be applied. Treatments are applied if all conditions specified by the user are met. Application of a treatment to a stand has two effects: the stand condition is modified to account for the treatment, and costs and revenues are generated for later economic analysis.

Cost parameters can be specified for all silvicultural activities. The user may set average cost (dollars per acre), real rate of change in costs (percent per year above inflation), an overhead or management fee charged for the activity (as a percent of direct cost), and a coefficient of variation (standard

deviation expressed as a percent of the mean total cost). Any cost parameter may be set to zero, if costs are not appropriate. Commercial thinning, final harvest, and salvage activities also generate revenues based on the value of timber cut.

Site Preparation

Site preparation is usually done before establishment of a new stand. The primary effect of site preparation in ITEMS runs is to determine survival of planted trees at 5 years. Site preparation has only one coded parameter to indicate the degree of site preparation. A value of 0 indicates the least amount of site preparation and 5 indicates very intensive preparation. Higher values increase mean survival and decrease survival variability. Application conditions for site preparation are usually AGE equal to 0, and PREP equal to 0.

Planting

Planting activities establish new timber stands. The user must specify two parameters: the number of stems planted and the species established. Planting is usually accomplished by specifying AGE equal to 0 and PREP greater than 0. When ITEMS exe-

cutes a planting activity, trees are planted and the stand begins to age, but the stand is not considered established until age 5.

Stocking Control Treatments

Stocking control or TSI treatments are noncommercial reductions in basal area such as precommercial thinning, control of undesirable trees, or release of crop trees. These treatments reduce basal area and volume, but mean height and diameter do not change. If a hardwood component is present in the stand, then the reduction in stocking is taken from the hardwood component before removal of any pine. No revenues are generated by this treatment. The user must specify either the residual number of trees or the residual basal area for this activity. Stocking control is usually triggered by setting a minimum and/or maximum age limit and a minimum basal area before treatment.

Commercial Thinning

Two types of commercial thinning, uniform (or row) thinning and thinning from below, may be applied to stands and generate revenues. Uniform thinning removes trees uniformly from the diameter distribution and the mean diameter remains constant. Thinning from below reduces stocking to the specified level, but removes proportionately more small trees. Volume removed in a uniform thinning is directly proportional to basal area removal. For a thinning from below, volume reduction is less than basal area reduction, on a percentage basis, because smaller trees are removed. For all thinning activities, the user must specify the residual stocking level. Typical application conditions for thinning are a minimum and maximum age and a minimum basal area.

Final Harvest

Final harvests remove all merchantable volume by clearcutting. Basal area, number of trees, and other stand variables are reset. No ITEMS parameters are required for final harvests other than cost specifications. Costs associated with clearcuts are usually commissions paid as a percent of gross revenues. Users can specify many conditions to trigger final harvests. Some examples are to cut at a pre-specified age, cut when value growth rate drops below some minimum, cut when volume increment falls below some set amount, or cut when a certain value or volume is reached.

Sample Management Activity Inputs

A sample ITEMS simulation run has been prepared to illustrate the capability of the model. The run consisted of eight nonstocked stands, each 100 acres in size. Site indexes were 60 and 80 feet (base age 25), and treatment variables were thinning treatment (thinned and unthinned), and planting density (622 and 907 trees per acre). The stands were all initially planted in 1985 and simulated for 40 years. Final harvests were set for age 35 on all stands. Pine beetles were also simulated in this run with an average long-run population level of 2.0 spots per 1,000 acres of pine host type per year. Another run was made with a similar format but for site 50 and 70 to produce additional results.

Seven management treatments were applied to the forest (composed of eight stands) as shown in table 5. The stands were separated for the three different treatments (site, thinning, and planting density) in several ways. A stand group number of 1 was assigned to stands planted with 622 stems per acre and group number 2 to stands at the 907 density. Thinning was accomplished by keying the activity to the stand number, (i.e., 1 to 8). Thinning was applied only if the stand number was less than 5. The site index variation was also accounted for by entering the stand inventory records in a specific order. Various results from these runs are presented throughout the text and in the Appendix.

TIMBER GROWTH AND YIELD

ITEMS can project growth for pine plantations and natural stands. Variable density stand yield models for Coastal Plain and Piedmont loblolly and slash pine (not old field) are included in ITEMS. Growth and volume estimates are based on stand models produced by Coile and Schumacher for natural stands (Schumacher and Coile 1960) and plantations (Coile and Schumacher 1964). Coile and Schumacher's yield models were modified to produce realistic thinning responses and to model growth of a minor hardwood component in stands.

Three main growth and yield processes—basal area increment, height growth, and survival—are modeled by ITEMS. These processes are described here in general terms. Similar projection procedures, but different equations, are used within ITEMS to model each of these three components of stand growth. Equations are taken directly from work by Schumacher and Coile and are contained in the computer code.

Table 5. — Seven sample management guidelines specified as input for a sample ITEMS simulation

Treatment activity	Application conditions	Cost parameters	Silvicultural parameters
Site preparation	TRES = 0.	Cost = \$ 90/ac	Chop and burn (site prep level 2)
	AGE = 0.	C.V. = 10%	
		Fee = 5%	
		Rate = 0%/yr	
Planting	AGE = 0.	Cost = \$ 43/ac	Plant 622 trees/ac Establish coastal loblolly
	PREP > 0.	C.V. = 10%	
	SGRP = 1.	Fee = 5%	
		Rate = 0%/yr	
Planting	AGE = 0.	Cost = \$ 55/ac	Plant 907 trees/ac Establish coastal loblolly
	PREP > 0.	C.V. = 10%	
	SGRP = 2.	Fee = 5%	
		Rate = 0%/yr	
Uniform thin	AGE > 15.	Cost = \$ 0/ac	Reduce BA to 80 sq ft/ac
	AGE < 35.	C.V. = 0%	
	BA > 120.	Fee = 5%	
	SNUM < 5.	Rate = 0%/yr	
Clearcut	AGE = 35.	Cost = \$ 0/ac	
		C.V. = \$ 0	
		Fee = 10%	
		Rate = 0%/yr	
Cut and leave	AGE > 12.	Cost = \$ 50/spot	Min. buffer-20 feet Min. spot size-10 trees
		Cost = \$ 1/tree	
		C.V. = \$ 0	
		Fee = 5%	
Salvage	AGE > 15.	Cost = \$100/spot	Min. spot size-10 trees
		C.V. = \$ 0	
		Fee = 5%	
		Rate = 0%/yr	

Definitions:

- AGE = stand age
- TRES = trees per acre
- PREP = site prep code
- SGRP = stand group number
- BA = basal area (sf/ac)
- SNUM = stand number

- Cost = treatment cost, (\$/acre, spot, < or tree)
- C.V. = coefficient of variation, (% of mean)
- Fee = fee or overhead charged,
(% of cost or revenue)
- Rate = rate of real change in costs, (%/year)

The growth equations have been arranged as first-order difference equations to predict the change in basal area, height, and number of trees. This increment is then treated as the mean for a normally distributed random variate with standard deviation equal to 10 percent of the mean. The actual increment is added to the previous year's base if no stochastic effects have been selected. If stochastic effects are called for by the user, then the result of a random draw from the normal distribution is taken as the increment. As a result of these random factors, accumulated height, stocking, diameter, and survival will be either above or below the amounts estimated by the original deterministic equations.

Initial Stocking (age 5)

Initial stocking and survival have a large effect on future stand development. The Coile and Schu-

macher survival equations for plantations are insensitive to site quality, but the number of trees surviving at 5 years of age does affect future survival. Within ITEMS, the number of trees established does not show up in stand reports until the fifth year. ITEMS computes survival and basal area at 5 years based on the published plantation or natural stand equations. The number of trees established depends upon trees planted or seeded and the degree of site preparation. A percentage of the expected survival at 5 years is used as the mean for a normally distributed random process. The mean is 97 percent of the expected survival for no site preparation and 110 percent for the most intense level of site preparation. The coefficient of variation ranges from 5 percent of the mean for no site preparation to 3 percent for intense preparation.

The natural stand models published by Schumacher and Coile normally begin at 20 years of age,

and survival is very sensitive to early stocking. The survival functions for these natural stand models cause rapid mortality, regardless of the actual number of trees. The net result is that stands that begin with what might be considered as ideal stocking at 5 years (e.g., 500 to 1,200 stems per acre) end up with very few stems as the stand matures. Natural stands younger than 20 years can be modeled by ITEMS, but care must be taken to determine an appropriate starting number of trees to avoid excessive, and perhaps unrealistic, mortality.

Volume Estimation

Three steps are involved in timber volume estimates: determination of cubic-foot volume, estimation of pulpwood and sawtimber percents, and conversions of cubic feet into cords and thousands of board feet. ITEMS computes cubic-foot volumes (inside bark, stump to tip) with equations provided by Coile and Schumacher. Total stand volume estimates are based on average diameter, height, and number of trees. No random variation is applied to cubic-foot volume estimates.

The percentage of sawtimber in total cubic volume depends on mean diameter and height. As stands increase in diameter and height, sawtimber volume increases as a percent of total volume. Cubic-foot volumes are converted into cords with a constant factor of 76 cubic feet of solid wood per cord for pine and 82 feet for hardwoods. An equation to convert cubic-foot sawtimber volume to thousands of board feet (International 1/4-inch log rule) was developed as a function of average stand diameter. Because the function estimates increased recovery from larger stems, fewer cubic feet are required per thousand board feet for volume from stands with larger average diameters. The effect of diameter and height on percent sawtimber and cubic feet per Mbf is illustrated in table 6.

Table 6. — *Effect of average stand diameter and height of dominants on sawtimber as a percent of the total stand volume*

Mean diameter (inches)	Cubic feet per Mbf ¹	Height of dominants in feet					
		40	50	60	70	80	90
<i>Percent sawtimber volume</i>							
8	181	0	0	10	20	21	21
10	169	26	34	41	47	47	47
12	161	50	55	59	62	62	62
14	155	64	66	68	70	70	70
16	150	71	72	74	75	75	75
18	147	75	76	76	77	77	77

¹ International 1/4-inch log rule.

Thinning Response

Thinning has been incorporated into the ITEMS model by modifying the procedures for predicting stand growth. These changes cause an increase in growth that declines over 5 years and a reduction in mortality. For plantations, the number of trees established at age 5 is reset to a lower number that would predict the after-thinning number of trees at the same age. Stand growth is projected as if the stand were 5 years younger in the first year after thinning, 4 years younger in the second year, and so on until the effective post-thin stand age is equal to the actual age. Mortality is also reduced for a period of 5 years for thinning from below to account for removal of less vigorous trees from the stand. The net effect of these modifications is to increase growth and reduce mortality for 5 years after thinning.

Growth of Hardwood Component

Schumacher and Coile's equations for pine plantations and natural stands do not provide directly for a hardwood component in pine stands. Adjustments have been made to account for some competing hardwoods within a stand. ITEMS cannot model growth and development of hardwood stands, but results are realistic if hardwood basal area is approximately 20 percent or less of total stocking. For purposes of survival and basal area and height growth, the stand is treated as if it were all pine. This approach implies that hardwood trees are equally as effective as pine in competing for site resources. An adjustment for hardwood is made in volume calculations. Fifty percent of the total hardwood volume is considered to be unmerchantable to account for cull and unmerchantable species. This volume is included in total cubic foot volume, but is deducted from pulpwood cords and sawtimber Mbf. Also, hardwood sawtimber is converted to thousands of board feet at the constant rate of 270 cubic feet per Mbf.

Sample Stand Conditions and Yields

Yields are available from the sample runs for site 50 to 80 land to illustrate the growth and volume components of ITEMS. Table 7 presents stand conditions and yields at 30 years for unthinned stands planted at 622 and 907 stems per acre. These results include stochastic variation in growth. Therefore, these may vary from actual published yields. When compared with tabular yields taken from Schumacher and Coile's work, these yields, without random variation, are within 2 percent of published values.

Table 7. — Comparison of typical simulated timber stand conditions and yields at 30 years for unthinned Coastal Plain loblolly plantations on four site indexes and for two planting densities. (stochastic variation in basal area growth, height growth, and survival is included)

Site index (age 25)	Planting density (trees/ac)	Surviving trees (number)	Stocking (sf/acre)	Mean d.b.h. (in)	Mean height (ft)	Total volume (cu ft)	Pine Volume	
							mbf (Int ¼)	cords
50	622	304	79	6.9	59	1361	0.0	17.9
60	622	297	106	8.1	70	2205	2.7	22.7
70	622	278	124	9.1	82	3060	6.5	25.4
80	622	321	162	9.6	96	4761	12.2	35.3
50	907	355	80	6.4	58	1344	0.0	17.7
60	907	374	133	8.1	69	2769	3.2	28.9
70	907	378	159	8.8	79	3852	7.3	33.9
80	907	380	168	9.0	93	4742	9.8	40.0

SOUTHERN PINE BEETLE INFESTATIONS

Five main southern pine beetle interactions are incorporated in the ITEMS model—fluctuations in beetle population levels, spot initiation, spot growth, spot inactivity, and spot control through specified treatments. These components are determined by equations derived from work by Reed (1979) and Daniels et al. (1979) at Virginia Tech.

The southern pine beetle portions of ITEMS are contained in separate program modules called from the simulation processor. Although ITEMS models timber stands with discrete time steps of 1 year, the beetle model operates on a monthly cycle. Figure 3 provides an overview of the beetle population dynamics portion of the model. Pine beetle interactions consist of two annual steps: (1) Determination of the pine beetle population level for the year, and (2) generation of new spots on the entire forest for the year. Then, each spot is acted upon for 9 months of each year with three more steps: (3) growth of the spot, (4) a determination of spot inactivity, and (5) spot treatment and control. Each of these processes is described below.

Through the simulation process, new beetle spots are formed in some stands each year. These spots then increase in size by converting unaffected trees into active beetle trees and converting active trees into dead trees. These spots may be treated by any one of three possible control treatments—cut-and-leave, cut-and-spray, and spot salvage. Once controlled, beetle spots become unproductive holes in the forest until the stand is regenerated. Beetle spots reduce the productive area of stands, but do not affect the average growth and development of trees outside the affected spot area.

Annual Beetle Population Level

A new beetle population level is determined for each stand during each year of the simulation. This population level represents the average number of beetle spots per 1,000 acres of pine host type per year for that stand. A different population level is set for each stand so that beetle activities among stands remain independent processes. No serial correlation is built into the series of beetle population levels, again for the purpose of maintaining independent processes. Therefore, beetle population levels in a given year are completely independent of the previous year's level.

Beetle population levels set for each year depend on the average long-run population level input by the user. An input value of 0.5 spots per 1,000 acres or less may be generally considered as endemic con-

Table 8. — Percent of years expected to have less than or equal to a specified number of SPB spots per 1,000 acres for average long-run population levels of 0.5 to 3.0 spots per 1,000 acres of host type per year

Number of SPB spots per 1,000 acres	Average long-run SPB population level (spots/1,000 acres host type)			
	0.5	1.0	2.0	3.0
	----- Percent -----			
0.0	85.6	64.6	42.8	27.8
1.0	97.8	85.5	66.3	49.9
2.0	99.9	95.4	78.9	64.0
3.0	99.9	98.1	88.0	75.5
4.0	100.0	99.5	91.9	81.0
5.0	100.0	99.8	95.8	85.7
6.0	100.0	100.0	97.4	90.0
7.0	100.0	100.0	98.4	93.3
8.0	100.0	100.0	99.1	95.3
9.0	100.0	100.0	99.5	97.1
10.0	100.0	100.0	99.7	97.7

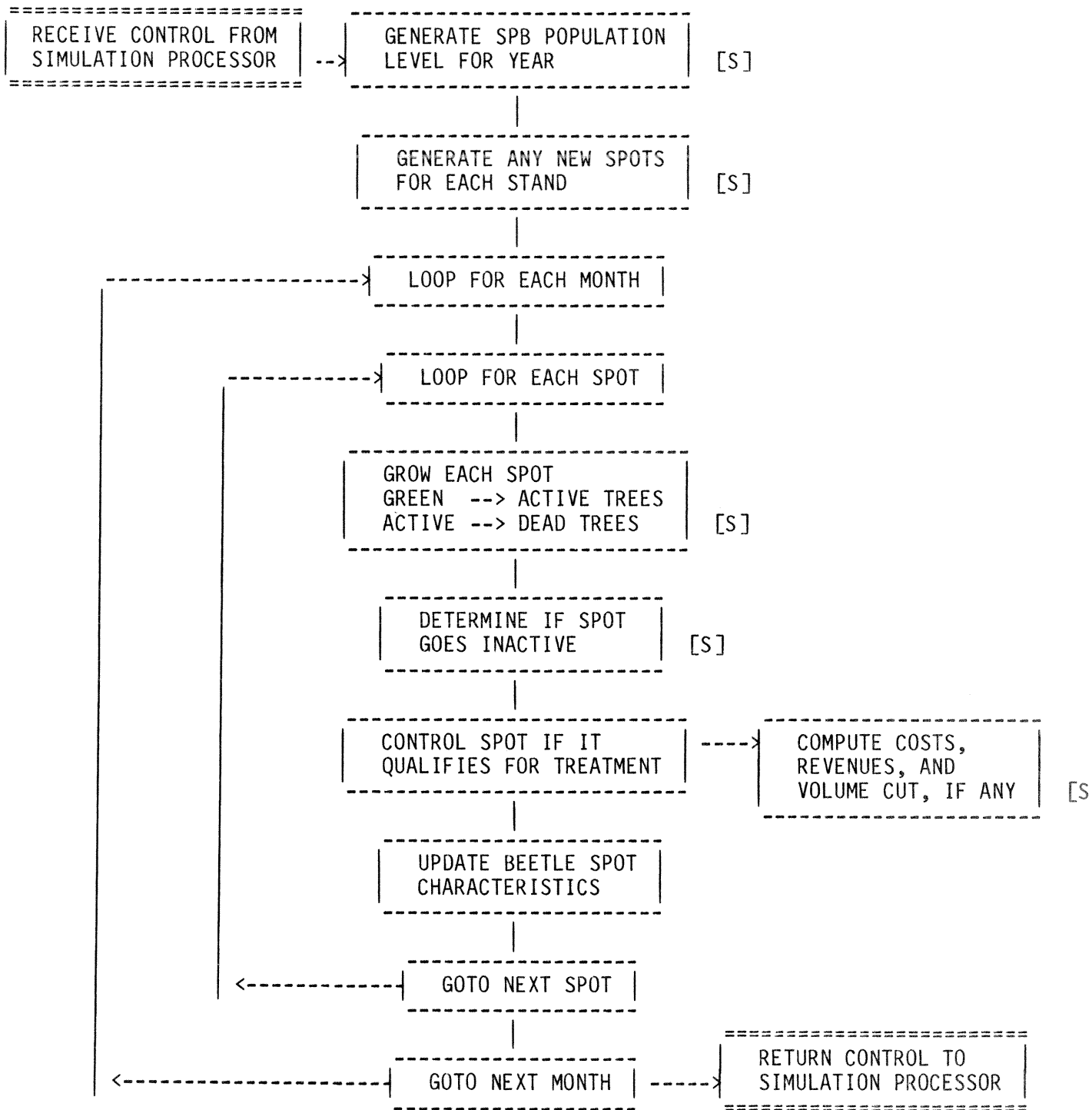

Figure 3.—Flowchart of ITEMS southern pine beetle activity submodel with stochastic components marked with [S].

Table 9. — *Differential effects of stand age, stocking, and site index on expected number of spots per 1,000 acres of loblolly host type for an average long-run SPB population level of 2.0 spots per 1,000 acres per year*

Site index (age 25)	Basal area (sq ft/ac)	Stand age (years)				
		15	20	25	30	35
<i>expected number of spots per 1,000 acres</i>						
50	70	2.41	2.19	2.06	1.98	1.93
	150	3.77	3.06	2.70	2.48	2.33
60	70	2.09	1.90	1.79	1.72	1.67
	150	3.27	2.65	2.34	2.15	2.03
70	70	1.81	1.64	1.55	1.49	1.45
	150	2.84	2.30	2.03	1.86	1.76
80	70	1.57	1.42	1.34	1.29	1.25
	150	2.46	1.99	1.76	1.62	1.52

ditions. Values of 2.0 or higher are appropriate for areas where epidemic conditions occur with some regularity. The actual number of spots per 1,000 acres of pine in any given year will vary from 0 upward. Epidemic conditions can occur, although at a reduced frequency, even for low long-run average beetle levels. Table 8 shows the expected cumulative distribution of annual population levels in tabular form.

Spot Incidence

The probability that new beetle spots occur in a stand each year is a function of the forest type, average long-run population level (input), the actual population level for each year (generated stochastically), site index, total basal area, percent pine type, stand acreage, and stand age. The effect of stand age, site index, and stocking on expected spot numbers is shown in table 9 for loblolly pine and an average long-run beetle population level of 2.0 spots per 1,000 acres of host type.

To initiate new beetle spots, a probability of occurrence is determined for each stand. Then, uniform random variates are generated and compared with the threshold probability to determine if one or more new spots occur within the stand. This process results in spots in some stands and none in others for each year. Once a new beetle spot has been established, ITEMS computes an initial number of active trees for the spot. Average number of active trees for new spots is generated with an exponential distribution with a mean of 15 trees. Initial spot size is independent of stand density or average beetle population level.

Spot Growth and Inactivity

Spot growth depends on several factors. Each spot is modeled for up to 9 active months each year. Probabilistic processes are used to increase the number of active trees, convert active to dead trees, and determine if the spot becomes inactive each month. These processes depend on both stand and beetle population parameters. The rate of spot growth or increase in the number of active trees (i.e., brood trees) is proportional to the number of active trees in the previous month as well as stocking and the beetle population level. A constant proportion, 50 percent, of active trees is converted to dead trees in each month.

With this process, spots continue to increase in size without limit. In order to check this growth process, some spots, chosen at random, become inactive each month. In general, the probability of a spot going inactive declines as the number of active trees increases. All spots become inactive at the end of each year or if control treatments are applied. Since each stand is considered to be independent of all other stands, spots can only expand in size until the spot size is equal to the stand acreage.

Spot Control

ITEMS automatically compares each active spot with user-specified control treatments each month. If minimum conditions are met, the least costly control treatment is applied. Three factors usually affect the application of spot control treatments: (1) The spot must be larger than some minimum number of trees, (2) the stand must meet an age requirement, and (3) the cost of treatment must not exceed some stated amount. The model does not consider delays for spot detection, but assumes that spots are treated as soon as spot size and stand age constraints are met. While this procedure may seem to disregard detection activities, delays associated with location of spots and planning control can be affected by increasing the minimum spot size needed for treatment or adding a random factor for application of control treatments to spots.

Three different spot control treatments may be used within ITEMS: (1) Cut-and-leave, (2) cut-and-spray, and (3) spot salvage. Each of these treatments is applied differently, but all are considered to be equally effective and stop all spot growth activity. All active trees and all green trees within a buffer zone are felled for cut-and-leave treatments. The buffer zone is figured as a ring of live trees equal in width to the height of dominant trees on the site, or a minimum distance, whichever is greater. For the

cut-and spray-treatment, only active brood trees are cut and treated. Salvage treatment calls for removal of all dead and active trees, plus a buffer zone of live trees.

ITEMS automatically computes the total cost for application of each treatment and selects the least-cost option. A different fixed cost per spot is charged for each treatment. Also, a cost per tree is charged for cut and leave or cut and spray treatments. For salvage, revenues are generated, but at reduced prices. Pulpwood revenues are 50 percent off and sawtimber revenues 35 percent off the trend value for undamaged timber. If called for by the user, random variations are applied to these treatment costs.

FINANCIAL ANALYSIS FEATURES

A financial assessment of all costs and revenues is conducted for each stand by the report generator after the completion of the simulation. An annual record of all costs and revenues is maintained for each stand. IRR and PNW are computed for each stand at several discount rates. These criteria (IRR and PNW) are computed for each simulated year and include all cash flows occurring in prior years plus the value of standing timber in that year. Hence, a progression of PNWs and IRRs is produced for each stand from the beginning of the simulation to the end.

Cost Estimation

Forest management costs are figured from cost data entered with each management activity. ITEMS determines costs at the time an activity is applied to a simulated stand. The projected total cost accounts for fixed and variable costs on all acres treated and for compounding for some real rate of change and inflation. The projected total cost (TC) is computed as:

$$TC = (FC + VC * A) * (1 + OV) * (1 + r)^N * (1 + i)^N$$

where TC = total cost in \$/acre

FC = base fixed cost in \$/spot (SPB spot treatments only)

VC = base variable cost in \$/acre (\$/tree for SPB spot treatments)

OV = management fee/overhead rate (percent of direct costs)

A = acres treated

r = real rate of price change in percent/year

i = annual rate of inflation in percent/year

N = years since start of the simulation.

If stochastic variation in costs is requested, then

this projected total cost is treated as the mean of a normally distributed random process with the coefficient of variation input by the user.

Price Projections

Timber prices are projected in nearly the same manner as costs. A trend price for pine and hardwood pulpwood and sawtimber is determined for each year of the simulation based on starting prices, real rates of change, and inflation. Timber sale revenues generated by commercial thinning or final harvest are figured by multiplying product yields (cords and Mbf) by trend unit prices. If specified, the total sale revenue is subjected to a random process similar to that used for costs.

Financial Analysis

ITEMS maintains an annual ledger of all costs and revenues for subsequent financial analyses by the ITEMS report generator. These financial analyses compute pretax IRR and PNW. Results for each stand are contained in the Stand Financial Report. No income tax effects are included in the financial analyses and no analysis is done on the aggregate cash flows for all stands in the simulated forest. If an inflation rate was specified in the simulation parameters, the results of these analyses should be considered as nominal or current dollar amounts.

IRR and PNW Calculations

IRR is computed using the secant algorithm for solution of nonlinear equations for each year. All costs and revenues generated by stand treatments done in the target year or earlier are included in the cash flow series. The value of merchantable timber in the target year assessed at the trend prices is also added to the cash flow series. The financial criteria that result from this process indicate the return that would be generated if the stand were clearcut in that year. One variation with this process occurs in the year the final harvest is done. When stands are clearcut, some random variation may be applied to the timber sale revenue. The result is a higher or lower measure of return than would be expected if the trend prices were used without any stochastic effects.

For PNW, five rates (0, 2, 4, 7, and 10 percent) are used to discount costs and revenues. Cash flows are all discounted back to the first year of the simulation.

Table 10. — *Internal rate of return (IRR) at 35 years, age of financial maturity, present net worth (PNW) at financial maturity, and internal rate of return at financial maturity for unthinned and thinned Coastal Plain loblolly pine plantations simulated with ITEMS*

Site index (age 25)	Planting density (trees/ac)	Unthinned plantations				Thinned plantations				Number of thins
		35 yrs IRR (%)	Financial maturity ¹			35 yrs IRR (%)	Financial maturity ¹			
			age (yrs)	PNW (\$)	IRR (%)		age (yrs)	PNW (\$)	IRR (%)	
50	622	1.9	20	— 97.16	1.2	2.2	20	— 91.53	1.0	0
60	622	6.7	34	15.29	7.4	6.9	34	11.47	7.2	0
70	622	9.0	31	154.61	10.1	8.5	32	99.25	8.9	1
80	622	9.9	31	320.38	11.2	10.2	30	270.67	11.4	2
50	907	1.9	19	— 113.17	0.5	2.4	21	— 89.95	2.5	0
60	907	7.3	34	26.45	7.5	5.8	34	— 34.77	6.1	1
70	907	8.6	33	169.69	9.6	6.8	34	46.93	7.9	1
80	907	9.3	31	252.67	10.4	10.5	33	252.09	11.1	2

¹ Financial maturity calculated as the age where the pre-tax present net worth is maximized for one rotation, excluding land costs, computed at a 7 percent real discount rate.

Sample Financial Results

Financial returns were computed for the 16 sample stands. These results, shown in table 10, are expressed in real terms (i.e., without inflation). They are based on the growth and development of 35-year-old thinned and unthinned Coastal Plain loblolly pine on sites 50 to 80, and planted at 622 and 907 stems per acre. Pine timber prices used for this analysis were \$15 per cord of pulpwood plus 0.5 percent increase per year and \$150 per Mbf (International 1/4-inch log rule) of sawtimber plus 2.0 percent per year.

Results in table 10 are shown for stand age 35 years and for the age of financial maturity. Financial maturity is the age when PNW is maximized for a 7 percent discount rate. Generally, financial maturities are shorter for better sites. However, on site 50 land, PNW is not positive for any age under these market conditions. The financial maturity for site 50 (19 to 21 years) is the age that minimizes investment losses. For sites 60 to 80, it is clear from the table that the IRR is greater for rotations shorter than 35 years.

AVAILABILITY OF ITEMS

The most recent version (6A) of ITEMS is available to users on magnetic tape. This model is considered to be a research tool rather than an operational planning program. The program components are documented internally. Some additional model documentation and user instructions are available.²

² Contact J. M. Vasievich at the Southeastern Forest Experiment Station, P.O. Box 12254, Research Triangle Park, NC, 27709. Phone (919) 541-4221, for more information on availability of ITEMS.

SUMMARY

Southern pine forests are complex, dynamic systems influenced by biological processes of timber stand growth and pest populations, as well as economic and management factors. Effects of these interacting forces on forest production are difficult to predict, but forest managers need to test the effects of management strategies on timber production and economic performance. ITEMS, the Integrated Timber Economic Management Simulator, is a computerized model to predict the development of southern pine timber stands under a wide variety of biological, economic, and management scenarios. It was designed to aid decisionmakers looking for more effective ways to manage pine forests.

ITEMS is a computerized system of three components: an input generator, a simulation processor, and an analytical report generator. The system predicts the growth of new or existing loblolly and slash pine plantations and natural stands for up to 40 years. Inputs include routine stand inventory data, a list of management activities, and simulation parameters.

The simulation processor projects timber stand growth, figures timber volumes and values, applies specified management activities, and computes costs and revenues. A major submodel of the simulation processor projects southern pine beetle populations, initiates new beetle spots, models spot growth and inactivity, and applies control treatments.

The report generator produces tables showing simulated results of forest and stand development. Tabular reports are produced to detail volume and value summaries of the entire forest, price trends, and acres treated each year. Other tables show the development of each stand and list management activities applied to each stand, including costs and

revenues. A financial analysis showing internal rate of return and present net worth is computed for each stand.

CONCLUSIONS

ITEMS models many interactions that take place in managed pine forests. The model is stochastic and can introduce random variation in stand growth, costs, prices, and beetle population levels as an option. Forest managers and researchers can utilize these powerful integrated and stochastic features to study the effects of different pine forest management methods under variable economic and biological conditions. Users of ITEMS can readily determine how different strategies affect timber volumes, financial returns, beetle infestations, and other measures of forest production.

LITERATURE CITED

Coile, T.S.; Schumacher, F.X. Soil-site relations,

stand structure, and yields of slash and loblolly pine plantations in the southern United States. Durham, NC: T.S. Coile, Inc.; 1964. 296 p.

Daniels, R.F.; Leuschner, W.A.; Zarnoch, S.J.; Burkhardt, H.E.; Hicks, R.R. A method for estimating the probability of southern pine beetle outbreaks. *For. Sci.* 25:265-269. 1979.

Reed, D.D. Estimating region-wide damages by the southern pine beetle. Blacksburg, VA: Virginia Polytechnic Institute and State University; 1979. 90 p.

Schumacher, F.X.; Coile, T.S. Growth and yield of natural stands of the southern pines. Durham, NC: T.S. Coile, Inc.; 1960. 115 p.

Thompson, W.A. SPB-MICROBEETLES: A simulation system for evaluating economic returns from pine stands under various management regimes and southern pine beetle simulation levels. In: Branham, Susan J.; Thatcher, Robert C., eds. *Proceedings, integrated pest management research symposium; 1985 April 15-18; Asheville, NC.* Gen. Tech. Rep. SO-56. New Orleans, LA: U.S. Department of Agriculture, Forest Service, Southern Forest Experiment Station; 1985: 292-299.

APPENDIX - Output Reports

Each ITEMS run produces many pages of printed output. The total number of printed pages is approximately equal to $(8 + 3N)$ where N is the number of stands simulated. Since some tables are wider than the standard 80 columns, a printer capable of 132 character lines is required. This Appendix contains printouts taken directly from a sample ITEMS simulation run. Five reports are reproduced here to illustrate the detailed output of the model.

A portion of a sample ITEMS run is illustrated in Tables A-1 through A-5. The simulation began in 1985 with 8 nonstocked stands, each 100 acres in size. The stands were all site prepared and planted to coastal plain loblolly pine in 1986. All stands were clearcut at 35 years of age in 2021.

All ITEMS output tables start on a new page and begin with a table heading that contains standard information. This heading lists the version of ITEMS, the simulation run title, the name of the report, and the years of data shown in the table. The stand number, acreage, site index, and stand name are also provided for each of the 3 stand level reports.

Table Heading Variables

RUN TITLE -- A descriptive title for the simulation, entered by the user.

REPORT NAME -- Identifies one of the five output reports.

STAND NUMBER -- A unique identification number for the stand, assigned as input.

ACRES -- Total number of acres in the stand, including unproductive areas in holes created by beetle spots.

SITE INDEX -- The site index (base age 25) for the stand, input by the user. This value remains constant throughout the simulation and changes in site index are not computed in cases where a different pine species is planted.

STAND NAME -- The stand name assigned to each stand as input.

Forest Management Report 1

This report, Table A-1, provides an overview of the ITEMS simulation for all stands combined. Included are timber volumes in cubic feet, cords and Mbf for hardwood and pine, value of all timber, and cost and revenue amounts for 1985 through 2025. Variables shown in this report are described below.

YEAR -- The calendar year for each line of data in tables.

FOREST AREA -- Total acres contained in all forest stands.

TOTAL VOLUME -- Total volume of all stems in cubic feet, stump to tip.

HARDWOOD VOLUME -- Total hardwood volume for pulpwood and sawtimber in cords and thousand board feet, International 1/4-inch log rule.

PINE VOLUME -- Total pine volume for pulpwood and sawtimber in cords and thousand board feet, International 1/4 log rule.

TIMBER VALUE -- The value of all merchantable timber on the stand figured on the trend values for pine and hardwood pulpwood and sawtimber.

MANAGEMENT FEES -- The cost paid for overhead assessment or management fees.

DIRECT COSTS -- The cost paid for stand treatment in current dollars, excluding charges for overhead or management fees.

GROSS REVENUE -- The total revenue received for sale of merchantable timber products from commercial thinnings, final harvests, and salvage of beetle spots.

NET REVENUE -- Total revenue less all direct and overhead costs, for management treatments applied to the stand.

Table A-1. Sample ITEMS Forest Management Report 1.

\$ I-T-E-M-S INTEGRATED TIMBER ECONOMIC MANAGEMENT SIMULATOR V-6A \$\$\$ TEST RUN, M. VASIEVICH, MARCH 1985 I FOREST MANAGEMENT REPORT 1 FOR 1985. TO 2025.											
YEAR	FOREST AREA (AC)	TOTAL VOLUME (CU FT)	HARDWOOD MBF (INT 1/4)	VOLUME CORDS	PINE MBF (INT 1/4)	VOLUME CORDS	TIMBER VALUE (\$)	MGMT. FEES (\$)	DIRECT COSTS (\$)	GROSS REVENUE (\$)	NET REVENUE (\$)
1985.	800.00	0.00	0.0	0.0	0.0	0.0	0.	0.	0.	0.	0.
1986.	800.00	0.00	0.0	0.0	0.0	0.0	0.	-5640.	-112810.	0.	-118450.
1987.	800.00	0.00	0.0	0.0	0.0	0.0	0.	0.	0.	0.	0.
1988.	800.00	0.00	0.0	0.0	0.0	0.0	0.	0.	0.	0.	0.
1989.	800.00	0.00	0.0	0.0	0.0	0.0	0.	0.	0.	0.	0.
1990.	800.00	0.00	0.0	0.0	0.0	0.0	0.	0.	0.	0.	0.
1991.	800.00	25960.15	0.0	0.0	0.0	341.6	5253.	0.	0.	0.	0.
1992.	800.00	62607.89	0.0	0.0	0.0	823.8	12732.	0.	0.	0.	0.
1993.	800.00	129174.20	0.0	0.0	0.0	1699.7	26401.	0.	0.	0.	0.
1994.	800.00	219256.80	0.0	0.0	0.0	2885.0	45036.	0.	0.	0.	0.
1995.	800.00	331633.20	0.0	0.0	0.0	4363.6	68458.	0.	0.	0.	0.
1996.	800.00	471323.10	0.0	0.0	0.0	6201.6	97781.	0.	0.	0.	0.
1997.	800.00	620874.80	0.0	0.0	0.0	8169.4	129451.	0.	0.	0.	0.
1998.	800.00	773971.90	0.0	0.0	0.0	10183.8	162178.	0.	0.	0.	0.
1999.	800.00	930062.50	0.0	0.0	0.0	12237.7	195859.	-11.	-219.	0.	-230.
2000.	800.00	1085336.00	0.0	0.0	0.0	14280.7	229700.	-17.	-343.	0.	-360.
2001.	800.00	1241653.00	0.0	0.0	0.0	16337.5	264097.	-2.	0.	35.	33.
2002.	800.00	1298382.00	0.0	0.0	0.0	17084.0	277543.	-986.	0.	19725.	18739.
2003.	800.00	1341871.00	0.0	0.0	54.8	17522.0	297596.	-768.	0.	15354.	14587.
2004.	800.00	1478015.00	0.0	0.0	288.1	18750.3	369395.	-21.	0.	412.	392.
2005.	800.00	1611021.00	0.0	0.0	659.8	19611.2	467574.	-21.	-47.	411.	343.
2006.	800.00	1739474.00	0.0	0.0	1034.5	20422.6	569045.	-2.	0.	42.	40.
2007.	800.00	1846480.00	0.0	0.0	1375.4	21045.4	663221.	-72.	0.	1443.	1371.
2008.	800.00	1952383.00	0.0	0.0	1697.0	21707.8	756897.	-37.	-8.	736.	691.
2009.	800.00	2052342.00	0.0	0.0	2024.0	22287.7	853688.	-2.	0.	39.	37.
2010.	800.00	2132592.00	0.0	0.0	2372.1	22560.3	953721.	-55.	0.	1108.	1052.
2011.	800.00	2214109.00	0.0	0.0	2780.6	22713.2	1070205.	-62.	0.	1239.	1177.
2012.	800.00	2290336.00	0.0	0.0	3187.5	22808.1	1189566.	-2.	0.	41.	39.
2013.	800.00	2356503.00	0.0	0.0	3603.8	22750.6	1313114.	-232.	0.	4638.	4407.
2014.	800.00	2302705.00	0.0	0.0	3786.3	21653.1	1362247.	-4923.	0.	98470.	93546.
2015.	800.00	2358133.00	0.0	0.0	4202.4	21463.8	1491461.	-28.	0.	561.	533.
2016.	800.00	2408890.00	0.0	0.0	4647.6	21144.1	1631081.	-66.	0.	1317.	1251.
2017.	800.00	2457917.00	0.0	0.0	5090.1	20821.9	1775180.	-37.	0.	737.	700.
2018.	800.00	2497732.00	0.0	0.0	5463.7	20545.7	1905960.	-218.	0.	4370.	4151.
2019.	800.00	2539278.00	0.0	0.0	5831.2	20311.8	2040476.	0.	0.	0.	0.
2020.	800.00	2571969.00	0.0	0.0	6166.0	20036.9	2169473.	-214.	0.	4271.	4057.
2021.	800.00	0.00	0.0	0.0	0.0	0.0	0.	-217428.	0.	2230180.	2012751.
2022.	800.00	0.00	0.0	0.0	0.0	0.0	0.	-5563.	-111255.	0.	-116817.
2023.	800.00	0.00	0.0	0.0	0.0	0.0	0.	0.	0.	0.	0.
2024.	800.00	0.00	0.0	0.0	0.0	0.0	0.	0.	0.	0.	0.
2025.	800.00	0.00	0.0	0.0	0.0	0.0	0.	0.	0.	0.	0.

Forest Management Report 2

This report, Table A-2, shows prices for hardwood and pine pulpwood and sawtimber, acres treated, non-merchantable acres and average volume and value per acre on the entire forest. Below is a list of the variables contained in this report.

HARDWOOD PRICES -- Projected trend price for hardwood pulpwood and sawtimber, based on initial price entered as input, compounded each year.

PINE PRICES -- Projected trend price for pine pulpwood and sawtimber, based on initial price entered as input, compounded each year.

ACRES CLEARCUT -- The number of acres clearcut from all stands for the year.

ACRES THINNED -- The number of acres commercially thinned for the year from all stands.

ACRES REGENERATED -- The number of acres planted for the year.

NON-MERCHANTABLE ACRES -- The number of acres on the forest in a nonstocked condition or with a stand less than 5 years of age.

VOLUME/ACRE -- Average volume per acre in cubic feet, based on total stand area.

VALUE/ACRE -- The average value per acre for all merchantable timber on the stand, based on the trend values for pine and hardwood pulpwood and sawtimber.

Table A-2. Sample ITEMS Forest Management Report 2.

YEAR	HARDWOOD PRICES \$/CORD	PINE PRICES \$/CORD	CL-CUT (ACRES)	ACRES THINNED (ACRES)	ACRES REGEN (ACRES)	NON-MERCH. ACRES (ACRES)	VOLUME/ ACRE (CU FT)	VALUE/ ACRE (\$)	I-T-E-M-S INTERATED TIMBER ECONOMIC MANAGEMENT SIMULATOR V-6A	
									TEST RUN, M. VASIEVICH, MARCH 1985	FOREST MANAGEMENT REPORT 2 FOR 1985. TO 2025.
1985.	8.00	75.00	15.00	150.00	0.	0.	0.	0.	\$	\$
1986.	8.00	75.00	15.00	150.00	0.	0.	0.	0.	\$1\$	\$1\$
1987.	8.00	75.37	15.07	153.00	0.	0.	0.	0.	\$1\$\$	\$1\$\$
1988.	8.00	75.75	15.15	156.06	0.	0.	0.	0.		
1989.	8.00	76.13	15.23	159.18	0.	0.	0.	0.		
1990.	8.00	76.51	15.30	162.36	0.	0.	0.	0.		
1991.	8.00	76.89	15.38	165.61	0.	0.	0.	0.		
1992.	8.00	77.28	15.46	168.92	0.	0.	0.	0.		
1993.	8.00	77.66	15.53	172.30	0.	0.	0.	0.		
1994.	8.00	78.05	15.61	175.75	0.	0.	0.	0.		
1995.	8.00	78.44	15.69	179.26	0.	0.	0.	0.		
1996.	8.00	78.83	15.77	182.85	0.	0.	0.	0.		
1997.	8.00	79.23	15.85	186.51	0.	0.	0.	0.		
1998.	8.00	79.62	15.92	190.24	0.	0.	0.	0.		
1999.	8.00	80.02	16.00	194.04	0.	0.	0.	0.		
2000.	8.00	80.42	16.08	197.92	0.	0.	0.	0.		
2001.	8.00	80.83	16.17	201.88	0.	0.	0.	0.		
2002.	8.00	81.23	16.25	205.92	0.	0.	0.	0.		
2003.	8.00	81.64	16.33	210.03	0.	0.	0.	0.		
2004.	8.00	82.04	16.41	214.23	0.	0.	0.	0.		
2005.	8.00	82.45	16.49	218.52	0.	0.	0.	0.		
2006.	8.00	82.87	16.57	222.89	0.	0.	0.	0.		
2007.	8.00	83.28	16.66	227.35	0.	0.	0.	0.		
2008.	8.00	83.70	16.74	231.89	0.	0.	0.	0.		
2009.	8.00	84.11	16.82	236.53	0.	0.	0.	0.		
2010.	8.00	84.54	16.91	241.26	0.	0.	0.	0.		
2011.	8.00	84.96	16.99	246.09	0.	0.	0.	0.		
2012.	8.00	85.38	17.08	251.01	0.	0.	0.	0.		
2013.	8.00	85.81	17.16	256.03	0.	0.	0.	0.		
2014.	8.00	86.24	17.25	261.15	0.	0.	0.	0.		
2015.	8.00	86.67	17.33	266.37	0.	0.	0.	0.		
2016.	8.00	87.10	17.42	271.70	0.	0.	0.	0.		
2017.	8.00	87.54	17.51	277.13	0.	0.	0.	0.		
2018.	8.00	87.98	17.60	282.68	0.	0.	0.	0.		
2019.	8.00	88.42	17.68	288.33	0.	0.	0.	0.		
2020.	8.00	88.86	17.77	294.10	0.	0.	0.	0.		
2021.	8.00	89.30	17.86	299.98	770.	0.	0.	0.		
2022.	8.00	89.75	17.95	305.98	0.	0.	0.	0.		
2023.	8.00	90.20	18.04	312.10	0.	0.	0.	0.		
2024.	8.00	90.65	18.13	318.34	0.	0.	0.	0.		
2025.	8.00	91.10	18.22	324.71	0.	0.	0.	0.		

Stand Report

Three reports describe the development of each stand over the simulation period. Reports are reproduced here for one stand. The stand, 100 acres of coastal plain loblolly (planted with 907 stems per acre in 1986), is on site index 80 land. Two uniform thinnings were applied by ITEMS at ages 16 and 28. The stand was site prepared and replanted in 2022, the year following harvest.

The Stand Report, Table A-3, shows common measures of stocking, volume, growth and value, among other information. Variables contained in the Stand Report are described below.

YEAR -- The calendar year for each line of data in all tables.

GREEN AREA -- Number of productive acres in the stand, excluding unproductive holes created by beetle spots.

STAND AGE -- Age of the stand in years. Plantations are zero years old in the year planted.

STOCKING (BASAL AREA) -- The stocking of all trees in the stand, pine and hardwood, in square feet per acre.

STOCKING (TREES) -- The number of all trees, pine and hardwood, in the stand.

DBH -- Diameter at breast height, in inches, of a tree of mean basal area.

HEIGHT -- Height in feet of dominant and codominant trees in the stand.

TOTAL VOLUME -- Total volume of all stems in cubic feet, stump to tip.

HARDWOOD VOLUME -- Total hardwood volume for pulpwood and sawtimber in cords and thousand board feet, International 1/4-inch log rule.

PINE VOLUME -- Total pine volume for pulpwood and sawtimber in cords and thousand board feet, International 1/4-inch log rule.

STAND VALUE -- The value of all merchantable timber on the stand figured on the trend values for pine and hardwood pulpwood and sawtimber.

GROWTH (VOLUME) -- Volume growth increment in cubic feet for the stand. This is the current annual increment for all trees, pine and hardwood.

GROWTH-VALUE (\$) -- Annual growth in stand value given in dollars per acre. This is the change in stand value from the previous year and includes the effects of volume increment, change in product mix, and trend prices.

GROWTH-VALUE (%) -- Annual growth in stand value given in percent increase over the value from the previous year. The effects of volume increment, change in product mix, and trend prices are included.

SPB SPOTS -- The number of southern pine beetle spots within the stand for the specified year.

FOREST TYPE -- The forest type such as NONSTOCKED or PLANTED LOB (CO).

Table A-3. Sample ITEMS Stand Report.

I-T-E-M-S INTEGRATED TIMBER ECONOMIC MANAGEMENT SIMULATOR V-6A																	
TEST RUN, M. VASIEVICH, MARCH 1985																	
STAND REPORT FOR 1985. TO 2025.																	

+I+																	
STAND- 4.0 100.0 ACRES SITE INDEX(25)= 80. STAND NAME=P80 907T																	

YEAR	GREEN AREA (AC)	STAND AGE (YRS)	STOCKING BA (SF/AC)	TREES (NO)	DBH (IN)	HT (FT)	TOTAL VOLUME (CU FT)	HARDWOOD MBF (INT 1/4)	CORDS (INT 1/4)	PINE MBF (INT 1/4)	CORDS (INT 1/4)	STAND VALUE (\$)	GROWTH VOLUME (CU FT)	VALUE (\$)	SPB VALUE (%)	SPB SPOTS (NO)	FOREST TYPE
1985.	100.0	0.	0.0	0.	0.0	0.	0.	0.0	0.0	0.0	0.0	0.	0.	0.	-99.0	0.	NONSTOCKED
1986.	100.0	0.	0.0	0.	0.0	0.	0.	0.0	0.0	0.0	0.0	0.	0.	0.	-99.0	0.	PLANTED LOB(CO)
1987.	100.0	1.	0.0	0.	0.0	0.	0.	0.0	0.0	0.0	0.0	0.	0.	0.	-99.0	0.	PLANTED LOB(CO)
1988.	100.0	2.	0.0	0.	0.0	0.	0.	0.0	0.0	0.0	0.0	0.	0.	0.	-99.0	0.	PLANTED LOB(CO)
1989.	100.0	3.	0.0	0.	0.0	0.	0.	0.0	0.0	0.0	0.0	0.	0.	0.	-99.0	0.	PLANTED LOB(CO)
1990.	100.0	4.	0.0	0.	0.0	0.	0.	0.0	0.0	0.0	0.0	0.	0.	0.	-99.0	0.	PLANTED LOB(CO)
1991.	100.0	5.	17.2	803.	2.0	12.	37.	0.0	0.0	0.0	0.5	7.	0.	7.	-99.0	0.	PLANTED LOB(CO)
1992.	100.0	6.	27.9	780.	2.6	16.	102.	0.0	0.0	0.0	1.3	21.	66.	13.	179.4	0.	PLANTED LOB(CO)
1993.	100.0	7.	41.3	756.	3.2	22.	230.	0.0	0.0	0.0	3.0	47.	128.	26.	125.9	0.	PLANTED LOB(CO)
1994.	100.0	8.	55.3	736.	3.7	27.	401.	0.0	0.0	0.0	5.3	82.	171.	35.	74.9	0.	PLANTED LOB(CO)
1995.	100.0	9.	66.3	715.	4.1	32.	586.	0.0	0.0	0.0	7.7	121.	185.	39.	46.9	0.	PLANTED LOB(CO)
1996.	100.0	10.	78.4	693.	4.6	38.	842.	0.0	0.0	0.0	11.1	175.	256.	54.	44.4	0.	PLANTED LOB(CO)
1997.	100.0	11.	89.0	673.	4.9	43.	1092.	0.0	0.0	0.0	14.4	228.	250.	53.	30.4	0.	PLANTED LOB(CO)
1998.	100.0	12.	99.2	652.	5.3	47.	1356.	0.0	0.0	0.0	17.8	284.	264.	56.	24.8	0.	PLANTED LOB(CO)
1999.	100.0	13.	108.3	633.	5.6	51.	1610.	0.0	0.0	0.0	21.2	339.	254.	55.	19.3	0.	PLANTED LOB(CO)
2000.	100.0	14.	115.9	612.	5.9	54.	1860.	0.0	0.0	0.0	24.5	394.	251.	55.	16.2	0.	PLANTED LOB(CO)
2001.	99.8	15.	122.4	594.	6.1	58.	2114.	0.0	0.0	0.0	27.8	450.	254.	56.	14.2	2.	PLANTED LOB(CO)
2002.	99.8	16.	80.0	357.	6.4	61.	1424.	0.0	0.0	0.0	18.7	304.	252.	-145.	-32.3	0.	PLANTED LOB(CO)
2003.	99.8	17.	83.8	347.	6.7	65.	1578.	0.0	0.0	0.0	20.8	339.	154.	35.	11.4	0.	PLANTED LOB(CO)
2004.	99.8	18.	92.1	339.	7.1	68.	1834.	0.0	0.0	0.0	24.1	396.	256.	57.	16.8	0.	PLANTED LOB(CO)
2005.	99.6	19.	97.8	332.	7.4	71.	2039.	0.0	0.0	0.9	24.7	599.	205.	203.	51.4	1.	PLANTED LOB(CO)
2006.	99.6	20.	103.8	324.	7.7	73.	2244.	0.0	0.0	1.8	25.3	812.	205.	212.	35.4	0.	PLANTED LOB(CO)
2007.	99.1	21.	107.9	316.	7.9	76.	2427.	0.0	0.0	2.6	25.8	1012.	183.	201.	24.7	1.	PLANTED LOB(CO)
2008.	98.2	22.	110.9	309.	8.1	78.	2573.	0.0	0.0	3.2	26.2	1186.	146.	173.	17.1	1.	PLANTED LOB(CO)
2009.	98.1	23.	113.3	302.	8.3	80.	2709.	0.0	0.0	3.9	26.5	1365.	136.	180.	15.1	1.	PLANTED LOB(CO)
2010.	98.0	24.	115.4	295.	8.5	82.	2834.	0.0	0.0	4.5	26.7	1544.	125.	179.	13.1	1.	PLANTED LOB(CO)
2011.	98.0	25.	117.0	289.	8.6	84.	2948.	0.0	0.0	5.1	26.8	1722.	114.	177.	11.5	0.	PLANTED LOB(CO)
2012.	97.9	26.	118.5	282.	8.8	86.	3052.	0.0	0.0	5.8	26.8	1903.	104.	182.	10.6	1.	PLANTED LOB(CO)
2013.	97.2	27.	119.7	274.	8.9	88.	3161.	0.0	0.0	6.4	26.9	2102.	109.	198.	10.4	1.	PLANTED LOB(CO)
2014.	96.6	28.	80.0	177.	9.1	90.	2081.	0.0	0.0	4.5	17.1	1464.	93.	-638.	-30.3	2.	PLANTED LOB(CO)
2015.	96.6	29.	81.1	174.	9.2	91.	2152.	0.0	0.0	4.9	17.2	1597.	71.	133.	9.1	0.	PLANTED LOB(CO)
2016.	96.6	30.	82.2	171.	9.4	93.	2221.	0.0	0.0	5.3	17.3	1731.	69.	134.	8.4	0.	PLANTED LOB(CO)
2017.	96.6	31.	83.2	168.	9.5	94.	2286.	0.0	0.0	5.7	17.3	1876.	65.	145.	8.4	0.	PLANTED LOB(CO)
2018.	95.9	32.	84.2	165.	9.7	96.	2349.	0.0	0.0	6.1	17.3	2021.	64.	146.	7.8	1.	PLANTED LOB(CO)
2019.	95.9	33.	85.0	163.	9.8	97.	2413.	0.0	0.0	6.4	17.3	2165.	64.	143.	7.1	0.	PLANTED LOB(CO)
2020.	95.9	34.	85.7	160.	9.9	98.	2464.	0.0	0.0	6.8	17.3	2298.	51.	133.	6.2	0.	PLANTED LOB(CO)
2021.	0.0	0.	0.0	0.	0.0	0.	0.	0.0	0.0	0.0	0.0	0.	0.	0.	-99.0	0.	PLANTED LOB(CO)
2022.	100.0	0.	0.0	0.	0.0	0.	0.	0.0	0.0	0.0	0.0	0.	0.	0.	-99.0	0.	PLANTED LOB(CO)
2023.	100.0	1.	0.0	0.	0.0	0.	0.	0.0	0.0	0.0	0.0	0.	0.	0.	-99.0	0.	PLANTED LOB(CO)
2024.	100.0	2.	0.0	0.	0.0	0.	0.	0.0	0.0	0.0	0.0	0.	0.	0.	-99.0	0.	PLANTED LOB(CO)
2025.	100.0	3.	0.0	0.	0.0	0.	0.	0.0	0.0	0.0	0.0	0.	0.	0.	-99.0	0.	PLANTED LOB(CO)

Stand Management Summary

The Stand Management Summary, Table A-4, lists all management practices applied to the stand over the simulation period. This report shows acres treated, volume removed, and cash flows. Each management treatment applied to the sample stand is detailed in this report. This report shows that four major beetle spots were salvaged accounting for 2.9 acres. The final harvest in 2021 cut timber on 95.9 acres. The remaining 1.2 acres ($100 - (95.9 + 2.9)$) were lost in other beetle spots too small for treatment. The stand produced a total of 4449 cubic feet on 100 acres over 35 years, or an average of 127 cubic feet per acre per year. The variables contained in this report are described below.

MANAGEMENT PRACTICE -- Descriptive name of the management practice.

ACRES TREATED -- Number of acres treated by a management practice. This is the total productive stand area for most silvicultural treatments or the spot size for SPB control treatments.

VOLUME REMOVED -- Cubic foot timber volume removed for commercial thins, final harvests, or beetle salvage treatments.

MANAGEMENT FEES -- Costs paid for overhead assessment or management fees.

DIRECT COSTS -- The cost paid for stand treatment in current dollars, excluding charges for overhead or management fees.

GROSS REVENUES -- The total revenue received for sale of merchantable timber products from commercial thinnings, final harvests, and salvage of beetle spots.

TOTAL COST PER ACRE -- Sum of the direct costs and management fees for the practice, expressed on a per acre basis.

NET REVENUE PER ACRE -- Net revenue divided by the area treated on the stand.

Table A-4. Sample ITEMS Stand Management Summary.

\$ I-T-E-M-S INTEGRATED TIMBER ECONOMIC MANAGEMENT SIMULATOR V-6A \$I\$ TEST RUN, M. VASIEVICH, MARCH 1985 I STAND MANAGEMENT SUMMARY FOR 1985. TO 2025. +I+										
STAND-		4.0	100.0 ACRES	SITE INDEX(25)= 80.		STAND NAME=P80 907T				
YEAR	STAND NUMBER	MANAGEMENT PRACTICE	ACRES TREATED (AC)	VOLUME REMOVED (CU FT)	MGMT. FEES (\$)	DIRECT COSTS (\$)	GROSS REVENUES (\$)	NET REVENUES (\$)	TOTAL COST PER ACRE (\$)	NET REV PER ACRE (\$)
1986.	4.	SITE PREPARE	100.0	0.	-478.	-9558.	0.	-10036.	-100.	-100.
1986.	4.	PLANT	100.0	0.	-253.	-5059.	0.	-5312.	-53.	-53.
2002.	4.	UNIFORM THIN	99.8	89542.	-981.	0.	19625.	18644.	-10.	187.
2007.	4.	SALVAGE	0.5	1205.	-17.	-0.	330.	314.	-33.	632.
2008.	4.	SALVAGE	0.9	2322.	-35.	-0.	703.	668.	-39.	740.
2013.	4.	SALVAGE	0.7	2337.	-57.	-0.	1149.	1091.	-78.	1476.
2014.	4.	UNIFORM THIN	97.2	106948.	-4797.	0.	95942.	91144.	-49.	938.
2018.	4.	SALVAGE	0.8	1763.	-60.	-0.	1196.	1136.	-80.	1514.
2021.	4.	CLEARCUT	95.9	240753.	-23251.	0.	232506.	209256.	-243.	2183.
2022.	4.	SITE PREPARE	100.0	0.	-420.	-8400.	0.	-8820.	-88.	-88.
2022.	4.	PLANT	100.0	0.	-291.	-5828.	0.	-6119.	-61.	-61.
TOTAL				444871.	-30640.	-28844.	351451.	291967.		
AVERAGE PER ACRE				4449.	-306.	-288.	3515.	2920.		

Stand Financial Report

The Stand Financial Report, Table A-5, shows a discounted cash flow analysis of the costs and revenues for the sample stand. All costs and revenues and the market value of the merchantable timber inventory are listed in the report. The Internal Rate of Return (IRR) shows -999. for the first 8 years. This entry indicates that the IRR could not be calculated because of insufficient value or revenues. Present net worth (PNW) is the value of discounted revenues less discounted costs. IRR and PNW are based on actual costs and revenues for the year calculated and earlier, plus the net revenues that would be generated if all remaining merchantable timber on the stand were clearcut in that year and produced revenues at the trend prices. With this procedure, IRR and PNW may be somewhat higher or lower than the expected amount because stochastic market price variation is introduced in the year the stand is actually clearcut.

The age of financial maturity can be determined by examining the list of PNWs for each discount rate. The year with the highest PNW value represents one measure of financial maturity for the scenario presented at that discount rate.

COST -- The total cost for stand management activities for the year.

REVENUE -- The total revenues from timber sales for the year.

VALUE -- Value of merchantable timber on the stand for the year.

INTERNAL RATE OF RETURN (IRR) -- The true internal rate of return for the stand in the year specified.

PRESENT NET WORTH (PNW-*nn*%) -- The present net worth for the stand in the year specified, given in percent and computed for 5 different discount rates. Data for these columns are labeled with PNW-*nn*%, where *nn* are discount rates of 0, 2, 4, 7, and 10 percent.

TOTAL ACRES -- Number of total acres in the stand, including unproductive areas in holes created by beetle spots.

Table A-5. Sample ITEMS Stand Financial Report.

I-T-E-M-S INTEGRATED TIMBER ECONOMIC MANAGEMENT SIMULATOR V-6A										
TEST RUN, M. VASIEVICH, MARCH 1985										
STAND FINANCIAL REPORT FOR 1985. TO 2025.										
STAND-	4.0	100.0 ACRES	SITE INDEX(25)= 80.		STAND NAME=P80 907T					
YEAR	COST (\$)	REVENUE (\$)	VALUE (\$)	IRR (%)	PNW-0% (\$)	PNW-2% (\$)	PNW-4% (\$)	PNW-7% (\$)	PNW-10% (\$)	TOTAL ACRES
1985.	0.00	0.00	0.00	-999.30	0.00	0.00	0.00	0.00	0.00	100.00
1986.	-153.47	0.00	0.00	-999.20	-153.47	-150.46	-147.57	-143.43	-139.52	100.00
1987.	0.00	0.00	0.00	-999.20	-153.47	-150.46	-147.57	-143.43	-139.52	100.00
1988.	0.00	0.00	0.00	-999.20	-153.47	-150.46	-147.57	-143.43	-139.52	100.00
1989.	0.00	0.00	0.00	-999.20	-153.47	-150.46	-147.57	-143.43	-139.52	100.00
1990.	0.00	0.00	0.00	-999.20	-153.47	-150.46	-147.57	-143.43	-139.52	100.00
1991.	0.00	0.00	7.46	-999.20	-146.01	-143.84	-141.68	-138.46	-135.31	100.00
1992.	0.00	0.00	20.84	-999.20	-132.63	-132.32	-131.73	-130.46	-128.83	100.00
1993.	0.00	0.00	47.07	-15.53	-106.40	-110.29	-113.17	-116.04	-117.56	100.00
1994.	0.00	0.00	82.34	-7.49	-71.13	-81.56	-89.72	-98.64	-104.60	100.00
1995.	0.00	0.00	120.95	-2.61	-32.53	-51.24	-65.86	-81.95	-92.89	100.00
1996.	0.00	0.00	174.64	1.30	21.16	-10.01	-34.13	-60.46	-78.31	100.00
1997.	0.00	0.00	227.70	3.65	74.22	29.07	-5.35	-42.33	-66.97	100.00
1998.	0.00	0.00	284.07	5.26	130.60	69.14	23.04	-25.55	-57.23	100.00
1999.	0.00	0.00	338.96	6.28	185.49	106.43	48.17	-11.98	-50.26	100.00
2000.	0.00	0.00	393.75	6.95	240.28	142.10	71.07	-0.72	-45.26	100.00
2001.	0.00	0.00	448.91	7.42	295.44	176.55	92.11	8.63	-41.82	100.00
2002.	-9.81	196.25	303.80	7.53	336.76	199.65	104.10	11.76	-42.53	100.00
2003.	0.00	0.00	338.45	7.67	371.41	219.65	115.21	15.72	-41.76	100.00
2004.	0.00	0.00	395.25	7.99	428.22	254.00	135.75	24.88	-38.01	100.00
2005.	0.00	0.00	596.95	9.36	629.92	384.42	220.58	69.85	-13.90	100.00
2006.	0.00	0.00	808.53	10.27	841.49	516.14	302.95	110.86	6.62	100.00
2007.	-0.17	3.30	1003.26	10.78	1039.36	633.67	372.80	142.75	21.00	100.00
2008.	-0.35	7.03	1164.45	10.99	1207.23	727.40	424.62	163.34	28.54	100.00
2009.	0.00	0.00	1339.27	11.14	1382.05	821.61	474.65	181.74	34.47	100.00
2010.	0.00	0.00	1512.65	11.20	1555.43	910.96	519.59	196.41	38.11	100.00
2011.	0.00	0.00	1686.49	11.21	1729.27	996.77	560.47	208.11	40.00	100.00
2012.	0.00	0.00	1863.30	11.18	1906.08	1080.60	598.40	217.57	40.63	100.00
2013.	-0.57	11.49	2042.08	11.15	2095.78	1168.15	636.80	226.48	40.86	100.00
2014.	-47.97	959.42	1414.58	11.23	2379.72	1305.05	701.66	246.30	45.89	100.00
2015.	0.00	0.00	1542.92	11.19	2508.06	1360.28	723.78	250.15	45.13	100.00
2016.	0.00	0.00	1672.02	11.14	2637.16	1413.46	743.76	252.74	43.82	100.00
2017.	0.00	0.00	1812.16	11.09	2777.30	1470.07	764.64	255.39	42.54	100.00
2018.	-0.60	11.96	1937.83	11.04	2914.33	1522.51	782.33	256.49	40.64	100.00
2019.	0.00	0.00	2075.05	10.97	3051.56	1572.73	798.07	256.64	38.42	100.00
2020.	0.00	0.00	2202.88	10.90	3179.38	1615.90	809.43	255.01	35.59	100.00
2021.	-232.51	2325.06	0.00	10.65	3069.06	1540.22	761.08	231.86	24.89	100.00
2022.	-149.39	0.00	0.00	10.53	2919.67	1468.42	726.08	219.63	20.50	100.00
2023.	0.00	0.00	0.00	10.53	2919.67	1468.42	726.08	219.63	20.50	100.00
2024.	0.00	0.00	0.00	10.53	2919.67	1468.42	726.08	219.63	20.50	100.00
2025.	0.00	0.00	0.00	10.53	2919.67	1468.42	726.08	219.63	20.50	100.00

Risk Assessment of Investments in Loblolly Pine Plantations Threatened by Bark Beetles

Walter C. Anderson, Richard W. Guldin, and J. Michael Vasievich¹

Abstract.—The Hertz-Thomas method of risk analysis, which involves Monte Carlo simulation, was applied to plantations grown on a 35-year rotation that included two site classes, two intermediate management options, and three beetle attack levels. The plantations were assessed in terms of internal rate of return earned on the investment. It was concluded that southern pine beetles (*Dendroctonus frontalis* Zimm.) are not a serious threat to loblolly pine (*Pinus taeda* L.) plantations being grown for sawtimber in the Coastal Plain, even where the attack level is high.

Additional keywords: Southern pine beetle, internal rate of return, Monte Carlo simulation.

INTRODUCTION

Stands of loblolly pine (*Pinus taeda* L.), the dominant yellow pine species in the South, suffer serious losses due to the most widespread and destructive insect of southern forests, the southern pine beetle (*Dendroctonus frontalis* Zimm.). The risk of timber value losses due to southern pine beetle attacks reduces the chances of obtaining an acceptable return from investments in loblolly pine plantations.

Stands of loblolly pine are found throughout the Piedmont and Coastal Plain. Because so much abandoned cropland was reseeded by loblolly pine, it is frequently called "old-field pine" (Wahlenberg 1960). After the old-growth pine was cut out in the mid-1920's, these old-field stands have sustained the southern forest products industry to the present day.

Characteristics associated with the most frequently attacked stands have been used to assign stand hazard ratings (Lorio 1978). Hazard-rating systems show where beetle outbreaks are most likely to occur and where beetle activity and losses are likely to be greatest. Southern pine beetles are an especially se-

vere threat to mature, densely stocked, slow-growing, old-field, natural stands of southern pine (Hedden 1983). The value lost when large trees in these stands are killed is substantial. Loblolly pine in the Coastal Plain is highly susceptible to southern pine beetle attacks, especially stands growing on poorly drained soils in low-lying areas (Belanger 1981).

Loblolly pine is also the most widely planted pine in the South. Approximately 20 million acres have been planted to this species in the past 25 years, and additional stands are being planted at the rate of 1.3 million acres a year. These plantations represent a huge investment. It can be conservatively estimated that at today's costs, each acre planted represents an outlay of \$135 if all materials and services are purchased.

Managed plantations undoubtedly face less risk from southern pine beetle attack than unmanaged mature natural stands, because they are not overly dense or slow growing. But the financial risk to plantations due to potential beetle attack is high because large direct-cash outlays have been made for growing timber. It is this financial risk that most concerns long-range planners scheduling investments to satisfy the wood needs of mills several decades hence. The potential of financial losses from a beetle attack affects the choices of land managers when they allocate a firm's funds striving for maximum profits. Is it worth investing \$135 per acre to create a loblolly pine plantation considering the risks involved? To answer this question, land managers need to know what rates of return can be expected on their capital outlays, taking into account the threat of potential losses from southern pine beetles and other destructive agents.

Forest managers need better investment guides than are currently available. Traditional forest investment models provide inadequate guides for making choices where insects present an indefinite threat, because these deterministic models assume it is known with certainty whether a stand will be attacked. But attacks cannot be predicted with certainty.

A method of investment analysis that recognizes risk has been developed but seldom applied to forestry investments. This procedure was used in the

¹ Respectively, Research Forest Economists, U.S. Department of Agriculture, Forest Service, Southern Forest Experiment Station, New Orleans, LA, and Research Forest Economist, Southeastern Forest Experiment Station, Durham, NC.

study of investments in loblolly pine plantations in the Coastal Plain where there is a high risk of frequent southern pine beetle infestations. In this paper, the method is described and its application is illustrated.

RISK IN PLANTATION INVESTMENTS

Knight (1921) wrote that uncertainty of outcome is increased by the span of time required to produce a product. The longer the production period, the less certain the outcome. Uncertainty is inherent in forestry, because timber growing is one of the longest production processes engaged in by man. Knight also pointed out that uncertainty takes one of two forms: "risk" and "uncertainty". Risk is defined as an outcome whose probability of occurrence can be quantified. Uncertainty is an outcome whose probability of occurrence cannot be quantified. Investment assessments can recognize risk, but the influence of uncertainty must be accepted by the investor as luck, either good or bad.

Foresters have tried in various ways to take a return estimated by a deterministic investment model and adjust it for risk. One common way to do this has been to add a percentage point or two to the rate of interest used for discounting future returns or capitalizing costs. Unless applied under appropriate conditions, however, this method gives unreasonable results (Guttenberg 1950). Other means have been used to take risk into account, but results have also been less than fully satisfactory.

THE HERTZ-THOMAS APPROACH TO RISK ANALYSIS

A method of investment analysis that specifically included risk was developed by Hertz and Thomas (1983). This method is a computer-based procedure involving Monte Carlo simulation. First, the variables significantly affecting the outcome of the investment are identified and a probability density function (pdf) is constructed for each one. Next, a value is randomly drawn from the pdf for each variable, and this set of values is used to calculate the return on the investment using present net worth, internal rate of return, or some other procedure. Repeatedly, additional sets of input values are selected, and the return is calculated for each new set. After numerous iterations, returns are sorted from lowest to highest, grouped, and group frequencies computed. Finally, the rates of return are plotted as a cumulative distribution function to produce a risk profile showing the chance of earning at least a certain rate of return

on the proposed investment.

In adapting the Hertz-Thomas approach to assessments of loblolly pine plantation investments, the risk of southern pine beetle attacks can be incorporated into the analysis. Beetle attacks are treated as another input variable influencing the outcome of the investment. The economic impact depends on the level of attack. Pdf's can be developed for each of the attack levels considered. Costs associated with attacks are included in the calculations of return on investment.

APPLICATION

The purpose of this study was to determine the magnitude of the risk that southern pine beetle infestations present to investors in loblolly pine plantations. The study proceeded in three steps. First, an existing forestry investment model was upgraded to simulate the impacts of southern pine beetle attack on plantation growth, yield, and financial return. Second, simulations were conducted to determine the distribution of rates of return under alternative forest management and beetle attack scenarios. Finally, the Hertz-Thomas method of risk analysis was applied to the model's output to evaluate the risk posed by various levels of bark beetle attack.

The Model

The study required a computer model that integrated beetle population dynamics with a timber growth and yield model in an economic framework. A search found that the *Integrated Timber Economic Management Simulator* (ITEMS) computer model developed by J. M. Vasievich and W. A. Thompson met the needs of the study. Vasievich developed a version of the model that allows for stochastic variation of treatment costs, timber revenues, and stand growth. It also generates beetle spot occurrence and expansion.

Although ITEMS was a state-of-the-art model at the time the study was initiated, it is now about 3 years old. Individual model components may be available today that are better than those on which the ITEMS model is based. For example, timber growth and yield for Coastal Plain loblolly pine plantations in ITEMS use equations presented in Coile and Schumacher (1964) for unthinned stands. The equations were adjusted to give reasonable responses to simulated thinning. The functional relationships involved in the initiations of new spots were similar to the natural loblolly pine incidence model of Reed et al. (1980). It is not known how well

these equations and relationships apply to plantations. Superior components, however, have not been integrated into any model similar to ITEMS. This points out the need to develop improved integrated models of this type, incorporating the latest knowledge. This would allow for more realistic and reliable appraisals of investments in growing timber that could be endangered by the threat of beetle attacks. Then it could be determined when it would be economical to use prevention and control measures to reduce serious losses from beetles.

The Case Examined

The Hertz-Thomas method was applied to loblolly pine plantation scenarios that included two site indexes (medium and good), three beetle attack levels (low, medium, and high), and two intermediate stand management options (thinning and no thinning). These categories provided 12 classes of plantations for analysis. The rotation age was set at 35 years, the most common for loblolly pine sawtimber.

Site indexes 60 and 80 (25-year base) were selected to depict medium and good sites. Stands on highly productive sites where radial growth is rapid were not included. Stands on wet and waterlogged sites where beetle outbreaks frequently occur were not included because plantations are not likely to be established on such sites.

Three beetle attack levels—0.01, 1.0, and 2.5 spots per 1,000 acres of pine host type per year—were specified to cover the spectrum experienced in nature. The 0.01 level portrayed an endemic degree of infestation; this was considered to be “risk-free.” The 2.5 level represented an infestation of epidemic proportions. Sustained infestation levels higher than this seldom occur.

Thinning is an intermediate silvicultural practice used to reduce the likelihood of large losses from southern pine beetles. It has been shown that stands with a high basal area are more susceptible to attack than stands with low stocking density (e.g., Coulson et al. 1974). However, few stands are thinned for the sole purpose of preventing or reducing beetle losses. In this study, thinning was used to control basal area and maintain rapid growth.

The degree of thinning is determined by many factors, among which are intensity of management, the kind of final product desired, and the availability of a market for small trees. Minimizing insect-caused dollar losses adds another factor to the decision on whether or not and how heavily to thin. The thinning rule applied to each stand in this study was to allow the stand to grow until its basal area reached 110 square feet per acre and then thin it back to 75 square feet per acre. A uniform thinning was applied,

mimicking a row thinning. Many foresters prefer row thinning over selective thinning because of its ease and lower cost. Also, the diameter distribution of the stand is not altered.

The forest manager may decide not to thin some stands and accept an increased risk of beetle infestations. Intensive surveillance may then be relied on to detect infestations. If any are found, the forest manager will then assess the potential damage to the stand and decide whether or not to treat the stand and what treatment to use.

Costs and Prices

Costs for regeneration activities were obtained from studies of silvicultural contracts (Guldin 1983, 1984). The average cost of site preparation was \$70 per acre, with a coefficient of variation (CV) of 60 percent, based on 126 site preparation contracts covering more than 16,000 acres in South Carolina, Alabama, Mississippi, and Louisiana prepared for the 1980-81 planting season. Information on planting costs and seedling densities came from 67 planting contracts covering 11,344 acres in the same States. The average cost of planting was \$45 per acre with a CV of 20 percent, and the mean seedling density was 726 stems per acre with a CV of 15 percent. There was no practical difference between hand planting and machine planting costs. A management fee equal to 5 percent of the cost was added to each regeneration activity. Other costs and input variables, and their probability distributions, were gleaned from the forestry literature. All of the pdf's were normal. The real costs of all management activities were assumed to be constant through the rotation. Land costs were not included.

Stumpage prices of timber removed in thinnings and final harvests were obtained by adjusting base period prices to the year of removal. The base sawtimber price of \$135 per thousand board feet (MBF; International ¼-inch log rule) was increased above the rate of inflation by 2 percent per year, and the pulpwood base price of \$25 per cord was increased by 0.5 percent annually to follow historical trends. Sales commissions of 5 percent for thinnings and 10 percent for final harvests were deducted from the total value of the stumpage removed. The expected stumpage value per acre was normally distributed with a CV of 15 percent.

Treatments

In this simulation, stands were subject to attack by southern pine beetles for 9 months each year. The other 3 months of the year were not included because we assumed beetle attacks cease during the

winter months. Consequently, there would be little or no increase in the size or number of beetle spots. When beetles are active, the beetle population dynamics has two dimensions—spot incidence and spot growth (Hedden 1983). Spot incidence (or occurrence) is defined as the probability of an infestation occurring in a stand. Spot incidence was simulated by random drawings to establish the beetle population level for the year, the probability that one or more new spots would be initiated, and the initial size of any new spots. Spot growth (or spread) is defined as the number of trees killed after an infestation becomes established. Probabilistic processes were used to grow each spot, creating an unproductive hole in the stand.

When treated, spots halt their growth. Whether or not spots are treated depends on forest conditions and other economic factors. Some spots receive high priority treatment while others are left untreated. In this simulation study, for example, no action was taken if a spot affected fewer than 10 trees. But if more trees were affected, a treatment was applied.

Spots can be controlled by various patterns of timber cutting. Spot salvage, cut-and-leave, and cut-and-spray were the alternative direct control options. When salvage or cut-and-leave treatments were used, the infested trees were cut along with a buffer strip of uninfested pines around the perimeter of the spot to halt further spot growth. Buffer strip widths will vary from 10 to 100 feet, depending on such factors as stage of brood development, stand density, and number of newly attacked and brood-producing trees. This study used the rule of thumb that the width of the buffer strip should be roughly equal to average tree height in the spot (Billings 1980). There was no buffer strip for the cut-and-spray control option because only infested trees were felled and treated.

It was assumed that no spots occurred in plantations under 12 years of age. In stands that were 12 years or older, cut-and-leave and cut-and-spray were alternative direct control options for spots. Because stands 15 years old and older contained merchantable trees, salvage was a third control measure. All of the treatments were assumed to be equally effective in halting the spread of beetle spots. Each spot was considered inactive after a control treatment had been applied or at the onset of winter. The costs of all possible treatments were considered and the least costly one was selected.

Costs for the cut-and-leave treatment included a \$50 per spot fixed cost plus \$1 per tree, including trees in the buffer strip. Costs for the cut-and-spray control included a \$50 per spot fixed cost plus \$3 per infested tree. The fixed cost for salvage was \$100 per spot. The value of salvaged sawtimber removed

was reduced by 35 percent from the projected stumpage price to account for the higher than normal cull volume expected in beetle-killed timber. The value of salvaged pulpwood was deflated by 50 percent.

Simulations

For each of the 12 plantation scenarios, fifty 120-acre stands were simulated using ITEMS. The growth and yield of the stand and incidence and growth of beetle spots were simulated. In this process, each stand was examined annually to determine whether any specified treatments were needed, and if needed, the stand was modified to reflect post-treatment conditions. After simulation of the stand was completed, a financial assessment was made. Costs and returns recorded as each year was simulated were used to compute the internal rate of return (IRR). Histograms and cumulative distribution functions of selected output variables were then produced and analyzed.

Table 1. — Mean number of southern pine beetle spots per 120-acre loblolly pine plantation over a 35-year rotation¹

Site index	Management option	Attack level		
		Low	Medium	High
-----Number-----				
60	Unthinned	0.02	2.75	7.30
60	Thinned	0.00	2.69	6.94
80	Unthinned	0.00	2.73	6.55
80	Thinned	0.02	2.32	4.74

¹ Each mean based on 50 stands, or 6000 acres.

Table 2. — Mean acreage of loblolly pine plantation uninfested by southern pine beetle at age 35¹

Site index	Management option	Attack level		
		Low	Medium	High
-----Number-----				
60	Unthinned	120.00	119.42	117.99
60	Thinned	120.00	119.29	117.94
80	Unthinned	120.00	119.18	117.99
80	Thinned	120.00	119.32	118.04

¹ Each mean based on 50 stands, or 6,000 acres.

Table 3. — *Real mean internal rate of return before taxes on loblolly pine plantation investments the 35-year rotation¹*

Site index	Management option	Attack level		
		Low	Medium	High
-----Number-----				
60	Unthinned	7.37 a	7.68 a	7.60 a
60	Thinned	7.24 a	7.58 a	7.32 a
80	Unthinned	11.67 bc	11.62 bc	11.29 b
80	Thinned	13.28 d	11.77 c	12.26 c

¹ Each mean based on 50 stands, or 6,000 acres. Means followed by the same letter are not significantly different at the 5 percent level.

The mean number of spots per stand varied by attack level, but not by site index or whether or not the stand had been thinned (table 1). For the 200 stands (24,000 acres) in each beetle attack category, the low level of attack caused a grand total of 2 spots; the medium level, 525 spots; and the high level, 1,276 spots.

Within the same attack level, there were no differences among the 12 scenarios in average uninfested acreage remaining at age 35 (table 2). However, there were differences by attack level. Stands subject to the highest level of attack had the least residual forested acreage at the end of the rotation. Nevertheless, the average loss amounted to less than 2 percent of stand acreage, and the maximum loss for any stand was only 5.6 acres.

The average IRR's for stands with a site index of 60 did not vary among attack levels or by thinning

regimes (table 3). Stands with a site index of 80 subject to the low attack level, however, had a much higher average IRR than the other stands, and thinned stands, regardless of attack level, had higher IRR's than unthinned stands.

Risk Results

The Hertz-Thomas method of risk analysis was used to determine the chances that an IRR will equal or exceed a target IRR. This information was based on risk profiles. Separate risk profiles were plotted for stands with site indexes of 60 and 80 (figs. 1, 2).

Because the IRR's for stands with a site index of 60 did not differ by attack level or thinning regime combinations, all 300 stands were combined to generate a single risk profile (fig. 1). IRR's ranged between 4.5 and 12 percent, indicating there is a 98 percent chance that the IRR will equal or exceed the target rate of 5 percent. This implies only a 2 percent risk of failure to obtain a 5 percent IRR on an investment in establishing a plantation on land with a site index of 60. There is a 16 percent risk of failure to obtain a target rate of 6 percent IRR.

For plantations growing on land with a site index of 80, there were differences in IRR's by attack level and thinning regime combinations. Therefore, IRR's for the low-attack thinned and high-attack unthinned stands were plotted separately from the risk profile generated by the 200 stands for the remaining four attack level-thinning regime combinations

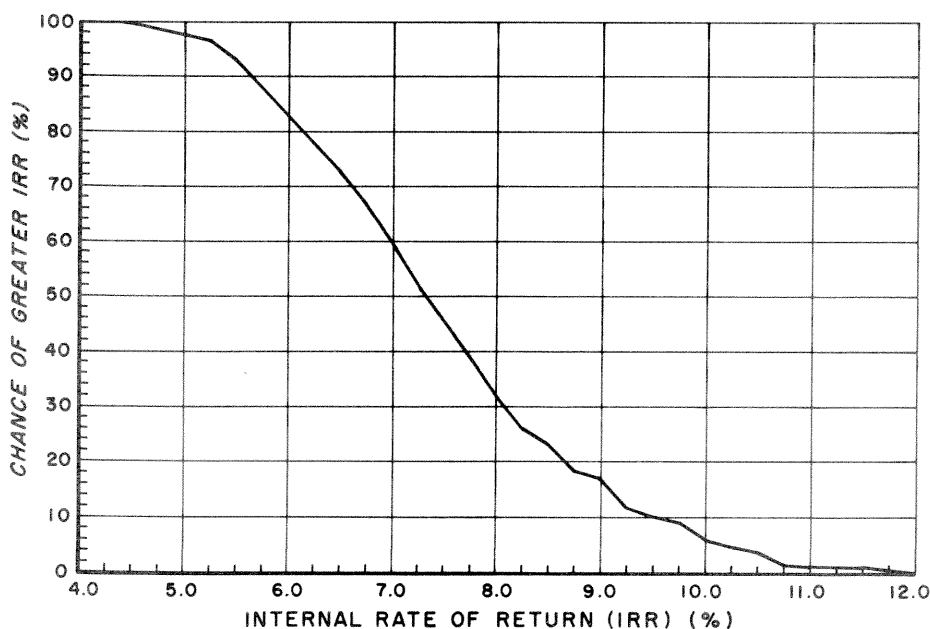

Figure 1. — *Risk profiles for loblolly pine stands (site index 60) for all thin and southern pine beetle attack combinations.*

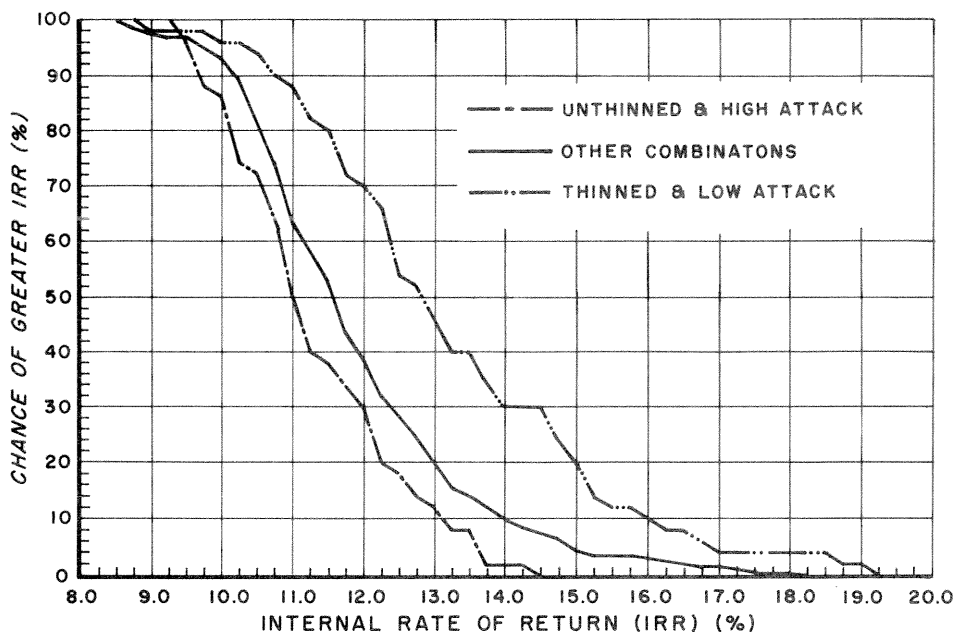

Figure 2. — Risk profiles for loblolly pine stands (site index 80) under unthinned-high attack (1), thinned-low attack (2), and other thin-attack combinations.

together (fig. 2). IRR's for low-attack thinned stands ranged between 8.75 and 19.25 percent, and for high-attack unthinned stands between 9.25 and 14.5 percent. All stands with a site index of 80 have essentially the same small risk (3 percent) of failure to earn at least a 9.5 percent return (fig. 2).

SUMMARY AND CONCLUSIONS

This study examined the economic threat of southern pine beetle attacks to loblolly pine plantations in the Coastal Plain. It did not, however, analyze losses in natural stands susceptible to attack where severe financial losses occur; i.e., densely stocked, slow-growing, old-field stands with over-mature trees. Public agencies, individual landowners, and forest products firms are investing huge sums of money to regenerate and intensively manage plantations, not densely stocked natural stands.

The study used a nontraditional method of investment analysis rarely employed in forestry. Traditional analysis methods do not provide an adequate answer where a major investment risk exists. Admittedly, the analysis is not perfect. For example, an unthinned plantation growth and yield model was adjusted to simulate thinning. Also, simplifying assumptions were made that may not be entirely true in all circumstances. Consequently, the rates of return may not be as high as an investor in loblolly pine planta-

tions in the Coastal Plain might reasonably expect, particularly if some control over the risks can be exercised. But, the form of the results, expressed as the chance of earning a given IRR, should be more useful to investors than the point estimates of the average expected return provided by traditional investment models.

The results indicate that southern pine beetles are not a serious threat to loblolly pine plantations in the Coastal Plain when grown for sawtimber on a 35-year rotation. This result contradicts neither the findings from research on southern pine beetles nor logic. Although pure pine plantations are attractive to southern pine beetles, the other elements that increase the hazard of attack are absent. Overly dense stocking levels rarely occur in plantations. Large over-mature trees do not develop in stands grown on relatively short sawtimber rotations. Even in the absence of thinning to control stocking and maintain rapid diameter growth, the threat of infestation is not great enough, regardless of the level of attack, to discourage investments in establishing loblolly pine plantations in the Coastal Plain.

LITERATURE CITED

Belanger, R. P. Silvicultural consideration in developing integrated southern pine beetle management procedures. In: Barnett, J. P., ed. Proceedings,

- first biennial southern silvicultural research conference; 1980 November 6–7; Atlanta, GA. Gen. Tech. Rep. SO-34. New Orleans, LA: U.S. Department of Agriculture, Forest Service, Southern Forest Experiment Station; 1981: 279–286.
- Billings, R. F. “Cut-and-leave” control of southern pine beetle. *Forest Farmer* 39(10):6ff; 1980.
- Coile, T. S.; Shumacher, F. X. Soil-site relations, stand structure and yield of slash and loblolly pine plantations in the southern United States. Durham, NC: T. S. Coile, Inc.; 1964.
- Coulson, R. N.; Hain, F. P.; Payne, T. L. Radial growth characteristics and stand density of loblolly pine in relation to occurrence of the southern pine beetle. *Environ. Entomol.* 3:425–428; 1974.
- Guldin, R. W. Site characteristics and preparation practices influence costs of handplanting southern pine. *J. For.* 82:97–100; 1984.
- Guldin, R. W. Site preparation costs in the southern coastal plain—an update. Res. Note SO-292. New Orleans, LA: U.S. Department of Agriculture, Forest Service, Southern Forest Experiment Station; 1983. 3 p.
- Guttenberg, S. The rate of interest in forest management. *J. For.* 48:3-7; 1950.
- Hedden, R. L. Evaluation of loblolly pine thinning regimes for reduction of losses from southern pine beetle attack. In: Jones, E. P., ed. Proceedings, second biennial southern silvicultural research conference; 1982 November 4–5; Atlanta, GA. Gen. Tech. Rep. SE-24. Asheville, NC: U.S. Department of Agriculture, Forest Service, Southeastern Forest Experiment Station; 1983: 371–375.
- Hertz, D. B.; Thomas, H. Risk analysis and its applications. New York, NY: John Wiley and Sons; 1983. 318 p.
- Knight, F. H. Risk, uncertainty and profit. Reprints of Scarce Tracts No. 16. London, U.K.: London School of Economics and Political Science; 1921. 381 p.
- Lorio, P. L., Jr. Developing stand risk classes for the southern pine beetle. Res. Pap. SO-144. New Orleans, LA: U.S. Department of Agriculture, Forest Service, Southern Forest Experiment Station; 1978. 9 p.
- Reed, D. D.; Daniels, R. F.; Hedden, R. L.; Burkhardt, H. E.; Leuschner, W. A. A regional southern pine beetle damage projection system. In: Stephens, F. M., and others, eds. Modeling southern pine beetle populations. Tech. Bull. 1630. Washington, DC: Department of Agriculture; 1980: 132–144.
- Vasievich, J. M.; Thompson, W. A. ITEMS: An integrated method to project southern pine stand development; 1985. [In press].
- Wahlenberg, W. G. Loblolly pine. Durham, NC: School of Forestry, Duke University; 1960. 580 p.

Development and Implementation of the Southern Pine Beetle Decision Support System

M. C. Saunders, P. K. Loh, R. N. Coulson, E. J. Rykiel, T. L. Payne, P. E. Pulley, and L. C. Hu¹

Abstract.—Recent research and development programs have been directed toward expanding our knowledge base for dealing with the southern pine beetle. One of their goals has been to provide forest managers with tools that enhance the decision-making capability. The problem has been that, even though potentially available, new technology was not easily accessible, particularly in the case of mathematical models. A multidisciplinary team undertook to archive SPB knowledge into a single, computer-based, accessible system. Building upon the concepts of traditional management information systems, decision support systems (DSS) are uniquely formulated to deal with *ad hoc* decisionmaking, which characterizes most pest management problems. The DSS allows decisionmakers to combine judgment with computer output in producing meaningful information. It uses mathematical or statistical models as well as data base elements for problem-solving. The process of developing the Southern Pine Beetle Decision Support System (SPBDSS) involved identifying and cataloging SPB-related problems and knowledge, developing single or multimodel problem processing subroutines for handling specific problem categories, devising an executive routine to direct the system's operation and link its components, and developing data storage facilities. SPBDSS is organized around a problem analysis routine that is built around four main problem categories. A major feature in its development was the collection of all available SPB simulation models,

evaluation and selection of an appropriate subset of these models, translation of their computer codes into a common language (FORTRAN IV), and modification of noninteractive models to permit interactive processing. SPBDSS includes subroutines for hazard rating, spot dynamics, regionwide damage projection, spot control benefit/cost analysis, and regionwide control project benefit/cost analysis.

Additional keywords: Management information systems, mathematical models. *Dendroctonus frontalis* Zimmermann, solution algorithm.

INTRODUCTION

Developing new ideas and concepts is the fundamental activity of the research scientist. Researchers have the flexibility in their work to focus on any of an almost limitless variety of problems, and the freedom not to focus on others. At the opposite end of this spectrum sits the extension or application specialist who must apply newly developed concepts to a discipline that is already established and perhaps entrenched in traditional activities. The inertia inherent in these applied disciplines makes it very difficult for new ideas and tools to be accepted into the mainstream of use.

The inevitable lag between development and implementation can be seen in the case of the southern pine beetle, *Dendroctonus frontalis* Zimmermann (SPB). Each year, this insect is responsible for the loss of thousands of acres of southern pines. A number of accelerated research and development programs in recent years has been directed toward improving our knowledge base for dealing with SPB.² The new knowledge gained from these programs exists in two principal forms: technical information about the insect and its influence on forests and mathematical models.

The technical information has been summarized in several types of publications including symposium

¹ Respectively, Assistant Professor, Department of Entomology, Pennsylvania State University, North East, PA; and Research Assistant, Department of Industrial Engineering; Professor, Department of Entomology; Assistant Professor, Department of Range Sciences; Professor, Department of Entomology; Associate Research Engineer, Data Processing Center; and Assistant Professor, Industrial Engineering, all Texas A&M University, College Station, TX. (The authors would like to thank A. M. Bunting, D. Watkins, and L. Gattis for technical assistance in preparation of the manuscript. This research was supported by a USDA-sponsored program, Integrated Pest Management For Bark Beetles of Southern Pines, through Grant Nos. USDA-SEA-6510 and U.S. Forest Service-6510, and by the Texas Agricultural Experiment Station through Grant No. TAES-6009. This is Texas Agric. Exp. Sta. Pap. No. 20552.)

² These programs include: the NSF-Huffaker Program, USDA Expanded Southern Pine Beetle Research and Applications Program (ESPBRAP), and the USDA Forest Service Integrated Pest Management Program (IPM).

SOUTHERN PINE BEETLE DECISION SUPPORT SYSTEM

Background

Since the mid-1970's, State forest service agencies have utilized the traditional concepts of management information systems (MIS) to help with technology integration and transfer. An MIS is a computer-based system with the capability of providing decision-oriented information for controlling operations that are definable within a well-structured framework (Thierauf 1982). These systems are commonly used for routine and structured tasks or managerial review. Accordingly, MIS are often report-oriented in the sense that data are extracted and summarized into predefined formats, usually on a periodic basis (Moore and Chang 1980). The Operational Information System (OIS) developed by the Texas Forest Service (Pace and Fagala 1978) is an example of an MIS. This system has been used to monitor aerial detection, ground survey, and control operations of SPB infestations throughout east Texas. With great efficiency, it carries out the routine tasks of listing SPB spots to be ground checked, listing active spots to be controlled, listing spots with action completed, and periodic evaluation and summary.

An MIS usually increases the efficiency of the predefined tasks it performs, but not necessarily their effectiveness (Thierauf 1982). Since most pest management problems are not predefinable, MIS are ill-suited for such *ad hoc* decisionmaking. MIS, with its rigid specifications and formalized procedures, often (1) intimidates the user/decisionmaker, (2) forces premature closure on problem approaches, and (3) inhibits the learning and searching processes that most managers must go through when addressing less structured problems (Moore and Chang 1983).

Fortunately, a new area of information technology, called expert or decision support systems (DSS), has been developed to deal with *ad hoc* problem-solving. Such systems build upon the concepts of MIS and extend them by (1) freeing the user from the structures imposed by the system, and (2) organizing, collecting, sequencing, and reporting information in a format that is relevant to each user's particular problem (Rykiel et al. 1984).

The DSS concept acknowledges that managers are discretionary users who may work with computers by choice, as opposed to committed users, who work with them as part of their profession. To capture the interest of discretionary users and support the

proceedings (e.g., Coster et al. 1979, Stephen et al. 1980, Payne et al. 1984); a compendium (Thatcher et al. 1980); USDA Forest Service handbooks and fact sheets, and numerous journal articles. There are more than 2,000 entries in cited literature dealing with SPB (Kulhavy et al. 1982).

In addition to the technical information on SPB, numerous mathematical models have been developed to deal with the various aspects of SPB problems. Some of the models have been available since the 1950's, but most were developed during the period 1976-1980. These models fall into five general categories (Turnbow et al. 1984):

- 1) stand hazard models—for predicting the likelihood of a SPB infestation (spot) occurring in a stand.

- 2) stand risk models—for predicting the proliferation of existing SPB spots.

- 3) spot growth models—for predicting the development and spread of an existing SPB spot.

- 4) stand growth and yield models—for projecting the timber volumes at rotation age from current stand characteristics.

- 5) economics models—for calculating cost/benefit ratios, and other economics information on control and salvage projects performed on SPB spots.

One of the goals of the accelerated programs was to provide technology to the forest manager that would serve to enhance decisionmaking capability. However, the knowledge base for SPB became so large that, although potentially available, it was not easily accessible. This problem was particularly acute with the model base. Because models were complex and generally inaccessible, these valuable decision aids were rarely used in forest management.

Forest pest management decisionmaking requires the ability to anticipate and evaluate changes in pest populations as well as their effect on forest resources. Conventionally, managers tend to focus attention on the content and credibility of the information available for solving a problem. The importance of helping managers to formulate a "quality problem" and organize information is very often ignored (Volkema 1983). Because of the relative paucity of properly trained personnel in the SPB management environment, this failure to integrate new technology in a usable format became a cause for concern. Accordingly, a multidisciplinary team at Texas A&M University undertook the task of archiving SPB knowledge in a single, computer-based, accessible system.

expertise of their judgment, the system must provide information directly related to the managers' problems and give them active control over the elements of the knowledge base from which they must draw (Bennett 1983). A DSS, therefore, is a computer based system that allows the decisionmaker to combine judgment with computer output in a human/machine interface for producing meaningful information to support the decisionmaking process (Thierauf 1982). When appropriate, a DSS will utilize mathematical and/or statistical models as well as data base elements for solving the problems under scrutiny. An authentic DSS differs from conventional data processing systems (including MIS) in four ways:

- (1) The focus is on decisionmaking in problem situations rather than simply information retrieval, processing, or reporting (Moore and Chang 1980).
- (2) The system is an integral part of a user's decision process rather than a tool sitting on a shelf waiting for use (Sprague and Watson 1975).
- (3) The procedures are "loosely defined" rather than pre-specified (Moore and Chang 1980).
- (4) The purpose is to improve the effectiveness of decisionmaking rather than improve efficiency of information retrieval (Bennett 1983).

The process of designing and building the Southern Pine Beetle Decision Support System (SPBDSS) involved several activities. These were: 1) Identifying and cataloguing SPB-related problems, 2) identifying and cataloguing SPB-related knowledge, 3) developing solution algorithms (single or multi-model problem processing subroutines) for dealing with specific problem categories, 4) developing an executive routine that directs the operation of the system and links its components to one another, and 5) developing data storage facilities where stand and spot data can be stored for future use in decisionmaking.

The remainder of this paper deals with these discrete activities, and how they were accomplished. The order in which the SPBDSS components are discussed is roughly analogous to their sequence of development.

The Problem Analysis Routine (FERRET)

Decision support systems are built around problems, not technology. The main objective of a DSS is to meet a manager's needs in problem-solving situations. In 1980, the ESPBRAP Technology Transfer Team requested participation by forest industry, State forestry agencies, and the U.S. Forest Service's State and Private Forestry Organization (S&PF) in

identifying specific needs of an SPBDSS "user community."³ These potential users were queried to determine what kinds of SPB-related questions would be addressable by SPBDSS.

Constrained by the available technology, four major categories of problems from the questionnaires were identified. These four were prediction/evaluation, prevention, suppression, and utilization. Problems in these categories generally have underspecified structures with information for solving them of a multisource nature and difficult to organize. The focus of an SPB decision support system should, therefore, be on such problem resolution. Following is a list of the SPB-related questions that were developed from these surveys.

PREDICTION

- (1) What is the probability of an infestation in a given stand over a given rotation and when will it occur?
- (2) When and in what geographic area will the next outbreak occur?
- (3) Of what value are biological evaluations conducted in October or January for predicting succeeding season losses?
- (4) What factors are responsible for SPB outbreak collapse?
- (5) What population levels can be used to predict outbreaks?

EVALUATION

- (1) How large will a detected (aerial) spot grow (need the ability to rank on site)?
- (2) What are predicted losses given variable stand parameters?
- (3) What are expected losses in a given spot (a) without control, (b) during the next month, and (c) until a spot goes inactive?
- (4) What is the impact of not controlling spots of given size by season?
- (5) Ascertain effects of parasites, predators, and weather on beetle populations and how they affect timber mortality.

SUPPRESSION

- (1) What are the chances and conditions for success of the different control tactics?
- (2) What is the best method based on cost-benefit for controlling a given spot (given size,

³ Participants included representatives from: Union Camp Corporation, Temple-Eastex Corporation, International Paper Company, the Georgia Forestry Commission, the Texas Forest Service, and the Forest Service's Southeastern Area S&PF.

location, infestation-level parameters, and considering total stand management)? What are the advantages and disadvantages of alternative control methods?

- (3) What proportion of active spots must be treated to affect outbreak trends?
- (4) What effects will the various control tactics have on other insect and disease problems?
- (5) If cut-and-leave is applied with a standard buffer, what are the limits of spot size and season for which it is economically feasible?
- (6) What are the effects of control tactics on spot proliferation?
- (7) What are the environmental impacts of various control tactics?
- (8) Evaluate the use of behavioral chemicals, natural enemies, and pathogens as suppression tactics.

PREVENTION

- (1) What conditions predispose a tree or stand to attack?
- (2) What strategies are available?
- (3) How much will these strategies prevent mortality?
- (4) What influence will various control levels have on continued losses?
- (5) What influence do thinning, fertilization, intensive site preparation, prescribed burns, double spacing, maintaining mixed stands, and species selection have on stand susceptibility?
- (6) What is the net effect on yield of thinning to prevent attack? (Assess net effects of prevention strategies on yield on a cost-benefit basis.)
- (7) What is the time factor between thinning and reduction of risk in given stands?
- (8) Can prevention and suppression activities be applied concurrently to achieve reduction in activity?
- (9) What are the influences of factors such as root rots, drought, and other bark beetles on initiating outbreaks?

UTILIZATION

- (1) How much degrading (identify damage classes) is acceptable and what is a fair price?
- (2) Assess market needs (supply and demand) for beetle-killed wood.
- (3) What are cutting-power demands and frequency of saw sharpening in mills using live versus beetle-killed trees?
- (4) Generate regional weight scales.

- (5) What are the markets for blue-stained wood and paneling?

Many of these questions/problems were found to be research and development problems, logistical, or technology transfer problems. Such problems are not amenable to solution by reference to a DSS at this time, due to a lack of technical knowledge. Several additional points can be made in reference to the problem set:

- (1) The problem list is only a sample of a much larger potential set.
- (2) It is not possible to anticipate what problem will be identified by users at a later date.
- (3) The sequence and timing of requests for aid in problem solving by users cannot be specified *a priori*.
- (4) The problem is presented on an *ad hoc* basis.
- (5) The problems do not have discrete solutions. There will always be an element of user judgment in decisionmaking.

Based upon this problem set, logical relationships were developed into a hierarchical system of menus built around the four major problem categories. This problem analysis decision tree was named FERRET (fig. 1a, b, c), and in its initial version, its function was to identify a user's problem and specify the models most appropriate for dealing with that problem (Turnbow et al. 1983). There are 49 unique pathways through FERRET for structuring a particular problem. Not all pathways lead to unique problem-solving procedures. The intent, rather, is to include all the various ways forest managers view and interpret what essentially may be one problem. This "stand alone" FERRET served as the template for the development of model-based solution algorithms for use in problem solving.

Simulation Models and Solution Algorithms

As mentioned previously, there are five general categories of simulation models developed to deal with SPB problems. These models were not programmed in a common computer language nor were they designed to run under a standard operating system. Accordingly, a major task in the development of SPBDSS was the collection of all available models, evaluation and selection of the most robust and appropriate subset of these models, translation of their computer codes to a common language (FORTRAN IV), and modification of non-interactive models to permit interactive processing. The current catalogue of models contained in SPBDSS is shown in table 1. Of the 31 listed, 13 were selected based upon an evaluation of model performance, and the recommendations of IPM Program management.

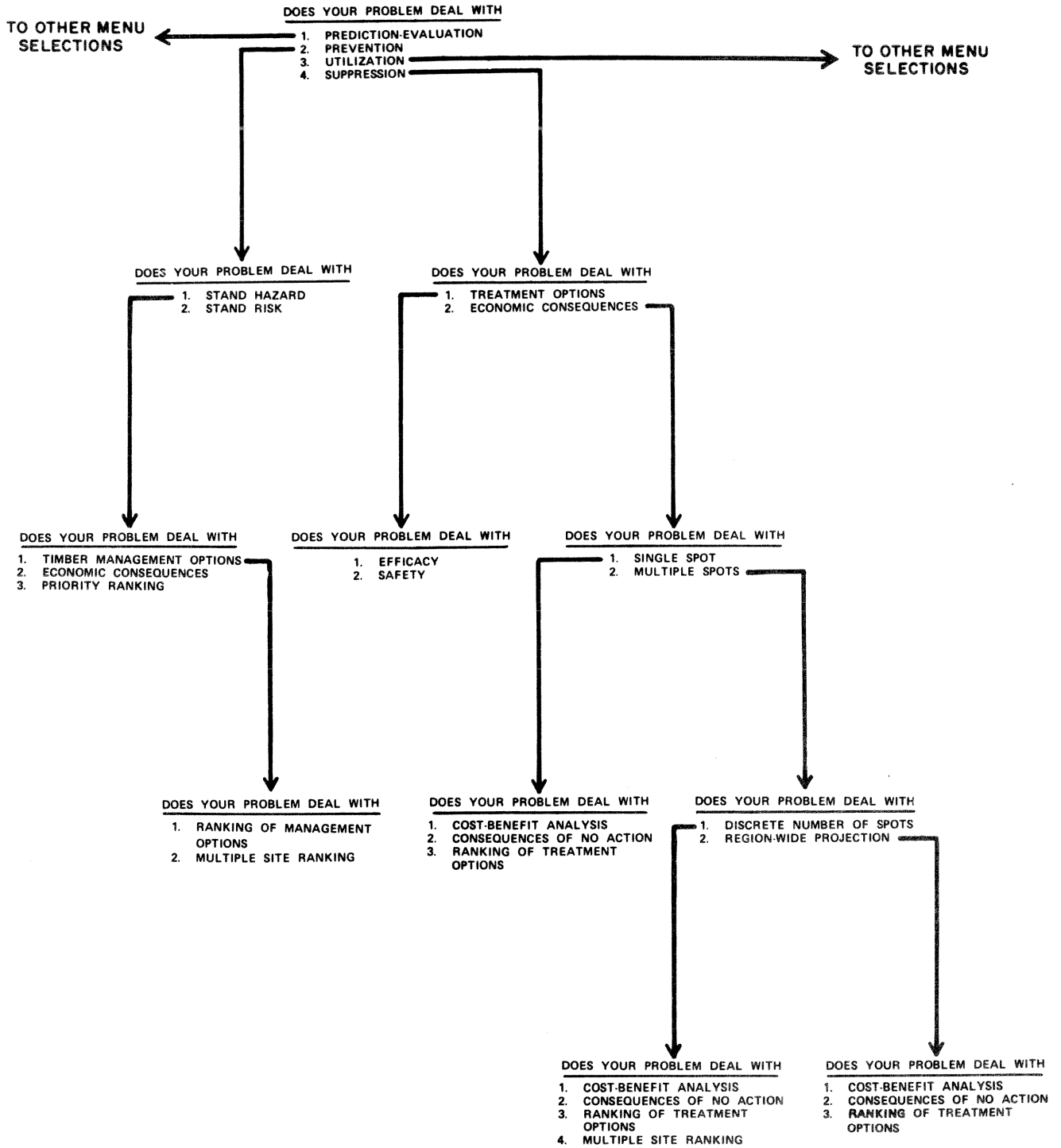

Figure 1—*a,b,c*—Continued

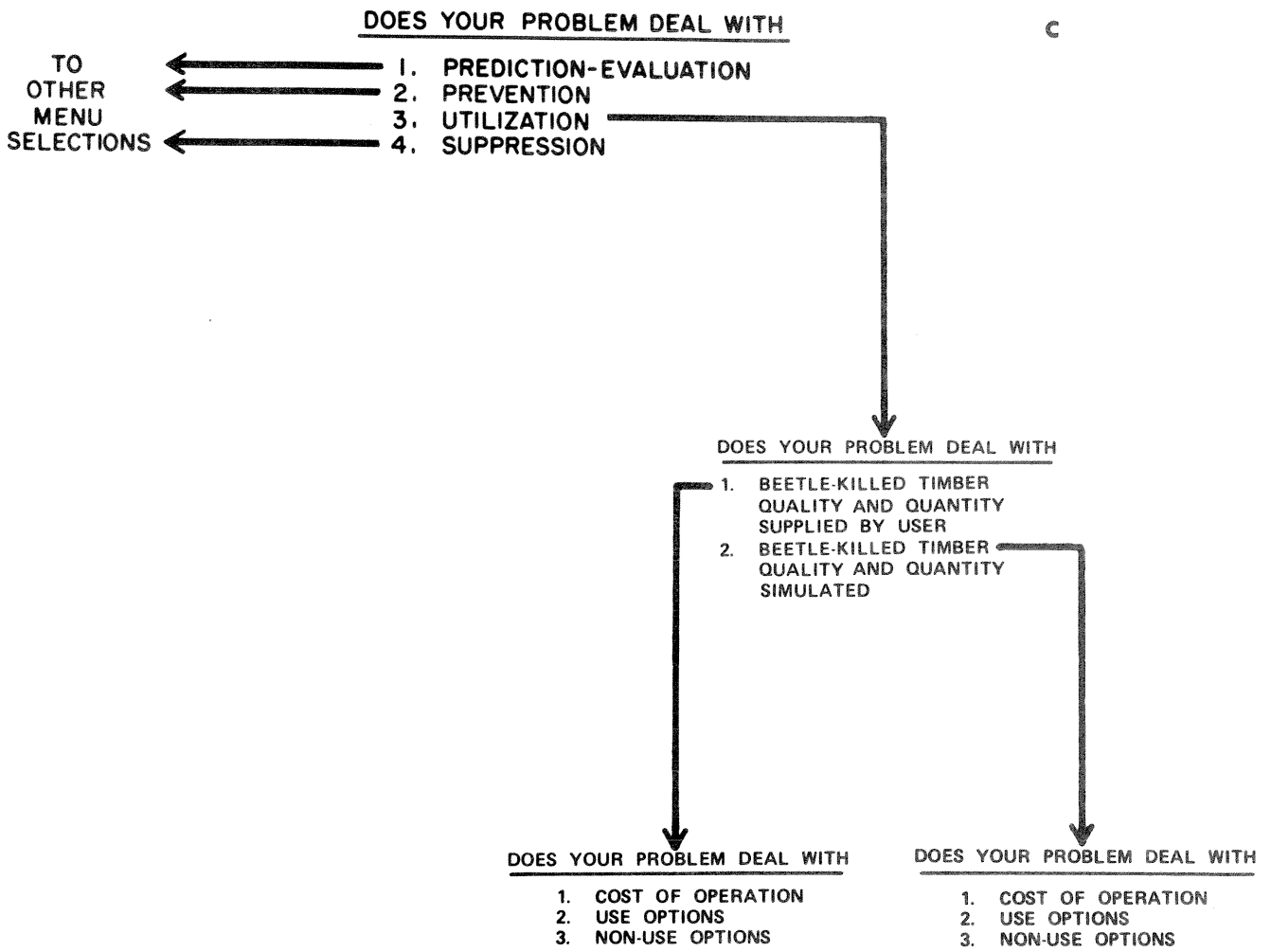

Figure 1—*a,b,c*—Continued

Table 1.—*Model technology available for use in the southern pine beetle decision support system. Models marked with (*) are interactively implemented within the system*

Model	Model description	Source(s)
TAMBEETLE*	southern pine beetle population and spot dynamics model	Feldman et al. (1981); Turnbow et al. (1982)
A/E	southern pine beetle population trend model	Moore (1978)
TFS Spot Growth*	east Texas southern pine beetle spot growth model	Hedden and Billings (1979); Billings and Hynum (1980)
ARKANSAS (SPB)	southern pine beetle population and spot dynamics model	Stephen and Taha (unpublished) ¹
DAMBUGS*	regionwide southern pine beetle damage projection system	Reed (1979)
FRONSIM	southern pine beetle damage simulator	Leuschner et al. (1977)
SPBEEP*	southern pine beetle economic evaluation procedure	Uhler and Lewis (unpublished) ²
TBAP	economic analysis procedure for insect damage	Leuschner et al. (1978)
OPTIONS*	southern pine forest management simulator	Thompson and Vasievich (unpublished) ³
AHAZARD*	southern pine beetle hazard-rating system for Arkansas	Ku et al. (1980)
PHAZARD*	southern pine beetle hazard-rating system for the Georgia Piedmont	Belanger et al. (1981)
THAZARD*	southern pine beetle hazard rating system for east Texas	Mason et al. (1981)
MS HAZARD B*	southern pine beetle hazard rating system for Mississippi	Kushmaul et al. (1979)
TRAS	timber resource analysis system	Larson and Goforth (1970, 1974)
Brender and Clutter	growth and yield model for natural stands of loblolly pine in Georgia	Brender and Clutter (1970)
Burkhart, Parker, and Oderwald	growth and yield model for natural stands of loblolly pine in the Virginia-North Carolina Coastal Plain	Burkhart et al. (1972a)
Burkhart, Parker, Strub, and Oderwald	growth and yield model for old-field loblolly pine plantations in the mid-Atlantic Coastal Plain	Burkhart et al. (1972b)
Burkhart and Strub	growth and yield model for loblolly pine plantations in the Piedmont and Coastal Plain of Delaware, Maryland, North Carolina, and Virginia	Burkhart and Strub (1974)
Coile and Schumacher*	growth and yield model for loblolly pine plantations	Coile and Schumacher (1964)
Goebel and Warner	growth and yield model for loblolly pine plantations in the South Carolina Piedmont	Goebel and Warner (1969)

Table 1.—*Model technology available for use in the southern pine beetle decision support system. Models marked with (*) are interactively implemented within the system—Continued*

Model	Model description	Source(s)
Lenhart	growth and yield model for old-field loblolly pine plantations in the interior West Gulf Coastal Plain	Lenhart (1972)
Lenhart and Clutter	growth and yield model for loblolly pine plantations in the Georgia Piedmont	Lenhart and Clutter (1971)
Murphy and Beltz*	growth and yield model for even-aged stands of shortleaf pine in the West Gulf region	Murphy and Beltz (1981)
PTAEDA	loblolly pine plantation growth simulator	Daniels and Burkhart (1975)
Schumacher and Coile*	growth and yield model for natural stands of loblolly pine	Schumacher and Coile (1960)
SeedPTAEDA	loblolly pine natural stand growth simulator	Daniels et al. (1979)
Smalley and Bailey	growth and yield model for shortleaf pine plantations in the Tennessee, Alabama, and Georgia highlands	Smalley and Bailey (1974)
Sullivan and Clutter	growth and yield model for natural stands of loblolly pine in the southeastern Coastal Plain	Sullivan and Clutter (1972)
USLYCOWG*	growth and yield model for loblolly and slash pine plantations on cutover sites in the West Gulf region	Dell et al. (1979); Feduccia et al. (1979)
YLDTBL	growth and yield model for loblolly pine plantations	Myers (1977)
SAWMOD	sawmill decision model	Sinclair (1980)

¹ Stephen, F. M., and H. A. Taha, Dept. of Entomology, University of Arkansas, Fayetteville, AR 72701.

² Uhler, R. J., and J. W. Lewis, USDA Forest Service, Southern Region, State and Private Forestry, 1720 Peachtree Rd., NW, Atlanta, GA 30309.

³ Thompson, W. A., and J. M. Vasievich, respectively, Appalachian Environmental Laboratory, University of Maryland-Frostburg, Frostburg, MD 21532 and Southeastern Forest Experiment Station, USDA Forest Service, Research Triangle Park, NC 27709.

A Model Routine was developed that described the function and applicability of all the models as well as their input requirements and outputs. This information was developed for incorporation into SPBDSS as an aid in selecting and running appropriate simulations. A publication detailing the information contained in the Model Routine was prepared and made available to help support use of SPBDSS (Turnbow et al. 1984).

The development of solution algorithms appropriate for solving the problems indexed by FERRET

was the next major task. A solution algorithm is a single or multiple model problem-processing subroutine. Currently, there are five unique solution algorithms comprised of elements of the 13 models that were selected from the complete model base (table 1). Following is a description of the various solution algorithms:

Hazard-rating algorithm (HRA).—HRA is used to determine the relative susceptibility of a forest stand to SPB attack (given that beetles are available). HRA are single model algorithms (fig. 2).

Four hazard-rating models can be used (HAZARD, PHAZARD, THAZARD, and MHAZARD B), and up to 30 stands can be hazard-rated in a single session. Any of the four hazard-rating models can be applied to any of the stands being evaluated. The inclusion of four hazard-rating models gives SPBDSS the flexibility to deal with forest stands in any region of the southeastern United States.

Spot dynamics for discrete spots algorithm (SDDSA).—SDDSA is used to predict the growth of an SPB spot. Two spot growth models can be selected by the user, TAMBEETLE and TFS Spot Growth (fig. 3). TAMBEETLE is a mechanistic model that will project SPB-induced timber losses for 99 days and can be used at any time of the year. TFS Spot Growth is a regression formula that projects 30-day SPB-induced timber losses. TFS Spot Growth is valid May through October.

Regionwide beetle damage projection algorithm (RBDPA).—RBDPA is used to predict the likely SPB population trend and its impact on timber vol-

ume on a yearly, regionwide basis. DAMBUGS is the current regionwide damage projection model (fig. 4).

Discrete spot(s) control project b/c analysis algorithm (DSBCA).—DSBCA is used to evaluate the benefit/cost ratio of control projects performed on discrete SPB spots. DSBCA begins with the algorithm SDDSA that projects SPB damages for discrete spots (fig. 3). After the projected damage has been calculated, one of the following four stand growth and yield models will be used to project current stand attributes to their rotation age values. (selection of the appropriate model is based upon the user-supplied description of the stand type):

- 1) Coile and Schumacher—for loblolly plantation stands
- 2) Schumacher and Coile—for loblolly natural stands
- 3) USLYCOWG—for slash and loblolly plantations
- 4) Murphy and Beltz—for even-age shortleaf pine stands

Each of these stand growth and yield models generates biannual summaries of stand attributes from current conditions to rotation age. After completion of this operation, the SPBEEP model is initialized. SPBEEP is an economics procedure that calculates the financial consequences of a proposed control and salvage project. The DSBCA algorithm permits the repetitive execution of SPBEEP so that the user can evaluate alternative control/salvage projects on the same SPB spot.

Regionwide control project b/c analysis algorithm (RPBCA).—RPBCA is used to perform benefit/cost analyses of control projects performed on SPB spots on a regionwide basis. RPBCA begins with the RPBDA algorithm, which projects SPB populations and trends for a region in the coming year (fig. 4). As in the DSBCA algorithm, SPBEEP is utilized to detail the economics of control and salvage projects. In RPBCA, these calculations concern operations performed on SPB spots for three major stand types on a regionwide basis. Again, the user has the option of repetitively running SPBEEP to evaluate alternative control/salvage projects.

The Executive Routine

With the development of the Executive Routine (control program), it became possible to link the various components of SPBDSS into a single working system (fig. 5). The responsibility for selecting, sequencing, and running the various model combinations is the function of the Executive Routine, which accomplishes these operations through the data base management system (DBMS) and model base man-

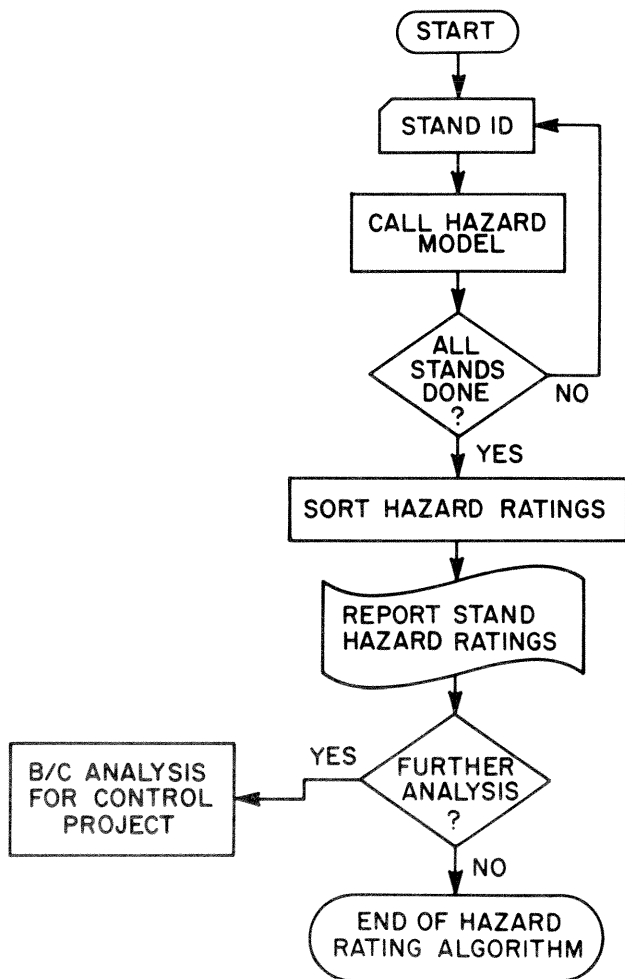

Figure 2.—Flow diagram of the Hazard-Rating Algorithm (HRA).

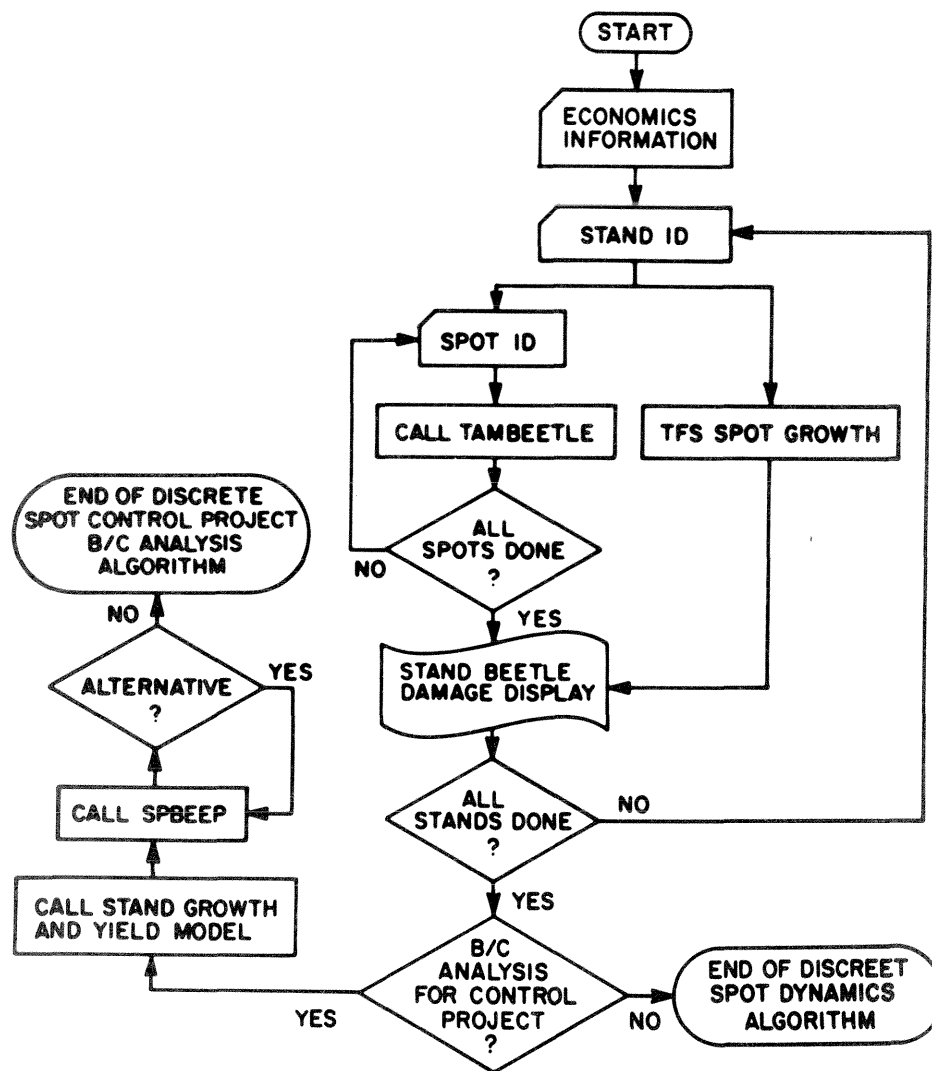

Figure 3.—Flow diagram of the Spot Dynamics for Discrete Spots Algorithm (SDDSA) and the Discrete Spot(s) Control Project B/C Analysis Algorithm (DSBCA).

agement system (MBMS) subprograms. Acting on the information it receives from FERRET, the Executive Routine fetches the needed elements of the model and data bases, sequences and links the models when necessary, and generates the reports that will be needed to arrive at decision alternatives. The nature of the models being executed and the linkage between those models are designed to be as transparent to the user as possible. All the user must do is respond to system prompts and then evaluate the reports that are generated.

The interface between SPBDSS and the user is termed the dialogue generation and management system (DGMS), and it is a vital component of the Executive Routine. From the user's perspective, there is a continuous dialogue with SPBDSS that is interactive, nontechnical, and error-proof. Inappro-

prate responses to system prompts merely result in the prompt being repeated.

Information Retrieval System

In addition to the models developed for dealing with SPB-related problems, a considerable amount of technical information is available on the SPBDSS. Much of this narrative information has been abstracted into U.S. Forest Service "SPB Fact Sheets." These are topical in nature and generally pertinent to one or more of the problems currently addressable by SPBDSS. The fact sheets were entered into direct access files in the SPBDSS data base and linked to appropriate problem categories (based upon the FERRET problem analysis routine), and thereby made available for use in decision support. (The cur-

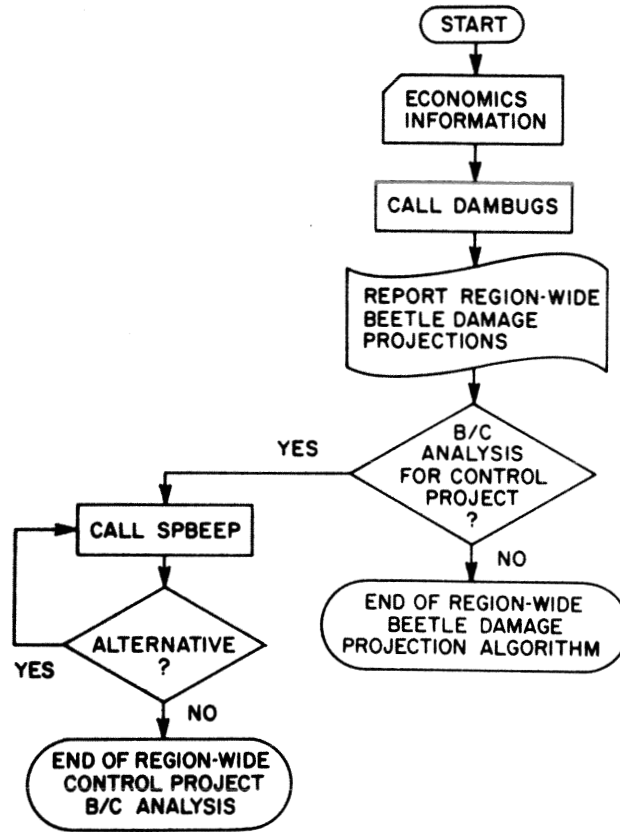

Figure 4.—Flow diagram for the Regionwide Beetle Damage Projection Algorithm (RBDPA) and the Regionwide Control Project B/C Analysis Algorithm (RPBCA).

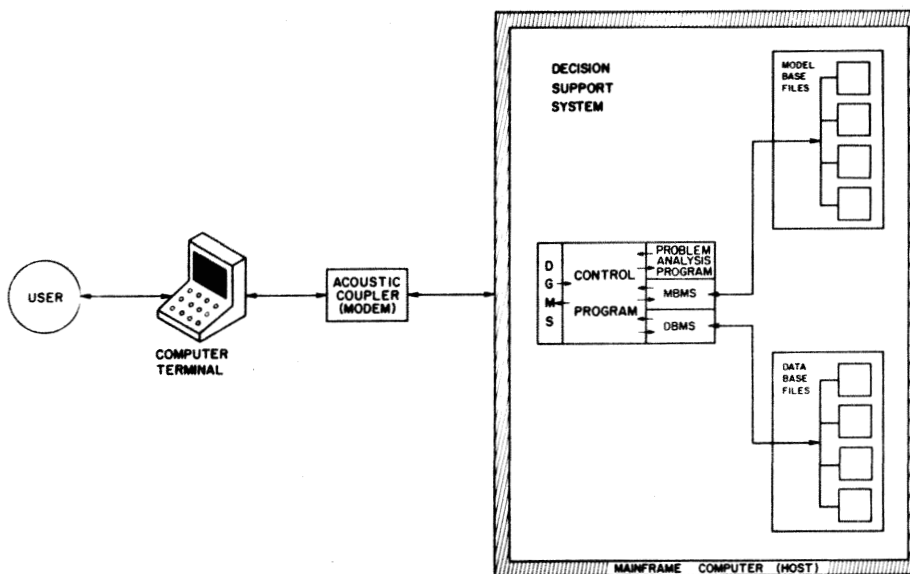

Figure 5.—Structural components of the Southern Pine Beetle Decision Support System.

Table 2.—*Titles of technical information found in SPBDSS. These U. S. Forest Service SPB Fact Sheets are automatically linked to a particular problem area for helping the user arrive at a management decision*

- (1) Fact sheet No. 1:
Use of beetle-killed timber for lumber.
 - (2) Fact sheet No. 2:
Use of beetle-killed timber for pulp, plywood, and panelling.
 - (3) Fact sheet No. 3:
Setting control priorities for the SPB.
 - (4) Fact sheet No. 4:
An aerial observer's guide to recognizing and reporting SPB spots.
 - (5) Fact sheet No. 5:
Insecticides for the SPB.
 - (6) Fact sheet No. 6:
Woodpeckers can help control the SPB.
 - (7) Fact sheet No. 7:
PTAEDA: a loblolly pine growth model.
 - (8) Fact sheet No. 8:
FRONSIM, a computer program model.
 - (9) Fact sheet No. 9:
Use of behavioral chemicals for SPB suppression.
 - (10) Fact sheet No. 10:
Rating the susceptibility of pine stands to SPB attack.
 - (11) Fact sheet No. 11:
The ESPBRAP site-stand data file.
 - (12) Fact sheet No. 12:
Loran-C navigation.
 - (13) Fact sheet No. 13:
Use of beetle-killed timber for particleboard and hardboard.
 - (14) Fact sheet No. 14:
TBAP-Timber benefits analysis program.
 - (15) Fact sheet No. 15:
Salvage removal.
 - (16) Fact sheet No. 16:
Cut-and-leave.
 - (17) Fact sheet No. 17:
Chemical control.
 - (18) Fact sheet No. 18:
Pile-and-burn.
 - (19) Fact sheet No. 19:
A method for assessing the impact of the SPB damage on esthetic values.
 - (20) Fact sheet No. 20:
Economic impact of the SPB on recreation—one approach.
 - (21) Fact sheet No. 21:
Silviculture: a means of preventing losses from the SPB.
 - (22) Fact sheet No. 22:
Setting control priorities using emergence: attack ratios—a research update.
 - (23) Fact sheet No. 23:
DAMBUGS—a case study.
 - (24) Fact sheet No. 24:
Buffer strip.
 - (25) Fact sheet No. 25:
Utilization of beetle-killed southern pine based on tree appearance.
-

rent SPBDSS library of fact sheets is listed in table 2.)

Other items of information were included in the SPBDSS data base to support use of the system. In addition to the Model Routine previously discussed, there is a Help Routine that details the operation of the system, data entry rules, keyword commands, error messages, and a glossary of SPB-related terminology. Both the Model and Help Routines can be accessed at any time prior to entry of a solution algorithm, and upon exiting these routines, the user is returned to the point in the program from which he departed.

Some of the models have complex data inputs that may not be available to forest managers. The SPBDSS data base contains default values generated from years of extensive data collection on SPB spots in east Texas. These defaults can be selected if needed when the model is initialized.

Data Storage Facilities

The ability to store and manipulate simulation data from operations performed on stands and spots greatly enhances the efficiency of SPBDSS. These functions are performed by another component of the SPBDSS data base, the User Files. Each user of the system is issued an I.D. that identifies the records containing spot and stand data generated from his use of SPBDSS. The User Files include stand files that can contain the projected timber loss from a SPB spot, stand growth and yield projections, and hazard-ratings. Data from up to 36 stands can be stored in the stand files. Data entry is automatically accomplished whenever a solution algorithm is executed.

Spot files are another component of the User Files subsystem. For each of the 36 stands stored in the stand files, 36 spots can be entered into the spot files. Spot file data are generated by the TAMBEETLE population dynamics model and include biweekly summaries of SPB activity for 99 days from the initiation date of the simulation. Again, data entry into the spot files is automatic.

Whenever a user desires further simulations dealing with stands and/or spots contained in the User Files, SPBDSS automatically retrieves any appropriate data for use in initializing those simulations. This function prevents redundant data entry on the part of the user. This function also performs the obvious service of providing the user with an efficient means for maintaining accurate, up-to-date records of stand and spot conditions. The structure of the User Files is depicted in figure 6.

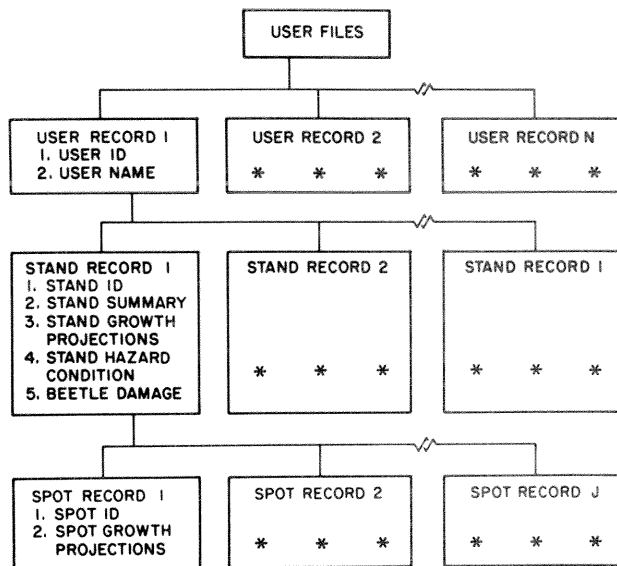

Figure 6.—The hierarchical structure of the User Files subsystem of the Southern Pine Beetle Decision Support System.

SPBDSS Access

SPBDSS resides on the Texas A&M Amdahl 470 computers and is executed under the timesharing option (TSO). When TSO is invoked, the AMDAHL 470 responds interactively to a user's inputs. To access SPBDSS, one must use either a computer terminal or microcomputer equipped with a modem. A procedural guide for using SPBDSS is available that details communication requirements and procedures as well as detailed examples of SPBDSS applications (Saunders et al. 1985).

There are several advantages in using a mainframe computer as the host for SPBDSS. The program size is simply too large (>10,000 lines) for most microcomputers. Some of the component models are complex mechanistic formulations that a microcomputer could not process in a timely manner. Furthermore, the lack of adequate peripheral memory devices on smaller computers would limit the implementation of many of the SPBDSS data base features.

Additionally, on a mainframe-based application, system updates can be accomplished rapidly, eliminating the costly and error-prone process of duplicating and distributing diskettes. A mainframe-based system can accumulate data for system validation as well as serve as a message board where regular users can learn of the latest developments in research, upcoming meetings, and system updates.

SPBDSS Sample Run

Table 3 presents an example that illustrates one of

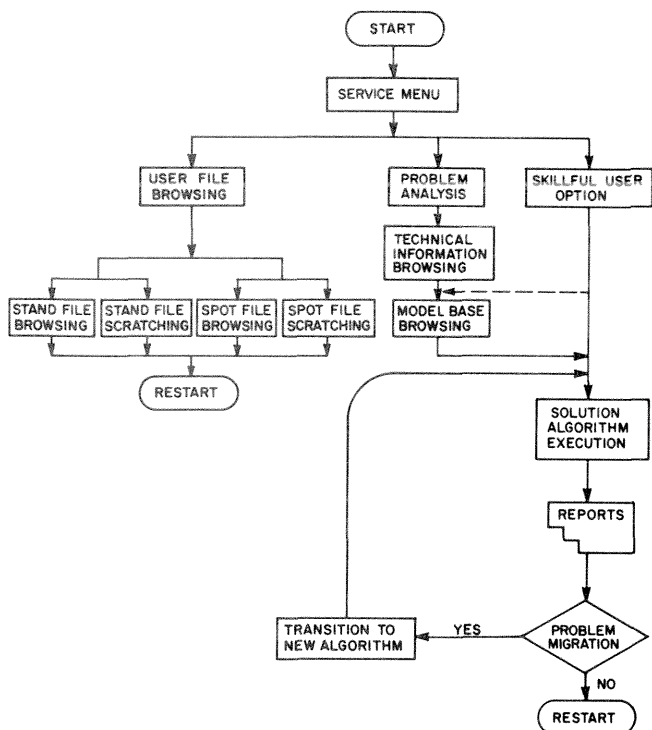

Figure 7.—Flow diagram of the Southern Pine Beetle Decision Support System illustrating the various options available for use in decision support.

the problem-solving pathways in SPBDSS. A flow diagram is presented in figure 7 that illustrates the various options available for use in decision support. In this example, a landowner is concerned about an SPB spot in a loblolly pine stand. The various sub-routines that will be encountered in dealing with this particular problem are shown in figure 3. From the service menu (14 to 20)⁴, problem analysis can be chosen (choice 5), which leads through FERRET to a solution algorithm. Expert users can select option 6, which bypasses FERRET and leads directly to the solution algorithm of their choice. A flow diagram depicting these user-defined pathways through SPBDSS is shown in figure 4.

Problem analysis is chosen in this example, and the landowner is instructed to enter his question (40 to 44). This question is for his reference during problem analysis. It will be repeated on the screen whenever a problem analysis menu is presented to remind the user of the specific question.

At the completion of problem analysis, a summary of the user's selections is displayed (96 to 100), and SPBDSS recognizes that two fact sheets are present in the data base that may relate to the landowner's

⁴ Numbers in parentheses refer to line numbers in the example.

problem. The titles of these fact sheets are presented (108 to 115) and, if desired, the full text can be displayed. In this example, no fact sheets are needed, so zero is the input (117).

SPBDSS is now prepared to initialize and run a solution algorithm. The user is informed of this (120 to 123), and is given an opportunity to review descriptions, input requirements, and outputs of the available models.

Now the user is in the problem-solving mode. Basic inputs regarding current market values and stand characteristics are requested. This particular algorithm deals only with spot growth. Accordingly, the TAMBEETLE spot growth model is initialized, the input is summarized (274 to 287), and a biweekly summary of the spot dynamics for the next 99 days is presented (292 to 302).

Having answered the question "Will it be a problem?" by projecting a 99-day loss of 329 trees or \$1,439.81, SPBDSS provides the option of problem migration (321 to 324). Logically, a user will be interested in suppressing the SPB infestation before the predicted damages occur, and SPBDSS allows this "horizontal movement" to another algorithm. In this case, the landowner chooses to run a benefit/cost analysis for the control project (326).

The inputs required for a benefit/cost analysis include the spot dynamics data and a stand growth and yield projection to rotation age. The Coile and Schumacher stand growth model is initialized (334 to 378) yielding a biannual summary of stand attributes to the expected rotation age of 45 years (380 to 399). These data are automatically supplied to the economics model (in this case SPBEEP) by the control program (Executive Routine).

SPBEEP begins on line 404, and SPBDSS informs the user that he must have a cost estimate of the control project. Nine fact sheets are available within SPBDSS to help the user arrive at this estimate (410 to 438). Having input a project cost of \$400 to salvage 75 percent of the infested timber volume (452 to 481), SPBEEP summarizes the economic consequences incurred "Without a Project" (484 to 504) and "With a Project" (509 to 529). A final report is generated detailing the project benefits, benefit/cost ratio, volume protected, etc. (535 to 543). Additionally, a user has the option of repetitively running the economics model with various control projects to evaluate alternative management strategies (546).

DISCUSSION AND CONCLUSIONS

The concepts of decision support embodied in SPBDSS and discussed in this paper are germane to

1. Table 3. Example run of SPBDSS. User responses are bolded
2. and underlined.
3. HOWDY, WELCOME TO "SPBDSS", THE DECISION SUPPORT SYSTEM
4. FOR SOUTHERN PINE BEETLE MANAGEMENT.
5.
6. PLEASE ENTER YOUR USER ID, (E.G. USFS IPM RT):
7. **TAMU ENTO MS**
8.
9. MIKE
10. NICE TO SEE YOU AGAIN!
11.
12.
13.
14. ENTER 1 TO BROWSE STAND FILES;
15. ENTER 2 TO SCRATCH STAND FILES;
16. ENTER 3 TO BROWSE SPOT FILES;
17. ENTER 4 TO SCRATCH SPOT FILES;
18. ENTER 5 FOR PROBLEM ANALYSIS; OR
19. ENTER 6 TO RUN SOLUTION ALGORITHM; OR
20. ENTER STOP TO EXIT THE PROGRAM:
21.
22.
23.
24. ?
25. **5**
26.
27.
28. THE QUESTION AND ANSWER SESSION BEGINS WITH THE TYPING IN
29. OF YOUR QUESTION. YOUR ENGLISH COMPOSITION ABILITY IS NOT
30. IMPORTANT BECAUSE THE QUESTION IS USED ONLY FOR REFERENCE.
31.
32.
33. NOW YOU MAY TYPE IN YOUR QUESTION. PLEASE DO NOT LET EACH
34. LINE EXCEED THE SLASH / / INDICATED ON THE SCREEN.
35. YOU MAY USE UP TO 6 LINES. PRESS THE RETURN KEY EVERY
36. TIME YOU FINISH A LINE. INPUT "END" AT THE BEGINNING OF A
37. LINE WHEN THE QUESTION IS FINISHED.
38.
39. / /
40. **I have a SPB spot in my loblolly stand. Will it be a**
41. / /
42. **problem?**
43. / /
44. **end**
45.
46.
47. ENTER THE ITEM NUMBER THAT MUST CLOSELY FITS YOUR QUESTION:
48. 1 PREDICTION-EVALUATION
49. 2 PREVENTION
50. 3 UTILIZATION
51. 4 SUPPRESSION
52. ?
53. **1**
54.

55. I HAVE A SPB SPOT IN MY LOBLOLLY STAND. WILL IT BE A
56. PROBLEM?

57.
58.
59. *** PREDICTION-EVALUATION CATEGORY ***
60.

61.
62. ENTER THE ITEM NUMBER THAT MOST CLOSELY FITS YOUR QUESTION:

63. 1 POTENTIAL SPOT(S)
64. 2 EXISTING SINGLE SPOT
65. 3 EXISTING MULTIPLE SPOTS

66. ?

67. 2

68.
69.
70. *** PREDICTION-EVALUATION CATEGORY ***
71.

72. ENTER THE ITEM NUMBER THAT MOST CLOSELY FITS YOUR QUESTION:

73. 1 TREES
74. 2 BEETLES
75. 3 ECONOMICS

76. ?

77. 3

78.
79. I HAVE A SPB SPOT IN MY LOBLOLLY STAND. WILL IT BE A
80. PROBLEM?

81.
82.
83. *** PREDICTION-EVALUATION CATEGORY ***
84.

85.
86. ENTER THE ITEM NUMBER THAT MOST CLOSELY FITS YOUR QUESTION:

87. 1 VALUE OF TREES KILLED
88. 2 POTENTIAL ECONOMIC LOSSES

89. ?

90. 2

91.
92.
93. I HAVE A SPB SPOT IN MY LOBLOLLY STAND. WILL IT BE A
94. PROBLEM?

95.
96. HERE IS A SUMMARY OF YOUR SELECTIONS

97. PREDICTION-EVALUATION

98. EXISTING SINGLE SPOT

99. ECONOMICS

100. POTENTIAL ECONOMIC LOSSES

101.
102. TECHNICAL INFORMATION RELATED TO YOUR PROBLEM IS
103. AVAILABLE;

104. ENTER 1 FOR MENU DISPLAY AND SELECTION;

105. OTHERWISE, ENTER 0 TO CONTINUE:

106. ?

107. 1

108. THE FOLLOWING 2 FACT SHEET(S) ARE AVAILABLE:

109. . FACT SHEET NO.19
110. A METHOD FOR ASSESSING THE IMPACT OF SOUTHERN PINE BEETLE
111. DAMAGE ON ESTHETIC VALUES
112. . FACT SHEET NO.20
113. ECONOMIC IMPACT OF THE SOUTHERN PINE
114. BEETLE ON RECREATION--ONE APPROACH
115. ENTER THE FACT SHEET NO. YOU DESIRE:
116. ?
117. 0
118.
119.
120. SIMULATION MAY AID YOU IN YOUR PROBLEM SOLVING;
121. INPUT 1 FOR MENU OF MODELS IN THE MODEL BASE;
122. INPUT START TO RESTART OR INPUT STOP TO EXIT;
123. OTHERWISE, HIT RETURN TO MAKE SIMULATION RUN(S).
124. ?
125.
126. THIS IS THE END OF THE FRONTEND SESSION, NOW YOU ARE
127. ENTERING THE PROBLEM SOLVING MODE.
128.
129. INPUT THE PRICE INFORMATION IN THE SEQUENCE OF
130. (1) GREEN PULPWOOD PRICE(\$/CORD);RANGE(10,30)
131. (2) GREEN SAWTIMBER PRICE(\$/MBF);RANGE(10,300)
132. (3) SALVAGE PULP PRICE(\$/CORD);RANGE(10,30)
133. (4) SALVAGE SAWTIMBER PRICE(\$/MBF);RANGE(10,200)
134.
135. VALUES ARE TO BE INPUT ON THE SAME LINE AND SEPARATED BY A
136. COMMA:
137.
138. ?
139. 18,180,10,150
140.
141. INPUT THE RATE OF CHANGE FOR THE STUMPAGE PRICE, WHICH
142. NORMALLY DOES NOT EXCEED 3.0. IF YOU ARE NOT SURE WHAT IT
143. MAY BE, INPUT 0:
144.
145. ?
146. 2.0
147.
148. STAND IDENTIFICATION FOR STAND NO. 1
149.
150. ?
151. Buggy1
152. INPUT THE STAND TYPE AS FOLLOWS:
153. INPUT : 1 SLASH PINE PLANTATION
154. INPUT : 2 LOBLOLLY PINE PLANTATION
155. INPUT : 3 LOBLOLLY PINE NATURAL STAND
156. INPUT : 4 SHORTLEAF PINE PLANTATION
157. ?
158. 2
159. ENTER 1 TO RUN TAMBEETLE;
160. ENTER 2 TO RUN TFS MODEL
161. NOTE: THE RUN TIME FOR TAMBEETLE MAY BE LENGTHY,
162. BUT IT PROVIDES A HIGH LEVEL OF RESOLUTION.

163. ?
 164. 1
 165. IDENTIFICATION FOR SPOT NO. 1?
 166. Spot1
 167. TO RUN TAMBEETLE:
 168. INPUT 0 IF YOU WISH TO USE THE LONG FORM FOR INPUT
 169. INPUT 1 IF YOU WISH TO USE THE SHORT FORM.
 170. ?
 171. 0
 172. INPUT A NUMBER BETWEEN 0 AND 1 FOR A RANDOMNESS INDEX
 172. 0 FOR REGULAR (UNIFORM) FOREST
 173. 1 FOR COMPLETELY RANDOM FOREST
 174. ?
 175. 0
 176. ?
 177. INPUT 0 IF YOU WILL BE USING METRIC UNITS,
 178. INPUT 1 IF YOU WILL BE USING NONMETRIC UNITS.
 179. ?
 180. 1
 181. ?
 182. ENTER THE CORRESPONDING NUMBER IF THE ENVIRONMENTAL DATA
 183. IS:
 184. 1) BASED ON STORED 31-YEAR AVERAGED DATA
 185. 11) ENTERED BY HAND USING BI-WEEKLY AVERAGES
 186. 12) ENTERED BY HAND USING MONTHLY AVERAGES
 187. 13) ENTERED BY HAND USING YEARLY AVERAGES
 188. E.G. FOR A TYPICAL YEAR, INPUT 1
 189. ?
 190. 1
 191. INPUT THE MONTH AND DAY REPRESENTING INITIATION
 192. OF SIMULATION. E.G. MAY 3 --- INPUT "5,3"
 193. DEFAULT: TODAY
 194. ?
 195. 0
 196. ?
 197. THE INFESTED TREES ARE DIVIDED INTO THREE STAGES:
 198. 1) TREES WITH FRESH ATTACKS
 199. 2) TREES WITH BROOD BUT NO LONGER UNDER ACTIVE ATTACK
 200. 3) DEAD TREES NO LONGER CONTAINING BROOD
 201. ?
 202. ENTER NO. TREES IN EACH STAGE
 203. (MAX. NOS. ARE 150,150,300)
 204. ?
 205. 5,5,10
 206. ?
 207. ?
 208. INPUT 1 IF YOU HAVE DBH DATA FOR SOME OR ALL OF THE
 209. INDIVIDUAL INFESTED TREES
 210. INPUT 0 IF YOU WISH TO ENTER AN AVERAGE VALUE OR USE A
 211. DEFAULT VALUE
 212. ?
 213. ?
 214. 0
 215. ?

216. INPUT AVERAGE VALUE AND STANDARD DEVIATION
 217. OF DBH FOR INFESTED TREES
 218. INPUT 0 IF AVG. UNKNOWN, LEAVE BLANK IF ST.DEV. UNKNOWN.
 219. DEFAULT: 11.4 IN.
 220. ?
 221. 0
 222. INPUT 1 IF YOU HAVE INFESTED BOLE HEIGHT DATA FOR SOME
 223. OR ALL OF THE INDIVIDUAL TREES
 224. INPUT 0 IF YOU WISH TO ENTER AN AVERAGE VALUE OR USE A
 225. DEFAULT VALUE
 226. ?
 227. 0
 228.
 229. INPUT AVERAGE VALUE AND STANDARD DEVIATION
 230. OF INFES. BOLE HT. FOR INFESTED TREES
 231. INPUT 0 IF AVG. UNKNOWN, LEAVE BLANK IF ST.DEV. UNKNOWN
 232. DEFAULT: 38.4 FT.
 233. ?
 234. 0
 235.
 236. INPUT INDICATOR FOR WITHIN-TREE SPB ESTIMATES AS:
 237. 0) TO USE DEFAULT VALUES
 238. 1) IF PREDOMINATE LIFE STAGE AT DBH IS KNOWN
 239. 2) IF DISK SAMPLES HAVE BEEN TAKEN
 240. ?
 241. 0
 242. THE FOLLOWING INFORMATION RELATES TO AVERAGE
 243. STAND CHARACTERISTICS, ESPECIALLY THE ACTIVE HEAD.
 244.
 245. INPUT PINE BASAL AREA
 246. 40 TO 250 FT*FT/A
 247. ?
 248. 170
 249.
 250.
 251. INPUT AVG. DBH ASSOCIATED WITH P. BASAL AREA MEASUREMENT
 252. HIT RETURN IF SAME AS INFESTED TREE DIAMETERS
 253. UNITS: IN.
 254. ?
 255. 0
 256.
 266. INPUT LANDFORM (FOR HAZARD RATING) INDEX:
 267. 0) UNKNOWN
 268. 1) RIDGE, STEEP SIDE SLOPE, OR DRY UPLAND
 269. 2) SIDE SLOPE, MOIST UPLAND, OR UPLAND FLAT
 270. 3) BOTTOM, FLOOD PLAIN, SWAMP OR STREAM TERRACE
 271. E.G. IF LANDFORM IS SIDE SLOPE, INPUT 2
 272. ?
 273. 2
 274. SUMMARY OF INPUT
 275.
 276. SPOT ID: SPOT1 INITIATED ON 6/25
 277. DEGREE OF RANDOMNESS: 0.0
 278. AVG. DBH 11.4 +/- 4.6

279. AVG. IBH 38.4 +/- 7.7
 280. P.BASAL A. 170.0
 281. WEATHER CONDITIONS: STORED DATA
 282. MASON'S (DBH) HAZARD RATE: -3.00000
 283. LANDFORM: 2, STAND HAZARD: VERY HIGH
 284. PERCENT PULPWOOD: 5.1%
 285. PULPWOOD PRICE: \$ 18.00 SAWTIMBER PRICE: \$180.00

286.
 287.
 288.
 289. HIT RETURN TO CONTINUE

290.
 291.

INTER.	TREES	CORD	BD.FT.	DOLLARS	
NO.	CUM FRESH	PULP	SAW	LOSS	
294.	0	20 5	0.0	205.1	36.93
295.	14	38 14	0.1	590.7	108.61
296.	28	67 26	0.3	1355.0	249.49
297.	42	96 26	0.5	2040.6	375.48
298.	56	132 31	0.7	2781.2	513.47
299.	70	196 56	1.3	4343.8	805.76
300.	84	249 45	1.8	5678.9	1053.79
301.	98	316 64	2.1	7486.3	1385.01
302.	99	329 71	2.3	7773.4	1439.81

303.
 304. INPUT 1 FOR SUMMARY OF DAILY INFO
 305. OTHERWISE, INPUT 0 OR HIT RETURN
 306. ?

307.
 308.
 309. INPUT 0 TO CONTINUE

310. INPUT 1 FOR INPUT SUMMARY
 311. ?

312. 0
 313. IF YOU FEEL THE RESULT FROM THE ABOVE SIMULATION IS
 314. DESIRABLE, INPUT 0; OTHERWISE, INPUT 1 TO MAKE A NEW RUN.

315.
 316. ?
 317. 0

318. FOR STAND BUGGY1
 319. THE INITIAL DAMAGE IS 0.4MCF
 320. THE FINAL DAMAGE IS 29.6MCF
 321. FOR YOUR PROBLEM, YOU MAY WANT TO REVIEW THE TECHNICAL
 322. INFORMATION FOR CONTROL TACTICS, IF SO ENTER 1;
 323. IF YOU WANT TO RUN B/C ANALYSIS FOR A CONTROL PROJECT
 324. ENTER 2 , OTHERWISE PRESS RETURN TO CONTINUE;

325. ?
 326. 2

327.
 328. FOR STAND BUGGY1
 329. THE INITIAL DAMAGE IS 0.4MCF
 330. THE FINAL DAMAGE IS 29.6MCF
 331. KEEP ABOVE BEETLE DAMAGE DATA IN FILE?

332. ok

333. FOR STAND BUGGY1
334. ENTER 1 IF YOU WANT TO USE USLYCOWG;
335. ENTER 2 IF YOU WANT TO USE COILE AND SCHUMACHER
336. TO COMPUTE THE STAND GROWTH:
337.
338. ?
339. 2
340.
341. INPUT THE CURRENT STAND AGE, WHICH SHOULD BE NO LESS THAN
342. 6 YEARS OLD
343.
344. ?
345. 25
346.
347. INPUT THE SITE INDEX IN FEET AT BASE AGE 25;RANGE(30,100)
348.
349.
350. ?
351. 35
352.
353. INPUT THE BASAL AREA PER ACRE IN SQUARE FEET;
354. RANGE(20,350)
355.
356. ?
357. 170
358.
359. INPUT THE ROTATION AGE;RANGE(25,65)
360.
361. ?
362. 45
363.
364. INPUT THE INITIAL PLANTING DENSITY;RANGE(300,3000)
365.
366. ?
367. 500
368.
369. INPUT NUMBER OF EXISTING TREES PER ACRE;
370. RANGE(20,5000)
371.
372. ?
373. 275
374.
375. INPUT THE SIZE OF THE STAND IN ACRES
376.
377. ?
378. 150
379.
380. NOTE: THE FOLLOWING REPORT IS COMPUTED BY THE COILE
381. AND SCHUMACHER STAND GROWTH MODEL
382.
383. PRESS "RETURN" OR "EXECUTE" TO CONTINUE
384.
385.

STAND GROWTH SUMMARY FOR BUGGY1						
AGE	NO. TREES	BASAL AREA	AVERAGE DBH	MEAN HEIGHT	CUFT VOLUME	
386.						
387.						
388.						
389.	25	275.00	170.00	10.65	35.00	1270.69
390.	27	274.90	174.41	10.79	36.57	1395.28
391.	29	274.80	178.28	10.91	37.99	1512.32
392.	31	274.71	181.71	11.01	39.26	1622.11
393.	33	274.61	184.76	11.11	40.42	1725.04
394.	35	274.51	187.50	11.19	41.47	1821.56
395.	37	274.41	189.96	11.27	42.44	1912.09
396.	39	274.32	192.19	11.33	43.32	1997.09
397.	41	274.22	194.22	11.40	44.13	2076.95
398.	43	274.12	196.07	11.45	44.88	2152.07
399.	45	274.02	197.77	11.50	45.57	2222.81
400.						

401. PRESS "RETURN" OR "EXECUTE" TO CONTINUE

402.
403.
404. THE FOLLOWING IS A B/C ANALYSIS BY SPBEEP. IT ASSUMES
405. THAT YOU HAVE SOME CONTROL PRACTICE IN MIND AND THE
406. COST IS ALREADY ESTIMATED. IF YOU WANT TO REVIEW THE CONTROL
407. TACTICS PLEASE ENTER "INFORMATION" OR "INFO", OTHERWISE HIT
408. THE RETURN KEY TO CONTINUE:

409. info

410. THE FOLLOWING 9 FACT SHEET(S) ARE AVAILABLE:

- 411. . FACT SHEET NO. 3
- 412. . SETTING CONTROL PRIORITIES
- 413. . FOR THE SOUTHERN PINE BEETLE
- 414. . FACT SHEET NO. 5
- 415. . INSECTICIDES FOR THE SOUTHERN PINE BEETLE
- 416. . FACT SHEET NO. 6
- 417. . WOODPECKERS CAN HELP CONTROL THE SOUTHERN PINE BEETLE
- 418. . FACT SHEET NO. 9
- 419. . USE OF BEHAVIORAL CHEMICALS FOR SOUTHERN PINE BEETLE
- 420. . SUPPRESSION-- A RESEARCH UPDATE
- 421. . FACT SHEET NO.15
- 422. . SALVAGE REMOVAL

423.
424.
425. NOTE: MORE FACT SHEET(S) COMING UP
426. ENTER THE FACT SHEET NO. YOU DESIRE:

427.
428. ?

429. 0

- 430. . FACT SHEET NO.16
- 431. . CUT-AND-LEAVE
- 432. . FACT SHEET NO.17
- 433. . CHEMICAL CONTROL
- 434. . FACT SHEET NO.18
- 435. . PILE-AND-BURN
- 436. . FACT SHEET NO.24
- 437. . BUFFER STRIP
- 438. ENTER THE FACT SHEET NO. YOU DESIRE:

439. ?

440. 0
 441.
 442.
 443. THE FOLLOWING IS A B/C ANALYSIS BY SPBEEP. IT ASSUMES
 444. THAT YOU HAVE SOME CONTROL PRACTICE IN MIND AND THE
 445. COST IS ALREADY ESTIMATED. IF YOU WANT TO REVIEW THE CONTROL
 446. TACTICS PLEASE ENTER "INFORMATION" OR "INFO", OTHERWISE HIT
 447. THE RETURN KEY TO CONTINUE:
 448.
 450.
 451. FOR THE ABOVE 1 STAND(S) IN QUESTION,
 452. INPUT THE PROJECT COST:
 453. ?
 454. 400
 455. INPUT THE DISCOUNT RATE, WHICH IS NOT TO EXCEED 15:
 456. 3
 457. INPUT THE PERCENTAGE OF VOLUME KILLED THAT MAY BE SALVAGED WITHOUT
 458. CONTROL, AND THE PERCENTAGE OF VOLUME KILLED THAT WILL BE SALVAGED
 459. WITH CONTROL. VALUES ARE TO BE ENTERED ON THE SAME LINE AND
 460. SEPARATED BY A COMMA.
 461. ?
 462. 0,75
 463. FOR STAND BUGGY1
 464. THE AGE IS AT 25
 465. INTERM HARVEST ?
 466. IF YES INPUT 1 , IF NO INPUT 0:
 467. 1
 468. AGE FOR THE INTERM HARVEST ?
 469. 30
 470. PERCENT REMOVED ?
 471. 40
 472.
 473.
 474. IF HARVEST FOR PULP INPUT 0,
 475. IF HARVEST FOR SAW TIMBER INPUT 1 :
 476. 0
 477.
 478. FOR STAND BUGGY1
 479. THE AGE FOR FINAL CUT IS 45
 480. IF HARVEST FOR PULP INPUT 0,
 481. IF HARVEST FOR SAW TIMBER INPUT 1 :
 482. 1
 483.
 484. WITHOUT A PROJECT
 485. -----
 486. VOLUME VOLUME AGE VOLUME AT PRICE VALUE AT PRESENT
 487. AGE HARV LOST THREAT AT HARVEST AT HARVEST AT VALUE
 488. OBJ. (MCF) (MCF) HARV. (MCF) HARV. HARVEST VALUE
 489. -----
 490. 25 P/I 0.18 11.67 30 14.40 225.2 3242.4 2715.5
 491. 25 S/F 0.26 17.51 45 30.63 1364.1 41777.1 22457.6
 492.
 493. PRESS RETURN OR EXECUTE KEY TO CONTINUE:
 494.

495.
 496.
 497. TOTAL VOLUME LOST(MCF): 0.4
 498. VOLUME THREAT(MCF): 29.2
 499. VOLUME AT HARVEST(MCF): 45.0
 500. VALUE AT HARVEST: 45019.4
 501. PRESENT VALUE: 25173.1
 502. VALUE OF THE VOLUME
 503. NOT SALVAGED(LOST): 48.9
 504. TOTAL VALUE LOST: 25221.9
 505.

506. PRESS RETURN OR EXECUTE KEY TO CONTINUE:
 507.
 508.

509. WITH A PROJECT
 510. -----
 511. VOLUME VOLUME AGE VOLUME AT PRICE VALUE AT PRESENT
 512. AGE HARV LOST THREAT AT HARVEST AT HARVEST VALUE
 513. OBJ. (MCF) (MCF) HARV. (MCF) HARV.
 514. -----
 515. 25 P/I 0.04 2.92 30 3.60 225.2 810.6 678.9
 516. 25 S/F 0.07 4.38 45 7.66 1364.1 10444.3 5614.4
 517.
 518.

519. PRESS RETURN OR EXECUTE KEY TO CONTINUE:
 520.
 521.

522. TOTAL VOLUME LOST(MCF): 0.1
 523. VOLUME THREAT (MCF): 7.3
 524. VOLUME AT HARVEST(MCF): 11.3
 525. VALUE AT HARVEST: 11254.9
 526. PRESENT VALUE: 6293.3
 527. VALUE OF THE VOLUME
 528. NOT SALVAGED(LOST): 12.2
 529. TOTAL VALUE LOST: 6305.5
 530.
 531.

532. PRESS RETURN OR EXECUTE KEY TO CONTINUE:
 533.
 534.

535. PROJECT BENEFITS: 18916
 536. TOTAL PROJECT COST: 400
 537. NET PRESENT VALUE: 18516
 538. BENEFIT COST RATIO: 47.29
 539. INTERNAL RATE OF RETURN: -----%
 540. COMPOSITE RATE OF RETURN: 23.76%
 541. TARGETS
 542. VOLUME REMOVED: 0.3
 543. VOLUME PROTECTED: 21.9
 544.
 545.

546. ONE MORE RUN WITH NEW CONTROL PROJECT?

547. no
 548.

```

549.
550. IF YOU WANT TO RESTART INPUT 1 IF NOT INPUT 0
551.
552.
553. 0
554.
555. MAY THE FOREST BE WITH YOU:
556.
557. READY
558. logoff
559.
560. TAM8001 REGION USED                612K
561. TAM8011 REGION REQUESTED          600K
562. TAM8021 BILLING PRIORITY           5
563. TAM8031 EXEC TIME                   47.65 SEC
564. TAM8041 TOTAL EXCPS                 77
565. TAM8051 TOTAL PAGES                 39
566. TAM8061 TERMINAL I/O COUNT         563
567. TAM8071 CALCULATED CPU              133.87 SEC      10.710
568. TAM8081 CONNECT TIME                9.63 MIN        0.054
569. TAM8101 TOTAL COST                  10.764

```

all IPM decisionmaking. As the amount and complexity of pest management information increase, forest managers are finding it increasingly difficult to keep up-to-date. By adopting a well-managed and continuously updated DSS approach to pest management, users will always have the best information available to them, regardless of their level of expertise.

In addition to technology transfer, the DSS structure can provide other support for the problem area it represents. Because decision support systems are structured around problems, administrators can identify where the current technology is ineffectual and where future research should be directed.

When used as an IPM teaching aid, a DSS provides a powerful tool for simulating the outcome of various treatment strategies. Although no computer-based instruction can replace hands-on field experience, DSS-based training can prevent the wasted effort of a trial and error approach to fieldwork.

The experience gained from the development of SBPDSS and the feedback received from southern foresters indicate that the DSS concept is an excellent approach to IPM decisionmaking. The only expenses incurred using SPBDSS are for computer time and telephone charges. These expenses are insignificant relative to the losses that could be incurred as a result of an incorrect management decision. In the example run presented in table 3, the direct expenses associated with using SPBDSS are \$10.76 (569) for computer costs, and (assuming the user is located in Atlanta) approximately \$10 for a 20-minute long distance phone call. The potential losses that could result in the first 99 days of this SPB spot are approximately \$45,000 (line 500). Embodied in the concepts of DSS is the philosophy that managers are, in general, competent, and that an inadequate decision reflects an inability to acquire and assimilate pertinent information (Keen and Morton 1978). These constraints can be overcome and better forest management decisions made by using a DSS.

LITERATURE CITED

- Belanger, R. P.; Porterfield, R. L.; Rowell, C. E. Development for rating the susceptibility of natural stands in the Piedmont of Georgia to attack by the southern pine beetle. In: Hedden, R. L.; Barras, S. J.; Coster, J.E., tech. coords.; Hazard-rating systems in forest insect pest management: symposium proceedings; 1980 July 31–August 1; Athens, GA. Gen. Tech. Rep. WO-27. Washington, DC: U.S. Department of Agriculture, Forest Service; 1981: 79–86.
- Bennett, J. L. Introduction note. In Bennett, J. L., ed. Building decision support systems. Reading, MA: Addison-Wesley Publishing Company; 1983: 1–14.
- Billings, R. F.; Hynum, B. G. Southern pine beetle: guide for predicting timber losses from expanding spots in east Texas. Tex. For. Serv. Circ. 149. Lufkin, TX: Texas Forest Service; 1980. 2 p.
- Brender, E. V.; Clutter, J. L. Yield of even-aged natural stands of loblolly pine. Ga. For. Res. Council. Rep. No. 23. Macon, GA: Georgia Forest Research Council; 1970. 7 p.
- Burkhart, H. E.; Parker, R. C.; Oderwald, R. G. Yields for natural stands of loblolly pine. Publ. FWS-2-72. Blacksburg, VA: Division of Forestry and Wildlife Resources, Virginia Polytechnic Institute and State University; 1972a. 63 p.
- Burkhart, H. E.; Parker, R. C.; Strub, M. R.; Oderwald, R. G. Yields of old-field loblolly pine plantations. Publ. FWS-3-72. Blacksburg, VA: Division of Forestry and Wildlife Resources, Virginia Polytechnic Institute and State University; 1972b. 51 p.
- Burkhart, H. E.; Strub, M. E. A model for simulation of planted loblolly pine stands. In: Fries, J., ed. Growth models for tree and stand simulation. Stockholm, Sweden: Royal College of Forestry; 1974. 258 p.
- Coile, T.S.; Schumacher, F.S. Soil-site relations, stand structure, and yields of slash and loblolly pine plantations in the southern United States. Durham, NC: T.S. Coile, Inc; 1964. 296 p.
- Coster, J.E.; Searcy, J.L., eds. Evaluating control tactics for the southern pine beetle, symposium proceedings; 1979 January 30–February 1; Many, LA. Tech. Bull. 1613. Atlanta, GA: U.S. Department of Agriculture, Forest Service; 1979. 118 p.
- Daniels, R.F.; Burkhart, H.E. Simulation of individual tree growth and stand development in managed loblolly pine plantations. FWS-5-75. Blacksburg, VA: Division of Forest and Wildlife Resources, Virginia Polytechnic Institute and State University; 1975. 69 p.
- Daniels, R.F.; Burkhart, H.E.; Spittle, G.D.; Somers, G.L. Methods for modeling individual tree growth and stand development in seeded loblolly pine stands. Publ. FWS-1-79. Blacksburg, VA: Division of Forest and Wildlife Resources, Virginia Polytechnic Institute and State University; 1979. 50 p.
- Dell, T.R.; Feduccia, D.P.; Campbell, T.E.; Mann, W.F., Jr.; Polmer, B.H. Yields of unthinned slash pine plantations on cutover sites in the west Gulf region. Res. Pap. SO-147. New Orleans, LA: U.S. Department of Agriculture, Forest Service, Southern Forest Experiment Station; 1979; 84 p.

- Feduccia, D.P., Dell, T.R.; Mann, W.F., Jr.; Campbell, T.E.; Polmer, B.H. Yields of unthinned loblolly pine plantations on cutover sites in the west Gulf region. Res. Pap. SO-148. New Orleans, LA: U.S. Department of Agriculture, Forest Service Southern Forest Experiment Station; 1979. 88 p.
- Feldman, R.M., Curry, G.L.; Coulson, R.N. A mathematical model of field population dynamics of the southern pine beetle, *Dendroctonus frontalis*. Ecol. Model. 13: 261-281; 1981.
- Goebel, N.B.; Warner, J.R. Volume yields of loblolly pine plantations for a variety of sites in the South Carolina Piedmont. Clemson, SC: Clemson University, Department of Forestry; 1969. 15 p.
- Hedden, R.L.; Billings, R.F. Southern pine beetle: factors influencing the growth and decline of summer infestations in east Texas. For Sci. 25: 547-556; 1979.
- Ku, T.T.; Sweeney, J.W.; Shelburne, V.B. Site and stand conditions associated with southern pine beetle outbreaks in Arkansas—a hazard rating system. South. J. Appl. For. 4: 103-106; 1980.
- Kulhavy, D.L.; Johnson, P.C. Southern pine beetle: annotated bibliography, 1868-1982. Lufkin, TX: Lufkin Printing Co.; 1983. 95 p.
- Kushmaul, R.J.; Cain, M.D.; Rowell, C.D.; Porterfield, R.L. Stand and site conditions related to southern pine beetle susceptibility. For. Sci. 25: 656-664; 1979.
- Larson, R.W.; Goforth, M.H. TRAS: a computer program for the projection of timber volume. Agric. Handb. 377. Washington, DC: U.S. Department of Agriculture; 1970. 63 p.
- Larson, R.W.; Goforth, M.H. TRAS: a timber volume projection model. Tech. Bull. 1508. Washington, DC: U.S. Department of Agriculture; 1974. 15 p.
- Lenhart, J.D. Cubic-foot yields for unthinned old-field loblolly plantations in the interior west Gulf coastal plain. Pap. No. 14. Nacogdoches, TX: Stephen F. Austin State University, School of Forestry; 1972. 46 p.
- Lenhart, J.D.; Clutter, J.L. Cubic-foot yield tables for old-field loblolly pine plantations in the Georgia Piedmont. Rep. No. 22, Ser. 3. Macon, GA: Georgia Forest Research Council; 1971; 12 p.
- Leuschner, W.A.; Matney, T.G.; Burkhart, H.E. Simulating southern pine beetle activity for pest management decisions. Can. J. For. Res. 7: 138-144; 1977.
- Leuschner, W.A.; Max, T.A.; Spittle, G.D.; Wisdom, H.W. Estimating southern pine beetle timber damages. Bull. Entomol. Soc. Am. 2: 29-34; 1978.
- Mason, G.N.; Hicks, R.R., Jr.; Bryant, C.M.; Mathews, M.L.; Kulhavy, D.L.; Howard, J.E. Rating southern pine beetle hazard by aerial photography. In: Hedden, R.L.; Barras, S.J.; Coster, J.E., tech. coords. Hazard-rating systems in forest insect pest management: symposium proceedings. 1980 July 31-August 1; Athens, GA. Gen. Tech. Rep. WO-27. Washington, DC: U.S. Department of Agriculture, Forest Service; 1981: 109-114.
- Moore, G.E. Factors determining population trends in southern pine beetle spots. Environ. Entomol. 7: 335-342; 1978.
- Moore, J.H.; Chang, M.G. Design of decision support systems. Data Base 12: 8-14; 1980.
- Moore, J.H.; Chang, M.G. Meta-design considerations in building DSS. In: Bennett, J.L., ed.: Building decision support systems. Reading, MA: Addison-Wesley Publishing Company; 1983: 173-204.
- Murphy, P.A.; Beltz, R.C. Growth and yield of shortleaf pine in the west Gulf region. Res. Pap. SO-169. New Orleans, LA: U.S. Department of Agriculture, Forest Service, Southern Forest Experiment Station; 1981. 15 p.
- Myers, C.A. A computer program for variable density yield tables for loblolly pine plantations. Tech. Rep. SO-11. New Orleans, LA: U.S. Department of Agriculture, Forest Service, Southern Forest Experiment Station; 1977. 31 p.
- Page, H.A.; Fagala, F.P. A computer-based information system to aid southern pine beetle control operations. Tex. For. Serv. Publ. 120. Lufkin, TX: Texas Forest Service; 1978. 21 p.
- Payne, T.L.; Billings, R.F.; Coulson, R.N.; Kulhavy, D.L., eds. History, status, and future needs for entomology research in southern forests. Tex. Agric. Exp. Sta. Misc. Publ. 1553. (East Texas Forest Entomology Seminar.) College Station, TX: Texas A&M University; 1984. 72 p.
- Reed, D.D. Estimating region-wide damages caused by the southern pine beetle. Blacksburg, VA: Virginia Polytechnic Institute and State University; 1979. [MS Thesis].
- Rykiel, E.J.; Saunders, M.C.; Wagner, T.L.; Loh, D.K.; Turnbow, R.H.; Hu, L.C.; Coulson, R.N. Computer-aided decisionmaking and information accessing in integrated pest management, with emphasis on the southern pine beetle. J. Econ. Entomol. 77: 1073-1082; 1984.
- Saunders, M.C.; Loh, D.K.; Coulson, R.N.; Payne, T.L.; Rykiel, E.J.; Pulley, P.E.; Hu, L.C. Procedural guide to the southern pine beetle decision support system. Texas A&M Agric. Exp. Sta. Misc. Publ. 1579. College Station, TX: Texas A&M University; 1985.

- Schumacher, F.X.; Coile, T.S. Growth and yield of natural stands of southern pines. Durham, NC: T.S. Coile; 1960. 115 p.
- Sinclair, S.A. SAWMOD: a tool for optimizing potential profit from beetle-killed southern pine sawtimber. *Wood and Fiber* 12: 29-39; 1980.
- Smalley, G.W.; Bailey, R.L. Yield tables and stand structure for shortleaf pine plantations in Tennessee, Alabama, and Georgia Highlands. Res. Pap. SO-97. New Orleans, LA: U.S. Department of Agriculture, Forest Service, Southern Forest Experiment Station; 1974. 58 p.
- Sprague, R.H.; Watson, H.J. MIS concepts. Part I. *J. System Manage.* 26: 34-37; 1975.
- Stephen, F.M.; Searcy, J.L.; Hertel, G.D., eds. Modeling southern pine beetle populations, symposium proceedings; 1980 February 20-22; Asheville, NC. Tech. Bull. 1630. Washington, DC: U.S. Department of Agriculture; 1980. 174 p.
- Sullivan, A.D.; Clutter, J.L. A simultaneous growth and yield model for loblolly pine. *For. Sci.* 18: 76-86; 1972.
- Thatcher, R.C.; Searcy, J.L.; Coster, J.E.; Hertel, G.D., eds. The southern pine beetle. Tech. Bull. 1631. Washington, DC: U.S. Department of Agriculture; 1980. 267 p.
- Thierauf, R.J. Decision support systems for effective planning and control. Englewood Cliffs, NJ: Prentice-Hall; 1982.
- Turnbow, R.H.; Coulson, R.N.; Hu, L.; Billings, R.F. Procedural guide for using the interactive version of the TAMBEETLE model of southern pine beetle population and spot dynamics. *Tex. Agric. Exp. Sta. Misc. Publ.* 1518. College Station, TX: Texas A&M University; 1982. 24 p.
- Turnbow, R.H.; Hu, L.C.; Rykiel, E.J.; Coulson, R.N.; Loh, D.K. Procedural guide for FERRET, the question analysis system for the decision support system for southern pine beetle management. *Tex. Agric. Exp. Sta. Misc. Publ.* 1553. College Station, TX: Texas A&M University; 1982. 21 p.
- Turnbow, R.H.; Loh, D.K.; Coulson, R.N.; Hu, L.C.; Rykiel, E.J.; Payne, T.L.; Pulley P.E. Component implementation of the decision support system for southern pine beetle management. *Sci. Rep. Series* 84-1. College Station, TX: Texas Agricultural Experiment Station, Texas A&M University; 1984. 104 p.
- Volkema, R.J. Problem formulating in planning and design. *Manage. Sci.* 29: 639-652; 1983.

OVERVIEW

Integrated Pest Management in the South: An Overview

R. C. Thatcher, G. N. Mason, and G. D. Hertel¹

INTRODUCTION

Southern pine forests have long been ravaged by a host of insect and disease organisms that seriously affect their productive capacity. Most damaging are five species of bark beetles—the southern pine beetle (*Dendroctonus frontalis* Zimm.) (SPB), three *Ips* engraver beetles (*Ips avulsus* (Eichh.), *I. grandicollis* (Eichh.), and *I. calligraphus* (Germ.)), and the black turpentine beetle (*D. terebrans* (Oliv.) (BTB)—and three tree-killing pathogens—fusiform rust (*Cronartium quercum* (Berk.) Miy. ex Shirai f. sp. *fusiforme*), annosus root rot (*Heterobasidion annosum* Fr. Bref.), and littleleaf disease (*Phytophthora cinnamomi* Rands). Every year, these organisms kill an estimated 1 billion cubic feet of timber in the southern United States, much of which is never utilized. Growth decline from disease adds to the loss. Thus, minimizing pest-caused losses has become a critical management issue for the southern forestry community.

Historically, pest control has been a crisis response to outbreaks after they have developed. But today's increasing demands dictate that greater volumes of high-quality timber and other forest resources be produced from an ever-diminishing southern land base. If we are to achieve this goal, the impact of insects and diseases on production objectives must be recognized and pest management incorporated into total resource management.

Integrated pest management (IPM), a concept virtually unrecognized a decade ago, involves all aspects of the forest system. It combines the use of appropriate information on forest pests to allow

timely, sound decisions on their suppression and prevention with environmentally acceptable, cost-effective means for regulating their numbers.

In 1973-74 and again in 1978-79, the projected needs for wood products from the South, coupled with recurring pest outbreaks, dictated that accelerated research, development, and applications efforts be undertaken to provide new or improved methods and materials for controlling these pests of southern pine forests. Under the Expanded Southern Pine Beetle Research and Applications Program (ESPBRAP)², the emphasis was on expanding the base of knowledge on the SPB, its impacts on multiple forest resources, the host systems in which outbreaks occur, and treatment tactics and strategies. The Integrated Pest Management Research, Development and Applications Program for Bark Beetles of Southern Pines (IPM Program) was initiated in 1980 to expand this knowledge base and to transfer the technology to the research and applications community in the South.

Because of continuing severe SPB outbreaks in five southeastern States in 1979-80, early emphasis in the IPM Program was given to completing unfinished development and applications studies and the implementation of new or improved technology concerned with the control of this pest.

PROGRAM MISSION

The mission of the 5-year IPM Program was to complete and apply technology resulting from ESPBRAP, begin to develop IPM systems for the bark beetle and disease complex of southern pines, and promote the use of pest management as a part of total resource management on all forest lands (Thatcher et al. 1981).

Major consideration was given to the management of bark beetle-susceptible forests in order to assist resource managers in attaining their management

¹Program Manager, Integrated Pest Management RD&A Program for Bark Beetles of Southern Pines, U.S. Department of Agriculture, Forest Service, Southern Forest Experiment Station, Pineville, LA; Project Leader, Silvicultural Options for the Gypsy, Northeastern Forest Experiment Station, Morgantown, WV (formerly Research Coordinator for IPM Program); Program Manager for Gypsy Moth Research, Northeastern Forest Experiment Station, Broomall, PA (formerly Applications Coordinator for IPM Program).

²USDA Expanded Southern Beetle Research and Applications Program (ESPBRAP), October 1, 1975-September 30, 1981.

objectives in an economically and environmentally acceptable manner.

PROGRAM PLANNING AND ORGANIZATION

A general program proposal was prepared by an 8-member planning team (see appendix table I). This document detailed the problem and the inadequacy of current technology to meet management's needs, defined the nature of integrated pest management, discussed the mission and targets for the proposed program, provided a rationale for undertaking a followup program, described the program objectives and the general approach to be taken to achieve them, displayed the Program's organizational structure, defined its duration, and provided a 5-year activity flow.

The program document was reviewed at the Washington Office level by USDA-Forest Service's Forest Insect and Disease Research and Forest Pest Management (S&PF) staffs and by representatives from the southern forestry community (appendix table I). The general proposal was then revised in response to reviewer suggestions.

An 8-member technical committee (appendix table I) was appointed by the planning team to develop a detailed 5-year IPM Program activity schedule, a document that would subsequently be updated periodically to reflect accomplishments.

The activity schedule was planned using the convergence analysis technique. This method utilizes some of the general features of systems and network approaches, but avoids the requirement of certainty of achievement and rigidity of time scheduling. It involves identification of an activity flow organized by targets and subtargets or lead arrays. The activities are presented in a logical series designed to attain Program objectives (targets and outputs). Successful completion of all activities and the convergence (or integration) of accomplishments leads to pest management strategies that can be incorporated into forest management plans, inventories, and operations.

The activity schedule prepared by the technical committee was reviewed by leaders in Federal, State, university, and industrial forestry organizations in the South and staff groups in the Washington Office of the Forest Service (appendix table I). Reviewer comments were incorporated into the final draft of the document. A benefit/cost analysis for the Program was also prepared by Joe Lewis, Economist, Southeastern Area, State and Private Forestry, U.S. Forest Service.

To accomplish the Program mission, six target areas were identified and defined. Seventeen program

outputs or end products relating to these six areas (and representing methods, techniques, procedures, and products) were also identified and described in the activity schedule as follows:

Target 1. Development of methods for measuring and predicting impacts and making control decisions.—Methods for estimating SPB impacts and infestation spot growth and procedures for determining the benefit/costs or cost effectiveness of control decisions will be developed, tested, and offered to users. Existing or new methods will be developed and tested for measuring and predicting the biological, economic, and environmental impacts of bark beetle outbreaks on multiple forest resources and for making control decisions. Information on benefit/costs or cost effectiveness of treatments, methods for sampling beetle populations, interactions between bark beetle species and roles of natural control agents, and models for describing and predicting host susceptibility will be integrated with impact findings. Biological, economic, and environmental impacts, utilization of beetle-killed timber, population estimates, host susceptibility, and treatment study findings will be integrated into pest management systems.

Outputs

01: Procedures for Measuring Bark Beetle and Disease Impacts

- Procedures developed and evaluated for measuring biological and economic impacts of bark beetle infestations, fusiform rust, and annosus root rot on timber resources. Analyses based on techniques developed in ESPBRAP for measuring impacts of SPB. Impacts on timber mortality measured at the management unit or multicounty area level.

02: Procedures for Predicting Bark Beetle and Disease Impacts

- Procedures for predicting future biological and economic impacts of SPB, fusiform rust, and annosus root rot on forest resources developed and/or tested.

03: Models for SPB and Disease Impacts

- Models for describing and/or predicting the biological and economic impacts of SPB, associated bark beetle species, fusiform rust, and annosus root rot developed and provided to users for feedback, refinement, and implementation.

04: Benefit/Costs of Management Strategies

- Simulation models (mainframe computer and microcomputer) developed for evaluating the benefit/costs of alternative stand and SPB management strategies for single and multiple stands for periods ranging from 1 year up to a rotation.

Target 2. Increased utilization of beetle-killed timber.—Sawmill decision guidelines, field procedures for determining the potential uses of beetle-killed timber based on tree appearance classes, and further work on the uses of beetle-killed timber for multiple forest products will be developed and/or implemented. Findings will be integrated into economic impact and control decision support systems.

Outputs

05: Sawmill Decision Model

- A sawmill decision model for use by medium- to large-size mills developed and offered to procurement people and mill operators for determining the profitability of sawing green and beetle-killed pines for lumber in the Gulf South.

06: Field Procedures for Determining Utilization Potential of Beetle-killed Timber

- Field procedures (appearance classes) for determining the state of deterioration and utilization potential of beetle-killed timber for various wood products validated and modified, if necessary, for the Piedmont and Coastal Plain.

Target 3. Measuring and evaluating the roles of biological and environmental factors affecting beetle populations.—Methods for sampling SPB populations will be simplified and procedures developed for sampling *Ips* spp. populations in standing trees and logging residue. Sampling methods will be used to determine biological impacts. Interactions within and between SPB and *Ips* spp. populations will be determined. The identity and collective roles of biological and environmental agents (*not* individual organisms) regulating bark beetle populations will also be determined. Results will be integrated into biological impact (spot growth), control decisionmaking, host susceptibility, suppression and prevention tactics, and pest management technologies.

Outputs

07: Sampling Techniques for SPB and Ips Populations

- Simplified sampling techniques for SPB in standing trees and *Ips* spp. in standing trees and logging residue.

08: Description of Beetle and Microenvironmental Interactions

- Beneficial or competitive relationships between two or more beetle species attacking the same host trees determined under controlled laboratory and endemic vs. epidemic conditions. Determination of effects of beetle density, temperature, and mycangial fungi on brood establishment, development, and survival.

Target 4. Developing methods for measuring and predicting host susceptibility to beetle attack.—Techniques and stand rating systems for measuring and predicting host susceptibility to southern pine beetle attack will be developed for a variety of stand and environmental conditions. Methods will be developed for identifying susceptible trees and stands or for determining the role of man-caused or natural disturbances in triggering bark beetle and/or disease outbreaks. Findings will be integrated with impact, control decisionmaking, factors regulating beetle populations, forest practices, behavioral chemicals, and pest management system results.

Outputs

09: Host and Environmental Conditions Favoring Beetle Attack and Brood Development

- Host and environmental conditions influencing host susceptibility to SPB-*Ips* spp. attack evaluated. Particular attention given to determining the effects of site, tree, stand, disease, and climatic conditions predisposing trees and stands to bark beetle attack and brood development.

10: Models for Describing and Predicting Host Susceptibility to Bark Beetle Attack

- Models developed to describe and predict host susceptibility to bark beetle attack.
- Southern pine beetle, annosus root rot, and littleleaf disease stand rating systems validated, refined, and implemented in natural stands and/or plantations.

Target 5. Formulating suppression and prevention tactics for bark beetles and associated tree pathogens.—Existing or new thinning and sanitation salvage studies will be undertaken and/or monitored in several areas to determine treatment effects on bark beetle and/or tree pathogen incidence and severity in planted and natural stands. Impact measurements, benefit/costs, beetle population estimates, measures of host susceptibility, and prediction techniques will be utilized in evaluating thinning or sanitation salvage treatment effects. Harvesting practices (e.g., tree-length logging, timing of removal of various wood products, treatment and/or removal of all infested material) will be examined to determine their effects on beetle spot or disease infection incidence, spot growth or proliferation, and the feasibility of modifying such practices to reduce losses. Attractant and inhibitor formulations will be tested, deployment strategies developed, and operational protocols provided for field use. Again, impact measures, benefit/costs, and beetle population sampling techniques will be utilized to evaluate treatment effects. The findings will be integrated into pest management systems. Uses of currently registered

toxicants will be extended to include *Ips* spp. and/or black turpentine beetle (BTB). New or improved toxicants will be developed and registered, if needed, for the preventive and remedial control of *Ips* spp. and/or BTB if the registrations of currently approved toxicants are proposed for cancellation by EPA.

Outputs

11: *Management Guidelines to Reduce Pest Losses in Natural and Planted Stands*

- Information on thinning and associated pest activity in managed stands summarized in USDA-Forest Service Technical Bulletin.
- Management guidelines developed to minimize losses from bark beetles and major tree pathogens in thinned or sanitation-salvaged stands.

12: *Identification of Harvesting and Thinning Practices Contributing to Bark Beetle- and Tree Pathogen-Caused Losses*

- The effects of current harvesting and thinning practices on site and stand disturbance and the incidence and severity of SPB, *Ips* spp., BTB, and major tree pathogens on industrial lands summarized in Mississippi Agricultural and Forestry Experiment Station Miscellaneous Publication.
- Recommendations developed for modifying these practices to minimize pest losses, if warranted.

13: *Bark Beetle Behavioral Chemical Formulations and Deployment Strategies*

- Best SPB attractant formulation, release device, and deployment strategy tested as a means for disrupting infestation spot growth.
- Behavioral chemicals used for monitoring *Ips* spp. and/or BTB flight activity and determining the best time for control.

14: *Registration of Dursban® and/or Sumithion® for Ips spp. and/or BTB*

- Efficacy (and safety data, if needed) determined and registration extended on use of Dursban® and/or Sumithion® for preventive treatment to protect high-value green trees from attack or remedial control of existing infestations of *Ips* spp. and/or BTB in standing or felled trees.

15: *Efficacy and Safety of Additional Chemicals*

- Efficacy and safety of several additional chemicals for controlling SPB, *Ips* spp., and/or BTB determined.

Target 6. Developing and incorporating pest management tactics and strategies into operational forestry programs.—Control decision guidelines/systems will be developed by integrating knowledge of impacts, benefit/costs or cost effectiveness of

treatment alternatives, utilization of beetle-killed timber, information on factors affecting beetle populations, measures of host susceptibility, and treatment tactics into pest management tactics and strategies that can then be incorporated into forest management systems. Management guidelines will be developed to provide information needed by resource managers and landowners to support control actions aimed at minimizing losses caused by bark beetles and tree diseases. As time and resources permit, management approaches will be evaluated and refined for different management situations. This should assure earlier acceptance and use of the new or improved technology throughout the geographic range of the bark beetles and diseases in the Southeast.

Outputs

16: *Pest Management Systems for SPB*

- Information relating to impacts, bark beetle populations, host systems, treatment tactics, and benefit/costs assembled and made available to resource managers and pest management specialists in an interactive, user-friendly decision support system.
- Training and onsite assistance provided to foresters, pest management specialists, and landowners to make them aware of available pest management methods and materials.
- Written and audiovisual information also provided to various user groups.

17: *Pest Management Approaches Incorporated into Forest Management Plans, Inventories, and Programs*

- Pest management tactics and strategies demonstrated to resource managers and landowners. Managers and landowners encouraged to include them in management plans, inventories, and operational programs.
- Field or pilot studies conducted to validate research findings.
- Operational pest management guidelines developed for users.
- Interactive, user-friendly management information systems provided that integrate impact, pest, host, and climatic information and display currently recommended best management approach(es) or predict pest population/damage trends for different management scenarios.

In addition to the above, more than 50 specific research and applications project end products were identified that would be produced by individual funded projects.

PROGRAM ADMINISTRATION

The Program Manager for the IPM Program was administratively responsible to the Director of the Southern Forest Experiment Station headquartered in New Orleans (fig. 1). He was in charge of Program planning, implementation, monitoring, reporting, and control. The Program Manager was assisted by a Research Coordinator and an Applications Coordinator who played major roles in organizing, coordinating, and monitoring the research and applications activities, respectively. Members of the Program management team were selected from the U.S. Forest Service and university communities. The management team also included a fulltime Writer-Editor and a Secretary.

A 13-member Oversight and Guidance Committee, made up of knowledgeable individuals from the southern forestry community (appendix table I), was appointed by the southern RPG-2 Cochairmen to review general plans, priorities, and accomplishments. The committee was responsible for recommending approval of original or revised plans of work and progress reports and suggesting any needed changes in direction, priorities, or other administrative matters to the Southern Station Director and RPG-2 Cochairmen.

An 8- to 10-member *ad hoc* Technical Review Panel, made up of scientists and users selected by

the Program Manager, reviewed all research, development, and applications proposals in fiscal year 1981-82 (appendix table I). They recommended actions—acceptance redirection, deferral, or rejection—on all proposals. An attempt was made to match the expertise of panel members with the program's areas of emphasis.

Study Proposals

All research, development, and applications proposals were solicited on a competitive basis. Those accepted for funding were supported either through the Forest Service or the Cooperative State Research Service, U.S. Department of Agriculture. Project duration varied from 1 to 5 years, but continued support for more than 1 year was based on accomplishment, Program needs and priorities, and the availability of funds.

Considerable assistance was provided by Federal, State, and university business offices in handling study proposals, fiscal negotiations, progress reports, and publications. This facilitated both the early resolution of administrative matters and smooth working relationships between funding organizations, program management, and the performing organizations and individuals. It allowed the program to efficiently handle up to 29 projects in a diverse group of organizations in a 12-State area each year.

More than 80 principal investigators and coinvestigators were funded during a portion or all of the Program (appendix table III).

Technology Transfer

Several technology transfer approaches were employed to provide research and development results to transfer agents (S&PF, State, and Extension specialists) and, on occasion, directly to forestry users (Hertel et al. 1985). An abbreviated (but very effective) means of keeping a large audience informed on a very timely basis was through the Program newsletter—*Pest Management News*, which was issued four to six times a year and mailed to over 2,000 readers. Other approaches included direct user involvement in the planning and execution of R&D projects; the preparation of technology transfer plans as a part of individual R&D proposals and for broader subject areas (e.g. stand hazard rating and silvicultural practices); involvement of R&D investigators in the technology transfer process (in technology transfer teams, field and pilot studies); preparation, packaging, and delivery of written and visual materials to forestry specialists and organizations; participation in training and professional society activities; and “hands-on” experience with computer-

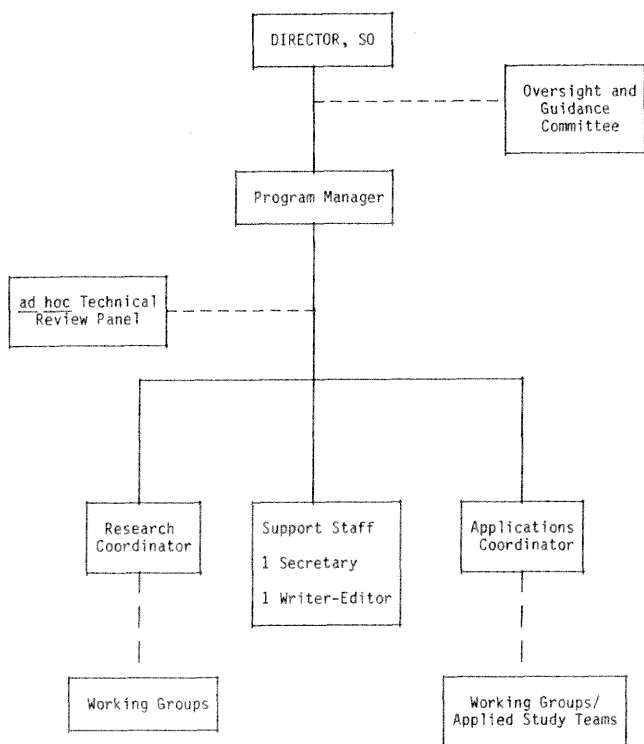

Figure 1.—Organization chart for the IPM Program.

ized management information and decision support systems. Demonstration projects were carried out in Texas, Mississippi, Alabama, and South Carolina.

PROGRAM ACCOMPLISHMENTS

Target 1: Impacts and Control Decisions

Incorporation of pest management tactics and strategies into forest management systems requires the capability to evaluate and predict immediate and long-term biological, economic, and environmental impacts of associated destructive agents on forest resources. This depends on an ability to accurately quantify such impacts and to understand their inter-relationship.

Southern pine beetle.—SPB damages can now be estimated at any point in time with aerial photographs of multicounty or management-unit-size areas (Ward 1985). In addition, trends in beetle activity can be projected from year to year based on current infestation detection records, timber resources, and climatic information (Michaels 1985).

SPB spot growth, tree mortality, and economic losses can be accurately predicted over a 30- to 90-day period based on pest population estimates, stand characteristics, weather, and economic data provided by the landowner or resource manager (Billings 1985, Feldman et al. 1985, Stephen and Lih 1985).

The economic consequences of management actions on southern pine forests, with or without beetle infestation, can be determined with ITEMS (Integrated Timber Economics Management Simulator) (Vasievich and Thompson 1985), or a microcomputer version of this model called SPB-MICRO-BEETLES (Thompson 1985). Inputs of stand conditions, management objectives, economic and time constraints, and SPB infestation frequency (number of infestations per 1,000 acres of susceptible host type) lead to user-specific reports on forest conditions and the cost/benefits of management options. Control actions can then be tailored to individual management situations. A spinoff from ITEMS, a microcomputer Forestry Investment Analysis Program (or the more recent version called QUICKSILVER) provides a detailed evaluation of investment alternatives (Vasievich 1984).

Tree diseases.—Fusiform rust, annosus root rot, and littleleaf disease cause plantation failures, growth and quality decline, and tree mortality losses amounting to hundreds of millions of dollars annually. Incidence and severity information is vital in making appropriate management decisions for specific pine stands. A yield prediction system has been

developed for unthinned slash and loblolly pine plantations infected with fusiform rust (Nance et al. 1985). Loss projections through the end of the rotation can serve as a basis for management actions.

An annosus root rot sampling system is now available to determine the percentage of root infection in thinned loblolly pine plantations (Alexander et al. 1985). Results from sampling can be used to make relative comparisons from one site to another or make management decisions that consider annosus infection severity. The data can also be used in a growth and yield computer model (GY-ANNOSUS) to project growth and volume losses over time and to evaluate management options and the need for and consequences of them (Hokans et al. 1985).

Target 2: Utilization

A costly consequence of the SPB outbreak of the seventies was that about half the timber killed was never utilized. More of this resource could have been used had timber buyers and mill operators been aware that such material was suitable for various wood products (Woodson 1985).

Timber utilization analysis models for green and beetle-killed sawtimber have now been developed that allow operators of mid-size and larger mills to consider market values, operating costs, and mill efficiency information in estimating profit margins for lumber based on size and grade and for residues based on weight (Patterson 1985). This system, called SAMTAM (for green logs), and its companion submodel, SAMTAM II (which considers reduced stumpage prices, reduced product yields, and greater residue overrun in determining potential profit from beetle-killed timber with differing log sizes and stages of deterioration), are available from the USDA Forest Service, Southern Region, for operational use.

A related development is the correlation of field appearance classes with suitability of beetle-killed timber for various wood products (Levi 1981). Visible indicators of stage of deterioration (crown color and density, presence of small twigs, branches and tops, condition of bark) can be used to determine utilization potential for a number of wood products when trees are marked for harvest.

In a Georgia project, various combinations of uninfested green and beetle-killed wood and resin adhesive mixes have been shown to have sufficient internal bond strength for use as corestock for COM-PLY panels. The economic feasibility of manufacturing such panels has been evaluated and technology from the study transferred to the wood products industry through seminars and meetings across the South.

Target 3: Population Change

Beetle outbreaks come and go, and their intensity varies geographically, seasonally, and from year to year. Measuring, interpreting, and anticipating these changes in activity levels are fundamental to developing means for reducing potential pest impacts. This requires a thorough understanding of the southern pine beetle's relationship with associated insects, microorganisms (mites, nematodes), fungi, host trees, and the environment.

Sampling techniques have been developed to estimate SPB and *Ips* engraver beetle numbers in standing trees, as well as *Ips* populations in logging residue following thinning or clearcutting (Berisford et al. 1985; Coulson et al. 1976; Foltz et al. 1977, 1985). A trapping technique for capturing flying BTB populations provides an estimate of population abundance that may affect residual stands (Fatzinger 1985). These estimates are useful to researchers, but also have practical implications in determining the relationships between beetle activity levels and subsequent tree mortality and the need for improved surveillance and control.

Procedures have also been developed that permit specialists to determine the role of various biological and environmental factors regulating beetle numbers (Haack et al. 1985; Hain 1985; Wagner et al. 1979, 1981, 1985). This will enable pest management specialists to predict population and tree mortality trends and to evaluate the effectiveness of treatment strategies.

The beneficial and competitive interactions within and between bark beetle species and with other insects attacking the same host tree, along with information on life processes and developmental rates under different environmental conditions, have been quantified and incorporated into two computerized population dynamics models (TAMBEETLE and ARKANSAS SPB) that mimic field conditions (Coulson et al. 1985, Feldman et al. 1985, Stephen and Lih 1985, Wagner et al. 1984). These models can be used to predict SPB population and tree mortality trends over the next 30 to 90 days and to evaluate treatment effects on these populations.

New information available on the relationship between SPB and the fungi they carry may explain the fluctuations in SPB activity trends (Bridges 1985). Results to date indicate that the presence of one fungus (a mycangial fungus carried by adult females) favors beetle brood development and survival. The absence of another fungus responsible for the blue stain observed in infested trees (*Ceratocystis minor* Hedg.) may signal favorable outbreak conditions. Confirmation of these preliminary findings

would permit pest management specialists to accurately predict the increase or decline of SPB outbreaks based on the presence or absence of the blue stain in beetle-infested trees in chronic problem areas.

Host preferences and switching habits of several wasps (*Roptrocera xylophagorum* Ratz., *Coeloides pissodis* (Ashm.), *Dendrosoter sulcatus* (Meus.), and *Meteorus* sp.) that parasitize southern pine and *Ips* engraver beetles have been demonstrated in trees simultaneously infested with two or more bark beetle species (Kudon and Berisford 1985). These wasps tend to attack the same host species on which they developed and only switch to an alternate host when their preferred one is unavailable. These findings have important implications in understanding the role that natural enemies play in regulating bark beetle populations during low and high beetle activity periods.

Target 4: Host Susceptibility

Susceptibility of host pines to beetle attack and their suitability for brood development and survival are critical factors in predicting outbreak and tree mortality trends and developing strategies to prevent or reduce losses. Attempts to define "susceptible" or "resistant" trees have included measurements of physical and chemical characteristics of host trees before and after they were stressed by natural and man-caused disturbance.

Studies of the reaction of pines inoculated with one of the fungi associated with SPB have demonstrated that the size and severity of the host reaction (often referred to as the hypersensitive reaction) could be an indicator of tree vigor (Cates et al. 1985, Paine and Stephen 1985). Similarly, the effects of varying degrees of root and basal stem wounding on host condition and its relationship to subsequent pest attack have been evaluated (Hodges and Nebeker 1985). Host data from individual trees, trees in the same stand, and trees in different stands have been correlated with beetle attack and brood development, spot growth patterns, and tree mortality. SPB "attack thresholds" have been formulated based on host physiological condition, and data from these studies used to develop a "tree vigor index" for ranking tree susceptibility to SPB attack (Hain and Perry 1985, Nebeker and Hodges 1985). Findings are being integrated into population dynamics models and will eventually be used to predict the risk potential for entire stands.

The effects of disturbances (basal stem and root damage) associated with thinning and logging operations on host condition have been evaluated and their initial effects on growth and site productivity deter-

mined (Blanche et al. 1983, Nebeker and Hodges 1985, Nebeker et al. 1985). Information on site, tree, stand, and environmental conditions, tree chemical and physical characteristics and defense mechanisms, seasonal variation in host condition, and SPB population characteristics is being incorporated into a host susceptibility model to better evaluate the likelihood of trees and stands being attacked by bark beetles (Sharpe et al. 1985).

Stand hazard rating can be a valuable tool in locating potential high-risk areas for SPB, annosus root rot, and littleleaf disease and evaluating the need for special surveillance and management actions. The likelihood of infestation depends on the presence of susceptible trees and stands, high hazard site conditions, and beetle and/or disease activity in a given area.

Bark beetle population estimates have been correlated with stand hazard to provide a means for determining the probability of an individual stand being attacked by the SPB (Billings and Bryant 1985, Hedden 1985, Lorio and Sommers 1985, Mason et al. 1985). Hazard-rating systems for SPB and annosus root rot have been applied to Federal, State, industrial, and small, private, nonindustrial holdings in several States with considerable success. Littleleaf and SPB hazard ratings have been applied on Federal lands in the Piedmont and their effectiveness confirmed (Oak 1985).

Another recent innovation in forecasting techniques is the development of large area models for predicting changes in areas affected by SPB outbreaks. The approach utilizes climatic information and multicounty climatic districts, beetle infestation history in large geographic subregions, and information on the availability of susceptible stands to forecast changes in infestation area in the coming season (Michaels 1985).

Target 5: Control Tactics

Losses caused by many forest pests can be effectively prevented or reduced by applying forest management practices that promote tree and stand vigor under different site and stand conditions (Belanger and Malac 1980). In other situations, direct control methods are required as a temporary expedient or because other management actions would be ineffective in dealing with extensive areas of susceptible host type and a high level of pest activity (Swain and Remion 1981). When outbreaks do occur, early detection is necessary, control priorities must be set, and the most effective method must be employed to minimize economic losses (Billings and Doggett 1980, Billings and Pase 1979, Billings and Ward 1984).

Fusiform rust sanitation salvage cutting operations in South Carolina, Georgia, and Alabama plantations removed a high percentage of severely infected slash and loblolly pine trees that would otherwise have died before final harvest (Belanger et al. 1985, Miller et al. 1985), leaving a significantly larger proportion of healthy trees in the residual stands. Preliminary guidelines for thinning or sanitation salvaging of such plantations have been developed, which should aid managers faced with similar management situations.

The resurgence of SPB across the South in 1982 and 1983 prompted Texas A&M and University of Georgia investigators to renew cooperative testing of a promising spot growth disruption technique that relies on the use of the SPB attractant frontalure. When properly deployed, using a microencapsulated slow release spray applied with a garden sprayer, this chemical successfully stopped spot spread in infestations with less than 50 actively infested trees and in areas where there was no competition with other nearby spots (Payne et al. 1985). The approach should serve as an alternative treatment technique, especially in high-value or special-use areas. Guidelines for its use will be released after the successful completion of field and pilot studies in 1985.

In a Florida project, black turpentine beetle flight was monitored with turpentine-baited traps in naval stores stands (Fatzinger 1985). The traps also captured other insects, such as *Ips* engraver beetles, woodborers, and reproduction weevils. Results from such monitoring should aid naval stores managers in determining periods of peak bark beetle flight and timing chemical spraying.

In the area of safer chemical controls, Dursban® (chlorpyrifos) and Sumithion® (fenitrothion) have proven effective against SPB and *Ips* spp., and have been registered for protecting green pines from beetle attack and controlling existing infestations in individual trees (Hastings and Coster 1981, Nord et al. 1985). (At this time, however, Sumithion® cannot be purchased from regular pesticide suppliers.) The efficacy of pine oil as a preventive control for bark beetles has also been evaluated, but the treatment is not recommended because of general ineffectiveness and undesirable phytotoxic side effects.

Target 6: Integrated Pest Management

The final target of the IPM Program involved drawing together information from the literature, operational experience, and Program-sponsored research and development activities focused on identifying or developing, demonstrating, and applying the best management practices. This effort provided an

opportunity—as well as a challenge—to incorporate the various pieces of existing, new, or improved information, as they became available, into management tactics or strategies, to demonstrate their benefits in the field, and to promote their use by State, Federal, industry, and private cooperators.

Management systems.—Pertinent information and computer models for economics, beetle population dynamics, stand hazard rating, growth and yield, and utilization have been assembled in an interactive, user-friendly SPB decision support system (Saunders et al. 1985). The system provides practical solutions to management problems as well as a means for evaluating the results from simulated treatments in various management situations. The decision support system and its individual component models can presently be accessed through the Texas A&M Computer Center and are described in detail in a user's manual available from the developers.

Guidelines and innovative management plans to reduce losses caused by SPB have been developed to meet the special management needs of the Georgia State parks system. This should minimize future losses caused by the SPB and permit managers to achieve overall management objectives.

Technology developed in the IPM Program and its predecessor, ESPBRAP, has been demonstrated on National Forests, industrial lands, and small, private nonindustrial ownerships in several States. Some of the more applied information has also been packaged and provided to resource managers and landowners for inclusion in forest management plans and operations.

ITEMS and the Forestry Investment Analysis Program have been used by consultants in developing management plans for private, nonindustrial landowners in the south Atlantic Coastal States (Vasievich and Thompson 1985). The Forestry Investment Analysis and QUICKSILVER software packages have been widely distributed by the developer and through the Forest Resources Systems Institute, Courtview Towers, Suite 24, 201 N. Pine Street, Florence, AL.

Demonstration projects.—Demonstration projects were established in four States (Texas, Mississippi, Alabama, South Carolina) to accelerate the transfer of new technology to potential users (Hertel et al. 1985). Field activities included hazard rating and mapping for SPB, littleleaf disease, and annosus root rot and reducing stand susceptibility through thinning or sanitation salvage. Publications, demonstrations, and educational programs were provided to users and recommendations for more efficient SPB control developed and implemented. Some of the

more significant achievements were:

- Implementation of SPB hazard rating and management recommendations on more than 30 demonstration forests in Alabama.
- Testing and application of an annosus root rot sampling procedure and hazard rating in these same demonstration forests.
- Completion of SPB and annosus hazard rating and implementation of IPM practices in District-level management decisionmaking on the Holly Springs National Forest in northern Mississippi.
- Preparation of composite maps of moderate- and high-hazard SPB and annosus sites for consideration in developing management prescriptions and guidelines for managing areas where multiple pest problems occur on the Holly Springs NF.
- Issuance of SPB stand hazard maps to industrial owners in a two-county (Polk and Tyler) demonstration area in Texas. (These maps have been digitized to permit computer storage, access, and future updating at Texas A&M University).
- Provision of a portable sawmill and trained operators for lease to small landowners in Texas and South Carolina to promote preventive control practices and aid in salvaging small infestations and thinning high-hazard stands.
- Development of a grid block (18,000-acre unit) hazard-rating method using small-scale aerial photography and SPB infestation records. Nearly 12 million acres of east Texas timberlands were rated and the results provided to landowners. This system has proven useful in monitoring changes in hazard and stand conditions over time, and in evaluating the general distribution of susceptible host types.
- Application of National Forest SPB risk rating using forest type, stand condition, and soil type on National Forests in Louisiana, Mississippi, Georgia, and South Carolina.
- Testing of a nondestructive plantation-level sampling technique for determining the amount of annosus colonization of root systems in thinned pine plantations in Mississippi, Alabama, Georgia, and South Carolina.
- Application of improved procedures for aerial detection, infestation spot growth predictions, control priority setting, and direct and indirect control practices.
- Use of interactive computer programs for record-keeping of SPB spots (SPBIS), setting treatment priorities, and projecting spot growth rate on National Forest Ranger Districts in Mississ-

- ippi, Arkansas, Louisiana, and Texas.
- Preparation of user's manuals for interactive computer models for predicting infestation spot numbers and changes in outbreak status.

TECHNOLOGY TRANSFER: A FINAL WORD

A major thrust of the IPM Program involved the packaging, transfer, and implementation of new or improved technology. Federal, State and Extension forest pest management specialists played a major role in disseminating program results to foresters and landowners. The southern forestry community, in turn, was kept informed of the latest developments as they were achieved. A complete description of the Program's and the Southern Region's approach to technology transfer is detailed in Hertel et al. 1985. Program-produced technology has reached a vast audience as a result of special efforts by a large number of organizations. Hopefully, these organizations will continue this effort beyond the Program's termination in September 1985.

Appendix table II summarizes some of the specific technology that was transferred by the IPM Program and its major cooperators during the 5-year period 1981-85.

CONCLUSION

The resource needs of the 21st Century require that forest managers rely more heavily on comprehensive systems that incorporate pest management technology into total resource management. This is particularly true in the South, where the highest average timber production potential of any section in the country exists, but where large volumes of timber have been lost to insects and diseases year after year. Southern forests have a great potential for fulfilling increased wood demands on a sustained yield basis in the future. But only through improved management practices that lessen threats to productive capacity can we succeed in capitalizing on this potential.

The approaches developed by the accelerated IPM Program to help prevent and reduce losses caused by destructive pests are part of a continuing effort by forestry research in the United States to find a means of assuring adequate timber supplies to meet present and future demands. New approaches that draw on the Program's findings and combine them with operational experience can now be extensively applied. The success of the Program and the realization of its goals have been and should continue to be closely linked to cooperation with the southern forestry community. The benefits that landowners

and resource managers derive from the technology summarized here may well help to shape the future course of resource management in the southern United States.

LITERATURE CITED

- Alexander, S.A.; Hokans, R.H.; Fanelli, E.S.; Kurdyla, T.M. Methods for estimating annosus root rot in loblolly pine stands. In: Branham, Susan J.; Thatcher, Robert C., eds. Proceedings, integrated pest management research symposium; 1985 April 15-18; Asheville, NC. Gen. Tech. Rep. SO-56. New Orleans, LA: U.S. Department of Agriculture, Forest Service, Southern Forest Experiment Station; 1985: 56-58.
- Belanger, R.P.; Miller, T.; Godbee, J.F. Fusiform rust: guidelines for selective cutting of rust-infected trees in merchantable slash pine plantations. In: Branham, Susan J.; Thatcher, Robert C., eds. Proceedings, integrated pest management research symposium; 1985 April 15-18; Asheville, NC. Gen. Tech. Rep. SO-56. New Orleans, LA: U.S. Department of Agriculture, Forest Service, Southern Forest Experiment Station; 1985: 254-257.
- Belanger, R.P.; Malac, B.F. Silviculture can reduce losses from the southern pine beetle. Agric. Handb. 576. Washington, DC: U.S. Department of Agriculture; 1980. 17 p.
- Berisford, C.W.; Mizell, R.F., III; Kudon, L.H. Line intersect sampling technique for estimating *Ips* populations in logging residue. In: Branham, Susan J.; Thatcher, Robert C., eds. Proceedings, integrated pest management research symposium; 1985 April 15-18; Asheville, NC. Gen. Tech. Rep. SO-56. New Orleans, LA: U.S. Department of Agriculture, Forest Service, Southern Forest Experiment Station; 1985: 13-25.
- Billings, R.F. TFS spot growth. For. Bull. R8-FB/P 20. Atlanta, GA: U.S. Department of Agriculture, Forest Service, Southern Region; Southern Pine Beetle Fact Sheet No. 33; 1985. 2 p.
- Billings, R.F.; Bryant, C.M. Development, implementation, and validation of a large area hazard-and risk-rating system for southern pine beetle. In: Branham, Susan J.; Thatcher, Robert C., eds. Proceedings, integrated pest management research symposium; 1985 April 15-18; Asheville, NC. Gen. Tech. Rep. SO-56. New Orleans, LA: U.S. Department of Agriculture, Forest Service, Southern Forest Experiment Station; 1985: 226-232.
- Billings, R.F.; Doggett, C. An aerial observer's guide for recognizing and reporting southern pine beetle spots. Agric. Handb. 560. Washington, DC: U.S. Department of Agriculture; 1980. 19 p.

- Billings, R.F.; Pase, H.A., III. Spot proliferation patterns as a measure of the area-wide effectiveness of southern pine beetle control tactics. In: Coster, J.E.; Searcy, J.L., eds. Evaluating control tactics for southern pine beetle: symposium proceedings. 1979 January/February. Tech. Bull. 1613. Washington, DC: U.S. Department of Agriculture; 1979: 86-97.
- Billings, R.F.; Ward, J.D. How to conduct a southern pine beetle aerial detection survey. Circ. 167. College Station, TX: Texas Forest Service; 1984. 19 p.
- Blanche, C.A.; Hodges, J.D.; Nebeker, T.E.; Moehring, D.M. Southern pine beetle: the host dimension. Bull. 917. Mississippi State, MS: Mississippi Agricultural and Forestry Experiment Station; 1983. 29 p.
- Bridges, J.R. Relationship of symbiotic fungi to southern pine beetle population trends. In: Branham, Susan J.; Thatcher, Robert C., eds. Proceedings, integrated pest management research symposium; 1985 April 15-18; Asheville, NC. Gen. Tech. Rep. SO-56. New Orleans, LA: U.S. Department of Agriculture, Forest Service, Southern Forest Experiment Station; 1985: 127-135.
- Coulson, R.N.; Flamm, R.O.; Wagner, T.L.; Rykiel, E.J.; Sharpe, P.J.H.; Payne, T.L.; Lin, F.K. Population dynamics of initiation and growth of southern pine beetle infestations. In: Branham, Susan J.; Thatcher, Robert C., eds. Proceedings, integrated pest management research symposium; 1985 April 15-18; Asheville, NC. Gen. Tech. Rep. SO-56. New Orleans, LA: U.S. Department of Agriculture, Forest Service, Southern Forest Experiment Station; 1985: 136-151.
- Coulson, R.N.; Pulley, P.E.; Foltz, J.L.; Martin, W.C. Procedural guide for quantitatively sampling within-tree populations of *Dendroctonus frontalis*. Misc. Pub. 1267. College Station, TX: Texas Agricultural Experiment Station; 1976. 26 p.
- Fatzinger, C.W. Turpentine-baited traps capture black turpentine beetles and other forest Coleoptera but do not prevent attacks on pines. In: Branham, Susan J.; Thatcher, Robert C., eds. Proceedings, integrated pest management research symposium; 1985 April 15-18; Asheville, NC. Gen. Tech. Rep. SO-56. New Orleans, LA: U.S. Department of Agriculture, Forest Service, Southern Forest Experiment Station; 1985: 26-31.
- Feldman, R.M.; Wagner, T.L.; Curry, G.L.; Coulson, R.N.; Sharpe, P.J.H. A methodology for biophysical modeling using TAMBEETLE as an example. In: Branham, Susan J.; Thatcher, Robert C., eds. Proceedings, integrated pest management research symposium; 1985 April 15-18; Asheville, NC. Gen. Tech. Rep. SO-56. New Orleans, LA: U.S. Department of Agriculture, Forest Service, Southern Forest Experiment Station; 1985: 195-201.
- Foltz, J. L.; Corneil, J. A.; Reich, R. M. Procedures for sampling six-spined *Ips* populations in slash pine. In: Branham, Susan J.; Thatcher, Robert C., eds. Proceedings, integrated pest management research symposium; 1985 April 15-18; Asheville, NC. Gen. Tech. Rep. SO-56. New Orleans, LA: U.S. Department of Agriculture, Forest Service, Southern Forest Experiment Station; 1985:6-12.
- Foltz, J. L.; Pulley, P. E.; Coulson, R. N.; Martin, W.C. Procedural guide for estimating within-spot populations of *Dendroctonus frontalis*. Misc. Publ. 1316. College Station, TX: Texas Agricultural Experiment Station; 1977. 27 p.
- Gambliel, H. A.; Cates, R. G.; Caffey-Moquin, W. K.; Paine, T. D. Variation in the chemistry of loblolly pine in relation to infection by the blue-stain fungus, *Ceratocystis minor* Hedg. In: Branham, Susan J.; Thatcher, Robert C., eds. Proceedings, integrated pest management research symposium; 1985 April 15-18; Asheville, NC. Gen. Tech. Rep. SO-56. New Orleans, LA: U.S. Department of Agriculture, Forest Service, Southern Forest Experiment Station; 1985: 177-184.
- Haack, R. A.; Foltz, J. L.; Wilkinson, R. C. Effects of temperature and slash pine phloem thickness on *Ips calligraphus* life processes. In: Branham, Susan J.; Thatcher, Robert C., eds. Proceedings, integrated pest management research symposium; 1985 April 15-18; Asheville, NC. Gen. Tech. Rep. SO-56. New Orleans, LA: U.S. Department of Agriculture, Forest Service, Southern Forest Experiment Station; 1985: 102-113.
- Hain, F. P.; Alya, A. B. Interactions of the southern pine beetle with competitor species and meteorological factors. In: Branham, Susan J.; Thatcher, Robert C., eds. Proceedings, integrated pest management research symposium; 1985 April 15-18; Asheville, NC. Gen. Tech. Rep. SO-56. New Orleans, LA: U.S. Department of Agriculture, Forest Service, Southern Forest Experiment Station; 1985: 114-126.
- Hain, F. P.; Cook, S. P.; Matson, P. A.; Wilson, K. G. Factors contributing to southern pine beetle host resistance. In: Branham, Susan J.; Thatcher, Robert C., eds. Proceedings, integrated pest management research symposium; 1985 April 15-18; Asheville, NC. Gen. Tech. Rep. SO-56. New Orleans, LA: U.S. Department of Agriculture, Forest Service, Southern Forest Experiment Station; 1985: 154-160.
- Hastings, F. L.; Coster, J. E., eds. Field and laboratory evaluations of insecticides for southern pine beetle control. Gen. Tech. Rep. SE-21. Asheville, NC: U.S. Department of Agriculture, Forest Ser-

- vice, Southeastern Forest Experiment Station; 1981. 40 p.
- Hedden, R. L.; Belanger, R. P. Predicting susceptibility to southern pine beetle attack in the Coastal Plain, Piedmont, and southern Appalachians. In: Branham, Susan J.; Thatcher Robert C. eds. Proceedings, integrated pest management research symposium; 1985 April 15–18; Asheville, NC. Gen. Tech. Rep. SO-56. New Orleans LA: U.S. Department of Agriculture, Forest Service, Southern Forest Experiment Station; 1985: 233–238.
- Hertel G. D.; Branham S. J.; Swain K. M. Sr. Technology transfer in integrated forest pest management in the South. Gen. Tech. Rep. SE-34. Asheville, NC: U.S. Department of Agriculture, Forest Service, Southeastern Forest Experiment Station; 1985.
- Hodges, J. D.; Nebeker, T. E.; DeAngelis, J. D.; Blanche, C. A. Host/beetle interactions: influence of associated microorganisms, tree disturbance, and host vigor. In: Branham, Susan J.; Thatcher, Robert C., eds. Proceedings, integrated pest management research symposium; 1985 April 15–18; Asheville, NC. Gen. Tech. Rep. SO-56. New Orleans, LA: U.S. Department of Agriculture, Forest Service, Southern Forest Experiment Station; 1985: 161–168.
- Hokans, R. H.; Fanelli, E. S.; Alexander, S. A. Growth following thinning model for loblolly pine plantations infected by annosus root rot. In: Branham, Susan J.; Thatcher, Robert C., eds. Proceedings, integrated pest management research symposium; 1985 April 15–18; Asheville, NC. Gen. Tech. Rep. SO-56. New Orleans, LA: U.S. Department of Agriculture, Forest Service, Southern Forest Experiment Station; 1985: 59–61.
- Kudon, L. H.; Berisford, C. W. Host preference behavior of insect parasites in the presence of southern pine beetle and one or more *Ips* species. In: Branham, Susan J.; Thatcher, Robert C., eds. Proceedings, integrated pest management research symposium; 1985 April 15–18; Asheville, NC. Gen. Tech. Rep. SO-56. New Orleans, LA: U.S. Department of Agriculture, Forest Service, Southern Forest Experiment Station; 1985: 74–86.
- Levi, M. P. A guide for using beetle-killed southern pine based on tree appearance. Agric. Handb. 572. Washington, DC: U.S. Department of Agriculture; 1981. 19 p.
- Lorio, P. L., Jr.; Sommers, R. A. Potential use of soil maps to estimate southern pine beetle risk. In: Branham, Susan J.; Thatcher, Robert C., eds. Proceedings, integrated pest management research symposium; 1985 April 15–18; Asheville, NC. Gen. Tech. Rep. SO-56. New Orleans, LA: U.S. Department of Agriculture, Forest Service, Southern Forest Experiment Station; 1985: 239–245.
- Mason, G. N.; Lorio, P. L., Jr.; Belanger, R. P.; Nettleton, W. A. Rating the susceptibility of stands to southern pine beetle attack. Agric. Handb. 645. Washington DC: U.S. Department of Agriculture; 1985. 31 p.
- Michaels, P. J.; Sappington, D. E.; Stenger, P. J. Objective prediction of climate-related changes in the distribution of southern pine beetle. In: Branham, Susan J.; Thatcher, Robert C., eds. Proceedings, integrated pest management research symposium; 1985 April 15–18; Asheville, NC. Gen. Tech. Rep. SO-56. New Orleans, LA: U.S. Department of Agriculture, Forest Service, Southern Forest Experiment Station; 1985.
- Miller, T.; Belanger, R. P.; Webb, R. S.; Godbee, J. F. Pest assessment after sanitation-salvage cutting in fusiform rust-infected slash pine plantations. In: Branham, Susan J.; Thatcher, Robert C., eds. Proceedings, integrated pest management research symposium; 1985 April 15–18; Asheville, NC. Gen. Tech. Rep. SO-56. New Orleans, LA: U.S. Department of Agriculture, Forest Service, Southern Forest Experiment Station; 1985.
- Nance, W. L.; Shoulders, E.; Dell, T. R. Predicting survival and yield of unthinned slash and loblolly pine plantations with different levels of fusiform rust. In: Branham, Susan J.; Thatcher, Robert C., eds. Proceedings, integrated pest management research symposium: 1985 April 15–18; Asheville, NC. Gen. Tech. Rep. SO-56. New Orleans, LA: U.S. Department of Agriculture, Forest Service, Southern Forest Experiment Station; 1985: 62–72.
- Nebeker, T. E.; Hodges, J. D. Thinning and harvesting practices to minimize site and stand disturbance and susceptibility to bark beetle and disease attacks. In: Branham, Susan J.; Thatcher, Robert C., eds. Proceedings, integrated pest management research symposium; 1985 April 15–18; Asheville, NC. Gen. Tech. Rep. SO-56. New Orleans, LA: U.S. Department of Agriculture, Forest Service, Southern Forest Experiment Station; 1985: 263–271.
- Nebeker, T. E.; Hodges, J. D.; Karr, B. L.; Moehring, D.M. 1985. Thinning practices in southern pines— with pest management recommendations. Tech. Bull. 1703. Washington DC: U.S. Department of Agriculture; 1985.
- Nord, J. C.; Jones, A. S.; Hastings, F. L. Field tests of insecticides for control of black turpentine beetle. In: Branham, Susan J.; Thatcher, Robert C., eds. Proceedings, integrated pest management research symposium; 1985 April 15–18; Asheville, NC. Gen. Tech. Rep. SO-56. New Orleans, LA: U.S. Department of Agriculture, Forest Service, Southern Forest Experiment Station; 1985: 272–280.

- Oak, S. W. Adaptation of littleleaf disease hazard rating for use in forest management in South Carolina National Forests. In: Branham, Susan J.; Thatcher, Robert C., eds. Proceedings, integrated pest management research symposium; 1985 April 15–18; Asheville NC. Gen. Tech. Rep. SO-56. New Orleans, LA: U.S. Department of Agriculture, Forest Service, Southern Forest Experiment Station; 1985: 246–251.
- Paine, T. D.; Stephen, F. M. Induced defenses against *Dendroctonus frontalis* and associated fungi: variation in loblolly pine resistance. In: Branham, Susan J.; Thatcher, Robert C., eds. Proceedings, integrated pest management research symposium; 1985 April 15–18; Asheville, NC. Gen. Tech. Rep. SO-56. New Orleans, LA: U.S. Department of Agriculture, Forest Service, Southern Forest Experiment Station; 1985: 169–176.
- Patterson, D. W. SAMTAM: a guide to sawmill profitability for green and beetle-killed timber. Agric. Handb. 648. Washington, DC: U.S. Department of Agriculture; 1985.
- Payne, T. L.; Kudon, L. H.; Berisford, C. W.; O'Donnell, B. P.; Walsh D. K. Effects of frontallure in suppressing southern pine beetle spot growth under endemic and epidemic population levels. In: Branham, Susan J.; Thatcher, Robert C., eds. Proceedings, integrated pest management research symposium; 1985 April 15–18; Asheville, NC. Gen. Tech. Rep. SO-56. New Orleans, LA: U.S. Department of Agriculture, Forest Service, Southern Forest Experiment Station; 1985: 281–285.
- Saunders, M. C.; Loh, D. K.; Coulson, R. N.; Rykiel, E. J.; Payne, T. L.; Pulley, P. E.; Hu, L. C. Development and implementation of the southern pine beetle decision support system. In: Branham, Susan J.; Thatcher, Robert C., eds. Proceedings, integrated pest management research symposium; 1985 April 15–18; Asheville NC. Gen. Tech. Rep. SO-56. New Orleans, LA: U.S. Department of Agriculture, Forest Service, Southern Forest Experiment Station; 1985: 335–363.
- Sharpe, P. J. H.; Wu, H.; Cates, R. G.; Goesch, J. D. Energetics of pine defense systems to bark beetle attack. In: Branham, Susan J.; Thatcher, Robert C., eds. Proceedings, integrated pest management research symposium; 1985 April 15–18; Asheville, NC. Gen. Tech. Rep. SO-56. New Orleans, LA: U.S. Department of Agriculture, Forest Service, Southern Forest Experiment Station; 1985: 206–223.
- Stephen, F. M.; Lih, M. A *Dendroctonus frontalis* infestation growth model: organization, refinement, and utilization. In: Branham, Susan J.; Thatcher, Robert C., eds. Proceedings, integrated pest management research symposium; 1985 April 15–18; Asheville, NC. Gen. Tech. Rep. SO-56. New Orleans, LA: U.S. Department of Agriculture, Forest Service, Southern Forest Experiment Station; 1985: 186–194.
- Swain, K. M.; Remion, M. C. Direct control methods for southern pine beetle. Agric. Handb. 575. Washington, DC: U.S. Department of Agriculture; 1981. 15 p.
- Thatcher, R. C.; Mason, G. N.; Hertel, G. D.; Searcy, J. L. New combined program for management of forest pests. For. Farmer 40:12. 1981.
- Thompson, W. A. SPB MICROBEETLES: a simulation system for evaluating economic performance of management alternatives for stands attacked by southern pine beetles. In: Branham, Susan J.; Thatcher, Robert C., eds. Proceedings, integrated pest management research symposium: 1985 April 15–18; Asheville, NC. Gen. Tech. Rep. SO-56. New Orleans, LA: U.S. Department of Agriculture, Forest Service, Southern Forest Experiment Station; 1985 292–299.
- Vasievich, J. M. Forest investment analysis program 1.1. In: Software directory—Economics. EC0048-01. Florence, AL: Forest Resources Systems Institute; 1984. 2 p.
- Vasievich, J. M.; Thompson, W. A. ITEMS: an integrated method to project southern pine stand development. In: Branham, Susan J.; Thatcher, Robert, C., eds. Proceedings, integrated pest management research symposium; 1985 April 15–18; Asheville, NC. Gen. Tech. Rep. SO-56. New Orleans, LA: U.S. Department of Agriculture, Forest Service, Southern Forest Experiment Station; 1985: 300–316.
- Wagner, T. L.; Gagne, J. A.; Doriswamy, P. C.; Coulson, R. N.; Brown, K. W. Development time and mortality of *Dendroctonus frontalis* in relation to changes in tree moisture and xylem water potential. Environmental Entomology 8:1129–1138; 1979.
- Wagner, T. L.; Flamm, R. O.; Coulson, R. N. Strategies for cohabitation among southern pine bark beetle species: comparisons of life process biologies. In: Branham, Susan J.; Thatcher, Robert C., eds. Proceedings, integrated pest management research symposium; 1985 April 15–18; Asheville, NC. Gen. Tech. Rep. SO-56. New Orleans, LA: U.S. Department of Agriculture, Forest Service, Southern Forest Experiment Station; 1985: 87–101.
- Wagner, T. L.; Wu, H.; Sharpe, P. J. H.; Schoolfield, R. M.; Coulson, R. N. Modeling insect development rates: a literature review and application of a biophysical model. Annals of the Entomological Society of America 77:208–225; 1984.
- Ward, J. D.; Dull, C. W.; Ryan, G. W.; Remion, M. C. Estimating southern pine beetle-caused tim-

ber losses over extensive areas. In: Branham, Susan J.; Thatcher, Robert C., eds. Proceedings, integrated pest management research symposium; 1985 April 15-18; Asheville, NC. Gen. Tech. Rep. SO-56. New Orleans, LA: U.S. Department of Agriculture, Forest Service, Southern Forest Experiment Station; 1985: 34-40.

Woodson, G. Utilization of beetle-killed southern pine. Gen. Tech. Rep. WO-47. Washington, DC: U.S. Department of Agriculture, Forest Service and Cooperative State Research Service; 1985.

Appendix Table I.—*Committee and Team Members Responsible for Documentation and/or Review for IPM Program¹*

I. *Planning Team, General Program Proposal*

Kent T. Adair, Dean, School of Forestry, Stephen F. Austin State University, Nacogdoches, TX.

Thomas L. Payne, Professor, Department of Entomology, Texas A&M University (also representing SEA-CR), College Station, TX.

Arnett C. Mace, Jr., Director, School of Forest Resources and Conservation, University of Florida, Gainesville, FL.

Amel E. Landgraf, Assistant Director, State and Private Forestry, Southeastern Area, U.S. Forest Service, Atlanta, GA.

Robert L. Scheer, Deputy Director, Southeastern Forest Experiment Station, U.S. Forest Service, Asheville, NC.

Thaddeus A. Harrington, Assistant Director, Southern Forest Experiment Station, U.S. Forest Service, New Orleans, LA.—*Coordinator*.

Robert C. Thatcher, Program Manager, Expanded Southern Pine Beetle R&A Program, Pineville, LA.—*Advisor*.

Robert L. Lyon, Staff Entomologist, Forest Insect and Disease Research Staff, U.S. Forest Service, Washington, DC.

II. *Reviewers, General Program Proposal*

B. G. Gresham, State Forester, Little Rock, AR. (Association of Southern State Foresters)

Richard O. Fitzgerald, Regional Silviculturist, Southern Region, U.S. Forest Service, Atlanta, GA. (National Forest System)

Lewis C. Peters, Executive Vice President, Bennett and Peters, Inc., Baton Rouge, LA. (Association of Consulting Foresters).

Darwin E. Fender, Manager, Forest Productivity and Research, International Paper Company, Mobile, AL. (Southern Forest Industry Research Council)

I. F. Trew, Research Forester, Westvaco Corporation, Crozet, VA. (Southern Forest Industry Research Council)

Washington Office Staffs of USDA Forest Service (Forest Insect and Disease Research, Forest Pest Management—State and Private Forestry, Deputy Chief-Research)

III. *Technical Committee, Detailed 5-Year Activity Flow*

Kent T. Adair, Dean, School of Forestry, Stephen F. Austin State University, Nacogdoches, TX.

Roy L. Hedden, Forest Entomologist, Clemson University, Clemson, SC.

Robert L. Lyon, Staff Entomologist, Forest Insect and Disease Research Staff, U.S. Forest Service, Washington, DC.

Thomas Miller, Project Leader, Integrated Pest Management Research Work Unit, Southeastern Forest Experiment Station, U.S. Forest Service, Gainesville, FL.

Caleb L. Morris, Chief, Insect and Disease Investigations, Virginia Division of Forestry, Charlottesville, VA.²

Thomas L. Payne, Professor, Department of Entomology, Texas A&M University, College Station, TX.

Harvey V. Toko, Staff Director, Forest Pest Management, Southeastern Area, State and Private Forestry, U.S. Forest Service, Atlanta, GA.

Robert C. Thatcher, Chairman and Program Manager, Expanded Southern Pine Beetle R&A Program, U.S. Forest Service, Pineville, LA.—*Advisor*.

Gerard D. Hertel, Research Coordinator, Expanded Southern Pine Beetle R&A Program, U.S. Forest Service, Pineville, LA.—*Observer*.²

IV. *Reviewers, Detailed 5-Year Activity Flow*

Deans/Directors, all forestry schools in the South (14)

All State Foresters in the South (13)

Regional Forester, Southern Region, U.S. Forest Service, Atlanta, GA

Area Director, Southeastern Area, State and Private Forestry, U.S. Forest Service, Atlanta, GA

Station Directors, Southeastern and Southern Forest Experiment Stations, U.S. Forest Service, Asheville, NC, and New Orleans, LA, respectively

Southern Forest Industry Research Council

User Representatives³

Jim L. Gillis, President, American Turpentine Farmers Association

Washington Office Staffs of USDA-Forest Service (Forest Insect and Disease Research, Timber Management Research, Forest Pest Management—State and Private Forestry), Deputy Chief-Research.

V. *IPM Oversight and Guidance Committee*

Dr. Stanley J. Barras, Assistant Director for Research-West, Southern Forest Experiment Station, U.S. Forest Service—New Orleans, LA (*Representing Forest Service-Research*)

Dr. Benton H. Box, Dean, College of Forest and Recreation Resources, Clemson University, Clemson, SC—(*Representing National Assn. of Professional Forestry Schools and Colleges*)

Eley Frazier, Consulting Forester, Albany, GA (*Representing Consulting Foresters*)

Dr. John F. Hosner, Director, School of Forestry and Wildlife Resources, Virginia Polytechnic Institute & State University, Blacksburg, VA—(*Representing Southern State Agricultural Experiment Stations*)

Dr. LeRoy Jones, Deputy Regional Forester, Southern Region, State & Private Forestry, U.S. Forest Service, Atlanta, GA—(*Representing Forest Service—State and Private Forestry*)

Leonard A. Kilian, Jr., State Forester, South Carolina Forestry Commission, Columbia, SC—(*Representing Southern State Foresters*)

Dr. Barry F. Malac, Technical Director, Woodlands Division, Union Camp Corporation, Savannah, GA—(*Representing Southern Forest Industry Research Council*)

James E. Neal, Regional Extension Forester, Cooperative Extension Service, University of Georgia, Athens, GA—(*Representing Extension Service*)

Dr. Jerry A. SESCO, Assistant Director, Research Programs in Georgia and Florida, Southeastern Forest Experiment Station, U.S. Forest Service, Asheville, NC—(*Representing Forest Service-Research*)

J. Ed Sheppard, Mid-South Raw Materials Planning &

- Supply Manager, Weyerhaeuser Company, Dierks, AR—
(Representing Southern Forest Industry Research Council)
- Dr. Thomas H. Ellis, Director, Southern Forest Experiment Station, New Orleans, LA—(Ex-officio Member, representing Forest Service-Research)
- Dr. Eldon W. Ross, Director, Southeastern Forest Experiment Station, Asheville, NC—(Ex-officio Member, representing Forest Service-Research, and Co-Chairman RPG-2)
- Dr. Arnett C. Mace, Jr., Director, School of Forest Resources & Conservation, University of Florida, Gainesville, FL—Chairman—(Representing NAPFSC, and Co-Chairman RPG-2)
- Dr. J. Charles Lee, Head, Department of Forest Science, Texas A&M University, College Station, TX—Former Chairman—(Representing ASCUFRO)
- VI. *IPM Program Technical Review Panel* (FY 1981 - FY 1982)
- Robert L. Anderson, Supervisory Plant Pathologist, Forest Pest Management, Southern Region, State & Private Forestry, U.S. Forest Service, Asheville, NC.
- Edwin H. Barron, Head, Forest Management Department, Texas Forest Service, College Station, TX.
- Stephen C. Cade, Unit Leader, Pest Management, Southern Forestry Research Center, Weyerhaeuser Company, Hot Springs, AR.
- Dr. Robert W. Campbell, Research Entomologist, Pacific Northwest Forest & Range Experiment Station, U.S. Forest Service, Corvallis, OR.
- Dr. Jack E. Coster, Director, Division of Forestry, West Virginia University, Morgantown, WV.
- Dr. John D. Hodges, Professor of Silviculture, Department of Forestry, Mississippi State University, Mississippi State, MS.
- Robert N. Kitchens, Silviculturist, Southern Region, U.S. Forest Service, Atlanta, GA.
- Joseph W. Lewis, Economist, Forest Pest Management, State & Private Forestry, U.S. Forest Service, Washington, DC.
- Caleb L. Morris, Chief, Insect & Disease Investigations, Virginia Department of Conservation & Economic Development, Charlottesville, VA.
- William D. Smith, Lecturer, Department of Forestry, North Carolina State University, Raleigh, NC.
- Dr. Jerry L. Stimac, Assistant Professor, Department of Entomology & Nematology, University of Florida, Gainesville, FL.
- M. Carlton White, Manager, Forest Technology Implementation, International Paper Company, Mobile, AL.

¹ All listed affiliations are as of the time active on the respective committees.

² Second Committee meeting only.

³ See I. above for listing.

Appendix Table II.—*Technology Transfer Activities in the IPM Program, 1981–85*

Activity	Year accomplished	Responsible cooperator	Description
<i>USDA Publications</i>			
Agriculture Handbook #597	1982	R8 FPM	Management strategies for reducing losses caused by fusiform rust, annosus root rot, and littleleaf disease
Agriculture Handbook #634	1985	IPM, R8 FMP	Identification and biology of southern pine bark beetles
Agriculture Handbook #645	1985	IPM, SO, SE, R8 FPM	Rating the susceptibility of stands to southern pine beetle attack
Agriculture Handbook #641	1985	LSU, Miss. State Univ.	Distinguishing immatures of insect associates of southern pine bark beetles
Agriculture Handbook #648	1985	Univ. WV, R8 S&PF	SAMTAM: A guide to sawmill profitability for green and beetle-killed timber
Agriculture Handbook #649	1985	SE, Clemson Univ.	Managing Piedmont forests to reduce losses from the littleleaf disease—southern pine beetle complex
Agriculture Handbook #650	1985	IPM	Integrated pest management in southern pine forests
General Technical Report #WO-47	1985	IPM, LA Tech. Univ.	Utilization of beetle-killed southern pine
General Technical Report #SO-56	1985	IPM	Integrated pest management research symposium: the proceedings
General Technical Report #SE-34	1985	IPM, R8 FPM	Technology transfer in IFPM in the South
Technical Report	1985	IPM	Forester's handbook for reducing bark beetle and disease-caused losses in southern pines
	1985	NASF	
Training Aid	1985	IPM	Predicting southern pine beetle and disease trends
Technical Bulletin #1703	1985	Miss. State Univ.	Thinning practices in southern pines—with pest management recommendations
Agric. Info. Bull. #491	1985	IPM	IPM in the South: highlights of a 5-year program

Appendix Table II.—*Technology Transfer Activities in the IPM Program, 1981–85—Continued*

Activity	Year accomplished	Responsible cooperator	Description
Forestry Fact Sheets #15–23	1981	R8 FPM, IPM	Salvage removal; cut and leave; chemical control; pile and burn; assessing SPB damage to esthetic values; economic impact of SPB on recreation; preventive silviculture; setting control priorities; DAMBUGS (computer model)
Forestry Fact Sheet #24	1982	R8 FPM, IPM	Buffer strip
Forestry Fact Sheet #25	1982	R8 FPM, IPM	Utilization of beetle-killed southern pine based on tree appearance
Forestry Fact Sheet #26	1983	R8 FPM, IPM	Use of computer simulation models to predict expected tree mortality and monetary loss from SPB
Forestry Fact Sheet #27	1983	R8 FPM, IPM	FERRET: a question analysis routine for the SPB decision support system
Forestry Fact Sheet #28	1983	R8 FPM, IPM	Texas hazard-rating guide
Forestry Fact Sheet #29	1984	R8 FPM, IPM	A computerized literature retrieval system for SPB
Forestry Fact Sheet #30	1985	R8 FPM, IPM	SAMTAM: sawmill analysis model for green and beetle-killed southern pine timber
Forestry Fact Sheet #_____	1985	R8 FPM, IPM	CLEMBEETLE
Forestry Fact Sheet #_____	1985	R8 FPM, IPM	TAMBEETLE
Forestry Fact Sheet #_____	1985	R8 FPM, IPM	TFS spot growth
Forestry Fact Sheet #_____	1985	R8 FPM, IPM	ARKANSAS SPB
Forestry Fact Sheet #_____	1985	R8 FPM, IPM	PIEDMONT RISK
Forestry Fact Sheet #_____	1985	R8 FPM, IPM	SPB COMP
Forestry Fact Sheet #_____	1985	R8 FPM, IPM	Fusiform rust yield-slash
Forestry Fact Sheet #_____	1985	R8 FPM, IPM	GY -ANNOSUS
Forestry Fact Sheet #_____	1985	R8 FPM, IPM	SPB decision support system
Forestry Fact Sheet #32	1985	R8 FPM, IPM	MS HAZARD B—a hazard-rating model
Forestry Fact Sheet #_____	1985	R8 FPM, IPM	NF RISK
Forestry Fact Sheet #_____	1985	R8 FPM, IPM	TFS GRID HAZARD
Forestry Fact Sheet #_____	1985	R8 FPM, IPM	AR HAZARD
Forestry Fact Sheet #_____	1985	R8 FPM, IPM	MOUNTAIN RISK
Forestry Fact Sheet #_____	1985	R8 FPM, IPM	IPM decision key
Forestry Fact Sheet #_____	1985	R8 FPM, IPM	AERIAL GA
Forestry Fact Sheet #_____	1985	R8 FPM, IPM	Borax for annosus prevention
Forestry Fact Sheet #_____	1985	R8 FPM, IPM	SPB control priority
Forestry Fact Sheet #_____	1985	R8 FPM, IPM	Estimating the severity of annosus root rot in loblolly pine stands
Forestry Fact Sheet #31	1985	R8 FPM, IPM	SPBEEP—a computer program
<i>Cooperator-Issued Publications</i>			
Tex. For. Serv. Circulars #256, 257, 258	1982	Tex. For. Serv.	Utilization, veneer recovery, weight loss, bending strength loss in southern pine beetle-killed timber
Tex. For. Serv. Circular #259	1982	Tex. For. Serv.	Southern pine beetle field guide for hazard rating, prevention, and control

Appendix Table II.—*Technology Transfer Activities in the IPM Program. 1981–85—Continued*

Activity	Year accomplished	Responsible cooperator	Description
Tex. For. Serv. Circular #267	1984	Tex. For. Serv.	How to conduct a southern pine beetle aerial detection survey
Tex. Agric. Exp. Sta. Misc. Publ. #1518, 1533	1982/1983	Texas A&M Univ.	Procedural guides for southern pine beetle computer models
Forestry Leaflets #5-8, 11-14	1983	Clemson Univ. Coop. Ext. Serv.	SPB identification; salvage removal; cut-and-leave; loss estimation; portable sawmills; utilization; predicting losses in Piedmont and Coastal Plain
Miss. Agr. & For. Exp. Sta. Bulletin #917	1983	Miss. State Univ.	Southern pine beetle: the host dimension
Unnumbered publication	1983	Stephen F. Austin State Univ.	SPB: annotated bibliography, 1868-1982
Monograph #12	1984	Univ. of FL	Annotated bibliography of black turpentine beetle and <i>Ips</i> species in the southeastern U.S.
IPM Fact Sheet #1	1984	SC For. Comm., Clemson Univ.	Portable sawmill converts SPB-killed pines to lumber
Unnumbered Fact Sheet	1984	SC For. Comm., Clemson Univ.	Portable sawmill lease arrangements
Unnumbered Fact Sheet	1984	SC For. Comm., Clemson Univ.	Convert your beetle-killed pines to lumber
NC Agric. Res. Serv. Tech. Bull. #277	1984	NC State Univ.	Association of insect arrival with severed pines during collapsing SPB epidemic
Publication #91	1983	Va. Div. For.	Thin your pines, it's good business
Ga. For. Comm. Publ. #235-1	1984	Ga. For. Comm.	Guidelines for managing pine bark beetles in Georgia
<i>Newsletters</i>			
Pest Management News, bimonthly, 27 regular issues plus 3 special editions	1981-85	IPM	Current events, research highlights and accomplishments, new publications
Spotlight on SPB, Quarterly, 18 issues	1981-85	Tex. For. Serv.	Status report of the east Texas demo project and southern pine beetle outbreak situation
Integrated Pest Management Newsletter, Semiannually	1984-85	Clemson Univ., SC For. Comm., USFS	Progress reports, technology transfer highlights, project accomplishments
<i>Visual Materials</i>			
Slide Tape	1982	Miss. Coop. Ext. Serv.	Control methods for the southern pine beetle (80 slides, 16-min. tape)
Slide Tape	1982	NC Coop. Ext. Serv.	Biology and identification of the southern pine beetle (46 slides, 7-min. tape)
Slide Tape	1982	NC Coop. Ext. Serv.	Insects associated with the southern pine beetle (79 slides, 14-min. tape)
Slide Tape	1982	NC Coop. Ext. Serv.	Building among the pines (121 slides, 19-min. tape)
Slide Tape	1982	Clemson Ext. Serv.	Silviculture can reduce southern pine beetle losses (65 slides, 9-min. tape)
Slide Tape	1982	R8 FPM	Chemical control of southern pine beetle (50 slides, 9-min. tape)
Slide Tape	1982	R8 FPM	Applying IPM principles in southern forests (80 slides, 14-min. tape)

Appendix Table II.—*Technology Transfer Activities in the IPM Program. 1981-85—Continued*

Activity	Year accomplished	Responsible cooperator	Description
Slide Tape	1985	R8 FPM	Fusiform rust management strategies
Slide Tape	1985	R8 FPM	Annosus root rot management strategies
Slide Tape	1985	Clemson Univ., Dept. For. & Coop. Ext. Serv.	Littleleaf disease management strategies
Movie	1985	Clemson Univ., Dept. For. & Coop. Ext. Serv.	Use of portable sawmills for utilization of beetle-killed timber
Movie	1985	Clemson Univ., Dept. For. & Coop. Ext. Serv.	Littleleaf disease in southern pine forests
<i>Other</i>			
22 proceedings papers	1982-85	Various	Papers on pest management topics presented at symposiums
56 journal/magazine articles	1982-85	Various	Articles on IPM topics in technical refereed journals or trade magazines

Note: Information given here is current as of the time this report went to press.

Appendix Table III.—*IPM Program Funded Organizations and Investigators*

Organization	Representative
Alabama Forestry Commission	Mr. James R. Hyland Mr. Robert C. Kucera
University of Arkansas, Fayetteville (Department of Entomology and Industrial Engineering)	Ms. Marita P. Lih Dr. Tim D. Paine Dr. Fred M. Stephen Dr. Hamdy A. Taha
Clemson University (Department of Forestry)	Dr. Donald L. Ham Dr. Roy L. Hedden Mr. Chet Karpinski, Jr. Dr. Frank H. Tainter
Duke University (School of Forestry and Environmental Studies)	Dr. William A. Thompson
University of Florida (Department of Entomology and Nematology and School of Forest Resources and Conservation)	Dr. Jeffrey A. Corneil Dr. John L. Foltz Dr. Roger S. Webb Dr. Robert C. Wilkinson
University of Georgia (Department of Entomology and School of Forest Resources)	Dr. Julian R. Beckwith III Dr. C. Wayne Berisford Dr. Louis H. Kudon Dr. James T. Rice
University of Maryland, Frostburg State College (Appalachian Environmental Laboratory)	Dr. William A. Thompson ¹

Appendix Table III.—*IPM Program Funded Organizations and Investigators—Continued*

Organization	Representative
Mississippi State University (Departments of Entomology and Forestry)	Dr. John D. Hodges Dr. Bob L. Karr Dr. David M. Moehring Dr. T. Evan Nebeker
University of New Mexico (Chemical Ecology Laboratory, Department of Biology)	Dr. Rex B. Cates Dr. Herve Gambliel
North Carolina State University (Department of Entomology and School of Forest Resources)	Dr. Fred P. Hain Dr. William D. Mawby Dr. Thomas O. Perry
South Carolina Forestry Commission	Mr. Michael C. Remion
Texas A&M University (Departments of Entomology, Range Science, and Industrial Engineering-Biosystems Research Division; Data Processing Center)	Dr. Robert N. Coulson Dr. Richard M. Feldman Dr. Lorinda C. Hu Dr. Joseph G. Massey Dr. Wayne K. Murphey Dr. David W. Patterson Dr. Thomas L. Payne Dr. Paul E. Pulley Dr. Edward J. Rykiel Dr. M. C. Saunders Dr. Peter J. H. Sharpe Dr. Terrence L. Wagner Dr. Hsin-i Wu
Texas Forest Service	Dr. Ronald F. Billings Mr. Charles M. Bryant, V Mr. Charles Walker
Union Camp Corporation	Mr. John F. Godbee
U.S. Forest Service Region 8, Holly Springs National Forest	Mr. John Fort Mr. Steven Weaver
Region 8, State & Private Forestry	Mr. Robert L. Anderson Mr. Michael D. Connor Mr. Charles W. Dull Mr. William H. Hoffard Mr. Wesley A. Nettleton Mr. Steven W. Oak Mr. Dale A. Starkey Mr. Robert J. Uhler Mr. J. Denny Ward
Southeastern Forest Experiment Station	Mr. Roger P. Belanger Dr. Carl W. Fatzinger Dr. Cynthia K. Franklin Dr. Felton L. Hastings Dr. Alice S. Jones Dr. Gerald K. Koenigshof Dr. Thomas Miller Dr. John C. Nord Dr. J. Michael Vasievich Mr. Isadore L. Williams

Appendix Table III.—*IPM Program Funded Organizations and Investigators—Continued*

Organization	Representative
Southern Forest Experiment Station	Dr. Walter C. Anderson Dr. J. Robert Bridges Dr. Tom R. Dell Mr. Ronald C. Froelich Dr. Richard W. Guldin Dr. Peter L. Lorio, Jr. Mr. Warren L. Nance Dr. Eugene Shoulders Mr. Robert A. Sommers
University of Virginia (Department of Environmental Sciences)	Dr. Patrick J. Michaels
Virginia Polytechnic Institute & State University (Departments of Forestry and Plant Pathology & Physiology)	Dr. Sam A. Alexander Dr. Rickard H. Hokans
West Virginia University (Division of Forestry)	Dr. David W. Patterson ²

¹ Formerly associated with Duke University.

² Formerly associated with Texas A&M University.

The use of trade or company names of products or services in these Proceedings is for the benefit of the reader. Such use does not constitute an endorsement or approval of any service or product by the Symposium sponsors to the exclusion of others that may be suitable.

Remarks about pesticides appear in some technical papers contained in these Proceedings. Publication of these statements does not constitute endorsement or recommendation of them by the Symposium sponsors, nor does it imply that uses discussed have been registered. Use of most pesticides is regulated by State or Federal law. Applicable regulations must be obtained from appropriate regulatory agencies.

CAUTION: Pesticides can be injurious to humans, domestic animals, desirable plants, and fish or other wildlife if they are not handled or applied properly. Use all pesticides selectively and carefully. Follow recommended practices given on the label for use and disposal of pesticides and pesticide containers.

Branham, Susan J.; Thatcher, Robert C.; eds. Integrated Pest Management Research Symposium: The Proceedings; 1985 April 15-18; Asheville, NC. Gen. Tech. Rep. SO-56. New Orleans, LA: U.S. Department of Agriculture, Forest Service, Southern Forest Experiment Station; 1985. 383 p.

Thirty-seven papers are presented that summarize the findings from research and development work conducted as a part of the Integrated Pest Management RD&A Program for Bark Beetles of Southern Pines during the 5-year period 1980-85. Presentations cover the areas of sampling and impact assessment, bark beetle biology and ecology, host susceptibility, host/pest interactions, direct and indirect control, and management approaches and IPM systems.