

OLYMPUS®

VOICE & MUSIC

DM-20

DM-10

**ONLINE
INSTRUCTIONS**

Thank you for purchasing an Olympus
Digital Voice Recorder.

Please read these instructions for information
about using the product correctly and safely.
Keep the instructions handy for future reference.

To ensure successful recordings, we recommend that
you test the record function and volume before use.

EN

Table of Contents

Table of Contents	2
Safe and Proper Usage	4
General Precautions	4

1 Getting Started

Main Features	6
Identification of Parts	8
Inserting Batteries	10
Using the AC Adapter	11
Switching Between the Voice Recorder and Music Player	11
Setting Time/Date (TIME&DATE)	12
Operating Environment	14
Installing Software	15
Uninstalling Software	19

2 When Using the Recorder as a Voice Recorder

Recording	21
Using the Variable Control Voice Actuator (VCVA)	23
Recording with External Microphone	25
Listening While Audio Is Recorded (Recording Monitor)	26
Recording Modes (REC MODE)	27
Microphone Sensitivity (MIC SENSE)	28
Recording From Another Audio Device	29
Playing	31

Continuous Playback (ALL PLAY)	34
Auto Backspace review (BACK SPACE)	35
Repeat Playback	36
Noise Cancel Function	38
Index Marks	39
Assigning File Comments (COMMENT)	40
LCD Display Information (VOICE mode)	41
Menu List (VOICE mode)	43

3 Managing Files on Your PC

Using DSS Player Software	44
Using Online Help	45
Connecting to Your PC	46
Running DSS Player	50
Window Names (DSS Player)	52
Download Voice Files from the Recorder	53
Play a Voice File	55
Upload Voice Files to the Recorder	56
Send Voice Files with E-mail	58
Changing User ID	58
Changing a Folder Name	59
Editing File Comments	59
Editing a Template	60

4 Using the Recorder as a Music Player

Using the Recorder as a Music Player ...	61
Using Windows Media Player	61
Window Names (Windows Media Player)	63
Copying Music from CD	64
Transferring Music File to the Recorder	65
Music Playback	66
Increasing the WOW effect (WOW EFFECT)	69
Changing the User Equalizer (USER EQ)	71
LCD Display Information (MUSIC mode)	73
Changing Playback Order of Music File	75
Menu List (MUSIC mode)	76

5 Feature Common to the Voice Recorder and Music Player

Erasing	77
Locking Files (LOCK)	80
Alarm Playback Function (ALARM)	81
LCD Contrast Adjustment (CONTRAST)	84
Backlight (BACKLIGHT)	85

System Sounds (BEEP)	86
Assigning Folder Names (FOLDER NAME)	87
Moving Files Across Folders	90
Hold	91
Formatting the Recorder (FORMAT)	92

6 Using the Recorder as a Reader / Writer

Using the Recorder as a Reader/Writer	94
--	----

7 Other Information

Alarm Message List	95
Troubleshooting	97
Accessories (optional)	98
Specifications	98
Technical Assistance And Support	100

1

2

3

4

5

6

7

Safe and Proper Usage

Before using your new recorder, read this manual carefully to ensure that you know how to operate it safely and correctly. Keep this manual in an easily accessible location for future reference.

- The warning symbols indicate important safety related information. To protect yourself and others from personal injury or damage to property, it is essential that you always read the warnings and information provided.

General Precautions

- Do not leave the recorder in hot, humid locations such as inside a closed automobile under direct sunlight or on the beach in the summer.
- Do not store the recorder in places exposed to excessive moisture or dust.
- Do not use organic solvents such as alcohol and lacquer thinner to clean the unit.
- Do not place the recorder on top of or near electric appliances such as TVs or refrigerators.
- Avoid recording or playing back near cellular phones or other wireless equipment, as they may cause interference and noise. If you experience noise, move to another place, or move the recorder further away from such equipment.
- Avoid sand or dirt. These can cause irreparable damage.
- Avoid strong vibrations or shocks.
- Do not disassemble, repair or modify the unit yourself.
- Do not operate the unit while operating a vehicle (such as a bicycle, motorcycle, or go-cart).
- Keep the unit out of the reach of children.

<Warning regarding data loss>

Recorded content in memory may be destroyed or erased by operating mistakes, unit malfunction, or during repair work.

It is recommended to back up and save important content to other media such as a computer hard disk.

Batteries

Warning

- Batteries should never be exposed to flame, heated, short-circuited or disassembled.
- Do not attempt to recharge alkaline, lithium or any other non-rechargeable batteries.
- Never use any battery with a torn or cracked outer cover.
- Keep batteries out of the reach of children.
- If you notice anything unusual when using this product such as abnormal noise, heat, smoke, or a burning odor:
 - ① remove the batteries immediately while being careful not to burn yourself, and;
 - ② call your dealer or local Olympus representative for service.

AC Adapter

Warning

- Do not attempt to disassemble, repair or modify the AC adapter in any way.
- Keep foreign objects including water, metal, or flammable substances from getting inside the product.
- Do not moisten the AC adapter or touch it with a wet hand.
- Do not use the AC adapter in the vicinity of flammable gas (including gasoline, benzene and lacquer thinner).

In case

- ... the internal parts of the AC adapter are exposed because it has been dropped or otherwise damaged:
- ... the AC adapter is dropped in water, or if water, metal flammable substances or other foreign objects get inside it:
- ... you notice anything unusual when using the AC adapter such as abnormal noise, heat, smoke, or a burning odor:
 - ① do not touch any of the exposed parts;
 - ② immediately disconnect the power supply plug from the power outlet, and;
 - ③ call your dealer or local Olympus representative for servicing. Continued use of the AC adapter under these circumstances could result in electric shock, fire or injury.

Main Features

1

Main Features

- Dual function recorder as a Digital Voice Recorder and a Digital Music Player (☞ P.21,61).
- Includes the Olympus DSS Player software and Windows Media Player (☞ P.15).
- Includes a dual function Remote Controller and Microphone (☞ P.25).¹
- A Ear/Mic/Remote Controller Jack with switch-over depending on the application.
- A USB connected Cradle for data download from the recorder to the PC (☞ P.46).
- The recorder can also be used as a removable external memory reader/writer (☞ P.94).
- The large LCD screen with backlight can be easily read even in the dark.
- You may assign your own names to folders (☞ P.87).

Main features of the Digital Voice Recorder

- The recorder stores highly compressed DSS and WMA format voice messages in integrated flash memory.²
- The recorder supports three recording modes, HQ (High Quality) mode, SP (Standard Playback) mode and LP (Long Playback) mode. If a stereo microphone (optional) is used, you can enjoy recording in SHQ (Stereo High Quality) mode (☞ P.27).

Recording time*3

● DM-20 (128MB)

SHQ mode : 4 hours 20 minutes

HQ mode : 8 hours 45 minutes

SP mode : 20 hours 55 minutes

LP mode : 44 hours 45 minutes

● DM-10 (64MB)

SHQ mode : 2 hours 10 minutes

HQ mode : 4 hours 20 minutes

SP mode : 10 hours 25 minutes

LP mode : 22 hours 20 minutes

- The five folders can hold 199 files each, for the maximum of 995 recordings (☞ P.21).
- You can input file comments (☞ P.40).⁴
- The recorder has a Noise Cancel Function (☞ P.38).
- Recorded files may be moved from one folder to another (☞ P.90).
- You can insert or delete index marks (☞ P.39).⁴
- The recorder has Fast Playback and Slow Playback functions to control playback speed (☞ P.32).
- Comes with DSS Player software (☞ P.44).

Main features of the Digital Music Player

- Can play back music files in MP3 and WMA format.

Playback time*5

DM-20 (128 MB) : 100 to 340 minutes

DM-10 (64 MB) : 50 to 170 minutes

- Has built-in WOW (P.69).
- You can change the playback equalizer settings (P.71).

*1: Depending on the product you purchased, the remote controller microphone may not be included. For the supplied components, see the descriptions on the package.

*2: DSS format in SP and LP mode recording, and WMA format in SHQ and HQ mode recording.

*3: Available recording time for one continuous file. Available recording time may be shorter if many short recordings are made. (The displayed available recording time and recorded time are approximate indications.)

*4: For WMA files, these functions are only available for files recorded with this recorder or the IC recorders from Olympus.

*5: The total storage time will vary depending on the bit rate of each music file.

IBM and PC/AT are the trademarks or registered trademarks of International Business Machines Corporation.

Microsoft, Windows and Windows Media are registered trademarks of Microsoft Corporation.

Apple, Macintosh, iMac, Mac, and PowerMac are trademarks or registered trademarks of Apple Computer, Inc.

Intel and Pentium are registered trademarks of Intel Corporation.

Adobe and Acrobat Reader are registered trademarks of Adobe Systems Incorporated.

WOW, SRS and (●) symbol are trademarks of SRS Labs, Inc.

WOW technology is incorporated under license from SRS Labs, Inc.

CORTOLOGIC is a registered trademark of Cortologic AG.

Other product and brand names mentioned herein may be the trademarks or registered trademarks of their respective owners.



Identification of Parts

1

Identification of Parts

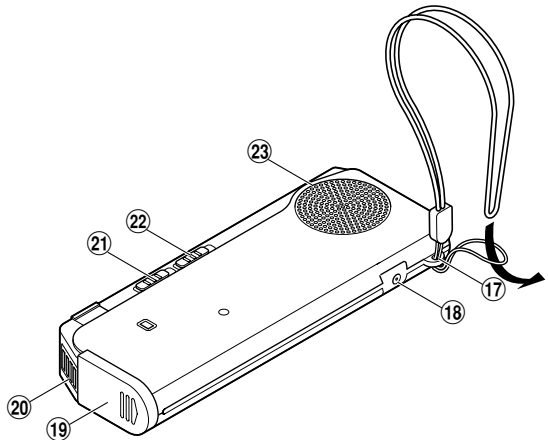
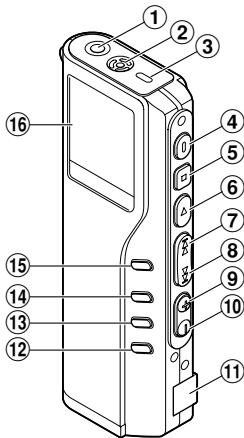

- ① EAR/MIC/REMOTE jack
- ② Built-in microphone
- ③ Record/Play indicator lamp
- ④ REC (Record) button
- ⑤ STOP button
- ⑥ PLAY button
- ⑦ FF (Fast Forward) button
- ⑧ REW (Rewind) button
- ⑨ VOL (+) button
- ⑩ VOL (-) button
- ⑪ PC (USB) terminal
- ⑫ ERASE button

- ⑬ FOLDER/REPEAT button
- ⑭ INDEX/EQ button
- ⑮ DISPLAY/MENU button
- ⑯ Display (LCD panel)
- ⑰ Strap hole
- ⑱ Power jack
- ⑲ Battery cover
- ⑳ Cradle attachment point
- ㉑ Mode (VOICE/MUSIC) switch
- ㉒ HOLD switch
- ㉓ Built-in speaker

Remote Controller Microphone

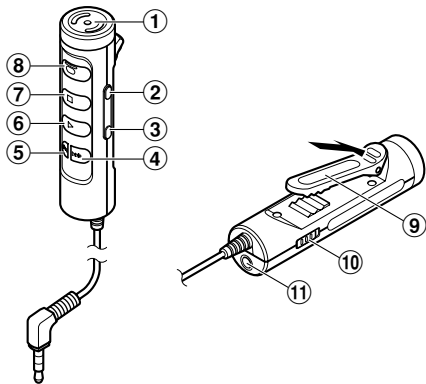

- ① Built-in microphone
- ② VOL (+) button
- ③ VOL (-) button
- ④ FF (Fast Forward) button
- ⑤ REW (Rewind) button
- ⑥ PLAY button
- ⑦ STOP button
- ⑧ REC (Record) button/
REC indicator lamp
- ⑨ Clip
- ⑩ HOLD switch
- ⑪ EAR jack

Display (LCD Panel)

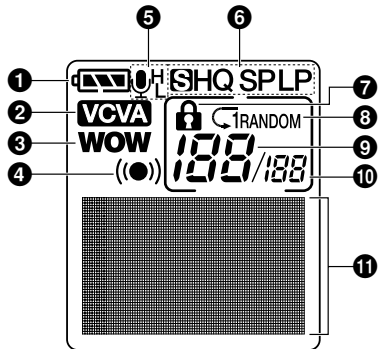

- ① Battery indicator
- ② VCVA (Variable Control Voice Actuator) indicator
- ③ WOW indicator
- ④ Alarm indicator
- ⑤ Microphone sensitivity display
- ⑥ Record mode indicator
- ⑦ Erase lock indicator
- ⑧ Repeat, Random play indicator
- ⑨ Current file number
- ⑩ Total number of recorded files in the folder
- ⑪ Character Information display

Depending on the product you purchased, the remote controller microphone may not be included. For the supplied components, see the descriptions on the package.

Inserting Batteries

1

Inserting Batteries

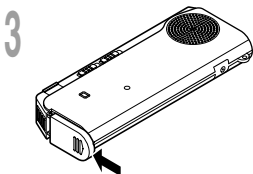
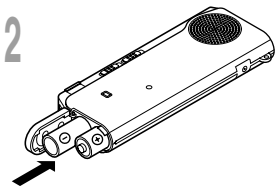
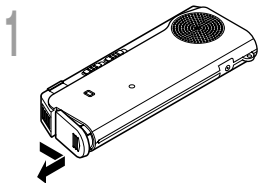

1 Lightly press down on the arrow and slide the battery cover open.

2 Insert two AAA alkaline batteries, observing the correct polarity.

3 Close the battery cover completely.

Replacing batteries

The battery indicator on the display changes as the batteries lose power.

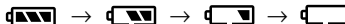

When  appears on the display, replace the batteries as soon as possible.

When the batteries are too weak, the recorder shuts down and “BATTERY LOW” appears on the display. AAA alkaline batteries are recommended.

An optional Ni-MH Rechargeable Battery from Olympus can be used for the recorder (P.98).

Notes

- **Be sure to stop the recorder before replacing the batteries.** Unloading the batteries while the recorder is in use may corrupt the file. If you are recording into a file and the batteries run out, you will lose your currently recorded file because the file header will not be able to close. It is crucial to change the batteries once you see only one Hash mark in the battery icon.
- Be sure to replace both batteries at the same time.
- **Never mix old and new batteries, or batteries of different types and/or brands.**
- If it takes longer than 1 minute to replace dead batteries, you may have to reset the time when you load fresh batteries (P.12).
- Remove the batteries if you are not going to use the recorder for an extended period of time.

Using the AC Adapter

Plug the optional AC adapter (Olympus Model A321 or A322) into household power outlet and connect the power plug to the recorder's power connector (DC 3 V) as shown in the illustration. Always stop recording before connection. Otherwise it may not be possible to play back the voice data being recorded.

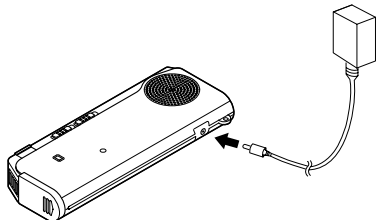

⚠ Warning

- **Always stop recording before connection or disconnection.**
- **When the AC adapter is not in use, disconnect the power supply plug from the power outlet.**
- **Use only the correct power supply voltage as indicated on the adapter.**
- **Do not use the AC adapter when connecting the recorder to the USB port.**

Switching Between the Voice Recorder and Music Player

This device can be used as a voice recorder or as a music player.

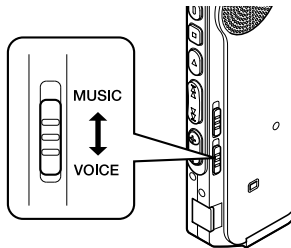

Using the mode switch, choose between **VOICE** or **MUSIC** option.

VOICE : For recording or playing back voice files.

MUSIC : For listening to music files.

Meaning of icons in this manual



Set the mode switch to **VOICE** before operating the recorder.



Set the mode switch to **MUSIC** before operating the recorder.



Convenient features that can be used with both the Voice Recorder and Music Player.

If you have set the time and date, information as to when an audio file is recorded is stored automatically with that file. The time and date should be set to ease file management tasks. The time and date setting is also needed to perform the alarm playback function (P.81).

The hour indicator will flash automatically when you load batteries before using the recorder for the first time, or after the recorder hasn't been used for a long time. Proceed from step 1.

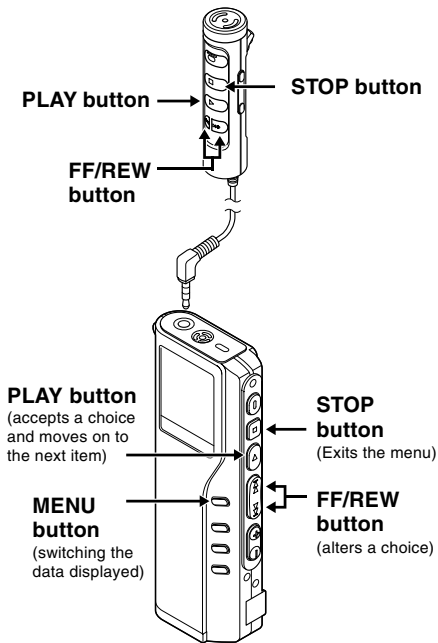

When the remote controller microphone is connected, buttons with the same names as those on the recorder work analogously.

1 Set the hour.

- ① Press the **FF** button or **REW** button to set the hour.
 - ② Press the **PLAY** button to accept the hour.
- You can choose between 12 and 24 hour display by pressing the **MENU** button while setting the hour and minute.

Example: 5:45 P.M.

PM 5:45 ↔ 17:45
(Initial setting)

2 Set the minute.

- ① Press the **FF** button or **REW** button to set the minute.
- ② Press the **PLAY** button to accept the minute.

3 Set the year.

- ① Press the **FF** button or **REW** button to set the year.
 - ② Press the **PLAY** button to accept the year.
- You can choose the order of the year, month, day by pressing the **MENU** button while setting them.

Example: March 14, 2003

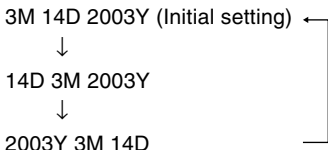

5 Set the date.

- ① Press the **FF** button or **REW** button to set the date.
- ② Press the **PLAY** button to accept the date.

6 Press the **STOP** button to close the menu.

Note

If you press the STOP button during the setup operation, the recorder will save the items that were set to that point.

4 Set the month.

- ① Press the **FF** button or **REW** button to set the month.
- ② Press the **PLAY** button to accept the month.

Changing the Time/Date

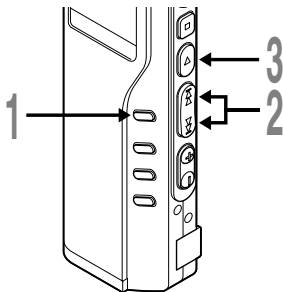

1 Press and hold the **MENU** button for 1 second or longer.

The menu opens (P.43,76).

2 Press the **FF** or **REW** button until “TIME & DATE” flashes on the display.

3 Press the **PLAY** button.

Time/Date screen appears. The hour indicator flashes, indicating the start of the Time/Date setup process.



Follow the same steps starting at step 1 in “Setting Time/Date” (P.12).

Operating Environment

Basic Operating Environment of DSS Player, Windows Media Player

Windows

DSS Player, Windows Media Player	
PC:	IBM PC/AT compatible PC
Operating System:	Microsoft Windows 98/ 98SE/ Me/ 2000 Professional/XP Professional,Home Edition For Windows Media Player, the operating system must be Windows 98SE or later.
CPU:	Intel Pentium II class 333 MHz processor or more (Processor 500MHz or more is recommended)
RAM:	64MB or more (128MB or more is recommended)
Hard drive space:	For installing DSS Player: 10MB or more For installing Windows Media Player: 50MB or more (Additional disk space is needed to store voice and music files)
Drive:	2x or faster CD-ROM, CD-R, CD-RW, DVD-ROM drive
Sound card:	Creative Labs Sound Blaster 16 or 100% compatible sound card
Browser:	Microsoft Internet Explorer 4.01 SP2 or later
Display:	800 x 600 pixels or more, 256 colors or more
USB port:	One free port
Audio I/O terminals:	Earphone output or speakers

Macintosh

PC:	iMac/ iBook/ Power Mac G3, G4/PowerBook G3 (The computer must support a standard USB port.)
Operating System:	Mac OS 9.0/9.1/9.2/10.1/10.2
RAM:	16 MB or more
Hard drive space:	5 MB or more (Additional disk space is needed to store voice and music files)
Drive:	2x or faster CD-ROM, CD-R, CD-RW, DVD-ROM drive
Display:	800 x 600 pixels or more, 256 colors or more
USB port:	One free port
Audio I/O terminals:	Earphone output or speakers

Note

USB ports are not supported on PCs running Windows 95 or that have been upgraded from Windows 95 to any other OS.

Installing Software

Before you connect the recorder to your PC and use it, you must first install the utility software from the included Software CD.

Applications included with “Voice & Music DM Series Utility Software”

- DSS Player: Recorded voice files can be downloaded to the PC for complete file management and playback solution.
- Windows Media Player: Music data can be converted into music files and uploaded to the recorder.
- Acrobat Reader is installed on your PC. It is required to view the accompanying manual in PDF format.

Be sure to confirm the following before installation:

- Exit all running applications.
- Eject the floppy disk if you are using one.
- If you are running Windows2000/XP or Mac OS X on the network, you need to log on as an Administrator.

Windows

1 Insert OLYMPUS Voice & Music DM Series Utility Software into the CD-ROM drive.

The installation program will start automatically. Once the program starts, jump to step 4. If it does not, follow the procedures in steps 2 and 3.

2 Click the [Start] button and select [Run].

3 Enter “D:\setup.exe” in the [Open] field and click [OK].

This is assuming the CD-ROM drive is D.

4 The installation Language Selection dialog box opens.

Click the desired language to select it.

5 Select the necessary software, when the OLYMPUS Voice & Music DM Series Utility Software opening screen appears.

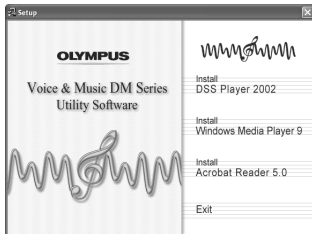

Installing DSS Player

6 Confirm your acceptance of the terms of the Licensing Agreement.

You must accept the terms of the Licensing Agreement to install DSS Player. If you accept them, click [Yes].

7 Register user information.

Register user information. Enter your name, company name, and license ID number (serial number).

The license ID number is printed on the license ID card. Click [Next]. A confirmation dialog box opens, click [Yes].

8 Select where to install DSS Player.

This lets you specify the folder in which to install DSS Player. Click [Browse] to find the desired installation folder. To accept the default folder, click [Next].

Note

If the installation folder does not exist, a confirmation dialog box opens to get your permission to create a folder for this purpose. Click [Yes].

9 Select a program menu folder.

You may change the program menu folder to another one, such as [Start Up]. To accept the default folder, click [Next].

10 Authorizing the start of file copying.

Confirm all “Current Settings”. To accept them, click [Next].

Note

To change the program menu folder or installation folder, click [Back].

11 Copy files.

Wait until DSS Player is installed on your PC, then click [Finish].

The screen returns to the opening screen automatically.

If you would like to install Windows Media Player at this time, please select “Install Windows Media Player” and proceed to step 12 below.

Installing Windows Media Player

12 Confirm acceptance of the terms of the Licensing Agreement.

You must accept the terms of the Licensing Agreement to install Windows Media Player. If you accept them, click [I Accept].

Installing Windows Media Player.

13 Select your Privacy Options.

You can set up your privacy options on this screen. If you want to install the software applying to your environment, change the check in the checkbox.

To select the default, click [Next].

14 Customize the Installation Option.

Select the installation options. To select the default, click [Finish]. Installation is complete and Windows Media Player will start up. Close Windows Media Player to return to the opening screen.

If you would like to install Acrobat Reader at this time, please select “Install Acrobat Reader” and proceed to step 15 below.

Install Acrobat Reader

15 Install Acrobat Reader according to the directions on the screen.

Installing the Device Driver

16 Connect the recorder to your PC, referring to “Connecting to Your PC” (P.46).

When you connect the recorder to your PC for the first time after installing DSS Player, the recorder’s driver will be installed automatically. If the driver is installed properly, DSS Player will start automatically.

(For details about operation for DSS Player see pages from P.52)

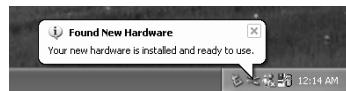

Macintosh

1 Insert OLYMPUS Voice & Music DM Series Utility Software into the CD-ROM drive.

2 Double-click CD icon.

Double-click the desired language to select it.

3 Double-click the following icon.

(OS 9.x)

DSS Player for Mac Installer

(OS X)

DSS Player (for Mac) Installer OS X

4 Click [Continue] when the DSS Player for Mac opening screen appears.

5 Confirm your acceptance of the terms of the Licensing Agreement.

You must accept the terms of the Licensing Agreement to install DSS Player for Mac. If you accept them, click [Agree].

6 Select where to install DSS Player for Mac.

This lets you specify the folder in which to install DSS Player for Mac. To accept the default folder, click [Choose].

Installing DSS Player for Mac.

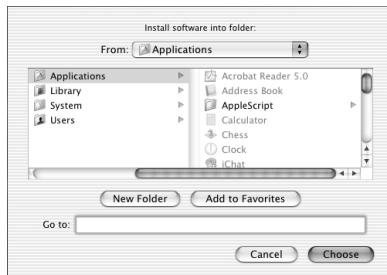

7 Completing setup.

Installation has finished. Click [Quit].

If you installed the software into the OS 9.x, you need restart your PC after completing the installation.

Uninstalling Software

To uninstall any of the software component of the DM series Utility software installed on your PC, follow the steps below.

Windows

- 1 Exit DSS Player and Windows Media Player.**
- 2 Select [Control Panel] from [Start] menu.**
- 3 Click [Add/Remove programs] in the control panel window.**
- 4 A list of applications that have been installed is displayed.**
Select the software you would like to uninstall/remove.
- 5 Click [Change/Remove].**
- 6 Confirmation of Deleting the File.**
Click the [OK] button to start uninstalling. An additional message may appear, if so, read it carefully and follow the instructions given.

- 7 When the [Maintenance Complete] screen is displayed, click [Finish] to complete uninstalling.**

Note

.....

The voice files and music files you made are stored in the [MESSAGE] folder. If you don't need them, delete them. You can confirm the location of the [MESSAGE] folder by clicking [Options] in the [Tools] menu before uninstalling.

Macintosh

1 Exit DSS Player.

2 Delete the Preferences File.

Delete the [DSS Preference] file in the following location.

(OS 9.x)

Macintosh HD : System Folder : Preferences (OS X)

Macintosh HD : User : Library : Preferences

3 Delete the Executable File.

Delete the [DSS Player for Mac] file in the location where you installed the file.

For OS X users, uninstalling has been completed. For OS 9.x users, proceed to step 4.

4 Delete the Driver File.

Delete the following file in the following location.

System Folder : Function Enhancement

[DSS 10USB Driver]

[DSS 10USB Shim]

[DSS 1USB Driver]

[DSS 1USB Shim]

[DSS FSUSB Driver]

[DSS FSUSB Shim]

[DSS USB Driver]

[DSS USB Shim]

5 Delete the Help File.

Delete the [DSS Player for Mac Help] file in the following location.
System Folder : Help

.....
Note

The voice files and music files you made are stored in the [MESSAGE] folder. If you don't need them, delete them. You can confirm the location of the [MESSAGE] folder by clicking on [Options] in the [Tools] menu before uninstalling.



Recording

The recorder provides five folders, A, B, C, D and E, and each message recorded in a folder is saved as a Digital Speech Standard (DSS) file or a Windows Media Audio (WMA) file. These five folders can be selectively used to distinguish the kind of recording; for example, Folder A might be used to store private information, while Folder B might be dedicated to holding business information. Up to 199 messages can be recorded per folder.

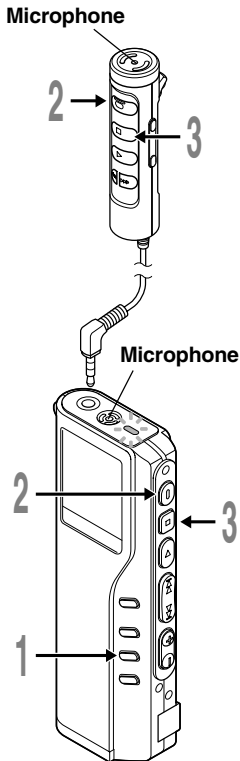

1 Press the FOLDER button to choose a folder.

The folder name is displayed.

- a Total number of recorded files in the folder
- b Current file number
- c Current folder

2 Press the REC button to start recording.

The record/play indicator lamp glows red. Aim the microphone at the sound source. When using the remote controller microphone for recording, the indicator lamp and internal microphone of the recorder are switched off.

- d Current recording mode
- e Recording time
- f Remaining recording time

3 Press the STOP button to stop recording.

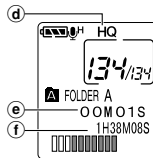
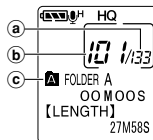

Notes

- A beep will sound when remaining recording time reaches 60 seconds, 30 seconds, and 10 seconds while recording.
- “MEMORY FULL” or “FOLDER FULL” will be displayed when the memory or folder capacity is full. Delete any unnecessary files before recording any further (☞ P.77) or transfer voice files to your computer using DSS Player Software (☞ P.53).

Recording functions

Pause Recording

Pause

Press the **REC** button while recording.

- ➡ “REC PAUSE” will flash on the display.

Resume Recording

Press the **REC** button again.

- ➡ Recording will resume at the point of interruption.

Note

The recorder will time out after 10 minutes when left in “REC PAUSE”.



Using the Variable Control Voice Actuator (VCVA)

When the microphone senses that sounds have reached a preset threshold volume level, the built-in Variable Control Voice Actuator (VCVA) starts recording automatically, and stops when the volume drops below the threshold level.

The VCVA feature help extend recording time and conserve memory by turning off recording during silent periods. This helps make the playback, with no lulls or dead space, more efficient and convenient.

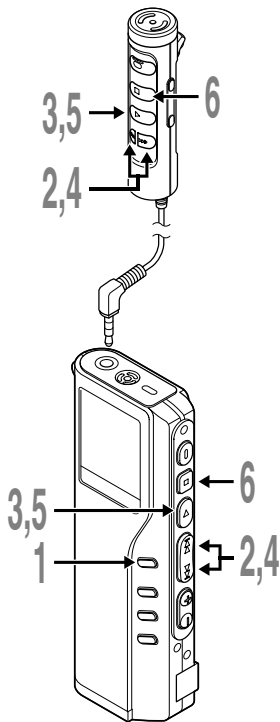

- 1 Press and hold the MENU button for 1 second or longer.**

The menu opens (P.43).

- 2 Press the FF or REW button until “VCVA” flashes on the display.**

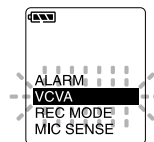

- 3 Press the PLAY button.**

The VCVA setup process begins.

- 4 Press the FF or REW button to choose between ON and OFF.**

ON : Will start recording in VCVA mode.

OFF : Will resume recording in normal mode.

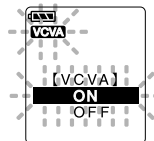

- 5 Press the PLAY button to complete the setup screen.**

- 6 Press the STOP button to close the menu.**

When ON is selected, a VCVA indication will be displayed on the screen.

2

Using the Variable Control Voice Actuator (VCVA)

2

Using the Variable Control Voice Actuator (VCVA)

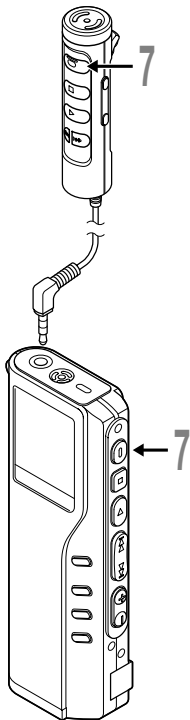

7 Press the REC button to start recording.

When the sound volume is lower than the preset threshold sound level, recording automatically stops after 1 sec approximately, recording automatically pauses after approximately 1 second, and “STANDBY” flashes on the display. The record/play indicator lamp glows when recording starts and flashes when recording pauses.

* When the remote controller is connected, the REC indicator lamp on the remote controller lights up but the record/play indicator lamp on the recorder will be switched off.

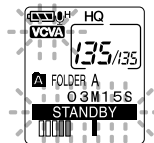

Adjust the start/stop actuation level

Press the FF or REW button to adjust the pause sound level during recording.

The VCVA level can be set to any of 15 different values. The higher the value, the more sensitive the recorder to sounds. At the highest value, even the faintest sound will activate recording.

The VCVA pause sound level can be adjusted according to the ambient (background) noise.

- Ⓐ Level meter (varies according to the sound volume being recorded)
- Ⓑ Start level (moves to the right/left according to the set level)

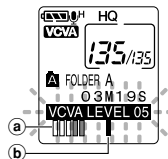

Notes

- The start/stop actuation level also varies depending on the selected microphone sensitivity mode (see P.28).
- To ensure successful recordings, prior testing and adjustment of the start/stop actuation level is recommended.



Recording with External Microphone

To enhance sound quality during recording, use the Remote Controller Microphone or an optional external microphone. If a stereo microphone is used, recording in SHQ (Stereo High-Quality) mode is possible. Please note, when a microphone is connected to the jack on the recorder, the jack functional switch-over is made automatically.

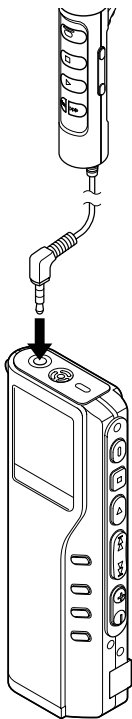

1 Make sure that the recorder has stopped.

2 Connect to the jack on the recorder.

If an external microphone is connected to the jack on the recorder, the built-in microphone is disabled.

Applicable external microphones

● **Remote controller microphone: MR12**

MR12 contains a non-directional microphone. With a clip, you can attach the microphone on your jacket's pocket, etc. This microphone is used to record your voice or voices of people close to you.

● **Noise-Cancellation microphone: ME12 (optional)
(Dictation microphone)**

This microphone is used to record your own voice while minimizing surrounding noise.

● **Stereo microphone: ME50S (optional)**

When using a stereo microphone, the recorder will switch-over to SHQ mode automatically and recording in WMA format, noise-free sound can be accomplished. Stereo recording is only possible in SHQ mode.

Notes

- Do not insert or remove a microphone into or from the jack while recording.
- If an earphone is connected to the remote controller recording is not possible.
- If an earphone is connected to the remote controller EAR jack while recording, recording will stop automatically.



Listening While Audio Is Recorded (Recording Monitor)

If you start recording after inserting the earphone into the jack on the recorder, you can hear the sound being recorded. The sound volume on the recording monitor can be adjusted by pressing the VOL (+) or VOL (-) button.

2

Listening While Audio Is Recorded (Recording Monitor)

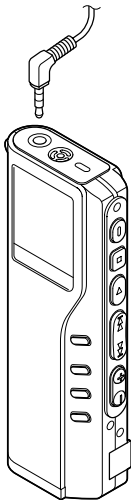

1 Make sure that the recorder has stopped.

2 Connect the earphone to the jack on the recorder.
After recording is started, you can hear the sound being recorded through the earphone.

Notes

- Recording cannot be monitored during recording with an external microphone.
- Recording level cannot be controlled using the volume button.
- When recording using the the remote controller microphone, recording cannot be monitored even though the earphone is connected to the EAR jack on the remote controller.
- When using the earphones, do NOT set the volume too high. Listening at very high volume may lead to hearing loss.



Recording Modes (REC MODE)

You can select from among three recording modes: HQ (High Quality) mode, SP (Standard Playback) mode and LP (Long Playback) mode.

If an optional stereo microphone is used, the only possible recording mode is SHQ (Stereo High Quality).

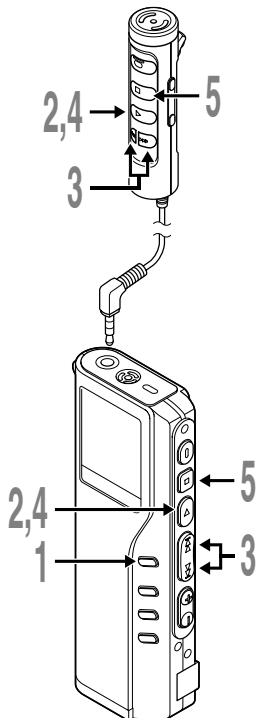

1 Press and hold the **MENU** button for 1 second or longer.

“REC MODE” will be displayed on the screen (see P.43).

2 Press the **PLAY** button.

The recording mode setup process begins.

3 Press the **FF** or **REW** button to choose from HQ, SP and LP.

4 Press the **PLAY** button to complete the setup screen.

5 Press the **STOP** button to close the menu.

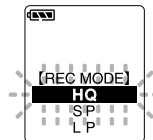

2

Recording Modes (REC MODE)

Note

Choose SHQ/HQ or SP mode for recording meetings or lectures with crisp clarity.



Microphone Sensitivity (MIC SENSE)

Microphone sensitivity is adjustable to meet recording needs.

2

Microphone Sensitivity (MIC SENSE)

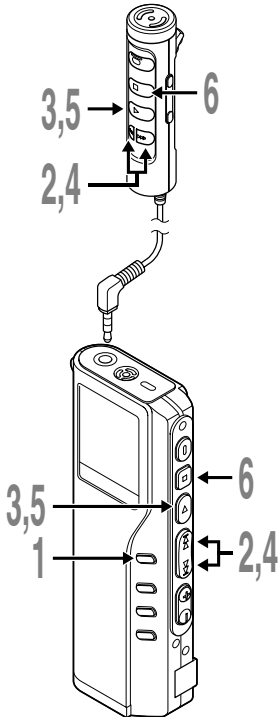

1 Press and hold the MENU button for 1 second or longer.

The menu opens (see P.43).

2 Press the FF or REW button until “MIC SENSE” flashes on the display.

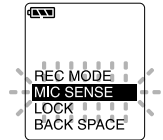

3 Press the PLAY button.

The microphone sensitivity setup process begins.

4 Press the FF or REW button to choose between CONFERENCE and DICTATION.

CONFERENCE: High-sensitivity mode that records sounds in all directions.

DICTATION: Low-sensitivity mode suited for dictation.



5 Press the PLAY button to complete the setup screen.

6 Press the STOP button to close the menu.

Notes

- If you want to record clear or noise-free dictation, select DICTATION mode and place the microphone 3 to 4 inches from the source.
- If the ambient (background) noise is too loud to get a clear recording even in DICTATION mode, we recommend that you use an ME12 single directional microphone (sold separately).



Recording From Another Audio Device

The recorder can record the sound played back by another device with a connecting cord.

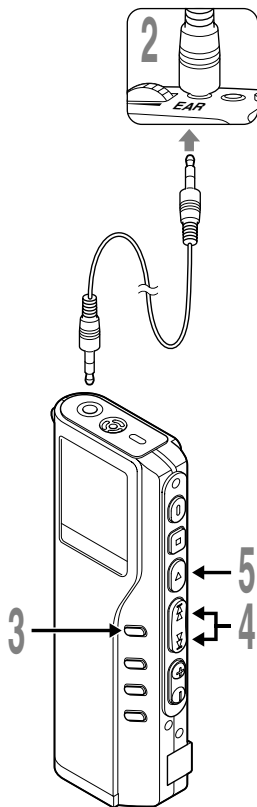

1 Make sure that the recorder has stopped.

2 Connect the recorder to the earphone jack on the other device with a connecting cord.

For recording monaural sound, use the optional connecting cord, KA232 (P.98) and, for stereo sound, use a commercially available connecting cord with attenuation resistance.

3 Press and hold the **MENU** button for 1 second or longer.

The menu opens (P.43).

4 Press the **FF** or **REW** button until “EXT.INPUT” flashes on the display.

5 Press the **PLAY** button.

The EXT.INPUT setup process begins.



2

Recording From Another Audio Device

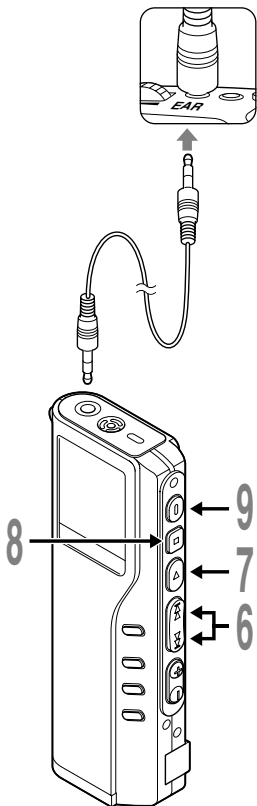

6 Press the **FF** or **REW** button to choose between “STEREO INPUT” and “MONAURAL INPUT”.

Choose “STEREO INPUT” for the stereo recording.

Choose “MONAURAL INPUT” for the monaural recording.

7 Press the **PLAY** button to complete the setup screen.

8 Press the **STOP** button to close the menu.

9 Press the **REC** button to start recording.



When set to STEREO INPUT, the recorder starts recording in SHQ mode. When set to MONAURAL INPUT, it starts recording in the specified recording mode.

Notes

- Be sure to set the external input before connecting a connecting cord to the jack on the recorder. Otherwise, the input setting may be disabled.
- Disconnecting the connecting cord or switching off the recorder cancels the external input setting and resets it to the automatic switching mode. To record sound using the connecting cord, follow the procedure from step 1 again.



Playing

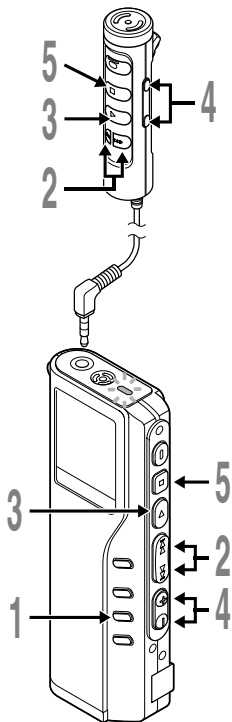

1 Press the FOLDER button to choose folder.

2 Press the FF or REW button to choose the file that you want to play.

If you keep pressing the FF or REW button in stop mode, the recorder continuously skips to the beginnings of files.

3 Press the PLAY button to start playback.

The record/play indicator lamp glows green.

- (a) Current playback time**
- (b) Total recording time of the file being played**

4 Press the VOL (+) or VOL (-) button to select the proper sound volume.

The display shows the volume level. You can choose between 0 to 30.

5 Press the STOP button at any point you want to stop the playback.

Resume playback by pressing PLAY button again.

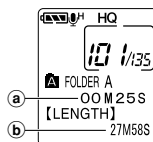
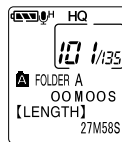

Playback functions	Operation	How to Cancel
Fast Playback (F.PLAY)	Press the PLAY button once while playing a file.*1 ➤ The recorder plays back at approximately 50% faster than normal rate.	Press the PLAY button 2 times while fast playing back. ➤ Playback returns to normal rate.
Slow Playback (S.PLAY)	Press the PLAY button once while fast playing back.*1 ➤ The recorder plays back at approximately 25% slower than normal rate.	Press the PLAY button once while slow playing back. ➤ Playback returns to normal rate.
Cue (CUE)	Hold the FF button while playing a file. ➤ The recorder stops when it reaches the end of the file. Continue pressing the FF button to proceed with the cue from the beginning of the next file.	Release the FF button. ➤ Replays at the original speed.
Review (REVIEW)	Hold the REW button while playing a file. ➤ The recorder stops when it reaches the beginning of the file. Continue pressing the REW button to proceed with the review from the end of the previous file.	Release the REW button. ➤ Replays at the original speed.
Skipping to beginning of a file*2	Press the FF button during playback, fast playback, or slow playback.*3 ➤ The next file is cued and playback starts at the original speed.	—
	Press the REW button during playback, fast playback, or slow playback.*3 ➤ The file being played is cued and playback starts at the original speed.	—

*1: As in normal playback, operations such as playback stop, file cueing, and index mark (⏏ P.39) insertion are possible in fast playback and slow playback.

*2: If you keep pressing the **FF** or **REW** button in stop mode, the recorder continuously skips to the beginnings of files (F.SKIP/B.SKIP).

*3: If an index mark is encountered midway, playback begins at that point.

Note

If you set Noise Cancel to “LOW” or “HIGH”, you cannot use the Fast Playback and Slow Playback functions.

Playback through earphone



You can listen to audio playback through the earphone connected to the jack on the recorder or the EAR jack on the remote controller.

When the earphone is used, the recorder speaker will be switched-off.

Notes

- When using earphone, adjust sound level moderately or hearing loose may result.
- When playing back through the earphone, sounds can be heard from either side of the earphone even for monaural recorded files.
- When you use an external speaker or an earphone with built-in volume, connect it to the EAR jack on the remote controller. If you directly connect it to the jack on the recorder, the external speaker or earphone may not work. When you record the playback sound with another recording device, connect the EAR jack on the remote controller and the microphone jack on the other recording device.



Continuous Playback (ALL PLAY)

When a file finishes playing back, the next file is played without stopping until it reaches the last file in the folder.

2

Continuous Playback (ALL PLAY)

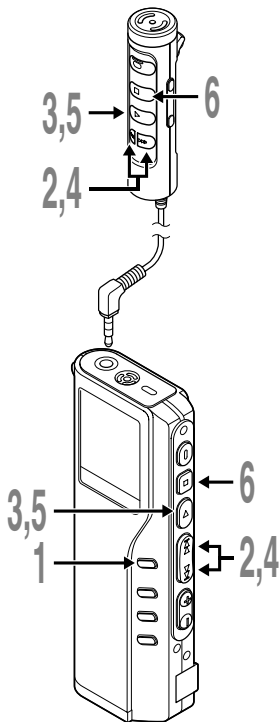

1 Press and hold the **MENU button for 1 second or longer.**

The menu opens (see P.43).

2 Press the **FF or **REW** button until “ALL PLAY” flashes on the display.**



3 Press the **PLAY button.**

The Continuous Playback setup process begins.

4 Press the **FF or **REW** button to choose between **ON** and **OFF**.**

ON :Continuous playback.

OFF:Returns to normal playback mode.

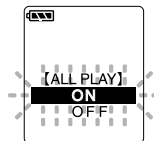

5 Press the **PLAY button to complete the setup screen.**

6 Press the **STOP button to close the menu.**

Note

After the last file in the folder plays, “END” appears on the screen and playback stops automatically .



Auto Backspace review (BACK SPACE)

If it is necessary to repeatedly listen to the last phrase, you can set the Auto Backspace function for either 1 or 2 seconds.

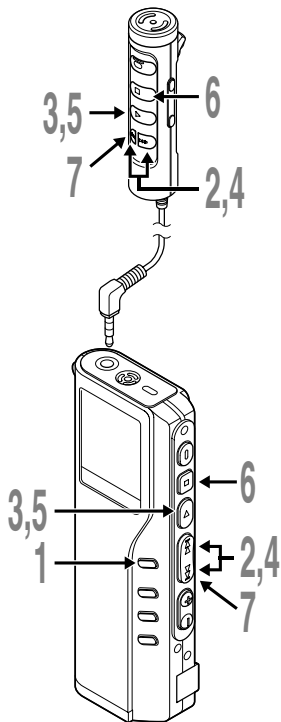

1 Press and hold the **MENU** button for 1 second or longer.

The menu opens (see P.43).

2 Press the **FF** or **REW** button until “**BACK SPACE**” flashes on the display.



3 Press the **PLAY** button.

The Back Space setup process begins.

4 Press the **FF** or **REW** button to choose from “**OFF**”, “**1 SEC SKIP**” and “**2 SEC SKIP**”.

OFF: Perform normal cueing.

1 SEC SKIP: Start playback from 1 second before.

2 SEC SKIP: Start playback from 2 seconds before.

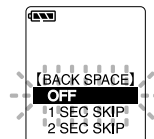

5 Press the **PLAY** button to complete the setup screen.

6 Press the **STOP** button to close the menu.

7 Press the **REW** button while the file is being replayed.

Playback starts at the set point of seconds before.

2

Auto Backspace review (BACK SPACE)



Repeat Playback

This function enables repeated playback of part of the file being played. If the continuous playback function is used together, two or more files can be repeatedly replayed as long as they are in the same folder.

2

Repeat Playback

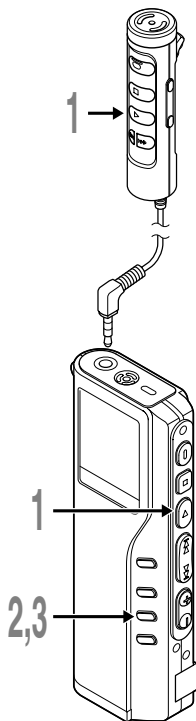

1 Choose the file for Repeat Playback, and press the **PLAY** button.

File playback begins.

2 Press the **REPEAT** button briefly at the point you want to start Repeat Playback.

“REPEAT END?” flashes until you designate the end point.

3 Press the **REPEAT** button briefly again at the position you want Repeat Playback to end.

The recorder repeatedly plays back the section between the start and the end positions until you cancel Repeat Playback.

If continuous playback is set to ON (P.34), the end position can be set to the extent of the last file in the folder.

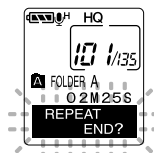

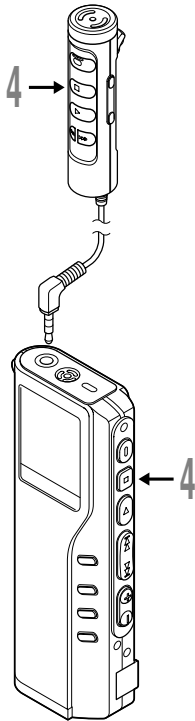

4 Press the **STOP** button.

Repeat Playback is cancelled.

You can use Fast Playback and Slow Playback functions, insert and delete index marks, and use the Noise Cancel function.

Notes

- If no end position is designated, the end of the file becomes automatically the end position. If continuous playback is set to "ON", the end of the last file in the folder is set to the end position and then repeated playback starts.
- If you pass the start or end position by pressing the REW or FF button, Repeat Playback will be cancelled.
- To use this function, briefly press the REPEAT button. If you hold it 1 second or longer, the Moving Files screen appears (P.90).



Noise Cancel Function

If recorded audio is difficult to understand because of noise, adjust the Noise Cancel setting level. Noise will be reduced in the file when its played back for better sound quality.

2

Noise Cancel Function

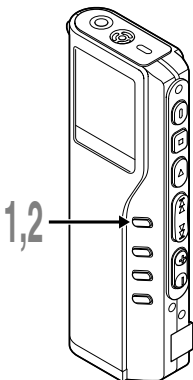

1 Press and hold the MENU button for 1 second or longer while the file is playing.

Displays currently set Noise Cancel level.

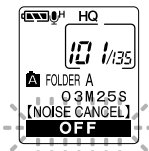

2 Press the MENU button again to choose a noise cancel level.

The levels switch in the following rotation, "OFF" "LOW" "HIGH".

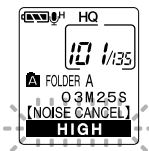

If the display is already set to Noise Cancel, start from step 2.

Change the Noise Cancel level within 8 seconds, otherwise the level is set at the displayed level and the display returns to its original view.

Notes

- If you set it to "LOW" or "HIGH", the display flashes the Noise Cancel level for about 2 seconds when a file is played back.
- If you set Noise Cancel to "LOW" or "HIGH", the setting remains valid until it's set to "OFF".
- If you set Noise Cancel to "LOW" or "HIGH", you cannot use the Fast Playback and Slow Playback functions.
- If Noise Cancel is used for files recorder in SHQ, the files will be played in monaural mode.



Index Marks

Index marks can be placed in a file during recording or playback to provide a quick and easy way of keeping track of important sections in the file.

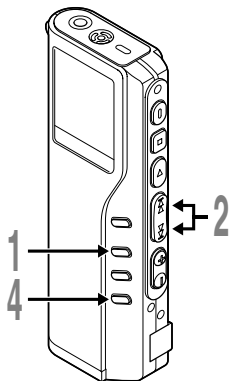

Setting an Index Mark

- 1 Press the **INDEX** button during recording or playback to set an index mark.

An index number appears on the display.

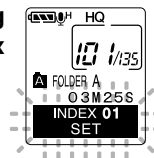

Locating an Index Mark

- 2 Hold the **FF** or **REW** button while playing a file.

The recorder stops for 1 second when it reaches the index mark.

Clearing an Index Mark

- 3 Locate the index mark you want to clear.

- 4 Press the **ERASE** button while the index number appears for approximately 2 seconds on the display.

The index mark is erased.

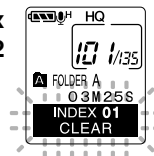

Notes

- Up to 16 index marks can be set in a file. Attempting to set more index marks will cause "INDEX FULL" to appear on the display.
- Index marks cannot be set or cleared in a locked file (P.80).
- In case of WMA files, index marks can only be placed in files recorded with Olympus recorders.

2

Index Marks



Assigning File Comments (COMMENT)

Comments of up to 100 characters can be added to each recorded file. Comments and other file information such as date and time can help identify recordings without having to playback.

2

Assigning File Comments (COMMENT)

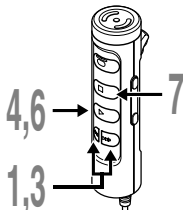

1,3

4,6

7

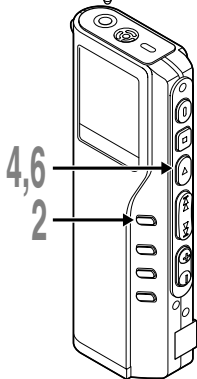

4,6

2

7

1,3

1 Press the **FF** or **REW** button to choose the file you want to comment setup.

2 Press and hold the **MENU** button for 1 second or longer.

The menu opens (P.43).

3 Press the **FF** or **REW** button until “COMMENT” flashes on the display.

4 Press the **PLAY** button.

The file comment setup process begins.

5 Input the character.

If you will input characters using the recorder, see step 6 of “Assigning Folder Names” (P.87).
If you will input characters using a computer, see “Editing File Comments” (P.59).

6 When you have finished setting the file comments, press and hold the **PLAY** button for 1 second or longer.

This completes the file comment input procedure.

7 Press the **STOP** button to close the menu.

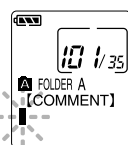

Note

In case of WMA files, file comments can only be added to files recorded with Olympus recorders.



LCD Display Information (VOICE mode)

The LCD screen on the recorder can display 6 different format of information by pressing the DISPLAY button. This help review and confirm different recorder settings and file information.

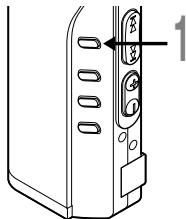

1 Press the **DISPLAY** button.

The LCD display views will switch every time the DISPLAY button is pressed.

While in stop or playback mode

When pressing Display, the recorder will cycle through ① to ⑥. If there is no file, ⑤ and ⑥ will display alternately.

① File length

Shows how long a file is.

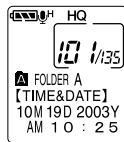
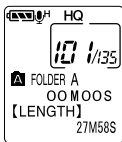

⑥ Current time and date

Shows the current time and date. (During playback, the "TIME & DATE" or the counter appears.)

② Time stamp

Shows the year, month, and date that the file was recorded.

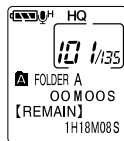

⑤ Memory remaining

Shows remaining recording time.

③ Time stamp

Shows the time that the file was recorded.

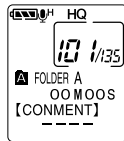
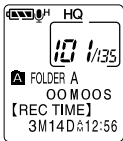

④ File comment*

Shows comment added to a file. (If there is no comment, "--" will appear.)

* If a comment contains many characters, it will scroll horizontally to display the complete comment.

While in record mode

Displays ① and ② alternately.

2

LCD Display Information (VOICE mode)

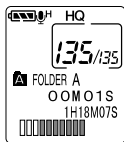

① **Recording level meter**

Displays the sound input level graphically and the remaining time available for recording in count-down mode.

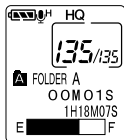

② **Remaining memory bars**

Displays the remaining time available for recording in bar mode and count-down mode.

While recording in VCVA mode

Displays ① and ② alternately.

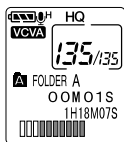

① **VCVA recording level meter**

Displays the sound input level graphically and the remaining time available for recording in count-down mode. ("STANDBY" appears if the VCVA actuation level isn't reached.)

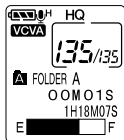

② **Remaining memory bars**

Displays the remaining time available for recording in bar mode and count-down mode.



Menu List (VOICE mode)

Press and hold the **MENU** button for 1 second or longer.

REC MODE

Selection from HQ, SP and LP modes.

MIC SENSE

Mic sense setting (☞P.28). Selection between CONFERENCE (high-sensitivity mode) and DICTATION (low-sensitivity mode).

LOCK

Locking files setting (☞P.80). Selection between ON (locked) and OFF (unlocked).

BACK SPACE

Back space setting (☞P.35). Selection from OFF, 1 SEC SKIP and 2 SEC SKIP.

ALL PLAY

Continuous playback setting (☞P.34). Selection between ON (enabled) and OFF (disabled).

TIME&DATE

Time/Date setting. In order of hour, minute, year, month and day (☞P.12).

FORMAT

Recorder formatting (☞P.92).

CONTRAST

LCD contrast adjustment (☞P.84). Adjust the level from 1 to 12.

BEEP

System sounds setting (☞P.86). Selection between ON (enabled) and OFF (disabled).

BACKLIGHT

Backlight setting (☞P.85). Selection between ON (enabled) and OFF (disabled).

EXT.INPUT

EXT.INPUT setting (☞P.29). Selection from AUTO SELECT, STEREO INPUT and MONAURAL INPUT.

COMMENT

Assigning file comments (☞P.40).

FOLDER NAME

Folder naming (☞P.87).

ALARM

Alarm playback setting (☞P.81). Selection between ON (enabled) and OFF (disabled).

VCVA

VCVA setting (☞P.23). Switch between ON (enabled) and OFF (disabled).



Press the **FF** button or **REW** button.

Notes

- Part of the menu is common with the MUSIC mode.
- If you press the **STOP** button or the **REC** button, during a menu setup operation, the recorder will stop and apply the items that were set to that point.
- The recorder will stop if you leave it idle for 3 minutes during a menu setup operation, when a selected item is not applied.



Using DSS Player Software

The DSS Player Software can be used to do the following:

- Playback voice files on your PC and on the recorder when connected via USB. Download files from the recorder to the PC or upload files from the PC to the recorder.
- Change the order of the music files stored in the recorder.

3

Precautions on using the recorder connected to a PC

- When you are downloading a file from the recorder or uploading a file to the recorder, do not remove the USB cable even if the screen is indicating you can. Data is still being transferred while the record/play indicator lamp is blinking. When removing the USB cable, be sure to follow the description in  P.47. If the USB cable is removed before the drive is stopped, data may not be successfully transferred.
- On a PC, do not format the drive of the recorder. Initialization is not successfully achieved on a PC. For initialization, follow the instructions in the menu screen of the recorder ( P.92).
- Folder (directory) names displayed by file management tools such as Explorer attached to Microsoft Windows and Finder attached to Mac OS are different from the folder names settable with the recorder or DSS player.
- If folders or files stored on the recorder are moved or renamed by using a file management tool such as Explorer or Finder, the order of files may be changed or files may become unrecognizable.
- Data can be written or uploaded to the recorder even though the attribute of the recorder drive is shown as Read-only by the operating system of the PC.
- As the noise may cause adverse effects on electronics devices nearby the recorder, unplug the earphone and remote controller when you connect the recorder to a PC.

Using Online Help

To open Online Help, you have the following options.

(Windows)

- Click the [Start] button, select [All Programs], then [Olympus DSS Player 2002], then click [Help].
- While DSS Player is running, choose [Contents] from the [Help] menu.
- While DSS Player is running, press [F1] on the keyboard.

(Macintosh)

- While DSS Player is running, choose [DSS Player for Mac Help] from the [Help] menu.

Search by Contents

1 Once the Online Help screen appears, click the Contents tab.

2 Double-click the  icon of the desired topic heading.

The title of the topic is displayed.

3 Double-click the  icon of the desired topic.

An explanation of the topic is displayed.

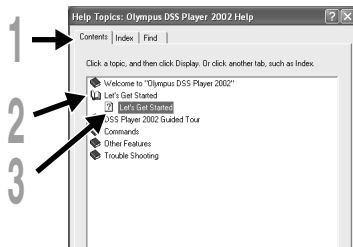

Search by Key word

1 Once the Online Help screen appears, click the Index tab.

2 Enter text.

Matching keywords are located automatically.

3 Choose a topic, then click [Display].

An explanation of the topic is displayed.

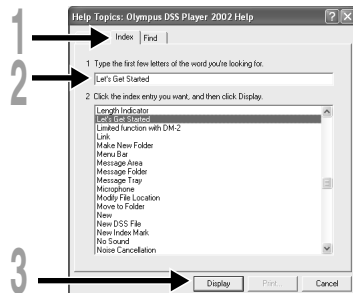

Note

For more information on menus and operations, refer to Online Help. You will be able to use Online Help after DSS Player is installed.

Connecting to Your PC

Be sure to finish installing DSS Player before connecting the recorder.

3

Connecting to Your PC

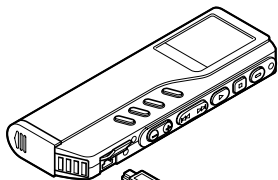
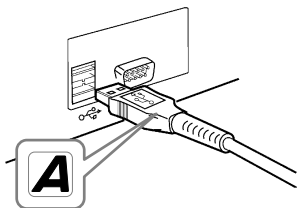

Connecting to your PC using the USB cable

- 1 Release the **HOLD** switch.
- 2 Insert end **A** of the **USB** cable to your PC's **USB** port or **USB** hub.
- 3 Confirm that the recorder is not in use before attaching end **b** of the **USB** cable to the terminal port of the recorder.

"REMOTE" is displayed on recorder if the USB cable is connected.

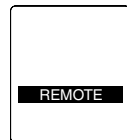

Windows

When the recorder is connected and "My Computer" is opened, a removable disk drive is displayed. If "Add New Hardware Wizard" appears, cancel the wizard by pressing the [Cancel] button and then install DSS Player.



Macintosh

If the recorder is connected to Mac OS, an icon with a drive name of "unlabeled" appears.

Disconnecting from Your PC

Windows 98/98 SE

- 1 Confirm that the record/play indicator lamp on the recorder is not flashing. Right-click the Removable Disk icon in My Computer and select [Eject].
- 2 Disconnect the USB cable.

Windows Me/2000/XP

- 1 Click the  on the task bar located at the lower-right corner of the screen. Click [Safely remove USB Mass Storage Device-Drive]. It will read [Stop USB Disk-Drive] for Windows Me. The drive letter will differ depending on the computer being used.



- 2 When the Safe To Remove Hardware window appears, click [OK].
- 3 Disconnect the USB cable.

3

Connecting to Your PC

Macintosh

- 1 Move the icon of the recorder's drive displayed on desktop to trash box by drag and drop.
- 2 Disconnect the USB cable.

3

Notes

- NEVER disconnect the USB cable while the record/play indicator lamp is flashing. If you do, the data will be destroyed.
- Refer to the user's manual for your PC regarding the USB port or USB hub on your PC.
- Be sure that you connect the USB cable either directly to the USB port on your PC or the self-power (AC adapter connection) USB hub.
- Be sure to push the cable connector all the way in. Otherwise, the recorder may not operate properly.
- Release the HOLD switch.

Connecting to your PC using the cradle

Place the recorder on the cradle

- 1 Insert end A of the USB cable to your PC's USB port or USB hub.
- 2 Connect the end b of the USB cable to the cradle.
- 3 Make sure that the recorder is off, and place it in the cradle.
 - ① Set the recorder vertically.

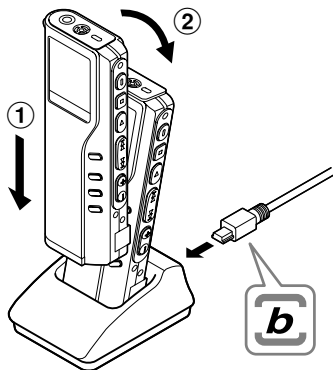

- ② While pushing down the top of the recorder, set the recorder on the cradle. In this case, make sure that concavity on the rear of the recorder fits convexity of the cradle.

“REMOTE” is displayed on recorder if the USB cable is connected.

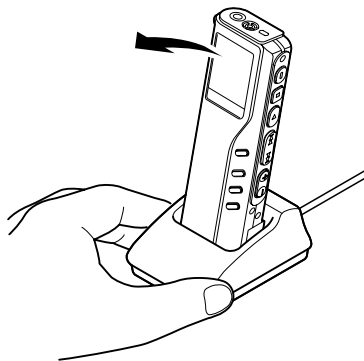
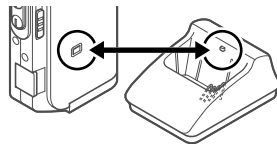

Remove the recorder from the cradle

Follow step 1 in “Disconnecting from Your PC” (P.47).

- 1 Make sure that the recorder's record/play indicator lamp isn't flashing, and remove the recorder from the cradle.**

Hold the cradle with your hand, and raise the recorder from the top end to remove it from the hook, as shown in the illustration.

Notes

- Do not touch the connection point on the front of the cradle (at the low end), as that may cause bad connection.
- The cradle does not have the recharging function.

Running DSS Player

Windows

By connecting the recorder to your PC, you can automatically start the application.

Disabling automatic start

1 Right click the  icon in the System Tray in the lower right-hand corner of the screen, then click Select startup application.

2 Select and click [DSS Player 2002].

The check mark on [DSS Player 2002] disappears. For automatic start, select and click DSS Player to reinstate again.

Manual start

1 Start Windows.

2 Click the [Start] button, select [All Programs], then [Olympus DSS Player 2002].

3 Click [Olympus DSS Player 2002].

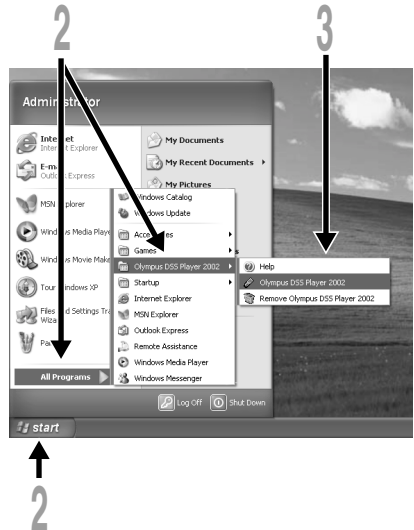

Notes

- You can not run more than one DSS Player program or multiple copies of the same program simultaneously.
- If you connect the recorder before installing DSS Player, the "Add New Hardware Wizard" dialog box will open. If this happens, click [Cancel] to exit the wizard, then install DSS Player.

Macintosh

To start, open the “DSS Player for Mac” folder created upon installation and double-click the  icon.

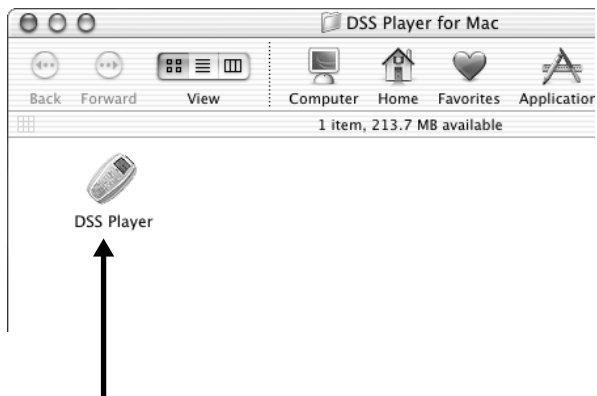

Note

DSS Player for Mac does not have the automatic start function.

Window Names (DSS Player)

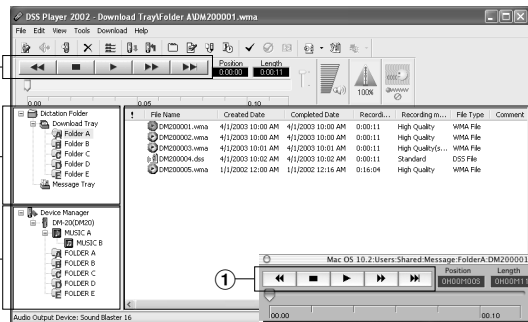

* Main screen displayed when DSS Player is started

(Windows)



(Macintosh)

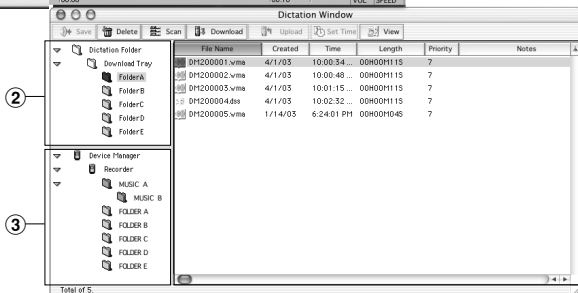

1 Play Control Bar

Control buttons to play and stop voice files.

2 Dictation Folder Window

Will display the directory structure of the DSS, WMA, WAVE (Windows only) and AIFF (Macintosh only)-format files stored on your PC's hard disk.

3 Device Manager Window

Will display the directory structure of the folders in the recorder.

4 Voice File List Box

Will display the voice files in the folder selected in 2 and 3.

Download Voice Files from the Recorder

There are 3 download options to transfer voice files from the recorder to the PC:

- Download Selected Files
Download one or several voice files to your PC.
- Download Folders
Download all the voice files in one folder.
- Download All
Click the  icon and download all the voice files stored in the recorder to your PC.

The following is an explanation of “Download Selected Files”. For explanations of “Download Folders” and “Download All”, refer to Online Help.

Download Selected Files

1 Select the folder.

From the Device Manager window, select the folder that contains the voice file you would like to download. The illustration shows that Folder A has been selected.

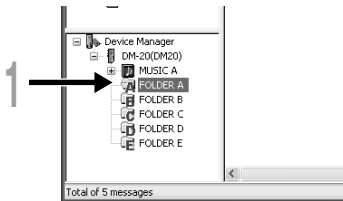

2 Select the voice file.

Select the voice file you would like to download from the Voice File List Box. To select more than one file, hold either the [Ctrl] or [Shift] key and select files. The illustration shows that one voice file is selected.

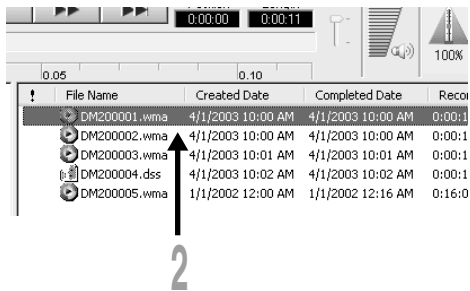

3 Download the voice file.

(Windows)

From the [Download] menu, click [Download Selected Files].

(Macintosh)

From the [Tools] menu, click [Download Selected Files].

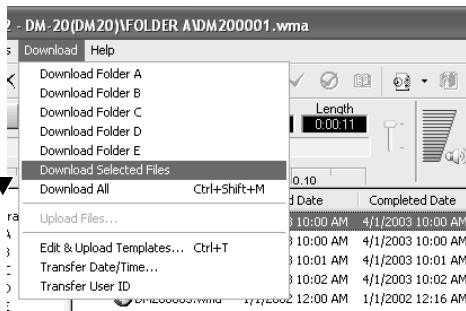

4 Download complete.

Do not disconnect the USB cable while the record/play indicator LED on the recorder is flashing. Disconnecting the USB cable when the recorder LED is flashing will result in data loss or corruption.

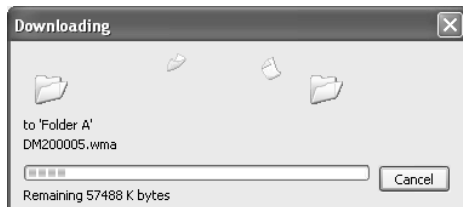

Notes

- NEVER disconnect the USB cable while the record/play indicator lamp is flashing. If you do, the data will be destroyed.
- Depending on the size of the voice file and your PC, it may take some time to download the files.
- The downloaded files will be stored in the download tray folder that corresponds to the folder in the recorder. (Example: A voice file downloaded from Folder A will be stored in download tray A on your PC.)
- If a voice file already exists on your PC with the same name, date and time recorded, the new file will not be downloaded.

Play a Voice File

- 1 Select the folder.**
Select the folder that contains the voice file you would like to play.
- 2 Select the voice file.**
Select the voice file to play from the Voice File List Box.
- 3 Play the voice file.**
Click the  (play) button of the Play Control Bar.

Other playback control such as Rewind, Fast Forward, Stop, Speed Control, Volume Control, Time Axis and Index Skip are available from the Play Control Bar.

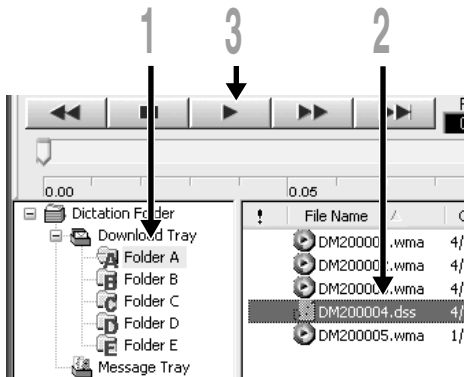

File name

File names are assigned in the following manner:

DM20 0004.dss

Extension

File number A serial number automatically assigned by a Digital Voice Recorder.

User ID The name that has been set on the Digital Voice Recorder. The default name on the Digital Voice Recorder is "DM20" or "DM10". The user ID can be modified with DSS Player (P.58).

Upload Voice Files to the Recorder

DSS Player has a feature to enable you to upload DSS-format voice files from your PC to the recorder.

1 Select the folder.
Select the folder that contains the voice file to upload from the Dictation Folder window.

2 Select the voice file.
Select the voice file to upload from the Voice File List Box.

3 Select the folder to upload.
(Windows)
From the [Download] menu select [Upload Files] or click the Upload icon. Once the folder list box where the file is to be uploaded is displayed, select the folder from which the file is to be uploaded.

(Macintosh)
From the [Tools] menu, click [Upload Files]. Once the folder list box where the file is to be uploaded is displayed, select the folder from which the file is to be uploaded.

4 Upload the voice file.
The voice file is uploaded to the recorder.

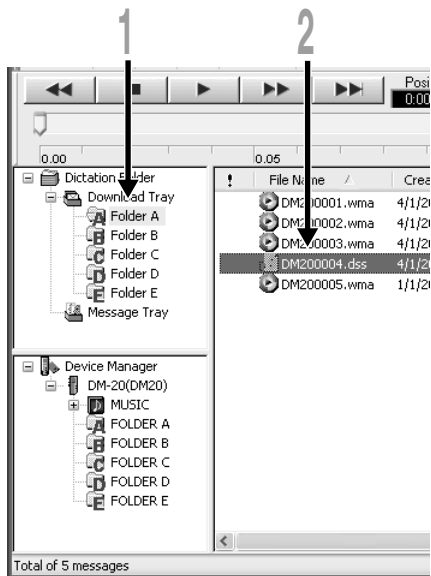

3

Upload Voice Files to the Recorder

5 Upload complete.

Once the transmission screen closes and the record/play indicator lamp on the recorder is OFF, upload is completed.*

* In general, it will take more than 5 seconds (more than 12 seconds with Windows 2000/XP) after the transmission screen closes before uploading is completed.

You can also drag and drop files from the Voice File List Box to the Device Manager window.

Note

NEVER disconnect the USB cable while the record/play indicator lamp is flashing. If you do, the data will be destroyed.

Send Voice Files with E-mail

Audio files are stored in the Message folder on the hard disk. If you want to send a voice file by attaching it to E-mail, select the file from the Message folder.

The Message folder location can be found from the [Tools] menu, [Options], and then "Download folder" tab.

The file can be replayed with DSS Player-Lite even though the recipient does not have DSS Player. Free DSS Player-Lite can be downloaded from Olympus homepage.

http://www.olympusamerica.com/cpg_section/cpg_downloads.asp

<http://cf.olympus-europa.com/consumer/voice/downloads/downloads.cfm>

3

Changing User ID

The user ID is used in file names that are recorded on a Digital Voice Recorder.

1 Enter the user ID in the [Transfer User ID] window.

(Windows) From the [Download] menu.
(Macintosh) From the [Tools] menu.

2 Click [Transfer].

The new user ID will be transferred to the Digital Voice Recorder.

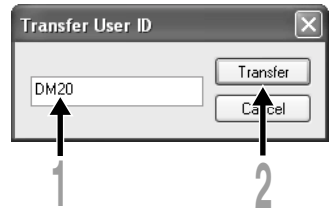

Note

NEVER disconnect the USB cable while the record/play indicator lamp is flashing. If you do, the data will be destroyed.

Changing a Folder Name

Changing a folder name in the Voice Folder window

(Windows)

You can change a folder name using the [Rename Folder] command from the [Edit] menu. A folder name can be up to 20 characters long and cannot use \/:*?"<>|.

(Macintosh)

Choose the [Rename Folder] command from the [File] menu.

Changing a folder name in the Device window

(Windows)

Right-click the folder name to change, select the [Rename Folder] and input the new folder name.

(Macintosh)

Choose the [Rename Folder] from the [File] menu and type a folder name.

The names of the folders on the Digital Voice Recorder is updated with the new folder names. Device Window folder names consist of a string of 12 or fewer single-byte alphanumeric characters.

Editing File Comments

You can use a PC to create or edit file comments in DSS Player in the [Edit Comments] window, and transfer them from the PC to the recorder. You can also edit file comments imported from the recorder to a PC.

Choose the [Edit Comments] command from the [Tools] menu.

Files comments can use up to 100 alphanumeric characters and symbols.

Note

NEVER disconnect the USB cable while the record/play indicator lamp is flashing. If you do, the data will be destroyed.

Editing a Template

You can edit folder name and file comment templates in DSS Player in the [Edit & Upload Templates] window and transfer them to the recorder. Templates downloaded from the recorder can also be edited.

(Windows)

Select [Edit & Upload Templates] from [Download] to open the [Edit and Upload Template] window.

(Macintosh)

Select [Edit & Upload Templates] from [Tools] to open the [Edit and Upload Template] window.

The maximum number of characters that can be entered is 8 characters for a folder name, and 20 characters for a comment.

3

Editing a Template

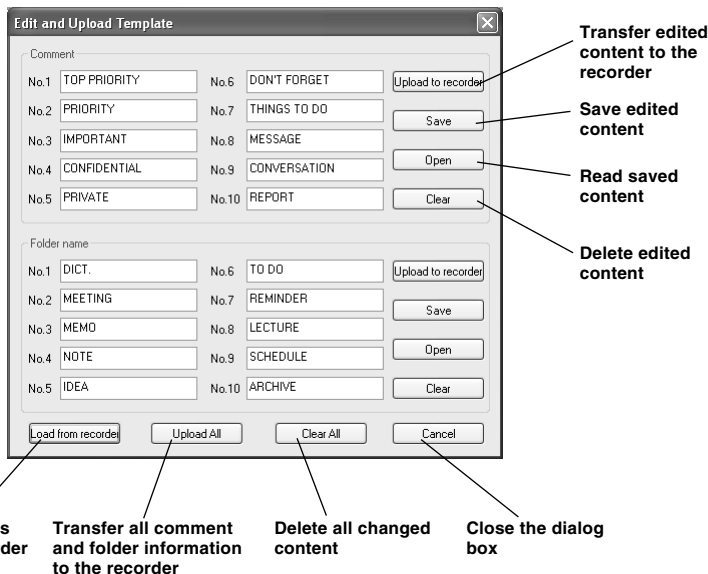

Note

NEVER disconnect the USB cable while the record/play indicator lamp is flashing. If you do, the data will be destroyed.

Using the Recorder as a Music Player

The recorder supports music files in MP3 and WMA formats, which can be transferred from the PC to the corresponding music folder of the recorder.

Using Windows Media Player

Windows

By using Windows Media Player, music files from music CDs can be converted (ripped) (☞ P.64) and music files that you bought from any music distribution sites can be easily transferred to the recorder (☞ P.65).

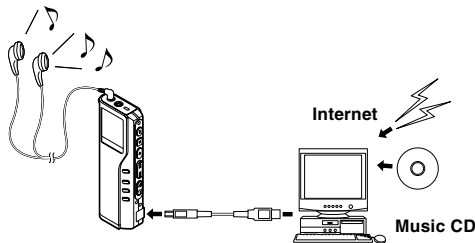

Macintosh

Windows Media Player included with the recorder is for Windows only. Please use your favorite application software according to your use.

Copyright and copyright protection feature (DRM)

By the Copyright Act, any voice/music files and music CDs downloaded from the Internet without the copyright holder's permission may not be reproduced, distributed, publicized/re-publicized on the Internet, or converted into MP3 or WMA files for the purpose of commercial business or sale.

A WMA file may be provided with DRM (Digital Right Management) for copyright protection. DRM limits the file to copy or distribute music files that are converted (ripped) from a music CD or downloaded from music distribution services. To transfer a WMA file with DRM to the recorder, you need to use appropriate methods such as Windows Media Player. Copying the music files with DRM purchased from online music distribution service to a portable device such as this recorder may be restricted.

Windows Media Audio License and Distribution Agreement

- You have acquired an item ("DM-20/10") that includes software licensed by OLYMPUS from Microsoft Licensing Inc. or its affiliates ("MS"). Those installed software products of MS origin, as well as associated media, printed materials, and "online" or electronic documentation ("SOFTWARE") are protected by copyright laws and international copyright treaties, as well as other intellectual property laws and treaties. The SOFTWARE is licensed, not sold.

* [Approved alternative text if OLYMPUS does not mention MS in the EULA text: "You have acquired an item("DM-20/10") which includes software licensed by OLYMPUS from one or more software licensors ("OLYMPUS's Software Suppliers"). Such software products, as well as associated media, printed materials, and "online" or electronic documentation ("SOFTWARE") are protected by copyright laws and international copyright treaties, as well as other intellectual property laws and treaties."]

- IF YOU DO NOT AGREE TO THIS END USER LICENSE AGREEMENT ("EULA"), DO NOT USE THE DM-20/10 OR COPY THE SOFTWARE. INSTEAD, PROMPTLY CONTACT OLYMPUS FOR INSTRUCTIONS ON RETURN OF THE UNUSED DM-20/10(S) FOR A REFUND. ANY USE OF THE SOFTWARE, INCLUDING BUT NOT LIMITED TO USE ON THE DM-20/10, WILL CONSTITUTE YOUR AGREEMENT TO THIS EULA (OR RATIFICATION OF ANY PREVIOUS CONSENT).
- GRANT OF LICENSE. The SOFTWARE is licensed, not sold. This EULA grants you the following rights to the SOFTWARE:
 - You may use the SOFTWARE only on the "DM-20/10".
 - NOT FAULT TOLERANT. THE SOFTWARE IS NOT FAULT TOLERANT. [OLYMPUS] HAS INDEPENDENTLY DETERMINED HOW TO USE THE SOFTWARE IN THE "DM-20/10", AND MS HAS RELIED UPON [OLYMPUS] TO CONDUCT SUFFICIENT TESTING TO DETERMINE THAT THE SOFTWARE IS SUITABLE FOR SUCH USE.
 - NO WARRANTIES FOR THE SOFTWARE. THE SOFTWARE is provided "ASIS" and with all faults. THE ENTIRE RISK AS TO SATISFACTORY QUALITY, PERFORMANCE, ACCURACY, AND EFFORT (INCLUDING LACK OF NEGLIGENCE) IS WITH YOU. ALSO, THERE IS NO WARRANTY AGAINST INTERFERENCE WITH YOUR ENJOYMENT OF THE SOFTWARE OR AGAINST INFRINGEMENT. IF YOU HAVE RECEIVED ANY WARRANTIES REGARDING THE "DM-20/10" OR THE SOFTWARE, THOSE WARRANTIES DO NOT ORIGINATE FROM, AND ARE NOT BINDING ON, MS.
 - Note on Java Support. The SOFTWARE may contain support for programs written in Java. Java technology is not fault tolerant and is not designed, manufactured, or intended for use or resale as online control equipment in hazardous environments requiring fail-safe performance, such as in the operation of nuclear facilities, aircraft navigation or communication systems, air traffic control, direct life support machines, or weapons systems, in which the failure of Java technology could lead directly to death, personal injury, or severe physical or environmental damage. Sun Microsystems, Inc. has contractually obligated MS to make this disclaimer.
 - No Liability for Certain Damages. EXCEPT AS PROHIBITED BY LAW, MS SHALL HAVE NO LIABILITY FOR ANY INDIRECT, SPECIAL CONSEQUENTIAL OR INCIDENTAL DAMAGES ARISING FROM OR IN CONNECTION WITH THE USE OR PERFORMANCE OF THE SOFTWARE. THIS LIMITATION SHALL APPLY EVEN IF ANY REMEDY FAILS OF ITS ESSENTIAL PURPOSE...
 - Limitations on Reverse Engineering, Decompilation, and Disassembly. You may not reverse engineer, decompile, or disassemble the SOFTWARE, except and only to the extent that such activity is expressly permitted by applicable law not withstanding this limitation.
 - SOFTWARE TRANSFER ALLOWED BUT WITH RESTRICTIONS. You may permanently transfer rights under this EULA only as part of a permanent sale or transfer of the "DM-20/10", and only if the recipient agrees to this EULA. If the SOFTWARE is an upgrade, any transfer must also include all prior versions of the SOFTWARE.
 - EXPORT RESTRICTIONS. You acknowledge that the SOFTWARE, or any part thereof, or any process or service that is the direct product of the SOFTWARE (the foregoing collectively referred to as the "Restricted Components") are of U.S. origin. You agree to comply with all applicable international and national laws that apply to these products, including the U.S. Export Administration Regulations, as well as end-user, end-user and destination restrictions issued by U.S. and other governments. For additional information on exporting Microsoft products, see <http://www.Microsoft.com/exporting/>.

Window Names (Windows Media Player)

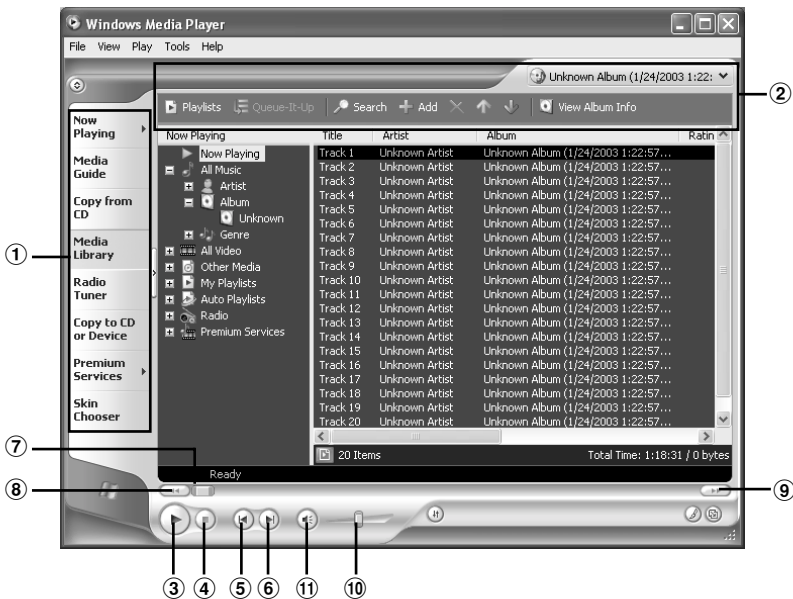

- ① Features taskbar
- ② Quick Access box
- ③ Play button
- ④ Stop button

- ⑤ Previous button
- ⑥ Next button
- ⑦ Seek slider
- ⑧ Rewind button

- ⑨ FastForward button
- ⑩ Volume slider
- ⑪ Mute button

4

Window Names (Windows Media Player)

Copying Music from CD

Windows

1 Insert CD into the CD-ROM drive and start Windows Media Player.

2 From the Features taskbar, click the [Copy from CD] menu.

3 Click [Find Album Info] of Quick Access box.

If Internet connectivity is available, CD information is searched.

4 Put a check mark on the music file that you want to copy.

5 Click [Copy Music] of Quick Access box.

Files copied to a PC are stored in WMA format. Music files copied are categorized by artist, album, genre, etc. and added to the play list.

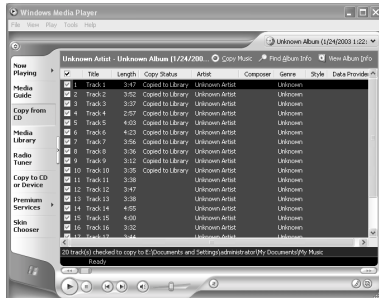

4

Copying Music from CD

Transferring Music File to the Recorder

Windows

- 1 Connect the recorder to a PC and start Windows Media Player.
- 2 From Features taskbar, click [Copy to CD or Drive].
- 3 Select the play list to be transferred to the recorder and put the check marks on the music file that you want to transfer.

The order of music pieces can be changed by Drag & Drop of the music file in the play list displayed.

- 4 From **Item on Device**, select the drive corresponding to the recorder. The recorder is recognized as a Removable Disk. If you skip to step 6 below, the music file is transferred to the music A folder (root of the device's drive).
- 5 Select the destination folder. To transfer to the music A folder: select the blank part^{*1} from **Item on Device**. To transfer to the music B folder: select DSS_FLDF.
- 6 Click the **[Copy]** button of **Quick Access box**. The file is transferred to the recorder. The music file transferred to the recorder is displayed in **Item on Device**.

Note

Copying the music files with DRM purchased online music distribution service to a portable device such as this recorder may be restricted.

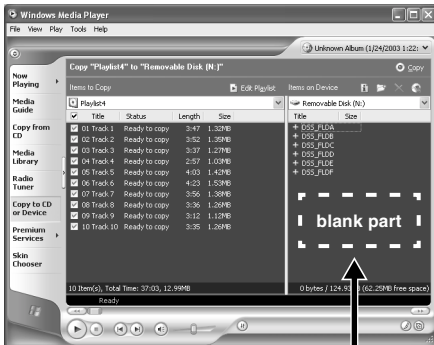

4

Transferring Music File to the Recorder



Music Playback

The recorder has 2 music folders; music A and music B, to store music files transferred from a PC. 2 folders can be conveniently used depending on the genre of music files.

4

Music Playback

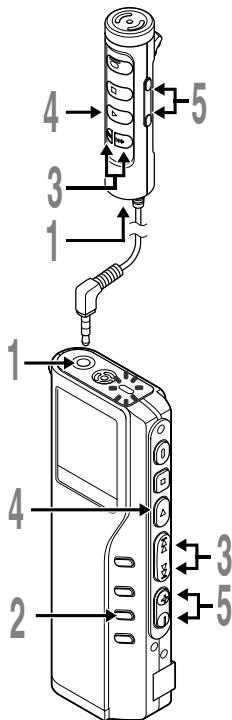

1 Insert the stereo earphone or remote controller into the jack on the recorder.

If a remote controller is used, insert the earphone into the EAR jack.

2 Press the **FOLDER** button to choose a folder.

3 Press the **FF** or **REW** button to choose the music file that you want to play.

The filename and the length of the music track will be displayed.

If you hold the FF or REW, files are skipped continuously.

- a File being selected
- b Length of the file being selected

4 Press the **PLAY** button to start playback.

The record/play indicator lamp will flash in green, and the title and artist name will scroll on the left side of the screen.

- c Title and artist name of the file being played
- d Play time of the file being played

5 Press the **VOL (+)** or **VOL (-)** button to select the proper sound volume.

The display shows the volume level. You can choose between 0 to 30.

The next track will automatically start once the track being played is finished.

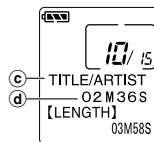
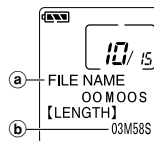

Notes

- The proper bit rate for playback on the recorder are 32 kbps to 160 kbps for both the MP3 and WMA format.
- It is possible to play back files with different bit rates (converting the bit rate within one file); however, the displayed time may not be accurate.
- When using the earphones, do NOT set the volume too high. Listening at very high volume may lead to hearing loss.
- It is possible to listen to music without the earphones, using the internal speakers; however, the sound will be in mono, not stereo.
- Up to 40 characters per track can be used to list title and artist name.

Playback Functions

Skip a Music File While Playing It

Press the **FF** button while playing a music file.

- ➡ The recorder skips to the beginning of the next track and starts playing it.

Press the **REW** button while playing a music file.

- ➡ The recorder skips to the beginning of the current track and starts playing it.

Fast Forward

Hold the **FF** button while playing a music file.

- ➡ Will fast-forward to the end of the track and stop at the beginning of the next track.

Canceling Fast Forward

Release the **FF** button where you want the music file played.

- ➡ Playback begins.

Fast Rewind

Hold the **REW** button while playing a music file.

- ➡ Will rewind to the beginning of the current track and resume playback.

Canceling Fast Rewind

Release the **REW** button where you want the music file played.

- ➡ Playback begins.

Canceling Playback

Press the **PLAY** or **STOP** button.

- ➡ Will stop playing the current track.

Various Playback Features

Equalizer

The equalizer mode is selected in the following order each time the **EQ** (equalizer) button is pressed.

→ FLAT → ROCK → POP → JAZZ → USER →

You can set/create your own equalizer preferences using the user equalizer (USER EQ) function (see P.71).



- If no action is taken within 2 seconds after the EQ button is pressed, the display will revert to the normal indication.

4

Repeat and Random Play

The play mode is switched in the following order each time the **REPEAT** button is pressed more than 1 second with playback stopped or is pressed during playback.

→ Normal play → Single music repeat play → All music repeat play →
 Random play ← Random repeat play ←

Function	Explanation	Display indicator
Normal play	Will stop after all the tracks been played.	No indication
Single music repeat play	Will play one track repeatedly.	
All music repeat play	Will play all the tracks from first to last continuously.	
Random repeat play	Will continuously play all the tracks in random order.	
Random play	Will stop after all the tracks have been played in random order.	RANDOM



Increasing the WOW effect (WOW EFFECT)

The recorder has WOW, an audio processing technology that increases sound clarity and bass quality. The level of the surround effect (SRS 3D) and the bass effect (TruBass) may be individually adjusted through three levels of processing or turned off.

Surround effect (SRS 3D): Increases the sound-expansion effect and sound clarity.

Bass effect (TruBass): Enriches the low sounds.

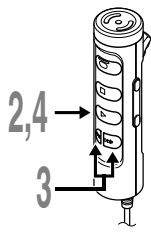

1 Press and hold the **MENU** button for 1 second or longer.

"WOW EFFECT" will be displayed on the screen (☞ P.76).



2 Press the **PLAY** button.

The surround effect setup process begins (SRS 3D).

3 Press the **FF** or **REW** button to select the surround effect level.

The levels switch in the following rotation, "OFF" "LOW" "MIDDLE" "HIGH".

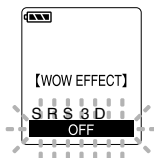

4 Press the **PLAY** button to register your setting.

The bass effect setup process begins (TruBass).

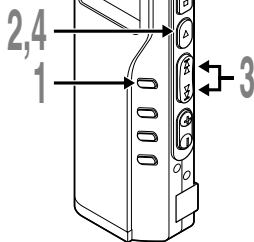

4

Increasing the WOW effect (WOW EFFECT)

Increasing the WOW effect (WOW EFFECT)

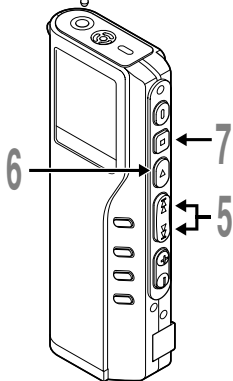
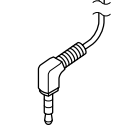
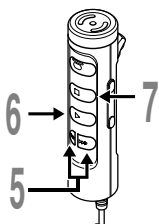

5 Press the FF or REW button to select the bass effect level.

The levels switch in the following rotation, "OFF" "LOW" "MIDDLE" "HIGH".

6 Press the PLAY button to save your setting.

7 Press the STOP button to close the menu.

If you wish to set other menus, press and hold the PLAY button for more than 1 second without pressing the STOP button.

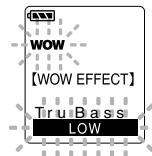

If you want to change the WOW level while listening to sound, press the MENU button for at least 1 second during playback and then start procedure from step 3.

Notes

- Both the surround effect and bass effect are OFF as the WOW default settings.
- If there is no action taken within 8 seconds during the WOW settings during playback, the recorder will revert to normal play.
- "WOW" will be displayed on the screen if the surround effect or the bass effect is set.
- The WOW effect will be weakened if the bit rate for any music file is less than 32 kbps.
- Depending on the song, the WOW effect will be heightened, and may sound like noise. If this happens, adjust the WOW effect.

4

Increasing the WOW effect (WOW EFFECT)



Changing the User Equalizer (USER EQ)

You can customize your own equalizer by changing the USER EQ settings.

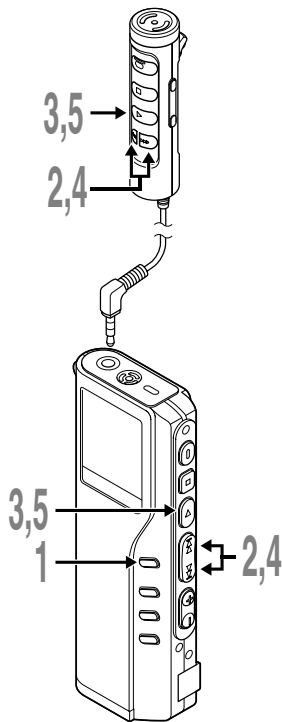

1 Press and hold the **MENU** button for 1 second or longer.

The menu opens (see P.76).

2 Press the **FF** or **REW** button to open the user equalizer setup screen.



3 Press the **PLAY** button.

Select the frequency band.

4 Press the **FF** or **REW** button to select the frequency band.

Low tone ↔ High tone

→ 60Hz ↔ 250Hz ↔ 1kHz ↔ 4kHz ↔ 12kHz ←

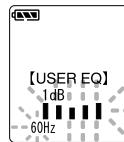

Will switch in this order.

5 Press the **PLAY** button to save your setting.

Changing the User Equalizer (USER EQ)

4

Changing the User Equalizer (USER EQ)

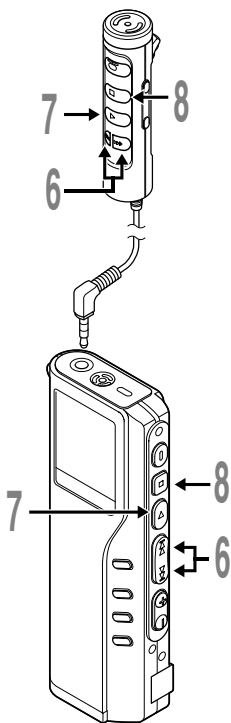

6 Press the **FF** or **REW** button to select the equalizer level.

You can select the equalizer level from -15 dB to 15 dB in 1 dB increments. The higher the decibel value, the louder the sound. The default setting is 0 dB.

7 Press the **PLAY** button to select the level of your choice.

To change the settings again, press the FF or REW button and repeat the procedure from step 4.

8 Press the **STOP** button to close the menu.

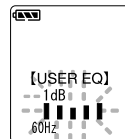

Notes

- The USER EQ default setting is FLAT.
- Your USER EQ settings will be retained in memory even when you change the batteries or reset the recorder.



LCD Display Information (MUSIC mode)

The LCD screen on the recorder can display 4 different format of information by pressing the DISPLAY button. This help review and confirm different recorder settings and file information.

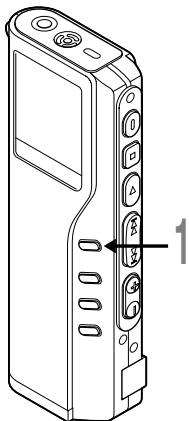

1 Press the **DISPLAY** button.

The LCD display views will switch every time the **DISPLAY** button is pressed.

While in Stop mode

When pressing Display, the recorder will cycle through ① to ④. If the number of characters of a music piece or artist is too large, not all of them are displayed.

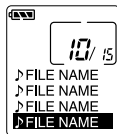
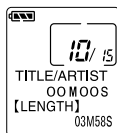
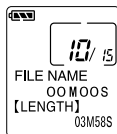

4

LCD Display Information (MUSIC mode)

While in Playback mode

It will repeatedly cycle through ① to ③. If the number of characters of the name of a music piece/artist name is long and cannot be displayed in a line, the name scrolls to the left. (Stop for 2 seconds and re-scroll are repeated after every turn.)

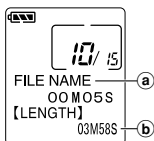

① Name of music piece/artist name

The name of music piece of the file/artist name and music length are displayed.

- a Name of music piece being replayed/artist name
- b Music length of the file being replayed

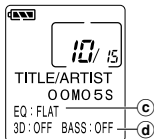

② User equalizer/WOW

Title/artist name of the file and user equalizer (USER EQ)/WOW setup information are displayed.

- c Current USER EQ setting
- d Current WOW setting

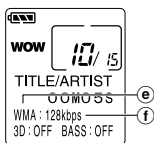

③ File format/bit rate

Title/artist name of the file and setup information of file format, bit rate, and WOW are displayed.

- e File format being replayed
- f Bit rate of the file being replayed.

Changing Playback Order of Music File

By using DSS Player, you can change the playback order of music files on the recorder.

1 Start DSS Player and connect the recorder.

2 From Device window, select music A or B folder.

3 Drag the music file in the file list to the desired position in the playback order.

You can also highlight the music file and change the track position by clicking on the order buttons in the toolbar (Windows version only).

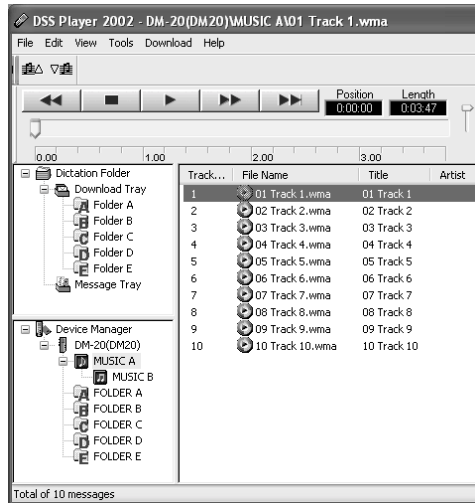

4

Changing Playback Order of Music File

Note

NEVER disconnect the USB cable while the record/play indicator lamp is flashing. When removing the USB cable, be sure to follow the description in P47. If the USB cable is removed before the drive is stopped, data may not be successfully transferred.



Menu List (MUSIC mode)

Press and hold the **MENU** button for 1 second or longer.

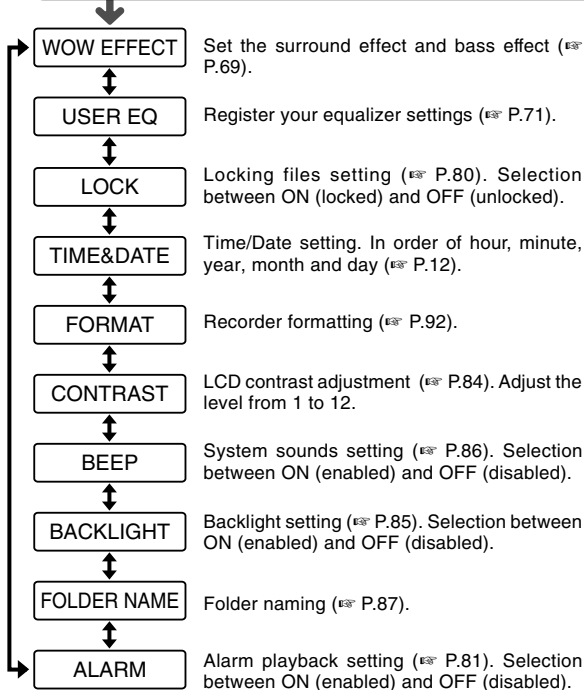

Press the **FF** button or **REW** button.

Notes

- Part of the menu is common with the VOICE mode.
- If you press the **STOP** button or the **REC** button, during a menu setup operation, the recorder will stop and apply the items that were set to that point.
- The recorder will stop if you leave it idle for 3 minutes during a menu setup operation, when a selected item is not applied.

4

Menu List (MUSIC mode)



Erasing

Erasing One File at a Time

A selected file can be erased from a folder.

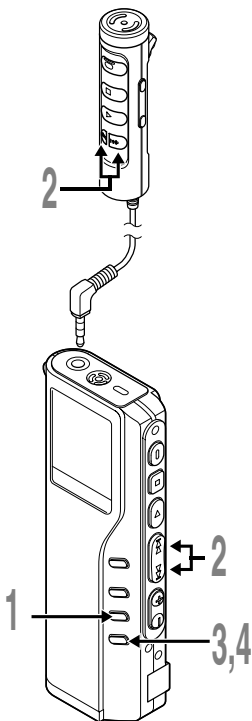

- 1 Press the **FOLDER** button to choose a folder.
- 2 Press the **FF** or **REW** button to choose the file you want to erase.

a File to be erased

- 3 Press the **ERASE** button.
"FILE ERASE?" flashes on the display for approximately 8 seconds.

- 4 Press the **ERASE** button once more when "FILE ERASE?" is flashing.
The display changes to "FILE ERASE!" and erasing will start.

"ERASE DONE" is displayed when the file is erased. File numbers will be reassigned automatically.

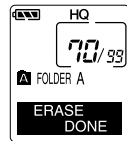
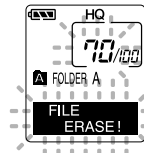
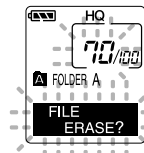

5 Erasing

Erase All Files from a Folder

All files in a folder can be erased simultaneously, except for locked files (see P.80).

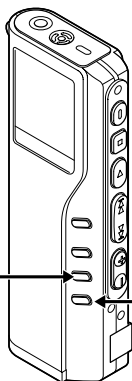

5

Erasing

- 1 Press the **FOLDER** button to choose the folder you want to erase all files.

Ⓐ Folder from which to erase files

- 2 Press the **ERASE** button for 3 seconds or longer.

“ALL ERASE?” flashes on the display for approximately 8 seconds.

- 3 Press the **ERASE** button once more when “ALL ERASE?” is flashing.

The display changes to “ALL ERASE!” and erasing will start.

“ERASE DONE” is displayed when the files are erased. Locked files are reassigned file numbers in ascending order.

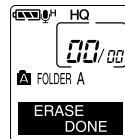
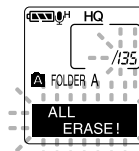
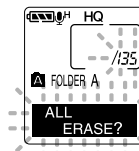
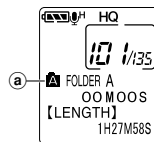

Notes

- An erased file cannot be restored.
- If the ERASE button is not pressed within the 8 seconds after “FILE ERASE?” or “ALL ERASE?” starts flashing, the recorder will revert to stop status.
- Completion of erasing may take 10 seconds. Never do anything during this period because data may be corrupted. Battery removal and AC adapter setting/removal are not permissible, whether or not the battery is set in the recorder.



Locking Files (LOCK)

Locking a file keeps important data from being accidentally erased.
Locked files are not erased when you choose to erase all files from a folder (P.78).

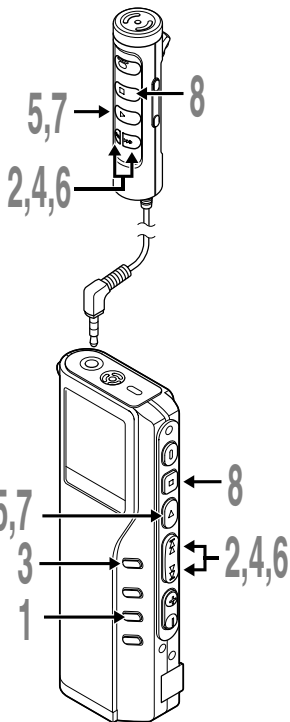

5

Locking Files (LOCK)

1 Press the **FOLDER** button to choose a folder.

2 Press the **FF** or **REW** button to choose the file you want to lock.

3 Press and hold the **MENU** button for 1 second or longer.
The menu opens (P.43,76).

4 Press the **FF** or **REW** button until “**LOCK**” flashes on the display.

5 Press the **PLAY** button.
The file locking setup process begins.

6 Press the **FF** or **REW** button to choose between **ON** and **OFF**.

ON : Locks the file and prevents it from being erased.

OFF : Unlocks the file and allows it to be erased.

7 Press the **PLAY** button to complete the setup screen.

8 Press the **STOP** button to close the menu.

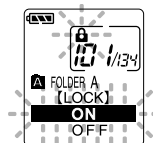



Alarm Playback Function (ALARM)

The alarm playback function can be set to play a selected file at a pre-set time.

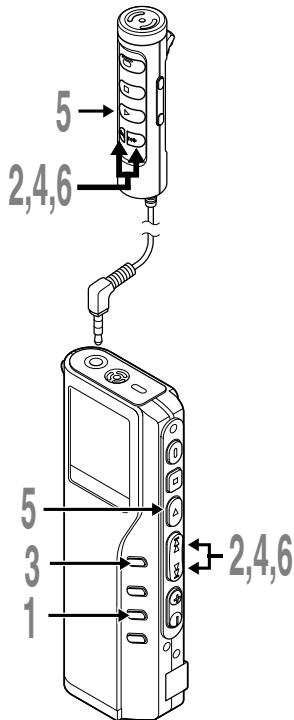

1 Press the **FOLDER** button to choose a folder.

2 Press the **FF** or **REW** button to choose the file to be played when the alarm sounds.

3 Press and hold the **MENU** button for 1 second or longer.
The menu opens (see P.43,76).

4 Press the **FF** or **REW** button until “ALARM” flashes on the display.

5 Press the **PLAY** button.
The alarm playback setup process begins.

6 Press the **FF** or **REW** button to choose between **ON** and **OFF**.

ON : Enables alarm playback.

OFF : Disables alarm playback.

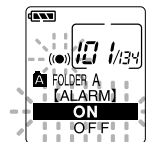
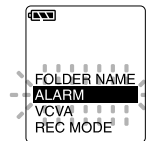

5

Alarm Playback Function (ALARM)

Alarm Playback Function (ALARM)

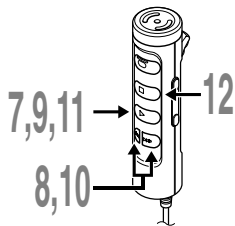

5

Alarm Playback Function (ALARM)

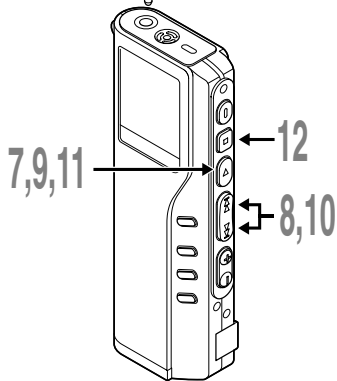

7 Press the **PLAY** button to complete the setup screen.

When you choose ON, the hour indicator flashes.

When you choose OFF, the alarm indicator disappears and finishes with Step 12.

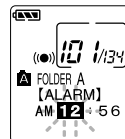

8 Press the **FF** or **REW** button to set the hour.

9 Press the **PLAY** button to accept the hour.

The minute indicator flashes.

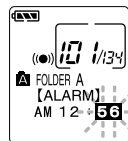

10 Press the **FF** or **REW** button to set the minute.

11 Press the **PLAY** button to accept the minute.

12 Press the **STOP** button to close the menu.

An alarm tone will sound at the scheduled time. Press any button while the alarm sounds to play the file you associated with the alarm.

To enable alarm sound only

To set an alarm without audio playback, set the alarm while an empty folder is selected.

- Start setting from step 3 (P.81) of “Alarm Playback Function”.
- When alarm sound goes at the preset time, pressing any button stops the sound.

Notes

- The alarm playback function can be set for only one file at a time.
- The alarm will sound at the scheduled time every day unless the alarm playback setting is cleared.
- If you wish to change the file for alarm play, first turn the alarm settings “OFF”, then make any desired new alarm settings.
- The alarm will sound for 5 minutes and then stop.
- If the recorder is in use at the scheduled time, the alarm will sound after the operation is finished.
- The alarm will sound at the scheduled time even if the recorder is set to hold. The recorder begins to play the file associated with the alarm when you press any button.
- The alarm playback setting is cleared if the selected file is erased.
- For the audio playback as an alarm, the selected file will play regardless of the mode (Voice/Music).

LCD Contrast Adjustment (CONTRAST)

If you find it difficult to read the display information due to lighting, temperature, or other conditions, you can adjust the contrast using this function to easily see the LCD display (display contrast). Display contrast can be adjusted in 12 levels.

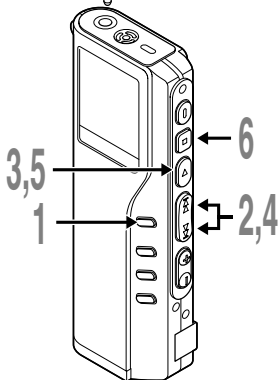
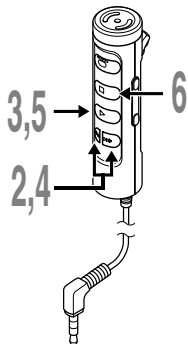

- 1 Press and hold the MENU button for 1 second or longer.**

The menu opens (P.43,76).

- 2 Press the FF or REW button until "CONTRAST" flashes on the display.**

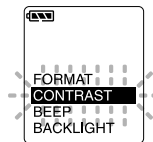

- 3 Press the PLAY button.**

The LCD display contrast setup process begins.

- 4 Press the FF or REW button to set the contrast level.**

You can adjust the LCD display contrast level from 1 to 12. (Initial setting6)

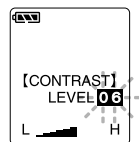

- 5 Press the PLAY button to complete the setup screen.**

- 6 Press the STOP button to close the menu.**

5

LCD Contrast Adjustment (CONTRAST)



Backlight (BACKLIGHT)

The recorder display backlight is ON by default. The display will lit for about 10 seconds when a button on the recorder is pressed. The backlight feature can be turned off from the menu.

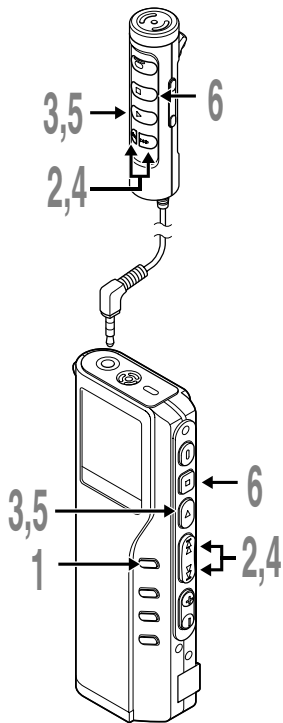

1 Press and hold the **MENU** button for 1 second or longer.

The menu opens (see P.43,76).

2 Press the **FF** or **REW** button until “**BACKLIGHT**” flashes on the display.



3 Press the **PLAY** button.

The backlight setup process begins.

4 Press the **FF** or **REW** button to choose between **ON** and **OFF**.

ON : Backlight is enabled.

OFF: Backlight is disabled.

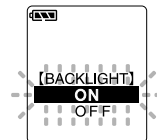

5 Press the **PLAY** button to complete the setup screen.

6 Press the **STOP** button to close the menu.

5

Backlight (BACKLIGHT)



System Sounds (BEEP)

The recorder beeps to alert you to button operations or warn you of errors. System sounds may be turned off.

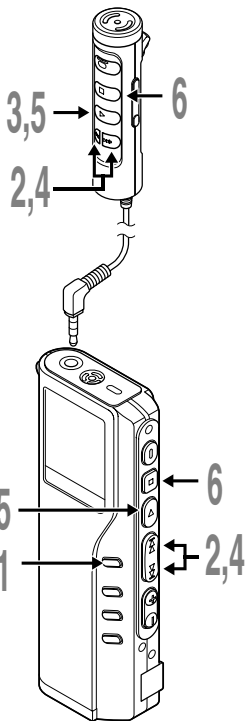

5

System Sounds (BEEP)

- 1 Press and hold the **MENU** button for 1 second or longer.

The menu opens (see P.43,76).

- 2 Press the **FF** or **REW** button until “BEEP” flashes on the display.

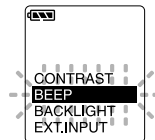

- 3 Press the **PLAY** button.

The system sound setup process begins.

- 4 Press the **FF** or **REW** button to choose between **ON** and **OFF**.

ON : System sounds are enabled.

OFF : System sounds are disabled.

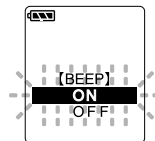

- 5 Press the **PLAY** button to complete the setup screen.

- 6 Press the **STOP** button to close the menu.

Note

If the alarm playback function has been set, the alarm will sound at the scheduled time even if system sounds are turned off.

Assigning Folder Names (FOLDER NAME)

The 5 folders on the recorder (Folder A to Folder E) can be easily renamed. The folder name is limited to 12 characters each. Frequently used names such as “dictation (DICT.)”, “meeting (MEETING)” and “schedule (SCHEDULE)” are pre-set in a template.

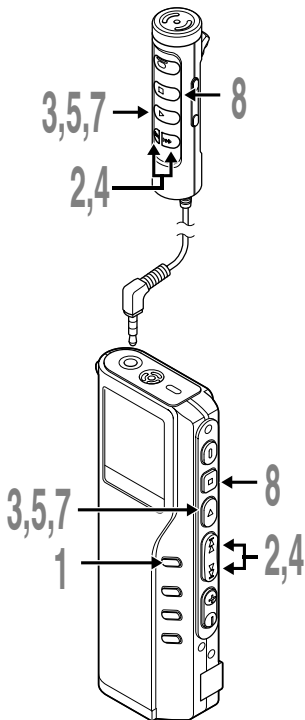

1 Press and hold the MENU button for 1 second or longer.

The menu opens (P.43,76).

2 Press the FF or REW button until “FOLDER NAME” flashes on the display.



3 Press the PLAY button.

The folder name setup process begins.

4 Press the FF or REW button to choose the folder you want to name.

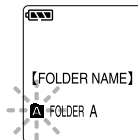

5 Press the PLAY button to accept the chosen folder.

a Current character being entered (a space is highlighted and blinks.)

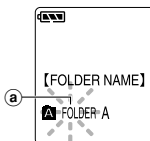

6 Press the FF or REW button to choose characters.

The recorder assigns the following buttons to inputting procedures.

Recorder buttons that are used to input characters

Button	Push	Action
PLAY	Press once	To input the selected character and advance the input position.
	Press and hold	Confirms folder name or file comment.
FF	Press once	Forward to next character in the character list.
	Press and hold	Scroll forward through the character list.
REW	Press once	Backward to previous character in the character list.
	Press and hold	Scroll backward through the character list.
FOLDER	-----	Returns to previous character.
ERASE	-----	To delete the flashing character.
INDEX	Press once	Switches between character groups (type).
	Press and hold	Quickly cycles through the character groups (types).
MENU	Press once	Selects character to be input: skips ahead by 5 characters.
	Press and hold	Quickly skips ahead in increments of five characters.

Use the two following methods to quickly find characters.

- When the **INDEX** button is pressed, the displayed character group (example: Uppercase, lowercase, template, symbols) will change, and you can then press the **FF** or **REW** buttons to select characters.
- Every time the **MENU** button is pressed, it will skip ahead by five characters, so you can quickly move closer to the character you want.

(Currently displayed character) → (Space) → DICT. → TO DO → A → F → K → P → U → Z → a → f → k → p → u → z → 1 → 6 → , → (→ # → ^ → (Space) → DICT. → TO DO...

If you press the **DISPLAY** button while a character other than one of the above appears, you will skip to the closest forward character in the above cycle.

Pressing the **DISPLAY** button again will then cycle through every fifth character as shown above.

example:

If you press the **DISPLAY** button while **"MEMO"** is displayed, **"TO DO"** will appear.

If you press the **DISPLAY** button while **"B"** is displayed, **"F"** will appear.

Available characters

Type of Characters	Action
Folder name input	DICT. → MEETING → MEMO → NOTE → IDEA → TO DO → REMINDER → LECTURE → SCHEDULE → ARCHIVE
Template File comment input	TOP PRIORITY → PRIORITY → IMPORTANT → CONFIDENTIAL → PRIVATE → DON'T FORGET → THINGS TO DO → MESSAGE → CONVERSATION → REPORT
Large caps	A → B → C → D → E → F → G → H → I → J → K → L → M → N → O → P → Q → R → S → T → U → V → W → X → Y → Z
Small caps	a → b → c → d → e → f → g → h → i → j → k → l → m → n → o → p → q → r → s → t → u → v → w → x → y → z
Numerics	1 → 2 → 3 → 4 → 5 → 6 → 7 → 8 → 9 → 0
Symbols	, → . → ; → ! → _ → (→) → + → - → = → # → \$ → % → & → ' → ^ → @

A comment cannot be entered in a music file.

7 When you have finished setting the folder name, press and hold the **PLAY** button for 1 second or longer.

This completes the folder naming procedure.

(If you wish to continue assigning names to folders, press the **PLAY** button and repeat the procedure from step 4.)

8 Press the **STOP** button to close the menu.

Notes

- The folder naming process ends automatically when the twelfth character is set.
- If you input more than 12 characters, "OVER-FLOW" appears on the display.
- You can use a PC to easily change the folder names on the recorder (☞ P.59).

Moving Files Across Folders

A recorded file can be transferred from one folder to another.
The file is added at the end of existing files in the destination folder.

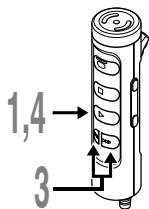

1 Choose the file you want to move and play it.

2 Press and hold the **FOLDER button for 1 second or longer while the file is playing.**
“FILE MOVE?” appears on the display.

- a File to transfer
- b Current folder
- c Destination folder

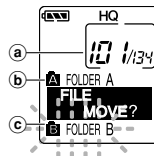

3 Press the **FF or **REW** button to choose a destination folder.**

If you choose the current folder as the destination folder, the selected file will move to the end of the existing files in it.

4 Press the **PLAY button to accept the chosen destination folder.**
The file is moved.

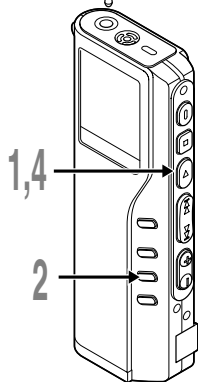

Transfer is complete when “MOVE DONE” appears.

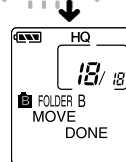
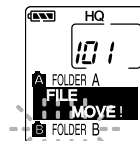

Notes

- If the destination folder is full (a maximum of 199 files), “FOLDER FULL” appears on the display and files cannot be transferred to it.
- The file transfer process is aborted if you press the STOP button or leave the recorder idle for 8 seconds.
- Files cannot be moved between the voice folder and music folder.

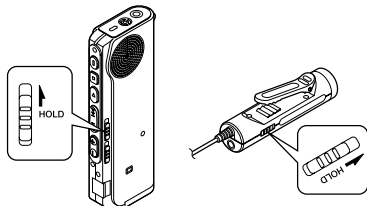

Setting the HOLD switch to the HOLD position.

If you set the recorder to HOLD status by sliding the HOLD switch in the direction of the arrow, the current conditions will be preserved, and all buttons and switches except the HOLD switch will be disabled. This feature is useful when the recorder has to be carried in a bag or pocket.

Remember to reset the HOLD switch when using the recorder.

Running state when HOLD is set

1: State of the recorder, 2: HOLD of the recorder, 3: HOLD of the remote controller, 4: Button operation on the recorder, 5: Button operation on remote controller

	1	2	3	4	5
STOPS	On	Not connected		The display goes out after "HOLD" blinks for 2 seconds.*1	_____
	On	Off		The display goes out after "HOLD" blinks for 2 seconds.*1	Normal operation. If the recorder stops after button operation, the display goes out 20 seconds later.
	Off	On		Normal operation	Button operation on the remote controller is invalid.
Running	On	Not connected		If HOLD is applied during playback (recording), operation is disabled with the playback (recording) state unchanged.*2	_____
	On	Off		If HOLD is applied during playback (recording), operation is disabled with the playback (recording) state unchanged.*2	Normal operation. If the recorder stops after button operation, the display goes out 20 seconds later.
	Off	On		Normal operation	Button operation on the remote controller is invalid. However, the REC lamp is lit while the recorder is recording.

*1: Pressing any button makes clock display blink for 2 seconds but the recorder does not start.

*2: The recorder stops when playback completes or recording terminates due to no memory space.

Note

The alarm will sound at the scheduled time even if the recorder is set to hold. The recorder begins to play the file associated with the alarm when you press any button.

Formatting the Recorder (FORMAT)

If you format the recorder, all function settings will return to their defaults*.

All files** stored in the recorder will be deleted.

If you have important files that you want to save, connect the recorder to a computer and transfer those files from the recorder to the computer before formatting the device.

* Date and time settings will not be cleared, so you won't need to set them again.

** Locked files will also be deleted.

5

Formatting the Recorder (FORMAT)

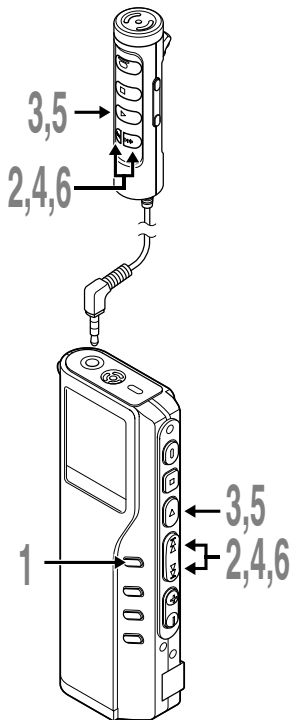

- 1 Press and hold the MENU button for 1 second or longer.**

The menu opens (P.43,76).

- 2 Press the FF or REW button until "FORMAT" flashes on the display.**

- 3 Press the PLAY button.**

The formatting process is selected.

- 4 Press the FF or REW button to choose "START".**

- 5 Press the PLAY button.**

"Data is cleared" appears for approximately 2 seconds.

- 6 Press the FF or REW button again to choose "START".**

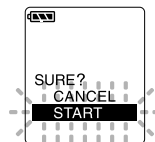
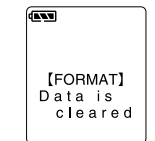
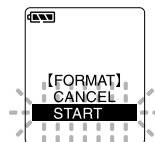
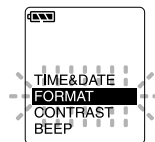

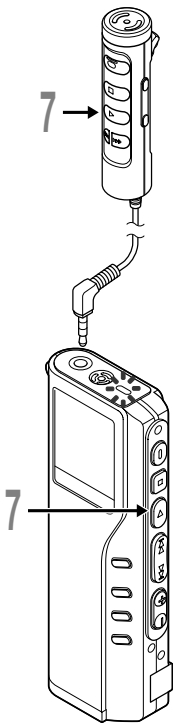

- 7 Press the PLAY button again.**
 Formatting begins and an indicator flashes on the display.

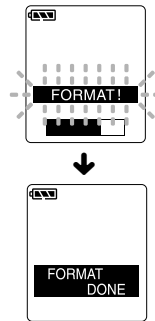

“FORMAT DONE” displays when formatting ends.

Notes

- During the formatting process, never remove batteries, or connect/disconnect AC adapter. If you do so, the data will be destroyed.
- Never format the recorder from a PC.
- After formatting, the first file name is 0001.
- When the recorder is formatted, all the stored data, including locked files, are erased.
- Once the recorder is formatted, the music files with DRM may not be transferred to the recorder again.

Using the Recorder as a Reader/Writer

With the recorder connected to your PC, you can download data from the memory to your PC and upload data stored on your PC to the memory.

- You will need to install the Olympus DSS Player Software if you are using Windows 98/ 98SE.

Example: Copying Data from PC to Recorder using Explorer or Finder

1 Start Windows.

2 Connecting the recorder to your PC.

For the connection procedure, refer to “Connecting to Your PC using the USB cable” (P.46).

3 Open the Explorer or Finder window.

The recorder will appear as a removable drive icon.

4 Copy the data.

While the data are being written or copied, the record/play indicator lamp on the recorder will flash.

Before disconnecting the recorder from your PC, refer to “Disconnecting from Your PC” (P.47).

.....
Note

NEVER disconnect the USB cable while the record/play indicator lamp is flashing. If you do, the data will be destroyed.

Alarm Message List

Message	Meaning	Explanation	Action
BATTERY LOW	Low battery power	Battery power is getting low.	Replace with new batteries (☞ P.10).
LOCK ON	Erase-locked	Tried to delete a locked file.	Unlock the file (☞ P.80).
INDEX FULL	Index full	The file is full of index marks (maximum of 16 marks).	Erase index marks that are no longer required (☞ P.39).
INDEX CAN'T BE ENTERED	File not supporting index	Tried to incorporate WMA file index marks into the music files or the files not recorded with the recorder.	You can incorporate index marks into the voice files recorded with the recorder or IC recorders from Olympus only.
FOLDER FULL	Folder full	The folder is full of files (maximum of 199 files).	Erase unnecessary files (☞ P.77).
	Maximum number	The destination folder already has the maximum number of files (199).	Erase unnecessary files (☞ P.77).
OVER-FLOW	Too many characters input	Exceeds the maximum number of characters that can be registered.	Reduce the number of characters within the limit. Up to 12 characters can be used for a folder name (☞ P.87-89). Up to 100 characters can be used for a file comment (☞ P.40).
COMMENT CAN'T BE ENTERED	File not supporting comment	Tried to incorporate comments into WMA files.	You can incorporate comments into the voice files recorded with the recorder or IC recorders from Olympus only.
MEMORY ERROR	Error in the internal flash memory	Error in the internal memory.	This is a malfunction, so go to the store where you purchased the recorder or an Olympus service station for repair.
LICENCE MISMATCH	Illegally copied file	The music files copied illegally.	Delete the file (☞ P.77).
MEMORY FULL	Zero remaining memory	No remaining internal memory.	Erase unnecessary files (☞ P.77).

Alarm Message List

Message	Meaning	Explanation	Action
NO FILE	No file	No files were found in the folder.	Select another folder.
FORMAT ERROR	Formatting error	There was an error while formatting the recorder's memory.	Reformat the memory (see P.92).
SAME FILE	Same named file	Tried to create or store a file that has same name as a file in the folder.	Change the file name.
SYSTEM ERROR	System error	System error detected in the recorder.	This is a malfunction. Contact the place of purchase or Olympus Service Center for repair.

Troubleshooting

Symptom	Probable cause	Action
Nothing appears on the display	The batteries are not loaded properly.	Verify polarity is correct.
	The batteries are dead.	Replace with new batteries (☞ P.10).
	The recorder is in HOLD mode.	Release the recorder from HOLD (☞ P.91).
Won't start	The recorder is in HOLD mode.	Release the recorder from HOLD (☞ P.91).
	The batteries are dead.	Replace with new batteries (☞ P.10).
Unable to record	Low remaining internal flash memory.	Erase unnecessary files (☞ P.77).
	The maximum number of files has been reached.	Check another folder.
	MUSIC mode is active.	Switch to VOICE mode (☞ P.11).
No playback tone heard	The earphone is connected.	Unplug the earphones to use the internal speaker.
	The VOLUME button is set to 0.	Adjust the VOLUME button.
Unable to erase	The file is locked.	Unlock the file (☞ P.80).
Noise heard during playback	The recorder was shaken during recording.	—
	The recorder was placed near a cell phone or fluorescent lamp while recording or during playback.	Move the recorder.
Recording level too low	The microphone sensitivity is too low.	Set the microphone sensitivity to CONFERENCE mode and try again (☞ P.28).
Unable to set index marks	The maximum number of index marks (16) has been reached.	Erase unnecessary index marks (☞ P.39).
	The file is locked.	Unlock the file (☞ P.80).
Won't work with AC adapter	A non-standard AC adapter is being used.	Use the Olympus A321 (for US, Canada) or A322 (for Europe except U.K) AC adapter (Optional).
Cannot find the downloaded file	The destination folder for downloading was other than the music A folder.	Copy the music file into the music A folder.
	VOICE mode is active.	Switch to MUSIC mode (☞ P.11).
Cannot find the recorded voice	MUSIC mode is active.	Switch to VOICE mode (☞ P.11).
	Wrong folder.	Switch to the right folder.

Accessories (optional)

Stereo Microphone: ME50S

To create stereo recordings in WMA format with clear sound and reduced noise.

Noise-Cancellation microphone: ME12

(Dictation microphone)

Used to get crisp recordings of your own voice by reducing the effects of ambient noise.

AC adapter: A321 (US and Canada) or A322 (Europe except U.K.)

Ni-MH Rechargeable Battery Charger: BU-400

Charger for AA batteries (1 to 4) or 1 to 2 AAA batteries.

Ni-MH Rechargeable Battery: BR401

High-efficiency rechargeable long life batteries.

Connecting cord: KA232*

Use to connect the microphone jack of this unit to a radio or other sound source.

Plug adapter: PA3

A mini plug adapter to connect 2.5 mm mini-plug devices such as microphone to the recorder 3.5 mm mini-jack.

* Use this accessory with the PA3 plug adapter.

Specifications

For the Digital Voice Recorder

Recording format

DSS (Digital Speech Standard)

WMA (Windows Media Audio)

Input level -70 dBv

Sampling frequency

SHQ mode: 44.1 kHz

HQ mode: 44.1 kHz

SP mode: 12 kHz

LP mode: 8 kHz

Overall frequency response

SHQ mode: 300 to 8,000 Hz

HQ mode: 300 to 7,000 Hz

SP mode: 300 to 5,000 Hz

LP mode: 300 to 3,000 Hz

Recording time

DM-20 (128 MB)

SHQ mode: 4 hours 20 minutes

HQ mode: 8 hours 45 minutes

SP mode: 20 hours 55 minutes

LP mode: 44 hours 45 minutes

DM-10 (64 MB)

SHQ mode: 2 hours 10 minutes

HQ mode: 4 hours 20 minutes

SP mode: 10 hours 25 minutes

LP mode: 22 hours 20 minutes

Alkaline battery life

Recording: Approx. 16 hours

Playback: Approx. 9 hours

Ni-MH Rechargeable Battery life

Recording: Approx. 12 hours

Playback: Approx. 8 hours

For the Digital Music Player

Compatible data format

WMA, MP3 format

Sampling frequency

44.1 kHz

Frequency band

20 to 20,000 Hz

Playback time

DM-20 (128 MB)

100 to 340 minutes

DM-10 (64 MB)

50 to 170 minutes

(Time may vary depending on the bit rate of the music data.)

Maximum headphone output

5mW + 5mW (at load of 32 Ω)

Alkaline battery life

Approx. 10 hours

Ni-MH Rechargeable Battery life

Approx. 8 hours

Common specifications

Recording medium

Built-in flash memory

128 MB (DM-20)

64 MB (DM-10)

Speaker

Built-in \varnothing 23 mm round dynamic speaker

MIC/EAR/REMOTE jack

\varnothing 3.5 mm mini-jack, impedance MIC 2k Ω ,
EAR 8 Ω or more

Maximum working output (3 V DC)

180 mW or more (8 Ω speaker)

Input power requirement

Rated voltage: 3 V

Batteries: Two AAA Alkaline batteries
(LR03 or R03) or Two Ni-MH
rechargeable batteries

External power supply: AC adapter

External dimensions

109.5 x 39.5 x 15 mm

(without protrusions)

Weight

85 g (including alkaline batteries)

* Specifications and design are subject to change without notice.

* Battery life is measured by Olympus. It varies greatly according to the type of batteries used and the conditions of use.

Technical Assistance And Support

The following are contact information for technical support for Olympus recorders and software only.

◆ Technical Hotline Number in the U.S. and Canada

1-888-553-4448

◆ User Support E-mail address in the U.S. and Canada

distec@olympus.com

◆ Technical Hotline Number in Europe

Toll free number

00800 67 10 83 00

available for Austria, Belgium, Denmark, Finland, France, Germany, Italy, Luxemburg, Netherlands, Norway, Portugal, Spain, Sweden, Switzerland, United Kingdom

Charged numbers for the Rest of Europe

+49 180 567 1083

+49 40 23773 899

◆ User Support E-mail address in Europe

dss.support@olympus-europa.com

OLYMPUS OPTICAL CO., LTD.

San-Ei Building, 22-2, Nishi Shinjuku 1-chome, Shinjuku-ku, Tokyo, Japan. Tel. 03-3340-2211

OLYMPUS AMERICA INC.

Two Corporate Center Drive, Melville, NY 11747-3157, U.S.A. Tel. 1-800-622-6372

OLYMPUS OPTICAL CO (EUROPA) GMBH.

(Premises/Goods delivery) Wendenstrasse 14-18, 20097 Hamburg, Germany. Tel. 040-237730
(Letters) Postfach 10 49 08. 20034 Hamburg. Germany.

OLYMPUS OPTICAL CO. (U.K.) LTD.

2-8 Honduras Street, London EC1Y 0TX, United Kingdom, Tel. 020-7253-2772
<http://www.olympus.com>

Declaration of Conformity

Model Number: DM-20, DM-10
Trade Name: DIGITAL VOICE RECORDER
Responsible Party: OLYMPUS AMERICA INC.
Address: 2 Corporate Center Drive, Melville, NY 11747-3157, U.S.A.
Telephone Number: 800-622-6372

This device Complies with Part 15 of the FCC Rules. Operation is subject to the following two conditions: (1) This device may not cause harmful interference, and (2) this device must accept any interference received, including interference that may cause undesired operation.



Tested To Comply
With FCC Standards

FOR HOME OR OFFICE USE

Canadian RFI

This digital apparatus does not exceed the Class B limits for radio noise emissions from digital apparatus as set out in the Radio Interference Regulations of the Canadian Department of Communications.

Cet appareil numérique ne dépasse pas limites de Catégorie B pour les émissions de bruit radio émanant d'appareils numériques, tel que prévu dans les Règlements sur l'Interférence Radio du Département Canadian des Communications.



"CE" mark indicates that this product complies with the European requirements for safety, health, environment and customer protection.



Das „CE“ Zeichen bestätigt die übereinstimmung mit den Europäischen Bestimmungen für Betriebssicherheit und Umweltschutz.



El distintivo "CE" indica que este producto cumple las exigencias europeas en materia de seguridad, salud, medio ambiente y protección al consumidor.



L'indication "CE" signifie que ce produit est conforme aux exigences concernant la sécurité, la santé, l'environnement et la protection du consommateur.



Il marchio "CE" indica che questo prodotto è conforme alle norme della comunità europea per quanto riguarda la sicurezza, la salute, l'ambiente e la protezione del consumatore.



Знак "CE" обозначает, что этот продукт соответствует европейским требованиям по безопасности, охране здоровья, экологической безопасности и безопасности пользователя.