



Stand-Alone Control Solutions: Easy Install & Commissioning

PRESENTED BY SEAN LAFFERTY
& SHAWN STEFANYAK

STEINEL: The inventors' company



We think outside the box and

Scrutinize things that are taken for granted

Providing **value-added features and functions** without the additional cost.

With technology invention in our veins, we think **without restrictions** and turn discoveries into **intelligent products** that meet the most exacting of demands.

Digital Done Better:



Smarter Solution



No Front End Needed



Easy to Install



High Value



Made by STEINEL.
Made in Europe.

DCS™ answers the demand for a **COST-EFFECTIVE digital controller** that **MAXIMIZES energy savings.**

Everything you need, code-compliant out of the box.

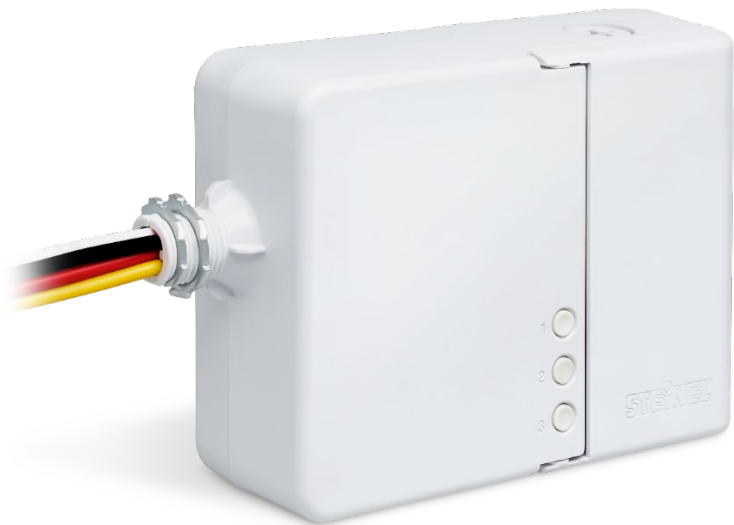

- Digital bus for sensors, switches, photo cells
- Wireless programming
- Predefined (out of the box) & custom use case generation
- Preset or custom scenes
- 3 independent 20A relays
- Current monitoring per relay
- 3 independent 0-10v dimming zones
- Receptacle control
- Multi-zone daylighting
- Min. & max. dimming levels
- Hold off / Force off photo sensor functions
- Partial on & off
- Demand response
- Astronomic and time clock functions
- Wireless BLE mesh interconnectivity
- BMS integration via BACnet * **DCS Connect**

Stand-Alone Solutions

Control Pro Series

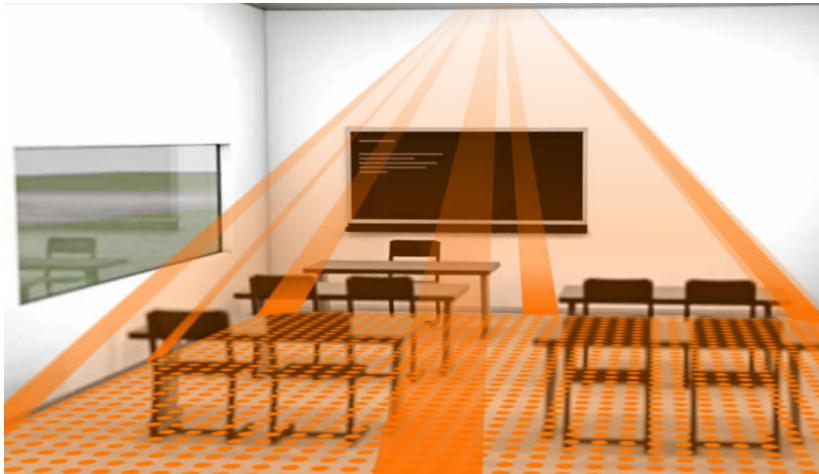
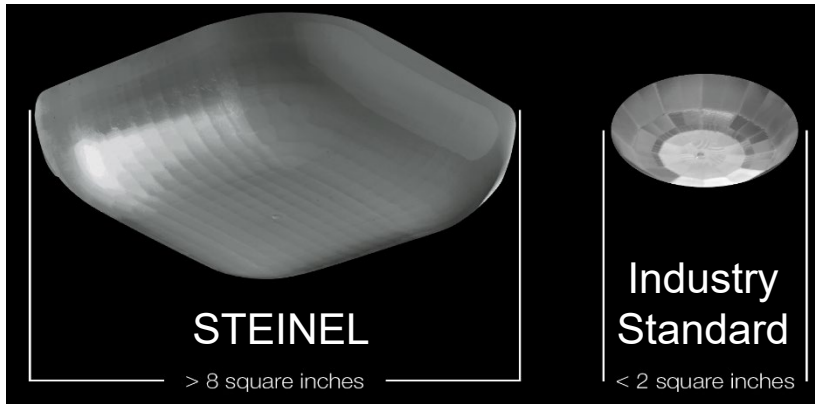

IR Quattro HD



- 4800 Detection Zones
- 4,200 sq. ft. of coverage
- Square Coverage pattern (vs. common round)
- Mechanically adjustable range
- Built-in Photocell

US Hallway



- Features extra long 65' x 6.5' detection range, prevents motion detection from adjacent rooms
- Built-in Photocell
- 40kHz frequency, furthest above human hearing

DT Quattro



- Square Coverage pattern (vs. common round)
- Built-in Photocell
- 530 switching zones
- PIR and US options available

Stand-Alone Solutions

Wall Sensors



Wall Switches



- IR / DT / PIR options available
- Available in 1 button, 2 Button or 0-10V dimming
- Built-in Photocell for Hold off / force off function
- Available in Gray, Black, White and Light Almond
- Custom designed rubber PIR lens
- Communication wire allows for 3-way dimming, as opposed to standard “master / auxiliary” setup

Coverage

Shown coverage diagram at 9 ft mounting height. Ultrasonic signal can be increased by hard surfaces and decreased by soft surfaces.

- PIR Tangential Detection
- - - - - PIR Radial Detection
- · - · - PIR Presence Detection
- Wall

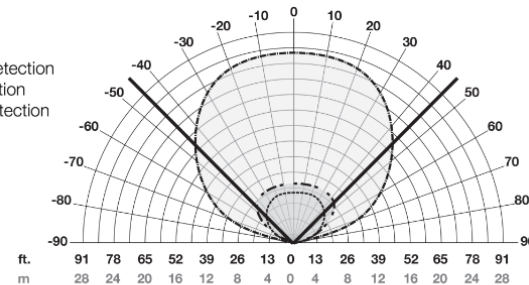

CM Sensors



- IR / DT / PIR options available.
- IR detection up to 82 feet tangential coverage
- Built in Photocell

- US Radial Detection
- - - - - US Tangential Detection
- US Presence Detection

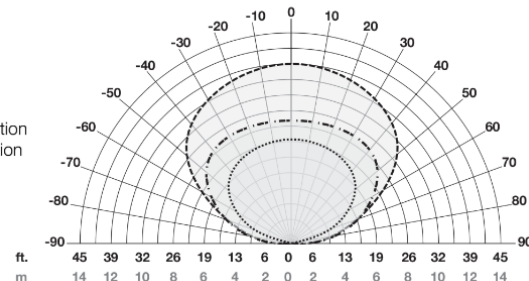

Where's the benefit?



Stand-Alone Solutions

Larger Sensor, Square Coverage Pattern

Larger Coverage Pattern:

- STEINEL saves you money
- Larger Coverage Pattern = Less sensors required = Less wiring required = Less Labor = **SAVING MONEY**

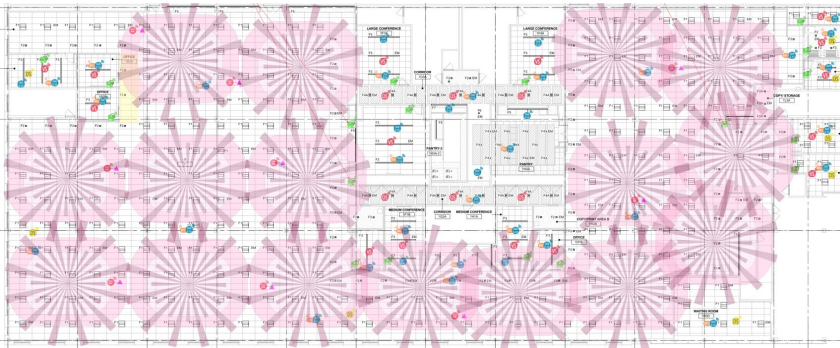

Issue: Overlap needed due to large space, 16 sensors total

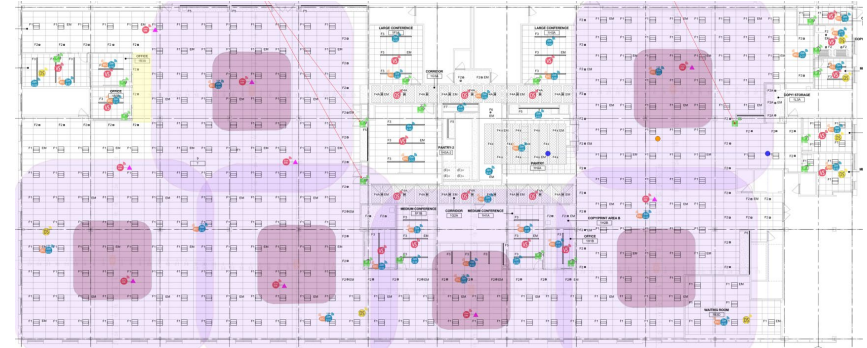

6 Sensors used, less than half the sensors

Square Coverage Pattern:

- STEINEL's square coverage pattern allows the capability to fill a complete room, which are normally square/rectangular shaped, not round
- With 2 round sensors, there is both significant overlap (causing the need for extra sensors) and an abnormal shaped pattern in comparison to the shape of a room

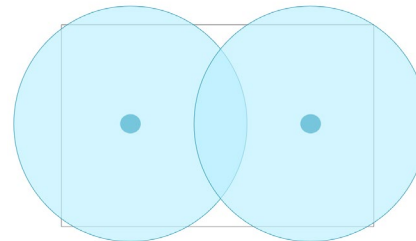
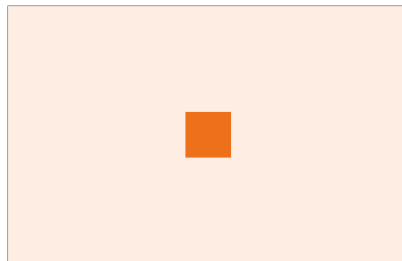

Stand-Alone Solutions

When to Use Stand-Alone

Stand-Alone Solution:

- Has benefits of standard room controller, at significantly reduced cost, use when you want many of the digital capabilities, but a smaller budget
- Less Components (20-30%) required on most projects when using stand-alone solutions
- **CODE COMPLIANT FOR HALF THE PRICE**

Competitor's Digital Solution

- 1 Room Controller
- 2 Occupancy Sensors
- 1 Daylight Sensor
- 1 Plug Load Controller
- 1 Dimming Switch

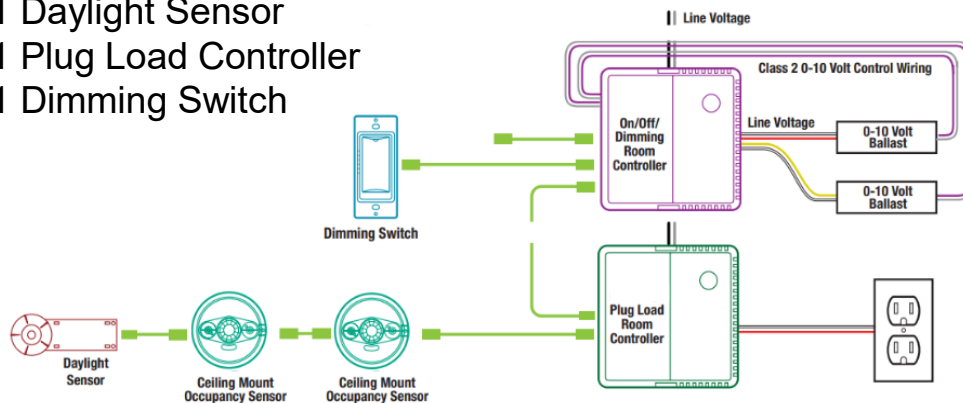

STEINEL STAND-ALONE SOLUTION

- 1 Dimming Switch
- 3 Power Packs
- 2 Control Pro Dim24 sensors with built-in Photocell

MCS-W



DIM-24 (2)



TR 200 (3)



Stand-Alone Solutions

Easy to Install & Commission



Easy Install:

- 18/3 wire can be used in most installs.
- No terminating Category Cables (16 chances to mess up).
- No need to hire / wait for someone to come out and commissioning (which also means NO COMMISSIONING FEE).
- 2 ways to set up sensors (Dip switches and Smart Phone IR device).
- No losing Installation instructions. All wiring diagrams are on our sensors and power packs.
- Same wired sensors (IE Com1 to Com1) can be replaced without re-wiring!

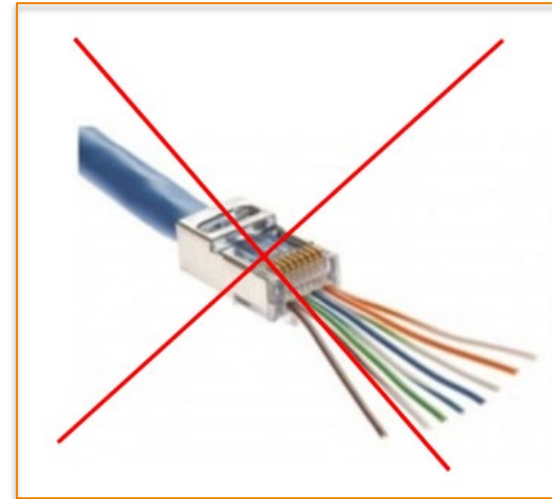
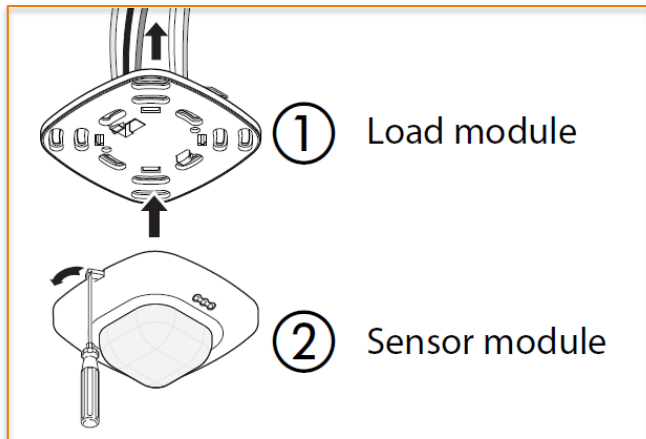

Easy Commission:

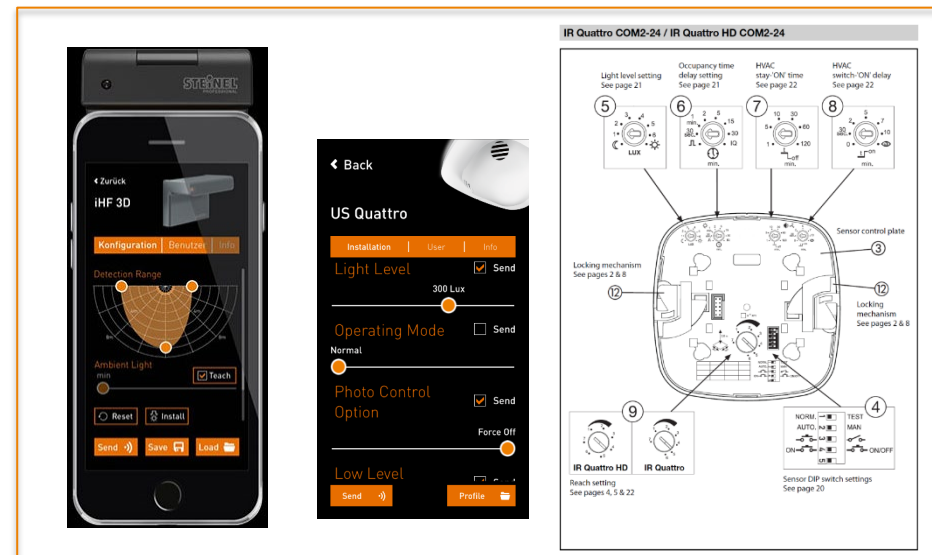

Stand-Alone Solutions

Project: Office Application



STEINEL CAME IN 3X LESS THAN SPECIFIED = HUGE SAVINGS

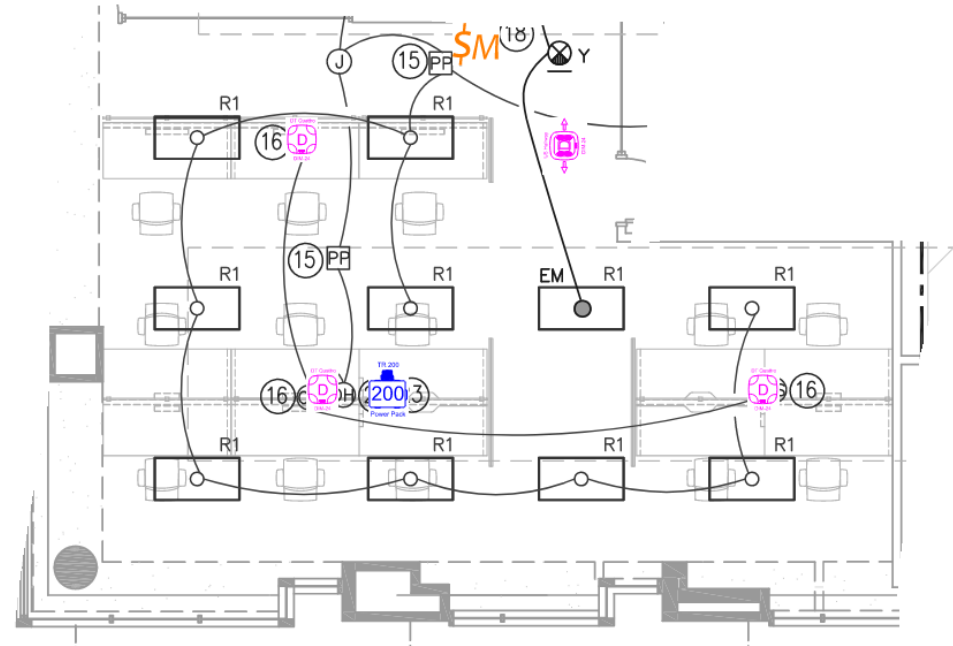
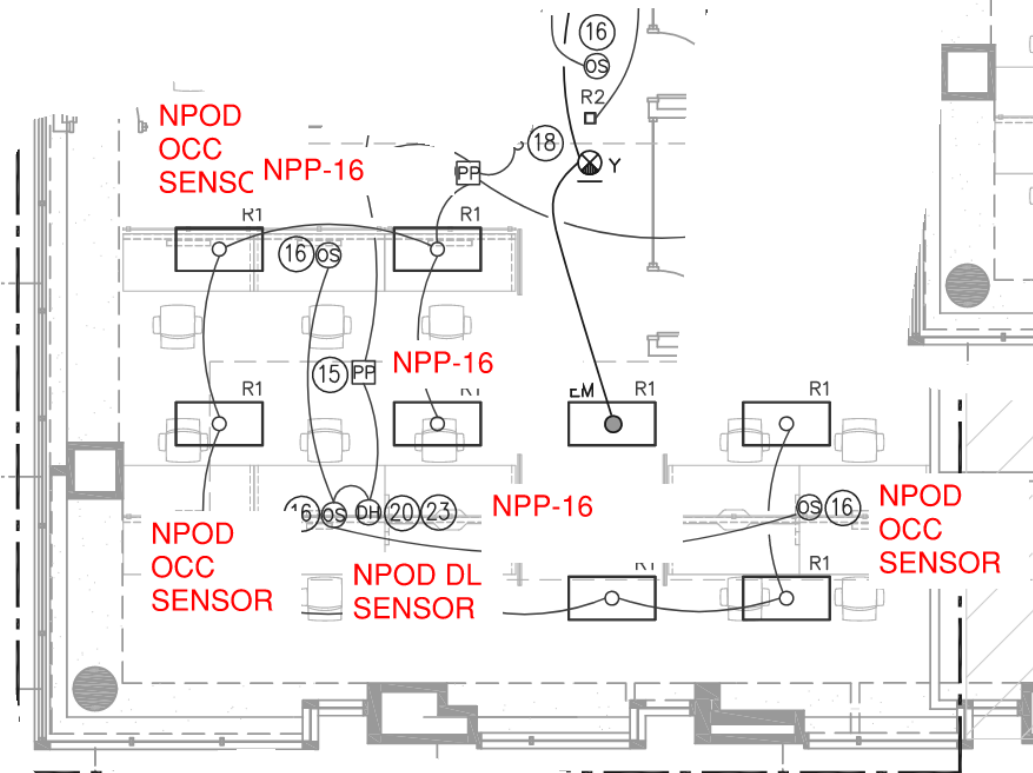



Stand-Alone Solutions

Project: Corridor Application



STEINEL SOLUTION:

- Occupancy sensors provide partial OFF to 25%
- All sensors to be set to automatic ON
- Power pack with mechanical latch provides fail-safe operation

Product	Description	
US Hallway DIM-24	Ultrasonic occupancy sensor w/ 0-10v dimming	
TR 250	Power Pack	

Total number of specified Sensors: **13**

STEINEL SENSORS: **5**

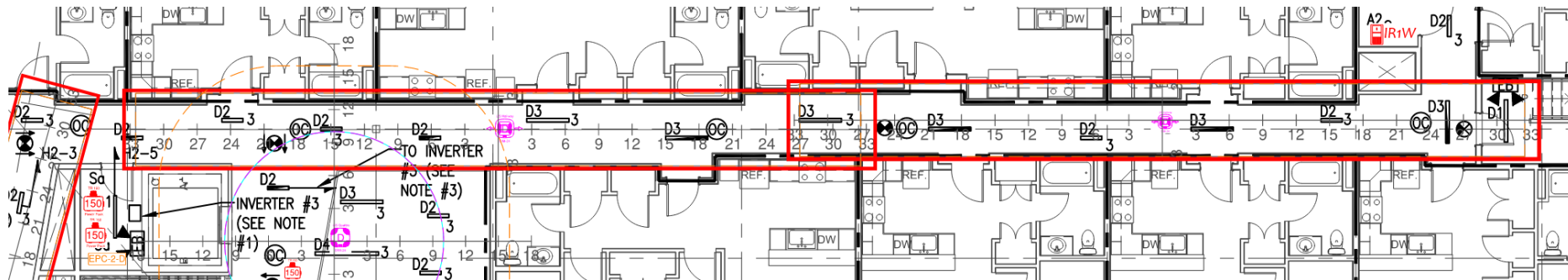

Stand-Alone Solutions

STEINEL Solutions Advantages



1. Place Order by 1 pm CST for **Same Day Shipping**
2. Quick Quote and **FREE Layouts**, 24-48 Hours
3. Significant **Cost Savings** on Digital Replacement
4. Wire Diagrams on the Sensors
5. Sensors Can Be Changed in field with No Re-wiring Required
6. No Waiting, **Easy and Fast Commissioning**
7. Out-of-the-Box Functionality
8. Photocells included in Control Pro Series (True Daylight Harvesting with Dim24)
9. Larger Coverage Pattern = Less Sensors Required = Less Wiring = Less Labor = **SAVINGS**

We Can Do More For Less

Contact Your Regional Sales Manager Today!

STEINEL Lighting Controls

All the Power – Half the Price



Your partner for cost-effective,
code-compliant projects:

Questions about our solutions?

tech@steinel.net

888.298.8298

Need layouts for your project?

Contact our tech team or your
Regional Sales Manager.

Need to connect with our sales team?

sales@steinel.net

800.852.4343

QUALITY PRODUCTS.
QUALITY SERVICE.

