

Annual Report 2003 Year Ended March 31, 2003

SUMITOMO CHEMICAL

Solid Fundamentals for Growth



PROFILE

Established in 1913, Sumitomo Chemical Co., Ltd. is one of Japan's leading chemical manufacturers, offering a diverse range of products including basic chemicals, petrochemicals, fine chemicals, IT-related chemicals, agricultural chemicals, and pharmaceuticals.

While expanding our business activities worldwide, we are constantly conducting vigorous research into state-of-the-art technologies and fulfilling our responsibility to ensure product quality, safety, and environmental protection.

Visions and Basic Policies of our Three-Year Corporate Business Plan (FY2001~2003)

THREE VISIONS

To use our expertise in chemistry and life sciences to develop and commercialize innovative manufacturing technologies and new generations of products

To expand our business globally, with particular focus on Asia during the three-year period

To establish a dynamic and innovative corporate culture imbued with an "entrepreneurial mind set"

EIGHT BASIC POLICIES

- 1) Achieving stable growth through "Creative Hybrid Chemistry"
- 2) Making a commitment to stronger operations and growth
- 3) Making a commitment to Asia
- 4) Taking strategic steps toward long-term growth
- 5) Strengthening consolidated management
- 6) Innovating job administration and establishing new business models
- 7) Coexisting with the Earth's environment
- 8) Making active investment of corporate resources and improving financial structure

CONTENTS

1	Consolidated Financial Highlights
2	To Our Shareholders, Customers and Partners
6	Research and Development
8	Sumitomo Chemical At a Glance
10	Review of Operations
22	Responsible Care Initiatives
23	Corporate Governance
24	Board of Directors, Executive Officers, and Corporate Auditors
25	Financial Section
51	Subsidiaries and Affiliates
54	Principal Overseas Operational Headquarters and Offices
55	Investor Information and Corporate Information

Forward-looking Statements

Statements made in this annual report with respect to plans, strategies and future performance that are not historical facts are forward-looking statements involving risks and uncertainties. Sumitomo Chemical cautions that a number of factors could cause actual results to differ materially from such statements including, but not limited to, general economic conditions in Sumitomo Chemical's markets; demand for, and competitive pricing pressure on, Sumitomo Chemical's products in the marketplace; Sumitomo Chemical's ability to continue to win acceptance for its products in these highly competitive markets; and movements of currency exchange rates.

CONSOLIDATED FINANCIAL HIGHLIGHTS

YEARS ENDED MARCH 31	Percent change	Millions of yen		Thousands of U.S. dollars
	2003/2002	2003	2002	2003
Operating results:				
Net sales	9.1%	¥1,111,128	¥1,018,352	\$9,243,993
Operating income	6.8%	73,520	68,836	611,647
Net income	3.1%	31,134	30,211	259,018
Capital expenditures	108.3%	152,001	72,983	1,264,567
Research and development expenses	9.2%	72,822	66,670	605,840
Financial position (at year-end):				
Total assets	6.5%	1,484,275	1,393,159	12,348,378
Total shareholders' equity	(0.1)%	444,334	444,579	3,696,622
Ratio(%)				
ROE		7.0%	6.7%	
Equity ratio		29.9%	31.9%	

Data per 1,000 shares:	Yen		U.S. dollars
	2003	2002	2003
Net income	¥18,742	¥ 18,250	\$155.92
Cash dividends	6,000	6,000	49.92

Note: U.S. dollar amounts are translated from yen, for convenience only, at the rate of ¥120.20=US\$1, the rate prevailing on March 31, 2003.

NET SALES

(Billions of yen)

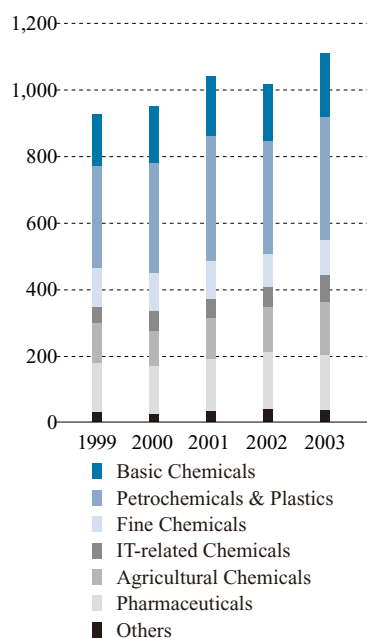

OPERATING INCOME

(Billions of yen)

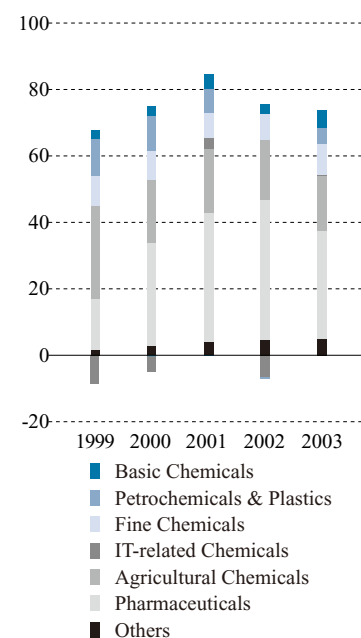

NET INCOME

(Billions of yen)

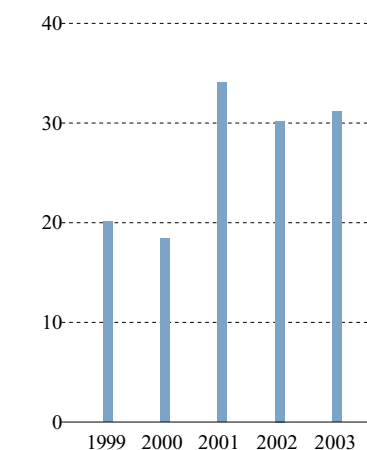

Note: 2003 refers to the year ended March 31, 2003.

TO OUR SHAREHOLDERS, CUSTOMERS AND PARTNERS

Sumitomo Chemical reaffirms its commitment to increasing corporate value, and will continue to build upon its *solid fundamentals for growth*—advanced technological capabilities, strong cost competitiveness, and robust financial position. We will further leverage these fundamentals to achieve the performance targets of our three-year corporate business plan, with focus on strengthening our priority business areas of polyolefins, life sciences, and IT-related materials.



Akio Kosai, Chairman

Hiromasa Yonekura, President

FISCAL 2002 RESULTS AND THE ECONOMIC ENVIRONMENT

Our business environment continued to present challenges. Costs rose significantly higher for crude oil and feedstock, affected in part by the situations in Venezuela and Iraq. Competition intensified in the Asian chemicals market. Multinational petrochemical firms increased their activities in the region, and some indigenous agrochemical makers stepped up their efforts to sell generics. Our domestic market also posed challenges. Deflation persisted in Japan, putting increasing price pressure on our industry.

Despite these challenges, Sumitomo Chemical posted record high net sales of ¥1,111.1 billion and improved performance over fiscal 2001 in both operating and net income. We achieved these results by remaining focused on the visions and policies of the three-year corporate business plan that we began in 2001. We made substantial investments in increased capacity, and made aggressive acquisitions of businesses to complement our portfolio.

DISCONTINUATION OF PLANNED CONSOLIDATION WITH MITSUI CHEMICALS

In March of this year we reached an agreement with Mitsui Chemicals not to pursue the planned October 2003 consolidation of our companies' overall businesses. Despite sincere efforts and intensive dialogue, no resolution was reached on the most critical issue: the consolidation ratio.

Our corporate strategy, however, remains unchanged. We seek to quickly grow businesses around the world and become a globally competitive player in the chemical industry. We aim for high earnings growth centered on businesses driven by our technological competencies—businesses that offer high added value for our customers and high returns for our investors. Consolidation with Mitsui Chemicals was one possible path, but certainly not the only means to reach our goal. We will continue pursuing growth strategies based on our solid fundamentals, and achieve high earnings growth to maximize corporate value.

ROUNDING OUT THE 2001-2003 CORPORATE BUSINESS PLAN

In line with our current three-year corporate business plan, which ends on March 31, 2004, we seek to deliver high earnings growth through creative hybrid chemistry by mobilizing our expertise into our three priority businesses: polyolefins, life sciences (agrochemicals and pharmaceuticals), and IT-related chemicals. We are investing aggressively to develop and commercialize innovative manufacturing technologies and new products.

Highlights of the Past Two Years

In Basic Chemicals and Petrochemicals, we showcased our advanced technological capabilities, one of our solid fundamentals for growth, when we successfully developed novel production processes for two of our major products—caprolactam and propylene oxide. The new plants incorporating these processes came on stream this spring in Japan, and commercial production is proceeding smoothly at both plants. They are expected to bring about significant production cost savings over conventional processes. Meanwhile, we have been expanding our basic chemicals and petrochemicals businesses,

in accordance with our commitment to Asia as set forth in our corporate business plan. We launched a joint feasibility study with Shell for construction of a new 1,000,000-ton world-scale ethylene cracker in Singapore. We also began construction of a methyl methacrylate (MMA) facility expansion in Singapore, to meet growing demand in Asia.

In life sciences, we have expanded and strengthened our agrochemical business through aggressive M&A activities. Following the acquisitions of Abbot Laboratories' biological pesticides business (now Valent BioSciences) and Aventis CropScience's household insecticide business, we established Sumitomo Chemical Takeda Agro Company in November 2002, acquiring the agricultural chemicals business of Takeda Chemical Industries, Ltd. We seek to maximize synergies between our existing operations and the newly formed joint venture company. There were also several exciting developments in our pharmaceuticals sector. Thanks to a strong R&D program, our pipeline contains a number of promising drugs, including a schizophrenia treatment that is in phase II clinical trials in the U.S and Japan. And Nihon Medi-Physics, our joint venture with the Amersham Group, has launched a major initiative in the diagnostic agents business for the PET (positron emission tomography) imaging procedure. The PET procedure is an innovative imaging method that allows early diagnosis of diseases such as cancer and other malignant tumors. As the leading producer of radiopharmaceuticals in Japan, Nihon Medi-Physics has begun constructing the first nationwide production and delivery system in order to serve customers better by providing imaging agents with extremely short half-lives.

Finally, our IT-related chemicals business has made strides in expanding production capacity in Asia for materials essential to the manufacture of liquid crystal displays. In March of this year, our plant in Korea started to produce color filters that are supplied to Samsung Electronics for use in its fifth-generation LCDs. We have developed close technological and business relationships with Samsung and other world-class LCD makers in Asia, and these relationships have produced a string of successful business expansions. In order to meet the rapidly increasing demand, we have already broken ground for a second plant in Korea to double our production capacity.

Financial Projections

The performance targets we set for fiscal 2003, the plan's final year, were ¥50.0 billion in net income, an ROE of 10%, and a shareholder's equity ratio of 30-35%. Based on the actual performance of the last two years and our budget for fiscal 2003, the results we envision for March 2004 point to a net income of ¥35.0 billion, an ROE of 7.7%, and a shareholders' equity ratio of around 30%.

The discrepancy between these results and our stated financial targets is due primarily to two non-operational factors. First, stock market declines resulted in a large gap between actual and expected returns on pension plan assets, and the ¥11.3 billion write-off of this difference will put a squeeze on margins. Secondly, we made a strategic increase of ¥9.0 billion in our R&D budget for the year, with focus on life sciences. These two factors combined will increase charges by more than ¥20.0 billion. With allowance for taxes, this is likely to reduce net income by ¥12.0 billion.

As an indicator of our strong operating performance, however, we have seen healthy levels of cash flow surpassing the projections of our plan. Net cash flow from operating activities during the three years is expected to reach approximately ¥340.0 billion.

ADVANCES IN CORPORATE GOVERNANCE

Sumitomo's business philosophy places prime importance on integrity and cautions against imprudence and the merely expedient or opportunistic pursuit of easy gains. These time-honored principles laid down by our predecessors serve as the foundation of Sumitomo Chemical's corporate governance today. We aim to earn the trust of society through our efforts to preserve the global environment, eliminate accidents and disasters, and ensure the safety of chemical substances, knowing this is the responsible way to achieve continued growth as a company. At the same time, guided by our board of directors and statutory auditors, we strive to maximize corporate value in the face of the many challenges posed by today's changing socio-economic environment. We understand this to be the basis of corporate governance.

To further enhance corporate governance, we are introducing a more comprehensive compliance program throughout the Sumitomo Chemical Group – in every company, and in every country where we operate. A newly-created compliance committee will promote accountability of Sumitomo Chemical employees at all levels, across all departments, and will encourage them to carry out their duties with the highest ethical standards and in full compliance with existing corporate rules as well as applicable laws and regulations.

In addition, we have recently made significant reductions in the number of directors on our board and adopted an executive officer structure of management. We believe this will help us make vital business decisions with greater speed and achieve our planned targets in today's increasingly competitive global marketplace.

In early 2004 we plan to announce our next medium-term corporate business plan. Building upon our solid fundamentals for growth, we will concentrate our efforts on increasing our corporate value, and continue on the path toward higher earnings growth for Sumitomo Chemical. We would like, in conclusion, to express our sincere appreciation to our shareholders, customers, partners and employees for their continued support and understanding. And we look forward to sharing a successful 2003 with you.

July 2003

香西昭夫

Akio Kosai, Chairman

米倉弘昌

Hiromasa Yonekura, President

RESEARCH AND DEVELOPMENT



Our diverse research and development programs are based on the Company's extensive technological foundation and fuel the achievement of "stable growth through creative hybrid chemistry," a primary policy of our ongoing three-year corporate business plan.

In accordance with this business plan, Sumitomo Chemical is aggressively investing in R&D for the future. In particular, we are focusing investment in those fields which will drive growth significantly in our core businesses of polyolefins, IT and electronics-related chemicals, and life sciences.

R&D TOPICS

Polymer LED

Sumitomo Chemical has developed a blue light-emitting material for polymer light-emitting diodes (PLED), anticipated to emerge as the next generation of flat panel displays. We plan to begin large-scale production of this new material by fall of 2003. Due to the PLED's low energy consumption and high image quality, companies worldwide are racing to develop this display device. A full-color low molecular weight organic LED (OLED) was launched this year, and is already being used in practical applications. However, because the OLED involves a complicated device structure and fabrication process, the PLED has a decided advantage in terms of conduciveness to full-scale commercialization due to its simple structure and easy printing-based manufacturing process. At present, we are studying further upgrading its performance and developing materials for full-color displays.

Our particular strengths derive from synergies we create by combining a diverse range of technologies.

In the area of catalyst technology, for example, we combined our catalyst design technology with process design technology to develop highly cost-competitive processes, including a propylene oxide-only process and a new caprolactam production process. Additionally, we developed a new class of polyolefins with both excellent processability and high strength by combining our catalyst technology with fine polymer processing.

In IT and electronics-related chemicals, optically functional films and color filters are the result of combining functional dye and pigment technologies, functional design of polymers, such as polarization, and fine polymer processing, which extrudes resins into a film while controlling their microstructure.

In the area of life sciences, we develop new drugs by mobilizing: proprietary drug design based on our comprehensive knowledge of structure activity relationships (compound structure vs. its physiological action) and our diverse and extensive compound library, world-class toxicological and safety evaluation technologies for chemical substances, and our state-of-the-art genomic science expertise.

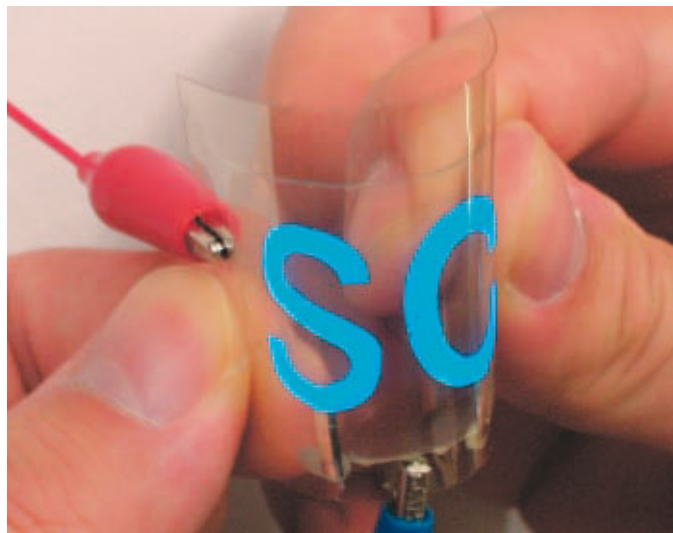

Flexible display using the blue light-emitting material

PDP Phosphors

Sumitomo Chemical has succeeded in improving the luminance of a long-lasting blue silicate phosphor, one of the phosphors it is developing for new PDPs (plasma display panels). PDP is currently the favorite large-screen display that is both thin and lightweight. Color PDPs made a major advance into the television market in 2001—the year of the PDP TV—and the PDP market is expanding rapidly. However, phosphors, a key material in color PDPs, still had drawbacks in great need of correction. The blue material in particular suffered from a short effective life and low luminance. We have successfully solved this problem by utilizing our expertise in the control of crystal structure technology and in calcination technology. We have already constructed a commercial plant at our Ehime Works.

CELL STRUCTURE OF PDP

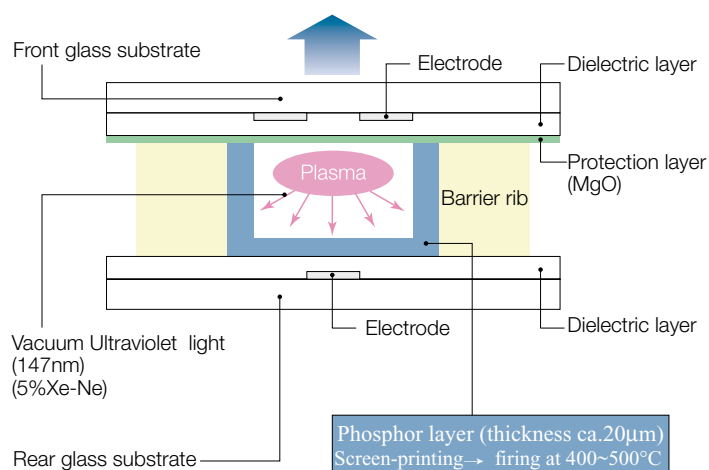

Elucidation of the Fibrogenesis Mechanism in Tissue, and Development of New Anti-Fibrotic Drugs

Sumitomo Chemical was the first in the world to uncover the new pathway by which interferon-gamma produces anti-fibrotic effects in tissue, a discovery that was published in *The Journal of Biological Chemistry*, a highly respected international journal, in February of this year. The anti-fibrotic intracellular factor uncovered by this research is considered to be a novel target for drugs, and by screening library compounds for anti-fibrotic effects the Company has discovered compounds that suppress fibrogenesis in animals.

Our researchers are now optimizing chemical structures to obtain leads based on factors such as safety and efficacy.

Administered by injection, interferon-gamma's positive effects are numerous, but it typically produces a number of side effects. A treatment based on the new low-molecular compound can be administered orally, and is expected to greatly reduce problems such as side effects. We anticipate this compound will lead to development of an effective treatment for hard-to-cure diseases caused by tissue fibrogenesis, such as cirrhosis of the liver, kidney fibrosis, and scleroderma.

MECHANISM REGULATING THE FORMATION OF COLLAGEN

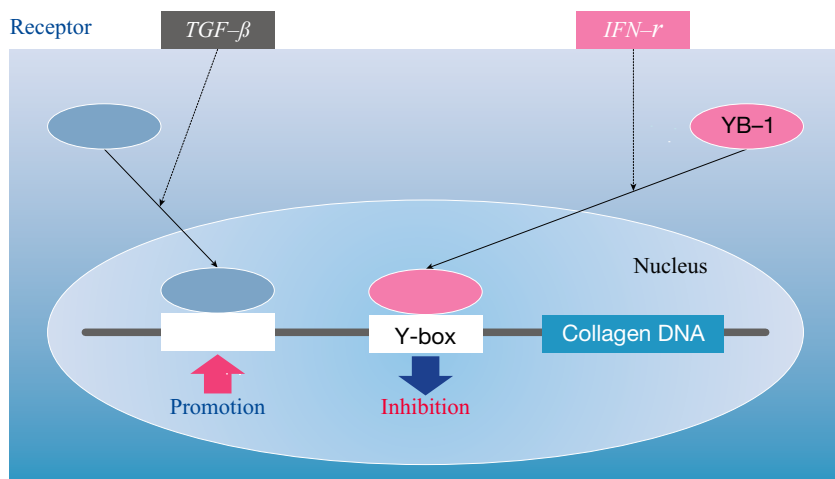

YB-1: Elucidation of Novel Signal Pathway



Novel Target for Fibrosis Therapeutic Drug

SUMITOMO CHEMICAL AT A GLANCE

Major Product Lines

RESEARCH AND DEVELOPMENT

(Billions of yen)

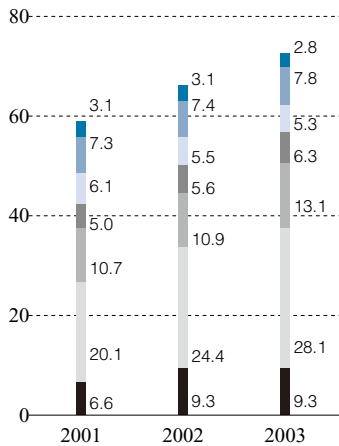

- Basic Chemicals
- Petrochemicals & Plastics
- Fine Chemicals
- IT-related Chemicals
- Agricultural Chemicals
- Pharmaceuticals
- Others

BASIC CHEMICALS SECTOR



Organics
Methyl methacrylate (MMA)
Inorganics
Aluminum

PETROCHEMICALS & PLASTICS SECTOR



Organics
Plastics
Elastomers and Synthetic rubber
Processed products

FINE CHEMICALS SECTOR



Specialty chemicals
Functional chemicals

CAPITAL EXPENDITURES

(Billions of yen)

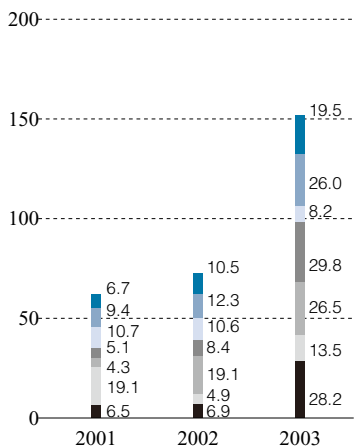

- Basic Chemicals
- Petrochemicals & Plastics
- Fine Chemicals
- IT-related Chemicals
- Agricultural Chemicals
- Pharmaceuticals
- Others

IT-RELATED CHEMICALS SECTOR



Optical materials
Semiconductor process materials
Electronic materials
Compound semiconductor materials

AGRICULTURAL CHEMICALS SECTOR



Plant protection chemicals
Environmental health chemicals
Farm chemicals and materials

PHARMACEUTICALS SECTOR



Pharmaceuticals

Note: Operations not covered in the above six sectors are classified as Others. Chemical engineering and construction, chemical analysis, electric power supply, and physical distribution and trading activities are included in this category.

Major Products	Works and Laboratories	Major Subsidiaries and Affiliates
Acrylonitrile, Caprolactam, Aniline, Methanol, MMA monomer, Polymethyl methacrylate (pellet, sheet), Nitric acid, Caustic soda, Aluminum hydroxide, Alumina, High-purity alumina Aluminum	Ehime Works Basic Chemicals Research Laboratory	Sumitomo Chemical Singapore Pte. Ltd. Singapore MMA Monomer Pte. Ltd. Sumika MMA Polymer Pte. Ltd. Sumika Glacial Acrylic Pte. Ltd. Asahi Chemical Co., Ltd. Sumika-Bayer Urethane Co., Ltd. Ceratec Co., Ltd. Sumipex (Thailand) Co., Ltd.
Ethylene, Propylene, Styrene monomer, Propylene oxide, Polyethylene, Polypropylene, Ethylene-vinyl acetate copolymer, Thermoplastic elastomer, Ethylene-propylene rubber, Acrylonitrile butadiene styrene copolymer, Polystyrene, Agricultural films, Corrugated polypropylene sheets, Gas-barrier films	Chiba Works Ehime Works (Petrochemicals & Plastics) Petrochemicals Research Laboratory Plastics Technical Center	Petrochemical Corporation of Singapore (Pte.) Ltd. The Polyolefin Company (Singapore) Pte. Ltd. Phillips Sumika Polypropylene Company Sumitomo Mitsui Polyolefin Co., Ltd. Nihon Oxirane Co., Ltd. Japan Polystyrene Inc. Nippon A&L Inc. Sumitomo Dow Ltd. Sumika Plastech Co., Ltd.
Organic intermediates, Bulk pharmaceuticals, Polymer additives, Photo chemicals, Imaging chemicals, Organic rubber chemicals, Dyestuffs, Paper-finishing resins, Textile-finishing resins, Ethlene-vinylacetate copolymer emulsions	Osaka Works Ehime Works (Fine Chemicals) Chiba Works (Fine Chemicals) Oita Works (Fine Chemicals) Fine Chemicals Research Laboratory	Sumika Chemtex Co., Ltd. Sumika Fine Chemicals Co., Ltd. Sumika-Merisol Co., Ltd. Taoka Chemical Co., Ltd. Sumitomo Chemical Belgium S.A./N.V. Bara Chemical Co., Ltd.
Optical functional films, Pigment dispersion color filters, Surface Protection sheets for PDP, Photoresists, High-purity chemicals, Sputtering targets, Epoxy resins, Super engineering plastics, MOEPI wafers, Metal organics, High-purity gallium	Ehime Works (IT-related Chemicals) Chiba Works (IT-related Chemicals) Osaka Works (IT-related Chemicals) IT-related Chemicals Research Laboratory	New STI Technology, Inc. O.L.S. Corp. Sumika EPI Solution Co., Ltd. Dongwoo Fine-Chem Co., Ltd. Dongwoo STI Co., Ltd. Dongwoo Optical Film Co., Ltd. Shanghai KSC Optical Device Co., Ltd. Shanghai Sumika High Purity Metal, Ltd. SC-IK Technology Co., Ltd. Sumika-Merisol RSA Sumika Electronic Materials, Inc.
Agricultural insecticides, Agricultural fungicides, Agricultural herbicides, Plant growth regulators, Household insecticides, Public hygiene insecticides, Animal health products, Feed additives, Fertilizers	Oita Works Misawa Works Ehime Works (Agricultural Chemicals) Agricultural Chemicals Research Laboratory	Sumitomo Chemical Takeda Agro Co., Ltd. Sumika-Takeda Garden Products Co., Ltd. Shinto Fine Co., Ltd., Sumika Agrotech Co., Ltd. Sumika Life Tech Co., Ltd., Nihon EcoAgro Co., Ltd. Rainbow Chemical Co., Ltd. SC Enviro Agro India Private Ltd. KenoGard S.A. Sumitomo Chemical Agro Europe S.A. Sumitomo Chemical India Private Limited Sumitomo Chemical Enviro-Agro Asia Pacific Sdn. Bhd. Sumitomo Chemical Australia Pty. Ltd. Sumitomo Chemical Shanghai Co., Ltd. Philagro South Africa (Pty) Ltd., Philagro France S.A. Valent U.S.A. Corp., Valent Biosciences Corp.
Pharmaceuticals, Diagnostic reagents, Health care products, Biomaterials, Radio-diagnostic reagents (<i>in vivo</i> products), Radio-diagnostic reagents (<i>in vitro</i> products)	Oita Works (Pharmaceuticals) Genomic Science Laboratories	Sumitomo Pharmaceuticals Co., Ltd. Nihon Medi-Physics Co., Ltd.

BASIC CHEMICALS SECTOR

CORE BUSINESS STRATEGIES

The Basic Chemicals Sector focuses on methyl methacrylate (MMA) and caprolactam (CPL) as its two core businesses. Leveraging unique and competitive production technologies, the sector is committed to becoming the leader in the rapidly growing Asian market.

An expansion project begun at our MMA production facility in Singapore is scheduled for completion in the summer of 2005, at which point the Sumitomo Chemical group will have the largest annual MMA monomer capacity in Asia, at 323,000 tons.

We also expanded CPL production this year at our Ehime Works in Japan, based on a proprietary new process, and are currently looking into building a new facility elsewhere in Asia.

BUSINESS PERFORMANCE IN FISCAL 2002

Sales in the Basic Chemicals Sector increased to ¥193.2 billion, an 11.1% gain over the ¥173.8 billion figure posted in fiscal 2001. Sales of aluminum and methyl methacrylate (MMA) grew on increased demand in Japan, while MMA sales in overseas markets rose owing to increased shipping volumes. Operating income increased 76.2% to ¥5.3 billion, up from

¥3.0 billion in fiscal 2001, as a result of increased sales volumes.

SPECIFIC PRODUCT STRATEGIES

Major Expansion of MMA Business

Our MMA Strengths

The Company will continue to draw on its unique, globally competitive technologies to aggressively develop its MMA business. These technologies include MMA monomer production via direct oxidation of isobutylene, a continuous bulk polymerization process capable of producing optical-grade MMA polymer for products like LCD light-guide panels, and a sheet extrusion technology suitable for thick optical-quality panels.

MMA Market Conditions

Demand for MMA monomer is expanding, especially in Asia, for use as a core material in transparent ABS resins and artificial marble, and for methacrylic resins used in IT-related materials such as those for LCD and projection television applications. The Asian MMA market currently stands at the 900,000-ton level, and it is expected to grow 5-6% annually. Supply shortages are likely to prevail in the near future, however, as new MMA plant construction in Asia will

NET SALES AND OPERATING MARGIN

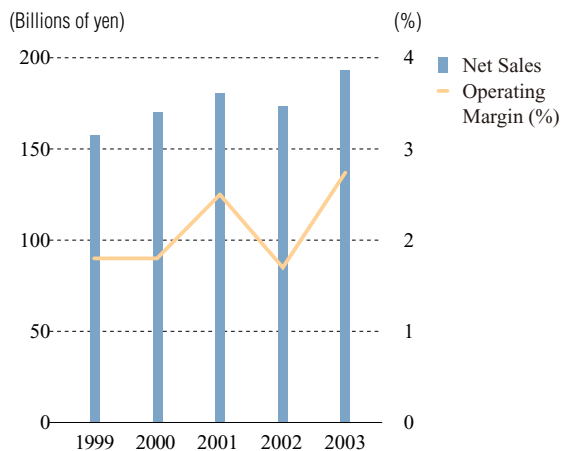

GROWING DEMAND OF PMMA FOR LCDs

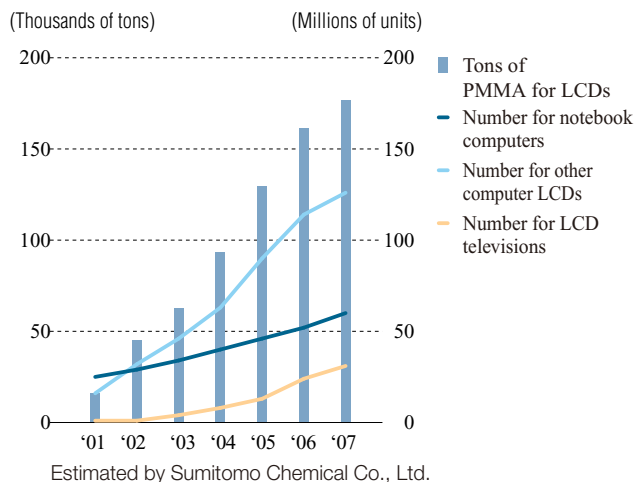

generally be limited. It is currently difficult to consistently secure the necessary raw materials at low costs, and substantial investment is required to construct brand-new plants. The Company, however, does not have such constraints. We have been producing MMA at our plant in Singapore for some years and own solid infrastructure. Moreover, our plant efficiently manufactures MMA monomer and polymer at an integrated production facility, thanks in part to stable sourcing of the main feedstock MTBE through pipeline from a nearby group company.

Capacity Expansion in Singapore

The Company, deploying its strengths to meet increases in demand for MMA monomer, will boost capacity in Singapore in the summer of 2005 from 53,000 tons to 133,000 tons, bringing its total capacity in Asia to 323,000 tons. Furthermore, MMA polymer production will be de-bottlenecked by 15,000 tons by summer 2004, increasing capacity to 50,000 tons. By fully utilizing the existing infrastructure and by using a new proprietary high-performance catalyst that enables production at lower temperatures, the upcoming capacity increase in Singapore will enable highly cost-competitive production.

Capacity Increase in Japan

Domestically, we are expanding MMA polymer capacity at our Ehime Works, from 30,000 to 45,000 tons. The same unique Sumitomo continuous bulk polymerization process used in Singapore will be applied to manufacture high-quality optical-grade MMA polymer. Combined with our production in Singapore, the domestic expansion will push our total annual supply capability in Asia to 100,000 tons.

In November 2002, we increased production capacity of MMA sheets for LCD light-guide panels by 5,000 tons at our Ehime Works, bringing total annual capacity to 20,000 tons. A new 10,000-ton facility is also scheduled for completion in November 2003. After these increases are complete, our total production capacity will reach 30,000 tons per annum. Through such initiatives, we are strengthening our ability to supply optical-grade MMA polymer and sheets, products for which demand is growing significantly, and are thereby solidifying our position as the leading supplier in Asia.

MMA Cast Sheets Production in Thailand

In May 2002, we established Sumipex (Thailand) as a joint venture with ITOCHU Corp., and began producing PMMA cast

sheets for signboards and illumination covers. Annual capacity is 8,400 tons. Making steady strides in both production and sales, Sumipex (Thailand) is expected to achieve annual sales of about ¥2.5 billion in a year or two. The company is also planning production of high value-added sanitary-grade sheets for bathtubs and other applications, and will aggressively develop markets in the U.S. and Europe as well as in Asia.

Strengthening of Caprolactam Business

The Caprolactam Market Condition

Caprolactam (CPL) is the key raw material for nylon 6, and has diverse applications as both a fiber and a plastic. Current demand for caprolactam is around 3,600,000 tons on a global basis, and 1,200,000 tons in Asia. Demand is expected to grow, especially in Asia. Annual growth rates of 4% for fibers and 7% for plastics such as engineering plastics are forecasted, and this would amount to a yearly increase of 60,000 to 70,000 tons.

Advantages of our New Proprietary Process

We have established a new proprietary process to manufacture CPL by combining a vapor-phase Beckmann rearrangement with Italian company EniChem's direct ammoximation method. It is the world's first process capable of manufacturing CPL without co-producing any ammonium sulfate. The conventional method generates between 1.6 and 4 tons of ammonium sulfate per ton of CPL. While this ammonium sulfate is also marketable, its low market value inflates CPL production costs. The new production process therefore makes possible highly cost-competitive CPL production a reality by lowering variable costs. It also reduces plant and equipment investment because facilities to recover ammonium sulfate are not necessary. In addition, it does not use sulfuric acid as a raw material and it further reduces environment impact because it efficiently produces only the target substance. In these ways, it contributes to our company-wide promotion of "green sustainable chemistry."

Production Capacity Increase based on a New Process Completed in Japan

We recently completed a 65,000-ton capacity expansion using the new process at the Ehime Works in Japan and smoothly transitioned to commercial operation in April 2003. Combined with the existing facility, total CPL production capacity is now at 160,000 tons. Another capacity expansion in the form of a 200,000-ton plant in Asia is currently under consideration.

CORE BUSINESS STRATEGIES

The Petrochemicals & Plastics Sector is expanding business and enhancing profitability, with a particular focus on polyolefins and propylene oxide. We expect demand to continue to grow substantially in Asia, particularly in China. In addition, high-performance products are witnessing rising demand in North America and Japan. In this operating environment, the Sector will deliver high returns on the strength of our technological edge, globally efficient production bases and the solid marketing channels established in Asia by The Polyolefin Company (Singapore) (TPC), our polyolefin production and sales company in Singapore.

In propylene oxide (PO), we are capitalizing on our technological advantages and are pursuing aggressive expansion in the high growth markets of Asia and the Middle East.

BUSINESS PERFORMANCE IN FISCAL 2002

Sales of polyolefins were strong, with sales of polypropylene rising compared to fiscal 2001, and polyethylene sales remaining largely unchanged in the domestic market. Supported by brisk demand, shipping volumes of both

polyethylene and polypropylene increased in Southeast Asia. Styrene monomer sales increased owing to higher selling prices and increased shipping volumes. As a result, net sales in the Sector increased ¥33.0 billion over last year to ¥371.6 billion, and operating income improved ¥5.3 billion from the previous year, reaching ¥4.9 billion.

SPECIFIC PRODUCT STRATEGIES

Polyolefins

Our proprietary catalyst technology and gas-phase process play an important role in developing high-performance products and help to significantly reduce the cost of polyolefin production. We plan to launch a new class of polyethylene in the near future that offers both high strength and excellent processability. Because of its unique features, this polyethylene is expected to create new high value-added markets. For its manufacture, we will replace our existing production lines with more advanced lines, a move that will greatly improve cost competitiveness.

We are always attentive to customer needs for higher product performance and requests for new products to replace existing resins, as well as to the increasing interest in environmentally friendly materials. In response, we are fully mobilizing our technological capabilities to further expand business with the high-performance polyolefins on the facing page.

Expansion in Singapore

We are undertaking business overseas mainly through The Petrochemical Corporation of Singapore (PCS) – an ethylene production center – and derivative producer The Polyolefin Company (Singapore) (TPC) in order to meet ever-increasing demand in Asia, which has been fueled by rapid economic development in China and other countries in the region.

In light of this market growth potential, we are conducting a feasibility study with Shell for construction of a new million-ton world-scale ethylene cracker on Singapore's Bukom Island. We have been working on petrochemical operations in Singapore jointly with Shell since 1984, through PCS and TPC. Our longstanding, close working relationship will enable us to procure major feedstock at low costs for the contemplated

NET SALES AND OPERATING MARGIN

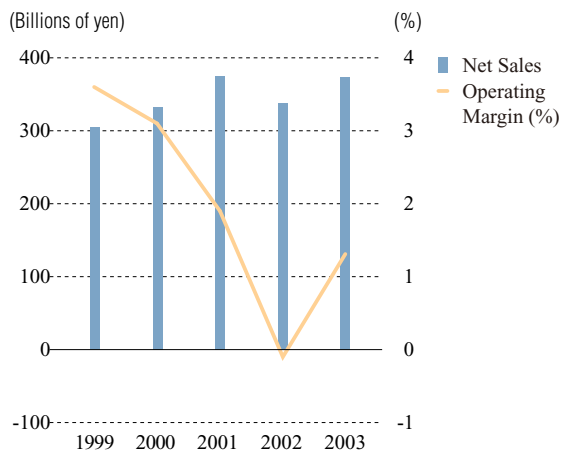

petrochemical operation. This cost advantage, coupled with our cutting-edge production technologies, will allow us to build a globally competitive petrochemicals complex.

We will strengthen our polyolefin business to compete effectively with multinational companies by exploring various opportunities, including the Singapore expansion project and other projects that might offer even greater advantages.

Propylene Oxide (PO)

This Sector positions PO as a core line, in light of the market’s high growth potential and the Company’s advanced proprietary technology in this field.

In March of this year, we further increased our commitment to this core business by raising to 60% our stake in Nihon Oxirane Co., Ltd. (NOC), our PO joint venture with Lyondell Chemical Company of the U.S. NOC has now become an even more important growth vehicle for the Company’s PO business throughout the Asian and Middle Eastern regions. Sumitomo and Lyondell will both continue providing NOC with technical support for PO manufacture, with Lyondell also contributing its PO marketing capabilities in Asia and the Middle East.

We began commercial operation of a new 200,000-ton PO plant in April of this year at our Chiba Works, based on a novel proprietary process developed by Sumitomo that produces PO only. With a PO-only plant alongside a conventional plant, which produces PO together with the co-product styrene monomer (SM), NOC will be able to flexibly allocate production in response to changes in PO and SM market demand.

NOC also intends to diversify its business into propylene glycol (PG), a PO derivative, and will construct a new plant to produce PG at its Chiba site under license from Lyondell. NOC will fully utilize Lyondell’s extensive marketing network to sell PG along with PO in Asia and the Middle East. The



The new plant uses a novel production process to manufacture PO with no co-product.

addition of the PG business will enable NOC to further improve its earnings base.

PO is the raw material used to manufacture PG and polypropylene glycol (PPG). PG, in turn, is the raw material used to produce unsaturated polyester resins, which are used in the manufacture of bathtubs and boat hulls, for example, as well as in the production of food additives and moisturizing agents used in cosmetics. PPG, on the other hand, is processed into urethane resins, which are used to make insulation and cushioning materials for automobiles and housing. Global demand for PO is expected to remain steady. Demand in Asia will be high, with growth forecast at 7-8% per year, particularly in the urethane resins market.

High-performance polyolefins

Product		Primary Applications
TPE	Thermoplastic elastomer	Automobile parts (airbag case lid, body seal), medical instruments
Excellen FX	Plastomer	Resin modifier, laminate for food packaging
Acryft	Ethylene/MMA copolymer	Wallpaper, power line insulation
Bondfast	Special ethylene copolymer	Engineering plastic modifier, laminate adhesive
Sumistran	Glass fiber-reinforced PP	Automobile parts (front end, etc.)
SEVIX	Functional gas-barrier film	Film to preserve food freshness

CORE BUSINESS STRATEGIES

The Fine Chemicals Sector places emphasis on a number of businesses: adhesive intermediate resorcinol and its derivatives, our *Sumilizer G* series of polymer additives, EVA emulsion adhesives, high fixation/highly colorfast reactive dyes, and custom synthesis of products including pharmaceutical intermediates and imaging chemicals. While forging ahead with development of new grades and applications based on our technological capabilities, we are working to increase sales throughout the world, including China.

BUSINESS PERFORMANCE IN FISCAL 2002

Sales of dyestuffs decreased due to an overall decline in demand, while sales of pharmaceutical intermediates enjoyed growth especially in overseas markets. Resorcinol also saw a rise in shipments overseas. As a result, sales increased ¥3.7 billion over fiscal 2001 to ¥103.5 billion, and operating income grew ¥1.1 billion compared to last year to ¥9.2 billion.

SPECIFIC PRODUCT STRATEGIES

Business expansion of the *Sumilizer GP* single additive system
Sumilizer GP is a hybrid polymer additive that combines the

benefits of a number of stabilizers normally used in mixture. *Sumilizer GP* has been very well received due to its excellent performance as an additive that does not need to be mixed with other additives. Substantial sales growth is therefore expected. We are constructing a full-scale production facility at our Oita Works in Japan, aiming for completion within 2003.

We decided to discontinue production of the commodity additive *Sumilizer BHT* as its profitability had dropped from previous levels due to declining domestic demand. We plan to expand our differentiated line of “G series” products, including *Sumilizer GP*, *GA-80*, and *GS*, and proceed with structural improvements in our polymer additives business.

Expansion of EVA (ethylene-vinyl acetate) emulsion adhesives business with environmentally-friendly and high-performance products

EVA emulsion is used in wood adhesives, interior coating materials, and other applications where there is a need for environmentally-friendly materials containing neither solvents nor plasticizers. During 2002, we made our entire line of EVA emulsions 100% formaldehyde-free using a new polymerization technology developed in-house. The Company will continue to reinforce its EVA emulsion business based on product differentiation and cost competitiveness, offering environmentally-friendly products that meet customers’ strict requirements.

Stronger sales of *Sumifix HF* series high fixation/highly colorfast reactive dyes

Our *Sumifix HF* products earn praise as high fixation and highly colorfast reactive dyes that make the dyeing process economical and reduce wastewater loading. They are used in the dye works of about 100 companies around the world, and we expect this number to grow. By maintaining production bases in Japan, the Company capitalizes on the corporate expertise and various resources it possesses domestically to achieve a competitive edge in both cost and product quality. Sumitomo Chemical is striving to strengthen its foothold in the domestic market as well as to increase sales to major overseas customers by expanding its differentiated product lines and leveraging its cutting-edge production technology.

NET SALES AND OPERATING MARGIN

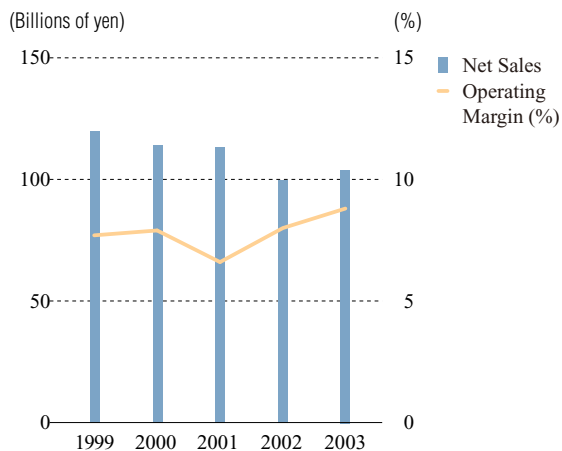

IT-RELATED CHEMICALS SECTOR

CORE BUSINESS STRATEGIES

The IT-related Chemicals Sector will strengthen and expand its businesses globally through timely setup of operations in regions of growing demand, and by using its technological capabilities to quickly launch new products. During fiscal 2001 and 2002, the Company's investment in plant and equipment totaled ¥55.0 billion, mainly in Taiwan and South Korea where demand is booming. We will continue to invest aggressively in fiscal 2003 as well. The total investment by far exceeded the ¥14.4 billion we originally planned for the three years of our Corporate Business Plan, but in light of rapid advances in the market, immediate strategic business expansion was deemed necessary for the Sector to capture the leading market position.

LCD materials account for about 50% of the Sector's net sales. Among these, prospects were particularly good for realizing vast quality improvements in color filters, by combining various core technologies we possess as a diversified chemical maker. Judging that a preemptive facility expansion would secure greater returns in our color filters business, we invested ¥27.0 billion to construct a fifth-generation color filter plant in South Korea. We completed this plant in March 2003, and have committed

another ¥28.0 billion toward construction of a second plant to begin production in spring of 2004. Based on our technological capabilities and high quality in LCD materials, we have formed strong relationships with industry leaders such as Korea's Samsung Electronics, and have secured steady business with them.

We continue to actively pursue new product development and business enhancement, from R&D to commercialization, in diverse areas including photoresists and other semiconductor process materials, and electronics materials such as liquid crystal polymers (LCP).

BUSINESS PERFORMANCE IN FISCAL 2002

Sales recovered dramatically in fiscal 2001, rising 38% from ¥59.8 billion to ¥82.5 billion. Sales volume of optical functional films for LCDs posted significant growth both at home and overseas. Shipments of photoresists and epoxy resins for IC encapsulation also increased, owing to recovery of demand in the IT and electronics industries. The Sector recorded operating income of ¥0.5 billion, in contrast to the operating loss of ¥6.3 billion in fiscal 2001.

NET SALES AND OPERATING MARGIN

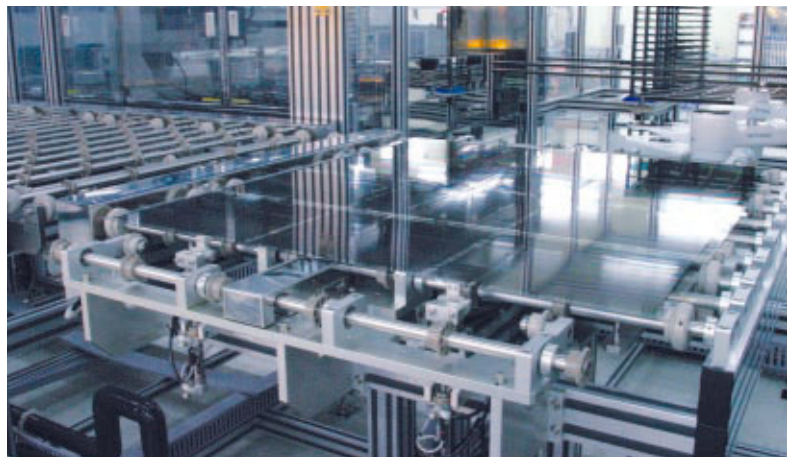
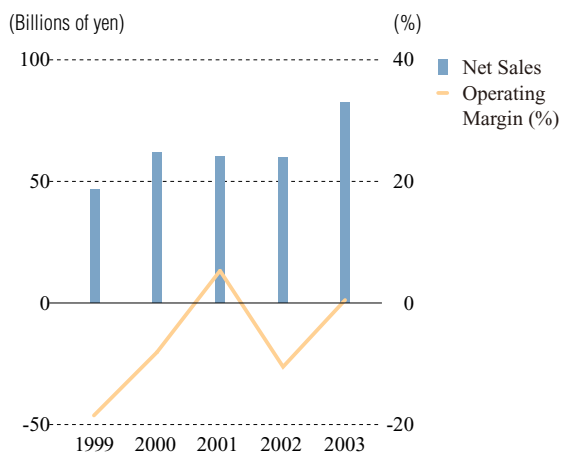

Automated, state-of-the-art color filter production facility processes glass plates for high-tech fifth-generation liquid crystal displays.

SPECIFIC PRODUCT STRATEGIES

Expansion of LCD Materials in South Korea and Taiwan

Growth of the Asian Market

Demand for polarizing film, color filters and other LCD materials is increasing rapidly, as the field of LCD applications has grown from small displays like cellular phones to large – including recent use in large-screen LCD TVs and computer monitors. The evolution of LCD makers is particularly striking in South Korea and Taiwan, which together make up 50% of the current ¥2.9 trillion global LCD market. The two countries are expected to account for a 60% share of a ¥3.7 trillion global market by fiscal 2005.

Investment Performance

The Company has expanded its overseas bases for this Sector since fiscal 2001, mainly in South Korea, Taiwan and China, increasing our overseas and domestic production bases from 6 to 14 companies over the two-year period.

In March of 2003, production began in South Korea at a new fifth-generation LCD color filter plant, and its annual output of 720,000 panels will be delivered to major LCD makers such as Samsung Electronics. Construction has since begun for a second plant of identical capacity, with plans to start commercial operation in spring of 2004. This will bring our total annual capacity to 1,440,000 color filter panels. We aim for ¥35.0 billion in group sales of LCD color filters in fiscal 2004, and ¥70 billion in fiscal 2005, capturing the second largest share worldwide.

Production of LCD polarizing film raw material rolls also began on the same site in July 2003, with an annual capacity of 4 million square meters. This addition of raw material roll

production completes a process of integrated production to final product, and an integrated production plant will be completed within the year. Our annual polarizing film capacity will be 12 million square meters at the end of this year and we target more than ¥60 billion in net sales for fiscal 2004.

Our Edge Over the Competition

<Cutting-edge spin-less coating for color filters and

Advantages of our core technologies>

A spin-coating method is commonly used to apply color resists and other coatings to glass plates in production of fourth and prior generation color filters. Since the fifth-generation color filters produced at our new plant in South Korea are much larger (1100mm x 1300mm) than those in previous generations, the traditional spin-coating method cannot achieve satisfactory productivity and yield, and it is very difficult to maintain high product quality. The new plant, however, uses the world's first spin-less process to achieve high-quality output at reduced costs.

Combining the various core technologies we possess as a diversified chemical maker, we have developed new materials including color resists, strippers, and ITO etchants, realizing high levels of quality and efficiency impossible for companies with only a single technology in the field. Moreover, these and other materials required for production of color filters are supplied by our South Korean group company Dongwoo Fine-Chem Co., Ltd., which is already successfully producing and marketing LCD materials. Working together, the two companies can generate synergies in quality improvement, cost management, and development of new technologies.

LCD MARKET EXPANSION

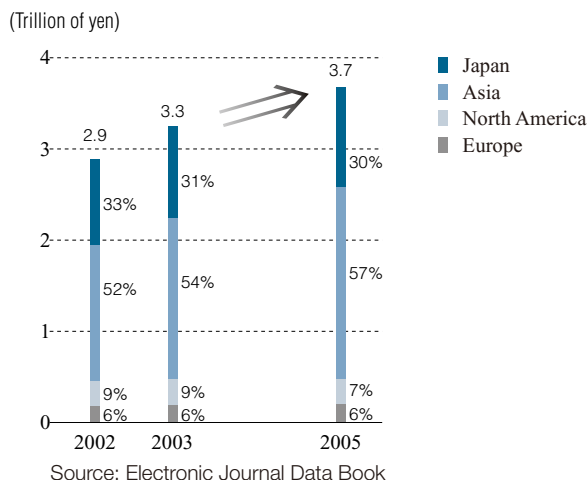

LCD STRUCTURE AND MATERIALS

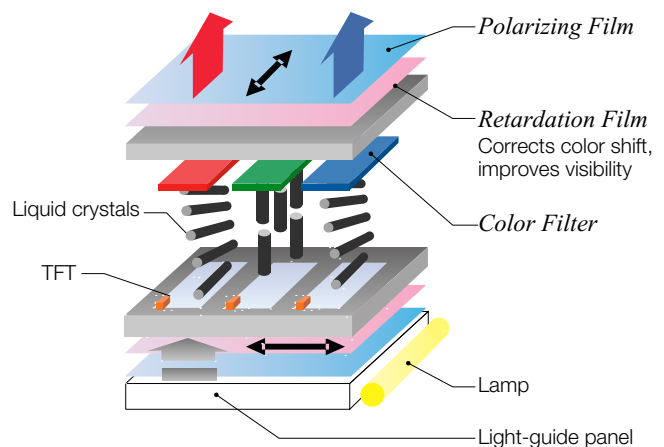

Other R&D Successes and Product Developments

Photoresists

While the Company holds a 10% share of the world market for photoresists, materials indispensable in processing semiconductors, it boasts a share exceeding 50% for top-line ArF (argon fluoride) resists.

Top device makers in fiscal 2002 began mass production of semiconductors using an ArF resist-based process, and our ArF resists were highly praised among them. In fiscal 2003, we plan to begin mass-producing an even higher-resolution ($0.09\mu\text{m} = 90\text{nm}$) product and complete development of a next-generation ($0.065\mu\text{m} = 65\text{nm}$) process, using the combined strength of our technological repertoire to ensure an advantageous position in the market.

To attain this goal, we must first:

- 1) accelerate development of commercialization technologies through prioritized investing and resource allocation.
- 2) Strengthen coordination with customers, offering recommendations and choices in materials for process design in production of devices.

Liquid Crystal Polymer (LCP)

The Company developed a new manufacturing process for LCP, a material for electronics parts, and began production based on this process. We applied our base technology of organic synthesis in creating the new process, the world's first to employ an organic catalyst.



Dongwoo STI is situated in South Korea's Pyungtaek city, with convenient access to several major LCD makers.

Because the new process greatly increases the rate of reaction between monomers and restrains undesired side reactions, productivity and quality are both considerably improved. Moreover, as production capacity can be raised simply by installing catalyst feed equipment in the existing facility, large capital investment is unnecessary and the output LCP remains highly cost competitive. We plan to expand our LCP business using this breakthrough process.

Investments Made and Committed (2001 – Present)

Color filters in South Korea – establishment of production and marketing base, with construction started on second plant	¥55.0 billion
Polarizing film in South Korea – new plant set up to produce raw material rolls	¥6.7 billion
Polarizing film in Taiwan – capacity expansion at Gaoxiong plant and construction of new Tainan plant	¥6.5 billion
Increased capitalization of New STI Technology, Inc.	¥4.6 billion
MO epitaxial wafers – establishment of production and marketing companies in the U.S. and Japan	¥1.3 billion
Polarizing film in Japan – introduction of new production process	¥1.0 billion
Reorganization of existing facilities in Shanghai to enable marketing in a broader product range	¥0.5 billion
Others	¥8.4 billion
Investment Total	¥84.0 billion

AGRICULTURAL CHEMICALS SECTOR

CORE BUSINESS STRATEGIES

The Agricultural Chemicals Sector currently has a total of 17 business locations worldwide, primarily for product development and marketing. More than 60% of its sales come from outside Japan. Although the global agrochemicals industry is led by several mega-corporations, we remain focused on our competencies rather than seeking a larger size of business. We are building a solid position for ourselves based on excellent R&D capabilities, advanced production technologies, and a global marketing network.

We are aggressively pursuing business alliance and acquisition opportunities to complement, strengthen, and expand our existing businesses. Further, we are expanding on our existing business platform to develop operations in areas previously peripheral to our traditional agrochemical businesses, and advancing farther into high value-added downstream businesses.

BUSINESS PERFORMANCE IN FISCAL 2002

The Agricultural Chemicals Sector posted sales of ¥158.1 billion, an increase of 17.2% over the ¥134.9 billion recorded in fiscal 2001. Sales of plant protection chemicals increased in

both Japanese and overseas markets. The sales were also boosted by establishing Sumitomo Chemical Takeda Agro Company with the acquisition of agrochemical business from Takeda Chemical Industries, Ltd. On the other hand, sales of household insecticides and feed additives declined because of lower prices and sluggish demand.

Operating income decreased to ¥16.6 billion, a change of 7.5% compared to the ¥17.9 billion earned in fiscal 2001. This result was due to a stronger yen and declines in selling prices.

SPECIFIC PRODUCT STRATEGIES

New product development driven by strong R&D capabilities

Sumitomo Chemical has traditionally been distinguished by its strong R&D capabilities. We are fifth in the world in terms of the number of new active ingredients launched over the past 20 years, with an average of one new active ingredient brought to market every year.

We have a large number of candidate products in our development pipeline, and will continue launching active ingredients at or exceeding this rate.

One example of a new Sumitomo product is *Eminence*, a household insecticide active ingredient that we began marketing in Japan in March of 2002. This ingredient is 40 times more effective than the products currently used against tropical disease-carrying *Culex quinquefasciatus* mosquitoes in Southeast Asia, where demand for household insecticides is growing. It has excellent vapor action at room temperature, and we anticipate increased demand for this ingredient because it is both highly active and functional. *Eminence* has been patented in the world's major countries, and we plan to launch it in markets globally this year.

Business expansion centering on M&A

Significant Contribution by Sumitomo Chemical Takeda Agro Company

Sumitomo Chemical Takeda Agro Company, established in November 2002, has domestic sales twice as large as those of Sumitomo Chemical, at around ¥36 billion. We expect to generate synergies in marketing, as many of their products

NET SALES AND OPERATING MARGIN

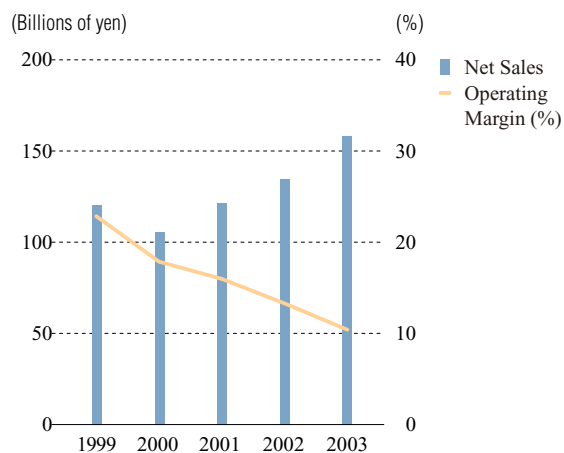

complement our product lines, and these will make a full year contribution to our annual performance beginning in fiscal 2003. One of their new insecticides, *Dantotsu*, is entering its third year on the market and continues to show strong sales growth. It is expected to be registered in major overseas countries during fiscal 2003. We plan to improve efficiency by streamlining distribution networks and coordinating the R&D strategies of the two companies, and then take steps to integrate research and production. Through the stronger agrochemicals marketing network we have formed with this acquisition, we will build and promote a new business system capable of offering farmers a total package of agricultural materials including plant protection chemicals, fertilizers, and auxiliary materials. To do so, we will maximize our advantages in product and technology diversity.

Expansion of Biological Pesticides Business by VBC.....

Following our acquisition in 2000 of the biological insecticides and plant growth regulators business of Abbott Laboratories in the U.S., the newly established Valent BioSciences Corporation (VBC) has expanded operations with its offices set up in various locations around the world. We are the world leader in biological insecticides, and VBC plays a pivotal role in strengthening this field of business.

In March 2003, VBC acquired the public health sector business of Certis USA, including its Bt-based Teknar® insecticides, and received exclusive worldwide forestry-sector marketing rights for the Bt-based Thuricide® biological insecticide. Bt insecticides are used in a broad range of

applications, including public health and forestry. Their effectiveness derives from the insecticidal activity of proteins produced by the *Bacillus thuringiensis* bacterium, found throughout the natural world, and the WHO permits their use around potable water. In the public health sector, Bt products help control mosquitoes that carry infectious diseases like the West Nile virus, an increasing concern worldwide. Demand for these products is growing, especially in the U.S.

Business Development Into Non-Traditional Fields

The Company has been actively exploring business opportunities in order to enter into fields previously peripheral to its agricultural chemicals operations, or to advance into downstream businesses. In April 2003, our wholly owned subsidiary Nihon Green & Garden merged with Hodogaya Agros, a joint venture between Sumitomo Chemical and Hodogaya Chemical Co. With the merger, we aim to further strengthen and develop our business in non-farming areas such as home and garden, golf courses, forestry, and railroads.

Among the high value-added downstream fields, the home and garden market is a particularly strong growth area, expanding around 5% per year. Accordingly, the Company acquired a majority stake in Rainbow Chemical, a major Japanese supplier of home and garden materials, in January 2002. It also added Sumika Takeda Garden Products to the Sumitomo Chemical group. As a result of these initiatives, we have become the top supplier of gardening materials in Japan.

New Active Ingredients: Leading Companies' Market Introductions (1980–2001)

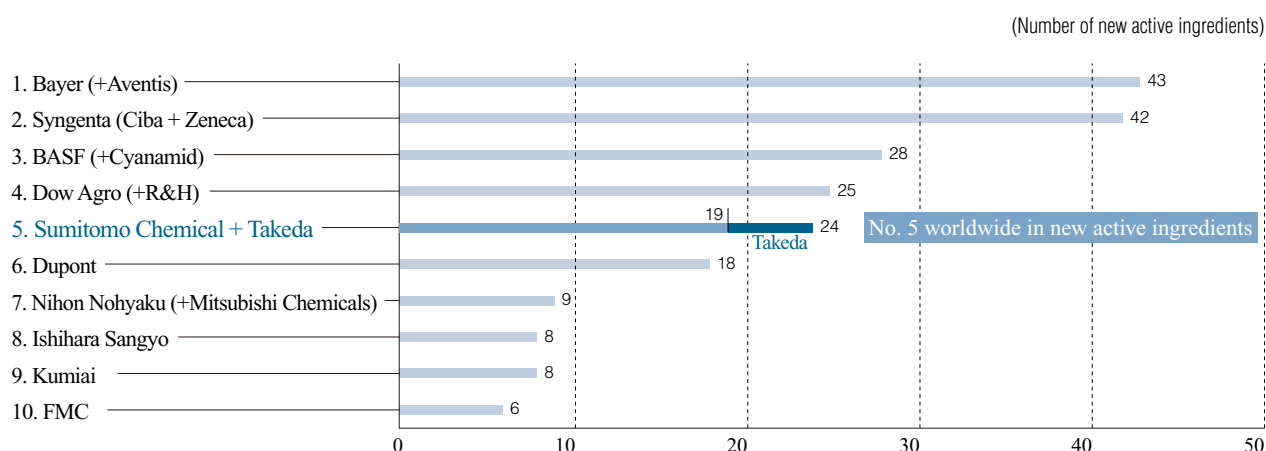

Source: Phillips McDougall Research Section 2002

PHARMACEUTICALS SECTOR

CORE BUSINESS STRATEGIES

Sumitomo Chemical is developing its pharmaceuticals business mainly through subsidiary Sumitomo Pharmaceuticals Co., Ltd., and its radiopharmaceuticals business through Nihon Medi-Physics Co., Ltd., a joint venture with the UK-based Amersham Group. Nihon Medi-Physics is the leading radiopharmaceuticals company in Japan.

Sumitomo Pharmaceuticals drew up a five-Year Corporate Business Plan in March 2003. Committed to being a pharmaceutical firm powered by high-level research and development capabilities, the company is focusing on the following actions.

1. Build a global operating base by setting up a marketing network overseas.
2. Strengthen domestic marketing capabilities by increasing the number of medical representatives as well as by providing advanced, higher-quality information in a timely fashion to medical doctors and other members of the medical profession through effective use of IT.
3. Invest vigorously in R&D for highly promising new drugs, while ensuring stable earnings from new and existing products.

4. Aggressively strengthen and expand our businesses through strategic alliances.

Nihon Medi-Physics will continue to strengthen its leading position in the *in vivo* radiopharmaceuticals market in Japan, and to expand into new fields, such as radio-therapeutic and non-radioactive diagnostic businesses.

BUSINESS PERFORMANCE IN FISCAL 2002

Sales of major products such as *Amlodin* (therapeutic agent for hypertension and angina pectoris) and *Meropen* (carbapenem antibiotic) showed continued growth, but net sales totaled ¥168.5 billion, down ¥5.5 billion from fiscal 2001, due in large part to price revisions made to our natural alpha interferon, *Sumiferon*.

We increased R&D expenditures this year, strategically investing in a number of promising projects to strengthen the Sector's business. A combination of these factors saw operating income decrease ¥9.7 billion from the previous year to ¥32.3 billion.

SPECIFIC PRODUCT STRATEGIES

Strengths Based on R&D Capabilities

The Company conducts research and development with focus on the cardiovascular system, neurological and mental disorders, immunology, and diabetes-related areas. Genomic drug discovery is carried out primarily at the Company's Genomic Science Laboratories. Its aim is to elucidate and characterize the action mechanisms of new drugs and predict the efficacy and side effects of these drug candidates. We are constantly searching the extensive genome database to identify target genes for new drug discovery, and these efforts are bearing fruit.

In September 2002, Sumitomo Pharmaceuticals reached an agreement with Fujisawa Pharmaceutical Co., Ltd. for joint research on orally administered carbapenem antibiotics. In October 2002, we acquired the pharmaceutical operations of Japan Energy Corp. In addition to inheriting Japan Energy's research expertise in immunology, we added around 50 of their top quality researchers to the staff of Sumitomo

NET SALES AND OPERATING MARGIN

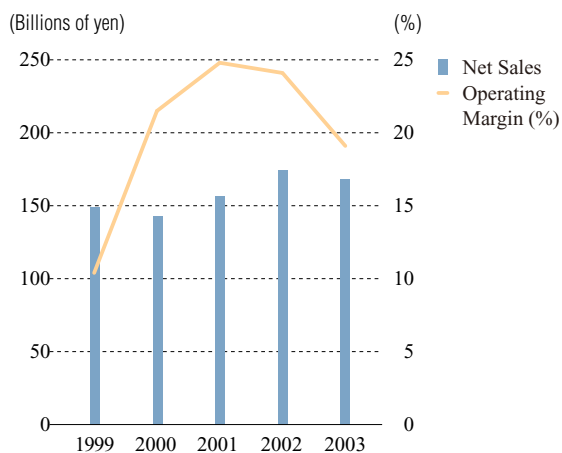

Pharmaceuticals. These undertakings are intended to speed up R&D so that we can more quickly strengthen our building blocks for our core business domain.

Sumitomo Pharmaceuticals is also actively engaged in projects to introduce high-quality products of other companies that complement our current line. In March 2003, the company obtained from Merck Sante, subsidiary of German company Merck, rights to develop and market a diabetes treatment drug, *Glucophage*, in Japan. We have begun clinical trials to gain regulatory approval, with a view to launching *Glucophage* in Japan early in 2009.

In fiscal 2002, Sumitomo Pharmaceuticals launched the anticancer antibiotic *Calsed* in December 2002. The new drug is expected to bring in domestic sales of ¥4 billion.

The company is investing in development of the following promising new drugs.

Building a Global Operating Base

At present, we have several drugs under development in the U.S. and Europe, and there are other highly promising new drugs in our pipeline for future development worldwide. With these drugs, we will build up our own marketing network in Europe and the U.S. while constantly assessing opportunities to form marketing partnerships with others on a product-by-product basis.

For Asia, we intend to strengthen our sales and marketing bases in East Asia, with initiatives including the incorporation of our marketing office and increase in number of medical representatives in China. We plan to use these initiatives to maximize sales of existing drugs, such as *Meropen*, and sales of *Sediel*, whose launch is upcoming. In the future, we will set up development bases in this region as our pharmaceutical sales expand.

Promising Drugs in Pipeline (developed in-house)

Product Number	Indication	Development Sites	Stage	Targeted Launch
SM-13496	Schizophrenia	U.S./Japan	Phase II	2007-8
SMP-114	Rheumatoid arthritis	Europe/Japan	Phase II	2010
SMP-797	Antilipemic	Undecided	Preclinical	2011-13

DISCOVERY AND DEVELOPMENT OF SM-13496

We have long been strong in psychoneurological treatments, and our research in neurotransmitters and their receptors successfully led to the commercialization of the drugs *Sediel* (anxiety medication) and *Lullan* (schizophrenia therapeutic). SM-13496 was discovered as a result of continued research in this area. It is effective against both positive and negative symptoms of schizophrenia, and is distinctive for its substantially reduced extrapyramidal side effects. We expect this drug to show curative effects for the cognitive dysfunction and affective disorders, such as anxiety and depression, that accompany schizophrenia, as well as for the problematic behaviors associated with senile dementia. We are currently developing this drug for schizophrenia in the U.S., Europe and Japan simultaneously, and Phase II trials are already underway in the U.S.

Entry into the PET Imaging Agent Business

Nihon Medi-Physics leverages its advanced expertise and state-of-the-art technologies as the leading *in vivo* radio-pharmaceutical company in Japan. It is planning to apply for Japanese regulatory approval for a radio-isotopic agent used in positron emission tomography (PET) imaging. Because of the very short half-life of this agent, companies engaged in this

business need to have production facilities and supply channels ready for quick delivery to users throughout a wide region. Nihon Medi-Physics is capable of fully utilizing its sophisticated production and quality assurance capabilities to commence nationwide PET-related business as soon as regulatory approval is granted.

RESPONSIBLE CARE INITIATIVES

Sumitomo Chemical has long played a leading role in the Japanese chemical industry and has made substantial contributions to its progress over many decades. Our industrial initiatives are complemented by our commitment to protecting the environment. Since early in our history we have always taken vigorous steps to minimize the environmental impact of our activities, and have made every effort to maintain the health of the environment.

Responsible Care constitutes a vital cornerstone of Sumitomo Chemical's corporate management. We are engaged in Responsible Care initiatives at every level of the Company, from head offices to individual plants and laboratories. Our Responsible Care Committee is composed of the board members heading the Company's business sectors

and the heads of each of the manufacturing works. Committees have also been set up at each of our manufacturing works and research laboratories to implement specific Responsible Care measures. Through solid and consistent practice of Responsible Care, we aim to preserve the global environment, avoid accidents and injuries, and ensure the safety of the chemicals we produce and supply to our customers. In these ways, we are fulfilling our social responsibilities, gaining public trust, and ensuring our own sustainable growth.

*Responsible Care refers to voluntary activities conducted by companies in the areas of environment, health and safety throughout their products' entire life cycles. As of March 2003, there were Responsible Care associations in 47 countries.

RESULTS OF RESPONSIBLE CARE ACTIVITIES IN FISCAL 2002

1. We collected major consolidated environmental performance data for Sumitomo Chemical and 13 domestic group companies, which we disclosed in an environmental report.
2. We completed overall risk assessments for major Pollutant Release and Transfer Register (PRTR)-targeted substances. Sumitomo Chemical, working voluntarily beyond the mere tracking of volumes specified in the PRTR Law, aims to communicate risks to the communities in which the Company operates. We conduct simulations of density distribution for substances emitted in large volumes, and compare results with actual measurements taken in the area around each plant. We then carry out human health risk assessments based on this data, and voluntarily disclose the resulting information to the local residents.
3. Our waste reduction efforts continued to show positive results. By reducing the amount of waste generated and promoting the recycling of waste, the volume of landfill waste in fiscal 2002 has declined 59% since fiscal 1990.
4. To reduce dioxin emissions, we made substantial improvements to incinerator furnaces, and implemented appropriate countermeasures to manage effluent at our organic pigments production facility, in accordance with the recent Japanese Law Concerning Special Measures Against Dioxins.
5. Sumitomo Chemical is constantly implementing energy-saving measures to help prevent global warming and is helping to build a recycling-based society. One target is to improve unit energy consumption by at least 1% per year. Our unit energy consumption in fiscal 2002 improved 1.1% compared with the previous fiscal year.

For a more detailed account of our activities in this area, please refer to our upcoming publication, "Environment, Health & Safety Report 2003," which will also appear on our website.

TOPICS IN FISCAL 2002

1. Manufacturing plants with lower environmental-impact processes completed

In fiscal 2002, we successively completed construction of several new plants and began operations based on novel production processes that apply the benefits of proprietary catalysts to reduce environmental burden.

- February 2003
Completed plant for vapor-phase production of caprolactam
- December 2002
Completed plant for production of propylene oxide with no by-product
- October 2002
Developed new process for liquid crystal polymers
- July 2002
Developed new production process for fatty acid methyl esters

2. Soil contamination assessments completed at all works

Following air and water pollution assessments, we completed soil contamination assessments at all works in Japan in March 2003. We will further tighten our control of chemical substances based on the results of these assessments.

3. OSHMS installed at all plants and research laboratories

In February 2003, we completed installation of our Occupational Safety and Health Management System (OSHMS) at all works and research laboratories throughout Japan. Launched at our Chiba Works prior to introduction at other companies in Japan, this management initiative has been highly praised for its value to society and has been certified by the Japan Industrial Safety and Health Association (JISHA).

CORPORATE GOVERNANCE

Sumitomo's business philosophy places prime importance on integrity, and cautions against imprudence and the merely expedient or opportunistic pursuit of easy gains. These time-honored principles laid down by our predecessors serve as the foundation of Sumitomo Chemical's corporate governance today. We strive to maximize corporate value in the face of the many challenges posed by today's changing socio-economic environment by improving management efficiency, maintaining the integrity and financial health of our businesses, and preserving transparency in our day-to-day operations.

REINFORCEMENT OF COMPLIANCE MANAGEMENT

Sumitomo Chemical Company, Ltd., the parent company, established *Our Code of Conduct* in July 1997, summarizing a set of principles for everyone at the Company to conduct their day-to-day business activities with high ethical standards. As our business spheres, however, have become more and more global, and as we have committed to more actively fulfilling our role as a responsible corporate citizen, we have decided that we must expand our code of business conduct to make it more comprehensive and enhance it in order to implement it more effectively. To this end, we introduced this July a new compliance system to be observed by every member of management and every employee at Sumitomo Chemical Company, Ltd. The system provides extensive details on proper business conduct and sets clear and strict rules. Our consolidated group companies throughout the world are also requested to adopt comparable compliance programs as early as possible. At the parent company, we already have a compliance system in place. It functions through several internal organizations, including the Internal Audit Department and various autonomous committees that oversee compliance with anti-trust laws, Responsible Care initiatives and other matters. The new compliance system is led by a Compliance Committee, composed of a number of board members and executive officers appointed by the Company's president. It is intended to reinforce the current system by overseeing compliance company-wide, across all departments, to ensure effective functioning of the compliance system. This Committee will also advise on improvements and reforms as needed. The Company has also introduced a "Speak-up" program to gather information as early as possible on any situation that violates or is likely to violate compliance, which we believe will contribute to creating greater transparency in our day-to-day activities. To give these changes a definite shape, we have established the *Sumitomo Chemical Charter of Corporate Conduct* and a new detailed *Sumitomo Chemical Code of Corporate Conduct*.

ADOPTION OF A NEW MANAGEMENT STRUCTURE

Amid the ever-intensifying competition in the world marketplace, a company's ability to thrive and grow has become increasingly dependent on its ability to quickly map out and execute management strategies that will ensure global competitiveness. By adopting a new management structure effective June 27, 2003, we firmly intend to make vital decisions with greater speed, manage our businesses with more flexibility, and quickly achieve our planned targets.

Reduction in the Number of Directors on the Board

To create a more dynamic board of directors and accelerate its decision-making, we significantly reduced the number of directors on the board, from 25 to 10.

Adoption of an Executive Officer Structure

The executive officer structure was introduced to increase speed and efficiency in business operations as well as to define more clearly operational responsibilities. Under the new structure, executive officers are entrusted by the president of the Company with responsibilities for specific businesses or other areas, and they execute their duties based on the corporate strategy governed by the board of directors.

Our statutory auditors, board of directors and accounting auditors oversee and supervise operations to ensure our management system is functioning effectively and appropriately. At present there are no outside directors on the board, but two of the four statutory auditors are independent.

TIMELY DISCLOSURE

Sumitomo Chemical is committed to providing a steady flow of important corporate information to all our shareholders and investors in a timely, accurate and equitable manner. To further improve the quality of information we disclose, in July of last year we formed our IR Committee, which consists of representatives from each business sector of the Company as well as from head office departments that help promote investor relations activities. And in May of 2003, to further strengthen lines of communication with our shareholders and investors, we combined functions previously handled by separate departments to form the new IR & Public Relations Department. The department is responsible for implementing the policies and programs established by the IR Committee.

BOARD OF DIRECTORS, EXECUTIVE OFFICERS, AND CORPORATE AUDITORS



Back Row	Hideaki Watanabe Managing Director	Shigehiro Oba Senior Managing Director	Satoshi Kawachi Senior Managing Director	Ichiro Miyawaki Managing Director	Yuji Ito Managing Director
Front Row	Masami Nakamoto Senior Managing Director	Hiromasa Yonekura President	Akio Kosai Chairman	Mitsuhiro Moroishi Senior Managing Director	Yasuo Okamoto Director

CHAIRMAN

Akio Kosai

PRESIDENT

*Hiromasa Yonekura

SENIOR MANAGING DIRECTORS

*Mitsuhiro Moroishi
General Affairs, Legal, Personnel,
IR & Public Relations,
Intellectual Property

*Masami Nakamoto
Fine Chemicals Sector,
IT-related Chemicals Sector

*Satoshi Kawachi
Technology,
Research & Development

*Shigehiro Oba
Agricultural Chemicals Sector

Directors marked with an asterisk () also serve as executive officers.

MANAGING DIRECTORS

*Ichiro Miyawaki
Petrochemicals & Plastics Sector

*Hideaki Watanabe
Basic Chemicals Sector

*Yuji Ito
Finance & Accounting Office,
IR & Public Relations Dept.,
Procurement & Logistics Office,
Internal Audit Dept.

DIRECTOR

*Yasuo Okamoto
Pharmaceuticals
(President, Sumitomo
Pharmaceuticals Co., Ltd.)

MANAGING EXECUTIVE OFFICERS

Naoya Kanda
IT-related Chemicals Sector -
Optical Materials Div. / Semiconductor
Process Materials Div. / Electronic
Materials Div. / IT-related Chemicals
Research Laboratory

Osamu Ishitobi
Petrochemicals & Plastics Sector -
Planning & Coordination Office /
Petrochemicals Div. / Polyethylene &
Polypropylene Dept.

Masayo Tada
Plant Protection Div.
- Domestic / International

Masashi Araki
Chiba Works,
Petrochemicals Research Laboratory,
Plastics Technical Center

EXECUTIVE OFFICERS

Masanori Hayashi
Basic Chemicals Sector -
Planning & Coordination Office /
Industrial Chemicals Div. / Inorganic
Materials Div. / Aluminium Div.

Yasuo Kamei
Corporate Planning & Coordination
Office (Corporate Planning)

Hiroshi Hirose
General Affairs Dept.,
IR & Public Relations Dept.

Hirokazu Hosaka
Fine Chemicals Sector -
Specialty Chemicals Div. / Functional
Chemicals Div. / Fine Chemicals
Research Laboratory

Iwao Nakatsuka
Responsible Care Office,
Organic Synthesis Research
Laboratory, Environmental Health
Science Laboratory

Takatsugu Enami
Environmental Health Div.

Kiyohiko Nakae
Tsukuba Research Laboratory,
Corporate Planning & Coordination
Office (Technology, Research &
Development)

Shinji Murakami
Oita Works,
Sumitomo Pharmaceuticals Co., Ltd.

Yoshimasa Takao
Personnel Office

Masakazu Tokura
Corporate Planning & Coordination
Office (Business Planning)

Yusuke Ueda
Legal Dept.

CORPORATE AUDITORS

Kunio Matura

Hiroaki Ninomiya

Hiroshi Hayasaki

Yoji Arakawa

CONTENTS

- 26 Consolidated Financial Summary
- 27 Financial Review
- 32 Consolidated Balance Sheets
- 34 Consolidated Statements of Income
- 35 Consolidated Statements of Shareholders' Equity
- 36 Consolidated Statements of Cash Flows
- 37 Notes to Consolidated Financial Statements
- 50 Independent Auditors' Report

CONSOLIDATED FINANCIAL SUMMARY

Sumitomo Chemical Company, Limited

	Billions of yen (except per 1,000 shares)					
	Years ended March 31,					
	1998	1999	2000	2001	2002	2003
Results of operations:						
Sales by business segment:						
Basic Chemicals	¥ 189.8	¥ 157.5	¥ 170.2	¥ 180.6	¥ 173.8	¥ 193.2
Petrochemicals & Plastics	339.6	305.6	331.8	375.5	338.6	371.6
Fine Chemicals	133.5	120.0	114.0	113.5	99.8	103.5
IT-related Chemicals	52.7	46.6	62.1	60.2	59.8	82.5
Agricultural Chemicals	120.8	120.8	105.6	121.6	134.9	158.1
Pharmaceuticals	155.3	149.1	143.1	156.7	174.0	168.5
Others	28.6	28.1	23.5	32.9	37.5	33.7
Net sales	¥ 1,020.3	¥ 927.7	¥ 950.3	¥ 1,041.0	¥ 1,018.4	¥ 1,111.1
Overseas operations	¥ 238.2	¥ 232.1	¥ 227.5	¥ 276.5	¥ 287.2	¥ 327.4
Operating income (loss) by business segment:						
Basic Chemicals	¥ 6.5	¥ 2.8	¥ 3.0	¥ 4.5	¥ 3.0	¥ 5.3
Petrochemicals & Plastics	10.2	11.1	10.4	7.3	(0.4)	4.9
Fine Chemicals	13.4	9.2	9.0	7.5	8.0	9.2
IT-related Chemicals	0.8	(8.6)	(5.0)	3.2	(6.3)	0.5
Agricultural Chemicals	25.7	27.7	18.9	19.4	17.9	16.6
Pharmaceuticals	15.5	15.5	30.8	38.8	42.0	32.3
Others	3.6	1.2	3.0	3.9	4.8	4.9
Elimination	(0.7)	0.4	(0.0)	0.1	(0.2)	(0.2)
Operating income	¥ 75.0	¥ 59.3	¥ 70.1	¥ 84.7	¥ 68.8	¥ 73.5
Income before income taxes and minority interests						
	¥ 45.9	¥ 36.3	¥ 32.0	¥ 64.4	¥ 57.8	¥ 63.2
Net income	22.1	20.1	18.4	34.1	30.2	31.1
Net income per 1,000 shares (yen)	¥ 13,637	¥ 12,406	¥ 11,329	¥ 20,756	¥ 18,250	¥ 18,742
Financial position (at year-end):						
Total current assets	¥ 630.7	¥ 591.8	¥ 584.4	¥ 596.5	¥ 595.7	¥ 634.8
Net property, plant and equipment	475.6	428.1	409.7	400.7	401.7	465.6
Investments and other non-current assets	261.9	266.7	272.7	406.4	342.7	307.0
Total assets	1,375.9	1,310.9	1,322.4	1,455.4	1,393.2	1,484.3
Total shareholders' equity	296.7	325.1	345.0	451.8	444.6	444.3
Book value per 1,000 shares (yen)	¥182,931	¥200,485	¥210,965	¥272,905	¥268,573	¥268,615
General:						
For the year:						
Capital expenditures	¥ 82.9	¥ 67.6	¥ 81.6	¥ 62.1	¥ 73.0	¥ 152.0
Depreciation and amortization	58.4	68.4	75.4	64.6	79.2	69.0
Research and development expenses	54.9	59.5	59.3	59.1	66.7	72.8
Dividends per 1,000 shares (yen)	¥ 5,000	¥ 5,000	¥ 5,000	¥ 6,000	¥ 6,000	¥ 6,000
At year-end:						
Employees	15,918	15,778	17,474	17,392	17,016	17,906
Shareholders of record	144,381	140,257	134,705	129,835	130,176	124,281
Consolidated subsidiaries	64	67	92	98	102	110

FINANCIAL REVIEW

The following comments should be read in conjunction with “To Our Shareholders, Customers and Partners” (pages 2-5), “Review of Operations” (pages 10-21) and the consolidated financial statements (pages 32-50). U. S. dollar amounts are translated from yen, for convenience only, at ¥120.20= \$1, the rate prevailing on March 31, 2003.

RESULTS OF OPERATIONS

Net sales for the fiscal year ended March 31, 2003, totaled ¥1,111.1 billion (US\$9,244 million), a 9.1% increase from ¥1,018.4 billion for the previous fiscal year.

Cost of sales was ¥798.0 billion (US\$6,639 million), compared with ¥724.9 billion for the previous fiscal year. The cost of sales ratio was 72%, the same level as the previous fiscal year. Selling, general and administrative expenses were ¥239.6 billion (US\$1,993 million), a 6.7% increase over the previous fiscal year. Operating income amounted to ¥73.5 billion (US\$612 million), up 6.8% from ¥68.8 billion for the previous fiscal year. The ratio of operating income to net sales was 6.6%, as compared with the previous year’s 6.8%.

Research and development expenses for the fiscal year ended March 31, 2003 were ¥72.8 billion (US\$606 million), 9.2% higher than the previous fiscal year’s ¥66.7 billion. Annual depreciation and amortization expenses were ¥69.0 billion (US\$574 million), a decrease of 13% compared with the last fiscal year’s ¥79.2 billion.

Interest expense, net of interest and dividend income, decreased 28.2% to ¥5.3 billion (US\$44 million), compared with ¥7.4 billion for the previous fiscal year. Equity in earnings of affiliates decreased to ¥2.6 billion (US\$22 million) from ¥6.7 billion in the previous fiscal year.

Restructuring charges, which mainly consisted of loss on disposal of property, plant and equipment, impairment loss on intangible assets, special severance benefits, and loss on investments in and loans to related companies, increased to ¥6.4 billion (US\$53 million) compared to ¥5.0 billion in the previous fiscal year. The company recorded loss on write-down of investment securities of ¥4.0 billion (US\$34 million), mainly due to a downturn in the general stock market conditions. Net gain on sale of investment securities decreased to ¥1.3 billion (US\$11 million) from ¥13.3 billion in the previous fiscal year.

Income before income taxes and minority interests for the fiscal year ended March 31, 2003 was ¥63.2 billion (US\$526 million) compared with ¥57.8 billion for the previous fiscal year. Income taxes were ¥25.8 billion (US\$214 million), up 10% from ¥23.3 billion for the previous fiscal year.

Net income was ¥31.1 billion (US\$259 million), a 3.1% increase from ¥30.2 billion for the previous fiscal year. Return on equity (ROE) was 7.0%, 0.3 points up from the previous fiscal year’s 6.7%. Net income per 1,000 shares, based on the weighted average number of shares outstanding during the fiscal year ended March 31, 2003, was ¥18,742 (US\$155.92), compared with ¥18,250 for the previous fiscal year. Annual dividends for the fiscal year ended March 31, 2003 were ¥6,000 (US\$49.9) per 1,000 shares, the same as for the previous fiscal year.

NET INCOME

(Billions of yen)

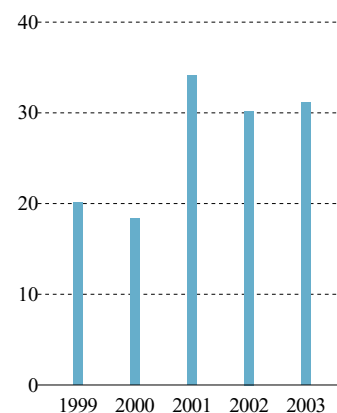

NET INCOME PER 1,000 SHARES

(Thousands of yen)

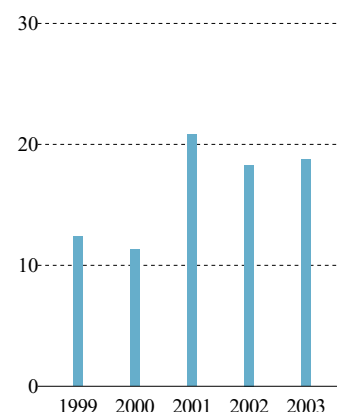

RESEARCH AND DEVELOPMENT EXPENSES

(Billions of yen)

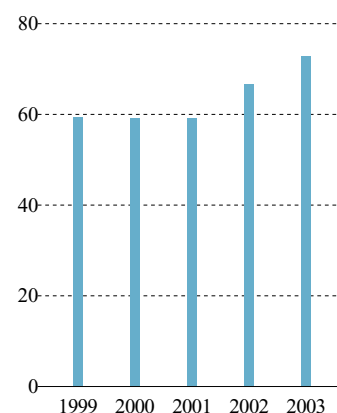

SEGMENT INFORMATION

Sumitomo Chemical's operations are classified into seven principal business segments; "Basic Chemicals", "Petrochemicals & Plastics", "Fine Chemicals", "IT-related Chemicals", "Agricultural Chemicals", "Pharmaceuticals", and "Others".

Basic Chemicals;

The sales of the segment increased 11.1% to ¥193.2 billion (US\$1,607 million), compared with ¥173.8 billion for the previous fiscal year. Sales of aluminum and methyl methacrylate grew thanks to increased demand in Japan. In addition, methyl methacrylate sales in overseas markets rose due to increased shipping volume.

The operating income of the segment increased 76.2% to ¥5.3 billion (US\$44 million), from ¥3.0 billion for the previous fiscal year, due to an increase in sales volume. The operating income ratio of the segment was 2.7%, compared with 1.7% for the previous fiscal year.

Major consolidated subsidiaries of this segment include Sumitomo Chemical Singapore Pte. Ltd and its subsidiaries, which engage in the MMA and acrylic acid businesses in Singapore.

Petrochemicals & Plastics;

The sales of the segment increased 9.8% to ¥371.6 billion (US\$3,091 million) from ¥338.6 billion for the previous fiscal year. Styrene monomer sales increased owing to a higher market price and increased shipping volume. The domestic sales prices of olefins increased, reflecting a rise in feedstock prices. Plastics sales also grew due to strong demand both in Japan and overseas.

The operating income of the segment was ¥4.9 billion (US\$41 million), compared to operating loss of ¥0.4 billion for the previous fiscal year. The improvement of operating income resulted mainly from increased shipping volume and reduction in manufacturing cost. The operating income ratio of the segment was 1.3%, compared with a loss of 0.1% for the previous fiscal year.

Major consolidated subsidiaries of this segment include The Polyolefin Company (Singapore) Pte. Ltd., a producer of low-density polyethylene and polypropylene.

BREAKDOWN OF SALES BY PRODUCT

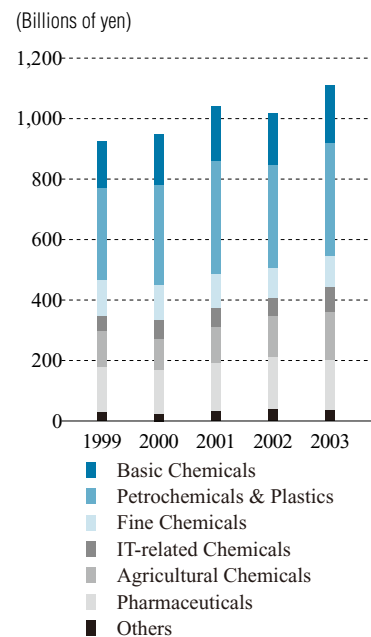

Industry Segment Results

Fiscal years ended March 31, 2003 and 2002

Segment information by product group	Millions of yen								
	Basic Chemicals	Petrochemicals & Plastics	Fine Chemicals	IT-related Chemicals	Agricultural Chemicals	Pharmaceuticals	Others	Adjustments & Elimination	Consolidated
Year ended March 31, 2003									
Sales to unaffiliated customers	¥193,217	¥371,597	¥103,532	¥82,516	¥158,131	¥168,446	¥33,689		¥1,111,128
Operating income (loss)	5,308	4,911	9,166	474	16,564	32,299	4,949	(151)	73,520
Operating income ratio	2.7%	1.3%	8.9%	0.6%	10.5%	19.2%	14.7%		6.6%
Operating income growth (decrease)	76.2%	—	14.1%	—	(7.5)%	(23.1)%	3.4%		6.8%
Year ended March 31, 2002									
Sales to unaffiliated customers	¥173,836	¥338,556	¥99,765	¥59,799	¥134,867	¥173,982	¥37,547		¥1,018,352
Operating income (loss)	3,012	(442)	8,032	(6,307)	17,909	42,017	4,786	(171)	68,836
Operating income (loss) ratio	1.7%	(0.1)%	8.1%	(10.5)%	13.3%	24.2%	12.7%		6.8%
Operating income growth (decrease)	(33.6)%	—	6.6%	—	(7.7)%	8.4%	24.1%		(18.7)%

Fine Chemicals;

The sales of the segment increased 3.8% to ¥103.5 billion (US\$861 million) from ¥99.8 billion for the previous fiscal year. Exports of pharmaceutical intermediates and resorcinol (a raw material for adhesives) increased, while dyestuffs sales declined due to a decreased demand.

The operating income of the segment was ¥9.2 billion (US\$76 million), 14.1% up over the previous fiscal year's ¥8.0 billion, thanks to an increase in shipping volume. The operating income ratio of the segment was 8.9%, compared with 8.1% for the previous fiscal year.

Major consolidated subsidiaries of this segment include Koei Chemical Co., Ltd., engaged principally in manufacturing and selling pharmaceutical intermediates, agrochemical intermediates, etc.

IT-related Chemicals;

The segment had drastic sales recovery of 38.0% to ¥82.5 billion (US\$686 million), from ¥59.8 billion for the previous fiscal year. Sales volume of optical functional films for LCDs posted a significant growth both at home and overseas. Photoresists and epoxy resins also increased in sales owing to recovery of demand in the IT and electronics related industries.

The segment recorded operating income of ¥0.5 billion (US\$4 million), in contrast to the operating loss of ¥6.3 billion for the previous fiscal year. The operating income ratio of the segment was 0.6%, compared with a loss of 10.5% for the previous fiscal year.

Major consolidated subsidiaries of this segment include Dongwoo Fine-Chem Co., Ltd., engaged in manufacturing and selling IT related products.

Agricultural Chemicals;

The segment showed the sales growth of 17.2% to ¥158.1 billion (US\$1,316 million) from ¥134.9 billion for the previous fiscal year. Sales of crop protection chemicals increased in both Japanese and overseas markets. Moreover, acquisition of agrochemical business from Takeda Chemical Industries, Limited increased the sales of the segment. Sales of household insecticides and feed additives declined because of lower prices and decreased shipping volumes.

The operating income of the segment decreased 7.5% to ¥16.6 billion (US\$138 million) compared to ¥17.9 billion for the previous fiscal year owing to a stronger yen and a decline in selling prices. The operating income ratio of the segment was 10.5%, compared with 13.3% for the previous fiscal year.

Major consolidated subsidiaries of this segment include: Valent U.S.A. Corporation, a U.S.-based subsidiary for the development and marketing of plant protection chemicals in the North America; Valent Biosciences Corporation, a subsidiary of Valent U.S.A. Corporation, for the development and marketing of biological pesticides.

Pharmaceuticals;

The sales of the segment decreased 3.2% to ¥168.5 billion (US\$1,401 million) compared to ¥174.0 billion for the previous fiscal year due to a significant price reduction of *Sumiferon* (natural alpha interferon) although sales of *Amlodin* (therapeutic agent for hypertension and angina pectoris), and *Meropen* (carbapenem antibiotic) expanded.

The operating income of the segment decreased 23.1% to ¥32.3 billion (US\$269 million) from ¥42.0 billion for the previous fiscal year. The decrease in the operating income of this segment was largely attributable to the price reduction and increased R&D expenses. The operating income ratio of the segment was 19.2%, compared with 24.2% for the previous fiscal year.

BREAKDOWN OF OVERSEAS OPERATIONS

(Billions of yen)

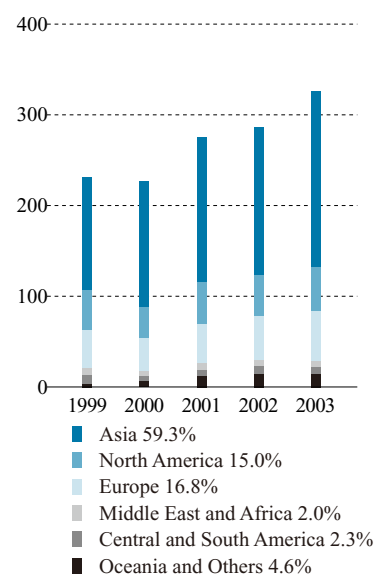

Note: Percentages are for the fiscal year ended March 31, 2003

Major consolidated subsidiaries of this segment include: Sumitomo Pharmaceuticals Co., Ltd., a core entity of the pharmaceuticals business; and Nihon Medi-Physics Co., Ltd., a joint venture with Amersham plc, of the United Kingdom, engaged in manufacturing and selling *in vivo* and *in vitro* radioactive diagnostics and related products.

Others;

The sales of the segment decreased 10.3% to ¥33.7 billion (US\$280 million) from the previous fiscal year's ¥37.5 billion. The segment posted a 3.4% increase in operating income to ¥4.9 billion (US\$41 million) compared with ¥4.8 billion for the previous fiscal year. The operating income ratio of the segment was 14.7%, compared with 12.7% for the previous fiscal year.

This segment encompasses electricity power supply by Sumitomo Joint Electric Power Co., Ltd., engineering services for plant construction by Sumitomo Chemical Engineering Co., Ltd., and chemical and mechanical analysis services by Sumika Chemical Analysis Service, Ltd.

OVERSEAS OPERATIONS

Revenues from overseas operations, including both sales by overseas subsidiaries and exports from Japan, for the fiscal year ended March 31, 2003 were ¥327.4 billion (US\$2,724 million), 14.0% higher than the ¥287.2 billion in the previous fiscal year, due mainly to the expanded overseas operations of Petrochemicals & Plastics and IT-related Chemicals. The ratio of revenues from overseas operations to net sales was 29.5%, compared with 28.2% for the previous fiscal year.

FINANCIAL POSITION

Current assets as of March 31, 2003 amounted to ¥634.8 billion (US\$5,281 million), up 6.6% from ¥595.7 billion as of March 31, 2002. Current liabilities were ¥576.0 billion (US\$4,792 million), up 21.9% from ¥472.6 billion at the end of the previous fiscal year. The current ratio was 110.2%, compared with 126.1% as of March 31, 2002. Investments and other non-current assets as of March 31, 2003 totaled ¥307.0 billion (US\$2,554 million), compared with ¥342.7 billion as of March 31, 2002. The total value of property, plant and equipment was ¥465.6 billion (US\$3,874 million), compared with ¥401.7 billion at the end of the previous fiscal year. Total assets were ¥1,484.3 billion (US\$12,348 million) and ¥1,393.2 billion at March 31, 2003 and March 31, 2002, respectively. Foreign currency translation adjustments amounted to ¥12.9 billion (US\$107 million), compared with ¥10.7 billion as of March 31, 2002. Unrealized gains on investment securities amounted to ¥43.0 billion (US\$357 million), compared with ¥60.2 billion as of March 31, 2002.

Total debt (short-term and long-term borrowings from banks, debt on bonds and notes, commercial paper, and trade notes discounted) as of March 31, 2003 amounted to ¥485.2 billion (US\$4,036 million), a 0.5% decrease from ¥487.6 billion as of March 31, 2002. Shareholders' equity was ¥444.3 billion (US\$3,697 million) at March 31, 2003, 0.1% lower than ¥444.6 billion at the end of the previous fiscal year. The ratio of shareholders' equity to total assets was 29.9% as of March 31, 2003, compared with 31.9% as of March 31, 2002. The number of shares issued and outstanding as of March 31, 2003 was 1,653,683,659 shares. Retained earnings amounted to ¥299.9 billion (US\$2,495 million), a 7.1% increase from ¥280.0 billion as of March 31, 2002.

TOTAL CURRENT ASSETS

(Billions of yen)

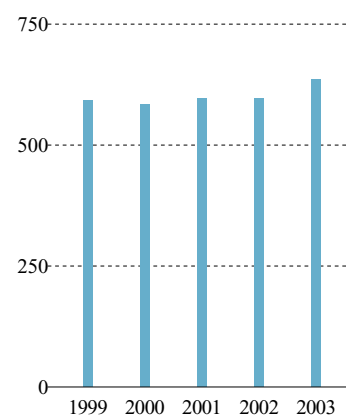

TOTAL ASSETS

(Billions of yen)

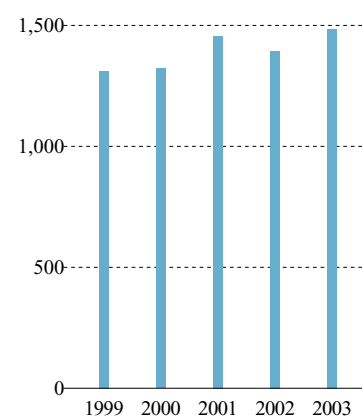

SHAREHOLDERS' EQUITY

(Billions of yen)

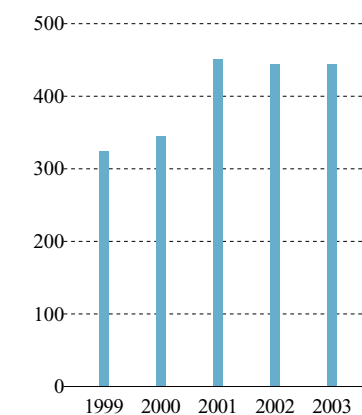

GEOGRAPHIC INFORMATION

Net sales from operations outside Japan were ¥183.1 billion (US\$1,523 million) and ¥161.2 billion for the years ended March 31, 2003 and 2002, respectively, and accounted for 16.5% and 15.8% of the respective consolidated total sales. Net sales from operations outside Japan increased 13.6% from the previous fiscal year. Operating income from operations outside Japan for the fiscal year ended March 31, 2003 was ¥13.1 billion (US\$109 million), up 82.9% from ¥7.2 billion for the previous fiscal year. Overseas assets as of March 31, 2003 amounted to ¥200.3 billion (US\$1,666 million), 13.9% higher than the previous fiscal year's ¥175.8 billion. The ratio of overseas assets to total assets for the fiscal year ended March 31, 2003 was 13.5%, up 0.9 percentage point from the previous fiscal year.

CASH FLOWS

Net cash provided from operating activities for the year ended March 31, 2003 was ¥141.7 billion (US\$1,179 million), up 125.4% from ¥62.9 billion for the previous fiscal year. Net cash used for investing activities for the year ended March 31, 2003 was ¥129.2 billion (US\$1,075 million), a 125.8% increase from ¥57.2 billion for the previous fiscal year. As a result, free cash flow for the year ended March 31, 2003 was ¥12.5 billion (US\$104 million), up 121.4% from ¥5.6 billion for the previous fiscal year.

CAPITAL EXPENDITURES

Capital expenditures for the fiscal year ended March 31, 2003 increased 108.3% to ¥152.0 billion (US\$1,265 million) from ¥73.0 billion for the fiscal year ended March 31, 2002.

Expenditures for new plants and expansions accounted for 60% of the total for the fiscal year ended March 31, 2003 and 50% for the fiscal year ended March 31, 2002. The breakdown of capital expenditures is shown below.

CAPITAL EXPENDITURES

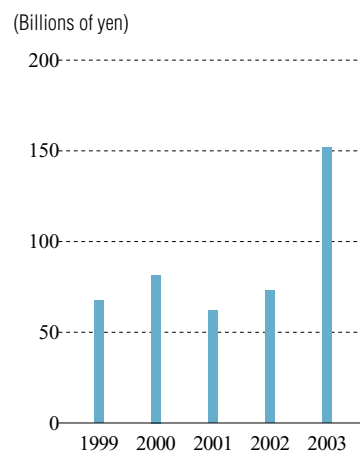

Breakdown of Capital Expenditures

	Billions of yen, %											
	1998		1999		2000		2001		2002		2003	
New plants and expansions*:												
Basic Chemicals	¥14.3	17%	¥12.8	19%	¥ 6.1	7%	¥ 2.8	4%	¥ 2.3	3%	¥ 11.3	7%
Petrochemicals & Plastics	13.0	16	2.2	3	6.7	8	3.2	5	6.3	9	20.3	13
Fine Chemicals	6.0	7	4.7	7	5.4	7	5.8	9	4.2	6	2.2	2
IT-related Chemicals	12.8	16	6.4	10	3.0	4	3.3	5	6.1	8	26.3	17
Agricultural Chemicals	6.1	7	2.6	4	24.4	30	1.7	3	16.4	22	23.5	16
Pharmaceuticals	2.1	2	1.0	1	0.5	1	3.4	6	0.5	1	1.7	1
Others	0.8	1	1.4	2	0.8	1	1.2	2	1.0	1	5.7	4
Subtotal	55.1	66	31.1	46	46.9	58	21.4	34	36.8	50	91.0	60
Rationalization of production processes	3.8	5	2.9	4	4.1	5	3.5	6	5.7	8	6.7	4
Research and development	5.1	6	13.0	19	6.8	8	6.6	11	6.5	9	8.9	6
Others	18.9	23	20.6	31	23.8	29	30.6	49	24.0	33	45.4	30
Total	¥82.9	100%	¥67.6	100%	¥81.6	100%	¥62.1	100%	¥73.0	100%	¥152.0	100%

*Includes acquisition

CONSOLIDATED BALANCE SHEETS

Sumitomo Chemical Company, Limited
March 31, 2003 and 2002

	Millions of yen		Thousands of U.S. dollars (Note 1)
	2003	2002	2003
Assets			
Current assets:			
Cash and cash equivalents (Note 3)	¥ 61,891	¥ 55,302	\$ 514,900
Short-term investments	59	338	491
Marketable securities (Note 3)	20	22	166
Receivables—			
Trade notes and accounts	294,824	293,094	2,452,779
Other	30,429	31,705	253,153
Allowance for doubtful receivables	(4,752)	(6,192)	(39,534)
	320,501	318,607	2,666,398
Inventories	218,983	198,726	1,821,822
Deferred tax assets (Note 9)	22,010	16,889	183,111
Other	11,332	5,858	94,277
Total current assets	634,796	595,742	5,281,165
Investments and other non-current assets:			
Investment securities (Notes 3, 4 and 5)	275,442	311,664	2,291,531
Other	33,053	32,548	274,983
Allowance for doubtful receivables	(1,466)	(1,471)	(12,196)
	307,029	342,741	2,554,318
Property, plant and equipment (Note 5):			
Land	79,507	74,177	661,456
Buildings and structures	394,450	376,473	3,281,614
Machinery and equipment	1,001,959	960,844	8,335,765
Construction in progress	56,668	14,996	471,448
	1,532,584	1,426,490	12,750,283
Less accumulated depreciation	(1,066,968)	(1,024,795)	(8,876,606)
	465,616	401,695	3,873,677
Other assets:			
Excess of cost over equity in net assets acquired	3,753	1,792	31,223
Deferred tax assets (Note 9)	23,170	16,588	192,762
Goodwill	18,688	9,547	155,474
Software	8,396	1,936	69,850
Products registration rights	6,746	8,127	56,123
Facilities rights and others	16,081	14,991	133,786
	76,834	52,981	639,218
	¥1,484,275	¥1,393,159	\$12,348,378

See accompanying notes.

	Millions of yen		Thousands of U.S. dollars (Note 1)
	2003	2002	2003
Liabilities and Shareholders' Equity			
Current liabilities:			
Short-term debt (Note 5)	¥ 136,714	¥ 127,102	\$ 1,137,388
Long-term debt due within one year (Note 5)	76,559	70,443	636,930
Payables—			
Trade notes and accounts	186,584	162,764	1,552,279
Other	83,489	48,113	694,584
	270,073	210,877	2,246,863
Accrued expenses	23,721	20,622	197,346
Income taxes payable	22,984	15,642	191,215
Deferred tax liabilities (Note 9)	52	34	433
Other	45,847	27,830	381,423
Total current liabilities	575,950	472,550	4,791,598
Long-term debt due after one year (Note 5)	271,891	289,773	2,261,988
Deferred tax liabilities (Note 9)	9,529	16,740	79,276
Retirement benefits (Note 7)	58,508	57,904	486,755
Other non-current liabilities	28,330	29,151	235,691
Minority interests in consolidated subsidiaries	95,733	82,462	796,448
Contingent liabilities (Note 11)			
Shareholders' equity:			
Common stock,			
Authorized —5,000,000,000 shares			
Issued —1,655,446,177 shares at March 31, 2003			
1,655,446,177 shares at March 31, 2002	89,699	89,699	746,248
Capital surplus	21,411	21,411	178,128
Retained earnings	299,896	280,042	2,494,975
Land revaluation reserve (Note 12)	3,982	3,916	33,128
Unrealized gains on investment securities	42,951	60,220	357,329
Foreign currency translation adjustments	(12,892)	(10,658)	(107,254)
Treasury stock, at cost			
1,762,518 shares at March 31, 2003			
110,154 shares at March 31, 2002	(713)	(51)	(5,932)
Total shareholders' equity	444,334	444,579	3,696,622
	¥1,484,275	¥1,393,159	\$12,348,378

CONSOLIDATED STATEMENTS OF INCOME

Sumitomo Chemical Company, Limited
Years ended March 31, 2003, 2002 and 2001

	Millions of yen			Thousands of U.S. dollars (Note 1)
	2003	2002	2001	2003
Net sales	¥1,111,128	¥1,018,352	¥1,040,950	\$9,243,993
Cost of sales	798,001	724,947	746,651	6,638,943
Selling, general and administrative expenses	239,607	224,569	209,626	1,993,403
Operating income	73,520	68,836	84,673	611,647
Other income (expenses):				
Interest and dividend income	3,986	4,530	5,485	33,161
Interest expense	(9,305)	(11,940)	(13,984)	(77,413)
Equity in earnings of affiliates	2,590	6,660	11,015	21,547
Gain on sale of property, plant and equipment	2,189	1,937	—	18,211
Reversal of (allowance for) doubtful receivables	2,185	(1,785)	(1,991)	18,178
Net gain on sale of securities	1,268	13,317	9,594	10,549
Restructuring charges (Note 8)	(6,423)	(5,039)	(11,317)	(53,436)
Loss on write-down of investment securities	(4,042)	(611)	(434)	(33,627)
Amortization of goodwill	—	(11,294)	—	—
Loss on settlement of patent dispute	—	(6,111)	—	—
Past period service costs of employees' retirement plan (Note 7)	—	—	(14,338)	—
Other, net	(2,754)	(735)	(4,328)	(22,910)
Income before income taxes and minority interests	63,214	57,765	64,375	525,907
Income taxes (Note 9):				
Current	35,332	24,912	34,966	293,944
Deferred	(9,571)	(1,589)	(10,130)	(79,626)
	25,761	23,323	24,836	214,318
Minority interests	6,319	4,231	5,460	52,571
Net income	¥ 31,134	¥ 30,211	¥ 34,079	\$ 259,018

	Yen			U.S. dollars (Note 1)
	2003	2002	2001	2003
Net income per 1,000 shares	¥ 18,742	¥ 18,250	¥ 20,756	\$155.92
Dilutive net income per 1,000 shares	18,528	18,047	20,420	154.14

See accompanying notes.

CONSOLIDATED STATEMENTS OF SHAREHOLDERS' EQUITY

Sumitomo Chemical Company, Limited
Years ended March 31, 2003, 2002 and 2001

	Millions of yen							
	Shares of common stock (thousands)	Common stock	Capital surplus	Retained earnings	Land revaluation reserve	Unrealized gains on investment securities	Foreign currency translation adjustments	Treasury stock
Balance at March 31, 2000	1,635,155	¥84,748	¥16,480	¥239,397	¥4,345	¥ —	¥ —	¥ (9)
Net income				34,079				
Cash dividends at ¥ 8.0 per share				(13,081)				
Bonuses to directors and statutory auditors				(112)				
Conversion of convertible bonds	20,291	4,951	4,931					
Unrealized gains on investment securities, net of tax						98,155		
Foreign currency translation adjustments							(21,293)	
Revaluation of property, plant and equipment by an affiliate, net of tax				675				
Adjustment for changes in affiliates accounted for by the equity method				(1,494)				
Net decrease in treasury stock								7
Balance at March 31, 2001	1,655,446	89,699	21,411	259,464	4,345	98,155	(21,293)	(2)
Net income				30,211				
Cash dividends at ¥ 6.0 per share				(9,933)				
Bonuses to directors and statutory auditors				(129)				
Net decrease in unrealized gains on investment securities, net of tax						(37,935)		
Revaluation of land by certain affiliates, net of tax				429	(429)			
Foreign currency translation adjustments							10,635	
Net increase in treasury stock								(49)
Balance at March 31, 2002	1,655,446	89,699	21,411	280,042	3,916	60,220	(10,658)	(51)
Net income				31,134				
Cash dividends at ¥ 6.0 per share				(9,931)				
Bonuses to directors and statutory auditors				(129)				
Adjustment for decrease in consolidated subsidiaries and affiliates accounted for by the equity method				535				
Decrease mainly due to changes in accounting policies by overseas subsidiaries and affiliates				(1,759)				
Net decrease in unrealized gains on investment securities, net of tax						(17,269)		
Revaluation of land by certain affiliates, net of tax				4	66			
Foreign currency translation adjustments							(2,234)	
Net increase in treasury stock								(662)
Balance at March 31, 2003	1,655,446	¥89,699	¥21,411	¥299,896	¥3,982	¥ 42,951	¥ (12,892)	¥ (713)

	Thousands of U.S. dollars (Note 1)						
	Common stock	Capital surplus	Retained earnings	Land revaluation reserve	Unrealized gains on investment securities	Foreign currency translation adjustments	Treasury stock
Balance at March 31, 2002	\$746,248	\$178,128	\$2,329,801	\$32,579	\$500,998	\$ (88,669)	\$ (424)
Net income			259,018				
Cash dividends at ¥ 6.0 (US\$0.050) per share			(82,621)				
Bonuses to directors and statutory auditors			(1,073)				
Adjustment for decrease in consolidated subsidiaries and affiliates accounted for by the equity method			4,451				
Decrease mainly due to changes in accounting policies by overseas subsidiaries and affiliates			(14,634)				
Net decrease in unrealized gains on investment securities, net of tax					(143,669)		
Revaluation of land by certain affiliates, net of tax			33	549			
Foreign currency translation adjustments						(18,585)	
Net increase in treasury stock							(5,508)
Balance at March 31, 2003	\$746,248	\$178,128	\$2,494,975	\$33,128	\$357,329	\$(107,254)	\$(5,932)

See accompanying notes.

CONSOLIDATED STATEMENTS OF CASH FLOWS

Sumitomo Chemical Company, Limited
Years ended March 31, 2003, 2002 and 2001

	Millions of yen			Thousands of U.S. dollars (Note 1)
	2003	2002	2001	2003
Cash flows from operating activities:				
Income before income taxes and minority interests	¥ 63,214	¥ 57,765	¥ 64,375	\$ 525,907
Adjustments to reconcile income before income taxes and minority interests to net cash provided by operating activities—				
Depreciation and amortization	69,026	79,247	64,609	574,260
Equity in earnings of affiliates	1,930	(2,686)	633	16,056
Interest and dividend income	(3,986)	(4,530)	(5,485)	(33,161)
Interest expense	9,305	11,940	13,984	77,413
Gain on sale of securities	(1,255)	(13,317)	(9,594)	(10,441)
Gain on sale of property, plant and equipment	(2,189)	(1,937)	—	(18,211)
Restructuring charges	5,031	2,541	10,845	41,855
Increase (decrease) of provision for retirement benefits and others	1,629	(10,660)	14,304	13,552
(Increase) decrease in notes and accounts receivable	(9,693)	20,481	(21,414)	(80,641)
Increase in inventories	(8,803)	(6,450)	(8,172)	(73,236)
Increase (decrease) in notes and accounts payable	37,187	(21,110)	7,569	309,376
Other, net	10,413	(7,103)	9,041	86,630
Subtotal	171,809	104,181	140,695	1,429,359
Interest and dividends received	4,041	4,191	6,079	33,619
Interest paid	(9,683)	(12,081)	(14,070)	(80,557)
Income taxes paid	(24,487)	(33,436)	(38,008)	(203,719)
Net cash provided by operating activities	141,680	62,855	94,696	1,178,702
Cash flows from investing activities:				
Acquisition of securities	(6,921)	(3,616)	(9,098)	(57,579)
Proceeds from sale of securities	7,558	19,914	16,908	62,878
Acquisition of property, plant and equipment	(90,984)	(71,943)	(70,690)	(756,938)
Proceeds from sale of property, plant and equipment	3,161	3,073	3,853	26,298
Advance of long-term loans receivable	(4,085)	(6,586)	(2,261)	(33,985)
Collection of long-term loans receivable	3,351	3,408	4,122	27,878
Acquisition of business, net of cash acquired	(36,363)	—	—	(302,521)
Time deposits, maturing after three months and other, net	(4,912)	(1,466)	2,254	(40,865)
Net cash used in investing activities	(129,195)	(57,216)	(54,912)	(1,074,834)
Cash flows from financing activities:				
Dividends paid	(9,931)	(9,933)	(13,081)	(82,621)
Net increase in commercial paper	13,000	—	17,000	108,153
Proceeds from other short-term debt	138,089	141,641	146,909	1,148,827
Repayments of other short-term debt	(141,021)	(132,381)	(189,112)	(1,173,220)
Proceeds from long-term debt	89,744	93,732	56,866	746,622
Repayments of long-term debt	(98,378)	(96,606)	(75,321)	(818,452)
Distributions to minority shareholders	(4,536)	(5,841)	(5,989)	(37,737)
Capital contributions from minority shareholders	8,541	589	79	71,057
Purchase of treasury stocks	(664)	(47)	—	(5,524)
Net cash used in financing activities	(5,156)	(8,846)	(62,649)	(42,895)
Effect of exchange rate changes on cash and cash equivalents	(643)	1,874	1,581	(5,349)
Net increase (decrease) in cash and cash equivalents	6,686	(1,333)	(21,284)	55,624
(Decrease) increase in cash resulting from changes in the number of consolidated subsidiaries	(97)	66	18	(807)
Cash and cash equivalents at beginning of year	55,302	56,569	77,835	460,083
Cash and cash equivalents at end of year	¥ 61,891	¥ 55,302	¥ 56,569	\$ 514,900
Supplemental schedule of non-cash transactions				
Conversion of convertible bonds	¥ —	¥ —	¥ 9,882	\$ —

See accompanying notes.

NOTES TO CONSOLIDATED FINANCIAL STATEMENTS

Sumitomo Chemical Company, Limited
Years ended March 31, 2003, 2002 and 2001

1. BASIS OF FINANCIAL STATEMENTS

(a) The Company and its consolidated domestic subsidiaries maintain their official accounting records in Japanese yen and in accordance with the provisions set forth in the Japanese Commercial Code and accounting principles and practices generally accepted in Japan (“Japanese GAAP”). The accounts of overseas subsidiaries are based on their accounting records maintained in conformity with generally accepted accounting principles and practices prevailing in the respective countries of domicile. Certain accounting principles and practices generally accepted in Japan are different from International Accounting Standards and standards in other countries in certain respects as to application and disclosure requirements. Accordingly, the accompanying consolidated financial statements are intended for use by those who are informed about Japanese accounting principles and practices.

The accompanying consolidated financial statements have been restructured and translated into English (with some expanded descriptions and the inclusion of consolidated statements of shareholders’ equity) from the consolidated financial statements of the Company prepared in accordance with Japanese GAAP and filed with the appropriate Local Finance Bureau of the Ministry of Finance as required by the Securities and Exchange Law. Some supplementary information included in the statutory Japanese language consolidated financial statements, but not required for fair presentation is not presented in the accompanying consolidated financial statements.

Certain reclassifications have been made in the previous consolidated financial statements to conform to the presentation for the current year.

(b) The translation of the Japanese yen amounts into U.S. dollars are included solely for the convenience of readers outside Japan, using the prevailing exchange rate at March 31, 2003, which was ¥120.20 to U.S.\$1.00. Such translations should not be construed as representations that the Japanese yen amounts have been, could have been, or could in the future be, converted into U.S. dollars at this or any other rate of exchange.

(c) In these notes, the “Company” means Sumitomo Chemical Company, Limited and the “Companies” means the Company and its consolidated subsidiaries.

2. SIGNIFICANT ACCOUNTING POLICIES

(a) Consolidation

The consolidated financial statements include the accounts of the Company and 110, 102 and 98 significant subsidiaries for the years ended March 31, 2003, 2002 and 2001, respectively. All significant intercompany transactions and accounts have been eliminated. Accounts of subsidiaries whose business year-ends precede that of the Company by more than three months have been included using appropriate interim financial information.

The accompanying consolidated financial statements include the accounts of the Company and significant companies, over which the Company has control through majority voting right or certain other conditions evidencing control by the Company. Investments in non-consolidated subsidiaries and affiliates (generally 20% - 50% ownership), over which the Company has the ability to exercise significant influence over operating and financial policies, are accounted for by the equity method. The equity method is applied to 40, 42 and 45 significant affiliates for the years ended March 31, 2003, 2002 and 2001, respectively.

Excess of cost over equity in net assets acquired is amortized within twenty years.

(b) Foreign currency translation

Foreign currency monetary assets and liabilities are translated into Japanese yen at the current rate at the end of the year and the resulting translation gains or losses are included in earnings.

All assets, liabilities, revenues and expenses of foreign subsidiaries and affiliates are translated into Japanese yen at the current rate at the end of the year and shareholders’ equity at historical rates.

Effective April 1, 2000, the Companies adopted the revised accounting standard for foreign currency translation (“Opinion Concerning Revision of Accounting Standard for Foreign Currency Transactions” issued by the Business Accounting Deliberation Council on October 22, 1999). The adoption had no significant effect on net income. Due to the accounting standard, foreign currency translation adjustments are included in shareholders’ equity and in minority interests.

(c) Allowance for doubtful receivables

The Companies provide for doubtful accounts principally at an amount computed based on the actual ratio of bad debts in the past plus the estimated uncollectible amounts based on the analysis of certain individual receivables.

(d) Securities

Effective April 1, 2000, the Company and its domestic subsidiaries adopted a new accounting standard for financial instruments (“Opinion Concerning Establishment of Accounting Standard for Financial Instrument” issued by the Business Accounting Deliberation Council on January 22, 1999). Upon applying the new accounting standard, all companies are required to examine the intent of holding each security and classify those securities as 1) securities held for trading purposes (“trading securities”), 2) debt securities intended to be held to maturity (“held-to-maturity debt securities”), 3) equity securities issued by subsidiaries and affiliates, and 4) all other securities that are not classified in any of the above categories (“available-for-sale securities”).

The Companies have no trading securities.

Held-to maturity debt securities are stated at amortized cost.

Equity securities issued by subsidiaries and affiliates which are not consolidated or accounted for using the equity method are stated at moving average cost.

Available-for-sale securities whose fair value is readily determinable are stated at fair value as of the end of the year with unrealized gains and losses, net of applicable deferred tax assets/liabilities and minority interests, not reflected in earnings but directly reported as a separate component of shareholders’ equity. Realized gains or losses on sales of such securities are computed using moving-average cost. Debt securities with no available fair market value are stated at amortized cost, net of the amount considered not collectible. Other securities with no available fair market value are stated at moving average cost.

If a decline in fair value below cost of an individual security is judged to be material and other than temporary, the carrying value of the individual security is written down.

(e) Derivatives and hedge accounting

The Companies enter into forward exchange contracts and currency swaps to hedge exchange rate risk associated with monetary items receivable and payable denominated in foreign currencies, interest rate swaps to hedge the risk related to interest on borrowings and reduce financing costs, and commodity forward contracts to manage exposures to fluctuations in market prices of aluminum. The Companies use derivative transactions for hedging market risk and not for speculation or dealing purposes. The Companies have established policies to manage both market and credit risk. In accordance with these policies, the Companies use highly-rated financial institutions and trading companies as counterparties, limit transaction types and amounts and report to the Board of Directors.

The Companies evaluate hedge effectiveness by comparing total cash flow of hedging instruments and hedged items.

The new accounting standard for financial instruments, effective April 1, 2000, required companies to state derivative financial instruments at fair value and to recognize changes in the fair value as gains or losses unless derivative instruments are used for hedging purposes. In accordance with the new accounting standard for financial instruments stated above, the Companies adopted the method which defers gains and losses resulting from changes in fair value of derivative financial instruments until the hedged transactions occur. When a foreign exchange forward contract or foreign currency swap contract meets certain conditions, the hedged item is stated by the forward exchange contract rate. If interest rate swap contracts are used as hedges and meet certain hedging criteria, the net amount to be paid or received under the interest rate swap contract is added to or deducted from the interest on the assets or liabilities for which the swap contract was executed.

(f) Inventories

The Companies’ inventories are stated at the lower of cost or market. Cost is determined by the last-in, first-out (LIFO) method. Inventories of certain consolidated subsidiaries are stated at average cost.

(g) Property, plant and equipment

Property, plant and equipment are carried at cost and depreciated by the declining balance method (straight-line method for certain subsidiaries) over estimated useful lives.

(h) Intangible assets

Goodwill, products registration rights and other intangible assets are amortized on the straight-line method over the estimated useful lives. However, goodwill of the Company is fully amortized at the time of acquisition.

The Company’s U.S. consolidated subsidiaries have adopted SFAS No. 142, “Goodwill and Other Intangible Assets,” in their fiscal year ended December 31, 2002. In accordance with SFAS No. 142, goodwill and other intangible assets that are determined to have an indefinite useful life are not amortized, but must be tested at least annually for impairment.

(i) Impairment of Long-Lived Assets

The Company’s U.S. consolidated subsidiaries have adopted SFAS No. 144, “Accounting for the Impairment or Disposal of Long-Lived Assets,” in their fiscal year ended December 31, 2002. Long-lived assets are evaluated for impairment whenever events or changes in

circumstances indicate that the carrying amount of an asset may not be recoverable. If an asset is considered impaired, the impairment loss to be recognized is measured as the amount by which the asset's carrying amount exceeds its fair value.

(j) Finance leases

Finance leases which do not transfer ownership are accounted for in the same manner as operating leases in accordance with Japanese GAAP. Under Japanese accounting policies for leases, finance leases that deem to transfer ownership of the leased property to the lessee are to be capitalized, while other finance leases are permitted to be accounted for as operating lease transactions if certain "as if capitalized" information is disclosed in the notes to the lessee's financial statements.

(k) Research and development

Expenses relating to research and development activities are charged to income as incurred. Research and development expenses were ¥72,822 million (US\$605,840 thousand), ¥ 66,670 million and ¥ 59,127 million for the years ended March 31, 2003, 2002 and 2001, respectively.

(l) Bond issue expenses

Bond issue expenses are charged to income as incurred.

(m) Income taxes

Income taxes comprise corporation tax, prefectural and municipal inhabitants taxes and enterprise tax.

Deferred taxes are accounted for using the asset and liability method under which deferred tax assets and liabilities are recognized for the future tax consequences of temporary differences between the carrying amount and tax basis of assets and liabilities using enacted tax rates.

(n) Retirement benefits

(i) Employees: The Company has two retirement plans in effect, a lump-sum benefit plan and a defined benefit pension plan. Under the terms of the lump-sum benefit plan, generally all employees are entitled, upon mandatory retirement or earlier voluntary severance, to indemnities based on compensation at the time of severance, and years of service. The Company's defined benefit plan is funded through outside trustees and covers all eligible employees. Certain consolidated subsidiaries also have similar plans.

Effective April 1, 2000 the Company and its domestic consolidated subsidiaries adopted the new accounting standard "Accounting for

Retirement Benefits" ("Opinion Concerning the Establishment of Accounting Standard for Retirement Benefits" issued by the Business Accounting Deliberation Council on June 16, 1998). Under this new accounting standard, the provision for employees' retirement benefits is calculated by subtracting the current value of pension assets from the present value of employees' future retirement benefits, i.e., projected benefit obligation for services rendered to the balance sheet date.

The unamortized net transition obligation at the adoption of the new accounting standard amounting to ¥14,338 million, which included effects of reducing the discount rate to 1.7%, was fully expensed in the year ended March 31, 2001.

(ii) Directors and statutory auditors: The liability for directors' and statutory auditors' retirement benefits of the Company and certain subsidiaries is provided based on the Companies' standards and ¥2,675 million (US\$22,255 thousand) and ¥2,747 million were included in the other non-current liabilities at March 31, 2003 and 2002, respectively.

(o) Net income per 1,000 shares

The computation of net income per 1,000 shares of common stock shown in the consolidated statements of income is based on the weighted average number of shares outstanding during the period and net income available to common shareholders. The computation of dilutive net income per 1,000 shares of common stock is based on the weighted average number of shares of common stock outstanding increased by the number of shares which would have been outstanding assuming the conversion of outstanding dilutive bonds at the beginning of the period. The related interest expense, net of income taxes, has been eliminated for the purposes of this calculation.

Effective April 1, 2002, the Company and its domestic subsidiaries adopted a new accounting standard for earnings per share and related guidance (Accounting Standards Boards Statement No.2, "Accounting Standard for Earnings Per Share" and Financial Standards Implementation Guidance No.4, "Implementation Guidance for Accounting Standard for Earning Per Share", issued by the Accounting Standards Board of Japan on September 25, 2002). The adoption had no significant effect on earnings per share.

(p) Cash and cash equivalents

Cash and cash equivalents include cash on hand, readily-available deposits and short-term investments, which are easily convertible into cash and present insignificant risk of changes in value, with original maturities of three months or less.

3. SECURITIES

Securities with available fair values included in investment securities as of March 31, 2003 were as follows:

Available-for-sale securities

(a) Securities with book values exceeding acquisition cost

	Millions of yen		
	Acquisition cost	Book value	Difference
Equity securities	¥32,431	¥114,784	¥82,353
Bonds	15	15	0
Total	¥32,446	¥114,799	¥82,353

(b) Other securities

	Millions of yen		
	Acquisition cost	Book value	Difference
Equity securities	¥17,248	¥14,379	¥(2,869)

Available-for-sale securities

(a) Securities with book values exceeding acquisition cost

	Thousands of U.S. dollars		
	Acquisition cost	Book value	Difference
Equity securities	\$269,809	\$954,942	\$685,133
Bonds	125	125	0
Total	\$269,934	\$955,067	\$685,133

(b) Other securities

	Thousands of U.S. dollars		
	Acquisition cost	Book value	Difference
Equity securities	\$143,494	\$119,626	\$(23,868)

Securities with no available fair values included in cash equivalents, marketable securities and investment securities as of March 31, 2003 were as follows:

	Millions of yen	Thousands of U.S. dollars
Held-to-maturity debt securities:		
Subordinated bonds and other	¥ 2,280	\$ 18,968
Available-for-sale securities:		
Non-listed equity securities	11,581	96,348
Preferred securities	18,009	149,825
Public and corporate bond investment trusts	60	499
Investment securities in non-consolidated subsidiaries and affiliates	114,414	951,864
Total	¥146,344	\$1,217,504

Available-for-sale securities with maturities and held-to-maturity debt securities at March 31, 2003 were as follows:

	Millions of yen			
	Within one year	Over one year but within five years	Over five years but within ten years	Over ten years
Bonds	¥37	¥105	¥ 106	¥ —
Subordinated bonds and other	32	15	2,000	—
Total	¥69	¥120	¥2,106	¥ —

	Thousands of U.S. dollars			
	Within one year	Over one year but within five years	Over five years but within ten years	Over ten years
Bonds	\$308	\$873	\$ 882	\$ —
Subordinated bonds and other	266	125	16,639	—
Total	\$574	\$998	\$17,521	\$ —

Total sales of available-for-sale securities in the year ended March 31, 2003 amounted to ¥7,170 million (US\$59,651 thousand) and the related gains and losses amounted to ¥3,081 million (US\$25,632 thousand) and ¥1,869 million (US\$15,549 thousand), respectively.

Securities with available fair values included in investment securities as of March 31, 2002 were as follows:

Available-for-sale securities

(a) Securities with book values exceeding acquisition cost

	Millions of yen		
	Acquisition cost	Book value	Difference
Equity securities	¥43,859	¥153,564	¥109,705
Bonds	124	142	18
Total	¥43,983	¥153,706	¥109,723

(b) Other securities

	Millions of yen		
	Acquisition cost	Book value	Difference
Equity securities	¥13,783	¥10,822	¥(2,961)
Bonds and other	15	15	(0)
Total	¥13,798	¥10,837	¥(2,961)

Securities with no available fair values included in cash equivalents, marketable securities and investment securities as of March 31, 2002 were as follows:

	Millions of yen
Held-to-maturity debt securities:	
Subordinated bonds and other	¥ 2,308
Available-for-sale securities:	
Non-listed equity securities	14,340
Preferred securities	18,009
Public and corporate bond investment trusts and other	70
Investment securities in non-consolidated subsidiaries and affiliates	112,474
Total	¥147,201

Available-for-sale securities with maturities and held-to-maturity debt securities at March 31, 2002 were as follows:

	Millions of yen			
	Within one year	Over one year but within five years	Over five years but within ten years	Over ten years
Bonds	¥157	¥131	¥ 106	¥21
Subordinated bonds and other	20	22	2,000	—
Total	¥177	¥153	¥2,106	¥21

Total sales of available-for-sale securities in the year ended March 31, 2002 amounted to ¥18,033 million and the related gains and losses amounted to ¥13,082 million and ¥10 million, respectively.

4. INVESTMENTS IN RELATED COMPANIES

Investments in non-consolidated subsidiaries and affiliates included in the balance sheet at March 31, 2003 and 2002 were as follows:

	Millions of yen		Thousands of U.S. dollars
	2003	2002	2003
Investment securities	¥114,414	¥112,474	\$951,864
Other non-current assets	7,544	4,004	62,762

5. SHORT-TERM DEBT AND LONG-TERM DEBT

Interest rates of short-term bank loans ranged from 0.28% to 13.5% and from 0.33% to 13.75% at March 31, 2003 and 2002, respectively.

Short-term debt at March 31, 2003 and 2002, consisted of the following:

	Millions of yen		Thousands of U.S. dollars
	2003	2002	2003
Bank loans	¥106,714	¥110,102	\$ 887,804
Commercial paper	30,000	17,000	249,584
	¥136,714	¥127,102	\$1,137,388

Long-term debt at March 31, 2003 and 2002, consisted of the following:

	Millions of yen		Thousands of U.S. dollars
	2003	2002	2003
1.7% convertible bonds due 2003, convertible into shares of the Company's common stock at a price of ¥983.20 per share	¥ 19,548	¥ 19,548	\$ 162,629
1.6% convertible bonds due 2004, convertible into shares of the Company's common stock at a price of ¥965.80 per share	19,914	19,914	165,674
0.035%-1.919% Euro notes under medium-term note programs due 2003-2006	16,047	25,974	133,502
0.49%-3.0% debentures due 2003-2012	187,000	197,000	1,555,740
0.248%-7.5% long-term bank loans payable due through 2036	105,941	97,780	881,373
	348,450	360,216	2,898,918
Less amounts due within one year	(76,559)	(70,443)	(636,930)
	¥271,891	¥289,773	\$2,261,988

The aggregate annual maturities of long-term debt subsequent to March 31, 2003, were as follows:

Year ending March 31	Millions of yen	Thousands of U.S. dollars
2004	¥ 76,559	\$ 636,930
2005	57,001	474,218
2006	37,334	310,599
2007	34,076	283,494
2008	32,997	274,517
2009 and thereafter	110,483	919,160
	¥348,450	\$2,898,918

At March 31, 2003, assets pledged as collateral for short-term debt, long-term debt and others were as follows:

	Millions of yen	Thousands of U.S. dollars
Property, plant and equipment, net of accumulated depreciation	¥43,712	\$363,661
Investment securities and other	8,384	69,750
	¥52,096	\$433,411
Liabilities secured thereby	¥21,411	\$178,128

6. LEASES

At March 31, 2003 and 2002, assets leased under non-capitalized financial leases were as follows:

	Millions of yen		Thousands of U.S. dollars
	2003	2002	2003
Machinery and equipment	¥ 9,771	¥8,696	\$ 81,289
Buildings and structures	27	27	225
Less accumulated depreciation and amortization	(4,147)	(4,897)	(34,501)
Total	¥ 5,651	¥ 3,826	\$ 47,013

The above "as if capitalized" depreciation and amortization is calculated on the straight line method over lease terms. If the above leases were capitalized, interest of ¥97 million (US\$807 thousand) and ¥119 million and depreciation and amortization of ¥1,856 million (US\$15,441 thousand) and ¥2,043 million would have been recorded for the years ended March 31, 2003 and 2002, respectively.

Total lease payments under non-capitalized finance leases were ¥1,981 million (US\$16,481 thousand), ¥2,282 million and ¥3,335 million for the years ended March 31, 2003, 2002 and 2001, respectively.

Obligations under finance leases at March 31, 2003 and 2002, were as follows:

	Millions of yen		Thousands of U.S. dollars
	2003	2002	2003
Due within one year	¥1,961	¥1,681	\$16,314
Due after one year	3,781	2,182	31,456
Total	¥5,742	¥3,863	\$47,770

Obligations under operating leases at March 31, 2003 and 2002, were as follows:

	Millions of yen		Thousands of U.S. dollars
	2003	2002	2003
Due within one year	¥1,357	¥ 1,610	\$11,289
Due after one year	8,200	9,672	68,220
Total	¥9,557	¥11,282	\$79,509

7. RETIREMENT BENEFITS

The liabilities for retirement benefits included in the liability section of the consolidated balance sheet as of March 31, 2003 and 2002 consisted of the following:

	Millions of yen		Thousands of U.S. dollars
	2003	2002	2003
Projected retirement benefit obligation	¥(250,696)	¥(248,446)	\$(2,085,657)
Plan assets	161,554	172,450	1,344,043
Unfunded retirement benefit obligation	(89,142)	(75,996)	(741,614)
Unrecognized actuarial changes in assumptions	30,677	18,151	255,217
Unrecognized past period service cost	(43)	(59)	(358)
Provision for employees' retirement benefits	¥ (58,508)	¥ (57,904)	\$ (486,755)

Net periodic costs for the years ended March 31, 2003, 2002 and 2001 were as follows:

	Millions of yen			Thousands of U.S. dollars
	2003	2002	2001	2003
Service cost	¥10,813	¥ 9,268	¥ 9,523	\$ 89,958
Interest cost	4,313	4,254	4,121	35,882
Expected return on retirement benefit plan assets	(2,901)	(2,752)	(2,654)	(24,135)
Net transition obligation	—	—	14,338	—
Amortization of actuarial loss	9,293	5,993	3,328	77,313
Net periodic cost	¥21,518	¥16,763	¥ 28,656	\$ 179,018

The assumptions and basis used for the calculation of retirement benefit obligation were as follows:

Discount rate	mainly 1.7%
Expected return rate for plan assets	mainly 1.7%
Amortization period for actuarial changes	mainly 3 years

The estimated amount of all retirement benefits to be paid at future retirement dates is allocated equally to each service year using the estimated number of total service years.

8. RESTRUCTURING CHARGES

Restructuring charges consisted of the following:

	Millions of yen			Thousands of U.S. dollars
	2003	2002	2001	2003
Loss on disposal of property, plant and equipment	¥2,824	¥1,897	¥ 4,425	\$23,494
Impairment loss on intangible assets in accordance with SFAS No.142 and No.144 (Note 2(h) and (i))	2,573	—	—	21,406
Special severance benefits	540	927	—	4,493
Loss on investments in and loans to related companies	314	2,130	6,892	2,612
Others	172	85	—	1,431
	¥6,423	¥5,039	¥11,317	\$53,436

9. DEFERRED TAXES

Significant components of deferred tax assets and liabilities at March 31, 2003 and 2002 were as follows:

	Millions of yen		Thousands of U.S. dollars
	2003	2002	2003
Depreciation and amortization	¥20,010	¥17,260	\$166,472
Retirement benefits	18,543	16,301	154,268
Accrued bonuses	5,256	3,864	43,727
Inventories	3,596	3,597	29,917
Enterprise tax	2,352	1,164	19,567
Unrealized intercompany profit	2,042	2,617	16,988
Other	23,404	20,489	194,709
Total deferred tax assets	75,203	65,292	625,648
Unrealized gain on investment securities	(30,748)	(42,076)	(255,807)
Deferred gain on property, plant and equipment	(3,763)	(3,287)	(31,306)
Foreign affiliates' undistributed earnings	(2,595)	(984)	(21,589)
Other	(2,498)	(2,242)	(20,782)
Total deferred tax liabilities	(39,604)	(48,589)	(329,484)
Net deferred tax assets	¥35,599	¥16,703	\$296,164

Significant items in the reconciliations of the normal income tax rate to the effective income tax rate for the years ended March 31, 2003, 2002 and 2001 were as follows:

	2003	2002	2001
Normal income tax rate in Japan	40.9%	40.9%	40.9%
Permanently non-deductible expenses	2.7	3.1	2.9
Permanently non-taxable dividends received	(0.8)	(1.8)	(1.4)
Other	(2.0)	(1.8)	(3.8)
Effective income tax rate	40.8%	40.4%	38.6%

Effective for the year commencing on April 1, 2004 or later, according to the revised local tax law, income tax rates for enterprise taxes will be reduced. At March 31, 2003, the Company and its domestic subsidiaries applied the reduced income tax rate for calculating deferred tax assets and liabilities that are expected to be recovered or settled in the years commencing on April 1, 2004 or later. The change of the income tax rates had no significant effect on net income.

10. SHAREHOLDERS' EQUITY

Under the Japanese Commercial Code, the entire amount of the issue price of shares is required to be accounted for as capital, although a company may, by resolution of its board of directors, account for an amount not exceeding one-half of the issue price of the new shares as additional paid-in capital which is included in capital surplus.

The Japanese Commercial Code provides that an amount equal to at least 10% of cash dividends and other cash appropriations shall be appropriated and set aside as a legal reserve until the total amount of legal reserve and additional paid-in capital equals 25% of common stock. The legal reserve is not available for dividends unless the total amount of legal reserve and additional paid-in capital exceeds 25% of common stock. The legal reserve may be used to eliminate or reduce a deficit by resolution of the stockholders or may be capitalized by resolution of the Board of Directors. Legal reserve is included in retained earnings.

Effective April 1, 2002, the Company and its domestic subsidiaries adopted a new accounting standard for treasury stock and reversal of statutory reserves (Accounting Standards Board Statement No.1, "Accounting Standard for Treasury Stock and Reversal of Statutory Reserves", issued by the Accounting Standards Board of Japan on February 21, 2002). The adoption had no significant effect on net income.

11. CONTINGENT LIABILITIES

At March 31, 2003, the Companies were contingently liable as follows:

	Millions of yen	Thousands of U.S. dollars
As endorser of notes discounted or endorsed	¥ 22	\$ 183
As guarantor of indebtedness	19,709	163,969
As issuer of letters of comfort	6,086	50,632
	¥25,795	\$214,601

12. LAND REVALUATION RESERVE

In the year ended March 31, 2000, certain affiliates, accounted for by the equity method, revalued land under the Land Revaluation Law and recorded unrealized gains on revaluation, net of tax, as a revaluation reserve directly in shareholders' equity. Investments in these affiliates increased in an amount equal to the Companies' equity in their reserves, as presented as Land revaluation reserve.

13. SEGMENT INFORMATION

The operations of the Companies for the years ended March 31, 2003, 2002 and 2001 were summarized by product group and geographic area as follows:

Segment information by product group	Millions of yen								Consolidated
	Basic Chemicals	Petrochemicals & Plastics	Fine Chemicals	IT-related Chemicals	Agricultural Chemicals	Pharmaceuticals	Others	Adjustments & Elimination	
Year ended March 31, 2003									
Sales to unaffiliated customers	¥193,217	¥371,597	¥103,532	¥ 82,516	¥158,131	¥168,446	¥ 33,689	¥ —	¥1,111,128
Inter-segment transfers	6,024	6,653	14,160	1,811	1,688	63	97,141	(127,540)	—
Total sales	199,241	378,250	117,692	84,327	159,819	168,509	130,830	(127,540)	1,111,128
Operating cost	193,933	373,339	108,526	83,853	143,255	136,210	125,881	(127,389)	1,037,608
Operating income (loss)	¥ 5,308	¥ 4,911	¥ 9,166	¥ 474	¥ 16,564	¥ 32,299	¥ 4,949	¥ (151)	¥ 73,520
Assets	¥174,566	¥341,216	¥145,284	¥153,247	¥218,993	¥228,483	¥178,607	¥ 43,879	¥1,484,275
Depreciation and amortization	9,217	13,917	10,421	7,390	11,543	9,535	4,910	2,093	69,026
Capital expenditure	19,528	26,069	8,280	29,831	26,526	13,527	21,072	7,168	152,001

Segment information by product group	Millions of yen								Consolidated
	Basic Chemicals	Petrochemicals & Plastics	Fine Chemicals	IT-related Chemicals	Agricultural Chemicals	Pharmaceuticals	Others	Adjustments & Elimination	
Year ended March 31, 2002									
Sales to unaffiliated customers	¥173,836	¥338,556	¥ 99,765	¥ 59,799	¥134,867	¥173,982	¥ 37,547	¥ —	¥1,018,352
Inter-segment transfers	5,375	3,033	13,582	29	1,304	77	80,423	(103,823)	—
Total sales	179,211	341,589	113,347	59,828	136,171	174,059	117,970	(103,823)	1,018,352
Operating cost	176,199	342,031	105,315	66,135	118,262	132,042	113,184	(103,652)	949,516
Operating income (loss)	¥ 3,012	¥ (442)	¥ 8,032	¥ (6,307)	¥ 17,909	¥ 42,017	¥ 4,786	¥ (171)	¥ 68,836
Assets	¥157,058	¥314,039	¥153,992	¥108,020	¥184,018	¥215,129	¥154,745	¥106,158	¥1,393,159
Depreciation and amortization	8,964	14,204	11,105	7,316	20,048	9,462	4,938	3,210	79,247
Capital expenditure	10,564	12,306	10,644	8,414	19,164	4,981	4,846	2,064	72,983

Segment information by product group	Millions of yen								Consolidated
	Basic Chemicals	Petrochemicals & Plastics	Fine Chemicals	IT-related Chemicals	Agricultural Chemicals	Pharmaceuticals	Others	Adjustments & Elimination	
Year ended March 31, 2001									
Sales to unaffiliated customers	¥180,609	¥375,471	¥113,499	¥60,199	¥121,585	¥156,748	¥ 32,839	¥ —	¥1,040,950
Inter-segment transfers	5,954	1,726	10,865	—	755	108	81,558	(100,966)	—
Total sales	186,563	377,197	124,364	60,199	122,340	156,856	114,397	(100,966)	1,040,950
Operating cost	182,027	369,879	116,827	57,054	102,932	118,096	110,540	(101,078)	956,277
Operating income	¥ 4,536	¥ 7,318	¥ 7,537	¥ 3,145	¥ 19,408	¥ 38,760	¥ 3,857	¥ 112	¥ 84,673
Assets	¥165,569	¥326,786	¥162,471	¥97,659	¥160,331	¥201,672	¥164,720	¥176,189	¥1,455,397
Depreciation and amortization	7,961	14,343	11,364	6,159	8,712	7,958	5,273	2,839	64,609
Capital expenditure	6,710	9,481	10,749	5,169	4,393	19,105	3,926	2,605	62,138

Segment information by product group	Thousands of U.S. dollars								Consolidated
	Basic Chemicals	Petrochemicals & Plastics	Fine Chemicals	IT-related Chemicals	Agricultural Chemicals	Pharmaceuticals	Others	Adjustments & Elimination	
Year ended March 31, 2003									
Sales to unaffiliated customers	\$1,607,463	\$3,091,489	\$ 861,331	\$ 686,489	\$1,315,566	\$1,401,381	\$ 280,274	\$ —	\$ 9,243,993
Inter-segment transfers	50,116	55,350	117,804	15,067	14,043	524	808,161	(1,061,065)	—
Total sales	1,657,579	3,146,839	979,135	701,556	1,329,609	1,401,905	1,088,435	(1,061,065)	9,243,993
Operating cost	1,613,419	3,105,982	902,879	697,613	1,191,805	1,133,195	1,047,262	(1,059,809)	8,632,346
Operating income (loss)	\$ 44,160	\$ 40,857	\$ 76,256	\$ 3,943	\$ 137,804	\$ 268,710	\$ 41,173	\$ (1,256)	\$ 611,647
Assets	\$1,452,296	\$2,838,735	\$1,208,686	\$1,274,933	\$1,821,905	\$1,900,857	\$1,485,916	\$ 365,050	\$12,348,378
Depreciation and amortization	76,681	115,782	86,697	61,481	96,032	79,326	40,848	17,413	574,260
Capital expenditure	162,463	216,880	68,885	248,178	220,682	112,537	175,308	59,634	1,264,567

Segment information by geographic area	Millions of yen			
	Domestic Companies	Overseas Companies	Adjustments & Elimination	Consolidated
Year ended March 31, 2003				
Sales to unaffiliated customers	¥ 928,029	¥183,099	¥ —	¥1,111,128
Inter-segment transfers	48,943	18,464	(67,407)	—
Total sales	976,972	201,563	(67,407)	1,111,128
Operating cost	918,157	188,457	(69,006)	1,037,608
Operating income	¥ 58,815	¥ 13,106	¥ 1,599	¥ 73,520
Assets	¥1,231,656	¥200,274	¥ 52,345	¥1,484,275

Segment information by geographic area	Millions of yen			
	Domestic Companies	Overseas Companies	Adjustments & Elimination	Consolidated
Year ended March 31, 2002				
Sales to unaffiliated customers	¥ 857,134	¥161,218	¥ —	¥1,018,352
Inter-segment transfers	41,486	17,869	(59,355)	—
Total sales	898,620	179,087	(59,355)	1,018,352
Operating cost	835,497	171,920	(57,901)	949,516
Operating income	¥ 63,123	¥ 7,167	¥ (1,454)	¥ 68,836
Assets	¥1,094,292	¥175,803	¥123,064	¥1,393,159

Segment information by geographic area	Millions of yen			
	Domestic Companies	Overseas Companies	Adjustments & Elimination	Consolidated
Year ended March 31, 2001				
Sales to unaffiliated customers	¥ 889,332	¥151,618	¥ —	¥1,040,950
Inter-segment transfers	31,874	15,729	(47,603)	—
Total sales	921,206	167,347	(47,603)	1,040,950
Operating cost	844,913	159,569	(48,205)	956,277
Operating income	¥ 76,293	¥ 7,778	¥ 602	¥ 84,673
Assets	¥1,097,843	¥163,300	¥194,254	¥1,455,397

Segment information by geographic area	Thousands of U.S. dollars			
	Domestic Companies	Overseas Companies	Adjustments & Elimination	Consolidated
Year ended March 31, 2003				
Sales to unaffiliated customers	\$ 7,720,707	\$1,523,286	\$ —	\$ 9,243,993
Inter-segment transfers	407,180	153,611	(560,791)	—
Total sales	8,127,887	1,676,897	(560,791)	9,243,993
Operating cost	7,638,578	1,567,862	(574,094)	8,632,346
Operating income	\$ 489,309	\$ 109,035	\$ 13,303	\$ 611,647
Assets	\$10,246,722	\$1,666,173	\$ 435,483	\$12,348,378

Corporate assets of ¥139,994 million (US\$1,164,676 thousand), ¥187,440 million and ¥251,907 million, included in the adjustments and elimination column for the years ended March 31, 2003, 2002 and 2001, respectively, consisted mainly of cash and cash equivalents, investment securities, deferred tax assets, and shared research facilities of the Company.

Overseas operations, which represent sales to unaffiliated customers outside Japan, of the Companies totaled ¥327,427 million (US\$2,724,018 thousand), ¥287,191 million and ¥276,500 million and accounted for 29.5%, 28.2% and 26.6% of the total sales to unaffiliated customers for the years ended March 31, 2003, 2002 and 2001, respectively. Overseas operations in the Asian region were ¥194,178 million (US\$1,615,458 thousand), ¥163,388 million and ¥160,447 million for the years ended March 31, 2003, 2002 and 2001, respectively.

14. SUBSEQUENT EVENTS

At the ordinary shareholders' meeting of the Company held on June 27, 2003, the appropriation of retained earnings at March 31, 2003 was duly approved as follows:

	Millions of yen	Thousands of U.S. dollars
Cash dividends at ¥3.0 (US\$0.025) per share	¥4,962	\$41,281
Bonuses to directors and statutory auditors	129	1,073

INDEPENDENT AUDITORS' REPORT

To the Board of Directors of
Sumitomo Chemical Company, Limited:

We have audited the accompanying consolidated balance sheets of Sumitomo Chemical Company, Limited and subsidiaries as of March 31, 2003 and 2002, and the related consolidated statements of income, shareholders' equity and cash flows for each of the three years in the period ended March 31, 2003, expressed in yen. These consolidated financial statements are the responsibility of the Company's management. Our responsibility is to express an opinion on these consolidated financial statements based on our audits.

We conducted our audits in accordance with auditing standards generally accepted in Japan. Those standards require that we plan and perform the audit to obtain reasonable assurance about whether the financial statements are free of material misstatement. An audit includes examining, on a test basis, evidence supporting the amounts and disclosures in the financial statements. An audit also includes assessing the accounting principles used and significant estimates made by management, as well as evaluating the overall financial statement presentation. We believe that our audits provide a reasonable basis for our opinion.

In our opinion, the consolidated financial statements referred to above present fairly, in all material respects, the consolidated financial position of Sumitomo Chemical Company, Limited and subsidiaries as of March 31, 2003 and 2002, and the consolidated results of their operations and their cash flows for each of the three years in the period ended March 31, 2003, in conformity with accounting principles generally accepted in Japan as described in Note 1 to the consolidated financial statements.

Without qualifying our opinion, we draw attention to the following. As described in Note 2 (b), (d), (e) and (n) to the consolidated financial statements, in the year ended March 31, 2001, Sumitomo Chemical Company, Limited and some of its subsidiaries adopted the revised Japanese accounting standard for foreign currency translation and the new Japanese accounting standards for financial instruments and retirement benefits.

The consolidated financial statements as of and for the year ended March 31, 2003 have been translated into United States dollars solely for the convenience of the reader. We have recomputed the translation and, in our opinion, the consolidated financial statements expressed in yen have been translated into United States dollars on the basis set forth in Note 1 (b) to the consolidated financial statements.



Osaka, Japan
June 27, 2003

SUBSIDIARIES AND AFFILIATES

Company Name	Major Business Fields	Sumitomo Chemical's Share (%)	Telephone	Facsimile
JAPAN				
»AstraZeneca K.K.	Pharmaceuticals	20.0	(6) 6453-7500	(6) 6453-7894
»Asahi Chemical Co., Ltd.	Inorganics	91.4	(6) 6220-8796	(6) 6220-8799
»Ceratec Co., Ltd.	Alumina, ITO and catalysts	100.0	(897) 33-8541	(897) 33-6005
»Dow Kakoh K.K.	Formed polystyrene	35.0	(3) 5460-2351	(3) 5460-6288
»GlaxoSmithKline K.K.	Pharmaceuticals	15.0	(3) 5786-5000	(3) 5786-5200
»Inabata & Co., Ltd.*	Trading in industrial chemicals, fine chemicals, and plastics	24.6	(6) 6267-6051	(6) 6267-6042
»Japan-Singapore Petrochemicals Co., Ltd.	Equity holder in Petrochemical Corporation of Singapore (Pte) Ltd.	53.9	(3) 5543-5867	(3) 5543-5947
»Japan Polystyrene Co., Ltd.	Polystyrene	50.0	(3) 5640-1551	(3) 5640-1573
»Keiyo Ethylene Co., Ltd.	Ethylene and propylene	22.5	(3) 3552-9373	(3) 3552-9443
»Koei Chemical Co., Ltd.*	Formaldehydes and pyridines	56.2	(6) 6204-1515	(6) 6204-1530
»New STI Technology, Inc.	Color filters for LCDs	92.3	(3) 5543-5861	(3) 5543-5937
»Nihon EcoAgro Co., Ltd.	Environment-friendly farm materials	100.0	(3) 5543-5686	(3) 5543-5929
»Nihon Methacryl Monomer Co., Ltd.	Methyl methacrylate monomer and methacrylic acid	80.0	(3) 5543-5302	(3) 5543-5907
»Nihon Medi-Physics Co., Ltd.	Radiopharmaceuticals	50.0	(3) 3234-2910	(3) 3264-6749
»Nihon Oxirane Co., Ltd.	Propylene oxide and styrene monomer	60.0	(3) 3272-0401	(3) 3271-6050
»Nihon Singapore Polyolefin Co., Ltd.	Equity holder in The Polyolefin Company (Singapore) Pte. Ltd.	95.7	(3) 5543-5309	(3) 5543-5911
»Nippon A&L Inc.	ABS resin and SBR latex	67.0	(6) 6220-3633	(6) 6220-3699
»O.L.S. Corp.	Optical functional films	50.0	(3) 5543-5820	(3) 5543-5919
»Rainbow Chemical Co., Ltd.	Agricultural chemicals for home and garden uses	60.0	(3) 3942-5631	(3) 3942-7571
»Shinto Fine Co., Ltd.	Household and public hygiene chemicals	100.0	(6) 6320-4961	(6) 6329-5189
»Shinto Paint Co., Ltd.*	Paints	45.2	(6) 6426-3355	(6) 6429-6188
»Sumika Agrotech Co., Ltd.	Agricultural and horticultural materials	100.0	(6) 6204-1245	(6) 6204-1207
»Sumika Bayer Urethane Co., Ltd.	Polyurethane raw materials	40.0	(6) 6497-2151	(6) 6499-9461
»Sumika Chemtex Co., Ltd.	Dyestuffs and functional chemicals	100.0	(6) 6466-5146	(6) 6466-5457
»Sumika EPI Solution Co., Ltd.	MOEPI wafers	100.0	(436) 61-4771	(436) 61-4746
»Sumika Fine Chemicals Co., Ltd.	Pharmaceutical intermediates, agricultural chemicals, photo chemicals, and imaging chemicals	100.0	(6) 6473-0331	(6) 6474-2468
»Sumika Life Tech Co., Ltd.	Public hygiene materials	100.0	(797) 74-1161	(797) 74-1045
»Sumika Plastech Co., Ltd.	Plastic sheets and films	100.0	(3) 5543-5438	(3) 5543-5935
»Sumika-Takeda Garden Products Co., Ltd.	Agricultural chemicals for home and garden uses	100.0	(3) 3270-9758	(3) 3270-9779
»Sumitomo Bakelite Co., Ltd.*	Resins and resin products	20.8	(3) 5462-4111	(3) 5462-4874
»Sumitomo Chemical Engineering Co., Ltd.	Engineering, procurement, maintenance and construction for chemical plants	100.0	(43) 299-0200	(43) 299-0210
»Sumitomo Chemical Takeda Agro Co., Ltd.	Agrochemicals and agricultural materials	60.0	(3) 3278-2816	(3) 3278-2750
»Sumitomo Dow Ltd.	Polycarbonates	50.0	(3) 3231-0405	(3) 3231-0406
»Sumitomo Joint Electric Power Co., Ltd.	Supply of electricity	52.5	(897) 37-2142	(897) 32-9862
»Sumitomo Mitsui Polyolefin Co., Ltd.	Polyethylene and polypropylene	50.0	(3) 5543-5400	(3) 5543-5994
»Sumitomo Pharmaceuticals Co., Ltd.	Pharmaceuticals	77.8	(6) 6229-5711	(6) 6233-2288
»Sumitomo Seika Chemicals Co., Ltd.*	Industrial chemicals and organic sulfur compounds	30.3	(6) 6220-8508	(6) 6220-8541
»Taoka Chemical Co., Ltd.*	Dyestuffs, industrial chemicals and adhesives	51.0	(6) 6394-1221	(6) 6394-1658

Notes: 1. Colors indicate the following sectors: » Basic Chemicals, Petrochemicals & Plastics » Fine Chemicals, IT-related Chemicals, Agricultural Chemicals, Pharmaceuticals » Others

2. Companies indicated by an asterisk are those listed on stock exchange markets in Japan.

Company Name	Major Business Fields	Sumitomo Chemical's Share (%)	Telephone	Facsimile
SINGAPORE				
»Petrochemical Corporation of Singapore (Pte) Ltd.	Ethylene and propylene	50.0	6291-0911	6291-7661
»Chevron Phillips Singapore Chemicals (Pte) Ltd	High-density polyethylene	20.0	6337-9700	6337-9619
» Sumitomo Chemical Singapore Pte Ltd	Crude acrylic acid, acrylic ester, glacial acrylic acid, super-absorbent polymer, MMA monomer, MMA polymer, household insecticides, dyestuffs and other products.	100.0	6291-2968	6296-3779
»Singapore Acrylic Ester Pte Ltd	Acrylic ester	25.0	—	—
»Singapore Acrylic Pte Ltd	Crude acrylic acid	60.0	—	—
»Singapore Methyl Methacrylate Pte Ltd	MMA monomer and MMA polymer	100.0	—	—
»Sumika Glacial Acrylic Pte Ltd	Glacial acrylic acid	100.0	—	—
»Sumitomo Seika Singapore Pte. Ltd.	Super water-absorbent polymer	20.0	—	—
»The Polyolefin Company (Singapore) Pte. Ltd.	Polyethylene and polypropylene	70.0	6292-9622	6293-8890
ASIA AND OCEANIA				
CHINA				
»Shanghai Lifetech Household Products Co., Ltd.	Products relating to household insecticides	100.0	(21) 6463-4779	(21) 6463-4778
»Shanghai KSC Optical Device Co., Ltd.	Optical functional film	60.0	(21) 5046-2296	(21) 5046-3133
»Shanghai Sumika High Purity Metal, Limited	High purity gallium	70.0	—	—
» Sumitomo Chemical Shanghai Co., Ltd.	Plant protection chemicals and household insecticides	100.0	(21) 5885-7700	(21) 5852-8191
INDIA				
»SC Enviro Agro India Private Limited	Household insecticides	90.0	(25) 25-72172	(25) 25-73332
» Sumitomo Chemical India Private Limited	Chemical products	100.0	(22) 204-0730	(22) 204-0722
SOUTH KOREA				
»Dongwoo Fine-Chem Co., Ltd.	Fine chemicals	90.9	(2) 6250-1100	(2) 6250-1198
»Dongwoo Optical Film Co., Ltd.	Optical functional films	100.0	(31) 618-4162	(31) 680-4161
»Dongwoo STI Co., Ltd.	Color filters for LCDs	100.0	(31) 682-8228	(31) 682-8226
»LG MMA Corp.	Methyl methacrylate	25.0	(2) 3770-1220	(2) 3770-1209
MALAYSIA				
» Sumitomo Chemical Enviro-Agro Asia Pacific Sdn. Bhd.	Household insecticides	100.0	(6) 679-3711	(6) 679-3698
TAIWAN				
»SC-IK Technology Co., Ltd.	Optical functional film	80.0	(7) 364-1316	(7) 364-6994
» Sumitomo Chemical Taiwan Co., Ltd.	Plant protection chemicals	100.0	(2) 2545-6345	(2) 2545-6333
THAILAND				
»Bara Chemical Co., Ltd.	Resins, optical brightening agents, and adhesives	55.0	(2) 709-4598	(2) 323-9997
»Sumipex (Thailand) Co., Ltd.	Polymethyl methacrylate sheets	51.0	(2) 632-1820	(2) 632-1831
AUSTRALIA				
» Sumitomo Chemical Australia Pty. Ltd.	Plant protection chemicals and household insecticides	100.0	(2) 9904-6499	(2) 9904-7499
NEW ZEALAND				
»New Zealand Aluminium Smelters Ltd.	Aluminum ingots	20.6	(3) 218-5999	(3) 218-9747

Notes: 1. Colors indicate the following: » Basic Chemicals, Petrochemicals & Plastics » Fine Chemicals, IT-related Chemicals, Agricultural Chemicals, Pharmaceuticals » Others

2. For those companies in bold type, office addresses, phone numbers, and other information can be found on page 54.

Company Name	Major Business Fields	Sumitomo Chemical's Share (%)	Telephone	Facsimile
AMERICAS				
UNITED STATES				
»Phillips Sumika Polypropylene Co.	Polypropylene	40.2	(713) 289-4847	(713) 289-4175
»Sumika Electronic Materials, Inc.	MOEPI wafers and other IT-related materials	100.0	(602) 659-2500	(602) 438-2277
»Sumika Polymers America Corp.	Plastics	100.0	(212) 572-8200	(212) 572-8234
» Sumitomo Chemical America, Inc.	Chemical products	100.0	(212) 572-8200	(212) 572-8234
» Sumitomo Chemical Capital America, Inc.	Financing	100.0	—	—
»Valent Biosciences Corp.	Plant protection chemicals	100.0	(847) 968-4700	(847) 968-4802
»Valent U.S.A. Corp.	Plant protection chemicals	100.0	(925) 256-2700	(925) 256-2776
MEXICO				
»Valent de Mexico, S.A. de C.V.	Plant protection chemicals	100.0	(3) 110-01-62	(3) 110-17-54
BRAZIL				
» Sumitomo Chemical do Brasil Representações Limitada	Plant protection chemicals and household insecticides	100.0	(11) 3174-0355	(11) 3174-0377
EUROPE AND AFRICA				
BELGIUM				
» Sumitomo Chemical Belgium S.A./N.V.	Chemical products	100.0	(2) 251-0650	(2) 251-2991
FRANCE				
»Philagro France S.A.	Plant protection chemicals	100.0	(478) 64-3227	(478) 47-7128
»Philagro Holding S.A.	Holding company for Philagro France S.A.	60.0	(478) 64-3227	(478) 47-7128
» Sumitomo Chemical Agro Europe S.A.	Plant protection chemicals	100.0	(478) 64-32-60	(478) 47-25-45
GERMANY				
» Sumitomo Chemical Deutschland GmbH	Chemical products	100.0	(211) 518791-0	(211) 518791-40
ITALY				
»Isagro Italia S.r.l.	Plant protection chemicals	50.0	(02) 45280-1	(02) 45280-350
SPAIN				
»Keno Gard S.A.	Plant protection chemicals	65.0	(93) 4481270	(93) 4881889
UNITED KINGDOM				
» Sumitomo Chemical (U.K.) plc	Household insecticides and financing	100.0	(20) 8600-7700	(20) 8600-7717
SOUTH AFRICA				
»Philagro South Africa (Pty) Ltd.	Plant protection chemicals and household insecticides	80.0	(12) 348-8808	(12) 348-3500
»Sumika-Merisol RSA (Pty) Ltd.	Ortho-cresol novolac resins	80.0	(16) 960-3130	(16) 960-3732

Notes: 1. Colors indicate the following: » Basic Chemicals, Petrochemicals & Plastics » Fine Chemicals, IT-related Chemicals, Agricultural Chemicals, Pharmaceuticals » Others

2. For those companies in bold type, office addresses, phone numbers, and other information can be found on page 54.

PRINCIPAL OVERSEAS OPERATIONAL HEADQUARTERS AND OFFICES

Sumitomo Chemical Singapore Pte Ltd

150 Beach Road
#19-05 Gateway West
Singapore 189720
Tel: 6291-2968
Fax: 6296-3779

Sumitomo Chemical Co., Ltd. Beijing Office

1012, Beijing Fortune Bldg.
5 Dong San Huan Bei Lu
Chaoyang District, Beijing 100004
People's Republic of China
Tel: (10) 6590-8542
Fax: (10) 6590-8540

Sumitomo Chemical Shanghai Co., Ltd.

204, CITIC Plaza Pent-Ox Metropolis
1085 Pudong Ave., Shanghai 200135
People's Republic of China
Tel: (21) 5885-7700
Fax: (21) 5852-8191

Sumitomo Chemical Taiwan Co., Ltd.

6F-3, No. 369, Fu-Shing North Road
Taipei, Taiwan, R.O.C.
Tel: (2) 2545-6345
Fax: (2) 2545-6333

Sumitomo Chemical Enviro-Agro Asia Pacific Sdn. Bhd.

Lot 62A, Persiaran Bunga Tanjung 1
Senawang Industrial Park 70400
Seremban Negeri Sembilan Darul
Khusus
Malaysia
Tel: (6) 679-3711
Fax: (6) 679-3698

Sumitomo Chemical India Private Limited

93/9th Floor, Maker Chambers VI, 220
Nariman Point, Mumbai-400 021
India
Tel: (22) 204-0730
Fax: (22) 204-0722

Sumitomo Chemical Australia Pty. Ltd.

501 Victoria Ave.
Chatswood NSW 2067
PO Box 5125, Chatswood, 1515
Australia
Tel: (2) 9904-6499
Fax: (2) 9904-7499

Sumitomo Chemical Co., Ltd. New Zealand Branch

Level 16, ASB Bank Tower
2 Hunter Street, PO Box
2278, Wellington
New Zealand
Tel: (4) 472-4512
Fax: (4) 473-1123

Sumitomo Chemical America, Inc.

New York Head Office
335 Madison Avenue, Suite 830
New York, NY 10017
U.S.A.
Tel: (212) 572-8200
Fax: (212) 572-8234

Houston Office

10077 Grogan's Mill Road, Suite 125
The Woodlands, TX 77380
U.S.A.
Tel: (281) 298-7779
Fax: (281) 362-4103

Sumitomo Chemical Capital America, Inc.

1013 Centre Road
Wilmington, DE 19805
U.S.A.

Sumitomo Chemical do Brasil Representações Limitada

Av. Paulista 854, 11° andar conj. 112
Edifício Top Center, São Paulo, SP
CEP 01311-913, Brazil
Tel: (11) 3174-0355
Fax: (11) 3174-0377

Sumitomo Chemical Belgium S.A./N.V.

Woluwelaan 57
B-1830 Machelen
Belgium
Tel: (2) 251-0650
Fax: (2) 251-2991

Sumitomo Chemical Agro Europe S.A.

2, rue Claude Chappe
69370 Saint Didier au Mont d'Or
France
Tel: (478) 64-32-60
Fax: (478) 47-25-45

Sumitomo Chemical Deutschland GmbH

Georg-Glock-Str.14
D-40474 Düsseldorf
Germany
Tel: (211) 518791-0
Fax: (211) 518791-40

Sumitomo Chemical (U.K.) plc

Horatio House
77-85 Fulham Palace Road
London W6 8JA
U.K.
Tel: (20) 8600-7700
Fax: (20) 8600-7717

INVESTOR INFORMATION AND CORPORATE INFORMATION

(As of March 31, 2003)

NUMBER OF EMPLOYEES:

Non-consolidated: 5,154
Consolidated: 17,906

PAID-IN CAPITAL:

¥89,699 million

CONTACT INFORMATION:

IR & Public Relations Dept.
TEL: +81-3-5543-5102
FAX: +81-3-5543-5901

COMMON STOCK:

Authorized: 5,000,000 thousand shares
Issued: 1,655,446 thousand shares
(Book value: ¥89,699 million)

TRANSFER AGENT AND REGISTRAR:

Sumitomo Trust & Banking Co., Ltd.
Stock Transfer Agency Division
Sumitomo Building, 5-33, Kitahama 4-chome
Chuo-ku, Osaka 541-0041, Japan

NUMBER OF SHAREHOLDERS:

124,281

INDEPENDENT CERTIFIED PUBLIC ACCOUNTANTS:

Asahi & Co.

LISTINGS:

Tokyo, Osaka, Nagoya and Fukuoka

DISTRIBUTION OF SHAREHOLDERS

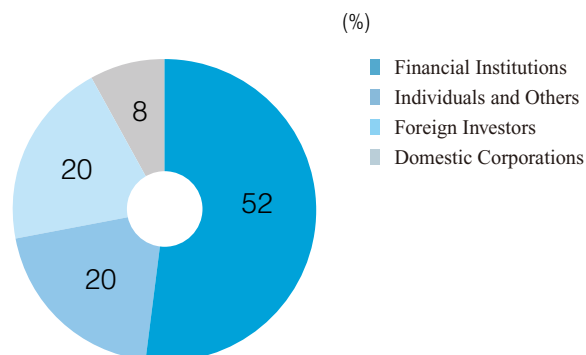

Major Shareholders

Major Shareholders	Number of shares held (1,000 shares)	Shareholding ratio (%)
Sumitomo Life Insurance Company	112,745	6.87
The Master Trust Bank of Japan, Ltd.	112,245	6.84
Japan Trustee Services Bank, Ltd.	93,124	5.68
Nippon Life Insurance Company	90,908	5.54
The Sumitomo Trust & Banking Co., Ltd.	65,066	3.97
Mitsui Asset Trust and Banking Co., Ltd.	47,349	2.89
Sumitomo Mitsui Banking Corporation	45,452	2.77
Trust & Custody Services Bank, Ltd.	34,857	2.12
The Norinchukin Bank	30,025	1.83
UFJ Trust Bank Limited	23,573	1.44

Share Performance of Sumitomo Chemical





Responsible Care

Sumitomo Chemical is a
Responsible Care company.

 **SUMITOMO CHEMICAL COMPANY, LIMITED**

27-1, Shinkawa 2-chome, Chuo-ku, Tokyo 104-8260, Japan

Tel: (3) 5543-5102 Fax: (3) 5543-5901

URL: <http://www.sumitomo-chem.co.jp>

Printed in Japan 03-08IM