



# MC17/MC17T

## Product Reference Guide





**MC17/MC17T**  
**Product Reference Guide**

72E-100467-03

Rev. A

October 2008

© 2007-8 by Motorola, Inc. All rights reserved.

No part of this publication may be reproduced or used in any form, or by any electrical or mechanical means, without permission in writing from Motorola. This includes electronic or mechanical means, such as photocopying, recording, or information storage and retrieval systems. The material in this manual is subject to change without notice.

The software is provided strictly on an “as is” basis. All software, including firmware, furnished to the user is on a licensed basis. Motorola grants to the user a non-transferable and non-exclusive license to use each software or firmware program delivered hereunder (licensed program). Except as noted below, such license may not be assigned, sublicensed, or otherwise transferred by the user without prior written consent of Motorola. No right to copy a licensed program in whole or in part is granted, except as permitted under copyright law. The user shall not modify, merge, or incorporate any form or portion of a licensed program with other program material, create a derivative work from a licensed program, or use a licensed program in a network without written permission from Motorola. The user agrees to maintain Motorola’s copyright notice on the licensed programs delivered hereunder, and to include the same on any authorized copies it makes, in whole or in part. The user agrees not to decompile, disassemble, decode, or reverse engineer any licensed program delivered to the user or any portion thereof.

Motorola reserves the right to make changes to any software or product to improve reliability, function, or design.

Motorola does not assume any product liability arising out of, or in connection with, the application or use of any product, circuit, or application described herein.

No license is granted, either expressly or by implication, estoppel, or otherwise under any Motorola, Inc., intellectual property rights. An implied license only exists for equipment, circuits, and subsystems contained in Motorola products.

MOTOROLA and the Stylized M Logo and Symbol and the Symbol logo are registered in the US Patent & Trademark Office. Bluetooth is a registered trademark of Bluetooth SIG. Microsoft, Windows and ActiveSync are either registered trademarks or trademarks of Microsoft Corporation. All other product or service names are the property of their respective owners.

Motorola, Inc.  
One Motorola Plaza  
Holtsville, New York 11742-1300  
<http://www.motorola.com/enterprisemobility>

---

## Patents

This product is covered by one or more of the patents listed on the web site: [www.motorola.com/enterprisemobility/patents](http://www.motorola.com/enterprisemobility/patents)

---

## Revision History

Changes to the original manual are listed below:

Change	Date	Description
-01 Rev. A	08/27/07	Initial release.
-02 Rev. A	11/16/07	Update battery installation procedures. Add note to wait 1 minute before inserting MC17 into cradle after new battery insertion. Add 802.11d information. Add application battery error message information.
-03 Rev. A	09/08	Add MC17T configuration specific information.



# Table of Contents

Patents.....	ii
Revision History.....	iii

## About This Guide

Introduction.....	xi
Documentation Set.....	xi
Configurations.....	xii
Software Versions.....	xii
OEM Software.....	xiii
Fusion Software.....	xiii
Chapter Descriptions.....	xiv
Notational Conventions.....	xv
Related Documents and Software.....	xv
Service Information.....	xvi

## Chapter 1: Getting Started

Introduction.....	1-1
Unpacking.....	1-1
Features.....	1-2
Accessories.....	1-4
LED Indicators.....	1-5
Keypad.....	1-5
Getting Started.....	1-6
Connecting the Battery.....	1-6
Charging the Battery.....	1-11
Manual Release of MC17 from the Charging Cradle.....	1-12
Software Release of MC17 from the Charging Cradle.....	1-14
Starting the Mobile Computer.....	1-15
Non-Touch and Touch Screens.....	1-16
Data Capture.....	1-16
Scanning Considerations.....	1-16
Scanning Bar Codes.....	1-16
Scanning Tips.....	1-17

LED Indications .....	1-17
Resetting the Mobile Computer .....	1-18
Performing a Warm Boot .....	1-18
Performing a Cold Boot .....	1-18
Replacing the Bezel .....	1-19

**Chapter 2: Staging and Provisioning**

Introduction .....	2-1
Staging .....	2-1
Bar Code Staging .....	2-2
On-Demand Staging .....	2-4
ActiveSync Connection Mode .....	2-4
Already existing IP Connection Mode .....	2-4
Well-known WLAN Connection Mode .....	2-4
RD Client Main Menu .....	2-6
Client Info .....	2-6
Log Menu .....	2-7
View Log .....	2-7
View Job Log .....	2-8
Set Log Level .....	2-8
Set Job Log Level .....	2-9
Package List .....	2-9
Provisioning .....	2-11
MSP Agent .....	2-11
MSP Agent Main Menu .....	2-11
Monitor Processing .....	2-12
Force Check-In .....	2-12
Package List .....	2-12
Client Info .....	2-13
Log Menu .....	2-13
View Log .....	2-14
View Job Log .....	2-14
Set Log Level .....	2-15
Set Job Log Level .....	2-15
Hide UI .....	2-16

**Chapter 3: Wireless Applications**

Introduction .....	3-1
802.11d Overview .....	3-1
Configuring My Country for Use with WLAN on a MC17 .....	3-1
Enabled 802.11d Network .....	3-2
Disabled 802.11d Network .....	3-2
Create WCS Options Registry File .....	3-2
Update MC17 via 802.11d Enabled Staging Network .....	3-3
Connect to the Non-802.11d Network .....	3-3
Wireless Application on the MC17T .....	3-3
Signal Strength Icon .....	3-4
Turning Off the Radio .....	3-5



**Chapter 4: ActiveSync**

ActiveSync .....	4-1
Installing ActiveSync .....	4-1
Mobile Computer Setup .....	4-2
Setting Up an ActiveSync Connection on the Host Computer .....	4-2
Setting up a Partnership .....	4-3

**Chapter 5: Using the Windows CE Desktop**

Introduction .....	5-1
ActiveSync .....	5-1
Remote Control Software .....	5-1
Connection to Host Computer .....	5-1
Development Cable Removal .....	5-5
App Launcher Window .....	5-6
Windows CE 5.0 Desktop .....	5-7
Status Icons .....	5-7
Battery Unknown Icon .....	5-9
Start Button .....	5-9
Programs Menu .....	5-9
Desktop Display Button .....	5-10
Entering Information Using the Keyboard Input Panel .....	5-10
Task Bar and Start Menu Properties .....	5-10
Properties .....	5-10
Advanced Tab .....	5-11
Screen Calibration .....	5-11
Waking the MC17 .....	5-12

**Chapter 6: Special Considerations**

Introduction .....	6-1
Fonts .....	6-1
Asian Font Installation .....	6-2
Software Development Considerations .....	6-2
Tips for Improving Battery Charge Time .....	6-2
Cradle-Backlight Feature .....	6-3
Tips for Improving Battery Life .....	6-3
Changing the Power Settings .....	6-4
Changing the Display Backlight Settings .....	6-4

**Chapter 7: Pocket Browser**

Introduction .....	7-1
Sample Application .....	7-1

**Chapter 8: Cradle Installation**

Introduction .....	8-1
Installation of the Charging Cradle .....	8-1
Removing the Front Cover .....	8-1

Mounting the Cradle .....	8-2
Wiring .....	8-4
Assembly .....	8-6
Cradle Location Bar Code .....	8-7
System Cabling .....	8-8
Mounting the Power Supply Housing .....	8-10

## Chapter 9: Application Deployment

Software Installation on Development PC .....	9-1
Device Configuration Package .....	9-1
Platform SDK .....	9-2
Symbol Mobility Developer Kits .....	9-2
Installing Other Development Software .....	9-2
Deployment .....	9-3
ActiveSync .....	9-3
IPL .....	9-4
Creating Hex Images .....	9-5
Starting Terminal Configuration Manager .....	9-5
Defining Script Properties .....	9-7
Creating the Script for the Hex Image .....	9-8
Opening a New or Existing Script .....	9-8
Updating TCM 1.X Scripts .....	9-8
Copying Components to the Script .....	9-9
Saving the Script .....	9-9
Building the Image .....	9-9
Sending the Hex Image Using IPL .....	9-10
TCM Error Messages .....	9-14
IPL Error Detection .....	9-16
Creating a Splash Screen .....	9-18
Splash Screen Format .....	9-18
OS Update .....	9-19
MC17 .....	9-19
MC17T .....	9-21
Flash Storage .....	9-23
FFS Partitions .....	9-23
Working with FFS Partitions .....	9-23
RegMerge.dll .....	9-23
CopyFiles .....	9-24
Non-FFS Partitions .....	9-24
Downloading Partitions to the Mobile Computer .....	9-25

## Chapter 10: Maintenance and Troubleshooting

Introduction .....	10-1
Maintaining the Mobile Computer .....	10-1
Battery Safety Guidelines .....	10-1
Battery Management .....	10-2
Clearing the Battery .....	10-2
Long Term Storage .....	10-3

Troubleshooting .....	10-4
Mobile Computer .....	10-4
Charging Cradle .....	10-7

## **Appendix A: Technical Specifications**

Technical Specifications .....	A-1
Charging Cradle .....	A-3
Cable Specifications .....	A-6
Power Supply Cable, Y-type .....	A-6
Cradle Interconnection Cable .....	A-6

## **Appendix B: AirBEAM Smart Client**

Introduction .....	B-1
AirBEAM Package Builder .....	B-1
AirBEAM Smart Client .....	B-2
AirBEAM License .....	B-2
Configuring the AirBEAM Smart Client .....	B-2
Packages(1) Tab .....	B-2
Packages(2) Tab .....	B-3
Server Tab .....	B-4
Misc(1) Tab .....	B-4
Misc(2) Tab .....	B-5
Misc(3) Tab .....	B-6
Misc(4) Tab .....	B-7
Synchronizing with the Server .....	B-8
Manual Synchronization .....	B-9
Automatic Synchronization .....	B-9
AirBEAM Staging .....	B-9

## **Appendix C: App Launcher Configuration**

Configuration .....	C-1
---------------------	-----

## **Glossary**

## **Index**



# About This Guide

---

## Introduction

This guide provides information about setting up and configuring MC17 mobile computers and accessories.



**NOTE** Screens and windows pictured in this guide are samples and can differ from actual screens.

## Documentation Set

The documentation set for the MC17 is divided into guides that provide information for specific user needs.

- **MC17/17T Mobile Computer Quick Reference Guide** - describes how to set up the MC17 and MC17T mobile computers.
- **MC17/MC17T Mobile Computer Product Reference Guide** - describes how to set up, operate and program the MC17 mobile computer and the accessories.
- **Microsoft Applications for Windows Mobile and WinCE 5.0 User Guide** - describes how to use Microsoft developed applications.
- **Application Guide for Motorola Enterprise Mobility Devices** - describes how to use Motorola developed applications.
- **EMDK Help File** - provides API information for writing applications.

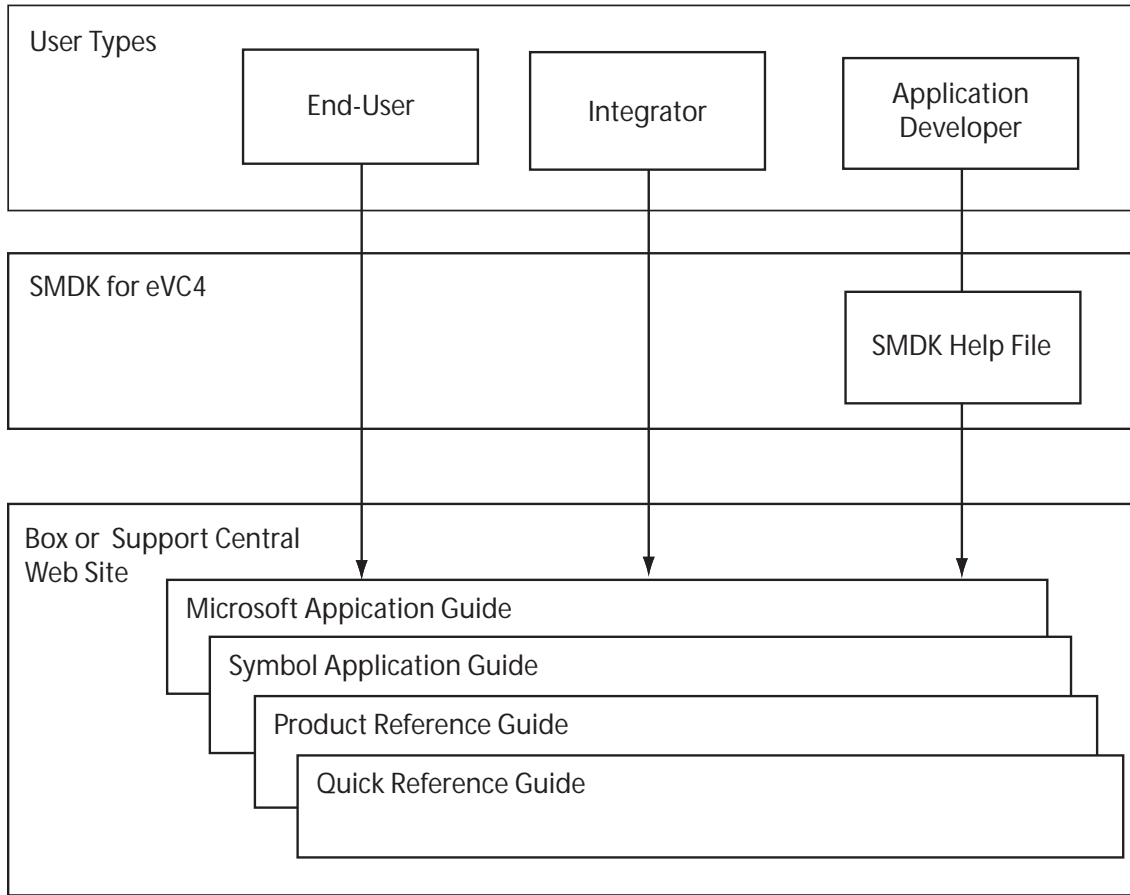

## Configurations

This guide covers the following configurations:

Configuration	Radio	Display	Memory	Data Capture	Operating System	Keypad
MC17-00	WLAN: 802.11b/g	2.8" QVGA Color	64 MB RAM/ 64 MB Flash	Laser scanner	Windows CE 5.0 Professional	6-key
MC17T-00	WLAN: 802.11a/b/g	2.8" QVGA Color touch screen	64 MB RAM/ 64 MB Flash + 1 GB Flash storage	Laser scanner	Windows CE 5.0 Professional	6-key

## Software Versions

This guide covers various software configurations and references are made to operating system or software versions.

## OEM Software

To determine the OEM software version on the MC17:

1. Connect the mobile computer to a host computer using the Development Cable.
2. Connect to the mobile computer using remote control software. See [Remote Control Software on page 5-1](#) for more information.
3. Click **Start > Settings > Control Panel > System Info** icon.

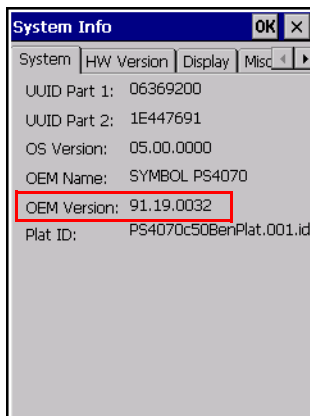

To determine the OEM software version on the MC17T or the MC17 with OEM Version 01.30.06 or greater:

In **App Launcher**, select **3 - Device Info**.

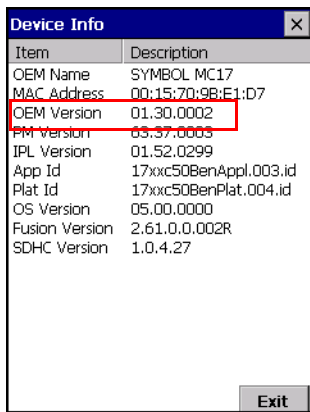

## Fusion Software

To determine the Fusion software version on MC17 with OEM version 01.30.06 or greater:

In **App Launcher**, select **3 - Device Info**.

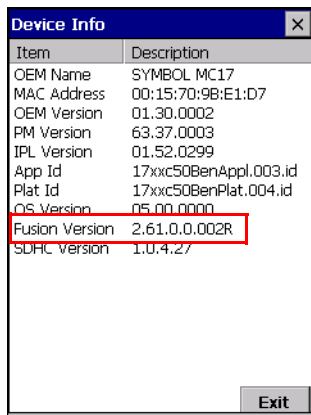

Item	Description
OEM Name	SYMBOL MC17
MAC Address	00:15:70:9B:E1:D7
OEM Version	01.30.0002
PM Version	63.37.0003
IPL Version	01.52.0299
App Id	17xxc50BenAppl.003.id
Plat Id	17xxc50BenPlat.004.id
OS Version	05.00.0000
Fusion Version	2.61.0.0.002R
SDHC Version	1.0.4.27

---

## Chapter Descriptions

Topics covered in this guide are as follows:

- [Chapter 1, Getting Started](#), lists the accessories for the mobile computer and explains how to install and charge the batteries and start the mobile computer for the first time.
- [Chapter 2, Staging and Provisioning](#), provides information for staging and provisioning the mobile computer using Mobility Software Platform (MSP).
- [Chapter 3, Wireless Applications](#), provides instructions for configuring the wireless adapter.
- [Chapter 4, ActiveSync](#), provides instructions on installing ActiveSync and setting up a partnership between the mobile computer and a host computer.
- [Chapter 5, Using the Windows CE Desktop](#), Provides instructions for accessing the OS desktop of the mobile computer.
- [Chapter 6, Special Considerations](#), provides information to consider when using and developing applications for the mobile computer.
- [Chapter 7, Pocket Browser](#), provides instructions for installing ActiveSync and setting up a partnership between the mobile computer and a host computer.
- [Chapter 8, Cradle Installation](#), provides the installation instructions for the Charging cradle and other accessories.
- [Chapter 9, Application Deployment](#), provides instructions for installing the Device Configuration Package (DCP) for MC17x0 and the EMDK for C on the host computer and downloading software and files to the mobile computer.
- [Chapter 10, Maintenance and Troubleshooting](#), includes instructions on cleaning and storing the mobile computer, and provides troubleshooting solutions for potential problems during mobile computer operation.
- [Appendix A, Technical Specifications](#), includes a table listing the technical specifications for the mobile computer and accessories.
- [Appendix B, AirBEAM Smart Client](#), provides information for staging and provisioning the mobile computer using the AirBEAM Smart Client.
- [Appendix C, App Launcher Configuration](#), provides information for configuring the App Launcher application.



---

## Notational Conventions

The following conventions are used in this document:

- “Mobile computer” refers to the Symbol MC17 series of mobile computers.
- *Italics* are used to highlight the following:
  - Chapters and sections in this guide
  - Related documents
- **Bold** text is used to highlight the following:
  - Dialog box, window and screen names
  - Drop-down list and list box names
  - Check box and radio button names
  - Icons on a screen
  - Key names on a keypad
  - Button names on a screen.
- Bullets (•) indicate:
  - Action items
  - Lists of alternatives
  - Lists of required steps that are not necessarily sequential.

Sequential lists (e.g., those that describe step-by-step procedures) appear as numbered lists.



**NOTE** This symbol indicates something of special interest or importance to the reader. Failure to read the note will not result in physical harm to the reader, equipment or data.



**CAUTION** This symbol indicates that if this information is ignored, the possibility of data or material damage may occur.



**WARNING!** This symbol indicates that if this information is ignored the possibility that serious personal injury may occur.

---

## Related Documents and Software

The following documents provide more information about the MC17 mobile computers.

- *MC17 Quick Reference Guide*, p/n 72-100298-xx
- *MC17 STEP User Guide*, p/n 72E-103347-xx
- *Mobility Services Platform 3.X User's Guide*, p/n 72E-100158-xx
- *Application Guide for Motorola Enterprise Mobility Devices*, p/n 72E-68901-xx
- *Microsoft Applications for Windows Mobile and CE 5.0 User Guide*, p/n 72E-78456-xx
- *Symbol Mobility Developer Kits*, available at: <http://www.motorola.com/enterprisemobility/support>

- Device Configuration Package (DCP for MC17xxc50) and Platform SDK for MC17 with Windows CE 5.0, available at: <http://www.motorola.com/enterprisemobility/support>
- Latest ActiveSync software, available at: <http://www.microsoft.com>.

For the latest version of this guide and all guides, go to: <http://www.motorola.com/enterprisemobility/manuals>.

---

## Service Information

If you have a problem with your equipment, contact Motorola Enterprise Mobility Support for your region. Contact information is available at: <http://www.motorola.com/enterprisemobility/contactsupport>.

When contacting Enterprise Mobility Support, please have the following information available:

- Serial number of the unit
- Model number or product name
- Software type and version number.

Motorola responds to calls by E-mail, telephone or fax within the time limits set forth in support agreements.

If your problem cannot be solved by Motorola Enterprise Mobility Support, you may need to return your equipment for servicing and will be given specific directions. Motorola is not responsible for any damages incurred during shipment if the approved shipping container is not used. Shipping the units improperly can possibly void the warranty.

If you purchased your Enterprise Mobility business product from a Motorola business partner, contact that business partner for support.



# Chapter 1 Getting Started

---

## Introduction

This chapter describes the features of the MC17 mobile computer and explains how to install and charge the battery, how to capture data using the integrated laser scanner and how to reset the mobile computer.

---

## Unpacking

Carefully remove all protective material from around the mobile computer and save the shipping container for later storage and shipping.

Verify that box contains all the equipment listed below:

- MC17 mobile computer
- Lithium-ion battery (installed in handle)
- Quick Reference Guide.

Inspect the equipment for damage. If you are missing any equipment or if you find any damaged equipment, contact the Motorola Enterprise Mobility Support immediately. See [Service Information on page xvi](#) for contact information.

## Features

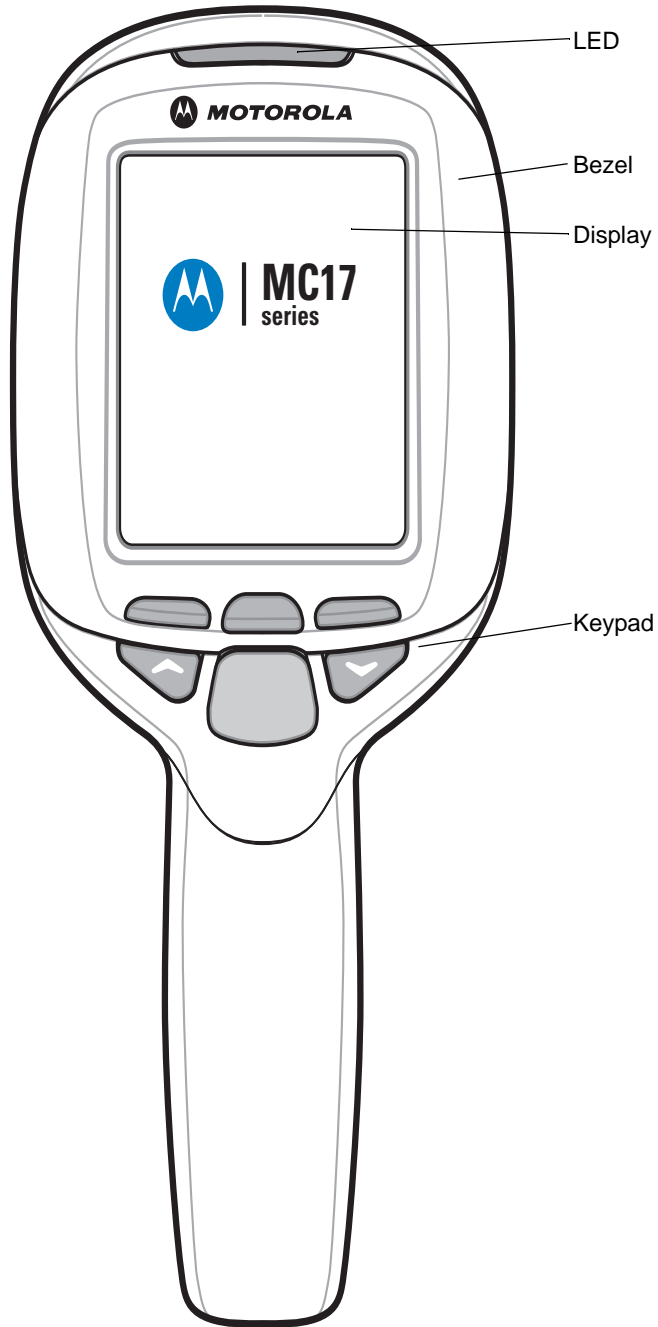
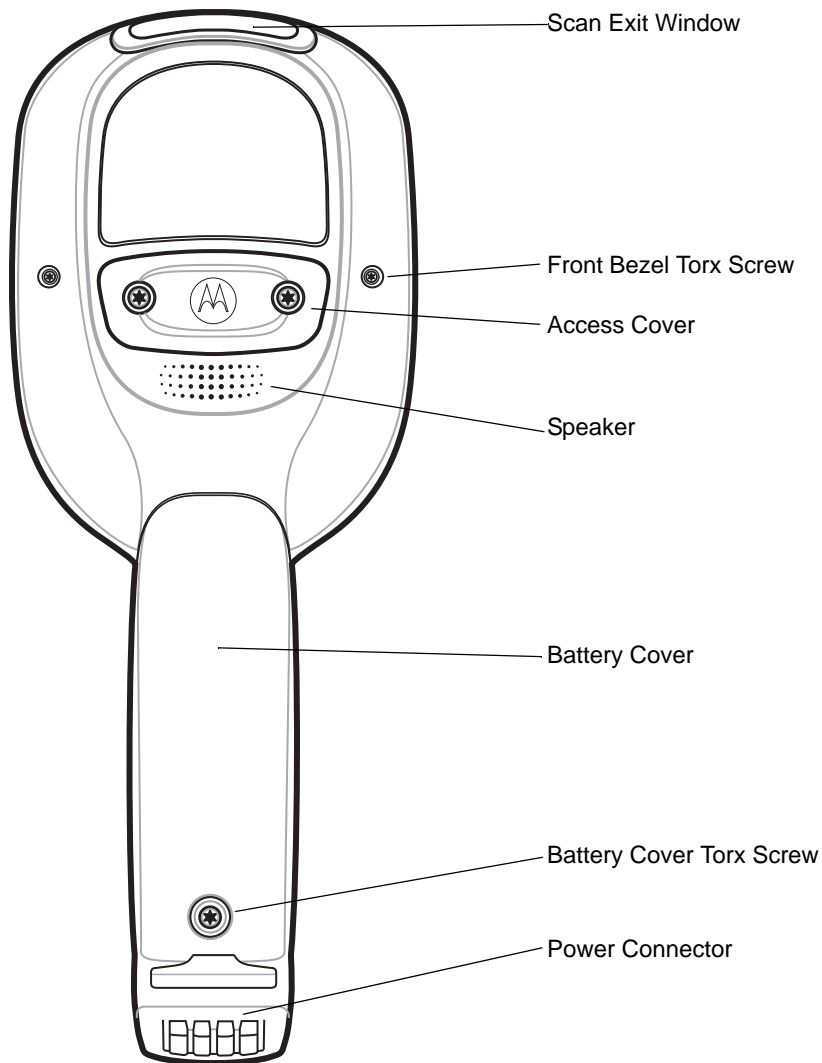

Figure 1-1 Front View



**Figure 1-2** *Back View*

## Accessories

**Table 1-1** *Accessories*

Item	Part Number	Description
Locking Charging Cradle	PSS-3CR01-00R	Provides power and storage for the mobile computer.
Non-Locking Charging Cradle	PSS-3CR01-NLR	Provides power and non-locking storage for the mobile computer.
Cradle Key	PSS-3KY01-00R	Manually releases the mobile computer from the Charging cradle.
Cradle Key Pack	PSS-3KY01-20R	Manually releases the mobile computer from the Charging cradle. (20-pack)
Power Supply	50-14000-241R	Provides power to the Charging cradle.
Power Supply Housing	PSS-3PS04-00R	Encloses the power supply.
Daisy Chain Cable	25-66431-01R	Interconnects two Charging cradles.
Power Cable	25-66420-01R	Connects the power supply to up to six Charging cradle (using the daisy chain cable).
Y-Power Cable	25-67592-01R	Connects the power supply to up to 12 Charging cradles (using the daisy chain cable).
Cradle Location Labels	PSS-3LB02-00R PSS-3LB03-00R PSS-3LB04-00R	Contains "1" - "300" pre-printed bar code labels. Contains six each, "1" - "300" pre-printed bar code labels. Contains "1" - "1000" pre-printed bar code labels.
Development Cable	25-101374-01R	Connects the mobile computer to a host computer along with the USB cable.
USB Cable	25-68596-01R	Connects the mobile computer to a host computer along with the Development cable.
Cart Holder	PSS-3SH01-00R	Provides a mounting solution for the mobile computer on a shopping cart.
Screen Protector Kit	KT-114012-01R	Package of 3 screen protectors.
MC17 Bezel	KT-098273-01R	Package of 50 replacement bezels for the MC17.
MC17T Bezel	KT-098274-00R	Package of 50 replacement bezels for the MC17T.

## LED Indicators

The LED indicates status of the MC17. [Table 1-2](#) describes the LED indications.



Figure 1-3 MC17 LED

Table 1-2 LED Indications

LED State	Indication
Solid red	Scanner is enabled.
Solid green	Bar code decoded successfully.

## Keypad

The keypad contains programmable function keys and a **Scan** key. Note that keypad functions can be changed by an application so the mobile computer's keypad may not function exactly as described. See [Table 1-3 on page 1-6](#). Refer to the *SDMK Help* file for detailed information for programming the function keys.

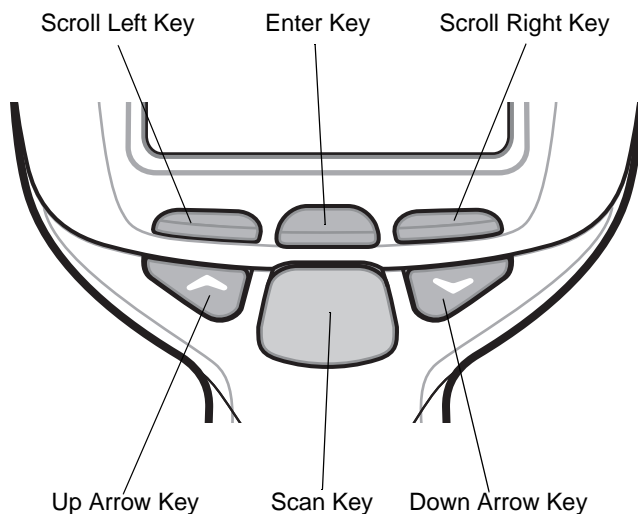

Figure 1-4 Keypad

**Table 1-3** Keypad Descriptions

Key	Description
Scroll Left Key	Moves the cursor focus to the left.
Enter Key	Executes a selected item or function.
Scroll Right Key	Moves the cursor focus to the right.
Up Arrow Key	Moves the cursor focus up.
Scan Key	Enables the laser scanner when a scanning application is active.
Down Arrow Key	Moves the cursor focus down.

---

## Getting Started

In order to start using the mobile computer for the first time:

- Install the battery
- Charge the battery.

---

## Connecting the Battery

Before using the mobile computer for the first time, connect the battery connector to the printed circuit board (PCB) connector.

1. Remove tape securing battery cover to handle.
2. Remove screw from screw hole (under tape).



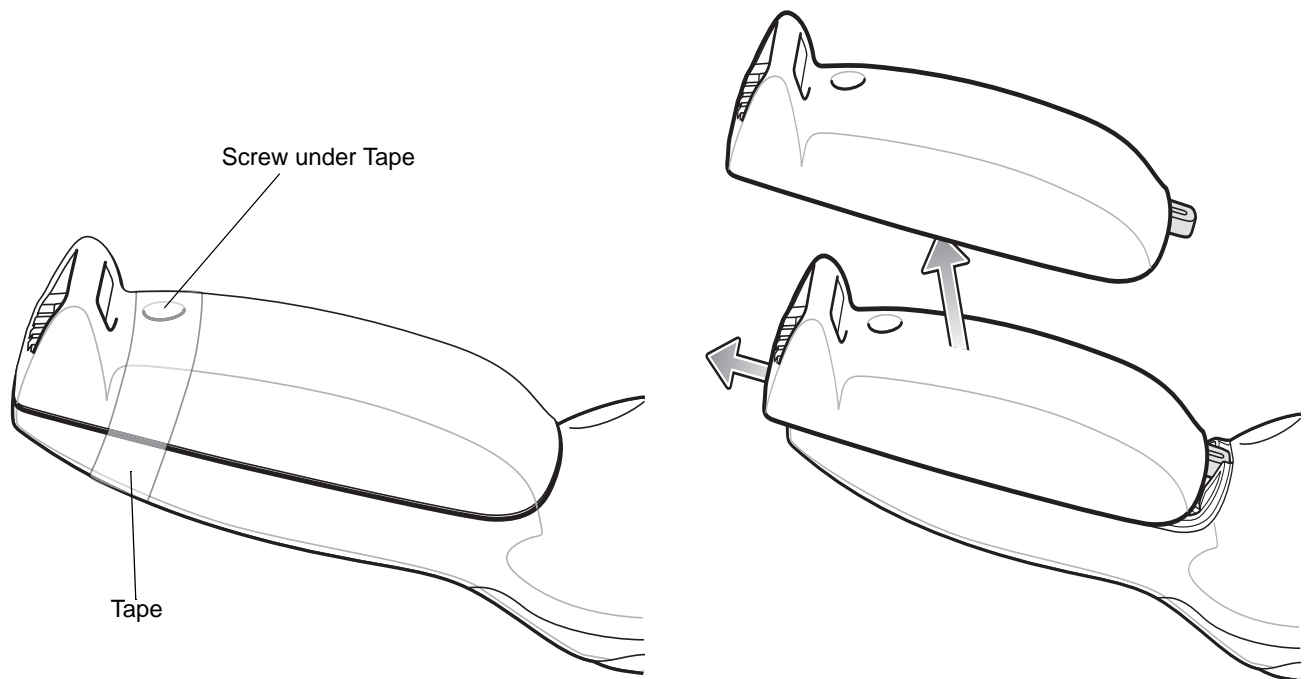

**Figure 1-5** *Remove Battery Cover*

3. Slide the battery cover toward the bottom of the handle.
4. Lift the battery cover.
5. Lift the battery from the battery compartment and support so that the battery wires are not extended.

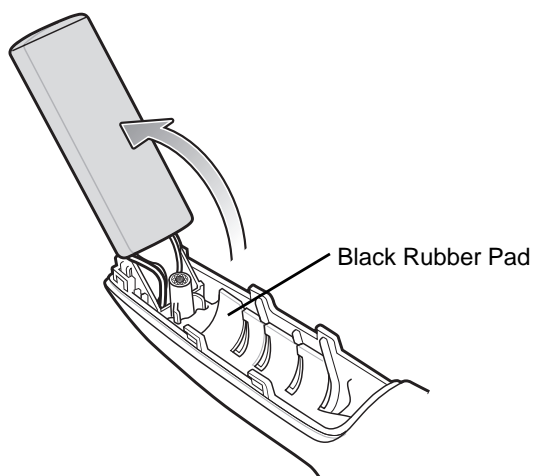

**Figure 1-6** *Remove Battery*

6. Remove the black rubber pad from the battery compartment.
7. Align the harness connector with the connector on the PCB.

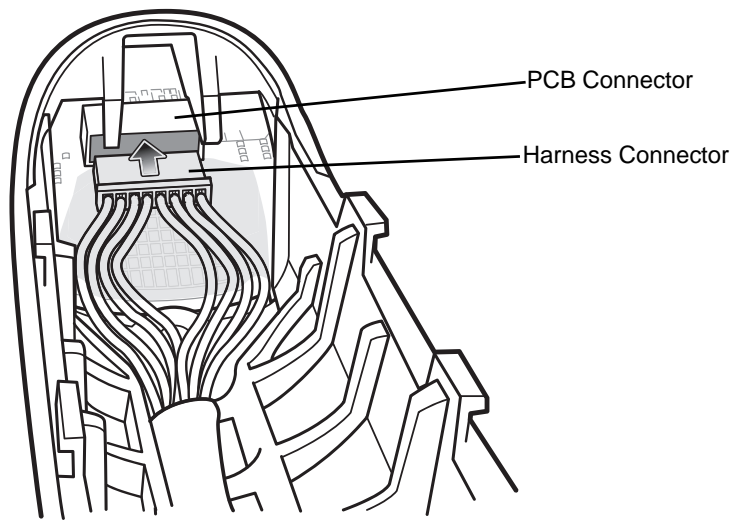

**Figure 1-7** *Align Harness Connector with PCB Connector*

8. Push the harness connector into the PCB connector. Use a plastic tool to ensure that the harness connector is fully seated.
9. Spread the wires out evenly as shown below. Ensure that the wires do not sit on top of the ribs.

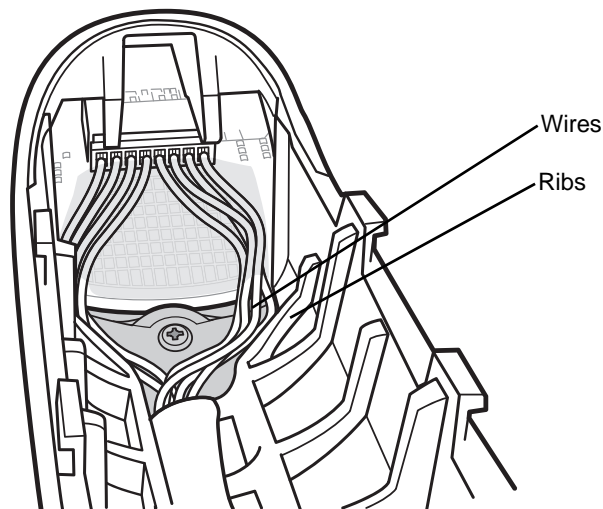

**Figure 1-8** *Spread out Harness Wires*

10. Ensure that the harness connector is fully mated with the PCB connector.
11. Replace the black rubber pad into the compartment ensuring that it is lying flat along the bottom of the compartment, with its smoother side facing up, and the rubber “fingers” straddling the screw boss.

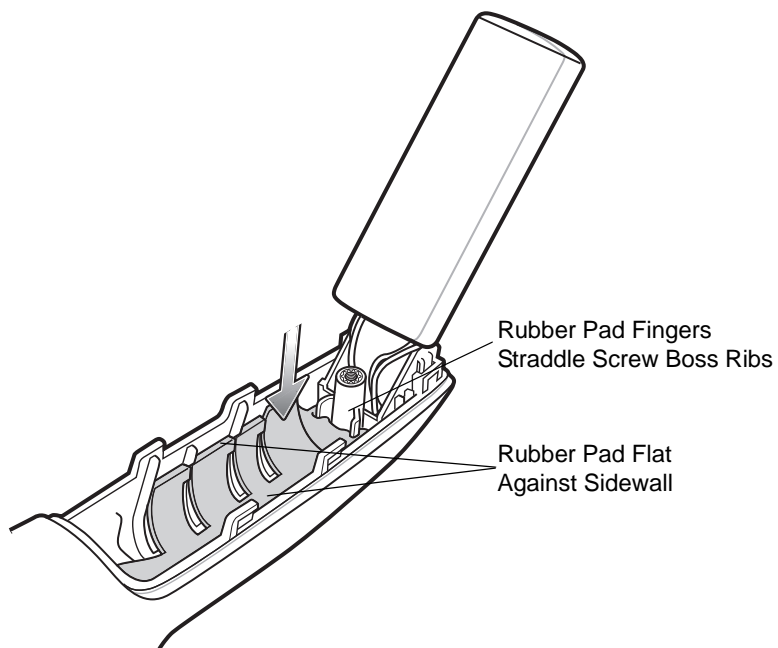

**Figure 1-9** *Proper Placement of Rubber Pad*

12. Place the battery, rounded side down, in the compartment ensuring that the black rubber pad stays in position.

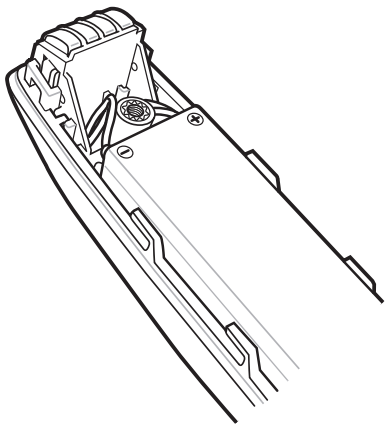

**Figure 1-10** *Place battery in Compartment*

13. Press the wires around the screw boss so that they do not interfere when installing the battery cover.

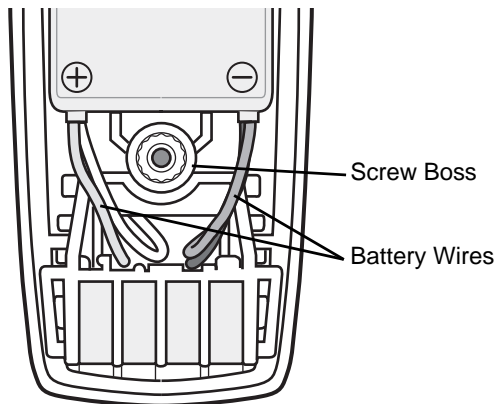

**Figure 1-11** Wires Around Screw Boss

14. Place the battery cover onto the handle and slide it as shown.

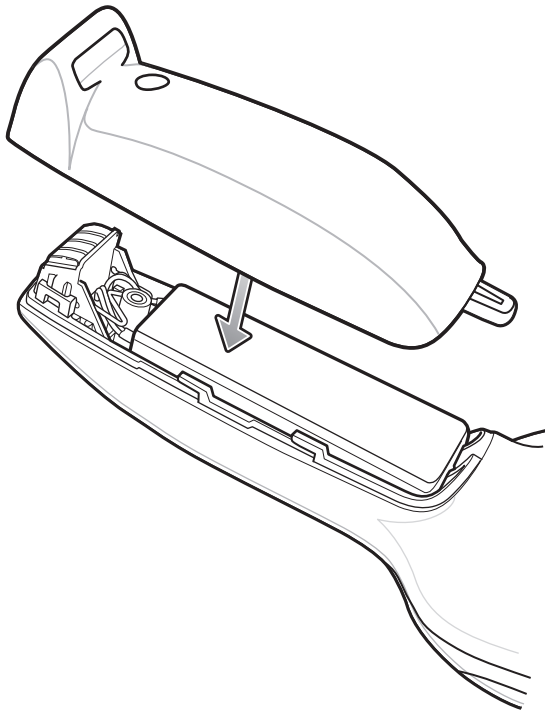

**Figure 1-12** Replace Battery Cover

15. Inspect the position of the battery cover with the main housing. If the door is misaligned, remove battery and black rubber pad and re-install.

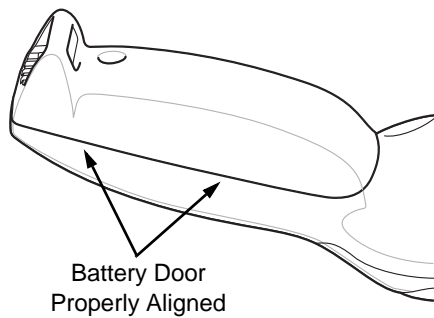

**Figure 1-13** *Inspect Battery Door Alignment*

16. Secure the battery cover with the Torx screw using a T8 Torx drive.

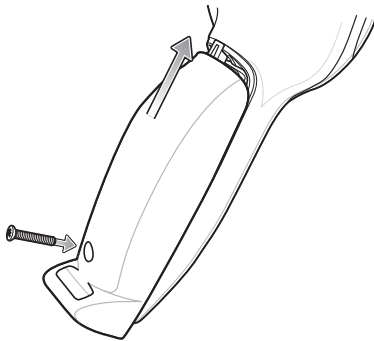

**Figure 1-14** *Secure Battery Cover with Screw*

17. Torque the screw to  $3.3 \pm 0.3$  kgf/cm ( $2.86 \pm 0.26$  in-lbs.).

✓ **NOTE** When installing a new battery or performing an OS Update, wait approximately one minute before inserting the MC17 into a cradle.

18. Run the battery service procedure. See [Clearing the Battery on page 10-2](#) for information.

## Charging the Battery



**CAUTION** Ensure that you follow the guidelines for battery safety described in [Battery Safety Guidelines on page 10-1](#).

✓ **NOTE** Charge time is based upon the following; WLAN radio is set to maximum power mode, WLAN is associated with an Access Point and display backlight set to 25% brightness.

Before using the mobile computer for the first time, charge the battery. The battery fully charges in approximately five hours.

To charge the battery:

1. Ensure the Charging cradle is connected to the appropriate power source. See [Chapter 8, Cradle Installation](#) for more information.
2. Insert the mobile computer into a cradle.

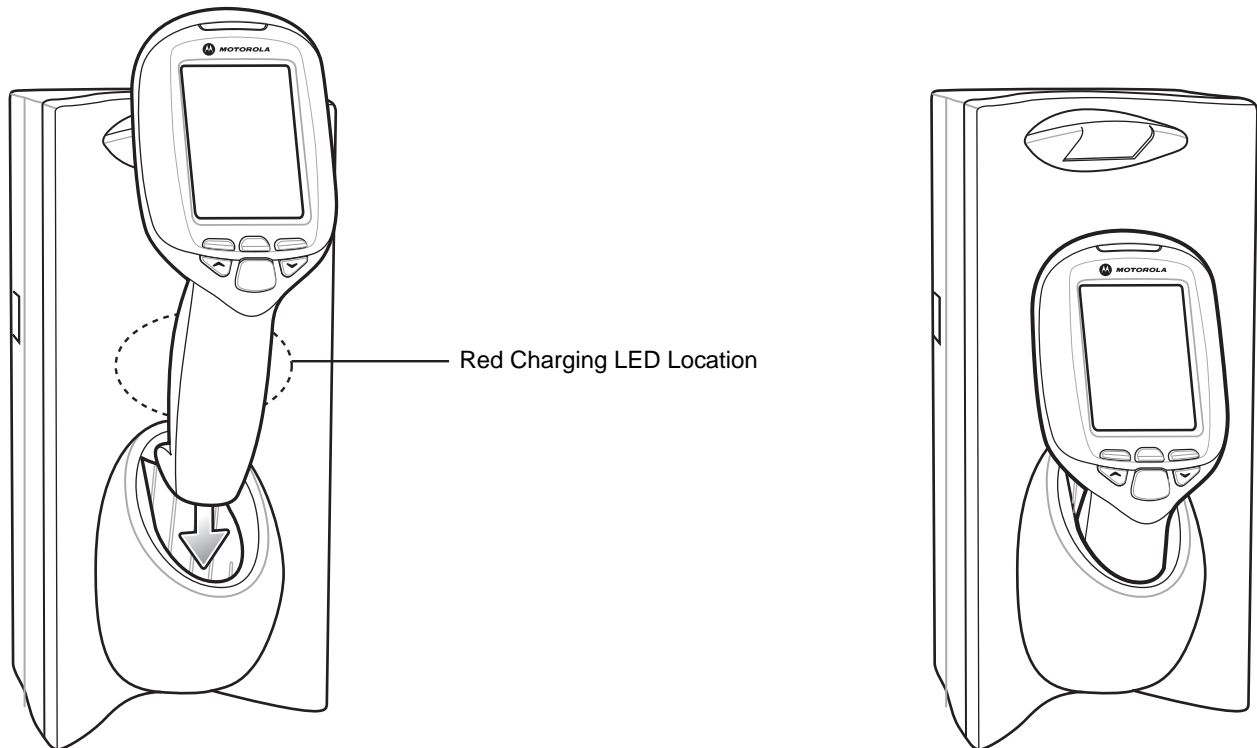

**Figure 1-15** Insert MC17 into Cradle

3. The mobile computer starts to charge automatically. While charging, a red charging LED can be seen through the front panel of the cradle behind the mobile computer.

### Manual Release of MC17 from the Charging Cradle

The Charging cradle, p/n PSS-3CR01-00R, contains a locking mechanism that locks the mobile computer into the cradle. The mobile computer releases from the cradle via a software command to the cradle. If the mobile computer does not have the capability to un-lock the cradle, un-lock it manually using the optional dispenser (cradle) key, (p/n PSS-3KY01-00R).

1. Hold key with hook end pointing to the right.

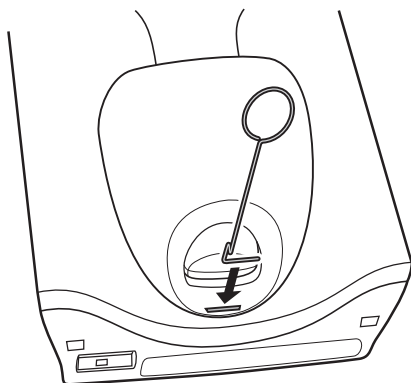

**Figure 1-16** Insert Key

2. Insert key straight into slot, only to point where bend stops on lip of slot.

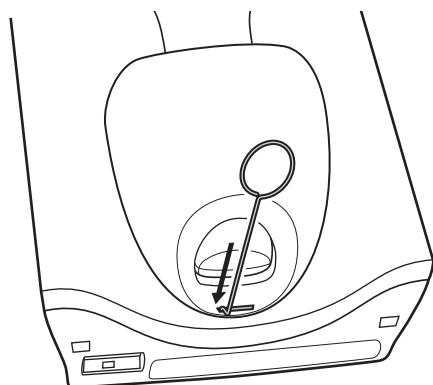

**Figure 1-17** Key

3. Slide key to the right until the handle is centered in the slot.

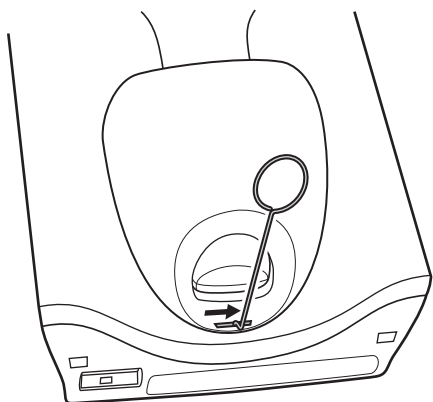

**Figure 1-18** Slide Key to the Right

4. Rotate the key 90 degrees (1/4 turn) counterclockwise.

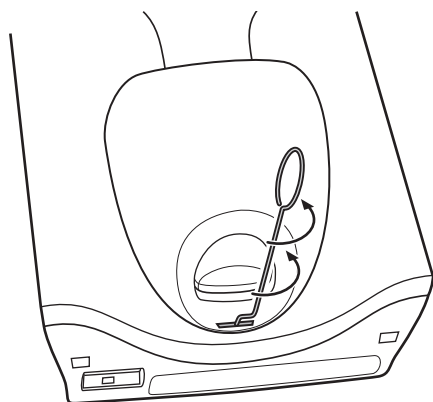

**Figure 1-19** Slide Key to the Rotate Key Counterclockwise

5. Keeping the handle of the key all the way to the right in the slot, press the key into the slot. The end of the key should press on a small spring loaded tab within the cradle and release the mobile computer. You should feel the tab moving as you press down.

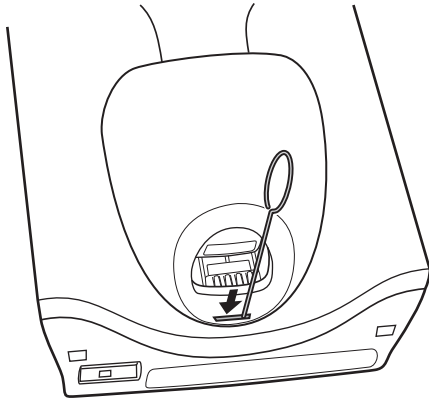

**Figure 1-20** *Press Key into Slot*

6. While holding the key down, lift the mobile computer out of the cradle.

### **Software Release of MC17 from the Charging Cradle**

The Charging cradle, p/n PSS-3CR01-00R, contains a locking mechanism that locks the mobile computer into the cradle. The mobile computer releases from the cradle via a software command to the cradle. See [Chapter 7, Pocket Browser](#) for more information.



## Starting the Mobile Computer

The mobile computer starts automatically as soon as power is applied; either with a charged battery installed or when inserted into the cradle. If the mobile computer does not power on, perform a cold boot. See [Performing a Cold Boot on page 1-18](#).

When the mobile computer is powered on for the first time, it initializes its system. The splash screen ([Figure 1-21](#)) appears for a short period of time.

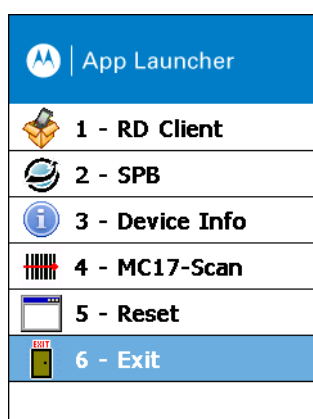

**Figure 1-21** *Splash Screen*

On the MC17, the splash screen is followed by the **App Launcher** window.

On the MC17T, the splash screen is followed by the **Calibration** screen. Carefully press and briefly hold a pointing instrument on the center of each target that appears on the screen. Repeat as the target moves around the screen, then tap the screen to continue. After completing the screen calibration, the **App Launcher** window appears.

✓ **NOTE** App Launcher window may vary depending upon the MC17's operating system version.



**Figure 1-22** *App Launcher Window*

---

## Non-Touch and Touch Screens

The MC17 configurations do not have touch screens. All interactions are performed using the keypad. The MC17T configurations have touch screens. Interactions are performed either with the keypad or by tapping on the screen.

Throughout this guide, the procedures are listed using the keypad for actions. On the MC17T these same procedures can be completed by tapping the buttons or menus on the display whenever supported.

---

## Data Capture

The MC17 uses a laser scanner to allow collection of data by scanning one dimensional bar codes.

The scanner has the following features:

- Reads a variety of bar code symbologies, including the most popular linear, postal, and 1-D code types.
- Contains advanced intuitive laser aiming for easy point-and-shoot operation.

## Scanning Considerations

Typically, scanning is a simple matter of aim, scan/decode and a few quick trial efforts master it. However, two important considerations can be used to optimize any scanning performance:

- Range

Any scanning device decodes well over a particular working range — minimum and maximum distances from the bar code. This range varies according to bar code density and scanning device optics.

Scanning within range brings quick and constant decodes; scanning too close or too far away prevents decodes. Move the mobile computer closer and further away to find the right working range for the bar codes being scanned. However, the situation is complicated by the availability of various integrated scanning modules. The best way to specify the appropriate working range per bar code density is through a chart called a decode zone for each scan module. A decode zone simply plots working range as a function of minimum element widths of bar code symbols.

- Angle

Scanning angle is important for promoting quick decodes. When laser beams reflect directly back into the scanner from the bar code, this specular reflection can “blind” the scanner.

To avoid this, scan the bar code so that the beam does not bounce directly back. But don't scan at too sharp an angle; the scanner needs to collect scattered reflections from the scan to make a successful decode. Practice quickly shows what tolerances to work within.



**NOTE** Contact the Motorola Enterprise Mobility Support if chronic scanning difficulties develop. Decoding of properly printed bar codes should be quick and effortless.

## Scanning Bar Codes

1. Ensure that a scan enabled application is loaded on the mobile computer.
2. Aim the scan exit window at the bar code.
3. Press the **Scan** key.

- Ensure the red scan beam covers the entire bar code. The LED lights red to indicate that the laser is on. The LED changes to green and audible beep might sound, if the application determines, to indicate the bar code was decoded successfully.



**Figure 1-23** Laser Scanner Aiming Pattern

4. Release the trigger.

### Scanning Tips

Optimal scanning distance varies with bar code density and scanner optics.

- Hold the scanner farther away for larger symbols.
- Move the scanner closer for symbols with bars that are close together.

✓ **NOTE** Scanning procedures depend on the application and mobile computer configuration. An application may use different scanning procedures from the one listed above.

### LED Indications

The LED on the mobile computer provides a visual indication of the scan status.

**Table 1-4** LED Indicators

LED Status	Indication
Off	Not scanning.
Solid red	Laser enabled, scanning in process.
Solid green	Successful decode.

---

## Resetting the Mobile Computer

There are two types of resets, warm boot and cold boot. A warm boot restarts the mobile computer by closing all running programs.

Perform a warm boot first. This restarts the mobile computer and saves all *stored* records and entries. If the mobile computer still does not respond, perform a cold boot.

A cold boot restarts the mobile computer, but erases all stored records and entries in RAM. Data saved in flash memory is not lost. In addition it returns formats, preferences, time zone information and other settings to the factory default settings except for the real-time clock.

### Performing a Warm Boot

To perform a warm boot, press and simultaneously hold the Up Arrow and the Down Arrow keys for 10 seconds and then press the Scan key. Release the Up Arrow and the Down Arrow keys. Wait one second and then release the Scan key.

### Performing a Cold Boot

A cold boot restarts the mobile computer and erases all user stored records and entries that are not saved in flash memory (Application and Platform folders). *Never perform a cold boot unless a warm boot does not solve the problem.*



**NOTE** Any data previously synchronized with a computer can be restored during the next ActiveSync operation.

To perform a cold boot, press and simultaneously hold the Up Arrow and Down Arrow keys for 10 seconds and then press and hold the Scan key. Release the Up and Down Arrow keys and continue to hold the Scan key until the display turns off. Release the Scan key.

---

## Replacing the Bezel

The plastic bezel that covers the display can be replaced if broken or to install a customer specific bezel.

1. Place the mobile computer on a desktop with the display facing down.
2. Using a T6 Torx drive, remove two screws securing the bezel to the housing.

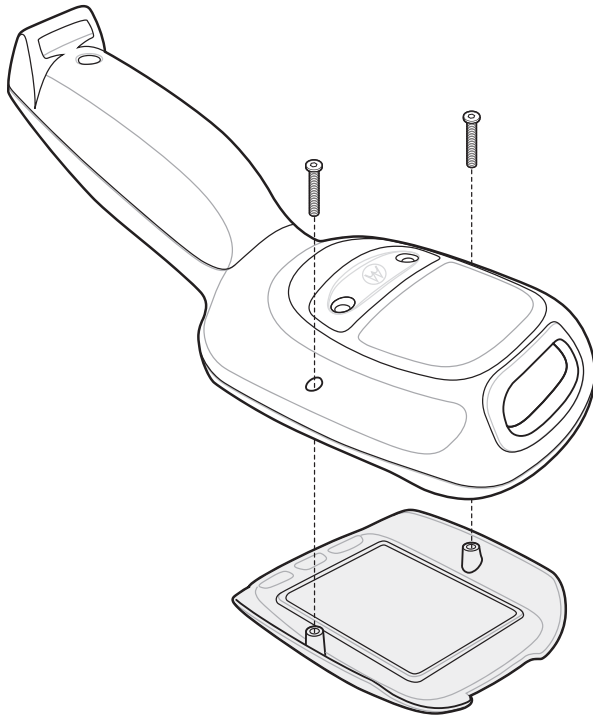

**Figure 1-24** *Bezel Removal*

3. Align the replacement bezel on the housing.
4. Using a T6 Torx drive, secure the bezel to the housing using the two Torx screws.
5. Torque the screws to  $2.5 \pm 0.2$  kgf/cm ( $2.17 \pm 0.17$  in-lbs.).



# Chapter 2 Staging and Provisioning

---

## Introduction

This chapter describes how to stage and provision mobile computers using Mobility Services Platform (MSP) 3.X.

---

## Staging

Staging is the process of setting up the mobile computer to download packages for provisioning. The mobile computer uses the Rapid Deployment (RD) Client for staging.

The RD Client enables simple and rapid provisioning of new (out of the box) mobile computers and simplifies the out-of-box provisioning by scanning bar codes or connecting to a profile server. The RD Client acts as a frontend for wireless radio configuration and AirBEAM Smart components, automating the manual configurations that would normally be required to use these tools.

- ✓ **NOTE** The MSP 3.0 Rapid Deployment Client enables staging by scanning staging profiles encoded into staging bar code sheets. It also enables staging to be performed without scanning bar codes through the use of On-Demand Staging. When using On-Demand Staging, the RD Client pulls staging profiles directly from an On-Demand Profile Server over some form of pre-configured or automatically-configured IP connection.

For detailed information about the MSP 3.X, refer to the *Mobility Services Platform 3.X User's Guide*.

An MSP Administrator uses the MSP Console for the creation of an RD profile that contains all the wireless network and security information (for example, ESSID, WEP Keys, etc.) required to get a mobile computer onto the wireless network. The profile also contains FTP server access information needed to connect to the provisioning MSP and the list of software packages to be provisioned to the mobile computer from the provisioning MSP. The RD profile can then be encoded into an RD bar code sheet and printed from the MSP Console or loaded onto a profile server.

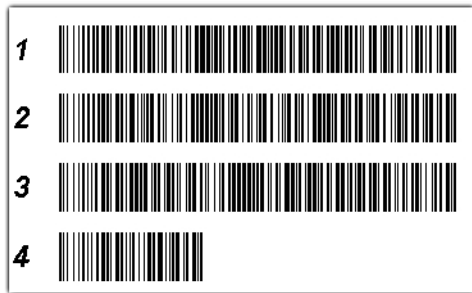

Figure 2-1 RD Bar Code Printout Sample

## Bar Code Staging

When the mobile computer boots for the first time (or after a cold boot) the **App Launcher** window appears. The **RD Client** option is highlighted.

✓ **NOTE** If the **App Launcher** screen does not display see your administrator.

1. Obtain the appropriate RD bar code sheet from the MSP Administrator.
2. Press the **Enter** key to launch the **RD Client**. The **Scan Barcodes To Deploy** window displays.

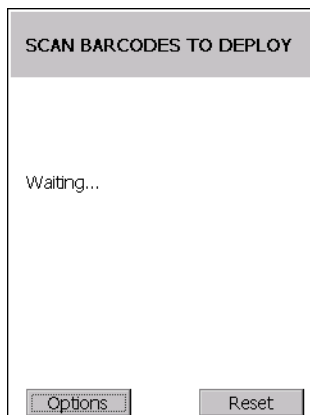

Figure 2-2 Waiting for Bar Codes

The **RD Client** waits for the first bar code scan.

3. Scan the first bar code. The window indicates which bar code to scan next.

✓ **NOTE** Multi-part linear bar codes (1-D bar codes) can require scanning several bar codes. Bar codes can be scanned in any order. The display indicate the bar code to scan.



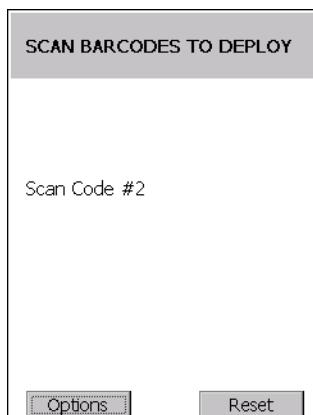

**Figure 2-3** *Rapid Deployment Window - Scanning Bar Codes*

4. After all the bar codes are scanned successfully, the mobile computer connects to the server and the **PROCESSING PROFILE** window displays while network settings are configured.

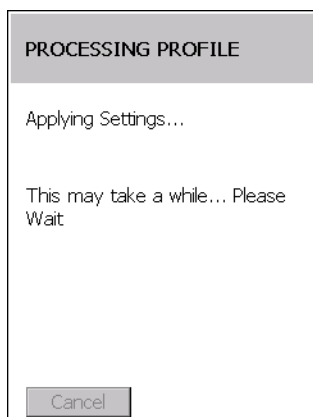

**Figure 2-4** *Rapid Deployment Window - Processing Profile*

5. When staging is complete the **STAGING COMPLETE** window displays.

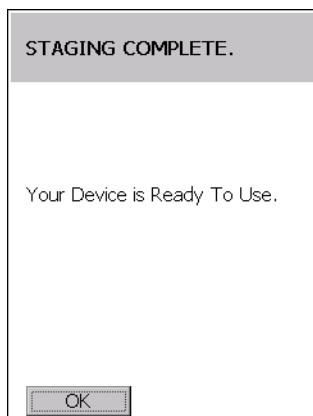

**Figure 2-5** *Staging Complete Window*

6. Press the left function key to exit the **RD Client**.

## On-Demand Staging

The MSP 3.0 **RD Client** also enables staging without having to scan bar codes through the use of On-Demand Staging (Electronic Staging).

When using On-Demand Staging, the RD Client pulls staging profiles directly from an On-Demand Profile Server over some form of pre-configured or automatically-configured IP connection. The following types of IP connection modes are currently supported for Electronic Staging:

### ActiveSync Connection Mode

This mode uses the IP connection that is established when the mobile computer is directly connected (via a USB cable, serial cable or cradle) to a host computer running ActiveSync. The most common scenario would be where the On-Demand Profile Server is running on the host computer to which the mobile computer is connected via ActiveSync. It would, however, also work with the On-Demand Profile Server running on any other host computer that is on the same subnet as the host computer to which the mobile computer is connected via ActiveSync.

### Already existing IP Connection Mode

This mode uses any IP connection that is already active on the mobile computer. This could be a direct Ethernet port (if available), or a WLAN connection that was configured and established before the **RD Client** was launched. It could also be any other form of IP connection that might be available on the mobile computer. The **RD Client** does not do anything to configure or establish such connections, but uses them if they exist. The On-Demand Profile Server must be running on a host computer that is on the same subnet that is accessible from the connection.

### Well-known WLAN Connection Mode

This mode works only on supported Motorola WLAN adapters. The **RD Client** attempts to configure and establish WLAN IP connections using pre-defined Motorola WLAN settings. If the **RD Client** is able to successfully configure and establish such a connection, and if an On-Demand Profile Server is running on a host computer that is on the same subnet that is accessible from the connection, then Electronic Staging proceeds using that connection.

To perform On-Demand Staging:

1. In the **App Launcher** menu, press the center function key to launch the **RD Client**. The **Scan Barcodes To Deploy** window displays.

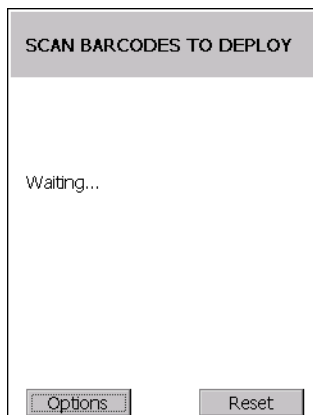

**Figure 2-6** *Waiting for Bar Codes*

2. Press the left function key to select **Options**. The **Main Menu** window appears.

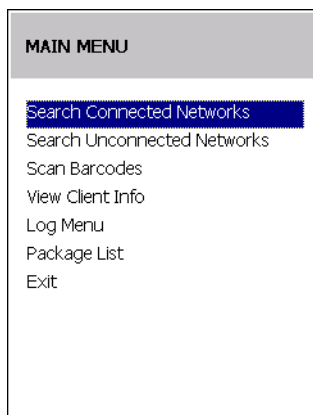

**Figure 2-7** RD Client Main Menu

- Use the up/down arrow keys to select **Search Connected Networks** or **Search Unconnected Networks** and then press the center function key. The **SEARCHING NETWORKS** window appears.

Connected networks are networks that are already connected and can be checked to see if a Staging Server can be found. Unconnected Networks are the well-known WLAN connections that are automatically configured and established to see if a Staging Server can be found.

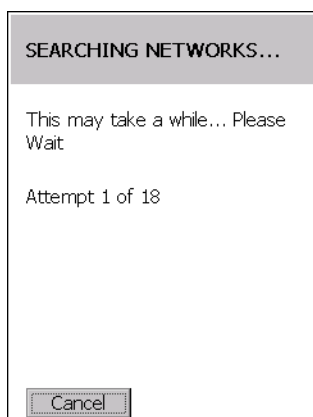

**Figure 2-8** RD Client Searching for On-Demand Profile Server

- When complete, the **STAGING COMPLETE** window displays.

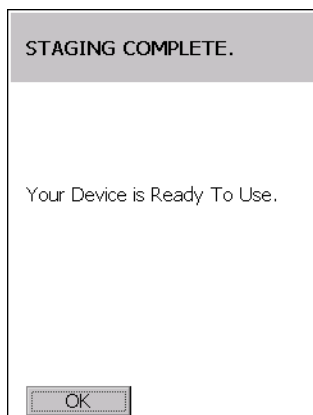

**Figure 2-9** Staging Complete Window

Press the left function key to exit.

## RD Client Main Menu

The RD Client **Main Menu** contains the following options:

- Search Connected Networks. See [On-Demand Staging on page 2-4](#) for detailed information.
- Search Unconnected Networks. See [On-Demand Staging on page 2-4](#) for detailed information.
- Scan Barcodes See [Bar Code Staging on page 2-2](#) for detailed information.
- View Client Info
- Log Menu
- Package List
- Exit - Closes the RD Client application.

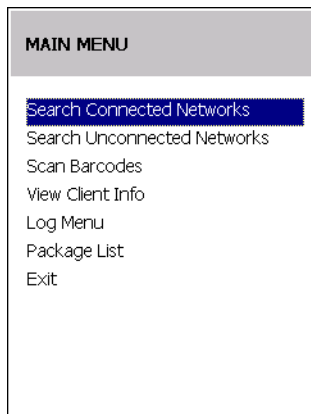

**Figure 2-10** RD Client Main Menu

## Client Info

Use the **Client Info** window to view the following information:

- RD Client version
- Product name
- Operating system type
- Plug-in type.

Use the up/down arrow keys to select **View Client Info** option and press the center function key.

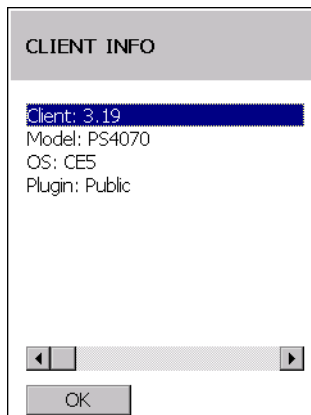

**Figure 2-11** *Client Info Window*

Press the left function key to return to the **Main Menu**.

## Log Menu

The **Log Menu** contains the following options:

- View Log
- View Job Log
- Set Log Level
- Set Job Log Level.

Use the up/down arrow keys to select **Log Menu** option and press the center function key.

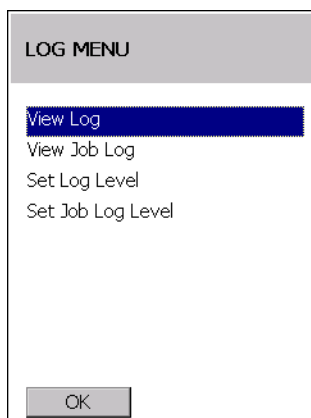

**Figure 2-12** *Log Menu Window*

Press the left function key to return to the **Main Menu**.

## View Log

Use the **View Log** option to display a list of events that have occurred.

Use the up/down arrow keys to select **View Log** option and press the center function key.

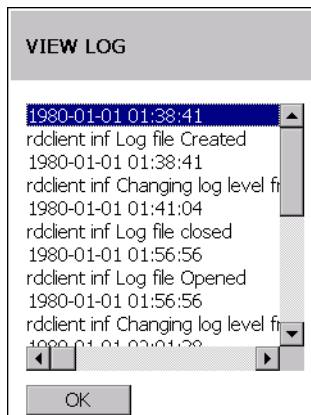

**Figure 2-13** *View Log Window*

Press the left function key to return to the **Log Menu**.

### View Job Log

Use the **View Job Log** option to display a list of jobs that have be processed.

Use the up/down arrow keys to select **View Job Log** option and press the center function key.

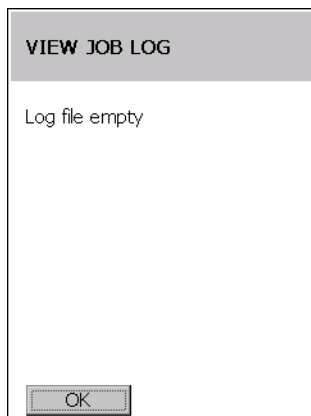
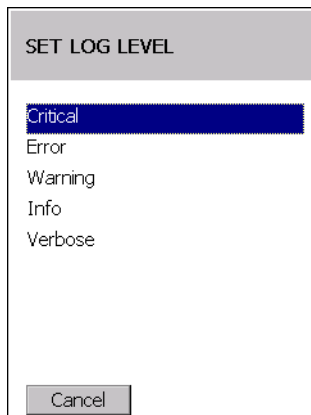

**Figure 2-14** *View Job Log Window*

Press the left function key to return to the **Log Menu**.

### Set Log Level

Use the **Set Log Level** option to set the level of the information that appears in the log.

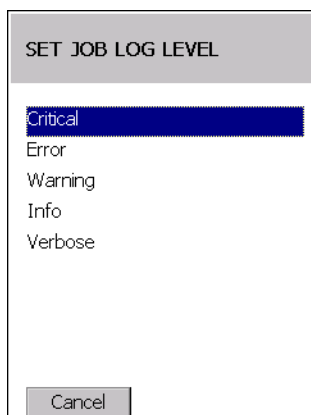

**Figure 2-15** *Set Log Level Window*

Use the up/down arrow keys to select a level option and press the center function key.

### **Set Job Log Level**

Use the **Set Job Log Level** option to set the level of the information that appears in the Job log.



**Figure 2-16** *Set Job Log Level Window*

Use the up/down arrow keys to select a level option and press the center function key.

### **Package List**

Use the **Package List** option to display the packages that have been installed on the mobile computer.

Use the up/down arrow keys to select the **Package List** option and press the center function key.

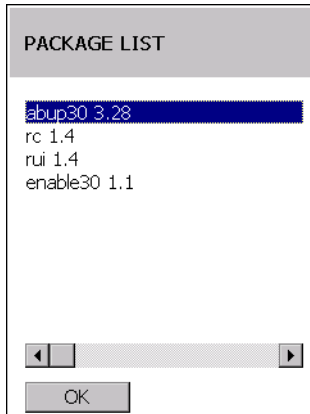

**Figure 2-17** *Package List Window*

Press the left function key to return to the **Main Menu**.



---

## Provisioning

Provisioning is the process of installing software packages onto mobile computers.

### MSP Agent

✓ **NOTE** MSP Agent is also known as MSP 3.X Provisioning Client.

The Provisioning Client is responsible for implementing device-side provisioning activities as defined by a policy. A policy is evaluated on the MSP 3.X system and delivered to mobile computers as job documents via relay servers.

The MSP 3.X Provisioning Client is 100% backward compatible to prior versions of the AirBEAM Client. Existing AirBEAM Smart users can use the MSP 3.X Provisioning Client as a 100% backward compatible replacement for prior versions of AirBEAM Client, when used in classic AirBEAM mode with existing FTP servers.

Existing MSP 2.X users can use the new Provisioning Client as a 100% backward compatible replacement for previous versions of AirBEAM Client, when used in Level 2 Agent and Level 3 Agent modes with existing MSP 2.X Appliances.

For more detailed information on MSP Agent (Provisioning Client), refer to the MSP 3.X User's Guide (p/n 72E-100158-xx).

### MSP Agent Main Menu

The MSP Agent **Main Menu** contains the following options:

- Monitoring Processing
- Force Check-In
- Package List
- View Client info
- Log Menu
- Hide UI
- Exit - exits the MSP Agent application.

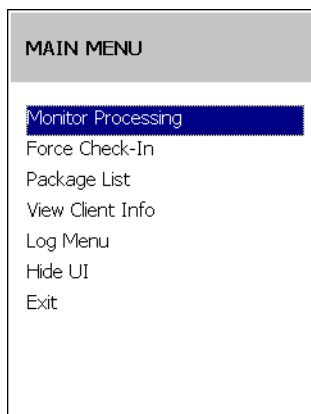
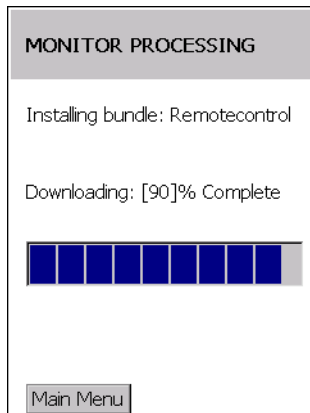

**Figure 2-18** MSP Agent Main Menu

## Monitor Processing

Use the **Monitor Processing** option to view the status of packages being processed.

Use the up/down arrow keys to select the **Monitor Processing** option and press the center function key.



**Figure 2-19** *Monitor Processing Window*

Press the left function key to return to the **Main Menu**.

## Force Check-In

Use the **Force Check-In** option to check instantly for pending package downloads instead of waiting for the next automatic check that the client performs.

Use the up/down arrow keys to select the **Force Check-In** option and press the center function key.

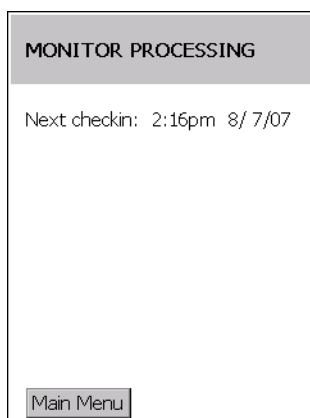

**Figure 2-20** *Force Check-in Window*

Press the left function key to return to the **Main Menu**.

## Package List

Use the **Package List** option to display the packages that have been installed on the mobile computer.

Use the up/down arrow keys to select the **Package List** option and press the center function key.

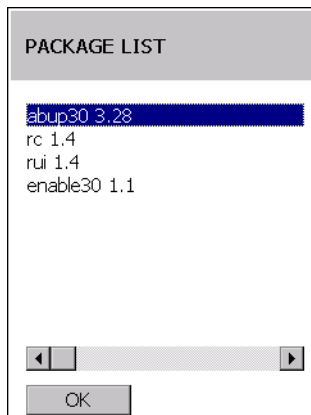

**Figure 2-21** *Package List Window*

Press the left function key to return to the **Main Menu**.

### Client Info

Use the **Client Info** window to view the following information:

- RD Client version
- Product name
- Operating system type
- Plug-in type.

Use the up/down arrow keys to select **View Client Info** option and press the center function key.

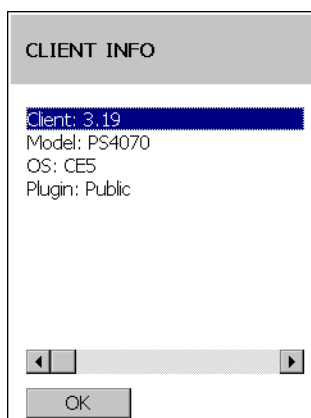

**Figure 2-22** *Client Info Window*

Press the left function key to return to the **Main Menu**.

### Log Menu

The **Log Menu** contains the following options:

- View Log
- View Job Log

- Set Log Level
- Set Job Log Level.

Use the up/down arrow keys to select **Log Menu** option and press the center function key.

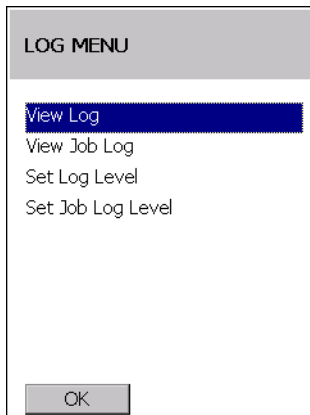

**Figure 2-23** Log Menu Window

Press the left function key to return to the **Main Menu**.

### View Log

Use the **View Log** option to display a list of events that have occurred.

Use the up/down arrow keys to select **View Log** option and press the center function key.

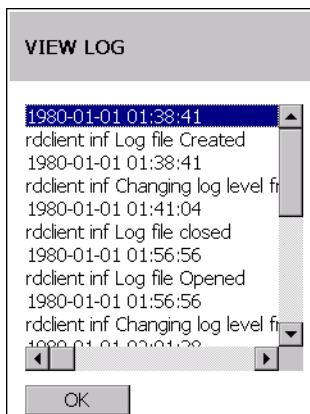

**Figure 2-24** View Log Window

Press the left function key to return to the **Log Menu**.

### View Job Log

Use the **View Job Log** option to display a list of jobs that have be processed.

Use the up/down arrow keys to select **View Job Log** option and press the center function key.

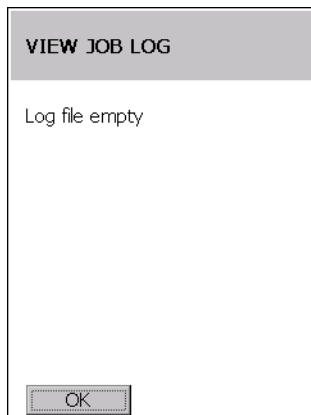
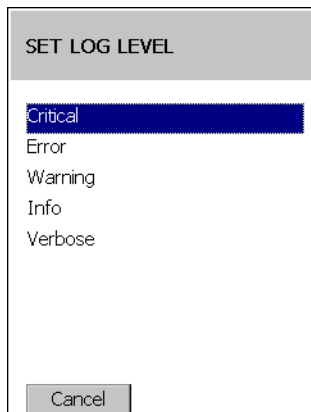

**Figure 2-25** *View Job Log Window*

Press the left function key to return to the **Log Menu**.

### **Set Log Level**

Use the **Set Log Level** option to set the level of the information that appears in the log.

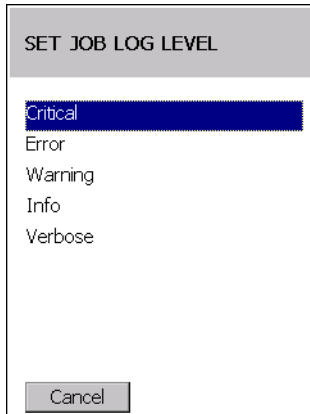

**Figure 2-26** *Set Log Level Window*

Use the up/down arrow keys to select a level option and press the center function key.

### **Set Job Log Level**

Use the **Set Job Log Level** option to set the level of the information that appears in the Job log.



**Figure 2-27** *Set Job Log Level Window*

Use the up/down arrow keys to select a level option and press the center function key.

### Hide UI

Use the **Hide UI** option to minimize the MSP Agent application. The MSP Agent application runs in the background while minimized.

To un-hide the application, select the **MSP Agent** icon in the task tray and select the **UnHide UI** menu item.

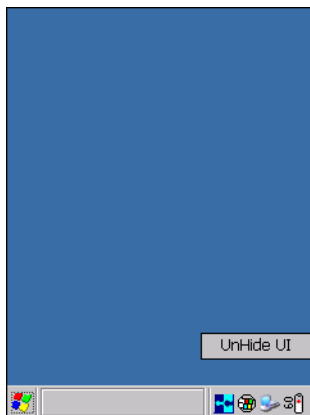

**Figure 2-28** *UnHide UI Selection*

# Chapter 3 Wireless Applications

---

## Introduction

Wireless Local Area Networks (WLANs) allow mobile computers to communicate wirelessly and send captured data to a host device in real time. The mobile computer supports the 802.11b and 802.11g standards. Before using the mobile computer on a WLAN, the facility must be set up with the required hardware to run the wireless LAN and the mobile computer must be configured. Refer to the documentation provided with the access points (APs) for instructions on setting up the hardware.

For MC17 devices, use the Fusion APIs in the Enterprise Mobility Developer's Kit (EMDK) to configure the radio in the mobile computer. Refer to the *EMDK Help* file for detailed information.

The MC17T devices, contain the Wireless Applications to allow configuration of the WLAN radio.

---

## 802.11d Overview

IEEE 802.11d, is an amendment to the IEEE 802.11 specification that adds support for additional regulatory domains. This includes additional country information to beacons, probe requests, and probe responses. The country information simplifies the creation of 802.11 wireless access points (APs) and clients that meet the different regulations enforced in various parts of the world.

The current implementation of Fusion (version 2.53) on the MC17 fully supports 802.11d for Regulatory purposes. By using 802.11d, the MC17 can easily connect to a wireless network and use only the valid channels for the country specified in the AP's beacons. By default, the MC17 software enables 802.11d mode to determine regulatory requirements.

---

## Configuring My Country for Use with WLAN on a MC17

Configuration can be done on:

- an enabled 802.11d network
- a disabled 802.11d network.

## Enabled 802.11d Network

There is no need to configure a country if 802.11d is used by the Access Point (AP). Verify that the wireless network infrastructure has 802.11d enabled.

To connect to a network with 802.11d enabled:

1. Use Mobility Services Platform (MSP) to generate bar codes that contain a Fusion wireless network profile for use with Rapid Deployment (RD). This profile should match the network that is being connected to (a properly configured ESSID).
2. On the MC17, use RD to scan the MSP Fusion Profile bar codes.
3. RD imports the Fusion Profile into the Fusion Database and attempts to connect to the network configured in the profile. Fusion uses the country code information provided in the AP's beacon (802.11d) to determine the regulatory requirements and connect to the network using a valid WLAN channel.

## Disabled 802.11d Network

If the network does not have 802.11d enabled, it is necessary to create:

- an WCS Options Registry file on another device
- a new staging network dedicated to the transition from 802.11d to using a specific country code.

This staging network needs to have 802.11d enabled. This staging network could be as simple as an AP connected to a host computer and multiple MC17s. A separate non-MC17 Fusion based device (MC70, MC9090, MC3000, etc.) is needed to create the WCS Options Registry file.

### Create WCS Options Registry File

To export a WCS Options Registry file that contains the proper settings for the network, perform the following steps:

1. Obtain another device that has the Fusion application on it. This device should have Fusion version 2.4 or greater.
2. Using the Fusion application on a separate device, tap the **Wireless** icon in the system tray and select **Options** from the menu. The **Options** window appears.
3. In the **Options** drop-down list, select **Regulatory**.
  - a. In the **Settings** drop-down list, select the country code to use.
  - b. Un-check the **Enable 802.11d** checkbox.
  - c. Tap **Save**.
4. In the **Options** drop-down list, select **Export**.
  - a. Tap the **Export Options** button. The **Save As** window appears.
  - b. Save the WCS Options Registry file to the device (name the file as desired).
5. Tap **X** to close the **Options** window.
6. Using ActiveSync, copy the WCS Options Registry file to a host computer. This file will be downloaded to configure MC17 devices with the correct country and 802.11d mode.



### Update MC17 via 802.11d Enabled Staging Network

Use the staging network to configure all devices with the correct country code and 802.11d mode:

1. Configure RD to download packages from a FTP server that is accessible from the staging network. This may require MSP bar codes, etc.
2. The Out of Box magic profile for the MC17 devices automatically attempts to connect to a wireless network with an ESSID of "101". This should be the same ESSID of the staging network.
3. Place the WCS Options Registry file (created using the alternate Fusion based device), on the staging network's FTP server.
4. The MC17 should download the WCS Options Registry file from the staging network and configure 802.11d mode and the country code.
5. The MC17 should perform a cold boot so that the new configuration takes effect.

### Connect to the Non-802.11d Network

Since the MC17 is now setup to not use 802.11d and is configured with the correct country code for the network, the normal RD procedure should be used from this point forward.

---

## Wireless Application on the MC17T

To configure the mobile computer, a set of wireless applications provide the user with the tools to configure and test the wireless radio embedded the mobile computer. The following wireless applications are available on the task tray from the **Wireless Application** menu:

- Wireless Status
- Wireless Diagnostics
- Find WLANs
- Manage Profiles
- Options
- Log On/Off
- Enable/Disable Radio.

Refer to the *Wireless Fusion Enterprise Mobility Suite User Guide for Version X.XX*, for information on configuring wireless profiles, where X.XX indicates the Fusion version. To determine the Fusion version see [Fusion Software on page xiii](#).

✓ **NOTE** The Windows CE 5.0 desktop may not be visible because the App Launcher application is active. To view the desktop, close all running applications.

Close all applications to access the Windows CE 5.0 desktop (if required).

By default, the taskbar is set to hide below the screen. To display the Taskbar place the cursor over the portion of the Taskbar that is visible (a thin gray line at the bottom of the screen). The Taskbar automatically appears.

Tap the **Signal Strength** icon to display the **Wireless Application** menu.

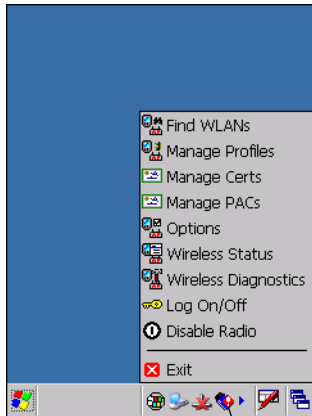

Signal Strength Icon

**Figure 3-1** *Wireless Applications Menu*

## Signal Strength Icon

The **Signal Strength** icon in the task tray indicates the mobile computer's wireless signal strength as follows:

**Table 3-1** *Wireless Applications Icons, Signal Strength Descriptions*

Icon	Status	Action
	Excellent signal strength	Wireless LAN network is ready to use.
	Very good signal strength	Wireless LAN network is ready to use.
	Good signal strength	Wireless LAN network is ready to use.
	Fair signal strength	Wireless LAN network is ready to use. Notify the network administrator that the signal strength is only "Fair".
	Poor signal strength	Wireless LAN network is ready to use. Performance may not be optimum. Notify the network administrator that the signal strength is "Poor".
	Out-of-network range (not associated)	No wireless LAN network connection. Notify the network administrator.
	No wireless LAN network card detected.	No wireless LAN network card detected. Notify the network administrator.

---

## Turning Off the Radio

To turn off the WLAN radio tap the **Wireless Connection Status** icon on the task tray and select **Disable Radio**.



**Figure 3-2** *Wireless Connection Status Icon - Radio On*

A red X appears across the icon indicating that the radio is disabled (off).

To turn the radio back on, tap the **Wireless Connection Status** icon on the task tray and select **Enable Radio**.



**Figure 3-3** *Wireless Connection Status Icon - Radio On*

The red X disappears from the icon indicating that the radio is enabled (on).



# Chapter 4 ActiveSync

---

## ActiveSync

To communicate with various host devices, install Microsoft ActiveSync (version 4.5 or higher) on the host computer. Use ActiveSync to synchronize information on the mobile computer with information on the host computer. Changes made on the mobile computer or host computer appear in both places after synchronization.

ActiveSync software:

- Allows working with mobile computer-compatible host applications on the host computer. ActiveSync replicates data from the mobile computer so the host application can view, enter, and modify data on the mobile computer.
- Synchronizes files between the mobile computer and host computer, converting the files to the correct format.
- Backs up the data stored on the mobile computer. Synchronization is a one-step procedure that ensures the data is always safe and up-to-date.
- Copies (rather than synchronizes) files between the mobile computer and host computer.
- Controls when synchronization occurs by selecting a synchronization mode, e.g., set to synchronize continually while the mobile computer is connected to the host computer, or set to only synchronize on command.
- Selects the types of information to synchronize and controls how much data is synchronized.

---

## Installing ActiveSync

To install ActiveSync on the host computer, download version 4.5 or higher from the Microsoft web site at <http://www.microsoft.com>. Refer to the installation included with the ActiveSync software.

---

## Mobile Computer Setup

- ✓ **NOTE** Microsoft recommends installing ActiveSync on the host computer before connecting the mobile computer.

The mobile computer is set by default to communicate using a USB connection. [Chapter 8, Cradle Installation](#) provides the accessory setup and cable connection information for use with the mobile computer. The mobile computer communication settings must be set to match the communication settings used with ActiveSync.

---

## Setting Up an ActiveSync Connection on the Host Computer

- ✓ **NOTE** The normal function of the product may be disturbed by Strong Electro Magnetic Interference (for example, static electricity). If so, simply remove and re-insert the mobile computer to resume normal operation. In case the function does not resume, please use the product in another location.

To start ActiveSync:

1. Select **Start > Programs > Microsoft ActiveSync** on the host computer. The **ActiveSync** window displays.

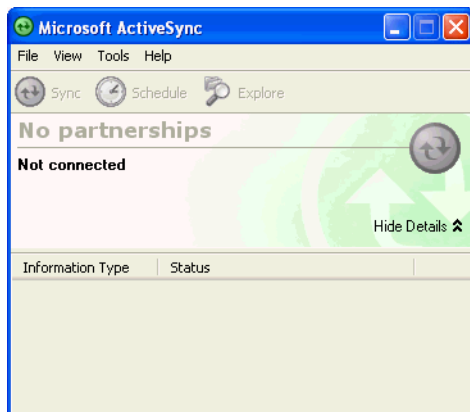

Figure 4-1 ActiveSync Window

- ✓ **NOTE** Assign each mobile computer a unique device name. Do not try to synchronize more than one mobile computer to the same name.
2. In the **ActiveSync** window, select **File > Connection Settings**. The **Connection Settings** window appears.



Figure 4-2 Connection Settings Window

3. Select **Allow USB connections** check box.
4. Select the **Show status icon in Taskbar** check box.
5. Select **OK** to save any changes made.

## Setting up a Partnership

To set up a partnership:

1. If the **Get Connected** window does not appear on the host computer, select **Start > All Programs > Microsoft ActiveSync**.

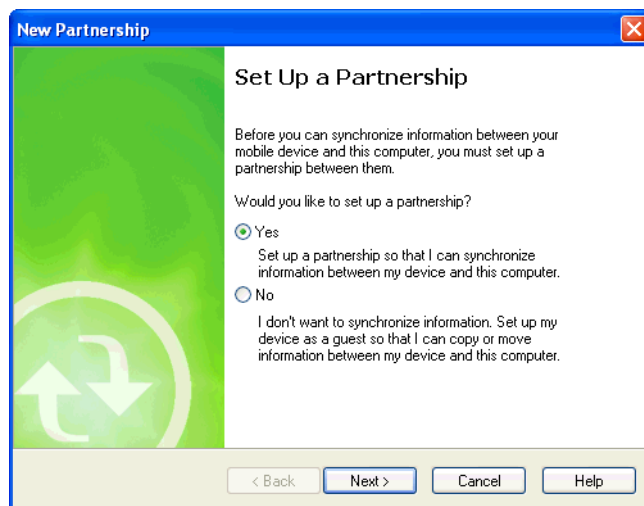

Figure 4-3 New Partnership Window

2. Select if you want to set up a partnership. Select either the **Yes** or **No** radio button.
3. Click **Next**.
4. If **No** is selected, skip to step 7.

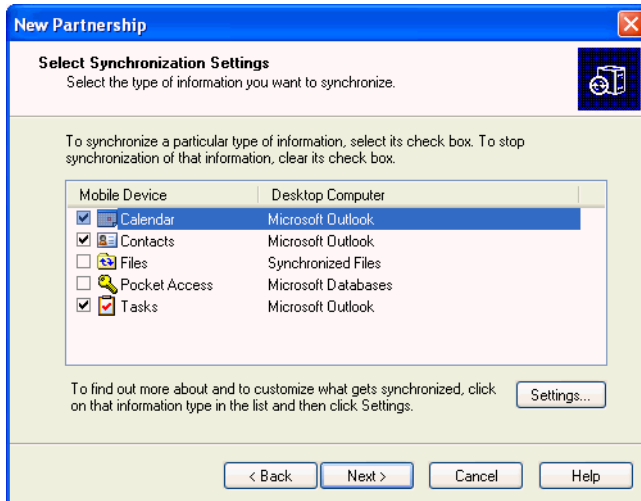

Figure 4-4 Select Synchronization Setting Window

5. Select the appropriate settings and click **Next**.

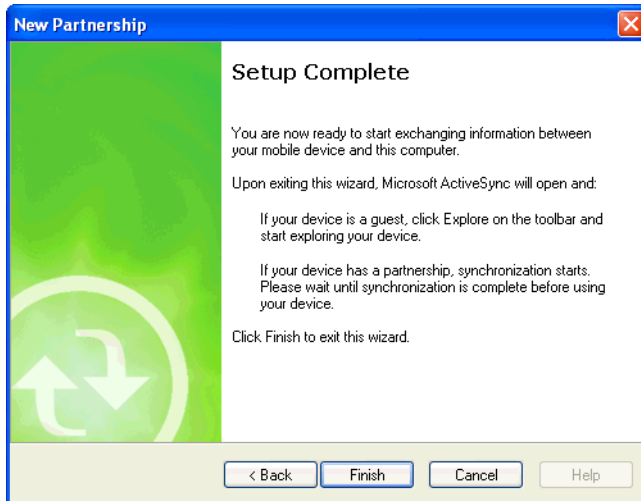

Figure 4-5 Setup Complete Window

6. Click **Finish**.
7. The Microsoft ActiveSync window displays.



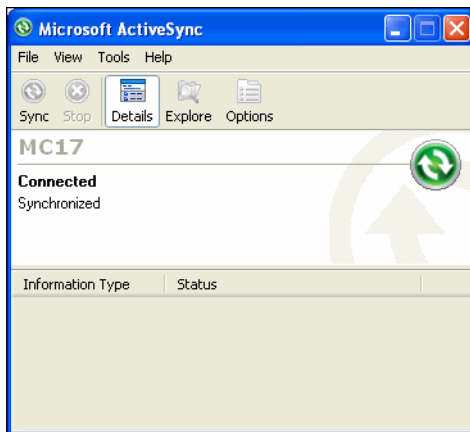

Figure 4-6 ActiveSync Connected Window

During the first synchronization, information stored on the mobile computer is copied to the host computer. When the copy is complete and all data is synchronized, the mobile computer can be disconnected from the host computer.

- ✓ **NOTE** The first ActiveSync operation must be performed with a local, direct connection. To retain partnerships after a cold boot, capture partnership registry information in a .reg file and save it in the Flash File System. See the detailed information provided in the EMDK Windows CE Help File for Mobile Computers.

For more information about using ActiveSync, start ActiveSync on the host computer, then see ActiveSync Help.



# Chapter 5 Using the Windows CE Desktop

---

## Introduction

The MC17 runs Windows CE 5.0 operating system and the operating system is only available for configuration when connected to a host computer via ActiveSync. Since the device is non-touch and has a limited keypad, control is only available using remote control software.

The MC17T is a touch enabled device and control is available using the user interface (UI).

---

## ActiveSync

See [Chapter 4, ActiveSync](#) for information on downloading and installing ActiveSync.

---

## Remote Control Software

To control the device from a host computer, a remote control software application, such as ActiveSync Remote Display, is required.

Download WindowsMobilePowerToys.msi application from the Microsoft web site: <http://www.microsoft.com>.

Following the instructions with the software to install the application on a host computer.

---

## Connection to Host Computer

To connect the mobile computer to a host computer:

1. Ensure that ActiveSync is installed properly on the host computer. See [Chapter 4, ActiveSync](#) for more information.
2. Using a T8 Torx drive, remove the two Torx screws securing the access panel to the back housing.

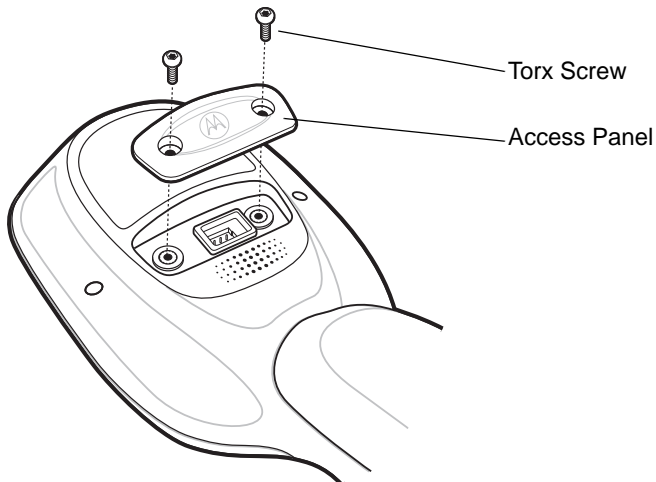
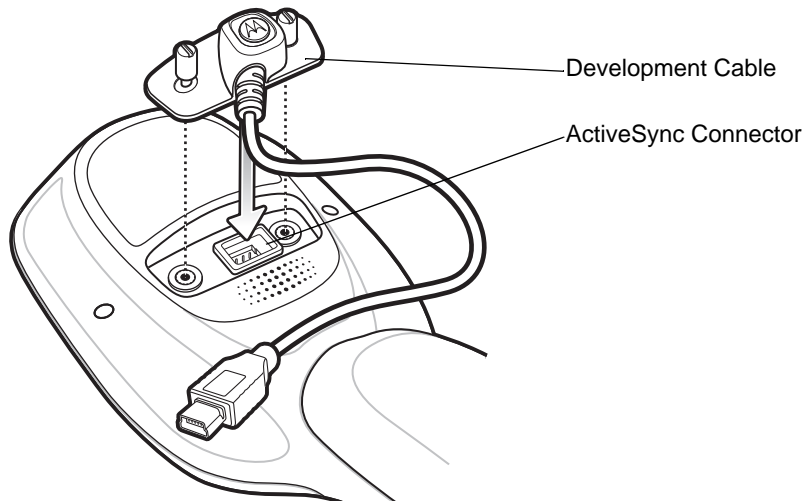

**Figure 5-1** Remove Access Panel



**CAUTION** Do not remove the access cover while the mobile computer is on and do not operate the mobile computer with the access cover removed. Follow proper Electro-Static Discharge (ESD) precautions to avoid damaging the MC17. Proper ESD precautions include, but are not limited to, working on an ESD mat and ensuring that the operator is properly grounded.

3. Align the Development Cable connector with the connector on the mobile computer.
4. Hand-tighten the two thumbscrews until tight.



**Figure 5-2** Install Development Cable

5. Insert the mobile computer into a cradle.

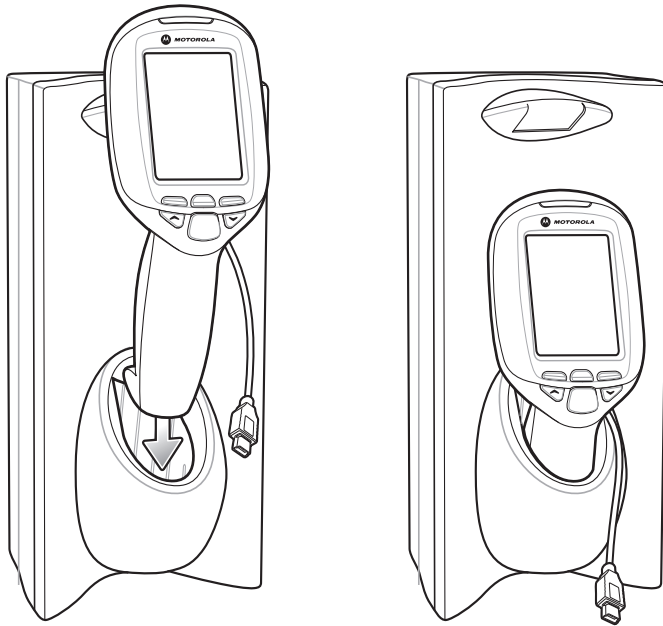

**Figure 5-3** *Insert Mobile Computer into Cradle*

6. Connect the mini USB B male connector of the USB cable to the mini USB female connector of the development cable.
7. Connect the USB A connector of the USB cable to the host computer.

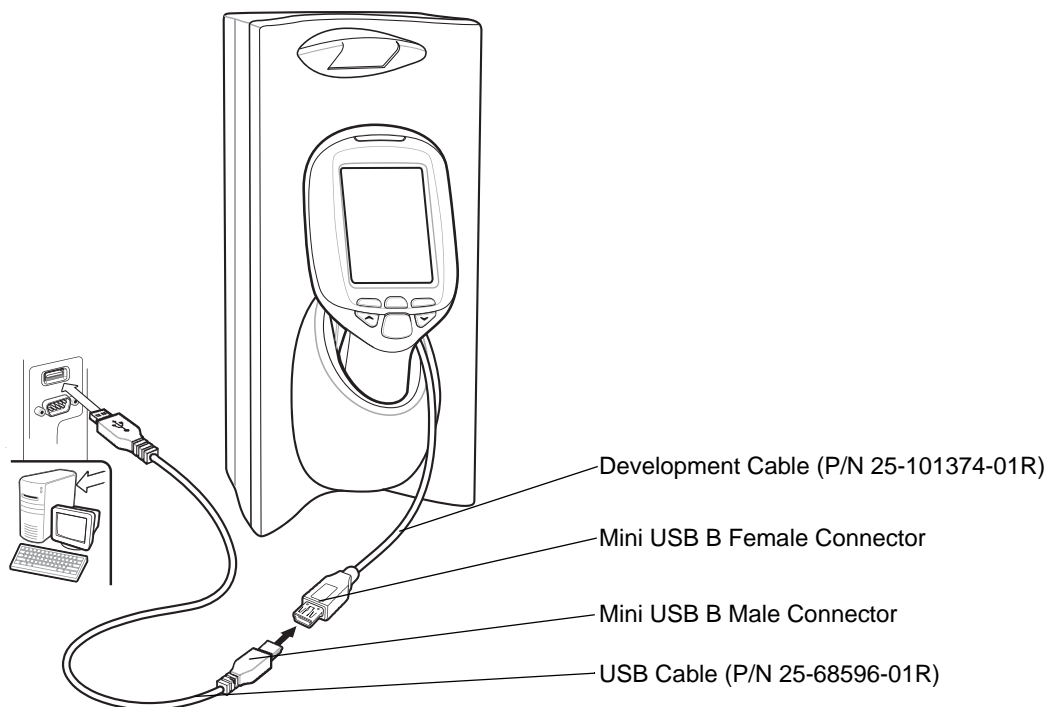

**Figure 5-4** *Connect to Host Computer*

8. If ActiveSync was installed properly, the host computer automatically detects the mobile computer and begins ActiveSync. The ActiveSync window appears.

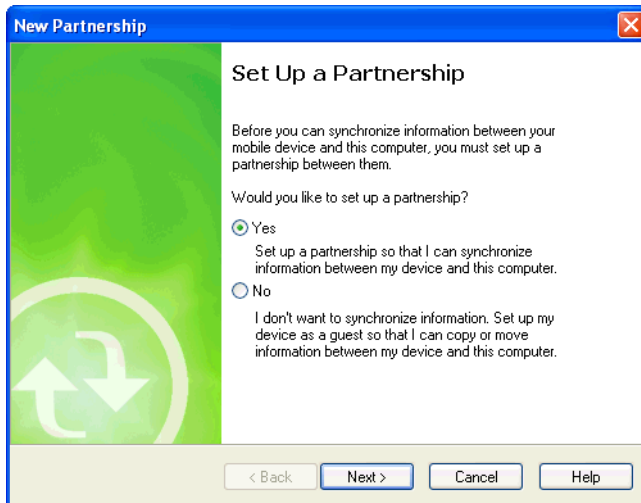

**Figure 5-5** *New Partnership Window*

9. Select the **Yes** radio button to create a partnership with the host computer or select the **No** radio button to connect as a guest.
10. Click **Next**. The Microsoft ActiveSync window indicates that it is connected to the mobile computer.

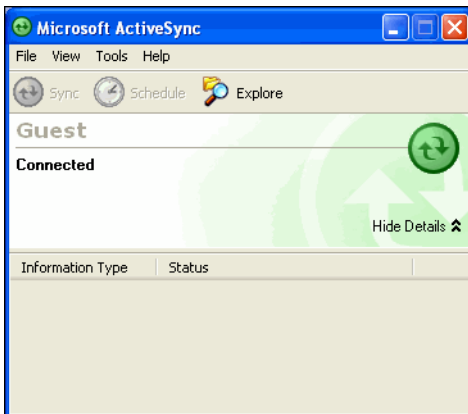
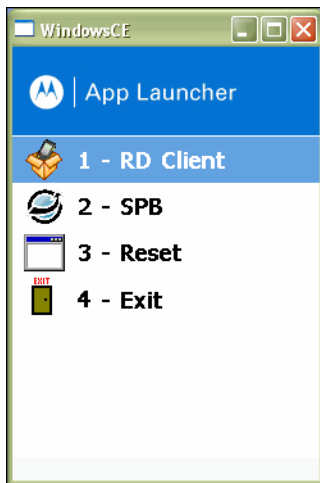

**Figure 5-6** *ActiveSync Connected Window*



**NOTE** In this procedure, ActiveSync Remote Display is used as the remote control software. Refer to the documentation supplied with the remote control software for operating instructions. Some programs require installation and setup.

11. On the host computer, click **Start > Programs > ActiveSync Remote Display**. The **ActiveSync Remote Display** window displays with the MC17 desktop shown.



**Figure 5-7** ActiveSync Remote Display Window

Use the host computer mouse to control the WinCE desktop.

## Development Cable Removal



**CAUTION** Follow proper Electro-Static Discharge (ESD) precautions to avoid damaging the MC17. Proper ESD precautions include, but are not limited to, working on an ESD mat and ensuring that the operator is properly grounded.

1. Loosen the two thumb screws securing the Development cable to the back housing and lift cable straight up.

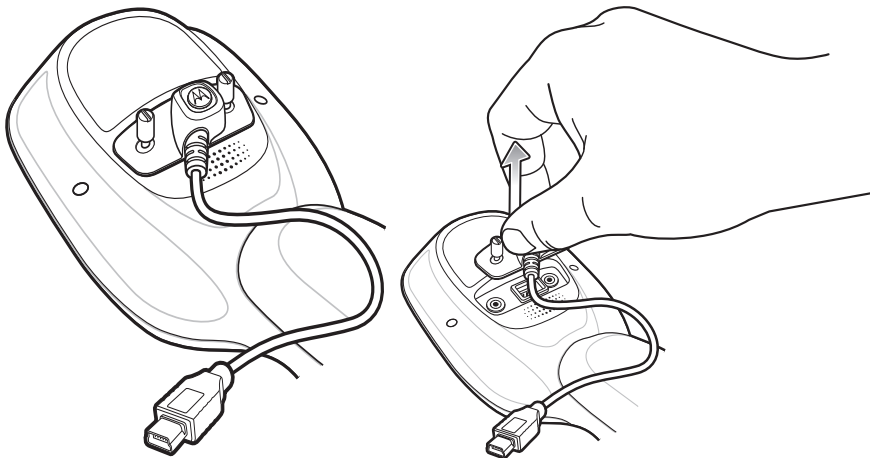

**Figure 5-8** Remove Development Cable

2. Using a T8 Torx drive, secure with access cover to the mobile computer using the two Torx screws.

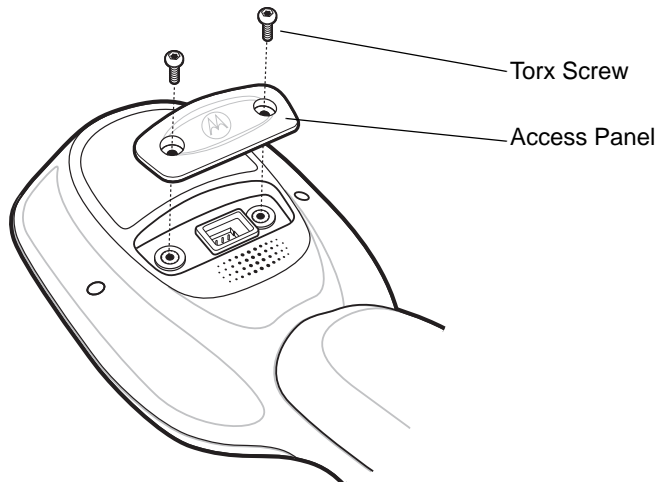

**Figure 5-9** Access Cover Replacement

3. Torque the screws to  $3.3 \pm 0.3$  kgf/cm ( $2.86 \pm 0.26$  in-lbs.).

## App Launcher Window

The **App Launcher** window allows the user to launch specific applications by using the keypad. Scroll up and down using the arrow keys and select **Enter** to select an item. If the **App Launcher** window is closed, launch the **App Launcher** window by selecting **AppLauncher.exe** in the *Windows* directory.

See [Appendix C, App Launcher Configuration](#) for instructions on modifying the **App Launcher** menu.

✓ **NOTE** App Launcher window may vary depending upon the MC17's operating system version.

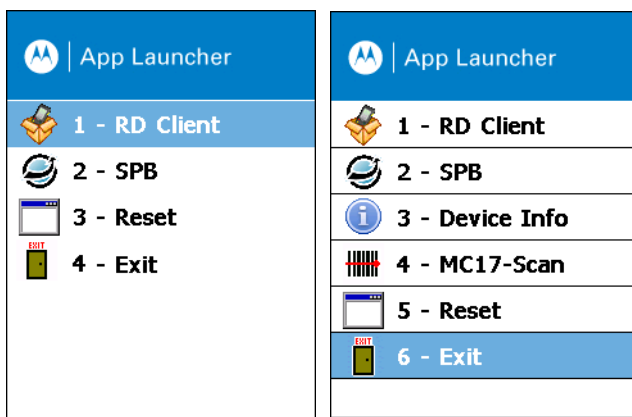

**Figure 5-10** App Launcher Window



**Table 5-1** App Launcher Item Descriptions

Item	Launch Number	Description
RD (Rapid Deployment) Client	1	Launches the Rapid Deployment application.
SPB (Symbol Pocket Browser)	2	Launches the SPB sample application.
Device Info	3	Display information about the MC17.
MC17-Scan	4	Launches a sample scan application with presentation mode.
Reset	5	Performs a warm boot that resets the mobile computer.
Exit	6	Closes the Start Up window.

---

## Windows CE 5.0 Desktop

✓ **NOTE** The Windows CE 5.0 desktop may not be visible because the App Launcher application is active. To view the desktop, close all running applications.

The following paragraphs describe the Windows CE 5.0 desktop. Depending upon the customer's configuration of the mobile computer, the desktop may not be available.

### Status Icons

The Taskbar at the bottom of the window displays the active programs, battery status and communication status. The taskbar (at the bottom of the screen) displays the **Start** button, active programs, battery status and communication status. The taskbar icons are described in [Table 5-2](#). The taskbar icons display the function status, indicate what programs are active and indicate the battery charge status. The Taskbar buttons are used to access menus, select/deselect functions or to change display windows.

- **Status Icons:** The status icons indicate the function key status.
- **Active Programs Icons:** The active applications icons are displayed on the taskbar. If more than one program is active, icons can be used to toggle between the open programs (applications). Tap on a taskbar application to maximize the application.
- **AC Power/Battery Status Icons:** The AC Power/Battery Status icons are shown in the taskbar to indicate the present power supply status of the mobile computer. The main battery status icons provide the battery status in 10% increments from 10% to 100%. The backup battery low icon indicates that the backup battery charge is low. See [Charging the Battery on page 1-11](#) for backup battery charging instructions.

By default, the Taskbar is set to automatically hide below the screen. To display the Taskbar place the cursor over the portion of the Taskbar that is visible (a thin gray line at the bottom of the screen). The Taskbar automatically appears. To set the properties of the taskbar, see [Properties on page 5-10](#).

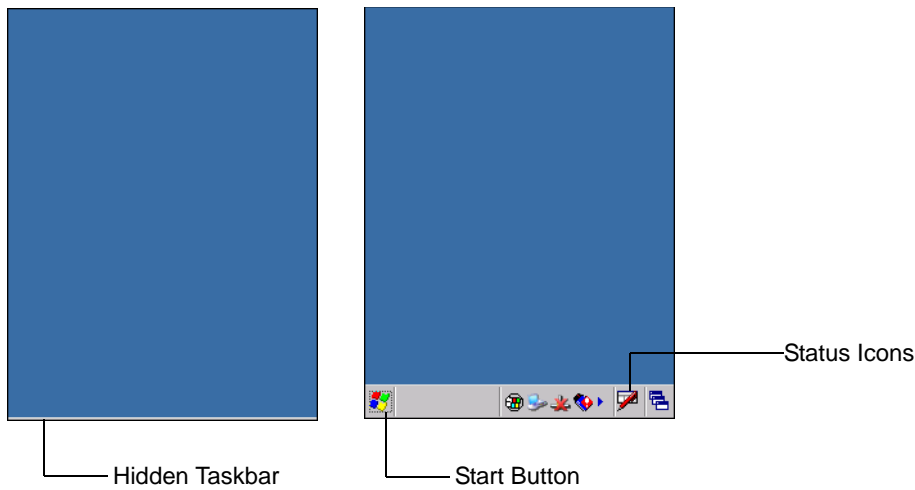

**Figure 5-11** Taskbar

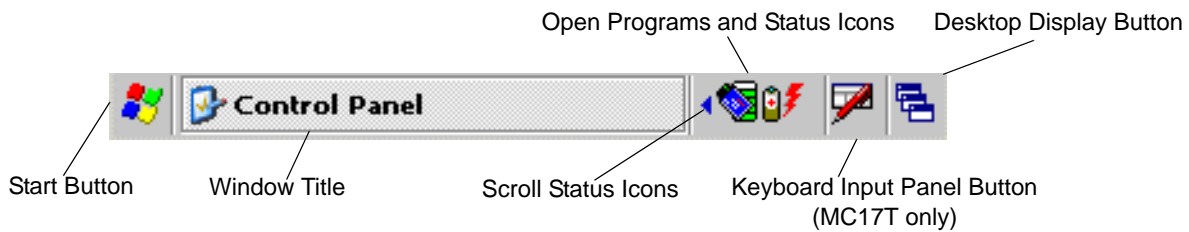

**Figure 5-12** Taskbar

**Table 5-2** Taskbar Icons

Icon	Description
	Indicates that the battery is charging.
	Indicates that the battery is fully charged (100% charged). The battery status icons provide the battery status in 10% increments from 10% to 100%.
	Indicates that the battery is fully charged and the mobile computer is running on external power.
	Indicates IP status. Only displays when the mobile computer is in emulation mode.
	Indicates that the ActiveSync application is running.
	Indicates that the wireless application radio is connected to a wireless LAN network with excellent signal strength.
	Indicates that the wireless application radio is not connected to a wireless LAN network.

## Battery Unknown Icon

The Battery Unknown icon displays when communication with the smart battery has not been established. As part of normal operation this icon may be displayed for 30 seconds following a mobile computer reset.

If the icon displays beyond this 30 second period:

1. Remove and re-seat the battery.
2. If after re-seating the battery, the icon remains, warm boot the mobile computer.
3. If after warm booting the mobile computer, the icon remains, then cold boot the mobile computer.
4. If after cold booting the mobile computer, the icon remains, install a new (tested and working) battery.
5. If the icon remains, return the mobile computer for servicing.

## Start Button

Tap the **Start** button to launch the *Start* menu.

- *Programs*: Use to access available programs.
- *Favorites*: Displays files in *Favorites* directory.
- *Documents*: Displays files in *Documents* directory.
- *Settings*: Accesses the Control Panel, the Network and Dial-up Connections and the Taskbar and *Start* menu.
- *Help*: Accesses the Windows CE Help. Not available on mobile computers running Windows CE .NET 5.0 Core.
- *Run . . .*: Runs a program or application.
- *Suspend*: Places the mobile computer in the suspend state.



Figure 5-13 Start Menu

## Programs Menu

From the **Start** menu, tap **Programs** to launch the **Programs** menu. Refer to the Application Guide for Motorola Enterprise Mobility Devices, p/n 72-68901-xx and the Microsoft® Applications for Windows Mobile and WinCE 5.0 User Guide, p/n 72E-78456-xx for application information.

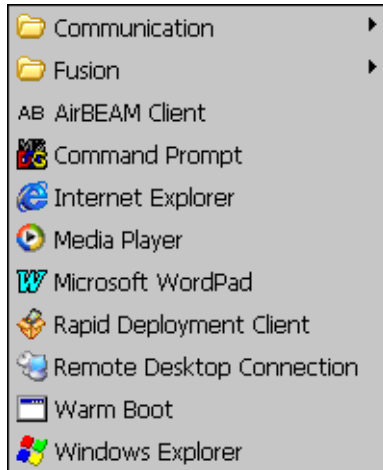



Figure 5-14 Programs Menu

## Desktop Display Button

Use the **Desktop Display** button to minimize all open programs and display the desktop.

## Entering Information Using the Keyboard Input Panel

✓ **NOTE** The Keyboard Input Panel is only available on the MC17T.

Use the keyboard input panel (soft keyboard) to enter information in any program. To launch the keyboard input panel, tap the  button on the taskbar. Tap a key to enter the value. Tap the keyboard input panel button to display or to hide the keyboard input panel.

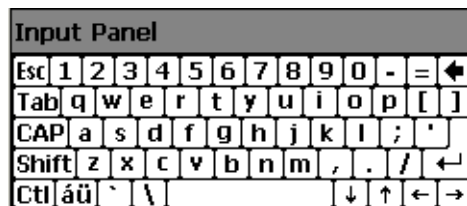

Figure 5-15 Keyboard Input Panel

## Task Bar and Start Menu Properties

Use the **Properties** functions to set display and clock options.

### Properties

1. Tap **Start > Settings > Taskbar and Start Menu ...** . The **Taskbar and Start Menu** window displays.



**Figure 5-16** Taskbar and Start Menu- General Tab

2. This window provides taskbar options:
  - Check the **Always on Top** checkbox to keep the taskbar on top of all other windows.
  - Check the **AutoHide** checkbox to make the taskbar disappear, touch the bottom of the display to make the taskbar return.
  - Check the **Show Clock** checkbox to display the clock on the taskbar.
3. Tap **OK** to save the settings and exit the window.

### Advanced Tab

1. Tap the **Advanced** tab.
2. Tap the **Clear** button to delete all of the documents listed in the **Start > Documents** entry, see [Start Button on page 5-9](#). Typically this list is empty, but if there were documents in the list the **Clear** button would delete them.
3. Tap the **Expand Control Panel** checkbox to display the entire contents of the Control Panel in list form, rather than icons.



**Figure 5-17** Taskbar and Start Menu-Advanced Tab

4. Tap **OK** to save the settings and exit the window.

---

## Screen Calibration

On the MC17T, if the screen does not react properly to screen touches, the screen might require re-calibration.

1. Select **Start > Settings > Control Panel > Stylus icon > Calibration** tab.
2. Tap the **Recalibrate** button.
3. Carefully press and briefly hold a pointing instrument on the center of each target that appears on the screen.

- Repeat as the target moves around the screen, then tap the screen to continue.

## Waking the MC17

The wake up conditions define what actions wake up the mobile computer after it has gone into suspend mode. The mobile computer can go into suspend mode automatically by control panel time-out settings. These settings are configurable and the factory default settings are shown in [Table 5-3](#). To set the wake up conditions select **Start** > **Control Panel** > **Power** icon > **Wakeup** tab.

**Table 5-3** *Wakeup Default Settings*

Condition for Wakeup	Automatic Time-out
AC power is applied.	Yes
Mobile computer is inserted into a cradle.	Yes
Mobile computer is removed from a cradle.	Yes
Mobile computer is connected to a USB device.	Yes
Mobile computer is disconnected from a USB device.	Yes
A key is pressed.	Yes
Trigger is pressed.	Yes
Screen Tap (MC17T only)	No

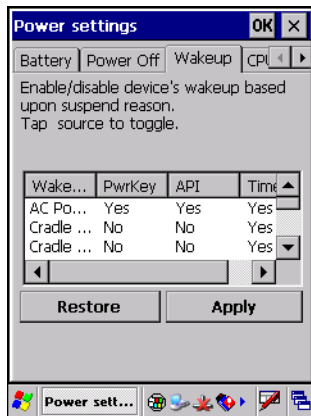

**Figure 5-18** *Wakeup Tab*

# Chapter 6 Special Considerations

---

## Introduction

The chapter provides information for:

- Using language fonts
- software development considerations
- Improving battery charge time
- Improving battery life.

---

## Fonts

The MC17 supports the following language fonts:

- Simplified Chinese
- Korean
- Japanese
- Greek
- Swedish
- Russian.

The MC17 supports the installation of font libraries for use with application and web development. Simplified Chinese, Korean, and Japanese font libraries are available on the Support Central Web site, <http://www.motorola.com/enterprisemobility/support>. Other standard UTF-8 encoded fonts are available from third party font vendors. Developers should refer to Microsoft and third party vendor documentation for development and usage details.

It should be noted that installing a language font library will not change the language configuration of the operating system image, i.e., Windows messages will still be displayed in the language designated in the factory supplied operating system image.

## Asian Font Installation

The Asian fonts must be installed onto the mobile computer:

1. Download the font package from Support Central.
2. Copy the language font files into the *Application* folder on the mobile computer:
  - .ttf, .ttc or .ac3 files
  - .reg files (required for Asian fonts)
  - .cpy files.
3. Cold boot the mobile computer.

After the mobile computer re-boots, the installed fonts are available for use.

Refer to <http://msdn2.microsoft.com/en-us/library/aa911446.aspx> for an explanation of font usage and installation.

---

## Software Development Considerations

- Dim or turn off the backlight when the mobile computer is idle.
- Whenever possible use default key code settings.
- To improve performance, use RAM instead of flash memory.
- Always lock the cradle after unlocking it.
- Cold booting the mobile computer erases all files in RAM. Be sure to save any critical files in *Application* folder, e.g.; Radio profile, time zone setting, license keys etc.
- It is not recommended to configure the mobile computer to suspend when in the cradle. The mobile computer will be unable to communicate with a server. Consequently, the server would be unable to unlock the cradle or toggle the cradle LEDs.
- User developed applications should provide a method for exiting or launching Rapid Deployment to enable re-staging the mobile computer.
- For detailed information on how to control the cradle LEDs and locking/unlocking the mobile computer in the cradle, refer to the EMDK Help file.
- Applications and servers should always treat a value of 255 (-1) as “unknown battery capacity.” Once the battery is fully charged the 255 value goes away.

---

## Tips for Improving Battery Charge Time

To improve battery charging time:

- Avoid unnecessary wireless communication while the mobile computer is in the cradle.
- Use maximum power save mode when setting up the wireless profile. (This greatly improves charging time since the radio accounts for a large amount of power).
- Ensure there is a good wireless signal nearby (a poor signal causes the radio to enter high power mode much more often than normal.)



- Turn off display while in the cradle. If customer requires display on all the time then reducing the brightness to minimum acceptable when in cradle will also help. See [Cradle-Backlight Feature](#) below.

## Cradle-Backlight Feature

The cradle-backlight feature provides improved battery charge time when the mobile computer is placed in the cradle. When the mobile computer is in the cradle, the backlight brightness is reduced to 25% of the maximum brightness. When the mobile computer is removed from the cradle, the brightness returns to the default value.

This value can be using a registry setting.

✓ **NOTE** By default this feature is enabled. To disable this feature, set *ACINBackLightChangeEnable* to 0.

Key Name: [HKEY\_LOCAL\_MACHINE\Drivers\BuiltIn\CradleLock]

- Name: ACINBackLightChangeEnable
  - Data Type: dword
  - Description: Enable =1; Disable=0
  - Default: 1
- Name: ACINBackLightLevel
  - Data Type: dword
  - Description: Backlight Level in cradle: 0 to 4 (dimmiest to brightest)
  - Default: 0

---

## Tips for Improving Battery Life

The MC17 has many functions to allow server/client applications control over its power management. To improve battery life:

- Place the mobile computer in a Charging cradle connected to AC power when not in use.

✓ **NOTE** In suspend mode, the radio cannot communicate with an AP.

- After the customer check-out, place the mobile computer in suspend mode. This prevents the mobile computer's battery from discharging while sitting at a counter before being returned to the Charging cradle. Once inserted in the cradle the mobile computer wakes up automatically.
- When the mobile computer is not used after a time-out period place it in suspend mode. Any key press wakes up the mobile computer. This can greatly increase battery life.
- If the user application does not allow placing the mobile computer in suspend mode, turn off the backlight after the time-out period.
- Set the backlight brightness to the minimum required by the application.
- Ensure a good wireless signal.
- Set the wireless profile to MAX Power Save mode. If CAM mode is selected, the device does not maximize power savings.

Running time for the MC17 is expected to be approximately 6 to 7 hours with the following profile:

- 2 scans/minute
- transmitting 32K bytes of data per scan
- 75% display brightness
- 50% On/Off backlight
- Associate to an access point (AP) with “Good” signal strength and configure the wireless profile to MAX Power Save mode.

## Changing the Power Settings

✓ **NOTE** Use remote control software to navigate the operating system. See [Chapter 5, Using the Windows CE Desktop](#) for instructions.

To set the mobile computer to turn off after a short period of non-use:

1. Select **Start > Settings > Control Panel > Power icon > Power Off** tab.
2. Select the **On battery power: Turn off device if not used for:** check box and select a value from the drop-down list box.
3. Select **OK**.

## Changing the Display Backlight Settings

✓ **NOTE** Use remote control software to navigate the operating system. See [Chapter 5, Using the Windows CE Desktop](#) for instructions.

To change the display backlight settings in order to conserve battery power:

1. Select **Start > Settings > Control Panel > Backlight icon > Battery Power** tab.
2. Select the **On battery power: Disable backlight if not used for:** check box and select a value from the drop-down list box.
3. Select the **Brightness** tab.
4. Select the **Disable backlight** check box to completely turn off the display backlight.
5. Use the slider to set the brightness of the backlight. Set it to a low value to save battery power.
6. Select **OK**.

# Chapter 7 Pocket Browser

---

## Introduction

This feature-rich, mobile application development tool is designed to allow Web developers to rapidly create robust mobile applications that can include a wide range of advanced data capture capabilities. Whether you want to streamline your warehouse, delivery or service operations, or enable more robust asset tracking or visibility, Pocket Browser will help you get your enterprise mobility solution up and running faster — and more cost efficiently.

The Pocket Browser 2.1 Developer Help provides detailed information about how to use each feature of the browser. Each feature includes a sample for you to use, however, please be aware that the sample does not necessarily show the only way to implement each feature.

Pocket Browser enables developers and integrators to provide advanced Web-based solutions to select Microsoft® Windows Mobile and Windows CE mobile computers. PocketBrowser makes the most of enterprise-level applications while speeding up development time and reducing costs. With it, making the transition to web-based solutions is now fast, easy and affordable - especially in high-volume mobile environments.

Pocket Browser is a software tool that extends the core rendering engine functionality of Microsoft PocketIE or Microsoft IE with Symbol application programming interfaces (APIs). It provides interfaces to the mobile computer hardware and features using meta tags and Microsoft ActiveX® components designed specifically for Motorola Enterprise Mobility systems. Pocket Browser offers easy integration with bar code scanners, RFID readers and other peripherals such as printers and magnetic stripe readers (MSR) for complete transaction processing.

---

## Sample Application

The mobile computer comes with a sample PocketBrowser applications factory-installed. The sample application is accessible from the App Launcher menu.

From the App Launcher menu, select SPB. The PocketBrowser window appears.

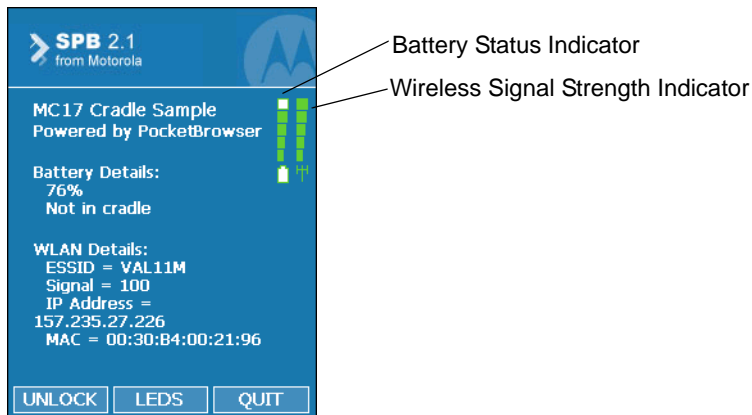

**Figure 7-1** Sample SPB Screen

The sample SPB provides the following information:

- Battery level status bars
- WLAN signal strength status bars
- Battery Details:
  - Battery strength in percentage
  - Whether in cradle or not
- WLAN details:
  - ESSID name
  - Signal
  - IP Address of the mobile computer
  - MAC address of the mobile computer.

The three buttons at the bottom of the screen:

- Unlock/Lock - Unlocks and locks the mobile computer into the cradle.
- LEDS - Illuminates the cradle LEDs
- Quit - Exits the ample SPB application.

# Chapter 8 Cradle Installation

---

## Introduction

A system is comprised of a family of hardware devices interconnected through a WLAN radio backbone to the retail establishment's server(s). The hardware devices are the MC17 mobile computers, charging cradles (one per MC17), power supplies, and cables. A *dispenser* typically refers to a piece of furniture which has mounted to it the Charging cradles, their power supplies, and cables.

Customers (retail establishments) design their own dispensers to meet their particular floor space and display requirements. The information in this chapter should help a customer to design a dispenser and to understand the installation requirements.

---

## Installation of the Charging Cradle

### Removing the Front Cover

To remove the front cover:

1. Loosen two captive screws securing the front cover to the base.

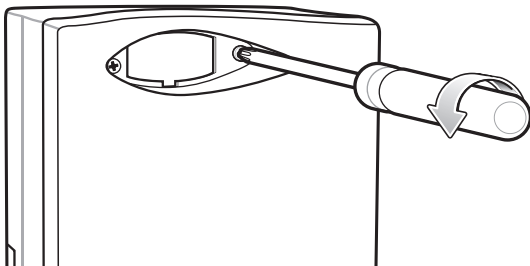

**Figure 8-1** Remove Screws

2. Pull front cover away from base and then lift out of the base.

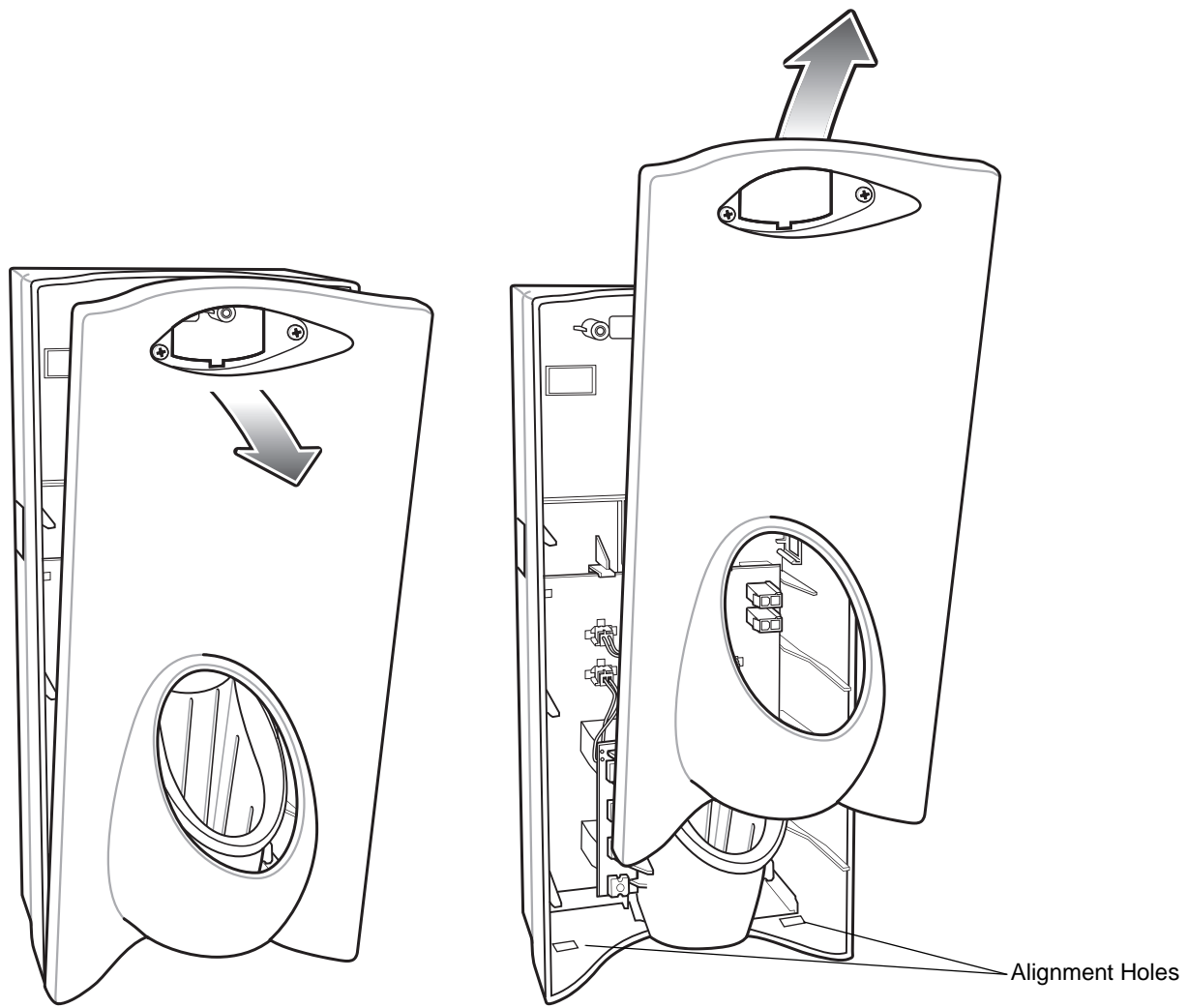

**Figure 8-2** Cover Removal

## Mounting the Cradle

The Charge cradle contains mounting holes in the back housing so that it can be bolted to supporting furniture. In addition, it come with plugs and a variety of cable routing outlets. Cable outlets not used can be concealed with the plugs provided. [Figure 8-3](#) provide the information required to design correct mounting holes for the charge cradles.

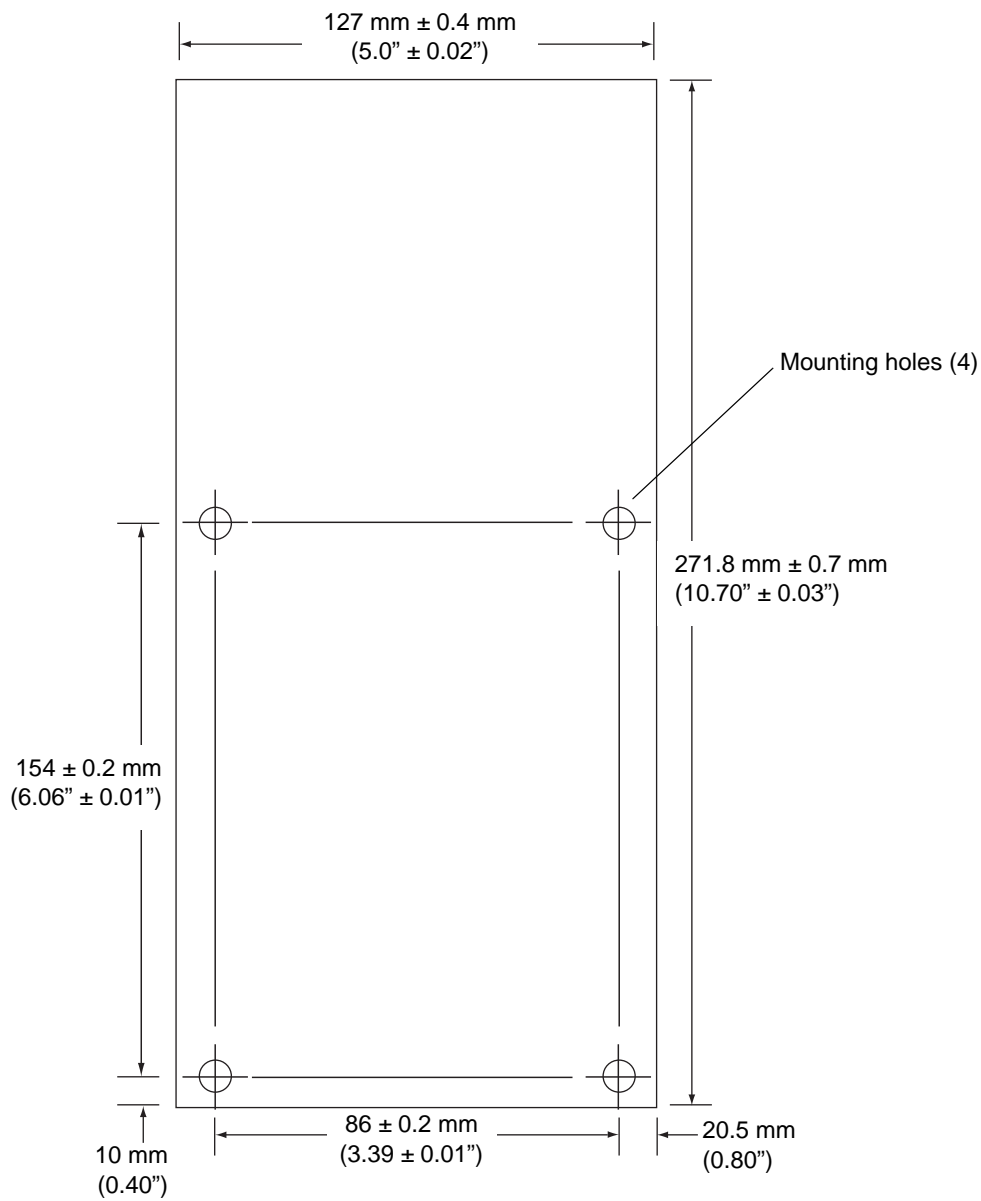

**Figure 8-3** Cradle Mounting Template

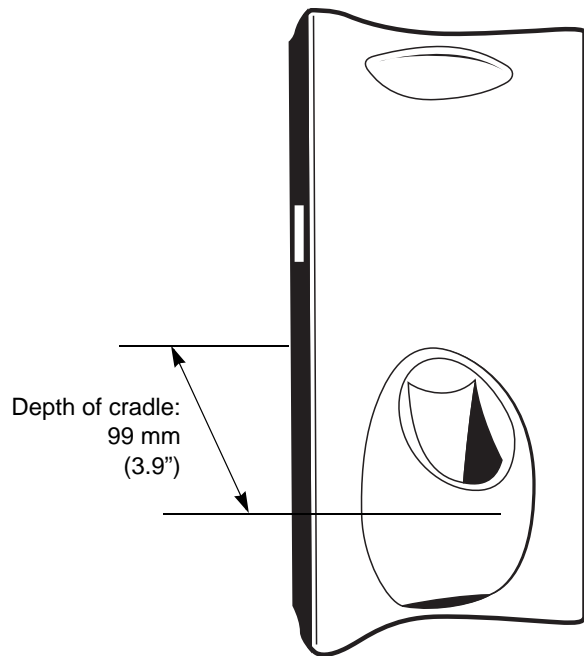

**Figure 8-4** Overall Depth of Cradle

---

## Wiring

✓ **NOTE** During installation ensure all interconnect cables are fully enclosed within the power supply or cradle enclosure.

1. Install power supply, including AC line cord and power cable, into Decorative Housing.



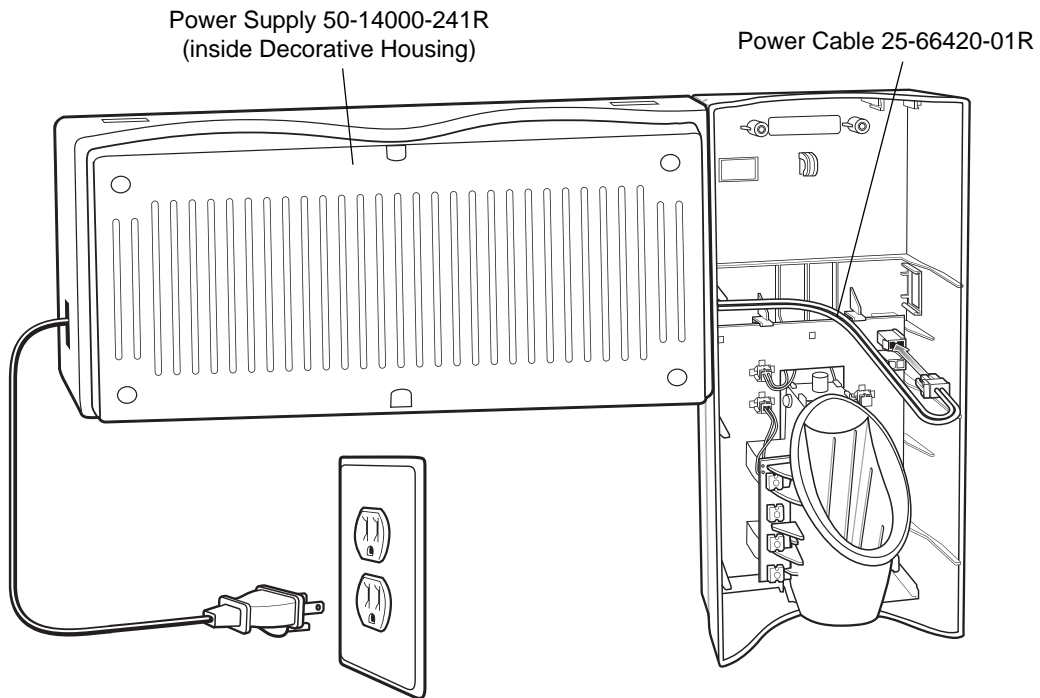

**Figure 8-5** *Connecting Power Supply*

2. Insert power cable through a cable outlet of cradle back housing.
3. Plug connector into power connector on printed circuit board.
4. If more than one cradle, connect the interconnect cable from the first cradle to the second cradle.

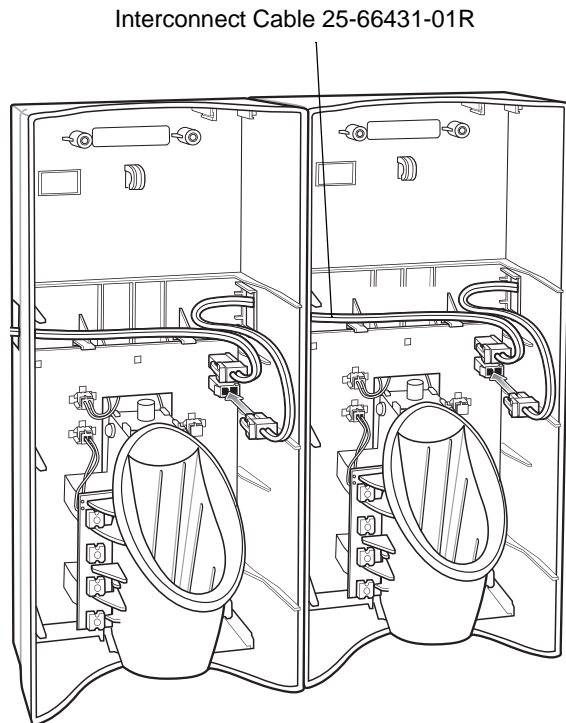

**Figure 8-6** *Daisy-Chaining Cradles*

5. Use plugs to cover un-used cable outlets.

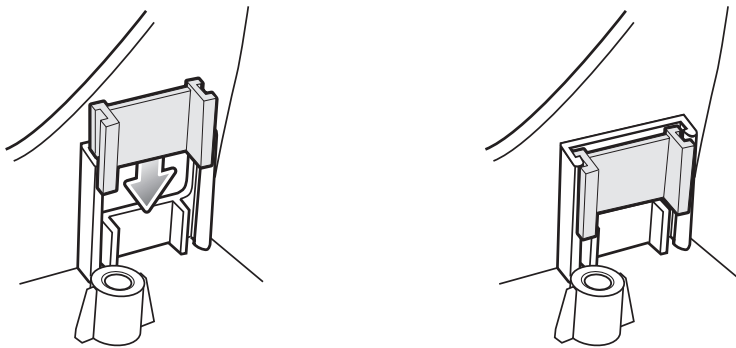
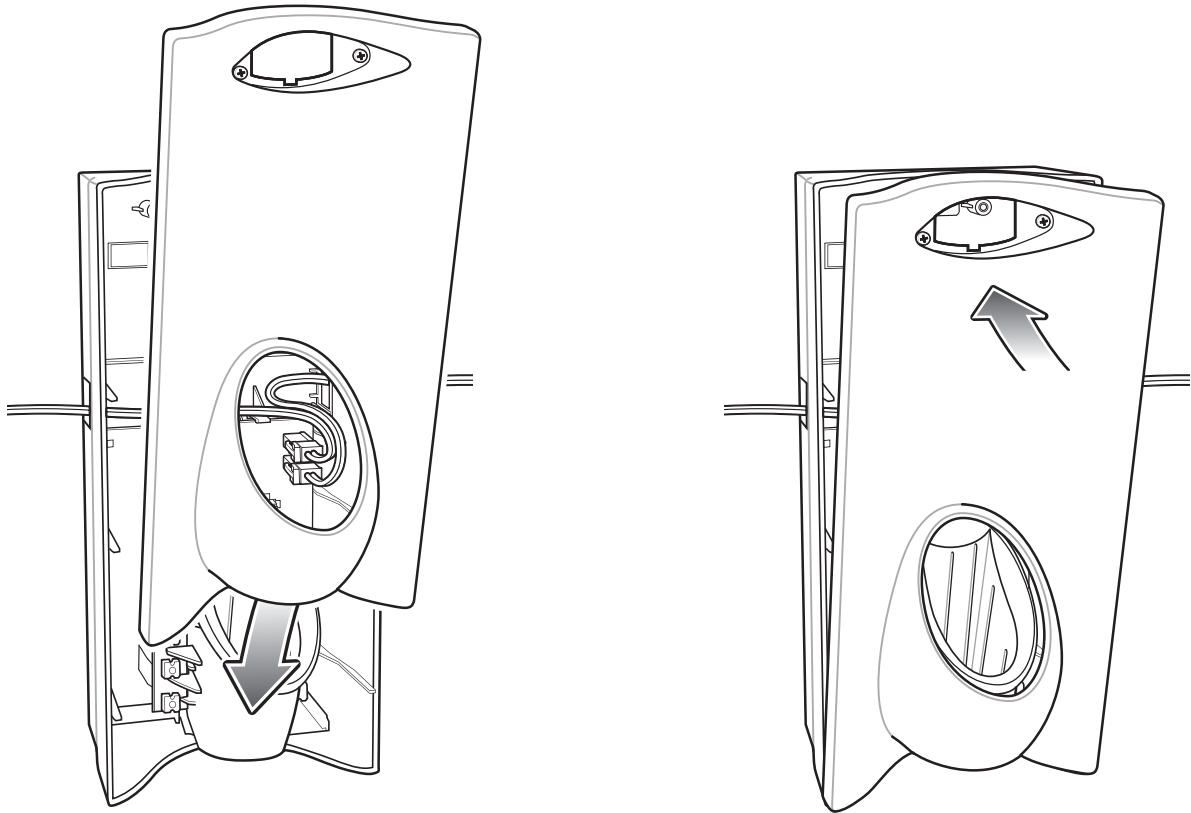

**Figure 8-7** *Cable Hole Plug Installation*

---

## Assembly

6. Replace cover.
7. Secure cover with screws.



**Figure 8-8** *Replace Cover*

✓ **NOTE** Do not install the target cover until you are sure that you do not need to remove the front cover again.

8. Insert bar code target cover.
9. Push target cover into front cover until it snaps into place.

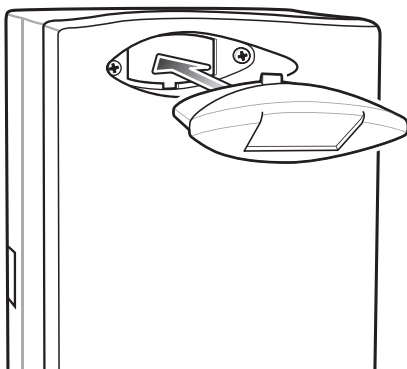

**Figure 8-9** *Replace Target Bar Code Cover*

## Cradle Location Bar Code

Note that a cradle location bar code can be mounted on the underside of the target plastic cover.

## System Cabling

There are some general limitations that must be taken into account when designing a dispenser and ordering hardware elements of a system:

- No more than six Charging cradles can be powered off of one power supply and power cable 25-66420-01R.
- No more than 12 Charging cradles can be powered off of one power supply and “Y” power cable 25-67592-01R.
- No more than six Charging cradles can be powered off each leg of the “Y” power cable.
- A power supply cable runs from the power supply to one or two Charging cradles.
- Cradle interconnection cables run between each successive cradle in the chain.
- The power supply is air cooled, and as such expects some circulation of fresh air around it. Do not enclose it in a small airtight enclosure.
- Power supplies must be mounted in their natural, landscape orientation. They contain fans and their vents must allow for the free flow of air.
- Power supplies should be mounted either above or below dispensers and entrance heads. Mounting of power supplies to the right or left is not preferred.
- When laying out furniture, cable routing should be as direct as possible. Routing should follow vertical and horizontal runs through the modules. As part of each power supply that is shipped is a set of labels numbered 1 through 12. These labels are to be used to track the number of loads on a particular supply. Each label is affixed to the cradle interconnection cable when a cradle is added to the daisy chain. When all labels are used, the supply is fully loaded.

*Figure 8-10* shows how the maximum number of Charging cradles can be cabled to a power supply using power cable 25-66420-01R.

*Figure 8-11* shows how the maximum number of Charging cradles can be cabled to a power supply using the “Y” power cable 25-67592-01R. Note that there are only six cradles per leg of the power supply cable, and only 12 cradles in total.

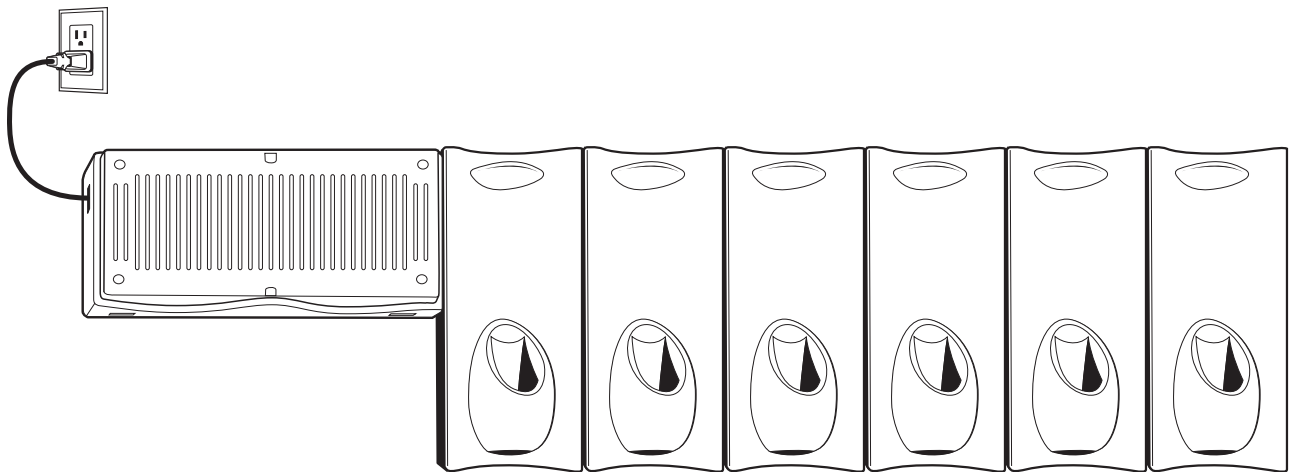

**Figure 8-10** Maximum Number of Charge Cradles per Power Supply

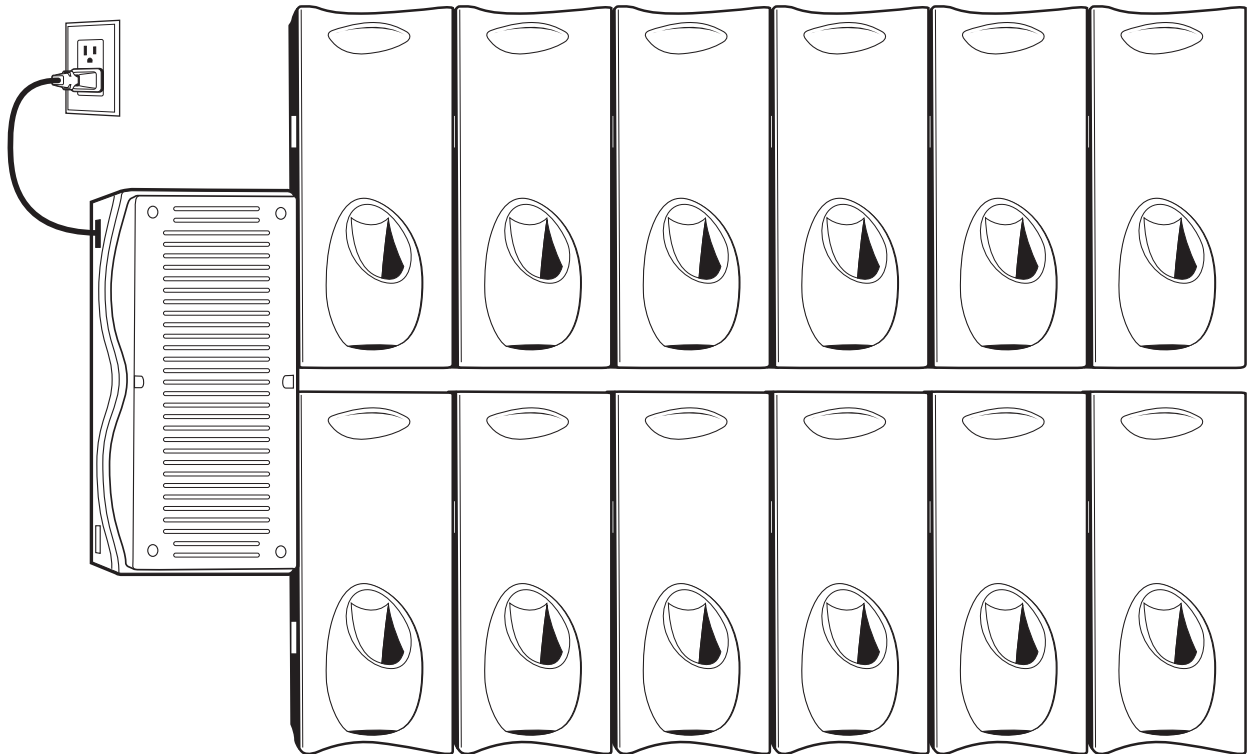
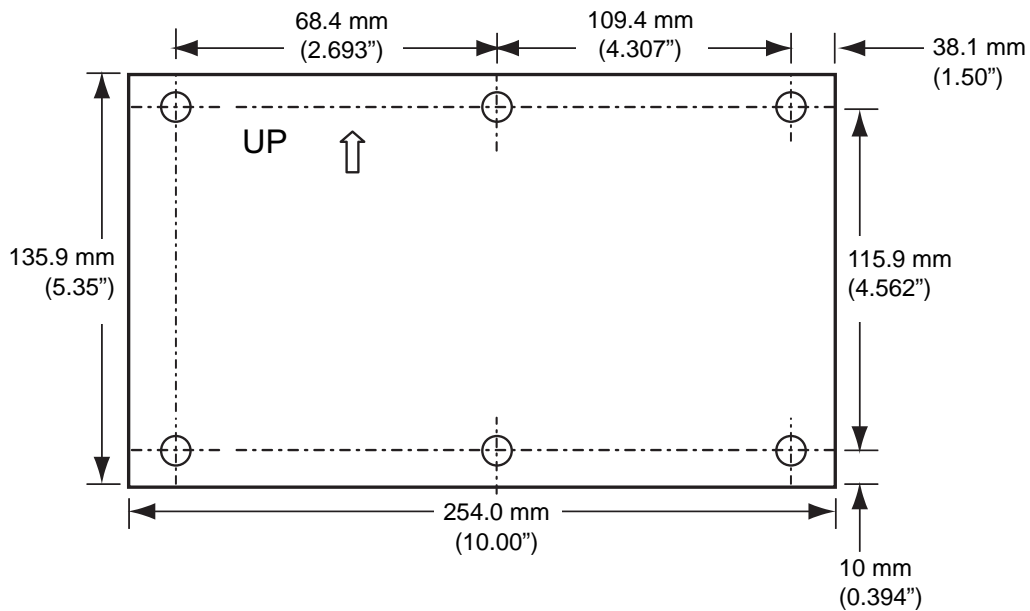

**Figure 8-11** *Maximum Number of Charge Cradles per Power Supply with “Y” Power Cable*

## Mounting the Power Supply Housing

The power supply can be housed in a plastic housing, p/n PSS-3PS04-00R, to match the Charging cradles and hide bare power supplies and cables. This section provides the information required to mount the plastic housing.

✓ **NOTE** The power supply should be mounted in landscape orientation.



(View from Inside Housing)

The depth of the fully-assembled power supply decorative housing is 81.23 mm (3.198").

**Figure 8-12** Power Supply Housing Mounting Template

1. Feed cables through access holes in bottom housing.
2. Plug connectors into power supply.
3. Place power supply into bottom housing.
4. Place two mounting brackets over power supply and secure each mounting bracket with two screws.

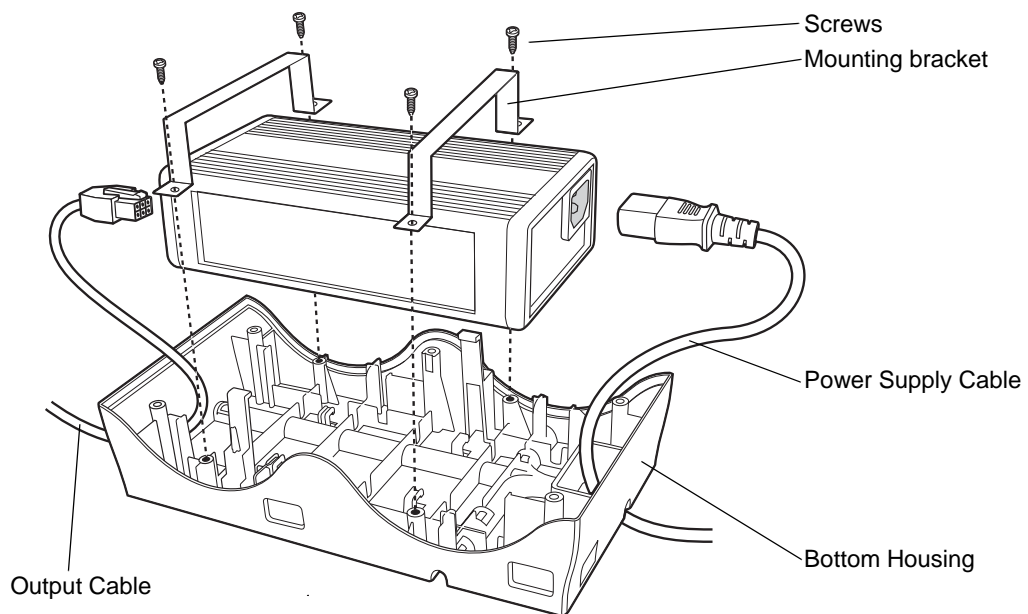

**Figure 8-13** *Power Supply Assembly*

5. Align top housing over bottom housing and secure using six screws.

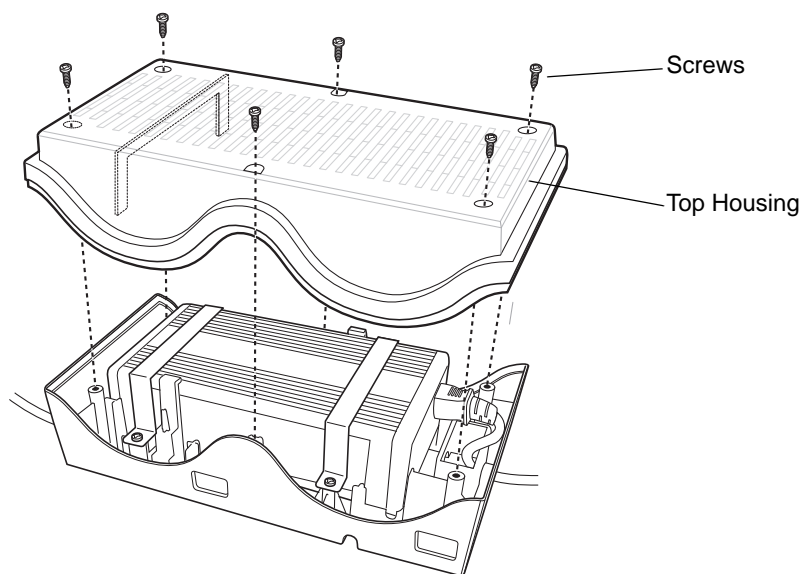

**Figure 8-14** *Top Housing Installation*





# Chapter 9 Application Deployment

---

## Software Installation on Development PC

To develop applications to run on the mobile computer, use one or all of the following:

- Enterprise Mobility Developer Kit (EMDK) for C
- Enterprise Mobility Developer Kit (EMDK) for .NET
- Enterprise Mobility Developer Kit (EMDK) for Java
- Enterprise Mobility Developer Kit (EMDK) for Pocket Browser
- Windows CE Platform SDK for MC17xxc50
- Device Configuration Package (DCP) for MC17xxc50.

Refer to the *Developer Guide*, p/n 72E-71161-xx, for detailed information on the EMDKs.

The Windows CE Platform SDK for the MC17xxc50 is used in conjunction with the EMDK for C to create Windows CE applications for the MC17xxc50 mobile computer. The Platform SDK installs a new Windows CE device type and its associated libraries onto the development PC.

The Device Configuration Package (DCP) is required to create and download hex images that represent flash partitions to the mobile computer. The DCP includes the user documentation, flash partitions, Terminal Configuration Manager (TCM) and the associated TCM scripts.

## Device Configuration Package

To install the DCP for MC17xxc50:

1. Download the DCP from the Support Central web site, <http://www.motorola.com/enterprisemobility/support>:
  - a. On <http://www.motorola.com/enterprisemobility/support>, select *Software Downloads*.
  - b. Select *Mobile Computers* and then select *MC17*.
  - c. Select the *Device Configuration Package (DCP)*.
  - d. Save the .exe file to the development computer.
2. Locate the .exe file on the development computer, double-click the file, and follow the install screen prompts.

3. Once installed, access the major components of the DCP from the *Symbol Device Configuration Package (DCP)* for MC17xxc50 program group of the *Windows Start Menu*.

## Platform SDK

Different Platform SDKs are required for the Microsoft® Windows CE 5.0 Professional and Microsoft® Windows CE 5.0 Core platforms. To download and install the appropriate Platform SDK:

1. Download the appropriate Platform SDK from the Support Central web [site](http://www.motorola.com/enterprisemobility/support), <http://www.motorola.com/enterprisemobility/support>:
  - a. On <http://www.motorola.com/enterprisemobility/support>, select *Software Downloads*.
  - b. Select *Mobile Computers* and then select *MC17*.
  - c. Select the *Platform SDK*.
  - d. Save the .exe file to the development computer.
2. Run the file and follow the screen prompts to install.

## Symbol Mobility Developer Kits

To install an EMDK:

1. Download the EMDK from the Support Central web site, <http://www.motorola.com/enterprisemobility/support>:
  - a. On <http://www.motorola.com/enterprisemobility/support>, select *Developer Downloads* and sign in.
  - b. Select *Mobile Computers* and then select *MC17*.
  - c. Select the latest version of the *Symbol Mobility Developer Kit*.
  - d. Download the .exe file to the development computer.
2. Double-click the executable file and follow the install screen prompts.

## Installing Other Development Software

Developing applications for the mobile computer may require installing other development software such as application development environments on the development PC. Follow the installation instructions provided with this software.

## Deployment

With the appropriate accessory, software, and connection, the mobile computer can share information with the host device. This section provides information about installing software and files on the mobile computer.

Download/install software using:

- ActiveSync
- IPL.

### ActiveSync

Use ActiveSync to copy files from a host computer to the mobile computer.

1. Ensure that ActiveSync is installed and that a partnership has been created, see [Chapter 4, ActiveSync](#).
2. Connect the mobile computer to the host computer using the Charging cradle, see [Chapter 8, Cradle Installation](#) for connection information.
3. On the host computer, select **Start > Programs > ActiveSync**.
4. Select **Explore**.

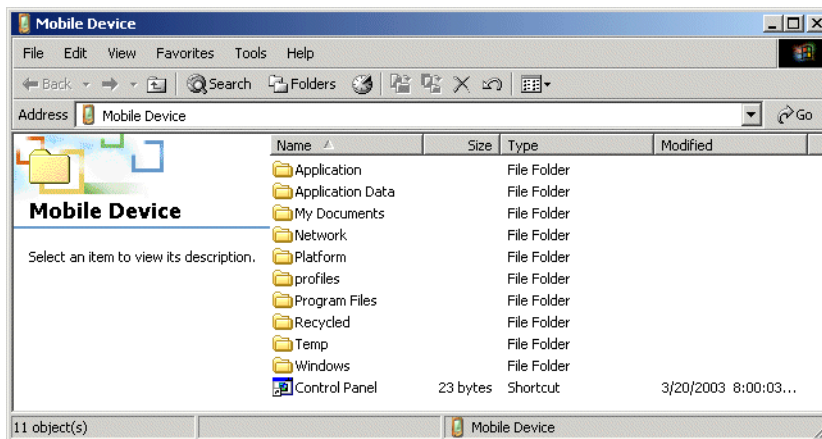

**Figure 9-1** ActiveSync Explorer

5. Double-click the folder to expand the contents of the folder.

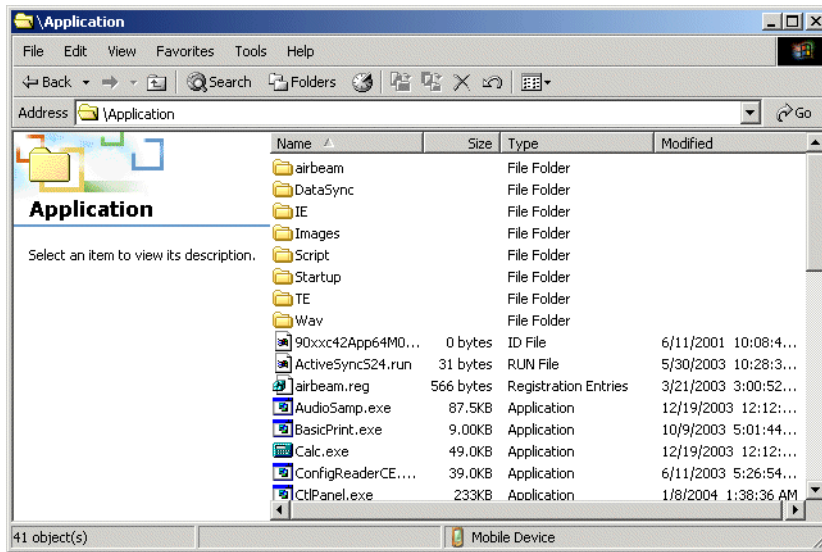

**Figure 9-2** My Pocket PC Contents

6. Use Explorer to locate the host computer directory that contains the file to download. Tap that directory in the left pane to display its contents in the right pane.
7. Drag the desired file(s) from the host computer to the desired mobile device folder.
  - *Program Files* folder: files stored in this folder are discarded after a cold boot.
  - *Application* folder: files stored in this folder are retained after a cold boot.

## IPL

Use IPL to download files onto the mobile computer, to download customized flash file system partitions to the mobile computer and load hex files to the flash memory of the mobile computer.

There are two types of updates supported by the mobile computer: partitions and files. The file system used by the mobile computer is the same as the file system used on a desktop computer. A file is a unit of data that can be accessed using a file name and a location in the file system. When a file is replaced, only the contents of the previous file are erased. The operating system must be running for a file to be updated, so the IPL cannot perform individual file updates as it is a stand-alone program that does not require the operating system to be running.

A typical partition is a group of files, combined into a single “partition” that represents a specific area of storage. Examples of partitions are the flash file systems such as *Platform* or *Application*. (Using the desktop computer comparison, these partitions are roughly equivalent to a C: or D: hard disk drive.) In addition to the “hard disk” partitions, some partitions are used for single items such as the operating system, monitor, or splash screen. (Again using a desktop computer comparison, these partitions are roughly the equivalent of the BIOS or special hidden system files.) When a partition is updated, all data that was previously in its storage region is erased - i.e. it is not a merge but rather a replacement operation. Typically, the operating system is not running when partitions are updated, so IPL can perform partition updates.

Partition images for selected partitions can be created by TCM. All partition images suitable for use by IPL are in hex file format for transfer by TCM from the development computer to the mobile computer.

Upgrade requirements:

- The hex files to be downloaded (on development computer)
- A connection from the host computer and the mobile computer (either serial or wireless)

- TCM (on development computer) to download the files.

Once these requirements are satisfied, the mobile computer can be upgraded by invoking IPL and navigating the menus. See [Sending the Hex Image Using IPL on page 9-10](#) for procedures on downloading a hex file to the mobile computer.

---

## Creating Hex Images

Terminal Configuration Manager (TCM) is an application used to customize flash file system partitions for the mobile computer. The most common use is to create an application partition hex file that contains the customer's application. TCM can also be used to load hex files to the flash memory of the mobile computer.

The program resident on the mobile computer that receives the hex file and burns it to the flash memory is called Initial Program Loader (IPL).

The customization of partitions is controlled by TCM scripts. The scripts contain all of the necessary information for building an image. The script is a list of copy commands specifying the files to copy from the development computer to the partition.

TCM works with a pair of directory windows, one displaying the script and the other displaying the source files resident on the development computer. Using standard windows drag and drop operations, files can be added and deleted from the script window.

The DCP for MC17xxc50 includes scripts used by Motorola to build the standard factory installed *Platform* and *Application* partitions provided on the mobile computer. The standard *Platform* partition contains drivers while the *Application* partition contains demo applications and optional components. The standard TCM scripts can be found in the following folder: *C:\Program Files\Symbol Device Configuration Packages\MC17xxc50 v1.0\TCM Scripts*.

- ✓ **NOTE** Before creating a script to build a hex image, identify the files required (system files, drivers, applications, etc.) and locate the files' source directories to make the script building process easier.

The required processes for building a hex image in TCM include:

- Starting TCM
- Defining script properties
- Creating the script for the hex image
- Building the image
- Sending the hex image
- Creating a splash screen
- Flash storage.

## Starting Terminal Configuration Manager



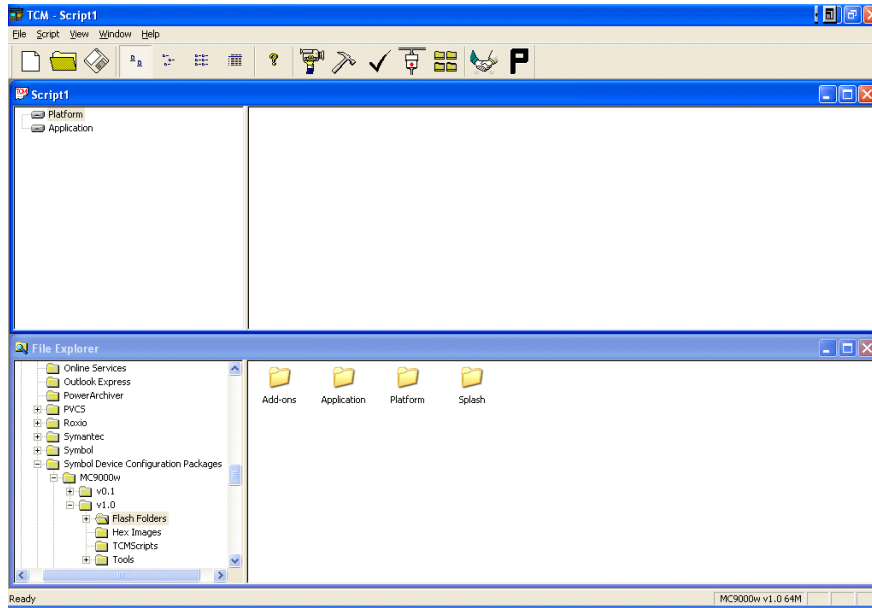







Click the Windows Start menu TCM icon (*Symbol Device Configuration Packages, MC17xxc50*) to start TCM. The **TCM** window appears displaying two child windows: **Script1** and **File Explorer**. The **Script1** window contains a newly created script and the **File Explorer** window contains a file explorer view used for selecting files to be placed in the script.









**Figure 9-3** TCM Startup Window

The following table lists the components of the TCM window.

**Table 9-1** TCM Components

Icon	Component	Function
	Script Window	Displays the files to be used in the creation of the partition(s).
	File Explorer Window	Used to select the files to be added to the script.
	Create button	Create a new script file.
	Open button	Open an existing script file.
	Save button	Save the current script file.
	Large icons button	View the current script items as large icon.
	Small icons button	View the current script items as small icon.
	List button	View the current script items as a list.
	Details button	View the current script items with more details.
	About button	Display version information for TCM.
	Properties button	View/change the current script properties.

**Table 9-1** TCM Components (Continued)

Icon	Component	Function
	Build button	Build the current script into a set of hex files.
	Check button	Check the script for errors (files not found).
	Send button	Download the hex image to the vehicle computer.
	Tile button	Arrange the sub-windows in a tiled orientation.
	Build and Send	Build the current script into a set of hex images and send the hex images to the vehicle computer.
	Preferences button	View/change the global TCM options.

## Defining Script Properties

Before a script is created, the script properties must be defined. This defines the type of mobile computer, flash type, number of disks being created and the memory configuration of each disk partition.

To define the script properties:

1. Select the **Script** window to make it active.
2. Click the **Properties** button. The **Script Properties** window > **Partition Data** tab appears.

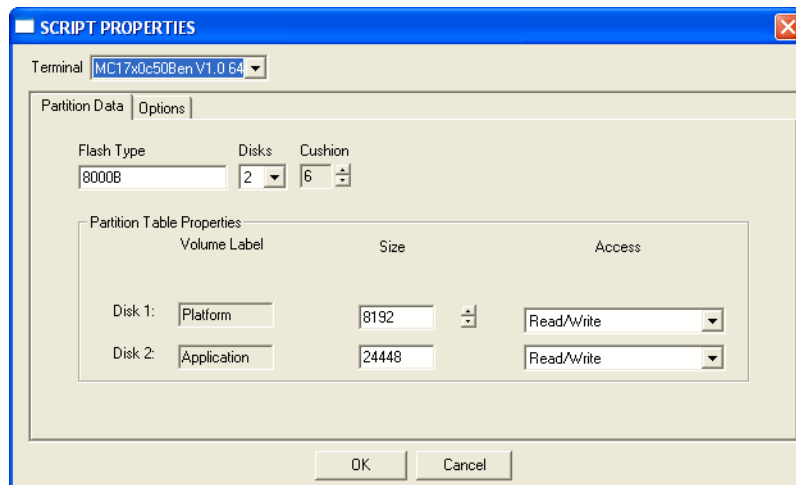
**Figure 9-4** Script Properties Window - Partition Data Tab

3. In the **Terminal** drop-down list, select the mobile computer type.
4. Use the default **Flash Type**.
5. In the **Disks** drop-down list, select the number of disk partitions to create.
6. Select the (memory) **Size** for each partition. Note that adding space to one disk. partition subtracts it from another.

7. In the **Access** drop-down list for each disk partition, determine and select the Read/Write access option.
8. Click the **Options** tab. The **Script Properties window Options** tab appears.

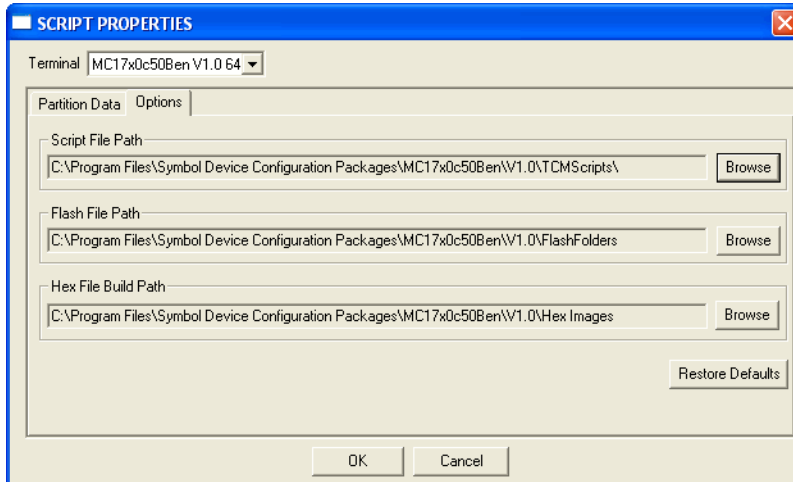

**Figure 9-5** Script Properties Window - Options Tab

9. Set the paths for the Script File, Flash File and Hex File Build.
10. Click **OK**.

## Creating the Script for the Hex Image

On start-up, **TCM** displays the **TCM** window with the **Script1** window and **File Explorer** window pointing to the following directory:

```
\Program Files\Symbol Device Configuration Packages\MC17xxc50\v0.1\TCMScripts\
```

The *Script1* window directory pane displays two partitions: *Platform* and *Application*. Depending on the type of flash chip, the number of partitions may change. Files can be added to each of the partitions. TCM functionality includes:

- Opening a new or existing script file
- Copying components to the script window
- Saving the script file.

### Opening a New or Existing Script

A script file can be created from scratch or based on an existing script file. Click **Create** to create a new script or click **Open** to open an existing script (for example, a script provided in the DCP for MC17xxc50). If an existing script is opened and changes are made, saving the changes overwrites the original script. To use an original or Symbol supplied standard script as a base and save the changes in a new script, use the *Save As* function to save the script using a different file name.

### Updating TCM 1.X Scripts

Script files that were created with older versions of TCM can be upgraded to TCM 2.0 scripts. Click **Open** to open an existing script created with an older version of TCM. The **Conversion** window appears automatically.



## Copying Components to the Script

Script contents are managed using standard file operations such as **New Folder**, **Delete** and **Rename**. Items can be added to the script by clicking files and folders in the **File Explorer** window and dragging them to the **Script** window. The **File Explorer** window supports standard windows; multiple files may be selected by clicking while holding the **SHIFT** or **CTRL** keys.

## Saving the Script

Modifications to a script file can be saved using the **Save** or the **Save As** function. Saving changes to an existing script writes over the original script. To use a Symbol-supplied standard script as a base and save the changes in a new script, use the **Save As** function.

## Building the Image

Once the script is created, the hex image defined by the script can be built.

As part of the build, TCM performs a check on the script which verifies that all files referenced in the script exist. This check is important for previously created scripts to ensure that files referenced in the script are still in the designated locations.

To build scripts:

1. Click **Build** on the TCM toolbar. The **Configure Build** window appears.

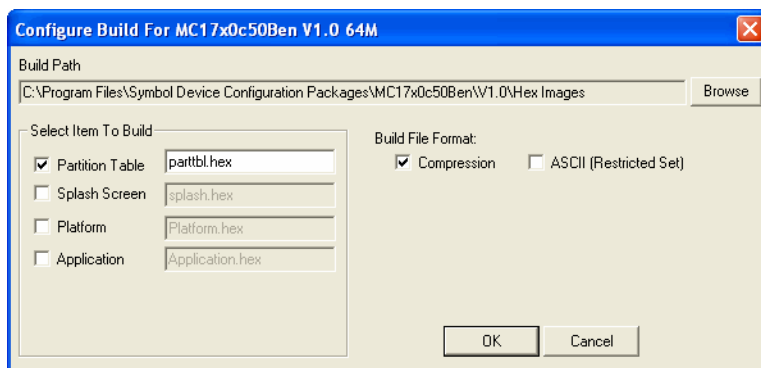

**Figure 9-6** *Configure Build Window*

2. Select the items (partitions) to build using the check box(es) to the left of each named partition.
3. The **Build Path** defines where to store all built partitions.
4. Select (hex image) **COMPRESSION** to reduce the size and speed up the download.
5. Click **OK** and follow the on-screen instructions.

If one of the partitions being built is the Splash Screen, a prompt appears requesting both the source Bitmap file and the destination HEX file.

6. A check is performed and if there are no errors, the partition hex files are created.

If the build fails, the hex files are not be created and TCM displays an error message. Two of the most common reasons for a build failure are:

- Files defined in the script can not be found. This error can occur when the files referenced by the script are no longer stored on the development computer or the folders where they are stored were renamed.

- The total amount of flash memory space required by the script exceeds the image size. To correct this, reduce the number of files in the partition or increase the size of the partition. See [Defining Script Properties on page 9-7](#) for more information about setting the image size appropriately.

---

## Sending the Hex Image Using IPL

Once the hex file is built, it can be downloaded to the mobile computer using IPL.

✓ **NOTE** The mobile computer must be inserted in the cradle with appropriate power supply connected to a power source, for the mobile computer to reset into IPL.

1. Press and simultaneously hold the Up Arrow and Down Arrow keys for 10 seconds.
2. Press and hold the Scan key for 10 seconds and release the Up Arrow and Down Arrow keys.
3. The screen blanks.
4. The **Initial Program Loader** menu displays.
5. Release the **Scan** key.

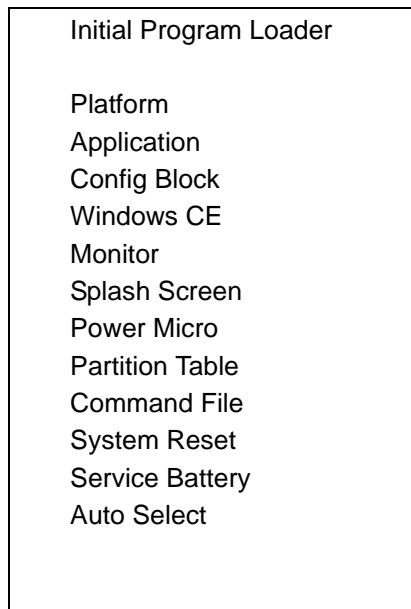

**Figure 9-7** Initial Program Loader (IPL) Menu



**CAUTION** To insure a successful download, do not remove power from the mobile computer while in IPL mode.



- NOTE** The hex images must be downloaded in the following order:
1. Monitor (mobile computer resets after downloading monitor)
  2. Config Block
  3. Partition Table and Power Micro
  4. Platform, Splash Screen, Application and Windows CE.

If the platform or application partition sizes are changed, you must download a new partition table first.

6. Choose Auto Select or use the up and down scroll buttons to select the partition to download, then press **Enter**.

**Table 9-2** *IPL Menu Partitions*

Partition Name	Description
Platform	Contains the files in the <i>Platform</i> folder.
Application	Contains the files in the <i>Application</i> folder.
Windows CE	Contains the operating system for the mobile computer.
Monitor	Contains the Monitor and IPL programs.
Splash Screen	Contains the splash screen that displays while booting the mobile computer. Note: Splash screens are generated from .bmp images and must be less than or equal to 240 pixels wide and 296 pixels deep. For color screens the color depth must be 8 bpp. Note: 8 bits per pixel only applies to splash screen images. Once Windows CE is running, the color density is 16 bits per pixel.
Power Micro	The Power Micro is a small computer contained within the mobile computer that controls several system resources. In the unlikely event that the Power Micro Firmware needs updating, selecting this item allows the device to be programmed.
Partition Table	Contains the partition information for all other partitions. Note: The partition table should never need changing unless the sizes of the platform and application images are changed within TCM. If this is done, then the new partition table should be loaded first, followed by both platform and application in any order.
Command File	Select to load a command file. A command file is a file that allows you to automatically load a number of partitions in a batch process.
System Reset	Selecting this item provides a simple method to exit IPL and to boot the operating system.
Auto Select	Selecting this item allows one or more files to be downloaded without having to manually select the destination. (The content of the files being downloaded automatically directs the file to the correct destination.) For technical reasons, Auto Select cannot be used to download Monitor, Power Micro, or Partition Table. These items must be specifically selected.

7. IPL displays the **Select Transport** menu which lists the available methods of downloading the file.

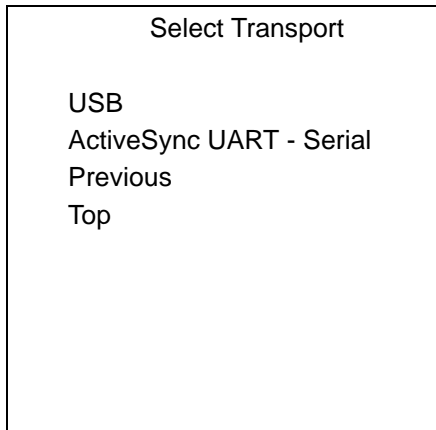

**Figure 9-8** *Select Transport Menu*

8. Use the up and down scroll buttons to select **USB** and press **Enter**. If this is the first time using USB transport, you might need to install the Symbol USB driver. Follow the screen prompts.

The **USB Configuration** menu appears.

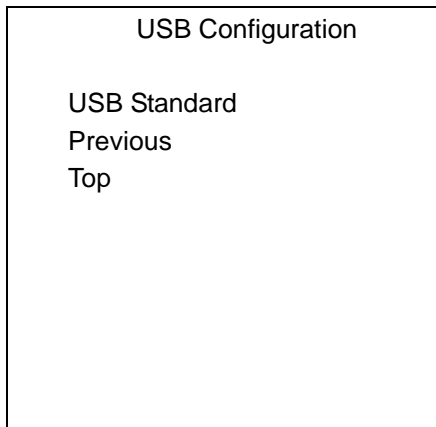

9. Select **USB Standard** and press **ENTER**. The **Download File?** menu appears.

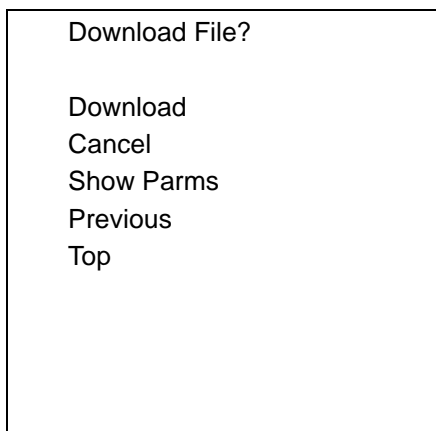

**Figure 9-9** *Download File? Menu*

10. Use the up and down scroll buttons to select **Show Parm**s to verify the file to download. Press **ENTER** to display the **Parameters** screen.

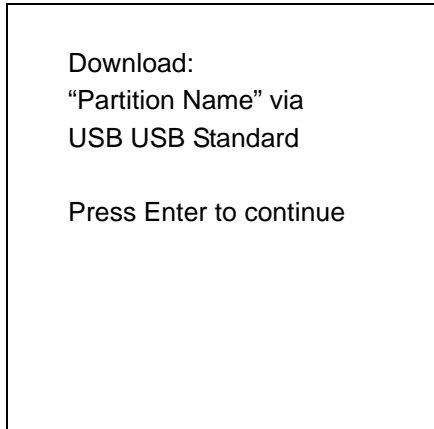

**Figure 9-10** *Parameters Screen*

**Partition Name** is the name of the partition selected in the **Initial Program Loader** menu.

11. Press **Enter** to return to the **Download File?** menu.
12. Use the up and down scroll buttons to select **Download**. Press **Enter**. The **Downloading** screen appears.



**Figure 9-11** *Downloading Screen*

13. On the development computer, click **Load** on the TCM toolbar. The **Load Terminal** window > **Serial** tab appears.

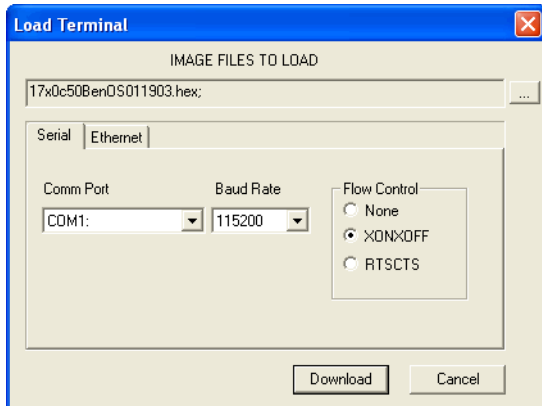

**Figure 9-12** Load Terminal Window - Serial and Ethernet Tabs

14. Select the **Image Files To Load**.
15. In the Comm Port drop-down list, select **USB: Symbol Device**.
16. Click **Download** to begin the operation.
17. During download, the **Downloading** screen on mobile computer displays the **Device Status** and a progress bar.
18. When complete, **Device Status** displays **Result was: Success!**, or in the case of an error, the cause of the error.
19. On completion, press **ENTER** to return to the IPL menu to select the next partition to download.
20. To exit IPL, select the **System Reset** item from the IPL menu (see [Figure 9-7 on page 9-10](#)).

## TCM Error Messages

TCM validates the cells in the partition table when the Execute button is clicked. Cells highlighted in red contain an error. Partition loading is disabled until all errors are corrected.

**Table 9-3** TCM Error Messages

Error	Description/Solution
Failed to build images: flash file system DLL not loaded!	TCM could not load the DLL required to build images for the targeting flash file system. Reinstall TCM or recover the DLL.
Failure finding directory xxx	Building process failed because directory xxx was not found.
Failure creating volume	Building process failed because a certain disk volume could not be created.
Failure adding system file to image	Build process failed because TCM failed to add a certain system file to the disk image.
INVALID PATH	The path for the image file to build is not valid.
Nothing Selected To Build	In the Config Build window, no item is selected to build.

**Table 9-3** TCM Error Messages (Continued)

Error	Description/Solution
Illegal ESS ID	In the Build ESSID Partition window, no ESS ID was entered or the ESS ID entered was illegal.
Disk Full	TCM failed to create Hex image file at the selected path. Check available disk space.
Target Disk Full	Build process failed because TCM failed to add file to the image of a disk volume. Remove some files or increase the disk size.
Hex file is READ ONLY	The Hex image file to be created exists and is read-only. Delete the existing file or change its attribute.
Error opening the file xxx with write access	TCM could not open file xxx with write access. Check if file is in use.
Failure creating binary file	TCM failed to open/create an intermediate binary file.
Hex File To load is missing or invalid	In Load Terminal window, the file selected to load has invalid status.
Could not locate mobile computer name in TCM.ini file	While loading the Script Properties window, TCM could not find the TCM.ini section corresponding to the mobile computer type specified by the current opening script. Either TCM.ini or the script file is invalid.
Incorrect disk sizes in TCM.ini file	The total disk size specified in the script does not match the total disk size defined in the corresponding TCM.ini section. Check if the script is corrupt or the TCM.ini has changed after the script was created.
INVALID DIRECTORY	In Script Properties window, the selected System File Path is not a valid directory.
One of the disk sizes is one sector in size	In Script Properties window, one of the disks is too small (one sector in size). This may cause problem while building images, especially when cushion is enabled. Increase the disk size.
INVALID VOLUME NAME	In Script Properties window, one of the volume labels is not valid.
Corrupt TCM.INI file! (Invalid value of VolumeDivisor)	The VolumeDivisor entry is missing or invalid in the TCM.ini. Reinstall TCM or recover TCM.ini.
Invalid version of TCM script file	The TCM script was not created by this version of TCM.
Corrupt or missing TCM.ini file	TCM could not find TCM.ini file.
FAILED CONNECTION TO COM PORT (Could not get status)	While downloading images to mobile computer, TCM failed to connect to the selected COM port. Check if the COM port is free and is properly configured.
FAILED CONNECTION TO TERMINAL (Terminal Not Connected Properly/Terminal Not Ready to Receive)	While downloading images, TCM failed to connect to the mobile computer. Check if the correct flow control protocol is selected and the mobile computer is properly connected and is in a listening state.

## IPL Error Detection

While receiving data, IPL performs many checks on the data to ensure that the data is received correctly. If an error is detected, IPL immediately aborts the download, and reports the error on an error screen.

Error screens may vary depending on the action being performed. A sample error screen may look like the screen pictured below:

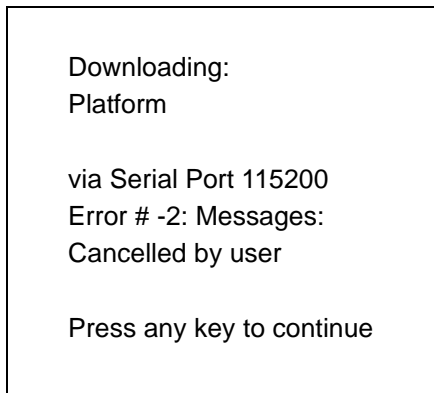

**Figure 9-13** IPL Error Screen

This error message screen displays until you press any key. Once the screen is acknowledged, IPL returns to the **Initial Program Loader** main menu to wait for a new selection.

To find the probable cause of the error, use the error number and/or the error text displayed on the screen to look up the error in [Table 9-4](#).

**Table 9-4** IPL Errors

Error Text	Error Number	Probable Cause
Unknown error	-1	A general error occurred. Retry the download. If the failure persists, it is most likely due to a hardware failure; the mobile computer requires servicing.
Cancelled by user	-2	The user canceled the download.
Can't open the source	-7	An error occurred opening the source device (either radio card or Serial port). Check source device connectivity and retry.
Can't open the destination	-8	An error occurred opening the destination device (either flash ROM or Power Micro). Retry the download. If the failure persists, it is most likely due to a hardware failure; the mobile computer requires servicing.
Can't read from the source device	-9	The source device (either radio card or Serial port) could not be read from. Check source device connectivity and retry.
Can't write to the destination device	-10	The destination device (either flash ROM or Power Micro) could not be written to. Retry the download. If the failure persists, it is most likely due to a hardware failure; the mobile computer requires servicing.
Transmission checksum error	-11	An error occurred during transmission from the source device (either radio card or Serial port) and the checksum check failed. Check source device connectivity and retry.



**Table 9-4** IPL Errors (Continued)

Error Text	Error Number	Probable Cause
Readback checksum error	-12	A checksum, generated from reading back data that was written to the destination device, was incorrect. An error during transmission or a write error to the destination device could cause this.
There is no more heap space available	-14	There is no more heap space available for the download procedure. Restart IPL and retry the download. If the failure persists, contact service with details of what is being downloaded.
Insufficient data available to complete record	-21	A Symbol HEX file download was attempted but the HEX file is invalid. Ensure the file is in Symbol HEX file format.
Invalid Symbol HEX file	-23	A Symbol HEX file download was attempted but the HEX file is invalid. Ensure the file is in Symbol HEX file format.
Unrecognized or unsupported HEX record	-24	The Symbol HEX file being downloaded contains an invalid or unrecognized HEX record. Ensure the file is in proper Symbol HEX file format.
Invalid data in HEX file	-25	The Symbol HEX file being downloaded contains invalid data. Ensure the file is in proper Symbol HEX file format with valid HEX data.
Exceeded max size	-26	The download file is too large to fit into the space allocated for it. Either make the file smaller or increase the space allocated for it by altering the partition table.
Partition is not valid on this device	-27	The downloaded file specifies a partition entry that does not exist on the device. Only download files that are valid for this device, or change the partition table so that the new file is valid on the device.
Wrong destination code	-28	A specific partition was chosen from the Main Menu (not Auto Select) but the file selected for download was for another partition. Ensure that the partition selected from the Main Menu matches the file selected for download.
File type does not support IPL Auto Select	-29	Monitor, Power Micro and Partition Table cannot be loaded with Auto Select. Select the appropriate area, and try again.
Non-contiguous record found	-30	A Symbol HEX file download was attempted but the HEX file is invalid. Ensure the file is in Symbol HEX file format.
Timed Out - No data	-31	IPL was waiting for data from the source device but timed out before receiving any. Check the source device connectivity and retry.
Fail: Buffer Overrun	-32	The serial port device could not keep up with incoming data. Retry the serial download with a lower baud rate.
Partition Table not Valid	-33	The size of flash memory is different than that described in the partition table. Retry the download with the correct partition table file.
Invalid file format	-34	The file format is invalid. Only Symbol HEX files are supported by IPL.

## Creating a Splash Screen

The source bitmap files used to create the default splash screens for the mobile computer are supplied with the DCP for MC17xxc50. These files can be modified using any of the standard windows image editors, allowing customization for particular customers.

To create a custom splash screen, perform the following steps:

1. Open the Splashcolor.bmp file supplied with the DCP for MC17xxc50 using an image editor.
2. Modify the bitmap file and save.
3. Create a splash partition using the steps shown in the [Building the Image on page 9-9](#).

## Splash Screen Format

If the default files are not used to create the new splash screens, be sure to preserve the image format. The formats are as follows:

**Table 9-5** *Splash Screen Format*

Screen Type	Dimensions	Color Format
Color	320 x 216	8 bits per pixel*

\* 8 bits per pixel only applies to splash screen images. Once Windows CE is running, the color density is 16 bits per pixel.

See [Sending the Hex Image Using IPL on page 9-10](#) for information about loading the splash screen using TCM and IPL.

---

## OS Update

### MC17

When operating system images are updated, new update images will be available as part of the Device Configuration Package (DCP) on the Support Central web site at:

<http://www.motorola.com/enterprisemobility/support>.

To load a new operating system using OS Update:

1. Download the latest DCP for MC17 from the Support Central web site. See for *Device Configuration Package on page 9-1* detailed instructions.
2. Connect the mobile computer to a host computer using ActiveSync.

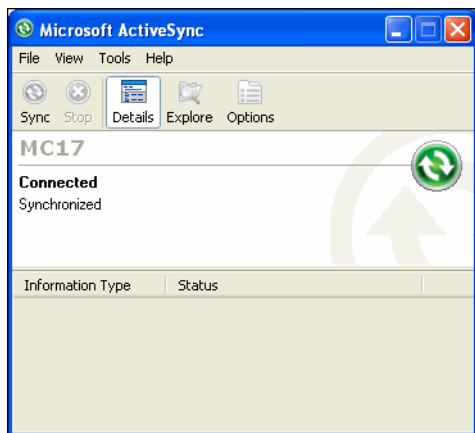

**Figure 9-14** ActiveSync - Connected

3. Use a remote control software on the host computer to view the CE desktop. See *Remote Control Software on page 5-1* for more information.
4. Open your ActiveSyncRemoteDisplay application on your desktop to give you a remote view to the WinCE device.
5. Select **Start > Settings > Control Panel**. The **Control Panel** window appears.
6. Click the **System** icon. The **System Properties** window appears.
7. Click the **Memory** tab.
8. Move the slider bar towards the right to increase total **Storage memory** to around 36000KB total.

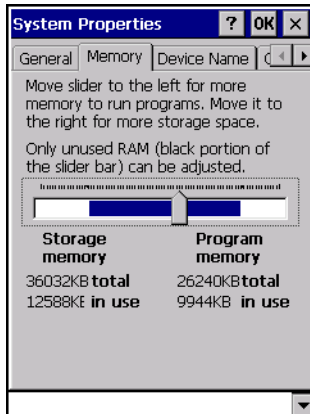

**Figure 9-15** *Memory Tab*

9. Select **OK** to close the **System Properties** window.
10. Close the **Control Panel** window.
11. On the host computer, open a **Windows Explorer** window and navigate to the C:\Program Files\Symbol Device Configuration Packages\MC17xxc50Ben\V1.x folder.
12. In the **ActiveSync** window, click the **Explore** button. A **Windows Explorer** window appears.

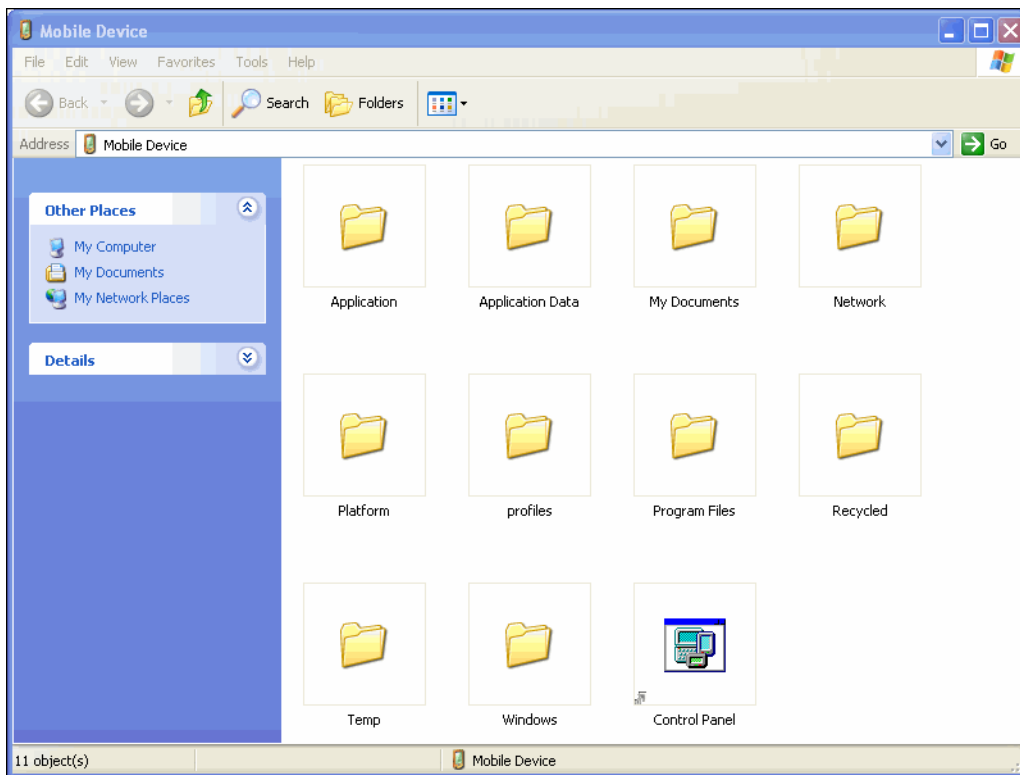

**Figure 9-16** *Explorer Window*

13. Copy the `/OSupdate` folder to the `/Temp` folder on the mobile computer.
14. Using the remote control software, navigate to `/Temp/OSUpdate` folder on the mobile computer. Select **View > Details** to display the whole filename.

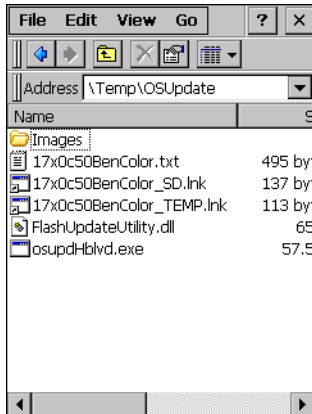

**Figure 9-17** Temp Directory

15. Double-click the *17xxc50BenColor\_TEMP.Ink* filename to launch the OSUpdate utility.
16. Once the update is completed the mobile computer automatically cold boots.
17. Remove the MC17 mobile computer from the cradle and re-insert after approximately one minute.

## MC17T

When operating system images are updated, new update images will be available as part of the Device Configuration Package (DCP) on the Support Central web site at:

<http://www.motorola.com/enterprisemobility/support>.

The OS Update files can be loaded in the /Temp directory or the /Storage Card directory. To load the files into the /Temp directory follow the procedures for the MC17, above.

To load a new operating system using OS Update and the /Storage Card folder:

1. Download the latest DCP for MC17 from the Support Central web site. See for *Device Configuration Package on page 9-1* detailed instructions.
2. Connect the mobile computer to a host computer using ActiveSync.

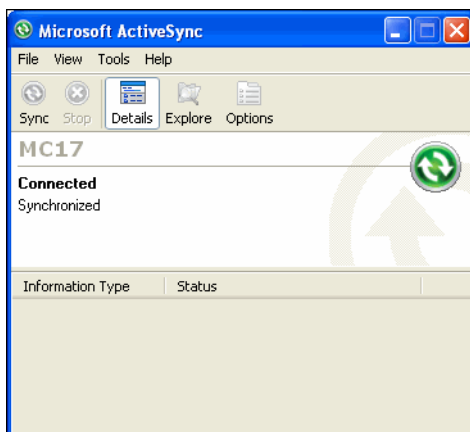

**Figure 9-18** ActiveSync - Connected

3. On the host computer, open a **Windows Explorer** window and navigate to the C:\Program Files\Symbol Device Configuration Packages\MC17xxc50Ben\V1.x folder.

- In the **ActiveSync** window, click the **Explore** button. A **Windows Explorer** window appears.

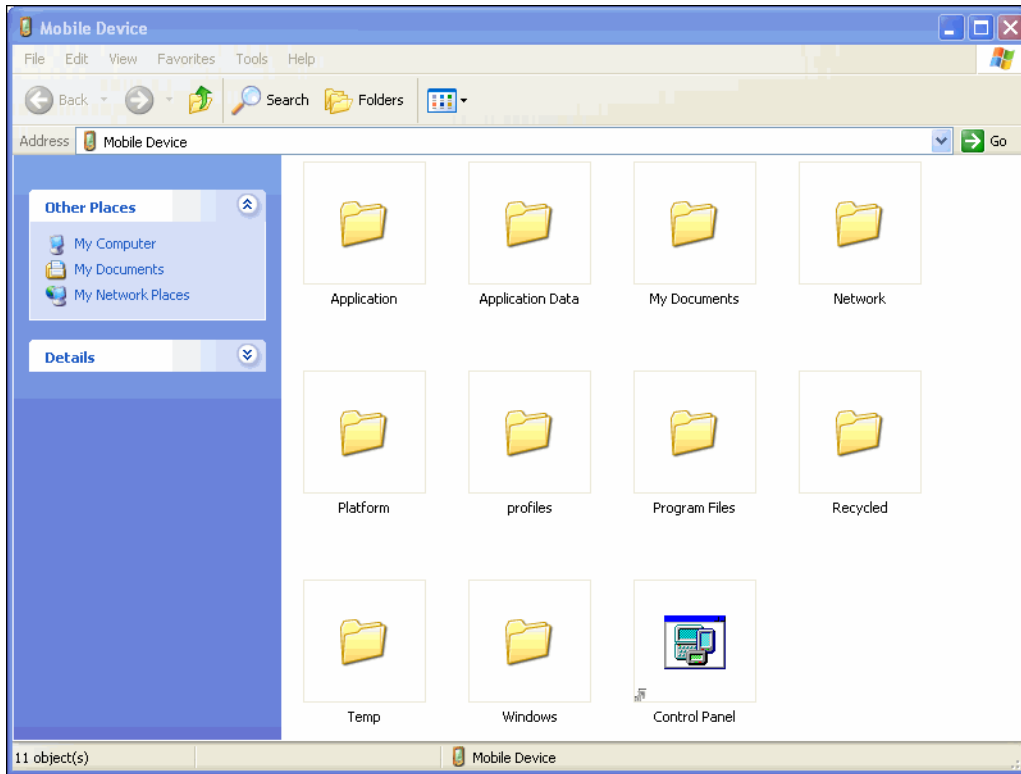

**Figure 9-19** Explorer Window

- Copy the `/OSupdate` folder to the `/Storage Card` folder on the mobile computer.
- Navigate to `/Storage Card/OSUpdate` folder on the mobile computer.
- Select **View > Details** to display the whole filename.

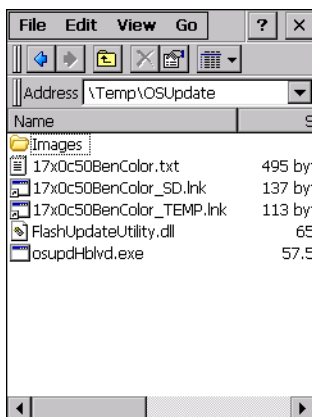

**Figure 9-20** Storage Card Directory

- Double-tap the `17xxc50BenColor_SD.Ink` filename to launch the OSUpdate utility.
- Once the update is completed the mobile computer automatically cold boots.
- Remove the MC17 mobile computer from the cradle and re-insert after approximately one minute.

---

## Flash Storage

In addition to the RAM-based storage standard on Windows CE mobile computers, the mobile computer is also equipped with a non-volatile Flash-based storage area which can store data (partitions) that can not be corrupted by a cold boot. This Flash area is divided into two categories: Flash File System (FFS) Partitions and Non-FFS Partitions.

### FFS Partitions

The mobile computer includes two FFS partitions. These partitions appear to the mobile computer as a hard drive that the OS file system can write files to and read files from. Data is retained even if power is removed.

The two FFS partitions appear as two separate folders in the Windows CE file system and are as follows:

- Platform: The Platform FFS partition contains Symbol-supplied programs and Dynamic Link Libraries (DLLs). This FFS is configured to include DLLs that control system operation. Since these drivers are required for basic mobile computer operation, only experienced users should modify the content of this partition.
- Application: The Application FFS partition is used to store application programs needed to operate the mobile computer.

### Working with FFS Partitions

Because the FFS partitions appear as folders under the Windows CE file system, they can be written to and read like any other folder. For example, an application program can write data to a file located in the Application folder just as it would to the Windows folder. However, the file in the Application folder is in non-volatile storage and is not lost on a cold boot (e.g., when power is removed for a long period of time).

Standard tools such as ActiveSync can be used to copy files to and from the FFS partitions. They appear as the "Application" and "Platform" folders to the ActiveSync explorer. This is useful when installing applications on the mobile computer. Applications stored in the Application folder are retained even when the mobile computer is cold booted.

There are two device drivers included in the Windows CE image to assist developers in configuring the mobile computer following a cold boot: RegMerge and CopyFiles.

#### RegMerge.dll

RegMerge.dll is a built-in driver that allows registry edits to be made to the Windows CE Registry. Regmerge.dll runs very early in the boot process and looks for registry files (.reg files) in certain Flash File System folders during a cold boot. It then merges the registry changes into the system registry located in RAM.

Since the registry is re-created on every cold boot from the default ROM image, the RegMerge driver is necessary to make registry modifications persistent over cold boots.

RegMerge is configured to look in the root of two specific folders for .reg files in the following order:

- \Platform
- \Application

Regmerge continues to look for .reg files in these folders until all folders are checked. This allows folders later in the list to override folders earlier in the list. This way, it is possible to override Registry changes made by the

Platforms partitions folders. Take care when using Regmerge to make Registry changes. The DCP for MC17xxc50 contains examples of .reg files.

✓ **NOTE** Regmerge only merges the .reg files on cold boots. The merge process is skipped during a warm boot.

Typically, do not make modifications to registry values for drivers loaded before RegMerge. However, these values may require modification during software development. Since these early loading drivers read these keys before RegMerge gets a chance to change them, the mobile computer must be cold booted. The warm boot does not re-initialize the registry and the early loading driver reads the new registry values.

Do not use Regmerge to modify built-in driver registry values, or merge the same Registry value to two files in the same folder, as the results are undefined.

## CopyFiles

Windows CE expects certain files to be in the Windows folder, residing in volatile storage. Windows CE maintains the System Registry in volatile storage. CopyFiles copies files from one folder to another on a cold boot. Files can be copied from a non-volatile partition (Application or Platform) to the Windows or other volatile partition during a cold boot. During a cold boot CopyFiles looks for files with a .CPY extension in the root of the Platform and Application FFS partitions (Platform first and then Application). These files are text files containing the source and destination for the desired files to be copied separated by ">". The following example from the file application.cpy is contained on the demo application partition included in the DCP for MC17xxc50. It can also be obtained from the web site at <http://www.motorola.com/enterprisemobility/support>.

Files are copied to the Windows folder from the Flash File System using copy files (\*.cpy) in the following order:

```
\Platform
  \Application
```

Example:

```
\Application\ScanSamp2.exe>\Windows\ScanSamp2.exe
```

This line directs CopyFiles to copy the ScanSamp2.exe application from the \Application folder to the \Windows folder.

## Non-FFS Partitions

Non-FFS Partitions include additional software and data pre-loaded on the mobile computer that can be upgraded. Unlike FFS Partitions, these partitions are not visible when the operating system is running. They also contain system information. Non-FFS partitions include the following:

- Windows CE: The complete Windows CE operating system is stored on Flash devices. If necessary, the entire OS image may be downloaded to the mobile computer using files provided by Motorola. The current OS partition on the mobile computer is included as part of the TCM installation package. Any upgrades must be obtained from Motorola. This partition is mandatory for the mobile computer.
- Splash Screen: a bitmap smaller than 16 kb (and limited to 8 bits per pixel) is displayed as the mobile computer cold boots. To download a customized screen to display, see [Creating a Splash Screen on page 9-18](#).

✓ **NOTE** 8 bits per pixel only applies to splash screen images. Once Windows CE is running, the color density is 16 bits per pixel.



- IPL: This program interfaces with the host computer and allows downloading via cradle or serial cable any or all of the partitions listed above, as well as updated versions of IPL. Use caution downloading updated IPL versions; incorrect downloading of an IPL causes permanent damage to the mobile computer. IPL is mandatory for the mobile computer.
- Partition Table: Identifies where each partition is loaded in the mobile computer.

## **Downloading Partitions to the Mobile Computer**

TCM is used to specify a hex destination file for each partition and download each file to the mobile computer. This download requires a program loader stored on the mobile computer. The mobile computer comes with a program loading utility, Initial Program Loader (IPL), stored in the mobile computer's write-protected flash.



# Chapter 10 Maintenance and Troubleshooting

---

## Introduction

This chapter includes instructions on cleaning and storing the mobile computer, battery maintenance and provides troubleshooting solutions for potential problems during mobile computer operating.

---

## Maintaining the Mobile Computer

For trouble-free service, observe the following tips when using the mobile computer:

- Protect the mobile computer from temperature extremes.
- Do not store or use the mobile computer in any location that is extremely dusty, damp, or wet.
- Use a soft lens cloth to clean the mobile computer. If the surface of the mobile computer screen becomes soiled, clean it with a soft cloth moistened with a diluted window-cleaning solution. Do not use bleach or ammonia.
- Periodically replace the rechargeable Li-ion battery to ensure maximum battery life and product performance. Battery life depends on individual usage patterns.
- Take care not to scratch the screen of the mobile computer.
- The display of the mobile computer contains glass. Take care not to drop the mobile computer or subject it to strong impact.

---

## Battery Safety Guidelines

- The area in which the units are charged should be clear of debris and combustible materials or chemicals. Particular care should be taken where the device is charged in a non-commercial environment.
- Do not use incompatible batteries and chargers. If you have any questions about the compatibility of a battery or a charger, contact Motorola Enterprise Mobility support. See [Service Information on page xvi](#) for contact information.
- Do not crush, puncture, or place a high degree of pressure on the battery.

- Severe impact from dropping any battery-operated device on a hard surface could cause the battery to overheat.
- Do not leave or store the equipment in or near areas that might get very hot, such as in a parked vehicle or near a radiator or other heat source. Do not place battery into a microwave oven or dryer.
- Do not dispose of batteries in fire.
- If you suspect damage to your equipment or battery, call Motorola Enterprise Mobility support to arrange for inspection. See [Service Information on page xvi](#) for contact information.

---

## Battery Management

### Clearing the Battery

After replacement of the battery.

✓ **NOTE** The mobile computer must be inserted in the cradle with appropriate power supply connected to a power source, for the mobile computer to reset into IPL.

1. Press and simultaneously hold the Up Arrow and Down Arrow keys for 10 seconds.
2. Press and hold the Scan key.
3. Release the Up and Down Arrow keys and continue to hold the Scan key until the display turns off.
4. Continue holding the Scan key.
5. The **Initial Program Loader** menu displays.
6. Release the **Scan** key and place into a cradle.

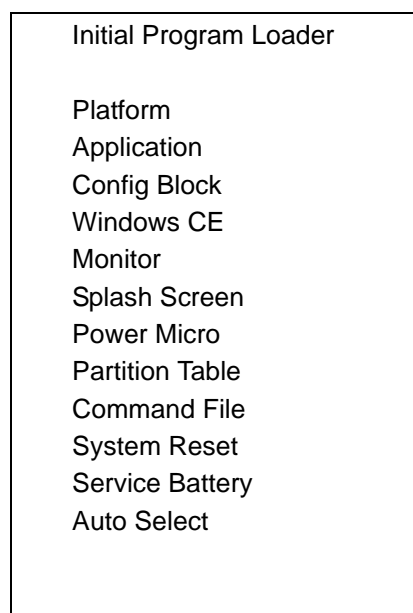

**Figure 10-1** Initial Program Loader (IPL) Menu

7. Select **Service Battery**.
8. Press Entry key.

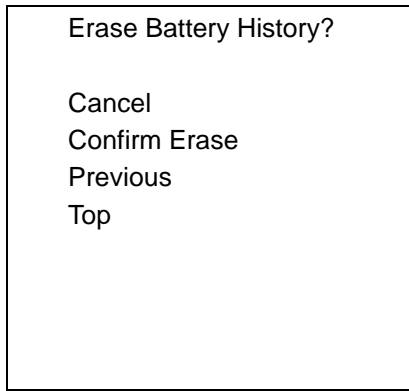

**Figure 10-2** *Erase Battery History Screen*

9. Select **Confirm Erase**.
10. Press Enter key.

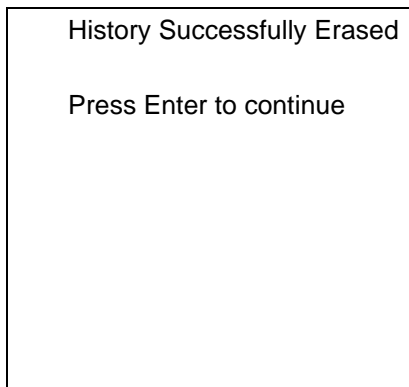

**Figure 10-3** *History Successfully Erased Screen*

11. Press Enter key.

---

## Long Term Storage

When storing the mobile computer for a long period of time it is recommended to remove the battery.

When returning the mobile computer to everyday operation, install a fully charged battery.

## Troubleshooting

### Mobile Computer

Table 10-1 Troubleshooting the Mobile Computer

Problem	Cause	Solution
Mobile computer does not turn on.	Lithium-ion battery not charged.	Charge or replace the lithium-ion battery in the mobile computer.
	Lithium-ion battery not installed properly.	Ensure battery is installed properly. See <a href="#">Connecting the Battery on page 1-6</a> .
	System crash.	Perform a warm boot. If the mobile computer still does not turn on, perform a cold boot. See <a href="#">Resetting the Mobile Computer on page 1-18</a> .
	Mobile Computer is in a critical suspend state due to low battery.	Place the mobile computer in the Charging cradle. The mobile computer re-boots and begins charging. Depending on how depleted the battery is, the mobile computer may take up to five minutes before it turns on.
Rechargeable lithium-ion battery did not charge.	Battery failed.	Replace battery. If the mobile computer still does not operate, try a warm boot, then a cold boot. See <a href="#">Resetting the Mobile Computer on page 1-18</a> .
	Mobile computer removed from cradle while battery was charging.	Insert mobile computer in the Charging cradle and begin charging. The battery fully charges in approximately five hours.
	Ambient temperature of the Charging cradle is too warm or too cold.	The ambient temperature must be between 0 °C and 40 °C (32 °F and 104 °F).
During data communication, no data was transmitted, or transmitted data was incomplete.	Mobile computer removed from Charging cradle or unplugged from host computer during communication.	Replace the mobile computer in the Charging cradle, or reattach the Development cable and re-transmit.
	Incorrect cable configuration.	See the System Administrator.
	Communication software was incorrectly installed or configured.	Perform setup. See <a href="#">Chapter 8, Cradle Installation</a> for details.
Ensure that Microsoft ActiveSync 4.5 or greater is installed on the host computer.		

Table 10-1 Troubleshooting the Mobile Computer (Continued)

Problem	Cause	Solution
Mobile computer turns itself off.	Mobile computer is inactive.	<p>The mobile computer turns off after a period of inactivity. If the mobile computer is running on battery power, this period can be set to 30 sec., 1, 2, 3, 4, 5 or 6 minutes. If the mobile computer is running on external power, this period can be set to 1, 2, 3, 5, 10, 15 and 30 minutes.</p> <p>Check the power settings by selecting <b>Start &gt; Settings &gt; Control Panel &gt; Power icon &gt; Power Off</b> tab.</p> <p>Change the setting if you need a longer delay before the automatic shutoff feature activates.</p>
	Battery is depleted.	Place the mobile computer in the Charging cradle to re-charge the battery.
	Battery is not inserted properly.	Insert the battery properly (see <a href="#">Connecting the Battery on page 1-6</a> ).
	The mobile computer's battery is low and it powers down to protect memory content.	Place the mobile computer in the Charging cradle to re-charge the battery.
Tapping the window buttons or icons does not activate the corresponding feature.	Screen is not calibrated correctly.	Re-calibrate the screen. See <a href="#">Screen Calibration on page 5-11</a> .
A message appears stating that the mobile computer memory is full.	Too many files stored on the mobile computer.	Delete unused memos and records. You can save these records on the host computer.
	Too many applications installed on the mobile computer.	<p>If you have installed additional applications on the mobile computer, remove them to recover memory.</p> <p>Select <b>Start &gt; Settings &gt; Control Panel &gt; Remove Programs</b> icon.</p> <p>Select the unused program and select <b>Remove</b>.</p>
Applications and servers a return an error value of 255 (-1).	Unknown battery charge level is returned to the application.	Remove the battery from the mobile computer and re-install. Wait approximately one minute before inserting into a cradle.

Table 10-1 Troubleshooting the Mobile Computer (Continued)

Problem	Cause	Solution
The mobile computer does not accept scan input.	Scanning application is not loaded.	Verify that the mobile computer is loaded with a scanning application. See the System Administrator.
	Unreadable bar code.	Ensure the symbol is not defaced.
	Distance between exit window and bar code is incorrect.	Ensure mobile computer is within proper scanning range.
	Mobile computer is not programmed for the bar code.	Program the mobile computer to accept the type of bar code being scanned. Ensure that the bar code parameters are set properly for the bar code being scanned.
	Mobile computer is not programmed to generate a beep.	If a beep on a good decode is expected and a beep is not heard, check that the application is set to generate a beep on good decode.
	Battery is low.	If the scanner stops emitting a laser beam when the Scan key is pressed, check the battery level. When the battery is low, the scanner shuts off before the mobile computer low battery condition notification. Note: If the scanner is still not reading symbols, contact the distributor or service.
During data communications, no data was transmitted, or transmitted data was incomplete.	Incorrect cable configuration.	See the System Administrator.
	Communications software is not installed or configured properly.	Perform setup as described in <a href="#">Chapter 8, Cradle Installation</a> . Ensure that Microsoft ActiveSync 4.5 or greater is installed on the host computer.
Cannot ActiveSync with Host Computer	Wrong USB cable used.	Ensure that the cable has a USB A connector on one end and a USB mini B connector on the other end.
	Host computer not configured properly.	Ensure that ActiveSync on the host computer is set to allow USB connections. See <a href="#">Chapter 4, ActiveSync</a> for more information.



## Charging Cradle

Table 10-2 Troubleshooting the Charging Cradle

Symptom	Possible Cause	Solution
The red LED does not light when mobile computer is inserted.	Cradle is not receiving power.	Ensure the power cable is connected securely to both the cradle and to AC power.
	Mobile computer is not seated firmly in the cradle.	Remove and re-insert the mobile computer into the cradle, ensuring it is firmly seated.
Mobile computer battery is not charging.	Mobile computer was removed from cradle or cradle was unplugged from AC power.	Ensure cradle is receiving power. Ensure mobile computer is seated correctly. Confirm main battery is charging. The standard capacity battery fully charges in approximately five hours. View battery status by selecting <b>Start &gt; Settings &gt; Control Panel &gt; Power</b> icon.
	Battery is faulty.	Verify that other batteries charge properly. If so, replace the faulty battery.
	The mobile computer is not fully seated in the cradle.	Remove and re-insert the mobile computer into the cradle, ensuring it is firmly seated.
	Ambient temperature of the cradle is too warm or too cold.	Move the cradle to an area where the ambient temperature is between 0 °C and 40 °C (32 °F and 104 °F).
It is taking longer than five hours to charge the mobile computer.	Mobile computer is not optimized for low radio signal strength.	Refer to <a href="#">Tips for Improving Battery Charge Time on page 6-2</a> for information on optimizing the mobile computer.



# Appendix A Technical Specifications

## Technical Specifications

The following tables summarize the mobile computer's intended operating environment and general technical hardware specifications.

Table A-1 Technical Specifications

Item	Description
<b>Physical and Environmental Characteristics</b>	
Dimensions	206 mm L x 58.5 mm H x 81 mm W (8.11 inches L x 2.30 inches H x 3.19 inch W)
Weight	270 g (9.52 oz) with battery
Keyboard	6-key keypad
Display	MC17: Color 2.8 inch 320 x 240 QVGA non-touch screen MC17T: Color 2.8 inch 320 x 240 QVGA touch screen
Main Battery	Removable, rechargeable 3.7 VDC Lithium Ion battery. Standard capacity: 2400 mAh
<b>Performance Characteristics</b>	
CPU	MC17: XScale PXA270 processor at 312 MHz MC17T: XScale PXA270 processor at 520 MHz
Operating System	Microsoft Windows CE 5.0 Professional
Memory	MC17: 64MB Flash/64MB RAM MC17T: 64 MB RAM/64 MB Flash + 1 GB Flash storage
Application Development	PSDK, DCP and EMDK available through Support Central web site
Data Capture Options	Laser scanning

Table A-1 Technical Specifications (Continued)

Item	Description																		
<b>User Environment</b>																			
Operating Temperature	0 °C to 40 °C (32 °F to 104 °F)																		
Storage Temperature	-20 °C to 60 °C (-4 °F to 140 °F)																		
Battery Charging Temperature	0 °C to +40 °C (32 °F to 104 °F) ambient temperature range.																		
Humidity	5% to 95% non condensing																		
Drop Specification	Multiple 4 ft.(1.2 m) drops to tile linoleum over concrete across operating temperature range																		
ESD	± 15k VDC air discharge ± 8k VDC direct discharge ± 8k VDC indirect discharge																		
<b>WLAN Wireless Data Communications</b>																			
WLAN radio	MC17: 802.11b/g MC17T: 802.11a/b/g																		
Operating Channels	Channel 1 - 13 (2412 - 2472 MHz) Channel 14 (2484 MHz) Japan only Actual operating frequencies depend on regulatory rules and certification agency																		
Security	WEP (40 or 128 bit), TKIP, TLS, TTLS (MS-CHAP), TTLS (MS-CHAP v2), TTLS (CHAP), TTLS-MD5, TTLS-PAP, PEAP-TLS, PEAP (MS-CHAP v2), AES, LEAP, WPA2																		
Output Power	100 mW U.S. and International																		
Data Rate	802.11b: up to 11Mb per second 802.11g: up to 54Mb per second																		
Frequency Range	802.11a: 5 Ghz; country-dependent (MC17T only) 802.11b: 2.4 GHz; country-dependent 802.11g: 2.4 GHz; country-dependent																		
Antenna	Internal																		
Laser Safety	IEC/FDA Class 1 in accordance with IEC/EN 60825-1 & 21 CFR 1040.10 & 11 (Laser Notice No. 50)																		
Laser Decode Capability	<table border="0"> <tr> <td>Code 39</td> <td>Code 128</td> <td>Code 93</td> </tr> <tr> <td>Codabar</td> <td>Code 11</td> <td>Discrete 2 of 5</td> </tr> <tr> <td>Interleaved 2 of 5</td> <td>EAN-8</td> <td>EAN-13</td> </tr> <tr> <td>MSI</td> <td>UPCA</td> <td>UPCE</td> </tr> <tr> <td>UPC/EAN supplementals</td> <td>Coupon Code</td> <td>Trioptic 39</td> </tr> <tr> <td>Webcode</td> <td>Chinese 2 of 5</td> <td>RSS</td> </tr> </table>	Code 39	Code 128	Code 93	Codabar	Code 11	Discrete 2 of 5	Interleaved 2 of 5	EAN-8	EAN-13	MSI	UPCA	UPCE	UPC/EAN supplementals	Coupon Code	Trioptic 39	Webcode	Chinese 2 of 5	RSS
Code 39	Code 128	Code 93																	
Codabar	Code 11	Discrete 2 of 5																	
Interleaved 2 of 5	EAN-8	EAN-13																	
MSI	UPCA	UPCE																	
UPC/EAN supplementals	Coupon Code	Trioptic 39																	
Webcode	Chinese 2 of 5	RSS																	

Table A-1 Technical Specifications (Continued)

Item	Description
<b>Peripherals and Accessories</b>	
Cradles	Charging cradle.
Printers	Supports various printers from Zebra, Monarch, O'Neil and Epson.
<b>Regulatory</b>	
Electrical Safety	Certified to UL/cJUL 60950-1, EN/IEC 60950-1
EMC	North America: FCC Part 15 Canada: ICES 003 Class B EU: EN55022 Class B, EN 301 489-1, EN 301 489-17, EN 60601-1-2 Australia: AS/NZS CISPR A 22
RF	USA: FCC Part 15.247 Canada: RSS-210 EU: EN 300 328 Japan: ARIB STD-T33, ARIB STD-T66 Australia: AS/NZS 4268

## Charging Cradle

Table A-2 Charging Cradle Specifications

Item	Description
Operating Temperature	0 °C to +50 °C (32 °F to 122 °F)
Storage Temperature	-40 °C to 70 °C (-40 °F to 158 °F)
Battery Charging Temperature	0 °C to +40 °C (32 °F to 104 °F) ambient temperature
Humidity	5% to 95% non-condensing
Size (L x W x H)	98 mm x 127 mm x 272 mm (4 in. x 5 in. x 10.7 in.)
Weight	652 g (23 oz)
Power Supply	12.0 VDC, 9.0 A
Electrostatic Discharge (ESD)	±15 kV air discharge, ± 8 kV contact discharge

## Mobile Computer Interface Connector Pin-Outs

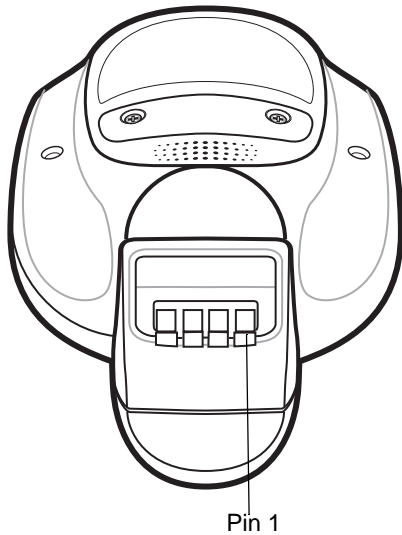

Figure A-1 Power Connector Pin-Outs

Table A-3 Power Connector Pin-Outs

PIN	Signal Name	Function
1	BATT+	Input power.
2	LED	Controls the cradle LEDs.
3	LOCK	Controls the cradle locking mechanism.
4	GND	Ground

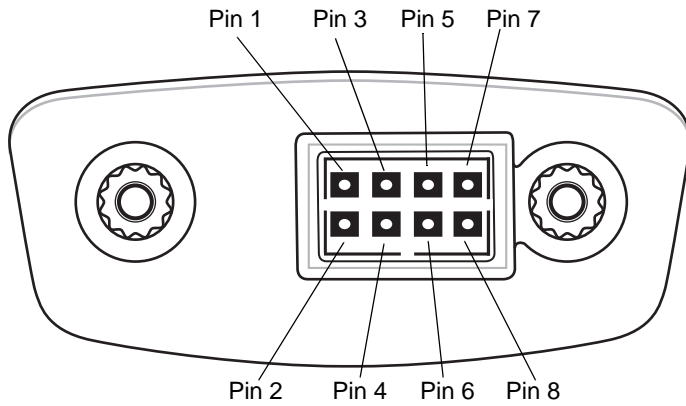

Figure A-2 ActiveSync Connector Pin-Outs

Table A-4 ActiveSync Connector Pin-Outs

PIN Number	Signal Name	Function
1	USB_5V	+5 VDC
2	USB_P	USB Data +
3	USB_N	USB Data -
4	GND	Ground
5	Not Used	Pin not used
6	Not Used	Pin not used
7	Not Used	Pin not used
8	Not Used	Pin not used

## Cable Specifications

### Power Supply Cable, Y-type

Table A-5 Wire Run List & Specifications

Wire Color	AWG	Connector 1 Molex 39-01-2060 housing; 4x, 39-00-0211 contacts	Connector 2 Molex 39-01-2025 housing; 2x, 39-00-0211 contacts	Connector 3 Molex 39-01-2025 housing; 2x, 39-00-0211 contacts	Function
Red	16	1	1		(+) term
Black	16	6	2		(-) term
Red	16	2		1	(+) term
Black	16	5		2	(-) term

The 16 AWG wire should have the following specifications: UL1007, 300 Volt, PVC, -40°C to 80°C operating temperature.

### Cradle Interconnection Cable

Table A-6 Wire Run List & Specifications

Wire Color	AWG	Connector 1 Molex 39-01-2025 housing; 2x, 39-00-0211 contacts	Connector 2 Molex 39-01-2025 housing; 2x, 39-00-0211 contacts	Function
Red	16	1	1	(+) term
Black	16	2	2	(-) term

The 16 AWG wire should have the following specifications: UL1007, 300 Volt, PVC, -40°C to 80°C operating temperature.



# Appendix B AirBEAM Smart Client

---

## Introduction

The AirBEAM Smart product allows specially designed software packages to be transferred between a host server and a mobile computer. Before transfer, AirBEAM Smart checks and compares package version, so that only updated packages are loaded.

AirBEAM Smart resides on the mobile computer and allows it to request, download and install software, as well as to upload files and status data. Both download and upload of files can be accomplished in a single communications session. The ability to transfer software over a wireless network can greatly reduce the logistical efforts of client software management.

In an AirBEAM Smart system, a network-accessible host server acts as the storage point for the software transfer. The AirBEAM Smart Client uses the industry standard FTP or TFTP file transfer protocols to check the host system for updates and, if necessary, to transfer updated software.

✓ **NOTE** For more detailed information about AirBEAM Smart, refer to the AirBEAM® Smart Windows® CE Client Product Reference Guide (p/n 72-63060-xx).

---

## AirBEAM Package Builder

In a typical distributed AirBEAM system, software to be transferred is organized into packages. In general, an AirBEAM package is simply a set of files that are assigned attributes both as an entire package and as individual component files. The package is assigned a version number and the transfer occurs when an updated version is available.

An AirBEAM package can optionally contain developer-specified logic to be used to install the package. Installation logic is typically used to update client device flash images or radio firmware. Examples of common AirBEAM packages would include packages for custom client application software, radio firmware and AirBEAM Smart Client software.

Once these packages are built, they are installed on the host server for retrieval by the mobile computer. The AirBEAM Package Builder is a utility used to define, generate and install AirBEAM packages to a server. The packages are then loaded from the server onto a client device equipped with an AirBEAM Smart Client executable.

For detailed instructions on how to define, generate and install AirBEAM packages to the server, refer to the *AirBEAM Package Builder Product Reference Guide*, p/n 72-55769-xx.

## AirBEAM Smart Client

The AirBEAM Smart Client is installed on the mobile computer. It is configured with the server access information, the names of the packages to be downloaded and other controlling parameters. When the AirBEAM Smart Client is launched, the device connects to the specified FTP server and checks the packages it is configured to look for. If the package version was updated, the client requests the transfer.

### AirBEAM License

The AirBEAM Smart Client is a licensed software product. The AirBEAM Smart Client's version synchronization functionality is enabled through a license key file that is stored on the mobile computer. The license key file can be built into AirBEAM Smart Client's image, or downloaded in a special AirBEAM package.

The AirBEAM license key file contains a unique key and a customer specific banner that is displayed when the AirBEAM Smart Client version synchronization logic is invoked.

### Configuring the AirBEAM Smart Client

1. Connect the mobile computer to a host computer using the Development Cable.
2. Connect to the mobile computer using Remote Desktop. See
3. Select **Start > Programs > AirBEAM Smart Client**. The **AirBEAM Smart CE** window appears.
4. Select **File > Configure**. The **AirBEAM** configuration window appears.

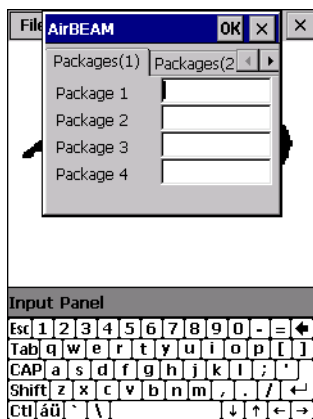
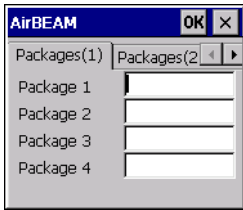

**Figure B-1** AirBEAM Configuration Window

The configuration window is used to view and edit AirBEAM Smart Client configurations. This dialog box has seven tabs that you can modify - Packages(1), Packages(2), Server, Misc(1), Misc(2), Misc(3) and Misc(4).

#### Packages(1) Tab

Use this tab to specify the package name of the first four of eight packages that are to be loaded during the AirBEAM synchronization process. The specified package name must correspond to a package that is available on the specified package server.



**Figure B-2** Package (1) Tab

**Table B-1** Package (1) Tab Descriptions

Field	Description
Package 1	Package name of the first of eight packages. This is an optional field.
Package 2	Package name of the second of eight packages. This is an optional field.
Package 3	Package name of the third of eight packages. This is an optional field.
Package 4	Package name of the fourth of eight packages. This is an optional field.

✓ **NOTE** No inadvertent trailing spaces should be entered on the Packages(1) tab. Information entered in these fields are case and space sensitive.

### Packages(2) Tab

Use this tab to specify the package name of the last four of eight packages that are to be loaded during the AirBEAM synchronization process. The specified package name must correspond to a package that is available on the specified package server.

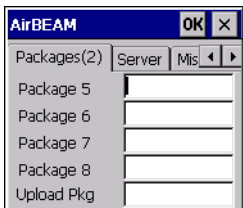

**Figure B-3** Package (2) Tab

**Table B-2** Package (2) Tab Descriptions

Field	Description
Package 5	Package name of the fifth of eight packages. This is an optional field.
Package 6	Package name of the sixth of eight packages. This is an optional field.
Package 7	Package name of the seventh of eight packages. This is an optional field.
Package 8	Package name of the eighth of eight packages. This is an optional field.
Upload Pkg	Package name of a package that is to be processed for “upload files” during the AirBEAM synchronization process. The specified package name must correspond to a package that is available on the specified package server. This is an optional field.

✓ **NOTE** No inadvertent trailing spaces should be entered on the Packages(2) tab. Information entered in these fields are case and space sensitive.

### Server Tab

Use this tab to specify the configurations of the server to which the client connects during the package synchronization process.

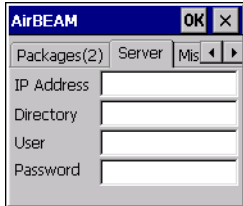

Figure B-4 Server Tab

Table B-3 Server Tab Descriptions

Field	Description
IP Address	The IP Address of the server. It may be a host name or a dot notation format.
Directory	The directory on the server that contains the AirBEAM package definition files. All AirBEAM package definition files are retrieved from this directory during the package synchronization process.
User	The FTP user name that is used during the login phase of the package synchronization process.
Password	The FTP password that corresponds to the FTP user specified in the <b>User</b> field. The specified password is used during the login phase of the package synchronization process.

✓ **NOTE** No inadvertent trailing spaces should be entered on the Server tab. Information entered in these fields are case and space sensitive.

### Misc(1) Tab

Use this tab to configure various miscellaneous features.

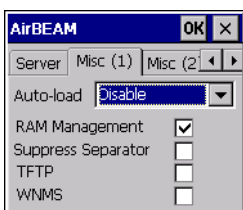

Figure B-5 Misc (1) Tab

**Table B-4** Misc (1) Tab Descriptions

Field	Description
Auto-load	<p>This drop-down list is used to specify how the AirBEAM Smart Client is to be invoked automatically when the client device is rebooted. The selections are:</p> <p><b>Disable:</b> the AirBEAM Smart Client is not invoked automatically during the boot sequence.</p> <p><b>Interactive:</b> the AirBEAM Smart Client is invoked automatically during the boot sequence. The package synchronization process is started automatically. The <i>Synchronization Dialog</i> box appears and the user is required to press the <b>OK</b> button when the process is complete.</p> <p><b>Non-interactive:</b> the AirBEAM Smart Client is invoked automatically during the boot sequence. The package synchronization process is started automatically. The <i>Synchronization Dialog</i> box is displayed, but the user is not required to select <b>OK</b> when the process is complete. The <i>Synchronization Dialog</i> box terminates automatically.</p> <p><b>Background:</b> the AirBEAM Smart Client is invoked automatically during the boot sequence. The package synchronization process is started automatically. Nothing is displayed while the synchronization process is occurring.</p>
RAM Management	<p>This check box specifies whether the automatic RAM management is enabled during the package synchronization process.</p> <p>If enabled, RAM management logic is invoked when there is not enough free disk space to download a package. The RAM management logic attempts to remove any discardable AirBEAM packages resident on the client.</p>
Suppress Separator	<p>This check box specifies whether the automatic insertion of a file path separator character should be suppressed when the client generated server package definition file names.</p> <p>When enabled, the parameter also disables the appending of .apd to the package. This feature is useful for AS/400 systems, in which the file path separator character is a period. When this feature is enabled, the server directory (Directory) and package name (Package 1, Package 2, Package 3 and Package 4) are appended "as is" when building the name for the server package definition file.</p> <p>When this feature is disabled, a standard file path separator is used to separate the server directory (Directory) and package name (Package 1, Package 2, Package 3 and Package 4) when building the name for the server package definition file. In addition, an .apd extension is appended automatically.</p>
TFTP	<p>This check box specifies whether the TFTP protocol is to be used to download files. By default, the AirBEAM Smart Client uses the FTP protocol.</p>
WNMS	<p>This check box specifies whether the AirBEAM Smart Client uploads a WNMS information file at the end of each version synchronization.</p>

## Misc(2) Tab

This tab is used to configure various miscellaneous features.

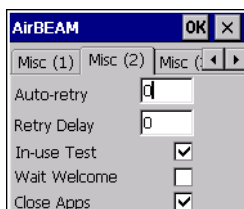
**Figure B-6** Misc (2) Tab

**Table B-5** *Misc (2) Tab Descriptions*

Field	Description
Auto-retry	<p>This field is used to specify whether the AirBEAM Smart Client automatically retries if there is a failure during the synchronization process.</p> <p>If this feature is enabled, the AirBEAM Smart Client displays a popup dialog indicating the attempt of a retry. The popup dialog is displayed for the number of seconds specified in the <i>Retry Delay</i> field.</p> <p>The valid values for this field are:</p> <ul style="list-style-type: none"> <li>-1: the AirBEAM Smart Client automatically retries indefinitely.</li> <li>0: the AirBEAM Smart Client does not automatically retry.</li> <li>-0: the AirBEAM Smart Client automatically retries up to the number of times specified.</li> </ul>
Retry Delay	This field specifies the amount of time, in seconds, that the AirBEAM Smart Client delays before automatically retrying after a synchronization failure.
In-use Test	This check box specifies whether the AirBEAM Smart Client tests to determine if a file is in-use before downloading. If the <i>In-use Test</i> feature is enabled, the AirBEAM Smart Client downloads a temporary copy of any files that are in-use. If any temporary in-use files are downloaded the AirBEAM Smart Client automatically resets the client to complete the copy of the in-use files. If the <i>In-use Test</i> feature is disabled, the synchronization process fails (-813) if any download files are in-use.
Wait Welcome	This check box specifies whether the AirBEAM Smart Client waits for the WELCOME windows to be completed before automatically launching the synchronization process after a reset.
Close Apps	This check box specifies whether the AirBEAM Smart Client automatically attempts to close non-system applications prior to resetting the mobile unit. If enabled the AirBEAM Smart Client sends a WM_CLOSE message to all non-system applications before resetting the mobile unit. This feature offers applications the opportunity to prepare (i.e. close open files) for the pending reset.

### Misc(3) Tab

Use this tab to configure various miscellaneous features.

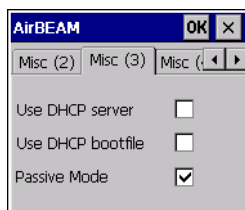
**Figure B-7** *Misc (3) Tab*

**Table B-6** *Misc (3) Tab Descriptions*

Field	Description
Use DHCP server	This check box control specifies whether the AirBEAM Smart Client uses the DHCP response option 66 to specify the <i>IP address</i> of the FTP/TFTP server. If enabled, special RF network registry settings are required to force the DHCP server to return the "TFTP server name" field (option 66). The special RF network registry settings are included, but commented out, in the radio network registry initialization files (essid_xxxx_yy.reg).
Use DHCP bootfile	This check box control specifies whether the AirBEAM Smart Client uses the DHCP response option 67 to specify the <i>Package</i> and <i>Package 1</i> parameters. If enabled, special RF network registry settings are required to force the DHCP server to return the "Bootfile name" field (option 67). The special RF network registry settings are included, but commented out, in the radio network registry initialization files (essid_xxxx_yy.reg).

**Misc(4) Tab**

Use this tab to configure various miscellaneous features.

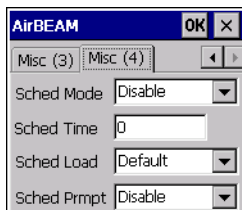
**Figure B-8** *Misc (4) Tab*

**Table B-7** Misc (4) Tab Descriptions

Field	Description
Sched Mode	<p>Specifies whether (and how) the scheduled mode is enabled. If enabled, schedule mode causes the AirBEAM synchronization process to occur periodically. The selections are:</p> <p><b>Disable</b> - The schedule mode is disabled.</p> <p><b>Fixed time</b> - The schedule mode is enabled. The AirBEAM synchronization will be launched once per day at the time specified in the Sched Time setting. The synchronization will be launched every day Sched Time minutes past midnight.</p> <p><b>Fixed period</b> - The schedule mode is enabled. The AirBEAM synchronization will be launched at a period by the Sched Time setting. The synchronization will be launched every Sched Time minutes.</p>
Sched Time	<p>This edit control specifies, in minutes, the period for the schedule mode. The Sched Mode setting specifies how the Sched Time value is used.</p>
Sched Load	<p>This drop-down menu specifies the load mode to be used for scheduled synchronization, if enabled. The selections are:</p> <p><b>Default</b> - Specifies that the load mode specified in the Auto-load setting is to be used for scheduled synchronization sessions.</p> <p><b>Interactive</b> - The Synchronization Dialog displays when a scheduled synchronization session occurs. The user is required to press the OK button to dismiss the dialog.</p> <p><b>Non-interactive</b> - The Synchronization Dialog displays when a scheduled synchronization session occurs. The dialog is automatically dismissed when the synchronization is complete, unless an error occurs. If an error occurs the user is required to press the OK button to dismiss the dialog.</p> <p><b>Background</b> - Nothing is displayed when the scheduled synchronization sessions occur.</p>
Sched Prompt	<p>Specifies whether the AirBEAM client prompts the user when updates are available in schedule mode. The settings are:</p> <p><b>Disable</b> - Updated packages are automatically downloaded. The user is not prompted.</p> <p><b>Alert</b> - Updated packages are not automatically downloaded. The user is prompted to warm boot the device to initiate the package downloads.</p> <p><b>Launch</b> - Updated packages are not automatically downloaded. The user is prompted to start the package download. The user can defer the package download by responding no to the prompt. The MAXNOPRESS registry setting can be used to limit the number of times the user can defer the update.</p> <p><b>Confirm</b> - Updated packages are not automatically downloaded. This value behaves the same as the Launch value, except that the user is required to confirm an additional prompt before the download starts.</p>

### Synchronizing with the Server

When the synchronization process is initiated, the AirBEAM Smart Client attempts to open an FTP session using the AirBEAM Smart Client configuration. Once connected, the client processes the specified packages. Packages are loaded only if the server version of a given package is different from the version loaded on the client. Once the upload process is complete, the AirBEAM Smart Client closes the FTP session with the server.

The AirBEAM Smart Client can launch an FTP session with the server either manually, when initiated by the user, or automatically.



## Manual Synchronization

1. Configure the AirBEAM Smart Client. See [Configuring the AirBEAM Smart Client on page B-2](#).
2. From the main *AirBEAM CE* window, press **ALT - ALT** and select **Synchronize**.
3. Once connected, the AirBEAM Synchronize window appears.

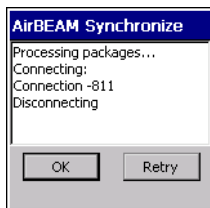

**Figure B-9** *AirBEAM Synchronize Window*

- The **Status List** displays status messages that indicate the progress of the synchronization process.
- Press **ENTER** to return to the Main Menu. This button remains inactive until the synchronization process is complete.
- Select **Retry** and press **ENTER** to restart the synchronization process. This button is activated only if there is an error during the synchronization process.

## Automatic Synchronization

The AirBEAM Smart Client can be configured to launch automatically using the Misc (1) Preference tab (see [Misc\(1\) Tab on page B-4](#)). When setting automatic synchronization, use the Auto-load drop-down list to specify how the AirBEAM Smart Client should be invoked automatically when the client device is rebooted. See [Misc\(1\) Tab on page B-4](#) for instructions on enabling Auto Sync.

## AirBEAM Staging

The AirBEAM Smart staging support is intended to speed up and simplify the process of staging custom or updated operating software onto mobile devices directly from manufacturing. The staging support is part of the AirBEAM Smart CE Client that is integrated into the mobile computer.

The AirBEAM Smart support works by defaulting the AirBEAM Client configuration to a known set of values and launching the AirBEAM Smart package download logic. A staging environment, including an RF network, FTP server and AirBEAM packages must be setup. Ideally a staging network and server should be setup to match the default AirBEAM Staging client configuration.

The AirBEAM Staging support provides several benefits:

- Many devices can be simultaneously loaded over the RF network.
- The AirBEAM staging utility provides a simple single dialog user interface that is used to quickly start the software installation process.



# Appendix C App Launcher Configuration

## Configuration

The menu on the **App Launcher** window can be modified to display and launch any application on the mobile computer.

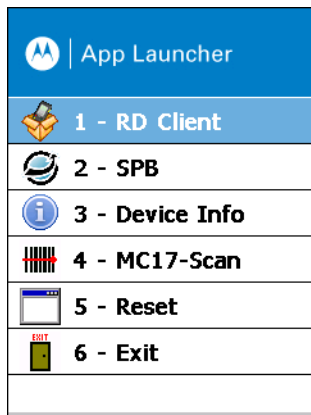

**Figure C-1** Default App Launcher Window

To customize the **App Launcher** menu:

1. ActiveSync the mobile computer with a host computer.
2. Copy the file `launcher.reg` from the /Application folder on the mobile computer to a local directory on the host computer.
3. Open the file using a text editor.
4. The following lists the five default menu items that appear on the App Launcher display. Note that Exit menu item is not listed in the registry file.

```
[HKEY_CURRENT_USER\Software\Symbol\Launcher\Default\Programs\Prog1]
"Description"="RD Client"
"Name"="\windows\rdclient.exe"
"Command"=" "
```

```
[HKEY_CURRENT_USER\Software\Symbol\Launcher\Default\Programs\Prog2]
```

```
"Description"="SPB"
"Name"="\program files\SPB2_CE.exe"
"Command"=" "
```

```
[HKEY_CURRENT_USER\Software\Symbol\Launcher\Default\Programs\Prog3]
"Description"="Device Info"
"Name"="\Windows\DeviceInfoApp.exe"
"Command"=" "
```

```
[HKEY_CURRENT_USER\Software\Symbol\Launcher\Default\Programs\Prog4]
"Description"="MC17-Scan"
"Name"="\Application\MC17-Scan.EXE"
"Command"=" "
```

```
[HKEY_CURRENT_USER\Software\Symbol\Launcher\Default\Programs\Prog5]
"Description"="Reset"
"Name"="\Windows\WarmBoot.EXE"
"Command"=" "
```

To add a sixth item to the list, enter the following after the warm boot entry:

```
[HKEY_CURRENT_USER\Software\Symbol\Launcher\Default\Programs\Prog6]
"Description"="Control Panel"
"Name"="\Windows\CtlPanel.EXE"
"Command"=" "
```

1. Save the registry file.
2. Copy the file back to the */Application* folder on the mobile computer.
3. Cold boot the mobile computer.

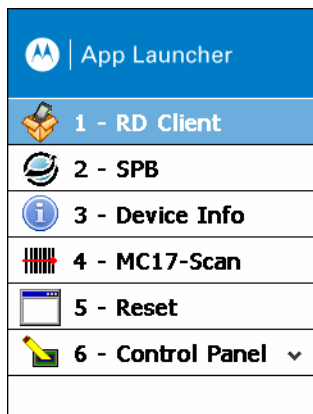

Figure C-2 Customized App Launcher Window

# Glossary

---

## Numeric

**802.11.** A group of wireless specifications developed by the Institute of Electrical and Electronics Engineers (IEEE). It specifies an over-the-air interface between a wireless client and a base station or between two wireless clients.

**802.11b.** Operates in the 2.4 GHz Industrial, Scientific and Measurement (ISM) band (2.4 to 2.4835 GHz) and provides signaling rates of up to 11Mbit/sec. This is a very commonly used frequency. Microwave ovens, cordless phones, medical and scientific equipment, as well as Bluetooth devices, all work within the 2.4 GHz ISM band.

**802.11g.** Similar to 802.11b, but this standard supports signaling rates of up to 54Mbit/sec. It also operates in the heavily used 2.4 GHz ISM band but uses a different radio technology to boost overall throughput. Compatible with the 802.11b.

---

## A

**Access Point.** Provides a bridge between Ethernet wired LANs and the wireless network. Access points are the connectivity point between Ethernet wired networks and devices (laptops, hand-held computers, point-of-sale terminals) equipped with a wireless LAN adapter card.

**Ad Hoc Mode.** A wireless network framework in which devices communicate directly with one another without using an access point.

**API.** Application Programming interface - An interface by means of which one software component communicates with or controls another. Usually used to refer to services provided by one software component to another, usually via software interrupts or function calls

**Association.** The process of determining the viability of the wireless connection and establishing a wireless network's root and designated access points. A mobile computer associates with its wireless network as soon as it is powered on or moves into range.

---

## B

**Bar Code.** A pattern of variable-width bars and spaces which represents numeric or alphanumeric data in machine-readable form. The general format of a bar code symbol consists of a leading margin, start character, data or message character, check character (if any), stop character, and trailing margin. Within this framework, each recognizable symbology uses its own unique format. See **Symbology**.

**Bits per Second (bps).** Bits transmitted or received.

**Bit.** Binary digit. One bit is the basic unit of binary information. Generally, eight consecutive bits compose one byte of data. The pattern of 0 and 1 values within the byte determines its meaning.

**Byte.** On an addressable boundary, eight adjacent binary digits (0 and 1) combined in a pattern to represent a specific character or numeric value. Bits are numbered from the right, 0 through 7, with bit 0 the low-order bit. One byte in memory is used to store one ASCII character.

**boot or boot-up.** The process a computer goes through when it starts. During boot-up, the computer can run self-diagnostic tests and configure hardware and software.

---

## C

**CAM.** (Continuously Aware Mode) Mode in which the adapter is instructed to continually check for network activity.

**CDRH.** (Center for Devices and Radiological Health) A federal agency responsible for regulating laser product safety. This agency specifies various laser operation classes based on power output during operation.

**CDRH Class 1.** This is the lowest power CDRH laser classification. This class is considered intrinsically safe, even if all laser output were directed into the eye's pupil. There are no special operating procedures for this class.

**CDRH Class 2.** No additional software mechanisms are needed to conform to this limit. Laser operation in this class poses no danger for unintentional direct human exposure.

**CHAP.** (Challenge Handshake Authentication Protocol) A type of authentication in which the authentication agent (typically a network server) sends the client program a random value that is used only once and an ID value. Both the sender and peer share a predefined secret. The peer concatenates the random value (or nonce), the ID and the secret and calculates a one-way hash using MD5. The hash value is sent to the authenticator, which in turn builds that same string on its side, calculates the MD5 sum itself and compares the result with the value received from the peer. If the values match, the peer is authenticated.

**Character.** A pattern of bars and spaces which either directly represents data or indicates a control function, such as a number, letter, punctuation mark, or communications control contained in a message.

**Character Set.** Those characters available for encoding in a particular bar code symbology.

**Cold Boot.** A cold boot restarts the mobile computer and erases all user stored records and entries.

**COM port.** Communication port; ports are identified by number, e.g., COM1, COM2.

**Continuous Code.** A bar code or symbol in which all spaces within the symbol are parts of characters. There are no intercharacter gaps in a continuous code. The absence of gaps allows for greater information density.

**Cradle.** A cradle is used for charging the mobile computer battery and for communicating with a host computer, and provides a storage place for the mobile computer when not in use.

---

## D

**DCP.** See **Device Configuration Package**.

**Decode.** To recognize a bar code symbology (e.g., UPC/EAN) and then analyze the content of the specific bar code scanned.

**Decode Algorithm.** A decoding scheme that converts pulse widths into data representation of the letters or numbers encoded within a bar code symbol.

**Decryption.** Decryption is the decoding and unscrambling of received encrypted data. Also see, **Encryption** and **Key**.

**Depth of Field.** The range between minimum and maximum distances at which a scanner can read a symbol with a certain minimum element width.

**Device Configuration Package.** The Device Configuration Package provides flash partitions, Terminal Configuration Manager (TCM) and the associated TCM scripts. With this package hex images that represent flash partitions can be created and downloaded to the mobile computer.

---

## E

**EAN.** (European Article Number) This European/International version of the UPC provides its own coding format and symbology standards. Element dimensions are specified metrically. EAN is used primarily in retail.

**EAP.** (Extensible Authentication Protocol) A general authentication protocol used to control network access. Many specific authentication methods work within this framework.

**EAP-PEAP.** (Extensible Authentication Protocol-Protected Extensible Authentication Protocol) A mutual authentication method that uses a combination of digital certificates and another system, such as passwords.

**EAP-TLS.** (Extensible Authentication Protocol-Transport Layer Security) A mutual authentication method that uses digital certificates.

**Encoded Area.** Total linear dimension occupied by all characters of a code pattern, including start/stop characters and data.

**Encryption.** Encoding data to prevent it from being read by unauthorized people.

**ENQ (RS-232).** ENQ software handshaking is also supported for the data sent to the host.

**EMDK.** Enterprise Mobility Developer's Kit.

**Ethernet.** An IEEE standard network protocol that specifies how data is placed on and retrieved from a common transmission medium.

---

## F

**Flash Memory.** Flash memory is nonvolatile, semi-permanent storage that can be electronically erased in the circuit and reprogrammed.

**File Transfer Protocol (FTP).** A TCP/IP application protocol governing file transfer via network or telephone lines. See **TCP/IP**.

---

## H

**Hard Reset.** See **Cold Boot**.

**Hz.** Hertz; A unit of frequency equal to one cycle per second.

**Host Computer.** A computer that serves other mobile computers in a network, providing such services as computation, database access, supervisory programs and network control.

---

## I

**IEC.** International Electrotechnical Commission. This international agency regulates laser safety by specifying various laser operation classes based on power output during operation.

**IEC (825) Class 1.** This is the lowest power IEC laser classification. Conformity is ensured through a software restriction of 120 seconds of laser operation within any 1000 second window and an automatic laser shutdown if the scanner's oscillating mirror fails.

**IEEE Address.** See **MAC Address**.

**Internet Protocol Address.** See **IP**.

**Input/Output Ports.** I/O ports are primarily dedicated to passing information into or out of the mobile computer's memory.

**IP.** (Internet Protocol) The IP part of the TCP/IP communications protocol. IP implements the network layer (layer 3) of the protocol, which contains a network address and is used to route a message to a different network or subnetwork. IP accepts "packets" from the layer 4 transport protocol (TCP or UDP), adds its own header to it and delivers a "datagram" to the layer 2 data link protocol. It may also break the packet into fragments to support the maximum transmission unit (MTU) of the network.

**IP Address.** (Internet Protocol address) The address of a computer attached to an IP network. Every client and server station must have a unique IP address. A 32-bit address used by a computer on a IP network. Client workstations have either a permanent address or one that is dynamically assigned to them each session. IP addresses are written as four sets of numbers separated by periods; for example, 204.171.64.2.



---

## K

**Key.** A key is the specific code used by the algorithm to encrypt or decrypt the data. Also see, **Encryption** and **Decrypting**.

---

## L

**laser scanner.** A type of bar code reader that uses a beam of laser light.

**LASER.** (Light Amplification by Stimulated Emission of Radiation) The laser is an intense light source. Light from a laser is all the same frequency, unlike the output of an incandescent bulb. Laser light is typically coherent and has a high energy density.

**LCD.** See **Liquid Crystal Display**.

**LEAP.** (Lightweight Extensible Authentication Protocol) A mutual authentication method that uses a username and password system.

**LED Indicator.** A semiconductor diode (LED - Light Emitting Diode) used as an indicator, often in digital displays. The semiconductor uses applied voltage to produce light of a certain frequency determined by the semiconductor's particular chemical composition.

**Liquid Crystal Display (LCD).** A display that uses liquid crystal sealed between two glass plates. The crystals are excited by precise electrical charges, causing them to reflect light outside according to their bias. They use little electricity and react relatively quickly. They require external light to reflect their information to the user.

---

## M

**Mobile Computer.** In this text, mobile computer refers to the MC17 mobile computer. It can be set up to run as a stand-alone device, or it can be set up to communicate with a network, using wireless radio technology.

**MS CHAP.** (Microsoft Challenge Handshake Authentication Protocol) is the Microsoft version of CHAP and is an extension to RFC 1994. Like the standard version of CHAP, MS-CHAP is used for PPP authentication; in this case, authentication occurs between a PC using Microsoft Windows NT or Microsoft Windows 95 and a Cisco router or access server acting as a network access server (NAS).

---

## N

**Nominal.** The exact (or ideal) intended value for a specified parameter. Tolerances are specified as positive and negative deviations from this value.

**Nominal Size.** Standard size for a bar code symbol. Most UPC/EAN codes are used over a range of magnifications (e.g., from 0.80 to 2.00 of nominal).

---

## O

**ODI.** See **Open Data-Link Interface**.

**Open Data-Link Interface (ODI).** Novell's driver specification for an interface between network hardware and higher-level protocols. It supports multiple protocols on a single NIC (Network Interface Controller). It is capable of understanding and translating any network information or request sent by any other ODI-compatible protocol into something a NetWare client can understand and process.

**Open System Authentication.** Open System authentication is a null authentication algorithm.

---

## P

**Parameter.** A variable that can have different values assigned to it.

**PING.** (Packet Internet Groper) An Internet utility used to determine whether a particular IP address is online. It is used to test and debug a network by sending out a packet and waiting for a response.

**Programming Mode.** The state in which a scanner is configured for parameter values. See **Scanning Mode**.

---

## Q

**Quiet Zone.** A clear space, containing no dark marks, which precedes the start character of a bar code symbol and follows the stop character.

---

## R

**RAM.** Random Access Memory. Data in RAM can be accessed in random order, and quickly written and read.

**RF.** Radio Frequency.

**ROM.** Read-Only Memory. Data stored in ROM cannot be changed or removed.

**Router.** A device that connects networks and supports the required protocols for packet filtering. Routers are typically used to extend the range of cabling and to organize the topology of a network into subnets. See **Subnet**.

**RS-232.** An Electronic Industries Association (EIA) standard that defines the connector, connector pins, and signals used to transfer data serially from one device to another.

---

## S

**Scanner.** An electronic device used to scan bar code symbols and produce a digitized pattern that corresponds to the bars and spaces of the symbol. Its three main components are:

1. Light source (laser or photoelectric cell) - illuminates a bar code.
2. Photodetector - registers the difference in reflected light (more light reflected from spaces).
3. Signal conditioning circuit - transforms optical detector output into a digitized bar pattern.

**Scanning Mode.** The scanner is energized, programmed and ready to read a bar code.

**Scanning Sequence.** A method of programming or configuring parameters for a bar code reading system by scanning bar code menus.

**SDK.** Software Development Kit

**Secure Sockets Layer (SSL).** SSL is a commonly-used protocol for managing the security of a message transmission on the Internet. SSL uses a program layer located between the Internet's Hypertext Transfer Protocol (HTTP) and Transport Control Protocol (TCP) layers. SSL is included as part of both the Microsoft and Netscape browsers and most Web server products. Developed by Netscape, SSL also gained the support of Microsoft and other Internet client/server developers as well and became the de facto standard until evolving into Transport Layer Security. The "sockets" part of the term refers to the sockets method of passing data back and forth between a client and a server program in a network or between program layers in the same computer. SSL uses the public-and-private key encryption system from RSA, which also includes the use of a digital certificate.

**Shared Key.** Shared Key authentication is an algorithm where both the AP and the MU share an authentication key.

**Soft Reset.** See **Warm Boot**.

**Specular Reflection.** The mirror-like direct reflection of light from a surface, which can cause difficulty decoding a bar code.

**Subnet.** A subset of nodes on a network that are serviced by the same router. See **Router**.

**Subnet Mask.** A 32-bit number used to separate the network and host sections of an IP address. A custom subnet mask subdivides an IP network into smaller subsections. The mask is a binary pattern that is matched up with the IP address to turn part of the host ID address field into a field for subnets. Default is often 255.255.255.0.

**Substrate.** A foundation material on which a substance or image is placed.

**Symbol.** A scannable unit that encodes data within the conventions of a certain symbology, usually including start/stop characters, quiet zones, data characters and check characters.

**Symbology.** The structural rules and conventions for representing data within a particular bar code type (e.g. UPC/EAN, Code 39, PDF417, etc.).

---

## T

**TCP/IP.** (Transmission Control Protocol/Internet Protocol) A communications protocol used to internetwork dissimilar systems. This standard is the protocol of the Internet and has become the global standard for communications. TCP provides transport functions, which ensures that the total amount of bytes sent is received correctly at the other end. UDP is an alternate transport that does not guarantee delivery. It is widely used for real-time voice and video

transmissions where erroneous packets are not retransmitted. IP provides the routing mechanism. TCP/IP is a routable protocol, which means that all messages contain not only the address of the destination station, but the address of a destination network. This allows TCP/IP messages to be sent to multiple networks within an organization or around the world, hence its use in the worldwide Internet. Every client and server in a TCP/IP network requires an IP address, which is either permanently assigned or dynamically assigned at startup.

**TFTP.** (Trivial File Transfer Protocol) A version of the TCP/IP FTP (File Transfer Protocol) protocol that has no directory or password capability. It is the protocol used for upgrading firmware, downloading software and remote booting of diskless devices.

**TKIP.** (Temporal Key Integrity Protocol) A wireless encryption protocol that periodically changes the encryption key, making it harder to decode.

**Transmission Control Protocol/Internet Protocol.** See **TCP/IP.**

**TLS.** (Transport Layer Security) TLS is a protocol that ensures privacy between communicating applications and their users on the Internet. When a server and client communicate, TLS ensures that no third party may eavesdrop or tamper with any message. TLS is the successor to the Secure Sockets Layer (SSL).

**Trivial File Transfer Protocol.** See **TFTP.**

---

## U

**UDP.** (User Datagram Protocol) A protocol within the IP protocol suite that is used in place of TCP when a reliable delivery is not required. For example, UDP is used for real-time audio and video traffic where lost packets are simply ignored, because there is no time to retransmit. If UDP is used and a reliable delivery is required, packet sequence checking and error notification must be written into the applications.

---

## W

**Warm Boot.** A warm boot restarts the mobile computer by closing all running programs. All data that is not saved to flash memory is lost.

**WAP.** (Wireless Application Protocol) A set of specifications, developed by the WAP Forum, that lets developers using Wireless Markup Language build networked applications designed for handheld wireless devices. WAP was designed to work within the constraints of these devices: a limited memory and CPU size, small, monochrome screens, low bandwidth and erratic connections.

**WEP.** Wired-Equivalent Privacy protocol was specified in the IEEE 802.11 standard to provide a WLAN with a minimal level of security and privacy comparable to a typical wired LAN, using data encryption.

**WPA.** Wi-Fi Protected Access is a data encryption specification for 802.11 wireless networks that replaces the weaker WEP. It improves on WEP by using dynamic keys, Extensible Authentication Protocol to secure network access, and an encryption method called Temporal Key Integrity Protocol (TKIP) to secure data transmissions.

**WPA2.** Wi-Fi Protected Access 2 is an enhanced version of WPA. It uses Advanced Encryption Standard instead of TKIP.

**WLAN.** Wireless local-area networks use radio waves instead of a cable to connect a user device, such as a mobile computer, to a LAN. They provide Ethernet connections over the air and operate under the 802.11 family of specifications developed by the IEEE.



# Index

## Numerics

802.11b/g ..... A-2

## A

accessories ..... 1-4  
active and indicate programs ..... 5-7  
ActiveSync ..... 4-1  
    downloading files ..... 9-3  
    installing ..... 4-1  
    setting up a connection ..... 4-2

### AirBEAM

Client ..... B-2  
configuring ..... B-2  
package builder ..... B-1  
staging ..... B-9  
synchronization with server ..... B-8

### AirBEAM configuration

Misc(1) tab ..... B-4  
Misc(2) tab ..... B-5  
Packages(2) tab ..... B-3  
Server tab ..... B-4

### App Launcher

configuration ..... C-1

## B

backlight ..... 6-2, 6-3

### battery

charging ..... 1-6, 1-11  
    temperature range ..... A-3  
clearing ..... 10-2  
improving battery life ..... 6-3  
installing ..... 1-6  
replacement ..... 10-2  
service ..... 10-2

status ..... 5-7  
battery charge status ..... 5-7  
battery charging temperature ..... A-2  
battery management ..... 10-2  
battery status ..... 5-7, 5-8  
bezel ..... 1-19  
bezel replacement ..... 1-19  
boot  
    cold ..... 1-15, 1-18  
    warm ..... 1-18  
bullets ..... xv

## C

changing the power settings ..... 6-4  
charging  
    temperature range ..... A-3  
charging battery ..... 1-11  
charging cradle ..... 1-4, 1-12, 1-14  
cleaning ..... 10-1  
clock, display ..... 5-11  
cold boot ..... 1-15, 1-18, 9-23  
communication status ..... 5-7  
configuration ..... xii  
configurations ..... xii  
conventions  
    notational ..... xv  
CPU ..... A-1  
cradle key ..... 1-4  
creating splash screen ..... 9-18

## D

daisy chain cable ..... 1-4  
data capture ..... xii  
    adjusting the distance ..... 1-17  
    indicator ..... 1-17

- scan angle . . . . . 1-16
- scan range . . . . . 1-16
- scanning . . . . . 1-16
- DCP . . . . . 9-1
- DCP for MC17xxc50 . . . . . xvi, 9-5, 9-8, 9-18, 9-24
- development cable . . . . . 1-4
- Device Configuration Package . . . . . 9-1
- Device Configuration Package for MC17xxc50 . . . . . xvi, 9-5, 9-8, . . . . . 9-18, 9-24
- dimensions . . . . . A-1
- dispenser key . . . . . 1-12
- display . . . . . xii, A-1
- display backlight
  - saving power . . . . . 6-4
- display clock . . . . . 5-11
- documents . . . . . 5-9
- downloading files . . . . . 9-3
- drop specification . . . . . A-2

**E**

- electrical safety . . . . . A-3
- EMDK for C . . . . . 9-1
- EMDK for eVC4 . . . . . xv
- Enterprise Mobility Developer Kit for C . . . . . 9-1
- Enterprise Mobility Developer Kit for eVC4 . . . . . xv
- error messages . . . . . 9-14, 9-16

**F**

- favorites . . . . . 5-9
- file explorer . . . . . 9-5
- flash file system . . . . . 9-23
  - downloading partitions . . . . . 9-25
  - non-FFS partitions . . . . . 9-24
    - IPL . . . . . 9-25
    - splash screen . . . . . 9-24
  - partitions . . . . . 9-23
    - copyfile . . . . . 9-24
    - regmerge . . . . . 9-23
- flash memory . . . . . 6-2
- flash storage . . . . . 9-23
- fonts . . . . . 6-1
  - asian font installation . . . . . 6-2
  - greek . . . . . 6-1
  - japanese . . . . . 6-1
  - korean . . . . . 6-1
  - russian . . . . . 6-1
  - simplified chinese . . . . . 6-1
  - swedish . . . . . 6-1
- function status . . . . . 5-7

**G**

- getting started . . . . . 1-6

**H**

- hard reset . . . . . 1-15, 1-18
- help . . . . . 5-9
- humidity . . . . . A-2

**I**

- information, service . . . . . xvi
- Initial Program Loader . . . . . 9-25
- installing development tools . . . . . 9-2
- IPL . . . . . 9-25
  - error messages . . . . . 9-16
  - error screen . . . . . 9-16

**K**

- key . . . . . 1-12
- key descriptions
  - two-color alphanumeric . . . . . 1-6
- keyboard . . . . . A-1
- keypads . . . . . xii

**L**

- laser safety . . . . . A-2
- laser scanning
  - See data capture . . . . . 1-16
- LED indicators . . . . . 1-5
- lithium-ion battery . . . . . 1-1

**M**

- main battery
  - charging
    - temperature range . . . . . A-3
- maintenance . . . . . 10-1
- memory . . . . . xii, A-1
- mobile computer
  - cold boot . . . . . 9-23
  - starting . . . . . 1-15

**O**

- operating system . . . . . xii, A-1
- operating temperature . . . . . A-2

**P**

- partitions



- downloading ..... 9-25
- FFS ..... 9-23
- non-FFS ..... 9-24
  - IPL ..... 9-25
  - splash screen ..... 9-24
- parts of the mobile computer ..... 1-1
- pin-outs
  - mobile computer ..... A-4
- power cable ..... 1-4
- power settings ..... 6-4
- power supply ..... 1-4
- power supply housing ..... 1-4
  - accessories ..... 1-4
- program menu ..... 5-9
- programs
  - flash file system ..... 9-23
- properties ..... 5-10
- provisioning ..... 2-1

## R

- radios ..... xii
- RAM ..... 6-2
- reset
  - hard ..... 1-15, 1-18
  - soft ..... 1-18
- resetting ..... 1-18
- run ..... 5-9

## S

- scan status ..... 1-17
- scan status *See also* data capture
- scanning
  - bar codes ..... 1-16
  - LED indicators ..... 1-17
  - See* data capture ..... 1-16
- screen
  - Symbol splash screen ..... 1-15
- scripts
  - creating ..... 9-8
  - saving ..... 9-9
- service information ..... xvi
- setting up a partnership
  - partnership ..... 4-3
- settings ..... 5-9
- show clock ..... 5-11
- soft reset ..... 1-18
- splash screen ..... 9-24
  - creating ..... 9-18
- staging ..... 2-1
- start menu ..... 5-9
- starting the mobile computer ..... 1-15
- status icon ..... 5-7, 5-8

- status icons
  - Windows CE 5.0 ..... 5-7
- storage temperature ..... A-2
- suspend ..... 5-9

## T

- taskbar ..... 5-7
- TCM
  - building hex image ..... 9-5, 9-9
  - creating script ..... 9-8
  - defining properties ..... 9-7
  - error messages ..... 9-14
  - hex image download ..... 9-10
  - saving script ..... 9-9
  - starting ..... 9-5
- temperature
  - battery charging ..... A-3
- troubleshooting ..... 10-4

## U

- unpacking ..... 1-1
- USB cable ..... 1-4

## W

- wake up conditions ..... 5-12
- warm boot ..... 1-18
- weight ..... A-1
- WLAN 802.11a/b/g ..... xii
- WLAN radio ..... A-2

## Y

- Y-power cable ..... 1-4







**MOTOROLA**

Motorola, Inc.  
One Motorola Plaza  
Holtsville, New York 11742, USA  
1-800-927-9626  
<http://www.motorola.com/enterprisemobility>

MOTOROLA and the Stylized M Logo and Symbol and the Symbol logo are registered in the U.S. Patent and Trademark Office.  
All other product or service names are the property of their registered owners.  
© Motorola, Inc. 2008