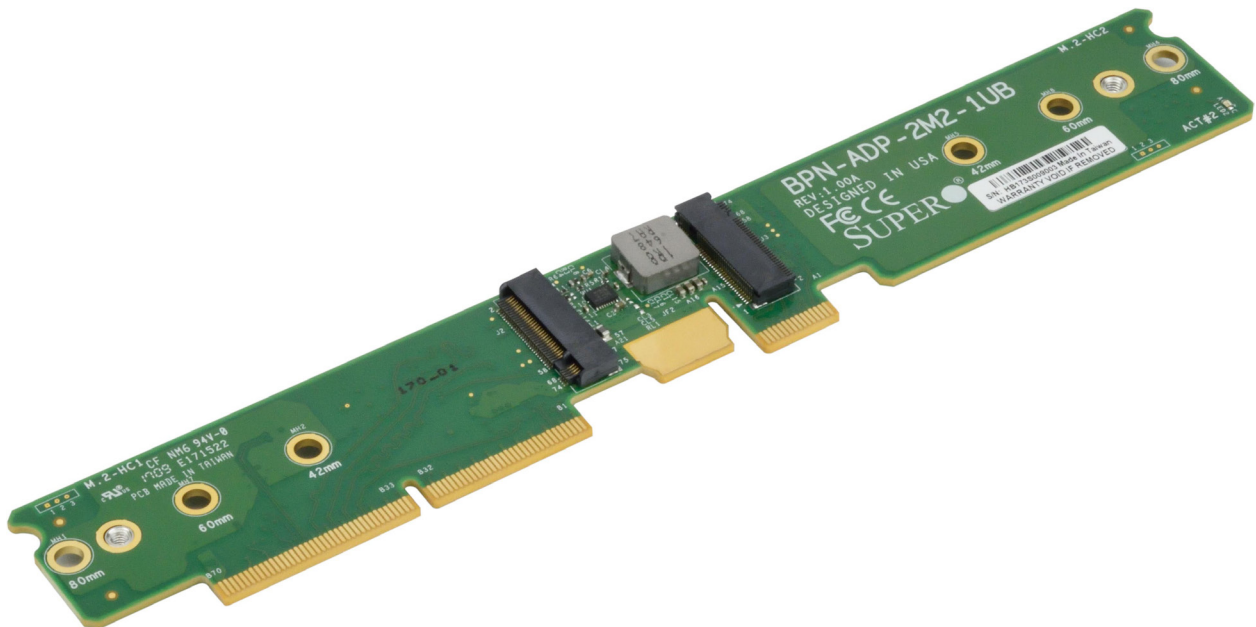




# BPN-ADP-2M2-1UB

## M.2 CARRIER CARD



### INSTALLATION GUIDE

Revision 1.0

The information in this User's Manual has been carefully reviewed and is believed to be accurate. The vendor assumes no responsibility for any inaccuracies that may be contained in this document, and makes no commitment to update or to keep current the information in this manual, or to notify any person or organization of the updates. **Please Note: For the most up-to-date version of this manual, please see our website at [www.supermicro.com](http://www.supermicro.com).**

Super Micro Computer, Inc. ("Supermicro") reserves the right to make changes to the product described in this manual at any time and without notice. This product, including software and documentation, is the property of Supermicro and/or its licensors, and is supplied only under a license. Any use or reproduction of this product is not allowed, except as expressly permitted by the terms of said license.

IN NO EVENT WILL Super Micro Computer, Inc. BE LIABLE FOR DIRECT, INDIRECT, SPECIAL, INCIDENTAL, SPECULATIVE OR CONSEQUENTIAL DAMAGES ARISING FROM THE USE OR INABILITY TO USE THIS PRODUCT OR DOCUMENTATION, EVEN IF ADVISED OF THE POSSIBILITY OF SUCH DAMAGES. IN PARTICULAR, SUPER MICRO COMPUTER, INC. SHALL NOT HAVE LIABILITY FOR ANY HARDWARE, SOFTWARE, OR DATA STORED OR USED WITH THE PRODUCT, INCLUDING THE COSTS OF REPAIRING, REPLACING, INTEGRATING, INSTALLING OR RECOVERING SUCH HARDWARE, SOFTWARE, OR DATA.

Any disputes arising between manufacturer and customer shall be governed by the laws of Santa Clara County in the State of California, USA. The State of California, County of Santa Clara shall be the exclusive venue for the resolution of any such disputes. Supermicro's total liability for all claims will not exceed the price paid for the hardware product.

FCC Statement: This equipment has been tested and found to comply with the limits for a Class A digital device pursuant to Part 15 of the FCC Rules. These limits are designed to provide reasonable protection against harmful interference when the equipment is operated in a commercial environment. This equipment generates, uses, and can radiate radio frequency energy and, if not installed and used in accordance with the manufacturer's instruction manual, may cause harmful interference with radio communications. Operation of this equipment in a residential area is likely to cause harmful interference, in which case you will be required to correct the interference at your own expense.

California Best Management Practices Regulations for Perchlorate Materials: This Perchlorate warning applies only to products containing CR (Manganese Dioxide) Lithium coin cells. "Perchlorate Material-special handling may apply. See [www.dtsc.ca.gov/hazardouswaste/perchlorate](http://www.dtsc.ca.gov/hazardouswaste/perchlorate)".

**WARNING**: Handling of lead solder materials used in this product may expose you to lead, a chemical known to the State of California to cause birth defects and other reproductive harm.

The products sold by Supermicro are not intended for and will not be used in life support systems, medical equipment, nuclear facilities or systems, aircraft, aircraft devices, aircraft/emergency communication devices or other critical systems whose failure to perform be reasonably expected to result in significant injury or loss of life or catastrophic property damage. Accordingly, Supermicro disclaims any and all liability, and should buyer use or sell such products for use in such ultra-hazardous applications, it does so entirely at its own risk. Furthermore, buyer agrees to fully indemnify, defend and hold Supermicro harmless for and against any and all claims, demands, actions, litigation, and proceedings of any kind arising out of or related to such ultra-hazardous use or sale.

Manual Revision 1.0

Release Date: May 19, 2017

Unless you request and receive written permission from Super Micro Computer, Inc., you may not copy any part of this document. Information in this document is subject to change without notice. Other products and companies referred to herein are trademarks or registered trademarks of their respective companies or mark holders.

Copyright © 2017 by Super Micro Computer, Inc.  
All rights reserved.

**Printed in the United States of America**

## M.2 Carrier Card BPN-ADP-2M2-1UB

The BPN-ADP-2M2-1UB card connects two M.2 solid state drives (SSDs). It supports SATA and NVMe, and three form factors: 22x42 mm, 22x60 mm, or 22x80 mm. It can be pre-installed on a server, or can be ordered and added separately. **Note:** For NVMe, the maximum system operating temperature is 30° C.

This document describes installation.

**Caution:** Use industry-standard anti-static equipment, such as gloves or wrist strap, and follow precautions to avoid damage caused by ESD.

### Installing M.2 Solid State Drives

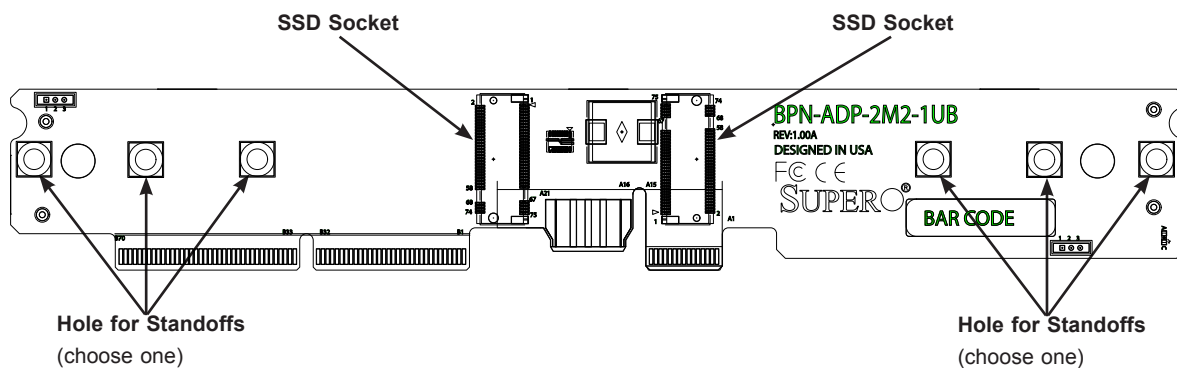
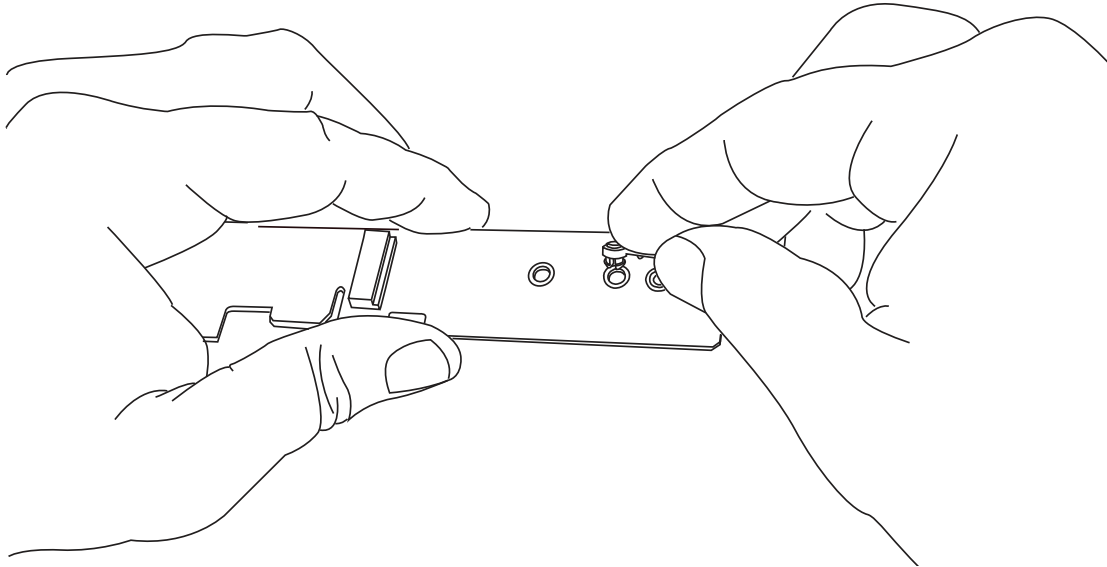


Figure 1. M.2 Carrier Card Layout

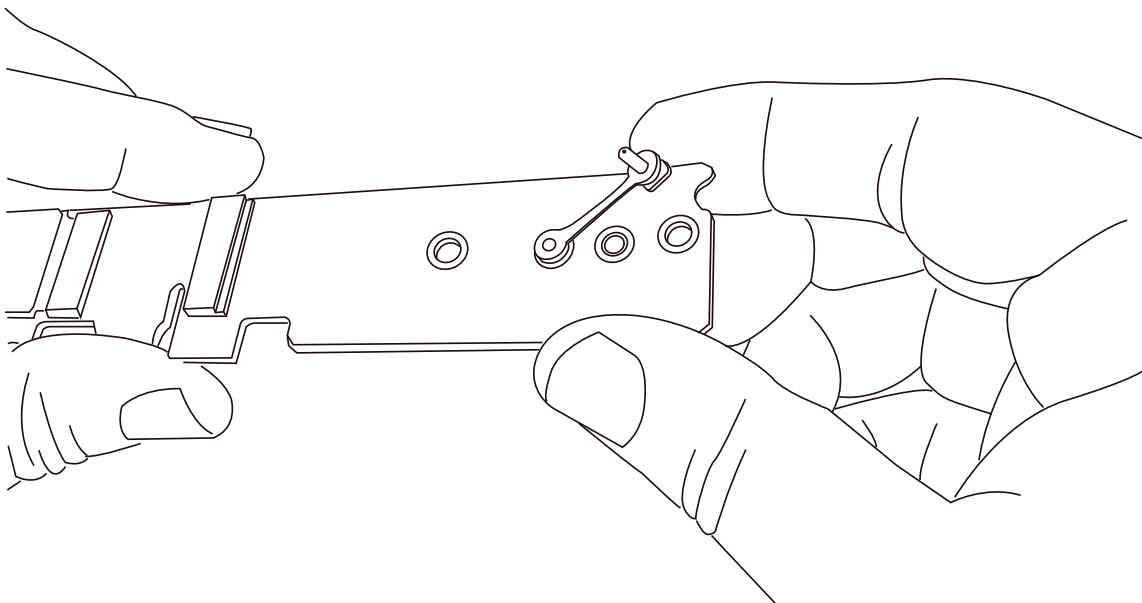
The installation procedure follows.

**To Install M.2 SSDs and the Carrier Card**

1. For each SSD, install the standoff in the appropriate hole that corresponds with the form factor of the SSD to be installed (42, 60, or 80 mm length SSDs are supported). Push the plastic standoff until it snaps into the carrier card.

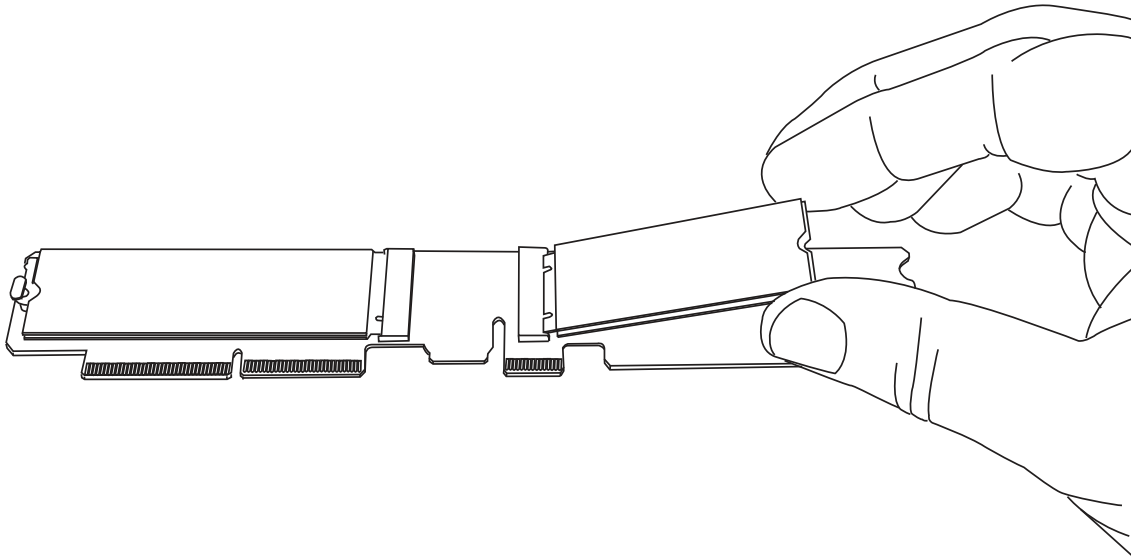


**Figure 2. Inserting the Standoff**  
(drawing shows hole for 60 mm SSD)

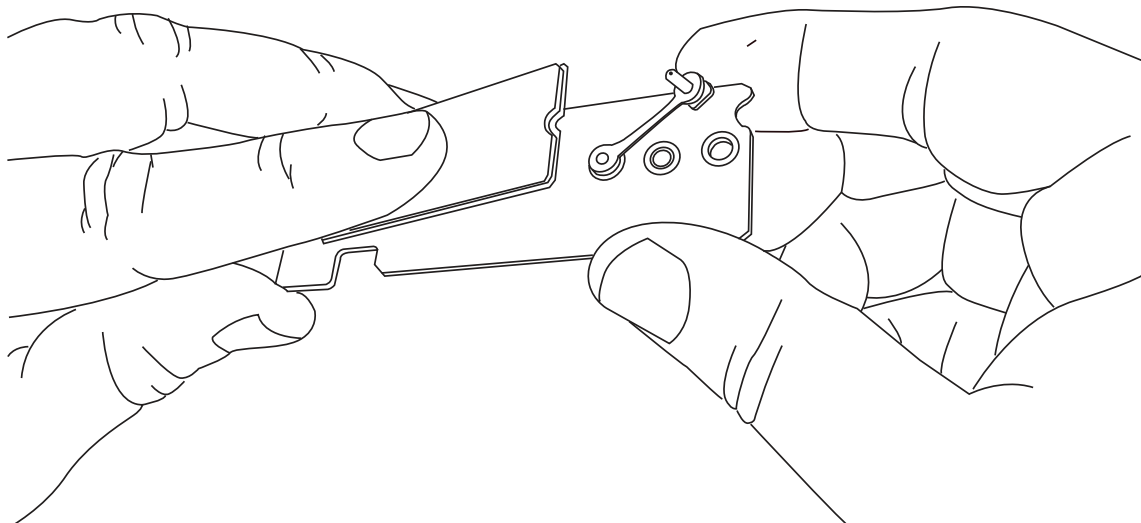


**Figure 3. Inserted Standoff**

2. Insert the SSD into the socket on the carrier card. Then push it flat against the carrier card and the plastic standoff.

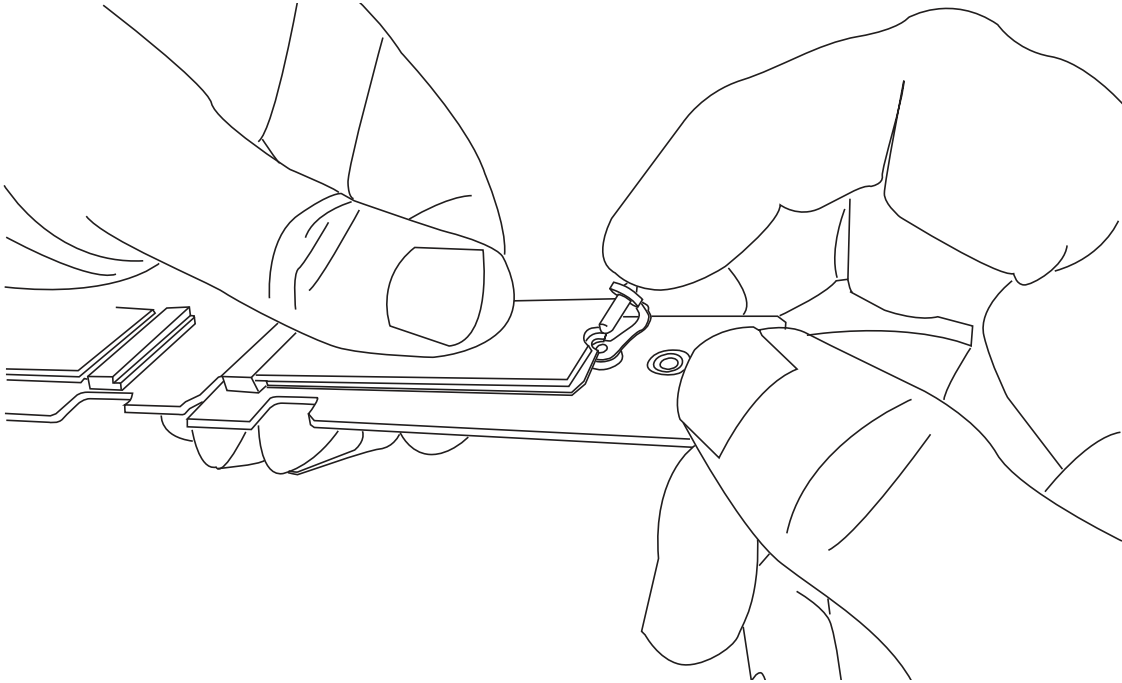


**Figure 4. Inserting SSD**

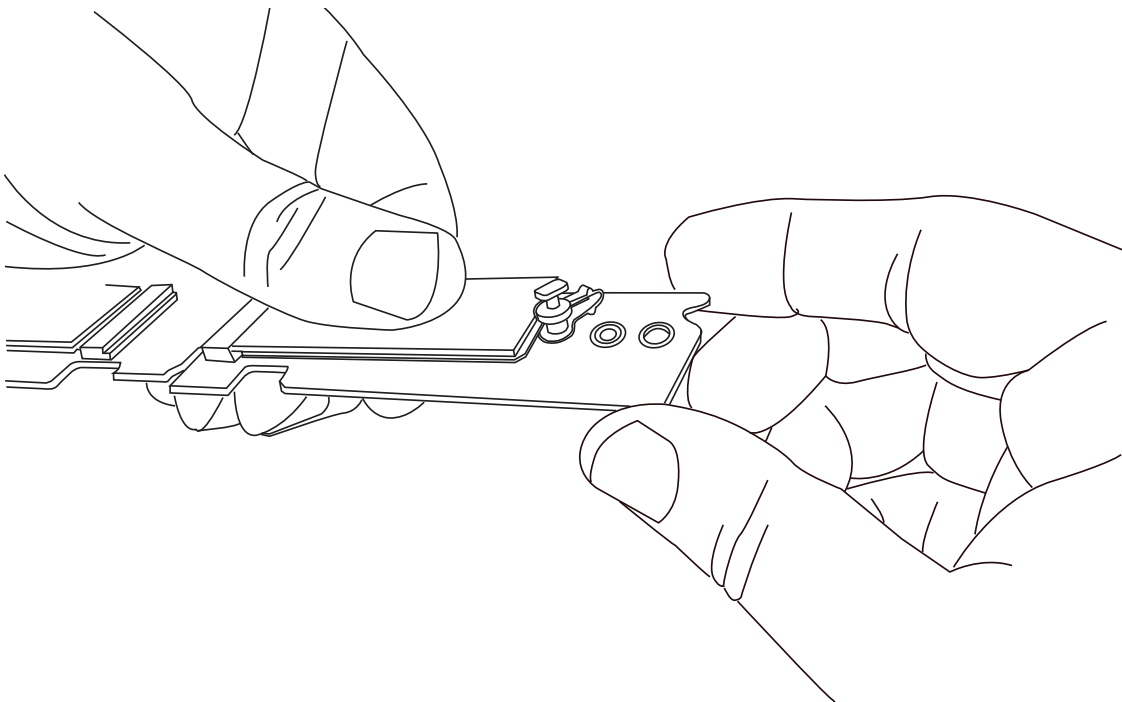


**Figure 5. Inserting SSD**

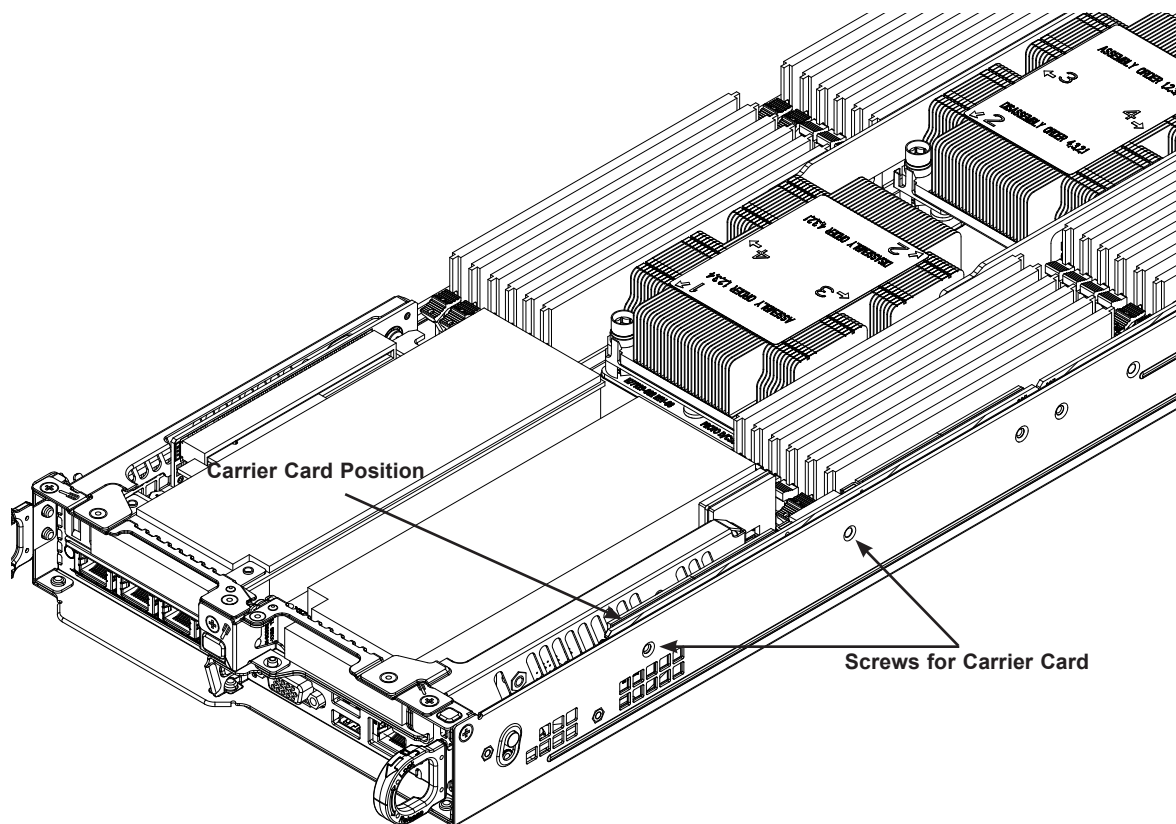
3. Secure the SSD by firmly inserting the standoff plug.



**Figure 6. Inserting Standoff Plug**



**Figure 7. Inserted Standoff Plug**



**Figure 8. Locating the M.2 Carrier Card Slot and Screws**

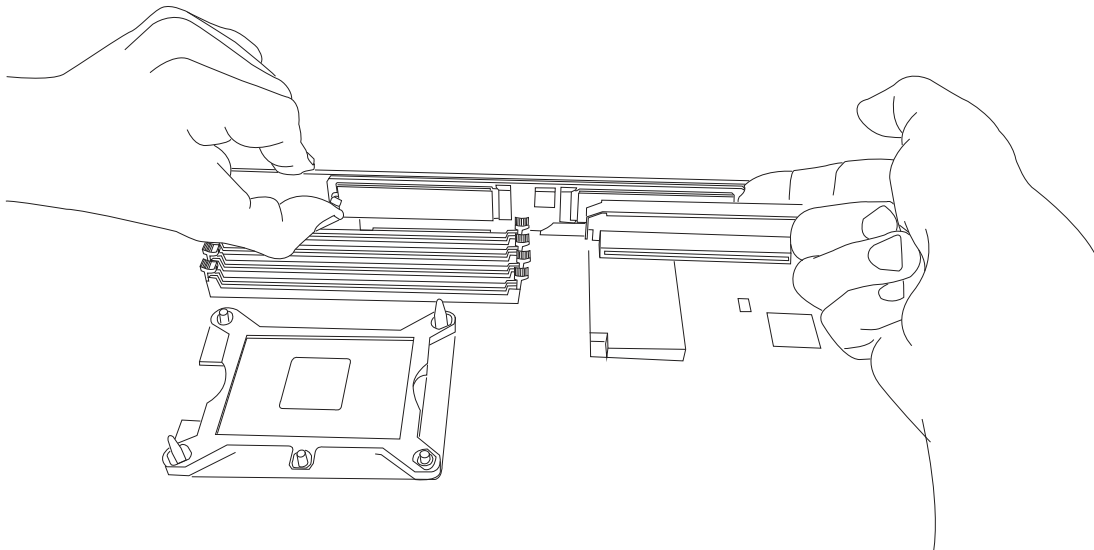
4. Power down the node and remove it from the chassis.
5. On the motherboard, remove any DIMMs obstructing access to the carrier card slot.
6. Push the carrier card into the slot on the motherboard. With the screws provided, secure it to the side of the node chassis.
7. Replace any DIMMs that may have been removed.
8. Replace the node into the chassis, and power up the system.

## Removing the M.2 Carrier Card

If an M.2 carrier card is installed in your server, remove it to add M.2 solid state devices (SSDs).

### **To Remove the M.2 Carrier Card**

1. Power down the node and remove it from the chassis.
2. Remove any DIMMs obstructing access to the carrier card.
3. Remove the two screws from the left side (viewed from the chassis front) of the node chassis that secure the carrier card to the node chassis. (See Figure 8)



**Figure 9. Removing the Carrier Card**

4. Pull the card out of the socket by both notched edges (front and back) of the card. Be careful not to exert any force on any M.2 SSDs already installed on the card.
5. If you want to remove an installed SSD, remove the plug from the standoff and allow the M.2 SSD to lift up at an angle before removing it from the M.2 socket.