



SEIKO LPW

PARTS LIST

MODEL: LPW-27BK, 28BK, 27BLK, 28BLK,

1 2 3 4 5 6 7 8 9 10 11 12 13 14 15

COVER PLATE, ARM SHAFT

カバー、上軸関係

A
B
C
D
E
F
G
H
J
K
L
M

15058 15059

15061

15057

8009

11006



16326

15039 15036

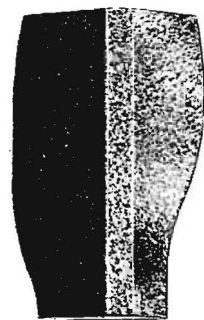

15038

15039

15037



7041

12853

LPW-27BK, 28BK

16504

LPW-27BLK, 28BLK

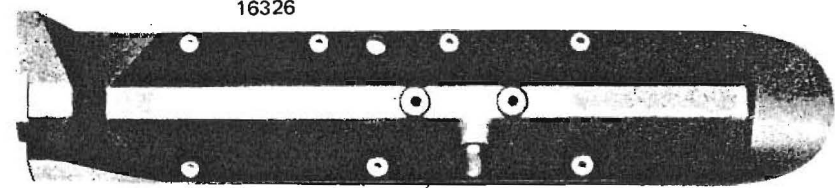

11007

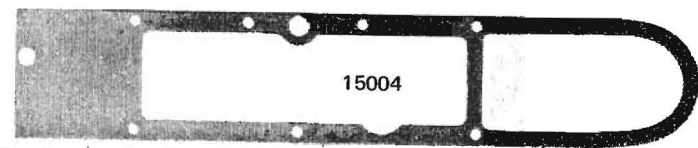

15004

10650



16257

10551

10597

11004

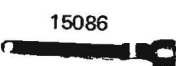

15086

8040

11142



15007

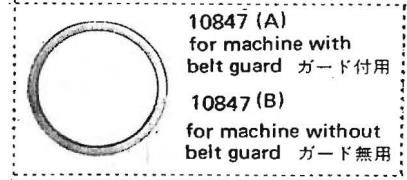

10847 (A)
for machine with
belt guard ガード付用
10847 (B)
for machine without
belt guard ガード無用

10524



10729

10725



10524



11012

15034

10566

10571

11042

16205



10563

10562



13074



10568



8040



15006

8040



for LPW-27BK, 28BK
10504 LPW-27BK, 28BK 用

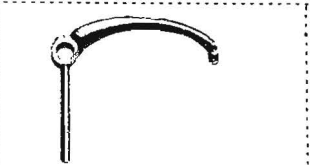
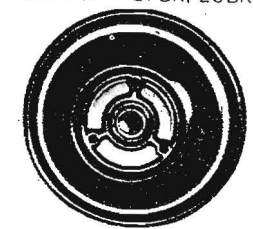

10905

LPW-27BK, 28BK

16403

LPW-27BLK, 28BLK



15209 LPW-28BK, 28BLK

15327 LPW-27BK, 27BLK

13075

10577

10566

10567

10576

10579

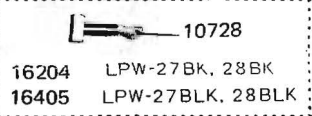

16204

LPW-27BK, 28BK

16405

LPW-27BLK, 28BLK

10728

10506

15033

10569

10571

10522

16203

10521



10570

10524

10574



15038



16293

10726

10524

12133



From the library of: Superior Sewing Machine & Supply LLC

COVER PLATE, ARM SHAFT

カバー、上軸関係

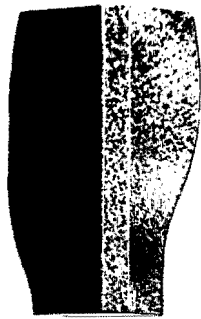
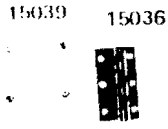
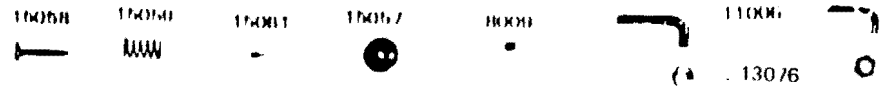

15038
15039
15037

7041

12853
LPW-27BK, 28BK
16504
LPW-27BLK, 28BLK

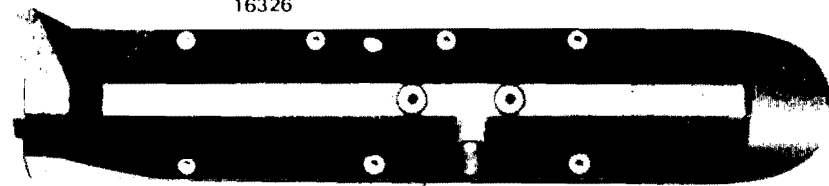

16326

11007

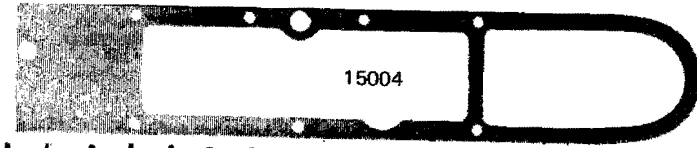

15004



10650

16257

10551

10597

8040

11004

15086

11142

11012



15007

15034

10566

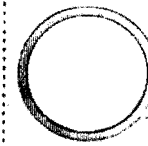

10847 (A)
for machine with
belt guard ガード付用
10847 (B)
for machine without
belt guard ガード無用

10524

10729

10725

10524

10571

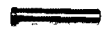

16205

11042

10563

10562

13074

10568

8040



15006

8040

for LPW-27BK, 28BK
10504 LPW-27BK, 28BK 用

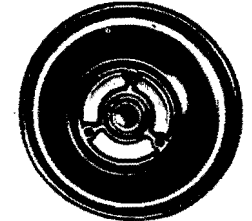

10905 LPW-27BK, 28BK
16403 LPW-27BLK, 28BLK

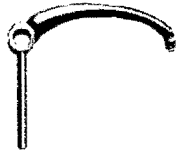

15209 LPW-28BK, 28BLK
15327 LPW-27BK, 27BLK

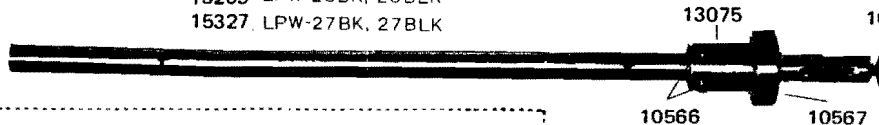

13075

10577

10566

10567

10576

10579

16204 LPW-27BK, 28BK
16405 LPW-27BLK, 28BLK



10728

10506

15033

10569

10571

10522

10521



10570

10524

10574

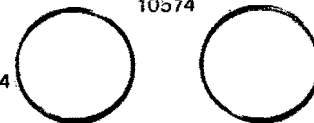

16203

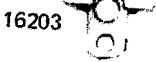

10524

10764

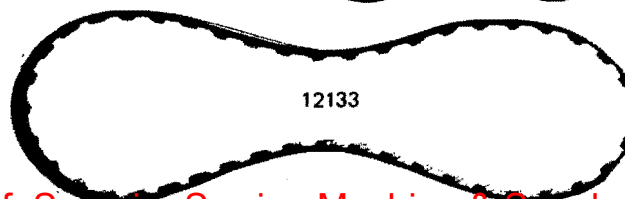

12133



14003 for LPW-27BLK, 28BLK
LPW-27BLK, 28BLK 用

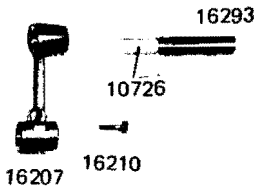

15038

16293

10726

16207

16210

From the library of: Superior Sewing Machine & Supply LLC

THREAD GUIDE, TENSION, CHANGE OVER MECHANISM

切り換え、糸掛、調子板関係

O
P
Q
R
S
T
U

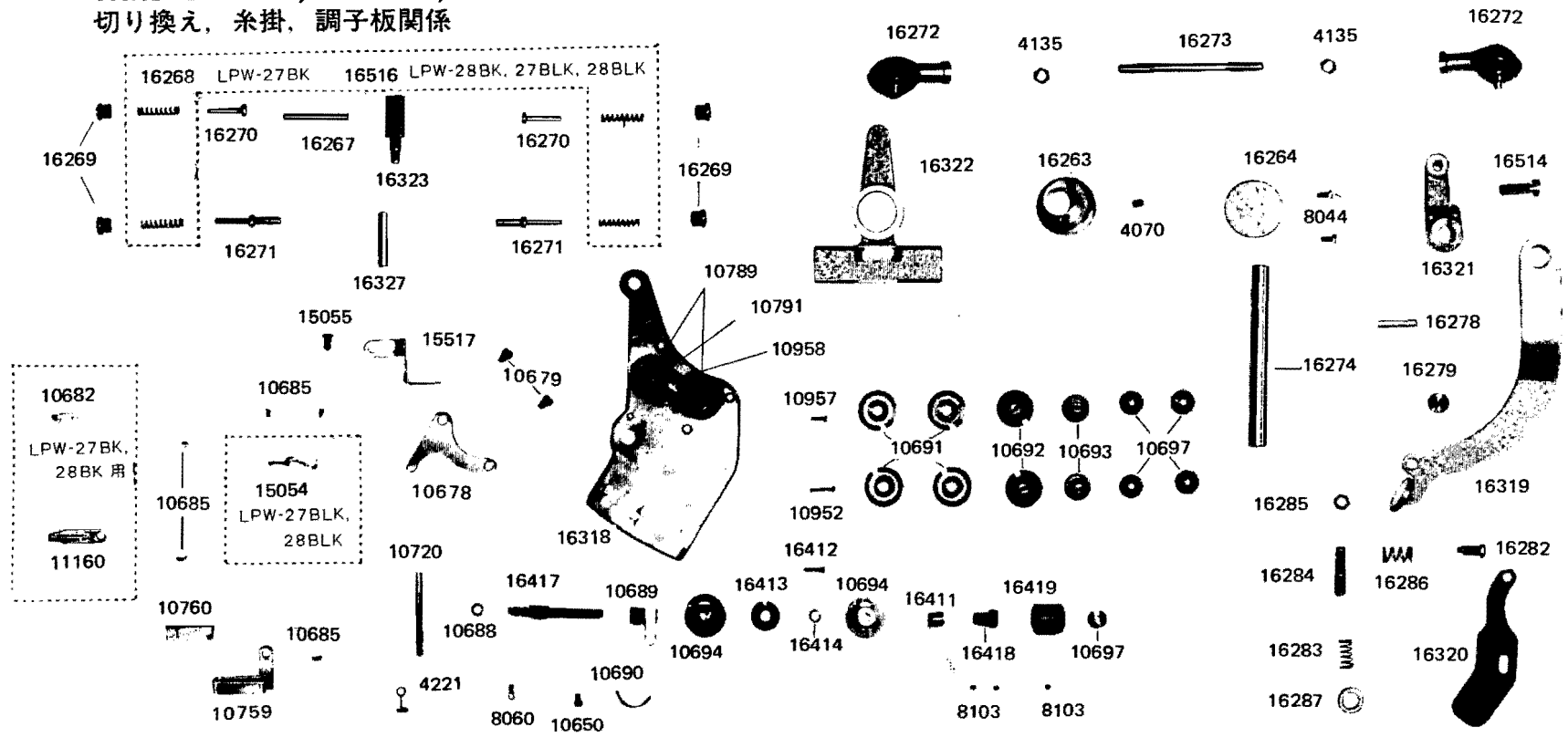

From the library of: Superior Sewing Machine & Supply J.C.

SEIKO SEWING MACHINE CO., LTD.

TOKYO · JAPAN

Telex: 2657148 SEIKO J.

LPW-27BK, 28BK, 27BLK, 28BLK

1 2 3 4 5 6 7 8 9 10 11 12 13 14 15

NEEDLE BAR MECHANISM

針棒関係

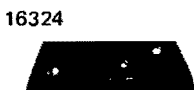

4070



4224



16219



16215

16212

16214

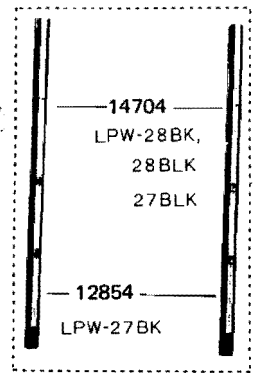

14704
LPW-28BK,
28BLK
27BLK

12854
LPW-27BK

16215

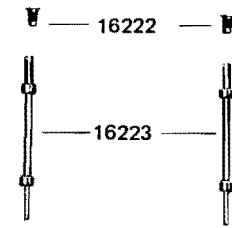

16222

16223

16224

16225

16227

16231

16230

16229

16232

16228

16226

16226

16250

16252

16253

16251

16249

16254

16216

16217

16242

16243

16245

16241

16263 (1/4")

ゲージ表参照

(see GAUGE LIST)

16244

16242

16243

16245

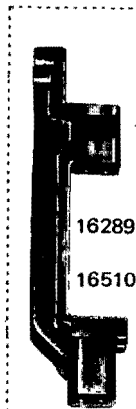

16289 LPW-27BK,
27BLK

16510 LPW-28BK,
28BLK



16209

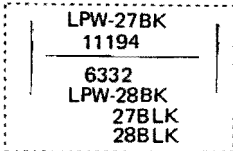

LPW-27BK
11194
6332
LPW-28BK
27BLK
28BLK

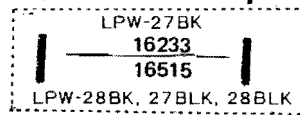

LPW-27BK
12855 LPW-27BK
16233
16515
LPW-28BK, 27BLK, 28BLK

10560

16288

16211

10726

10561

16235

12855 LPW-27BK

16235

14705 LPW-27BLK, 28BK, 28BLK

PRESSER BAR MECHANISM FOR LPW-28BK, 28BLK LPW-28BK, 28BLK, 押え棒関係

10543



10761



10540



16325



10761



10541

10662

10544



10559



10548



10545



10660



10539



10761



10659



10547



10664



10546



lifting presser foot

外押え

10185(1/4')



(See GAUGE LIST)

ゲージ表参照

10532



10549

LIFTING ROCK SHAFT MECHANISM FOR LPW-28BK, 28BLK

LPW-28BK, 28BLK, 橫軸關係

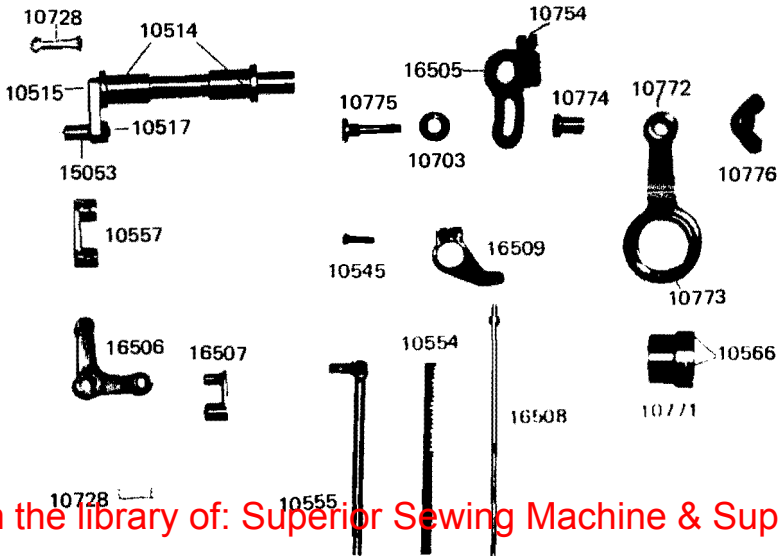

PRESSER BAR MECHANISM FOR—27BK, 27BLK LPW-27BK, 27BLK, 押え棒関係

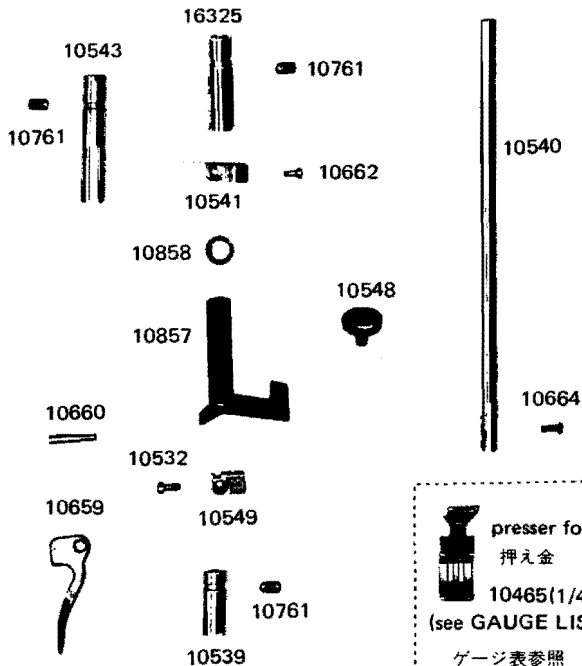



presser foot
押え金
10465(1/4")
(see GAUGE LIST)
ゲージ表参照

KNEE LIFTER LIFTING LEVER CONNEC TING ROD

弓, 吊り棒関係

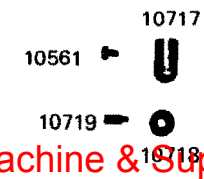
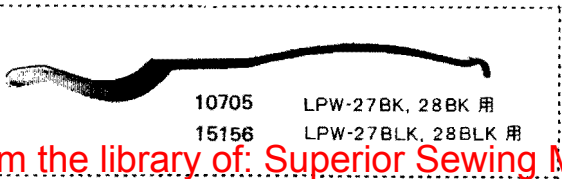
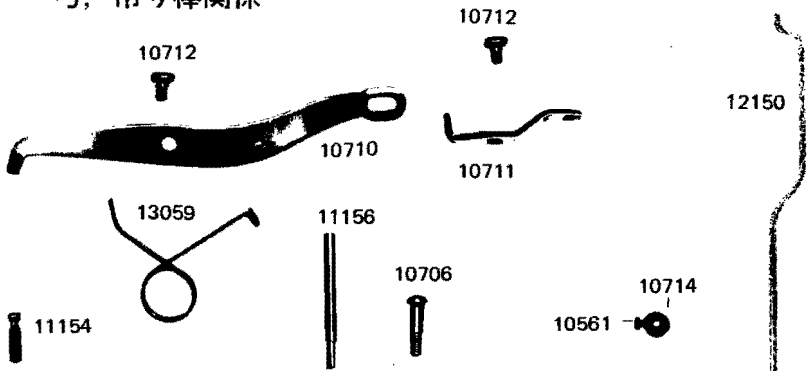

LPW-27BK, 28BK, 27BLK, 28BLK

LOWER SHAFT, FEED MECHANISM

送り機構, 下軸関係

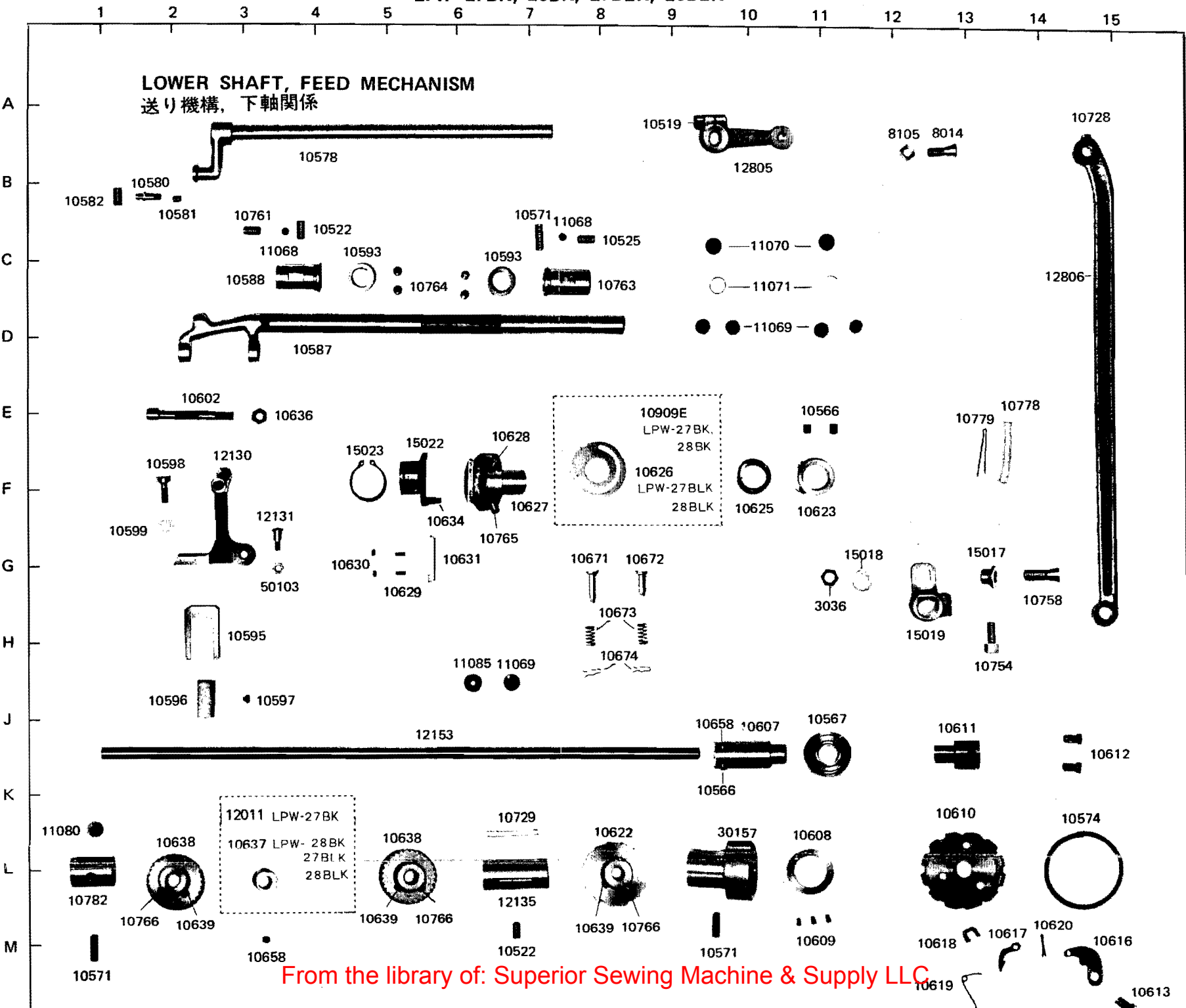

OIL WICK FOR BED

ベッド油芯関係

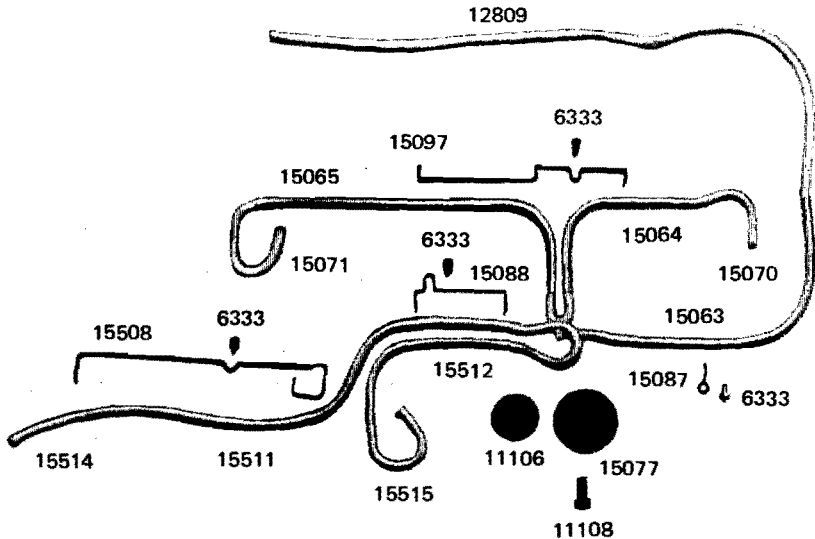

LPW-27BK, 28BK, 27BLK, 28BLK

BELT GUARD (Optional Equipment)
 ベルトガード (別注品)

LPW-27BK, 28BK

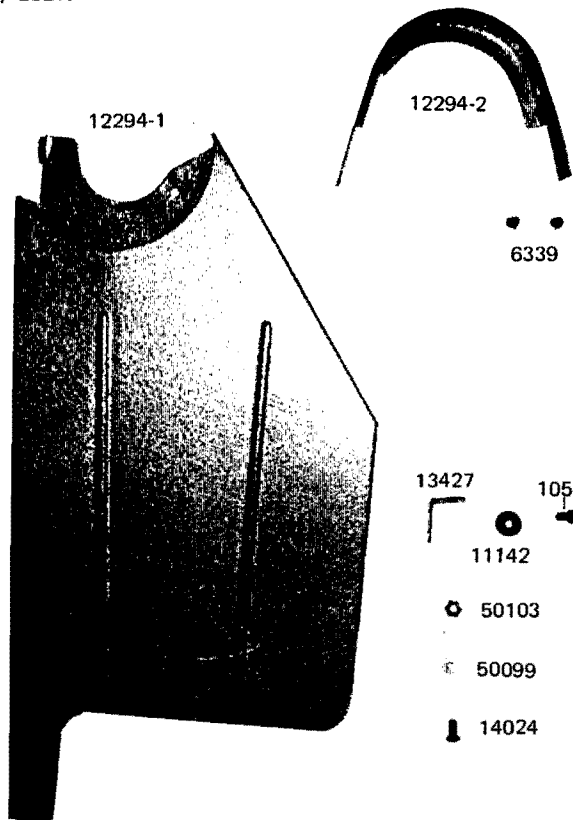

LPW-27BLK, 28BLK

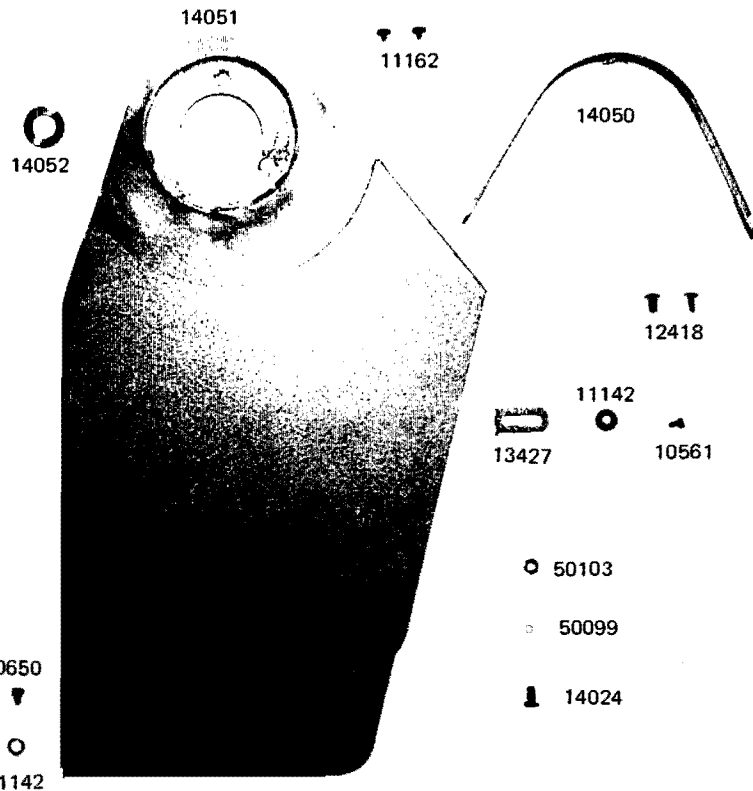

From the library of: Superior Sewing Machine & Supply LLC

ACCESSORIES 付属品

K
L
M
N
O
P
Q
R
S
T
U
V

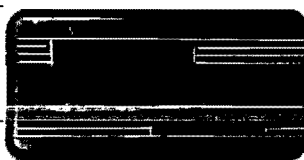

8132

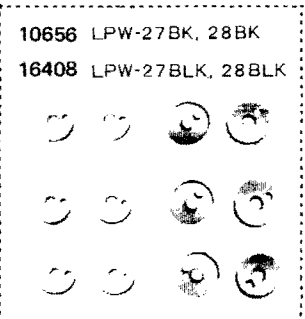

10656 LPW-27BK, 28BK
16408 LPW-27BLK, 28BLK

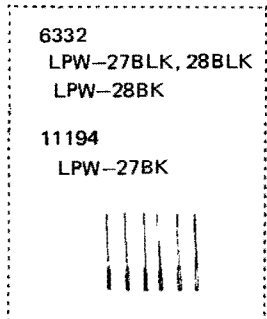

6332 LPW-27BLK, 28BLK
LPW-28BK
11194 LPW-27BK



11196

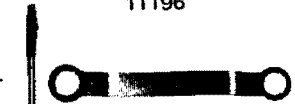

10748

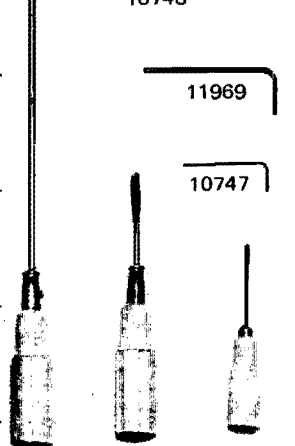

8118 8120 8121

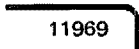

11969

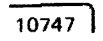

10747



8124



11193



8125



15082

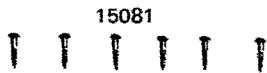

15081

15080

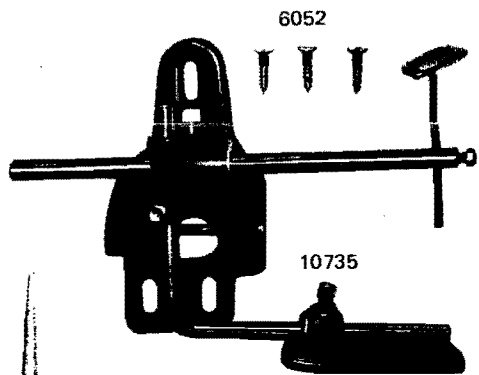
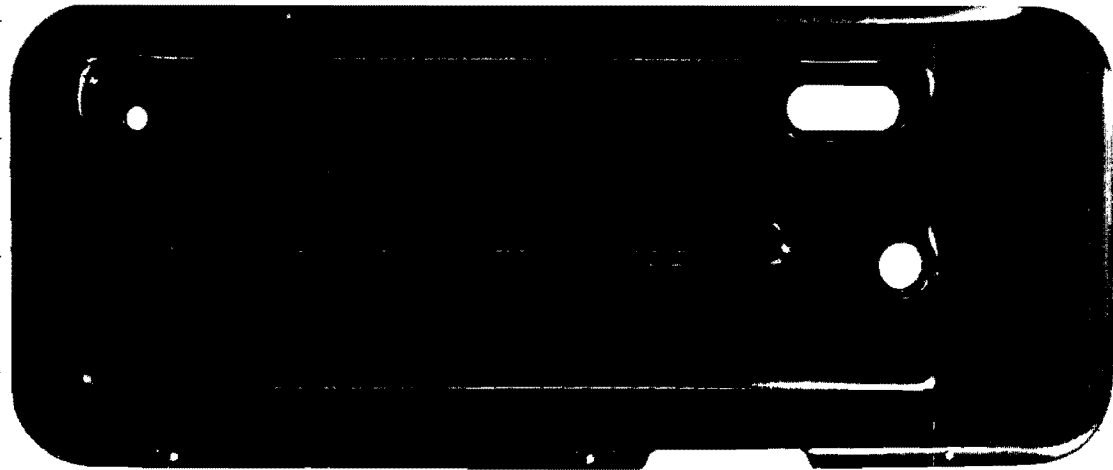

6052

10735

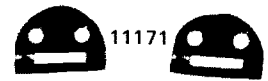

11171

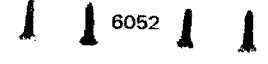

6052

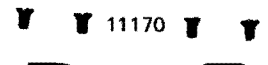

11170

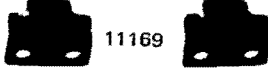

11169

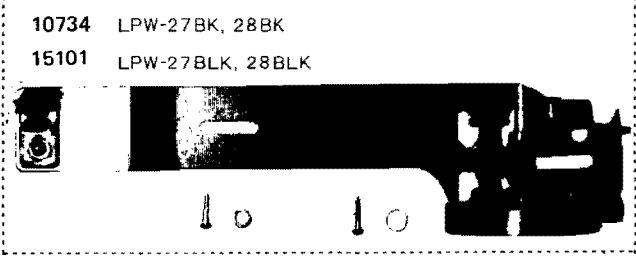

10734 LPW-27BK, 28BK

15101 LPW-27BLK, 28BLK

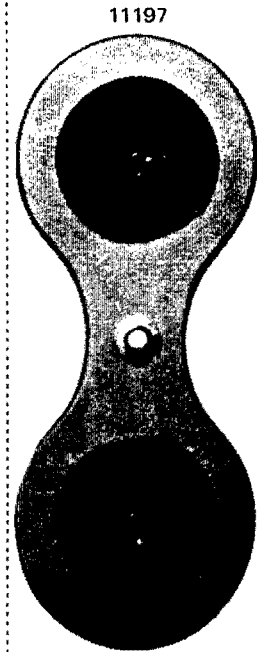

11197

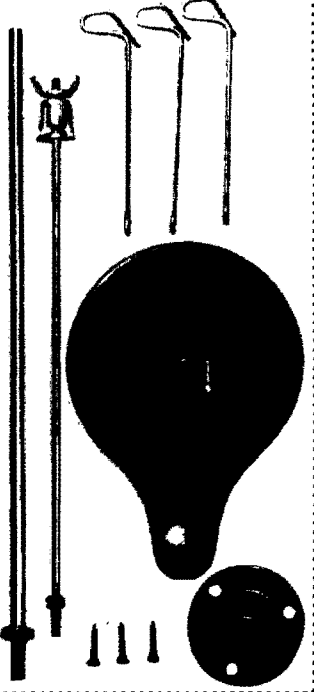

FEED DOG LEVER POST, HOOK SADDLE MECHANISM FOR LPW-27BK, 28BK
 LPW-27BK, 28BK, 針板土台, カマ土台関係

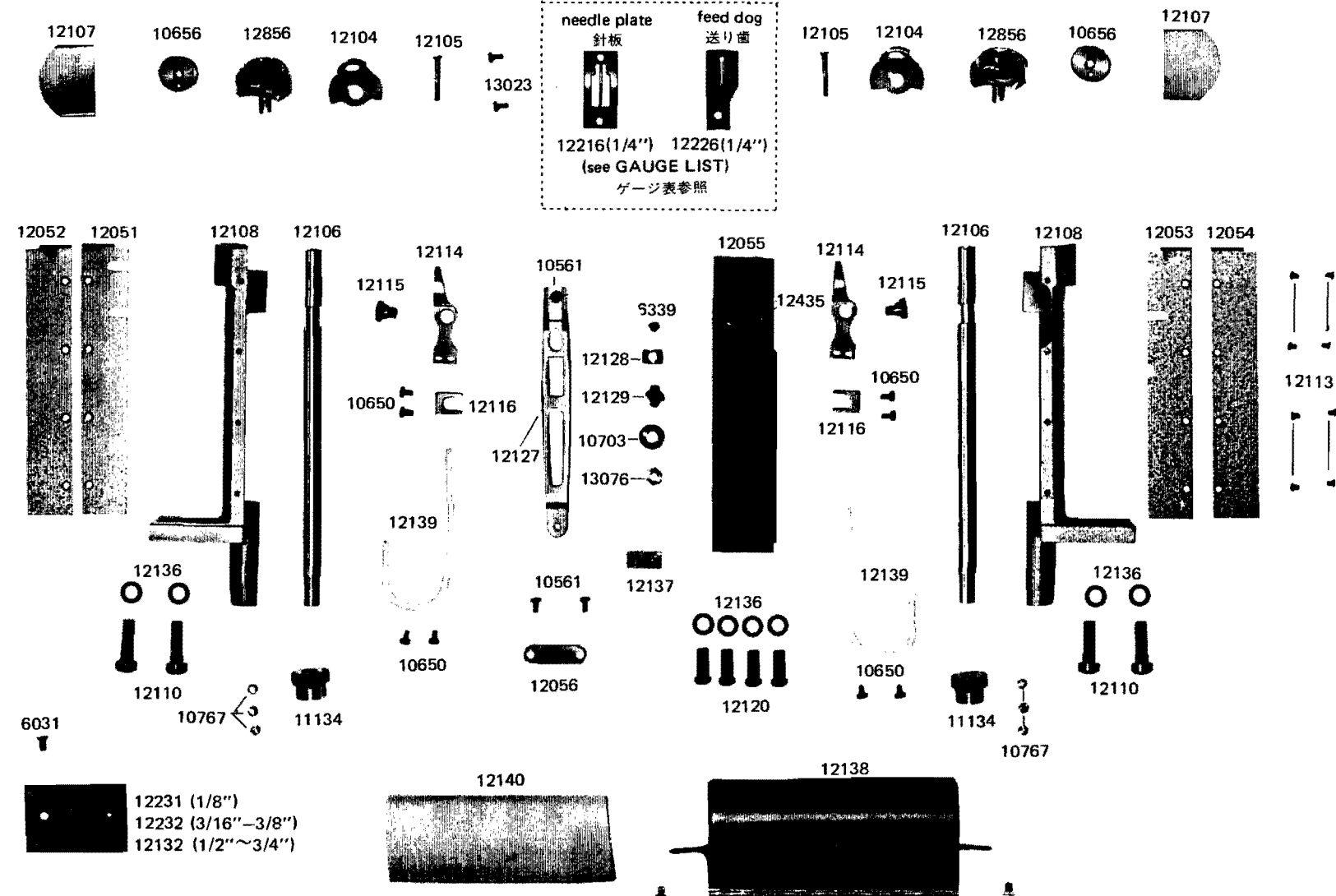

HOOK カマ

Hook complete number 12856
カマセット番号



13086-1



12856-9

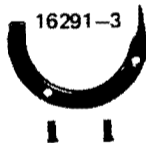

16291-3

16407-4



16291-2

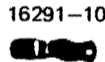

16291-10

16291-8



16407-11

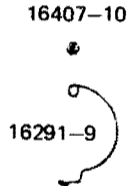

16407-10

16291-9

From the library of: Superior Sewing Machine & Supply LLC

GAUGE LIST FOR LPW-27BK, 28BK
LPW-27BK, 28BK ゲージ表

common use for LPW-27BK, 28BK

LPW-27BK, 28BK 共通ゲージ

needle calmp

針株



16295 (1/8")
 16296 (3/16")
 16297 (7/32")
 16236 (1/4")
 16237 (5/16")
 16238 (3/8")
 16298 (7/16")
 16239 (1/2")
 16303 (5/8")
 16304 (3/4")

needle plate

針板



12211 (1/8")
 12213 (3/16")
 10364 (7/32")
 12216 (1/4")
 10366 (5/16")
 10367 (3/8")
 10368 (7/16")
 10369 (1/2")
 12240 (5/8")
 12241 (3/4")

feed dog

送り歯



12221 (1/8")
 12223 (3/16")
 10394 (7/32")
 12226 (1/4")
 10396 (5/16")
 10397 (3/8")
 10398 (7/16")
 10399 (1/2")
 12250 (5/8")
 12251 (3/4")

for LPW-27BK

LPW-27BK 用

presser foot

押え金



11212 (1/8")
 11213 (3/16")
 10164 (7/32")
 11214 (1/4")
 11215 (5/16")
 11216 (3/8")
 10168 (7/16")
 10169 (1/2")
 10171 (5/8")
 10172 (3/4")

for LPW-28BK

LPW-28BK 用

lifting presser foot

外押え



10182 (1/8")
 10183 (3/16")
 10184 (7/32")
 10185 (1/4")
 10186 (5/16")
 10187 (3/8")
 10188 (7/16")
 10189 (1/2")
 10191 (5/8")
 10192 (3/4")

vibrating presser foot

中押え



16522 (1/8")
 16523 (3/16")
 16524 (7/32")
 16525 (1/4")
 16526 (5/16")
 16527 (3/8")
 16528 (7/16")
 16529 (1/2")
 16531 (5/8")
 16532 (3/4")

HOOK
カマ

Hook complete number 14706
カマセット番号

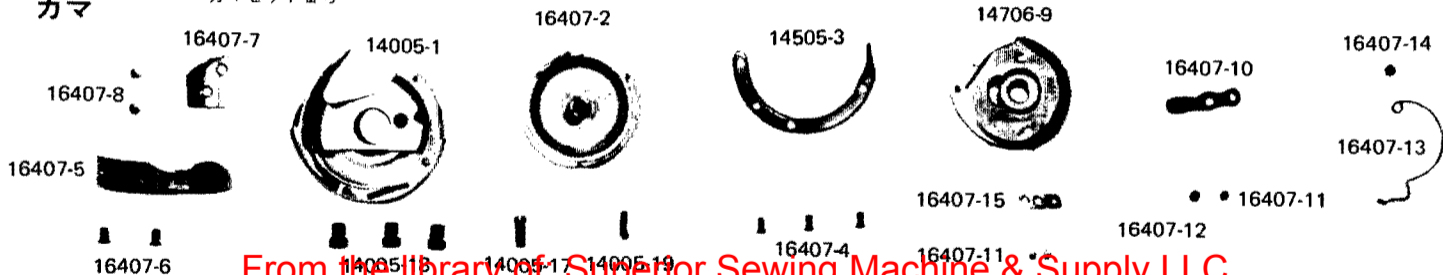

From the library of: Superior Sewing Machine & Supply LLC

GAUGE LIST FOR LPW-27BLK, 28BLK

LPW-27BLK, 28BLK, ゲージ表

common use for LPW-27BLK, 28BLK

LPW-27BLK, 28BLK 共通ゲージ

needle clamp

針株



16295 (1/8")
16296 (3/16")
16297(7/32")
16236 (1/4")
16237 (5/16")
16238 (3/8")
16239 (1/2")
16303 (5/8")
16304 (3/4")

needle plate

針板

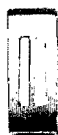

14543 (1/8")
14545 (3/16")
14554 (7/32")
14546 (1/4")
14547 (5/16")
14548 (3/8")
14549 (1/2")
14550 (5/8")
14551 (3/4")

feed dog

送り歯



14563 (1/8")
14565 (3/16")
14574(7/32")
14566 (1/4")
14567 (5/16")
14568 (3/8")
14569 (1/2")
14570 (5/8")
14571 (3/4")

base for needle plate

針板受台

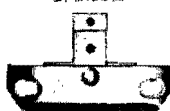

14508 (1/8")
14509 (3/16"-3/8")
14510 (1/2"-3/4")

base plate for

needle plate

針板下板



14523 (1/8")
14525 (3/16")
14534(7/32")
14526 (1/4")
14527 (5/16")
14528 (3/8")
14529 (1/2")
14530 (5/8")
14531 (3/4")

for LPW-27BLK

LPW-27BLK 用

presser foot

押え金



14583 (1/8")
14585 (3/16")
14594(7/32")
14586 (1/4")
14587 (5/16")
14588 (3/8")
14589 (1/2")
14590 (5/8")
14591 (3/4")

for LPW-28BLK

LPW-28BLK 用

vibrating presser foot

外押え



10182(1/8")
10183(3/16")
10184(7/32")
10185(1/4")
10186(5/16")
10187(3/8")
10189(1/2")
10191(5/8")
10192(3/4")

vibrating presser foot

中押え



16522T(1/8")
16523T(3/16")
16524T(7/32")
16525T(1/4")
16526T(5/16")
16527T(3/8")
16529T(1/2")
16531T(5/8")
16532T(3/4")