

JUNG



Radio Management

Wireless control for

- lighting
- heating
- blinds



Radio Management – the simple route to more convenience

Nowadays electrical installations are expected to be more flexible, economically efficient and userfriendly – for example, it should be possible to switch all the lights in the house on or off from a central point or to control various light moods at the touch of a button.

The increasing need for security has also grown in importance.

For this reason, a forward-looking electrical installation must offer the possibility of integrating monitoring components and safety devices.

Existing installations though rarely have such extensive possibilities for control. In only a few cases is there sufficient cable available to achieve the desired functions during retrofitting or change of usage. The dirt and mess caused by walls and ceilings being prised open is followed by extensive renovation work. The resulting costs no longer bear any relation to the additional benefit and extremely useful additions are not implemented.

The Radio Management system from JUNG was developed specifically for this market. It makes it possible to realise additional comfort and safety functions using the existing electrical installation.

All the components are connected via radio and are either independent of existing cables or added to them.

The installation is extremely simple and the system can easily be combined with existing systems.



Radio Management demo set

JUNG

The two demo displays are equipped with original devices of the JUNG Radio Management. The transmission of radio signals can be simulated under realistic conditions. Radio applications are shown precise and demonstrative.

The Radio Management demo set can be obtained under Ref. No. FUNKDISPLAY-NL at € 350,- net.



JUNG



System overview

Transmitter



Radio hand held transmitter



Radio hand held transmitter „Mini“



“Flat” Wall-mounted radio transmitter



Flush mounted radio transmitter with 2-gang push-button sensor



“Flat” wall-mounted radio automatic switch



Radio timer thermostat



Radio multifunction transmitter



Universal radio transmitter



Radio presence detector



Radio observer 180

Radio Management Controller



The JUNG Radio Management system operates at approx. 433 MHz within the limited ISM frequency band that is enabled for industrial, scientific and medical applications. The range as well as the ability to penetrate matter are very good in this area of frequency. They even penetrate walls and ceilings and can therefore relay signals throughout the building. The JUNG Radio Management system operates with the minimum level of radiated power. There is no danger of negative effects on the human body as a result of radiation. The system is divided into the three device groups of transmitter, repeater and receiver.



Master receiver

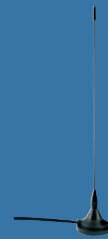

Radio antenna

Repeater



Basic version



Repeater in plug adapter housing with SCHUKO socket

Receiver

Lighting control



Radio-controlled actuator, switch or push-button



Radio-controlled blinds actuator



Radio-controlled universal in-line dimmer

DIN rail devices



Funk-Schaltaktor



Radio universal dimming actuator



Radio-controlled push-button controller
Radio-controlled universal dimmer



Center plate with radio receiver



Radio-controlled plug adapter switch/dimmer



Radio switch actuator



Radio push-button controller

Blinds control

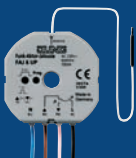

Radio-controlled blinds actuator



Center plate for motor control inserts



Radio blinds actuator



Radio switch actuator, 4-gang

KNX



Radio-controlled push-button, 4-gang for bus coupling unit



Radio-controlled EIB converter

Temperature Management



Radio-controlled valve drive

Transmitter

① Radio wall-mounted transmitter

The modular designed device consists of the transmitter insert and the 1- to 4-gang instabus push-button sensors in the JUNG A 500, AS 500, CD 500, CD plus, LS 990, Aluminium and Stainless Steel ranges. Up to four receivers can be individually addressed.

These carry out ON/OFF, UP/DOWN and dimming commands depending on the receiver. 24 radio receivers can be operated individually with this capacity. A particular practical feature is the fact that all the receiving devices that have been taught into the function can be switched on or off with the ALL ON/ ALL OFF button.



⑤ Radio universal transmitter

The universal transmitter can be used in connection with conventional light or shutter switches. Due to the compact design, it fits behind the switch in a flush-mounted box. Existing installations can also be easily integrated into the radio system.

⑥ Radio Management Controller

The Radio Management controller is a recent addition to the range and takes over the central control of all the receivers in a radio-controlled installation. This happens in three ways: using manual settings, fully automatically via individually coordinated time programs or using lifestyle or event programs.

ALL OFF and ALL ON commands are possible as well as the control of light moods. As the wall-mounted transmitter is battery-operated and therefore not connected to the network, the device can be placed in any position. It is a good idea to use wall-mounted transmitters wherever a fixed installation is required for example in the entrance hall.

The comfort variant has in addition the ability to store and retrieve light moods which can also be dimmed together using the master push button.

③ "Flat" Wall-mounted radio transmitter

Whenever a flush-mounted installation is not advisable or possible for visual or structural reasons, this transmitter is used.

④ Radio hand-held transmitter

The mobile radio hand-held transmitter can be operated from any point and thus offers maximum comfort. After a push-button operation, the transmitter sends a radio telegram which is understood and evaluated by all the receivers. Groups A, B and C are available, each with 8 channels.

The "flat" radio wall-mounted transmitter, which does not require a flush-mounted box, can always be placed in an optimum position for operation.

The device can also be fixed to glass surfaces, tiles or furniture.

The "flat" radio wall-mounted transmitter operates with a long life battery and is thus independent of cables.



④ Universal radio transmitter with L conductor

The component extends existing installations through the wireless transmission of switching commands. It can be operated for switching, dimming or blind control functions.

Due to its compact design, it fits behind the respective switch insert in a flush-mounted box.

For example, depending on the predefined scenario, the blinds in the bedroom and living room are closed, the lighting in the children's room is dimmed down to 50% and specific luminaires are switched on or off or dimmed – regardless of whether someone is at home or not. All the important information is indicated on the illuminated text display of the controller. This includes input data, operating states and the ambient temperature.

JUNG offers the right transmitter in the appropriate design for all areas of application. There are transmitters for flush mounting or for flat installation on glass surfaces, tiles or furniture – without a flush-mounted box. There are also hand-held transmitters available in different versions as well as the Radio Management controller as a central control unit.



Receiver

① Radio-controlled switch and blinds actuator

If there is only a small amount of space available, these variants are used for lighting or blind control: Thanks to its particularly compact design, the respective actuator fits into a flush-mounted box, behind inserts and blanking covers or in a luminaire.

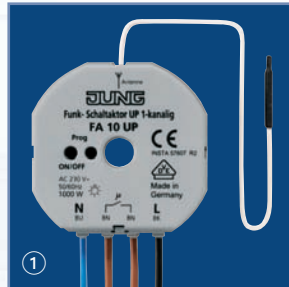

② Center plate with radio receiver for motor control inserts

This flush-mounted system module offers the possibility of controlling blind motors centrally via radio and without control cables. The operation is carried out either via a radio transmitter or directly on the device.

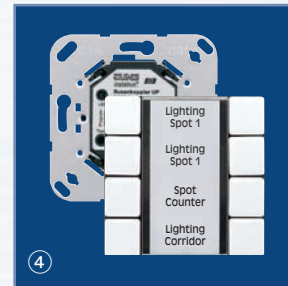
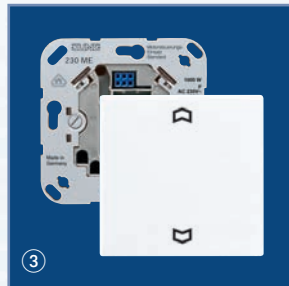

③ Radio-controlled switch/push-button actuator, built-in

This component has a relay output level which can be used to switch larger loads. The compact radio-controlled actuator can be inserted easily in false ceilings or luminaires.

It is also possible to operate extension units via conventional push-buttons.

④ Radio-controlled push-button controller, built-in

This radio receiver switches and dims lighting systems with 1 – 10 V control input and is mounted in false ceilings to save space. Integration in scene setting is also possible.

⑤ Radio-controlled plug adapter, switch or dimmer

This enables devices which are not linked to a specific location to be integrated in the radio system. The mobile receiver is inserted in the socket and the mains plug e.g. of standard and table lamps is simply plugged in. These lamps can now be switched or dimmed via radio.

⑥ Radio-controlled universal cord dimmer

With this device, larger loads can also be dimmed. The radio-controlled universal pull cord dimmer detects the connected load automatically and the initial brightness can be stored in the device as a memory value.

⑦ Center plate with radio receiver

The operation of universal and standard touch dimmers as well as relay inserts is carried out via the center plate with radio receiver in the JUNG ranges AS 500, A 500, CD 500, SL 500, LS 990, Aluminium and Stainless Steel.

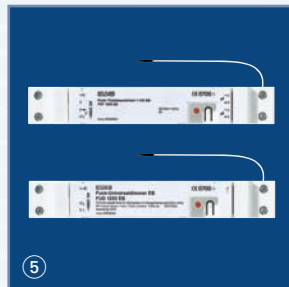

The functional spectrum can be conveniently extended through the connection of different sensors for glass breakage and/or sun.

⑧ Universal radio-controlled EIB push-button

This device consists of a bus coupler and the radio-controlled switch sensor. The KNX/EIB universal switch sensor with radio receiver creates the link between radio technology and the KNX/EIB system.

The lighting is either operated via the transmitter or directly on the device.

JUNG



Radio devices for DIN rail mounting

The application spectrum in Radio Management has been universally extended by the new DIN rail radio components.

① Master receiver

The master receiver is the central unit for the receipt of radio telegrams. These telegrams are routed to the connected radio devices.

Up to 30 radio-controlled actuators can be linked with a master receiver. It has an integrated antenna for receiving the radio signals.

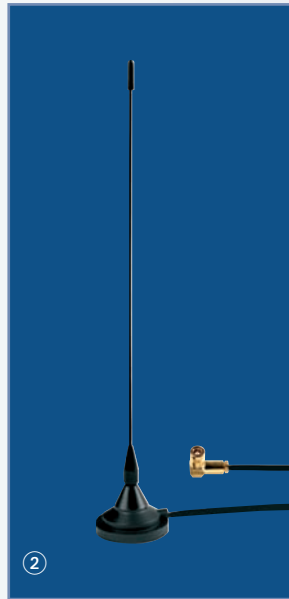

If the installation conditions are unfavourable e.g. in the case of a steel distribution box, an ② additional antenna can be connected and placed outside the shield.

③ Radio push-button controller

The radio push-button controller is the optimum device for the radio-controlled switching and dimming of lighting.

The initial brightness can be stored in the device as a memory value.

The radio push-button controller can teach in up to 30 radio channels.

④ Universal radio-controlled dimmer

The universal radio-controlled dimmer automatically detects the connected load.

In combination with the master receiver, it switches and dims the lighting via radio commands.

The initial brightness can also be set as a memory value in this device.



⑤ Radio-controlled blinds actuator

With the radio-controlled blinds actuator, blinds or roller shutter motors can be controlled by radio.

Depending on the operation of a taught-in radio transmitter, louvres are adjusted or the shutter is raised and lowered.

⑥/⑦ Radio-controlled switch actuator

This device enables the radio-controlled switching of electronic loads such as incandescent lamps, conventional transformers or fluorescent lamps.

If the radio-controlled switch actuator receives e.g. a signal from the radio-controlled observer via the master receiver, it switches light on for approx. 1 min when it goes dark.

The device is available in 1-gang and 4-gang version.



Radio-controlled observer/Radio-controlled presence detector



① **Radio-controlled observer 180**

This sensor monitors a detection area of 180°. With a mounting height of 2.40 m, the field of detection is approx. 16x32 m. The observer is operated at the ② **radio-controlled performance unit**. The operating time and brightness can be adjusted as required. The radio-controlled Observer operates with a 9 V monobloc battery.



The operating state and under-voltage of the battery are indicated at any time on the LED display.

③ **Radio-controlled presence detector**

The flexibility of the radio-controlled presence detector opens up new areas of application, where cables cannot be laid for technical or visual reasons. The radio-controlled presence detector can be positioned anywhere on the ceiling in



interior rooms – without a flush-mounted box and without a supply cable.

It can therefore be installed quickly and cleanly without the need for costly renovation work.

Regardless of whether it is installed in the office, in meeting rooms or conference rooms – the radio-controlled presence detector only switches the light on when it is actually required.

This demand-orientated activation results in an economical use of energy.

The operating state and low battery indication are displayed via the red LED on the device.

The signals are transmitted wirelessly via radio from the observer to the radio-controlled performance unit where the Observer settings such as the operating time can also be carried out. Up to 30 radio-controlled Observers can therefore be taught in per performance unit.

This enables complete monitoring even when a large number of people are present. Constant lighting control is also possible using the appropriate radio-controlled dimming actuator technology.

Radio Management Transmitter

For more details see technical appendix.

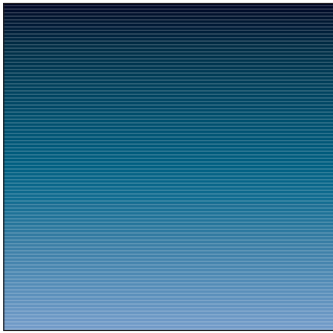

Radio hand-held transmitter

The hand-held transmitter sends a radio telegram after a push-button operation. This telegram is understood and evaluated by all the receivers of the Radio Management system. There are three groups available (A, B, C), each with 8 channel push-buttons (on/off – up/down – dimming) i.e. 24 radio receivers can be operated individually. Central control by ALL ON / ALL OFF buttons. Transmission range: max. 100 m (free field). The hand-held transmitter is operated with 4 x micro (AAA), alkaline (LR03) batteries (not included). Battery life: approx. 3 years.



Description	Ref.-no.
Radio hand-held transmitter	
Standard version	48 FH
colour: anthracite	



Comfort version	48 KFH
additional function: 5 light scenes, master dimming	
colour: anthracite	



Wall-fixing	
for 48 FH / 48 KFH	WH 48
colour: anthracite	



Mini version	42 FH
The "Mini" hand-held transmitter controls 2 channels (On/Off, Up/Down and dimming function)	
colour: anthracite	
Battery operation with one lithium button cell (CR 2032) which is supplied with the device.	
Transmission range: max. 30 m (free field)	
Battery life: approx. 5 years	

For technical details see appendix.

Description	Ref.-no.
Universal radio transmitter	FUS 22 UP
mains operated	

The universal radio transmitter can be used to extend an existing electrical installation by the possibility of transmitting 230 V control commands by radio. The transmitter can be operated for switching, dimming or blind/shutter control functions. When mains voltage (230 V ~) is applied to inputs (E1, E2), the universal radio transmitter transmits radio telegrams which are evaluated by all radio-controlled receivers. For selection and indication of the mode of operation, the device is equipped with a push-button and an LED.

Mode A:	2-channel dimming, toggling (E1 and E2)
Mode B:	2-channel switching (E1 and E2)
Mode C:	1-channel dimming (E1/E2)
Mode D:	1-channel blind/shutter (E1/E2)

Technical data

Power supply:	AC 230 V ~
Transmit frequency:	433.42 MHz, ASK
Transmitting range:	appr. 100 m (in free field)
Operating temperature:	ca. -20° C ... +55° C
Protection level:	IP 20
Dimension (Ø x H):	52 mm x 23 mm

Radio multifunction transmitter

FMS 4 UP

The radio multifunction transmitter is a **battery-operated** four-channel radio transmitter for the extension of an existing radio control installation.

At its four inputs the multifunction radio transmitter detects switching states of volt-free installation switches or push-buttons.

It transmits radio telegrams which can be decoded by all radio control receivers.

A 5-digit dipswitch facilitates the selection of eight different modes of operation.

A red LED indicates the transmission of radio telegrams (slow unsymmetrical blinking, 4 Hz) or an empty battery „LowBatt“ (quick symmetrical blinking, 10 Hz).

The multifunction transmitter is powered by a lithium button cell (CR 2032) which is supplied with the device.

Technical data

Power supply:	3 VDC
Battery:	1 x CR 2032 lithium cell
Length of connecting lines:	approx. 290 mm
Transmit frequency:	433.42 MHz, ASK
Transmitting range:	100 m max. (in free field)
Protection level:	IP 20
Temperature range:	approx. -20° C to +55° C
Dimensions (L x W x H):	45 x 40 x 10 mm

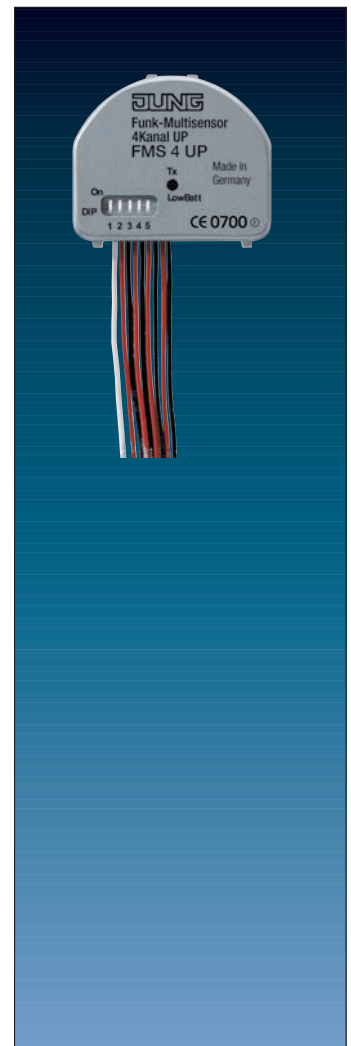
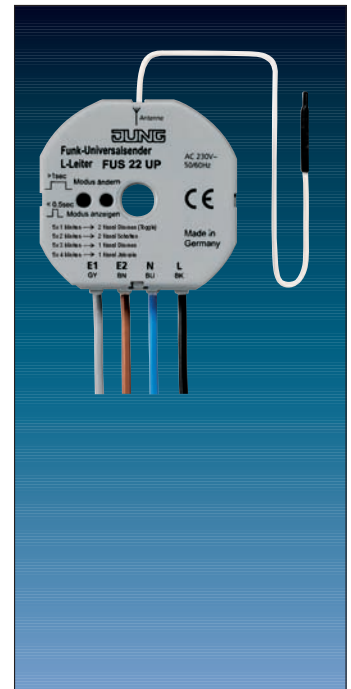

Description	Ref.-no.
Standard push-button module for flush-mounted radio transmitter 40 FW for range Flat-design	
The device has to be extended with the desired cover for push-button module .	
1-gang	2071 TSM
2-gang	2072 TSM
3-gang	2073 TSM
4-gang	2074 TSM

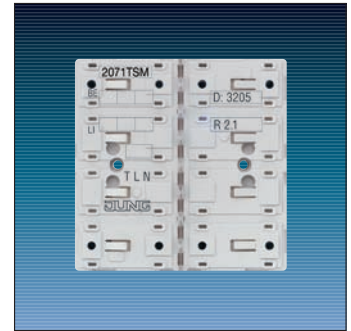

Covers for push-button module in ivory, white (WW) and light grey (LG)

for 1-gang push-button module

standard	FD 901 TSA ..
with symbols	FD 901 TSAP ..
with inscription plate 68.5 x 68.5 mm	FD 901 TSANA ..

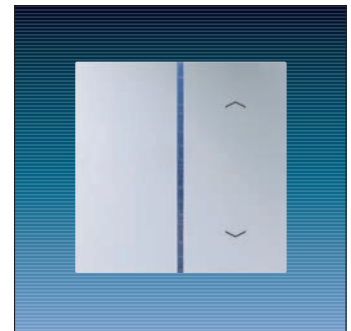

for 2/3-gang push-button module

standard	FD 902 TSA ..
with symbols	FD 902 TSAP ..
with inscription plate 32 x 68.5 mm	FD 902 TSANA ..

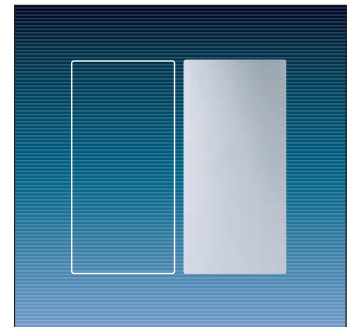

for 3/4-gang push-button module

standard	FD 904 TSA ..
with symbols	FD 904 TSAP ..
with inscription plate 32 x 33 mm	FD 904 TSANA ..

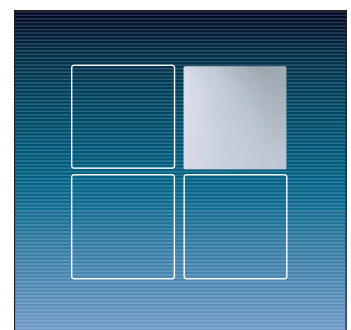

Metal versions

Stainless Steel (ES), Aluminium (AL) and Anthracite (AL .. AN)

for 1-gang push-button module

standard	FD .. 901 TSA ..
with symbols	FD .. 901 TSAP ..
with inscription plate 68.5 x 68.5 mm	FD .. 901 TSANA ..

for 2/3-gang push-button module

standard	FD .. 902 TSA ..
with symbols	FD .. 902 TSAP ..
with inscription plate 32 x 68.5 mm	FD .. 902 TSANA ..

for 3/4-gang push-button module

standard	FD .. 904 TSA ..
with symbols	FD .. 904 TSAP ..
with inscription plate 32 x 33 mm	FD .. 904 TSANA ..

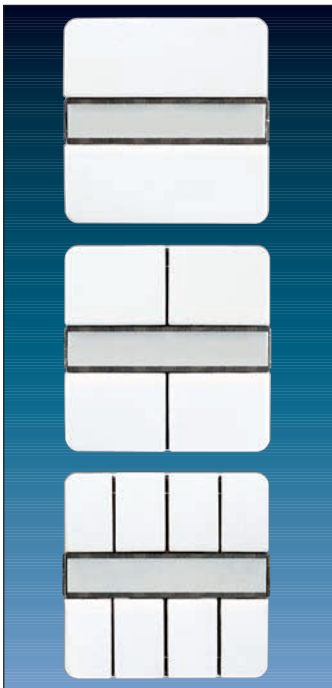
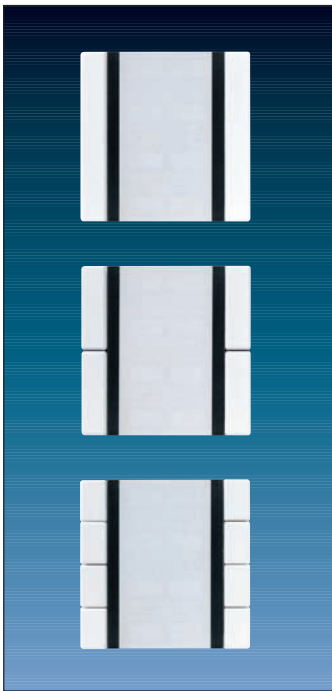

"Flat" Wall-mounted radio transmitter

sends a radio telegram after a push-button sensor is pressed. The telegram is understood and evaluated by all the radio receivers of the Radio Management system. Possible modes: on/off, dimming, light scene, central off (to be selected by microswitches). Range: approx. 30 m (free field). Battery operation with two lithium button cells (CR 2016) which are included. Battery life: approx. 3 years. Installation is carried out with the appropriate frame directly onto a level surface (plaster, wood, glass, mirror or flush box) using adhesive or screws. The number of radio channels available depends on the sensor control used. Two opposite keys are assigned to one channel.

Description	Ref.-no.
-------------	----------

"Flat" Wall-mounted radio transmitter

for ranges A 500, AS 500 and A plus

1-channel	ivory	A 41 F
	white	A 41 F WW
	aluminium	A 41 F AL
2-channel	ivory	A 42 F
	white	A 42 F WW
	aluminium	A 42 F AL
4-channel	ivory	A 44 F
	white	A 44 F WW
	aluminium	A 44 F AL

"Flat" Wall-mounted radio transmitter

for ranges CD 500 and CD plus

1-channel	ivory	CD 41 F
	white	CD 41 F WW
2-channel	ivory	CD 42 F
	white	CD 42 F WW
4-channel	ivory	CD 44 F



Description		Ref.-no.
"Flat" Wall-mounted radio transmitter		
for ranges Stainless Steel and LS plus		
1-channel	stainless steel	ES 41 F
2-channel	stainless steel	ES 42 F
4-channel	stainless steel	ES 44 F
for ranges Aluminium and LS plus		
1-channel	aluminium (lacquered)	AL 41 F
2-channel	aluminium (lacquered)	AL 42 F
4-channel	aluminium (lacquered)	AL 44 F
for ranges Anthracite and LS plus		
1-channel	anthracite (lacquered)	AL 41 F AN
2-channel	anthracite (lacquered)	AL 42 F AN
4-channel	anthracite (lacquered)	AL 44 F AN
for ranges Gold and LS plus		
1-channel	gold (lacquered)	AL 41 F GO
2-channel	gold (lacquered)	AL 42 F GO
4-channel	gold (lacquered)	AL 44 F GO
for ranges Chrome and LS plus		
1-channel	chrome (lacquered)	GCR 41 F
2-channel	chrome (lacquered)	GCR 42 F
4-channel	chrome (lacquered)	GCR 44 F
for ranges LS 990 and LS plus		
1-channel	ivory	LS 41 F
	white	LS 41 F WW
	light grey	LS 41 F LG
2-channel	ivory	LS 42 F
	white	LS 42 F WW
	light grey	LS 42 F LG
4-channel	ivory	LS 44 F
	white	LS 44 F WW
	light grey	LS 44 F LG

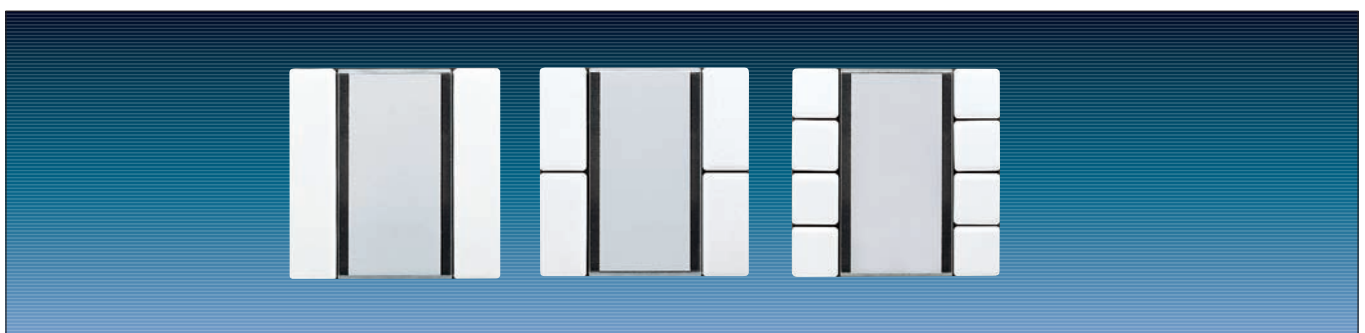
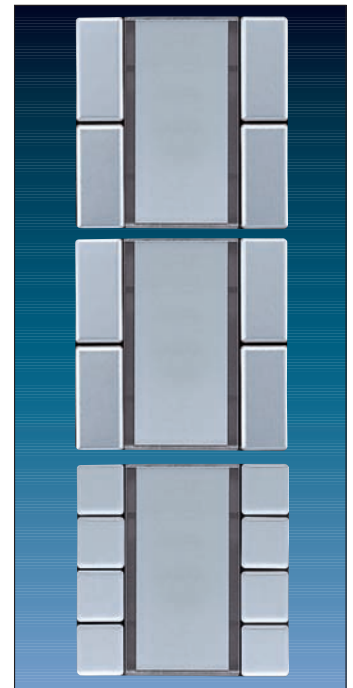
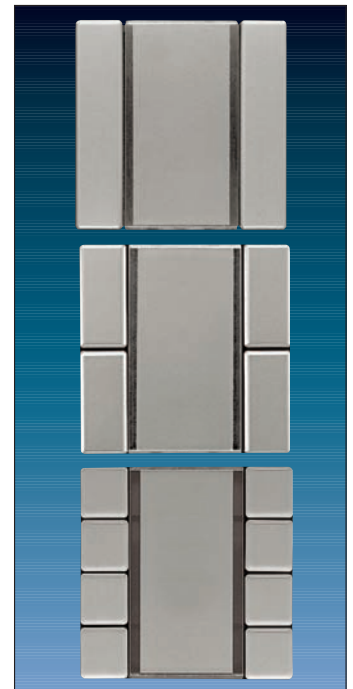

Radio Management Repeater



Description	Ref.-no.
Repeater	100 FR

The operating range of the Radio Management system is extended by the use of the repeater.
 The repeater receives radio telegrams from a taught-in radio transmitter and repeats them.
 The telegram is received and evaluated by a radio-controlled receiver.
 It is not possible to cascade the repeaters i.e. telegrams sent from a repeater are not repeated by another repeater.
 Up to 60 radio transmitters can be taught.

Technical data

Power supply:	230 V ~, 50 Hz
Temperature range:	-20 °C to +55 °C
Type of protection:	IP 20
Length of the mains cable:	1.5 m
Dimensions (W x H x D):	110 x 94 x 38 mm



Repeater	100 FRSG
-----------------	-----------------

in plug adapter housing with SCHUKO-socket (only suitable in countries with german socket system)

The SCHUKO-socket with child protection retains all functions.

By the use of this repeater, the radius of action of the Radio Management system is highly extended. The repeater receives radio telegrams from a programmed radio transmitter and repeats them . The telegram is received and evaluated by a radio receiver.

Cascading of repeaters is not possible, i. e. telegrams sent by a repeater are not repeated by another repeater. Several repeaters can be installed within one system, for example, two repeaters transmit to a radio actuator.
 Install the repeater in the middle of the desired radio link, if possible.
 Up to 60 radio transmitters can be taught into one repeater.

Technical data

Power supply:	230 V ~
Temperature range:	-20 °C to +55 °C
Frequency:	433,42 MHz, ASK
Type of protection:	IP 20
Dimensions:	163 x 70 x 72 mm

Reception frequency: 433.42 MHz, ASK
For technical details see appendix.

Description	Ref.-no.
Radio-controlled switch actuator mains operated, live + neutral required	
1-channel switch	FA 10 UP
1-channel push-button	FA 10 UPT

Max. pulse duration of 10 sec.

The radio-controlled switch actuator switches electrical loads (230 V ~ / 8 A) as soon as it has received an appropriate taught-in radio signal.

Up to 14 radio transmitters can be taught into the radio-controlled switch actuator. On receipt of a radio signal from a radio-controlled Observer, the "1-channel-switch" switches on for an overshoot period of approx. 1 min.

Light scene

The operation of light scene (switching only) is possible using the radio hand-held or wall-mounted transmitter (e.g. the lighting is switched on).

The required light scene push-button of the radio hand-held or wall-mounted transmitter must be taught into the radio-controlled actuator. Up to 5 light scenes can be stored.

Technical data

Nominal voltage:	230 V ~, 50/60 Hz
Switching contact:	Relay, floating contact, 8 A
Miniature circuit-breaker:	10 A
Switching capacity:	
Incandescent lamps	1000 W
High voltage halogen lamps	1000 W
Low voltage halogen lamps	
– conventional transformers	750 VA, with min. 85 % nominal load
– TRONIC-transformers	750 W
Fluorescent lamps	
– not compensated	500 VA
– parallel compensated	400 VA
– lead-lag circuit	1000 VA
Temperature range:	-20 °C to +55 °C
Type of protection:	IP 20
Dimensions (Ø x H):	52 x 23 mm, centre hole Ø 7,5 mm

Note: Energy-saving lamps generate extremely high current peaks when they are switched on which can lead to bonding of the switching contact. You should therefore check the suitability of the lamps before use. The make contact has basic insulation internally and is separated from the phase.

The following **loads** can be switched:

Functional extra-low voltage (FELV) or one phase L (230 V ~) against the neutral conductor N.

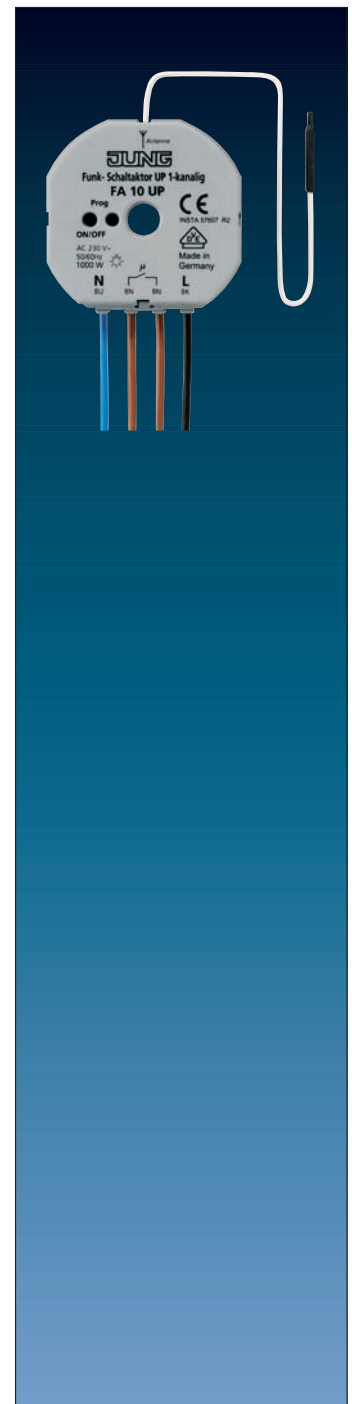

Radio Management Receiver

Reception frequency: 433.42 MHz, ASK
 For technical details see appendix.

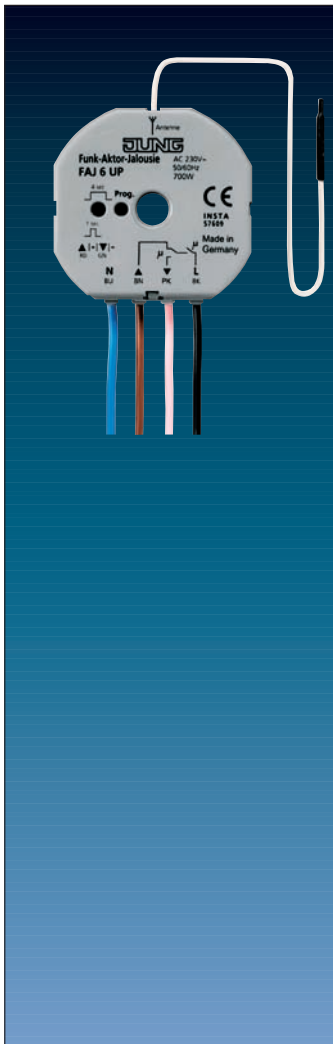
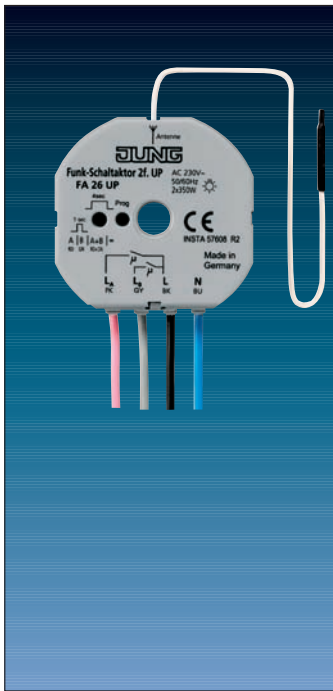

Description	Ref.-no.
Radio-controlled switch actuator FM mains operated, live + neutral required	
2-channel switch	FA 26 UP
2-channel push-button	FA 26 UPT

Max. pulse duration of 10 sec.
 The 2-channel, radio-controlled switch actuator enables two electrical loads to be switched independently by radio control.
 Up to 7 radio transmitters per channel can be taught into the actuator.
 On receipt of a taught-in radio signal from a radio-controlled Observer, the "2-channel switch" switches on for an overshoot period of approx. 1 minute.

Light scene

The operation of light scene (switching only) is possible using the radio hand-held or wall-mounted transmitter (e.g. the lighting is switched on).
 The required light scene push-button of the radio hand-held or wall-mounted transmitter must be taught into the radio-controlled actuator. Up to 5 light scenes can be stored.

Technical data

Nominal voltage:	230 V ~, 50/60 Hz
Switching contact:	Relay, μ floating contact, 6 A (only for resistive load)
Miniature circuit-breaker:	10 A
Switching capacity (per channel):	
Incandescent lamps	350 W
High voltage halogen lamps	300 W
Low voltage halogen lamps	
– conventional transformers	350 VA, with min. 85 % nominal load
– TRONIC transformers	300 W
Fluorescent lamps	
– not compensated	350 VA
Number of possible transmitters:	max. 7 per channel
Temperature range:	-20 °C to +55 °C
Type of protection:	IP 20
Dimensions (\varnothing x H):	52 x 23 mm, centre hole \varnothing 7,5 mm

Not suitable for fluorescent lamps with parallel compensation 47 μ F) or lead-lag circuit as well as energy-saving lamps.

Radio-controlled blinds actuator FM mains operated, live + neutral required	FAJ 6 UP
--	-----------------

The radio-controlled blinds actuator enables the wireless remote control of a shutter or blinds motor.
 Dependent on the operation of a radio transmitter, the louvres are adjusted (short push-button action <1 sec) or the blinds are moved (long push-button action >1 sec).
 Up to 14 radio-controlled transmitters can be taught into the radio-controlled blinds actuator.

Light scene

The limit position of the blind (top or bottom) can be integrated together with the lighting into a maximum of 5 light scenes.
 The required light scene push-button of the radio hand-held or wall-mounted transmitter must be taught into the radio-controlled actuator.

Technical data

Nominal voltage:	230 V ~, 50/60 Hz
Miniature circuit-breaker:	10 A
Switching capacity:	max. 1 motor 700 W
Relay output:	2 make contacts (non-floating and interlocked)
Reversing time for change in direction:	approx. 1 sec
Continuous operation:	approx. 2 min
Temperature range:	-20 °C to +55 °C
Type of protection:	IP 20
Dimensions (\varnothing x H):	52 x 23 mm, centre hole \varnothing 7,5 mm

The **radio-controlled plug adapters** permit radio-controlled switching and dimming (only FZD 1254 WW) of non-stationary and mains-plug equipped electrical appliances (230 V ~) as, for instance, table or standard lamps. The adapter is operated either with a radio transmitter of the Radio Management System or locally (only switching). The starting brightness can be stored in the device as memory brightness. On receipt of the radio signal from a radio-controlled observer, it switches on for an overshoot period of approx. 1 min. Up to 30 radio transmitters can be taught into the plug adapter dimmer.

Light scene

The radio-controlled adapter can be integrated in up to five light scenes which are activated with the corresponding radio transmitters (e.g. hand-held transmitter 'Comfort') and stored. The desired light scene key must be taught into the radio-controlled adapter.

Description	Ref.-no.
Radio-controlled plug adapter switch	FZS 10 WW
in SCHUKO-socket housing	
(only suitable in countries with german socket system)	
Technical data	
Nominal voltage:	230 V ~, 50 Hz
Fuse:	T 6.3 H 250 V
Switching capacity (relay contact):	
Incandescent lamps	1000 W
High voltage halogen lamps	1000 W
Low voltage halogen lamps	
– conventional transformers	750 VA
– TRONIC transformer	750 W
Fluorescent lamps	
– not compensated	500 VA
– parallel compensated	400 VA
– lead-lag circuit	1000 VA
Temperature range:	-20 °C to +55 °C
Type of protection:	IP 20
Dimensions (L x W x D):	136 x 70 x 72 mm

Description	Ref.-no.
Radio-controlled plug adapter dimmer	FZD 1254 WW
in SCHUKO-socket housing	
(only suitable in countries with german socket system)	

Technical data

Nominal voltage:	230 V ~, 50/60 Hz
Fuse:	T 6,3 H 250 V
Connected load:	50 – 315 W/VA
	230 V Incandescent lamps
	High voltage halogen lamps
	Low voltage halogen lamps with
	– conventional transformers
	– TRONIC transformer
	Mixed loads of specific load types are permitted
	(not capacitive with inductive loads).
Dimensions (L x W x D):	136 x 70 x 72 mm



Note: Energy-saving lamps generate extremely high current peaks when they are switched on which can lead to bonding of the switching contact. You should therefore check the suitability of the lamps before use

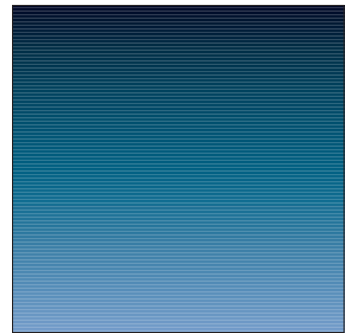

Radio Management Receiver

Reception frequency: 433.42 MHz, ASK
For technical details see appendix.

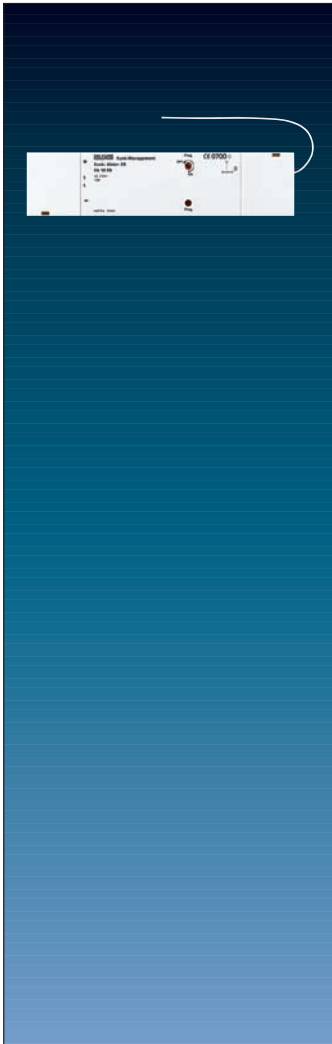

Description	Ref.-no.
Radio-controlled switch actuator, built-in switch	FA 10 EB

The radio-controlled switch actuator switches electrical loads (230 V / 10 A) as soon as it has received a corresponding taught-in radio-signal. Up to 30 transmitters can be taught into the radio-controlled switch actuator. On receipt of a radio signal from the radio-controlled observer, it switches on for an overshoot period of approx. 1 min. The radio-controlled switch actuator can be operated via a satellite station signal (230 V) e.g. push-button 531 U or satellite station 1220 NE.

Light scene

The operation of light scene (switching only) is possible using the radio hand-held or wall-mounted transmitter (e.g. the lighting is switched on). The required light scene push-button of the radio hand-held or wall-mounted transmitter must be taught into the radio-controlled actuator. Up to 5 light scenes can be stored.

Technical data

Nominal voltage:	230 V ~, 50 Hz
Switching contact:	Relay (10 A)
Switching capacity:	
Incandescent lamps	2300 W
High voltage halogen lamps	
– conventional transformers	1000 W
– TRONIC transformers	1500 W
Fluorescent lamps	
– not compensated	1200 W
– parallel compensated	920 W
– lead-lag circuit	2300 W
Temperature range:	–20 °C to +55 °C
Type of protection:	IP 20
Number of satellite stations:	unlimited
Dimensions (L x W x H):	175 x 42 x 18 mm

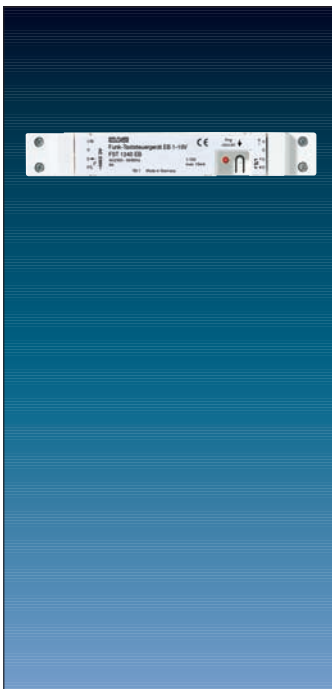

Radio-controlled push-button controller, built-in	FST 1240 EB
--	--------------------

The radio-controlled push-button controller 1...10 V enables the lighting to be controlled remotely via radio. The luminaire can thus be switched (short switch operation) or dimmed (long switch operation). On receipt of a radio signal from the radio-controlled observer, it switches on for an overshoot period of approx. 1 min. The operation in light scene is possible. Up to 30 radio transmitters can be taught into the radio-controlled push-button controller.

Technical data

Power supply:	230 V ~, 50/60 Hz
Control voltage:	1 – 10 V
Control current:	max. 15 mA
Electrical isolation 1 – 10 V:	2 kV basic insulation
Switching contact:	μ relay contact
Connected load:	
Resistive load	max. 1800 W
Electronic ballast, transformer	type-dependent
Line protection:	10 A
Temperature range:	–20 °C to +55 °C
Type of protection:	IP 20
Dimensions (L x W x H):	187 x 28 x 28 mm

Description	Ref.-no.
Radio-controlled universal dimmer, built-in	FUD 1253 EB

The radio-controlled universal dimmer enables the wireless remote control and manual triggering of luminaires.

The lighting can be switched (short switch operation) or dimmed (long switch operation).

On receipt of a radio signal from the radio-controlled observer, it switches on for an overshoot period of approx. 1 min. The operation in light scene is possible.

Up to 30 radio transmitters can be taught into the radio-controlled universal dimmer.

The radio-controlled universal dimmer can be operated via a satellite station signal (230 V) e.g. satellite station ref.-no. 1220 NE or push-button ref.-no. 531 U.

Technical data

Power supply: 230 V ~, 50 Hz (neutral conductor not required)
 Connected load: 50 – 315 W/VA



230 V incandescent lamps
 230 V halogen lamps
 TRONIC transformers
 Conventional transformers

Mixed loads of specified load types are permitted (not capacitive with inductive loads).

In the case of a mixed load with conventional transformers, 50 % of the resistive load (incandescent lamps, high voltage lamps) should not be exceeded.

Number of connected power amplifiers: max. 10 (ref.-nos. 245 TL REG or 247 EB or 245 NL REG or 246 EB)

Number of satellite stations: unlimited

Emitted interference: according to EN 55015

Temperature range: 0 °C to +55 °C

Type of protection: IP 20

Dimensions (L x W x H): 187 x 28 x 28 mm

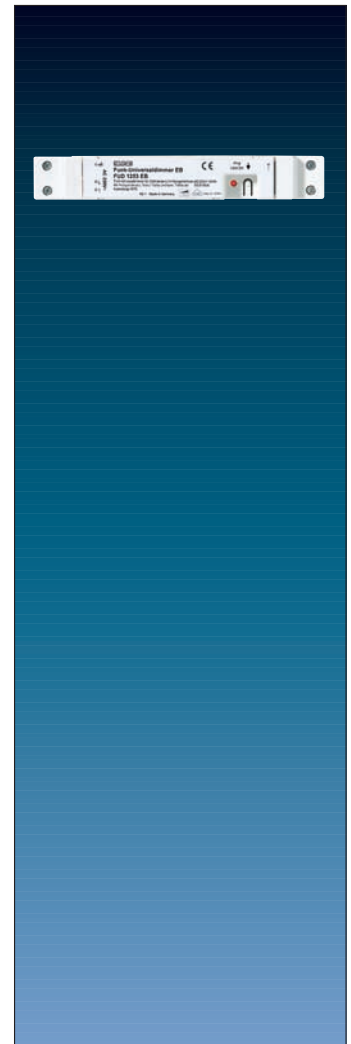

Description	Ref.-no.
Radio-controlled universal in-line dimmer	FUSD 1253 SW

The radio-controlled universal in-line dimmer enables the wireless remote control of luminaires.

The luminaire can thus be switched (short switch operation) or dimmed (long switch operation).

The operation can be carried out with a radio-controlled hand-held or wall-mounted transmitter.

The required initial brightness value can be stored (memory function).

Up to 30 radio transmitters can be taught into the universal in-line dimmer.

Light scene

The universal in-line dimmer can be integrated into light scene.

These are recalled using the radio hand-held or wall-mounted transmitter.

The required light scene push-button of the radio hand-held or wall-mounted transmitter must be taught into the universal in-line dimmer. Up to 5 light scenes can be stored.

Technical data

Nominal voltage: 230 V ~, 50 Hz

Connected load: 50 – 315 W/VA



230 V incandescent lamps
 230 V halogen lamps
 TRONIC transformers
 Conventional transformers

Mixed loads of specified load types are permitted (not capacitive with inductive loads).

In the case of a mixed load with conventional transformers, 50 % of the resistive load (incandescent lamps, high voltage lamps) should not be exceeded.

Dimensions (L x W x H): 126 x 60 x 28 mm

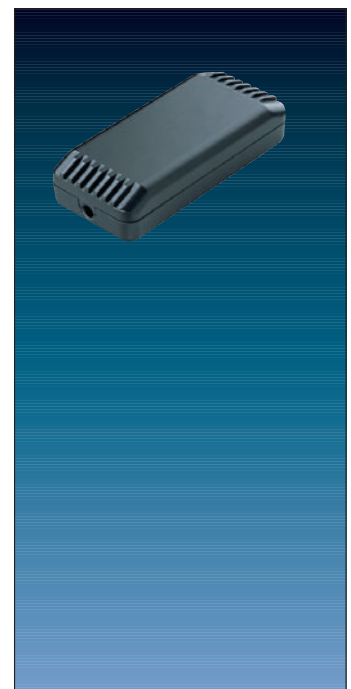

For more details see technical appendix.



Function of the radio center plate:

1. Longer operation of the upper half: dimming from min. to max.
2. Short operation of the upper half: ON
3. Longer operation of the lower half: dimming from max. to min.
4. Short operation of the lower half: OFF
5. Short operation of the whole surface area: ON or OFF
6. Operation of the whole surface area when supply is connected for min. 3 sec.: the current dimming value is stored as a memory value



Description

Ref.-no.

Radio center plate

for switching and dimming inserts

1201 URE, 1201-1 URE, 1202 URE, 1225 SDE, 1240 STE, 1244 NVSE, 1254 TSE, 1254 UDE

for ranges CD 500 and CD plus

ivory*	CD 1561.07 F
blue	CD 1561.07 F BL
brown	CD 1561.07 F BR
grey	CD 1561.07 F GR
light grey	CD 1561.07 F LG
red	CD 1561.07 F RT
black	CD 1561.07 F SW
white	CD 1561.07 F WW
gold bronze	CD 1561.07 F GB
platinum	CD 1561.07 F PT



for ranges AS 500 and A plus

ivory	AS 1561.07 F
white	AS 1561.07 F WW



for ranges A 500 and A plus

white	A 1561.07 F WW
aluminium	A 1561.07 F AL

for range SL 500

white	SL 1561.07 F WW
gold bronze	SL 1561.07 F GB
black	SL 1561.07 F SW



for ranges LS 990 and LS plus

ivory	LS 1561.07 F
white	LS 1561.07 F WW
light grey	LS 1561.07 F LG

Description	Ref.-no.
Radio center plate for switching and dimming inserts 1201 URE, 1201-1 URE, 1202 URE, 1225 SDE, 1240 STE, 1244 NVSE, 1254 TSE, 1254 UDE	
for ranges Stainless Steel and LS plus stainless steel	ES 1561.07 F
for ranges Aluminium and LS plus aluminium	AL 1561.07 F
for ranges Anthracite and LS plus anthracite	AL 1561.07 F AN
for ranges Chrome and LS plus chrome	GCR 1561.07 F
for ranges Gold and LS plus gold	AL 1561.07 F GO

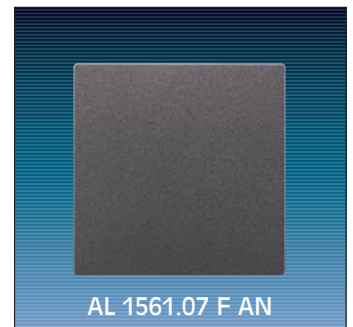

For further techn. information refer to main catalogue or www.jung.de.

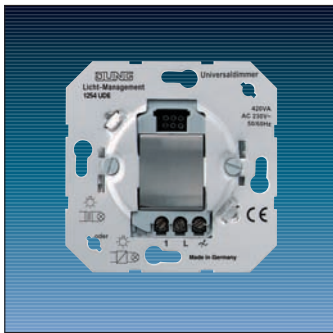

Description	Ref.-no.
Universal dimmer insert	1254 UDE

(short circuit proof)

nominal voltage:	230 V ~, 50/60 Hz
connected load:	50 – 420 W/VA
	230 V incandescent lamps
	230 V halogen lamps
	TRONIC transformers
	conventional transformers



Mixed loads of specific load types are permitted (however, not capacitive with inductive loads).



Standard dimmer insert	1225 SDE
-------------------------------	-----------------

nominal voltage:	230 V ~, 50/60 Hz
connected load:	20 – 500 W/VA
	230 V incandescent lamps
	230 V halogen lamps
	conventional transformers



Mixed loads of specific load types are permitted.



Universal relay switch insert	1201 URE
--------------------------------------	-----------------

(neutral line necessary)

nominal voltage:	230 V ~, 50/60 Hz
Connected load:	230 V incandescent lamps (2300 W)
	230 V halogen lamps (2300 W)
	TRONIC transformers (1500 W)
	conventional transformers (1000 W)
	fluorescent lamps
	not compensated 1200 W
	parallel compensated 920 W
	lead-lag circuit 2300 W

Attention: energy saving lamps cause high peak current, reduction of capacity necessary!
Please check suitability of lamps before installation!

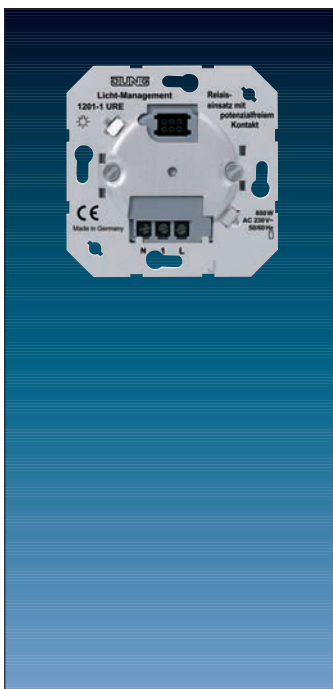

Universal relay switch insert	1201-1 URE
--------------------------------------	-------------------

1-channel switch with additional floating contact for switching of different external conductors (min. 12 V, 100 mA /no SELV)

N-conductor required

Nominal voltage:	AC 230 V ~, 50/60 Hz
Connected load:	230 V incandescent lamps 800 W
	230 V halogen lamps 750 W
	Mixed loads of the specified types
Minimum load:	12 V, 100 mA
Number of satellite:	unlimited number of 1220 NE
	unlimited number of conventional push-buttons
	10 satellites of 1223 NE
	Different types of satellites can be combined

Total length of satellite

connecting cable: max. 100 m

Short-circuit protection: The load output has no internal protection.

For protection install a circuit-breaker of 10 A ahead of the device.

Description	Ref.-no.
Universal relay switch insert 2-gang	1202 URE
(neutral line necessary)	
nominal voltage:	230 V ~, 50/60 Hz
connected load:	
channel 1:	incandescent lamps (1000 W) 230 V halogen lamps (1000 W) TRONIC transformer (750 W) conventional transformer (750 W) fluorescent lamps not compensated 500 W parallel compensated 400 W
channel 2 (HVAC-channel):	suitable for HVAC applications incandescent lamps (800 W) 230 V halogen lamps (750 W) i.e. ventilation make MAICO EZF 45/4 A (floating contact, suitable for second line) OFF delay time: adjustable (2, 10, 30, 60 or 120 min.) ON delay time: 3 min. (can be deactivated, then no delay)
Attention: energy saving lamps cause high peak current, reduction of capacity necessary! Please check suitability of lamps before installation!	

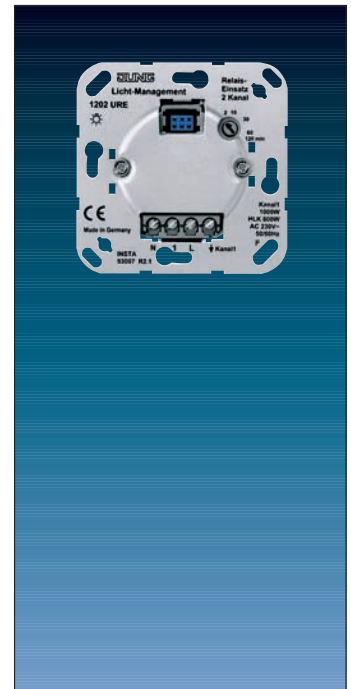

TRONIC switch insert (short-circuit proof)	1254 TSE
nominal voltage:	230 V ~, 50/60 Hz
connected load:	50 – 420 W/VA 230 V incandescent lamps 230 V halogen lamps TRONIC transformers

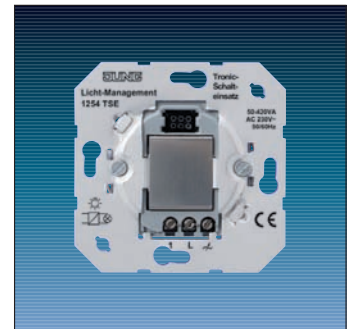

LV-Triac switch insert	1244 NVSE
nominal voltage:	230 V ~, 50/60 Hz
connected load:	40 – 400 W/VA 230 V incandescent lamps 230 V halogen lamps conventional transformers 400 W



Control unit 1 – 10 V	1240 STE
(neutral line necessary)	
Used for switching and dimming of electronic lamp ballasts (EVC) with 1 – 10 V interface and/or TRONIC transformers with 1 – 10 V interface.	
nominal voltage:	230 V ~, 50/60 Hz
connected load:	700 W incandescent lamps electronic lamp ballasts with 1 – 10 V interface, dependent on manufacturer
signal voltage:	0,5 ... 10 V
signal current:	max. 50 mA
performance:	relay with make-contact
For short-circuit protection of the output of the device, please install a circuit breaker in front.	



For more details see technical appendix.



Function of the center plate with radio receiver for motor control inserts:

1. The center plate with radio receiver is a component of the Blinds Management system.
When used with the motor controller insert, it is possible to control a shutter motor by radio remote control and manually.
2. Short operation (up to 1 sec.): The blind remains in motion for the duration of the push-button action.
This function is used to adjust the louvres of the blind. Long operation (at least 1 sec.): Shutter control remains locked for approx. 2 min. i.e. "continuous operation".
3. Up to 30 radio transmitters can be taught in. Radio hand-held transmitter, radio wall-mounted transmitter and radio universal transmitter can be used.
4. The limit positions of a blind (Up or Down) can be integrated into light scene.

Description	Ref.-no.
Center plate with radio receiver for motor control inserts 220 ME, 230 ME, 232 ME and 224 ME	
for ranges CD 500 and CD plus	
ivory	CD 5232 F
blue	CD 5232 F BL
brown	CD 5232 F BR
grey	CD 5232 F GR
light grey	CD 5232 F LG
red	CD 5232 F RT
black	CD 5232 F SW
white	CD 5232 F WW
bronze	CD 5232 F GB
platinum	CD 5232 F PT
with terminals for sensors 32 G, 32 SD and connector 32 K	
ivory	CD 5232 FS
blue	CD 5232 FS BL
brown	CD 5232 FS GR
light grey	CD 5232 FS LG
red	CD 5232 FS RT
black	CD 5232 FS SW
white	CD 5232 FS WW
bronze	CD 5232 FS GB
platinum	CD 5232 FS PT
for ranges AS 500	
ivory	AS 5232 F
white	AS 5232 F WW
with terminals for sensors 32 G, 32 SD and connector 32 K	
ivory	AS 5232 FS
white	AS 5232 FS WW
for ranges A 500 and A plus	
white	A 5232 F WW
aluminium	A 5232 F AL
with terminals for sensors 32 G, 32 SD and connector 32 K	
white	A 5232 FS WW
aluminium	A 5232 FS AL
for range SL 500	
bronze	SL 5232 F GB
black	SL 5232 F SW
white	SL 5232 F WW
with terminals for sensors 32 G, 32 SD and connector 32 K	
bronze	SL 5232 FS GB
black	SL 5232 FS SW
white	SL 5232 FS WW

Description	Ref.-no.
Center plate with radio receiver for motor control inserts 220 ME, 230 ME, 232 ME and 224 ME	
for ranges LS 990 and LS plus	
ivory	LS 5232 F
light grey	LS 5232 F LG
white	LS 5232 F WW
with terminals for sensors 32 G, 32 SD and connector 32 K	
ivory	LS 5232 FS
light grey	LS 5232 FS LG
white	LS 5232 FS WW



for ranges Stainless Steel and LS plus	
stainless steel	ES 5232 F
with terminals for sensors 32 G, 32 SD and connector 32 K	
stainless steel	ES 5232 FS



for ranges Aluminium, Anthrazit and LS plus	
aluminium	AL 5232 F
anthracite	AL 5232 F AN
with terminals for sensors 32 G, 32 SD and connector 32 K	
aluminium	AL 5232 FS
anthracite	AL 5232 FS AN



for ranges Gold and LS plus	
gold	AL 5232 F GO
with terminals for sensors 32 G, 32 SD and connector 32 K	
gold	AL 5232 FS GO



for ranges Chrome and LS plus	
chrome	GCR 5232 F



For further techn. information refer to main catalogue or www.jung.de.



Description	Ref.-no.
Motor controller insert "Universal"	232 ME

Nominal voltage: 230 V ~, 50/60 Hz, neutral line necessary
 Switching capacity: max. 1 motor 1000 VA
 Relay output: 2 non-floating make contacts, interlocked with each other

1 motor with a limit position switch up to a maximum of 1000 VA can be controlled per motor controller insert. Observe the instructions from the manufacturer of the motor.
 Satellite inputs allow you to connect the system to further mechanical push-buttons and blinds controllers. You can also use the satellite inputs for a „wind alert“ function. Furthermore, the complete functionality of the Blinds Management system including sensors can be implemented (for detailed information please refer to corresponding documentation).



Motor controller insert "Standard" stand-alone device	230 ME
--	---------------

No satellite operation possible.

Nominal voltage: 230 V ~, 50/60 Hz, neutral line necessary
 Switching capacity: max. 1 motor 1000 VA
 Relay output: 2 non-floating make contacts, interlocked with each other
 1 motor with a limit position switch up to a maximum of 1000 VA can be controlled per motor controller insert. Observe the instructions from the manufacturer of the motor.



Motor controller insert "Direct" stand-alone device, neutral line not required	220 ME
---	---------------

No satellite operation possible.

Nominal voltage: 230 V ~, 50/60 Hz,
 Switching capacity: max. 1 motor 1000 VA
 Relay output: 2 non-floating make contacts, interlocked with each other
 1 motor with a limit position switch up to a maximum of 1000 VA can be controlled per motor controller insert. Observe the instructions from the manufacturer of the motor.

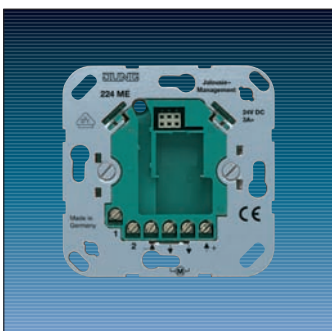

Motor controller insert "Universal" 24 V DC	224 ME
--	---------------

Nominal voltage: DC 24 V, ±10 %
 Switching capacity: max. 3 A
 Relay output: 2 change-over relays in a reversing polarity circuit
 The motor controller insert can control one or more motors with a total current of 3 A. Please observe the information given by the motor manufactures. The motor controller insert requires a power supply unit for 24 V DC SELV. A protected separation between primary and secondary side of the power supply unit must be ensured.

Description	Ref.-no.
Master receiver	FK 100 REG
for DIN rail mounting, 2 units	

Function:

The Master receiver is used to receive radio signals from various radio transmitters. It converts the radio signal and sends the information to the radio actuators via a bus line. It is possible to connect up to 30 radio actuators to the Master receiver. The device has an integrated antenna. For a better radio reception it can be extended with an external radio antenna.

Connection:

The Master receiver is connected to the Radio actuators via a two-wire busline. The total length of the wire between all actuators mustn't be longer than 3 m. A wire (twisted with \varnothing 0,8 mm) with a testing voltage of AC 2.5 kV has to be used (e.g. YCM 2x2x0.8 or J-Y(St)Y 2x2x0.8).

Technical data

Power supply:	230 V ~, 50/60 Hz
Temperature range:	0 °C to +45 °C
Frequency:	433.42 MHz
Type of protection:	IP 20
Dimensions:	36 mm (2 units)

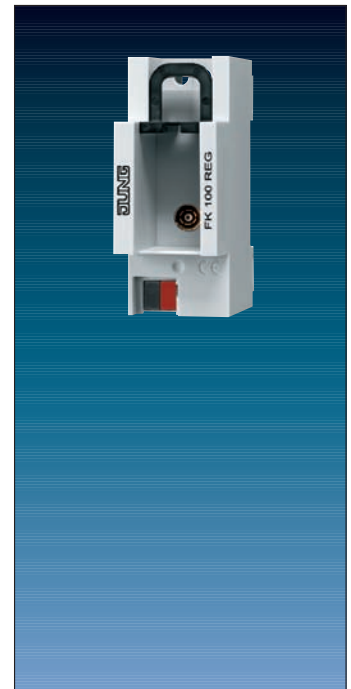

Radio antenna	F-ANT
for Master Radio receiver FK 100 REG	
with magnetic connection and 275 cm cable extension	
Height: 20 cm	



Radio switch actuator	FA 10 REG
for DIN rail mounting, 2 units	

Function:

In connection with the Master receiver the radio switch actuator enables radio controlled switching of electrical loads. It receives radio signals from various radio transmitters. On receipt of the radio signal from a radio-controlled observer, it switches on for an overshoot period of approx. 1 min. Up to 30 radio transmitters can be taught into the radio switch actuator.

Light scene:

The radio switch actuator can be integrated in up to five light scenes which are activated with the corresponding radio transmitters (e.g. hand-held transmitter 'Comfort') and stored. The desired light scene key must be taught into the radio switch actuator.

Technical data

Nominal voltage:	230 V ~, 50/60 Hz	connected load:	
Temperature range:	0 °C to +45 °C	Incandescent lamps	2300 W
Frequency:	433.42 MHz	HV-halogen lamps with	
Type of protection:	IP 20	– conventional transformer	1000 W
switching contact:	relay (10 A)	– TRONIC transformer	1500 W
Number of satellites:	unlimited	Fluorescent lamps	
Dimensions:	36 mm (2 units)	– not compensated	1200 W
		– parallel compens.	920 W
		– dual circuit	2300 W



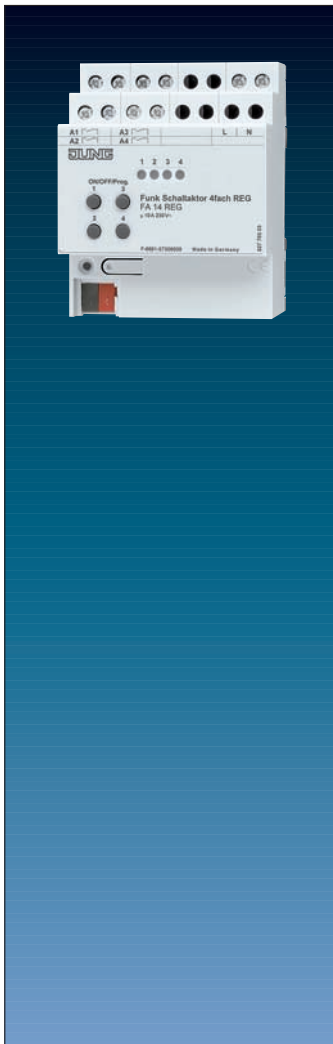

Description

Ref.-no.

Radio switch actuator, 4-gang

FA 14 REG

for DIN rail mounting, 4 units

Function:

In connection with the Master receiver the radio switch actuator enables radio controlled switching of electrical loads. It receives radio signals from various radio transmitters. On receipt of the radio signal from a radio-controlled observer, it switches on for an overshoot period of approx. 1 min. Up to 30 radio transmitters can be taught into the radio switch actuator.

The device is equipped with 4 push-buttons for local operation and 4 status LED

Light scene:

The radio switch actuator can be integrated in up to five light scenes which are activated with the corresponding radio transmitters (e.g. hand-held transmitter 'Comfort') and stored. The desired light scene key must be taught into the radio switch actuator.

Technical data

Nominal voltage:	230 V ~, 50/60 Hz
Contacts:	4 floating contacts, 10 A
Temperature range:	0 °C to +45 °C
Frequency:	433.42 MHz
Type of protection:	IP 20
Dimensions:	72 mm (4 units)
Switching capacity (each channel):	
Incandescent lamps	2300 W
230 V halogen lamps	2300 W
Tronic transformers	1500 W
Conventional transformers	1000 W
Fluorescent lamps	
– not compensated	1200 W
– parallel compens.	920 W
– dual circuit	2300 W



Radio push-button controller

FST 1240 REG

for DIN rail mounting, 4 units

Function:

In connection with the Master receiver the radio push-button-controller actuator enables radio controlled switching and dimming of electrical loads with a control voltage of 1 –10 V (e.g. for dimming of fluorescent lamps controlled by electronic ballasts). It receives radio signals from various radio transmitters. A selected brightness level can be stored as memory value in the device.

On receipt of the radio signal from a radio-controlled observer, it switches on for an overshoot period of approx. 1 min. Up to 30 radio transmitters can be taught into the radio push-button-controller actuator.

Light scene:

The radio push-button-controller actuator can be integrated in up to five light scenes which are activated with the corresponding radio transmitters (e.g. hand-held transmitter 'Comfort') and stored. The desired light scene key must be taught into the device.

Technical data

Nominal voltage:	230 V ~, 50/60 Hz	Switch contact:	µ relay contact
Temperature range:	0 °C to +45 °C	Resistive load:	max. 1800 W
Frequency:	433.42 MHz	Electric ballast,	
Type of protection:	IP 20	Transformer:	type-dependent
Dimensions:	72 mm (4 units)		
Control voltage:	1 – 10 V		
Control current:	max 15 mA		

Description	Ref.-no.
Radio blinds actuator	FAJ 6 REG
for DIN rail mounting, 2 units	

Function:

In connection with the Master receiver the Radio blinds actuator enables radio controlled switching of shutter-motors. It receives radio signals from various radio transmitters to open or close the blinds. A short depression of the radio transmitter is used to adjust the louvres. Up to 14 radio transmitters can be taught into the radio blinds actuator.

Light scene:

The radio blinds actuator can be integrated in up to five light scenes which are activated with the corresponding radio transmitters (e.g. hand-held transmitter 'Comfort') and stored. The desired light scene key must be taught into the radio blinds actuator.

Technical data

Nominal voltage:	230 V ~, 50/60 Hz
Temperature range:	0 °C to +45 °C
Frequency:	433.42 MHz
Type of protection:	IP 20
Switching capacity:	max. one motor 700 VA
Operation time:	2 minutes
Switching time:	1 second (shift in direction)
Dimensions:	36 mm (2 units)



Radio universal dimming actuator	FUD 1254 REG
for DIN rail mounting, 4 units	

Function:

In connection with the Master receiver the radio universal dimming actuator enables radio controlled switching and dimming of electrical loads. It receives radio signals from various radio transmitters. Beside the radio transmitter the light can be switched with satellites or directly on the device. The type of load is automatically learned by the universal dimmer. A selected brightness level can be stored as memory value in the device. On receipt of the radio signal from a radio-controlled observer, it switches on for an overshoot period of approx. 1 min. Up to 30 radio transmitters can be taught into the radio switch actuator.

Light scene:

The radio universal dimming actuator can be integrated in up to five light scenes which are activated with the corresponding radio transmitters (e.g. hand-held transmitter 'Comfort') and stored. The desired light scene key must be taught into the radio universal dimming actuator.

Technical data

Nominal voltage:	230 V ~, 50/60 Hz
Temperature range:	0 °C to +45 °C
Frequency:	433.42 MHz
Type of protection:	IP 20
Power attachment:	max. 10
satellites:	unlimited
Dimensions:	72 mm (4 units)
Connected load:	50 – 400 W/VA
	230 V incandescent lamps
	230 V halogen lamps
	Tronic transformers
	Conventional transformers
	Mixed loads of the specified types

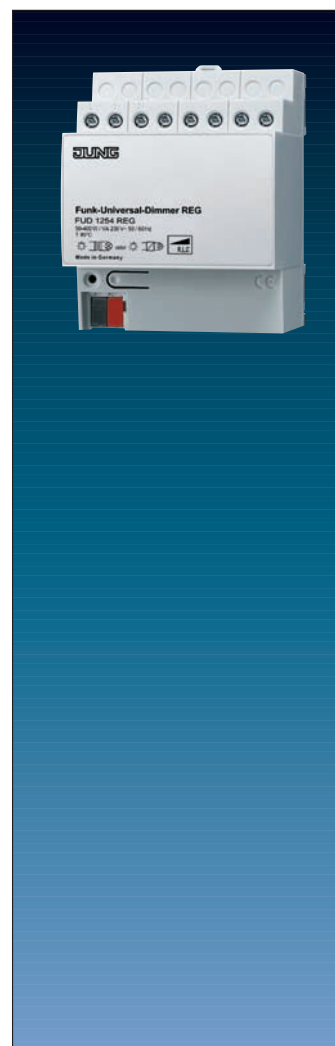

Radio Management



Description	Ref.-no.
-------------	----------

Radio Management Controller	
Version: V0 with DCF 77 time switch	
language version	
German	FMC 1000
English	FMC 1000 GB
Dutch	FMC 1000 NL

Spanish: available via JUNG Electro Iberia, Spain

Connection via white, 1.5 m power cable supplied with Euro plug or directly on the 230 V installation cable.

Power consumption max. 2.1 W.

Emergency power supply via 5 micro batteries (type: AAA 1.5 V LR 03 – not included with supply).

Radio operation (send/receive) for approx. 2 to 6 hours (depending on the charge level of the batteries).

With the **Radio Management controller**, all the installed radio components can be regulated and monitored fully automatically from a central location using time control i.e. when required. This is carried out either using individually created time programs or spontaneously via lifestyle or event programs (lightmoods): depending on the programming, the blinds in the bedroom are closed, the lighting in the nursery is dimmed to 50 %, the blinds in the lounge are closed and the lights are switched off or dimmed – regardless of whether the occupant is at home or away. All the functions can also be implemented locally. Data entries, operating states, the current time and ambient temperature are indicated on the illuminated text display and evaluated. Settings are saved and new functions are read into the device using chip cards. Data exchange is possible with external devices e.g. PC, GSM module etc.(in preparation) via the interface (RJ 45 socket).

The following functions are possible with version 0 (V0):

- Commissioning possible with 230 V mains connection and with batteries
- Time-dependent signal issued at intervals via buzzer when device is battery-operated or 'LOW-BAT' display when mains-operated
- Existing radio assignment is NOT deleted by the Radio Management controller
- Subdivision into 20 groups e.g. rooms
- Control of actuators for the lighting: dimming via absolute values (%).
- Control of actuators for the blinds: movement into limit position via long operation, louvre adjustment via short operation, possible to teach in the operating time of the blinds
- Lightmoods 1 to 5, all ON, all OFF; 'Coming', 'going' scenarios, quick dial
- Master reset for parameters or logic operations, taught-in transmitters/receivers are retained
- Time function with DCF 77 time switch (switching increment 1 min.): 'Time and switch object' logic operation, presence simulation/random function, no permanent display of the logo (flashing antenna) when signal is not received
- Repeater function
- Save/download configuration onto chip card (master card) and retrieve
- Firmware update possible with chip card
- Preselected programs e.g. conservatory, awning, roller blind programs with astro function
- Staggered operation of the blinds (limitation of inrush currents, fixed period = 3 sec.)
- Logic and time-dependent operation of sensors/actuators, AND, OR, EXOR, NOT functions
- Alphanumeric text input similar to mobile phone (SMS) with keys (0) to (9), (*), (#)
- Soft keys (F1) to (F4) with fixed programming, freely programmable 'blue' key
- Quick dial (lightmoods, scenarios) with numerical keys (1) to (9)
- 'Transmitter test' menu: taught-in transmitters are displayed with the associated designation
- 7 x 20 text characters only in accordance with ISO 8859/1.2, ASCII 0-255 (Latin letters, Arabic numbers)
- During mains operation, the display is illuminated for approx. 1 min. when the keys are pressed
- Display of the room temperature
- More features and details in the operation manual

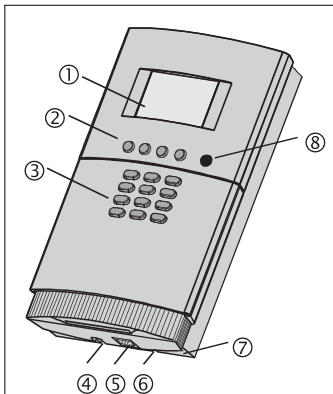

Display/operating elements

- ① Display
(7 lines with 20 characters each)
- ② 4 function keys (soft keys)
- ③ 12 keys (keypad)
- ④ Mains connection
(230/240 V 50/60 Hz)
- ⑤ Interface (RJ 45 socket)
- ⑥ Digital input
- ⑦ Temperature sensor
- ⑧ Key for messages

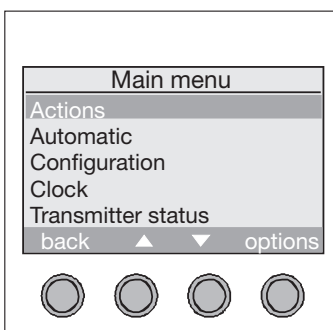

Behaviour on mains voltage failure/recovery

Failure: Storing of all parameters (transmitters, actuators, logic operations). Fault indication via display and via integrated buzzer at intervals. Emergency power supply is activated if batteries have been inserted.

Recovery: Normal function is activated. Display 'Time mains failure'.

Master reset: With the FMC master reset card supplied, all the data in the Radio Management controller can be irrevocably deleted. The Radio Management controller is then returned to the supplied state.

Radio automatic switch

JUNG

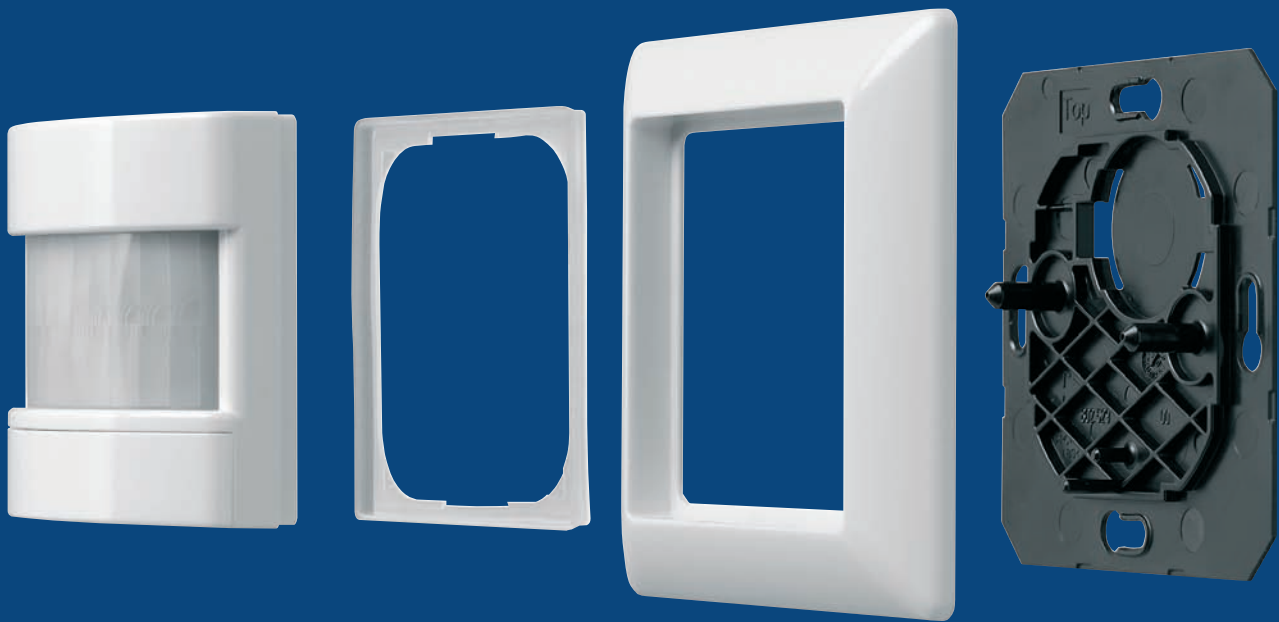

The Radio automatic switch is an ideal solution for presence detected lighting control. The flat base plate of the device can easily be fixed by means of screws or adhesive even on wall tiles and glass. Consequently flush mounted wall boxes are unnecessary. The battery supplied transmitter communicates wireless with the respective actuator via radio signals. The Radio automatic switch enables presence detected lighting control in locations where visual or technical reasons disable wiring solutions.



Radio Management automatic switch



Description	Ref.-no.
-------------	----------

**Radio automatic switch 180°
for radio-controlled switching
lens type 1.1 m**

for ranges A 500 / AS 500 and A plus

ivory	A FAS 180
white	A FAS 180 WW



for ranges ST 550 / CD 500 and CD plus

ivory	CD FAS 180
white	CD FAS 180 WW

Other colours on request



for ranges LS 990 and LS plus

ivory	LS FAS 180
white	LS FAS 180 WW

Other LS 990 colours on request



for ranges Aluminium and LS plus

aluminium	AL FAS 180
-----------	-------------------



for ranges Stainless Steel and LS plus

stainless steel	ES FAS 180
-----------------	-------------------

Function:

The radio automatic switch responds to thermal movements caused by persons, animals or objects and initiates switching operations.

The radio automatic switch transmits a radio data telegram which is received and evaluated by all switching and dimming actuators of the Radio Management system (exception: shutter actuators) and the radio-controlled performance unit.

When using radio switching and dimming actuators, observe the switch on time preset in the actuator (see operating instructions).

Battery

The radio automatic switch is operated with a lithium button cell (CR 2450) (supplied with the insert).

Fitting

Stick or screw the bottom plate of the radio automatic switch directly to the background (e.g. plastered surface, wood, glass, mirror or switch box).

The "TOP/OBEN" mark must be on top.

The Radio automatic switch is plugged onto the bottom plate together with frame as shown in fig. ①.

Tighten the screws only to such a degree that the frame can no longer be moved.

Note: Do not mount in direct sunlight!

The rated detection range may vary as a function of different installation heights. This lens is not suitable for exterior applications.

Technical data:

detection angle:	180°
type of protection:	IP 20
nominal range, front:	10 m
nominal range, lateral:	2 x 6 m
installation height for nominal range:	1.10 m
battery:	3 V DC (CR 2450)
frequency:	433,42 MHz
lense levels:	2
lense amount:	18

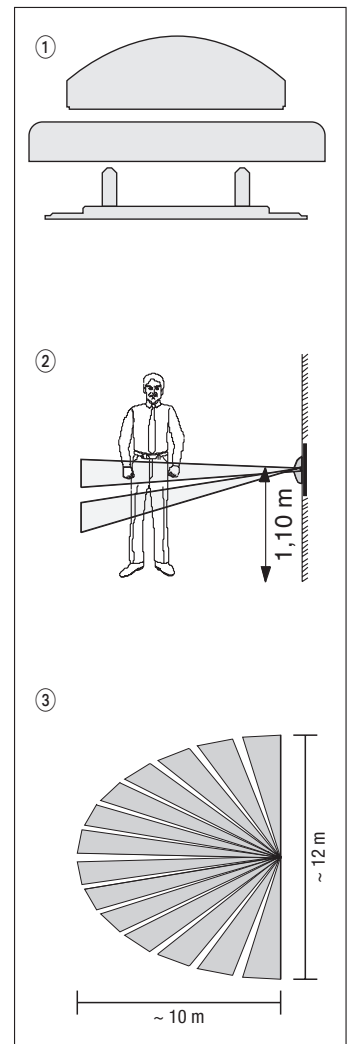

IP 55

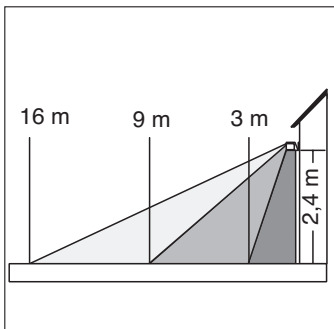
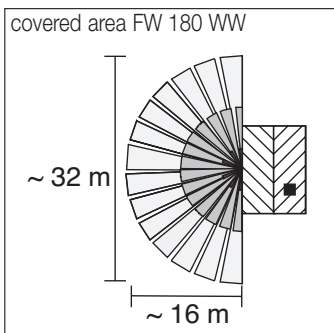

Not suitable for alarm systems!

For technical details see appendix.

Description	Ref.-no.
Radio-controlled Observer 180 IP 55	FW 180 WW

With a semicircular field of detection 16 x 32 m (180°) at a mounting height of approx. 2,40 m. 144 switching segments on 3 levels with an LED functional display and a clip-on cover for limiting the field of detection. The sensitivity can be adjusted by approx. 20 – 100 %. Depending on the programming, the radio telegrams from the radio-controlled Observer and received by the radio-controlled performance unit (operating time can be set in steps from 30 sec. to 15 min.), by the short-touch key of the radio receiver and by the radio-controlled actuator Built-in which then switch in for approx. 1 min.

Technical data

Nominal voltage:	9 V DC	Range:	approx. 100 m (free field)
Battery type:	9 V monobloc battery	Detection radius:	180°
Battery life:		Detection field:	16 x 32 m
Lithium (1,2 Ah):	approx. 4 years	Mounting height:	approx. 2,40 m
Alkaline (0,55 Ah):	approx. 1,5 years	Sensitivity:	20 % – 100 %
Power consumption		Evaluation	
Daytime operation:	approx. 0,14 mW	Operation range:	3 – 200 lux, ± 50 %
Night operation:	approx. 0,27 mW	Temperatur range:	-25 °C up to +55 °C
Radio transmission:	approx. 27 mW	Type of protection:	IP 55
Transmission power:	< 10 mW		
Transm. frequency:	433,42 MHz, ASK		

Radio-controlled performance unit	FWL 2200 WW
-----------------------------------	-------------

in connection with the radio-controlled Observer ref.-no. FW 180 WW. Additional function: ON for 2 hours, OFF for 2 hours are possible with conventional push-button or hand-held transmitter ref.no. 42 FH, 48 FH, 48 KFH, wall-mounted transmitter 40 FW, ..41 F., ..42 F., ..44 F., multifunction transmitter FMS 4 UP and Universal transmitter 20 FP.

Technical data

Nominal voltage:	AC 230 V ~, 50 Hz	Miniature circuit-breaker:	10 A
Switch contact:	Relay	Power consumption:	2 W
Switching capacity		Inrush current:	max. 20 A
Incandescent lamps	2500 W	Operating time:	approx. 10 sec. – 15 min. ± 10 % retriggered
High voltage		Brightness setting:	approx. 3 – 80 lux ± 10 %
halogen lamps:	2500 W	Transmission frequency:	433,42 MHz, ASK
Fluorescent lamps		Temperature range:	-25 °C up to +55 °C
not compensated:	1200 W	Type of protection:	IP 55
parallel comp.:	920 W		
lead-lag circuit:	2400 W		

Additional function via push-button (break contact)

Pulse duration:	400 ms, ± 50 %
Pulse interval:	600 ms
1st function:	1 x pulse, operating time
2nd function:	2 x pulse, ON = 2 hrs, ± 10 %
3rd function:	3 x pulse, OFF = 2 hrs, ± 10 %

Attention: energy saving lamps cause high peak current, reduction of capacity necessary! Please check suitability of lamps before installation!

Description	Ref.-no.
Radio-controlled presence detector	FPM 360 WW

Dimensions: diameter 103 mm – height 42 mm

The battery-operated, radio-controlled presence detector enables optimum energy savings by presence-controlled lighting.

It operates with a passive infrared sensor (PIR) and reacts to thermal movements triggered by people, animals or objects. It sends a radio telegram that can be evaluated by all radio-controlled dimming and switch actuators.

It can also control the heating, ventilation and air conditioning systems, independent of presence or lighting, in connection with the 2-channel relay insert with floating contacts.

If the brightness level falls below an adjustable setpoint and on detection of movement, the presence detector switches on the taught-in radio-controlled switch actuator.

This device carries out lighting control dependent on the brightness setpoint value.

The lighting controller remains switched on while the presence detector can sense movement.

If no further movements is detected, it is switched off once an adjustable overshoot period has elapsed.

It is also switched off if an upper brightness limit is exceeded. To monitor larger areas, several presence detectors can be used together in one system. In this case, one presence detector acts as the master while all other presence detectors are used as slaves.

Technical data

Nominal voltage:	6 V
Batteries:	4 x 1,5 V micro RL03 (AAA) alkaline (not included with supply)

Note: Do not use zinc carbon batteries (R03).

Transmission frequency:	433.42 MHz
Modulation:	AKS
Transmission range:	max. 100 m in free field
Radio codes:	> 1 billion
Detection angle:	approx. 360°
Nominal range:	
Desk height	approx. Ø 5 m
Floor	approx. Ø 8 m
Mounting height for nominal range:	2.5 m
Overshoot period:	approx. 2 min to 1 hour
Brightness:	approx. 3 to 2000 lux
Temperature range:	0 °C to +45 °C
Type of protection:	IP 20

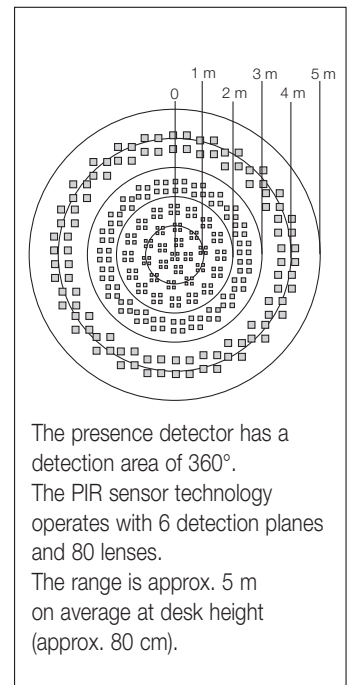
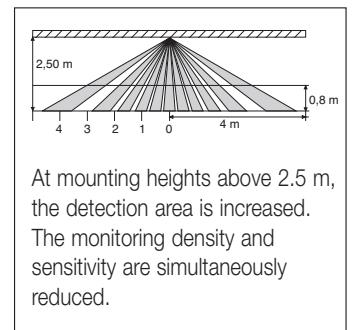

Radio-controlled EIB converter	2700 AP
--------------------------------	---------

surface mounted, in connection with radio-controlled Observer ref.-no. FW 100 WW,

universal transmitter ref.-no. 20 FP,

hand-held transmitter ref.-no. 48 KFH, 48 FH, 42 FH,

wall-mounted transmitter ref.-no. 40 FW, ..41 F., ..42 F., ..44 F. and

multifunction transmitter ref.-no. FMS 4 UP

Function

The instabus Radio Control Converter can be used to integrate Radio Management transmitters into the instabus EIB system. Radio data telegrams received from components learned in are converted into corresponding EIB telegrams. Data transfer is unidirectional.

Further information available on request.



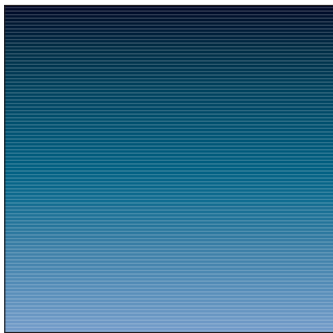

Description	Ref.-no.
-------------	----------

Radio-controlled push-button, 4-gang "Universal"

The KNX/EIB radio-controlled 4-gang push-button can be used to integrate Radio Management transmitters into the instabus EIB system. Radio telegrams received from components are converted into corresponding EIB telegrams. Data transfer is unidirectional.

Up to 8 channels with different functions can be parameterised.

EIB push-button "Universal" only to be used in combination with bus coupling unit (2070 U).

Possible radio transmitters are:

radio controlled observer ref.-no. FW 100 W,

universal transmitter ref.-no. 20 FP,

hand-held transmitter ref.-no. 48 KFH, 48 FH, 42 FH,

wall-mounted transmitter ref.-no. 40 W, ..41 F., ..42 F., ..44 F. and

multifunction transmitter ref.-no. FMS 4 UP

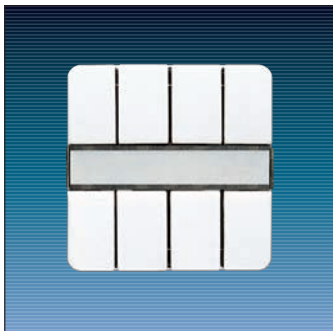

Radio-controlled EIB push-button, 4-gang "Universal" for ranges CD 500 and CD plus

ivory*	CD 2094 F
white*	CD 2094 F WW
blue	CD 2094 F BL
brown	CD 2094 F BR
grey	CD 2094 F GR
light grey	CD 2094 F LG
black	CD 2094 F SW

* suitable for ST 550



Radio-controlled EIB push-button, 4-gang "Universal" for ranges LS 990 and LS plus

ivory	LS 2094 F
white	LS 2094 F WW
light grey	LS 2094 F LG
black	LS 2094 F SW



Radio-controlled EIB push-button, 4-gang "Universal" for ranges Stainless Steel and LS plus

stainless steel	ES 2094 F
-----------------	-----------

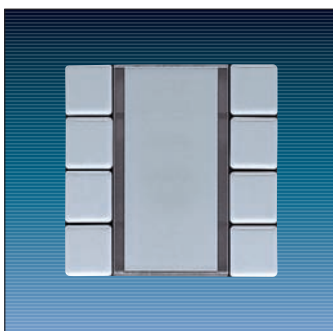

Radio-controlled EIB push-button, 4-gang "Universal" for ranges Aluminium and LS plus

aluminium (lacquered)	AL 2094 F
-----------------------	-----------

Radio-controlled heating system

JUNG



The Radio Management has been extended by the introduction of a temperature control system. The temperature system is operated with the new radio thermostat display or the Radio Management controller. Additional wires between control devices and the valve drives are not required. The system consists of the radio display with the corresponding insert and the battery-operated valve drive. The Radio thermostat controls the temperature dependent on time. For this purpose the device transmits time-controlled signals to adjust the valve drive. This is supplied by two mignon batteries and can be mounted on almost every commercial radiator. From now on, complete building control systems consisting of light, blinds and the new temperature control can be operated by the Radio Management controller.



Radio Management

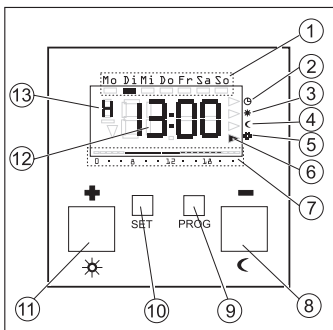

Radio timer thermostat display for radio-controlled temperature control

The Radio timer thermostat is an electronic controlling device with an integral clock. It can activate an external temperature or time controlled switching relay via radio transmission. Temperature measurement is carried out via an implemented sensor. Informations like the desired temperature or the actual value are transmitted to the Radio Management Controller or directly to the radio-controlled valve drive.

Technical data

Power supply:	230 V ~
Power consumption:	approx. 4 VA
Transmitted frequency:	433,42 MHz
Temperature ranges:	+18 ... +30 °C comfort temperature +10 ... +22 °C lowering temperature +5 ... +15 °C anti-freeze temperature



Description	Ref.-no.
for ranges AS 500, A 500 and A plus	
ivory	A HLK-FT
white	A HLK-FT WW
aluminium	A HLK-FT AL



for ranges ST 500, CD 500 and CD plus	
ivory	CD HLK-FT
white	CD HLK-FT WW



for ranges LS 990 and LS plus	
ivory	LS HLK-FT
white	LS HLK-FT WW



for ranges Aluminium and LS plus	
aluminium	AL HLK-FT

for ranges Stainless Steel and LS plus	
stainless steel	ES HLK-FT

Description	Ref.-no.
Radio timer thermostat insert for radio-controlled temperature control	F-HLKE

The Radio timer thermostat insert is used in conjunction with the Radio timer thermostat display. It can be mounted into a flush-mounted wall box. The recommended mounting height is 1.50 m.

Technical data

Power supply:	230 V ~
Power consumption:	approx. 4 VA
Transmitted frequency:	433,42 MHz
Max. ambient temperature:	0 to +50 °C



Radio-controlled valve drive	HLK-FMS
-------------------------------------	----------------

The Radio-controlled valve drive is used to control radiators or under floor heating systems. The device is battery-operated and can be controlled by radio signals of the Radio timer thermostat or the Radio Management Controller. The valve drive is equipped with two push-buttons to adjust the desired temperature.

Technical data

Power supply:	3 V
Battery:	2 x 1.5 V Mignon LR06 (AA) 2600 mAh (batteries not included)
Valve power:	80 N
Valve stroke:	7.5 mm
Dimension:	51 x 80 x 60 mm
Suitable for:	valve bases from Roth, KaMo, MNG, Heimeier, Gampper



Radio Management

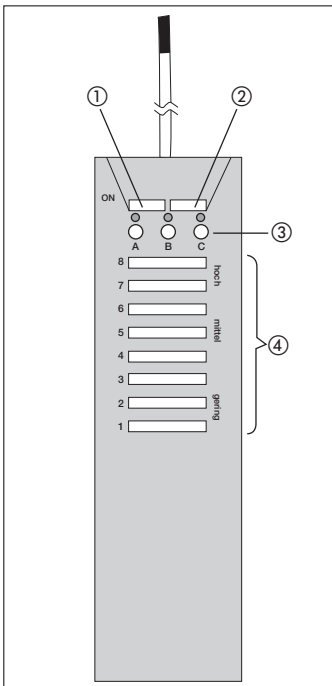

Description

Ref.-no.

Radio signal quality meter

FSM 1

The Radio signal quality meter is a measuring instrument to assess the reception of radio-signals (433,42 MHz).

It has to be used at the location of the radio receiver in order to assess the signal strength.

The Radio signal quality meter operates on 4 alkaline micro batteries.

The Radio signal quality meter offers the following control elements:

- ① Push button switch "ON"
- ② Push button switch "OFF"
- ③ Operation-mode push-button and LED (A, B, C)
- ④ LED bar graph display with reset push-button

The device offers three different operation modes:

- A – Radio signal quality
- B – External radio levels
- C – Checksum quality

A – Radio signal quality

In this operation mode solely JUNG radio telegrams (433,42 MHz) will be evaluated.

In this case the quality (system reserve) of the received telegram will be displayed.

The higher the bar graph display, the better is the momentary signal quality.

B – External radio levels

In this operation mode all radio signals within the 433,42 MHz range will be displayed (JUNG- and external radio levels).

The signal-to-noise ratio, the distance between a maximum level and a noise level, will be displayed.

C – Checksum quality

In this operation mode the relation between the correct checksum and the received telegrams is displayed.

The value 8 on the bar graph states that approx. 100 % of all received telegrams can be evaluated.

A value of 4 corresponds to approx. 50 % valuable telegrams; approx. each second telegram can be evaluated.

Description	Ref.-no.	Page
Radio hand-held transmitter		
Standard	48 FH	46
Comfort	48 KFH	46
Mini	42 FH	48
Radio wall-mounted transmitter	40 FW	50
“Flat” radio wall-mounted transmitter		51
Radio multifunction transmitter	FMS 4 UP	52
Universal radio transmitter	FUS 22 UP	54
Radio-controlled actuator, built-in	FA 10 EB	55
Radio-controlled push-button controller, built-in, 1 – 10 V	FST 1240 EB	56
Radio-controlled universal dimmer, built-in	FUD 1253 EB	57
Radio-controlled in-line dimmer	FUSD 1253	58
Mini radio-controlled switch actuator	FA 10 UP	59
Radio-controlled blinds actuator	FAJ 6 UP	60
Radio-controlled plug adapter switch	FZS 10 WW	61
Radio-controlled plug adapter dimmer	FZD 1254 WW	62
Center plate with radio receiver	.. 1561.07 ..	63
Master receiver / DIN rail devices	FK 100 REG	64
Radio-controlled Observer	FW 180 WW	65
Radio-controlled performance unit	FWL 2200 WW	65
Radio-controlled presence detector	FPM 360 WW	66

Radio hand-held transmitter

standard Ref.no. 48 FH

comfort Ref.no. 48 KFH

Function

The radio hand-held transmitter makes it possible to carry out wireless remote control. The hand-held transmitter sends a radio telegram after a push-button operation.

This radio telegram is understood and evaluated by all the radio receivers of the Radio Management system.

The hand-held transmitter has the following operating elements

- ① Group push-buttons (A, B, C), with the associated group LED
- ② Channel push-buttons (1 ... 8)
- ③ ALL ON button
- ④ ALL OFF button

Additionally for the comfort variant of the radio hand-held transmitter

- ⑤ Light scene push-buttons (1 ... 5)
- ⑥ Master push-button

There are 3 groups (A, B, C) ① available, each with 8 channels ② for switching, dimming and shutter control i.e. 24 radio receivers can be operated individually.

All the taught in switching and dimming loads are controlled in the factory setting with the ALL OFF ③ or ALL ON ④ button. (These buttons correspond to user-definable light moods.)

Up to 5 light scene ⑤ can be stored and retrieved using the comfort variant of the radio hand-held transmitter.

The range of light scenes includes

- Fixed dimming value of a luminaire (e.g. 70 % auf the maximum brightness),

or

- fixed switching state of a load (e.g. fan switched on),

or

- fixed limit position of a blind (e.g. blind lowered).

When using covers with radio receivers, a light scene can be dimmed brighter/darker or switched on/off with the master push-button ⑥.

Teaching in the radio receiver

In order for a radio receiver to understand a radio telegram from the hand-held transmitter, this receiver must first 'learn' this radio telegram.

The number of receivers that can be assigned to a channel of the hand-held transmitter is unlimited.

The learning process leads exclusively to an assignment in the radio receiver.

Procedure

1. Switch the radio receiver to the learning mode.
2. **Teaching in a channel**
Press the \wedge / \vee button ② of the required channel (e.g. Group C, Channel 6) for at least 1 sec.

Teaching in a light scene push-button

Press the required light scene push-button ⑤ for at least 3 sec. The selected group LED flashes for confirmation.

Teaching in the ALL OFF or ALL ON button
Press the ALL OFF or ALL ON button ③ for at least 10 sec. All the group LEDs flash for confirmation.

3. Switch the radio receiver to normal mode.

The learning process is complete !

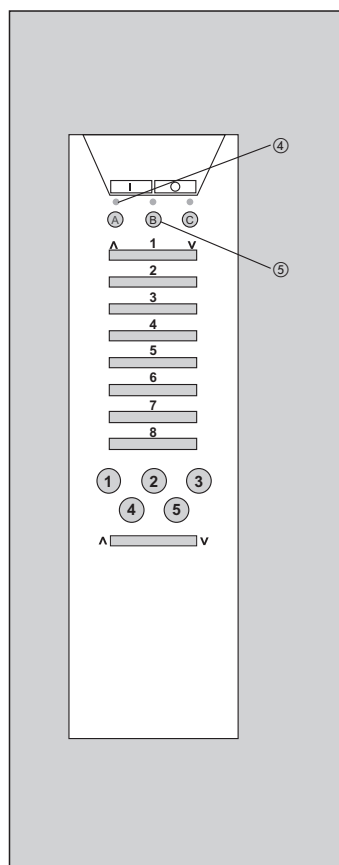
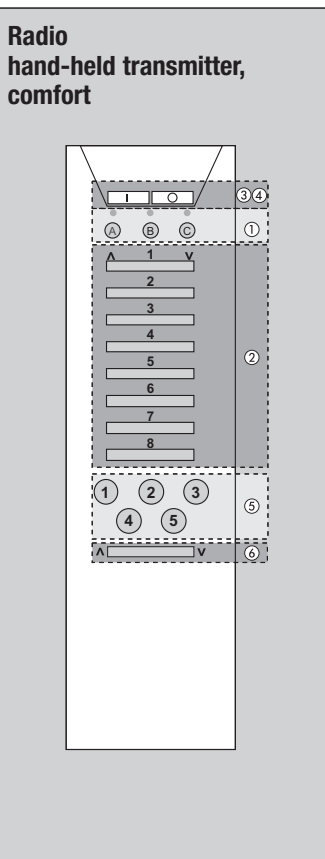
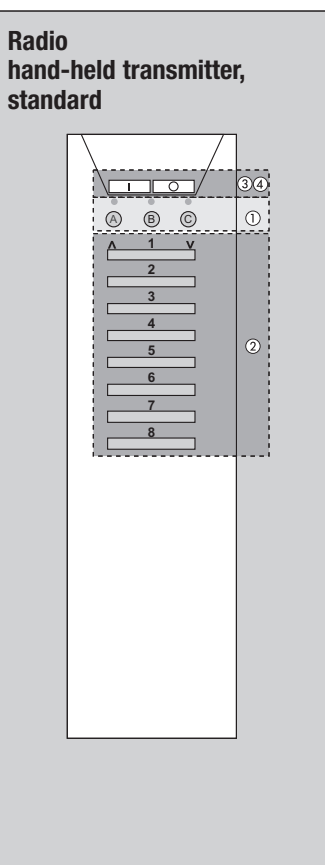

Deleting channels

If the channel, light scene or ALL OFF/ALL ON buttons of the radio hand-held transmitter are taught in again, the assignment in the radio receiver is deleted.

Assignment of the groups

There are 3 groups available (A, B, C), each with 8 channels (3 x 8 channels = 24 channels).

A group with eight functions can be operated for each.

When one of the 8 rockers is pressed, the active group is indicated by the group LED lighting up briefly ④ (e.g. Group A).

Group A is active once the batteries have been inserted.

You can switch between the groups by pressing a group push-button ⑤ (e.g. Group B).

Changing the group temporarily (for approx. 4 sec.)

1. Press a group push-button briefly (less than 4 sec.).
2. Press the required channel push-button within this period.

Changing the group

1. Press a group push-button for a long period (at least 4 sec.).
2. The relevant group LED flashes for approx. 4 sec.

Technical data

Power supply	6 V DC
Batteries	4 x micro, alkaline (LR 03)
Capacity	1 Ah
Battery life	approx. 3 years
Transmission frequency	433.42 MHz (ASK)
Transmission range	approx. 100 m (free field)
Dimensions (LxWxH)	192 x 53 x 23 mm
Temperature range	+4°C up to +55°C
Weight	approx. 100 g

Note

If all the LEDs flash for approx. 4 sec. after a push-button operation, the batteries need to be changed.

The maximum transmission length is 12 sec. even if another push-button is pressed afterwards.

If several push-buttons are pressed simultaneously, a radio telegram is not sent.

Radio transmission

Radio transmission is not carried out via an exclusive transmission route, therefore disruptions cannot be ruled out.

Radio transmission is not suitable for security applications e.g. emergency stop, emergency calls.

The transmission range of the radiohand-held transmitter (max. 100 m in free field according to EN) is dependent on the structural conditions of the property:

Dry material	Penetration
Wood, plaster, plaster boards	approx. 90 %
Brick, pressboards	approx. 70 %
Reinforced concrete	approx. 30 %
Metal, metal gates, aluminium covers	approx. 10 %

Radio hand-held transmitter

standard Ref.no. 48 FH

comfort Ref.no. 48 KFH

Operation

Normal function

Each rocker ① has 2 functions (∧ and ∨).

Refer to the table for possible functions.

Additional function

If you wish the radio-controlled performance unit to be switched on continuously for approx. 2 hours, it is necessary to press the taught-in channel push button ∧ for at least 1 sec.

If the radio-controlled performance unit is to ignore the transmissions of the radio-controlled Observer for approx. 2 hours, you must press the channel push-button ∨ for at least 1 sec.

ALL OFF / ALL ON

During the learning process for a radio channel, the ALL OFF and ALL ON buttons are automatically 'learnt' as well by the radio receiver (exception: radio-controlled shutter cover).

When calling up the ALL OFF or ALL ON button, you must press the respective push-button for at least 1 sec. to avoid maloperations.

With the ALL OFF button ②, the load is disconnected at all the taught-in radio receivers or connected with the ALL ON button ③.

All the group LEDs light up for approx. 12 seconds for confirmation.

Deleting ALL OFF / ALL ON

If a specific radio receiver is not supposed to react to the ALL OFF or ALL ON button, this function must be 'unlearnt'.

Rocker	Duration	Light	Blind
Left ∧	max. 1 sec.	ON	Louvre adjustment
Left ∧	min. 1 sec.	Brighter	Continual movement UP
Right ∨	max. 1 sec.	OFF	Louvre adjustment
Right ∨	min. 1 sec.	Darker	Contin. movement DOWN

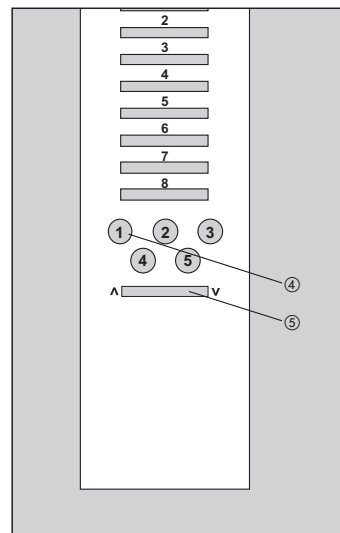
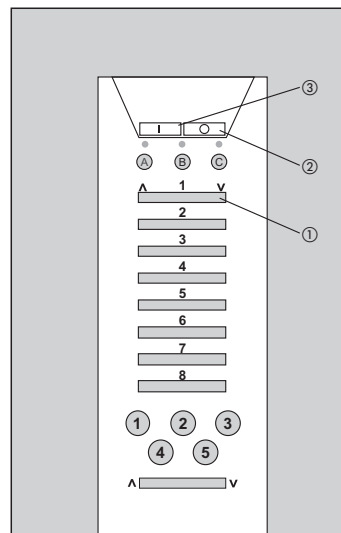

Master

(only for the comfort variant of the radio-controlled hand-held transmitter)

With the MASTER button ⑤ you can dim the last retrieved light scene brighter/darker with

the active radio dimmer (press for at least 1 sec.) or switch it on/off (press for less than 1 sec.).

Blinds cannot be operated.

Procedure

1. Switch the radio receiver to the learning mode.
2. Press the ALL OFF ② or ③ for at least 10 sec. All the group LEDs flash for confirmation.
3. Switch the radio receiver to the normal mode.

The deletion process is complete!

Light scene

(only for the comfort variant of the radio-controlled hand-held transmitter)

You can store (long switch operation min. 3 sec.) and retrieve (short switch operation max. 3 sec.) 5 light scenes with the round buttons (1 ... 5) ④.

This light scene push-button must be taught in before storing or recalling a light scene (see 'Teaching in a light scene push button').

Changing light scene

1. Set the required lighting scenario.
2. Press the light scene push-button (1 ... 5) for at least 3 sec.
Note: The previous light scene is retrieved first and then the new one is activated.
3. The relevant group LED flashes for confirmation.
In addition a short signal tone is emitted at the flush-mounted radio receiver.

Radio hand-held transmitter

„Mini“ Ref.no. 42 FH

Function

The "Mini" radio hand-held transmitter enables the wireless remote control of a light or blind.

The "Mini" radio hand-held transmitter has two independent radio channels available (channel 1 and channel 2).

Two push buttons (▲ and ▼) are assigned to each radio channel.

Application example

The lighting is dimmed with channel 1 while channel 2 operates the blind.

The hand-held transmitter sends a radio telegram after a push-button operation.

This radio telegram is understood and evaluated by all the radio receivers of the Radio-Management system.

Commissioning

The hand-held transmitter is immediately ready for operation.

Battery

The radio hand-held transmitter is operated with one lithium button cell (CR 2032) (supplied with the device).

Teaching in the radio receiver

In order for a radio receiver to understand a radio telegram from the hand-held transmitter, the receiver must first "learn" the radio telegram.

The number of receivers that can be assigned to a channel of the hand-held transmitter is unlimited.

The learning process leads solely to an assignment in the radio receiver.

Procedure

1. Switch the radio receiver to the learning mode.
2. Press the ▲- or ▼ button of the required channel for at least 1 second.
3. Switch the radio receiver to normal mode.

The learning process is complete.

Deletion in the radio receiver

If a channel of the "Mini" radio hand-held transmitter is taught in again, the assignment in the radio receiver is deleted.

Radio transmission

Radio transmission is not carried out via an exclusive transmission route, therefore disruptions cannot be ruled out. Radio transmission is not suitable for security applications e.g. emergency stop, emergency calls.

The transmission range of the radio hand-held transmitter (max. 30 m in free field) is dependent on the structural conditions of the property:

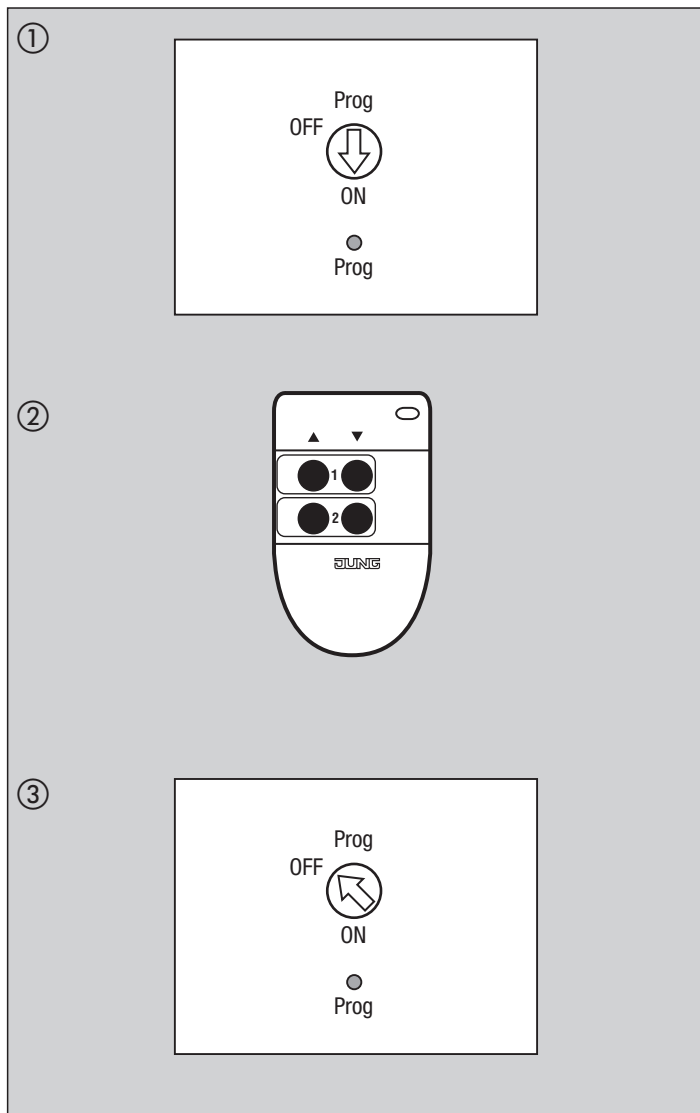

Rocker	Duration	Light	Blind
Left ▲	max. 1 sec.	ON	Louvre adjustment
Left ▲	min. 1 sec.	ON/Brighter	Continual movement UP
Right ▼	max. 1 sec.	OFF	Louvre adjustment
Right ▼	min. 1 sec.	OFF/Darker	Cont. movement DOWN

Dry material	Penetration
Wood, plaster, platerboard	approx. 90 %
Brick, plywood panels	approx. 70 %
Reinforced concrete	approx. 30 %
Metal, metal grids, aluminium laminate	approx. 10 %

Operation

Each radio channel (1 and 2) ① has two push-buttons (▲ and ▼).

A push-button action is displayed by the flashing of the red LED ②.

In order to prevent maloperations, only press **one button at a time**.

The following functions are possible (see table below).

Special function with the radio-controlled performance unit

If you wish the radio-controlled performance unit to be switched on continually for approx. 2 hours, it is necessary to press the taught-in channel push-button ▲ for at least 1 second.

If the radio-controlled performance unit is to ignore the transmissions of the radio-controlled Observer for approx. 2 hours, you must press the channel push-button ▼ for at least 1 second.

The maximum transmission length is 12 seconds even if another push-button is pressed afterwards.

Technical data

Power supply	3 V DC
Batteries	1 x lithium-button cell (CR 2032)
Battery life	approx. 5 years
Transmission frequency	433.42 MHz, ASK
Transmission range	max. 30 m (in free field)
Postal approval	LPD-D
Dimensions (L x W x H)	73 x 43 x 18 mm
Temperature range	0°C up to + 55°C
Relative humidity	max. 80 %

Function

The radio wall-mounted transmitter makes it possible to have wireless remote control but from a fixed installation.

The wall-mounted transmitter is operated in combination with standard push-button sensors (1-gang, 2-gang or 4-gang) from the CD 500, CD plus, A 500, LS 990 and Stainless Steel ranges (see page 83).

The electrical contact is made via a 10-pole plug connector.

The wall-mounted transmitter sends a radio telegram after a push-button action. This radio telegram is understood and evaluated by all the radio receivers of the Radio Management system.

The number of radio channels is dependent on the push-button sensor in use (e.g. 1-gang push-button sensor => 1-channel radio-wall-mounted transmitter).

Each set of two facing push-buttons belongs to one channel.

The wall-mounted transmitter is fitted with a 4-gang switch **S**. The function can thus be selected before the push-button sensor is placed on top. The function can be changed at any time.

Individual channels of the push-button sensor can transmit special functions such as 'ALL OFF' or 'Light scene'.

The radio wall-mounted transmitter ① is secured with screws in a flush-mounted switch box or a surface-mounted cover.

The label TOP must lie above.

Commissioning

- Put the 'Batt.' switch ② into the ON position (right).
- Select the function of the push-buttons with switch **S** ②. Once the push-button sensor has been removed, the function can be changed at any time by toggling the single switch **S**. The factory setting is shown in bold type.
- Plug in the push-button sensor ③. The electrical contact is made via a 10-pole plug connector ④.
- Press any push-button for approx. 1 sec.

Technical data

Power supply	6 V DC
Batteries	2 x lithium button cells (CR2032)
Capacity	0,22 Ah
Battery life	approx. 3 years
Transmission frequency	433,42 MHz (ASK)
Transmission range	approx. 100 m (free field)
Temperature range	+4°C up to +55°C

S	= Function	OFF (left)	ON (right)
S1	= wall-m. transmitter is	disconnected	connected
S2	= Push-button 1 -	ALL OFF	Channel 1 -
	= Push-button 1 +	Light scene 1 (on)	Channel 1 +
S3	= Push-button 2 -	Light scene 2 (on)	Channel 2 -
	= Push-button 2 +	Light scene 3 (on)	Channel 2 +
S4	= Push-button 3 -	Light scene 4 (on)	Channel 3 -
	= Push-button 3 +	Light scene 5 (on)	Channel 3 +

Note: Push-button 4 + or 4 - always corresponds to Channel 4 + or 4 -.

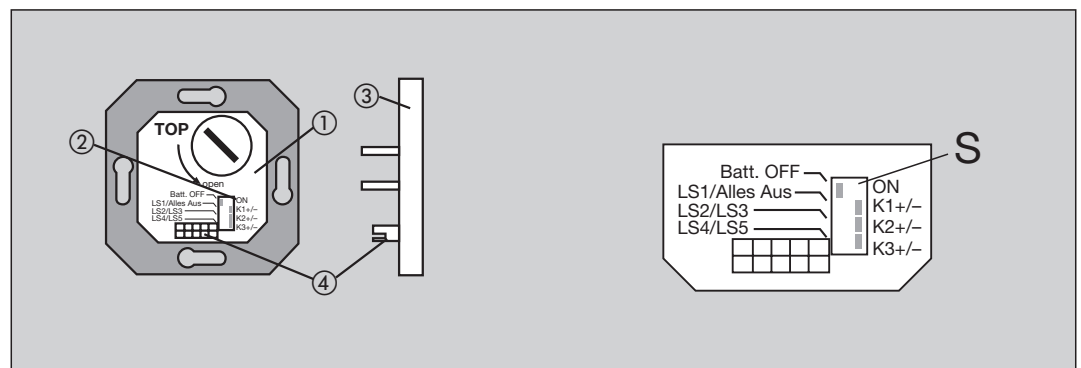

Note

To protect the batteries, disconnect the radio wall-mounted transmitter as soon as a push-button sensor has been permanently removed.

Therefore switch the function switch 'Batt.' to the OFF position (left).

The batteries need to be changed if all the LEDs flash 5 times after a push-button action of less than 3 sec.

Antenna

In order to maintain the maximum radio transmission power, lay the antenna ④ flat and as far away from the radio transmitter as possible.

The antenna should not be wound up and must be positioned at the greatest distance possible away from metal components with a large surface area e.g. metal door frames.

You should not strip the insulation from the antenna or shorten or extend it.

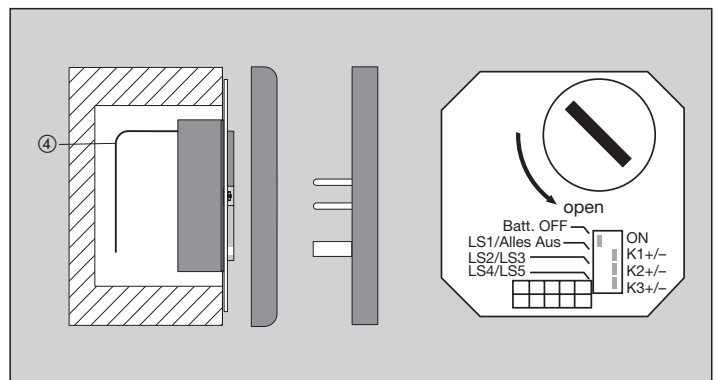

Radio wall-mounted transmitter

Ref.no. 40 FW

Teaching in the radio receiver

In order for a radio receiver to understand a radio telegram from the wall-mounted transmitter, this receiver must first 'learn' this radio telegram.

The number of receivers that can be assigned to a channel of the wall-mounted transmitter is unlimited. The learning process only leads to an assignment in the radio receiver.

Procedure

1. Switch the radio receiver to the learning mode.

2. Teaching in a channel

Press the +/- button of the required channel for at least 1 sec.

Teaching in the ALL OFF button

Press the ALL OFF button for at least 10 sec. The channel LED flashes for confirmation.

Teaching in a light scene push-button

Press the required light scene push button for at least 3 sec.

The channel LED flashes for confirmation.

3. Switch the radio receiver to normal mode.

The learning process is complete!

Deleting channels

If the channel, light scene or ALL OFF buttons of the radio wall-mounted transmitter are taught in again, the assignment in the radio receiver is deleted.

Operation

A radio telegram is sent when a channel push-button is pressed. The respective red channel LED lights up for confirmation.

The maximum transmission length is 12 sec. even if another push-button is pressed afterwards.

If several push-buttons are pressed simultaneously, a radio telegram is not sent.

A telegram is sent by pressing a channel push-button e.g. 1+.

The reaction is dependent on the type of radio receiver (see table).

Additional functions

If you wish the radio-controlled performance unit to be switched on continuously for approx. 2 hours, it is necessary to press the taught-in channel push-button \wedge for at least 1 sec. If the radio-controlled performance unit is to ignore the transmissions of the radio-controlled Observer for approx. 2 hours, you must press the channel push-button \vee for at least 1 sec.

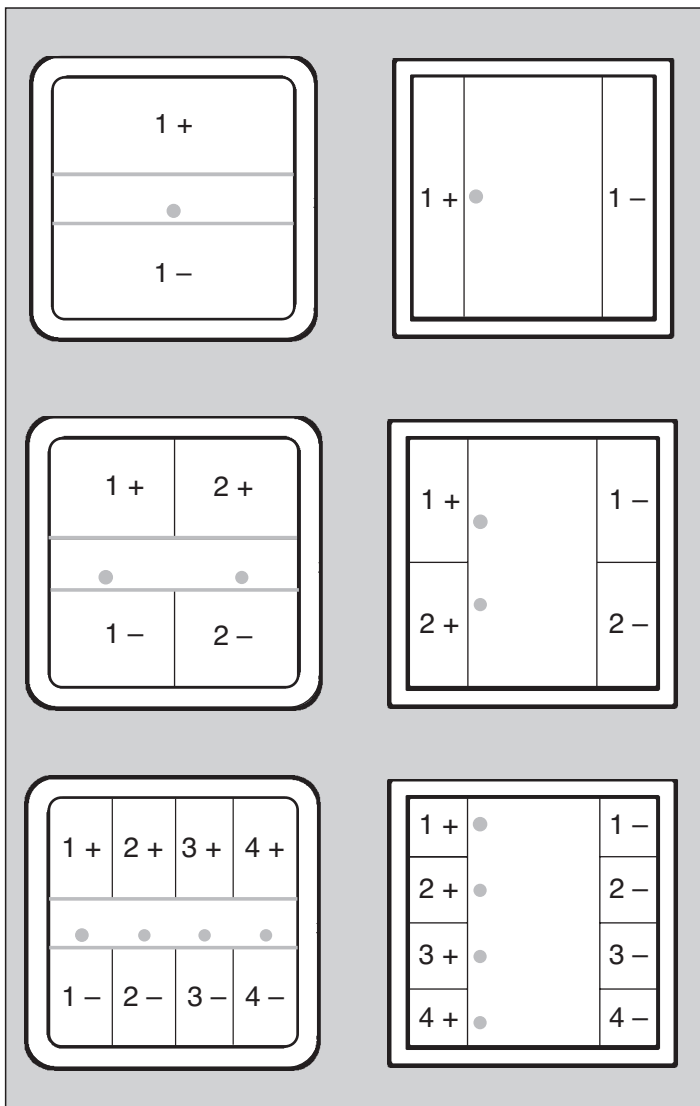

Push-button	Duration	Light	Shutter
X +	max. 1 sec.	Switch on	Louvre adjustment
X -	max. 1 sec.	Switch off	Louvre adjustment
X +	min. 1 sec.	Dim brighter	Continual movement UP
X -	min. 1 sec.	Dim darker	Contin. movement DOWN

Light scenes

You can store (long switch operation: min. 3 sec.) and retrieve (short switch operation: less than 3 sec.) 5 light scenes.

This light scene push-button must be taught in before storing or recalling a light scene (see 'Teaching in a light scene push-button').

Changing light scene

1. Set the required lighting scenario.

2. Press the required light scene push-button for at least 3 sec.

Note:

The previous light scene is retrieved first (do not release the push-button) and then the new one is activated.

3. The relevant channel LED flashes for confirmation. In addition a short signal tone is emitted at the flush-mounted radio receiver.

ALL OFF

During the learning process for a radio channel, the additional light scene 'ALL OFF' is automatically 'learnt' as well by the radio receiver (exception: radio-controlled shutter cover).

When retrieving 'ALL OFF', you must press push-button 1- for at least 1 sec. in order to avoid maloperations.

The load is disconnected at all the taught-in radio receivers.

Deleting ALL OFF

If a specific radio receiver is not supposed to react to the ALL OFF button, this function must be 'deleted'.

Procedure

1. Switch the radio receiver to the learning mode.

2. Press the ALL OFF button 1- for at least 10 sec. The channel LED flashes for confirmation.

3. Switch the radio receiver to the normal mode.

The deletion process is complete!

„Flat“ radio wall-mounted transmitter

1-channel Ref.no. ..41 F.

2-channel Ref.no. ..42 F.

4-channel Ref.no. ..44 F.

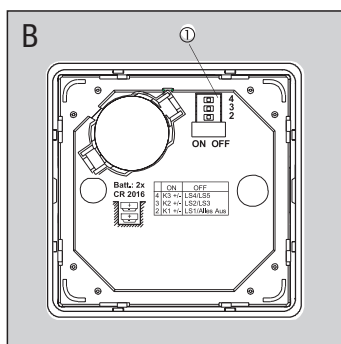
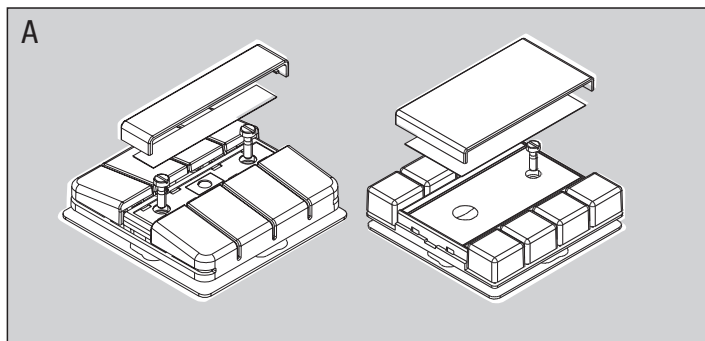

Function

The radio wall-mounted transmitter enables the wireless remote control of all the receivers in the Radio-Management system.

The radio wall-mounted transmitter is available as 1-channel, 2-channel or 4-channel in the CD 500, CD plus, Stainless Steel, Aluminium, LS 990 and LS plus design ranges. The wall-mounted transmitter sends a radio telegram after a push-button operation.

This radio telegram is understood and evaluated by all the radio receivers of the Radio Management system.

Each set of two opposing push-buttons belongs to one channel.

The wall-mounted transmitter is fitted with a 3-gang function switch. The function can thus be selected and can be changed at any time. Special functions such as "ALL OFF" or "Light scene" can be assigned to individual buttons of the push-button sensor.

Batteries

The radio wall-mounted transmitter is operated with two lithium button cells (CR 2016) (supplied with the device).

If the LEDs flash five times after a push-button operation of less than 2 seconds, the batteries must be changed.

Changing the batteries

1. Un screw the wall-mounted transmitter from the base plate (Diagram A).
2. Remove the used batteries with a screwdriver via the notch in the housing (Diagram C).
Note: Do not place the screwdriver under the battery holder.
3. When inserting the new batteries, note the correct polarity according to Diagram D (+ at the top).
4. Press any button for approx. 1 second.

Teaching in the radio receiver

In order for a radio receiver to understand a radio telegram from the wall-mounted trans-

mitter, the receiver must first "learn" this radio telegram. The number of receivers that can be assigned to a channel of the wall-mounted transmitter is unlimited. The learning process for the taught-in channel leads solely to an assignment in the radio receiver.

Procedure

1. Switch the radio receiver to the learning mode.
2. **Teaching in a channel:**
Press the +/- button of the required channel for at least 1 second.
Teaching in the ALL OFF button:
Press the ALL OFF button for at least 10 seconds.
Teaching in the light scene push-button:
Press the required light scene push-button for at least 3 seconds.
3. Switch the radio receiver to normal mode.

The learning process is complete.

Deleting channels

If the channel, light scene or ALL OFF buttons of the radio wall-mounted transmitter are taught in again, the assignment in the radio receiver is deleted.

Radio transmission is not carried out via an exclusive transmission route, therefore disruptions cannot be ruled out.

Radio transmission is not suitable for security applications e.g. emergency stop, emergency calls.

Technical data

Power supply	6 V DC
Batteries	2 x lithium button cells (CR2016) approx. 3 years
Battery life	
Transmission frequency	433,42 MHz, ASK
Transmission range	Typ. 30 m (in free field)
Postal approval	LPD-D
Temperature range	0 °C up to +55 °C
Rel. humidity	max. 80% (without moisture condens.)
Type of protection	IP 20

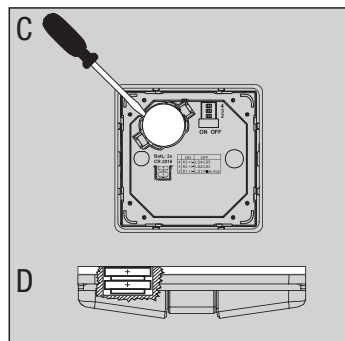

Commissioning

1. Unscrew the wall-mounted transmitter from the base according to Diagram A.
2. Select the function of the push-buttons with the functions witch ① at the back of the wall-mounted transmitter (Diagram B). It is possible to change the function once the push-button sensor has been removed by toggling the individual + switches (2..4).

Note:

- **Push-button 4+ or 4- always corresponds to channel 4+ or 4-.**
 - See Diagram E for the position of the push-buttons (1-, 1+, 2-, ...).
3. Screw the wall-mounted transmitter back onto the base plate.

E	Function	OFF	ON
F2	= Push-button 1-	ALL OFF	Channel 1-
	= Push-button 1+	Light scene 1 (ON)	Channel 1+
F3	= Push-button 2-	Light scene 2 (ON)	Channel 2-
	= Push-button 2+	Light scene 3 (ON)	Channel 2+
F4	= Push-button 3-	Light scene 4 (ON)	Channel 3-
	= Push-button 3+	Light scene 5 (ON)	Channel 3+

Operation (E)

A radio telegram is sent when a channel push-button (e.g. 1+) is pressed.

Push-button	Duration	Light	Blind
x+	max. 1 sec.	Switch ON	Louvre adjustment
x-	max. 1 sec.	Switch OFF	Louvre adjustment
x+	min. 1 sec.	Dim brighter	Continual movement UP
x-	min. 1 sec.	Dim darker	Continual movement DOWN

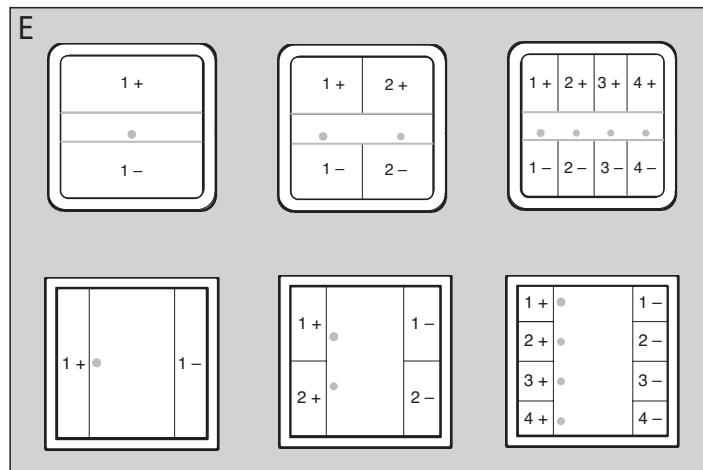

The maximum transmission length is 12 seconds even if another push-button is pressed afterwards. If several push-buttons are pressed at the same time, no radio telegram is sent. If you wish the radio-controlled performance unit to be switched on continuously for approx. 2 hours, it is necessary to press the taught-in channel push-button X for at least 1 second.

Light scenes

The light scene push-button must be taught in before storing or recalling a light scene.

5 light moods can be stored (long switch operation: min. 3 seconds) and retrieved (short switch operation: max. 3 seconds).

Changing light scenes

1. Set the required lighting scenario.
2. Press the required light scene push-button for at least 3 seconds.
Note: The previous light scene is recalled first (do not release the push-button) and then the new one is activated.
3. A short signal tone is emitted for confirmation at the flush-mounted radio receivers.

ALL OFF

During the learning process for a radio channel, the ALL OFF button is automatically "learnt" as well by the radio receiver (exception: radio-controlled shutter cover).

When retrieving the ALL OFF function, you must press push-button 1- for at least 1 second to avoid maloperations. The load is disconnected at all the taught-in radio receivers.

Deleting ALL OFF

If a specific radio receiver is not supposed to react to the ALL OFF button, this function must be deleted.

Procedure

1. Switch the radio receiver to the learning mode.
2. Press the ALL OF button 1- for at least 10 seconds.
3. Switch the radio receiver to normal mode.

The deletion process is complete.

Multi Function radio transmitter

Ref.no. FMS 4 UP

Function

This multifunction radio transmitter (Fig. A) is a battery-operated four-channel radio transmitter for the extension of an existing radio control installation.

At its four inputs E1 to E4 (see Fig. B), the multifunction radio transmitter detects switching states of potential-free installation switches or push-buttons.

It transmits radio data telegrams which can be decoded by all radio-controlled receivers.

A 5-digit microswitch (Fig. A ①) facilitates the selection of eight different modes of operation.

A red LED (Fig. A ②) indicates the transmission of radio telegrams (slow unsymmetrical blinking, 4 Hz) or an empty battery "LowBatt" (quick symmetrical blinking, 10 Hz).

Installation

Install the multifunction transmitter in a surface-mounted or flush-mounted box behind a potential-free installation switch or push-button. The multifunction transmitter has no pull-relief.

Important

To avoid saturation of the radio receivers (actuators), the distance between the transmitter and the receiver must be approximately 1 m.

Cable

The eight-wire cable serves to connect potential-free installation switches and push-buttons. Wires not used should be insulated and must not be brought into contact with live parts to prevent the device from being irreparably damaged.

Plug the connector of the eight-wire multi-colour cable and the white antenna into the multifunction transmitter (Fig. B).

Wire colour assignment:

Yellow (YE) and yellow/black: input E1.
Green (GN) and green/black: input E2.
Grey (GY) and grey/black: input E3.
Pink (PK) and pink/black: input E4.

The black-striped wires form a common reference potential.

Antenna

To obtain maximum radio transmitting power unroll and install the antenna in a straight line.

Keep away from large-surface metal parts (e. g. metal door frame). Do not strip, shorten or extend the white antenna.

Battery

The multifunction transmitter is powered by a lithium button cell (CR 2032). The device comes with the battery inserted.

Safety and disposal instructions

Attention: Keep button cells away from children. Seek medical advice immediately when button cells have been swallowed.

Remove used batteries immediately and discard without polluting the environment. Replace battery by identical or equivalent types only.

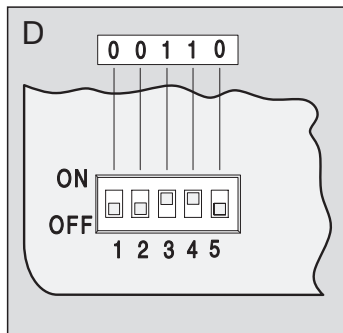
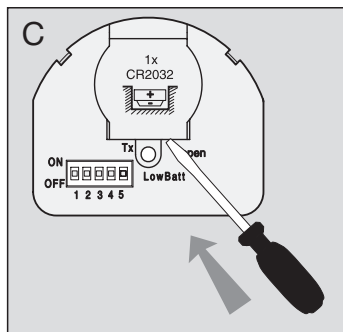
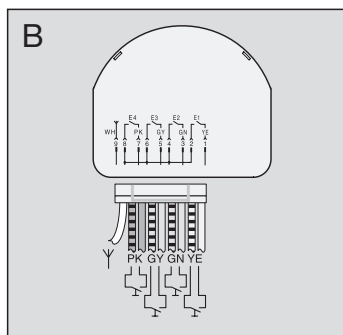
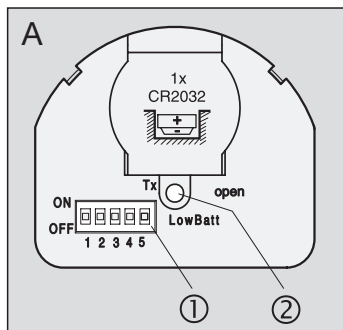

Modes of operation

The following pages explain the eight selectable modes of operation with their associated microswitch positions.

They are divided into:

Modes 1 – 2: Connection of installation push-buttons.

Modes 3 – 4: Connection of installation switches.

Modes 5 – 8: Light scene operation using installation push-buttons.

For the microswitches, position 1 is ON and position 0 is OFF.

For example, Figure D shows microswitch position 00110 for mode 4.

Operation

For the connection of installation push-buttons, a distinction is made between 1-gang and 2-gang operation:

1-gang operation using installation push-buttons

Connection of a push-button to a wire pair of the multifunction transmitter. The rocker of the push-button can be used for switching on and off, or for increasing or lowering of the brightness (Fig. E1).

2-gang operation using installation push-buttons

Connection of a 2-gang push-button, for example, to two wire pairs of the multifunction transmitter. One rocker serves to switch on, increase the brightness or move up a blind; the other one to switch off, dim the lights or to lower a blind (Fig. E2).

Actuation Times

When installation push-buttons are connected, a distinction is made between long (> 1 s) and short actuation (< 1 s). Accordingly, different reactions of the radio receivers are possible:

	Short	Long
Switching actuator	Switching on/off	Switching on/off
Dimming actuator	Switching on/off	brighter/darker
Venetian blind actuator	Slat adjustment	Cont. up/down run

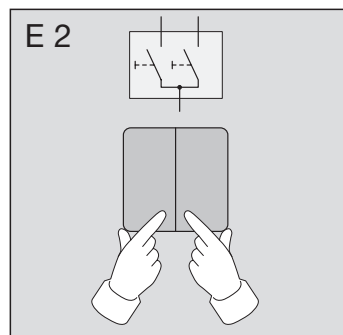
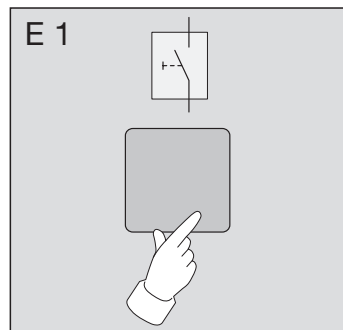

Important

Venetian blind operation is only possible with the rocker element (no. 2) and in the light scene (nos. 5 – 8) modes.

The maximum transmission time is 12 s, even though another push-button connected is still being pressed.

Mode Selection

1) Single-rocker operation using installation push-buttons

Single-rocker switching or dimming using up to four installation push-buttons (E1 – E4).

Actuation leads to switching over (toggling) of the telegram type (on/off, brighter/darker) in the multifunction transmitter. Toggling takes place in the transmitter. Therefore, to obtain the desired response, the multifunction transmitter will possibly have to be actuated twice after local operation or when the receiver has been controlled by a different transmitter.

2) Double-rocker operation using installation push-buttons

Double-rocker switching, dimming or blind operation using installation push-buttons. Inputs E1/E2 and E3/E4 form one channel each.

3) Connection of installation switches (normally open contacts)

Inputs E1 to E4 form one switching channel for controlling radio receivers with installation switches (normally open contacts).

The switching contact acts in the same way as the switch connected to the multifunction transmitter.

4) Connection of installation switches (normally closed contacts)

Inputs E1 to E4 form one switching channel for controlling radio receivers with installation switches (normally closed contacts). The switching action of the contact is opposed to that of the switch connected to the multifunction transmitter.

5) ALL-ON, ALL-OFF, light scenes 1 and 2

E1: Switching ON all programmed receivers. (ALL-ON function).

E2: Switching OFF all programmed receivers. (ALL-OFF function).

E3: Calling or saving light scene 1.

E4: Calling or saving light scene 2.

6) ALL-OFF, light scenes 1 to 3

E1: Switching OFF all programmed receivers. (ALL-OFF function).

E2: Calling or saving light scene 1.

E3: Calling or saving light scene 2.

E4: Calling or saving light scene 3.

7) ALL-OFF, light scenes 3 to 5

E1: Switching OFF all programmed receivers. (ALL-OFF function).

E2: Calling or saving light scene 3.

E3: Calling or saving light scene 4.

E4: Calling or saving light scene 5.

8) Light scenes 1 – 4

E1 to E4: Calling or saving light scene 1 to 4.

Other microswitch positions not described are without function.

Programming of radio receivers

A multifunction transmitter channel can be programmed into any number of radio receivers. Programming affects only the radio receiver.

During programming of a transmitter, the sensitivity of the receiver is reduced to approx. 5 m. The distance between the radio receiver and the radio transmitter to be programmed should therefore be between 0.5 m and 5 m.

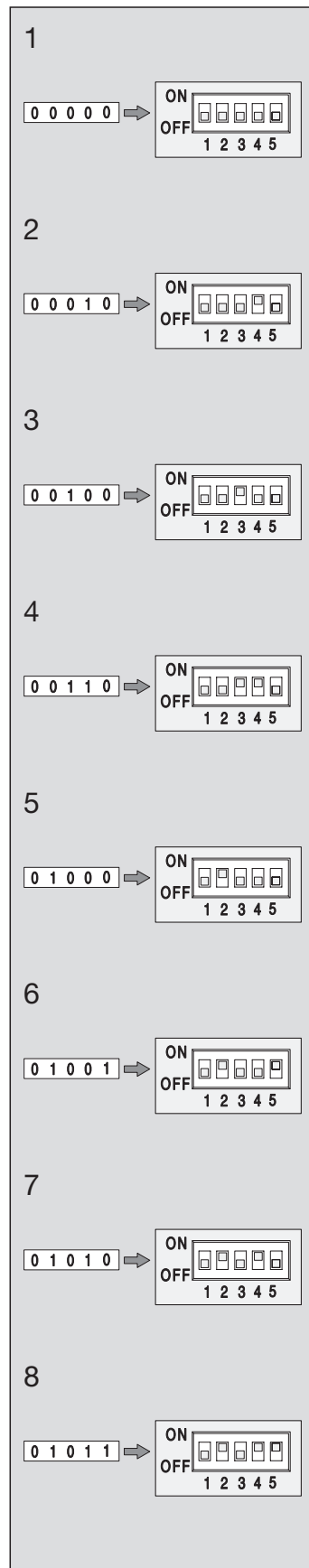

Procedure

1. Switch the radio receiver into the programming mode.
(Refer to the "Radio Receiver" operating instructions).

2a. Programming of modes 1 and 2:

- Set microswitch to the desired position.
- Press the installation push-button of the desired input for at least 1 s.

Note: For double rocker modes, press one push-button per radio channel only.

2b. Programming of modes 3 and 4:

- Set microswitch first to position 00000 (refer to Fig. F).
- Press the connected switch of the desired input for at least 1 s.
- Now, set the associated microswitch position.

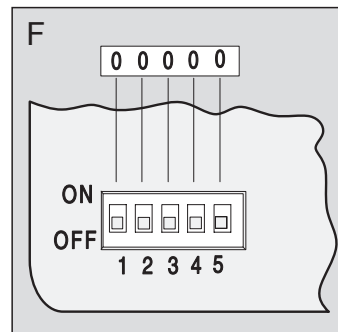

2c. Programming of modes 5 to 8:

- Set microswitch to the desired position.
- Depending on the function selected, press the light scene key for at least 3 s or the ALL-ON or ALL-OFF key for at least 10 s.

Important:

When a light scene key is programmed, the ALL-ON or ALL-OFF key will be stored automatically by the radio receiver. (Refer to the "ALL-ON/ALL-OFF" or "Calling / Saving a Light scene" chapters.)

Clearing of channels

Reprogramming of the transmitting channel to be deleted cancels the old assignment in the radio receiver.

ALL-ON/ALL-OFF (for modes 5 to 7 only)

When programming the ALL-ON or ALL-OFF key, make sure the light scene is on or off if ALL-ON or ALL-OFF assignments are already available. Otherwise, the existing light scene will be changed. (Refer to "Changing ALL-ON/ALL-OFF".)

Changing ALL-ON/ALL-OFF

Example:

One of the receivers (bathroom light) is supposed not to respond to the ALL-ON function, while all the other receivers switch on the light.

Procedure

1. Press the ALL-ON key for at least 1 s.
This switches on all programmed radio receivers.
2. Set your lights in the way you expect them to respond later when the ALL-ON key is pressed, i. e. since all receivers are on, now switch OFF the light in the bathroom, for example.
3. Press the ALL-ON key for at least 10 s to save the light setting.

Important

First of all, the previous light setting is recalled (do not release the key). After approx. 10 s, the new setting will be activated and saved.

This completes the new assignment of the ALL-ON key. To change the ALL-OFF key, proceed accordingly.

Recalling/saving a light scene (for modes 5 to 8 only)

Before you can save (long actuation for at least 3 s) or call (short actuation) a light scene, the light scene key must have been programmed (refer to "Programming of Radio Receivers") and the light scene set.

Setting or changing a light scene

1. Set your desired light scene (e. g. light 1 = 50 % brightness, light 2 = 70 % brightness, Venetian blind up).

2. Press the desired light scene key for at least 3 s.

Important

First of all, the previous light scene is called (do not release the key). After approx. 3 s, the new light scene will be activated and saved.

Important for venetian blinds

If a venetian blind is not in one of its end positions or not on its way to such position while a light scene is being saved, this blind will not be stored in the light scene.

Radio transmission

Radio transmission is not carried out via an exclusive transmission route, therefore disruptions cannot be ruled out.

Radio transmission is not suitable for security applications e.g. emergency stop, emergency calls.

The transmission range of the radio handheld transmitter (max. 30 m in free field according to EN) is dependent on the structural conditions of the property:

Dry material	Penetration approx.
Wood, plaster, plaster boards	90 %
Brick, pressboards	70 %
Reinforced concrete	30 %
Metal, metal gates, aluminium covers	10 %

Specifications

Power supply	3 VDC
Battery	1 x CR 2032 lithium cell
Length of connecting lines	approx. 290 mm
Transmission frequency	433.42 MHz, ASK
Transmitting range	100 m max. (in the free field)
Coding	> 10 ⁹ different possibilities
Protective system	IP 20
Temperature range	approx. -20 °C to +55 °C
Relative atmospheric humidity	65 % max. (without condens.)
Dimensions (LxWxH)	45 x 40 x 10 mm
Subject to technical modifications.	

Function

The universal radio transmitter can be used to extend an existing electrical installation by the possibility of transmitting 230 V control commands by radio. The transmitter can be operated for switching, dimming or blind/shutter control functions.

When mains voltage (230 V ~) is applied to inputs (E1, E2), the universal radio transmitter transmits radio telegrams which are evaluated by all radio-controlled receivers. For selection an indication of the mode of operation, the device is equipped with a push button ① and an LED ②.

The universal radio-controlled transmitter has 3 modes of operation:

Mode A: 2-channel dimming (toggling) (E1 and E2)

Mode B: 2-channel switching (E1 and E2)

Mode C: 1-channel blind/shutter resp. dimming (E1/E2)

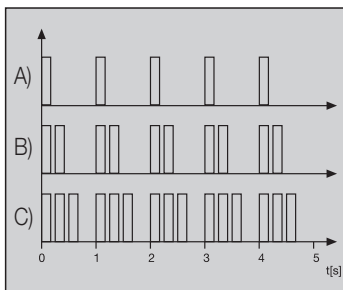

Modes of operation

The universal radio transmitter has 3 modes of operation which can be selected or indicated with push button ①.

The modes are signalled by the LED ② as follows:

- A) 2-channel dimming, toggling (E1 and E2)
2 brief flashes per second for 5 s altogether
- B) 2-channel switching (E1 and E2)
1 brief flash per second for 5 s altogether
- C) 1-channel blind/shutter resp. dimming (E1/E2)
3 brief flashes per second for 5 s altogether

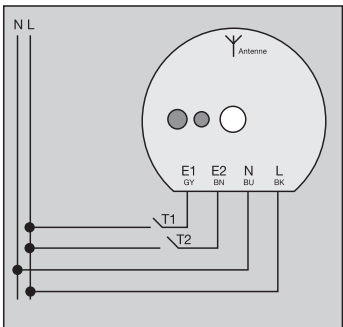

Mode A: 2-channel dimming, toggling (E1 and E2)

For independent control of two radio-controlled dimming actuators. Connection of conventional push buttons (n.o. contacts):

A press on the button switches over (toggles) the type of telegram from the transmitter:

brief press (< 1s): switching on / off
long press (> 1s): lamp brighter / darker

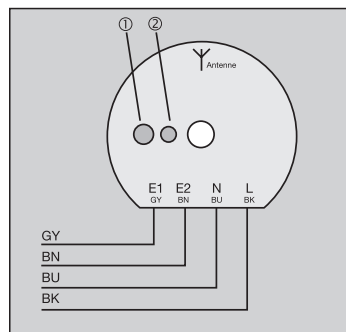

Fitting

Install the universal radio transmitter in a deep flushmounting box behind a flush-mounting insert (60 mm-deep mounting box recommended).

Antenna

For maximum transmission range, the antenna should be stretched out to full length and not be left coiled up.

Keep away as far as possible from large metal surfaces such as metallic door frames. Do not shorten or lengthen the antenna and do not strip off the insulation.

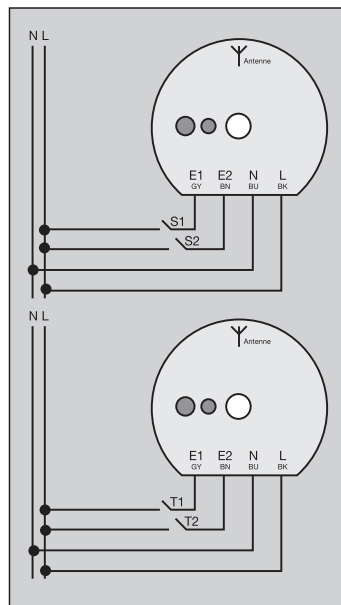

Mode B: 2-channel switching (E1 and E2)

For independent control of two radio-controlled switching actuators.

Connection of conventional switches (n.o. contact):
the universal transmitter transmits switch-on telegrams when closed and switch-off telegrams when opened.

Connection of conventional push buttons (n.o. contact):
the transmitter is in the special „doorbell“ mode and transmits switch-on telegrams when closed and switchoff telegrams when opened.

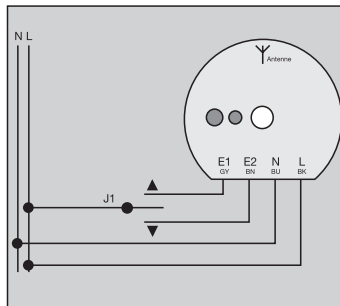

Mode C: 1-channel blind/shutter (E1/E2)

For controlling of a radio-controlled blind/shutter

Dimming

Connection of conventional pushbuttons (n.o. contacts):

Actuation:

T1 < 1 s: switch on T1 > 1 s: lamp brighter
T2 < 1 s: switch off T2 > 1 s: lamp darker

Important

When the load is off a long press (> 1s) of T2 causes suitable dimmers to switch on with their minimal brightness.

Blind/shutter

Connection of a blind/shutter switch or a motor control insert:
The universal transmitter transmits blind/shutter control telegrams (short-step / long-step) for one channel.

Important

The radio universal transmitter must not be connected in parallel with blind/shutter motor.

Programming

A universal radio transmitter channel can be programmed into an unlimited number of radio receivers.

Programming information is stored only in the radio-controlled receiver. During programming of a radio transmitter, the sensitivity of the receivers is reduced to approx. 5 m.

The distance between the receiver and the transmitter to be programmed should therefore be between 0.5 m and 5 m.

Procedure

1. Switch the radio-controlled receiver into the programming mode (see „radio-controlled receiver“ operating instructions)
- 2a. Programming of operating mode A or C
Actuate the connected pushbutton or switch for at least 1 s.
- 2b. Programming of operating mode B
The switching telegrams of operating mode B are not suitable for programming. Set the universal transmitter therefore at first to operating mode A. Press or actuate the corresponding buttons or switches for at least 1 s. Then go back to operating mode B.
3. Switch the radio-controlled receiver back into the operating mode (see „radio-controlled receiver“ operating instructions).

Clearing a programmed channel

Reprogramming of the transmit channel to be cleared in the same mode of operation deletes the assignment stored in the radio-controlled receiver.

Technical data

Power supply:	230 V ~
Transmit frequency:	433,42 MHz, ASK
Transmitting range:	approx. 100 m
Operating temperature:	approx. -20 °C to +55 °C
Typo of protection:	IP 20
Dimension (Ø x H):	52 mm x 23 mm

Function

The radio-controlled actuator switches electrical loads (230 V/10 A) as soon as it receives a corresponding (learnt) radio signal.

The radio-controlled actuator can 'teach in' up to 30 radio transmitters.

When it receives a radio signal from the radio-controlled Observer, it switches on for approx. 1 minute.

The radio-controlled actuator can be operated via a satellite station signal (230 V).

Light scenes

Limited light scene operation is possible (only switching) using the radio-controlled hand-held or wall-mounted transmitter e.g. switching on the light.

The required light scene push-button of the radio-controlled hand-held or wall-mounted transmitter must be learnt in the radio-controlled actuator.

Up to 5 light scenes can be stored.

ALL OFF

The operation of the ALL OFF button of a learnt radio-controlled hand-held or wall-mounted transmitter leads to the load being disconnected.

ALL ON

The operation of the ALL ON button of a learnt radio-controlled hand-held or wall-mounted transmitter leads to the load being connected.

Satellite station signal

The satellite station signal (230 V) is connected via a push-button (make contact) with terminal 1 of the radio-controlled actuator.

The radio-controlled actuator works in an 'ON/OFF' two-way' mode.

Note

The distance away from electrical loads (e.g. electronic transformers, devices with electronic ballast, TV) must be at least 0.5 m.

Antenna

The radio reception power can be improved if required by bringing out the antenna that is rolled up in the device.

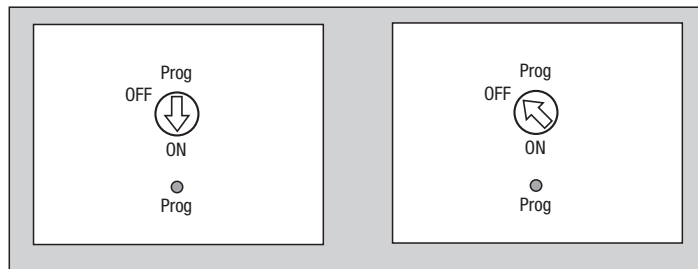
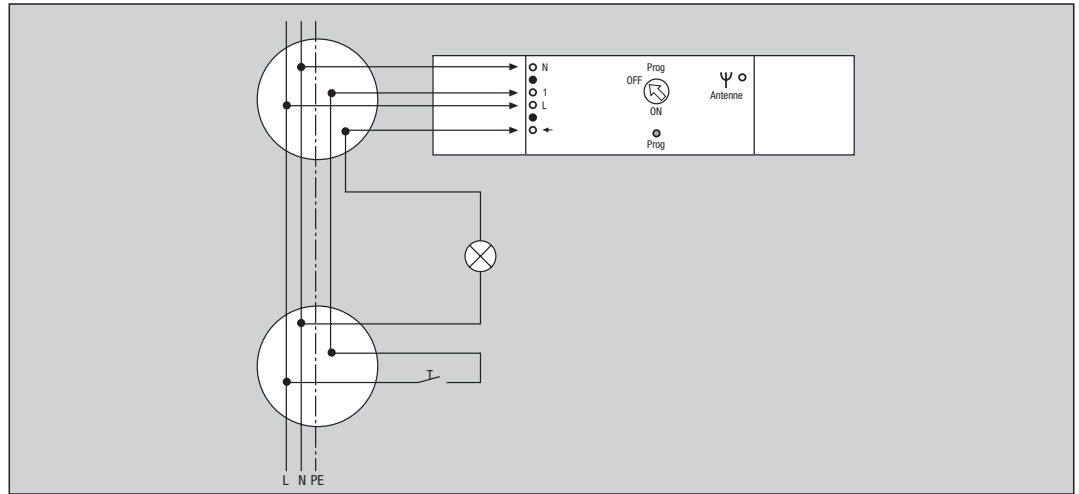

Teaching in a radio transmitter

In order to be able to operate the radio-controlled actuator by radio remote control, this remote control must be taught into the radio-controlled actuator.

The distance between the radio-controlled actuator and the radio transmitter that is to be taught may not exceed 5 m.

Activation at the device

1. Turn the Prog switch to the ON position. The red Prog LED flashes.

2. The required radio transmitter must trigger a radio transmission.

Teaching in a radio channel:

Press the required channel push-button for at least 1 sec.

Teaching in a light scene push-button: Press the required light scene push-button for at least 3 seconds.

Teaching in the ALL OFF/ALL ON button: Press the ALL OFF or ALL ON button for at least 10 sec.

Teaching in a radio-controlled Observer: Carry out a movement in the detection field of the radio-controlled Observer.

3. To check that a radio transmission has been received, the red Prog LED lights up. The load (relay) is connected.

The radio transmitter has been taught in!

4. Turn the Prog switch to the OFF position. The red Prog LED goes out. The load (relay) is disconnected.

Note:

When teaching in a radio channel, ALL OFF/ALL ON is automatically learnt as well.

Activation via satellite station T

1. Press push-button T for approx. 10 sec. The load (relay) is connected and disconnected in cycles (approx. 1 sec.).
2. The required radio transmitter must trigger a radio transmission within 1 min. by ... see 'Activation at the device'.
3. To check that a radio transmission has been received, the load (relay) is connected. The radio channel is learnt!

You can exit the learning mode at any time via a further satellite station signal.

Note

If all 30 memory locations are occupied, you must delete an already taught-in radio transmitter.

Deleting a radio transmitter

The deletion of a taught-in radio transmitter is carried out by a new learning process for this radio transmitter.

All the channels and light scene push buttons must be deleted individually.

A successful deletion process is indicated by the red Prog LED going out and the load (relay) being disconnected.

Technical data

Power supply	AC 230 V ~
Switch contact	Relay (10 A)
Switching capacity	
Incandescent lamps	2300 W
High voltage halogen lamps	2300 W
Temperature range	-20° C up to 55° C
Reception frequency	433,42 MHz ASK
Dimensions (BxHxT)	175 x 42 x 18 mm

Radio-controlled push-button controller

Built-in 1 – 10 V Ref.no. FST 1240 EB

Functions

The radio-controlled push-button controller 1 – 10 V enables the lighting to be controlled remotely via radio. This lighting can be switched (brief actuation) or dimmed (longer actuation).

The radio-controlled push-button controller can teach in up to 30 radio transmitters.

On receipt of a radio signal from the radio-controlled Observer, it switches on for an overshoot time of approx. 1 minute.

Light scene

The operation of light scenes is possible using the radio-controlled hand-held or wall-mounted transmitter.

The required light scene push-button of the radio-controlled hand-held or wall-mounted transmitter must be taught into the radio-controlled push-button controller

The scope of a light scene includes:

- **the dimming value of a luminaire** (e.g. 70 % of the maximum brightness level)
- **the switching state of a load** (e.g. the lighting is switched on)

ALL OFF

The operation of the ALL OFF button of a taught-in radio-controlled hand-held or wall-mounted transmitter leads to the **load being disconnected**.

ALL ON

The operation of the ALL ON button of a taught-in radio-controlled hand-held or wall-mounted transmitter leads to the **load being connected**.

Installation

The device must be placed at a distance of at least 0.5 m from any electrical loads (e.g. TRONIC transformer, electronic lamp ballast, TV).

The technical operating conditions of the power stations must be observed.

Check that the electronic lamp ballast is suitable prior to the installation. Only electronic lamp ballasts and fluorescent lamps or transformers from the **same** manufacturer and of the **same** type and rating class should be used.

Only use electronic lamp ballasts or transformers with a standard 1 – 10 V interface in accordance with DIN EN 60928 (electrical isolation between the mains supply and the 1 – 10 V input).

Note

Some electronic lamp ballasts switch the fluorescent lamps to maximum brightness for a short period once the supply voltage has been applied. This type of electronic ballast only reacts to the applied control voltage once this period has elapsed and sets the brightness level of the luminaire accordingly.

The control line should be laid (type, cross section) in accordance with VDE specifications for 250 V cables (control voltage with basic insulation). The load and control line should be laid in the same cable.

Teaching in a radio transmitter

In order to be able to operate the radio-controlled push-button controller with a radio transmitter, this radio transmitter must be taught into the radio-controlled push-button controller.

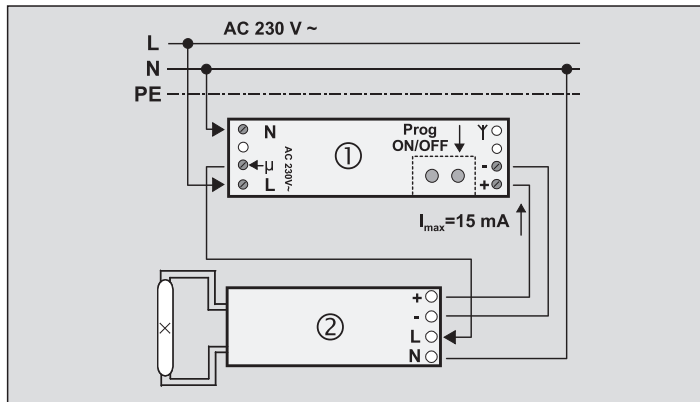

The distance between the radio-controlled push-button controller and the radio transmitter that is to be taught in must not exceed 5 m.

Procedure

1. Switch off the connected load.
2. Press the ON/OFF button for at least 3 seconds.
The red **Prog** LED flashes to indicate that the learning mode has been activated (duration of approx. 1 minute). During this period, **one** radio channel can be taught in.
3. The required radio transmitter must trigger a radio transmission.
Teaching in a radio channel: Press the required channel push-button for at least 1 second.
Teaching in a light scene push-button: Press the required light scene push-button for at least 3 seconds.
Teaching in the ALL ON or ALL OFF button: Press the ALL ON or ALL OFF button for at least 10 seconds.
Teaching in a radio-controlled Observer: Carry out a movement in the detection field of the radio-controlled Observer.
4. The red **Prog** LED glows continually to check that a radio transmission has been received.

The learning process can be interrupted at any time by pressing the ON/OFF button.

The radio channel has been taught in.

Note

- When teaching in a radio channel, the ALL ON/ALL OFF button is automatically learnt as well.
- If all 30 memory locations are occupied, an already taught-in radio transmitter must be deleted.

Deleting a radio transmitter

A taught-in radio transmitter is deleted by carrying out a new learning process for this radio transmitter. All the channels and light scene push-buttons must be deleted individually. A successful deletion process is indicated by the red **Prog** LED flashing rapidly.

Modes

The radio-controlled push-button controller can be operated directly at the device or on receipt of a taught-in radio telegram from a radio-controlled hand-held or wall-mounted transmitter.

(A) Permanent ON/OFF

By pressing the **Prog** button for less than 1 second, the radio-controlled push-button controller is switched permanently on or off.

(B) Memory

If the current dimming value is to be stored as a memory value in the radio-controlled push-button controller, the **Prog** button must be pressed for at least 3 seconds, **while the load is connected**.

A "softstart" is carried out as confirmation i.e. the lamp is dimmed brighter until it reaches the stored memory value.

This stored value is retrieved the next time that the lamp is switched on.

When the device is supplied, the memory value is set at the maximum brightness level.

(C) Light scene

The brightness of a luminaire can be stored in a light scene.

This light scene can be changed at any time by storing it again.

A light scene push-button of the radio transmitter must be taught in before storing or retrieving a light scene.

(D) Storing a light scene

1. Set the brightness of the luminaire.
2. Press the required light scene push-button of the radio transmitter for at least 3 seconds.

(E) Detection

If a taught-in radio telegram from a radio-controlled Observer is received, the radio-controlled push-button controller switches on for approx. 1 minute.

Technical data

Power supply	AC 230 V ~ 50/60 Hz
Control voltage	1 – 10 V
Control current	max. 15 mA
Electrical isolation 1 – 10 V	2 KV- basic insulation
Switch contact	μ relay contact
Connected load Resistive load	max. 1800 W
Electronic ballast, transformer	type-dependent
Series-connected miniature circuit-breaker	10 A
Number of radio transmitters	max. 30
Transmission frequency	433,42 MHz, ASK
Postal approval	LPD-D
Dimensions (LxWxH)	187 x 28 x 28 mm
Temperature range	0 up to +55 °C

Functions

The radio-controlled universal dimmer enables the radio remote control and manual triggering of luminaires.

The lighting can be switched (brief actuation) or dimmed (longer actuation).

The radio-controlled universal dimmer can teach in up to 30 radio transmitters.

On receipt of a radio signal from the radio-controlled Observer, it switches on for an overshoot time of approx. 1 minute.

The radio-controlled universal dimmer can only be operated via a satellite station (ref.no. 1220 NE) using the twin area principle.

Light scene

The operation of light scenes is possible using the radio-controlled hand-held or wall-mounted transmitter.

The required light scene push-button of the radio-controlled hand-held or wall-mounted transmitter must be taught into the radio-controlled universal dimmer.

Up to 5 light moods can be stored.

The scope of a light scene includes:

- **The dimming value of a luminaire** (e.g. 70 % of the maximum brightness level)

ALL OFF

The operation of the ALL ON button of a taught-in radio-controlled hand-held or wall-mounted transmitter leads to the **load being connected**.

ALL ON

The operation of the ALL ON button of a taught-in radio-controlled hand-held or wall-mounted transmitter leads to the **load being connected**.

Installation

The device must be placed at a distance of at least 0.5 m from any electrical loads (e.g. TRONIC transformer, electronic lamp ballast, TV).

The technical operating conditions of the power stations must be observed. In a low dimming setting, ripple control pulses from the power stations can be seen by a brief flickering.

Satellite station signal

The radio-controlled universal dimmer can be operated with a satellite station (ref.no. 1220 NE) according to the twin area principle. One or several satellite stations (SS) are linked with **terminal 1** of the radio-controlled universal dimmer.

Conventional push-button is not working!

Teaching in a radio transmitter

In order to be able to operate the radio-controlled universal dimmer with a radio transmitter, this radio transmitter must be taught into the radio-controlled universal dimmer.

The distance between the radio-controlled universal dimmer and the radio transmitter that is to be taught must not exceed 5 m.

Procedure

1. Switch off the connected load.
2. Press the ON/OFF button for at least 3 seconds. The red **Prog** LED flashes to indicate that the learning mode has been activated (duration of approx. 1 minute). During this period, **one** radio channel can be taught in.
3. The required radio transmitter must trigger a radio transmission.

Teaching in a radio channel:

Press the required channel push-button for at least 1 second.

Teaching in a light scene push-button: Press the required light scene push-button for at least 3 seconds.

Teaching in the ALL ON or ALL OFF button: Press the ALL ON or ALL OFF button for at least 10 seconds.

Teaching in a radio-controlled Observer: Carry out a movement in the detection field of the radio-controlled Observer.

4. The red **Prog** LED glows continually to check that a radio transmission has been received.

The learning process can be interrupted at any time by pressing the ON/OFF button.

The radio channel has been taught in.

Note

- When teaching in a radio channel, the ALL ON/ALL OFF button is automatically learnt as well.
- If all 30 memory locations are occupied, an already taught-in radio transmitter must be deleted.

Deleting a radio transmitter

A taught-in radio transmitter is deleted by carrying out a new learning process for this radio transmitter. **All** the channels and light scene push-buttons must be deleted individually. A successful deletion process is indicated by the red **Prog** LED flashing rapidly.

Power amplifiers

Depending on the capacity utilisation of the universal dimmer, up to 10 power amplifiers can be connected.

TRONIC power amplifiers (built-in or series embodied) are used in combination with TRONIC transformers (capacitive loads). Low voltage power amplifiers (built-in or series embodied) are used in combination with conventional transformers (inductive loads).

Automatic load detection

After the initial installation and isolation from the supply, the universal dimmer detects the load automatically.

Capacitive loads (e.g. TRONIC transformers) and inductive loads (e.g. conventional transformers) should not be connected together to the universal dimmer.

The detection process is indicated for resistive loads (incandescent lamps, high voltage halogen lamps) by a brief flickering.

Depending on the network conditions, the detection process lasts between 1 – 10 seconds. No operations are possible during this period. If a short circuit occurs during the detection process, the load must be re-measured once the short circuit has been removed. A mains failure that lasts longer than 0.7 sec. leads to the dimmer being switched off.

Short-circuit protection Operation with trailing edge control (capacitive load, resistive load)

Disconnection with automatic restart if the short circuit has been removed within 7 seconds. After this period, the universal dimmer remains disconnected until it is switched on again manually.

Operation with leading edge control (inductive load)

Disconnection with automatic restart if the short circuit has been removed within 100 ms. After this period, the universal dimmer remains disconnected until it is switched on again manually.

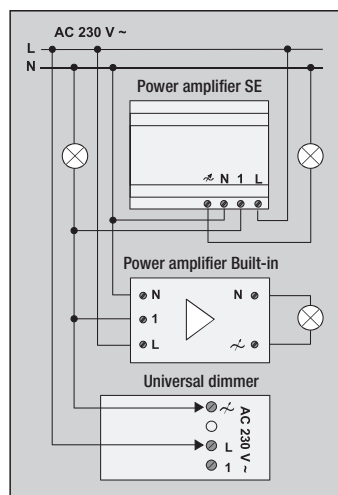
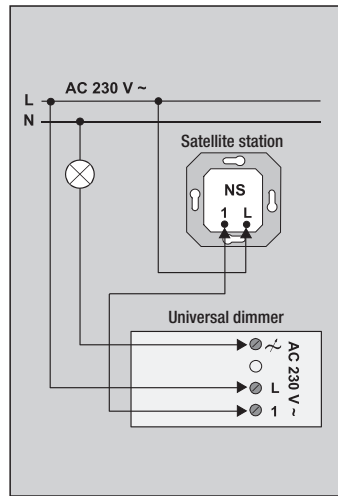

Overtemperature protection

Disconnection when the ambient temperature is too high. Once it has cooled down, the device must be switched on again.

Modes

The radio-controlled universal dimmer can be operated directly at the device, via a satellite station (ref.no. 1220 NE) according to the twin area principle or via the receipt of a taught-in radio telegram from a radio-controlled hand-held or wall-mounted transmitter.

(A) Permanent ON/OFF

By pressing the Prog button for less than 1 second, the radio-controlled universal dimmer is permanently switched on or off (two-way operation).

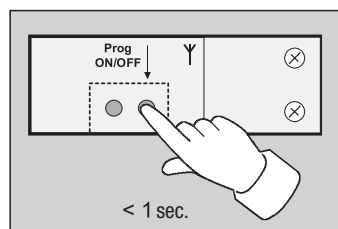

(B) Memory

If the current dimming value is to be stored as a memory value in the radio-controlled

universal dimmer, the Prog button must be pressed for at least 3 seconds, while the load is connected. A "softstart" is carried out as confirmation i.e. the lamp is dimmed brighter until it reaches the stored memory value.

This stored value is retrieved the next time that the lamp is switched on.

When the device is supplied, the memory value is set at the maximum brightness level.

(C) Satellite station

The radio-controlled universal dimmer can be switched on or off or dimmed with a satellite station (ref.no. 1220 NE) according to the twin area principle.

- Brief actuation (max. 0.4 seconds)
The lamp is switched.
The lamp switches on with the memory value.
- Longer actuation (min. 0.4 seconds)
Operation of upper contact:
Dimming to maximum brightness
Operation of lower contact:
Dimming to minimum brightness

(D) Light scene

The brightness of a luminaire can be stored in a light scene. This light scene can be changed at any time by storing it again.

A light scene push-button of the radio transmitter must first be taught in before storing or retrieving a light scene.

(E) Storing a light scene

1. Set the brightness of the luminaire.
2. Press the required light scene push-button of the radio transmitter for at least 3 seconds.

(F) Detection

If a taught-in radio telegram from a radio-controlled Observer is received, the radio-controlled universal dimmer switches on for approx. 1 minute.

Technical data

Power supply	AC 230 V ~, 50 Hz (neutral line is not required)
Connected load	50 – 315 VA
230 V incandescent lamps (resistive load, trailing edge control)	
High voltage halogen lamps (resistive load, trailing edge control)	
TRONIC transformers (capacitive load, trailing edge control)	
or Conventional transformers (inductive load, leading edge control)	
Mixed loads of specific load types are permitted. (not capacitive with inductive loads)	
In the case of a mixed load with conventional transformers, 50 % of the resistive load (incandescent lamps, high voltage lamps) should not be exceeded.	
No. of connected power amplifiers	max. 10
No. of satellite stations	unlimited
Emitted interference	according to EN 55015
Transmission frequency	433.42 MHz, ASK
Postal approval	LPD-D
Dimensions (LxWxH)	187 x 28 x 28 mm
Temperature range	0°C up to +55°C

Radio-controlled universal in-line dimmer

Ref.no. FUSD 1253

Functions

The radio-controlled universal in-line dimmer enables the radio remote control and manual triggering of luminaires. The lighting can be switched (brief actuation) or dimmed (longer actuation). The radio-controlled universal in-line dimmer can teach in up to 30 radio transmitters.

Light scene

The operation of light moods is possible using the radio-controlled hand-held or wall-mounted transmitter. The required light scene push-button of the radio-controlled hand-held or wall-mounted transmitter must be taught into the radio-controlled universal in-line dimmer. Up to 5 light scenes can be stored.

The scope of a light scene includes:

- the dimming value of a luminaire (e.g. 70 % of the maximum brightness level)

ALL OFF

The operation of the ALL OFF button of a taught-in radio-controlled hand-held or wall-mounted transmitter leads to the **load being disconnected**.

ALL ON

The operation of the ALL ON button of a taught-in radio-controlled hand-held or wall-mounted transmitter leads to the **load being connected**.

Installation

The device must be placed at a distance of at least 0.5 m from any electrical loads (e.g. TRONIC transformer, electronic lamp ballast, TV).

The technical operating conditions of the power stations must be observed. In a low dimming setting, ripple control pulses from the power stations can be seen by a brief flickering. Connect the radio-controlled universal in-line dimmer according to the diagram.

Teaching in a radio transmitter

In order to be able to operate the radio-controlled universal in-line dimmer with a radio transmitter, this radio transmitter must be taught into the radio-controlled universal in-line dimmer.

The distance between the radio-controlled universal in-line dimmer and the radio transmitter that is to be taught must not exceed 5 m.

Procedure

1. Switch off the load that is connected to the pull cord dimmer.
2. Press the ON/OFF button for at least 3 seconds. The red Prog LED flashes to indicate that the learning mode has been activated (duration of approx. 1 minute). During this period, one radio channel can be taught in.
3. The required radio transmitter must trigger a radio transmission.

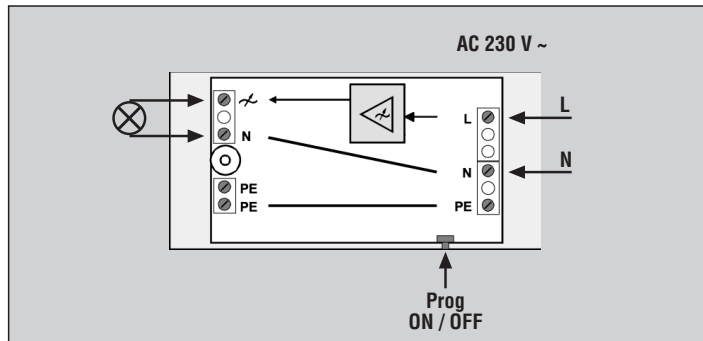

Teaching in a radio channel:

Press the required channel push-button for at least 1 second.

Teaching in a light scene push-button: Press the required light scene push-button for at least 3 seconds.

Teaching in the ALL ON or ALL OFF button:

Press the ALL ON or ALL OFF button for at least 10 seconds.

Teaching in a radio-controlled Observer: Carry out a movement in the detection field of the radio-controlled Observer.

4. The red Prog LED glows continually to check that a radio transmission has been received.

The learning process can be interrupted at any time by pressing the ON/OFF button.

The radio channel has been taught in.

Note

- When teaching in a radio channel, the ALL ON/ALL OFF button is automatically learnt as well.
- If all 30 memory locations are occupied, an already taught-in radio transmitter must be deleted.

Deleting a radio transmitter

A taught-in radio transmitter is deleted by carrying out a new learning process for this radio transmitter. All the channels and light scene push-buttons must be deleted individually. A successful deletion process is indicated by the red Prog LED flashing rapidly.

Automatic load detection

After the initial installation and isolation from the supply, the universal in-line dimmer detects the load automatically.

Capacitive loads (e.g. TRONIC transformers) and inductive loads (e.g. conventional transformers) should not be connected together to the universal in-line dimmer.

The detection process is indicated for resistive loads (incandescent lamps, high voltage halogen lamps) by a brief flickering.

Depending on the network conditions, the detection process lasts between 1 – 10 seconds. No operations are possible during this period. If a short circuit occurs during the detection process, the load must be reconnected once the short circuit has been removed. A mains failure that lasts longer than 0.7 seconds leads to the dimmer being switched off.

Short-circuit protection Operation with trailing edge control (capacitive load, resistive load)

Disconnection with automatic restart if the short circuit has been removed within 7 seconds. After this period, the universal in-line dimmer remains disconnected until it is switched on again manually.

Operation with leading edge control (inductive load)

Disconnection with automatic restart if the short circuit has been removed within 100 ms. After this period, the universal in-line dimmer remains disconnected until it is switched on again manually.

Overtemperature protection

Disconnection when the ambient temperature is too high. Once it has cooled down, the device must be switched on again.

Modes

The radio-controlled universal pull dimmer can be operated directly at the device or on receipt of a taught-in radio telegram from a radio-controlled hand-held or wall-mounted transmitter.

(A) Permanent ON/OFF

By pressing the **Prog** button for less than 1 second, the radio-controlled universal in-line dimmer is permanently switched on or off (two-way operation).

(B) Memory

If the current dimming value is to be stored as a memory value in the radio-controlled universal in-line dimmer, the **Prog** button must be pressed for at least 3 seconds, **while the load is connected**. A "softstart" is carried out as confirmation i.e. the lamp is dimmed brighter until it reaches the stored memory value.

This stored value is retrieved the next time that the lamp is switched on. When the device is supplied, the memory value is set at the maximum brightness level.

(C) Light scene

The brightness of a luminaire can be stored in a light scene. This light scene can be changed at any time by storing it again. A light scene push-button of the radio transmitter must first be taught in before storing or retrieving a light scene.

(D) Storing a light scene

1. Set the brightness of the luminaire.
2. Press the required light scene push button of the radio transmitter for at least 3 seconds.

(E) Detection

If a taught-in radio telegram from a radio-controlled Observer is received, the radio-controlled universal in-line dimmer switches on for approx. 1 minute.

Technical data

Power supply	AC 230 V ~, 50 Hz
Connected load	50 – 315 VA
230 V incandescent lamps (resistive load, trailing edge control)	
High voltage halogen lamps (resistive load, trailing edge control)	
TRONIC transformers (capacitive load, trailing edge control)	
or	
Conventional transformers (inductive load, leading edge control)	
Mixed loads of specific load types are permitted.	
(not capacitive with inductive loads)	
In the case of a mixed load with conventional transformers, 50 % of the resistive load (incandescent lamps, high voltage lamps) should not be exceeded.	
No. of connected power amplifiers	max. 10
Emitted interference	according to EN 55015
Transmission frequency	433,42 MHz, ASK
Postal approval	LPD-D
Dimensions (LxWxH)	126 x 60 x 28 mm

Functions

The radio-controlled switch actuator switches electrical loads (AC 230 V ~/8 A) as soon as it has received an appropriate taught-in radio signal.

The radio-controlled switch actuator can teach in up to 14 radio transmitters. On receipt of a radio signal from a radio-controlled Observer, it switches on for an overshoot time of approx. 1 minute.

Light scenes

The operation of light scenes (switching only) is possible using the radio-controlled hand-held or wall-mounted transmitter e.g. light is switched on.

The required light scene push-button of the radio-controlled hand-held or wall-mounted transmitter must be taught into the radio-controlled actuator. Up to 5 light scenes can be stored.

ALL ON

The operation of the ALL ON button of a taught-in radio-controlled hand-held or wall-mounted transmitter leads to the **load being connected**.

ALL OFF

The operation of the ALL OFF button of a taught-in radio-controlled hand-held or wall-mounted transmitter leads to the **load being disconnected**.

Installation

Blue cable, BU: N, neutral conductor

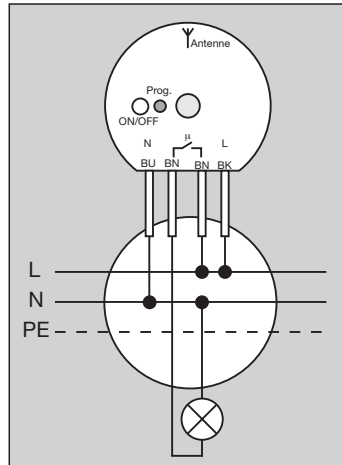

Black cable, BK: L, AC 230 V ~
Brown cable, BN: μ , potential-free, make contact

Note

The potential-free, make contact is separated internally from the phase with basic insulation.

The following load potentials can be connected:

- Functional extra-low voltage (FELV)
- One phase L (AC 230 V ~) against neutral conductor N

„Mini“ radio-controlled switch actuator, 2-channel

Ref.no. FA 26 UP

Functions

The 2-channel "Mini" radio-controlled switch actuator is a component of the Radio Management system.

It enables two electrical loads (AC 230 V / 6 A) to be switched independently, as soon as it has received a taught-in radio telegram. The switch actuator can be programmed to store up to 7 radio-controlled transmitters per channel. If a taught-in radio telegram from a radio-controlled Observer is received, the actuator is switched on for an overshoot time of approx. 1 minute.

Note

If all 7 locations of a channel are occupied, an already taught-in radio transmitter must be deleted so that an additional transmitter can be taught in.

Installation

Connect the 2-channel "Mini" radio-controlled switch actuator according to the diagram.

Note

- The device must be placed at a distance of at least 5 m from electrical loads (e.g. microwaves, hi-fi systems, TV).
- The distance between the "Mini" switch actuator and a transmitter must be at least 1 m.

Antenna

In order to maintain the maximum radio transmission power, the antenna should be laid as far away as possible. It must be positioned away from metal components with a large surface area e.g. metal door frames.

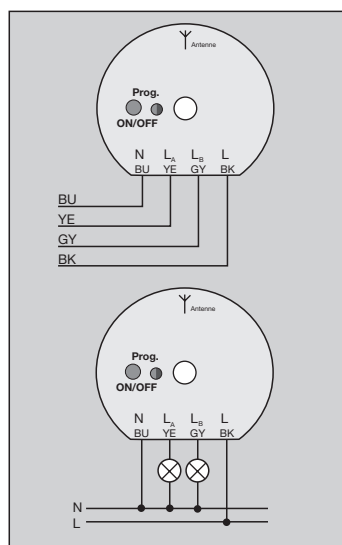

You should not shorten or extend the antenna or strip away the insulation.

Teaching in a radio transmitter

When teaching in a radio transmitter, the sensitivity of the radio receiver is reduced to approx. 5 m. The distance between the 2-channel "Mini" radio-controlled switch actuator and the radio transmitter that is to be taught should therefore not exceed 5 m.

Teaching in a radio transmitter

In order to be able to operate the radio-controlled switch actuator with a radio transmitter, this radio transmitter must be taught into the radio-controlled switch actuator.

The distance between the radio-controlled switch actuator and the radio transmitter that is to be taught must not exceed 5 m.

Procedure

1. Press the ON/OFF button for at least 3 seconds. The red **Prog** LED flashes to indicate that the learning mode has been activated (duration of approx. 1 minute). During this period, **one** radio channel can be taught in.
2. The required radio transmitter must trigger a radio transmission.

Teaching in a radio channel:

Press the required channel push-button for at least 1 second.

Teaching in a light scene push-button: Press the required light scene push-button for at least 3 seconds.

Teaching in the ALL ON or ALL OFF button:

Press the ALL ON or ALL OFF button for at least 10 seconds.

Teaching in a radio-controlled Observer: Carry out a movement in the detection field of the radio-controlled Observer.

3. The red **Prog** LED glows continually to check that a radio transmission has been received.

The learning process can be interrupted at any time by pressing the ON/OFF button.

The radio channel has been taught in.

Procedure

1. Press the ON/OFF button for at least 3 sec. in order to switch to the channel selection mode. Both channels are switched off and the Prog LED lights up in red and green for approx. 2 seconds. Both channels are switched off and the Prog LED flashes red for the first channel. When the second channel has to be selected, the ON/OFF button has to be pressed for approx. 3 sec. Now the green LED flashes and can be taught in. The learning mode is now activated for approx. 1 minute.

2. Trigger the radio telegram at the selected radio transmitter.

Teaching in a channel:

Press the channel push-button for longer than 1 second.

Teaching in a light scene push-button: Press the light scene push-button for longer than 3 seconds.

Teaching in the ALL ON/ALL OFF button: Press the ALL ON or ALL OFF button for longer than 10 seconds.

Teaching in a radio-controlled Observer: Carry out a movement in the detection field of the radio-controlled Observer.

3. The Prog LED of the 2-channel "Mini" radio-controlled switch actuator glows continually to indicate that the learning process has been successful.

4. You exit the programming mode either automatically after approx. 1 minute or by pressing the ON/OFF button. The 2-channel "Mini" radio-controlled switch actuator is then ready for operation.

Light modes

The 2-channel "Mini" radio-controlled switch actuator can be integrated into light scenes.

Deleting a radio transmitter

A taught-in radio transmitter is deleted by carrying out a new learning process for this radio transmitter.

All the channels and light scene push-buttons must be deleted individually. A successful deletion process is indicated by the red **Prog** LED flashing rapidly.

Technical data

Nominal voltage	AC 230 V ~, 50/60 Hz
Switch contact	Relay, μ contact, 8 A
Miniature circuit-breaker	10 A
Switching capacity	
Incandescent lamps:	1000 W
High voltage halogen lamps	1000 W
Low voltage halogen lamps with conventional transformer	750 VA, with a nominal load of 85 %
Fluorescent lamps not compensated	500 VA
parallel compensated (47 μ F)	400 VA
lead-lag circuit	1000 VA

Energy-saving lamps

Pay attention to high inrush peaks when using energy-saving lamps. Check the suitability of the lamps before use.

The required light scene push-button of the radio-controlled hand-held or wall-mounted transmitter must be taught into the radio-controlled actuator. Up to 5 light scenes can be stored.

ALL ON/ALL OFF

When teaching in a channel push-button, the ALL ON or ALL OFF button of the radio-controlled hand-held or wall-mounted transmitter is automatically learnt as well. Pressing the ALL ON (ALL OFF) button of a taught-in radio-controlled hand-held or wall-mounted transmitter (dis)connects the load.

Deleting a radio transmitter

A taught-in radio transmitter is deleted by carrying out a new learning process for this radio transmitter. All the channels and light scene push-buttons must be deleted individually. A successful deletion process is indicated by the Prog LED flashing rapidly.

Technical data

Nominal voltage	AC 230 V ~, 50/60 Hz
Switch contacts	Relay, μ contact, 6 A
Miniature circuit-breaker	10 A
Switching capacity per channel	
Incandescent lamps	350 W
High voltage halogen lamps	300 W
Low voltage halogen lamps with conventional transformer	350 VA, with a nominal load of 85%
with TRONIC transf.	300 W
Fluorescent lamps not compensated	350 VA
Transmission frequency	433,42 MHz, ASK
Postal approval	LPD-D
Temperature range	0°C up to +55°C
Type of protection	IP 20

Radio-controlled blinds actuator

Ref.no. FAJ 6 UP

Function

The radio-controlled blinds actuator is a component of the Radio Management system. It enables the wireless remote control of a shutter or blinds motor.

Dependent on the operation of a radio-controlled hand-held or wall-mounted transmitter, the louvres are adjusted (short push-button action < 1 second) or the blind is moved into position (long push-button action > 1 second).

The radio-controlled blinds actuator can teach in up to 14 radio transmitters.

The limit position of the blind (upper or lower) can be combined together with the lighting into a light scene.

Note

If all 14 memory locations are occupied, an already taught-in radio transmitter must be deleted so that an additional transmitter can be taught in.

The device must be placed at a distance of at least 0.5 m from electrical loads (e.g. electronic transformers, electronic lamp ballasts, TV).

The radio-controlled blinds actuator FM was exclusively developed for operating motors for blinds or shutters.

Do not switch any other loads!

Other applications can prove dangerous e.g. controlling security gates.

Observe the instructions from the motor manufacturer when switching shutter motors in parallel. Only blinds or shutters with mechanical or electronic limit switches should be used. Due to the electronic lock-out of the device, a minimum reversing time of approx. 1 second is implemented after a change in direction.

Observe the instructions from the motor manufacturer with regard to the reversing time and maximum operating time.

Antenna

In order to maintain the maximum radio transmission power, the antenna should be laid as far away as possible. It must be positioned away from metal components with a large surface area e.g. metal door frames. You should not shorten or extend the antenna or strip away the insulation.

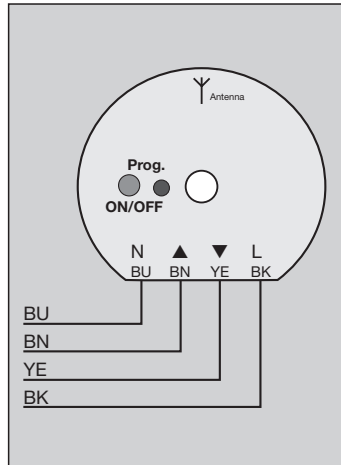

Teaching in a radio transmitter

When teaching in a radio transmitter, the sensitivity of the radio receiver is reduced to approx. 5 m.

The distance between the radio-controlled blinds actuator and the radio transmitter that is to be taught may not exceed 5 m.

Procedure

1. Press the ON/OFF button for at least 3 seconds. The red Prog LED flashes for approx. 1 minute. During this period, one radio channel can be taught in.

2. Trigger a radio telegram at the selected radio transmitter.

Teaching in a channel:

Press the channel push-button for longer than 1 second.

Teaching in a light scene push-button: Press the light scene push-button for longer than 3 seconds.

3. The Prog LED of the radio-controlled blinds actuator glows continually to indicate that the learning process has been successful.

4. You exit the programming mode either automatically after approx. 1 minute or by pressing the ON/OFF button. The radio-controlled blinds actuator is then ready for operation.

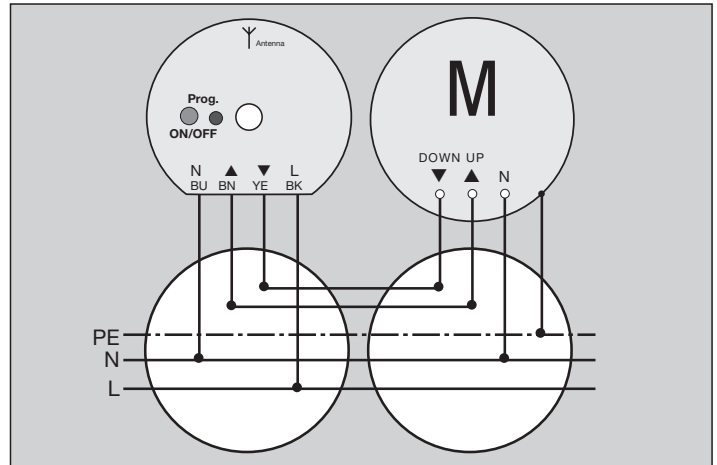

Light scenes

The limit position of a blind can be stored in a light scene.

This light scene can be changed at any time by storing it again.

Before storing or retrieving a light scene, a light scene push-button of the radio-controlled transmitter must be taught in.

Storing a light scene

1. Move the blind into the required limit position.
2. Press the required light scene push-button of the radio transmitter for at least 3 seconds.

Note

If the blind is not in the limit position during the teaching of a light scene, this blind is not stored in this light scene.

Deleting a radio transmitter

A taught-in radio transmitter is deleted by carrying out a new learning process for this radio transmitter.

All the channels and light scene push-buttons must be deleted individually. A successful deletion process is indicated by the Prog LED flashing rapidly.

Technical data

Nominal voltage	AC 230 V ~, 50/60 Hz (neutral line required)
Switching capacity	max. 1 motor 400 VA
Relay output	2 make contacts (non-floating and interlocked)
Reversing time for change in direction	approx. 1 second
Continuous operation	2 minutes
Transmission frequency	433,42 MHz, ASK
Postal approval	LPD-D
Temperature range	0°C up to +55°C
Dimensions	Height 23 mm ø approx. 52 mm
Type of protection	IP 20

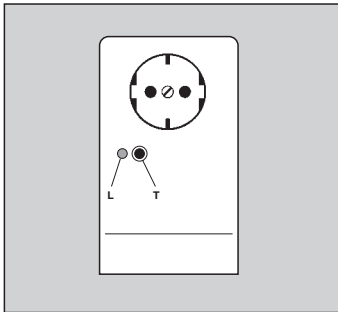

Functions

A special transmission telegram is used in the Radio Management system which can only be produced and evaluated by this family of products.

In connection with a radio-controlled wall-mounted, hand-held or universal transmitter (switching mode) or a radio-controlled Observer, the radio-controlled plug adapter switch enables the remote switching of portable appliances (e.g. floor lamps) with a mains plug.

The radio-controlled plug adapter switch operates electrical loads (AC 230 V ~) as soon as it has received a (taught-in) Radio Management signal.

On receipt of the radio signal from a radio-controlled Observer, it switches on for an overshoot time of approx. 1 minute.

The plug adapter switch can teach in up to 30 radio transmitters. Each radio transmitter has at least one radio channel.

The plug adapter switch has an increased level of protection against electric shocks.

Light scenes

When using the radio-controlled hand-held or wall-mounted transmitter, the lamp that is plugged in can be integrated in light moods with the states "ON" or "OFF" e.g. light scene 1 = floor lamp is switched on.

The required light scene push-button of the radio-controlled hand-held or wall-mounted transmitter must be taught into the radio-controlled plug adapter switch.

Up to 5 light moods can be stored.

ALL ON

The operation of the ALL ON button of a taught-in radio-controlled hand-held transmitter leads to the load being connected.

ALL OFF

The operation of the ALL OFF button of a taught-in radio-controlled hand-held or wall-mounted transmitter leads to the load being disconnected.

Note

When teaching in a radio channel, the ALL ON/ALL OFF button is automatically learnt as well. The device must be placed at a distance of at least 0.5 m from loads that cause electrical interference (e.g. microwaves, hi-fi system, TV).

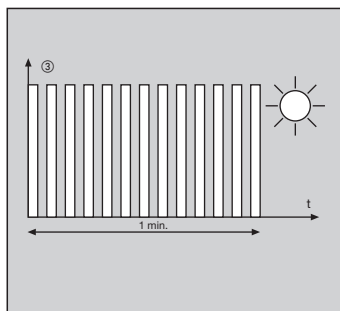
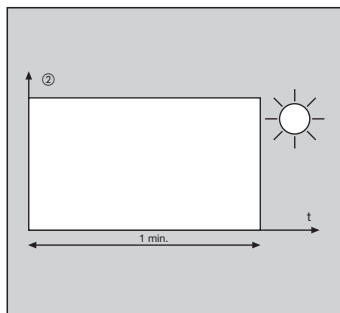
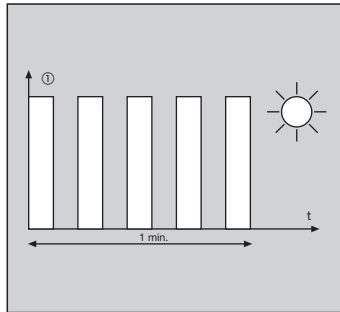

Operation

By pressing push-button **T** for less than 3 seconds, the plug adapter switch is permanently switched on or off (two-way operation). Alternatively, the device can be operated via taught-in radio transmitters. The red LED **L** indicates that the load is connected.

Fuse

In the case of a malfunction, you should first of all check the fuse (T 6.3 H 250 V) (in the event of an overload, the fuse is tripped). The fuse holder contains a spare fuse. The fuse holder **S** is located between the plug-in contacts.

Only the original fuse should be used!

Radio transmission

Radio transmission is not carried out via an exclusive transmission route, therefore disruptions cannot be ruled out. Radio transmission is therefore not suitable for security applications e.g. emergency stop, emergency calls.

Teaching in a radio transmitter

In order to be able to operate the plug adapter switch with a radio transmitter, the radio channel of the required radio transmitter must be taught in. The distance between the radio-controlled plug adapter switch and the radio transmitter that is to be taught in should not exceed 5 m.

1. Press the push button **T** for approx. 3 seconds. The radio-controlled plug adapter switch switches off the connected load. One radio transmitter can be taught in within approx. 1 minute. The red LED ① flashes during this period.
2. The required radio transmitter must trigger a radio transmission.

• Teaching in a radio channel:

Press the required channel push-button for at least 1 second.

• **Teaching in a light scene push-button:** Press the required light scene push-button for at least 3 seconds.

• **Teaching in a radio-controlled Observer**

Carry out a movement in the detection field of the radio-controlled Observer.

• **Teaching in the ALL ON or ALL OFF button:** Press the ALL ON or ALL OFF button for at least 10 seconds.

3. The red LED ② lights up to check that a radio transmission has been learnt.

4. You exit the learning process either automatically after approx. 1 minute or by pressing the push-button **T**. The radio-controlled plug adapter switch then switches to the normal receiving mode.

If a further radio channel is to be taught in, the learning process is retrieved again. If all 30 memory locations of the radio transmitters are occupied, you must first delete an already taught-in radio transmitter. You must delete the channel and light scene push-button individually.

Deleting a taught-in radio channel

A taught-in radio channel is deleted by carrying out a new learning process as described above.

A successful deletion process is indicated by the red LED ③ flashing in quick session.

You exit the deletion process either automatically after approx. 1 minute or by pressing the push-button **T**. The radio-controlled plug adapter switch then switches to the normal receiving mode.

Technical data

Power supply AC 230 V ~

Fuse T 6.3 H 250 V

Switching capacity (relay contact)

Incandescent lamps 1000 W

High voltage halogen lamps 1000 W

Low voltage halogen lamps with conventional transformers 750 VA

lamps with TRONIC transf. 750 W

Fluorescent lamps not compensated 500 VA

parallel compensated 400 VA

lead-lag circuit 1000 VA

Temperature range -20°C up to 55°C

Transmission frequency 433,42 MHz, ASK

Postal approval LPD-D

Dimensions (LxWxT) 163 x 70 x 72 mm

Energy-saving lamps

Pay attention to high inrush peaks when using energy-saving lamps.

Check the suitability of the lamps before use.

Radio-controlled plug adapter dimmer Ref.-No. FZD 1254 WW



The symbols used to identify dimmer loads designate the type of the electrical behaviour of loads connected to dimmers: R = ohmic, L = inductive, C = capacitive

Function

The radio-controlled plug adapter dimmer is a universal dimmer with automatic load detection permitting radio-controlled switching and dimming of mobile luminaires.

The turn-on brightness can be stored in the device as memory value.

The adapter is operated from a programmed radio-controlled transmitter (e.g. radio-controlled hand-held transmitter, etc.) or directly on the device itself (only switching).

Depending on the actuation of the radio-controlled transmitter, the lights are either switched on or off (short press on key) or dimmed (long press on key). When a programmed telegram from a radio detector is received by the dimmer while deactivated, the dimmer will switch on for a delay of about 1 minute with the preset memory value when it is dark. All functions described are available only if the radio-controlled adapter plug with dimmer is plugged into a socket outlet and if a specified load is plugged into the socket of the radio-controlled adapter plug with dimmer. The radio-controlled adapter plug with dimmer can be programmed to identify up to 30 radio channels.

Light moods

The radio controlled adapter plug dimmer can be integrated into up to 5 light scenes which are recalled and stored with radio-controlled transmitters (e.g. handheld transmitter 'Komfort'). The corresponding light-scene key must have been programmed beforehand into the radio-controlled adapter plug with dimmer.

Light control

A light control can be realized with a radio controlled adapter plug dimmer and an identified radio control presence detector or light sensor.

Installation instructions

- The distance to electric loads (e.g. microwave ovens, Hi-fi equipment and TV sets) must be at least 0.5 m.
- To avoid overloading of the radio-controlled receiver (actuator) the distance between the radio-controlled adapter plug dimmer and a transmitter must be at least 1 m.

Automatic load detection

After first installation and disconnection of the mains, the radio-controlled adapter plug dimmer detects the load automatically. With resistive loads, the detection of the load is accompanied by short flickering of the lamps (incandescent and HV halogen lamps). Depending on mains conditions, the detection procedure as such lasts between 1 s and 10 s. During this time, no operation is possible. A mains failure of more than 0.2 s causes the adapter plug to shut off.

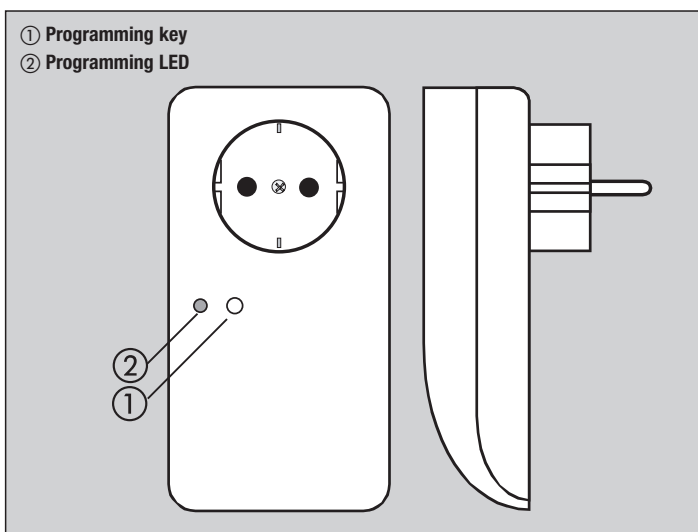

Programming of radio-controlled transmitters

During programming of a radio-controlled transmitter into receiver, the sensitivity of the receiver is reduced to approx. 5 m. For the programming procedure, the adapter plug must be plugged into a socket outlet and a specified load be plugged into the dimmer.

Procedure

1. Switch off the load plugged into the adapter plug with a brief press (< 1 s) on the programming button.
2. Press the programming button for abt. 4 s in order to get into the programming mode. The LED flashes for abt. 1 min. The adapter plug is now in its programming mode.
3. Send a radio telegram from the selected transmitter.

Programming a channel

Depress the channel key for more than 1 second.

Programming a light scenes key

Depress the light scenes key for more than 3 seconds.

Programming a detector

Remove the battery for about 2 minutes from the detector. Put the the battery back in place and make a movement inside the detection range of the detector within the next 15 minutes.

Programming a presence detector or a light sensor

Remove the battery(ies) for about 2 minutes from the transmitter. After putting the battery(ies) back in place, the device starts transmitting programming telegrams for about 30 s.

Important

It is not possible to program a combination consisting of presence-control detector, light sensor and detector.

4. The adapter plug confirms storage of the data transmitted by a permanently lit LED.
5. The programming mode ends automatically after about 1 minute or can be terminated by a short depression of the programming key. The adapter plug is then again in the normal operating mode.

Deleting a radio-controlled transmitter

A radio control transmitter in the adapter's memory is deleted when the same transmitter is programmed again into the memory. All channels and light scenes keys must be deleted one by one. Successful deletion is signalled by the LED blinking faster.

Deleting all radio-controlled transmitters

It is possible to delete all transmitters stored in the device by resetting the radio-controlled adapter plug with dimmer to the state of delivery.

For this deleting procedure, a load must be plugged into the adapter plug .

1. Switch off the load connected to the adapter plug with a brief press (< 1 s) on the programming button.
2. Depress the programming key for about 20 s. After 4 s, the programming LED begins to flash and after 20 s the flashing sequences is replaced for about 6 s by periodic high-intensity light pulses.
3. Release the programming button briefly during these 6 s and depress once again for about 1 s to start deletion.
4. During the deleting procedure, the LED is permanently lit. Successful deletion of all radio-controlled transmitters stored is then signalled by the LED flashing faster. The flashing sequence ends after about 1 min or can be terminated by a brief press on the button.

Memory value (switch-on brightness)

A preset brightness value can be stored in the device as memory value. This memory value can then be recalled as the switch-on brightness.

Storing the memory value

1. Set the lamp to the desired brightness.
2. Depress the programming key for at least 4 s. This action is confirmed by a „soft start“, i.e. the lamp is switched off for a short moment and then increased in brightness up to the memory value.

Light scenes

Before storing or recalling a lightscape, the lightscape key of the radio-controlled transmitter must be programmed into adapter plug.

After transmitter programming, the light-moods data (lamp brightness) can be stored in the adapter plug. The new light scene can be changed at any time by storing it again.

Storing a light scene

1. Adjust the desired brightness of the lamp.
2. Depress the light scenes key of the radio-controlled transmitter for at least 3 s. The old light scene is recalled (do not release the key). The new light scene is activated and stored 3 s later.

Technical data

Nominal voltage: 230 V ~, 50/60 Hz

Fuse: T 6,3 H 250 V

Power rating: 50 – 420 W/VA

– 230 V incandescent lamps (resistive load, phase cut-off)

– HV halogen lamps (resistive load, phase cut-off)

– JUNG-Tronic transformers (capacitive load, phase cut-off)

or

– Conventional transformers (inductive load, phase cut-on)

When mixed loads are connected to conventional transformers, the resistive part of the load (incandescent lamps, HV halogen lamps) must not exceed 50 % of the total load.

(Do not mix capacitive with inductive loads.)

Faultless operation is guaranteed only if JUNG Tronic transformers or conventional iron-copper transformers are used.

Receive frequency: 433,42 MHz, ASK

Type op protection: IP 20

Temperature range: approx. +5 to +35 °C

Humidity in operation: max. 65 % (without condensation)

Dimensions (LxWxD): 136 x 70 x 72 mm

Center plate with radio receiver

Ref.nos. ..1561.07 F.

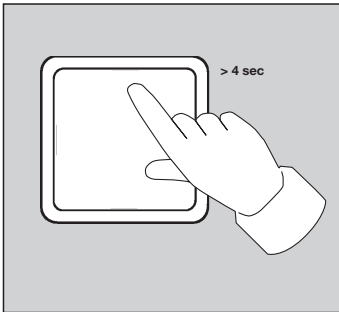

Technical data

Power supply	from the flush-mounted insert
Transmission frequency	433,42 MHz (ASK)
Temperature range	-20°C up to +55°C

Teaching in a radio transmitter

In order to be able to operate the center plate with radio remote control, this remote control must be taught in to the center plate. The distance between the center plate and the radio transmitter that is to be taught in must not exceed 5 m.

1. Switch the lighting off with the center plate.
2. Press a push-button for at least 3 seconds. The transmitter signals its readiness to learn (duration approx. 1 min.) by a long pulsing tone ①. During this period a radio channel can be taught in.
3. The required radio transmitter must trigger a radio transmission.

Teaching in a radio channel:

Press the required push-button for at least 1 sec.

Teaching in a light scene push-button:
Press the required light scene push-button for at least 3 sec.

Teaching in the ALL OFF/ALL ON button:
Press the ALL OFF/ALL ON button for at least 10 sec.

4. A successful learning process is confirmed by a continuous tone ② (duration approx. 1 min.).

You can interrupt the learning process at any time by a push-button action.

Note:

If all 30 memory locations are occupied, you must delete an already taught-in radio transmitter.

Deleting a radio-transmitter

The deletion of a taught-in radio transmitter is carried out by a new learning process.

All the channels and light scene push-buttons must be deleted individually.

A successful deletion process is confirmed by a short pulsing tone ③ (duration approx. 1 min.).

You can interrupt the deletion process at any time by pressing a push-button.

Operation

The lighting is dimmed brighter with the upper half of the center plate and dimmed darker with the lower half.

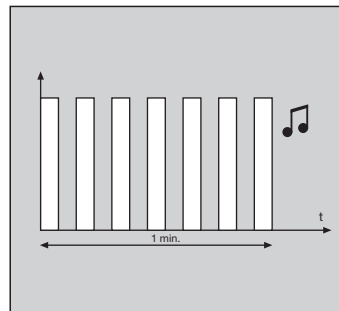
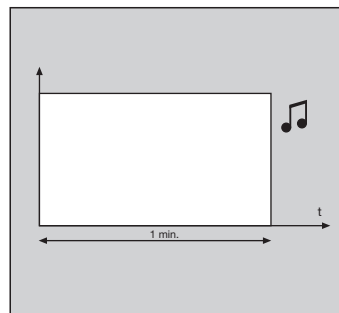
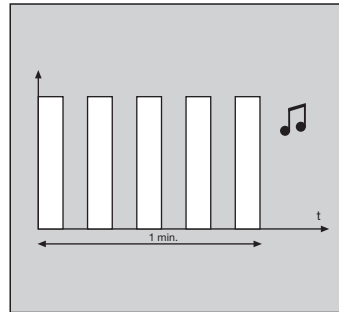

Short operation (< 0,4 sec.)

The lighting is switched (to the memory value).

Long operation (≥ 0,4 sec.)

The lighting is dimmed.

Memory function

If the current dimming value is to be stored as a memory value in the center plate, press the entire surface area of the push-button while the load is connected for at least 3 seconds.

A 'softstart' is carried out as confirmation i.e. the lamp is dimmed brighter until it reaches the stored memory value.

When the lamp is switched on the next time, this stored value is retrieved.

It is switched on via the receipt of a taught-in radio telegram from a radio-controlled, hand-held or wall-mounted transmitter or a 2-channel flush-mounted transmitter.

If a taught-in radio telegram from a radio-controlled Observer is received, the radio-controlled push-button switches on for approx. 1 minute with the memory value.

Light scene

The brightness of a luminaire can be integrated into a light scene.

This light scene can be changed at any time by storing it again.

A light scene push-button of the radio transmitter must be taught in before storing or retrieving a light scene.

Storing a light scene

1. Set the brightness of the luminaire.
2. Press the required light scene push-button of the radio transmitter for at least 3 sec.
3. A short signal (approx. 1 sec.) sounds as confirmation that this light scene has been stored.

Functions

When combined with the universal dimmer, the center plate with a radio receiver makes it possible to have radio remote control and manual lighting control.

The lighting can be switched (brief actuation) or dimmed (longer actuation).

When a radio signal is received from the radio-controlled Observer, it switches on for approx. 1 minute.

The required brightness value can be stored (memory function).

The center plate with radio receiver can 'teach in' up to 30 radio transmitters.

Light scenes

Light scene operation is possible using the radio-controlled hand-held or wall-mounted transmitter.

The required light scene push-button of the radio-controlled hand-held or wall-mounted transmitter must be learnt in the center plate with radio receiver.

Up to 5 light scenes can be stored.

ALL OFF

Pressing the ALL OFF button of a taught-in radio-controlled hand-held or wall-mounted transmitter leads to the load being disconnected.

ALL ON

Pressing the ALL ON button of a taught-in radio-controlled hand-held or wall-mounted transmitter leads to the load being connected.

The center plate with radio receiver can only be put into operation when it is combined with the universal dimmer.

Note

The center plate should not be plugged in when the mains voltage (230 V) is connected otherwise a malfunction may occur.

The distance away from electrical loads (e.g. electronic transformers, devices with electronic ballast, TV) must be at least 0.5 m.

Function

The Master receiver is a modular DIN-rail device for the reception of radio-control telegrams. The telegrams are converted to wire-bound data and transmitted for evaluation to DIN-rail radio-controlled actuators (e.g. switching, dimming or shutter actuators). Up to 30 DIN-rail radio-controlled actuators can be connected to one Master receiver.

For the reception of radio-control telegrams, the device is equipped with an integrated antenna. In locations with unfavourable receiving conditions (e.g. metallic distribution cabinet), an external antenna can be connected as an option.

Instructions

- The overall length of the bus lines to the DIN-rail radio-controlled actuators must not exceed 3 m.
- To prevent saturation of the radio-controlled receiver (actuator), the distance between the DIN-rail radio-controlled receiver and a transmitter must be at least 1 m.
- The polarity of the bus lines must not be reversed.
- Up to 30 DIN-rail radio-controlled actuators can be connected to a DIN-rail radio-controlled receiver.

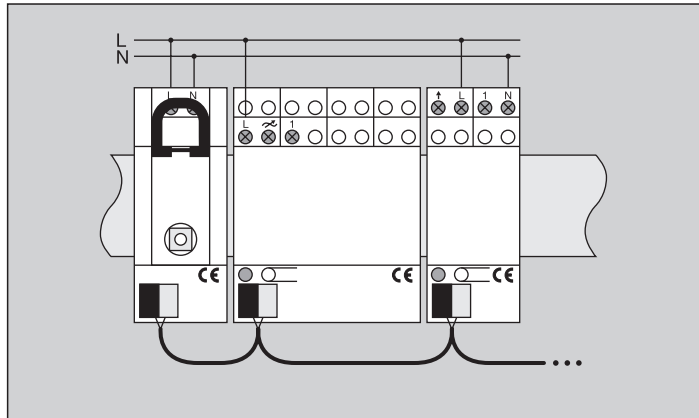

Antenna

For the reception of radio-control telegrams, the device is equipped with an integrated antenna. In locations with unfavourable receiving conditions (e.g. metallic distribution cabinet), an external antenna can be connected as an option (accessory Ref. no.: F-Ant).

Fitting and connection

Snap the Master receiver onto the DIN rail and connect as shown in the figure.

Connect the **Master** receiver by means of the connecting terminals with the DIN-rail radio-control actuators using a bus line.

The bus line used must be a shielded cable (with twisted wires and a wire dia. of 0.8 mm) designed for a test voltage of 2.5 kV AC.

Specifications

Rated supply voltage:	AC 230 V ~ 50/60 Hz
Screw terminals:	1,5 to 4 mm ² single-wire 0,75 to 4 mm ² stranded wire (without ferrule) 0,5 to 2,5 mm ² stranded wire (with ferrule)
Receive frequency:	433,42 MHz
Operating temperature:	approx. 0 °C ... +45 °C
Storage temperature:	approx. -25°C ... + 70 °C
Type of protection:	IP 20
Mounting width:	36 mm (2 TE)

The functions of the DIN rail actuators are similar to the comparable built-in or flush-mounted actuators of the Radio Management system.

Radio-controlled Observer Ref.no. FW 180 WW

Radio-controlled performance unit Ref.no. FWL 2200 WW

The radio-controlled Observer reacts to thermal movements triggered by people, animals or objects and sends any detected movement to the radio-controlled performance unit which evaluates the information and connects the load(s).

It is a good idea to implement the radio-controlled Observer system when local conditions require the use of several sensors. The radio-controlled Observer is operated using a 9 V monobloc battery and therefore does not require a supply cable. The devices can therefore be installed where they are needed and not where a mains connection is available.

Visual displays signal the activation of the device.

The load remains connected while movement is being detected. If no movement is detected, the radio-controlled performance unit disconnects the load once the set delay period has elapsed.

Additional functions are supported such as a 2 hour ON period or 2 hour OFF period. Both the operating time and the brightness value which activates the system when the value drops below this level can be set in the radio-controlled performance unit.

Technical data Radio-controlled Observer ref.no. FW 180 WW

Nominal voltage	9 V DC
Battery type	9 V monobloc battery
Battery life	
Lithium (1,2 Ah)	approx. 4 years
Alkaline (0,55 Ah)	approx. 1,5 years
Power consumption	
Daytime operation	approx. 0,14 mW
Night operation	approx. 0,27 mW
Radio transmission	approx. 27 mW
Transmission power	< 10 mW
Transmission frequency	433,42 MHz, ASK
Range	approx. 100 m (free field)
Detection radius	180°
Detection field	16 m x 32 m
Mounting height	approx. 2,40 m
Sensitivity	20% – 100%
Evaluation	
Operation range	3 – 200 lux ± 50%
Sensor for retriggering	80 lux
Sensor is off	> 200 lux
Temperature range	–25°C up to +55°C
Type of protection	IP 55

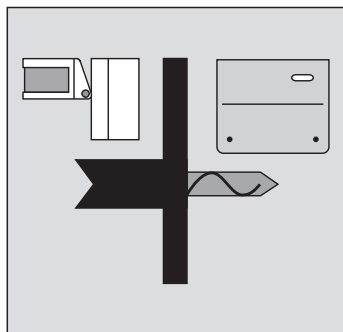
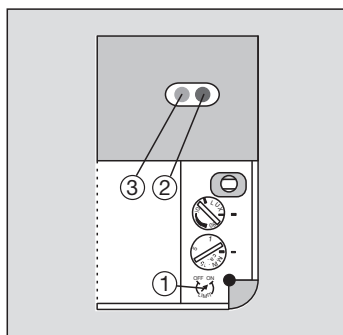
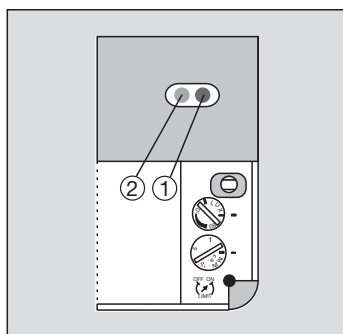
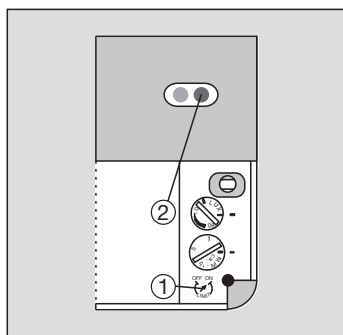
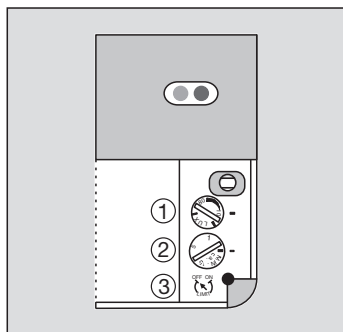

Settings of the radio-controlled performance unit

The following are located in the terminal housing of the radio-controlled performance unit:

Brightness setting ①

Recommendation: Setting the device to 10 lux (see diagram) activates the device as dusk falls.

Time setting ②

Can be set between 10 seconds and 15 minutes.

Programming ③

OFF: normal mode

ON: learning mode

Teaching in the radio-controlled Observer

During the initial installation, the radio-controlled Observer is to assign to the radio-controlled performance unit i.e. "learnt". The radio-controlled performance unit can only understand and evaluate signals from taught-in radio-controlled Observers.

1. The Prog rotary switch ① on the radio-controlled performance unit must be set to the ON position in order to activate the learning mode. The right red LED ② flashes. A movement must be carried out to trigger the radio-controlled Observer into sending a radio transmission. This applies both to normal mode and test mode.
2. The right red LED ① and the left green LED ② light up to check that a radio transmission has been received. The load is connected. The radio-controlled Observer has been taught in.
3. The Prog rotary switch ① must be set to the OFF position in order to activate normal mode. The right red LED ② and the left green LED ③ are extinguished. The load is disconnected.

Up to 30 radio-controlled Observers can be taught into the system.

Deleting the radio-controlled Observer

If an already taught-in radio-controlled Observer is taught in for a second time, it is deleted. A successful deletion process is indicated as follows:

Right red LED ② -> lights up

Left green LED ③ -> does not light up

Technical data

Radio-controlled performance unit, ref.no. FWL 2200 WW

Nominal voltage	AC 230 V ~, 50 Hz
Switch contact	Relay
Switching capacity Incandescent lamps	2500 W
High voltage halogen lamps	2500 W
Fluorescent lamps not compensated	1200 W
parallel compensated	920 W
lead-lag circuit	2400 W

Note:

Pay attention to high inrush peaks when using energy-saving lamps. Check suitability of the lamps before use.

Miniature circuit-breaker 10 A

Power consumption 2 W

Inrush current max. 20 A

Operating time approx. 10 sec. – 15 min ± 10% retriggered

Brightness setting approx. 3 – 80 lux ± 10%

Additional function via push-button (break contact)

Pulse duration 400 ms, ± 50%

Pulse interval 600 ms

1st function 1 x pulse, operating time

2nd function 2 x pulse, ON = 2 hrs, ±10%

3rd function 3 x pulse, OFF = 2 hrs, ±10%

Transmission frequency 433,42 MHz, ASK

Temperature range –25°C up to +55°C

Type of protection IP 55

Interference suppression in accordance VDE 0875, part 1/12.88

Night operation

On detection of a movement, the radio-controlled Observer measures and evaluates the light intensity E:

- E < set brightness level: radio signal to the performance unit
- Set brightness level < E < 200 lux: radio signal (retriggered) to the performance unit
- E > 200 lux: Change to daytime operation

Daytime operation

The radio-controlled Observer measures the level of light intensity every 10 seconds. If the value falls below 80 lux, the device switches to night operation.

Low battery voltage

A "Low-Bat" signal is sent to the radio-controlled performance unit as soon as the battery voltage falls below the critical value ($U_{\text{Bat}} < 8,0 \text{ V}$). The signal is indicated by the red LED of the radio-controlled Observer and the radio-controlled performance unit.

Note:

The radio-controlled Observer is not tamper-proof and is therefore not suitable for use in alarm systems.

Radio transmission

The transmission range of the radio-controlled hand-held Observer is dependent on the structural conditions of the property:

Dry material	Penetration
Wood, plaster, plasterboard	90 ... 100%
Brick, plywood panels	65 ... 95%
Reinforced concrete	10 ... 70%
Metal, metal grids, aluminium laminate	0 ... 10%

Radio-controlled Presence Detector

Ref.no. FPM 360 WW

Function

The radio controlled presence detector (fig. A) permits to achieve optimal energy savings by controlling the illumination of a room depending on the presence of persons.

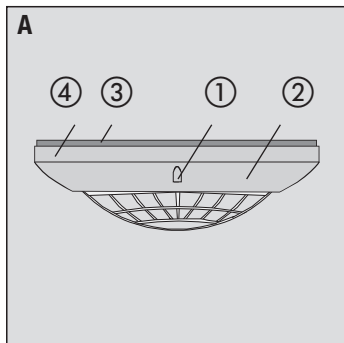

The radio presence detector consists of:

- ① sensor window with LED
- ② ornamental ring
- ③ base plate
- ④ push button

Installation

The presence detector is fitted under the room ceiling and monitors the working surface below (fig. B). Since the actual brightness measured by the presence detector depends on the reflection properties of the working surface, the characteristics of the surface should not change too often.

Avoid direct sunlight into the sensor window. The sensors might be irreparably damaged by the high amounts of heat energy received.

If needed, the detection field can be confined by means of the shield supplied with the device.

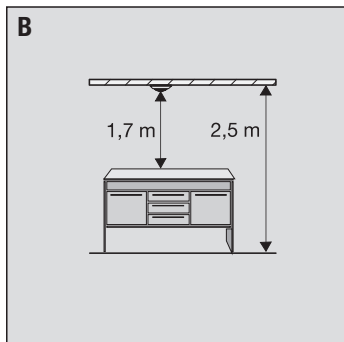

Batteries

The radio controlled presence detector operates on 4 alkaline micro batteries as shown in fig. C (LR 03, not included in the scope of supply). Batteries of the carbon-zinc type (R 03) must not be used.

After insertion of the batteries, the device is at first for ca. 30 seconds in the programming mode. To avoid undesired programming, make sure that none of the actuators is in the programming mode during this time.

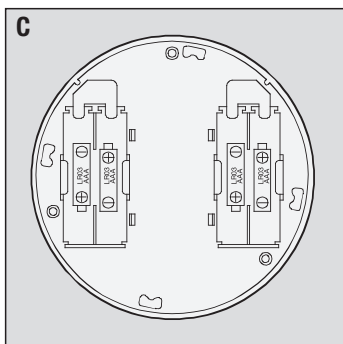

Important

When programming the first presence detector into the radio controlled receiver make sure the brightness control (fig. D) does not point to the "Moon" symbol. A presence detector with this setting will be identified as a slave unit and can therefore not be programmed as first unit into an actuator.

The radio-controlled presence detector cannot be operated together with a radio-controlled detector or a radio-controlled light sensor.

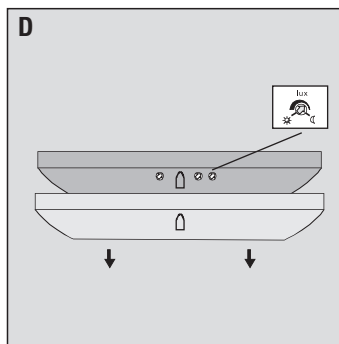

② Switch-off delay "time"

The potentiometer permits adjustment of the switch-off delay for automatic operation in fine steps between approx. 2 minutes (2 min) to approx. 1 hour (1 h).

③ Sensitivity "sens"

The potentiometer permits adjusting the sensitivity of the sensor between maximum and minimum.

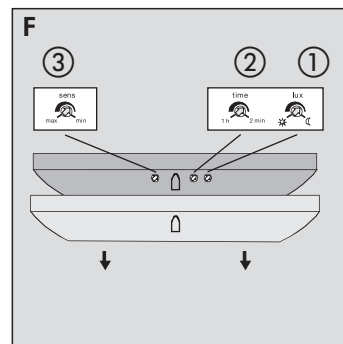

Teaching in of a detector into a radio controlled receiver

For the purpose of constant light control, the radio controlled presence detector must be taught into only one radio controlled receiver. The programming information is stored in the radio controlled receiver only.

During teaching in of a radio controlled presence detector, the sensitivity of the radio controlled receivers is reduced to approx. 5 m. The distance between the receiver and the presence detector should therefore be not less than 0.5 m and not more than 5 m.

Procedure

1. Remove the battery for approx. 3 minutes from the presence detector (capacitor discharge time).
2. Switch the receiver into the teaching in mode.
3. Put the battery back in place. The presence detector now starts transmitting special programming information telegrams for approx. 30 seconds. The receiver confirms the programming cycle.
4. Switch the receiver back to the operating mode.

Deleting a detector in the radio controlled receiver

An already programmed presence detector can be deleted by starting a new teaching in cycle in the receiver.

Detector window shield

The snap-on shield supplied with the detector can be used to blank out undesired zones or sources of interference by confining the field of detection.

The shield is snapped onto the sensor window. Cut out the shield only along the marked lines (fig. E).

Cutting out the shield changes the diameter of the detection field on the floor.

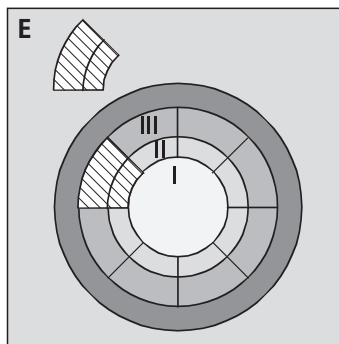

Settings

The presence detector is equipped with potentiometers to control the following parameters (fig. F):

① Reference brightness "lux"

The potentiometer permits the adjustment of reference brightness values in fine steps between approx. 3 lux (moon symbol) to approx. 2000 lux (sun symbol).

The setting is taken over by the radio actuator only after activation of the "light control test mode".

To change the brightness, switch-off time delay or sensitivity settings, withdraw the ornamental ring from the presence detector. The 3 control potentiometers are then accessible.

Operation modes

1. Light control test mode

The reference brightness can only be adjusted on the presence detector when the device is in the light control test mode. In this mode, there is no movement detection, but a fast adjustment of the actual reference brightness values (light control).

The reference brightness preset on the detector is stored in the taught in actuator and compared to the actual brightness value transmitted by the presence detector.

2. Movement test mode

In the movement test mode, the detection field of the presence detector can be tested independently of the brightness.

When the detector detects a movement in the movement test mode, the taught in receiver will be activated for a fixed switch-off time delay of 10 seconds.

3. Constant light control with a dimming actuator

A dimming actuator from release 2 (R2) onwards can be used to implement a constant light control function. For this purpose, the dimming value in the actuator is adjusted in such a way that the brightness measured at the presence detector corresponds to the reference value preset in the detector.

Automatic light control operation

After a presence detector has been taught into a radio controlled dimming actuator, the actuator operates permanently in the automatic mode.

If the actual brightness value measured at the presence detector is below the reference brightness, the dimming actuator is started with full brightness (100%) when presence is detected.

Thereafter, the degree of dimming is adjusted between 100 % and 0 % in such a way that the actual brightness measured at the presence detector corresponds to the reference value preset in the presence detector (constant light control).

If the actuator is regulated down to 0 % and if the switch-off time delay is permanently retriggered by presence in the shut-off phase, the actuator restarts with the lowest dimming level when it is switched on again.

If – in the light control mode – no presence is detected any more during the preset switch-off delay time, the dimming actuator shuts off, but remains in the automatic mode.

Manual activation of the constant light control

To activate the constant light control manually when the load is switched off (without presence detection), depress briefly a key on any of the radio controlled transmitters taught into the radio-controlled actuator.

If used with a radio controlled cover for switching and dimming the constant light control can also be activated locally. When the presence detector has been taught into the device, the constant light control can be terminated by depressing briefly either the upper or the lower rocker of the cover.

Important:

If no presence is detected for a period of at least 2 minutes after manual activation, the dimming actuator is switched off.

Temporary change of the reference brightness setting

The reference brightness is adjusted in the light control test mode on the presence detector. This permanent reference brightness can be changed temporarily.

With a prolonged depression of a key (> 1 s) on a radio transmitter taught into the dimming actuator or by prolonged local actuation of a radio controlled cover for switching and dimming, the brightness of the connected lamps can be changed.

This new illumination level is temporarily stored in the actuator as reference brightness until the next shut-off.

Permanent change of the reference brightness setting

When a hand-held transmitter of the Standard/Comfort type has been taught into the dimming actuator, the temporary reference brightness value can be stored as permanent reference brightness in the dimming actuator.

Depress channel key 8 (Λ or V) of channel group C longer (> 1 s) (fig. G).

To go back to the reference brightness adjusted on the presence detector, activate the light control test mode in the presence detector.

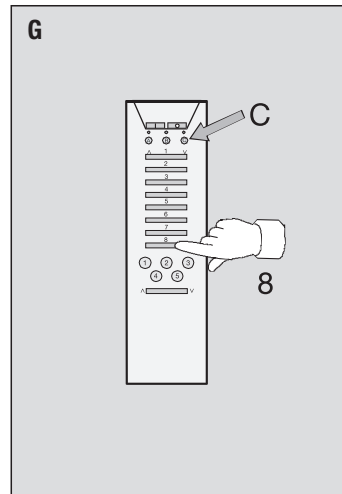

6. Presence detector system (Master/Slave)

If larger areas are to be monitored, it is possible to use several presence detectors together in the same system.

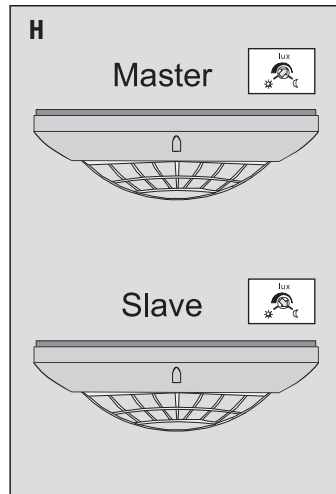

Technical data

Nominal voltage	6 V DC
Batteries	4x1,5 V Micro LR03 (AAA) Alkaline

Note: Never use carbon-zinc batteries (R 03).

Transmission frequency	433.42 MHz
Modulation	ASK
Transmitting range	max. 100 m (free field)
Coding	> 1 billion
Angle of detection	360°
Nominal range	
– at desk height	ca. Δ 5 m
– at floor level	ca. Δ 8 m
Fitting height for nominal range	2.5 m
Switch-off delay	ca. 2 min – 1 h
Brightness	ca. 3 – 2000 lux
Temperature range	0°C ... 45°C
Degree of protection	IP 20
Dimensions diameter	103 mm
height	42 mm

Switching on / switching off for 2 hours

After a presence detector and a hand-held transmitter of the Standard/Comfort type have been taught into a dimming actuator for constant light control, the additional functions "Switching on for 2 hours" and "Switching off for 2 hours" can be selected.

4. Light control with a switching actuator

A radio controlled switching actuator from release 2 (R2) onwards offers the possibility of implementing a two-point light control with ON and OFF as the only two switching states available.

For the further adjustments see chapter constant light control with a dimming actuator.

5. Light scene operation

During the switch-off delay time, the radio controlled actuator involved in a constant light control can be integrated together with other radio controlled actuators into light moods.

The light scenes can be recalled, stored and changed with a hand-held transmitter of the Comfort type, a wall-mounted transmitter or a multi-function transmitter. Please refer to the corresponding transmitter operating instructions

The recalled light scene is statical, i.e. there is no constant light control.

If the presence detector detects movement, the switch-off time delay will be retriggered. If no movement is detected anymore, the actuator involved in a constant light control switches off after the adjusted switch-off time delay and returns to automatic operation.

Important

When a multi-function transmitter is used it is necessary after recalling of a light scene to wait until the switch-off time delay has passed before it is possible to return to the constant light control mode. Switching off the light scene with a multi-function transmitter earlier is not possible.

Reference brightness value

In a presence detector system one presence detector must be specified as the master unit. The desired reference brightness is adjusted on this master unit and is then valid for the whole system.

In all other presence detectors (slaves), the reference brightness must be set to minimum (moon symbol, fig. H).

Switch-off delay times

The switch-off delay times can be adjusted separately on all presence detectors used. If an actuator is switched by a presence detector, the switch-off time delay of this device starts running.

Teaching in of the presence detectors

When teaching in the presence detectors into the radio controlled receiver make sure the presence detector specified as master unit must be taught in first. The brightness reference control must therefore not be set to minimum (moon symbol) since the detector would otherwise be identified as slave, which means that it cannot be programmed in first place into an actuator.

The slave detectors can only be programmed thereafter. In the slaves, the brightness reference must be set to minimum (moon symbol).

If a master has already been taught in, any further teaching in of a master overwrites the previous one, i.e. only one unit can be stored as master detector.

JUNG

P-GB-FM05



4 011377 010048



A. JUNG GMBH & CO. KG
P.O. Box 1320
D-58569 Schalksmühle

Volmestraße 1
D-58579 Schalksmühle
Germany

Tel: +49 2355 806-553
Fax: +49 2355 806-254
E-mail: mail.vka@jung.de
Internet: www.jung.de

For sales contacts in your country see:
www.jung-salescontact.com

Member of



Custom
Electronic
Design &
Installation
Association